



GSP AUTO PARTS

CAT.NO.31019/E

**DRIVE SHAFTS
CONSTANT VELOCITY JOINT KITS
CATALOGUE 2019**





CERTIFIED DATA SUPPLIER



- GSP manufactures drive shafts, CV joint kits, boot kits and hub assemblies
- GSP supplies to the worldwide aftermarket into more than 120 countries and to OEM's
- GSP is the loyal and reliable partner to customers since 1985 with a full comprehensive range of car applications



ABOUT GSP

GSP AUTOMOTIVE group is the leading manufacturer for automotive driveline components for the worldwide aftermarket. The company was established in 1985 and produces drive shafts, constant velocity joint kits, hub assemblies and rubber-to-metal components. The product ranges cover around 95% of the car park around the world. GSP supplies products into more than 120 countries.

The annual production capacity exceeds 13 million CV joint kits, 4 million drive shafts, 2.5 million hub assemblies and 10 million rubber-to-metal components.

More than 2.000 highly motivated and skilled employees work for the GSP Group around the globe. GSP operates production facilities in China and North America and distribution centres in Germany and in the United States.

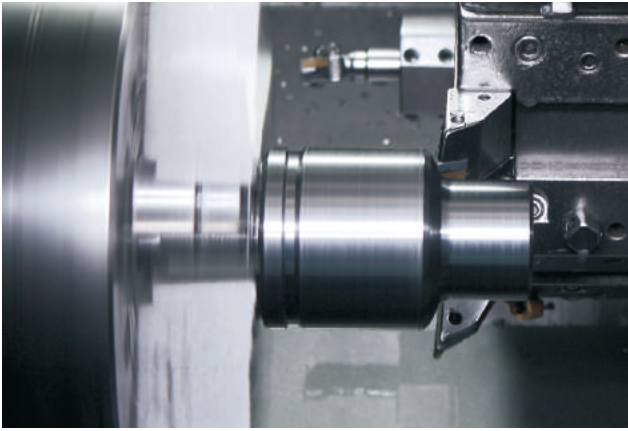

01

Outer C.V. Joints

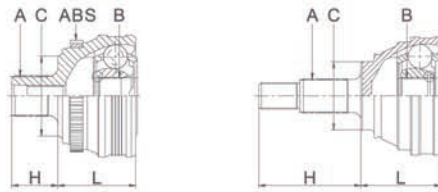

A: External Teeth, wheel side
 B: Internal Teeth, wheel side
 C: Seal Diameter [mm]
 H: Bell pin length
 L: Length
 ABS: Number of teeth on ABS ring
 I: Groove type: Inner
 M: Groove type: Middle
 O: Groove type: Outer
 P: Groove position

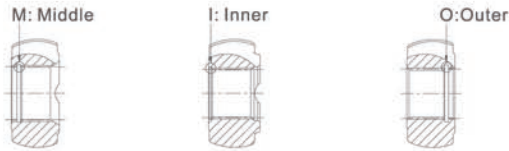

02

Inner C.V. Joints

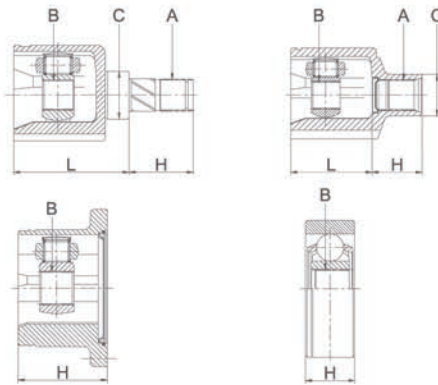

A: External Teeth, diff. side
 B: Internal Teeth, diff. side
 C: Seal Diameter [mm]
 H: Bell pin length
 L: Length



03

Drive Shafts

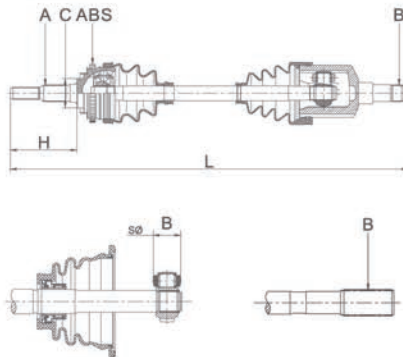

A: External Teeth, wheel side
 B: External Teeth, diff. side/
 Tripod roller Diameter
 C: Seal Diameter [mm]
 H: Bell pin length (wheel side)
 L: Length
 ABS: Number of teeth on ABS ring



04

Stub Shaft

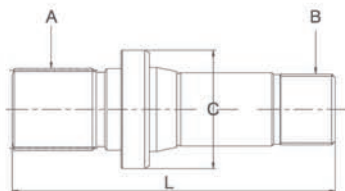

A: External Teeth, wheel side
 B: External Teeth, diff. side
 C: Seal Diameter [mm]
 L: Length



MT/AT: Manual and Automatic integrated
 MT&AT: Manual or Automatic

L/R: Left/Right
 F/R: Front/Rear

GENERAL INDEX





Vehicle index.....page.A- T





Applications.....page.001-1248





Cross references list.....page.1249-1299





New applications (compared with catalogue 2018).....page.1300-1304





YEAR	TRANSM	L/R	F/R	REMARKS	GSP Ref.	PRODUCT	ABS	Technical Specifications							
								A	B	C	H	L	P		
ABARTH															
GRANDE PUNTO (199_)															
1.4 (132 kW)	2007.012-	2012.12	-	L/R	F	Hatchback Engine 199 A8.000/955 A8.000	817063	Outer Joint		25	25	51.1	84.5	61	M
PUNTO EVO (199_)															
1.4(120 kW)	2009.1-	2012.02	-	L/R	F	Hatchback Engine 955 A8.000	817063	Outer Joint		25	25	51.1	84.5	61	M
1.4(132 kW)	2008.07-	2012.02	-	L/R	F	Hatchback Engine 955 A8.000	817063	Outer Joint		25	25	51.1	84.5	61	M
ACURA															
CL															
2.2	1997-	-	MT	L	-	-	201019	Drive Shaft	50T	28	27	60	88	615	
2.3	1997-	1999	MT	L	-	-	201019	Drive Shaft	50T	28	27	60	88	615	
3.0	1997-	1999	-	L	-	-	201039	Drive Shaft	50T	28	29	60	88	634	
EL															
-	2001-	2005	AT	R	-	-	623008	Inner Joint		25	30	35	54.5	92	
	2001-	2005	AT	L	-	-	223128	Drive Shaft	50T	26	25	60	78	903	
	2001-	2005	AT	R	-	-	223127	Drive Shaft	50T	26	25	60	78	606	
INTEGRA															
-	1990-	1993	-	L	-	-	201037	Drive Shaft	50T	26	27	55	78.5	597	
	1990-	1993	-	L	-	-	223118	Drive Shaft		26	27	55	78.5	594	
	1990-	1993	-	L	-	W/O GSR PKG	201052	Drive Shaft	50T	26	27	55	78.5	594	
	1994-	1997	-	-	-	-	623011	Inner Joint		27	32	40	45.5	85	
	1994-	2000	-	L	-	-	201022	Drive Shaft		26	27	55	78.5	566.5	
2.0	1995-	2000	-	-	-	-	823074	Outer Joint		26	23	55	78.5	56.5	M
	1995-	2000	-	-	-	-	823075	Outer Joint	50T	26	23	55	78.5	56.5	M
	1995-	2000	-	R	-	-	223080	Drive Shaft		26	27	55	78.5	618.5	
	1995-	2000	-	R	-	-	223049	Drive Shaft	50T	26	27	55	78.5	618.5	
	1995-	2000	-	L	-	-	223081	Drive Shaft		26	27	55	78.5	594	
	1995-	2000	-	L	-	-	223050	Drive Shaft	50T	26	27	55	78.5	594	
LEGEND															
2.7 (130 kW)	1987.01-	1991.08	AT/MT	L/R	F	Coupe Engine C27A1	823044	Outer Joint		28	34	60	88	57.5	M
LEGEND II															
3.2 (151 kW)	1991.08-	1996.08	AT/MT	L/R	F	Saloon Engine C32A	801005	Outer Joint		30	36	64	89	65.5	M
	1991.08-	1996.08	AT/MT	L/R	F	Coupe Engine C32A2	801005	Outer Joint		30	36	64	89	65.5	M
MDX (YD1)															
3.5 (179 kW)	2001.03-	2005.12	AT	-	F	All-wheel Drive Closed Off-Road Vehicle Engine J35A3	823162	Outer Joint	50T	30	35	68	89	61.5	I
	2001.03-	2005.12	AT	-	F	All-wheel Drive Closed Off-Road Vehicle Engine J35A3	823152	Outer Joint	50T	28	35	64	89	61.5	I
	2001.03-	2005.12	AT	R	F	All-wheel Drive Closed Off-Road Vehicle Engine J35A3	623107	Inner Joint		29	35	42		126.5	
MDX (YD2)															
3.7 (224 kW)	2006.10-	-	AT	-	F	All-wheel Drive Closed Closed Off-Road Vehicle Engine J37A2	823148	Outer Joint		30	36	64	106	64	I
3.7(220 kW)	2006.1-	-	AT	-	F	All-wheel Drive Closed Off-Road Vehicle Engine J37A2	823148	Outer Joint		30	36	64	106	64	I
3.7(227 kW)	2006.1-	-	AT	-	F	All-wheel Drive Closed Off-Road Vehicle Engine J37A1	823148	Outer Joint		30	36	64	106	64	I
VIGOR															
-	1992-	1994	-	-	-	-	801004	Outer Joint		28	34	60	93	59	M
ALFA ROMEO															
145 (930_)															
1.4 i.e. (66 kW)	1994.07-	1996.12	MT	L/R	F	Hatchback Engine AR 33501	817004	Outer Joint		25	25	52	85	58	I
	1994.07-	1996.12	-	-	F	Hatchback Engine AR 33501	802004	Outer Joint	44T	25	25	52	85	58	I
1.4 i.e. 16V T.S. (76 kW)	1996.12-	2001.01	AT/MT	L/R	F	Hatchback Engine AR 38501/AR 33508	618070	Inner Joint			25		32		
	1996.12-	2001.01	MT	L/R	F	Hatchback Engine AR 38501/AR 33508	817023	Outer Joint		25	22	52	84	57	O
	1996.12-	2001.01	-	-	F	Hatchback Engine AR 38501/AR 33508	802006	Outer Joint	44T	25	25	52	85	58	O
	1996.12-	2001.01	MT	L/R	F	Hatchback Engine AR 38501/AR 33508	602011	Inner Joint			25		32		
	1996.12-	2001.01	-	-	F	Hatchback Engine AR 38501/AR 33508	602005	Inner Joint			25		32		
1.6 i.e. (76 kW)	1994.10-	1996.12	MT	L/R	F	Hatchback Engine AR 33201	817004	Outer Joint		25	25	52	85	58	I
	1994.10-	1996.12	-	-	F	Hatchback Engine AR 33201	802004	Outer Joint	44T	25	25	52	85	58	I
1.6 i.e. 16V T.S. (88 kW)	1996.12-	2001.01	-	-	F	Hatchback Engine AR 67601/AR 38201	602005	Inner Joint			25		32		
	1996.12-	2001.01	AT/MT	L/R	F	Hatchback Engine AR 67601/AR 38201	618070	Inner Joint			25		32		
	1996.12-	2001.01	-	-	F	Hatchback Engine AR 67601/AR 38201	602006	Inner Joint			25		32		
	1996.12-	2001.01	-	-	F	Hatchback Engine AR 67601/AR 38201	802006	Outer Joint	44T	25	25	52	85	58	O
	1996.12-	2001.01	MT	L/R	F	Hatchback Engine AR 67601/AR 38201	602011	Inner Joint			25		32		
1.7 i.e. 16V (95 kW)	1994.10-	1996.12	-	-	F	Hatchback Engine AR 33401	602006	Inner Joint			25		32		
	1994.10-	1996.12	MT	L/R	F	Hatchback Engine AR 33401	817004	Outer Joint		25	25	52	85	58	I
	1994.10-	1996.12	-	-	F	Hatchback Engine AR 33401	802004	Outer Joint	44T	25	25	52	85	58	I
1.8 i.e. 16V (106 kW)	1998.03-	2001.01	-	-	F	Hatchback Engine AR 32201	602005	Inner Joint			25		32		
	1998.03-	2001.01	-	-	F	Hatchback Engine AR 32201	802006	Outer Joint	44T	25	25	52	85	58	O
	1998.03-	2001.01	-	-	F	Hatchback Engine AR 32201	602006	Inner Joint			25		32		
	1998.03-	2001.01	MT	L/R	F	Hatchback Engine AR 32201	602011	Inner Joint			25		32		
1.8 i.e. 16V T.S. (103 kW)	1996.12-	1998.12	-	-	F	Hatchback Engine AR 67106/AR 38401/AR 67199	602005	Inner Joint			25		32		
	1996.12-	1998.12	AT/MT	L/R	F	Hatchback Engine AR 67106/AR 38401/AR 67199	618070	Inner Joint			25		32		





	 YEAR	TRANSM	L/R	F/R	REMARKS	GSP Ref.	 PRODUCT	 ABS	Technical Specifications						
									A	B	C	H	L	P	
ALFA ROMEO															
145 (930_)															
1.8 i.e. 16V T.S. (103 kW)	1996.12-1998.12	-	-	F	Hatchback Engine AR 67106/AR 38401/AR 67199	802006	Outer Joint	44T	25	25	52	85	58	O	
	1996.12-1998.12	-	-	F	Hatchback Engine AR 67106/AR 38401/AR 67199	602006	Inner Joint			25		32			
	1996.12-1998.12	MT	L/R	F	Hatchback Engine AR 67106/AR 38401/AR 67199	602011	Inner Joint			25		32			
1.9 JTD (77 kW)	1999.02-2001.01	AT/MT	R	F	Hatchback Engine AR 32302	618070	Inner Joint			25		32			
	1999.02-2001.01	MT	L/R	F	Hatchback Engine AR 32302	802003	Outer Joint		25	25	52	85	58	O	
1.9 TD (66 kW)	1994.10-1999.02	-	-	F	Hatchback Engine AR 67501/AR 33601	802006	Outer Joint	44T	25	25	52	85	58	O	
	1994.10-1999.02	MT	L/R	F	Hatchback Engine AR 67501/AR 33601	602011	Inner Joint			25		32			
	1994.10-1999.02	-	-	F	Hatchback Engine AR 67501/AR 33601	602005	Inner Joint			25		32			
	1994.10-1999.02	AT/MT	L/R	F	Hatchback Engine AR 67501/AR 33601	618070	Inner Joint			25		32			
2.0 16V Quadrifoglio (114 kW)	1998.03-2001.01	-	-	F	Hatchback Engine AR 32301	602005	Inner Joint			25		32			
	1998.03-2001.01	-	-	F	Hatchback Engine AR 32301	802006	Outer Joint	44T	25	25	52	85	58	O	
	1998.03-2001.01	-	-	F	Hatchback Engine AR 32301	602006	Inner Joint			25		32			
2.0 16V T.S. (110 kW)	1995.10-2001.01	-	-	F	Hatchback Engine AR 67204	602006	Inner Joint			25		32			
	1995.10-2001.01	-	-	F	Hatchback Engine AR 67204	802006	Outer Joint	44T	25	25	52	85	58	O	
	1995.10-2001.01	-	L/R	F	Hatchback Engine AR 67204	817042	Outer Joint		25	25	51	85	58	O	
	1995.10-2001.01	MT	L/R	F	Hatchback Engine AR 67204	602011	Inner Joint			25		32			
	1995.10-2001.01	-	-	F	Hatchback Engine AR 67204	602005	Inner Joint			25		32			
	1995.10-2001.01	AT/MT	L/R	F	Hatchback Engine AR 67204	618070	Inner Joint			25		32			
145/146 (930)															
1.4 i.e. 16V T.S. (76 kW)	1998-	1999.01	-	-	-	617009	Inner Joint			25		32			
1.6 i.e. (76 kW)	1994.10-	1996.11	-	-	-	617009	Inner Joint			25		32			
1.6 i.e. 16V T.S. (88 kW)	1996.12-	1998.10	-	-	-	617009	Inner Joint			25		32			
1.7 i.e. 16V (95 kW)	-	1996	-	-	-	617009	Inner Joint			25		32			
1.8 16V T.S. (103 kW)	1996.12-	2001.01	-	-	-	617009	Inner Joint			25		32			
1.8 16V T.S. (106 kW)	1998-	2001	-	-	-	617009	Inner Joint			25		32			
1.8 i.e. 16V (106 kW)	1998-	2001.01	-	-	-	617009	Inner Joint			25		32			
1.9 JTD (77 kW)	1999-	2001	-	L	-	602007	Inner Joint			34		47.5			
1.9 TD (66 kW)	1994.10-	1999.02	-	-	-	617009	Inner Joint			25		32			
2.0 16V Q (114 kW)	1998.11-	2001	-	-	-	617009	Inner Joint			25		32			
2.0 16V T.S. (110 kW)	1996.12-	2001.01	-	-	-	617009	Inner Joint			25		32			
146 (930_)															
1.4 i.e. (66 kW)	1994.12-	1996.12	MT	L/R	F	Hatchback Engine AR 33501	817004	Outer Joint		25	25	52	85	58	I
	1994.12-	1996.12	-	-	F	Hatchback Engine AR 33501	802004	Outer Joint	44T	25	25	52	85	58	I
1.4 i.e. 16V T.S. (76 kW)	1996.11-	2001.01	AT/MT	L/R	F	Hatchback Engine AR 33503/AR 38501	618070	Inner Joint		25		32			
	1996.11-	2001.01	MT	L/R	F	Hatchback Engine AR 33503/AR 38501	817023	Outer Joint		25	22	52	84	57	O
	1996.11-	2001.01	-	-	F	Hatchback Engine AR 33503/AR 38501	802006	Outer Joint	44T	25	25	52	85	58	O
	1996.11-	2001.01	MT	L/R	F	Hatchback Engine AR 33503/AR 38501	602011	Inner Joint			25		32		
	1996.11-	2001.01	-	-	F	Hatchback Engine AR 33503/AR 38501	602005	Inner Joint			25		32		
1.6 i.e. (76 kW)	1994.12-	1996.12	MT	L/R	F	Hatchback Engine AR 33201	817004	Outer Joint		25	25	52	85	58	I
	1994.12-	1996.12	-	-	F	Hatchback Engine AR 33201	802004	Outer Joint	44T	25	25	52	85	58	I
1.6 i.e. 16V T.S. (88 kW)	1996.11-	2001.01	-	-	F	Hatchback Engine AR 38201/AR 67601	602005	Inner Joint		25		32			
	1996.11-	2001.01	AT/MT	L/R	F	Hatchback Engine AR 38201/AR 67601	618070	Inner Joint			25		32		
	1996.11-	2001.01	-	-	F	Hatchback Engine AR 38201/AR 67601	802006	Outer Joint	44T	25	25	52	85	58	O
	1996.11-	2001.01	-	-	F	Hatchback Engine AR 38201/AR 67601	602006	Inner Joint			25		32		
	1996.11-	2001.01	MT	L/R	F	Hatchback Engine AR 38201/AR 67601	602011	Inner Joint			25		32		
1.7 i.e. 16V (95 kW)	1994.12-	1996.12	MT	L/R	F	Hatchback Engine AR 33401	817004	Outer Joint		25	25	52	85	58	I
	1994.12-	1996.12	-	-	F	Hatchback Engine AR 33401	802004	Outer Joint	44T	25	25	52	85	58	I
1.8 i.e. 16V T.S. (103 kW)	1996.11-	2001.01	-	-	F	Hatchback Engine AR 38401/AR 67106	602005	Inner Joint			25		32		
	1996.11-	2001.01	AT/MT	L/R	F	Hatchback Engine AR 38401/AR 67106	618070	Inner Joint			25		32		
	1996.11-	2001.01	-	-	F	Hatchback Engine AR 38401/AR 67106	802006	Outer Joint	44T	25	25	52	85	58	O
	1996.11-	2001.01	-	-	F	Hatchback Engine AR 38401/AR 67106	602006	Inner Joint			25		32		
	1996.11-	2001.01	MT	L/R	F	Hatchback Engine AR 38401/AR 67106	602011	Inner Joint			25		32		
1.8 i.e. 16V T.S. (106 kW)	1998.03-	2001.01	-	-	F	Hatchback Engine AR 32201	602005	Inner Joint			25		32		
	1998.03-	2001.01	-	-	F	Hatchback Engine AR 32201	802006	Outer Joint	44T	25	25	52	85	58	O
	1998.03-	2001.01	-	-	F	Hatchback Engine AR 32201	602006	Inner Joint			25		32		
	1998.03-	2001.01	MT	L/R	F	Hatchback Engine AR 32201	602011	Inner Joint			25		32		
1.9 JTD (77 kW)	1999.02-	2001.01	AT/MT	R	F	Hatchback Engine AR 32302	618070	Inner Joint			25		32		
	1999.02-	2001.01	MT	L/R	F	Hatchback Engine AR 32302	802003	Outer Joint		25	25	52	85	58	O
1.9 TD (66 kW)	1994.12-	1999.02	-	-	F	Hatchback Engine AR 33601/AR 67501	802006	Outer Joint	44T	25	25	52	85	58	O
	1994.12-	1999.02	MT	L/R	F	Hatchback Engine AR 33601/AR 67501	602011	Inner Joint			25		32		
	1994.12-	1999.02	-	-	F	Hatchback Engine AR 33601/AR 67501	602005	Inner Joint			25		32		
	1994.12-	1999.02	AT/MT	L/R	F	Hatchback Engine AR 33601/AR 67501	618070	Inner Joint			25		32		
2.0 16V Quadrifoglio (114 kW)	1998.03-	2001.01	-	-	F	Hatchback Engine AR 32301	602005	Inner Joint			25		32		
	1998.03-	2001.01	-	-	F	Hatchback Engine AR 32301	802006	Outer Joint	44T	25	25	52	85	58	O
	1998.03-	2001.01	-	-	F	Hatchback Engine AR 32301	602006	Inner Joint			25		32		
2.0 16V T.S. (110 kW)	1995.10-	2001.01	-	-	F	Hatchback Engine AR 67204	602006	Inner Joint			25		32		





	 YEAR	TRANSM	L/R	F/R	REMARKS	GSP Ref.	 PRODUCT	 ABS	Technical Specifications								
									A	B	C	H	L	P			
ALFA ROMEO																	
146 (930_)																	
2.0 16V T.S. (110 kW)	1995.10-	2001.01	-	-	F	Hatchback Engine AR 67204	802006	Outer Joint	44T	25	25	52	85	58	O		
	1995.10-	2001.01	MT	L/R	F	Hatchback Engine AR 67204	602011	Inner Joint			25		32				
	1995.10-	2001.01	-	-	F	Hatchback Engine AR 67204	602005	Inner Joint			25		32				
	1995.10-	2001.01	AT/MT	L/R	F	Hatchback Engine AR 67204	618070	Inner Joint			25		32				
147 (937)																	
1.6 16V T.S. (88 kW)	2001.01-	-	-	-	-	-	617009	Inner Joint			25		32				
1.6 16V T.S. ECO (77 kW)	2001.01-	-	-	-	-	-	617009	Inner Joint			25		32				
1.9 JTD (74 kW)	2003.06-	-	-	-	-	-	617009	Inner Joint			25		32				
1.9 JTD (85 kW)	2001.04-	-	-	L	-	-	602007	Inner Joint			34		47.5				
	2003.11-	-	-	R	-	-	617006	Inner Joint		25	26	29.8	377	108			
	2003.11-	-	-	L	-	-	617005	Inner Joint		25	26	32	91	95			
1.9 JTD 16V (100 kW)	2001.04-	2003.10	-	L	-	-	602007	Inner Joint			34		47.5				
1.9 JTD 16V (103 kW)	2001.04-	2003.10	-	L	-	-	602007	Inner Joint			34		47.5				
	2003.11-	-	-	R	-	-	617006	Inner Joint		25	26	29.8	377	108			
	2003.11-	-	-	L	-	-	617005	Inner Joint		25	26	32	91	95			
1.9 JTD 16V (110 kW)	2007.04-	2010.01	-	R	-	-	617006	Inner Joint		25	26	29.8	377	108			
	2007.04-	2010.01	-	L	-	-	617005	Inner Joint		25	26	32	91	95			
1.9 JTD 16V (125 kW)	2007.04-	2010.01	-	R	-	-	617006	Inner Joint		25	26	29.8	377	108			
	2007.04-	2010.01	-	L	-	-	617005	Inner Joint		25	26	32	91	95			
1.9 JTD 16V (93 kW)	2003.09-	2004.09	-	R	-	-	617006	Inner Joint		25	26	29.8	377	108			
	2003.09-	2004.09	-	L	-	-	617005	Inner Joint		25	26	32	91	95			
	2003.09-	2004.09	-	L	-	-	602007	Inner Joint			34		47.5				
1.9 JTD 8V (88 kW)	2005.07-	-	-	R	-	-	617006	Inner Joint		25	26	29.8	377	108			
	2005.07-	-	-	L	-	-	617005	Inner Joint		25	26	32	91	95			
2.0 16V T.S. (110 kW)	2001.01-	-	-	-	-	-	617009	Inner Joint			25		32				
147 (937_)																	
1.6 16V T.SPARK (88 kW)	2001.01-	2010.03	-	-	F	Hatchback Engine AR 32104	602005	Inner Joint			25		32				
	2001.01-	2010.03	MT	L/R	F	Hatchback Engine AR 32104	817042	Outer Joint		25	25	51	85	58	O		
	2001.01-	2010.03	-	-	F	Hatchback Engine AR 32104	602006	Inner Joint			25		32				
	2001.01-	2010.03	MT	L/R	F	Hatchback Engine AR 32104	602011	Inner Joint			25		32				
	2001.01-	2010.03	-	L/R	F	Hatchback Engine AR 32104	617038	Inner Joint			25		32				
	2001.01-	2010.03	-	L/R	F	Hatchback Engine AR 32104	202009	Drive Shaft		25		51	85	494			
	2001.01-	2010.03	-	-	F	Hatchback Engine AR 32104	802020	Outer Joint		25	25	51	85	58	O		
	2001.01-	2010.03	MT	L/R	F	Hatchback Engine AR 32104	618070	Inner Joint			25		32				
1.6 16V T.SPARK ECO (77 kW)	2001.01-	2010.03	-	-	F	Hatchback Engine AR 37203	602005	Inner Joint			25		32				
	2001.01-	2010.03	MT	L/R	F	Hatchback Engine AR 37203	817042	Outer Joint		25	25	51	85	58	O		
	2001.01-	2010.03	-	-	F	Hatchback Engine AR 37203	602006	Inner Joint			25		32				
	2001.01-	2010.03	MT	L/R	F	Hatchback Engine AR 37203	602011	Inner Joint			25		32				
	2001.01-	2010.03	-	L/R	F	Hatchback Engine AR 37203	617038	Inner Joint			25		32				
	2001.01-	2010.03	MT	L/R	F	Hatchback Engine AR 37203	618070	Inner Joint			25		32				
	2001.01-	2010.03	-	L/R	F	Hatchback Engine AR 37203	202009	Drive Shaft		25		51	85	494			
	2001.01-	2010.03	-	-	F	Hatchback Engine AR 37203	802020	Outer Joint		25	25	51	85	58	O		
1.9 JTD (74 kW)	2003.06-	2010.03	-	-	F	Hatchback Engine 182 B9.000	602005	Inner Joint			25		32				
	2003.06-	2010.03	MT	L/R	F	Hatchback Engine 182 B9.000	602011	Inner Joint			25		32				
	2003.06-	2010.03	-	L/R	F	Hatchback Engine 182 B9.000	617038	Inner Joint			25		32				
	2003.06-	2010.03	-	L/R	F	Hatchback Engine 182 B9.000	202009	Drive Shaft		25		51	85	494			
	2003.06-	2010.03	MT	L/R	F	Hatchback Engine 182 B9.000	618070	Inner Joint			25		32				
1.9 JTD (85 kW)	2001.04-	2010.03	-	R	F	Hatchback Engine 937 A2.000	202008	Drive Shaft		25	25	51	84.5	931.5			
	2001.04-	2010.03	MT	R	F	Hatchback Engine 937 A2.000	202011	Drive Shaft		25		51	84.5	521			
	2001.04-	2010.03	-	L	F	Hatchback Engine 937 A2.000	217150	Drive Shaft		25	25	51	84.5	615			
	2001.04-	2010.03	-	L/R	F	Hatchback Engine 937 A2.000	802025	Outer Joint		25	26	51	84.5	64.5	M		
	2001.04-	2010.03	-	L/R	F	Hatchback Engine 937 A2.000	802014	Outer Joint		25	28	51	84.5	64	O		
1.9 JTD 16V (100 kW)	2004.10-	2010.03	-	R	F	Hatchback Engine 192 B1.000	202008	Drive Shaft		25	25	51	84.5	931.5			
	2004.10-	2010.03	-	L/R	F	Hatchback Engine 192 B1.000	802025	Outer Joint		25	26	51	84.5	64.5	M		
1.9 JTD 16V (103 kW)	2002.11-	2010.03	-	R	F	Hatchback Engine 192 A5.000	202008	Drive Shaft		25	25	51	84.5	931.5			
	2002.11-	2010.03	MT	R	F	Hatchback Engine 192 A5.000	202011	Drive Shaft		25		51	84.5	521			
	2002.11-	2010.03	-	L	F	Hatchback Engine 192 A5.000	217150	Drive Shaft		25	25	51	84.5	615			
	2002.11-	2010.03	-	L/R	F	Hatchback Engine 192 A5.000	802025	Outer Joint		25	26	51	84.5	64.5	M		
	2002.11-	2010.03	-	L/R	F	Hatchback Engine 192 A5.000	802014	Outer Joint		25	28	51	84.5	64	O		
1.9 JTD 16V (93 kW)	2003.09-	2004.09	-	R	F	Hatchback Engine 937 A4.000	202008	Drive Shaft		25	25	51	84.5	931.5			
	2003.09-	2004.09	-	L/R	F	Hatchback Engine 937 A4.000	802025	Outer Joint		25	26	51	84.5	64.5	M		
1.9 JTDM (85 kW)	2004.10-	2010.03	-	R	F	Hatchback Engine 939 A7.000	202008	Drive Shaft		25	25	51	84.5	931.5			
	2004.10-	2010.03	-	L	F	Hatchback Engine 939 A7.000	217150	Drive Shaft		25	25	51	84.5	615			
	2004.10-	2010.03	-	L/R	F	Hatchback Engine 939 A7.000	802025	Outer Joint		25	26	51	84.5	64.5	M		
1.9 JTDM 16V (110 kW)	2004.09-	2010.03	-	R	F	Hatchback Engine 937 A5.000	202008	Drive Shaft		25	25	51	84.5	931.5			
	2004.09-	2010.03	-	L	F	Hatchback Engine 937 A5.000	217150	Drive Shaft		25	25	51	84.5	615			

	 YEAR	TRANSM	L/R	F/R	REMARKS	GSP Ref.	 PRODUCT	 ABS	Technical Specifications						
									A	B	C	H	L	P	
ALFA ROMEO															
147 (937_)															
1.9 JTDM 16V (110 kW)	2004.09-2010.03	-	L/R	F	Hatchback Engine 937 A5.000	802025	Outer Joint		25	26	51	84.5	64.5	M	
1.9 JTDM 16V (125 kW)	2008.06-2010.03	-	R	F	Hatchback Engine 937 A6.000	202008	Drive Shaft		25	25	51	84.5	931.5		
1.9 JTDM 8V (88 kW)	2005.07-2010.03	-	R	F	Hatchback Engine 937 A3.000/937 A2.000	202008	Drive Shaft		25	25	51	84.5	931.5		
	2005.07-2010.03	-	L	F	Hatchback Engine 937 A3.000/937 A2.000	217150	Drive Shaft		25	25	51	84.5	615		
	2005.07-2010.03	-	L/R	F	Hatchback Engine 937 A3.000/937 A2.000	802025	Outer Joint		25	26	51	84.5	64.5	M	
2.0 16V T.SPARK (110 kW)	2001.01-2010.03	-	-	F	Hatchback Engine AR 32310	602005	Inner Joint		25		32				
	2001.01-2010.03	MT	L/R	F	Hatchback Engine AR 32310	817042	Outer Joint		25	25	51	85	58	O	
	2001.01-2010.03	-	-	F	Hatchback Engine AR 32310	602006	Inner Joint		25		32				
	2001.01-2010.03	MT	L/R	F	Hatchback Engine AR 32310	602011	Inner Joint		25		32				
	2001.01-2010.03	-	L/R	F	Hatchback Engine AR 32310	617038	Inner Joint		25		32				
	2001.01-2010.03	-	L/R	F	Hatchback Engine AR 32310	202009	Drive Shaft		25		51	85	494		
	2001.01-2010.03	-	-	F	Hatchback Engine AR 32310	802020	Outer Joint		25	25	51	85	58	O	
2001.01-2010.03	MT	L/R	F	Hatchback Engine AR 32310	618070	Inner Joint		25		32					
155 (167)															
1.6 16V T.S. (88 kW)	1996.05-	-	-	-	-	617009	Inner Joint		25		32				
1.7 16V T.S. (103 kW)	1996-	1997	-	-	-	617009	Inner Joint		25		32				
1.9 TD (66 kW)	1993.04-	1997.12	-	-	-	648006	Inner Joint		25		32				
2.0 16V T Q4 (137 kW)	1992.01-	1997.12	-	-	-	648006	Inner Joint		25		32				
2.0 16V T Q4 (140 kW)	1992.01-	1997.12	-	-	-	648006	Inner Joint		25		32				
2.0 16V T.S. (110 kW)	1995.03-	1997.12	-	-	-	648006	Inner Joint		25		32				
2.0 T.S. (104 kW)	1992-	1995	-	-	-	648006	Inner Joint		25		32				
2.0 T.S. (106 kW)	1992-	1995	-	-	-	648006	Inner Joint		25		32				
155 (167_)															
1.6 16V T.S. (88 kW)	1996.05-	1997.12	AT/MT	L/R	F	Saloon Engine AR 67601	618070	Inner Joint		25		32			
	1996.05-	1997.12	MT	L/R	F	Saloon Engine AR 67601	817004	Outer Joint		25	25	52	85	58	I
	1996.05-	1997.12	-	-	F	Saloon Engine AR 67601	802006	Outer Joint	44T	25	25	52	85	58	O
	1996.05-	1997.12	-	-	F	Saloon Engine AR 67601	602005	Inner Joint		25		32			
1.7 T.S. (83 kW)	1993.04-	1996.04	-	-	F	Saloon Engine AR 67103	602005	Inner Joint		25		32			
	1993.04-	1996.04	-	-	F	Saloon Engine AR 67103	802004	Outer Joint	44T	25	25	52	85	58	I
1.7 T.S. (85 kW)	1993.04-	1996.04	-	-	F	Saloon Engine AR 67105	802004	Outer Joint	44T	25	25	52	85	58	I
	1993.04-	1996.04	-	-	F	Saloon Engine AR 67105	602005	Inner Joint		25		32			
1.7 T.S. 16V (103 kW)	1996.05-	1997.12	-	-	F	Saloon Engine AR 67106	802004	Outer Joint	44T	25	25	52	85	58	I
	1996.05-	1997.12	-	-	F	Saloon Engine AR 67106	602005	Inner Joint		25		32			
1.8 T.S. (77 kW)	1992.02-	1997.12	-	-	F	Saloon Engine AR 67402	802004	Outer Joint	44T	25	25	52	85	58	I
	1992.02-	1997.12	-	-	F	Saloon Engine AR 67402	602005	Inner Joint		25		32			
	1992.02-	1997.12	-	-	F	Saloon Engine AR 67402	602006	Inner Joint		25		32			
1.8 T.S. (95 kW)	1992.02-	1993.06	-	-	F	Saloon Engine AR 67101	802004	Outer Joint	44T	25	25	52	85	58	I
	1992.02-	1993.06	-	-	F	Saloon Engine AR 67101	602005	Inner Joint		25		32			
	1992.02-	1993.06	-	-	F	Saloon Engine AR 67101	602006	Inner Joint		25		32			
1.8 T.S. Sport (93 kW)	1992.01-	1996.12	-	-	F	Saloon Engine AR 67101/AR 67102	602006	Inner Joint		25		32			
1.9 TD (66 kW)	1993.04-	1997.12	-	-	F	Saloon Engine AR 67501	802006	Outer Joint	44T	25	25	52	85	58	O
	1993.04-	1997.12	-	-	F	Saloon Engine AR 67501	602005	Inner Joint		25		32			
2.0 16V Turbo Q4 (137 kW)	1992.01-	1997.12	MT	L/R	F	All-wheel Drive Saloon Engine AR 67203	802009	Outer Joint	44T	25	28	56	85	63.5	O
	1992.01-	1997.12	-	-	F	All-wheel Drive Saloon Engine AR 67203	602006	Inner Joint		25		32			
2.0 16V Turbo Q4 (140 kW)	1992.01-	1997.12	-	-	F	All-wheel Drive Saloon Engine AR 67203	602006	Inner Joint		25		32			
	1992.01-	1997.12	MT	L/R	F	All-wheel Drive Saloon Engine AR 67203	802009	Outer Joint	44T	25	28	56	85	63.5	O
2.0 T.S. (104 kW)	1992.02-	1995.02	-	-	F	Saloon Engine AR 67202/AR 67201	802004	Outer Joint	44T	25	25	52	85	58	I
	1992.02-	1995.02	-	-	F	Saloon Engine AR 67202/AR 67201	602005	Inner Joint		25		32			
	1992.02-	1995.02	-	-	F	Saloon Engine AR 67202/AR 67201	602006	Inner Joint		25		32			
2.0 T.S. (106 kW)	1992.02-	1993.04	-	-	F	Saloon Engine AR 67202/AR 67201	802004	Outer Joint	44T	25	25	52	85	58	I
	1992.02-	1993.04	-	-	F	Saloon Engine AR 67202/AR 67201	602005	Inner Joint		25		32			
	1992.02-	1993.04	-	-	F	Saloon Engine AR 67202/AR 67201	602006	Inner Joint		25		32			
2.0 T.S. 16V (110 kW)	1995.03-	1997.12	-	-	F	Saloon Engine AR 67204/AR 67299	602006	Inner Joint		25		32			
	1995.03-	1997.12	-	-	F	Saloon Engine AR 67204/AR 67299	802006	Outer Joint	44T	25	25	52	85	58	O
	1995.03-	1997.12	-	-	F	Saloon Engine AR 67204/AR 67299	602005	Inner Joint		25		32			
2.5 TD (92 kW)	1993.04-	1997.12	MT	L/R	F	Saloon Engine VM 07 B/VW 31 B	802009	Outer Joint	44T	25	28	56	85	63.5	O
2.5 V6 (120 kW)	1992.10-	1997.12	-	-	F	Saloon Engine AR 67302/AR 67303	602006	Inner Joint		25		32			
	1992.10-	1997.12	MT	L/R	F	Saloon Engine AR 67302/AR 67303	802009	Outer Joint	44T	25	28	56	85	63.5	O
2.5 V6 (121 kW)	1992.02-	1996.09	-	-	F	Saloon Engine AR 67301	602006	Inner Joint		25		32			
	1992.02-	1996.09	MT	L/R	F	Saloon Engine AR 67301	802009	Outer Joint	44T	25	28	56	85	63.5	O
156 (932_)															
1.6 16V T.SPARK (88 kW)	1997.09-	2005.09	-	-	F	Saloon Engine AR 32102/AR 32104/AR 32103/AR 67601	602005	Inner Joint		25		32			
	1997.09-	2005.09	-	L/R	F	Saloon Engine AR 32102/AR 32104/AR 32103/AR 67601	217159	Drive Shaft		25		58.8	85	490	
	1997.09-	2005.09	-	-	F	Saloon Engine AR 32102/AR 32104/AR 32103/AR 67601	602006	Inner Joint		25		32			
	1997.09-	2005.09	MT	L/R	F	Saloon Engine AR 32102/AR 32104/AR 32103/AR 67601	802017	Outer Joint		25	25	58.8	85	58.3	O
	1997.09-	2005.09	MT	L/R	F	Saloon Engine AR 32102/AR 32104/AR 32103/AR 67601	618070	Inner Joint		25		32			





	 YEAR	TRANSM	L/R	F/R	REMARKS	GSP Ref.	 PRODUCT	 ABS	Technical Specifications								
									A	B	C	H	L	P			
ALFA ROMEO																	
156 (932_)																	
1.8 16V T.SPARK (103 kW)	2000.10-2005.09	-	L/R	F	Saloon Engine AR 32205	217159	Drive Shaft		25		58.8	85	490				
	2000.10-2005.09	-	-	F	Saloon Engine AR 32205	602005	Inner Joint			25		32					
	2000.10-2005.09	-	-	F	Saloon Engine AR 32205	602006	Inner Joint			25		32					
1.8 16V T.SPARK (106 kW)	1997.09-2000.10	-	-	F	Saloon Engine AR 32201	602005	Inner Joint			25		32					
	1997.09-2000.10	-	L/R	F	Saloon Engine AR 32201	217159	Drive Shaft		25		58.8	85	490				
	1997.09-2000.10	-	-	F	Saloon Engine AR 32201	602006	Inner Joint			25		32					
	1997.09-2000.10	MT	L/R	F	Saloon Engine AR 32201	802017	Outer Joint		25	25	58.8	85	58.3	O			
	1997.09-2000.10	MT	L/R	F	Saloon Engine AR 32201	618070	Inner Joint			25		32					
	1997.09-2000.10	MT	L	F	Saloon Engine AR 32201	202003	Drive Shaft		25	26.65	59	84	502				
1.9 JTD (100 kW)	2002.11-2004.11	MT	L	F	Saloon Engine 192 B1.000	217107	Drive Shaft		25	25	59	84	615				
	2002.11-2004.11	MT	L	F	Saloon Engine 192 B1.000	202003	Drive Shaft		25	26.65	59	84	502				
	2002.11-2004.11	MT	R	F	Saloon Engine 192 B1.000	202004	Drive Shaft		25	26.65	59	84	521				
1.9 JTD (110 kW)	2004.07-2005.09	-	L/R	F	Saloon Engine 937 A5.000	817009	Outer Joint		25	26	59	84	63	M			
	2004.07-2005.09	-	L	F	Saloon Engine 937 A5.000	217107	Drive Shaft		25	25	59	84	615				
	2004.07-2005.09	-	L	F	Saloon Engine 937 A5.000	202003	Drive Shaft		25	26.65	59	84	502				
	2004.07-2005.09	-	R	F	Saloon Engine 937 A5.000	202004	Drive Shaft		25	26.65	59	84	521				
1.9 JTD (77 kW)	1997.09-2000.10	AT/MT	R	F	Saloon Engine AR 32302	618070	Inner Joint			25		32					
	1997.09-2000.10	MT	L/R	F	Saloon Engine AR 32302	802012	Outer Joint		25	28	59	85	63	O			
	1997.09-2000.10	-	R	F	Saloon Engine AR 32302	602003	Inner Joint			28		32					
	1997.09-2000.10	MT	L	F	Saloon Engine AR 32302	202001	Drive Shaft		25		59	85	520				
	1997.09-2000.10	MT	R	F	Saloon Engine AR 32302	202002	Drive Shaft		25		59	85	521				
	1997.09-2000.10	MT	R	F	Saloon Engine AR 32302	202002	Drive Shaft		25		59	85	521				
1.9 JTD (81 kW)	2000.10-2001.05	MT	L/R	F	Saloon Engine AR 37101	802012	Outer Joint		25	28	59	85	63	O			
	2000.10-2001.05	-	R	F	Saloon Engine AR 37101	602003	Inner Joint			28		32					
	2000.10-2001.05	MT	L	F	Saloon Engine AR 37101	202001	Drive Shaft		25		59	85	520				
	2000.10-2001.05	MT	R	F	Saloon Engine AR 37101	202002	Drive Shaft		25		59	85	521				
1.9 JTD (85 kW)	2001.05-2005.09	-	L	F	Saloon Engine 937 A2.000	217107	Drive Shaft		25	25	59	84	615				
	2001.05-2005.09	MT	L/R	F	Saloon Engine 937 A2.000	802012	Outer Joint		25	28	59	85	63	O			
	2001.05-2005.09	MT	L	F	Saloon Engine 937 A2.000	202001	Drive Shaft		25		59	85	520				
	2001.05-2005.09	MT	R	F	Saloon Engine 937 A2.000	202002	Drive Shaft		25		59	85	521				
	2001.05-2005.09	MT	L	F	Saloon Engine 937 A2.000	202003	Drive Shaft		25	26.65	59	84	502				
	2001.05-2005.09	MT	R	F	Saloon Engine 937 A2.000	202004	Drive Shaft		25	26.65	59	84	521				
1.9 JTD (93 kW)	2003.11-2005.09	-	L	F	Saloon Engine 937 A4.000	217107	Drive Shaft		25	25	59	84	615				
	2003.11-2005.09	-	L/R	F	Saloon Engine 937 A4.000	817009	Outer Joint		25	26	59	84	63	M			
	2003.11-2005.09	-	L	F	Saloon Engine 937 A4.000	202003	Drive Shaft		25	26.65	59	84	502				
	2003.11-2005.09	-	R	F	Saloon Engine 937 A4.000	202004	Drive Shaft		25	26.65	59	84	521				
1.9 JTD 16V (103 kW)	2002.11-2005.09	-	L/R	F	Saloon Engine 192 A5.000	817009	Outer Joint		25	26	59	84	63	M			
	2002.11-2005.09	-	L	F	Saloon Engine 192 A5.000	217107	Drive Shaft		25	25	59	84	615				
	2002.11-2005.09	-	L	F	Saloon Engine 192 A5.000	202001	Drive Shaft		25		59	85	520				
	2002.11-2005.09	-	R	F	Saloon Engine 192 A5.000	202002	Drive Shaft		25		59	85	521				
	2002.11-2005.09	MT	L	F	Saloon Engine 192 A5.000	202003	Drive Shaft		25	26.65	59	84	502				
	2002.11-2005.09	MT	R	F	Saloon Engine 192 A5.000	202004	Drive Shaft		25	26.65	59	84	521				
2.0 16V T.SPARK (110 kW)	2000.10-2002.03	-	L/R	F	Saloon Engine AR 32310	217159	Drive Shaft		25		58.8	85	490				
	2000.10-2002.03	-	-	F	Saloon Engine AR 32310	602005	Inner Joint			25		32					
	2000.10-2002.03	-	-	F	Saloon Engine AR 32310	602006	Inner Joint			25		32					
	2000.10-2002.03	MT	L/R	F	Saloon Engine AR 32310	618070	Inner Joint			25		32					
2.0 16V T.SPARK (114 kW)	1997.09-2002.06	-	-	F	Saloon Engine AR 32310/ AR 32301	602005	Inner Joint			25		32					
	1997.09-2002.06	-	L/R	F	Saloon Engine AR 32310/ AR 32301	217159	Drive Shaft		25		58.8	85	490				
	1997.09-2002.06	-	-	F	Saloon Engine AR 32310/ AR 32301	602006	Inner Joint			25		32					
	1997.09-2002.06	MT	L/R	F	Saloon Engine AR 32310/ AR 32301	802017	Outer Joint		25	25	58.8	85	58.3	O			
	1997.09-2002.06	MT	L/R	F	Saloon Engine AR 32310/ AR 32301	618070	Inner Joint			25		32					
2.0 JTS (119 kW)	2002.01-2005.09	-	L/R	F	Saloon Engine 932 A2.000	802017	Outer Joint		25	25	58.8	85	58.3	O			
2.0 JTS (122 kW)	2002.03-2005.09	-	L/R	F	Saloon Engine 937 A1.000	217159	Drive Shaft		25		58.8	85	490				
	2002.03-2005.09	AT/MT	L/R	F	Saloon Engine 937 A1.000	618070	Inner Joint			25		32					
	2002.03-2005.09	-	-	F	Saloon Engine 937 A1.000	602005	Inner Joint			25		32					
	2002.03-2005.09	-	-	F	Saloon Engine 937 A1.000	602006	Inner Joint			25		32					
2.4 JTD (100 kW)	1997.09-2003.09	-	-	F	Saloon Engine AR 32501	802019	Outer Joint		25	28	56	85	63.5	O			
	1997.09-2003.09	MT	L/R	F	Saloon Engine AR 32501	802012	Outer Joint		25	28	59	85	63	O			
2.4 JTD (103 kW)	2000.10-2005.09	-	-	F	Saloon Engine 839 A6.000	802019	Outer Joint		25	28	56	85	63.5	O			
2.4 JTD (110 kW)	2002.03-2005.09	-	-	F	Saloon Engine 841 C000	802019	Outer Joint		25	28	56	85	63.5	O			
2.4 JTD (129 kW)	2003.10-2005.09	-	R	F	Saloon Engine 841 G.000	217110	Drive Shaft		25	27	59	84	1000				
	2003.10-2005.09	MT	L	F	Saloon Engine 841 G.000	217117	Drive Shaft		25	27	59	84	550				
	2003.10-2005.09	-	L/R	F	Saloon Engine 841 G.000	817009	Outer Joint		25	26	59	84	63	M			
2.5 V6 24V (140 kW)	1997.09-2001.12	-	-	F	Saloon Engine AR 32401/AR 32402	602005	Inner Joint			25		32					
	1997.09-2001.12	AT/MT	L/R	F	Saloon Engine AR 32401/AR 32402	618070	Inner Joint			25		32					
	1997.09-2001.12	-	-	F	Saloon Engine AR 32401/AR 32402	802019	Outer Joint		25	28	56	85	63.5	O			
	1997.09-2001.12	MT	L/R	F	Saloon Engine AR 32401/AR 32402	802012	Outer Joint		25	28	59	85	63	O			
2.5 V6 24V (141 kW)	2000.10-2005.09	AT/MT	L/R	F	Saloon Engine AR 32405	618070	Inner Joint			25		32					

	 YEAR	TRANSM	L/R	F/R	REMARKS	GSP Ref.	 PRODUCT	 ABS	Technical Specifications					
									A	B	C	H	L	P
ALFA ROMEO														
156 (932_)														
2.5 V6 24V (141 kW)	2000.10-2005.09	-	-	F	Saloon Engine AR 32405	602005	Inner Joint		25	32				
	2000.10-2005.09	-	-	F	Saloon Engine AR 32405	802019	Outer Joint		25	28	56	85	63.5	O
156 SPORTWAGON (932)														
1.6 16V T.S. (88 kW)	2000.05-2006.05	-	-	-		802008	Outer Joint		25	25	59	85	58	O
	2000.05-2006.05	-	-	-		617009	Inner Joint		25	32				
1.8 16V T.S. (103 kW)	2000.10-2006.05	-	-	-		802008	Outer Joint		25	25	59	85	58	O
	2000.10-2006.05	-	-	-		617009	Inner Joint		25	32				
1.8 16V T.S. (106 kW)	2000.05-2000.10	-	-	-		802008	Outer Joint		25	25	59	85	58	O
	2000.10-2006.05	-	-	-		617009	Inner Joint		25	32				
1.9 JTD (77 kW)	2000.05-2000.10	-	L	-		602007	Inner Joint		34	47.5				
1.9 JTD (81 kW)	2000.10-2001.05	-	L	-		602007	Inner Joint		34	47.5				
1.9 JTD (85 kW)	2001.05-2006.05	-	L	-		602007	Inner Joint		34	47.5				
1.9 JTD 16V (103 kW)	2002.11-2006.05	-	R	-		617006	Inner Joint		25	26	29.8	377	108	
	2002.11-2006.05	-	L	-		617005	Inner Joint		25	26	32	91	95	
	2002.11-2006.05	-	L	-		602007	Inner Joint		34	47.5				
1.9 JTD 16V Q4 (110 kW)	2004.07-2006.05	-	-	-		617009	Inner Joint		25	32				
2.0 16V T.S. (110 kW)	2000.10-2002.03	-	-	-		802008	Outer Joint		25	25	59	85	58	O
	2000.10-2002.03	-	-	-		617009	Inner Joint		25	32				
2.0 16V T.S. (114 kW)	2000.05-2000.10	-	-	-		802008	Outer Joint		25	25	59	85	58	O
	2000.10-2002.03	-	-	-		617009	Inner Joint		25	32				
2.0 JTS (122 kW)	2002.03-2006.05	-	-	-		617009	Inner Joint		25	32				
2.4 JTD (100 kW)	2000.05-2006.05	-	L	-		602007	Inner Joint		34	47.5				
2.4 JTD (103 kW)	2000.05-2006.05	-	L	-		602007	Inner Joint		34	47.5				
2.4 JTD (110 kW)	2000.05-2006.05	-	L	-		602007	Inner Joint		34	47.5				
2.4 JTD (120 kW)	2003.10-2006.05	-	L	-		621016	Inner Joint		27	26	35	78.5	112	
2.4 JTD (129 kW)	2003.10-2006.05	-	L	-		621016	Inner Joint		27	26	35	78.5	112	
2.5 V6 24V (140 kW)	2000.05-2000.10	-	-	-		617009	Inner Joint		25	32				
156 Sportwagon (932_)														
1.6 16V T.SPARK. (88 kW)	2000.05-2006.05	-	L/R	F	Estate Engine AR 32102/AR 32104/AR 32103/AR 67601	217159	Drive Shaft		25	58.8	85	490		
	2000.05-2006.05	-	-	F	Estate Engine AR 32102/AR 32104/AR 32103/AR 67601	602005	Inner Joint		25	32				
	2000.05-2006.05	-	-	F	Estate Engine AR 32102/AR 32104/AR 32103/AR 67601	602006	Inner Joint		25	32				
1.8 16V T.SPARK (103 kW)	2000.10-2006.05	-	L/R	F	Estate Engine AR 32205	217159	Drive Shaft		25	58.8	85	490		
	2000.10-2006.05	-	-	F	Estate Engine AR 32205	602005	Inner Joint		25	32				
	2000.10-2006.05	-	-	F	Estate Engine AR 32205	602006	Inner Joint		25	32				
1.8 16V T.SPARK (106 kW)	2000.05-2000.10	-	L/R	F	Estate Engine AR 32201	217159	Drive Shaft		25	58.8	85	490		
	2000.05-2000.10	-	-	F	Estate Engine AR 32201	602005	Inner Joint		25	32				
	2000.05-2000.10	MT	L/R	F	Estate Engine AR 32201	802017	Outer Joint		25	25	58.8	85	58.3	O
	2000.05-2000.10	-	-	F	Estate Engine AR 32201	602006	Inner Joint		25	32				
1.9 JTD (100 kW)	2002.11-2004.11	-	L/R	F	Estate Engine 192 B1.000	817009	Outer Joint		25	26	59	84	63	M
	2002.11-2004.11	-	L	F	Estate Engine 192 B1.000	217107	Drive Shaft		25	25	59	84	615	
	2002.11-2004.11	-	L/R	F	Estate Engine 192 B1.000	802012	Outer Joint		25	28	59	85	63	O
	2002.11-2004.11	-	L	F	Estate Engine 192 B1.000	202001	Drive Shaft		25	59	85	520		
	2002.11-2004.11	-	R	F	Estate Engine 192 B1.000	202002	Drive Shaft		25	59	85	521		
	2002.11-2004.11	-	L	F	Estate Engine 192 B1.000	202003	Drive Shaft		25	26.65	59	84	502	
	2002.11-2004.11	-	R	F	Estate Engine 192 B1.000	202004	Drive Shaft		25	26.65	59	84	521	
1.9 JTD (110 kW)	2005.03-2006.05	-	L/R	F	Estate Engine 937 A5.000	817009	Outer Joint		25	26	59	84	63	M
	2005.03-2006.05	-	L	F	Estate Engine 937 A5.000	217107	Drive Shaft		25	25	59	84	615	
	2005.03-2006.05	-	L	F	Estate Engine 937 A5.000	202003	Drive Shaft		25	26.65	59	84	502	
	2005.03-2006.05	-	R	F	Estate Engine 937 A5.000	202004	Drive Shaft		25	26.65	59	84	521	
1.9 JTD (77 kW)	2000.05-2000.10	MT	L/R	F	Estate Engine AR 32302	802012	Outer Joint		25	28	59	85	63	O
	2000.05-2000.10	-	R	F	Estate Engine AR 32302	602003	Inner Joint		28	32				
	2000.05-2000.10	MT	L	F	Estate Engine AR 32302	202001	Drive Shaft		25	59	85	520		
	2000.05-2000.10	MT	R	F	Estate Engine AR 32302	202002	Drive Shaft		25	59	85	521		
1.9 JTD (81 kW)	2000.10-2001.05	MT	L/R	F	Estate Engine AR 37101	802012	Outer Joint		25	28	59	85	63	O
	2000.10-2001.05	-	R	F	Estate Engine AR 37101	602003	Inner Joint		28	32				
	2000.10-2001.05	MT	L	F	Estate Engine AR 37101	202001	Drive Shaft		25	59	85	520		
	2000.10-2001.05	MT	R	F	Estate Engine AR 37101	202002	Drive Shaft		25	59	85	521		
1.9 JTD (85 kW)	2001.05-2006.05	-	L/R	F	Estate Engine 937 A2.000	817009	Outer Joint		25	26	59	84	63	M
	2001.05-2006.05	-	L	F	Estate Engine 937 A2.000	217107	Drive Shaft		25	25	59	84	615	
	2001.05-2006.05	MT	L/R	F	Estate Engine 937 A2.000	802012	Outer Joint		25	28	59	85	63	O
	2001.05-2006.05	MT	L	F	Estate Engine 937 A2.000	202001	Drive Shaft		25	59	85	520		
	2001.05-2006.05	MT	R	F	Estate Engine 937 A2.000	202002	Drive Shaft		25	59	85	521		
	2001.05-2006.05	MT	L	F	Estate Engine 937 A2.000	202003	Drive Shaft		25	26.65	59	84	502	
	2001.05-2006.05	MT	R	F	Estate Engine 937 A2.000	202004	Drive Shaft		25	26.65	59	84	521	
1.9 JTD (93 kW)	2003.11-2006.05	-	L/R	F	Estate Engine 937 A4.000	817009	Outer Joint		25	26	59	84	63	M
	2003.11-2006.05	-	L	F	Estate Engine 937 A4.000	202003	Drive Shaft		25	26.65	59	84	502	





	 YEAR	TRANSM	L/R	F/R	REMARKS	GSP Ref.	 PRODUCT	 ABS	Technical Specifications					
									A	B	C	H	L	P
ALFA ROMEO														
156 Sportwagon (932_)														
1.9 JTD (93 kW)	2003.11-2006.05	-	R	F	Estate Engine 937 A4.000	202004	Drive Shaft		25	26.65	59	84	521	
1.9 JTD 16V (103 kW)	2002.11-2006.05	-	L/R	F	Estate Engine 192 A5.000	817009	Outer Joint		25	26	59	84	63	M
	2002.11-2006.05	-	L	F	Estate Engine 192 A5.000	217107	Drive Shaft		25	25	59	84	615	
	2002.11-2006.05	-	L	F	Estate Engine 192 A5.000	202001	Drive Shaft		25		59	85	520	
	2002.11-2006.05	-	R	F	Estate Engine 192 A5.000	202002	Drive Shaft		25		59	85	521	
	2002.11-2006.05	MT	L	F	Estate Engine 192 A5.000	202003	Drive Shaft		25	26.65	59	84	502	
	2002.11-2006.05	MT	R	F	Estate Engine 192 A5.000	202004	Drive Shaft		25	26.65	59	84	521	
1.9 JTD 16V Q4 (110 kW)	2004.07-2006.05	-	L/R	F	All-wheel Drive Estate Engine 937 A5.000	817009	Outer Joint		25	26	59	84	63	M
	2004.07-2006.05	-	L	F	All-wheel Drive Estate Engine 937 A5.000	217107	Drive Shaft		25	25	59	84	615	
	2004.07-2006.05	-	L	F	All-wheel Drive Estate Engine 937 A5.000	202003	Drive Shaft		25	26.65	59	84	502	
	2004.07-2006.05	-	R	F	All-wheel Drive Estate Engine 937 A5.000	202004	Drive Shaft		25	26.65	59	84	521	
2.0 16V T.SPARK (110 kW)	2000.10-2002.03	-	L/R	F	Estate Engine AR 32310	217159	Drive Shaft		25		58.8	85	490	
	2000.10-2002.03	-	-	F	Estate Engine AR 32310	602005	Inner Joint			25		32		
	2000.10-2002.03	-	-	F	Estate Engine AR 32310	602006	Inner Joint			25		32		
2.0 16V T.SPARK (114 kW)	2000.05-2002.06	-	L/R	F	Estate Engine AR 32301/AR 32310	217159	Drive Shaft		25		58.8	85	490	
	2000.05-2002.06	-	-	F	Estate Engine AR 32301/AR 32310	602005	Inner Joint			25		32		
	2000.05-2002.06	MT	L/R	F	Estate Engine AR 32301/AR 32310	802017	Outer Joint		25	25	58.8	85	58.3	O
	2000.05-2002.06	-	-	F	Estate Engine AR 32301/AR 32310	602006	Inner Joint			25		32		
2.0 JTS (119 kW)	2002.03-2006.05	-	L/R	F	Estate Engine 932 A2.000	802017	Outer Joint		25	25	58.8	85	58.3	O
	2002.03-2006.05	-	-	F	Estate Engine 932 A2.000	602006	Inner Joint			25		32		
2.0 JTS (122 kW)	2002.03-2006.05	-	L/R	F	Estate Engine 937 A1.000	217159	Drive Shaft		25		58.8	85	490	
	2002.03-2006.05	AT/MT	L/R	F	Estate Engine 937 A1.000	618070	Inner Joint			25		32		
	2002.03-2006.05	-	-	F	Estate Engine 937 A1.000	602005	Inner Joint			25		32		
	2002.03-2006.05	-	-	F	Estate Engine 937 A1.000	602006	Inner Joint			25		32		
2.4 JTD (100 kW)	2000.05-2003.09	-	-	F	Estate Engine AR 32501	802019	Outer Joint		25	28	56	85	63.5	O
	2000.05-2003.09	MT	L/R	F	Estate Engine AR 32501	802012	Outer Joint		25	28	59	85	63	O
2.4 JTD (103 kW)	2000.10-2006.05	-	-	F	Estate Engine 839 A6.000	802019	Outer Joint		25	28	56	85	63.5	O
2.4 JTD (129 kW)	2003.10-2006.05	-	R	F	Estate Engine 841 G.000	217110	Drive Shaft		25	27	59	84	1000	
	2003.10-2006.05	MT	L	F	Estate Engine 841 G.000	217117	Drive Shaft		25	27	59	84	550	
	2003.10-2006.05	-	L/R	F	Estate Engine 841 G.000	817009	Outer Joint		25	26	59	84	63	M
2.5 V6 24V (140 kW)	2000.05-2003.08	-	-	F	Estate Engine AR 32401	602005	Inner Joint			25		32		
	2000.05-2003.08	-	-	F	Estate Engine AR 32401	802019	Outer Joint		25	28	56	85	63.5	O
	2000.05-2003.08	MT	L/R	F	Estate Engine AR 32401	802012	Outer Joint		25	28	59	85	63	O
2.5 V6 24V (141 kW)	2000.10-2006.05	-	-	F	Estate Engine AR 32405	602005	Inner Joint			25		32		
	2000.10-2006.05	-	-	F	Estate Engine AR 32405	802019	Outer Joint		25	28	56	85	63.5	O
159 (939)														
1.8 MPI (103 kW)	2005.03-	-	R	-		617055	Inner Joint		22	24	34.9	378.5	106.5	
	2005.03-	-	L	-		602014	Inner Joint		22	24	34.95	57.5	111	
1.8 MPI (121 kW)	2005.03-	-	R	-		617055	Inner Joint		22	24	34.9	378.5	106.5	
	2005.03-	-	L	-		602014	Inner Joint		22	24	34.95	57.5	111	
1.8 MPI (147 kW)	2005.03-	-	R	-		617055	Inner Joint		22	24	34.9	378.5	106.5	
	2005.03-	-	L	-		602014	Inner Joint		22	24	34.95	57.5	111	
1.8 MPI (96 kW)	2005.03-	-	R	-		617055	Inner Joint		22	24	34.9	378.5	106.5	
	2005.03-	-	L	-		602014	Inner Joint		22	24	34.95	57.5	111	
1.9 JTDM 16V (100 kW)	2005.09-	-	L	-		602009	Inner Joint		25	26	34.9	57.5	114.5	
	2005.09-	-	R	-		602010	Inner Joint		25	26	34.9	439.5	108.5	
1.9 JTDM 16V (110 kW)	2005.09-	-	L	-		602009	Inner Joint		25	26	34.9	57.5	114.5	
	2005.09-	-	R	-		602010	Inner Joint		25	26	34.9	439.5	108.5	
1.9 JTDM 8V (88 kW)	2005.09-	-	L	-		602009	Inner Joint		25	26	34.9	57.5	114.5	
	2005.09-	-	R	-		602010	Inner Joint		25	26	34.9	439.5	108.5	
2.0 JTD (100 kW)	2010-	-	R	-		617075	Inner Joint		25	26	29.75	440	108.5	
	2010-	-	L	-		617031	Inner Joint		25	26	32	59	110.5	
2.0 JTDM (125 kW)	2009.05-	-	L	-	G. Box: 6 Sp	621017	Inner Joint		27	27	35	78.5	112	
2.2 JTS (136 kW)	2005.09-	-	L	-		602009	Inner Joint		25	26	34.9	57.5	114.5	
	2005.09-	-	R	-		602010	Inner Joint		25	26	34.9	439.5	108.5	
2.4 JTDM 20V 4x2 (147 kW)	2005.09-	MT/AT	R	-		617008	Inner Joint		27	27	35	498	108.5	
	2005.09-	MT/AT	L	-		621017	Inner Joint		27	27	35	78.5	112	
2.4 JTDM 20V 4x2 (154 kW)	2007.05-	-	R	-		617008	Inner Joint		27	27	35	498	108.5	
	2007.05-	-	L	-		621017	Inner Joint		27	27	35	78.5	112	
2.4 JTDM Q4 (154 kW)	2007.05-	-	L	-		621016	Inner Joint		27	26	35	78.5	112	
2.4 JTDM,Q4 (154)	2007.05-	-	R	-		617007	Inner Joint		27	26	35	453	108.5	
3.2 JTS (191 kW)	2005-	-	L	-		621017	Inner Joint		27	27	35	78.5	112	
3.2 JTS (195 kW)	2005-	-	L	-		621017	Inner Joint		27	27	35	78.5	112	
3.2 JTS Q4 (191 kW)	2005.12-2008	-	L	-		621016	Inner Joint		27	26	35	78.5	112	
3.2 JTS Q4 (191)	2005.12-2008	-	R	-		617007	Inner Joint		27	26	35	453	108.5	

	 YEAR	TRANSM	L/R	F/R	REMARKS	GSP Ref.	 PRODUCT	 ABS	Technical Specifications									
									A	B	C	H	L	P				
ALFA ROMEO																		
159 (939_)																		
1.8 MPI (103 kW)	2007.03-	2011.11	-	-	F	Saloon Engine 939 A4.000	802026	Outer Joint		30	24	61	93	58	M			
	2007.03-	2011.11	-	L/R	F	Saloon Engine 939 A4.000	802024	Outer Joint		30	27	61	93	65	M			
1.8 TBI (147 kW)	2009.05-	2011.11	-	L/R	F	Saloon Engine 939 B1.000	802024	Outer Joint		30	27	61	93	65	M			
1.9 JTDM 16V (100 kW)	2005.09-	2011.11	AT/MT	R	F	Saloon Engine 937 A8.000/939 A8.000	217124	Drive Shaft		30	25	61	94	1015				
	2005.09-	2011.11	-	-	F	Saloon Engine 937 A8.000/939 A8.000	802023	Outer Joint		30	26	61	94	63.5	M			
	2005.09-	2011.11	-	L	F	Saloon Engine 937 A8.000/939 A8.000	217122	Drive Shaft		30	25	61	94	640				
1.9 JTDM 16V (110 kW)	2005.09-	2011.11	MT	R	F	Saloon Engine 939 A2.000	217124	Drive Shaft		30	25	61	94	1015				
	2005.09-	2011.11	-	-	F	Saloon Engine 939 A2.000	802023	Outer Joint		30	26	61	94	63.5	M			
	2005.09-	2011.11	MT	L	F	Saloon Engine 939 A2.000	217122	Drive Shaft		30	25	61	94	640				
1.9 JTDM 8V (85 kW)	2005.09-	2011.11	AT/MT	R	F	Saloon Engine 939 A7.000	217124	Drive Shaft		30	25	61	94	1015				
	2005.09-	2011.11	-	-	F	Saloon Engine 939 A7.000	802023	Outer Joint		30	26	61	94	63.5	M			
	2005.09-	2011.11	-	L	F	Saloon Engine 939 A7.000	217122	Drive Shaft		30	25	61	94	640				
1.9 JTDM 8V (88 kW)	2005.09-	2011.11	AT/MT	R	F	Saloon Engine 939 A1.000	217124	Drive Shaft		30	25	61	94	1015				
	2005.09-	2011.11	-	-	F	Saloon Engine 939 A1.000	802023	Outer Joint		30	26	61	94	63.5	M			
	2005.09-	2011.11	-	L	F	Saloon Engine 939 A1.000	217122	Drive Shaft		30	25	61	94	640				
1.9 JTS (118 kW)	2005.09-	2011.11	-	-	F	Saloon Engine 939 A6.000	802026	Outer Joint		30	24	61	93	58	M			
2.0 JTDM (120 kW)	2009.05-	2011.11	MT	L	F	Saloon Engine 844 A2.000	217116	Drive Shaft		30	27	61	93	627				
	2009.05-	2011.11	MT	R	F	Saloon Engine 844 A2.000	217115	Drive Shaft		30	27	61	93	1028				
	2009.05-	2011.11	MT	R	F	Saloon Engine 844 A2.000	617051	Inner Joint		27	27	35	453	110				
	2009.05-	2011.11	-	-	F	Saloon Engine 844 A2.000	802023	Outer Joint		30	26	61	94	63.5	M			
	2009.05-	2011.11	MT	L/R	F	Saloon Engine 844 A2.000	802024	Outer Joint		30	27	61	93	65	M			
2.0 JTDM (125 kW)	2009.05-	2011.11	-	L/R	F	Saloon Engine 939 B3.000	802024	Outer Joint		30	27	61	93	65	M			
	2009.05-	2011.11	-	L	F	Saloon Engine 939 B3.000	217116	Drive Shaft		30	27	61	93	627				
	2009.05-	2011.11	-	R	F	Saloon Engine 939 B3.000	217115	Drive Shaft		30	27	61	93	1028				
	2009.05-	2011.11	-	R	F	Saloon Engine 939 B3.000	617051	Inner Joint		27	27	35	453	110				
2.2 JTS (136 kW)	2005.09-	2011.11	-	R	F	Saloon Engine 939 A5.000	217124	Drive Shaft		30	25	61	94	1015				
	2005.09-	2011.11	-	-	F	Saloon Engine 939 A5.000	802023	Outer Joint		30	26	61	94	63.5	M			
	2005.09-	2011.11	-	L	F	Saloon Engine 939 A5.000	217122	Drive Shaft		30	25	61	94	640				
2.4 JTDM (147 kW)	2005.09-	2011.11	MT	L	F	Saloon Engine 939 A3.000	217123	Drive Shaft		30	27	61	93	598				
	2005.09-	2011.11	MT	R	F	Saloon Engine 939 A3.000	217145	Drive Shaft		30	27	61	93	1059				
	2005.09-	2011.11	-	L/R	F	Saloon Engine 939 A3.000	802024	Outer Joint		30	27	61	93	65	M			
2.4 JTDM (154 kW)	2007.05-	2011.11	MT	L	F	Saloon Engine 939 A9.000	217123	Drive Shaft		30	27	61	93	598				
	2007.05-	2011.11	MT	R	F	Saloon Engine 939 A9.000	217145	Drive Shaft		30	27	61	93	1059				
	2007.05-	2011.11	-	L/R	F	Saloon Engine 939 A9.000	802024	Outer Joint		30	27	61	93	65	M			
2.4 JTDM Q4 (154 kW)	2007.05-	2011.11	MT	L	F	All-wheel Drive Saloon Engine 939 A9.000	217123	Drive Shaft		30	27	61	93	598				
	2007.05-	2011.11	MT	R	F	All-wheel Drive Saloon Engine 939 A9.000	217145	Drive Shaft		30	27	61	93	1059				
3.2 JTS (191 kW)	2008.02-	2011.11	-	-	F	Saloon Engine 939 A.000	802023	Outer Joint		30	26	61	94	63.5	M			
	2008.02-	2011.11	-	L/R	F	Saloon Engine 939 A.000	802024	Outer Joint		30	27	61	93	65	M			
3.2 JTS Q4 (191 kW)	2005.12-	2011.11	-	-	F	All-wheel Drive Saloon Engine 939 A.000	802023	Outer Joint		30	26	61	94	63.5	M			
159 SPORTWAGON (939)																		
1.8 MPI (103 kW)	2005.03-	-	-	-	R	-	617055	Inner Joint		22	24	34.9	378.5	106.5				
	2005.03-	-	-	-	L	-	602014	Inner Joint		22	24	34.95	57.5	111				
1.9 JTDM 16V (100 kW)	2006.03-	-	-	-	L	-	602009	Inner Joint		25	26	34.9	57.5	114.5				
	2006.03-	-	-	-	R	-	602010	Inner Joint		25	26	34.9	439.5	108.5				
1.9 JTDM 16V (110 kW)	2006.03-	-	-	-	L	-	602009	Inner Joint		25	26	34.9	57.5	114.5				
	2006.03-	-	-	-	R	-	602010	Inner Joint		25	26	34.9	439.5	108.5				
1.9 JTDM 8V (88 kW)	2006.03-	-	-	-	L	-	602009	Inner Joint		25	26	34.9	57.5	114.5				
	2006.03-	-	-	-	R	-	602010	Inner Joint		25	26	34.9	439.5	108.5				
2.0 JTD (100 kW)	2010-	-	-	-	R	-	617075	Inner Joint		25	26	29.75	440	108.5				
	2010-	-	-	-	L	-	617031	Inner Joint		25	26	32	59	110.5				
2.0 JTDM (125 kW)	2009.05-	-	-	-	L	-	G. Box: 6 Sp	621017	Inner Joint		27	27	35	78.5	112			
2.2 JTS (136 kW)	2006.03-	-	-	-	L	-	-	602009	Inner Joint		25	26	34.9	57.5	114.5			
	2006.03-	-	-	-	R	-	-	602010	Inner Joint		25	26	34.9	439.5	108.5			
2.4 JTDM 20V 4x2 (147 kW)	2006.03-	-	-	-	R	-	G. Box: 6 Sp	617008	Inner Joint		27	27	35	498	108.5			
	2006.03-	-	-	-	L	-	G. Box: 6 Sp	621017	Inner Joint		27	27	35	78.5	112			
2.4 JTDM 20V 4x2 (154 kW)	2007.05-	-	-	-	R	-	G. Box: 6 Sp	617008	Inner Joint		27	27	35	498	108.5			
	2007.05-	-	-	-	L	-	G. Box: 6 Sp	621017	Inner Joint		27	27	35	78.5	112			
2.4 JTDM Q4 (154 kW)	2007.05-	-	-	-	L	-	-	621016	Inner Joint		27	26	35	78.5	112			
2.4 JTDM,Q4 (154)	2007.05-	-	-	-	R	-	-	617007	Inner Joint		27	26	35	453	108.5			
3.2 JTS (191 kW)	2008.02-	-	-	-	L	-	-	621017	Inner Joint		27	27	35	78.5	112			
3.2 JTS (195 kW)	2008.02-	-	-	-	L	-	-	621017	Inner Joint		27	27	35	78.5	112			
3.2 JTS Q4 (191 kW)	2006.03-	-	-	-	L	-	-	621016	Inner Joint		27	26	35	78.5	112			
3.2 JTS Q4 (191)	2006.03-	-	-	-	R	-	-	617007	Inner Joint		27	26	35	453	108.5			
159 Sportwagon (939_)																		
1.8 MPI (103 kW)	2007.03-	2011.11	MT	-	F	Estate Engine 939 A4.000	802026	Outer Joint		30	24	61	93	58	M			
	2007.03-	2011.11	-	L/R	F	Estate Engine 939 A4.000	802024	Outer Joint		30	27	61	93	65	M			





YEAR	TRANSM	L/R	F/R	REMARKS	GSP Ref.	PRODUCT	ABS	Technical Specifications								
								A	B	C	H	L	P			
ALFA ROMEO																
159 Sportwagon (939_)																
1.8 Tbi (147 kW)	2009.05-2011.11	-	L/R	F	Estate Engine 939 B1.000	802024	Outer Joint	30	27	61	93	65	M			
	2009.05-2011.11	-	-	F	Estate Engine 939 B1.000	802026	Outer Joint	30	24	61	93	58	M			
1.9 JTDM 16V (100 kW)	2006.03-2011.11	-	R	F	Estate Engine 937 A8.000	217124	Drive Shaft	30	25	61	94	1015				
	2006.03-2011.11	-	-	F	Estate Engine 937 A8.000	802023	Outer Joint	30	26	61	94	63.5	M			
	2006.03-2011.11	-	L	F	Estate Engine 937 A8.000	217122	Drive Shaft	30	25	61	94	640				
1.9 JTDM 16V (110 kW)	2006.03-2011.11	MT	R	F	Estate Engine 939 A2.000	217124	Drive Shaft	30	25	61	94	1015				
	2006.03-2011.11	-	-	F	Estate Engine 939 A2.000	802023	Outer Joint	30	26	61	94	63.5	M			
	2006.03-2011.11	MT	L	F	Estate Engine 939 A2.000	217122	Drive Shaft	30	25	61	94	640				
1.9 JTDM 8V (85 kW)	2006.03-2011.11	AT/MT	R	F	Estate Engine 937 A7.000	217124	Drive Shaft	30	25	61	94	1015				
	2006.03-2011.11	-	-	F	Estate Engine 937 A7.000	802023	Outer Joint	30	26	61	94	63.5	M			
	2006.03-2011.11	-	L	F	Estate Engine 937 A7.000	217122	Drive Shaft	30	25	61	94	640				
1.9 JTDM 8V (88 kW)	2006.03-2011.11	AT/MT	R	F	Estate Engine 939 A1.000	217124	Drive Shaft	30	25	61	94	1015				
	2006.03-2011.11	-	-	F	Estate Engine 939 A1.000	802023	Outer Joint	30	26	61	94	63.5	M			
	2006.03-2011.11	-	L	F	Estate Engine 939 A1.000	217122	Drive Shaft	30	25	61	94	640				
1.9 JTS (118 kW)	2006.03-2011.11	-	-	F	Estate Engine 939 A6.000	802026	Outer Joint	30	24	61	93	58	M			
2.0 JTDM (120 kW)	2009.05-2011.11	MT	L	F	Estate Engine 844 A2.000	217116	Drive Shaft	30	27	61	93	627				
	2009.05-2011.11	MT	R	F	Estate Engine 844 A2.000	217115	Drive Shaft	30	27	61	93	1028				
	2009.05-2011.11	MT	R	F	Estate Engine 844 A2.000	617051	Inner Joint	27	27	35	453	110				
	2009.05-2011.11	-	-	F	Estate Engine 844 A2.000	802023	Outer Joint	30	26	61	94	63.5	M			
	2009.05-2011.11	MT	L/R	F	Estate Engine 844 A2.000	802024	Outer Joint	30	27	61	93	65	M			
2.0 JTDM (125 kW)	2009.05-2011.11	-	L/R	F	Estate Engine 939 B3.000	802024	Outer Joint	30	27	61	93	65	M			
	2009.05-2011.11	-	L	F	Estate Engine 939 B3.000	217116	Drive Shaft	30	27	61	93	627				
	2009.05-2011.11	-	R	F	Estate Engine 939 B3.000	217115	Drive Shaft	30	27	61	93	1028				
	2009.05-2011.11	-	R	F	Estate Engine 939 B3.000	617051	Inner Joint	27	27	35	453	110				
2.2 JTS (136 kW)	2006.03-2011.11	MT	R	F	Estate Engine 939 A5.000	217124	Drive Shaft	30	25	61	94	1015				
	2006.03-2011.11	-	-	F	Estate Engine 939 A5.000	802023	Outer Joint	30	26	61	94	63.5	M			
	2006.03-2011.11	-	L	F	Estate Engine 939 A5.000	217122	Drive Shaft	30	25	61	94	640				
2.4 JTDM (147 kW)	2006.03-2011.11	MT	L	F	Estate Engine 939 A3.000	217123	Drive Shaft	30	27	61	93	598				
	2006.03-2011.11	MT	R	F	Estate Engine 939 A3.000	217145	Drive Shaft	30	27	61	93	1059				
	2006.03-2011.11	-	L/R	F	Estate Engine 939 A3.000	802024	Outer Joint	30	27	61	93	65	M			
2.4 JTDM (154 kW)	2007.05-2011.11	MT	L	F	Estate Engine 939 A9.000	217123	Drive Shaft	30	27	61	93	598				
	2007.05-2011.11	MT	R	F	Estate Engine 939 A9.000	217145	Drive Shaft	30	27	61	93	1059				
	2007.05-2011.11	-	L/R	F	Estate Engine 939 A9.000	802024	Outer Joint	30	27	61	93	65	M			
2.4 JTDM Q4 (154 kW)	2007.05-2011.11	MT	L	F	All-wheel Drive Estate Engine 939 A9.000	217123	Drive Shaft	30	27	61	93	598				
	2007.05-2011.11	MT	R	F	All-wheel Drive Estate Engine 939 A9.000	217145	Drive Shaft	30	27	61	93	1059				
3.2 JTS (191 kW)	2008.02-2011.11	-	-	F	Estate Engine 939 A.000	802023	Outer Joint	30	26	61	94	63.5	M			
	2008.02-2011.11	-	L/R	F	Estate Engine 939 A.000	802024	Outer Joint	30	27	61	93	65	M			
3.2 JTS Q4 (191 kW)	2006.03-2011.11	-	-	F	All-wheel Drive Estate Engine 939 A.000	802023	Outer Joint	30	26	61	94	63.5	M			
164 (164)																
2.0 (102 kW)	1987.06-1998.09	-	-	-	-	648006	Inner Joint			25	32					
2.0 T.S. (105 kW)	1987.07-1992.09	-	-	-	-	648006	Inner Joint			25	32					
2.0 T.S. (106 kW)	1992.09-1998.09	-	-	-	-	648006	Inner Joint			25	32					
2.0 T.S. (109 kW)	1987.07-1992.09	-	-	-	-	648006	Inner Joint			25	32					
164 (164_)/168																
2.0 (102 kW)	1987.06-1998.09	-	-	F	Saloon Engine AR 06416	602006	Inner Joint			25	32					
	1987.06-1998.09	-	-	-	Saloon Engine AR 06416	817002	Outer Joint	25	25	54.5	77	58	I			
2.0 (105 kW)	1987.11-1992.10	-	-	F	Saloon Engine AR 64103	602006	Inner Joint			25	32					
2.0 T.S. (105 kW)	1987.06-1992.09	-	-	F	Saloon Engine AR 06416	602006	Inner Joint			25	32					
	1987.06-1992.09	-	-	-	Saloon Engine AR 06416	817002	Outer Joint	25	25	54.5	77	58	I			
2.0 T.S. (106 kW)	1992.09-1998.09	-	-	F	Saloon Engine AR 64103	602006	Inner Joint			25	32					
2.0 T.S. (109 kW)	1987.06-1998.04	-	-	F	Saloon Engine AR 06420/AR64103	602006	Inner Joint			25	32					
	1987.06-1998.04	-	-	-	Saloon Engine AR 06420/AR64103	817002	Outer Joint	25	25	54.5	77	58	I			
2.0 Turbo (128 kW)	1987.10-1998.09	-	-	F	Saloon Engine AR 06476	602006	Inner Joint			25	32					
	1987.10-1998.09	-	-	-	Saloon Engine AR 06476	817002	Outer Joint	25	25	54.5	77	58	I			
2.0 Twin Spark (105 kW)	1990.07-1992.10	-	-	F	Saloon Engine AR 06416	602006	Inner Joint			25	32					
2.0 V6 Turbo (148 kW)	1992.09-1998.09	-	-	F	Saloon Engine AR 64102	602006	Inner Joint			25	32					
	1992.09-1998.09	MT	L/R	F	Saloon Engine AR 64102	602004	Inner Joint			28	32					
2.0 V6 Turbo (150 kW)	1991.03-1992.09	-	-	F	Saloon Engine AR 64101	602006	Inner Joint			25	32					
	1991.03-1992.09	MT	L/R	F	Saloon Engine AR 64101	602004	Inner Joint			28	32					
2.5 TD (84 kW)	1987.06-1992.09	-	-	F	Saloon Engine VM 84 A	802007	Outer Joint	90T	27	28	56	85	63.5	O		
	1987.06-1992.09	MT	L/R	F	Saloon Engine VM 84 A	602004	Inner Joint			28	32					
2.5 TD (92 kW)	1992.09-1998.09	AT/MT	L/R	F	Saloon Engine VM 08 B/VW 32B	602004	Inner Joint			28	32					
3.0 24V Q4 (170 kW)	1994.02-1998.09	MT	L/R	F	All-wheel Drive Saloon Engine AR 64308/AR 64307	602004	Inner Joint			28	32					
3.0 V6 (132 kW)	1992.09-1998.09	AT/MT	L/R	F	Saloon Engine AR 66303/AR 64305/AR 64399/AR 64303	602004	Inner Joint			28	32					
3.0 V6 (135 kW)	1987.06-1992.09	-	-	F	Saloon Engine AR 06412	802007	Outer Joint	90T	27	28	56	85	63.5	O		
	1987.06-1992.09	AT/MT	L/R	F	Saloon Engine AR 06412	802021	Outer Joint			27	28	56	85	63.5	O	





	 YEAR	TRANSM	L/R	F/R	REMARKS	GSP Ref.	 PRODUCT	 ABS	Technical Specifications					
									A	B	C	H	L	P
ALFA ROMEO														
164 (164_) /168														
3.0 V6 (135 kW)	1987.06-1992.09	AT/MT	L/R	F	Saloon Engine AR 06412	602004	Inner Joint			28		32		
3.0 V6 (141 kW)	1987.06-1992.09	MT	-	F	Saloon Engine AR 06410	802007	Outer Joint	90T	27	28	56	85	63.5	O
	1987.06-1992.09	AT/MT	L/R	F	Saloon Engine AR 06410	802021	Outer Joint		27	28	56	85	63.5	O
	1987.06-1992.09	AT/MT	L/R	F	Saloon Engine AR 06410	602004	Inner Joint			28		32		
166 (936)														
2.0 T.S. (110 kW)	2000.10-	-	-	-	-	617009	Inner Joint			25		32		
2.0 T.S. (114 kW)	1998.09-2000.10	-	-	-	-	617009	Inner Joint			25		32		
2.4 JTD (100 kW)	1998.09-2000.10	-	L	-	-	602007	Inner Joint			34		47.5		
2.4 JTD (103 kW)	2000.10-	-	L	-	-	602007	Inner Joint			34		47.5		
2.4 JTD (110 kW)	2002.04-	-	L	-	-	602007	Inner Joint			34		47.5		
2.4 JTD (122 kW)	2003.1-	AT	L	-	-	617048	Inner Joint		26	26	31	68	94.5	
	2003.1-	AT	R	-	-	617069	Inner Joint		26	26	31	418.5	108.5	
	2003.1-	MT	L	-	-	621016	Inner Joint		27	26	35	78.5	112	
	2003.10-	MT	R	-	-	617076	Inner Joint		27	26	35	428	108.5	
2.4 JTD (129 kW)	2003.1-	AT	L	-	-	617048	Inner Joint		26	26	31	68	94.5	
	2003.1-	AT	R	-	-	617069	Inner Joint		26	26	31	418.5	108.5	
	2003.1-	MT	L	-	-	621016	Inner Joint		27	26	35	78.5	112	
	2003.10-	MT	R	-	-	617076	Inner Joint		27	26	35	428	108.5	
2.4 JTD (132 kW)	2003.1-	MT	L	-	-	621016	Inner Joint		27	26	35	78.5	112	
	2003.10-	MT	R	-	-	617076	Inner Joint		27	26	35	428	108.5	
166 (936_)														
2.0 T.Spark (110 kW)	2000.10-2007.06	-	-	F	Saloon Engine AR 36301	602005	Inner Joint			25		32		
	2000.10-2007.06	-	-	F	Saloon Engine AR 36301	802002	Outer Joint		27	25	59	84.5	58	O
	2000.10-2007.06	-	-	F	Saloon Engine AR 36301	602006	Inner Joint			25		32		
2.0 T.Spark (114 kW)	1998.09-2000.10	-	-	F	Saloon Engine AR 34103	602005	Inner Joint			25		32		
	1998.09-2000.10	AT/MT	L/R	F	Saloon Engine AR 34103	618070	Inner Joint			25		32		
	1998.09-2000.10	-	-	F	Saloon Engine AR 34103	602006	Inner Joint			25		32		
	1998.09-2000.10	-	-	F	Saloon Engine AR 34103	802002	Outer Joint		27	25	59	84.5	58	O
2.0 V6 (151 kW)	1998.09-2000.10	-	L/R	F	Saloon Engine AR 34102	217131	Drive Shaft		27		59	83.5	541	
	1998.09-2000.10	-	-	F	Saloon Engine AR 34102	802002	Outer Joint		27	25	59	84.5	58	O
	1998.09-2000.10	AT/MT	L/R	F	Saloon Engine AR 34102	802013	Outer Joint		27	28	59	83.5	63	O
2.4 JTD (100 kW)	1998.09-2000.10	MT	L/R	F	Saloon Engine AR 34202	802013	Outer Joint		27	28	59	83.5	63	O
2.4 JTD (129 kW)	2003.10-2007.06	-	-	F	Saloon Engine 841 G.000/841.H.000	899298	Outer Joint		27	26	59	84.5	63	M
2.4 JTD (132 kW)	2006.07-2007.06	-	-	F	Saloon Engine 841 M.000	899298	Outer Joint		27	26	59	84.5	63	M
2.4 JTD (136 kW)	2005.07-2007.06	-	-	F	Saloon Engine 841 M.000/936 B.000	899298	Outer Joint		27	26	59	84.5	63	M
2.5 V6 24V (138 kW)	2000.10-2007.06	MT	L/R	F	Saloon Engine AR 36201	217131	Drive Shaft		27		59	83.5	541	
2.5 V6 24V (140 kW)	1998.09-2006.12	MT	L/R	F	Saloon Engine AR 34201	217131	Drive Shaft		27		59	83.5	541	
	1998.09-2006.12	AT/MT	L/R	F	Saloon Engine AR 34201	802013	Outer Joint		27	28	59	83.5	63	O
	1998.09-2006.12	AT/MT	L/R	F	Saloon Engine AR 34201	802013	Outer Joint		27	28	59	83.5	63	O
3.0 V6 24V (162 kW)	2000.10-2007.06	-	R	F	Saloon Engine AR 36101	217131	Drive Shaft		27		59	83.5	541	
3.0 V6 24V (166 kW)	1998.09-2007.06	-	R	F	Saloon Engine AR 34301/AR 34302	217131	Drive Shaft		27		59	83.5	541	
	1998.09-2007.06	AT/MT	L/R	F	Saloon Engine AR 34301/AR 34302	802013	Outer Joint		27	28	59	83.5	63	O
3.2 V6 24V (176 kW)	2003.10-2007.06	-	L/R	F	Saloon Engine 936 A.000	217131	Drive Shaft		27		59	83.5	541	
33 (907A_)														
1.4 i.e. (65 kW)	1991.06-1994.09	-	-	-	Hatchback Engine AR 30755/AR 30753	802001	Outer Joint		25	24	52	85	58	O
	1991.06-1994.09	MT	L/R	F	Hatchback Engine AR 30755/AR 30753	802015	Outer Joint		28	24	55	96	58	O
1.4 i.e. (66 kW)	1991.06-1994.09	-	-	-	Hatchback Engine AR 30755/AR 30753	802001	Outer Joint		25	24	52	85	58	O
1.5 (77 kW)	1990.01-1993.04	-	-	-	Hatchback Engine AR 30734	802001	Outer Joint		25	24	52	85	58	O
1.5 i.e (71 kW)	1990.01-1994.09	-	-	-	Hatchback Engine AR 30751	802001	Outer Joint		25	24	52	85	58	O
1.7 16V (101 kW)	1990.01-1992.03	-	-	-	Hatchback Engine AR 30746	802001	Outer Joint		25	24	52	85	58	O
	1990.01-1994.09	-	-	-	All-wheel Drive Hatchback Engine AR 30746	802001	Outer Joint		25	24	52	85	58	O
1.7 16V (95 kW)	1990.01-1994.09	-	-	-	Hatchback Engine AR 30747	802001	Outer Joint		25	24	52	85	58	O
	1990.01-1994.09	-	-	-	All-wheel Drive Hatchback Engine AR 30747	802001	Outer Joint		25	24	52	85	58	O
1.7 16V (97 kW)	1990.01-1992.03	-	-	-	Hatchback Engine AR 30747	802001	Outer Joint		25	24	52	85	58	O
	1990.01-1994.09	-	-	-	All-wheel Drive Hatchback Engine AR 30747	802001	Outer Joint		25	24	52	85	58	O
1.7 i.e. (79 kW)	1990.01-1994.09	-	-	-	Hatchback Engine AR 30737/AR 30737	802001	Outer Joint		25	24	52	85	58	O
1.8 TD (62 kW)	1990.07-1994.09	-	-	-	Hatchback Engine VM 96 A	802001	Outer Joint		25	24	52	85	58	O
33 Sportwagon (905A_)														
1.5 (77 kW)	1986.12-1989.12	AT/MT	L/R	F	Estate Engine AR 30146/AR 30508/AR 30588	802015	Outer Joint		28	24	55	96	58	O
1.7 (87 kW)	1988.03-1989.12	MT	L/R	F	Estate Engine AR 30550	802015	Outer Joint		28	24	55	96	58	O
1.7 i.e. (77 kW)	1988.09-1989.12	MT	L/R	F	Estate Engine AR 30558	802015	Outer Joint		28	24	55	96	58	O
33 Sportwagon (907B_)														
1.4 i.e. (65 kW)	1991.06-1994.09	-	-	-	Estate Engine AR 30755/AR 30753	802001	Outer Joint		25	24	52	85	58	O
1.4 i.e. (66 kW)	1991.06-1994.09	-	-	-	Estate Engine AR 30755	802001	Outer Joint		25	24	52	85	58	O
1.5 i.e (71 kW)	1990.01-1994.09	-	-	-	Estate Engine AR 30751	802001	Outer Joint		25	24	52	85	58	O
1.7 16V (101 kW)	1990.07-1994.09	-	-	-	Estate Engine AR 30746	802001	Outer Joint		25	24	52	85	58	O
1.7 16V (95 kW)	1990.01-1994.09	-	-	-	Estate Engine AR 30747	802001	Outer Joint		25	24	52	85	58	O





YEAR	TRANSM	L/R	F/R	REMARKS	GSP Ref.	PRODUCT	ABS	Technical Specifications								
								A	B	C	H	L	P			
ALFA ROMEO																
33 Sportwagon (907B_)																
1.7 16V (95 kW)	1990.01-1994.09	-	-	-	All-wheel Drive Estate Engine AR 30747	802001	Outer Joint	25	24	52	85	58	O			
1.7 16V (97 kW)	1990.01-1994.09	-	-	-	Estate Engine AR 30747	802001	Outer Joint	25	24	52	85	58	O			
	1990.01-1992.03	-	-	-	All-wheel Drive Estate Engine AR 30747	802001	Outer Joint	25	24	52	85	58	O			
1.7 i.e. (79 kW)	1990.01-1992.03	-	-	-	Estate Engine AR 30737/AR 30736	802001	Outer Joint	25	24	52	85	58	O			
	1990.01-1992.03	-	-	-	All-wheel Drive Estate Engine AR 30737/AR 30736	802001	Outer Joint	25	24	52	85	58	O			
75 (162B_)																
1.6 (81 kW)	1985.05-1989.09	-	-	-	Saloon Engine AR 06100	602001	Inner Joint		24		32					
1.6 Cat (81 kW)	1989.05-1992.02	-	-	-	Saloon Engine AR 61101	602001	Inner Joint		24		32					
1.8 (85 kW)	1985.09-1989.06	-	-	-	Saloon Engine AR 06202	602001	Inner Joint		24		32					
1.8 (88 kW)	1988.09-1992.02	-	-	-	Saloon Engine AR 06168/AR 06202	602001	Inner Joint		24		32					
1.8 (90 kW)	1989.08-1992.02	-	-	-	Saloon Engine AR 61201	602001	Inner Joint		24		32					
1.8 (95 kW)	1989.08-1992.02	-	-	-	Saloon Engine AR 67101	602001	Inner Joint		24		32					
2.0 T.S Cat (109 kW)	1985.05-1992.02	-	-	-	Saloon Engine AR 06224	602001	Inner Joint		24		32					
2.0 T.S. (107 kW)	1987.01-1992.02	-	-	-	Saloon Engine AR 06166/AR 06224	602001	Inner Joint		24		32					
2.0 TD (70 kW)	1985.05-1992.09	-	-	-	Saloon Engine VM 80 A	602001	Inner Joint		24		32					
ALFASUD Sprint (902_)																
1.7 i.e. (77 kW)	1987.10-1989.12	AT/MT	L/R	F	Coupe Engine AR 30558	802015	Outer Joint	28	24	55	96	58	O			
BRERA (939_)																
1.8 Tbi (147 kW)	2009.05-2010.06	-	L/R	F	Hatchback Engine 939 B1.000	802024	Outer Joint	30	27	61	93	65	M			
2.0 JTDM (120 kW)	2008.03-2010.06	-	L/R	F	Hatchback Engine 844 A2.000	802024	Outer Joint	30	27	61	93	65	M			
2.0 JTDM (125 kW)	2009.05-2010.06	-	L/R	F	Hatchback Engine 939 B3.000	802024	Outer Joint	30	27	61	93	65	M			
2.2 JTS (136 kW)	2006.01-2010.06	MT	R	F	Hatchback Engine 939 A5.000	217124	Drive Shaft	30	25	61	94	1015				
	2006.01-2010.06	-	-	F	Hatchback Engine 939 A5.000	802023	Outer Joint	30	26	61	94	63.5	M			
	2006.01-2010.06	-	L	F	Hatchback Engine 939 A5.000	217122	Drive Shaft	30	25	61	94	640				
2.4 JTDM 20V (147 kW)	2006.01-2010.06	MT	L	F	Hatchback Engine 939 A3.000	217123	Drive Shaft	30	27	61	93	598				
	2006.01-2010.06	MT	R	F	Hatchback Engine 939 A3.000	217145	Drive Shaft	30	27	61	93	1059				
	2006.01-2010.06	-	L/R	F	Hatchback Engine 939 A3.000	802024	Outer Joint	30	27	61	93	65	M			
2.4 JTDM 20V (154 kW)	2007.05-2010.06	MT	L	F	Hatchback Engine 939 A9.000	217123	Drive Shaft	30	27	61	93	598				
	2007.05-2010.06	MT	R	F	Hatchback Engine 939 A9.000	217145	Drive Shaft	30	27	61	93	1059				
	2007.05-2010.06	-	L/R	F	Hatchback Engine 939 A9.000	802024	Outer Joint	30	27	61	93	65	M			
3.2 JTS (191 kW)	2008.03-2010.06	-	-	F	Hatchback Engine 939 A.000	802023	Outer Joint	30	26	61	94	63.5	M			
	2008.03-2010.06	-	L/R	F	Hatchback Engine 939 A.000	802024	Outer Joint	30	27	61	93	65	M			
3.2 JTS Q4 (191 kW)	2006.01-2010.06	-	-	-	All-wheel Drive Hatchback Engine 939 A.000	802023	Outer Joint	30	26	61	94	63.5	M			
BRERA COUPE (177)																
2.0 JTDM (125 kW)	2009.05-	-	L	-	-	621017	Inner Joint	27	27	35	78.5	112				
2.2 JTS (136 kW)	2006.01-	-	L	-	-	602009	Inner Joint	25	26	34.9	57.5	114.5				
	2006.01-	-	R	-	-	602010	Inner Joint	25	26	34.9	439.5	108.5				
2.4 JTDM 20V (147 kW)	2006.01-	MT/AT	R	-	-	617008	Inner Joint	27	27	35	498	108.5				
	2006.01-	MT/AT	L	-	-	621017	Inner Joint	27	27	35	78.5	112				
2.4 JTDM 20V (154 kW)	2006.01-	MT/AT	R	-	-	617008	Inner Joint	27	27	35	498	108.5				
	2006.01-	MT/AT	L	-	-	621017	Inner Joint	27	27	35	78.5	112				
3.2 JTS 4x2 (191 kW)	2008.03-	-	L	-	-	621017	Inner Joint	27	27	35	78.5	112				
3.2 JTS Q4 (195 kW)	2006.01-	MT	L	-	-	621016	Inner Joint	27	26	35	78.5	112				
3.2 JTS Q4 (195)	2006.01-	MT	R	-	-	617007	Inner Joint	27	26	35	453	108.5				
GIULIETTA (940_)																
1.4 BiFuel (88 kW)	2011.12-	MT	-	F	Hatchback Engine 198 A4.000	899348	Outer Joint	27	25	59	84	61.5	M			
1.4 TB (120 kW)	2010.04-	MT	-	F	Hatchback Engine 955 A8.000	899348	Outer Joint	27	25	59	84	61.5	M			
1.4 TB (125 kW)	2010.04-	MT	-	F	Hatchback Engine 940 A2.000	899348	Outer Joint	27	25	59	84	61.5	M			
1.4 TB (77 kW)	2011.04-	MT	-	F	Hatchback Engine 940 B1.000/940 B8.000	899348	Outer Joint	27	25	59	84	61.5	M			
1.4 TB (85 kW)	2010.04-	MT	-	F	Hatchback Engine 940 A6.000	899348	Outer Joint	27	25	59	84	61.5	M			
1.4 TB (88 kW)	2010.04-	MT	-	F	Hatchback Engine 198 A4.000/940 B7.000	899348	Outer Joint	27	25	59	84	61.5	M			
1.6 JTDM (77 kW)	2010.04-	MT	-	F	Hatchback Engine 940 A3.000	899348	Outer Joint	27	25	59	84	61.5	M			
1.8 Tbi (169 kW)	2010.04-2013.09	MT	-	F	Hatchback Engine 940 A1.000	817064	Outer Joint	27	27	59	84.5	64	M			
1.8 Tbi (173 kW)	2010.04-	MT	-	F	Hatchback Engine 940 A1.000	817064	Outer Joint	27	27	59	84.5	64	M			
1.8 Tbi (177 kW)	2013.09-	-	-	F	Hatchback Engine 940 B2.000/960 A1.000	817064	Outer Joint	27	27	59	84.5	64	M			
2.0 JTDM (100 kW)	2010.04-	MT	-	F	Hatchback Engine 940 A8.000/940 B6.000/940 C4.000	817064	Outer Joint	27	27	59	84.5	64	M			
2.0 JTDM (103 kW)	2010.04-	MT	-	F	Hatchback Engine 940 A5.000/940 C3.000	817064	Outer Joint	27	27	59	84.5	64	M			
2.0 JTDM (110 kW)	2013.08-	-	-	F	Hatchback Engine 940 B5.000/940 C3.000	817064	Outer Joint	27	27	59	84.5	64	M			
2.0 JTDM (120 kW)	2010.04-	MT	-	F	Hatchback Engine 940 A7.000/940 B9.000	817064	Outer Joint	27	27	59	84.5	64	M			
2.0 JTDM (125 kW)	2010.04-	-	-	F	Hatchback Engine 940 A4.000/940 B4.000	817064	Outer Joint	27	27	59	84.5	64	M			
GIULIETTA X7 (940)																
1.4 TB (125 kW)	2010.04-2013.04	-	L	-	-	617031	Inner Joint	25	26	32	59	110.5				
1.4 TB (77 kW)	2010.04-2013.04	-	L	-	-	617031	Inner Joint	25	26	32	59	110.5				
1.4 TB (88 kW)	2010.04-2013.04	-	L	-	-	617031	Inner Joint	25	26	32	59	110.5				
1.6 JTD (77 kW)	2010.04-2013.04	-	L	-	-	617031	Inner Joint	25	26	32	59	110.5				
1.6 JTD (77 kW)	2010.04-2013.04	-	L	-	-	617031	Inner Joint	25	26	32	59	110.5				





	 YEAR	TRANSM	L/R	F/R	REMARKS	GSP Ref.	 PRODUCT	 ABS	Technical Specifications						
									A	B	C	H	L	P	
ALFA ROMEO															
GT (937)															
1.8 T.S. (103 kW)	2003.11-	-	-	-	-	802008	Outer Joint		25	25	59	85	58	O	
	2003.11-	-	-	-	-	617009	Inner Joint			25		32			
1.9 JTD (110 kW)	2003.11-	-	-	R	-	617006	Inner Joint		25	26	29.8	377	108		
	2003.11-	-	-	L	-	617005	Inner Joint		25	26	32	91	95		
1.9 JTD (125 kW)	2008.05-	-	-	R	-	617006	Inner Joint		25	26	29.8	377	108		
	2008.05-	-	-	L	-	617005	Inner Joint		25	26	32	91	95		
2.0 JTS (121 kW)	2003.11-	-	-	-	-	802008	Outer Joint		25	25	59	85	58	O	
	2003.11-	-	-	-	-	617009	Inner Joint			25		32			
GT (937_)															
1.8 TS (103 kW)	2003.11-	2010.09	-	L/R	F	Coupe Engine AR 32205	217159	Drive Shaft		25		58.8	85	490	
	2003.11-	2010.09	-	-	F	Coupe Engine AR 32205	602005	Inner Joint			25		32		
	2003.11-	2010.09	-	-	F	Coupe Engine AR 32205	602006	Inner Joint			25		32		
1.9 JTD (110 kW)	2003.11-	2010.09	MT	R	F	Coupe Engine 937 A5.000	202008	Drive Shaft	25	25	51	84.5	931.5		
	2003.11-	2010.09	-	L	F	Coupe Engine 937 A5.000	217150	Drive Shaft	25	25	51	84.5	615		
	2003.11-	2010.09	-	L/R	F	Coupe Engine 937 A5.000	802025	Outer Joint	25	26	51	84.5	64.5	M	
1.9 JTD (125 kW)	2008.05-	2010.09	MT	R	F	Coupe Engine 937 A6.000	202008	Drive Shaft	25	25	51	84.5	931.5		
	2008.05-	2010.09	-	L	F	Coupe Engine 937 A6.000	217150	Drive Shaft	25	25	51	84.5	615		
	2008.05-	2010.09	-	L/R	F	Coupe Engine 937 A6.000	802025	Outer Joint	25	26	51	84.5	64.5	M	
2.0 JTS (119 kW)	2006.12-	2010.09	-	-	F	Coupe Engine 932 A2.000	602006	Inner Joint			25		32		
2.0 JTS (121 kW)	2003.11-	2010.09	-	L/R	F	Coupe Engine 932 A2.000/927 A1.000	217159	Drive Shaft	25		58.8	85	490		
	2003.11-	2010.09	-	-	F	Coupe Engine 932 A2.000/927 A1.000	602005	Inner Joint			25		32		
	2003.11-	2010.09	-	-	F	Coupe Engine 932 A2.000/927 A1.000	602006	Inner Joint			25		32		
GTV (916_)															
1.8 16V (106 kW)	1998.05-	2005.10	AT/MT	L/R	F	Coupe Engine AR 32201	618070	Inner Joint			25		32		
2.0 JTS (121 kW)	2003.04-	2005.10	MT	-	F	Coupe Engine 937 A1.000	802020	Outer Joint	25	25	51	85	58	O	
2.0 T.SPARK 16V (110 kW)	1995.06-	2005.10	MT	-	F	Coupe Engine AR 16201/AR 16201	802020	Outer Joint	25	25	51	85	58	O	
	1995.06-	2005.10	MT	-	F	Coupe Engine AR 16201/AR 16201	602006	Inner Joint			25		32		
	1995.06-	2005.10	AT/MT	L/R	F	Coupe Engine AR 16201/AR 16201	618070	Inner Joint			25		32		
2.0 V6 Turbo (148 kW)	1995.06-	1998.09	MT	L/R	F	Coupe Engine AR 16202	802009	Outer Joint	44T	25	28	56	85	63.5	O
3.0 V6 24V (162 kW)	1996.10-	2000.10	MT	L/R	F	Coupe Engine AR 16102	802009	Outer Joint	44T	25	28	56	85	63.5	O
3.2 V6 24V (176 kW)	2003.04-	2005.10	-	L/R	F	Coupe Engine 936 A6.000	817009	Outer Joint	25	26	59	84	63	M	
MITO (955)															
1.3 SDE (61 kW)	2008.09-	-	-	R	-	-	617026	Inner Joint		24	24	29.7	379	100.5	
1.3 SDE (66 kW)	2008.09-	-	-	R	-	-	617056	Inner Joint		25	23	34.9	400	97	
1.3 SDE (70 kW)	2008.09-	-	-	R	-	-	617026	Inner Joint		24	24	29.7	379	100.5	
1.4 TRB (120 kW)	2008.09-	-	-	L	-	-	617031	Inner Joint		25	26	32	59	110.5	
1.6 JTD (88 kW)	2011-	-	MT	L	-	-	617031	Inner Joint		25	26	32	59	110.5	
MITO (955_)															
1.3 MultiJet (59 kW)	2013.12-	-	MT	L/R	F	Hatchback Engine 199 B8.000	817063	Outer Joint		25	25	51.1	84.5	61	M
1.3 MultiJet (62 kW)	2011.01-	-	5AT	L	F	Hatchback Engine 199 B4.000	217148	Drive Shaft	25	24	51.1	84.5	614		
	2011.01-	-	5AT	R	F	Hatchback Engine 199 B4.000	217144	Drive Shaft	25	24	51.1	84.5	908		
	2011.01-	-	-	L/R	F	Hatchback Engine 199 B4.000	817063	Outer Joint	25	25	51.1	84.5	61	M	
1.3 MultiJet (66 kW)	2008.09-	-	5AT	L	F	Hatchback Engine 199 A3.000/955 B2.000	217148	Drive Shaft	25	24	51.1	84.5	614		
	2008.09-	-	5AT	R	F	Hatchback Engine 199 A3.000/955 B2.000	217144	Drive Shaft	25	24	51.1	84.5	908		
	2008.09-	-	CVT	L/R	F	Hatchback Engine 199 A3.000/955 B2.000	817053	Outer Joint	25	23	51	84.5	60	M	
1.3 MultiJet (70 kW)	2009.10-	-	5AT	L	F	Hatchback Engine 199 B1.000/330 A1.000	217148	Drive Shaft	25	24	51.1	84.5	614		
	2009.10-	-	5AT	R	F	Hatchback Engine 199 B1.000/330 A1.000	217144	Drive Shaft	25	24	51.1	84.5	908		
	2009.10-	-	-	L/R	F	Hatchback Engine 199 B1.000/330 A1.000	817063	Outer Joint	25	25	51.1	84.5	61	M	
1.4 (51 kW)	2011.05-	-	-	R	F	Hatchback Engine 955 A9.000	617004	Inner Joint	22	21	36	61	93.5		
	2011.05-	-	-	L	F	Hatchback Engine 955 A9.000	899325	Outer Joint	22	27	51	79.5	54	O	
	2011.05-	-	-	L	F	Hatchback Engine 955 A9.000	617103	Inner Joint	22	27	36	61.5	93.5		
1.4 (57 kW)	2011.03-	-	-	L	F	Hatchback Engine 955 A1.000	617103	Inner Joint	22	27	36	61.5	93.5		
	2011.03-	-	-	L	F	Hatchback Engine 350 A1.000	617103	Inner Joint	22	27	36	61.5	93.5		
	2011.03-	-	-	R	F	Hatchback Engine 955 A1.000	617004	Inner Joint	22	21	36	61	93.5		
	2011.03-	-	-	R	F	Hatchback Engine 350 A1.000	617004	Inner Joint	22	21	36	61	93.5		
	2011.03-	-	-	L/R	F	Hatchback Engine 955 A1.000	817063	Outer Joint	25	25	51.1	84.5	61	M	
	2011.03-	-	-	L/R	F	Hatchback Engine 350 A1.000	817052	Outer Joint	22	21	51.2	79.5	54	M	
	2011.03-	-	-	L	F	Hatchback Engine 955 A1.000	899325	Outer Joint	22	27	51	79.5	54	O	
	2011.03-	-	-	L	F	Hatchback Engine 350 A1.000	899325	Outer Joint	22	27	51	79.5	54	O	
1.4 (58 kW)	2008.09-	-	MT	L	F	Hatchback Engine 955 A1.000	217045	Drive Shaft	22	22	51	79.5	649		
	2008.09-	-	MT	R	F	Hatchback Engine 955 A1.000	217111	Drive Shaft	22	22	51.2	79.5	887		
	2008.09-	-	MT	L	F	Hatchback Engine 955 A1.000	899325	Outer Joint	22	27	51	79.5	54	O	
	2008.09-	-	-	L	F	Hatchback Engine 955 A1.000	217222	Drive Shaft	22	22	51	79.5	646		
	2008.09-	-	MT	L	F	Hatchback Engine 955 A1.000	617103	Inner Joint	22	27	36	61.5	93.5		
	2008.09-	-	-	L	F	Hatchback Engine 955 A1.000	617004	Inner Joint	22	21	36	61	93.5		
1.4 (70 kW)	2008.09-	-	MT	L	F	Hatchback Engine 199 A6.000	217045	Drive Shaft	22	22	51	79.5	649		





YEAR	TRANSM	L/R	F/R	REMARKS	GSP Ref.	PRODUCT	ABS	Technical Specifications									
								A	B	C	H	L	P				
ALFA ROMEO																	
MITO (955_)																	
1.4 (70 kW)	2008.09-	-	MT	R	F	Hatchback Engine 199 A6.000	217111	Drive Shaft		22	22	51.2	79.5	887			
	2008.09-	-	MT	L	F	Hatchback Engine 199 A6.000	899325	Outer Joint		22	27	51	79.5	54	O		
	2008.09-	-	-	L	F	Hatchback Engine 199 A6.000	217222	Drive Shaft		22	22	51	79.5	646			
	2008.09-	-	-	L/R	F	Hatchback Engine 199 A6.000	817063	Outer Joint		25	25	51.1	84.5	61	M		
	2008.09-	-	MT	L	F	Hatchback Engine 199 A6.000	617103	Inner Joint		22	27	36	61.5	93.5			
	2008.09-	-	-	L	F	Hatchback Engine 199 A6.000	617004	Inner Joint		22	21	36	61	93.5			
1.4 Bifuel (88 kW)	2011.07-	-	-	L/R	F	Hatchback Engine 198 A4.000	817063	Outer Joint		25	25	51.1	84.5	61	M		
	2016.04-	-	-	L/R	F	Hatchback Engine 198 A4.000	817063	Outer Joint		25	25	51.1	84.5	61	M		
1.4 MultiAir (77 kW)	2010.08-	-	-	L/R	F	Hatchback Engine 955 A6.000	817070	Outer Joint		22	22	51	79	57.5	M		
1.4 TB (103 kW)	2013.12-	-	Semi-AT	L/R	F	Hatchback Engine 955 B1.000	817063	Outer Joint		25	25	51.1	84.5	61	M		
1.4 TJet (110 kW)	2008.09-	-	-	-	F	Hatchback Engine 198 A1.000	817065	Outer Joint		25	33	51.1	84.5	61	I		
1.4 TJet (114 kW)	2008.09-	-	-	-	F	Hatchback Engine 199 A8.000	817065	Outer Joint		25	33	51.1	84.5	61	I		
1.4 TJet (88 kW)	2008.09-	-	-	L/R	F	Hatchback Engine 198 A4.000	817063	Outer Joint		25	25	51.1	84.5	61	M		
1.4 Turbo MultiAir (120 kW)	2009.10-	-	-	L/R	F	Hatchback Engine 955 A8.000	817063	Outer Joint		25	25	51.1	84.5	61	M		
1.4 Turbo MultiAir (125 kW)	2009.10-	-	-	L/R	F	Hatchback Engine 940 A2.000	817070	Outer Joint		22	22	51	79	57.5	M		
	2009.10-	-	-	L/R	F	Hatchback Engine 940 A2.000	817063	Outer Joint		25	25	51.1	84.5	61	M		
1.4 Turbo MultiAir (99 kW)	2009.10-	-	-	L/R	F	Hatchback Engine 955 A2.000/955 A7.000	817063	Outer Joint		25	25	51.1	84.5	61	M		
1.6 JTDM (85 kW)	2008.09-	-	-	-	F	Hatchback Engine 955 A4.000	817065	Outer Joint		25	33	51.1	84.5	61	I		
1.6 JTDM (88 kW)	2008.09-	-	-	-	F	Hatchback Engine 198 A2.000/955 A3.000	817065	Outer Joint		25	33	51.1	84.5	61	I		
SPIDER (916S)																	
1.8 16V (147 kW)	2009.05-	-	-	-	-		617009	Inner Joint			25		32				
2.0 16V T.S. (110 kW)	1995.06-	2000.08	-	-	-		617009	Inner Joint			25		32				
2.0 16V T.S. (114 kW)	1995.06-	2005.04	-	-	-		617009	Inner Joint			25		32				
2.0 JTS (121 kW)	2003.04-	2005.04	-	-	-		617009	Inner Joint			25		32				
SPIDER (916_)																	
1.8 16V (106 kW)	1998.05-	2005.04	-	-	F	Convertible Engine AR 32201	602005	Inner Joint			25		32				
	1998.05-	2005.04	AT/MT	L/R	F	Convertible Engine AR 32201	618070	Inner Joint			25		32				
	1998.05-	2005.04	-	-	F	Convertible Engine AR 32201	802006	Outer Joint	44T	25	25	52	85	58	O		
2.0 JTS (121 kW)	2003.04-	2005.04	-	-	F	Convertible Engine 937 A1.000	602005	Inner Joint			25		32				
	2003.04-	2005.04	-	-	F	Convertible Engine 937 A1.000	802006	Outer Joint	44T	25	25	52	85	58	O		
	2003.04-	2005.04	MT	-	F	Convertible Engine 937 A1.000	802020	Outer Joint		25	25	51	85	58	O		
2.0 T.SPARK 16V (110 kW)	1995.06-	2005.04	AT/MT	L/R	F	Convertible Engine AR 16201/AR 32310	618070	Inner Joint			25		32				
	1995.06-	2005.04	-	-	F	Convertible Engine AR 16201/AR 32310	802006	Outer Joint	44T	25	25	52	85	58	O		
	1995.06-	2005.04	MT	-	F	Convertible Engine AR 16201/AR 32310	802020	Outer Joint		25	25	51	85	58	O		
	1995.06-	2005.04	-	-	F	Convertible Engine AR 16201/AR 32310	602005	Inner Joint			25		32				
2.0 T.SPARK 16V (114 kW)	1998.05-	2000.08	-	-	F	Convertible Engine AR 32301	602005	Inner Joint			25		32				
	1998.05-	2000.08	AT/MT	L/R	F	Convertible Engine AR 32301	618070	Inner Joint			25		32				
	1998.05-	2000.08	-	-	F	Convertible Engine AR 32301	802006	Outer Joint	44T	25	25	52	85	58	O		
	1998.05-	2000.08	-	-	F	Convertible Engine AR 32301	802020	Outer Joint		25	25	51	85	58	O		
	1998.05-	2000.08	-	-	F	Convertible Engine AR 32301	602006	Inner Joint			25		32				
2.0 V6 Turbo (148 kW)	1998.05-	2005.04	MT	L/R	F	Convertible Engine AR 16202	802009	Outer Joint	44T	25	28	56	85	63.5	O		
	1998.05-	2005.04	MT	-	F	Convertible Engine AR 16202	802020	Outer Joint		25	25	51	85	58	O		
3.0 V6 (141 kW)	1995.06-	2005.04	AT/MT	L/R	F	Convertible Engine AR 16101	618070	Inner Joint			25		32				
	1995.06-	2005.04	MT	L/R	F	Convertible Engine AR 16101	802009	Outer Joint	44T	25	28	56	85	63.5	O		
	1995.06-	2005.04	-	L/R	F	Convertible Engine AR 16101	802012	Outer Joint		25	28	59	85	63	O		
3.2 V6 24V (176 kW)	2003.04-	2005.04	-	L/R	F	Convertible Engine 936 A6.000	817009	Outer Joint		25	26	59	84	63	M		
SPIDER (939)																	
2.0 JTDM (125 kW)	2009.05-	-	-	L	-		621017	Inner Joint		27	27	35	78.5	112			
2.2 JTS (136 kW)	2006.01-	-	-	L	-		602009	Inner Joint		25	26	34.9	57.5	114.5			
	2006.01-	-	-	R	-		602010	Inner Joint		25	26	34.9	439.5	108.5			
2.4 JTDM 20V (147 kW)	2006.01-	-	MT/AT	R	-		617008	Inner Joint		27	27	35	498	108.5			
	2006.01-	-	MT/AT	L	-		621017	Inner Joint		27	27	35	78.5	112			
2.4 JTDM 20V (154 kW)	2006.01-	-	MT/AT	R	-		617008	Inner Joint		27	27	35	498	108.5			
	2006.01-	-	MT/AT	L	-		621017	Inner Joint		27	27	35	78.5	112			
3.2 JTS 4x2 (191 kW)	2008.03-	-	-	L	-		621017	Inner Joint		27	27	35	78.5	112			
3.2 JTS Q4 (195 kW)	2006.01-	-	MT	L	-		621016	Inner Joint		27	26	35	78.5	112			
3.2 JTS Q4 (195)	2006.01-	-	MT	R	-		617007	Inner Joint		27	26	35	453	108.5			
SPIDER (939_)																	
1.8 TBi (147 kW)	2009.05-	2010.06	-	L/R	F	Convertible Engine 939 B1.000	802024	Outer Joint		30	27	61	93	65	M		
2.0 JTDM (120 kW)	2009.04-	2010.06	-	L/R	F	Convertible Engine 844 A2.000	802024	Outer Joint		30	27	61	93	65	M		
2.0 JTDM (125 kW)	2009.05-	2010.06	-	L/R	F	Convertible Engine 939 B3.000	802024	Outer Joint		30	27	61	93	65	M		
2.2 JTS (136 kW)	2006.03-	2010.06	-	-	F	Convertible Engine 939 A5.000	802023	Outer Joint		30	26	61	94	63.5	M		
	2006.03-	2010.06	-	L	F	Convertible Engine 939 A5.000	217122	Drive Shaft		30	25	61	94	640			
2.4 JTDM (147 kW)	2007.04-	2010.06	MT	R	F	Convertible Engine 939 A3.000	217124	Drive Shaft		30	25	61	94	1015			
	2007.04-	2010.06	-	L/R	F	Convertible Engine 939 A3.000	802024	Outer Joint		30	27	61	93	65	M		
2.4 JTDM (154 kW)	2008.03-	2010.06	MT	R	F	Convertible Engine 939 A3.000	217124	Drive Shaft		30	25	61	94	1015			

	 YEAR	TRANSM	L/R	F/R	REMARKS	GSP Ref.	 PRODUCT	 ABS	Technical Specifications					
									A	B	C	H	L	P
ALFA ROMEO														
SPIDER (939_)														
2.4 JTDM (154 kW)	2008.03-2010.06	-	L/R	F	Convertible Engine 939 A3.000	802024	Outer Joint		30	27	61	93	65	M
3.2 JTS (191 kW)	2008.03-2010.06	-	-	F	Convertible Engine 939 A.000	802023	Outer Joint		30	26	61	94	63.5	M
	2008.03-2010.06	-	L/R	F	Convertible Engine 939 A.000	802024	Outer Joint		30	27	61	93	65	M
3.2 JTS Q4 (191 kW)	2006.03-2010.06	-	-	F	All-wheel Drive Convertible Engine 939 A.000	802023	Outer Joint		30	26	61	94	63.5	M
AUDI														
100														
1.8	-	-	-	L	-	203028	Drive Shaft		38		59.5	34.5	599	
2.0	-	-	-	L	-	203028	Drive Shaft		38		59.5	34.5	599	
100 (44 44Q C3)														
1.8 (66 kW)	1983.08-1989.07	AT/MT	L/R	F	Saloon Engine DS/JW/NP	803004	Outer Joint		26	25	56.5	84.5	61.5	O
	1983.08-1989.07	AT	-	F	Saloon Engine DS/JW/NP	803005	Outer Joint	45T	26	25	56.5	84.5	61.5	O
	1983.08-1989.07	-	-	F	Saloon Engine DS/JW/NP	803006	Outer Joint	96T	26	25	56.5	84.5	61.5	O
	1983.08-1989.07	AT/MT	L/R	F	Saloon Engine DS/JW/NP	603002	Inner Joint			33		32		
1.8 Cat (66 kW)	1985.03-1990.11	AT/MT	L/R	F	Saloon Engine 4B/PH	803002	Inner Joint			33		32		
	1985.03-1990.11	-	-	F	Saloon Engine 4B/PH	803006	Outer Joint	96T	26	25	56.5	84.5	61.5	O
	1985.03-1990.11	AT/MT	L/R	F	Saloon Engine 4B/PH	803004	Outer Joint		26	25	56.5	84.5	61.5	O
1.8 Cat quattro (66 kW)	1985.08-1990.11	-	-	F/R	All-wheel Drive Saloon Engine 4B/PH	803006	Outer Joint	96T	26	25	56.5	84.5	61.5	O
	1985.08-1990.11	AT/MT	L/R	R	All-wheel Drive Saloon Engine 4B/PH	803014	Outer Joint	45T	38	25	59.5	34.5	61	O
	1985.08-1990.11	AT/MT	L/R/F/R		All-wheel Drive Saloon Engine 4B/PH	803004	Outer Joint		26	25	56.5	84.5	61.5	O
	1985.08-1990.11	AT/MT	L/R/F/R		All-wheel Drive Saloon Engine 4B/PH	603001	Inner Joint			28		32		
1.8 quattro (65 kW)	1986.08-1990.07	AT/MT	L/R/F/R		All-wheel Drive Saloon Engine SH	603001	Inner Joint			28		32		
	1986.08-1990.07	-	-	F/R	All-wheel Drive Saloon Engine SH	803006	Outer Joint	96T	26	25	56.5	84.5	61.5	O
	1986.08-1990.07	AT/MT	L/R	R	All-wheel Drive Saloon Engine SH	803014	Outer Joint	45T	38	25	59.5	34.5	61	O
	1986.08-1990.07	AT/MT	L/R/F/R		All-wheel Drive Saloon Engine SH	803004	Outer Joint		26	25	56.5	84.5	61.5	O
2.0 Cat (85 kW)	1988.01-1990.11	AT/MT	L/R	F	Saloon Engine RT	603001	Inner Joint			28		32		
	1988.01-1990.11	-	-	F	Saloon Engine RT	803005	Outer Joint	45T	26	25	56.5	84.5	61.5	O
	1988.01-1990.11	AT/MT	L/R	F	Saloon Engine RT	803004	Outer Joint		26	25	56.5	84.5	61.5	O
2.0 D Turbo (74 kW)	1988.03-1990.11	MT	L/R	F	Saloon Engine NC	603001	Inner Joint			28		32		
2.2 Cat (101 kW)	1989.06-1990.11	AT/MT	L/R	F	Saloon Engine HX/KU	603001	Inner Joint			28		32		
	1989.06-1990.11	5MT	-	F	Saloon Engine HX/KU	803013	Outer Joint		38	25	59.5	34.5	61	O
	1989.06-1990.11	AT/MT	L/R	F	Saloon Engine HX/KU	803004	Outer Joint		26	25	56.5	84.5	61.5	O
2.2 Cat quattro (101 kW)	1989.06-1990.11	AT/MT	L/R/F/R		All-wheel Drive Saloon Engine HX/KU	603001	Inner Joint			28		32		
	1989.06-1990.11	-	-	F/R	All-wheel Drive Saloon Engine HX/KU	803006	Outer Joint	96T	26	25	56.5	84.5	61.5	O
	1989.06-1990.11	AT/MT	L/R	R	All-wheel Drive Saloon Engine HX/KU	803014	Outer Joint	45T	38	25	59.5	34.5	61	O
	1989.06-1990.11	AT/MT	L/R/F/R		All-wheel Drive Saloon Engine HX/KU	803004	Outer Joint		26	25	56.5	84.5	61.5	O
2.2 E Turbo quattro (121 kW)	1986.08-1990.11	-	-	F	All-wheel Drive Saloon Engine MC	803003	Outer Joint		26	28	56.5	84.5	66.5	O
	1986.08-1990.11	MT	L/R	F	All-wheel Drive Saloon Engine MC	803106	Outer Joint	45T	38	28	59.6	34.5	66.5	O
	1986.08-1990.11	AT/MT	L/R	R	All-wheel Drive Saloon Engine MC	803014	Outer Joint	45T	38	25	59.5	34.5	61	O
	1986.08-1990.11	AT/MT	L/R	R	All-wheel Drive Saloon Engine MC	803004	Outer Joint		26	25	56.5	84.5	61.5	O
	1986.08-1990.11	AT/MT	L/R/F/R		All-wheel Drive Saloon Engine MC	603001	Inner Joint			28		32		
2.2 Turbo (121 kW)	1986.08-1990.11	-	-	F	Saloon Engine MC	803003	Outer Joint		26	28	56.5	84.5	66.5	O
	1986.08-1990.11	AT/MT	L/R	F	Saloon Engine MC	603001	Inner Joint			28		32		
	1986.08-1990.11	MT	L/R	F	Saloon Engine MC	803106	Outer Joint	45T	38	28	59.6	34.5	66.5	O
2.3 E (100 kW)	1986.10-1990.11	3AT/MT	L/R	F	Saloon Engine NF	603001	Inner Joint			28		32		
	1986.10-1990.11	3AT/MT	-	F	Saloon Engine NF	803005	Outer Joint	45T	26	25	56.5	84.5	61.5	O
	1986.10-1990.11	-	-	F	Saloon Engine NF	803006	Outer Joint	96T	26	25	56.5	84.5	61.5	O
	1986.10-1990.11	5MT	-	F	Saloon Engine NF	803013	Outer Joint		38	25	59.5	34.5	61	O
	1986.10-1990.11	AT/MT	L/R	F	Saloon Engine NF	803004	Outer Joint		26	25	56.5	84.5	61.5	O
2.3 E (98 kW)	1990.01-1990.11	3AT	-	F	Saloon Engine NF	803005	Outer Joint	45T	26	25	56.5	84.5	61.5	O
	1990.01-1990.11	-	-	F	Saloon Engine NF	803013	Outer Joint		38	25	59.5	34.5	61	O
2.3 E quattro (100 kW)	1986.08-1990.11	AT/MT	L/R/F/R		All-wheel Drive Saloon Engine NF	603001	Inner Joint			28		32		
	1986.08-1990.11	-	-	F/R	All-wheel Drive Saloon Engine NF	803006	Outer Joint	96T	26	25	56.5	84.5	61.5	O
	1986.08-1990.11	AT/MT	L/R	R	All-wheel Drive Saloon Engine NF	803014	Outer Joint	45T	38	25	59.5	34.5	61	O
	1986.08-1990.11	AT/MT	L/R/F/R		All-wheel Drive Saloon Engine NF	803004	Outer Joint		26	25	56.5	84.5	61.5	O
2.3 quattro (98 kW)	1990.01-1990.11	-	-	F/R	All-wheel Drive Saloon Engine NF	803006	Outer Joint	96T	26	25	56.5	84.5	61.5	O
2.4 D (60 kW)	1989.08-1991.07	-	-	F	Saloon Engine 3D	803013	Outer Joint		38	25	59.5	34.5	61	O
2.5 TDI (88 kW)	1990.01-1990.11	MT	L/R	F	Saloon Engine 1T	803106	Outer Joint	45T	38	28	59.6	34.5	66.5	O
100 (4A2 C4)														
2.0 (74 kW)	1990.12-1994.07	MT	L/R	F	Saloon Engine AAE	603001	Inner Joint			28		32		
	1990.12-1994.07	-	-	F	Saloon Engine AAE	803015	Outer Joint		38	30	59.5	34	61	I
	1990.12-1994.07	AT/MT	L/R	F	Saloon Engine AAE	803016	Outer Joint	45T	38	30	59.5	34	61	I
2.0 E (85 kW)	1990.12-1994.07	MT	L/R	F	Saloon Engine ABK/AAD	603001	Inner Joint			28		32		
	1990.12-1994.07	-	-	F	Saloon Engine ABK/AAD	803015	Outer Joint		38	30	59.5	34	61	I
	1990.12-1994.07	AT/MT	L/R	F	Saloon Engine ABK/AAD	803016	Outer Joint	45T	38	30	59.5	34	61	I
2.0 E 16V (103 kW)	1992.01-1994.07	MT	L/R	F	Saloon Engine ACE	603001	Inner Joint			28		32		





	 YEAR	TRANSM	L/R	F/R	REMARKS	GSP Ref.	 PRODUCT	 ABS	Technical Specifications					
									A	B	C	H	L	P
AUDI														
100 (4A2 C4)														
2.0 E 16V (103 kW)	1992.01-1994.07	AT/MT	L/R	F	Saloon Engine ACE	803016	Outer Joint	45T	38	30	59.5	34	61	I
2.0 E quattro (85 kW)	1990.12-1992.07	MT	L/R	F	All-wheel Drive Saloon Engine AAD	803016	Outer Joint	45T	38	30	59.5	34	61	I
	1990.12-1992.07	AT/MT	L/R	R	All-wheel Drive Saloon Engine AAD	803014	Outer Joint	45T	38	25	59.5	34.5	61	O
	1990.12-1992.07	AT/MT	L/R	R	All-wheel Drive Saloon Engine AAD	603005	Inner Joint			33		32		
2.3 E (98 kW)	1990.12-1994.07	3AT/MT	L/R	F	Saloon Engine AAR	603001	Inner Joint			28		32		
	1990.12-1994.07	-	-	F	Saloon Engine AAR	803015	Outer Joint		38	30	59.5	34	61	I
	1990.12-1994.07	AT/MT	L/R	F	Saloon Engine AAR	803016	Outer Joint	45T	38	30	59.5	34	61	I
	1990.12-1994.07	3AT	L/R	F	Saloon Engine AAR	803004	Outer Joint		26	25	56.5	84.5	61.5	O
2.3 E quattro (98 kW)	1990.12-1994.07	MT	L/R	F	All-wheel Drive Saloon Engine AAR	803016	Outer Joint	45T	38	30	59.5	34	61	I
2.4 D (60 kW)	1990.12-1994.07	-	-	F	Saloon Engine AAS	803015	Outer Joint		38	30	59.5	34	61	I
	1990.12-1994.07	AT/MT	L/R	F	Saloon Engine AAS	803016	Outer Joint	45T	38	30	59.5	34	61	I
2.5 TDI (85 kW)	1990.12-1994.07	AT/MT	L/R	F	Saloon Engine AAT/ABP	661033	Inner Joint			34		85		
	1990.12-1994.07	-	-	-	Saloon Engine AAT/ABP	803056	Outer Joint		38	27	59.5	34.5	68.5	I
	1990.12-1994.07	MT	L/R	F	Saloon Engine AAT/ABP	803017	Outer Joint	45T	38	27	59.5	34.5	68.5	I
	1990.12-1994.07	MT	R	F	Saloon Engine AAT/ABP	203051	Drive Shaft	45T	38		59.5	34.5	647	
	1990.12-1994.07	MT	L	F	Saloon Engine AAT/ABP	203050	Drive Shaft	45T	38		59.5	34.5	612	
2.6 (110 kW)	1992.03-1994.07	-	-	F	Saloon Engine ABC	803015	Outer Joint		38	30	59.5	34	61	I
	1992.03-1994.07	AT/MT	L/R	F	Saloon Engine ABC	803016	Outer Joint	45T	38	30	59.5	34	61	I
2.6 quattro (110 kW)	1992.04-1994.07	MT	L/R	F	All-wheel Drive Saloon Engine ABC	803016	Outer Joint	45T	38	30	59.5	34	61	I
	1992.04-1994.07	AT/MT	L/R	R	All-wheel Drive Saloon Engine ABC	803014	Outer Joint	45T	38	25	59.5	34.5	61	O
2.8 E (128 kW)	1990.12-1994.07	AT	L	F	Saloon Engine AAH	203060	Drive Shaft	45T	38		59.5	34	565	
	1990.12-1994.07	AT/MT	L/R	F	Saloon Engine AAH	661033	Inner Joint			34		85		
	1990.12-1994.07	-	-	-	Saloon Engine AAH	803056	Outer Joint		38	27	59.5	34.5	68.5	I
	1990.12-1994.07	AT/MT	L/R	F	Saloon Engine AAH	803017	Outer Joint	45T	38	27	59.5	34.5	68.5	I
	1990.12-1994.07	MT	R	F	Saloon Engine AAH	203051	Drive Shaft	45T	38		59.5	34.5	647	
	1990.12-1994.07	AT	R	F	Saloon Engine AAH	203061	Drive Shaft	45T	38		59.5	34	488	
	1990.12-1994.07	MT	L	F	Saloon Engine AAH	203050	Drive Shaft	45T	38		59.5	34.5	612	
2.8 E quattro (128 kW)	1990.12-1994.07	AT/MT	L/R/F/R	F	All-wheel Drive Saloon Engine AAH	603001	Inner Joint			28		32		
	1990.12-1994.07	-	-	-	All-wheel Drive Saloon Engine AAH	803056	Outer Joint		38	27	59.5	34.5	68.5	I
	1990.12-1994.07	AT/MT	L/R	F	All-wheel Drive Saloon Engine AAH	803017	Outer Joint	45T	38	27	59.5	34.5	68.5	I
	1990.12-1994.07	AT/MT	L/R	R	All-wheel Drive Saloon Engine AAH	803014	Outer Joint	45T	38	25	59.5	34.5	61	O
S4 Turbo quattro (169 kW)	1991.08-1994.07	MT	L/R	F	All-wheel Drive Saloon Engine AAN	603001	Inner Joint			28		32		
	1991.08-1994.07	AT/MT	L/R	F	All-wheel Drive Saloon Engine AAN	803017	Outer Joint	45T	38	27	59.5	34.5	68.5	I
S4 V8 quattro (206 kW)	1992.10-1994.07	AT/MT	L/R/F/R	F	All-wheel Drive Saloon Engine ABH	603001	Inner Joint			28		32		
	1992.10-1994.07	MT	L/R	F	All-wheel Drive Saloon Engine ABH	803017	Outer Joint	45T	38	27	59.5	34.5	68.5	I
100 Avant (44 44Q C3)														
1.8 (65 kW)	1986.02-1990.07	AT/MT	L/R	F	Estate Engine SH	603002	Inner Joint			33		32		
	1986.02-1990.07	-	-	F	Estate Engine SH	803005	Outer Joint	45T	26	25	56.5	84.5	61.5	O
	1986.02-1990.07	-	-	F	Estate Engine SH	803006	Outer Joint	96T	26	25	56.5	84.5	61.5	O
	1986.02-1990.07	AT/MT	L/R	F	Estate Engine SH	803004	Outer Joint		26	25	56.5	84.5	61.5	O
1.8 (66 kW)	1983.08-1989.07	AT/MT	L/R	F	Estate Engine JW/DS/NP	803004	Outer Joint		26	25	56.5	84.5	61.5	O
	1983.08-1989.07	-	-	F	Estate Engine JW/DS/NP	803005	Outer Joint	45T	26	25	56.5	84.5	61.5	O
	1983.08-1989.07	-	-	F	Estate Engine JW/DS/NP	803006	Outer Joint	96T	26	25	56.5	84.5	61.5	O
	1983.08-1989.07	-	-	F	Estate Engine JW/DS/NP	803013	Outer Joint		38	25	59.5	34.5	61	O
	1983.08-1989.07	AT/MT	L/R	F	Estate Engine JW/DS/NP	603002	Inner Joint			33		32		
1.8 Cat (66 kW)	1985.03-1990.11	AT/MT	L/R	F	Estate Engine 4B/PH	603002	Inner Joint			33		32		
	1985.03-1990.11	-	-	F	Estate Engine 4B/PH	803006	Outer Joint	96T	26	25	56.5	84.5	61.5	O
	1985.03-1990.11	AT/MT	L/R	F	Estate Engine 4B/PH	803004	Outer Joint		26	25	56.5	84.5	61.5	O
1.8 Cat quattro (66 kW)	1985.08-1990.10	AT/MT	L/R/F/R	F	All-wheel Drive Estate Engine PH/48	603001	Inner Joint			28		32		
	1985.08-1990.10	-	-	F/R	All-wheel Drive Estate Engine PH/48	803006	Outer Joint	96T	26	25	56.5	84.5	61.5	O
	1985.08-1990.10	AT/MT	L/R	R	All-wheel Drive Estate Engine PH/48	803014	Outer Joint	45T	38	25	59.5	34.5	61	O
	1985.08-1990.10	AT/MT	L/R/F/R	F	All-wheel Drive Estate Engine PH/48	803004	Outer Joint		26	25	56.5	84.5	61.5	O
1.8 quattro (65 kW)	1986.08-1990.07	AT/MT	L/R/F/R	F	All-wheel Drive Estate Engine SH	603001	Inner Joint			28		32		
	1986.08-1990.07	-	-	F/R	All-wheel Drive Estate Engine SH	803006	Outer Joint	96T	26	25	56.5	84.5	61.5	O
	1986.08-1990.07	AT/MT	L/R	R	All-wheel Drive Estate Engine SH	803014	Outer Joint	45T	38	25	59.5	34.5	61	O
	1986.08-1990.07	AT/MT	L/R/F/R	F	All-wheel Drive Estate Engine SH	803004	Outer Joint		26	25	56.5	84.5	61.5	O
2.0 D (51 kW)	1983.03-1990.11	AT	-	F	Estate Engine CN	803005	Outer Joint	45T	26	25	56.5	84.5	61.5	O
	1983.03-1990.11	AT/MT	L/R	F	Estate Engine CN	603001	Inner Joint			28		32		
	1983.03-1990.11	-	-	F	Estate Engine CN	803006	Outer Joint	96T	26	25	56.5	84.5	61.5	O
	1983.03-1990.11	AT/MT	L/R	F	Estate Engine CN	803004	Outer Joint		26	25	56.5	84.5	61.5	O
2.0 E Cat (85 kW)	1988.01-1990.11	AT	-	F	Estate Engine RT	803005	Outer Joint	45T	26	25	56.5	84.5	61.5	O
	1988.01-1990.11	AT/MT	L/R	F	Estate Engine RT	603001	Inner Joint			28		32		
	1988.01-1990.11	AT/MT	L/R	F	Estate Engine RT	803004	Outer Joint		26	25	56.5	84.5	61.5	O
2.0 TD (74 kW)	1988.03-1990.11	MT	L/R	F	Estate Engine NC	603001	Inner Joint			28		32		
2.2 Cat (101 kW)	1989.06-1990.11	AT/MT	L/R	F	Estate Engine KU/HX	603001	Inner Joint			28		32		
	1989.06-1990.11	-	-	F/R	Estate Engine KU/HX	803006	Outer Joint	96T	26	25	56.5	84.5	61.5	O





	 YEAR	TRANSM	L/R	F/R	REMARKS	GSP Ref.	 PRODUCT	 ABS	Technical Specifications					
									A	B	C	H	L	P
AUDI														
100 Avant (44 44Q C3)														
2.2 Cat (101 kW)	1989.06-1990.11	AT/MT	L/R	F	Estate Engine KU/HX	803004	Outer Joint		26	25	56.5	84.5	61.5	O
2.2 Cat quattro (101 kW)	1989.06-1990.11	AT/MT	L/R/F/R		All-wheel Drive Estate Engine HX/KU	603001	Inner Joint			28		32		
	1989.06-1990.11	-	-	F/R	All-wheel Drive Estate Engine HX/KU	803006	Outer Joint	96T	26	25	56.5	84.5	61.5	O
	1989.06-1990.11	AT/MT	L/R	R	All-wheel Drive Estate Engine HX/KU	803014	Outer Joint	45T	38	25	59.5	34.5	61	O
	1989.06-1990.11	AT/MT	L/R/F/R		All-wheel Drive Estate Engine HX/KU	803004	Outer Joint		26	25	56.5	84.5	61.5	O
2.2 Turbo (121 kW)	1986.08-1990.11	-	-	F	Estate Engine MC	803003	Outer Joint		26	28	56.5	84.5	66.5	O
	1986.08-1990.11	AT/MT	L/R	F	Estate Engine MC	603001	Inner Joint			28		32		
	1986.08-1990.11	MT	L/R	F	Estate Engine MC	803106	Outer Joint	45T	38	28	59.6	34.5	66.5	O
2.2 Turbo quattro (121 kW)	1986.08-1990.11	AT/MT	L/R/F/R		All-wheel Drive Estate Engine MC	603001	Inner Joint			28		32		
	1986.08-1990.11	-	-	F	All-wheel Drive Estate Engine MC	803003	Outer Joint		26	28	56.5	84.5	66.5	O
	1986.08-1990.11	MT	L/R	F	All-wheel Drive Estate Engine MC	803106	Outer Joint	45T	38	28	59.6	34.5	66.5	O
	1986.08-1990.11	AT/MT	L/R	R	All-wheel Drive Estate Engine MC	803014	Outer Joint	45T	38	25	59.5	34.5	61	O
	1986.08-1990.11	AT/MT	L/R	R	All-wheel Drive Estate Engine MC	803004	Outer Joint		26	25	56.5	84.5	61.5	O
2.3 (100 kW)	1986.08-1990.11	3AT	-	F	Estate Engine NF	803005	Outer Joint	45T	26	25	56.5	84.5	61.5	O
	1986.08-1990.11	3AT/MT	L/R	F	Estate Engine NF	603001	Inner Joint			28		32		
	1986.08-1990.11	-	-	F	Estate Engine NF	803006	Outer Joint	96T	26	25	56.5	84.5	61.5	O
	1986.08-1990.11	5MT	-	F	Estate Engine NF	803013	Outer Joint		38	25	59.5	34.5	61	O
	1986.08-1990.11	AT/MT	L/R	F	Estate Engine NF	803004	Outer Joint		26	25	56.5	84.5	61.5	O
2.3 (98 kW)	1990.03-1990.11	3AT	-	F	Estate Engine NF	803005	Outer Joint	45T	26	25	56.5	84.5	61.5	O
2.3 E quattro (100 kW)	1986.08-1990.11	AT/MT	L/R/F/R		All-wheel Drive Estate Engine NF	603001	Inner Joint			28		32		
	1986.08-1990.11	-	-	F/R	All-wheel Drive Estate Engine NF	803006	Outer Joint	96T	26	25	56.5	84.5	61.5	O
	1986.08-1990.11	AT/MT	L/R	R	All-wheel Drive Estate Engine NF	803014	Outer Joint	45T	38	25	59.5	34.5	61	O
	1986.08-1990.11	AT/MT	L/R/F/R		All-wheel Drive Estate Engine NF	803004	Outer Joint		26	25	56.5	84.5	61.5	O
2.3 quattro (98 kW)	1990.01-1990.11	-	-	F/R	All-wheel Drive Estate Engine NF	803006	Outer Joint	96T	26	25	56.5	84.5	61.5	O
2.4 D (60 kW)	1989.08-1990.11	-	-	F	Estate Engine 3D	803013	Outer Joint		38	25	59.5	34.5	61	O
2.5 TDI (88 kW)	1990.01-1990.11	MT	L/R	F	Estate Engine 1T	803106	Outer Joint	45T	38	28	59.6	34.5	66.5	O
100 Avant (4A5 C4)														
2.0 E (74 kW)	1991.09-1994.07	MT	L/R	F	Estate Engine AAE	603001	Inner Joint			28		32		
	1991.09-1994.07	AT/MT	L/R	F	Estate Engine AAE	803016	Outer Joint	45T	38	30	59.5	34	61	I
2.0 E (85 kW)	1991.09-1994.07	MT	L/R	F	Estate Engine AAD/ABK	603001	Inner Joint			28		32		
	1991.09-1994.07	AT/MT	L/R	F	Estate Engine AAD/ABK	803016	Outer Joint	45T	38	30	59.5	34	61	I
2.0 E quattro (85 kW)	1990.12-1992.07	MT	L/R	F	All-wheel Drive Estate Engine AAD	803016	Outer Joint	45T	38	30	59.5	34	61	I
	1990.12-1992.07	AT/MT	L/R	R	All-wheel Drive Estate Engine AAD	803014	Outer Joint	45T	38	25	59.5	34.5	61	O
	1990.12-1992.07	AT/MT	L/R	R	All-wheel Drive Estate Engine AAD	603005	Inner Joint			33		32		
2.3 E (98 kW)	1991.09-1994.07	3AT/MT	L/R	F	Estate Engine AAR	603001	Inner Joint			28		32		
	1991.09-1994.07	AT/MT	L/R	F	Estate Engine AAR	803016	Outer Joint	45T	38	30	59.5	34	61	I
	1991.09-1994.07	3AT	L/R	F	Estate Engine AAR	803004	Outer Joint		26	25	56.5	84.5	61.5	O
2.3 E quattro (98 kW)	1991.09-1994.07	MT	L/R	F	All-wheel Drive Estate Engine AAR	603001	Inner Joint			28		32		
	1991.09-1994.07	MT	L/R	F	All-wheel Drive Estate Engine AAR	803016	Outer Joint	45T	38	30	59.5	34	61	I
2.4 D (60 kW)	1990.12-1994.07	AT/MT	L/R	F	Estate Engine AAS	803016	Outer Joint	45T	38	30	59.5	34	61	I
2.5 TDI (85 kW)	1990.12-1994.07	AT/MT	L/R	F	Estate Engine AAT/ABP	661033	Inner Joint			34		85		
	1990.12-1994.07	-	-	-	Estate Engine AAT/ABP	803056	Outer Joint		38	27	59.5	34.5	68.5	I
	1990.12-1994.07	MT	L/R	F	Estate Engine AAT/ABP	803017	Outer Joint	45T	38	27	59.5	34.5	68.5	I
	1990.12-1994.07	MT	R	F	Estate Engine AAT/ABP	203051	Drive Shaft	45T	38		59.5	34.5	647	
	1990.12-1994.07	MT	L	F	Estate Engine AAT/ABP	203050	Drive Shaft	45T	38		59.5	34.5	612	
2.6 (110 kW)	1992.03-1994.07	AT/MT	L/R	F	Estate Engine ABC	803016	Outer Joint	45T	38	30	59.5	34	61	I
2.6 quattro (110 kW)	1992.07-1994.07	MT	L/R	F	All-wheel Drive Estate Engine ABC	803016	Outer Joint	45T	38	30	59.5	34	61	I
	1992.07-1994.07	AT/MT	L/R	R	All-wheel Drive Estate Engine ABC	803014	Outer Joint	45T	38	25	59.5	34.5	61	O
2.8 E (128 kW)	1991.09-1994.07	MT	L	F	Estate Engine AAH	203050	Drive Shaft	45T	38		59.5	34.5	612	
	1991.09-1994.07	AT	L	F	Estate Engine AAH	203060	Drive Shaft	45T	38		59.5	34	565	
	1991.09-1994.07	AT/MT	L/R	F	Estate Engine AAH	661033	Inner Joint			34		85		
	1991.09-1994.07	-	-	-	Estate Engine AAH	803056	Outer Joint		38	27	59.5	34.5	68.5	I
	1991.09-1994.07	AT/MT	L/R	F	Estate Engine AAH	803017	Outer Joint	45T	38	27	59.5	34.5	68.5	I
	1991.09-1994.07	MT	R	F	Estate Engine AAH	203051	Drive Shaft	45T	38		59.5	34.5	647	
	1991.09-1994.07	AT	R	F	Estate Engine AAH	203061	Drive Shaft	45T	38		59.5	34	488	
2.8 E quattro (128 kW)	1991.09-1994.07	AT/MT	L/R/F/R		All-wheel Drive Estate Engine AAH	603001	Inner Joint			28		32		
	1991.09-1994.07	-	-	-	All-wheel Drive Estate Engine AAH	803056	Outer Joint		38	27	59.5	34.5	68.5	I
	1991.09-1994.07	AT/MT	L/R	F	All-wheel Drive Estate Engine AAH	803017	Outer Joint	45T	38	27	59.5	34.5	68.5	I
	1991.09-1994.07	AT/MT	L/R	R	All-wheel Drive Estate Engine AAH	803014	Outer Joint	45T	38	25	59.5	34.5	61	O
S4 Turbo quattro (169 kW)	1991.09-1994.07	MT	L/R	F	All-wheel Drive Estate Engine AAN	603001	Inner Joint			28		32		
	1991.09-1994.07	AT/MT	L/R	F	All-wheel Drive Estate Engine AAN	803017	Outer Joint	45T	38	27	59.5	34.5	68.5	I
S4 V8 quattro (206 kW)	1992.10-1994.07	AT/MT	L/R/F/R		All-wheel Drive Estate Engine ABH	603001	Inner Joint			28		32		
	1992.10-1994.07	MT	L/R	F	All-wheel Drive Estate Engine ABH	803017	Outer Joint	45T	38	27	59.5	34.5	68.5	I
200 (44 44Q)														
2.2 20V Turbo quattro (162 kW)	1989.03-1990.12	AT/MT	L/R/F/R		All-wheel Drive Saloon Engine 3B	603001	Inner Joint			28		32		
	1989.03-1990.12	MT	L/R	F	All-wheel Drive Saloon Engine 3B	803106	Outer Joint	45T	38	28	59.6	34.5	66.5	O





	 YEAR	TRANSM	L/R	F/R	REMARKS	GSP Ref.	 PRODUCT	 ABS	Technical Specifications						
									A	B	C	H	L	P	
AUDI															
200 (44 44Q)															
2.2 20V Turbo quattro (162 kW)	1989.03-1990.12	AT/MT	L/R	R	All-wheel Drive Saloon Engine 3B	803014	Outer Joint	45T	38	25	59.5	34.5	61	O	
2.2 Turbo (121 kW)	1985.08-1991.09	-	-	-	Saloon Engine MC	803054	Outer Joint	96T	26	28	56.5	84	66	O	
	1985.08-1991.09	AT/MT	L/R	F	Saloon Engine MC	603001	Inner Joint			28		32			
	1985.08-1991.09	MT	L/R	F	Saloon Engine MC	803106	Outer Joint	45T	38	28	59.6	34.5	66.5	O	
2.2 Turbo (147 kW)	1988.02-1990.12	AT/MT	L/R	F	Saloon Engine 1B	603001	Inner Joint			28		32			
	1988.02-1990.12	MT	L/R	F	Saloon Engine 1B	803106	Outer Joint	45T	38	28	59.6	34.5	66.5	O	
2.2 Turbo quattro (121 kW)	1985.01-1991.12	AT/MT	L/R/F/R		All-wheel Drive Saloon Engine MC	603001	Inner Joint			28		32			
	1985.01-1991.12	-	-	-	All-wheel Drive Saloon Engine MC	803054	Outer Joint	96T	26	28	56.5	84	66	O	
	1985.01-1991.12	MT	L/R	F	All-wheel Drive Saloon Engine MC	803106	Outer Joint	45T	38	28	59.6	34.5	66.5	O	
	1985.01-1991.12	AT/MT	L/R	R	All-wheel Drive Saloon Engine MC	803014	Outer Joint	45T	38	25	59.5	34.5	61	O	
2.2 Turbo quattro (147 kW)	1988.02-1990.11	AT/MT	L/R	R	All-wheel Drive Saloon Engine 1B	603001	Inner Joint			28		32			
	1988.02-1990.11	MT	L/R	F	All-wheel Drive Saloon Engine 1B	803106	Outer Joint	45T	38	28	59.6	34.5	66.5	O	
	1988.02-1990.11	AT/MT	L/R	R	All-wheel Drive Saloon Engine 1B	803014	Outer Joint	45T	38	25	59.5	34.5	61	O	
200 Avant (44 44Q)															
2.2 20V Turbo quattro (162 kW)	1989.07-1990.12	AT/MT	L/R/F/R		All-wheel Drive Estate Engine 3B	603001	Inner Joint			28		32			
	1989.07-1990.12	MT	L/R	F	All-wheel Drive Estate Engine 3B	803106	Outer Joint	45T	38	28	59.6	34.5	66.5	O	
	1989.07-1990.12	AT/MT	L/R	R	All-wheel Drive Estate Engine 3B	803014	Outer Joint	45T	38	25	59.5	34.5	61	O	
2.2 Turbo (121 kW)	1985.08-1991.09	-	-	-	Estate Engine MC	803054	Outer Joint	96T	26	28	56.5	84	66	O	
	1985.08-1991.09	AT/MT	L/R	F	Estate Engine MC	603001	Inner Joint			28		32			
	1985.08-1991.09	MT	L/R	F	Estate Engine MC	803106	Outer Joint	45T	38	28	59.6	34.5	66.5	O	
2.2 Turbo quattro (121 kW)	1983.09-1990.12	AT/MT	L/R/F/R		All-wheel Drive Estate Engine MC	603001	Inner Joint			28		32			
	1983.09-1990.12	-	-	-	All-wheel Drive Estate Engine MC	803054	Outer Joint	96T	26	28	56.5	84	66	O	
	1983.09-1990.12	MT	L/R	F	All-wheel Drive Estate Engine MC	803106	Outer Joint	45T	38	28	59.6	34.5	66.5	O	
	1983.09-1990.12	AT/MT	L/R	R	All-wheel Drive Estate Engine MC	803014	Outer Joint	45T	38	25	59.5	34.5	61	O	
2.2 Turbo quattro (147 kW)	1988.02-1991.12	AT/MT	L/R/F/R		All-wheel Drive Estate Engine 1B	603001	Inner Joint			28		32			
	1988.02-1991.12	MT	L/R	F	All-wheel Drive Estate Engine 1B	803106	Outer Joint	45T	38	28	59.6	34.5	66.5	O	
	1988.02-1991.12	AT/MT	L/R	R	All-wheel Drive Estate Engine 1B	803014	Outer Joint	45T	38	25	59.5	34.5	61	O	
80 (89 89Q 8A B3)															
1.6 (51 kW)	1987.08-1991.09	MT	L/R	F	Saloon Engine PP	803008	Outer Joint			33	30	53	30.5	51.5	I
	1987.08-1991.09	MT	L/R	F	Saloon Engine PP	803009	Outer Joint	45T	33	30	53	30.5	51.5	I	
	1987.08-1991.09	MT	-	-	Saloon Engine PP	603006	Inner Joint			33		34			
	1987.08-1991.09	MT	L/R	F	Saloon Engine PP	603004	Inner Joint			33		32			
	1987.08-1991.09	-	-	F	Saloon Engine PP	803023	Outer Joint	96T	22	30	51	78.7	51.1	I	
	1987.08-1991.09	MT	L/R	F	Saloon Engine PP	603005	Inner Joint			33		32			
	1987.08-1991.09	MT	L/R	F	Saloon Engine PP	803007	Outer Joint		22	30	51	78.7	51.1	I	
	1987.08-1991.09	MT	L/R	F	Saloon Engine PP	603020	Inner Joint			33		32			
1.6 (55 kW)	1986.09-1991.08	MT	L/R	F	Saloon Engine RN	803008	Outer Joint			33	30	53	30.5	51.5	I
	1986.09-1991.08	MT	L/R	F	Saloon Engine RN	803009	Outer Joint	45T	33	30	53	30.5	51.5	I	
	1986.09-1991.08	MT	-	-	Saloon Engine RN	603006	Inner Joint			33		34			
	1986.09-1991.08	MT	L/R	F	Saloon Engine RN	603004	Inner Joint			33		32			
	1986.09-1991.08	-	-	F	Saloon Engine RN	803023	Outer Joint	96T	22	30	51	78.7	51.1	I	
	1986.09-1991.08	MT	L/R	F	Saloon Engine RN	603005	Inner Joint			33		32			
	1986.09-1991.08	MT	L/R	F	Saloon Engine RN	803007	Outer Joint		22	30	51	78.7	51.1	I	
	1986.09-1991.08	MT	L/R	F	Saloon Engine RN	603020	Inner Joint			33		32			
1.6 (75 kW)	1990.08-1991.10	AT/MT	L/R	F	Saloon Engine ABB	603014	Inner Joint			33		32			
	1990.08-1991.10	MT	L	F	Saloon Engine ABB	203059	Drive Shaft			33		53	31	586	
	1990.08-1991.10	AT/MT	L/R	F	Saloon Engine ABB	803012	Outer Joint	45T	33	30	53	31	62	I	
	1990.08-1991.10	MT	R	F	Saloon Engine ABB	203297	Drive Shaft	45T	33	0	53	30	575		
	1990.08-1991.10	AT/MT	L/R	F	Saloon Engine ABB	803051	Outer Joint			33	30	53	30	61	I
	1990.08-1991.10	MT	L	F	Saloon Engine ABB	203003	Drive Shaft	45T	33		53	31	586		
	1990.08-1991.10	-	-	F	Saloon Engine ABB	803011	Outer Joint			33	30	53	31	62	I
1.6 D (40 kW)	1987.02-1989.07	AT/MT	L/R	F	Saloon Engine JK	803007	Outer Joint		22	30	51	78.7	51.1	I	
	1987.02-1989.07	-	-	F	Saloon Engine JK	803023	Outer Joint	96T	22	30	51	78.7	51.1	I	
	1987.02-1989.07	MT	L/R	F	Saloon Engine JK	603020	Inner Joint			33		32			
	1987.02-1989.07	AT/MT	L/R	F	Saloon Engine JK	603004	Inner Joint			33		32			
	1987.02-1989.07	MT	L/R	F	Saloon Engine JK	803008	Outer Joint		33	30	53	30.5	51.5	I	
	1987.02-1989.07	MT	-	-	Saloon Engine JK	603006	Inner Joint			33		34			
	1987.02-1989.07	AT/MT	L/R	F	Saloon Engine JK	603005	Inner Joint			33		32			
1.6 TD (59 kW)	1986.09-1991.08	MT	L/R	F	Saloon Engine SB/RA	803008	Outer Joint			33	30	53	30.5	51.5	I
	1986.09-1991.08	AT	L/R	F	Saloon Engine SB/RA	603014	Inner Joint			33		32			
	1986.09-1991.08	MT	L/R	F	Saloon Engine SB/RA	803009	Outer Joint	45T	33	30	53	30.5	51.5	I	
	1986.09-1991.08	MT	-	-	Saloon Engine SB/RA	603006	Inner Joint			33		34			
	1986.09-1991.08	AT	L/R	F	Saloon Engine SB/RA	803012	Outer Joint	45T	33	30	53	31	62	I	
	1986.09-1991.08	-	-	F	Saloon Engine SB/RA	803023	Outer Joint	96T	22	30	51	78.7	51.1	I	
	1986.09-1991.08	AT	L/R	F	Saloon Engine SB/RA	803051	Outer Joint			33	30	53	30	61	I
1986.09-1991.08	-	-	F	Saloon Engine SB/RA	803011	Outer Joint			33	30	53	31	62	I	

	 YEAR	TRANSM	L/R	F/R	REMARKS	GSP Ref.	 PRODUCT	 ABS	Technical Specifications						
									A	B	C	H	L	P	
AUDI															
80 (89 89Q 8A B3)															
1.6 TD (59 kW)	1986.09-1991.08	MT	L/R	F	Saloon Engine SB/RA	603005	Inner Joint			33		32			
	1986.09-1991.08	MT	L/R	F	Saloon Engine SB/RA	603020	Inner Joint			33		32			
1.8 (55 kW)	1986.10-1990.01	MT	L/R	F	Saloon Engine RU	803008	Outer Joint		33	30	53	30.5	51.5	I	
	1986.10-1990.01	AT	L/R	F	Saloon Engine RU	603014	Inner Joint			33		32			
	1986.10-1990.01	MT	L/R	F	Saloon Engine RU	803009	Outer Joint	45T	33	30	53	30.5	51.5	I	
	1986.10-1990.01	AT	L/R	F	Saloon Engine RU	603003	Inner Joint			33		32			
	1986.10-1990.01	AT	L/R	F	Saloon Engine RU	803012	Outer Joint	45T	33	30	53	31	62	I	
	1986.10-1990.01	AT	-	-	Saloon Engine RU	803032	Outer Joint		22	30	51	78	61	I	
	1986.10-1990.01	MT	L/R	F	Saloon Engine RU	603004	Inner Joint			33		32			
	1986.10-1990.01	MT	-	F	Saloon Engine RU	803023	Outer Joint	96T	22	30	51	78.7	51.1	I	
	1986.10-1990.01	AT	L/R	F	Saloon Engine RU	803051	Outer Joint		33	30	53	30	61	I	
	1986.10-1990.01	AT	-	-	Saloon Engine RU	803034	Outer Joint	96T	22	30	51	78	61	I	
	1986.10-1990.01	MT	L/R	F	Saloon Engine RU	603005	Inner Joint			33		32			
	1986.10-1990.01	-	-	-	Saloon Engine RU	661007	Inner Joint			33		32			
	1986.10-1990.01	MT	L/R	F	Saloon Engine RU	803007	Outer Joint		22	30	51	78.7	51.1	I	
1986.10-1990.01	MT	L/R	F	Saloon Engine RU	603020	Inner Joint			33		32				
1.8 E (82 kW)	1986.06-1991.08	MT	L/R	F	Saloon Engine DZ	603014	Inner Joint			33		32			
	1986.06-1991.08	MT	L/R	F	Saloon Engine DZ	603003	Inner Joint			33		32			
	1986.06-1991.08	MT	-	-	Saloon Engine DZ	603006	Inner Joint			33		34			
	1986.06-1991.08	MT	L/R	F	Saloon Engine DZ	803012	Outer Joint	45T	33	30	53	31	62	I	
	1986.06-1991.08	MT	L	F	Saloon Engine DZ	203059	Drive Shaft		33		53	31	586		
	1986.06-1991.08	AT	-	-	Saloon Engine DZ	803032	Outer Joint		22	30	51	78	61	I	
	1986.06-1991.08	MT	R	F	Saloon Engine DZ	203297	Drive Shaft	45T	33	0	53	30	575		
	1986.06-1991.08	MT	L/R	F	Saloon Engine DZ	803051	Outer Joint		33	30	53	30	61	I	
	1986.06-1991.08	MT	L	F	Saloon Engine DZ	203003	Drive Shaft	45T	33		53	31	586		
	1986.06-1991.08	-	-	F	Saloon Engine DZ	803011	Outer Joint		33	30	53	31	62	I	
	1986.06-1991.08	AT	-	-	Saloon Engine DZ	803034	Outer Joint	96T	22	30	51	78	61	I	
1.8 E quattro (82 kW)	1986.09-1991.08	MT	L/R	R	All-wheel Drive Saloon Engine DZ	803009	Outer Joint	45T	33	30	53	30.5	51.5	I	
	1986.09-1991.08	MT	L/R	F	All-wheel Drive Saloon Engine DZ	603003	Inner Joint			33		32			
	1986.09-1991.08	MT	L/R	F	All-wheel Drive Saloon Engine DZ	803012	Outer Joint	45T	33	30	53	31	62	I	
	1986.09-1991.08	MT	L/R	R	All-wheel Drive Saloon Engine DZ	603004	Inner Joint			33		32			
	1986.09-1991.08	AT	-	-	All-wheel Drive Saloon Engine DZ	803032	Outer Joint		22	30	51	78	61	I	
	1986.09-1991.08	MT	R	F	All-wheel Drive Saloon Engine DZ	203297	Drive Shaft	45T	33	0	53	30	575		
	1986.09-1991.08	MT	-	-	All-wheel Drive Saloon Engine DZ	603006	Inner Joint			33		34			
	1986.09-1991.08	MT	-	R	All-wheel Drive Saloon Engine DZ	803006	Outer Joint	96T	26	25	56.5	84.5	61.5	O	
	1986.09-1991.08	MT	L	F	All-wheel Drive Saloon Engine DZ	203003	Drive Shaft	45T	33		53	31	586		
	1986.09-1991.08	MT	-	R	All-wheel Drive Saloon Engine DZ	603019	Inner Joint			33		32			
	1986.09-1991.08	AT	-	-	All-wheel Drive Saloon Engine DZ	803034	Outer Joint	96T	22	30	51	78	61	I	
	1986.09-1991.08	-	-	-	All-wheel Drive Saloon Engine DZ	661007	Inner Joint			33		32			
	1986.09-1991.08	MT	L/R	R	All-wheel Drive Saloon Engine DZ	603005	Inner Joint			33		32			
	1986.09-1991.08	MT	L/R	R	All-wheel Drive Saloon Engine DZ	803004	Outer Joint		26	25	56.5	84.5	61.5	O	
1.8 quattro (83 kW)	1986.09-1990.08	MT	L/R	R	All-wheel Drive Saloon Engine SD	803009	Outer Joint	45T	33	30	53	30.5	51.5	I	
	1986.09-1990.08	MT	L/R	F	All-wheel Drive Saloon Engine SD	603003	Inner Joint			33		32			
	1986.09-1990.08	MT	L/R	R	All-wheel Drive Saloon Engine SD	603004	Inner Joint			33		32			
	1986.09-1990.08	MT	L/R	F	All-wheel Drive Saloon Engine SD	803012	Outer Joint	45T	33	30	53	31	62	I	
	1986.09-1990.08	AT	-	-	All-wheel Drive Saloon Engine SD	803032	Outer Joint		22	30	51	78	61	I	
	1986.09-1990.08	MT	R	F	All-wheel Drive Saloon Engine SD	203297	Drive Shaft	45T	33	0	53	30	575		
	1986.09-1990.08	MT	L	F	All-wheel Drive Saloon Engine SD	203003	Drive Shaft	45T	33		53	31	586		
	1986.09-1990.08	MT	L/R	R	All-wheel Drive Saloon Engine SD	603005	Inner Joint			33		32			
	1986.09-1990.08	AT	-	-	All-wheel Drive Saloon Engine SD	803034	Outer Joint	96T	22	30	51	78	61	I	
	1986.09-1990.08	-	-	-	All-wheel Drive Saloon Engine SD	661007	Inner Joint			33		32			
1986.09-1990.08	MT	L/R	R	All-wheel Drive Saloon Engine SD	803004	Outer Joint		26	25	56.5	84.5	61.5	O		
1.8 S (65 kW)	1986.08-1990.01	MT	L/R	F	Saloon Engine SF	803008	Outer Joint		33	30	53	30.5	51.5	I	
	1986.08-1990.01	AT	L/R	F	Saloon Engine SF	603014	Inner Joint			33		32			
	1986.08-1990.01	MT	L/R	F	Saloon Engine SF	803009	Outer Joint	45T	33	30	53	30.5	51.5	I	
	1986.08-1990.01	AT	L/R	F	Saloon Engine SF	603003	Inner Joint			33		32			
	1986.08-1990.01	AT	L/R	F	Saloon Engine SF	803012	Outer Joint	45T	33	30	53	31	62	I	
	1986.08-1990.01	AT	-	-	Saloon Engine SF	803032	Outer Joint		22	30	51	78	61	I	
	1986.08-1990.01	MT	L/R	F	Saloon Engine SF	603004	Inner Joint			33		32			
	1986.08-1990.01	-	-	F	Saloon Engine SF	803023	Outer Joint	96T	22	30	51	78.7	51.1	I	
	1986.08-1990.01	AT	L/R	F	Saloon Engine SF	803051	Outer Joint		33	30	53	30	61	I	
	1986.08-1990.01	AT	-	-	Saloon Engine SF	803034	Outer Joint	96T	22	30	51	78	61	I	
	1986.08-1990.01	MT	L/R	F	Saloon Engine SF	603005	Inner Joint			33		32			
	1986.08-1990.01	MT	L/R	F	Saloon Engine SF	803007	Outer Joint		22	30	51	78.7	51.1	I	
	1986.08-1990.01	MT	L/R	F	Saloon Engine SF	603020	Inner Joint			33		32			
1.8 S (66 kW)	1986.09-1991.10	MT	L/R	F	Saloon Engine PM/JN/NE	803008	Outer Joint		33	30	53	30.5	51.5	I	

YEAR	TRANSM	L/R	F/R	REMARKS	GSP Ref.	PRODUCT	ABS	Technical Specifications										
								A	B	C	H	L	P					
AUDI																		
80 (89 89Q 8A B3)																		
1.8 S (66 kW)																		
1986.09-1991.10	AT	L/R	F	Saloon Engine PM/JN/NE	603014	Inner Joint			33		32							
1986.09-1991.10	MT	L/R	F	Saloon Engine PM/JN/NE	803009	Outer Joint	45T	33	30	53	30.5	51.5	I					
1986.09-1991.10	AT	L/R	F	Saloon Engine PM/JN/NE	603003	Inner Joint			33		32							
1986.09-1991.10	AT	L/R	F	Saloon Engine PM/JN/NE	803012	Outer Joint	45T	33	30	53	31	62	I					
1986.09-1991.10	AT	-	-	Saloon Engine PM/JN/NE	803032	Outer Joint		22	30	51	78	61	I					
1986.09-1991.10	MT	L/R	F	Saloon Engine PM/JN/NE	603004	Inner Joint			33		32							
1986.09-1991.10	-	-	F	Saloon Engine PM/JN/NE	803023	Outer Joint	96T	22	30	51	78.7	51.1	I					
1986.09-1991.10	AT	L/R	F	Saloon Engine PM/JN/NE	803051	Outer Joint		33	30	53	30	61	I					
1986.09-1991.10	AT	-	-	Saloon Engine PM/JN/NE	803034	Outer Joint	96T	22	30	51	78	61	I					
1986.09-1991.10	MT	L/R	F	Saloon Engine PM/JN/NE	603005	Inner Joint			33		32							
1986.09-1991.10	MT	L/R	F	Saloon Engine PM/JN/NE	803007	Outer Joint		22	30	51	78.7	51.1	I					
1986.09-1991.10	MT	L/R	F	Saloon Engine PM/JN/NE	603020	Inner Joint			33		32							
1.8 S quattro (65 kW)																		
1986.09-1990.07	MT	L/R	R	All-wheel Drive Saloon Engine SF	803009	Outer Joint	45T	33	30	53	30.5	51.5	I					
1986.09-1990.07	MT	L/R	F	All-wheel Drive Saloon Engine SF	603003	Inner Joint			33		32							
1986.09-1990.07	MT	L/R	F	All-wheel Drive Saloon Engine SF	803012	Outer Joint	45T	33	30	53	31	62	I					
1986.09-1990.07	MT	L/R	R	All-wheel Drive Saloon Engine SF	603004	Inner Joint			33		32							
1986.09-1990.07	AT	-	-	All-wheel Drive Saloon Engine SF	803032	Outer Joint		22	30	51	78	61	I					
1986.09-1990.07	MT	R	F	All-wheel Drive Saloon Engine SF	203297	Drive Shaft	45T	33	0	53	30	575						
1986.09-1990.07	MT	L	F	All-wheel Drive Saloon Engine SF	203003	Drive Shaft	45T	33		53	31	586						
1986.09-1990.07	AT	-	-	All-wheel Drive Saloon Engine SF	803034	Outer Joint	96T	22	30	51	78	61	I					
1986.09-1990.07	MT	L/R	R	All-wheel Drive Saloon Engine SF	603005	Inner Joint			33		32							
1986.09-1990.07	-	-	-	All-wheel Drive Saloon Engine SF	661007	Inner Joint			33		32							
1986.09-1990.07	MT	L/R	R	All-wheel Drive Saloon Engine SF	803004	Outer Joint		26	25	56.5	84.5	61.5	O					
1.8 S quattro (66 kW)																		
1986.09-1991.09	MT	L/R	R	All-wheel Drive Saloon Engine PM/JN/NE	803009	Outer Joint	45T	33	30	53	30.5	51.5	I					
1986.09-1991.09	MT	L/R	F	All-wheel Drive Saloon Engine PM/JN/NE	603003	Inner Joint			33		32							
1986.09-1991.09	MT	L/R	F	All-wheel Drive Saloon Engine PM/JN/NE	803012	Outer Joint	45T	33	30	53	31	62	I					
1986.09-1991.09	MT	L/R	R	All-wheel Drive Saloon Engine PM/JN/NE	603004	Inner Joint			33		32							
1986.09-1991.09	AT	-	-	All-wheel Drive Saloon Engine PM/JN/NE	803032	Outer Joint		22	30	51	78	61	I					
1986.09-1991.09	MT	R	F	All-wheel Drive Saloon Engine PM/JN/NE	203297	Drive Shaft	45T	33	0	53	30	575						
1986.09-1991.09	MT	L	F	All-wheel Drive Saloon Engine PM/JN/NE	203003	Drive Shaft	45T	33		53	31	586						
1986.09-1991.09	MT	-	R	All-wheel Drive Saloon Engine PM/JN/NE	803006	Outer Joint	96T	26	25	56.5	84.5	61.5	O					
1986.09-1991.09	MT	-	R	All-wheel Drive Saloon Engine PM/JN/NE	603019	Inner Joint			33		32							
1986.09-1991.09	AT	-	-	All-wheel Drive Saloon Engine PM/JN/NE	803034	Outer Joint	96T	22	30	51	78	61	I					
1986.09-1991.09	MT	L/R	R	All-wheel Drive Saloon Engine PM/JN/NE	603005	Inner Joint			33		32							
1986.09-1991.09	-	-	-	All-wheel Drive Saloon Engine PM/JN/NE	661007	Inner Joint			33		32							
1986.09-1991.09	MT	L/R	R	All-wheel Drive Saloon Engine PM/JN/NE	803004	Outer Joint		26	25	56.5	84.5	61.5	O					
1.9 D (50 kW)																		
1989.08-1991.08	MT	L/R	F	Saloon Engine 1Y	803008	Outer Joint		33	30	53	30.5	51.5	I					
1989.08-1991.08	MT	L/R	F	Saloon Engine 1Y	803009	Outer Joint	45T	33	30	53	30.5	51.5	I					
1989.08-1991.08	MT	L/R	F	Saloon Engine 1Y	603005	Inner Joint			33		32							
1989.08-1991.08	MT	L/R	F	Saloon Engine 1Y	603020	Inner Joint			33		32							
2.0 (82 kW)																		
1990.10-1991.08	AT/MT	L/R	F	Saloon Engine AAD	603014	Inner Joint			33		32							
1990.10-1991.08	MT	L	F	Saloon Engine AAD	203059	Drive Shaft		33		53	31	586						
1990.10-1991.08	AT/MT	L/R	F	Saloon Engine AAD	803012	Outer Joint	45T	33	30	53	31	62	I					
1990.10-1991.08	MT	R	F	Saloon Engine AAD	203297	Drive Shaft	45T	33	0	53	30	575						
1990.10-1991.08	MT	-	-	Saloon Engine AAD	603006	Inner Joint			33		34							
1990.10-1991.08	AT/MT	L/R	F	Saloon Engine AAD	803051	Outer Joint		33	30	53	30	61	I					
1990.10-1991.08	MT	L	F	Saloon Engine AAD	203003	Drive Shaft	45T	33		53	31	586						
1990.10-1991.08	-	-	F	Saloon Engine AAD	803011	Outer Joint		33	30	53	31	62	I					
1990.10-1991.08	-	-	-	Saloon Engine AAD	661007	Inner Joint			33		32							
2.0 E (83 kW)																		
1988.08-1990.10	AT/MT	L/R	F	Saloon Engine 3A	603014	Inner Joint			33		32							
1988.08-1990.10	MT	L	F	Saloon Engine 3A	203059	Drive Shaft		33		53	31	586						
1988.08-1990.10	AT	L/R	F	Saloon Engine 3A	803012	Outer Joint	45T	33	30	53	31	62	I					
1988.08-1990.10	MT	R	F	Saloon Engine 3A	203297	Drive Shaft	45T	33	0	53	30	575						
1988.08-1990.10	AT/MT	L/R	F	Saloon Engine 3A	803051	Outer Joint		33	30	53	30	61	I					
1988.08-1990.10	MT	L	F	Saloon Engine 3A	203003	Drive Shaft	45T	33		53	31	586						
1988.08-1990.10	-	-	F	Saloon Engine 3A	803011	Outer Joint		33	30	53	31	62	I					
2.0 E 16V (101 kW)																		
1990.03-1991.09	MT	-	-	Saloon Engine 6A	603006	Inner Joint			33		34							
1990.03-1991.09	MT	L/R	F	Saloon Engine 6A	603001	Inner Joint			28		32							
1990.03-1991.09	MT	L/R	F	Saloon Engine 6A	803012	Outer Joint	45T	33	30	53	31	62	I					
1990.03-1991.09	-	R	F	Saloon Engine 6A	203044	Drive Shaft	45T	33		53	31	563						
1990.03-1991.09	MT	L/R	F	Saloon Engine 6A	803051	Outer Joint		33	30	53	30	61	I					
1990.03-1991.09	-	-	F	Saloon Engine 6A	803011	Outer Joint		33	30	53	31	62	I					
2.0 E 16V quattro (101 kW)																		
1990.03-1991.08	MT	-	-	All-wheel Drive Saloon Engine 6A	603006	Inner Joint			33		34							
1990.03-1991.08	MT	L/R/F/R		All-wheel Drive Saloon Engine 6A	603003	Inner Joint			33		32							
1990.03-1991.08	MT	R	F	All-wheel Drive Saloon Engine 6A	203297	Drive Shaft	45T	33	0	53	30	575						
1990.03-1991.08	MT	L/R/F/R		All-wheel Drive Saloon Engine 6A	803012	Outer Joint	45T	33	30	53	31	62	I					





	 YEAR	TRANSM	L/R	F/R	REMARKS	GSP Ref.	 PRODUCT	 ABS	Technical Specifications					
									A	B	C	H	L	P
AUDI														
80 (89 89Q 8A B3)														
2.0 E 16V quattro (101 kW)	1990.03-1991.08	MT	L	F	All-wheel Drive Saloon Engine 6A	203003	Drive Shaft	45T	33		53	31	586	
	1990.03-1991.08	-	-	-	All-wheel Drive Saloon Engine 6A	661007	Inner Joint			33		32		
2.0 E quattro (83 kW)	1988.08-1990.09	MT	L/R	R	All-wheel Drive Saloon Engine 3A	803009	Outer Joint	45T	33	30	53	30.5	51.5	I
	1988.08-1990.09	MT	L/R	F	All-wheel Drive Saloon Engine 3A	603003	Inner Joint			33		32		
	1988.08-1990.09	MT	L/R	F	All-wheel Drive Saloon Engine 3A	803012	Outer Joint	45T	33	30	53	31	62	I
	1988.08-1990.09	MT	L/R	R	All-wheel Drive Saloon Engine 3A	603004	Inner Joint			33		32		
	1988.08-1990.09	MT	R	F	All-wheel Drive Saloon Engine 3A	203297	Drive Shaft	45T	33	0	53	30	575	
	1988.08-1990.09	MT	L	F	All-wheel Drive Saloon Engine 3A	203003	Drive Shaft	45T	33		53	31	586	
	1988.08-1990.09	-	-	F	All-wheel Drive Saloon Engine 3A	803011	Outer Joint		33	30	53	31	62	I
	1988.08-1990.09	MT	L/R	R	All-wheel Drive Saloon Engine 3A	603005	Inner Joint			33		32		
2.0 quattro (82 kW)	1988.08-1990.07	MT	L/R	R	All-wheel Drive Saloon Engine 3A	803009	Outer Joint	45T	33	30	53	30.5	51.5	I
	1988.08-1990.07	MT	L/R	F	All-wheel Drive Saloon Engine 3A	603003	Inner Joint			33		32		
	1988.08-1990.07	MT	L/R	F	All-wheel Drive Saloon Engine 3A	803012	Outer Joint	45T	33	30	53	31	62	I
	1988.08-1990.07	MT	R	F	All-wheel Drive Saloon Engine 3A	203297	Drive Shaft	45T	33	0	53	30	575	
	1988.08-1990.07	MT	L/R	R	All-wheel Drive Saloon Engine 3A	603004	Inner Joint			33		32		
	1988.08-1990.07	MT	L	F	All-wheel Drive Saloon Engine 3A	203003	Drive Shaft	45T	33		53	31	586	
	1988.08-1990.07	MT	L/R	R	All-wheel Drive Saloon Engine 3A	603005	Inner Joint			33		32		
	1988.08-1990.07	MT	L/R	R	All-wheel Drive Saloon Engine 3A	803009	Outer Joint	45T	33	30	53	30.5	51.5	I
2.0 quattro (85 kW)	1990.10-1991.08	MT	L/R	R	All-wheel Drive Saloon Engine AAD	803009	Outer Joint	45T	33	30	53	30.5	51.5	I
	1990.10-1991.08	MT	L/R	F	All-wheel Drive Saloon Engine AAD	603003	Inner Joint			33		32		
	1990.10-1991.08	MT	-	-	All-wheel Drive Saloon Engine AAD	603006	Inner Joint			33		34		
	1990.10-1991.08	MT	L/R	F	All-wheel Drive Saloon Engine AAD	803012	Outer Joint	45T	33	30	53	31	62	I
	1990.10-1991.08	MT	L/R	R	All-wheel Drive Saloon Engine AAD	603004	Inner Joint			33		32		
	1990.10-1991.08	MT	R	F	All-wheel Drive Saloon Engine AAD	203297	Drive Shaft	45T	33	0	53	30	575	
	1990.10-1991.08	MT	L	F	All-wheel Drive Saloon Engine AAD	203003	Drive Shaft	45T	33		53	31	586	
	1990.10-1991.08	MT	L/R	R	All-wheel Drive Saloon Engine AAD	603005	Inner Joint			33		32		
1990.10-1991.08	-	-	-	All-wheel Drive Saloon Engine AAD	661007	Inner Joint			33		32			
80 (8C2 B4)														
1.6 (52 kW)	1991.09-1994.12	MT	L/R	F	Saloon Engine ABM	603014	Inner Joint			33		32		
	1991.09-1994.12	MT	L/R	F	Saloon Engine ABM	803012	Outer Joint	45T	33	30	53	31	62	I
	1991.09-1994.12	MT	L	F	Saloon Engine ABM	203059	Drive Shaft		33		53	31	586	
	1991.09-1994.12	MT	R	F	Saloon Engine ABM	203297	Drive Shaft	45T	33	0	53	30	575	
	1991.09-1994.12	MT	L/R	F	Saloon Engine ABM	803051	Outer Joint		33	30	53	30	61	I
	1991.09-1994.12	MT	L	F	Saloon Engine ABM	203003	Drive Shaft	45T	33		53	31	586	
	1991.09-1994.12	MT	L/R	F	Saloon Engine ABM	603005	Inner Joint			33		32		
	1991.09-1994.12	-	-	-	Saloon Engine ABM	661007	Inner Joint			33		32		
	1991.09-1994.12	MT	L/R	F	Saloon Engine ABM	603020	Inner Joint			33		32		
	1991.09-1994.12	MT	L/R	F	Saloon Engine ADA	603014	Inner Joint			33		32		
1.6 E (74 kW)	1993.06-1994.12	MT	L/R	F	Saloon Engine ADA	803012	Outer Joint	45T	33	30	53	31	62	I
	1993.06-1994.12	MT	R	F	Saloon Engine ADA	203297	Drive Shaft	45T	33	0	53	30	575	
	1993.06-1994.12	MT	L	F	Saloon Engine ADA	203003	Drive Shaft	45T	33		53	31	586	
	1993.06-1994.12	-	-	-	Saloon Engine ADA	661007	Inner Joint			33		32		
	1993.06-1994.12	MT	L/R	F	Saloon Engine ADA	603014	Inner Joint			33		32		
1.9 TD (55 kW)	1991.09-1994.12	MT	L/R	F	Saloon Engine AAZ	603014	Inner Joint			33		32		
	1991.09-1994.12	MT	L	F	Saloon Engine AAZ	203059	Drive Shaft		33		53	31	586	
	1991.09-1994.12	AT/MT	L/R	F	Saloon Engine AAZ	803012	Outer Joint	45T	33	30	53	31	62	I
	1991.09-1994.12	MT	R	F	Saloon Engine AAZ	203297	Drive Shaft	45T	33	0	53	30	575	
	1991.09-1994.12	AT/MT	L/R	F	Saloon Engine AAZ	803051	Outer Joint		33	30	53	30	61	I
	1991.09-1994.12	MT	L	F	Saloon Engine AAZ	203003	Drive Shaft	45T	33		53	31	586	
	1991.09-1994.12	-	-	F	Saloon Engine AAZ	803011	Outer Joint		33	30	53	31	62	I
	1991.09-1994.12	MT	L/R	F	Saloon Engine AAZ	603005	Inner Joint			33		32		
	1991.09-1994.12	MT	L/R	F	Saloon Engine AAZ	603020	Inner Joint			33		32		
1.9 TDI (66 kW)	1991.09-1994.12	MT	L/R	F	Saloon Engine 1Z	661033	Inner Joint			34		85		
	1991.09-1994.12	MT	L	F	Saloon Engine 1Z	203243	Drive Shaft	45T	33		53	31	573	
	1991.09-1994.12	MT	L/R	F	Saloon Engine 1Z	803012	Outer Joint	45T	33	30	53	31	62	I
	1991.09-1994.12	MT	R	F	Saloon Engine 1Z	203242	Drive Shaft	45T	33		53	31	556	
	1991.09-1994.12	-	-	F	Saloon Engine 1Z	803011	Outer Joint		33	30	53	31	62	I
2.0 (66 kW)	1991.09-1994.12	MT	L/R	F	Saloon Engine ABT	603014	Inner Joint			33		32		
	1991.09-1994.12	MT	L/R	F	Saloon Engine ABT	803009	Outer Joint	45T	33	30	53	30.5	51.5	I
	1991.09-1994.12	MT	L	F	Saloon Engine ABT	203059	Drive Shaft		33		53	31	586	
	1991.09-1994.12	4AT/MT	L/R	F	Saloon Engine ABT	803012	Outer Joint	45T	33	30	53	31	62	I
	1991.09-1994.12	MT	R	F	Saloon Engine ABT	203297	Drive Shaft	45T	33	0	53	30	575	
	1991.09-1994.12	4AT/MT	L/R	F	Saloon Engine ABT	803051	Outer Joint		33	30	53	30	61	I
	1991.09-1994.12	MT	L	F	Saloon Engine ABT	203003	Drive Shaft	45T	33		53	31	586	
	1991.09-1994.12	-	-	F	Saloon Engine ABT	803011	Outer Joint		33	30	53	31	62	I
	1991.09-1994.12	MT	L/R	F	Saloon Engine ABT	603005	Inner Joint			33		32		
	1991.09-1994.12	MT	L/R	F	Saloon Engine ABT	603020	Inner Joint			33		32		





	 YEAR	TRANSM	L/R	F/R	REMARKS	GSP Ref.	 PRODUCT	 ABS	Technical Specifications						
									A	B	C	H	L	P	
AUDI															
80 (8C2 B4)															
2.0 E (85 kW)	1991.09-1994.12	MT	L/R	F	Saloon Engine ABK	603014	Inner Joint			33		32			
	1991.09-1994.12	MT	-	-	Saloon Engine ABK	603006	Inner Joint			33		34			
	1991.09-1994.12	MT	L	F	Saloon Engine ABK	203059	Drive Shaft		33		53	31	586		
	1991.09-1994.12	4AT/MT	L/R	F	Saloon Engine ABK	803012	Outer Joint	45T	33	30	53	31	62	I	
	1991.09-1994.12	MT	R	F	Saloon Engine ABK	203297	Drive Shaft	45T	33	0	53	30	575		
	1991.09-1994.12	4AT/MT	L/R	F	Saloon Engine ABK	803051	Outer Joint		33	30	53	30	61	I	
	1991.09-1994.12	MT	L	F	Saloon Engine ABK	203003	Drive Shaft	45T	33		53	31	586		
	1991.09-1994.12	-	-	F	Saloon Engine ABK	803011	Outer Joint		33	30	53	31	62	I	
	1991.09-1994.12	MT	L/R	F	Saloon Engine ABK	603005	Inner Joint			33		32			
	1991.09-1994.12	-	-	-	Saloon Engine ABK	661007	Inner Joint			33		32			
	1991.09-1994.12	MT	L/R	F	Saloon Engine ABK	603020	Inner Joint			33		32			
2.0 E 16V (101 kW)	1991.09-1992.07	MT	-	-	Saloon Engine 6A	603006	Inner Joint			33		34			
2.0 E 16V (103 kW)	1992.08-1994.12	MT	L/R	F	Saloon Engine ACE	603001	Inner Joint			28		32			
	1992.08-1994.12	MT	R	F	Saloon Engine ACE	203044	Drive Shaft	45T	33		53	31	563		
	1992.08-1994.12	4AT/MT	L/R	F	Saloon Engine ACE	803012	Outer Joint	45T	33	30	53	31	62	I	
	1992.08-1994.12	4AT/MT	L/R	F	Saloon Engine ACE	803051	Outer Joint		33	30	53	30	61	I	
	1992.08-1994.12	-	-	F	Saloon Engine ACE	803011	Outer Joint		33	30	53	31	62	I	
2.0 E 16V quattro (103 kW)	1992.04-1994.12	MT	L/R	R	All-wheel Drive Saloon Engine ACE	803009	Outer Joint	45T	33	30	53	30.5	51.5	I	
	1992.04-1994.12	MT	L/R	F	All-wheel Drive Saloon Engine ACE	603003	Inner Joint			33		32			
	1992.04-1994.12	MT	L/R	R	All-wheel Drive Saloon Engine ACE	603004	Inner Joint			33		32			
	1992.04-1994.12	MT	-	-	All-wheel Drive Saloon Engine ACE	603006	Inner Joint			33		34			
	1992.04-1994.12	MT	L/R	F	All-wheel Drive Saloon Engine ACE	803012	Outer Joint	45T	33	30	53	31	62	I	
	1992.04-1994.12	MT	R	F	All-wheel Drive Saloon Engine ACE	203297	Drive Shaft	45T	33	0	53	30	575		
	1992.04-1994.12	MT	L/R	R	All-wheel Drive Saloon Engine ACE	603005	Inner Joint			33		32			
	1992.04-1994.12	MT	L	F	All-wheel Drive Saloon Engine ACE	203003	Drive Shaft	45T	33		53	31	586		
	1992.04-1994.12	MT	L/R	R	All-wheel Drive Saloon Engine ACE	603011	Inner Joint			33		34			
	1992.04-1994.12	-	-	F	All-wheel Drive Saloon Engine ACE	803011	Outer Joint		33	30	53	31	62	I	
	1992.04-1994.12	MT	L/R	R	All-wheel Drive Saloon Engine ACE	803026	Outer Joint	45T	33	30	53	31	62	I	
	1992.04-1994.12	-	-	-	All-wheel Drive Saloon Engine ACE	661007	Inner Joint			33		32			
2.0 E quattro (85 kW)	1991.09-1994.12	MT	L/R	R	All-wheel Drive Saloon Engine ABK	803009	Outer Joint	45T	33	30	53	30.5	51.5	I	
	1991.09-1994.12	MT	L/R	F	All-wheel Drive Saloon Engine ABK	603003	Inner Joint			33		32			
	1991.09-1994.12	MT	-	-	All-wheel Drive Saloon Engine ABK	603006	Inner Joint			33		34			
	1991.09-1994.12	MT	L/R	R	All-wheel Drive Saloon Engine ABK	603004	Inner Joint			33		32			
	1991.09-1994.12	MT	L/R	F	All-wheel Drive Saloon Engine ABK	803012	Outer Joint	45T	33	30	53	31	62	I	
	1991.09-1994.12	MT	R	F	All-wheel Drive Saloon Engine ABK	203297	Drive Shaft	45T	33	0	53	30	575		
	1991.09-1994.12	MT	L	F	All-wheel Drive Saloon Engine ABK	203003	Drive Shaft	45T	33		53	31	586		
	1991.09-1994.12	MT	L/R	R	All-wheel Drive Saloon Engine ABK	603011	Inner Joint			33		34			
	1991.09-1994.12	MT	L/R	R	All-wheel Drive Saloon Engine ABK	803026	Outer Joint	45T	33	30	53	31	62	I	
	1991.09-1994.12	-	-	F	All-wheel Drive Saloon Engine ABK	803011	Outer Joint		33	30	53	31	62	I	
	1991.09-1994.12	MT	L/R	R	All-wheel Drive Saloon Engine ABK	603005	Inner Joint			33		32			
	1991.09-1994.12	MT	L/R	R	All-wheel Drive Saloon Engine ABK	803026	Outer Joint	45T	33	30	53	31	62	I	
2.3 E (98 kW)	1991.09-1994.12	MT	-	-	Saloon Engine NG	603006	Inner Joint			33		34			
	1991.09-1994.12	MT	L/R	F	Saloon Engine NG	603001	Inner Joint			28		32			
	1991.09-1994.12	MT	R	F	Saloon Engine NG	203044	Drive Shaft	45T	33		53	31	563		
	1991.09-1994.12	4AT/MT	L/R	F	Saloon Engine NG	803012	Outer Joint	45T	33	30	53	31	62	I	
	1991.09-1994.12	4AT/MT	L/R	F	Saloon Engine NG	803051	Outer Joint		33	30	53	30	61	I	
	1991.09-1994.12	-	-	F	Saloon Engine NG	803011	Outer Joint		33	30	53	31	62	I	
2.3 E quattro (98 kW)	1991.09-1994.12	MT	L/R	R	All-wheel Drive Saloon Engine NG	803009	Outer Joint	45T	33	30	53	30.5	51.5	I	
	1991.09-1994.12	MT	L/R	F	All-wheel Drive Saloon Engine NG	603003	Inner Joint			33		32			
	1991.09-1994.12	MT	-	-	All-wheel Drive Saloon Engine NG	603006	Inner Joint			33		34			
	1991.09-1994.12	MT	L/R	R	All-wheel Drive Saloon Engine NG	603004	Inner Joint			33		32			
	1991.09-1994.12	MT	L/R	F	All-wheel Drive Saloon Engine NG	803012	Outer Joint	45T	33	30	53	31	62	I	
	1991.09-1994.12	MT	R	F	All-wheel Drive Saloon Engine NG	203297	Drive Shaft	45T	33	0	53	30	575		
	1991.09-1994.12	MT	L	F	All-wheel Drive Saloon Engine NG	203003	Drive Shaft	45T	33		53	31	586		
	1991.09-1994.12	MT	L/R	R	All-wheel Drive Saloon Engine NG	603011	Inner Joint			33		34			
	1991.09-1994.12	-	-	F	All-wheel Drive Saloon Engine NG	803011	Outer Joint		33	30	53	31	62	I	
	1991.09-1994.12	MT	L/R	R	All-wheel Drive Saloon Engine NG	603005	Inner Joint			33		32			
	1991.09-1994.12	MT	L/R	R	All-wheel Drive Saloon Engine NG	803026	Outer Joint	45T	33	30	53	31	62	I	
	1991.09-1994.12	-	-	-	All-wheel Drive Saloon Engine NG	661007	Inner Joint			33		32			
2.6 (110 kW)	1992.07-1994.12	MT	-	-	Saloon Engine ABC	603006	Inner Joint			33		34			
2.6 quattro (110 kW)	1992.06-1994.12	MT	L/R	F	All-wheel Drive Saloon Engine ABC	603003	Inner Joint			33		32			
	1992.06-1994.12	MT	-	-	All-wheel Drive Saloon Engine ABC	603006	Inner Joint			33		34			
	1992.06-1994.12	MT	L/R	R	All-wheel Drive Saloon Engine ABC	803026	Outer Joint	45T	33	30	53	31	62	I	
	1992.06-1994.12	-	-	-	All-wheel Drive Saloon Engine ABC	661007	Inner Joint			33		32			
	1992.06-1994.12	MT	L/R	R	All-wheel Drive Saloon Engine ABC	603011	Inner Joint			33		34			
2.8 (128 kW)	1991.09-1994.12	MT	-	-	Saloon Engine AAH	603006	Inner Joint			33		34			
2.8 quattro (128 kW)	1991.09-1994.12	MT	L/R	F	All-wheel Drive Saloon Engine AAH	603003	Inner Joint			33		32			





	 YEAR	TRANSM	L/R	F/R	REMARKS	GSP Ref.	 PRODUCT	 ABS	Technical Specifications					
									A	B	C	H	L	P
AUDI														
80 (8C2 B4)														
2.8 quattro (128 kW)	1991.09-1994.12	MT	-	-	All-wheel Drive Saloon Engine AAH	603006	Inner Joint			33		34		
	1991.09-1994.12	MT	L/R	R	All-wheel Drive Saloon Engine AAH	803026	Outer Joint	45T	33	30	53	31	62	I
	1991.09-1994.12	-	-	-	All-wheel Drive Saloon Engine AAH	661007	Inner Joint			33		32		
	1991.09-1994.12	MT	L/R	R	All-wheel Drive Saloon Engine AAH	603011	Inner Joint			33		34		
S2 quattro (169 kW)	1993.02-1994.12	MT	-	-	All-wheel Drive Saloon Engine ABY	603006	Inner Joint			33		34		
	1993.02-1994.12	MT	L/R	F/R	All-wheel Drive Saloon Engine ABY	603001	Inner Joint			28		32		
	1993.02-1994.12	MT	L/R	R	All-wheel Drive Saloon Engine ABY	803014	Outer Joint	45T	38	25	59.5	34.5	61	O
80 Avant (8C5 B4)														
1.6 E (74 kW)	1993.06-1996.01	MT	L/R	F	Estate Engine ADA	603014	Inner Joint			33		32		
	1993.06-1996.01	MT	L/R	F	Estate Engine ADA	803012	Outer Joint	45T	33	30	53	31	62	I
	1993.06-1996.01	MT	R	F	Estate Engine ADA	203297	Drive Shaft	45T	33	0	53	30	575	
	1993.06-1996.01	MT	L	F	Estate Engine ADA	203003	Drive Shaft	45T	33		53	31	586	
1.9 TD (55 kW)	1991.09-1994.12	-	-	F	Estate Engine AAZ	803011	Outer Joint		33	30	53	31	62	I
1.9 TDI (66 kW)	1992.07-1996.01	MT	L/R	F	Estate Engine 1Z	803012	Outer Joint	45T	33	30	53	31	62	I
	1992.07-1996.01	MT	L	F	Estate Engine 1Z	203243	Drive Shaft	45T	33		53	31	573	
2.0 (66 kW)	1992.07-1996.01	MT	L/R	F	Estate Engine ABT	603014	Inner Joint			33		32		
	1992.07-1996.01	4AT/MT	L/R	F	Estate Engine ABT	803012	Outer Joint	45T	33	30	53	31	62	I
	1992.07-1996.01	MT	L	F	Estate Engine ABT	203059	Drive Shaft		33		53	31	586	
	1992.07-1996.01	MT	R	F	Estate Engine ABT	203297	Drive Shaft	45T	33	0	53	30	575	
	1992.07-1996.01	4AT/MT	L/R	F	Estate Engine ABT	803051	Outer Joint		33	30	53	30	61	I
	1992.07-1996.01	MT	L	F	Estate Engine ABT	203003	Drive Shaft	45T	33		53	31	586	
2.0 E (85 kW)	1992.07-1996.01	MT	L/R	F	Estate Engine ABK	603014	Inner Joint			33		32		
	1992.07-1996.01	MT	-	-	Estate Engine ABK	603006	Inner Joint			33		34		
	1992.07-1996.01	4AT/MT	L/R	F	Estate Engine ABK	803012	Outer Joint	45T	33	30	53	31	62	I
	1992.07-1996.01	MT	L	F	Estate Engine ABK	203059	Drive Shaft		33		53	31	586	
	1992.07-1996.01	MT	R	F	Estate Engine ABK	203297	Drive Shaft	45T	33	0	53	30	575	
	1992.07-1996.01	4AT/MT	L/R	F	Estate Engine ABK	803051	Outer Joint		33	30	53	30	61	I
	1992.07-1996.01	MT	L	F	Estate Engine ABK	203003	Drive Shaft	45T	33		53	31	586	
2.0 E 16V (103 kW)	1993.02-1996.01	MT	L/R	F	Estate Engine ACE	603001	Inner Joint			28		32		
	1993.02-1996.01	MT	-	-	Estate Engine ACE	603006	Inner Joint			33		34		
	1993.02-1996.01	4AT/MT	L/R	F	Estate Engine ACE	803012	Outer Joint	45T	33	30	53	31	62	I
	1993.02-1996.01	MT	R	F	Estate Engine ACE	203044	Drive Shaft	45T	33		53	31	563	
	1993.02-1996.01	4AT/MT	L/R	F	Estate Engine ACE	803051	Outer Joint		33	30	53	30	61	I
1993.02-1996.01	-	-	-	F Estate Engine ACE	803011	Outer Joint		33	30	53	31	62	I	
2.0 E 16V quattro (103 kW)	1992.12-1995.07	MT	L/R	F	All-wheel Drive Estate Engine ACE	603003	Inner Joint			33		32		
	1992.12-1995.07	MT	L/R	F	All-wheel Drive Estate Engine ACE	803012	Outer Joint	45T	33	30	53	31	62	I
	1992.12-1995.07	MT	R	F	All-wheel Drive Estate Engine ACE	203297	Drive Shaft	45T	33	0	53	30	575	
	1992.12-1995.07	MT	L	F	All-wheel Drive Estate Engine ACE	203003	Drive Shaft	45T	33		53	31	586	
	1992.12-1995.07	-	-	F/R	All-wheel Drive Estate Engine ACE	803011	Outer Joint		33	30	53	31	62	I
	1992.12-1995.07	MT	-	-	All-wheel Drive Estate Engine ACE	603006	Inner Joint			33		34		
	1992.12-1995.07	MT	L/R	R	All-wheel Drive Estate Engine ACE	803014	Outer Joint	45T	38	25	59.5	34.5	61	O
1992.12-1995.07	-	-	-	All-wheel Drive Estate Engine ACE	661007	Inner Joint			33		32			
2.3 E (98 kW)	1992.07-1996.01	MT	L/R	F	Estate Engine NG	603001	Inner Joint			28		32		
	1992.07-1996.01	4AT/MT	L/R	F	Estate Engine NG	803012	Outer Joint	45T	33	30	53	31	62	I
	1992.07-1996.01	MT	-	-	Estate Engine NG	603006	Inner Joint			33		34		
	1992.07-1996.01	MT	R	F	Estate Engine NG	203044	Drive Shaft	45T	33		53	31	563	
	1992.07-1996.01	4AT/MT	L/R	F	Estate Engine NG	803051	Outer Joint		33	30	53	30	61	I
	1992.07-1996.01	-	-	-	F Estate Engine NG	803011	Outer Joint		33	30	53	31	62	I
2.3 E quattro (98 kW)	1991.09-1994.11	MT	L/R	F	All-wheel Drive Estate Engine NG	603003	Inner Joint			33		32		
	1991.09-1994.11	MT	L/R	F	All-wheel Drive Estate Engine NG	803012	Outer Joint	45T	33	30	53	31	62	I
	1991.09-1994.11	MT	R	F	All-wheel Drive Estate Engine NG	203297	Drive Shaft	45T	33	0	53	30	575	
	1991.09-1994.11	MT	L	F	All-wheel Drive Estate Engine NG	203003	Drive Shaft	45T	33		53	31	586	
	1991.09-1994.11	MT	-	-	All-wheel Drive Estate Engine NG	603006	Inner Joint			33		34		
	1991.09-1994.11	MT	L/R	R	All-wheel Drive Estate Engine NG	803014	Outer Joint	45T	38	25	59.5	34.5	61	O
1991.09-1994.11	-	-	-	F All-wheel Drive Estate Engine NG	803011	Outer Joint		33	30	53	31	62	I	
2.6 (110 kW)	1992.07-1996.01	MT	-	-	Estate Engine ABC	603006	Inner Joint			33		34		
2.6 quattro (110 kW)	1992.07-1995.07	MT	L/R	F	All-wheel Drive Estate Engine ABC	603003	Inner Joint			33		32		
	1992.07-1995.07	MT	-	-	All-wheel Drive Estate Engine ABC	603006	Inner Joint			33		34		
	1992.07-1995.07	MT	L/R	R	All-wheel Drive Estate Engine ABC	803014	Outer Joint	45T	38	25	59.5	34.5	61	O
2.8 (128 kW)	1991.09-1996.01	MT	-	-	Estate Engine AAH	603006	Inner Joint			33		34		
2.8 quattro (128 kW)	1992.08-1995.07	MT	L/R	F	All-wheel Drive Estate Engine AAH	603003	Inner Joint			33		32		
	1992.08-1995.07	MT	-	-	All-wheel Drive Estate Engine AAH	603006	Inner Joint			33		34		
	1992.08-1995.07	MT	L/R	R	All-wheel Drive Estate Engine AAH	803014	Outer Joint	45T	38	25	59.5	34.5	61	O
S2 quattro (169 kW)	1993.02-1995.07	MT	L/R	F/R	All-wheel Drive Estate Engine ABY	603001	Inner Joint			28		32		
	1993.02-1995.07	MT	-	-	All-wheel Drive Estate Engine ABY	603006	Inner Joint			33		34		

YEAR	TRANSM	L/R	F/R	REMARKS	GSP Ref.	PRODUCT	ABS	Technical Specifications									
								A	B	C	H	L	P				
AUDI																	
80 Avant (8C5 B4)																	
S2 quattro (169 kW)	1993.02-	1995.07	MT	L/R	R	All-wheel Drive Estate Engine ABY	803014	Outer Joint	45T	38	25	59.5	34.5	61	O		
80 III (89, 89Q, 8A, B3)																	
1.6 (75 kW)	1990.08-	1991.10	-	-	-	Ch89H300001 89J373598	603013	Inner Joint				33		34			
1.6 TD (59 kW)	1986.09-	1991.08	-	-	-	Ch8AL000018AN20000	603013	Inner Joint				33		34			
1.8 (55 kW)	1986.10-	1990.01	-	-	-	Ch89J3735998AN20000	603013	Inner Joint				33		34			
1.8 (83 kW)	1986.10-	1990.01	-	-	-	Ch89J3735998AN20000	603013	Inner Joint				33		34			
1.8 E (82 kW)	1986.10-	1990.01	-	-	-	Ch89J3735998AN200000	603013	Inner Joint				33		34			
1.8 E Quattro (82 kW)	1986.09-	1991.09	MT	-	F	Ch89J351000	603013	Inner Joint				33		34			
1.8 S (65 kW)	1986.10-	1990.01	-	-	-	Ch89J3735998AN20000	603013	Inner Joint				33		34			
1.8 S (66 kW)	1986.10-	1990.01	-	-	-	Ch89J3735998AN20000	603013	Inner Joint				33		34			
1.8 S Quattro (65 kW)	1988.03-	1991.09	-	-	-	Ch89F135100189N200000	603013	Inner Joint				33		34			
1.8 S Quattro (66 kW)	1988.03-	1991.09	-	-	-	Ch89F135100189N200000	603013	Inner Joint				33		34			
2.0 (82 kW)	1990.10-	1991.08	-	-	-	-	603013	Inner Joint				33		34			
2.0 E (83 kW)	1988.08-	2009.10	-	-	-	Ch89J3735998CP300000	603013	Inner Joint				33		34			
2.0 E 16V Quattro (101 kW)	1990.03-	1991.09	-	-	-	-	603013	Inner Joint				33		34			
2.0 E Quattro (82 kW)	1988.08-	1991.08	-	-	-	Ch89H351001	603013	Inner Joint				33		34			
2.0 Quattro (82 kW)	1990.10-	1991.08	-	-	-	-	603013	Inner Joint				33		34			
80 IV (8C, B4), AVANT																	
1.6 (52 kW)	1991.09-	1994.12	-	-	-	Ch8CN0861348CP30000	603013	Inner Joint				33		34			
1.6 E (74 kW)	1993.06-	1996.01	-	-	-	Ch8CN0861348CP30000	603013	Inner Joint				33		34			
1.9 TD (55 kW)	1991.09-	1994.12	-	-	-	-	603013	Inner Joint				33		34			
1.9 TDi (66 kW)	1991-	1996	-	-	-	-	603013	Inner Joint				33		34			
2.0 (66 kW)	1992.07-	1996.01	-	-	-	-	603013	Inner Joint				33		34			
2.0 E (85 kW)	1992.07-	1996.01	-	-	-	-	603013	Inner Joint				33		34			
2.0 E 16V Quattro (103 kW)	1992.12-	1995.07	-	-	-	Ch89H351001	603013	Inner Joint				33		34			
2.0 E Quattro (85 kW)	1992.07-	1996.01	-	-	-	Ch89H351001	603013	Inner Joint				33		34			
2.3 E Quattro (98 kW)	1991.09-	1996.12	MT	-	F	-	603013	Inner Joint				33		34			
2.6 (110 kW)	1992.07-	1996.01	MT	-	F	-	603013	Inner Joint				33		34			
2.6 Quattro (110 kW)	1992.07-	1996.01	-	-	-	-	603013	Inner Joint				33		34			
2.8 (128 kW)	1991.09-	1994.12	MT/AT	-	-	-	603013	Inner Joint				33		34			
2.8 Quattro (128 kW)	1991.09-	1994.12	-	-	F	-	603013	Inner Joint				33		34			
90 (89 89Q 8A B3)																	
1.6 TD (59 kW)	1987.04-	1991.09	MT	L/R	F	Saloon Engine RA/SB	803008	Outer Joint				33	30	53	30.5	51.5	I
	1987.04-	1991.09	AT	L/R	F	Saloon Engine RA/SB	603014	Inner Joint				33		32			
	1987.04-	1991.09	AT	L/R	F	Saloon Engine RA/SB	803012	Outer Joint	45T	33	30	53	31	62		I	
	1987.04-	1991.09	AT	L/R	F	Saloon Engine RA/SB	803051	Outer Joint		33	30	53	30	61		I	
	1987.04-	1991.09	MT	L/R	F	Saloon Engine RA/SB	603005	Inner Joint				33		32			
	1987.04-	1991.09	MT	-	-	Saloon Engine RA/SB	603006	Inner Joint				33		34			
2.0 (85 kW)	1987.04-	1991.09	MT	L/R	F	Saloon Engine RA/SB	603020	Inner Joint				33		32			
	1988.07-	1991.09	AT/MT	L/R	F	Saloon Engine PS	603014	Inner Joint				33		32			
	1988.07-	1991.09	MT	-	-	Saloon Engine PS	603006	Inner Joint				33		34			
	1988.07-	1991.09	MT	L	F	Saloon Engine PS	203059	Drive Shaft		33		53	31	586			
	1988.07-	1991.09	AT/MT	L/R	F	Saloon Engine PS	803012	Outer Joint	45T	33	30	53	31	62		I	
	1988.07-	1991.09	MT	R	F	Saloon Engine PS	203297	Drive Shaft	45T	33	0	53	30	575			
	1988.07-	1991.09	AT/MT	L/R	F	Saloon Engine PS	803051	Outer Joint		33	30	53	30	61		I	
	1988.07-	1991.09	MT	L	F	Saloon Engine PS	203003	Drive Shaft	45T	33		53	31	586			
2.0 20 V (118 kW)	1988.07-	1991.09	-	-	-	Saloon Engine PS	803011	Outer Joint				33	30	53	31	62	I
	1989.08-	1991.07	MT	L/R	F	Saloon Engine NM	803012	Outer Joint	45T	33	30	53	31	62		I	
	1989.08-	1991.07	MT	L/R	F	Saloon Engine NM	603001	Inner Joint				28		32			
	1989.08-	1991.07	MT	L/R	F	Saloon Engine NM	803051	Outer Joint		33	30	53	30	61		I	
2.0 20 V quattro (118 kW)	1989.08-	1991.07	MT	-	-	Saloon Engine NM	603006	Inner Joint				33		34			
	1988.08-	1991.09	MT	-	-	All-wheel Drive Saloon Engine NM	603006	Inner Joint				33		34			
2.2 E (100 kW)	1987.04-	1991.07	AT/MT	L/R	F	Saloon Engine KV	603001	Inner Joint				28		32			
	1987.04-	1991.07	-	-	-	Saloon Engine KV	803032	Outer Joint				22	30	51	78	61	I
	1987.04-	1991.07	AT/MT	L/R	F	Saloon Engine KV	803012	Outer Joint	45T	33	30	53	31	62		I	
	1987.04-	1991.07	MT	R	F	Saloon Engine KV	203044	Drive Shaft	45T	33		53	31	563			
	1987.04-	1991.07	AT/MT	L/R	F	Saloon Engine KV	803051	Outer Joint		33	30	53	30	61		I	
	1987.04-	1991.07	MT	-	-	Saloon Engine KV	603006	Inner Joint				33		34			
	1987.04-	1991.07	-	-	-	Saloon Engine KV	803034	Outer Joint	96T	22	30	51	78	61		I	
	1987.04-	1991.07	-	-	-	Saloon Engine KV	661007	Inner Joint				33		32			
	2.2 E quattro (100 kW)	1987.04-	1991.09	MT	L/R	R	All-wheel Drive Saloon Engine KV	803009	Outer Joint	45T	33	30	53	30.5	51.5		I
1987.04-		1991.09	MT	L/R	F/R	All-wheel Drive Saloon Engine KV	603003	Inner Joint				33		32			
1987.04-		1991.09	MT	L/R	F/R	All-wheel Drive Saloon Engine KV	803012	Outer Joint	45T	33	30	53	31	62		I	
1987.04-		1991.09	-	-	-	All-wheel Drive Saloon Engine KV	803032	Outer Joint		22	30	51	78	61		I	
1987.04-		1991.09	MT	L	F	All-wheel Drive Saloon Engine KV	203059	Drive Shaft		33		53	31	586			
1987.04-	1991.09	MT	L/R	R	All-wheel Drive Saloon Engine KV	603004	Inner Joint				33		32				





YEAR	TRANSM	L/R	F/R	REMARKS	GSP Ref.	PRODUCT	ABS	Technical Specifications									
								A	B	C	H	L	P				
AUDI																	
90 (89 89Q 8A B3)																	
2.2 E quattro (100 kW)	1987.04-1991.09	MT	R	F	All-wheel Drive Saloon Engine KV	203297	Drive Shaft	45T	33	0	53	30	575				
	1987.04-1991.09	MT	-	-	All-wheel Drive Saloon Engine KV	603006	Inner Joint			33		34					
	1987.04-1991.09	MT	L	F	All-wheel Drive Saloon Engine KV	203003	Drive Shaft	45T	33		53	31	586				
	1987.04-1991.09	MT	L/R	F	All-wheel Drive Saloon Engine KV	803051	Outer Joint		33	30	53	30	61	I			
	1987.04-1991.09	-	-	F	All-wheel Drive Saloon Engine KV	803011	Outer Joint		33	30	53	31	62	I			
	1987.04-1991.09	-	-	-	All-wheel Drive Saloon Engine KV	803034	Outer Joint	96T	22	30	51	78	61	I			
	1987.04-1991.09	MT	L/R	R	All-wheel Drive Saloon Engine KV	603005	Inner Joint			33		32					
2.3 E (100 kW)	1987.04-1991.07	-	-	-	Saloon Engine NG	803032	Outer Joint		22	30	51	78	61	I			
	1987.04-1991.07	MT	R	F	Saloon Engine NG	203044	Drive Shaft	45T	33		53	31	563				
	1987.04-1991.07	-	-	-	Saloon Engine NG	803034	Outer Joint	96T	22	30	51	78	61	I			
2.3 E (98 kW)	1987.04-1991.09	AT/MT	L/R	F	Saloon Engine NG	603001	Inner Joint			28		32					
	1987.04-1991.09	MT	-	-	Saloon Engine NG	603006	Inner Joint			33		34					
	1987.04-1991.09	-	-	-	Saloon Engine NG	803032	Outer Joint		22	30	51	78	61	I			
	1987.04-1991.09	AT/MT	L/R	F	Saloon Engine NG	803012	Outer Joint	45T	33	30	53	31	62	I			
	1987.04-1991.09	MT	R	F	Saloon Engine NG	203044	Drive Shaft	45T	33		53	31	563				
	1987.04-1991.09	AT/MT	L/R	F	Saloon Engine NG	803051	Outer Joint		33	30	53	30	61	I			
	1987.04-1991.09	-	-	-	Saloon Engine NG	803034	Outer Joint	96T	22	30	51	78	61	I			
2.3 E 20V (123 kW)	1990.04-1991.07	MT	-	-	Saloon Engine 7A	603006	Inner Joint			33		34					
2.3 E 20V (125 kW)	1988.08-1991.07	MT	L/R	F	Saloon Engine 7A	603001	Inner Joint			28		32					
2.3 E 20V quattro (123 kW)	1990.04-1991.09	MT	-	-	All-wheel Drive Saloon Engine 7A	603006	Inner Joint			33		34					
2.3 E 20V quattro (125 kW)	1988.06-1991.09	MT	L/R/F/R	-	All-wheel Drive Saloon Engine 7A	603003	Inner Joint			33		32					
	1988.06-1991.09	MT	L/R	R	All-wheel Drive Saloon Engine 7A	803012	Outer Joint	45T	33	30	53	31	62	I			
	1988.06-1991.09	-	-	-	All-wheel Drive Saloon Engine 7A	661007	Inner Joint			33		32					
2.3 E quattro (100 kW)	1987.04-1991.07	MT	L/R	R	All-wheel Drive Saloon Engine NG	803009	Outer Joint	45T	33	30	53	30.5	51.5	I			
	1987.04-1991.07	MT	L/R/F/R	-	All-wheel Drive Saloon Engine NG	603003	Inner Joint			33		32					
	1987.04-1991.07	-	-	-	All-wheel Drive Saloon Engine NG	803032	Outer Joint		22	30	51	78	61	I			
	1987.04-1991.07	MT	-	-	All-wheel Drive Saloon Engine NG	603006	Inner Joint			33		34					
	1987.04-1991.07	MT	L/R/F/R	-	All-wheel Drive Saloon Engine NG	803012	Outer Joint	45T	33	30	53	31	62	I			
	1987.04-1991.07	MT	L	F	All-wheel Drive Saloon Engine NG	203059	Drive Shaft		33		53	31	586				
	1987.04-1991.07	MT	L/R	R	All-wheel Drive Saloon Engine NG	603004	Inner Joint			33		32					
	1987.04-1991.07	MT	R	F	All-wheel Drive Saloon Engine NG	203297	Drive Shaft	45T	33	0	53	30	575				
	1987.04-1991.07	MT	L	F	All-wheel Drive Saloon Engine NG	203003	Drive Shaft	45T	33		53	31	586				
	1987.04-1991.07	MT	L/R	F	All-wheel Drive Saloon Engine NG	803051	Outer Joint		33	30	53	30	61	I			
	1987.04-1991.07	-	-	F	All-wheel Drive Saloon Engine NG	803011	Outer Joint		33	30	53	31	62	I			
	1987.04-1991.07	-	-	-	All-wheel Drive Saloon Engine NG	803034	Outer Joint	96T	22	30	51	78	61	I			
	1987.04-1991.07	MT	L/R	R	All-wheel Drive Saloon Engine NG	603005	Inner Joint			33		32					
	1987.04-1991.07	-	-	-	All-wheel Drive Saloon Engine NG	661007	Inner Joint			33		32					
2.3 E quattro (98 kW)	1987.04-1991.09	MT	L/R	R	All-wheel Drive Saloon Engine NG	803009	Outer Joint	45T	33	30	53	30.5	51.5	I			
	1987.04-1991.09	MT	L/R	F	All-wheel Drive Saloon Engine NG	603003	Inner Joint			33		32					
	1987.04-1991.09	MT	L/R	R	All-wheel Drive Saloon Engine NG	603004	Inner Joint			33		32					
	1987.04-1991.09	MT	L/R	F	All-wheel Drive Saloon Engine NG	803012	Outer Joint	45T	33	30	53	31	62	I			
	1987.04-1991.09	-	-	-	All-wheel Drive Saloon Engine NG	803032	Outer Joint		22	30	51	78	61	I			
	1987.04-1991.09	MT	-	-	All-wheel Drive Saloon Engine NG	603006	Inner Joint			33		34					
	1987.04-1991.09	MT	R	F	All-wheel Drive Saloon Engine NG	203297	Drive Shaft	45T	33	0	53	30	575				
	1987.04-1991.09	MT	L/R	R	All-wheel Drive Saloon Engine NG	603005	Inner Joint			33		32					
	1987.04-1991.09	MT	L	F	All-wheel Drive Saloon Engine NG	203003	Drive Shaft	45T	33		53	31	586				
	1987.04-1991.09	-	-	-	All-wheel Drive Saloon Engine NG	803034	Outer Joint	96T	22	30	51	78	61	I			
90 II (89, 89Q, 8A, B3)																	
1.6 TD (59 kW)	1987.04-1991.09	-	-	-	Ch8AL0000018AN200000	603013	Inner Joint			33		34					
2.0 (85 kW)	1988.07-1991.09	-	-	-	-	603013	Inner Joint			33		34					
2.0 20V (118 kW)	1989.08-1991.07	AT	-	-	-	603013	Inner Joint			33		34					
2.2 E (100 kW)	1987.04-1991.07	-	-	-	Ch89J373598	603013	Inner Joint			33		34					
2.2 E Quattro (100 kW)	1987.04-1991.09	-	-	F	Ch8AL360000Ch89J35100	603013	Inner Joint			33		34					
2.3 E 20V Quattro (123 kW)	1988.08-1991.07	-	-	-	-	603013	Inner Joint			33		34					
2.3 E 20V Quattro (125 kW)	1988.08-1991.07	-	-	-	-	603013	Inner Joint			33		34					
2.3 E Quattro (100 kW)	1987.04-1991.09	MT	-	F	Ch89H30000189J35100	603013	Inner Joint			33		34					
A1 (8X1 8XK)																	
1.0 TFSI (70 kW)	2015.03-	AT	-	-	Hatchback Engine CHZB	603006	Inner Joint			33		34					
	2015.03-	AT	-	-	Hatchback Engine CHZB	603016	Inner Joint			28		32					
	2015.03-	AT	L	F	Hatchback Engine CHZB	661054	Inner Joint		40	28	46.9	51	53				
1.2 TFSI (63 kW)	2010.05-	MT	-	F	Hatchback Engine CBZA	803024	Outer Joint		36	30	50.75	59	54.5	I			
	2010.05-	MT	L	F	Hatchback Engine CBZA	261297	Drive Shaft		36		50.5	59	513				
	2010.05-	MT	R	F	Hatchback Engine CBZA	261301	Drive Shaft		36		50.5	59	771				
	2010.05-	MT	L	F	Hatchback Engine CBZA	261263	Drive Shaft		36		52	59	514				
	2010.05-	-	L/R	F	Hatchback Engine CBZA	603011	Inner Joint			33		34					
	2010.05-	MT	L	F	Hatchback Engine CBZA	854006	Outer Joint		36	30	52	59	55.5	I			

	 YEAR	TRANSM	L/R	F/R	REMARKS	GSP Ref.	 PRODUCT	 ABS	Technical Specifications						
									A	B	C	H	L	P	
AUDI															
A1 (8X1 8XK)															
1.2 TFSI (63 kW)	2010.05-	-	MT	-	-	Hatchback Engine CBZA	603006	Inner Joint			33		34		
	2010.05-	-	-	L	F	Hatchback Engine CBZA	261274	Drive Shaft	36		50.5	59	514		
1.4 TDI (66 kW)	2014.11-	-	-	L/R	F	Hatchback Engine CUSB	603011	Inner Joint		33		34			
1.4 TFSI (103 kW)	2012.04-	-	7AT	L	F	Hatchback Engine CPTA	261260	Drive Shaft	36		52	75	498		
	2012.04-	-	7AT/MT	-	F	Hatchback Engine CPTA	803041	Outer Joint	36	27	50.5	75	65	I	
1.4 TFSI (110 kW)	2014.11-	-	AT	L	F	Hatchback Engine CZEA	661054	Inner Joint	40	28	46.9	51	53		
	2014.11-	-	AT	-	-	Hatchback Engine CZEA	603006	Inner Joint		33		34			
	2014.11-	-	AT	-	-	Hatchback Engine CZEA	603016	Inner Joint		28		32			
	2014.11-	-	-	L/R	F	Hatchback Engine CZEA	603011	Inner Joint		33		34			
	2014.11-	-	7AT/MT	-	F	Hatchback Engine CZEA	803041	Outer Joint	36	27	50.5	75	65	I	
1.4 TFSI (136 kW)	2011.01-	-	7AT	L	F	Hatchback Engine CAVG/CTHG/CTJA	261260	Drive Shaft	36		52	75	498		
	2011.01-	-	7AT	-	F	Hatchback Engine CAVG/CTHG/CTJA	803041	Outer Joint	36	27	50.5	75	65	I	
	2011.01-	-	7AT	R	F	Hatchback Engine CAVG/CTHG/CTJA	261261	Drive Shaft	36		52	75	785		
	2011.01-	-	AT	-	-	Hatchback Engine CAVG/CTHG/CTJA	603016	Inner Joint		28		32			
1.4 TFSI (90 kW)	2010.05-	-	7DCT/MT	-	F	Hatchback Engine CAXA/CNVA	803024	Outer Joint	36	30	50.75	59	54.5	I	
	2010.05-	-	MT	L	F	Hatchback Engine CAXA/CNVA	261297	Drive Shaft	36		50.5	59	513		
	2010.05-	-	MT	L	F	Hatchback Engine CAXA/CNVA	261263	Drive Shaft	36		52	59	514		
	2010.05-	-	MT	R	F	Hatchback Engine CAXA/CNVA	261301	Drive Shaft	36		50.5	59	771		
	2010.05-	-	-	L/R	F	Hatchback Engine CAXA/CNVA	603011	Inner Joint		33		34			
	2010.05-	-	MT	L	F	Hatchback Engine CAXA/CNVA	854006	Outer Joint	36	30	52	59	55.5	I	
	2010.05-	-	-	L	F	Hatchback Engine CAXA/CNVA	261274	Drive Shaft	36		50.5	59	514		
1.4 TFSI (92 kW)	2014.11-	-	MT	L	F	Hatchback Engine CZCA/CZDB	261263	Drive Shaft	36		52	59	514		
	2014.11-	-	AT	L	F	Hatchback Engine CZCA/CZDB	661054	Inner Joint	40	28	46.9	51	53		
	2014.11-	-	MT	L	F	Hatchback Engine CZCA/CZDB	854006	Outer Joint	36	30	52	59	55.5	I	
	2014.11-	-	AT	-	-	Hatchback Engine CZCA/CZDB	603006	Inner Joint		33		34			
	2014.11-	-	AT	-	-	Hatchback Engine CZCA/CZDB	603016	Inner Joint		28		32			
	2014.11-	-	-	L/R	F	Hatchback Engine CZCA/CZDB	603011	Inner Joint		33		34			
1.6 TDI (66 kW)	2011.03-	-	Semi-AT	L	F	Hatchback Engine CAYB	261260	Drive Shaft	36		52	75	498		
	2011.03-	-	MT	L	F	Hatchback Engine CAYB	261184	Drive Shaft	36		52	59	496		
	2011.03-	-	Semi-AT	-	F	Hatchback Engine CAYB	803041	Outer Joint	36	27	50.5	75	65	I	
	2011.03-	-	MT	R	F	Hatchback Engine CAYB	261185	Drive Shaft	36		52	59	785		
	2011.03-	-	-	-	F	Hatchback Engine CAYB	803024	Outer Joint	36	30	50.75	59	54.5	I	
	2011.03-	-	MT	L/R	F	Hatchback Engine CAYB	603011	Inner Joint		33		34			
	2011.03-	-	Semi-AT	R	F	Hatchback Engine CAYB	261261	Drive Shaft	36		52	75	785		
	2011.03-	-	MT	L	F	Hatchback Engine CAYB	854006	Outer Joint	36	30	52	59	55.5	I	
	2011.03-	-	MT	R	F	Hatchback Engine CAYB	261025	Drive Shaft	36		52	75	773.5		
1.6 TDI (77 kW)	2010.05-	-	5MT	-	F	Hatchback Engine CAYC	803024	Outer Joint	36	30	50.75	59	54.5	I	
	2010.05-	-	MT	L	F	Hatchback Engine CAYC	261184	Drive Shaft	36		52	59	496		
	2010.05-	-	MT	R	F	Hatchback Engine CAYC	261185	Drive Shaft	36		52	59	785		
	2010.05-	-	-	L/R	F	Hatchback Engine CAYC	603011	Inner Joint		33		34			
	2010.05-	-	MT	-	-	Hatchback Engine CAYC	603006	Inner Joint		33		34			
	2010.05-	-	MT	L	F	Hatchback Engine CAYC	854006	Outer Joint	36	30	52	59	55.5	I	
	2010.05-	-	-	R	F	Hatchback Engine CAYC	261025	Drive Shaft	36		52	75	773.5		
1.6 TDI (85 kW)	2014.11-	-	7AT	L	F	Hatchback Engine CXMA	261260	Drive Shaft	36		52	75	498		
	2014.11-	-	Semi-AT	-	F	Hatchback Engine CXMA	803041	Outer Joint	36	27	50.5	75	65	I	
	2014.11-	-	MT	L	F	Hatchback Engine CXMA	261184	Drive Shaft	36		52	59	496		
	2014.11-	-	MT	R	F	Hatchback Engine CXMA	261185	Drive Shaft	36		52	59	785		
	2014.11-	-	7AT	R	F	Hatchback Engine CXMA	261261	Drive Shaft	36		52	75	785		
	2014.11-	-	MT	L	F	Hatchback Engine CXMA	854006	Outer Joint	36	30	52	59	55.5	I	
	2014.11-	-	AT/MT	R	F	Hatchback Engine CXMA	261025	Drive Shaft	36		52	75	773.5		
	2014.11-	-	-	L/R	F	Hatchback Engine CXMA	603011	Inner Joint		33		34			
1.8 TFSI (141 kW)	2015.02-	-	AT	-	-	Hatchback Engine DAJB	603006	Inner Joint		33		34			
	2015.02-	-	AT	-	-	Hatchback Engine DAJB	603016	Inner Joint		28		32			
	2015.02-	-	AT	L	F	Hatchback Engine DAJB	661054	Inner Joint	40	28	46.9	51	53		
2.0 TDI (100 kW)	2012.05-	-	-	-	F	Hatchback Engine CFHB	803041	Outer Joint	36	27	50.5	75	65	I	
	2012.05-	-	MT	-	-	Hatchback Engine CFHB	603016	Inner Joint		28		32			
2.0 TDI (105 kW)	2011.09-	-	-	-	F	Hatchback Engine CFHD	803041	Outer Joint	36	27	50.5	75	65	I	
	2011.09-	-	MT	-	-	Hatchback Engine CFHD	603016	Inner Joint		28		32			
2.0 TFSI quattro (188 kW)	2012.03-	-	-	L/R	F	All-wheel Drive Hatchback Engine CDLH	803002	Outer Joint	36	27	59.5	40	66	I	
	2012.03-	-	MT	-	-	All-wheel Drive Hatchback Engine CDLH	603016	Inner Joint		28		32			
A1 Sportback (8XA 8XF)															
1.0 TFSI (70 kW)	2015.03-	-	AT	-	-	Hatchback Engine CHZB	603006	Inner Joint		33		34			
	2015.03-	-	AT	-	-	Hatchback Engine CHZB	603016	Inner Joint		28		32			
	2015.03-	-	AT	L	F	Hatchback Engine CHZB	661054	Inner Joint	40	28	46.9	51	53		
1.2 TFSI (63 kW)	2012.01-	-	MT	-	F	Hatchback Engine CBZA	803024	Outer Joint	36	30	50.75	59	54.5	I	
	2012.01-	-	MT	L	F	Hatchback Engine CBZA	261297	Drive Shaft	36		50.5	59	513		

	 YEAR	TRANSM	L/R	F/R	REMARKS	GSP Ref.	 PRODUCT	 ABS	Technical Specifications						
									A	B	C	H	L	P	
AUDI															
A1 Sportback (8XA 8XF)															
1.2 TFSI (63 kW)	2012.01-	-	MT	L	F	Hatchback Engine CBZA	261263	Drive Shaft	36		52	59	514		
	2012.01-	-	MT	R	F	Hatchback Engine CBZA	261301	Drive Shaft	36		50.5	59	771		
	2012.01-	-	-	L/R	F	Hatchback Engine CBZA	603011	Inner Joint		33		34			
	2012.01-	-	MT	L	F	Hatchback Engine CBZA	854006	Outer Joint	36	30	52	59	55.5	I	
	2012.01-	-	-	L	F	Hatchback Engine CBZA	261274	Drive Shaft	36		50.5	59	514		
	2012.01-	-	MT	-	-	Hatchback Engine CBZA	603006	Inner Joint		33		34			
1.4 TDI (66 kW)	2014.11-	-	-	L/R	F	Hatchback Engine CUSB	603011	Inner Joint		33		34			
1.4 TFSI (103 kW)	2012.04-	-	7AT	L	F	Hatchback Engine CPTA	261260	Drive Shaft	36		52	75	498		
	2012.04-	-	7AT/MT	-	F	Hatchback Engine CPTA	803041	Outer Joint	36	27	50.5	75	65	I	
1.4 TFSI (110 kW)	2014.11-	-	AT	L	F	Hatchback Engine CZEA	661054	Inner Joint	40	28	46.9	51	53		
	2014.11-	-	AT	-	-	Hatchback Engine CZEA	603006	Inner Joint		33		34			
	2014.11-	-	AT	-	-	Hatchback Engine CZEA	603016	Inner Joint		28		32			
	2014.11-	-	-	L/R	F	Hatchback Engine CZEA	603011	Inner Joint		33		34			
	2014.11-	-	7AT/MT	-	F	Hatchback Engine CZEA	803041	Outer Joint	36	27	50.5	75	65	I	
1.4 TFSI (136 kW)	2011.11-	-	7AT	L	F	Hatchback Engine CAVG/CTHG/CTJA	261260	Drive Shaft	36		52	75	498		
	2011.11-	-	7AT	-	F	Hatchback Engine CAVG/CTHG/CTJA	803041	Outer Joint	36	27	50.5	75	65	I	
	2011.11-	-	7AT	R	F	Hatchback Engine CAVG/CTHG/CTJA	261261	Drive Shaft	36		52	75	785		
	2011.11-	-	AT	-	-	Hatchback Engine CAVG/CTHG/CTJA	603016	Inner Joint		28		32			
1.4 TFSI (90 kW)	2011.11-	-	7DCT/MT	-	F	Hatchback Engine CAXA/CNVA	803024	Outer Joint	36	30	50.75	59	54.5	I	
	2011.11-	-	MT	L	F	Hatchback Engine CAXA/CNVA	261297	Drive Shaft	36		50.5	59	513		
	2011.11-	-	MT	L	F	Hatchback Engine CAXA/CNVA	261263	Drive Shaft	36		52	59	514		
	2011.11-	-	MT	R	F	Hatchback Engine CAXA/CNVA	261301	Drive Shaft	36		50.5	59	771		
	2011.11-	-	-	L/R	F	Hatchback Engine CAXA/CNVA	603011	Inner Joint		33		34			
	2011.11-	-	MT	L	F	Hatchback Engine CAXA/CNVA	854006	Outer Joint	36	30	52	59	55.5	I	
	2011.11-	-	-	L	F	Hatchback Engine CAXA/CNVA	261274	Drive Shaft	36		50.5	59	514		
1.4 TFSI (92 kW)	2014.11-	-	MT	L	F	Hatchback Engine CZCA	261263	Drive Shaft	36		52	59	514		
	2014.11-	-	AT	L	F	Hatchback Engine CZCA	661054	Inner Joint	40	28	46.9	51	53		
	2014.11-	-	MT	L	F	Hatchback Engine CZCA	854006	Outer Joint	36	30	52	59	55.5	I	
	2014.11-	-	AT	-	-	Hatchback Engine CZCA	603006	Inner Joint		33		34			
	2014.11-	-	AT	-	-	Hatchback Engine CZCA	603016	Inner Joint		28		32			
	2014.11-	-	-	L/R	F	Hatchback Engine CZCA	603011	Inner Joint		33		34			
1.6 TDI (66 kW)	2011.11-	-	5MT	-	F	Hatchback Engine CAYB	803024	Outer Joint	36	30	50.75	59	54.5	I	
	2011.11-	-	AT	-	F	Hatchback Engine CAYB	803041	Outer Joint	36	27	50.5	75	65	I	
	2011.11-	-	MT	L	F	Hatchback Engine CAYB	261184	Drive Shaft	36		52	59	496		
	2011.11-	-	MT	R	F	Hatchback Engine CAYB	261185	Drive Shaft	36		52	59	785		
	2011.11-	-	MT	L/R	F	Hatchback Engine CAYB	603011	Inner Joint		33		34			
	2011.11-	-	AT	R	F	Hatchback Engine CAYB	261261	Drive Shaft	36		52	75	785		
	2011.11-	-	MT	L	F	Hatchback Engine CAYB	854006	Outer Joint	36	30	52	59	55.5	I	
	2011.11-	-	-	R	F	Hatchback Engine CAYB	261025	Drive Shaft	36		52	75	773.5		
	2011.11-	-	AT	L	F	Hatchback Engine CAYB	261260	Drive Shaft	36		52	75	498		
1.6 TDI (77 kW)	2011.11-	-	5MT	-	F	Hatchback Engine CAYC	803024	Outer Joint	36	30	50.75	59	54.5	I	
	2011.11-	-	MT	L	F	Hatchback Engine CAYC	261184	Drive Shaft	36		52	59	496		
	2011.11-	-	-	R	F	Hatchback Engine CAYC	261185	Drive Shaft	36		52	59	785		
	2011.11-	-	-	L/R	F	Hatchback Engine CAYC	603011	Inner Joint		33		34			
	2011.11-	-	MT	L	F	Hatchback Engine CAYC	854006	Outer Joint	36	30	52	59	55.5	I	
	2011.11-	-	MT	R	F	Hatchback Engine CAYC	261025	Drive Shaft	36		52	75	773.5		
1.6 TDI (85 kW)	2011.11-	-	MT	-	-	Hatchback Engine CAYC	603006	Inner Joint		33		34			
	2014.11-	-	Semi-AT	L	F	Hatchback Engine CXMA	261260	Drive Shaft	36		52	75	498		
	2014.11-	-	Semi-AT	-	F	Hatchback Engine CXMA	803041	Outer Joint	36	27	50.5	75	65	I	
	2014.11-	-	MT	L	F	Hatchback Engine CXMA	261184	Drive Shaft	36		52	59	496		
	2014.11-	-	MT	R	F	Hatchback Engine CXMA	261185	Drive Shaft	36		52	59	785		
	2014.11-	-	Semi-AT	R	F	Hatchback Engine CXMA	261261	Drive Shaft	36		52	75	785		
	2014.11-	-	MT	L	F	Hatchback Engine CXMA	854006	Outer Joint	36	30	52	59	55.5	I	
	2014.11-	-	AT/MT	L/R	F	Hatchback Engine CXMA	603011	Inner Joint		33		34			
1.8 TFSI (141 kW)	2015.02-	-	AT	-	-	Hatchback Engine DAJB	261025	Drive Shaft	36		52	75	773.5		
	2015.02-	-	AT	-	-	Hatchback Engine DAJB	603006	Inner Joint		33		34			
	2015.02-	-	AT	-	-	Hatchback Engine DAJB	603016	Inner Joint		28		32			
2.0 TDI (100 kW)	2012.05-	-	-	-	F	Hatchback Engine CFHB	803041	Outer Joint	36	27	50.5	75	65	I	
	2012.05-	-	MT	-	-	Hatchback Engine CFHB	603016	Inner Joint		28		32			
2.0 TDI (105 kW)	2011.09-	-	-	-	F	Hatchback Engine CFHD	803041	Outer Joint	36	27	50.5	75	65	I	
	2011.09-	-	MT	-	-	Hatchback Engine CFHD	603016	Inner Joint		28		32			
A2 (8Z0)															
1.2 TDI (45 kW)	2001.03-	2005.08	AT/MT	L/R	F	Hatchback Engine ANY	899268	Outer Joint		20	26	43	56	45	M
1.4 (55 kW)	2000.02-	2005.08	-	R	F	Hatchback Engine AUA/BBY	261063	Drive Shaft		36		50.7	58.5	751	
	2000.02-	2005.08	-	R	F	Hatchback Engine AUA/BBY	261077	Drive Shaft		36		50.7	58.5	750	

	 YEAR	TRANSM	L/R	F/R	REMARKS	GSP Ref.	 PRODUCT	 ABS	Technical Specifications					
									A	B	C	H	L	P
AUDI														
A2 (820)														
1.4 (55 kW)	2000.02-2005.08	-	-	F	Hatchback Engine AUA/BBY	803027	Outer Joint		36	30	50.7	58.5	47.5	I
1.4 TDI (55 kW)	2000.02-2005.08	MT	L	F	Hatchback Engine BHC/AMF	261265	Drive Shaft		36		52	59	536	
	2000.02-2005.08	MT	R	F	Hatchback Engine BHC/AMF	261278	Drive Shaft		36		52	59	726	
	2000.02-2005.08	-	-	F	Hatchback Engine BHC/AMF	803024	Outer Joint		36	30	50.75	59	54.5	I
	2000.02-2005.08	MT	L	F	Hatchback Engine BHC/AMF	854006	Outer Joint		36	30	52	59	55.5	I
	2000.02-2005.08	-	L/R	F	Hatchback Engine BHC/AMF	661006	Inner Joint			30		57.6		
1.4 TDI (66 kW)	2003.11-2005.08	-	L	F	Hatchback Engine ATL	261265	Drive Shaft		36		52	59	536	
	2003.11-2005.08	-	R	F	Hatchback Engine ATL	261278	Drive Shaft		36		52	59	726	
	2003.11-2005.08	-	L	F	Hatchback Engine ATL	854006	Outer Joint		36	30	52	59	55.5	I
	2003.11-2005.08	-	L/R	F	Hatchback Engine ATL	661006	Inner Joint			30		57.6		
	2003.11-2005.08	-	-	F	Hatchback Engine ATL	803024	Outer Joint		36	30	50.75	59	54.5	I
1.6 FSI (81 kW)	2002.05-2005.08	-	-	F	Hatchback Engine BAD	803024	Outer Joint		36	30	50.75	59	54.5	I
A3														
1.6	1999.01-2006.12	MT	-	-	-	803070	Outer Joint		36	30	53	78	60	I
A3 (8L1)														
1.6 (74 kW)	1996.09-2003.05	AT	L/R	F	Hatchback Engine APF/AKL/AEH	803036	Outer Joint		36	30	53.2	77.5	61	I
	1996.09-2003.05	AT	L	F	Hatchback Engine APF/AKL/AEH	261020	Drive Shaft		36		53.2	77.5	547	
	1996.09-2003.05	MT	L	F	Hatchback Engine APF/AKL/AEH	261045	Drive Shaft		36		53	78.5	555	
	1996.09-2003.05	MT	L/R	F	Hatchback Engine APF/AKL/AEH	603004	Inner Joint			33		32		
	1996.09-2003.05	AT	L	F	Hatchback Engine APF/AKL/AEH	261156	Drive Shaft		36		53	78	554.5	
	1996.09-2003.05	AT	L	F	Hatchback Engine APF/AKL/AEH	661062	Inner Joint			30		59		
	1996.09-2003.05	MT	L/R	F	Hatchback Engine APF/AKL/AEH	803033	Outer Joint		36	30	53	78.5	51	I
	1996.09-2003.05	-	L/R	F	Hatchback Engine APF/AKL/AEH	603008	Inner Joint			33		32		
1.6 (75 kW)	2000.08-2003.05	AT	L/R	F	Hatchback Engine AVU/BFQ	803036	Outer Joint		36	30	53.2	77.5	61	I
	2000.08-2003.05	AT	L	F	Hatchback Engine AVU/BFQ	261020	Drive Shaft		36		53.2	77.5	547	
	2000.08-2003.05	MT	L	F	Hatchback Engine AVU/BFQ	261045	Drive Shaft		36		53	78.5	555	
	2000.08-2003.05	AT	L	F	Hatchback Engine AVU/BFQ	261156	Drive Shaft		36		53	78	554.5	
	2000.08-2003.05	MT	L/R	F	Hatchback Engine AVU/BFQ	803033	Outer Joint		36	30	53	78.5	51	I
	2000.08-2003.05	AT	L	F	Hatchback Engine AVU/BFQ	661062	Inner Joint			30		59		
	2000.08-2003.05	-	L/R	F	Hatchback Engine AVU/BFQ	603008	Inner Joint			33		32		
1.8 (92 kW)	1996.09-2003.05	AT	L	F	Hatchback Engine AGN/APG	261020	Drive Shaft		36		53.2	77.5	547	
	1996.09-2003.05	MT	L	F	Hatchback Engine AGN/APG	261314	Drive Shaft		36		53	78	558	
	1996.09-2003.05	AT	L	F	Hatchback Engine AGN/APG	261156	Drive Shaft		36		53	78	554.5	
	1996.09-2003.05	MT	L	F	Hatchback Engine AGN/APG	261021	Drive Shaft		36		53.2	77.5	564.5	
	1996.09-2003.05	MT	R	F	Hatchback Engine AGN/APG	603009	Inner Joint			33		34		
	1996.09-2003.05	AT	L	F	Hatchback Engine AGN/APG	661062	Inner Joint			30		59		
	1996.09-2003.05	MT	L	F	Hatchback Engine AGN/APG	603011	Inner Joint			33		34		
	1996.09-2003.05	AT/MT	L/R	F	Hatchback Engine AGN/APG	803036	Outer Joint		36	30	53.2	77.5	61	I
1.8 T (110 kW)	1996.12-2003.05	AT	R	F	Hatchback Engine AUM/AQA/ARZ/AGU	261243	Drive Shaft		36		53	77.5	813	
	1996.12-2003.05	MT	L	F	Hatchback Engine AUM/AQA/ARZ/AGU	261020	Drive Shaft		36		53.2	77.5	547	
	1996.12-2003.05	AT	L	F	Hatchback Engine AUM/AQA/ARZ/AGU	261244	Drive Shaft		36		53	77.5	523	
	1996.12-2003.05	AT	L/R	F	Hatchback Engine AUM/AQA/ARZ/AGU	803035	Outer Joint		36	27	53	77.5	65	I
	1996.12-2003.05	AT	L	F	Hatchback Engine AUM/AQA/ARZ/AGU	261314	Drive Shaft		36		53	78	558	
	1996.12-2003.05	MT	L	F	Hatchback Engine AUM/AQA/ARZ/AGU	603011	Inner Joint			33		34		
	1996.12-2003.05	MT	L	F	Hatchback Engine AUM/AQA/ARZ/AGU	261156	Drive Shaft		36		53	78	554.5	
	1996.12-2003.05	MT	L	F	Hatchback Engine AUM/AQA/ARZ/AGU	261021	Drive Shaft		36		53.2	77.5	564.5	
	1996.12-2003.05	MT	R	F	Hatchback Engine AUM/AQA/ARZ/AGU	603009	Inner Joint			33		34		
	1996.12-2003.05	MT	L	F	Hatchback Engine AUM/AQA/ARZ/AGU	661062	Inner Joint			30		59		
	1996.12-2003.05	AT/MT	L/R	F	Hatchback Engine AUM/AQA/ARZ/AGU	803036	Outer Joint		36	30	53.2	77.5	61	I
	1996.12-2003.05	AT	L	F	Hatchback Engine AUM/AQA/ARZ/AGU	203374	Drive Shaft		36		53	77.5	521	
1.8 T (132 kW)	1998.12-2003.05	Semi-AT	L	F	Hatchback Engine AJQ/APP/ARY/AUQ	203374	Drive Shaft		36		53	77.5	521	
	1998.12-2003.05	AT	L/R	F	Hatchback Engine AJQ/APP/ARY/AUQ	803035	Outer Joint		36	27	53	77.5	65	I
	1998.12-2003.05	Semi-AT	R	F	Hatchback Engine AJQ/APP/ARY/AUQ	261243	Drive Shaft		36		53	77.5	813	
	1998.12-2003.05	MT	L	F	Hatchback Engine AJQ/APP/ARY/AUQ	261156	Drive Shaft		36		53	78	554.5	
	1998.12-2003.05	MT	L	F	Hatchback Engine AJQ/APP/ARY/AUQ	661062	Inner Joint			30		59		
	1998.12-2003.05	MT	L/R	F	Hatchback Engine AJQ/APP/ARY/AUQ	803036	Outer Joint		36	30	53.2	77.5	61	I
1.8 T quattro (110 kW)	1996.12-2003.05	-	R	F	All-wheel Drive Hatchback Engine AQA/AGU/ARX	261186	Drive Shaft		36		53	77.5	653	
	1996.12-2003.05	MT	R	F	All-wheel Drive Hatchback Engine AQA/AGU/ARX	603009	Inner Joint			33		34		
	1996.12-2003.05	-	L	F	All-wheel Drive Hatchback Engine AQA/AGU/ARX	261314	Drive Shaft		36		53	78	558	
	1996.12-2003.05	-	L/R	R	All-wheel Drive Hatchback Engine AQA/AGU/ARX	803033	Outer Joint		36	30	53	78.5	51	I
	1996.12-2003.05	MT	L	F	All-wheel Drive Hatchback Engine AQA/AGU/ARX	603011	Inner Joint			33		34		
	1996.12-2003.05	AT/MT	L/R	F	All-wheel Drive Hatchback Engine AQA/AGU/ARX	803036	Outer Joint		36	30	53.2	77.5	61	I
	1996.12-2003.05	-	L/R	F	All-wheel Drive Hatchback Engine AQA/AGU/ARX	803035	Outer Joint		36	27	53	77.5	65	I
1.8 T quattro (132 kW)	1998.10-2003.05	Semi-AT	L	F	All-wheel Drive Hatchback Engine ARY/AJQ	203374	Drive Shaft		36		53	77.5	521	
	1998.10-2003.05	AT/MT	L/R	F	All-wheel Drive Hatchback Engine ARY/AJQ	803035	Outer Joint		36	27	53	77.5	65	I





YEAR	TRANSM	L/R	F/R	REMARKS	GSP Ref.	PRODUCT	ABS	Technical Specifications							
								A	B	C	H	L	P		
AUDI															
A3 (8L1)															
1.8 T quattro (132 kW)	1998.10-2003.05	MT	L	F	All-wheel Drive Hatchback Engine ARY/AJQ	261123	Drive Shaft	36		53	77.5	520			
	1998.10-2003.05	Semi-AT	R	F	All-wheel Drive Hatchback Engine ARY/AJQ	261243	Drive Shaft	36		53	77.5	813			
	1998.10-2003.05	-	L/R	R	All-wheel Drive Hatchback Engine ARY/AJQ	603011	Inner Joint		33		34				
	1998.10-2003.05	MT	R	F	All-wheel Drive Hatchback Engine ARY/AJQ	261186	Drive Shaft	36		53	77.5	653			
	1998.10-2003.05	-	L/R	R	All-wheel Drive Hatchback Engine ARY/AJQ	803033	Outer Joint	36	30	53	78.5	51	I		
1.9 TDI (66 kW)	1996.09-2001.07	AT	L	F	Hatchback Engine AGR/ALH	261020	Drive Shaft	36		53.2	77.5	547			
	1996.09-2001.07	MT	L	F	Hatchback Engine AGR/ALH	203006	Drive Shaft	36		53.2	77.5	557			
	1996.09-2001.07	MT	R	F	Hatchback Engine AGR/ALH	203004	Drive Shaft	36		53.2	77.5	822			
	1996.09-2001.07	MT	L	F	Hatchback Engine AGR/ALH	261021	Drive Shaft	36		53.2	77.5	564.5			
	1996.09-2001.07	MT	R	F	Hatchback Engine AGR/ALH	603009	Inner Joint		33		34				
	1996.09-2001.07	AT/MT	L/R	F	Hatchback Engine AGR/ALH	803036	Outer Joint	36	30	53.2	77.5	61	I		
1.9 TDI (74 kW)	2000.10-2003.05	AT	R	F	Hatchback Engine ATD/AXR	261243	Drive Shaft	36		53	77.5	813			
	2000.10-2003.05	AT	L	F	Hatchback Engine ATD/AXR	261244	Drive Shaft	36		53	77.5	523			
	2000.10-2003.05	MT	R	F	Hatchback Engine ATD/AXR	603009	Inner Joint		33		34				
	2000.10-2003.05	MT	L	F	Hatchback Engine ATD/AXR	203006	Drive Shaft	36		53.2	77.5	557			
	2000.10-2003.05	MT	L	F	Hatchback Engine ATD/AXR	603011	Inner Joint		33		34				
	2000.10-2003.05	MT	R	F	Hatchback Engine ATD/AXR	203004	Drive Shaft	36		53.2	77.5	822			
	2000.10-2003.05	MT	L/R	F	Hatchback Engine ATD/AXR	803036	Outer Joint	36	30	53.2	77.5	61	I		
	2000.10-2003.05	MT	L	F	Hatchback Engine ATD/AXR	261021	Drive Shaft	36		53.2	77.5	564.5			
	2000.10-2003.05	AT	L	F	Hatchback Engine ATD/AXR	203374	Drive Shaft	36		53	77.5	521			
	2000.10-2003.05	AT	L/R	F	Hatchback Engine ATD/AXR	803035	Outer Joint	36	27	53	77.5	65	I		
1.9 TDI (81 kW)	1997.08-2001.07	AT	L	F	Hatchback Engine AHF/ASV	261020	Drive Shaft	36		53.2	77.5	547			
	1997.08-2001.07	MT	L	F	Hatchback Engine AHF/ASV	203006	Drive Shaft	36		53.2	77.5	557			
	1997.08-2001.07	MT	R	F	Hatchback Engine AHF/ASV	203004	Drive Shaft	36		53.2	77.5	822			
	1997.08-2001.07	MT	L	F	Hatchback Engine AHF/ASV	261021	Drive Shaft	36		53.2	77.5	564.5			
	1997.08-2001.07	MT	R	F	Hatchback Engine AHF/ASV	603009	Inner Joint		33		34				
	1997.08-2001.07	AT/MT	L/R	F	Hatchback Engine AHF/ASV	803036	Outer Joint	36	30	53.2	77.5	61	I		
1.9 TDI (96 kW)	2000.08-2003.05	AT	L	F	Hatchback Engine ASZ	203374	Drive Shaft	36		53	77.5	521			
	2000.08-2003.05	AT	R	F	Hatchback Engine ASZ	261243	Drive Shaft	36		53	77.5	813			
	2000.08-2003.05	AT	L	F	Hatchback Engine ASZ	261244	Drive Shaft	36		53	77.5	523			
	2000.08-2003.05	AT/MT	L/R	F	Hatchback Engine ASZ	803035	Outer Joint	36	27	53	77.5	65	I		
	2000.08-2003.05	MT	L	F	Hatchback Engine ASZ	261123	Drive Shaft	36		53	77.5	520			
	2000.08-2003.05	-	R	F	Hatchback Engine ASZ	299114	Drive Shaft	36		53	77.5	809			
	2000.08-2003.05	MT	R	F	Hatchback Engine ASZ	261121	Drive Shaft	36		53	77.5	806			
	2000.08-2003.05	AT/MT	L/R	F	All-wheel Drive Hatchback Engine ASZ	803035	Outer Joint	36	27	53	77.5	65	I		
S3 quattro (154 kW)	1999.03-2002.04	-	L	F	All-wheel Drive Hatchback Engine APY/AMK/AUL	261123	Drive Shaft	36		53	77.5	520			
	1999.03-2002.04	AT/MT	L/R	F	All-wheel Drive Hatchback Engine APY/AMK/AUL	803035	Outer Joint	36	27	53	77.5	65	I		
	1999.03-2002.04	-	L/R	R	All-wheel Drive Hatchback Engine APY/AMK/AUL	603011	Inner Joint		33		34				
	1999.03-2002.04	-	R	F	All-wheel Drive Hatchback Engine APY/AMK/AUL	261186	Drive Shaft	36		53	77.5	653			
	1999.03-2002.04	MT	L	F	All-wheel Drive Hatchback Engine APY/AMK/AUL	203304	Drive Shaft	36		59.5	40	481			
	1999.03-2002.04	MT	L/R	F	All-wheel Drive Hatchback Engine APY/AMK/AUL	861021	Outer Joint	36	27	53	40	65	I		
	1999.03-2002.04	-	L/R	R	All-wheel Drive Hatchback Engine APY/AMK/AUL	803033	Outer Joint	36	30	53	78.5	51	I		
S3 quattro (165 kW)	2001.10-2003.05	-	L/R	R	All-wheel Drive Hatchback Engine BAM	603011	Inner Joint		33		34				
	2001.10-2003.05	MT	L	F	All-wheel Drive Hatchback Engine BAM	203304	Drive Shaft	36		59.5	40	481			
	2001.10-2003.05	MT	L/R	F	All-wheel Drive Hatchback Engine BAM	861021	Outer Joint	36	27	53	40	65	I		
2001.10-2003.05	-	L/R	R	All-wheel Drive Hatchback Engine BAM	803033	Outer Joint	36	30	53	78.5	51	I			
A3 (8P1)															
1.2 TSI (77 kW)	2010.04-2012.08	Semi-AT	L	F	Hatchback Engine CBZB	261201	Drive Shaft	36		59.5	40.5	535			
	2010.04-2012.08	Semi-AT	-	F	Hatchback Engine CBZB	803100	Outer Joint	36	33	59.5	38	55	I		
	2010.04-2012.08	-	L/R	F	Hatchback Engine CBZB	603011	Inner Joint		33		34				
1.4 TFSI (92 kW)	2007.09-2012.08	-	-	-	Hatchback Engine CAXC/CMSA	603016	Inner Joint		28		32				
	2007.09-2012.08	MT	L/R	F	Hatchback Engine CAXC/CMSA	603011	Inner Joint		33		34				
	2007.09-2012.08	MT	L/R	F	Hatchback Engine CAXC/CMSA	803037	Outer Joint	36	30	59.5	40.5	55	I		
	2007.09-2012.08	-	-	-	Hatchback Engine CAXC/CMSA	861059	Outer Joint	36	33	59.5	40	59.5	I		
	2007.09-2012.08	AT	L/R	F	Hatchback Engine CAXC/CMSA	803002	Outer Joint	36	27	59.5	40	66	I		
1.6 (75 kW)	2003.05-2012.08	-	R	F	Hatchback Engine BSE/BGU/BSF	261113	Drive Shaft	36		59.5	40	814			
	2003.05-2012.08	-	-	-	Hatchback Engine BSE/BGU/BSF	261237	Stub Axle	23	37	54		142.5			
	2003.05-2012.08	MT	L	F	Hatchback Engine BSE/BGU/BSF	261097	Drive Shaft	36		59.5	40.5	543			
	2003.05-2012.08	5MT	R	F	Hatchback Engine BSE/BGU/BSF	261096	Drive Shaft	36		59.5	40.5	799			
	2003.05-2012.08	MT	L/R	F	Hatchback Engine BSE/BGU/BSF	603011	Inner Joint		33		34				
	2003.05-2012.08	6AT	L	F	Hatchback Engine BSE/BGU/BSF	803116	Outer Joint	36	30	59.5	38	55	I		
	2003.05-2012.08	-	L/R	F	Hatchback Engine BSE/BGU/BSF	803037	Outer Joint	36	30	59.5	40.5	55	I		





	 YEAR	TRANSM	L/R	F/R	REMARKS	GSP Ref.	 PRODUCT	 ABS	Technical Specifications					
									A	B	C	H	L	P
AUDI														
A3 (8P1)														
1.6 (75 kW)	2003.05-2012.08	AT	L/R	F	Hatchback Engine BSE/BGU/BSF	661011	Inner Joint		26	32	31	68.5	85	
	2003.05-2012.08	MT	L	F	Hatchback Engine BSE/BGU/BSF	203320	Drive Shaft		36		59.5	40	546	
	2003.05-2012.08	6AT	L	F	Hatchback Engine BSE/BGU/BSF	203318	Drive Shaft		36	26	59.5	38	581	
	2003.05-2012.08	6AT	L	F	Hatchback Engine BSE/BGU/BSF	261093	Drive Shaft		36	26	59.5	40.5	587.5	
1.6 E-Power (75 kW)	2011.01-2012.08	-	L/R	F	Hatchback Engine CMXA/CCSA	603011	Inner Joint			33		34		
	2011.01-2012.08	-	L/R	F	Hatchback Engine CMXA/CCSA	261097	Drive Shaft		36		59.5	40.5	543	
	2011.01-2012.08	MT	-	-	Hatchback Engine CMXA/CCSA	603006	Inner Joint			33		34		
	2011.01-2012.08	-	R	F	Hatchback Engine CMXA/CCSA	261096	Drive Shaft		36		59.5	40.5	799	
	2011.01-2012.08	-	L/R	F	Hatchback Engine CMXA/CCSA	803037	Outer Joint		36	30	59.5	40.5	55	I
	2011.01-2012.08	-	L/R	F	Hatchback Engine CMXA/CCSA	203320	Drive Shaft		36		59.5	40	546	
1.6 FSI (85 kW)	2003.08-2007.09	MT	-	-	Hatchback Engine BAG/BLP/BLF	661050	Inner Joint		26	32	31	68.5	89	
	2003.08-2007.09	-	L/R	F	Hatchback Engine BAG/BLP/BLF	803037	Outer Joint		36	30	59.5	40.5	55	I
	2003.08-2007.09	-	-	-	Hatchback Engine BAG/BLP/BLF	261237	Stub Axle		23	37	54		142.5	
	2003.08-2007.09	MT	-	-	Hatchback Engine BAG/BLP/BLF	603016	Inner Joint			28		32		
	2003.08-2007.09	MT	L/R	F	Hatchback Engine BAG/BLP/BLF	603011	Inner Joint			33		34		
	2003.08-2007.09	6MT	R	F	Hatchback Engine BAG/BLP/BLF	261211	Drive Shaft		36		59.5	40.5	784	
	2003.08-2007.09	6MT	L	F	Hatchback Engine BAG/BLP/BLF	803116	Outer Joint		36	30	59.5	38	55	I
	2003.08-2007.09	AT	L/R	F	Hatchback Engine BAG/BLP/BLF	661011	Inner Joint		26	32	31	68.5	85	
	2003.08-2007.09	6MT	L	F	Hatchback Engine BAG/BLP/BLF	203319	Drive Shaft		36		59.5	38	557	
	2003.08-2007.09	MT	-	-	Hatchback Engine BAG/BLP/BLF	603006	Inner Joint			33		34		
1.6 TDI (66 kW)	2009.05-2012.08	-	L	F	Hatchback Engine CAYB	203294	Drive Shaft		36		59.5	38	519	
	2009.05-2012.08	MT	-	-	Hatchback Engine CAYB	603006	Inner Joint			33		34		
	2009.05-2012.08	-	L/R	F	Hatchback Engine CAYB	603011	Inner Joint			33		34		
	2009.05-2012.08	-	L	F	Hatchback Engine CAYB	803116	Outer Joint		36	30	59.5	38	55	I
	2009.05-2012.08	-	R	F	Hatchback Engine CAYB	201585	Drive Shaft		36		59.5	40	805	
	2009.05-2012.08	-	R	F	Hatchback Engine CAYB	261042	Drive Shaft		36		59.5	40.5	814	
	2009.05-2012.08	-	L/R	F	Hatchback Engine CAYB	803037	Outer Joint		36	30	59.5	40.5	55	I
	2009.05-2012.08	MT	-	-	Hatchback Engine CAYB	861059	Outer Joint		36	33	59.5	40	59.5	I
	2009.05-2012.08	MT	-	-	Hatchback Engine CAYC	203294	Drive Shaft		36		59.5	38	519	
1.6 TDI (77 kW)	2009.05-2012.08	MT	L	F	Hatchback Engine CAYC	603016	Inner Joint			28		32		
	2009.05-2012.08	MT	L/R	F	Hatchback Engine CAYC	603011	Inner Joint			33		34		
	2009.05-2012.08	MT	L/R	F	Hatchback Engine CAYC	803037	Outer Joint		36	30	59.5	40.5	55	I
	2009.05-2012.08	Semi-AT	L	F	Hatchback Engine CAYC	261089	Drive Shaft		36		59.5	40.5	521	
	2009.05-2012.08	MT	L	F	Hatchback Engine CAYC	803116	Outer Joint		36	30	59.5	38	55	I
	2009.05-2012.08	MT	R	F	Hatchback Engine CAYC	261042	Drive Shaft		36		59.5	40.5	814	
	2009.05-2012.08	-	R	F	Hatchback Engine CAYC	201585	Drive Shaft		36		59.5	40	805	
	2009.05-2012.08	Semi-AT	R	F	Hatchback Engine CAYC	261280	Drive Shaft		36		59.5	40	801	
	2009.05-2012.08	AT	L/R	F	Hatchback Engine CAYC	803002	Outer Joint		36	27	59.5	40	66	I
	2009.05-2012.08	MT	L	F	Hatchback Engine CAYC	261100	Drive Shaft		36		59.5	40	513	
1.8 TFSI (118 kW)	2006.11-2012.08	MT	R	F	Hatchback Engine BZB/AYT/CDA	203313	Drive Shaft		36		59.5	40	792	
	2006.11-2012.08	MT	L/R	F	Hatchback Engine BZB/AYT/CDA	803002	Outer Joint		36	27	59.5	40	66	I
	2006.11-2012.08	AT/MT	L	F	Hatchback Engine BZB/AYT/CDA	203295	Drive Shaft		36		59.5	40	491	
	2006.11-2012.08	-	-	-	Hatchback Engine BZB/AYT/CDA	861059	Outer Joint		36	33	59.5	40	59.5	I
	2006.11-2012.08	-	L/R	F	Hatchback Engine BZB/AYT/CDA	603011	Inner Joint			33		34		
	2006.11-2012.08	MT	L	F	Hatchback Engine BZB/AYT/CDA	261131	Drive Shaft		36		59.5	40	515	
	2006.11-2012.08	-	-	-	All-wheel Drive Hatchback Engine CDA	603006	Inner Joint			33		34		
1.8 TFSI quattro (118 kW)	2008.07-2012.08	AT/MT	L/R	F	All-wheel Drive Hatchback Engine CDA	803002	Outer Joint		36	27	59.5	40	66	I
	2008.07-2012.08	-	L	F	All-wheel Drive Hatchback Engine CDA	203295	Drive Shaft		36		59.5	40	491	
	2008.07-2012.08	-	R	F	All-wheel Drive Hatchback Engine CDA	203266	Drive Shaft		36		59.5	40	601	
	2008.07-2012.08	-	L/R	R	All-wheel Drive Hatchback Engine CDA	603011	Inner Joint			33		34		
	2008.07-2012.08	-	-	-	All-wheel Drive Hatchback Engine CDA	861059	Outer Joint		36	33	59.5	40	59.5	I
	2008.07-2012.08	-	-	-	All-wheel Drive Hatchback Engine CDA	603011	Inner Joint			33		34		
1.9 TDI (77 kW)	2003.05-2010.05	MT	L/R	F	Hatchback Engine BLS/BKC/BXE	603011	Inner Joint			33		34		
	2003.05-2010.05	MT	L	F	Hatchback Engine BLS/BKC/BXE	203294	Drive Shaft		36		59.5	38	519	
	2003.05-2010.05	AT	L/R	F	Hatchback Engine BLS/BKC/BXE	661057	Inner Joint			34		86		
	2003.05-2010.05	-	-	-	Hatchback Engine BLS/BKC/BXE	261237	Stub Axle		23	37	54		142.5	
	2003.05-2010.05	MT	L/R	F	Hatchback Engine BLS/BKC/BXE	803037	Outer Joint		36	30	59.5	40.5	55	I
	2003.05-2010.05	6AT	L	F	Hatchback Engine BLS/BKC/BXE	254013	Drive Shaft		36		59.5	40	479.5	
	2003.05-2010.05	6AT	L	F	Hatchback Engine BLS/BKC/BXE	654004	Inner Joint			34		85		
	2003.05-2010.05	MT	L	F	Hatchback Engine BLS/BKC/BXE	803116	Outer Joint		36	30	59.5	38	55	I
	2003.05-2010.05	MT	R	F	Hatchback Engine BLS/BKC/BXE	261042	Drive Shaft		36		59.5	40.5	814	
	2003.05-2010.05	-	R	F	Hatchback Engine BLS/BKC/BXE	201585	Drive Shaft		36		59.5	40	805	
	2003.05-2010.05	AT	L/R	F	Hatchback Engine BLS/BKC/BXE	861045	Outer Joint		36	27	59.5	40	65	M
	2003.05-2010.05	AT	L/R	F	Hatchback Engine BLS/BKC/BXE	803002	Outer Joint		36	27	59.5	40	66	I
	2003.05-2010.05	AT	R	F	Hatchback Engine BLS/BKC/BXE	254011	Drive Shaft		36		59.5	40	755	
	2.0 FSI (110 kW)	2003.05-2008.06	MT	R	F	Hatchback Engine BVZ/AXW/BMB/BLX/BLY/BLR/BVY	261113	Drive Shaft		36		59.5	40	814
2003.05-2008.06		MT	L/R	F	Hatchback Engine BVZ/AXW/BMB/BLX/BLY/BLR/BVY	603011	Inner Joint			33		34		

YEAR	TRANSM	L/R	F/R	REMARKS	GSP Ref.	PRODUCT	ABS	Technical Specifications							
								A	B	C	H	L	P		
AUDI															
A3 (8P1)															
2.0 FSI (110 kW)	2003.05-2008.06	AT	R	F	Hatchback Engine BVZ/AXW/BMB/BLX/BLY/BLR/BVY	261094	Drive Shaft	36	26	59.5	40.5	884			
	2003.05-2008.06	-	L/R	F	Hatchback Engine BVZ/AXW/BMB/BLX/BLY/BLR/BVY	803037	Outer Joint	36	30	59.5	40.5	55	I		
	2003.05-2008.06	AT	L/R	F	Hatchback Engine BVZ/AXW/BMB/BLX/BLY/BLR/BVY	661011	Inner Joint	26	32	31	68.5	85			
	2003.05-2008.06	MT	L	F	Hatchback Engine BVZ/AXW/BMB/BLX/BLY/BLR/BVY	803116	Outer Joint	36	30	59.5	38	55	I		
	2003.05-2008.06	AT	L	F	Hatchback Engine BVZ/AXW/BMB/BLX/BLY/BLR/BVY	261093	Drive Shaft	36	26	59.5	40.5	587.5			
2.0 TDI (100 kW)	2003.05-2012.08	MT	L	F	Hatchback Engine AZV/CBAA/CFFA	203295	Drive Shaft	36		59.5	40	491			
	2003.05-2012.08	AT	L/R	F	Hatchback Engine AZV/CBAA/CFFA	661057	Inner Joint		34		86				
	2003.05-2012.08	-	L/R	F	Hatchback Engine AZV/CBAA/CFFA	803002	Outer Joint	36	27	59.5	40	66	I		
	2003.05-2012.08	MT	L	F	Hatchback Engine AZV/CBAA/CFFA	203265	Drive Shaft	36		59.5	40	487			
	2003.05-2012.08	AT	L	F	Hatchback Engine AZV/CBAA/CFFA	254013	Drive Shaft	36		59.5	40	479.5			
	2003.05-2012.08	AT/Semi-AT	L	F	Hatchback Engine AZV/CBAA/CFFA	654004	Inner Joint		34		85				
	2003.05-2012.08	AT	R	F	Hatchback Engine AZV/CBAA/CFFA	203355	Drive Shaft	36	23	59.5	40	799			
	2003.05-2012.08	MT	R	F	Hatchback Engine AZV/CBAA/CFFA	203313	Drive Shaft	36		59.5	40	792			
	2003.05-2012.08	MT	R	F	Hatchback Engine AZV/CBAA/CFFA	261126	Drive Shaft	36		59.5	40	793			
	2003.05-2012.08	AT	R	F	Hatchback Engine AZV/CBAA/CFFA	254011	Drive Shaft	36		59.5	40	755			
	2003.05-2012.08	AT	L/R	F	Hatchback Engine AZV/CBAA/CFFA	861045	Outer Joint	36	27	59.5	40	65	M		
	2.0 TDI (103 kW)	2005.06-2008.06	AT	R	F	Hatchback Engine BMM	254011	Drive Shaft	36		59.5	40	755		
		2005.06-2008.06	MT	L	F	Hatchback Engine BMM	203295	Drive Shaft	36		59.5	40	491		
2005.06-2008.06		MT	L	F	Hatchback Engine BMM	203265	Drive Shaft	36		59.5	40	487			
2005.06-2008.06		AT	L/R	F	Hatchback Engine BMM	661057	Inner Joint		34		86				
2005.06-2008.06		MT	R	F	Hatchback Engine BMM	203236	Drive Shaft	36		59.5	40	484			
2005.06-2008.06		AT/AT	L	F	Hatchback Engine BMM	203241	Drive Shaft	36		59.5	40	475			
2005.06-2008.06		MT	R	F	Hatchback Engine BMM	203313	Drive Shaft	36		59.5	40	792			
2005.06-2008.06		AT	L	F	Hatchback Engine BMM	254013	Drive Shaft	36		59.5	40	479.5			
2005.06-2008.06		AT	L	F	Hatchback Engine BMM	654004	Inner Joint		34		85				
2005.06-2008.06		MT	L/R	F	Hatchback Engine BMM	803002	Outer Joint	36	27	59.5	40	66	I		
2005.06-2008.06		MT	R	F	Hatchback Engine BMM	261126	Drive Shaft	36		59.5	40	793			
2005.06-2008.06		AT	L/R	F	Hatchback Engine BMM	861045	Outer Joint	36	27	59.5	40	65	M		
2.0 TDI (120 kW)		2006.06-2008.06	AT	R	F	Hatchback Engine BUY	254011	Drive Shaft	36		59.5	40	755		
	2006.06-2008.06	MT	L	F	Hatchback Engine BUY	203265	Drive Shaft	36		59.5	40	487			
	2006.06-2008.06	AT	L/R	F	Hatchback Engine BUY	661057	Inner Joint		34		86				
	2006.06-2008.06	MT	R	F	Hatchback Engine BUY	261126	Drive Shaft	36		59.5	40	793			
	2006.06-2008.06	-	L/R	F	Hatchback Engine BUY	861045	Outer Joint	36	27	59.5	40	65	M		
	2006.06-2008.06	AT	R	F	Hatchback Engine BUY	654004	Inner Joint		34		85				
2.0 TDI (125 kW)	2006.03-2012.08	AT	L/R	F	Hatchback Engine BMN/CBBB/CFGB	661057	Inner Joint		34		86				
	2006.03-2012.08	MT	L	F	Hatchback Engine BMN/CBBB/CFGB	203265	Drive Shaft	36		59.5	40	487			
	2006.03-2012.08	AT/AT	L	F	Hatchback Engine BMN/CBBB/CFGB	203241	Drive Shaft	36		59.5	40	475			
	2006.03-2012.08	MT	R	F	Hatchback Engine BMN/CBBB/CFGB	261126	Drive Shaft	36		59.5	40	793			
	2006.03-2012.08	AT	R	F	Hatchback Engine BMN/CBBB/CFGB	654004	Inner Joint		34		85				
	2006.03-2012.08	-	L/R	F	Hatchback Engine BMN/CBBB/CFGB	861045	Outer Joint	36	27	59.5	40	65	M		
2.0 TDI 16V (103 kW)	2006.03-2012.08	AT	R	F	Hatchback Engine BMN/CBBB/CFGB	254011	Drive Shaft	36		59.5	40	755			
	2003.05-2012.08	AT	L/R	F	Hatchback Engine CLJA/CFFB/CBAB/BKD	661057	Inner Joint		34		86				
	2003.05-2012.08	AT/MT/Semi-AT	L/R	F	Hatchback Engine CLJA/CFFB/CBAB/BKD	803002	Outer Joint	36	27	59.5	40	66	I		
	2003.05-2012.08	MT	L	F	Hatchback Engine CLJA/CFFB/CBAB/BKD	203265	Drive Shaft	36		59.5	40	487			
	2003.05-2012.08	MT	R	F	Hatchback Engine CLJA/CFFB/CBAB/BKD	203313	Drive Shaft	36		59.5	40	792			
	2003.05-2012.08	AT	R	F	Hatchback Engine CLJA/CFFB/CBAB/BKD	203355	Drive Shaft	36	23	59.5	40	799			
	2003.05-2012.08	AT	L	F	Hatchback Engine CLJA/CFFB/CBAB/BKD	254013	Drive Shaft	36		59.5	40	479.5			
	2003.05-2012.08	MT	R	F	Hatchback Engine CLJA/CFFB/CBAB/BKD	203236	Drive Shaft	36		59.5	40	484			
	2003.05-2012.08	AT/AT	L	F	Hatchback Engine CLJA/CFFB/CBAB/BKD	203241	Drive Shaft	36		59.5	40	475			
	2003.05-2012.08	AT	L	F	Hatchback Engine CLJA/CFFB/CBAB/BKD	654004	Inner Joint		34		85				
	2003.05-2012.08	MT	R	F	Hatchback Engine CLJA/CFFB/CBAB/BKD	261126	Drive Shaft	36		59.5	40	793			
	2003.05-2012.08	AT	R	F	Hatchback Engine CLJA/CFFB/CBAB/BKD	254011	Drive Shaft	36		59.5	40	755			
	2003.05-2012.08	MT	L/R	F	Hatchback Engine CLJA/CFFB/CBAB/BKD	203295	Drive Shaft	36		59.5	40	491			
2003.05-2012.08	MT/Semi-AT	L/R	F	Hatchback Engine CLJA/CFFB/CBAB/BKD	861045	Outer Joint	36	27	59.5	40	65	M			
2.0 TDI 16V quattro (103 kW)	2004.08-2012.08	-	L/R	R	All-wheel Drive Hatchback Engine BKD/CBAB/CFFB	803037	Outer Joint	36	30	59.5	40.5	55	I		
	2004.08-2012.08	-	L/R	R	All-wheel Drive Hatchback Engine BKD/CBAB/CFFB	603011	Inner Joint		33		34				
	2004.08-2012.08	-	L/R	F	All-wheel Drive Hatchback Engine BKD/CBAB/CFFB	803002	Outer Joint	36	27	59.5	40	66	I		
	2004.08-2012.08	-	R	F	All-wheel Drive Hatchback Engine BKD/CBAB/CFFB	203266	Drive Shaft	36		59.5	40	601			
	2004.08-2012.08	MT	L	R	All-wheel Drive Hatchback Engine BKD/CBAB/CFFB	261284	Drive Shaft	36		59.5	79	594			
	2004.08-2012.08	MT	R	R	All-wheel Drive Hatchback Engine BKD/CBAB/CFFB	261293	Drive Shaft	36		59.5	79	631			
2.0 TDI quattro (103 kW)	2004.08-2012.08	-	L	F	All-wheel Drive Hatchback Engine BKD/CBAB/CFFB	203295	Drive Shaft	36		59.5	40	491			
	2006.01-2008.06	-	L/R	R	All-wheel Drive Hatchback Engine BMM	803037	Outer Joint	36	30	59.5	40.5	55	I		
	2006.01-2008.06	MT	L/R	R	All-wheel Drive Hatchback Engine BMM	603011	Inner Joint		33		34				
	2006.01-2008.06	MT	L/R	F	All-wheel Drive Hatchback Engine BMM	803002	Outer Joint	36	27	59.5	40	66	I		
	2006.01-2008.06	AT/AT	L	F	All-wheel Drive Hatchback Engine BMM	654004	Inner Joint		34		85				
2006.01-2008.06	MT	R	F	All-wheel Drive Hatchback Engine BMM	203266	Drive Shaft	36		59.5	40	601				

YEAR	TRANSM	L/R	F/R	REMARKS	GSP Ref.	PRODUCT	ABS	Technical Specifications							
								A	B	C	H	L	P		
AUDI															
A3 (8P1)															
2.0 TDI quattro (103 kW)	2006.01-2008.06	AT/AT	L	F	All-wheel Drive Hatchback Engine BMM	203241	Drive Shaft		36		59.5	40	475		
	2006.01-2008.06	MT	L	R	All-wheel Drive Hatchback Engine BMM	261284	Drive Shaft		36		59.5	79	594		
	2006.01-2008.06	MT	R	R	All-wheel Drive Hatchback Engine BMM	261293	Drive Shaft		36		59.5	79	631		
	2006.01-2008.06	MT	L	F	All-wheel Drive Hatchback Engine BMM	203295	Drive Shaft		36		59.5	40	491		
2.0 TDI quattro (125 kW)	2006.03-2012.08	-	L/R	R	All-wheel Drive Hatchback Engine BMN/CBBB/CFGB	803037	Outer Joint		36	30	59.5	40.5	55	I	
	2006.03-2012.08	MT	L	F	All-wheel Drive Hatchback Engine BMN/CBBB/CFGB	203295	Drive Shaft		36		59.5	40	491		
	2006.03-2012.08	MT	L/R	R	All-wheel Drive Hatchback Engine BMN/CBBB/CFGB	603011	Inner Joint			33		34			
	2006.03-2012.08	MT	R	F	All-wheel Drive Hatchback Engine BMN/CBBB/CFGB	203266	Drive Shaft		36		59.5	40	601		
	2006.03-2012.08	MT	L	R	All-wheel Drive Hatchback Engine BMN/CBBB/CFGB	261284	Drive Shaft		36		59.5	79	594		
	2006.03-2012.08	MT	R	R	All-wheel Drive Hatchback Engine BMN/CBBB/CFGB	261293	Drive Shaft		36		59.5	79	631		
	2006.03-2012.08	MT	L/R	F	All-wheel Drive Hatchback Engine BMN/CBBB/CFGB	803002	Outer Joint		36	27	59.5	40	66	I	
2.0 TFSI (147 kW)	2004.09-2012.08	MT	L/R	F	Hatchback Engine AXX/BWA/CAWB/CCZA	803002	Outer Joint		36	27	59.5	40	66	I	
	2004.09-2012.08	AMT	R	F	Hatchback Engine AXX/BWA/CAWB/CCZA	203349	Drive Shaft		36		59.5	40	784		
	2004.09-2012.08	-	L	F	Hatchback Engine AXX/BWA/CAWB/CCZA	203295	Drive Shaft		36		59.5	40	491		
2.0 TFSI quattro (147 kW)	2004.09-2012.08	-	L/R	R	All-wheel Drive Hatchback Engine BWA/AXX/CCZA/CCTA	803037	Outer Joint		36	30	59.5	40.5	55	I	
	2004.09-2012.08	MT	L/R	R	All-wheel Drive Hatchback Engine BWA/AXX/CCZA/CCTA	603011	Inner Joint			33		34			
	2004.09-2012.08	-	L	F	All-wheel Drive Hatchback Engine BWA/AXX/CCZA/CCTA	203295	Drive Shaft		36		59.5	40	491		
	2004.09-2012.08	MT	L/R	F	All-wheel Drive Hatchback Engine BWA/AXX/CCZA/CCTA	803002	Outer Joint		36	27	59.5	40	66	I	
	2004.09-2012.08	AMT	R	F	All-wheel Drive Hatchback Engine BWA/AXX/CCZA/CCTA	203349	Drive Shaft		36		59.5	40	784		
	2004.09-2012.08	-	R	R	All-wheel Drive Hatchback Engine BWA/AXX/CCZA/CCTA	635026	Inner Joint		36	33	59.5	40	39		
3.2 V6 quattro (184 kW)	2003.07-2009.05	-	L/R	R	All-wheel Drive Hatchback Engine BDB/BMJ/BUB	803037	Outer Joint		36	30	59.5	40.5	55	I	
	2003.07-2009.05	MT	L/R	R	All-wheel Drive Hatchback Engine BDB/BMJ/BUB	603011	Inner Joint			33		34			
	2003.07-2009.05	AT/MT	R	F	All-wheel Drive Hatchback Engine BDB/BMJ/BUB	203266	Drive Shaft		36		59.5	40	601		
	2003.07-2009.05	AT/AT	L	F	All-wheel Drive Hatchback Engine BDB/BMJ/BUB	654004	Inner Joint			34		85			
	2003.07-2009.05	AT/AT	L	F	All-wheel Drive Hatchback Engine BDB/BMJ/BUB	203241	Drive Shaft		36		59.5	40	475		
	2003.07-2009.05	MT	L	R	All-wheel Drive Hatchback Engine BDB/BMJ/BUB	261284	Drive Shaft		36		59.5	79	594		
	2003.07-2009.05	-	L/R	F	All-wheel Drive Hatchback Engine BDB/BMJ/BUB	803002	Outer Joint		36	27	59.5	40	66	I	
	2003.07-2009.05	MT	R	R	All-wheel Drive Hatchback Engine BDB/BMJ/BUB	261293	Drive Shaft		36		59.5	79	631		
S3 quattro (188 kW)	2007.02-2012.08	-	L/R	R	All-wheel Drive Hatchback Engine BZC/CDLC	803037	Outer Joint		36	30	59.5	40.5	55	I	
	2007.02-2012.08	MT	-	-	All-wheel Drive Hatchback Engine BZC/CDLC	661050	Inner Joint		26	32	31	68.5	89		
	2007.02-2012.08	-	L/R	F	All-wheel Drive Hatchback Engine BZC/CDLC	803002	Outer Joint		36	27	59.5	40	66	I	
	2007.02-2012.08	MT	L/R	R	All-wheel Drive Hatchback Engine BZC/CDLC	603011	Inner Joint			33		34			
	2007.02-2012.08	-	L	F	All-wheel Drive Hatchback Engine BZC/CDLC	203295	Drive Shaft		36		59.5	40	491		
	2007.02-2012.08	-	R	R	All-wheel Drive Hatchback Engine BZC/CDLC	635026	Inner Joint		36	33	59.5	40	39		
S3 quattro (195 kW)	2006.11-2012.08	-	L/R	R	All-wheel Drive Hatchback Engine CDLA/BHZ	803037	Outer Joint		36	30	59.5	40.5	55	I	
	2006.11-2012.08	MT	-	-	All-wheel Drive Hatchback Engine CDLA/BHZ	661050	Inner Joint		26	32	31	68.5	89		
	2006.11-2012.08	MT	L/R	R	All-wheel Drive Hatchback Engine CDLA/BHZ	603011	Inner Joint			33		34			
	2006.11-2012.08	-	L/R	F	All-wheel Drive Hatchback Engine CDLA/BHZ	803002	Outer Joint		36	27	59.5	40	66	I	
	2006.11-2012.08	-	L	F	All-wheel Drive Hatchback Engine CDLA/BHZ	203295	Drive Shaft		36		59.5	40	491		
2006.11-2012.08	-	R	R	All-wheel Drive Hatchback Engine CDLA/BHZ	635026	Inner Joint		36	33	59.5	40	39			
A3 (8P7)															
1.2 TFSI (77 kW)	2010.03-2013.05	Semi-AT	L	F	Convertible Engine CBZB	261201	Drive Shaft		36		59.5	40.5	535		
	2010.03-2013.05	MT	-	-	Convertible Engine CBZB	603006	Inner Joint			33		34			
	2010.03-2013.05	Semi-AT	-	F	Convertible Engine CBZB	803100	Outer Joint		36	33	59.5	38	55	I	
	2010.03-2013.05	-	L/R	F	Convertible Engine CBZB	603011	Inner Joint			33		34			
1.4 TFSI (92 kW)	2011.02-2013.05	-	L/R	F	Convertible Engine CAXC	603011	Inner Joint			33		34			
	2011.02-2013.05	MT	R	F	Convertible Engine CAXC	201586	Drive Shaft		36		59.5	40	806		
	2011.02-2013.05	MT	-	-	Convertible Engine CAXC	603006	Inner Joint			33		34			
1.6 (75 kW)	2011.02-2013.05	MT	-	-	Convertible Engine CAXC	861059	Outer Joint		36	33	59.5	40	59.5	I	
	2008.09-2010.05	MT	-	-	Convertible Engine BSE	603006	Inner Joint			33		34			
	2008.09-2010.05	-	L	F	Convertible Engine BSE	261097	Drive Shaft		36		59.5	40.5	543		
	2008.09-2010.05	-	L/R	F	Convertible Engine BSE	603011	Inner Joint			33		34			
	2008.09-2010.05	5MT	R	F	Convertible Engine BSE	261096	Drive Shaft		36		59.5	40.5	799		
	2008.09-2010.05	-	L	F	Convertible Engine BSE	203320	Drive Shaft		36		59.5	40	546		
1.6 TDI (77 kW)	2009.05-2013.05	-	L	F	Convertible Engine CAYC	203294	Drive Shaft		36		59.5	38	519		
	2009.05-2013.05	MT	-	-	Convertible Engine CAYC	603006	Inner Joint			33		34			
	2009.05-2013.05	-	L/R	F	Convertible Engine CAYC	603011	Inner Joint			33		34			
	2009.05-2013.05	-	L	F	Convertible Engine CAYC	803116	Outer Joint		36	30	59.5	38	55	I	
	2009.05-2013.05	-	R	F	Convertible Engine CAYC	201585	Drive Shaft		36		59.5	40	805		
	2009.05-2013.05	-	R	F	Convertible Engine CAYC	261042	Drive Shaft		36		59.5	40.5	814		
	2009.05-2013.05	-	L/R	F	Convertible Engine CAYC	803037	Outer Joint		36	30	59.5	40.5	55	I	
1.8 TFSI (118 kW)	2008.04-2013.05	6AT	L	F	Convertible Engine BZB/CDA	203295	Drive Shaft		36		59.5	40	491		
	2008.04-2013.05	MT	L	F	Convertible Engine BZB/CDA	261100	Drive Shaft		36		59.5	40	513		

YEAR	TRANSM	L/R	F/R	REMARKS	GSP Ref.	PRODUCT	ABS	Technical Specifications								
								A	B	C	H	L	P			
AUDI																
A3 (8P7)																
1.8 TFSI (118 kW)	2008.04-2013.05	-	-	-	Convertible Engine BZB/CDA	603006	Inner Joint		33		34					
	2008.04-2013.05	6AT/MT	L/R	F	Convertible Engine BZB/CDA	803002	Outer Joint	36	27	59.5	40	66	I			
	2008.04-2013.05	-	-	-	Convertible Engine BZB/CDA	861059	Outer Joint	36	33	59.5	40	59.5	I			
	2008.04-2013.05	MT	L/R	F	Convertible Engine BZB/CDA	603011	Inner Joint		33		34					
	2008.04-2013.05	MT	L	F	Convertible Engine BZB/CDA	261131	Drive Shaft	36		59.5	40	515				
1.9 TDI (77 kW)	2008.04-2009.10	-	L	F	Convertible Engine BLS	203294	Drive Shaft	36		59.5	38	519				
	2008.04-2009.10	MT	-	-	Convertible Engine BLS	603006	Inner Joint		33		34					
	2008.04-2009.10	-	L/R	F	Convertible Engine BLS	603011	Inner Joint		33		34					
	2008.04-2009.10	-	L	F	Convertible Engine BLS	803116	Outer Joint	36	30	59.5	38	55	I			
	2008.04-2009.10	-	R	F	Convertible Engine BLS	201585	Drive Shaft	36		59.5	40	805				
	2008.04-2009.10	-	R	F	Convertible Engine BLS	261042	Drive Shaft	36		59.5	40.5	814				
2.0 TDI (100 kW)	2008.04-2013.05	-	L/R	F	Convertible Engine CBAA/CFFA	803037	Outer Joint	36	30	59.5	40.5	55	I			
	2008.04-2013.05	AT	L/R	F	Convertible Engine CBAA/CFFA	661057	Inner Joint		34		86					
	2008.04-2013.05	MT	L	F	Convertible Engine CBAA/CFFA	203295	Drive Shaft	36		59.5	40	491				
	2008.04-2013.05	AT	R	F	Convertible Engine CBAA/CFFA	254011	Drive Shaft	36		59.5	40	755				
	2008.04-2013.05	-	L/R	F	Convertible Engine CBAA/CFFA	803002	Outer Joint	36	27	59.5	40	66	I			
	2008.04-2013.05	AT	L	F	Convertible Engine CBAA/CFFA	254013	Drive Shaft	36		59.5	40	479.5				
	2008.04-2013.05	AT	L	F	Convertible Engine CBAA/CFFA	654004	Inner Joint		34		85					
	2008.04-2013.05	MT	R	F	Convertible Engine CBAA/CFFA	203236	Drive Shaft	36		59.5	40	484				
2.0 TDI (103 kW)	2008.04-2013.05	AT	L	F	Convertible Engine CBAA/CFFA	203241	Drive Shaft	36		59.5	40	475				
	2008.04-2013.05	MT	R	F	Convertible Engine CBAA/CFFA	203313	Drive Shaft	36		59.5	40	792				
	2008.04-2013.05	AT	R	F	Convertible Engine CBAB/CFFB	254011	Drive Shaft	36		59.5	40	755				
	2008.04-2013.05	MT	L	F	Convertible Engine CBAB/CFFB	203295	Drive Shaft	36		59.5	40	491				
	2008.04-2013.05	AT	L/R	F	Convertible Engine CBAB/CFFB	661057	Inner Joint		34		86					
	2008.04-2013.05	AT	L	F	Convertible Engine CBAB/CFFB	254013	Drive Shaft	36		59.5	40	479.5				
	2008.04-2013.05	AT	L	F	Convertible Engine CBAB/CFFB	654004	Inner Joint		34		85					
	2008.04-2013.05	MT	R	F	Convertible Engine CBAB/CFFB	203236	Drive Shaft	36		59.5	40	484				
2.0 TFSI (147 kW)	2008.04-2013.05	AT	R	F	Convertible Engine CBAB/CFFB	203313	Drive Shaft	36		59.5	40	792				
	2008.04-2013.05	MT	R	F	Convertible Engine CBAB/CFFB	803002	Outer Joint	36	27	59.5	40	66	I			
	2008.04-2013.05	Semi-AT	L	F	Convertible Engine CBAB/CFFB	203241	Drive Shaft	36		59.5	40	475				
	2008.04-2013.05	AT	R	F	Convertible Engine CAWB/CCZA	203349	Drive Shaft	36		59.5	40	784				
	2008.04-2013.05	-	L	F	Convertible Engine CAWB/CCZA	203295	Drive Shaft	36		59.5	40	491				
	2008.04-2013.05	MT	L/R	F	Convertible Engine CAWB/CCZA	803002	Outer Joint	36	27	59.5	40	66	I			
	A3 (8V1 8VK)															
	1.0 TFSI (85 kW)	2016.07-	-	MT	-	F Hatchback Engine CHZD	803100	Outer Joint	36	33	59.5	38	55	I		
1.2 TFSI (77 kW)	2013.02-	-	MT	-	F Hatchback Engine CJZA	803100	Outer Joint	36	33	59.5	38	55	I			
	2013.02-	-	-	L/R	F Hatchback Engine CJZA	603011	Inner Joint		33		34					
	2013.02-	-	MT	L	F Hatchback Engine CJZA	261089	Drive Shaft	36		59.5	40.5	521				
	2013.02-	-	MT	L	F Hatchback Engine CJZA	261277	Drive Shaft	36		59.5	40	516				
	2013.02-	-	MT	R	F Hatchback Engine CJZA	261200	Drive Shaft	36		59.5	40.5	820				
1.2 TFSI (81 kW)	2014.05-	-	MT	L/R	F Hatchback Engine CYVB	803037	Outer Joint	36	30	59.5	40.5	55	I			
	2014.05-	-	MT	-	F Hatchback Engine CYVB	803100	Outer Joint	36	33	59.5	38	55	I			
	2014.05-	-	MT	L/R	F Hatchback Engine CYVB	603011	Inner Joint		33		34					
	2014.05-	-	MT	L	F Hatchback Engine CYVB	261089	Drive Shaft	36		59.5	40.5	521				
	2014.05-	-	MT	L	F Hatchback Engine CYVB	203373	Drive Shaft	36		59.5	38	511				
	2014.05-	-	MT	R	F Hatchback Engine CYVB	261200	Drive Shaft	36		59.5	40.5	820				
	2014.05-	-	MT	L	F Hatchback Engine CYVB	803116	Outer Joint	36	30	59.5	38	55	I			
1.4 TFSI (103 kW)	2013.03-	-	MT	-	F Hatchback Engine CPTA	803100	Outer Joint	36	33	59.5	38	55	I			
	2013.03-	-	AT	-	F Hatchback Engine CPTA	803101	Outer Joint	36	27	59.5	40	65	M			
1.4 TFSI (110 kW)	2014.05-	-	AT	-	F Hatchback Engine CZEA	803101	Outer Joint	36	27	59.5	40	65	M			
	2014.05-	-	MT	-	F Hatchback Engine CZEA	803100	Outer Joint	36	33	59.5	38	55	I			
	2014.05-	-	MT	L/R	F Hatchback Engine CZEA	603011	Inner Joint		33		34					
1.4 TFSI (90 kW)	2012.04-	-	MT	-	F Hatchback Engine CMBA/CXSA	803100	Outer Joint	36	33	59.5	38	55	I			
	2012.04-	-	-	L/R	F Hatchback Engine CMBA/CXSA	603011	Inner Joint		33		34					
	2012.04-	-	MT	L	F Hatchback Engine CMBA/CXSA	261089	Drive Shaft	36		59.5	40.5	521				
	2012.04-	-	MT	R	F Hatchback Engine CMBA/CXSA	261200	Drive Shaft	36		59.5	40.5	820				
1.4 TFSI (92 kW)	2014.05-	-	MT	-	F Hatchback Engine CXSB/CZCA	803100	Outer Joint	36	33	59.5	38	55	I			
	2014.05-	-	MT	L/R	F Hatchback Engine CXSB/CZCA	603011	Inner Joint		33		34					
	2014.05-	-	MT	L	F Hatchback Engine CXSB/CZCA	261089	Drive Shaft	36		59.5	40.5	521				
	2014.05-	-	MT	R	F Hatchback Engine CXSB/CZCA	261200	Drive Shaft	36		59.5	40.5	820				
1.6 TDI (77 kW)	2012.10-	-	MT	-	F Hatchback Engine CLHA	803100	Outer Joint	36	33	59.5	38	55	I			
	2012.10-	-	-	L/R	F Hatchback Engine CLHA	603011	Inner Joint		33		34					
	2012.10-	-	7AT/MT	L	F Hatchback Engine CLHA	261089	Drive Shaft	36		59.5	40.5	521				
	2012.10-	-	MT	R	F Hatchback Engine CLHA	261200	Drive Shaft	36		59.5	40.5	820				
	2012.10-	-	7AT	R	F Hatchback Engine CLHA	261280	Drive Shaft	36		59.5	40	801				
1.6 TDI (81 kW)	2013.09-	-	MT	-	F Hatchback Engine CRKB/CXXB/DBKA	803100	Outer Joint	36	33	59.5	38	55	I			

	 YEAR	TRANSM	L/R	F/R	REMARKS	GSP Ref.	 PRODUCT	 ABS	Technical Specifications					
									A	B	C	H	L	P
AUDI														
A3 (8V1, 8VK)														
1.6 TDI (81 kW)	2013.09-	7AT/MT	L	F	Hatchback Engine CRKB/CXXB/DBKA	261089	Drive Shaft		36		59.5	40.5	521	
	2013.09-	MT/DCT	L/R	F	Hatchback Engine CRKB/CXXB/DBKA	603011	Inner Joint			33		34		
	2013.09-	MT	R	F	Hatchback Engine CRKB/CXXB/DBKA	261200	Drive Shaft		36		59.5	40.5	820	
	2013.09-	7AT	R	F	Hatchback Engine CRKB/CXXB/DBKA	261280	Drive Shaft		36		59.5	40	801	
1.6 TDI (85 kW)	2017.02-	-	L/R	F	Hatchback Engine DDYA	603011	Inner Joint			33		34		
1.8 TFSI (132 kW)	2012.04-	MT	-	F	Hatchback Engine CJSA	803101	Outer Joint		36	27	59.5	40	65	M
	2012.04-	MT	L	F	Hatchback Engine CJSA	261304	Drive Shaft		36		59.5	40	511	
1.8 TFSI quattro (132 kW)	2012.08-	AT	-	-	All-wheel Drive Hatchback Engine CJSB	603016	Inner Joint			28		32		
2.0 TDI (100 kW)	2013.05-	-	-	F	Hatchback Engine CRBD/CRLC	803101	Outer Joint		36	27	59.5	40	65	M
	2013.05-	AT	L	F	Hatchback Engine CRBD/CRLC	261285	Drive Shaft		36		59.5	40	472	
	2013.05-	AT	R	F	Hatchback Engine CRBD/CRLC	203354	Drive Shaft		36		59.5	40	763	
2.0 TDI (105 kW)	2012.09-	-	-	F	Hatchback Engine CRFC	803101	Outer Joint		36	27	59.5	40	65	M
	2012.09-	AT	L	F	Hatchback Engine CRFC	261285	Drive Shaft		36		59.5	40	472	
	2012.09-	AT	R	F	Hatchback Engine CRFC	203354	Drive Shaft		36		59.5	40	763	
2.0 TDI (110 kW)	2012.04-	MT	-	F	Hatchback Engine CRBC/CRLB/CRUA/DEJA/DBGA	803101	Outer Joint		36	27	59.5	40	65	M
	2012.04-	AT	L	F	Hatchback Engine CRBC/CRLB/CRUA/DEJA/DBGA	261285	Drive Shaft		36		59.5	40	472	
	2012.04-	AT	R	F	Hatchback Engine CRBC/CRLB/CRUA/DEJA/DBGA	203354	Drive Shaft		36		59.5	40	763	
2.0 TDI (135 kW)	2013.05-	Semi-AT	L	F	Hatchback Engine CUNA	261285	Drive Shaft		36		59.5	40	472	
	2013.05-	AT	-	-	Hatchback Engine CUNA	603016	Inner Joint			28		32		
2.0 TDI (81 kW)	2013.01-	MT	-	F	Hatchback Engine CRFA	803100	Outer Joint		36	33	59.5	38	55	I
	2013.01-	MT	L	F	Hatchback Engine CRFA	261089	Drive Shaft		36		59.5	40.5	521	
	2013.01-	-	L/R	F	Hatchback Engine CRFA	603011	Inner Joint			33		34		
	2013.01-	MT	R	F	Hatchback Engine CRFA	261200	Drive Shaft		36		59.5	40.5	820	
2.0 TDI quattro (110 kW)	2012.10-	-	-	F	All-wheel Drive Hatchback Engine CRBC	803101	Outer Joint		36	27	59.5	40	65	M
2.0 TDI quattro (135 kW)	2012.12-	Semi-AT	L	F	All-wheel Drive Hatchback Engine CUNA	261285	Drive Shaft		36		59.5	40	472	
	2012.12-	AT	-	-	All-wheel Drive Hatchback Engine CUNA	603016	Inner Joint			28		32		
A3 (8V1, 8VK)														
1.5 TFSI(110 kW)	2017.05-	6MT	L/R	F	Hatchback Engine DADA	603011	Inner Joint			33		34		
A3 (8V7, 8VE)														
1.4 TFSI (103 kW)	2013.10-	-	L/R	F	Convertible Engine CPTA	603011	Inner Joint			33		34		
	2013.10-	MT	-	F	Convertible Engine CPTA	803100	Outer Joint		36	33	59.5	38	55	I
1.4 TFSI (110 kW)	2014.05-	AT	-	F	Convertible Engine CZEA	803101	Outer Joint		36	27	59.5	40	65	M
	2014.05-	MT	-	F	Convertible Engine CZEA	803100	Outer Joint		36	33	59.5	38	55	I
	2014.05-	-	L/R	F	Convertible Engine CZEA	603011	Inner Joint			33		34		
1.4 TFSI (85 kW)	2016.02-	-	L/R	F	Convertible Engine CZCC	603011	Inner Joint			33		34		
1.4 TFSI (92 kW)	2014.02-	MT	-	F	Convertible Engine CXSB/CZCA	803100	Outer Joint		36	33	59.5	38	55	I
	2014.02-	AT/MT	L/R	F	Convertible Engine CXSB/CZCA	603011	Inner Joint			33		34		
	2014.02-	MT	L	F	Convertible Engine CXSB/CZCA	261089	Drive Shaft		36		59.5	40.5	521	
	2014.02-	MT	L	F	Convertible Engine CXSB/CZCA	253007	Drive Shaft		36		59.5	40	559	
	2014.02-	MT	R	F	Convertible Engine CXSB/CZCA	261200	Drive Shaft		36		59.5	40.5	820	
1.6 TDI (81 kW)	2014.02-	MT	-	-	Convertible Engine CRKB/CXXB	861059	Outer Joint		36	33	59.5	40	59.5	I
	2014.02-	MT	-	F	Convertible Engine CRKB/CXXB	803100	Outer Joint		36	33	59.5	38	55	I
	2014.02-	MT	L	F	Convertible Engine CRKB/CXXB	261089	Drive Shaft		36		59.5	40.5	521	
	2014.02-	AT/MT	L/R	F	Convertible Engine CRKB/CXXB	603011	Inner Joint			33		34		
	2014.02-	MT	-	-	Convertible Engine CRKB/CXXB	603006	Inner Joint			33		34		
	2014.02-	MT	R	F	Convertible Engine CRKB/CXXB	261200	Drive Shaft		36		59.5	40.5	820	
1.8 TFSI quattro (132 kW)	2014.03-	AT	-	-	All-wheel Drive Convertible Engine CJSB	603016	Inner Joint			28		32		
2.0 TDI (100 kW)	2013.10-	-	-	F	Convertible Engine CRLC	803101	Outer Joint		36	27	59.5	40	65	M
	2013.10-	AT	L	F	Convertible Engine CRLC	261285	Drive Shaft		36		59.5	40	472	
	2013.10-	AT	R	F	Convertible Engine CRLC	203354	Drive Shaft		36		59.5	40	763	
	2013.10-	AT	-	-	Convertible Engine CRLC	603016	Inner Joint			28		32		
2.0 TDI (110 kW)	2013.10-	MT	-	F	Convertible Engine CRLB	803101	Outer Joint		36	27	59.5	40	65	M
	2013.10-	AT	L	F	Convertible Engine CRLB	261285	Drive Shaft		36		59.5	40	472	
	2013.10-	AT	R	F	Convertible Engine CRLB	203354	Drive Shaft		36		59.5	40	763	
	2013.10-	AT	-	-	Convertible Engine CRLB	603016	Inner Joint			28		32		
2.0 TDI (135 kW)	2014.05-	Semi-AT	L	F	Convertible Engine CUNA	261285	Drive Shaft		36		59.5	40	472	
	2014.05-	AT	-	-	Convertible Engine CUNA	603016	Inner Joint			28		32		
2.0 TDI quattro (110 kW)	2014.03-	-	-	F	All-wheel Drive Convertible Engine CRLB	803101	Outer Joint		36	27	59.5	40	65	M
	2014.03-	AT	-	-	All-wheel Drive Convertible Engine CRLB	603016	Inner Joint			28		32		
2.0 TDI quattro (135 kW)	2014.05-	Semi-AT	L	F	All-wheel Drive Convertible Engine CUNA	261285	Drive Shaft		36		59.5	40	472	
	2014.05-	AT	-	-	All-wheel Drive Convertible Engine CUNA	603016	Inner Joint			28		32		
40 TFSI (132 kW)	2013.10-	MT	-	F	Convertible Engine CJSA	803101	Outer Joint		36	27	59.5	40	65	M
	2013.10-	MT	L	F	Convertible Engine CJSA	261304	Drive Shaft		36		59.5	40	511	
A3 (8V7, 8VE)														
1.5 TFSI(110 kW)	2017.05-	-	-	L/R	Convertible Engine DADA	603011	Inner Joint			33		34		
A3 (8VA, 8VF)														

	 YEAR	TRANSM	L/R	F/R	REMARKS	GSP Ref.	 PRODUCT	 ABS	Technical Specifications					
									A	B	C	H	L	P
AUDI														
A3 (8VA, 8VF)														
1.5 TFSI(110 kW)	2017.05-	6MT	L/R	F	Hatchback/Sportback/运动掀背车 Engine DADA	603011	Inner Joint		33	34				
A3 (8VS, 8VM)														
1.5 TFSI(110 kW)	2017.05-	6MT	L/R	F	Saloon/Limousine Engine DADA	603011	Inner Joint		33	34				
A3 I														
1.9 TDi	1996.09-2001.07	MT	-	F	All	603013	Inner Joint		33	34				
A3 I QUATTRO														
1.8	1996.09-2003.05	MT	-	F	All	603013	Inner Joint		33	34				
1.8 Turbo	1996.09-2003.05	MT	-	F	All	603013	Inner Joint		33	34				
A3 Limousine (8VS 8VM)														
1.0 TFSI (85 kW)	2016.07-	MT	-	F	Saloon Engine CHZD	803100	Outer Joint		36	33	59.5	38	55	I
1.2 TFSI (77 kW)	2013.10-	MT	L/R	F	Saloon Engine CJZA	803037	Outer Joint		36	30	59.5	40.5	55	I
	2013.10-	MT	-	F	Saloon Engine CJZA	803100	Outer Joint		36	33	59.5	38	55	I
	2013.10-	MT	L	F	Saloon Engine CJZA	261089	Drive Shaft		36		59.5	40.5	521	
	2013.10-	MT	L/R	F	Saloon Engine CJZA	603011	Inner Joint		33		34			
	2013.10-	MT	L	F	Saloon Engine CJZA	261277	Drive Shaft		36		59.5	40	516	
	2013.10-	MT	L	F	Saloon Engine CJZA	203373	Drive Shaft		36		59.5	38	511	
	2013.10-	MT	R	F	Saloon Engine CJZA	261200	Drive Shaft		36		59.5	40.5	820	
	2013.10-	MT	L	F	Saloon Engine CJZA	803116	Outer Joint		36	30	59.5	38	55	I
1.2 TFSI (81 kW)	2014.05-	MT	-	-	Saloon Engine CYVB	861059	Outer Joint		36	33	59.5	40	59.5	I
	2014.05-	MT	L/R	F	Saloon Engine CYVB	803037	Outer Joint		36	30	59.5	40.5	55	I
	2014.05-	MT	-	F	Saloon Engine CYVB	803100	Outer Joint		36	33	59.5	38	55	I
	2014.05-	MT	L/R	F	Saloon Engine CYVB	603011	Inner Joint		33		34			
	2014.05-	MT	L	F	Saloon Engine CYVB	261089	Drive Shaft		36		59.5	40.5	521	
	2014.05-	MT	L	F	Saloon Engine CYVB	203373	Drive Shaft		36		59.5	38	511	
	2014.05-	MT	-	-	Saloon Engine CYVB	603006	Inner Joint		33		34			
	2014.05-	MT	R	F	Saloon Engine CYVB	261200	Drive Shaft		36		59.5	40.5	820	
1.4 TFSI (103 kW)	2013.05-	Semi-AT	-	F	Saloon Engine CPTA	803101	Outer Joint		36	27	59.5	40	65	M
	2013.05-	MT	L/R	F	Saloon Engine CPTA	603011	Inner Joint		33		34			
1.4 TFSI (110 kW)	2014.05-	AT	-	F	Saloon Engine CZEA	803101	Outer Joint		36	27	59.5	40	65	M
	2014.05-	MT	-	F	Saloon Engine CZEA	803100	Outer Joint		36	33	59.5	38	55	I
	2014.05-	MT	L/R	F	Saloon Engine CZEA	603011	Inner Joint		33		34			
1.4 TFSI (90 kW)	2013.09-	AT	-	-	Saloon Engine CMBA/CXSA	861059	Outer Joint		36	33	59.5	40	59.5	I
	2013.09-	MT	-	F	Saloon Engine CMBA/CXSA	803100	Outer Joint		36	33	59.5	38	55	I
	2013.09-	MT	L	F	Saloon Engine CMBA/CXSA	261089	Drive Shaft		36		59.5	40.5	521	
	2013.09-	MT	R	F	Saloon Engine CMBA/CXSA	261200	Drive Shaft		36		59.5	40.5	820	
	2013.09-	AT	-	-	Saloon Engine CMBA/CXSA	603006	Inner Joint		33		34			
1.4 TFSI (92 kW)	2013.09-	MT	-	F	Saloon Engine CXSB/CZCA	803100	Outer Joint		36	33	59.5	38	55	I
	2013.09-	MT	L	F	Saloon Engine CXSB/CZCA	261089	Drive Shaft		36		59.5	40.5	521	
	2013.09-	AT/MT	L/R	F	Saloon Engine CXSB/CZCA	603011	Inner Joint		33		34			
	2013.09-	MT	R	F	Saloon Engine CXSB/CZCA	261200	Drive Shaft		36		59.5	40.5	820	
1.6 TDI (77 kW)	2013.09-	MT	-	F	Saloon Engine CLHA	803100	Outer Joint		36	33	59.5	38	55	I
	2013.09-	7AT/MT	L	F	Saloon Engine CLHA	261089	Drive Shaft		36		59.5	40.5	521	
	2013.09-	MT	R	F	Saloon Engine CLHA	261200	Drive Shaft		36		59.5	40.5	820	
	2013.09-	7AT	R	F	Saloon Engine CLHA	261280	Drive Shaft		36		59.5	40	801	
1.6 TDI (81 kW)	2014.05-	MT	-	F	Saloon Engine CRKB/CXXB/DBKA	803100	Outer Joint		36	33	59.5	38	55	I
	2014.05-	7AT/MT	L	F	Saloon Engine CRKB/CXXB/DBKA	261089	Drive Shaft		36		59.5	40.5	521	
	2014.05-	MT	L/R	F	Saloon Engine CRKB/CXXB/DBKA	603011	Inner Joint		33		34			
	2014.05-	MT	R	F	Saloon Engine CRKB/CXXB/DBKA	261200	Drive Shaft		36		59.5	40.5	820	
	2014.05-	7AT	R	F	Saloon Engine CRKB/CXXB/DBKA	261280	Drive Shaft		36		59.5	40	801	
1.6 TDI (85 kW)	2017.03-	-	L/R	F	Saloon Engine DDYA	603011	Inner Joint		33	34				
1.8 TFSI (132 kW)	2013.05-	MT	-	F	Saloon Engine CJSA/CJSB	803101	Outer Joint		36	27	59.5	40	65	M
	2013.05-	MT	L	F	Saloon Engine CJSA/CJSB	261304	Drive Shaft		36		59.5	40	511	
1.8 TFSI quattro (132 kW)	2013.11-	AT	-	-	All-wheel Drive Saloon Engine CJSB	603016	Inner Joint		28		32			
2.0 TDI (100 kW)	2013.09-	-	-	F	Saloon Engine CRLC/CRBD	803101	Outer Joint		36	27	59.5	40	65	M
	2013.09-	AT	L	F	Saloon Engine CRLC/CRBD	261285	Drive Shaft		36		59.5	40	472	
	2013.09-	AT	R	F	Saloon Engine CRLC/CRBD	203354	Drive Shaft		36		59.5	40	763	
2.0 TDI (105 kW)	2013.10-	-	-	F	Saloon Engine CRFC	803101	Outer Joint		36	27	59.5	40	65	M
	2013.10-	AT	L	F	Saloon Engine CRFC	261285	Drive Shaft		36		59.5	40	472	
	2013.10-	AT	R	F	Saloon Engine CRFC	203354	Drive Shaft		36		59.5	40	763	
2.0 TDI (110 kW)	2013.05-	MT	-	F	Saloon Engine CRLB/CRBC/CRUA/DEJA/DBGA	803101	Outer Joint		36	27	59.5	40	65	M
	2013.05-	AT	L	F	Saloon Engine CRLB/CRBC/CRUA/DEJA/DBGA	261285	Drive Shaft		36		59.5	40	472	
	2013.05-	AT	R	F	Saloon Engine CRLB/CRBC/CRUA/DEJA/DBGA	203354	Drive Shaft		36		59.5	40	763	
2.0 TDI (135 kW)	2014.05-	Semi-AT	L	F	Saloon Engine CUNA	261285	Drive Shaft		36		59.5	40	472	
	2014.05-	AT	-	-	Saloon Engine CUNA	603016	Inner Joint		28		32			
2.0 TDI (81 kW)	2013.05-	MT	-	F	Saloon Engine CRFA/DEJB	803100	Outer Joint		36	33	59.5	38	55	I

YEAR	TRANSM	L/R	F/R	REMARKS	GSP Ref.	PRODUCT	ABS	Technical Specifications						
								A	B	C	H	L	P	
AUDI														
A3 Limousine (8VS 8VM)														
2.0 TDI (81 kW)	2013.05-	-	MT	L F	Saloon Engine CRFA/DEJB	261089	Drive Shaft	36		59.5	40.5	521		
	2013.05-	-	MT	L/R F	Saloon Engine CRFA/DEJB	603011	Inner Joint		33		34			
	2013.05-	-	MT	R F	Saloon Engine CRFA/DEJB	261200	Drive Shaft	36		59.5	40.5	820		
2.0 TDI quattro (110 kW)	2013.10-	-	-	- F	All-wheel Drive Saloon Engine CRBC/CRLB	803101	Outer Joint	36	27	59.5	40	65	M	
2.0 TDI quattro (135 kW)	2014.05-	-	Semi-AT	L F	All-wheel Drive Saloon Engine CUNA	261285	Drive Shaft	36		59.5	40	472		
	2014.05-	-	AT	- -	All-wheel Drive Saloon Engine CUNA	603016	Inner Joint		28		32			
A3 Limousine (8VS, 8VM)														
RS3 quattro (294 kW)	2017.04-	-	-	L/R R	All-wheel Drive Saloon Engine DAZA	603011	Inner Joint		33		34			
A3 Sportback (8PA)														
1.2 TSI (77 kW)	2010.04-	2013.03	Semi-AT	L F	Hatchback Engine CBZB	261201	Drive Shaft	36		59.5	40.5	535		
	2010.04-	2013.03	Semi-AT	- F	Hatchback Engine CBZB	803100	Outer Joint	36	33	59.5	38	55	I	
	2010.04-	2013.03	-	L/R F	Hatchback Engine CBZB	603011	Inner Joint		33		34			
	2010.04-	2013.03	-	- R	Hatchback Engine CBZB	635026	Inner Joint	36	33	59.5	40	39		
1.4 TFSI (92 kW)	2007.09-	2013.03	-	- -	Hatchback Engine CAXC/CMSA	603016	Inner Joint		28		32			
	2007.09-	2013.03	MT	L/R F	Hatchback Engine CAXC/CMSA	603011	Inner Joint		33		34			
	2007.09-	2013.03	MT	L/R F	Hatchback Engine CAXC/CMSA	803037	Outer Joint	36	30	59.5	40.5	55	I	
	2007.09-	2013.03	-	- -	Hatchback Engine CAXC/CMSA	861059	Outer Joint	36	33	59.5	40	59.5	I	
	2007.09-	2013.03	AT	L/R F	Hatchback Engine CAXC/CMSA	803002	Outer Joint	36	27	59.5	40	66	I	
1.6 (75 kW)	2004.09-	2013.03	-	R F	Hatchback Engine BGU/BSE/BSF	261113	Drive Shaft	36		59.5	40	814		
	2004.09-	2013.03	MT	L F	Hatchback Engine BGU/BSE/BSF	261097	Drive Shaft	36		59.5	40.5	543		
	2004.09-	2013.03	5MT	R F	Hatchback Engine BGU/BSE/BSF	261096	Drive Shaft	36		59.5	40.5	799		
	2004.09-	2013.03	MT	L/R F	Hatchback Engine BGU/BSE/BSF	603011	Inner Joint		33		34			
	2004.09-	2013.03	6AT	L F	Hatchback Engine BGU/BSE/BSF	803116	Outer Joint	36	30	59.5	38	55	I	
	2004.09-	2013.03	AT	L/R F	Hatchback Engine BGU/BSE/BSF	661011	Inner Joint	26	32	31	68.5	85		
	2004.09-	2013.03	MT	L F	Hatchback Engine BGU/BSE/BSF	203320	Drive Shaft	36		59.5	40	546		
	2004.09-	2013.03	-	L/R F	Hatchback Engine BGU/BSE/BSF	803037	Outer Joint	36	30	59.5	40.5	55	I	
	2004.09-	2013.03	6AT	L F	Hatchback Engine BGU/BSE/BSF	203318	Drive Shaft	36	26	59.5	38	581		
	2004.09-	2013.03	6AT	L F	Hatchback Engine BGU/BSE/BSF	261093	Drive Shaft	36	26	59.5	40.5	587.5		
1.6 E-Power (75 kW)	2011.01-	2013.03	-	L/R F	Hatchback Engine CMXA/CCSA	603011	Inner Joint		33		34			
	2011.01-	2013.03	-	L/R F	Hatchback Engine CMXA/CCSA	261097	Drive Shaft	36		59.5	40.5	543		
	2011.01-	2013.03	MT	- -	Hatchback Engine CMXA/CCSA	603006	Inner Joint		33		34			
	2011.01-	2013.03	-	R F	Hatchback Engine CMXA/CCSA	261096	Drive Shaft	36		59.5	40.5	799		
	2011.01-	2013.03	-	L/R F	Hatchback Engine CMXA/CCSA	803037	Outer Joint	36	30	59.5	40.5	55	I	
	2011.01-	2013.03	-	L/R F	Hatchback Engine CMXA/CCSA	203320	Drive Shaft	36		59.5	40	546		
1.6 FSI (85 kW)	2004.09-	2007.09	MT	- -	Hatchback Engine BLP/BLF	603006	Inner Joint		33		34			
	2004.09-	2007.09	MT	- -	Hatchback Engine BLP/BLF	661050	Inner Joint	26	32	31	68.5	89		
	2004.09-	2007.09	-	L/R F	Hatchback Engine BLP/BLF	603011	Inner Joint		33		34			
	2004.09-	2007.09	MT	- -	Hatchback Engine BLP/BLF	603016	Inner Joint		28		32			
	2004.09-	2007.09	6MT	R F	Hatchback Engine BLP/BLF	261211	Drive Shaft	36		59.5	40.5	784		
	2004.09-	2007.09	6MT	L F	Hatchback Engine BLP/BLF	803116	Outer Joint	36	30	59.5	38	55	I	
	2004.09-	2007.09	-	L/R F	Hatchback Engine BLP/BLF	803037	Outer Joint	36	30	59.5	40.5	55	I	
	2004.09-	2007.09	AT	L/R F	Hatchback Engine BLP/BLF	661011	Inner Joint	26	32	31	68.5	85		
	2004.09-	2007.09	6MT	L F	Hatchback Engine BLP/BLF	203319	Drive Shaft	36		59.5	38	557		
1.6 TDI (66 kW)	2009.05-	2013.03	-	L F	Hatchback Engine CAYB	203294	Drive Shaft	36		59.5	38	519		
	2009.05-	2013.03	MT	- -	Hatchback Engine CAYB	603006	Inner Joint		33		34			
	2009.05-	2013.03	-	L/R F	Hatchback Engine CAYB	603011	Inner Joint		33		34			
	2009.05-	2013.03	-	L F	Hatchback Engine CAYB	803116	Outer Joint	36	30	59.5	38	55	I	
	2009.05-	2013.03	-	R F	Hatchback Engine CAYB	201585	Drive Shaft	36		59.5	40	805		
	2009.05-	2013.03	-	R F	Hatchback Engine CAYB	261042	Drive Shaft	36		59.5	40.5	814		
	2009.05-	2013.03	-	L/R F	Hatchback Engine CAYB	803037	Outer Joint	36	30	59.5	40.5	55	I	
	2009.05-	2013.03	MT	- -	Hatchback Engine CAYB	861059	Outer Joint	36	33	59.5	40	59.5	I	
1.6 TDI (77 kW)	2009.05-	2013.03	MT	L F	Hatchback Engine CAYC	203294	Drive Shaft	36		59.5	38	519		
	2009.05-	2013.03	MT	L/R F	Hatchback Engine CAYC	803037	Outer Joint	36	30	59.5	40.5	55	I	
	2009.05-	2013.03	MT	L/R F	Hatchback Engine CAYC	603011	Inner Joint		33		34			
	2009.05-	2013.03	-	- -	Hatchback Engine CAYC	603016	Inner Joint		28		32			
	2009.05-	2013.03	MT	L F	Hatchback Engine CAYC	803116	Outer Joint	36	30	59.5	38	55	I	
	2009.05-	2013.03	AT	L/R F	Hatchback Engine CAYC	803002	Outer Joint	36	27	59.5	40	66	I	
	2009.05-	2013.03	MT	R F	Hatchback Engine CAYC	261042	Drive Shaft	36		59.5	40.5	814		
	2009.05-	2013.03	MT	R F	Hatchback Engine CAYC	201585	Drive Shaft	36		59.5	40	805		
1.8 TFSI (118 kW)	2006.11-	2013.03	AT/MT	L F	Hatchback Engine BYT/BZB/CDA	203295	Drive Shaft	36		59.5	40	491		
	2006.11-	2013.03	MT	L F	Hatchback Engine BYT/BZB/CDA	261100	Drive Shaft	36		59.5	40	513		
	2006.11-	2013.03	MT	R F	Hatchback Engine BYT/BZB/CDA	203313	Drive Shaft	36		59.5	40	792		
	2006.11-	2013.03	MT	L/R F	Hatchback Engine BYT/BZB/CDA	803002	Outer Joint	36	27	59.5	40	66	I	
	2006.11-	2013.03	-	- -	Hatchback Engine BYT/BZB/CDA	861059	Outer Joint	36	33	59.5	40	59.5	I	
	2006.11-	2013.03	-	L/R F	Hatchback Engine BYT/BZB/CDA	603011	Inner Joint		33		34			
	2006.11-	2013.03	MT	L F	Hatchback Engine BYT/BZB/CDA	261131	Drive Shaft	36		59.5	40	515		





YEAR	TRANSM	L/R	F/R	REMARKS	GSP Ref.	PRODUCT	ABS	Technical Specifications							
								A	B	C	H	L	P		
AUDI															
A3 Sportback (8PA)															
1.8 TFSI quattro (118 kW)	2008.07-2013.03	-	-	-	All-wheel Drive Hatchback Engine CDAA	603006	Inner Joint			33		34			
	2008.07-2013.03	AT/MT	L/R	F	All-wheel Drive Hatchback Engine CDAA	803002	Outer Joint	36	27	59.5	40	66	I		
	2008.07-2013.03	-	L	F	All-wheel Drive Hatchback Engine CDAA	203295	Drive Shaft	36		59.5	40	491			
	2008.07-2013.03	-	R	F	All-wheel Drive Hatchback Engine CDAA	203266	Drive Shaft	36		59.5	40	601			
	2008.07-2013.03	-	-	-	All-wheel Drive Hatchback Engine CDAA	861059	Outer Joint	36	33	59.5	40	59.5	I		
	2008.07-2013.03	-	L/R	F	All-wheel Drive Hatchback Engine CDAA	603011	Inner Joint			33		34			
1.9 TDI (77 kW)	2004.09-2010.05	MT	L	F	Hatchback Engine BKC/BLS/BXE	203294	Drive Shaft	36		59.5	38	519			
	2004.09-2010.05	MT	L/R	F	Hatchback Engine BKC/BLS/BXE	603011	Inner Joint			33		34			
	2004.09-2010.05	AT	L/R	F	Hatchback Engine BKC/BLS/BXE	661057	Inner Joint			34		86			
	2004.09-2010.05	MT	L/R	F	Hatchback Engine BKC/BLS/BXE	803037	Outer Joint	36	30	59.5	40.5	55	I		
	2004.09-2010.05	6AT	L	F	Hatchback Engine BKC/BLS/BXE	254013	Drive Shaft	36		59.5	40	479.5			
	2004.09-2010.05	6AT	L	F	Hatchback Engine BKC/BLS/BXE	654004	Inner Joint			34		85			
	2004.09-2010.05	MT	L	F	Hatchback Engine BKC/BLS/BXE	803116	Outer Joint	36	30	59.5	38	55	I		
	2004.09-2010.05	6AT	L/R	F	Hatchback Engine BKC/BLS/BXE	803002	Outer Joint	36	27	59.5	40	66	I		
	2004.09-2010.05	MT	R	F	Hatchback Engine BKC/BLS/BXE	261042	Drive Shaft	36		59.5	40.5	814			
	2004.09-2010.05	-	R	F	Hatchback Engine BKC/BLS/BXE	201585	Drive Shaft	36		59.5	40	805			
	2004.09-2010.05	AT	L/R	F	Hatchback Engine BKC/BLS/BXE	861045	Outer Joint	36	27	59.5	40	65	M		
	2004.09-2010.05	AT	R	F	Hatchback Engine BKC/BLS/BXE	254011	Drive Shaft	36		59.5	40	755			
2.0 FSI (110 kW)	2004.09-2008.06	MT	R	F	Hatchback Engine BLX/BLY/AXW/BMB/BLR/BVY/BVZ	261113	Drive Shaft	36		59.5	40	814			
	2004.09-2008.06	MT	L/R	F	Hatchback Engine BLX/BLY/AXW/BMB/BLR/BVY/BVZ	603011	Inner Joint			33		34			
	2004.09-2008.06	AT	R	F	Hatchback Engine BLX/BLY/AXW/BMB/BLR/BVY/BVZ	261094	Drive Shaft	36	26	59.5	40.5	884			
	2004.09-2008.06	AT	L/R	F	Hatchback Engine BLX/BLY/AXW/BMB/BLR/BVY/BVZ	661011	Inner Joint			26	32	31	68.5	85	
	2004.09-2008.06	MT	L	F	Hatchback Engine BLX/BLY/AXW/BMB/BLR/BVY/BVZ	803116	Outer Joint	36	30	59.5	38	55	I		
	2004.09-2008.06	-	L/R	F	Hatchback Engine BLX/BLY/AXW/BMB/BLR/BVY/BVZ	803037	Outer Joint	36	30	59.5	40.5	55	I		
	2004.09-2008.06	AT	L	F	Hatchback Engine BLX/BLY/AXW/BMB/BLR/BVY/BVZ	261093	Drive Shaft	36	26	59.5	40.5	587.5			
	2004.09-2008.06	AT	L/R	F	Hatchback Engine BLX/BLY/AXW/BMB/BLR/BVY/BVZ	261093	Drive Shaft	36	26	59.5	40.5	587.5			
2.0 TDI (100 kW)	2004.09-2013.03	-	L/R	F	Hatchback Engine AZV/CBAA/CFFA	803002	Outer Joint	36	27	59.5	40	66	I		
	2004.09-2013.03	AT	L/R	F	Hatchback Engine AZV/CBAA/CFFA	661057	Inner Joint			34		86			
	2004.09-2013.03	MT	L	F	Hatchback Engine AZV/CBAA/CFFA	203265	Drive Shaft	36		59.5	40	487			
	2004.09-2013.03	MT	R	F	Hatchback Engine AZV/CBAA/CFFA	203313	Drive Shaft	36		59.5	40	792			
	2004.09-2013.03	MT	R	F	Hatchback Engine AZV/CBAA/CFFA	203236	Drive Shaft	36		59.5	40	484			
	2004.09-2013.03	AT	L	F	Hatchback Engine AZV/CBAA/CFFA	254013	Drive Shaft	36		59.5	40	479.5			
	2004.09-2013.03	AT	L	F	Hatchback Engine AZV/CBAA/CFFA	654004	Inner Joint			34		85			
	2004.09-2013.03	MT	R	F	Hatchback Engine AZV/CBAA/CFFA	261126	Drive Shaft	36		59.5	40	793			
	2004.09-2013.03	MT	L	F	Hatchback Engine AZV/CBAA/CFFA	203295	Drive Shaft	36		59.5	40	491			
	2004.09-2013.03	AT	R	F	Hatchback Engine AZV/CBAA/CFFA	254011	Drive Shaft	36		59.5	40	755			
2004.09-2013.03	AT	L/R	F	Hatchback Engine AZV/CBAA/CFFA	861045	Outer Joint	36	27	59.5	40	65	M			
2.0 TDI (103 kW)	2005.06-2008.06	AT	R	F	Hatchback Engine BMM	254011	Drive Shaft	36		59.5	40	755			
	2005.06-2008.06	MT	L	F	Hatchback Engine BMM	203295	Drive Shaft	36		59.5	40	491			
	2005.06-2008.06	MT	L	F	Hatchback Engine BMM	203265	Drive Shaft	36		59.5	40	487			
	2005.06-2008.06	AT	L/R	F	Hatchback Engine BMM	661057	Inner Joint			34		86			
	2005.06-2008.06	MT	R	F	Hatchback Engine BMM	203236	Drive Shaft	36		59.5	40	484			
	2005.06-2008.06	MT	R	F	Hatchback Engine BMM	203313	Drive Shaft	36		59.5	40	792			
	2005.06-2008.06	AT	L	F	Hatchback Engine BMM	254013	Drive Shaft	36		59.5	40	479.5			
	2005.06-2008.06	AT	L	F	Hatchback Engine BMM	654004	Inner Joint			34		85			
	2005.06-2008.06	AT	L	F	Hatchback Engine BMM	203241	Drive Shaft	36		59.5	40	475			
	2005.06-2008.06	MT	L/R	F	Hatchback Engine BMM	803002	Outer Joint	36	27	59.5	40	66	I		
	2005.06-2008.06	MT	R	F	Hatchback Engine BMM	261126	Drive Shaft	36		59.5	40	793			
	2005.06-2008.06	AT	L/R	F	Hatchback Engine BMM	861045	Outer Joint	36	27	59.5	40	65	M		
2.0 TDI (120 kW)	2006.06-2008.06	AT	R	F	Hatchback Engine BUY	254011	Drive Shaft	36		59.5	40	755			
	2006.06-2008.06	MT	L	F	Hatchback Engine BUY	203265	Drive Shaft	36		59.5	40	487			
	2006.06-2008.06	AT	L/R	F	Hatchback Engine BUY	661057	Inner Joint			34		86			
	2006.06-2008.06	MT	L/R	F	Hatchback Engine BUY	861045	Outer Joint	36	27	59.5	40	65	M		
	2006.06-2008.06	MT	R	F	Hatchback Engine BUY	261126	Drive Shaft	36		59.5	40	793			
	2006.06-2008.06	AT	R	F	Hatchback Engine BUY	654004	Inner Joint			34		85			
2.0 TDI (125 kW)	2006.03-2013.03	MT	L	F	Hatchback Engine CBBB/BMN/CFGB	203265	Drive Shaft	36		59.5	40	487			
	2006.03-2013.03	AT	L/R	F	Hatchback Engine CBBB/BMN/CFGB	661057	Inner Joint			34		86			
	2006.03-2013.03	MT	R	F	Hatchback Engine CBBB/BMN/CFGB	261126	Drive Shaft	36		59.5	40	793			
	2006.03-2013.03	AT	R	F	Hatchback Engine CBBB/BMN/CFGB	654004	Inner Joint			34		85			
	2006.03-2013.03	-	L/R	F	Hatchback Engine CBBB/BMN/CFGB	861045	Outer Joint	36	27	59.5	40	65	M		
	2006.03-2013.03	Semi-AT	L	F	Hatchback Engine CBBB/BMN/CFGB	203241	Drive Shaft	36		59.5	40	475			
	2006.03-2013.03	AT	R	F	Hatchback Engine CBBB/BMN/CFGB	254011	Drive Shaft	36		59.5	40	755			
2.0 TDI 16V (103 kW)	2004.09-2013.03	AT/MT/Semi-AT	L/R	F	Hatchback Engine BKD/CBAB/CFFB/CLJA	803002	Outer Joint	36	27	59.5	40	66	I		
	2004.09-2013.03	AT	L/R	F	Hatchback Engine BKD/CBAB/CFFB/CLJA	661057	Inner Joint			34		86			
	2004.09-2013.03	MT	L	F	Hatchback Engine BKD/CBAB/CFFB/CLJA	203265	Drive Shaft	36		59.5	40	487			
	2004.09-2013.03	MT	R	F	Hatchback Engine BKD/CBAB/CFFB/CLJA	203313	Drive Shaft	36		59.5	40	792			
	2004.09-2013.03	AT	L	F	Hatchback Engine BKD/CBAB/CFFB/CLJA	254013	Drive Shaft	36		59.5	40	479.5			

YEAR		TRANSM	L/R	F/R	REMARKS	GSP Ref.	PRODUCT	ABS	Technical Specifications									
									A	B	C	H	L	P				
AUDI																		
A3 Sportback (8PA)																		
2.0 TDI 16V (103 kW)		2004.09-2013.03	MT	R	F	Hatchback Engine BKD/CBAB/CFFB/CLJA	203236	Drive Shaft		36		59.5	40	484				
		2004.09-2013.03	AT	L	F	Hatchback Engine BKD/CBAB/CFFB/CLJA	654004	Inner Joint			34		85					
		2004.09-2013.03	AT	L	F	Hatchback Engine BKD/CBAB/CFFB/CLJA	203241	Drive Shaft		36		59.5	40	475				
		2004.09-2013.03	MT/Semi-AT	L/R	F	Hatchback Engine BKD/CBAB/CFFB/CLJA	861045	Outer Joint		36	27	59.5	40	65	M			
		2004.09-2013.03	MT	R	F	Hatchback Engine BKD/CBAB/CFFB/CLJA	261126	Drive Shaft		36		59.5	40	793				
		2004.09-2013.03	MT	L	F	Hatchback Engine BKD/CBAB/CFFB/CLJA	203295	Drive Shaft		36		59.5	40	491				
		2004.09-2013.03	AT	R	F	Hatchback Engine BKD/CBAB/CFFB/CLJA	254011	Drive Shaft		36		59.5	40	755				
2.0 TDI 16V quattro (103 kW)		2005.11-2013.03	-	L/R	R	All-wheel Drive Hatchback Engine BKD/CBAB/CFFB	803037	Outer Joint		36	30	59.5	40.5	55	I			
		2005.11-2013.03	MT	L/R	R	All-wheel Drive Hatchback Engine BKD/CBAB/CFFB	603011	Inner Joint			33		34					
		2005.11-2013.03	-	L/R	F	All-wheel Drive Hatchback Engine BKD/CBAB/CFFB	803002	Outer Joint		36	27	59.5	40	66	I			
		2005.11-2013.03	AT	L/R	F	All-wheel Drive Hatchback Engine BKD/CBAB/CFFB	661057	Inner Joint			34		86					
		2005.11-2013.03	-	R	F	All-wheel Drive Hatchback Engine BKD/CBAB/CFFB	203266	Drive Shaft		36		59.5	40	601				
		2005.11-2013.03	MT	L	R	All-wheel Drive Hatchback Engine BKD/CBAB/CFFB	261284	Drive Shaft		36		59.5	79	594				
		2005.11-2013.03	MT	R	R	All-wheel Drive Hatchback Engine BKD/CBAB/CFFB	261293	Drive Shaft		36		59.5	79	631				
		2005.11-2013.03	-	L	F	All-wheel Drive Hatchback Engine BKD/CBAB/CFFB	203295	Drive Shaft		36		59.5	40	491				
		2005.11-2013.03	AT	L/R	F	All-wheel Drive Hatchback Engine BKD/CBAB/CFFB	861045	Outer Joint		36	27	59.5	40	65	M			
2.0 TDI quattro (103 kW)		2006.01-2008.06	AT	L/R	F	All-wheel Drive Hatchback Engine BMM	661057	Inner Joint			34		86					
		2006.01-2008.06	MT	L/R	F	All-wheel Drive Hatchback Engine BMM	803002	Outer Joint		36	27	59.5	40	66	I			
		2006.01-2008.06	-	R	F	All-wheel Drive Hatchback Engine BMM	203266	Drive Shaft		36		59.5	40	601				
		2006.01-2008.06	Semi-AT	L	F	All-wheel Drive Hatchback Engine BMM	654004	Inner Joint			34		85					
		2006.01-2008.06	MT	L	R	All-wheel Drive Hatchback Engine BMM	261284	Drive Shaft		36		59.5	79	594				
		2006.01-2008.06	MT	R	R	All-wheel Drive Hatchback Engine BMM	261293	Drive Shaft		36		59.5	79	631				
		2006.01-2008.06	AT	L/R	F	All-wheel Drive Hatchback Engine BMM	861045	Outer Joint		36	27	59.5	40	65	M			
		2006.01-2008.06	MT	L/R	R	All-wheel Drive Hatchback Engine BMM	603011	Inner Joint			33		34					
		2006.01-2008.06	-	L	F	All-wheel Drive Hatchback Engine BMM	203295	Drive Shaft		36		59.5	40	491				
		2006.01-2008.06	Semi-AT	L	F	All-wheel Drive Hatchback Engine BMM	203241	Drive Shaft		36		59.5	40	475				
		2006.01-2008.06	-	L/R	R	All-wheel Drive Hatchback Engine BMM	803037	Outer Joint		36	30	59.5	40.5	55	I			
2.0 TDI quattro (125 kW)		2006.03-2013.03	-	L/R	R	All-wheel Drive Hatchback Engine CBBB/BNM/CFGB	803037	Outer Joint		36	30	59.5	40.5	55	I			
		2006.03-2013.03	AT	L/R	F	All-wheel Drive Hatchback Engine CBBB/BNM/CFGB	661057	Inner Joint			34		86					
		2006.03-2013.03	MT	L/R	R	All-wheel Drive Hatchback Engine CBBB/BNM/CFGB	603011	Inner Joint			33		34					
		2006.03-2013.03	-	L/R	F	All-wheel Drive Hatchback Engine CBBB/BNM/CFGB	803002	Outer Joint		36	27	59.5	40	66	I			
		2006.03-2013.03	-	L	F	All-wheel Drive Hatchback Engine CBBB/BNM/CFGB	203295	Drive Shaft		36		59.5	40	491				
		2006.03-2013.03	-	R	F	All-wheel Drive Hatchback Engine CBBB/BNM/CFGB	203266	Drive Shaft		36		59.5	40	601				
		2006.03-2013.03	MT	L	R	All-wheel Drive Hatchback Engine CBBB/BNM/CFGB	261284	Drive Shaft		36		59.5	79	594				
		2006.03-2013.03	MT	R	R	All-wheel Drive Hatchback Engine CBBB/BNM/CFGB	261293	Drive Shaft		36		59.5	79	631				
		2006.03-2013.03	-	L/R	F	All-wheel Drive Hatchback Engine CBBB/BNM/CFGB	861045	Outer Joint		36	27	59.5	40	65	M			
		2006.03-2013.03	-	R	F	All-wheel Drive Hatchback Engine CBBB/BNM/CFGB	635026	Inner Joint		36	33	59.5	40	39				
2.0 TFSI (147 kW)		2004.09-2013.03	-	L/R	F	Hatchback Engine AXX/BWA/BPY/CAWB/CCZA/CBFA	803002	Outer Joint		36	27	59.5	40	66	I			
		2004.09-2013.03	AMT	R	F	Hatchback Engine AXX/BWA/BPY/CAWB/CCZA/CBFA	203349	Drive Shaft		36		59.5	40	784				
		2004.09-2013.03	-	-	-	Hatchback Engine AXX/BWA/BPY/CAWB/CCZA/CBFA	861059	Outer Joint		36	33	59.5	40	59.5	I			
		2004.09-2013.03	AT/MT	L	F	Hatchback Engine AXX/BWA/BPY/CAWB/CCZA/CBFA	203295	Drive Shaft		36		59.5	40	491				
2.0 TFSI quattro (147 kW)		2004.09-2013.03	-	L/R	R	All-wheel Drive Hatchback Engine AXX/BWA/BPY/CAWB/CCZA/CBFA	803037	Outer Joint		36	30	59.5	40.5	55	I			
		2004.09-2013.03	MT	L/R	R	All-wheel Drive Hatchback Engine AXX/BWA/BPY/CAWB/CCZA/CBFA	603011	Inner Joint			33		34					
		2004.09-2013.03	-	L/R	F	All-wheel Drive Hatchback Engine AXX/BWA/BPY/CAWB/CCZA/CBFA	803002	Outer Joint		36	27	59.5	40	66	I			
		2004.09-2013.03	-	R	F	All-wheel Drive Hatchback Engine AXX/BWA/BPY/CAWB/CCZA/CBFA	635026	Inner Joint		36	33	59.5	40	39				
		2004.09-2013.03	-	-	-	All-wheel Drive Hatchback Engine AXX/BWA/BPY/CAWB/CCZA/CBFA	861059	Outer Joint		36	33	59.5	40	59.5	I			
		2004.09-2013.03	-	L	F	All-wheel Drive Hatchback Engine AXX/BWA/BPY/CAWB/CCZA/CBFA	203295	Drive Shaft		36		59.5	40	491				
3.2 V6 quattro (184 kW)		2004.09-2009.05	-	L/R	R	All-wheel Drive Hatchback Engine BMJ/BUB	803037	Outer Joint		36	30	59.5	40.5	55	I			
		2004.09-2009.05	MT	L/R	R	All-wheel Drive Hatchback Engine BMJ/BUB	603011	Inner Joint			33		34					
		2004.09-2009.05	AT/MT	R	F	All-wheel Drive Hatchback Engine BMJ/BUB	203266	Drive Shaft		36		59.5	40	601				
		2004.09-2009.05	AT/AT	L	F	All-wheel Drive Hatchback Engine BMJ/BUB	654004	Inner Joint			34		85					
		2004.09-2009.05	AT/AT	L	F	All-wheel Drive Hatchback Engine BMJ/BUB	203241	Drive Shaft		36		59.5	40	475				
		2004.09-2009.05	MT	L	R	All-wheel Drive Hatchback Engine BMJ/BUB	261284	Drive Shaft		36		59.5	79	594				
		2004.09-2009.05	MT	R	R	All-wheel Drive Hatchback Engine BMJ/BUB	261293	Drive Shaft		36		59.5	79	631				
		2004.09-2009.05	MT	L/R	F	All-wheel Drive Hatchback Engine BMJ/BUB	803002	Outer Joint		36	27	59.5	40	66	I			
		2004.09-2009.05	AT/MT	L	F	All-wheel Drive Hatchback Engine BMJ/BUB	203295	Drive Shaft		36		59.5	40	491				
RS3 quattro (250 kW)		2011.01-2012.12	-	L/R	R	All-wheel Drive Hatchback Engine CEPA	603011	Inner Joint			33		34					
		2011.01-2012.12	AT	R	F	All-wheel Drive Hatchback Engine CEPA	661048	Inner Joint		40	34	46.9	47	80.5				
		2011.01-2012.12	AT	R	F	All-wheel Drive Hatchback Engine CEPA	261347	Drive Shaft		36	40	59.5	40	593				
		2011.01-2012.12	-	L/R	R	All-wheel Drive Hatchback Engine CEPA	803037	Outer Joint		36	30	59.5	40.5	55	I			
		2011.01-2012.12	AT	-	-	All-wheel Drive Hatchback Engine CEPA	603006	Inner Joint			33		34					
		2011.01-2012.12	AT	L	F	All-wheel Drive Hatchback Engine CEPA	201265	Drive Shaft		36	37	59.5	40	557				
S3 quattro (188 kW)		2008.07-2013.03	-	-	-	All-wheel Drive Hatchback Engine CDLC	603006	Inner Joint			33		34					
		2008.07-2013.03	-	L	F	All-wheel Drive Hatchback Engine CDLC	203295	Drive Shaft		36		59.5	40	491				
		2008.07-2013.03	-	L/R	F	All-wheel Drive Hatchback Engine CDLC	803002	Outer Joint		36	27	59.5	40	66	I			
		2008.07-2013.03	-	L/R	R	All-wheel Drive Hatchback Engine CDLC	603011	Inner Joint			33		34					





YEAR	TRANSM	L/R	F/R	REMARKS	GSP Ref.	PRODUCT	ABS	Technical Specifications									
								A	B	C	H	L	P				
AUDI																	
A3 Sportback (8PA)																	
S3 quattro (188 kW)	2008.07-	2013.03	-	-	R	All-wheel Drive Hatchback Engine CDLC	635026	Inner Joint		36	33	59.5	40	39			
S3 quattro (195 kW)	2008.06-	2013.03	-	-	-	All-wheel Drive Hatchback Engine BHZ/CDLA	603006	Inner Joint			33		34				
	2008.06-	2013.03	-	L/R	F	All-wheel Drive Hatchback Engine BHZ/CDLA	803002	Outer Joint	36	27	59.5	40	66	I			
	2008.06-	2013.03	-	L	F	All-wheel Drive Hatchback Engine BHZ/CDLA	203295	Drive Shaft	36		59.5	40	491				
	2008.06-	2013.03	-	L/R	R	All-wheel Drive Hatchback Engine BHZ/CDLA	603011	Inner Joint			33		34				
	2008.06-	2013.03	-	-	R	All-wheel Drive Hatchback Engine BHZ/CDLA	635026	Inner Joint	36	33	59.5	40	39				
A3 Sportback (8VA 8VF)																	
1.0 TFSI (85 kW)	2016.07-	-			MT	-	F	Hatchback Engine CHZD	803100	Outer Joint	36	33	59.5	38	55	I	
1.2 TFSI (77 kW)	2013.05-	-			MT	L/R	F	Hatchback Engine CJZA	803037	Outer Joint	36	30	59.5	40.5	55	I	
	2013.05-	-			MT	L/R	F	Hatchback Engine CJZA	603011	Inner Joint		33		34			
	2013.05-	-			MT	L	F	Hatchback Engine CJZA	261089	Drive Shaft	36		59.5	40.5	521		
	2013.05-	-			MT	L	F	Hatchback Engine CJZA	203373	Drive Shaft	36		59.5	38	511		
	2013.05-	-			-	-	-	F	Hatchback Engine CJZA	803100	Outer Joint	36	33	59.5	38	55	I
	2013.05-	-			MT	R	F	Hatchback Engine CJZA	261200	Drive Shaft	36		59.5	40.5	820		
	2013.05-	-			MT	L	F	Hatchback Engine CJZA	803116	Outer Joint	36	30	59.5	38	55	I	
1.2 TFSI (81 kW)	2014.05-	-			MT	L/R	F	Hatchback Engine CYVB	803037	Outer Joint	36	30	59.5	40.5	55	I	
	2014.05-	-			MT	L/R	F	Hatchback Engine CYVB	603011	Inner Joint		33		34			
	2014.05-	-			MT	L	F	Hatchback Engine CYVB	261089	Drive Shaft	36		59.5	40.5	521		
	2014.05-	-			MT	L	F	Hatchback Engine CYVB	203373	Drive Shaft	36		59.5	38	511		
	2014.05-	-			-	-	-	F	Hatchback Engine CYVB	803100	Outer Joint	36	33	59.5	38	55	I
	2014.05-	-			MT	R	F	Hatchback Engine CYVB	261200	Drive Shaft	36		59.5	40.5	820		
	2014.05-	-			MT	L	F	Hatchback Engine CYVB	803116	Outer Joint	36	30	59.5	38	55	I	
1.4 TFSI (103 kW)	2013.03-	-			MT	L/R	F	Hatchback Engine CPTA	803037	Outer Joint	36	30	59.5	40.5	55	I	
	2013.03-	-			AT	-	-	F	Hatchback Engine CPTA	803101	Outer Joint	36	27	59.5	40	65	M
	2013.03-	-			MT	L/R	F	Hatchback Engine CPTA	603011	Inner Joint		33		34			
	2013.03-	-			MT	-	-	F	Hatchback Engine CPTA	803100	Outer Joint	36	33	59.5	38	55	I
1.4 TFSI (110 kW)	2014.05-	-			AT	-	-	F	Hatchback Engine CZEZ	803101	Outer Joint	36	27	59.5	40	65	M
	2014.05-	-			MT	-	-	F	Hatchback Engine CZEZ	803100	Outer Joint	36	33	59.5	38	55	I
	2014.05-	-			MT	L/R	F	Hatchback Engine CZEZ	603011	Inner Joint		33		34			
1.4 TFSI (90 kW)	2012.09-	-			MT	-	-	F	Hatchback Engine CXSA/CMBA	803100	Outer Joint	36	33	59.5	38	55	I
	2012.09-	-			MT	L	F	Hatchback Engine CXSA/CMBA	261089	Drive Shaft	36		59.5	40.5	521		
	2012.09-	-			-	L/R	F	Hatchback Engine CXSA/CMBA	603011	Inner Joint		33		34			
	2012.09-	-			MT	R	F	Hatchback Engine CXSA/CMBA	261200	Drive Shaft	36		59.5	40.5	820		
1.4 TFSI (92 kW)	2014.05-	-			MT	-	-	F	Hatchback Engine CZCA/CXSB	803100	Outer Joint	36	33	59.5	38	55	I
	2014.05-	-			MT	L/R	F	Hatchback Engine CZCA/CXSB	603011	Inner Joint		33		34			
	2014.05-	-			MT	L	F	Hatchback Engine CZCA/CXSB	261089	Drive Shaft	36		59.5	40.5	521		
	2014.05-	-			MT	R	F	Hatchback Engine CZCA/CXSB	261200	Drive Shaft	36		59.5	40.5	820		
1.4 TFSI e-tron (110 kW)	2014.05-	-		Semi-AT	-	-	F	Hatchback Engine CUKB/CXUA	803101	Outer Joint	36	27	59.5	40	65	M	
1.4 TFSI g-tron (81 kW)	2013.11-	-			MT	L	F	Hatchback Engine CPWA	261089	Drive Shaft	36		59.5	40.5	521		
	2013.11-	-			-	-	-	F	Hatchback Engine CPWA	803100	Outer Joint	36	33	59.5	38	55	I
	2013.11-	-			MT	R	F	Hatchback Engine CPWA	261200	Drive Shaft	36		59.5	40.5	820		
1.6 TDI (77 kW)	2012.10-	-			-	L/R	F	Hatchback Engine CLHA	803037	Outer Joint	36	30	59.5	40.5	55	I	
	2012.10-	-			MT	-	-	F	Hatchback Engine CLHA	803100	Outer Joint	36	33	59.5	38	55	I
	2012.10-	-			7AT/MT	L	F	Hatchback Engine CLHA	261089	Drive Shaft	36		59.5	40.5	521		
	2012.10-	-			MT	R	F	Hatchback Engine CLHA	261200	Drive Shaft	36		59.5	40.5	820		
	2012.10-	-			AT/MT	L/R	F	Hatchback Engine CLHA	603011	Inner Joint		33		34			
	2012.10-	-			7AT	R	F	Hatchback Engine CLHA	261280	Drive Shaft	36		59.5	40	801		
1.6 TDI (81 kW)	2013.09-	-			MT	-	-	F	Hatchback Engine CRKB/CXXB/DBKA	803100	Outer Joint	36	33	59.5	38	55	I
	2013.09-	-			7AT/MT	L	F	Hatchback Engine CRKB/CXXB/DBKA	261089	Drive Shaft	36		59.5	40.5	521		
	2013.09-	-			MT/DCT	L/R	F	Hatchback Engine CRKB/CXXB/DBKA	603011	Inner Joint		33		34			
	2013.09-	-			MT	R	F	Hatchback Engine CRKB/CXXB/DBKA	261200	Drive Shaft	36		59.5	40.5	820		
	2013.09-	-			7AT	R	F	Hatchback Engine CRKB/CXXB/DBKA	261280	Drive Shaft	36		59.5	40	801		
1.6 TDI (85 kW)	2017.02-	-		-	L/R	F	Hatchback Engine DDYA	603011	Inner Joint		33		34				
1.8 TFSI quattro (132 kW)	2013.05-	-			AT	-	-	All-wheel Drive Hatchback Engine CJSB	603016	Inner Joint		28		32			
2.0 TDI (100 kW)	2013.05-	-			-	-	-	F	Hatchback Engine CRLC/CRBD	803101	Outer Joint	36	27	59.5	40	65	M
	2013.05-	-			AT	L	F	Hatchback Engine CRLC/CRBD	261285	Drive Shaft	36		59.5	40	472		
	2013.05-	-			AT	R	F	Hatchback Engine CRLC/CRBD	203354	Drive Shaft	36		59.5	40	763		
2.0 TDI (105 kW)	2013.03-	-			-	-	-	F	Hatchback Engine CRFC	803101	Outer Joint	36	27	59.5	40	65	M
	2013.03-	-			AT	L	F	Hatchback Engine CRFC	261285	Drive Shaft	36		59.5	40	472		
	2013.03-	-			AT	R	F	Hatchback Engine CRFC	203354	Drive Shaft	36		59.5	40	763		
2.0 TDI (110 kW)	2012.09-	-			-	-	-	F	Hatchback Engine CRBC/CRLB/CRUA/DEJA/DBGA	803101	Outer Joint	36	27	59.5	40	65	M
	2012.09-	-			AT	L	F	Hatchback Engine CRBC/CRLB/CRUA/DEJA/DBGA	261285	Drive Shaft	36		59.5	40	472		
	2012.09-	-			AT	R	F	Hatchback Engine CRBC/CRLB/CRUA/DEJA/DBGA	203354	Drive Shaft	36		59.5	40	763		
2.0 TDI (135 kW)	2013.05-	-			Semi-AT	-	-	F	Hatchback Engine CUNA	261285	Drive Shaft	36		59.5	40	472	
	2013.05-	-			AT	-	-	-	Hatchback Engine CUNA	603016	Inner Joint		28		32		
2.0 TDI (81 kW)	2013.05-	-			MT	L	F	Hatchback Engine DEJB/CRFA	261089	Drive Shaft	36		59.5	40.5	521		





YEAR	TRANSM	L/R	F/R	REMARKS	GSP Ref.	PRODUCT	ABS	Technical Specifications										
								A	B	C	H	L	P					
AUDI																		
A3 Sportback (8VA 8VF)																		
2.0 TDI (81 kW)	2013.05-	-	MT	L/R	F	Hatchback Engine DEJB/CRFA	603011	Inner Joint			33		34					
	2013.05-	-	-	-	F	Hatchback Engine DEJB/CRFA	803100	Outer Joint		36	33	59.5	38	55		I		
	2013.05-	-	MT	R	F	Hatchback Engine DEJB/CRFA	261200	Drive Shaft		36		59.5	40.5	820				
2.0 TDI quattro (110 kW)	2013.02-	-	-	-	F	All-wheel Drive Hatchback Engine CRBC/CRLB	803101	Outer Joint		36	27	59.5	40	65		M		
2.0 TDI quattro (135 kW)	2013.05-	-	Semi-AT	L	F	All-wheel Drive Hatchback Engine CUNA	261285	Drive Shaft		36		59.5	40	472				
	2013.05-	-	AT	-	-	All-wheel Drive Hatchback Engine CUNA	603016	Inner Joint			28		32					
40 TFSI (132 kW)	2012.09-	-	MT	-	F	Hatchback Engine CJSJA/CJSB	803101	Outer Joint		36	27	59.5	40	65		M		
	2012.09-	-	MT	L	F	Hatchback Engine CJSJA/CJSB	261304	Drive Shaft		36		59.5	40	511				
RS3 quattro (270 kW)	2015.03-	-	AT	-	-	All-wheel Drive Hatchback Engine CZGB	603006	Inner Joint			33		34					
	2015.03-	-	AT	R	F	All-wheel Drive Hatchback Engine CZGB	661048	Inner Joint		40	34	46.9	47	80.5				
	2015.03-	-	AT	L/R	F	All-wheel Drive Hatchback Engine CZGB	603011	Inner Joint			33		34					
A3 Sportback (8VA, 8VF)																		
RS3 quattro (294 kW)	2017.04-	-	-	-	L/R	R	All-wheel Drive Hatchback Engine DAZA	603011	Inner Joint			33		34				
A3/S3/SPORTB/QU.																		
-	1997-	2003	-	-	-	-	201587	Drive Shaft		36		53	78.5	522				
A4																		
-	-	-	-	-	-	-	803050	Outer Joint		33	27	53	30	63		I		
1.6	1995.03-	2001.09	MT	R	F	-	203055	Drive Shaft	45W	33		53	30	636				
1.8 20V Turbo	1999.05-	2001.09	MT	R	F	-	203055	Drive Shaft	45W	33		53	30	636				
1.9 TDi	1994.11-	-	-	L	-	-	203030	Drive Shaft		33		53	30	599				
	1994.11-	-	-	R	-	-	203029	Drive Shaft		33		53	30	617				
2.4	1995.01-	2000.12	AT	-	-	-	803049	Outer Joint		38	30	59.5	34	59.5		I		
2.4 V6	1997.09-	2001.09	MT	L	F	-	203054	Drive Shaft	45W	38		59.5	34.5	601				
2.5 TDI V6	1998.05-	2001.09	MT	L	F	-	203054	Drive Shaft	45W	38		59.5	34.5	601				
2.6	1995.01-	2000.12	MT	-	-	-	803049	Outer Joint		38	30	59.5	34	59.5		I		
2.6 V6	1995.03-	2001.09	MT	L	F	-	203054	Drive Shaft	45W	38		59.5	34.5	601				
2.8	1995.01-	-	MT	-	-	-	803049	Outer Joint		38	30	59.5	34	59.5		I		
2.8 Quattro	1996-	2001	AT	-	-	-	803091	Outer Joint	45W	38	30	59.5	34	59.5		I		
2.8 V6	1996.04-	2001.09	MT	L	F	-	203054	Drive Shaft	45W	38		59.5	34.5	601				
A4 (8D2 B5)																		
1.6 (74 kW)	1994.11-	2000.10	MT	L	F	Saloon Engine ADP/AHL/ANA/ARM	203002	Drive Shaft	45W	33		53	30	614				
	1994.11-	2000.10	AT	L/R	F	Saloon Engine ADP/AHL/ANA/ARM	661033	Inner Joint			34		85					
	1994.11-	2000.10	-	L/R	F	Saloon Engine ADP/AHL/ANA/ARM	803018	Outer Joint	45W	33	30	53	30	62		I		
	1994.11-	2000.10	AT	R	F	Saloon Engine ADP/AHL/ANA/ARM	299108	Drive Shaft	45W	33		53	30	586				
	1994.11-	2000.10	-	-	-	Saloon Engine ADP/AHL/ANA/ARM	661007	Inner Joint			33		32					
	1994.11-	2000.10	AT	L	F	Saloon Engine ADP/AHL/ANA/ARM	203012	Drive Shaft	45W	33		53	30	498				
	1994.11-	2000.10	MT	R	F	Saloon Engine ADP/AHL/ANA/ARM	299111	Drive Shaft	45W	33		53	30	636				
1.6 (75 kW)	2000.07-	2000.11	MT	L	F	Saloon Engine ALZ	203002	Drive Shaft	45W	33		53	30	614				
	2000.07-	2000.11	-	L/R	F	Saloon Engine ALZ	803018	Outer Joint	45W	33	30	53	30	62		I		
	2000.07-	2000.11	-	-	-	Saloon Engine ALZ	661007	Inner Joint			33		32					
	2000.07-	2000.11	-	R	F	Saloon Engine ALZ	299108	Drive Shaft	45W	33		53	30	586				
	2000.07-	2000.11	AT	L	F	Saloon Engine ALZ	203012	Drive Shaft	45W	33		53	30	498				
	2000.07-	2000.11	MT	R	F	Saloon Engine ALZ	299111	Drive Shaft	45W	33		53	30	636				
1.8 (92 kW)	1994.11-	2000.11	MT	R	F	Saloon Engine AVV/ADR/APT/ARG	203001	Drive Shaft	45W	33		53	30	634				
	1994.11-	2000.11	-	L/R	F	Saloon Engine AVV/ADR/APT/ARG	861012	Outer Joint	45W	33	30	53	30	62		I		
	1994.11-	2000.11	MT	L	F	Saloon Engine AVV/ADR/APT/ARG	203005	Drive Shaft	45W	33		53	30	614				
	1994.11-	2000.11	AT	L/R	F	Saloon Engine AVV/ADR/APT/ARG	661033	Inner Joint			34		85					
	1994.11-	2000.11	MT	-	-	Saloon Engine AVV/ADR/APT/ARG	603006	Inner Joint			33		34					
	1994.11-	2000.11	AT	R	F	Saloon Engine AVV/ADR/APT/ARG	299108	Drive Shaft	45W	33		53	30	586				
	1994.11-	2000.11	AT	L	F	Saloon Engine AVV/ADR/APT/ARG	203012	Drive Shaft	45W	33		53	30	498				
	1994.11-	2000.11	MT	R	F	Saloon Engine AVV/ADR/APT/ARG	203013	Drive Shaft	45W	33		53	30	636				
1.8 quattro (92 kW)	1995.01-	2000.11	-	L/R	F	All-wheel Drive Saloon Engine ADR/ARG/APT	861012	Outer Joint	45W	33	30	53	30	62		I		
	1995.01-	2000.11	MT	L	F	All-wheel Drive Saloon Engine ADR/ARG/APT	203002	Drive Shaft	45W	33		53	30	614				
	1995.01-	2000.11	-	L/R	R	All-wheel Drive Saloon Engine ADR/ARG/APT	603011	Inner Joint			33		34					
	1995.01-	2000.11	5MT	L/R	F	All-wheel Drive Saloon Engine ADR/ARG/APT	603002	Inner Joint			33		32					
	1995.01-	2000.11	-	L/R	F	All-wheel Drive Saloon Engine ADR/ARG/APT	803018	Outer Joint	45W	33	30	53	30	62		I		
	1995.01-	2000.11	MT	L	F	All-wheel Drive Saloon Engine ADR/ARG/APT	203005	Drive Shaft	45W	33		53	30	614				
	1995.01-	2000.11	-	L/R	F	All-wheel Drive Saloon Engine ADR/ARG/APT	603001	Inner Joint			28		32					
	1995.01-	2000.11	MT	-	-	All-wheel Drive Saloon Engine ADR/ARG/APT	603006	Inner Joint			33		34					
	1995.01-	2000.11	5MT	L/R	R	All-wheel Drive Saloon Engine ADR/ARG/APT	803026	Outer Joint	45T	33	30	53	31	62		I		
	1995.01-	2000.11	-	R	F	All-wheel Drive Saloon Engine ADR/ARG/APT	299108	Drive Shaft	45W	33		53	30	586				
	1995.01-	2000.11	AT	L	F	All-wheel Drive Saloon Engine ADR/ARG/APT	203012	Drive Shaft	45W	33		53	30	498				
	1995.01-	2000.11	5MT	R	F	All-wheel Drive Saloon Engine ADR/ARG/APT	299111	Drive Shaft	45W	33		53	30	636				
1.8 T (110 kW)	1995.01-	2000.11	MT	L	F	Saloon Engine AEB/ARK/APU/ANB/AWT	203002	Drive Shaft	45W	33		53	30	614				
	1995.01-	2000.11	MT	R	F	Saloon Engine AEB/ARK/APU/ANB/AWT	203001	Drive Shaft	45W	33		53	30	634				
	1995.01-	2000.11	-	L/R	F	Saloon Engine AEB/ARK/APU/ANB/AWT	803018	Outer Joint	45W	33	30	53	30	62		I		

YEAR	TRANSM	L/R	F/R	REMARKS	GSP Ref.	PRODUCT	ABS	Technical Specifications										
								A	B	C	H	L	P					
AUDI																		
A4 (8D2 B5)																		
1.8 T (110 kW)	1995.01-2000.11	MT	L	F	Saloon Engine AEB/ARK/APU/ANB/AWT	203005	Drive Shaft	45W	33		53	30	614					
	1995.01-2000.11	-	L/R	F	Saloon Engine AEB/ARK/APU/ANB/AWT	603001	Inner Joint			28		32						
	1995.01-2000.11	5AT	L	F	Saloon Engine AEB/ARK/APU/ANB/AWT	203036	Drive Shaft	45W	33		53	30	524					
	1995.01-2000.11	MT	-	-	Saloon Engine AEB/ARK/APU/ANB/AWT	603006	Inner Joint			33		34						
	1995.01-2000.11	AT	R	F	Saloon Engine AEB/ARK/APU/ANB/AWT	203012	Drive Shaft	45W	33		53	30	498					
	1995.01-2000.11	MT	R	F	Saloon Engine AEB/ARK/APU/ANB/AWT	203013	Drive Shaft	45W	33		53	30	636					
	1995.01-2000.11	-	L/R	F	Saloon Engine AEB/ARK/APU/ANB/AWT	861012	Outer Joint	45W	33	30	53	30	62		I			
1.8 T (132 kW)	1997.12-2000.11	-	L/R	F	Saloon Engine AJL	803019	Outer Joint	45W	38	27	59.5	34.5	63		I			
	1997.12-2000.11	-	L/R	F	Saloon Engine AJL	603001	Inner Joint			28		32						
	1997.12-2000.11	MT	R	F	Saloon Engine AJL	203013	Drive Shaft	45W	33		53	30	636					
1.8 T quattro (110 kW)	1995.01-2000.11	MT	L	F	All-wheel Drive Saloon Engine AEB/ARK/APU/ANB/AWT	203002	Drive Shaft	45W	33		53	30	614					
	1995.01-2000.11	-	L/R	F	All-wheel Drive Saloon Engine AEB/ARK/APU/ANB/AWT	603002	Inner Joint			33		32						
	1995.01-2000.11	-	L/R	F	All-wheel Drive Saloon Engine AEB/ARK/APU/ANB/AWT	861012	Outer Joint	45W	33	30	53	30	62		I			
	1995.01-2000.11	MT	L	F	All-wheel Drive Saloon Engine AEB/ARK/APU/ANB/AWT	203005	Drive Shaft	45W	33		53	30	614					
	1995.01-2000.11	AT	L/R	R	All-wheel Drive Saloon Engine AEB/ARK/APU/ANB/AWT	661033	Inner Joint			34		85						
	1995.01-2000.11	-	L/R	F	All-wheel Drive Saloon Engine AEB/ARK/APU/ANB/AWT	803018	Outer Joint	45W	33	30	53	30	62		I			
	1995.01-2000.11	-	L/R	F	All-wheel Drive Saloon Engine AEB/ARK/APU/ANB/AWT	603001	Inner Joint			28		32						
	1995.01-2000.11	5AT	L	F	All-wheel Drive Saloon Engine AEB/ARK/APU/ANB/AWT	203036	Drive Shaft	45W	33		53	30	524					
	1995.01-2000.11	MT	-	-	All-wheel Drive Saloon Engine AEB/ARK/APU/ANB/AWT	603006	Inner Joint			33		34						
	1995.01-2000.11	-	L/R	R	All-wheel Drive Saloon Engine AEB/ARK/APU/ANB/AWT	803026	Outer Joint	45T	33	30	53	31	62		I			
	1995.01-2000.11	AT	R	F	All-wheel Drive Saloon Engine AEB/ARK/APU/ANB/AWT	203012	Drive Shaft	45W	33		53	30	498					
1.8 T quattro (132 kW)	1997.12-2000.11	-	L/R	F	All-wheel Drive Saloon Engine AJL	603002	Inner Joint			33		32						
	1997.12-2000.11	-	R	F	All-wheel Drive Saloon Engine AJL	203007	Drive Shaft	45W	33		53	30	622					
	1997.12-2000.11	-	L	F	All-wheel Drive Saloon Engine AJL	261122	Drive Shaft	45W	33		53	30	602					
	1997.12-2000.11	-	L/R	F	All-wheel Drive Saloon Engine AJL	803020	Outer Joint	45W	38	30	59.5	34	59.5		I			
	1997.12-2000.11	-	L/R	R	All-wheel Drive Saloon Engine AJL	803026	Outer Joint	45T	33	30	53	31	62		I			
1.9 TDI (55 kW)	1995.12-2000.11	AT/MT	L/R	F	Saloon Engine AFF	803018	Outer Joint	45W	33	30	53	30	62		I			
	1995.12-2000.11	MT	R	F	Saloon Engine AFF	203007	Drive Shaft	45W	33		53	30	622					
	1995.12-2000.11	MT	L	F	Saloon Engine AFF	261122	Drive Shaft	45W	33		53	30	602					
	1995.12-2000.11	AT/MT	L/R	F	Saloon Engine AFF	661033	Inner Joint			34		85						
	1995.12-2000.11	AT	R	F	Saloon Engine AFF	299108	Drive Shaft	45W	33		53	30	586					
	1995.12-2000.11	AT	L	F	Saloon Engine AFF	203012	Drive Shaft	45W	33		53	30	498					
1.9 TDI (66 kW)	1995.01-2000.11	-	L/R	F	Saloon Engine AHU/AHH/1Z	803018	Outer Joint	45W	33	30	53	30	62		I			
	1995.01-2000.11	MT	L	F	Saloon Engine AHU/AHH/1Z	203010	Drive Shaft	45W	33		53	30	599					
	1995.01-2000.11	AT/MT	L/R	F	Saloon Engine AHU/AHH/1Z	661033	Inner Joint			34		85						
	1995.01-2000.11	MT	R	F	Saloon Engine AHU/AHH/1Z	203007	Drive Shaft	45W	33		53	30	622					
	1995.01-2000.11	MT	L	F	Saloon Engine AHU/AHH/1Z	261122	Drive Shaft	45W	33		53	30	602					
	1995.01-2000.11	AT	R	F	Saloon Engine AHU/AHH/1Z	299108	Drive Shaft	45W	33		53	30	586					
	1995.01-2000.11	AT	L	F	Saloon Engine AHU/AHH/1Z	203012	Drive Shaft	45W	33		53	30	498					
	1995.01-2000.11	MT	R	F	Saloon Engine AHU/AHH/1Z	203009	Drive Shaft	45W	33		53	30	617					
1.9 TDI (81 kW)	1995.01-2000.11	-	L/R	F	Saloon Engine AHU/AHH/1Z	861012	Outer Joint	45W	33	30	53	30	62		I			
	1995.10-2000.11	-	L/R	F	Saloon Engine AFN/AVG	803018	Outer Joint	45W	33	30	53	30	62		I			
	1995.10-2000.11	MT	L	F	Saloon Engine AFN/AVG	203010	Drive Shaft	45W	33		53	30	599					
	1995.10-2000.11	MT	R	F	Saloon Engine AFN/AVG	203007	Drive Shaft	45W	33		53	30	622					
	1995.10-2000.11	AT/MT	L/R	F	Saloon Engine AFN/AVG	661033	Inner Joint			34		85						
	1995.10-2000.11	MT	-	-	Saloon Engine AFN/AVG	603006	Inner Joint			33		34						
	1995.10-2000.11	MT	L	F	Saloon Engine AFN/AVG	261122	Drive Shaft	45W	33		53	30	602					
	1995.10-2000.11	AT	R	F	Saloon Engine AFN/AVG	299108	Drive Shaft	45W	33		53	30	586					
	1995.10-2000.11	AT	L	F	Saloon Engine AFN/AVG	203012	Drive Shaft	45W	33		53	30	498					
	1995.10-2000.11	MT	R	F	Saloon Engine AFN/AVG	203009	Drive Shaft	45W	33		53	30	617					
	1995.10-2000.11	-	L/R	F	Saloon Engine AFN/AVG	803018	Outer Joint	45W	33	30	53	30	62		I			
1.9 TDI (85 kW)	2000.03-2000.11	AT/MT	L/R	F	Saloon Engine AJM	803021	Outer Joint	45W	33	27	53	30	63		I			
	2000.03-2000.11	MT	L	F	Saloon Engine AJM	261083	Drive Shaft	45W	33		53	30	603					
	2000.03-2000.11	MT	R	F	Saloon Engine AJM	261082	Drive Shaft	45W	33		53	30	620					
	2000.03-2000.11	MT	L	F	Saloon Engine AJM	203010	Drive Shaft	45W	33		53	30	599					
	2000.03-2000.11	MT	L/R	F	Saloon Engine AJM	661033	Inner Joint			34		85						
	2000.03-2000.11	MT	R	F	Saloon Engine AJM	203009	Drive Shaft	45W	33		53	30	617					
	2000.03-2000.11	MT	L	F	Saloon Engine AJM	203005	Drive Shaft	45W	33		53	30	614					
1.9 TDI quattro (81 kW)	1996.09-2000.11	5MT	L/R	F	All-wheel Drive Saloon Engine AFN/AVG	861012	Outer Joint	45W	33	30	53	30	62		I			
	1996.09-2000.11	5MT	L/R	F	All-wheel Drive Saloon Engine AFN/AVG	603002	Inner Joint			33		32						
	1996.09-2000.11	-	L/R	F	All-wheel Drive Saloon Engine AFN/AVG	803018	Outer Joint	45W	33	30	53	30	62		I			
	1996.09-2000.11	MT	L/R	F	All-wheel Drive Saloon Engine AFN/AVG	661033	Inner Joint			34		85						
	1996.09-2000.11	MT	L	F	All-wheel Drive Saloon Engine AFN/AVG	203010	Drive Shaft	45W	33		53	30	599					
	1996.09-2000.11	MT	R	F	All-wheel Drive Saloon Engine AFN/AVG	203007	Drive Shaft	45W	33		53	30	622					
	1996.09-2000.11	MT	L	F	All-wheel Drive Saloon Engine AFN/AVG	261122	Drive Shaft	45W	33		53	30	602					
	1996.09-2000.11	MT	-	-	All-wheel Drive Saloon Engine AFN/AVG	603006	Inner Joint			33		34						
1996.09-2000.11	5MT	L/R	R	All-wheel Drive Saloon Engine AFN/AVG	803026	Outer Joint	45T	33	30	53	31	62		I				

	 YEAR	TRANSM	L/R	F/R	REMARKS	GSP Ref.	 PRODUCT	 ABS	Technical Specifications					
									A	B	C	H	L	P
AUDI														
A4 (8D2 B5)														
1.9 TDI quattro (81 kW)	1996.09-2000.11	AT	R	F	All-wheel Drive Saloon Engine AFN/AVG	299108	Drive Shaft	45W	33		53	30	586	
	1996.09-2000.11	AT	L	F	All-wheel Drive Saloon Engine AFN/AVG	203012	Drive Shaft	45W	33		53	30	498	
	1996.09-2000.11	MT	R	F	All-wheel Drive Saloon Engine AFN/AVG	203009	Drive Shaft	45W	33		53	30	617	
1.9 TDI quattro (85 kW)	2000.03-2000.11	MT	L/R	F	All-wheel Drive Saloon Engine AJM/ATJ	803019	Outer Joint	45W	38	27	59.5	34.5	63	I
	2000.03-2000.11	MT	R	F	All-wheel Drive Saloon Engine AJM/ATJ	203007	Drive Shaft	45W	33		53	30	622	
	2000.03-2000.11	6MT	L/R	R	All-wheel Drive Saloon Engine AJM/ATJ	603001	Inner Joint			28		32		
	2000.03-2000.11	AT/MT	L/R	F	All-wheel Drive Saloon Engine AJM/ATJ	661033	Inner Joint			34		85		
	2000.03-2000.11	MT	L	F	All-wheel Drive Saloon Engine AJM/ATJ	261122	Drive Shaft	45W	33		53	30	602	
	2000.03-2000.11	MT	L/R	R	All-wheel Drive Saloon Engine AJM/ATJ	803026	Outer Joint	45T	33	30	53	31	62	I
2.4 (120 kW)	2000.03-2000.11	MT	L	F	All-wheel Drive Saloon Engine AJM/ATJ	261157	Drive Shaft	45W	38		59.5	34.5	601	
	1997.08-2000.11	AT	-	F	Saloon Engine AJG/APZ/AMM	650019	Inner Joint			34		59.5		
	1997.08-2000.11	-	L/R	F	Saloon Engine AJG/APZ/AMM	803019	Outer Joint	45W	38	27	59.5	34.5	63	I
	1997.08-2000.11	MT	R	F	Saloon Engine AJG/APZ/AMM	261019	Drive Shaft	45W	38		59.5	34.5	624	
	1997.08-2000.11	MT	L/R	F	Saloon Engine AJG/APZ/AMM	661033	Inner Joint			34		85		
2.4 (121 kW)	1997.08-2000.11	MT	L	F	Saloon Engine AJG/APZ/AMM	203008	Drive Shaft	45W	38		59.5	34.5	603	
	1997.03-2000.11	AT	-	F	Saloon Engine AGA/ALF/ARJ/AML/APS	650019	Inner Joint			34		59.5		
	1997.03-2000.11	MT	R	F	Saloon Engine AGA/ALF/ARJ/AML/APS	261019	Drive Shaft	45W	38		59.5	34.5	624	
	1997.03-2000.11	MT	L/R	F	Saloon Engine AGA/ALF/ARJ/AML/APS	661033	Inner Joint			34		85		
	1997.03-2000.11	MT	L	F	Saloon Engine AGA/ALF/ARJ/AML/APS	203008	Drive Shaft	45W	38		59.5	34.5	603	
2.4 quattro (120 kW)	1997.03-2000.11	-	L/R	F	Saloon Engine AGA/ALF/ARJ/AML/APS	803019	Outer Joint	45W	38	27	59.5	34.5	63	I
	1997.08-2000.11	5MT	L/R	F	All-wheel Drive Saloon Engine APZ	603002	Inner Joint			33		32		
	1997.08-2000.11	MT	R	F	All-wheel Drive Saloon Engine APZ	261019	Drive Shaft	45W	38		59.5	34.5	624	
	1997.08-2000.11	MT	L/R	F	All-wheel Drive Saloon Engine APZ	661033	Inner Joint			34		85		
	1997.08-2000.11	-	L/R	F	All-wheel Drive Saloon Engine APZ	803020	Outer Joint	45W	38	30	59.5	34	59.5	I
	1997.08-2000.11	-	L/R	R	All-wheel Drive Saloon Engine APZ	803026	Outer Joint	45T	33	30	53	31	62	I
2.4 quattro (121 kW)	1997.08-2000.11	MT	L	F	All-wheel Drive Saloon Engine APZ	203008	Drive Shaft	45W	38		59.5	34.5	603	
	1997.03-2000.11	MT	L/R	F	All-wheel Drive Saloon Engine AGA/ALF/ARJ/AML/APS	603002	Inner Joint			33		32		
	1997.03-2000.11	MT	L/R	F	All-wheel Drive Saloon Engine AGA/ALF/ARJ/AML/APS	661033	Inner Joint			34		85		
	1997.03-2000.11	-	L/R	F	All-wheel Drive Saloon Engine AGA/ALF/ARJ/AML/APS	803020	Outer Joint	45W	38	30	59.5	34	59.5	I
	1997.03-2000.11	-	L/R	R	All-wheel Drive Saloon Engine AGA/ALF/ARJ/AML/APS	803026	Outer Joint	45T	33	30	53	31	62	I
2.5 TDI (110 kW)	1997.09-2000.11	AT/MT	L/R	F	Saloon Engine AFB/AKN	803019	Outer Joint	45W	38	27	59.5	34.5	63	I
	1997.09-2000.11	MT	R	F	Saloon Engine AFB/AKN	261019	Drive Shaft	45W	38		59.5	34.5	624	
	1997.09-2000.11	AT/MT	L/R	F	Saloon Engine AFB/AKN	661033	Inner Joint			34		85		
	1997.09-2000.11	MT	L	F	Saloon Engine AFB/AKN	203008	Drive Shaft	45W	38		59.5	34.5	603	
2.5 TDI quattro (110 kW)	1997.09-2000.11	AT	L	F	All-wheel Drive Saloon Engine AFB/AKN	203015	Drive Shaft	45W	38		59.5	34.5	527	
	1997.09-2000.11	AT/MT	L/R	F	All-wheel Drive Saloon Engine AFB/AKN	803019	Outer Joint	45W	38	27	59.5	34.5	63	I
	1997.09-2000.11	AT	R	F	All-wheel Drive Saloon Engine AFB/AKN	203048	Drive Shaft	45W	38		59.5	34.5	502	
	1997.09-2000.11	MT	L/R	F	All-wheel Drive Saloon Engine AFB/AKN	661033	Inner Joint			34		85		
	1997.09-2000.11	MT	R	F	All-wheel Drive Saloon Engine AFB/AKN	261019	Drive Shaft	45W	38		59.5	34.5	624	
	1997.09-2000.11	6MT	L/R	R	All-wheel Drive Saloon Engine AFB/AKN	603001	Inner Joint			28		32		
	1997.09-2000.11	-	L/R	R	All-wheel Drive Saloon Engine AFB/AKN	803026	Outer Joint	45T	33	30	53	31	62	I
	1997.09-2000.11	MT	L	F	All-wheel Drive Saloon Engine AFB/AKN	203008	Drive Shaft	45W	38		59.5	34.5	603	
2.6 (110 kW)	1995.01-2000.11	MT	L/R	F	Saloon Engine ABC	661033	Inner Joint			34		85		
	1995.01-2000.11	MT	R	F	Saloon Engine ABC	261019	Drive Shaft	45W	38		59.5	34.5	624	
	1995.01-2000.11	AT	L/R	F	Saloon Engine ABC	803020	Outer Joint	45W	38	30	59.5	34	59.5	I
	1995.01-2000.11	MT	L/R	F	Saloon Engine ABC	803019	Outer Joint	45W	38	27	59.5	34.5	63	I
	1995.01-2000.11	MT	L/R	R	All-wheel Drive Saloon Engine ABC	603011	Inner Joint			33		34		
2.6 quattro (110 kW)	1995.01-2000.11	5MT	L/R	F	All-wheel Drive Saloon Engine ABC	603002	Inner Joint			33		32		
	1995.01-2000.11	MT	R	F	All-wheel Drive Saloon Engine ABC	261019	Drive Shaft	45W	38		59.5	34.5	624	
	1995.01-2000.11	MT	L/R	F	All-wheel Drive Saloon Engine ABC	803020	Outer Joint	45W	38	30	59.5	34	59.5	I
	1995.01-2000.11	MT	L/R	R	All-wheel Drive Saloon Engine ABC	803026	Outer Joint	45T	33	30	53	31	62	I
	1995.01-2000.11	MT	L	F	All-wheel Drive Saloon Engine ABC	203008	Drive Shaft	45W	38		59.5	34.5	603	
	1995.01-2000.11	MT	L/R	F	All-wheel Drive Saloon Engine ABC	803019	Outer Joint	45W	38	27	59.5	34.5	63	I
	1995.01-2000.11	AT/MT	L/R	F	Saloon Engine AAH	803019	Outer Joint	45W	38	27	59.5	34.5	63	I
	1995.01-2000.11	AT	R	F	Saloon Engine AAH	203048	Drive Shaft	45W	38		59.5	34.5	502	
2.8 (128 kW)	1995.09-1997.07	MT	R	F	Saloon Engine AAH	261019	Drive Shaft	45W	38		59.5	34.5	624	
	1995.09-1997.07	AT/MT	L/R	F	Saloon Engine AAH	661033	Inner Joint			34		85		
	1995.09-1997.07	-	L/R	F	Saloon Engine AAH	803020	Outer Joint	45W	38	30	59.5	34	59.5	I
	1995.09-1997.07	MT	L	F	Saloon Engine AAH	203008	Drive Shaft	45W	38		59.5	34.5	603	
	1995.09-1997.07	AT	L	F	Saloon Engine AAH	203015	Drive Shaft	45W	38		59.5	34.5	527	
	1995.09-1997.07	AT/MT	L/R	F	Saloon Engine AAH	803019	Outer Joint	45W	38	27	59.5	34.5	63	I
	1995.09-1997.07	AT	L	F	Saloon Engine AAH	203015	Drive Shaft	45W	38		59.5	34.5	527	
	1995.09-1997.07	AT/MT	L/R	F	Saloon Engine AAH	803019	Outer Joint	45W	38	27	59.5	34.5	63	I
2.8 (142 kW)	1996.10-2000.11	AT	L	F	Saloon Engine APR/ACK/ALG/AMX/AQD/AHA	203015	Drive Shaft	45W	38		59.5	34.5	527	
	1996.10-2000.11	AT/MT	L/R	F	Saloon Engine APR/ACK/ALG/AMX/AQD/AHA	803019	Outer Joint	45W	38	27	59.5	34.5	63	I
	1996.10-1999.07	AT	L	F	Saloon Engine AHA	203015	Drive Shaft	45W	38		59.5	34.5	527	
	1996.10-1999.07	AT/MT	L/R	F	Saloon Engine AHA	803019	Outer Joint	45W	38	27	59.5	34.5	63	I
	1996.10-2000.11	AT	R	F	Saloon Engine APR/ACK/ALG/AMX/AQD/AHA	203048	Drive Shaft	45W	38		59.5	34.5	502	
	1996.10-1999.07	AT	R	F	Saloon Engine AHA	203048	Drive Shaft	45W	38		59.5	34.5	502	





YEAR	TRANSM	L/R	F/R	REMARKS	GSP Ref.	PRODUCT	ABS	Technical Specifications										
								A	B	C	H	L	P					
AUDI																		
A4 (8D2 B5)																		
2.8 (142 kW)	1996.10-2000.11	MT	R	F	Saloon Engine APR/ACK/ALG/AMX/AQD/AHA	261019	Drive Shaft	45W	38		59.5	34.5	624					
	1996.10-1999.07	MT	R	F	Saloon Engine AHA	261019	Drive Shaft	45W	38		59.5	34.5	624					
	1996.10-2000.11	AT/MT	L/R	F	Saloon Engine APR/ACK/ALG/AMX/AQD/AHA	661033	Inner Joint			34		85						
	1996.10-2000.11	-	L/R	F	Saloon Engine APR/ACK/ALG/AMX/AQD/AHA	803020	Outer Joint	45W	38	30	59.5	34	59.5	I				
	1996.10-1999.07	-	L/R	F	Saloon Engine AHA	803020	Outer Joint	45W	38	30	59.5	34	59.5	I				
	1996.10-2000.11	MT	L	F	Saloon Engine APR/ACK/ALG/AMX/AQD/AHA	203008	Drive Shaft	45W	38		59.5	34.5	603					
	1996.10-1999.07	MT	L	F	Saloon Engine AHA	203008	Drive Shaft	45W	38		59.5	34.5	603					
2.8 quattro (128 kW)	1995.01-1997.07	5MT	L/R	F	All-wheel Drive Saloon Engine AAH	603002	Inner Joint			33		32						
	1995.01-1997.07	MT	R	F	All-wheel Drive Saloon Engine AAH	261019	Drive Shaft	45W	38		59.5	34.5	624					
	1995.01-1997.07	AT/MT	L/R	F	All-wheel Drive Saloon Engine AAH	803020	Outer Joint	45W	38	30	59.5	34	59.5	I				
	1995.01-1997.07	MT	L/R	R	All-wheel Drive Saloon Engine AAH	803026	Outer Joint	45T	33	30	53	31	62	I				
	1995.01-1997.07	MT	L	F	All-wheel Drive Saloon Engine AAH	203008	Drive Shaft	45W	38		59.5	34.5	603					
	1995.01-1997.07	-	L/R	F	All-wheel Drive Saloon Engine AAH	803019	Outer Joint	45W	38	27	59.5	34.5	63	I				
2.8 quattro (142 kW)	1996.10-2001.08	MT	L/R	F	All-wheel Drive Saloon Engine APR/ACK/ALG/AMX/AQD/AHA	803019	Outer Joint	45W	38	27	59.5	34.5	63	I				
	1996.10-2001.08	5MT	L	F	All-wheel Drive Saloon Engine APR/ACK/ALG/AMX/AQD/AHA	603002	Inner Joint			33		32						
	1996.10-2001.08	MT	R	F	All-wheel Drive Saloon Engine APR/ACK/ALG/AMX/AQD/AHA	261019	Drive Shaft	45W	38		59.5	34.5	624					
	1996.10-2001.08	MT	L/R	F	All-wheel Drive Saloon Engine APR/ACK/ALG/AMX/AQD/AHA	803020	Outer Joint	45W	38	30	59.5	34	59.5	I				
	1996.10-2001.08	MT	L/R	R	All-wheel Drive Saloon Engine APR/ACK/ALG/AMX/AQD/AHA	803026	Outer Joint	45T	33	30	53	31	62	I				
	1996.10-2001.08	MT	L	F	All-wheel Drive Saloon Engine APR/ACK/ALG/AMX/AQD/AHA	203008	Drive Shaft	45W	38		59.5	34.5	603					
S4 quattro (195 kW)	1997.09-2001.09	-	L/R	F	All-wheel Drive Saloon Engine AGB/AZB	803019	Outer Joint	45W	38	27	59.5	34.5	63	I				
	1997.09-2001.09	-	L/R/R	F	All-wheel Drive Saloon Engine AGB/AZB	603001	Inner Joint			28		32						
	1997.09-2001.09	-	L/R	R	All-wheel Drive Saloon Engine AGB/AZB	803026	Outer Joint	45T	33	30	53	31	62	I				
A4 (8E2 B6)																		
1.6 (75 kW)	2000.11-2004.12	MT	-	-	Saloon Engine ALZ	661044	Inner Joint			34		85						
	2000.11-2004.12	MT	L/R	F	Saloon Engine ALZ	803058	Outer Joint	45W	38	33	59.5	34	55	M				
	2000.11-2004.12	-	-	F	Saloon Engine ALZ	803030	Outer Joint			38	33	59.5	34	55	M			
1.8 T (110 kW)	2000.11-2002.07	MT	L	F	Saloon Engine AVJ	261115	Drive Shaft	45W	38		59.5	34	597					
	2000.11-2002.07	MT	L	F	Saloon Engine AVJ	203057	Drive Shaft	45W	38		59.5	34.5	593					
	2000.11-2002.07	MT/Semi-AT	L/R	F	Saloon Engine AVJ	803092	Outer Joint	45W	38	27	59.5	34	68	I				
	2000.11-2002.07	-	R	F	Saloon Engine AVJ	203058	Drive Shaft	45W	38		59.5	34.5	613					
	2000.11-2002.07	-	R	F	Saloon Engine AVJ	203362	Drive Shaft	45W	38		59.5	34	621					
	2000.11-2002.07	MT	L/R	F	Saloon Engine AVJ	803058	Outer Joint	45W	38	33	59.5	34	55	M				
	2000.11-2002.07	Semi-AT	L/R	F	Saloon Engine AVJ	203052	Drive Shaft	45W	38		59.5	34.5	522					
	2000.11-2002.07	-	-	F	Saloon Engine AVJ	803030	Outer Joint			38	33	59.5	34	55	M			
1.8 T (120 kW)	2002.07-2004.12	MT	L/R	F	Saloon Engine BFB	803092	Outer Joint	45W	38	27	59.5	34	68	I				
	2002.07-2004.12	MT	L	F	Saloon Engine BFB	203057	Drive Shaft	45W	38		59.5	34.5	593					
	2002.07-2004.12	MT	R	F	Saloon Engine BFB	203058	Drive Shaft	45W	38		59.5	34.5	613					
	2002.07-2004.12	AT	L/R	F	Saloon Engine BFB	203052	Drive Shaft	45W	38		59.5	34.5	522					
	2002.07-2004.12	MT	L	F	Saloon Engine BFB	661076	Inner Joint			34		85						
	2002.07-2004.12	-	-	F	Saloon Engine BFB	803030	Outer Joint			38	33	59.5	34	55	M			
	2002.07-2004.12	MT	L/R	F	Saloon Engine BFB	803067	Outer Joint	45W	38	27	59.5	34	68	M				
	2002.07-2004.12	-	-	F	Saloon Engine BFB	803069	Outer Joint	45W	38	27	59.5	34.5	63	M				
	2002.07-2004.12	MT	L	F	Saloon Engine BFB	203352	Drive Shaft	45W	38		59.5	34.5	594					
	2002.07-2004.12	-	-	F	Saloon Engine BFB	203352	Drive Shaft	45W	38		59.5	34.5	594					
1.8 T (140 kW)	2002.11-2004.12	AT	L/R	F	Saloon Engine BEX	203052	Drive Shaft	45W	38		59.5	34.5	522					
	2002.11-2004.12	-	-	-	Saloon Engine BEX	803078	Outer Joint	45W	38	27	59.5	34.5	63	M				
	2002.11-2004.12	-	L	F	Saloon Engine BEX	661076	Inner Joint			34		85						
	2002.11-2004.12	CVT/MT	-	F	Saloon Engine BEX	803069	Outer Joint	45W	38	27	59.5	34.5	63	M				
	2002.11-2004.12	-	L/R	F	Saloon Engine BEX	803067	Outer Joint	45W	38	27	59.5	34	68	M				
	1.8 T quattro (110 kW)	2000.11-2002.07	MT	L	F	All-wheel Drive Saloon Engine AVJ	261115	Drive Shaft	45W	38		59.5	34	597				
		2000.11-2002.07	MT	L/R	F	All-wheel Drive Saloon Engine AVJ	803092	Outer Joint	45W	38	27	59.5	34	68	I			
2000.11-2002.07		-	R	F	All-wheel Drive Saloon Engine AVJ	203362	Drive Shaft	45W	38		59.5	34	621					
2000.11-2002.07		MT	L/R	F	All-wheel Drive Saloon Engine AVJ	803058	Outer Joint	45W	38	33	59.5	34	55	M				
2000.11-2002.07		-	-	F	All-wheel Drive Saloon Engine AVJ	803030	Outer Joint			38	33	59.5	34	55	M			
1.8 T quattro (120 kW)	2002.07-2004.12	-	L	F	All-wheel Drive Saloon Engine BFB	261115	Drive Shaft	45W	38		59.5	34	597					
	2002.07-2004.12	-	R	F	All-wheel Drive Saloon Engine BFB	203311	Drive Shaft	45W	38		59.5	34	617					
	2002.07-2004.12	-	L	F	All-wheel Drive Saloon Engine BFB	661070	Inner Joint			24		85						
	2002.07-2004.12	-	L/R	F	All-wheel Drive Saloon Engine BFB	803058	Outer Joint	45W	38	33	59.5	34	55	M				
	2002.07-2004.12	-	L	F	All-wheel Drive Saloon Engine BFB	861075	Outer Joint	45W	38	33	59.5	34	56.5	M				
	2002.07-2004.12	-	-	F	All-wheel Drive Saloon Engine BFB	803030	Outer Joint			38	33	59.5	34	55	M			
	2002.07-2004.12	-	L	F	All-wheel Drive Saloon Engine BFB	203310	Drive Shaft	45W	38		59.5	34	594					
1.8 T quattro (140 kW)	2002.11-2004.12	-	L	F	All-wheel Drive Saloon Engine BEX	261115	Drive Shaft	45W	38		59.5	34	597					
	2002.11-2004.12	-	R	F	All-wheel Drive Saloon Engine BEX	203311	Drive Shaft	45W	38		59.5	34	617					
	2002.11-2004.12	-	L	F	All-wheel Drive Saloon Engine BEX	661070	Inner Joint			24		85						





	 YEAR	TRANSM	L/R	F/R	REMARKS	GSP Ref.	 PRODUCT	 ABS	Technical Specifications						
									A	B	C	H	L	P	
AUDI															
A4 (8E2 B6)															
1.8 T quattro (140 kW)	2002.11-2004.12	MT	L/R	F	All-wheel Drive Saloon Engine BEX	803058	Outer Joint	45W	38	33	59.5	34	55	M	
	2002.11-2004.12	-	L	F	All-wheel Drive Saloon Engine BEX	861075	Outer Joint	45W	38	33	59.5	34	56.5	M	
	2002.11-2004.12	-	-	F	All-wheel Drive Saloon Engine BEX	803030	Outer Joint		38	33	59.5	34	55	M	
	2002.11-2004.12	-	L	F	All-wheel Drive Saloon Engine BEX	203310	Drive Shaft	45W	38		59.5	34	594		
1.9 TDI (74 kW)	2001.05-2004.12	-	L/R	F	Saloon Engine AVB	803092	Outer Joint	45W	38	27	59.5	34	68	I	
	2001.05-2004.12	MT	L	F	Saloon Engine AVB	203057	Drive Shaft	45W	38		59.5	34.5	593		
	2001.05-2004.12	MT	R	F	Saloon Engine AVB	203058	Drive Shaft	45W	38		59.5	34.5	613		
	2001.05-2004.12	MT	-	-	Saloon Engine AVB	803078	Outer Joint	45W	38	27	59.5	34.5	63	M	
	2001.05-2004.12	MT	L	F	Saloon Engine AVB	661076	Inner Joint			34		85			
	2001.05-2004.12	MT	-	-	Saloon Engine AVB	661044	Inner Joint			34		85			
	2001.05-2004.12	-	L/R	F	Saloon Engine AVB	803067	Outer Joint	45W	38	27	59.5	34	68	M	
	2001.05-2004.12	MT	-	F	Saloon Engine AVB	803069	Outer Joint	45W	38	27	59.5	34.5	63	M	
1.9 TDI (85 kW)	2004.06-2004.12	-	L	F	Saloon Engine BKE	203352	Drive Shaft	45W	38		59.5	34.5	594		
	2004.06-2004.12	MT	-	-	Saloon Engine BKE	661044	Inner Joint			34		85			
	2004.06-2004.12	-	-	-	Saloon Engine BKE	803078	Outer Joint	45W	38	27	59.5	34.5	63	M	
	2004.06-2004.12	-	L	F	Saloon Engine BKE	661076	Inner Joint			34		85			
	2004.06-2004.12	-	L/R	F	Saloon Engine BKE	803067	Outer Joint	45W	38	27	59.5	34	68	M	
1.9 TDI (96 kW)	2000.11-2004.12	-	L/R	F	Saloon Engine AVF/AWX	803092	Outer Joint	45W	38	27	59.5	34	68	I	
	2000.11-2004.12	MT	L	F	Saloon Engine AVF/AWX	203057	Drive Shaft	45W	38		59.5	34.5	593		
	2000.11-2004.12	MT	R	F	Saloon Engine AVF/AWX	203058	Drive Shaft	45W	38		59.5	34.5	613		
	2000.11-2004.12	AT	L/R	F	Saloon Engine AVF/AWX	203052	Drive Shaft	45W	38		59.5	34.5	522		
	2000.11-2004.12	-	-	-	Saloon Engine AVF/AWX	803078	Outer Joint	45W	38	27	59.5	34.5	63	M	
	2000.11-2004.12	MT	L	F	Saloon Engine AVF/AWX	661076	Inner Joint			34		85			
	2000.11-2004.12	MT	L/R	F	Saloon Engine AVF/AWX	803067	Outer Joint	45W	38	27	59.5	34	68	M	
	2000.11-2004.12	CVT/MT	-	F	Saloon Engine AVF/AWX	803069	Outer Joint	45W	38	27	59.5	34.5	63	M	
1.9 TDI quattro (96 kW)	2001.11-2004.12	-	L	F	All-wheel Drive Saloon Engine AVF	261115	Drive Shaft	45W	38		59.5	34	597		
	2001.11-2004.12	-	L/R	F	All-wheel Drive Saloon Engine AVF	803092	Outer Joint	45W	38	27	59.5	34	68	I	
	2001.11-2004.12	-	L	F	All-wheel Drive Saloon Engine AVF	203057	Drive Shaft	45W	38		59.5	34.5	593		
	2001.11-2004.12	-	R	F	All-wheel Drive Saloon Engine AVF	203058	Drive Shaft	45W	38		59.5	34.5	613		
	2001.11-2004.12	-	L/R	F	All-wheel Drive Saloon Engine AVF	803058	Outer Joint	45W	38	33	59.5	34	55	M	
2.0 (96 kW)	2000.11-2004.12	-	-	F	All-wheel Drive Saloon Engine AVF	803030	Outer Joint		38	33	59.5	34	55	M	
	2000.11-2004.12	MT	L	F	Saloon Engine ALT	261115	Drive Shaft	45W	38		59.5	34	597		
	2000.11-2004.12	MT	L/R	F	Saloon Engine ALT	803092	Outer Joint	45W	38	27	59.5	34	68	I	
	2000.11-2004.12	MT	L	F	Saloon Engine ALT	203057	Drive Shaft	45W	38		59.5	34.5	593		
	2000.11-2004.12	Semi-AT	L/R	F	Saloon Engine ALT	203364	Drive Shaft	45W	38		59.5	34	522		
	2000.11-2004.12	MT	R	F	Saloon Engine ALT	203058	Drive Shaft	45W	38		59.5	34.5	613		
	2000.11-2004.12	-	R	F	Saloon Engine ALT	203311	Drive Shaft	45W	38		59.5	34	617		
	2000.11-2004.12	-	R	F	Saloon Engine ALT	203362	Drive Shaft	45W	38		59.5	34	621		
	2000.11-2004.12	-	L	F	Saloon Engine ALT	661070	Inner Joint			24		85			
	2000.11-2004.12	AT/MT	L/R	F	Saloon Engine ALT	803058	Outer Joint	45W	38	33	59.5	34	55	M	
	2000.11-2004.12	-	L	F	Saloon Engine ALT	861075	Outer Joint	45W	38	33	59.5	34	56.5	M	
	2000.11-2004.12	-	-	F	Saloon Engine ALT	803030	Outer Joint		38	33	59.5	34	55	M	
	2000.11-2004.12	-	L	F	Saloon Engine ALT	203310	Drive Shaft	45W	38		59.5	34	594		
2.0 FSI (110 kW)	2002.07-2004.12	MT	L	F	Saloon Engine AWA	261115	Drive Shaft	45W	38		59.5	34	597		
	2002.07-2004.12	Semi-AT	L/R	F	Saloon Engine AWA	203364	Drive Shaft	45W	38		59.5	34	522		
	2002.07-2004.12	MT	R	F	Saloon Engine AWA	203311	Drive Shaft	45W	38		59.5	34	617		
	2002.07-2004.12	-	R	F	Saloon Engine AWA	203362	Drive Shaft	45W	38		59.5	34	621		
	2002.07-2004.12	MT	L	F	Saloon Engine AWA	661070	Inner Joint			24		85			
	2002.07-2004.12	Semi-AT	L/R	F	Saloon Engine AWA	203052	Drive Shaft	45W	38		59.5	34.5	522		
	2002.07-2004.12	MT	L/R	F	Saloon Engine AWA	803058	Outer Joint	45W	38	33	59.5	34	55	M	
	2002.07-2004.12	MT	L	F	Saloon Engine AWA	861075	Outer Joint	45W	38	33	59.5	34	56.5	M	
	2002.07-2004.12	MT	-	F	Saloon Engine AWA	803030	Outer Joint		38	33	59.5	34	55	M	
	2002.07-2004.12	Semi-AT	L/R	F	Saloon Engine AWA	803067	Outer Joint	45W	38	27	59.5	34	68	M	
2002.07-2004.12	MT	L	F	Saloon Engine AWA	203310	Drive Shaft	45W	38		59.5	34	594			
2.4 (120 kW)	2001.09-2004.12	MT	L/R	F	Saloon Engine AMM	803092	Outer Joint	45W	38	27	59.5	34	68	I	
	2001.09-2004.12	MT	L	F	Saloon Engine AMM	203057	Drive Shaft	45W	38		59.5	34.5	593		
	2001.09-2004.12	MT	R	F	Saloon Engine AMM	203058	Drive Shaft	45W	38		59.5	34.5	613		
	2001.09-2004.12	AT	L/R	F	Saloon Engine AMM	203052	Drive Shaft	45W	38		59.5	34.5	522		
	2001.09-2004.12	MT	L	F	Saloon Engine AMM	661076	Inner Joint			34		85			
	2001.09-2004.12	MT	L/R	F	Saloon Engine AMM	803067	Outer Joint	45W	38	27	59.5	34	68	M	
2.4 (125 kW)	2001.09-2004.12	MT	-	F	Saloon Engine AMM	803069	Outer Joint	45W	38	27	59.5	34.5	63	M	
	2001.09-2004.12	MT	L	F	Saloon Engine AMM	203352	Drive Shaft	45W	38		59.5	34.5	594		
	2001.09-2004.12	MT	L/R	F	Saloon Engine BDV	803092	Outer Joint	45W	38	27	59.5	34	68	I	
	2001.09-2004.12	MT	L	F	Saloon Engine BDV	203057	Drive Shaft	45W	38		59.5	34.5	593		

	 YEAR	TRANSM	L/R	F/R	REMARKS	GSP Ref.	 PRODUCT	 ABS	Technical Specifications					
									A	B	C	H	L	P
AUDI														
A4 (8E2 B6)														
2.4 (125 kW)	2001.09-2004.12	MT	R	F	Saloon Engine BDV	203058	Drive Shaft	45W	38		59.5	34.5	613	
	2001.09-2004.12	AT	L/R	F	Saloon Engine BDV	203052	Drive Shaft	45W	38		59.5	34.5	522	
	2001.09-2004.12	MT	L	F	Saloon Engine BDV	661076	Inner Joint			34		85		
	2001.09-2004.12	MT	L/R	F	Saloon Engine BDV	803067	Outer Joint	45W	38	27	59.5	34	68	M
	2001.09-2004.12	AT/MT	-	F	Saloon Engine BDV	803069	Outer Joint	45W	38	27	59.5	34.5	63	M
	2001.09-2004.12	MT	L	F	Saloon Engine BDV	203352	Drive Shaft	45W	38		59.5	34.5	594	
2.5 TDI (114 kW)	2001.08-2002.07	MT	L	F	Saloon Engine AYM	203363	Drive Shaft	45W	38		59.5	34.5	611	
	2001.08-2002.07	MT	L/R	F	Saloon Engine AYM	661033	Inner Joint			34		85		
	2001.08-2002.07	MT	L	F	Saloon Engine AYM	203057	Drive Shaft	45W	38		59.5	34.5	593	
	2001.08-2002.07	MT	L/R	F	Saloon Engine AYM	803092	Outer Joint	45W	38	27	59.5	34	68	I
	2001.08-2002.07	MT	R	F	Saloon Engine AYM	203058	Drive Shaft	45W	38		59.5	34.5	613	
	2001.08-2002.07	AT	L/R	F	Saloon Engine AYM	203052	Drive Shaft	45W	38		59.5	34.5	522	
	2001.08-2002.07	CVT/MT	-	F	Saloon Engine AYM	803069	Outer Joint	45W	38	27	59.5	34.5	63	M
2.5 TDI (120 kW)	2001.08-2002.07	MT	L/R	F	Saloon Engine AYM	803067	Outer Joint	45W	38	27	59.5	34	68	M
	2002.07-2004.12	MT	L	F	Saloon Engine BDG/BFC/BCZ	203363	Drive Shaft	45W	38		59.5	34.5	611	
	2002.07-2004.12	MT	L/R	F	Saloon Engine BDG/BFC/BCZ	661033	Inner Joint			34		85		
	2002.07-2004.12	-	L/R	F	Saloon Engine BDG/BFC/BCZ	803092	Outer Joint	45W	38	27	59.5	34	68	I
	2002.07-2004.12	MT	L	F	Saloon Engine BDG/BFC/BCZ	203057	Drive Shaft	45W	38		59.5	34.5	593	
	2002.07-2004.12	MT	R	F	Saloon Engine BDG/BFC/BCZ	203058	Drive Shaft	45W	38		59.5	34.5	613	
	2002.07-2004.12	AT	L/R	F	Saloon Engine BDG/BFC/BCZ	203052	Drive Shaft	45W	38		59.5	34.5	522	
	2002.07-2004.12	-	-	-	Saloon Engine BDG/BFC/BCZ	803078	Outer Joint	45W	38	27	59.5	34.5	63	M
2.5 TDI quattro (132 kW)	2002.07-2004.12	CVT/MT	-	F	Saloon Engine BDG/BFC/BCZ	803069	Outer Joint	45W	38	27	59.5	34.5	63	M
	2002.07-2004.12	-	L/R	F	Saloon Engine BDG/BFC/BCZ	803067	Outer Joint	45W	38	27	59.5	34	68	M
	2000.11-2004.12	MT	L	F	All-wheel Drive Saloon Engine AKE/BAU/BDH	203352	Drive Shaft	45W	38		59.5	34.5	594	
	2000.11-2004.12	-	L/R	F	All-wheel Drive Saloon Engine AKE/BAU/BDH	803092	Outer Joint	45W	38	27	59.5	34	68	I
	2000.11-2004.12	MT	L	F	All-wheel Drive Saloon Engine AKE/BAU/BDH	203057	Drive Shaft	45W	38		59.5	34.5	593	
	2000.11-2004.12	MT	R	F	All-wheel Drive Saloon Engine AKE/BAU/BDH	203058	Drive Shaft	45W	38		59.5	34.5	613	
	2000.11-2004.12	AT	L	F	All-wheel Drive Saloon Engine AKE/BAU/BDH	203052	Drive Shaft	45W	38		59.5	34.5	522	
	2000.11-2004.12	MT	L	F	All-wheel Drive Saloon Engine AKE/BAU/BDH	661076	Inner Joint			34		85		
3.0 (160 kW)	2000.11-2004.12	MT	L/R	F	All-wheel Drive Saloon Engine AKE/BAU/BDH	803067	Outer Joint	45W	38	27	59.5	34	68	M
	2000.11-2004.12	AT	-	F	All-wheel Drive Saloon Engine AKE/BAU/BDH	803069	Outer Joint	45W	38	27	59.5	34.5	63	M
	2001.04-2004.12	-	L/R	F	Saloon Engine BBJ	803092	Outer Joint	45W	38	27	59.5	34	68	I
	2001.04-2004.12	MT	L	F	Saloon Engine BBJ	203057	Drive Shaft	45W	38		59.5	34.5	593	
	2001.04-2004.12	MT	R	F	Saloon Engine BBJ	203058	Drive Shaft	45W	38		59.5	34.5	613	
	2001.04-2004.12	-	-	-	Saloon Engine BBJ	803078	Outer Joint	45W	38	27	59.5	34.5	63	M
	2001.04-2004.12	AT	L/R	F	Saloon Engine BBJ	203052	Drive Shaft	45W	38		59.5	34.5	522	
	2001.04-2004.12	MT	L	F	Saloon Engine BBJ	661076	Inner Joint			34		85		
3.0 (162 kW)	2001.04-2004.12	MT	L	F	Saloon Engine BBJ	803067	Outer Joint	45W	38	27	59.5	34	68	M
	2001.04-2004.12	AT/MT	-	F	Saloon Engine BBJ	803069	Outer Joint	45W	38	27	59.5	34.5	63	M
	2001.04-2004.12	MT	L	F	Saloon Engine BBJ	203352	Drive Shaft	45W	38		59.5	34.5	594	
	2000.11-2004.12	MT	L/R	F	Saloon Engine ASN/AVK	803092	Outer Joint	45W	38	27	59.5	34	68	I
	2000.11-2004.12	MT	L	F	Saloon Engine ASN/AVK	203057	Drive Shaft	45W	38		59.5	34.5	593	
	2000.11-2004.12	MT	R	F	Saloon Engine ASN/AVK	203058	Drive Shaft	45W	38		59.5	34.5	613	
	2000.11-2004.12	AT	L/R	F	Saloon Engine ASN/AVK	203052	Drive Shaft	45W	38		59.5	34.5	522	
	2000.11-2004.12	MT	L	F	Saloon Engine ASN/AVK	661076	Inner Joint			34		85		
3.0 quattro (160 kW)	2000.11-2004.12	MT	L/R	F	Saloon Engine ASN/AVK	803067	Outer Joint	45W	38	27	59.5	34	68	M
	2000.11-2004.12	CVT/AT/MT	-	F	Saloon Engine ASN/AVK	803069	Outer Joint	45W	38	27	59.5	34.5	63	M
	2000.11-2004.12	MT	L	F	Saloon Engine ASN/AVK	203352	Drive Shaft	45W	38		59.5	34.5	594	
	2001.04-2004.12	-	L/R	F	All-wheel Drive Saloon Engine BBJ	803092	Outer Joint	45W	38	27	59.5	34	68	I
3.0 quattro (162 kW)	2001.04-2004.12	AT	L	F	All-wheel Drive Saloon Engine BBJ	203052	Drive Shaft	45W	38		59.5	34.5	522	
	2001.04-2004.12	-	-	-	All-wheel Drive Saloon Engine BBJ	803078	Outer Joint	45W	38	27	59.5	34.5	63	M
	2001.04-2004.12	AT	-	F	All-wheel Drive Saloon Engine BBJ	803069	Outer Joint	45W	38	27	59.5	34.5	63	M
	2000.11-2004.12	-	L/R	F	All-wheel Drive Saloon Engine ASN/AVK	803092	Outer Joint	45W	38	27	59.5	34	68	I
S4 quattro (253 kW)	2000.11-2004.12	AT	L/R	F	All-wheel Drive Saloon Engine ASN/AVK	203052	Drive Shaft	45W	38		59.5	34.5	522	
	2000.11-2004.12	AT/MT	L/R	F	All-wheel Drive Saloon Engine ASN/AVK	803067	Outer Joint	45W	38	27	59.5	34	68	M
	2000.11-2004.12	AT/MT	-	F	All-wheel Drive Saloon Engine ASN/AVK	803069	Outer Joint	45W	38	27	59.5	34.5	63	M
	2003.03-2004.12	MT	L	F	All-wheel Drive Saloon Engine BBK	203352	Drive Shaft	45W	38		59.5	34.5	594	
	2003.03-2004.12	AT	L	F	All-wheel Drive Saloon Engine BBK	203347	Drive Shaft	45W	38		59.5	34.5	580	
A4 (8EC B7)	2003.03-2004.12	-	-	-	All-wheel Drive Saloon Engine BBK	803078	Outer Joint	45W	38	27	59.5	34.5	63	M
	2003.03-2004.12	MT	L	F	All-wheel Drive Saloon Engine BBK	661076	Inner Joint			34		85		
	2003.03-2004.12	MT	R	F	All-wheel Drive Saloon Engine BBK	203255	Drive Shaft	45W	38		59.5	34.5	621	
	2003.03-2004.12	-	L/R	F	All-wheel Drive Saloon Engine BBK	803067	Outer Joint	45W	38	27	59.5	34	68	M
	2003.03-2004.12	AT	-	F	All-wheel Drive Saloon Engine BBK	803069	Outer Joint	45W	38	27	59.5	34.5	63	M
	2003.03-2004.12	AT	-	F	All-wheel Drive Saloon Engine BBK	203352	Drive Shaft	45W	38		59.5	34.5	594	
1.6 (75 kW)	2004.11-2008.06	-	L/R	F	Saloon Engine ALZ	803058	Outer Joint	45W	38	33	59.5	34	55	M
	2004.11-2008.06	MT	-	-	Saloon Engine ALZ	661044	Inner Joint			34		85		





YEAR	TRANSM	L/R	F/R	REMARKS	GSP Ref.	PRODUCT	ABS	Technical Specifications								
								A	B	C	H	L	P			
AUDI																
A4 (8E2 B6)																
1.6 (75 kW)	2004.11-2008.06	-	-	F	Saloon Engine ALZ	803030	Outer Joint		38	33	59.5	34	55	M		
	2004.11-2008.06	-	-	-	Saloon Engine ALZ	803078	Outer Joint	45W	38	27	59.5	34.5	63	M		
1.8 T (120 kW)	2004.11-2008.06	MT	L	F	Saloon Engine BFB	203352	Drive Shaft	45W	38		59.5	34.5	594			
	2004.11-2008.06	CVT	L/R	F	Saloon Engine BFB	203052	Drive Shaft	45W	38		59.5	34.5	522			
	2004.11-2008.06	MT	-	F	Saloon Engine BFB	803078	Outer Joint	45W	38	27	59.5	34.5	63	M		
	2004.11-2008.06	MT	L	F	Saloon Engine BFB	661076	Inner Joint			34		85				
	2004.11-2008.06	MT	R	F	Saloon Engine BFB	203255	Drive Shaft	45W	38		59.5	34.5	621			
	2004.11-2008.06	CVT/MT	-	F	Saloon Engine BFB	803069	Outer Joint	45W	38	27	59.5	34.5	63	M		
	2004.11-2008.06	-	L/R	F	Saloon Engine BFB	803067	Outer Joint	45W	38	27	59.5	34	68	M		
1.8 T quattro (120 kW)	2004.11-2008.06	-	R	F	All-wheel Drive Saloon Engine BFB	203311	Inner Shaft	45W	38		59.5	34	617			
	2004.11-2008.06	-	L	F	All-wheel Drive Saloon Engine BFB	661070	Outer Joint			24		85				
	2004.11-2008.06	-	L/R	F	All-wheel Drive Saloon Engine BFB	803058	Outer Joint	45W	38	33	59.5	34	55	M		
	2004.11-2008.06	-	L	F	All-wheel Drive Saloon Engine BFB	861075	Outer Joint	45W	38	33	59.5	34	56.5	M		
	2004.11-2008.06	-	-	F	All-wheel Drive Saloon Engine BFB	803030	Outer Joint		38	33	59.5	34	55	M		
	2004.11-2008.06	-	L/R	F	All-wheel Drive Saloon Engine BFB	803067	Outer Joint	45W	38	27	59.5	34	68	M		
	2004.11-2008.06	MT	R	F	All-wheel Drive Saloon Engine BFB	203255	Drive Shaft	45W	38		59.5	34.5	621			
	2004.11-2008.06	AT/MT	-	F	All-wheel Drive Saloon Engine BFB	803069	Outer Joint	45W	38	27	59.5	34.5	63	M		
	2004.11-2008.06	-	L	F	All-wheel Drive Saloon Engine BFB	203310	Drive Shaft	45W	38		59.5	34	594			
1.9 TDI (85 kW)	2004.11-2008.06	-	L	F	Saloon Engine BKE/BRB	203352	Inner Shaft	45W	38		59.5	34.5	594			
	2004.11-2008.06	MT	-	-	Saloon Engine BKE/BRB	661044	Inner Joint			34		85				
	2004.11-2008.06	-	-	-	Saloon Engine BKE/BRB	803078	Outer Joint	45W	38	27	59.5	34.5	63	M		
	2004.11-2008.06	-	L	F	Saloon Engine BKE/BRB	661076	Inner Joint			34		85				
	2004.11-2008.06	MT	R	F	Saloon Engine BKE/BRB	203255	Drive Shaft	45W	38		59.5	34.5	621			
	2004.11-2008.06	MT	-	F	Saloon Engine BKE/BRB	803069	Outer Joint	45W	38	27	59.5	34.5	63	M		
	2004.11-2008.06	-	L/R	F	Saloon Engine BKE/BRB	803067	Outer Joint	45W	38	27	59.5	34	68	M		
2.0 (96 kW)	2004.11-2008.06	CVT/Semi-AT	L/R	F	Saloon Engine ALT	203364	Drive Shaft	45W	38		59.5	34	522			
	2004.11-2008.06	-	R	F	Saloon Engine ALT	203311	Drive Shaft	45W	38		59.5	34	617			
	2004.11-2008.06	MT	L	F	Saloon Engine ALT	661070	Inner Joint			24		85				
	2004.11-2008.06	-	L/R	F	Saloon Engine ALT	803058	Outer Joint	45W	38	33	59.5	34	55	M		
	2004.11-2008.06	MT	L	F	Saloon Engine ALT	861075	Outer Joint	45W	38	33	59.5	34	56.5	M		
	2004.11-2008.06	-	-	F	Saloon Engine ALT	803030	Outer Joint		38	33	59.5	34	55	M		
	2004.11-2008.06	MT	L	F	Saloon Engine ALT	203310	Drive Shaft	45W	38		59.5	34	594			
2.0 TDI (100 kW)	2004.11-2008.06	MT	L	F	Saloon Engine BNA/BRF	203363	Drive Shaft	45W	38		59.5	34.5	611			
	2004.11-2008.06	MT	L	F	Saloon Engine BNA/BRF	203352	Drive Shaft	45W	38		59.5	34.5	594			
	2004.11-2008.06	MT	L/R	F	Saloon Engine BNA/BRF	661033	Inner Joint			34		85				
	2004.11-2008.06	CVT	L/R	F	Saloon Engine BNA/BRF	201132	Drive Shaft	45W	38		59.5	34.5	525			
	2004.11-2008.06	-	-	-	Saloon Engine BNA/BRF	803078	Outer Joint	45W	38	27	59.5	34.5	63	M		
	2004.11-2008.06	MT	L	F	Saloon Engine BNA/BRF	661076	Inner Joint			34		85				
	2004.11-2008.06	MT	R	F	Saloon Engine BNA/BRF	203255	Drive Shaft	45W	38		59.5	34.5	621			
	2004.11-2008.06	-	L/R	F	Saloon Engine BNA/BRF	803067	Outer Joint	45W	38	27	59.5	34	68	M		
	2004.11-2008.06	-	-	F	Saloon Engine BNA/BRF	803069	Outer Joint	45W	38	27	59.5	34.5	63	M		
2.0 TDI (103 kW)	2004.11-2008.06	-	L	F	Saloon Engine BPW	203363	Drive Shaft	45W	38		59.5	34.5	611			
	2004.11-2008.06	MT	L	F	Saloon Engine BPW	203352	Drive Shaft	45W	38		59.5	34.5	594			
	2004.11-2008.06	CVT	L/R	F	Saloon Engine BPW	201132	Drive Shaft	45W	38		59.5	34.5	525			
	2004.11-2008.06	AT/MT	-	-	Saloon Engine BPW	803078	Outer Joint	45W	38	27	59.5	34.5	63	M		
	2004.11-2008.06	MT	L	F	Saloon Engine BPW	661076	Inner Joint			34		85				
	2004.11-2008.06	MT	R	F	Saloon Engine BPW	203255	Drive Shaft	45W	38		59.5	34.5	621			
	2004.11-2008.06	-	L/R	F	Saloon Engine BPW	803067	Outer Joint	45W	38	27	59.5	34	68	M		
2.0 TDI (120 kW)	2006.06-2008.06	-	L	F	Saloon Engine BVA	203352	Drive Shaft	45W	38		59.5	34.5	594			
	2006.06-2008.06	MT	-	-	Saloon Engine BVA	661044	Inner Joint			34		85				
	2006.06-2008.06	-	L	F	Saloon Engine BVA	661076	Inner Joint			34		85				
	2006.06-2008.06	-	-	-	Saloon Engine BVA	803078	Outer Joint	45W	38	27	59.5	34.5	63	M		
	2006.06-2008.06	-	L/R	F	Saloon Engine BVA	803067	Outer Joint	45W	38	27	59.5	34	68	M		
2.0 TDI (125 kW)	2006.06-2008.06	-	L	F	Saloon Engine BRD	203352	Drive Shaft	45W	38		59.5	34.5	594			
	2006.06-2008.06	-	L	F	Saloon Engine BRD	661076	Inner Joint			34		85				
	2006.06-2008.06	MT	-	-	Saloon Engine BRD	661044	Inner Joint			34		85				
	2006.06-2008.06	-	-	-	Saloon Engine BRD	803078	Outer Joint	45W	38	27	59.5	34.5	63	M		
	2006.06-2008.06	-	L/R	F	Saloon Engine BRD	803067	Outer Joint	45W	38	27	59.5	34	68	M		
	2006.06-2008.06	MT	R	F	Saloon Engine BRD	203255	Drive Shaft	45W	38		59.5	34.5	621			
	2006.06-2008.06	MT	-	F	Saloon Engine BRD	803069	Outer Joint	45W	38	27	59.5	34.5	63	M		
2.0 TDI (89 kW)	2005.09-2006.09	CVT	L/R	F	Saloon Engine BVG	201132	Drive Shaft	45W	38		59.5	34.5	525			
	2005.09-2006.09	-	-	-	Saloon Engine BVG	803078	Outer Joint	45W	38	27	59.5	34.5	63	M		
	2005.09-2006.09	AT	-	-	Saloon Engine BVG	661044	Inner Joint			34		85				
	2005.09-2006.09	-	L/R	F	Saloon Engine BVG	803067	Outer Joint	45W	38	27	59.5	34	68	M		
2.0 TDI (93 kW)	2005.11-2006.11	-	L	F	Saloon Engine BVF	203352	Drive Shaft	45W	38		59.5	34.5	594			
	2005.11-2006.11	MT	-	-	Saloon Engine BVF	661044	Inner Joint			34		85				





YEAR	TRANSM	L/R	F/R	REMARKS	GSP Ref.	PRODUCT	ABS	Technical Specifications								
								A	B	C	H	L	P			
AUDI																
A4 (8E2 B6)																
2.0 TDI (93 kW)	2005.11-2006.11	-	L	F	Saloon Engine BVF	661076	Inner Joint			34		85				
	2005.11-2006.11	-	-	-	Saloon Engine BVF	803078	Outer Joint	45W	38	27	59.5	34.5	63	M		
	2005.11-2006.11	MT	-	F	Saloon Engine BVF	803069	Outer Joint	45W	38	27	59.5	34.5	63	M		
	2005.11-2006.11	-	L/R	F	Saloon Engine BVF	803067	Outer Joint	45W	38	27	59.5	34	68	M		
2.0 TDI 16V (103 kW)	2004.11-2008.06	MT	L	F	Saloon Engine BLB/BRE	203352	Drive Shaft	45W	38		59.5	34.5	594			
	2004.11-2008.06	MT	L/R	F	Saloon Engine BLB/BRE	661033	Inner Joint			34		85				
	2004.11-2008.06	CVT	L/R	F	Saloon Engine BLB/BRE	201132	Drive Shaft	45W	38		59.5	34.5	525			
	2004.11-2008.06	AT/MT	-	-	Saloon Engine BLB/BRE	803078	Outer Joint	45W	38	27	59.5	34.5	63	M		
	2004.11-2008.06	MT	L	F	Saloon Engine BLB/BRE	661076	Inner Joint			34		85				
	2004.11-2008.06	MT	R	F	Saloon Engine BLB/BRE	203255	Drive Shaft	45W	38		59.5	34.5	621			
	2004.11-2008.06	CVT/MT	-	F	Saloon Engine BLB/BRE	803069	Outer Joint	45W	38	27	59.5	34.5	63	M		
2.0 TDI quattro (103 kW)	2006.01-2008.06	-	R	F	All-wheel Drive Saloon Engine BPW	203311	Drive Shaft	45W	38		59.5	34	617			
	2006.01-2008.06	-	L	F	All-wheel Drive Saloon Engine BPW	661070	Inner Joint			24		85				
	2006.01-2008.06	-	L/R	F	All-wheel Drive Saloon Engine BPW	803058	Outer Joint	45W	38	33	59.5	34	55	M		
	2006.01-2008.06	-	L	F	All-wheel Drive Saloon Engine BPW	861075	Outer Joint	45W	38	33	59.5	34	56.5	M		
	2006.01-2008.06	MT	-	F	All-wheel Drive Saloon Engine BPW	803030	Outer Joint		38	33	59.5	34	55	M		
	2006.01-2008.06	-	L/R	F	All-wheel Drive Saloon Engine BPW	803067	Outer Joint	45W	38	27	59.5	34	68	M		
2.0 TDI quattro (120 kW)	2006.06-2008.06	-	R	F	All-wheel Drive Saloon Engine BVA	203311	Drive Shaft	45W	38		59.5	34	617			
	2006.06-2008.06	-	L	F	All-wheel Drive Saloon Engine BVA	661070	Inner Joint			24		85				
	2006.06-2008.06	-	L/R	F	All-wheel Drive Saloon Engine BVA	803058	Outer Joint	45W	38	33	59.5	34	55	M		
	2006.06-2008.06	MT	-	-	All-wheel Drive Saloon Engine BVA	661044	Inner Joint			34		85				
	2006.06-2008.06	-	L	F	All-wheel Drive Saloon Engine BVA	861075	Outer Joint	45W	38	33	59.5	34	56.5	M		
	2006.06-2008.06	-	L	F	All-wheel Drive Saloon Engine BVA	203310	Drive Shaft	45W	38		59.5	34	594			
2.0 TDI quattro (125 kW)	2006.06-2008.06	-	R	F	All-wheel Drive Saloon Engine BRD	203311	Drive Shaft	45W	38		59.5	34	617			
	2006.06-2008.06	-	L	F	All-wheel Drive Saloon Engine BRD	661070	Inner Joint			24		85				
	2006.06-2008.06	-	L/R	F	All-wheel Drive Saloon Engine BRD	803058	Outer Joint	45W	38	33	59.5	34	55	M		
	2006.06-2008.06	MT	-	-	All-wheel Drive Saloon Engine BRD	661044	Inner Joint			34		85				
	2006.06-2008.06	-	L	F	All-wheel Drive Saloon Engine BRD	861075	Outer Joint	45W	38	33	59.5	34	56.5	M		
	2006.06-2008.06	-	-	F	All-wheel Drive Saloon Engine BRD	803030	Outer Joint		38	33	59.5	34	55	M		
	2006.06-2008.06	-	L	F	All-wheel Drive Saloon Engine BRD	203310	Drive Shaft	45W	38		59.5	34	594			
	2006.06-2008.06	-	L/R	F	All-wheel Drive Saloon Engine BRD	803067	Outer Joint	45W	38	27	59.5	34	68	M		
2.0 TFSI (125 kW)	2006.10-2008.06	-	L	F	Saloon Engine BYK/BPJ	203352	Drive Shaft	45W	38		59.5	34.5	594			
	2006.10-2008.06	-	L/R	F	Saloon Engine BYK/BPJ	803092	Outer Joint	45W	38	27	59.5	34	68	I		
	2006.10-2008.06	-	L	F	Saloon Engine BYK/BPJ	661076	Inner Joint			34		85				
	2006.10-2008.06	-	-	-	Saloon Engine BYK/BPJ	803078	Outer Joint	45W	38	27	59.5	34.5	63	M		
	2006.10-2008.06	-	L/R	F	Saloon Engine BYK/BPJ	803067	Outer Joint	45W	38	27	59.5	34	68	M		
2.0 TFSI (147 kW)	2004.11-2008.06	MT	L	F	Saloon Engine BGB/BWE/BWT/BPG	203352	Drive Shaft	45W	38		59.5	34.5	594			
	2004.11-2008.06	CVT	L/R	F	Saloon Engine BGB/BWE/BWT/BPG	203052	Drive Shaft	45W	38		59.5	34.5	522			
	2004.11-2008.06	MT	L	F	Saloon Engine BGB/BWE/BWT/BPG	661076	Inner Joint			34		85				
	2004.11-2008.06	-	-	-	Saloon Engine BGB/BWE/BWT/BPG	803078	Outer Joint	45W	38	27	59.5	34.5	63	M		
	2004.11-2008.06	-	L/R	F	Saloon Engine BGB/BWE/BWT/BPG	803067	Outer Joint	45W	38	27	59.5	34	68	M		
	2004.11-2008.06	MT	R	F	Saloon Engine BGB/BWE/BWT/BPG	203255	Drive Shaft	45W	38		59.5	34.5	621			
	2004.11-2008.06	CVT/MT	-	F	Saloon Engine BGB/BWE/BWT/BPG	803069	Outer Joint	45W	38	27	59.5	34.5	63	M		
2.0 TFSI (162 kW)	2005.06-2008.06	-	L	F	Saloon Engine BUL	203352	Drive Shaft	45W	38		59.5	34.5	594			
	2005.06-2008.06	-	L	F	Saloon Engine BUL	661076	Inner Joint			34		85				
	2005.06-2008.06	MT	-	-	Saloon Engine BUL	661044	Inner Joint			34		85				
	2005.06-2008.06	-	-	-	Saloon Engine BUL	803078	Outer Joint	45W	38	27	59.5	34.5	63	M		
	2005.06-2008.06	MT	R	F	Saloon Engine BUL	203255	Drive Shaft	45W	38		59.5	34.5	621			
	2005.06-2008.06	-	L/R	F	Saloon Engine BUL	803067	Outer Joint	45W	38	27	59.5	34	68	M		
	2005.06-2008.06	MT	-	F	Saloon Engine BUL	803069	Outer Joint	45W	38	27	59.5	34.5	63	M		
2.0 TFSI quattro (147 kW)	2004.11-2008.06	-	R	F	All-wheel Drive Saloon Engine BGB/BWE/BWT/BPG	203311	Drive Shaft	45W	38		59.5	34	617			
	2004.11-2008.06	MT	L	F	All-wheel Drive Saloon Engine BGB/BWE/BWT/BPG	661070	Inner Joint			24		85				
	2004.11-2008.06	-	L/R	F	All-wheel Drive Saloon Engine BGB/BWE/BWT/BPG	803058	Outer Joint	45W	38	33	59.5	34	55	M		
	2004.11-2008.06	MT	L	F	All-wheel Drive Saloon Engine BGB/BWE/BWT/BPG	861075	Outer Joint	45W	38	33	59.5	34	56.5	M		
	2004.11-2008.06	-	-	F	All-wheel Drive Saloon Engine BGB/BWE/BWT/BPG	803030	Outer Joint		38	33	59.5	34	55	M		
	2004.11-2008.06	AT/MT	-	F	All-wheel Drive Saloon Engine BGB/BWE/BWT/BPG	803069	Outer Joint	45W	38	27	59.5	34.5	63	M		
	2004.11-2008.06	-	L/R	F	All-wheel Drive Saloon Engine BGB/BWE/BWT/BPG	803067	Outer Joint	45W	38	27	59.5	34	68	M		
	2004.11-2008.06	MT	L	F	All-wheel Drive Saloon Engine BGB/BWE/BWT/BPG	203310	Drive Shaft	45W	38		59.5	34	594			
2.0 TFSI quattro (162 kW)	2005.06-2008.06	-	R	F	All-wheel Drive Saloon Engine BUL	203311	Drive Shaft	45W	38		59.5	34	617			
	2005.06-2008.06	-	L	F	All-wheel Drive Saloon Engine BUL	661070	Inner Joint			24		85				
	2005.06-2008.06	-	L/R	F	All-wheel Drive Saloon Engine BUL	803058	Outer Joint	45W	38	33	59.5	34	55	M		
	2005.06-2008.06	MT	-	-	All-wheel Drive Saloon Engine BUL	661044	Inner Joint			34		85				
	2005.06-2008.06	-	L	F	All-wheel Drive Saloon Engine BUL	861075	Outer Joint	45W	38	33	59.5	34	56.5	M		





	 YEAR	TRANSM	L/R	F/R	REMARKS	GSP Ref.	 PRODUCT	 ABS	Technical Specifications					
									A	B	C	H	L	P
AUDI														
A4 (8E2 B6)														
2.0 TFSI quattro (162 kW)	2005.06-2008.06	-	L	F	All-wheel Drive Saloon Engine BUL	203310	Drive Shaft	45W	38		59.5	34	594	
	2005.06-2008.06	-	L/R	F	All-wheel Drive Saloon Engine BUL	803067	Outer Joint	45W	38	27	59.5	34	68	M
2.5 TDI (120 kW)	2004.11-2006.05	MT	L	F	Saloon Engine BDG	203363	Drive Shaft	45W	38		59.5	34.5	611	
	2004.11-2006.05	MT	-	-	Saloon Engine BDG	803078	Outer Joint	45W	38	27	59.5	34.5	63	M
	2004.11-2006.05	CVT	L/R	F	Saloon Engine BDG	203052	Drive Shaft	45W	38		59.5	34.5	522	
	2004.11-2006.05	MT	L/R	F	Saloon Engine BDG	803067	Outer Joint	45W	38	27	59.5	34	68	M
	2004.11-2006.05	CVT	-	F	Saloon Engine BDG	803069	Outer Joint	45W	38	27	59.5	34.5	63	M
2.7 TDI (120 kW)	2005.11-2008.06	CVT/MT	-	F	Saloon Engine BSG	803069	Outer Joint	45W	38	27	59.5	34.5	63	M
2.7 TDI (132 kW)	2006.01-2008.06	CVT	-	F	Saloon Engine BPP	803069	Outer Joint	45W	38	27	59.5	34.5	63	M
3.0 quattro (160 kW)	2004.11-2006.07	AT	L	F	All-wheel Drive Saloon Engine BBJ	203052	Drive Shaft	45W	38		59.5	34.5	522	
	2004.11-2006.07	-	-	-	All-wheel Drive Saloon Engine BBJ	803078	Outer Joint	45W	38	27	59.5	34.5	63	M
	2004.11-2006.07	AT/MT	-	F	All-wheel Drive Saloon Engine BBJ	803069	Outer Joint	45W	38	27	59.5	34.5	63	M
	2004.11-2006.07	-	L/R	F	All-wheel Drive Saloon Engine BBJ	803067	Outer Joint	45W	38	27	59.5	34	68	M
3.0 TDI quattro (150 kW)	2004.11-2008.06	MT	L	F	All-wheel Drive Saloon Engine BKN	203352	Drive Shaft	45W	38		59.5	34.5	594	
	2004.11-2008.06	AT	L	F	All-wheel Drive Saloon Engine BKN	203347	Drive Shaft	45W	38		59.5	34.5	580	
	2004.11-2008.06	MT	L	F	All-wheel Drive Saloon Engine BKN	661076	Inner Joint			34		85		
	2004.11-2008.06	-	-	-	All-wheel Drive Saloon Engine BKN	803078	Outer Joint	45W	38	27	59.5	34.5	63	M
	2004.11-2008.06	-	L/R	F	All-wheel Drive Saloon Engine BKN	803067	Outer Joint	45W	38	27	59.5	34	68	M
	2004.11-2008.06	MT	R	F	All-wheel Drive Saloon Engine BKN	203255	Drive Shaft	45W	38		59.5	34.5	621	
	2004.11-2008.06	-	-	F	All-wheel Drive Saloon Engine BKN	803069	Outer Joint	45W	38	27	59.5	34.5	63	M
3.0 TDI quattro (171 kW)	2006.01-2008.06	MT	L	F	All-wheel Drive Saloon Engine ASB	203352	Drive Shaft	45W	38		59.5	34.5	594	
	2006.01-2008.06	AT	L	F	All-wheel Drive Saloon Engine ASB	203347	Drive Shaft	45W	38		59.5	34.5	580	
	2006.01-2008.06	MT	L	F	All-wheel Drive Saloon Engine ASB	661076	Inner Joint			34		85		
	2006.01-2008.06	-	-	-	All-wheel Drive Saloon Engine ASB	803078	Outer Joint	45W	38	27	59.5	34.5	63	M
	2006.01-2008.06	MT	R	F	All-wheel Drive Saloon Engine ASB	203255	Drive Shaft	45W	38		59.5	34.5	621	
	2006.01-2008.06	-	L/R	F	All-wheel Drive Saloon Engine ASB	803067	Outer Joint	45W	38	27	59.5	34	68	M
	2006.01-2008.06	-	-	F	All-wheel Drive Saloon Engine ASB	803069	Outer Joint	45W	38	27	59.5	34.5	63	M
3.2 FSI (188 kW)	2005.01-2008.06	-	L/R	F	Saloon Engine AUK	203052	Drive Shaft	45W	38		59.5	34.5	522	
	2005.01-2008.06	AT	-	-	Saloon Engine AUK	803078	Outer Joint	45W	38	27	59.5	34.5	63	M
	2005.01-2008.06	MT	L/R	F	Saloon Engine AUK	803067	Outer Joint	45W	38	27	59.5	34	68	M
	2005.01-2008.06	CVT	-	F	Saloon Engine AUK	803069	Outer Joint	45W	38	27	59.5	34.5	63	M
3.2 FSI quattro (188 kW)	2005.01-2008.06	AT	L	F	All-wheel Drive Saloon Engine AUK/BKH	203347	Drive Shaft	45W	38		59.5	34.5	580	
	2005.01-2008.06	-	-	F	All-wheel Drive Saloon Engine AUK/BKH	803030	Outer Joint		38	33	59.5	34	55	M
	2005.01-2008.06	AT	L	F	All-wheel Drive Saloon Engine AUK/BKH	661076	Inner Joint			34		85		
	2005.01-2008.06	-	L/R	F	All-wheel Drive Saloon Engine AUK/BKH	803067	Outer Joint	45W	38	27	59.5	34	68	M
	2005.01-2008.06	-	-	F	All-wheel Drive Saloon Engine AUK/BKH	803069	Outer Joint	45W	38	27	59.5	34.5	63	M
RS4 quattro (309 kW)	2005.09-2008.06	-	L	F	All-wheel Drive Saloon Engine BNS	203352	Drive Shaft	45W	38		59.5	34.5	594	
	2005.09-2008.06	MT	-	-	All-wheel Drive Saloon Engine BNS	803078	Outer Joint	45W	38	27	59.5	34.5	63	M
	2005.09-2008.06	MT	-	-	All-wheel Drive Saloon Engine BNS	661044	Inner Joint			34		85		
	2005.09-2008.06	-	L	F	All-wheel Drive Saloon Engine BNS	661076	Inner Joint			34		85		
	2005.09-2008.06	MT	-	F/R	All-wheel Drive Saloon Engine BNS	803069	Outer Joint	45W	38	27	59.5	34.5	63	M
	2005.09-2008.06	-	L/R	F	All-wheel Drive Saloon Engine BNS	803067	Outer Joint	45W	38	27	59.5	34	68	M
S4 quattro (253 kW)	2004.11-2008.06	MT	L	F	All-wheel Drive Saloon Engine BBK/BHF	203352	Drive Shaft	45W	38		59.5	34.5	594	
	2004.11-2008.06	-	L	F	All-wheel Drive Saloon Engine BBK/BHF	203347	Drive Shaft	45W	38		59.5	34.5	580	
	2004.11-2008.06	MT	L	F	All-wheel Drive Saloon Engine BBK/BHF	661076	Inner Joint			34		85		
	2004.11-2008.06	-	-	-	All-wheel Drive Saloon Engine BBK/BHF	803078	Outer Joint	45W	38	27	59.5	34.5	63	M
	2004.11-2008.06	MT	R	F	All-wheel Drive Saloon Engine BBK/BHF	203255	Drive Shaft	45W	38		59.5	34.5	621	
	2004.11-2008.06	AT/MT	-	F	All-wheel Drive Saloon Engine BBK/BHF	803069	Outer Joint	45W	38	27	59.5	34.5	63	M
	2004.11-2008.06	-	L/R	F	All-wheel Drive Saloon Engine BBK/BHF	803067	Outer Joint	45W	38	27	59.5	34	68	M
A4 (8H7 B6 8HE B7)														
1.8 T (120 kW)	2002.07-2009.03	-	L/R	F	Convertible Engine BFB	803092	Outer Joint	45W	38	27	59.5	34	68	I
	2002.07-2009.03	MT	L	F	Convertible Engine BFB	203057	Drive Shaft	45W	38		59.5	34.5	593	
	2002.07-2009.03	MT	R	F	Convertible Engine BFB	203058	Drive Shaft	45W	38		59.5	34.5	613	
	2002.07-2009.03	AT/CVT	L/R	F	Convertible Engine BFB	203052	Drive Shaft	45W	38		59.5	34.5	522	
	2002.07-2009.03	MT	L	F	Convertible Engine BFB	661076	Inner Joint			34		85		
	2002.07-2009.03	CVT/MT	-	F	Convertible Engine BFB	803069	Outer Joint	45W	38	27	59.5	34.5	63	M
	2002.07-2009.03	MT	L/R	F	Convertible Engine BFB	803067	Outer Joint	45W	38	27	59.5	34	68	M
	2002.07-2009.03	MT	L	F	Convertible Engine BFB	203352	Drive Shaft	45W	38		59.5	34.5	594	
1.8 T quattro (120 kW)	2003.05-2009.03	-	L	F	All-wheel Drive Convertible Engine BFB	261115	Drive Shaft	45W	38		59.5	34	597	
	2003.05-2009.03	MT	R	F	All-wheel Drive Convertible Engine BFB	203311	Drive Shaft	45W	38		59.5	34	617	
	2003.05-2009.03	MT	L	F	All-wheel Drive Convertible Engine BFB	661070	Inner Joint			24		85		
	2003.05-2009.03	-	L/R	F	All-wheel Drive Convertible Engine BFB	803058	Outer Joint	45W	38	33	59.5	34	55	M
	2003.05-2009.03	MT	L	F	All-wheel Drive Convertible Engine BFB	861075	Outer Joint	45W	38	33	59.5	34	56.5	M
	2003.05-2009.03	MT	L	F	All-wheel Drive Convertible Engine BFB	203310	Drive Shaft	45W	38		59.5	34	594	
2.0 (96 kW)	2004.09-2005.12	MT	L/R	F	Convertible Engine ALT	803092	Outer Joint	45W	38	27	59.5	34	68	I
	2004.09-2005.12	-	R	F	Convertible Engine ALT	203311	Drive Shaft	45W	38		59.5	34	617	





	 YEAR	TRANSM	L/R	F/R	REMARKS	GSP Ref.	 PRODUCT	 ABS	Technical Specifications						
									A	B	C	H	L	P	
AUDI															
A4 (8H7 B6 8HE B7)															
2.0 (96 kW)	2004.09-2005.12	AT/MT	L/R	F	Convertible Engine ALT	803058	Outer Joint	45W	38	33	59.5	34	55	M	
	2004.09-2005.12	-	L	F	Convertible Engine ALT	661070	Inner Joint				24		85		
	2004.09-2005.12	MT	-	-	Convertible Engine ALT	661044	Inner Joint				34		85		
	2004.09-2005.12	-	L	F	Convertible Engine ALT	861075	Outer Joint	45W	38	33	59.5	34	56.5	M	
	2004.09-2005.12	-	-	-	Convertible Engine ALT	803030	Outer Joint			38	33	59.5	34	55	M
	2004.09-2005.12	-	L	F	Convertible Engine ALT	203310	Drive Shaft	45W	38			59.5	34	594	
2.0 TDI (100 kW)	2006.01-2009.03	MT	L	F	Convertible Engine BRC	203352	Drive Shaft	45W	38		59.5	34.5	594		
	2006.01-2009.03	Semi-AT	L/R	F	Convertible Engine BRC	201132	Drive Shaft	45W	38		59.5	34.5	525		
	2006.01-2009.03	AT/MT	-	-	Convertible Engine BRC	803078	Outer Joint	45W	38	27	59.5	34.5	63	M	
	2006.01-2009.03	MT	L	F	Convertible Engine BRC	661076	Inner Joint				34		85		
	2006.01-2009.03	MT	L/R	F	Convertible Engine BRC	803067	Outer Joint	45W	38	27	59.5	34	68	M	
2.0 TDI (103 kW)	2006.01-2009.03	-	-	-	Convertible Engine BRC	803069	Outer Joint	45W	38	27	59.5	34.5	63	M	
	2006.01-2009.03	MT	L	F	Convertible Engine BPW	203352	Drive Shaft	45W	38		59.5	34.5	594		
	2006.01-2009.03	AT	L	F	Convertible Engine BPW	203347	Drive Shaft	45W	38		59.5	34.5	580		
	2006.01-2009.03	CVT	L/R	F	Convertible Engine BPW	201132	Drive Shaft	45W	38		59.5	34.5	525		
	2006.01-2009.03	MT	L	F	Convertible Engine BPW	661076	Inner Joint				34		85		
	2006.01-2009.03	-	-	-	Convertible Engine BPW	803078	Outer Joint	45W	38	27	59.5	34.5	63	M	
	2006.01-2009.03	MT	R	F	Convertible Engine BPW	203255	Drive Shaft	45W	38		59.5	34.5	621		
2.0 TFSI 16V (147 kW)	2006.01-2009.03	CVT/MT	-	-	Convertible Engine BPW	803069	Outer Joint	45W	38	27	59.5	34.5	63	M	
	2006.01-2009.03	MT	L/R	F	Convertible Engine BPW	803067	Outer Joint	45W	38	27	59.5	34	68	M	
	2006.01-2009.03	MT	L	F	Convertible Engine BWE/BWT	203352	Drive Shaft	45W	38		59.5	34.5	594		
	2006.01-2009.03	CVT	L/R	F	Convertible Engine BWE/BWT	203052	Drive Shaft	45W	38		59.5	34.5	522		
	2006.01-2009.03	MT	L	F	Convertible Engine BWE/BWT	661076	Inner Joint				34		85		
	2006.01-2009.03	-	-	-	Convertible Engine BWE/BWT	803078	Outer Joint	45W	38	27	59.5	34.5	63	M	
2.4 (120 kW)	2006.01-2009.03	CVT/MT	-	-	Convertible Engine BWE/BWT	803069	Outer Joint	45W	38	27	59.5	34.5	63	M	
	2006.01-2009.03	MT	L/R	F	Convertible Engine BWE/BWT	803067	Outer Joint	45W	38	27	59.5	34	68	M	
	2002.04-2005.12	-	L/R	F	Convertible Engine AMM	803092	Outer Joint	45W	38	27	59.5	34	68	I	
	2002.04-2005.12	MT	L	F	Convertible Engine AMM	203057	Drive Shaft	45W	38		59.5	34.5	593		
	2002.04-2005.12	MT	R	F	Convertible Engine AMM	203058	Drive Shaft	45W	38		59.5	34.5	613		
	2002.04-2005.12	AT	L/R	F	Convertible Engine AMM	203052	Drive Shaft	45W	38		59.5	34.5	522		
	2002.04-2005.12	MT	L	F	Convertible Engine AMM	661076	Inner Joint				34		85		
	2002.04-2005.12	MT	L/R	F	Convertible Engine AMM	803067	Outer Joint	45W	38	27	59.5	34	68	M	
2.4 (125 kW)	2002.04-2005.12	AT/MT	-	-	Convertible Engine AMM	803069	Outer Joint	45W	38	27	59.5	34.5	63	M	
	2002.04-2005.12	MT	L	F	Convertible Engine AMM	203352	Drive Shaft	45W	38		59.5	34.5	594		
	2002.04-2005.12	-	L/R	F	Convertible Engine BDV	803092	Outer Joint	45W	38	27	59.5	34	68	I	
	2002.04-2005.12	MT	L	F	Convertible Engine BDV	203057	Drive Shaft	45W	38		59.5	34.5	593		
	2002.04-2005.12	MT	R	F	Convertible Engine BDV	203058	Drive Shaft	45W	38		59.5	34.5	613		
	2002.04-2005.12	AT	L/R	F	Convertible Engine BDV	203052	Drive Shaft	45W	38		59.5	34.5	522		
	2002.04-2005.12	MT	L	F	Convertible Engine BDV	661076	Inner Joint				34		85		
	2002.04-2005.12	MT	L/R	F	Convertible Engine BDV	803067	Outer Joint	45W	38	27	59.5	34	68	M	
2.5 TDI (120 kW)	2002.04-2005.12	CVT/MT	-	-	Convertible Engine BDV	803069	Outer Joint	45W	38	27	59.5	34.5	63	M	
	2002.04-2005.12	MT	L	F	Convertible Engine BDV	203352	Drive Shaft	45W	38		59.5	34.5	594		
	2002.08-2005.12	MT	L	F	Convertible Engine BCZ/BFC/BDG	203363	Drive Shaft	45W	38		59.5	34.5	611		
	2002.08-2005.12	MT	L/R	F	Convertible Engine BCZ/BFC/BDG	661033	Inner Joint				34		85		
	2002.08-2005.12	-	L/R	F	Convertible Engine BCZ/BFC/BDG	803092	Outer Joint	45W	38	27	59.5	34	68	I	
	2002.08-2005.12	MT	L	F	Convertible Engine BCZ/BFC/BDG	203057	Drive Shaft	45W	38		59.5	34.5	593		
	2002.08-2005.12	MT	R	F	Convertible Engine BCZ/BFC/BDG	203058	Drive Shaft	45W	38		59.5	34.5	613		
	2002.08-2005.12	AT	L/R	F	Convertible Engine BCZ/BFC/BDG	203052	Drive Shaft	45W	38		59.5	34.5	522		
2.7 TDI (132 kW)	2002.08-2005.12	-	-	-	Convertible Engine BCZ/BFC/BDG	803078	Outer Joint	45W	38	27	59.5	34.5	63	M	
	2002.08-2005.12	CVT/MT	-	-	Convertible Engine BCZ/BFC/BDG	803069	Outer Joint	45W	38	27	59.5	34.5	63	M	
	2002.08-2005.12	-	L/R	F	Convertible Engine BCZ/BFC/BDG	803067	Outer Joint	45W	38	27	59.5	34	68	M	
	2006.06-2009.03	AT	-	-	Convertible Engine BPP	661044	Inner Joint				34		85		
	2006.06-2009.03	-	-	-	Convertible Engine BPP	803069	Outer Joint	45W	38	27	59.5	34.5	63	M	
	3.0 (160 kW)	2002.04-2005.12	MT	L/R	F	Convertible Engine BBJ	803092	Outer Joint	45W	38	27	59.5	34	68	I
		2002.04-2005.12	MT	L	F	Convertible Engine BBJ	203057	Drive Shaft	45W	38		59.5	34.5	593	
		2002.04-2005.12	MT	R	F	Convertible Engine BBJ	203058	Drive Shaft	45W	38		59.5	34.5	613	
2002.04-2005.12		AT	L/R	F	Convertible Engine BBJ	203052	Drive Shaft	45W	38		59.5	34.5	522		
2002.04-2005.12		MT	L	F	Convertible Engine BBJ	661076	Inner Joint				34		85		
2002.04-2005.12		MT	L/R	F	Convertible Engine BBJ	803067	Outer Joint	45W	38	27	59.5	34	68	M	
3.0 (162 kW)	2002.04-2005.12	MT	L	F	Convertible Engine BBJ	203352	Drive Shaft	45W	38		59.5	34.5	594		
	2002.04-2005.12	-	L/R	F	Convertible Engine ASN	803092	Outer Joint	45W	38	27	59.5	34	68	I	
	2002.04-2005.12	MT	L	F	Convertible Engine ASN	203057	Drive Shaft	45W	38		59.5	34.5	593		
	2002.04-2005.12	MT	R	F	Convertible Engine ASN	203058	Drive Shaft	45W	38		59.5	34.5	613		
	2002.04-2005.12	AT	L/R	F	Convertible Engine ASN	203052	Drive Shaft	45W	38		59.5	34.5	522		
	2002.04-2005.12	MT	L	F	Convertible Engine ASN	661076	Inner Joint				34		85		
3.0 (162 kW)	2002.04-2005.12	MT	L/R	F	Convertible Engine ASN	803067	Outer Joint	45W	38	27	59.5	34	68	M	





YEAR	TRANSM	L/R	F/R	REMARKS	GSP Ref.	PRODUCT	ABS	Technical Specifications							
								A	B	C	H	L	P		
AUDI															
A4 (8H7 B6 8HE B7)															
3.0 (162 kW)	2002.04-2005.12	-	-	F	Convertible Engine ASN	803030	Outer Joint		38	33	59.5	34	55	M	
	2002.04-2005.12	CVT/MT	-	F	Convertible Engine ASN	803069	Outer Joint	45W	38	27	59.5	34.5	63	M	
	2002.04-2005.12	MT	L	F	Convertible Engine ASN	203352	Drive Shaft	45W	38		59.5	34.5	594		
3.0 quattro (162 kW)	2003.05-2005.12	-	L/R	F	All-wheel Drive Convertible Engine ASN	803092	Outer Joint	45W	38	27	59.5	34	68	I	
	2003.05-2005.12	AT	L/R	F	All-wheel Drive Convertible Engine ASN	203052	Drive Shaft	45W	38		59.5	34.5	522		
	2003.05-2005.12	AT/MT	L/R	F	All-wheel Drive Convertible Engine ASN	803067	Outer Joint	45W	38	27	59.5	34	68	M	
	2003.05-2005.12	MT	-	F	All-wheel Drive Convertible Engine ASN	803069	Outer Joint	45W	38	27	59.5	34.5	63	M	
3.0 TDI quattro (150 kW)	2006.01-2009.03	MT	L	F	All-wheel Drive Convertible Engine BKN	203352	Drive Shaft	45W	38		59.5	34.5	594		
	2006.01-2009.03	AT	L	F	All-wheel Drive Convertible Engine BKN	203347	Drive Shaft	45W	38		59.5	34.5	580		
	2006.01-2009.03	AT/MT	-	-	All-wheel Drive Convertible Engine BKN	803078	Outer Joint	45W	38	27	59.5	34.5	63	M	
	2006.01-2009.03	MT	L	F	All-wheel Drive Convertible Engine BKN	661076	Inner Joint			34		85			
	2006.01-2009.03	-	L/R	F	All-wheel Drive Convertible Engine BKN	803067	Outer Joint	45W	38	27	59.5	34	68	M	
	2006.01-2009.03	-	-	F	All-wheel Drive Convertible Engine BKN	803069	Outer Joint	45W	38	27	59.5	34.5	63	M	
3.0 TDI quattro (171 kW)	2006.01-2009.03	MT	L	F	All-wheel Drive Convertible Engine ASB	203352	Drive Shaft	45W	38		59.5	34.5	594		
	2006.01-2009.03	AT	L	F	All-wheel Drive Convertible Engine ASB	203347	Drive Shaft	45W	38		59.5	34.5	580		
	2006.01-2009.03	MT	L	F	All-wheel Drive Convertible Engine ASB	661076	Inner Joint			34		85			
	2006.01-2009.03	-	-	-	All-wheel Drive Convertible Engine ASB	803078	Outer Joint	45W	38	27	59.5	34.5	63	M	
	2006.01-2009.03	MT	R	F	All-wheel Drive Convertible Engine ASB	203255	Drive Shaft	45W	38		59.5	34.5	621		
	2006.01-2009.03	-	L/R	F	All-wheel Drive Convertible Engine ASB	803067	Outer Joint	45W	38	27	59.5	34	68	M	
	2006.01-2009.03	-	-	F	All-wheel Drive Convertible Engine ASB	803069	Outer Joint	45W	38	27	59.5	34.5	63	M	
3.2 FSI (188 kW)	2006.01-2009.03	-	L/R	F	Convertible Engine AUK	203052	Drive Shaft	45W	38		59.5	34.5	522		
	2006.01-2009.03	-	-	-	Convertible Engine AUK	803078	Outer Joint	45W	38	27	59.5	34.5	63	M	
	2006.01-2009.03	-	L/R	F	Convertible Engine AUK	803067	Outer Joint	45W	38	27	59.5	34	68	M	
	2006.01-2009.03	-	-	F	Convertible Engine AUK	803069	Outer Joint	45W	38	27	59.5	34.5	63	M	
3.2 FSI quattro (188 kW)	2006.01-2009.03	AT	L	F	All-wheel Drive Convertible Engine AUK	203347	Drive Shaft	45W	38		59.5	34.5	580		
	2006.01-2009.03	-	-	-	All-wheel Drive Convertible Engine AUK	803078	Outer Joint	45W	38	27	59.5	34.5	63	M	
	2006.01-2009.03	AT	L	F	All-wheel Drive Convertible Engine AUK	661076	Inner Joint			34		85			
	2006.01-2009.03	-	L/R	F	All-wheel Drive Convertible Engine AUK	803067	Outer Joint	45W	38	27	59.5	34	68	M	
	2006.01-2009.03	-	-	F	All-wheel Drive Convertible Engine AUK	803069	Outer Joint	45W	38	27	59.5	34.5	63	M	
	2006.01-2009.03	-	-	-	All-wheel Drive Convertible Engine AUK	803078	Outer Joint	45W	38	27	59.5	34.5	63	M	
RS4 quattro (309 kW)	2006.06-2009.03	-	L	F	All-wheel Drive Convertible Engine BNS	203352	Drive Shaft	45W	38		59.5	34.5	594		
	2006.06-2009.03	MT	-	-	All-wheel Drive Convertible Engine BNS	661044	Inner Joint			34		85			
	2006.06-2009.03	-	L	F	All-wheel Drive Convertible Engine BNS	661076	Inner Joint			34		85			
	2006.06-2009.03	-	L/R	F	All-wheel Drive Convertible Engine BNS	803067	Outer Joint	45W	38	27	59.5	34	68	M	
	2006.06-2009.03	-	-	F/R	All-wheel Drive Convertible Engine BNS	803069	Outer Joint	45W	38	27	59.5	34.5	63	M	
S4 quattro (253 kW)	2004.03-2009.03	AT	L	F	All-wheel Drive Convertible Engine BBK	203347	Drive Shaft	45W	38		59.5	34.5	580		
	2004.03-2009.03	MT	L	F	All-wheel Drive Convertible Engine BBK	661076	Inner Joint			34		85			
	2004.03-2009.03	-	L/R	F	All-wheel Drive Convertible Engine BBK	803067	Outer Joint	45W	38	27	59.5	34	68	M	
	2004.03-2009.03	-	-	-	All-wheel Drive Convertible Engine BBK	803078	Outer Joint	45W	38	27	59.5	34.5	63	M	
	2004.03-2009.03	MT	R	F	All-wheel Drive Convertible Engine BBK	203255	Drive Shaft	45W	38		59.5	34.5	621		
	2004.03-2009.03	MT	L	F	All-wheel Drive Convertible Engine BBK	203352	Drive Shaft	45W	38		59.5	34.5	594		
2004.03-2009.03	-	-	F	All-wheel Drive Convertible Engine BBK	803069	Outer Joint	45W	38	27	59.5	34.5	63	M		
A4 (8K2 B8)															
1.8 TFSI (118 kW)	2007.11-2012.03	-	-	F	Saloon Engine CABB/CDHB	803103	Outer Joint		42	28	76.4	34	54	I	
	2007.11-2012.03	AT/MT	L/R	F	Saloon Engine CABB/CDHB	203291	Drive Shaft		42		76.4	34	464		
	2007.11-2012.03	6MT/CVT	L/R	F	Saloon Engine CABB/CDHB	203273	Drive Shaft		42		76.5	34	460		
	2007.11-2012.03	6MT/CVT	L/R	F	Saloon Engine CABB/CDHB	803087	Outer Joint		42	27	76.5	34	54.5	M	
1.8 TFSI (125 kW)	2011.11-2015.12	-	-	F	Saloon Engine CJEB	803103	Outer Joint		42	28	76.4	34	54	I	
1.8 TFSI (88 kW)	2008.01-2015.12	-	-	F	Saloon Engine CABA/CDHA	803103	Outer Joint		42	28	76.4	34	54	I	
	2008.01-2015.12	AT/MT	L/R	F	Saloon Engine CABA/CDHA	203291	Drive Shaft		42		76.4	34	464		
	2008.01-2015.12	6MT/CVT	L/R	F	Saloon Engine CABA/CDHA	203273	Drive Shaft		42		76.5	34	460		
	2008.01-2015.12	6MT/CVT	L/R	F	Saloon Engine CABA/CDHA	803087	Outer Joint		42	27	76.5	34	54.5	M	
1.8 TFSI quattro (118 kW)	2008.09-2012.03	6AT/6MT	L/R	F	All-wheel Drive Saloon Engine CDHB	603029	Inner Joint			24		88.5			
	2008.09-2012.03	-	L/R	F	All-wheel Drive Saloon Engine CDHB	803086	Outer Joint		42	33	76.5	34	45.5	M	
	2008.09-2012.03	6MT/CVT	L/R	F	All-wheel Drive Saloon Engine CDHB	203273	Drive Shaft		42		76.5	34	460		
	2008.09-2012.03	6AT/6MT	L/R	F	All-wheel Drive Saloon Engine CDHB	203345	Drive Shaft		42		76.5	34	463		
1.8 TFSI quattro (125 kW)	2011.11-2015.12	-	-	F	All-wheel Drive Saloon Engine CJEB	803103	Outer Joint		42	28	76.4	34	54	I	
2.0 TDI (100 kW)	2007.11-2015.12	MT	-	F	Saloon Engine CJC/CAGB/CSUB	803103	Outer Joint		42	28	76.4	34	54	I	
	2007.11-2015.12	AT/MT	L/R	F	Saloon Engine CJC/CAGB/CSUB	203291	Drive Shaft		42		76.4	34	464		
	2007.11-2015.12	6MT/CVT	L/R	F	Saloon Engine CJC/CAGB/CSUB	203273	Drive Shaft		42		76.5	34	460		
	2007.11-2015.12	6MT	L/R	F	Saloon Engine CJC/CAGB/CSUB	803109	Outer Joint		42	27	76.5	34	54.5	M	
	2007.11-2015.12	6MT/CVT	L/R	F	Saloon Engine CJC/CAGB/CSUB	803087	Outer Joint		42	27	76.5	34	54.5	M	
2.0 TDI (105 kW)	2007.11-2015.12	-	-	F	Saloon Engine CMFA/CAGA/CMEA/CJCA	803103	Outer Joint		42	28	76.4	34	54	I	
	2007.11-2015.12	AT/MT	L/R	F	Saloon Engine CMFA/CAGA/CMEA/CJCA	203291	Drive Shaft		42		76.4	34	464		
	2007.11-2015.12	6MT/CVT	L/R	F	Saloon Engine CMFA/CAGA/CMEA/CJCA	203273	Drive Shaft		42		76.5	34	460		
	2007.11-2015.12	6MT	L/R	F	Saloon Engine CMFA/CAGA/CMEA/CJCA	803109	Outer Joint		42	27	76.5	34	54.5	M	
	2007.11-2015.12	-	L/R	F	Saloon Engine CMFA/CAGA/CMEA/CJCA	803087	Outer Joint		42	27	76.5	34	54.5	M	





	 YEAR	TRANSM	L/R	F/R	REMARKS	GSP Ref.	 PRODUCT	 ABS	Technical Specifications					
									A	B	C	H	L	P
AUDI														
A4 (8K2 B8)														
2.0 TDI (110 kW)	2013.05-2015.12	CVT/MT	-	F	Saloon Engine CSUA/CJCD/CMFB	803103	Outer Joint		42	28	76.4	34	54	I
2.0 TDI (120 kW)	2008.08-2015.12	-	-	F	Saloon Engine CAHB/CGLD/CNHC	803103	Outer Joint		42	28	76.4	34	54	I
	2008.08-2015.12	AT/MT	L/R	F	Saloon Engine CAHB/CGLD/CNHC	203291	Drive Shaft		42		76.4	34	464	
	2008.08-2015.12	6MT/CVT	L/R	F	Saloon Engine CAHB/CGLD/CNHC	203273	Drive Shaft		42		76.5	34	460	
	2008.08-2015.12	6MT	L/R	F	Saloon Engine CAHB/CGLD/CNHC	803109	Outer Joint		42	27	76.5	34	54.5	M
	2008.08-2015.12	MT	L/R	F	Saloon Engine CAHB/CGLD/CNHC	803087	Outer Joint		42	27	76.5	34	54.5	M
2.0 TDI (125 kW)	2008.01-2012.03	-	-	F	Saloon Engine CAHA	803103	Outer Joint		42	28	76.4	34	54	I
	2008.01-2012.03	AT/MT	L/R	F	Saloon Engine CAHA	203291	Drive Shaft		42		76.4	34	464	
	2008.01-2012.03	6MT/CVT	L/R	F	Saloon Engine CAHA	203273	Drive Shaft		42		76.5	34	460	
	2008.01-2012.03	6MT	L/R	F	Saloon Engine CAHA	803109	Outer Joint		42	27	76.5	34	54.5	M
	2008.01-2012.03	-	L/R	F	Saloon Engine CAHA	803087	Outer Joint		42	27	76.5	34	54.5	M
	2008.01-2012.03	MT	-	-	Saloon Engine CAHA	603022	Inner Joint			34		88		
2.0 TDI (130 kW)	2011.11-2015.12	-	-	F	Saloon Engine CGLC/CMGB	803102	Outer Joint		42	29	76.5	34	60	I
	2011.11-2015.12	CVT/MT	L/R	F	Saloon Engine CGLC/CMGB	203337	Drive Shaft		42		76.5	34	461	
2.0 TDI (140 kW)	2013.09-2015.12	Semi-AT/MT	-	F	Saloon Engine CNHA	803102	Outer Joint		42	29	76.5	34	60	I
	2013.09-2015.12	Semi-AT/MT	L/R	F	Saloon Engine CNHA	203337	Drive Shaft		42		76.5	34	461	
2.0 TDI (88 kW)	2008.06-2015.12	MT	-	F	Saloon Engine CAGC/CJCC	803103	Outer Joint		42	28	76.4	34	54	I
	2008.06-2015.12	AT/MT	L/R	F	Saloon Engine CAGC/CJCC	203291	Drive Shaft		42		76.4	34	464	
	2008.06-2015.12	6MT/CVT	L/R	F	Saloon Engine CAGC/CJCC	203273	Drive Shaft		42		76.5	34	460	
	2008.06-2015.12	6MT	L/R	F	Saloon Engine CAGC/CJCC	803109	Outer Joint		42	27	76.5	34	54.5	M
	2008.06-2015.12	-	L/R	F	Saloon Engine CAGC/CJCC	803087	Outer Joint		42	27	76.5	34	54.5	M
	2008.06-2015.12	MT	-	-	Saloon Engine CAGC/CJCC	603022	Inner Joint			34		88		
2.0 TDI 16V (103 kW)	2008.07-	-	-	F	Saloon Engine BRE	803103	Outer Joint		42	28	76.4	34	54	I
2.0 TDI quattro (105 kW)	2008.11-2015.12	6AT/6MT	L/R	F	All-wheel Drive Saloon Engine CAGA/CJCA	603029	Inner Joint			24		88.5		
	2008.11-2015.12	-	-	F	All-wheel Drive Saloon Engine CAGA/CJCA	803103	Outer Joint		42	28	76.4	34	54	I
	2008.11-2015.12	-	L/R	F	All-wheel Drive Saloon Engine CAGA/CJCA	803086	Outer Joint		42	33	76.5	34	45.5	M
	2008.11-2015.12	6AT/6MT	L/R	F	All-wheel Drive Saloon Engine CAGA/CJCA	203345	Drive Shaft		42		76.5	34	463	
2.0 TDI quattro (110 kW)	2013.05-2015.12	-	-	F	All-wheel Drive Saloon Engine CJCD/CSUA	803107	Outer Joint		42	25	76.5	34	47.5	I
2.0 TDI quattro (125 kW)	2008.01-2012.03	6AT/6MT	L/R	F	All-wheel Drive Saloon Engine CAHA	603029	Inner Joint			24		88.5		
	2008.01-2012.03	-	-	F	All-wheel Drive Saloon Engine CAHA	803103	Outer Joint		42	28	76.4	34	54	I
	2008.01-2012.03	-	L/R	F	All-wheel Drive Saloon Engine CAHA	803086	Outer Joint		42	33	76.5	34	45.5	M
	2008.01-2012.03	6AT/6MT	L/R	F	All-wheel Drive Saloon Engine CAHA	203345	Drive Shaft		42		76.5	34	463	
	2008.01-2012.03	MT	-	-	All-wheel Drive Saloon Engine CAHA	603022	Inner Joint			34		88		
2.0 TDI quattro (130 kW)	2011.11-2015.12	-	-	F	All-wheel Drive Saloon Engine CGLC	803107	Outer Joint		42	25	76.5	34	47.5	I
	2011.11-2015.12	MT	L/R	F	All-wheel Drive Saloon Engine CGLC	203371	Drive Shaft		42		76.5	34	465	
2.0 TDI quattro (140 kW)	2013.09-2015.12	CVT/MT	-	F	All-wheel Drive Saloon Engine CNHA	803107	Outer Joint		42	25	76.5	34	47.5	I
2.0 TFSI (132 kW)	2008.06-2015.12	-	-	F	Saloon Engine CFKA/CDNB/CAEA	803103	Outer Joint		42	28	76.4	34	54	I
	2008.06-2015.12	AT/MT	L/R	F	Saloon Engine CFKA/CDNB/CAEA	203291	Drive Shaft		42		76.4	34	464	
	2008.06-2015.12	6AT/6MT	L/R	F	Saloon Engine CFKA/CDNB/CAEA	803086	Outer Joint		42	33	76.5	34	45.5	M
	2008.06-2015.12	6MT/CVT	L/R	F	Saloon Engine CFKA/CDNB/CAEA	203273	Drive Shaft		42		76.5	34	460	
	2008.06-2015.12	6MT	L/R	F	Saloon Engine CFKA/CDNB/CAEA	803109	Outer Joint		42	27	76.5	34	54.5	M
	2008.06-2015.12	-	L/R	F	Saloon Engine CFKA/CDNB/CAEA	803087	Outer Joint		42	27	76.5	34	54.5	M
2.0 TFSI (155 kW)	2008.06-2013.05	CVT/MT	-	F	Saloon Engine CDNC/CAEB	803103	Outer Joint		42	28	76.4	34	54	I
2.0 TFSI (165 kW)	2008.06-2013.05	AT/MT	L/R	F	Saloon Engine CDNC/CAEB	203291	Drive Shaft		42		76.4	34	464	
	2008.06-2013.05	6MT/CVT	L/R	F	Saloon Engine CDNC/CAEB	203273	Drive Shaft		42		76.5	34	460	
	2008.06-2013.05	6MT	L/R	F	Saloon Engine CDNC/CAEB	803109	Outer Joint		42	27	76.5	34	54.5	M
	2008.06-2013.05	-	L/R	F	Saloon Engine CDNC/CAEB	803087	Outer Joint		42	27	76.5	34	54.5	M
	2013.05-2015.12	CVT/MT	-	F	Saloon Engine CNCD	803103	Outer Joint		42	28	76.4	34	54	I
	2.0 TFSI flexible fuel (132 kW)	2009.11-2015.12	CVT/MT	-	F	Saloon Engine CFKA	803103	Outer Joint		42	28	76.4	34	54
2009.11-2015.12		AT/MT	L/R	F	Saloon Engine CFKA	203291	Drive Shaft		42		76.4	34	464	
2009.11-2015.12		-	L/R	F	Saloon Engine CFKA	203273	Drive Shaft		42		76.5	34	460	
2009.11-2015.12		-	L/R	F	Saloon Engine CFKA	803109	Outer Joint		42	27	76.5	34	54.5	M
2009.11-2015.12		-	L/R	F	Saloon Engine CFKA	803087	Outer Joint		42	27	76.5	34	54.5	M
2009.11-2015.12		MT	-	-	Saloon Engine CFKA	603022	Inner Joint			34		88		
2009.11-2015.12		-	L/R	F	All-wheel Drive Saloon Engine CFKA	603029	Inner Joint			24		88.5		
2.0 TFSI flexible fuel quattro (132 kW)	2009.11-2015.12	-	L/R	F	All-wheel Drive Saloon Engine CFKA	803086	Outer Joint		42	33	76.5	34	45.5	M
	2009.11-2015.12	-	L/R	F	All-wheel Drive Saloon Engine CFKA	203345	Drive Shaft		42		76.5	34	463	
	2009.11-2015.12	MT	-	-	All-wheel Drive Saloon Engine CFKA	603022	Inner Joint			34		88		
	2009.11-2015.12	-	-	-	All-wheel Drive Saloon Engine CFKA	603029	Inner Joint			24		88.5		
2.0 TFSI quattro (155 kW)	2008.06-2015.12	6AT/6MT	L/R	F	All-wheel Drive Saloon Engine CDNC/CAEB/CPMA	603029	Inner Joint			24		88.5		
	2008.06-2015.12	AT/MT	L/R	F	All-wheel Drive Saloon Engine CDNC/CAEB/CPMA	803086	Outer Joint		42	33	76.5	34	45.5	M
	2008.06-2015.12	6AT/6MT	L/R	F	All-wheel Drive Saloon Engine CDNC/CAEB/CPMA	203345	Drive Shaft		42		76.5	34	463	
2.0 TFSI quattro (162 kW)	2013.05-2015.12	AT/MT	-	F	All-wheel Drive Saloon Engine CPMB/CAED	803107	Outer Joint		42	25	76.5	34	47.5	I
2.0 TFSI quattro (165 kW)	2013.05-2015.12	-	-	F	All-wheel Drive Saloon Engine CNCD	803103	Outer Joint		42	28	76.4	34	54	I
2.7 TDI (120 kW)	2007.11-2012.03	-	-	F	Saloon Engine CAMB/CGKB	803102	Outer Joint		42	29	76.5	34	60	I
	2007.11-2012.03	AT	-	-	Saloon Engine CAMB/CGKB	603022	Inner Joint			34		88		
	2007.11-2012.03	CVT/MT	L/R	F	Saloon Engine CAMB/CGKB	203337	Drive Shaft		42		76.5	34	461	





	 YEAR	TRANSM	L/R	F/R	REMARKS	GSP Ref.	 PRODUCT	 ABS	Technical Specifications					
									A	B	C	H	L	P
AUDI														
A4 (8K2 B8)														
2.7 TDI (120 kW)	2007.11-2012.03	-	L/R	F	Saloon Engine CAMB/CGKB	803088	Outer Joint		42	29	76.5	34	61.5	M
	2007.11-2012.03	6MT/CVT	L/R	F	Saloon Engine CAMB/CGKB	203321	Drive Shaft		42		76.5	34	462	
2.7 TDI (140 kW)	2007.11-2012.03	-	-	F	Saloon Engine CAMA/CGKA	803102	Outer Joint		42	29	76.5	34	60	I
	2007.11-2012.03	CVT/MT	L/R	F	Saloon Engine CAMA/CGKA	203337	Drive Shaft		42		76.5	34	461	
	2007.11-2012.03	-	L/R	F	Saloon Engine CAMA/CGKA	803088	Outer Joint		42	29	76.5	34	61.5	M
	2007.11-2012.03	6MT/CVT	L/R	F	Saloon Engine CAMA/CGKA	203321	Drive Shaft		42		76.5	34	462	
3.0 TDI (150 kW)	2011.11-2015.12	-	-	F	Saloon Engine CLAB	803102	Outer Joint		42	29	76.5	34	60	I
	2011.11-2015.12	CVT/MT	L/R	F	Saloon Engine CLAB	203337	Drive Shaft		42		76.5	34	461	
3.0 TDI quattro (155 kW)	2008.06-2010.05	-	L/R	F	All-wheel Drive Saloon Engine CCWB	803087	Outer Joint		42	27	76.5	34	54.5	M
	2008.06-2010.05	AT	-	-	All-wheel Drive Saloon Engine CCWB	603022	Inner Joint			34		88		
	2008.06-2010.05	-	L/R	F	All-wheel Drive Saloon Engine CCWB	203273	Drive Shaft		42		76.5	34	460	
3.0 TDI quattro (176 kW)	2007.11-2012.03	CVT/MT	-	F	All-wheel Drive Saloon Engine CAPA/CCWA/CCLA	803103	Outer Joint		42	28	76.4	34	54	I
	2007.11-2012.03	6AT/6MT	L/R	F	All-wheel Drive Saloon Engine CAPA/CCWA/CCLA	203273	Drive Shaft		42		76.5	34	460	
	2007.11-2012.03	6MT/CVT	L/R	F	All-wheel Drive Saloon Engine CAPA/CCWA/CCLA	203321	Drive Shaft		42		76.5	34	462	
	2007.11-2012.03	6MT/CVT	L/R	F	All-wheel Drive Saloon Engine CAPA/CCWA/CCLA	803087	Outer Joint		42	27	76.5	34	54.5	M
3.0 TDI quattro (180 kW)	2011.11-2015.12	-	-	F	All-wheel Drive Saloon Engine CKVB/CDUC/CKVC	803103	Outer Joint		42	28	76.4	34	54	I
3.0 TFSI quattro (200 kW)	2012.02-2015.12	AT	-	-	All-wheel Drive Saloon Engine CMUA/CRED	603022	Inner Joint			34		88		
	2012.02-2015.12	-	-	F	All-wheel Drive Saloon Engine CMUA/CRED	803103	Outer Joint		42	28	76.4	34	54	I
3.2 FSI (195 kW)	2008.09-2012.03	CVT	-	F	Saloon Engine CALA	803103	Outer Joint		42	28	76.4	34	54	I
	2008.09-2012.03	AT/MT	L/R	F	Saloon Engine CALA	203291	Drive Shaft		42		76.4	34	464	
	2008.09-2012.03	CVT	L/R	F	Saloon Engine CALA	203273	Drive Shaft		42		76.5	34	460	
	2008.09-2012.03	-	L/R	F	Saloon Engine CALA	803109	Outer Joint		42	27	76.5	34	54.5	M
	2008.09-2012.03	-	L/R	F	Saloon Engine CALA	803087	Outer Joint		42	27	76.5	34	54.5	M
3.2 FSI quattro (195 kW)	2007.11-2012.03	6AT/6MT	L/R	F	All-wheel Drive Saloon Engine CALA	603029	Inner Joint			24		88.5		
	2007.11-2012.03	-	L/R	F	All-wheel Drive Saloon Engine CALA	803086	Outer Joint		42	33	76.5	34	45.5	M
	2007.11-2012.03	CVT	L/R	F	All-wheel Drive Saloon Engine CALA	203273	Drive Shaft		42		76.5	34	460	
	2007.11-2012.03	6AT/6MT	L/R	F	All-wheel Drive Saloon Engine CALA	203345	Drive Shaft		42		76.5	34	463	
S4 quattro (245 kW)	2008.11-2015.12	-	-	F	All-wheel Drive Saloon Engine CGWC/CAKA/CCBA/CGXC/CTUBI/CREC	803103	Outer Joint		42	28	76.4	34	54	I
	2008.11-2015.12	-	L/R	F	All-wheel Drive Saloon Engine CGWC/CAKA/CCBA/CGXC/CTUBI/CREC	203273	Drive Shaft		42		76.5	34	460	
	2008.11-2015.12	-	L/R	F	All-wheel Drive Saloon Engine CGWC/CAKA/CCBA/CGXC/CTUBI/CREC	803087	Outer Joint		42	27	76.5	34	54.5	M
A4 Allroad (8KH B8)														
2.0 TDI quattro (100 kW)	2009.09-2016.05	-	-	F	All-wheel Drive Estate Engine CAGB/CJCB/CSUB	803107	Outer Joint		42	25	76.5	34	47.5	I
	2009.09-2016.05	7AT/6MT	L/R	F	All-wheel Drive Estate Engine CAGB/CJCB/CSUB	603029	Inner Joint			24		88.5		
	2009.09-2016.05	MT	L/R	F	All-wheel Drive Estate Engine CAGB/CJCB/CSUB	803086	Outer Joint		42	33	76.5	34	45.5	M
	2009.09-2016.05	MT	L	F	All-wheel Drive Estate Engine CAGB/CJCB/CSUB	203371	Drive Shaft		42		76.5	34	465	
	2009.09-2016.05	MT	R	F	All-wheel Drive Estate Engine CAGB/CJCB/CSUB	203371	Drive Shaft		42		76.5	34	465	
	2009.09-2016.05	7AT/6MT	L/R	F	All-wheel Drive Estate Engine CAGB/CJCB/CSUB	203345	Drive Shaft		42		76.5	34	463	
2.0 TDI quattro (105 kW)	2009.09-2016.05	-	-	F	All-wheel Drive Estate Engine CJCA/CJCA	803107	Outer Joint		42	25	76.5	34	47.5	I
	2009.09-2016.05	7AT/6MT	L/R	F	All-wheel Drive Estate Engine CJCA/CJCA	603029	Inner Joint			24		88.5		
	2009.09-2016.05	-	L/R	F	All-wheel Drive Estate Engine CJCA/CJCA	803086	Outer Joint		42	33	76.5	34	45.5	M
	2009.09-2016.05	MT	L	F	All-wheel Drive Estate Engine CJCA/CJCA	203371	Drive Shaft		42		76.5	34	465	
	2009.09-2016.05	MT	R	F	All-wheel Drive Estate Engine CJCA/CJCA	203371	Drive Shaft		42		76.5	34	465	
	2009.09-2016.05	7AT/6MT	L/R	F	All-wheel Drive Estate Engine CJCA/CJCA	203345	Drive Shaft		42		76.5	34	463	
2.0 TDI quattro (110 kW)	2013.05-2016.05	-	-	F	All-wheel Drive Estate Engine CSUA/CJCD	803107	Outer Joint		42	25	76.5	34	47.5	I
2.0 TDI quattro (120 kW)	2009.04-2016.05	-	-	F	All-wheel Drive Estate Engine CAHB/CLGD/CNHC	803107	Outer Joint		42	25	76.5	34	47.5	I
	2009.04-2016.05	7AT/6MT	L/R	F	All-wheel Drive Estate Engine CAHB/CLGD/CNHC	603029	Inner Joint			24		88.5		
	2009.04-2016.05	AT/MT	L/R	F	All-wheel Drive Estate Engine CAHB/CLGD/CNHC	803086	Outer Joint		42	33	76.5	34	45.5	M
	2009.04-2016.05	MT	L	F	All-wheel Drive Estate Engine CAHB/CLGD/CNHC	203371	Drive Shaft		42		76.5	34	465	
	2009.04-2016.05	MT	R	F	All-wheel Drive Estate Engine CAHB/CLGD/CNHC	203371	Drive Shaft		42		76.5	34	465	
	2009.04-2016.05	7AT/6MT	L/R	F	All-wheel Drive Estate Engine CAHB/CLGD/CNHC	203345	Drive Shaft		42		76.5	34	463	
2.0 TDI quattro (125 kW)	2009.04-2016.05	-	-	F	All-wheel Drive Estate Engine CAHA	803107	Outer Joint		42	25	76.5	34	47.5	I
	2009.04-2016.05	7AT/6MT	L/R	F	All-wheel Drive Estate Engine CAHA	603029	Inner Joint			24		88.5		
	2009.04-2016.05	-	L/R	F	All-wheel Drive Estate Engine CAHA	803086	Outer Joint		42	33	76.5	34	45.5	M
	2009.04-2016.05	MT	L	F	All-wheel Drive Estate Engine CAHA	203371	Drive Shaft		42		76.5	34	465	
	2009.04-2016.05	MT	R	F	All-wheel Drive Estate Engine CAHA	203371	Drive Shaft		42		76.5	34	465	
2.0 TDI quattro (130 kW)	2009.04-2016.05	7AT/6MT	L/R	F	All-wheel Drive Estate Engine CAHA	203345	Drive Shaft		42		76.5	34	463	
	2011.11-2016.05	-	-	F	All-wheel Drive Estate Engine CGLC	803107	Outer Joint		42	25	76.5	34	47.5	I
	2011.11-2016.05	MT	R	F	All-wheel Drive Estate Engine CGLC	203371	Drive Shaft		42		76.5	34	465	
	2011.11-2016.05	MT	L	F	All-wheel Drive Estate Engine CGLC	203371	Drive Shaft		42		76.5	34	465	
2.0 TDI quattro (140 kW)	2013.09-2016.05	-	-	F	All-wheel Drive Estate Engine CNHA	803107	Outer Joint		42	25	76.5	34	47.5	I
2.0 TFSI quattro (155 kW)	2009.04-2016.05	-	-	F	All-wheel Drive Estate Engine CDNC/CPMA	803107	Outer Joint		42	25	76.5	34	47.5	I
	2009.04-2016.05	7AT/6MT	L/R	F	All-wheel Drive Estate Engine CDNC/CPMA	603029	Inner Joint			24		88.5		
	2009.04-2016.05	-	L/R	F	All-wheel Drive Estate Engine CDNC/CPMA	803086	Outer Joint		42	33	76.5	34	45.5	M
	2009.04-2016.05	MT	L	F	All-wheel Drive Estate Engine CDNC/CPMA	203371	Drive Shaft		42		76.5	34	465	
	2009.04-2016.05	MT	R	F	All-wheel Drive Estate Engine CDNC/CPMA	203371	Drive Shaft		42		76.5	34	465	
	2009.04-2016.05	7AT/6MT	L/R	F	All-wheel Drive Estate Engine CDNC/CPMA	203345	Drive Shaft		42		76.5	34	463	





	 YEAR	TRANSM	L/R	F/R	REMARKS	GSP Ref.	 PRODUCT	 ABS	Technical Specifications					
									A	B	C	H	L	P
AUDI														
A4 Allroad (8KH B8)														
2.0 TFSI quattro (162 kW)	2013.05-2016.05	-	-	F	All-wheel Drive Estate Engine CPMB	803107	Outer Joint		42	25	76.5	34	47.5	I
3.0 TDI quattro (176 kW)	2009.04-2012.01	7AT/6MT	L/R	F	All-wheel Drive Estate Engine CCWA	203273	Drive Shaft		42		76.5	34	460	
	2009.04-2012.01	7AT/6MT	L/R	F	All-wheel Drive Estate Engine CCWA	803087	Outer Joint		42	27	76.5	34	54.5	M
3.0 TDI quattro (180 kW)	2012.01-2016.05	AT	-	-	All-wheel Drive Estate Engine CKVB/CDUC/CKVC	603022	Inner Joint			34		88		
	2012.01-2016.05	-	-	F	All-wheel Drive Estate Engine CKVB/CDUC/CKVC	803103	Outer Joint		42	28	76.4	34	54	I
A4 Avant (8D5 B5)														
1.6 (74 kW)	1994.11-2001.09	MT	L	F	Estate Engine ADP/AHL/ANA/ARM	203002	Drive Shaft	45W	33		53	30	614	
	1994.11-2001.09	AT	L/R	F	Estate Engine ADP/AHL/ANA/ARM	661033	Inner Joint			34		85		
	1994.11-2001.09	-	L/R	F	Estate Engine ADP/AHL/ANA/ARM	803018	Outer Joint	45W	33	30	53	30	62	I
	1994.11-2001.09	AT	R	F	Estate Engine ADP/AHL/ANA/ARM	299108	Drive Shaft	45W	33		53	30	586	
	1994.11-2001.09	AT	L	F	Estate Engine ADP/AHL/ANA/ARM	203012	Drive Shaft	45W	33		53	30	498	
	1994.11-2001.09	MT	R	F	Estate Engine ADP/AHL/ANA/ARM	299111	Drive Shaft	45W	33		53	30	636	
1.6 (75 kW)	2000.07-2001.09	MT	L	F	Estate Engine ALZ	203002	Drive Shaft	45W	33		53	30	614	
	2000.07-2001.09	-	L/R	F	Estate Engine ALZ	803018	Outer Joint	45W	33	30	53	30	62	I
	2000.07-2001.09	-	R	F	Estate Engine ALZ	299108	Drive Shaft	45W	33		53	30	586	
	2000.07-2001.09	AT	L	F	Estate Engine ALZ	203012	Drive Shaft	45W	33		53	30	498	
	2000.07-2001.09	MT	R	F	Estate Engine ALZ	299111	Drive Shaft	45W	33		53	30	636	
1.8 (92 kW)	1996.02-2001.09	-	L/R	F	Estate Engine APT/ARG/ADR	861012	Outer Joint	45W	33	30	53	30	62	I
	1996.02-2001.09	MT	R	F	Estate Engine APT/ARG/ADR	203001	Drive Shaft	45W	33		53	30	634	
	1996.02-2001.09	MT	L	F	Estate Engine APT/ARG/ADR	203005	Drive Shaft	45W	33		53	30	614	
	1996.02-2001.09	AT	L/R	F	Estate Engine APT/ARG/ADR	661033	Inner Joint			34		85		
	1996.02-2001.09	-	L/R	F	Estate Engine APT/ARG/ADR	803018	Outer Joint	45W	33	30	53	30	62	I
	1996.02-2001.09	MT	L/R	F	Estate Engine APT/ARG/ADR	603001	Inner Joint			28		32		
	1996.02-2001.09	MT	-	-	Estate Engine APT/ARG/ADR	603006	Inner Joint			33		34		
	1996.02-2001.09	AT	R	F	Estate Engine APT/ARG/ADR	299108	Drive Shaft	45W	33		53	30	586	
	1996.02-2001.09	AT	L	F	Estate Engine APT/ARG/ADR	203012	Drive Shaft	45W	33		53	30	498	
1.8 quattro (92 kW)	1996.01-2001.09	-	L/R	F	All-wheel Drive Estate Engine AVV/APT/ARG/ADR	861012	Outer Joint	45W	33	30	53	30	62	I
	1996.01-2001.09	MT	L	F	All-wheel Drive Estate Engine AVV/APT/ARG/ADR	203002	Drive Shaft	45W	33		53	30	614	
	1996.01-2001.09	5MT	L/R	F	All-wheel Drive Estate Engine AVV/APT/ARG/ADR	603002	Inner Joint			33		32		
	1996.01-2001.09	-	L/R	F	All-wheel Drive Estate Engine AVV/APT/ARG/ADR	803018	Outer Joint	45W	33	30	53	30	62	I
	1996.01-2001.09	MT	L	F	All-wheel Drive Estate Engine AVV/APT/ARG/ADR	203005	Drive Shaft	45W	33		53	30	614	
	1996.01-2001.09	-	L/R	F	All-wheel Drive Estate Engine AVV/APT/ARG/ADR	603001	Inner Joint			28		32		
	1996.01-2001.09	MT	-	-	All-wheel Drive Estate Engine AVV/APT/ARG/ADR	603006	Inner Joint			33		34		
	1996.01-2001.09	5MT	L/R	R	All-wheel Drive Estate Engine AVV/APT/ARG/ADR	803026	Outer Joint	45T	33	30	53	31	62	I
	1996.01-2001.09	AT	R	F	All-wheel Drive Estate Engine AVV/APT/ARG/ADR	299108	Drive Shaft	45W	33		53	30	586	
	1996.01-2001.09	AT	L	F	All-wheel Drive Estate Engine AVV/APT/ARG/ADR	203012	Drive Shaft	45W	33		53	30	498	
1996.01-2001.09	5MT	R	F	All-wheel Drive Estate Engine AVV/APT/ARG/ADR	299111	Drive Shaft	45W	33		53	30	636		
1.8 T (110 kW)	1996.03-2001.09	MT	L	F	Estate Engine ARK/AEB/APU/ANB/AWT	203002	Drive Shaft	45W	33		53	30	614	
	1996.03-2001.09	MT	R	F	Estate Engine ARK/AEB/APU/ANB/AWT	203001	Drive Shaft	45W	33		53	30	634	
	1996.03-2001.09	MT	L	F	Estate Engine ARK/AEB/APU/ANB/AWT	203005	Drive Shaft	45W	33		53	30	614	
	1996.03-2001.09	-	L/R	F	Estate Engine ARK/AEB/APU/ANB/AWT	861012	Outer Joint	45W	33	30	53	30	62	I
	1996.03-2001.09	-	L/R	F	Estate Engine ARK/AEB/APU/ANB/AWT	803018	Outer Joint	45W	33	30	53	30	62	I
	1996.03-2001.09	-	L/R	F	Estate Engine ARK/AEB/APU/ANB/AWT	603001	Inner Joint			28		32		
	1996.03-2001.09	AT	L	F	Estate Engine ARK/AEB/APU/ANB/AWT	203036	Drive Shaft	45W	33		53	30	524	
	1996.03-2001.09	MT	-	-	Estate Engine ARK/AEB/APU/ANB/AWT	603006	Inner Joint			33		34		
	1996.03-2001.09	AT	R	F	Estate Engine ARK/AEB/APU/ANB/AWT	203012	Drive Shaft	45W	33		53	30	498	
1.8 T (132 kW)	1997.12-2001.09	-	L/R	F	Estate Engine AJL	803019	Outer Joint	45W	38	27	59.5	34.5	63	I
	1997.12-2001.09	-	L/R	F	Estate Engine AJL	603001	Inner Joint			28		32		
1.8 T quattro (110 kW)	1996.01-2001.09	MT	L	F	All-wheel Drive Estate Engine ARK/AEB/APU/ANB/AWT	203002	Drive Shaft	45W	33		53	30	614	
	1996.01-2001.09	-	L/R	F	All-wheel Drive Estate Engine ARK/AEB/APU/ANB/AWT	603002	Inner Joint			33		32		
	1996.01-2001.09	-	L/R	F	All-wheel Drive Estate Engine ARK/AEB/APU/ANB/AWT	861012	Outer Joint	45W	33	30	53	30	62	I
	1996.01-2001.09	MT	L	F	All-wheel Drive Estate Engine ARK/AEB/APU/ANB/AWT	203005	Drive Shaft	45W	33		53	30	614	
	1996.01-2001.09	AT	L/R	F	All-wheel Drive Estate Engine ARK/AEB/APU/ANB/AWT	661033	Inner Joint			34		85		
	1996.01-2001.09	-	L/R	F	All-wheel Drive Estate Engine ARK/AEB/APU/ANB/AWT	803018	Outer Joint	45W	33	30	53	30	62	I
	1996.01-2001.09	-	L/R	F	All-wheel Drive Estate Engine ARK/AEB/APU/ANB/AWT	603001	Inner Joint			28		32		
	1996.01-2001.09	AT	L	F	All-wheel Drive Estate Engine ARK/AEB/APU/ANB/AWT	203036	Drive Shaft	45W	33		53	30	524	
	1996.01-2001.09	MT	-	-	All-wheel Drive Estate Engine ARK/AEB/APU/ANB/AWT	603006	Inner Joint			33		34		
	1996.01-2001.09	-	L/R	R	All-wheel Drive Estate Engine ARK/AEB/APU/ANB/AWT	803026	Outer Joint	45T	33	30	53	31	62	I
	1996.01-2001.09	AT	R	F	All-wheel Drive Estate Engine ARK/AEB/APU/ANB/AWT	203012	Drive Shaft	45W	33		53	30	498	
	1996.01-2001.09	MT	R	F	All-wheel Drive Estate Engine ARK/AEB/APU/ANB/AWT	299111	Drive Shaft	45W	33		53	30	636	
1.8 T quattro (132 kW)	1997.12-2001.09	-	L/R	F	All-wheel Drive Estate Engine AJL	603002	Inner Joint			33		32		
	1997.12-2001.09	-	R	F	All-wheel Drive Estate Engine AJL	203007	Drive Shaft	45W	33		53	30	622	
	1997.12-2001.09	-	L	F	All-wheel Drive Estate Engine AJL	261122	Drive Shaft	45W	33		53	30	602	
	1997.12-2001.09	-	L/R	F	All-wheel Drive Estate Engine AJL	803020	Outer Joint	45W	38	30	59.5	34	59.5	I
	1997.12-2001.09	-	L/R	R	All-wheel Drive Estate Engine AJL	803026	Outer Joint	45T	33	30	53	31	62	I
1.9 DUO (66 kW)	1998.03-2001.09	MT	R	F	Estate Engine AHU	203009	Drive Shaft	45W	33		53	30	617	





	 YEAR	TRANSM	L/R	F/R	REMARKS	GSP Ref.	 PRODUCT	 ABS	Technical Specifications					
									A	B	C	H	L	P
AUDI														
A4 Avant (8D5 B5)														
1.9 DUO (66 kW)	1998.03-2001.09	-	L/R	F	Estate Engine AHU	861012	Outer Joint	45W	33	30	53	30	62	I
	1998.03-2001.09	-	L/R	F	Estate Engine AHU	803018	Outer Joint	45W	33	30	53	30	62	I
	1998.03-2001.09	MT	L	F	Estate Engine AHU	203010	Drive Shaft	45W	33		53	30	599	
	1998.03-2001.09	-	R	F	Estate Engine AHU	203007	Drive Shaft	45W	33		53	30	622	
	1998.03-2001.09	-	L	F	Estate Engine AHU	261122	Drive Shaft	45W	33		53	30	602	
1.9 TDI (55 kW)	1996.03-2001.09	AT/MT	L/R	F	Estate Engine AFF	803018	Outer Joint	45W	33	30	53	30	62	I
	1996.03-2001.09	MT	R	F	Estate Engine AFF	203007	Drive Shaft	45W	33		53	30	622	
	1996.03-2001.09	AT/MT	L/R	F	Estate Engine AFF	661033	Inner Joint			34		85		
	1996.03-2001.09	MT	L	F	Estate Engine AFF	261122	Drive Shaft	45W	33		53	30	602	
	1996.03-2001.09	AT	R	F	Estate Engine AFF	299108	Drive Shaft	45W	33		53	30	586	
	1996.03-2001.09	AT	L	F	Estate Engine AFF	203012	Drive Shaft	45W	33		53	30	498	
1.9 TDI (66 kW)	1996.02-2001.09	-	L/R	F	Estate Engine AHH/AHU/1Z	861012	Outer Joint	45W	33	30	53	30	62	I
	1996.02-2001.09	-	L/R	F	Estate Engine AHH/AHU/1Z	803018	Outer Joint	45W	33	30	53	30	62	I
	1996.02-2001.09	MT	L	F	Estate Engine AHH/AHU/1Z	203010	Drive Shaft	45W	33		53	30	599	
	1996.02-2001.09	AT/MT	L/R	F	Estate Engine AHH/AHU/1Z	661033	Inner Joint			34		85		
	1996.02-2001.09	MT	R	F	Estate Engine AHH/AHU/1Z	203007	Drive Shaft	45W	33		53	30	622	
	1996.02-2001.09	MT	L	F	Estate Engine AHH/AHU/1Z	261122	Drive Shaft	45W	33		53	30	602	
	1996.02-2001.09	AT	R	F	Estate Engine AHH/AHU/1Z	299108	Drive Shaft	45W	33		53	30	586	
	1996.02-2001.09	AT	L	F	Estate Engine AHH/AHU/1Z	203012	Drive Shaft	45W	33		53	30	498	
	1996.02-2001.09	MT	R	F	Estate Engine AHH/AHU/1Z	203009	Drive Shaft	45W	33		53	30	617	
1.9 TDI (81 kW)	1996.02-2001.09	-	L/R	F	Estate Engine AFN/AVG	803018	Outer Joint	45W	33	30	53	30	62	I
	1996.02-2001.09	MT	R	F	Estate Engine AFN/AVG	203007	Drive Shaft	45W	33		53	30	622	
	1996.02-2001.09	AT/MT	L/R	F	Estate Engine AFN/AVG	661033	Inner Joint			34		85		
	1996.02-2001.09	MT	L	F	Estate Engine AFN/AVG	261122	Drive Shaft	45W	33		53	30	602	
	1996.02-2001.09	MT	-	-	Estate Engine AFN/AVG	603006	Inner Joint			33		34		
	1996.02-2001.09	AT	R	F	Estate Engine AFN/AVG	299108	Drive Shaft	45W	33		53	30	586	
	1996.02-2001.09	AT	L	F	Estate Engine AFN/AVG	203012	Drive Shaft	45W	33		53	30	498	
1.9 TDI (85 kW)	2000.03-2001.09	5AT/5MT	L/R	F	Estate Engine AJM	803021	Outer Joint	45W	33	27	53	30	63	I
	2000.03-2001.09	-	L/R	F	Estate Engine AJM	803019	Outer Joint	45W	38	27	59.5	34.5	63	I
	2000.03-2001.09	-	L/R	F	Estate Engine AJM	803018	Outer Joint	45W	33	30	53	30	62	I
	2000.03-2001.09	5MT	L	F	Estate Engine AJM	261083	Drive Shaft	45W	33		53	30	603	
	2000.03-2001.09	5MT	R	F	Estate Engine AJM	261082	Drive Shaft	45W	33		53	30	620	
	2000.03-2001.09	MT	L	F	Estate Engine AJM	203010	Drive Shaft	45W	33		53	30	599	
	2000.03-2001.09	MT	R	F	Estate Engine AJM	203007	Drive Shaft	45W	33		53	30	622	
	2000.03-2001.09	MT	L	F	Estate Engine AJM	261122	Drive Shaft	45W	33		53	30	602	
	2000.03-2001.09	MT	R	F	Estate Engine AJM	203009	Drive Shaft	45W	33		53	30	617	
1.9 TDI quattro (81 kW)	1996.09-2001.09	5MT	L/R	F	All-wheel Drive Estate Engine AFN/AVG	861012	Outer Joint	45W	33	30	53	30	62	I
	1996.09-2001.09	5MT	L/R	F	All-wheel Drive Estate Engine AFN/AVG	603002	Inner Joint			33		32		
	1996.09-2001.09	MT	L/R	F	All-wheel Drive Estate Engine AFN/AVG	803018	Outer Joint	45W	33	30	53	30	62	I
	1996.09-2001.09	MT	L	F	All-wheel Drive Estate Engine AFN/AVG	203010	Drive Shaft	45W	33		53	30	599	
	1996.09-2001.09	MT	R	F	All-wheel Drive Estate Engine AFN/AVG	203007	Drive Shaft	45W	33		53	30	622	
	1996.09-2001.09	AT/MT	L/R	F	All-wheel Drive Estate Engine AFN/AVG	661033	Inner Joint			34		85		
	1996.09-2001.09	MT	L	F	All-wheel Drive Estate Engine AFN/AVG	261122	Drive Shaft	45W	33		53	30	602	
	1996.09-2001.09	MT	-	-	All-wheel Drive Estate Engine AFN/AVG	603006	Inner Joint			33		34		
	1996.09-2001.09	5MT	L/R	R	All-wheel Drive Estate Engine AFN/AVG	803026	Outer Joint	45T	33	30	53	31	62	I
	1996.09-2001.09	AT	R	F	All-wheel Drive Estate Engine AFN/AVG	299108	Drive Shaft	45W	33		53	30	586	
	1996.09-2001.09	AT	L	F	All-wheel Drive Estate Engine AFN/AVG	203012	Drive Shaft	45W	33		53	30	498	
1.9 TDI quattro (85 kW)	1996.09-2001.09	MT	R	F	All-wheel Drive Estate Engine AFN/AVG	203009	Drive Shaft	45W	33		53	30	617	
	2000.03-2001.09	MT	L/R	F	All-wheel Drive Estate Engine AJM/ATJ	803019	Outer Joint	45W	38	27	59.5	34.5	63	I
	2000.03-2001.09	MT	R	F	All-wheel Drive Estate Engine AJM/ATJ	203007	Drive Shaft	45W	33		53	30	622	
	2000.03-2001.09	6MT	L/R	R	All-wheel Drive Estate Engine AJM/ATJ	603001	Inner Joint			28		32		
	2000.03-2001.09	AT/MT	L/R	F	All-wheel Drive Estate Engine AJM/ATJ	661033	Inner Joint			34		85		
	2000.03-2001.09	MT	L	F	All-wheel Drive Estate Engine AJM/ATJ	261122	Drive Shaft	45W	33		53	30	602	
	2000.03-2001.09	6MT	L/R	R	All-wheel Drive Estate Engine AJM/ATJ	803026	Outer Joint	45T	33	30	53	31	62	I
	2000.03-2001.09	MT	L	F	All-wheel Drive Estate Engine AJM/ATJ	261157	Drive Shaft	45W	38		59.5	34.5	601	
2.4 (120 kW)	1997.08-2001.09	AT	-	F	Estate Engine AMM/AJG/APZ	650019	Inner Joint			34		59.5		
	1997.08-2001.09	-	L/R	F	Estate Engine AMM/AJG/APZ	803019	Outer Joint	45W	38	27	59.5	34.5	63	I
	1997.08-2001.09	MT	R	F	Estate Engine AMM/AJG/APZ	261019	Drive Shaft	45W	38		59.5	34.5	624	
	1997.08-2001.09	MT	L/R	F	Estate Engine AMM/AJG/APZ	661033	Inner Joint			34		85		
	1997.08-2001.09	MT	L	F	Estate Engine AMM/AJG/APZ	203008	Drive Shaft	45W	38		59.5	34.5	603	
2.4 (121 kW)	1997.03-2001.09	AT	-	F	Estate Engine ARJ/ALF/AML/APS/AGA	650019	Inner Joint			34		59.5		
	1997.03-2001.09	MT	R	F	Estate Engine ARJ/ALF/AML/APS/AGA	261019	Drive Shaft	45W	38		59.5	34.5	624	
	1997.03-2001.09	MT	L/R	F	Estate Engine ARJ/ALF/AML/APS/AGA	661033	Inner Joint			34		85		
	1997.03-2001.09	MT	L	F	Estate Engine ARJ/ALF/AML/APS/AGA	203008	Drive Shaft	45W	38		59.5	34.5	603	
	1997.03-2001.09	-	L/R	F	Estate Engine ARJ/ALF/AML/APS/AGA	803019	Outer Joint	45W	38	27	59.5	34.5	63	I
2.4 quattro (120 kW)	1997.08-2001.09	5MT	L/R	F	All-wheel Drive Estate Engine APZ	603002	Inner Joint			33		32		





	 YEAR	TRANSM	L/R	F/R	REMARKS	GSP Ref.	 PRODUCT	 ABS	Technical Specifications						
									A	B	C	H	L	P	
AUDI															
A4 Avant (8D5 B5)															
2.4 quattro (120 kW)	1997.08-2001.09	MT	R	F	All-wheel Drive Estate Engine APZ	261019	Drive Shaft	45W	38		59.5	34.5	624		
	1997.08-2001.09	MT	L/R	F	All-wheel Drive Estate Engine APZ	661033	Inner Joint			34		85			
	1997.08-2001.09	-	L/R	F	All-wheel Drive Estate Engine APZ	803020	Outer Joint	45W	38	30	59.5	34	59.5	I	
	1997.08-2001.09	-	L/R	R	All-wheel Drive Estate Engine APZ	803026	Outer Joint	45T	33	30	53	31	62	I	
	1997.08-2001.09	MT	L	F	All-wheel Drive Estate Engine APZ	203008	Drive Shaft	45W	38		59.5	34.5	603		
2.4 quattro (121 kW)	1997.03-2001.09	MT	L/R	F	All-wheel Drive Estate Engine ARJ/ALF/AML/APS/AGA	603002	Inner Joint			33		32			
	1997.03-2001.09	MT	L/R	F	All-wheel Drive Estate Engine ARJ/ALF/AML/APS/AGA	661033	Inner Joint			34		85			
	1997.03-2001.09	-	L/R	F	All-wheel Drive Estate Engine ARJ/ALF/AML/APS/AGA	803020	Outer Joint	45W	38	30	59.5	34	59.5	I	
	1997.03-2001.09	-	L/R	R	All-wheel Drive Estate Engine ARJ/ALF/AML/APS/AGA	803026	Outer Joint	45T	33	30	53	31	62	I	
2.5 TDI (110 kW)	1997.09-2001.09	AT/MT	L/R	F	Estate Engine AKN/AFB	803019	Outer Joint	45W	38	27	59.5	34.5	63	I	
	1997.09-2001.09	MT	R	F	Estate Engine AKN/AFB	261019	Drive Shaft	45W	38		59.5	34.5	624		
	1997.09-2001.09	AT/MT	L/R	F	Estate Engine AKN/AFB	661033	Inner Joint			34		85			
	1997.09-2001.09	MT	L	F	Estate Engine AKN/AFB	203008	Drive Shaft	45W	38		59.5	34.5	603		
2.5 TDI quattro (110 kW)	1997.09-2001.09	AT	L	F	All-wheel Drive Estate Engine AKN/AFB	203015	Drive Shaft	45W	38		59.5	34.5	527		
	1997.09-2001.09	MT	L/R	F	All-wheel Drive Estate Engine AKN/AFB	803019	Outer Joint	45W	38	27	59.5	34.5	63	I	
	1997.09-2001.09	AT	R	F	All-wheel Drive Estate Engine AKN/AFB	203048	Drive Shaft	45W	38		59.5	34.5	502		
	1997.09-2001.09	MT	L/R	F	All-wheel Drive Estate Engine AKN/AFB	661033	Inner Joint			34		85			
	1997.09-2001.09	MT	R	F	All-wheel Drive Estate Engine AKN/AFB	261019	Drive Shaft	45W	38		59.5	34.5	624		
	1997.09-2001.09	6MT	L/R	R	All-wheel Drive Estate Engine AKN/AFB	603001	Inner Joint			28		32			
	1997.09-2001.09	AT	L/R	F	All-wheel Drive Estate Engine AKN/AFB	803020	Outer Joint	45W	38	30	59.5	34	59.5	I	
	1997.09-2001.09	AT/MT	L/R	R	All-wheel Drive Estate Engine AKN/AFB	803026	Outer Joint	45T	33	30	53	31	62	I	
	1997.09-2001.09	MT	L	F	All-wheel Drive Estate Engine AKN/AFB	203008	Drive Shaft	45W	38		59.5	34.5	603		
2.6 (110 kW)	1996.02-2001.09	MT	L/R	F	Estate Engine ABC	661033	Inner Joint			34		85			
	1996.02-2001.09	AT	L/R	F	Estate Engine ABC	803020	Outer Joint	45W	38	30	59.5	34	59.5	I	
	1996.02-2001.09	MT	L/R	F	Estate Engine ABC	803019	Outer Joint	45W	38	27	59.5	34.5	63	I	
2.6 quattro (110 kW)	1996.01-2001.09	MT	L/R	R	All-wheel Drive Estate Engine ABC	603011	Inner Joint			33		34			
	1996.01-2001.09	5MT	L/R	F	All-wheel Drive Estate Engine ABC	603002	Inner Joint			33		32			
	1996.01-2001.09	MT	L/R	F	All-wheel Drive Estate Engine ABC	803020	Outer Joint	45W	38	30	59.5	34	59.5	I	
	1996.01-2001.09	MT	L/R	R	All-wheel Drive Estate Engine ABC	803026	Outer Joint	45T	33	30	53	31	62	I	
	1996.01-2001.09	MT	L/R	F	All-wheel Drive Estate Engine ABC	803019	Outer Joint	45W	38	27	59.5	34.5	63	I	
2.8 (128 kW)	1996.03-1996.09	AT/MT	L/R	F	Estate Engine AAH	803019	Outer Joint	45W	38	27	59.5	34.5	63	I	
	1996.03-1996.09	AT	R	F	Estate Engine AAH	203048	Drive Shaft	45W	38		59.5	34.5	502		
	1996.03-1996.09	MT	R	F	Estate Engine AAH	261019	Drive Shaft	45W	38		59.5	34.5	624		
	1996.03-1996.09	AT/MT	L/R	F	Estate Engine AAH	661033	Inner Joint			34		85			
	1996.03-1996.09	MT	L	F	Estate Engine AAH	203008	Drive Shaft	45W	38		59.5	34.5	603		
	1996.03-1996.09	AT	L	F	Estate Engine AAH	203015	Drive Shaft	45W	38		59.5	34.5	527		
2.8 (142 kW)	1996.10-2001.09	MT	R	F	Estate Engine AHA/ACK/ALG/AMK/APR/AQD	261019	Drive Shaft	45W	38		59.5	34.5	624		
	1996.10-2001.09	AT/MT	L/R	F	Estate Engine AHA/ACK/ALG/AMK/APR/AQD	661033	Inner Joint			34		85			
	1996.10-2001.09	-	L/R	F	Estate Engine AHA/ACK/ALG/AMK/APR/AQD	803020	Outer Joint	45W	38	30	59.5	34	59.5	I	
	1996.10-2001.09	MT	L	F	Estate Engine AHA/ACK/ALG/AMK/APR/AQD	203008	Drive Shaft	45W	38		59.5	34.5	603		
	1996.10-2001.09	AT/MT	L/R	F	Estate Engine AHA/ACK/ALG/AMK/APR/AQD	803019	Outer Joint	45W	38	27	59.5	34.5	63	I	
2.8 quattro (128 kW)	1996.01-1996.09	AT	L	F	All-wheel Drive Estate Engine AAH	203015	Drive Shaft	45W	38		59.5	34.5	527		
	1996.01-1996.09	AT	R	F	All-wheel Drive Estate Engine AAH	203048	Drive Shaft	45W	38		59.5	34.5	502		
	1996.01-1996.09	-	L/R	F	All-wheel Drive Estate Engine AAH	803019	Outer Joint	45W	38	27	59.5	34.5	63	I	
	1996.01-1996.09	AT/MT	L/R	F	All-wheel Drive Estate Engine AAH	803020	Outer Joint	45W	38	30	59.5	34	59.5	I	
	1996.01-1996.09	MT	L/R	R	All-wheel Drive Estate Engine AAH	803026	Outer Joint	45T	33	30	53	31	62	I	
	1996.01-1996.09	MT	L/R	R	All-wheel Drive Estate Engine AAH	603011	Inner Joint			33		34			
2.8 quattro (142 kW)	1996.10-2001.09	5MT	L	F	All-wheel Drive Estate Engine AHA/ACK/ALG/AMK/APR/AQD	603002	Inner Joint			33		32			
	1996.10-2001.09	-	L/R	F	All-wheel Drive Estate Engine AHA/ACK/ALG/AMK/APR/AQD	803019	Outer Joint	45W	38	27	59.5	34.5	63	I	
	1996.10-2001.09	MT	R	F	All-wheel Drive Estate Engine AHA/ACK/ALG/AMK/APR/AQD	261019	Drive Shaft	45W	38		59.5	34.5	624		
	1996.10-2001.09	MT	L/R	F	All-wheel Drive Estate Engine AHA/ACK/ALG/AMK/APR/AQD	803020	Outer Joint	45W	38	30	59.5	34	59.5	I	
	1996.10-2001.09	MT	L/R	R	All-wheel Drive Estate Engine AHA/ACK/ALG/AMK/APR/AQD	803026	Outer Joint	45T	33	30	53	31	62	I	
	1996.10-2001.09	MT	L	F	All-wheel Drive Estate Engine AHA/ACK/ALG/AMK/APR/AQD	203008	Drive Shaft	45W	38		59.5	34.5	603		
	1996.10-2001.09	MT	L/R	R	All-wheel Drive Estate Engine AHA/ACK/ALG/AMK/APR/AQD	603011	Inner Joint			33		34			
RS4 quattro (280 kW)	2000.05-2001.09	-	L/R	F	All-wheel Drive Estate Engine ASJ/AZR	803019	Outer Joint	45W	38	27	59.5	34.5	63	I	
	2000.05-2001.09	-	L/R	R	All-wheel Drive Estate Engine ASJ/AZR	603001	Inner Joint			28		32			
	2000.05-2001.09	-	L/R	R	All-wheel Drive Estate Engine ASJ/AZR	803026	Outer Joint	45T	33	30	53	31	62	I	
S4 quattro (195 kW)	1997.09-2001.09	-	L/R	F	All-wheel Drive Estate Engine AGB/AZB	803019	Outer Joint	45W	38	27	59.5	34.5	63	I	
	1997.09-2001.09	-	L/R	R	All-wheel Drive Estate Engine AGB/AZB	603001	Inner Joint			28		32			
	1997.09-2001.09	-	L/R	R	All-wheel Drive Estate Engine AGB/AZB	803026	Outer Joint	45T	33	30	53	31	62	I	
A4 Avant (8E5 B6)															
1.6 (75 kW)	2001.09-2004.12	MT	-	-	Estate Engine ALZ	661044	Inner Joint			34		85			
	2001.09-2004.12	MT	L/R	F	Estate Engine ALZ	803058	Outer Joint	45W	38	33	59.5	34	55	M	
	2001.09-2004.12	-	-	-	Estate Engine ALZ	803030	Outer Joint			38	33	59.5	34	M	
1.8 T (110 kW)	2001.09-2002.07	MT	L	F	Estate Engine AVJ	261115	Drive Shaft	45W	38		59.5	34	597		
	2001.09-2002.07	MT/Semi-AT	L/R	F	Estate Engine AVJ	803092	Outer Joint	45W	38	27	59.5	34	68	I	





	 YEAR	TRANSM	L/R	F/R	REMARKS	GSP Ref.	 PRODUCT	 ABS	Technical Specifications					
									A	B	C	H	L	P
AUDI														
A4 Avant (8E5 B6)														
1.8 T (110 kW)	2001.09-2002.07	-	R	F	Estate Engine AVJ	203362	Drive Shaft	45W	38		59.5	34	621	
	2001.09-2002.07	MT	L/R	F	Estate Engine AVJ	803058	Outer Joint	45W	38	33	59.5	34	55	M
	2001.09-2002.07	Semi-AT	L/R	F	Estate Engine AVJ	203052	Drive Shaft	45W	38		59.5	34.5	522	
	2001.09-2002.07	-	-	F	Estate Engine AVJ	803030	Outer Joint		38	33	59.5	34	55	M
1.8 T (120 kW)	2002.07-2004.12	Semi-AT	L/R	F	Estate Engine BFB	803092	Outer Joint	45W	38	27	59.5	34	68	I
	2002.07-2004.12	MT	L	F	Estate Engine BFB	203057	Drive Shaft	45W	38		59.5	34.5	593	
	2002.07-2004.12	MT	R	F	Estate Engine BFB	203058	Drive Shaft	45W	38		59.5	34.5	613	
	2002.07-2004.12	AT	L/R	F	Estate Engine BFB	203052	Drive Shaft	45W	38		59.5	34.5	522	
	2002.07-2004.12	MT	L	F	Estate Engine BFB	661076	Inner Joint			34		85		
	2002.07-2004.12	MT	L/R	F	Estate Engine BFB	803067	Outer Joint	45W	38	27	59.5	34	68	M
	2002.07-2004.12	-	-	F	Estate Engine BFB	803030	Outer Joint		38	33	59.5	34	55	M
	2002.07-2004.12	CVT/MT	-	F	Estate Engine BFB	803069	Outer Joint	45W	38	27	59.5	34.5	63	M
1.8 T (140 kW)	2002.11-2004.12	-	L	F	Estate Engine BEX	203352	Drive Shaft	45W	38		59.5	34.5	594	
	2002.11-2004.12	AT	L/R	F	Estate Engine BEX	203052	Drive Shaft	45W	38		59.5	34.5	522	
	2002.11-2004.12	-	-	-	Estate Engine BEX	803078	Outer Joint	45W	38	27	59.5	34.5	63	M
	2002.11-2004.12	-	L	F	Estate Engine BEX	661076	Inner Joint			34		85		
	2002.11-2004.12	CVT/MT	-	F	Estate Engine BEX	803069	Outer Joint	45W	38	27	59.5	34.5	63	M
	2002.11-2004.12	-	L/R	F	Estate Engine BEX	803067	Outer Joint	45W	38	27	59.5	34	68	M
1.8 T quattro (110 kW)	2001.09-2002.07	MT	L	F	All-wheel Drive Estate Engine AVJ	261115	Drive Shaft	45W	38		59.5	34	597	
	2001.09-2002.07	MT	L/R	F	All-wheel Drive Estate Engine AVJ	803092	Outer Joint	45W	38	27	59.5	34	68	I
	2001.09-2002.07	-	R	F	All-wheel Drive Estate Engine AVJ	203362	Drive Shaft	45W	38		59.5	34	621	
	2001.09-2002.07	MT	L/R	F	All-wheel Drive Estate Engine AVJ	803058	Outer Joint	45W	38	33	59.5	34	55	M
	2001.09-2002.07	-	-	F	All-wheel Drive Estate Engine AVJ	803030	Outer Joint		38	33	59.5	34	55	M
1.8 T quattro (120 kW)	2002.07-2004.12	MT	L	F	All-wheel Drive Estate Engine BFB	261115	Drive Shaft	45W	38		59.5	34	597	
	2002.07-2004.12	-	R	F	All-wheel Drive Estate Engine BFB	203311	Drive Shaft	45W	38		59.5	34	617	
	2002.07-2004.12	-	L	F	All-wheel Drive Estate Engine BFB	661070	Inner Joint			24		85		
	2002.07-2004.12	-	L/R	F	All-wheel Drive Estate Engine BFB	803058	Outer Joint	45W	38	33	59.5	34	55	M
	2002.07-2004.12	-	L	F	All-wheel Drive Estate Engine BFB	861075	Outer Joint	45W	38	33	59.5	34	56.5	M
	2002.07-2004.12	-	-	F	All-wheel Drive Estate Engine BFB	803030	Outer Joint		38	33	59.5	34	55	M
1.8 T quattro (140 kW)	2002.11-2004.12	-	L	F	All-wheel Drive Estate Engine BEX	261115	Drive Shaft	45W	38		59.5	34	597	
	2002.11-2004.12	-	R	F	All-wheel Drive Estate Engine BEX	203311	Drive Shaft	45W	38		59.5	34	617	
	2002.11-2004.12	-	L	F	All-wheel Drive Estate Engine BEX	661070	Inner Joint			24		85		
	2002.11-2004.12	MT	L/R	F	All-wheel Drive Estate Engine BEX	803058	Outer Joint	45W	38	33	59.5	34	55	M
	2002.11-2004.12	-	L	F	All-wheel Drive Estate Engine BEX	861075	Outer Joint	45W	38	33	59.5	34	56.5	M
	2002.11-2004.12	-	-	F	All-wheel Drive Estate Engine BEX	803030	Outer Joint		38	33	59.5	34	55	M
	2002.11-2004.12	-	L	F	All-wheel Drive Estate Engine BEX	203310	Drive Shaft	45W	38		59.5	34	594	
1.9 TDI (74 kW)	2001.11-2004.12	-	L/R	F	Estate Engine AVB	803092	Outer Joint	45W	38	27	59.5	34	68	I
	2001.11-2004.12	MT	L	F	Estate Engine AVB	203057	Drive Shaft	45W	38		59.5	34.5	593	
	2001.11-2004.12	MT	R	F	Estate Engine AVB	203058	Drive Shaft	45W	38		59.5	34.5	613	
	2001.11-2004.12	MT	-	-	Estate Engine AVB	803078	Outer Joint	45W	38	27	59.5	34.5	63	M
	2001.11-2004.12	MT	L	F	Estate Engine AVB	661076	Inner Joint			34		85		
	2001.11-2004.12	MT	-	-	Estate Engine AVB	661044	Inner Joint			34		85		
	2001.11-2004.12	-	L/R	F	Estate Engine AVB	803067	Outer Joint	45W	38	27	59.5	34	68	M
	2001.11-2004.12	MT	-	F	Estate Engine AVB	803069	Outer Joint	45W	38	27	59.5	34.5	63	M
	2001.11-2004.12	MT	L	F	Estate Engine AVB	203352	Drive Shaft	45W	38		59.5	34.5	594	
1.9 TDI (85 kW)	2004.06-2004.12	-	L	F	Estate Engine BKE	203352	Drive Shaft	45W	38		59.5	34.5	594	
	2004.06-2004.12	MT	-	-	Estate Engine BKE	661044	Inner Joint			34		85		
	2004.06-2004.12	-	-	-	Estate Engine BKE	803078	Outer Joint	45W	38	27	59.5	34.5	63	M
	2004.06-2004.12	-	L	F	Estate Engine BKE	661076	Inner Joint			34		85		
	2004.06-2004.12	-	L/R	F	Estate Engine BKE	803067	Outer Joint	45W	38	27	59.5	34	68	M
1.9 TDI (96 kW)	2001.09-2004.12	-	L/R	F	Estate Engine AVF/AWX	803092	Outer Joint	45W	38	27	59.5	34	68	I
	2001.09-2004.12	MT	L	F	Estate Engine AVF/AWX	203057	Drive Shaft	45W	38		59.5	34.5	593	
	2001.09-2004.12	MT	R	F	Estate Engine AVF/AWX	203058	Drive Shaft	45W	38		59.5	34.5	613	
	2001.09-2004.12	AT	L/R	F	Estate Engine AVF/AWX	203052	Drive Shaft	45W	38		59.5	34.5	522	
	2001.09-2004.12	-	-	-	Estate Engine AVF/AWX	803078	Outer Joint	45W	38	27	59.5	34.5	63	M
	2001.09-2004.12	MT	L	F	Estate Engine AVF/AWX	661076	Inner Joint			34		85		
	2001.09-2004.12	MT	L/R	F	Estate Engine AVF/AWX	803067	Outer Joint	45W	38	27	59.5	34	68	M
	2001.09-2004.12	CVT/MT	-	F	Estate Engine AVF/AWX	803069	Outer Joint	45W	38	27	59.5	34.5	63	M
1.9 TDI quattro (96 kW)	2001.11-2004.12	-	L	F	All-wheel Drive Estate Engine AVF	261115	Drive Shaft	45W	38		59.5	34	597	
	2001.11-2004.12	-	L/R	F	All-wheel Drive Estate Engine AVF	803092	Outer Joint	45W	38	27	59.5	34	68	I
	2001.11-2004.12	-	L	F	All-wheel Drive Estate Engine AVF	203057	Drive Shaft	45W	38		59.5	34.5	593	
	2001.11-2004.12	-	R	F	All-wheel Drive Estate Engine AVF	203058	Drive Shaft	45W	38		59.5	34.5	613	
	2001.11-2004.12	-	L/R	F	All-wheel Drive Estate Engine AVF	803058	Outer Joint	45W	38	33	59.5	34	55	M





	 YEAR	TRANSM	L/R	F/R	REMARKS	GSP Ref.	 PRODUCT	 ABS	Technical Specifications					
									A	B	C	H	L	P
AUDI														
A4 Avant (8E5 B6)														
2.0 (96 kW)	2001.09-2004.12	MT	L	F	Estate Engine ALT	261115	Drive Shaft	45W	38		59.5	34	597	
	2001.09-2004.12	MT	L/R	F	Estate Engine ALT	803092	Outer Joint	45W	38	27	59.5	34	68	I
	2001.09-2004.12	Semi-AT	L/R	F	Estate Engine ALT	203364	Drive Shaft	45W	38		59.5	34	522	
	2001.09-2004.12	MT	R	F	Estate Engine ALT	203311	Drive Shaft	45W	38		59.5	34	617	
	2001.09-2004.12	-	R	F	Estate Engine ALT	203362	Drive Shaft	45W	38		59.5	34	621	
	2001.09-2004.12	MT	L	F	Estate Engine ALT	661070	Inner Joint			24		85		
	2001.09-2004.12	AT/MT	L/R	F	Estate Engine ALT	803058	Outer Joint	45W	38	33	59.5	34	55	M
	2001.09-2004.12	MT	L	F	Estate Engine ALT	861075	Outer Joint	45W	38	33	59.5	34	56.5	M
	2001.09-2004.12	-	-	F	Estate Engine ALT	803030	Outer Joint		38	33	59.5	34	55	M
	2001.09-2004.12	MT	L	F	Estate Engine ALT	203310	Drive Shaft	45W	38		59.5	34	594	
2.0 FSI (110 kW)	2002.07-2004.12	MT	L	F	Estate Engine AWA	261115	Drive Shaft	45W	38		59.5	34	597	
	2002.07-2004.12	Semi-AT	L/R	F	Estate Engine AWA	203364	Drive Shaft	45W	38		59.5	34	522	
	2002.07-2004.12	MT	R	F	Estate Engine AWA	203311	Drive Shaft	45W	38		59.5	34	617	
	2002.07-2004.12	-	R	F	Estate Engine AWA	203362	Drive Shaft	45W	38		59.5	34	621	
	2002.07-2004.12	MT	L	F	Estate Engine AWA	661070	Inner Joint			24		85		
	2002.07-2004.12	Semi-AT	L/R	F	Estate Engine AWA	203052	Drive Shaft	45W	38		59.5	34.5	522	
	2002.07-2004.12	MT	L/R	F	Estate Engine AWA	803058	Outer Joint	45W	38	33	59.5	34	55	M
	2002.07-2004.12	MT	L	F	Estate Engine AWA	861075	Outer Joint	45W	38	33	59.5	34	56.5	M
	2002.07-2004.12	MT	-	F	Estate Engine AWA	803030	Outer Joint		38	33	59.5	34	55	M
	2002.07-2004.12	Semi-AT	L/R	F	Estate Engine AWA	803067	Outer Joint	45W	38	27	59.5	34	68	M
2002.07-2004.12	MT	L	F	Estate Engine AWA	203310	Drive Shaft	45W	38		59.5	34	594		
2.4 (120 kW)	2001.09-2004.12	MT	L/R	F	Estate Engine AMM	803092	Outer Joint	45W	38	27	59.5	34	68	I
	2001.09-2004.12	MT	L	F	Estate Engine AMM	203057	Drive Shaft	45W	38		59.5	34.5	593	
	2001.09-2004.12	MT	R	F	Estate Engine AMM	203058	Drive Shaft	45W	38		59.5	34.5	613	
	2001.09-2004.12	AT	L/R	F	Estate Engine AMM	203052	Drive Shaft	45W	38		59.5	34.5	522	
	2001.09-2004.12	MT	L	F	Estate Engine AMM	661076	Inner Joint			34		85		
	2001.09-2004.12	MT	L/R	F	Estate Engine AMM	803067	Outer Joint	45W	38	27	59.5	34	68	M
	2001.09-2004.12	AT/MT	-	F	Estate Engine AMM	803069	Outer Joint	45W	38	27	59.5	34.5	63	M
	2001.09-2004.12	MT	L	F	Estate Engine AMM	203352	Drive Shaft	45W	38		59.5	34.5	594	
2.4 (125 kW)	2001.09-2004.12	MT	L/R	F	Estate Engine BDV	803092	Outer Joint	45W	38	27	59.5	34	68	I
	2001.09-2004.12	MT	L	F	Estate Engine BDV	203057	Drive Shaft	45W	38		59.5	34.5	593	
	2001.09-2004.12	MT	R	F	Estate Engine BDV	203058	Drive Shaft	45W	38		59.5	34.5	613	
	2001.09-2004.12	AT	L/R	F	Estate Engine BDV	203052	Drive Shaft	45W	38		59.5	34.5	522	
	2001.09-2004.12	MT	L	F	Estate Engine BDV	661076	Inner Joint			34		85		
	2001.09-2004.12	MT	L/R	F	Estate Engine BDV	803067	Outer Joint	45W	38	27	59.5	34	68	M
	2001.09-2004.12	CVT/MT	-	F	Estate Engine BDV	803069	Outer Joint	45W	38	27	59.5	34.5	63	M
	2001.09-2004.12	MT	L	F	Estate Engine BDV	203352	Drive Shaft	45W	38		59.5	34.5	594	
2.5 TDI (114 kW)	2001.09-2002.07	MT	L	F	Estate Engine AYM	203363	Drive Shaft	45W	38		59.5	34.5	611	
	2001.09-2002.07	MT	L/R	F	Estate Engine AYM	661033	Inner Joint			34		85		
	2001.09-2002.07	MT	L	F	Estate Engine AYM	203057	Drive Shaft	45W	38		59.5	34.5	593	
	2001.09-2002.07	MT	L/R	F	Estate Engine AYM	803092	Outer Joint	45W	38	27	59.5	34	68	I
	2001.09-2002.07	MT	R	F	Estate Engine AYM	203058	Drive Shaft	45W	38		59.5	34.5	613	
	2001.09-2002.07	AT	L/R	F	Estate Engine AYM	203052	Drive Shaft	45W	38		59.5	34.5	522	
	2001.09-2002.07	CVT/MT	-	F	Estate Engine AYM	803069	Outer Joint	45W	38	27	59.5	34.5	63	M
	2001.09-2002.07	MT	L/R	F	Estate Engine AYM	803067	Outer Joint	45W	38	27	59.5	34	68	M
2.5 TDI (120 kW)	2002.07-2004.12	MT	L	F	Estate Engine BFC/BCZ/BDG	203363	Drive Shaft	45W	38		59.5	34.5	611	
	2002.07-2004.12	MT	L/R	F	Estate Engine BFC/BCZ/BDG	661033	Inner Joint			34		85		
	2002.07-2004.12	MT	L	F	Estate Engine BFC/BCZ/BDG	203057	Drive Shaft	45W	38		59.5	34.5	593	
	2002.07-2004.12	MT	L/R	F	Estate Engine BFC/BCZ/BDG	803092	Outer Joint	45W	38	27	59.5	34	68	I
	2002.07-2004.12	MT	R	F	Estate Engine BFC/BCZ/BDG	203058	Drive Shaft	45W	38		59.5	34.5	613	
	2002.07-2004.12	AT	L/R	F	Estate Engine BFC/BCZ/BDG	203052	Drive Shaft	45W	38		59.5	34.5	522	
	2002.07-2004.12	-	-	-	Estate Engine BFC/BCZ/BDG	803078	Outer Joint	45W	38	27	59.5	34.5	63	M
	2002.07-2004.12	CVT/MT	-	F	Estate Engine BFC/BCZ/BDG	803069	Outer Joint	45W	38	27	59.5	34.5	63	M
	2002.07-2004.12	-	L/R	F	Estate Engine BFC/BCZ/BDG	803067	Outer Joint	45W	38	27	59.5	34	68	M
	2002.07-2004.12	-	-	-	Estate Engine BFC/BCZ/BDG	203352	Drive Shaft	45W	38		59.5	34.5	594	
2.5 TDI quattro (132 kW)	2001.09-2004.12	MT	L	F	All-wheel Drive Estate Engine AKE/BAU/BDH	203352	Drive Shaft	45W	38		59.5	34.5	594	
	2001.09-2004.12	-	L/R	F	All-wheel Drive Estate Engine AKE/BAU/BDH	803092	Outer Joint	45W	38	27	59.5	34	68	I
	2001.09-2004.12	MT	L	F	All-wheel Drive Estate Engine AKE/BAU/BDH	203057	Drive Shaft	45W	38		59.5	34.5	593	
	2001.09-2004.12	MT	R	F	All-wheel Drive Estate Engine AKE/BAU/BDH	203058	Drive Shaft	45W	38		59.5	34.5	613	
	2001.09-2004.12	AT	L	F	All-wheel Drive Estate Engine AKE/BAU/BDH	203052	Drive Shaft	45W	38		59.5	34.5	522	
	2001.09-2004.12	MT	L	F	All-wheel Drive Estate Engine AKE/BAU/BDH	661076	Inner Joint			34		85		
	2001.09-2004.12	MT	L/R	F	All-wheel Drive Estate Engine AKE/BAU/BDH	803067	Outer Joint	45W	38	27	59.5	34	68	M
	2001.09-2004.12	AT	-	F	All-wheel Drive Estate Engine AKE/BAU/BDH	803069	Outer Joint	45W	38	27	59.5	34.5	63	M
3.0 (160 kW)	2001.04-2004.12	MT	L/R	F	Estate Engine BBJ	803092	Outer Joint	45W	38	27	59.5	34	68	I
	2001.04-2004.12	MT	L	F	Estate Engine BBJ	203057	Drive Shaft	45W	38		59.5	34.5	593	
	2001.04-2004.12	MT	R	F	Estate Engine BBJ	203058	Drive Shaft	45W	38		59.5	34.5	613	
	2001.04-2004.12	-	-	-	Estate Engine BBJ	803078	Outer Joint	45W	38	27	59.5	34.5	63	M

	 YEAR	TRANSM	L/R	F/R	REMARKS	GSP Ref.	 PRODUCT	 ABS	Technical Specifications						
									A	B	C	H	L	P	
AUDI															
A4 Avant (8E5 B6)															
3.0 (160 kW)	2001.04-2004.12	AT	L/R	F	Estate Engine BBJ	203052	Drive Shaft	45W	38		59.5	34.5	522		
	2001.04-2004.12	MT	L	F	Estate Engine BBJ	661076	Inner Joint			34		85			
	2001.04-2004.12	MT	L/R	F	Estate Engine BBJ	803067	Outer Joint	45W	38	27	59.5	34	68	M	
	2001.04-2004.12	MT	-	F	Estate Engine BBJ	803069	Outer Joint	45W	38	27	59.5	34.5	63	M	
	2001.04-2004.12	MT	L	F	Estate Engine BBJ	203352	Drive Shaft	45W	38		59.5	34.5	594		
3.0 (162 kW)	2001.09-2004.12	-	L/R	F	Estate Engine ASN	803092	Outer Joint	45W	38	27	59.5	34	68	I	
	2001.09-2004.12	MT	L	F	Estate Engine ASN	203057	Drive Shaft	45W	38		59.5	34.5	593		
	2001.09-2004.12	MT	R	F	Estate Engine ASN	203058	Drive Shaft	45W	38		59.5	34.5	613		
	2001.09-2004.12	AT	L/R	F	Estate Engine ASN	203052	Drive Shaft	45W	38		59.5	34.5	522		
	2001.09-2004.12	MT	L	F	Estate Engine ASN	661076	Inner Joint			34		85			
	2001.09-2004.12	MT	L/R	F	Estate Engine ASN	803067	Outer Joint	45W	38	27	59.5	34	68	M	
	2001.09-2004.12	AT/MT	-	F	Estate Engine ASN	803069	Outer Joint	45W	38	27	59.5	34.5	63	M	
3.0 quattro (160 kW)	2001.04-2004.12	-	L/R	F	All-wheel Drive Estate Engine BBJ	803092	Outer Joint	45W	38	27	59.5	34	68	I	
	2001.04-2004.12	AT	R	F	All-wheel Drive Estate Engine BBJ	203052	Drive Shaft	45W	38		59.5	34.5	522		
	2001.04-2004.12	-	-	-	All-wheel Drive Estate Engine BBJ	803078	Outer Joint	45W	38	27	59.5	34.5	63	M	
3.0 quattro (162 kW)	2001.04-2004.12	AT/MT	-	F	All-wheel Drive Estate Engine BBJ	803069	Outer Joint	45W	38	27	59.5	34.5	63	M	
	2001.09-2004.12	-	L/R	F	All-wheel Drive Estate Engine ASN/AVK	803092	Outer Joint	45W	38	27	59.5	34	68	I	
	2001.09-2004.12	AT	L	F	All-wheel Drive Estate Engine ASN/AVK	203052	Drive Shaft	45W	38		59.5	34.5	522		
	2001.09-2004.12	AT/MT	L/R	F	All-wheel Drive Estate Engine ASN/AVK	803067	Outer Joint	45W	38	27	59.5	34	68	M	
S4 quattro (253 kW)	2001.09-2004.12	AT/MT	-	F	All-wheel Drive Estate Engine ASN/AVK	803069	Outer Joint	45W	38	27	59.5	34.5	63	M	
	2003.03-2004.12	MT	L	F	All-wheel Drive Estate Engine BBK	203352	Drive Shaft	45W	38		59.5	34.5	594		
	2003.03-2004.12	AT	L	F	All-wheel Drive Estate Engine BBK	203347	Drive Shaft	45W	38		59.5	34.5	580		
	2003.03-2004.12	-	-	-	All-wheel Drive Estate Engine BBK	803078	Outer Joint	45W	38	27	59.5	34.5	63	M	
	2003.03-2004.12	MT	L	F	All-wheel Drive Estate Engine BBK	661076	Inner Joint			34		85			
A4 Avant (8ED B7)	2003.03-2004.12	-	L/R	F	All-wheel Drive Estate Engine BBK	803067	Outer Joint	45W	38	27	59.5	34	68	M	
	2003.03-2004.12	-	-	F	All-wheel Drive Estate Engine BBK	803069	Outer Joint	45W	38	27	59.5	34.5	63	M	
	1.6 (75 kW)	2004.11-2008.06	-	L/R	F	Estate Engine ALZ	803058	Outer Joint	45W	38	33	59.5	34	55	M
	2004.11-2008.06	MT	-	-	Estate Engine ALZ	661044	Inner Joint			34		85			
	2004.11-2008.06	-	-	-	Estate Engine ALZ	803078	Outer Joint	45W	38	27	59.5	34.5	63	M	
	2004.11-2008.06	-	-	F	Estate Engine ALZ	803030	Outer Joint			38	33	59.5	34	55	M
1.8 T (120 kW)	2004.11-2008.06	MT	L	F	Estate Engine BFB	203352	Drive Shaft	45W	38		59.5	34.5	594		
	2004.11-2008.06	MT	-	-	Estate Engine BFB	803078	Outer Joint	45W	38	27	59.5	34.5	63	M	
	2004.11-2008.06	CVT	L/R	F	Estate Engine BFB	203052	Drive Shaft	45W	38		59.5	34.5	522		
	2004.11-2008.06	MT	L	F	Estate Engine BFB	661076	Inner Joint			34		85			
	2004.11-2008.06	MT	R	F	Estate Engine BFB	203255	Drive Shaft	45W	38		59.5	34.5	621		
	2004.11-2008.06	CVT/MT	-	F	Estate Engine BFB	803069	Outer Joint	45W	38	27	59.5	34.5	63	M	
	2004.11-2008.06	-	L/R	F	Estate Engine BFB	803067	Outer Joint	45W	38	27	59.5	34	68	M	
1.8 T quattro (120 kW)	2004.11-2008.06	-	R	F	All-wheel Drive Estate Engine BFB	203311	Drive Shaft	45W	38		59.5	34	617		
	2004.11-2008.06	-	L	F	All-wheel Drive Estate Engine BFB	661070	Inner Joint			24		85			
	2004.11-2008.06	-	L/R	F	All-wheel Drive Estate Engine BFB	803058	Outer Joint	45W	38	33	59.5	34	55	M	
	2004.11-2008.06	-	L	F	All-wheel Drive Estate Engine BFB	861075	Outer Joint	45W	38	33	59.5	34	56.5	M	
	2004.11-2008.06	-	-	F	All-wheel Drive Estate Engine BFB	803030	Outer Joint			38	33	59.5	34	55	M
	2004.11-2008.06	-	L/R	F	All-wheel Drive Estate Engine BFB	803067	Outer Joint	45W	38	27	59.5	34	68	M	
	2004.11-2008.06	MT	R	F	All-wheel Drive Estate Engine BFB	203255	Drive Shaft	45W	38		59.5	34.5	621		
	2004.11-2008.06	MT	-	F	All-wheel Drive Estate Engine BFB	803069	Outer Joint	45W	38	27	59.5	34.5	63	M	
	2004.11-2008.06	-	L	F	All-wheel Drive Estate Engine BFB	203310	Drive Shaft	45W	38		59.5	34	594		
1.9 TDI (85 kW)	2004.11-2008.06	-	L	F	Estate Engine BKE/BRB	203352	Drive Shaft	45W	38		59.5	34.5	594		
	2004.11-2008.06	MT	-	-	Estate Engine BKE/BRB	661044	Inner Joint			34		85			
	2004.11-2008.06	-	-	-	Estate Engine BKE/BRB	803078	Outer Joint	45W	38	27	59.5	34.5	63	M	
	2004.11-2008.06	-	L	F	Estate Engine BKE/BRB	661076	Inner Joint			34		85			
	2004.11-2008.06	MT	R	F	Estate Engine BKE/BRB	203255	Drive Shaft	45W	38		59.5	34.5	621		
	2004.11-2008.06	MT	-	F	Estate Engine BKE/BRB	803069	Outer Joint	45W	38	27	59.5	34.5	63	M	
	2004.11-2008.06	-	L/R	F	Estate Engine BKE/BRB	803067	Outer Joint	45W	38	27	59.5	34	68	M	
	2004.11-2008.06	-	L	F	Estate Engine BKE/BRB	203310	Drive Shaft	45W	38		59.5	34	594		
2.0 (96 kW)	2004.11-2008.06	Semi-AT	L/R	F	Estate Engine ALT	203364	Drive Shaft	45W	38		59.5	34	522		
	2004.11-2008.06	-	R	F	Estate Engine ALT	203311	Drive Shaft	45W	38		59.5	34	617		
	2004.11-2008.06	MT	L	F	Estate Engine ALT	661070	Inner Joint			24		85			
	2004.11-2008.06	-	L/R	F	Estate Engine ALT	803058	Outer Joint	45W	38	33	59.5	34	55	M	
	2004.11-2008.06	MT	L	F	Estate Engine ALT	861075	Outer Joint	45W	38	33	59.5	34	56.5	M	
	2004.11-2008.06	-	-	F	Estate Engine ALT	803030	Outer Joint			38	33	59.5	34	55	M
	2004.11-2008.06	MT	L	F	Estate Engine ALT	203310	Drive Shaft	45W	38		59.5	34	594		
	2004.11-2008.06	CVT	-	F	Estate Engine ALT	803069	Outer Joint	45W	38	27	59.5	34.5	63	M	
	2004.11-2008.06	MT	L	F	Estate Engine BRF/BNA	203363	Drive Shaft	45W	38		59.5	34.5	611		
2.0 TDI (100 kW)	2004.11-2008.06	MT	L	F	Estate Engine BRF/BNA	203352	Drive Shaft	45W	38		59.5	34.5	594		
	2004.11-2008.06	MT	L/R	F	Estate Engine BRF/BNA	661033	Inner Joint			34		85			

	 YEAR	TRANSM	L/R	F/R	REMARKS	GSP Ref.	 PRODUCT	 ABS	Technical Specifications						
									A	B	C	H	L	P	
AUDI															
A4 Avant (8ED B7)															
2.0 TDI (100 kW)	2004.11-2008.06	CVT	L/R	F	Estate Engine BRF/BNA	201132	Drive Shaft	45W	38		59.5	34.5	525		
	2004.11-2008.06	MT	L	F	Estate Engine BRF/BNA	661076	Inner Joint			34		85			
	2004.11-2008.06	-	-	-	Estate Engine BRF/BNA	803078	Outer Joint	45W	38	27	59.5	34.5	63	M	
	2004.11-2008.06	MT	R	F	Estate Engine BRF/BNA	203255	Drive Shaft	45W	38			59.5	34.5	621	
	2004.11-2008.06	MT	-	F	Estate Engine BRF/BNA	803069	Outer Joint	45W	38	27	59.5	34.5	63	M	
	2004.11-2008.06	-	L/R	F	Estate Engine BRF/BNA	803067	Outer Joint	45W	38	27	59.5	34	68	M	
2.0 TDI (103 kW)	2004.11-2008.06	MT	L	F	Estate Engine BPW	203352	Drive Shaft	45W	38		59.5	34.5	594		
	2004.11-2008.06	CVT	L/R	F	Estate Engine BPW	201132	Drive Shaft	45W	38		59.5	34.5	525		
	2004.11-2008.06	AT/MT	-	-	Estate Engine BPW	803078	Outer Joint	45W	38	27	59.5	34.5	63	M	
	2004.11-2008.06	MT	L	F	Estate Engine BPW	661076	Inner Joint			34		85			
	2004.11-2008.06	MT	R	F	Estate Engine BPW	203255	Drive Shaft	45W	38			59.5	34.5	621	
	2004.11-2008.06	MT	L/R	F	Estate Engine BPW	803067	Outer Joint	45W	38	27	59.5	34	68	M	
2.0 TDI (120 kW)	2004.11-2008.06	MT	-	F	Estate Engine BPW	803069	Outer Joint	45W	38	27	59.5	34.5	63	M	
	2006.06-2008.06	-	L	F	Estate Engine BVA	203352	Drive Shaft	45W	38		59.5	34.5	594		
	2006.06-2008.06	MT	-	-	Estate Engine BVA	661044	Inner Joint			34		85			
	2006.06-2008.06	-	L	F	Estate Engine BVA	661076	Inner Joint			34		85			
	2006.06-2008.06	-	-	-	Estate Engine BVA	803078	Outer Joint	45W	38	27	59.5	34.5	63	M	
	2006.06-2008.06	-	L/R	F	Estate Engine BVA	803067	Outer Joint	45W	38	27	59.5	34	68	M	
2.0 TDI (125 kW)	2006.06-2008.06	-	L	F	Estate Engine BRD	203352	Drive Shaft	45W	38		59.5	34.5	594		
	2006.06-2008.06	-	L	F	Estate Engine BRD	661076	Inner Joint			34		85			
	2006.06-2008.06	MT	-	-	Estate Engine BRD	661044	Inner Joint			34		85			
	2006.06-2008.06	-	-	-	Estate Engine BRD	803078	Outer Joint	45W	38	27	59.5	34.5	63	M	
	2006.06-2008.06	-	L/R	F	Estate Engine BRD	803067	Outer Joint	45W	38	27	59.5	34	68	M	
	2006.06-2008.06	MT	R	F	Estate Engine BRD	203255	Drive Shaft	45W	38			59.5	34.5	621	
2.0 TDI (89 kW)	2006.06-2008.06	MT	-	F	Estate Engine BRD	803069	Outer Joint	45W	38	27	59.5	34.5	63	M	
	2005.09-2006.09	CVT	L/R	F	Estate Engine BVG	201132	Drive Shaft	45W	38		59.5	34.5	525		
	2005.09-2006.09	-	L/R	F	Estate Engine BVG	803067	Outer Joint	45W	38	27	59.5	34	68	M	
	2005.09-2006.09	-	-	-	Estate Engine BVG	803078	Outer Joint	45W	38	27	59.5	34.5	63	M	
2.0 TDI (93 kW)	2005.09-2006.09	AT	-	-	Estate Engine BVG	661044	Inner Joint			34		85			
	2005.11-2006.11	-	L	F	Estate Engine BVF	203352	Drive Shaft	45W	38		59.5	34.5	594		
	2005.11-2006.11	MT	-	-	Estate Engine BVF	661044	Inner Joint			34		85			
	2005.11-2006.11	-	L	F	Estate Engine BVF	661076	Inner Joint			34		85			
	2005.11-2006.11	-	-	-	Estate Engine BVF	803078	Outer Joint	45W	38	27	59.5	34.5	63	M	
	2005.11-2006.11	MT	-	F	Estate Engine BVF	803069	Outer Joint	45W	38	27	59.5	34.5	63	M	
2.0 TDI 16V (103 kW)	2005.11-2006.11	-	L/R	F	Estate Engine BVF	803067	Outer Joint	45W	38	27	59.5	34	68	M	
	2004.11-2008.06	MT	L	F	Estate Engine BLB/BRE	203363	Drive Shaft	45W	38		59.5	34.5	611		
	2004.11-2008.06	MT	L	F	Estate Engine BLB/BRE	203352	Drive Shaft	45W	38		59.5	34.5	594		
	2004.11-2008.06	MT	L/R	F	Estate Engine BLB/BRE	661033	Inner Joint			34		85			
	2004.11-2008.06	CVT	L/R	F	Estate Engine BLB/BRE	201132	Drive Shaft	45W	38		59.5	34.5	525		
	2004.11-2008.06	AT/MT	-	-	Estate Engine BLB/BRE	803078	Outer Joint	45W	38	27	59.5	34.5	63	M	
	2004.11-2008.06	MT	L	F	Estate Engine BLB/BRE	661076	Inner Joint			34		85			
	2004.11-2008.06	MT	R	F	Estate Engine BLB/BRE	203255	Drive Shaft	45W	38			59.5	34.5	621	
2.0 TDI quattro (103 kW)	2004.11-2008.06	CVT/MT	-	F	Estate Engine BLB/BRE	803069	Outer Joint	45W	38	27	59.5	34.5	63	M	
	2004.11-2008.06	MT	L/R	F	Estate Engine BLB/BRE	803067	Outer Joint	45W	38	27	59.5	34	68	M	
	2006.01-2008.06	-	R	F	All-wheel Drive Estate Engine BPW	203311	Drive Shaft	45W	38		59.5	34	617		
	2006.01-2008.06	-	L	F	All-wheel Drive Estate Engine BPW	661070	Inner Joint			24		85			
	2006.01-2008.06	-	L/R	F	All-wheel Drive Estate Engine BPW	803058	Outer Joint	45W	38	33	59.5	34	55	M	
	2006.01-2008.06	-	L	F	All-wheel Drive Estate Engine BPW	861075	Outer Joint	45W	38	33	59.5	34	56.5	M	
	2006.01-2008.06	MT	-	F	All-wheel Drive Estate Engine BPW	803030	Outer Joint			38	33	59.5	34	55	M
	2006.01-2008.06	-	L/R	F	All-wheel Drive Estate Engine BPW	803067	Outer Joint	45W	38	27	59.5	34	68	M	
2.0 TDI quattro (120 kW)	2006.01-2008.06	-	L	F	All-wheel Drive Estate Engine BPW	203310	Drive Shaft	45W	38		59.5	34	594		
	2006.06-2008.06	-	R	F	All-wheel Drive Estate Engine BVA	203311	Drive Shaft	45W	38		59.5	34	617		
	2006.06-2008.06	-	L	F	All-wheel Drive Estate Engine BVA	661070	Inner Joint			24		85			
	2006.06-2008.06	-	L/R	F	All-wheel Drive Estate Engine BVA	803058	Outer Joint	45W	38	33	59.5	34	55	M	
	2006.06-2008.06	-	L	F	All-wheel Drive Estate Engine BVA	861075	Outer Joint	45W	38	33	59.5	34	56.5	M	
	2006.06-2008.06	MT	-	-	All-wheel Drive Estate Engine BVA	661044	Inner Joint			34		85			
	2006.06-2008.06	-	L	F	All-wheel Drive Estate Engine BVA	203310	Drive Shaft	45W	38		59.5	34	594		
	2006.06-2008.06	-	L/R	F	All-wheel Drive Estate Engine BVA	803067	Outer Joint	45W	38	27	59.5	34	68	M	
2.0 TDI quattro (125 kW)	2006.06-2008.06	-	R	F	All-wheel Drive Estate Engine BRD	203311	Drive Shaft	45W	38		59.5	34	617		
	2006.06-2008.06	-	L	F	All-wheel Drive Estate Engine BRD	661070	Inner Joint			24		85			
	2006.06-2008.06	-	L/R	F	All-wheel Drive Estate Engine BRD	803058	Outer Joint	45W	38	33	59.5	34	55	M	
	2006.06-2008.06	-	L	F	All-wheel Drive Estate Engine BRD	861075	Outer Joint	45W	38	33	59.5	34	56.5	M	
	2006.06-2008.06	MT	-	-	All-wheel Drive Estate Engine BRD	661044	Inner Joint			34		85			
	2006.06-2008.06	-	-	F	All-wheel Drive Estate Engine BRD	803030	Outer Joint			38	33	59.5	34	55	M
	2006.06-2008.06	-	L/R	F	All-wheel Drive Estate Engine BRD	803067	Outer Joint	45W	38	27	59.5	34	68	M	
	2006.06-2008.06	-	L	F	All-wheel Drive Estate Engine BRD	203310	Drive Shaft	45W	38		59.5	34	594		

	 YEAR	TRANSM	L/R	F/R	REMARKS	GSP Ref.	 PRODUCT	 ABS	Technical Specifications									
									A	B	C	H	L	P				
AUDI																		
A4 Avant (8ED B7)																		
2.0 TFSI (125 kW)	2006.10-2008.06	-	L	F	Estate Engine BYK/BPJ	203352	Drive Shaft	45W	38		59.5	34.5	594					
	2006.10-2008.06	-	L/R	F	Estate Engine BYK/BPJ	803092	Outer Joint	45W	38	27	59.5	34	68	I				
	2006.10-2008.06	-	L	F	Estate Engine BYK/BPJ	661076	Inner Joint				34		85					
	2006.10-2008.06	MT	-	-	Estate Engine BYK/BPJ	661044	Inner Joint				34		85					
	2006.10-2008.06	-	-	-	Estate Engine BYK/BPJ	803078	Outer Joint	45W	38	27	59.5	34.5	63	M				
	2006.10-2008.06	-	L/R	F	Estate Engine BYK/BPJ	803067	Outer Joint	45W	38	27	59.5	34	68	M				
2.0 TFSI (147 kW)	2004.11-2008.06	MT	L	F	Estate Engine BGB/BWE	203352	Drive Shaft	45W	38		59.5	34.5	594					
	2004.11-2008.06	CVT	L/R	F	Estate Engine BGB/BWE	203052	Drive Shaft	45W	38		59.5	34.5	522					
	2004.11-2008.06	MT	L	F	Estate Engine BGB/BWE	661076	Inner Joint				34		85					
	2004.11-2008.06	-	-	-	Estate Engine BGB/BWE	803078	Outer Joint	45W	38	27	59.5	34.5	63	M				
	2004.11-2008.06	-	L/R	F	Estate Engine BGB/BWE	803067	Outer Joint	45W	38	27	59.5	34	68	M				
	2004.11-2008.06	MT	R	F	Estate Engine BGB/BWE	203255	Drive Shaft	45W	38		59.5	34.5	621					
2.0 TFSI (162 kW)	2005.06-2008.06	-	L	F	Estate Engine BUL	661076	Inner Joint				34		85					
	2005.06-2008.06	MT	-	-	Estate Engine BUL	661044	Inner Joint				34		85					
	2005.06-2008.06	-	-	-	Estate Engine BUL	803078	Outer Joint	45W	38	27	59.5	34.5	63	M				
	2005.06-2008.06	-	L/R	F	Estate Engine BUL	803067	Outer Joint	45W	38	27	59.5	34	68	M				
	2005.06-2008.06	MT	R	F	Estate Engine BUL	203255	Drive Shaft	45W	38		59.5	34.5	621					
	2005.06-2008.06	MT	-	F	Estate Engine BUL	803069	Outer Joint	45W	38	27	59.5	34.5	63	M				
2.0 TFSI quattro (147 kW)	2004.11-2008.06	-	R	F	All-wheel Drive Estate Engine BWT/BWE/BGB	203311	Drive Shaft	45W	38		59.5	34	617					
	2004.11-2008.06	MT	L	F	All-wheel Drive Estate Engine BWT/BWE/BGB	661070	Inner Joint				24		85					
	2004.11-2008.06	-	L/R	F	All-wheel Drive Estate Engine BWT/BWE/BGB	803058	Outer Joint	45W	38	33	59.5	34	55	M				
	2004.11-2008.06	MT	L	F	All-wheel Drive Estate Engine BWT/BWE/BGB	861075	Outer Joint	45W	38	33	59.5	34	56.5	M				
	2004.11-2008.06	-	-	F	All-wheel Drive Estate Engine BWT/BWE/BGB	803030	Outer Joint			38	33	59.5	34	55	M			
	2004.11-2008.06	AT	-	F	All-wheel Drive Estate Engine BWT/BWE/BGB	803069	Outer Joint	45W	38	27	59.5	34.5	63	M				
2.0 TFSI quattro (162 kW)	2004.11-2008.06	-	L/R	F	All-wheel Drive Estate Engine BWT/BWE/BGB	203310	Drive Shaft	45W	38		59.5	34	594					
	2004.11-2008.06	-	L/R	F	All-wheel Drive Estate Engine BWT/BWE/BGB	803067	Outer Joint	45W	38	27	59.5	34	68	M				
	2005.06-2008.06	-	R	F	All-wheel Drive Estate Engine BUL	203311	Drive Shaft	45W	38		59.5	34	617					
	2005.06-2008.06	-	L	F	All-wheel Drive Estate Engine BUL	661070	Inner Joint				24		85					
	2005.06-2008.06	-	L/R	F	All-wheel Drive Estate Engine BUL	803058	Outer Joint	45W	38	33	59.5	34	55	M				
	2005.06-2008.06	-	L	F	All-wheel Drive Estate Engine BUL	861075	Outer Joint	45W	38	33	59.5	34	56.5	M				
2.5 TDI (120 kW)	2005.06-2008.06	MT	-	-	All-wheel Drive Estate Engine BUL	661044	Inner Joint				34		85					
	2005.06-2008.06	-	L/R	F	All-wheel Drive Estate Engine BUL	803067	Outer Joint	45W	38	27	59.5	34	68	M				
	2005.06-2008.06	-	L	F	All-wheel Drive Estate Engine BUL	203310	Drive Shaft	45W	38		59.5	34	594					
	2004.11-2006.05	MT	L	F	Estate Engine BDG	203363	Drive Shaft	45W	38		59.5	34.5	611					
	2004.11-2006.05	MT	-	-	Estate Engine BDG	803078	Outer Joint	45W	38	27	59.5	34.5	63	M				
	2004.11-2006.05	CVT	L/R	F	Estate Engine BDG	203052	Drive Shaft	45W	38		59.5	34.5	522					
2.7 TDi (120 kW)	2004.11-2006.05	MT	L/R	F	Estate Engine BDG	803067	Outer Joint	45W	38	27	59.5	34	68	M				
	2004.11-2006.05	-	-	F	Estate Engine BDG	803069	Outer Joint	45W	38	27	59.5	34.5	63	M				
2.7 TDi (132 kW)	2005.11-2008.03	-	-	F	Estate Engine BSG	803069	Outer Joint	45W	38	27	59.5	34.5	63	M				
3.0 (160 kW)	2006.01-2008.06	-	-	F	Estate Engine BPP	803069	Outer Joint	45W	38	27	59.5	34.5	63	M				
3.0 (160 kW)	2004.11-2006.05	MT	L	F	Estate Engine BBJ	203352	Drive Shaft	45W	38		59.5	34.5	594					
	2004.11-2006.05	CVT	L/R	F	Estate Engine BBJ	203052	Drive Shaft	45W	38		59.5	34.5	522					
	2004.11-2006.05	MT	L	F	Estate Engine BBJ	661076	Inner Joint				34		85					
	2004.11-2006.05	-	-	-	Estate Engine BBJ	803078	Outer Joint	45W	38	27	59.5	34.5	63	M				
	2004.11-2006.05	-	L/R	F	Estate Engine BBJ	803067	Outer Joint	45W	38	27	59.5	34	68	M				
	2004.11-2006.05	MT	-	F	Estate Engine BBJ	803069	Outer Joint	45W	38	27	59.5	34.5	63	M				
3.0 quattro (160 kW)	2004.11-2006.07	AT	L	F	All-wheel Drive Estate Engine BBJ	203052	Drive Shaft	45W	38		59.5	34.5	522					
	2004.11-2006.07	-	-	-	All-wheel Drive Estate Engine BBJ	803078	Outer Joint	45W	38	27	59.5	34.5	63	M				
	2004.11-2006.07	-	L/R	F	All-wheel Drive Estate Engine BBJ	803067	Outer Joint	45W	38	27	59.5	34	68	M				
3.0 TDI quattro (150 kW)	2004.11-2008.06	MT	L	F	All-wheel Drive Estate Engine BKN	203352	Drive Shaft	45W	38		59.5	34.5	594					
	2004.11-2008.06	AT	L	F	All-wheel Drive Estate Engine BKN	203347	Drive Shaft	45W	38		59.5	34.5	580					
	2004.11-2008.06	MT	L	F	All-wheel Drive Estate Engine BKN	661076	Inner Joint				34		85					
	2004.11-2008.06	-	-	-	All-wheel Drive Estate Engine BKN	803078	Outer Joint	45W	38	27	59.5	34.5	63	M				
	2004.11-2008.06	-	L/R	F	All-wheel Drive Estate Engine BKN	803067	Outer Joint	45W	38	27	59.5	34	68	M				
	2004.11-2008.06	MT	R	F	All-wheel Drive Estate Engine BKN	203255	Drive Shaft	45W	38		59.5	34.5	621					
3.0 TDI quattro (171 kW)	2004.11-2008.06	-	-	F	All-wheel Drive Estate Engine BKN	803069	Outer Joint	45W	38	27	59.5	34.5	63	M				
	2006.01-2008.06	MT	L	F	All-wheel Drive Estate Engine ASB	203352	Drive Shaft	45W	38		59.5	34.5	594					
	2006.01-2008.06	AT	L	F	All-wheel Drive Estate Engine ASB	203347	Drive Shaft	45W	38		59.5	34.5	580					
	2006.01-2008.06	MT	L	F	All-wheel Drive Estate Engine ASB	661076	Inner Joint				34		85					
	2006.01-2008.06	-	-	-	All-wheel Drive Estate Engine ASB	803078	Outer Joint	45W	38	27	59.5	34.5	63	M				
	2006.01-2008.06	MT	R	F	All-wheel Drive Estate Engine ASB	203255	Drive Shaft	45W	38		59.5	34.5	621					
3.2 FSI (188 kW)	2006.01-2008.06	-	L/R	F	All-wheel Drive Estate Engine ASB	803067	Outer Joint	45W	38	27	59.5	34	68	M				
	2006.01-2008.06	-	-	F	All-wheel Drive Estate Engine ASB	803069	Outer Joint	45W	38	27	59.5	34.5	63	M				
	2005.01-2008.06	-	L/R	F	Estate Engine AUK	203052	Drive Shaft	45W	38		59.5	34.5	522					

	 YEAR	TRANSM	L/R	F/R	REMARKS	GSP Ref.	 PRODUCT	 ABS	Technical Specifications					
									A	B	C	H	L	P
AUDI														
A4 Avant (8ED B7)														
3.2 FSI (188 kW)	2005.01-2008.06	AT	-	-	Estate Engine AUK	803078	Outer Joint	45W	38	27	59.5	34.5	63	M
	2005.01-2008.06	MT	L/R	F	Estate Engine AUK	803067	Outer Joint	45W	38	27	59.5	34	68	M
	2005.01-2008.06	CVT	-	F	Estate Engine AUK	803069	Outer Joint	45W	38	27	59.5	34.5	63	M
3.2 FSI quattro (188 kW)	2005.01-2008.06	AT	L	F	All-wheel Drive Estate Engine AUK	203347	Drive Shaft	45W	38		59.5	34.5	580	
	2005.01-2008.06	-	-	F	All-wheel Drive Estate Engine AUK	803030	Outer Joint		38	33	59.5	34	55	M
	2005.01-2008.06	AT	L	F	All-wheel Drive Estate Engine AUK	661076	Inner Joint			34		85		
	2005.01-2008.06	-	L/R	F	All-wheel Drive Estate Engine AUK	803067	Outer Joint	45W	38	27	59.5	34	68	M
	2005.01-2008.06	-	-	F	All-wheel Drive Estate Engine AUK	803069	Outer Joint	45W	38	27	59.5	34.5	63	M
RS4 quattro (309 kW)	2005.09-2008.06	-	L	F	All-wheel Drive Estate Engine BNS	203352	Drive Shaft	45W	38		59.5	34.5	594	
	2005.09-2008.06	MT	-	-	All-wheel Drive Estate Engine BNS	803078	Outer Joint	45W	38	27	59.5	34.5	63	M
	2005.09-2008.06	-	L	F	All-wheel Drive Estate Engine BNS	661076	Inner Joint			34		85		
	2005.09-2008.06	MT	-	-	All-wheel Drive Estate Engine BNS	661044	Inner Joint			34		85		
	2005.09-2008.06	-	L/R	F	All-wheel Drive Estate Engine BNS	803067	Outer Joint	45W	38	27	59.5	34	68	M
	2005.09-2008.06	MT	-	F/R	All-wheel Drive Estate Engine BNS	803069	Outer Joint	45W	38	27	59.5	34.5	63	M
S4 quattro (253 kW)	2004.11-2008.06	MT	L	F	All-wheel Drive Estate Engine BBK	203352	Drive Shaft	45W	38		59.5	34.5	594	
	2004.11-2008.06	AT	L	F	All-wheel Drive Estate Engine BBK	203347	Drive Shaft	45W	38		59.5	34.5	580	
	2004.11-2008.06	MT	L	F	All-wheel Drive Estate Engine BBK	661076	Inner Joint			34		85		
	2004.11-2008.06	-	-	-	All-wheel Drive Estate Engine BBK	803078	Outer Joint	45W	38	27	59.5	34.5	63	M
	2004.11-2008.06	MT	R	F	All-wheel Drive Estate Engine BBK	203255	Drive Shaft	45W	38		59.5	34.5	621	
	2004.11-2008.06	AT	-	F	All-wheel Drive Estate Engine BBK	803069	Outer Joint	45W	38	27	59.5	34.5	63	M
	2004.11-2008.06	-	L/R	F	All-wheel Drive Estate Engine BBK	803067	Outer Joint	45W	38	27	59.5	34	68	M
A4 Avant (8K5 B8)														
1.8 TFSI (118 kW)	2007.11-2012.03	-	-	F	Estate Engine CABB/CDHB	803103	Outer Joint		42	28	76.4	34	54	I
	2007.11-2012.03	AT/MT	L/R	F	Estate Engine CABB/CDHB	203291	Drive Shaft		42		76.4	34	464	
	2007.11-2012.03	6MT/CVT	L/R	F	Estate Engine CABB/CDHB	203273	Drive Shaft		42		76.5	34	460	
	2007.11-2012.03	6MT/CVT	L/R	F	Estate Engine CABB/CDHB	803087	Outer Joint		42	27	76.5	34	54.5	M
1.8 TFSI (125 kW)	2011.11-2015.12	-	-	F	Estate Engine CJEB	803103	Outer Joint		42	28	76.4	34	54	I
1.8 TFSI (88 kW)	2008.04-2015.12	-	-	F	Estate Engine CDHA	803103	Outer Joint		42	28	76.4	34	54	I
	2008.04-2015.12	AT/MT	L/R	F	Estate Engine CDHA	203291	Drive Shaft		42		76.4	34	464	
	2008.04-2015.12	6MT/CVT	L/R	F	Estate Engine CDHA	203273	Drive Shaft		42		76.5	34	460	
	2008.04-2015.12	6MT/CVT	L/R	F	Estate Engine CDHA	803087	Outer Joint		42	27	76.5	34	54.5	M
1.8 TFSI quattro (118 kW)	2008.09-2012.03	6AT/6MT	L/R	F	All-wheel Drive Estate Engine CDHB	603029	Inner Joint			24		88.5		
	2008.09-2012.03	-	L/R	F	All-wheel Drive Estate Engine CDHB	803086	Outer Joint		42	33	76.5	34	45.5	M
	2008.09-2012.03	6MT/CVT	L/R	F	All-wheel Drive Estate Engine CDHB	203273	Drive Shaft		42		76.5	34	460	
	2008.09-2012.03	6AT/6MT	L/R	F	All-wheel Drive Estate Engine CDHB	203345	Drive Shaft		42		76.5	34	463	
1.8 TFSI quattro (125 kW)	2011.11-2015.12	-	-	F	All-wheel Drive Estate Engine CJEB	803103	Outer Joint		42	28	76.4	34	54	I
2.0 TDI (100 kW)	2008.04-2015.12	-	-	F	Estate Engine CAGB/CJCB/CSUB	803103	Outer Joint		42	28	76.4	34	54	I
	2008.04-2015.12	AT/MT	L/R	F	Estate Engine CAGB/CJCB/CSUB	203291	Drive Shaft		42		76.4	34	464	
	2008.04-2015.12	6MT/CVT	L/R	F	Estate Engine CAGB/CJCB/CSUB	203273	Drive Shaft		42		76.5	34	460	
	2008.04-2015.12	6MT	L/R	F	Estate Engine CAGB/CJCB/CSUB	803109	Outer Joint		42	27	76.5	34	54.5	M
	2008.04-2015.12	-	L/R	F	Estate Engine CAGB/CJCB/CSUB	803087	Outer Joint		42	27	76.5	34	54.5	M
2.0 TDI (105 kW)	2008.04-2015.12	CVT/MT	-	F	Estate Engine CMFA/CJCA/CMEA/CAGA	803103	Outer Joint		42	28	76.4	34	54	I
	2008.04-2015.12	AT/MT	L/R	F	Estate Engine CMFA/CJCA/CMEA/CAGA	203291	Drive Shaft		42		76.4	34	464	
	2008.04-2015.12	6MT/CVT	L/R	F	Estate Engine CMFA/CJCA/CMEA/CAGA	203273	Drive Shaft		42		76.5	34	460	
	2008.04-2015.12	6MT	L/R	F	Estate Engine CMFA/CJCA/CMEA/CAGA	803109	Outer Joint		42	27	76.5	34	54.5	M
	2008.04-2015.12	-	L/R	F	Estate Engine CMFA/CJCA/CMEA/CAGA	803087	Outer Joint		42	27	76.5	34	54.5	M
2.0 TDI (110 kW)	2013.05-2015.12	-	-	F	Estate Engine CJCD/CMFB	803103	Outer Joint		42	28	76.4	34	54	I
2.0 TDI (120 kW)	2008.08-2015.12	-	-	F	Estate Engine CAHB/CGLD/CNHC	803103	Outer Joint		42	28	76.4	34	54	I
	2008.08-2015.12	AT/MT	L/R	F	Estate Engine CAHB/CGLD/CNHC	203291	Drive Shaft		42		76.4	34	464	
	2008.08-2015.12	6MT/CVT	L/R	F	Estate Engine CAHB/CGLD/CNHC	203273	Drive Shaft		42		76.5	34	460	
	2008.08-2015.12	6MT	L/R	F	Estate Engine CAHB/CGLD/CNHC	803109	Outer Joint		42	27	76.5	34	54.5	M
	2008.08-2015.12	MT	L/R	F	Estate Engine CAHB/CGLD/CNHC	803087	Outer Joint		42	27	76.5	34	54.5	M
2.0 TDI (125 kW)	2008.04-2012.03	-	-	F	Estate Engine CAHA	803103	Outer Joint		42	28	76.4	34	54	I
	2008.04-2012.03	AT/MT	L/R	F	Estate Engine CAHA	203291	Drive Shaft		42		76.4	34	464	
	2008.04-2012.03	6AT/6MT	L/R	F	Estate Engine CAHA	803086	Outer Joint		42	33	76.5	34	45.5	M
	2008.04-2012.03	6MT/CVT	L/R	F	Estate Engine CAHA	203273	Drive Shaft		42		76.5	34	460	
	2008.04-2012.03	6MT	L/R	F	Estate Engine CAHA	803109	Outer Joint		42	27	76.5	34	54.5	M
	2008.04-2012.03	-	L/R	F	Estate Engine CAHA	803087	Outer Joint		42	27	76.5	34	54.5	M
	2008.04-2012.03	MT	-	-	Estate Engine CAHA	603022	Inner Joint			34		88		
2.0 TDI (130 kW)	2011.11-2015.12	-	-	F	Estate Engine CGLC	803102	Outer Joint		42	29	76.5	34	60	I
	2011.11-2015.12	CVT/MT	L/R	F	Estate Engine CGLC	203337	Drive Shaft		42		76.5	34	461	
2.0 TDI (140 kW)	2013.09-2015.12	CVT/MT	-	F	Estate Engine CNHA	803102	Outer Joint		42	29	76.5	34	60	I
	2013.09-2015.12	CVT/MT	L/R	F	Estate Engine CNHA	203337	Drive Shaft		42		76.5	34	461	
2.0 TDI (88 kW)	2008.06-2015.12	-	-	F	Estate Engine CAGC/CJCC	803103	Outer Joint		42	28	76.4	34	54	I
	2008.06-2015.12	AT/MT	L/R	F	Estate Engine CAGC/CJCC	203291	Drive Shaft		42		76.4	34	464	
	2008.06-2015.12	6MT/CVT	L/R	F	Estate Engine CAGC/CJCC	203273	Drive Shaft		42		76.5	34	460	

	 YEAR	TRANSM	L/R	F/R	REMARKS	GSP Ref.	 PRODUCT	 ABS	Technical Specifications						
									A	B	C	H	L	P	
AUDI															
A4 Avant (8K5 B8)															
2.0 TDI (88 kW)	2008.06-2015.12	6MT	L/R	F	Estate Engine CAGC/CJCC	803109	Outer Joint		42	27	76.5	34	54.5	M	
	2008.06-2015.12	-	L/R	F	Estate Engine CAGC/CJCC	803087	Outer Joint		42	27	76.5	34	54.5	M	
	2008.06-2015.12	MT	-	-	Estate Engine CAGC/CJCC	603022	Inner Joint			34		88			
2.0 TDI quattro (105 kW)	2008.04-2015.12	-	-	F	All-wheel Drive Estate Engine CAGA/CJCA	803107	Outer Joint		42	25	76.5	34	47.5	I	
	2008.04-2015.12	6AT/6MT	L/R	F	All-wheel Drive Estate Engine CAGA/CJCA	603029	Inner Joint			24		88.5			
	2008.04-2015.12	-	L/R	F	All-wheel Drive Estate Engine CAGA/CJCA	803086	Outer Joint		42	33	76.5	34	45.5	M	
	2008.04-2015.12	MT	R	F	All-wheel Drive Estate Engine CAGA/CJCA	203371	Drive Shaft		42		76.5	34	465		
	2008.04-2015.12	MT	L	F	All-wheel Drive Estate Engine CAGA/CJCA	203371	Drive Shaft		42		76.5	34	465		
	2008.04-2015.12	6AT/6MT	L/R	F	All-wheel Drive Estate Engine CAGA/CJCA	203345	Drive Shaft		42		76.5	34	463		
2.0 TDI quattro (110 kW)	2013.05-2015.12	-	-	F	All-wheel Drive Estate Engine CJCD/CSUA	803107	Outer Joint		42	25	76.5	34	47.5	I	
2.0 TDI quattro (125 kW)	2008.08-2012.03	6AT/6MT	L/R	F	All-wheel Drive Estate Engine CAHA	603029	Inner Joint			24		88.5			
	2008.08-2012.03	-	L/R	F	All-wheel Drive Estate Engine CAHA	803086	Outer Joint		42	33	76.5	34	45.5	M	
	2008.08-2012.03	6AT/6MT	L/R	F	All-wheel Drive Estate Engine CAHA	203345	Drive Shaft		42		76.5	34	463		
	2008.08-2012.03	MT	-	-	All-wheel Drive Estate Engine CAHA	603022	Inner Joint			34		88			
2.0 TDI quattro (130 kW)	2011.11-2015.12	-	-	F	All-wheel Drive Estate Engine CGLC	803107	Outer Joint		42	25	76.5	34	47.5	I	
	2011.11-2015.12	MT	L	F	All-wheel Drive Estate Engine CGLC	203371	Drive Shaft		42		76.5	34	465		
	2011.11-2015.12	MT	R	F	All-wheel Drive Estate Engine CGLC	203371	Drive Shaft		42		76.5	34	465		
2.0 TDI quattro (140 kW)	2013.09-2015.12	CVT/MT	-	F	All-wheel Drive Estate Engine CNHA	803107	Outer Joint		42	25	76.5	34	47.5	I	
2.0 TFSI (132 kW)	2008.06-2015.12	-	-	F	Estate Engine CFKA/CDNB/CAEA	803103	Outer Joint		42	28	76.4	34	54	I	
	2008.06-2015.12	AT/MT	L/R	F	Estate Engine CFKA/CDNB/CAEA	203291	Drive Shaft		42		76.4	34	464		
	2008.06-2015.12	6MT/6MT	L/R	F	Estate Engine CFKA/CDNB/CAEA	203273	Drive Shaft		42		76.5	34	460		
	2008.06-2015.12	6MT	L/R	F	Estate Engine CFKA/CDNB/CAEA	803109	Outer Joint		42	27	76.5	34	54.5	M	
	2008.06-2015.12	-	L/R	F	Estate Engine CFKA/CDNB/CAEA	803087	Outer Joint		42	27	76.5	34	54.5	M	
	2008.06-2015.12	-	-	F	Estate Engine CDNC/CAEB	803103	Outer Joint		42	28	76.4	34	54	I	
2.0 TFSI (155 kW)	2008.06-2013.05	-	-	F	Estate Engine CDNC/CAEB	803103	Outer Joint		42	28	76.4	34	54	I	
	2008.06-2013.05	AT/MT	L/R	F	Estate Engine CDNC/CAEB	203291	Drive Shaft		42		76.4	34	464		
	2008.06-2013.05	6AT/6MT	L/R	F	Estate Engine CDNC/CAEB	803086	Outer Joint		42	33	76.5	34	45.5	M	
	2008.06-2013.05	6MT/6MT	L/R	F	Estate Engine CDNC/CAEB	203273	Drive Shaft		42		76.5	34	460		
	2008.06-2013.05	6MT	L/R	F	Estate Engine CDNC/CAEB	803109	Outer Joint		42	27	76.5	34	54.5	M	
	2008.06-2013.05	-	L/R	F	Estate Engine CDNC/CAEB	803087	Outer Joint		42	27	76.5	34	54.5	M	
2.0 TFSI (165 kW)	2013.05-2015.12	-	-	F	Estate Engine CNCD	803103	Outer Joint		42	28	76.4	34	54	I	
2.0 TFSI flexible fuel (132 kW)	2009.11-2015.12	AT/MT	L/R	F	Estate Engine CFKA	203291	Drive Shaft		42		76.4	34	464		
	2009.11-2015.12	-	L/R	F	Estate Engine CFKA	203273	Drive Shaft		42		76.5	34	460		
	2009.11-2015.12	-	L/R	F	Estate Engine CFKA	803109	Outer Joint		42	27	76.5	34	54.5	M	
	2009.11-2015.12	-	L/R	F	Estate Engine CFKA	803087	Outer Joint		42	27	76.5	34	54.5	M	
	2009.11-2015.12	MT	-	-	Estate Engine CFKA	603022	Inner Joint			34		88			
2.0 TFSI flexible fuel quattro (132 kW)	2009.11-2015.12	-	L/R	F	All-wheel Drive Estate Engine CFKA	603029	Inner Joint			24		88.5			
	2009.11-2015.12	-	L/R	F	All-wheel Drive Estate Engine CFKA	803086	Outer Joint		42	33	76.5	34	45.5	M	
	2009.11-2015.12	-	L/R	F	All-wheel Drive Estate Engine CFKA	203345	Drive Shaft		42		76.5	34	463		
	2009.11-2015.12	MT	-	-	All-wheel Drive Estate Engine CFKA	603022	Inner Joint			34		88			
2.0 TFSI quattro (155 kW)	2008.06-2015.12	6AT/6MT	L/R	F	All-wheel Drive Estate Engine CDNC/CAEB	603029	Inner Joint			24		88.5			
	2008.06-2015.12	-	L/R	F	All-wheel Drive Estate Engine CDNC/CAEB	803086	Outer Joint		42	33	76.5	34	45.5	M	
	2008.06-2015.12	6AT/6MT	L/R	F	All-wheel Drive Estate Engine CDNC/CAEB	203345	Drive Shaft		42		76.5	34	463		
2.0 TFSI quattro (165 kW)	2013.05-2015.12	-	-	F	All-wheel Drive Estate Engine CNCD	803103	Outer Joint		42	28	76.4	34	54	I	
2.7 TDI (120 kW)	2008.06-2012.03	-	-	F	Estate Engine CAMB/CGKB	803102	Outer Joint		42	29	76.5	34	60	I	
	2008.06-2012.03	AT	-	-	Estate Engine CAMB/CGKB	603022	Inner Joint			34		88			
	2008.06-2012.03	CVT/MT	L/R	F	Estate Engine CAMB/CGKB	203337	Drive Shaft		42		76.5	34	461		
	2008.06-2012.03	-	L/R	F	Estate Engine CAMB/CGKB	803088	Outer Joint		42	29	76.5	34	61.5	M	
	2008.06-2012.03	6MT/6MT	L/R	F	Estate Engine CAMB/CGKB	203321	Drive Shaft		42		76.5	34	462		
	2008.06-2012.03	6MT/6MT	L/R	F	Estate Engine CAMB/CGKB	203321	Drive Shaft		42		76.5	34	462		
2.7 TDI (140 kW)	2008.04-2012.03	-	-	F	Estate Engine CAMA/CGKA	803102	Outer Joint		42	29	76.5	34	60	I	
	2008.04-2012.03	CVT/MT	L/R	F	Estate Engine CAMA/CGKA	203337	Drive Shaft		42		76.5	34	461		
	2008.04-2012.03	-	L/R	F	Estate Engine CAMA/CGKA	803088	Outer Joint		42	29	76.5	34	61.5	M	
	2008.04-2012.03	6MT/6MT	L/R	F	Estate Engine CAMA/CGKA	203321	Drive Shaft		42		76.5	34	462		
3.0 TDI (150 kW)	2011.11-2015.12	-	-	F	Estate Engine CLAB	803102	Outer Joint		42	29	76.5	34	60	I	
	2011.11-2015.12	CVT/MT	L/R	F	Estate Engine CLAB	203337	Drive Shaft		42		76.5	34	461		
3.0 TDI quattro (155 kW)	2008.06-2010.05	-	L/R	F	All-wheel Drive Estate Engine CCWB	803087	Outer Joint		42	27	76.5	34	54.5	M	
	2008.06-2010.05	AT	-	-	All-wheel Drive Estate Engine CCWB	603022	Inner Joint			34		88			
	2008.06-2010.05	-	L/R	F	All-wheel Drive Estate Engine CCWB	203273	Drive Shaft		42		76.5	34	460		
3.0 TDI quattro (176 kW)	2008.04-2012.03	-	-	F	All-wheel Drive Estate Engine CCWA/CAPA/CCLA	803103	Outer Joint		42	28	76.4	34	54	I	
	2008.04-2012.03	-	L/R	F	All-wheel Drive Estate Engine CCWA/CAPA/CCLA	203273	Drive Shaft		42		76.5	34	460		
	2008.04-2012.03	-	L/R	F	All-wheel Drive Estate Engine CCWA/CAPA/CCLA	803087	Outer Joint		42	27	76.5	34	54.5	M	
3.0 TDI quattro (180 kW)	2011.11-2015.12	-	-	F	All-wheel Drive Estate Engine CDUC/CKVB/CKVC	803103	Outer Joint		42	28	76.4	34	54	I	
3.0 TFSI quattro (200 kW)	2012.02-2015.12	AT	-	-	All-wheel Drive Estate Engine CRED/CNUA	603022	Inner Joint			34		88			
	2012.02-2015.12	-	-	F	All-wheel Drive Estate Engine CRED/CNUA	803103	Outer Joint		42	28	76.4	34	54	I	
3.2 FSI (195 kW)	2008.09-2012.03	-	-	F	Estate Engine CALA	803103	Outer Joint		42	28	76.4	34	54	I	
	2008.09-2012.03	AT/MT	L/R	F	Estate Engine CALA	203291	Drive Shaft		42		76.4	34	464		
	2008.09-2012.03	6AT/6MT	L/R	F	Estate Engine CALA	803086	Outer Joint		42	33	76.5	34	45.5	M	





YEAR	TRANSM	L/R	F/R	REMARKS	GSP Ref.	PRODUCT	ABS	Technical Specifications							
								A	B	C	H	L	P		
AUDI															
A4 Avant (8K5 B8)															
3.2 FSI (195 kW)	2008.09-2012.03	6MT/CVT	L/R	F	Estate Engine CALA	203273	Drive Shaft		42		76.5	34	460		
	2008.09-2012.03	-	L/R	F	Estate Engine CALA	803109	Outer Joint	42	27	76.5	34	54.5	M		
	2008.09-2012.03	-	L/R	F	Estate Engine CALA	803087	Outer Joint	42	27	76.5	34	54.5	M		
3.2 FSI quattro (195 kW)	2008.04-2012.03	6AT/6MT	L/R	F	All-wheel Drive Estate Engine CALA	603029	Inner Joint		24		88.5				
	2008.04-2012.03	-	L/R	F	All-wheel Drive Estate Engine CALA	803086	Outer Joint	42	33	76.5	34	45.5	M		
	2008.04-2012.03	6AT/6MT	L/R	F	All-wheel Drive Estate Engine CALA	203345	Drive Shaft	42		76.5	34	463			
RS4 quattro (331 kW)	2012.05-2015.08	AT	-	-	All-wheel Drive Estate Engine CFSA	603022	Inner Joint		34		88				
	2012.05-2015.08	Semi-AT	-	F	All-wheel Drive Estate Engine CFSA	803103	Outer Joint	42	28	76.4	34	54	I		
S4 quattro (245 kW)	2008.11-2015.12	-	-	F	All-wheel Drive Estate Engine CAKA/CCBA/CGXC/CTUB/CGWCI/CREC	803103	Outer Joint	42	28	76.4	34	54	I		
	2008.11-2015.12	-	L/R	F	All-wheel Drive Estate Engine CAKA/CCBA/CGXC/CTUB/CGWCI/CREC	203273	Drive Shaft	42		76.5	34	460			
	2008.11-2015.12	-	L/R	F	All-wheel Drive Estate Engine CAKA/CCBA/CGXC/CTUB/CGWCI/CREC	803087	Outer Joint	42	27	76.5	34	54.5	M		
A4 I AVANT															
1.6	1995.03-2001.09	MT	-	F	All	603013	Inner Joint			33		34			
2.4 V6	1997.09-2001.09	MT	-	F	-	803064	Outer Joint	45T	38	27	60	34	64	I	
2.5 TDi V6	1998.05-2001.09	AT	-	F	-	803064	Outer Joint	45T	38	27	60	34	64	I	
	1998.05-2001.09	MT	-	F	-	803064	Outer Joint	45T	38	27	60	34	64	I	
2.6 V6	1995.03-2001.09	MT	-	F	-	803064	Outer Joint	45T	38	27	60	34	64	I	
2.8 V6	1996.04-2001.09	AT	-	F	-	803064	Outer Joint	45T	38	27	60	34	64	I	
	1996.04-2001.09	MT	-	F	-	803064	Outer Joint	45T	38	27	60	34	64	I	
A4 I QUATTRO AVANT															
1.8 Turbo 20V	1999.05-2001.09	MT	-	F	All	603013	Inner Joint			33		34			
2.5 TDi V6	1998.05-2001.09	MT	-	F	-	803064	Outer Joint	45T	38	27	60	34	64	I	
A4/A4 AVANT															
1.6	-	-	MT/AT	-	-	803045	Outer Joint		33	30	53	30	62	I	
1.8	-	-	MT/AT	-	-	803045	Outer Joint		33	30	53	30	62	I	
1.9	-	-	MT/AT	-	-	803045	Outer Joint		33	30	53	30	62	I	
A5 (8F7)															
1.8 TFSI (118 kW)	2009.09-2012.03	AT/MT	L/R	F	Convertible Engine CDHB	203291	Drive Shaft				76.4	34	464		
	2009.09-2012.03	6MT/CVT	L/R	F	Convertible Engine CDHB	203273	Drive Shaft		42		76.5	34	460		
	2009.09-2012.03	-	-	F	Convertible Engine CDHB	803103	Outer Joint	42	28	76.4	34	54	I		
	2009.09-2012.03	-	L/R	F	Convertible Engine CDHB	803087	Outer Joint	42	27	76.5	34	54.5	M		
1.8 TFSI (125 kW)	2011.10-2016.03	AT/MT	L/R	F	Convertible Engine CJEB/CABD	203291	Drive Shaft		42		76.4	34	464		
	2011.10-2016.03	-	-	F	Convertible Engine CJEB/CABD	803103	Outer Joint	42	28	76.4	34	54	I		
	2011.10-2016.03	-	-	-	Convertible Engine CJEB/CABD	603022	Inner Joint		34		88				
1.8 TFSI (130 kW)	2015.05-2017.01	-	-	F	Convertible Engine CJEE	803103	Outer Joint	42	28	76.4	34	54	I		
2.0 TDI (105 kW)	2011.10-2015.05	-	-	F	Convertible Engine CJCA	803103	Outer Joint	42	28	76.4	34	54	I		
	2011.10-2015.05	MT	-	-	Convertible Engine CJCA	603022	Inner Joint		34		88				
2.0 TDI (110 kW)	2013.05-2017.01	-	-	F	Convertible Engine CJCD/CSUA	803103	Outer Joint	42	28	76.4	34	54	I		
	2013.05-2017.01	MT	-	-	Convertible Engine CJCD/CSUA	603022	Inner Joint		34		88				
2.0 TDI (120 kW)	2009.05-2014.06	-	L/R	F	Convertible Engine CAHB/CGLD	803088	Outer Joint	42	29	76.5	34	61.5	M		
	2009.05-2014.06	6MT/CVT	L/R	F	Convertible Engine CAHB/CGLD	203273	Drive Shaft		42		76.5	34	460		
	2009.05-2014.06	-	-	F	Convertible Engine CAHB/CGLD	803103	Outer Joint	42	28	76.4	34	54	I		
	2009.05-2014.06	-	-	F	Convertible Engine CAHB/CGLD	203321	Drive Shaft		42		76.5	34	462		
	2009.05-2014.06	-	L/R	F	Convertible Engine CAHB/CGLD	803087	Outer Joint	42	27	76.5	34	54.5	M		
2.0 TDI (125 kW)	2009.05-2012.03	-	-	F	Convertible Engine CAHA	803103	Outer Joint	42	28	76.4	34	54	I		
	2009.05-2012.03	AT/MT	L/R	F	Convertible Engine CAHA	203291	Drive Shaft		42		76.4	34	464		
	2009.05-2012.03	6MT/CVT	L/R	F	Convertible Engine CAHA	203273	Drive Shaft		42		76.5	34	460		
	2009.05-2012.03	-	L/R	F	Convertible Engine CAHA	803087	Outer Joint	42	27	76.5	34	54.5	M		
	2009.05-2012.03	MT	-	-	Convertible Engine CAHA	603022	Inner Joint		34		88				
2.0 TDI (130 kW)	2011.10-2017.01	-	-	F	Convertible Engine CGLC	803102	Outer Joint	42	29	76.5	34	60	I		
	2011.10-2017.01	CVT/MT	L/R	F	Convertible Engine CGLC	203337	Drive Shaft		42		76.5	34	461		
	2011.10-2017.01	MT	-	-	Convertible Engine CGLC	603022	Inner Joint		34		88				
2.0 TDI (140 kW)	2013.09-2017.01	-	-	F	Convertible Engine CNHA	803102	Outer Joint	42	29	76.5	34	60	I		
	2013.09-2017.01	-	L/R	F	Convertible Engine CNHA	203337	Drive Shaft		42		76.5	34	461		
2.0 TDI quattro (130 kW)	2012.01-2015.05	-	-	F	All-wheel Drive Convertible Engine CGLC	803107	Outer Joint	42	25	76.5	34	47.5	I		
	2012.01-2015.05	MT	L	F	All-wheel Drive Convertible Engine CGLC	203371	Drive Shaft		42		76.5	34	465		
	2012.01-2015.05	MT	R	F	All-wheel Drive Convertible Engine CGLC	203371	Drive Shaft		42		76.5	34	465		
	2012.01-2015.05	MT	-	-	All-wheel Drive Convertible Engine CGLC	603022	Inner Joint		34		88				
2.0 TDI quattro (140 kW)	2013.09-2017.01	-	-	F	All-wheel Drive Convertible Engine CNHA	803107	Outer Joint	42	25	76.5	34	47.5	I		
2.0 TFSI (132 kW)	2009.03-2012.03	AT	-	-	Convertible Engine CAEA/CDNB	603022	Inner Joint		34		88				
	2009.03-2012.03	AT/MT	L/R	F	Convertible Engine CAEA/CDNB	203291	Drive Shaft		42		76.4	34	464		
	2009.03-2012.03	6MT/CVT	L/R	F	Convertible Engine CAEA/CDNB	203273	Drive Shaft		42		76.5	34	460		
	2009.03-2012.03	-	-	F	Convertible Engine CAEA/CDNB	803103	Outer Joint	42	28	76.4	34	54	I		
	2009.03-2012.03	-	L/R	F	Convertible Engine CAEA/CDNB	803087	Outer Joint	42	27	76.5	34	54.5	M		
2.0 TFSI (155 kW)	2009.03-2014.06	AT/MT	L/R	F	Convertible Engine CDNC/CAEB	203291	Drive Shaft		42		76.4	34	464		
	2009.03-2014.06	-	L/R	F	Convertible Engine CDNC/CAEB	803088	Outer Joint	42	29	76.5	34	61.5	M		

YEAR	TRANSM	L/R	F/R	REMARKS	GSP Ref.	PRODUCT	ABS	Technical Specifications						
								A	B	C	H	L	P	
AUDI														
A5 (8F7)														
2.0 TFSI (155 kW)	2009.03-2014.06	6MT/CVT	L/R	F	Convertible Engine CDNC/CAEB	203273	Drive Shaft		42		76.5	34	460	
	2009.03-2014.06	-	-	F	Convertible Engine CDNC/CAEB	803103	Outer Joint		42	28	76.4	34	54	I
	2009.03-2014.06	-	-	F	Convertible Engine CDNC/CAEB	203321	Drive Shaft		42		76.5	34	462	
	2009.03-2014.06	-	L/R	F	Convertible Engine CDNC/CAEB	803087	Outer Joint		42	27	76.5	34	54.5	M
2.0 TFSI (162 kW)	2013.05-2014.12	-	-	F	Convertible Engine CAED	803103	Outer Joint		42	28	76.4	34	54	I
2.0 TFSI quattro (155 kW)	2009.03-2017.01	7AT	L/R	F	All-wheel Drive Convertible Engine CDNC/CAEB/CPMA	603029	Inner Joint			24		88.5		
	2009.03-2017.01	-	L/R	F	All-wheel Drive Convertible Engine CDNC/CAEB/CPMA	803086	Outer Joint		42	33	76.5	34	45.5	M
	2009.03-2017.01	7AT	L/R	F	All-wheel Drive Convertible Engine CDNC/CAEB/CPMA	203345	Drive Shaft		42		76.5	34	463	
	2009.03-2017.01	-	-	F	All-wheel Drive Convertible Engine CDNC/CAEB/CPMA	803103	Outer Joint		42	28	76.4	34	54	I
	2009.03-2017.01	6MT	L/R	F	All-wheel Drive Convertible Engine CDNC/CAEB/CPMA	803109	Outer Joint		42	27	76.5	34	54.5	M
2.0 TFSI quattro (162 kW)	2012.03-2017.01	-	-	F	All-wheel Drive Convertible Engine CPMB	803107	Outer Joint		42	25	76.5	34	47.5	I
2.7 TDI (120 kW)	2009.05-2012.03	AT	-	-	Convertible Engine CGKB	603022	Inner Joint			34		88		
	2009.05-2012.03	-	L/R	F	Convertible Engine CGKB	803088	Outer Joint		42	29	76.5	34	61.5	M
	2009.05-2012.03	6MT/CVT	L/R	F	Convertible Engine CGKB	203321	Drive Shaft		42		76.5	34	462	
2.7 TDI (140 kW)	2009.03-2012.03	-	-	F	Convertible Engine CGKA	803102	Outer Joint		42	29	76.5	34	60	I
	2009.03-2012.03	-	L/R	F	Convertible Engine CGKA	203337	Drive Shaft		42		76.5	34	461	
	2009.03-2012.03	-	L/R	F	Convertible Engine CGKA	803088	Outer Joint		42	29	76.5	34	61.5	M
	2009.03-2012.03	6MT/CVT	L/R	F	Convertible Engine CGKA	203321	Drive Shaft		42		76.5	34	462	
3.0 TDI (150 kW)	2011.10-2017.01	-	-	F	Convertible Engine CLAB	803102	Outer Joint		42	29	76.5	34	60	I
	2011.10-2017.01	-	L/R	F	Convertible Engine CLAB	203337	Drive Shaft		42		76.5	34	461	
3.0 TDI quattro (160 kW)	2015.05-2017.01	-	-	F	All-wheel Drive Convertible Engine CKVD	803103	Outer Joint		42	28	76.4	34	54	I
3.0 TDI quattro (176 kW)	2009.03-2012.03	AT	-	-	All-wheel Drive Convertible Engine CCWA	603022	Inner Joint			34		88		
	2009.03-2012.03	AT/MT	L/R	F	All-wheel Drive Convertible Engine CCWA	203291	Drive Shaft		42		76.4	34	464	
	2009.03-2012.03	7AT	L/R	F	All-wheel Drive Convertible Engine CCWA	203273	Drive Shaft		42		76.5	34	460	
	2009.03-2012.03	-	L/R	F	All-wheel Drive Convertible Engine CCWA	803087	Outer Joint		42	27	76.5	34	54.5	M
3.0 TDI quattro (180 kW)	2011.10-2017.01	AT	-	-	All-wheel Drive Convertible Engine CDUC/CKVC	603022	Inner Joint			34		88		
	2011.10-2017.01	-	-	F	All-wheel Drive Convertible Engine CDUC/CKVC	803103	Outer Joint		42	28	76.4	34	54	I
3.0 TFSI quattro (200 kW)	2011.11-2017.01	AT	-	-	All-wheel Drive Convertible Engine CMUA/CRED	603022	Inner Joint			34		88		
	2011.11-2017.01	-	-	F	All-wheel Drive Convertible Engine CMUA/CRED	803103	Outer Joint		42	28	76.4	34	54	I
3.2 FSI (195 kW)	2009.03-2012.03	AT	-	-	Convertible Engine CALA	603022	Inner Joint			34		88		
	2009.03-2012.03	AT/MT	L/R	F	Convertible Engine CALA	203291	Drive Shaft		42		76.4	34	464	
	2009.03-2012.03	6MT/CVT	L/R	F	Convertible Engine CALA	203273	Drive Shaft		42		76.5	34	460	
	2009.03-2012.03	-	-	F	Convertible Engine CALA	803103	Outer Joint		42	28	76.4	34	54	I
	2009.03-2012.03	-	L/R	F	Convertible Engine CALA	803087	Outer Joint		42	27	76.5	34	54.5	M
3.2 FSI quattro (195 kW)	2009.03-2012.03	AT	-	-	All-wheel Drive Convertible Engine CALA	603022	Inner Joint			34		88		
	2009.03-2012.03	7AT	L/R	F	All-wheel Drive Convertible Engine CALA	603029	Inner Joint			24		88.5		
	2009.03-2012.03	-	L/R	F	All-wheel Drive Convertible Engine CALA	803086	Outer Joint		42	33	76.5	34	45.5	M
	2009.03-2012.03	7AT	L/R	F	All-wheel Drive Convertible Engine CALA	203345	Drive Shaft		42		76.5	34	463	
45 TFSI 2.0 (165 kW)	2013.05-2016.05	-	-	F	All-wheel Drive Convertible Engine CNCD	803107	Outer Joint		42	25	76.5	34	47.5	I
	2013.05-2016.05	-	-	F	Convertible Engine CNCD	803103	Outer Joint		42	28	76.4	34	54	I
45 TFSI 2.0 (169 kW)	2015.08-2017.01	-	-	F	All-wheel Drive Convertible Engine CNCE	803107	Outer Joint		42	25	76.5	34	47.5	I
	2015.08-2017.01	-	-	F	Convertible Engine CNCE	803103	Outer Joint		42	28	76.4	34	54	I
RS 5 quattro (331 kW)	2012.11-2015.08	AT	-	-	All-wheel Drive Convertible Engine CFSA	603022	Inner Joint			34		88		
	2012.11-2015.08	-	-	F	All-wheel Drive Convertible Engine CFSA	803103	Outer Joint		42	28	76.4	34	54	I
S5 quattro (245 kW)	2009.06-2017.01	AT	-	-	All-wheel Drive Convertible Engine CGXC/CAKA/CBBA/CTUB/CGWC/CREC/CTDA	603022	Inner Joint			34		88		
	2009.06-2017.01	7AT	L/R	F	All-wheel Drive Convertible Engine CGXC/CAKA/CBBA/CTUB/CGWC/CREC/CTDA	203273	Drive Shaft		42		76.5	34	460	
	2009.06-2017.01	-	-	F	All-wheel Drive Convertible Engine CGXC/CAKA/CBBA/CTUB/CGWC/CREC/CTDA	803103	Outer Joint		42	28	76.4	34	54	I
	2009.06-2017.01	7AT	L/R	F	All-wheel Drive Convertible Engine CGXC/CAKA/CBBA/CTUB/CGWC/CREC/CTDA	803087	Outer Joint		42	27	76.5	34	54.5	M
A5 (8T3)														
1.8 TFSI (118 kW)	2009.05-2011.09	AT/MT	L/R	F	Coupe Engine CDHB	203291	Drive Shaft		42		76.4	34	464	
	2009.05-2011.09	6MT/CVT	L/R	F	Coupe Engine CDHB	203273	Drive Shaft		42		76.5	34	460	
	2009.05-2011.09	6MT/CVT	L/R	F	Coupe Engine CDHB	803087	Outer Joint		42	27	76.5	34	54.5	M
1.8 TFSI (125 kW)	2007.10-2017.01	CVT/MT	-	F	Coupe Engine CJEB/CABD	803103	Outer Joint		42	28	76.4	34	54	I
	2007.10-2017.01	AT/MT	L/R	F	Coupe Engine CJEB/CABD	203291	Drive Shaft		42		76.4	34	464	
	2007.10-2017.01	6MT/CVT	L/R	F	Coupe Engine CJEB/CABD	203273	Drive Shaft		42		76.5	34	460	
	2007.10-2017.01	6MT/CVT	L/R	F	Coupe Engine CJEB/CABD	803087	Outer Joint		42	27	76.5	34	54.5	M
2.0 TDI (120 kW)	2008.08-2017.01	-	L/R	F	Coupe Engine CAHB/CGLD/CNHC	203273	Drive Shaft		42		76.5	34	460	
	2008.08-2017.01	AT/MT	L/R	F	Coupe Engine CAHB/CGLD/CNHC	803088	Outer Joint		42	29	76.5	34	61.5	M
	2008.08-2017.01	-	-	F	Coupe Engine CAHB/CGLD/CNHC	803103	Outer Joint		42	28	76.4	34	54	I
	2008.08-2017.01	-	L/R	F	Coupe Engine CAHB/CGLD/CNHC	203321	Drive Shaft		42		76.5	34	462	
	2008.08-2017.01	AT/MT	L/R	F	Coupe Engine CAHB/CGLD/CNHC	803087	Outer Joint		42	27	76.5	34	54.5	M
2.0 TDI (125 kW)	2008.08-2012.03	AT/MT	L/R	F	Coupe Engine CAHA	203291	Drive Shaft		42		76.4	34	464	
	2008.08-2012.03	6MT/CVT	L/R	F	Coupe Engine CAHA	203273	Drive Shaft		42		76.5	34	460	
	2008.08-2012.03	-	-	F	Coupe Engine CAHA	803103	Outer Joint		42	28	76.4	34	54	I
	2008.08-2012.03	-	L/R	F	Coupe Engine CAHA	803087	Outer Joint		42	27	76.5	34	54.5	M
	2008.08-2012.03	MT	-	-	Coupe Engine CAHA	603022	Inner Joint			34		88		





YEAR	TRANSM	L/R	F/R	REMARKS	GSP Ref.	PRODUCT	ABS	Technical Specifications							
								A	B	C	H	L	P		
AUDI															
A5 (8T3)															
2.0 TDI (130 kW)	2011.10-2017.01	AT	-	-	Coupe Engine CGLC	603022	Inner Joint			34		88			
	2011.10-2017.01	-	-	F	Coupe Engine CGLC	803102	Outer Joint	42	29	76.5	34	60	I		
	2011.10-2017.01	CVT/MT	L/R	F	Coupe Engine CGLC	203337	Drive Shaft	42		76.5	34	461			
2.0 TDI (140 kW)	2013.09-2017.01	-	-	F	Coupe Engine CNHA	803102	Outer Joint	42	29	76.5	34	60	I		
	2013.09-2017.01	-	L/R	F	Coupe Engine CNHA	203337	Drive Shaft	42		76.5	34	461			
	2013.09-2017.01	AT/MT	L/R	F	Coupe Engine CNHA	803088	Outer Joint	42	29	76.5	34	61.5	M		
2.0 TDI quattro (125 kW)	2008.08-2012.03	6AT/6MT	L/R	F	All-wheel Drive Coupe Engine CAHA	603029	Inner Joint		24		88.5				
	2008.08-2012.03	-	L/R	F	All-wheel Drive Coupe Engine CAHA	803086	Outer Joint	42	33	76.5	34	45.5	M		
	2008.08-2012.03	6AT/6MT	L/R	F	All-wheel Drive Coupe Engine CAHA	203345	Drive Shaft	42		76.5	34	463			
	2008.08-2012.03	MT	-	-	All-wheel Drive Coupe Engine CAHA	603022	Inner Joint		34		88				
2.0 TDI quattro (130 kW)	2011.12-2017.01	-	-	F	All-wheel Drive Coupe Engine CGLC	803107	Outer Joint	42	25	76.5	34	47.5	I		
	2011.12-2017.01	AT	-	-	All-wheel Drive Coupe Engine CGLC	603022	Inner Joint		34		88				
	2011.12-2017.01	MT	L	F	All-wheel Drive Coupe Engine CGLC	203371	Drive Shaft	42		76.5	34	465			
	2011.12-2017.01	MT	R	F	All-wheel Drive Coupe Engine CGLC	203371	Drive Shaft	42		76.5	34	465			
2.0 TDI quattro (140 kW)	2013.09-2017.01	-	-	F	All-wheel Drive Coupe Engine CNHA	803107	Outer Joint	42	25	76.5	34	47.5	I		
2.0 TFSI (132 kW)	2008.11-2012.03	AT/MT	L/R	F	Coupe Engine CDNB	203291	Drive Shaft	42		76.4	34	464			
	2008.11-2012.03	6MT/CVT	L/R	F	Coupe Engine CDNB	203273	Drive Shaft	42		76.5	34	460			
	2008.11-2012.03	-	L	R	Coupe Engine CDNB	603040	Inner Joint	42	25	76.5	34	42			
	2008.11-2012.03	-	L	R	Coupe Engine CDNB	603044	Inner Joint		25		26				
	2008.11-2012.03	6MT/CTV	R	F	Coupe Engine CDNB	203367	Drive Shaft	42		76.5	34	621			
	2008.11-2012.03	-	-	F	Coupe Engine CDNB	803103	Outer Joint	42	28	76.4	34	54	I		
	2008.11-2012.03	6MT/CVT	L/R	F	Coupe Engine CDNB	803087	Outer Joint	42	27	76.5	34	54.5	M		
2.0 TFSI (155 kW)	2008.06-2013.11	AT/MT	L/R	F	Coupe Engine CDNC	203291	Drive Shaft	42		76.4	34	464			
	2008.06-2013.11	CVT/MT	-	F	Coupe Engine CDNC	803103	Outer Joint	42	28	76.4	34	54	I		
	2008.06-2013.11	6MT/CVT	L/R	F	Coupe Engine CDNC	203273	Drive Shaft	42		76.5	34	460			
	2008.06-2013.11	-	L	R	Coupe Engine CDNC	603040	Inner Joint	42	25	76.5	34	42			
	2008.06-2013.11	-	L	R	Coupe Engine CDNC	603044	Inner Joint		25		26				
	2008.06-2013.11	6MT/CTV	R	F	Coupe Engine CDNC	203367	Drive Shaft	42		76.5	34	621			
	2008.06-2013.11	-	-	F	Coupe Engine CDNC	803087	Outer Joint	42	27	76.5	34	54.5	M		
2.0 TFSI quattro (155 kW)	2008.06-2017.01	6AT/6MT	L/R	F	All-wheel Drive Coupe Engine CAEB/CDNC	603029	Inner Joint		24		88.5				
	2008.06-2017.01	-	-	F	All-wheel Drive Coupe Engine CAEB/CDNC	803103	Outer Joint	42	28	76.4	34	54	I		
	2008.06-2017.01	AT/MT	L/R	F	All-wheel Drive Coupe Engine CAEB/CDNC	803086	Outer Joint	42	33	76.5	34	45.5	M		
	2008.06-2017.01	6AT/6MT	L/R	F	All-wheel Drive Coupe Engine CAEB/CDNC	203345	Drive Shaft	42		76.5	34	463			
2.0 TFSI quattro (162 kW)	2012.03-2017.01	-	-	F	All-wheel Drive Coupe Engine CAED/CPMB	803107	Outer Joint	42	25	76.5	34	47.5	I		
2.7 TDI (120 kW)	2007.09-2012.03	-	-	F	Coupe Engine CAMB/CGKB	803102	Outer Joint	42	29	76.5	34	60	I		
	2007.09-2012.03	AT	-	-	Coupe Engine CAMB/CGKB	603022	Inner Joint		34		88				
	2007.09-2012.03	-	L/R	F	Coupe Engine CAMB/CGKB	203337	Drive Shaft	42		76.5	34	461			
	2007.09-2012.03	-	L/R	F	Coupe Engine CAMB/CGKB	803088	Outer Joint	42	29	76.5	34	61.5	M		
	2007.09-2012.03	6MT/CVT	L/R	F	Coupe Engine CAMB/CGKB	203321	Drive Shaft	42		76.5	34	462			
2.7 TDI (140 kW)	2007.06-2012.03	-	-	F	Coupe Engine CAMA/CGKA	803102	Outer Joint	42	29	76.5	34	60	I		
	2007.06-2012.03	-	L/R	F	Coupe Engine CAMA/CGKA	203337	Drive Shaft	42		76.5	34	461			
	2007.06-2012.03	-	L/R	F	Coupe Engine CAMA/CGKA	803088	Outer Joint	42	29	76.5	34	61.5	M		
	2007.06-2012.03	6MT/CVT	L/R	F	Coupe Engine CAMA/CGKA	203321	Drive Shaft	42		76.5	34	462			
3.0 TDI (150 kW)	2011.10-2017.01	-	-	F	Coupe Engine CLAB	803102	Outer Joint	42	29	76.5	34	60	I		
	2011.10-2017.01	-	L/R	F	Coupe Engine CLAB	203337	Drive Shaft	42		76.5	34	461			
3.0 TDI quattro (155 kW)	2008.03-2010.05	AT	-	-	All-wheel Drive Coupe Engine CCWB	603022	Inner Joint		34		88				
	2008.03-2010.05	6AT/6MT	L/R	F	All-wheel Drive Coupe Engine CCWB	203273	Drive Shaft	42		76.5	34	460			
	2008.03-2010.05	-	L/R	F	All-wheel Drive Coupe Engine CCWB	803087	Outer Joint	42	27	76.5	34	54.5	M		
3.0 TDI quattro (160 kW)	2015.05-2017.01	-	-	F	All-wheel Drive Coupe Engine CKVD	803103	Outer Joint	42	28	76.4	34	54	I		
3.0 TDI quattro (176 kW)	2007.06-2012.03	6AT/6MT	L/R	F	All-wheel Drive Coupe Engine CAPA/CCWA	203273	Drive Shaft	42		76.5	34	460			
	2007.06-2012.03	-	L/R	F	All-wheel Drive Coupe Engine CAPA/CCWA	803087	Outer Joint	42	27	76.5	34	54.5	M		
3.0 TDI quattro (180 kW)	2011.10-2017.01	AT	-	-	All-wheel Drive Coupe Engine CDUC/CKVB/CKVC	603022	Inner Joint		34		88				
	2011.10-2017.01	-	-	F	All-wheel Drive Coupe Engine CDUC/CKVB/CKVC	803103	Outer Joint	42	28	76.4	34	54	I		
3.0 TFSI quattro (200 kW)	2011.12-2017.01	AT	-	-	All-wheel Drive Coupe Engine CMUA/CRED	603022	Inner Joint		34		88				
	2011.12-2017.01	-	-	F	All-wheel Drive Coupe Engine CMUA/CRED	803103	Outer Joint	42	28	76.4	34	54	I		
3.2 FSI (195 kW)	2007.06-2012.03	AT/MT	L/R	F	Coupe Engine CALA	203291	Drive Shaft	42		76.4	34	464			
	2007.06-2012.03	6MT/CVT	L/R	F	Coupe Engine CALA	203273	Drive Shaft	42		76.5	34	460			
	2007.06-2012.03	-	-	F	Coupe Engine CALA	803103	Outer Joint	42	28	76.4	34	54	I		
	2007.06-2012.03	-	L/R	F	Coupe Engine CALA	803087	Outer Joint	42	27	76.5	34	54.5	M		
3.2 FSI quattro (195 kW)	2007.06-2012.03	6AT/6MT	L/R	F	All-wheel Drive Coupe Engine CALA	603029	Inner Joint		24		88.5				
	2007.06-2012.03	-	L/R	F	All-wheel Drive Coupe Engine CALA	803086	Outer Joint	42	33	76.5	34	45.5	M		
	2007.06-2012.03	6AT/6MT	L/R	F	All-wheel Drive Coupe Engine CALA	203345	Drive Shaft	42		76.5	34	463			
35 TFSI 1.8 (130 kW)	2015.05-2017.01	-	-	F	Coupe Engine CJEE	803103	Outer Joint	42	28	76.4	34	54	I		
45 TFSI 2.0 (165 kW)	2013.05-2016.05	-	-	F	All-wheel Drive Coupe Engine CNCD	803107	Outer Joint	42	25	76.5	34	47.5	I		
	2013.05-2016.05	-	-	F	Coupe Engine CNCD	803103	Outer Joint	42	28	76.4	34	54	I		
45 TFSI 2.0 (169 kW)	2015.08-2017.01	-	-	F	All-wheel Drive Coupe Engine CNCE	803107	Outer Joint	42	25	76.5	34	47.5	I		





YEAR	TRANSM	L/R	F/R	REMARKS	GSP Ref.	PRODUCT	ABS	Technical Specifications								
								A	B	C	H	L	P			
AUDI																
A5 (8T3)																
45 TFSI 2.0 (169 kW)	2015.08-2017.01	CVT/MT	-	F	Coupe Engine CNCE	803103	Outer Joint	42	28	76.4	34	54	I			
RS 5 quattro (331 kW)	2010.03-2015.08	-	L/R	F	All-wheel Drive Coupe Engine CFSA	203273	Drive Shaft	42		76.5	34	460				
	2010.03-2015.08	-	-	F	All-wheel Drive Coupe Engine CFSA	803103	Outer Joint	42	28	76.4	34	54	I			
	2010.03-2015.08	-	L/R	F	All-wheel Drive Coupe Engine CFSA	803087	Outer Joint	42	27	76.5	34	54.5	M			
	2010.03-2015.08	AT	-	-	All-wheel Drive Coupe Engine CFSA	603022	Inner Joint			34		88				
S5 quattro (245 kW)	2011.10-2017.01	AT	-	-	All-wheel Drive Coupe Engine CGXC/CAKA/CTUB/CGWC/CREC/CTDA	603022	Inner Joint			34		88				
	2011.10-2017.01	-	-	F	All-wheel Drive Coupe Engine CGXC/CAKA/CTUB/CGWC/CREC/CTDA	803103	Outer Joint	42	28	76.4	34	54	I			
S5 quattro (260 kW)	2007.06-2012.03	AT/MT	L/R	F	All-wheel Drive Coupe Engine CAUA	203291	Drive Shaft	42		76.4	34	464				
	2007.06-2012.03	6AT/6MT	L/R	F	All-wheel Drive Coupe Engine CAUA	203273	Drive Shaft	42		76.5	34	460				
	2007.06-2012.03	-	L/R	F	All-wheel Drive Coupe Engine CAUA	803087	Outer Joint	42	27	76.5	34	54.5	M			
A5 Sportback (8TA)																
1.8 TFSI (106 kW)	2014.09-2017.01	-	-	F	Hatchback Engine CJED	803103	Outer Joint	42	28	76.4	34	54	I			
1.8 TFSI (118 kW)	2009.11-2011.09	-	L/R	F	Hatchback Engine CDHB	803087	Outer Joint	42	27	76.5	34	54.5	M			
	2009.11-2011.09	AT/MT	L/R	F	Hatchback Engine CDHB	203291	Drive Shaft	42		76.4	34	464				
	2009.11-2011.09	-	L/R	F	Hatchback Engine CDHB	203273	Drive Shaft	42		76.5	34	460				
1.8 TFSI (125 kW)	2011.08-2017.01	-	-	F	Hatchback Engine CJEB	803103	Outer Joint	42	28	76.4	34	54	I			
	2011.08-2017.01	-	L/R	F	Hatchback Engine CJEB	203273	Drive Shaft	42		76.5	34	460				
	2011.08-2017.01	-	L/R	F	Hatchback Engine CJEB	803087	Outer Joint	42	27	76.5	34	54.5	M			
	2011.08-2017.01	-	-	-	Hatchback Engine CJEB	603022	Inner Joint			34		88				
2.0 TDI (100 kW)	2009.09-2017.01	-	L/R	F	Hatchback Engine CAGB/CJCB/CSUB	203273	Drive Shaft	42		76.5	34	460				
	2009.09-2017.01	-	-	-	Hatchback Engine CAGB/CJCB/CSUB	603022	Inner Joint			34		88				
	2009.09-2017.01	-	L/R	F	Hatchback Engine CAGB/CJCB/CSUB	803087	Outer Joint	42	27	76.5	34	54.5	M			
2.0 TDI (105 kW)	2009.09-2017.01	AT/MT	L/R	F	Hatchback Engine CAGA/CMEA/CJCA/CMFA	203291	Drive Shaft	42		76.4	34	464				
	2009.09-2017.01	-	L/R	F	Hatchback Engine CAGA/CMEA/CJCA/CMFA	203273	Drive Shaft	42		76.5	34	460				
	2009.09-2017.01	-	-	F	Hatchback Engine CAGA/CMEA/CJCA/CMFA	803103	Outer Joint	42	28	76.4	34	54	I			
	2009.09-2017.01	-	L/R	F	Hatchback Engine CAGA/CMEA/CJCA/CMFA	803087	Outer Joint	42	27	76.5	34	54.5	M			
2.0 TDI (110 kW)	2013.05-2017.01	-	-	F	Hatchback Engine CMFB/CJCD/CSUA	803103	Outer Joint	42	28	76.4	34	54	I			
2.0 TDI (120 kW)	2009.09-2017.01	-	L/R	F	Hatchback Engine CAHB/CGLD/CNHC	803087	Outer Joint	42	27	76.5	34	54.5	M			
	2009.09-2017.01	-	-	F	Hatchback Engine CAHB/CGLD/CNHC	803103	Outer Joint	42	28	76.4	34	54	I			
	2009.09-2017.01	-	L/R	F	Hatchback Engine CAHB/CGLD/CNHC	203273	Drive Shaft	42		76.5	34	460				
	2009.09-2017.01	-	L/R	F	Hatchback Engine CAHB/CGLD/CNHC	803088	Outer Joint	42	29	76.5	34	61.5	M			
	2009.09-2017.01	-	L/R	F	Hatchback Engine CAHB/CGLD/CNHC	203321	Drive Shaft	42		76.5	34	462				
2.0 TDI (125 kW)	2009.09-2012.03	AT/MT	L/R	F	Hatchback Engine CAHA	203291	Drive Shaft	42		76.4	34	464				
	2009.09-2012.03	-	L/R	F	Hatchback Engine CAHA	203273	Drive Shaft	42		76.5	34	460				
	2009.09-2012.03	-	-	F	Hatchback Engine CAHA	803103	Outer Joint	42	28	76.4	34	54	I			
	2009.09-2012.03	MT	-	-	Hatchback Engine CAHA	603022	Inner Joint			34		88				
	2009.09-2012.03	-	L/R	F	Hatchback Engine CAHA	803087	Outer Joint	42	27	76.5	34	54.5	M			
2.0 TDI (130 kW)	2011.10-2017.01	AT	-	-	Hatchback Engine CGLC	603022	Inner Joint			34		88				
	2011.10-2017.01	-	-	F	Hatchback Engine CGLC	803102	Outer Joint	42	29	76.5	34	60	I			
	2011.10-2017.01	-	L/R	F	Hatchback Engine CGLC	203337	Drive Shaft	42		76.5	34	461				
	2011.10-2017.01	-	L	F	Hatchback Engine CGLC	203371	Drive Shaft	42		76.5	34	465				
	2011.10-2017.01	-	R	F	Hatchback Engine CGLC	203371	Drive Shaft	42		76.5	34	465				
2.0 TDI (140 kW)	2013.09-2017.01	-	-	F	Hatchback Engine CNHA	803102	Outer Joint	42	29	76.5	34	60	I			
	2013.09-2017.01	-	L/R	F	Hatchback Engine CNHA	203337	Drive Shaft	42		76.5	34	461				
	2013.09-2017.01	AT/MT	L/R	F	Hatchback Engine CNHA	803088	Outer Joint	42	29	76.5	34	61.5	M			
2.0 TDI quattro (125 kW)	2009.09-2012.03	-	L/R	F	All-wheel Drive Hatchback Engine CAHA	603029	Inner Joint			24		88.5				
	2009.09-2012.03	-	L/R	F	All-wheel Drive Hatchback Engine CAHA	803086	Outer Joint	42	33	76.5	34	45.5	M			
	2009.09-2012.03	-	L/R	F	All-wheel Drive Hatchback Engine CAHA	203345	Drive Shaft	42		76.5	34	463				
	2009.09-2012.03	MT	-	-	All-wheel Drive Hatchback Engine CAHA	603022	Inner Joint			34		88				
2.0 TDI quattro (130 kW)	2011.12-2017.01	-	-	F	All-wheel Drive Hatchback Engine CGLC	803107	Outer Joint	42	25	76.5	34	47.5	I			
	2011.12-2017.01	AT	-	-	All-wheel Drive Hatchback Engine CGLC	603022	Inner Joint			34		88				
	2011.12-2017.01	MT	L	F	All-wheel Drive Hatchback Engine CGLC	203371	Drive Shaft	42		76.5	34	465				
	2011.12-2017.01	MT	R	F	All-wheel Drive Hatchback Engine CGLC	203371	Drive Shaft	42		76.5	34	465				
2.0 TDI quattro (140 kW)	2013.09-2017.01	-	-	F	All-wheel Drive Hatchback Engine CNHA	803107	Outer Joint	42	25	76.5	34	47.5	I			
2.0 TFSI (132 kW)	2009.09-2014.06	AT/MT	L/R	F	Hatchback Engine CDN B	203291	Drive Shaft	42		76.4	34	464				
	2009.09-2014.06	-	L/R	F	Hatchback Engine CDN B	203273	Drive Shaft	42		76.5	34	460				
	2009.09-2014.06	-	-	F	Hatchback Engine CDN B	803103	Outer Joint	42	28	76.4	34	54	I			
	2009.09-2014.06	-	L/R	F	Hatchback Engine CDN B	803087	Outer Joint	42	27	76.5	34	54.5	M			
2.0 TFSI (155 kW)	2009.09-2013.11	-	-	F	Hatchback Engine CDNC	803103	Outer Joint	42	28	76.4	34	54	I			
	2009.09-2013.11	AT/MT	L/R	F	Hatchback Engine CDNC	203291	Drive Shaft	42		76.4	34	464				
	2009.09-2013.11	-	L/R	F	Hatchback Engine CDNC	203273	Drive Shaft	42		76.5	34	460				
	2009.09-2013.11	-	L/R	F	Hatchback Engine CDNC	803087	Outer Joint	42	27	76.5	34	54.5	M			
2.0 TFSI quattro (155 kW)	2009.09-2017.01	-	L/R	F	All-wheel Drive Hatchback Engine CDNC/CAEB	603029	Inner Joint			24		88.5				
	2009.09-2017.01	-	L/R	F	All-wheel Drive Hatchback Engine CDNC/CAEB	803086	Outer Joint	42	33	76.5	34	45.5	M			
	2009.09-2017.01	-	L/R	F	All-wheel Drive Hatchback Engine CDNC/CAEB	203345	Drive Shaft	42		76.5	34	463				
	2009.09-2017.01	-	-	F	All-wheel Drive Hatchback Engine CDNC/CAEB	803103	Outer Joint	42	28	76.4	34	54	I			





YEAR	TRANSM	L/R	F/R	REMARKS	GSP Ref.	PRODUCT	ABS	Technical Specifications							
								A	B	C	H	L	P		
AUDI															
A5 Sportback (8TA)															
2.7 TDI (120 kW)	2009-09-2017.01	-	-	F	Hatchback Engine CAMB/CGKB	803102	Outer Joint		42	29	76.5	34	60	I	
	2009-09-2017.01	AT	-	-	Hatchback Engine CAMB/CGKB	603022	Inner Joint			34		88			
	2009-09-2017.01	-	L/R	F	Hatchback Engine CAMB/CGKB	203337	Drive Shaft		42		76.5	34	461		
	2009-09-2017.01	-	L/R	F	Hatchback Engine CAMB/CGKB	803088	Outer Joint		42	29	76.5	34	61.5	M	
	2009-09-2017.01	-	L/R	F	Hatchback Engine CAMB/CGKB	203321	Drive Shaft		42		76.5	34	462		
	2009-09-2017.01	-	L/R	F	Hatchback Engine CAMB/CGKB	803087	Outer Joint		42	27	76.5	34	54.5	M	
2.7 TDI (140 kW)	2009-09-2012.03	-	L/R	F	Hatchback Engine CAMA/CGKA	803087	Outer Joint		42	27	76.5	34	54.5	M	
	2009-09-2012.03	-	-	F	Hatchback Engine CAMA/CGKA	803102	Outer Joint		42	29	76.5	34	60	I	
	2009-09-2012.03	-	L/R	F	Hatchback Engine CAMA/CGKA	203337	Drive Shaft		42		76.5	34	461		
	2009-09-2012.03	-	L/R	F	Hatchback Engine CAMA/CGKA	803088	Outer Joint		42	29	76.5	34	61.5	M	
	2009-09-2012.03	-	L/R	F	Hatchback Engine CAMA/CGKA	203321	Drive Shaft		42		76.5	34	462		
3.0 TDI (150 kW)	2011-10-2017.01	-	-	F	Hatchback Engine CLAB	803102	Outer Joint		42	29	76.5	34	60	I	
	2011-10-2017.01	-	L/R	F	Hatchback Engine CLAB	203337	Drive Shaft		42		76.5	34	461		
3.0 TDI quattro (160 kW)	2015-05-2017.01	-	-	F	All-wheel Drive Hatchback Engine CKVD	803103	Outer Joint		42	28	76.4	34	54	I	
3.0 TDI quattro (176 kW)	2009-09-2012.03	-	L/R	F	All-wheel Drive Hatchback Engine CAPA/CCWA	203273	Drive Shaft		42		76.5	34	460		
	2009-09-2012.03	-	L/R	F	All-wheel Drive Hatchback Engine CAPA/CCWA	803087	Outer Joint		42	27	76.5	34	54.5	M	
3.0 TDI quattro (180 kW)	2011-10-2017.01	AT	-	-	All-wheel Drive Hatchback Engine CDUC/CKVB/CKVC	603022	Inner Joint			34		88			
	2011-10-2017.01	-	-	F	All-wheel Drive Hatchback Engine CDUC/CKVB/CKVC	803103	Outer Joint		42	28	76.4	34	54	I	
3.0 TFSI quattro (200 kW)	2011.12-2017.01	AT	-	-	All-wheel Drive Hatchback Engine CMUA/CRED	603022	Inner Joint			34		88			
	2011.12-2017.01	-	-	F	All-wheel Drive Hatchback Engine CMUA/CRED	803103	Outer Joint		42	28	76.4	34	54	I	
3.2 FSI quattro (195 kW)	2009-09-2012.03	AT	-	-	All-wheel Drive Hatchback Engine CALA	603022	Inner Joint			34		88			
	2009-09-2012.03	-	L/R	F	All-wheel Drive Hatchback Engine CALA	603029	Inner Joint			24		88.5			
	2009-09-2012.03	-	L/R	F	All-wheel Drive Hatchback Engine CALA	803086	Outer Joint		42	33	76.5	34	45.5	M	
	2009-09-2012.03	-	L/R	F	All-wheel Drive Hatchback Engine CALA	203345	Drive Shaft		42		76.5	34	463		
35 TFSI 1.8 (130 kW)	2015-05-2017.01	-	-	F	Hatchback Engine CJEE	803103	Outer Joint		42	28	76.4	34	54	I	
45 TFSI 2.0 (165 kW)	2013-05-2016.05	-	-	F	All-wheel Drive Hatchback Engine CNCD	803107	Outer Joint		42	25	76.5	34	47.5	I	
	2013-05-2016.05	-	-	F	Hatchback Engine CNCD	803103	Outer Joint		42	28	76.4	34	54	I	
45 TFSI 2.0 (169 kW)	2015-08-2017.01	-	-	F	All-wheel Drive Hatchback Engine CNCE	803107	Outer Joint		42	25	76.5	34	47.5	I	
	2015-08-2017.01	-	-	F	Hatchback Engine CNCE	803103	Outer Joint		42	28	76.4	34	54	I	
S5 quattro (245 kW)	2010-01-2017.01	AT	-	-	All-wheel Drive Hatchback Engine CGXC/CAKA/CTUB/CGWC/CREC/CTDA	603022	Inner Joint			34		88			
	2010-01-2017.01	-	L/R	F	All-wheel Drive Hatchback Engine CGXC/CAKA/CTUB/CGWC/CREC/CTDA	203273	Drive Shaft		42		76.5	34	460		
	2010-01-2017.01	-	-	F	All-wheel Drive Hatchback Engine CGXC/CAKA/CTUB/CGWC/CREC/CTDA	803103	Outer Joint		42	28	76.4	34	54	I	
	2010-01-2017.01	-	L/R	F	All-wheel Drive Hatchback Engine CGXC/CAKA/CTUB/CGWC/CREC/CTDA	803087	Outer Joint		42	27	76.5	34	54.5	M	
A6															
-	-	-	-	-	-	803055	Outer Joint	45T	38	30	59.5	34	61	I	
2.6 V6	1994-01-1997.09	-	-	-	-	803049	Outer Joint		38	30	59.5	34	59.5	I	
3.0 TDI quattro	2011-2016	-	L	R	4G2, C7 [20112016] Saloon/4G5, C7 [20112016] Estate	261291	Drive Shaft		42		76.5	34	620		
	2011-2016	-	L	R	4G2, C7 Saloon/4G5, C7 [20112016] Estate	603039	Inner Joint		42	28	76.5	34	43		
	2011-2016	-	L	R	4G2, C7 Saloon/4G5, C7 [20112016] Estate	661069	Inner Joint			28		32			
A6 (4A2 C4)															
1.9 TDI (66 kW)	1994-06-1997.10	-	R	F	Saloon Engine 1Z/AHU	261076	Drive Shaft	45W	38		59.5	34.5	645		
2.0 (74 kW)	1994-06-1997.10	MT	L/R	F	Saloon Engine AAE	603001	Inner Joint			28		32			
	1994-06-1997.10	AT/MT	L/R	F	Saloon Engine AAE	803016	Outer Joint	45T	38	30	59.5	34	61	I	
2.0 (85 kW)	1994-06-1997.10	MT	L/R	F	Saloon Engine ABK	603001	Inner Joint			28		32			
	1994-06-1997.10	AT/MT	L/R	F	Saloon Engine ABK	803016	Outer Joint	45T	38	30	59.5	34	61	I	
2.0 16V (103 kW)	1994-06-1997.10	MT	L/R	F	Saloon Engine ACE	603001	Inner Joint			28		32			
	1994-06-1997.10	AT/MT	L/R	F	Saloon Engine ACE	803016	Outer Joint	45T	38	30	59.5	34	61	I	
2.0 16V quattro (103 kW)	1994-06-1997.10	AT/MT	L/R	R	All-wheel Drive Saloon Engine ACE	603001	Inner Joint			28		32			
	1994-06-1997.10	MT	L/R	F	All-wheel Drive Saloon Engine ACE	803016	Outer Joint	45T	38	30	59.5	34	61	I	
	1994-06-1997.10	AT/MT	L/R	R	All-wheel Drive Saloon Engine ACE	803014	Outer Joint	45T	38	25	59.5	34.5	61	O	
2.3 (98 kW)	1994-06-1995.12	MT	L/R	F	Saloon Engine AAR	603001	Inner Joint			28		32			
	1994-06-1995.12	MT	L/R	F	Saloon Engine AAR	803016	Outer Joint	45T	38	30	59.5	34	61	I	
2.5 TDI (103 kW)	1994-08-1997.10	MT	L	F	Saloon Engine AEL	203050	Drive Shaft	45T	38		59.5	34.5	612		
	1994-08-1997.10	AT	L	F	Saloon Engine AEL	203060	Drive Shaft	45T	38		59.5	34	565		
	1994-08-1997.10	AT/MT	L/R	F	Saloon Engine AEL	661033	Inner Joint			34		85			
	1994-08-1997.10	AT/MT	L/R	F	Saloon Engine AEL	803017	Outer Joint	45T	38	27	59.5	34.5	68.5	I	
	1994-08-1997.10	MT	R	F	Saloon Engine AEL	203051	Drive Shaft	45T	38		59.5	34.5	647		
	1994-08-1997.10	AT	R	F	Saloon Engine AEL	203061	Drive Shaft	45T	38		59.5	34	488		
2.5 TDI (84 kW)	1995-01-1997.10	MT	L	F	Saloon Engine AAT	203050	Drive Shaft	45T	38		59.5	34.5	612		
	1995-01-1997.10	AT	L	F	Saloon Engine AAT	203060	Drive Shaft	45T	38		59.5	34	565		
	1995-01-1997.10	AT/MT	L/R	F	Saloon Engine AAT	661033	Inner Joint			34		85			
	1995-01-1997.10	AT/MT	L/R	F	Saloon Engine AAT	803017	Outer Joint	45T	38	27	59.5	34.5	68.5	I	
	1995-01-1997.10	MT	R	F	Saloon Engine AAT	203051	Drive Shaft	45T	38		59.5	34.5	647		
	1995-01-1997.10	AT	R	F	Saloon Engine AAT	203061	Drive Shaft	45T	38		59.5	34	488		
2.5 TDI (85 kW)	1994-06-1997.10	MT	L	F	Saloon Engine AAT	203050	Drive Shaft	45T	38		59.5	34.5	612		
	1994-06-1997.10	AT	L	F	Saloon Engine AAT	203060	Drive Shaft	45T	38		59.5	34	565		





	 YEAR	TRANSM	L/R	F/R	REMARKS	GSP Ref.	 PRODUCT	 ABS	Technical Specifications						
									A	B	C	H	L	P	
AUDI															
A6 (4A2 C4)															
2.5 TDI (85 kW)	1994.06-1997.10	AT/MT	L/R	F	Saloon Engine AAT	661033	Inner Joint			34		85			
	1994.06-1997.10	AT/MT	L/R	F	Saloon Engine AAT	803017	Outer Joint	45T	38	27	59.5	34.5	68.5	I	
	1994.06-1997.10	MT	R	F	Saloon Engine AAT	203051	Drive Shaft	45T	38		59.5	34.5	647		
	1994.06-1997.10	AT	R	F	Saloon Engine AAT	203061	Drive Shaft	45T	38		59.5	34	488		
2.6 (110 kW) 2.6 quattro (110 kW)	1994.06-1997.10	AT/MT	L/R	F	Saloon Engine ABC	803016	Outer Joint	45T	38	30	59.5	34	61	I	
	1994.06-1997.10	AT/MT	L/R	R	All-wheel Drive Saloon Engine ABC	603001	Inner Joint			28		32			
	1994.06-1997.10	MT	L/R	F	All-wheel Drive Saloon Engine ABC	803016	Outer Joint	45T	38	30	59.5	34	61	I	
2.8 (128 kW)	1994.06-1997.10	AT/MT	L/R	R	All-wheel Drive Saloon Engine ABC	803014	Outer Joint	45T	38	25	59.5	34.5	61	O	
	1994.06-1997.10	MT	L	F	Saloon Engine AAH/AFC/AEJ	203050	Drive Shaft	45T	38		59.5	34.5	612		
	1994.06-1997.10	AT	L	F	Saloon Engine AAH/AFC/AEJ	203060	Drive Shaft	45T	38		59.5	34	565		
	1994.06-1997.10	AT/MT	L/R	F	Saloon Engine AAH/AFC/AEJ	661033	Inner Joint			34		85			
	1994.06-1997.10	AT/MT	L/R	F	Saloon Engine AAH/AFC/AEJ	803017	Outer Joint	45T	38	27	59.5	34.5	68.5	I	
	1994.06-1997.10	MT	R	F	Saloon Engine AAH/AFC/AEJ	203051	Drive Shaft	45T	38		59.5	34.5	647		
2.8 quattro (128 kW)	1994.06-1997.10	AT	R	F	Saloon Engine AAH/AFC/AEJ	203061	Drive Shaft	45T	38		59.5	34	488		
	1994.06-1997.10	MT	L	F	All-wheel Drive Saloon Engine AAH/AEJ	203050	Drive Shaft	45T	38		59.5	34.5	612		
	1994.06-1997.10	AT/MT	L/R/R	F	All-wheel Drive Saloon Engine AAH/AEJ	603001	Inner Joint			28		32			
	1994.06-1997.10	AT	L	F	All-wheel Drive Saloon Engine AAH/AEJ	203060	Drive Shaft	45T	38		59.5	34	565		
	1994.06-1997.10	AT/MT	L/R	F	All-wheel Drive Saloon Engine AAH/AEJ	661033	Inner Joint			34		85			
	1994.06-1997.10	AT/MT	L/R	F	All-wheel Drive Saloon Engine AAH/AEJ	803017	Outer Joint	45T	38	27	59.5	34.5	68.5	I	
S6 4.2 quattro (213 kW)	1994.06-1997.10	AT	L	F	All-wheel Drive Saloon Engine AAH/AEJ	803014	Outer Joint	45T	38	25	59.5	34.5	61	O	
	1994.06-1997.10	MT	R	F	All-wheel Drive Saloon Engine AAH/AEJ	203051	Drive Shaft	45T	38		59.5	34.5	647		
	1994.06-1997.10	AT	R	F	All-wheel Drive Saloon Engine AAH/AEJ	203061	Drive Shaft	45T	38		59.5	34	488		
	1994.06-1997.10	AT	L	F	All-wheel Drive Saloon Engine AEC	203060	Drive Shaft	45T	38		59.5	34	565		
	1994.06-1997.10	AT/MT	L/R/R	F	All-wheel Drive Saloon Engine AEC	603001	Inner Joint			28		32			
	1994.06-1997.10	AT	L/R	F	All-wheel Drive Saloon Engine AEC	661033	Inner Joint			34		85			
S6 Plus quattro (240 kW)	1994.06-1997.10	AT/MT	L/R	F	All-wheel Drive Saloon Engine AEC	803017	Outer Joint	45T	38	27	59.5	34.5	68.5	I	
	1994.06-1997.10	AT	R	F	All-wheel Drive Saloon Engine AEC	203061	Drive Shaft	45T	38		59.5	34	488		
	1996.04-1997.10	-	L/R/R	F	All-wheel Drive Saloon Engine AHK	603001	Inner Joint			28		32			
	1996.04-1997.10	-	L/R	R	All-wheel Drive Saloon Engine AHK	803017	Outer Joint	45T	38	27	59.5	34.5	68.5	I	
S6 Turbo quattro (169 kW)	1996.04-1997.10	-	L/R	R	All-wheel Drive Saloon Engine AHK	803014	Outer Joint	45T	38	25	59.5	34.5	61	O	
	1994.06-1997.10	AT/MT	L/R/R	F	All-wheel Drive Saloon Engine AAN	603001	Inner Joint			28		32			
	1994.06-1997.10	AT	L	F	All-wheel Drive Saloon Engine AAN	203060	Drive Shaft	45T	38		59.5	34	565		
	1994.06-1997.10	AT	L/R	F	All-wheel Drive Saloon Engine AAN	661033	Inner Joint			34		85			
	1994.06-1997.10	AT/MT	L/R	F	All-wheel Drive Saloon Engine AAN	803017	Outer Joint	45T	38	27	59.5	34.5	68.5	I	
	1994.06-1997.10	AT	L/R	R	All-wheel Drive Saloon Engine AAN	803014	Outer Joint	45T	38	25	59.5	34.5	61	O	
A6 (4B2 C5)	1994.06-1997.10	AT	R	F	All-wheel Drive Saloon Engine AAN	203061	Drive Shaft	45T	38		59.5	34	488		
	1.8 (92 kW)	1997.07-2005.01	-	L/R	F	Saloon Engine ANQ/AJP/AQE/ARH	803018	Outer Joint	45W	33	30	53	30	62	I
	1997.07-2005.01	-	L/R	F	Saloon Engine ANQ/AJP/AQE/ARH	603001	Inner Joint			28		32			
	1997.07-2005.01	MT	L/R	F	Saloon Engine ANQ/AJP/AQE/ARH	661033	Inner Joint			34		85			
	1.8 T (110 kW)	1997.01-2005.01	4AT/MT	-	F	Saloon Engine ANQ/AJP/AQE/ARH	661033	Inner Joint			34		85		
		1997.01-2005.01	4AT/MT	-	F	Saloon Engine AEB/APU/ARK/ANB/AWT/AWL	650019	Inner Joint			34		59.5		
1997.01-2005.01		-	L/R	F	Saloon Engine AEB/APU/ARK/ANB/AWT/AWL	803018	Outer Joint	45W	33	30	53	30	62	I	
1997.01-2005.01		-	L/R	F	Saloon Engine AEB/APU/ARK/ANB/AWT/AWL	603001	Inner Joint			28		32			
1997.01-2005.01		-	L/R	F	Saloon Engine AEB/APU/ARK/ANB/AWT/AWL	803058	Outer Joint	45W	38	33	59.5	34	55	M	
1997.01-2005.01		AT	L/R	F	Saloon Engine AEB/APU/ARK/ANB/AWT/AWL	803020	Outer Joint	45W	38	30	59.5	34	59.5	I	
1997.01-2005.01		CVT	L/R	F	Saloon Engine AEB/APU/ARK/ANB/AWT/AWL	203066	Drive Shaft	45W	38		59.5	34.5	544		
1.8 T (132 kW)	1997.01-2005.01	MT	-	F	Saloon Engine AEB/APU/ARK/ANB/AWT/AWL	803030	Outer Joint			38	33	59.5	34	55	M
	1997.01-2005.01	CVT	L/R	F	Saloon Engine AEB/APU/ARK/ANB/AWT/AWL	803019	Outer Joint	45W	38	27	59.5	34.5	63	I	
	1997.12-2005.01	-	L/R	F	Saloon Engine AJL	803018	Outer Joint	45W	33	30	53	30	62	I	
1.8 T quattro (110 kW)	1997.12-2005.01	-	R	F	Saloon Engine AJL	299113	Drive Shaft	45W	38		59.5	34.5	654		
	1997.12-2005.01	MT	L/R	F	Saloon Engine AJL	661033	Inner Joint			34		85			
	1997.02-2005.01	-	L/R	F	All-wheel Drive Saloon Engine AEB/APU/ARK/ANB/AWT/AWL	803018	Outer Joint	45W	33	30	53	30	62	I	
1.8 T quattro (132 kW)	1997.02-2005.01	-	L/R	F	All-wheel Drive Saloon Engine AEB/APU/ARK/ANB/AWT/AWL	603001	Inner Joint			28		32			
	1997.02-2005.01	-	L/R	F	All-wheel Drive Saloon Engine AEB/APU/ARK/ANB/AWT/AWL	803058	Outer Joint	45W	38	33	59.5	34	55	M	
	1997.02-2005.01	AT	R	F	All-wheel Drive Saloon Engine AEB/APU/ARK/ANB/AWT/AWL	203066	Drive Shaft	45W	38		59.5	34.5	544		
	1997.12-2005.01	-	L/R	F	All-wheel Drive Saloon Engine AJL	803018	Outer Joint	45W	33	30	53	30	62	I	
1.9 TDI (81 kW)	1997.12-2005.01	MT	R	F	All-wheel Drive Saloon Engine AJL	299113	Drive Shaft	45W	38		59.5	34.5	654		
	1997.04-2000.10	AT/MT	L/R	F	Saloon Engine AFN/AVG	803019	Outer Joint	45W	38	27	59.5	34.5	63	I	
	1997.04-2000.10	AT/MT	L/R	F	Saloon Engine AFN/AVG	661033	Inner Joint			34		85			
	1997.04-2000.10	MT	R	F	Saloon Engine AFN/AVG	299113	Drive Shaft	45W	38		59.5	34.5	654		
	1997.04-2000.10	-	R	F	Saloon Engine AFN/AVG	261076	Drive Shaft	45W	38		59.5	34.5	645		
1.9 TDI (85 kW)	1997.04-2000.10	AT	L	F	Saloon Engine AFN/AVG	203020	Drive Shaft	45W	38		59.5	34.5	522		
	2000.07-2005.01	AT/MT	L/R	F	Saloon Engine AJM	803021	Outer Joint	45W	33	27	53	30	63	I	
	2000.07-2005.01	MT	-	-	Saloon Engine AJM	661044	Inner Joint			34		85			
	2000.07-2005.01	MT	R	F	Saloon Engine AJM	299113	Drive Shaft	45W	38		59.5	34.5	654		
	2000.07-2005.01	AT/MT	L/R	F	Saloon Engine AJM	661033	Inner Joint			34		85			

YEAR	TRANSM	L/R	F/R	REMARKS	GSP Ref.	PRODUCT	ABS	Technical Specifications							
								A	B	C	H	L	P		
AUDI															
A6 (4B2 C5)															
1.9 TDI (85 kW)	2000.07-2005.01	AT	L	F	Saloon Engine AJM	203019	Drive Shaft	45W	38		59.5	34.5	550		
	2000.07-2005.01	-	R	F	Saloon Engine AJM	261076	Drive Shaft	45W	38		59.5	34.5	645		
	2000.07-2005.01	AT	R	F	Saloon Engine AJM	203020	Drive Shaft	45W	38		59.5	34.5	522		
	2000.07-2005.01	-	L/R	F	Saloon Engine AJM	803019	Outer Joint	45W	38	27	59.5	34.5	63	I	
1.9 TDI (96 kW)	2001.08-2005.01	MT	L/R	F	Saloon Engine AVF/AWX	803019	Outer Joint	45W	38	27	59.5	34.5	63	I	
	2001.08-2005.01	MT	L/R	F	Saloon Engine AVF/AWX	661033	Inner Joint			34		85			
	2001.08-2005.01	AT	L/R	F	Saloon Engine AVF/AWX	203066	Drive Shaft	45W	38		59.5	34.5	544		
	2001.08-2005.01	5MT	R	F	Saloon Engine AVF/AWX	299113	Drive Shaft	45W	38		59.5	34.5	654		
	2001.08-2005.01	-	R	F	Saloon Engine AVF/AWX	261076	Drive Shaft	45W	38		59.5	34.5	645		
2.0 (96 kW)	2001.08-2005.01	MT	L/R	F	Saloon Engine ALT	803019	Outer Joint	45W	38	27	59.5	34.5	63	I	
	2001.08-2005.01	MT	-	F	Saloon Engine ALT	650019	Inner Joint			34		59.5			
	2001.08-2005.01	MT	L/R	F	Saloon Engine ALT	661033	Inner Joint			34		85			
	2001.08-2005.01	AT	L/R	F	Saloon Engine ALT	803058	Outer Joint	45W	38	33	59.5	34	55	M	
	2001.08-2005.01	MT	R	F	Saloon Engine ALT	299113	Drive Shaft	45W	38		59.5	34.5	654		
	2001.08-2005.01	-	-	F	Saloon Engine ALT	803030	Outer Joint		38	33	59.5	34	55	M	
	2001.08-2005.01	-	R	F	Saloon Engine ALT	261076	Drive Shaft	45W	38		59.5	34.5	645		
2.4 (100 kW)	1998.07-2005.01	MT	-	F	Saloon Engine ALW/ARN/ASM	650019	Inner Joint			34		59.5			
	1998.07-2005.01	AT/MT	L/R	F	Saloon Engine ALW/ARN/ASM	661033	Inner Joint			34		85			
	1998.07-2005.01	MT	R	F	Saloon Engine ALW/ARN/ASM	299113	Drive Shaft	45W	38		59.5	34.5	654		
	1998.07-2005.01	-	R	F	Saloon Engine ALW/ARN/ASM	261076	Drive Shaft	45W	38		59.5	34.5	645		
	1998.07-2005.01	AT	L	F	Saloon Engine ALW/ARN/ASM	203019	Drive Shaft	45W	38		59.5	34.5	550		
	1998.07-2005.01	AT	R	F	Saloon Engine ALW/ARN/ASM	203020	Drive Shaft	45W	38		59.5	34.5	522		
	1998.07-2005.01	AT	L/R	F	Saloon Engine ALW/ARN/ASM	803019	Outer Joint	45W	38	27	59.5	34.5	63	I	
2.4 (115 kW)	1997.02-2005.01	MT	R	F	Saloon Engine APC	299113	Drive Shaft	45W	38		59.5	34.5	654		
	1997.02-2005.01	AT/MT	L/R	F	Saloon Engine APC	661033	Inner Joint			34		85			
	1997.02-2005.01	AT	L	F	Saloon Engine APC	203019	Drive Shaft	45W	38		59.5	34.5	550		
	1997.02-2005.01	-	R	F	Saloon Engine APC	261076	Drive Shaft	45W	38		59.5	34.5	645		
	1997.02-2005.01	MT	L/R	F	Saloon Engine APC	803019	Outer Joint	45W	38	27	59.5	34.5	63	I	
	1997.02-2005.01	AT	R	F	Saloon Engine APC	203020	Drive Shaft	45W	38		59.5	34.5	522		
2.4 (120 kW)	1997.02-2005.01	MT	-	F	Saloon Engine AJG/APZ/AMM	650019	Inner Joint			34		59.5			
	1997.02-2005.01	MT	R	F	Saloon Engine AJG/APZ/AMM	299113	Drive Shaft	45W	38		59.5	34.5	654		
	1997.02-2005.01	-	L/R	F	Saloon Engine AJG/APZ/AMM	803020	Outer Joint	45W	38	30	59.5	34	59.5	I	
	1997.02-2005.01	AT/MT	L/R	F	Saloon Engine AJG/APZ/AMM	661033	Inner Joint			34		85			
	1997.02-2005.01	-	R	F	Saloon Engine AJG/APZ/AMM	261076	Drive Shaft	45W	38		59.5	34.5	645		
	1997.02-2005.01	AT	L	F	Saloon Engine AJG/APZ/AMM	203019	Drive Shaft	45W	38		59.5	34.5	550		
	1997.02-2005.01	-	L/R	F	Saloon Engine AJG/APZ/AMM	803019	Outer Joint	45W	38	27	59.5	34.5	63	I	
	1997.02-2005.01	AT	R	F	Saloon Engine AJG/APZ/AMM	203020	Drive Shaft	45W	38		59.5	34.5	522		
2.4 (121 kW)	1997.02-2005.01	MT	-	F	Saloon Engine ALF/APS/ARJ/AGA/AML	650019	Inner Joint			34		59.5			
	1997.02-2005.01	MT	R	F	Saloon Engine ALF/APS/ARJ/AGA/AML	299113	Drive Shaft	45W	38		59.5	34.5	654		
	1997.02-2005.01	AT/MT	L/R	F	Saloon Engine ALF/APS/ARJ/AGA/AML	661033	Inner Joint			34		85			
	1997.02-2005.01	AT/MT	L/R	F	Saloon Engine ALF/APS/ARJ/AGA/AML	803020	Outer Joint	45W	38	30	59.5	34	59.5	I	
	1997.02-2005.01	AT	L	F	Saloon Engine ALF/APS/ARJ/AGA/AML	203019	Drive Shaft	45W	38		59.5	34.5	550		
	1997.02-2005.01	-	R	F	Saloon Engine ALF/APS/ARJ/AGA/AML	261076	Drive Shaft	45W	38		59.5	34.5	645		
	1997.02-2005.01	AT/MT	L/R	F	Saloon Engine ALF/APS/ARJ/AGA/AML	803019	Outer Joint	45W	38	27	59.5	34.5	63	I	
	1997.02-2005.01	AT	R	F	Saloon Engine ALF/APS/ARJ/AGA/AML	203020	Drive Shaft	45W	38		59.5	34.5	522		
2.4 (125 kW)	2001.08-2005.01	-	L/R	F	Saloon Engine BDV	803019	Outer Joint	45W	38	27	59.5	34.5	63	I	
	2001.08-2005.01	MT	-	F	Saloon Engine BDV	650019	Inner Joint			34		59.5			
	2001.08-2005.01	AT	L/R	F	Saloon Engine BDV	203066	Drive Shaft	45W	38		59.5	34.5	544		
	2001.08-2005.01	MT	R	F	Saloon Engine BDV	299113	Drive Shaft	45W	38		59.5	34.5	654		
	2001.08-2005.01	AT/MT	L/R	F	Saloon Engine BDV	661033	Inner Joint			34		85			
	2001.08-2005.01	-	R	F	Saloon Engine BDV	261076	Drive Shaft	45W	38		59.5	34.5	645		
2.4 quattro (115 kW)	1998.08-1999.07	-	L/R	F	All-wheel Drive Saloon Engine APC	803019	Outer Joint	45W	38	27	59.5	34.5	63	I	
	1998.08-1999.07	MT	R	F	All-wheel Drive Saloon Engine APC	299113	Drive Shaft	45W	38		59.5	34.5	654		
	1998.08-1999.07	AT/MT	L/R	F	All-wheel Drive Saloon Engine APC	661033	Inner Joint			34		85			
	1998.08-1999.07	-	R	F	All-wheel Drive Saloon Engine APC	261076	Drive Shaft	45W	38		59.5	34.5	645		
	1998.08-1999.07	AT	L	F	All-wheel Drive Saloon Engine APC	203019	Drive Shaft	45W	38		59.5	34.5	550		
	1998.08-1999.07	AT	R	F	All-wheel Drive Saloon Engine APC	203020	Drive Shaft	45W	38		59.5	34.5	522		
2.4 quattro (120 kW)	1997.02-2005.01	-	L/R	F	All-wheel Drive Saloon Engine AJG/APZ	803020	Outer Joint	45W	38	30	59.5	34	59.5	I	
	1997.02-2005.01	MT	R	F	All-wheel Drive Saloon Engine AJG/APZ	299113	Drive Shaft	45W	38		59.5	34.5	654		
	1997.02-2005.01	AT	L	F	All-wheel Drive Saloon Engine AJG/APZ	203019	Drive Shaft	45W	38		59.5	34.5	550		
	1997.02-2005.01	-	R	F	All-wheel Drive Saloon Engine AJG/APZ	261076	Drive Shaft	45W	38		59.5	34.5	645		
	1997.02-2005.01	AT	R	F	All-wheel Drive Saloon Engine AJG/APZ	203020	Drive Shaft	45W	38		59.5	34.5	522		
	1997.02-2005.01	-	L/R	F	All-wheel Drive Saloon Engine AJG/APZ	803019	Outer Joint	45W	38	27	59.5	34.5	63	I	
2.4 quattro (121 kW)	1997.02-2005.01	AT/MT	L/R	F	All-wheel Drive Saloon Engine AML/ALF/APS/ARJ/AGA	661033	Inner Joint			34		85			
	1997.02-2005.01	MT	R	F	All-wheel Drive Saloon Engine AML/ALF/APS/ARJ/AGA	299113	Drive Shaft	45W	38		59.5	34.5	654		
	1997.02-2005.01	-	L/R	F	All-wheel Drive Saloon Engine AML/ALF/APS/ARJ/AGA	803020	Outer Joint	45W	38	30	59.5	34	59.5	I	

	 YEAR	TRANSM	L/R	F/R	REMARKS	GSP Ref.	 PRODUCT	 ABS	Technical Specifications					
									A	B	C	H	L	P
AUDI														
A6 (4B2 C5)														
2.4 quattro (121 kW)	1997.02-2005.01	AT	L	F	All-wheel Drive Saloon Engine AML/ALF/APS/ARJ/JAGA	203019	Drive Shaft	45W	38		59.5	34.5	550	
	1997.02-2005.01	-	R	F	All-wheel Drive Saloon Engine AML/ALF/APS/ARJ/JAGA	261076	Drive Shaft	45W	38		59.5	34.5	645	
	1997.02-2005.01	AT/MT	L/R	F	All-wheel Drive Saloon Engine AML/ALF/APS/ARJ/JAGA	803019	Outer Joint	45W	38	27	59.5	34.5	63	I
	1997.02-2005.01	AT	R	F	All-wheel Drive Saloon Engine AML/ALF/APS/ARJ/JAGA	203020	Drive Shaft	45W	38		59.5	34.5	522	
2.4 quattro (125 kW)	2001.08-2005.01	MT	-	F	All-wheel Drive Saloon Engine BDV	650019	Inner Joint			34		59.5		
	2001.08-2005.01	AT	L/R	F	All-wheel Drive Saloon Engine BDV	203066	Drive Shaft	45W	38		59.5	34.5	544	
	2001.08-2005.01	MT	R	F	All-wheel Drive Saloon Engine BDV	299113	Drive Shaft	45W	38		59.5	34.5	654	
	2001.08-2005.01	AT/MT	L/R	F	All-wheel Drive Saloon Engine BDV	661033	Inner Joint			34		85		
	2001.08-2005.01	-	R	F	All-wheel Drive Saloon Engine BDV	261076	Drive Shaft	45W	38		59.5	34.5	645	
2.5 TDI (110 kW)	1997.07-2005.01	MT	-	F	Saloon Engine AFB/AKN	650019	Inner Joint			34		59.5		
	1997.07-2005.01	AT/MT	L/R	F	Saloon Engine AFB/AKN	661033	Inner Joint			34		85		
	1997.07-2005.01	MT	R	F	Saloon Engine AFB/AKN	299113	Drive Shaft	45W	38		59.5	34.5	654	
	1997.07-2005.01	-	R	F	Saloon Engine AFB/AKN	261076	Drive Shaft	45W	38		59.5	34.5	645	
	1997.07-2005.01	AT	R	F	Saloon Engine AFB/AKN	203020	Drive Shaft	45W	38		59.5	34.5	522	
	1997.07-2005.01	AT/MT	L/R	F	Saloon Engine AFB/AKN	803019	Outer Joint	45W	38	27	59.5	34.5	63	I
2.5 TDI (114 kW)	2001.08-2005.01	AT/MT	L/R	F	Saloon Engine AYM	661033	Inner Joint			34		85		
	2001.08-2005.01	MT	-	F	Saloon Engine AYM	650019	Inner Joint			34		59.5		
	2001.08-2005.01	CVT	L/R	F	Saloon Engine AYM	203066	Drive Shaft	45W	38		59.5	34.5	544	
	2001.08-2005.01	-	R	F	Saloon Engine AYM	261076	Drive Shaft	45W	38		59.5	34.5	645	
	2001.08-2005.01	-	L/R	F	Saloon Engine AYM	803019	Outer Joint	45W	38	27	59.5	34.5	63	I
	2001.08-2005.01	AT/MT	L/R	F	Saloon Engine AYM	661033	Inner Joint			34		85		
2.5 TDI (120 kW)	2002.07-2005.01	-	L/R	F	Saloon Engine BFC/BCZ/BDG	803019	Outer Joint	45W	38	27	59.5	34.5	63	I
	2002.07-2005.01	AT/SAT/MT/SMT	L/R	F	Saloon Engine BFC/BCZ/BDG	661033	Inner Joint			34		85		
	2002.07-2005.01	MT	-	F	Saloon Engine BFC/BCZ/BDG	650019	Inner Joint			34		59.5		
	2002.07-2005.01	CVT	L/R	F	Saloon Engine BFC/BCZ/BDG	203066	Drive Shaft	45W	38		59.5	34.5	544	
	2002.07-2005.01	-	R	F	Saloon Engine BFC/BCZ/BDG	261076	Drive Shaft	45W	38		59.5	34.5	645	
2.5 TDI (132 kW)	2000.02-2005.01	MT/Semi-AT	L/R	F	Saloon Engine AKE/BAU/BDH/BDN	803019	Outer Joint	45W	38	27	59.5	34.5	63	I
	2000.02-2005.01	MT	-	F	Saloon Engine AKE/BAU/BDH/BDN	650019	Inner Joint			34		59.5		
	2000.02-2005.01	CVT	L/R	F	Saloon Engine AKE/BAU/BDH/BDN	203066	Drive Shaft	45W	38		59.5	34.5	544	
	2000.02-2005.01	AT/MT	L/R	F	Saloon Engine AKE/BAU/BDH/BDN	661033	Inner Joint			34		85		
	2000.02-2005.01	-	R	F	Saloon Engine AKE/BAU/BDH/BDN	261076	Drive Shaft	45W	38		59.5	34.5	645	
2.5 TDI quattro (110 kW)	1997.07-2005.01	MT	-	F	All-wheel Drive Saloon Engine AKN/AFB	650019	Inner Joint			34		59.5		
	1997.07-2005.01	MT	L/R	F	All-wheel Drive Saloon Engine AKN/AFB	803018	Outer Joint	45W	33	30	53	30	62	I
	1997.07-2005.01	AT/MT	L/R	F	All-wheel Drive Saloon Engine AKN/AFB	661033	Inner Joint			34		85		
	1997.07-2005.01	MT	R	F	All-wheel Drive Saloon Engine AKN/AFB	299113	Drive Shaft	45W	38		59.5	34.5	654	
	1997.07-2005.01	AT	L	F	All-wheel Drive Saloon Engine AKN/AFB	203019	Drive Shaft	45W	38		59.5	34.5	550	
	1997.07-2005.01	-	R	F	All-wheel Drive Saloon Engine AKN/AFB	261076	Drive Shaft	45W	38		59.5	34.5	645	
	1997.07-2005.01	AT	R	F	All-wheel Drive Saloon Engine AKN/AFB	203020	Drive Shaft	45W	38		59.5	34.5	522	
	1997.07-2005.01	AT	L/R	F	All-wheel Drive Saloon Engine AKN/AFB	803019	Outer Joint	45W	38	27	59.5	34.5	63	I
2.5 TDI quattro (132 kW)	2000.02-2005.01	AT	L/R	F	All-wheel Drive Saloon Engine AKE/BAU/BDH	803019	Outer Joint	45W	38	27	59.5	34.5	63	I
	2000.02-2005.01	MT	-	F	All-wheel Drive Saloon Engine AKE/BAU/BDH	650019	Inner Joint			34		59.5		
	2000.02-2005.01	MT	L/R	F	All-wheel Drive Saloon Engine AKE/BAU/BDH	803018	Outer Joint	45W	33	30	53	30	62	I
	2000.02-2005.01	-	L/R	R	All-wheel Drive Saloon Engine AKE/BAU/BDH	603001	Inner Joint			28		32		
	2000.02-2005.01	MT	R	F	All-wheel Drive Saloon Engine AKE/BAU/BDH	299113	Drive Shaft	45W	38		59.5	34.5	654	
	2000.02-2005.01	AT/MT	L/R	F	All-wheel Drive Saloon Engine AKE/BAU/BDH	661033	Inner Joint			34		85		
	2000.02-2005.01	AT	L	F	All-wheel Drive Saloon Engine AKE/BAU/BDH	203019	Drive Shaft	45W	38		59.5	34.5	550	
	2000.02-2005.01	-	R	F	All-wheel Drive Saloon Engine AKE/BAU/BDH	261076	Drive Shaft	45W	38		59.5	34.5	645	
	2000.02-2005.01	AT	R	F	All-wheel Drive Saloon Engine AKE/BAU/BDH	203020	Drive Shaft	45W	38		59.5	34.5	522	
2.7 T (169 kW)	1999.02-2005.01	-	L/R	F	Saloon Engine AJK	603001	Inner Joint			28		32		
	1999.02-2005.01	MT	L/R	F	Saloon Engine AJK	661033	Inner Joint			34		85		
	1999.02-2005.01	MT	R	F	Saloon Engine AJK	299113	Drive Shaft	45W	38		59.5	34.5	654	
	1999.02-2005.01	-	R	F	Saloon Engine AJK	261076	Drive Shaft	45W	38		59.5	34.5	645	
	1999.02-2005.01	MT	L/R	F	Saloon Engine AJK	803019	Outer Joint	45W	38	27	59.5	34.5	63	I
2.7 T quattro (169 kW)	1997.12-2005.01	MT	-	F	All-wheel Drive Saloon Engine AJK/AZA	650019	Inner Joint			34		59.5		
	1997.12-2005.01	-	L/R/R	F	All-wheel Drive Saloon Engine AJK/AZA	603001	Inner Joint			28		32		
	1997.12-2005.01	MT	L/R	F	All-wheel Drive Saloon Engine AJK/AZA	661033	Inner Joint			34		85		
	1997.12-2005.01	MT	R	F	All-wheel Drive Saloon Engine AJK/AZA	299113	Drive Shaft	45W	38		59.5	34.5	654	
	1997.12-2005.01	-	R	F	All-wheel Drive Saloon Engine AJK/AZA	261076	Drive Shaft	45W	38		59.5	34.5	645	
	1997.12-2005.01	MT	L/R	F	All-wheel Drive Saloon Engine AJK/AZA	803019	Outer Joint	45W	38	27	59.5	34.5	63	I
2.7 T quattro (184 kW)	2001.08-2005.01	MT	-	F	All-wheel Drive Saloon Engine BES/ARE	650019	Inner Joint			34		59.5		
	2001.08-2005.01	-	L/R	F	All-wheel Drive Saloon Engine BES/ARE	803019	Outer Joint	45W	38	27	59.5	34.5	63	I
	2001.08-2005.01	-	L/R/R	F	All-wheel Drive Saloon Engine BES/ARE	603001	Inner Joint			28		32		
	2001.08-2005.01	-	R	F	All-wheel Drive Saloon Engine BES/ARE	261076	Drive Shaft	45W	38		59.5	34.5	645	
2.8 (132 kW)	1997.10-2000.05	AT/MT	L/R	F	Saloon Engine AGE	661033	Inner Joint			34		85		
	1997.10-2000.05	MT	-	F	Saloon Engine AGE	850058	Outer Joint	44T	23	35	57	87	71	I
	1997.10-2000.05	MT	-	F	Saloon Engine AGE	850052	Outer Joint	44T	23	30	57.5	86.5	58.5	I
	1997.10-2000.05	MT	R	F	Saloon Engine AGE	299113	Drive Shaft	45W	38		59.5	34.5	654	





	 YEAR	TRANSM	L/R	F/R	REMARKS	GSP Ref.	 PRODUCT	 ABS	Technical Specifications							
									A	B	C	H	L	P		
AUDI																
A6 (4B2 C5)																
2.8 (132 kW)	1997.10-2000.05	-	L/R	F	Saloon Engine AGE	803020	Outer Joint	45W	38	30	59.5	34	59.5	I		
	1997.10-2000.05	AT	L	F	Saloon Engine AGE	203019	Drive Shaft	45W	38		59.5	34.5	550			
	1997.10-2000.05	-	R	F	Saloon Engine AGE	261076	Drive Shaft	45W	38		59.5	34.5	645			
	1997.10-2000.05	AT	L/R	F	Saloon Engine AGE	803019	Outer Joint	45W	38	27	59.5	34.5	63	I		
	1997.10-2000.05	AT	R	F	Saloon Engine AGE	203020	Drive Shaft	45W	38		59.5	34.5	522			
2.8 (140 kW)	1999.07-2005.01	MT	R	F	Saloon Engine ATX/BBG	299113	Drive Shaft	45W	38		59.5	34.5	654			
	1999.07-2005.01	AT	L	F	Saloon Engine ATX/BBG	203019	Drive Shaft	45W	38		59.5	34.5	550			
	1999.07-2005.01	-	R	F	Saloon Engine ATX/BBG	261076	Drive Shaft	45W	38		59.5	34.5	645			
	1999.07-2005.01	AT	R	F	Saloon Engine ATX/BBG	203020	Drive Shaft	45W	38		59.5	34.5	522			
	1999.07-2005.01	-	L/R	F	Saloon Engine ATX/BBG	803019	Outer Joint	45W	38	27	59.5	34.5	63	I		
2.8 (142 kW)	1997.02-2005.01	MT	-	F	Saloon Engine AMX/ACK/APR/AHA/ALG/AQD	650019	Inner Joint				34		59.5			
	1997.02-2005.01	MT	R	F	Saloon Engine AMX/ACK/APR/AHA/ALG/AQD	299113	Drive Shaft	45W	38		59.5	34.5	654			
	1997.02-2005.01	AT/MT	L/R	F	Saloon Engine AMX/ACK/APR/AHA/ALG/AQD	803020	Outer Joint	45W	38	30	59.5	34	59.5	I		
	1997.02-2005.01	AT/MT	L/R	F	Saloon Engine AMX/ACK/APR/AHA/ALG/AQD	661033	Inner Joint				34		85			
	1997.02-2005.01	AT	L	F	Saloon Engine AMX/ACK/APR/AHA/ALG/AQD	203019	Drive Shaft	45W	38		59.5	34.5	550			
	1997.02-2005.01	AT/MT	L/R	F	Saloon Engine AMX/ACK/APR/AHA/ALG/AQD	803019	Outer Joint	45W	38	27	59.5	34.5	63	I		
	1997.02-2005.01	AT	R	F	Saloon Engine AMX/ACK/APR/AHA/ALG/AQD	203020	Drive Shaft	45W	38		59.5	34.5	522			
2.8 quattro (140 kW)	1999.07-2001.05	-	L/R	F	All-wheel Drive Saloon Engine ATX	803020	Outer Joint	45W	38	30	59.5	34	59.5	I		
	1999.07-2001.05	-	L/R	R	All-wheel Drive Saloon Engine ATX	803026	Outer Joint	45T	33	30	53	31	62	I		
2.8 quattro (142 kW)	1997.02-2005.01	MT	-	F	All-wheel Drive Saloon Engine ALG/ACK/AQD/APR/AMX/AHA	650019	Inner Joint				34		59.5			
	1997.02-2005.01	AT/MT	L/R	F	All-wheel Drive Saloon Engine ALG/ACK/AQD/APR/AMX/AHA	661033	Inner Joint				34		85			
	1997.02-2005.01	-	L/R	F	All-wheel Drive Saloon Engine ALG/ACK/AQD/APR/AMX/AHA	803020	Outer Joint	45W	38	30	59.5	34	59.5	I		
	1997.02-2005.01	MT	R	F	All-wheel Drive Saloon Engine ALG/ACK/AQD/APR/AMX/AHA	299113	Drive Shaft	45W	38		59.5	34.5	654			
	1997.02-2005.01	AT	L	F	All-wheel Drive Saloon Engine ALG/ACK/AQD/APR/AMX/AHA	203019	Drive Shaft	45W	38		59.5	34.5	550			
	1997.02-2005.01	AT/MT	L/R	F	All-wheel Drive Saloon Engine ALG/ACK/AQD/APR/AMX/AHA	803019	Outer Joint	45W	38	27	59.5	34.5	63	I		
	1997.02-2005.01	-	R	F	All-wheel Drive Saloon Engine ALG/ACK/AQD/APR/AMX/AHA	261076	Drive Shaft	45W	38		59.5	34.5	645			
3.0 (162 kW)	2001.08-2005.01	-	L/R	F	Saloon Engine ASN	803019	Outer Joint	45W	38	27	59.5	34.5	63	I		
	2001.08-2005.01	MT	L/R	F	Saloon Engine ASN	661033	Inner Joint				34		85			
3.0 quattro (160 kW)	2001.08-2005.01	AT	L/R	F	Saloon Engine ASN	203066	Drive Shaft	45W	38		59.5	34.5	544			
	2001.08-2005.01	MT	R	F	Saloon Engine ASN	299113	Drive Shaft	45W	38		59.5	34.5	654			
	2001.08-2005.01	MT	-	F	All-wheel Drive Saloon Engine BBJ	650019	Inner Joint				34		59.5			
3.0 quattro (162 kW)	2001.06-2004.07	-	L/R	F	All-wheel Drive Saloon Engine BBJ	803019	Outer Joint	45W	38	27	59.5	34.5	63	I		
	2001.06-2004.07	AT	L/R	F	All-wheel Drive Saloon Engine BBJ	203066	Drive Shaft	45W	38		59.5	34.5	544			
	2001.06-2004.07	MT	R	F	All-wheel Drive Saloon Engine BBJ	299113	Drive Shaft	45W	38		59.5	34.5	654			
	2001.06-2004.07	AT/MT	L/R	F	All-wheel Drive Saloon Engine ASN	661033	Inner Joint				34		85			
3.0 quattro (162 kW)	2001.08-2005.01	MT	-	F	All-wheel Drive Saloon Engine ASN	650019	Inner Joint				34		59.5			
	2001.08-2005.01	-	L/R	F	All-wheel Drive Saloon Engine ASN	803019	Outer Joint	45W	38	27	59.5	34.5	63	I		
	2001.08-2005.01	AT	L/R	F	All-wheel Drive Saloon Engine ASN	203066	Drive Shaft	45W	38		59.5	34.5	544			
	2001.08-2005.01	MT	R	F	All-wheel Drive Saloon Engine ASN	299113	Drive Shaft	45W	38		59.5	34.5	654			
4.2 quattro (220 kW)	1998.11-2005.01	MT	-	F	All-wheel Drive Saloon Engine ARS/AWN/ASG	650019	Inner Joint				34		59.5			
	1998.11-2005.01	-	L/R	F	All-wheel Drive Saloon Engine ARS/AWN/ASG	603001	Inner Joint				28		32			
	1998.11-2005.01	AT	L	F	All-wheel Drive Saloon Engine ARS/AWN/ASG	203066	Drive Shaft	45W	38		59.5	34.5	544			
	1998.11-2005.01	-	L/R	F	All-wheel Drive Saloon Engine ARS/AWN/ASG	803019	Outer Joint	45W	38	27	59.5	34.5	63	I		
RS6 quattro (331 kW)	2002.07-2005.01	-	L/R	F	All-wheel Drive Saloon Engine BCY	803019	Outer Joint	45W	38	27	59.5	34.5	63	I		
	2002.07-2005.01	-	L/R	R	All-wheel Drive Saloon Engine BCY	603001	Inner Joint				28		32			
	2002.07-2005.01	-	L	F	All-wheel Drive Saloon Engine BCY	203066	Drive Shaft	45W	38		59.5	34.5	544			
S6 quattro (250 kW)	1999.09-2005.01	-	L/R	F	All-wheel Drive Saloon Engine ANK/AQJ	803019	Outer Joint	45W	38	27	59.5	34.5	63	I		
	1999.09-2005.01	MT	L/R	F	All-wheel Drive Saloon Engine ANK/AQJ	603001	Inner Joint				28		32			
	1999.09-2005.01	AT	L	F	All-wheel Drive Saloon Engine ANK/AQJ	203066	Drive Shaft	45W	38		59.5	34.5	544			
A6 (4F2 C6)																
2.0 TDI (100 kW)	2004.07-2011.03	CVT	R	F	Saloon Engine BNA/BRF/CAGB	203292	Drive Shaft				38		59.5	34.5	483	
	2004.07-2011.03	CVT	L	F	Saloon Engine BNA/BRF/CAGB	203025	Drive Shaft				38		59.5	34	543	
	2004.07-2011.03	-	L/R	F	Saloon Engine BNA/BRF/CAGB	803077	Outer Joint				38	27	59.5	34	63	M
	2004.07-2011.03	MT	L	F	Saloon Engine BNA/BRF/CAGB	203290	Drive Shaft				38		59.5	34	617	
	2004.07-2011.03	CVT/MT	-	F	Saloon Engine BNA/BRF/CAGB	803099	Outer Joint				38	27	59.5	34.5	64	M
	2004.07-2011.03	MT	R	F	Saloon Engine BNA/BRF/CAGB	203329	Drive Shaft				38		59.5	34	655	
2.0 TDI (103 kW)	2004.07-2008.10	CVT	R	F	Saloon Engine BLB/BRE	203292	Drive Shaft				38		59.5	34.5	483	
	2004.07-2008.10	CVT	L	F	Saloon Engine BLB/BRE	203025	Drive Shaft				38		59.5	34	543	
	2004.07-2008.10	-	L/R	F	Saloon Engine BLB/BRE	803077	Outer Joint				38	27	59.5	34	63	M
	2004.07-2008.10	MT	L	F	Saloon Engine BLB/BRE	203290	Drive Shaft				38		59.5	34	617	
	2004.07-2008.10	CVT/MT	-	F	Saloon Engine BLB/BRE	803099	Outer Joint				38	27	59.5	34.5	64	M
	2004.07-2008.10	MT	R	F	Saloon Engine BLB/BRE	203329	Drive Shaft				38		59.5	34	655	
2.0 TDI (120 kW)	2009.04-2011.03	CVT	R	F	Saloon Engine CAHB	203292	Drive Shaft				38		59.5	34.5	483	
	2009.04-2011.03	CVT	L	F	Saloon Engine CAHB	203025	Drive Shaft				38		59.5	34	543	





	 YEAR	TRANSM	L/R	F/R	REMARKS	GSP Ref.	 PRODUCT	 ABS	Technical Specifications								
									A	B	C	H	L	P			
AUDI																	
A6 (4F2 C6)																	
2.0 TDI (120 kW)	2009.04-2011.03	-	L/R	F	Saloon Engine CAHB	803077	Outer Joint		38	27	59.5	34	63	M			
	2009.04-2011.03	MT	L	F	Saloon Engine CAHB	203290	Drive Shaft		38		59.5	34	617				
	2009.04-2011.03	CVT/MT	-	F	Saloon Engine CAHB	803099	Outer Joint		38	27	59.5	34.5	64	M			
	2009.04-2011.03	MT	R	F	Saloon Engine CAHB	203329	Drive Shaft		38		59.5	34	655				
2.0 TDI (125 kW)	2008.11-2011.03	CVT	R	F	Saloon Engine CAHA	203292	Drive Shaft		38		59.5	34.5	483				
	2008.11-2011.03	CVT	L	F	Saloon Engine CAHA	203025	Drive Shaft		38		59.5	34	543				
	2008.11-2011.03	-	L/R	F	Saloon Engine CAHA	803077	Outer Joint		38	27	59.5	34	63	M			
	2008.11-2011.03	MT	L	F	Saloon Engine CAHA	203290	Drive Shaft		38		59.5	34	617				
	2008.11-2011.03	CVT/MT	-	F	Saloon Engine CAHA	803099	Outer Joint		38	27	59.5	34.5	64	M			
	2008.11-2011.03	MT	R	F	Saloon Engine CAHA	203329	Drive Shaft		38		59.5	34	655				
2.0 TDI (89 kW)	2005.09-2006.06	-	L/R	F	Saloon Engine BVG	803077	Outer Joint		38	27	59.5	34	63	M			
	2005.09-2006.06	MT	-	-	Saloon Engine BVG	661044	Inner Joint			34		85					
	2005.09-2006.06	MT	L	F	Saloon Engine BVG	203290	Drive Shaft		38		59.5	34	617				
	2005.09-2006.06	MT	R	F	Saloon Engine BVG	203329	Drive Shaft		38		59.5	34	655				
	2005.09-2006.06	-	-	F	Saloon Engine BVG	803099	Outer Joint		38	27	59.5	34.5	64	M			
2.0 TFSI (125 kW)	2005.06-2011.03	-	L/R	F	Saloon Engine BYK/BPJ	803077	Outer Joint		38	27	59.5	34	63	M			
	2005.06-2011.03	MT	L	F	Saloon Engine BYK/BPJ	203290	Drive Shaft		38		59.5	34	617				
	2005.06-2011.03	MT	R	F	Saloon Engine BYK/BPJ	203329	Drive Shaft		38		59.5	34	655				
	2005.06-2011.03	CVT	L	F	Saloon Engine BYK/BPJ	203271	Drive Shaft		38		59.5	34	548				
	2005.06-2011.03	-	-	F	Saloon Engine BYK/BPJ	803099	Outer Joint		38	27	59.5	34.5	64	M			
	2005.06-2011.03	CVT	R	F	Saloon Engine BYK/BPJ	203026	Drive Shaft		38		59.5	34	558				
2.4 (130 kW)	2004.05-2008.10	-	L/R	F	Saloon Engine BDW	803077	Outer Joint		38	27	59.5	34	63	M			
	2004.05-2008.10	MT	L	F	Saloon Engine BDW	203290	Drive Shaft		38		59.5	34	617				
	2004.05-2008.10	CVT/MT	-	F	Saloon Engine BDW	803099	Outer Joint		38	27	59.5	34.5	64	M			
	2004.05-2008.10	MT	R	F	Saloon Engine BDW	203329	Drive Shaft		38		59.5	34	655				
2.4 quattro (130 kW)	2005.01-2008.10	MT	L	F	All-wheel Drive Saloon Engine BDW	203290	Drive Shaft		38		59.5	34	617				
	2005.01-2008.10	MT	R	F	All-wheel Drive Saloon Engine BDW	203329	Drive Shaft		38		59.5	34	655				
	2005.01-2008.10	-	-	F	All-wheel Drive Saloon Engine BDW	803099	Outer Joint		38	27	59.5	34.5	64	M			
2.7 TDI (120 kW)	2004.11-2011.03	MT	L	F	Saloon Engine BSG/CANB	203290	Drive Shaft		38		59.5	34	617				
	2004.11-2011.03	MT	R	F	Saloon Engine BSG/CANB	203329	Drive Shaft		38		59.5	34	655				
	2004.11-2011.03	-	-	F	Saloon Engine BSG/CANB	899351	Outer Joint		38	29	59.5	34	70	M			
2.7 TDI (132 kW)	2004.11-2008.10	MT	L	F	Saloon Engine BPP	203290	Drive Shaft		38		59.5	34	617				
	2004.11-2008.10	MT	R	F	Saloon Engine BPP	203329	Drive Shaft		38		59.5	34	655				
	2004.11-2008.10	-	-	F	Saloon Engine BPP	899351	Outer Joint		38	29	59.5	34	70	M			
2.7 TDI (140 kW)	2008.10-2011.03	MT	L	F	Saloon Engine CANA	203290	Drive Shaft		38		59.5	34	617				
	2008.10-2011.03	MT	R	F	Saloon Engine CANA	203329	Drive Shaft		38		59.5	34	655				
	2008.10-2011.03	-	-	F	Saloon Engine CANA	899351	Outer Joint		38	29	59.5	34	70	M			
2.7 TDI quattro (120 kW)	2005.06-2011.03	AT	L	F	All-wheel Drive Saloon Engine BSG/CAND	203306	Drive Shaft		38		59.5	34	525				
	2005.06-2011.03	-	-	F	All-wheel Drive Saloon Engine BSG/CAND	803099	Outer Joint		38	27	59.5	34.5	64	M			
2.7 TDI quattro (132 kW)	2004.11-2008.10	MT	L	F	All-wheel Drive Saloon Engine BPP	203290	Drive Shaft		38		59.5	34	617				
	2004.11-2008.10	MT	R	F	All-wheel Drive Saloon Engine BPP	203329	Drive Shaft		38		59.5	34	655				
	2004.11-2008.10	MT	-	F	All-wheel Drive Saloon Engine BPP	899351	Outer Joint		38	29	59.5	34	70	M			
2.7 TDI quattro (140 kW)	2008.10-2011.03	AT	-	-	All-wheel Drive Saloon Engine CANC	661044	Inner Joint			34		85					
2.8 FSI (140 kW)	2008.10-2011.03	-	L/R	F	Saloon Engine CCDA	803077	Outer Joint		38	27	59.5	34	63	M			
	2008.10-2011.03	MT	L	F	Saloon Engine CCDA	203290	Drive Shaft		38		59.5	34	617				
	2008.10-2011.03	MT	R	F	Saloon Engine CCDA	203329	Drive Shaft		38		59.5	34	655				
	2008.10-2011.03	AT	L	F	Saloon Engine CCDA	203271	Drive Shaft		38		59.5	34	548				
	2008.10-2011.03	AT	R	F	Saloon Engine CCDA	203026	Drive Shaft		38		59.5	34	558				
	2008.10-2011.03	-	-	F	Saloon Engine CCDA	803099	Outer Joint		38	27	59.5	34.5	64	M			
2.8 FSI (154 kW)	2006.11-2008.10	-	L/R	F	Saloon Engine BDX	803077	Outer Joint		38	27	59.5	34	63	M			
	2006.11-2008.10	MT	L	F	Saloon Engine BDX	203290	Drive Shaft		38		59.5	34	617				
	2006.11-2008.10	MT	R	F	Saloon Engine BDX	203329	Drive Shaft		38		59.5	34	655				
	2006.11-2008.10	CVT	L	F	Saloon Engine BDX	203271	Drive Shaft		38		59.5	34	548				
	2006.11-2008.10	-	-	F	Saloon Engine BDX	803099	Outer Joint		38	27	59.5	34.5	64	M			
	2006.11-2008.10	CVT	R	F	Saloon Engine BDX	203026	Drive Shaft		38		59.5	34	558				
2.8 FSI (162 kW)	2008.10-2011.03	-	L/R	F	Saloon Engine CCEA	803077	Outer Joint		38	27	59.5	34	63	M			
	2008.10-2011.03	AT	-	-	Saloon Engine CCEA	661044	Inner Joint			34		85					
	2008.10-2011.03	CVT	L	F	Saloon Engine CCEA	203271	Drive Shaft		38		59.5	34	548				
	2008.10-2011.03	CVT	R	F	Saloon Engine CCEA	203026	Drive Shaft		38		59.5	34	558				
	2008.10-2011.03	-	-	F	Saloon Engine CCEA	803099	Outer Joint		38	27	59.5	34.5	64	M			
2.8 FSI quattro (140 kW)	2008.10-2011.03	AT	L	F	All-wheel Drive Saloon Engine CCDA	203306	Drive Shaft		38		59.5	34	525				
	2008.10-2011.03	MT	L	F	All-wheel Drive Saloon Engine CCDA	203290	Drive Shaft		38		59.5	34	617				
	2008.10-2011.03	MT	R	F	All-wheel Drive Saloon Engine CCDA	203329	Drive Shaft		38		59.5	34	655				
	2008.10-2011.03	-	-	F	All-wheel Drive Saloon Engine CCDA	803099	Outer Joint		38	27	59.5	34.5	64	M			
2.8 FSI quattro (154 kW)	2007.06-2008.10	AT	L	F	All-wheel Drive Saloon Engine BDX	203306	Drive Shaft		38		59.5	34	525				
	2007.06-2008.10	AT	-	F	All-wheel Drive Saloon Engine BDX	803099	Outer Joint		38	27	59.5	34.5	64	M			

	 YEAR	TRANSM	L/R	F/R	REMARKS	GSP Ref.	 PRODUCT	 ABS	Technical Specifications					
									A	B	C	H	L	P
AUDI														
A6 (4F2 C6)														
2.8 FSI quattro (162 kW)	2008.10-2011.03	AT	L	F	All-wheel Drive Saloon Engine CCEA	203306	Drive Shaft		38		59.5	34	525	
	2008.10-2011.03	AT	-	-	All-wheel Drive Saloon Engine CCEA	661044	Inner Joint			34		85		
	2008.10-2011.03	AT	-	F	All-wheel Drive Saloon Engine CCEA	803099	Outer Joint	38	27	59.5	34.5	64	M	
3.0 (160 kW)	2004.08-2006.05	-	L/R	F	Saloon Engine BBJ	803077	Outer Joint	38	27	59.5	34	63	M	
	2004.08-2006.05	AT	-	-	Saloon Engine BBJ	661044	Inner Joint			34		85		
	2004.08-2006.05	AT	L	F	Saloon Engine BBJ	203271	Drive Shaft	38		59.5	34	548		
	2004.08-2006.05	AT	R	F	Saloon Engine BBJ	203026	Drive Shaft	38		59.5	34	558		
	2004.08-2006.05	-	-	F	Saloon Engine BBJ	803099	Outer Joint	38	27	59.5	34.5	64	M	
3.0 quattro (160 kW)	2004.05-2006.05	AT	L	F	All-wheel Drive Saloon Engine BBJ	203306	Drive Shaft	38		59.5	34	525		
	2004.05-2006.05	AT	-	-	All-wheel Drive Saloon Engine BBJ	661044	Inner Joint			34		85		
	2004.05-2006.05	-	-	F	All-wheel Drive Saloon Engine BBJ	803099	Outer Joint	38	27	59.5	34.5	64	M	
3.0 TDI quattro (155 kW)	2004.05-2011.03	CVT	L	F	All-wheel Drive Saloon Engine BNG/CDYB	203306	Drive Shaft	38		59.5	34	525		
	2004.05-2011.03	-	-	F	All-wheel Drive Saloon Engine BNG/CDYB	803099	Outer Joint	38	27	59.5	34.5	64	M	
3.0 TDI quattro (165 kW)	2004.05-2006.05	AT	L	F	All-wheel Drive Saloon Engine BMK	203306	Drive Shaft	38		59.5	34	525		
	2004.05-2006.05	MT	L	F	All-wheel Drive Saloon Engine BMK	203290	Drive Shaft	38		59.5	34	617		
	2004.05-2006.05	AT/MT	-	F	All-wheel Drive Saloon Engine BMK	803099	Outer Joint	38	27	59.5	34.5	64	M	
	2004.05-2006.05	MT	R	F	All-wheel Drive Saloon Engine BMK	203329	Drive Shaft	38		59.5	34	655		
3.0 TDI quattro (171 kW)	2006.06-2008.10	AT	L	F	All-wheel Drive Saloon Engine ASB	203306	Drive Shaft	38		59.5	34	525		
	2006.06-2008.10	MT	L	F	All-wheel Drive Saloon Engine ASB	203290	Drive Shaft	38		59.5	34	617		
	2006.06-2008.10	AT/MT	-	F	All-wheel Drive Saloon Engine ASB	803099	Outer Joint	38	27	59.5	34.5	64	M	
	2006.06-2008.10	MT	R	F	All-wheel Drive Saloon Engine ASB	203329	Drive Shaft	38		59.5	34	655		
3.0 TDI quattro (176 kW)	2008.10-2011.03	AT	L	F	All-wheel Drive Saloon Engine CDYA/CDYC	203306	Drive Shaft	38		59.5	34	525		
	2008.10-2011.03	MT	L	F	All-wheel Drive Saloon Engine CDYA/CDYC	203290	Drive Shaft	38		59.5	34	617		
	2008.10-2011.03	AT/MT	-	F	All-wheel Drive Saloon Engine CDYA/CDYC	803099	Outer Joint	38	27	59.5	34.5	64	M	
	2008.10-2011.03	MT	R	F	All-wheel Drive Saloon Engine CDYA/CDYC	203329	Drive Shaft	38		59.5	34	655		
3.0 TFSI quattro (213 kW)	2008.10-2011.03	AT	L	F	All-wheel Drive Saloon Engine CAJA	203306	Drive Shaft	38		59.5	34	525		
	2008.10-2011.03	AT	-	-	All-wheel Drive Saloon Engine CAJA	661044	Inner Joint			34		85		
	2008.10-2011.03	-	-	F	All-wheel Drive Saloon Engine CAJA	803099	Outer Joint	38	27	59.5	34.5	64	M	
3.0 TFSI quattro (220 kW)	2008.10-2011.03	CVT	L	F	All-wheel Drive Saloon Engine CCAA	203306	Drive Shaft	38		59.5	34	525		
	2008.10-2011.03	AT	-	-	All-wheel Drive Saloon Engine CCAA	661044	Inner Joint			34		85		
	2008.10-2011.03	-	-	F	All-wheel Drive Saloon Engine CCAA	803099	Outer Joint	38	27	59.5	34.5	64	M	
3.2 FSI (188 kW)	2004.05-2009.05	-	L/R	F	Saloon Engine AUK/BKH	803077	Outer Joint	38	27	59.5	34	63	M	
	2004.05-2009.05	MT	L	F	Saloon Engine AUK/BKH	203290	Drive Shaft	38		59.5	34	617		
	2004.05-2009.05	MT	R	F	Saloon Engine AUK/BKH	203329	Drive Shaft	38		59.5	34	655		
	2004.05-2009.05	-	-	F	Saloon Engine AUK/BKH	803099	Outer Joint	38	27	59.5	34.5	64	M	
	2004.05-2009.05	CVT	L	F	Saloon Engine AUK/BKH	203271	Drive Shaft	38		59.5	34	548		
	2004.05-2009.05	CVT	R	F	Saloon Engine AUK/BKH	203026	Drive Shaft	38		59.5	34	558		
3.2 FSI (195 kW)	2009.05-2011.03	AT	-	-	Saloon Engine CALA	661044	Inner Joint			34		85		
	2009.05-2011.03	-	-	F	Saloon Engine CALA	803099	Outer Joint	38	27	59.5	34.5	64	M	
	2009.05-2011.03	AT	L	F	Saloon Engine CALA	203271	Drive Shaft	38		59.5	34	548		
	2009.05-2011.03	AT	R	F	Saloon Engine CALA	203026	Drive Shaft	38		59.5	34	558		
3.2 FSI quattro (188 kW)	2004.05-2008.10	AT	L	F	All-wheel Drive Saloon Engine AUK/BKH	203306	Drive Shaft	38		59.5	34	525		
	2004.05-2008.10	MT	L	F	All-wheel Drive Saloon Engine AUK/BKH	203290	Drive Shaft	38		59.5	34	617		
	2004.05-2008.10	AT/MT	-	F	All-wheel Drive Saloon Engine AUK/BKH	803099	Outer Joint	38	27	59.5	34.5	64	M	
	2004.05-2008.10	MT	R	F	All-wheel Drive Saloon Engine AUK/BKH	203329	Drive Shaft	38		59.5	34	655		
4.2 FSI quattro (257 kW)	2006.06-2011.03	AT	L	F	All-wheel Drive Saloon Engine BVJ	203306	Drive Shaft	38		59.5	34	525		
	2006.06-2011.03	AT	-	-	All-wheel Drive Saloon Engine BVJ	661044	Inner Joint			34		85		
	2006.06-2011.03	-	-	F	All-wheel Drive Saloon Engine BVJ	803099	Outer Joint	38	27	59.5	34.5	64	M	
4.2 quattro (246 kW)	2004.05-2006.05	AT	L	F	All-wheel Drive Saloon Engine BAT	203306	Drive Shaft	38		59.5	34	525		
	2004.05-2006.05	AT	-	-	All-wheel Drive Saloon Engine BAT	661044	Inner Joint			34		85		
	2004.05-2006.05	-	-	F	All-wheel Drive Saloon Engine BAT	803099	Outer Joint	38	27	59.5	34.5	64	M	
RS6 quattro (426 kW)	2008.09-2010.08	AT	-	F	All-wheel Drive Saloon Engine BUH	899351	Outer Joint	38	29	59.5	34	70	M	
S6 quattro (320 kW)	2006.03-2011.03	AT	-	-	All-wheel Drive Saloon Engine BXA	661044	Inner Joint			34		85		
	2006.03-2011.03	AT	-	F	All-wheel Drive Saloon Engine BXA	803099	Outer Joint	38	27	59.5	34.5	64	M	
A6 (4G2 4GC C7)														
1.8 TFSI (140 kW)	2014.09-	AT	-	-	Saloon Engine CYGA	603022	Inner Joint			34		88		
2.0 TDI (100 kW)	2012.01-	-	-	F	Saloon Engine CGLC/CSUE	803103	Outer Joint	42	28	76.4	34	54	I	
2.0 TDI (110 kW)	2014.09-	-	-	F	Saloon Engine CSUD/DDCB	803102	Outer Joint	42	29	76.5	34	60	I	
	2014.09-	AT	-	-	Saloon Engine CSUD/DDCB	603022	Inner Joint			34		88		
2.0 TDI (120 kW)	2011.03-	MT/ CVT	L/R	F	Saloon Engine CGLD	803088	Outer Joint	42	29	76.5	34	61.5	M	
2.0 TDI (130 kW)	2011.03-	MT/ CVT	L/R	F	Saloon Engine CGLC/CMGB	803088	Outer Joint	42	29	76.5	34	61.5	M	
2.0 TDI (140 kW)	2013.11-	-	-	F	Saloon Engine CZJA/CNHA/DDDA	803102	Outer Joint	42	29	76.5	34	60	I	
	2013.11-	AT/ MT	L/R	F	Saloon Engine CZJA/CNHA/DDDA	803088	Outer Joint	42	29	76.5	34	61.5	M	
2.0 TDI quattro (140 kW)	2015.04-	AT	-	-	All-wheel Drive Saloon Engine DDDA/CNHA	603022	Inner Joint			34		88		
	2015.04-	-	-	F	All-wheel Drive Saloon Engine DDDA/CNHA	803103	Outer Joint	42	28	76.4	34	54	I	
2.0 TFSI (132 kW)	2011.05-	-	-	F	Saloon Engine CDN B	803103	Outer Joint	42	28	76.4	34	54	I	





YEAR	TRANSM	L/R	F/R	REMARKS	GSP Ref.	PRODUCT	ABS	Technical Specifications							
								A	B	C	H	L	P		
AUDI															
A6 (4G2 4GC C7)															
2.0 TFSI (132 kW)	2011.05-	-	AT/MT	L/R	F	Saloon Engine CDNB	803088	Outer Joint		42	29	76.5	34	61.5	M
2.0 TFSI (155 kW)	2011.03-	2013.05	AT	-	-	Saloon Engine CAEB	603022	Inner Joint			34		88		
	2011.03-	2013.05	-	-	F	Saloon Engine CAEB	803103	Outer Joint	42	28	76.4	34	54	I	
2.0 TFSI (162 kW)	2013.05-	-	AT	-	-	Saloon Engine CAED	603022	Inner Joint			34		88		
2.0 TFSI (185 kW)	2014.09-	-	-	-	F	Saloon Engine CYNB/CYPA	803102	Outer Joint	42	29	76.5	34	60	I	
	2014.09-	-	AT	-	-	Saloon Engine CYNB/CYPA	603022	Inner Joint			34		88		
2.0 TFSI hybrid (155 kW)	2011.11-	-	AT	-	-	Saloon Engine CHJA	603022	Inner Joint			34		88		
	2011.11-	-	AT	L/R	F	Saloon Engine CHJA	803088	Outer Joint	42	29	76.5	34	61.5	M	
	2011.11-	-	-	-	F	Saloon Engine CHJA	803103	Outer Joint	42	28	76.4	34	54	I	
2.0 TFSI quattro (155 kW)	2012.05-	2013.05	AT	-	-	All-wheel Drive Saloon Engine CAEB	603022	Inner Joint			34		88		
	2012.05-	2013.05	-	-	F	All-wheel Drive Saloon Engine CAEB	803103	Outer Joint	42	28	76.4	34	54	I	
2.0 TFSI quattro (183 kW)	2015.05-	-	-	-	F	All-wheel Drive Saloon Engine CYPB	803103	Outer Joint	42	28	76.4	34	54	I	
2.0 TFSI quattro (185 kW)	2014.05-	-	AT	-	-	All-wheel Drive Saloon Engine CYNB/CYPA	603022	Inner Joint			34		88		
	2014.05-	-	-	-	F	All-wheel Drive Saloon Engine CYNB/CYPA	803103	Outer Joint	42	28	76.4	34	54	I	
2.8 FSI (150 kW)	2010.11-	2015.04	-	L/R	F	Saloon Engine CHVA	803087	Outer Joint	42	27	76.5	34	54.5	M	
	2010.11-	2015.04	-	-	F	Saloon Engine CHVA	803103	Outer Joint	42	28	76.4	34	54	I	
2.8 FSI quattro (150 kW)	2010.11-	2015.04	-	-	F	All-wheel Drive Saloon Engine CHVA	803103	Outer Joint	42	28	76.4	34	54	I	
2.8 FSI quattro (162 kW)	2014.09-	-	-	-	F	All-wheel Drive Saloon Engine CVPA	803103	Outer Joint	42	28	76.4	34	54	I	
3.0 TDI (150 kW)	2010.11-	-	MT/CVT	L/R	F	Saloon Engine CLAB	803088	Outer Joint	42	29	76.5	34	61.5	M	
3.0 TDI (155 kW)	2014.09-	-	-	-	F	Saloon Engine CTCB/CZVD	803102	Outer Joint	42	29	76.5	34	60	I	
	2014.09-	-	AT	-	-	Saloon Engine CTCB/CZVD	603022	Inner Joint			34		88		
3.0 TDI (160 kW)	2014.09-	-	-	-	F	Saloon Engine CZVB/CTCC	803102	Outer Joint	42	29	76.5	34	60	I	
	2014.09-	-	AT	-	-	Saloon Engine CZVB/CTCC	603022	Inner Joint			34		88		
3.0 TDI quattro (150 kW)	2011.03-	-	Semi-AT	-	F	All-wheel Drive Saloon Engine CLAA	803103	Outer Joint	42	28	76.4	34	54	I	
	2011.03-	-	CVT	L	F	All-wheel Drive Saloon Engine CLAA	261290	Drive Shaft	42		76.4	34	493		
	2011.03-	-	CVT	R	F	All-wheel Drive Saloon Engine CLAA	261290	Drive Shaft	42		76.4	34	493		
	2011.03-	-	AT	-	-	All-wheel Drive Saloon Engine CLAA	603022	Inner Joint			34		88		
3.0 TDI quattro (155 kW)	2014.09-	-	-	-	F	All-wheel Drive Saloon Engine CRTF/CZVC	803103	Outer Joint	42	28	76.4	34	54	I	
3.0 TDI quattro (160 kW)	2014.09-	-	-	-	F	All-wheel Drive Saloon Engine CRTE/CZVA	803103	Outer Joint	42	28	76.4	34	54	I	
3.0 TDI quattro (180 kW)	2011.03-	-	Semi-AT	-	F	All-wheel Drive Saloon Engine CKVC/CDUC/CKVB/CDUD	803103	Outer Joint	42	28	76.4	34	54	I	
	2011.03-	-	CVT	L	F	All-wheel Drive Saloon Engine CKVC/CDUC/CKVB/CDUD	261290	Drive Shaft	42		76.4	34	493		
	2011.03-	-	CVT	R	F	All-wheel Drive Saloon Engine CKVC/CDUC/CKVB/CDUD	261290	Drive Shaft	42		76.4	34	493		
	2011.03-	-	AT	-	-	All-wheel Drive Saloon Engine CKVC/CDUC/CKVB/CDUD	603022	Inner Joint			34		88		
3.0 TDI quattro (200 kW)	2014.09-	-	-	-	F	All-wheel Drive Saloon Engine CRTD	803103	Outer Joint	42	28	76.4	34	54	I	
3.0 TDI quattro (230 kW)	2011.11-	-	AT	-	-	All-wheel Drive Saloon Engine CGQB	603022	Inner Joint			34		88		
	2011.11-	-	-	-	F	All-wheel Drive Saloon Engine CGQB	803103	Outer Joint	42	28	76.4	34	54	I	
	2011.11-	-	CVT	L	F	All-wheel Drive Saloon Engine CGQB	261290	Drive Shaft	42		76.4	34	493		
	2011.11-	-	CVT	R	F	All-wheel Drive Saloon Engine CGQB	261290	Drive Shaft	42		76.4	34	493		
3.0 TDI quattro (235 kW)	2014.09-	-	-	-	F	All-wheel Drive Saloon Engine CVUA	803103	Outer Joint	42	28	76.4	34	54	I	
3.0 TDI quattro (240 kW)	2014.09-	-	-	-	F	All-wheel Drive Saloon Engine CVUB	803103	Outer Joint	42	28	76.4	34	54	I	
3.0 TFSI quattro (220 kW)	2010.11-	2012.05	Semi-AT	-	F	All-wheel Drive Saloon Engine CGWB	803103	Outer Joint	42	28	76.4	34	54	I	
	2010.11-	2012.05	CVT	L	F	All-wheel Drive Saloon Engine CGWB	261290	Drive Shaft	42		76.4	34	493		
	2010.11-	2012.05	CVT	R	F	All-wheel Drive Saloon Engine CGWB	261290	Drive Shaft	42		76.4	34	493		
	2010.11-	2012.05	AT	-	-	All-wheel Drive Saloon Engine CGWB	603022	Inner Joint			34		88		
3.0 TFSI quattro (228 kW)	2011.03-	-	AT	-	-	All-wheel Drive Saloon Engine CGXB/CTUA/CGWD	603022	Inner Joint			34		88		
	2011.03-	-	Semi-AT	-	F	All-wheel Drive Saloon Engine CGXB/CTUA/CGWD	803103	Outer Joint	42	28	76.4	34	54	I	
	2011.03-	-	CVT	L	F	All-wheel Drive Saloon Engine CGXB/CTUA/CGWD	261290	Drive Shaft	42		76.4	34	493		
	2011.03-	-	CVT	R	F	All-wheel Drive Saloon Engine CGXB/CTUA/CGWD	261290	Drive Shaft	42		76.4	34	493		
3.0 TFSI quattro (245 kW)	2014.09-	-	-	-	F	All-wheel Drive Saloon Engine CREC	803103	Outer Joint	42	28	76.4	34	54	I	
S6 (331 kW)	2014.10-	-	-	-	F	All-wheel Drive Saloon Engine CTGE	803103	Outer Joint	42	28	76.4	34	54	I	
	S6 quattro (309 kW)	2012.02-	-	AT	-	-	All-wheel Drive Saloon Engine CEUC	603022	Inner Joint			34		88	
		2012.02-	-	-	-	F	All-wheel Drive Saloon Engine CEUC	803103	Outer Joint	42	28	76.4	34	54	I
	2012.02-	-	AT	L	F	All-wheel Drive Saloon Engine CEUC	261290	Drive Shaft	42		76.4	34	493		
2012.02-	-	AT	R	F	All-wheel Drive Saloon Engine CEUC	261290	Drive Shaft	42		76.4	34	493			
A6 (4G2, C7, 4GC)															
3.0 TDI quattro (176 kW)	2013.05-	-	AT	L	R	All-wheel Drive Saloon Engine CPNB	203368	Drive Shaft		42		76.5	34	660	
A6 (C5, 4B2)															
1.8 TURBO (110 kW)	2000.01-	2005.12	MT	R	-	Saloon Engine BGC/AWL	203250	Drive Shaft	45W	33		53	30	656	
	2000.01-	2005.12	AT	L	-	Saloon Engine BGC/AWL	203254	Drive Shaft	45W	38		59.5	34	552	
	2000.01-	2005.12	AT	R	-	Saloon Engine BGC/AWL	203257	Drive Shaft	45W	38		59.5	34	518	
A6 Allroad (4FH C6)															
2.7 TDI quattro (120 kW)	2006.05-	2011.08	AT	L	F	All-wheel Drive Estate Engine BSG/CAND	203306	Drive Shaft		38		59.5	34	525	
	2006.05-	2011.08	AT	-	-	All-wheel Drive Estate Engine BSG/CAND	661044	Inner Joint			34		85		
	2006.05-	2011.08	-	-	F	All-wheel Drive Estate Engine BSG/CAND	803099	Outer Joint	38	27	59.5	34.5	64	M	
2.7 TDI quattro (132 kW)	2006.05-	2008.10	AT	-	-	All-wheel Drive Estate Engine BPP	661044	Inner Joint			34		85		
2.7 TDI quattro (140 kW)	2008.10-	2011.08	AT	L	F	All-wheel Drive Estate Engine CANC	203306	Drive Shaft		38		59.5	34	525	





YEAR	TRANSM	L/R	F/R	REMARKS	GSP Ref.	PRODUCT	ABS	Technical Specifications									
								A	B	C	H	L	P				
AUDI																	
A6 Allroad (4FH C6)																	
2.7 TDI quattro (140 kW)	2008.10-2011.08	AT	-	F	All-wheel Drive Estate Engine CANC	803099	Outer Joint		38	27	59.5	34.5	64	M			
	2008.10-2011.08	AT	-	-	All-wheel Drive Estate Engine CANC	661044	Inner Joint			34		85					
3.0 TDI quattro (155 kW)	2006.05-2011.08	CVT	L	F	All-wheel Drive Estate Engine BNG/CDYB	203306	Drive Shaft		38		59.5	34	525				
	2006.05-2011.08	-	-	F	All-wheel Drive Estate Engine BNG/CDYB	803099	Outer Joint		38	27	59.5	34.5	64	M			
3.0 TDI quattro (171 kW)	2006.05-2008.10	AT	L	F	All-wheel Drive Estate Engine ASB	203306	Drive Shaft		38		59.5	34	525				
	2006.05-2008.10	MT	L	F	All-wheel Drive Estate Engine ASB	203290	Drive Shaft		38		59.5	34	617				
	2006.05-2008.10	MT	R	F	All-wheel Drive Estate Engine ASB	203329	Drive Shaft		38		59.5	34	655				
	2006.05-2008.10	-	-	F	All-wheel Drive Estate Engine ASB	803099	Outer Joint		38	27	59.5	34.5	64	M			
3.0 TDI quattro (176 kW)	2008.10-2011.08	AT	L	F	All-wheel Drive Estate Engine CDYA/CDYC	203306	Drive Shaft		38		59.5	34	525				
	2008.10-2011.08	AT	-	F	All-wheel Drive Estate Engine CDYA/CDYC	803099	Outer Joint		38	27	59.5	34.5	64	M			
3.0 TFSI quattro (213 kW)	2008.10-2011.08	-	-	F	All-wheel Drive Estate Engine CAJA	803099	Outer Joint		38	27	59.5	34.5	64	M			
	2008.10-2011.08	AT	L	F	All-wheel Drive Estate Engine CAJA	203306	Drive Shaft		38		59.5	34	525				
	2008.10-2011.08	AT	-	-	All-wheel Drive Estate Engine CAJA	661044	Inner Joint			34		85					
3.2 FSI quattro (188 kW)	2006.05-2008.10	AT	L	F	All-wheel Drive Estate Engine AUK	203306	Drive Shaft		38		59.5	34	525				
	2006.05-2008.10	MT	L	F	All-wheel Drive Estate Engine AUK	203290	Drive Shaft		38		59.5	34	617				
	2006.05-2008.10	AT/MT	-	F	All-wheel Drive Estate Engine AUK	803099	Outer Joint		38	27	59.5	34.5	64	M			
	2006.05-2008.10	MT	R	F	All-wheel Drive Estate Engine AUK	203329	Drive Shaft		38		59.5	34	655				
4.2 FSI quattro (257 kW)	2006.05-2010.12	AT	L	F	All-wheel Drive Estate Engine BVJ	203306	Drive Shaft		38		59.5	34	525				
	2006.05-2010.12	AT	-	-	All-wheel Drive Estate Engine BVJ	661044	Inner Joint			34		85					
	2006.05-2010.12	-	-	F	All-wheel Drive Estate Engine BVJ	803099	Outer Joint		38	27	59.5	34.5	64	M			
A6 Allroad (4GH 4GJ)																	
3.0 TDI quattro (140 kW)	2015.11-	Semi-AT	-	F	All-wheel Drive Estate Engine CZVF	803103	Outer Joint		42	28	76.4	34	54	I			
3.0 TDI quattro (150 kW)	2012.01-	AT	-	-	All-wheel Drive Estate Engine CLAA	603022	Inner Joint			34		88					
	2012.01-	Semi-AT	-	F	All-wheel Drive Estate Engine CLAA	803103	Outer Joint		42	28	76.4	34	54	I			
	2012.01-	CVT	L	F	All-wheel Drive Estate Engine CLAA	261290	Drive Shaft		42		76.4	34	493				
	2012.01-	CVT	R	F	All-wheel Drive Estate Engine CLAA	261290	Drive Shaft		42		76.4	34	493				
3.0 TDI quattro (155 kW)	2014.09-	Semi-AT	-	F	All-wheel Drive Estate Engine CZVC/CRTF	803103	Outer Joint		42	28	76.4	34	54	I			
3.0 TDI quattro (160 kW)	2014.09-	Semi-AT	-	F	All-wheel Drive Estate Engine CRTE/CZVA	803103	Outer Joint		42	28	76.4	34	54	I			
3.0 TDI quattro (180 kW)	2012.01-	AT	-	-	All-wheel Drive Estate Engine CDUD/CKVC	603022	Inner Joint			34		88					
	2012.01-	Semi-AT	-	F	All-wheel Drive Estate Engine CDUD/CKVC	803103	Outer Joint		42	28	76.4	34	54	I			
	2012.01-	CVT	L	F	All-wheel Drive Estate Engine CDUD/CKVC	261290	Drive Shaft		42		76.4	34	493				
	2012.01-	CVT	R	F	All-wheel Drive Estate Engine CDUD/CKVC	261290	Drive Shaft		42		76.4	34	493				
3.0 TDI quattro (200 kW)	2014.09-	Semi-AT	-	F	All-wheel Drive Estate Engine CRTD	803103	Outer Joint		42	28	76.4	34	54	I			
3.0 TDI quattro (230 kW)	2012.01-	AT	-	-	All-wheel Drive Estate Engine CGQB	603022	Inner Joint			34		88					
	2012.01-	AT	-	F	All-wheel Drive Estate Engine CGQB	803103	Outer Joint		42	28	76.4	34	54	I			
	2012.01-	CVT	L	F	All-wheel Drive Estate Engine CGQB	261290	Drive Shaft		42		76.4	34	493				
	2012.01-	CVT	R	F	All-wheel Drive Estate Engine CGQB	261290	Drive Shaft		42		76.4	34	493				
3.0 TDI quattro (235 kW)	2012.01-	AT	-	-	All-wheel Drive Estate Engine CVUA	603022	Inner Joint			34		88					
	2012.01-	Semi-AT	-	F	All-wheel Drive Estate Engine CVUA	803103	Outer Joint		42	28	76.4	34	54	I			
3.0 TFSI quattro (228 kW)	2012.01-	AT	-	-	All-wheel Drive Estate Engine CGWD	603022	Inner Joint			34		88					
	2012.01-	Semi-AT	-	F	All-wheel Drive Estate Engine CGWD	803103	Outer Joint		42	28	76.4	34	54	I			
	2012.01-	CVT	L	F	All-wheel Drive Estate Engine CGWD	261290	Drive Shaft		42		76.4	34	493				
	2012.01-	CVT	R	F	All-wheel Drive Estate Engine CGWD	261290	Drive Shaft		42		76.4	34	493				
3.0 TFSI quattro (245 kW)	2014.09-	Semi-AT	-	F	All-wheel Drive Estate Engine CREC	803103	Outer Joint		42	28	76.4	34	54	I			
A6 ALLROAD QUATTRO																	
-	2007-2011	-	-	-	-	201590	Drive Shaft		38		59.5	34	523				
	2007-2011	-	-	-	-	201591	Drive Shaft		38		59.5	34	653				
A6 Avant (4A5 C4)																	
1.9 TDI (66 kW)	1994.06-1997.12	-	R	F	Estate Engine 1Z/AHU	261076	Drive Shaft	45W	38		59.5	34.5	645				
2.0 (74 kW)	1994.06-1997.12	MT	L/R	F	Estate Engine AAE	603001	Inner Joint			28		32					
	1994.06-1997.12	AT/MT	L/R	F	Estate Engine AAE	803016	Outer Joint	45T	38	30	59.5	34	61	I			
2.0 (85 kW)	1994.06-1997.12	MT	L/R	F	Estate Engine ABK	603001	Inner Joint			28		32					
	1994.06-1997.12	AT/MT	L/R	F	Estate Engine ABK	803016	Outer Joint	45T	38	30	59.5	34	61	I			
2.0 16V (103 kW)	1994.06-1997.12	MT	L/R	F	Estate Engine ACE	603001	Inner Joint			28		32					
	1994.06-1997.12	AT/MT	L/R	F	Estate Engine ACE	803016	Outer Joint	45T	38	30	59.5	34	61	I			
2.0 16V quattro (103 kW)	1994.06-1997.12	AT/MT	L/R	R	All-wheel Drive Estate Engine ACE	603001	Inner Joint			28		32					
	1994.06-1997.12	MT	L/R	F	All-wheel Drive Estate Engine ACE	803016	Outer Joint	45T	38	30	59.5	34	61	I			
	1994.06-1997.12	AT/MT	L/R	R	All-wheel Drive Estate Engine ACE	803014	Outer Joint	45T	38	25	59.5	34.5	61	O			
2.3 (98 kW)	1994.06-1995.12	MT	L/R	F	Estate Engine AAR	603001	Inner Joint			28		32					
	1994.06-1995.12	MT	L/R	F	Estate Engine AAR	803016	Outer Joint	45T	38	30	59.5	34	61	I			
2.5 TDI (103 kW)	1994.08-1997.12	MT	L	F	Estate Engine AEL	203050	Drive Shaft	45T	38		59.5	34.5	612				
	1994.08-1997.12	AT	L	F	Estate Engine AEL	203060	Drive Shaft	45T	38		59.5	34	565				
	1994.08-1997.12	AT/MT	L/R	F	Estate Engine AEL	661033	Inner Joint			34		85					
	1994.08-1997.12	AT/MT	L/R	F	Estate Engine AEL	803017	Outer Joint	45T	38	27	59.5	34.5	68.5	I			
	1994.08-1997.12	MT	R	F	Estate Engine AEL	203051	Drive Shaft	45T	38		59.5	34.5	647				
	1994.08-1997.12	AT	R	F	Estate Engine AEL	203061	Drive Shaft	45T	38		59.5	34	488				

	 YEAR	TRANSM	L/R	F/R	REMARKS	GSP Ref.	 PRODUCT	 ABS	Technical Specifications					
									A	B	C	H	L	P
AUDI														
A6 Avant (4A5 C4)														
2.5 TDI (84 kW)	1995.01-1997.12	MT	L	F	Estate Engine AAT	203050	Drive Shaft	45T	38		59.5	34.5	612	
	1995.01-1997.12	AT	L	F	Estate Engine AAT	203060	Drive Shaft	45T	38		59.5	34	565	
	1995.01-1997.12	AT/MT	L/R	F	Estate Engine AAT	661033	Inner Joint			34		85		
	1995.01-1997.12	AT/MT	L/R	F	Estate Engine AAT	803017	Outer Joint	45T	38	27	59.5	34.5	68.5	I
	1995.01-1997.12	MT	R	F	Estate Engine AAT	203051	Drive Shaft	45T	38		59.5	34.5	647	
	1995.01-1997.12	AT	R	F	Estate Engine AAT	203061	Drive Shaft	45T	38		59.5	34	488	
2.5 TDI (85 kW)	1994.06-1997.12	MT	L	F	Estate Engine AAT	203050	Drive Shaft	45T	38		59.5	34.5	612	
	1994.06-1997.12	AT	L	F	Estate Engine AAT	203060	Drive Shaft	45T	38		59.5	34	565	
	1994.06-1997.12	AT/MT	L/R	F	Estate Engine AAT	661033	Inner Joint			34		85		
	1994.06-1997.12	AT/MT	L/R	F	Estate Engine AAT	803017	Outer Joint	45T	38	27	59.5	34.5	68.5	I
	1994.06-1997.12	MT	R	F	Estate Engine AAT	203051	Drive Shaft	45T	38		59.5	34.5	647	
	1994.06-1997.12	AT	R	F	Estate Engine AAT	203061	Drive Shaft	45T	38		59.5	34	488	
2.6 (110 kW)	1994.06-1997.12	AT/MT	L/R	F	Estate Engine ABC	803016	Outer Joint	45T	38	30	59.5	34	61	I
2.6 quattro (110 kW)	1994.06-1997.12	AT/MT	L/R	R	All-wheel Drive Estate Engine ABC	603001	Inner Joint			28		32		
	1994.06-1997.12	MT	L/R	F	All-wheel Drive Estate Engine ABC	803016	Outer Joint	45T	38	30	59.5	34	61	I
	1994.06-1997.12	AT/MT	L/R	R	All-wheel Drive Estate Engine ABC	803014	Outer Joint	45T	38	25	59.5	34.5	61	O
2.8 (128 kW)	1994.06-1997.12	MT	L	F	Estate Engine AEJ/AAH	203050	Drive Shaft	45T	38		59.5	34.5	612	
	1994.06-1997.12	AT	L	F	Estate Engine AEJ/AAH	203060	Drive Shaft	45T	38		59.5	34	565	
	1994.06-1997.12	AT/MT	L/R	F	Estate Engine AEJ/AAH	661033	Inner Joint			34		85		
	1994.06-1997.12	AT/MT	L/R	F	Estate Engine AEJ/AAH	803017	Outer Joint	45T	38	27	59.5	34.5	68.5	I
	1994.06-1997.12	MT	R	F	Estate Engine AEJ/AAH	203051	Drive Shaft	45T	38		59.5	34.5	647	
	1994.06-1997.12	AT	R	F	Estate Engine AEJ/AAH	203061	Drive Shaft	45T	38		59.5	34	488	
2.8 quattro (128 kW)	1994.06-1997.12	MT	L	F	All-wheel Drive Estate Engine AAH/AEJ	203050	Drive Shaft	45T	38		59.5	34.5	612	
	1994.06-1997.12	AT/MT	L/R	R	All-wheel Drive Estate Engine AAH/AEJ	603001	Inner Joint			28		32		
	1994.06-1997.12	AT	L	F	All-wheel Drive Estate Engine AAH/AEJ	203060	Drive Shaft	45T	38		59.5	34	565	
	1994.06-1997.12	AT/MT	L/R	F	All-wheel Drive Estate Engine AAH/AEJ	661033	Inner Joint			34		85		
	1994.06-1997.12	AT/MT	L/R	F	All-wheel Drive Estate Engine AAH/AEJ	803017	Outer Joint	45T	38	27	59.5	34.5	68.5	I
	1994.06-1997.12	MT	R	F	All-wheel Drive Estate Engine AAH/AEJ	203051	Drive Shaft	45T	38		59.5	34.5	647	
	1994.06-1997.12	AT	R	F	All-wheel Drive Estate Engine AAH/AEJ	803014	Outer Joint	45T	38	25	59.5	34.5	61	O
	1994.06-1997.12	AT	R	F	All-wheel Drive Estate Engine AAH/AEJ	203061	Drive Shaft	45T	38		59.5	34	488	
	1994.06-1997.12	AT	R	F	All-wheel Drive Estate Engine AAH/AEJ	203061	Drive Shaft	45T	38		59.5	34	488	
S6 4.2 quattro (213 kW)	1994.06-1997.12	AT/MT	L/R	R	All-wheel Drive Estate Engine AEC	603001	Inner Joint			28		32		
	1994.06-1997.12	AT	L	F	All-wheel Drive Estate Engine AEC	203060	Drive Shaft	45T	38		59.5	34	565	
	1994.06-1997.12	AT/MT	L/R	F	All-wheel Drive Estate Engine AEC	661033	Inner Joint			34		85		
	1994.06-1997.12	AT/MT	L/R	F	All-wheel Drive Estate Engine AEC	803017	Outer Joint	45T	38	27	59.5	34.5	68.5	I
	1994.06-1997.12	AT	R	F	All-wheel Drive Estate Engine AEC	203061	Drive Shaft	45T	38		59.5	34	488	
	1994.06-1997.12	AT	R	F	All-wheel Drive Estate Engine AEC	203061	Drive Shaft	45T	38		59.5	34	488	
S6 Plus quattro (240 kW)	1996.04-1997.12	-	L/R	R	All-wheel Drive Estate Engine AHK	603001	Inner Joint			28		32		
	1996.04-1997.12	-	L/R	F	All-wheel Drive Estate Engine AHK	803017	Outer Joint	45T	38	27	59.5	34.5	68.5	I
	1996.04-1997.12	-	L/R	R	All-wheel Drive Estate Engine AHK	803014	Outer Joint	45T	38	25	59.5	34.5	61	O
S6 Turbo quattro (169 kW)	1994.06-1997.12	AT/MT	L/R	R	All-wheel Drive Estate Engine AAN	603001	Inner Joint			28		32		
	1994.06-1997.12	AT	L	F	All-wheel Drive Estate Engine AAN	203060	Drive Shaft	45T	38		59.5	34	565	
	1994.06-1997.12	AT	L/R	F	All-wheel Drive Estate Engine AAN	661033	Inner Joint			34		85		
	1994.06-1997.12	AT/MT	L/R	F	All-wheel Drive Estate Engine AAN	803017	Outer Joint	45T	38	27	59.5	34.5	68.5	I
	1994.06-1997.12	AT	L/R	R	All-wheel Drive Estate Engine AAN	803014	Outer Joint	45T	38	25	59.5	34.5	61	O
	1994.06-1997.12	AT	R	F	All-wheel Drive Estate Engine AAN	203061	Drive Shaft	45T	38		59.5	34	488	
A6 Avant (4B5 C5)														
1.8 (92 kW)	1997.12-2005.01	-	L/R	F	Estate Engine ARH/AJP/AQE	803018	Outer Joint	45W	33	30	53	30	62	I
	1997.12-2005.01	MT	L/R	F	Estate Engine ARH/AJP/AQE	603001	Inner Joint			28		32		
	1997.12-2005.01	MT	L/R	F	Estate Engine ARH/AJP/AQE	661033	Inner Joint			34		85		
1.8 T (110 kW)	1997.12-2005.01	4AT/MT	-	F	Estate Engine AWT/AEB/APU/ARK/ANB	650019	Inner Joint			34		59.5		
	1997.12-2005.01	-	L/R	F	Estate Engine AWT/AEB/APU/ARK/ANB	803018	Outer Joint	45W	33	30	53	30	62	I
	1997.12-2005.01	-	L/R	F	Estate Engine AWT/AEB/APU/ARK/ANB	603001	Inner Joint			28		32		
	1997.12-2005.01	-	L/R	F	Estate Engine AWT/AEB/APU/ARK/ANB	803058	Outer Joint	45W	38	33	59.5	34	55	M
	1997.12-2005.01	AT	L/R	F	Estate Engine AWT/AEB/APU/ARK/ANB	203066	Drive Shaft	45W	38		59.5	34.5	544	
	1997.12-2005.01	-	L/R	F	Estate Engine AWT/AEB/APU/ARK/ANB	803020	Outer Joint	45W	38	30	59.5	34	59.5	I
	1997.12-2005.01	MT	-	F	Estate Engine AWT/AEB/APU/ARK/ANB	803030	Outer Joint			38	33	59.5	34	55
1.8 T (132 kW)	1999.04-2005.01	MT	-	F	Estate Engine AJL	650019	Inner Joint			34		59.5		
	1999.04-2005.01	-	L/R	F	Estate Engine AJL	803018	Outer Joint	45W	33	30	53	30	62	I
	1999.04-2005.01	-	R	F	Estate Engine AJL	299113	Drive Shaft	45W	38		59.5	34.5	654	
	1999.04-2005.01	MT	L/R	F	Estate Engine AJL	661033	Inner Joint			34		85		
1.8 T quattro (110 kW)	1997.12-2005.01	-	L/R	F	All-wheel Drive Estate Engine AEB/APU/ARK/ANB/AWT	803018	Outer Joint	45W	33	30	53	30	62	I
	1997.12-2005.01	-	L/R	F	All-wheel Drive Estate Engine AEB/APU/ARK/ANB/AWT	603001	Inner Joint			28		32		
	1997.12-2005.01	-	L/R	F	All-wheel Drive Estate Engine AEB/APU/ARK/ANB/AWT	803058	Outer Joint	45W	38	33	59.5	34	55	M
	1997.12-2005.01	AT	R	F	All-wheel Drive Estate Engine AEB/APU/ARK/ANB/AWT	203066	Drive Shaft	45W	38		59.5	34.5	544	
1.8 T quattro (132 kW)	1997.12-2005.01	-	L/R	F	All-wheel Drive Estate Engine AJL	803018	Outer Joint	45W	33	30	53	30	62	I
	1997.12-2005.01	MT	R	F	All-wheel Drive Estate Engine AJL	299113	Drive Shaft	45W	38		59.5	34.5	654	
1.9 TDI (81 kW)	1998.02-2001.04	AT/MT	L/R	F	Estate Engine AFN	803019	Outer Joint	45W	38	27	59.5	34.5	63	I





	 YEAR	TRANSM	L/R	F/R	REMARKS	GSP Ref.	 PRODUCT	 ABS	Technical Specifications									
									A	B	C	H	L	P				
AUDI																		
A6 Avant (4B5 C5)																		
1.9 TDI (81 kW)	1998.02-2001.04	AT/MT	L/R	F	Estate Engine AFN	661033	Inner Joint			34		85						
	1998.02-2001.04	MT	R	F	Estate Engine AFN	299113	Drive Shaft	45W	38		59.5	34.5	654					
	1998.02-2001.04	-	R	F	Estate Engine AFN	261076	Drive Shaft	45W	38		59.5	34.5	645					
	1998.02-2001.04	AT	L	F	Estate Engine AFN	203020	Drive Shaft	45W	38		59.5	34.5	522					
1.9 TDI (85 kW)	2000.07-2005.01	AT/MT	L/R	F	Estate Engine AJM	803021	Outer Joint	45W	33	27	53	30	63	I				
	2000.07-2005.01	MT	-	-	Estate Engine AJM	661044	Inner Joint			34		85						
	2000.07-2005.01	MT	R	F	Estate Engine AJM	299113	Drive Shaft	45W	38		59.5	34.5	654					
	2000.07-2005.01	AT/MT	L/R	F	Estate Engine AJM	661033	Inner Joint			34		85						
	2000.07-2005.01	AT	L	F	Estate Engine AJM	203019	Drive Shaft	45W	38		59.5	34.5	550					
	2000.07-2005.01	AT	R	F	Estate Engine AJM	203020	Drive Shaft	45W	38		59.5	34.5	522					
	2000.07-2005.01	-	R	F	Estate Engine AJM	261076	Drive Shaft	45W	38		59.5	34.5	645					
	2000.07-2005.01	-	L/R	F	Estate Engine AJM	803019	Outer Joint	45W	38	27	59.5	34.5	63	I				
1.9 TDI (96 kW)	2001.08-2005.01	MT	L/R	F	Estate Engine AVF/AWX	803019	Outer Joint	45W	38	27	59.5	34.5	63	I				
	2001.08-2005.01	MT	L/R	F	Estate Engine AVF/AWX	661033	Inner Joint			34		85						
	2001.08-2005.01	AT	L/R	F	Estate Engine AVF/AWX	203066	Drive Shaft	45W	38		59.5	34.5	544					
	2001.08-2005.01	5MT	R	F	Estate Engine AVF/AWX	299113	Drive Shaft	45W	38		59.5	34.5	654					
	2001.08-2005.01	-	R	F	Estate Engine AVF/AWX	261076	Drive Shaft	45W	38		59.5	34.5	645					
2.0 (96 kW)	2001.08-2005.01	MT	L/R	F	Estate Engine ALT	803019	Outer Joint	45W	38	27	59.5	34.5	63	I				
	2001.08-2005.01	MT	-	-	Estate Engine ALT	650019	Inner Joint			34		59.5						
	2001.08-2005.01	MT	L/R	F	Estate Engine ALT	661033	Inner Joint			34		85						
	2001.08-2005.01	AT	L/R	F	Estate Engine ALT	803058	Outer Joint	45W	38	33	59.5	34	55	M				
	2001.08-2005.01	MT	R	F	Estate Engine ALT	299113	Drive Shaft	45W	38		59.5	34.5	654					
	2001.08-2005.01	-	R	F	Estate Engine ALT	261076	Drive Shaft	45W	38		59.5	34.5	645					
2.4 (100 kW)	1998.07-2005.01	AT	L/R	F	Estate Engine ALW/ARN/ASM	803019	Outer Joint	45W	38	27	59.5	34.5	63	I				
	1998.07-2005.01	AT/MT	L/R	F	Estate Engine ALW/ARN/ASM	661033	Inner Joint			34		85						
	1998.07-2005.01	MT	R	F	Estate Engine ALW/ARN/ASM	299113	Drive Shaft	45W	38		59.5	34.5	654					
	1998.07-2005.01	AT	L	F	Estate Engine ALW/ARN/ASM	203019	Drive Shaft	45W	38		59.5	34.5	550					
	1998.07-2005.01	-	R	F	Estate Engine ALW/ARN/ASM	261076	Drive Shaft	45W	38		59.5	34.5	645					
	1998.07-2005.01	AT	R	F	Estate Engine ALW/ARN/ASM	203020	Drive Shaft	45W	38		59.5	34.5	522					
2.4 (115 kW)	1997.12-2005.01	MT	R	F	Estate Engine APC	299113	Drive Shaft	45W	38		59.5	34.5	654					
	1997.12-2005.01	AT/MT	L/R	F	Estate Engine APC	661033	Inner Joint			34		85						
	1997.12-2005.01	AT	L	F	Estate Engine APC	203019	Drive Shaft	45W	38		59.5	34.5	550					
	1997.12-2005.01	MT	L/R	F	Estate Engine APC	803019	Outer Joint	45W	38	27	59.5	34.5	63	I				
	1997.12-2005.01	AT	R	F	Estate Engine APC	203020	Drive Shaft	45W	38		59.5	34.5	522					
	1997.12-2005.01	-	R	F	Estate Engine APC	261076	Drive Shaft	45W	38		59.5	34.5	645					
2.4 (120 kW)	1997.12-2005.01	MT	-	-	Estate Engine AJG/APZ/AMM	650019	Inner Joint			34		59.5						
	1997.12-2005.01	MT	R	F	Estate Engine AJG/APZ/AMM	299113	Drive Shaft	45W	38		59.5	34.5	654					
	1997.12-2005.01	-	L/R	F	Estate Engine AJG/APZ/AMM	803020	Outer Joint	45W	38	30	59.5	34	59.5	I				
	1997.12-2005.01	AT/MT	L/R	F	Estate Engine AJG/APZ/AMM	661033	Inner Joint			34		85						
	1997.12-2005.01	AT	L	F	Estate Engine AJG/APZ/AMM	203019	Drive Shaft	45W	38		59.5	34.5	550					
	1997.12-2005.01	-	L/R	F	Estate Engine AJG/APZ/AMM	803019	Outer Joint	45W	38	27	59.5	34.5	63	I				
	1997.12-2005.01	-	R	F	Estate Engine AJG/APZ/AMM	261076	Drive Shaft	45W	38		59.5	34.5	645					
	1997.12-2005.01	AT	R	F	Estate Engine AJG/APZ/AMM	203020	Drive Shaft	45W	38		59.5	34.5	522					
2.4 (121 kW)	1997.12-2005.01	MT	-	-	Estate Engine ALF/APS/ARJ/AGA/AML	650019	Inner Joint			34		59.5						
	1997.12-2005.01	AT/MT	L/R	F	Estate Engine ALF/APS/ARJ/AGA/AML	661033	Inner Joint			34		85						
	1997.12-2005.01	AT/MT	L/R	F	Estate Engine ALF/APS/ARJ/AGA/AML	803020	Outer Joint	45W	38	30	59.5	34	59.5	I				
	1997.12-2005.01	MT	R	F	Estate Engine ALF/APS/ARJ/AGA/AML	299113	Drive Shaft	45W	38		59.5	34.5	654					
	1997.12-2005.01	AT	L	F	Estate Engine ALF/APS/ARJ/AGA/AML	203019	Drive Shaft	45W	38		59.5	34.5	550					
	1997.12-2005.01	AT/MT	L/R	F	Estate Engine ALF/APS/ARJ/AGA/AML	803019	Outer Joint	45W	38	27	59.5	34.5	63	I				
	1997.12-2005.01	AT	R	F	Estate Engine ALF/APS/ARJ/AGA/AML	203020	Drive Shaft	45W	38		59.5	34.5	522					
	1997.12-2005.01	-	R	F	Estate Engine ALF/APS/ARJ/AGA/AML	261076	Drive Shaft	45W	38		59.5	34.5	645					
2.4 (125 kW)	2001.08-2005.01	MT	-	-	Estate Engine BDV	650019	Inner Joint			34		59.5						
	2001.08-2005.01	-	L/R	F	Estate Engine BDV	803019	Outer Joint	45W	38	27	59.5	34.5	63	I				
	2001.08-2005.01	AT	L/R	F	Estate Engine BDV	203066	Drive Shaft	45W	38		59.5	34.5	544					
	2001.08-2005.01	MT	R	F	Estate Engine BDV	299113	Drive Shaft	45W	38		59.5	34.5	654					
	2001.08-2005.01	AT/MT	L/R	F	Estate Engine BDV	661033	Inner Joint			34		85						
	2001.08-2005.01	-	R	F	Estate Engine BDV	261076	Drive Shaft	45W	38		59.5	34.5	645					
2.4 quattro (115 kW)	1998.08-2001.05	-	L/R	F	All-wheel Drive Estate Engine APC	803019	Outer Joint	45W	38	27	59.5	34.5	63	I				
	1998.08-2001.05	MT	R	F	All-wheel Drive Estate Engine APC	299113	Drive Shaft	45W	38		59.5	34.5	654					
	1998.08-2001.05	AT/MT	L/R	F	All-wheel Drive Estate Engine APC	661033	Inner Joint			34		85						
	1998.08-2001.05	AT	L	F	All-wheel Drive Estate Engine APC	203019	Drive Shaft	45W	38		59.5	34.5	550					
	1998.08-2001.05	-	R	F	All-wheel Drive Estate Engine APC	261076	Drive Shaft	45W	38		59.5	34.5	645					
	1998.08-2001.05	AT	R	F	All-wheel Drive Estate Engine APC	203020	Drive Shaft	45W	38		59.5	34.5	522					
2.4 quattro (120 kW)	1997.12-2005.01	MT	R	F	All-wheel Drive Estate Engine AJG/APZ	299113	Drive Shaft	45W	38		59.5	34.5	654					
	1997.12-2005.01	-	L/R	F	All-wheel Drive Estate Engine AJG/APZ	803020	Outer Joint	45W	38	30	59.5	34	59.5	I				
	1997.12-2005.01	AT	L	F	All-wheel Drive Estate Engine AJG/APZ	203019	Drive Shaft	45W	38		59.5	34.5	550					

YEAR	TRANSM	L/R	F/R	REMARKS	GSP Ref.	PRODUCT	ABS	Technical Specifications								
								A	B	C	H	L	P			
AUDI																
A6 Avant (4B5 C5)																
2.4 quattro (120 kW)	1997.12-2005.01	-	L/R	F	All-wheel Drive Estate Engine AJG/APZ	803019	Outer Joint	45W	38	27	59.5	34.5	63	I		
	1997.12-2005.01	AT	R	F	All-wheel Drive Estate Engine AJG/APZ	203020	Drive Shaft	45W	38		59.5	34.5	522			
	1997.12-2005.01	-	R	F	All-wheel Drive Estate Engine AJG/APZ	261076	Drive Shaft	45W	38		59.5	34.5	645			
2.4 quattro (121 kW)	1997.12-2005.01	MT	R	F	All-wheel Drive Estate Engine ALF/APS/ARJ/JAGA/AML	299113	Drive Shaft	45W	38		59.5	34.5	654			
	1997.12-2005.01	AT/MT	L/R	F	All-wheel Drive Estate Engine ALF/APS/ARJ/JAGA/AML	661033	Inner Joint			34	85					
	1997.12-2005.01	-	L/R	F	All-wheel Drive Estate Engine ALF/APS/ARJ/JAGA/AML	803020	Outer Joint	45W	38	30	59.5	34	59.5	I		
	1997.12-2005.01	AT	L	F	All-wheel Drive Estate Engine ALF/APS/ARJ/JAGA/AML	203019	Drive Shaft	45W	38		59.5	34.5	550			
	1997.12-2005.01	AT/MT	L/R	F	All-wheel Drive Estate Engine ALF/APS/ARJ/JAGA/AML	803019	Outer Joint	45W	38	27	59.5	34.5	63	I		
	1997.12-2005.01	-	R	F	All-wheel Drive Estate Engine ALF/APS/ARJ/JAGA/AML	261076	Drive Shaft	45W	38		59.5	34.5	645			
2.4 quattro (125 kW)	1997.12-2005.01	AT	R	F	All-wheel Drive Estate Engine ALF/APS/ARJ/JAGA/AML	203020	Drive Shaft	45W	38		59.5	34.5	522			
	2001.08-2005.01	MT	-	F	All-wheel Drive Estate Engine BDV	650019	Inner Joint			34	59.5					
	2001.08-2005.01	AT	L/R	F	All-wheel Drive Estate Engine BDV	203066	Drive Shaft	45W	38		59.5	34.5	544			
	2001.08-2005.01	MT	R	F	All-wheel Drive Estate Engine BDV	299113	Drive Shaft	45W	38		59.5	34.5	654			
	2001.08-2005.01	AT/MT	L/R	F	All-wheel Drive Estate Engine BDV	661033	Inner Joint			34	85					
2.5 TDI (110 kW)	1997.12-2005.01	-	R	F	All-wheel Drive Estate Engine BDV	261076	Drive Shaft	45W	38		59.5	34.5	645			
	2001.08-2005.01	MT	-	F	Estate Engine AFB/AKN	650019	Inner Joint			34	59.5					
	1997.12-2005.01	AT/MT	L/R	F	Estate Engine AFB/AKN	661033	Inner Joint			34	85					
	1997.12-2005.01	MT	R	F	Estate Engine AFB/AKN	299113	Drive Shaft	45W	38		59.5	34.5	654			
	1997.12-2005.01	AT	R	F	Estate Engine AFB/AKN	203020	Drive Shaft	45W	38		59.5	34.5	522			
2.5 TDI (114 kW)	1997.12-2005.01	-	R	F	Estate Engine AFB/AKN	261076	Drive Shaft	45W	38		59.5	34.5	645			
	1997.12-2005.01	AT/MT	L/R	F	Estate Engine AFB/AKN	803019	Outer Joint	45W	38	27	59.5	34.5	63	I		
	2001.08-2005.01	MT	-	F	Estate Engine AYM	650019	Inner Joint			34	59.5					
	2001.08-2005.01	CVT	L/R	F	Estate Engine AYM	203066	Drive Shaft	45W	38		59.5	34.5	544			
	2001.08-2005.01	MT	R	F	Estate Engine AYM	299113	Drive Shaft	45W	38		59.5	34.5	654			
2.5 TDI (120 kW)	2001.08-2005.01	AT/MT	L/R	F	Estate Engine AYM	661033	Inner Joint			34	85					
	2001.08-2005.01	-	R	F	Estate Engine AYM	261076	Drive Shaft	45W	38		59.5	34.5	645			
	2001.08-2005.01	AT/MT	L/R	F	Estate Engine AYM	803019	Outer Joint	45W	38	27	59.5	34.5	63	I		
	2002.07-2005.01	AT/MT/CVT	L/R	F	Estate Engine BDG/BFC/BCZ	803019	Outer Joint	45W	38	27	59.5	34.5	63	I		
	2002.07-2005.01	AT/SAT/MT/SMT	L/R	F	Estate Engine BDG/BFC/BCZ	661033	Inner Joint			34	85					
2.5 TDI (132 kW)	2002.07-2005.01	MT	-	F	Estate Engine BDG/BFC/BCZ	650019	Inner Joint			34	59.5					
	2002.07-2005.01	CVT	L/R	F	Estate Engine BDG/BFC/BCZ	203066	Drive Shaft	45W	38		59.5	34.5	544			
	2002.07-2005.01	-	R	F	Estate Engine BDG/BFC/BCZ	261076	Drive Shaft	45W	38		59.5	34.5	645			
	2000.02-2005.01	SAT/MT/Semi-AT	L/R	F	Estate Engine BAU/BDH/AKE	803019	Outer Joint	45W	38	27	59.5	34.5	63	I		
	2000.02-2005.01	MT	-	F	Estate Engine BAU/BDH/AKE	650019	Inner Joint			34	59.5					
2.5 TDI quattro (110 kW)	2000.02-2005.01	AT/MT	L/R	F	Estate Engine BAU/BDH/AKE	661033	Inner Joint			34	85					
	2000.02-2005.01	CVT	L/R	F	Estate Engine BAU/BDH/AKE	203066	Drive Shaft	45W	38		59.5	34.5	544			
	2000.02-2005.01	-	R	F	Estate Engine BAU/BDH/AKE	261076	Drive Shaft	45W	38		59.5	34.5	645			
	1997.12-2005.01	MT	L/R	F	All-wheel Drive Estate Engine AFB/AKN	803018	Outer Joint	45W	33	30	53	30	62	I		
	1997.12-2005.01	AT/MT	L/R	F	All-wheel Drive Estate Engine AFB/AKN	661033	Inner Joint			34	85					
	1997.12-2005.01	MT	R	F	All-wheel Drive Estate Engine AFB/AKN	299113	Drive Shaft	45W	38		59.5	34.5	654			
	1997.12-2005.01	AT	L	F	All-wheel Drive Estate Engine AFB/AKN	203019	Drive Shaft	45W	38		59.5	34.5	550			
	1997.12-2005.01	AT	R	F	All-wheel Drive Estate Engine AFB/AKN	203020	Drive Shaft	45W	38		59.5	34.5	522			
	1997.12-2005.01	-	R	F	All-wheel Drive Estate Engine AFB/AKN	261076	Drive Shaft	45W	38		59.5	34.5	645			
	1997.12-2005.01	AT	L/R	F	All-wheel Drive Estate Engine AFB/AKN	803019	Outer Joint	45W	38	27	59.5	34.5	63	I		
2.5 TDI quattro (132 kW)	2000.02-2005.01	MT	-	F	All-wheel Drive Estate Engine BAU/BDH/AKE	650019	Inner Joint			34	59.5					
	2000.02-2005.01	AT	L/R	F	All-wheel Drive Estate Engine BAU/BDH/AKE	803019	Outer Joint	45W	38	27	59.5	34.5	63	I		
	2000.02-2005.01	MT	L/R	F	All-wheel Drive Estate Engine BAU/BDH/AKE	803018	Outer Joint	45W	33	30	53	30	62	I		
	2000.02-2005.01	-	L/R	R	All-wheel Drive Estate Engine BAU/BDH/AKE	603001	Inner Joint			28	32					
	2000.02-2005.01	AT/MT	L/R	F	All-wheel Drive Estate Engine BAU/BDH/AKE	661033	Inner Joint			34	85					
	2000.02-2005.01	MT	R	F	All-wheel Drive Estate Engine BAU/BDH/AKE	299113	Drive Shaft	45W	38		59.5	34.5	654			
	2000.02-2005.01	AT	L	F	All-wheel Drive Estate Engine BAU/BDH/AKE	203019	Drive Shaft	45W	38		59.5	34.5	550			
	2000.02-2005.01	-	R	F	All-wheel Drive Estate Engine BAU/BDH/AKE	261076	Drive Shaft	45W	38		59.5	34.5	645			
	2000.02-2005.01	AT	R	F	All-wheel Drive Estate Engine BAU/BDH/AKE	203020	Drive Shaft	45W	38		59.5	34.5	522			
2.7 T (169 kW)	1999.02-2005.01	-	L/R	F	Estate Engine AJK	603001	Inner Joint			28	32					
	1999.02-2005.01	MT	L/R	F	Estate Engine AJK	661033	Inner Joint			34	85					
	1999.02-2005.01	MT	R	F	Estate Engine AJK	299113	Drive Shaft	45W	38		59.5	34.5	654			
	1999.02-2005.01	-	R	F	Estate Engine AJK	261076	Drive Shaft	45W	38		59.5	34.5	645			
	1999.02-2005.01	MT	L/R	F	Estate Engine AJK	803019	Outer Joint	45W	38	27	59.5	34.5	63	I		
2.7 T quattro (169 kW)	1997.12-2005.01	MT	-	F	All-wheel Drive Estate Engine AJK/AZA	650019	Inner Joint			34	59.5					
	1997.12-2005.01	-	L/R/F/R	F	All-wheel Drive Estate Engine AJK/AZA	603001	Inner Joint			28	32					
	1997.12-2005.01	MT	L/R	F	All-wheel Drive Estate Engine AJK/AZA	661033	Inner Joint			34	85					
	1997.12-2005.01	MT	R	F	All-wheel Drive Estate Engine AJK/AZA	299113	Drive Shaft	45W	38		59.5	34.5	654			
	1997.12-2005.01	MT	L/R	F	All-wheel Drive Estate Engine AJK/AZA	803019	Outer Joint	45W	38	27	59.5	34.5	63	I		
2.7 T quattro (184 kW)	1997.12-2005.01	-	R	F	All-wheel Drive Estate Engine AJK/AZA	261076	Drive Shaft	45W	38		59.5	34.5	645			
	2001.08-2005.01	MT	-	F	All-wheel Drive Estate Engine ARE/BES	650019	Inner Joint			34	59.5					
2001.08-2005.01	-	L/R	F	All-wheel Drive Estate Engine ARE/BES	803019	Outer Joint	45W	38	27	59.5	34.5	63	I			

	 YEAR	TRANSM	L/R	F/R	REMARKS	GSP Ref.	 PRODUCT	 ABS	Technical Specifications					
									A	B	C	H	L	P
AUDI														
A6 Avant (4B5 C5)														
2.7 T quattro (184 kW)	2001.08-2005.01	-	L/R	F/R	All-wheel Drive Estate Engine ARE/BES	603001	Inner Joint		28		32			
	2001.08-2005.01	-	R	F	All-wheel Drive Estate Engine ARE/BES	261076	Drive Shaft	45W	38	59.5	34.5	645		
2.8 (132 kW)	1997.12-2000.05	AT/MT	L/R	F	Estate Engine AGE	661033	Inner Joint		34		85			
	1997.12-2000.05	MT	R	F	Estate Engine AGE	299113	Drive Shaft	45W	38	59.5	34.5	654		
	1997.12-2000.05	-	L/R	F	Estate Engine AGE	803020	Outer Joint	45W	38	30	59.5	34	59.5	I
	1997.12-2000.05	AT	L	F	Estate Engine AGE	203019	Drive Shaft	45W	38		59.5	34.5	550	
	1997.12-2000.05	AT	L/R	F	Estate Engine AGE	803019	Outer Joint	45W	38	27	59.5	34.5	63	I
	1997.12-2000.05	AT	R	F	Estate Engine AGE	203020	Drive Shaft	45W	38		59.5	34.5	522	
	1997.12-2000.05	-	R	F	Estate Engine AGE	261076	Drive Shaft	45W	38		59.5	34.5	645	
2.8 (140 kW)	1999.07-2005.01	MT	R	F	Estate Engine ATX	299113	Drive Shaft	45W	38		59.5	34.5	654	
	1999.07-2005.01	AT	L	F	Estate Engine ATX	203019	Drive Shaft	45W	38		59.5	34.5	550	
	1999.07-2005.01	AT	R	F	Estate Engine ATX	203020	Drive Shaft	45W	38		59.5	34.5	522	
	1999.07-2005.01	-	R	F	Estate Engine ATX	261076	Drive Shaft	45W	38		59.5	34.5	645	
	1999.07-2005.01	-	L/R	F	Estate Engine ATX	803019	Outer Joint	45W	38	27	59.5	34.5	63	I
2.8 (142 kW)	1997.12-2005.01	MT	-	F	Estate Engine AHA/ACK/APR/AQD/ALG/AMX	650019	Inner Joint		34		59.5			
	1997.12-2005.01	MT	L/R	F	Estate Engine AHA/ACK/APR/AQD/ALG/AMX	661033	Inner Joint		34		85			
	1997.12-2005.01	MT	R	F	Estate Engine AHA/ACK/APR/AQD/ALG/AMX	299113	Drive Shaft	45W	38		59.5	34.5	654	
	1997.12-2005.01	AT/MT	L/R	F	Estate Engine AHA/ACK/APR/AQD/ALG/AMX	803020	Outer Joint	45W	38	30	59.5	34	59.5	I
	1997.12-2005.01	AT	L	F	Estate Engine AHA/ACK/APR/AQD/ALG/AMX	203019	Drive Shaft	45W	38		59.5	34.5	550	
	1997.12-2005.01	AT/MT	L/R	F	Estate Engine AHA/ACK/APR/AQD/ALG/AMX	803019	Outer Joint	45W	38	27	59.5	34.5	63	I
	1997.12-2005.01	AT	R	F	Estate Engine AHA/ACK/APR/AQD/ALG/AMX	203020	Drive Shaft	45W	38		59.5	34.5	522	
2.8 quattro (142 kW)	1997.12-2005.01	MT	-	F	All-wheel Drive Estate Engine AHA/ACK/APR/AQD/ALG/AMX	650019	Inner Joint		34		59.5			
	1997.12-2005.01	AT/MT	L/R	F	All-wheel Drive Estate Engine AHA/ACK/APR/AQD/ALG/AMX	661033	Inner Joint		34		85			
	1997.12-2005.01	-	L/R	F	All-wheel Drive Estate Engine AHA/ACK/APR/AQD/ALG/AMX	803020	Outer Joint	45W	38	30	59.5	34	59.5	I
	1997.12-2005.01	MT	R	F	All-wheel Drive Estate Engine AHA/ACK/APR/AQD/ALG/AMX	299113	Drive Shaft	45W	38		59.5	34.5	654	
	1997.12-2005.01	AT	L	F	All-wheel Drive Estate Engine AHA/ACK/APR/AQD/ALG/AMX	203019	Drive Shaft	45W	38		59.5	34.5	550	
	1997.12-2005.01	AT/MT	L/R	F	All-wheel Drive Estate Engine AHA/ACK/APR/AQD/ALG/AMX	803019	Outer Joint	45W	38	27	59.5	34.5	63	I
	1997.12-2005.01	AT	R	F	All-wheel Drive Estate Engine AHA/ACK/APR/AQD/ALG/AMX	203020	Drive Shaft	45W	38		59.5	34.5	522	
3.0 (162 kW)	2001.08-2005.01	-	L/R	F	Estate Engine ASN	803019	Outer Joint	45W	38	27	59.5	34.5	63	I
	2001.08-2005.01	MT	L/R	F	Estate Engine ASN	661033	Inner Joint		34		85			
	2001.08-2005.01	AT	L/R	F	Estate Engine ASN	203066	Drive Shaft	45W	38		59.5	34.5	544	
	2001.08-2005.01	MT	R	F	Estate Engine ASN	299113	Drive Shaft	45W	38		59.5	34.5	654	
	3.0 quattro (162 kW)	2001.08-2005.01	MT	-	F	All-wheel Drive Estate Engine ASN	650019	Inner Joint		34		59.5		
		2001.08-2005.01	-	L/R	F	All-wheel Drive Estate Engine ASN	803019	Outer Joint	45W	38	27	59.5	34.5	63
2001.08-2005.01		AT	L/R	F	All-wheel Drive Estate Engine ASN	203066	Drive Shaft	45W	38		59.5	34.5	544	
2001.08-2005.01		MT	R	F	All-wheel Drive Estate Engine ASN	299113	Drive Shaft	45W	38		59.5	34.5	654	
2001.08-2005.01		AT/MT	L/R	F	All-wheel Drive Estate Engine ASN	661033	Inner Joint		34		85			
4.2 quattro (220 kW)	1998.11-2005.01	MT	-	F	All-wheel Drive Estate Engine AWN/ARS/ASG	650019	Inner Joint		34		59.5			
	1998.11-2005.01	-	L/R	F/R	All-wheel Drive Estate Engine AWN/ARS/ASG	603001	Inner Joint		28		32			
	1998.11-2005.01	AT	L	F	All-wheel Drive Estate Engine AWN/ARS/ASG	203066	Drive Shaft	45W	38		59.5	34.5	544	
	1998.11-2005.01	-	L/R	F	All-wheel Drive Estate Engine AWN/ARS/ASG	803019	Outer Joint	45W	38	27	59.5	34.5	63	I
RS6 plus quattro (353 kW)	2004.04-2005.01	-	L/R	F	All-wheel Drive Estate Engine BRV	803019	Outer Joint	45W	38	27	59.5	34.5	63	I
	2004.04-2005.01	-	L/R	R	All-wheel Drive Estate Engine BRV	603001	Inner Joint		28		32			
	2004.04-2005.01	-	L	F	All-wheel Drive Estate Engine BRV	203066	Drive Shaft	45W	38		59.5	34.5	544	
	2004.04-2005.01	AT	-	F	All-wheel Drive Estate Engine BRV	899351	Outer Joint		38	29	59.5	34	70	M
RS6 quattro (331 kW)	2002.07-2005.01	-	L/R	F	All-wheel Drive Estate Engine BCY	803019	Outer Joint	45W	38	27	59.5	34.5	63	I
	2002.07-2005.01	-	L/R	R	All-wheel Drive Estate Engine BCY	603001	Inner Joint		28		32			
	2002.07-2005.01	-	L	F	All-wheel Drive Estate Engine BCY	203066	Drive Shaft	45W	38		59.5	34.5	544	
S6 quattro (250 kW)	1999.09-2005.01	-	L/R	F	All-wheel Drive Estate Engine ANK/AQJ	803019	Outer Joint	45W	38	27	59.5	34.5	63	I
	1999.09-2005.01	MT	L/R	F/R	All-wheel Drive Estate Engine ANK/AQJ	603001	Inner Joint		28		32			
	1999.09-2005.01	AT	L	F	All-wheel Drive Estate Engine ANK/AQJ	203066	Drive Shaft	45W	38		59.5	34.5	544	
A6 Avant (4F5 C6)														
2.0 TDI (100 kW)	2005.06-2011.08	CVT	R	F	Estate Engine BNA/BRF/CAGB	203292	Drive Shaft		38		59.5	34.5	483	
	2005.06-2011.08	CVT	L	F	Estate Engine BNA/BRF/CAGB	203025	Drive Shaft		38		59.5	34	543	
	2005.06-2011.08	-	L/R	F	Estate Engine BNA/BRF/CAGB	803077	Outer Joint		38	27	59.5	34	63	M
	2005.06-2011.08	MT	L	F	Estate Engine BNA/BRF/CAGB	203290	Drive Shaft		38		59.5	34	617	
	2005.06-2011.08	CVT/MT	-	F	Estate Engine BNA/BRF/CAGB	803099	Outer Joint		38	27	59.5	34.5	64	M
	2005.06-2011.08	MT	R	F	Estate Engine BNA/BRF/CAGB	203329	Drive Shaft		38		59.5	34	655	
2.0 TDI (103 kW)	2005.06-2008.10	CVT	R	F	Estate Engine BLB/BRE	203292	Drive Shaft		38		59.5	34.5	483	
	2005.06-2008.10	CVT	L	F	Estate Engine BLB/BRE	203025	Drive Shaft		38		59.5	34	543	
	2005.06-2008.10	-	L/R	F	Estate Engine BLB/BRE	803077	Outer Joint		38	27	59.5	34	63	M
	2005.06-2008.10	MT	L	F	Estate Engine BLB/BRE	203290	Drive Shaft		38		59.5	34	617	
	2005.06-2008.10	CVT/MT	-	F	Estate Engine BLB/BRE	803099	Outer Joint		38	27	59.5	34.5	64	M
	2005.06-2008.10	MT	R	F	Estate Engine BLB/BRE	203329	Drive Shaft		38		59.5	34	655	

	 YEAR	TRANSM	L/R	F/R	REMARKS	GSP Ref.	 PRODUCT	 ABS	Technical Specifications					
									A	B	C	H	L	P
AUDI														
A6 Avant (4F5 C6)														
2.0 TDI (120 kW)	2009.04-2011.08	CVT	R	F	Estate Engine CAHB	203292	Drive Shaft		38		59.5	34.5	483	
	2009.04-2011.08	CVT	L	F	Estate Engine CAHB	203025	Drive Shaft		38		59.5	34	543	
	2009.04-2011.08	-	L/R	F	Estate Engine CAHB	803077	Outer Joint		38	27	59.5	34	63	M
	2009.04-2011.08	-	L	F	Estate Engine CAHB	250428	Drive Shaft		25	39	52.6	89	656	
	2009.04-2011.08	MT	L	F	Estate Engine CAHB	203290	Drive Shaft		38		59.5	34	617	
	2009.04-2011.08	CVT/MT	-	F	Estate Engine CAHB	803099	Outer Joint		38	27	59.5	34.5	64	M
	2009.04-2011.08	MT	R	F	Estate Engine CAHB	203329	Drive Shaft		38		59.5	34	655	
2.0 TDI (125 kW)	2008.10-2011.08	CVT	R	F	Estate Engine CAHA	203292	Drive Shaft		38		59.5	34.5	483	
	2008.10-2011.08	CVT	L	F	Estate Engine CAHA	203025	Drive Shaft		38		59.5	34	543	
	2008.10-2011.08	-	L/R	F	Estate Engine CAHA	803077	Outer Joint		38	27	59.5	34	63	M
	2008.10-2011.08	MT	L	F	Estate Engine CAHA	203290	Drive Shaft		38		59.5	34	617	
	2008.10-2011.08	CVT/MT	-	F	Estate Engine CAHA	803099	Outer Joint		38	27	59.5	34.5	64	M
2.0 TDI (89 kW)	2005.09-2006.06	CVT	R	F	Estate Engine BVG	203292	Drive Shaft		38		59.5	34.5	483	
	2005.09-2006.06	CVT	L	F	Estate Engine BVG	203025	Drive Shaft		38		59.5	34	543	
	2005.09-2006.06	-	L/R	F	Estate Engine BVG	803077	Outer Joint		38	27	59.5	34	63	M
	2005.09-2006.06	MT	-	-	Estate Engine BVG	661044	Inner Joint			34		85		
	2005.09-2006.06	MT	L	F	Estate Engine BVG	203290	Drive Shaft		38		59.5	34	617	
	2005.09-2006.06	CVT/MT	-	F	Estate Engine BVG	803099	Outer Joint		38	27	59.5	34.5	64	M
	2005.09-2006.06	MT	R	F	Estate Engine BVG	203329	Drive Shaft		38		59.5	34	655	
2.0 TFSI (125 kW)	2005.06-2011.08	-	L/R	F	Estate Engine BPJ	803077	Outer Joint		38	27	59.5	34	63	M
	2005.06-2011.08	MT	L	F	Estate Engine BPJ	203290	Drive Shaft		38		59.5	34	617	
	2005.06-2011.08	MT	R	F	Estate Engine BPJ	203329	Drive Shaft		38		59.5	34	655	
	2005.06-2011.08	CVT	L	F	Estate Engine BPJ	203271	Drive Shaft		38		59.5	34	548	
	2005.06-2011.08	-	-	F	Estate Engine BPJ	803099	Outer Joint		38	27	59.5	34.5	64	M
	2005.06-2011.08	CVT	R	F	Estate Engine BPJ	203026	Drive Shaft		38		59.5	34	558	
2.4 (130 kW)	2005.03-2008.10	-	L/R	F	Estate Engine BDW	803077	Outer Joint		38	27	59.5	34	63	M
	2005.03-2008.10	MT	L	F	Estate Engine BDW	203290	Drive Shaft		38		59.5	34	617	
	2005.03-2008.10	AT/MT	-	F	Estate Engine BDW	803099	Outer Joint		38	27	59.5	34.5	64	M
	2005.03-2008.10	MT	R	F	Estate Engine BDW	203329	Drive Shaft		38		59.5	34	655	
	2005.03-2008.10	CVT	L	F	Estate Engine BDW	203271	Drive Shaft		38		59.5	34	548	
2.4 quattro (130 kW)	2005.03-2008.10	CVT	R	F	Estate Engine BDW	203026	Drive Shaft		38		59.5	34	558	
	2005.03-2008.10	MT	L	F	All-wheel Drive Estate Engine BDW	203290	Drive Shaft		38		59.5	34	617	
	2005.03-2008.10	AT/MT	-	F	All-wheel Drive Estate Engine BDW	803099	Outer Joint		38	27	59.5	34.5	64	M
	2005.03-2008.10	MT	R	F	All-wheel Drive Estate Engine BDW	203329	Drive Shaft		38		59.5	34	655	
	2005.03-2008.10	AT	L	F	All-wheel Drive Estate Engine BDW	203271	Drive Shaft		38		59.5	34	548	
2.7 TDI (120 kW)	2005.03-2008.10	AT	R	F	All-wheel Drive Estate Engine BDW	203026	Drive Shaft		38		59.5	34	558	
	2005.03-2011.08	MT	L	F	Estate Engine BSG/CANB	203290	Drive Shaft		38		59.5	34	617	
	2005.03-2011.08	MT	R	F	Estate Engine BSG/CANB	203329	Drive Shaft		38		59.5	34	655	
	2005.03-2011.08	-	-	F	Estate Engine BSG/CANB	899351	Outer Joint		38	29	59.5	34	70	M
	2005.03-2008.10	MT	L	F	Estate Engine BPP	203290	Drive Shaft		38		59.5	34	617	
2.7 TDI (132 kW)	2005.03-2008.10	MT	R	F	Estate Engine BPP	203329	Drive Shaft		38		59.5	34	655	
	2005.03-2008.10	-	-	F	Estate Engine BPP	899351	Outer Joint		38	29	59.5	34	70	M
	2005.03-2008.10	MT	L	F	Estate Engine CANA	203290	Drive Shaft		38		59.5	34	617	
2.7 TDI (140 kW)	2008.10-2011.08	MT	R	F	Estate Engine CANA	203329	Drive Shaft		38		59.5	34	655	
	2008.10-2011.08	-	-	F	Estate Engine CANA	899351	Outer Joint		38	29	59.5	34	70	M
	2008.10-2011.08	MT	L	F	Estate Engine CANA	203290	Drive Shaft		38		59.5	34	617	
2.7 TDI quattro (120 kW)	2005.06-2011.08	AT	L	F	All-wheel Drive Estate Engine BSG/CAND	203306	Drive Shaft		38		59.5	34	525	
	2005.06-2011.08	-	-	F	All-wheel Drive Estate Engine BSG/CAND	803099	Outer Joint		38	27	59.5	34.5	64	M
2.7 TDI quattro (132 kW)	2005.03-2008.10	MT	-	F	All-wheel Drive Estate Engine BPP	650019	Inner Joint			34		59.5		
2.7 TDI quattro (140 kW)	2008.10-2011.08	AT	L	F	All-wheel Drive Estate Engine CANC	203306	Drive Shaft		38		59.5	34	525	
	2008.10-2011.08	AT	-	-	All-wheel Drive Estate Engine CANC	661044	Inner Joint			34		85		
	2008.10-2011.08	AT	-	F	All-wheel Drive Estate Engine CANC	803099	Outer Joint		38	27	59.5	34.5	64	M
2.8 FSI (140 kW)	2008.10-2011.08	-	-	F	Estate Engine CCDA	803099	Outer Joint		38	27	59.5	34.5	64	M
	2008.10-2011.08	-	L/R	F	Estate Engine CCDA	803077	Outer Joint		38	27	59.5	34	63	M
	2008.10-2011.08	MT	L	F	Estate Engine CCDA	203290	Drive Shaft		38		59.5	34	617	
	2008.10-2011.08	MT	R	F	Estate Engine CCDA	203329	Drive Shaft		38		59.5	34	655	
2.8 FSI (154 kW)	2006.11-2008.10	-	L/R	F	Estate Engine BDX	803077	Outer Joint		38	27	59.5	34	63	M
	2006.11-2008.10	MT	L	F	Estate Engine BDX	203290	Drive Shaft		38		59.5	34	617	
	2006.11-2008.10	MT	R	F	Estate Engine BDX	203329	Drive Shaft		38		59.5	34	655	
	2006.11-2008.10	CVT	L	F	Estate Engine BDX	203271	Drive Shaft		38		59.5	34	548	
	2006.11-2008.10	-	-	F	Estate Engine BDX	803099	Outer Joint		38	27	59.5	34.5	64	M
2.8 FSI (162 kW)	2006.11-2008.10	CVT	R	F	Estate Engine BDX	203026	Drive Shaft		38		59.5	34	558	
	2008.10-2011.08	-	-	F	Estate Engine CCEA	803099	Outer Joint		38	27	59.5	34.5	64	M
	2008.10-2011.08	-	L/R	F	Estate Engine CCEA	803077	Outer Joint		38	27	59.5	34	63	M
	2008.10-2011.08	AT	-	-	Estate Engine CCEA	661044	Inner Joint			34		85		
2008.10-2011.08	CVT	L	F	Estate Engine CCEA	203271	Drive Shaft		38		59.5	34	548		





YEAR	TRANSM	L/R	F/R	REMARKS	GSP Ref.	PRODUCT	ABS	Technical Specifications							
								A	B	C	H	L	P		
AUDI															
A6 Avant (4F5 C6)															
2.8 FSI (162 kW)	2008.10-	2011.08	CVT	R	F	Estate Engine CCEA	203026	Drive Shaft		38		59.5	34	558	
2.8 FSI quattro (140 kW)	2008.10-	2011.08	-	-	F	All-wheel Drive Estate Engine CCDA	803099	Outer Joint	38	27	59.5	34.5	64	M	
	2008.10-	2011.08	CVT	L	F	All-wheel Drive Estate Engine CCDA	203306	Drive Shaft	38		59.5	34	525		
2.8 FSI quattro (154 kW)	2007.06-	2008.10	AT	L	F	All-wheel Drive Estate Engine BDY	203306	Drive Shaft	38		59.5	34	525		
	2007.06-	2008.10	AT	-	F	All-wheel Drive Estate Engine BDY	803099	Outer Joint	38	27	59.5	34.5	64	M	
2.8 FSI quattro (162 kW)	2008.10-	2011.08	AT	L	F	All-wheel Drive Estate Engine CCEA	203306	Drive Shaft	38		59.5	34	525		
	2008.10-	2011.08	AT	-	-	All-wheel Drive Estate Engine CCEA	661044	Inner Joint		34		85			
	2008.10-	2011.08	AT	-	F	All-wheel Drive Estate Engine CCEA	803099	Outer Joint	38	27	59.5	34.5	64	M	
3.0 (160 kW)	2005.03-	2006.05	-	-	F	Estate Engine BBJ	803099	Outer Joint	38	27	59.5	34.5	64	M	
	2005.03-	2006.05	-	L/R	F	Estate Engine BBJ	803077	Outer Joint	38	27	59.5	34	63	M	
	2005.03-	2006.05	AT	-	-	Estate Engine BBJ	661044	Inner Joint		34		85			
	2005.03-	2006.05	CVT	L	F	Estate Engine BBJ	203271	Drive Shaft	38		59.5	34	548		
	2005.03-	2006.05	CVT	R	F	Estate Engine BBJ	203026	Drive Shaft	38		59.5	34	558		
3.0 quattro (160 kW)	2005.03-	2006.05	AT	L	F	All-wheel Drive Estate Engine BBJ	203306	Drive Shaft	38		59.5	34	525		
	2005.03-	2006.05	AT	-	-	All-wheel Drive Estate Engine BBJ	661044	Inner Joint		34		85			
	2005.03-	2006.05	-	-	F	All-wheel Drive Estate Engine BBJ	803099	Outer Joint	38	27	59.5	34.5	64	M	
3.0 TDI quattro (155 kW)	2005.03-	2011.08	CVT	L	F	All-wheel Drive Estate Engine BNG/CDYB	203306	Drive Shaft	38		59.5	34	525		
	2005.03-	2011.08	-	-	F	All-wheel Drive Estate Engine BNG/CDYB	803099	Outer Joint	38	27	59.5	34.5	64	M	
3.0 TDI quattro (165 kW)	2005.03-	2006.05	AT	L	F	All-wheel Drive Estate Engine BMK	203306	Drive Shaft	38		59.5	34	525		
	2005.03-	2006.05	MT	L	F	All-wheel Drive Estate Engine BMK	203290	Drive Shaft	38		59.5	34	617		
	2005.03-	2006.05	AT/MT	-	F	All-wheel Drive Estate Engine BMK	803099	Outer Joint	38	27	59.5	34.5	64	M	
	2005.03-	2006.05	MT	R	F	All-wheel Drive Estate Engine BMK	203329	Drive Shaft	38		59.5	34	655		
3.0 TDI quattro (171 kW)	2006.06-	2008.10	AT	L	F	All-wheel Drive Estate Engine ASB	203306	Drive Shaft	38		59.5	34	525		
	2006.06-	2008.10	MT	L	F	All-wheel Drive Estate Engine ASB	203290	Drive Shaft	38		59.5	34	617		
	2006.06-	2008.10	AT/MT	-	F	All-wheel Drive Estate Engine ASB	803099	Outer Joint	38	27	59.5	34.5	64	M	
	2006.06-	2008.10	MT	R	F	All-wheel Drive Estate Engine ASB	203329	Drive Shaft	38		59.5	34	655		
3.0 TDI quattro (176 kW)	2008.10-	2011.08	AT	L	F	All-wheel Drive Estate Engine CDYA/CDYC	203306	Drive Shaft	38		59.5	34	525		
	2008.10-	2011.08	MT	L	F	All-wheel Drive Estate Engine CDYA/CDYC	203290	Drive Shaft	38		59.5	34	617		
	2008.10-	2011.08	AT/MT	-	F	All-wheel Drive Estate Engine CDYA/CDYC	803099	Outer Joint	38	27	59.5	34.5	64	M	
	2008.10-	2011.08	MT	R	F	All-wheel Drive Estate Engine CDYA/CDYC	203329	Drive Shaft	38		59.5	34	655		
3.0 TFSI quattro (213 kW)	2008.10-	2011.08	-	-	F	All-wheel Drive Estate Engine CAJA	803099	Outer Joint	38	27	59.5	34.5	64	M	
	2008.10-	2011.08	AT	L	F	All-wheel Drive Estate Engine CAJA	203306	Drive Shaft	38		59.5	34	525		
	2008.10-	2011.08	AT	-	-	All-wheel Drive Estate Engine CAJA	661044	Inner Joint		34		85			
3.0 TFSI quattro (220 kW)	2008.10-	2011.08	CVT	L	F	All-wheel Drive Estate Engine CCAA	203306	Drive Shaft	38		59.5	34	525		
	2008.10-	2011.08	AT	-	-	All-wheel Drive Estate Engine CCAA	661044	Inner Joint		34		85			
	2008.10-	2011.08	-	-	F	All-wheel Drive Estate Engine CCAA	803099	Outer Joint	38	27	59.5	34.5	64	M	
3.2 FSI (188 kW)	2005.03-	2008.10	-	L/R	F	Estate Engine AUK	803077	Outer Joint	38	27	59.5	34	63	M	
	2005.03-	2008.10	MT	L	F	Estate Engine AUK	203290	Drive Shaft	38		59.5	34	617		
	2005.03-	2008.10	MT	R	F	Estate Engine AUK	203329	Drive Shaft	38		59.5	34	655		
	2005.03-	2008.10	-	-	F	Estate Engine AUK	803099	Outer Joint	38	27	59.5	34.5	64	M	
	2005.03-	2008.10	CVT	L	F	Estate Engine AUK	203271	Drive Shaft	38		59.5	34	548		
	2005.03-	2008.10	CVT	R	F	Estate Engine AUK	203026	Drive Shaft	38		59.5	34	558		
3.2 FSI quattro (188 kW)	2005.03-	2008.10	AT	L	F	All-wheel Drive Estate Engine AUK	203306	Drive Shaft	38		59.5	34	525		
	2005.03-	2008.10	MT	L	F	All-wheel Drive Estate Engine AUK	203290	Drive Shaft	38		59.5	34	617		
	2005.03-	2008.10	AT/MT	-	F	All-wheel Drive Estate Engine AUK	803099	Outer Joint	38	27	59.5	34.5	64	M	
	2005.03-	2008.10	MT	R	F	All-wheel Drive Estate Engine AUK	203329	Drive Shaft	38		59.5	34	655		
4.2 FSI quattro (257 kW)	2006.06-	2011.08	AT	L	F	All-wheel Drive Estate Engine BVJ	203306	Drive Shaft	38		59.5	34	525		
	2006.06-	2011.08	AT	-	-	All-wheel Drive Estate Engine BVJ	661044	Inner Joint		34		85			
	2006.06-	2011.08	-	-	F	All-wheel Drive Estate Engine BVJ	803099	Outer Joint	38	27	59.5	34.5	64	M	
4.2 quattro (246 kW)	2005.03-	2006.05	AT	L	F	All-wheel Drive Estate Engine BAT	203306	Drive Shaft	38		59.5	34	525		
	2005.03-	2006.05	AT	-	-	All-wheel Drive Estate Engine BAT	661044	Inner Joint		34		85			
	2005.03-	2006.05	-	-	F	All-wheel Drive Estate Engine BAT	803099	Outer Joint	38	27	59.5	34.5	64	M	
S6 quattro (320 kW)	2006.03-	2011.08	AT	-	-	All-wheel Drive Estate Engine BXA	661044	Inner Joint		34		85			
	2006.03-	2011.08	AT	-	F	All-wheel Drive Estate Engine BXA	803099	Outer Joint	38	27	59.5	34.5	64	M	
A6 Avant (4G5 4GD C7)															
1.8 TFSI (140 kW)	2014.09-	-	AT	-	-	Estate Engine CYGA	603022	Inner Joint		34		88			
2.0 TDI (100 kW)	2012.01-	-	-	-	F	Estate Engine CGLE/CSUE	803103	Outer Joint	42	28	76.4	34	54	I	
2.0 TDI (110 kW)	2014.09-	-	AT	-	-	Estate Engine CSUD/DDCB	603022	Inner Joint		34		88			
2.0 TDI (120 kW)	2011.05-	-	MT/ CVT	L/R	F	Estate Engine CGLD	803088	Outer Joint	42	29	76.5	34	61.5	M	
2.0 TDI (130 kW)	2011.05-	-	MT/ CVT	L/R	F	Estate Engine CGLC/CMGB	803088	Outer Joint	42	29	76.5	34	61.5	M	
2.0 TDI (140 kW)	2013.11-	-	-	-	F	Estate Engine CZJA/CNHA/DDDA	803102	Outer Joint	42	29	76.5	34	60	I	
2.0 TDI quattro (140 kW)	2015.04-	-	AT	-	-	All-wheel Drive Estate Engine CNHA/DDDA	603022	Inner Joint		34		88			
	2015.04-	-	-	-	F	All-wheel Drive Estate Engine CNHA/DDDA	803103	Outer Joint	42	28	76.4	34	54	I	
2.0 TFSI (132 kW)	2011.06-	-	-	-	F	Estate Engine CDN B	803103	Outer Joint	42	28	76.4	34	54	I	
	2011.06-	-	AT/ MT	L/R	F	Estate Engine CDN B	803088	Outer Joint	42	29	76.5	34	61.5	M	
2.0 TFSI (185 kW)	2014.09-	-	-	-	F	Estate Engine CYNB/CYPA	803102	Outer Joint	42	29	76.5	34	60	I	





	 YEAR	TRANSM	L/R	F/R	REMARKS	GSP Ref.	 PRODUCT	 ABS	Technical Specifications						
									A	B	C	H	L	P	
AUDI															
A6 Avant (4G5 4GD C7)															
2.0 TFSI (185 kW)	2014.09-	-	AT	-	Estate Engine CYNB/CYPA	603022	Inner Joint			34		88			
2.0 TFSI quattro (183 kW)	2015.05-	-	-	F	All-wheel Drive Estate Engine CYPB	803103	Outer Joint		42	28	76.4	34	54	I	
2.0 TFSI quattro (185 kW)	2015.05-	-	AT	-	All-wheel Drive Estate Engine CYPB	603022	Inner Joint			34		88			
	2015.05-	-	-	F	All-wheel Drive Estate Engine CYPB	803103	Outer Joint		42	28	76.4	34	54	I	
2.8 FSI (150 kW)	2011.05-2015.04	-	L/R	F	Estate Engine CHVA	803087	Outer Joint		42	27	76.5	34	54.5	M	
	2011.05-2015.04	-	-	F	Estate Engine CHVA	803103	Outer Joint		42	28	76.4	34	54	I	
2.8 FSI quattro (150 kW)	2011.05-2015.04	-	-	F	All-wheel Drive Estate Engine CHVA	803103	Outer Joint		42	28	76.4	34	54	I	
	2011.05-2015.04	CVT	L	F	All-wheel Drive Estate Engine CHVA	261290	Drive Shaft		42		76.4	34	493		
	2011.05-2015.04	CVT	R	F	All-wheel Drive Estate Engine CHVA	261290	Drive Shaft		42		76.4	34	493		
2.8 FSI quattro (162 kW)	2014.09-	-	-	F	All-wheel Drive Estate Engine CVPA	803103	Outer Joint		42	28	76.4	34	54	I	
3.0 TDI (150 kW)	2011.05-	-	MT/CVT	L/R	Estate Engine CLAB	803088	Outer Joint		42	29	76.5	34	61.5	M	
3.0 TDI (155 kW)	2014.09-	-	-	F	Estate Engine CTCB/CZVD	803102	Outer Joint		42	29	76.5	34	60	I	
	2014.09-	-	AT	-	Estate Engine CTCB/CZVD	603022	Inner Joint			34		88			
3.0 TDI (160 kW)	2014.09-	-	-	F	Estate Engine CTCC/CZVB	803102	Outer Joint		42	29	76.5	34	60	I	
	2014.09-	-	AT	-	Estate Engine CTCC/CZVB	603022	Inner Joint			34		88			
3.0 TDI quattro (150 kW)	2011.05-	-	AT	-	All-wheel Drive Estate Engine CLAA	603022	Inner Joint			34		88			
	2011.05-	-	CVT	-	All-wheel Drive Estate Engine CLAA	803103	Outer Joint		42	28	76.4	34	54	I	
	2011.05-	-	CVT	L	All-wheel Drive Estate Engine CLAA	261290	Drive Shaft		42		76.4	34	493		
	2011.05-	-	CVT	R	All-wheel Drive Estate Engine CLAA	261290	Drive Shaft		42		76.4	34	493		
3.0 TDI quattro (155 kW)	2014.09-	-	AT	-	All-wheel Drive Estate Engine CZVC/CRTF	803103	Outer Joint		42	28	76.4	34	54	I	
3.0 TDI quattro (160 kW)	2014.09-	-	AT	-	All-wheel Drive Estate Engine CRTE/CZVA	803103	Outer Joint		42	28	76.4	34	54	I	
3.0 TDI quattro (180 kW)	2011.05-	-	AT	-	All-wheel Drive Estate Engine CDUC/CKVB/CKVC/CDUD	603022	Inner Joint			34		88			
	2011.05-	-	Semi-AT	-	All-wheel Drive Estate Engine CDUC/CKVB/CKVC/CDUD	803103	Outer Joint		42	28	76.4	34	54	I	
3.0 TDI quattro (200 kW)	2014.09-	-	AT	-	All-wheel Drive Estate Engine CRTD	803103	Outer Joint		42	28	76.4	34	54	I	
3.0 TDI quattro (230 kW)	2011.11-	-	AT	-	All-wheel Drive Estate Engine CGQB	603022	Inner Joint			34		88			
	2011.11-	-	AT	-	All-wheel Drive Estate Engine CGQB	803103	Outer Joint		42	28	76.4	34	54	I	
3.0 TDI quattro (235 kW)	2014.09-	-	AT	-	All-wheel Drive Estate Engine CVUA	803103	Outer Joint		42	28	76.4	34	54	I	
3.0 TDI quattro (240 kW)	2014.09-	-	AT	-	All-wheel Drive Estate Engine CVUB	803103	Outer Joint		42	28	76.4	34	54	I	
3.0 TFSI quattro (220 kW)	2011.05-2012.05	-	AT	-	All-wheel Drive Estate Engine CGWB	603022	Inner Joint			34		88			
	2011.05-2012.05	-	Semi-AT	-	All-wheel Drive Estate Engine CGWB	803103	Outer Joint		42	28	76.4	34	54	I	
3.0 TFSI quattro (228 kW)	2011.11-	-	AT	-	All-wheel Drive Estate Engine CGWD	603022	Inner Joint			34		88			
	2011.11-	-	Semi-AT	-	All-wheel Drive Estate Engine CGWD	803103	Outer Joint		42	28	76.4	34	54	I	
3.0 TFSI quattro (245 kW)	2014.09-	-	AT	-	All-wheel Drive Estate Engine CREC	803103	Outer Joint		42	28	76.4	34	54	I	
RS6 (412 kW)	2013.01-	-	AT	-	All-wheel Drive Estate Engine CRDB/CWUB	603022	Inner Joint			34		88			
	2013.01-	-	-	F	All-wheel Drive Estate Engine CRDB/CWUB	803103	Outer Joint		42	28	76.4	34	54	I	
S6 quattro (309 kW)	2012.02-	-	AT	-	All-wheel Drive Estate Engine CEUC	603022	Inner Joint			34		88			
S6 quattro (331 kW)	2012.02-	-	-	F	All-wheel Drive Estate Engine CEUC	803103	Outer Joint		42	28	76.4	34	54	I	
	2014.10-	-	AT	-	All-wheel Drive Estate Engine CTGE	803103	Outer Joint		42	28	76.4	34	54	I	
A6 I, AVANT															
1.9 TDi	1995.01-1996.12	-	AT	-	F -	803064	Outer Joint	45T	38	27	60	34	64	I	
	1995.01-1996.12	-	MT	-	F -	803064	Outer Joint	45T	38	27	60	34	64	I	
A6 II QUATTRO, AVANT															
2.4 V6	1997.05-2003.05	-	Semi-AT	-	F -	803064	Outer Joint	45T	38	27	60	34	64	I	
	1999.12-	-	AT	-	F -	803064	Outer Joint	45T	38	27	60	34	64	I	
	1999.12-	-	MT	-	F -	803064	Outer Joint	45T	38	27	60	34	64	I	
2.5 TDi V6	1998.04-2004.10	-	Semi-AT	-	F -	803064	Outer Joint	45T	38	27	60	34	64	I	
	1998.04-	-	AT	-	F -	803064	Outer Joint	45T	38	27	60	34	64	I	
	1998.04-	-	MT	-	F -	803064	Outer Joint	45T	38	27	60	34	64	I	
2.7 Turbo	1999.06-2003.05	-	Semi-AT	-	F -	803064	Outer Joint	45T	38	27	60	34	64	I	
	1999.06-	-	AT	-	F -	803064	Outer Joint	45T	38	27	60	34	64	I	
	1999.06-	-	MT	-	F -	803064	Outer Joint	45T	38	27	60	34	64	I	
2.8 V6	1997.05-2001.07	-	AT	-	F -	803064	Outer Joint	45T	38	27	60	34	64	I	
	1997.05-2001.07	-	MT	-	F -	803064	Outer Joint	45T	38	27	60	34	64	I	
	1997.05-2001.07	-	Semi-AT	-	F -	803064	Outer Joint	45T	38	27	60	34	64	I	
3.0 V6	2001.08-2005.01	-	Semi-AT	-	F -	803064	Outer Joint	45T	38	27	60	34	64	I	
	2001.08-	-	AT	-	F -	803064	Outer Joint	45T	38	27	60	34	64	I	
	2001.08-	-	MT	-	F -	803064	Outer Joint	45T	38	27	60	34	64	I	
A6 II, AVANT															
1.9 TDi	1997.05-2000.09	-	MT	-	F -	803064	Outer Joint	45T	38	27	60	34	64	I	
	1997.05-2005.01	-	AT	-	F -	803064	Outer Joint	45T	38	27	60	34	64	I	
2.0 20V	2001.08-	-	AT	-	F -	803064	Outer Joint	45T	38	27	60	34	64	I	
	2001.08-	-	MT	-	F -	803064	Outer Joint	45T	38	27	60	34	64	I	
2.4 V6	1997.05-2003.05	-	Semi-AT	-	F -	803064	Outer Joint	45T	38	27	60	34	64	I	
	1997.05-	-	AT	-	F -	803064	Outer Joint	45T	38	27	60	34	64	I	
	1997.05-	-	MT	-	F -	803064	Outer Joint	45T	38	27	60	34	64	I	
2.5 TDi V6	1997.11-	-	MT	-	F -	803064	Outer Joint	45T	38	27	60	34	64	I	





YEAR	TRANSM	L/R	F/R	REMARKS	GSP Ref.	PRODUCT	ABS	Technical Specifications							
								A	B	C	H	L	P		
AUDI															
A6 II, AVANT															
2.5 TDi V6	1998.04-2004.10	Semi-AT	-	F	-	803064	Outer Joint	45T	38	27	60	34	64	I	
	1998.04-	AT	-	F	-	803064	Outer Joint	45T	38	27	60	34	64	I	
2.8 V6	1997.05-1999.06	AT	-	F	-	803064	Outer Joint	45T	38	27	60	34	64	I	
	1997.05-1999.06	MT	-	F	-	803064	Outer Joint	45T	38	27	60	34	64	I	
	1997.05-2001.07	Semi-AT	-	F	-	803064	Outer Joint	45T	38	27	60	34	64	I	
A6/AVANT															
-	2005-2011	-	-	-	-	201590	Drive Shaft		38		59.5	34	523		
	2005-2011	-	-	-	-	201591	Drive Shaft		38		59.5	34	653		
A6/AVANT QU.															
-	2005-2011	-	-	-	-	201590	Drive Shaft		38		59.5	34	523		
	2005-2011	-	-	-	-	201591	Drive Shaft		38		59.5	34	653		
A7 Sportback (4GA 4GF)															
2.0 TFSI quattro (183 kW)	2015.05-	-	-	F	All-wheel Drive Hatchback Engine CYPB	803103	Outer Joint		42	28	76.4	34	54	I	
2.0 TFSI quattro (185 kW)	2015.05-	AT	-	-	All-wheel Drive Hatchback Engine CYNB/CYPA	603022	Inner Joint			34		88			
	2015.05-	-	-	F	All-wheel Drive Hatchback Engine CYNB/CYPA	803103	Outer Joint		42	28	76.4	34	54	I	
2.8 FSI (150 kW)	2011.02-	AT	-	-	Hatchback Engine CHVA	603022	Inner Joint			34		88			
	2011.02-	CVT	-	F	Hatchback Engine CHVA	803103	Outer Joint		42	28	76.4	34	54	I	
	2011.02-	-	L/R	F	Hatchback Engine CHVA	803087	Outer Joint		42	27	76.5	34	54.5	M	
	2011.02-	AT	L/R	F	Hatchback Engine CHVA	203317	Drive Shaft		42		76.5	34	490		
2.8 FSI quattro (150 kW)	2010.10-	AT	-	-	All-wheel Drive Hatchback Engine CNYA/CHVA	603022	Inner Joint			34		88			
	2010.10-	Semi-AT	-	F	All-wheel Drive Hatchback Engine CNYA/CHVA	803103	Outer Joint		42	28	76.4	34	54	I	
2.8 FSI quattro (162 kW)	2014.09-	-	-	F	All-wheel Drive Hatchback Engine CVPA	803103	Outer Joint		42	28	76.4	34	54	I	
3.0 TDI (150 kW)	2010.11-	CVT	L/R	F	Hatchback Engine CLAB	203370	Drive Shaft		42		76.5	34	494		
	2010.11-	-	L/R	F	Hatchback Engine CLAB	803088	Outer Joint		42	29	76.5	34	61.5	M	
	2010.11-	AT	-	-	Hatchback Engine CLAB	603022	Inner Joint			34		88			
3.0 TDI (160 kW)	2014.07-	AT	-	-	Hatchback Engine CTCC/CZVB	603022	Inner Joint			34		88			
3.0 TDI quattro (140 kW)	2015.11-	-	-	F	All-wheel Drive Hatchback Engine CZVF	803103	Outer Joint		42	28	76.4	34	54	I	
3.0 TDI quattro (150 kW)	2010.12-	AT	-	-	All-wheel Drive Hatchback Engine CLAA	603022	Inner Joint			34		88			
	2010.12-	Semi-AT	-	F	All-wheel Drive Hatchback Engine CLAA	803103	Outer Joint		42	28	76.4	34	54	I	
3.0 TDI quattro (155 kW)	2014.07-	AT	-	-	All-wheel Drive Hatchback Engine CRTF/CTCB	603022	Inner Joint			34		88			
	2014.07-	-	-	F	All-wheel Drive Hatchback Engine CRTF/CTCB	803103	Outer Joint		42	28	76.4	34	54	I	
3.0 TDI quattro (160 kW)	2014.07-	-	-	F	All-wheel Drive Hatchback Engine CZVA/CRTE	803103	Outer Joint		42	28	76.4	34	54	I	
3.0 TDI quattro (176 kW)	2013.05-	AT	-	-	All-wheel Drive Hatchback Engine CPNB	603022	Inner Joint			34		88			
	2013.05-	-	-	F	All-wheel Drive Hatchback Engine CPNB	803103	Outer Joint		42	28	76.4	34	54	I	
3.0 TDI quattro (180 kW)	2010.10-	AT	-	-	All-wheel Drive Hatchback Engine CDUC/CKVC/CKVC/CDUD	603022	Inner Joint			34		88			
	2010.10-	Semi-AT	-	F	All-wheel Drive Hatchback Engine CDUC/CKVC/CKVC/CDUD	803103	Outer Joint		42	28	76.4	34	54	I	
3.0 TDI quattro (200 kW)	2014.05-	-	-	F	All-wheel Drive Hatchback Engine CRTD	803103	Outer Joint		42	28	76.4	34	54	I	
3.0 TDI quattro (230 kW)	2011.11-	AT	-	-	All-wheel Drive Hatchback Engine CGQB	603022	Inner Joint			34		88			
	2011.11-	-	-	F	All-wheel Drive Hatchback Engine CGQB	803103	Outer Joint		42	28	76.4	34	54	I	
3.0 TDI quattro (235 kW)	2014.05-	-	-	F	All-wheel Drive Hatchback Engine CVUA	803103	Outer Joint		42	28	76.4	34	54	I	
3.0 TDI quattro (240 kW)	2014.09-	-	-	F	All-wheel Drive Hatchback Engine CVUB	803103	Outer Joint		42	28	76.4	34	54	I	
3.0 TFSI quattro (220 kW)	2010.10-	AT	-	-	All-wheel Drive Hatchback Engine CGWB/CHMA	603022	Inner Joint			34		88			
	2010.10-	Semi-AT	-	F	All-wheel Drive Hatchback Engine CGWB/CHMA	803103	Outer Joint		42	28	76.4	34	54	I	
3.0 TFSI quattro (228 kW)	2011.01-	AT	-	-	All-wheel Drive Hatchback Engine CTTA/CGXB/CTUA/CGWD	603022	Inner Joint			34		88			
	2011.01-	Semi-AT	-	F	All-wheel Drive Hatchback Engine CTTA/CGXB/CTUA/CGWD	803103	Outer Joint		42	28	76.4	34	54	I	
35 TFSI 1.8 (140 kW)	2015.04-	AT	-	-	Hatchback Engine CYGA	603022	Inner Joint			34		88			
40 TFSI (185 kW)	2014.09-	AT	-	-	Hatchback Engine CYPB	603022	Inner Joint			34		88			
50 TFSI (245 kW)	2014.05-	-	-	F	All-wheel Drive Hatchback Engine CREC	803103	Outer Joint		42	28	76.4	34	54	I	
RS7 performance quattro (445 kW)	2015.11-	-	-	F	All-wheel Drive Hatchback Engine CWUC	803103	Outer Joint		42	28	76.4	34	54	I	
RS7 quattro (412 kW)	2013.10-	AT	-	-	All-wheel Drive Hatchback Engine CRDB/CWUB	603022	Inner Joint			34		88			
	2013.10-	-	-	F	All-wheel Drive Hatchback Engine CRDB/CWUB	803103	Outer Joint		42	28	76.4	34	54	I	
S7 (331 kW)	2014.07-	-	-	F	All-wheel Drive Hatchback Engine CTGE	803103	Outer Joint		42	28	76.4	34	54	I	
S7 quattro (309 kW)	2012.02-	AT	-	-	All-wheel Drive Hatchback Engine CEUC	603022	Inner Joint			34		88			
	2012.02-	-	-	F	All-wheel Drive Hatchback Engine CEUC	803103	Outer Joint		42	28	76.4	34	54	I	
A8															
-	2004-2010	-	-	-	-	201589	Drive Shaft		38		59.5	34	612		
2.8 V6	1994.03-2000.10	AT	-	F	-	803064	Outer Joint	45T	38	27	60	34	64	I	
3.7 V8	1995.10-1999.03	AT	-	F	-	803064	Outer Joint	45T	38	27	60	34	64	I	
A8 (4D2 4D8)															
2.5 TDI (110 kW)	1997.01-2000.04	AT	L/R	F	Saloon Engine AFB/AKN	661033	Inner Joint			34		85			
	1997.01-2000.04	-	L/R	F	Saloon Engine AFB/AKN	803019	Outer Joint	45W	38	27	59.5	34.5	63	I	
2.5 TDI (132 kW)	2000.09-2002.09	-	L/R	F	Saloon Engine AKE	803019	Outer Joint	45W	38	27	59.5	34.5	63	I	
2.5 TDI quattro (110 kW)	1997.07-2000.04	-	L/R	F	All-wheel Drive Saloon Engine AFB/AKN	803019	Outer Joint	45W	38	27	59.5	34.5	63	I	
	1997.07-2000.04	AT/MT	L/R	R	All-wheel Drive Saloon Engine AFB/AKN	603001	Inner Joint			28		32			
2.5 TDI quattro (132 kW)	2000.09-2002.09	-	L/R	F	All-wheel Drive Saloon Engine AKE	803019	Outer Joint	45W	38	27	59.5	34.5	63	I	
	2000.09-2002.09	AT/MT	L/R	R	All-wheel Drive Saloon Engine AKE	603001	Inner Joint			28		32			

YEAR	TRANSM	L/R	F/R	REMARKS	GSP Ref.	PRODUCT	ABS	Technical Specifications								
								A	B	C	H	L	P			
AUDI																
A8 (4D2 4D8)																
2.8 (120 kW)	1995.07-1996.03	-	L/R	F	Saloon Engine AEJ	803019	Outer Joint	45W	38	27	59.5	34.5	63	I		
2.8 (128 kW)	1994.03-1996.03	AT/MT	L/R	F	Saloon Engine AAH	803019	Outer Joint	45W	38	27	59.5	34.5	63	I		
2.8 (142 kW)	1996.04-2002.09	AT	-	F	Saloon Engine ACK/ALG/AMX/APR/AQD	650019	Inner Joint				34	59.5				
	1996.04-2002.09	-	L/R	F	Saloon Engine ACK/ALG/AMX/APR/AQD	803019	Outer Joint	45W	38	27	59.5	34.5	63	I		
2.8 quattro (120 kW)	1995.07-1996.03	-	L/R	F	All-wheel Drive Saloon Engine AEJ	803019	Outer Joint	45W	38	27	59.5	34.5	63	I		
	1995.07-1996.03	AT/MT	L/R	R	All-wheel Drive Saloon Engine AEJ	603001	Inner Joint				28	32				
2.8 quattro (128 kW)	1994.03-1996.03	AT/MT	L/R	R	All-wheel Drive Saloon Engine AAH	603001	Inner Joint				28	32				
	1994.03-1996.03	-	-	F	All-wheel Drive Saloon Engine AAH	650019	Inner Joint				34	59.5				
	1994.03-1996.03	AT/MT	L/R	F	All-wheel Drive Saloon Engine AAH	803019	Outer Joint	45W	38	27	59.5	34.5	63	I		
2.8 quattro (142 kW)	1996.04-2002.09	-	L/R	F	All-wheel Drive Saloon Engine ACK/AQD/APR/AMX	803019	Outer Joint	45W	38	27	59.5	34.5	63	I		
	1996.04-2002.09	-	-	F	All-wheel Drive Saloon Engine ACK/AQD/APR/AMX	650019	Inner Joint				34	59.5				
	1996.04-2002.09	AT/MT	L/R	R	All-wheel Drive Saloon Engine ACK/AQD/APR/AMX	603001	Inner Joint				28	32				
3.3 TDI quattro (165 kW)	2000.06-2002.09	-	L/R	F	All-wheel Drive Saloon Engine AKF	803019	Outer Joint	45W	38	27	59.5	34.5	63	I		
	2000.06-2002.09	AT/MT	L/R	R	All-wheel Drive Saloon Engine AKF	603001	Inner Joint				28	32				
3.7 (169 kW)	1995.07-1998.12	-	L/R	F	Saloon Engine AEW	803019	Outer Joint	45W	38	27	59.5	34.5	63	I		
3.7 (191 kW)	1998.11-2002.09	-	L/R	F	Saloon Engine AKC/AQG	803019	Outer Joint	45W	38	27	59.5	34.5	63	I		
	1998.11-2002.09	-	-	F	Saloon Engine AKC/AQG	650019	Inner Joint				34	59.5				
3.7 quattro (169 kW)	1995.07-1998.11	-	L/R	F	All-wheel Drive Saloon Engine AEW/AKJ	803019	Outer Joint	45W	38	27	59.5	34.5	63	I		
	1995.07-1998.11	AT/MT	L/R	R	All-wheel Drive Saloon Engine AEW/AKJ	603001	Inner Joint				28	32				
3.7 quattro (191 kW)	1998.11-2002.09	-	L/R	F	All-wheel Drive Saloon Engine AKC/AQG	803019	Outer Joint	45W	38	27	59.5	34.5	63	I		
	1998.11-2002.09	-	-	F	All-wheel Drive Saloon Engine AKC/AQG	650019	Inner Joint				34	59.5				
	1998.11-2002.09	AT/MT	L/R	R	All-wheel Drive Saloon Engine AKC/AQG	603001	Inner Joint				28	32				
4.2 quattro (175 kW)	1999.02-2000.04	-	L/R	F	All-wheel Drive Saloon Engine ARU	803019	Outer Joint	45W	38	27	59.5	34.5	63	I		
	1999.02-2000.04	AT/MT	L/R	R	All-wheel Drive Saloon Engine ARU	603001	Inner Joint				28	32				
4.2 quattro (180 kW)	1994.03-1996.07	AT/MT	L/R	R	All-wheel Drive Saloon Engine AEM	603001	Inner Joint				28	32				
	1994.03-1996.07	-	L/R	F	All-wheel Drive Saloon Engine AEM	803019	Outer Joint	45W	38	27	59.5	34.5	63	I		
4.2 quattro (220 kW)	1994.03-1998.11	AT/MT	L/R	R	All-wheel Drive Saloon Engine AKG/ABZ	603001	Inner Joint				28	32				
	1994.03-1998.11	-	-	F	All-wheel Drive Saloon Engine AKG/ABZ	650019	Inner Joint				34	59.5				
	1994.03-1998.11	AT	L/R	F	All-wheel Drive Saloon Engine AKG/ABZ	803019	Outer Joint	45W	38	27	59.5	34.5	63	I		
4.2 quattro (228 kW)	1998.11-2002.09	AT	-	F	All-wheel Drive Saloon Engine AQF/AUX/AUW	650019	Inner Joint				34	59.5				
	1998.11-2002.09	-	L/R	F	All-wheel Drive Saloon Engine AQF/AUX/AUW	803019	Outer Joint	45W	38	27	59.5	34.5	63	I		
	1998.11-2002.09	AT/MT	L/R	R	All-wheel Drive Saloon Engine AQF/AUX/AUW	603001	Inner Joint				28	32				
6.0 W12 quattro (309 kW)	2001.01-2002.09	AT/MT	L/R	F	All-wheel Drive Saloon Engine AZC	803019	Outer Joint	45W	38	27	59.5	34.5	63	I		
	2001.01-2002.09	AT/MT	L/R	R	All-wheel Drive Saloon Engine AZC	603001	Inner Joint				28	32				
S 8 quattro (265 kW)	1999.06-2002.09	-	-	F	All-wheel Drive Saloon Engine AQH/AVP	650019	Inner Joint				34	59.5				
	1999.06-2002.09	-	L/R	F	All-wheel Drive Saloon Engine AQH/AVP	803019	Outer Joint	45W	38	27	59.5	34.5	63	I		
	1999.06-2002.09	AT/MT	L/R	R	All-wheel Drive Saloon Engine AQH/AVP	603001	Inner Joint				28	32				
S8 quattro (250 kW)	1996.07-1999.06	AT/MT	L/R	R	All-wheel Drive Saloon Engine AKH/AHC	603001	Inner Joint				28	32				
	1996.07-1999.06	-	-	F	All-wheel Drive Saloon Engine AKH/AHC	650019	Inner Joint				34	59.5				
	1996.07-1999.06	AT/MT	L/R	F	All-wheel Drive Saloon Engine AKH/AHC	661033	Inner Joint				34	85				
	1996.07-1999.06	-	L/R	F	All-wheel Drive Saloon Engine AKH/AHC	803019	Outer Joint	45W	38	27	59.5	34.5	63	I		
A8 (4E2 4E8)																
2.8 FSI (154 kW)	2007.08-2010.07	AT	-	-	Saloon Engine BDX	661044	Inner Joint				34	85				
3.0 (160 kW)	2003.07-2006.05	AT	-	-	Saloon Engine BBJ	661044	Inner Joint				34	85				
3.0 (162 kW)	2003.07-2005.05	AT	-	-	Saloon Engine ASN	661044	Inner Joint				34	85				
3.0 TDI quattro (155 kW)	2003.11-2010.07	AT	-	-	All-wheel Drive Saloon Engine BNG	661044	Inner Joint				34	85				
3.0 TDI quattro (171 kW)	2003.08-2010.07	AT	-	-	All-wheel Drive Saloon Engine ASB	661044	Inner Joint				34	85				
	2003.08-2010.07	AT	-	F	All-wheel Drive Saloon Engine ASB	803099	Outer Joint	38	27	59.5	34.5	64	M			
3.2 FSI (191 kW)	2005.06-2010.07	AT	-	-	Saloon Engine BPK	661044	Inner Joint				34	85				
3.2 FSI quattro (191 kW)	2005.06-2010.07	AT	-	-	All-wheel Drive Saloon Engine BPK	661044	Inner Joint				34	85				
3.7 quattro (206 kW)	2002.10-2006.05	AT	L	F	All-wheel Drive Saloon Engine BFL	201596	Drive Shaft				38	59.5	34	558		
	2002.10-2006.05	AT	R	F	All-wheel Drive Saloon Engine BFL	201588	Drive Shaft				38	59.5	34	477		
	2002.10-2006.05	-	-	F	All-wheel Drive Saloon Engine BFL	803099	Outer Joint	38	27	59.5	34.5	64	M			
4.0 TDI quattro (202 kW)	2003.05-2005.07	AT	L	F	All-wheel Drive Saloon Engine ASE	201596	Drive Shaft				38	59.5	34	558		
	2003.05-2005.07	AT	R	F	All-wheel Drive Saloon Engine ASE	201588	Drive Shaft				38	59.5	34	477		
	2003.05-2005.07	AT	-	-	All-wheel Drive Saloon Engine ASE	661044	Inner Joint				34	85				
	2003.05-2005.07	-	-	F	All-wheel Drive Saloon Engine ASE	803099	Outer Joint	38	27	59.5	34.5	64	M			
4.2 FSI quattro (257 kW)	2006.06-2010.07	AT	-	-	All-wheel Drive Saloon Engine BVJ	661044	Inner Joint				34	85				
	2006.06-2010.07	AT	-	F	All-wheel Drive Saloon Engine BVJ	803099	Outer Joint	38	27	59.5	34.5	64	M			
4.2 quattro (246 kW)	2002.10-2010.07	AT	L	F	All-wheel Drive Saloon Engine BFM	201596	Drive Shaft				38	59.5	34	558		
	2002.10-2010.07	AT	R	F	All-wheel Drive Saloon Engine BFM	201588	Drive Shaft				38	59.5	34	477		
	2002.10-2010.07	-	L/R	F	All-wheel Drive Saloon Engine BFM	803077	Outer Joint	38	27	59.5	34	63	M			
	2002.10-2010.07	AT	-	-	All-wheel Drive Saloon Engine BFM	661044	Inner Joint				34	85				
	2002.10-2010.07	AT	-	F	All-wheel Drive Saloon Engine BFM	803099	Outer Joint	38	27	59.5	34.5	64	M			
4.2 TDI quattro (235 kW)	2005.01-2005.06	AT	L	F	All-wheel Drive Saloon Engine BMC	201596	Drive Shaft				38	59.5	34	558		
	2005.01-2005.06	AT	R	F	All-wheel Drive Saloon Engine BMC	201588	Drive Shaft				38	59.5	34	477		





YEAR	TRANSM	L/R	F/R	REMARKS	GSP Ref.	PRODUCT	ABS	Technical Specifications						
								A	B	C	H	L	P	
AUDI														
A8 (4E2 4E8)														
4.2 TDI quattro (235 kW)	2005.01-2005.06	AT	-	-	All-wheel Drive Saloon Engine BMC	661044	Inner Joint			34		85		
	2005.01-2005.06	AT	-	F	All-wheel Drive Saloon Engine BMC	803099	Outer Joint	38	27	59.5	34.5	64	M	
4.2 TDI quattro (240 kW)	2005.07-2010.07	AT	L	F	All-wheel Drive Saloon Engine BVN	201596	Drive Shaft	38		59.5	34	558		
	2005.07-2010.07	AT	R	F	All-wheel Drive Saloon Engine BVN	201588	Drive Shaft	38		59.5	34	477		
	2005.07-2010.07	AT	-	-	All-wheel Drive Saloon Engine BVN	661044	Inner Joint			34		85		
	2005.07-2010.07	AT	-	F	All-wheel Drive Saloon Engine BVN	803099	Outer Joint	38	27	59.5	34.5	64	M	
6.0 W12 quattro (331 kW)	2003.12-2010.07	AT	L	F	All-wheel Drive Saloon Engine BSB/BHT/BTE	201596	Drive Shaft	38		59.5	34	558		
	2003.12-2010.07	AT	R	F	All-wheel Drive Saloon Engine BSB/BHT/BTE	201588	Drive Shaft	38		59.5	34	477		
	2003.12-2010.07	AT	-	-	All-wheel Drive Saloon Engine BSB/BHT/BTE	661044	Inner Joint			34		85		
	2003.12-2010.07	AT	-	F	All-wheel Drive Saloon Engine BSB/BHT/BTE	803099	Outer Joint	38	27	59.5	34.5	64	M	
S8 quattro (331 kW)	2006.06-2010.07	AT	L	F	All-wheel Drive Saloon Engine BSM	201596	Drive Shaft	38		59.5	34	558		
	2006.06-2010.07	AT	R	F	All-wheel Drive Saloon Engine BSM	201588	Drive Shaft	38		59.5	34	477		
	2006.06-2010.07	AT	-	-	All-wheel Drive Saloon Engine BSM	661044	Inner Joint			34		85		
	2006.06-2010.07	AT	-	F	All-wheel Drive Saloon Engine BSM	803099	Outer Joint	38	27	59.5	34.5	64	M	
A8 (4H2 4H8 4HC 4HL)														
2.0 TFSI hybrid (155 kW)	2012.02-	-	-	-	F Saloon Engine CHJA	803102	Outer Joint	42	29	76.5	34	60	I	
2.5 FSI (150 kW)	2012.07-	-	-	-	F Saloon Engine CPAA/CVBA	803103	Outer Joint	42	28	76.4	34	54	I	
3.0 TDI (150 kW)	2011.09-	-	-	L/R	F Saloon Engine CLAB	803088	Outer Joint	42	29	76.5	34	61.5	M	
3.0 TDI quattro (155 kW)	2010.08-	AT	-	-	All-wheel Drive Saloon Engine CDTB/CTBB	603022	Inner Joint			34		88		
	2010.08-	-	-	-	F All-wheel Drive Saloon Engine CDTB/CTBB	803103	Outer Joint	42	28	76.4	34	54	I	
3.0 TDI quattro (176 kW)	2012.11-	-	-	-	F All-wheel Drive Saloon Engine CPNA	803103	Outer Joint	42	28	76.4	34	54	I	
3.0 TDI quattro (184 kW)	2010.07-	AT	-	-	All-wheel Drive Saloon Engine CDTA/CMHA/CDTC	603022	Inner Joint			34		88		
	2010.07-	AT	-	F	All-wheel Drive Saloon Engine CDTA/CMHA/CDTC	803103	Outer Joint	42	28	76.4	34	54	I	
3.0 TDI quattro (190 kW)	2013.10-	-	-	-	F All-wheel Drive Saloon Engine CTBA	803103	Outer Joint	42	28	76.4	34	54	I	
3.0 TDI quattro (193 kW)	2015.05-	AT	-	-	F All-wheel Drive Saloon Engine CTBD	803103	Outer Joint	42	28	76.4	34	54	I	
3.0 TFSI quattro (213 kW)	2010.07-	AT	-	-	All-wheel Drive Saloon Engine CGXA/CGWA/CREG	603022	Inner Joint			34		88		
	2010.07-	AT	-	F	All-wheel Drive Saloon Engine CGXA/CGWA/CREG	803103	Outer Joint	42	28	76.4	34	54	I	
3.0 TFSI quattro (228 kW)	2011.11-	AT	-	-	All-wheel Drive Saloon Engine CGWD/CREA	603022	Inner Joint			34		88		
	2011.11-	AT	-	F	All-wheel Drive Saloon Engine CGWD/CREA	803103	Outer Joint	42	28	76.4	34	54	I	
3.0 FSI (185 kW)	2016.09-	-	-	-	F All-wheel Drive Saloon Engine CYP A	803103	Outer Joint	42	28	76.4	34	54	I	
4.0 TFSI quattro (309 kW)	2012.03-	AT	-	-	All-wheel Drive Saloon Engine CEUA	603022	Inner Joint			34		88		
	2012.03-	AT	-	F	All-wheel Drive Saloon Engine CEUA	803103	Outer Joint	42	28	76.4	34	54	I	
4.2 FSI quattro (273 kW)	2009.11-	AT	-	-	All-wheel Drive Saloon Engine CDRA	603022	Inner Joint			34		88		
	2009.11-	AT	-	F	All-wheel Drive Saloon Engine CDRA	803103	Outer Joint	42	28	76.4	34	54	I	
4.2 TDI quattro (258 kW)	2009.11-	-	L/R	F	All-wheel Drive Saloon Engine CDSB	803088	Outer Joint	42	29	76.5	34	61.5	M	
4.2 TDI quattro (283 kW)	2013.10-	AT	L/R	F	All-wheel Drive Saloon Engine CTEC	803088	Outer Joint	42	29	76.5	34	61.5	M	
	2013.10-	-	-	-	F All-wheel Drive Saloon Engine CTEC	803103	Outer Joint	42	28	76.4	34	54	I	
5.0 TSI (245 kW)	2010.06-	-	-	-	F All-wheel Drive Saloon Engine CTDA/CREC/CTUB/CGXC/CMDA	803103	Outer Joint	42	28	76.4	34	54	I	
	2010.06-	AT	-	-	All-wheel Drive Saloon Engine CTDA/CREC/CTUB/CGXC/CMDA	603022	Inner Joint			34		88		
6.3 FSI W12 (368 kW)	2011.01-	-	-	-	F All-wheel Drive Saloon Engine CTNA/CEJA	803103	Outer Joint	42	28	76.4	34	54	I	
	2011.01-	AT	-	-	All-wheel Drive Saloon Engine CTNA/CEJA	603022	Inner Joint			34		88		
6.0 TSI (320 kW)	2013.10-	-	-	-	F All-wheel Drive Saloon Engine CTGA	803103	Outer Joint	42	28	76.4	34	54	I	
S8 plus quattro (445 kW)	2015.11-	AT	-	-	F All-wheel Drive Saloon Engine DDTA	803103	Outer Joint	42	28	76.4	34	54	I	
S8 quattro (382 kW)	2012.04-	AT	-	-	All-wheel Drive Saloon Engine CTFA/CGTA	603022	Inner Joint			34		88		
	2012.04-	-	-	-	F All-wheel Drive Saloon Engine CTFA/CGTA	803103	Outer Joint	42	28	76.4	34	54	I	
A8 QUATTRO														
2.8 V6	2000.10-	AT	-	R	-	803064	Outer Joint	45T	38	27	60	34	64	I
	2000.10-	AT	-	F	-	803064	Outer Joint	45T	38	27	60	34	64	I
3.7 V8	1999.03-	AT	-	R	-	803064	Outer Joint	45T	38	27	60	34	64	I
	1999.03-	AT	-	F	-	803064	Outer Joint	45T	38	27	60	34	64	I
4.2 V8	1994.10-	AT	-	F	-	803064	Outer Joint	45T	38	27	60	34	64	I
	1994.10-	AT	-	R	-	803064	Outer Joint	45T	38	27	60	34	64	I
A8/S8 QUATTRO														
-	2003-2010	-	-	-	-	201589	Drive Shaft	38		59.5	34	612		
ALLROAD (4BH C5)														
2.5 TDI quattro (120 kW)	2003.05-2005.08	-	L/R	F	All-wheel Drive Estate Engine BCZ	803019	Outer Joint	45W	38	27	59.5	34.5	63	I
	2003.05-2005.08	MT	-	-	All-wheel Drive Estate Engine BCZ	661044	Inner Joint			34		85		
2.5 TDI quattro (132 kW)	2000.05-2005.08	-	L/R	F	All-wheel Drive Estate Engine AKE/BAU	803019	Outer Joint	45W	38	27	59.5	34.5	63	I
2.7 T quattro (184 kW)	2000.05-2005.08	-	L/R	F	All-wheel Drive Estate Engine BES/ARE	803019	Outer Joint	45W	38	27	59.5	34.5	63	I
4.2 V8 quattro (220 kW)	2002.07-2005.08	AT	-	-	All-wheel Drive Estate Engine BAS	661044	Inner Joint			34		85		
	2002.07-2005.08	-	L/R	F	All-wheel Drive Estate Engine BAS	803019	Outer Joint	45W	38	27	59.5	34.5	63	I
CABRIOLET (8G7 B4)														
1.8 (92 kW)	1997.01-2000.08	-	-	-	Convertible Engine ADR	661007	Inner Joint			33		32		
1.9 TDI (66 kW)	1995.06-2000.08	-	L/R	F	Convertible Engine 1Z/AHU	803012	Outer Joint	45T	33	30	53	31	62	I
2.0 16V (103 kW)	1995.06-1996.07	-	-	-	Convertible Engine ACE	661007	Inner Joint			33		32		
2.0 E (85 kW)	1993.01-1998.07	MT	L/R	F	Convertible Engine ABK	603014	Inner Joint			33		32		





	 YEAR	TRANSM	L/R	F/R	REMARKS	GSP Ref.	 PRODUCT	 ABS	Technical Specifications					
									A	B	C	H	L	P
AUDI														
CABRIOLET (8G7 B4)														
2.0 E (85 kW)	1993.01-1998.07	MT	L	F	Convertible Engine ABK	203059	Drive Shaft		33		53	31	586	
	1993.01-1998.07	AT/MT	L/R	F	Convertible Engine ABK	803012	Outer Joint	45T	33	30	53	31	62	I
	1993.01-1998.07	MT	R	F	Convertible Engine ABK	203297	Drive Shaft	45T	33	0	53	30	575	
	1993.01-1998.07	AT/MT	L/R	F	Convertible Engine ABK	803051	Outer Joint		33	30	53	30	61	I
	1993.01-1998.07	MT	L	F	Convertible Engine ABK	203003	Drive Shaft	45T	33		53	31	586	
	1993.01-1998.07	-	-	-	Convertible Engine ABK	661007	Inner Joint			33		32		
2.3 E (98 kW)	1991.05-1994.07	MT	L/R	F	Convertible Engine NG	603001	Inner Joint			28		32		
	1991.05-1994.07	MT	L/R	F	Convertible Engine NG	803012	Outer Joint	45T	33	30	53	31	62	I
	1991.05-1994.07	MT	L/R	F	Convertible Engine NG	803051	Outer Joint		33	30	53	30	61	I
2.6 (110 kW)	1993.06-2000.08	AT/MT	L/R	F	Convertible Engine ABC	661033	Inner Joint			34		85		
COUPE (89, 8B)														
2.0 (82 kW)	1990.03-1990.07	-	-	F	Coupe Engine 3A	803011	Outer Joint		33	30	53	31	62	I
	1990.03-1990.07	-	-	-	Coupe Engine 3A	661007	Inner Joint			33		32		
2.0 (83 kW)	1989.05-1990.03	-	-	F	Coupe Engine 3A	803011	Outer Joint		33	30	53	31	62	I
2.0 (85 kW)	1989.05-1996.12	3AT/MT	L/R	F	Coupe Engine AAD/ABK	603014	Inner Joint			33		32		
	1989.05-1996.12	MT	L	F	Coupe Engine AAD/ABK	203059	Drive Shaft		33		53	31	586	
	1989.05-1996.12	AT/MT	L/R	F	Coupe Engine AAD/ABK	803012	Outer Joint	45T	33	30	53	31	62	I
	1989.05-1996.12	MT	R	F	Coupe Engine AAD/ABK	203297	Drive Shaft	45T	33	0	53	30	575	
	1989.05-1996.12	3AT/MT	L/R	F	Coupe Engine AAD/ABK	803051	Outer Joint		33	30	53	30	61	I
	1989.05-1996.12	MT	L	F	Coupe Engine AAD/ABK	203003	Drive Shaft	45T	33		53	31	586	
	1989.05-1996.12	-	-	F	Coupe Engine AAD/ABK	803011	Outer Joint		33	30	53	31	62	I
2.0 16 V (101 kW)	1992.01-1992.07	MT	R	F	Coupe Engine 6A	203044	Drive Shaft	45T	33		53	31	563	
2.0 16 V (103 kW)	1992.08-1996.12	MT	L/R	F	Coupe Engine ACE	603001	Inner Joint			28		32		
	1992.08-1996.12	MT	L/R	F	Coupe Engine ACE	803012	Outer Joint	45T	33	30	53	31	62	I
	1992.08-1996.12	MT	R	F	Coupe Engine ACE	203044	Drive Shaft	45T	33		53	31	563	
	1992.08-1996.12	MT	L/R	F	Coupe Engine ACE	803051	Outer Joint		33	30	53	30	61	I
	1992.08-1996.12	-	-	-	Coupe Engine ACE	661007	Inner Joint			33		32		
2.0 20 V (118 kW)	1989.08-1991.07	MT	-	-	Coupe Engine NM	603006	Inner Joint			33		34		
	1989.08-1991.07	MT	R	F	Coupe Engine NM	203044	Drive Shaft	45T	33		53	31	563	
	1989.08-1991.07	-	-	F	Coupe Engine NM	803011	Outer Joint		33	30	53	31	62	I
2.0 20 V quattro (118 kW)	1989.08-1991.07	MT	L/R	R	All-wheel Drive Coupe Engine NM	803009	Outer Joint	45T	33	30	53	30.5	51.5	I
	1989.08-1991.07	MT	L/R	F	All-wheel Drive Coupe Engine NM	603003	Inner Joint			33		32		
	1989.08-1991.07	MT	L/R	F	All-wheel Drive Coupe Engine NM	803012	Outer Joint	45T	33	30	53	31	62	I
	1989.08-1991.07	MT	R	F	All-wheel Drive Coupe Engine NM	203297	Drive Shaft	45T	33	0	53	30	575	
	1989.08-1991.07	MT	L/R	R	All-wheel Drive Coupe Engine NM	603004	Inner Joint			33		32		
	1989.08-1991.07	MT	L	F	All-wheel Drive Coupe Engine NM	203003	Drive Shaft	45T	33		53	31	586	
	1989.08-1991.07	MT	-	-	All-wheel Drive Coupe Engine NM	603006	Inner Joint			33		34		
	1989.08-1991.07	MT	L/R	R	All-wheel Drive Coupe Engine NM	603005	Inner Joint			33		32		
2.2 quattro (100 kW)	1988.11-1991.07	MT	-	-	All-wheel Drive Coupe Engine KV	603006	Inner Joint			33		34		
2.3 (100 kW)	1988.10-1994.07	MT	L/R	F	Coupe Engine NG	603001	Inner Joint			28		32		
	1988.10-1994.07	AT/MT	L/R	F	Coupe Engine NG	803012	Outer Joint	45T	33	30	53	31	62	I
	1988.10-1994.07	MT	R	F	Coupe Engine NG	203044	Drive Shaft	45T	33		53	31	563	
	1988.10-1994.07	-	-	F	Coupe Engine NG	803011	Outer Joint		33	30	53	31	62	I
2.3 (98 kW)	1990.03-1996.12	MT	-	-	Coupe Engine NG	603006	Inner Joint			33		34		
	1990.03-1996.12	MT	L/R	F	Coupe Engine NG	603001	Inner Joint			28		32		
	1990.03-1996.12	AT/MT	L/R	F	Coupe Engine NG	803012	Outer Joint	45T	33	30	53	31	62	I
	1990.03-1996.12	MT	R	F	Coupe Engine NG	203044	Drive Shaft	45T	33		53	31	563	
	1990.03-1996.12	-	-	F	Coupe Engine NG	803011	Outer Joint		33	30	53	31	62	I
2.3 20V (123 kW)	1990.08-1991.07	MT	L/R	F	Coupe Engine 7A	603001	Inner Joint			28		32		
	1990.08-1991.07	-	-	F	Coupe Engine 7A	803011	Outer Joint		33	30	53	31	62	I
2.3 20V (125 kW)	1989.08-1991.07	MT	L/R	F	Coupe Engine 7A	603001	Inner Joint			28		32		
	1989.08-1991.07	MT	-	-	Coupe Engine 7A	603006	Inner Joint			33		34		
	1989.08-1991.07	-	-	F	Coupe Engine 7A	803011	Outer Joint		33	30	53	31	62	I
2.3 20V quattro (123 kW)	1990.05-1996.12	-	-	F	All-wheel Drive Coupe Engine 7A	803011	Outer Joint		33	30	53	31	62	I
2.3 20V quattro (125 kW)	1988.11-1991.07	-	-	F	All-wheel Drive Coupe Engine 7A	803011	Outer Joint		33	30	53	31	62	I
2.3 quattro (100 kW)	1988.11-1992.12	-	-	F	All-wheel Drive Coupe Engine NG	803011	Outer Joint		33	30	53	31	62	I
2.3 quattro (98 kW)	1990.05-1996.12	MT	-	-	All-wheel Drive Coupe Engine NG	603006	Inner Joint			33		34		
	1990.05-1996.12	-	-	F	All-wheel Drive Coupe Engine NG	803011	Outer Joint		33	30	53	31	62	I
S2 quattro (162 kW)	1990.09-1992.09	MT	-	-	All-wheel Drive Coupe Engine 3B	603006	Inner Joint			33		34		
S2 quattro (169 kW)	1992.10-1996.12	MT	-	-	All-wheel Drive Coupe Engine ABY	603006	Inner Joint			33		34		
Q2 (GAB)														
1.0 TFSI (85 kW)	2016.09-	MT	-	F	Closed Off-Road Vehicle Engine CHZJ	803100	Outer Joint		36	33	59.5	38	55	I
1.4 TFSI (110 kW)	2016.06-	-	-	F	Closed Off-Road Vehicle Engine CZEA	803101	Outer Joint		36	27	59.5	40	65	M
1.6 TDI (85 kW)	2016.06-	-	L/R	F	Closed Off-Road Vehicle Engine DDYA	603011	Inner Joint			33		34		
	2016.06-	MT	-	F	Closed Off-Road Vehicle Engine DDYA	803100	Outer Joint		36	33	59.5	38	55	I
	2016.06-	MT	L	F	Closed Off-Road Vehicle Engine DDYA	261089	Drive Shaft		36		59.5	40.5	521	

	 YEAR	TRANSM	L/R	F/R	REMARKS	GSP Ref.	 PRODUCT	 ABS	Technical Specifications					
									A	B	C	H	L	P
AUDI														
Q2 (GAB)														
1.6 TDI (85 kW)	2016.06.-	-	MT	R	F	Closed Off-Road Vehicle Engine DDYA	261200	Drive Shaft	36		59.5	40.5	820	
2.0 TDI (110 kW)	2016.09.-	-	-	-	F	Closed Off-Road Vehicle Engine DCYA	803101	Outer Joint	36	27	59.5	40	65	M
	2016.09.-	-	Semi-AT	L	F	Closed Off-Road Vehicle Engine DCYA	261285	Drive Shaft	36		59.5	40	472	
	2016.09.-	-	Semi-AT	R	F	Closed Off-Road Vehicle Engine DCYA	203354	Drive Shaft	36		59.5	40	763	
Q3 (8UB 8UG)														
1.4 TFSI (110 kW)	2013.10.-	-	AT	L	F	Closed Off-Road Vehicle Engine CZDA/CHPB/CZEA	661038	Inner Joint	26	34	31	68.5	88.5	
	2013.10.-	-	MT	-	F	Closed Off-Road Vehicle Engine CZDA/CHPB/CZEA	803101	Outer Joint	36	27	59.5	40	65	M
	2013.10.-	-	AT	R	F	Closed Off-Road Vehicle Engine CZDA/CHPB/CZEA	661048	Inner Joint	40	34	46.9	47	80.5	
	2013.10.-	-	MT	L	F	Closed Off-Road Vehicle Engine CZDA/CHPB/CZEA	261146	Drive Shaft	36		59.5	40	490	
	2013.10.-	-	MT	R	F	Closed Off-Road Vehicle Engine CZDA/CHPB/CZEA	261147	Drive Shaft	36		59.5	40	795	
2.0 TDI (100 kW)	2011.09.-	-	MT	-	F	Closed Off-Road Vehicle Engine CFFA	803101	Outer Joint	36	27	59.5	40	65	M
	2011.09.-	-	MT	L	F	Closed Off-Road Vehicle Engine CFFA	661054	Inner Joint	40	28	46.9	51	53	
	2011.09.-	-	MT	L	F	Closed Off-Road Vehicle Engine CFFA	261146	Drive Shaft	36		59.5	40	490	
	2011.09.-	-	MT	R	F	Closed Off-Road Vehicle Engine CFFA	261147	Drive Shaft	36		59.5	40	795	
	2011.09.-	-	MT	-	-	Closed Off-Road Vehicle Engine CFFA	603016	Inner Joint		28		32		
2.0 TDI (103 kW)	2011.09.-	-	MT	-	F	Closed Off-Road Vehicle Engine CFFB/CJLA	803101	Outer Joint	36	27	59.5	40	65	M
	2011.09.-	-	MT	L	F	Closed Off-Road Vehicle Engine CFFB/CJLA	261146	Drive Shaft	36		59.5	40	490	
	2011.09.-	-	MT	R	F	Closed Off-Road Vehicle Engine CFFB/CJLA	261147	Drive Shaft	36		59.5	40	795	
2.0 TDI (110 kW)	2014.11.-	-	AT	L	F	Closed Off-Road Vehicle Engine DBBA/CUVC/DFTA	661038	Inner Joint	26	34	31	68.5	88.5	
	2014.11.-	-	AT	R	F	Closed Off-Road Vehicle Engine DBBA/CUVC/DFTA	661048	Inner Joint	40	34	46.9	47	80.5	
	2014.11.-	-	AT	L	F	Closed Off-Road Vehicle Engine DBBA/CUVC/DFTA	661054	Inner Joint	40	28	46.9	51	53	
	2014.11.-	-	AT	-	-	Closed Off-Road Vehicle Engine DBBA/CUVC/DFTA	603016	Inner Joint		28		32		
2.0 TDI (130 kW)	2013.05.-	-	MT	-	F	Closed Off-Road Vehicle Engine CFGC	803101	Outer Joint	36	27	59.5	40	65	M
	2013.05.-	-	MT	L	F	Closed Off-Road Vehicle Engine CFGC	261146	Drive Shaft	36		59.5	40	490	
	2013.05.-	-	MT	R	F	Closed Off-Road Vehicle Engine CFGC	261147	Drive Shaft	36		59.5	40	795	
2.0 TDI (135 kW)	2015.05.-	-	AT	L	F	Closed Off-Road Vehicle Engine CUWA	661038	Inner Joint	26	34	31	68.5	88.5	
	2015.05.-	-	AT	R	F	Closed Off-Road Vehicle Engine CUWA	661048	Inner Joint	40	34	46.9	47	80.5	
	2015.05.-	-	AT	-	-	Closed Off-Road Vehicle Engine CUWA	603016	Inner Joint		28		32		
	2015.05.-	-	AT	L	F	Closed Off-Road Vehicle Engine CUWA	661054	Inner Joint	40	28	46.9	51	53	
2.0 TDI quattro (103 kW)	2012.01.-	-	MT	R	F	All-wheel Drive Closed Off-Road Vehicle Engine CFFB	261300	Drive Shaft	36		59.5	40	602	
	2012.01.-	-	-	L/R	R	All-wheel Drive Closed Off-Road Vehicle Engine CFFB	603011	Inner Joint		33		34		
	2012.01.-	-	-	L/R	F	All-wheel Drive Closed Off-Road Vehicle Engine CFFB	803002	Outer Joint	36	27	59.5	40	66	I
	2012.01.-	-	MT	L	F	All-wheel Drive Closed Off-Road Vehicle Engine CFFB	261296	Drive Shaft	36	40	59.5	40	500	
	2012.01.-	-	MT	R	F	All-wheel Drive Closed Off-Road Vehicle Engine CFFB	203369	Drive Shaft	36	40	59.5	40	598	
	2012.01.-	-	AT	R	F	All-wheel Drive Closed Off-Road Vehicle Engine CFFB	261347	Drive Shaft	36	40	59.5	40	593	
	2012.01.-	-	MT	L	F	All-wheel Drive Closed Off-Road Vehicle Engine CFFB	661090	Inner Joint	40	28	46.9		104	
	2012.01.-	-	-	-	R	All-wheel Drive Closed Off-Road Vehicle Engine CFFB	635026	Inner Joint	36	33	59.5	40	39	
	2012.01.-	-	MT	L/R	F	All-wheel Drive Closed Off-Road Vehicle Engine CFFB	261214	Stub Axle	40	37	60		125	
	2012.01.-	-	AT	R	F	All-wheel Drive Closed Off-Road Vehicle Engine CFFB	603025	Inner Joint	40	34	46.9	47	80.5	
2012.01.-	-	AT	L	F	All-wheel Drive Closed Off-Road Vehicle Engine CFFB	201265	Drive Shaft	36	37	59.5	40	557		
2.0 TDI quattro (110 kW)	2014.11.-	-	-	L/R	R	All-wheel Drive Closed Off-Road Vehicle Engine CUVC/DFTA	603011	Inner Joint		33		34		
	2014.11.-	-	AT	L	F	All-wheel Drive Closed Off-Road Vehicle Engine CUVC/DFTA	661038	Inner Joint	26	34	31	68.5	88.5	
	2014.11.-	-	AT	R	F	All-wheel Drive Closed Off-Road Vehicle Engine CUVC/DFTA	661048	Inner Joint	40	34	46.9	47	80.5	
	2014.11.-	-	AT	L	F	All-wheel Drive Closed Off-Road Vehicle Engine CUVC/DFTA	661054	Inner Joint	40	28	46.9	51	53	
	2014.11.-	-	AT	-	-	All-wheel Drive Closed Off-Road Vehicle Engine CUVC/DFTA	603016	Inner Joint		28		32		
2.0 TDI quattro (120 kW)	2011.06.-	-	AT	R	F	All-wheel Drive Closed Off-Road Vehicle Engine CFGD	661048	Inner Joint	40	34	46.9	47	80.5	
	2011.06.-	-	-	L/R	R	All-wheel Drive Closed Off-Road Vehicle Engine CFGD	603011	Inner Joint		33		34		
	2011.06.-	-	AT	R	F	All-wheel Drive Closed Off-Road Vehicle Engine CFGD	261347	Drive Shaft	36	40	59.5	40	593	
	2011.06.-	-	AT	-	-	All-wheel Drive Closed Off-Road Vehicle Engine CFGD	603006	Inner Joint		33		34		
	2011.06.-	-	MT	L/R	F	All-wheel Drive Closed Off-Road Vehicle Engine CFGD	261214	Stub Axle	40	37	60		125	
	2011.06.-	-	AT	R	F	All-wheel Drive Closed Off-Road Vehicle Engine CFGD	603025	Inner Joint	40	34	46.9	47	80.5	
	2011.06.-	-	AT	L	F	All-wheel Drive Closed Off-Road Vehicle Engine CFGD	201265	Drive Shaft	36	37	59.5	40	557	
2.0 TDI quattro (130 kW)	2011.06.-	-	AT	L	F	All-wheel Drive Closed Off-Road Vehicle Engine CFGC/CLLB	661038	Inner Joint	26	34	31	68.5	88.5	
	2011.06.-	-	-	L/R	R	All-wheel Drive Closed Off-Road Vehicle Engine CFGC/CLLB	603011	Inner Joint		33		34		
	2011.06.-	-	AT	R	F	All-wheel Drive Closed Off-Road Vehicle Engine CFGC/CLLB	261347	Drive Shaft	36	40	59.5	40	593	
	2011.06.-	-	AT	R	F	All-wheel Drive Closed Off-Road Vehicle Engine CFGC/CLLB	603025	Inner Joint	40	34	46.9	47	80.5	
	2011.06.-	-	AT	L	F	All-wheel Drive Closed Off-Road Vehicle Engine CFGC/CLLB	201265	Drive Shaft	36	37	59.5	40	557	
2.0 TDI quattro (135 kW)	2014.11.-	-	AT	L	F	All-wheel Drive Closed Off-Road Vehicle Engine CUWA/CYLA/DFUA	661038	Inner Joint	26	34	31	68.5	88.5	
	2014.11.-	-	AT	R	F	All-wheel Drive Closed Off-Road Vehicle Engine CUWA/CYLA/DFUA	661048	Inner Joint	40	34	46.9	47	80.5	
	2014.11.-	-	AT	L	F	All-wheel Drive Closed Off-Road Vehicle Engine CUWA/CYLA/DFUA	661054	Inner Joint	40	28	46.9	51	53	
	2014.11.-	-	AT	-	-	All-wheel Drive Closed Off-Road Vehicle Engine CUWA/CYLA/DFUA	603016	Inner Joint		28		32		
2.0 TFSI (132 kW)	2015.05.-	-	AT	L	F	Closed Off-Road Vehicle Engine CULB	661038	Inner Joint	26	34	31	68.5	88.5	
	2015.05.-	-	AT	R	F	Closed Off-Road Vehicle Engine CULB	661048	Inner Joint	40	34	46.9	47	80.5	
	2015.05.-	-	AT	-	-	Closed Off-Road Vehicle Engine CULB	603016	Inner Joint		28		32		
	2015.05.-	-	AT	L	F	Closed Off-Road Vehicle Engine CULB	661054	Inner Joint	40	28	46.9	51	53	

	 YEAR	TRANSM	L/R	F/R	REMARKS	GSP Ref.	 PRODUCT	 ABS	Technical Specifications						
									A	B	C	H	L	P	
AUDI															
Q3 (8UB 8UG)															
2.0 TFSI quattro (125 kW)	2011.06-	-	MT	R	F	All-wheel Drive Closed Off-Road Vehicle Engine CCZC	261300	Drive Shaft		36		59.5	40	602	
	2011.06-	-	-	L/R	R	All-wheel Drive Closed Off-Road Vehicle Engine CCZC	603011	Inner Joint			33		34		
	2011.06-	-	MT	L/R	F	All-wheel Drive Closed Off-Road Vehicle Engine CCZC	803002	Outer Joint		36	27	59.5	40	66	I
	2011.06-	-	6MT	L	F	All-wheel Drive Closed Off-Road Vehicle Engine CCZC	261296	Drive Shaft		36	40	59.5	40	500	
	2011.06-	-	AT	R	F	All-wheel Drive Closed Off-Road Vehicle Engine CCZC	261347	Drive Shaft		36	40	59.5	40	593	
	2011.06-	-	-	-	R	All-wheel Drive Closed Off-Road Vehicle Engine CCZC	635026	Inner Joint		36	33	59.5	40	39	
	2011.06-	-	AT	R	F	All-wheel Drive Closed Off-Road Vehicle Engine CCZC	603025	Inner Joint		40	34	46.9	47	80.5	
	2011.06-	-	AT	L	F	All-wheel Drive Closed Off-Road Vehicle Engine CCZC	201265	Drive Shaft		36	37	59.5	40	557	
2.0 TFSI quattro (132 kW)	2014.11-	-	AT	L	F	All-wheel Drive Closed Off-Road Vehicle Engine CULB	661038	Inner Joint		26	34	31	68.5	88.5	
	2014.11-	-	AT	R	F	All-wheel Drive Closed Off-Road Vehicle Engine CULB	661048	Inner Joint		40	34	46.9	47	80.5	
	2014.11-	-	AT	L	F	All-wheel Drive Closed Off-Road Vehicle Engine CULB	661054	Inner Joint		40	28	46.9	51	53	
	2014.11-	-	AT	-	-	All-wheel Drive Closed Off-Road Vehicle Engine CULB	603016	Inner Joint			28		32		
2.0 TFSI quattro (155 kW)	2011.06-	-	AT	R	F	All-wheel Drive Closed Off-Road Vehicle Engine CPSA	661048	Inner Joint		40	34	46.9	47	80.5	
	2011.06-	-	-	L/R	R	All-wheel Drive Closed Off-Road Vehicle Engine CPSA	603011	Inner Joint			33		34		
	2011.06-	-	AT	R	F	All-wheel Drive Closed Off-Road Vehicle Engine CPSA	261347	Drive Shaft		36	40	59.5	40	593	
	2011.06-	-	AT	-	-	All-wheel Drive Closed Off-Road Vehicle Engine CPSA	603006	Inner Joint			33		34		
	2011.06-	-	AT	R	F	All-wheel Drive Closed Off-Road Vehicle Engine CPSA	603025	Inner Joint		40	34	46.9	47	80.5	
	2011.06-	-	AT	L	F	All-wheel Drive Closed Off-Road Vehicle Engine CPSA	201265	Drive Shaft		36	37	59.5	40	557	
2.0 TFSI quattro (162 kW)	2014.11-	-	AT	L	F	All-wheel Drive Closed Off-Road Vehicle	661038	Inner Joint		26	34	31	68.5	88.5	
	2014.11-	-	AT	R	F	All-wheel Drive Closed Off-Road Vehicle	661048	Inner Joint		40	34	46.9	47	80.5	
	2014.11-	-	AT	L	F	All-wheel Drive Closed Off-Road Vehicle	661054	Inner Joint		40	28	46.9	51	53	
	2014.11-	-	AT	-	-	All-wheel Drive Closed Off-Road Vehicle	603016	Inner Joint			28		32		
RS 2.5 quattro (228 kW)	2013.10-	-	AT	R	F	All-wheel Drive Closed Off-Road Vehicle Engine CTSA	661048	Inner Joint		40	34	46.9	47	80.5	
RS 2.5 quattro (250 kW)	2013.05-	-	AT	R	F	All-wheel Drive Closed Off-Road Vehicle Engine CZGA	661048	Inner Joint		40	34	46.9	47	80.5	
Q5															
2.0 TFSI	-	-	-	-	-	4x4 7G DSG Quattro	661093	Propshaft CV Joint				25		27	
Q5 (8RB)															
2.0 TDI (100 kW)	2010.11-	-	-	L/R	F	Closed Off-Road Vehicle Engine CJCB/CSUB	603029	Inner Joint			24		88.5		
	2010.11-	-	MT	L/R	F	Closed Off-Road Vehicle Engine CJCB/CSUB	803086	Outer Joint		42	33	76.5	34	45.5	M
	2010.11-	-	-	L/R	F	Closed Off-Road Vehicle Engine CJCB/CSUB	203316	Drive Shaft		42		76.5	34	490	
	2010.11-	-	MT	-	-	Closed Off-Road Vehicle Engine CJCB/CSUB	603022	Inner Joint			34		88		
2.0 TDI (105 kW)	2010.11-	-	-	L/R	F	Closed Off-Road Vehicle Engine CJCA	603029	Inner Joint			24		88.5		
	2010.11-	-	-	L/R	F	Closed Off-Road Vehicle Engine CJCA	803086	Outer Joint		42	33	76.5	34	45.5	M
	2010.11-	-	-	L/R	F	Closed Off-Road Vehicle Engine CJCA	203316	Drive Shaft		42		76.5	34	490	
	2010.11-	-	MT	-	-	Closed Off-Road Vehicle Engine CJCA	603022	Inner Joint			34		88		
	2010.11-	-	-	-	F	Closed Off-Road Vehicle Engine CJCA	803107	Outer Joint		42	25	76.5	34	47.5	I
2.0 TDI (110 kW)	2013.05-	-	MT	-	-	Closed Off-Road Vehicle Engine CSUA/CJCD	603022	Inner Joint			34		88		
2.0 TDI quattro (100 kW)	2009.08-	-	-	L/R	F	All-wheel Drive Closed Off-Road Vehicle Engine CAGB/CJCB/CSUB	603029	Inner Joint			24		88.5		
	2009.08-	-	MT	L/R	F	All-wheel Drive Closed Off-Road Vehicle Engine CAGB/CJCB/CSUB	803086	Outer Joint		42	33	76.5	34	45.5	M
	2009.08-	-	-	L/R	F	All-wheel Drive Closed Off-Road Vehicle Engine CAGB/CJCB/CSUB	203316	Drive Shaft		42		76.5	34	490	
	2009.08-	-	MT	-	-	All-wheel Drive Closed Off-Road Vehicle Engine CAGB/CJCB/CSUB	603022	Inner Joint			34		88		
2.0 TDI quattro (105 kW)	2009.08-	-	-	L/R	F	All-wheel Drive Closed Off-Road Vehicle Engine CJCA/CAGA	603029	Inner Joint			24		88.5		
	2009.08-	-	-	L/R	F	All-wheel Drive Closed Off-Road Vehicle Engine CJCA/CAGA	803086	Outer Joint		42	33	76.5	34	45.5	M
	2009.08-	-	-	L/R	F	All-wheel Drive Closed Off-Road Vehicle Engine CJCA/CAGA	203316	Drive Shaft		42		76.5	34	490	
	2009.08-	-	MT	-	-	All-wheel Drive Closed Off-Road Vehicle Engine CJCA/CAGA	603022	Inner Joint			34		88		
	2009.08-	-	-	-	F	All-wheel Drive Closed Off-Road Vehicle Engine CJCA/CAGA	803107	Outer Joint		42	25	76.5	34	47.5	I
2.0 TDI quattro (110 kW)	2013.05-	-	CVT	-	F	All-wheel Drive Closed Off-Road Vehicle Engine CSUA/CJCD	803103	Outer Joint		42	28	76.4	34	54	I
	2013.05-	-	MT	-	-	All-wheel Drive Closed Off-Road Vehicle Engine CSUA/CJCD	603022	Inner Joint			34		88		
	2013.05-	-	MT	-	F	All-wheel Drive Closed Off-Road Vehicle Engine CSUA/CJCD	803107	Outer Joint		42	25	76.5	34	47.5	I
2.0 TDI quattro (120 kW)	2008.11-	-	6MT	L/R	F	All-wheel Drive Closed Off-Road Vehicle Engine CAHB/CGLA/CGLD/CNHC	603029	Inner Joint			24		88.5		
	2008.11-	-	MT	L/R	F	All-wheel Drive Closed Off-Road Vehicle Engine CAHB/CGLA/CGLD/CNHC	803086	Outer Joint		42	33	76.5	34	45.5	M
	2008.11-	-	6MT	L/R	F	All-wheel Drive Closed Off-Road Vehicle Engine CAHB/CGLA/CGLD/CNHC	203316	Drive Shaft		42		76.5	34	490	
	2008.11-	-	7AT	L/R	F	All-wheel Drive Closed Off-Road Vehicle Engine CAHB/CGLA/CGLD/CNHC	203317	Drive Shaft		42		76.5	34	490	
	2008.11-	-	7AT	L/R	F	All-wheel Drive Closed Off-Road Vehicle Engine CAHB/CGLA/CGLD/CNHC	803087	Outer Joint		42	27	76.5	34	54.5	M
2.0 TDI quattro (125 kW)	2008.11-	-	6MT	L/R	F	All-wheel Drive Closed Off-Road Vehicle Engine CAHA/CGLB/CMGA	603029	Inner Joint			24		88.5		
	2008.11-	-	-	L/R	F	All-wheel Drive Closed Off-Road Vehicle Engine CAHA/CGLB/CMGA	803086	Outer Joint		42	33	76.5	34	45.5	M
	2008.11-	-	6MT	L/R	F	All-wheel Drive Closed Off-Road Vehicle Engine CAHA/CGLB/CMGA	203316	Drive Shaft		42		76.5	34	490	
	2008.11-	-	7AT	L/R	F	All-wheel Drive Closed Off-Road Vehicle Engine CAHA/CGLB/CMGA	203317	Drive Shaft		42		76.5	34	490	
2.0 TDI quattro (130 kW)	2012.06-	-	AT	-	-	All-wheel Drive Closed Off-Road Vehicle Engine CGLC/CMGB	603022	Inner Joint			34		88		
	2012.06-	-	CVT	-	F	All-wheel Drive Closed Off-Road Vehicle Engine CGLC/CMGB	803103	Outer Joint		42	28	76.4	34	54	I
	2012.06-	-	MT	-	F	All-wheel Drive Closed Off-Road Vehicle Engine CGLC/CMGB	803107	Outer Joint		42	25	76.5	34	47.5	I
2.0 TDI quattro (140 kW)	2013.11-	-	MT	-	F	All-wheel Drive Closed Off-Road Vehicle Engine CNHA	803107	Outer Joint		42	25	76.5	34	47.5	I
	2013.11-	-	CVT	-	F	All-wheel Drive Closed Off-Road Vehicle Engine CNHA	803103	Outer Joint		42	28	76.4	34	54	I
2.0 TFSI hybrid quattro (155 kW)	2011.06-	-	AT	-	-	All-wheel Drive Closed Off-Road Vehicle Engine CHJA	603022	Inner Joint			34		88		
	2011.06-	-	-	L/R	F	All-wheel Drive Closed Off-Road Vehicle Engine CHJA	203317	Drive Shaft		42		76.5	34	490	
	2011.06-	-	-	L/R	F	All-wheel Drive Closed Off-Road Vehicle Engine CHJA	803087	Outer Joint		42	27	76.5	34	54.5	M





YEAR	TRANSM	L/R	F/R	REMARKS	GSP Ref.	PRODUCT	ABS	Technical Specifications							
								A	B	C	H	L	P		
AUDI															
Q5 (8RB)															
2.0 TFSI quattro (132 kW)	2009.08-	-	MT	L/R	F	All-wheel Drive Closed Off-Road Vehicle Engine CDNB/CNCB	603029	Inner Joint			24		88.5		
	2009.08-	-	MT	L/R	F	All-wheel Drive Closed Off-Road Vehicle Engine CDNB/CNCB	803086	Outer Joint	42	33	76.5	34	45.5	M	
	2009.08-	-	MT	L/R	F	All-wheel Drive Closed Off-Road Vehicle Engine CDNB/CNCB	203316	Drive Shaft	42		76.5	34	490		
	2009.08-	-	MT	-	-	All-wheel Drive Closed Off-Road Vehicle Engine CDNB/CNCB	603022	Inner Joint			34		88		
2.0 TFSI quattro (155 kW)	2008.11-	-	AT	-	-	All-wheel Drive Closed Off-Road Vehicle Engine CPMA/CAEB/CDNC	603022	Inner Joint			34		88		
	2008.11-	-	7AT/6MT	L/R	F	All-wheel Drive Closed Off-Road Vehicle Engine CPMA/CAEB/CDNC	603029	Inner Joint			24		88.5		
	2008.11-	-	-	L/R	F	All-wheel Drive Closed Off-Road Vehicle Engine CPMA/CAEB/CDNC	803086	Outer Joint	42	33	76.5	34	45.5	M	
	2008.11-	-	CVT	-	F	All-wheel Drive Closed Off-Road Vehicle Engine CPMA/CAEB/CDNC	803103	Outer Joint	42	28	76.4	34	54	I	
	2008.11-	-	7AT/6MT	L/R	F	All-wheel Drive Closed Off-Road Vehicle Engine CPMA/CAEB/CDNC	203316	Drive Shaft	42		76.5	34	490		
	2008.11-	-	MT	-	F	All-wheel Drive Closed Off-Road Vehicle Engine CPMA/CAEB/CDNC	803107	Outer Joint	42	25	76.5	34	47.5	I	
2.0 TFSI quattro (162 kW)	2013.05-	-	AT	-	-	All-wheel Drive Closed Off-Road Vehicle Engine CPMB	603022	Inner Joint			34		88		
	2013.05-	-	CVT	-	F	All-wheel Drive Closed Off-Road Vehicle Engine CPMB	803103	Outer Joint	42	28	76.4	34	54	I	
	2013.05-	-	MT	-	F	All-wheel Drive Closed Off-Road Vehicle Engine CPMB	803107	Outer Joint	42	25	76.5	34	47.5	I	
2.0 TFSI quattro (165 kW)	2012.06-	-	CVT	-	F	All-wheel Drive Closed Off-Road Vehicle Engine CNCD	803103	Outer Joint	42	28	76.4	34	54	I	
	2012.06-	-	MT	-	F	All-wheel Drive Closed Off-Road Vehicle Engine CNCD	803107	Outer Joint	42	25	76.5	34	47.5	I	
2.0 TFSI quattro (169 kW)	2015.08-	-	MT	-	F	All-wheel Drive Closed Off-Road Vehicle Engine CNCE	803107	Outer Joint	42	25	76.5	34	47.5	I	
	2015.08-	-	CVT	-	F	All-wheel Drive Closed Off-Road Vehicle Engine CNCE	803103	Outer Joint	42	28	76.4	34	54	I	
3.0 TDI quattro (155 kW)	2008.11-	-	AT	-	-	All-wheel Drive Closed Off-Road Vehicle Engine CCWB	603022	Inner Joint			34		88		
	2008.11-	-	-	-	F	All-wheel Drive Closed Off-Road Vehicle Engine CCWB	803103	Outer Joint	42	28	76.4	34	54	I	
	2008.11-	-	6AT	L/R	F	All-wheel Drive Closed Off-Road Vehicle Engine CCWB	203317	Drive Shaft	42		76.5	34	490		
	2008.11-	-	6AT	L/R	F	All-wheel Drive Closed Off-Road Vehicle Engine CCWB	803087	Outer Joint	42	27	76.5	34	54.5	M	
3.0 TDI quattro (176 kW)	2008.11-	-	AT	-	-	All-wheel Drive Closed Off-Road Vehicle Engine CPNB/CCWA	603022	Inner Joint			34		88		
	2008.11-	-	AT	L/R	F	All-wheel Drive Closed Off-Road Vehicle Engine CPNB/CCWA	203317	Drive Shaft	42		76.5	34	490		
	2008.11-	-	AT	L/R	F	All-wheel Drive Closed Off-Road Vehicle Engine CPNB/CCWA	803087	Outer Joint	42	27	76.5	34	54.5	M	
3.0 TDI quattro (180 kW)	2012.06-	-	AT	-	-	All-wheel Drive Closed Off-Road Vehicle Engine CDUD	603022	Inner Joint			34		88		
	2012.06-	-	-	-	F	All-wheel Drive Closed Off-Road Vehicle Engine CDUD	803103	Outer Joint	42	28	76.4	34	54	I	
3.0 TDI quattro (184 kW)	2012.06-	-	AT	-	-	All-wheel Drive Closed Off-Road Vehicle Engine CTBC	603022	Inner Joint			34		88		
	2012.06-	-	AT	-	F	All-wheel Drive Closed Off-Road Vehicle Engine CTBC	803103	Outer Joint	42	28	76.4	34	54	I	
3.0 TDI quattro (190 kW)	2013.11-	-	AT	-	-	All-wheel Drive Closed Off-Road Vehicle Engine CTBA	603022	Inner Joint			34		88		
	2013.11-	-	-	-	F	All-wheel Drive Closed Off-Road Vehicle Engine CTBA	803103	Outer Joint	42	28	76.4	34	54	I	
3.0 TFSI quattro (200 kW)	2012.06-	-	AT	-	-	All-wheel Drive Closed Off-Road Vehicle Engine CTUC/CTVA	603022	Inner Joint			34		88		
	2012.06-	-	-	-	F	All-wheel Drive Closed Off-Road Vehicle Engine CTUC/CTVA	803103	Outer Joint	42	28	76.4	34	54	I	
3.2 FSI quattro (199 kW)	2008.11-	-	AT	-	-	All-wheel Drive Closed Off-Road Vehicle Engine CALB	603022	Inner Joint			34		88		
	2008.11-	-	6AT	L/R	F	All-wheel Drive Closed Off-Road Vehicle Engine CALB	203317	Drive Shaft	42		76.5	34	490		
	2008.11-	-	6AT	L/R	F	All-wheel Drive Closed Off-Road Vehicle Engine CALB	803087	Outer Joint	42	27	76.5	34	54.5	M	
SQ5 TDI quattro (230 kW)	2012.12-	-	AT	-	-	All-wheel Drive Closed Off-Road Vehicle Engine CQGB/CVUC	603022	Inner Joint			34		88		
	2012.12-	-	-	-	F	All-wheel Drive Closed Off-Road Vehicle Engine CQGB/CVUC	803103	Outer Joint	42	28	76.4	34	54	I	
SQ5 TDI quattro (240 kW)	2015.04-	-	-	-	F	All-wheel Drive Closed Off-Road Vehicle Engine CVUB	803103	Outer Joint	42	28	76.4	34	54	I	
SQ5 TDI quattro (250 kW)	2015.11-	-	-	-	F	All-wheel Drive Closed Off-Road Vehicle Engine DEHA	803103	Outer Joint	42	28	76.4	34	54	I	
SQ5 TFSI quattro (260 kW)	2013.05-	-	AT	-	-	All-wheel Drive Closed Off-Road Vehicle Engine CTUD/CTXA	603022	Inner Joint			34		88		
	2013.05-	-	-	-	F	All-wheel Drive Closed Off-Road Vehicle Engine CTUD/CTXA	803103	Outer Joint	42	28	76.4	34	54	I	
Q5(8R)															
2.0 TDI Quattro (100 kW)	2009.08-	-	-	-	-	Transmission Type: DSG; Type: 7G DSG	661093	Propshaft CV Joint			25		27		
2.0 TDI Quattro (105 kW)	2009.08-	-	-	-	-	Transmission Type: DSG; Type: 7G DSG	661093	Propshaft CV Joint			25		27		
2.0 TDI Quattro (120 kW)	2008.11-	-	-	-	-	Transmission Type: DSG; Type: 7G DSG	661093	Propshaft CV Joint			25		27		
2.0 TDI Quattro (125 kW)	2008.11-	-	-	-	-	Transmission Type: DSG; Type: 7G DSG	661093	Propshaft CV Joint			25		27		
2.0 TFSI Quattro (132 kW)	2009.08-	-	-	-	-	Transmission Type: DSG; Type: 7G DSG	661093	Propshaft CV Joint			25		27		
2.0 TFSI Quattro (155 kW)	2008.11-	-	-	-	-	Transmission Type: DSG; Type: 7G DSG	661093	Propshaft CV Joint			25		27		
3.0 TDI Quattro (120 kW)	-	-	-	-	-	Transmission Type: DSG; Type: 7G DSG	661093	Propshaft CV Joint			25		27		
3.0 TDI Quattro (155 kW)	2008.11-	-	-	-	-	Transmission Type: DSG; Type: 7G DSG	661093	Propshaft CV Joint			25		27		
3.2 FSI Quattro (199 kW)	2008.11-	-	-	-	-	Transmission Type: DSG; Type: 7G DSG	661093	Propshaft CV Joint			25		27		
Q7															
3.0L V6	2011-	2015	-	-	R	-	205106	Drive Shaft	30	37	64	103.5	877		
Q7 (4LB)															
3.0 TDI quattro (150 kW)	2010.05-	2015.08	-	L/R	F	All-wheel Drive Closed Off-Road Vehicle Engine C/JMA/CJGC	235085	Drive Shaft	30		64.4	103.5	525		
	2010.05-	2015.08	AT	-	F	All-wheel Drive Closed Off-Road Vehicle Engine C/JMA/CJGC	835045	Outer Joint	30	28	64.4	103.5	62.5	I	
	2010.05-	2015.08	-	L/R	F	All-wheel Drive Closed Off-Road Vehicle Engine C/JMA/CJGC	699148	Inner Joint			28		34		
	2010.05-	2015.08	-	-	F	All-wheel Drive Closed Off-Road Vehicle Engine C/JMA/CJGC	803117	Outer Joint	30	28	64.4	103.5	62.5	I	
3.0 TDI quattro (155 kW)	2006.03-	2010.05	-	L/R	R	All-wheel Drive Closed Off-Road Vehicle Engine BUN/CASB	205098	Drive Shaft	30		64	103	740		
	2006.03-	2010.05	-	L/R	F	All-wheel Drive Closed Off-Road Vehicle Engine BUN/CASB	235085	Drive Shaft	30		64.4	103.5	525		
	2006.03-	2010.05	-	-	F	All-wheel Drive Closed Off-Road Vehicle Engine BUN/CASB	235043	Drive Shaft	30		64	103.5	535		
	2006.03-	2010.05	-	L/R	F	All-wheel Drive Closed Off-Road Vehicle Engine BUN/CASB	299213	Drive Shaft	30		64	103.5	523		
	2006.03-	2010.05	-	L/R	F	All-wheel Drive Closed Off-Road Vehicle Engine BUN/CASB	699148	Inner Joint			28		34		
	2006.03-	2010.05	-	L/R	F	All-wheel Drive Closed Off-Road Vehicle Engine BUN/CASB	861050	Outer Joint	30	27	64	103.5	63.5	M	
	2006.03-	2010.05	-	L/R	R	All-wheel Drive Closed Off-Road Vehicle Engine BUN/CASB	603027	Inner Joint			28		28		
3.0 TDI quattro (165 kW)	2009.06-	2012.05	6AT	L/R	R	All-wheel Drive Closed Off-Road Vehicle Engine CATA	205098	Drive Shaft	30		64	103	740		

	 YEAR	TRANSM	L/R	F/R	REMARKS	GSP Ref.	 PRODUCT	 ABS	Technical Specifications					
									A	B	C	H	L	P
AUDI														
Q7 (4LB)														
3.0 TDI quattro (165 kW)	2009.06-2012.05	-	L/R	F	All-wheel Drive Closed Off-Road Vehicle Engine CATA	235085	Drive Shaft		30		64.4	103.5	525	
	2009.06-2012.05	AT	-	F	All-wheel Drive Closed Off-Road Vehicle Engine CATA	835045	Outer Joint		30	28	64.4	103.5	62.5	I
	2009.06-2012.05	-	L/R	F	All-wheel Drive Closed Off-Road Vehicle Engine CATA	699148	Inner Joint			28		34		
	2009.06-2012.05	6AT	L/R	R	All-wheel Drive Closed Off-Road Vehicle Engine CATA	603027	Inner Joint			28		28		
	2009.06-2012.05	-	-	F	All-wheel Drive Closed Off-Road Vehicle Engine CATA	803117	Outer Joint		30	28	64.4	103.5	62.5	I
3.0 TDI quattro (171 kW)	2006.03-2008.05	-	L/R	R	All-wheel Drive Closed Off-Road Vehicle Engine BUG	205098	Drive Shaft		30		64	103	740	
	2006.03-2008.05	-	-	F	All-wheel Drive Closed Off-Road Vehicle Engine BUG	235043	Drive Shaft		30		64	103.5	535	
	2006.03-2008.05	-	L/R	F	All-wheel Drive Closed Off-Road Vehicle Engine BUG	299213	Drive Shaft		30		64	103.5	523	
	2006.03-2008.05	-	L/R	F	All-wheel Drive Closed Off-Road Vehicle Engine BUG	699148	Inner Joint			28		34		
	2006.03-2008.05	-	L/R	F	All-wheel Drive Closed Off-Road Vehicle Engine BUG	861050	Outer Joint		30	27	64	103.5	63.5	M
3.0 TDI quattro (176 kW)	2007.11-2015.08	6AT	L/R	R	All-wheel Drive Closed Off-Road Vehicle Engine CJGA/CNRB/CASA/CCMA	205098	Drive Shaft		30		64	103	740	
	2007.11-2015.08	-	L/R	F	All-wheel Drive Closed Off-Road Vehicle Engine CJGA/CNRB/CASA/CCMA	235085	Drive Shaft		30		64.4	103.5	525	
	2007.11-2015.08	-	-	F	All-wheel Drive Closed Off-Road Vehicle Engine CJGA/CNRB/CASA/CCMA	235043	Drive Shaft		30		64	103.5	535	
	2007.11-2015.08	AT	-	F	All-wheel Drive Closed Off-Road Vehicle Engine CJGA/CNRB/CASA/CCMA	835045	Outer Joint		30	28	64.4	103.5	62.5	I
	2007.11-2015.08	-	L/R	F	All-wheel Drive Closed Off-Road Vehicle Engine CJGA/CNRB/CASA/CCMA	299213	Drive Shaft		30		64	103.5	523	
	2007.11-2015.08	-	L/R	F	All-wheel Drive Closed Off-Road Vehicle Engine CJGA/CNRB/CASA/CCMA	699148	Inner Joint			28		34		
	2007.11-2015.08	-	L/R	F	All-wheel Drive Closed Off-Road Vehicle Engine CJGA/CNRB/CASA/CCMA	861050	Outer Joint		30	27	64	103.5	63.5	M
	2007.11-2015.08	6AT	L/R	R	All-wheel Drive Closed Off-Road Vehicle Engine CJGA/CNRB/CASA/CCMA	603027	Inner Joint			28		28		
3.0 TDI quattro (180 kW)	2011.05-2015.08	-	L/R	F	All-wheel Drive Closed Off-Road Vehicle Engine CRCA/CJGD/CLZB	235085	Drive Shaft		30		64.4	103.5	525	
	2011.05-2015.08	AT	-	F	All-wheel Drive Closed Off-Road Vehicle Engine CRCA/CJGD/CLZB	835045	Outer Joint		30	28	64.4	103.5	62.5	I
	2011.05-2015.08	-	L/R	F	All-wheel Drive Closed Off-Road Vehicle Engine CRCA/CJGD/CLZB	699148	Inner Joint			28		34		
	2011.05-2015.08	-	-	F	All-wheel Drive Closed Off-Road Vehicle Engine CRCA/CJGD/CLZB	803117	Outer Joint		30	28	64.4	103.5	62.5	I
3.0 TFSI quattro (200 kW)	2010.05-2015.08	-	L/R	F	All-wheel Drive Closed Off-Road Vehicle Engine CJTC/CJWC	235085	Drive Shaft		30		64.4	103.5	525	
	2010.05-2015.08	AT	-	F	All-wheel Drive Closed Off-Road Vehicle Engine CJTC/CJWC	835045	Outer Joint		30	28	64.4	103.5	62.5	I
	2010.05-2015.08	-	L/R	F	All-wheel Drive Closed Off-Road Vehicle Engine CJTC/CJWC	699148	Inner Joint			28		34		
3.0 TFSI quattro (206 kW)	2010.05-2015.08	-	-	F	All-wheel Drive Closed Off-Road Vehicle Engine CJTC/CJWC	803117	Outer Joint		30	28	64.4	103.5	62.5	I
	2011.05-2015.08	-	L/R	F	All-wheel Drive Closed Off-Road Vehicle Engine CTWB/CJWE	235085	Drive Shaft		30		64.4	103.5	525	
	2011.05-2015.08	AT	-	F	All-wheel Drive Closed Off-Road Vehicle Engine CTWB/CJWE	835045	Outer Joint		30	28	64.4	103.5	62.5	I
	2011.05-2015.08	-	L/R	F	All-wheel Drive Closed Off-Road Vehicle Engine CTWB/CJWE	699148	Inner Joint			28		34		
3.0 TFSI quattro (245 kW)	2010.05-2015.08	-	L/R	F	All-wheel Drive Closed Off-Road Vehicle Engine CTWA/CNAA/CJWB/CJTB	235085	Drive Shaft		30		64.4	103.5	525	
	2010.05-2015.08	AT	-	F	All-wheel Drive Closed Off-Road Vehicle Engine CTWA/CNAA/CJWB/CJTB	835045	Outer Joint		30	28	64.4	103.5	62.5	I
	2010.05-2015.08	-	L/R	F	All-wheel Drive Closed Off-Road Vehicle Engine CTWA/CNAA/CJWB/CJTB	699148	Inner Joint			28		34		
	2010.05-2015.08	-	-	F	All-wheel Drive Closed Off-Road Vehicle Engine CTWA/CNAA/CJWB/CJTB	803117	Outer Joint		30	28	64.4	103.5	62.5	I
3.6 FSI quattro (206 kW)	2006.08-2010.05	-	L/R	R	All-wheel Drive Closed Off-Road Vehicle Engine BHK	205098	Drive Shaft		30		64	103	740	
	2006.08-2010.05	-	L/R	F	All-wheel Drive Closed Off-Road Vehicle Engine BHK	235085	Drive Shaft		30		64.4	103.5	525	
	2006.08-2010.05	-	-	F	All-wheel Drive Closed Off-Road Vehicle Engine BHK	235043	Drive Shaft		30		64	103.5	535	
	2006.08-2010.05	-	L/R	F	All-wheel Drive Closed Off-Road Vehicle Engine BHK	299213	Drive Shaft		30		64	103.5	523	
	2006.08-2010.05	-	L/R	F	All-wheel Drive Closed Off-Road Vehicle Engine BHK	699148	Inner Joint			28		34		
	2006.08-2010.05	-	L/R	F	All-wheel Drive Closed Off-Road Vehicle Engine BHK	861050	Outer Joint		30	27	64	103.5	63.5	M
	2006.08-2010.05	-	L/R	R	All-wheel Drive Closed Off-Road Vehicle Engine BHK	603027	Inner Joint			28		28		
4.2 FSI quattro (257 kW)	2006.03-2010.05	-	L/R	R	All-wheel Drive Closed Off-Road Vehicle Engine BAR	205098	Drive Shaft		30		64	103	740	
	2006.03-2010.05	-	L/R	F	All-wheel Drive Closed Off-Road Vehicle Engine BAR	235085	Drive Shaft		30		64.4	103.5	525	
	2006.03-2010.05	-	-	F	All-wheel Drive Closed Off-Road Vehicle Engine BAR	235043	Drive Shaft		30		64	103.5	535	
	2006.03-2010.05	-	L/R	F	All-wheel Drive Closed Off-Road Vehicle Engine BAR	299213	Drive Shaft		30		64	103.5	523	
	2006.03-2010.05	-	L/R	F	All-wheel Drive Closed Off-Road Vehicle Engine BAR	699148	Inner Joint			28		34		
	2006.03-2010.05	-	L/R	F	All-wheel Drive Closed Off-Road Vehicle Engine BAR	861050	Outer Joint		30	27	64	103.5	63.5	M
	2006.03-2010.05	-	L/R	R	All-wheel Drive Closed Off-Road Vehicle Engine BAR	603027	Inner Joint			28		28		
4.2 TDI quattro (240 kW)	2007.03-2009.06	-	L/R	R	All-wheel Drive Closed Off-Road Vehicle Engine BTR	635051	Inner Joint			30		30.5		
	2007.03-2009.06	-	L/R	R	All-wheel Drive Closed Off-Road Vehicle Engine BTR	235086	Drive Shaft		30		64.3	103.5	724	
	2007.03-2009.06	-	L/R	F	All-wheel Drive Closed Off-Road Vehicle Engine BTR	803085	Outer Joint		30	29	64	103	72.5	M
	2007.03-2009.06	-	L/R	F	All-wheel Drive Closed Off-Road Vehicle Engine BTR	201127	Drive Shaft		30		64	103	522	
4.2 TDI quattro (250 kW)	2009.05-2015.08	6AT	L/R	R	All-wheel Drive Closed Off-Road Vehicle Engine CCF A/CCFC	635051	Inner Joint			30		30.5		
	2009.05-2015.08	6AT	L/R	R	All-wheel Drive Closed Off-Road Vehicle Engine CCF A/CCFC	235086	Drive Shaft		30		64.3	103.5	724	
	2009.05-2015.08	-	L/R	F	All-wheel Drive Closed Off-Road Vehicle Engine CCF A/CCFC	803085	Outer Joint		30	29	64	103	72.5	M
	2009.05-2015.08	-	L/R	F	All-wheel Drive Closed Off-Road Vehicle Engine CCF A/CCFC	699148	Inner Joint			28		34		
	2009.05-2015.08	-	L/R	F	All-wheel Drive Closed Off-Road Vehicle Engine CCF A/CCFC	235085	Drive Shaft		30		64.4	103.5	525	
	2009.05-2015.08	AT	-	F	All-wheel Drive Closed Off-Road Vehicle Engine CCF A/CCFC	835045	Outer Joint		30	28	64.4	103.5	62.5	I
	2009.05-2015.08	-	L/R	F	All-wheel Drive Closed Off-Road Vehicle Engine CCF A/CCFC	201127	Drive Shaft		30		64	103	522	
	2009.05-2015.08	-	-	F	All-wheel Drive Closed Off-Road Vehicle Engine CCF A/CCFC	803117	Outer Joint		30	28	64.4	103.5	62.5	I
6.0 TDI quattro (368 kW)	2008.09-2014.05	-	L/R	R	All-wheel Drive Closed Off-Road Vehicle Engine CCGA	635051	Inner Joint			30		30.5		
	2008.09-2014.05	-	L/R	R	All-wheel Drive Closed Off-Road Vehicle Engine CCGA	235086	Drive Shaft		30		64.3	103.5	724	
	2008.09-2014.05	-	L/R	F	All-wheel Drive Closed Off-Road Vehicle Engine CCGA	803085	Outer Joint		30	29	64	103	72.5	M
	2008.09-2014.05	AT	-	F	All-wheel Drive Closed Off-Road Vehicle Engine CCGA	835045	Outer Joint		30	28	64.4	103.5	62.5	I





	 YEAR	TRANSM	L/R	F/R	REMARKS	GSP Ref.	 PRODUCT	 ABS	Technical Specifications					
									A	B	C	H	L	P
AUDI														
Q7 (4LB)														
6.0 TDI quattro (368 kW)	2008.09-2014.05	-	L/R	F	All-wheel Drive Closed Off-Road Vehicle Engine CCGA	201127	Drive Shaft		30		64	103	522	
	2008.09-2014.05	-	-	F	All-wheel Drive Closed Off-Road Vehicle Engine CCGA	803117	Outer Joint		30	28	64.4	103.5	62.5	I
QUATTRO (85)														
2.2 20V Turbo (162 kW)	1989.08-1991.07	MT	L/R	F/R	All-wheel Drive Coupe Engine RR	603001	Inner Joint			28		32		
2.2 Turbo (147 kW)	1987.08-1989.07	MT	L/R	F/R	All-wheel Drive Coupe Engine MB	603001	Inner Joint			28		32		
S3														
-	2001-2004	-	-	-	-	201587	Drive Shaft		36		53	78.5	522	
TT (8J3)														
1.8 TFSI (118 kW)	2008.06-2014.06	-	L/R	F	Coupe Engine CDAA	803002	Outer Joint		36	27	59.5	40	66	I
2.0 TDI quattro (125 kW)	2008.06-2014.06	MT	L	F	All-wheel Drive Coupe Engine CBBB/CFGB	203350	Drive Shaft		36		59.5	40	495	
	2008.06-2014.06	-	L/R	F	All-wheel Drive Coupe Engine CBBB/CFGB	803002	Outer Joint		36	27	59.5	40	66	I
	2008.06-2014.06	MT	R	F	All-wheel Drive Coupe Engine CBBB/CFGB	203322	Drive Shaft		36		59.5	40	613	
	2008.06-2014.06	-	L/R	R	All-wheel Drive Coupe Engine CBBB/CFGB	603011	Inner Joint			33		34		
	2008.06-2014.06	AT	L	F	All-wheel Drive Coupe Engine CBBB/CFGB	254013	Drive Shaft		36		59.5	40	479.5	
	2008.06-2014.06	AT	L	F	All-wheel Drive Coupe Engine CBBB/CFGB	654004	Inner Joint			34		85		
2.0 TFSI (147 kW)	2006.08-2010.06	-	L	F	Coupe Engine BWA/BPY/CCTA	203350	Drive Shaft		36		59.5	40	495	
	2006.08-2010.06	MT	L/R	F	Coupe Engine BWA/BPY/CCTA	803002	Outer Joint		36	27	59.5	40	66	I
2.0 TFSI quattro (147 kW)	2008.06-2010.06	AT	L	F	All-wheel Drive Coupe Engine CCZA/BWA	203350	Drive Shaft		36		59.5	40	495	
	2008.06-2010.06	-	L/R	F	All-wheel Drive Coupe Engine CCZA/BWA	803002	Outer Joint		36	27	59.5	40	66	I
	2008.06-2010.06	AT	R	F	All-wheel Drive Coupe Engine CCZA/BWA	203322	Drive Shaft		36		59.5	40	613	
	2008.06-2010.06	-	L/R	R	All-wheel Drive Coupe Engine CCZA/BWA	603011	Inner Joint			33		34		
2.0 TTS quattro (195 kW)	2008.05-2014.06	AT	L	F	All-wheel Drive Coupe Engine CDMA/CDLA	203303	Drive Shaft		36		59.5	40	495	
	2008.05-2014.06	-	L/R	R	All-wheel Drive Coupe Engine CDMA/CDLA	603011	Inner Joint			33		34		
2.0 TTS quattro (200 kW)	2008.05-2014.06	AT/MT	L	F	All-wheel Drive Coupe Engine CDLB	203303	Drive Shaft		36		59.5	40	495	
	2008.05-2014.06	-	L/R	R	All-wheel Drive Coupe Engine CDLB	603011	Inner Joint			33		34		
2.5 RS quattro (250 kW)	2009.07-2014.06	-	-	-	All-wheel Drive Coupe Engine CEPA	603006	Inner Joint			33		34		
	2009.07-2014.06	-	L/R	R	All-wheel Drive Coupe Engine CEPA	603011	Inner Joint			33		34		
	2009.07-2014.06	AT	R	F	All-wheel Drive Coupe Engine CEPA	261347	Drive Shaft		36	40	59.5	40	593	
	2009.07-2014.06	MT	L/R	F	All-wheel Drive Coupe Engine CEPA	261214	Stub Axle		40	37	60		125	
	2009.07-2014.06	AT	R	F	All-wheel Drive Coupe Engine CEPA	603025	Inner Joint		40	34	46.9	47	80.5	
	2009.07-2014.06	AT	L	F	All-wheel Drive Coupe Engine CEPA	201265	Drive Shaft		36	37	59.5	40	557	
2.5 RS quattro (265 kW)	2011.05-2014.06	-	-	-	All-wheel Drive Coupe Engine CEPB	603006	Inner Joint			33		34		
	2011.05-2014.06	-	L/R	R	All-wheel Drive Coupe Engine CEPB	603011	Inner Joint			33		34		
	2011.05-2014.06	AT	R	F	All-wheel Drive Coupe Engine CEPB	261347	Drive Shaft		36	40	59.5	40	593	
	2011.05-2014.06	MT	L/R	F	All-wheel Drive Coupe Engine CEPB	261214	Stub Axle		40	37	60		125	
	2011.05-2014.06	AT	R	F	All-wheel Drive Coupe Engine CEPB	603025	Inner Joint		40	34	46.9	47	80.5	
	2011.05-2014.06	AT	L	F	All-wheel Drive Coupe Engine CEPB	201265	Drive Shaft		36	37	59.5	40	557	
3.2 V6 quattro (184 kW)	2006.08-2010.06	MT	L	F	All-wheel Drive Coupe Engine BUB	203350	Drive Shaft		36		59.5	40	495	
	2006.08-2010.06	-	L/R	F	All-wheel Drive Coupe Engine BUB	803002	Outer Joint		36	27	59.5	40	66	I
	2006.08-2010.06	-	L/R	R	All-wheel Drive Coupe Engine BUB	603011	Inner Joint			33		34		
	2006.08-2010.06	AT	L	F	All-wheel Drive Coupe Engine BUB	654004	Inner Joint			34		85		
	2006.08-2010.06	AT	L	F	All-wheel Drive Coupe Engine BUB	203241	Drive Shaft		36		59.5	40	475	
	2006.08-2010.06	-	L/R	R	All-wheel Drive Coupe Engine BUB	803037	Outer Joint		36	30	59.5	40.5	55	I
45 TFSI (155 kW)	2010.05-2014.06	-	L/R	R	All-wheel Drive Coupe Engine CETA/CESA	603011	Inner Joint			33		34		
	2010.05-2014.06	AT/MT	L	F	Coupe Engine CESA	203303	Drive Shaft		36		59.5	40	495	
	2010.05-2014.06	-	-	-	Coupe Engine CESA	603016	Inner Joint			28		32		
	2010.05-2014.06	-	-	-	All-wheel Drive Coupe Engine CETA/CESA	603016	Inner Joint			28		32		
TT (8N3)														
1.8 T (110 kW)	2002.09-2006.06	-	L/R	F	Coupe Engine AUM	803036	Outer Joint		36	30	53.2	77.5	61	I
	2002.09-2006.06	5AT	L	F	Coupe Engine AUM	261020	Drive Shaft		36		53.2	77.5	547	
	2002.09-2006.06	-	L	F	Coupe Engine AUM	261156	Drive Shaft		36		53	78	554.5	
	2002.09-2006.06	-	L	F	Coupe Engine AUM	661062	Inner Joint			30		59		
	2002.09-2006.06	-	L/R	F	Coupe Engine AUM	661006	Inner Joint			30		57.6		
	2002.09-2006.06	MT	-	-	Coupe Engine AUM	603006	Inner Joint			33		34		
	2002.09-2006.06	MT	-	-	Coupe Engine AUM	603006	Inner Joint			33		34		
1.8 T (120 kW)	2005.09-2006.06	-	L/R	F	Coupe Engine BVP	803036	Outer Joint		36	30	53.2	77.5	61	I
	2005.09-2006.06	5AT	L	F	Coupe Engine BVP	261020	Drive Shaft		36		53.2	77.5	547	
	2005.09-2006.06	-	L	F	Coupe Engine BVP	261156	Drive Shaft		36		53	78	554.5	
	2005.09-2006.06	-	L	F	Coupe Engine BVP	661062	Inner Joint			30		59		
	2005.09-2006.06	-	L/R	F	Coupe Engine BVP	661006	Inner Joint			30		57.6		
	2005.09-2006.06	-	L/R	F	Coupe Engine BVP	661006	Inner Joint			30		57.6		
1.8 T (132 kW)	1998.10-2006.06	-	-	-	Coupe Engine AJQ/APP/AUQ/ATC	603016	Inner Joint			28		32		
	1998.10-2006.06	5AT	L	F	Coupe Engine AJQ/APP/AUQ/ATC	261020	Drive Shaft		36		53.2	77.5	547	
	1998.10-2006.06	MT	L/R	F	Coupe Engine AJQ/APP/AUQ/ATC	661006	Inner Joint			30		57.6		
	1998.10-2006.06	MT	L	F	Coupe Engine AJQ/APP/AUQ/ATC	261156	Drive Shaft		36		53	78	554.5	
	1998.10-2006.06	MT	L	F	Coupe Engine AJQ/APP/AUQ/ATC	661062	Inner Joint			30		59		
	1998.10-2006.06	MT	L/R	F	Coupe Engine AJQ/APP/AUQ/ATC	803036	Outer Joint		36	30	53.2	77.5	61	I





YEAR	TRANSM	L/R	F/R	REMARKS	GSP Ref.	PRODUCT	ABS	Technical Specifications						
								A	B	C	H	L	P	
AUDI														
TT (8N3)														
1.8 T (140 kW)	2005.09-2006.06	MT	L/R	F	Coupe Engine BVR	803036	Outer Joint	36	30	53.2	77.5	61	I	
	2005.09-2006.06	5AT	L	F	Coupe Engine BVR	261020	Drive Shaft	36		53.2	77.5	547		
	2005.09-2006.06	MT	L/R	F	Coupe Engine BVR	661006	Inner Joint		30		57.6			
	2005.09-2006.06	MT	L	F	Coupe Engine BVR	261156	Drive Shaft	36		53	78	554.5		
	2005.09-2006.06	MT	L	F	Coupe Engine BVR	661062	Inner Joint		30		59			
1.8 T quattro (132 kW)	1998.10-2006.06	MT	L/R	F	All-wheel Drive Coupe Engine AJQ/ARY/AUQ	803035	Outer Joint	36	27	53	77.5	65	I	
	1998.10-2006.06	MT	L	F	All-wheel Drive Coupe Engine AJQ/ARY/AUQ	261123	Drive Shaft	36		53	77.5	520		
	1998.10-2006.06	-	L/R	R	All-wheel Drive Coupe Engine AJQ/ARY/AUQ	603011	Inner Joint		33		34			
	1998.10-2006.06	-	-	-	All-wheel Drive Coupe Engine AJQ/ARY/AUQ	603016	Inner Joint		28		32			
	1998.10-2006.06	MT	R	F	All-wheel Drive Coupe Engine AJQ/ARY/AUQ	261186	Drive Shaft	36		53	77.5	653		
	1998.10-2006.06	MT	L	F	All-wheel Drive Coupe Engine AJQ/ARY/AUQ	203304	Drive Shaft	36		59.5	40	481		
	1998.10-2006.06	MT	L/R	F	All-wheel Drive Coupe Engine AJQ/ARY/AUQ	861021	Outer Joint	36	27	53	40	65	I	
	1998.10-2006.06	-	L/R	R	All-wheel Drive Coupe Engine AJQ/ARY/AUQ	803033	Outer Joint	36	30	53	78.5	51	I	
1.8 T quattro (140 kW)	2005.09-2006.06	-	L/R	R	All-wheel Drive Coupe Engine BVR	603011	Inner Joint		33		34			
	2005.09-2006.06	MT	L	F	All-wheel Drive Coupe Engine BVR	203304	Drive Shaft	36		59.5	40	481		
	2005.09-2006.06	MT	L/R	F	All-wheel Drive Coupe Engine BVR	861021	Outer Joint	36	27	53	40	65	I	
	2005.09-2006.06	-	L/R	R	All-wheel Drive Coupe Engine BVR	803033	Outer Joint	36	30	53	78.5	51	I	
1.8 T quattro (165 kW)	1998.10-2006.06	MT	L/R	F	All-wheel Drive Coupe Engine BAM/APX	803035	Outer Joint	36	27	53	77.5	65	I	
	1998.10-2006.06	MT	L	F	All-wheel Drive Coupe Engine BAM/APX	261123	Drive Shaft	36		53	77.5	520		
	1998.10-2006.06	-	L/R	R	All-wheel Drive Coupe Engine BAM/APX	603011	Inner Joint		33		34			
	1998.10-2006.06	-	-	-	All-wheel Drive Coupe Engine BAM/APX	603016	Inner Joint		28		32			
	1998.10-2006.06	MT	R	F	All-wheel Drive Coupe Engine BAM/APX	261186	Drive Shaft	36		53	77.5	653		
	1998.10-2006.06	MT	L	F	All-wheel Drive Coupe Engine BAM/APX	203304	Drive Shaft	36		59.5	40	481		
	1998.10-2006.06	MT	L/R	F	All-wheel Drive Coupe Engine BAM/APX	861021	Outer Joint	36	27	53	40	65	I	
	1998.10-2006.06	-	L/R	R	All-wheel Drive Coupe Engine BAM/APX	803033	Outer Joint	36	30	53	78.5	51	I	
1.8 T quattro (176 kW)	2005.03-2006.06	-	L/R	R	All-wheel Drive Coupe Engine BFV	603011	Inner Joint		33		34			
	2005.03-2006.06	MT	L	F	All-wheel Drive Coupe Engine BFV	203304	Drive Shaft	36		59.5	40	481		
	2005.03-2006.06	MT	L/R	F	All-wheel Drive Coupe Engine BFV	861021	Outer Joint	36	27	53	40	65	I	
	2005.03-2006.06	-	L/R	R	All-wheel Drive Coupe Engine BFV	803033	Outer Joint	36	30	53	78.5	51	I	
3.2 VR6 quattro (184 kW)	2003.07-2006.06	MT	L	F	All-wheel Drive Coupe Engine BPF/BHE	203350	Drive Shaft	36		59.5	40	495		
	2003.07-2006.06	-	L/R	R	All-wheel Drive Coupe Engine BPF/BHE	603011	Inner Joint		33		34			
	2003.07-2006.06	AT	L	F	All-wheel Drive Coupe Engine BPF/BHE	654004	Inner Joint		34		85			
	2003.07-2006.06	AT	L	F	All-wheel Drive Coupe Engine BPF/BHE	203241	Drive Shaft	36		59.5	40	475		
	2003.07-2006.06	AT	L/R	F	All-wheel Drive Coupe Engine BPF/BHE	861021	Outer Joint	36	27	53	40	65	I	
	2003.07-2006.06	-	L/R	R	All-wheel Drive Coupe Engine BPF/BHE	803033	Outer Joint	36	30	53	78.5	51	I	
TT (FV3)														
1.8 TFSI (132 kW)	2015.08-	-	-	L/R	F	Coupe Engine CJSA/CJSB	803002	Outer Joint	36	27	59.5	40	66	I
TT Roadster (8J9)														
1.8 TFSI (118 kW)	2008.06-2014.06	-	L/R	F	Convertible Engine CDAA	803002	Outer Joint	36	27	59.5	40	66	I	
2.0 TDI quattro (125 kW)	2008.06-2014.06	MT	L	F	All-wheel Drive Convertible Engine CBBB/CFGB	203350	Drive Shaft	36		59.5	40	495		
	2008.06-2014.06	-	L/R	F	All-wheel Drive Convertible Engine CBBB/CFGB	803002	Outer Joint	36	27	59.5	40	66	I	
	2008.06-2014.06	MT	R	F	All-wheel Drive Convertible Engine CBBB/CFGB	203322	Drive Shaft	36		59.5	40	613		
	2008.06-2014.06	-	L/R	R	All-wheel Drive Convertible Engine CBBB/CFGB	603011	Inner Joint		33		34			
	2008.06-2014.06	AT	L	F	All-wheel Drive Convertible Engine CBBB/CFGB	254013	Drive Shaft	36		59.5	40	479.5		
	2008.06-2014.06	AT	L	F	All-wheel Drive Convertible Engine CBBB/CFGB	654004	Inner Joint		34		85			
2.0 TFSI (147 kW)	2007.03-2010.06	AT/MT	L	F	Convertible Engine BPY/BWA/CCTA	203350	Drive Shaft	36		59.5	40	495		
	2007.03-2010.06	MT	L/R	F	Convertible Engine BPY/BWA/CCTA	803002	Outer Joint	36	27	59.5	40	66	I	
2.0 TFSI (155 kW)	2010.05-2014.06	AT/MT	L	F	Convertible Engine CESA	203303	Drive Shaft	36		59.5	40	495		
	2010.05-2014.06	-	-	-	Convertible Engine CESA	603016	Inner Joint		28		32			
2.0 TFSI quattro (147 kW)	2008.06-2010.06	AT	L	F	All-wheel Drive Convertible Engine CCZA	203350	Drive Shaft	36		59.5	40	495		
	2008.06-2010.06	-	L/R	F	All-wheel Drive Convertible Engine CCZA	803002	Outer Joint	36	27	59.5	40	66	I	
	2008.06-2010.06	AT	R	F	All-wheel Drive Convertible Engine CCZA	203322	Drive Shaft	36		59.5	40	613		
	2008.06-2010.06	-	L/R	R	All-wheel Drive Convertible Engine CCZA	603011	Inner Joint		33		34			
	2008.06-2010.06	AT	-	-	All-wheel Drive Convertible Engine CCZA	603016	Inner Joint		28		32			
	2008.06-2010.06	AT	-	-	All-wheel Drive Convertible Engine CCZA	603006	Inner Joint		33		34			
2.0 TFSI quattro (155 kW)	2010.05-2014.06	-	L/R	R	All-wheel Drive Convertible Engine CESA/CETA	603011	Inner Joint		33		34			
	2010.05-2014.06	-	-	-	All-wheel Drive Convertible Engine CESA/CETA	603016	Inner Joint		28		32			
2.0 TTS quattro (195 kW)	2008.05-2014.06	AT/MT	L	F	All-wheel Drive Convertible Engine CDLA/CDMA	203303	Drive Shaft	36		59.5	40	495		
	2008.05-2014.06	-	L/R	R	All-wheel Drive Convertible Engine CDLA/CDMA	603011	Inner Joint		33		34			
2.0 TTS quattro (200 kW)	2008.05-2014.06	AT/MT	L	F	All-wheel Drive Convertible Engine CDLB	203303	Drive Shaft	36		59.5	40	495		
	2008.05-2014.06	-	L/R	R	All-wheel Drive Convertible Engine CDLB	603011	Inner Joint		33		34			
2.5 RS quattro (250 kW)	2009.07-2014.06	-	-	-	All-wheel Drive Convertible Engine CEPA	603006	Inner Joint		33		34			
	2009.07-2014.06	-	L/R	R	All-wheel Drive Convertible Engine CEPA	603011	Inner Joint		33		34			
	2009.07-2014.06	AT	R	F	All-wheel Drive Convertible Engine CEPA	261347	Drive Shaft	36	40	59.5	40	593		
	2009.07-2014.06	MT	L/R	F	All-wheel Drive Convertible Engine CEPA	261214	Stub Axle	40	37	60		125		
	2009.07-2014.06	AT	L	F	All-wheel Drive Convertible Engine CEPA	201265	Drive Shaft	36	37	59.5	40	557		

YEAR	TRANSM	L/R	F/R	REMARKS	GSP Ref.	PRODUCT	ABS	Technical Specifications								
								A	B	C	H	L	P			
AUDI																
TT Roadster (8J9)																
2.5 RS quattro (265 kW)	2012.03-2014.06	-	-	-	All-wheel Drive Convertible Engine CEPB	603006	Inner Joint			33		34				
	2012.03-2014.06	-	L/R	R	All-wheel Drive Convertible Engine CEPB	603011	Inner Joint			33		34				
	2012.03-2014.06	AT	R	F	All-wheel Drive Convertible Engine CEPB	261347	Drive Shaft	36	40	59.5	40	593				
	2012.03-2014.06	MT	L/R	F	All-wheel Drive Convertible Engine CEPB	261214	Stub Axle	40	37	60		125				
	2012.03-2014.06	AT	L	F	All-wheel Drive Convertible Engine CEPB	201265	Drive Shaft	36	37	59.5	40	557				
3.2 V6 quattro (184 kW)	2007.03-2010.06	MT	L	F	All-wheel Drive Convertible Engine BUB	203350	Drive Shaft	36		59.5	40	495				
	2007.03-2010.06	-	L/R	F	All-wheel Drive Convertible Engine BUB	803002	Outer Joint	36	27	59.5	40	66	I			
	2007.03-2010.06	AMT	L	F	All-wheel Drive Convertible Engine BUB	654004	Inner Joint			34		85				
	2007.03-2010.06	-	L/R	R	All-wheel Drive Convertible Engine BUB	603011	Inner Joint			33		34				
	2007.03-2010.06	AMT	L	F	All-wheel Drive Convertible Engine BUB	203241	Drive Shaft	36		59.5	40	475				
2007.03-2010.06	-	L/R	R	All-wheel Drive Convertible Engine BUB	803037	Outer Joint	36	30	59.5	40.5	55	I				
TT Roadster (8N9)																
1.8 T (110 kW)	2001.01-2006.06	-	L/R	F	Convertible Engine AUM	803036	Outer Joint	36	30	53.2	77.5	61	I			
	2001.01-2006.06	-	-	-	Convertible Engine AUM	603016	Inner Joint			28		32				
	2001.01-2006.06	5AT	L	F	Convertible Engine AUM	261020	Drive Shaft	36		53.2	77.5	547				
	2001.01-2006.06	-	L	F	Convertible Engine AUM	261156	Drive Shaft	36		53	78	554.5				
	2001.01-2006.06	-	L/R	F	Convertible Engine AUM	661006	Inner Joint			30		57.6				
	2001.01-2006.06	-	L	F	Convertible Engine AUM	661062	Inner Joint			30		59				
1.8 T (120 kW)	2005.09-2006.06	MT	-	-	Convertible Engine BVP	603006	Inner Joint			33		34				
	2005.09-2006.06	-	L/R	F	Convertible Engine BVP	803036	Outer Joint	36	30	53.2	77.5	61	I			
	2005.09-2006.06	5AT	L	F	Convertible Engine BVP	261020	Drive Shaft	36		53.2	77.5	547				
	2005.09-2006.06	-	L	F	Convertible Engine BVP	261156	Drive Shaft	36		53	78	554.5				
	2005.09-2006.06	-	L	F	Convertible Engine BVP	661062	Inner Joint			30		59				
	2005.09-2006.06	-	L/R	F	Convertible Engine BVP	661006	Inner Joint			30		57.6				
1.8 T (132 kW)	1999.10-2006.06	MT	L/R	F	Convertible Engine AJQ/APP/AUQ/ATC	803036	Outer Joint	36	30	53.2	77.5	61	I			
	1999.10-2006.06	-	-	-	Convertible Engine AJQ/APP/AUQ/ATC	603016	Inner Joint			28		32				
	1999.10-2006.06	MT	L/R	F	Convertible Engine AJQ/APP/AUQ/ATC	661006	Inner Joint			30		57.6				
	1999.10-2006.06	MT	L	F	Convertible Engine AJQ/APP/AUQ/ATC	261156	Drive Shaft	36		53	78	554.5				
	1999.10-2006.06	MT	L	F	Convertible Engine AJQ/APP/AUQ/ATC	661062	Inner Joint			30		59				
1.8 T (140 kW)	2005.09-2006.06	MT	L/R	F	Convertible Engine BVR	803036	Outer Joint	36	30	53.2	77.5	61	I			
	2005.09-2006.06	5AT	L	F	Convertible Engine BVR	261020	Drive Shaft	36		53.2	77.5	547				
	2005.09-2006.06	MT	L/R	F	Convertible Engine BVR	661006	Inner Joint			30		57.6				
	2005.09-2006.06	MT	L	F	Convertible Engine BVR	261156	Drive Shaft	36		53	78	554.5				
	2005.09-2006.06	MT	L	F	Convertible Engine BVR	661062	Inner Joint			30		59				
1.8 T quattro (132 kW)	2000.02-2006.06	MT	L/R	F	All-wheel Drive Convertible Engine AJQ/ARY/AUQ	803035	Outer Joint	36	27	53	77.5	65	I			
	2000.02-2006.06	MT	L	F	All-wheel Drive Convertible Engine AJQ/ARY/AUQ	261123	Drive Shaft	36		53	77.5	520				
	2000.02-2006.06	-	L/R	R	All-wheel Drive Convertible Engine AJQ/ARY/AUQ	603011	Inner Joint			33		34				
	2000.02-2006.06	-	-	-	All-wheel Drive Convertible Engine AJQ/ARY/AUQ	603016	Inner Joint			28		32				
	2000.02-2006.06	MT	R	F	All-wheel Drive Convertible Engine AJQ/ARY/AUQ	261186	Drive Shaft	36		53	77.5	653				
	2000.02-2006.06	MT	L	F	All-wheel Drive Convertible Engine AJQ/ARY/AUQ	203304	Drive Shaft	36		59.5	40	481				
	2000.02-2006.06	MT	L/R	F	All-wheel Drive Convertible Engine AJQ/ARY/AUQ	861021	Outer Joint	36	27	53	40	65	I			
	2000.02-2006.06	-	L/R	R	All-wheel Drive Convertible Engine AJQ/ARY/AUQ	803033	Outer Joint	36	30	53	78.5	51	I			
1.8 T quattro (140 kW)	2005.09-2006.06	-	L/R	R	All-wheel Drive Convertible Engine BVR	603011	Inner Joint			33		34				
	2005.09-2006.06	MT	L	F	All-wheel Drive Convertible Engine BVR	203304	Drive Shaft	36		59.5	40	481				
	2005.09-2006.06	MT	L/R	F	All-wheel Drive Convertible Engine BVR	861021	Outer Joint	36	27	53	40	65	I			
	2005.09-2006.06	-	L/R	R	All-wheel Drive Convertible Engine BVR	803033	Outer Joint	36	30	53	78.5	51	I			
1.8 T quattro (165 kW)	1999.10-2006.06	MT	L/R	F	All-wheel Drive Convertible Engine BAM/APX	803035	Outer Joint	36	27	53	77.5	65	I			
	1999.10-2006.06	MT	L	F	All-wheel Drive Convertible Engine BAM/APX	261123	Drive Shaft	36		53	77.5	520				
	1999.10-2006.06	-	L/R	R	All-wheel Drive Convertible Engine BAM/APX	603011	Inner Joint			33		34				
	1999.10-2006.06	-	-	-	All-wheel Drive Convertible Engine BAM/APX	603016	Inner Joint			28		32				
	1999.10-2006.06	MT	R	F	All-wheel Drive Convertible Engine BAM/APX	261186	Drive Shaft	36		53	77.5	653				
	1999.10-2006.06	MT	L	F	All-wheel Drive Convertible Engine BAM/APX	203304	Drive Shaft	36		59.5	40	481				
	1999.10-2006.06	MT	L/R	F	All-wheel Drive Convertible Engine BAM/APX	861021	Outer Joint	36	27	53	40	65	I			
	1999.10-2006.06	-	L/R	R	All-wheel Drive Convertible Engine BAM/APX	803033	Outer Joint	36	30	53	78.5	51	I			
3.2 VR6 quattro (184 kW)	2003.07-2006.06	MT	L	F	All-wheel Drive Convertible Engine BHE/BPF	203350	Drive Shaft	36		59.5	40	495				
	2003.07-2006.06	-	L/R	R	All-wheel Drive Convertible Engine BHE/BPF	603011	Inner Joint			33		34				
	2003.07-2006.06	6AT	L	F	All-wheel Drive Convertible Engine BHE/BPF	654004	Inner Joint			34		85				
	2003.07-2006.06	AT	L/R	F	All-wheel Drive Convertible Engine BHE/BPF	861021	Outer Joint	36	27	53	40	65	I			
	2003.07-2006.06	6AT	L	F	All-wheel Drive Convertible Engine BHE/BPF	203241	Drive Shaft	36		59.5	40	475				
2003.07-2006.06	-	L/R	R	All-wheel Drive Convertible Engine BHE/BPF	803033	Outer Joint	36	30	53	78.5	51	I				
TT Roadster (FV9)																
1.8 TFSI (132 kW)	2015.08-	-	-	L/R	F	Convertible Engine CJSB/CJSA	803002	Outer Joint	36	27	59.5	40	66	I		
TT/TTS COUPE/RO.																
-	1999-	2006	-	-	-	-	201587	Drive Shaft	36		53	78.5	522			
-	2007-	2010	-	-	-	-	201597	Drive Shaft	36		59.5	40	652			





	 YEAR	TRANSM	L/R	F/R	REMARKS	GSP Ref.	 PRODUCT	 ABS	Technical Specifications						
									A	B	C	H	L	P	
AUDI															
V8 (441442 4C2 4C8)															
3.6 quattro (180 kW)	1993.04-1994.02	-	-	-	All-wheel Drive Saloon Engine PT	803056	Outer Joint		38	27	59.5	34.5	68.5	I	
3.6 quattro (184 kW)	1988.10-1994.02	AT/MT	L/R	R	All-wheel Drive Saloon Engine PT	603001	Inner Joint		28		32				
	1988.10-1994.02	-	-	-	All-wheel Drive Saloon Engine PT	803056	Outer Joint		38	27	59.5	34.5	68.5	I	
4.2 quattro (206 kW)	1991.10-1994.02	AT/MT	L/R	F/R	All-wheel Drive Saloon Engine ABH	603001	Inner Joint		28		32				
	1991.10-1994.02	-	-	-	All-wheel Drive Saloon Engine ABH	803056	Outer Joint		38	27	59.5	34.5	68.5	I	
AUDI (FAW)															
A6 (C5 4B2)															
1.8 (92 kW)	2000.01-2005.12	MT	R	-	Saloon Engine ANQ/ADR	203250	Drive Shaft	45W	33		53	30	656		
	2000.01-2005.12	AT	L	-	Saloon Engine ANQ/ADR	203254	Drive Shaft	45W	38		59.5	34	552		
	2000.01-2005.12	AT	R	-	Saloon Engine ANQ/ADR	203257	Drive Shaft	45W	38		59.5	34	518		
1.8 T (110 kW)	2000.07-2005.12	MT	R	-	Saloon Engine AWL/BGC	203250	Drive Shaft	45W	33		53	30	656		
	2000.07-2005.12	AT	L	-	Saloon Engine AWL/BGC	203254	Drive Shaft	45W	38		59.5	34	552		
	2000.07-2005.12	AT	R	-	Saloon Engine AWL/BGC	203257	Drive Shaft	45W	38		59.5	34	518		
2.4 (125 kW)	2002.06-2005.12	CVT	L/R	-	Saloon Engine BDV	203233	Drive Shaft	45W	38		59.5	34.5	537		
	2002.06-2005.12	AT	R	-	Saloon Engine BDV	203260	Drive Shaft	45W	38		59.5	34.5	522		
	2002.06-2005.12	AT	L	-	Saloon Engine BDV	210260	Drive Shaft	45W	38		59.5	34.5	550		
2.8 (140 kW)	2000.09-2005.07	CVT	L/R	-	Saloon Engine ATX/BBG	203233	Drive Shaft	45W	38		59.5	34.5	537		
AUSTIN															
MAESTRO (XC)															
1.3 (47 kW)	1986.01-1992.09	-	-	F	Hatchback Engine 12 H	851010	Outer Joint		25	22	50	82	56	I	
1.3 (50 kW)	1986.01-1992.09	-	-	F	Hatchback Engine 12 HE	851010	Outer Joint		25	22	50	82	56	I	
1.3 LS (49 kW)	1983.03-1990.08	-	-	F	Hatchback Engine 12 H	851010	Outer Joint		25	22	50	82	56	I	
1.6 Mayfair HLS (61 kW)	1983.03-1990.08	MT	-	F	Hatchback Engine 16 HC37	851010	Outer Joint		25	22	50	82	56	I	
1.6 MG (73 kW)	1983.03-1990.08	MT	-	F	Hatchback Engine 16 HA35AL	851010	Outer Joint		25	22	50	82	56	I	
2.0 EFi (83 kW)	1984.10-1990.08	-	-	F	Hatchback Engine 20 HC81/20 HA50AA/20 HC51AA	851010	Outer Joint		25	22	50	82	56	I	
MINI															
1.0 Mayfair (31 kW)	1982.08-1993.06	-	-	F	Hatchback Engine 99 HA53P/99 H997P/99 HC20P	699098	Inner Joint		21	19	31.8	46	53		
	1982.08-1993.06	-	-	F	Hatchback Engine 99 HA53P/99 H997P/99 HC20P	851009	Outer Joint		19	19	48	93	55	I	
1.0 Mayfair Sport (30 kW)	1988.09-1993.06	-	-	F	Hatchback Engine 99 HD81	699098	Inner Joint		21	19	31.8	46	53		
MONTEGO (XE)															
2.0 (74 kW)	1984.10-1991.08	-	-	F	Estate Engine 20 H/20 HSC	851010	Outer Joint		25	22	50	82	56	I	
2.0 HLI (83 kW)	1984.10-1992.09	-	-	F	Estate Engine 20 H	851010	Outer Joint		25	22	50	82	56	I	
BAOJUN															
LECHI															
1.0 (47 kW)	2012.08-	MT	L	-	Hatchback Engine B10S1	208113	Drive Shaft	40T	23	22	51	92.5	564		
	2012.08-	MT	R	-	Hatchback Engine B10S1	208114	Drive Shaft	40T	23	22	51	92.5	813.5		
BAOJUN (SGMW)															
630															
1.5 (81 kW)	2011.08-	MT	L	-	Saloon Engine L2C	275057	Drive Shaft	47T	33	34	52	95	611		
	2011.08-	MT	R	-	Saloon Engine L2C	275058	Drive Shaft	47T	33	34	52	95	937		
1.5 (82 kW)	2012.03-	MT	L	-	Saloon Engine L2B	275057	Drive Shaft	47T	33	34	52	95	611		
	2012.03-	MT	R	-	Saloon Engine L2B	275058	Drive Shaft	47T	33	34	52	95	937		
LECHI															
1.0 (51 kW)	2012.08-	MT	L	-	Hatchback Engine LMT	208113	Drive Shaft	40T	23	22	51	92.5	564		
	2012.08-	MT	R	-	Hatchback Engine LMT	208114	Drive Shaft	40T	23	22	51	92.5	813.5		
1.2 (63 kW)	2012.08-	MT	L	-	Hatchback Engine LMU	208113	Drive Shaft	40T	23	22	51	92.5	564		
	2012.08-	MT	R	-	Hatchback Engine LMU	208114	Drive Shaft	40T	23	22	51	92.5	813.5		
BENTLEY															
CONTINENTAL (3W_)															
4.0 FLEX AWD (388 kW)	2013.12-	-	-	-	All-wheel Drive Coupe Engine CMMD/CYCA	899351	Outer Joint		38	29	59.5	34	70	M	
4.0 FLEX AWD (426 kW)	2014.10-	-	-	-	All-wheel Drive Coupe Engine DCCA	899351	Outer Joint		38	29	59.5	34	70	M	
4.0 GT (373 kW)	2011.09-	-	-	-	All-wheel Drive Coupe Engine CMMC/CYCB	899351	Outer Joint		38	29	59.5	34	70	M	
6.0 (449 kW)	2007.08-	-	-	-	All-wheel Drive Convertible Engine MTBHT	899351	Outer Joint		38	29	59.5	34	70	M	
6.0 AWD (412 kW)	2003.06-2011.12	-	-	-	All-wheel Drive Coupe Engine BEB/BWR	899351	Outer Joint		38	29	59.5	34	70	M	
	2006.12-	-	-	-	All-wheel Drive Convertible Engine MTBHT	899351	Outer Joint		38	29	59.5	34	70	M	
6.0 AWD (449 kW)	2007.09-2011.12	-	-	-	All-wheel Drive Coupe Engine BWRA	899351	Outer Joint		38	29	59.5	34	70	M	
6.0 AWD (463 kW)	2009.10-	-	-	-	All-wheel Drive Coupe Engine BWRB/CKHA	899351	Outer Joint		38	29	59.5	34	70	M	
6.0 AWD (467 kW)	2014.05-	-	-	-	All-wheel Drive Convertible Engine CVAC	899351	Outer Joint		38	29	59.5	34	70	M	
6.0 CS ISR (471 kW)	2011.03-	-	-	-	All-wheel Drive Convertible Engine CVAC/CKHE	899351	Outer Joint		38	29	59.5	34	70	M	
6.0 FLEX AWD (423 kW)	2010.11-2011.12	-	-	-	All-wheel Drive Coupe Engine MTBHT	899351	Outer Joint		38	29	59.5	34	70	M	
	2010.11-	-	-	-	All-wheel Drive Convertible Engine CVAB/MTBHT	899351	Outer Joint		38	29	59.5	34	70	M	
6.0 FLEX AWD (429 kW)	2011.09-2012.12	-	-	-	All-wheel Drive Convertible Engine MTBHT	899351	Outer Joint		38	29	59.5	34	70	M	
	2011.09-2013.12	-	-	-	All-wheel Drive Coupe Engine MTBHT	899351	Outer Joint		38	29	59.5	34	70	M	
6.0 FLEX AWD (460 kW)	2012.09-	-	-	-	All-wheel Drive Coupe Engine CVAA	899351	Outer Joint		38	29	59.5	34	70	M	

YEAR	TRANSM	L/R	F/R	REMARKS	GSP Ref.	PRODUCT	ABS	Technical Specifications							
								A	B	C	H	L	P		
BENTLEY															
CONTINENTAL (3W_)															
6.0 FLEX AWD (460 kW)	2013.03-	-	-	-	F	All-wheel Drive Convertible Engine CVAA	899351	Outer Joint		38	29	59.5	34	70	M
6.0 FLEX AWD (463 kW)	2010.03-	-	-	-	F	All-wheel Drive Convertible Engine CKHA/BWRB/MTBHT	899351	Outer Joint		38	29	59.5	34	70	M
6.0 FLEX AWD (467 kW)	2014.05-	-	-	-	F	All-wheel Drive Coupe Engine CVAC	899351	Outer Joint		38	29	59.5	34	70	M
	2014.05-	-	-	-	F	All-wheel Drive Coupe Engine CVAC	899351	Outer Joint		38	29	59.5	34	70	M
BMW															
-	-	-	-	L	F	-	205075	Drive Shaft		30	27	59	73	584	
-	-	-	-	R	F	-	205076	Drive Shaft		30	27	59	73	967	
-	-	-	-	L	F	-	205075	Drive Shaft		30	27	59	73	584	
-	-	-	-	F	-	-	205076	Drive Shaft		30	27	59	73	967	
1 (E81)															
1.6 (85 kW)	2007.04-	2011.12	AT	R	R	Hatchback Engine N45 B16 A/N43 B16 A	205032	Drive Shaft	48W	27		69.3	68	664	
	2007.04-	2011.12	AT	L	R	Hatchback Engine N45 B16 A/N43 B16 A	205040	Drive Shaft	48W	27		69.3	68	611	
	2007.04-	2011.12	MT	R	R	Hatchback Engine N45 B16 A/N43 B16 A	205036	Drive Shaft	48W	27		69.3	68	664	
	2007.04-	2011.12	MT	L	R	Hatchback Engine N45 B16 A/N43 B16 A	205037	Drive Shaft	48W	27		69.3	68	611	
1.6 (90 kW)	2007.03-	2011.11	-	R	R	Hatchback Engine N43 B16 A/N43 B16 AA	205032	Drive Shaft	48W	27		69.3	68	664	
	2007.03-	2011.11	-	L	R	Hatchback Engine N43 B16 A/N43 B16 AA	205040	Drive Shaft	48W	27		69.3	68	611	
116 d (66 kW)	2011.01-	2011.12	MT	R	R	Hatchback Engine N47 D20 C/N47 D20 A	205023	Drive Shaft	48W	27		69	68	660	
	2011.01-	2011.12	MT	L	R	Hatchback Engine N47 D20 C/N47 D20 A	205022	Drive Shaft	48W	27		69	68	607	
116 d (85 kW)	2008.11-	2011.12	-	R	R	Hatchback Engine N47 D20 A/N47 D20 C	205023	Drive Shaft	48W	27		69	68	660	
	2008.11-	2011.12	-	L	R	Hatchback Engine N47 D20 A/N47 D20 C	205022	Drive Shaft	48W	27		69	68	607	
116 i (89 kW)	2007.08-	2011.11	-	R	R	Hatchback Engine N43 B16 A/N43 B16 AA	205032	Drive Shaft	48W	27		69.3	68	664	
	2007.08-	2011.11	-	L	R	Hatchback Engine N43 B16 A/N43 B16 AA	205040	Drive Shaft	48W	27		69.3	68	611	
116 i (90 kW)	2008.11-	2011.12	-	R	R	Hatchback Engine N43 B20 A	205032	Drive Shaft	48W	27		69.3	68	664	
	2008.11-	2011.12	-	L	R	Hatchback Engine N43 B20 A	205040	Drive Shaft	48W	27		69.3	68	611	
118 d (100 kW)	2006.09-	2011.12	-	R	R	Hatchback Engine N47 D20 A/N47 D20 C	205023	Drive Shaft	48W	27		69	68	660	
	2006.09-	2011.12	-	L	R	Hatchback Engine N47 D20 A/N47 D20 C	205022	Drive Shaft	48W	27		69	68	607	
120 i (115 kW)	2006.09-	2011.10	-	R	R	Hatchback Engine N46 B20 C/N46 B20 B	205032	Drive Shaft	48W	27		69.3	68	664	
	2006.09-	2011.10	-	L	R	Hatchback Engine N46 B20 C/N46 B20 B	205040	Drive Shaft	48W	27		69.3	68	611	
120 i (120 kW)	2006.09-	2011.12	-	R	R	Hatchback Engine N43 B20 A	205032	Drive Shaft	48W	27		69.3	68	664	
	2006.09-	2011.12	-	L	R	Hatchback Engine N43 B20 A	205040	Drive Shaft	48W	27		69.3	68	611	
2.0 (105 kW)	2006.09-	2011.12	-	R	R	Hatchback Engine N47 D20 A/N47 D20 C	205023	Drive Shaft	48W	27		69	68	660	
	2006.09-	2011.12	-	R	R	Hatchback Engine N43 B20 A	205032	Drive Shaft	48W	27		69.3	68	664	
	2006.09-	2011.12	-	L	R	Hatchback Engine N43 B20 A	205040	Drive Shaft	48W	27		69.3	68	611	
	2006.09-	2011.12	-	L	R	Hatchback Engine N47 D20 A/N47 D20 C	205022	Drive Shaft	48W	27		69	68	607	
2.0 (120 kW)	2006.09-	2011.12	-	R	R	Hatchback Engine N47 D20 A/N47 D20 C	205023	Drive Shaft	48W	27		69	68	660	
	2006.09-	2011.12	-	L	R	Hatchback Engine N47 D20 A/N47 D20 C	205022	Drive Shaft	48W	27		69	68	607	
2.0 (125 kW)	2006.09-	2011.12	-	R	R	Hatchback Engine N43 B20 A	205032	Drive Shaft	48W	27		69.3	68	664	
	2006.09-	2011.12	-	L	R	Hatchback Engine N43 B20 A	205040	Drive Shaft	48W	27		69.3	68	611	
2.0 (130 kW)	2006.09-	2011.12	-	R	R	Hatchback Engine N47 D20 A/N47 D20 C	205023	Drive Shaft	48W	27		69	68	660	
	2006.09-	2011.12	-	L	R	Hatchback Engine N47 D20 A/N47 D20 C	205022	Drive Shaft	48W	27		69	68	607	
2.0 (150 kW)	2007.03-	2011.12	MT	R	R	Hatchback Engine N47 D20 B/N47 D20 D	205079	Drive Shaft		30		58.7	73	653	
	2007.03-	2011.12	MT	L	R	Hatchback Engine N47 D20 B/N47 D20 D	205085	Drive Shaft		30		58.7	73	598	
	2007.03-	2011.12	AT	R	R	Hatchback Engine N47 D20 B/N47 D20 D	605036	Inner Joint		30	25	58.7	73	58	I
	2007.03-	2011.12	AT	R	R	Hatchback Engine N47 D20 B/N47 D20 D	635025	Inner Joint			25		26		
	2007.03-	2011.12	AT	R	R	Hatchback Engine N47 D20 B/N47 D20 D	205134	Drive Shaft		30		58.7	73	665	
3.0 (190 kW)	2006.09-	2011.12	-	R	R	Hatchback Engine N52 B30 A/N52 B30 BF/N52 B30 B	205038	Drive Shaft		30		58.7	73	663	
	2006.09-	2011.12	-	L	R	Hatchback Engine N52 B30 A/N52 B30 BF/N52 B30 B	205039	Drive Shaft		30		58.7	73	610	
3.0 (195 kW)	2006.09-	2011.12	MT	R	R	Hatchback Engine N52 B30 BF/N52 B30 A/N52 B30 B	205038	Drive Shaft		30		58.7	73	663	
	2006.09-	2011.12	MT	L	R	Hatchback Engine N52 B30 BF/N52 B30 A/N52 B30 B	205039	Drive Shaft		30		58.7	73	610	
1 (E82)															
118 d (100 kW)	2009.09-	2013.10	-	R	R	Coupe Engine N47 D20 C	205023	Drive Shaft	48W	27		69	68	660	
	2009.09-	2013.10	-	L	R	Coupe Engine N47 D20 C	205022	Drive Shaft	48W	27		69	68	607	
118 d (105 kW)	2009.09-	2013.10	-	R	R	Coupe Engine N47 D20 C	205023	Drive Shaft	48W	27		69	68	660	
	2009.09-	2013.10	-	L	R	Coupe Engine N47 D20 C	205022	Drive Shaft	48W	27		69	68	607	
120 d (120 kW)	2007.10-	2013.10	-	R	R	Coupe Engine N47 D20 A/N47 D20 C	205023	Drive Shaft	48W	27		69	68	660	
	2007.10-	2013.10	-	L	R	Coupe Engine N47 D20 A/N47 D20 C	205022	Drive Shaft	48W	27		69	68	607	
120 i (115 kW)	2009.09-	2013.10	-	-	R	Coupe Engine N46 B20 B	605056	Inner Joint		27	24	69.3	68	51	I
	2009.09-	2013.10	-	R	R	Coupe Engine N46 B20 B	205032	Drive Shaft	48W	27		69.3	68	664	
	2009.09-	2013.10	-	L	R	Coupe Engine N46 B20 B	205040	Drive Shaft	48W	27		69.3	68	611	
120 i (125 kW)	2007.10-	2013.10	-	-	R	Coupe Engine N43 B20 A	605056	Inner Joint		27	24	69.3	68	51	I
	2007.10-	2013.10	-	R	R	Coupe Engine N43 B20 A	205032	Drive Shaft	48W	27		69.3	68	664	
	2007.10-	2013.10	-	L	R	Coupe Engine N43 B20 A	205040	Drive Shaft	48W	27		69.3	68	611	
2.0 (130 kW)	2007.10-	2013.10	-	R	R	Coupe Engine N47 D20 A/N47 D20 C	205023	Drive Shaft	48W	27		69	68	660	
	2007.10-	2013.10	-	L	R	Coupe Engine N47 D20 A/N47 D20 C	205022	Drive Shaft	48W	27		69	68	607	





	 YEAR	TRANSM	L/R	F/R	REMARKS	GSP Ref.	 PRODUCT	 ABS	Technical Specifications									
									A	B	C	H	L	P				
BMW																		
1 (E82)																		
2.0 (150 kW)	2007.10-2013.10	2007.10-2013.10	MT	L	R	Coupe Engine N47 D20 B/N47 D20 D	205085	Drive Shaft		30		58.7	73	598				
	2007.10-2013.10	2007.10-2013.10	MT	R	R	Coupe Engine N47 D20 B/N47 D20 D	205079	Drive Shaft		30		58.7	73	653				
	2007.10-2013.10	2007.10-2013.10	AT	R	R	Coupe Engine N47 D20 B/N47 D20 D	605036	Inner Joint		30	25	58.7	73	58	I			
	2007.10-2013.10	2007.10-2013.10	AT	R	R	Coupe Engine N47 D20 B/N47 D20 D	635025	Inner Joint			25		26					
	2007.10-2013.10	2007.10-2013.10	AT	R	R	Coupe Engine N47 D20 B/N47 D20 D	205134	Drive Shaft		30		58.7	73	665				
3.0 (225 kW)	2007.10-2013.10	2007.10-2013.10	AT	R	R	Coupe Engine N55 B30 A/N54 B30 A	205038	Drive Shaft		30		58.7	73	663				
	2007.10-2013.10	2007.10-2013.10	AT	L	R	Coupe Engine N55 B30 A/N54 B30 A	205039	Drive Shaft		30		58.7	73	610				
1 (E87)																		
116 d (85 kW)	2008.12-2012.09	2008.12-2012.09	-	R	R	Hatchback Engine N47 D20 A	205023	Drive Shaft	48W	27		69	68	660				
	2008.12-2012.09	2008.12-2012.09	-	L	R	Hatchback Engine N47 D20 A	205022	Drive Shaft	48W	27		69	68	607				
116 i (85 kW)	2003.11-2011.06	2003.11-2011.06	AT/MT	R	R	Hatchback Engine N45 B16 A/N43 B16 A	205032	Drive Shaft	48W	27		69.3	68	664				
	2003.11-2011.06	2003.11-2011.06	AT/MT	L	R	Hatchback Engine N45 B16 A/N43 B16 A	205040	Drive Shaft	48W	27		69.3	68	611				
	2003.11-2011.06	2003.11-2011.06	MT	R	R	Hatchback Engine N45 B16 A/N43 B16 A	205036	Drive Shaft	48W	27		69.3	68	664				
	2003.11-2011.06	2003.11-2011.06	MT	L	R	Hatchback Engine N45 B16 A/N43 B16 A	205037	Drive Shaft	48W	27		69.3	68	611				
116 i (89 kW)	2007.03-2011.06	2007.03-2011.06	-	R	R	Hatchback Engine N43 B16 A	205032	Drive Shaft	48W	27		69.3	68	664				
	2007.03-2011.06	2007.03-2011.06	-	L	R	Hatchback Engine N43 B16 A	205040	Drive Shaft	48W	27		69.3	68	611				
116 i (90 kW)	2007.03-2011.06	2007.03-2011.06	-	R	R	Hatchback Engine N43 B16 A/N45 B16 A	205032	Drive Shaft	48W	27		69.3	68	664				
	2007.03-2011.06	2007.03-2011.06	-	L	R	Hatchback Engine N43 B16 A/N45 B16 A	205040	Drive Shaft	48W	27		69.3	68	611				
	2009.01-2011.06	2009.01-2011.06	-	R	R	Hatchback Engine N43 B20 A	205032	Drive Shaft	48W	27		69.3	68	664				
	2009.01-2011.06	2009.01-2011.06	-	L	R	Hatchback Engine N43 B20 A	205040	Drive Shaft	48W	27		69.3	68	611				
118 d (100 kW)	2006.09-2011.06	2006.09-2011.06	-	R	R	Hatchback Engine N47 D20 C/N47 D20 A	205023	Drive Shaft	48W	27		69	68	660				
	2006.09-2011.06	2006.09-2011.06	-	L	R	Hatchback Engine N47 D20 C/N47 D20 A	205022	Drive Shaft	48W	27		69	68	607				
118 d (105 kW)	2006.09-2011.06	2006.09-2011.06	-	R	R	Hatchback Engine N47 D20 A	205023	Drive Shaft	48W	27		69	68	660				
	2006.09-2011.06	2006.09-2011.06	-	L	R	Hatchback Engine N47 D20 A	205022	Drive Shaft	48W	27		69	68	607				
118 d (90 kW)	2003.11-2007.02	2003.11-2007.02	MT	R	R	Hatchback Engine M47 D20 (204D4)	205033	Drive Shaft	48W	27		69.3	68	664				
	2003.11-2007.02	2003.11-2007.02	MT	L	R	Hatchback Engine M47 D20 (204D4)	205034	Drive Shaft	48W	27		69.3	68	611				
118 i (100 kW)	2006.10-2011.06	2006.10-2011.06	-	R	R	Hatchback Engine N46 B20 B	205032	Drive Shaft	48W	27		69.3	68	664				
	2006.10-2011.06	2006.10-2011.06	-	L	R	Hatchback Engine N46 B20 B	205040	Drive Shaft	48W	27		69.3	68	611				
118 i (105 kW)	2006.09-2011.06	2006.09-2011.06	-	R	R	Hatchback Engine N43 B20 A	205032	Drive Shaft	48W	27		69.3	68	664				
	2006.09-2011.06	2006.09-2011.06	-	L	R	Hatchback Engine N43 B20 A	205040	Drive Shaft	48W	27		69.3	68	611				
118 i (95 kW)	2004.07-2007.02	2004.07-2007.02	MT	R	R	Hatchback Engine N46 B20 B	205032	Drive Shaft	48W	27		69.3	68	664				
	2004.07-2007.02	2004.07-2007.02	MT	L	R	Hatchback Engine N46 B20 B	205040	Drive Shaft	48W	27		69.3	68	611				
120 d (120 kW)	2003.03-2011.06	2003.03-2011.06	MT	R	R	Hatchback Engine N47 D20 A/N47 D20 C/M47 D20 (204D4)	205023	Drive Shaft	48W	27		69	68	660				
	2003.03-2011.06	2003.03-2011.06	MT	L	R	Hatchback Engine N47 D20 A/N47 D20 C/M47 D20 (204D4)	205022	Drive Shaft	48W	27		69	68	607				
120 d (130 kW)	2006.09-2011.06	2006.09-2011.06	-	R	R	Hatchback Engine N47 D20 A/N47 D20 C	205023	Drive Shaft	48W	27		69	68	660				
	2006.09-2011.06	2006.09-2011.06	-	L	R	Hatchback Engine N47 D20 A/N47 D20 C	205022	Drive Shaft	48W	27		69	68	607				
120 i (110 kW)	2003.11-2011.06	2003.11-2011.06	AT/MT	R	R	Hatchback Engine N46 B20 CC/N46 B20 B/N46 B20 C/N46 B20 BD	205032	Drive Shaft	48W	27		69.3	68	664				
	2003.11-2011.06	2003.11-2011.06	AT/MT	L	R	Hatchback Engine N46 B20 CC/N46 B20 B/N46 B20 C/N46 B20 BD	205040	Drive Shaft	48W	27		69.3	68	611				
	2003.11-2011.06	2003.11-2011.06	-	R	R	Hatchback Engine N46 B20 A/N46 B20 C/N46 B20 B/N46 B20 CC/N46 B20 BD	205032	Drive Shaft	48W	27		69.3	68	664				
120 i (115 kW)	2003.11-2011.06	2003.11-2011.06	-	L	R	Hatchback Engine N46 B20 A/N46 B20 C/N46 B20 B/N46 B20 CC/N46 B20 BD	205040	Drive Shaft	48W	27		69.3	68	611				
	2006.09-2011.06	2006.09-2011.06	MT	R	R	Hatchback Engine N43 B20 A	205032	Drive Shaft	48W	27		69.3	68	664				
120 i (120 kW)	2006.09-2011.06	2006.09-2011.06	MT	L	R	Hatchback Engine N43 B20 A	205040	Drive Shaft	48W	27		69.3	68	611				
	2006.09-2011.06	2006.09-2011.06	-	R	R	Hatchback Engine N43 B20 A	205032	Drive Shaft	48W	27		69.3	68	664				
120 i (125 kW)	2006.09-2011.06	2006.09-2011.06	-	L	R	Hatchback Engine N43 B20 A	205040	Drive Shaft	48W	27		69.3	68	611				
	2006.09-2011.06	2006.09-2011.06	-	R	R	Hatchback Engine N43 B20 A	205032	Drive Shaft	48W	27		69.3	68	664				
130 i (190 kW)	2005.03-2012.09	2005.03-2012.09	AT/MT	R	R	Hatchback Engine N52 B30 A/N52 B30 BF/N52 B30 B/N52 B30 AF	205038	Drive Shaft		30		58.7	73	663				
	2005.03-2012.09	2005.03-2012.09	AT/MT	L	R	Hatchback Engine N52 B30 A/N52 B30 BF/N52 B30 B/N52 B30 AF	205039	Drive Shaft		30		58.7	73	610				
130 i (195 kW)	2005.03-2012.09	2005.03-2012.09	MT	R	R	Hatchback Engine N52 B30 A/N52 B30 BF/N52 B30 B/N52 B30 AF	205038	Drive Shaft		30		58.7	73	663				
	2005.03-2012.09	2005.03-2012.09	MT	L	R	Hatchback Engine N52 B30 A/N52 B30 BF/N52 B30 B/N52 B30 AF	205039	Drive Shaft		30		58.7	73	610				
2.0 (150 kW)	2007.03-2012.09	2007.03-2012.09	AT	R	R	Hatchback Engine N47 D20 C/N47 D20 B/N47 D20 D	605036	Inner Joint		30	25	58.7	73	58	I			
	2007.03-2012.09	2007.03-2012.09	AT	R	R	Hatchback Engine N47 D20 C/N47 D20 B/N47 D20 D	635025	Inner Joint			25		26					
	2007.03-2012.09	2007.03-2012.09	MT	R	R	Hatchback Engine N47 D20 C/N47 D20 B/N47 D20 D	205079	Drive Shaft		30		58.7	73	653				
	2007.03-2012.09	2007.03-2012.09	MT	L	R	Hatchback Engine N47 D20 C/N47 D20 B/N47 D20 D	205085	Drive Shaft		30		58.7	73	598				
	2007.03-2012.09	2007.03-2012.09	AT	R	R	Hatchback Engine N47 D20 C/N47 D20 B/N47 D20 D	205134	Drive Shaft		30		58.7	73	665				
1 (E88)																		
118 d (100 kW)	2008.09-2013.12	2008.09-2013.12	-	R	R	Convertible Engine N47 D20 A/N47 D20 C	205023	Drive Shaft	48W	27		69	68	660				
	2008.09-2013.12	2008.09-2013.12	-	L	R	Convertible Engine N47 D20 A/N47 D20 C	205022	Drive Shaft	48W	27		69	68	607				
118 d (105 kW)	2008.09-2013.12	2008.09-2013.12	-	R	R	Convertible Engine N47 D20 C/N47 D20 A	205023	Drive Shaft	48W	27		69	68	660				
	2008.09-2013.12	2008.09-2013.12	-	L	R	Convertible Engine N47 D20 C/N47 D20 A	205022	Drive Shaft	48W	27		69	68	607				
118 i (100 kW)	2008.09-2013.12	2008.09-2013.12	-	-	R	Convertible Engine N46 B20 B	605056	Inner Joint		27	24	69.3	68	51	I			
	2008.09-2013.12	2008.09-2013.12	-	R	R	Convertible Engine N46 B20 B	205032	Drive Shaft	48W	27		69.3	68	664				
	2008.09-2013.12	2008.09-2013.12	-	L	R	Convertible Engine N46 B20 B	205040	Drive Shaft	48W	27		69.3	68	611				
120 d (120 kW)	2008.03-2013.12	2008.03-2013.12	MT	R	R	Convertible Engine N47 D20 A/N47 D20 C	205023	Drive Shaft	48W	27		69	68	660				
	2008.03-2013.12	2008.03-2013.12	MT	L	R	Convertible Engine N47 D20 A/N47 D20 C	205022	Drive Shaft	48W	27		69	68	607				
120 d (145 kW)	2008.03-2013.12	2008.03-2013.12	MT	R	R	Convertible Engine N47 D20 C	205023	Drive Shaft	48W	27		69	68	660				
	2008.03-2013.12	2008.03-2013.12	MT	L	R	Convertible Engine N47 D20 C	205022	Drive Shaft	48W	27		69	68					





	 YEAR	TRANSM	L/R	F/R	REMARKS	GSP Ref.	 PRODUCT	 ABS	Technical Specifications					
									A	B	C	H	L	P
BMW														
1 (E88)														
120 i (115 kW)	2008.03-2013.12	-	R	R	Convertible Engine N46 B20 C/N46 B20 B/N46 B20 E	205032	Drive Shaft	48W	27		69.3	68	664	
	2008.03-2013.12	-	L	R	Convertible Engine N46 B20 C/N46 B20 B/N46 B20 E	205040	Drive Shaft	48W	27		69.3	68	611	
120 i (120 kW)	2008.03-2013.12	-	-	R	Convertible Engine N43 B20 A	605056	Inner Joint		27	24	69.3	68	51	I
	2008.03-2013.12	-	R	R	Convertible Engine N43 B20 A	205032	Drive Shaft	48W	27		69.3	68	664	
	2008.03-2013.12	-	L	R	Convertible Engine N43 B20 A	205040	Drive Shaft	48W	27		69.3	68	611	
135 i (225 kW)	2008.03-2013.12	AT	R	R	Convertible Engine N54 B30 A/N55 B30 A	205038	Drive Shaft		30		58.7	73	663	
	2008.03-2013.12	AT	L	R	Convertible Engine N54 B30 A/N55 B30 A	205039	Drive Shaft		30		58.7	73	610	
2.0 (105 kW)	2008.03-2013.12	-	-	R	Convertible Engine N43 B20 A	605056	Inner Joint		27	24	69.3	68	51	I
	2008.03-2013.12	-	R	R	Convertible Engine N43 B20 A	205032	Drive Shaft	48W	27		69.3	68	664	
	2008.03-2013.12	-	L	R	Convertible Engine N43 B20 A	205040	Drive Shaft	48W	27		69.3	68	611	
2.0 (125 kW)	2008.03-2013.12	-	-	R	Convertible Engine N43 B20 A	605056	Inner Joint		27	24	69.3	68	51	I
	2008.03-2013.12	-	R	R	Convertible Engine N43 B20 A	205032	Drive Shaft	48W	27		69.3	68	664	
	2008.03-2013.12	-	L	R	Convertible Engine N43 B20 A	205040	Drive Shaft	48W	27		69.3	68	611	
2.0 (130 kW)	2008.03-2013.12	-	R	R	Convertible Engine N47 D20 A/N47 D20 C	205023	Drive Shaft	48W	27		69	68	660	
	2008.03-2013.12	-	L	R	Convertible Engine N47 D20 A/N47 D20 C	205022	Drive Shaft	48W	27		69	68	607	
2.0 (150 kW)	2008.09-2013.12	MT	L	R	Convertible Engine N47 D20 B/N47 D20 D	205085	Drive Shaft		30		58.7	73	598	
	2008.09-2013.12	MT	R	R	Convertible Engine N47 D20 B/N47 D20 D	205079	Drive Shaft		30		58.7	73	653	
	2008.09-2013.12	AT	R	R	Convertible Engine N47 D20 B/N47 D20 D	605036	Inner Joint		30	25	58.7	73	58	I
	2008.09-2013.12	AT	R	R	Convertible Engine N47 D20 B/N47 D20 D	635025	Inner Joint			25		26		
	2008.09-2013.12	AT	R	R	Convertible Engine N47 D20 B/N47 D20 D	205134	Drive Shaft		30		58.7	73	665	
1 (F20)														
1.5 (100 kW)	2015.03- -	AT	L	R	Hatchback Engine B38 B15 A	205107	Drive Shaft		28	27	57.4	71	749	
	2015.03- -	MT	L	R	Hatchback Engine B38 B15 A	205066	Drive Shaft		28	27	57.4	71	739	
	2015.03- -	MT	R	R	Hatchback Engine B38 B15 A	205067	Drive Shaft		28	27	57.4	71	793	
1.5 (70 kW)	2015.06- -	-	L/R	R	Hatchback Engine B37 D15 A	805024	Outer Joint		28	33	57.2	70.5	58	I
1.5 (85 kW)	2015.03- -	-	L/R	R	Hatchback Engine B37 D15 A	805024	Outer Joint		28	33	57.2	70.5	58	I
1.6 (100 kW)	2010.12- -	MT	L	R	Hatchback Engine N13 B16 A	205066	Drive Shaft		28	27	57.4	71	739	
	2010.12- -	AT	L	R	Hatchback Engine N13 B16 A	205107	Drive Shaft		28	27	57.4	71	749	
	2010.12- -	MT	R	R	Hatchback Engine N13 B16 A	205067	Drive Shaft		28	27	57.4	71	793	
1.6 (125 kW)	2010.11- -	MT	L	R	Hatchback Engine N13 B16 A	205066	Drive Shaft		28	27	57.4	71	739	
	2010.11- -	AT	L	R	Hatchback Engine N13 B16 A	205107	Drive Shaft		28	27	57.4	71	749	
	2010.11- -	MT	R	R	Hatchback Engine N13 B16 A	205067	Drive Shaft		28	27	57.4	71	793	
1.6 (130 kW)	2015.03- -	AT	L	R	Hatchback Engine N13 B16 A	205107	Drive Shaft		28	27	57.4	71	749	
	2015.03- -	MT	L	R	Hatchback Engine N13 B16 A	205066	Drive Shaft		28	27	57.4	71	739	
	2015.03- -	MT	R	R	Hatchback Engine N13 B16 A	205067	Drive Shaft		28	27	57.4	71	793	
114 i (75 kW)	2011.11- -	MT	L	R	Hatchback Engine N13 B16 A	205066	Drive Shaft		28	27	57.4	71	739	
	2011.11- -	MT	R	R	Hatchback Engine N13 B16 A	205067	Drive Shaft		28	27	57.4	71	793	
116 i (80 kW)	2015.03- -	MT	L	R	Hatchback Engine B38 B15 A	205066	Drive Shaft		28	27	57.4	71	739	
	2015.03- -	MT	R	R	Hatchback Engine B38 B15 A	205067	Drive Shaft		28	27	57.4	71	793	
120 i (135 kW)	2015.09- -	MT	L	R	Hatchback Engine B48 B20 A	205066	Drive Shaft		28	27	57.4	71	739	
	2015.09- -	MT	R	R	Hatchback Engine B48 B20 A	205067	Drive Shaft		28	27	57.4	71	793	
2.0 (155 kW)	2011.08- -	AT	R	R	Hatchback Engine N47 D20 D	205109	Drive Shaft		28	32	57	71	802	
	2011.08- -	AT	L	R	Hatchback Engine N47 D20 D	205110	Drive Shaft		28	32	57	71	748	
	2011.08- -	AT	R	R	Hatchback Engine N47 D20 D	605086	Inner Joint		28	28	57	71	64	
	2011.08- -	AT	R	R	Hatchback Engine N47 D20 D	605087	Inner Joint		32	28	50	85	72.5	
2.0 (160 kW)	2011.08- -	AT	R	R	Hatchback Engine N47 D20 D	205109	Drive Shaft		28	32	57	71	802	
	2011.08- -	AT	R	R	Hatchback Engine N47 D20 D	205110	Drive Shaft		28	32	57	71	748	
	2011.08- -	AT	R	R	Hatchback Engine N47 D20 D	605086	Inner Joint		28	28	57	71	64	
	2011.08- -	AT	R	R	Hatchback Engine N47 D20 D	605087	Inner Joint		32	28	50	85	72.5	
	2011.08- -	AT	R	R	Hatchback Engine N47 D20 D	605088	Inner Joint		32	28	50	85	72.5	
2.0 (165 kW)	2015.03- -	AT	R	R	Hatchback Engine B47 D20 B	205109	Drive Shaft		28	32	57	71	802	
	2015.03- -	AT	L	R	Hatchback Engine B47 D20 B	205110	Drive Shaft		28	32	57	71	748	
	2015.03- -	AT	L/R	R	Hatchback Engine B47 D20 B	605086	Inner Joint		28	28	57	71	64	
	2015.03- -	AT	L/R	R	Hatchback Engine B47 D20 B	605087	Inner Joint		32	28	50	85	72.5	
S 63 L AMG (100 kW)	2015.03- -	AT	L	R	Hatchback Engine N13 B16 A	205107	Drive Shaft		28	27	57.4	71	749	
	2015.03- -	MT	L	R	Hatchback Engine N13 B16 A	205066	Drive Shaft		28	27	57.4	71	739	
	2015.03- -	MT	R	R	Hatchback Engine N13 B16 A	205067	Drive Shaft		28	27	57.4	71	793	
1 (F21)														
1.5 (70 kW)	2015.06- -	-	L/R	R	Hatchback Engine B37 D15 A	805024	Outer Joint		28	33	57.2	70.5	58	I
1.5 (85 kW)	2015.03- -	-	L/R	R	Hatchback Engine B37 D15 A	805024	Outer Joint		28	33	57.2	70.5	58	I
1.6 (100 kW)	2015.03- -	AT	L	R	Hatchback Engine N13 B16 A	205107	Drive Shaft		28	27	57.4	71	749	
	2015.03- -	MT	L	R	Hatchback Engine N13 B16 A	205066	Drive Shaft		28	27	57.4	71	739	
	2015.03- -	AT	L	R	Hatchback Engine B38 B15 A	205107	Drive Shaft		28	27	57.4	71	749	
	2015.03- -	MT	L	R	Hatchback Engine B38 B15 A	205066	Drive Shaft		28	27	57.4	71	739	
	2015.03- -	MT	R	R	Hatchback Engine N13 B16 A	205067	Drive Shaft		28	27	57.4	71	793	
	2015.03- -	MT	R	R	Hatchback Engine B38 B15 A	205067	Drive Shaft		28	27	57.4	71	793	
1.6 (125 kW)	2012.07- -	MT	L	R	Hatchback Engine N13 B16 A	205066	Drive Shaft		28	27	57.4	71	739	
	2012.07- -	AT	L	R	Hatchback Engine N13 B16 A	205107	Drive Shaft		28	27	57.4	71	749	

YEAR	TRANSM	L/R	F/R	REMARKS	GSP Ref.	PRODUCT	ABS	Technical Specifications					
								A	B	C	H	L	P
BMW													
1 (F21)													
1.6 (125 kW)	2012.07-	-	MT	R R	Hatchback Engine N13 B16 A	205067	Drive Shaft		28	27	57.4	71	793
1.6 (130 kW)	2015.03-	-	AT	L R	Hatchback Engine N13 B16 A	205107	Drive Shaft		28	27	57.4	71	749
	2015.03-	-	MT	L R	Hatchback Engine N13 B16 A	205066	Drive Shaft		28	27	57.4	71	739
	2015.03-	-	MT	R R	Hatchback Engine N13 B16 A	205067	Drive Shaft		28	27	57.4	71	793
114 d (70 kW)	2012.07-	-	MT	L R	Hatchback Engine N47 D16 A	205066	Drive Shaft		28	27	57.4	71	739
	2012.07-	-	MT	R R	Hatchback Engine N47 D16 A	205067	Drive Shaft		28	27	57.4	71	793
114 i (75 kW)	2011.12-	-	MT	L R	Hatchback Engine N13 B16 A	205066	Drive Shaft		28	27	57.4	71	739
	2011.12-	-	MT	R R	Hatchback Engine N13 B16 A	205067	Drive Shaft		28	27	57.4	71	793
116 i (80 kW)	2015.03-	-	MT	L R	Hatchback Engine B38 B15 A	205066	Drive Shaft		28	27	57.4	71	739
	2015.03-	-	MT	R R	Hatchback Engine B38 B15 A	205067	Drive Shaft		28	27	57.4	71	793
120 i (135 kW)	2015.10-	-	MT	L R	Hatchback Engine B48 B20 B	205066	Drive Shaft		28	27	57.4	71	739
	2015.10-	-	MT	R R	Hatchback Engine B48 B20 B	205067	Drive Shaft		28	27	57.4	71	793
2.0 (100 kW)	2011.12-	-	MT	L R	Hatchback Engine N13 B16 A	205066	Drive Shaft		28	27	57.4	71	739
	2011.12-	-	AT	L R	Hatchback Engine N13 B16 A	205107	Drive Shaft		28	27	57.4	71	749
	2011.12-	-	MT	R R	Hatchback Engine N13 B16 A	205067	Drive Shaft		28	27	57.4	71	793
2.0 (155 kW)	2011.12-	-	AT	R R	Hatchback Engine N47 D20 D	605086	Inner Joint		28	28	57	71	64
	2011.12-	-	AT	R R	Hatchback Engine N47 D20 D	605087	Inner Joint		32	28	50	85	72.5
	2011.12-	-	AT	R R	Hatchback Engine N47 D20 D	205109	Drive Shaft		28	32	57	71	802
	2011.12-	-	AT	L R	Hatchback Engine N47 D20 D	205110	Drive Shaft		28	32	57	71	748
	2011.12-	-	AT	R R	Hatchback Engine N47 D20 D	205109	Drive Shaft		28	32	57	71	802
2.0 (160 kW)	2011.12-	-	AT	L R	Hatchback Engine N47 D20 D	605086	Inner Joint		28	28	57	71	64
	2011.12-	-	AT	L R	Hatchback Engine N47 D20 D	605087	Inner Joint		32	28	50	85	72.5
	2011.12-	-	AT	R R	Hatchback Engine N47 D20 D	205109	Drive Shaft		28	32	57	71	802
	2011.12-	-	AT	L R	Hatchback Engine N47 D20 D	205110	Drive Shaft		28	32	57	71	748
2.0 (165 kW)	2015.03-	-	AT	R R	Hatchback Engine B47 D20 B	205109	Drive Shaft		28	32	57	71	802
	2015.03-	-	AT	L R	Hatchback Engine B47 D20 B	205110	Drive Shaft		28	32	57	71	748
	2015.03-	-	AT	L/R	Hatchback Engine B47 D20 B	605086	Inner Joint		28	28	57	71	64
	2015.03-	-	AT	L/R	Hatchback Engine B47 D20 B	605087	Inner Joint		32	28	50	85	72.5
2 (F22 F87)													
2.0 d (160 kW)	2014.01-	-	-	R R	Coupe Engine N47 D20 D	205109	Drive Shaft		28	32	57	71	802
	2014.01-	-	AT/MT	L R	Coupe Engine N47 D20 D	205110	Drive Shaft		28	32	57	71	748
	2014.01-	-	MT/AT	L/R	Coupe Engine N47 D20 D	605086	Inner Joint		28	28	57	71	64
	2014.01-	-	MT/AT	L/R	Coupe Engine N47 D20 D	605087	Inner Joint		32	28	50	85	72.5
2.0 d (165 kW)	2015.07-	-	-	R R	Coupe Engine B47 D20 B	205109	Drive Shaft		28	32	57	71	802
	2015.07-	-	AT	L R	Coupe Engine B47 D20 B	205110	Drive Shaft		28	32	57	71	748
	2015.07-	-	AT	L/R	Coupe Engine B47 D20 B	605086	Inner Joint		28	28	57	71	64
	2015.07-	-	AT	L/R	Coupe Engine B47 D20 B	605087	Inner Joint		32	28	50	85	72.5
2.2 i (135 kW)	2013.10-	-	MT	L R	Coupe Engine N20 B20 B	205066	Drive Shaft		28	27	57.4	71	739
	2013.10-	-	MT	R R	Coupe Engine N20 B20 B	205067	Drive Shaft		28	27	57.4	71	793
218 i (100 kW)	2015.03-	-	MT	L R	Coupe Engine B38 B15 A	205066	Drive Shaft		28	27	57.4	71	739
	2015.03-	-	MT	R R	Coupe Engine B38 B15 A	205067	Drive Shaft		28	27	57.4	71	793
2 (F23)													
2.0 d (165 kW)	2015.07-	-	-	R R	Convertible Engine B47 D20 B	205109	Drive Shaft		28	32	57	71	802
	2015.07-	-	AT	L R	Convertible Engine B47 D20 B	205110	Drive Shaft		28	32	57	71	748
	2015.07-	-	AT	L/R	Convertible Engine B47 D20 B	605086	Inner Joint		28	28	57	71	64
	2015.07-	-	AT	L/R	Convertible Engine B47 D20 B	605087	Inner Joint		32	28	50	85	72.5
218 i (100 kW)	2015.03-	-	MT	L R	Convertible Engine B38 B15 A	205066	Drive Shaft		28	27	57.4	71	739
	2015.03-	-	MT	R R	Convertible Engine B38 B15 A	205067	Drive Shaft		28	27	57.4	71	793
3 (E30)													
2.3 (143 kW)	1986.07-	1991.06	AT/MT	L/R	Saloon Engine S14 B23 (234S2)/S14 B23 (234S1)/S14 B23 (234EA)	699052	Inner Joint				25		32
	1986.07-	1991.06	AT/MT	L/R	Saloon Engine S14 B23 (234S2)/S14 B23 (234S1)/S14 B23 (234EA)	205004	Drive Shaft	48T	27		63.8	66.5	574
2.3 (147 kW)	1987.02-	1989.05	AT/MT	L/R	Saloon Engine S14 B23 (234S2)	699052	Inner Joint			25		32	
	1987.02-	1989.05	AT/MT	L/R	Saloon Engine S14 B23 (234S2)	205004	Drive Shaft	48T	27		63.8	66.5	574
2.3 (158 kW)	1989.06-	1991.06	AT/MT	L/R	Saloon Engine S14 B23 (234EA)	699052	Inner Joint			25		32	
	1989.06-	1991.06	AT/MT	L/R	Saloon Engine S14 B23 (234EA)	205004	Drive Shaft	48T	27		63.8	66.5	574
316 (66 kW)	1983.09-	1990.12	AT	-	R Saloon Engine M10 B18 (184VD)	205003	Drive Shaft		27		63.8	66.5	574
316 i (73 kW)	1987.09-	1991.06	AT	-	R Saloon Engine M40 B16 (164E1)	205003	Drive Shaft		27		63.8	66.5	574
316 i (75 kW)	1988.07-	1991.06	AT	-	R Saloon Engine M40 B16 (164E1)	205003	Drive Shaft		27		63.8	66.5	574
318 i (83 kW)	1987.09-	1991.06	AT	-	R Saloon Engine M40 B18 (184E1)	205003	Drive Shaft		27		63.8	66.5	574
	1990.09-	1993.10	AT	-	R Convertible Engine M40 B18 (184E1)	205003	Drive Shaft		27		63.8	66.5	574
318 i (85 kW)	1987.09-	1991.06	AT	-	R Saloon Engine M40 B18 (184E1)	205003	Drive Shaft		27		63.8	66.5	574
320 i (95 kW)	1985.12-	1991.06	AT	-	R Saloon Engine M20 B20 (206KA)	205003	Drive Shaft		27		63.8	66.5	574
	1986.04-	1993.10	AT	-	R Convertible Engine M20 B20 (206KA)	205003	Drive Shaft		27		63.8	66.5	574
324 td (85 kW)	1987.09-	1991.08	AT/MT	L/R	Saloon Engine M21 D24 (246TB)	699052	Inner Joint			25		32	
	1987.09-	1991.08	AT/MT	L/R	Saloon Engine M21 D24 (246TB)	205004	Drive Shaft	48T	27		63.8	66.5	574
325 i (125 kW)	1986.12-	1991.06	AT/MT	L/R	Saloon Engine M20 B25 (256K1)/M20 B25 (256EX)/M20 B25 (256E2)/M20 B25 (256E1)	699052	Inner Joint			25		32	
	1986.12-	1991.06	AT/MT	L/R	Saloon Engine M20 B25 (256K1)/M20 B25 (256EX)/M20 B25 (256E2)/M20 B25 (256E1)	205004	Drive Shaft	48T	27		63.8	66.5	574

	 YEAR	TRANSM	L/R	F/R	REMARKS	GSP Ref.	 PRODUCT	 ABS	Technical Specifications					
									A	B	C	H	L	P
BMW														
3 (E30)														
325 i (125 kW)	1987.09-1993.10	AT/MT	L/R	R	Convertible Engine M20 B25 (256K1)/M20 B25 (256EX)/M20 B25 (256E1)	699052	Inner Joint		25	32				
	1987.09-1993.10	AT/MT	L/R	R	Convertible Engine M20 B25 (256K1)/M20 B25 (256EX)/M20 B25 (256E1)	205004	Drive Shaft	48T	27	63.8	66.5	574		
325 i (126 kW)	1983.09-1989.11	AT/MT	L/R	R	Saloon Engine M20 B25 (256E2)	699052	Inner Joint		25	32				
	1983.09-1989.11	AT/MT	L/R	R	Saloon Engine M20 B25 (256E2)	205004	Drive Shaft	48T	27	63.8	66.5	574		
3 (E36)														
316 i (73 kW)	1990.09-1993.09	AT/MT	L/R	R	Saloon Engine M40 B16 (164E1)	205014	Drive Shaft		27	64	68.5	615		
	1990.09-1993.09	-	-	R	Saloon Engine M40 B16 (164E1)	605001	Inner Joint		24	24				
	1990.09-1993.09	MT	-	R	Saloon Engine M40 B16 (164E1)	205005	Drive Shaft	48W	27	63.8	68.5	625		
	1990.09-1993.09	-	-	R	Saloon Engine M40 B16 (164E1)	205013	Drive Shaft		27	63.8	68.5	625		
	1990.09-1993.09	AT/MT	L/R	R	Saloon Engine M40 B16 (164E1)	205002	Drive Shaft	48W	27	64	68.5	615		
	1990.09-1993.09	-	-	R	Saloon Engine M40 B16 (164E1)	605009	Inner Joint	27	24	64	68.5	58		
316 i (75 kW)	1990.09-1993.09	AT/MT	L/R	R	Saloon Engine M43 B16 (164E2)	205014	Drive Shaft		27	64	68.5	615		
	1990.09-1993.09	-	-	R	Saloon Engine M43 B16 (164E2)	605001	Inner Joint		24	24				
	1990.09-1993.09	-	L/R	R	Saloon Engine M43 B16 (164E2)	605009	Inner Joint	27	24	64	68.5	58		
	1990.09-1993.09	AT/MT	-	R	Saloon Engine M43 B16 (164E2)	205005	Drive Shaft	48W	27	63.8	68.5	625		
	1990.09-1993.09	AT/MT	-	R	Saloon Engine M43 B16 (164E2)	205013	Drive Shaft		27	63.8	68.5	625		
	1990.09-1993.09	AT/MT	L/R	R	Saloon Engine M43 B16 (164E2)	205002	Drive Shaft	48W	27	64	68.5	615		
	1993.07-1998.02	AT/MT	L/R	R	Saloon Engine M43 B16 (164E2)	205014	Drive Shaft		27	64	68.5	615		
	1993.07-1998.02	-	-	R	Saloon Engine M43 B16 (164E2)	605001	Inner Joint		24	24				
	1993.07-1998.02	AT/MT	-	R	Saloon Engine M43 B16 (164E2)	205005	Drive Shaft	48W	27	63.8	68.5	625		
	1993.07-1998.02	AT/MT	-	R	Saloon Engine M43 B16 (164E2)	205013	Drive Shaft		27	63.8	68.5	625		
	1993.07-1998.02	AT/MT	L/R	R	Saloon Engine M43 B16 (164E2)	205002	Drive Shaft	48W	27	64	68.5	615		
	1993.07-1998.02	-	L/R	R	Saloon Engine M43 B16 (164E2)	605009	Inner Joint	27	24	64	68.5	58		
	1993.09-1999.04	AT/MT	L/R	R	Coupe Engine M43 B16 (164E2)	205014	Drive Shaft		27	64	68.5	615		
	1993.09-1999.04	-	-	R	Coupe Engine M43 B16 (164E2)	605001	Inner Joint		24	24				
	1993.09-1999.04	AT/MT	-	R	Coupe Engine M43 B16 (164E2)	205005	Drive Shaft	48W	27	63.8	68.5	625		
	1993.09-1999.04	AT/MT	-	R	Coupe Engine M43 B16 (164E2)	205013	Drive Shaft		27	63.8	68.5	625		
1993.09-1999.04	AT/MT	L/R	R	Coupe Engine M43 B16 (164E2)	205002	Drive Shaft	48W	27	64	68.5	615			
1993.09-1999.04	-	-	R	Coupe Engine M43 B16 (164E2)	605009	Inner Joint	27	24	64	68.5	58			
318 i (83 kW)	1990.12-1993.10	-	-	R	Saloon Engine M40 B18 (184E1)	605001	Inner Joint		24	24				
	1990.12-1993.10	AT/MT	-	R	Saloon Engine M40 B18 (184E1)	205005	Drive Shaft	48W	27	63.8	68.5	625		
	1990.12-1993.10	AT/MT	-	R	Saloon Engine M40 B18 (184E1)	205013	Drive Shaft		27	63.8	68.5	625		
	1990.12-1993.10	AT/MT	L/R	R	Saloon Engine M40 B18 (184E1)	205002	Drive Shaft	48W	27	64	68.5	615		
	1990.12-1993.10	-	L/R	R	Saloon Engine M40 B18 (184E1)	605009	Inner Joint	27	24	64	68.5	58		
318 i (85 kW)	1993.10-1998.02	-	-	R	Saloon Engine M43 B18 (184E2)	605001	Inner Joint		24	24				
	1993.10-1998.02	AT/MT	-	R	Saloon Engine M43 B18 (184E2)	205005	Drive Shaft	48W	27	63.8	68.5	625		
	1993.10-1998.02	AT/MT	-	R	Saloon Engine M43 B18 (184E2)	205013	Drive Shaft		27	63.8	68.5	625		
	1993.10-1998.02	AT/MT	L/R	R	Saloon Engine M43 B18 (184E2)	205002	Drive Shaft	48W	27	64	68.5	615		
	1993.10-1998.02	-	L/R	R	Saloon Engine M43 B18 (184E2)	605009	Inner Joint	27	24	64	68.5	58		
	1994.01-1999.04	AT/MT	L/R	R	Convertible Engine M43 B18 (184E2)	205014	Drive Shaft		27	64	68.5	615		
	1994.01-1999.04	-	-	R	Convertible Engine M43 B18 (184E2)	605001	Inner Joint		24	24				
	1994.01-1999.04	AT/MT	-	R	Convertible Engine M43 B18 (184E2)	205005	Drive Shaft	48W	27	63.8	68.5	625		
	1994.01-1999.04	AT/MT	-	R	Convertible Engine M43 B18 (184E2)	205013	Drive Shaft		27	63.8	68.5	625		
	1994.01-1999.04	AT/MT	L/R	R	Convertible Engine M43 B18 (184E2)	205002	Drive Shaft	48W	27	64	68.5	615		
	1994.01-1999.04	-	L/R	R	Convertible Engine M43 B18 (184E2)	605009	Inner Joint	27	24	64	68.5	58		
318 is (103 kW)	1992.03-1995.10	-	L/R	R	Coupe Engine M42 B18 (184S1)	605009	Inner Joint	27	24	64	68.5	58		
	1992.03-1995.10	AT/MT	L/R	R	Coupe Engine M42 B18 (184S1)	205014	Drive Shaft		27	64	68.5	615		
	1992.03-1995.10	-	-	R	Coupe Engine M42 B18 (184S1)	605001	Inner Joint		24	24				
	1992.03-1995.10	AT/MT	-	R	Coupe Engine M42 B18 (184S1)	205005	Drive Shaft	48W	27	63.8	68.5	625		
	1992.03-1995.10	AT/MT	-	R	Coupe Engine M42 B18 (184S1)	205013	Drive Shaft		27	63.8	68.5	625		
	1992.03-1995.10	AT/MT	L/R	R	Coupe Engine M42 B18 (184S1)	205002	Drive Shaft	48W	27	64	68.5	615		
	1993.03-1998.02	-	L/R	R	Saloon Engine M42 B18 (184S1)	605009	Inner Joint	27	24	64	68.5	58		
	1993.03-1998.02	-	-	R	Saloon Engine M42 B18 (184S1)	605001	Inner Joint		24	24				
	1993.03-1998.02	AT/MT	-	R	Saloon Engine M42 B18 (184S1)	205005	Drive Shaft	48W	27	63.8	68.5	625		
	1993.03-1998.02	AT/MT	-	R	Saloon Engine M42 B18 (184S1)	205013	Drive Shaft		27	63.8	68.5	625		
	1993.03-1998.02	AT/MT	L/R	R	Saloon Engine M42 B18 (184S1)	205002	Drive Shaft	48W	27	64	68.5	615		
	1995.09-1999.04	-	-	R	Coupe Engine M44 B19 (194S1)	605001	Inner Joint		24	24				
	1995.09-1999.04	AT/MT	-	R	Coupe Engine M44 B19 (194S1)	205005	Drive Shaft	48W	27	63.8	68.5	625		
	1995.09-1998.02	AT/MT	-	R	Saloon Engine M44 B19 (194S1)	205005	Drive Shaft	48W	27	63.8	68.5	625		
	1995.09-1999.04	AT/MT	-	R	Coupe Engine M44 B19 (194S1)	205013	Drive Shaft		27	63.8	68.5	625		
	1995.09-1998.02	AT/MT	-	R	Saloon Engine M44 B19 (194S1)	205013	Drive Shaft		27	63.8	68.5	625		
	1995.09-1999.04	AT/MT	L/R	R	Coupe Engine M44 B19 (194S1)	205002	Drive Shaft	48W	27	64	68.5	615		
	1995.09-1999.04	-	L/R	R	Coupe Engine M44 B19 (194S1)	605009	Inner Joint	27	24	64	68.5	58		
1995.09-1998.02	-	L/R	R	Saloon Engine M44 B19 (194S1)	605009	Inner Joint	27	24	64	68.5	58			
318 tds (66 kW)	1995.01-1998.02	MT	-	R	Saloon Engine M41 D17 (174T1)	205005	Drive Shaft	48W	27	63.8	68.5	625		
	1995.01-1998.02	MT	-	R	Saloon Engine M41 D17 (174T1)	205013	Drive Shaft		27	63.8	68.5	625		

YEAR	TRANSM	L/R	F/R	REMARKS	GSP Ref.	PRODUCT	ABS	Technical Specifications							
								A	B	C	H	L	P		
BMW															
3 (E36)															
318 tds (66 kW)	1995.01-1998.02	-	L/R	R	Saloon Engine M41 D17 (174T1)	605009	Inner Joint		27	24	64	68.5	58		
320 i (110 kW)	1990.09-1998.02	-	L/R	R	Saloon Engine M52 B20 (206S3)/M52 B20 (206S2)/M52 B20 (206S1)	605009	Inner Joint		27	24	64	68.5	58		
	1990.09-1998.02	AT/MT	L/R	R	Saloon Engine M52 B20 (206S3)/M52 B20 (206S2)/M52 B20 (206S1)	205014	Drive Shaft		27		64	68.5	615		
	1990.09-1998.02	-	-	R	Saloon Engine M52 B20 (206S3)/M52 B20 (206S2)/M52 B20 (206S1)	605001	Inner Joint			24		24			
	1990.09-1998.02	AT/MT	-	R	Saloon Engine M52 B20 (206S3)/M52 B20 (206S2)/M52 B20 (206S1)	205005	Drive Shaft	48W	27		63.8	68.5	625		
	1990.09-1998.02	AT/MT	-	R	Saloon Engine M52 B20 (206S3)/M52 B20 (206S2)/M52 B20 (206S1)	205013	Drive Shaft		27		63.8	68.5	625		
	1990.09-1998.02	AT/MT	L/R	R	Saloon Engine M52 B20 (206S3)/M52 B20 (206S2)/M52 B20 (206S1)	205002	Drive Shaft	48W	27		64	68.5	615		
	1992.03-1999.04	-	L/R	R	Coupe Engine M50 B20 (206S2)/M50 B20 (206S1)/M50 B20 (206S3)	605009	Inner Joint		27	24	64	68.5	58		
	1992.03-1999.04	AT/MT	L/R	R	Coupe Engine M50 B20 (206S2)/M50 B20 (206S1)/M50 B20 (206S3)	205014	Drive Shaft		27		64	68.5	615		
	1992.03-1999.04	-	-	R	Coupe Engine M50 B20 (206S2)/M50 B20 (206S1)/M50 B20 (206S3)	605001	Inner Joint			24		24			
	1992.03-1999.04	AT/MT	-	R	Coupe Engine M50 B20 (206S2)/M50 B20 (206S1)/M50 B20 (206S3)	205005	Drive Shaft	48W	27		63.8	68.5	625		
	1992.03-1999.04	AT/MT	-	R	Coupe Engine M50 B20 (206S2)/M50 B20 (206S1)/M50 B20 (206S3)	205013	Drive Shaft		27		63.8	68.5	625		
	1992.03-1999.04	AT/MT	L/R	R	Coupe Engine M50 B20 (206S2)/M50 B20 (206S1)/M50 B20 (206S3)	205002	Drive Shaft	48W	27		64	68.5	615		
	1993.12-1999.04	AT/MT	L/R	R	Convertible Engine M52 B20 (206S3)/M52 B20 (206S2)	205014	Drive Shaft		27		64	68.5	615		
	1993.12-1999.04	-	-	R	Convertible Engine M52 B20 (206S3)/M52 B20 (206S2)	605001	Inner Joint			24		24			
	1993.12-1999.04	AT/MT	-	R	Convertible Engine M52 B20 (206S3)/M52 B20 (206S2)	205005	Drive Shaft	48W	27		63.8	68.5	625		
1993.12-1999.04	AT/MT	-	R	Convertible Engine M52 B20 (206S3)/M52 B20 (206S2)	205013	Drive Shaft		27		63.8	68.5	625			
1993.12-1999.04	-	L/R	R	Convertible Engine M52 B20 (206S3)/M52 B20 (206S2)	605009	Inner Joint		27	24	64	68.5	58			
1993.12-1999.04	AT/MT	L/R	R	Convertible Engine M52 B20 (206S3)/M52 B20 (206S2)	205002	Drive Shaft	48W	27		64	68.5	615			
323 i (125 kW)	1995.03-1999.04	AT	L/R	R	Coupe Engine M52 B25 (256S3)	205007	Drive Shaft	48W	27		64	68.5	615		
325 i (141 kW)	1990.09-1995.09	AT/MT	L/R	R	Saloon Engine M50 B25 (256S2)/M50 B25 (256S1)	205007	Drive Shaft	48W	27		64	68.5	615		
	1992.03-1999.04	AT/MT	L/R	R	Coupe Engine M50 B25 (256S1)/M50 B25 (256S2)	205007	Drive Shaft	48W	27		64	68.5	615		
	1993.03-1995.03	AT/MT	L/R	R	Convertible Engine M50 B25 (256S2)	205007	Drive Shaft	48W	27		64	68.5	615		
325 td (85 kW)	1991.09-1998.02	AT/MT	L/R	R	Saloon Engine M51 D25 (256T1)	205007	Drive Shaft	48W	27		64	68.5	615		
325 tds (105 kW)	1993.05-1998.02	AT/MT	L/R	R	Saloon Engine M51 D25 (256T1)	205007	Drive Shaft	48W	27		64	68.5	615		
328 i (142 kW)	1995.01-1999.04	AT	L/R	R	Coupe Engine M52 B28 (286S1)	205007	Drive Shaft	48W	27		64	68.5	615		
	1995.03-1999.04	-	L/R	R	Convertible Engine M52 B28 (286S1)	205007	Drive Shaft	48W	27		64	68.5	615		
M3 3.2 (236 kW)	1995.09-1998.02	MT	-	R	Saloon Engine S50 B32 (326S1)	299199	Drive Shaft	48W	30		69	73	602		
	1995.10-1999.04	MT	-	R	Coupe Engine S50 B32 (326S1)	299199	Drive Shaft	48W	30		69	73	602		
	1995.10-1999.04	MT	-	R	Convertible Engine S50 B32 (326S1)	299199	Drive Shaft	48W	30		69	73	602		
3 (E46)															
316 Ci (77 kW)	2000.04-2006.07	AT/MT	L	R	Coupe Engine M43 B16 (164E3)	205002	Drive Shaft	48W	27		64	68.5	615		
	2000.04-2006.07	AT/MT	R	R	Coupe Engine M43 B16 (164E3)	205017	Drive Shaft	48W	27		64	68.5	675		
316 Ci (85 kW)	2002.06-2006.07	AT/MT	L	R	Coupe Engine N45 B16 A	205002	Drive Shaft	48W	27		64	68.5	615		
	2002.06-2006.07	AT/MT	R	R	Coupe Engine N45 B16 A	205017	Drive Shaft	48W	27		64	68.5	675		
316 i (77 kW)	1998.09-2005.02	AT/MT	L	R	Saloon Engine M43 B19 (194E1)	205002	Drive Shaft	48W	27		64	68.5	615		
	1998.09-2005.02	AT/MT	R	R	Saloon Engine M43 B19 (194E1)	205017	Drive Shaft	48W	27		64	68.5	675		
	2000.04-2005.02	AT/MT	L	R	Saloon Engine M43 B16 (164E3)	205002	Drive Shaft	48W	27		64	68.5	615		
	2000.04-2005.02	AT/MT	R	R	Saloon Engine M43 B16 (164E3)	205017	Drive Shaft	48W	27		64	68.5	675		
316 i (85 kW)	2002.02-2005.02	AT/MT	L	R	Saloon Engine N46 B18 A/N42 B18 A	205002	Drive Shaft	48W	27		64	68.5	615		
	2002.02-2005.02	AT/MT	R	R	Saloon Engine N46 B18 A/N42 B18 A	205017	Drive Shaft	48W	27		64	68.5	675		
	2002.06-2005.02	AT/MT	L	R	Saloon Engine N40 B16 A/N45 B16 A	205002	Drive Shaft	48W	27		64	68.5	615		
	2002.06-2005.02	AT/MT	R	R	Saloon Engine N40 B16 A/N45 B16 A	205017	Drive Shaft	48W	27		64	68.5	675		
318 Ci (100 kW)	2000.12-2006.08	-	L	R	Convertible Engine N46 B20 A	205002	Drive Shaft	48W	27		64	68.5	615		
	2000.12-2006.05	-	L	R	Coupe Engine N46 B20 A	205002	Drive Shaft	48W	27		64	68.5	615		
	2000.12-2006.08	-	R	R	Convertible Engine N46 B20 A	205017	Drive Shaft	48W	27		64	68.5	675		
	2000.12-2006.05	-	R	R	Coupe Engine N46 B20 A	205017	Drive Shaft	48W	27		64	68.5	675		
318 Ci (105 kW)	2000.12-2006.05	AT/MT	L	R	Coupe Engine N46 B20 A	205002	Drive Shaft	48W	27		64	68.5	615		
	2000.12-2006.05	AT/MT	R	R	Coupe Engine N46 B20 A	205017	Drive Shaft	48W	27		64	68.5	675		
	2001.09-2007.12	AT/MT	L	R	Convertible Engine N46 B20 A	205002	Drive Shaft	48W	27		64	68.5	615		
	2001.09-2007.12	AT/MT	R	R	Convertible Engine N46 B20 A	205017	Drive Shaft	48W	27		64	68.5	675		
318 Ci (110 kW)	2005.02-2007.12	AT/MT	L	R	Convertible Engine N46 B20 A	205002	Drive Shaft	48W	27		64	68.5	615		
	2005.02-2007.12	AT/MT	R	R	Convertible Engine N46 B20 A	205017	Drive Shaft	48W	27		64	68.5	675		
	2005.03-2006.07	AT/MT	L	R	Coupe Engine N46 B20 A	205002	Drive Shaft	48W	27		64	68.5	615		
2005.03-2006.07	AT/MT	R	R	Coupe Engine N46 B20 A	205017	Drive Shaft	48W	27		64	68.5	675			
318 Ci (87 kW)	1999.11-2001.09	AT/MT	L	R	Coupe Engine M43 B19 (194E1)	205002	Drive Shaft	48W	27		64	68.5	615		
	1999.11-2001.09	AT/MT	R	R	Coupe Engine M43 B19 (194E1)	205017	Drive Shaft	48W	27		64	68.5	675		
318 d (85 kW)	2001.09-2003.03	-	R	R	Saloon Engine M47 D20 (204D1)	205042	Drive Shaft	48W	27		64	69	665		
	2001.09-2003.03	-	L	R	Saloon Engine M47 D20 (204D1)	205051	Drive Shaft	48W	27		64	69	608		
	2003.03-2005.02	-	R	R	Saloon Engine M47 D20 (204D4)	205042	Drive Shaft	48W	27		64	69	665		
	2003.03-2005.02	-	L	R	Saloon Engine M47 D20 (204D4)	205051	Drive Shaft	48W	27		64	69	608		
318 i (105 kW)	2001.09-2005.02	AT/MT	L	R	Saloon Engine N46 B20 A/N42 B20 A	205002	Drive Shaft	48W	27		64	68.5	615		
	2001.09-2005.02	AT/MT	R	R	Saloon Engine N46 B20 A/N42 B20 A	205017	Drive Shaft	48W	27		64	68.5	675		
318 i (87 kW)	1998.02-2001.09	AT/MT	L	R	Saloon Engine M43 B19 (194E1)	205002	Drive Shaft	48W	27		64	68.5	615		
	1998.02-2001.09	AT/MT	R	R	Saloon Engine M43 B19 (194E1)	205017	Drive Shaft	48W	27		64	68.5	675		
320 Cd (110 kW)	2003.11-2006.07	AT	R	R	Coupe Engine M47 D20 (204D4)	205042	Drive Shaft	48W	27		64	69	665		





	 YEAR	TRANSM	L/R	F/R	REMARKS	GSP Ref.	 PRODUCT	 ABS	Technical Specifications					
									A	B	C	H	L	P
BMW														
3 (E46)														
320 Cd (110 kW)	2003.11-2006.07	AT	L	R	Coupe Engine M47 D20 (204D4)	205051	Drive Shaft	48W	27		64	69	608	
	2005.02-2007.12	AT	R	R	Convertible Engine M47 D20 (204D4)	205042	Drive Shaft	48W	27		64	69	665	
	2005.02-2007.12	AT	L	R	Convertible Engine M47 D20 (204D4)	205051	Drive Shaft	48W	27		64	69	608	
320 Ci (110 kW)	1999.02-2001.08	AT/MT	R	R	Coupe Engine M52 B20 (206S4)	205042	Drive Shaft	48W	27		64	69	665	
	1999.02-2001.08	AT/MT	L	R	Coupe Engine M52 B20 (206S4)	205051	Drive Shaft	48W	27		64	69	608	
	1999.02-2001.08	MT	L	R	Coupe Engine M52 B20 (206S4)	205002	Drive Shaft	48W	27		64	68.5	615	
	1999.02-2001.08	MT	R	R	Coupe Engine M52 B20 (206S4)	205017	Drive Shaft	48W	27		64	68.5	675	
320 Ci (120 kW)	2000.01-2006.05	-	L	R	Coupe Engine M54 B22 (226S1)	205002	Drive Shaft	48W	27		64	68.5	615	
	2000.01-2006.05	-	R	R	Coupe Engine M54 B22 (226S1)	205017	Drive Shaft	48W	27		64	68.5	675	
	2006.01-2007.12	MT	L	R	Convertible Engine M54 B22 (226S1)	205002	Drive Shaft	48W	27		64	68.5	615	
	2006.01-2007.12	MT	R	R	Convertible Engine M54 B22 (226S1)	205017	Drive Shaft	48W	27		64	68.5	675	
320 Ci (125 kW)	2000.01-2006.05	AT/MT	R	R	Coupe Engine M54 B22 (226S1)	205042	Drive Shaft	48W	27		64	69	665	
	2000.01-2006.05	AT/MT	L	R	Coupe Engine M54 B22 (226S1)	205051	Drive Shaft	48W	27		64	69	608	
	2000.01-2006.05	MT	L	R	Coupe Engine M54 B22 (226S1)	205002	Drive Shaft	48W	27		64	68.5	615	
	2000.01-2006.05	MT	R	R	Coupe Engine M54 B22 (226S1)	205017	Drive Shaft	48W	27		64	68.5	675	
	2000.09-2007.12	AT/MT	R	R	Convertible Engine M54 B22 (226S1)	205042	Drive Shaft	48W	27		64	69	665	
	2000.09-2007.12	AT/MT	L	R	Convertible Engine M54 B22 (226S1)	205051	Drive Shaft	48W	27		64	69	608	
	2000.09-2007.12	MT	L	R	Convertible Engine M54 B22 (226S1)	205002	Drive Shaft	48W	27		64	68.5	615	
320 d (100 kW)	1998.04-2001.09	-	R	R	Saloon Engine M47 D20 (204D1)	205042	Drive Shaft	48W	27		64	69	665	
	1998.04-2001.09	-	L	R	Saloon Engine M47 D20 (204D1)	205051	Drive Shaft	48W	27		64	69	608	
320 d (110 kW)	2001.09-2005.02	AT	R	R	Saloon Engine M47 D20 (204D4)	205042	Drive Shaft	48W	27		64	69	665	
	2001.09-2005.02	AT	L	R	Saloon Engine M47 D20 (204D4)	205051	Drive Shaft	48W	27		64	69	608	
320 d (95 kW)	1998.02-2005.04	AT/MT	R	R	Saloon Engine M47 D20 (204D1)	205042	Drive Shaft	48W	27		64	69	665	
	1998.02-2005.04	AT/MT	L	R	Saloon Engine M47 D20 (204D1)	205051	Drive Shaft	48W	27		64	69	608	
320 i (110 kW)	1998.03-2000.09	AT/MT	R	R	Saloon Engine M52 B20 (206S4)	205042	Drive Shaft	48W	27		64	69	665	
	1998.03-2000.09	AT/MT	L	R	Saloon Engine M52 B20 (206S4)	205051	Drive Shaft	48W	27		64	69	608	
	1998.03-2000.09	MT	L	R	Saloon Engine M52 B20 (206S4)	205002	Drive Shaft	48W	27		64	68.5	615	
	1998.03-2000.09	MT	R	R	Saloon Engine M52 B20 (206S4)	205017	Drive Shaft	48W	27		64	68.5	675	
320 i (125 kW)	2000.09-2005.02	AT/MT	R	R	Saloon Engine M54 B22 (226S1)	205042	Drive Shaft	48W	27		64	69	665	
	2000.09-2005.02	AT/MT	L	R	Saloon Engine M54 B22 (226S1)	205051	Drive Shaft	48W	27		64	69	608	
	2000.09-2005.02	MT	L	R	Saloon Engine M54 B22 (226S1)	205002	Drive Shaft	48W	27		64	68.5	615	
	2000.09-2005.02	MT	R	R	Saloon Engine M54 B22 (226S1)	205017	Drive Shaft	48W	27		64	68.5	675	
323 Ci (125 kW)	1999.04-2000.09	-	R	R	Coupe Engine M52 B25 (256S4)	205042	Drive Shaft	48W	27		64	69	665	
	1999.04-2000.09	-	L	R	Coupe Engine M52 B25 (256S4)	205051	Drive Shaft	48W	27		64	69	608	
	2000.04-2000.09	-	R	R	Convertible Engine M52 B25 (256S4)	205042	Drive Shaft	48W	27		64	69	665	
	2000.04-2000.09	-	L	R	Convertible Engine M52 B25 (256S4)	205051	Drive Shaft	48W	27		64	69	608	
323 i (125 kW)	1998.03-2000.09	-	R	R	Saloon Engine M52 B25 (256S4)	205042	Drive Shaft	48W	27		64	69	665	
	1998.03-2000.09	-	L	R	Saloon Engine M52 B25 (256S4)	205051	Drive Shaft	48W	27		64	69	608	
325 Ci (141 kW)	2000.09-2007.12	-	R	R	Convertible Engine M54 B25 (256S5)	205042	Drive Shaft	48W	27		64	69	665	
	2000.09-2006.07	-	R	R	Coupe Engine M54 B25 (256S5)	205042	Drive Shaft	48W	27		64	69	665	
	2000.09-2007.12	-	L	R	Convertible Engine M54 B25 (256S5)	205051	Drive Shaft	48W	27		64	69	608	
	2000.09-2006.07	-	L	R	Coupe Engine M54 B25 (256S5)	205051	Drive Shaft	48W	27		64	69	608	
325 i (141 kW)	2000.09-2005.02	-	R	R	Saloon Engine M54 B25 (256S5)	205042	Drive Shaft	48W	27		64	69	665	
	2000.09-2005.02	-	L	R	Saloon Engine M54 B25 (256S5)	205051	Drive Shaft	48W	27		64	69	608	
325 xi (141 kW)	2000.09-2005.02	AT/MT	R	R	All-wheel Drive Saloon Engine M54 B25 (256S5)	205042	Drive Shaft	48W	27		64	69	665	
	2000.09-2005.02	-	L	R	All-wheel Drive Saloon Engine M54 B25 (256S5)	205051	Drive Shaft	48W	27		64	69	608	
	2000.09-2005.02	AT/MT	L	F	All-wheel Drive Saloon Engine M54 B25 (256S5)	205047	Drive Shaft		30	27	59	73	577	
	2000.09-2005.02	AT/MT	R	F	All-wheel Drive Saloon Engine M54 B25 (256S5)	205048	Drive Shaft		30	27	59	73	897	
328 Ci (142 kW)	1999.04-2000.06	AT/MT	R	R	Coupe Engine M52 B28 (286S2)	205042	Drive Shaft	48W	27		64	69	665	
	1999.04-2000.06	AT/MT	L	R	Coupe Engine M52 B28 (286S2)	205051	Drive Shaft	48W	27		64	69	608	
328 i (142 kW)	1998.02-2000.06	-	R	R	Saloon Engine M52 B28 (286S2)	205042	Drive Shaft	48W	27		64	69	665	
	1998.02-2000.06	-	L	R	Saloon Engine M52 B28 (286S2)	205051	Drive Shaft	48W	27		64	69	608	
330 Ci (170 kW)	2000.06-2007.12	AT	R	R	Convertible Engine M54 B30 (306S3)	201120	Drive Shaft	48W	30		69	73	672	
330 i (170 kW)	2000.06-2005.02	MT	R	R	Saloon Engine M54 B30 (306S3)	201120	Drive Shaft	48W	30		69	73	672	
330 xd (135 kW)	2000.01-2003.02	AT/MT	L	F	All-wheel Drive Saloon Engine M57 D30 (306D1)	205047	Drive Shaft		30	27	59	73	577	
	2000.01-2003.02	AT/MT	R	F	All-wheel Drive Saloon Engine M57 D30 (306D1)	205048	Drive Shaft		30	27	59	73	897	
330 xd (150 kW)	2002.09-2004.12	AT/MT	L	F	All-wheel Drive Saloon Engine M57 D30 (306D2)	205047	Drive Shaft		30	27	59	73	577	
	2002.09-2004.12	AT/MT	R	F	All-wheel Drive Saloon Engine M57 D30 (306D2)	205048	Drive Shaft		30	27	59	73	897	
330 xi (170 kW)	2000.06-2005.02	AT/MT	L	F	All-wheel Drive Saloon Engine M54 B30 (306S3)	205047	Drive Shaft		30	27	59	73	577	
	2000.06-2005.02	AT/MT	R	F	All-wheel Drive Saloon Engine M54 B30 (306S3)	205048	Drive Shaft		30	27	59	73	897	
M3 (252 kW)	2000.06-2006.07	-	R	R	Coupe Engine S54 B32 (326S4)	201116	Drive Shaft	48W	30		69	73	615	
	2000.06-2006.07	-	R	R	Coupe Engine S54 B32 (326S4)	205108	Drive Shaft	48W	30		69	73	655	
M3 (265 kW)	2003.06-2006.07	-	R	R	Coupe Engine S54 B32 (326S4)	201116	Drive Shaft	48W	30		69	73	615	
M3 3.2 (252 kW)	2001.04-2007.12	MT	R	R	Convertible Engine S54 B32 (326S4)	201116	Drive Shaft	48W	30		69	73	615	
3 (E90)														

	 YEAR	TRANSM	L/R	F/R	REMARKS	GSP Ref.	 PRODUCT	 ABS	Technical Specifications					
									A	B	C	H	L	P
BMW														
3 (E90)														
316 d (85 kW)	2009.07-2011.12	-	R	R	Saloon Engine N47 D20 C	205023	Drive Shaft	48W	27		69	68	660	
	2009.07-2011.12	-	L	R	Saloon Engine N47 D20 C	205022	Drive Shaft	48W	27		69	68	607	
316 i (85 kW)	2005.03-2011.10	-	-	R	Saloon Engine N45 B16 A	605056	Inner Joint		27	24	69.3	68	51	I
316 i (90 kW)	2007.02-2011.10	6AT	R	R	Saloon Engine N43 B16 A	205032	Drive Shaft	48W	27		69.3	68	664	
	2007.02-2011.10	6AT	L	R	Saloon Engine N43 B16 A	205040	Drive Shaft	48W	27		69.3	68	611	
318 d (100 kW)	2007.02-2010.03	-	R	R	Saloon Engine N47 D20 A	205023	Drive Shaft	48W	27		69	68	660	
	2007.02-2010.03	-	L	R	Saloon Engine N47 D20 A	205022	Drive Shaft	48W	27		69	68	607	
318 d (105 kW)	2009.09-2011.10	-	R	R	Saloon Engine N47 D20 C	205023	Drive Shaft	48W	27		69	68	660	
	2009.09-2011.10	-	L	R	Saloon Engine N47 D20 C	205022	Drive Shaft	48W	27		69	68	607	
318 d (90 kW)	2005.01-2007.08	MT	R	R	Saloon Engine M47 D20 (204D4)	205023	Drive Shaft	48W	27		69	68	660	
	2005.01-2007.08	MT	L	R	Saloon Engine M47 D20 (204D4)	205022	Drive Shaft	48W	27		69	68	607	
318 i (100 kW)	2007.03-2011.10	AT	R	R	Saloon Engine N46 B20 B	205032	Drive Shaft	48W	27		69.3	68	664	
	2007.03-2011.10	AT	L	R	Saloon Engine N46 B20 B	205040	Drive Shaft	48W	27		69.3	68	611	
318 i (105 kW)	2007.02-2011.10	Semi-AT	R	R	Saloon Engine N43 B20 A	205032	Drive Shaft	48W	27		69.3	68	664	
	2007.02-2011.10	Semi-AT	L	R	Saloon Engine N43 B20 A	205040	Drive Shaft	48W	27		69.3	68	611	
318 i (95 kW)	2004.08-2007.08	AT	R	R	Saloon Engine N46 B20 B	205032	Drive Shaft	48W	27		69.3	68	664	
	2004.08-2007.08	AT	L	R	Saloon Engine N46 B20 B	205040	Drive Shaft	48W	27		69.3	68	611	
320 d (110 kW)	2005.09-2011.12	-	R	R	Saloon Engine M47 D20 (204D4)	605036	Inner Joint		30	25	58.7	73	58	I
	2005.09-2011.12	-	R	R	Saloon Engine M47 D20 (204D4)	635025	Inner Joint			25		26		
	2005.09-2011.12	MT	R	R	Saloon Engine M47 D20 (204D4)	205023	Drive Shaft	48W	27		69	68	660	
	2005.09-2011.12	-	R	R	Saloon Engine M47 D20 (204D4)	205134	Drive Shaft		30		58.7	73	665	
	2005.09-2011.12	MT	L	R	Saloon Engine M47 D20 (204D4)	205022	Drive Shaft	48W	27		69	68	607	
320 d (120 kW)	2004.02-2011.12	-	R	R	Saloon Engine N47 D20 C	205023	Drive Shaft	48W	27		69	68	660	
	2004.02-2011.12	-	-	R	Saloon Engine N47 D20 C	805020	Outer Joint	48W	30	33	64.8	77	60	M
	2004.02-2011.12	-	R	R	Saloon Engine N47 D20 C	205134	Drive Shaft		30		58.7	73	665	
	2004.02-2011.12	-	R	R	Saloon Engine N47 D20 C	605036	Inner Joint		30	25	58.7	73	58	I
	2004.02-2011.12	-	R	R	Saloon Engine N47 D20 C	635025	Inner Joint			25		26		
	2004.02-2011.12	-	L	R	Saloon Engine N47 D20 C	205022	Drive Shaft	48W	27		69	68	607	
320 d (130 kW)	2007.09-2011.12	-	R	R	Saloon Engine N47 D20 A	205023	Drive Shaft	48W	27		69	68	660	
	2007.09-2011.12	-	R	R	Saloon Engine N47 D20 A	605036	Inner Joint		30	25	58.7	73	58	I
	2007.09-2011.12	-	R	R	Saloon Engine N47 D20 A	635025	Inner Joint			25		26		
	2007.09-2011.12	-	-	R	Saloon Engine N47 D20 A	805020	Outer Joint	48W	30	33	64.8	77	60	M
	2007.09-2011.12	-	R	R	Saloon Engine N47 D20 A	205134	Drive Shaft		30		58.7	73	665	
	2007.09-2011.12	-	L	R	Saloon Engine N47 D20 A	205022	Drive Shaft	48W	27		69	68	607	
320 d (135 kW)	2010.01-2011.12	-	R	R	Saloon Engine N47 D20 C	205023	Drive Shaft	48W	27		69	68	660	
	2010.01-2011.12	-	R	R	Saloon Engine N47 D20 C	205134	Drive Shaft		30		58.7	73	665	
	2010.01-2011.12	-	R	R	Saloon Engine N47 D20 C	605036	Inner Joint		30	25	58.7	73	58	I
	2010.01-2011.12	-	R	R	Saloon Engine N47 D20 C	635025	Inner Joint			25		26		
	2010.01-2011.12	-	-	R	Saloon Engine N47 D20 C	805020	Outer Joint	48W	30	33	64.8	77	60	M
	2010.01-2011.12	-	L	R	Saloon Engine N47 D20 C	205022	Drive Shaft	48W	27		69	68	607	
320 d xDrive (120 kW)	2008.07-2011.12	-	-	R	All-wheel Drive Saloon Engine N47 D20 C	805020	Outer Joint	48W	30	33	64.8	77	60	M
320 d xDrive (130 kW)	2008.09-2011.12	-	R	R	All-wheel Drive Saloon Engine N47 D20 C	205134	Drive Shaft		30		58.7	73	665	
	2008.09-2011.12	-	R	R	All-wheel Drive Saloon Engine N47 D20 C	605036	Inner Joint		30	25	58.7	73	58	I
	2008.09-2011.12	-	R	R	All-wheel Drive Saloon Engine N47 D20 C	635025	Inner Joint			25		26		
	2008.09-2011.12	-	-	R	All-wheel Drive Saloon Engine N47 D20 C	805020	Outer Joint	48W	30	33	64.8	77	60	M
	2008.09-2011.12	-	L	F	All-wheel Drive Saloon Engine N47 D20 C	205124	Drive Shaft	48W	30	27	64.8	77	571	
	2008.09-2011.12	-	R	F	All-wheel Drive Saloon Engine N47 D20 C	205125	Drive Shaft	48W	30	27	64.8	77	892	
320 d xDrive (135 kW)	2010.01-2011.12	-	-	R	All-wheel Drive Saloon Engine N47 D20 C	805020	Outer Joint	48W	30	33	64.8	77	60	M
320 i (110 kW)	2004.06-2007.03	AT	R	R	Saloon Engine N46 B20 A	205032	Drive Shaft	48W	27		69.3	68	664	
	2004.06-2007.03	AT	L	R	Saloon Engine N46 B20 A	205040	Drive Shaft	48W	27		69.3	68	611	
320 i (115 kW)	2006.09-2011.12	6AT	R	R	Saloon Engine N46 B20 E	205032	Drive Shaft	48W	27		69.3	68	664	
	2006.09-2011.12	6AT	L	R	Saloon Engine N46 B20 E	205040	Drive Shaft	48W	27		69.3	68	611	
320 i (120 kW)	2007.03-2011.12	AT	R	R	Saloon Engine N43 B20 A	205032	Drive Shaft	48W	27		69.3	68	664	
	2007.03-2011.12	AT	L	R	Saloon Engine N43 B20 A	205040	Drive Shaft	48W	27		69.3	68	611	
320 i (125 kW)	2007.03-2011.12	Semi-AT	R	R	Saloon Engine N43 B20 A	205032	Drive Shaft	48W	27		69.3	68	664	
	2007.03-2011.12	Semi-AT	L	R	Saloon Engine N43 B20 A	205040	Drive Shaft	48W	27		69.3	68	611	
320 si (127 kW)	2005.09-2006.08	MT	R	R	Saloon Engine N45 B20 A	205038	Drive Shaft		30		58.7	73	663	
	2005.09-2006.08	MT	L	R	Saloon Engine N45 B20 A	205039	Drive Shaft		30		58.7	73	610	
320 xd (130 kW)	2007.09-2011.12	-	R	R	Saloon Engine N47 D20 C	605036	Inner Joint		30	25	58.7	73	58	I
	2007.09-2011.12	-	R	R	Saloon Engine N47 D20 C	635025	Inner Joint			25		26		
323 i (140 kW)	2008.03-2011.12	6AT	R	R	Saloon Engine N52 B25 A	205033	Drive Shaft	48W	27		69.3	68	664	
	2008.03-2011.12	6AT	L	R	Saloon Engine N52 B25 A	205034	Drive Shaft	48W	27		69.3	68	611	
	2008.03-2011.12	MT	R	R	Saloon Engine N52 B25 A	205036	Drive Shaft	48W	27		69.3	68	664	
	2008.03-2011.12	MT	L	R	Saloon Engine N52 B25 A	205037	Drive Shaft	48W	27		69.3	68	611	
325 d (145 kW)	2006.09-2011.12	AT	R	R	Saloon Engine M57 D30 (306D3)	605036	Inner Joint		30	25	58.7	73	58	I
	2006.09-2011.12	AT	R	R	Saloon Engine M57 D30 (306D3)	635025	Inner Joint			25		26		

YEAR	TRANSM	L/R	F/R	REMARKS	GSP Ref.	PRODUCT	ABS	Technical Specifications									
								A	B	C	H	L	P				
BMW																	
3 (E90)																	
325 d (145 kW)	2006.09-2011.12	MT	L	R	Saloon Engine M57 D30 (306D3)	205085	Drive Shaft		30		58.7	73	598				
	2006.09-2011.12	MT	R	R	Saloon Engine M57 D30 (306D3)	205079	Drive Shaft		30		58.7	73	653				
	2006.09-2011.12	AT	R	R	Saloon Engine M57 D30 (306D3)	205134	Drive Shaft		30		58.7	73	665				
325 d (150 kW)	2010.01-2011.12	MT	L	R	Saloon Engine N57 D30 A	205085	Drive Shaft		30		58.7	73	598				
	2010.01-2011.12	-	R	R	Saloon Engine N57 D30 A	205079	Drive Shaft		30		58.7	73	653				
325 i (155 kW)	2006.01-2011.12	MT	R	R	Saloon Engine N52 B25 A	205038	Drive Shaft		30		58.7	73	663				
	2006.01-2011.12	6MT	L	R	Saloon Engine N52 B25 A	205039	Drive Shaft		30		58.7	73	610				
	2006.01-2011.12	-	-	R	Saloon Engine N52 B25 A	805020	Outer Joint	48W	30	33	64.8	77	60	M			
325 i (160 kW)	2005.01-2011.12	-	-	R	Saloon Engine N52 B25 A	805020	Outer Joint	48W	30	33	64.8	77	60	M			
	2005.01-2011.12	MT	R	R	Saloon Engine N52 B25 A	205038	Drive Shaft		30		58.7	73	663				
	2005.01-2011.12	MT	L	R	Saloon Engine N52 B25 A	205039	Drive Shaft		30		58.7	73	610				
	2007.03-2011.12	-	R	R	Saloon Engine N53 B30 A	205038	Drive Shaft		30		58.7	73	663				
	2007.03-2011.12	-	-	R	Saloon Engine N53 B30 A	805020	Outer Joint	48W	30	33	64.8	77	60	M			
	2007.03-2011.12	-	L	R	Saloon Engine N53 B30 A	205039	Drive Shaft		30		58.7	73	610				
325 i xDrive (160 kW)	2008.06-2011.10	-	-	R	All-wheel Drive Saloon Engine N53 B30 A	805020	Outer Joint	48W	30	33	64.8	77	60	M			
325 xi (160 kW)	2005.03-2011.10	-	-	R	All-wheel Drive Saloon Engine N52 B25 A	805020	Outer Joint	48W	30	33	64.8	77	60	M			
	2005.03-2011.10	MT	R	R	All-wheel Drive Saloon Engine N52 B25 A	205038	Drive Shaft		30		58.7	73	663				
	2005.03-2011.10	MT	L	R	All-wheel Drive Saloon Engine N52 B25 A	205039	Drive Shaft		30		58.7	73	610				
	2007.03-2008.06	-	-	R	All-wheel Drive Saloon Engine N53 B30 A	805020	Outer Joint	48W	30	33	64.8	77	60	M			
330 d (155 kW)	2004.09-2011.12	-	R	R	Saloon Engine M57 D30 (306D3)/N57 D30 A	205079	Drive Shaft		30		58.7	73	653				
	2004.09-2011.12	-	-	R	Saloon Engine M57 D30 (306D3)/N57 D30 A	805020	Outer Joint	48W	30	33	64.8	77	60	M			
330 d (170 kW)	2004.09-2008.08	-	R	R	Saloon Engine M57 D30 (306D3)	205079	Drive Shaft		30		58.7	73	653				
	2004.09-2008.08	AT	L	R	Saloon Engine M57 D30 (306D3)	205085	Drive Shaft		30		58.7	73	598				
	2004.09-2008.08	-	-	R	Saloon Engine M57 D30 (306D3)	805020	Outer Joint	48W	30	33	64.8	77	60	M			
330 d (180 kW)	2008.02-2011.12	AT/MT	L	R	Saloon Engine N57 D30 A	205085	Drive Shaft		30		58.7	73	598				
	2008.02-2011.12	-	R	R	Saloon Engine N57 D30 A	205079	Drive Shaft		30		58.7	73	653				
	2008.02-2011.12	-	-	R	Saloon Engine N57 D30 A	805020	Outer Joint	48W	30	33	64.8	77	60	M			
330 d xDrive (180 kW)	2009.01-2011.12	MT	R	R	All-wheel Drive Saloon Engine N57 D30 A	205079	Drive Shaft		30		58.7	73	653				
	2009.01-2011.12	MT	L	R	All-wheel Drive Saloon Engine N57 D30 A	205085	Drive Shaft		30		58.7	73	598				
	2009.01-2011.12	AT	R	R	All-wheel Drive Saloon Engine N57 D30 A	205134	Drive Shaft		30		58.7	73	665				
	2009.01-2011.12	AT	R	R	All-wheel Drive Saloon Engine N57 D30 A	605036	Inner Joint		30	25	58.7	73	58	I			
	2009.01-2011.12	AT	R	R	All-wheel Drive Saloon Engine N57 D30 A	635025	Inner Joint			25	26						
	2009.01-2011.12	-	-	R	All-wheel Drive Saloon Engine N57 D30 A	805020	Outer Joint	48W	30	33	64.8	77	60	M			
	2009.01-2011.12	-	L	F	All-wheel Drive Saloon Engine N57 D30 A	205124	Drive Shaft	48W	30	27	64.8	77	571				
	2009.01-2011.12	-	R	F	All-wheel Drive Saloon Engine N57 D30 A	205125	Drive Shaft	48W	30	27	64.8	77	892				
330 i (190 kW)	2005.01-2007.08	-	-	R	Saloon Engine N52 B30 A	805020	Outer Joint	48W	30	33	64.8	77	60	M			
	2005.01-2007.08	MT	R	R	Saloon Engine N52 B30 A	205038	Drive Shaft		30		58.7	73	663				
	2005.01-2007.08	MT	L	R	Saloon Engine N52 B30 A	205039	Drive Shaft		30		58.7	73	610				
330 i (200 kW)	2007.09-2011.12	-	R	R	Saloon Engine N53 B30 A	205038	Drive Shaft		30		58.7	73	663				
	2007.09-2011.12	-	-	R	Saloon Engine N53 B30 A	805020	Outer Joint	48W	30	33	64.8	77	60	M			
	2007.09-2011.12	-	R	R	Saloon Engine N52 B30 A	205038	Drive Shaft		30		58.7	73	663				
	2007.09-2011.12	-	L	R	Saloon Engine N53 B30 A	205039	Drive Shaft		30		58.7	73	610				
	2007.09-2011.12	-	L	R	Saloon Engine N52 B30 A	205039	Drive Shaft		30		58.7	73	610				
330 i xDrive (200 kW)	2008.09-2011.12	-	-	R	All-wheel Drive Saloon Engine N53 B30 A	805020	Outer Joint	48W	30	33	64.8	77	60	M			
330 xd (170 kW)	2005.09-2011.12	MT	L	R	All-wheel Drive Saloon Engine M57 D30 (306D3)	205085	Drive Shaft		30		58.7	73	598				
	2005.09-2011.12	MT	R	R	All-wheel Drive Saloon Engine M57 D30 (306D3)	205079	Drive Shaft		30		58.7	73	653				
	2005.09-2011.12	-	-	R	All-wheel Drive Saloon Engine M57 D30 (306D3)	805020	Outer Joint	48W	30	33	64.8	77	60	M			
	2005.09-2011.12	AT	R	R	All-wheel Drive Saloon Engine M57 D30 (306D3)	205134	Drive Shaft		30		58.7	73	665				
	2005.09-2011.12	AT	R	R	All-wheel Drive Saloon Engine M57 D30 (306D3)	605036	Inner Joint		30	25	58.7	73	58	I			
	2005.09-2011.12	AT	R	R	All-wheel Drive Saloon Engine M57 D30 (306D3)	635025	Inner Joint			25	26						
330 xi (190 kW)	2005.01-2007.08	-	-	R	All-wheel Drive Saloon Engine N52 B30 A	805020	Outer Joint	48W	30	33	64.8	77	60	M			
	2005.01-2007.08	MT	R	R	All-wheel Drive Saloon Engine N52 B30 A	205038	Drive Shaft		30		58.7	73	663				
	2005.01-2007.08	MT	L	R	All-wheel Drive Saloon Engine N52 B30 A	205039	Drive Shaft		30		58.7	73	610				
330 xi (200 kW)	2007.09-2011.12	-	-	R	All-wheel Drive Saloon Engine N53 B30 A	805020	Outer Joint	48W	30	33	64.8	77	60	M			
335 d (210 kW)	2006.09-2011.12	-	R	R	Saloon Engine M57 D30 (306D5)	205079	Drive Shaft		30		58.7	73	653				
335 i (224 kW)	2006.09-2011.12	AT	L	R	Saloon Engine M57 D30 (306D5)	205085	Drive Shaft		30		58.7	73	598				
	2006.03-2011.12	-	-	R	Saloon Engine N54 B30 A	805020	Outer Joint	48W	30	33	64.8	77	60	M			
	2006.03-2011.12	6AT	R	R	Saloon Engine N54 B30 A	205038	Drive Shaft		30		58.7	73	663				
	2006.03-2011.12	-	-	R	Saloon Engine N54 B30 A	805020	Outer Joint	48W	30	33	64.8	77	60	M			
	2006.03-2011.12	6AT	L	R	Saloon Engine N54 B30 A	205039	Drive Shaft		30		58.7	73	610				
335 i (240 kW)	2006.03-2011.12	-	-	R	Saloon Engine N54 B30 A/N55 B30 A	805020	Outer Joint	48W	30	33	64.8	77	60	M			
335 i xDrive (225 kW)	2008.05-2011.10	-	-	R	All-wheel Drive Saloon Engine N55 B30 A	805020	Outer Joint	48W	30	33	64.8	77	60	M			
335 i xDrive (240 kW)	2008.05-2011.10	6AT	R	R	All-wheel Drive Saloon Engine N54 B30 A/N55 B30 A	205038	Drive Shaft		30		58.7	73	663				
	2008.05-2011.10	6AT	L	R	All-wheel Drive Saloon Engine N54 B30 A/N55 B30 A	205039	Drive Shaft		30		58.7	73	610				
	2008.05-2011.10	-	-	R	All-wheel Drive Saloon Engine N54 B30 A/N55 B30 A	805020	Outer Joint	48W	30	33	64.8	77	60	M			
335 xi (224 kW)	2006.09-2008.06	-	-	R	All-wheel Drive Saloon Engine N54 B30 A	805020	Outer Joint	48W	30	33	64.8	77	60	M			

YEAR	TRANSM	L/R	F/R	REMARKS	GSP Ref.	PRODUCT	ABS	Technical Specifications								
								A	B	C	H	L	P			
BMW																
3 (E90)																
335 xi (225 kW)	2006.09-2008.06	-	-	R	All-wheel Drive Saloon Engine N54 B30 A	805020	Outer Joint	48W	30	33	64.8	77	60	M		
335 xi (240 kW)	2006.09-2008.06	6AT	R	R	All-wheel Drive Saloon Engine N54 B30 A	205038	Drive Shaft		30		58.7	73	663			
	2006.09-2008.06	6AT	L	R	All-wheel Drive Saloon Engine N54 B30 A	205039	Drive Shaft		30		58.7	73	610			
	2006.09-2008.06	-	-	R	All-wheel Drive Saloon Engine N54 B30 A	805020	Outer Joint	48W	30	33	64.8	77	60	M		
M3 (309 kW)	2007.03-2011.12	MT	R	R	Saloon Engine S65 B40 A	605081	Inner joint			30		32				
3 (E92)																
320 d (120 kW)	2007.03-2013.06	-	-	R	Coupe Engine N47 D20 C	205023	Drive Shaft	48W	27		69	68	660			
	2007.03-2013.06	-	-	R	Coupe Engine N47 D20 C	805020	Outer Joint	48W	30	33	64.8	77	60	M		
	2007.03-2013.06	-	-	L	R	Coupe Engine N47 D20 C	205022	Drive Shaft	48W	27		69	68	607		
320 d (130 kW)	2006.09-2010.02	-	-	R	Coupe Engine N47 D20 A	205023	Drive Shaft	48W	27		69	68	607			
	2006.09-2010.02	-	-	R	Coupe Engine N47 D20 A	805020	Outer Joint	48W	30	33	64.8	77	60	M		
	2006.09-2010.02	-	-	L	R	Coupe Engine N47 D20 A	205022	Drive Shaft	48W	27		69	68	607		
320 d (135 kW)	2010.03-2013.06	-	-	R	Coupe Engine N47 D20 C	205023	Drive Shaft	48W	27		69	68	660			
	2010.03-2013.06	-	-	R	Coupe Engine N47 D20 C	805020	Outer Joint	48W	30	33	64.8	77	60	M		
	2010.03-2013.06	-	-	L	R	Coupe Engine N47 D20 C	205022	Drive Shaft	48W	27		69	68	607		
320 d (145 kW)	2006.09-2010.02	-	-	L	R	Coupe Engine N47 D20 A	205022	Drive Shaft	48W	27		69	68	607		
	2006.09-2010.02	-	-	R	R	Coupe Engine N47 D20 A	205023	Drive Shaft	48W	27		69	68	660		
	2006.09-2010.02	-	-	R	R	Coupe Engine N47 D20 A	205134	Drive Shaft		30		58.7	73	665		
	2006.09-2010.02	-	-	R	R	Coupe Engine N47 D20 A	805020	Outer Joint	48W	30	33	64.8	77	60	M	
320 d (147 kW)	2010.03-2013.06	-	-	R	Coupe Engine N47 D20 C	205023	Drive Shaft	48W	27		69	68	660			
	2010.03-2013.06	-	-	R	R	Coupe Engine N47 D20 C	205134	Drive Shaft		30		58.7	73	665		
	2010.03-2013.06	-	-	R	Coupe Engine N47 D20 C	805020	Outer Joint	48W	30	33	64.8	77	60	M		
	2010.03-2013.06	-	-	L	R	Coupe Engine N47 D20 C	205022	Drive Shaft	48W	27		69	68	607		
320 d xDrive (120 kW)	2010.03-2013.06	-	-	R	All-wheel Drive Coupe Engine N47 D20 C	805020	Outer Joint	48W	30	33	64.8	77	60	M		
320 d xDrive (130 kW)	2009.09-2010.02	-	-	R	All-wheel Drive Coupe Engine N47 D20 C	805020	Outer Joint	48W	30	33	64.8	77	60	M		
	2009.09-2010.02	-	-	L	F	All-wheel Drive Coupe Engine N47 D20 C	205124	Drive Shaft	48W	30	27	64.8	77	571		
	2009.09-2010.02	-	-	R	F	All-wheel Drive Coupe Engine N47 D20 C	205125	Drive Shaft	48W	30	27	64.8	77	892		
320 d xDrive (135 kW)	2010.03-2013.06	-	-	R	All-wheel Drive Coupe Engine N47 D20 C	805020	Outer Joint	48W	30	33	64.8	77	60	M		
320 d xDrive (145 kW)	2009.09-2010.02	-	-	R	All-wheel Drive Coupe Engine N47 D20 C	805020	Outer Joint	48W	30	33	64.8	77	60	M		
320 d xDrive (147 kW)	2010.03-2013.06	-	-	R	All-wheel Drive Coupe Engine N47 D20 C	805020	Outer Joint	48W	30	33	64.8	77	60	M		
320 i (115 kW)	2007.06-2013.12	-	-	R	Coupe Engine N46 B20 B	605056	Inner Joint		27	24	69.3	68	51	I		
	2007.06-2013.12	AT	R	R	Coupe Engine N46 B20 B	205032	Drive Shaft	48W	27		69.3	68	664			
	2007.06-2013.12	AT	L	R	Coupe Engine N46 B20 B	205040	Drive Shaft	48W	27		69.3	68	611			
320 i (120 kW)	2007.01-2013.12	-	-	R	Coupe Engine N43 B20 A	605056	Inner Joint		27	24	69.3	68	51	I		
	2007.01-2013.12	AT	R	R	Coupe Engine N43 B20 A	205032	Drive Shaft	48W	27		69.3	68	664			
	2007.01-2013.12	AT	L	R	Coupe Engine N43 B20 A	205040	Drive Shaft	48W	27		69.3	68	611			
320 i (125 kW)	2007.03-2013.12	-	-	R	Coupe Engine N43 B20 A	605056	Inner Joint		27	24	69.3	68	51	I		
	2007.03-2013.12	AT	R	R	Coupe Engine N43 B20 A	205032	Drive Shaft	48W	27		69.3	68	664			
	2007.03-2013.12	AT	L	R	Coupe Engine N43 B20 A	205040	Drive Shaft	48W	27		69.3	68	611			
320 xd (120 kW)	2008.03-2010.02	-	-	R	All-wheel Drive Coupe Engine N47 D20 A	205134	Drive Shaft		30		58.7	73	665			
	2008.03-2010.02	-	-	R	All-wheel Drive Coupe Engine N47 D20 A	805020	Outer Joint	48W	30	33	64.8	77	60	M		
320 xd (130 kW)	2008.03-2010.02	-	-	R	All-wheel Drive Coupe Engine N47 D20 A	205134	Drive Shaft		30		58.7	73	665			
	2008.03-2010.02	-	-	R	All-wheel Drive Coupe Engine N47 D20 A	605036	Inner Joint		30	25	58.7	73	58	I		
	2008.03-2010.02	-	-	R	All-wheel Drive Coupe Engine N47 D20 A	635025	Inner Joint			25		26				
	2008.03-2010.02	-	-	R	All-wheel Drive Coupe Engine N47 D20 A	805020	Outer Joint	48W	30	33	64.8	77	60	M		
320 xd (145 kW)	2008.03-2010.02	-	-	R	All-wheel Drive Coupe Engine N47 D20 C	805020	Outer Joint	48W	30	33	64.8	77	60	M		
323 i (140 kW)	2006.04-2012.02	-	-	R	Coupe Engine N52 B25 BE	205036	Drive Shaft	48W	27		69.3	68	664			
	2006.04-2012.02	-	-	L	R	Coupe Engine N52 B25 BE	205037	Drive Shaft	48W	27		69.3	68	611		
325 d (145 kW)	2007.03-2013.12	AT	R	R	Coupe Engine M57 D30 (306D3)	605036	Inner Joint		30	25	58.7	73	58	I		
	2007.03-2013.12	AT	R	R	Coupe Engine M57 D30 (306D3)	635025	Inner Joint			25		26				
	2007.03-2013.12	AT/MT	L	R	Coupe Engine M57 D30 (306D3)	205085	Drive Shaft		30		58.7	73	598			
	2007.03-2013.12	MT	R	R	Coupe Engine M57 D30 (306D3)	205079	Drive Shaft		30		58.7	73	653			
	2007.03-2013.12	AT	R	R	Coupe Engine M57 D30 (306D3)	205134	Drive Shaft		30		58.7	73	665			
325 d (150 kW)	2010.04-2013.12	-	-	R	Coupe Engine N57 D30 A	205079	Drive Shaft		30		58.7	73	653			
	2010.04-2013.12	MT	L	R	Coupe Engine N57 D30 A	205085	Drive Shaft		30		58.7	73	598			
325 d (155 kW)	2007.01-2009.12	-	-	R	Coupe Engine M57 D30 (306D3)	205079	Drive Shaft		30		58.7	73	653			
325 i (155 kW)	2005.01-2013.06	-	-	R	Coupe Engine N53 B30 A	805020	Outer Joint	48W	30	33	64.8	77	60	M		
	2005.05-2013.06	-	-	R	Coupe	805020	Outer Joint	48W	30	33	64.8	77	60	M		
325 i (160 kW)	2005.01-2013.06	-	-	R	Coupe Engine N53 B30 A	805020	Outer Joint	48W	30	33	64.8	77	60	M		
	2005.05-2013.06	-	-	R	Coupe Engine N52 B25 A	805020	Outer Joint	48W	30	33	64.8	77	60	M		
325 i xDrive (160 kW)	2008.09-2013.12	-	-	R	All-wheel Drive Coupe Engine N53 B30 A	205038	Drive Shaft		30		58.7	73	663			
	2008.09-2013.12	-	-	L	R	All-wheel Drive Coupe Engine N53 B30 A	205039	Drive Shaft		30		58.7	73	610		
	2008.09-2013.12	-	-	R	All-wheel Drive Coupe Engine N53 B30 A	805020	Outer Joint	48W	30	33	64.8	77	60	M		
325 i xDrive(155 kW)	2010.03-2013.04	-	-	R	All-wheel Drive Coupe Engine N52 B25 AF	805020	Outer Joint	48W	30	33	64.8	77	60	M		
325 xi (160 kW)	2006.09-2013.12	-	-	R	All-wheel Drive Coupe Engine N52 B25 A	805020	Outer Joint	48W	30	33	64.8	77	60	M		
	2006.09-2013.12	MT	R	R	All-wheel Drive Coupe Engine N52 B25 A	205038	Drive Shaft		30		58.7	73	663			





YEAR	TRANSM	L/R	F/R	REMARKS	GSP Ref.	PRODUCT	ABS	Technical Specifications							
								A	B	C	H	L	P		
BMW															
3 (E92)															
325 xi (160 kW)	2006.09-2013.12	MT	L	R	All-wheel Drive Coupe Engine N52 B25 A	205039	Drive Shaft		30		58.7	73	610		
	2007.09-2013.12	-	R	R	All-wheel Drive Coupe Engine N53 B30 A	205038	Drive Shaft		30		58.7	73	663		
	2007.09-2013.12	-	-	R	All-wheel Drive Coupe Engine N53 B30 A	805020	Outer Joint	48W	30	33	64.8	77	60	M	
	2007.09-2013.12	-	L	R	All-wheel Drive Coupe Engine N53 B30 A	205039	Drive Shaft		30		58.7	73	610		
330 d (170 kW)	2006.09-2013.12	-	R	R	Coupe Engine M57 D30 (306D3)	205079	Drive Shaft		30		58.7	73	653		
	2006.09-2013.12	AT/MT	L	R	Coupe Engine M57 D30 (306D3)	205085	Drive Shaft		30		58.7	73	598		
	2006.09-2013.12	-	-	R	Coupe Engine M57 D30 (306D3)	805020	Outer Joint	48W	30	33	64.8	77	60	M	
330 d (180 kW)	2009.01-2013.12	AT/MT	L	R	Coupe Engine N57 D30 A	205085	Drive Shaft		30		58.7	73	598		
	2009.01-2013.12	-	R	R	Coupe Engine N57 D30 A	205079	Drive Shaft		30		58.7	73	653		
	2009.01-2013.12	-	-	R	Coupe Engine N57 D30 A	805020	Outer Joint	48W	30	33	64.8	77	60	M	
330 d xDrive (180 kW)	2009.01-2013.12	MT	R	R	All-wheel Drive Coupe Engine N57 D30 A	205079	Drive Shaft		30		58.7	73	653		
	2009.01-2013.12	MT	L	R	All-wheel Drive Coupe Engine N57 D30 A	205085	Drive Shaft		30		58.7	73	598		
	2009.01-2013.12	AT	R	R	All-wheel Drive Coupe Engine N57 D30 A	205134	Drive Shaft		30		58.7	73	665		
	2009.01-2013.12	AT	R	R	All-wheel Drive Coupe Engine N57 D30 A	605036	Inner Joint		30	25	58.7	73	58	I	
	2009.01-2013.12	AT	R	R	All-wheel Drive Coupe Engine N57 D30 A	635025	Inner Joint			25		26			
	2009.01-2013.12	-	-	R	All-wheel Drive Coupe Engine N57 D30 A	805020	Outer Joint	48W	30	33	64.8	77	60	M	
	2009.01-2013.12	-	L	F	All-wheel Drive Coupe Engine N57 D30 A	205124	Drive Shaft	48W	30	27	64.8	77	571		
330 i (190 kW)	2006.09-2013.12	-	-	R	Coupe Engine N52 B30 A	805020	Outer Joint	48W	30	33	64.8	77	60	M	
	2006.09-2013.12	-	R	R	Coupe Engine N52 B30 A	205038	Drive Shaft		30		58.7	73	663		
	2006.09-2013.12	-	L	R	Coupe Engine N52 B30 A	205039	Drive Shaft		30		58.7	73	610		
330 i (200 kW)	2006.09-2010.02	MT	R	R	Coupe Engine N52 B30 AF	205038	Drive Shaft		30		58.7	73	663		
	2006.09-2010.02	-	-	R	Coupe Engine N52 B30 AF	805020	Outer Joint	48W	30	33	64.8	77	60	M	
	2006.09-2010.02	MT	L	R	Coupe Engine N52 B30 AF	205039	Drive Shaft		30		58.7	73	610		
	2007.03-2013.12	MT	R	R	Coupe Engine N53 B30 A	205038	Drive Shaft		30		58.7	73	663		
	2007.03-2013.12	MT	L	R	Coupe Engine N53 B30 A	205039	Drive Shaft		30		58.7	73	610		
	2007.03-2013.12	-	-	R	Coupe Engine N53 B30 A	805020	Outer Joint	48W	30	33	64.8	77	60	M	
330 i xDrive (200 kW)	2008.09-2013.12	-	R	R	All-wheel Drive Coupe Engine N53 B30 A	205038	Drive Shaft		30		58.7	73	663		
	2008.09-2013.12	-	-	R	All-wheel Drive Coupe Engine N53 B30 A	805020	Outer Joint	48W	30	33	64.8	77	60	M	
	2008.09-2013.12	-	L	R	All-wheel Drive Coupe Engine N53 B30 A	205039	Drive Shaft		30		58.7	73	610		
330 xd (170 kW)	2006.09-2013.12	AT	R	R	All-wheel Drive Coupe Engine M57 D30 (306D3)	605036	Inner Joint		30	25	58.7	73	58	I	
	2006.09-2013.12	AT	R	R	All-wheel Drive Coupe Engine M57 D30 (306D3)	635025	Inner Joint			25		26			
	2006.09-2013.12	MT	R	R	All-wheel Drive Coupe Engine M57 D30 (306D3)	205079	Drive Shaft		30		58.7	73	653		
	2006.09-2013.12	-	-	R	All-wheel Drive Coupe Engine M57 D30 (306D3)	805020	Outer Joint	48W	30	33	64.8	77	60	M	
	2006.09-2013.12	AT	R	R	All-wheel Drive Coupe Engine M57 D30 (306D3)	205134	Drive Shaft		30		58.7	73	665		
330 xd (180 kW)	2009.01-2013.12	MT	R	R	All-wheel Drive Coupe Engine N57 D30 A	205079	Drive Shaft		30		58.7	73	653		
	2009.01-2013.12	MT	L	R	All-wheel Drive Coupe Engine N57 D30 A	205085	Drive Shaft		30		58.7	73	598		
	2009.01-2013.12	AT	R	R	All-wheel Drive Coupe Engine N57 D30 A	205134	Drive Shaft		30		58.7	73	665		
	2009.01-2013.12	AT	R	R	All-wheel Drive Coupe Engine N57 D30 A	605036	Inner Joint		30	25	58.7	73	58	I	
	2009.01-2013.12	AT	R	R	All-wheel Drive Coupe Engine N57 D30 A	635025	Inner Joint			25		26			
	2009.01-2013.12	-	-	R	All-wheel Drive Coupe Engine N57 D30 A	805020	Outer Joint	48W	30	33	64.8	77	60	M	
330 xi (200 kW)	2006.09-2013.12	-	-	R	All-wheel Drive Coupe Engine N52 B30 A	805020	Outer Joint	48W	30	33	64.8	77	60	M	
330 xi(200 kW)	2007.03-2010.02	MT	R	R	All-wheel Drive Coupe Engine N53 B30 A	205038	Drive Shaft		30		58.7	73	663		
	2007.03-2010.02	MT	L	R	All-wheel Drive Coupe Engine N53 B30 A	205039	Drive Shaft		30		58.7	73	610		
	2007.03-2010.02	-	-	R	All-wheel Drive Coupe Engine N53 B30 A	805020	Outer Joint	48W	30	33	64.8	77	60	M	
335 d (210 kW)	2006.09-2013.12	-	R	R	Coupe Engine M57 D30 (306D5)	205079	Drive Shaft		30		58.7	73	653		
	2006.09-2013.12	AT/MT	L	R	Coupe Engine M57 D30 (306D5)	205085	Drive Shaft		30		58.7	73	598		
335 i (225 kW)	2005.11-2013.06	Semi-AT	R	R	Coupe Engine N54 B30 A	205038	Drive Shaft		30		58.7	73	663		
	2005.11-2013.06	-	-	R	Coupe Engine N54 B30 A	805020	Outer Joint	48W	30	33	64.8	77	60	M	
	2005.11-2013.06	Semi-AT	L	R	Coupe Engine N54 B30 A	205039	Drive Shaft		30		58.7	73	610		
335 i (240 kW)	2005.11-2013.06	6AT	R	R	Coupe Engine N55 B30 A	205038	Drive Shaft		30		58.7	73	663		
	2005.11-2013.06	6AT	L	R	Coupe Engine N55 B30 A	205039	Drive Shaft		30		58.7	73	610		
	2005.11-2013.06	-	-	R	Coupe Engine N55 B30 A	805020	Outer Joint	48W	30	33	64.8	77	60	M	
335 i xDrive (225 kW)	2008.11-2013.12	AT	R	R	All-wheel Drive Coupe Engine N54 B30 A	205038	Drive Shaft		30		58.7	73	663		
	2008.11-2013.12	AT	L	R	All-wheel Drive Coupe Engine N54 B30 A	205039	Drive Shaft		30		58.7	73	610		
	2008.11-2013.12	-	-	R	All-wheel Drive Coupe Engine N54 B30 A	805020	Outer Joint	48W	30	33	64.8	77	60	M	
335 i xDrive (240 kW)	2008.11-2013.06	-	-	R	All-wheel Drive Coupe Engine N55 B30 A	805020	Outer Joint	48W	30	33	64.8	77	60	M	
335 xi (225 kW)	2007.03-2010.02	CVT	R	R	All-wheel Drive Coupe Engine N54 B30 A	205038	Drive Shaft		30		58.7	73	663		
	2007.03-2010.02	-	-	R	All-wheel Drive Coupe Engine N54 B30 A	805020	Outer Joint	48W	30	33	64.8	77	60	M	
	2007.03-2010.02	CVT	L	R	All-wheel Drive Coupe Engine N54 B30 A	205039	Drive Shaft		30		58.7	73	610		
335 xi (240 kW)	2007.03-2010.02	-	-	R	All-wheel Drive Coupe Engine N54 B30 A	805020	Outer Joint	48W	30	33	64.8	77	60	M	
M (309 kW)	2007.03-2013.12	MT	R	R	Coupe Engine S65 B40 A	605081	Inner joint		30		32				
3 (E93)															
320 d (120 kW)	2008.01-2013.12	-	R	R	Convertible Engine N47 D20 C	205134	Drive Shaft		30		58.7	73	665		
320 d (130 kW)	2007.09-2010.02	-	R	R	Convertible Engine N47 D20 C	605036	Inner Joint		30	25	58.7	73	58	I	
	2007.09-2010.02	-	R	R	Convertible Engine N47 D20 C	635025	Inner Joint			25		26			

	 YEAR	TRANSM	L/R	F/R	REMARKS	GSP Ref.	 PRODUCT	 ABS	Technical Specifications					
									A	B	C	H	L	P
BMW														
3 (E93)														
320 d (130 kW)	2007.09-2010.02	-	R	R	Convertible Engine N47 D20 C	205134	Drive Shaft		30		58.7	73	665	
320 d (135 kW)	2010.03-2013.10	-	R	R	Convertible Engine N47 D20 C	205134	Drive Shaft		30		58.7	73	665	
	2010.03-2013.10	-	R	R	Convertible Engine N47 D20 C	605036	Inner Joint		30	25	58.7	73	58	I
	2010.03-2013.10	-	R	R	Convertible Engine N47 D20 C	635025	Inner Joint			25		26		
320 d (145 kW)	2007.09-2010.02	-	R	R	Convertible Engine N47 D20 C	205134	Drive Shaft		30		58.7	73	665	
320 d (147 kW)	2010.03-2013.10	-	R	R	Convertible Engine N47 D20 C	205134	Drive Shaft		30		58.7	73	665	
320 i (115 kW)	2007.01-2013.08	-	-	R	Convertible Engine N46 B20 B	605056	Inner Joint		27	24	69.3	68	51	I
	2007.01-2013.08	AT	R	R	Convertible Engine N46 B20 B	205032	Drive Shaft	48W	27		69.3	68	664	
	2007.01-2013.08	AT	L	R	Convertible Engine N46 B20 B	205040	Drive Shaft	48W	27		69.3	68	611	
	2007.01-2013.08	MT	L	R	Convertible Engine N46 B20 B	201121	Drive Shaft		30		58.5	73	613	
320 i (120 kW)	2006.09-2013.10	-	-	R	Convertible Engine N43 B20 A	605056	Inner Joint		27	24	69.3	68	51	I
	2006.09-2013.10	AT	R	R	Convertible Engine N43 B20 A	205032	Drive Shaft	48W	27		69.3	68	664	
	2006.09-2013.10	AT	L	R	Convertible Engine N43 B20 A	205040	Drive Shaft	48W	27		69.3	68	611	
	2006.09-2013.10	MT	L	R	Convertible Engine N43 B20 A	201121	Drive Shaft		30		58.5	73	613	
320 i (125 kW)	2006.09-2013.10	-	-	R	Convertible Engine N43 B20 A	605056	Inner Joint		27	24	69.3	68	51	I
	2006.09-2013.10	AT	R	R	Convertible Engine N43 B20 A	205032	Drive Shaft	48W	27		69.3	68	664	
	2006.09-2013.10	AT	L	R	Convertible Engine N43 B20 A	205040	Drive Shaft	48W	27		69.3	68	611	
	2006.09-2013.10	MT	L	R	Convertible Engine N43 B20 A	201121	Drive Shaft		30		58.5	73	613	
325 d (145 kW)	2007.03-2010.12	MT	R	R	Convertible Engine M57 D30 (306D3)	205079	Drive Shaft		30		58.7	73	653	
	2007.03-2010.12	MT	L	R	Convertible Engine M57 D30 (306D3)	205085	Drive Shaft		30		58.7	73	598	
	2007.03-2010.12	AT	R	R	Convertible Engine M57 D30 (306D3)	605036	Inner Joint		30	25	58.7	73	58	I
	2007.03-2010.12	AT	R	R	Convertible Engine M57 D30 (306D3)	635025	Inner Joint			25		26		
	2007.03-2010.12	AT	R	R	Convertible Engine M57 D30 (306D3)	205134	Drive Shaft		30		58.7	73	665	
325 d (150 kW)	2009.09-2013.09	MT	L	R	Convertible Engine N57 D30 A	205085	Drive Shaft		30		58.7	73	598	
	2009.09-2013.09	-	R	R	Convertible Engine N57 D30 A	205079	Drive Shaft		30		58.7	73	653	
325 d (155 kW)	2007.03-2010.12	MT	R	R	Convertible Engine M57 D30 (306D3)	205079	Drive Shaft		30		58.7	73	653	
	2007.03-2010.12	AT	R	R	Convertible Engine M57 D30 (306D3)	205134	Drive Shaft		30		58.7	73	665	
325 i (155 kW)	2006.10-2013.12	-	R	R	Convertible Engine N53 B30 A	205038	Drive Shaft		30		58.7	73	663	
	2006.10-2013.12	-	L	R	Convertible Engine N53 B30 A	205039	Drive Shaft		30		58.7	73	610	
325 i (160 kW)	2007.03-2013.12	MT	R	R	Convertible Engine N53 B30 A	205038	Drive Shaft		30		58.7	73	663	
	2007.03-2013.12	MT	R	R	Convertible Engine N52 B25 A	205038	Drive Shaft		30		58.7	73	663	
	2007.03-2013.12	MT	L	R	Convertible Engine N53 B30 A	205039	Drive Shaft		30		58.7	73	610	
	2007.03-2013.12	MT	L	R	Convertible Engine N52 B25 A	205039	Drive Shaft		30		58.7	73	610	
330 d (170 kW)	2007.03-2013.12	AT/MT	L	R	Convertible Engine M57 D30 (306D3)	205085	Drive Shaft		30		58.7	73	598	
	2007.03-2013.12	-	R	R	Convertible Engine M57 D30 (306D3)	205079	Drive Shaft		30		58.7	73	653	
330 d (180 kW)	2009.01-2013.12	AT/MT	L	R	Convertible Engine N57 D30 A	205085	Drive Shaft		30		58.7	73	598	
	2009.01-2013.12	-	R	R	Convertible Engine N57 D30 A	205079	Drive Shaft		30		58.7	73	653	
330 i (190 kW)	2007.03-2013.12	-	R	R	Convertible Engine N52 B30 A	205038	Drive Shaft		30		58.7	73	663	
	2007.03-2013.12	-	L	R	Convertible Engine N52 B30 A	205039	Drive Shaft		30		58.7	73	610	
330 i (200 kW)	2007.03-2013.12	MT	R	R	Convertible Engine N53 B30 A	205038	Drive Shaft		30		58.7	73	663	
	2007.03-2013.12	MT	R	R	Convertible Engine N52 B30 A	205038	Drive Shaft		30		58.7	73	663	
	2007.03-2013.12	MT	L	R	Convertible Engine N53 B30 A	205039	Drive Shaft		30		58.7	73	610	
	2007.03-2013.12	MT	L	R	Convertible Engine N52 B30 A	205039	Drive Shaft		30		58.7	73	610	
335 i (225 kW)	2006.05-2013.10	Semi-AT	R	R	Convertible Engine N54 B30 B	205038	Drive Shaft		30		58.7	73	663	
	2006.05-2013.10	Semi-AT	L	R	Convertible Engine N54 B30 B	205039	Drive Shaft		30		58.7	73	610	
335 i (240 kW)	2006.05-2013.10	6AT	R	R	Convertible Engine N54 B30 A	205038	Drive Shaft		30		58.7	73	663	
	2006.05-2013.10	6AT	L	R	Convertible Engine N54 B30 A	205039	Drive Shaft		30		58.7	73	610	
M3 (309 kW)	2007.03-2013.10	MT	R	R	Convertible Engine S65 B40 A	605081	Inner joint			30		32		
3 (F30 F80)														
316 i (100 kW)	2012.10-2016.08	MT	L	R	Saloon Engine N13 B16 A	205066	Drive Shaft		28	27	57.4	71	739	
	2012.10-2016.08	AT	L	R	Saloon Engine N13 B16 A	205107	Drive Shaft		28	27	57.4	71	749	
	2012.10-2016.08	MT	R	R	Saloon Engine N13 B16 A	205067	Drive Shaft		28	27	57.4	71	793	
318 i (100 kW)	2015.03-2016.08	MT	L	R	Saloon Engine B38 B15 A	205066	Drive Shaft		28	27	57.4	71	739	
	2015.03-2016.08	MT	R	R	Saloon Engine B38 B15 A	205067	Drive Shaft		28	27	57.4	71	793	
320 i (135 kW)	2011.04-2016.08	MT	L	R	Saloon Engine N20 B20 A	205066	Drive Shaft		28	27	57.4	71	739	
	2011.04-2016.08	MT	R	R	Saloon Engine N20 B20 A	205067	Drive Shaft		28	27	57.4	71	793	
	2014.09-2016.08	MT	L	R	Saloon Engine B48 B20 A	205066	Drive Shaft		28	27	57.4	71	739	
	2014.09-2016.08	MT	R	R	Saloon Engine B48 B20 A	205067	Drive Shaft		28	27	57.4	71	793	
320 i Efficient Dynamics (125 kW)	2012.04-2016.06	AT	L	R	Saloon Engine N13 B16 A	205107	Drive Shaft		28	27	57.4	71	749	
	2012.04-2016.06	MT	L	R	Saloon Engine N13 B16 A	205066	Drive Shaft		28	27	57.4	71	739	
	2012.04-2016.06	MT	R	R	Saloon Engine N13 B16 A	205067	Drive Shaft		28	27	57.4	71	793	
320 i xDrive (135 kW)	2011.05-2015.06	MT	L	R	All-wheel Drive Saloon Engine N20 B20 A	205066	Drive Shaft		28	27	57.4	71	739	
	2011.05-2015.06	MT	R	R	All-wheel Drive Saloon Engine N20 B20 A	205067	Drive Shaft		28	27	57.4	71	793	
325 d (155 kW)	2012.07-2016.02	AT	R	R	Saloon Engine N47 D20 D	205109	Drive Shaft		28	32	57	71	802	
	2012.07-2016.02	AT	L	R	Saloon Engine N47 D20 D	205110	Drive Shaft		28	32	57	71	748	
	2012.07-2016.02	AT	L/R	R	Saloon Engine N47 D20 D	605086	Inner Joint		28	28	57	71	64	





YEAR	TRANSM	L/R	F/R	REMARKS	GSP Ref.	PRODUCT	ABS	Technical Specifications							
								A	B	C	H	L	P		
BMW															
3 (F30 F80)															
325 d (155 kW)	2012.07-	2016.02	AT	L/R	R	Saloon Engine N47 D20 D	605087	Inner Joint		32	28	50	85	72.5	
325 d (160 kW)	2012.07-	2016.02	AT	L/R	R	Saloon Engine N47 D20 D	605086	Inner Joint		28	28	57	71	64	
	2012.07-	2016.02	AT	L/R	R	Saloon Engine N47 D20 D	605087	Inner Joint		32	28	50	85	72.5	
	2012.07-	2016.02	AT	R	R	Saloon Engine N47 D20 D	205109	Drive Shaft		28	32	57	71	802	
	2012.07-	2016.02	AT	L	R	Saloon Engine N47 D20 D	205110	Drive Shaft		28	32	57	71	748	
	2012.07-	2016.02	AT	L	R	Saloon Engine N47 D20 D	205110	Drive Shaft		28	32	57	71	748	
325 d (165 kW)	2015.04-	-	AT	R	R	Saloon Engine B47 D20 B	205109	Drive Shaft		28	32	57	71	802	
	2015.04-	-	MT/AT	L	R	Saloon Engine B47 D20 B	605086	Inner Joint		28	28	57	71	64	
	2015.04-	-	MT/AT	L	R	Saloon Engine B47 D20 B	605087	Inner Joint		32	28	50	85	72.5	
	2015.04-	-	AT/MT	L	R	Saloon Engine B47 D20 B	205110	Drive Shaft		28	32	57	71	748	
328 i (180 kW)	2011.04-	2016.07	AT	L	R	Saloon Engine N20 B20 A	205148	Drive Shaft		28	27	57.2	70.5	749	
	2011.04-	2016.07	AT	R	R	Saloon Engine N20 B20 A	205147	Drive Shaft		28	27	57.2	70.5	803	
	2011.04-	2016.07	-	L/R	R	Saloon Engine N20 B20 A	605082	Inner joint		27	33	44	96	81	
	2011.04-	2016.07	-	L/R	R	Saloon Engine N20 B20 A	805024	Outer Joint		28	33	57.2	70.5	58	I
328 i xDrive (180 kW)	2011.05-	2016.07	AT	L	R	All-wheel Drive Saloon Engine N20 B20 A	205148	Drive Shaft		28	27	57.2	70.5	749	
	2011.05-	2016.07	AT	R	R	All-wheel Drive Saloon Engine N20 B20 A	205147	Drive Shaft		28	27	57.2	70.5	803	
	2011.05-	2016.07	-	R	R	All-wheel Drive Saloon Engine N20 B20 A	201117	Drive Shaft		28	27	57.2	70.5	805	
	2011.05-	2016.07	-	L	R	All-wheel Drive Saloon Engine N20 B20 A	201118	Drive Shaft		28	27	57.2	70.5	750	
	2011.05-	2016.07	-	L/R	R	All-wheel Drive Saloon Engine N20 B20 A	605082	Inner joint		27	33	44	96	81	
	2011.05-	2016.07	-	L/R	R	All-wheel Drive Saloon Engine N20 B20 A	805024	Outer Joint		28	33	57.2	70.5	58	I
330 d (190 kW)	2012.01-	-	AT	L/R	R	Saloon Engine N57 D30 A	605086	Inner Joint		28	28	57	71	64	
	2012.01-	-	AT	L/R	R	Saloon Engine N57 D30 A	605087	Inner Joint		32	28	50	85	72.5	
	2012.01-	-	-	R	R	Saloon Engine N57 D30 A	205109	Drive Shaft		28	32	57	71	802	
	2012.01-	-	AT	L	R	Saloon Engine N57 D30 A	205110	Drive Shaft		28	32	57	71	748	
330 d (210 kW)	2012.01-	-	AT	L	R	Saloon Engine N57 D30 A	605086	Inner Joint		28	28	57	71	64	
	2012.01-	-	AT	L	R	Saloon Engine N57 D30 A	605087	Inner Joint		32	28	50	85	72.5	
	2012.01-	-	AT	L	R	Saloon Engine N57 D30 A	205110	Drive Shaft		28	32	57	71	748	
330 d xDrive (190 kW)	2012.01-	-	AT	L/R	R	All-wheel Drive Saloon Engine N57 D30 A	605086	Inner Joint		28	28	57	71	64	
	2012.01-	-	AT	L/R	R	All-wheel Drive Saloon Engine N57 D30 A	605087	Inner Joint		32	28	50	85	72.5	
	2012.01-	-	-	R	R	All-wheel Drive Saloon Engine N57 D30 A	205109	Drive Shaft		28	32	57	71	802	
	2012.01-	-	AT	L	R	All-wheel Drive Saloon Engine N57 D30 A	205110	Drive Shaft		28	32	57	71	748	
330 d xDrive (210 kW)	2012.01-	-	AT	L	R	All-wheel Drive Saloon Engine N57 D30 A	605086	Inner Joint		28	28	57	71	64	
	2012.01-	-	AT	L	R	All-wheel Drive Saloon Engine N57 D30 A	605087	Inner Joint		32	28	50	85	72.5	
	2012.01-	-	-	R	R	All-wheel Drive Saloon Engine N57 D30 A	205109	Drive Shaft		28	32	57	71	802	
	2012.01-	-	AT	L	R	All-wheel Drive Saloon Engine N57 D30 A	205110	Drive Shaft		28	32	57	71	748	
330 i (185 kW)	2014.09-	-	AT	L	R	Saloon Engine B46 B20 B/B48 B20 A/B48 B20 B	205148	Drive Shaft		28	27	57.2	70.5	749	
	2014.09-	-	AT	R	R	Saloon Engine B46 B20 B/B48 B20 A/B48 B20 B	205147	Drive Shaft		28	27	57.2	70.5	803	
	2014.09-	-	-	L/R	R	Saloon Engine B46 B20 B/B48 B20 A/B48 B20 B	605082	Inner joint		27	33	44	96	81	
	2014.09-	-	-	L/R	R	Saloon Engine B46 B20 B/B48 B20 A/B48 B20 B	805024	Outer Joint		28	33	57.2	70.5	58	I
330 i xDrive (185 kW)	2014.10-	-	-	R	R	All-wheel Drive Saloon Engine B48 B20 B	201117	Drive Shaft		28	27	57.2	70.5	805	
	2014.10-	-	-	L	R	All-wheel Drive Saloon Engine B48 B20 B	201118	Drive Shaft		28	27	57.2	70.5	750	
	2014.10-	-	-	L/R	R	All-wheel Drive Saloon Engine B48 B20 B	805024	Outer Joint		28	33	57.2	70.5	58	I
335 d xDrive (230 kW)	2012.11-	-	AT	L/R	R	All-wheel Drive Saloon Engine N57 D30 B	605086	Inner Joint		28	28	57	71	64	
	2012.11-	-	AT	L/R	R	All-wheel Drive Saloon Engine N57 D30 B	605087	Inner Joint		32	28	50	85	72.5	
	2012.11-	-	-	R	R	All-wheel Drive Saloon Engine N57 D30 B	205109	Drive Shaft		28	32	57	71	802	
	2012.11-	-	AT	L	R	All-wheel Drive Saloon Engine N57 D30 B	205110	Drive Shaft		28	32	57	71	748	
3 Compact (E36)															
316 g (75 kW)	1994.03-	2000.08	-	R	-	Hatchback Engine M43 B16 (164E2)	605009	Inner Joint		27	24	64	68.5	58	
	1994.03-	2000.08	-	L/R	R	Hatchback Engine M43 B16 (164E2)	205006	Drive Shaft	48W	27		64	68.5	585	
316 i (75 kW)	1994.03-	2000.08	-	-	R	Hatchback Engine M43 B16 (164E2)	605001	Inner Joint			24		24		
	1994.03-	2000.08	-	L/R	R	Hatchback Engine M43 B16 (164E2)	205006	Drive Shaft	48W	27		64	68.5	585	
	1994.03-	2000.08	-	R	-	Hatchback Engine M43 B16 (164E2)	605009	Inner Joint		27	24	64	68.5	58	
316 i (77 kW)	1998.12-	2000.08	-	R	-	Hatchback Engine M43 B19 (194E1)	605009	Inner Joint		27	24	64	68.5	58	
	1998.12-	2000.08	-	L/R	R	Hatchback Engine M43 B19 (194E1)	205006	Drive Shaft	48W	27		64	68.5	585	
318 tds (66 kW)	1995.01-	2000.08	-	-	R	Hatchback Engine M41 D17 (174T1)	605001	Inner Joint			24		24		
	1995.01-	2000.08	MT	-	R	Hatchback Engine M41 D17 (174T1)	205005	Drive Shaft	48W	27		63.8	68.5	625	
	1995.01-	2000.08	MT	-	R	Hatchback Engine M41 D17 (174T1)	205013	Drive Shaft		27		63.8	68.5	625	
	1995.01-	2000.08	-	L/R	R	Hatchback Engine M41 D17 (174T1)	205006	Drive Shaft	48W	27		64	68.5	585	
	1995.01-	2000.08	-	R	-	Hatchback Engine M41 D17 (174T1)	605009	Inner Joint		27	24	64	68.5	58	
318 ti (103 kW)	1994.11-	1995.08	-	-	R	Hatchback Engine M42 B18 (184S1)	605001	Inner Joint			24		24		
	1994.11-	1995.08	-	L/R	R	Hatchback Engine M42 B18 (184S1)	205006	Drive Shaft	48W	27		64	68.5	585	
	1995.07-	2000.08	-	-	R	Hatchback Engine M44 B19 (194S1)	605001	Inner Joint			24		24		
	1995.07-	2000.08	-	L/R	R	Hatchback Engine M44 B19 (194S1)	205006	Drive Shaft	48W	27		64	68.5	585	
3 Compact (E46)															
316 ti (85 kW)	2001.06-	2005.02	AT/MT	L	R	Hatchback Engine N46 B18 A	205002	Drive Shaft	48W	27		64	68.5	615	
	2001.06-	2005.02	AT/MT	R	R	Hatchback Engine N46 B18 A	205017	Drive Shaft	48W	27		64	68.5	675	
	2002.06-	2005.02	5MT	L	R	Hatchback Engine N45 B16 A	205002	Drive Shaft	48W	27		64	68.5	615	





YEAR	TRANSM	L/R	F/R	REMARKS	GSP Ref.	PRODUCT	ABS	Technical Specifications						
								A	B	C	H	L	P	
BMW														
3 Compact (E46)														
316 ti (85 kW)	2002.06-2005.02	5MT	R	R	Hatchback Engine N45 B16 A	205017	Drive Shaft	48W	27	64	68.5	675		
318 td (85 kW)	2003.03-2005.02	-	R	R	Hatchback Engine M47 D20 (204D4)	205042	Drive Shaft	48W	27	64	69	665		
	2003.03-2005.02	-	L	R	Hatchback Engine M47 D20 (204D4)	205051	Drive Shaft	48W	27	64	69	608		
318 ti (105 kW)	2001.03-2004.12	AT/MT	L	R	Hatchback Engine N42 B20 A	205002	Drive Shaft	48W	27	64	68.5	615		
	2001.03-2004.12	AT/MT	R	R	Hatchback Engine N42 B20 A	205017	Drive Shaft	48W	27	64	68.5	675		
320 td (110 kW)	2001.09-2005.02	AT	R	R	Hatchback Engine M47 D20 (204D4)	205042	Drive Shaft	48W	27	64	69	665		
	2001.09-2005.02	AT	L	R	Hatchback Engine M47 D20 (204D4)	205051	Drive Shaft	48W	27	64	69	608		
325 ti (141 kW)	2001.06-2005.02	-	R	R	Hatchback Engine M54 B25 (256S5)	205042	Drive Shaft	48W	27	64	69	665		
	2001.06-2005.02	-	L	R	Hatchback Engine M54 B25 (256S5)	205051	Drive Shaft	48W	27	64	69	608		
3 Gran Turismo (F34)														
320 d xDrive (120 kW)	2013.03-	-	L	R	All-wheel Drive Hatchback Engine N47 D20 C	205110	Drive Shaft		28	32	57	71	748	
320 d xDrive (147 kW)	2013.05-	-	L	R	All-wheel Drive Hatchback Engine N47 D20 C	205110	Drive Shaft		28	32	57	71	748	
320 i (120 kW)	2012.07-2016.06	MT	L	R	Hatchback Engine N20 B20 B	205066	Drive Shaft		28	27	57.4	71	739	
	2012.07-2016.06	MT	R	R	Hatchback Engine N20 B20 B	205067	Drive Shaft		28	27	57.4	71	793	
320 i (135 kW)	2012.07-2016.06	MT	L	R	Hatchback Engine N20 B20 A	205066	Drive Shaft		28	27	57.4	71	739	
	2012.07-2016.06	MT	R	R	Hatchback Engine N20 B20 A	205067	Drive Shaft		28	27	57.4	71	793	
	2015.09-	MT	L	R	Hatchback Engine B48 B20 A	205066	Drive Shaft		28	27	57.4	71	739	
	2015.09-	MT	R	R	Hatchback Engine B48 B20 A	205067	Drive Shaft		28	27	57.4	71	793	
325 d (155 kW)	2013.07-	AT	L/R	R	Hatchback Engine N47 D20 D	605086	Inner Joint		28	28	57	71	64	
	2013.07-	AT	L/R	R	Hatchback Engine N47 D20 D	605087	Inner Joint		32	28	50	85	72.5	
	2013.07-	AT	R	R	Hatchback Engine N47 D20 D	205109	Drive Shaft		28	32	57	71	802	
	2013.07-	AT	L	R	Hatchback Engine N47 D20 D	205110	Drive Shaft		28	32	57	71	748	
325 d (160 kW)	2013.03-	AT	L	R	Hatchback Engine N47 D20 D	605086	Inner Joint		28	28	57	71	64	
	2013.03-	AT	L	R	Hatchback Engine N47 D20 D	605087	Inner Joint		32	28	50	85	72.5	
	2013.03-	AT	L	R	Hatchback Engine N47 D20 D	205110	Drive Shaft		28	32	57	71	748	
325 d (165 kW)	2016.07-	-	R	R	Hatchback Engine B47 D20 B	205109	Drive Shaft		28	32	57	71	802	
	2016.07-	-	R	R	Hatchback Engine B47 D20 B	605086	Inner Joint		28	28	57	71	64	
	2016.07-	-	R	R	Hatchback Engine B47 D20 B	605087	Inner Joint		32	28	50	85	72.5	
328 i (180 kW)	2012.08-2015.02	AT	L	R	Hatchback Engine N20 B20 A	205148	Drive Shaft		28	27	57.2	70.5	749	
	2012.08-2015.02	AT	R	R	Hatchback Engine N20 B20 A	205147	Drive Shaft		28	27	57.2	70.5	803	
	2012.08-2015.02	-	L/R	R	Hatchback Engine N20 B20 A	605082	Inner joint		27	33	44	96	81	
	2012.08-2015.02	-	L/R	R	Hatchback Engine N20 B20 A	805024	Outer Joint		28	33	57.2	70.5	58	I
328 i xDrive (180 kW)	2013.03-2016.07	AT	L	R	All-wheel Drive Hatchback Engine N20 B20 A	205148	Drive Shaft		28	27	57.2	70.5	749	
	2013.03-2016.07	AT	R	R	All-wheel Drive Hatchback Engine N20 B20 A	205147	Drive Shaft		28	27	57.2	70.5	803	
	2013.03-2016.07	-	R	R	All-wheel Drive Hatchback Engine N20 B20 A	201117	Drive Shaft		28	27	57.2	70.5	805	
	2013.03-2016.07	-	L	R	All-wheel Drive Hatchback Engine N20 B20 A	201118	Drive Shaft		28	27	57.2	70.5	750	
	2013.03-2016.07	-	L/R	R	All-wheel Drive Hatchback Engine N20 B20 A	605082	Inner joint		27	33	44	96	81	
	2013.03-2016.07	-	L/R	R	All-wheel Drive Hatchback Engine N20 B20 A	805024	Outer Joint		28	33	57.2	70.5	58	I
330 d (190 kW)	2014.01-	AT	R	R	Hatchback Engine N57 D30 A	205109	Drive Shaft		28	32	57	71	802	
	2014.01-	AT	L	R	Hatchback Engine N57 D30 A	205110	Drive Shaft		28	32	57	71	748	
	2014.01-	AT	L/R	R	Hatchback Engine N57 D30 A	605086	Inner Joint		28	28	57	71	64	
	2014.01-	AT	L/R	R	Hatchback Engine N57 D30 A	605087	Inner Joint		32	28	50	85	72.5	
330 d (210 kW)	2014.01-	-	R	R	Hatchback Engine N57 D30 A	205109	Drive Shaft		28	32	57	71	802	
	2014.01-	AT	L	R	Hatchback Engine N57 D30 A	205110	Drive Shaft		28	32	57	71	748	
	2014.01-	AT	L/R	R	Hatchback Engine N57 D30 A	605086	Inner Joint		28	28	57	71	64	
	2014.01-	AT	L/R	R	Hatchback Engine N57 D30 A	605087	Inner Joint		32	28	50	85	72.5	
330 i (185 kW)	2015.10-	-	L	R	Hatchback Engine B48 B20 B	205148	Drive Shaft		28	27	57.2	70.5	749	
	2015.10-	-	R	R	Hatchback Engine B48 B20 B	205147	Drive Shaft		28	27	57.2	70.5	803	
3 III (E36)														
-	1990-1998	-	-	-	-	605002	Inner Joint		27	24	63.8	68.5	58	
	1992-1999	-	-	-	-	605002	Inner Joint		27	24	63.8	68.5	58	
	1995-1999	-	-	-	-	605002	Inner Joint		27	24	63.8	68.5	58	
3 SERIES (E46)														
1.6 i	2000-2005	-	L	R	-	205019	Drive Shaft	48W	27	64	68.5	622.5		
3 SERIES E46														
-	2012-2013	-	R	F	-	834189	Outer Joint		28	32	58.6	90	60	M
3 Touring (E30)														
316 i (73 kW)	1991.09-1994.06	AT	-	R	Estate Engine M40 B16 (164E1)	205003	Drive Shaft		27	63.8	66.5	574		
	1991.09-1994.06	MT	L/R	R	Estate Engine M40 B16 (164E1)	699052	Inner Joint		25	32				
	1991.09-1994.06	MT	L/R	R	Estate Engine M40 B16 (164E1)	205004	Drive Shaft	48T	27	63.8	66.5	574		
316 i (75 kW)	1991.09-1994.06	AT	-	R	Estate Engine M40 B16 (164E1)	205003	Drive Shaft		27	63.8	66.5	574		
	1991.09-1994.06	MT	L/R	R	Estate Engine M40 B16 (164E1)	699052	Inner Joint		25	32				
	1991.09-1994.06	MT	L/R	R	Estate Engine M40 B16 (164E1)	205004	Drive Shaft	48T	27	63.8	66.5	574		
318 i (83 kW)	1989.04-1994.06	AT	-	R	Estate Engine M40 B18 (184E1)	205003	Drive Shaft		27	63.8	66.5	574		
	1989.04-1994.06	MT	L/R	R	Estate Engine M40 B18 (184E1)	699052	Inner Joint		25	32				
	1989.04-1994.06	MT	L/R	R	Estate Engine M40 B18 (184E1)	205004	Drive Shaft	48T	27	63.8	66.5	574		





YEAR	TRANSM	L/R	F/R	REMARKS	GSP Ref.	PRODUCT	ABS	Technical Specifications								
								A	B	C	H	L	P			
BMW																
3 Touring (E30)																
318 i (85 kW)	1987.09-1991.06	AT	-	R	Estate Engine M40 B18 (184E1)	205003	Drive Shaft		27		63.8	66.5	574			
	1987.09-1991.06	MT	L/R	R	Estate Engine M40 B18 (184E1)	699052	Inner Joint			25		32				
	1987.09-1991.06	MT	L/R	R	Estate Engine M40 B18 (184E1)	205004	Drive Shaft	48T	27		63.8	66.5	574			
320 i (95 kW)	1988.01-1991.12	AT	-	R	Estate Engine M20 B20 (206KA)	205003	Drive Shaft		27		63.8	66.5	574			
	1988.01-1991.12	AT/MT	L/R	R	Estate Engine M20 B20 (206KA)	699052	Inner Joint			25		32				
	1988.01-1991.12	MT	L/R	R	Estate Engine M20 B20 (206KA)	205004	Drive Shaft	48T	27		63.8	66.5	574			
324 td (85 kW)	1988.01-1993.06	AT/MT	L/R	R	Estate Engine M21 D24 (246TB)	699052	Inner Joint			25		32				
	1988.01-1993.06	AT/MT	L/R	R	Estate Engine M21 D24 (246TB)	205004	Drive Shaft	48T	27		63.8	66.5	574			
325 i (125 kW)	1987.07-1993.03	AT/MT	L/R	R	Estate Engine M20 B25 (256K1)	699052	Inner Joint			25		32				
	1987.07-1993.03	AT/MT	L/R	R	Estate Engine M20 B25 (256K1)	205004	Drive Shaft	48T	27		63.8	66.5	574			
3 Touring (E36)																
316 i (75 kW)	1996.01-1999.10	AT/MT	-	R	Estate Engine M43 B16 (164E2)	205005	Drive Shaft	48W	27		63.8	68.5	625			
	1996.01-1999.10	AT/MT	-	R	Estate Engine M43 B16 (164E2)	205013	Drive Shaft		27		63.8	68.5	625			
	1996.01-1999.10	-	L/R	R	Estate Engine M43 B16 (164E2)	605009	Inner Joint		27	24	64	68.5	58			
318 i (85 kW)	1995.07-1999.10	-	-	R	Estate Engine M43 B18 (184E2)	605001	Inner Joint			24		24				
	1995.07-1999.10	AT/MT	-	R	Estate Engine M43 B18 (184E2)	205005	Drive Shaft	48W	27		63.8	68.5	625			
	1995.07-1999.10	AT/MT	-	R	Estate Engine M43 B18 (184E2)	205013	Drive Shaft		27		63.8	68.5	625			
	1995.07-1999.10	AT/MT	L/R	R	Estate Engine M43 B18 (184E2)	205002	Drive Shaft	48W	27		64	68.5	615			
318 tds (66 kW)	1995.01-1999.10	AT/MT	L/R	R	Estate Engine M41 D17 (174T1)	205014	Drive Shaft		27	24	64	68.5	58			
	1995.01-1999.10	-	-	R	Estate Engine M41 D17 (174T1)	605001	Inner Joint			24		24				
	1995.01-1999.10	MT	-	R	Estate Engine M41 D17 (174T1)	205005	Drive Shaft	48W	27		63.8	68.5	625			
	1995.01-1999.10	MT	-	R	Estate Engine M41 D17 (174T1)	205013	Drive Shaft		27		63.8	68.5	625			
	1995.01-1999.10	AT/MT	L/R	R	Estate Engine M41 D17 (174T1)	205002	Drive Shaft	48W	27		64	68.5	615			
	1995.01-1999.10	-	L/R	R	Estate Engine M41 D17 (174T1)	605009	Inner Joint		27	24	64	68.5	58			
	1995.01-1999.10	AT	L/R	R	Estate Engine M52 B20 (206S3)	205014	Drive Shaft		27		64	68.5	615			
320 i (110 kW)	1995.01-1999.10	AT	-	R	Estate Engine M52 B20 (206S3)	605001	Inner Joint			24		24				
	1995.01-1999.10	AT/MT	-	R	Estate Engine M52 B20 (206S3)	205005	Drive Shaft	48W	27		63.8	68.5	625			
	1995.01-1999.10	AT/MT	-	R	Estate Engine M52 B20 (206S3)	205013	Drive Shaft		27		63.8	68.5	625			
	1995.01-1999.10	AT	L/R	R	Estate Engine M52 B20 (206S3)	205002	Drive Shaft	48W	27		64	68.5	615			
	1995.01-1999.10	MT	L/R	R	Estate Engine M52 B20 (206S3)	205007	Drive Shaft	48W	27		64	68.5	615			
	1995.01-1999.10	-	L/R	R	Estate Engine M52 B20 (206S3)	605009	Inner Joint		27	24	64	68.5	58			
323 i (125 kW)	1995.09-1999.10	AT	L/R	R	Estate Engine M52 B25 (256S3)	205007	Drive Shaft	48W	27		64	68.5	615			
325 tds (105 kW)	1995.01-1999.10	AT	L/R	R	Estate Engine M51 D25 (256T1)	205007	Drive Shaft	48W	27		64	68.5	615			
328 i (142 kW)	1995.01-1999.10	AT	L/R	R	Estate Engine M52 B28 (286S1)	205007	Drive Shaft	48W	27		64	68.5	615			
3 Touring (E46)																
316 i (85 kW)	2002.03-2005.02	AT/MT	L	R	Estate Engine N46 B18 A	205002	Drive Shaft	48W	27		64	68.5	615			
	2002.03-2005.02	AT/MT	R	R	Estate Engine N46 B18 A	205017	Drive Shaft	48W	27		64	68.5	675			
318 d (85 kW)	2002.10-2003.03	-	-	R	Estate Engine M47 D20 (204D1)	205042	Drive Shaft	48W	27		64	69	665			
	2002.10-2003.03	-	-	L	Estate Engine M47 D20 (204D1)	205051	Drive Shaft	48W	27		64	69	608			
	2003.03-2005.02	-	-	R	Estate Engine M47 D20 (204D4)	205042	Drive Shaft	48W	27		64	69	665			
	2003.03-2005.02	-	-	L	Estate Engine M47 D20 (204D4)	205051	Drive Shaft	48W	27		64	69	608			
318 i (105 kW)	2001.09-2005.02	AT/MT	L	R	Estate Engine N46 B20 A	205002	Drive Shaft	48W	27		64	68.5	615			
	2001.09-2005.02	AT/MT	R	R	Estate Engine N46 B20 A	205017	Drive Shaft	48W	27		64	68.5	675			
318 i (85 kW)	1999.10-2001.09	-	-	L	Estate Engine M43 B19 (194E1)	205002	Drive Shaft	48W	27		64	68.5	615			
	1999.10-2001.09	-	-	R	Estate Engine M43 B19 (194E1)	205017	Drive Shaft	48W	27		64	68.5	675			
318 i (87 kW)	1999.10-2001.09	AT/MT	L	R	Estate Engine M43 B19 (194E1)	205002	Drive Shaft	48W	27		64	68.5	615			
	1999.10-2001.09	AT/MT	R	R	Estate Engine M43 B19 (194E1)	205017	Drive Shaft	48W	27		64	68.5	675			
320 d (100 kW)	2000.03-2001.09	-	-	R	Estate Engine M47 D20 (204D1)	205042	Drive Shaft	48W	27		64	69	665			
	2000.03-2001.09	-	-	L	Estate Engine M47 D20 (204D1)	205051	Drive Shaft	48W	27		64	69	608			
320 d (110 kW)	2001.09-2005.02	AT	R	R	Estate Engine M47 D20 (204D4)	205042	Drive Shaft	48W	27		64	69	665			
	2001.09-2005.02	AT	L	R	Estate Engine M47 D20 (204D4)	205051	Drive Shaft	48W	27		64	69	608			
320 i (110 kW)	1999.10-2000.09	AT/MT	R	R	Estate Engine M52 B20 (206S4)	205042	Drive Shaft	48W	27		64	69	665			
	1999.10-2000.09	AT/MT	L	R	Estate Engine M52 B20 (206S4)	205051	Drive Shaft	48W	27		64	69	608			
	1999.10-2000.09	MT	L	R	Estate Engine M52 B20 (206S4)	205002	Drive Shaft	48W	27		64	68.5	615			
	1999.10-2000.09	MT	R	R	Estate Engine M52 B20 (206S4)	205017	Drive Shaft	48W	27		64	68.5	675			
320 i (125 kW)	2000.09-2005.02	AT/MT	R	R	Estate Engine M54 B22 (226S1)	205042	Drive Shaft	48W	27		64	69	665			
	2000.09-2005.02	AT/MT	L	R	Estate Engine M54 B22 (226S1)	205051	Drive Shaft	48W	27		64	69	608			
	2000.09-2005.02	MT	L	R	Estate Engine M54 B22 (226S1)	205002	Drive Shaft	48W	27		64	68.5	615			
	2000.09-2005.02	MT	R	R	Estate Engine M54 B22 (226S1)	205017	Drive Shaft	48W	27		64	68.5	675			
325 i (141 kW)	2000.09-2005.02	-	-	R	Estate Engine M54 B25 (256S5)	205042	Drive Shaft	48W	27		64	69	665			
	2000.09-2005.02	-	-	L	Estate Engine M54 B25 (256S5)	205051	Drive Shaft	48W	27		64	69	608			
325 xi (141 kW)	2000.09-2005.02	AT/MT	R	R	All-wheel Drive Estate Engine M54 B25 (256S5)	205042	Drive Shaft	48W	27		64	69	665			
	2000.09-2005.02	AT/MT	L	R	All-wheel Drive Estate Engine M54 B25 (256S5)	205051	Drive Shaft	48W	27		64	69	608			
	2000.09-2005.02	AT/MT	L	F	All-wheel Drive Estate Engine M54 B25 (256S5)	205047	Drive Shaft		30	27	59	73	577			
	2000.09-2005.02	AT/MT	R	F	All-wheel Drive Estate Engine M54 B25 (256S5)	205048	Drive Shaft		30	27	59	73	897			

	 YEAR	TRANSM	L/R	F/R	REMARKS	GSP Ref.	 PRODUCT	 ABS	Technical Specifications					
									A	B	C	H	L	P
BMW														
3 Touring (E46)														
328 i (142 kW)	1999.10-2000.06	AT/MT	R	R	Estate Engine M52 B28 (286S2)	205042	Drive Shaft	48W	27		64	69	665	
	1999.10-2000.06	AT/MT	L	R	Estate Engine M52 B28 (286S2)	205051	Drive Shaft	48W	27		64	69	608	
330 i (170 kW)	2000.06-2005.02	MT	R	R	Estate Engine M54 B30 (306S3)	201120	Drive Shaft	48W	30		69	73	672	
330 xd (135 kW)	2000.01-2003.03	AT/MT	L	F	All-wheel Drive Estate Engine M57 D30 (306D1)	205047	Drive Shaft		30	27	59	73	577	
	2000.01-2003.03	AT/MT	R	F	All-wheel Drive Estate Engine M57 D30 (306D1)	205048	Drive Shaft		30	27	59	73	897	
330 xd (150 kW)	2002.08-2005.05	AT/MT	L	F	All-wheel Drive Estate Engine M57 D30 (306D2)	205047	Drive Shaft		30	27	59	73	577	
	2002.08-2005.05	AT/MT	R	F	All-wheel Drive Estate Engine M57 D30 (306D2)	205048	Drive Shaft		30	27	59	73	897	
330 xi (170 kW)	2000.06-2005.02	AT/MT	L	F	All-wheel Drive Estate Engine M54 B30 (306S3)	205047	Drive Shaft		30	27	59	73	577	
	2000.06-2005.02	AT/MT	R	F	All-wheel Drive Estate Engine M54 B30 (306S3)	205048	Drive Shaft		30	27	59	73	897	
3 Touring (E91)														
316 d (85 kW)	2009.09-2012.06	-	R	R	Estate Engine N47 D20 C	205023	Drive Shaft	48W	27		69	68	660	
	2009.09-2012.06	-	R	R	Estate Engine N47 D20 C	205134	Drive Shaft		30		58.7	73	665	
	2009.09-2012.06	-	L	R	Estate Engine N47 D20 C	205022	Drive Shaft	48W	27		69	68	607	
316 i (90 kW)	2008.05-2012.05	-	L	R	Estate Engine N43 B16 A	201121	Drive Shaft		30		58.5	73	613	
318 d (100 kW)	2007.07-2012.06	-	R	R	Estate Engine N47 D20 C	205023	Drive Shaft	48W	27		69	68	660	
	2007.07-2012.06	-	R	R	Estate Engine N47 D20 C	205134	Drive Shaft		30		58.7	73	665	
	2007.07-2012.06	-	L	R	Estate Engine N47 D20 C	205022	Drive Shaft	48W	27		69	68	607	
	2007.07-2012.06	-	R	R	Estate Engine N47 D20 C	605036	Inner Joint		30	25	58.7	73	58	I
318 d (105 kW)	2007.09-2012.06	-	R	R	Estate Engine N47 D20 A	205023	Drive Shaft	48W	27		69	68	660	
	2007.09-2012.06	-	R	R	Estate Engine N47 D20 A	605036	Inner Joint		30	25	58.7	73	58	I
	2007.09-2012.06	-	R	R	Estate Engine N47 D20 A	635025	Inner Joint			25		26		
	2007.09-2012.06	-	R	R	Estate Engine N47 D20 A	205134	Drive Shaft		30		58.7	73	665	
	2007.09-2012.06	-	L	R	Estate Engine N47 D20 A	205022	Drive Shaft	48W	27		69	68	607	
318 d (90 kW)	2005.09-2012.06	-	R	R	Estate Engine M47 D20 (204D4)	205134	Drive Shaft		30		58.7	73	665	
	2005.09-2012.06	-	R	R	Estate Engine M47 D20 (204D4)	605036	Inner Joint		30	25	58.7	73	58	I
	2005.09-2012.06	-	R	R	Estate Engine M47 D20 (204D4)	635025	Inner Joint			25		26		
318 i (100 kW)	2007.09-2012.03	-	R	R	Estate Engine N46 B20 B	605056	Inner Joint		27	24	69.3	68	51	I
	2007.09-2012.03	MT	L	R	Estate Engine N46 B20 B	201121	Drive Shaft		30		58.5	73	613	
	2007.09-2012.03	6AT	R	R	Estate Engine N46 B20 B	205032	Drive Shaft	48W	27		69.3	68	664	
	2007.09-2012.03	6AT	L	R	Estate Engine N46 B20 B	205040	Drive Shaft	48W	27		69.3	68	611	
318 i (105 kW)	2007.05-2012.05	-	R	R	Estate Engine N43 B20 A	605056	Inner Joint		27	24	69.3	68	51	I
	2007.05-2012.05	MT	L	R	Estate Engine N43 B20 A	201121	Drive Shaft		30		58.5	73	613	
	2007.05-2012.05	6AT	R	R	Estate Engine N43 B20 A	205032	Drive Shaft	48W	27		69.3	68	664	
	2007.05-2012.05	6AT	L	R	Estate Engine N43 B20 A	205040	Drive Shaft	48W	27		69.3	68	611	
318 i (95 kW)	2006.01-2007.08	-	L	R	Estate Engine N46 B20 B	201121	Drive Shaft		30		58.5	73	613	
320 d (110 kW)	2004.12-2007.08	-	R	R	Estate Engine M47 D20 (204D4)	605036	Inner Joint		30	25	58.7	73	58	I
	2004.12-2007.08	-	R	R	Estate Engine M47 D20 (204D4)	635025	Inner Joint			25		26		
	2004.12-2007.08	-	R	R	Estate Engine M47 D20 (204D4)	205134	Drive Shaft		30		58.7	73	665	
320 d (120 kW)	2004.12-2007.08	-	R	R	Estate Engine M47 D20 (204D4)	205023	Drive Shaft	48W	27		69	68	660	
	2004.12-2007.08	-	R	R	Estate Engine M47 D20 (204D4)	805020	Outer Joint	48W	30	33	64.8	77	60	M
	2004.12-2007.08	-	R	R	Estate Engine M47 D20 (204D4)	205134	Drive Shaft		30		58.7	73	665	
	2004.12-2007.08	-	L	R	Estate Engine M47 D20 (204D4)	205022	Drive Shaft	48W	27		69	68	607	
	2004.12-2007.08	-	R	R	Estate Engine M47 D20 (204D4)	605036	Inner Joint		30	25	58.7	73	58	I
	2004.12-2007.08	-	R	R	Estate Engine M47 D20 (204D4)	635025	Inner Joint			25		26		
320 d (130 kW)	2007.02-2010.02	-	R	R	Estate Engine N47 D20 A	205023	Drive Shaft	48W	27		69	68	660	
	2007.02-2010.02	-	R	R	Estate Engine N47 D20 A	605036	Inner Joint		30	25	58.7	73	58	I
	2007.02-2010.02	-	R	R	Estate Engine N47 D20 A	635025	Inner Joint			25		26		
	2007.02-2010.02	-	R	R	Estate Engine N47 D20 A	205134	Drive Shaft		30		58.7	73	665	
	2007.02-2010.02	-	R	R	Estate Engine N47 D20 A	805020	Outer Joint	48W	30	33	64.8	77	60	M
	2007.02-2010.02	-	L	R	Estate Engine N47 D20 A	205022	Drive Shaft	48W	27		69	68	607	
320 d (135 kW)	2010.03-2012.05	-	R	R	Estate Engine N47 D20 C	205023	Drive Shaft	48W	27		69	68	660	
	2010.03-2012.05	-	R	R	Estate Engine N47 D20 C	205134	Drive Shaft		30		58.7	73	665	
	2010.03-2012.05	-	R	R	Estate Engine N47 D20 C	805020	Outer Joint	48W	30	33	64.8	77	60	M
	2010.03-2012.05	-	L	R	Estate Engine N47 D20 C	205022	Drive Shaft	48W	27		69	68	607	
320 d (145 kW)	2007.02-2010.02	-	R	R	Estate Engine N47 D20 C/N47 D20 A	205023	Drive Shaft	48W	27		69	68	660	
	2007.02-2010.02	-	R	R	Estate Engine N47 D20 C/N47 D20 A	205134	Drive Shaft		30		58.7	73	665	
	2007.02-2010.02	-	L	R	Estate Engine N47 D20 C/N47 D20 A	205022	Drive Shaft	48W	27		69	68	607	
	2007.02-2010.02	-	R	R	Estate Engine N47 D20 C/N47 D20 A	805020	Outer Joint	48W	30	33	64.8	77	60	M
320 d (147 kW)	2010.03-2012.05	-	L	R	Estate Engine N47 D20 C	205022	Drive Shaft	48W	27		69	68	607	
	2010.03-2012.05	-	R	R	Estate Engine N47 D20 C	205023	Drive Shaft	48W	27		69	68	660	
	2010.03-2012.05	-	R	R	Estate Engine N47 D20 C	205134	Drive Shaft		30		58.7	73	665	
	2010.03-2012.05	-	R	R	Estate Engine N47 D20 C	805020	Outer Joint	48W	30	33	64.8	77	60	M
320 d ed (120 kW)	2010.10-2012.05	-	R	R	Estate Engine N47 D20 C	605036	Inner Joint		30	25	58.7	73	58	I
	2010.10-2012.05	-	R	R	Estate Engine N47 D20 C	635025	Inner Joint			25		26		
	2010.10-2012.05	-	R	R	Estate Engine N47 D20 C	205134	Drive Shaft		30		58.7	73	665	
320 d xDrive (120 kW)	2009.07-2012.06	-	R	R	All-wheel Drive Estate Engine N47 D20 C	205134	Drive Shaft		30		58.7	73	665	

YEAR	TRANSM	L/R	F/R	REMARKS	GSP Ref.	PRODUCT	ABS	Technical Specifications								
								A	B	C	H	L	P			
BMW																
3 Touring (E91)																
320 d xDrive (120 kW)	2009.07-2012.06	-	-	R	All-wheel Drive Estate Engine N47 D20 C	805020	Outer Joint	48W	30	33	64.8	77	60	M		
	2009.07-2012.06	-	R	R	All-wheel Drive Estate Engine N47 D20 C	605036	Inner Joint		30	25	58.7	73	58	I		
	2009.07-2012.06	-	R	R	All-wheel Drive Estate Engine N47 D20 C	635025	Inner Joint			25		26				
320 d xDrive (130 kW)	2008.02-2010.02	-	R	R	All-wheel Drive Estate Engine N47 D20 C	205134	Drive Shaft		30		58.7	73	665			
	2008.02-2010.02	-	R	R	All-wheel Drive Estate Engine N47 D20 C	605036	Inner Joint		30	25	58.7	73	58	I		
	2008.02-2010.02	-	R	R	All-wheel Drive Estate Engine N47 D20 C	635025	Inner Joint			25		26				
	2008.02-2010.02	-	-	R	All-wheel Drive Estate Engine N47 D20 C	805020	Outer Joint	48W	30	33	64.8	77	60	M		
	2008.02-2010.02	-	L	F	All-wheel Drive Estate Engine N47 D20 C	205124	Drive Shaft	48W	30	27	64.8	77	571			
	2008.02-2010.02	-	R	F	All-wheel Drive Estate Engine N47 D20 C	205125	Drive Shaft	48W	30	27	64.8	77	892			
320 d xDrive (135 kW)	2010.03-2012.05	-	-	R	All-wheel Drive Estate Engine N47 D20 C	805020	Outer Joint	48W	30	33	64.8	77	60	M		
320 d xDrive (145 kW)	2008.02-2010.02	-	-	R	All-wheel Drive Estate Engine N47 D20 C	805020	Outer Joint	48W	30	33	64.8	77	60	M		
320 d xDrive (147 kW)	2010.03-2012.05	-	-	R	All-wheel Drive Estate Engine N47 D20 C	805020	Outer Joint	48W	30	33	64.8	77	60	M		
320 i (110 kW)	2005.09-2012.06	MT	L	R	Estate Engine N46 B20 B	201121	Drive Shaft		30		58.5	73	613			
	2005.09-2012.06	6AT	R	R	Estate Engine N46 B20 B	205032	Drive Shaft	48W	27		69.3	68	664			
	2005.09-2012.06	6AT	L	R	Estate Engine N46 B20 B	205040	Drive Shaft	48W	27		69.3	68	611			
	2005.09-2012.06	-	-	R	Estate Engine N46 B20 B	605056	Inner Joint		27	24	69.3	68	51	I		
320 i (120 kW)	2007.02-2012.05	6AT	R	R	Estate Engine N43 B20A	205032	Drive Shaft	48W	27		69.3	68	664			
	2007.02-2012.05	6AT	L	R	Estate Engine N43 B20A	205040	Drive Shaft	48W	27		69.3	68	611			
	2007.02-2012.05	-	-	R	Estate Engine N43 B20A	605056	Inner Joint		27	24	69.3	68	51	I		
	2007.02-2012.05	MT	L	R	Estate Engine N43 B20A	201121	Drive Shaft		30		58.5	73	613			
320 i (125 kW)	2007.02-2012.05	6AT	R	R	Estate Engine N43 B20 A	205032	Drive Shaft	48W	27		69.3	68	664			
	2007.02-2012.05	6AT	L	R	Estate Engine N43 B20 A	205040	Drive Shaft	48W	27		69.3	68	611			
	2007.02-2012.05	-	-	R	Estate Engine N43 B20 A	605056	Inner Joint		27	24	69.3	68	51	I		
	2007.02-2012.05	MT	L	R	Estate Engine N43 B20 A	201121	Drive Shaft		30		58.5	73	613			
325 d (145 kW)	2006.09-2012.06	AT	R	R	Estate Engine M57 D30 (306D3)	605036	Inner Joint		30	25	58.7	73	58	I		
	2006.09-2012.06	AT	R	R	Estate Engine M57 D30 (306D3)	635025	Inner Joint			25		26				
	2006.09-2012.06	MT	L	R	Estate Engine M57 D30 (306D3)	205085	Drive Shaft		30		58.7	73	598			
	2006.09-2012.06	MT	R	R	Estate Engine M57 D30 (306D3)	205079	Drive Shaft		30		58.7	73	653			
	2006.09-2012.06	AT	R	R	Estate Engine M57 D30 (306D3)	205134	Drive Shaft		30		58.7	73	665			
325 d (150 kW)	2010.02-2012.06	AT/MT	L	R	Estate Engine N57 D30 A	205085	Drive Shaft		30		58.7	73	598			
	2010.02-2012.06	-	R	R	Estate Engine N57 D30 A	205079	Drive Shaft		30		58.7	73	653			
325 i (155 kW)	2004.12-2010.12	6MT	R	R	Estate Engine N52 B25BA/N52 B25 AF	205038	Drive Shaft		30		58.7	73	663			
	2004.12-2010.12	6MT	L	R	Estate Engine N52 B25BA/N52 B25 AF	205039	Drive Shaft		30		58.7	73	610			
	2004.12-2010.12	-	-	R	Estate Engine N52 B25BA/N52 B25 AF	805020	Outer Joint	48W	30	33	64.8	77	60	M		
	2007.09-2012.06	-	-	R	Estate Engine N53 B30 A	805020	Outer Joint	48W	30	33	64.8	77	60	M		
	2007.09-2012.06	-	R	R	Estate Engine N53 B30 A	205038	Drive Shaft		30		58.7	73	663			
325 i (160 kW)	2007.09-2012.06	-	L	R	Estate Engine N53 B30 A	205039	Drive Shaft		30		58.7	73	610			
	2004.12-2010.12	-	-	R	Estate Engine N52 B25 A	805020	Outer Joint	48W	30	33	64.8	77	60	M		
	2004.12-2010.12	MT	R	R	Estate Engine N52 B25 A	205038	Drive Shaft		30		58.7	73	663			
	2004.12-2010.12	MT	L	R	Estate Engine N52 B25 A	205039	Drive Shaft		30		58.7	73	610			
	2007.09-2012.06	-	R	R	Estate Engine N53 B30 A	205038	Drive Shaft		30		58.7	73	663			
325 i (160 kW)	2007.09-2012.06	-	-	R	Estate Engine N53 B30 A	805020	Outer Joint	48W	30	33	64.8	77	60	M		
	2007.09-2012.06	-	L	R	Estate Engine N53 B30 A	205039	Drive Shaft		30		58.7	73	610			
	2007.09-2012.06	-	-	R	All-wheel Drive Estate Engine N53 B30 A	805020	Outer Joint	48W	30	33	64.8	77	60	M		
325 xi (160 kW)	2005.09-2011.08	-	-	R	All-wheel Drive Estate Engine N52 B25 A	805020	Outer Joint	48W	30	33	64.8	77	60	M		
330 d (155 kW)	2005.09-2011.08	MT	R	R	All-wheel Drive Estate Engine N52 B25 A	205038	Drive Shaft		30		58.7	73	663			
	2005.09-2011.08	MT	L	R	All-wheel Drive Estate Engine N52 B25 A	205039	Drive Shaft		30		58.7	73	610			
	2007.09-2012.06	-	-	R	All-wheel Drive Estate Engine N53 B30 A	805020	Outer Joint	48W	30	33	64.8	77	60	M		
	2007.09-2012.06	-	-	R	All-wheel Drive Estate Engine N53 B30 A	805020	Outer Joint	48W	30	33	64.8	77	60	M		
330 d (170 kW)	2004.12-2012.05	-	-	R	Estate Engine N47 D20 C	805020	Outer Joint	48W	30	33	64.8	77	60	M		
330 d (180 kW)	2004.12-2008.08	-	R	R	Estate Engine M57 D30 (306D3)	205079	Drive Shaft		30		58.7	73	653			
	2004.12-2008.08	AT/MT	L	R	Estate Engine M57 D30 (306D3)	205085	Drive Shaft		30		58.7	73	598			
	2004.12-2008.08	-	-	R	Estate Engine M57 D30 (306D3)	805020	Outer Joint	48W	30	33	64.8	77	60	M		
330 d (180 kW)	2008.02-2012.05	-	R	R	Estate Engine N57 D30 A	205079	Drive Shaft		30		58.7	73	653			
	2008.02-2012.05	AT/MT	L	R	Estate Engine N57 D30 A	205085	Drive Shaft		30		58.7	73	598			
	2008.02-2012.05	-	-	R	Estate Engine N57 D30 A	805020	Outer Joint	48W	30	33	64.8	77	60	M		
	2009.01-2012.06	MT	R	R	All-wheel Drive Estate Engine N57 D30 A	205079	Drive Shaft		30		58.7	73	653			
	2009.01-2012.06	MT	L	R	All-wheel Drive Estate Engine N57 D30 A	205085	Drive Shaft		30		58.7	73	598			
330 d xDrive (180 kW)	2009.01-2012.06	AT	R	R	All-wheel Drive Estate Engine N57 D30 A	205134	Drive Shaft		30		58.7	73	665			
	2009.01-2012.06	AT	R	R	All-wheel Drive Estate Engine N57 D30 A	605036	Inner Joint		30	25	58.7	73	58	I		
	2009.01-2012.06	AT	R	R	All-wheel Drive Estate Engine N57 D30 A	635025	Inner Joint			25		26				
	2009.01-2012.06	-	-	R	All-wheel Drive Estate Engine N57 D30 A	805020	Outer Joint	48W	30	33	64.8	77	60	M		
	2009.01-2012.06	-	L	F	All-wheel Drive Estate Engine N57 D30 A	205124	Drive Shaft	48W	30	27	64.8	77	571			
	2009.01-2012.06	-	R	F	All-wheel Drive Estate Engine N57 D30 A	205125	Drive Shaft	48W	30	27	64.8	77	892			
	2009.01-2012.06	-	-	R	All-wheel Drive Estate Engine N57 D30 A	805020	Outer Joint	48W	30	33	64.8	77	60	M		
	2009.01-2012.06	-	-	R	All-wheel Drive Estate Engine N57 D30 A	805020	Outer Joint	48W	30	33	64.8	77	60	M		
330 i (190 kW)	2005.09-2007.08	-	-	R	Estate Engine N52 B30 A	805020	Outer Joint	48W	30	33	64.8	77	60	M		
	2005.09-2007.08	MT	R	R	Estate Engine N52 B30 A	205038	Drive Shaft		30		58.7	73	663			
	2005.09-2007.08	MT	L	R	Estate Engine N52 B30 A	205039	Drive Shaft		30		58.7	73	610			

	 YEAR	TRANSM	L/R	F/R	REMARKS	GSP Ref.	 PRODUCT	 ABS	Technical Specifications					
									A	B	C	H	L	P
BMW														
3 Touring (E91)														
330 i (200 kW)	2007.09-2012.06	-	R	R	Estate Engine N53 B30 A	205038	Drive Shaft		30		58.7	73	663	
	2007.09-2012.06	-	-	R	Estate Engine N53 B30 A	805020	Outer Joint	48W	30	33	64.8	77	60	M
	2007.09-2012.06	-	L	R	Estate Engine N53 B30 A	205039	Drive Shaft		30		58.7	73	610	
330 i xDrive (200 kW)	2007.09-2012.06	-	-	R	All-wheel Drive Estate Engine N53 B30 A	805020	Outer Joint	48W	30	33	64.8	77	60	M
330 xd (170 kW)	2005.09-2012.06	MT	R	R	All-wheel Drive Estate Engine M57 D30 (306D3)	205079	Drive Shaft		30		58.7	73	653	
	2005.09-2012.06	-	-	R	All-wheel Drive Estate Engine M57 D30 (306D3)	805020	Outer Joint	48W	30	33	64.8	77	60	M
	2005.09-2012.06	AT	R	R	All-wheel Drive Estate Engine M57 D30 (306D3)	205134	Drive Shaft		30		58.7	73	665	
	2005.09-2012.06	AT	R	R	All-wheel Drive Estate Engine M57 D30 (306D3)	605036	Inner Joint		30	25	58.7	73	58	I
	2005.09-2012.06	AT	R	R	All-wheel Drive Estate Engine M57 D30 (306D3)	635025	Inner Joint			25		26		
330 xi (190 kW)	2005.09-2007.08	-	-	R	All-wheel Drive Estate Engine N52 B30 A	805020	Outer Joint	48W	30	33	64.8	77	60	M
	2005.09-2007.08	MT	R	R	All-wheel Drive Estate Engine N52 B30 A	205038	Drive Shaft		30		58.7	73	663	
	2005.09-2007.08	MT	L	R	All-wheel Drive Estate Engine N52 B30 A	205039	Drive Shaft		30		58.7	73	610	
330 xi (200 kW)	2007.09-2012.06	-	-	R	All-wheel Drive Estate Engine N53 B30 A	805020	Outer Joint	48W	30	33	64.8	77	60	M
335 d (210 kW)	2006.09-2012.06	AT/MT	L	R	Estate Engine M57 D30 (306D5)	205085	Drive Shaft		30		58.7	73	598	
	2006.09-2012.06	-	R	R	Estate Engine M57 D30 (306D5)	205079	Drive Shaft		30		58.7	73	653	
335 i (225 kW)	2006.03-2012.05	6AT	R	R	Estate Engine N54 B30 A	205038	Drive Shaft		30		58.7	73	663	
	2006.03-2012.05	-	-	R	Estate Engine N54 B30 A	805020	Outer Joint	48W	30	33	64.8	77	60	M
	2006.03-2012.05	6AT	L	R	Estate Engine N54 B30 A	205039	Drive Shaft		30		58.7	73	610	
335 i (240 kW)	2006.03-2012.05	-	-	R	Estate Engine N54 B30 A/N55 B30 A	805020	Outer Joint	48W	30	33	64.8	77	60	M
335 i xDrive (225 kW)	2008.05-2012.05	-	-	R	All-wheel Drive Estate Engine N54 B30 A	805020	Outer Joint	48W	30	33	64.8	77	60	M
335 i xDrive (240 kW)	2008.05-2012.05	-	-	R	All-wheel Drive Estate Engine N54 B30 A/N55 B30 A	805020	Outer Joint	48W	30	33	64.8	77	60	M
335 xi (225 kW)	2006.09-2008.08	-	-	R	All-wheel Drive Estate Engine N54 B30 A	805020	Outer Joint	48W	30	33	64.8	77	60	M
335 xi (240 kW)	2006.09-2008.08	-	-	R	All-wheel Drive Estate Engine N54 B30 A	805020	Outer Joint	48W	30	33	64.8	77	60	M
3 Touring (F31)														
316 i (100 kW)	2012.03-2016.08	AT	L	R	Estate Engine N13 B16 A	205107	Drive Shaft		28	27	57.4	71	749	
	2012.03-2016.08	MT	L	R	Estate Engine N13 B16 A	205066	Drive Shaft		28	27	57.4	71	739	
	2012.03-2016.08	MT	R	R	Estate Engine N13 B16 A	205067	Drive Shaft		28	27	57.4	71	793	
320 i (135 kW)	2012.02-2015.06	MT	L	R	Estate Engine N20 B20 B	205066	Drive Shaft		28	27	57.4	71	739	
	2012.02-2015.06	MT	R	R	Estate Engine N20 B20 B	205067	Drive Shaft		28	27	57.4	71	793	
325 d (155 kW)	2012.09-2016.02	AT	L	R	Estate Engine N47 D20 D	605086	Inner Joint		28	28	57	71	64	
	2012.09-2016.02	AT	L	R	Estate Engine N47 D20 D	605087	Inner Joint		32	28	50	85	72.5	
	2012.09-2016.02	AT	L	R	Estate Engine N47 D20 D	205110	Drive Shaft		28	32	57	71	748	
325 d (160 kW)	2012.09-2016.02	AT	L	R	Estate Engine N47 D20 D	605086	Inner Joint		28	28	57	71	64	
	2012.09-2016.02	AT	L	R	Estate Engine N47 D20 D	605087	Inner Joint		32	28	50	85	72.5	
	2012.09-2016.02	AT	L	R	Estate Engine N47 D20 D	205110	Drive Shaft		28	32	57	71	748	
325 d (165 kW)	2015.04--	MT/AT	L	R	Estate Engine B47 D20 B	605086	Inner Joint		28	28	57	71	64	
	2015.04--	MT/AT	L	R	Estate Engine B47 D20 B	605087	Inner Joint		32	28	50	85	72.5	
	2015.04--	AT/MT	L	R	Estate Engine B47 D20 B	205110	Drive Shaft		28	32	57	71	748	
328 i (180 kW)	2012.01-2015.06	AT	L	R	Estate Engine N20 B20 A	205148	Drive Shaft		28	27	57.2	70.5	749	
	2012.01-2015.06	AT	R	R	Estate Engine N20 B20 A	205147	Drive Shaft		28	27	57.2	70.5	803	
	2012.01-2015.06	-	L/R	R	Estate Engine N20 B20 A	605082	Inner joint		27	33	44	96	81	
	2012.01-2015.06	-	L/R	R	Estate Engine N20 B20 A	805024	Outer Joint		28	33	57.2	70.5	58	I
328 i xDrive (180 kW)	2012.06-2016.06	AT	L	R	All-wheel Drive Estate Engine N20 B20 A	205148	Drive Shaft		28	27	57.2	70.5	749	
	2012.06-2016.06	AT	R	R	All-wheel Drive Estate Engine N20 B20 A	205147	Drive Shaft		28	27	57.2	70.5	803	
	2012.06-2016.06	-	R	R	All-wheel Drive Estate Engine N20 B20 A	201117	Drive Shaft		28	27	57.2	70.5	805	
	2012.06-2016.06	-	L/R	R	All-wheel Drive Estate Engine N20 B20 A	201118	Drive Shaft		28	27	57.2	70.5	750	
	2012.06-2016.06	-	L/R	R	All-wheel Drive Estate Engine N20 B20 A	605082	Inner joint		27	33	44	96	81	
	2012.06-2016.06	-	L/R	R	All-wheel Drive Estate Engine N20 B20 A	805024	Outer Joint		28	33	57.2	70.5	58	I
330 d (190 kW)	2012.01--	AT	L	R	Estate Engine N57 D30 A	605086	Inner Joint		28	28	57	71	64	
	2012.01--	AT	L	R	Estate Engine N57 D30 A	605087	Inner Joint		32	28	50	85	72.5	
	2012.01--	AT	R	R	Estate Engine N57 D30 A	205109	Drive Shaft		28	32	57	71	802	
	2012.01--	AT	L	R	Estate Engine N57 D30 A	205110	Drive Shaft		28	32	57	71	748	
330 d (210 kW)	2012.01--	AT	L	R	Estate Engine N57 D30 A	605086	Inner Joint		28	28	57	71	64	
	2012.01--	AT	L	R	Estate Engine N57 D30 A	605087	Inner Joint		32	28	50	85	72.5	
	2012.01--	-	R	R	Estate Engine N57 D30 A	205109	Drive Shaft		28	32	57	71	802	
	2012.01--	AT	L	R	Estate Engine N57 D30 A	205110	Drive Shaft		28	32	57	71	748	
330 d xDrive (190 kW)	2012.06--	AT	L	R	All-wheel Drive Estate Engine N57 D30 A	605086	Inner Joint		28	28	57	71	64	
	2012.06--	AT	L	R	All-wheel Drive Estate Engine N57 D30 A	605087	Inner Joint		32	28	50	85	72.5	
	2012.06--	AT	L	R	All-wheel Drive Estate Engine N57 D30 A	205110	Drive Shaft		28	32	57	71	748	
330 d xDrive (210 kW)	2012.06--	AT	L	R	All-wheel Drive Estate Engine N57 D30 A	605086	Inner Joint		28	28	57	71	64	
	2012.06--	AT	L	R	All-wheel Drive Estate Engine N57 D30 A	605087	Inner Joint		32	28	50	85	72.5	
	2012.06--	AT	L	R	All-wheel Drive Estate Engine N57 D30 A	205110	Drive Shaft		28	32	57	71	748	
330 i (185 kW)	2014.09--	-	L/R	R	Estate Engine B48 B20 A	605082	Inner joint		27	33	44	96	81	
	2014.09--	-	L/R	R	Estate Engine B48 B20 A	805024	Outer Joint		28	33	57.2	70.5	58	I
330 i xDrive (185 kW)	2014.10--	-	-	R	All-wheel Drive Estate Engine B48 B20 A	201117	Drive Shaft		28	27	57.2	70.5	805	
	2014.10--	-	-	L	All-wheel Drive Estate Engine B48 B20 A	201118	Drive Shaft		28	27	57.2	70.5	750	





	 YEAR	TRANSM	L/R	F/R	REMARKS	GSP Ref.	 PRODUCT	 ABS	Technical Specifications					
									A	B	C	H	L	P
BMW														
3 Touring (F31)														
330 i xDrive (185 kW)	2014.10-	-	L/R	R	All-wheel Drive Estate Engine B48 B20 A	805024	Outer Joint		28	33	57.2	70.5	58	I
335 d xDrive (230 kW)	2013.04-	-	AT	L	R	All-wheel Drive Estate Engine N57 D30 B	205110	Drive Shaft	28	32	57	71	748	
	2013.04-	-	AT	L	R	All-wheel Drive Estate Engine N57 D30 B	605086	Inner Joint	28	28	57	71	64	
	2013.04-	-	AT	L	R	All-wheel Drive Estate Engine N57 D30 B	605087	Inner Joint	32	28	50	85	72.5	
4 (F32 F82)														
418 i (100 kW)	2016.02-	-	MT	L	R	Coupe Engine B38 B15 A	205066	Drive Shaft	28	27	57.4	71	739	
	2016.02-	-	MT	R	R	Coupe Engine B38 B15 A	205067	Drive Shaft	28	27	57.4	71	793	
420 i (120 kW)	2013.11-	-	MT	L	R	Coupe Engine N20 B20 B	205066	Drive Shaft	28	27	57.4	71	739	
	2013.11-	-	MT	R	R	Coupe Engine N20 B20 B	205067	Drive Shaft	28	27	57.4	71	793	
420 i (135 kW)	2013.11-	-	MT	L	R	Coupe Engine N20 B20 B	205066	Drive Shaft	28	27	57.4	71	739	
	2013.11-	-	MT	R	R	Coupe Engine N20 B20 B	205067	Drive Shaft	28	27	57.4	71	793	
	2016.02-	-	MT	L	R	Coupe Engine B48 B20 A	205066	Drive Shaft	28	27	57.4	71	739	
	2016.02-	-	MT	R	R	Coupe Engine B48 B20 A	205067	Drive Shaft	28	27	57.4	71	793	
425 d (155 kW)	2014.01-	-	AT	L	R	Coupe Engine N47 D20 D	605086	Inner Joint	28	28	57	71	64	
	2014.01-	-	AT	L	R	Coupe Engine N47 D20 D	605087	Inner Joint	32	28	50	85	72.5	
	2014.01-	-	-	R	R	Coupe Engine N47 D20 D	205109	Drive Shaft	28	32	57	71	802	
	2014.01-	-	AT	L	R	Coupe Engine N47 D20 D	205110	Drive Shaft	28	32	57	71	748	
425 d (160 kW)	2014.01-	-	AT	L	R	Coupe Engine N47 D20 D	605086	Inner Joint	28	28	57	71	64	
	2014.01-	-	AT	L	R	Coupe Engine N47 D20 D	605087	Inner Joint	32	28	50	85	72.5	
	2014.01-	-	-	R	R	Coupe Engine N47 D20 D	205109	Drive Shaft	28	32	57	71	802	
	2014.01-	-	AT	L	R	Coupe Engine N47 D20 D	205110	Drive Shaft	28	32	57	71	748	
425 d (165 kW)	2016.03-	-	MT/AT	L	R	Coupe Engine B47 D20 B	605086	Inner Joint	28	28	57	71	64	
	2016.03-	-	MT/AT	L	R	Coupe Engine B47 D20 B	605087	Inner Joint	32	28	50	85	72.5	
	2016.03-	-	-	R	R	Coupe Engine B47 D20 B	205109	Drive Shaft	28	32	57	71	802	
	2016.03-	-	AT/MT	L	R	Coupe Engine B47 D20 B	205110	Drive Shaft	28	32	57	71	748	
428 i (180 kW)	2013.07-	-	AT	L	R	Coupe Engine N20 B20 A	205148	Drive Shaft	28	27	57.2	70.5	749	
	2013.07-	-	AT	R	R	Coupe Engine N20 B20 A	205147	Drive Shaft	28	27	57.2	70.5	803	
	2013.07-	-	-	L/R	R	Coupe Engine N20 B20 A	605082	Inner joint	27	33	44	96	81	
	2013.07-	-	-	L/R	R	Coupe Engine N20 B20 A	805024	Outer Joint	28	33	57.2	70.5	58	I
428 i xDrive (180 kW)	2013.07-	-	AT	L	R	All-wheel Drive Coupe Engine N20 B20 A	205148	Drive Shaft	28	27	57.2	70.5	749	
	2013.07-	-	AT	R	R	All-wheel Drive Coupe Engine N20 B20 A	205147	Drive Shaft	28	27	57.2	70.5	803	
	2013.07-	-	-	R	R	All-wheel Drive Coupe Engine N20 B20 A	201117	Drive Shaft	28	27	57.2	70.5	805	
	2013.07-	-	-	L	R	All-wheel Drive Coupe Engine N20 B20 A	201118	Drive Shaft	28	27	57.2	70.5	750	
	2013.07-	-	-	L/R	R	All-wheel Drive Coupe Engine N20 B20 A	605082	Inner joint	27	33	44	96	81	
	2013.07-	-	-	L/R	R	All-wheel Drive Coupe Engine N20 B20 A	805024	Outer Joint	28	33	57.2	70.5	58	I
430 d (190 kW)	2013.11-	-	-	R	R	Coupe Engine N57 D30 A	205109	Drive Shaft	28	32	57	71	802	
430 d (210 kW)	2013.11-	-	-	R	R	Coupe Engine N57 D30 A	205109	Drive Shaft	28	32	57	71	802	
430 d xDrive (190 kW)	2014.01-	-	AT	L	R	All-wheel Drive Coupe Engine N57 D30 A	605086	Inner Joint	28	28	57	71	64	
	2014.01-	-	AT	L	R	All-wheel Drive Coupe Engine N57 D30 A	605087	Inner Joint	32	28	50	85	72.5	
	2014.01-	-	-	R	R	All-wheel Drive Coupe Engine N57 D30 A	205109	Drive Shaft	28	32	57	71	802	
	2014.01-	-	AT	L	R	All-wheel Drive Coupe Engine N57 D30 A	205110	Drive Shaft	28	32	57	71	748	
430 d xDrive (210 kW)	2013.11-	-	AT	L	R	All-wheel Drive Coupe Engine N57 D30 A	605086	Inner Joint	28	28	57	71	64	
	2013.11-	-	AT	L	R	All-wheel Drive Coupe Engine N57 D30 A	605087	Inner Joint	32	28	50	85	72.5	
	2013.11-	-	-	R	R	All-wheel Drive Coupe Engine N57 D30 A	205109	Drive Shaft	28	32	57	71	802	
	2013.11-	-	AT	L	R	All-wheel Drive Coupe Engine N57 D30 A	205110	Drive Shaft	28	32	57	71	748	
435 d xDrive (230 kW)	2013.11-	-	AT	L	R	All-wheel Drive Coupe Engine N57 D30 B	605086	Inner Joint	28	28	57	71	64	
	2013.11-	-	AT	L	R	All-wheel Drive Coupe Engine N57 D30 B	605087	Inner Joint	32	28	50	85	72.5	
	2013.11-	-	-	R	R	All-wheel Drive Coupe Engine N57 D30 B	205109	Drive Shaft	28	32	57	71	802	
	2013.11-	-	AT	L	R	All-wheel Drive Coupe Engine N57 D30 B	205110	Drive Shaft	28	32	57	71	748	
440 i xDrive (240 kW)	2016.03-	-	8AT	L	R	All-wheel Drive Coupe Engine B58 B30 A	205110	Drive Shaft	28	32	57	71	748	
440 i xDrive (265 kW)	2016.03-	-	8AT	L	R	All-wheel Drive Coupe Engine B58 B30 A	205110	Drive Shaft	28	32	57	71	748	
4 (F33 F83)														
420 i (120 kW)	2014.07-	-	MT	L	R	Convertible Engine N20 B20 B	205066	Drive Shaft	28	27	57.4	71	739	
	2014.07-	-	MT	R	R	Convertible Engine N20 B20 B	205067	Drive Shaft	28	27	57.4	71	793	
420 i (135 kW)	2014.07-	-	MT	L	R	Convertible Engine N20 B20 B	205066	Drive Shaft	28	27	57.4	71	739	
	2014.07-	-	MT	R	R	Convertible Engine N20 B20 B	205067	Drive Shaft	28	27	57.4	71	793	
	2016.02-	-	MT	L	R	Convertible Engine B48 B20 A	205066	Drive Shaft	28	27	57.4	71	739	
	2016.02-	-	MT	R	R	Convertible Engine B48 B20 A	205067	Drive Shaft	28	27	57.4	71	793	
425 d (155 kW)	2014.07-	-	AT	L	R	Convertible Engine N47 D20 D	605086	Inner Joint	28	28	57	71	64	
	2014.07-	-	AT	L	R	Convertible Engine N47 D20 D	605087	Inner Joint	32	28	50	85	72.5	
	2014.07-	-	AT	L	R	Convertible Engine N47 D20 D	205110	Drive Shaft	28	32	57	71	748	
425 d (160 kW)	2014.07-	-	AT	L	R	Convertible Engine N47 D20 D	605086	Inner Joint	28	28	57	71	64	
	2014.07-	-	AT	L	R	Convertible Engine N47 D20 D	605087	Inner Joint	32	28	50	85	72.5	
	2014.07-	-	AT	L	R	Convertible Engine N47 D20 D	205110	Drive Shaft	28	32	57	71	748	
425 d (165 kW)	2016.03-	-	MT/AT	L	R	Convertible Engine B47 D20 B	605086	Inner Joint	28	28	57	71	64	
	2016.03-	-	MT/AT	L	R	Convertible Engine B47 D20 B	605087	Inner Joint	32	28	50	85	72.5	





	 YEAR	TRANSM	L/R	F/R	REMARKS	GSP Ref.	 PRODUCT	 ABS	Technical Specifications					
									A	B	C	H	L	P
BMW														
4 (F33 F83)														
425 d (165 kW)	2016.03-	-	AT/MT	L	R	Convertible Engine B47 D20 B	205110	Drive Shaft	28	32	57	71	748	
428 i (180 kW)	2013.10-	-	AT	L	R	Convertible Engine N20 B20 A	205148	Drive Shaft	28	27	57.2	70.5	749	
	2013.10-	-	AT	R	R	Convertible Engine N20 B20 A	205147	Drive Shaft	28	27	57.2	70.5	803	
	2013.10-	-	-	L/R	R	Convertible Engine N20 B20 A	605082	Inner joint	27	33	44	96	81	
	2013.10-	-	-	L/R	R	Convertible Engine N20 B20 A	805024	Outer Joint	28	33	57.2	70.5	58	I
428 i xDrive (180 kW)	2014.01-	-	AT	L	R	All-wheel Drive Convertible Engine N20 B20 A	205148	Drive Shaft	28	27	57.2	70.5	749	
	2014.01-	-	AT	R	R	All-wheel Drive Convertible Engine N20 B20 A	205147	Drive Shaft	28	27	57.2	70.5	803	
	2014.01-	-	-	R	R	All-wheel Drive Convertible Engine N20 B20 A	201117	Drive Shaft	28	27	57.2	70.5	805	
	2014.01-	-	-	L	R	All-wheel Drive Convertible Engine N20 B20 A	201118	Drive Shaft	28	27	57.2	70.5	750	
	2014.01-	-	-	L/R	R	All-wheel Drive Convertible Engine N20 B20 A	805024	Outer Joint	28	33	57.2	70.5	58	I
430 d (190 kW)	2014.07-	-	AT	L	R	Convertible Engine N57 D30 A	605086	Inner Joint	28	28	57	71	64	
	2014.07-	-	AT	L	R	Convertible Engine N57 D30 A	605087	Inner Joint	32	28	50	85	72.5	
	2014.07-	-	-	R	R	Convertible Engine N57 D30 A	205109	Drive Shaft	28	32	57	71	802	
	2014.07-	-	AT	L	R	Convertible Engine N57 D30 A	205110	Drive Shaft	28	32	57	71	748	
430 d (210 kW)	2013.10-	-	AT	L	R	Convertible Engine N57 D30 A	605086	Inner Joint	28	28	57	71	64	
	2013.10-	-	AT	L	R	Convertible Engine N57 D30 A	605087	Inner Joint	32	28	50	85	72.5	
	2013.10-	-	-	R	R	Convertible Engine N57 D30 A	205109	Drive Shaft	28	32	57	71	802	
	2013.10-	-	AT	L	R	Convertible Engine N57 D30 A	205110	Drive Shaft	28	32	57	71	748	
430 i (185 kW)	2016.03-	-	AT	L	R	Convertible Engine B48 B20 B	205148	Drive Shaft	28	27	57.2	70.5	749	
	2016.03-	-	AT	R	R	Convertible Engine B48 B20 B	205147	Drive Shaft	28	27	57.2	70.5	803	
435 d xDrive (230 kW)	2014.07-	-	AT	L	R	All-wheel Drive Convertible Engine N57 D30 B	605086	Inner Joint	28	28	57	71	64	
	2014.07-	-	AT	L	R	All-wheel Drive Convertible Engine N57 D30 B	605087	Inner Joint	32	28	50	85	72.5	
	2014.07-	-	-	R	R	All-wheel Drive Convertible Engine N57 D30 B	205109	Drive Shaft	28	32	57	71	802	
	2014.07-	-	AT	L	R	All-wheel Drive Convertible Engine N57 D30 B	205110	Drive Shaft	28	32	57	71	748	
4 Gran (F36)														
418 i (100 kW)	2015.07-	-	MT	L	R	Coupe Engine B38 B15 A	205066	Drive Shaft	28	27	57.4	71	739	
	2015.07-	-	MT	R	R	Coupe Engine B38 B15 A	205067	Drive Shaft	28	27	57.4	71	793	
420 i (120 kW)	2014.03-	-	AT	L	R	Coupe Engine N20 B20 B	205107	Drive Shaft	28	27	57.4	71	749	
	2014.03-	-	MT	L	R	Coupe Engine N20 B20 B	205066	Drive Shaft	28	27	57.4	71	739	
	2014.03-	-	MT	R	R	Coupe Engine N20 B20 B	205067	Drive Shaft	28	27	57.4	71	793	
	2014.03-	-	AT	L	R	Coupe Engine N20 B20 B	205107	Drive Shaft	28	27	57.4	71	749	
420 i (135 kW)	2014.03-	-	MT	L	R	Coupe Engine N20 B20 B	205066	Drive Shaft	28	27	57.4	71	739	
	2014.03-	-	MT	R	R	Coupe Engine N20 B20 B	205067	Drive Shaft	28	27	57.4	71	793	
	2014.03-	-	-	R	R	Coupe Engine N20 B20 B	205109	Drive Shaft	28	32	57	71	802	
	2014.03-	-	8AT	L	R	Coupe Engine B47 D20 B	205110	Drive Shaft	28	32	57	71	748	
425 d (155 kW)	2016.03-	-	-	R	R	Coupe Engine B47 D20 B	205109	Drive Shaft	28	32	57	71	802	
	2016.03-	-	-	R	R	Coupe Engine B47 D20 B	605086	Inner Joint	28	28	57	71	64	
	2016.03-	-	-	R	R	Coupe Engine B47 D20 B	605087	Inner Joint	32	28	50	85	72.5	
	2016.03-	-	8AT	L	R	Coupe Engine B47 D20 B	205110	Drive Shaft	28	32	57	71	748	
425 d (165 kW)	2016.03-	-	MT/AT	L	R	Coupe Engine B47 D20 B	605086	Inner Joint	28	28	57	71	64	
	2016.03-	-	MT/AT	L	R	Coupe Engine B47 D20 B	605087	Inner Joint	32	28	50	85	72.5	
	2016.03-	-	-	R	R	Coupe Engine B47 D20 B	205109	Drive Shaft	28	32	57	71	802	
	2016.03-	-	AT/MT	L	R	Coupe Engine B47 D20 B	205110	Drive Shaft	28	32	57	71	748	
428 i (180 kW)	2014.03-	-	AT	L	R	Coupe Engine N20 B20 A	205148	Drive Shaft	28	27	57.2	70.5	749	
	2014.03-	-	AT	R	R	Coupe Engine N20 B20 A	205147	Drive Shaft	28	27	57.2	70.5	803	
	2014.03-	-	-	L/R	R	Coupe Engine N20 B20 A	605082	Inner joint	27	33	44	96	81	
	2014.03-	-	-	L/R	R	Coupe Engine N20 B20 A	805024	Outer Joint	28	33	57.2	70.5	58	I
428 i xDrive (180 kW)	2014.03-	-	-	R	R	All-wheel Drive Coupe Engine N20 B20 A	201117	Drive Shaft	28	27	57.2	70.5	805	
	2014.03-	-	-	L	R	All-wheel Drive Coupe Engine N20 B20 A	201118	Drive Shaft	28	27	57.2	70.5	750	
	2014.03-	-	-	L/R	R	All-wheel Drive Coupe Engine N20 B20 A	805024	Outer Joint	28	33	57.2	70.5	58	I
	2014.03-	-	-	R	R	Coupe Engine N57 D30 A	205109	Drive Shaft	28	32	57	71	802	
430 d (190 kW)	2014.07-	-	-	R	R	Coupe Engine N57 D30 A	205109	Drive Shaft	28	32	57	71	802	
	2014.07-	-	AT	L	R	Coupe Engine N57 D30 A	205110	Drive Shaft	28	32	57	71	748	
	2014.07-	-	AT	L/R	R	Coupe Engine N57 D30 A	605086	Inner Joint	28	28	57	71	64	
	2014.07-	-	AT	L/R	R	Coupe Engine N57 D30 A	605087	Inner Joint	32	28	50	85	72.5	
430 d (210 kW)	2014.07-	-	-	R	R	Coupe Engine N57 D30 A	205109	Drive Shaft	28	32	57	71	802	
	2014.07-	-	AT	L	R	Coupe Engine N57 D30 A	205110	Drive Shaft	28	32	57	71	748	
	2014.07-	-	AT	L/R	R	Coupe Engine N57 D30 A	605086	Inner Joint	28	28	57	71	64	
	2014.07-	-	AT	L/R	R	Coupe Engine N57 D30 A	605087	Inner Joint	32	28	50	85	72.5	
430 d xDrive (190 kW)	2014.07-	-	-	R	R	All-wheel Drive Coupe Engine N57 D30 A	205109	Drive Shaft	28	32	57	71	802	
	2014.07-	-	AT	L	R	All-wheel Drive Coupe Engine N57 D30 A	205110	Drive Shaft	28	32	57	71	748	
	2014.07-	-	AT	L/R	R	All-wheel Drive Coupe Engine N57 D30 A	605086	Inner Joint	28	28	57	71	64	
	2014.07-	-	AT	L/R	R	All-wheel Drive Coupe Engine N57 D30 A	605087	Inner Joint	32	28	50	85	72.5	
430 d xDrive (210 kW)	2014.07-	-	-	R	R	All-wheel Drive Coupe Engine N57 D30 A	205109	Drive Shaft	28	32	57	71	802	
	2014.07-	-	AT	L	R	All-wheel Drive Coupe Engine N57 D30 A	205110	Drive Shaft	28	32	57	71	748	
	2014.07-	-	AT	L/R	R	All-wheel Drive Coupe Engine N57 D30 A	605086	Inner Joint	28	28	57	71	64	
	2014.07-	-	AT	L/R	R	All-wheel Drive Coupe Engine N57 D30 A	605087	Inner Joint	32	28	50	85	72.5	
435 d xDrive (230 kW)	2014.07-	-	-	R	R	All-wheel Drive Coupe Engine N57 D30 B	205109	Drive Shaft	28	32	57	71	802	
	2014.07-	-	AT	L	R	All-wheel Drive Coupe Engine N57 D30 B	205110	Drive Shaft	28	32	57	71	748	





YEAR	TRANSM	L/R	F/R	REMARKS	GSP Ref.	PRODUCT	ABS	Technical Specifications							
								A	B	C	H	L	P		
BMW															
4 Gran (F36)															
435 d xDrive (230 kW)	2014.07-	-	AT	L/R	R	All-wheel Drive Coupe Engine N57 D30 B	605086	Inner Joint		28	28	57	71	64	
	2014.07-	-	AT	L/R	R	All-wheel Drive Coupe Engine N57 D30 B	605087	Inner Joint		32	28	50	85	72.5	
5 (E34)															
518 i (83 kW)	1989.08-	1995.09	-	L/R	R	Saloon Engine M40 B18 (184E1)	205001	Drive Shaft					32	465	
	1989.08-	1995.09	AT/MT	L/R	R	Saloon Engine M40 B18 (184E1)	699052	Inner Joint		25			32		
518 i (85 kW)	1989.08-	1995.09	-	L/R	R	Saloon Engine M43 B18 (184E2)	205001	Drive Shaft					32	465	
	1989.08-	1995.09	AT/MT	L/R	R	Saloon Engine M43 B18 (184E2)	699052	Inner Joint		25			32		
520 i (95 kW)	1988.01-	1991.08	-	L/R	R	Saloon Engine M20 B20 (206KA)	205001	Drive Shaft					32	465	
	1988.01-	1991.08	AT/MT	L/R	R	Saloon Engine M20 B20 (206KA)	699052	Inner Joint		25			32		
520 i 24V (110 kW)	1989.09-	1995.09	-	L/R	R	Saloon Engine M50 B20 (206S1)	205001	Drive Shaft					32	465	
	1989.09-	1995.09	AT	L/R	R	Saloon Engine M50 B20 (206S1)	699052	Inner Joint		25			32		
524 td (85 kW)	1988.03-	1995.09	-	L/R	R	Saloon Engine M21 D24 (246TB)	205001	Drive Shaft					32	465	
	1988.03-	1995.09	AT/MT	L/R	R	Saloon Engine M21 D24 (246TB)	699052	Inner Joint		25			32		
525 i (125 kW)	1988.01-	1991.08	-	L/R	R	Saloon Engine M20 B25 (256K1)	205001	Drive Shaft					32	465	
	1988.01-	1991.08	AT/MT	L/R	R	Saloon Engine M20 B25 (256K1)	699052	Inner Joint		25			32		
525 i 24V (141 kW)	1989.09-	1995.09	-	L/R	R	Saloon Engine M50 B25 (256S2)	205001	Drive Shaft					32	465	
	1989.09-	1995.09	AT/MT	L/R	R	Saloon Engine M50 B25 (256S2)	699052	Inner Joint		25			32		
525 iX 24V (141 kW)	1991.10-	1995.09	-	L/R	R	All-wheel Drive Saloon Engine M50 B25 (256S1)	205001	Drive Shaft					32	465	
	1991.10-	1995.09	AT/MT	L/R	R	All-wheel Drive Saloon Engine M50 B25 (256S1)	699052	Inner Joint		25			32		
525 td (85 kW)	1993.04-	1995.09	-	L/R	R	Saloon Engine M51 D25 (256T1)	205001	Drive Shaft					32	465	
	1993.04-	1995.09	AT/MT	L/R	R	Saloon Engine M51 D25 (256T1)	699052	Inner Joint		25			32		
525 tds (105 kW)	1991.09-	1995.09	-	L/R	R	Saloon Engine M51 D25 (256T1)	205001	Drive Shaft					32	465	
	1991.09-	1995.09	AT/MT	L/R	R	Saloon Engine M51 D25 (256T1)	699052	Inner Joint		25			32		
530 i V8 (160 kW)	1992.09-	1995.09	AT	L/R	R	Saloon Engine M60 B30 (308S1)	205001	Drive Shaft					32	465	
	1992.09-	1995.09	AT	L/R	R	Saloon Engine M60 B30 (308S1)	699052	Inner Joint		25			32		
5 (E39)															
520 d (100 kW)	2000.02-	2003.06	MT	L/R	R	Saloon Engine M47 D20 (204D1)	201112	Drive Shaft		30		58.5	73	620	
	2000.02-	2003.06	MT	-	R	Saloon Engine M47 D20 (204D1)	605057	Inner Joint			32		28		
520 i (100 kW)	1999.04-	2003.06	-	-	R	Saloon Engine M52 B20 (206S3)	201111	Drive Shaft		30		59	73	629	
520 i (110 kW)	1996.01-	2000.09	AT/MT	-	R	Saloon Engine M52 B20 (206S3)	201111	Drive Shaft		30		59	73	629	
523 i (125 kW)	1995.11-	2000.09	-	L/R	R	Saloon Engine M52 B25 (256S3)	205021	Drive Shaft		30		59	73	615	
525 d (120 kW)	2000.02-	2003.06	AT/MT	-	R	Saloon Engine M57 D25 (256D1)	605057	Inner Joint			32		28		
	2000.02-	2003.06	AT/MT	-	R	Saloon Engine M57 D25 (256D1)	205064	Drive Shaft		30		58.9	73	618	
525 i (141 kW)	2000.09-	2003.06	-	L/R	R	Saloon Engine M54 B25 (256S5)	205021	Drive Shaft		30		59	73	615	
525 td (85 kW)	1997.01-	2003.06	AT/MT	L/R	R	Saloon Engine M51 D25 (256T1)	201112	Drive Shaft		30		58.5	73	620	
525 tds (105 kW)	1996.01-	2003.06	AT/MT	L/R	R	Saloon Engine M51 D25 (256T1)	201112	Drive Shaft		30		58.5	73	620	
	1996.01-	2003.06	AT/MT	-	R	Saloon Engine M51 D25 (256T1)	605057	Inner Joint			32		28		
	1996.01-	2003.06	AT/MT	-	R	Saloon Engine M51 D25 (256T1)	205064	Drive Shaft		30		58.9	73	618	
528 i (142 kW)	1995.11-	2000.09	-	L/R	R	Saloon Engine M52 B28 (286S2)	205021	Drive Shaft		30		59	73	615	
	1995.11-	2000.09	AT/MT	-	R	Saloon Engine M52 B28 (286S2)	605057	Inner Joint			32		28		
530 d (135 kW)	1998.08-	2000.09	MT	L/R	R	Saloon Engine M57 D30 (306D1)	201112	Drive Shaft		30		58.5	73	620	
	1998.08-	2000.09	AT/MT	-	R	Saloon Engine M57 D30 (306D1)	205064	Drive Shaft		30		58.9	73	618	
530 d (142 kW)	2000.09-	2003.06	MT	L/R	R	Saloon Engine M57 D30 (306D1)	201112	Drive Shaft		30		58.5	73	620	
	2000.09-	2003.06	AT/MT	-	R	Saloon Engine M57 D30 (306D1)	205064	Drive Shaft		30		58.9	73	618	
530 i (170 kW)	2000.09-	2003.06	AT/MT	L/R	R	Saloon Engine M54 B30 (306S3)	201112	Drive Shaft		30		58.5	73	620	
	2000.09-	2003.06	AT	L/R	R	Saloon Engine M54 B30 (306S3)	205021	Drive Shaft		30		59	73	615	
	2000.09-	2003.06	AT/MT	-	R	Saloon Engine M54 B30 (306S3)	605057	Inner Joint			32		28		
535 i (173 kW)	1996.04-	1999.03	AT	L/R	R	Saloon Engine M62 B35 (358S1)	205021	Drive Shaft		30		59	73	615	
	1996.04-	1999.03	AT/MT	-	R	Saloon Engine M62 B35 (358S1)	605057	Inner Joint			32		28		
	1996.04-	1999.03	AT	-	R	Saloon Engine M62 B35 (358S1)	205064	Drive Shaft		30		58.9	73	618	
535 i (180 kW)	1999.04-	2003.06	AT/MT	-	R	Saloon Engine M62 B35 (358S2)	605057	Inner Joint			32		28		
	1999.04-	2003.06	AT	-	R	Saloon Engine M62 B35 (358S2)	205064	Drive Shaft		30		58.9	73	618	
540 i (210 kW)	1996.04-	2003.06	MT	-	R	Saloon Engine M62 B44 (448S2)	205064	Drive Shaft		30		58.9	73	618	
5 (E60)															
520 d (110 kW)	2005.02-	2008.02	MT	R	R	Saloon Engine M47 D20 (204D4)	605033	Inner Joint		30	28	58.7	73	62	
	2005.02-	2008.02	MT	L/R	R	Saloon Engine M47 D20 (204D4)	205091	Drive Shaft		30		58.7	73	658	
	2005.02-	2008.02	MT	L/R	R	Saloon Engine M47 D20 (204D4)	661075	Inner Joint			28		26		
520 d (120 kW)	2005.02-	2008.02	MT	R	R	Saloon Engine M47 D20 (204D4)	605033	Inner Joint		30	28	58.7	73	62	
	2005.02-	2008.02	MT	L/R	R	Saloon Engine M47 D20 (204D4)	205091	Drive Shaft		30		58.7	73	658	
	2005.02-	2008.02	MT	L/R	R	Saloon Engine M47 D20 (204D4)	661075	Inner Joint			28		26		
520 d (130 kW)	2006.04-	2009.12	MT	R	R	Saloon Engine N47 D20 A	605033	Inner Joint		30	28	58.7	73	62	
	2006.04-	2009.12	MT	L/R	R	Saloon Engine N47 D20 A	205091	Drive Shaft		30		58.7	73	658	
	2006.04-	2009.12	MT	L/R	R	Saloon Engine N47 D20 A	661075	Inner Joint			28		26		
525 d (120 kW)	2004.12-	2010.03	-	-	R	Saloon Engine M57 D25 (256D1)	805020	Outer Joint	48W	30	33	64.8	77	60	M
	2004.12-	2010.03	-	L/R	R	Saloon Engine M57 D25 (256D1)	205073	Drive Shaft		30		58.8	73	649	
	2004.12-	2010.03	-	L/R	R	Saloon Engine M57 D25 (256D1)	205082	Drive Shaft		30		58.7	73	653	





YEAR	TRANSM	L/R	F/R	REMARKS	GSP Ref.	PRODUCT	ABS	Technical Specifications										
								A	B	C	H	L	P					
BMW																		
5 (E39)																		
525 d (130 kW)	2004.06-2010.03	-	-	R	Saloon Engine M57 D25 (256D2)	805020	Outer Joint	48W	30	33	64.8	77	60	M				
	2004.06-2010.03	-	L/R	R	Saloon Engine M57 D25 (256D2)	205073	Drive Shaft		30		58.8	73	649					
	2004.06-2010.03	-	L/R	R	Saloon Engine M57 D25 (256D2)	205082	Drive Shaft		30		58.7	73	653					
525 d (145 kW)	2007.01-2010.03	-	-	R	Saloon Engine M57 D30 (306D3)	805020	Outer Joint	48W	30	33	64.8	77	60	M				
	2007.01-2010.03	MT	L/R	R	Saloon Engine M57 D30 (306D3)	205073	Drive Shaft		30		58.8	73	649					
	2007.01-2010.03	MT	L/R	R	Saloon Engine M57 D30 (306D3)	205082	Drive Shaft		30		58.7	73	653					
525 d xDrive (145 kW)	2007.09-2009.12	AT/MT	L	F	All-wheel Drive Saloon Engine M57 D30 (306D3)	201109	Drive Shaft	48W	30	27	64.8	77	610					
	2007.09-2009.12	AT/MT	R	F	All-wheel Drive Saloon Engine M57 D30 (306D3)	201108	Drive Shaft	48W	30	27	64.8	77	932					
	2007.09-2009.12	-	-	R	All-wheel Drive Saloon Engine M57 D30 (306D3)	805020	Outer Joint	48W	30	33	64.8	77	60	M				
	2007.09-2009.12	MT	L/R	R	All-wheel Drive Saloon Engine M57 D30 (306D3)	205082	Drive Shaft		30		58.7	73	653					
525 i (155 kW)	2005.07-2010.03	-	-	R	Saloon Engine N52 B25 A	805020	Outer Joint	48W	30	33	64.8	77	60	M				
	2007.01-2010.03	-	-	R	Saloon Engine N53 B30 A	805020	Outer Joint	48W	30	33	64.8	77	60	M				
525 i (160 kW)	2005.07-2010.03	-	-	R	Saloon Engine N52 B25 A	805020	Outer Joint	48W	30	33	64.8	77	60	M				
	2007.01-2010.03	MT	R	R	Saloon Engine N53 B30 A	605033	Inner Joint		30	28	58.7	73	62					
	2007.01-2010.03	MT	L/R	R	Saloon Engine N53 B30 A	205091	Drive Shaft		30		58.7	73	658					
	2007.01-2010.03	-	-	R	Saloon Engine N53 B30 A	805020	Outer Joint	48W	30	33	64.8	77	60	M				
	2007.01-2010.03	MT	L/R	R	Saloon Engine N53 B30 A	661075	Inner Joint			28		26						
525 i xDrive (160 kW)	2008.09-2010.03	-	L	F	All-wheel Drive Saloon Engine N53 B30 A	201109	Drive Shaft	48W	30	27	64.8	77	610					
	2008.09-2010.03	-	R	F	All-wheel Drive Saloon Engine N53 B30 A	201108	Drive Shaft	48W	30	27	64.8	77	932					
	2008.09-2010.03	-	-	R	All-wheel Drive Saloon Engine N53 B30 A	805020	Outer Joint	48W	30	33	64.8	77	60	M				
525 xd (145 kW)	2006.11-2007.08	-	-	R	All-wheel Drive Saloon Engine M57 D30 (306D3)	805020	Outer Joint	48W	30	33	64.8	77	60	M				
525 xi (160 kW)	2005.07-2010.03	-	-	R	All-wheel Drive Saloon Engine N52 B25 A	805020	Outer Joint	48W	30	33	64.8	77	60	M				
	2005.07-2010.03	AT/MT	L	F	All-wheel Drive Saloon Engine N52 B25 A	201109	Drive Shaft	48W	30	27	64.8	77	610					
	2005.07-2010.03	AT/MT	R	F	All-wheel Drive Saloon Engine N52 B25 A	201108	Drive Shaft	48W	30	27	64.8	77	932					
	2007.01-2010.03	-	L	F	All-wheel Drive Saloon Engine N53 B30 A	201109	Drive Shaft	48W	30	27	64.8	77	610					
	2007.01-2010.03	-	-	R	All-wheel Drive Saloon Engine N53 B30 A	805020	Outer Joint	48W	30	33	64.8	77	60	M				
	2007.01-2010.03	-	R	F	All-wheel Drive Saloon Engine N53 B30 A	201108	Drive Shaft	48W	30	27	64.8	77	932					
530 d (155 kW)	2002.02-2009.12	-	L/R	R	Saloon Engine M57 D30 (306D3)	205073	Drive Shaft		30		58.8	73	649					
	2002.02-2009.12	-	-	R	Saloon Engine M57 D30 (306D3)	805020	Outer Joint	48W	30	33	64.8	77	60	M				
530 d (160 kW)	2002.02-2005.09	-	-	R	Saloon Engine M57 D30 (306D2)	805020	Outer Joint	48W	30	33	64.8	77	60	M				
	2002.02-2005.09	-	L/R	R	Saloon Engine M57 D30 (306D2)	205073	Drive Shaft		30		58.8	73	649					
	2002.02-2005.09	-	L/R	R	Saloon Engine M57 D30 (306D2)	205082	Drive Shaft		30		58.7	73	653					
530 d (170 kW)	2005.02-2007.02	-	-	R	Saloon Engine M57 D30 (306D3)	805020	Outer Joint	48W	30	33	64.8	77	60	M				
	2005.02-2007.02	-	L/R	R	Saloon Engine M57 D30 (306D3)	205073	Drive Shaft		30		58.8	73	649					
	2005.02-2007.02	-	L/R	R	Saloon Engine M57 D30 (306D3)	205082	Drive Shaft		30		58.7	73	653					
530 d (173 kW)	2006.09-2009.12	-	-	R	Saloon Engine M57 D30 (306D3)	805020	Outer Joint	48W	30	33	64.8	77	60	M				
	2006.09-2009.12	-	L/R	R	Saloon Engine M57 D30 (306D3)	205073	Drive Shaft		30		58.8	73	649					
	2006.09-2009.12	-	L/R	R	Saloon Engine M57 D30 (306D3)	205082	Drive Shaft		30		58.7	73	653					
530 d xDrive (173 kW)	2007.09-2009.12	AT/MT	L	F	All-wheel Drive Saloon Engine M57 D30 (306D3)	201109	Drive Shaft	48W	30	27	64.8	77	610					
	2007.09-2009.12	AT/MT	R	F	All-wheel Drive Saloon Engine M57 D30 (306D3)	201108	Drive Shaft	48W	30	27	64.8	77	932					
	2007.09-2009.12	-	-	R	All-wheel Drive Saloon Engine M57 D30 (306D3)	805020	Outer Joint	48W	30	33	64.8	77	60	M				
	2007.09-2009.12	MT	L/R	R	All-wheel Drive Saloon Engine M57 D30 (306D3)	205082	Drive Shaft		30		58.7	73	653					
530 i (187 kW)	2005.03-2010.03	-	-	R	Saloon Engine N52 B30 A	805020	Outer Joint	48W	30	33	64.8	77	60	M				
530 i (190 kW)	2004.09-2007.02	MT	R	R	Saloon Engine N52 B30 A	605033	Inner Joint		30	28	58.7	73	62					
	2004.09-2007.02	-	-	R	Saloon Engine N52 B30 A	805020	Outer Joint	48W	30	33	64.8	77	60	M				
	2004.09-2007.02	MT	L/R	R	Saloon Engine N52 B30 A	205091	Drive Shaft		30		58.7	73	658					
	2004.09-2007.02	MT	L/R	R	Saloon Engine N52 B30 A	661075	Inner Joint			28		26						
	2006.09-2009.12	MT	R	R	Saloon Engine N53 B30 A	605033	Inner Joint		30	28	58.7	73	62					
	2006.09-2009.12	MT	L/R	R	Saloon Engine N53 B30 A	205091	Drive Shaft		30		58.7	73	658					
530 i (200 kW)	2006.09-2009.12	-	-	R	Saloon Engine N53 B30 A	805020	Outer Joint	48W	30	33	64.8	77	60	M				
	2006.09-2009.12	MT	L/R	R	Saloon Engine N53 B30 A	205091	Drive Shaft		30		58.7	73	658					
	2006.09-2009.12	-	-	R	Saloon Engine N53 B30 A	805020	Outer Joint	48W	30	33	64.8	77	60	M				
	2006.09-2009.12	MT	L/R	R	Saloon Engine N53 B30 A	661075	Inner Joint			28		26						
	2007.01-2009.12	MT	L/R	R	Saloon Engine N52 B30 A/N52 B30 B/N52 B30 BF	205091	Drive Shaft		30		58.7	73	658					
	2007.01-2009.12	-	-	R	Saloon Engine N52 B30 A/N52 B30 B/N52 B30 BF	805020	Outer Joint	48W	30	33	64.8	77	60	M				
530 i xDrive (200 kW)	2007.09-2009.12	AT/MT	L	F	All-wheel Drive Saloon Engine N53 B30 A	201109	Drive Shaft	48W	30	27	64.8	77	610					
	2007.09-2009.12	AT/MT	R	F	All-wheel Drive Saloon Engine N53 B30 A	201108	Drive Shaft	48W	30	27	64.8	77	932					
	2007.09-2009.12	-	-	R	All-wheel Drive Saloon Engine N53 B30 A	805020	Outer Joint	48W	30	33	64.8	77	60	M				
	2007.09-2009.12	-	-	R	All-wheel Drive Saloon Engine N53 B30 A	805020	Outer Joint	48W	30	33	64.8	77	60	M				
530 xd (170 kW)	2005.02-2007.02	-	-	R	All-wheel Drive Saloon Engine M57 D30 (306D3)	805020	Outer Joint	48W	30	33	64.8	77	60	M				
	2005.02-2007.02	AT/MT	L	F	All-wheel Drive Saloon Engine M57 D30 (306D3)	201109	Drive Shaft	48W	30	27	64.8	77	610					
	2005.02-2007.02	AT/MT	R	F	All-wheel Drive Saloon Engine M57 D30 (306D3)	201108	Drive Shaft	48W	30	27	64.8	77	932					
	2005.02-2007.02	AT	L/R	R	All-wheel Drive Saloon Engine M57 D30 (306D3)	205073	Drive Shaft		30		58.8	73	649					
	2005.02-2007.02	MT	L/R	R	All-wheel Drive Saloon Engine M57 D30 (306D3)	205082	Drive Shaft		30		58.7	73	653					
530 xd (173 kW)	2006.09-2007.08	AT/MT	L	F	All-wheel Drive Saloon Engine M57 D30 (306D3)	201109	Drive Shaft	48W	30	27	64.8	77	610					
	2006.09-2007.08	-	-	R	All-wheel Drive Saloon Engine M57 D30 (306D3)	805020	Outer Joint	48W	30	33	64.8	77	60	M				
	2006.09-2007.08	AT/MT	R	F	All-wheel Drive Saloon Engine M57 D30 (306D3)	201108	Drive Shaft	48W	30	27	64.8	77	932					
	2006.09-2007.08	MT	L/R	R	All-wheel Drive Saloon Engine M57 D30 (306D3)	205082	Drive Shaft		30		58.7	73	653					

YEAR	TRANSM	L/R	F/R	REMARKS	GSP Ref.	PRODUCT	ABS	Technical Specifications										
								A	B	C	H	L	P					
BMW																		
5 (E39)																		
530 xi (190 kW)	2004.09-2007.02	-	-	R	All-wheel Drive Saloon Engine N52 B30 A	805020	Outer Joint	48W	30	33	64.8	77	60	M				
	2004.09-2007.02	AT/MT	L	F	All-wheel Drive Saloon Engine N52 B30 A	201109	Drive Shaft	48W	30	27	64.8	77	610					
	2004.09-2007.02	AT/MT	R	F	All-wheel Drive Saloon Engine N52 B30 A	201108	Drive Shaft	48W	30	27	64.8	77	932					
	2004.09-2007.02	-	L/R	R	All-wheel Drive Saloon Engine N52 B30 A	205082	Drive Shaft		30		58.7	73	653					
530 xi (200 kW)	2005.11-2007.08	-	-	R	All-wheel Drive Saloon Engine N53 B30 A	805020	Outer Joint	48W	30	33	64.8	77	60	M				
	2005.11-2007.08	-	L	F	All-wheel Drive Saloon Engine N53 B30 A	201109	Drive Shaft	48W	30	27	64.8	77	610					
	2005.11-2007.08	-	R	F	All-wheel Drive Saloon Engine N53 B30 A	201108	Drive Shaft	48W	30	27	64.8	77	932					
530 xi(200 kW)	2007.03-2009.10	-	L	F	All-wheel Drive Saloon Engine N52 B30 A	201109	Drive Shaft	48W	30	27	64.8	77	610					
	2007.03-2009.10	-	R	F	All-wheel Drive Saloon Engine N52 B30 A	201108	Drive Shaft	48W	30	27	64.8	77	932					
	2007.03-2009.10	-	-	R	All-wheel Drive Saloon Engine N52 B30 A	805020	Outer Joint	48W	30	33	64.8	77	60	M				
535 d (200 kW)	2004.09-2010.03	-	L/R	R	Saloon Engine M57 D30 (306D4)	205073	Drive Shaft		30		58.8	73	649					
	2004.09-2010.03	-	L/R	R	Saloon Engine M57 D30 (306D4)	205082	Drive Shaft		30		58.7	73	653					
535 d (210 kW)	2007.01-2010.03	-	L/R	R	Saloon Engine M57 D30 (306D5)	205073	Drive Shaft		30		58.8	73	649					
	2007.01-2010.03	-	L/R	R	Saloon Engine M57 D30 (306D5)	205082	Drive Shaft		30		58.7	73	653					
540 i (225 kW)	2005.07-2010.03	MT	L/R	R	Saloon Engine N62 B40 A	205073	Drive Shaft		30		58.8	73	649					
	2005.07-2010.03	MT	L/R	R	Saloon Engine N62 B40 A	205082	Drive Shaft		30		58.7	73	653					
545 i (245 kW)	2003.09-2010.03	MT	L/R	R	Saloon Engine N62 B44 A	205073	Drive Shaft		30		58.8	73	649					
	2003.09-2010.03	MT	L/R	R	Saloon Engine N62 B44 A	205082	Drive Shaft		30		58.7	73	653					
550 i (270 kW)	2005.07-2010.03	MT	L/R	R	Saloon Engine N62 B48 B	205073	Drive Shaft		30		58.8	73	649					
	2005.07-2010.03	MT	L/R	R	Saloon Engine N62 B48 B	205082	Drive Shaft		30		58.7	73	653					
5 (E61)																		
530 xi(200 kW)	2006.09-2008.09	-	L	F	All-wheel Drive Estate/Touring Engine N53 B30 A	201109	Drive Shaft	48W	30	27	64.8	77	610					
	2006.09-2008.09	-	R	F	All-wheel Drive Estate/Touring Engine N53 B30 A	201108	Drive Shaft	48W	30	27	64.8	77	932					
	2006.09-2008.09	-	-	R	All-wheel Drive Estate/Touring Engine N53 B30 A	805020	Outer Joint	48W	30	33	64.8	77	60	M				
5 (F10)																		
518 d (100 kW)	2013.02-2014.06	MT	R	R	Saloon Engine N47 D20 C	205115	Drive Shaft		30	27	65	77	823					
	2013.02-2014.06	-	R	R	Saloon Engine N47 D20 C	605054	Inner Joint		30	25	64.9	77	58					
	2013.02-2014.06	-	R	R	Saloon Engine N47 D20 C	605055	Inner Joint		27	25	43.9	80	72					
518 d (105 kW)	2013.02-2014.06	MT	R	R	Saloon Engine N47 D20 C	205115	Drive Shaft		30	27	65	77	823					
	2013.02-2014.06	-	R	R	Saloon Engine N47 D20 C	605054	Inner Joint		30	25	64.9	77	58					
	2013.02-2014.06	-	R	R	Saloon Engine N47 D20 C	605055	Inner Joint		27	25	43.9	80	72					
518 d (110 kW)	2013.10-2016.10	MT	R	R	Saloon Engine B47 D20 A	205115	Drive Shaft		30	27	65	77	823					
	2013.10-2016.10	-	R	R	Saloon Engine B47 D20 A	605054	Inner Joint		30	25	64.9	77	58					
	2013.10-2016.10	-	R	R	Saloon Engine B47 D20 A	605055	Inner Joint		27	25	43.9	80	72					
	2013.10-2016.10	MT	L	R	Saloon Engine B47 D20 A	205114	Drive Shaft		30	27	65	77	767					
518 d (120 kW)	2013.10-2016.10	6MT	L	R	Saloon Engine B47 D20 A	205114	Drive Shaft		30	27	65	77	767					
	2013.10-2016.10	6MT	R	R	Saloon Engine B47 D20 A	205115	Drive Shaft		30	27	65	77	823					
520 d (100 kW)	2013.01-2016.10	6MT	L	R	Saloon Engine N47 D20 C	205114	Drive Shaft		30	27	65	77	767					
	2013.01-2016.10	6MT	R	R	Saloon Engine N47 D20 C	205115	Drive Shaft		30	27	65	77	823					
520 d (120 kW)	2009.01-2016.10	MT	R	R	Saloon Engine N47 D20 C	205115	Drive Shaft		30	27	65	77	823					
	2009.01-2016.10	-	R	R	Saloon Engine N47 D20 C	605054	Inner Joint		30	25	64.9	77	58					
	2009.01-2016.10	-	R	R	Saloon Engine N47 D20 C	605055	Inner Joint		27	25	43.9	80	72					
	2009.01-2016.10	MT	L	R	Saloon Engine N47 D20 C	205114	Drive Shaft		30	27	65	77	767					
520 d (135 kW)	2013.01-2016.10	MT	R	R	Saloon Engine N47 D20 C	205115	Drive Shaft		30	27	65	77	823					
	2013.01-2016.10	-	R	R	Saloon Engine N47 D20 C	605054	Inner Joint		30	25	64.9	77	58					
	2013.01-2016.10	-	R	R	Saloon Engine N47 D20 C	605055	Inner Joint		27	25	43.9	80	72					
	2013.01-2016.10	MT	L	R	Saloon Engine N47 D20 C	205114	Drive Shaft		30	27	65	77	767					
520 d (140 kW)	2013.10-2016.10	MT	L	R	Saloon Engine B47 D20 A	205114	Drive Shaft		30	27	65	77	767					
	2013.10-2016.10	MT	R	R	Saloon Engine B47 D20 A	205115	Drive Shaft		30	27	65	77	823					
	2013.10-2016.10	-	R	R	Saloon Engine B47 D20 A	605054	Inner Joint		30	25	64.9	77	58					
	2013.10-2016.10	-	R	R	Saloon Engine B47 D20 A	605055	Inner Joint		27	25	43.9	80	72					
520 d (147 kW)	2013.01-2016.10	MT	L	R	Saloon Engine N47 D20 C	205114	Drive Shaft		30	27	65	77	767					
	2013.01-2016.10	MT	R	R	Saloon Engine N47 D20 C	205115	Drive Shaft		30	27	65	77	823					
520 d (155 kW)	2013.10-2016.10	6MT	L	R	Saloon Engine B47 D20 A	205114	Drive Shaft		30	27	65	77	767					
	2013.10-2016.10	6MT	R	R	Saloon Engine B47 D20 A	205115	Drive Shaft		30	27	65	77	823					
520 d xDrive (100 kW)	2013.01-2014.06	8AT	L	F	All-wheel Drive Saloon Engine N47 D20 C	201581	Drive Shaft		37	27	65		562					
520 d xDrive (120 kW)	2013.10-2016.10	AT	L	F	All-wheel Drive Saloon Engine B47 D20 A	201581	Drive Shaft		37	27	65		562					
	2013.10-2016.10	-	R	R	All-wheel Drive Saloon Engine B47 D20 A	605054	Inner Joint		30	25	64.9	77	58					
	2013.10-2016.10	-	R	R	All-wheel Drive Saloon Engine B47 D20 A	605055	Inner Joint		27	25	43.9	80	72					
520 d xDrive (135 kW)	2013.01-2014.06	-	R	R	All-wheel Drive Saloon Engine N47 D20 C	605054	Inner Joint		30	25	64.9	77	58					
	2013.01-2014.06	-	R	R	All-wheel Drive Saloon Engine N47 D20 C	605055	Inner Joint		27	25	43.9	80	72					
520 d xDrive (140 kW)	2013.10-2016.10	-	R	R	All-wheel Drive Saloon Engine B47 D20 A	605054	Inner Joint		30	25	64.9	77	58					
	2013.10-2016.10	-	R	R	All-wheel Drive Saloon Engine B47 D20 A	605055	Inner Joint		27	25	43.9	80	72					
520 i (120 kW)	2010.10-2016.10	MT	R	R	Saloon Engine N20 B20 A	205115	Drive Shaft		30	27	65	77	823					
	2010.10-2016.10	AT	R	R	Saloon Engine N20 B20 A	205113	Drive Shaft		30	27	64.9	77	811					
	2010.10-2016.10	AT	L	R	Saloon Engine N20 B20 A	205112	Drive Shaft		30	27	64.9	77	758					

	 YEAR	TRANSM	L/R	F/R	REMARKS	GSP Ref.	 PRODUCT	 ABS	Technical Specifications					
									A	B	C	H	L	P
BMW														
5 (F10)														
520 i (120 kW)	2010.10-	2016.10	MT	L	R	Saloon Engine N20 B20 A	205114	Drive Shaft	30	27	65	77	767	
520 i (125 kW)	2013.07-	2016.10	AT	R	R	Saloon Engine N20 B16 A	205113	Drive Shaft	30	27	64.9	77	811	
	2013.07-	2016.10	AT	L	R	Saloon Engine N20 B16 A	205112	Drive Shaft	30	27	64.9	77	758	
520 i (135 kW)	2010.10-	2016.10	MT	R	R	Saloon Engine N20 B20 A	205115	Drive Shaft	30	27	65	77	823	
	2010.10-	2016.10	AT	R	R	Saloon Engine N20 B20 A	205113	Drive Shaft	30	27	64.9	77	811	
	2010.10-	2016.10	AT	L	R	Saloon Engine N20 B20 A	205112	Drive Shaft	30	27	64.9	77	758	
	2010.10-	2016.10	MT	L	R	Saloon Engine N20 B20 A	205114	Drive Shaft	30	27	65	77	767	
525 d (150 kW)	2009.06-	2011.08	AT	L	R	Saloon Engine N57 D30 A	205114	Drive Shaft	30	27	65	77	767	
	2009.06-	2011.08	AT	R	R	Saloon Engine N57 D30 A	205115	Drive Shaft	30	27	65	77	823	
525 d xDrive (155 kW)	2011.01-	2016.10	-	L	F	All-wheel Drive Saloon Engine N47 D20 D	201581	Drive Shaft	37	27	65		562	
525 d xDrive (160 kW)	2011.01-	2016.10	-	L	F	All-wheel Drive Saloon Engine N47 D20 D	201581	Drive Shaft	37	27	65		562	
528 i (180 kW)	2010.10-	2016.10	MT	R	R	Saloon Engine N20 B20 A	205115	Drive Shaft	30	27	65	77	823	
	2010.10-	2016.10	AT	R	R	Saloon Engine N20 B20 A	205113	Drive Shaft	30	27	64.9	77	811	
	2010.10-	2016.10	AT	L	R	Saloon Engine N20 B20 A	205112	Drive Shaft	30	27	64.9	77	758	
	2010.10-	2016.10	MT	L	R	Saloon Engine N20 B20 A	205114	Drive Shaft	30	27	65	77	767	
528 i xDrive (180 kW)	2010.10-	2016.10	-	L	F	All-wheel Drive Saloon Engine N20 B20 A	201581	Drive Shaft	37	27	65		562	
	2010.10-	2016.10	AT	R	R	All-wheel Drive Saloon Engine N20 B20 A	205113	Drive Shaft	30	27	64.9	77	811	
	2010.10-	2016.10	-	L	R	All-wheel Drive Saloon Engine N20 B20 A	205112	Drive Shaft	30	27	64.9	77	758	
530 d xDrive (190 kW)	2010.09-	2013.06	AT	L	R	All-wheel Drive Saloon Engine N57 D30 A	605063	Inner Joint	30	28	65	77	62	
	2010.09-	2013.06	AT	L	R	All-wheel Drive Saloon Engine N57 D30 A	605074	Inner Joint	32	28	49.9	85.5	73	
530 d xDrive (210 kW)	2013.02-	2016.10	-	L	F	All-wheel Drive Saloon Engine N57 D30 A	201581	Drive Shaft	37	27	65		562	
	2013.02-	2016.10	AT	L	R	All-wheel Drive Saloon Engine N57 D30 A	605063	Inner Joint	30	28	65	77	62	
	2013.02-	2016.10	AT	L	R	All-wheel Drive Saloon Engine N57 D30 A	605074	Inner Joint	32	28	49.9	85.5	73	
535 d xDrive (230 kW)	2011.02-	2016.10	-	L	F	All-wheel Drive Saloon Engine N57 D30 B	201581	Drive Shaft	37	27	65		562	
	2011.02-	2016.10	AT	L	R	All-wheel Drive Saloon Engine N57 D30 B	605063	Inner Joint	30	28	65	77	62	
	2011.02-	2016.10	AT	L	R	All-wheel Drive Saloon Engine N57 D30 B	605074	Inner Joint	32	28	49.9	85.5	73	
535 i xDrive (225 kW)	2010.03-	2016.10	-	L	F	All-wheel Drive Saloon Engine N55 B30 A	201581	Drive Shaft	37	27	65		562	
535 i xDrive (225 kW)	2010.03-	2016.10	-	R	R	All-wheel Drive Saloon Engine N55 B30 A	205113	Drive Shaft	30	27	64.9	77	811	
	2010.03-	2016.10	-	L	R	All-wheel Drive Saloon Engine N55 B30 A	205112	Drive Shaft	30	27	64.9	77	758	
535 i xDrive (240 kW)	2013.07-	2016.10	AT	L	F	All-wheel Drive Saloon Engine N55 B30 A	201581	Drive Shaft	37	27	65		562	
550 i xDrive (300 kW)	2010.08-	2013.06	-	L	F	All-wheel Drive Saloon Engine N63 B44 A	201581	Drive Shaft	37	27	65		562	
550 i xDrive (330 kW)	2013.01-	2016.10	AT	L	F	All-wheel Drive Saloon Engine N63 B44 B	201581	Drive Shaft	37	27	65		562	
ActiveHybrid (225 kW)	2010.09-	2016.08	-	R	R	Saloon Engine N55 B30 A	205115	Drive Shaft	30	27	65	77	823	
	2010.09-	2016.08	-	L	R	Saloon Engine N55 B30 A	205114	Drive Shaft	30	27	65	77	767	
ActiveHybrid (250 kW)	2010.09-	2016.08	-	R	R	Saloon Engine N55 B30 A	205115	Drive Shaft	30	27	65	77	823	
	2010.09-	2016.08	-	L	R	Saloon Engine N55 B30 A	205114	Drive Shaft	30	27	65	77	767	
M 550 d xDrive (280 kW)	2011.07-	2016.10	-	L	F	All-wheel Drive Saloon Engine N57 D30 C	201581	Drive Shaft	37	27	65		562	
5 Gran Turismo (F07)														
530 d (155 kW)	2010.03-	-	AT	R	R	Hatchback Engine N57 D30 A	605063	Inner Joint	30	28	65	77	62	
	2010.03-	-	AT	R	R	Hatchback Engine N57 D30 A	205111	Drive Shaft	30	32	65	77	831	
530 d (180 kW)	2009.01-	2012.06	AT	R	R	Hatchback Engine N57 D30 A	605063	Inner Joint	30	28	65	77	62	
	2009.01-	2012.06	AT	R	R	Hatchback Engine N57 D30 A	205111	Drive Shaft	30	32	65	77	831	
530 d (190 kW)	2011.10-	-	AT	L/R	R	Hatchback Engine N57 D30 A	605063	Inner Joint	30	28	65	77	62	
	2011.10-	-	AT	R	R	Hatchback Engine N57 D30 A	205111	Drive Shaft	30	32	65	77	831	
530 d xDrive (180 kW)	2010.01-	2012.06	AT	R	R	All-wheel Drive Hatchback Engine N57 D30 A	605063	Inner Joint	30	28	65	77	62	
	2010.01-	2012.06	AT	R	R	All-wheel Drive Hatchback Engine N57 D30 A	205111	Drive Shaft	30	32	65	77	831	
530 d xDrive (190 kW)	2011.11-	-	AT	L/R	R	All-wheel Drive Hatchback Engine N57 D30 A	605063	Inner Joint	30	28	65	77	62	
	2011.11-	-	AT	R	R	All-wheel Drive Hatchback Engine N57 D30 A	205111	Drive Shaft	30	32	65	77	831	
535 d (220 kW)	2009.05-	2012.06	AT	L/R	R	Hatchback Engine N57 D30 B	605063	Inner Joint	30	28	65	77	62	
	2009.05-	2012.06	AT	R	R	Hatchback Engine N57 D30 B	205111	Drive Shaft	30	32	65	77	831	
535 d (230 kW)	2012.01-	-	AT	L/R	R	Hatchback Engine N57 D30 B	605063	Inner Joint	30	28	65	77	62	
	2012.01-	-	AT	R	R	Hatchback Engine N57 D30 B	205111	Drive Shaft	30	32	65	77	831	
535 d xDrive (220 kW)	2009.05-	2012.06	AT	L/R	R	All-wheel Drive Hatchback Engine N57 D30 B	605063	Inner Joint	30	28	65	77	62	
	2009.05-	2012.06	AT	R	R	All-wheel Drive Hatchback Engine N57 D30 B	205111	Drive Shaft	30	32	65	77	831	
535 d xDrive (230 kW)	2012.01-	-	AT	L/R	R	All-wheel Drive Hatchback Engine N57 D30 B	605063	Inner Joint	30	28	65	77	62	
	2012.01-	-	AT	R	R	All-wheel Drive Hatchback Engine N57 D30 B	205111	Drive Shaft	30	32	65	77	831	
535 i (225 kW)	2009.01-	-	-	L	R	Hatchback Engine N55 B30 A	205116	Drive Shaft	30	32	65	77	777	
535 i xDrive (225 kW)	2010.01-	-	-	L	R	All-wheel Drive Hatchback Engine N55 B30 A	205116	Drive Shaft	30	32	65	77	777	
550 i (300 kW)	2009.01-	2012.05	-	L	R	Hatchback Engine N63 B44 A	205116	Drive Shaft	30	32	65	77	777	
550 i (330 kW)	2012.01-	2016.07	-	L	R	Hatchback Engine N63 B44 B	205116	Drive Shaft	30	32	65	77	777	
550 i xDrive (300 kW)	2009.04-	2012.06	-	L	R	All-wheel Drive Hatchback Engine N63 B44 A	205116	Drive Shaft	30	32	65	77	777	
550 i xDrive (330 kW)	2011.04-	-	-	L	R	All-wheel Drive Hatchback Engine N63 B44 B	205116	Drive Shaft	30	32	65	77	777	
5 Touring (E34)														
518 g (85 kW)	1995.11-	1996.06	-	L/R	R	Estate Engine M43 B18 (184E2)	205001	Drive Shaft				32	465	
518 i (83 kW)	1993.03-	1994.09	-	L/R	R	Estate Engine M43 B18 (184E2)	205001	Drive Shaft				32	465	
	1993.03-	1994.09	AT/MT	L/R	R	Estate Engine M43 B18 (184E2)	699052	Inner Joint	25		32			

	 YEAR	TRANSM	L/R	F/R	REMARKS	GSP Ref.	 PRODUCT	 ABS	Technical Specifications					
									A	B	C	H	L	P
BMW														
5 Touring (E34)														
518 i (85 kW)	1994.09-1997.01	-	L/R	R	Estate Engine M43 B18 (184E2)	205001	Drive Shaft				32	465		
	1994.09-1997.01	AT/MT	L/R	R	Estate Engine M43 B18 (184E2)	699052	Inner Joint		25		32			
520 i (110 kW)	1991.11-1997.01	-	L/R	R	Estate Engine M50 B20 (206S1)	205001	Drive Shaft				32	465		
	1991.11-1997.01	AT	L/R	R	Estate Engine M50 B20 (206S1)	699052	Inner Joint		25		32			
525 i (141 kW)	1991.11-1997.01	-	L/R	R	Estate Engine M50 B25 (256S1)	205001	Drive Shaft				32	465		
	1991.11-1997.01	AT	L/R	R	Estate Engine M50 B25 (256S1)	699052	Inner Joint		25		32			
525 ix (141 kW)	1992.02-1997.01	-	L/R	R	All-wheel Drive Estate Engine M50 B25 (256S2)	205001	Drive Shaft				32	465		
	1992.02-1997.01	AT/MT	L/R	R	All-wheel Drive Estate Engine M50 B25 (256S2)	699052	Inner Joint		25		32			
525 td (85 kW)	1993.03-1997.01	-	L/R	R	Estate Engine M51 D25 (256T1)	205001	Drive Shaft				32	465		
	1993.03-1997.01	AT/MT	L/R	R	Estate Engine M51 D25 (256T1)	699052	Inner Joint		25		32			
525 tds (105 kW)	1991.12-1997.01	-	L/R	R	Estate Engine M51 D25 (256T1)	205001	Drive Shaft				32	465		
	1991.12-1997.01	AT/MT	L/R	R	Estate Engine M51 D25 (256T1)	699052	Inner Joint		25		32			
530 i V8 (160 kW)	1992.09-1997.01	AT	L/R	R	Estate Engine M60 B30 (308S1)	205001	Drive Shaft				32	465		
	1992.09-1997.01	AT	L/R	R	Estate Engine M60 B30 (308S1)	699052	Inner Joint		25		32			
5 Touring (E39)														
520 d (100 kW)	2000.02-2003.09	MT	L/R	R	Estate Engine M47 D20 (204D1)	201112	Drive Shaft		30		58.5	73	620	
	2000.02-2003.09	MT	-	R	Estate Engine M47 D20 (204D1)	605057	Inner Joint			32		28		
520 i (100 kW)	1999.04-2004.05	-	-	R	Estate Engine M52 B20 (206S3)	201111	Drive Shaft		30		59	73	629	
520 i (110 kW)	1997.01-2000.09	AT/MT	-	R	Estate Engine M52 B20 (206S3)	201111	Drive Shaft		30		59	73	629	
523 i (125 kW)	1997.01-2000.09	-	L/R	R	Estate Engine M52 B25 (256S3)	205021	Drive Shaft		30		59	73	615	
525 d (120 kW)	2000.02-2004.05	AT/MT	-	R	Estate Engine M57 D25 (256D1)	605057	Inner Joint			32		28		
	2000.02-2004.05	AT/MT	-	R	Estate Engine M57 D25 (256D1)	205064	Drive Shaft		30		58.9	73	618	
525 i (141 kW)	2000.09-2004.05	-	L/R	R	Estate Engine M54 B25 (256S5)	205021	Drive Shaft		30		59	73	615	
525 tds (105 kW)	1997.03-2004.05	AT/MT	L/R	R	Estate Engine M51 D25 (256T1)	201112	Drive Shaft		30		58.5	73	620	
	1997.03-2004.05	AT/MT	-	R	Estate Engine M51 D25 (256T1)	605057	Inner Joint			32		28		
	1997.03-2004.05	AT/MT	-	R	Estate Engine M51 D25 (256T1)	205064	Drive Shaft		30		58.9	73	618	
528 i (142 kW)	1997.01-2000.09	-	L/R	R	Estate Engine M52 B28 (286S2)	205021	Drive Shaft		30		59	73	615	
	1997.01-2000.09	AT/MT	-	R	Estate Engine M52 B28 (286S2)	605057	Inner Joint			32		28		
530 d (135 kW)	1998.08-2000.09	MT	L/R	R	Estate Engine M57 D30 (306D1)	201112	Drive Shaft		30		58.5	73	620	
	1998.08-2000.09	AT/MT	-	R	Estate Engine M57 D30 (306D1)	205064	Drive Shaft		30		58.9	73	618	
530 d (142 kW)	2000.09-2004.05	MT	L/R	R	Estate Engine M57 D30 (306D1)	201112	Drive Shaft		30		58.5	73	620	
	2000.09-2004.05	AT/MT	-	R	Estate Engine M57 D30 (306D1)	205064	Drive Shaft		30		58.9	73	618	
530 i (170 kW)	2000.09-2004.05	AT	L/R	R	Estate Engine M54 B30 (306S3)	205021	Drive Shaft		30		59	73	615	
	2000.09-2004.05	AT/MT	-	R	Estate Engine M54 B30 (306S3)	605057	Inner Joint			32		28		
540 i (210 kW)	1997.01-2004.05	MT	-	R	Estate Engine M62 B44 (448S2)	205064	Drive Shaft		30		58.9	73	618	
5 Touring (E61)														
520 d (110 kW)	2005.04-2008.02	MT	R	R	Estate Engine M47 D20 (204D4)	605033	Inner Joint		30	28	58.7	73	62	
	2005.04-2008.02	MT	L/R	R	Estate Engine M47 D20 (204D4)	205091	Drive Shaft		30		58.7	73	658	
	2005.04-2008.02	MT	L/R	R	Estate Engine M47 D20 (204D4)	661075	Inner Joint			28		26		
520 d (120 kW)	2005.04-2008.02	MT	R	R	Estate Engine M47 D20 (204D4)	605033	Inner Joint		30	28	58.7	73	62	
	2005.04-2008.02	MT	L/R	R	Estate Engine M47 D20 (204D4)	205091	Drive Shaft		30		58.7	73	658	
	2005.04-2008.02	MT	L/R	R	Estate Engine M47 D20 (204D4)	661075	Inner Joint			28		26		
520 d (130 kW)	2007.03-2010.05	MT	R	R	Estate Engine N47 D20 A	605033	Inner Joint		30	28	58.7	73	62	
	2007.03-2010.05	MT	L/R	R	Estate Engine N47 D20 A	205091	Drive Shaft		30		58.7	73	658	
	2007.03-2010.05	MT	L/R	R	Estate Engine N47 D20 A	661075	Inner Joint			28		26		
525 d (120 kW)	2004.12-2010.12	-	-	R	Estate Engine M57N 256 D4	805020	Outer Joint	48W	30	33	64.8	77	60	M
	2004.12-2010.12	-	L/R	R	Estate Engine M57N 256 D4	205073	Drive Shaft		30		58.8	73	649	
	2004.12-2010.12	-	L/R	R	Estate Engine M57N 256 D4	205082	Drive Shaft		30		58.7	73	653	
525 d (130 kW)	2004.06-2010.12	-	-	R	Estate Engine M57 D25 (256D2)	805020	Outer Joint	48W	30	33	64.8	77	60	M
	2004.06-2010.12	-	L/R	R	Estate Engine M57 D25 (256D2)	205073	Drive Shaft		30		58.8	73	649	
	2004.06-2010.12	-	L/R	R	Estate Engine M57 D25 (256D2)	205082	Drive Shaft		30		58.7	73	653	
525 d (145 kW)	2007.01-2010.12	-	-	R	Estate Engine M57 D30 (306D3)	805020	Outer Joint	48W	30	33	64.8	77	60	M
	2007.01-2010.12	MT	L/R	R	Estate Engine M57 D30 (306D3)	205073	Drive Shaft		30		58.8	73	649	
525 d xDrive (145 kW)	2008.09-2010.12	AT/MT	L	F	All-wheel Drive Estate Engine M57 D30 (306D3)	201109	Drive Shaft	48W	30	27	64.8	77	610	
	2008.09-2010.12	AT/MT	R	F	All-wheel Drive Estate Engine M57 D30 (306D3)	201108	Drive Shaft	48W	30	27	64.8	77	932	
	2008.09-2010.12	-	-	R	All-wheel Drive Estate Engine M57 D30 (306D3)	805020	Outer Joint	48W	30	33	64.8	77	60	M
	2008.09-2010.12	MT	L/R	R	All-wheel Drive Estate Engine M57 D30 (306D3)	205082	Drive Shaft		30		58.7	73	653	
525 i (155 kW)	2005.07-2010.12	-	-	R	Saloon Engine N57 D30 A/M57 D30	805020	Outer Joint	48W	30	33	64.8	77	60	M
	2007.01-2010.12	-	-	R	Saloon Engine N53 B30 A	805020	Outer Joint	48W	30	33	64.8	77	60	M
525 i (160 kW)	2005.07-2010.12	-	-	R	Estate Engine N52 B25 A	805020	Outer Joint	48W	30	33	64.8	77	60	M
	2007.01-2010.12	MT	R	R	Estate Engine N53 B30 A	605033	Inner Joint		30	28	58.7	73	62	
	2007.01-2010.12	MT	L/R	R	Estate Engine N53 B30 A	205091	Drive Shaft		30		58.7	73	658	
	2007.01-2010.12	-	-	R	Estate Engine N53 B30 A	805020	Outer Joint	48W	30	33	64.8	77	60	M
	2007.01-2010.12	MT	L/R	R	Estate Engine N53 B30 A	661075	Inner Joint			28		26		
525 i xDrive (160 kW)	2008.09-2010.12	-	L	F	All-wheel Drive Estate Engine N53 B30 A	201109	Drive Shaft	48W	30	27	64.8	77	610	
	2008.09-2010.12	-	R	F	All-wheel Drive Estate Engine N53 B30 A	201108	Drive Shaft	48W	30	27	64.8	77	932	

	 YEAR	TRANSM	L/R	F/R	REMARKS	GSP Ref.	 PRODUCT	 ABS	Technical Specifications					
									A	B	C	H	L	P
BMW														
5 Touring (E61)														
525 i xDrive (160 kW)	2008.09-2010.12	-	-	R	All-wheel Drive Estate Engine N53 B30 A	805020	Outer Joint	48W	30	33	64.8	77	60	M
525 xd (145 kW)	2007.01-2010.12	AT/MT	L	F	All-wheel Drive Estate Engine M57 D30 (306D3)	201109	Drive Shaft	48W	30	27	64.8	77	610	
525 xd (145 kW)	2007.01-2010.12	-	-	R	All-wheel Drive Estate Engine M57 D30 (306D3)	805020	Outer Joint	48W	30	33	64.8	77	60	M
	2007.01-2010.12	AT/MT	R	F	All-wheel Drive Estate Engine M57 D30 (306D3)	201108	Drive Shaft	48W	30	27	64.8	77	932	
	2007.01-2010.12	MT	L/R	R	All-wheel Drive Estate Engine M57 D30 (306D3)	205082	Drive Shaft		30		58.7	73	653	
525 xi (160 kW)	2005.07-2010.12	-	-	R	All-wheel Drive Estate Engine N52 B25 A	805020	Outer Joint	48W	30	33	64.8	77	60	M
	2005.07-2010.12	AT/MT	L	F	All-wheel Drive Estate Engine N52 B25 A	201109	Drive Shaft	48W	30	27	64.8	77	610	
	2005.07-2010.12	AT/MT	R	F	All-wheel Drive Estate Engine N52 B25 A	201108	Drive Shaft	48W	30	27	64.8	77	932	
	2007.01-2010.12	-	L	F	All-wheel Drive Estate Engine N53 B30 A	201109	Drive Shaft	48W	30	27	64.8	77	610	
	2007.01-2010.12	-	R	F	All-wheel Drive Estate Engine N53 B30 A	805020	Outer Joint	48W	30	33	64.8	77	60	M
530 d (155 kW)	2005.11-2010.12	MT	L/R	R	Estate Engine M57 D30 (306D3)	205073	Drive Shaft		30		58.8	73	649	
	2005.11-2010.12	-	-	R	Estate Engine M57 D30 (306D3)	805020	Outer Joint	48W	30	33	64.8	77	60	M
530 d (160 kW)	2004.06-2010.12	-	-	R	Estate Engine M57 D30 (306D2)	805020	Outer Joint	48W	30	33	64.8	77	60	M
	2004.06-2010.12	-	L/R	R	Estate Engine M57 D30 (306D2)	205073	Drive Shaft		30		58.8	73	649	
	2004.06-2010.12	-	L/R	R	Estate Engine M57 D30 (306D2)	205082	Drive Shaft		30		58.7	73	653	
530 d (170 kW)	2005.07-2010.12	-	-	R	Estate Engine M57 D30 (306D3)	805020	Outer Joint	48W	30	33	64.8	77	60	M
	2005.07-2010.12	-	L/R	R	Estate Engine M57 D30 (306D3)	205073	Drive Shaft		30		58.8	73	649	
	2005.07-2010.12	-	L/R	R	Estate Engine M57 D30 (306D3)	205082	Drive Shaft		30		58.7	73	653	
530 d (173 kW)	2007.01-2010.12	-	-	R	Estate Engine M57 D30 (306D3)	805020	Outer Joint	48W	30	33	64.8	77	60	M
	2007.01-2010.12	-	L/R	R	Estate Engine M57 D30 (306D3)	205073	Drive Shaft		30		58.8	73	649	
	2007.01-2010.12	-	L/R	R	Estate Engine M57 D30 (306D3)	205082	Drive Shaft		30		58.7	73	653	
530 d xDrive (173 kW)	2008.09-2010.12	AT/MT	L	F	All-wheel Drive Estate Engine M57 D30 (306D3)	201109	Drive Shaft	48W	30	27	64.8	77	610	
	2008.09-2010.12	AT/MT	R	F	All-wheel Drive Estate Engine M57 D30 (306D3)	201108	Drive Shaft	48W	30	27	64.8	77	932	
	2008.09-2010.12	-	-	R	All-wheel Drive Estate Engine M57 D30 (306D3)	805020	Outer Joint	48W	30	33	64.8	77	60	M
	2008.09-2010.12	MT	L/R	R	All-wheel Drive Estate Engine M57 D30 (306D3)	205082	Drive Shaft		30		58.7	73	653	
530 i (190 kW)	2005.07-2010.12	MT	R	R	Estate Engine N52 B30 A	605033	Inner Joint		30	28	58.7	73	62	
	2005.07-2010.12	-	-	R	Estate Engine N52 B30 A	805020	Outer Joint	48W	30	33	64.8	77	60	M
	2005.07-2010.12	MT	L/R	R	Estate Engine N52 B30 A	205091	Drive Shaft		30		58.7	73	658	
	2005.07-2010.12	MT	L/R	R	Estate Engine N52 B30 A	661075	Inner Joint			28		26		
530 i (200 kW)	2007.01-2010.12	MT	R	R	Estate Engine N53 B30 A	605033	Inner Joint		30	28	58.7	73	62	
	2007.01-2010.12	MT	L/R	R	Saloon Engine N53 B30 A	205091	Drive Shaft		30		58.7	73	658	
	2007.01-2010.12	MT	L/R	R	Estate Engine N53 B30 A	205091	Drive Shaft		30		58.7	73	658	
	2007.01-2010.12	-	-	R	Estate Engine N53 B30 A	805020	Outer Joint	48W	30	33	64.8	77	60	M
	2007.01-2010.12	-	-	R	Saloon Engine N53 B30 A	805020	Outer Joint	48W	30	33	64.8	77	60	M
	2007.01-2010.12	MT	L/R	R	Saloon Engine N53 B30 A	661075	Inner Joint			28		26		
	2007.01-2010.12	MT	L/R	R	Estate Engine N53 B30 A	661075	Inner Joint			28		26		
530 i xDrive (200 kW)	2008.09-2010.12	-	L	F	All-wheel Drive Estate Engine N53 B30 A	201109	Drive Shaft	48W	30	27	64.8	77	610	
	2008.09-2010.12	-	R	F	All-wheel Drive Estate Engine N53 B30 A	201108	Drive Shaft	48W	30	27	64.8	77	932	
	2008.09-2010.12	-	-	R	All-wheel Drive Estate Engine N53 B30 A	805020	Outer Joint	48W	30	33	64.8	77	60	M
530 xd (170 kW)	2005.07-2010.12	-	-	R	All-wheel Drive Estate Engine M57 D30 (306D3)	805020	Outer Joint	48W	30	33	64.8	77	60	M
	2005.07-2010.12	AT/MT	L	F	All-wheel Drive Estate Engine M57 D30 (306D3)	201109	Drive Shaft	48W	30	27	64.8	77	610	
	2005.07-2010.12	AT/MT	R	F	All-wheel Drive Estate Engine M57 D30 (306D3)	201108	Drive Shaft	48W	30	27	64.8	77	932	
	2005.07-2010.12	AT	L/R	R	All-wheel Drive Estate Engine M57 D30 (306D3)	205073	Drive Shaft		30		58.8	73	649	
	2005.07-2010.12	AT	L/R	R	All-wheel Drive Estate Engine M57 D30 (306D3)	205082	Drive Shaft		30		58.7	73	653	
530 xd (173 kW)	2007.01-2010.12	AT/MT	L	F	All-wheel Drive Estate Engine M57 D30 (306D3)	201109	Drive Shaft	48W	30	27	64.8	77	610	
	2007.01-2010.12	-	-	R	All-wheel Drive Estate Engine M57 D30 (306D3)	805020	Outer Joint	48W	30	33	64.8	77	60	M
	2007.01-2010.12	AT/MT	R	F	All-wheel Drive Estate Engine M57 D30 (306D3)	201108	Drive Shaft	48W	30	27	64.8	77	932	
	2007.01-2010.12	MT	L/R	R	All-wheel Drive Estate Engine M57 D30 (306D3)	205082	Drive Shaft		30		58.7	73	653	
530 xi (190 kW)	2005.07-2010.12	-	-	R	All-wheel Drive Estate Engine N52 B30 A	805020	Outer Joint	48W	30	33	64.8	77	60	M
	2005.07-2010.12	AT/MT	L	F	All-wheel Drive Estate Engine N52 B30 A	201109	Drive Shaft	48W	30	27	64.8	77	610	
	2005.07-2010.12	AT/MT	R	F	All-wheel Drive Estate Engine N52 B30 A	201108	Drive Shaft	48W	30	27	64.8	77	932	
530 xi (200 kW)	2007.01-2010.12	-	L	F	All-wheel Drive Estate Engine N52 B30 A	201109	Drive Shaft	48W	30	27	64.8	77	610	
	2007.01-2010.12	-	-	R	All-wheel Drive Estate Engine N52 B30 A	805020	Outer Joint	48W	30	33	64.8	77	60	M
	2007.01-2010.12	-	R	F	All-wheel Drive Estate Engine N52 B30 A	201108	Drive Shaft	48W	30	27	64.8	77	932	
535 d (200 kW)	2004.09-2010.12	-	L/R	R	Estate Engine M57 D30 (306D4)	205073	Drive Shaft		30		58.8	73	649	
	2004.09-2010.12	-	L/R	R	Estate Engine M57 D30 (306D4)	205082	Drive Shaft		30		58.7	73	653	
535 d (210 kW)	2007.01-2010.12	-	L/R	R	Estate Engine M57 D30 (306D5)	205073	Drive Shaft		30		58.8	73	649	
	2007.01-2010.12	-	L/R	R	Estate Engine M57 D30 (306D5)	205082	Drive Shaft		30		58.7	73	653	
545 i (245 kW)	2004.06-2010.12	MT	L/R	R	Estate Engine N62 B44 A	205073	Drive Shaft		30		58.8	73	649	
	2004.06-2010.12	-	L/R	R	Estate Engine N62 B44 A	205082	Drive Shaft		30		58.7	73	653	
550 i (270 kW)	2005.07-2010.12	MT	L/R	R	Estate Engine N62 B48 A	205073	Drive Shaft		30		58.8	73	649	
	2005.07-2010.12	MT	L/R	R	Estate Engine N62 B48 A	205082	Drive Shaft		30		58.7	73	653	
5 Touring (F11)														
518 d (105 kW)	2012.10-2014.07	MT	R	R	Estate Engine N47 D20 C	205115	Drive Shaft		30	27	65	77	823	
	2012.10-2014.07	-	R	R	Estate Engine N47 D20 C	605054	Inner Joint		30	25	64.9	77	58	





	 YEAR	TRANSM	L/R	F/R	REMARKS	GSP Ref.	 PRODUCT	 ABS	Technical Specifications					
									A	B	C	H	L	P
BMW														
5 Touring (F11)														
518 d (105 kW)	2012.10-2014.07	-	R	R	Estate Engine N47 D20 C	605055	Inner Joint		27	25	43.9	80	72	
518 d (110 kW)	2014.01-	MT	R	R	Estate Engine B47 D20 A	205115	Drive Shaft		30	27	65	77	823	
518 d (120 kW)	2014.05-	6MT	L	R	Estate Engine B47 D20 A	205114	Drive Shaft		30	27	65	77	767	
	2014.05-	6MT	R	R	Estate Engine B47 D20 A	205115	Drive Shaft		30	27	65	77	823	
520 d (120 kW)	2013.10-	MT	L	R	Estate Engine B47 D20 A	205114	Drive Shaft		30	27	65	77	767	
	2013.10-	MT	R	R	Estate Engine B47 D20 A	205115	Drive Shaft		30	27	65	77	823	
520 d (135 kW)	2009.02-2016.10	MT	R	R	Estate Engine N47 D20 C	205115	Drive Shaft		30	27	65	77	823	
	2009.02-2016.10	-	R	R	Estate Engine N47 D20 C	605054	Inner Joint		30	25	64.9	77	58	
	2009.02-2016.10	-	R	R	Estate Engine N47 D20 C	605055	Inner Joint		27	25	43.9	80	72	
	2009.02-2016.10	MT	L	R	Estate Engine N47 D20 C	205114	Drive Shaft		30	27	65	77	767	
520 d (140 kW)	2013.10-	MT	L	R	Estate Engine B47 D20 A	205114	Drive Shaft		30	27	65	77	767	
	2013.10-	MT	R	R	Estate Engine B47 D20 A	205115	Drive Shaft		30	27	65	77	823	
520 d (147 kW)	2009.02-2016.10	MT	L	R	Estate Engine N47 D20 C	205114	Drive Shaft		30	27	65	77	767	
	2009.02-2016.10	MT	R	R	Estate Engine N47 D20 C	205115	Drive Shaft		30	27	65	77	823	
520 d (155 kW)	2013.10-	6MT	L	R	Estate Engine B47 D20 A	205114	Drive Shaft		30	27	65	77	767	
	2013.10-	6MT	R	R	Estate Engine B47 D20 A	205115	Drive Shaft		30	27	65	77	823	
520 d xDrive (100 kW)	2013.02-2014.07	-	L	F	All-wheel Drive Estate Engine N47 D20 C	201581	Drive Shaft		37	27	65		562	
520 d xDrive (120 kW)	2013.10-	AT	L	F	All-wheel Drive Estate Engine B47 D20 A	201581	Drive Shaft		37	27	65		562	
520 d xDrive (135 kW)	2013.02-2014.07	AT	L	F	All-wheel Drive Estate Engine N47 D20 C	201581	Drive Shaft		37	27	65		562	
	2013.02-2014.07	-	R	R	All-wheel Drive Estate Engine N47 D20 C	605054	Inner Joint		30	25	64.9	77	58	
	2013.02-2014.07	-	R	R	All-wheel Drive Estate Engine N47 D20 C	605055	Inner Joint		27	25	43.9	80	72	
520 d xDrive (140 kW)	2013.10-	AT	L	F	All-wheel Drive Estate Engine B47 D20 A	201581	Drive Shaft		37	27	65		562	
520 d xDrive (147 kW)	2013.02-2014.07	AT	L	F	All-wheel Drive Estate Engine N47 D20 C	201581	Drive Shaft		37	27	65		562	
520 d xDrive (155 kW)	2013.10-	8AT	L	F	All-wheel Drive Estate Engine B47 D20 A	201581	Drive Shaft		37	27	65		562	
520 i (120 kW)	2011.09-	MT	L	R	Estate Engine N20 B20 A	205114	Drive Shaft		30	27	65	77	767	
	2011.09-	MT	R	R	Estate Engine N20 B20 A	205115	Drive Shaft		30	27	65	77	823	
	2011.09-	AT	R	R	Estate Engine N20 B20 A	205113	Drive Shaft		30	27	64.9	77	811	
	2011.09-	AT	L	R	Estate Engine N20 B20 A	205112	Drive Shaft		30	27	64.9	77	758	
520 i (135 kW)	2010.10-	MT	R	R	Estate Engine N20 B20 A	205115	Drive Shaft		30	27	65	77	823	
	2010.10-	AT	R	R	Estate Engine N20 B20 A	205113	Drive Shaft		30	27	64.9	77	811	
	2010.10-	AT	L	R	Estate Engine N20 B20 A	205112	Drive Shaft		30	27	64.9	77	758	
	2010.10-	MT	L	R	Estate Engine N20 B20 A	205114	Drive Shaft		30	27	65	77	767	
525 d (150 kW)	2009.11-2011.08	AT	R	R	Estate Engine N57 D30 A	205115	Drive Shaft		30	27	65	77	823	
	2009.11-2011.08	AT	L	R	Estate Engine N57 D30 A	205114	Drive Shaft		30	27	65	77	767	
525 d xDrive (155 kW)	2011.02-	-	L	F	All-wheel Drive Estate Engine N47 D20 D	201581	Drive Shaft		37	27	65		562	
525 d xDrive (160 kW)	2011.02-	-	L	F	All-wheel Drive Estate Engine N47 D20 D	201581	Drive Shaft		37	27	65		562	
528 i (180 kW)	2010.10-	MT	R	R	Estate Engine N20 B20 A	205115	Drive Shaft		30	27	65	77	823	
	2010.10-	AT	R	R	Estate Engine N20 B20 A	205113	Drive Shaft		30	27	64.9	77	811	
	2010.10-	AT	L	R	Estate Engine N20 B20 A	205112	Drive Shaft		30	27	64.9	77	758	
	2010.10-	MT	L	R	Estate Engine N20 B20 A	205114	Drive Shaft		30	27	65	77	767	
528 i xDrive (180 kW)	2011.03-	-	L	F	All-wheel Drive Estate Engine N20 B20 A	201581	Drive Shaft		37	27	65		562	
	2011.03-	-	R	R	All-wheel Drive Estate Engine N20 B20 A	205113	Drive Shaft		30	27	64.9	77	811	
	2011.03-	-	L	R	All-wheel Drive Estate Engine N20 B20 A	205112	Drive Shaft		30	27	64.9	77	758	
530 d xDrive (190 kW)	2010.07-	-	L	F	All-wheel Drive Estate Engine N57 D30 A	201581	Drive Shaft		37	27	65		562	
530 d xDrive (210 kW)	2011.09-	AT	L	F	All-wheel Drive Estate Engine N57 D30 A	201581	Drive Shaft		37	27	65		562	
535 d xDrive (230 kW)	2011.01-	-	L	F	All-wheel Drive Estate Engine N57 D30 B	201581	Drive Shaft		37	27	65		562	
	2010.07-	-	L	F	All-wheel Drive Estate Engine N55 B30 A	201581	Drive Shaft		37	27	65		562	
	2010.07-	-	R	R	All-wheel Drive Estate Engine N55 B30 A	205113	Drive Shaft		30	27	64.9	77	811	
535 i xDrive (225 kW)	2010.07-	-	L	R	All-wheel Drive Estate Engine N55 B30 A	205112	Drive Shaft		30	27	64.9	77	758	
	2010.07-	-	L	R	All-wheel Drive Estate Engine N55 B30 A	205112	Drive Shaft		30	27	64.9	77	758	
535 i xDrive (240 kW)	2013.07-	AT	L	F	All-wheel Drive Estate Engine N55 B30 A	201581	Drive Shaft		37	27	65		562	
M 550 d xDrive (280 kW)	2010.10-	-	L	F	All-wheel Drive Estate Engine N57 D30 C	201581	Drive Shaft		37	27	65		562	
6 (E63)														
630 i (190 kW)	2004.09-2010.07	MT	R	R	Coupe Engine N52 B30 A	605033	Inner Joint		30	28	58.7	73	62	
	2004.09-2010.07	MT	L/R	R	Coupe Engine N52 B30 A	205091	Drive Shaft		30		58.7	73	658	
	2004.09-2010.07	MT	L/R	R	Coupe Engine N52 B30 A	661075	Inner Joint			28		26		
630 i (200 kW)	2007.07-2010.07	-	L/R	R	Coupe Engine N53 B30 A	205091	Drive Shaft		30		58.7	73	658	
	2007.07-2010.07	-	L/R	R	Coupe Engine N52 B30 A	205091	Drive Shaft		30		58.7	73	658	
	2007.07-2010.07	-	L/R	R	Coupe Engine N53 B30 A	661075	Inner Joint			28		26		
	2007.07-2010.07	-	L/R	R	Coupe Engine N52 B30 A	661075	Inner Joint			28		26		
635 d (210 kW)	2007.07-2010.07	-	L/R	R	Coupe Engine M57 D30 (306D5)	205073	Drive Shaft		30		58.8	73	649	
	2007.07-2010.07	-	L/R	R	Coupe Engine M57 D30 (306D5)	205082	Drive Shaft		30		58.7	73	653	
645 Ci (245 kW)	2004.01-2005.08	-	L/R	R	Coupe Engine N62 B44 A	205073	Drive Shaft		30		58.8	73	649	
	2004.01-2005.08	-	L/R	R	Coupe Engine N62 B44 A	205082	Drive Shaft		30		58.7	73	653	
650 i (270 kW)	2005.07-2010.07	MT	L/R	R	Coupe Engine N62 B48 B	205073	Drive Shaft		30		58.8	73	649	
	2005.07-2010.07	MT	L/R	R	Coupe Engine N62 B48 B	205082	Drive Shaft		30		58.7	73	653	
6 (E64)														

YEAR	TRANS	L/R	F/R	REMARKS	GSP Ref.	PRODUCT	ABS	Technical Specifications					
								A	B	C	H	L	P
BMW													
6 (E64)													
630 i (190 kW)	2004.09-2010.07	MT	L/R	R	Convertible Engine N52 B30 A	205091	Drive Shaft		30		58.7	73	658
	2004.09-2010.07	MT	L/R	R	Convertible Engine N52 B30 A	661075	Inner Joint			28		26	
630 i (200 kW)	2007.07-2010.07	-	L/R	R	Convertible Engine N53 B30 A	205091	Drive Shaft		30		58.7	73	658
	2007.07-2010.07	-	L/R	R	Convertible Engine N52 B30 A	205091	Drive Shaft		30		58.7	73	658
	2007.07-2010.07	-	L/R	R	Convertible Engine N53 B30 A	661075	Inner Joint			28		26	
	2007.07-2010.07	-	L/R	R	Convertible Engine N52 B30 A	661075	Inner Joint			28		26	
635 d (210 kW)	2007.07-2010.07	-	L/R	R	Convertible Engine M57 D30 (306D5)	205073	Drive Shaft		30		58.8	73	649
	2007.07-2010.07	-	L/R	R	Convertible Engine M57 D30 (306D5)	205082	Drive Shaft		30		58.7	73	653
645 Ci (245 kW)	2004.04-2005.08	MT	L/R	R	Convertible Engine N62 B44 A	205073	Drive Shaft		30		58.8	73	649
	2004.04-2005.08	MT	L/R	R	Convertible Engine N62 B44 A	205082	Drive Shaft		30		58.7	73	653
650 i (270 kW)	2005.07-2010.07	MT	L/R	R	Convertible Engine N62 B48 B	205073	Drive Shaft		30		58.8	73	649
	2005.07-2010.07	MT	L/R	R	Convertible Engine N62 B48 B	205082	Drive Shaft		30		58.7	73	653
6 (F12)													
640 d (230 kW)	2011.09- -	-	L/R	R	Convertible Engine N57 D30 B	605063	Inner Joint		30	28	65	77	62
	2011.09- -	-	R	R	Convertible Engine N57 D30 B	205111	Drive Shaft		30	32	65	77	831
640 d xDrive (230 kW)	2011.09- -	-	L	F	All-wheel Drive Convertible Engine N57 D30 B	201581	Drive Shaft		37	27	65		562
	2011.09- -	-	L/R	R	All-wheel Drive Convertible Engine N57 D30 B	605063	Inner Joint		30	28	65	77	62
	2011.09- -	-	R	R	All-wheel Drive Convertible Engine N57 D30 B	205111	Drive Shaft		30	32	65	77	831
640 i xDrive (235 kW)	2013.01- -	AT	L	F	All-wheel Drive Convertible Engine N55 B30 A	201581	Drive Shaft		37	27	65		562
	2013.01- -	AT	R	R	All-wheel Drive Convertible Engine N55 B30 A	205113	Drive Shaft		30	27	64.9	77	811
	2013.01- -	AT	L	R	All-wheel Drive Convertible Engine N55 B30 A	205112	Drive Shaft		30	27	64.9	77	758
650 i (300 kW)	2011.03- -	-	L	R	Convertible Engine N63 B44 A	205116	Drive Shaft		30	32	65	77	777
650 i (330 kW)	2011.10- -	-	L	R	Convertible Engine N63 B44 A	205116	Drive Shaft		30	32	65	77	777
650 i xDrive (300 kW)	2011.06- -	-	L	F	All-wheel Drive Convertible Engine N63 B44 A	201581	Drive Shaft		37	27	65		562
	2011.06- -	-	L	R	All-wheel Drive Convertible Engine N63 B44 A	205116	Drive Shaft		30	32	65	77	777
650 i xDrive (330 kW)	2011.11- -	-	L	F	All-wheel Drive Convertible Engine N63 B44 A	201581	Drive Shaft		37	27	65		562
	2011.11- -	-	L	R	All-wheel Drive Convertible Engine N63 B44 A	205116	Drive Shaft		30	32	65	77	777
6 (F13)													
640 d (230 kW)	2010.11- -	AT	R	R	Coupe Engine N57 D30 B	205111	Drive Shaft		30	32	65	77	831
	2010.11- -	AT	L/R	R	Coupe Engine N57 D30 B	605063	Inner Joint		30	28	65	77	62
640 d xDrive (230 kW)	2011.09- -	-	L	F	All-wheel Drive Coupe Engine N57 D30 B	201581	Drive Shaft		37	27	65		562
	2011.09- -	-	R	R	All-wheel Drive Coupe Engine N57 D30 B	205111	Drive Shaft		30	32	65	77	831
	2011.09- -	-	L/R	R	All-wheel Drive Coupe Engine N57 D30 B	605063	Inner Joint		30	28	65	77	62
640 i xDrive (235 kW)	2013.01- -	AT	L	F	All-wheel Drive Coupe Engine N55 B30 A	201581	Drive Shaft		37	27	65		562
	2013.01- -	AT	R	R	All-wheel Drive Coupe Engine N55 B30 A	205113	Drive Shaft		30	27	64.9	77	811
	2013.01- -	AT	L	R	All-wheel Drive Coupe Engine N55 B30 A	205112	Drive Shaft		30	27	64.9	77	758
650 i (300 kW)	2010.11- -	-	L	R	Coupe Engine N63 B44 A	205116	Drive Shaft		30	32	65	77	777
650 i (330 kW)	2011.10- -	-	L	R	Coupe Engine N63 B44 B	205116	Drive Shaft		30	32	65	77	777
650 i xDrive (330 kW)	2011.06- -	-	L	F	All-wheel Drive Coupe Engine N63 B44 A	201581	Drive Shaft		37	27	65		562
	2011.06- -	-	L	R	All-wheel Drive Coupe Engine N63 B44 A	205116	Drive Shaft		30	32	65	77	777
	2011.11- -	-	L	F	All-wheel Drive Coupe Engine N63 B44 B	201581	Drive Shaft		37	27	65		562
2011.11- -	-	L	R	All-wheel Drive Coupe Engine N63 B44 B	205116	Drive Shaft		30	32	65	77	777	
6 Gran (F06)													
640 d (230 kW)	2011.09- -	AT	L/R	R	Coupe Engine N57 D30 B	605063	Inner Joint		30	28	65	77	62
	2011.09- -	AT	R	R	Coupe Engine N57 D30 B	205111	Drive Shaft		30	32	65	77	831
640 d xDrive (230 kW)	2013.01- -	AT	L/R	R	All-wheel Drive Coupe Engine N57 D30 B	605063	Inner Joint		30	28	65	77	62
	2013.01- -	AT	R	R	All-wheel Drive Coupe Engine N57 D30 B	205111	Drive Shaft		30	32	65	77	831
640 i xDrive (235 kW)	2013.01- -	AT	R	R	All-wheel Drive Coupe Engine N55 B30 A	205113	Drive Shaft		30	27	64.9	77	811
	2013.01- -	AT	L	R	All-wheel Drive Coupe Engine N55 B30 A	205112	Drive Shaft		30	27	64.9	77	758
650 i (330 kW)	2011.11- -	-	L	R	Coupe Engine N63 B44 B	205116	Drive Shaft		30	32	65	77	777
650 i xDrive (330 kW)	2011.11- -	-	L	R	All-wheel Drive Coupe Engine N63 B44 B	205116	Drive Shaft		30	32	65	77	777
7 (E38)													
725 tds (105 kW)	1996.04-2001.11	AT/MT	-	R	Saloon Engine M51 D25 (256T1)	605057	Inner Joint			32		28	
728 i, iL (142 kW)	1995.08-2001.11	AT/MT	-	R	Saloon Engine M52 B28 (286S1)	605057	Inner Joint			32		28	
730 d (135 kW)	1998.08-2000.04	-	R	-	Saloon Engine M57 D30 (306D1)	201113	Drive Shaft		30		59	73	636
735 i, iL (173 kW)	1996.01-1998.12	AT/MT	-	R	Saloon Engine M62 B35 (358S1)	605057	Inner Joint			32		28	
7 (E65 E66 E67)													
730 d (155 kW)	2002.10-2008.07	-	L/R	R	Saloon Engine M57 D30 (306D3)	205073	Drive Shaft		30		58.8	73	649
730 d (160 kW)	2002.10-2008.07	-	L/R	R	Saloon Engine M57 D30 (306D2)	205073	Drive Shaft		30		58.8	73	649
730 i, Li (190 kW)	2005.03-2008.07	MT	L/R	R	Saloon Engine N52 B30 A	205082	Drive Shaft		30		58.7	73	653
730 Ld (170 kW)	2005.07-2009.12	-	L/R	R	Saloon Engine M57 D30 (306D3)	205073	Drive Shaft		30		58.8	73	649
740 d (190 kW)	2002.10-2005.02	-	L/R	R	Saloon Engine M67 D39 (398D1)	635051	Inner Joint			30		30.5	
	2002.10-2005.02	-	L/R	R	Saloon Engine M67 D39 (398D1)	201114	Drive Shaft		30		59	73	649
740 i, Li (225 kW)	2005.07-2008.07	MT	L/R	R	Saloon Engine N62 B40 A	205082	Drive Shaft		30		58.7	73	653
745 d (220 kW)	2005.03-2005.08	-	L/R	R	Saloon Engine M67 D44 (448D1)	635051	Inner Joint			30		30.5	
	2005.03-2005.08	-	L/R	R	Saloon Engine M67 D44 (448D1)	201114	Drive Shaft		30		59	73	649





YEAR	TRANSM	L/R	F/R	REMARKS	GSP Ref.	PRODUCT	ABS	Technical Specifications							
								A	B	C	H	L	P		
BMW															
7 (E65 E66 E67)															
745 d (242 kW)	2005.07-2008.07	-	L/R	R	Saloon Engine M67 D44 (448D1)	635051	Inner Joint		30		30.5				
	2005.07-2008.07	-	L/R	R	Saloon Engine M67 D44 (448D1)	201114	Drive Shaft	30		59	73	649			
750 i, Li (270 kW)	2005.07-2008.07	MT	L/R	R	Saloon Engine N62 B48 B	205082	Drive Shaft	30		58.7	73	653			
760 i, LI (326 kW)	2001.11-2009.12	-	L/R	R	Saloon Engine N73 B60 A	635051	Inner Joint		30		30.5				
	2001.11-2009.12	-	L/R	R	Saloon Engine N73 B60 A	201114	Drive Shaft	30		59	73	649			
760 i, Li (327 kW)	2003.01-2008.07	-	L/R	R	Saloon Engine N73 B60 A	635051	Inner Joint		30		30.5				
	2003.01-2008.07	-	L/R	R	Saloon Engine N73 B60 A	201114	Drive Shaft	30		59	73	649			
7 (F01 F02 F03 F04)															
730 d (180 kW)	2008.02-2012.07	AT	L/R	R	Saloon Engine N57 D30 A	605063	Inner Joint	30	28	65	77	62			
	2008.02-2012.07	AT	R/R	R	Saloon Engine N57 D30 A	205111	Drive Shaft	30	32	65	77	831			
730 d (190 kW)	2012.07-2015.05	AT	L/R	R	Saloon Engine N57 D30 A	605063	Inner Joint	30	28	65	77	62			
	2012.07-2015.05	AT	R/R	R	Saloon Engine N57 D30 A	205111	Drive Shaft	30	32	65	77	831			
730 d xDrive (190 kW)	2011.11-2015.05	AT	L/R	R	All-wheel Drive Saloon Engine N57 D30 A	605063	Inner Joint	30	28	65	77	62			
	2011.11-2015.05	AT	R/R	R	All-wheel Drive Saloon Engine N57 D30 A	205111	Drive Shaft	30	32	65	77	831			
740 d (225 kW)	2009.09-2015.12	AT	L/R	R	Saloon Engine N57 D30 B	605063	Inner Joint	30	28	65	77	62			
	2009.09-2015.12	AT	R/R	R	Saloon Engine N57 D30 B	205111	Drive Shaft	30	32	65	77	831			
740 d (230 kW)	2012.07-2015.12	AT	L/R	R	Saloon Engine N57 D30 B	605063	Inner Joint	30	28	65	77	62			
	2012.07-2015.12	AT	R/R	R	Saloon Engine N57 D30 B	205111	Drive Shaft	30	32	65	77	831			
740 d xDrive (225 kW)	2009.09-2015.12	AT	L/R	R	All-wheel Drive Saloon Engine N57 D30 B	605063	Inner Joint	30	28	65	77	62			
	2009.09-2015.12	AT	R/R	R	All-wheel Drive Saloon Engine N57 D30 B	205111	Drive Shaft	30	32	65	77	831			
740 d xDrive (230 kW)	2012.07-2015.12	AT	L/R	R	All-wheel Drive Saloon Engine N57 D30 B	605063	Inner Joint	30	28	65	77	62			
	2012.07-2015.12	AT	R/R	R	All-wheel Drive Saloon Engine N57 D30 B	205111	Drive Shaft	30	32	65	77	831			
740 Li (235 kW)	2012.07-2015.12	AT	L/R	R	Saloon Engine N55 B30 A	205116	Drive Shaft	30	32	65	77	777			
750 i (330 kW)	2012.10-2015.12	AT	L/R	R	Saloon Engine N63 B44 B	205116	Drive Shaft	30	32	65	77	777			
750 i xDrive (330 kW)	2012.10-2015.12	AT	L/R	R	All-wheel Drive Saloon Engine N63 B44 B	205116	Drive Shaft	30	32	65	77	777			
750 i, Li (300 kW)	2008.10-2015.12	-	L/R	R	Saloon Engine N63 B44 A	205116	Drive Shaft	30	32	65	77	777			
	2009.09-2015.12	-	L/R	R	All-wheel Drive Saloon Engine N63 B44 A	205116	Drive Shaft	30	32	65	77	777			
7 (G11 G12)															
740 i, Li xDrive (240 kW)	2016.03-	-	L/R	F	Saloon Engine B58 B30 A	205052	Drive Shaft	30	27	64.8	86.5	634			
	2016.03-	-	R/R	F	Saloon Engine B58 B30 A	205043	Drive Shaft	30	27	64.8	86.5	1020			
	2016.03-	-	L/R	F	Saloon Engine B58 B30 A	605030	Inner Joint	27	26	43.9	62	121			
	2016.03-	-	R/R	F	Saloon Engine B58 B30 A	605014	Inner Joint	27	26	29.97	448	121			
E23															
-	-	-	-	-	-	205008	Drive Shaft	27		63.8	66.5	569			
E46 325XI															
-	-	-	L/R	F	-	805002	Outer Joint	30	27	59	73	69	M		
E46 330XI															
-	-	-	L/R	F	-	805002	Outer Joint	30	27	59	73	69	M		
X1 (E84)															
sDrive 18 d (100 kW)	2009.03-2015.06	MT/AT	L/R	R	Estate Engine N47 D20 C	205135	Drive Shaft	30		58.7	73	618			
	2009.03-2015.06	-	R/R	R	Estate Engine N47 D20 C	605036	Inner Joint	30	25	58.7	73	58	I		
	2009.03-2015.06	-	R/R	R	Estate Engine N47 D20 C	635025	Inner Joint		25		26				
sDrive 18 d (105 kW)	2009.10-2015.06	MT/AT	L/R	R	Estate Engine N47 D20 C	605036	Inner Joint	30	25	58.7	73	58	I		
	2009.10-2015.06	MT/AT	L/R	R	Estate Engine N47 D20 C	635025	Inner Joint		25		26				
	2009.10-2015.06	MT/AT	L/R	R	Estate Engine N47 D20 C	205135	Drive Shaft	30		58.7	73	618			
sDrive 20 d (120 kW)	2010.03-2015.06	-	R/R	R	Estate Engine N47 D20 C	605036	Inner Joint	30	25	58.7	73	58	I		
	2010.03-2015.06	-	R/R	R	Estate Engine N47 D20 C	635025	Inner Joint		25		26				
	2010.03-2015.06	MT/AT	L/R	R	Estate Engine N47 D20 C	205135	Drive Shaft	30		58.7	73	618			
sDrive 20 d (130 kW)	2009.10-2015.06	MT/AT	L/R	R	Estate Engine N47 D20 C	605036	Inner Joint	30	25	58.7	73	58	I		
	2009.10-2015.06	MT/AT	L/R	R	Estate Engine N47 D20 C	635025	Inner Joint		25		26				
	2009.10-2015.06	MT/AT	L/R	R	Estate Engine N47 D20 C	205135	Drive Shaft	30		58.7	73	618			
xDrive 18 d (100 kW)	2009.03-2015.06	MT/AT	L/R	R	All-wheel Drive Estate Engine N47 D20 C	205135	Drive Shaft	30		58.7	73	618			
	2009.03-2015.06	-	R/R	R	All-wheel Drive Estate Engine N47 D20 C	605036	Inner Joint	30	25	58.7	73	58	I		
	2009.03-2015.06	-	R/R	R	All-wheel Drive Estate Engine N47 D20 C	635025	Inner Joint		25		26				
xDrive 18 d (105 kW)	2009.10-2015.06	MT/AT	L/R	R	All-wheel Drive Estate Engine N47 D20 C	605036	Inner Joint	30	25	58.7	73	58	I		
	2009.10-2015.06	MT/AT	L/R	R	All-wheel Drive Estate Engine N47 D20 C	635025	Inner Joint		25		26				
	2009.10-2015.06	MT/AT	L/R	R	All-wheel Drive Estate Engine N47 D20 C	205135	Drive Shaft	30		58.7	73	618			
xDrive 20 d (120 kW)	2010.03-2015.06	-	R/R	R	All-wheel Drive Estate Engine N47 D20 C	605036	Inner Joint	30	25	58.7	73	58	I		
	2010.03-2015.06	-	R/R	R	All-wheel Drive Estate Engine N47 D20 C	635025	Inner Joint		25		26				
	2010.03-2015.06	MT/AT	L/R	R	All-wheel Drive Estate Engine N47 D20 C	205135	Drive Shaft	30		58.7	73	618			
xDrive 20 d (130 kW)	2009.10-2015.06	MT/AT	L/R	R	All-wheel Drive Estate Engine N47 D20 C	605036	Inner Joint	30	25	58.7	73	58	I		
	2009.10-2015.06	MT/AT	L/R	R	All-wheel Drive Estate Engine N47 D20 C	635025	Inner Joint		25		26				
	2009.10-2015.06	MT/AT	L/R	R	All-wheel Drive Estate Engine N47 D20 C	205135	Drive Shaft	30		58.7	73	618			
xDrive 23 d (150 kW)	2009.10-2015.06	MT/AT	L/R	R	All-wheel Drive Estate Engine N47S D20 D	605036	Inner Joint	30	25	58.7	73	58	I		
	2009.10-2015.06	MT/AT	L/R	R	All-wheel Drive Estate Engine N47S D20 D	635025	Inner Joint		25		26				
	2009.10-2015.06	MT/AT	L/R	R	All-wheel Drive Estate Engine N47S D20 D	205135	Drive Shaft	30		58.7	73	618			

YEAR	TRANSM	L/R	F/R	REMARKS	GSP Ref.	PRODUCT	ABS	Technical Specifications							
								A	B	C	H	L	P		
BMW															
X1 (E84)															
xDrive 28 i (180 kW)	2011.04-2015.06	MT/AT	L	R	All-wheel Drive Estate Engine N20 B20 A	205135	Drive Shaft		30		58.7	73	618		
	2011.04-2015.06	MT/AT	L/R	R	All-wheel Drive Estate Engine N20 B20 A	605036	Inner Joint		30	25	58.7	73	58	I	
	2011.04-2015.06	MT/AT	L/R	R	All-wheel Drive Estate Engine N20 B20 A	635025	Inner Joint			25		26			
xDrive 28 i Flex (180 kW)	2011.04-2015.06	MT/AT	L	R	All-wheel Drive Saloon Engine N20 B20 A	205135	Drive Shaft		30		58.7	73	618		
	2011.04-2015.06	-	R	R	All-wheel Drive Saloon Engine N20 B20 A	605036	Inner Joint		30	25	58.7	73	58	I	
	2011.04-2015.06	-	R	R	All-wheel Drive Saloon Engine N20 B20 A	635025	Inner Joint			25		26			
X3 (E83)															
2.0 d (110 kW)	2003.11-2007.08	AT	L/R	R	All-wheel Drive Closed Off-Road Vehicle Engine M47 D20 (204D4)	605089	Inner Joint			24		24			
	2003.11-2007.08	AT	L/R	R	All-wheel Drive Closed Off-Road Vehicle Engine M47 D20 (204D4)	605090	Inner Joint	48W	30	24	69	73	52		
	2003.11-2007.08	AT/MT	L	F	All-wheel Drive Closed Off-Road Vehicle Engine M47 D20 (204D4)	299215	Drive Shaft		30	27	64.8	77	598		
	2003.11-2007.08	AT/MT	R	F	All-wheel Drive Closed Off-Road Vehicle Engine M47 D20 (204D4)	205078	Drive Shaft		30	27	64.8	77	919		
	2003.11-2007.08	AT	L	R	All-wheel Drive Closed Off-Road Vehicle Engine M47 D20 (204D4)	205141	Drive Shaft	48W	30		69	73	626		
	2003.11-2007.08	AT	R	R	All-wheel Drive Closed Off-Road Vehicle Engine M47 D20 (204D4)	205140	Drive Shaft	48W	30		69	73	679		
	2003.11-2007.08	-	-	F	All-wheel Drive Closed Off-Road Vehicle Engine M47 D20 (204D4)	805010	Outer Joint		30	33	64.8	77	60	M	
	2003.11-2007.08	MT	L	R	All-wheel Drive Closed Off-Road Vehicle Engine M47 D20 (204D4)	205062	Drive Shaft	48W	30		69	73	621		
	2003.11-2007.08	MT	R	F	All-wheel Drive Closed Off-Road Vehicle Engine M47 D20 (204D4)	205044	Drive Shaft		30	27	64.8	77	921		
	2003.11-2007.08	MT	R	R	All-wheel Drive Closed Off-Road Vehicle Engine M47 D20 (204D4)	205074	Drive Shaft	48W	30		69	73	675		
2.0 d (130 kW)	2003.11-2007.08	AT/MT	L	F	All-wheel Drive Closed Off-Road Vehicle Engine M47 D20 (204D4)	605026	Inner Joint		27	24	44	60	114.5		
	2007.03-2007.08	AT	L/R	R	All-wheel Drive Closed Off-Road Vehicle Engine N47 D20 A	605089	Inner Joint			24		24			
	2007.03-2007.08	AT	L/R	R	All-wheel Drive Closed Off-Road Vehicle Engine N47 D20 A	605090	Inner Joint	48W	30	24	69	73	52		
	2007.03-2007.08	AT	L	R	All-wheel Drive Closed Off-Road Vehicle Engine N47 D20 A	205069	Drive Shaft	48W	30		69	73	625		
	2007.03-2007.08	AT	R	R	All-wheel Drive Closed Off-Road Vehicle Engine N47 D20 A	205093	Drive Shaft	48W	30		69	73	678		
	2007.03-2007.08	-	-	F	All-wheel Drive Closed Off-Road Vehicle Engine N47 D20 A	805010	Outer Joint		30	33	64.8	77	60	M	
	2007.03-2007.08	MT	R	F	All-wheel Drive Closed Off-Road Vehicle Engine N47 D20 A	205044	Drive Shaft		30	27	64.8	77	921		
2.0 i (110 kW)	2005.07-2008.08	-	L	R	All-wheel Drive Closed Off-Road Vehicle Engine N46 B20 B	205062	Drive Shaft	48W	30		69	73	621		
	2005.07-2008.08	MT	R	F	All-wheel Drive Closed Off-Road Vehicle Engine N46 B20 B	205044	Drive Shaft		30	27	64.8	77	921		
	2005.07-2008.08	-	R	R	All-wheel Drive Closed Off-Road Vehicle Engine N46 B20 B	205074	Drive Shaft	48W	30		69	73	675		
2.5 i (141 kW)	2004.01-2006.08	AMT	L/R	R	All-wheel Drive Closed Off-Road Vehicle Engine M54 B25 (256S5)	605089	Inner Joint			24		24			
	2004.01-2006.08	AMT	L/R	R	All-wheel Drive Closed Off-Road Vehicle Engine M54 B25 (256S5)	605090	Inner Joint	48W	30	24	69	73	52		
	2004.01-2006.08	AT/MT	L	F	All-wheel Drive Closed Off-Road Vehicle Engine M54 B25 (256S5)	299215	Drive Shaft		30	27	64.8	77	598		
	2004.01-2006.08	AT/MT	R	F	All-wheel Drive Closed Off-Road Vehicle Engine M54 B25 (256S5)	205078	Drive Shaft		30	27	64.8	77	919		
	2004.01-2006.08	Semi-AT	L	R	All-wheel Drive Closed Off-Road Vehicle Engine M54 B25 (256S5)	205141	Drive Shaft	48W	30		69	73	626		
	2004.01-2006.08	Semi-AT	R	R	All-wheel Drive Closed Off-Road Vehicle Engine M54 B25 (256S5)	205140	Drive Shaft	48W	30		69	73	679		
	2004.01-2006.08	AT	L	R	All-wheel Drive Closed Off-Road Vehicle Engine M54 B25 (256S5)	205069	Drive Shaft	48W	30		69	73	625		
	2004.01-2006.08	AT	R	R	All-wheel Drive Closed Off-Road Vehicle Engine M54 B25 (256S5)	205093	Drive Shaft	48W	30		69	73	678		
	2004.01-2006.08	-	-	F	All-wheel Drive Closed Off-Road Vehicle Engine M54 B25 (256S5)	805010	Outer Joint		30	33	64.8	77	60	M	
	2004.01-2006.08	AT/MT	R	F	All-wheel Drive Closed Off-Road Vehicle Engine M54 B25 (256S5)	205044	Drive Shaft		30	27	64.8	77	921		
2004.01-2006.08	AT/MT	L	F	All-wheel Drive Closed Off-Road Vehicle Engine M54 B25 (256S5)	605026	Inner Joint		27	24	44	60	114.5			
2.5 si (160 kW)	2006.09-2008.08	-	L	F	All-wheel Drive Closed Off-Road Vehicle Engine N52 B25 A	299215	Drive Shaft		30	27	64.8	77	598		
	2006.09-2008.08	-	R	F	All-wheel Drive Closed Off-Road Vehicle Engine N52 B25 A	205078	Drive Shaft		30	27	64.8	77	919		
	2006.09-2008.08	-	-	F	All-wheel Drive Closed Off-Road Vehicle Engine N52 B25 A	805010	Outer Joint		30	33	64.8	77	60	M	
	2006.09-2008.08	AT/MT	R	F	All-wheel Drive Closed Off-Road Vehicle Engine N52 B25 A	205044	Drive Shaft		30	27	64.8	77	921		
	2006.09-2008.08	-	L	F	All-wheel Drive Closed Off-Road Vehicle Engine N52 B25 A	605026	Inner Joint		27	24	44	60	114.5		
2.5 si xDrive (155 kW)	2006.07-2008.12	-	L	F	All-wheel Drive Closed Off-Road Vehicle Engine N52 B25 A	299215	Drive Shaft		30	27	64.8	77	598		
	2006.07-2008.12	-	R	F	All-wheel Drive Closed Off-Road Vehicle Engine N52 B25 A	205078	Drive Shaft		30	27	64.8	77	919		
	2006.07-2008.12	-	L	F	All-wheel Drive Closed Off-Road Vehicle Engine N52 B25 A	605026	Inner Joint		27	24	44	60	114.5		
3.0 d (150 kW)	2003.01-2005.08	AT/MT	L	F	All-wheel Drive Closed Off-Road Vehicle Engine M57 D30 (306D2)	299215	Drive Shaft		30	27	64.8	77	598		
	2003.01-2005.08	AT/MT	R	F	All-wheel Drive Closed Off-Road Vehicle Engine M57 D30 (306D2)	205078	Drive Shaft		30	27	64.8	77	919		
	2003.01-2005.08	-	-	F	All-wheel Drive Closed Off-Road Vehicle Engine M57 D30 (306D2)	805010	Outer Joint		30	33	64.8	77	60	M	
	2003.01-2005.08	AT	L	R	All-wheel Drive Closed Off-Road Vehicle Engine M57 D30 (306D2)	205062	Drive Shaft	48W	30		69	73	621		
	2003.01-2005.08	AT	R	R	All-wheel Drive Closed Off-Road Vehicle Engine M57 D30 (306D2)	205074	Drive Shaft	48W	30		69	73	675		
	2003.01-2005.08	AT/MT	R	F	All-wheel Drive Closed Off-Road Vehicle Engine M57 D30 (306D2)	205044	Drive Shaft		30	27	64.8	77	921		
	2003.01-2005.08	AT/MT	L	F	All-wheel Drive Closed Off-Road Vehicle Engine M57 D30 (306D2)	605026	Inner Joint		27	24	44	60	114.5		
3.0 d (155 kW)	2004.10-2006.07	-	L	F	All-wheel Drive Closed Off-Road Vehicle Engine M57 D30 (306D3)	299215	Drive Shaft		30	27	64.8	77	598		
	2004.10-2006.07	-	R	F	All-wheel Drive Closed Off-Road Vehicle Engine M57 D30 (306D3)	205078	Drive Shaft		30	27	64.8	77	919		
	2004.10-2006.07	-	L	F	All-wheel Drive Closed Off-Road Vehicle Engine M57 D30 (306D3)	605026	Inner Joint		27	24	44	60	114.5		
3.0 d (160 kW)	2004.10-2006.07	MT/Semi-AT	L	F	All-wheel Drive Closed Off-Road Vehicle Engine M57 D30 (306D3)	299215	Drive Shaft		30	27	64.8	77	598		
	2004.10-2006.07	MT/Semi-AT	R	F	All-wheel Drive Closed Off-Road Vehicle Engine M57 D30 (306D3)	205078	Drive Shaft		30	27	64.8	77	919		
	2004.10-2006.07	-	-	F	All-wheel Drive Closed Off-Road Vehicle Engine M57 D30 (306D3)	805010	Outer Joint		30	33	64.8	77	60	M	
	2004.10-2006.07	AT/MT	R	F	All-wheel Drive Closed Off-Road Vehicle Engine M57 D30 (306D3)	205044	Drive Shaft		30	27	64.8	77	921		
	2004.10-2006.07	MT/Semi-AT	L	F	All-wheel Drive Closed Off-Road Vehicle Engine M57 D30 (306D3)	605026	Inner Joint		27	24	44	60	114.5		
3.0 D SUV	2006.03-2010.08	-	-	-	Engine M57N2	630003	Propshaft CV Joint			32		28			
3.0 i xDrive (170 kW)	2004.01-2006.08	AT/MT	L	F	All-wheel Drive Closed Off-Road Vehicle Engine M54 B30 (306S3)	299215	Drive Shaft		30	27	64.8	77	598		
	2004.01-2006.08	AT/MT	R	F	All-wheel Drive Closed Off-Road Vehicle Engine M54 B30 (306S3)	205078	Drive Shaft		30	27	64.8	77	919		
	2004.01-2006.08	AT	L	R	All-wheel Drive Closed Off-Road Vehicle Engine M54 B30 (306S3)	205141	Drive Shaft	48W	30		69	73	626		
	2004.01-2006.08	AT	R	R	All-wheel Drive Closed Off-Road Vehicle Engine M54 B30 (306S3)	205140	Drive Shaft	48W	30		69	73	679		

YEAR	TRANSM	L/R	F/R	REMARKS	GSP Ref.	PRODUCT	ABS	Technical Specifications										
								A	B	C	H	L	P					
BMW																		
X3 (E83)																		
3.0 i xDrive (170 kW)	2004.01-2006.08	AT	L	R	All-wheel Drive Closed Off-Road Vehicle Engine M54 B30 (306S3)	205069	Drive Shaft	48W	30		69	73	625					
	2004.01-2006.08	AT	R	R	All-wheel Drive Closed Off-Road Vehicle Engine M54 B30 (306S3)	205093	Drive Shaft	48W	30		69	73	678					
	2004.01-2006.08	-	-	F	All-wheel Drive Closed Off-Road Vehicle Engine M54 B30 (306S3)	805010	Outer Joint		30	33	64.8	77	60	M				
	2004.01-2006.08	MT	L	R	All-wheel Drive Closed Off-Road Vehicle Engine M54 B30 (306S3)	205062	Drive Shaft	48W	30		69	73	621					
	2004.01-2006.08	MT	R	R	All-wheel Drive Closed Off-Road Vehicle Engine M54 B30 (306S3)	205074	Drive Shaft	48W	30		69	73	675					
	2004.01-2006.08	AT/MT	R	F	All-wheel Drive Closed Off-Road Vehicle Engine M54 B30 (306S3)	205044	Drive Shaft		30	27	64.8	77	921					
	2004.01-2006.08	AT/MT	L	F	All-wheel Drive Closed Off-Road Vehicle Engine M54 B30 (306S3)	605026	Inner Joint		27	24	44	60	114.5					
	2004.01-2006.08	AT	L/R	R	All-wheel Drive Closed Off-Road Vehicle Engine M54 B30 (306S3)	605089	Inner Joint			24		24						
	2004.01-2006.08	AT	L/R	R	All-wheel Drive Closed Off-Road Vehicle Engine M54 B30 (306S3)	605090	Inner Joint	48W	30	24	69	73	52					
3.0 sd (210 kW)	2006.09-2008.08	-	L	F	All-wheel Drive Closed Off-Road Vehicle Engine M57 D30 (306D5)	299215	Drive Shaft		30	27	64.8	77	598					
	2006.09-2008.08	-	R	F	All-wheel Drive Closed Off-Road Vehicle Engine M57 D30 (306D5)	205078	Drive Shaft		30	27	64.8	77	919					
	2006.09-2008.08	-	-	F	All-wheel Drive Closed Off-Road Vehicle Engine M57 D30 (306D5)	805010	Outer Joint		30	33	64.8	77	60	M				
	2006.09-2008.08	-	L	R	All-wheel Drive Closed Off-Road Vehicle Engine M57 D30 (306D5)	205062	Drive Shaft	48W	30		69	73	621					
	2006.09-2008.08	AT/MT	R	F	All-wheel Drive Closed Off-Road Vehicle Engine M57 D30 (306D5)	205044	Drive Shaft		30	27	64.8	77	921					
	2006.09-2008.08	-	L	F	All-wheel Drive Closed Off-Road Vehicle Engine M57 D30 (306D5)	605026	Inner Joint		27	24	44	60	114.5					
3.0 SD SUV	2006.03-2010.08	-	-	-	Engine M57N2	630003	Propshaft CV Joint			32		28						
3.0 si (200 kW)	2006.09-2008.08	-	L	F	All-wheel Drive Closed Off-Road Vehicle Engine N52 B30 A	299215	Drive Shaft		30	27	64.8	77	598					
	2006.09-2008.08	-	R	F	All-wheel Drive Closed Off-Road Vehicle Engine N52 B30 A	205078	Drive Shaft		30	27	64.8	77	919					
	2006.09-2008.08	-	-	F	All-wheel Drive Closed Off-Road Vehicle Engine N52 B30 A	805010	Outer Joint		30	33	64.8	77	60	M				
	2006.09-2008.08	AT/MT	R	F	All-wheel Drive Closed Off-Road Vehicle Engine N52 B30 A	205044	Drive Shaft		30	27	64.8	77	921					
	2006.09-2008.08	-	L	F	All-wheel Drive Closed Off-Road Vehicle Engine N52 B30 A	605026	Inner Joint		27	24	44	60	114.5					
xDrive 20 d (120 kW)	2007.09-2010.08	AT	L	R	All-wheel Drive Closed Off-Road Vehicle Engine N47 D20 C	205141	Drive Shaft	48W	30		69	73	626					
	2007.09-2010.08	AT	R	R	All-wheel Drive Closed Off-Road Vehicle Engine N47 D20 C	205140	Drive Shaft	48W	30		69	73	679					
	2007.09-2010.08	AT	L	R	All-wheel Drive Closed Off-Road Vehicle Engine N47 D20 C	205069	Drive Shaft	48W	30		69	73	625					
	2007.09-2010.08	AT	R	R	All-wheel Drive Closed Off-Road Vehicle Engine N47 D20 C	205093	Drive Shaft	48W	30		69	73	678					
	2007.09-2010.08	AT	L/R	R	All-wheel Drive Closed Off-Road Vehicle Engine N47 D20 C	605089	Inner Joint			24		24						
	2007.09-2010.08	AT	L/R	R	All-wheel Drive Closed Off-Road Vehicle Engine N47 D20 C	605090	Inner Joint	48W	30	24	69	73	52					
xDrive 20 d (130 kW)	2007.09-2010.08	AMT	L/R	R	All-wheel Drive Closed Off-Road Vehicle Engine N47 D20 C	605089	Inner Joint			24		24						
	2007.09-2010.08	AMT	L/R	R	All-wheel Drive Closed Off-Road Vehicle Engine N47 D20 C	605090	Inner Joint	48W	30	24	69	73	52					
	2007.09-2010.08	Semi-AT	L	R	All-wheel Drive Closed Off-Road Vehicle Engine N47 D20 C	205141	Drive Shaft	48W	30		69	73	626					
	2007.09-2010.08	Semi-AT	R	R	All-wheel Drive Closed Off-Road Vehicle Engine N47 D20 C	205140	Drive Shaft	48W	30		69	73	679					
	2007.09-2010.08	AT	L	R	All-wheel Drive Closed Off-Road Vehicle Engine N47 D20 C	205069	Drive Shaft	48W	30		69	73	625					
	2007.09-2010.08	AT	R	R	All-wheel Drive Closed Off-Road Vehicle Engine N47 D20 C	205093	Drive Shaft	48W	30		69	73	678					
	2007.09-2010.08	MT	R	F	All-wheel Drive Closed Off-Road Vehicle Engine N47 D20 C	205044	Drive Shaft		30	27	64.8	77	921					
xDrive 20 i (110 kW)	2008.09-2011.08	-	L	R	All-wheel Drive Closed Off-Road Vehicle Engine N46 B20 B	205062	Drive Shaft	48W	30		69	73	621					
	2008.09-2011.08	-	R	R	All-wheel Drive Closed Off-Road Vehicle Engine N46 B20 B	205074	Drive Shaft	48W	30		69	73	675					
xDrive 25 i (160 kW)	2008.09-2011.12	AT/MT	R	F	All-wheel Drive Closed Off-Road Vehicle Engine N52 B25 A	205044	Drive Shaft		30	27	64.8	77	921					
xDrive 30 d (155 kW)	2006.03-2010.08	AT/MT	R	F	All-wheel Drive Closed Off-Road Vehicle Engine M57 D30 (306D3)	205044	Drive Shaft		30	27	64.8	77	921					
xDrive 30 d (160 kW)	2006.03-2010.08	AT/MT	R	F	All-wheel Drive Closed Off-Road Vehicle Engine M57 D30 (306D3)	205044	Drive Shaft		30	27	64.8	77	921					
xDrive 30 i (200 kW)	2008.09-2011.12	AT/MT	R	F	All-wheel Drive Closed Off-Road Vehicle Engine N52 B30 A	205044	Drive Shaft		30	27	64.8	77	921					
xDrive 35 d (210 kW)	2008.09-2011.08	-	L	R	All-wheel Drive Closed Off-Road Vehicle Engine M57 D30 (306D5)	205062	Drive Shaft	48W	30		69	73	621					
	2008.09-2011.08	AT/MT	R	F	All-wheel Drive Closed Off-Road Vehicle Engine M57 D30 (306D5)	205044	Drive Shaft		30	27	64.8	77	921					
X3 (F25)																		
sDrive 18 d (105 kW)	2011.08-2011.08	-	-	R	R	Closed Off-Road Vehicle Engine N47 D20 C	605063	Inner Joint		30	28	65	77	62				
	2011.08-2011.08	-	-	R	R	Closed Off-Road Vehicle Engine N47 D20 C	205118	Drive Shaft		30	27	65	77	829				
sDrive 18 d (110 kW)	2014.02-2014.02	AT	L	-	Closed Off-Road Vehicle Engine B47 D20 A	605075	Inner Joint		27	28	44	75	75					
	2014.02-2014.02	AT	L/R	R	Closed Off-Road Vehicle Engine B47 D20 A	605063	Inner Joint		30	28	65	77	62					
	2014.02-2014.02	-	-	R	R	Closed Off-Road Vehicle Engine B47 D20 A	205118	Drive Shaft		30	27	65	77	829				
sDrive 18 i (125 kW)	2013.07-2013.07	AT	L	R	Closed Off-Road Vehicle Engine N20 B16 A	205117	Drive Shaft		30	27	64.9	77	769					
	2013.07-2013.07	AT	R	R	Closed Off-Road Vehicle Engine N20 B16 A	205121	Drive Shaft		30	27	64.9	77	825					
sDrive 20 i (135 kW)	2014.02-2014.02	AT	L	R	Closed Off-Road Vehicle Engine N20 B20 A	205117	Drive Shaft		30	27	64.9	77	769					
	2014.02-2014.02	AT	R	R	Closed Off-Road Vehicle Engine N20 B20 A	205121	Drive Shaft		30	27	64.9	77	825					
xDrive 20 d (120 kW)	2010.09-2010.09	MT	L	R	All-wheel Drive Closed Off-Road Vehicle Engine N47 D20 C	205117	Drive Shaft		30	27	64.9	77	769					
	2010.09-2010.09	MT	R	R	All-wheel Drive Closed Off-Road Vehicle Engine N47 D20 C	205121	Drive Shaft		30	27	64.9	77	825					
xDrive 20 d (135 kW)	2010.09-2010.09	MT	L	R	All-wheel Drive Closed Off-Road Vehicle Engine N47 D20 C	205117	Drive Shaft		30	27	64.9	77	769					
	2010.09-2010.09	MT	R	R	All-wheel Drive Closed Off-Road Vehicle Engine N47 D20 C	205121	Drive Shaft		30	27	64.9	77	825					
	2010.09-2010.09	-	-	R	R	All-wheel Drive Closed Off-Road Vehicle Engine N47 D20 C	605063	Inner Joint		30	28	65	77	62				
	2010.09-2010.09	MT	L	R	All-wheel Drive Closed Off-Road Vehicle Engine N47 D20 C	205118	Drive Shaft		30	27	65	77	829					
xDrive 20 d (140 kW)	2014.02-2014.02	-	-	R	R	All-wheel Drive Closed Off-Road Vehicle Engine B47 D20 A	605063	Inner Joint		30	28	65	77	62				
	2014.02-2014.02	AT/MT	L	R	All-wheel Drive Closed Off-Road Vehicle Engine B47 D20 A	205117	Drive Shaft		30	27	64.9	77	769					
	2014.02-2014.02	AT/MT	R	R	All-wheel Drive Closed Off-Road Vehicle Engine B47 D20 A	205121	Drive Shaft		30	27	64.9	77	825					
	2014.02-2014.02	AT	L	R	All-wheel Drive Closed Off-Road Vehicle Engine B47 D20 A	205118	Drive Shaft		30	27	65	77	829					
xDrive 20 i (135 kW)	2011.09-2011.09	-	L	R	All-wheel Drive Closed Off-Road Vehicle Engine N20 B20 A	205117	Drive Shaft		30	27	64.9	77	769					
	2011.09-2011.09	-	R	R	All-wheel Drive Closed Off-Road Vehicle Engine N20 B20 A	205121	Drive Shaft		30	27	64.9	77	825					
xDrive 28 i (180 kW)	2011.08-2011.08	-	L	R	All-wheel Drive Closed Off-Road Vehicle Engine N20 B20 A	205117	Drive Shaft		30	27	64.9	77	769					
	2011.08-2011.08	-	R	R	All-wheel Drive Closed Off-Road Vehicle Engine N20 B20 A	205121	Drive Shaft		30	27	64.9	77	825					





	 YEAR	TRANSM	L/R	F/R	REMARKS	GSP Ref.	 PRODUCT	 ABS	Technical Specifications						
									A	B	C	H	L	P	
BMW															
X3 (F25)															
xDrive 30 d (155 kW)	2011.05-	-	-	R	R	All-wheel Drive Closed Off-Road Vehicle Engine N57 D30 A	205119	Drive Shaft	30	32	64.9	77	827		
xDrive 30 d (183 kW)	2015.04-	-	-	R	R	All-wheel Drive Closed Off-Road Vehicle Engine N57 D30 A	205119	Drive Shaft	30	32	64.9	77	827		
xDrive 30 d (190 kW)	2011.05-	-	-	L	R	All-wheel Drive Closed Off-Road Vehicle Engine N57 D30 A	605054	Inner Joint	30	25	64.9	77	58		
	2011.05-	-	-	L	R	All-wheel Drive Closed Off-Road Vehicle Engine N57 D30 A	605065	Inner Joint	32	25	50	86	73		
	2011.05-	-	-	R	R	All-wheel Drive Closed Off-Road Vehicle Engine N57 D30 A	205119	Drive Shaft	30	32	64.9	77	827		
	2011.05-	-	-	R	R	All-wheel Drive Closed Off-Road Vehicle Engine N57 D30 A	205120	Drive Shaft	30	32	64.9	77	771		
xDrive 30 d (204 kW)	2016.06-	-	8AT	R	R	All-wheel Drive Closed Off-Road Vehicle Engine N57 D30 A	205119	Drive Shaft	30	32	64.9	77	827		
xDrive 30 d (210 kW)	2014.04-	-	-	R	R	All-wheel Drive Closed Off-Road Vehicle Engine N57 D30 A	205119	Drive Shaft	30	32	64.9	77	827		
xDrive 35 d (230 kW)	2011.09-	-	-	L	R	All-wheel Drive Closed Off-Road Vehicle Engine N57 D30 B	605054	Inner Joint	30	25	64.9	77	58		
	2011.09-	-	-	L	R	All-wheel Drive Closed Off-Road Vehicle Engine N57 D30 B	605065	Inner Joint	32	25	50	86	73		
	2011.09-	-	-	R	R	All-wheel Drive Closed Off-Road Vehicle Engine N57 D30 B	205119	Drive Shaft	30	32	64.9	77	827		
	2011.09-	-	-	R	R	All-wheel Drive Closed Off-Road Vehicle Engine N57 D30 B	205120	Drive Shaft	30	32	64.9	77	771		
X4 (F26)															
xDrive 20 d (120 kW)	2013.07-	-	AT/MT	L	R	All-wheel Drive Closed Off-Road Vehicle Engine B47 D20 A	205117	Drive Shaft	30	27	64.9	77	769		
	2013.07-	-	AT/MT	R	R	All-wheel Drive Closed Off-Road Vehicle Engine B47 D20 A	205121	Drive Shaft	30	27	64.9	77	825		
xDrive 20 d (140 kW)	2013.07-	-	AT/MT	L	R	All-wheel Drive Closed Off-Road Vehicle Engine B47 D20 A	205117	Drive Shaft	30	27	64.9	77	769		
	2013.07-	-	AT/MT	R	R	All-wheel Drive Closed Off-Road Vehicle Engine B47 D20 A	205121	Drive Shaft	30	27	64.9	77	825		
xDrive 20 i (135 kW)	2013.07-	-	AT	L	R	All-wheel Drive Closed Off-Road Vehicle Engine N20 B20 A	205117	Drive Shaft	30	27	64.9	77	769		
	2013.07-	-	AT	R	R	All-wheel Drive Closed Off-Road Vehicle Engine N20 B20 A	205121	Drive Shaft	30	27	64.9	77	825		
xDrive 28 i (180 kW)	2013.05-	-	AT	L	R	All-wheel Drive Closed Off-Road Vehicle Engine N20 B20 A	205117	Drive Shaft	30	27	64.9	77	769		
	2013.05-	-	AT	R	R	All-wheel Drive Closed Off-Road Vehicle Engine N20 B20 A	205121	Drive Shaft	30	27	64.9	77	825		
xDrive 30 d (155 kW)	2013.06-	-	AT	R	R	All-wheel Drive Closed Off-Road Vehicle Engine N57 D30 A	205119	Drive Shaft	30	32	64.9	77	827		
xDrive 30 d (183 kW)	2015.06-	-	AT	R	R	All-wheel Drive Closed Off-Road Vehicle Engine N57 D30 A	205119	Drive Shaft	30	32	64.9	77	827		
xDrive 30 d (190 kW)	2013.06-	-	-	L	R	All-wheel Drive Closed Off-Road Vehicle Engine N57 D30 A	605054	Inner Joint	30	25	64.9	77	58		
	2013.06-	-	-	L	R	All-wheel Drive Closed Off-Road Vehicle Engine N57 D30 A	605065	Inner Joint	32	25	50	86	73		
	2013.06-	-	AT	R	R	All-wheel Drive Closed Off-Road Vehicle Engine N57 D30 A	205119	Drive Shaft	30	32	64.9	77	827		
	2013.06-	-	AT	R	R	All-wheel Drive Closed Off-Road Vehicle Engine N57 D30 A	205120	Drive Shaft	30	32	64.9	77	771		
xDrive 30 d (204 kW)	2013.06-	-	8AT	R	R	All-wheel Drive Closed Off-Road Vehicle Engine N57 D30 A	205119	Drive Shaft	30	32	64.9	77	827		
xDrive 30 d (210 kW)	2013.06-	-	AT	R	R	All-wheel Drive Closed Off-Road Vehicle Engine N57 D30 A	205119	Drive Shaft	30	32	64.9	77	827		
xDrive 35 d (230 kW)	2013.05-	-	-	L	R	All-wheel Drive Closed Off-Road Vehicle Engine N57 D30 B	605054	Inner Joint	30	25	64.9	77	58		
	2013.05-	-	-	L	R	All-wheel Drive Closed Off-Road Vehicle Engine N57 D30 B	605065	Inner Joint	32	25	50	86	73		
	2013.05-	-	AT	R	R	All-wheel Drive Closed Off-Road Vehicle Engine N57 D30 B	205119	Drive Shaft	30	32	64.9	77	827		
	2013.05-	-	AT	R	R	All-wheel Drive Closed Off-Road Vehicle Engine N57 D30 B	205120	Drive Shaft	30	32	64.9	77	771		
X5 (E53)															
3.0 d (135 kW)	2001.05-	2003.12	MT	-	R	All-wheel Drive Closed Off-Road Vehicle Engine M57 D30 (306D1)	205057	Drive Shaft	30		58.8	73	650		
	2001.05-	2003.12	AT/MT	-	R	All-wheel Drive Closed Off-Road Vehicle Engine M57 D30 (306D1)	605057	Inner Joint		32		28			
	2001.05-	2003.12	-	-	R	All-wheel Drive Closed Off-Road Vehicle Engine M57 D30 (306D1)	699127	Inner Joint		25		26			
	2001.05-	2003.12	MT/AT	L	F	All-wheel Drive Closed Off-Road Vehicle Engine M57 D30 (306D1)	605021	Inner Joint	27	26	44	64	114.5		
	2001.05-	2003.12	AT/MT	L	F	All-wheel Drive Closed Off-Road Vehicle Engine M57 D30 (306D1)	205010	Drive Shaft	30	27	64.8	77	586		
	2001.05-	2003.12	AT/MT	R	F	All-wheel Drive Closed Off-Road Vehicle Engine M57 D30 (306D1)	205011	Drive Shaft	30	27	64.8	77	970		
	2001.05-	2003.12	AT/MT	L	F	All-wheel Drive Closed Off-Road Vehicle Engine M57 D30 (306D1)	205029	Drive Shaft	30	27	64.8	77	586		
	2001.05-	2003.12	AT/MT	R	F	All-wheel Drive Closed Off-Road Vehicle Engine M57 D30 (306D1)	205018	Drive Shaft	30	27	64.8	77	970		
	2001.05-	2003.12	MT	L/R	R	All-wheel Drive Closed Off-Road Vehicle Engine M57 D30 (306D1)	205049	Drive Shaft	30		58.9	73	640		
	2001.05-	2003.12	AT	L/R	R	All-wheel Drive Closed Off-Road Vehicle Engine M57 D30 (306D1)	205050	Drive Shaft	30		58.8	73	637		
3.0 d (155 kW)	2003.09-	2006.12	-	-	R	All-wheel Drive Closed Off-Road Vehicle Engine M57 D30 (306D2)	205057	Drive Shaft	30		58.8	73	650		
	2003.09-	2006.12	-	-	F	All-wheel Drive Closed Off-Road Vehicle Engine M57 D30 (306D2)	805001	Outer Joint	30	27	64.8	77	67.5	M	
	2003.09-	2006.12	AT/MT	-	R	All-wheel Drive Closed Off-Road Vehicle Engine M57 D30 (306D2)	605057	Inner Joint		32		28			
	2003.09-	2006.12	AT/MT	L	F	All-wheel Drive Closed Off-Road Vehicle Engine M57 D30 (306D2)	205010	Drive Shaft	30	27	64.8	77	586		
	2003.09-	2006.12	AT/MT	R	F	All-wheel Drive Closed Off-Road Vehicle Engine M57 D30 (306D2)	205011	Drive Shaft	30	27	64.8	77	970		
	2003.09-	2006.12	-	-	L	F	All-wheel Drive Closed Off-Road Vehicle Engine M57 D30 (306D2)	205029	Drive Shaft	30	27	64.8	77	586	
	2003.09-	2006.12	-	-	R	F	All-wheel Drive Closed Off-Road Vehicle Engine M57 D30 (306D2)	205018	Drive Shaft	30	27	64.8	77	970	
	2003.09-	2006.12	-	-	L/R	R	All-wheel Drive Closed Off-Road Vehicle Engine M57 D30 (306D2)	205049	Drive Shaft	30		58.9	73	640	
	2003.09-	2006.12	-	-	L/R	R	All-wheel Drive Closed Off-Road Vehicle Engine M57 D30 (306D2)	205050	Drive Shaft	30		58.8	73	637	
	2003.09-	2006.12	-	-	R	F	All-wheel Drive Closed Off-Road Vehicle Engine M57 D30 (306D2)	205018	Drive Shaft	30	27	64.8	77	970	
3.0 d (160 kW)	2003.12-	2006.12	MT	-	R	All-wheel Drive Closed Off-Road Vehicle Engine M57 D30 (306D2)	205057	Drive Shaft	30		58.8	73	650		
	2003.12-	2006.12	-	-	F	All-wheel Drive Closed Off-Road Vehicle Engine M57 D30 (306D2)	805001	Outer Joint	30	27	64.8	77	67.5	M	
	2003.12-	2006.12	AT/MT	-	R	All-wheel Drive Closed Off-Road Vehicle Engine M57 D30 (306D2)	605057	Inner Joint		32		28			
	2003.12-	2006.12	AT/MT	L	F	All-wheel Drive Closed Off-Road Vehicle Engine M57 D30 (306D2)	205010	Drive Shaft	30	27	64.8	77	586		
	2003.12-	2006.12	AT/MT	R	F	All-wheel Drive Closed Off-Road Vehicle Engine M57 D30 (306D2)	205011	Drive Shaft	30	27	64.8	77	970		
	2003.12-	2006.12	-	-	L	F	All-wheel Drive Closed Off-Road Vehicle Engine M57 D30 (306D2)	205029	Drive Shaft	30	27	64.8	77	586	
	2003.12-	2006.12	-	-	L	F	All-wheel Drive Closed Off-Road Vehicle Engine M57 D30 (306D2)	605021	Inner Joint	27	26	44	64	114.5	
	2003.12-	2006.12	-	-	R	F	All-wheel Drive Closed Off-Road Vehicle Engine M57 D30 (306D2)	205018	Drive Shaft	30	27	64.8	77	970	
	2003.12-	2006.12	-	-	L/R	R	All-wheel Drive Closed Off-Road Vehicle Engine M57 D30 (306D2)	205049	Drive Shaft	30		58.9	73	640	
	2003.12-	2006.12	-	-	R	F	All-wheel Drive Closed Off-Road Vehicle Engine M57 D30 (306D2)	205018	Drive Shaft	30	27	64.8	77	970	
3.0 i (170 kW)	2000.05-	2006.12	MT	-	R	All-wheel Drive Closed Off-Road Vehicle Engine M54 B30 (306S3)	205057	Drive Shaft	30		58.8	73	650		
	2000.05-	2006.12	AT/MT	-	R	All-wheel Drive Closed Off-Road Vehicle Engine M54 B30 (306S3)	605057	Inner Joint		32		28			
	2000.05-	2006.12	-	-	F	All-wheel Drive Closed Off-Road Vehicle Engine M54 B30 (306S3)	805001	Outer Joint	30	27	64.8	77	67.5	M	
	2000.05-	2006.12	-	-	R	All-wheel Drive Closed Off-Road Vehicle Engine M54 B30 (306S3)	699127	Inner Joint		25		26			
	2000.05-	2006.12	-	-	R	All-wheel Drive Closed Off-Road Vehicle Engine M54 B30 (306S3)	699127	Inner Joint		25		26			





YEAR	TRANSM	L/R	F/R	REMARKS	GSP Ref.	PRODUCT	ABS	Technical Specifications							
								A	B	C	H	L	P		
BMW															
X5 (E53)															
3.0 i (170 kW)	2000.05-2006.12	AT/MT	L	F	All-wheel Drive Closed Off-Road Vehicle Engine M54 B30 (306S3)	205010	Drive Shaft	30	27	64.8	77	586			
	2000.05-2006.12	AT/MT	R	F	All-wheel Drive Closed Off-Road Vehicle Engine M54 B30 (306S3)	205011	Drive Shaft	30	27	64.8	77	970			
	2000.05-2006.12	AT/MT	L	F	All-wheel Drive Closed Off-Road Vehicle Engine M54 B30 (306S3)	205029	Drive Shaft	30	27	64.8	77	586			
	2000.05-2006.12	MT/AT	L	F	All-wheel Drive Closed Off-Road Vehicle Engine M54 B30 (306S3)	605021	Inner Joint	27	26	44	64	114.5			
	2000.05-2006.12	AT/MT	R	F	All-wheel Drive Closed Off-Road Vehicle Engine M54 B30 (306S3)	205018	Drive Shaft	30	27	64.8	77	970			
	2000.05-2006.12	MT	L/R	R	All-wheel Drive Closed Off-Road Vehicle Engine M54 B30 (306S3)	205049	Drive Shaft	30		58.9	73	640			
	2000.05-2006.12	-	L/R	R	All-wheel Drive Closed Off-Road Vehicle Engine M54 B30 (306S3)	205050	Drive Shaft	30		58.8	73	637			
4.4 i (210 kW)	2000.05-2003.12	AT/MT	-	R	All-wheel Drive Closed Off-Road Vehicle Engine M62 B44 (448S2)	605057	Inner Joint		32		28				
	2000.05-2003.12	-	-	F	All-wheel Drive Closed Off-Road Vehicle Engine M62 B44 (448S2)	805001	Outer Joint	30	27	64.8	77	67.5	M		
	2000.05-2003.12	-	-	R	All-wheel Drive Closed Off-Road Vehicle Engine M62 B44 (448S2)	699127	Inner Joint		25		26				
	2000.05-2003.12	-	L	F	All-wheel Drive Closed Off-Road Vehicle Engine M62 B44 (448S2)	605021	Inner Joint	27	26	44	64	114.5			
	2000.05-2003.12	AT/MT	L	F	All-wheel Drive Closed Off-Road Vehicle Engine M62 B44 (448S2)	205010	Drive Shaft	30	27	64.8	77	586			
	2000.05-2003.12	AT/MT	R	F	All-wheel Drive Closed Off-Road Vehicle Engine M62 B44 (448S2)	205011	Drive Shaft	30	27	64.8	77	970			
	2000.05-2003.12	-	L	F	All-wheel Drive Closed Off-Road Vehicle Engine M62 B44 (448S2)	205029	Drive Shaft	30	27	64.8	77	586			
	2000.05-2003.12	-	R	F	All-wheel Drive Closed Off-Road Vehicle Engine M62 B44 (448S2)	205018	Drive Shaft	30	27	64.8	77	970			
4.4 i (235 kW)	2000.05-2003.12	-	L/R	R	All-wheel Drive Closed Off-Road Vehicle Engine M62 B44 (448S2)	205050	Drive Shaft	30		58.8	73	637			
	2003.12-2006.09	AT/MT	-	R	All-wheel Drive Closed Off-Road Vehicle Engine N62 B44	205057	Drive Shaft	30		58.8	73	650			
	2003.12-2006.09	AT/MT	-	R	All-wheel Drive Closed Off-Road Vehicle Engine N62 B44	605057	Inner Joint		32		28				
	2003.12-2006.09	AT/MT	R	F	All-wheel Drive Closed Off-Road Vehicle Engine N62 B44	205011	Drive Shaft	30	27	64.8	77	970			
	2003.12-2006.09	AT	L	F	All-wheel Drive Closed Off-Road Vehicle Engine N62 B44	205029	Drive Shaft	30	27	64.8	77	586			
	2003.12-2006.09	AT	L	F	All-wheel Drive Closed Off-Road Vehicle Engine N62 B44	605021	Inner Joint	27	26	44	64	114.5			
	2003.12-2006.09	AT	R	F	All-wheel Drive Closed Off-Road Vehicle Engine N62 B44	205018	Drive Shaft	30	27	64.8	77	970			
4.6 is (255 kW)	2003.12-2006.09	AT	L/R	R	All-wheel Drive Closed Off-Road Vehicle Engine N62 B44	205049	Drive Shaft	30		58.9	73	640			
	2002.02-2003.12	-	-	R	All-wheel Drive Closed Off-Road Vehicle Engine M62 B46 (468S1)	205057	Drive Shaft	30		58.8	73	650			
	2002.02-2003.12	-	-	F	All-wheel Drive Closed Off-Road Vehicle Engine M62 B46 (468S1)	805001	Outer Joint	30	27	64.8	77	67.5	M		
	2002.02-2003.12	AT/MT	-	R	All-wheel Drive Closed Off-Road Vehicle Engine M62 B46 (468S1)	605057	Inner Joint		32		28				
	2002.02-2003.12	AT	L	F	All-wheel Drive Closed Off-Road Vehicle Engine M62 B46 (468S1)	205010	Drive Shaft	30	27	64.8	77	586			
	2002.02-2003.12	AT	R	F	All-wheel Drive Closed Off-Road Vehicle Engine M62 B46 (468S1)	205011	Drive Shaft	30	27	64.8	77	970			
	2002.02-2003.12	-	L	F	All-wheel Drive Closed Off-Road Vehicle Engine M62 B46 (468S1)	605021	Inner Joint	27	26	44	64	114.5			
	2002.02-2003.12	-	L	F	All-wheel Drive Closed Off-Road Vehicle Engine M62 B46 (468S1)	205029	Drive Shaft	30	27	64.8	77	586			
2002.02-2003.12	-	R	F	All-wheel Drive Closed Off-Road Vehicle Engine M62 B46 (468S1)	205018	Drive Shaft	30	27	64.8	77	970				
4.8 is (265 kW)	2002.02-2003.12	-	L/R	R	All-wheel Drive Closed Off-Road Vehicle Engine M62 B46 (468S1)	205049	Drive Shaft	30		58.9	73	640			
	2004.04-2006.09	AT	-	R	All-wheel Drive Closed Off-Road Vehicle Engine N62 B48 A	205057	Drive Shaft	30		58.8	73	650			
	2004.04-2006.09	AT/MT	-	R	All-wheel Drive Closed Off-Road Vehicle Engine N62 B48 A	605057	Inner Joint		32		28				
	2004.04-2006.09	AT	L	F	All-wheel Drive Closed Off-Road Vehicle Engine N62 B48 A	205010	Drive Shaft	30	27	64.8	77	586			
	2004.04-2006.09	AT	R	F	All-wheel Drive Closed Off-Road Vehicle Engine N62 B48 A	205011	Drive Shaft	30	27	64.8	77	970			
	2004.04-2006.09	-	L	F	All-wheel Drive Closed Off-Road Vehicle Engine N62 B48 A	205029	Drive Shaft	30	27	64.8	77	586			
	2004.04-2006.09	-	L	F	All-wheel Drive Closed Off-Road Vehicle Engine N62 B48 A	605021	Inner Joint	27	26	44	64	114.5			
	2004.04-2006.09	-	R	F	All-wheel Drive Closed Off-Road Vehicle Engine N62 B48 A	205018	Drive Shaft	30	27	64.8	77	970			
2004.04-2006.09	-	L/R	R	All-wheel Drive Closed Off-Road Vehicle Engine N62 B48 A	205049	Drive Shaft	30		58.9	73	640				
X5 (E70)															
3.0 d (155 kW)	2007.02-2008.09	-	L	F	All-wheel Drive Closed Off-Road Vehicle Engine M57 D30 (306D3)	205052	Drive Shaft	30	27	64.8	86.5	634			
	2007.02-2008.09	AT	L/R	R	All-wheel Drive Closed Off-Road Vehicle Engine M57 D30 (306D3)	205081	Drive Shaft	30	37	68.7	84	810			
	2007.02-2008.09	-	R	F	All-wheel Drive Closed Off-Road Vehicle Engine M57 D30 (306D3)	205043	Drive Shaft	30	27	64.8	86.5	1020			
	2007.02-2008.09	AT	-	F	All-wheel Drive Closed Off-Road Vehicle Engine M57 D30 (306D3)	805006	Outer Joint	30	33	64.8	86.5	59.5	M		
	2007.02-2008.09	-	L	F	All-wheel Drive Closed Off-Road Vehicle Engine M57 D30 (306D3)	605030	Inner Joint	27	26	43.9	62	121			
	2007.02-2008.09	-	R	F	All-wheel Drive Closed Off-Road Vehicle Engine M57 D30 (306D3)	605014	Inner Joint	27	26	29.97	448	121			
	2007.02-2008.09	-	L	F	All-wheel Drive Closed Off-Road Vehicle Engine M57 D30 (306D3)	205052	Drive Shaft	30	27	64.8	86.5	634			
3.0 d (173 kW)	2007.02-2008.09	AT	L/R	R	All-wheel Drive Closed Off-Road Vehicle Engine M57 D30 (306D3)	205081	Drive Shaft	30	37	68.7	84	810			
	2007.02-2008.09	-	R	F	All-wheel Drive Closed Off-Road Vehicle Engine M57 D30 (306D3)	205043	Drive Shaft	30	27	64.8	86.5	1020			
	2007.02-2008.09	AT	-	F	All-wheel Drive Closed Off-Road Vehicle Engine M57 D30 (306D3)	805006	Outer Joint	30	33	64.8	86.5	59.5	M		
	2007.02-2008.09	-	L	F	All-wheel Drive Closed Off-Road Vehicle Engine M57 D30 (306D3)	605030	Inner Joint	27	26	43.9	62	121			
	2007.02-2008.09	-	R	F	All-wheel Drive Closed Off-Road Vehicle Engine M57 D30 (306D3)	605014	Inner Joint	27	26	29.97	448	121			
	2007.02-2008.09	-	L	F	All-wheel Drive Closed Off-Road Vehicle Engine M57 D30 (306D3)	205052	Drive Shaft	30	27	64.8	86.5	634			
3.0 sd (210 kW)	2007.09-2009.02	-	L	F	All-wheel Drive Closed Off-Road Vehicle Engine M57 D30 (306D5)	205052	Drive Shaft	30	27	64.8	86.5	634			
	2007.09-2009.02	-	R	F	All-wheel Drive Closed Off-Road Vehicle Engine M57 D30 (306D5)	205043	Drive Shaft	30	27	64.8	86.5	1020			
	2007.09-2009.02	AT	-	F	All-wheel Drive Closed Off-Road Vehicle Engine M57 D30 (306D5)	805006	Outer Joint	30	33	64.8	86.5	59.5	M		
	2007.09-2009.02	-	L	F	All-wheel Drive Closed Off-Road Vehicle Engine M57 D30 (306D5)	605030	Inner Joint	27	26	43.9	62	121			
	2007.09-2009.02	-	R	F	All-wheel Drive Closed Off-Road Vehicle Engine M57 D30 (306D5)	605014	Inner Joint	27	26	29.97	448	121			
3.0 si (200 kW)	2006.02-2008.09	-	L	F	All-wheel Drive Closed Off-Road Vehicle Engine N52 B30 B	205052	Drive Shaft	30	27	64.8	86.5	634			
	2006.02-2008.09	-	R	F	All-wheel Drive Closed Off-Road Vehicle Engine N52 B30 B	205043	Drive Shaft	30	27	64.8	86.5	1020			
	2006.02-2008.09	AT	-	F	All-wheel Drive Closed Off-Road Vehicle Engine N52 B30 B	805006	Outer Joint	30	33	64.8	86.5	59.5	M		
	2006.02-2008.09	-	L	F	All-wheel Drive Closed Off-Road Vehicle Engine N52 B30 B	605030	Inner Joint	27	26	43.9	62	121			
	2006.02-2008.09	-	R	F	All-wheel Drive Closed Off-Road Vehicle Engine N52 B30 B	605014	Inner Joint	27	26	29.97	448	121			
4.8 i xDrive (261 kW)	2007.02-2008.09	-	L	F	All-wheel Drive Closed Off-Road Vehicle Engine N62 B48 B	205052	Drive Shaft	30	27	64.8	86.5	634			
	2007.02-2008.09	AT	L/R	R	All-wheel Drive Closed Off-Road Vehicle Engine N62 B48 B	205081	Drive Shaft	30	37	68.7	84	810			
	2007.02-2008.09	-	R	F	All-wheel Drive Closed Off-Road Vehicle Engine N62 B48 B	205043	Drive Shaft	30	27	64.8	86.5	1020			

	 YEAR	TRANSM	L/R	F/R	REMARKS	GSP Ref.	 PRODUCT	 ABS	Technical Specifications						
									A	B	C	H	L	P	
BMW															
X5 (E70)															
4.8 i xDrive (261 kW)	2007.02-2008.09	AT	-	F	All-wheel Drive Closed Off-Road Vehicle Engine N62 B48 B	805006	Outer Joint		30	33	64.8	86.5	59.5	M	
	2007.02-2008.09	-	L	F	All-wheel Drive Closed Off-Road Vehicle Engine N62 B48 B	605030	Inner Joint		27	26	43.9	62	121		
	2007.02-2008.09	-	R	F	All-wheel Drive Closed Off-Road Vehicle Engine N62 B48 B	605014	Inner Joint		27	26	29.97	448	121		
M (408 kW)	2009.09-2013.06	-	L	F	All-wheel Drive Closed Off-Road Vehicle Engine S63 B44 A	205052	Drive Shaft		30	27	64.8	86.5	634		
	2009.09-2013.06	-	R	F	All-wheel Drive Closed Off-Road Vehicle Engine S63 B44 A	205043	Drive Shaft		30	27	64.8	86.5	1020		
	2009.09-2013.06	AT	-	F	All-wheel Drive Closed Off-Road Vehicle Engine S63 B44 A	805006	Outer Joint		30	33	64.8	86.5	59.5	M	
	2009.09-2013.06	-	L	F	All-wheel Drive Closed Off-Road Vehicle Engine S63 B44 A	605030	Inner Joint		27	26	43.9	62	121		
	2009.09-2013.06	-	R	F	All-wheel Drive Closed Off-Road Vehicle Engine S63 B44 A	605014	Inner Joint		27	26	29.97	448	121		
M 50 d (280 kW)	2011.08-2013.06	AT	L	F	All-wheel Drive Closed Off-Road Vehicle Engine N57 D30 C	201110	Drive Shaft		30	27	64.8	86.5	663		
	2011.08-2013.06	AT	R	F	All-wheel Drive Closed Off-Road Vehicle Engine N57 D30 C	205123	Drive Shaft		30	27	64.8	86.5	973		
	2011.08-2013.06	AT	R	F	All-wheel Drive Closed Off-Road Vehicle Engine N57 D30 C	201119	Drive Shaft		30	32	68.7	84	820		
xDrive 30 d (155 kW)	2008.09-2013.06	AT	L	F	All-wheel Drive Closed Off-Road Vehicle Engine N57 D30 A	201110	Drive Shaft		30	27	64.8	86.5	663		
	2008.09-2013.06	AT	R	F	All-wheel Drive Closed Off-Road Vehicle Engine N57 D30 A	205123	Drive Shaft		30	27	64.8	86.5	973		
	2008.09-2013.06	-	L	F	All-wheel Drive Closed Off-Road Vehicle Engine N57 D30 A	205052	Drive Shaft		30	27	64.8	86.5	634		
	2008.09-2013.06	AT	-	R	All-wheel Drive Closed Off-Road Vehicle Engine N57 D30 A	205081	Drive Shaft		30	37	68.7	84	810		
	2008.09-2013.06	-	R	F	All-wheel Drive Closed Off-Road Vehicle Engine N57 D30 A	205043	Drive Shaft		30	27	64.8	86.5	1020		
	2008.09-2013.06	-	L	F	All-wheel Drive Closed Off-Road Vehicle Engine N57 D30 A	605030	Inner Joint		27	26	43.9	62	121		
	2008.09-2013.06	-	R	F	All-wheel Drive Closed Off-Road Vehicle Engine N57 D30 A	605014	Inner Joint		27	26	29.97	448	121		
xDrive 30 d (173 kW)	2008.09-2013.06	6AT	L	F	All-wheel Drive Closed Off-Road Vehicle Engine N57 D30 A	201110	Drive Shaft		30	27	64.8	86.5	663		
	2008.09-2013.06	6AT	R	F	All-wheel Drive Closed Off-Road Vehicle Engine N57 D30 A	205123	Drive Shaft		30	27	64.8	86.5	973		
	2008.09-2013.06	-	L	F	All-wheel Drive Closed Off-Road Vehicle Engine N57 D30 A	205052	Drive Shaft		30	27	64.8	86.5	634		
	2008.09-2013.06	-	L/R	R	All-wheel Drive Closed Off-Road Vehicle Engine N57 D30 A	205081	Drive Shaft		30	37	68.7	84	810		
	2008.09-2013.06	-	R	F	All-wheel Drive Closed Off-Road Vehicle Engine N57 D30 A	205043	Drive Shaft		30	27	64.8	86.5	1020		
	2008.09-2013.06	-	L	F	All-wheel Drive Closed Off-Road Vehicle Engine N57 D30 A	605030	Inner Joint		27	26	43.9	62	121		
	2008.09-2013.06	-	R	F	All-wheel Drive Closed Off-Road Vehicle Engine N57 D30 A	605014	Inner Joint		27	26	29.97	448	121		
xDrive 30 d (180 kW)	2010.09-2013.06	AT	L	F	All-wheel Drive Closed Off-Road Vehicle Engine N57 D30 A	201110	Drive Shaft		30	27	64.8	86.5	663		
	2010.09-2013.06	AT	R	F	All-wheel Drive Closed Off-Road Vehicle Engine N57 D30 A	205123	Drive Shaft		30	27	64.8	86.5	973		
	2010.09-2013.06	-	L/R	R	All-wheel Drive Closed Off-Road Vehicle Engine N57 D30 A	205081	Drive Shaft		30	37	68.7	84	810		
xDrive 30 i (200 kW)	2008.09-2010.03	-	L	F	All-wheel Drive Closed Off-Road Vehicle Engine N52 B30 A	205052	Drive Shaft		30	27	64.8	86.5	634		
	2008.09-2010.03	-	R	F	All-wheel Drive Closed Off-Road Vehicle Engine N52 B30 A	205043	Drive Shaft		30	27	64.8	86.5	1020		
	2008.09-2010.03	-	L	F	All-wheel Drive Closed Off-Road Vehicle Engine N52 B30 A	605030	Inner Joint		27	26	43.9	62	121		
	2008.09-2010.03	-	R	F	All-wheel Drive Closed Off-Road Vehicle Engine N52 B30 A	605014	Inner Joint		27	26	29.97	448	121		
xDrive 35 d (210 kW)	2008.09-2013.06	-	L	F	All-wheel Drive Closed Off-Road Vehicle Engine M57 D30 (306D5)	205052	Drive Shaft		30	27	64.8	86.5	634		
	2008.09-2013.06	-	R	F	All-wheel Drive Closed Off-Road Vehicle Engine M57 D30 (306D5)	205043	Drive Shaft		30	27	64.8	86.5	1020		
	2008.09-2013.06	AT	-	F	All-wheel Drive Closed Off-Road Vehicle Engine M57 D30 (306D5)	805006	Outer Joint		30	33	64.8	86.5	59.5	M	
	2008.09-2013.06	-	L	F	All-wheel Drive Closed Off-Road Vehicle Engine M57 D30 (306D5)	605030	Inner Joint		27	26	43.9	62	121		
	2008.09-2013.06	-	R	F	All-wheel Drive Closed Off-Road Vehicle Engine M57 D30 (306D5)	605014	Inner Joint		27	26	29.97	448	121		
xDrive 35 i (225 kW)	2010.09-2013.06	AT	L	F	All-wheel Drive Closed Off-Road Vehicle Engine N55 B30 A	201110	Drive Shaft		30	27	64.8	86.5	663		
	2010.09-2013.06	AT	R	F	All-wheel Drive Closed Off-Road Vehicle Engine N55 B30 A	205123	Drive Shaft		30	27	64.8	86.5	973		
	2010.09-2013.06	-	L	F	All-wheel Drive Closed Off-Road Vehicle Engine N55 B30 A	205052	Drive Shaft		30	27	64.8	86.5	634		
	2010.09-2013.06	AT	L/R	R	All-wheel Drive Closed Off-Road Vehicle Engine N55 B30 A	205081	Drive Shaft		30	37	68.7	84	810		
	2010.09-2013.06	-	R	F	All-wheel Drive Closed Off-Road Vehicle Engine N55 B30 A	205043	Drive Shaft		30	27	64.8	86.5	1020		
	2010.09-2013.06	AT	-	F	All-wheel Drive Closed Off-Road Vehicle Engine N55 B30 A	805006	Outer Joint		30	33	64.8	86.5	59.5	M	
	2010.09-2013.06	-	L	F	All-wheel Drive Closed Off-Road Vehicle Engine N55 B30 A	605030	Inner Joint		27	26	43.9	62	121		
	2010.09-2013.06	-	R	F	All-wheel Drive Closed Off-Road Vehicle Engine N55 B30 A	605014	Inner Joint		27	26	29.97	448	121		
xDrive 35 i (235 kW)	2012.02-2013.06	AT	L	F	All-wheel Drive Closed Off-Road Vehicle Engine N55 B30 A	205052	Drive Shaft		30	27	64.8	86.5	634		
	2012.02-2013.06	AT	L/R	R	All-wheel Drive Closed Off-Road Vehicle Engine N55 B30 A	205081	Drive Shaft		30	37	68.7	84	810		
	2012.02-2013.06	AT	R	F	All-wheel Drive Closed Off-Road Vehicle Engine N55 B30 A	205043	Drive Shaft		30	27	64.8	86.5	1020		
	2012.02-2013.06	AT	-	F	All-wheel Drive Closed Off-Road Vehicle Engine N55 B30 A	805006	Outer Joint		30	33	64.8	86.5	59.5	M	
	2012.02-2013.06	AT	L	F	All-wheel Drive Closed Off-Road Vehicle Engine N55 B30 A	605030	Inner Joint		27	26	43.9	62	121		
	2012.02-2013.06	AT	R	F	All-wheel Drive Closed Off-Road Vehicle Engine N55 B30 A	605014	Inner Joint		27	26	29.97	448	121		
xDrive 40 d (225 kW)	2010.09-2013.06	AT	L	F	All-wheel Drive Closed Off-Road Vehicle Engine N57 D30 B	201110	Drive Shaft		30	27	64.8	86.5	663		
	2010.09-2013.06	AT	R	F	All-wheel Drive Closed Off-Road Vehicle Engine N57 D30 B	205123	Drive Shaft		30	27	64.8	86.5	973		
xDrive 48 i (261 kW)	2008.09-2013.06	-	L	F	All-wheel Drive Closed Off-Road Vehicle Engine N62 B48 B	205052	Drive Shaft		30	27	64.8	86.5	634		
	2008.09-2013.06	AT	L/R	R	All-wheel Drive Closed Off-Road Vehicle Engine N62 B48 B	205081	Drive Shaft		30	37	68.7	84	810		
	2008.09-2013.06	-	R	F	All-wheel Drive Closed Off-Road Vehicle Engine N62 B48 B	205043	Drive Shaft		30	27	64.8	86.5	1020		
	2008.09-2013.06	-	L	F	All-wheel Drive Closed Off-Road Vehicle Engine N62 B48 B	605030	Inner Joint		27	26	43.9	62	121		
	2008.09-2013.06	-	R	F	All-wheel Drive Closed Off-Road Vehicle Engine N62 B48 B	605014	Inner Joint		27	26	29.97	448	121		
xDrive 50 i (300 kW)	2010.06-2013.06	-	L	F	All-wheel Drive Closed Off-Road Vehicle Engine N63 B44 A	205052	Drive Shaft		30	27	64.8	86.5	634		
	2010.06-2013.06	-	L/R	R	All-wheel Drive Closed Off-Road Vehicle Engine N63 B44 A	205070	Drive Shaft		30	32	68.7	84	809		
	2010.06-2013.06	-	R	F	All-wheel Drive Closed Off-Road Vehicle Engine N63 B44 A	205043	Drive Shaft		30	27	64.8	86.5	1020		
	2010.06-2013.06	AT	-	F	All-wheel Drive Closed Off-Road Vehicle Engine N63 B44 A	805006	Outer Joint		30	33	64.8	86.5	59.5	M	
	2010.06-2013.06	-	L	F	All-wheel Drive Closed Off-Road Vehicle Engine N63 B44 A	605030	Inner Joint		27	26	43.9	62	121		
	2010.06-2013.06	-	R	F	All-wheel Drive Closed Off-Road Vehicle Engine N63 B44 A	605014	Inner Joint		27	26	29.97	448	121		
X5 (F15 F85)															
M (423 kW)	2014.12-	-	AT	L	F	All-wheel Drive Closed Off-Road Vehicle Engine S63 B44 B	205052	Drive Shaft		30	27	64.8	86.5	634	





YEAR	TRANSM	L/R	F/R	REMARKS	GSP Ref.	PRODUCT	ABS	Technical Specifications						
								A	B	C	H	L	P	
BMW														
X5 (F15 F85)														
M (423 kW)	2014.12-	-	AT	R	F	All-wheel Drive Closed Off-Road Vehicle Engine S63 B44 B	205043	Drive Shaft	30	27	64.8	86.5	1020	
	2014.12-	-	AT	L	F	All-wheel Drive Closed Off-Road Vehicle Engine S63 B44 B	605030	Inner Joint	27	26	43.9	62	121	
	2014.12-	-	AT	R	F	All-wheel Drive Closed Off-Road Vehicle Engine S63 B44 B	605014	Inner Joint	27	26	29.97	448	121	
M 50 d (280 kW)	2013.07-	-	-	L	F	All-wheel Drive Closed Off-Road Vehicle Engine N57 D30 C	201110	Drive Shaft	30	27	64.8	86.5	663	
	2013.07-	-	-	R	F	All-wheel Drive Closed Off-Road Vehicle Engine N57 D30 C	205123	Drive Shaft	30	27	64.8	86.5	973	
	2013.07-	-	AT	R	-	All-wheel Drive Closed Off-Road Vehicle Engine N57 D30 C	201119	Drive Shaft	30	32	68.7	84	820	
xDrive 30 d (183 kW)	2015.04-	-	AT	L/R	R	All-wheel Drive Closed Off-Road Vehicle Engine N57 D30 A	661075	Inner Joint		28		26		
	2015.04-	-	AT	L/R	R	All-wheel Drive Closed Off-Road Vehicle Engine N57 D30 A	205149	Drive Shaft	30		68.7	84	630	
xDrive 30 d (190 kW)	2013.07-	-	-	L/R	R	All-wheel Drive Closed Off-Road Vehicle Engine N57 D30 A	661075	Inner Joint		28		26		
	2013.07-	-	-	L/R	R	All-wheel Drive Closed Off-Road Vehicle Engine N57 D30 A	205149	Drive Shaft	30		68.7	84	630	
	2013.07-	-	-	L	F	All-wheel Drive Closed Off-Road Vehicle Engine N57 D30 A	201110	Drive Shaft	30	27	64.8	86.5	663	
	2013.07-	-	-	R	F	All-wheel Drive Closed Off-Road Vehicle Engine N57 D30 A	205123	Drive Shaft	30	27	64.8	86.5	973	
xDrive 30 d (204 kW)	2013.11-	-	-	L/R	R	All-wheel Drive Closed Off-Road Vehicle Engine N57 D30 A	661075	Inner Joint		28		26		
	2013.11-	-	-	L/R	R	All-wheel Drive Closed Off-Road Vehicle Engine N57 D30 A	205149	Drive Shaft	30		68.7	84	630	
	2013.11-	-	-	L	F	All-wheel Drive Closed Off-Road Vehicle Engine N57 D30 A	201110	Drive Shaft	30	27	64.8	86.5	663	
	2013.11-	-	-	R	F	All-wheel Drive Closed Off-Road Vehicle Engine N57 D30 A	205123	Drive Shaft	30	27	64.8	86.5	973	
xDrive 30 d (210 kW)	2013.07-	-	-	L/R	R	All-wheel Drive Closed Off-Road Vehicle Engine N57 D30 A	661075	Inner Joint		28		26		
	2013.07-	-	-	L/R	R	All-wheel Drive Closed Off-Road Vehicle Engine N57 D30 A	205149	Drive Shaft	30		68.7	84	630	
xDrive 35 i (240 kW)	2013.11-	-	-	L/R	R	All-wheel Drive Closed Off-Road Vehicle Engine N55 B30 A	661075	Inner Joint		28		26		
	2013.11-	-	-	L/R	R	All-wheel Drive Closed Off-Road Vehicle Engine N55 B30 A	205149	Drive Shaft	30		68.7	84	630	
xDrive 40 d (230 kW)	2013.12-	-	AT	L/R	R	All-wheel Drive Closed Off-Road Vehicle Engine N57 D30 B	205149	Drive Shaft	30		68.7	84	630	
	2013.12-	-	-	L	F	All-wheel Drive Closed Off-Road Vehicle Engine N57 D30 B	201110	Drive Shaft	30	27	64.8	86.5	663	
	2013.12-	-	-	R	F	All-wheel Drive Closed Off-Road Vehicle Engine N57 D30 B	205123	Drive Shaft	30	27	64.8	86.5	973	
	2013.12-	-	AT	L/R	R	All-wheel Drive Closed Off-Road Vehicle Engine N57 D30 B	661075	Inner Joint		28		26		
X5(E53)SAV														
3.0i	2000.04-	2000.04	-	L	F	-	205075	Drive Shaft	30	27	59	73	584	
	2000.04-	2000.04	-	R	F	Engine M54	205076	Drive Shaft	30	27	59	73	967	
	2000.04-	2000.04	-	L	F	Engine M54	205075	Drive Shaft	30	27	59	73	584	
	2000.04-	2000.04	-	R	F	Engine M54	205076	Drive Shaft	30	27	59	73	967	
4.4i	2000.04-	2000.04	-	L	F	Engine M62	205075	Drive Shaft	30	27	59	73	584	
	2000.04-	2000.04	-	R	F	Engine M62	205076	Drive Shaft	30	27	59	73	967	
	2000.04-	2000.04	-	L	F	Engine M62	205075	Drive Shaft	30	27	59	73	584	
	2000.04-	2000.04	-	R	F	Engine M62	205076	Drive Shaft	30	27	59	73	967	
X6 (E71 E72)														
ActiveHybrid (300 kW)	2009.01-	2011.10	-	L	F	All-wheel Drive Closed Off-Road Vehicle Engine N63 B44 A	205052	Drive Shaft	30	27	64.8	86.5	634	
	2009.01-	2011.10	-	R	F	All-wheel Drive Closed Off-Road Vehicle Engine N63 B44 A	205043	Drive Shaft	30	27	64.8	86.5	1020	
	2009.01-	2011.10	AT	-	F	All-wheel Drive Closed Off-Road Vehicle Engine N63 B44 A	805006	Outer Joint	30	33	64.8	86.5	59.5	M
	2009.01-	2011.10	-	L	F	All-wheel Drive Closed Off-Road Vehicle Engine N63 B44 A	605030	Inner Joint	27	26	43.9	62	121	
	2009.01-	2011.10	-	R	F	All-wheel Drive Closed Off-Road Vehicle Engine N63 B44 A	605014	Inner Joint	27	26	29.97	448	121	
ActiveHybrid (357 kW)	2009.01-	2011.10	-	L	F	All-wheel Drive Closed Off-Road Vehicle Engine N63 B44 A	205052	Drive Shaft	30	27	64.8	86.5	634	
	2009.01-	2011.10	-	R	F	All-wheel Drive Closed Off-Road Vehicle Engine N63 B44 A	205043	Drive Shaft	30	27	64.8	86.5	1020	
	2009.01-	2011.10	AT	-	F	All-wheel Drive Closed Off-Road Vehicle Engine N63 B44 A	805006	Outer Joint	30	33	64.8	86.5	59.5	M
	2009.01-	2011.10	-	L	F	All-wheel Drive Closed Off-Road Vehicle Engine N63 B44 A	605030	Inner Joint	27	26	43.9	62	121	
	2009.01-	2011.10	-	R	F	All-wheel Drive Closed Off-Road Vehicle Engine N63 B44 A	605014	Inner Joint	27	26	29.97	448	121	
M (408 kW)	2008.07-	2014.06	-	L	F	All-wheel Drive Closed Off-Road Vehicle Engine S63 B44 A	205052	Drive Shaft	30	27	64.8	86.5	634	
	2008.07-	2014.06	-	R	F	All-wheel Drive Closed Off-Road Vehicle Engine S63 B44 A	205043	Drive Shaft	30	27	64.8	86.5	1020	
	2008.07-	2014.06	AT	-	F	All-wheel Drive Closed Off-Road Vehicle Engine S63 B44 A	805006	Outer Joint	30	33	64.8	86.5	59.5	M
	2008.07-	2014.06	-	L	F	All-wheel Drive Closed Off-Road Vehicle Engine S63 B44 A	605030	Inner Joint	27	26	43.9	62	121	
	2008.07-	2014.06	-	R	F	All-wheel Drive Closed Off-Road Vehicle Engine S63 B44 A	605014	Inner Joint	27	26	29.97	448	121	
M 50 d (280 kW)	2011.08-	2014.06	-	L	F	All-wheel Drive Closed Off-Road Vehicle Engine N57 D30 C	201110	Drive Shaft	30	27	64.8	86.5	663	
	2011.08-	2014.06	-	R	F	All-wheel Drive Closed Off-Road Vehicle Engine N57 D30 C	205123	Drive Shaft	30	27	64.8	86.5	973	
xDrive 30 d (155 kW)	2009.07-	2014.06	-	L/R	R	All-wheel Drive Closed Off-Road Vehicle Engine N57 D30 A	205149	Drive Shaft	30		68.7	84	630	
	2009.07-	2014.06	-	L	F	All-wheel Drive Closed Off-Road Vehicle Engine N57 D30 A	201110	Drive Shaft	30	27	64.8	86.5	663	
	2009.07-	2014.06	-	R	F	All-wheel Drive Closed Off-Road Vehicle Engine N57 D30 A	205123	Drive Shaft	30	27	64.8	86.5	973	
	2009.07-	2014.06	-	L/R	R	All-wheel Drive Closed Off-Road Vehicle Engine N57 D30 A	661075	Inner Joint		28		26		
xDrive 30 d (173 kW)	2007.09-	2010.03	-	L/R	R	All-wheel Drive Closed Off-Road Vehicle Engine M57 D30 (306D3)	205149	Drive Shaft	30		68.7	84	630	
	2007.09-	2010.03	AT	L	F	All-wheel Drive Closed Off-Road Vehicle Engine M57 D30 (306D3)	201110	Drive Shaft	30	27	64.8	86.5	663	
	2007.09-	2010.03	AT	R	F	All-wheel Drive Closed Off-Road Vehicle Engine M57 D30 (306D3)	205123	Drive Shaft	30	27	64.8	86.5	973	
	2007.09-	2010.03	-	L	F	All-wheel Drive Closed Off-Road Vehicle Engine M57 D30 (306D3)	205052	Drive Shaft	30	27	64.8	86.5	634	
	2007.09-	2010.03	-	R	F	All-wheel Drive Closed Off-Road Vehicle Engine M57 D30 (306D3)	205043	Drive Shaft	30	27	64.8	86.5	1020	
	2007.09-	2010.03	AT	-	F	All-wheel Drive Closed Off-Road Vehicle Engine M57 D30 (306D3)	805006	Outer Joint	30	33	64.8	86.5	59.5	M
	2007.09-	2010.03	-	L	F	All-wheel Drive Closed Off-Road Vehicle Engine M57 D30 (306D3)	605030	Inner Joint	27	26	43.9	62	121	
	2007.09-	2010.03	-	R	F	All-wheel Drive Closed Off-Road Vehicle Engine M57 D30 (306D3)	605014	Inner Joint	27	26	29.97	448	121	
	2007.09-	2010.03	-	L/R	R	All-wheel Drive Closed Off-Road Vehicle Engine M57 D30 (306D3)	661075	Inner Joint		28		26		
xDrive 30 d (180 kW)	2009.04-	2014.06	-	L/R	R	All-wheel Drive Closed Off-Road Vehicle Engine N57 D30 A	205149	Drive Shaft	30		68.7	84	630	
	2009.04-	2014.06	-	L	F	All-wheel Drive Closed Off-Road Vehicle Engine N57 D30 A	201110	Drive Shaft	30	27	64.8	86.5	663	

YEAR	TRANSM	L/R	F/R	REMARKS	GSP Ref.	PRODUCT	ABS	Technical Specifications					
								A	B	C	H	L	P
BMW													
X6 (E71 E72)													
xDrive 30 d (180 kW)	2009.04-2014.06	-	R	F	All-wheel Drive Closed Off-Road Vehicle Engine N57 D30 A	205123	Drive Shaft	30	27	64.8	86.5	973	
	2009.04-2014.06	-	L/R	R	All-wheel Drive Closed Off-Road Vehicle Engine N57 D30 A	661075	Inner Joint		28		26		
xDrive 35 d (210 kW)	2007.06-2010.03	-	L/R	R	All-wheel Drive Closed Off-Road Vehicle Engine M57 D30 (306D5)	205149	Drive Shaft	30		68.7	84	630	
	2007.06-2010.03	AT	-	F	All-wheel Drive Closed Off-Road Vehicle Engine M57 D30 (306D5)	805006	Outer Joint	30	33	64.8	86.5	59.5 M	
	2007.06-2010.03	-	L/R	R	All-wheel Drive Closed Off-Road Vehicle Engine M57 D30 (306D5)	661075	Inner Joint		28		26		
xDrive 35 i (240 kW)	2007.06-2010.03	AT	L/R	R	All-wheel Drive Closed Off-Road Vehicle Engine N54 B30 A	205149	Drive Shaft	30		68.7	84	630	
	2007.06-2010.03	AT	L	F	All-wheel Drive Closed Off-Road Vehicle Engine N54 B30 A	205052	Drive Shaft	30	27	64.8	86.5	634	
	2007.06-2010.03	AT	R	F	All-wheel Drive Closed Off-Road Vehicle Engine N54 B30 A	205043	Drive Shaft	30	27	64.8	86.5	1020	
	2007.06-2010.03	AT	-	F	All-wheel Drive Closed Off-Road Vehicle Engine N54 B30 A	805006	Outer Joint	30	33	64.8	86.5	59.5 M	
	2007.06-2010.03	AT	L	F	All-wheel Drive Closed Off-Road Vehicle Engine N54 B30 A	605030	Inner Joint	27	26	43.9	62	121	
	2007.06-2010.03	AT	R	F	All-wheel Drive Closed Off-Road Vehicle Engine N54 B30 A	605014	Inner Joint	27	26	29.97	448	121	
	2007.06-2010.03	AT	L/R	R	All-wheel Drive Closed Off-Road Vehicle Engine N54 B30 A	661075	Inner Joint		28		26		
	2007.06-2010.03	AT	-	F	All-wheel Drive Closed Off-Road Vehicle Engine N54 B30 A	661075	Inner Joint		28		26		
xDrive 40 d (225 kW)	2009.07-2014.06	-	L/R	R	All-wheel Drive Closed Off-Road Vehicle Engine N57 D30 B	205149	Drive Shaft	30		68.7	84	630	
	2009.07-2014.06	-	L	F	All-wheel Drive Closed Off-Road Vehicle Engine N57 D30 B	201110	Drive Shaft	30	27	64.8	86.5	663	
	2009.07-2014.06	-	R	F	All-wheel Drive Closed Off-Road Vehicle Engine N57 D30 B	205123	Drive Shaft	30	27	64.8	86.5	973	
	2009.07-2014.06	-	L/R	R	All-wheel Drive Closed Off-Road Vehicle Engine N57 D30 B	661075	Inner Joint		28		26		
xDrive 40 i (225 kW)	2007.06-2010.03	-	L/R	R	All-wheel Drive Closed Off-Road Vehicle Engine N54 B30 A	205149	Drive Shaft	30		68.7	84	630	
	2007.06-2010.03	-	L	F	All-wheel Drive Closed Off-Road Vehicle Engine N54 B30 A	205052	Drive Shaft	30	27	64.8	86.5	634	
	2007.06-2010.03	-	R	F	All-wheel Drive Closed Off-Road Vehicle Engine N54 B30 A	205043	Drive Shaft	30	27	64.8	86.5	1020	
	2007.06-2010.03	AT	-	F	All-wheel Drive Closed Off-Road Vehicle Engine N54 B30 A	805006	Outer Joint	30	33	64.8	86.5	59.5 M	
	2007.06-2010.03	-	L	F	All-wheel Drive Closed Off-Road Vehicle Engine N54 B30 A	605030	Inner Joint	27	26	43.9	62	121	
	2007.06-2010.03	-	R	F	All-wheel Drive Closed Off-Road Vehicle Engine N54 B30 A	605014	Inner Joint	27	26	29.97	448	121	
	2007.06-2010.03	-	L/R	R	All-wheel Drive Closed Off-Road Vehicle Engine N54 B30 A	661075	Inner Joint		28		26		
	2007.06-2010.03	-	L	F	All-wheel Drive Closed Off-Road Vehicle Engine N54 B30 A	661075	Inner Joint		28		26		
xDrive 40 i (235 kW)	2009.07-2014.06	AT	L/R	R	All-wheel Drive Closed Off-Road Vehicle Engine N55 B30 A	205149	Drive Shaft	30		68.7	84	630	
	2009.07-2014.06	AT	L	F	All-wheel Drive Closed Off-Road Vehicle Engine N55 B30 A	205052	Drive Shaft	30	27	64.8	86.5	634	
	2009.07-2014.06	AT	R	F	All-wheel Drive Closed Off-Road Vehicle Engine N55 B30 A	205043	Drive Shaft	30	27	64.8	86.5	1020	
	2009.07-2014.06	AT	-	F	All-wheel Drive Closed Off-Road Vehicle Engine N55 B30 A	805006	Outer Joint	30	33	64.8	86.5	59.5 M	
	2009.07-2014.06	AT	L	F	All-wheel Drive Closed Off-Road Vehicle Engine N55 B30 A	605030	Inner Joint	27	26	43.9	62	121	
	2009.07-2014.06	AT	R	F	All-wheel Drive Closed Off-Road Vehicle Engine N55 B30 A	605014	Inner Joint	27	26	29.97	448	121	
xDrive 50 i (300 kW)	2007.10-2014.06	-	L/R	R	All-wheel Drive Closed Off-Road Vehicle Engine N63 B44 A	205149	Drive Shaft	30		68.7	84	630	
	2007.10-2014.06	-	L	F	All-wheel Drive Closed Off-Road Vehicle Engine N63 B44 A	205052	Drive Shaft	30	27	64.8	86.5	634	
	2007.10-2014.06	-	R	F	All-wheel Drive Closed Off-Road Vehicle Engine N63 B44 A	205043	Drive Shaft	30	27	64.8	86.5	1020	
	2007.10-2014.06	AT	-	F	All-wheel Drive Closed Off-Road Vehicle Engine N63 B44 A	805006	Outer Joint	30	33	64.8	86.5	59.5 M	
	2007.10-2014.06	-	L	F	All-wheel Drive Closed Off-Road Vehicle Engine N63 B44 A	605030	Inner Joint	27	26	43.9	62	121	
	2007.10-2014.06	-	R	F	All-wheel Drive Closed Off-Road Vehicle Engine N63 B44 A	605014	Inner Joint	27	26	29.97	448	121	
	2007.10-2014.06	-	L/R	R	All-wheel Drive Closed Off-Road Vehicle Engine N63 B44 A	661075	Inner Joint		28		26		
	2007.10-2014.06	-	L	F	All-wheel Drive Closed Off-Road Vehicle Engine N63 B44 A	661075	Inner Joint		28		26		
xDrive 50 i (330 kW)	2007.10-2014.06	AT	L/R	R	All-wheel Drive Closed Off-Road Vehicle Engine N63 B44 A	205149	Drive Shaft	30		68.7	84	630	
	2007.10-2014.06	AT	L	F	All-wheel Drive Closed Off-Road Vehicle Engine N63 B44 A	205052	Drive Shaft	30	27	64.8	86.5	634	
	2007.10-2014.06	AT	R	F	All-wheel Drive Closed Off-Road Vehicle Engine N63 B44 A	205043	Drive Shaft	30	27	64.8	86.5	1020	
	2007.10-2014.06	AT	-	F	All-wheel Drive Closed Off-Road Vehicle Engine N63 B44 A	805006	Outer Joint	30	33	64.8	86.5	59.5 M	
	2007.10-2014.06	AT	L	F	All-wheel Drive Closed Off-Road Vehicle Engine N63 B44 A	605030	Inner Joint	27	26	43.9	62	121	
	2007.10-2014.06	AT	R	F	All-wheel Drive Closed Off-Road Vehicle Engine N63 B44 A	605014	Inner Joint	27	26	29.97	448	121	
	2007.10-2014.06	AT	L/R	R	All-wheel Drive Closed Off-Road Vehicle Engine N63 B44 A	661075	Inner Joint		28		26		
	2007.10-2014.06	AT	-	F	All-wheel Drive Closed Off-Road Vehicle Engine N63 B44 A	661075	Inner Joint		28		26		
X6 (F16 F86)													
M (423 kW)	2014.12-	-	AT	L	F	All-wheel Drive Closed Off-Road Vehicle Engine S63 B44 B	205052	Drive Shaft	30	27	64.8	86.5	634
	2014.12-	-	AT	R	F	All-wheel Drive Closed Off-Road Vehicle Engine S63 B44 B	205043	Drive Shaft	30	27	64.8	86.5	1020
	2014.12-	-	AT	L	F	All-wheel Drive Closed Off-Road Vehicle Engine S63 B44 B	605030	Inner Joint	27	26	43.9	62	121
	2014.12-	-	AT	R	F	All-wheel Drive Closed Off-Road Vehicle Engine S63 B44 B	605014	Inner Joint	27	26	29.97	448	121
M 50 d (280 kW)	2014.08-	-	-	L	F	All-wheel Drive Closed Off-Road Vehicle Engine N57 D30 C	201110	Drive Shaft	30	27	64.8	86.5	663
	2014.08-	-	-	R	F	All-wheel Drive Closed Off-Road Vehicle Engine N57 D30 C	205123	Drive Shaft	30	27	64.8	86.5	973
	2014.08-	-	AT	R	-	All-wheel Drive Closed Off-Road Vehicle Engine N57 D30 C	201119	Drive Shaft	30	32	68.7	84	820
xDrive 30 d (155 kW)	2014.08-	-	AT	L/R	R	All-wheel Drive Closed Off-Road Vehicle Engine N57 D30 A	661075	Inner Joint		28		26	
	2014.08-	-	AT	L/R	R	All-wheel Drive Closed Off-Road Vehicle Engine N57 D30 A	205149	Drive Shaft	30		68.7	84	630
xDrive 30 d (183 kW)	2015.12-	-	AT	L/R	R	All-wheel Drive Closed Off-Road Vehicle Engine N57 D30 A	661075	Inner Joint		28		26	
	2015.12-	-	AT	L/R	R	All-wheel Drive Closed Off-Road Vehicle Engine N57 D30 A	205149	Drive Shaft	30		68.7	84	630
xDrive 30 d (190 kW)	2014.08-	-	AT	L/R	R	All-wheel Drive Closed Off-Road Vehicle Engine N57 D30 A	205149	Drive Shaft	30		68.7	84	630
	2014.08-	-	-	L	F	All-wheel Drive Closed Off-Road Vehicle Engine N57 D30 A	201110	Drive Shaft	30	27	64.8	86.5	663
	2014.08-	-	-	R	F	All-wheel Drive Closed Off-Road Vehicle Engine N57 D30 A	205123	Drive Shaft	30	27	64.8	86.5	973
	2014.08-	-	AT	L/R	R	All-wheel Drive Closed Off-Road Vehicle Engine N57 D30 A	661075	Inner Joint		28		26	
xDrive 30 d (204 kW)	2015.02-	-	AT	L/R	R	All-wheel Drive Closed Off-Road Vehicle Engine N57 D30 A	661075	Inner Joint		28		26	
	2015.02-	-	AT	L/R	R	All-wheel Drive Closed Off-Road Vehicle Engine N57 D30 A	205149	Drive Shaft	30		68.7	84	630
	2015.02-	-	-	L	F	All-wheel Drive Closed Off-Road Vehicle Engine N57 D30 A	201110	Drive Shaft	30	27	64.8	86.5	663
	2015.02-	-	-	R	F	All-wheel Drive Closed Off-Road Vehicle Engine N57 D30 A	205123	Drive Shaft	30	27	64.8	86.5	973
xDrive 35 i (225 kW)	2014.12-	-	AT	L/R	R	All-wheel Drive Closed Off-Road Vehicle Engine N55 B30 A	661075	Inner Joint		28		26	
	2014.12-	-	AT	L/R	R	All-wheel Drive Closed Off-Road Vehicle Engine N55 B30 A	205149	Drive Shaft	30		68.7	84	630

	 YEAR	TRANSM	L/R	F/R	REMARKS	GSP Ref.	 PRODUCT	 ABS	Technical Specifications						
									A	B	C	H	L	P	
BMW															
X6 (F16 F86)															
xDrive 35 i (240 kW)	2015.02-	-	AT	L/R	R	All-wheel Drive Closed Off-Road Vehicle Engine N55 B30 A	661075	Inner Joint			28		26		
	2015.02-	-	AT	L/R	R	All-wheel Drive Closed Off-Road Vehicle Engine N55 B30 A	205149	Drive Shaft	30		68.7	84	630		
xDrive 40 d (230 kW)	2014.12-	-	-	L/R	R	All-wheel Drive Closed Off-Road Vehicle Engine N57 D30 B	661075	Inner Joint		28		26			
	2014.12-	-	-	L/R	R	All-wheel Drive Closed Off-Road Vehicle Engine N57 D30 B	205149	Drive Shaft	30		68.7	84	630		
	2014.12-	-	-	L	F	All-wheel Drive Closed Off-Road Vehicle Engine N57 D30 B	201110	Drive Shaft	30	27	64.8	86.5	663		
	2014.12-	-	-	R	F	All-wheel Drive Closed Off-Road Vehicle Engine N57 D30 B	205123	Drive Shaft	30	27	64.8	86.5	973		
xDrive 50 i (330 kW)	2014.08-	-	AT	L/R	R	All-wheel Drive Closed Off-Road Vehicle Engine N63 B44 B	661075	Inner Joint		28		26			
	2014.08-	-	AT	L/R	R	All-wheel Drive Closed Off-Road Vehicle Engine N63 B44 B	205149	Drive Shaft	30		68.7	84	630		
	2014.08-	-	AT	L	F	All-wheel Drive Closed Off-Road Vehicle Engine N63 B44 B	205052	Drive Shaft	30	27	64.8	86.5	634		
	2014.08-	-	AT	R	F	All-wheel Drive Closed Off-Road Vehicle Engine N63 B44 B	205043	Drive Shaft	30	27	64.8	86.5	1020		
	2014.08-	-	AT	L	F	All-wheel Drive Closed Off-Road Vehicle Engine N63 B44 B	605030	Inner Joint	27	26	43.9	62	121		
	2014.08-	-	AT	R	F	All-wheel Drive Closed Off-Road Vehicle Engine N63 B44 B	605014	Inner Joint	27	26	29.97	448	121		
Z3 Roadster (E36)															
1.8 i (85 kW)	1995.10-	1998.10	-	R	-	Convertible Engine M43 B18 (184E2)	605009	Inner Joint		27	24	64	68.5	58	
	1995.10-	1998.10	-	-	R	Convertible Engine M43 B18 (184E2)	605001	Inner Joint			24		24		
	1995.10-	1998.10	-	L/R	R	Convertible Engine M43 B18 (184E2)	205006	Drive Shaft	48W	27		64	68.5	585	
1.9 i (103 kW)	1995.10-	1999.03	-	R	-	Convertible Engine M44 B19 (194S1)	605009	Inner Joint		27	24	64	68.5	58	
	1995.10-	1999.03	-	-	R	Convertible Engine M44 B19 (194S1)	605001	Inner Joint			24		24		
	1995.10-	1999.03	-	L/R	R	Convertible Engine M44 B19 (194S1)	205006	Drive Shaft	48W	27		64	68.5	585	
1.9 i (85 kW)	1999.01-	2003.01	-	R	-	Convertible Engine M43 B19 (194E1)	605009	Inner Joint		27	24	64	68.5	58	
	1999.01-	2003.01	-	L/R	R	Convertible Engine M43 B19 (194E1)	205006	Drive Shaft	48W	27		64	68.5	585	
1.9 i (87 kW)	1998.07-	2003.01	-	R	-	Convertible Engine M43 B19 (194E1)	605009	Inner Joint		27	24	64	68.5	58	
	1998.07-	2003.01	-	-	R	Convertible Engine M43 B19 (194E1)	605001	Inner Joint			24		24		
	1998.07-	2003.01	-	L/R	R	Convertible Engine M43 B19 (194E1)	205006	Drive Shaft	48W	27		64	68.5	585	
2.0 i (110 kW)	1999.04-	2003.01	-	-	R	Convertible Engine M52 B20 (206S4)	605001	Inner Joint			24		24		
Z4 (E86)															
3.0 si (195 kW)	2006.03-	2009.01	MT/AT	L	R	Coupe Engine N52 B30 A	605078	Inner Joint		27	25	63.7	68	58	
	2006.03-	2009.01	MT/AT	L	R	Coupe Engine N52 B30 A	635025	Inner Joint			25		26		
Z4 Roadster (E85)															
2.5 i (141 kW)	2003.02-	2005.12	MT/Semi-AT	R	R	Convertible Engine M54 B25 (256S5)	205042	Drive Shaft	48W	27		64	69	665	
	2003.02-	2005.12	MT/Semi-AT	L	R	Convertible Engine M54 B25 (256S5)	205051	Drive Shaft	48W	27		64	69	608	
3.0 i (170 kW)	2003.02-	2005.10	MT/Semi-AT	R	R	Convertible Engine M54 B30 (306S3)	205042	Drive Shaft	48W	27		64	69	665	
	2003.02-	2005.10	MT/Semi-AT	L	R	Convertible Engine M54 B30 (306S3)	205051	Drive Shaft	48W	27		64	69	608	
3.0 si (195 kW)	2006.01-	2008.12	MT/AT	L	R	Convertible Engine N52 B30 A	605078	Inner Joint		27	25	63.7	68	58	
	2006.01-	2008.12	MT/AT	L	R	Convertible Engine N52 B30 A	635025	Inner Joint			25		26		
Z4 Roadster (E89)															
sDrive 23 i (150 kW)	2009.05-	-	-	R	R	Convertible Engine N52 B25 A	201115	Drive Shaft	48W	27		69	68	676	
sDrive 30 i (190 kW)	2009.05-	-	-	R	R	Convertible Engine N52 B30 A	201115	Drive Shaft	48W	27		69	68	676	
sDrive 35 i (225 kW)	2009.05-	-	-	R	R	Convertible Engine N54 B30 A	223297	Drive Shaft		30	29	68.1	88	686	
Z8 Roadster (E52)															
4.9 (294 kW)	2000.06-	2003.06	AT/MT	-	R	Convertible Engine S62 B50 (508S1)	605057	Inner Joint			32		28		
BUICK															
EXCELLE															
1.5 (83 kW)	2013.02-	-	MT	L	-	Saloon Engine L2B	206060	Drive Shaft	47T	33	34	52	95	625	
	2013.02-	-	AT	L	-	Saloon Engine L2B	206061	Drive Shaft	47T	33	22	52	95	632	
	2013.02-	-	MT	R	-	Saloon Engine L2B	206062	Drive Shaft	47T	33	34	52	95	917	
	2013.02-	-	AT	R	-	Saloon Engine L2B	206063	Drive Shaft	47T	33	22	52	95	905	
RAINIER															
-	2004-	2007	-	-	F	AWD/PROPELLER SHAFT	608073	Propshaft CV Joint		17	22	44		119	
RANIER															
-	2004-	2005	-	-	-	America SUV/Truck/VAN	808011	Outer Joint		27	34	55.8	127.5	64	O
REGAL															
-	1988-	1996	-	-	-		806011	Outer Joint	47T	33	32	73	88	55	O
	1988-	1996	-	-	-		806002	Outer Joint		33	32	73	88	55	O
3.0	-	-	-	-	-		606001	Inner Joint		34	32	35	56.5	79.5	
	-	-	-	-	-		606003	Inner Joint		34	32	35	56.8	120.7	
RENDEZVOUS															
-	-	-	-	-	-		806021	Propshaft CV Joint			21		27.5		I
RENDEZVOUZ															
3.4 AWD (138 kW)	2000.04-	2006.09	-	-	-	All-wheel Drive Closed Off-Road Vehicle Engine LA1	606026	Propshaft CV Joint			25		40		
SKYLARK (N-BODY)															
-	1991-	1995	AT	-	-	3 Speed	821018	Outer Joint	48T	33	29	47.6	108	63	O
BUICK (SGM)															
CENTURY															
3.0 (126 kW)	1999.07-	2002.12	AT	R	-	Saloon Engine LW9	206028	Drive Shaft		33	34	50	105	654	

	 YEAR	TRANSM	L/R	F/R	REMARKS	GSP Ref.	 PRODUCT	 ABS	Technical Specifications									
									A	B	C	H	L	P				
BUICK (SGM) CENTURY																		
3.0 (126 kW)	1999.07-2002.12	AT	L	-	Saloon Engine LW9	206029	Drive Shaft		33	34	50	105	575					
	1999.07-2002.12	AT	R	-	Saloon Engine LW9	299051	Drive Shaft		33	34	50	105	640					
	1999.07-2002.12	AT	L	-	Saloon Engine LW9	299052	Drive Shaft		33	34	50	105	565					
ENCORE																		
1.4 T (103 kW)	2012.10-	-	L	-	Closed Off-Road Vehicle Engine LFF	206064	Drive Shaft		25	34	52.4	92	646					
	2012.10-	-	R	-	Closed Off-Road Vehicle Engine LFF	206065	Drive Shaft		25	34	52.4	92	585					
EXCELLE																		
1.6 (78 kW)	2003.08-2008.05	AT	R	F	Saloon Engine F16D3D	206042	Drive Shaft	47T	33	22	52	95.5	943					
	2003.08-2008.05	MT	L	F	Saloon Engine F16D3D	206057	Drive Shaft	47T	33	34	52	95.5	606					
	2003.08-2008.05	MT	L	F	Saloon Engine F16D3D	206058	Drive Shaft	47T	33	34	52	95.5	612.5					
	2003.08-2008.05	MT	R	F	Saloon Engine F16D3D	206059	Drive Shaft	47T	33	34	52	95.5	934					
	2003.08-2008.05	MT	R	F	Saloon Engine F16D3D	221023	Drive Shaft	47T	33	34	52	95.5	931					
	2003.08-2008.05	AT	L	F	Saloon Engine F16D3D	221025	Drive Shaft	47T	33	22	52	95.5	611					
	2008.01-2013.12	AT	R	-	Estate Engine F16D3	206042	Drive Shaft	47T	33	22	52	95.5	943					
	2008.01-2013.12	MT	L	-	Estate Engine F16D3	206057	Drive Shaft	47T	33	34	52	95.5	606					
	2008.01-2013.12	MT	R	-	Estate Engine F16D3	221023	Drive Shaft	47T	33	34	52	95.5	931					
	2008.01-2013.12	AT	L	-	Estate Engine F16D3	221025	Drive Shaft	47T	33	22	52	95.5	611					
	2008.05-2013.12	AT	R	-	Saloon Engine F16D3	206042	Drive Shaft	47T	33	22	52	95.5	943					
	2008.05-2013.12	MT	L	-	Saloon Engine F16D3	206057	Drive Shaft	47T	33	34	52	95.5	606					
	2008.05-2013.12	MT	R	-	Saloon Engine F16D3	221023	Drive Shaft	47T	33	34	52	95.5	931					
	2008.05-2013.12	AT	L	-	Saloon Engine F16D3	221025	Drive Shaft	47T	33	22	52	95.5	611					
1.6 (81 kW)	2010.08-2013.12	AT	R	-	Saloon Engine F16D3	206042	Drive Shaft	47T	33	22	52	95.5	943					
	2010.08-2013.12	MT	L	-	Saloon Engine F16D3	206057	Drive Shaft	47T	33	34	52	95.5	606					
	2010.08-2013.12	MT	R	-	Saloon Engine F16D3	221023	Drive Shaft	47T	33	34	52	95.5	931					
	2010.08-2013.12	AT	L	-	Saloon Engine F16D3	221025	Drive Shaft	47T	33	22	52	95.5	611					
1.8 (88 kW)	2005.11-2013.12	-	-	-	Estate Engine T18SED	221046	Drive Shaft	47T	33	34	52	95.5	588					
	2005.11-2013.12	-	-	-	Estate Engine T18SED	221047	Drive Shaft	47T	33	34	52	95.5	940					
	2005.11-2013.12	-	-	-	Estate Engine T18SED	206050	Drive Shaft	47T	33	34	52	95.5	611					
	2005.11-2013.12	-	-	-	Estate Engine T18SED	206051	Drive Shaft	47T	33	34	52	95.5	936					
	2005.11-2013.12	-	-	-	Estate Engine T18SED	221024	Drive Shaft	47T	33	34	52	95.5	941					
	2005.11-2013.12	-	-	-	Estate Engine T18SED	221031	Drive Shaft	47T	33	34	52	95.5	589					
	2008.05-2010.12	AT	R	-	Saloon Engine T18SED	221024	Drive Shaft	47T	33	34	52	95.5	941					
	2008.05-2010.12	AT	L	-	Saloon Engine T18SED	221031	Drive Shaft	47T	33	34	52	95.5	589					
	2008.05-2010.12	AT	L	-	Saloon Engine T18SED	221046	Drive Shaft	47T	33	34	52	95.5	588					
	2008.05-2010.12	AT	R	-	Saloon Engine T18SED	221047	Drive Shaft	47T	33	34	52	95.5	940					
2008.05-2010.12	MT	L	-	Saloon Engine T18SED	206050	Drive Shaft	47T	33	34	52	95.5	611						
2008.05-2010.12	MT	R	-	Saloon Engine T18SED	206051	Drive Shaft	47T	33	34	52	95.5	936						
EXCELLE GT																		
1.6 (89 kW)	2010.06-2015.12	-	-	-	Saloon Engine LDE	261137	Drive Shaft		30	34	52.5	94.5	640					
	2010.06-2015.12	-	-	-	Saloon Engine LDE	261138	Drive Shaft		30	27	52.5	94.5	598					
	2010.06-2015.12	-	-	-	Saloon Engine LDE	208076	Drive Shaft		33	34	53	95	626					
	2010.06-2015.12	-	-	-	Saloon Engine LDE	208078	Drive Shaft		33	34	53	95	976					
	2010.06-2015.12	-	-	-	Saloon Engine LDE	208079	Drive Shaft		33	34	52.5	94	643					
1.6 T (135 kW)	2010.06-2015.12	-	-	-	Saloon Engine LLU	261137	Drive Shaft		30	34	52.5	94.5	640					
	2010.06-2015.12	-	-	-	Saloon Engine LLU	261138	Drive Shaft		30	27	52.5	94.5	598					
	2010.06-2015.12	-	-	-	Saloon Engine LLU	208076	Drive Shaft		33	34	53	95	626					
	2010.06-2015.12	-	-	-	Saloon Engine LLU	208078	Drive Shaft		33	34	53	95	976					
	2010.06-2015.12	-	-	-	Saloon Engine LLU	208079	Drive Shaft		33	34	52.5	94	643					
1.8 (108 kW)	2010.06-2015.12	AT	L	F	Saloon Engine 2H0	208079	Drive Shaft		33	34	52.5	94	643					
EXCELLE XT																		
1.6 (89 kW)	2010.01-2015.12	-	-	-	Hatchback Engine LDE	261137	Drive Shaft		30	34	52.5	94.5	640					
	2010.01-2015.12	-	-	-	Hatchback Engine LDE	261138	Drive Shaft		30	27	52.5	94.5	598					
	2010.01-2015.12	-	-	-	Hatchback Engine LDE	208076	Drive Shaft		33	34	53	95	626					
	2010.01-2015.12	-	-	-	Hatchback Engine LDE	208078	Drive Shaft		33	34	53	95	976					
	2010.01-2015.12	-	-	-	Hatchback Engine LDE	208079	Drive Shaft		33	34	52.5	94	643					
1.6 T (135 kW)	2010.01-2015.12	-	-	-	Hatchback Engine LLU	261137	Drive Shaft		30	34	52.5	94.5	640					
	2010.01-2015.12	-	-	-	Hatchback Engine LLU	261138	Drive Shaft		30	27	52.5	94.5	598					
	2010.01-2015.12	-	-	-	Hatchback Engine LLU	208076	Drive Shaft		33	34	53	95	626					
	2010.01-2015.12	-	-	-	Hatchback Engine LLU	208078	Drive Shaft		33	34	53	95	976					
	2010.01-2015.12	-	-	-	Hatchback Engine LLU	208079	Drive Shaft		33	34	52.5	94	643					
1.8 (108 kW)	2010.01-2012.12	AT	L	-	Hatchback Engine 2H0	208079	Drive Shaft		33	34	52.5	94	643					
GL8 I (CU2)																		
2.5 (112 kW)	2005.11-2010.11	AT	L	-	MPV Engine LB8	206055	Drive Shaft		33	34	50	105	574					
	2005.11-2010.11	AT	R	-	MPV Engine LB8	206056	Drive Shaft		33	34	50	105	651					
3.0 (126 kW)	2005.07-2006.05	-	L	F	MPV Engine LW9	206055	Drive Shaft		33	34	50	105	574					
	2005.07-2006.05	-	R	F	MPV Engine LW9	206056	Drive Shaft		33	34	50	105	651					

YEAR	TRANSM	L/R	F/R	REMARKS	GSP Ref.	PRODUCT	ABS	Technical Specifications						
								A	B	C	H	L	P	
BUICK (SGM)														
GL8 I (CU2)														
3.0 (126 kW)	2006.05-2010.12	-	L	F	MPV Engine LZC	206055	Drive Shaft		33	34	50	105	574	
	2006.05-2010.12	-	R	F	MPV Engine LZC	206056	Drive Shaft		33	34	50	105	651	
LACROSSE														
2.4 (125 kW)	2006.03-2009.07	4AT	L/R	-	Saloon Engine LE5	206052	Drive Shaft		33	34	50	105	582	
	2006.03-2009.07	6AT	L	-	Saloon Engine LE5	206053	Drive Shaft		33	34	50	105	674	
	2006.03-2009.07	6AT	R	-	Saloon Engine LE5	206054	Drive Shaft		33	34	50	105	542	
	2009.07-2012.12	-	-	-	Saloon Engine LE5	206052	Drive Shaft		33	34	50	105	582	
	2009.07-2012.12	-	-	-	Saloon Engine LE5	206053	Drive Shaft		33	34	50	105	674	
	2009.07-2012.12	-	-	-	Saloon Engine LE5	206054	Drive Shaft		33	34	50	105	542	
	2009.07-2012.12	-	-	-	Saloon Engine LE5	221041	Drive Shaft		30	27	53	94.5	615	
	2009.07-2012.12	-	-	-	Saloon Engine LE5	221042	Drive Shaft		30	34	53	94.5	668	
2.4 (137 kW)	2011.01-	AT	L/R	-	Saloon Engine LAF	206052	Drive Shaft		33	34	50	105	582	
	2011.01-	6AT	L	-	Saloon Engine LAF	206053	Drive Shaft		33	34	50	105	674	
	2011.01-	6AT	-	-	Saloon Engine LAF	206054	Drive Shaft		33	34	50	105	542	
2.4 Hybrid (131 kW)	2008.07-2009.07	4AT	L/R	-	Saloon Engine LE5	206052	Drive Shaft		33	34	50	105	582	
	2008.07-2009.07	6AT	L	-	Saloon Engine LE5	206053	Drive Shaft		33	34	50	105	674	
	2008.07-2009.07	6AT	R	-	Saloon Engine LE5	206054	Drive Shaft		33	34	50	105	542	
2.4 Hybrid (137 kW)	2011.08-	AT	L/R	-	Saloon Engine LUK	206052	Drive Shaft		33	34	50	105	582	
	2011.08-	6AT	L	-	Saloon Engine LUK	206053	Drive Shaft		33	34	50	105	674	
	2011.08-	6AT	-	-	Saloon Engine LUK	206054	Drive Shaft		33	34	50	105	542	
REGAL I														
2.0 (91 kW)	2003.02-2008.12	MT	L	F	Saloon Engine L34	208007	Drive Shaft		33	34	50	105	667	
	2003.02-2008.12	MT	R	F	Saloon Engine L34	208008	Drive Shaft		33	34	50	105	998	
2.5 (112 kW)	2002.12-2008.12	AT	R	F	Saloon Engine LB8	206028	Drive Shaft		33	34	50	105	654	
	2002.12-2008.12	AT	L	F	Saloon Engine LB8	206029	Drive Shaft		33	34	50	105	575	
3.0 (126 kW)	2002.10-2006.05	AT	R	F	Saloon Engine LW9	206028	Drive Shaft		33	34	50	105	654	
	2002.10-2006.05	AT	L	F	Saloon Engine LW9	206029	Drive Shaft		33	34	50	105	575	
REGAL II														
1.6 Turbo (135 kW)	2009.09-2012.12	-	L	F	Saloon Engine LLU	221043	Drive Shaft		30	25	52.5	94.5	624.5	
	2009.09-2012.12	-	R	F	Saloon Engine LLU	221044	Drive Shaft		30	34	52.5	94.5	606	
2.0 (108 kW)	2008.12-2013.12	MT	L	-	Saloon Engine LTD	208007	Drive Shaft		33	34	50	105	667	
	2008.12-2013.12	MT	R	-	Saloon Engine LTD	208008	Drive Shaft		33	34	50	105	998	
	2008.12-2013.12	AT	R	-	Saloon Engine LTD	221041	Drive Shaft		30	27	53	94.5	615	
	2008.12-2013.12	AT	L	-	Saloon Engine LTD	221042	Drive Shaft		30	34	53	94.5	668	
2.4 (125 kW)	2008.12-2011.12	AT	R	F	Saloon Engine LE5	221041	Drive Shaft		30	27	53	94.5	615	
	2008.12-2011.12	AT	L	F	Saloon Engine LE5	221042	Drive Shaft		30	34	53	94.5	668	
GS 2.0 (162 kW)	2009.06-2013.12	MT	L	-	Saloon Engine LDK	208007	Drive Shaft		33	34	50	105	667	
	2009.06-2013.12	MT	R	-	Saloon Engine LDK	208008	Drive Shaft		33	34	50	105	998	
	2009.06-2013.12	AT	L	-	Saloon Engine LDK	221042	Drive Shaft		30	34	53	94.5	668	
GS 2.0 (187 kW)	2013.09-	MT	-	-	Saloon Engine LDK	208007	Drive Shaft		33	34	50	105	667	
SAIL														
1.6 (68 kW)	2001.06-2004.07	AT/MT	L	F	Saloon Engine L01	207001	Drive Shaft	29T	22	22	52	98	570.5	
	2001.06-2005.02	AT/MT	L	F	Estate Engine L01	207001	Drive Shaft	29T	22	22	52	98	570.5	
LACROSSE														
3.0 (190 kW)	2009.07-2012.12	AT	-	-	-	208083	Drive Shaft		30	34	52.5	94.5	665	
BYD														
F0														
1.0 (50 kW)	2008.09-	MT	L	-	Hatchback Engine 371QA	269003	Drive Shaft	48T	24	24	50.9	85	645	
	2008.09-	MT	R	-	Hatchback Engine 371QA	269004	Drive Shaft	48T	24	24	50.9	85	837	
F3														
1.0 DM (50 kW)	2009.01-	-	L	F	Saloon Engine BYD371QA	269001	Drive Shaft	48T	26	25	58	96.5	635	
	2009.01-	-	R	F	Saloon Engine BYD371QA	269002	Drive Shaft	48T	26	25	58	96.5	919	
1.5 (78 kW)	2007.09-2010.12	-	L	F	Saloon Engine 4G15S	269001	Drive Shaft	48T	26	25	58	96.5	635	
	2007.09-2010.12	-	R	F	Saloon Engine 4G15S	269002	Drive Shaft	48T	26	25	58	96.5	919	
1.5 (79 kW)	2009.11-2012.12	-	R	-	Saloon Engine 4G15S/BYD473QB	269001	Drive Shaft	48T	26	25	58	96.5	635	
	2009.11-2012.12	-	L	-	Saloon Engine 4G15S/BYD473QB	269002	Drive Shaft	48T	26	25	58	96.5	919	
1.5 (80 kW)	2011.01-	-	L	-	Saloon Engine BYD473QD/BYD473QE	269001	Drive Shaft	48T	26	25	58	96.5	635	
	2011.01-	-	R	-	Saloon Engine BYD473QD/BYD473QE	269002	Drive Shaft	48T	26	25	58	96.5	919	
1.5 TI (113 kW)	2012.08-	-	L	-	Saloon Engine BYD476ZQA	269001	Drive Shaft	48T	26	25	58	96.5	635	
	2012.08-	-	R	-	Saloon Engine BYD476ZQA	269002	Drive Shaft	48T	26	25	58	96.5	919	
1.6	2006-	MT	-	-	-	869005	Outer Joint	48T	26	32	58	96.5	64.5	M
	2007-	MT	-	-	-	869006	Outer Joint	48T	26	30	58	96.5	62.5	I
1.6 (74 kW)	2005.09-2013.12	-	L	-	Saloon Engine DA4G18	269001	Drive Shaft	48T	26	25	58	96.5	635	
	2005.09-2013.12	-	R	-	Saloon Engine DA4G18	269002	Drive Shaft	48T	26	25	58	96.5	919	
1.8 (90 kW)	2007.05-2008.12	-	L	-	Saloon Engine BYD483QA	269001	Drive Shaft	48T	26	25	58	96.5	635	

	 YEAR	TRANSM	L/R	F/R	REMARKS	GSP Ref.	 PRODUCT	 ABS	Technical Specifications					
									A	B	C	H	L	P
BYD														
F3														
1.8 (90 kW)	2007.05-2008.12	-	R	-	Saloon Engine BYD483QA	269002	Drive Shaft	48T	26	25	58	96.5	919	
F6														
2.0	-	-	MT	L/R	-	699082	Inner Joint		25	24	41	63	94	
2.0 (103 kW)	2008.03-2014.12	MT	L	-	Saloon Engine BYD483QB	269005	Drive Shaft	48T	26	25	63	89.5	656	
	2008.03-2014.12	MT	R	-	Saloon Engine BYD483QB	269006	Drive Shaft	48T	26	25	63	89.5	996	
L3														
1.8 (90 kW)	2010.08-2015.12	AT	-	-	Saloon Engine BYD483QA	259322	Drive Shaft	48T	26	23	58	96.5	646	
CADILLAC														
-	-	-	-	-	-	835068	Propshaft CV Joint		21		27.5			
CTS														
2.8 (155 kW)	2008.01-	-	R	-	Saloon Engine LP1	207018	Drive Shaft		30		54.5	105	759	
	2008.01-	-	L	-	Saloon Engine LP1	299226	Drive Shaft		30	34	55	103.5	678	
2.8 (158 kW)	2005.03-2007.09	-	R	-	Saloon Engine LP1	207011	Drive Shaft		30	27	55	106.5	865	
	2005.03-2007.09	-	L	-	Saloon Engine LP1	207012	Drive Shaft		30	27	55	106.5	792	
3.0 (203 kW)	2008.01-	-	-	-	Saloon Engine LF1	207018	Drive Shaft		30		54.5	105	759	
	2008.01-	-	-	-	Saloon Engine LF1	299226	Drive Shaft		30	34	55	103.5	678	
3.6 (189 kW)	2005.03-2007.09	-	-	-	Saloon Engine LY7	207013	Drive Shaft		30	27	55	106.5	778	
3.6 (229 kW)	2008.01-	-	R	-	Saloon Engine LLT	207018	Drive Shaft		30		54.5	105	759	
	2008.01-	-	L	-	Saloon Engine LLT	299226	Drive Shaft		30	34	55	103.5	678	
6.2 (415 kW)	2009.01-	-	R	-	Saloon Engine LSA	207018	Drive Shaft		30		54.5	105	759	
	2009.01-	-	L	-	Saloon Engine LSA	299226	Drive Shaft		30	34	55	103.5	678	
ELDORADO														
-	1985-	-	-	-	EBody	808007	Outer Joint		27	34	55.8	127.5	64	O
4.6 (220 kW)	1991.09-1994.09	-	-	-	Coupe Engine L37	808008	Outer Joint		27	32	61.5	120	64.5	O
ESCALADE														
5.7 AWD (190 kW)	1998.10-2006.10	-	-	F	All-wheel Drive Closed Off-Road Vehicle Engine LO5	844054	Outer Joint		33	35	72.8	112.5	73.5	O
6.0 HYBRID AWD (248 kW)	2010.11-2013.12	-	-	F	All-wheel Drive Closed Off-Road Vehicle Engine LZ1	807001	Outer Joint		33	41	80	112	88.5	O
6.0L V8 - Electric/Flex	2012-	-	L/R	-	Base, Hybrid, Hybrid Platinum, Luxury, Platinum, Premium	207007	Drive Shaft		33		72.8	112.5	583	
	2013-	-	L/R	-	Base, Hybrid, Hybrid Platinum, Luxury, Platinum, Premium	207007	Drive Shaft		33		72.8	112.5	583	
6.2 AWD (301 kW)	2006.10-2014.12	-	-	F	All-wheel Drive Closed Off-Road Vehicle Engine L94	807001	Outer Joint		33	41	80	112	88.5	O
	2006.10-2014.12	-	-	F	All-wheel Drive Closed Off-Road Vehicle Engine L94	844054	Outer Joint		33	35	72.8	112.5	73.5	O
6.2 Flex AWD (301 kW)	2010.01-	-	-	F	All-wheel Drive Pickup Engine L92	807001	Outer Joint		33	41	80	112	88.5	O
6.2 FLEXFUEL AWD (301 kW)	2006.10-2014.12	-	-	F	All-wheel Drive Closed Off-Road Vehicle Engine L92	807001	Outer Joint		33	41	80	112	88.5	O
	2006.10-2014.12	-	-	F	All-wheel Drive Closed Off-Road Vehicle Engine L92	844054	Outer Joint		33	35	72.8	112.5	73.5	O
6.2L V8 - Flex	2012-	-	L/R	-	Base, Hybrid, Hybrid Platinum, Luxury, Platinum, Premium	207007	Drive Shaft		33		72.8	112.5	583	
	2013-	-	L/R	-	Base, Hybrid, Hybrid Platinum, Luxury, Platinum, Premium	207007	Drive Shaft		33		72.8	112.5	583	
	2014-	-	L/R	F	Base, Luxury, Platinum, Premium	207007	Drive Shaft		33		72.8	112.5	583	
ESCALADE ESV														
6.2L V8 - Flex	2012-	-	L/R	-	Base, Luxury, Platinum, Premium	207007	Drive Shaft		33		72.8	112.5	583	
	2013-	-	L/R	-	Base, Luxury, Platinum, Premium	207007	Drive Shaft		33		72.8	112.5	583	
	2014-	-	L/R	-	Base, Luxury, Platinum, Premium	207007	Drive Shaft		33		72.8	112.5	583	
	2013-	-	-	-	Base, Luxury, Premium	207007	Drive Shaft		33		72.8	112.5	583	
SEVILLE														
4.6 SLS V8 (205 kW)	1997.09-2004.09	-	-	-	Saloon Engine LH2	808008	Outer Joint		27	32	61.5	120	64.5	O
4.6 STS V8 (224 kW)	1997.09-2004.09	-	-	-	Saloon Engine LH2	808008	Outer Joint		27	32	61.5	120	64.5	O
All Models	1985.01-1990.12	-	-	-	-	808005	Outer Joint		27	34	56	109	63	O
SEVILLE II (K)														
4.5 V8 (134 kW)	1987.09-1990.09	-	-	-	Saloon Engine LW2	808008	Outer Joint		27	32	61.5	120	64.5	O
SRX														
2.8 AWD (224 kW)	2009.01-	-	L	-	All-wheel Drive Closed Off-Road Vehicle Engine LAU	207009	Drive Shaft		30	27	54.5	105	801	
	2009.01-	-	R	-	All-wheel Drive Closed Off-Road Vehicle Engine LAU	207014	Drive Shaft		30	27	52.1	94.5	645	
	2009.01-	-	R	-	All-wheel Drive Closed Off-Road Vehicle Engine LAU	207017	Drive Shaft		30	34	53	94.5	877	
3.0 (198 kW)	2009.01-	-	L	-	Closed Off-Road Vehicle Engine LF1	207009	Drive Shaft		30	27	54.5	105	801	
	2009.01-	-	R	-	Closed Off-Road Vehicle Engine LF1	207014	Drive Shaft		30	27	52.1	94.5	645	
	2009.01-	-	R	-	Closed Off-Road Vehicle Engine LF1	207017	Drive Shaft		30	34	53	94.5	877	
3.0 AWD (198 kW)	2009.01-	-	L	-	All-wheel Drive Closed Off-Road Vehicle Engine LF1	207009	Drive Shaft		30	27	54.5	105	801	
	2009.01-	-	R	-	All-wheel Drive Closed Off-Road Vehicle Engine LF1	207014	Drive Shaft		30	27	52.1	94.5	645	
	2009.01-	-	R	-	All-wheel Drive Closed Off-Road Vehicle Engine LF1	207017	Drive Shaft		30	34	53	94.5	877	
3.6 (190 kW)	2004.01-2008.12	-	L	R	Closed Off-Road Vehicle Engine LY7	207009	Drive Shaft		30	27	54.5	105	801	
3.6 AWD (190 kW)	2004.07-2008.12	-	L	-	All-wheel Drive Closed Off-Road Vehicle Engine LY7	207009	Drive Shaft		30	27	54.5	105	801	
	2004.07-2008.12	-	L	-	All-wheel Drive Closed Off-Road Vehicle Engine LY7	299226	Drive Shaft		30	34	55	103.5	678	
3.6 AWD (234 kW)	2012.10-	-	-	-	All-wheel Drive Closed Off-Road Vehicle Engine LFX	207014	Drive Shaft		30	27	52.1	94.5	645	
4.6 (239 kW)	2003.09-2009.12	-	-	F	Closed Off-Road Vehicle Engine LH2	821071	Outer Joint		30	24	55	103.5	59	M
4.6 (240 kW)	2004.01-2008.12	-	L	R	Closed Off-Road Vehicle Engine LH2	207009	Drive Shaft		30	27	54.5	105	801	

YEAR	TRANSM	L/R	F/R	REMARKS	GSP Ref.	PRODUCT	ABS	Technical Specifications							
								A	B	C	H	L	P		
CADILLAC SRX															
4.6 AWD (239 kW)	2003.09-2009.12	-	L	-	All-wheel Drive Closed Off-Road Vehicle Engine LH2	207009	Drive Shaft	30	27	54.5	105	801			
	2003.09-2009.12	-	L	-	All-wheel Drive Closed Off-Road Vehicle Engine LH2	299226	Drive Shaft	30	34	55	103.5	678			
	2003.09-2009.12	-	-	F	All-wheel Drive Closed Off-Road Vehicle Engine LH2	821071	Outer Joint	30	24	55	103.5	59	M		
CADILLAC (SGM) SLS															
2.0 T (193 kW)	2010.12-2013.12	-	R	F	Saloon Engine LNF	207015	Drive Shaft	30	27	54.5	103.5	867			
	2010.12-2013.12	-	L	F	Saloon Engine LNF	207016	Drive Shaft	30	27	54.5	103.5	800			
2.8 (155 kW)	2006.12-2009.12	-	R	-	Saloon Engine LP1	207015	Drive Shaft	30	27	54.5	103.5	867			
	2006.12-2009.12	-	L	-	Saloon Engine LP1	207016	Drive Shaft	30	27	54.5	103.5	800			
3.0 (234 kW)	2009.12-2013.12	-	R	R	Saloon Engine LF1	207015	Drive Shaft	30	27	54.5	103.5	867			
	2009.12-2013.12	-	L	R	Saloon Engine LF1	207016	Drive Shaft	30	27	54.5	103.5	800			
3.6 (190 kW)	2006.12-2009.12	-	R	-	Saloon Engine LY7	207015	Drive Shaft	30	27	54.5	103.5	867			
	2006.12-2009.12	-	L	-	Saloon Engine LY7	207016	Drive Shaft	30	27	54.5	103.5	800			
3.6 (229 kW)	2009.12-2012.12	-	R	R	Saloon Engine LLT	207015	Drive Shaft	30	27	54.5	103.5	867			
	2009.12-2012.12	-	L	R	Saloon Engine LLT	207016	Drive Shaft	30	27	54.5	103.5	800			
4.6 (239 kW)	2006.12-2009.12	-	R	-	Saloon Engine L37 LH2	207015	Drive Shaft	30	27	54.5	103.5	867			
	2006.12-2009.12	-	L	-	Saloon Engine L37 LH2	207016	Drive Shaft	30	27	54.5	103.5	800			
CHANGAN BENNI MINI/BENBEN MINI															
1.0 (51 kW)	2010.03-		MT	L	-	Hatchback Engine JL466Q5/JL466QL	238006	Drive Shaft	40T	23	22	51	92.5	562.5	
	2010.03-		MT	R	-	Hatchback Engine JL466Q5/JL466QL	238007	Drive Shaft	40T	23	22	51	92.5	832	
BENNI/BENBEN															
1.3 (63 kW)	2006.11-2011.12		MT	L	-	Hatchback Engine G 13 B/JL474Q2/JL474Q6/JL474Q8/JL474QB	257056	Drive Shaft	42T	23	22	49	77.5	609.5	
	2006.11-2011.12		MT	R	-	Hatchback Engine G 13 B/JL474Q2/JL474Q6/JL474Q8/JL474QB	257057	Drive Shaft	42T	23	22	49	77.5	847.5	
CS35															
1.6	2012-		MT	-	-		675021	Inner Joint		23	28	40	61	98	
	2012-		MT	-	-		875023	Outer Joint	46T	27	29	60	92.5	55.5 M	
1.6 (92 kW)	2012.10-		4AT	R	-	Closed Off-Road Vehicle Engine JL478QEE/JL478QEG	275032	Drive Shaft	46T	27	23	60	92.5	979	
	2012.10-		4AT	L	-	Closed Off-Road Vehicle Engine JL478QEE/JL478QEG	275033	Drive Shaft	46T	27	23	60	92.5	652	
	2012.10-		MT	L	-	Closed Off-Road Vehicle Engine JL478QEE/JL478QEG	275034	Drive Shaft	46T	27	23	60	92.5	637	
	2012.10-		MT	R	-	Closed Off-Road Vehicle Engine JL478QEE/JL478QEG	275035	Drive Shaft	46T	27	23	60	92.5	997	
CX20															
1.3 (63 kW)	2010.10-2012.12		MT	R	-	Hatchback Engine JL474QK	275036	Drive Shaft	41T	23	22	49	78	865	
	2010.10-2012.12		MT	L	-	Hatchback Engine JL474QK	275037	Drive Shaft	41T	23	22	49	78	624	
	2010.10-2012.12		AT	L	-	Hatchback Engine JL474QK	275038	Drive Shaft	41T	23	22	49	78	602	
	2010.10-2012.12		AT	R	-	Hatchback Engine JL474QK	275039	Drive Shaft	41T	23	22	49	78	878	
EADO															
1.6 (92 kW)	2012.03-		MT	R	-	Saloon Engine JL478QEB	275028	Drive Shaft	46T	27	23	60	94.5	961	
	2012.03-		MT	L	-	Saloon Engine JL478QEB	275029	Drive Shaft	46T	27	23	60	94.5	660	
	2012.03-		4AT	R	-	Saloon Engine JL478QEB	275030	Drive Shaft	46T	27	23	60	92	939	
	2012.03-		4AT	L	-	Saloon Engine JL478QEB	275031	Drive Shaft	46T	27	23	60	92	662	
	2013.08-		MT	R	-	Hatchback Engine JL478QEJ	275028	Drive Shaft	46T	27	23	60	94.5	961	
	2013.08-		MT	L	-	Hatchback Engine JL478QEJ	275029	Drive Shaft	46T	27	23	60	94.5	660	
	2013.08-		AT	R	-	Hatchback Engine JL478QEJ	275030	Drive Shaft	46T	27	23	60	92	939	
	2013.08-		AT	L	-	Hatchback Engine JL478QEJ	275031	Drive Shaft	46T	27	23	60	92	662	
YUEXIANG															
1.5 (72 kW)	2009.01-2012.12		MT	L	F	Saloon Engine JL475Q7	234105	Drive Shaft	43T	25	23	52.5	92.5	639	
	2009.01-2012.12		MT	R	F	Saloon Engine JL475Q7	234106	Drive Shaft	43T	25	23	52.5	92.5	921.5	
	2009.01-2012.12		-	-	-	Hatchback Engine JL475Q7	234105	Drive Shaft	43T	25	23	52.5	92.5	639	
	2009.01-2012.12		-	-	-	Hatchback Engine JL475Q7	234106	Drive Shaft	43T	25	23	52.5	92.5	921.5	
CHANGFENG LEOPAARD															
2.4 (92 kW)	2004.09-		MT	L	-	All-wheel Drive Closed Off-Road Vehicle Engine 4 G 64	239124	Drive Shaft		28	28	56	154	604.5	
	2004.09-		MT	R	-	All-wheel Drive Closed Off-Road Vehicle Engine 4 G 64	239125	Drive Shaft		28		56	154	523	
LEOPAARD/LIEBAO															
3.0 (133 kW)	1999.01-2010.01		MT	L	-	All-wheel Drive MPV Engine 6 G 72 (24V)	239124	Drive Shaft		28	28	56	154	604.5	
	1999.01-2010.01		MT	R	-	All-wheel Drive MPV Engine 6 G 72 (24V)	239125	Drive Shaft		28		56	154	523	
PAJERO															
3.0 (123 kW)	2004.12-2006.12		AT	R	-	All-wheel Drive Closed Off-Road Vehicle Engine 6 G 72 (24V)	239165	Drive Shaft		28		56	155.5	531	
	2004.12-2006.12		AT	L	-	All-wheel Drive Closed Off-Road Vehicle Engine 6 G 72 (24V)	239166	Drive Shaft		28	28	56	155.5	607	
	2004.12-2006.12		AT	R	-	All-wheel Drive Closed Off-Road Vehicle Engine 6 G 72 (24V)	239095	Drive Shaft	50T	30		66	98	527	
3.8 (150 kW)	2004.12-2005.12		AT	R	-	All-wheel Drive Closed Off-Road Vehicle Engine 6 G 75	239165	Drive Shaft		28		56	155.5	531	
	2004.12-2005.12		AT	L	-	All-wheel Drive Closed Off-Road Vehicle Engine 6 G 75	239166	Drive Shaft		28	28	56	155.5	607	
	2004.12-2005.12		AT	R	-	All-wheel Drive Closed Off-Road Vehicle Engine 6 G 75	239095	Drive Shaft	50T	30		66	98	527	





YEAR	TRANSM	L/R	F/R	REMARKS	GSP Ref.	PRODUCT	ABS	Technical Specifications						
								A	B	C	H	L	P	
CHANGHE IDEAL														
1.0 (34 kW)	2003.10-2014.12	MT	-	-	MPV Engine DA465Q-2/DA465Q-2/D1	257052	Drive Shaft		23	22	49	78	830	
CHERY A5														
1.5	-	-	-	-	-	699082	Inner Joint		25	24	41	63	94	
1.6	-	-	MT	-	-	868002	Outer Joint		28	30	55.5	99	61	I
2.0	-	-	-	-	-	668004	Inner Joint		25	28	41	61.5	104.5	
A5/ELARA/ALIA/FORA														
1.6 Hybrid (88 kW)	2009.01-2012.12	MT	L	-	Saloon Engine SQR481F	268005	Drive Shaft		28	25	55.5	99	620	
	2009.01-2012.12	MT	R	-	Saloon Engine SQR481F	268006	Drive Shaft		28	25	55.5	99	976	
1.6 LPG (87 kW)	2006.01-2009.01	MT	L	-	Saloon Engine SQR481F	268005	Drive Shaft		28	25	55.5	99	620	
	2006.01-2009.01	MT	R	-	Saloon Engine SQR481F	268006	Drive Shaft		28	25	55.5	99	976	
COWIN														
1.6 (65 kW)	2003.08-2007.09	-	L	-	Saloon Engine SQR480	268007	Drive Shaft		22		53	78	524	
	2003.08-2007.09	AT	L	-	Saloon Engine SQR480	268008	Drive Shaft		22	25	53	78	596	
	2003.08-2007.09	AT	R	-	Saloon Engine SQR480	268009	Drive Shaft		22	25	53	78	896	
1.6 (71 kW)	2007.09-2008.07	-	L	-	Saloon Engine SQR480	268007	Drive Shaft		22		53	78	524	
	2007.09-2008.07	AT	L	-	Saloon Engine SQR480	268008	Drive Shaft		22	25	53	78	596	
	2007.09-2008.07	AT	R	-	Saloon Engine SQR480	268009	Drive Shaft		22	25	53	78	896	
1.6/2.0	-	-	MT/AT	-	-	868003	Outer Joint		22	30	53	78	61	I
COWIN(A15)														
1.5	-	-	-	-	-	868010	Outer Joint		22	22	55	84.5	61	I
COWIN/AMULET														
1.3 (60 kW)	2006.09-2008.07	-	-	-	Saloon Engine SQR475E	268007	Drive Shaft		22		53	78	524	
1.5 (80 kW)+G44G44931:H44984	2008.07-2010.05	-	-	-	Saloon Engine SQR477F	268007	Drive Shaft		22		53	78	524	
1.6 (85 kW)	2003.08-2007.09	-	L	-	Saloon Engine T16B3	268007	Drive Shaft		22		53	78	524	
	2003.08-2007.09	AT	L	-	Saloon Engine T16B3	268008	Drive Shaft		22	25	53	78	596	
	2003.08-2007.09	AT	R	-	Saloon Engine T16B3	268009	Drive Shaft		22	25	53	78	896	
EASTAR														
1.6	2006-	-	-	-	-	668005	Inner Joint		25	33	41	61.5	95	
2.0	-	-	-	-	-	699082	Inner Joint		25	24	41	63	94	
	2004-	-	MT/AT	-	-	699082	Inner Joint		25	24	41	63	94	
EASTAR CROSS														
2.4 (95 kW)	2007.06-2008.12	AT	L	-	MPV Engine 4G64-S4M	674001	Inner Joint		27	24	41	62.5	93	
	2007.06-2008.12	AT	L	-	MPV Engine 4G64-S4M	899175	Outer Joint		28	25	55.5	99	61	O
FULWIN														
-	-	-	MT	-	-	899133	Outer Joint		22	32	53.2	78	61	O
1.8	-	-	MT	-	-	899133	Outer Joint		22	32	53.2	78	61	O
	-	-	MT	-	-	699051	Inner Joint			32		34		
QQ III														
1.1	2004-	-	MT	-	-	868009	Outer Joint	40T	22	19	51	91	56.5	M
QQ VI														
-	-	-	-	-	-	868005	Outer Joint	43T	23	21	51	94	54	I
QQ3														
0.8 (38 kW)	2004.03-2012.12	MT	L	-	Hatchback Engine SQR372	268001	Drive Shaft							
	2004.03-2012.12	MT	R	-	Hatchback Engine SQR372	268002	Drive Shaft							
	2004.03-2012.12	MT	-	-	Hatchback Engine SQR372	899103	Outer Joint		22	19	51	91	56.5	O
1.1 (39 kW)	2003.06-	MT	L	-	Hatchback Engine F11A/LJ465Q-1ANE1	268003	Drive Shaft							
	2003.06-	MT	R	-	Hatchback Engine F11A/LJ465Q-1ANE1	268004	Drive Shaft							
1.1 (50 kW)	2006.06-2010.12	MT	L	-	Hatchback Engine SQR472	268003	Drive Shaft							
	2006.06-2010.12	MT	R	-	Hatchback Engine SQR472	268004	Drive Shaft							
SPERANZA														
-	-	-	-	-	-	868002	Outer Joint		28	30	55.5	99	61	I
TIGGO														
2.0	-	-	-	-	-	699082	Inner Joint		25	24	41	63	94	
TIGGO(T11)														
-	-	-	MT	-	-	868002	Outer Joint		28	30	55.5	99	61	I
2.0	2006-	-	-	-	-	868001	Outer Joint	48T	26	30	63	100	59	I
CHEVROLET AGILE														
-	2010-2017	-	-	-	-	821026	Outer Joint		22	22	52	97.5	55	O
	2010-2017	-	-	-	-	821026	Outer Joint		22	22	52	97.5	55	O
1.4 8V	2009-	-	-	-	-	821045	Outer Joint		22	21	52	90	55.5	M
ASTRO														
-	1990-2000	-	-	-	VAN MBody 4WD	808006	Outer Joint		33	35	77	112.5	73.5	O

YEAR	TRANSM	L/R	F/R	REMARKS	GSP Ref.	PRODUCT	ABS	Technical Specifications						
								A	B	C	H	L	P	
CHEVROLET														
ASTRO														
-	1990-2000	-	-	-	VAN MBody 4WD	821019	Outer Joint	55T	33	35	77	112.5	73.5	O
ASTRO VAN														
AWD	1992-1998	-	-	-	-	699117	Propshaft CV Joint			22		88.5		
	1992-1998	-	-	-	-	699117	Inner Joint			22		88.5		
ASTRO VAN (AWD)														
-	1992-1998	-	-	-	-	699117	Propshaft CV Joint			22		88.5		
AVALANCHE														
-	2002-2005	-	-	-	4WD SUV/Truck/VAN	839029	Outer Joint		33	41	80	112	88.5	O
5.3 Flex-Fuel AWD (227 kW)	2007.01-	-	-	-	F All-wheel Drive Pickup	807001	Outer Joint		33	41	80	112	88.5	O
	2007.01-	-	-	-	F All-wheel Drive Pickup	844054	Outer Joint		33	35	72.8	112.5	73.5	O
5.3L V8 - Flex	2013-	-	-	-	Black Diamond LS, Black Diamond LT, Black Diamond LTZ	207007	Drive Shaft		33		72.8	112.5	583	
AVEO														
-	-	-	-	-	-	808025	Outer Joint	47T	22	23	52	96	56	M
	2008-	-	MT	L/R	-	621021	Inner Joint		34	22	35	56.5	106	
	2008-	-	AT	L/R	-	608043	Inner Joint		22	22	38	59.5	101.5	
	2008-	-	MT/AT	L/R	-	844096	Outer Joint		22	22	52	95	56.5	M
AVEO (T200)														
-	2003-2008	-	-	-	-	624068	Inner Joint		22	29	38	59.5	97.5	
	2003-2008	-	-	-	-	699107	Inner Joint		22	19	35	50.5	78	
	2003-2008	-	-	-	-	612004	Inner Joint		22	29	38	59	116	
1.4 (61 kW)	2005.03-	-	MT	L	F Hatchback Engine F14S3	212058	Drive Shaft	47T	22	34	52	96.5	606	
	2005.03-	-	MT	R	F Hatchback Engine F14S3	212057	Drive Shaft	47T	22	34	52	96.5	923	
	2005.03-	-	-	-	F Hatchback Engine F14S3	812042	Outer Joint	47T	22	22	52	96.5	53.5	O
	2005.03-	-	-	-	F Hatchback Engine F14S3	812005	Outer Joint	47T	22	22	52	96	56	I
	2005.03-	-	-	-	F Hatchback Engine F14S3	644001	Inner Joint		34	22	35	56.2	76	
1.4 16V (69 kW)	2005.03-	-	MT	L	F Hatchback Engine F14D3	212058	Drive Shaft	47T	22	34	52	96.5	606	
	2005.03-	-	MT	R	F Hatchback Engine F14D3	212057	Drive Shaft	47T	22	34	52	96.5	923	
	2005.03-	-	-	-	F Hatchback Engine F14D3	812042	Outer Joint	47T	22	22	52	96.5	53.5	O
	2005.03-	-	-	L/R	F Hatchback Engine F14D3	808021	Outer Joint	47T	22	22	52	96.5	53.5	O
	2005.03-	-	MT	-	F Hatchback Engine F14D3	644001	Inner Joint		34	22	35	56.2	76	
1.5	2003.09-2008.10	-	-	-	-	808025	Outer Joint	47T	22	23	52	96	56	M
AVEO (T250 T255)/KALOS														
1.2 (53 kW)	2006.03-2007.12	-	L/R	F	Saloon Engine F12S3	808021	Outer Joint	47T	22	22	52	96.5	53.5	O
1.2 (55 kW)	2008.01-	-	MT	-	F Saloon Engine B12D1	812042	Outer Joint	47T	22	22	52	96.5	53.5	O
	2008.01-	-	MT	L	F Saloon Engine B12D1	244069	Drive Shaft	47T	22	22	52	96.5	657	
	2008.01-	-	MT	R	F Saloon Engine B12D1	244070	Drive Shaft	47T	22	22	52	96.5	875	
	2008.04-	-	-	L/R	F Hatchback Engine LMU	808021	Outer Joint	47T	22	22	52	96.5	53.5	O
1.2 (62 kW)	2008.01-	-	MT	-	F Saloon Engine LMU	812042	Outer Joint	47T	22	22	52	96.5	53.5	O
	2008.01-	-	MT	L	F Saloon Engine LMU	244069	Drive Shaft	47T	22	22	52	96.5	657	
	2008.01-	-	MT	R	F Saloon Engine LMU	244070	Drive Shaft	47T	22	22	52	96.5	875	
	2008.01-	-	-	L/R	F Saloon Engine LMU	808021	Outer Joint	47T	22	22	52	96.5	53.5	O
	2008.04-	-	-	L	F Hatchback Engine LMU	244069	Drive Shaft	47T	22	22	52	96.5	657	
	2008.04-	-	-	-	F Hatchback Engine LMU	812042	Outer Joint	47T	22	22	52	96.5	53.5	O
	2008.04-	-	-	R	F Hatchback Engine LMU	244070	Drive Shaft	47T	22	22	52	96.5	875	
	2008.04-	-	-	L/R	F Hatchback Engine LMU	808021	Outer Joint	47T	22	22	52	96.5	53.5	O
1.2 LPG (62 kW)	2008.04-	-	MT	-	F Hatchback Engine LMU	812042	Outer Joint	47T	22	22	52	96.5	53.5	O
	2008.04-	-	MT	L	F Hatchback Engine LMU	244069	Drive Shaft	47T	22	22	52	96.5	657	
	2008.04-	-	MT	R	F Hatchback Engine LMU	244070	Drive Shaft	47T	22	22	52	96.5	875	
	2008.04-	-	-	L/R	F Hatchback Engine LMU	808021	Outer Joint	47T	22	22	52	96.5	53.5	O
	2009.01-	-	MT	-	F Saloon Engine LMU	812042	Outer Joint	47T	22	22	52	96.5	53.5	O
	2009.01-	-	MT	L	F Saloon Engine LMU	244069	Drive Shaft	47T	22	22	52	96.5	657	
	2009.01-	-	MT	R	F Saloon Engine LMU	244070	Drive Shaft	47T	22	22	52	96.5	875	
1.4 (61 kW)	2005.03-	-	MT	L	F Saloon Engine F14S3	212058	Drive Shaft	47T	22	34	52	96.5	606	
	2005.03-	-	MT	R	F Saloon Engine F14S3	212057	Drive Shaft	47T	22	34	52	96.5	923	
	2005.03-	-	-	-	F Saloon Engine F14S3	812042	Outer Joint	47T	22	22	52	96.5	53.5	O
	2005.03-	-	-	-	F Saloon Engine F14S3	812005	Outer Joint	47T	22	22	52	96	56	I
	2005.03-	-	-	L/R	F Saloon Engine F14S3	808021	Outer Joint	47T	22	22	52	96.5	53.5	O
	2005.03-	-	-	-	F Saloon Engine F14S3	644001	Inner Joint		34	22	35	56.2	76	
1.4 (69 kW)	2006.03-2007.12	-	-	-	Saloon Engine F14D3	812005	Outer Joint	47T	22	22	52	96	56	I
	2006.03-2007.12	-	L/R	F	Saloon Engine F14D3	808021	Outer Joint	47T	22	22	52	96.5	53.5	O
1.4 (74 kW)	2008.04-	-	-	-	F Hatchback Engine F14D4	812042	Outer Joint	47T	22	22	52	96.5	53.5	O
	2008.04-	-	-	L/R	F Hatchback Engine F14D4	808021	Outer Joint	47T	22	22	52	96.5	53.5	O
	2008.09-	-	-	-	F Saloon Engine F14D4	812042	Outer Joint	47T	22	22	52	96.5	53.5	O
	2008.09-	-	-	L/R	F Saloon Engine F14D4	808021	Outer Joint	47T	22	22	52	96.5	53.5	O
AVEO (T250)														
-	2006-2008	-	-	-	-	699107	Inner Joint		22	19	35	50.5	78	

YEAR	TRANSM	L/R	F/R	REMARKS	GSP Ref.	PRODUCT	ABS	Technical Specifications									
								A	B	C	H	L	P				
CHEVROLET																	
AVEO (T250)																	
-	2006-	2008	-	-	-			612004	Inner Joint		22	29	38	59	116		
AVEO (T250, T255)																	
1.2 (62 kW)	2008.04-	-	-	-	-			608021	Inner Joint		22	22	35	50	76	O	
1.4 (74 kW)	2008.04-	-	-	-	-			608021	Inner Joint		22	22	35	50	76	O	
-	2009-	-	-	-	-			624068	Inner Joint		22	29	38	59.5	97.5		
BERETTA (1_37)																	
2.2 (71 kW)	1991.01-	1996.12	-	-	-	Coupe Engine LN2		806001	Outer Joint		33	29	47.6	108	63	O	
2.3 16V (130 kW)	1990.09-	1996.12	-	-	-	Coupe Engine LGO		806001	Outer Joint		33	29	47.6	108	63	O	
BERETTA (L-BODY)																	
2.2	1992-	1995	MT	-	-	-		821018	Outer Joint	48T	33	29	47.6	108	63	O	
3.1	1992-	1993	-	-	-	W.O FE3.FE7 Option		821018	Outer Joint	48T	33	29	47.6	108	63	O	
BLAZER																	
-	1999-	2005	-	-	-	-		299304	DRIVE SHAFT					119	727		
-	2000-	2005	-	-	F	4WD/PROPELLER SHAFT		608072	Propshaft CV Joint		17	22	44		119		
AWD	1995-	1997	-	-	-	-		699117	Propshaft CV Joint			22		88.5			
-	1995-	1997	-	-	-	-		699117	Inner Joint			22		88.5			
BLAZER (AWD MODELS)																	
-	1995-	1997	-	-	-	-		699117	Propshaft CV Joint			22		88.5			
BLAZER/K1500/K2500/K3500																	
-	1988-	1997	-	-	-	-		808009	Outer Joint		33	29	80	112	88.5	O	
-	1992-	1994	-	-	-	4WD SUV/Truck/Van		821022	Outer Joint	55T	33	29	80	112	88.5	O	
-	1998-	2000	-	-	-	4WD SUV/Truck/VAN		839029	Outer Joint		33	41	80	112	88.5	O	
CAPTIVA																	
2.4	2008-	2012	AT	L/R	-	-		808064	Outer Joint		30	24	54.4	104.5	64	M	
CAPTIVA (C100 C140)																	
2.0 D (110 kW)	2006.10-	-	MT	L	F	All-wheel Drive Closed Off-Road Vehicle Engine Z 20 S		208093	Drive Shaft		30	27	54	105.5	618.5		
	2006.10-	-	MT	R	F	All-wheel Drive Closed Off-Road Vehicle Engine Z 20 S		208094	Drive Shaft		30	27	54	105.5	542		
	2006.10-	-	-	-	F	All-wheel Drive Closed Off-Road Vehicle Engine Z 20 S		822009	Outer Joint		30	34	54	105.5	64.5	O	
	2006.10-	-	MT	L	F	All-wheel Drive Closed Off-Road Vehicle Engine Z 20 S		608034	Inner Joint		27	34	35	68.5	111.5		
	2006.10-	-	MT	R	F	All-wheel Drive Closed Off-Road Vehicle Engine Z 20 S		608035	Inner Joint		27	34	43.3	51	77		
	2007.09-	-	MT	L	F	Closed Off-Road Vehicle Engine Z 20 DMH		208093	Drive Shaft		30	27	54	105.5	618.5		
	2007.09-	-	MT	R	F	Closed Off-Road Vehicle Engine Z 20 DMH		208094	Drive Shaft		30	27	54	105.5	542		
	2007.09-	-	-	-	F	Closed Off-Road Vehicle Engine Z 20 DMH		822009	Outer Joint		30	34	54	105.5	64.5	O	
	2007.09-	-	MT	L	F	Closed Off-Road Vehicle Engine Z 20 DMH		608034	Inner Joint		27	34	35	68.5	111.5		
	2007.09-	-	MT	R	F	Closed Off-Road Vehicle Engine Z 20 DMH		608035	Inner Joint		27	34	43.3	51	77		
2.0 D (93 kW)	2006.10-	-	MT	L	F	All-wheel Drive Closed Off-Road Vehicle Engine Z 20 S		208093	Drive Shaft		30	27	54	105.5	618.5		
	2006.10-	-	MT	L	F	Closed Off-Road Vehicle Engine Z 20 S		208093	Drive Shaft		30	27	54	105.5	618.5		
	2006.10-	-	MT	R	F	All-wheel Drive Closed Off-Road Vehicle Engine Z 20 S		208094	Drive Shaft		30	27	54	105.5	542		
	2006.10-	-	MT	R	F	Closed Off-Road Vehicle Engine Z 20 S		208094	Drive Shaft		30	27	54	105.5	542		
	2006.10-	-	-	-	F	All-wheel Drive Closed Off-Road Vehicle Engine Z 20 S		822009	Outer Joint		30	34	54	105.5	64.5	O	
	2006.10-	-	-	-	F	Closed Off-Road Vehicle Engine Z 20 S		822009	Outer Joint		30	34	54	105.5	64.5	O	
	2006.10-	-	MT	L	F	All-wheel Drive Closed Off-Road Vehicle Engine Z 20 S		608034	Inner Joint		27	34	35	68.5	111.5		
	2006.10-	-	MT	L	F	Closed Off-Road Vehicle Engine Z 20 S		608034	Inner Joint		27	34	35	68.5	111.5		
	2006.10-	-	MT	R	F	All-wheel Drive Closed Off-Road Vehicle Engine Z 20 S		608035	Inner Joint		27	34	43.3	51	77		
	2006.10-	-	MT	R	F	Closed Off-Road Vehicle Engine Z 20 S		608035	Inner Joint		27	34	43.3	51	77		
2.2 D (120 kW)	2011.03-	-	MT	L	F	Closed Off-Road Vehicle Engine Z 22 D1		208093	Drive Shaft		30	27	54	105.5	618.5		
	2011.03-	-	MT	L	F	All-wheel Drive Closed Off-Road Vehicle Engine Z 22 D1		208093	Drive Shaft		30	27	54	105.5	618.5		
	2011.03-	-	MT	R	F	Closed Off-Road Vehicle Engine Z 22 D1		208094	Drive Shaft		30	27	54	105.5	542		
	2011.03-	-	MT	R	F	All-wheel Drive Closed Off-Road Vehicle Engine Z 22 D1		208094	Drive Shaft		30	27	54	105.5	542		
	2011.03-	-	5AT/5AT	-	F	Closed Off-Road Vehicle Engine Z 22 D1		822009	Outer Joint		30	34	54	105.5	64.5	O	
	2011.03-	-	5AT/5AT	-	F	All-wheel Drive Closed Off-Road Vehicle Engine Z 22 D1		822009	Outer Joint		30	34	54	105.5	64.5	O	
	2011.03-	-	MT	L	F	Closed Off-Road Vehicle Engine Z 22 D1		608034	Inner Joint		27	34	35	68.5	111.5		
	2011.03-	-	MT	L	F	All-wheel Drive Closed Off-Road Vehicle Engine Z 22 D1		608034	Inner Joint		27	34	35	68.5	111.5		
	2011.03-	-	MT	R	F	Closed Off-Road Vehicle Engine Z 22 D1		608035	Inner Joint		27	34	43.3	51	77		
	2011.03-	-	MT	R	F	All-wheel Drive Closed Off-Road Vehicle Engine Z 22 D1		608035	Inner Joint		27	34	43.3	51	77		
2.2 D (135 kW)	2011.03-	-	MT	L	F	All-wheel Drive Closed Off-Road Vehicle Engine A 22 DMH		208093	Drive Shaft		30	27	54	105.5	618.5		
	2011.03-	-	MT	R	F	All-wheel Drive Closed Off-Road Vehicle Engine A 22 DMH		208094	Drive Shaft		30	27	54	105.5	542		
	2011.03-	-	5AT/5AT	-	F	All-wheel Drive Closed Off-Road Vehicle Engine A 22 DMH		822009	Outer Joint		30	34	54	105.5	64.5	O	
	2011.03-	-	MT	L	F	All-wheel Drive Closed Off-Road Vehicle Engine A 22 DMH		608034	Inner Joint		27	34	35	68.5	111.5		
	2011.03-	-	MT	R	F	All-wheel Drive Closed Off-Road Vehicle Engine A 22 DMH		608035	Inner Joint		27	34	43.3	51	77		
2.4 (100 kW)	2006.06-	-	MT	L	F	Closed Off-Road Vehicle Engine Z 24 SED		208093	Drive Shaft		30	27	54	105.5	618.5		
	2006.06-	-	MT	L	F	All-wheel Drive Closed Off-Road Vehicle Engine Z 24 SED		208093	Drive Shaft		30	27	54	105.5	618.5		
	2006.06-	-	MT	R	F	Closed Off-Road Vehicle Engine Z 24 SED		208094	Drive Shaft		30	27	54	105.5	542		
	2006.06-	-	MT	R	F	All-wheel Drive Closed Off-Road Vehicle Engine Z 24 SED		208094	Drive Shaft		30	27	54	105.5	542		
	2006.06-	-	-	-	F	Closed Off-Road Vehicle Engine Z 24 SED		822009	Outer Joint		30	34	54	105.5	64.5	O	
	2006.06-	-	-	-	F	All-wheel Drive Closed Off-Road Vehicle Engine Z 24 SED		822009	Outer Joint		30	34	54	105.5	64.5	O	





YEAR	TRANSM	L/R	F/R	REMARKS	GSP Ref.	PRODUCT	ABS	Technical Specifications									
								A	B	C	H	L	P				
CHEVROLET																	
CAPTIVA (C100 C140)																	
2.4 (100 kW)	2006.06-	-	MT	L F	Closed Off-Road Vehicle Engine Z 24 SED	608034	Inner Joint		27	34	35	68.5	111.5				
	2006.06-	-	MT	L F	All-wheel Drive Closed Off-Road Vehicle Engine Z 24 SED	608034	Inner Joint		27	34	35	68.5	111.5				
	2006.06-	-	MT	R F	Closed Off-Road Vehicle Engine Z 24 SED	608035	Inner Joint		27	34	43.3	51	77				
	2006.06-	-	MT	R F	All-wheel Drive Closed Off-Road Vehicle Engine Z 24 SED	608035	Inner Joint		27	34	43.3	51	77				
2.4 (123 kW)	2011.03-	-	AT/MT	- F	Closed Off-Road Vehicle Engine A 24 XE	822009	Outer Joint		30	34	54	105.5	64.5	O			
	2011.03-	-	AT/MT	- F	All-wheel Drive Closed Off-Road Vehicle Engine A 24 XE	822009	Outer Joint		30	34	54	105.5	64.5	O			
2.4 LPG (100 kW)	2007.01-	-	MT	L F	Closed Off-Road Vehicle Engine Z 24 SED	208093	Drive Shaft		30	27	54	105.5	618.5				
	2007.01-	-	MT	L F	All-wheel Drive Closed Off-Road Vehicle Engine Z 24 SED	208093	Drive Shaft		30	27	54	105.5	618.5				
	2007.01-	-	MT	R F	Closed Off-Road Vehicle Engine Z 24 SED	208094	Drive Shaft		30	27	54	105.5	542				
	2007.01-	-	MT	R F	All-wheel Drive Closed Off-Road Vehicle Engine Z 24 SED	208094	Drive Shaft		30	27	54	105.5	542				
	2007.01-	-	-	- F	Closed Off-Road Vehicle Engine Z 24 SED	822009	Outer Joint		30	34	54	105.5	64.5	O			
	2007.01-	-	-	- F	All-wheel Drive Closed Off-Road Vehicle Engine Z 24 SED	822009	Outer Joint		30	34	54	105.5	64.5	O			
	2007.01-	-	MT	L F	Closed Off-Road Vehicle Engine Z 24 SED	608034	Inner Joint		27	34	35	68.5	111.5				
	2007.01-	-	MT	L F	All-wheel Drive Closed Off-Road Vehicle Engine Z 24 SED	608034	Inner Joint		27	34	35	68.5	111.5				
	2007.01-	-	MT	R F	Closed Off-Road Vehicle Engine Z 24 SED	608035	Inner Joint		27	34	43.3	51	77				
	2007.01-	-	MT	R F	All-wheel Drive Closed Off-Road Vehicle Engine Z 24 SED	608035	Inner Joint		27	34	43.3	51	77				
3.2 (169 kW)	2006.06-	-	-	- F	All-wheel Drive Closed Off-Road Vehicle Engine 10 HM	822009	Outer Joint		30	34	54	105.5	64.5	O			
CAPTIVA (C100)																	
-	2007-	-	-	-	-	821047	Outer Joint		30	22		105.5	53.5	O			
CAPTIVA SPORT(MEXICO)																	
-	2007-	-	-	-	R -	699239	Propshaft CV Joint			30		37					
CAVALIER																	
-	1987-	1991	-	-	-	821021	Outer Joint	48T	33	32	47.7	108	67.5	O			
	1987-	1991	-	-	-	806004	Outer Joint		33	32	47.7	108	67.5	O			
	1995-	2000	-	-	-	821009	Outer Joint		33	32	47.7	108	67	I			
CAVALIER (J-BODY)																	
-	1992-	1995	-	-	-	LD Driveline&Brakes	821018	Outer Joint	48T	33	29	47.6	108	63	O		
CAVALIER Z-24																	
-	1987-	1991	-	-	-	821021	Outer Joint	48T	33	32	47.7	108	67.5	O			
	1987-	1991	-	-	-	806004	Outer Joint		33	32	47.7	108	67.5	O			
	1995-	2000	-	-	-	821009	Outer Joint		33	32	47.7	108	67	I			
CAVALIER/Z24																	
-	1995-	2004	MT/AT	L/R	-	808023	Outer Joint	48T	33	29	47.6	108	63	M			
	1995-	2004	MT/AT	L/R	-	808010	Outer Joint		33	29	47.6	108	63	M			
CAVALIER/Z24(CONT)																	
-	1995-	2004	MT/AT	L/R	-	808023	Outer Joint	48T	33	29	47.6	108	63	M			
CELTA																	
-	2001-	2009	-	-	-	699023	Inner Joint		22	28	34.95	57.5	72.5				
	2010-	2015	-	-	-	821026	Outer Joint		22	22	52	97.5	55	O			
	2010-	2015	-	-	-	821026	Outer Joint		22	22	52	97.5	55	O			
1.0 8V	2013-	-	-	-	-	821045	Outer Joint		22	21	52	90	55.5	M			
CHEVROLET ASTRO VAN (AWD)																	
-	1992-	1998	-	-	-	699117	Inner Joint			22		88.5					
CHEVROLET BLAZER (AWD MODELS)																	
-	1995-	1997	-	-	-	699117	Inner Joint			22		88.5					
CHEVY (MEXICO)																	
-	1996-	2003	-	-	-	821026	Outer Joint		22	22	52	97.5	55	O			
COBALT																	
1.4 8V	2012-	-	MT	-	-	821058	Outer Joint		25	22	51	92	54.5	M			
	2012-	-	MT	L	-	221119	Drive Shaft		25	22	51	91	606				
COLORADO																	
-	2004-	2009	-	-	F	AWD/PROPELLER SHAFT	608074	Propshaft CV Joint			34		57				
CORSA																	
-	-	-	-	R	-	244018	Drive Shaft		22	22	52	97.5	912				
	-	-	-	L	-	244019	Drive Shaft		22	22	52	97.5	562				
	1994-	2017	-	-	-	821026	Outer Joint		22	22	52	97.5	55	O			
	1994-	2012	-	L	F	699023	Inner Joint		22	28	34.95	57.5	72.5				
	1994-	2009	-	-	-	699023	Inner Joint		22	28	34.95	57.5	72.5				
	1994-	2017	-	L	F	821026	Outer Joint		22	22	52	97.5	55	O			
1.0 8V	2009-	-	-	-	-	821045	Outer Joint		22	21	52	90	55.5	M			
1.4 8V	2010-	-	-	-	-	821045	Outer Joint		22	21	52	90	55.5	M			
CORSA TH																	
-	-	-	-	-	-	899065	Outer Joint		22	30	52.2	97.5	55	O			
CORSICA (L-BODY)																	
-	1992-	1993	-	-	-	LD Driveline&Brakes	821018	Outer Joint	48T	33	29	47.6	108	63	O		

YEAR	TRANSM	L/R	F/R	REMARKS	GSP Ref.	PRODUCT	ABS	Technical Specifications							
								A	B	C	H	L	P		
CHEVROLET															
CRUZE															
-	2008-	-	AT	L	-	-	208107	Drive Shaft	33	34	59	94.5	640		
-	2008-	-	AT	R	-	-	208108	Drive Shaft	33	34	59	94.5	951		
-	2008-	-	MT	L	-	-	299246	Drive Shaft	33	34	59	94.5	621		
-	2008-	-	MT	R	-	-	299247	Drive Shaft	33	34	59	94.5	970		
-	2008-	-	AT	L	-	-	608041	Inner Joint	34	31	35	138	98		
-	2008-	-	AT	R	-	-	608040	Inner Joint	34	31	35	55.5	142		
-	2008-	-	MT	L	-	-	608039	Inner Joint	34	31	35	56.5	141.5		
-	2008-	-	MT	R	-	-	608039	Inner Joint	34	31	35	56.5	141.5		
-	2010-	2012	AT	L/R	-	-	821052	Outer Joint	33	31	56	93.5	62	M	
1.6 16V	2009-	-	AT	R	F	-	299247	Drive Shaft	33	34	59	94.5	970		
-	2009-	-	MT	L	F	-	208107	Drive Shaft	33	34	59	94.5	640		
-	2009-	-	AT	L	F	-	299246	Drive Shaft	33	34	59	94.5	621		
CRUZE (J300)															
-	2009-	-	-	-	-	-	608054	Inner Joint	34	23	37.5		121.5		
1.6 (91 kW)	2009.05-	-	-	-	-	Saloon Engine F16D4	821043	Outer Joint	33	31	59	94.5	62.5	M	
1.7 D (96 kW)	2012.01-	-	-	-	-	Saloon Engine LUD	808066	Outer Joint	30	34	59	95	65	M	
1.8 LPG (104 kW)	2011.06-	-	-	-	-	Saloon Engine 2H0	821043	Outer Joint	33	31	59	94.5	62.5	M	
2.0 CDI (110 kW)	2009.05-	-	MT	L	F	Saloon Engine Z 20 S1	208095	Drive Shaft	30	27	57.5	95	582		
2.0 CDI (120 kW)	2010.08-	-	MT	L	F	Saloon Engine Z 20 D1	208095	Drive Shaft	30	27	57.5	95	582		
-	2010.08-	-	-	-	-	Saloon Engine Z 20 D1	808066	Outer Joint	30	34	59	95	65	M	
2.0 CDI (90 kW)	2009.05-	-	MT	L	F	Saloon Engine Z 20 S1	208095	Drive Shaft	30	27	57.5	95	582		
CRUZE (J305)															
1.4 (103 kW)	2012.06-	-	-	-	-	Hatchback Engine LUJ	808066	Outer Joint	30	34	59	95	65	M	
1.6 (91 kW)	2011.06-	-	-	-	-	Hatchback Engine F16D4	821043	Outer Joint	33	31	59	94.5	62.5	M	
1.7 D (96 kW)	2012.01-	-	-	-	-	Hatchback Engine LUD	808066	Outer Joint	30	34	59	95	65	M	
2.0 CDI (120 kW)	2011.06-	-	-	-	-	Hatchback Engine Z 20 D1	808066	Outer Joint	30	34	59	95	65	M	
CRUZE Station Wagon (J308)															
1.4 (103 kW)	2012.08-	-	-	-	-	Estate Engine LUJ	808066	Outer Joint	30	34	59	95	65	M	
1.6 (91 kW)	2012.08-	-	-	-	-	Estate Engine LDE	821043	Outer Joint	33	31	59	94.5	62.5	M	
1.7 TD (96 kW)	2012.08-	-	-	-	-	Estate Engine LUD	808066	Outer Joint	30	34	59	95	65	M	
2.0 TD (120 kW)	2012.08-	-	-	-	-	Estate Engine LNP	808066	Outer Joint	30	34	59	95	65	M	
EPICA															
-	-	-	MT	L	-	-	212027	Drive Shaft	28	34	55.5	99	643		
-	-	-	MT	R	-	-	212026	Drive Shaft	28	26	55.5	99	682		
-	-	-	MT	R	-	-	608019	Inner Joint	26	32	43	52	78		
-	2004-	-	-	L	F	-	621005	Inner Joint	34	29	40	64	110		
1.8 (105 kW)	2009.10-	2015.12	-	-	-	Saloon Engine 2H0	208144	Drive Shaft	28	26	56	98	599		
-	2009.10-	2015.12	AT/MT	-	-	Saloon Engine 2H0	208145	Drive Shaft	28	34	56	98	638		
2.0	2007-	2008	MT	L	-	-	208072	Drive Shaft	28	34	55.5	99	622		
-	2007-	2008	MT	R	-	-	208071	Drive Shaft	28	26	55.5	99	554		
-	2007-	2008	MT	R	-	-	608019	Inner Joint	26	32	43	52	78		
EPICA (KL1_/TOSCA)															
2.0 (105 kW)	2006.06-	-	AT	L/R	F	Saloon Engine X 20 D1	824021	Outer Joint	28	29	55.5	99	61	O	
-	2006.06-	-	-	-	F	Saloon Engine X 20 D1	808038	Outer Joint	28	32	55.5	99	66	O	
2.0 (94 kW)	2005.01-	2006.12	-	-	F	Saloon Engine C 20 SED	808038	Outer Joint	28	32	55.5	99	66	O	
2.0 (98 kW)	2005.01-	2006.12	-	-	F	Saloon Engine T20SED	808038	Outer Joint	28	32	55.5	99	66	O	
2.0 D (110 kW)	2007.01-	-	MT	L	F	Saloon Engine Z 20 S	239183	Drive Shaft	28	27	55.5	99	622		
-	2007.01-	-	MT	R	F	Saloon Engine Z 20 S	239182	Drive Shaft	28	27	55.5	99	529		
-	2007.01-	-	AT	-	F	Saloon Engine Z 20 S	808038	Outer Joint	28	32	55.5	99	66	O	
-	2007.01-	-	MT	-	F	Saloon Engine Z 20 S	868008	Outer Joint	28	34	55.5	99	66	O	
-	2007.01-	-	MT	L	F	Saloon Engine Z 20 S	608034	Inner Joint	27	34	35	68.5	111.5		
-	2007.01-	-	MT	R	F	Saloon Engine Z 20 S	608035	Inner Joint	27	34	43.3	51	77		
EQUINOX															
-	2005-	2006	-	-	R	AWD	635046	Propshaft CV Joint		25		26			
EVANDA															
2.0 (96 kW)	2005.03-	-	AT	L/R	F	Saloon Engine X 20 SED	824021	Outer Joint	28	29	55.5	99	61	O	
-	2005.03-	-	-	-	F	Saloon Engine X 20 SED	812018	Outer Joint	33	29	52	95.5	62.5	O	
GRAND AM															
-	1999-	2002	MT/AT	-	-	-	808012	Outer Joint	30	32	55	103.5	61	O	
K 1500															
-	1988-	1997	-	-	-	4WD GVW	808006	Outer Joint	33	35	77	112.5	73.5	O	
-	1988-	1997	-	-	-	4WD GVW	821019	Outer Joint	55T	33	35	77	112.5	73.5	O
-	1999-	2000	-	-	-	4WD GVW	808006	Outer Joint	33	35	77	112.5	73.5	O	
-	1999-	2000	-	-	-	4WD GVW	821019	Outer Joint	55T	33	35	77	112.5	73.5	O
K 2500															
-	1988-	1997	-	-	-	4WD GVW	808006	Outer Joint	33	35	77	112.5	73.5	O	





	 YEAR	TRANSM	L/R	F/R	REMARKS	GSP Ref.	 PRODUCT	 ABS	Technical Specifications						
									A	B	C	H	L	P	
CHEVROLET															
K 2500															
-	1988-1997	-	-	-	4WD GVW	821019	Outer Joint	55T	33	35	77	112.5	73.5	O	
KALOS															
-	2003-2008	-	-	-	-	808037	Outer Joint		22	19	52	95.5	53	O	
-	2003-2008	-	-	-	-	624068	Inner Joint		22	29	38	59.5	97.5		
-	2003-2008	-	-	-	-	699107	Inner Joint		22	19	35	50.5	78		
-	2003-2008	-	-	-	-	612004	Inner Joint		22	29	38	59	116		
1.2 16V	2004-2006	-	L/R	F	-	699107	Inner Joint		22	19	35	50.5	78		
1.2 8V	2004-2006	-	L/R	F	-	699107	Inner Joint		22	19	35	50.5	78		
1.5 GL	-	-	-	-	-	612004	Inner Joint		22	29	38	59	116		
LACETTI															
-	2003-2008	-	-	-	-	612004	Inner Joint		22	29	38	59	116		
1.6 (80 kW)	2005.03-2013.03	-	-	-	Saloon Engine F16D3	812011	Outer Joint		33	22	52	95.5	53	O	
LACETTI (J200)															
1.4 16V (70 kW)	2005.03-	-	-	-	Hatchback Engine F14D3	808019	Outer Joint	47T	33	22	52	95.5	53	O	
	2005.03-	-	-	-	F Hatchback Engine F14D3	844086	Outer Joint	47T	33	22	52	96	56	O	
	2005.03-	-	-	-	Hatchback Engine F14D3	812011	Outer Joint		33	22	52	95.5	53	O	
1.6 (80 kW)	2005.03-	-	-	-	Hatchback Engine F16D3	808019	Outer Joint	47T	33	22	52	95.5	53	O	
	2005.03-	-	-	-	F Estate Engine F16D3	844086	Outer Joint	47T	33	22	52	96	56	O	
	2005.03-	-	-	-	F Hatchback Engine F16D3	844086	Outer Joint	47T	33	22	52	96	56	O	
	2005.03-	-	-	-	F Estate Engine F16D3	812002	Outer Joint	47T	33	29	52	95.5	63	O	
	2005.03-	-	MT	-	F Estate Engine F16D3	644001	Inner Joint		34	22	35	56.2	76		
	2005.03-	-	-	-	F Hatchback Engine F16D3	812002	Outer Joint	47T	33	29	52	95.5	63	O	
	2005.03-	-	MT	-	F Hatchback Engine F16D3	644001	Inner Joint		34	22	35	56.2	76		
	2005.03-	-	-	-	Estate Engine F16D3	812011	Outer Joint		33	22	52	95.5	53	O	
	2005.03-	-	-	-	Hatchback Engine F16D3	812011	Outer Joint		33	22	52	95.5	53	O	
1.8 (89 kW)	2005.08-	-	-	-	Hatchback Engine F18D3	808019	Outer Joint	47T	33	22	52	95.5	53	O	
	2005.08-	-	MT	-	F Hatchback Engine F18D3	812002	Outer Joint	47T	33	29	52	95.5	63	O	
	2005.08-	-	-	-	F Estate Engine T18SED	812002	Outer Joint	47T	33	29	52	95.5	63	O	
	2005.08-	-	-	-	Estate Engine T18SED	812011	Outer Joint		33	22	52	95.5	53	O	
	2005.08-	-	-	-	Hatchback Engine F18D3	812011	Outer Joint		33	22	52	95.5	53	O	
	2005.08-	-	-	-	Estate Engine F18D3	812011	Outer Joint		33	22	52	95.5	53	O	
	2005.08-	-	-	-	F Estate Engine F18D3	812002	Outer Joint	47T	33	29	52	95.5	63	O	
1.8 (90 kW)	2005.03-	-	-	-	Hatchback Engine T18SED	808019	Outer Joint	47T	33	22	52	95.5	53	O	
	2005.03-	-	-	-	F Hatchback Engine T18SED	812002	Outer Joint	47T	33	29	52	95.5	63	O	
LUMINA															
-	1990-1993	AT	-	-	3 Speed	808024	Outer Joint		33	29	73	88	54.5	O	
	1990-2001	-	-	-	Excl. A/T, 3 Speed.	806011	Outer Joint	47T	33	32	73	88	55	O	
	1990-2001	-	-	-	Excl. A/T, 3 Speed.	806002	Outer Joint		33	32	73	88	55	O	
LUMINA APV															
2.3 (101 kW)	1993.10-1996.07	-	-	F	MPV Engine LD2	859005	Outer Joint		26	23	56	95.5	55	I	
3.1 (119 kW)	1994.01-1996.07	-	-	-	MPV Engine L82	808008	Outer Joint		27	32	61.5	120	64.5	O	
3.8 (129 kW)	1992.12-1996.07	-	-	-	MPV Engine L27	808008	Outer Joint		27	32	61.5	120	64.5	O	
MALIBU															
-	1997-2003	AT	R	-	-	608055	Inner Joint		34	32	41.8	59	125		
	1997-2003	AT	L	-	-	608007	Inner Joint		34	32	36.7	39	90		
	1997-2003	MT/AT	-	-	-	808012	Outer Joint		30	32	55	103.5	61	O	
MATIZ (M200 M250)															
0.8 (38 kW)	2005.03-	-	-	-	Hatchback Engine F8CV	812046	Outer Joint	40T	23	19	46	92	56.5	O	
	2005.03-	-	MT	L/R	F Hatchback Engine F8CV	812021	Outer Joint	40T	23	19	46	92	56.5	O	
	2005.03-	-	MT	R	F Hatchback Engine F8CV	212012	Drive Shaft	40T	23	22	46	92	785		
	2005.03-	-	MT	R	F Hatchback Engine F8CV	612001	Inner Joint		22	19	35	54.5	79		
0.8 LPG (38 kW)	2005.03-	-	-	L/R	F Hatchback Engine F8CV	812046	Outer Joint	40T	23	19	46	92	56.5	O	
	2005.03-	-	MT	L/R	F Hatchback Engine F8CV	812021	Outer Joint	40T	23	19	46	92	56.5	O	
	2005.03-	-	MT	R	F Hatchback Engine F8CV	212012	Drive Shaft	40T	23	22	46	92	785		
	2005.03-	-	MT	R	F Hatchback Engine F8CV	612001	Inner Joint		22	19	35	54.5	79		
1.0 (47 kW)	2005.03-	-	MT	L	F Hatchback Engine B10S	257177	Drive Shaft	40T	23	22	46	92	562		
	2005.03-	-	MT	R	F Hatchback Engine B10S	257176	Drive Shaft	40T	23	22	46	92	831		
	2005.03-	-	-	-	Hatchback Engine B10S	812046	Outer Joint	40T	23	19	46	92	56.5	O	
	2005.03-	-	MT	L/R	F Hatchback Engine B10S	812021	Outer Joint	40T	23	19	46	92	56.5	O	
1.0 (49 kW)	2005.03-	-	MT	L	F Hatchback Engine B10S1	257177	Drive Shaft	40T	23	22	46	92	562		
	2005.03-	-	MT	R	F Hatchback Engine B10S1	257176	Drive Shaft	40T	23	22	46	92	831		
	2005.03-	-	-	-	Hatchback Engine B10S1	812046	Outer Joint	40T	23	19	46	92	56.5	O	
	2005.03-	-	MT	L/R	F Hatchback Engine B10S1	812021	Outer Joint	40T	23	19	46	92	56.5	O	
1.0 LPG (49 kW)	2005.03-	-	-	L	F Hatchback Engine B10S1	257177	Drive Shaft	40T	23	22	46	92	562		
	2005.03-	-	MT	R	F Hatchback Engine B10S1	257176	Drive Shaft	40T	23	22	46	92	831		
	2005.03-	-	MT	L/R	F Hatchback Engine B10S1	812021	Outer Joint	40T	23	19	46	92	56.5	O	

YEAR	TRANS	L/R	F/R	REMARKS	GSP Ref.	PRODUCT	ABS	Technical Specifications									
								A	B	C	H	L	P				
CHEVROLET																	
MATIZ (M200 M250)																	
1.0 LPG (49 kW)	2005.03-	-	-	L/R	F	Hatchback Engine B10S1	812046	Outer Joint	40T	23	19	46	92	56.5	O		
METRO																	
-	1995-	2000	-	-	-	-	857043	Outer Joint	42T	23	19	46	92	56.5	I		
-	1995-	2000	-	-	-	Housing Stamped 75 LAC	808018	Outer Joint		23	19	46	92	56.5	I		
MONTANA																	
1.8 8V	2002-	-	-	L/R	-	-	844066	Outer Joint		22	23	52	97.5	61	M		
-	2002-	-	-	R	-	-	244035	Drive Shaft		22	22	52	97.5	929			
-	2002-	-	-	L	-	-	244034	Drive Shaft		22	22	52	97.5	580			
-	2002-	-	-	L/R	-	-	644015	Inner Joint		22	23	35	57.5	82			
MONTANA NOVA																	
-	2011-	2017	-	-	-	-	821026	Outer Joint		22	22	52	97.5	55	O		
-	2011-	2017	-	-	-	-	821026	Outer Joint		22	22	52	97.5	55	O		
MONTE CARLO																	
-	1995-	1999	-	-	-	-	806011	Outer Joint	47T	33	32	73	88	55	O		
-	1995-	1999	-	-	-	-	806002	Outer Joint		33	32	73	88	55	O		
NUBIRA																	
1.4 (70 kW)	2006.01-	-	-	-	-	Saloon Engine F14D3	812011	Outer Joint		33	22	52	95.5	53	O		
1.6 (80 kW)	2005.03-	-	-	-	-	Saloon Engine F16D3	808019	Outer Joint	47T	33	22	52	95.5	53	O		
-	2005.03-	-	-	-	-	Estate Engine F16D3	808019	Outer Joint	47T	33	22	52	95.5	53	O		
-	2005.03-	-	-	-	F	Saloon Engine F16D3	844086	Outer Joint	47T	33	22	52	96	56	O		
-	2005.03-	-	-	-	F	Estate Engine F16D3	844086	Outer Joint	47T	33	22	52	96	56	O		
-	2005.03-	-	-	-	F	Saloon Engine F16D3	812022	Outer Joint	47T	33	22	52	96	56	I		
-	2005.03-	-	-	-	-	Saloon Engine F16D3	812011	Outer Joint		33	22	52	95.5	53	O		
-	2005.03-	-	-	-	F	Estate Engine F16D3	812022	Outer Joint	47T	33	22	52	96	56	I		
-	2005.03-	-	-	-	-	Estate Engine F16D3	812011	Outer Joint		33	22	52	95.5	53	O		
ONIX																	
1.0	-	-	MT	R	F	-	208156	Drive Shaft		25	22	51	91	940			
-	-	-	MT	R	F	-	817091	Outer Joint		25	20	51	91	52	M		
-	-	-	MT	R	F	-	621058	Inner Joint		22	19	34.9	57	93			
-	-	-	MT	L	F	-	208157	Drive Shaft		25	22	51	91	607			
-	-	-	MT	L	F	-	817091	Outer Joint		25	20	51	91	52	M		
-	-	-	MT	L	F	-	621058	Inner Joint		22	19	34.9	57	93			
1.0 8V	2013-	-	-	-	-	-	817091	Outer Joint		25	20	51	91	52	M		
1.4 8V	2012-	-	MT	-	-	-	821058	Outer Joint		25	22	51	92	54.5	M		
-	2012-	-	MT	L	-	-	221119	Drive Shaft		25	22	51	91	606			
OPTRA																	
-	-	-	-	-	-	-	612004	Inner Joint		22	29	38	59	116			
-	2004-	-	-	L	F	-	621005	Inner Joint		34	29	40	64	110			
-	2006-	2010	MT/AT	L/R	-	-	621013	Inner Joint		34	29	35	56.5	119			
-	2006-	2008	AT	L	-	-	212015	Drive Shaft		33	22	52	95.5	615			
-	2006-	2008	AT	R	-	-	221021	Drive Shaft		33	22	52	95.5	945			
-	2006-	2008	MT	R	-	-	221020	Drive Shaft		33	34	52	95.5	932			
-	2006-	2008	MT	L	-	-	221019	Drive Shaft		33	34	52	95.5	611			
1.6	2004-	2007	MT	L	-	-	212045	Drive Shaft		33	34	52	95.5	612.5			
-	2004-	2007	MT	R	-	-	212046	Drive Shaft		33	34	52	95.5	934			
OPTRA (J200)																	
-	2003-	2008	-	-	-	-	612004	Inner Joint		22	29	38	59	116			
ORLANDO (J309)																	
2.0 D (120 kW)	2011.02-	-	-	-	-	MPV Engine Z 20 D1	808066	Outer Joint		30	34	59	95	65	M		
2.0 D (96 kW)	2011.02-	-	-	-	-	MPV Engine Z 20 D1	808066	Outer Joint		30	34	59	95	65	M		
PICKUP																	
-	2001-	2003	-	-	-	-	299304	DRIVE SHAFT						119	727		
PRISMA																	
-	2007-	2009	-	-	-	-	699023	Inner Joint		22	28	34.95	57.5	72.5			
-	2010-	2012	-	-	-	-	821026	Outer Joint		22	22	52	97.5	55	O		
-	2010-	2012	-	-	-	-	821026	Outer Joint		22	22	52	97.5	55	O		
1.0 8V	2013-	-	-	-	-	-	817091	Outer Joint		25	20	51	91	52	M		
1.4 8V	2012-	-	MT	-	-	-	821058	Outer Joint		25	22	51	92	54.5	M		
-	2012-	-	MT	L	-	-	221119	Drive Shaft		25	22	51	91	606			
PRIZM																	
-	1993-	2000	-	-	-	-	859163	Outer Joint	48T	26	29	56	99.5	62.5	O		
REZZO (U100)/TACUMA																	
1.6 (77 kW)	2005.03-	-	-	L/R	F	MPV Engine A16DMS	812027	Outer Joint	47T	33	29	52	95.5	63	O		
-	2005.03-	-	-	-	F	MPV Engine A16DMS	812002	Outer Joint	47T	33	29	52	95.5	63	O		
-	2005.03-	-	MT	-	F	MPV Engine A16DMS	644001	Inner Joint		34	22	35	56.2	76			





YEAR	TRANSM	L/R	F/R	REMARKS	GSP Ref.	PRODUCT	ABS	Technical Specifications							
								A	B	C	H	L	P		
CHEVROLET															
REZZO (U100)/TACUMA															
1.6 (79 kW)	2005.08-	-	-	L/R	F	MPV Engine A16DMS	812027	Outer Joint	47T	33	29	52	95.5	63	O
	2005.08-	-	MT	-	F	MPV Engine A16DMS	812002	Outer Joint	47T	33	29	52	95.5	63	O
	2005.08-	-	MT	-	F	MPV Engine A16DMS	644001	Inner Joint		34	22	35	56.2	76	
2.0 (89 kW)	2005.03-	-	MT	-	F	MPV Engine T20SED	812023	Outer Joint	47T	33	32	52	95.5	66	O
	2005.03-	-	AT	-	F	MPV Engine T20SED	812002	Outer Joint	47T	33	29	52	95.5	63	O
2.0 (90 kW)	2005.08-	-	-	-	-	MPV Engine T20SED	812009	Outer Joint		33	29	52	109	63	O
	2005.08-	-	MT	-	F	MPV Engine T20SED	812023	Outer Joint	47T	33	32	52	95.5	66	O
	2005.08-	-	AT	-	F	MPV Engine T20SED	812002	Outer Joint	47T	33	29	52	95.5	63	O
S10															
-	1998-	-	-	R	-	4WD	208080	Drive Shaft		27	26	55.8	127.5	542	
	1998-	-	-	L	-	4WD	208081	Drive Shaft		27	26	55.8	127.5	594	
	1999-	2005	-	-	-	-	299304	DRIVE SHAFT					119	727	
	2013-	-	-	L/R	-	-	226016	Drive Shaft		17	28	53	136.5	650	
S10 BLAZER															
-	1985-	1993	-	-	-	4WD S& TBody w/HD Shocks	808007	Outer Joint		27	34	55.8	127.5	64	O
	1985-	1993	-	-	-	4WD S& TBody w/Std Shocks	808007	Outer Joint		27	34	55.8	127.5	64	O
All Models	1985.01-	1990.12	-	-	-	-	808005	Outer Joint		27	34	56	109	63	O
S10 PICK UP															
-	1985-	1993	-	-	-	4WD S& TBody w/HD Shocks	808007	Outer Joint		27	34	55.8	127.5	64	O
	1985-	1993	-	-	-	4WD S& TBody w/Std Shocks	808007	Outer Joint		27	34	55.8	127.5	64	O
S10/S10 BLAZER															
-	1997-	2005	-	-	-	4WD SUV/Truck/VAN	808011	Outer Joint		27	34	55.8	127.5	64	O
	1997-	2005	-	-	-	-	608008	Inner Joint		26	34	40	92	98	
	1997-	2005	-	-	-	4WD	608009	Inner Joint		26	34	40	55	85	
SILVERADO 1500															
4.3L V6 - Gas	2013-	-	-	-	-	Hybrid, LS, LT, LTZ, WT, XFE	207007	Drive Shaft		33		72.8	112.5	583	
4.8L V8 - Flex	2013-	-	-	-	-	Hybrid, LS, LT, LTZ, WT, XFE	207007	Drive Shaft		33		72.8	112.5	583	
5.3 AWD (232 kW)	2007.01-	-	-	-	F	All-wheel Drive Pickup Engine LH6	807001	Outer Joint		33	41	80	112	88.5	O
	2007.01-	-	-	-	F	All-wheel Drive Pickup Engine LH6	844054	Outer Joint		33	35	72.8	112.5	73.5	O
5.3 FlexFuel AWD (232 kW)	2007.01-	-	-	-	F	All-wheel Drive Pickup	807001	Outer Joint		33	41	80	112	88.5	O
	2007.01-	-	-	-	F	All-wheel Drive Pickup	844054	Outer Joint		33	35	72.8	112.5	73.5	O
5.3L V8 - Flex	2013-	-	-	-	-	Hybrid, LS, LT, LTZ, WT, XFE	207007	Drive Shaft		33		72.8	112.5	583	
6.0L V8 - Electric/Flex	2013-	-	-	-	-	Hybrid, LS, LT, LTZ, WT, XFE	207007	Drive Shaft		33		72.8	112.5	583	
6.2L V8 - Flex	2013-	-	-	-	-	Hybrid, LS, LT, LTZ, WT, XFE	207007	Drive Shaft		33		72.8	112.5	583	
SILVERADO 2500															
6.0 AWD (224 kW)	1999.10-	-	-	-	F	All-wheel Drive Pickup Engine LQ4	807001	Outer Joint		33	41	80	112	88.5	O
	1999.10-	-	-	-	F	All-wheel Drive Pickup Engine LQ4	844054	Outer Joint		33	35	72.8	112.5	73.5	O
SILVERADO 2500 HD															
6.6 TD (268 kW)	2007.01-	-	-	-	F	All-wheel Drive Pickup Engine LBZ	807001	Outer Joint		33	41	80	112	88.5	O
	2007.01-	-	-	-	F	All-wheel Drive Pickup Engine LBZ	844054	Outer Joint		33	35	72.8	112.5	73.5	O
SILVERADO PICK UP															
-	1999-	2005	-	-	-	SUV/Truck/VAN	839029	Outer Joint		33	41	80	112	88.5	O
SONIC															
1.6	2012-	-	MT	L/R	-	-	821053	Outer Joint		25	31	52.5	91.5	62.5	M
SPARK															
0.8 (37 kW)	2005.05-	-	-	L/R	F	Hatchback Engine F8CV	812046	Outer Joint	40T	23	19	46	92	56.5	O
1.0 SX (46 kW)	2005.05-	-	MT	L	F	Hatchback Engine LA2	844090	Outer Joint	47T	22	20	52	96	52	M
	2005.05-	-	MT	L	F	Hatchback Engine LA2	257179	Drive Shaft	47T	22	22	52	96	623	
1.2	2011-	2014	MT	L	-	-	657108	Inner Joint		22	19	35	50	85	
	2011-	2014	MT	L/R	-	-	812045	Outer Joint		23	19	46	91.5	56.5	O
SPARK (M300)															
1.0 (50 kW)	2010.03-	-	MT	L	F	Hatchback Engine B10D1	208164	Drive Shaft	47T	22	22	52	96	621	
	2010.03-	-	MT	R	F	Hatchback Engine B10D1	208165	Drive Shaft	47T	22	22	52	96	868	
	2010.03-	-	MT	L	F	Hatchback Engine B10D1	844090	Outer Joint	47T	22	20	52	96	52	M
	2010.03-	-	MT	L	F	Hatchback Engine B10D1	257179	Drive Shaft	47T	22	22	52	96	623	
1.0 LPG (50 kW)	2010.03-	-	MT	L	F	Hatchback Engine B10D1	208164	Drive Shaft	47T	22	22	52	96	621	
	2010.03-	-	MT	R	F	Hatchback Engine B10D1	208165	Drive Shaft	47T	22	22	52	96	868	
	2010.03-	-	MT	L	F	Hatchback Engine B10D1	844090	Outer Joint	47T	22	20	52	96	52	M
	2010.03-	-	MT	L	F	Hatchback Engine B10D1	257179	Drive Shaft	47T	22	22	52	96	623	
1.2 (60 kW)	2010.03-	-	MT	L	F	Hatchback Engine LMU/B12D1	208164	Drive Shaft	47T	22	22	52	96	621	
	2010.03-	-	MT	R	F	Hatchback Engine LMU/B12D1	208165	Drive Shaft	47T	22	22	52	96	868	
	2010.03-	-	MT	L	F	Hatchback Engine LMU/B12D1	844090	Outer Joint	47T	22	20	52	96	52	M
	2010.03-	-	MT	L	F	Hatchback Engine LMU/B12D1	257179	Drive Shaft	47T	22	22	52	96	623	
1.2 LPG (60 kW)	2010.03-	-	MT	L	F	Hatchback Engine LMU/B12D1	208164	Drive Shaft	47T	22	22	52	96	621	
	2010.03-	-	MT	R	F	Hatchback Engine LMU/B12D1	208165	Drive Shaft	47T	22	22	52	96	868	

	 YEAR	TRANSM	L/R	F/R	REMARKS	GSP Ref.	 PRODUCT	 ABS	Technical Specifications						
									A	B	C	H	L	P	
CHEVROLET															
SPARK (M300)															
1.2 LPG (60 kW)	2010.03-	-	MT	L	F	Hatchback Engine LMU/B12D1	844090	Outer Joint	47T	22	20	52	96	52	M
	2010.03-	-	MT	L	F	Hatchback Engine LMU/B12D1	257179	Drive Shaft	47T	22	22	52	96	623	
SPIN															
1.8 8V	-	-	-	-	-	-	817091	Outer Joint		25	20	51	91	52	M
SPRINT															
-	-	-	-	-	-	-	839044	Outer Joint		23	20	44	89	54	O
-	-	-	-	-	-	-	699100	Inner Joint		22	19	35	51.5	83	
STORM															
-	1990-	1993	MT	-	-	DOHC	808015	Outer Joint		24	30	50	87.5	55	M
SUBURBAN (GMT 900)															
5.3 Flex-Fuel (228 kW)	2007.01-	-	-	-	F	All-wheel Drive Closed Off-Road Vehicle Engine LMG	807001	Outer Joint		33	41	80	112	88.5	O
	2007.01-	-	-	-	F	All-wheel Drive Closed Off-Road Vehicle Engine LMG	844054	Outer Joint		33	35	72.8	112.5	73.5	O
SUBURBAN 1500															
5.3L V8 - Flex	2013-	-	-	-	-	LS, LT, LTZ	207007	Drive Shaft		33		72.8	112.5	583	
	2014-	-	-	-	-	LS, LT, LTZ	207007	Drive Shaft		33		72.8	112.5	583	
SUBURBAN 2500															
6.0L V8 - Flex	2013-	-	-	-	-	LS, LT	207007	Drive Shaft		33		72.8	112.5	583	
SUBURBAN/TAHOE															
-	1988-	1997	-	-	-	-	808009	Outer Joint		33	29	80	112	88.5	O
-	1992-	1994	-	-	-	Suv/Truck/Van	821022	Outer Joint	55T	33	29	80	112	88.5	O
-	1998-	2005	-	-	-	SUV/Truck/VAN	839029	Outer Joint		33	41	80	112	88.5	O
TAHOE															
5.3L V8 - Flex	2014-	-	-	-	-	LS, LT, LTZ, PPV, SSV	207007	Drive Shaft		33		72.8	112.5	583	
5.3L V8 - Flex, 6.0L V8 - Electric/Flex	2013-	-	-	-	-	Hybrid, LS, LT, LTZ, PPV, SSV	207007	Drive Shaft		33		72.8	112.5	583	
TRAILBLAZER															
-	1999-	2005	-	-	-	-	299304	DRIVE SHAFT					119	727	
-	1999-	2009	-	-	F	4WD/PROPELLER SHAFT	608073	Propshaft CV Joint		17	22	44		119	
TRAX															
1.8 Lts	2013-	2014	MT	-	-	-	608071	Inner Joint		34	23	41		120	
UTILITY															
-	2012-	2017	-	-	-	-	821026	Outer Joint		22	22	52	97.5	55	O
-	2012-	2017	-	-	-	-	821026	Outer Joint		22	22	52	97.5	55	O
VECTRA															
-	1994-	1996	-	-	-	-	844069	Outer Joint	29T	33	25	52	109	61	O
VECTRA/MONZA/KADETT															
-	-	-	-	-	-	-	844107	Outer Joint		33	25	52	109.5	61	O
VENTURE															
-	1997-	2004	AT	L/R	-	-	808042	Outer Joint		33	32	50	105	62.5	O
VIVANT															
-	2004-	-	-	L	F	-	621005	Inner Joint		34	29	40	64	110	
CHEVROLET (SGM)															
AVEO (T250)															
1.4 (69 kW)	2005.07-	2010.05	MT	L	-	Hatchback Engine L95	208104	Drive Shaft	47T	22	34	52	95	606	
	2005.07-	2010.05	MT	R	-	Hatchback Engine L95	208105	Drive Shaft	47T	22	34	52	95	916	
	2005.07-	2010.05	AT	L	-	Hatchback Engine L95	208106	Drive Shaft	47T	22	22	52	95	596	
	2005.07-	2010.05	AT	R	-	Hatchback Engine L95	275004	Drive Shaft	47T	22	22	52	95	925	
1.6 (78 kW)	2008.03-	2010.05	MT	L	-	Hatchback Engine F16D3D	208104	Drive Shaft	47T	22	34	52	95	606	
	2008.03-	2010.05	MT	R	-	Hatchback Engine F16D3D	208105	Drive Shaft	47T	22	34	52	95	916	
	2008.03-	2010.05	AT	L	-	Hatchback Engine F16D3D	208106	Drive Shaft	47T	22	22	52	95	596	
	2008.03-	2010.05	AT	R	-	Hatchback Engine F16D3D	275004	Drive Shaft	47T	22	22	52	95	925	
AVEO (T300)															
1.4 (76 kW)	2011.05-	-	MT	L	-	Hatchback Engine LCU	208104	Drive Shaft	47T	22	34	52	95	606	
	2011.05-	-	MT	R	-	Hatchback Engine LCU	208105	Drive Shaft	47T	22	34	52	95	916	
	2011.05-	-	AT	L	-	Hatchback Engine LCU	208106	Drive Shaft	47T	22	22	52	95	596	
	2011.05-	-	AT	R	-	Hatchback Engine LCU	275004	Drive Shaft	47T	22	22	52	95	925	
	2011.05-	-	MT	L	-	Saloon Engine LCU	208104	Drive Shaft	47T	22	34	52	95	606	
	2011.05-	-	MT	R	-	Saloon Engine LCU	208105	Drive Shaft	47T	22	34	52	95	916	
	2011.05-	-	AT	L	-	Saloon Engine LCU	208106	Drive Shaft	47T	22	22	52	95	596	
	2011.05-	-	AT	R	-	Saloon Engine LCU	275004	Drive Shaft	47T	22	22	52	95	925	
1.6 (89 kW)	2011.05-	-	MT	L	-	Hatchback Engine LDE	208104	Drive Shaft	47T	22	34	52	95	606	
	2011.05-	-	MT	R	-	Hatchback Engine LDE	208105	Drive Shaft	47T	22	34	52	95	916	
	2011.05-	-	AT	L	-	Hatchback Engine LDE	208106	Drive Shaft	47T	22	22	52	95	596	
	2011.05-	-	AT	R	-	Hatchback Engine LDE	275004	Drive Shaft	47T	22	22	52	95	925	
	2011.05-	-	MT	L	-	Saloon Engine LDE	208104	Drive Shaft	47T	22	34	52	95	606	
	2011.05-	-	MT	R	-	Saloon Engine LDE	208105	Drive Shaft	47T	22	34	52	95	916	





YEAR	TRANS	L/R	F/R	REMARKS	GSP Ref.	PRODUCT	ABS	Technical Specifications							
								A	B	C	H	L	P		
CHEVROLET (SGM)															
AVEO (T300)															
1.6 (89 kW)	2011.05-	-	AT	L	-	Saloon Engine LDE	208106	Drive Shaft	47T	22	22	52	95	596	
	2011.05-	-	AT	R	-	Saloon Engine LDE	275004	Drive Shaft	47T	22	22	52	95	925	
CRUZE															
1.6 (89 kW)	2009.04-	2013.12	MT	L	-	Saloon Engine LDE	208076	Drive Shaft		33	34	53	95	626	
	2009.04-	2013.12	MT	R	-	Saloon Engine LDE	208078	Drive Shaft		33	34	53	95	976	
	2009.04-	2013.12	AT	L	-	Saloon Engine LDE	208079	Drive Shaft		33	34	52.5	94	643	
1.6 T (135 kW)	2010.11-	2013.12	MT	L	-	Saloon Engine LLU	208076	Drive Shaft		33	34	53	95	626	
	2010.11-	2013.12	MT	L	-	Saloon Engine LLU	208078	Drive Shaft		33	34	53	95	976	
	2010.11-	2013.12	AT	L	-	Saloon Engine LLU	208079	Drive Shaft		33	34	52.5	94	643	
1.8 (108 kW)	2009.04-	2011.12	-	L	F	Saloon Engine 2H0	208079	Drive Shaft		33	34	52.5	94	643	
EPICA															
1.8 (105 kW)	2009.10-	2015.12	-	-	-	Saloon Engine 2H0	208146	Drive Shaft		28	34	56	98	657	
2.0 (95 kW)	2006.04-	2009.09	AT	L	-	Saloon Engine L34/T20SED	208067	Drive Shaft		28	34	55.5	99	609	
	2006.04-	2009.09	MT	L	-	Saloon Engine L34/T20SED	208068	Drive Shaft		28	34	55.5	99	653	
	2006.04-	2009.09	AT	R	-	Saloon Engine L34/T20SED	208069	Drive Shaft		28	26	55.5	99	680	
	2006.04-	2009.09	MT/AT	R	-	Saloon Engine L34/T20SED	208092	Drive Shaft		28	26	56	98	685	
LOVA (T250)															
1.4 (69 kW)	2006.03-	2011.07	MT	L	-	Saloon Engine L95	208104	Drive Shaft	47T	22	34	52	95	606	
	2006.03-	2011.07	MT	R	-	Saloon Engine L95	208105	Drive Shaft	47T	22	34	52	95	916	
	2006.03-	2011.07	AT	L	-	Saloon Engine L95	208106	Drive Shaft	47T	22	22	52	95	596	
	2006.03-	2011.07	AT	R	-	Saloon Engine L95	275004	Drive Shaft	47T	22	22	52	95	925	
1.6 (78 kW)	2006.03-	2011.03	MT	L	-	Saloon Engine F16D3D	208104	Drive Shaft	47T	22	34	52	95	606	
	2006.03-	2011.03	MT	R	-	Saloon Engine F16D3D	208105	Drive Shaft	47T	22	34	52	95	916	
	2006.03-	2011.03	AT	L	-	Saloon Engine F16D3D	208106	Drive Shaft	47T	22	22	52	95	596	
	2006.03-	2011.03	AT	R	-	Saloon Engine F16D3D	275004	Drive Shaft	47T	22	22	52	95	925	
CHRYSLER															
300 M															
-	1999-	2001	-	-	-	-	809039	Outer Joint	50T	33	32	49.6	102.5	57	O
	1999-	2000	-	-	-	-	699062	Inner Joint		27	32	39.5	49	76	
	2002-	2004	-	-	-	Excl. Special	809039	Outer Joint	50T	33	32	49.6	102.5	57	O
	2002-	2004	-	-	-	-	699062	Inner Joint		27	32	39.5	49	76	
BREZZE															
-	1996-	1999	-	-	-	-	809043	Outer Joint	56T	26	32	54.1	95	63.5	I
CARAVAN															
-	-	-	-	-	-	-	809034	Outer Joint	47T	26	32	54	98.5	61.5	I
	1992-	1995	-	-	-	-	809023	Outer Joint		26	30	54	97.5	62.5	I
CIRRUS															
-	1995-	1999	-	-	-	-	609010	Inner Joint		25	32	40	74	113	
	1996-	1997	-	-	-	-	809043	Outer Joint	56T	26	32	54.1	95	63.5	I
2.0 LX (98 kW)	1997.10-	2000.09	-	-	-	Saloon Engine ECB	809015	Outer Joint		26	32	54.1	95	64	O
2.4	2007-	2010	AT	L	-	-	609033	Inner Joint		25	24	40	74	113	
	2007-	2010	AT	R	-	-	635037	Inner Joint		28	24	42.5	126		
	2007-	2010	AT	L/R	-	-	899327	Outer Joint		32	32	56.7	104.5	62	I
3.5	2007-	2010	AT	L	-	-	635035	Inner Joint		29	26	40	81	108.5	
	2007-	2010	AT	R	-	-	635036	Inner Joint		28	26	42.5		126	
CIRRUS/STRATUS															
-	1996-	1999	AT	-	-	-	809014	Outer Joint		26	32	54.1	95	63.5	I
	1996-	1998	AT	-	-	-	809043	Outer Joint	56T	26	32	54.1	95	63.5	I
	1999-	-	MT/AT	-	-	-	809041	Outer Joint	46T	26	32	54.1	95	63.5	I
	2000-	2004	MT/AT	-	-	-	815012	Outer Joint	46T	26	32	54	98.5	61.5	I
	2000-	2004	MT/AT	-	-	-	609023	Inner Joint		25	32	40	74	113	
	2000-	2004	MT/AT	-	-	-	809014	Outer Joint		26	32	54.1	95	63.5	I
	2000-	2004	MT/AT	-	-	-	809037	Outer Joint	46T	26	32	54.1	95	63.5	I
CONCORDE															
-	1993-	2004	-	-	-	-	699062	Inner Joint		27	32	39.5	49	76	
	1993-	1995	-	-	-	-	809038	Outer Joint	50W	33	32	49.6	102.5	60	O
	1996-	1997	-	R	-	-	209013	Drive Shaft	50T	33	27	49.6	102.5	537	
	1996-	1997	-	-	-	-	808022	Outer Joint	50T	33	32	49.6	102.5	60	O
	1996-	1997	-	-	-	-	609009	Inner Joint		27	32	39.8	47.5	77.5	
	1998-	2004	-	-	-	-	809039	Outer Joint	50T	33	32	49.6	102.5	57	O
2.7 LX (149 kW)	1997.10-	2003.09	-	-	-	Saloon Engine EER	809017	Outer Joint		33	32	49.6	102.5	57	O
3.3 LX (120 kW)	1992.10-	1997.09	-	-	-	Saloon Engine EGB	809016	Outer Joint		33	32	49.6	102.5	60	O
3.5 LX (174 kW)	1997.10-	2003.09	-	-	-	Saloon Engine EWZ	809017	Outer Joint		33	32	49.6	102.5	57	O
3.5 LX Supercharged (186 kW)	1997.10-	2003.09	-	-	-	Saloon Engine EWZ	809017	Outer Joint		33	32	49.6	102.5	57	O
CROSSFIRE															





	 YEAR	TRANSM	L/R	F/R	REMARKS	GSP Ref.	 PRODUCT	 ABS	Technical Specifications							
									A	B	C	H	L	P		
CHRYSLER CROSSFIRE																
3.2 (160 kW)	2003.07-2008.12	-	-	F	Coupe Engine EGX	824119	Outer Joint	54T	35	29	71.5	127	71	I		
DAKOTA																
4X4	1997-1999	-	-	-		815001	Outer Joint		31	34	61	114	64.5	O		
	2000-2004	-	-	-		809025	Outer Joint		31	35	61	114	64.5	O		
DART/VOLARE/LE BARON																
-	1982-1993	AT	-	-		809026	Outer Joint		26	23	54	98.5	61.5	I		
DURANGO																
4X4	1997-1999	-	-	-		815001	Outer Joint		31	34	61	114	64.5	O		
	2000-2004	-	-	-		809025	Outer Joint		31	35	61	114	64.5	O		
E-CLASS																
-	1984-	-	-	-		615002	Inner Joint		23	23	40	57	105.5			
FIFTH AVENUE																
-	1990-	-	-	-	Saginaw	809010	Outer Joint		26	29	54	99.5	62.5	O		
GRAND CARAVAN																
-	1991-1995	-	-	-		809023	Outer Joint		26	30	54	97.5	62.5	I		
GRAND VOYAGER V (RT)																
2.8 CRD (120 kW)	2007.10-	-	AT	R	F	MPV Engine ENS	208137	Drive Shaft	32	29	55	105.5	1058			
	2007.10-	-	-	-	F	MPV Engine ENS	809051	Outer Joint	32	34	55	105.5	60	M		
2.8 CRD (132 kW)	2012.09-	-	AT	R	F	MPV Engine ENS	208137	Drive Shaft	32	29	55	105.5	1058			
	2012.09-	-	AT	-	F	MPV Engine ENS	809051	Outer Joint	32	34	55	105.5	60	M		
3.3 (125 kW)	2008.01-	-	AT	R	F	MPV Engine EGV	208137	Drive Shaft	32	29	55	105.5	1058			
	2008.01-	-	-	-	F	MPV Engine EGV	809051	Outer Joint	32	34	55	105.5	60	M		
3.6 (208 kW)	2011.02-	-	AT	R	F	MPV Engine ERB	208137	Drive Shaft	32	29	55	105.5	1058			
	2011.02-	-	-	-	F	MPV Engine ERB	809051	Outer Joint	32	34	55	105.5	60	M		
3.8 (142 kW)	2007.10-	-	AT	R	F	MPV Engine EGL	208137	Drive Shaft	32	29	55	105.5	1058			
	2007.10-	-	-	-	F	MPV Engine EGL	809051	Outer Joint	32	34	55	105.5	60	M		
IMPERIAL																
-	1990-	-	-	-	Saginaw	809010	Outer Joint		26	29	54	99.5	62.5	O		
JEEP LIBERTY																
-	2002-2010	AT	-	-		616003	Inner Joint		29	35	45	55.5	101			
LE BARON																
-	1987-1995	-	-	-		809008	Outer Joint		26	28	54	98	58	I		
	1988-1990	-	-	-		809012	Outer Joint		26	24	54	90	63.5	I		
2.2 i Turbo (109 kW)	1986.09-1990.12	-	-	-	Convertible Engine EDR	809044	Outer Joint		26	29	54	98.5	61.5	O		
2.2 i Turbo (130 kW)	1986.09-1990.12	-	-	-	Convertible Engine EDR	809044	Outer Joint		26	29	54	98.5	61.5	O		
	1989.09-1991.01	-	-	-	Saloon Engine EDR	809044	Outer Joint		26	29	54	98.5	61.5	O		
2.5 i (75 kW)	1986.09-1993.12	-	-	-	Convertible Engine EDM	809044	Outer Joint		26	29	54	98.5	61.5	O		
	1989.01-1994.12	-	-	-	Saloon Engine EDM	809044	Outer Joint		26	29	54	98.5	61.5	O		
2.5 i Turbo (112 kW)	1989.01-1993.12	-	-	-	Convertible Engine EDT	809044	Outer Joint		26	29	54	98.5	61.5	O		
	1989.01-1994.12	-	-	-	Saloon Engine EDT	809044	Outer Joint		26	29	54	98.5	61.5	O		
3.0 i V6 (105 kW)	1990.01-1994.12	AT/MT	L/R	F	Saloon Engine EFA	809005	Outer Joint		26	32	54.1	98	62	I		
	1990.01-1996.12	-	-	-	Convertible Engine 6G72	809044	Outer Joint		26	29	54	98.5	61.5	O		
	1990.01-1994.12	-	-	-	Saloon Engine EFA	809044	Outer Joint		26	29	54	98.5	61.5	O		
LE BARON/CONVERTIBLE/COUPE/SEDAN/GTC/GTS																
-	1986-1991	-	-	-	Saginaw	809010	Outer Joint		26	29	54	99.5	62.5	O		
	1991-1993	-	-	-		609026	Inner Joint		25	32	40	71	124			
	1991-1993	-	-	-	Turbo GKN Passenger	609027	Inner Joint		25	32	28	172	137			
LEBARON K																
-	1992-1995	-	-	-		809023	Outer Joint		26	30	54	97.5	62.5	I		
LHS																
-	1994-2001	-	-	-		699062	Inner Joint		27	32	39.5	49	76			
	1994-1995	-	-	-		809038	Outer Joint	50W	33	32	49.6	102.5	60	O		
	1996-1997	-	-	-		808022	Outer Joint	50T	33	32	49.6	102.5	60	O		
	1998-2001	-	-	-		809039	Outer Joint	50T	33	32	49.6	102.5	57	O		
MAGNUM																
-	1987-1989	MT/AT	-	-		809012	Outer Joint		26	24	54	90	63.5	I		
	1987-1989	MT/AT	-	-		609016	Inner Joint		25	24	40	71.5	99.5			
N.YORKER,PHANTOM																
-	1990-1994	AT	L/R	-		809058	Outer Joint		26	32	54	98.5	61.5	I		
	1990-1994	AT	L/R	-		809058	Outer Joint		26	32	54	98.5	61.5	I		
NEON																
-	1994-1999	MT	-	-		609020	Inner Joint		25	28	40	71.5	109.5			
	1998-1999	AT	R	-		215009	Drive Shaft		23	25	57.7	91.8	942			
	1998-1999	AT	-	-		809035	Outer Joint	46T	23	28	57.7	91.8	58	I		
	1998-1999	MT	-	-		809035	Outer Joint	46T	23	28	57.7	91.8	58	I		





YEAR	TRANSM	L/R	F/R	REMARKS	GSP Ref.	PRODUCT	ABS	Technical Specifications									
								A	B	C	H	L	P				
CHRYSLER																	
NEON																	
-	2000-2004	MT/AT	-	-	-	609017	Inner Joint		25	23	40	74	113.5				
-	2000-2008	MT/AT	-	-	-	608057	Inner Joint		25	23	40	73.5	111				
-	2000-2007	-	-	-	-	809021	Outer Joint		26	22	57.7	92.5	58	M			
-	2000-2004	-	-	-	-	809022	Outer Joint		26	23	57.7	92.5	58	M			
NEON (PL)																	
1.8 16V (85 kW)	1997.09-1999.08	MT	L/R	F	Saloon Engine EBD	809036	Outer Joint	56T	23	28	57.7	91.8	58	I			
2.0 16V (107 kW)	1994.06-1999.08	AT/MT	L/R	F	Saloon Engine ECC	809036	Outer Joint	56T	23	28	57.7	91.8	58	I			
2.0 16V (109 kW)	1996.04-1999.08	AT/MT	L/R	F	Saloon Engine 420T	809036	Outer Joint	56T	23	28	57.7	91.8	58	I			
2.0 16V (98 kW)	1994.05-1999.08	AT/MT	L/R	F	Saloon Engine 420H	809036	Outer Joint	56T	23	28	57.7	91.8	58	I			
NEON II																	
2.0 16V (97 kW)	2002.10-2006.12	-	-	F	Saloon Engine ECB	809033	Outer Joint	46T	26	22	57.7	92.5	58	M			
	2002.10-2006.12	-	-	F	Saloon Engine ECB	809040	Outer Joint	46T	26	23	57.7	92.5	58	M			
2.0 16V (98 kW)	1999.08-2006.12	-	-	F	Saloon Engine ECB/420H	809033	Outer Joint	46T	26	22	57.7	92.5	58	M			
	1999.08-2006.12	-	-	F	Saloon Engine ECB/420H	809040	Outer Joint	46T	26	23	57.7	92.5	58	M			
NEW YORKER																	
-	1986-1990	-	-	-	Saginaw	809010	Outer Joint		26	29	54	99.5	62.5	O			
-	1994-1996	-	-	-	SAGINAW	699062	Inner Joint		27	32	39.5	49	76				
-	1994-1995	-	-	-	SAGINAW	809038	Outer Joint	50W	33	32	49.6	102.5	60	O			
-	1996-	-	-	-	-	808022	Outer Joint	50T	33	32	49.6	102.5	60	O			
NEW YORKER/PHANTOM																	
-	1988-1989	MT	-	-	-	609016	Inner Joint		25	24	40	71.5	99.5				
NEW YORKER/PHANTOM/LE BARON																	
-	1988-1990	-	-	-	-	809012	Outer Joint		26	24	54	90	63.5	I			
-	1988-1990	-	-	-	-	609016	Inner Joint		25	24	40	71.5	99.5				
NEW YORKER/PHANTOM/SHADOW																	
-	1988-1989	MT	-	-	-	809012	Outer Joint		26	24	54	90	63.5	I			
-	1988-1989	MT	-	-	-	609016	Inner Joint		25	24	40	71.5	99.5				
NEW YORKER/PHANTOM/SPIRIT/SHADOW																	
-	1990-1994	AT	-	-	-	809019	Outer Joint		26	32	54	90	63.5	I			
-	1990-1994	AT	-	-	-	609003	Inner Joint		25	25	40	71.5	107.5				
-	1990-1994	AT	-	-	-	809014	Outer Joint		26	32	54.1	95	63.5	I			
NEW YORKER/SPIRIT/SHADOW																	
-	1990-1994	AT	-	-	-	609003	Inner Joint		25	25	40	71.5	107.5				
PACIFICA																	
-	2004-2008	-	-	-	-	809048	Outer Joint		26	32	54	111	61.5	I			
PHANTOM																	
-	1992-1995	-	-	-	-	809023	Outer Joint		26	30	54	97.5	62.5	I			
PT CRUISER																	
-	2000-2004	MT/AT	-	-	-	609017	Inner Joint		25	23	40	74	113.5				
-	2000-2008	MT/AT	-	-	-	608057	Inner Joint		25	23	40	73.5	111				
-	2000-2009	-	-	-	-	809021	Outer Joint		26	22	57.7	92.5	58	M			
-	2006-2008	AT	L	-	-	209048	Drive Shaft		26	25	57.7	92.5	595				
-	2006-2008	AT	R	-	-	209049	Drive Shaft		26	25	57.7	92.5	950				
2.4 (105 kW)	2004.03-2008.03	-	-	F	Convertible Engine EDZ	809040	Outer Joint	46T	26	23	57.7	92.5	58	M			
PT CRUISER (PT_)																	
2.0 (100 kW)	2004.10-2010.12	-	-	F	Estate Engine ECC	809040	Outer Joint	46T	26	23	57.7	92.5	58	M			
2.0 (104 kW)	2000.06-2010.12	-	-	F	Estate Engine ECC	809040	Outer Joint	46T	26	23	57.7	92.5	58	M			
2.2 CRD (110 kW)	2005.08-2010.12	-	-	F	Estate Engine EDJ	809033	Outer Joint	46T	26	22	57.7	92.5	58	M			
	2005.08-2010.12	-	-	F	Estate Engine EDJ	809040	Outer Joint	46T	26	23	57.7	92.5	58	M			
	2005.08-2010.12	-	-	F	Estate Engine EDJ	809032	Outer Joint	46T	26	24	57.7	92.5	58	M			
	2005.08-2010.12	MT	L	F	Estate Engine EDJ	209074	Drive Shaft	46T	26	28	57.7	92.5	556				
	2005.08-2010.12	MT	R	F	Estate Engine EDJ	209073	Drive Shaft	46T	26	32	57.7	92.5	490				
2.2 CRD (89 kW)	2002.03-2010.12	-	-	F	Estate Engine EDJ	809033	Outer Joint	46T	26	22	57.7	92.5	58	M			
	2002.03-2010.12	-	-	F	Estate Engine EDJ	809040	Outer Joint	46T	26	23	57.7	92.5	58	M			
	2002.03-2010.12	-	-	F	Estate Engine EDJ	809032	Outer Joint	46T	26	24	57.7	92.5	58	M			
	2002.03-2010.12	MT	L	F	Estate Engine EDJ	209074	Drive Shaft	46T	26	28	57.7	92.5	556				
	2002.03-2010.12	MT	R	F	Estate Engine EDJ	209073	Drive Shaft	46T	26	32	57.7	92.5	490				
2.4 (105 kW)	2005.08-2010.12	-	-	F	Estate Engine EDZ	809040	Outer Joint	46T	26	23	57.7	92.5	58	M			
2.4 (110 kW)	2000.06-2010.12	-	-	F	Estate Engine EDZ	809040	Outer Joint	46T	26	23	57.7	92.5	58	M			
PT TURBO ATX																	
-	2003-2006	AT	-	-	-	809028	Outer Joint		26	24	57.7	92.5	58	M			
SEBRING																	
2.4L 4 Cyl DOHC 16V Dual VVT	2008-	-	-	-	Convertible LX	235042	Propshaft					30	745				
	2008-	-	-	-	Limited	235042	Propshaft					30	745				
	2008-	-	-	-	LX	235042	Propshaft					30	745				





	 YEAR	TRANSM	L/R	F/R	REMARKS	GSP Ref.	 PRODUCT	 ABS	Technical Specifications						
									A	B	C	H	L	P	
CHRYSLER SEBRING															
2.4L 4 Cyl DOHC 16V Dual VVT	2008-	-	-	-	Touring	235042	Propshaft					30	745		
	2008-	-	-	-	Convertible LX	235041	Propshaft					30	770		
	2008-	-	-	-	Limited	235041	Propshaft					30	770		
	2008-	-	-	-	LX	235041	Propshaft					30	770		
	2008-	-	-	-	Touring	235041	Propshaft					30	770		
2.4L I4 16V Dual VVT	2008-	-	-	-	Engine PZEV Limited	235041	Propshaft					30	770		
	2008-	-	-	-	Engine PZEV LX	235041	Propshaft					30	770		
	2008-	-	-	-	Engine PZEV Touring	235041	Propshaft					30	770		
2.4L I4 PZEV 16V Dual VVT	2008-	-	-	-	Engine Limited	235042	Propshaft					30	745		
	2008-	-	-	-	Engine LX	235042	Propshaft					30	745		
	2008-	-	-	-	Engine Touring	235042	Propshaft					30	745		
2.7L V6 24V FFV	2004-	-	4AT	-	-	216024	Propshaft					30	868		
	2004-	-	4AT	-	CONVERTIBLE	216024	Propshaft					30	868		
	2004-	-	4AT	-	CONVERTIBLE Limited	216024	Propshaft					30	868		
	2004-	-	4AT	-	CONVERTIBLE Touring	216024	Propshaft					30	868		
	2004-	-	4AT	-	GTC Convertible	216024	Propshaft					30	868		
	2004-	-	4AT	-	Limited	216024	Propshaft					30	868		
	2004-	-	4AT	-	Touring	216024	Propshaft					30	868		
2.7L V6 DOHC 24 Valve MPI	2004-	-	4AT	-	-	216024	Propshaft					30	868		
	2004-	-	4AT	-	CONVERTIBLE	216024	Propshaft					30	868		
	2004-	-	4AT	-	CONVERTIBLE Limited	216024	Propshaft					30	868		
	2004-	-	4AT	-	CONVERTIBLE Touring	216024	Propshaft					30	868		
	2004-	-	4AT	-	GTC Convertible	216024	Propshaft					30	868		
	2004-	-	4AT	-	Limited	216024	Propshaft					30	868		
	2004-	-	4AT	-	Touring	216024	Propshaft					30	868		
	2004-	-	5MT	-	GTC Convertible	216024	Propshaft					30	868		
	2008-	-	-	-	CONVERTIBLE Touring	235042	Propshaft					30	745		
	2008-	-	-	-	Limited	235042	Propshaft					30	745		
	2008-	-	-	-	LX	235042	Propshaft					30	745		
	2008-	-	-	-	Touring	235042	Propshaft					30	745		
	2008-	-	-	-	CONVERTIBLE Touring	235041	Propshaft					30	770		
	2008-	-	-	-	Limited	235041	Propshaft					30	770		
	2008-	-	-	-	LX	235041	Propshaft					30	770		
	2008-	-	-	-	Touring	235041	Propshaft					30	770		
3.5L High Output V6 24V MPI	2008-	-	6AT	-	62TE CONVERTIBLE Limited	235042	Propshaft					30	745		
	2008-	-	6AT	-	62TE Limited	235042	Propshaft					30	745		
	2008-	-	6AT	-	AWD	235042	Propshaft					30	745		
	2008-	-	6AT	-	62TE CONVERTIBLE Limited	235041	Propshaft					30	770		
	2008-	-	6AT	-	62TE Limited	235041	Propshaft					30	770		
	2008-	-	6AT	-	62TE Limited AWD	235041	Propshaft					30	770		
SEBRING (JR)															
2.0 (104 kW)	2001.04-	2007.06	-	-	F Convertible Engine ECC	809040	Outer Joint	46T	26	23	57.7	92.5	58	M	
2.4 (112 kW)	2001.04-	2007.06	-	-	F Convertible Engine EDZ	809040	Outer Joint	46T	26	23	57.7	92.5	58	M	
SEBRING CONV															
-	1996-	1997	-	-	-	809043	Outer Joint	56T	26	32	54.1	95	63.5	I	
SEBRING COUPE															
-	1995-	1999	-	-	-	839041	Outer Joint		25	25	54	95.5	65	M	
SHADOW															
-	1988-	1989	MT	-	-	809012	Outer Joint		26	24	54	90	63.5	I	
	1992-	1995	-	-	-	809023	Outer Joint		26	30	54	97.5	62.5	I	
2.5	1991-	1994	AT	R	-	609007	Inner Joint		25	25	28	172.3	122		
	1991-	1994	MT	L/R	-	609007	Inner Joint		25	25	28	172.3	122		
SPIRIT															
-	1990-	-	MT	-	-	809012	Outer Joint		26	24	54	90	63.5	I	
	1990-	-	MT	-	-	609016	Inner Joint		25	24	40	71.5	99.5		
	1992-	1995	-	-	-	809023	Outer Joint		26	30	54	97.5	62.5	I	
SPIRIT,SHADOW															
-	1991-	1994	MT/AT	L/R	-	809058	Outer Joint		26	32	54	98.5	61.5	I	
	1991-	1994	MT/AT	L/R	-	809058	Outer Joint		26	32	54	98.5	61.5	I	
SPIRIT/SHADOW															
-	1991-	1994	AT	-	-	609003	Inner Joint		25	25	40	71.5	107.5		
	1991-	1994	MT/AT	-	-	609003	Inner Joint		25	25	40	71.5	107.5		
	1991-	1994	MT/AT	-	-	809014	Outer Joint		26	32	54.1	95	63.5	I	
	1991-	1994	MT/AT	-	-	609018	Inner Joint		25	25	28	172	116		
STRATUS															
-	1996-	1997	-	-	-	809043	Outer Joint	56T	26	32	54.1	95	63.5	I	





YEAR	TRANS	L/R	F/R	REMARKS	GSP Ref.	PRODUCT	ABS	Technical Specifications							
								A	B	C	H	L	P		
CHRYSLER STRATUS															
-	1996-1997	AT	-	-	-	809014	Outer Joint		26	32	54.1	95	63.5	I	
-	2000-	AT	-	-	-	809014	Outer Joint		26	32	54.1	95	63.5	I	
STRATUS 3ATX															
-	2000-	AT	-	-	-	609023	Inner Joint		25	32	40	74	113		
STRATUS TURBO															
-	2000-2004	MT/AT	-	-	-	609023	Inner Joint		25	32	40	74	113		
-	2000-2004	MT/AT	-	-	-	809037	Outer Joint	46T	26	32	54.1	95	63.5	I	
TOWN & COUNTRY															
-	1992-1995	-	-	-	-	809023	Outer Joint		26	30	54	97.5	62.5	I	
-AWD	2001-2004	-	-	-	-	609034	Propshaft CV Joint			25		32			
TOWN/COUNTRY															
-	1991-1995	-	-	-	-	609026	Inner Joint		25	32	40	71	124		
-	1991-1995	-	-	-	SUV/Truck/VAN GKN PASSENGER	609027	Inner Joint		25	32	28	172	137		
-	1996-2000	-	-	-	SUV/Truck/VAN	609021	Inner Joint		25	32	28	173	107		
-	1996-2004	-	-	-	SUV/Truck/VAN	699059	Inner Joint		25	32	40	71.5	107		
TOWN/COUNTRY MINI VAN															
-	1996-1997	-	-	-	TRUCK	609011	Inner Joint		25	32	40	71.5	107		
TOWN/COUNTRY VAN															
-	1987-1995	-	-	-	TRUCK / VAN	609005	Inner Joint		25	32	40	71	122		
-	1990-	-	L/R	F	Truck	209001	Drive Shaft	47T	26	25	54	98.5	611		
-	1991-1995	-	L/R	F	Truck	209001	Drive Shaft	47T	26	25	54	98.5	611		
-	1991-1995	-	-	F	Truck	609006	Inner Joint		25	32	28	172.3	122		
-	1992-1995	-	L/R	F	Truck	209001	Drive Shaft	47T	26	25	54	98.5	611		
VISION															
3.5 TSi (155 kW)	1993.09-1997.12	-	-	-	Saloon Engine F01/F00/EGE	809045	Outer Joint		33	32	50	90.5	56.5	O	
VOYAGER															
-	1991-1994	AT	-	-	-	608056	Inner Joint		25	25	28	147	129		
-	1991-1994	AT	-	-	-	809014	Outer Joint		26	32	54.1	95	63.5	I	
-	1991-1994	AT	-	-	-	609025	Inner Joint		25	25	28	172.5	98		
-	1991-1994	AT	L/R	-	-	809058	Outer Joint		26	32	54	98.5	61.5	I	
-	1991-1994	AT	L/R	-	-	809058	Outer Joint		26	32	54	98.5	61.5	I	
-	1992-1995	-	-	-	-	809023	Outer Joint		26	30	54	97.5	62.5	I	
-	1996-2000	AT	-	-	-	609021	Inner Joint		25	32	28	173	107		
-	1996-2000	AT	-	-	-	609023	Inner Joint		25	32	40	74	113		
2.0 i (98 kW)	1995.01-2001.03	-	R	-	-	209064	Drive Shaft		26	25	54	98.5	1028		
2.4 i (111 kW)	1995.01-2001.03	-	R	-	-	209064	Drive Shaft		26	25	54	98.5	1028		
2.5 TD (85 kW)	1995.01-2001.03	-	R	-	-	209064	Drive Shaft		26	25	54	98.5	1028		
3.3 (110 kW)	1991.03-1995.01	-	L	-	-	215004	Drive Shaft		26	25	54	98.5	611		
3.3 (110 kW)	1991.03-1995.01	-	R	-	-	209015	Drive Shaft		26	25	54	98.5	1000		
3.3 (110 kW)	1991.03-1995.01	-	R	-	-	209061	Drive Shaft	47T	26	25	54	98.5	1000		
3.3 (120 kW)	1991.03-1995.01	-	L	-	-	215004	Drive Shaft		26	25	54	98.5	611		
3.3 (120 kW)	1991.03-1995.01	-	R	-	-	209015	Drive Shaft		26	25	54	98.5	1000		
3.3 (120 kW)	1991.03-1995.01	-	R	-	-	209061	Drive Shaft	47T	26	25	54	98.5	1000		
VOYAGER I (ES)															
-	1990.08-1995.09	-	-	-	-	609006	Inner Joint		25	32	28	172.3	122		
-	1990.08-1995.09	-	-	-	-	609005	Inner Joint		25	32	40	71	122		
VOYAGER II (ES)															
2.5 i (72 kW)	1991.01-1995.09	-	L	F	MPV Engine K00	209002	Drive Shaft	47T	26	25	54	98.5	611		
2.5 i (72 kW)	1991.01-1995.09	-	R	F	MPV Engine K00	209028	Drive Shaft	47T	26	25	54	98.5	1001		
2.5 i (72 kW)	1991.01-1995.09	MT	L/R	F	MPV Engine K00	809005	Outer Joint		26	32	54.1	98	62	I	
2.5 i (74 kW)	1990.08-1995.09	-	L	F	MPV Engine K	209002	Drive Shaft	47T	26	25	54	98.5	611		
2.5 i (74 kW)	1990.08-1995.09	-	R	F	MPV Engine K	209028	Drive Shaft	47T	26	25	54	98.5	1001		
2.5 TD (87 kW)	1992.01-1995.09	-	L	F	MPV Engine M00/098	209002	Drive Shaft	47T	26	25	54	98.5	611		
2.5 TD (87 kW)	1992.01-1995.09	-	R	F	MPV Engine M00/098	209028	Drive Shaft	47T	26	25	54	98.5	1001		
2.5 TD (87 kW)	1992.01-1995.09	MT	L/R	F	MPV Engine M00/098	809005	Outer Joint		26	32	54.1	98	62	I	
3.0 (104 kW)	1990.10-1995.09	-	L	F	MPV Engine EFA	209002	Drive Shaft	47T	26	25	54	98.5	611		
3.0 (104 kW)	1990.10-1995.09	-	R	F	MPV Engine EFA	209028	Drive Shaft	47T	26	25	54	98.5	1001		
3.0 (104 kW)	1990.10-1995.09	MT	L/R	F	MPV Engine EFA	809005	Outer Joint		26	32	54.1	98	62	I	
3.0 i (108 kW)	1991.01-1995.09	-	L	F	MPV Engine 66G72/300	209002	Drive Shaft	47T	26	25	54	98.5	611		
3.0 i (108 kW)	1991.01-1995.09	-	R	F	MPV Engine 66G72/300	209028	Drive Shaft	47T	26	25	54	98.5	1001		
3.0 i (108 kW)	1991.01-1995.09	MT	L/R	F	MPV Engine 66G72/300	809005	Outer Joint		26	32	54.1	98	62	I	
3.3 i (110 kW)	1990.08-1995.09	-	L	F	MPV Engine EGA	209002	Drive Shaft	47T	26	25	54	98.5	611		
3.3 i (110 kW)	1990.08-1995.09	-	R	F	MPV Engine EGA	209028	Drive Shaft	47T	26	25	54	98.5	1001		
3.3 i (110 kW)	1990.08-1995.09	AT	-	-	MPV Engine EGA	809009	Outer Joint		26	32	54	98.5	61.5	I	
3.3 i (120 kW)	1990.08-1995.09	-	L	F	MPV Engine EGA	209002	Drive Shaft	47T	26	25	54	98.5	611		
3.3 i (120 kW)	1990.08-1995.09	-	R	F	MPV Engine EGA	209028	Drive Shaft	47T	26	25	54	98.5	1001		





	 YEAR	TRANSM	L/R	F/R	REMARKS	GSP Ref.	 PRODUCT	 ABS	Technical Specifications					
									A	B	C	H	L	P
CHRYSLER														
VOYAGER II (ES)														
3.3 i (120 kW)	1990.08-1995.09	AT	-	-	MPV Engine EGA	809009	Outer Joint		26	32	54	98.5	61.5	I
3.3 i AWD (110 kW)	1990.08-1995.09	AT	-	-	All-wheel Drive MPV Engine EGA	809009	Outer Joint		26	32	54	98.5	61.5	I
	1990.08-1995.09	AT/MT	L/R	F	All-wheel Drive MPV Engine EGA	809005	Outer Joint		26	32	54.1	98	62	I
3.3 i AWD (120 kW)	1990.08-1995.09	AT	-	-	All-wheel Drive MPV Engine R00	809009	Outer Joint		26	32	54	98.5	61.5	I
	1990.08-1995.09	AT	L/R	F	All-wheel Drive MPV Engine R00	809005	Outer Joint		26	32	54.1	98	62	I
VOYAGER IV (RG RS)/GRAND VOYAGER														
2.4 (108 kW)	2000.02-2008.12	-	R	F	MPV Engine EDZ	209066	Drive Shaft	47T	26	27	54.1	98	1032	
	2000.02-2008.12	MT	L	F	MPV Engine EDZ	209067	Drive Shaft	47T	26	27	54.1	98	639	
	2000.02-2008.12	MT	R	F	MPV Engine EDZ	209082	Drive Shaft	47T	26	27	54	98.5	1031	
	2000.02-2008.12	4AT	-	F	MPV Engine EDZ	809029	Outer Joint	47T	26	32	54	98.5	61.5	I
	2000.02-2008.12	AT/MT	L/R	F	MPV Engine EDZ	809005	Outer Joint		26	32	54.1	98	62	I
2.5 CRD (105 kW)	2000.02-2008.12	-	R	F	MPV Engine ENJ	209066	Drive Shaft	47T	26	27	54.1	98	1032	
	2000.02-2008.12	MT	L	F	MPV Engine ENJ	209067	Drive Shaft	47T	26	27	54.1	98	639	
	2000.02-2008.12	MT	R	F	MPV Engine ENJ	209082	Drive Shaft	47T	26	27	54	98.5	1031	
	2000.02-2008.12	4AT	-	F	MPV Engine ENJ	809029	Outer Joint	47T	26	32	54	98.5	61.5	I
	2000.02-2008.12	MT	L/R	F	MPV Engine ENJ	809005	Outer Joint		26	32	54.1	98	62	I
2.5 CRD (88 kW)	2005.08-2008.12	MT	L	F	MPV Engine EDK	209067	Drive Shaft	47T	26	27	54.1	98	639	
	2005.08-2008.12	MT	R	F	MPV Engine EDK	209082	Drive Shaft	47T	26	27	54	98.5	1031	
	2005.08-2008.12	4AT	-	F	MPV Engine EDK	809029	Outer Joint	47T	26	32	54	98.5	61.5	I
	2005.08-2008.12	AT/MT	L/R	F	MPV Engine EDK	809005	Outer Joint		26	32	54.1	98	62	I
2.8 CRD (110 kW)	2004.06-2008.12	AT	R	F	MPV Engine ENR	209005	Drive Shaft	47T	26	25	54	98.5	1030	
	2004.06-2008.12	4AT	-	F	MPV Engine ENR	809029	Outer Joint	47T	26	32	54	98.5	61.5	I
	2004.06-2008.12	AT/MT	L/R	F	MPV Engine ENR	809005	Outer Joint		26	32	54.1	98	62	I
3.3 (128 kW)	2000.02-2008.12	AT	R	F	MPV Engine EGA/EGM	209005	Drive Shaft	47T	26	25	54	98.5	1030	
	2000.02-2008.12	4AT	-	F	MPV Engine EGA/EGM	809029	Outer Joint	47T	26	32	54	98.5	61.5	I
3.3 AWD (128 kW)	2000.02-2008.12	AT	R	F	All-wheel Drive MPV Engine EGA	209005	Drive Shaft	47T	26	25	54	98.5	1030	
	2000.02-2008.12	4AT	-	F	All-wheel Drive MPV Engine EGA	809029	Outer Joint	47T	26	32	54	98.5	61.5	I
3.3 Flex-Fuel (128 kW)	2000.02-2008.12	AT	R	F	MPV Engine EGM	209005	Drive Shaft	47T	26	25	54	98.5	1030	
	2000.02-2008.12	4AT	-	F	MPV Engine EGM	809029	Outer Joint	47T	26	32	54	98.5	61.5	I
3.8 (160 kW)	2000.02-2008.12	4AT	-	F	MPV Engine EGH	809029	Outer Joint	47T	26	32	54	98.5	61.5	I
3.8 AWD (160 kW)	2000.02-2008.12	4AT	-	F	All-wheel Drive MPV Engine EGH	809029	Outer Joint	47T	26	32	54	98.5	61.5	I
VOYAGER/GRAND VOYAGER III (GS)/TACUMA														
2.0 i (98 kW)	1995.01-2001.03	MT	L	F	MPV Engine C00	208024	Drive Shaft	47T	26	25	54	98.5	640	
	1995.01-2001.03	MT	R	F	MPV Engine C00	209039	Drive Shaft	47T	26	25	54	98.5	1028	
	1995.01-2001.03	5MT	-	F	MPV Engine C00	809029	Outer Joint	47T	26	32	54	98.5	61.5	I
2.4 AWD (111 kW)	1997.02-2001.03	5MT	-	F	All-wheel Drive MPV Engine EDZ	809029	Outer Joint	47T	26	32	54	98.5	61.5	I
2.4 i (111 kW)	1995.01-2001.03	MT	L	F	MPV Engine B00	208024	Drive Shaft	47T	26	25	54	98.5	640	
	1995.01-2001.03	MT	R	F	MPV Engine B00	209039	Drive Shaft	47T	26	25	54	98.5	1028	
	1995.01-2001.03	5MT	-	F	MPV Engine B00	809029	Outer Joint	47T	26	32	54	98.5	61.5	I
2.5 TD (85 kW)	1995.01-2001.03	MT	L	F	MPV Engine 425 CLIRS/X/ENC	208024	Drive Shaft	47T	26	25	54	98.5	640	
	1995.01-2001.03	MT	R	F	MPV Engine 425 CLIRS/X/ENC	209039	Drive Shaft	47T	26	25	54	98.5	1028	
	1995.01-2001.03	5MT	-	F	MPV Engine 425 CLIRS/X/ENC	809029	Outer Joint	47T	26	32	54	98.5	61.5	I
2.5 TDi AWD (85 kW)	1995.10-2001.03	5MT	-	F	All-wheel Drive MPV Engine ENC	809029	Outer Joint	47T	26	32	54	98.5	61.5	I
3.0 (112 kW)	1995.01-2001.03	5MT	-	F	MPV Engine EFA	809029	Outer Joint	47T	26	32	54	98.5	61.5	I
3.3 i (116 kW)	1995.01-2001.03	5MT	-	F	MPV Engine R00	809029	Outer Joint	47T	26	32	54	98.5	61.5	I
	1995.01-2001.03	AT	L	F	MPV Engine R00	209004	Drive Shaft	47T	26	25	54	98.5	638	
3.8 i AWD (122 kW)	1995.01-2001.03	5MT	-	F	All-wheel Drive MPV Engine L00	809029	Outer Joint	47T	26	32	54	98.5	61.5	I
3.8 i AWD (131 kW)	1995.01-2001.03	5MT	-	F	All-wheel Drive MPV Engine EGH	809029	Outer Joint	47T	26	32	54	98.5	61.5	I
VOYAGER/PHANTOM/NEW YORKER														
-	1990-1994	MT/AT	-	-	-	809058	Outer Joint		26	32	54	98.5	61.5	I
	1990-1994	MT/AT	-	-	-	809058	Outer Joint		26	32	54	98.5	61.5	I
CITROEN														
988														
-	-	-	-	-	-	810058	Outer Joint	29T	25	30	59	79	61	I
AX														
1.4	1993.02-1994.06	-	R	F	-	245046	Drive Shaft	48T	21	22	58.5	76	800	
AX (ZA-)														
1.0 (32 kW)	1986.09-1992.06	-	-	F	Hatchback Engine C1A	808016	Outer Joint		22	22	52	96.5	53.5	O
	1986.09-1992.06	MT	R	F	Hatchback Engine C1A	210062	Drive Shaft		21	22	49.9	81	798	
	1986.09-1992.06	MT	L	F	Hatchback Engine C1A	810034	Outer Joint		21	20	50	81.5	54	O
	1986.09-1992.06	MT	R	F	Hatchback Engine C1A	210008	Drive Shaft		21	22	50	81.5	800	
	1986.09-1992.06	MT	L	F	Hatchback Engine C1A	210005	Drive Shaft		21	22	50	81.5	619	
	1986.09-1992.06	MT	L	F	Hatchback Engine C1A	210009	Drive Shaft		21	22	50	81.5	618	
	1986.09-1992.06	MT	R	F	Hatchback Engine C1A	210003	Drive Shaft		21	22	49	81	798	
	1986.09-1992.06	MT	L	F	Hatchback Engine C1A	210061	Drive Shaft		21	22	49.9	81	620	





	 YEAR	TRANSM	L/R	F/R	REMARKS	GSP Ref.	 PRODUCT	 ABS	Technical Specifications					
									A	B	C	H	L	P
CITROEN														
AX (ZA-)														
1.0 (33 kW)	1986.07-1998.12	MT	R	F	Hatchback Engine CDY (TU9M)	210062	Drive Shaft		21	22	49.9	81	798	
	1986.07-1998.12	-	-	F	Hatchback Engine CDY (TU9M)	808016	Outer Joint		22	22	52	96.5	53.5	O
	1986.07-1998.12	MT	L	F	Hatchback Engine CDY (TU9M)	810034	Outer Joint		21	20	50	81.5	54	O
	1986.07-1998.12	MT	R	F	Hatchback Engine CDY (TU9M)	210008	Drive Shaft		21	22	50	81.5	800	
	1986.07-1998.12	MT	L	F	Hatchback Engine CDY (TU9M)	210005	Drive Shaft		21	22	50	81.5	619	
	1986.07-1998.12	MT	L	F	Hatchback Engine CDY (TU9M)	210009	Drive Shaft		21	22	50	81.5	618	
	1986.07-1998.12	MT	L	F	Hatchback Engine CDY (TU9M)	210061	Drive Shaft		21	22	49.9	81	620	
	1986.07-1998.12	MT	R	F	Hatchback Engine CDY (TU9M)	210003	Drive Shaft		21	22	49	81	798	
1.0 (37 kW)	1987.02-1998.12	-	-	F	Hatchback Engine CDZ (TU9M)	808016	Outer Joint		22	22	52	96.5	53.5	O
	1987.02-1998.12	MT	R	F	Hatchback Engine CDZ (TU9M)	210062	Drive Shaft		21	22	49.9	81	798	
	1987.02-1998.12	MT	L	F	Hatchback Engine CDZ (TU9M)	810034	Outer Joint		21	20	50	81.5	54	O
	1987.02-1998.12	MT	L	F	Hatchback Engine CDZ (TU9M)	210009	Drive Shaft		21	22	50	81.5	618	
	1987.02-1998.12	MT	L	F	Hatchback Engine CDZ (TU9M)	210061	Drive Shaft		21	22	49.9	81	620	
1.1 (40 kW)	1986.12-1994.04	MT	R	F	Hatchback Engine H1B/H1A	210062	Drive Shaft		21	22	49.9	81	798	
	1986.12-1994.04	-	-	F	Hatchback Engine H1B/H1A	808016	Outer Joint		22	22	52	96.5	53.5	O
	1986.12-1994.04	MT	L	F	Hatchback Engine H1B/H1A	810034	Outer Joint		21	20	50	81.5	54	O
	1986.12-1994.04	MT	R	F	Hatchback Engine H1B/H1A	210008	Drive Shaft		21	22	50	81.5	800	
	1986.12-1994.04	MT	L	F	Hatchback Engine H1B/H1A	210005	Drive Shaft		21	22	50	81.5	619	
	1986.12-1994.04	MT	L	F	Hatchback Engine H1B/H1A	210061	Drive Shaft		21	22	49.9	81	620	
	1986.12-1994.04	MT	R	F	Hatchback Engine H1B/H1A	210003	Drive Shaft		21	22	49	81	798	
1.1 (44 kW)	1986.09-1997.12	MT	R	F	Hatchback Engine HDZ (TU1M)/H1B	210062	Drive Shaft		21	22	49.9	81	798	
	1986.09-1997.12	-	-	F	Hatchback Engine HDZ (TU1M)/H1B	808016	Outer Joint		22	22	52	96.5	53.5	O
	1986.09-1997.12	MT	L	F	Hatchback Engine HDZ (TU1M)/H1B	810034	Outer Joint		21	20	50	81.5	54	O
	1986.09-1997.12	MT	R	F	Hatchback Engine HDZ (TU1M)/H1B	210008	Drive Shaft		21	22	50	81.5	800	
	1986.09-1997.12	MT	L	F	Hatchback Engine HDZ (TU1M)/H1B	210005	Drive Shaft		21	22	50	81.5	619	
	1986.09-1997.12	MT	L	F	Hatchback Engine HDZ (TU1M)/H1B	210009	Drive Shaft		21	22	50	81.5	618	
	1986.09-1997.12	MT	R	F	Hatchback Engine HDZ (TU1M)/H1B	210003	Drive Shaft		21	22	49	81	798	
1.1 Cat (40 kW)	1988.09-1989.12	MT	L	F	Hatchback Engine HAZ (TU1CP)	810034	Outer Joint		21	20	50	81.5	54	O
	1988.09-1989.12	MT	R	F	Hatchback Engine HAZ (TU1CP)	210008	Drive Shaft		21	22	50	81.5	800	
	1988.09-1989.12	MT	L	F	Hatchback Engine HAZ (TU1CP)	210061	Drive Shaft		21	22	49.9	81	620	
	1988.09-1989.12	MT	R	F	Hatchback Engine HAZ (TU1CP)	210062	Drive Shaft		21	22	49.9	81	798	
	1988.09-1989.12	MT	L	F	Hatchback Engine HAZ (TU1CP)	210005	Drive Shaft		21	22	50	81.5	619	
	1988.09-1989.12	-	-	F	Hatchback Engine HAZ (TU1CP)	808016	Outer Joint		22	22	52	96.5	53.5	O
	1988.09-1989.12	MT	R	F	Hatchback Engine HAZ (TU1CP)	210003	Drive Shaft		21	22	49	81	798	
	1988.09-1989.12	MT	L	F	Hatchback Engine HAZ (TU1CP)	210009	Drive Shaft		21	22	50	81.5	618	
1.4 (49 kW)	1988.06-1989.12	MT	L	F	Hatchback Engine K1F	810034	Outer Joint		21	20	50	81.5	54	O
	1988.06-1989.12	MT	R	F	Hatchback Engine K1F	210008	Drive Shaft		21	22	50	81.5	800	
	1988.06-1989.12	MT	L	F	Hatchback Engine K1F	210061	Drive Shaft		21	22	49.9	81	620	
	1988.06-1989.12	MT	R	F	Hatchback Engine K1F	210062	Drive Shaft		21	22	49.9	81	798	
	1988.06-1989.12	MT	L	F	Hatchback Engine K1F	210094	Drive Shaft		21	22	56.4	76	615	
	1988.06-1989.12	MT	R	F	Hatchback Engine K1F	210093	Drive Shaft		21	22	56.4	76	796	
	1988.06-1989.12	MT	L	F	Hatchback Engine K1F	210005	Drive Shaft		21	22	50	81.5	619	
	1988.06-1989.12	-	-	F	Hatchback Engine K1F	808016	Outer Joint		22	22	52	96.5	53.5	O
	1988.06-1989.12	MT	R	F	Hatchback Engine K1F	210003	Drive Shaft		21	22	49	81	798	
1.4 (55 kW)	1987.04-1997.04	-	-	-	Hatchback Engine KDY (TU3M)/KDZ (TU3M)/Z/KDY (TU3M)/KDY (TU3FM)	210089	Drive Shaft		21	22	56.4	76	790	
	1987.04-1997.04	MT	R	F	Hatchback Engine KDY (TU3M)/KDZ (TU3M)/Z/KDY (TU3M)/KDY (TU3FM)	210062	Drive Shaft		21	22	49.9	81	798	
	1987.04-1997.04	MT	L	F	Hatchback Engine KDY (TU3M)/KDZ (TU3M)/Z/KDY (TU3M)/KDY (TU3FM)	810034	Outer Joint		21	20	50	81.5	54	O
	1987.04-1997.04	MT	L	F	Hatchback Engine KDY (TU3M)/KDZ (TU3M)/Z/KDY (TU3M)/KDY (TU3FM)	210094	Drive Shaft		21	22	56.4	76	615	
	1987.04-1997.04	MT	R	F	Hatchback Engine KDY (TU3M)/KDZ (TU3M)/Z/KDY (TU3M)/KDY (TU3FM)	210008	Drive Shaft		21	22	50	81.5	800	
	1987.04-1997.04	MT	L	F	Hatchback Engine KDY (TU3M)/KDZ (TU3M)/Z/KDY (TU3M)/KDY (TU3FM)	210164	Drive Shaft		21	22	58.5	76	614	
	1987.04-1997.04	MT	R	F	Hatchback Engine KDY (TU3M)/KDZ (TU3M)/Z/KDY (TU3M)/KDY (TU3FM)	210093	Drive Shaft		21	22	56.4	76	796	
	1987.04-1997.04	MT	L	F	Hatchback Engine KDY (TU3M)/KDZ (TU3M)/Z/KDY (TU3M)/KDY (TU3FM)	210005	Drive Shaft		21	22	50	81.5	619	
	1987.04-1997.04	MT	R	F	Hatchback Engine KDY (TU3M)/KDZ (TU3M)/Z/KDY (TU3M)/KDY (TU3FM)	210085	Drive Shaft		21	22	56.4	76	798	
	1987.04-1997.04	MT	R	F	Hatchback Engine KDY (TU3M)/KDZ (TU3M)/Z/KDY (TU3M)/KDY (TU3FM)	210186	Drive Shaft	48T	21	22	54	75.5	799	
	1987.04-1997.04	MT	L	F	Hatchback Engine KDY (TU3M)/KDZ (TU3M)/Z/KDY (TU3M)/KDY (TU3FM)	210038	Drive Shaft	48T	21	22	58.5	76	614	
	1987.04-1997.04	MT	R	F	Hatchback Engine KDY (TU3M)/KDZ (TU3M)/Z/KDY (TU3M)/KDY (TU3FM)	210042	Drive Shaft	48T	21	22	56.4	76	798	
	1987.04-1997.04	MT	R	F	Hatchback Engine KDY (TU3M)/KDZ (TU3M)/Z/KDY (TU3M)/KDY (TU3FM)	210003	Drive Shaft		21	22	49	81	798	
	1987.04-1997.04	MT	L	F	Hatchback Engine KDY (TU3M)/KDZ (TU3M)/Z/KDY (TU3M)/KDY (TU3FM)	210061	Drive Shaft		21	22	49.9	81	620	
	1.4 (62 kW)	1988.01-1992.12	MT	R	F	Hatchback Engine K2A/K2B	210062	Drive Shaft		21	22	49.9	81	798
1988.01-1992.12		MT	L	F	Hatchback Engine K2A/K2B	810034	Outer Joint		21	20	50	81.5	54	O
1988.01-1992.12		MT	L	F	Hatchback Engine K2A/K2B	210094	Drive Shaft		21	22	56.4	76	615	
1988.01-1992.12		MT	R	F	Hatchback Engine K2A/K2B	210008	Drive Shaft		21	22	50	81.5	800	
1988.01-1992.12		MT	R	F	Hatchback Engine K2A/K2B	210093	Drive Shaft		21	22	56.4	76	796	
1988.01-1992.12		MT	L	F	Hatchback Engine K2A/K2B	210005	Drive Shaft		21	22	50	81.5	619	
1988.01-1992.12		MT	L	F	Hatchback Engine K2A/K2B	210061	Drive Shaft		21	22	49.9	81	620	
1988.01-1992.12		MT	R	F	Hatchback Engine K2A/K2B	210003	Drive Shaft		21	22	49	81	798	

	 YEAR	TRANSM	L/R	F/R	REMARKS	GSP Ref.	 PRODUCT	 ABS	Technical Specifications					
									A	B	C	H	L	P
CITROEN														
AX (ZA-)														
1.4 D (37 kW)	1991.08-1997.12	-	-	-	Hatchback Engine K9Y (TUD3Y)	210089	Drive Shaft		21	22	56.4	76	790	
	1991.08-1997.12	-	-	F	Hatchback Engine K9Y (TUD3Y)	808016	Outer Joint		22	22	52	96.5	53.5	O
	1991.08-1997.12	MT	L	F	Hatchback Engine K9Y (TUD3Y)	810034	Outer Joint		21	20	50	81.5	54	O
	1991.08-1997.12	MT	L	F	Hatchback Engine K9Y (TUD3Y)	210094	Drive Shaft		21	22	56.4	76	615	
	1991.08-1997.12	MT	R	F	Hatchback Engine K9Y (TUD3Y)	210008	Drive Shaft		21	22	50	81.5	800	
	1991.08-1997.12	MT	L	F	Hatchback Engine K9Y (TUD3Y)	210164	Drive Shaft		21	22	58.5	76	614	
	1991.08-1997.12	MT	R	F	Hatchback Engine K9Y (TUD3Y)	210093	Drive Shaft		21	22	56.4	76	796	
	1991.08-1997.12	MT	L	F	Hatchback Engine K9Y (TUD3Y)	210005	Drive Shaft		21	22	50	81.5	619	
	1991.08-1997.12	MT	R	F	Hatchback Engine K9Y (TUD3Y)	210085	Drive Shaft		21	22	56.4	76	798	
	1991.08-1997.12	MT	R	F	Hatchback Engine K9Y (TUD3Y)	210186	Drive Shaft	48T	21	22	54	75.5	799	
	1991.08-1997.12	MT	L	F	Hatchback Engine K9Y (TUD3Y)	210038	Drive Shaft	48T	21	22	58.5	76	614	
	1991.08-1997.12	MT	R	F	Hatchback Engine K9Y (TUD3Y)	210003	Drive Shaft		21	22	49	81	798	
1991.08-1997.12	MT	R	F	Hatchback Engine K9Y (TUD3Y)	210042	Drive Shaft	48T	21	22	56.4	76	798		
1.4 D (38 kW)	1988.09-1992.06	MT	R	F	Hatchback Engine K9A (TUD3)	210062	Drive Shaft		21	22	49.9	81	798	
	1988.09-1992.06	-	-	F	Hatchback Engine K9A (TUD3)	808016	Outer Joint		22	22	52	96.5	53.5	O
	1988.09-1992.06	MT	L	F	Hatchback Engine K9A (TUD3)	810034	Outer Joint		21	20	50	81.5	54	O
	1988.09-1992.06	MT	L	F	Hatchback Engine K9A (TUD3)	210094	Drive Shaft		21	22	56.4	76	615	
	1988.09-1992.06	MT	R	F	Hatchback Engine K9A (TUD3)	210008	Drive Shaft		21	22	50	81.5	800	
	1988.09-1992.06	MT	L	F	Hatchback Engine K9A (TUD3)	210164	Drive Shaft		21	22	58.5	76	614	
	1988.09-1992.06	MT	R	F	Hatchback Engine K9A (TUD3)	210093	Drive Shaft		21	22	56.4	76	796	
	1988.09-1992.06	MT	L	F	Hatchback Engine K9A (TUD3)	210005	Drive Shaft		21	22	50	81.5	619	
	1988.09-1992.06	MT	R	F	Hatchback Engine K9A (TUD3)	210085	Drive Shaft		21	22	56.4	76	798	
	1988.09-1992.06	MT	R	F	Hatchback Engine K9A (TUD3)	210186	Drive Shaft	48T	21	22	54	75.5	799	
	1988.09-1992.06	MT	L	F	Hatchback Engine K9A (TUD3)	210038	Drive Shaft	48T	21	22	58.5	76	614	
	1988.09-1992.06	MT	L	F	Hatchback Engine K9A (TUD3)	210061	Drive Shaft		21	22	49.9	81	620	
	1988.09-1992.06	MT	R	F	Hatchback Engine K9A (TUD3)	210003	Drive Shaft		21	22	49	81	798	
	1988.09-1992.06	MT	R	F	Hatchback Engine K9A (TUD3)	210042	Drive Shaft	48T	21	22	56.4	76	798	
1.4 GTi (66 kW)	1991.08-1996.12	MT	L	F	Hatchback Engine KFY (TU3FJ2)	299160	Drive Shaft	48T	21	22	54	75.5	608	
	1991.08-1996.12	MT	R	F	Hatchback Engine KFY (TU3FJ2)	299158	Drive Shaft	48T	21	22	54	75.5	801	
	1991.08-1996.12	MT	L	F	Hatchback Engine KFY (TU3FJ2)	210054	Drive Shaft		21	22	56.4	76	610	
	1991.08-1996.12	MT	R	F	Hatchback Engine KFY (TU3FJ2)	299203	Drive Shaft		21	22	54	75.5	801	
1.4 GTi (69 kW)	1991.06-1996.12	MT	L	F	Hatchback Engine KFZ (TU3FJ2)	299160	Drive Shaft	48T	21	22	54	75.5	608	
	1991.06-1996.12	MT	R	F	Hatchback Engine KFZ (TU3FJ2)	299158	Drive Shaft	48T	21	22	54	75.5	801	
	1991.06-1996.12	MT	L	F	Hatchback Engine KFZ (TU3FJ2)	210054	Drive Shaft		21	22	56.4	76	610	
	1991.06-1996.12	MT	R	F	Hatchback Engine KFZ (TU3FJ2)	299203	Drive Shaft		21	22	54	75.5	801	
1.4 GTi (74 kW)	1991.06-1992.12	MT	L	F	Hatchback Engine KFZ (TU3FJ2)	299160	Drive Shaft	48T	21	22	54	75.5	608	
	1991.06-1992.12	MT	R	F	Hatchback Engine KFZ (TU3FJ2)	299158	Drive Shaft	48T	21	22	54	75.5	801	
	1991.06-1992.12	MT	L	F	Hatchback Engine KFZ (TU3FJ2)	210054	Drive Shaft		21	22	56.4	76	610	
	1991.06-1992.12	MT	R	F	Hatchback Engine KFZ (TU3FJ2)	299203	Drive Shaft		21	22	54	75.5	801	
11 (40 kW)	1991.06-1992.07	MT	R	F	All-wheel Drive Hatchback Engine H1A	210062	Drive Shaft		21	22	49.9	81	798	
	1991.06-1992.07	-	-	F	All-wheel Drive Hatchback Engine H1A	808016	Outer Joint		22	22	52	96.5	53.5	O
	1991.06-1992.07	MT	L	F	All-wheel Drive Hatchback Engine H1A	210061	Drive Shaft		21	22	49.9	81	620	
14 (51 kW)	1989.01-1991.12	MT	L	F	Hatchback Engine K1G	210061	Drive Shaft		21	22	49.9	81	620	
	1989.01-1991.12	-	-	F	Hatchback Engine K1G	808016	Outer Joint		22	22	52	96.5	53.5	O
	1989.01-1991.12	MT	R	F	Hatchback Engine K1G	210062	Drive Shaft		21	22	49.9	81	798	
	1989.01-1991.12	MT	L	F	Hatchback Engine K1G	210094	Drive Shaft		21	22	56.4	76	615	
1989.01-1991.12	MT	R	F	Hatchback Engine K1G	210093	Drive Shaft		21	22	56.4	76	796		
14 (55 kW)	1991.08-1996.12	-	R	F	All-wheel Drive Hatchback Engine KDY (TU3MJKDZ (TU3MZYKDY (TU3MJKDY (TU3FM)	210089	Drive Shaft		21	22	56.4	76	790	
	1991.08-1996.12	-	-	F	All-wheel Drive Hatchback Engine KDY (TU3MJKDZ (TU3MZYKDY (TU3MJKDY (TU3FM)	808016	Outer Joint		22	22	52	96.5	53.5	O
	1991.08-1996.12	MT	L	F	All-wheel Drive Hatchback Engine KDY (TU3MJKDZ (TU3MZYKDY (TU3MJKDY (TU3FM)	210094	Drive Shaft		21	22	56.4	76	615	
	1991.08-1996.12	MT	L	F	All-wheel Drive Hatchback Engine KDY (TU3MJKDZ (TU3MZYKDY (TU3MJKDY (TU3FM)	210164	Drive Shaft		21	22	58.5	76	614	
	1991.08-1996.12	MT	R	F	All-wheel Drive Hatchback Engine KDY (TU3MJKDZ (TU3MZYKDY (TU3MJKDY (TU3FM)	210093	Drive Shaft		21	22	56.4	76	796	
	1991.08-1996.12	MT	R	F	All-wheel Drive Hatchback Engine KDY (TU3MJKDZ (TU3MZYKDY (TU3MJKDY (TU3FM)	210085	Drive Shaft		21	22	56.4	76	798	
1991.08-1996.12	MT	R	F	All-wheel Drive Hatchback Engine KDY (TU3MJKDZ (TU3MZYKDY (TU3MJKDY (TU3FM)	210186	Drive Shaft	48T	21	22	54	75.5	799		
14 (61 kW)	1988.01-1992.12	-	-	F	Hatchback Engine K2A	808016	Outer Joint		22	22	52	96.5	53.5	O
	1988.01-1992.12	MT	R	F	Hatchback Engine K2A	210062	Drive Shaft		21	22	49.9	81	798	
	1988.01-1992.12	MT	L	F	Hatchback Engine K2A	210094	Drive Shaft		21	22	56.4	76	615	
	1988.01-1992.12	MT	R	F	Hatchback Engine K2A	210093	Drive Shaft		21	22	56.4	76	796	
	1988.01-1992.12	MT	L	F	Hatchback Engine K2A	210061	Drive Shaft		21	22	49.9	81	620	
15 D (40 kW)	1994.08-1997.12	MT	R	F	Hatchback Engine VJY (TUD5)	210089	Drive Shaft		21	22	56.4	76	790	
	1994.08-1997.12	-	-	F	Hatchback Engine VJY (TUD5)	808016	Outer Joint		22	22	52	96.5	53.5	O
	1994.08-1997.12	MT	L	F	Hatchback Engine VJY (TUD5)	210094	Drive Shaft		21	22	56.4	76	615	
	1994.08-1997.12	MT	L	F	Hatchback Engine VJY (TUD5)	210164	Drive Shaft		21	22	58.5	76	614	
	1994.08-1997.12	MT	R	F	Hatchback Engine VJY (TUD5)	210093	Drive Shaft		21	22	56.4	76	796	
	1994.08-1997.12	MT	L	F	Hatchback Engine VJY (TUD5)	299007	Drive Shaft	48T	21	22	58.5	76	608	
1994.08-1997.12	MT	R	F	Hatchback Engine VJY (TUD5)	210085	Drive Shaft		21	22	56.4	76	798		

	 YEAR	TRANSM	L/R	F/R	REMARKS	GSP Ref.	 PRODUCT	 ABS	Technical Specifications					
									A	B	C	H	L	P
CITROEN														
AX (ZA-)														
15 D (40 kW)	1994.08-1997.12	MT	R	F	Hatchback Engine VJY (TUD5)	210186	Drive Shaft	48T	21	22	54	75.5	799	
	1994.08-1997.12	MT	R	F	Hatchback Engine VJY (TUD5)	299009	Drive Shaft	48T	21	22	58.5	76	797	
	1994.08-1997.12	MT	L	F	Hatchback Engine VJY (TUD5)	210038	Drive Shaft	48T	21	22	58.5	76	614	
	1994.08-1997.12	MT	R	F	Hatchback Engine VJY (TUD5)	210042	Drive Shaft	48T	21	22	56.4	76	798	
15 D (43 kW)	1994.08-1997.12	MT	R	F	Hatchback Engine VJZ (TUD5)/VJY (TUD5)	210089	Drive Shaft		21	22	56.4	76	790	
	1994.08-1997.12	-	-	F	Hatchback Engine VJZ (TUD5)/VJY (TUD5)	808016	Outer Joint		22	22	52	96.5	53.5	O
	1994.08-1997.12	MT	L	F	Hatchback Engine VJZ (TUD5)/VJY (TUD5)	210094	Drive Shaft		21	22	56.4	76	615	
	1994.08-1997.12	MT	L	F	Hatchback Engine VJZ (TUD5)/VJY (TUD5)	210164	Drive Shaft		21	22	58.5	76	614	
	1994.08-1997.12	MT	R	F	Hatchback Engine VJZ (TUD5)/VJY (TUD5)	210093	Drive Shaft		21	22	56.4	76	796	
	1994.08-1997.12	MT	R	F	Hatchback Engine VJZ (TUD5)/VJY (TUD5)	210085	Drive Shaft		21	22	56.4	76	798	
	1994.08-1997.12	MT	R	F	Hatchback Engine VJZ (TUD5)/VJY (TUD5)	210186	Drive Shaft	48T	21	22	54	75.5	799	
	1994.08-1997.12	MT	L	F	Hatchback Engine VJZ (TUD5)/VJY (TUD5)	210038	Drive Shaft	48T	21	22	58.5	76	614	
	1994.08-1997.12	MT	R	F	Hatchback Engine VJZ (TUD5)/VJY (TUD5)	210042	Drive Shaft	48T	21	22	56.4	76	798	
Electric (25 kW)	1993.04-1996.10	-	-	F	Hatchback	808016	Outer Joint		22	22	52	96.5	53.5	O
Electric (28 kW)	1996.11-1997.04	-	-	F	Hatchback	808016	Outer Joint		22	22	52	96.5	53.5	O
BERLINGO														
-	-	-	-	-	-	845042	Outer Joint	29T	25	25	55	79.5	56	O
1.6 16V Essenc	-	-	R	-	-	210077	Drive Shaft		25	24	55.7	79	872	
1.8	1980.01-1990.12	MT	-	-	-	810038	Outer Joint		25	25	60	79	61.5	O
1.8 Essence/Diesel	-	-	L	-	-	210079	Drive Shaft		25	24	55.7	79	597	
1.8 Essence/Diesel 1.9 Diesel	-	-	-	-	Engine XU BE3	810049	Outer Joint		25	34	55.7	79	55	I
	-	-	R	-	Engine XU BE3	210077	Drive Shaft		25	24	55.7	79	872	
1.9 D	-	-	L	-	Moterur Xu	210079	Drive Shaft		25	24	55.7	79	597	
2.0 HDi	1999.01-	-	R	-	-	210077	Drive Shaft		25	24	55.7	79	872	
BERLINGO (B9)														
1.2 PureTech 110 (81 kW)	2016.02-	MT	L	F	MPV	610057	Inner Joint		24	34	40	52.5	90	
	2016.02-	MT	R	F	MPV	610058	Inner Joint		24	34	29.8	365	88	
	2016.02-	MT	L	F	MPV	210255	Drive Shaft		25	24	58.5	79	616	
	2016.02-	MT	R	F	MPV	210254	Drive Shaft		25	24	58.5	79	939	
1.6 (66 kW)	2008.04-	MT	R	F	MPV Engine NFR (TU5JP4B)	210229	Drive Shaft		25	24	58.5	79	935	
	2008.04-	-	-	F	MPV Engine NFR (TU5JP4B)	810028	Outer Joint		25	34	58	89	56	I
	2008.04-	MT	R	F	Box Engine NFR (TU5JP4B)	210229	Drive Shaft		25	24	58.5	79	935	
	2008.04-	-	-	F	Box Engine NFR (TU5JP4B)	810028	Outer Joint		25	34	58	89	56	I
	2008.04-	MT	L	F	Box Engine NFR (TU5JP4B)	245105	Drive Shaft		25	24	58	79	625	
	2008.04-	5MT	L	F	MPV Engine NFR (TU5JP4B)	245126	Drive Shaft		25	24	58.5	89	630	
	2008.04-	-	L	F	MPV Engine NFR (TU5JP4B)	245105	Drive Shaft		25	24	58	79	625	
	2008.04-	-	L	F	Box Engine NFR (TU5JP4B)	245126	Drive Shaft		25	24	58.5	89	630	
	2008.04-	MT	L	F	MPV Engine NFR (TU5JP4B)	299019	Drive Shaft	29T	25	24	55.7	79	620	
	2008.04-	MT	L	F	Box Engine NFR (TU5JP4B)	299019	Drive Shaft	29T	25	24	55.7	79	620	
	2008.04-	MT	R	F	Box Engine NFR (TU5JP4B)	245104	Drive Shaft		25	24	58	79	925	
	2008.04-	-	R	F	MPV Engine NFR (TU5JP4B)	245104	Drive Shaft		25	24	58	79	925	
1.6 (80 kW)	2008.04-	MT	R	F	MPV Engine NFU (TU5JP4)	210229	Drive Shaft		25	24	58.5	79	935	
	2008.04-	-	-	F	MPV Engine NFU (TU5JP4)	810028	Outer Joint		25	34	58	89	56	I
	2008.04-	MT	R	F	Box Engine NFU (TU5JP4)	210229	Drive Shaft		25	24	58.5	79	935	
	2008.04-	-	-	F	Box Engine NFU (TU5JP4)	810028	Outer Joint		25	34	58	89	56	I
	2008.04-	MT	L	F	Box Engine NFU (TU5JP4)	245105	Drive Shaft		25	24	58	79	625	
	2008.04-	-	L	F	MPV Engine NFU (TU5JP4)	245105	Drive Shaft		25	24	58	79	625	
	2008.04-	-	L	F	MPV Engine NFU (TU5JP4)	245126	Drive Shaft		25	24	58.5	89	630	
	2008.04-	-	L	F	Box Engine NFU (TU5JP4)	245126	Drive Shaft		25	24	58.5	89	630	
	2008.04-	MT	L	F	MPV Engine NFU (TU5JP4)	299019	Drive Shaft	29T	25	24	55.7	79	620	
	2008.04-	MT	L	F	Box Engine NFU (TU5JP4)	299019	Drive Shaft	29T	25	24	55.7	79	620	
	2008.04-	MT	R	F	Box Engine NFU (TU5JP4)	245104	Drive Shaft		25	24	58	79	925	
	2008.04-	-	R	F	MPV Engine NFU (TU5JP4)	245104	Drive Shaft		25	24	58	79	925	
1.6 BlueHDi 100 (73 kW)	2014.12-	MT	-	-	MPV Engine BHY (DV6FD)	899366	Outer Joint		25	34	58.5	79	55	I
	2014.12-	MT	-	-	Box Engine BHY (DV6FD)	899366	Outer Joint		25	34	58.5	79	55	I
	2014.12-	-	R	F	MPV Engine BHY (DV6FD)	245104	Drive Shaft		25	24	58	79	925	
	2014.12-	-	R	F	Box Engine BHY (DV6FD)	245104	Drive Shaft		25	24	58	79	925	
	2014.12-	MT	-	-	Platform/Chassis Engine BHY (DV6FD)	899366	Outer Joint		25	34	58.5	79	55	I
	2014.12-	MT	-	-	All-wheel Drive Box Engine BHY (DV6FD)	899366	Outer Joint		25	34	58.5	79	55	I
	2014.12-	6MT	L	F	MPV Engine BHY (DV6FD)	610057	Inner Joint		24	34	40	52.5	90	
	2014.12-	6MT	R	F	MPV Engine BHY (DV6FD)	610058	Inner Joint		24	34	29.8	365	88	
	2014.12-	MT	R	F	MPV Engine BHY (DV6FD)	210229	Drive Shaft		25	24	58.5	79	935	
	2014.12-	MT	R	F	Box Engine BHY (DV6FD)	210229	Drive Shaft		25	24	58.5	79	935	
	2014.12-	6MT	L	F	MPV Engine BHY (DV6FD)	210255	Drive Shaft		25	24	58.5	79	616	
	2014.12-	MT	L	F	Platform/Chassis Engine BHY (DV6FD)	245105	Drive Shaft		25	24	58	79	625	
	2014.12-	MT	R	F	Platform/Chassis Engine BHY (DV6FD)	210229	Drive Shaft		25	24	58.5	79	935	

	 YEAR	TRANSM	L/R	F/R	REMARKS	GSP Ref.	 PRODUCT	 ABS	Technical Specifications						
									A	B	C	H	L	P	
CITROEN															
BERLINGO (B9)															
1.6 BlueHDi 100 (73 kW)	2014.12.-	-	MT	L	F	Platform/Chassis Engine BHY (DV6FD)	245126	Drive Shaft		25	24	58.5	89	630	
	2014.12.-	-	6MT	R	F	MPV Engine BHY (DV6FD)	210254	Drive Shaft		25	24	58.5	79	939	
	2014.12.-	-	-	L	F	MPV Engine BHY (DV6FD)	245105	Drive Shaft		25	24	58	79	625	
	2014.12.-	-	-	L	F	Box Engine BHY (DV6FD)	245105	Drive Shaft		25	24	58	79	625	
	2014.12.-	-	-	L	F	MPV Engine BHY (DV6FD)	245126	Drive Shaft		25	24	58.5	89	630	
	2014.12.-	-	-	L	F	Box Engine BHY (DV6FD)	245126	Drive Shaft		25	24	58.5	89	630	
	2014.12.-	-	MT	L	F	MPV Engine BHY (DV6FD)	299019	Drive Shaft	29T	25	24	55.7	79	620	
	2014.12.-	-	MT	L	F	Box Engine BHY (DV6FD)	299019	Drive Shaft	29T	25	24	55.7	79	620	
	2014.12.-	-	MT	L	F	Platform/Chassis Engine BHY (DV6FD)	299019	Drive Shaft	29T	25	24	55.7	79	620	
1.6 BlueHDi 120 (88 kW)	2014.12.-	-	MT	L	F	MPV Engine BHZ (DV6FC)	610057	Inner Joint		24	34	40	52.5	90	
	2014.12.-	-	MT	-	-	Box Engine BHZ (DV6FC)	899366	Outer Joint		25	34	58.5	79	55	I
	2014.12.-	-	MT	L	F	Box Engine BHZ (DV6FC)	610057	Inner Joint		24	34	40	52.5	90	
	2014.12.-	-	MT	R	F	MPV Engine BHZ (DV6FC)	610058	Inner Joint		24	34	29.8	365	88	
	2014.12.-	-	MT	R	F	Box Engine BHZ (DV6FC)	610058	Inner Joint		24	34	29.8	365	88	
	2014.12.-	-	MT	L	F	MPV Engine BHZ (DV6FC)	210255	Drive Shaft		25	24	58.5	79	616	
	2014.12.-	-	MT	L	F	Box Engine BHZ (DV6FC)	210255	Drive Shaft		25	24	58.5	79	616	
	2014.12.-	-	MT	R	F	MPV Engine BHZ (DV6FC)	210229	Drive Shaft		25	24	58.5	79	935	
	2014.12.-	-	MT	R	F	Box Engine BHZ (DV6FC)	210229	Drive Shaft		25	24	58.5	79	935	
	2014.12.-	-	MT	R	F	MPV Engine BHZ (DV6FC)	210254	Drive Shaft		25	24	58.5	79	939	
	2014.12.-	-	MT	R	F	Box Engine BHZ (DV6FC)	210254	Drive Shaft		25	24	58.5	79	939	
	2014.12.-	-	MT	L	F	MPV Engine BHZ (DV6FC)	299019	Drive Shaft	29T	25	24	55.7	79	620	
1.6 BlueHDi 75 (55 kW)	2015.04.-	-	-	R	F	MPV Engine BHW (DV6FE)/9HN(DV6ETED4)	245104	Drive Shaft		25	24	58	79	925	
	2015.04.-	-	-	-	-	MPV Engine BHW (DV6FE)/9HN(DV6ETED4)	899366	Outer Joint		25	34	58.5	79	55	I
	2015.04.-	-	MT	R	F	MPV Engine BHW (DV6FE)/9HN(DV6ETED4)	210229	Drive Shaft		25	24	58.5	79	935	
	2015.04.-	-	-	L	F	MPV Engine BHW (DV6FE)/9HN(DV6ETED4)	245105	Drive Shaft		25	24	58	79	625	
	2015.04.-	-	-	L	F	MPV Engine BHW (DV6FE)/9HN(DV6ETED4)	245126	Drive Shaft		25	24	58.5	89	630	
	2015.04.-	-	MT	L	F	MPV Engine BHW (DV6FE)/9HN(DV6ETED4)	299019	Drive Shaft	29T	25	24	55.7	79	620	
1.6 HDi / BlueHDi 75 (55 kW)	2010.07.-	-	-	-	-	Box Engine BHW (DV6FE)	899366	Outer Joint		25	34	58.5	79	55	I
	2010.07.-	-	MT	L	F	Box Engine BHW (DV6FE)	245105	Drive Shaft		25	24	58	79	625	
	2010.07.-	-	MT	R	F	Box Engine BHW (DV6FE)	210229	Drive Shaft		25	24	58.5	79	935	
	2010.07.-	-	MT	L	F	Box Engine BHW (DV6FE)	245126	Drive Shaft		25	24	58.5	89	630	
	2010.07.-	-	MT	L	F	Box Engine BHW (DV6FE)	299019	Drive Shaft	29T	25	24	55.7	79	620	
	2010.07.-	-	MT	R	F	Box Engine BHW (DV6FE)	245104	Drive Shaft		25	24	58	79	925	
1.6 HDi 110 (80 kW)	2008.04.-	-	MT	R	F	MPV Engine 9HZ (DV6TED4)	210229	Drive Shaft		25	24	58.5	79	935	
	2008.04.-	-	-	-	F	MPV Engine 9HZ (DV6TED4)	810028	Outer Joint		25	34	58	89	56	I
	2008.04.-	-	-	-	F	Box Engine 9HZ (DV6TED4)	810028	Outer Joint		25	34	58	89	56	I
	2008.04.-	-	MT	R	F	Box Engine 9HZ (DV6TED4)	210229	Drive Shaft		25	24	58.5	79	935	
	2008.04.-	-	MT	L	F	Box Engine 9HZ (DV6TED4)	245105	Drive Shaft		25	24	58	79	625	
	2008.04.-	-	-	L	F	MPV Engine 9HZ (DV6TED4)	245105	Drive Shaft		25	24	58	79	625	
	2008.04.-	-	-	L	F	MPV Engine 9HZ (DV6TED4)	245126	Drive Shaft		25	24	58.5	89	630	
	2008.04.-	-	-	L	F	Box Engine 9HZ (DV6TED4)	245126	Drive Shaft		25	24	58.5	89	630	
	2008.04.-	-	MT	L	F	MPV Engine 9HZ (DV6TED4)	299019	Drive Shaft	29T	25	24	55.7	79	620	
	2008.04.-	-	MT	L	F	Box Engine 9HZ (DV6TED4)	299019	Drive Shaft	29T	25	24	55.7	79	620	
	2008.04.-	-	MT	R	F	Box Engine 9HZ (DV6TED4)	245104	Drive Shaft		25	24	58	79	925	
	2008.04.-	-	-	R	F	MPV Engine 9HZ (DV6TED4)	245104	Drive Shaft		25	24	58	79	925	
1.6 HDi 110 (82 kW)	2010.07.-	-	-	L	F	MPV Engine 9HR (DV6C)/9HL (DV6C)	610057	Inner Joint		24	34	40	52.5	90	
	2010.07.-	-	-	-	-	Box Engine 9HR (DV6C)/9HL (DV6C)	899366	Outer Joint		25	34	58.5	79	55	I
	2010.07.-	-	-	-	-	MPV Engine 9HR (DV6C)/9HL (DV6C)	899366	Outer Joint		25	34	58.5	79	55	I
	2010.07.-	-	-	-	F	Box Engine 9HR (DV6C)/9HL (DV6C)	810028	Outer Joint		25	34	58	89	56	I
	2010.07.-	-	-	R	F	Box Engine 9HR (DV6C)/9HL (DV6C)	610058	Inner Joint		24	34	29.8	365	88	
	2010.07.-	-	-	R	F	MPV Engine 9HR (DV6C)/9HL (DV6C)	610058	Inner Joint		24	34	29.8	365	88	
	2010.07.-	-	-	L	F	Box Engine 9HR (DV6C)/9HL (DV6C)	245105	Drive Shaft		25	24	58	79	625	
	2010.07.-	-	-	L	F	Box Engine 9HR (DV6C)/9HL (DV6C)	210255	Drive Shaft		25	24	58.5	79	616	
	2010.07.-	-	-	-	F	MPV Engine 9HR (DV6C)/9HL (DV6C)	810028	Outer Joint		25	34	58	89	56	I
	2010.07.-	-	MT	R	F	MPV Engine 9HR (DV6C)/9HL (DV6C)	210229	Drive Shaft		25	24	58.5	79	935	
	2010.07.-	-	-	L	F	Box Engine 9HR (DV6C)/9HL (DV6C)	245126	Drive Shaft		25	24	58.5	89	630	
	2010.07.-	-	-	L	F	MPV Engine 9HR (DV6C)/9HL (DV6C)	245126	Drive Shaft		25	24	58.5	89	630	
	2010.07.-	-	-	L	F	MPV Engine 9HR (DV6C)/9HL (DV6C)	245105	Drive Shaft		25	24	58	79	625	
	2010.07.-	-	-	L	F	MPV Engine 9HR (DV6C)/9HL (DV6C)	210255	Drive Shaft		25	24	58.5	79	616	
	2010.07.-	-	-	R	F	Box Engine 9HR (DV6C)/9HL (DV6C)	210254	Drive Shaft		25	24	58.5	79	939	
	2010.07.-	-	-	R	F	MPV Engine 9HR (DV6C)/9HL (DV6C)	210254	Drive Shaft		25	24	58.5	79	939	
	2010.07.-	-	MT	L	F	Box Engine 9HR (DV6C)/9HL (DV6C)	299019	Drive Shaft	29T	25	24	55.7	79	620	
	2010.07.-	-	MT	L	F	MPV Engine 9HR (DV6C)/9HL (DV6C)	299019	Drive Shaft	29T	25	24	55.7	79	620	
	2010.07.-	-	-	R	F	Box Engine 9HR (DV6C)/9HL (DV6C)	245104	Drive Shaft		25	24	58	79	925	

	 YEAR	TRANSM	L/R	F/R	REMARKS	GSP Ref.	 PRODUCT	 ABS	Technical Specifications						
									A	B	C	H	L	P	
CITROEN BERLINGO (B9)															
1.6 HDi 110 (82 kW)	2010.07.-	-	-	R	F	MPV Engine 9HR (DV6C)/9HL (DV6C)	245104	Drive Shaft		25	24	58	79	925	
	2010.07.-	-	MT	R	F	Box Engine 9HR (DV6C)/9HL (DV6C)	210229	Drive Shaft		25	24	58.5	79	935	
	2010.07.-	-	-	L	F	Box Engine 9HR (DV6C)/9HL (DV6C)	610057	Inner Joint		24	34	40	52.5	90	
1.6 HDi 115 (84 kW)	2010.07.-	-	MT/5MT	-	-	MPV Engine 9HR (DV6C)	899366	Outer Joint		25	34	58.5	79	55	I
	2010.07.-	-	MT/5MT	-	-	Box Engine 9HL (DV6C)	899366	Outer Joint		25	34	58.5	79	55	I
	2010.07.-	-	-	L	F	MPV Engine 9HR (DV6C)	610057	Inner Joint		24	34	40	52.5	90	
	2010.07.-	-	-	L	F	Box Engine 9HL (DV6C)	610057	Inner Joint		24	34	40	52.5	90	
	2010.07.-	-	-	R	F	MPV Engine 9HR (DV6C)	610058	Inner Joint		24	34	29.8	365	88	
	2010.07.-	-	-	R	F	Box Engine 9HL (DV6C)	610058	Inner Joint		24	34	29.8	365	88	
	2010.07.-	-	MT	R	F	MPV Engine 9HR (DV6C)	210229	Drive Shaft		25	24	58.5	79	935	
	2010.07.-	-	MT	R	F	Box Engine 9HL (DV6C)	210229	Drive Shaft		25	24	58.5	79	935	
	2010.07.-	-	-	L	F	MPV Engine 9HR (DV6C)	245126	Drive Shaft		25	24	58.5	89	630	
	2010.07.-	-	-	L	F	MPV Engine 9HR (DV6C)	245105	Drive Shaft		25	24	58	79	625	
	2010.07.-	-	-	L	F	MPV Engine 9HR (DV6C)	210255	Drive Shaft		25	24	58.5	79	616	
	2010.07.-	-	-	L	F	Box Engine 9HL (DV6C)	245126	Drive Shaft		25	24	58.5	89	630	
	2010.07.-	-	-	L	F	Box Engine 9HL (DV6C)	245105	Drive Shaft		25	24	58	79	625	
	2010.07.-	-	-	L	F	Box Engine 9HL (DV6C)	210255	Drive Shaft		25	24	58.5	79	616	
	2010.07.-	-	-	R	F	MPV Engine 9HR (DV6C)	210254	Drive Shaft		25	24	58.5	79	939	
	2010.07.-	-	-	R	F	Box Engine 9HL (DV6C)	210254	Drive Shaft		25	24	58.5	79	939	
	2010.07.-	-	MT	L	F	MPV Engine 9HR (DV6C)	299019	Drive Shaft	29T	25	24	55.7	79	620	
	2010.07.-	-	MT	L	F	Box Engine 9HL (DV6C)	299019	Drive Shaft	29T	25	24	55.7	79	620	
	2010.07.-	-	-	R	F	MPV Engine 9HR (DV6C)	245104	Drive Shaft		25	24	58	79	925	
	2010.07.-	-	-	R	F	Box Engine 9HL (DV6C)	245104	Drive Shaft		25	24	58	79	925	
	2012.02.-	-	MT	-	-	All-wheel Drive MPV Engine 9HR (DV6C)	899366	Outer Joint		25	34	58.5	79	55	I
1.6 HDi 75 (55 kW)	2008.04.-	-	MT	R	F	MPV Engine 9HT (DV6BTED4)	210229	Drive Shaft		25	24	58.5	79	935	
	2008.04.-	-	-	-	F	MPV Engine 9HT (DV6BTED4)	810028	Outer Joint		25	34	58	89	56	I
	2008.04.-	-	MT	R	F	Box Engine 9HT (DV6BUTED4)/9HT (DV6BTED4)	210229	Drive Shaft		25	24	58.5	79	935	
	2008.04.-	-	MT	L	F	Box Engine 9HT (DV6BUTED4)/9HT (DV6BTED4)	245105	Drive Shaft		25	24	58	79	625	
	2008.04.-	-	-	L	F	MPV Engine 9HT (DV6BTED4)	245105	Drive Shaft		25	24	58	79	625	
	2008.04.-	-	-	L	F	MPV Engine 9HT (DV6BTED4)	245126	Drive Shaft		25	24	58.5	89	630	
	2008.04.-	-	-	L	F	Box Engine 9HT (DV6BUTED4)/9HT (DV6BTED4)	245126	Drive Shaft		25	24	58.5	89	630	
	2008.04.-	-	MT	L	F	MPV Engine 9HT (DV6BTED4)	299019	Drive Shaft	29T	25	24	55.7	79	620	
	2008.04.-	-	MT	L	F	Box Engine 9HT (DV6BUTED4)/9HT (DV6BTED4)	299019	Drive Shaft	29T	25	24	55.7	79	620	
	2008.04.-	-	MT	R	F	Box Engine 9HT (DV6BUTED4)/9HT (DV6BTED4)	245104	Drive Shaft		25	24	58	79	925	
	2008.04.-	-	-	R	F	MPV Engine 9HT (DV6BTED4)	245104	Drive Shaft		25	24	58	79	925	
	2012.02.-	-	-	-	-	All-wheel Drive Box Engine 9HN (DV6ETED)/BHW (DV6FE)	899366	Outer Joint		25	34	58.5	79	55	I
1.6 HDi 90 (66 kW)	2008.04.-	-	-	-	-	Platform/Chassis Engine 9HX (DV6ATED4)	899366	Outer Joint		25	34	58.5	79	55	I
	2008.04.-	-	-	-	F	MPV Engine 9HX (DV6ATED4)	810028	Outer Joint		25	34	58	89	56	I
	2008.04.-	-	MT	R	F	Platform/Chassis Engine 9HX (DV6ATED4)	210229	Drive Shaft		25	24	58.5	79	935	
	2008.04.-	-	MT	L	F	MPV Engine 9HX (DV6ATED4)	245126	Drive Shaft		25	24	58.5	89	630	
	2008.04.-	-	MT	L	F	Platform/Chassis Engine 9HX (DV6ATED4)	245105	Drive Shaft		25	24	58	79	625	
	2008.04.-	-	MT	L	F	Platform/Chassis Engine 9HX (DV6ATED4)	245126	Drive Shaft		25	24	58.5	89	630	
	2008.04.-	-	-	R	F	MPV Engine 9HX (DV6ATED4)	210229	Drive Shaft		25	24	58.5	79	935	
	2008.04.-	-	-	L	F	MPV Engine 9HX (DV6ATED4)	245105	Drive Shaft		25	24	58	79	625	
	2008.04.-	-	MT	L	F	Platform/Chassis Engine 9HX (DV6ATED4)	299019	Drive Shaft	29T	25	24	55.7	79	620	
	2008.04.-	-	MT	R	F	Platform/Chassis Engine 9HX (DV6ATED4)	245104	Drive Shaft		25	24	58	79	925	
	2008.04.-	-	-	L	F	MPV Engine 9HX (DV6ATED4)	299019	Drive Shaft	29T	25	24	55.7	79	620	
	2008.04.-	-	-	R	F	MPV Engine 9HX (DV6ATED4)	245104	Drive Shaft		25	24	58	79	925	
	2010.07.-	-	AT	L	F	Box Engine 9HF (DV6DTEED)	610057	Inner Joint		24	34	40	52.5	90	
	2010.07.-	-	-	-	-	Box Engine 9HF (DV6DTEED)	899366	Outer Joint		25	34	58.5	79	55	I
	2010.07.-	-	MT	R	F	Box Engine 9HF (DV6DTEED)	610058	Inner Joint		24	34	29.8	365	88	
	2010.07.-	-	MT	L	F	Box Engine 9HF (DV6DTEED)	245126	Drive Shaft		25	24	58.5	89	630	
	2010.07.-	-	AT	L	F	Box Engine 9HF (DV6DTEED)	210255	Drive Shaft		25	24	58.5	79	616	
	2010.07.-	-	MT	L	F	Box Engine 9HF (DV6DTEED)	245105	Drive Shaft		25	24	58	79	625	
	2010.07.-	-	MT	R	F	Box Engine 9HF (DV6DTEED)	210229	Drive Shaft		25	24	58.5	79	935	
	2010.07.-	-	MT	R	F	Box Engine 9HF (DV6DTEED)	210254	Drive Shaft		25	24	58.5	79	939	
	2010.07.-	-	MT	L	F	Box Engine 9HF (DV6DTEED)	299019	Drive Shaft	29T	25	24	55.7	79	620	
	2010.07.-	-	MT	R	F	Box Engine 9HF (DV6DTEED)	245104	Drive Shaft		25	24	58	79	925	
	2012.02.-	-	-	-	-	All-wheel Drive MPV Engine 9HF (DV6DTEED)	899366	Outer Joint		25	34	58.5	79	55	I
	2012.02.-	-	-	-	-	All-wheel Drive Box Engine 9HF (DV6DTEED)	899366	Outer Joint		25	34	58.5	79	55	I
	2012.02.-	-	5MT	L	F	All-wheel Drive Box Engine 9HF (DV6DTEED)	245105	Drive Shaft		25	24	58	79	625	
	2012.02.-	-	5MT	L	F	All-wheel Drive Box Engine 9HF (DV6DTEED)	245126	Drive Shaft		25	24	58.5	89	630	
	2012.02.-	-	5MT	R	F	All-wheel Drive Box Engine 9HF (DV6DTEED)	245104	Drive Shaft		25	24	58	79	925	
1.6 HDi 90 (68 kW)	2010.07.-	-	-	-	-	MPV Engine 9HP (DV6DTEED)	899366	Outer Joint		25	34	58.5	79	55	I
	2010.07.-	-	-	-	-	Box Engine 9HP (DV6DTEED)	899366	Outer Joint		25	34	58.5	79	55	I
	2010.07.-	-	-	-	F	MPV Engine 9HP (DV6DTEED)	810028	Outer Joint		25	34	58	89	56	I

	 YEAR	TRANSM	L/R	F/R	REMARKS	GSP Ref.	 PRODUCT	 ABS	Technical Specifications					
									A	B	C	H	L	P
CITROEN BERLINGO (B9)														
1.6 HDi 90 (68 kW)	2010.07-	-	-	F	Box Engine 9HP (DV6DTEd)	810028	Outer Joint		25	34	58	89	56	I
	2010.07-	-	-	R	MPV Engine 9HP (DV6DTEd)	610058	Inner Joint		24	34	29.8	365	88	
	2010.07-	-	-	L	MPV Engine 9HP (DV6DTEd)	245105	Drive Shaft		25	24	58	79	625	
	2010.07-	-	-	L	MPV Engine 9HP (DV6DTEd)	210255	Drive Shaft		25	24	58.5	79	616	
	2010.07-	-	-	L	MPV Engine 9HP (DV6DTEd)	245126	Drive Shaft		25	24	58.5	89	630	
	2010.07-	-	-	R	MPV Engine 9HP (DV6DTEd)	210254	Drive Shaft		25	24	58.5	79	939	
	2010.07-	-	-	L	Box Engine 9HP (DV6DTEd)	245105	Drive Shaft		25	24	58	79	625	
	2010.07-	-	-	R	MPV Engine 9HP (DV6DTEd)	210229	Drive Shaft		25	24	58.5	79	935	
	2010.07-	-	-	L	Box Engine 9HP (DV6DTEd)	245126	Drive Shaft		25	24	58.5	89	630	
	2010.07-	-	MT	L	Box Engine 9HP (DV6DTEd)	299019	Drive Shaft	29T	25	24	55.7	79	620	
	2010.07-	-	-	R	MPV Engine 9HP (DV6DTEd)	245104	Drive Shaft		25	24	58	79	925	
	2010.07-	-	-	L	MPV Engine 9HP (DV6DTEd)	299019	Drive Shaft	29T	25	24	55.7	79	620	
	2010.07-	-	-	R	Box Engine 9HP (DV6DTEd)	245104	Drive Shaft		25	24	58	79	925	
	2010.07-	-	MT	R	Box Engine 9HP (DV6DTEd)	210229	Drive Shaft		25	24	58.5	79	935	
	2010.07-	-	-	L	MPV Engine 9HP (DV6DTEd)	610057	Inner Joint		24	34	40	52.5	90	
1.6 HDi 90 16V (66 kW)	2008.04-	-	MT	R	Box Engine 9HX (DV6ATED4)/9HS (DV6TED4BU)	210229	Drive Shaft		25	24	58.5	79	935	
	2008.04-	-	MT	L	Box Engine 9HX (DV6ATED4)/9HS (DV6TED4BU)	245105	Drive Shaft		25	24	58	79	625	
	2008.04-	-	-	L	Box Engine 9HX (DV6ATED4)/9HS (DV6TED4BU)	245126	Drive Shaft		25	24	58.5	89	630	
	2008.04-	-	MT	L	Box Engine 9HX (DV6ATED4)/9HS (DV6TED4BU)	299019	Drive Shaft	29T	25	24	55.7	79	620	
	2008.04-	-	MT	R	Box Engine 9HX (DV6ATED4)/9HS (DV6TED4BU)	245104	Drive Shaft		25	24	58	79	925	
1.6 HDi 90(66 kW)	2010.07-	-	-	-	Platform/Chassis Engine 9HF (DV6DTEd)	899366	Outer Joint		25	34	58.5	79	55	I
	2010.07-	-	MT	L	Platform/Chassis Engine 9HF (DV6DTEd)	245105	Drive Shaft		25	24	58	79	625	
	2010.07-	-	MT	L	Platform/Chassis Engine 9HF (DV6DTEd)	245126	Drive Shaft		25	24	58.5	89	630	
	2010.07-	-	MT	R	Platform/Chassis Engine 9HF (DV6DTEd)	210229	Drive Shaft		25	24	58.5	79	935	
	2010.07-	-	MT	R	Platform/Chassis Engine 9HF (DV6DTEd)	245104	Drive Shaft		25	24	58	79	925	
	2010.07-	-	MT	L	Platform/Chassis Engine 9HF (DV6DTEd)	299019	Drive Shaft	29T	25	24	55.7	79	620	
1.6 HDi 92 (68 kW)	2010.07-	-	-	-	Platform/Chassis Engine 9HJ (DV6DTEdM)	899366	Outer Joint		25	34	58.5	79	55	I
	2010.07-	-	MT	R	Platform/Chassis Engine 9HJ (DV6DTEdM)	210229	Drive Shaft		25	24	58.5	79	935	
	2010.07-	-	MT	L	Platform/Chassis Engine 9HJ (DV6DTEdM)	299019	Drive Shaft	29T	25	24	55.7	79	620	
1.6 VTi 120 (88 kW)	2009.11-	-	-	R	MPV Engine 5FS (EP6C)	245104	Drive Shaft		25	24	58	79	925	
	2009.11-	-	-	-	Box Engine 5FS (EP6C)	899366	Outer Joint		25	34	58.5	79	55	I
	2009.11-	-	-	-	MPV Engine 5FS (EP6C)	899366	Outer Joint		25	34	58.5	79	55	I
	2009.11-	-	-	F	Box Engine 5FS (EP6C)	810028	Outer Joint		25	34	58	89	56	I
	2009.11-	-	-	F	MPV Engine 5FS (EP6C)	810028	Outer Joint		25	34	58	89	56	I
	2009.11-	-	MT	R	MPV Engine 5FS (EP6C)	210229	Drive Shaft		25	24	58.5	79	935	
	2009.11-	-	5MT	L	Box Engine 5FS (EP6C)	245126	Drive Shaft		25	24	58.5	89	630	
	2009.11-	-	5MT	L	MPV Engine 5FS (EP6C)	245126	Drive Shaft		25	24	58.5	89	630	
	2009.11-	-	-	L	Box Engine 5FS (EP6C)	245105	Drive Shaft		25	24	58	79	625	
	2009.11-	-	MT	L	Box Engine 5FS (EP6C)	299019	Drive Shaft	29T	25	24	55.7	79	620	
	2009.11-	-	-	L	MPV Engine 5FS (EP6C)	245105	Drive Shaft		25	24	58	79	625	
	2009.11-	-	MT	L	MPV Engine 5FS (EP6C)	299019	Drive Shaft	29T	25	24	55.7	79	620	
	2009.11-	-	-	R	Box Engine 5FS (EP6C)	245104	Drive Shaft		25	24	58	79	925	
	2009.11-	-	MT	R	Box Engine 5FS (EP6C)	210229	Drive Shaft		25	24	58.5	79	935	
1.6 VTi 95 (72 kW)	2010.07-	-	-	R	MPV Engine 5FK (EP6CB)	245104	Drive Shaft		25	24	58	79	925	
	2010.07-	-	-	R	Box Engine 5FK (EP6CB)	245104	Drive Shaft		25	24	58	79	925	
	2010.07-	-	-	-	MPV Engine 5FK (EP6CB)	899366	Outer Joint		25	34	58.5	79	55	I
	2010.07-	-	-	F	MPV Engine 5FK (EP6CB)	810028	Outer Joint		25	34	58	89	56	I
	2010.07-	-	MT	R	MPV Engine 5FK (EP6CB)	210229	Drive Shaft		25	24	58.5	79	935	
	2010.07-	-	-	F	Box Engine 5FK (EP6CB)	810028	Outer Joint		25	34	58	89	56	I
	2010.07-	-	MT	R	Box Engine 5FK (EP6CB)	210229	Drive Shaft		25	24	58.5	79	935	
	2010.07-	-	-	L	MPV Engine 5FK (EP6CB)	245105	Drive Shaft		25	24	58	79	625	
	2010.07-	-	-	L	Box Engine 5FK (EP6CB)	245105	Drive Shaft		25	24	58	79	625	
	2010.07-	-	-	L	MPV Engine 5FK (EP6CB)	245126	Drive Shaft		25	24	58.5	89	630	
	2010.07-	-	-	L	Box Engine 5FK (EP6CB)	245126	Drive Shaft		25	24	58.5	89	630	
	2010.07-	-	MT	L	MPV Engine 5FK (EP6CB)	299019	Drive Shaft	29T	25	24	55.7	79	620	
	2010.07-	-	MT	L	Box Engine 5FK (EP6CB)	299019	Drive Shaft	29T	25	24	55.7	79	620	
1.6(81 kW)	2008.11-	-	-	-	MPV Engine NFU (TU5JP4)	899366	Outer Joint		25	34	58.5	79	55	I
BERLINGO MULTISPACE														
1.6 16V	2000.11-	-	MT/AT	L	-	210050	Drive Shaft		25	24	55.7	79	583	
1.6 HDi	2005.10-	-	MT/AT	-	F	845047	Outer Joint	48T	25	34	59	78.5	54	I
1.8	1998.06-2000.10		MT/AT	L	-	210050	Drive Shaft		25	24	55.7	79	583	
BERLINGO VAN														
1.8 D/1.9 D	1996.10-	-	MT/AT	L	-	210050	Drive Shaft		25	24	55.7	79	583	
BERLINGO/BERLINGO FIRST (MF)														
1.1 i (44 kW)	1996.07-2008.05		-	R	MPV Engine HDZ (TU1M)/HFX (TU1JP)	210205	Drive Shaft		25	22	58.5	79	866	
	1996.07-2008.05		-	L	MPV Engine HDZ (TU1M)/HFX (TU1JP)	210075	Drive Shaft	29T	25	22	54.5	79.5	587	





YEAR	TRANSM	L/R	F/R	REMARKS	GSP Ref.	PRODUCT	ABS	Technical Specifications									
								A	B	C	H	L	P				
CITROEN																	
BERLINGO/BERLINGO FIRST (MF)																	
1.1 i (44 kW)	1996.07-2008.05	-	R	F	MPV Engine HDZ (TU1M)/HFX (TU1JP)	210188	Drive Shaft	29T	25	22	54.5	79.5	860				
	1996.07-2008.05	-	L	F	MPV Engine HDZ (TU1M)/HFX (TU1JP)	210026	Drive Shaft		25	22	56.7	79	594				
	1996.07-2008.05	-	R	F	MPV Engine HDZ (TU1M)/HFX (TU1JP)	210015	Drive Shaft		25	22	56.7	79	868				
	1996.07-2008.05	-	R	F	MPV Engine HDZ (TU1M)/HFX (TU1JP)	210019	Drive Shaft	29T	25	22	60	80	867				
	1996.07-2008.05	-	L	F	MPV Engine HDZ (TU1M)/HFX (TU1JP)	210021	Drive Shaft	29T	25	22	60	80	593				
1.4 (53 kW)	2002.11-2005.10	-	R	F	MPV Engine KFW (TU3JP)	210205	Drive Shaft		25	22	58.5	79	866				
1.4 bivalent (48 kW)	2002.11-2011.12	-	R	F	MPV Engine KFW (TU3JP)	210205	Drive Shaft		25	22	58.5	79	866				
	2002.11-2011.12	-	R	F	MPV Engine KFW (TU3JP)	210188	Drive Shaft	29T	25	22	54.5	79.5	860				
	2002.11-2011.12	-	L	F	MPV Engine KFW (TU3JP)	210026	Drive Shaft		25	22	56.7	79	594				
	2002.11-2011.12	MT	R	F	MPV Engine KFW (TU3JP)	210110	Drive Shaft		25	22	54.5	79.5	862				
	2002.11-2011.12	-	R	F	MPV Engine KFW (TU3JP)	210015	Drive Shaft		25	22	56.7	79	868				
	2002.11-2011.12	-	R	F	MPV Engine KFW (TU3JP)	210019	Drive Shaft	29T	25	22	60	80	867				
	2002.11-2011.12	-	L	F	MPV Engine KFW (TU3JP)	210021	Drive Shaft	29T	25	22	60	80	593				
1.4 i (55 kW)	1996.07-2008.10	-	R	F	MPV Engine KFX (TU3JP)/KFW (TU3JP)	210205	Drive Shaft		25	22	58.5	79	866				
	1996.07-2008.10	-	L	F	MPV Engine KFX (TU3JP)/KFW (TU3JP)	210075	Drive Shaft	29T	25	22	54.5	79.5	587				
	1996.07-2008.10	-	R	F	MPV Engine KFX (TU3JP)/KFW (TU3JP)	210188	Drive Shaft	29T	25	22	54.5	79.5	860				
	1996.07-2008.10	-	L	F	MPV Engine KFX (TU3JP)/KFW (TU3JP)	210026	Drive Shaft		25	22	56.7	79	594				
	1996.07-2008.10	MT	R	F	MPV Engine KFX (TU3JP)/KFW (TU3JP)	210110	Drive Shaft		25	22	54.5	79.5	862				
	1996.07-2008.10	-	R	F	MPV Engine KFX (TU3JP)/KFW (TU3JP)	210015	Drive Shaft		25	22	56.7	79	868				
	1996.07-2008.10	-	R	F	MPV Engine KFX (TU3JP)/KFW (TU3JP)	210019	Drive Shaft	29T	25	22	60	80	867				
	1996.07-2008.10	-	L	F	MPV Engine KFX (TU3JP)/KFW (TU3JP)	210021	Drive Shaft	29T	25	22	60	80	593				
1.4 i bivalent (55 kW)	2003.04-2008.10	-	R	F	MPV Engine KFW (TU3JP)	210205	Drive Shaft		25	22	58.5	79	866				
	2003.04-2008.10	-	L	F	MPV Engine KFW (TU3JP)	210026	Drive Shaft		25	22	56.7	79	594				
	2003.04-2008.10	MT	R	F	MPV Engine KFW (TU3JP)	210110	Drive Shaft		25	22	54.5	79.5	862				
	2003.04-2008.10	-	-	F	MPV Engine KFW (TU3JP)	810067	Outer Joint	48W	25	34	58.5	79	55	I			
	2003.04-2008.10	-	R	F	MPV Engine KFW (TU3JP)	210015	Drive Shaft		25	22	56.7	79	868				
	2003.04-2008.10	-	R	F	MPV Engine KFW (TU3JP)	210019	Drive Shaft	29T	25	22	60	80	867				
	2003.04-2008.10	-	L	F	MPV Engine KFW (TU3JP)	210021	Drive Shaft	29T	25	22	60	80	593				
	2003.04-2008.10	-	L	F	MPV Engine KFW (TU3JP)	210187	Drive Shaft	29T	25	22	54.5	79.5	590.5				
1.6 16V (80 kW)	2000.10-2011.12	MT	L/R	F	MPV Engine NFU (TU5JP4)	810003	Outer Joint	29T	25	23	54.8	78.5	56	I			
	2000.10-2011.12	MT	L	F	MPV Engine NFU (TU5JP4)	210025	Drive Shaft	29T	25	24	54.8	78.5	593				
	2000.10-2011.12	-	L	F	MPV Engine NFU (TU5JP4)	210128	Drive Shaft	29T	25	24	55.7	79	594				
	2000.10-2011.12	-	-	F	MPV Engine NFU (TU5JP4)	899293	Outer Joint	48W	25	34	58.5	79	55	I			
	2000.10-2011.12	-	R	F	MPV Engine NFU (TU5JP4)	299196	Drive Shaft	48W	25	24	58.5	79	869				
	2000.10-2011.12	-	-	F	MPV Engine NFU (TU5JP4)	810022	Outer Joint	29W	25	34	55.7	79	55	I			
	2000.10-2011.12	MT	R	F	MPV Engine NFU (TU5JP4)	210167	Drive Shaft		25	24	55.7	79	868				
	2000.10-2011.12	-	L	F	MPV Engine NFU (TU5JP4)	210131	Drive Shaft	29T	25	24	54.8	78.5	583				
	2000.10-2011.12	MT	L	F	MPV Engine NFU (TU5JP4)	299025	Drive Shaft	29W	25	24	55.7	79	597				
	2000.10-2011.12	MT	R	F	MPV Engine NFU (TU5JP4)	210023	Drive Shaft	29T	25	24	55.7	79	868				
	2000.10-2011.12	MT	R	F	MPV Engine NFU (TU5JP4)	210078	Drive Shaft	29W	25	24	55.7	79	872				
	2000.10-2011.12	MT	R	F	MPV Engine NFU (TU5JP4)	210091	Drive Shaft		25	24	54.8	78.5	869.5				
	2000.10-2011.12	-	-	F	MPV Engine NFU (TU5JP4)	810042	Outer Joint		25	34	54.8	78.5	56	I			
	2000.10-2011.12	-	L	F	MPV Engine NFU (TU5JP4)	299195	Drive Shaft	48W	25	24	58.5	79	585				
1.6 16V (81 kW)	2002.11-2008.10	-	L	F	MPV Engine NFU (TU5JP4)	210128	Drive Shaft	29T	25	24	55.7	79	594				
	2002.11-2008.10	-	L	F	MPV Engine NFU (TU5JP4)	299195	Drive Shaft	48W	25	24	58.5	79	585				
	2002.11-2008.10	-	-	F	MPV Engine NFU (TU5JP4)	899293	Outer Joint	48W	25	34	58.5	79	55	I			
	2002.11-2008.10	-	L	F	MPV Engine NFU (TU5JP4)	210163	Drive Shaft		25	24	54.8	78.5	583				
	2002.11-2008.10	-	R	F	MPV Engine NFU (TU5JP4)	299196	Drive Shaft	48W	25	24	58.5	79	869				
	2002.11-2008.10	-	-	F	MPV Engine NFU (TU5JP4)	810022	Outer Joint	29W	25	34	55.7	79	55	I			
	2002.11-2008.10	-	L	F	MPV Engine NFU (TU5JP4)	210131	Drive Shaft	29T	25	24	54.8	78.5	583				
	2002.11-2008.10	MT	L	F	MPV Engine NFU (TU5JP4)	299025	Drive Shaft	29W	25	24	55.7	79	597				
	2002.11-2008.10	MT	R	F	MPV Engine NFU (TU5JP4)	210078	Drive Shaft	29W	25	24	55.7	79	872				
	2002.11-2008.10	-	L	F	MPV Engine NFU (TU5JP4)	210165	Drive Shaft		25	24	55.7	79	594				
	2002.11-2008.10	MT	R	F	MPV Engine NFU (TU5JP4)	210091	Drive Shaft		25	24	54.8	78.5	869.5				
	2002.11-2008.10	-	-	F	MPV Engine NFU (TU5JP4)	810042	Outer Joint		25	34	54.8	78.5	56	I			
1.6 HDI 75 (55 kW)	2005.07-2011.12	-	L	F	MPV Engine DV6B/9HW (DV6BTED4)	210080	Drive Shaft	29W	25	24	55.7	79	597				
	2005.07-2011.12	-	R	F	MPV Engine DV6B/9HW (DV6BTED4)	299196	Drive Shaft	48W	25	24	58.5	79	869				
	2005.07-2011.12	-	-	F	MPV Engine DV6B/9HW (DV6BTED4)	899293	Outer Joint	48W	25	34	58.5	79	55	I			
	2005.07-2011.12	-	-	F	MPV Engine DV6B/9HW (DV6BTED4)	810022	Outer Joint	29W	25	34	55.7	79	55	I			
	2005.07-2011.12	MT	-	F	MPV Engine DV6B/9HW (DV6BTED4)	810067	Outer Joint	48W	25	34	58.5	79	55	I			
	2005.07-2011.12	-	R	F	MPV Engine DV6B/9HW (DV6BTED4)	210019	Drive Shaft	29T	25	22	60	80	867				
	2005.07-2011.12	-	L	F	MPV Engine DV6B/9HW (DV6BTED4)	210021	Drive Shaft	29T	25	22	60	80	593				
	2005.07-2011.12	-	-	F	MPV Engine DV6B/9HW (DV6BTED4)	810042	Outer Joint		25	34	54.8	78.5	56	I			
	2005.07-2011.12	-	L	F	MPV Engine DV6B/9HW (DV6BTED4)	299195	Drive Shaft	48W	25	24	58.5	79	585				
1.6 HDI 90 (66 kW)	2005.07-2008.05	-	L	F	MPV Engine 9HX (DV6ATED4)	299195	Drive Shaft	48W	25	24	58.5	79	585				
	2005.07-2008.05	-	L	F	MPV Engine 9HX (DV6ATED4)	210080	Drive Shaft	29W	25	24	55.7	79	597				





YEAR	TRANSM	L/R	F/R	REMARKS	GSP Ref.	PRODUCT	ABS	Technical Specifications									
								A	B	C	H	L	P				
CITROEN																	
BERLINGO/BERLINGO FIRST (MF)																	
1.6 HDI 90 (66 kW)	2005.07-2008.05	-	-	F	MPV Engine 9HX (DV6ATED4)	899293	Outer Joint	48W	25	34	58.5	79	55	I			
	2005.07-2008.05	-	-	F	MPV Engine 9HX (DV6ATED4)	810022	Outer Joint	29W	25	34	55.7	79	55	I			
	2005.07-2008.05	-	R	F	MPV Engine 9HX (DV6ATED4)	299196	Drive Shaft	48W	25	24	58.5	79	869				
	2005.07-2008.05	-	-	F	MPV Engine 9HX (DV6ATED4)	810042	Outer Joint		25	34	54.8	78.5	56	I			
1.8 D (43 kW)	1998.07-2002.10	MT	L/R	F	MPV Engine A9A (XUD7)	810003	Outer Joint	29T	25	23	54.8	78.5	56	I			
	1998.07-2002.10	-	-	F	MPV Engine A9A (XUD7)	899293	Outer Joint	48W	25	34	58.5	79	55	I			
	1998.07-2002.10	-	L	F	MPV Engine A9A (XUD7)	210128	Drive Shaft	29T	25	24	55.7	79	594				
	1998.07-2002.10	-	L	F	MPV Engine A9A (XUD7)	210227	Drive Shaft		25	24	58.5	78.5	595				
	1998.07-2002.10	MT	L	F	MPV Engine A9A (XUD7)	299025	Drive Shaft	29W	25	24	55.7	79	597				
	1998.07-2002.10	-	R	F	MPV Engine A9A (XUD7)	210226	Drive Shaft	29T	25	24	58	78.5	867				
	1998.07-2002.10	MT	R	F	MPV Engine A9A (XUD7)	210078	Drive Shaft	29W	25	24	55.7	79	872				
	1998.07-2002.10	MT	-	F	MPV Engine A9A (XUD7)	810042	Outer Joint		25	34	54.8	78.5	56	I			
	1998.07-2002.10	MT	R	F	MPV Engine A9A (XUD7)	210091	Drive Shaft		25	24	54.8	78.5	869.5				
	1998.07-2002.10	MT	-	F	MPV Engine A9A (XUD7)	810022	Outer Joint	29W	25	34	55.7	79	55	I			
	1998.07-2002.10	-	L	F	MPV Engine A9A (XUD7)	210165	Drive Shaft		25	24	55.7	79	594				
1.8 i (66 kW)	1997.04-2001.10	MT	L	F	All-wheel Drive MPV Engine LFX (XU7JB)	210128	Drive Shaft	29T	25	24	55.7	79	594				
	1997.04-2001.10	-	-	-	All-wheel Drive MPV Engine LFX (XU7JB)	899293	Outer Joint	48W	25	34	58.5	79	55	I			
	1997.04-2001.10	MT	L/R	F	All-wheel Drive MPV Engine LFX (XU7JB)	810003	Outer Joint	29T	25	23	54.8	78.5	56	I			
	1997.04-2001.10	-	L	F	All-wheel Drive MPV Engine LFX (XU7JB)	210227	Drive Shaft		25	24	58.5	78.5	595				
	1997.04-2001.10	MT	L	F	All-wheel Drive MPV Engine LFX (XU7JB)	210131	Drive Shaft	29T	25	24	54.8	78.5	583				
	1997.04-2001.10	MT	L	F	All-wheel Drive MPV Engine LFX (XU7JB)	299025	Drive Shaft	29W	25	24	55.7	79	597				
	1997.04-2001.10	-	R	F	All-wheel Drive MPV Engine LFX (XU7JB)	210226	Drive Shaft	29T	25	24	58	78.5	867				
	1997.04-2001.10	-	-	-	All-wheel Drive MPV Engine LFX (XU7JB)	810020	Outer Joint	29T	25	34	58	78.5	55	I			
	1997.04-2001.10	MT	-	-	All-wheel Drive MPV Engine LFX (XU7JB)	810042	Outer Joint		25	34	54.8	78.5	56	I			
	1997.04-2001.10	MT	R	F	All-wheel Drive MPV Engine LFX (XU7JB)	210078	Drive Shaft	29W	25	24	55.7	79	872				
	1997.04-2001.10	MT	R	F	All-wheel Drive MPV Engine LFX (XU7JB)	210091	Drive Shaft		25	24	54.8	78.5	869.5				
	1997.04-2001.10	MT	-	-	All-wheel Drive MPV Engine LFX (XU7JB)	810022	Outer Joint	29W	25	34	55.7	79	55	I			
	1997.05-2002.10	-	-	F	MPV Engine LFX (XU7JB)	899293	Outer Joint	48W	25	34	58.5	79	55	I			
	1997.05-2002.10	-	L	F	MPV Engine LFX (XU7JB)	210128	Drive Shaft	29T	25	24	55.7	79	594				
	1997.05-2002.10	MT	L/R	F	MPV Engine LFX (XU7JB)	810003	Outer Joint	29T	25	23	54.8	78.5	56	I			
	1997.05-2002.10	-	L	F	MPV Engine LFX (XU7JB)	210227	Drive Shaft		25	24	58.5	78.5	595				
	1997.05-2002.10	MT	L	F	MPV Engine LFX (XU7JB)	299025	Drive Shaft	29W	25	24	55.7	79	597				
	1997.05-2002.10	-	R	F	MPV Engine LFX (XU7JB)	210226	Drive Shaft	29T	25	24	58	78.5	867				
	1997.05-2002.10	MT	R	F	MPV Engine LFX (XU7JB)	210078	Drive Shaft	29W	25	24	55.7	79	872				
	1997.05-2002.10	-	-	-	MPV Engine LFX (XU7JB)	810020	Outer Joint	29T	25	34	58	78.5	55	I			
	1997.05-2002.10	MT	-	F	MPV Engine LFX (XU7JB)	810042	Outer Joint		25	34	54.8	78.5	56	I			
	1997.05-2002.10	MT	R	F	MPV Engine LFX (XU7JB)	210091	Drive Shaft		25	24	54.8	78.5	869.5				
	1997.05-2002.10	MT	-	F	MPV Engine LFX (XU7JB)	810022	Outer Joint	29W	25	34	55.7	79	55	I			
	1997.05-2002.10	-	L	F	MPV Engine LFX (XU7JB)	210165	Drive Shaft		25	24	55.7	79	594				
1.9 D (50 kW)	1996.07-2003.12	MT	L	F	MPV Engine DJY (XUD9A)/D9B(XUD9A/L)	210025	Drive Shaft	29T	25	24	54.8	78.5	593				
	1996.07-2003.12	-	-	F	MPV Engine DJY (XUD9A)/D9B(XUD9A/L)	899293	Outer Joint	48W	25	34	58.5	79	55	I			
	1996.07-2003.12	-	L	F	MPV Engine DJY (XUD9A)/D9B(XUD9A/L)	210128	Drive Shaft	29T	25	24	55.7	79	594				
	1996.07-2003.12	-	L	F	MPV Engine DJY (XUD9A)/D9B(XUD9A/L)	210227	Drive Shaft		25	24	58.5	78.5	595				
	1996.07-2003.12	-	R	F	MPV Engine DJY (XUD9A)/D9B(XUD9A/L)	210226	Drive Shaft	29T	25	24	58	78.5	867				
	1996.07-2003.12	MT	R	F	MPV Engine DJY (XUD9A)/D9B(XUD9A/L)	210167	Drive Shaft		25	24	55.7	79	868				
	1996.07-2003.12	-	L	F	MPV Engine DJY (XUD9A)/D9B(XUD9A/L)	299025	Drive Shaft	29W	25	24	55.7	79	597				
	1996.07-2003.12	MT	R	F	MPV Engine DJY (XUD9A)/D9B(XUD9A/L)	210023	Drive Shaft	29T	25	24	55.7	79	868				
	1996.07-2003.12	-	-	-	MPV Engine DJY (XUD9A)/D9B(XUD9A/L)	810020	Outer Joint	29T	25	34	58	78.5	55	I			
	1996.07-2003.12	-	R	F	MPV Engine DJY (XUD9A)/D9B(XUD9A/L)	210078	Drive Shaft	29W	25	24	55.7	79	872				
	1996.07-2003.12	-	-	F	MPV Engine DJY (XUD9A)/D9B(XUD9A/L)	845036	Outer Joint	29T	25	22	60	80	54	I			
	1996.07-2003.12	-	-	F	MPV Engine DJY (XUD9A)/D9B(XUD9A/L)	810042	Outer Joint		25	34	54.8	78.5	56	I			
	1996.07-2003.12	-	R	F	MPV Engine DJY (XUD9A)/D9B(XUD9A/L)	210091	Drive Shaft		25	24	54.8	78.5	869.5				
	1996.07-2003.12	-	L	F	MPV Engine DJY (XUD9A)/D9B(XUD9A/L)	210165	Drive Shaft		25	24	55.7	79	594				
	1996.07-2003.12	-	L	F	MPV Engine DJY (XUD9A)/D9B(XUD9A/L)	810022	Outer Joint	29W	25	34	55.7	79	55	I			
1.9 D (51 kW)	1998.07-2005.10	MT	L	F	All-wheel Drive MPV Engine WJY (DW8B)/WJZ (DW8)	210128	Drive Shaft	29T	25	24	55.7	79	594				
	1998.07-2005.10	-	-	F	MPV Engine WJY (DW8B)/WJZ (DW8)	810022	Outer Joint	29W	25	34	55.7	79	55	I			
	1998.07-2005.10	-	-	F	MPV Engine WJY (DW8B)/WJZ (DW8)	899293	Outer Joint	48W	25	34	58.5	79	55	I			
	1998.07-2005.10	-	-	-	All-wheel Drive MPV Engine WJY (DW8B)/WJZ (DW8)	810022	Outer Joint	29W	25	34	55.7	79	55	I			
	1998.07-2005.10	-	L	F	MPV Engine WJY (DW8B)/WJZ (DW8)	210128	Drive Shaft	29T	25	24	55.7	79	594				
	1998.07-2005.10	-	-	-	All-wheel Drive MPV Engine WJY (DW8B)/WJZ (DW8)	899293	Outer Joint	48W	25	34	58.5	79	55	I			
	1998.07-2005.10	-	L	F	MPV Engine WJY (DW8B)/WJZ (DW8)	210227	Drive Shaft		25	24	58.5	78.5	595				
	1998.07-2005.10	-	L	F	All-wheel Drive MPV Engine WJY (DW8B)/WJZ (DW8)	210227	Drive Shaft		25	24	58.5	78.5	595				
	1998.07-2005.10	MT	L	F	All-wheel Drive MPV Engine WJY (DW8B)/WJZ (DW8)	210131	Drive Shaft	29T	25	24	54.8	78.5	583				
	1998.07-2005.10	-	R	F	MPV Engine WJY (DW8B)/WJZ (DW8)	210226	Drive Shaft	29T	25	24	58	78.5	867				
	1998.07-2005.10	-	R	F	All-wheel Drive MPV Engine WJY (DW8B)/WJZ (DW8)	210226	Drive Shaft	29T	25	24	58	78.5	867				
	1998.07-2005.10	-	L	F	MPV Engine WJY (DW8B)/WJZ (DW8)	299025	Drive Shaft	29W	25	24	55.7	79	597				

YEAR	TRANSM	L/R	F/R	REMARKS	GSP Ref.	PRODUCT	ABS	Technical Specifications						
								A	B	C	H	L	P	
CITROEN														
BERLINGO/BERLINGO FIRST (MF)														
1.9 D (51 kW)	1998.07-2005.10	-	L	F	All-wheel Drive MPV Engine WJY (DW8B)/WJZ (DW8)	299025	Drive Shaft	29W	25	24	55.7	79	597	
	1998.07-2005.10	-	R	F	MPV Engine WJY (DW8B)/WJZ (DW8)	210078	Drive Shaft	29W	25	24	55.7	79	872	
	1998.07-2005.10	-	R	F	All-wheel Drive MPV Engine WJY (DW8B)/WJZ (DW8)	210078	Drive Shaft	29W	25	24	55.7	79	872	
	1998.07-2005.10	-	-	F	MPV Engine WJY (DW8B)/WJZ (DW8)	845036	Outer Joint	29T	25	22	60	80	54	I
	1998.07-2005.10	-	-	-	All-wheel Drive MPV Engine WJY (DW8B)/WJZ (DW8)	845036	Outer Joint	29T	25	22	60	80	54	I
	1998.07-2005.10	-	-	-	MPV Engine WJY (DW8B)/WJZ (DW8)	810076	Outer Joint	29W	25	34	58.5	79	55	I
	1998.07-2005.10	-	-	F	MPV Engine WJY (DW8B)/WJZ (DW8)	810042	Outer Joint		25	34	54.8	78.5	56	I
	1998.07-2005.10	-	-	-	All-wheel Drive MPV Engine WJY (DW8B)/WJZ (DW8)	810042	Outer Joint		25	34	54.8	78.5	56	I
	1998.07-2005.10	-	R	F	MPV Engine WJY (DW8B)/WJZ (DW8)	210091	Drive Shaft		25	24	54.8	78.5	869.5	
2.0 HDi (66 kW)	2002.11-2005.10	-	-	F	All-wheel Drive MPV Engine RHY (DW10TD)	808016	Outer Joint		22	22	52	96.5	53.5	O
	2002.11-2005.10	-	-	F	All-wheel Drive MPV Engine RHY (DW10TD)	808016	Outer Joint		22	22	52	96.5	53.5	O
2.0 HDi 90 (66 kW)	1999.12-2005.10	MT	L/R	F	MPV Engine RHY (DW10TD)	810003	Outer Joint	29T	25	23	54.8	78.5	56	I
	1999.12-2005.10	-	L	F	MPV Engine RHY (DW10TD)	299195	Drive Shaft	48W	25	24	58.5	79	585	
	1999.12-2005.10	-	L	F	MPV Engine RHY (DW10TD)	210080	Drive Shaft	29W	25	24	55.7	79	597	
	1999.12-2005.10	-	-	F	MPV Engine RHY (DW10TD)	899293	Outer Joint	48W	25	34	58.5	79	55	I
	1999.12-2005.10	-	-	F	MPV Engine RHY (DW10TD)	810022	Outer Joint	29W	25	34	55.7	79	55	I
	1999.12-2005.10	-	R	F	MPV Engine RHY (DW10TD)	299196	Drive Shaft	48W	25	24	58.5	79	869	
	1999.12-2005.10	MT	L	F	MPV Engine RHY (DW10TD)	210163	Drive Shaft		25	24	54.8	78.5	583	
	1999.12-2005.10	MT	L	F	MPV Engine RHY (DW10TD)	210131	Drive Shaft	29T	25	24	54.8	78.5	583	
	1999.12-2005.10	-	R	F	MPV Engine RHY (DW10TD)	210226	Drive Shaft	29T	25	24	58	78.5	867	
	1999.12-2005.10	MT	L	F	MPV Engine RHY (DW10TD)	610018	Inner Joint		24	29	40	62.5	99	
1999.12-2005.10	-	-	F	MPV Engine RHY (DW10TD)	810042	Outer Joint		25	34	54.8	78.5	56	I	
BERLINGO/BERLINGO FIRST (M_)														
1.1 i (44 kW)	1996.07-2008.03	-	R	F	Box Engine HDZ (TU1M)/HFX (TU1JP)	210205	Drive Shaft		25	22	58.5	79	866	
	1996.07-2008.03	-	L	F	Box Engine HDZ (TU1M)/HFX (TU1JP)	210075	Drive Shaft	29T	25	22	54.5	79.5	587	
	1996.07-2008.03	-	R	F	Box Engine HDZ (TU1M)/HFX (TU1JP)	210188	Drive Shaft	29T	25	22	54.5	79.5	860	
	1996.07-2008.03	-	L	F	Box Engine HDZ (TU1M)/HFX (TU1JP)	210026	Drive Shaft		25	22	56.7	79	594	
	1996.07-2008.03	-	R	F	Box Engine HDZ (TU1M)/HFX (TU1JP)	210015	Drive Shaft		25	22	56.7	79	868	
	1996.07-2008.03	-	R	F	Box Engine HDZ (TU1M)/HFX (TU1JP)	210019	Drive Shaft	29T	25	22	60	80	867	
	1996.07-2008.03	-	L	F	Box Engine HDZ (TU1M)/HFX (TU1JP)	210021	Drive Shaft	29T	25	22	60	80	593	
1.4 BiFuel (55 kW)	1996.07-2002.10	-	R	F	Box Engine KFW (TU3JP)	210205	Drive Shaft		25	22	58.5	79	866	
	1996.07-2002.10	-	L	F	Box Engine KFW (TU3JP)	210026	Drive Shaft		25	22	56.7	79	594	
	1996.07-2002.10	-	R	F	Box Engine KFW (TU3JP)	210015	Drive Shaft		25	22	56.7	79	868	
	1996.07-2002.10	-	R	F	Box Engine KFW (TU3JP)	210019	Drive Shaft	29T	25	22	60	80	867	
	1996.07-2002.10	-	L	F	Box Engine KFW (TU3JP)	210021	Drive Shaft	29T	25	22	60	80	593	
1.4 bivalent (48 kW)	2002.11-2011.12	-	R	F	Box Engine KFW (TU3JP)	210205	Drive Shaft		25	22	58.5	79	866	
	2002.11-2011.12	-	R	F	Box Engine KFW (TU3JP)	210188	Drive Shaft	29T	25	22	54.5	79.5	860	
	2002.11-2011.12	-	L	F	Box Engine KFW (TU3JP)	210026	Drive Shaft		25	22	56.7	79	594	
	2002.11-2011.12	MT	R	F	Box Engine KFW (TU3JP)	210110	Drive Shaft		25	22	54.5	79.5	862	
	2002.11-2011.12	-	R	F	Box Engine KFW (TU3JP)	210015	Drive Shaft		25	22	56.7	79	868	
	2002.11-2011.12	-	R	F	Box Engine KFW (TU3JP)	210019	Drive Shaft	29T	25	22	60	80	867	
	2002.11-2011.12	-	L	F	Box Engine KFW (TU3JP)	210021	Drive Shaft	29T	25	22	60	80	593	
1.4 i (55 kW)	1996.07-2011.12	-	R	F	Box Engine KFX (TU3JP)/KFW (TU3JP)	210205	Drive Shaft		25	22	58.5	79	866	
	1996.07-2011.12	-	L	F	Box Engine KFX (TU3JP)/KFW (TU3JP)	210075	Drive Shaft	29T	25	22	54.5	79.5	587	
	1996.07-2011.12	-	R	F	Box Engine KFX (TU3JP)/KFW (TU3JP)	210188	Drive Shaft	29T	25	22	54.5	79.5	860	
	1996.07-2011.12	-	L	F	Box Engine KFX (TU3JP)/KFW (TU3JP)	210026	Drive Shaft		25	22	56.7	79	594	
	1996.07-2011.12	MT	R	F	Box Engine KFX (TU3JP)/KFW (TU3JP)	210110	Drive Shaft		25	22	54.5	79.5	862	
	1996.07-2011.12	-	R	F	Box Engine KFX (TU3JP)/KFW (TU3JP)	210015	Drive Shaft		25	22	56.7	79	868	
	1996.07-2011.12	-	R	F	Box Engine KFX (TU3JP)/KFW (TU3JP)	210019	Drive Shaft	29T	25	22	60	80	867	
	1996.07-2011.12	-	L	F	Box Engine KFX (TU3JP)/KFW (TU3JP)	210021	Drive Shaft	29T	25	22	60	80	593	
1.4 i bivalent (55 kW)	2003.04-2005.10	-	R	F	Box Engine KFW (TU3JP)	210205	Drive Shaft		25	22	58.5	79	866	
	2003.04-2005.10	-	L	F	Box Engine KFW (TU3JP)	210026	Drive Shaft		25	22	56.7	79	594	
	2003.04-2005.10	MT	R	F	Box Engine KFW (TU3JP)	210110	Drive Shaft		25	22	54.5	79.5	862	
	2003.04-2005.10	MT	-	F	Box Engine KFW (TU3JP)	810067	Outer Joint	48W	25	34	58.5	79	55	I
	2003.04-2005.10	-	R	F	Box Engine KFW (TU3JP)	210015	Drive Shaft		25	22	56.7	79	868	
	2003.04-2005.10	-	R	F	Box Engine KFW (TU3JP)	210019	Drive Shaft	29T	25	22	60	80	867	
	2003.04-2005.10	-	L	F	Box Engine KFW (TU3JP)	210021	Drive Shaft	29T	25	22	60	80	593	
	2003.04-2005.10	-	L	F	Box Engine KFW (TU3JP)	210187	Drive Shaft	29T	25	22	54.5	79.5	590.5	
1.6 16V (80 kW)	2000.10-2008.03	-	R	F	Box Engine NFU (TU5JP4)	299196	Drive Shaft	48W	25	24	58.5	79	869	
	2000.10-2008.03	-	-	F	Box Engine NFU (TU5JP4)	899293	Outer Joint	48W	25	34	58.5	79	55	I
	2000.10-2008.03	-	-	F	Box Engine NFU (TU5JP4)	810022	Outer Joint	29W	25	34	55.7	79	55	I
	2000.10-2008.03	-	L	F	Box Engine NFU (TU5JP4)	210163	Drive Shaft		25	24	54.8	78.5	583	
	2000.10-2008.03	-	L	F	Box Engine NFU (TU5JP4)	210131	Drive Shaft	29T	25	24	54.8	78.5	583	
	2000.10-2008.03	MT	L	F	Box Engine NFU (TU5JP4)	299025	Drive Shaft	29W	25	24	55.7	79	597	
	2000.10-2008.03	MT	R	F	Box Engine NFU (TU5JP4)	210078	Drive Shaft	29W	25	24	55.7	79	872	





YEAR	TRANSM	L/R	F/R	REMARKS	GSP Ref.	PRODUCT	ABS	Technical Specifications									
								A	B	C	H	L	P				
CITROEN																	
BERLINGO/BERLINGO FIRST (M_)																	
1.6 16V (80 kW)	2000.10-2008.03	-	-	-	Box Engine NFU (TU5JP4)	810076	Outer Joint	29W	25	34	58.5	79	55	I			
	2000.10-2008.03	MT	R	F	Box Engine NFU (TU5JP4)	210091	Drive Shaft		25	24	54.8	78.5	869.5				
	2000.10-2008.03	-	-	F	Box Engine NFU (TU5JP4)	810042	Outer Joint		25	34	54.8	78.5	56	I			
	2000.10-2008.03	-	L	F	Box Engine NFU (TU5JP4)	299195	Drive Shaft	48W	25	24	58.5	79	585				
1.6 16V (81 kW)	2005.08-2007.12	-	-	-	Box Engine NFU (TU5JP4)	810076	Outer Joint	29W	25	34	58.5	79	55	I			
1.6 HDI 75 (55 kW)	2005.07-2011.12	-	L	F	Box Engine DV68/9HW (DV6BTED4)	210080	Drive Shaft	29W	25	24	55.7	79	597				
	2005.07-2011.12	-	R	F	Box Engine DV68/9HW (DV6BTED4)	299196	Drive Shaft	48W	25	24	58.5	79	869				
	2005.07-2011.12	-	-	F	Box Engine DV68/9HW (DV6BTED4)	899293	Outer Joint	48W	25	34	58.5	79	55	I			
	2005.07-2011.12	-	-	F	Box Engine DV68/9HW (DV6BTED4)	810022	Outer Joint	29W	25	34	55.7	79	55	I			
	2005.07-2011.12	-	-	F	Box Engine DV68/9HW (DV6BTED4)	810042	Outer Joint		25	34	54.8	78.5	56	I			
	2005.07-2011.12	-	L	F	Box Engine DV68/9HW (DV6BTED4)	299195	Drive Shaft	48W	25	24	58.5	79	585				
1.6 HDI 90 (66 kW)	2005.07-2011.12	MT	R	F	Box Engine 9HX (DV6ATED4)	299196	Drive Shaft	48W	25	24	58.5	79	869				
	2005.07-2011.12	MT	L	F	Box Engine 9HX (DV6ATED4)	245105	Drive Shaft		25	24	58	79	625				
	2005.07-2011.12	-	L	F	Box Engine 9HX (DV6ATED4)	210080	Drive Shaft	29W	25	24	55.7	79	597				
	2005.07-2011.12	-	-	F	Box Engine 9HX (DV6ATED4)	899293	Outer Joint	48W	25	34	58.5	79	55	I			
	2005.07-2011.12	-	-	F	Box Engine 9HX (DV6ATED4)	810022	Outer Joint	29W	25	34	55.7	79	55	I			
	2005.07-2011.12	MT	-	F	Box Engine 9HX (DV6ATED4)	810067	Outer Joint	48W	25	34	58.5	79	55	I			
	2005.07-2011.12	MT	R	F	Box Engine 9HX (DV6ATED4)	245104	Drive Shaft		25	24	58	79	925				
	2005.07-2011.12	-	-	F	Box Engine 9HX (DV6ATED4)	810042	Outer Joint		25	34	54.8	78.5	56	I			
	2005.07-2011.12	MT	L	F	Box Engine 9HX (DV6ATED4)	299195	Drive Shaft	48W	25	24	58.5	79	585				
	2005.07-2011.12	MT	R	F	Box Engine 9HX (DV6ATED4)	299195	Drive Shaft	48W	25	24	58.5	79	585				
1.8 D (43 kW)	1996.07-2002.10	MT	L/R	F	Box Engine A9A (XUD7)	810003	Outer Joint	29T	25	23	54.8	78.5	56	I			
	1996.07-2002.10	-	-	F	Box Engine A9A (XUD7)	899293	Outer Joint	48W	25	34	58.5	79	55	I			
	1996.07-2002.10	-	L	F	Box Engine A9A (XUD7)	210128	Drive Shaft	29T	25	24	55.7	79	594				
	1996.07-2002.10	-	L	F	Box Engine A9A (XUD7)	210227	Drive Shaft		25	24	58.5	78.5	595				
	1996.07-2002.10	MT	L	F	Box Engine A9A (XUD7)	299025	Drive Shaft	29W	25	24	55.7	79	597				
	1996.07-2002.10	-	R	F	Box Engine A9A (XUD7)	210226	Drive Shaft	29T	25	24	58	78.5	867				
	1996.07-2002.10	MT	R	F	Box Engine A9A (XUD7)	210078	Drive Shaft	29W	25	24	55.7	79	572				
	1996.07-2002.10	MT	-	F	Box Engine A9A (XUD7)	810042	Outer Joint		25	34	54.8	78.5	869.5				
	1996.07-2002.10	MT	R	F	Box Engine A9A (XUD7)	210091	Drive Shaft		25	24	54.8	78.5	869.5				
	1996.07-2002.10	MT	-	F	Box Engine A9A (XUD7)	810022	Outer Joint	29W	25	34	55.7	79	55	I			
	1996.07-2002.10	-	L	F	Box Engine A9A (XUD7)	210165	Drive Shaft		25	24	55.7	79	594				
	1.8 i (66 kW)	1999.08-2002.10	-	-	F	Box Engine LFX (XU7JB)	899293	Outer Joint	48W	25	34	58.5	79	55	I		
1999.08-2002.10		-	L	F	Box Engine LFX (XU7JB)	210128	Drive Shaft	29T	25	24	55.7	79	594				
1999.08-2002.10		-	-	F	Box Engine LFX (XU7JB)	810022	Outer Joint	29W	25	34	55.7	79	55	I			
1999.08-2002.10		-	L	F	Box Engine LFX (XU7JB)	210227	Drive Shaft		25	24	58.5	78.5	595				
1999.08-2002.10		MT	L	F	Box Engine LFX (XU7JB)	299025	Drive Shaft	29W	25	24	55.7	79	597				
1999.08-2002.10		-	R	F	Box Engine LFX (XU7JB)	210226	Drive Shaft	29T	25	24	58	78.5	867				
1999.08-2002.10		MT	R	F	Box Engine LFX (XU7JB)	210078	Drive Shaft	29W	25	24	55.7	79	872				
1999.08-2002.10		MT	R	F	Box Engine LFX (XU7JB)	210091	Drive Shaft		25	24	54.8	78.5	869.5				
1999.08-2002.10		-	L	F	Box Engine LFX (XU7JB)	210165	Drive Shaft		25	24	55.7	79	594				
1999.08-2002.10		-	-	F	Box Engine LFX (XU7JB)	210165	Drive Shaft		25	24	55.7	79	594				
1.9 D (51 kW)	1996.07-2003.12	-	-	F	Box Engine DJY (XUD9A)	899293	Outer Joint	48W	25	34	58.5	79	55	I			
	1996.07-2003.12	-	L	F	Box Engine DJY (XUD9A)	210128	Drive Shaft	29T	25	24	55.7	79	594				
	1996.07-2003.12	-	L	F	Box Engine DJY (XUD9A)	210227	Drive Shaft		25	24	58.5	78.5	595				
	1996.07-2003.12	-	L	F	Box Engine DJY (XUD9A)	299025	Drive Shaft	29W	25	24	55.7	79	597				
	1996.07-2003.12	-	-	-	Box Engine DJY (XUD9A)	810020	Outer Joint	29T	25	34	58	78.5	55	I			
	1996.07-2003.12	-	R	F	Box Engine DJY (XUD9A)	210078	Drive Shaft	29W	25	24	55.7	79	872				
	1996.07-2003.12	-	-	F	Box Engine DJY (XUD9A)	845036	Outer Joint	29T	25	22	60	80	54	I			
	1996.07-2003.12	-	-	F	Box Engine DJY (XUD9A)	810042	Outer Joint		25	34	54.8	78.5	56	I			
	1996.07-2003.12	-	R	F	Box Engine DJY (XUD9A)	210091	Drive Shaft		25	24	54.8	78.5	869.5				
	1996.07-2003.12	-	L	F	Box Engine DJY (XUD9A)	210165	Drive Shaft		25	24	55.7	79	594				
	1996.07-2003.12	-	-	F	Box Engine DJY (XUD9A)	810022	Outer Joint	29W	25	34	55.7	79	55	I			
	1.9 D 70 (51 kW)	1998.07-2006.03	-	-	-	All-wheel Drive Box Engine WJZ (DW8)/WJY (DW88)	810022	Outer Joint	29W	25	34	55.7	79	55	I		
1998.07-2006.03		-	-	-	All-wheel Drive Box Engine WJZ (DW8)/WJY (DW88)	899293	Outer Joint	48W	25	34	58.5	79	55	I			
1998.07-2006.03		-	L	F	All-wheel Drive Box Engine WJZ (DW8)/WJY (DW88)	210128	Drive Shaft	29T	25	24	55.7	79	594				
1998.07-2006.03		-	L	F	All-wheel Drive Box Engine WJZ (DW8)/WJY (DW88)	210227	Drive Shaft		25	24	58.5	78.5	595				
1998.07-2006.03		-	R	F	All-wheel Drive Box Engine WJZ (DW8)/WJY (DW88)	210226	Drive Shaft	29T	25	24	58	78.5	867				
1998.07-2006.03		-	L	F	All-wheel Drive Box Engine WJZ (DW8)/WJY (DW88)	299025	Drive Shaft	29W	25	24	55.7	79	597				
1998.07-2006.03		-	L	-	All-wheel Drive Box Engine WJZ (DW8)/WJY (DW88)	610018	Inner Joint		24	29	40	62.5	99				
1998.07-2006.03		-	R	F	All-wheel Drive Box Engine WJZ (DW8)/WJY (DW88)	210078	Drive Shaft	29W	25	24	55.7	79	872				
1998.07-2006.03		-	-	-	All-wheel Drive Box Engine WJZ (DW8)/WJY (DW88)	845036	Outer Joint	29T	25	22	60	80	54	I			
1998.07-2006.03		-	-	-	All-wheel Drive Box Engine WJZ (DW8)/WJY (DW88)	810042	Outer Joint		25	34	54.8	78.5	56	I			
1998.07-2006.03		-	R	F	All-wheel Drive Box Engine WJZ (DW8)/WJY (DW88)	210091	Drive Shaft		25	24	54.8	78.5	869.5				
1998.07-2006.03		-	L	F	All-wheel Drive Box Engine WJZ (DW8)/WJY (DW88)	210165	Drive Shaft		25	24	55.7	79	594				
1999.04-2011.12		-	L	F	Box Engine WJZ (DW8)/WJY (DW88)	210128	Drive Shaft	29T	25	24	55.7	79	594				
1999.04-2011.12		-	-	F	Box Engine WJZ (DW8)/WJY (DW88)	899293	Outer Joint	48W	25	34	58.5	79	55	I			
1999.04-2011.12		-	-	F	Box Engine WJZ (DW8)/WJY (DW88)	810022	Outer Joint	29W	25	34	55.7	79	55	I			

YEAR	TRANSM	L/R	F/R	REMARKS	GSP Ref.	PRODUCT	ABS	Technical Specifications						
								A	B	C	H	L	P	
CITROEN														
BERLINGO/BERLINGO FIRST (M_)														
1.9 D 70 (51 kW)	1999.04-2011.12	-	L	F	Box Engine WJZ (DW8)/WJY (DW88)	210227	Drive Shaft		25	24	58.5	78.5	595	
	1999.04-2011.12	-	L	F	Box Engine WJZ (DW8)/WJY (DW88)	299025	Drive Shaft	29W	25	24	55.7	79	597	
	1999.04-2011.12	-	R	F	Box Engine WJZ (DW8)/WJY (DW88)	210078	Drive Shaft	29W	25	24	55.7	79	872	
	1999.04-2011.12	-	-	F	Box Engine WJZ (DW8)/WJY (DW88)	845036	Outer Joint	29T	25	22	60	80	54	I
	1999.04-2011.12	-	L	F	Box Engine WJZ (DW8)/WJY (DW88)	210165	Drive Shaft		25	24	55.7	79	594	
	1999.04-2011.12	-	-	F	Box Engine WJZ (DW8)/WJY (DW88)	810042	Outer Joint		25	34	54.8	78.5	56	I
2.0 HDI 90 (66 kW)	1999.04-2011.12	-	R	F	Box Engine WJZ (DW8)/WJY (DW88)	210091	Drive Shaft		25	24	54.8	78.5	869.5	
	1999.12-2011.12	MT	L/R	F	Box Engine RHY (DW10TD)	810003	Outer Joint	29T	25	23	54.8	78.5	56	I
	1999.12-2011.12	-	L	F	Box Engine RHY (DW10TD)	210080	Drive Shaft	29W	25	24	55.7	79	597	
	1999.12-2011.12	-	-	F	Box Engine RHY (DW10TD)	899293	Outer Joint	48W	25	34	58.5	79	55	I
	1999.12-2011.12	-	R	F	Box Engine RHY (DW10TD)	299196	Drive Shaft	48W	25	24	58.5	79	869	
	1999.12-2011.12	-	-	F	Box Engine RHY (DW10TD)	810022	Outer Joint	29W	25	34	55.7	79	55	I
	1999.12-2011.12	MT	L	F	Box Engine RHY (DW10TD)	210163	Drive Shaft		25	24	54.8	78.5	583	
	1999.12-2011.12	MT	L	F	Box Engine RHY (DW10TD)	210131	Drive Shaft	29T	25	24	54.8	78.5	583	
	1999.12-2011.12	MT	L	F	Box Engine RHY (DW10TD)	610018	Inner Joint		24	29	40	62.5	99	
	1999.12-2011.12	-	-	F	Box Engine RHY (DW10TD)	810042	Outer Joint		25	34	54.8	78.5	56	I
	1999.12-2011.12	-	L	F	Box Engine RHY (DW10TD)	299195	Drive Shaft	48W	25	24	58.5	79	585	
	2000.11-2005.10	MT	L/R	F	All-wheel Drive Box Engine RHY (DW10TD)	810003	Outer Joint	29T	25	23	54.8	78.5	56	I
	2000.11-2005.10	-	L	F	All-wheel Drive Box Engine RHY (DW10TD)	299195	Drive Shaft	48W	25	24	58.5	79	585	
	2000.11-2005.10	-	L	F	All-wheel Drive Box Engine RHY (DW10TD)	210080	Drive Shaft	29W	25	24	55.7	79	597	
	2000.11-2005.10	-	-	-	All-wheel Drive Box Engine RHY (DW10TD)	899293	Outer Joint	48W	25	34	58.5	79	55	I
	2000.11-2005.10	-	-	-	All-wheel Drive Box Engine RHY (DW10TD)	810022	Outer Joint	29W	25	34	55.7	79	55	I
	2000.11-2005.10	-	R	F	All-wheel Drive Box Engine RHY (DW10TD)	299196	Drive Shaft	48W	25	24	58.5	79	869	
	2000.11-2005.10	-	L	F	All-wheel Drive Box Engine RHY (DW10TD)	210163	Drive Shaft		25	24	54.8	78.5	583	
	2000.11-2005.10	-	L	F	All-wheel Drive Box Engine RHY (DW10TD)	210131	Drive Shaft	29T	25	24	54.8	78.5	583	
	2000.11-2005.10	-	R	F	All-wheel Drive Box Engine RHY (DW10TD)	210226	Drive Shaft	29T	25	24	58	78.5	867	
2000.11-2005.10	-	-	-	All-wheel Drive Box Engine RHY (DW10TD)	810042	Outer Joint		25	34	54.8	78.5	56	I	
BX (XB_)														
1.1 (40 kW)	1988.10-1992.06	-	L	F	Hatchback Engine HDZ (TU1M)	210127	Drive Shaft		25	22	54.8	79	599	
	1988.10-1992.06	-	R	F	Hatchback Engine HDZ (TU1M)	210188	Drive Shaft	29T	25	22	54.5	79.5	860	
	1988.10-1992.06	MT	L/R	F	Hatchback Engine HDZ (TU1M)	810001	Outer Joint		25	22	54.8	79	48	I
1.4 (47 kW)	1989.01-1989.12	MT	L/R	F	Hatchback Engine K1H (TU3A)	810001	Outer Joint		25	22	54.8	79	48	I
	1989.01-1989.12	-	R	F	Hatchback Engine K1H (TU3A)	210188	Drive Shaft	29T	25	22	54.5	79.5	860	
	1989.01-1989.12	-	L	F	Hatchback Engine K1H (TU3A)	210127	Drive Shaft		25	22	54.8	79	599	
1.4 (55 kW)	1989.01-1993.02	-	L	F	Hatchback Engine KDY (TU3M)/KDY(TU3M/Z)	210127	Drive Shaft		25	22	54.8	79	599	
	1989.01-1993.02	-	R	F	Hatchback Engine KDY (TU3M)/KDY(TU3M/Z)	210188	Drive Shaft	29T	25	22	54.5	79.5	860	
	1989.01-1993.02	MT	L/R	F	Hatchback Engine KDY (TU3M)/KDY(TU3M/Z)	810001	Outer Joint		25	22	54.8	79	48	I
1.4 E (49 kW)	1985.09-1993.02	-	L	F	Hatchback Engine 150F	210127	Drive Shaft		25	22	54.8	79	599	
	1985.09-1993.02	-	R	F	Hatchback Engine 150F	210188	Drive Shaft	29T	25	22	54.5	79.5	860	
	1985.09-1993.02	MT	L/R	F	Hatchback Engine 150F	810001	Outer Joint		25	22	54.8	79	48	I
1.4 E (52 kW)	1983.04-1989.07	MT	L/R	F	Hatchback Engine 150C/K1G	810001	Outer Joint		25	22	54.8	79	48	I
	1983.04-1989.07	-	R	F	Hatchback Engine 150C/K1G	210188	Drive Shaft	29T	25	22	54.5	79.5	860	
	1983.04-1989.07	-	L	F	Hatchback Engine 150C/K1G	210127	Drive Shaft		25	22	54.8	79	599	
1.4 E (53 kW)	1983.04-1993.02	-	L	F	Hatchback Engine 150C	210127	Drive Shaft		25	22	54.8	79	599	
	1983.04-1993.02	-	R	F	Hatchback Engine 150C	210188	Drive Shaft	29T	25	22	54.5	79.5	860	
	1983.04-1993.02	MT	L/R	F	Hatchback Engine 150C	810001	Outer Joint		25	22	54.8	79	48	I
1.6 (53 kW)	1987.01-1993.02	-	L	F	Hatchback Engine B1E (XU51C)	210117	Drive Shaft		25	22	54.8	79	592.5	
	1987.01-1993.02	MT	L/R	F	Hatchback Engine B1E (XU51C)	810001	Outer Joint		25	22	54.8	79	48	I
	1987.01-1993.02	MT	L	F	Hatchback Engine B1E (XU51C)	210278	Drive Shaft		25	24	54.8	79	595	
	1987.01-1993.02	MT	R	F	Hatchback Engine B1E (XU51C)	210167	Drive Shaft		25	24	55.7	79	868	
	1987.01-1993.02	MT	R	F	Hatchback Engine B1E (XU51C)	210024	Drive Shaft		25	24	54.8	79	867	
1.6 (55 kW)	1988.09-1993.02	-	L	F	Hatchback Engine BAY (XU5CP)/BAZ (XU5CP)	210117	Drive Shaft		25	24	54.8	79	592.5	
	1988.09-1993.02	MT	L	F	Hatchback Engine BAY (XU5CP)/BAZ (XU5CP)	210278	Drive Shaft		25	24	54.8	79	595	
	1988.09-1993.02	MT	L/R	F	Hatchback Engine BAY (XU5CP)/BAZ (XU5CP)	810001	Outer Joint		25	22	54.8	79	48	I
	1988.09-1993.02	MT	R	F	Hatchback Engine BAY (XU5CP)/BAZ (XU5CP)	210024	Drive Shaft		25	24	54.8	79	867	
	1988.09-1993.02	MT	R	F	Hatchback Engine BAY (XU5CP)/BAZ (XU5CP)	210167	Drive Shaft		25	24	55.7	79	868	
1.6 (59 kW)	1987.10-1992.05	-	L	F	Hatchback Engine B1E (XU51C)	210117	Drive Shaft		25	24	54.8	79	592.5	
	1987.10-1992.05	MT	L	F	Hatchback Engine B1E (XU51C)	210278	Drive Shaft		25	24	54.8	79	595	
	1987.10-1992.05	MT	R	F	Hatchback Engine B1E (XU51C)	210024	Drive Shaft		25	24	54.8	79	867	
	1987.10-1992.05	MT	L/R	F	Hatchback Engine B1E (XU51C)	810001	Outer Joint		25	22	54.8	79	48	I
	1987.10-1992.05	MT	R	F	Hatchback Engine B1E (XU51C)	210167	Drive Shaft		25	24	55.7	79	868	
1.6 (64 kW)	1985.07-1993.02	-	L	F	Hatchback Engine 171D	210117	Drive Shaft		25	24	54.8	79	592.5	
	1985.07-1993.02	MT	L/R	F	Hatchback Engine 171D	810001	Outer Joint		25	22	54.8	79	48	I
	1985.07-1993.02	MT	L	F	Hatchback Engine 171D	210278	Drive Shaft		25	24	54.8	79	595	
	1985.07-1993.02	MT	L/R	F	Hatchback Engine 171D	810005	Outer Joint	90T	25	23	54.8	78.5	56	I
	1985.07-1993.02	MT	R	F	Hatchback Engine 171D	210167	Drive Shaft		25	24	55.7	79	868	





	 YEAR	TRANSM	L/R	F/R	REMARKS	GSP Ref.	 PRODUCT	 ABS	Technical Specifications					
									A	B	C	H	L	P
CITROEN														
BX (XB-)														
1.6 (64 kW)	1985.07-1993.02	MT	R	F	Hatchback Engine 171D	210024	Drive Shaft		25	24	54.8	79	867	
1.6 (68 kW)	1982.10-1992.12	-	L	F	Hatchback Engine XU52C	210117	Drive Shaft		25	24	54.8	79	592.5	
	1982.10-1992.12	MT	L/R	F	Hatchback Engine XU52C	810001	Outer Joint		25	22	54.8	79	48	I
	1982.10-1992.12	MT	L	F	Hatchback Engine XU52C	210278	Drive Shaft		25	24	54.8	79	595	
	1982.10-1992.12	MT	R	F	Hatchback Engine XU52C	210167	Drive Shaft		25	24	55.7	79	868	
	1982.10-1992.12	MT	R	F	Hatchback Engine XU52C	210024	Drive Shaft		25	24	54.8	79	867	
1.6 (76 kW)	1986.03-1993.02	-	L	F	Hatchback Engine 180Z	210117	Drive Shaft		25	24	54.8	79	592.5	
	1986.03-1993.02	MT	L/R	F	Hatchback Engine 180Z	810001	Outer Joint		25	22	54.8	79	48	I
	1986.03-1993.02	MT	L	F	Hatchback Engine 180Z	210278	Drive Shaft		25	24	54.8	79	595	
	1986.03-1993.02	MT	L/R	F	Hatchback Engine 180Z	810005	Outer Joint	90T	25	23	54.8	78.5	56	I
	1986.03-1993.02	MT	R	F	Hatchback Engine 180Z	210167	Drive Shaft		25	24	55.7	79	868	
1.6 E (65 kW)	1989.05-1993.02	-	L	F	Hatchback Engine BDZ (XU5M)/BDY (XU5M)	210117	Drive Shaft		25	24	54.8	79	592.5	
	1989.05-1993.02	MT	L/R	F	Hatchback Engine BDZ (XU5M)/BDY (XU5M)	810001	Outer Joint		25	22	54.8	79	48	I
	1989.05-1993.02	MT	L	F	Hatchback Engine BDZ (XU5M)/BDY (XU5M)	210278	Drive Shaft		25	24	54.8	79	595	
	1989.05-1993.02	MT	R	F	Hatchback Engine BDZ (XU5M)/BDY (XU5M)	210167	Drive Shaft		25	24	55.7	79	868	
	1989.05-1993.02	MT	R	F	Hatchback Engine BDZ (XU5M)/BDY (XU5M)	210024	Drive Shaft		25	24	54.8	79	867	
1.8 D (44 kW)	1985.10-1993.09	-	L	F	Hatchback Engine 161 (XUD7)	210117	Drive Shaft		25	24	54.8	79	592.5	
	1985.10-1993.09	MT	L	F	Hatchback Engine 161 (XUD7)	210278	Drive Shaft		25	24	54.8	79	595	
	1985.10-1993.09	MT	L/R	F	Hatchback Engine 161 (XUD7)	810001	Outer Joint		25	22	54.8	79	48	I
	1985.10-1993.09	MT	R	F	Hatchback Engine 161 (XUD7)	210024	Drive Shaft		25	24	54.8	79	867	
	1985.10-1993.09	MT	R	F	Hatchback Engine 161 (XUD7)	210167	Drive Shaft		25	24	55.7	79	868	
1.8 TRD Turbo (66 kW)	1988.03-1993.02	MT	L/R	F	Hatchback Engine A8A (XUD7TE)/AJZ (XUD7TE)	810003	Outer Joint	29T	25	23	54.8	78.5	56	I
	1988.03-1993.02	-	L	F	Hatchback Engine A8A (XUD7TE)/AJZ (XUD7TE)	210117	Drive Shaft		25	24	54.8	79	592.5	
	1988.03-1993.02	MT	L/R	F	Hatchback Engine A8A (XUD7TE)/AJZ (XUD7TE)	810002	Outer Joint		25	23	54.8	78.5	56	I
1.9 (70 kW)	1986.09-1989.11	MT	L/R	F	Hatchback Engine D2C (XU92C)	810001	Outer Joint		25	22	54.8	79	48	I
	1986.09-1989.11	-	L	F	Hatchback Engine D2C (XU92C)	210117	Drive Shaft		25	24	54.8	79	592.5	
	1986.09-1989.11	MT	R	F	Hatchback Engine D2C (XU92C)	210167	Drive Shaft		25	24	55.7	79	868	
	1986.09-1989.11	MT	L	F	Hatchback Engine D2C (XU92C)	210278	Drive Shaft		25	24	54.8	79	595	
	1986.09-1989.11	MT	R	F	Hatchback Engine D2C (XU92C)	210024	Drive Shaft		25	24	54.8	79	867	
1.9 (75 kW)	1986.07-1989.05	MT	L/R	F	Hatchback Engine 159A	810001	Outer Joint		25	22	54.8	79	48	I
	1986.07-1989.05	-	L	F	Hatchback Engine 159A	210117	Drive Shaft		25	24	54.8	79	592.5	
	1986.07-1989.05	MT	R	F	Hatchback Engine 159A	210167	Drive Shaft		25	24	55.7	79	868	
	1986.07-1989.05	MT	L	F	Hatchback Engine 159A	210278	Drive Shaft		25	24	54.8	79	595	
	1986.07-1989.05	MT	R	F	Hatchback Engine 159A	210024	Drive Shaft		25	24	54.8	79	867	
1.9 (77 kW)	1986.07-1989.05	MT	L/R	F	Hatchback Engine D2A (XU92C)	810001	Outer Joint		25	22	54.8	79	48	I
	1986.07-1989.05	-	L	F	Hatchback Engine D2A (XU92C)	210117	Drive Shaft		25	24	54.8	79	592.5	
	1986.07-1989.05	MT	R	F	Hatchback Engine D2A (XU92C)	210167	Drive Shaft		25	24	55.7	79	868	
	1986.07-1989.05	MT	L	F	Hatchback Engine D2A (XU92C)	210278	Drive Shaft		25	24	54.8	79	595	
	1986.07-1989.05	MT	R	F	Hatchback Engine D2A (XU92C)	210024	Drive Shaft		25	24	54.8	79	867	
1.9 D (47 kW)	1983.09-1993.09	-	L	F	Hatchback Engine 162 (XUD9)/DJZ(XUD9Y)/D9A(XUD9)	210117	Drive Shaft		25	24	54.8	79	592.5	
	1983.09-1993.09	MT	L/R	F	Hatchback Engine 162 (XUD9)/DJZ(XUD9Y)/D9A(XUD9)	810001	Outer Joint		25	22	54.8	79	48	I
	1983.09-1993.09	MT	R	F	Hatchback Engine 162 (XUD9)/DJZ(XUD9Y)/D9A(XUD9)	210167	Drive Shaft		25	24	55.7	79	868	
	1983.09-1993.09	MT	L/R	F	Hatchback Engine 162 (XUD9)/DJZ(XUD9Y)/D9A(XUD9)	810005	Outer Joint	90T	25	23	54.8	78.5	56	I
	1983.09-1993.09	MT	L	F	Hatchback Engine 162 (XUD9)/DJZ(XUD9Y)/D9A(XUD9)	210278	Drive Shaft		25	24	54.8	79	595	
1.9 D (51 kW)	1983.09-1993.09	MT	R	F	Hatchback Engine 162 (XUD9)/DJZ(XUD9Y)/D9A(XUD9)	210024	Drive Shaft		25	24	54.8	79	867	
	1987.03-1993.02	-	L	F	Hatchback Engine D9B (XUD9A/U)	210117	Drive Shaft		25	24	54.8	79	592.5	
	1987.03-1993.02	MT	L/R	F	Hatchback Engine D9B (XUD9A/U)	810001	Outer Joint		25	22	54.8	79	48	I
	1987.03-1993.02	MT	L/R	F	Hatchback Engine D9B (XUD9A/U)	810005	Outer Joint	90T	25	23	54.8	78.5	56	I
	1987.03-1993.02	MT	R	F	Hatchback Engine D9B (XUD9A/U)	210167	Drive Shaft		25	24	55.7	79	868	
	1987.03-1993.02	MT	L	F	Hatchback Engine D9B (XUD9A/U)	210278	Drive Shaft		25	24	54.8	79	595	
1.9 E (80 kW)	1987.03-1993.02	MT	R	F	Hatchback Engine D9B (XUD9A/U)	210024	Drive Shaft		25	24	54.8	79	867	
	1988.06-1993.02	-	L	F	Hatchback Engine DDZ (XU9M)	210117	Drive Shaft		25	24	54.8	79	592.5	
	1988.06-1993.02	MT	L/R	F	Hatchback Engine DDZ (XU9M)	810001	Outer Joint		25	22	54.8	79	48	I
	1988.06-1993.02	MT	R	F	Hatchback Engine DDZ (XU9M)	210167	Drive Shaft		25	24	55.7	79	868	
	1988.06-1993.02	MT	L	F	Hatchback Engine DDZ (XU9M)	210278	Drive Shaft		25	24	54.8	79	595	
	1988.06-1993.02	MT	R	F	Hatchback Engine DDZ (XU9M)	210024	Drive Shaft		25	24	54.8	79	867	
	1989.04-1993.02	-	L	F	All-wheel Drive Hatchback Engine D2F	210117	Drive Shaft		25	24	54.8	79	592.5	
	1989.04-1993.02	MT	L/R	F	All-wheel Drive Hatchback Engine D2F	810001	Outer Joint		25	22	54.8	79	48	I
	1989.04-1993.02	MT	L/R	F	All-wheel Drive Hatchback Engine D2F	810005	Outer Joint	90T	25	23	54.8	78.5	56	I
	1989.04-1993.02	MT	R	F	All-wheel Drive Hatchback Engine D2F	210167	Drive Shaft		25	24	55.7	79	868	
1.9 GTi (88 kW)	1989.04-1993.02	MT	L	-	All-wheel Drive Hatchback Engine D2F	210278	Drive Shaft		25	24	54.8	79	595	
	1989.04-1993.02	MT	-	R	All-wheel Drive Hatchback Engine D2F	210024	Drive Shaft		25	24	54.8	79	867	
	1988.06-1993.02	-	L	F	Hatchback Engine DKZ (XU9JA)	210117	Drive Shaft		25	24	54.8	79	592.5	
	1988.06-1993.02	-	L	F	All-wheel Drive Hatchback Engine DKZ (XU9JA)	210117	Drive Shaft		25	24	54.8	79	592.5	
	1988.06-1993.02	MT	L/R	F	All-wheel Drive Hatchback Engine DKZ (XU9JA)	810001	Outer Joint		25	22	54.8	79	48	I





	 YEAR	TRANSM	L/R	F/R	REMARKS	GSP Ref.	 PRODUCT	 ABS	Technical Specifications					
									A	B	C	H	L	P
CITROEN														
BX (XB-)														
1.9 GTi (88 kW)	1988.06-1993.02	MT	L/R	F	Hatchback Engine DKZ (XU9JA)	810001	Outer Joint		25	22	54.8	79	48	I
	1988.06-1993.02	MT	R	F	All-wheel Drive Hatchback Engine DKZ (XU9JA)	210167	Drive Shaft		25	24	55.7	79	868	
	1988.06-1993.02	MT	L/R	F	Hatchback Engine DKZ (XU9JA)	810005	Outer Joint	90T	25	23	54.8	78.5	56	I
	1988.06-1993.02	MT	R	F	Hatchback Engine DKZ (XU9JA)	210167	Drive Shaft		25	24	55.7	79	868	
	1988.06-1993.02	MT	L/R	F	All-wheel Drive Hatchback Engine DKZ (XU9JA)	810005	Outer Joint	90T	25	23	54.8	78.5	56	I
	1988.06-1993.02	MT	L	F	Hatchback Engine DKZ (XU9JA)	210278	Drive Shaft		25	24	54.8	79	595	
	1988.06-1993.02	MT	L	-	All-wheel Drive Hatchback Engine DKZ (XU9JA)	210278	Drive Shaft		25	24	54.8	79	595	
	1988.06-1993.02	MT	R	F	Hatchback Engine DKZ (XU9JA)	210024	Drive Shaft		25	24	54.8	79	867	
1.9 GTi (90 kW)	1986.07-1993.02	MT	L/R	F	Hatchback Engine D6A (XU9J2)	810003	Outer Joint	29T	25	23	54.8	78.5	56	I
	1986.07-1993.02	-	L	F	Hatchback Engine D6A (XU9J2)	210117	Drive Shaft		25	24	54.8	79	592.5	
	1986.07-1993.02	MT	L/R	F	Hatchback Engine D6A (XU9J2)	810005	Outer Joint	90T	25	23	54.8	78.5	56	I
	1986.07-1993.02	MT	L/R	F	Hatchback Engine D6A (XU9J2)	810002	Outer Joint		25	23	54.8	78.5	56	I
14 E (59 kW)	1985.10-1989.05	MT	L/R	F	Hatchback	810001	Outer Joint		25	22	54.8	79	48	I
	1985.10-1989.05	-	R	F	Hatchback	210188	Drive Shaft	29T	25	22	54.5	79.5	860	
	1985.10-1989.05	-	L	F	Hatchback	210127	Drive Shaft		25	22	54.8	79	599	
16 (58 kW)	1987.09-1993.02	-	L	F	Hatchback Engine B1A (XU51C/K)	210117	Drive Shaft		25	24	54.8	79	592.5	
	1987.09-1993.02	MT	L/R	F	Hatchback Engine B1A (XU51C/K)	810001	Outer Joint		25	22	54.8	79	48	I
	1987.09-1993.02	MT	R	F	Hatchback Engine B1A (XU51C/K)	210167	Drive Shaft		25	24	55.7	79	868	
19 GTi (90 kW)	1984.10-1994.06	MT	L/R	F	Hatchback Engine D6A (XU9J2)	810002	Outer Joint		25	23	54.8	78.5	56	I
19 GTi 16V (108 kW)	1988.03-1993.02	MT	L/R	F	Hatchback Engine DFW (XU9J4)	810003	Outer Joint	29T	25	23	54.8	78.5	56	I
	1988.03-1993.02	-	L	F	Hatchback Engine DFW (XU9J4)	210117	Drive Shaft		25	24	54.8	79	592.5	
BX Break (XB-)														
1.4 (47 kW)	1989.01-1989.12	MT	L/R	F	Estate Engine K1H (TU3A)	810001	Outer Joint		25	22	54.8	79	48	I
	1989.01-1989.12	-	R	F	Estate Engine K1H (TU3A)	210188	Drive Shaft	29T	25	22	54.5	79.5	860	
	1989.01-1989.12	-	L	F	Estate Engine K1H (TU3A)	210127	Drive Shaft		25	22	54.8	79	599	
1.4 (55 kW)	1989.01-1993.02	-	L	F	Estate Engine KDY (TU3M)	210127	Drive Shaft		25	22	54.8	79	599	
	1989.01-1993.02	-	R	F	Estate Engine KDY (TU3M)	210188	Drive Shaft	29T	25	22	54.5	79.5	860	
	1989.01-1993.02	MT	L/R	F	Estate Engine KDY (TU3M)	810001	Outer Joint		25	22	54.8	79	48	I
1.5 (59 kW)	1987.10-1992.05	-	L	F	Estate Engine B1E (XU51C)	210117	Drive Shaft		25	24	54.8	79	592.5	
	1987.10-1992.05	MT	L	F	Estate Engine B1E (XU51C)	210278	Drive Shaft		25	24	54.8	79	595	
	1987.10-1992.05	MT	R	F	Estate Engine B1E (XU51C)	210024	Drive Shaft		25	24	54.8	79	867	
	1987.10-1992.05	MT	L/R	F	Estate Engine B1E (XU51C)	810001	Outer Joint		25	22	54.8	79	48	I
	1987.10-1992.05	MT	R	F	Estate Engine B1E (XU51C)	210167	Drive Shaft		25	24	55.7	79	868	
1.6 (53 kW)	1988.09-1994.12	-	L	F	Estate Engine B1E (XU51C)	210117	Drive Shaft		25	24	54.8	79	592.5	
	1988.09-1994.12	MT	L/R	F	Estate Engine B1E (XU51C)	810001	Outer Joint		25	22	54.8	79	48	I
	1988.09-1994.12	MT	L	F	Estate Engine B1E (XU51C)	210278	Drive Shaft		25	24	54.8	79	595	
	1988.09-1994.12	MT	R	F	Estate Engine B1E (XU51C)	210167	Drive Shaft		25	24	55.7	79	868	
	1988.09-1994.12	MT	R	F	Estate Engine B1E (XU51C)	210024	Drive Shaft		25	24	54.8	79	867	
1.6 (64 kW)	1985.07-1994.12	-	L	F	Estate Engine 171D	210117	Drive Shaft		25	24	54.8	79	592.5	
	1985.07-1994.12	MT	L/R	F	Estate Engine 171D	810001	Outer Joint		25	22	54.8	79	48	I
	1985.07-1994.12	MT	L	F	Estate Engine 171D	210278	Drive Shaft		25	24	54.8	79	595	
	1985.07-1994.12	MT	L/R	F	Estate Engine 171D	810005	Outer Joint	90T	25	23	54.8	78.5	56	I
	1985.07-1994.12	MT	R	F	Estate Engine 171D	210167	Drive Shaft		25	24	55.7	79	868	
	1985.07-1994.12	MT	R	F	Estate Engine 171D	210024	Drive Shaft		25	24	54.8	79	867	
1.6 (65 kW)	1989.05-1994.12	-	L	F	Estate Engine BDZ (XU5M)/BDY (XU5M)	210117	Drive Shaft		25	24	54.8	79	592.5	
	1989.05-1994.12	MT	L/R	F	Estate Engine BDZ (XU5M)/BDY (XU5M)	810001	Outer Joint		25	22	54.8	79	48	I
	1989.05-1994.12	MT	L	F	Estate Engine BDZ (XU5M)/BDY (XU5M)	210278	Drive Shaft		25	24	54.8	79	595	
	1989.05-1994.12	MT	R	F	Estate Engine BDZ (XU5M)/BDY (XU5M)	210167	Drive Shaft		25	24	55.7	79	868	
	1989.05-1994.12	MT	R	F	Estate Engine BDZ (XU5M)/BDY (XU5M)	210024	Drive Shaft		25	24	54.8	79	867	
1.6 (76 kW)	1986.03-1994.12	-	L	F	Estate Engine 180Z	210117	Drive Shaft		25	24	54.8	79	592.5	
	1986.03-1994.12	MT	L/R	F	Estate Engine 180Z	810001	Outer Joint		25	22	54.8	79	48	I
	1986.03-1994.12	MT	L	F	Estate Engine 180Z	210278	Drive Shaft		25	24	54.8	79	595	
	1986.03-1994.12	MT	L/R	F	Estate Engine 180Z	810005	Outer Joint	90T	25	23	54.8	78.5	56	I
	1986.03-1994.12	MT	R	F	Estate Engine 180Z	210167	Drive Shaft		25	24	55.7	79	868	
	1986.03-1994.12	MT	R	F	Estate Engine 180Z	210024	Drive Shaft		25	24	54.8	79	867	
1.8 D (44 kW)	1985.10-1993.09	-	L	F	Estate Engine 161A (XUD7)	210117	Drive Shaft		25	24	54.8	79	592.5	
	1985.10-1993.09	MT	L	F	Estate Engine 161A (XUD7)	210278	Drive Shaft		25	24	54.8	79	595	
	1985.10-1993.09	MT	L/R	F	Estate Engine 161A (XUD7)	810001	Outer Joint		25	22	54.8	79	48	I
	1985.10-1993.09	MT	R	F	Estate Engine 161A (XUD7)	210167	Drive Shaft		25	24	55.7	79	868	
	1985.10-1993.09	MT	R	F	Estate Engine 161A (XUD7)	210024	Drive Shaft		25	24	54.8	79	867	
1.8 TRD Turbo (66 kW)	1988.03-1994.12	-	L	F	Estate Engine A8A (XUD7TE)/AJZ (XUD7TE)	210117	Drive Shaft		25	24	54.8	79	592.5	
	1988.03-1994.12	MT	L/R	F	Estate Engine A8A (XUD7TE)/AJZ (XUD7TE)	810002	Outer Joint		25	23	54.8	78.5	56	I
1.9 (70 kW)	1987.12-1989.12	MT	L/R	F	Estate Engine D2C (XU92C)	810001	Outer Joint		25	22	54.8	79	48	I
	1987.12-1989.12	MT	R	F	Estate Engine D2C (XU92C)	210167	Drive Shaft		25	24	55.7	79	868	
	1987.12-1989.12	MT	L	F	Estate Engine D2C (XU92C)	210278	Drive Shaft		25	24	54.8	79	595	





YEAR	TRANSM	L/R	F/R	REMARKS	GSP Ref.	PRODUCT	ABS	Technical Specifications							
								A	B	C	H	L	P		
CITROEN															
BX Break (XB-)															
1.9 (70 kW)	1987.12-1989.12	MT	R	F	Estate Engine D2C (XU92C)	210024	Drive Shaft		25	24	54.8	79	867		
1.9 (75 kW)	1986.07-1994.12	MT	L/R	F	Estate Engine D2A (XU92C)	810001	Outer Joint		25	22	54.8	79	48	I	
	1986.07-1994.12	MT	L	F	Estate Engine D2A (XU92C)	210278	Drive Shaft		25	24	54.8	79	595		
	1986.07-1994.12	MT	R	F	Estate Engine D2A (XU92C)	210167	Drive Shaft		25	24	55.7	79	868		
	1986.07-1994.12	MT	R	F	Estate Engine D2A (XU92C)	210024	Drive Shaft		25	24	54.8	79	867		
1.9 (80 kW)	1988.06-1994.12	MT	L/R	F	Estate Engine DDZ (XU9M)	810001	Outer Joint		25	22	54.8	79	48	I	
	1988.06-1994.12	MT	L	F	Estate Engine DDZ (XU9M)	210278	Drive Shaft		25	24	54.8	79	595		
	1988.06-1994.12	MT	R	F	Estate Engine DDZ (XU9M)	210167	Drive Shaft		25	24	55.7	79	868		
	1988.06-1994.12	MT	R	F	Estate Engine DDZ (XU9M)	210024	Drive Shaft		25	24	54.8	79	867		
	1990.10-1991.05	MT	L	-	All-wheel Drive Estate Engine DDZ (XU9M)	210278	Drive Shaft		25	24	54.8	79	595		
	1990.10-1991.05	MT	L/R	F	All-wheel Drive Estate Engine DDZ (XU9M)	810001	Outer Joint		25	22	54.8	79	48	I	
	1990.10-1991.05	MT	R	F	All-wheel Drive Estate Engine DDZ (XU9M)	210167	Drive Shaft		25	24	55.7	79	868		
1.9 (88 kW)	1988.06-1994.12	MT	L/R	F	Estate Engine DKZ (XU9JA)	810001	Outer Joint		25	22	54.8	79	48	I	
	1988.06-1994.12	MT	L	F	Estate Engine DKZ (XU9JA)	210278	Drive Shaft		25	24	54.8	79	595		
	1988.06-1994.12	MT	R	F	Estate Engine DKZ (XU9JA)	210167	Drive Shaft		25	24	55.7	79	868		
	1988.06-1994.12	MT	R	F	Estate Engine DKZ (XU9JA)	210024	Drive Shaft		25	24	54.8	79	867		
1.9 Cat (75 kW)	1986.07-1994.12	MT	L	F	Estate Engine DFZ (XU9J1)	210278	Drive Shaft		25	24	54.8	79	595		
	1986.07-1994.12	MT	L/R	F	Estate Engine DFZ (XU9J1)	810001	Outer Joint		25	22	54.8	79	48	I	
	1986.07-1994.12	MT	R	F	Estate Engine DFZ (XU9J1)	210167	Drive Shaft		25	24	55.7	79	868		
	1986.07-1994.12	MT	R	F	Estate Engine DFZ (XU9J1)	210024	Drive Shaft		25	24	54.8	79	867		
1.9 D (47 kW)	1983.09-1994.11	-	L	F	Estate Engine 162 (XUD9)/DJZ(XUD9Y)/D9A(XUD9)	210117	Drive Shaft		25	24	54.8	79	592.5		
	1983.09-1994.11	MT	L/R	F	Estate Engine 162 (XUD9)/DJZ(XUD9Y)/D9A(XUD9)	810001	Outer Joint		25	22	54.8	79	48	I	
	1983.09-1994.11	MT	L/R	F	Estate Engine 162 (XUD9)/DJZ(XUD9Y)/D9A(XUD9)	810005	Outer Joint	90T	25	23	54.8	78.5	56	I	
	1983.09-1994.11	MT	L	F	Estate Engine 162 (XUD9)/DJZ(XUD9Y)/D9A(XUD9)	210278	Drive Shaft		25	24	54.8	79	595		
	1983.09-1994.11	MT	R	F	Estate Engine 162 (XUD9)/DJZ(XUD9Y)/D9A(XUD9)	210167	Drive Shaft		25	24	55.7	79	868		
	1983.09-1994.11	MT	R	F	Estate Engine 162 (XUD9)/DJZ(XUD9Y)/D9A(XUD9)	210024	Drive Shaft		25	24	54.8	79	867		
1.9 D (51 kW)	1987.03-1994.12	-	L	F	Estate Engine D9B (XUD9A/U)	210117	Drive Shaft		25	24	54.8	79	592.5		
	1987.03-1994.12	MT	L/R	F	Estate Engine D9B (XUD9A/U)	810001	Outer Joint		25	22	54.8	79	48	I	
	1987.03-1994.12	MT	L/R	F	Estate Engine D9B (XUD9A/U)	810005	Outer Joint	90T	25	23	54.8	78.5	56	I	
	1987.03-1994.12	MT	L	F	Estate Engine D9B (XUD9A/U)	210278	Drive Shaft		25	24	54.8	79	595		
	1987.03-1994.12	MT	R	F	Estate Engine D9B (XUD9A/U)	210167	Drive Shaft		25	24	55.7	79	868		
	1987.03-1994.12	MT	R	F	Estate Engine D9B (XUD9A/U)	210024	Drive Shaft		25	24	54.8	79	867		
C-CROSSER (EP_)															
2.2 HDi (115 kW)	2007.02-	-	MT	L	F	All-wheel Drive Closed Off-Road Vehicle Engine 4HN (DW12MTED4)	659140	Inner Joint		24	36	50	67	116	
	2007.02-	-	MT	R	F	All-wheel Drive Closed Off-Road Vehicle Engine 4HN (DW12MTED4)	651021	Inner Joint		24	36	32	280.5	129	
	2007.02-	-	MT	R	F	All-wheel Drive Closed Off-Road Vehicle Engine 4HN (DW12MTED4)	251050	Drive Shaft		28	24	59.5	94.5	993	
C-CROSSER ENTERPRISE															
2.2 HDi (115 kW)	2009.01-	-	MT	L	F	All-wheel Drive Box Engine 4HN (DW12MTED4)	659140	Inner Joint		24	36	50	67	116	
	2009.01-	-	MT	R	F	All-wheel Drive Box Engine 4HN (DW12MTED4)	651021	Inner Joint		24	36	32	280.5	129	
	2009.01-	-	MT	R	F	All-wheel Drive Box Engine 4HN (DW12MTED4)	251050	Drive Shaft		28	24	59.5	94.5	993	
C-ELYSEE															
1.2 VTI 72 (53 kW)	2012.11-	-	MT	L	F	Saloon Engine HMY (EB2M)	210346	Drive Shaft		21	22	49	86	668	
	2012.11-	-	MT	R	F	Saloon Engine HMY (EB2M)	210347	Drive Shaft		21	22	49	86	884	
1.6 HDi 92 (68 kW)	2012.11-	-	MT	L	F	Saloon Engine 9HJ (DV6DTEDM)/9HP(DV6DTEDE)	210307	Drive Shaft		21	24	48.2	85.5	660	
	2012.11-	-	MT	R	F	Saloon Engine 9HJ (DV6DTEDM)/9HP(DV6DTEDE)	210308	Drive Shaft		21	24	48.2	85.5	890	
C1 (PM, PN)															
1.0 (50 kW)	2002.06-	-	-	-	-	-	659069	Inner Joint		23	19	34	60	101	
1.4 HDi (40 kW)	2005.06-	-	-	-	-	-	659069	Inner Joint		23	19	34	60	101	
C1 (PM_ PN_)															
1.0 (50 kW)	2005.06-	-	AT/MT	L	F	Hatchback Engine 1KR-FE	210232	Drive Shaft		24	23	49.5	91	650	
	2005.06-	-	AT/MT	R	F	Hatchback Engine 1KR-FE	210231	Drive Shaft		24	23	49.5	91	841	
	2005.06-	-	-	-	F	Hatchback Engine 1KR-FE	859268	Outer Joint		24	26	47	85.5	47.5	I
	2005.06-	-	-	L/R	F	Hatchback Engine 1KR-FE	899128	Outer Joint		24	19	49.5	91	46	M
1.4 HDi (40 kW)	2005.06-	-	-	L	F	Hatchback Engine 8HT (DV4TD)	259495	Drive Shaft		24	23	49.5	91	593	
	2005.06-	-	-	L/R	F	Hatchback Engine 8HT (DV4TD)	845058	Outer Joint		24	20	49.5	91	46	M
C15															
1.1 (44 kW)	1988.08-1996.07	-	L	F	Estate Engine HDZ (TU1M)	245015	Drive Shaft		21	22	56.4	76	576		
	1988.08-1996.07	-	R	F	Estate Engine HDZ (TU1M)	210096	Drive Shaft		21	22	56.4	76	834		
	1988.08-1996.07	-	L	F	Estate Engine HDZ (TU1M)	245068	Drive Shaft		21	24	56.4	76	563		
1.4 (44 kW)	1987.05-1992.10	-	R	F	Estate Engine 150D (XY7)	210044	Drive Shaft		21	22	56.4	76	832.5		
1.4 (49 kW)	1987.05-1992.09	-	R	F	Estate Engine KAZ	210044	Drive Shaft		21	22	56.4	76	832.5		
1.4 (55 kW)	1991.05-1996.07	-	R	F	Estate Engine KDY (TU3M)	210044	Drive Shaft		21	22	56.4	76	832.5		
1.8 D (44 kW)	1987.04-2000.08	MT	L	F	Estate Engine 161A (XUD7)	210039	Drive Shaft		21	24	56.4	76	567		
	1987.04-2000.08	MT	R	F	Estate Engine 161A (XUD7)	210007	Drive Shaft		21	24	48	75.5	845		
C15 (VD-)															





	 YEAR	TRANSM	L/R	F/R	REMARKS	GSP Ref.	 PRODUCT	 ABS	Technical Specifications					
									A	B	C	H	L	P
CITROEN														
C15 (VD-)														
1.0 (33 kW)	1984.10-1997.12	MT	R	F	Box Engine XV8/TU9	245001	Drive Shaft		21	22	56.4	76	830.5	
	1984.10-1997.12	-	R	F	Box Engine XV8/TU9	210087	Drive Shaft		21	24	56	79	851.5	
	1984.10-1997.12	MT	L	F	Box Engine XV8/TU9	210010	Drive Shaft		21	22	54	76	572	
	1984.10-1997.12	MT	L/R	F	Box Engine XV8/TU9	210130	Drive Shaft		21	22	54	90	683	
	1984.10-1997.12	-	-	-	Box Engine XV8/TU9	810048	Outer Joint		21	22	56	76	58	I
	1984.10-1997.12	-	R	F	Box Engine XV8/TU9	210044	Drive Shaft		21	22	56.4	76	832.5	
1.1 (35 kW)	1984.10-1996.12	-	L	F	Box Engine E1A/109K	245015	Drive Shaft		21	22	56.4	76	576	
	1984.10-1996.12	-	R	F	Box Engine E1A/109K	210087	Drive Shaft		21	24	56	79	851.5	
	1984.10-1996.12	-	R	F	Box Engine E1A/109K	210096	Drive Shaft		21	22	56.4	76	834	
	1984.10-1996.12	-	L	F	Box Engine E1A/109K	245068	Drive Shaft		21	24	56.4	76	563	
	1984.10-1996.12	MT	L/R	F	Box Engine E1A/109K	210130	Drive Shaft		21	22	54	90	683	
	1984.10-1996.12	MT	L	F	Box Engine E1A/109K	210039	Drive Shaft		21	24	56.4	76	567	
	1984.10-1996.12	-	-	-	Box Engine E1A/109K	810048	Outer Joint		21	22	56	76	58	I
	1984.10-1996.12	MT	R	F	Box Engine E1A/109K	210007	Drive Shaft		21	24	48	75.5	845	
1.1 i (44 kW)	1988.07-1996.12	MT	R	F	Box Engine HDZ (TU1M)	245001	Drive Shaft		21	22	56.4	76	830.5	
	1988.07-1996.12	-	L	F	Box Engine HDZ (TU1M)	245015	Drive Shaft		21	22	56.4	76	576	
	1988.07-1996.12	-	R	F	Box Engine HDZ (TU1M)	210087	Drive Shaft		21	24	56	79	851.5	
	1988.07-1996.12	MT	L	F	Box Engine HDZ (TU1M)	210010	Drive Shaft		21	22	54	76	572	
	1988.07-1996.12	-	R	F	Box Engine HDZ (TU1M)	210096	Drive Shaft		21	22	56.4	76	834	
	1988.07-1996.12	-	L	F	Box Engine HDZ (TU1M)	245068	Drive Shaft		21	24	56.4	76	563	
	1988.07-1996.12	-	R	F	Box Engine HDZ (TU1M)	210044	Drive Shaft		21	22	56.4	76	832.5	
1.4 (49 kW)	1987.07-1996.12	MT	R	F	Box Engine K1H (TU3A)	245001	Drive Shaft		21	22	56.4	76	830.5	
	1987.07-1996.12	-	R	F	Box Engine K1H (TU3A)	210087	Drive Shaft		21	24	56	79	851.5	
	1987.07-1996.12	MT	L	F	Box Engine K1H (TU3A)	210010	Drive Shaft		21	22	54	76	572	
	1987.07-1996.12	-	L	F	Box Engine K1H (TU3A)	245068	Drive Shaft		21	24	56.4	76	563	
	1987.07-1996.12	MT	L/R	F	Box Engine K1H (TU3A)	210130	Drive Shaft		21	22	54	90	683	
	1987.07-1996.12	-	R	F	Box Engine K1H (TU3A)	210044	Drive Shaft		21	22	56.4	76	832.5	
1.4 E (44 kW)	1987.05-1996.12	MT	R	F	Box Engine 150D (XY7)	245001	Drive Shaft		21	22	56.4	76	830.5	
	1987.05-1996.12	-	R	F	Box Engine 150D (XY7)	210087	Drive Shaft		21	24	56	79	851.5	
	1987.05-1996.12	MT	L	F	Box Engine 150D (XY7)	210010	Drive Shaft		21	22	54	76	572	
	1987.05-1996.12	-	L	F	Box Engine 150D (XY7)	245068	Drive Shaft		21	24	56.4	76	563	
	1987.05-1996.12	MT	L/R	F	Box Engine 150D (XY7)	210130	Drive Shaft		21	22	54	90	683	
	1987.05-1996.12	-	-	-	Box Engine 150D (XY7)	810048	Outer Joint		21	22	56	76	58	I
	1987.05-1996.12	-	R	F	Box Engine 150D (XY7)	210044	Drive Shaft		21	22	56.4	76	832.5	
1.4 i (55 kW)	1991.05-1996.12	MT	R	F	Box Engine KDY (TU3FM)/KDY (TU3M)	245001	Drive Shaft		21	22	56.4	76	830.5	
	1991.05-1996.12	MT	L	F	Box Engine KDY (TU3FM)/KDY (TU3M)	210010	Drive Shaft		21	22	54	76	572	
	1991.05-1996.12	-	R	F	Box Engine KDY (TU3FM)/KDY (TU3M)	210087	Drive Shaft		21	24	56	79	851.5	
	1991.05-1996.12	-	R	F	Box Engine KDY (TU3FM)/KDY (TU3M)	210044	Drive Shaft		21	22	56.4	76	832.5	
1.8 D (44 kW)	1986.07-2000.12	-	R	F	Box Engine 161A (XUD7)	210087	Drive Shaft		21	24	56	79	851.5	
	1986.07-2000.12	-	-	-	Box Engine 161A (XUD7)	810009	Outer Joint		21	22	56	79	60	I
	1986.07-2000.12	-	L	F	Box Engine 161A (XUD7)	245068	Drive Shaft		21	24	56.4	76	563	
	1986.07-2000.12	-	-	-	Box Engine 161A (XUD7)	810017	Outer Joint		21	31	56	77	59	I
	1986.07-2000.12	MT	L	F	Box Engine 161A (XUD7)	210039	Drive Shaft		21	24	56.4	76	567	
	1986.07-2000.12	-	-	-	Box Engine 161A (XUD7)	810048	Outer Joint		21	22	56	76	58	I
	1986.07-2000.12	MT	R	F	Box Engine 161A (XUD7)	210007	Drive Shaft		21	24	48	75.5	845	
1.9 D (44 kW)	2000.12-2005.12	-	L	F	Box Engine WJX (DW8B)	245068	Drive Shaft		21	24	56.4	76	563	
1.9 D (51 kW)	2000.10-2002.10	MT	L	F	Box Engine WJY (DW8B)	210039	Drive Shaft		21	24	56.4	76	567	
	2000.10-2002.10	MT	R	F	Box Engine WJY (DW8B)	210007	Drive Shaft		21	24	48	75.5	845	
C2 (JM_)														
1.1 (44 kW)	2003.09-	MT	-	F	Hatchback Engine HFX (TU1JP)	810053	Outer Joint		21	20	49	86	51	M
	2003.09-	-	L	F	Hatchback Engine HFX (TU1JP)	210030	Drive Shaft		21	22	48	86.5	643	
	2003.09-	-	R	F	Hatchback Engine HFX (TU1JP)	210031	Drive Shaft		21	22	48	86.5	841	
1.4 (54 kW)	2003.09-	AT	R	F	Hatchback Engine KFV (TU3JP)	210206	Drive Shaft		21	26	48.5	86	754	
	2003.09-	MT	-	F	Hatchback Engine KFV (TU3JP)	810053	Outer Joint		21	20	49	86	51	M
	2003.09-	AT/MT	-	F	Hatchback Engine KFV (TU3JP)	810069	Outer Joint		21	21	48	86.5	54	I
	2003.09-	MT	L	F	Hatchback Engine KFV (TU3JP)	210030	Drive Shaft		21	22	48	86.5	643	
	2003.09-	MT	R	F	Hatchback Engine KFV (TU3JP)	210031	Drive Shaft		21	22	48	86.5	841	
	2003.09-	-	-	-	Box Engine 161A (XUD7)	810048	Outer Joint		21	22	56	76	58	I
1.4 (55 kW)	2006.10-	MT	-	F	Hatchback Engine KFV (TU3JP)	810053	Outer Joint		21	20	49	86	51	M
	2006.10-	Semi-AT	-	F	Hatchback Engine KFV (TU3JP)	810069	Outer Joint		21	21	48	86.5	54	I
	2006.10-	-	L	F	Hatchback Engine KFV (TU3JP)	210030	Drive Shaft		21	22	48	86.5	643	
	2006.10-	-	R	F	Hatchback Engine KFV (TU3JP)	210031	Drive Shaft		21	22	48	86.5	841	
1.4 16V (65 kW)	2006.06-	-	L	F	Hatchback Engine KFV (ET3J4)	210146	Drive Shaft		21	22	48	86.5	642	
	2006.06-	-	-	-	Hatchback Engine KFV (ET3J4)	810069	Outer Joint		21	21	48	86.5	54	I
	2006.06-	-	R	F	Hatchback Engine KFV (ET3J4)	210144	Drive Shaft		21	22	48	86.5	843	
1.4 HDi (50 kW)	2003.09-	-	L	F	Hatchback Engine 8HZ (DV4TD)/8HX (DV4TD)	210276	Drive Shaft		21	22	48	86.5	643	
	2003.09-	-	R	F	Hatchback Engine 8HZ (DV4TD)/8HX (DV4TD)	210259	Drive Shaft		21	22	48.5	86	849	

YEAR	TRANSM	L/R	F/R	REMARKS	GSP Ref.	PRODUCT	ABS	Technical Specifications								
								A	B	C	H	L	P			
CITROEN																
C2 (JM_)																
1.4 HDi (50 kW)	2003.09-	-	AT/MT	-	F	Hatchback Engine 8HZ (DV4TD)/8HX (DV4TD)	810069	Outer Joint		21	21	48	86.5	54	I	
	2003.09-	-	MT	L/R	F	Hatchback Engine 8HZ (DV4TD)/8HX (DV4TD)	845057	Outer Joint		21	22	48	86.5	54	I	
1.6 (80 kW)	2003.09-	-	-	L	F	Hatchback Engine NFU (TU5JP4)	210146	Drive Shaft		21	22	48	86.5	642		
	2003.09-	-	-	R	F	Hatchback Engine NFU (TU5JP4)	210144	Drive Shaft		21	22	48	86.5	843		
1.6 HDi (80 kW)	2005.09-	-	-	R	F	Hatchback Engine 9HZ (DV6TED4)	610082	Inner Joint		24	34	29.8	291	88		
	2005.09-	-	-	L	F	Hatchback Engine 9HZ (DV6TED4)	610080	Inner Joint		24	34	40	69	89.5		
	2005.09-	-	-	L	F	Hatchback Engine 9HZ (DV6TED4)	610092	Inner Joint		24	22	40	69	86		
	2005.09-	-	-	L	F	Hatchback Engine 9HZ (DV6TED4)	210364	Drive Shaft		21	24	50	85	631		
	2005.09-	-	-	R	F	Hatchback Engine 9HZ (DV6TED4)	245226	Drive Shaft		21	24	48.3	86.5	856		
	2005.09-	-	-	L	F	Hatchback Engine 9HZ (DV6TED4)	899301	Outer Joint		21	22	50	85	53	I	
	2005.09-	-	MT	R	F	Hatchback Engine 9HZ (DV6TED4)	210288	Drive Shaft		21	24	48	86.5	858		
1.6 VTS (90 kW)	2005.01-	-	-	L	F	Hatchback Engine NFS (TU5JP4S)	210146	Drive Shaft		21	22	48	86.5	642		
	2005.01-	-	-	R	F	Hatchback Engine NFS (TU5JP4S)	210144	Drive Shaft		21	22	48	86.5	843		
C2 ENTERPRISE (JG_)																
1.4 HDi (50 kW)	2009.04-	-	-	L	F	Box Engine 8HX (DV4TD)	210276	Drive Shaft		21	22	48	86.5	643		
	2009.04-	-	-	R	F	Box Engine 8HX (DV4TD)	210259	Drive Shaft		21	22	48.5	86	849		
	2009.04-	-	AT/MT	-	F	Box Engine 8HX (DV4TD)	810069	Outer Joint		21	21	48	86.5	54	I	
C25																
-	-	-	-	-	-	-	810104	Outer Joint	54T	28	27	63	112.5	63	I	
C25 (280_ 290_)																
1.8 E (51 kW)	1987.07-	1994.02	MT	R	F	BUS Engine 169 (XM7T)	210029	Drive Shaft		28	25	63	112.5	1073		
	1987.07-	1994.02	MT	L/R	F	BUS Engine 169 (XM7T)	810010	Outer Joint		28	27	63	112.5	63	I	
	1987.07-	1994.02	MT	R	F	BUS Engine 169 (XM7T)	210068	Drive Shaft		28	25	63	112.5	1068		
	1987.07-	1994.02	MT	L	F	BUS Engine 169 (XM7T)	210034	Drive Shaft		28	25	63	112.5	701		
1.9 D (51 kW)	1987.07-	1994.02	MT	R	F	BUS Engine D9B (XUD9A/U)	210013	Drive Shaft		28	25	63	112.5	1072		
	1987.07-	1994.02	MT	L/R	F	BUS Engine D9B (XUD9A/U)	810010	Outer Joint		28	27	63	112.5	63	I	
	1987.07-	1994.02	MT	R	F	BUS Engine D9B (XUD9A/U)	210068	Drive Shaft		28	25	63	112.5	1068		
	1987.07-	1994.02	MT	L	F	BUS Engine D9B (XUD9A/U)	210034	Drive Shaft		28	25	63	112.5	701		
2.0 (62 kW)	1987.01-	1994.03	MT	L	F	Platform/Chassis Engine 170C (XN1T)	210034	Drive Shaft		28	25	63	112.5	701		
	1987.01-	1994.03	MT	R	F	Platform/Chassis Engine 170C (XN1T)	210029	Drive Shaft		28	25	63	112.5	1073		
	1987.01-	1994.03	MT	L/R	F	Platform/Chassis Engine 170C (XN1T)	810010	Outer Joint		28	27	63	112.5	63	I	
	1987.01-	1994.03	MT	R	F	Platform/Chassis Engine 170C (XN1T)	210068	Drive Shaft		28	25	63	112.5	1068		
	1991.02-	1994.03	MT	L	F	Box Engine 170C (XN1T)	210034	Drive Shaft		28	25	63	112.5	701		
	1991.02-	1994.02	MT	R	F	BUS Engine 170C (XN1T)	210029	Drive Shaft		28	25	63	112.5	1073		
	1991.02-	1994.03	MT	R	F	Box Engine 170C (XN1T)	210029	Drive Shaft		28	25	63	112.5	1073		
	1991.02-	1994.02	MT	L/R	F	BUS Engine 170C (XN1T)	810010	Outer Joint		28	27	63	112.5	63	I	
	1991.02-	1994.02	MT	R	F	BUS Engine 170C (XN1T)	210068	Drive Shaft		28	25	63	112.5	1068		
	1991.02-	1994.03	MT	L/R	F	Box Engine 170C (XN1T)	810010	Outer Joint		28	27	63	112.5	63	I	
	1991.02-	1994.03	MT	R	F	Box Engine 170C (XN1T)	210068	Drive Shaft		28	25	63	112.5	1068		
	1991.02-	1994.02	MT	L	F	BUS Engine 170C (XN1T)	210034	Drive Shaft		28	25	63	112.5	701		
2.0 E (58 kW)	1981.09-	1994.03	MT	L	F	Box Engine 170B (XN1T)/170A (XN1T)	210034	Drive Shaft		28	25	63	112.5	701		
	1981.09-	1994.02	MT	R	F	BUS Engine 170B (XN1T)/170A (XN1T)	210029	Drive Shaft		28	25	63	112.5	1073		
	1981.09-	1994.03	MT	R	F	Box Engine 170B (XN1T)/170A (XN1T)	210029	Drive Shaft		28	25	63	112.5	1073		
	1981.09-	1994.02	MT	L/R	F	BUS Engine 170B (XN1T)/170A (XN1T)	810010	Outer Joint		28	27	63	112.5	63	I	
	1981.09-	1994.02	MT	R	F	BUS Engine 170B (XN1T)/170A (XN1T)	210068	Drive Shaft		28	25	63	112.5	1068		
	1981.09-	1994.03	MT	L/R	F	Box Engine 170B (XN1T)/170A (XN1T)	810010	Outer Joint		28	27	63	112.5	63	I	
	1981.09-	1994.03	MT	R	F	Box Engine 170B (XN1T)/170A (XN1T)	210068	Drive Shaft		28	25	63	112.5	1068		
	1981.09-	1994.02	MT	L	F	BUS Engine 170B (XN1T)/170A (XN1T)	210034	Drive Shaft		28	25	63	112.5	701		
2.5 D (54 kW)	1985.10-	1994.02	MT	R	F	BUS Engine CRD93L (U25-661)	210029	Drive Shaft		28	25	63	112.5	1073		
	1985.10-	1994.02	MT	L/R	F	BUS Engine CRD93L (U25-661)	810010	Outer Joint		28	27	63	112.5	63	I	
	1985.10-	1994.02	MT	R	F	BUS Engine CRD93L (U25-661)	210068	Drive Shaft		28	25	63	112.5	1068		
	1985.10-	1994.02	MT	L	F	BUS Engine CRD93L (U25-661)	210034	Drive Shaft		28	25	63	112.5	701		
	1987.01-	1994.02	MT	R	F	All-wheel Drive BUS Engine CRD93L (U25-661)	210029	Drive Shaft		28	25	63	112.5	1073		
2.5 D Turbo (70 kW)	1987.08-	1994.02	MT	R	F	All-wheel Drive BUS Engine CRD93LS (U25-673)	210029	Drive Shaft		28	25	63	112.5	1073		
	1987.08-	1994.02	MT	R	F	BUS Engine CRD93LS (U25-673)	210029	Drive Shaft		28	25	63	112.5	1073		
	1987.08-	1994.02	MT	L/R	F	All-wheel Drive BUS Engine CRD93LS (U25-673)	810010	Outer Joint		28	27	63	112.5	63	I	
	1987.08-	1994.02	MT	R	F	All-wheel Drive BUS Engine CRD93LS (U25-673)	210068	Drive Shaft		28	25	63	112.5	1068		
	1987.08-	1994.02	MT	L/R	F	BUS Engine CRD93LS (U25-673)	810010	Outer Joint		28	27	63	112.5	63	I	
	1987.08-	1994.02	MT	R	F	BUS Engine CRD93LS (U25-673)	210068	Drive Shaft		28	25	63	112.5	1068		
	1987.08-	1994.02	MT	L	F	All-wheel Drive BUS Engine CRD93LS (U25-673)	210034	Drive Shaft		28	25	63	112.5	701		
	1987.08-	1994.02	MT	L	F	BUS Engine CRD93LS (U25-673)	210034	Drive Shaft		28	25	63	112.5	701		
C3 I (FC_)																
1.1 i (44 kW)	2002.02-	-	-	L	F	Hatchback Engine HFX (TU1A)	810026	Outer Joint		21	21	48	86.5	54	I	
	2002.02-	-	-	L	F	Hatchback Engine HFX (TU1A)	210181	Drive Shaft		21	26	48.5	86	618		
	2002.02-	-	-	R	F	Hatchback Engine HFX (TU1A)	210206	Drive Shaft		21	26	48.5	86	754		
	2002.02-	-	-	F	F	Hatchback Engine HFX (TU1A)	810053	Outer Joint		21	20	49	86	51	M	

	 YEAR	TRANSM	L/R	F/R	REMARKS	GSP Ref.	 PRODUCT	 ABS	Technical Specifications					
									A	B	C	H	L	P
CITROEN														
C3 I (FC_)														
1.1 i (44 kW)	2002.02-	-	-	R	F	Hatchback Engine HFX (TU1A)	845065	Outer Joint	21	21	48.5	86	54	I
	2002.02-	-	-	-	F	Hatchback Engine HFX (TU1A)	810069	Outer Joint	21	21	48	86.5	54	I
	2002.02-	-	-	L	F	Hatchback Engine HFX (TU1A)	210030	Drive Shaft	21	22	48	86.5	643	
	2002.02-	-	-	R	F	Hatchback Engine HFX (TU1A)	210031	Drive Shaft	21	22	48	86.5	841	
1.4 16V (65 kW)	2003.12-	-	-	L	F	Hatchback Engine KFU (ET3J4)	210146	Drive Shaft	21	22	48	86.5	642	
	2003.12-	-	-	R	F	Hatchback Engine KFU (ET3J4)	210144	Drive Shaft	21	22	48	86.5	843	
1.4 16V HDi (66 kW)	2002.02-	-	-	L	F	Hatchback Engine 8HY (DV4TED4)	210001	Drive Shaft	21	22	48	86.5	636	
	2002.02-	-	-	R	F	Hatchback Engine 8HY (DV4TED4)	210002	Drive Shaft	21	22	48	86.5	852	
	2002.02-	-	-	L	F	Hatchback Engine 8HY (DV4TED4)	210147	Drive Shaft	21	24	48	86.5	633	
	2002.02-	-	-	R	F	Hatchback Engine 8HY (DV4TED4)	245103	Drive Shaft	21	24	48	86.5	854	
	2002.02-	-	-	L	F	Hatchback Engine 8HY (DV4TED4)	810026	Outer Joint	21	21	48	86.5	54	I
	2002.02-	-	MT	R	F	Hatchback Engine 8HY (DV4TED4)	210288	Drive Shaft	21	24	48	86.5	858	
	2002.02-	-	-	R	F	Hatchback Engine 8HY (DV4TED4)	845065	Outer Joint	21	21	48.5	86	54	I
	2002.02-	-	MT	L/R	F	Hatchback Engine 8HY (DV4TED4)	845057	Outer Joint	21	22	48	86.5	54	I
1.4 HDi (50 kW)	2002.02-	-	-	L	F	Hatchback Engine 8HX (DV4TD)	810026	Outer Joint	21	21	48	86.5	54	I
	2002.02-	-	-	L	F	Hatchback Engine 8HX (DV4TD)	210276	Drive Shaft	21	22	48	86.5	643	
	2002.02-	-	-	R	F	Hatchback Engine 8HX (DV4TD)	210259	Drive Shaft	21	22	48.5	86	849	
	2002.02-	-	-	R	F	Hatchback Engine 8HX (DV4TD)	845065	Outer Joint	21	21	48.5	86	54	I
	2002.02-	-	-	L	F	Hatchback Engine 8HX (DV4TD)	210419	Drive Shaft	21	22	48.5	86	643	
	2002.02-	-	-	L	F	Hatchback Engine 8HX (DV4TD)	210420	Drive Shaft	21	22	48	86.5	637	
	2002.02-	-	MT	L/R	F	Hatchback Engine 8HX (DV4TD)	845057	Outer Joint	21	22	48	86.5	54	I
	2002.02-	-	-	-	F	Hatchback Engine 8HX (DV4TD)	810069	Outer Joint	21	21	48	86.5	54	I
1.4 HDi (52 kW)	2003.07-	2011.02	-	-	F	Hatchback Engine 8HZ (DV4TD)	810069	Outer Joint	21	21	48	86.5	54	I
1.4 i (54 kW)	2002.02-	-	AT/MT	L	F	Hatchback Engine KFV (TU3JP)	810026	Outer Joint	21	21	48	86.5	54	I
	2002.02-	-	-	L	F	Hatchback Engine KFV (TU3JP)	210181	Drive Shaft	21	26	48.5	86	618	
	2002.02-	-	-	R	F	Hatchback Engine KFV (TU3JP)	210206	Drive Shaft	21	26	48.5	86	754	
	2002.02-	-	MT	L	F	Hatchback Engine KFV (TU3JP)	210241	Drive Shaft	21	22	48	86.5	642	
	2002.02-	-	-	-	F	Hatchback Engine KFV (TU3JP)	810053	Outer Joint	21	20	49	86	51	M
	2002.02-	-	AT/MT	R	F	Hatchback Engine KFV (TU3JP)	845065	Outer Joint	21	21	48.5	86	54	I
	2002.02-	-	MT	L	F	Hatchback Engine KFV (TU3JP)	210125	Drive Shaft	21	22	48	86.5	649	
	2002.02-	-	MT	R	F	Hatchback Engine KFV (TU3JP)	210124	Drive Shaft	21	22	48	86.5	840	
	2002.02-	-	MT	L	F	Hatchback Engine KFV (TU3JP)	210030	Drive Shaft	21	22	48	86.5	643	
	2002.02-	-	-	-	F	Hatchback Engine KFV (TU3JP)	810069	Outer Joint	21	21	48	86.5	54	I
1.4 i Bivalent (54 kW)	2002.02-	-	AT/MT	L	F	Hatchback Engine KFV (TU3JP)	810026	Outer Joint	21	21	48	86.5	54	I
	2002.02-	-	-	L	F	Hatchback Engine KFV (TU3JP)	210181	Drive Shaft	21	26	48.5	86	618	
	2002.02-	-	-	R	F	Hatchback Engine KFV (TU3JP)	210206	Drive Shaft	21	26	48.5	86	754	
	2002.02-	-	MT	R	F	Hatchback Engine KFV (TU3JP)	210242	Drive Shaft	21	22	48	86.5	844	
	2002.02-	-	MT	L	F	Hatchback Engine KFV (TU3JP)	210241	Drive Shaft	21	22	48	86.5	642	
	2002.02-	-	AT/MT	R	F	Hatchback Engine KFV (TU3JP)	845065	Outer Joint	21	21	48.5	86	54	I
	2002.02-	-	MT	L	F	Hatchback Engine KFV (TU3JP)	210125	Drive Shaft	21	22	48	86.5	649	
	2002.02-	-	MT	R	F	Hatchback Engine KFV (TU3JP)	210124	Drive Shaft	21	22	48	86.5	840	
	2002.02-	-	-	-	F	Hatchback Engine KFV (TU3JP)	810069	Outer Joint	21	21	48	86.5	54	I
	2002.02-	-	MT	L	F	Hatchback Engine KFV (TU3JP)	210030	Drive Shaft	21	22	48	86.5	643	
	2002.02-	-	MT	R	F	Hatchback Engine KFV (TU3JP)	210031	Drive Shaft	21	22	48	86.5	841	
	1.6 16V (80 kW)	2002.02-	-	MT	L	F	Hatchback Engine NFU (TU5JP4)	210241	Drive Shaft	21	22	48	86.5	642
2002.02-		-	MT	L	F	Hatchback Engine NFU (TU5JP4)	210146	Drive Shaft	21	22	48	86.5	642	
2002.02-		-	AT/MT	-	F	Hatchback Engine NFU (TU5JP4)	810077	Outer Joint	21	28	49	86	56.5	O
2002.02-		-	MT	R	F	Hatchback Engine NFU (TU5JP4)	210144	Drive Shaft	21	22	48	86.5	843	
1.6 16V (81 kW)	2003.05-	2005.09	MT	R	F	Hatchback Engine NFU (TU5JP4)	210144	Drive Shaft	21	22	48	86.5	843	
	2003.05-	2005.09	MT	R	F	Hatchback Engine NFU (TU5JP4)	210242	Drive Shaft	21	22	48	86.5	844	
	2003.05-	2005.09	MT	L	F	Hatchback Engine NFU (TU5JP4)	210241	Drive Shaft	21	22	48	86.5	642	
	2003.05-	2005.09	MT	L	F	Hatchback Engine NFU (TU5JP4)	210146	Drive Shaft	21	22	48	86.5	642	
	2003.05-	2005.09	-	-	F	Hatchback Engine NFU (TU5JP4)	810077	Outer Joint	21	28	49	86	56.5	O
1.6 16V HDi (66 kW)	2005.10-	-	-	L	F	Hatchback Engine 9HX (DV6ATED4)	210147	Drive Shaft	21	24	48	86.5	633	
	2005.10-	-	-	R	F	Hatchback Engine 9HX (DV6ATED4)	245103	Drive Shaft	21	24	48	86.5	854	
	2005.10-	-	-	R	F	Hatchback Engine 9HX (DV6ATED4)	610082	Inner Joint	24	34	29.8	291	88	
	2005.10-	-	-	L	F	Hatchback Engine 9HX (DV6ATED4)	610080	Inner Joint	24	34	40	69	89.5	
	2005.10-	-	-	L	F	Hatchback Engine 9HX (DV6ATED4)	610092	Inner Joint	24	22	40	69	86	
	2005.10-	-	-	L	F	Hatchback Engine 9HX (DV6ATED4)	210364	Drive Shaft	21	24	50	85	631	
	2005.10-	-	-	R	F	Hatchback Engine 9HX (DV6ATED4)	245226	Drive Shaft	21	24	48.3	86.5	856	
	2005.10-	-	-	L	F	Hatchback Engine 9HX (DV6ATED4)	899301	Outer Joint	21	22	50	85	53	I
	2005.10-	-	MT	R	F	Hatchback Engine 9HX (DV6ATED4)	210288	Drive Shaft	21	24	48	86.5	858	
1.6 16V HDi (80 kW)	2005.10-	-	MT	L/R	F	Hatchback Engine 9HX (DV6ATED4)	845057	Outer Joint	21	22	48	86.5	54	I
	2005.09-	-	-	R	F	Hatchback Engine 9HZ (DV6TED4)	610082	Inner Joint	24	34	29.8	291	88	
	2005.09-	-	-	L	F	Hatchback Engine 9HZ (DV6TED4)	610080	Inner Joint	24	34	40	69	89.5	





	 YEAR	TRANSM	L/R	F/R	REMARKS	GSP Ref.	 PRODUCT	 ABS	Technical Specifications					
									A	B	C	H	L	P
CITROEN														
C3 I (FC_)														
1.6 16V HDi (80 kW)	2005.09-	-	-	L	F	Hatchback Engine 9HZ (DV6TED4)	610092	Inner Joint	24	22	40	69	86	
	2005.09-	-	-	L	F	Hatchback Engine 9HZ (DV6TED4)	210364	Drive Shaft	21	24	50	85	631	
	2005.09-	-	-	R	F	Hatchback Engine 9HZ (DV6TED4)	245226	Drive Shaft	21	24	48.3	86.5	856	
	2005.09-	-	-	L	F	Hatchback Engine 9HZ (DV6TED4)	899301	Outer Joint	21	22	50	85	53	I
	2005.09-	-	MT	R	F	Hatchback Engine 9HZ (DV6TED4)	210288	Drive Shaft	21	24	48	86.5	858	
	2005.09-	-	MT	L/R	F	Hatchback Engine 9HZ (DV6TED4)	845057	Outer Joint	21	22	48	86.5	54	I
C3 II (SC_)														
1.0 VTi 68 (50 kW)	2012.08-	-	-	-	F	Hatchback Engine ZMZ (EB0)	810028	Outer Joint	25	34	58	89	56	I
	2012.08-	-	MT	L	F	Hatchback Engine ZMZ (EB0)	210340	Drive Shaft	21	22	49	86	655	
1.1 (44 kW)	2009.11-	-	-	-	F	Hatchback Engine HFX (TU1JP)	810077	Outer Joint	21	28	49	86	56.5	O
1.2 VTi 82 (60 kW)	2012.06-	-	-	-	F	Hatchback Engine HMZ (EB2F)	810028	Outer Joint	25	34	58	89	56	I
	2012.06-	-	MT	L	F	Hatchback Engine HMZ (EB2F)	210340	Drive Shaft	21	22	49	86	655	
1.4 HDi 70 (50 kW)	2009.11-	-	-	L	F	Hatchback Engine 8HR (DV4C)/8HZ (DV4TD)	210311	Drive Shaft	21	22	48	86.5	647	
	2009.11-	-	Semi-AT	L	F	Hatchback Engine 8HR (DV4C)/8HZ (DV4TD)	210340	Drive Shaft	21	22	49	86	655	
1.4 LPG (70 kW)	2013.06-	-	-	L	F	Hatchback Engine 8FN (EP3)	210311	Drive Shaft	21	22	48	86.5	647	
1.4 VTi (72 kW)	2009.11-	-	-	L	F	Hatchback Engine 8FR (EP3)	210311	Drive Shaft	21	22	48	86.5	647	
1.4 VTi 95 (70 kW)	2009.11-	-	-	L	F	Hatchback Engine 8FP (EP3)	210311	Drive Shaft	21	22	48	86.5	647	
1.6 BlueHDi 100 (73 kW)	2014.07-	-	MT	R	F	Hatchback Engine BHY (DV6FD)	210249	Drive Shaft	25	24	58.5	79	864	
1.6 BlueHDi 75 (55 kW)	2015.04-	-	MT	R	F	Hatchback Engine BHW (DV6FE)	210249	Drive Shaft	25	24	58.5	79	864	
1.6 HDi (68 kW)	2009.11-	-	-	-	F	Hatchback Engine 9HP (DV6DTEED)	845012	Outer Joint	21	34	48.5	86	55.5	I
	2009.11-	-	MT	L	F	Hatchback Engine 9HP (DV6DTEED)	210309	Drive Shaft	21	24	48.3	86.5	641	
1.6 HDi 110 (82 kW)	2009.11-	-	-	L	F	Hatchback Engine 9HR (DV6C)	810148	Outer Joint	25	34	58.5	79	55.5	I
	2009.11-	-	-	L	F	Hatchback Engine 9HR (DV6C)	610057	Inner Joint	24	34	40	52.5	90	
	2009.11-	-	-	L	F	Hatchback Engine 9HR (DV6C)	210253	Drive Shaft	25	24	58.5	79	626	
1.6 HDi 115 (84 kW)	2012.09-	-	MT	L	F	Hatchback Engine 9HD (DV6C)	810148	Outer Joint	25	34	58.5	79	55.5	I
	2012.09-	-	MT	L	F	Hatchback Engine 9HD (DV6C)	610057	Inner Joint	24	34	40	52.5	90	
	2012.09-	-	MT	L	F	Hatchback Engine 9HD (DV6C)	210253	Drive Shaft	25	24	58.5	79	626	
1.6 HDi 90 (66 kW)	2009.11-	-	-	-	F	Hatchback Engine 9HX (DV6ATED4)	845012	Outer Joint	21	34	48.5	86	55.5	I
	2009.11-	-	MT	L	F	Hatchback Engine 9HX (DV6ATED4)	210309	Drive Shaft	21	24	48.3	86.5	641	
1.6 VTi 120 (88 kW)	2009.11-	-	AT	-	F	Hatchback Engine 5FS (EP6C)	810097	Outer Joint	25	30	58.5	79.5	55	I
	2009.11-	-	MT	-	F	Hatchback Engine 5FS (EP6C)	810077	Outer Joint	21	28	49	86	56.5	O
C3 Picasso														
1.4 VTi 95 (70 kW)	2009.02-	-	-	L	F	MPV Engine 8FP (EP3)/8FS (EP3)/8FN (EP3)	210414	Drive Shaft	25	24	58.5	78.5	632	
	2009.02-	-	-	-	-	MPV Engine 8FP (EP3)/8FS (EP3)/8FN (EP3)	810156	Outer Joint	25	22	58.5	78.5	55	I
	2009.02-	-	-	L	F	MPV Engine 8FP (EP3)/8FS (EP3)/8FN (EP3)	210415	Drive Shaft	25	24	58.5	78.5	637	
	2009.02-	-	-	R	F	MPV Engine 8FP (EP3)/8FS (EP3)/8FN (EP3)	210413	Drive Shaft	25	24	58.5	78.5	860	
1.4 VTi 95 LPG (70 kW)	2012.01-	-	-	L	F	MPV Engine 8FN (EP3)	210414	Drive Shaft	25	24	58.5	78.5	632	
	2012.01-	-	-	L	F	MPV Engine 8FN (EP3)	210250	Drive Shaft	25	24	58.5	79	634	
	2012.01-	-	-	R	F	MPV Engine 8FN (EP3)	210249	Drive Shaft	25	24	58.5	79	864	
	2012.01-	-	-	L	F	MPV Engine 8FN (EP3)	210415	Drive Shaft	25	24	58.5	78.5	637	
	2012.01-	-	-	R	F	MPV Engine 8FN (EP3)	210413	Drive Shaft	25	24	58.5	78.5	860	
1.6 BlueHDi 100 (73 kW)	2015.01-	-	5MT	R	F	MPV Engine BHY (DV6FD)	210249	Drive Shaft	25	24	58.5	79	864	
C3 PICASSO														
1.6 HDi	-	-	-	-	-	-	210319	Drive Shaft	25	24	55.7	79	636	
C3 Picasso														
1.6 HDi (66 kW)	2009.02-	-	MT	L	F	MPV Engine 9HX (DV6ATED4)	210250	Drive Shaft	25	24	58.5	79	634	
	2009.02-	-	-	R	F	MPV Engine 9HX (DV6ATED4)	210249	Drive Shaft	25	24	58.5	79	864	
1.6 HDi (80 kW)	2009.02-	-	MT	L	F	MPV Engine 9HZ (DV6TED4)	210250	Drive Shaft	25	24	58.5	79	634	
	2009.02-	-	-	R	F	MPV Engine 9HZ (DV6TED4)	210249	Drive Shaft	25	24	58.5	79	864	
1.6 HDi 110 (82 kW)	2010.05-	-	-	L	F	MPV Engine 9HR (DV6C)	610057	Inner Joint	24	34	40	52.5	90	
	2010.05-	-	-	L	F	MPV Engine 9HR (DV6C)	210253	Drive Shaft	25	24	58.5	79	626	
	2010.05-	-	-	L	F	MPV Engine 9HR (DV6C)	810148	Outer Joint	25	34	58.5	79	55.5	I
1.6 HDi 115 (84 kW)	2013.01-	-	MT	L	F	MPV Engine 9HD (DV6C)	810148	Outer Joint	25	34	58.5	79	55.5	I
	2013.01-	-	MT	L	F	MPV Engine 9HD (DV6C)	610057	Inner Joint	24	34	40	52.5	90	
	2013.01-	-	MT	L	F	MPV Engine 9HD (DV6C)	210253	Drive Shaft	25	24	58.5	79	626	
1.6 HDi 90 (68 kW)	2010.07-	-	-	R	F	MPV Engine 9HP (DV6DTEED)	210249	Drive Shaft	25	24	58.5	79	864	
1.6 VTi 120 (88 kW)	2009.02-	-	-	L	F	MPV Engine 5FW (EP6)/5FS (EP6C)	210414	Drive Shaft	25	24	58.5	78.5	632	
	2009.02-	-	-	-	-	MPV Engine 5FW (EP6)/5FS (EP6C)	810156	Outer Joint	25	22	58.5	78.5	55	I
	2009.02-	-	-	L	F	MPV Engine 5FW (EP6)/5FS (EP6C)	699001	Inner Joint	26	34	42.5	46.5	103.5	
	2009.02-	-	-	L	F	MPV Engine 5FW (EP6)/5FS (EP6C)	210415	Drive Shaft	25	24	58.5	78.5	637	
	2009.02-	-	-	R	F	MPV Engine 5FW (EP6)/5FS (EP6C)	210413	Drive Shaft	25	24	58.5	78.5	860	
	2009.02-	-	-	L	F	MPV Engine 5FW (EP6)/5FS (EP6C)	210286	Drive Shaft	25	26	58.5	79	613	
1.6 VTRi (84 kW)	2016.10-	-	-	L	F	MPV Engine 5FP (EP6)	210414	Drive Shaft	25	24	58.5	78.5	632	
	2016.10-	-	-	L	F	MPV Engine 5FP (EP6)	210415	Drive Shaft	25	24	58.5	78.5	637	
	2016.10-	-	-	R	F	MPV Engine 5FP (EP6)	210413	Drive Shaft	25	24	58.5	78.5	860	
C3 Pluriel (HB_)														





	 YEAR	TRANSM	L/R	F/R	REMARKS	GSP Ref.	 PRODUCT	 ABS	Technical Specifications						
									A	B	C	H	L	P	
CITROEN															
C3 Pluriel (HB_)															
1.4 (54 kW)	2003.05-	-	AT/MT	L	F	Convertible Engine KJV (TU3JP)	810026	Outer Joint	21	21	48	86.5	54	I	
	2003.05-	-	-	L	F	Convertible Engine KJV (TU3JP)	210146	Drive Shaft	21	22	48	86.5	642		
	2003.05-	-	-	-	F	Convertible Engine KJV (TU3JP)	810053	Outer Joint	21	20	49	86	51	M	
	2003.05-	-	AT/MT	R	F	Convertible Engine KJV (TU3JP)	845065	Outer Joint	21	21	48.5	86	54	I	
	2003.05-	-	MT	L	F	Convertible Engine KJV (TU3JP)	210030	Drive Shaft	21	22	48	86.5	643		
	2003.05-	-	-	-	F	Convertible Engine KJV (TU3JP)	810069	Outer Joint	21	21	48	86.5	54	I	
	2003.05-	-	MT	R	F	Convertible Engine KJV (TU3JP)	210031	Drive Shaft	21	22	48	86.5	841		
	2003.05-	-	-	R	F	Convertible Engine KJV (TU3JP)	210144	Drive Shaft	21	22	48	86.5	843		
1.4 (55 kW)	2003.07-	-	AT/MT	L	F	Convertible Engine KJV (TU3A)	810026	Outer Joint	21	21	48	86.5	54	I	
	2003.07-	-	-	L	F	Convertible Engine KJV (TU3A)	210146	Drive Shaft	21	22	48	86.5	642		
	2003.07-	-	AT/MT	R	F	Convertible Engine KJV (TU3A)	845065	Outer Joint	21	21	48.5	86	54	I	
	2003.07-	-	MT	L	F	Convertible Engine KJV (TU3A)	210030	Drive Shaft	21	22	48	86.5	643		
	2003.07-	-	MT	R	F	Convertible Engine KJV (TU3A)	210031	Drive Shaft	21	22	48	86.5	841		
	2003.07-	-	-	R	F	Convertible Engine KJV (TU3A)	210144	Drive Shaft	21	22	48	86.5	843		
1.4 HDi (50 kW)	2004.04-	-	-	L	F	Convertible Engine 8HX (DV4TD)	810026	Outer Joint	21	21	48	86.5	54	I	
	2004.04-	-	-	R	F	Convertible Engine 8HX (DV4TD)	845065	Outer Joint	21	21	48.5	86	54	I	
	2004.04-	-	-	L	F	Convertible Engine 8HX (DV4TD)	210420	Drive Shaft	21	22	48	86.5	637		
	2004.04-	-	MT	L/R	F	Convertible Engine 8HX (DV4TD)	845057	Outer Joint	21	22	48	86.5	54	I	
	2004.04-	-	-	-	F	Convertible Engine 8HX (DV4TD)	810069	Outer Joint	21	21	48	86.5	54	I	
1.6 (80 kW)	2003.05-	-	-	R	F	Convertible Engine NFU (TU5JP4)	210242	Drive Shaft	21	22	48	86.5	844		
	2003.05-	-	-	L	F	Convertible Engine NFU (TU5JP4)	210241	Drive Shaft	21	22	48	86.5	642		
	2003.05-	-	-	L	F	Convertible Engine NFU (TU5JP4)	210146	Drive Shaft	21	22	48	86.5	642		
	2003.05-	-	-	-	F	Convertible Engine NFU (TU5JP4)	810077	Outer Joint	21	28	49	86	56.5	O	
	2003.05-	-	-	R	F	Convertible Engine NFU (TU5JP4)	210144	Drive Shaft	21	22	48	86.5	843		
C4															
1.6 16V (80 kW)	2006.07-2011.07	-	R	F	Saloon Engine NFU (TU5JP4)	245104	Drive Shaft		25	24	58	79	925		
	2006.07-2011.07	MT	R	F	Saloon Engine NFU (TU5JP4)	210229	Drive Shaft		25	24	58.5	79	935		
	2006.07-2011.07	MT	-	F	Saloon Engine NFU (TU5JP4)	810097	Outer Joint		25	30	58.5	79.5	55	I	
	2006.07-2011.07	MT	R	F	Saloon Engine NFU (TU5JP4)	299170	Drive Shaft		25	22	60	80	910		
	2006.07-2011.07	AT	R	F	Saloon Engine NFU (TU5JP4)	210291	Drive Shaft		25	26	58.5	79	833		
	2006.07-2011.07	-	L	F	Saloon Engine NFU (TU5JP4)	245105	Drive Shaft		25	24	58	79	625		
	2006.07-2011.07	-	L	F	Saloon Engine NFU (TU5JP4)	245126	Drive Shaft		25	24	58.5	89	630		
	2006.07-2011.07	MT	L	F	Saloon Engine NFU (TU5JP4)	299019	Drive Shaft	29T	25	24	55.7	79	620		
1.6 HDi (80 kW)	2006.07-2011.07	AT	L	F	Saloon Engine 9HZ (DV6TED4)/9HY (DV6TED4)	610057	Inner Joint		24	34	40	52.5	90		
	2006.07-2011.07	AT	R	F	Saloon Engine 9HZ (DV6TED4)/9HY (DV6TED4)	610058	Inner Joint		24	34	29.8	365	88		
	2006.07-2011.07	MT	R	F	Saloon Engine 9HZ (DV6TED4)/9HY (DV6TED4)	210229	Drive Shaft		25	24	58.5	79	935		
	2006.07-2011.07	MT	L	F	Saloon Engine 9HZ (DV6TED4)/9HY (DV6TED4)	245105	Drive Shaft		25	24	58	79	625		
	2006.07-2011.07	AT	L	F	Saloon Engine 9HZ (DV6TED4)/9HY (DV6TED4)	210255	Drive Shaft		25	24	58.5	79	616		
	2006.07-2011.07	MT	L	F	Saloon Engine 9HZ (DV6TED4)/9HY (DV6TED4)	245126	Drive Shaft		25	24	58.5	89	630		
	2006.07-2011.07	AT	R	F	Saloon Engine 9HZ (DV6TED4)/9HY (DV6TED4)	210254	Drive Shaft		25	24	58.5	79	939		
	2006.07-2011.07	MT	L	F	Saloon Engine 9HZ (DV6TED4)/9HY (DV6TED4)	299019	Drive Shaft	29T	25	24	55.7	79	620		
	2006.07-2011.07	MT	R	F	Saloon Engine 9HZ (DV6TED4)/9HY (DV6TED4)	245104	Drive Shaft		25	24	58	79	925		
2.0 16V (103 kW)	2006.07-	-	MT	R	F	Saloon Engine RFJ (EW10A)	210229	Drive Shaft		25	24	58.5	79	935	
	2006.07-	-	AT	R	F	Saloon Engine RFJ (EW10A)	210291	Drive Shaft		25	26	58.5	79	833	
	2006.07-	-	MT	L	F	Saloon Engine RFJ (EW10A)	299019	Drive Shaft	29T	25	24	55.7	79	620	
C4 (LA_)															
1.4 16V (65 kW)	2004.11-2011.07	AT	L	F	Coupe Engine KFU (ET3J4)	610057	Inner Joint		24	34	40	52.5	90		
	2004.11-2011.07	AT	R	F	Coupe Engine KFU (ET3J4)	610058	Inner Joint		24	34	29.8	365	88		
	2004.11-2011.07	-	-	F	Coupe Engine KFU (ET3J4)	810097	Outer Joint		25	30	58.5	79.5	55	I	
	2004.11-2011.07	AT	L	F	Coupe Engine KFU (ET3J4)	210255	Drive Shaft		25	24	58.5	79	616		
	2004.11-2011.07	MT	R	F	Coupe Engine KFU (ET3J4)	299170	Drive Shaft		25	22	60	80	910		
	2004.11-2011.07	AT	R	F	Coupe Engine KFU (ET3J4)	210254	Drive Shaft		25	24	58.5	79	939		
	2004.11-2011.07	MT	L	F	Coupe Engine KFU (ET3J4)	245119	Drive Shaft		25	22	58.5	79.5	633		
	2004.11-2011.07	MT	R	F	Coupe Engine KFU (ET3J4)	245113	Drive Shaft		25	22	58.5	79.5	915		
1.6 16V (80 kW)	2004.11-2011.07	MT	R	F	Coupe Engine NFU (TU5JP4)	210229	Drive Shaft		25	24	58.5	79	935		
	2004.11-2011.07	MT	-	F	Coupe Engine NFU (TU5JP4)	810097	Outer Joint		25	30	58.5	79.5	55	I	
	2004.11-2011.07	MT	L	F	Coupe Engine NFU (TU5JP4)	245105	Drive Shaft		25	24	58	79	625		
	2004.11-2011.07	MT	L	F	Coupe Engine NFU (TU5JP4)	245126	Drive Shaft		25	24	58.5	89	630		
	2004.11-2011.07	MT	R	F	Coupe Engine NFU (TU5JP4)	299170	Drive Shaft		25	22	60	80	910		
	2004.11-2011.07	-	L	F	Coupe Engine NFU (TU5JP4)	699001	Inner Joint		26	34	42.5	46.5	103.5		
	2004.11-2011.07	MT	L	F	Coupe Engine NFU (TU5JP4)	299019	Drive Shaft	29T	25	24	55.7	79	620		
	2004.11-2011.07	MT	L	F	Coupe Engine NFU (TU5JP4)	245119	Drive Shaft		25	22	58.5	79.5	633		
	2004.11-2011.07	MT	R	F	Coupe Engine NFU (TU5JP4)	245113	Drive Shaft		25	22	58.5	79.5	915		
	2004.11-2011.07	-	-	F	Coupe Engine NFU (TU5JP4)	810028	Outer Joint		25	34	58	89	56	I	
	2004.11-2011.07	MT	R	F	Coupe Engine NFU (TU5JP4)	245104	Drive Shaft		25	24	58	79	925		
	2004.11-2011.07	-	L	F	Coupe Engine NFU (TU5JP4)	210286	Drive Shaft		25	26	58.5	79	613		

	 YEAR	TRANSM	L/R	F/R	REMARKS	GSP Ref.	 PRODUCT	 ABS	Technical Specifications					
									A	B	C	H	L	P
CITROEN														
C4 (LA_)														
1.6 HDi (66 kW)	2004.11-2011.07	-	R	F	Coupe Engine 9HX (DV6ATED4)	210173	Drive Shaft	29W	25	24	58.5	79	921	
	2004.11-2011.07	AT/MT	R	F	Coupe Engine 9HX (DV6ATED4)	210229	Drive Shaft		25	24	58.5	79	935	
	2004.11-2011.07	MT	L	F	Coupe Engine 9HX (DV6ATED4)	245105	Drive Shaft		25	24	58	79	625	
	2004.11-2011.07	-	L	F	Coupe Engine 9HX (DV6ATED4)	245126	Drive Shaft		25	24	58.5	89	630	
	2004.11-2011.07	AT/MT	L	F	Coupe Engine 9HX (DV6ATED4)	299019	Drive Shaft	29T	25	24	55.7	79	620	
	2004.11-2011.07	MT	R	F	Coupe Engine 9HX (DV6ATED4)	245104	Drive Shaft		25	24	58	79	925	
1.6 HDi (80 kW)	2004.11-2011.07	-	R	F	Coupe Engine 9HZ (DV6TED4)/9HY (DV6TED4)	210173	Drive Shaft	29W	25	24	58.5	79	921	
	2004.11-2011.07	AT	L	F	Coupe Engine 9HZ (DV6TED4)/9HY (DV6TED4)	610057	Inner Joint		24	34	40	52.5	90	
	2004.11-2011.07	MT	R	F	Coupe Engine 9HZ (DV6TED4)/9HY (DV6TED4)	210229	Drive Shaft		25	24	58.5	79	935	
	2004.11-2011.07	AT	R	F	Coupe Engine 9HZ (DV6TED4)/9HY (DV6TED4)	610058	Inner Joint		24	34	29.8	365	88	
	2004.11-2011.07	MT	L	F	Coupe Engine 9HZ (DV6TED4)/9HY (DV6TED4)	245105	Drive Shaft		25	24	58	79	625	
	2004.11-2011.07	MT	L	F	Coupe Engine 9HZ (DV6TED4)/9HY (DV6TED4)	245126	Drive Shaft		25	24	58.5	89	630	
	2004.11-2011.07	AT	L	F	Coupe Engine 9HZ (DV6TED4)/9HY (DV6TED4)	210255	Drive Shaft		25	24	58.5	79	616	
	2004.11-2011.07	AT	R	F	Coupe Engine 9HZ (DV6TED4)/9HY (DV6TED4)	210254	Drive Shaft		25	24	58.5	79	939	
	2004.11-2011.07	MT	L	F	Coupe Engine 9HZ (DV6TED4)/9HY (DV6TED4)	299019	Drive Shaft	29T	25	24	55.7	79	620	
	2004.11-2011.07	-	-	F	Coupe Engine 9HZ (DV6TED4)/9HY (DV6TED4)	810028	Outer Joint		25	34	58	89	56	I
1.6 THP 150 (110 kW)	2008.07-2011.07	-	R	F	Coupe Engine 5FX (EP6DT)	245104	Drive Shaft		25	24	58	79	925	
	2008.07-2011.07	-	-	F	Coupe Engine 5FX (EP6DT)	810028	Outer Joint		25	34	58	89	56	I
	2008.07-2011.07	MT	R	F	Coupe Engine 5FX (EP6DT)	210229	Drive Shaft		25	24	58.5	79	935	
	2008.07-2011.07	AT	-	-	Coupe Engine 5FX (EP6DT)	899366	Outer Joint		25	34	58.5	79	55	I
	2008.07-2011.07	-	L	F	Coupe Engine 5FX (EP6DT)	245105	Drive Shaft		25	24	58	79	625	
	2008.07-2011.07	-	L	F	Coupe Engine 5FX (EP6DT)	699001	Inner Joint		26	34	42.5	46.5	103.5	
	2008.07-2011.07	-	L	F	Coupe Engine 5FX (EP6DT)	245126	Drive Shaft		25	24	58.5	89	630	
	2008.07-2011.07	MT	L	F	Coupe Engine 5FX (EP6DT)	299019	Drive Shaft	29T	25	24	55.7	79	620	
	2008.07-2011.07	-	L	F	Coupe Engine 5FX (EP6DT)	210286	Drive Shaft		25	26	58.5	79	613	
	1.6 VTi 120 (88 kW)	2008.07-2011.07	MT	L	F	Coupe Engine 5FW (EP6)	245105	Drive Shaft		25	24	58	79	625
2008.07-2011.07		AT	-	-	Coupe Engine 5FW (EP6)	899366	Outer Joint		25	34	58.5	79	55	I
2008.07-2011.07		MT	L	F	Coupe Engine 5FW (EP6)	245126	Drive Shaft		25	24	58.5	89	630	
2008.07-2011.07		AT	R	F	Coupe Engine 5FW (EP6)	210229	Drive Shaft		25	24	58.5	79	935	
2008.07-2011.07		-	L	F	Coupe Engine 5FW (EP6)	699001	Inner Joint		26	34	42.5	46.5	103.5	
2008.07-2011.07		AT/MT	L	F	Coupe Engine 5FW (EP6)	299019	Drive Shaft	29T	25	24	55.7	79	620	
2008.07-2011.07		MT	R	F	Coupe Engine 5FW (EP6)	245104	Drive Shaft		25	24	58	79	925	
2008.07-2011.07		AT	-	F	Coupe Engine 5FW (EP6)	810028	Outer Joint		25	34	58	89	56	I
2.0 16V (100 kW)	2004.11-2007.07	-	R	F	Coupe Engine RFN (EW10J4)	210173	Drive Shaft	29W	25	24	58.5	79	921	
	2004.11-2007.07	MT	R	F	Coupe Engine RFN (EW10J4)	210229	Drive Shaft		25	24	58.5	79	935	
	2004.11-2007.07	MT	L	F	Coupe Engine RFN (EW10J4)	245105	Drive Shaft		25	24	58	79	625	
	2004.11-2007.07	AT	R	F	Coupe Engine RFN (EW10J4)	210291	Drive Shaft		25	26	58.5	79	833	
	2004.11-2007.07	-	L	F	Coupe Engine RFN (EW10J4)	245126	Drive Shaft		25	24	58.5	89	630	
	2004.11-2007.07	MT	L	F	Coupe Engine RFN (EW10J4)	299019	Drive Shaft	29T	25	24	55.7	79	620	
	2004.11-2007.07	MT	R	F	Coupe Engine RFN (EW10J4)	245104	Drive Shaft		25	24	58	79	925	
	2004.11-2007.07	-	-	F	Coupe Engine RFN (EW10J4)	810028	Outer Joint		25	34	58	89	56	I
2.0 16V (130 kW)	2004.11-2010.12	-	R	F	Coupe Engine RFK (EW10J4S)	210173	Drive Shaft	29W	25	24	58.5	79	921	
	2004.11-2010.12	MT	R	F	Coupe Engine RFK (EW10J4S)	210229	Drive Shaft		25	24	58.5	79	935	
	2004.11-2010.12	MT	L	F	Coupe Engine RFK (EW10J4S)	245105	Drive Shaft		25	24	58	79	625	
	2004.11-2010.12	-	L	F	Coupe Engine RFK (EW10J4S)	245126	Drive Shaft		25	24	58.5	89	630	
	2004.11-2010.12	MT	L	F	Coupe Engine RFK (EW10J4S)	299019	Drive Shaft	29T	25	24	55.7	79	620	
	2004.11-2010.12	MT	R	F	Coupe Engine RFK (EW10J4S)	245104	Drive Shaft		25	24	58	79	925	
	2004.11-2010.12	-	-	F	Coupe Engine RFK (EW10J4S)	810028	Outer Joint		25	34	58	89	56	I
2.0 HDi (100 kW)	2004.11-2010.12	6MT	L	F	Coupe Engine RHR (DW10BTED4)	210268	Drive Shaft		25	37	58.5	89	621	
	2004.11-2010.12	6MT	R	F	Coupe Engine RHR (DW10BTED4)	208082	Drive Shaft		25	37	58.5	89	949	
	2004.11-2010.12	-	-	F	Coupe Engine RHR (DW10BTED4)	810085	Outer Joint		25	39	59	89	63.5	I
	2004.11-2010.12	6MT	R	F	Coupe Engine RHR (DW10BTED4)	610041	Inner Joint		37	39	32	399	95.5	
2.0 HDi (103 kW)	2008.07-2011.07	MT	L	F	Coupe Engine RHF (DW10BTED4)	210268	Drive Shaft		25	37	58.5	89	621	
	2008.07-2011.07	MT	R	F	Coupe Engine RHF (DW10BTED4)	208082	Drive Shaft		25	37	58.5	89	949	
	2008.07-2011.07	MT	R	F	Coupe Engine RHF (DW10BTED4)	610041	Inner Joint		37	39	32	399	95.5	
2.0 VTR (103 kW)	2006.10-2007.12	MT	R	F	Coupe Engine RFJ (EW10A)	210229	Drive Shaft		25	24	58.5	79	935	
	2006.10-2007.12	MT	L	F	Coupe Engine RFJ (EW10A)	245105	Drive Shaft		25	24	58	79	625	
	2006.10-2007.12	MT	L	F	Coupe Engine RFJ (EW10A)	245126	Drive Shaft		25	24	58.5	89	630	
	2006.10-2007.12	MT	L	F	Coupe Engine RFJ (EW10A)	299019	Drive Shaft	29T	25	24	55.7	79	620	
	2006.10-2007.12	MT	R	F	Coupe Engine RFJ (EW10A)	245104	Drive Shaft		25	24	58	79	925	
C4 Grand Picasso I (UA_)														
1.6 16V (103 kW)	2008.07-	-	-	F	MPV Engine 5FT (EP6DT)	810028	Outer Joint		25	34	58	89	56	I
	2008.07-	-	AT/MT	-	MPV Engine 5FT (EP6DT)	899366	Outer Joint		25	34	58.5	79	55	I
	2008.07-	-	AT	R	MPV Engine 5FT (EP6DT)	210229	Drive Shaft		25	24	58.5	79	935	





YEAR	TRANSM	L/R	F/R	REMARKS	GSP Ref.	PRODUCT	ABS	Technical Specifications										
								A	B	C	H	L	P					
CITROEN																		
C4 Grand Picasso I (UA_)																		
1.6 16V (103 kW)	2008.07-	-	-	L F	MPV Engine 5FT (EP6DT)	699001	Inner Joint		26	34	42.5	46.5	103.5					
	2008.07-	-	AT	L F	MPV Engine 5FT (EP6DT)	299019	Drive Shaft	29T	25	24	55.7	79	620					
	2008.07-	-	-	L F	MPV Engine 5FT (EP6DT)	210286	Drive Shaft		25	26	58.5	79	613					
1.6 16V (110 kW)	2008.10-	-	-	L F	MPV Engine 5FX (EP6DT)	210286	Drive Shaft		25	26	58.5	79	613					
	2008.10-	-	-	R F	MPV Engine 5FX (EP6DT)	610058	Inner Joint		24	34	29.8	365	88					
	2008.10-	-	-	F	MPV Engine 5FX (EP6DT)	810028	Outer Joint		25	34	58	89	56	I				
	2008.10-	-	-	L F	MPV Engine 5FX (EP6DT)	210255	Drive Shaft		25	24	58.5	79	616					
	2008.10-	-	AT/MT	-	MPV Engine 5FX (EP6DT)	899366	Outer Joint		25	34	58.5	79	55	I				
	2008.10-	-	-	R F	MPV Engine 5FX (EP6DT)	210254	Drive Shaft		25	24	58.5	79	939					
	2008.10-	-	-	L F	MPV Engine 5FX (EP6DT)	699001	Inner Joint		26	34	42.5	46.5	103.5					
	2008.10-	-	-	L F	MPV Engine 5FX (EP6DT)	610057	Inner Joint		24	34	40	52.5	90					
1.6 HDi (80 kW)	2006.10-	-	AT	R F	MPV Engine 9HZ (DV6TED4)/9HY (DV6TED4)	610058	Inner Joint		24	34	29.8	365	88					
	2006.10-	-	MT	R F	MPV Engine 9HZ (DV6TED4)/9HY (DV6TED4)	210229	Drive Shaft		25	24	58.5	79	935					
	2006.10-	-	MT	L F	MPV Engine 9HZ (DV6TED4)/9HY (DV6TED4)	245105	Drive Shaft		25	24	58	79	625					
	2006.10-	-	MT	L F	MPV Engine 9HZ (DV6TED4)/9HY (DV6TED4)	245126	Drive Shaft		25	24	58.5	89	630					
	2006.10-	-	AT	L F	MPV Engine 9HZ (DV6TED4)/9HY (DV6TED4)	210255	Drive Shaft		25	24	58.5	79	616					
	2006.10-	-	AT	R F	MPV Engine 9HZ (DV6TED4)/9HY (DV6TED4)	210254	Drive Shaft		25	24	58.5	79	939					
	2006.10-	-	-	L F	MPV Engine 9HZ (DV6TED4)/9HY (DV6TED4)	699001	Inner Joint		26	34	42.5	46.5	103.5					
	2006.10-	-	MT	L F	MPV Engine 9HZ (DV6TED4)/9HY (DV6TED4)	299019	Drive Shaft	29T	25	24	55.7	79	620					
	2006.10-	-	MT	R F	MPV Engine 9HZ (DV6TED4)/9HY (DV6TED4)	245104	Drive Shaft		25	24	58	79	925					
	2006.10-	-	-	F	MPV Engine 9HZ (DV6TED4)/9HY (DV6TED4)	810028	Outer Joint		25	34	58	89	56	I				
	2006.10-	-	-	L F	MPV Engine 9HZ (DV6TED4)/9HY (DV6TED4)	210286	Drive Shaft		25	26	58.5	79	613					
	2006.10-	-	AT	L F	MPV Engine 9HZ (DV6TED4)/9HY (DV6TED4)	610057	Inner Joint		24	34	40	52.5	90					
1.6 HDi 110 (82 kW)	2010.09-	-	-	F	MPV Engine 9HR (DV6C)/9HL (DV6C)	810028	Outer Joint		25	34	58	89	56	I				
	2010.09-	-	AT	R F	MPV Engine 9HR (DV6C)/9HL (DV6C)	610058	Inner Joint		24	34	29.8	365	88					
	2010.09-	-	MT	L F	MPV Engine 9HR (DV6C)/9HL (DV6C)	245105	Drive Shaft		25	24	58	79	625					
	2010.09-	-	MT	L F	MPV Engine 9HR (DV6C)/9HL (DV6C)	245126	Drive Shaft		25	24	58.5	89	630					
	2010.09-	-	AT	L F	MPV Engine 9HR (DV6C)/9HL (DV6C)	210255	Drive Shaft		25	24	58.5	79	616					
	2010.09-	-	AT	R F	MPV Engine 9HR (DV6C)/9HL (DV6C)	210254	Drive Shaft		25	24	58.5	79	939					
	2010.09-	-	MT	R F	MPV Engine 9HR (DV6C)/9HL (DV6C)	245104	Drive Shaft		25	24	58	79	925					
	2010.09-	-	AT/MT/4MT	-	MPV Engine 9HR (DV6C)/9HL (DV6C)	899366	Outer Joint		25	34	58.5	79	55	I				
	2010.09-	-	AT	L F	MPV Engine 9HR (DV6C)/9HL (DV6C)	610057	Inner Joint		24	34	40	52.5	90					
1.6 THP 155 (115 kW)	2010.09-	-	-	F	MPV Engine 5FV (EP6CDT)	810028	Outer Joint		25	34	58	89	56	I				
	2010.09-	-	-	R F	MPV Engine 5FV (EP6CDT)	610058	Inner Joint		24	34	29.8	365	88					
	2010.09-	-	-	L F	MPV Engine 5FV (EP6CDT)	210255	Drive Shaft		25	24	58.5	79	616					
	2010.09-	-	-	-	MPV Engine 5FV (EP6CDT)	899366	Outer Joint		25	34	58.5	79	55	I				
	2010.09-	-	-	R F	MPV Engine 5FV (EP6CDT)	210254	Drive Shaft		25	24	58.5	79	939					
	2010.09-	-	AT	R F	MPV Engine 5FV (EP6CDT)	210229	Drive Shaft		25	24	58.5	79	935					
	2010.09-	-	AT	L F	MPV Engine 5FV (EP6CDT)	299019	Drive Shaft	29T	25	24	55.7	79	620					
	2010.09-	-	-	L F	MPV Engine 5FV (EP6CDT)	610057	Inner Joint		24	34	40	52.5	90					
1.6 VTi 120 (88 kW)	2008.07-	-	-	L F	MPV Engine 5FW (EP6)	245105	Drive Shaft		25	24	58	79	625					
	2008.07-	-	-	F	MPV Engine 5FW (EP6)	810028	Outer Joint		25	34	58	89	56	I				
	2008.07-	-	MT	R F	MPV Engine 5FW (EP6)	210229	Drive Shaft		25	24	58.5	79	935					
	2008.07-	-	-	L F	MPV Engine 5FW (EP6)	245126	Drive Shaft		25	24	58.5	89	630					
	2008.07-	-	-	L F	MPV Engine 5FW (EP6)	699001	Inner Joint		26	34	42.5	46.5	103.5					
	2008.07-	-	-	R F	MPV Engine 5FW (EP6)	245104	Drive Shaft		25	24	58	79	925					
	2008.07-	-	MT	L F	MPV Engine 5FW (EP6)	299019	Drive Shaft	29T	25	24	55.7	79	620					
	2008.07-	-	-	L F	MPV Engine 5FW (EP6)	210286	Drive Shaft		25	26	58.5	79	613					
1.8 i 16V (92 kW)	2006.10-	-	MT	R F	MPV Engine 6FY (EW7A)	210229	Drive Shaft		25	24	58.5	79	935					
	2006.10-	-	-	L F	MPV Engine 6FY (EW7A)	245105	Drive Shaft		25	24	58	79	625					
	2006.10-	-	-	L F	MPV Engine 6FY (EW7A)	245126	Drive Shaft		25	24	58.5	89	630					
	2006.10-	-	-	R F	MPV Engine 6FY (EW7A)	245104	Drive Shaft		25	24	58	79	925					
	2006.10-	-	-	F	MPV Engine 6FY (EW7A)	810028	Outer Joint		25	34	58	89	56	I				
	2006.10-	-	-	L F	MPV Engine 6FY (EW7A)	299019	Drive Shaft	29T	25	24	55.7	79	620					
2.0 HDi 138 (100 kW)	2006.10-	-	-	F	MPV Engine RHJ (DW10BTED4)/RHR (DW10BTED4)	810118	Outer Joint		25	26	58.7	79	61.5	M				
	2006.10-	-	-	L F	MPV Engine RHJ (DW10BTED4)/RHR (DW10BTED4)	699001	Inner Joint		26	34	42.5	46.5	103.5					
	2006.10-	-	Semi-AT	R F	MPV Engine RHJ (DW10BTED4)/RHR (DW10BTED4)	210295	Drive Shaft		25	24	58.7	79	948					
	2006.10-	-	-	L F	MPV Engine RHJ (DW10BTED4)/RHR (DW10BTED4)	210293	Drive Shaft		25	24	58.7	79	610					
	2006.10-	-	-	L F	MPV Engine RHJ (DW10BTED4)/RHR (DW10BTED4)	210286	Drive Shaft		25	26	58.5	79	613					
2.0 HDi 150 (110 kW)	2009.07-	-	-	F	MPV Engine RHE (DW10CTED4)	810028	Outer Joint		25	34	58	89	56	I				
	2009.07-	-	-	L F	MPV Engine RHE (DW10CTED4)	210293	Drive Shaft		25	24	58.7	79	610					
	2009.07-	-	AT/4MT	-	MPV Engine RHE (DW10CTED4)	899366	Outer Joint		25	34	58.5	79	55	I				
2.0 HDi 165 (120 kW)	2010.09-	-	-	F	MPV Engine RHH (DW10CTED4)	810028	Outer Joint		25	34	58	89	56	I				
	2010.09-	-	AT/4MT	-	MPV Engine RHH (DW10CTED4)	899366	Outer Joint		25	34	58.5	79	55	I				
2.0 i 16V (103 kW)	2006.10-	-	6AT	R F	MPV Engine RFJ (EW10A)	610058	Inner Joint		24	34	29.8	365	88					
	2006.10-	-	-	F	MPV Engine RFJ (EW10A)	810028	Outer Joint		25	34	58	89	56	I				

YEAR	TRANSM	L/R	F/R	REMARKS	GSP Ref.	PRODUCT	ABS	Technical Specifications							
								A	B	C	H	L	P		
CITROEN															
C4 Grand Picasso I (UA_)															
2.0 i 16V (103 kW)	2006.10-	-	6AT	L F	MPV Engine RFJ (EW10A)	210255	Drive Shaft		25	24	58.5	79	616		
	2006.10-	-	AT/MT	- -	MPV Engine RFJ (EW10A)	899366	Outer Joint		25	34	58.5	79	55	I	
	2006.10-	-	6AT	R F	MPV Engine RFJ (EW10A)	210254	Drive Shaft		25	24	58.5	79	939		
	2006.10-	-	-	L F	MPV Engine RFJ (EW10A)	699001	Inner Joint		26	34	42.5	46.5	103.5		
	2006.10-	-	-	L F	MPV Engine RFJ (EW10A)	210286	Drive Shaft		25	26	58.5	79	613		
	2006.10-	-	6AT	L F	MPV Engine RFJ (EW10A)	610057	Inner Joint		24	34	40	52.5	90		
C4 Grand Picasso II															
1.6 BlueHDi 120 (88 kW)	2014.07-	-	-	-	F	MPV Engine BHZ (DV6FC)	810052	Outer Joint		28	34	58.5	92	55	I
1.6 HDi / BlueHDi 115 (85 kW)	2013.09-	-	-	-	F	MPV Engine 9HC (DV6C)/BHX(DV6FC)	810052	Outer Joint		28	34	58.5	92	55	I
C4 I (LC_)															
1.4 16V (65 kW)	2004.11-	2011.07	AT	L F	Hatchback Engine KFU (ET3J4)	610057	Inner Joint		24	34	40	52.5	90		
	2004.11-	2011.07	AT	R F	Hatchback Engine KFU (ET3J4)	610058	Inner Joint		24	34	29.8	365	88		
	2004.11-	2011.07	-	-	F	Hatchback Engine KFU (ET3J4)	810097	Outer Joint		25	30	58.5	79.5	55	I
	2004.11-	2011.07	AT	L F	Hatchback Engine KFU (ET3J4)	210255	Drive Shaft		25	24	58.5	79	616		
	2004.11-	2011.07	MT	R F	Hatchback Engine KFU (ET3J4)	299170	Drive Shaft		25	22	60	80	910		
	2004.11-	2011.07	AT	R F	Hatchback Engine KFU (ET3J4)	210254	Drive Shaft		25	24	58.5	79	939		
	2004.11-	2011.07	MT	L F	Hatchback Engine KFU (ET3J4)	245119	Drive Shaft		25	22	58.5	79.5	633		
	2004.11-	2011.07	MT	R F	Hatchback Engine KFU (ET3J4)	245113	Drive Shaft		25	22	58.5	79.5	915		
1.6 16V (80 kW)	2004.11-	2011.07	MT	R F	Hatchback Engine NFU (TU5JP4)	210229	Drive Shaft		25	24	58.5	79	935		
	2004.11-	2011.07	MT	- F	Hatchback Engine NFU (TU5JP4)	810097	Outer Joint		25	30	58.5	79.5	55	I	
	2004.11-	2011.07	MT	L F	Hatchback Engine NFU (TU5JP4)	245105	Drive Shaft		25	24	58	79	625		
	2004.11-	2011.07	MT	L F	Hatchback Engine NFU (TU5JP4)	245126	Drive Shaft		25	24	58.5	89	630		
	2004.11-	2011.07	MT	R F	Hatchback Engine NFU (TU5JP4)	299170	Drive Shaft		25	22	60	80	910		
	2004.11-	2011.07	AT	R F	Hatchback Engine NFU (TU5JP4)	210291	Drive Shaft		25	26	58.5	79	833		
	2004.11-	2011.07	-	L F	Hatchback Engine NFU (TU5JP4)	699001	Inner Joint		26	34	42.5	46.5	103.5		
	2004.11-	2011.07	MT	L F	Hatchback Engine NFU (TU5JP4)	299019	Drive Shaft	29T	25	24	55.7	79	620		
	2004.11-	2011.07	MT	L F	Hatchback Engine NFU (TU5JP4)	245119	Drive Shaft		25	22	58.5	79.5	633		
	2004.11-	2011.07	MT	R F	Hatchback Engine NFU (TU5JP4)	245113	Drive Shaft		25	22	58.5	79.5	915		
	2004.11-	2011.07	-	-	F	Hatchback Engine NFU (TU5JP4)	810028	Outer Joint		25	34	58	89	56	I
	2004.11-	2011.07	MT	R F	Hatchback Engine NFU (TU5JP4)	245104	Drive Shaft		25	24	58	79	925		
	2004.11-	2011.07	-	L F	Hatchback Engine NFU (TU5JP4)	210286	Drive Shaft		25	26	58.5	79	613		
1.6 16V Bio-Flex (80 kW)	2007.09-	2008.07	MT	R F	Hatchback Engine NFU (TU5JP4)	210229	Drive Shaft		25	24	58.5	79	935		
	2007.09-	2008.07	MT	- F	Hatchback Engine NFU (TU5JP4)	810097	Outer Joint		25	30	58.5	79.5	55	I	
	2007.09-	2008.07	MT	L F	Hatchback Engine NFU (TU5JP4)	245126	Drive Shaft		25	24	58.5	89	630		
	2007.09-	2008.07	MT	L F	Hatchback Engine NFU (TU5JP4)	245105	Drive Shaft		25	24	58	79	625		
	2007.09-	2008.07	MT	R F	Hatchback Engine NFU (TU5JP4)	299170	Drive Shaft		25	22	60	80	910		
	2007.09-	2008.07	-	L F	Hatchback Engine NFU (TU5JP4)	699001	Inner Joint		26	34	42.5	46.5	103.5		
	2007.09-	2008.07	MT	L F	Hatchback Engine NFU (TU5JP4)	299019	Drive Shaft	29T	25	24	55.7	79	620		
	2007.09-	2008.07	MT	R F	Hatchback Engine NFU (TU5JP4)	245104	Drive Shaft		25	24	58	79	925		
	2007.09-	2008.07	-	L F	Hatchback Engine NFU (TU5JP4)	210286	Drive Shaft		25	26	58.5	79	613		
1.6 HDi (66 kW)	2004.11-	2011.07	MT	R F	Hatchback Engine 9HX (DV6ATED4)	210229	Drive Shaft		25	24	58.5	79	935		
	2004.11-	2011.07	-	R F	Hatchback Engine 9HX (DV6ATED4)	210173	Drive Shaft	29W	25	24	58.5	79	921		
	2004.11-	2011.07	MT	L F	Hatchback Engine 9HX (DV6ATED4)	245105	Drive Shaft		25	24	58	79	625		
	2004.11-	2011.07	-	L F	Hatchback Engine 9HX (DV6ATED4)	245126	Drive Shaft		25	24	58.5	89	630		
	2004.11-	2011.07	MT	L F	Hatchback Engine 9HX (DV6ATED4)	299019	Drive Shaft	29T	25	24	55.7	79	620		
	2004.11-	2011.07	MT	R F	Hatchback Engine 9HX (DV6ATED4)	245104	Drive Shaft		25	24	58	79	925		
	2004.11-	2011.07	-	-	F	Hatchback Engine 9HX (DV6ATED4)	810028	Outer Joint		25	34	58	89	56	I
1.6 HDi (80 kW)	2004.11-	2011.07	MT	R F	Hatchback Engine 9HY (DV6TED4)/9HZ (DV6TED4)	210229	Drive Shaft		25	24	58.5	79	935		
	2004.11-	2011.07	AT	L F	Hatchback Engine 9HY (DV6TED4)/9HZ (DV6TED4)	610057	Inner Joint		24	34	40	52.5	90		
	2004.11-	2011.07	-	R F	Hatchback Engine 9HY (DV6TED4)/9HZ (DV6TED4)	210173	Drive Shaft	29W	25	24	58.5	79	921		
	2004.11-	2011.07	AT	R F	Hatchback Engine 9HY (DV6TED4)/9HZ (DV6TED4)	610058	Inner Joint		24	34	29.8	365	88		
	2004.11-	2011.07	MT	L F	Hatchback Engine 9HY (DV6TED4)/9HZ (DV6TED4)	245105	Drive Shaft		25	24	58	79	625		
	2004.11-	2011.07	MT	L F	Hatchback Engine 9HY (DV6TED4)/9HZ (DV6TED4)	245126	Drive Shaft		25	24	58.5	89	630		
	2004.11-	2011.07	AT	L F	Hatchback Engine 9HY (DV6TED4)/9HZ (DV6TED4)	210255	Drive Shaft		25	24	58.5	79	616		
	2004.11-	2011.07	AT	R F	Hatchback Engine 9HY (DV6TED4)/9HZ (DV6TED4)	210254	Drive Shaft		25	24	58.5	79	939		
	2004.11-	2011.07	MT	L F	Hatchback Engine 9HY (DV6TED4)/9HZ (DV6TED4)	299019	Drive Shaft	29T	25	24	55.7	79	620		
	2004.11-	2011.07	-	-	F	Hatchback Engine 9HY (DV6TED4)/9HZ (DV6TED4)	810028	Outer Joint		25	34	58	89	56	I
	2004.11-	2011.07	MT	R F	Hatchback Engine 9HY (DV6TED4)/9HZ (DV6TED4)	245104	Drive Shaft		25	24	58	79	925		
1.6 THP 140 (103 kW)	2008.07-	2011.07	-	R F	Hatchback Engine 5FT (EP6DT)	245104	Drive Shaft		25	24	58	79	925		
	2008.07-	2011.07	AT	- -	Hatchback Engine 5FT (EP6DT)	899366	Outer Joint		25	34	58.5	79	55	I	
	2008.07-	2011.07	-	L F	Hatchback Engine 5FT (EP6DT)	245105	Drive Shaft		25	24	58	79	625		
	2008.07-	2011.07	-	L F	Hatchback Engine 5FT (EP6DT)	699001	Inner Joint		26	34	42.5	46.5	103.5		
	2008.07-	2011.07	-	L F	Hatchback Engine 5FT (EP6DT)	245126	Drive Shaft		25	24	58.5	89	630		
	2008.07-	2011.07	AT	- F	Hatchback Engine 5FT (EP6DT)	810028	Outer Joint		25	34	58	89	56	I	
	2008.07-	2011.07	-	L F	Hatchback Engine 5FT (EP6DT)	210286	Drive Shaft		25	26	58.5	79	613		
1.6 THP 150 (110 kW)	2008.07-	2011.07	-	R F	Hatchback Engine 5FX (EP6DT)	245104	Drive Shaft		25	24	58	79	925		

	 YEAR	TRANSM	L/R	F/R	REMARKS	GSP Ref.	 PRODUCT	 ABS	Technical Specifications								
									A	B	C	H	L	P			
CITROEN																	
C4 I (LC_)																	
1.6 THP 150 (110 kW)	2008.07-2011.07	MT	R	F	Hatchback Engine 5FX (EP6DT)	210229	Drive Shaft		25	24	58.5	79	935				
	2008.07-2011.07	AT	-	-	Hatchback Engine 5FX (EP6DT)	899366	Outer Joint		25	34	58.5	79	55	I			
	2008.07-2011.07	-	L	F	Hatchback Engine 5FX (EP6DT)	245105	Drive Shaft		25	24	58	79	625				
	2008.07-2011.07	-	L	F	Hatchback Engine 5FX (EP6DT)	699001	Inner Joint		26	34	42.5	46.5	103.5				
	2008.07-2011.07	-	L	F	Hatchback Engine 5FX (EP6DT)	245126	Drive Shaft		25	24	58.5	89	630				
	2008.07-2011.07	MT	L	F	Hatchback Engine 5FX (EP6DT)	299019	Drive Shaft	29T	25	24	55.7	79	620				
	2008.07-2011.07	AT	-	F	Hatchback Engine 5FX (EP6DT)	810028	Outer Joint		25	34	58	89	56	I			
	2008.07-2011.07	-	L	F	Hatchback Engine 5FX (EP6DT)	210286	Drive Shaft		25	26	58.5	79	613				
1.6 VTi 120 (88 kW)	2008.07-2011.07	-	R	F	Hatchback Engine 5FW (EP6)	245104	Drive Shaft		25	24	58	79	925				
	2008.07-2011.07	AT	-	-	Hatchback Engine 5FW (EP6)	899366	Outer Joint		25	34	58.5	79	55	I			
	2008.07-2011.07	MT	L	F	Hatchback Engine 5FW (EP6)	245126	Drive Shaft		25	24	58.5	89	630				
	2008.07-2011.07	AT	R	F	Hatchback Engine 5FW (EP6)	210291	Drive Shaft		25	26	58.5	79	833				
	2008.07-2011.07	-	L	F	Hatchback Engine 5FW (EP6)	245105	Drive Shaft		25	24	58	79	625				
	2008.07-2011.07	-	L	F	Hatchback Engine 5FW (EP6)	699001	Inner Joint		26	34	42.5	46.5	103.5				
	2008.07-2011.07	AT	-	F	Hatchback Engine 5FW (EP6)	810028	Outer Joint		25	34	58	89	56	I			
	2008.07-2011.07	-	L	F	Hatchback Engine 5FW (EP6)	210286	Drive Shaft		25	26	58.5	79	613				
2.0 16V (100 kW)	2004.11-2007.07	MT	R	F	Hatchback Engine RFN (EW10J4)	210229	Drive Shaft		25	24	58.5	79	935				
	2004.11-2007.07	-	R	F	Hatchback Engine RFN (EW10J4)	210173	Drive Shaft	29W	25	24	58.5	79	921				
	2004.11-2007.07	MT	L	F	Hatchback Engine RFN (EW10J4)	245105	Drive Shaft		25	24	58	79	625				
	2004.11-2007.07	-	L	F	Hatchback Engine RFN (EW10J4)	245126	Drive Shaft		25	24	58.5	89	630				
	2004.11-2007.07	MT	L	F	Hatchback Engine RFN (EW10J4)	299019	Drive Shaft	29T	25	24	55.7	79	620				
	2004.11-2007.07	MT	R	F	Hatchback Engine RFN (EW10J4)	245104	Drive Shaft		25	24	58	79	925				
	2004.11-2007.07	-	-	F	Hatchback Engine RFN (EW10J4)	810028	Outer Joint		25	34	58	89	56	I			
	2004.11-2007.07	-	-	F	Hatchback Engine RFN (EW10J4)	810028	Outer Joint		25	34	58	89	56	I			
2.0 16V (103 kW)	2004.11-2011.07	MT	R	F	Hatchback Engine RFJ (EW10A)	210229	Drive Shaft		25	24	58.5	79	935				
	2004.11-2011.07	-	R	F	Hatchback Engine RFJ (EW10A)	210173	Drive Shaft	29W	25	24	58.5	79	921				
	2004.11-2011.07	MT	L	F	Hatchback Engine RFJ (EW10A)	245105	Drive Shaft		25	24	58	79	625				
	2004.11-2011.07	MT	L	F	Hatchback Engine RFJ (EW10A)	245126	Drive Shaft		25	24	58.5	89	630				
	2004.11-2011.07	AT	R	F	Hatchback Engine RFJ (EW10A)	210291	Drive Shaft		25	26	58.5	79	833				
	2004.11-2011.07	-	L	F	Hatchback Engine RFJ (EW10A)	699001	Inner Joint		26	34	42.5	46.5	103.5				
	2004.11-2011.07	MT	L	F	Hatchback Engine RFJ (EW10A)	299019	Drive Shaft	29T	25	24	55.7	79	620				
	2004.11-2011.07	MT	R	F	Hatchback Engine RFJ (EW10A)	245104	Drive Shaft		25	24	58	79	925				
2.0 16V (105 kW)	2006.09-2009.07	MT	R	F	Hatchback Engine RFJ (EW10A)	210229	Drive Shaft		25	24	58.5	79	935				
	2006.09-2009.07	5MT	L	F	Hatchback Engine RFJ (EW10A)	245105	Drive Shaft		25	24	58	79	625				
	2006.09-2009.07	5MT	L	F	Hatchback Engine RFJ (EW10A)	245126	Drive Shaft		25	24	58.5	89	630				
	2006.09-2009.07	MT	L	F	Hatchback Engine RFJ (EW10A)	299019	Drive Shaft	29T	25	24	55.7	79	620				
	2006.09-2009.07	5MT	R	F	Hatchback Engine RFJ (EW10A)	245104	Drive Shaft		25	24	58	79	925				
	2006.09-2009.07	5MT	R	F	Hatchback Engine RFJ (EW10A)	245104	Drive Shaft		25	24	58	79	925				
2.0 16V (130 kW)	2004.11-2008.07	-	R	F	Hatchback Engine RFK (EW10J4S)	210173	Drive Shaft	29W	25	24	58.5	79	921				
	2004.11-2008.07	MT	L	F	Hatchback Engine RFK (EW10J4S)	245105	Drive Shaft		25	24	58	79	625				
	2004.11-2008.07	MT	R	F	Hatchback Engine RFK (EW10J4S)	210229	Drive Shaft		25	24	58.5	79	935				
	2004.11-2008.07	-	L	F	Hatchback Engine RFK (EW10J4S)	245126	Drive Shaft		25	24	58.5	89	630				
	2004.11-2008.07	MT	R	F	Hatchback Engine RFK (EW10J4S)	245104	Drive Shaft		25	24	58	79	925				
	2004.11-2008.07	MT	L	F	Hatchback Engine RFK (EW10J4S)	299019	Drive Shaft	29T	25	24	55.7	79	620				
	2004.11-2008.07	-	-	F	Hatchback Engine RFK (EW10J4S)	810028	Outer Joint		25	34	58	89	56	I			
	2004.11-2008.07	-	-	F	Hatchback Engine RFK (EW10J4S)	810028	Outer Joint		25	34	58	89	56	I			
2.0 HDi (100 kW)	2004.11-2011.07	6MT	L	F	Hatchback Engine RHR (DW10BTED4)	210268	Drive Shaft		25	37	58.5	89	621				
	2004.11-2011.07	6MT	R	F	Hatchback Engine RHR (DW10BTED4)	208082	Drive Shaft		25	37	58.5	89	949				
	2004.11-2011.07	6MT	-	F	Hatchback Engine RHR (DW10BTED4)	810085	Outer Joint		25	39	59	89	63.5	I			
	2004.11-2011.07	AT	L	F	Hatchback Engine RHR (DW10BTED4)	210293	Drive Shaft		25	24	58.7	79	610				
	2004.11-2011.07	6MT	R	F	Hatchback Engine RHR (DW10BTED4)	610041	Inner Joint		37	39	32	399	95.5				
2.0 HDi (103 kW)	2008.07-2011.07	-	L	F	Hatchback Engine RHF (DW10BTED4)	210268	Drive Shaft		25	37	58.5	89	621				
	2008.07-2011.07	-	R	F	Hatchback Engine RHF (DW10BTED4)	208082	Drive Shaft		25	37	58.5	89	949				
	2008.07-2011.07	AT	L	F	Hatchback Engine RHF (DW10BTED4)	210293	Drive Shaft		25	24	58.7	79	610				
	2008.07-2011.07	-	R	F	Hatchback Engine RHF (DW10BTED4)	610041	Inner Joint		37	39	32	399	95.5				
2.0 HDi (81 kW)	2007.04-2008.07	-	R	F	Hatchback Engine RHZ (DW10ATED)	245104	Drive Shaft		25	24	58	79	925				
	2007.04-2008.07	-	L	F	Hatchback Engine RHZ (DW10ATED)	245105	Drive Shaft		25	24	58	79	625				
	2007.04-2008.07	-	L	F	Hatchback Engine RHZ (DW10ATED)	245126	Drive Shaft		25	24	58.5	89	630				
C4 II (B7)																	
1.2 THP 110 (81 kW)	2015.02-	MT	R	F	Hatchback Engine HNZ (EB2DT)	210251	Drive Shaft		25	24	58.5	79	935				
1.4 VTi 95 (70 kW)	2009.11-	-	R	F	Hatchback Engine 8FP (EP3)	210251	Drive Shaft		25	24	58.5	79	935				
	2009.11-	MT	L	F	Hatchback Engine 8FP (EP3)	210312	Drive Shaft		25	37	58.5	89	625				
1.6 BlueHDi 100 (73 kW)	2014.07-	MT	R	F	Hatchback Engine BHY (DV6FD)	210251	Drive Shaft		25	24	58.5	79	935				
	2014.07-	MT	R	F	Hatchback Engine BHY (DV6FD)	210229	Drive Shaft		25	24	58.5	79	935				
	2014.07-	MT	L	F	Hatchback Engine BHY (DV6FD)	299019	Drive Shaft	29T	25	24	55.7	79	620				
1.6 BlueHDi 115 (85 kW)	2014.08-	MT	L	F	Hatchback Engine BHX (DV6FC)	210253	Drive Shaft		25	24	58.5	79	626				
	2014.08-	MT	L	F	Hatchback Engine BHX (DV6FC)	810148	Outer Joint		25	34	58.5	79	55.5	I			
	2014.08-	MT	R	F	Hatchback Engine BHX (DV6FC)	210325	Drive Shaft		25	24	58.5	79	940				





	 YEAR	TRANSM	L/R	F/R	REMARKS	GSP Ref.	 PRODUCT	 ABS	Technical Specifications									
									A	B	C	H	L	P				
CITROEN																		
C4 II (B7)																		
1.6 BlueHDi 115 (85 kW)	2014.08-	-	MT	R	F	Hatchback Engine BHX (DV6FC)	210229	Drive Shaft		25	24	58.5	79	935				
	2014.08-	-	MT	L	F	Hatchback Engine BHX (DV6FC)	610057	Inner Joint		24	34	40	52.5	90				
	2014.08-	-	MT	R	F	Hatchback Engine BHX (DV6FC)	610058	Inner Joint		24	34	29.8	365	88				
	2014.08-	-	MT	L	F	Hatchback Engine BHX (DV6FC)	299019	Drive Shaft	29T	25	24	55.7	79	620				
1.6 BlueHDi 120 (88 kW)	2015.02-	-	MT	L	F	Hatchback Engine BHZ (DV6FC)	810148	Outer Joint		25	34	58.5	79	55.5	I			
	2015.02-	-	MT	R	F	Hatchback Engine BHZ (DV6FC)	210325	Drive Shaft		25	24	58.5	79	940				
	2015.02-	-	MT	R	F	Hatchback Engine BHZ (DV6FC)	210229	Drive Shaft		25	24	58.5	79	935				
	2015.02-	-	MT	L	F	Hatchback Engine BHZ (DV6FC)	610057	Inner Joint		24	34	40	52.5	90				
	2015.02-	-	MT	R	F	Hatchback Engine BHZ (DV6FC)	610058	Inner Joint		24	34	29.8	365	88				
	2015.02-	-	MT	L	F	Hatchback Engine BHZ (DV6FC)	299019	Drive Shaft	29T	25	24	55.7	79	620				
1.6 HDi 110 (82 kW)	2015.02-	-	MT	L	F	Hatchback Engine BHZ (DV6FC)	210253	Drive Shaft		25	24	58.5	79	626				
	2009.11-	-	-	L	F	Hatchback Engine 9HR (DV6C)	210253	Drive Shaft		25	24	58.5	79	626				
	2009.11-	-	-	L	F	Hatchback Engine 9HR (DV6C)	810148	Outer Joint		25	34	58.5	79	55.5	I			
	2009.11-	-	-	R	F	Hatchback Engine 9HR (DV6C)	210325	Drive Shaft		25	24	58.5	79	940				
	2009.11-	-	-	L	F	Hatchback Engine 9HR (DV6C)	210312	Drive Shaft		25	37	58.5	89	625				
	2009.11-	-	-	L	F	Hatchback Engine 9HR (DV6C)	610057	Inner Joint		24	34	40	52.5	90				
1.6 HDi 115 (84 kW)	2009.11-	-	-	R	F	Hatchback Engine 9HR (DV6C)	610058	Inner Joint		24	34	29.8	365	88				
	2009.11-	-	-	R	F	Hatchback Engine 9HR (DV6C)	610058	Inner Joint		24	34	29.8	365	88				
	2012.07-	-	AT/MT	L	F	Hatchback Engine 9HR (DV6C)/9HD (DV6C)	810148	Outer Joint		25	34	58.5	79	55.5	I			
	2012.07-	-	AT/MT	R	F	Hatchback Engine 9HR (DV6C)/9HD (DV6C)	210325	Drive Shaft		25	24	58.5	79	940				
	2012.07-	-	AT/MT	L	F	Hatchback Engine 9HR (DV6C)/9HD (DV6C)	610057	Inner Joint		24	34	40	52.5	90				
	2012.07-	-	MT	L	F	Hatchback Engine 9HR (DV6C)/9HD (DV6C)	210312	Drive Shaft		25	37	58.5	89	625				
1.6 HDi 90 (68 kW)	2012.07-	-	AT/MT	R	F	Hatchback Engine 9HR (DV6C)/9HD (DV6C)	610058	Inner Joint		24	34	29.8	365	88				
	2012.07-	-	AT/MT	L	F	Hatchback Engine 9HR (DV6C)/9HD (DV6C)	210253	Drive Shaft		25	24	58.5	79	626				
	2009.11-	-	-	R	F	Hatchback Engine 9HP (DV6DTEd)	210251	Drive Shaft		25	24	58.5	79	935				
	2009.11-	-	-	L	F	Hatchback Engine 9HP (DV6DTEd)	210312	Drive Shaft		25	37	58.5	89	625				
	2009.11-	-	-	-	F	Hatchback Engine 9HP (DV6DTEd)	810067	Outer Joint	48W	25	34	58.5	79	55	I			
	2009.11-	-	-	-	F	Hatchback Engine 9HP (DV6DTEd)	810067	Outer Joint	48W	25	34	58.5	79	55	I			
1.6 THP 155 (115 kW)	2009.11-	-	-	L	F	Hatchback Engine 5FV (EP6CDT)	210253	Drive Shaft		25	24	58.5	79	626				
	2009.11-	-	-	L	F	Hatchback Engine 5FV (EP6CDT)	810148	Outer Joint		25	34	58.5	79	55.5	I			
	2009.11-	-	-	R	F	Hatchback Engine 5FV (EP6CDT)	210325	Drive Shaft		25	24	58.5	79	940				
	2009.11-	-	MT	L	F	Hatchback Engine 5FV (EP6CDT)	210312	Drive Shaft		25	37	58.5	89	625				
	2009.11-	-	-	L	F	Hatchback Engine 5FV (EP6CDT)	610057	Inner Joint		24	34	40	52.5	90				
	2009.11-	-	-	R	F	Hatchback Engine 5FV (EP6CDT)	610058	Inner Joint		24	34	29.8	365	88				
	2009.11-	-	AT	-	F	Hatchback Engine 5FV (EP6CDT)	810028	Outer Joint		25	34	58	89	56	I			
	2009.11-	-	AT	-	-	Hatchback Engine 5FV (EP6CDT)	899366	Outer Joint		25	34	58.5	79	55	I			
	2009.11-	-	AT	-	-	Hatchback Engine 5FV (EP6CDT)	899366	Outer Joint		25	34	58.5	79	55	I			
1.6 VTi 120 (88 kW)	2009.11-	-	MT	R	F	Hatchback Engine 5FS (EP6C)	210251	Drive Shaft		25	24	58.5	79	935				
	2009.11-	-	AT	L	F	Hatchback Engine 5FS (EP6C)	699001	Inner Joint		26	34	42.5	46.5	103.5				
	2009.11-	-	MT	L	F	Hatchback Engine 5FS (EP6C)	210312	Drive Shaft		25	37	58.5	89	625				
	2009.11-	-	AT	L	F	Hatchback Engine 5FS (EP6C)	210362	Drive Shaft		25	26	58.5	79	624				
	2009.11-	-	AT	R	F	Hatchback Engine 5FS (EP6C)	210383	Drive Shaft		25	26	58	79	842				
	2009.11-	-	AT	-	F	Hatchback Engine 5FS (EP6C)	810028	Outer Joint		25	34	58	89	56	I			
	2009.11-	-	AT	R	F	Hatchback Engine 5FS (EP6C)	810035	Outer Joint		25	34	58	79	55.5	I			
	2009.11-	-	AT	-	-	Hatchback Engine 5FS (EP6C)	899366	Outer Joint		25	34	58.5	79	55	I			
	2009.11-	-	AT	-	-	Hatchback Engine 5FS (EP6C)	899366	Outer Joint		25	34	58.5	79	55	I			
1.6 VTi 120 LPG (88 kW)	2011.09-	-	-	R	F	Hatchback Engine 5FS (EP6C)	210251	Drive Shaft		25	24	58.5	79	935				
	2011.09-	-	MT	L	F	Hatchback Engine 5FS (EP6C)	210312	Drive Shaft		25	37	58.5	89	625				
2.0 BlueHDi 150 (110 kW)	2009.11-	-	-	-	-	Hatchback Engine RHE (DW10CTED4)/AHR(DW10FD)	899366	Outer Joint		25	34	58.5	79	55	I			
	2009.11-	-	-	-	F	Hatchback Engine RHE (DW10CTED4)/AHR(DW10FD)	810028	Outer Joint		25	34	58	89	56	I			
	2009.11-	-	MT	R	F	Hatchback Engine RHE (DW10CTED4)/AHR(DW10FD)	610041	Inner Joint		37	39	32	399	95.5				
	2009.11-	-	-	L	F	Hatchback Engine RHE (DW10CTED4)/AHR(DW10FD)	810158	Outer Joint		25	26	58.5	89	61.5	M			
	2009.11-	-	-	L	F	Hatchback Engine RHE (DW10CTED4)/AHR(DW10FD)	210427	Drive Shaft		25	37	58.5	89	638				
	2009.11-	-	MT	L	F	Hatchback Engine RHE (DW10CTED4)/AHR(DW10FD)	210312	Drive Shaft		25	37	58.5	89	625				
	2009.11-	-	-	R	F	Hatchback Engine RHE (DW10CTED4)/AHR(DW10FD)	210421	Drive Shaft		25	37	58.5	89	972				
	2009.11-	-	MT	L	F	Hatchback Engine RHE (DW10CTED4)/AHR(DW10FD)	210210	Drive Shaft		25	37	58.5	89	638				
	2009.11-	-	MT	R	F	Hatchback Engine RHE (DW10CTED4)/AHR(DW10FD)	210361	Drive Shaft		25	37	58.5	89	959				
C4 Picasso I (UD_)																		
1.6 16V (110 kW)	2008.07-	2013.08	-	L	F	MPV Engine 5FX (EP6DT)	210286	Drive Shaft		25	26	58.5	79	613				
	2008.07-	2013.08	-	L	F	MPV Engine 5FX (EP6DT)	610057	Inner Joint		24	34	40	52.5	90				
	2008.07-	2013.08	-	R	F	MPV Engine 5FX (EP6DT)	610058	Inner Joint		24	34	29.8	365	88				
	2008.07-	2013.08	AT	-	-	MPV Engine 5FX (EP6DT)	899366	Outer Joint		25	34	58.5	79	55	I			
	2008.07-	2013.08	-	L	F	MPV Engine 5FX (EP6DT)	210255	Drive Shaft		25	24	58.5	79	616				
	2008.07-	2013.08	-	R	F	MPV Engine 5FX (EP6DT)	210254	Drive Shaft		25	24	58.5	79	939				
	2008.07-	2013.08	-	L	F	MPV Engine 5FX (EP6DT)	699001	Inner Joint		26	34	42.5	46.5	103.5				
	2008.07-	2013.08	AT	-	F	MPV Engine 5FX (EP6DT)	810028	Outer Joint		25	34	58	89	56	I			
1.6 HDi (80 kW)	2007.02-	2013.08	-	-	-	MPV Engine 9HY (DV6TED4)9HZ(DV6TED4)	899366	Outer Joint		25	34	58.5	79	55	I			
	2007.02-	2013.08	AT	L	F	MPV Engine 9HY (DV6TED4)9HZ(DV6TED4)	610057	Inner Joint		24	34	40	52.5	90				
	2007.02-	2013.08	MT	R	F	MPV Engine 9HY (DV6TED4)9HZ(DV6TED4)	210229	Drive Shaft		25	24	58.5	79	935				
	2007.02-	2013.08	AT	R	F	MPV Engine 9HY (DV6TED4)9HZ(DV6TED4)	610058	Inner Joint		24	34	29.8	365	88				





YEAR	TRANSM	L/R	F/R	REMARKS	GSP Ref.	PRODUCT	ABS	Technical Specifications										
								A	B	C	H	L	P					
CITROEN																		
C4 Picasso I (UD_)																		
1.6 HDi (80 kW)	2007.02-2013.08	MT	L	F	MPV Engine 9HY (DV6TED4)9HZ(DV6TED4)	245105	Drive Shaft		25	24	58	79	625					
	2007.02-2013.08	MT	L	F	MPV Engine 9HY (DV6TED4)9HZ(DV6TED4)	245126	Drive Shaft		25	24	58.5	89	630					
	2007.02-2013.08	AT	L	F	MPV Engine 9HY (DV6TED4)9HZ(DV6TED4)	210255	Drive Shaft		25	24	58.5	79	616					
	2007.02-2013.08	-	L	F	MPV Engine 9HY (DV6TED4)9HZ(DV6TED4)	699001	Inner Joint		26	34	42.5	46.5	103.5					
	2007.02-2013.08	AT	R	F	MPV Engine 9HY (DV6TED4)9HZ(DV6TED4)	210254	Drive Shaft		25	24	58.5	79	939					
	2007.02-2013.08	MT	L	F	MPV Engine 9HY (DV6TED4)9HZ(DV6TED4)	299019	Drive Shaft	29T	25	24	55.7	79	620					
	2007.02-2013.08	-	-	F	MPV Engine 9HY (DV6TED4)9HZ(DV6TED4)	810028	Outer Joint		25	34	58	89	56	I				
	2007.02-2013.08	MT	R	F	MPV Engine 9HY (DV6TED4)9HZ(DV6TED4)	245104	Drive Shaft		25	24	58	79	925					
1.6 HDi 110 (82 kW)	2007.02-2013.08	-	L	F	MPV Engine 9HY (DV6TED4)9HZ(DV6TED4)	210286	Drive Shaft		25	26	58.5	79	613					
	2010.09-2013.08	AT	L	F	MPV Engine 9HR (DV6C)	610057	Inner Joint		24	34	40	52.5	90					
	2010.09-2013.08	AT	R	F	MPV Engine 9HR (DV6C)	610058	Inner Joint		24	34	29.8	365	88					
	2010.09-2013.08	MT	L	F	MPV Engine 9HR (DV6C)	245105	Drive Shaft		25	24	58	79	625					
	2010.09-2013.08	MT	L	F	MPV Engine 9HR (DV6C)	245126	Drive Shaft		25	24	58.5	89	630					
	2010.09-2013.08	AT	-	-	MPV Engine 9HR (DV6C)	899366	Outer Joint		25	34	58.5	79	55	I				
	2010.09-2013.08	AT	L	F	MPV Engine 9HR (DV6C)	210255	Drive Shaft		25	24	58.5	79	616					
	2010.09-2013.08	-	L	F	MPV Engine 9HR (DV6C)	699001	Inner Joint		26	34	42.5	46.5	103.5					
	2010.09-2013.08	AT	R	F	MPV Engine 9HR (DV6C)	210254	Drive Shaft		25	24	58.5	79	939					
	2010.09-2013.08	MT	R	F	MPV Engine 9HR (DV6C)	245104	Drive Shaft		25	24	58	79	925					
	2010.09-2013.08	-	L	F	MPV Engine 9HR (DV6C)	210286	Drive Shaft		25	26	58.5	79	613					
1.6 THP 140 (103 kW)	2010.09-2013.08	AT	-	-	MPV Engine 9HR (DV6C)	810028	Outer Joint		25	34	58	89	56	I				
	2008.07-2013.08	AT	-	-	MPV Engine 5FT (EP6DT)	899366	Outer Joint		25	34	58.5	79	55	I				
	2008.07-2013.08	AT	R	F	MPV Engine 5FT (EP6DT)	210229	Drive Shaft		25	24	58.5	79	935					
	2008.07-2013.08	-	L	F	MPV Engine 5FT (EP6DT)	699001	Inner Joint		26	34	42.5	46.5	103.5					
	2008.07-2013.08	AT	L	F	MPV Engine 5FT (EP6DT)	299019	Drive Shaft	29T	25	24	55.7	79	620					
	2008.07-2013.08	AT	-	F	MPV Engine 5FT (EP6DT)	810028	Outer Joint		25	34	58	89	56	I				
1.6 THP 155 (115 kW)	2008.07-2013.08	-	L	F	MPV Engine 5FT (EP6DT)	210286	Drive Shaft		25	26	58.5	79	613					
	2010.09-2013.08	-	L	F	MPV Engine 5FV (EP6CDT)	610057	Inner Joint		24	34	40	52.5	90					
	2010.09-2013.08	-	R	F	MPV Engine 5FV (EP6CDT)	610058	Inner Joint		24	34	29.8	365	88					
	2010.09-2013.08	AT	-	-	MPV Engine 5FV (EP6CDT)	899366	Outer Joint		25	34	58.5	79	55	I				
	2010.09-2013.08	-	L	F	MPV Engine 5FV (EP6CDT)	210255	Drive Shaft		25	24	58.5	79	616					
	2010.09-2013.08	AT	R	F	MPV Engine 5FV (EP6CDT)	210229	Drive Shaft		25	24	58.5	79	935					
	2010.09-2013.08	-	R	F	MPV Engine 5FV (EP6CDT)	210254	Drive Shaft		25	24	58.5	79	939					
	2010.09-2013.08	AT	-	F	MPV Engine 5FV (EP6CDT)	810028	Outer Joint		25	34	58	89	56	I				
	2010.09-2013.08	AT	L	F	MPV Engine 5FV (EP6CDT)	299019	Drive Shaft	29T	25	24	55.7	79	620					
	1.6 VTi 120 (88 kW)	2008.07-2013.08	-	R	F	MPV Engine 5FW (EP6)	245104	Drive Shaft		25	24	58	79	925				
2008.07-2013.08		MT	R	F	MPV Engine 5FW (EP6)	210229	Drive Shaft		25	24	58.5	79	935					
2008.07-2013.08		AT	-	-	MPV Engine 5FW (EP6)	899366	Outer Joint		25	34	58.5	79	55	I				
2008.07-2013.08		-	L	F	MPV Engine 5FW (EP6)	245105	Drive Shaft		25	24	58	79	625					
2008.07-2013.08		-	L	F	MPV Engine 5FW (EP6)	699001	Inner Joint		26	34	42.5	46.5	103.5					
2008.07-2013.08		-	L	F	MPV Engine 5FW (EP6)	245126	Drive Shaft		25	24	58.5	89	630					
2008.07-2013.08		MT	L	F	MPV Engine 5FW (EP6)	299019	Drive Shaft	29T	25	24	55.7	79	620					
2008.07-2013.08		AT	-	F	MPV Engine 5FW (EP6)	810028	Outer Joint		25	34	58	89	56	I				
2008.07-2013.08		-	L	F	MPV Engine 5FW (EP6)	210286	Drive Shaft		25	26	58.5	79	613					
1.8 i 16V (92 kW)		2007.02-2011.12	MT	R	F	MPV Engine 6FY (EW7A)	210229	Drive Shaft		25	24	58.5	79	935				
	2007.02-2011.12	-	L	F	MPV Engine 6FY (EW7A)	245105	Drive Shaft		25	24	58	79	625					
	2007.02-2011.12	-	L	F	MPV Engine 6FY (EW7A)	245126	Drive Shaft		25	24	58.5	89	630					
	2007.02-2011.12	MT	L	F	MPV Engine 6FY (EW7A)	299019	Drive Shaft	29T	25	24	55.7	79	620					
	2007.02-2011.12	-	R	F	MPV Engine 6FY (EW7A)	245104	Drive Shaft		25	24	58	79	925					
	2007.02-2011.12	-	-	F	MPV Engine 6FY (EW7A)	810028	Outer Joint		25	34	58	89	56	I				
2.0 HDi 138 (100 kW)	2006.10-2013.08	-	-	F	MPV Engine RHR (DW10BTED4)/RHJ (DW10BTED4)	810118	Outer Joint		25	26	58.7	79	61.5	M				
	2006.10-2013.08	-	L	F	MPV Engine RHR (DW10BTED4)/RHJ (DW10BTED4)	699001	Inner Joint		26	34	42.5	46.5	103.5					
	2006.10-2013.08	MT	R	F	MPV Engine RHR (DW10BTED4)/RHJ (DW10BTED4)	210295	Drive Shaft		25	24	58.7	79	948					
	2006.10-2013.08	AT	L	F	MPV Engine RHR (DW10BTED4)/RHJ (DW10BTED4)	210293	Drive Shaft		25	24	58.7	79	610					
	2006.10-2013.08	-	L	F	MPV Engine RHR (DW10BTED4)/RHJ (DW10BTED4)	210286	Drive Shaft		25	26	58.5	79	613					
2.0 HDi 150 (110 kW)	2009.07-2013.08	-	-	F	MPV Engine RHE (DW10CTED4)	810118	Outer Joint		25	26	58.7	79	61.5	M				
	2009.07-2013.08	AT	-	-	MPV Engine RHE (DW10CTED4)	899366	Outer Joint		25	34	58.5	79	55	I				
	2009.07-2013.08	Semi-AT	R	F	MPV Engine RHE (DW10CTED4)	210295	Drive Shaft		25	24	58.7	79	948					
	2009.07-2013.08	-	L	F	MPV Engine RHE (DW10CTED4)	210293	Drive Shaft		25	24	58.7	79	610					
	2009.07-2013.08	AT	-	F	MPV Engine RHE (DW10CTED4)	810028	Outer Joint		25	34	58	89	56	I				
2.0 HDi 165 (120 kW)	2010.09-2013.08	AT	-	-	MPV Engine RHH (DW10CTED4)	899366	Outer Joint		25	34	58.5	79	55	I				
	2010.09-2013.08	AT	-	F	MPV Engine RHH (DW10CTED4)	810028	Outer Joint		25	34	58	89	56	I				
2.0 i 16V (103 kW)	2007.02-2013.08	6AT	L	F	MPV Engine RFJ (EW10A)	610057	Inner Joint		24	34	40	52.5	90					
	2007.02-2013.08	-	-	F	MPV Engine RFJ (EW10A)	810028	Outer Joint		25	34	58	89	56	I				
	2007.02-2013.08	AT/MT	-	-	MPV Engine RFJ (EW10A)	899366	Outer Joint		25	34	58.5	79	55	I				
	2007.02-2013.08	6AT	R	F	MPV Engine RFJ (EW10A)	610058	Inner Joint		24	34	29.8	365	88					
	2007.02-2013.08	6AT	L	F	MPV Engine RFJ (EW10A)	210255	Drive Shaft		25	24	58.5	79	616					





	 YEAR	TRANSM	L/R	F/R	REMARKS	GSP Ref.	 PRODUCT	 ABS	Technical Specifications					
									A	B	C	H	L	P
CITROEN														
C4 Picasso I (UD_)														
2.0 i 16V (103 kW)	2007.02-2013.08	-	L	F	MPV Engine RFJ (EW10A)	699001	Inner Joint		26	34	42.5	46.5	103.5	
	2007.02-2013.08	6AT	R	F	MPV Engine RFJ (EW10A)	210254	Drive Shaft		25	24	58.5	79	939	
	2007.02-2013.08	-	L	F	MPV Engine RFJ (EW10A)	210286	Drive Shaft		25	26	58.5	79	613	
C4 Picasso II														
1.6 BlueHDi 120 (88 kW)	2014.07-	-	-	F	MPV Engine BHZ (DV6FC)	810052	Outer Joint		28	34	58.5	92	55	I
1.6 HDi / BlueHDi 115 (85 kW)	2013.02-	-	-	F	MPV Engine 9HC (DV6C)/BHX(DV6FC)	810052	Outer Joint		28	34	58.5	92	55	I
1.6 THP 155 (115 kW)	2013.02-	AT	-	F	MPV Engine 5FV (EP6CDT)	810028	Outer Joint		25	34	58	89	56	I
1.6 VTi 120 (88 kW)	2013.02-	AT	-	F	MPV Engine 5FS (EP6C)	810028	Outer Joint		25	34	58	89	56	I
2.0 BlueHDi 150 (110 kW)	2013.09-	-	-	F	MPV Engine AHX (DW10FD)	810028	Outer Joint		25	34	58	89	56	I
C5 I (DC_)														
1.8 16V (85 kW)	2001.03-2004.08	MT	L	F	Hatchback Engine 6FZ (EW7J4)	810158	Outer Joint		25	26	58.5	89	61.5	M
	2001.03-2004.08	MT	L	F	Hatchback Engine 6FZ (EW7J4)	210192	Drive Shaft		25	24	58.5	89	655	
	2001.03-2004.08	MT	L	F	Hatchback Engine 6FZ (EW7J4)	245140	Drive Shaft		25	24	58.5	89	650	
	2001.03-2004.08	MT	R	F	Hatchback Engine 6FZ (EW7J4)	210143	Drive Shaft		25	24	58.5	89	936	
	2001.03-2004.08	MT	R	F	Hatchback Engine 6FZ (EW7J4)	299189	Drive Shaft		25	24	58.5	89	936	
	2001.03-2004.08	MT	L	F	Hatchback Engine 6FZ (EW7J4)	210142	Drive Shaft		25	24	58.5	89	648	
	2001.03-2004.08	AT/MT	L/R	F	Hatchback Engine 6FZ (EW7J4)	845038	Outer Joint		25	34	58.5	89	55	I
	2001.03-2004.08	AT	R	F	Hatchback Engine 6FZ (EW7J4)	210444	Drive Shaft		25	26	58	89	843	
	2001.03-2004.08	AT	L	F	Hatchback Engine 6FZ (EW7J4)	210443	Drive Shaft		25	26	58	89	635	
	2001.03-2004.08	AT	L	F	Hatchback Engine 6FZ (EW7J4)	699001	Inner Joint		26	34	42.5	46.5	103.5	
	2001.03-2004.08	-	-	F	Hatchback Engine 6FZ (EW7J4)	845041	Outer Joint	48T	25	34	58.5	89	55	I
2.0 16V (100 kW)	2001.03-2004.08	MT	L	F	Hatchback Engine RFN (EW10J4)	810158	Outer Joint		25	26	58.5	89	61.5	M
	2001.03-2004.08	MT	L	F	Hatchback Engine RFN (EW10J4)	210192	Drive Shaft		25	24	58.5	89	655	
	2001.03-2004.08	MT	L	F	Hatchback Engine RFN (EW10J4)	245140	Drive Shaft		25	24	58.5	89	650	
	2001.03-2004.08	MT	R	F	Hatchback Engine RFN (EW10J4)	210143	Drive Shaft		25	24	58.5	89	936	
	2001.03-2004.08	MT	R	F	Hatchback Engine RFN (EW10J4)	299189	Drive Shaft		25	24	58.5	89	936	
	2001.03-2004.08	MT	L	F	Hatchback Engine RFN (EW10J4)	210142	Drive Shaft		25	24	58.5	89	648	
	2001.03-2004.08	AT/MT	L/R	F	Hatchback Engine RFN (EW10J4)	845038	Outer Joint		25	34	58.5	89	55	I
	2001.03-2004.08	AT	R	F	Hatchback Engine RFN (EW10J4)	210444	Drive Shaft		25	26	58	89	843	
	2001.03-2004.08	AT	L	F	Hatchback Engine RFN (EW10J4)	210443	Drive Shaft		25	26	58	89	635	
	2001.03-2004.08	AT	L	F	Hatchback Engine RFN (EW10J4)	699001	Inner Joint		26	34	42.5	46.5	103.5	
	2001.03-2004.08	AT	-	F	Hatchback Engine RFN (EW10J4)	810075	Outer Joint		25	26	58.5	89	63	M
	2001.03-2004.08	MT	-	F	Hatchback Engine RFN (EW10J4)	845041	Outer Joint	48T	25	34	58.5	89	55	I
2.0 16V HPI (103 kW)	2001.03-2004.08	-	L	F	Hatchback Engine RLZ (EW10D)	810158	Outer Joint		25	26	58.5	89	61.5	M
	2001.03-2004.08	-	L	F	Hatchback Engine RLZ (EW10D)	210192	Drive Shaft		25	24	58.5	89	655	
	2001.03-2004.08	MT	R	F	Hatchback Engine RLZ (EW10D)	210143	Drive Shaft		25	24	58.5	89	936	
	2001.03-2004.08	MT	L	F	Hatchback Engine RLZ (EW10D)	245140	Drive Shaft		25	24	58.5	89	650	
	2001.03-2004.08	MT	L	F	Hatchback Engine RLZ (EW10D)	210142	Drive Shaft		25	24	58.5	89	648	
	2001.03-2004.08	MT	R	F	Hatchback Engine RLZ (EW10D)	299189	Drive Shaft		25	24	58.5	89	936	
	2001.03-2004.08	AT/MT	L/R	F	Hatchback Engine RLZ (EW10D)	845038	Outer Joint		25	34	58.5	89	55	I
	2001.03-2004.08	AT	R	F	Hatchback Engine RLZ (EW10D)	210444	Drive Shaft		25	26	58	89	843	
	2001.03-2004.08	AT	L	F	Hatchback Engine RLZ (EW10D)	210443	Drive Shaft		25	26	58	89	635	
	2001.03-2004.08	AT	L	F	Hatchback Engine RLZ (EW10D)	699001	Inner Joint		26	34	42.5	46.5	103.5	
	2001.03-2004.08	MT	-	F	Hatchback Engine RLZ (EW10D)	845041	Outer Joint	48T	25	34	58.5	89	55	I
2.0 HDi (66 kW)	2001.03-2004.08	-	L	F	Hatchback Engine RHY (DW10TD)	810158	Outer Joint		25	26	58.5	89	61.5	M
	2001.03-2004.08	-	L	F	Hatchback Engine RHY (DW10TD)	210192	Drive Shaft		25	24	58.5	89	655	
	2001.03-2004.08	-	R	F	Hatchback Engine RHY (DW10TD)	210143	Drive Shaft		25	24	58.5	89	936	
	2001.03-2004.08	MT	L	F	Hatchback Engine RHY (DW10TD)	245140	Drive Shaft		25	24	58.5	89	650	
	2001.03-2004.08	-	L	F	Hatchback Engine RHY (DW10TD)	210142	Drive Shaft		25	24	58.5	89	648	
	2001.03-2004.08	MT	R	F	Hatchback Engine RHY (DW10TD)	299189	Drive Shaft		25	24	58.5	89	936	
	2001.03-2004.08	AT	L/R	F	Hatchback Engine RHY (DW10TD)	845038	Outer Joint		25	34	58.5	89	55	I
	2001.03-2004.08	AT	R	F	Hatchback Engine RHY (DW10TD)	210444	Drive Shaft		25	26	58	89	843	
	2001.03-2004.08	AT	L	F	Hatchback Engine RHY (DW10TD)	210443	Drive Shaft		25	26	58	89	635	
	2001.03-2004.08	AT	L	F	Hatchback Engine RHY (DW10TD)	699001	Inner Joint		26	34	42.5	46.5	103.5	
	2001.03-2004.08	-	-	F	Hatchback Engine RHY (DW10TD)	845041	Outer Joint	48T	25	34	58.5	89	55	I
2.0 HDi (79 kW)	2001.03-2004.08	MT	L	F	Hatchback Engine RHS (DW10ATED)/RHZ (DW10ATED)	299172	Drive Shaft		25	37	58.5	89	623	
	2001.03-2004.08	MT	L	F	Hatchback Engine RHS (DW10ATED)/RHZ (DW10ATED)	210141	Drive Shaft		25	37	58.5	89	638	
	2001.03-2004.08	MT	R	F	Hatchback Engine RHS (DW10ATED)/RHZ (DW10ATED)	210139	Drive Shaft		25	37	58.5	89	944	
	2001.03-2004.08	AT	L/R	F	Hatchback Engine RHS (DW10ATED)/RHZ (DW10ATED)	845038	Outer Joint		25	34	58.5	89	55	I
	2001.03-2004.08	AT	R	F	Hatchback Engine RHS (DW10ATED)/RHZ (DW10ATED)	210444	Drive Shaft		25	26	58	89	843	
	2001.03-2004.08	-	-	-	Hatchback Engine RHS (DW10ATED)/RHZ (DW10ATED)	810096	Outer Joint		25	26	58.5	89	61.5	M
	2001.03-2004.08	AT	L	F	Hatchback Engine RHS (DW10ATED)/RHZ (DW10ATED)	210443	Drive Shaft		25	26	58	89	635	
	2001.03-2004.08	MT	-	F	Hatchback Engine RHS (DW10ATED)/RHZ (DW10ATED)	810075	Outer Joint		25	26	58.5	89	63	M
	2001.03-2004.08	AT	L	F	Hatchback Engine RHS (DW10ATED)/RHZ (DW10ATED)	699001	Inner Joint		26	34	42.5	46.5	103.5	
	2001.03-2004.08	AT	-	F	Hatchback Engine RHS (DW10ATED)/RHZ (DW10ATED)	845041	Outer Joint	48T	25	34	58.5	89	55	I
2.0 HDi (80 kW)	2001.03-2004.08	MT	L	F	Hatchback Engine RHZ (DW10ATED)	299172	Drive Shaft		25	37	58.5	89	623	

YEAR	TRANSM	L/R	F/R	REMARKS	GSP Ref.	PRODUCT	ABS	Technical Specifications							
								A	B	C	H	L	P		
CITROEN															
C5 I (DC_)															
2.0 HDi (80 kW)	2001.03-2004.08	MT	L	F	Hatchback Engine RHZ (DW10ATED)	210141	Drive Shaft		25	37	58.5	89	638		
	2001.03-2004.08	MT	R	F	Hatchback Engine RHZ (DW10ATED)	210139	Drive Shaft		25	37	58.5	89	944		
	2001.03-2004.08	AT	L/R	F	Hatchback Engine RHZ (DW10ATED)	845038	Outer Joint		25	34	58.5	89	55	I	
	2001.03-2004.08	AT	R	F	Hatchback Engine RHZ (DW10ATED)	210444	Drive Shaft		25	26	58	89	843		
	2001.03-2004.08	AT	L	F	Hatchback Engine RHZ (DW10ATED)	210443	Drive Shaft		25	26	58	89	635		
	2001.03-2004.08	-	-	-	Hatchback Engine RHZ (DW10ATED)	810096	Outer Joint		25	26	58.5	89	61.5	M	
	2001.03-2004.08	MT	-	F	Hatchback Engine RHZ (DW10ATED)	810075	Outer Joint		25	26	58.5	89	63	M	
	2001.03-2004.08	AT	L	F	Hatchback Engine RHZ (DW10ATED)	699001	Inner Joint		26	34	42.5	46.5	103.5		
2.2 HDi (98 kW)	2001.03-2004.08	AT	-	F	Hatchback Engine RHZ (DW10ATED)	845041	Outer Joint	48T	25	34	58.5	89	55	I	
	2001.03-2004.08	MT	L	F	Hatchback Engine 4HX (DW12TED4/FAP)	299172	Drive Shaft		25	37	58.5	89	623		
	2001.03-2004.08	MT	L	F	Hatchback Engine 4HX (DW12TED4/FAP)	210312	Drive Shaft		25	37	58.5	89	625		
	2001.03-2004.08	MT	L	F	Hatchback Engine 4HX (DW12TED4/FAP)	210121	Drive Shaft		25	37	58.5	89	628		
	2001.03-2004.08	MT	R	F	Hatchback Engine 4HX (DW12TED4/FAP)	210140	Drive Shaft		25	37	58.5	89	948		
	2001.03-2004.08	AT	L	F	Hatchback Engine 4HX (DW12TED4/FAP)	210207	Drive Shaft		25	37	58.5	89	602		
	2001.03-2004.08	AT	R	F	Hatchback Engine 4HX (DW12TED4/FAP)	210208	Drive Shaft		25	37	58.5	89	908		
	2001.03-2004.08	AT	L	F	Hatchback Engine 4HX (DW12TED4/FAP)	610043	Inner Joint		37	26	40.5	67.5	104		
3.0 V6 (152 kW)	2001.03-2004.08	-	-	F	Hatchback Engine 4HX (DW12TED4/FAP)	810075	Outer Joint		25	26	58.5	89	63	M	
	2001.03-2004.08	AT	L	F	Hatchback Engine XFX (ES9J4S)	210344	Drive Shaft		25	37	58.5	89	607		
	2001.03-2004.08	MT	L	F	Hatchback Engine XFX (ES9J4S)	210141	Drive Shaft		25	37	58.5	89	638		
	2001.03-2004.08	MT	R	F	Hatchback Engine XFX (ES9J4S)	210139	Drive Shaft		25	37	58.5	89	944		
	2001.03-2004.08	-	-	-	Hatchback Engine XFX (ES9J4S)	810096	Outer Joint		25	26	58.5	89	61.5	M	
C5 I Break (DE_)	2001.03-2004.08	AT	L	F	Hatchback Engine XFX (ES9J4S)	610043	Inner Joint		37	26	40.5	67.5	104		
	2001.03-2004.08	AT	-	F	Hatchback Engine XFX (ES9J4S)	810075	Outer Joint		25	26	58.5	89	63	M	
	1.8 16V (85 kW)	2001.06-2004.08	MT	L	F	Estate Engine 6FZ (EW7J4)	810158	Outer Joint		25	26	58.5	89	61.5	M
		2001.06-2004.08	MT	L	F	Estate Engine 6FZ (EW7J4)	210192	Drive Shaft		25	24	58.5	89	655	
		2001.06-2004.08	MT	R	F	Estate Engine 6FZ (EW7J4)	210143	Drive Shaft		25	24	58.5	89	936	
2001.06-2004.08		MT	L	F	Estate Engine 6FZ (EW7J4)	245140	Drive Shaft		25	24	58.5	89	650		
2001.06-2004.08		MT	R	F	Estate Engine 6FZ (EW7J4)	299189	Drive Shaft		25	24	58.5	89	936		
2001.06-2004.08		MT	L	F	Estate Engine 6FZ (EW7J4)	210142	Drive Shaft		25	24	58.5	89	648		
2001.06-2004.08		AT/MT	L/R	F	Estate Engine 6FZ (EW7J4)	845038	Outer Joint		25	34	58.5	89	55	I	
2001.06-2004.08		AT	R	F	Estate Engine 6FZ (EW7J4)	210444	Drive Shaft		25	26	58	89	843		
2001.06-2004.08		AT	L	F	Estate Engine 6FZ (EW7J4)	210443	Drive Shaft		25	26	58	89	635		
2001.06-2004.08		AT	L	F	Estate Engine 6FZ (EW7J4)	699001	Inner Joint		26	34	42.5	46.5	103.5		
2.0 16V (100 kW)	2001.06-2004.08	-	-	F	Estate Engine 6FZ (EW7J4)	845041	Outer Joint	48T	25	34	58.5	89	55	I	
	2001.06-2004.08	MT	L	F	Estate Engine RFN (EW10J4)	810158	Outer Joint		25	26	58.5	89	61.5	M	
	2001.06-2004.08	MT	L	F	Estate Engine RFN (EW10J4)	210192	Drive Shaft		25	24	58.5	89	655		
	2001.06-2004.08	MT	R	F	Estate Engine RFN (EW10J4)	210143	Drive Shaft		25	24	58.5	89	936		
	2001.06-2004.08	MT	L	F	Estate Engine RFN (EW10J4)	245140	Drive Shaft		25	24	58.5	89	650		
	2001.06-2004.08	MT	R	F	Estate Engine RFN (EW10J4)	299189	Drive Shaft		25	24	58.5	89	936		
	2001.06-2004.08	MT	L	F	Estate Engine RFN (EW10J4)	210142	Drive Shaft		25	24	58.5	89	648		
	2001.06-2004.08	AT/MT	L/R	F	Estate Engine RFN (EW10J4)	845038	Outer Joint		25	34	58.5	89	55	I	
	2001.06-2004.08	AT	R	F	Estate Engine RFN (EW10J4)	210444	Drive Shaft		25	26	58	89	843		
	2001.06-2004.08	AT	L	F	Estate Engine RFN (EW10J4)	210443	Drive Shaft		25	26	58	89	635		
2.0 16V HPi (103 kW)	2001.06-2004.08	AT	-	F	Estate Engine RFN (EW10J4)	810075	Outer Joint		25	26	58.5	89	63	M	
	2001.06-2004.08	AT	L	F	Estate Engine RFN (EW10J4)	699001	Inner Joint		26	34	42.5	46.5	103.5		
	2001.06-2004.08	MT	-	F	Estate Engine RFN (EW10J4)	845041	Outer Joint	48T	25	34	58.5	89	55	I	
	2001.06-2004.08	-	L	F	Estate Engine RLZ (EW10D)	810158	Outer Joint		25	26	58.5	89	61.5	M	
	2001.06-2004.08	-	L	F	Estate Engine RLZ (EW10D)	210192	Drive Shaft		25	24	58.5	89	655		
	2001.06-2004.08	MT	R	F	Estate Engine RLZ (EW10D)	210143	Drive Shaft		25	24	58.5	89	936		
	2001.06-2004.08	MT	L	F	Estate Engine RLZ (EW10D)	245140	Drive Shaft		25	24	58.5	89	650		
	2001.06-2004.08	MT	L	F	Estate Engine RLZ (EW10D)	210142	Drive Shaft		25	24	58.5	89	648		
	2001.06-2004.08	MT	R	F	Estate Engine RLZ (EW10D)	299189	Drive Shaft		25	24	58.5	89	936		
	2001.06-2004.08	AT/MT	L/R	F	Estate Engine RLZ (EW10D)	845038	Outer Joint		25	34	58.5	89	55	I	
2.0 HDi (66 kW)	2001.06-2004.08	AT	R	F	Estate Engine RLZ (EW10D)	210444	Drive Shaft		25	26	58	89	843		
	2001.06-2004.08	AT	L	F	Estate Engine RLZ (EW10D)	210443	Drive Shaft		25	26	58	89	635		
	2001.06-2004.08	AT	L	F	Estate Engine RLZ (EW10D)	699001	Inner Joint		26	34	42.5	46.5	103.5		
	2001.06-2004.08	MT	-	F	Estate Engine RLZ (EW10D)	845041	Outer Joint	48T	25	34	58.5	89	55	I	
	2001.06-2004.08	-	L	F	Estate Engine RHY (DW10TD)	810158	Outer Joint		25	26	58.5	89	61.5	M	
	2001.06-2004.08	-	L	F	Estate Engine RHY (DW10TD)	210192	Drive Shaft		25	24	58.5	89	655		
	2001.06-2004.08	-	R	F	Estate Engine RHY (DW10TD)	210143	Drive Shaft		25	24	58.5	89	936		
	2001.06-2004.08	MT	L	F	Estate Engine RHY (DW10TD)	245140	Drive Shaft		25	24	58.5	89	650		
	2001.06-2004.08	-	L	F	Estate Engine RHY (DW10TD)	210142	Drive Shaft		25	24	58.5	89	648		
	2001.06-2004.08	MT	R	F	Estate Engine RHY (DW10TD)	299189	Drive Shaft		25	24	58.5	89	936		
2.0 HDi (79 kW)	2001.06-2004.08	-	-	F	Estate Engine RHY (DW10TD)	845041	Outer Joint	48T	25	34	58.5	89	55	I	
	2001.06-2004.08	MT	L	F	Estate Engine RHZ (DW10ATED)/RHS (DW10ATED)	299172	Drive Shaft		25	37	58.5	89	623		





YEAR	TRANSM	L/R	F/R	REMARKS	GSP Ref.	PRODUCT	ABS	Technical Specifications						
								A	B	C	H	L	P	
CITROEN														
C5 I Break (DE_)														
2.0 HDi (79 kW)	2001.06-2004.08	MT	L	F	Estate Engine RHZ (DW10ATED)/RHS (DW10ATED)	210141	Drive Shaft		25	37	58.5	89	638	
	2001.06-2004.08	MT	R	F	Estate Engine RHZ (DW10ATED)/RHS (DW10ATED)	210139	Drive Shaft		25	37	58.5	89	944	
	2001.06-2004.08	-	-	-	Estate Engine RHZ (DW10ATED)/RHS (DW10ATED)	810096	Outer Joint		25	26	58.5	89	61.5	M
	2001.06-2004.08	MT	-	F	Estate Engine RHZ (DW10ATED)/RHS (DW10ATED)	810075	Outer Joint		25	26	58.5	89	63	M
	2001.06-2004.08	AT	-	F	Estate Engine RHZ (DW10ATED)/RHS (DW10ATED)	845041	Outer Joint	48T	25	34	58.5	89	55	I
2.0 HDi (80 kW)	2001.06-2004.08	MT	L	F	Estate Engine RHZ (DW10ATED)	299172	Drive Shaft		25	37	58.5	89	623	
	2001.06-2004.08	MT	L	F	Estate Engine RHZ (DW10ATED)	210141	Drive Shaft		25	37	58.5	89	638	
	2001.06-2004.08	MT	R	F	Estate Engine RHZ (DW10ATED)	210139	Drive Shaft		25	37	58.5	89	944	
	2001.06-2004.08	AT	R	F	Estate Engine RHZ (DW10ATED)	210444	Drive Shaft		25	26	58	89	843	
	2001.06-2004.08	-	-	-	Estate Engine RHZ (DW10ATED)	810096	Outer Joint		25	26	58.5	89	61.5	M
	2001.06-2004.08	AT	L	F	Estate Engine RHZ (DW10ATED)	210443	Drive Shaft		25	26	58	89	635	
	2001.06-2004.08	MT	-	F	Estate Engine RHZ (DW10ATED)	810075	Outer Joint		25	26	58.5	89	63	M
	2001.06-2004.08	AT	L	F	Estate Engine RHZ (DW10ATED)	699001	Inner Joint		26	34	42.5	46.5	103.5	
2.2 HDi (98 kW)	2001.06-2004.08	MT	L	F	Estate Engine RHZ (DW10ATED)	845041	Outer Joint	48T	25	34	58.5	89	55	I
	2001.06-2004.08	MT	L	F	Estate Engine 4HX (DW12TED4/FAP)	299172	Drive Shaft		25	37	58.5	89	623	
	2001.06-2004.08	MT	L	F	Estate Engine 4HX (DW12TED4/FAP)	210312	Drive Shaft		25	37	58.5	89	625	
	2001.06-2004.08	MT	L	F	Estate Engine 4HX (DW12TED4/FAP)	210121	Drive Shaft		25	37	58.5	89	628	
	2001.06-2004.08	MT	R	F	Estate Engine 4HX (DW12TED4/FAP)	210140	Drive Shaft		25	37	58.5	89	948	
	2001.06-2004.08	AT	L	F	Estate Engine 4HX (DW12TED4/FAP)	210207	Drive Shaft		25	37	58.5	89	602	
	2001.06-2004.08	AT	R	F	Estate Engine 4HX (DW12TED4/FAP)	210208	Drive Shaft		25	37	58.5	89	908	
	2001.06-2004.08	AT	L	F	Estate Engine 4HX (DW12TED4/FAP)	610043	Inner Joint		37	26	40.5	67.5	104	
3.0 Carlsson (173 kW)	2001.06-2004.08	AT	-	F	Estate Engine 4HX (DW12TED4/FAP)	810075	Outer Joint		25	26	58.5	89	63	M
	2001.06-2004.08	AT	-	F	Estate Engine RHZ (DW10ATED)	845041	Outer Joint	48T	25	34	58.5	89	55	I
3.0 V6 (152 kW)	2001.06-2004.08	MT	L	F	Estate Engine 4HX (DW12TED4/FAP)	299172	Drive Shaft		25	37	58.5	89	623	
	2001.06-2004.08	MT	L	F	Estate Engine 4HX (DW12TED4/FAP)	210312	Drive Shaft		25	37	58.5	89	625	
3.0 V6 (152 kW)	2003.09-2004.08	MT	L	F	Estate Engine XFX (ES9J4S)	210141	Drive Shaft		25	37	58.5	89	638	
	2003.09-2004.08	MT	R	F	Estate Engine XFX (ES9J4S)	210139	Drive Shaft		25	37	58.5	89	944	
3.0 V6 (152 kW)	2001.06-2004.08	AT	L	F	Estate Engine XFX (ES9J4S)	210344	Drive Shaft		25	37	58.5	89	607	
	2001.06-2004.08	MT	L	F	Estate Engine XFX (ES9J4S)	210141	Drive Shaft		25	37	58.5	89	638	
	2001.06-2004.08	MT	R	F	Estate Engine XFX (ES9J4S)	210139	Drive Shaft		25	37	58.5	89	944	
	2001.06-2004.08	-	-	-	Estate Engine XFX (ES9J4S)	810096	Outer Joint		25	26	58.5	89	61.5	M
	2001.06-2004.08	AT	L	F	Estate Engine XFX (ES9J4S)	610043	Inner Joint		37	26	40.5	67.5	104	
3.0 V6 (152 kW)	2001.06-2004.08	AT	-	F	Estate Engine XFX (ES9J4S)	810075	Outer Joint		25	26	58.5	89	63	M
	2001.06-2004.08	AT	-	F	Estate Engine RHZ (DW10ATED)	845041	Outer Joint	48T	25	34	58.5	89	55	I
C5 II (RC_)														
1.6 HDi (80 kW)	2004.09- -	-	L	F	Hatchback Engine 9HZ (DV6TED4)/9HY (DV6TED4)	810158	Outer Joint		25	26	58.5	89	61.5	M
	2004.09- -	-	L	F	Hatchback Engine 9HZ (DV6TED4)/9HY (DV6TED4)	210192	Drive Shaft		25	24	58.5	89	655	
	2004.09- -	-	R	F	Hatchback Engine 9HZ (DV6TED4)/9HY (DV6TED4)	210143	Drive Shaft		25	24	58.5	89	936	
	2004.09- -	MT	L	F	Hatchback Engine 9HZ (DV6TED4)/9HY (DV6TED4)	245140	Drive Shaft		25	24	58.5	89	650	
	2004.09- -	-	L	F	Hatchback Engine 9HZ (DV6TED4)/9HY (DV6TED4)	210142	Drive Shaft		25	24	58.5	89	648	
	2004.09- -	MT	R	F	Hatchback Engine 9HZ (DV6TED4)/9HY (DV6TED4)	299189	Drive Shaft		25	24	58.5	89	936	
	2004.09- -	MT	L/R	F	Hatchback Engine 9HZ (DV6TED4)/9HY (DV6TED4)	845038	Outer Joint		25	34	58.5	89	55	I
	2004.09- -	-	-	F	Hatchback Engine 9HZ (DV6TED4)/9HY (DV6TED4)	845041	Outer Joint	48T	25	34	58.5	89	55	I
1.8 16V (85 kW)	2004.09- -	-	L	F	Hatchback Engine 6FZ (EW7J4)	810158	Outer Joint		25	26	58.5	89	61.5	M
	2004.09- -	-	L	F	Hatchback Engine 6FZ (EW7J4)	210192	Drive Shaft		25	24	58.5	89	655	
	2004.09- -	-	R	F	Hatchback Engine 6FZ (EW7J4)	210143	Drive Shaft		25	24	58.5	89	936	
	2004.09- -	MT	L	F	Hatchback Engine 6FZ (EW7J4)	245140	Drive Shaft		25	24	58.5	89	650	
	2004.09- -	-	L	F	Hatchback Engine 6FZ (EW7J4)	210142	Drive Shaft		25	24	58.5	89	648	
	2004.09- -	MT	R	F	Hatchback Engine 6FZ (EW7J4)	299189	Drive Shaft		25	24	58.5	89	936	
	2004.09- -	MT	L/R	F	Hatchback Engine 6FZ (EW7J4)	845038	Outer Joint		25	34	58.5	89	55	I
	2004.09- -	-	-	F	Hatchback Engine 6FZ (EW7J4)	845041	Outer Joint	48T	25	34	58.5	89	55	I
1.8 16V (92 kW)	2005.09- -	-	L	F	Hatchback Engine 6FY (EW7A)	810158	Outer Joint		25	26	58.5	89	61.5	M
	2005.09- -	-	L	F	Hatchback Engine 6FY (EW7A)	210192	Drive Shaft		25	24	58.5	89	655	
	2005.09- -	-	R	F	Hatchback Engine 6FY (EW7A)	210143	Drive Shaft		25	24	58.5	89	936	
	2005.09- -	-	L	F	Hatchback Engine 6FY (EW7A)	210142	Drive Shaft		25	24	58.5	89	648	
	2005.09- -	-	-	F	Hatchback Engine 6FY (EW7A)	810052	Outer Joint		28	34	58.5	92	55	I
	2005.09- -	MT	L	F	Hatchback Engine 6FY (EW7A)	210238	Drive Shaft		28	24	58.5	92	669	
	2005.09- -	MT	L/R	F	Hatchback Engine 6FY (EW7A)	845038	Outer Joint		25	34	58.5	89	55	I
2.0 16V (103 kW)	2004.09- -	MT	L	F	Hatchback Engine RFJ (EW10A)	810158	Outer Joint		25	26	58.5	89	61.5	M
	2004.09- -	MT	L	F	Hatchback Engine RFJ (EW10A)	210192	Drive Shaft		25	24	58.5	89	655	
	2004.09- -	MT	R	F	Hatchback Engine RFJ (EW10A)	210143	Drive Shaft		25	24	58.5	89	936	
	2004.09- -	MT	L	F	Hatchback Engine RFJ (EW10A)	210142	Drive Shaft		25	24	58.5	89	648	
	2004.09- -	MT	L/R	F	Hatchback Engine RFJ (EW10A)	845038	Outer Joint		25	34	58.5	89	55	I
	2004.09- -	AT	R	F	Hatchback Engine RFJ (EW10A)	210444	Drive Shaft		25	26	58	89	843	
	2004.09- -	AT	L	F	Hatchback Engine RFJ (EW10A)	210443	Drive Shaft		25	26	58	89	635	
	2004.09- -	AT	-	F	Hatchback Engine RFJ (EW10A)	810075	Outer Joint		25	26	58.5	89	63	M
2.0 HDi (100 kW)	2004.09- -	AT	L	F	Hatchback Engine RFJ (EW10A)	699001	Inner Joint		26	34	42.5	46.5	103.5	
	2004.09- -	5AT	L	F	Hatchback Engine RHR (DW10BTED4)	299172	Drive Shaft		25	37	58.5	89	623	
	2004.09- -	MT	L	F	Hatchback Engine RHR (DW10BTED4)	210312	Drive Shaft		25	37	58.5	89	625	
	2004.09- -	MT	L	F	Hatchback Engine RHR (DW10BTED4)	210121	Drive Shaft		25	37	58.5	89	628	





	 YEAR	TRANSM	L/R	F/R	REMARKS	GSP Ref.	 PRODUCT	 ABS	Technical Specifications							
									A	B	C	H	L	P		
CITROEN																
C5 II (RC_)																
2.0 HDi (100 kW)	2004.09.-	-	AT	R	F	Hatchback Engine RHR (DW10BTED4)	610090	Inner Joint		37	26	31.5	379.5	112		
	2004.09.-	-	MT	R	F	Hatchback Engine RHR (DW10BTED4)	299197	Drive Shaft		25	37	58.5	89	947		
	2004.09.-	-	MT	-	F	Hatchback Engine RHR (DW10BTED4)	810075	Outer Joint		25	26	58.5	89	63	M	
	2004.09.-	-	AT	L	F	Hatchback Engine RHR (DW10BTED4)	210381	Drive Shaft		25	37	58.5	89	595		
	2004.09.-	-	AT	R	F	Hatchback Engine RHR (DW10BTED4)	210348	Drive Shaft		25	37	58.5	89	927		
2.2 HDi (120 kW)	2006.05.-	-	MT	R	F	Hatchback Engine 4HP (DW12BTED4)/4Hr (DW12BTED4)	210313	Drive Shaft		25	37	58.5	89	950		
	2006.05.-	-	AT	L	F	Hatchback Engine 4HP (DW12BTED4)/4Hr (DW12BTED4)	210381	Drive Shaft		25	37	58.5	89	595		
2.2 HDi (125 kW)	2006.04.-	-	MT	L	F	Hatchback Engine 4HT (DW12BTED4)	210312	Drive Shaft		25	37	58.5	89	625		
	2006.04.-	-	MT	R	F	Hatchback Engine 4HT (DW12BTED4)	210313	Drive Shaft		25	37	58.5	89	950		
	2006.04.-	-	AT	-	F	Hatchback Engine 4HT (DW12BTED4)	810075	Outer Joint		25	26	58.5	89	63	M	
	2006.04.-	-	AT	L	F	Hatchback Engine 4HT (DW12BTED4)	210381	Drive Shaft		25	37	58.5	89	595		
2.2 HDi (98 kW)	2004.09.-	-	MT	L	F	Hatchback Engine 4HX (DW12TED4/FAP)	210312	Drive Shaft		25	37	58.5	89	625		
	2004.09.-	-	MT	L	F	Hatchback Engine 4HX (DW12TED4/FAP)	210121	Drive Shaft		25	37	58.5	89	628		
	2004.09.-	-	MT	R	F	Hatchback Engine 4HX (DW12TED4/FAP)	210140	Drive Shaft		25	37	58.5	89	948		
	2004.09.-	-	AT	L	F	Hatchback Engine 4HX (DW12TED4/FAP)	210207	Drive Shaft		25	37	58.5	89	602		
	2004.09.-	-	AT	R	F	Hatchback Engine 4HX (DW12TED4/FAP)	210208	Drive Shaft		25	37	58.5	89	908		
	2004.09.-	-	AT	L	F	Hatchback Engine 4HX (DW12TED4/FAP)	610043	Inner Joint		37	26	40.5	67.5	104		
3.0 V6 (152 kW)	2004.09.-	-	AT	L	F	Hatchback Engine XFX (ES9J4S)/XFU (ES9J4S)	210344	Drive Shaft		25	37	58.5	89	607		
	2004.09.-	-	AT	L	F	Hatchback Engine XFX (ES9J4S)/XFU (ES9J4S)	610043	Inner Joint		37	26	40.5	67.5	104		
	2004.09.-	-	AT	L	F	Hatchback Engine XFX (ES9J4S)/XFU (ES9J4S)	210381	Drive Shaft		25	37	58.5	89	595		
	2004.09.-	-	AT	R	F	Hatchback Engine XFX (ES9J4S)/XFU (ES9J4S)	210382	Drive Shaft		25	37	58.5	89	929		
	2004.09.-	-	AT	-	F	Hatchback Engine XFX (ES9J4S)/XFU (ES9J4S)	810075	Outer Joint		25	26	58.5	89	63	M	
3.0 V6 (155 kW)	2004.10.-	2007.04	AT	L	F	Hatchback Engine XFV (ES9A)	210344	Drive Shaft		25	37	58.5	89	607		
	2004.10.-	2007.04	AT	L	F	Hatchback Engine XFV (ES9A)	610043	Inner Joint		37	26	40.5	67.5	104		
	2004.10.-	2007.04	AT	-	F	Hatchback Engine XFV (ES9A)	810075	Outer Joint		25	26	58.5	89	63	M	
C5 II Break (RE_)																
1.6 HDi (80 kW)	2004.09.-	-	-	-	F	Estate Engine 9Hz (DV6TED4)/9hY (DV6TED4)	845041	Outer Joint	48T	25	34	58.5	89	55	I	
	2004.09.-	-	-	-	L	F	Estate Engine 9Hz (DV6TED4)/9hY (DV6TED4)	810158	Outer Joint		25	26	58.5	89	61.5	M
	2004.09.-	-	-	-	L	F	Estate Engine 9Hz (DV6TED4)/9hY (DV6TED4)	210192	Drive Shaft		25	24	58.5	89	655	
	2004.09.-	-	-	-	R	F	Estate Engine 9Hz (DV6TED4)/9hY (DV6TED4)	210143	Drive Shaft		25	24	58.5	89	936	
	2004.09.-	-	MT	L	F	Estate Engine 9Hz (DV6TED4)/9hY (DV6TED4)	245140	Drive Shaft		25	24	58.5	89	650		
	2004.09.-	-	-	-	L	F	Estate Engine 9Hz (DV6TED4)/9hY (DV6TED4)	210142	Drive Shaft		25	24	58.5	89	648	
	2004.09.-	-	MT	R	F	Estate Engine 9Hz (DV6TED4)/9hY (DV6TED4)	299189	Drive Shaft		25	24	58.5	89	936		
	2004.09.-	-	MT	L/R	F	Estate Engine 9Hz (DV6TED4)/9hY (DV6TED4)	845038	Outer Joint		25	34	58.5	89	55	I	
1.8 16V (85 kW)	2004.09.-	-	-	-	F	Estate Engine 6FZ (EW7J4)	845041	Outer Joint	48T	25	34	58.5	89	55	I	
	2004.09.-	-	-	-	L	F	Estate Engine 6FZ (EW7J4)	810158	Outer Joint		25	26	58.5	89	61.5	M
	2004.09.-	-	-	-	L	F	Estate Engine 6FZ (EW7J4)	210192	Drive Shaft		25	24	58.5	89	655	
	2004.09.-	-	-	-	R	F	Estate Engine 6FZ (EW7J4)	210143	Drive Shaft		25	24	58.5	89	936	
	2004.09.-	-	-	-	L	F	Estate Engine 6FZ (EW7J4)	210142	Drive Shaft		25	24	58.5	89	648	
	2004.09.-	-	MT	L	F	Estate Engine 6FZ (EW7J4)	245140	Drive Shaft		25	24	58.5	89	650		
	2004.09.-	-	MT	R	F	Estate Engine 6FZ (EW7J4)	299189	Drive Shaft		25	24	58.5	89	936		
	2004.09.-	-	MT	L/R	F	Estate Engine 6FZ (EW7J4)	845038	Outer Joint		25	34	58.5	89	55	I	
1.8 16V (92 kW)	2005.09.-	-	-	-	L	F	Estate Engine 6FY (EW7A)	810158	Outer Joint		25	26	58.5	89	61.5	M
	2005.09.-	-	-	-	L	F	Estate Engine 6FY (EW7A)	210192	Drive Shaft		25	24	58.5	89	655	
	2005.09.-	-	-	-	R	F	Estate Engine 6FY (EW7A)	210143	Drive Shaft		25	24	58.5	89	936	
	2005.09.-	-	-	-	L	F	Estate Engine 6FY (EW7A)	210142	Drive Shaft		25	24	58.5	89	648	
	2005.09.-	-	-	-	-	F	Estate Engine 6FY (EW7A)	810052	Outer Joint		28	34	58.5	92	55	I
	2005.09.-	-	MT	L	F	Estate Engine 6FY (EW7A)	210238	Drive Shaft		28	24	58.5	92	669		
	2005.09.-	-	MT	L/R	F	Estate Engine 6FY (EW7A)	845038	Outer Joint		25	34	58.5	89	55	I	
2.0 16V (103 kW)	2004.09.-	-	MT	L	F	Estate Engine RFJ (EW10A)	810158	Outer Joint		25	26	58.5	89	61.5	M	
	2004.09.-	-	MT	L	F	Estate Engine RFJ (EW10A)	210192	Drive Shaft		25	24	58.5	89	655		
	2004.09.-	-	MT	L	F	Estate Engine RFJ (EW10A)	299172	Drive Shaft		25	37	58.5	89	623		
	2004.09.-	-	AT	R	F	Estate Engine RFJ (EW10A)	210143	Drive Shaft		25	24	58.5	89	936		
	2004.09.-	-	MT	L	F	Estate Engine RFJ (EW10A)	210142	Drive Shaft		25	24	58.5	89	648		
	2004.09.-	-	MT	L/R	F	Estate Engine RFJ (EW10A)	845038	Outer Joint		25	34	58.5	89	55	I	
	2004.09.-	-	AT	-	F	Estate Engine RFJ (EW10A)	810075	Outer Joint		25	26	58.5	89	63	M	
2.0 HDi (100 kW)	2004.09.-	-	5AT	L	F	Estate Engine RHR (DW10BTED4)	299172	Drive Shaft		25	37	58.5	89	623		
	2004.09.-	-	AT	L	F	Estate Engine RHR (DW10BTED4)	210344	Drive Shaft		25	37	58.5	89	607		
	2004.09.-	-	MT	L	F	Estate Engine RHR (DW10BTED4)	210312	Drive Shaft		25	37	58.5	89	625		
	2004.09.-	-	MT	L	F	Estate Engine RHR (DW10BTED4)	210121	Drive Shaft		25	37	58.5	89	628		
	2004.09.-	-	AT	R	F	Estate Engine RHR (DW10BTED4)	610090	Inner Joint		37	26	31.5	379.5	112		
	2004.09.-	-	AT	L	F	Estate Engine RHR (DW10BTED4)	610043	Inner Joint		37	26	40.5	67.5	104		
	2004.09.-	-	MT	R	F	Estate Engine RHR (DW10BTED4)	299197	Drive Shaft		25	37	58.5	89	947		
	2004.09.-	-	AT	L	F	Estate Engine RHR (DW10BTED4)	210381	Drive Shaft		25	37	58.5	89	595		
	2004.09.-	-	AT	R	F	Estate Engine RHR (DW10BTED4)	210348	Drive Shaft		25	37	58.5	89	927		
2.2 HDi (120 kW)	2006.05.-	-	MT	R	F	Estate Engine 4Hp (DW12BTED4)/4HR (DW12BTED4)	210313	Drive Shaft		25	37	58.5	89	950		

	 YEAR	TRANSM	L/R	F/R	REMARKS	GSP Ref.	 PRODUCT	 ABS	Technical Specifications						
									A	B	C	H	L	P	
CITROEN															
C5 II Break (RE_)															
2.2 HDi (120 kW)	2006.05-	-	AT	L	F	Estate Engine 4Hp (DW12BTE4)/4HR (DW12BTE4)	210381	Drive Shaft		25	37	58.5	89	595	
2.2 HDi (125 kW)	2006.04-	-	MT	L	F	Estate Engine 4HT (DW12BTE4)	210312	Drive Shaft		25	37	58.5	89	625	
	2006.04-	-	MT	R	F	Estate Engine 4HT (DW12BTE4)	210313	Drive Shaft		25	37	58.5	89	950	
	2006.04-	-	AT	L	F	Estate Engine 4HT (DW12BTE4)	210381	Drive Shaft		25	37	58.5	89	595	
	2006.04-	-	-	-	F	Estate Engine 4HT (DW12BTE4)	810075	Outer Joint		25	26	58.5	89	63	M
2.2 HDi (98 kW)	2004.09-	-	MT	L	F	Estate Engine 4HX (DW12TED4/FAP)	210312	Drive Shaft		25	37	58.5	89	625	
	2004.09-	-	MT	L	F	Estate Engine 4HX (DW12TED4/FAP)	210121	Drive Shaft		25	37	58.5	89	628	
	2004.09-	-	MT	R	F	Estate Engine 4HX (DW12TED4/FAP)	210140	Drive Shaft		25	37	58.5	89	948	
	2004.09-	-	AT	L	F	Estate Engine 4HX (DW12TED4/FAP)	210207	Drive Shaft		25	37	58.5	89	602	
	2004.09-	-	AT	R	F	Estate Engine 4HX (DW12TED4/FAP)	210208	Drive Shaft		25	37	58.5	89	908	
	2004.09-	-	AT	L	F	Estate Engine 4HX (DW12TED4/FAP)	610043	Inner Joint		37	26	40.5	67.5	104	
3.0 (173 kW)	2004.09-	-	AT	-	F	Estate Engine 4HX (DW12TED4/FAP)	810075	Outer Joint		25	26	58.5	89	63	M
	2004.09-	-	AT	L	F	Estate Engine XFX (ES9J4S)	210344	Drive Shaft		25	37	58.5	89	607	
	2004.09-	-	AT	L	F	Estate Engine XFX (ES9J4S)	610043	Inner Joint		37	26	40.5	67.5	104	
	2004.09-	-	AT	L	F	Estate Engine XFX (ES9J4S)	210381	Drive Shaft		25	37	58.5	89	595	
3.0 V6 (152 kW)	2004.09-	-	AT	R	F	Estate Engine XFX (ES9J4S)	210382	Drive Shaft		25	37	58.5	89	929	
	2004.09-	-	-	-	F	Estate Engine XFX (ES9J4S)	810075	Outer Joint		25	26	58.5	89	63	M
	2004.09-	-	AT	L	F	Estate Engine XFU (ES9A)	210344	Drive Shaft		25	37	58.5	89	607	
	2004.09-	-	AT	L	F	Estate Engine XFU (ES9A)	610043	Inner Joint		37	26	40.5	67.5	104	
	2004.09-	-	AT	L	F	Estate Engine XFU (ES9A)	210381	Drive Shaft		25	37	58.5	89	595	
3.0 V6 (155 kW)	2004.09-	-	AT	R	F	Estate Engine XFU (ES9A)	210382	Drive Shaft		25	37	58.5	89	929	
	2004.09-	-	-	-	F	Estate Engine XFU (ES9A)	810075	Outer Joint		25	26	58.5	89	63	M
	2004.10-2007.04		AT	L	F	Estate Engine XFU (ES9A)	210344	Drive Shaft		25	37	58.5	89	607	
	2004.10-2007.04		AT	L	F	Estate Engine XFU (ES9A)	610043	Inner Joint		37	26	40.5	67.5	104	
	2004.10-2007.04		AT	L	F	Estate Engine XFU (ES9A)	210381	Drive Shaft		25	37	58.5	89	595	
2004.10-2007.04		AT	R	F	Estate Engine XFU (ES9A)	210382	Drive Shaft		25	37	58.5	89	929		
2004.10-2007.04		-	-	F	Estate Engine XFU (ES9A)	810075	Outer Joint		25	26	58.5	89	63	M	
C5 III (RD_)															
1.6 HDi 110 (80 kW)	2008.02-	-	-	-	F	Saloon Engine 9HZ (DV6TED4)	810052	Outer Joint		28	34	58.5	92	55	I
	2008.02-	-	MT	L	F	Saloon Engine 9HZ (DV6TED4)	210238	Drive Shaft		28	24	58.5	92	669	
	2008.02-	-	5MT	R	F	Saloon Engine 9HZ (DV6TED4)	210265	Drive Shaft		28	24	59	91	951	
	2008.02-	-	5MT	L	F	Saloon Engine 9HZ (DV6TED4)	210310	Drive Shaft		28	24	59	91	670	
	2008.02-	-	-	-	F	Saloon Engine 9HZ (DV6TED4)	810051	Outer Joint		28	39	58.6	94	63	I
1.6 HDi 115 (84 kW)	2012.01-	-	-	-	F	Saloon Engine 9HR (DV6C)/9HL (DV6C)	810052	Outer Joint		28	34	58.5	92	55	I
1.8 16V (92 kW)	2008.02-	-	-	-	F	Saloon Engine 6FY (EW7A)	810052	Outer Joint		28	34	58.5	92	55	I
	2008.02-	-	MT	L	F	Saloon Engine 6FY (EW7A)	210238	Drive Shaft		28	24	58.5	92	669	
	2008.02-	-	5MT	R	F	Saloon Engine 6FY (EW7A)	210265	Drive Shaft		28	24	59	91	951	
	2008.02-	-	5MT	L	F	Saloon Engine 6FY (EW7A)	210310	Drive Shaft		28	24	59	91	670	
2.0 16V (103 kW)	2008.02-	-	AT	L	F	Saloon Engine RFJ (EW10A)	699001	Inner Joint		26	34	42.5	46.5	103.5	
	2008.02-	-	-	-	F	Saloon Engine RFJ (EW10A)	810052	Outer Joint		28	34	58.5	92	55	I
	2008.02-	-	MT	L	F	Saloon Engine RFJ (EW10A)	210238	Drive Shaft		28	24	58.5	92	669	
	2008.02-	-	5MT	R	F	Saloon Engine RFJ (EW10A)	210265	Drive Shaft		28	24	59	91	951	
	2008.02-	-	AT	L	F	Saloon Engine RFJ (EW10A)	210285	Drive Shaft		28	26	58.5	92	661	
	2008.02-	-	5MT	L	F	Saloon Engine RFJ (EW10A)	210310	Drive Shaft		28	24	59	91	670	
	2008.02-	-	AT	R	F	Saloon Engine RFJ (EW10A)	210283	Drive Shaft		28	26	58.5	92	866	
	2008.02-	-	MT	R	F	Saloon Engine RHR (DW10BTE4)/RHF (DW10BTE4)	610041	Inner Joint		37	39	32	399	95.5	
2008.02-	-	AT	R	F	Saloon Engine RHR (DW10BTE4)/RHF (DW10BTE4)	210396	Drive Shaft		28	37	58.6	94	925		
2.0 HDi (100 kW)	2008.02-	-	MT	L	F	Saloon Engine RHR (DW10BTE4)/RHF (DW10BTE4)	645032	Inner Joint		37	39	40	68.5	100	
	2008.02-	-	AT	-	F	Saloon Engine RHR (DW10BTE4)/RHF (DW10BTE4)	810115	Outer Joint		28	26	58.5	92.5	61.5	M
	2008.02-	-	MT	-	F	Saloon Engine RHR (DW10BTE4)/RHF (DW10BTE4)	845074	Outer Joint		28	26	59	91	61.5	M
	2008.02-	-	AT	R	F	Saloon Engine RHR (DW10BTE4)/RHF (DW10BTE4)	810159	Outer Joint		28	39	58.6	94	63	I
	2008.02-	-	AT	R	F	Saloon Engine RHR (DW10BTE4)/RHF (DW10BTE4)	210384	Drive Shaft		28	37	59	91	960	
	2008.02-	-	MT	R	F	Saloon Engine RHR (DW10BTE4)/RHF (DW10BTE4)	210302	Drive Shaft		28	37	58.6	94	969	
	2008.02-	-	MT	R	F	Saloon Engine RHR (DW10BTE4)/RHF (DW10BTE4)	210342	Drive Shaft		28	37	58.5	92.5	976	
	2008.02-	-	AT	R	F	Saloon Engine RHR (DW10BTE4)/RHF (DW10BTE4)	210243	Drive Shaft		28	37	58.5	92.5	957	
	2008.02-	-	AT	L	F	Saloon Engine RHR (DW10BTE4)/RHF (DW10BTE4)	210335	Drive Shaft		28	37	58.5	92.5	618	
	2008.02-	-	-	-	F	Saloon Engine RHR (DW10BTE4)/RHF (DW10BTE4)	810051	Outer Joint		28	39	58.6	94	63	I
	2008.02-	-	AT	L	F	Saloon Engine RHR (DW10BTE4)/RHF (DW10BTE4)	610043	Inner Joint		37	26	40.5	67.5	104	
	2.0 HDi 140 (103 kW)	2009.04-	-	MT	R	F	Saloon Engine RHF (DW10BTE4)	610041	Inner Joint		37	39	32	399	95.5
2009.04-		-	AT	R	F	Saloon Engine RHF (DW10BTE4)	210396	Drive Shaft		28	37	58.6	94	925	
2009.04-		-	AT	-	F	Saloon Engine RHF (DW10BTE4)	810115	Outer Joint		28	26	58.5	92.5	61.5	M
2009.04-		-	MT	-	F	Saloon Engine RHF (DW10BTE4)	845074	Outer Joint		28	26	59	91	61.5	M
2009.04-		-	AT	R	F	Saloon Engine RHF (DW10BTE4)	810159	Outer Joint		28	39	58.6	94	63	I
2009.04-		-	MT	L	F	Saloon Engine RHF (DW10BTE4)	645032	Inner Joint		37	39	40	68.5	100	
2009.04-		-	AT	R	F	Saloon Engine RHF (DW10BTE4)	210384	Drive Shaft		28	37	59	91	960	
2009.04-		-	MT	R	F	Saloon Engine RHF (DW10BTE4)	210302	Drive Shaft		28	37	58.6	94	969	





	 YEAR	TRANSM	L/R	F/R	REMARKS	GSP Ref.	 PRODUCT	 ABS	Technical Specifications									
									A	B	C	H	L	P				
CITROEN																		
C5 III (RD_)																		
2.0 HDi 140 (103 kW)	2009.04.-	-	MT	R	F	Saloon Engine RHF (DW10BTED4)	210342	Drive Shaft		28	37	58.5	92.5	976				
	2009.04.-	-	AT	R	F	Saloon Engine RHF (DW10BTED4)	210243	Drive Shaft		28	37	58.5	92.5	957				
	2009.04.-	-	AT	L	F	Saloon Engine RHF (DW10BTED4)	210335	Drive Shaft		28	37	58.5	92.5	618				
	2009.04.-	-	-	-	F	Saloon Engine RHF (DW10BTED4)	810051	Outer Joint		28	39	58.6	94	63	I			
	2009.04.-	-	AT	L	F	Saloon Engine RHF (DW10BTED4)	610043	Inner Joint		37	26	40.5	67.5	104				
2.0 HDi 150 / BlueHDi 150 (110 kW)	2009.04.-	-	AT	L	F	Saloon Engine RHE (DW10CTED4)/AHR(DW10FD)	610161	Inner joint		37	26	40.5	65.5	100				
	2009.04.-	-	MT	R	F	Saloon Engine RHE (DW10CTED4)/AHR(DW10FD)	610041	Inner Joint		37	39	32	399	95.5				
	2009.04.-	-	AT	L	F	Saloon Engine RHE (DW10CTED4)/AHR(DW10FD)	245225	Drive Shaft		28	37	59	91	621				
	2009.04.-	-	AT	R	F	Saloon Engine RHE (DW10CTED4)/AHR(DW10FD)	210416	Drive Shaft		28	37	59	91	955				
	2009.04.-	-	AT	-	F	Saloon Engine RHE (DW10CTED4)/AHR(DW10FD)	810115	Outer Joint		28	26	58.5	92.5	61.5	M			
	2009.04.-	-	MT	-	F	Saloon Engine RHE (DW10CTED4)/AHR(DW10FD)	845074	Outer Joint		28	26	59	91	61.5	M			
	2009.04.-	-	AT	R	F	Saloon Engine RHE (DW10CTED4)/AHR(DW10FD)	210384	Drive Shaft		28	37	59	91	960				
	2009.04.-	-	MT	R	F	Saloon Engine RHE (DW10CTED4)/AHR(DW10FD)	210302	Drive Shaft		28	37	58.6	94	969				
	2009.04.-	-	MT	L	F	Saloon Engine RHE (DW10CTED4)/AHR(DW10FD)	210314	Drive Shaft		28	37	59	91	655				
	2009.04.-	-	-	-	F	Saloon Engine RHE (DW10CTED4)/AHR(DW10FD)	810051	Outer Joint		28	39	58.6	94	63	I			
2.0 HDi 165 (120 kW)	2009.04.-	-	AT	L	F	Saloon Engine RHH (DW10CTED4)	610161	Inner joint		37	26	40.5	65.5	100				
	2009.04.-	-	MT	R	F	Saloon Engine RHH (DW10CTED4)	610041	Inner Joint		37	39	32	399	95.5				
	2009.04.-	-	AT	L	F	Saloon Engine RHH (DW10CTED4)	245225	Drive Shaft		28	37	59	91	621				
	2009.04.-	-	AT	R	F	Saloon Engine RHH (DW10CTED4)	210416	Drive Shaft		28	37	59	91	955				
	2009.04.-	-	AT	-	F	Saloon Engine RHH (DW10CTED4)	810115	Outer Joint		28	26	58.5	92.5	61.5	M			
	2009.04.-	-	MT	-	F	Saloon Engine RHH (DW10CTED4)	845074	Outer Joint		28	26	59	91	61.5	M			
	2009.04.-	-	MT	L	F	Saloon Engine RHH (DW10CTED4)	645032	Inner Joint		37	39	40	68.5	100				
	2009.04.-	-	AT	R	F	Saloon Engine RHH (DW10CTED4)	210384	Drive Shaft		28	37	59	91	960				
	2009.04.-	-	MT	R	F	Saloon Engine RHH (DW10CTED4)	210302	Drive Shaft		28	37	58.6	94	969				
	2009.04.-	-	MT	L	F	Saloon Engine RHH (DW10CTED4)	210314	Drive Shaft		28	37	59	91	655				
2.2 HDi (125 kW)	2008.02.-	-	6MT	R	F	Saloon Engine 4HT (DW12BTED4)	210320	Drive Shaft		28	37	59	91	980				
2.2 HDi 200 (150 kW)	2010.07.-	-	-	L	F	Saloon Engine 4HL (DW12C)	610161	Inner joint		37	26	40.5	65.5	100				
	2010.07.-	-	-	L	F	Saloon Engine 4HL (DW12C)	245225	Drive Shaft		28	37	59	91	621				
	2010.07.-	-	-	R	F	Saloon Engine 4HL (DW12C)	210416	Drive Shaft		28	37	59	91	955				
2.7 HDi (150 kW)	2008.02.-	-	AT	R	F	Saloon Engine DT17ED4	210396	Drive Shaft		28	37	58.6	94	925				
	2008.02.-	-	AT	R	F	Saloon Engine DT17ED4	810159	Outer Joint		28	39	58.6	94	63	I			
	2008.02.-	-	-	L	F	Saloon Engine DT17ED4	210335	Drive Shaft		28	37	58.5	92.5	618				
	2008.02.-	-	-	L	F	Saloon Engine DT17ED4	610043	Inner Joint		37	26	40.5	67.5	104				
3.0 HDi 240 (177 kW)	2009.04.-	-	-	L	F	Saloon Engine DT20C	610161	Inner joint		37	26	40.5	65.5	100				
	2009.04.-	-	-	L	F	Saloon Engine DT20C	245225	Drive Shaft		28	37	59	91	621				
	2009.04.-	-	AT	R	F	Saloon Engine DT20C	210384	Drive Shaft		28	37	59	91	960				
3.0 V6 (155 kW)	2008.02.-	-	-	L	F	Saloon Engine XFU (ES9A)	210335	Drive Shaft		28	37	58.5	92.5	618				
	2008.02.-	-	-	L	F	Saloon Engine XFU (ES9A)	610043	Inner Joint		37	26	40.5	67.5	104				
C5 III Break (TD_)																		
1.6 HDi 110 (80 kW)	2008.02.-	-	-	-	F	Saloon Engine 9HZ (DV6TED4)	810052	Outer Joint		28	34	58.5	92	55	I			
	2008.02.-	-	MT	L	F	Saloon Engine 9HZ (DV6TED4)	210238	Drive Shaft		28	24	58.5	92	669				
	2008.02.-	-	-	R	F	Saloon Engine 9HZ (DV6TED4)	210265	Drive Shaft		28	24	59	91	951				
	2008.02.-	-	-	L	F	Saloon Engine 9HZ (DV6TED4)	210310	Drive Shaft		28	24	59	91	670				
	2008.02.-	-	-	-	F	Saloon Engine 9HZ (DV6TED4)	810051	Outer Joint		28	39	58.6	94	63	I			
1.6 HDi 110 (82 kW)	2010.07.-	-	-	-	F	Saloon Engine 9HR (DV6C)/9HL (DV6C)	810052	Outer Joint		28	34	58.5	92	55	I			
	2010.07.-	-	MT	L	F	Saloon Engine 9HR (DV6C)/9HL (DV6C)	210238	Drive Shaft		28	24	58.5	92	669				
	2010.07.-	-	-	-	F	Saloon Engine 9HR (DV6C)/9HL (DV6C)	810051	Outer Joint		28	39	58.6	94	63	I			
1.6 HDi 115 (84 kW)	2012.01.-	-	-	-	F	Saloon Engine 9HR (DV6C)/9HL (DV6C)	810052	Outer Joint		28	34	58.5	92	55	I			
1.8 16V (92 kW)	2008.02.-	-	-	-	F	Saloon Engine 6FY (EW7A)	810052	Outer Joint		28	34	58.5	92	55	I			
	2008.02.-	-	MT	L	F	Saloon Engine 6FY (EW7A)	210238	Drive Shaft		28	24	58.5	92	669				
	2008.02.-	-	-	R	F	Saloon Engine 6FY (EW7A)	210265	Drive Shaft		28	24	59	91	951				
2.0 16V (103 kW)	2008.02.-	-	AT	L	F	Saloon Engine RFJ (EW10A)	699001	Inner Joint		26	34	42.5	46.5	103.5				
	2008.02.-	-	-	-	F	Saloon Engine RFJ (EW10A)	810052	Outer Joint		28	34	58.5	92	55	I			
	2008.02.-	-	MT	L	F	Saloon Engine RFJ (EW10A)	210238	Drive Shaft		28	24	58.5	92	669				
	2008.02.-	-	5MT	R	F	Saloon Engine RFJ (EW10A)	210265	Drive Shaft		28	24	59	91	951				
	2008.02.-	-	AT	L	F	Saloon Engine RFJ (EW10A)	210285	Drive Shaft		28	26	58.5	92	661				
	2008.02.-	-	5MT	L	F	Saloon Engine RFJ (EW10A)	210310	Drive Shaft		28	24	59	91	670				
	2008.02.-	-	AT	R	F	Saloon Engine RFJ (EW10A)	210283	Drive Shaft		28	26	58.5	92	866				
2.0 HDi (100 kW)	2008.02.-	-	MT	R	F	Saloon Engine RHR (DW10BTED4)	610041	Inner Joint		37	39	32	399	95.5				
	2008.02.-	-	AT	R	F	Saloon Engine RHR (DW10BTED4)	210396	Drive Shaft		28	37	58.6	94	925				
	2008.02.-	-	MT	L	F	Saloon Engine RHR (DW10BTED4)	645032	Inner Joint		37	39	40	68.5	100				
	2008.02.-	-	AT	-	F	Saloon Engine RHR (DW10BTED4)	810115	Outer Joint		28	26	58.5	92.5	61.5	M			
	2008.02.-	-	MT	-	F	Saloon Engine RHR (DW10BTED4)	845074	Outer Joint		28	26	59	91	61.5	M			
	2008.02.-	-	AT	R	F	Saloon Engine RHR (DW10BTED4)	810159	Outer Joint		28	39	58.6	94	63	I			
	2008.02.-	-	AT	R	F	Saloon Engine RHR (DW10BTED4)	210384	Drive Shaft		28	37	59	91	960				

YEAR	TRANSM	L/R	F/R	REMARKS	GSP Ref.	PRODUCT	ABS	Technical Specifications						
								A	B	C	H	L	P	
CITROEN														
C5 III Break (TD_)														
2.0 HDi (100 kW)	2008.02.-	-	MT	R	F	Saloon Engine RHR (DW10BTED4)	210302	Drive Shaft	28	37	58.6	94	969	
	2008.02.-	-	MT	R	F	Saloon Engine RHR (DW10BTED4)	210342	Drive Shaft	28	37	58.5	92.5	976	
	2008.02.-	-	AT	R	F	Saloon Engine RHR (DW10BTED4)	210243	Drive Shaft	28	37	58.5	92.5	957	
	2008.02.-	-	6AT	L	F	Saloon Engine RHR (DW10BTED4)	210335	Drive Shaft	28	37	58.5	92.5	618	
	2008.02.-	-	-	-	F	Saloon Engine RHR (DW10BTED4)	810051	Outer Joint	28	39	58.6	94	63	I
	2008.02.-	-	6AT	L	F	Saloon Engine RHR (DW10BTED4)	610043	Inner Joint	37	26	40.5	67.5	104	
2.0 HDi 140 (103 kW)	2009.04.-	-	MT	R	F	Saloon Engine RHF (DW10BTED4)	610041	Inner Joint	37	39	32	399	95.5	
	2009.04.-	-	AT	R	F	Saloon Engine RHF (DW10BTED4)	210396	Drive Shaft	28	37	58.6	94	925	
	2009.04.-	-	AT	-	F	Saloon Engine RHF (DW10BTED4)	810115	Outer Joint	28	26	58.5	92.5	61.5	M
	2009.04.-	-	MT	-	F	Saloon Engine RHF (DW10BTED4)	845074	Outer Joint	28	26	59	91	61.5	M
	2009.04.-	-	AT	R	F	Saloon Engine RHF (DW10BTED4)	810159	Outer Joint	28	39	58.6	94	63	I
	2009.04.-	-	MT	L	F	Saloon Engine RHF (DW10BTED4)	645032	Inner Joint	37	39	40	68.5	100	
	2009.04.-	-	AT	R	F	Saloon Engine RHF (DW10BTED4)	210384	Drive Shaft	28	37	59	91	960	
	2009.04.-	-	MT	R	F	Saloon Engine RHF (DW10BTED4)	210302	Drive Shaft	28	37	58.6	94	969	
	2009.04.-	-	MT	R	F	Saloon Engine RHF (DW10BTED4)	210342	Drive Shaft	28	37	58.5	92.5	976	
	2009.04.-	-	AT	R	F	Saloon Engine RHF (DW10BTED4)	210243	Drive Shaft	28	37	58.5	92.5	957	
	2009.04.-	-	AT	L	F	Saloon Engine RHF (DW10BTED4)	210335	Drive Shaft	28	37	58.5	92.5	618	
	2009.04.-	-	-	-	F	Saloon Engine RHF (DW10BTED4)	810051	Outer Joint	28	39	58.6	94	63	I
	2009.04.-	-	AT	L	F	Saloon Engine RHF (DW10BTED4)	610043	Inner Joint	37	26	40.5	67.5	104	
2.0 HDi 150 / BlueHDi 150 (110 kW)	2009.04.-	-	AT	L	F	Saloon Engine RHE(DW10CTED)/AHR (DW10FD)	610161	Inner joint	37	26	40.5	65.5	100	
	2009.04.-	-	MT	L	F	Saloon Engine RHE(DW10CTED)/AHR (DW10FD)	645032	Inner Joint	37	39	40	68.5	100	
	2009.04.-	-	MT	R	F	Saloon Engine RHE(DW10CTED)/AHR (DW10FD)	610041	Inner Joint	37	39	32	399	95.5	
	2009.04.-	-	AT	L	F	Saloon Engine RHE(DW10CTED)/AHR (DW10FD)	245225	Drive Shaft	28	37	59	91	621	
	2009.04.-	-	AT	R	F	Saloon Engine RHE(DW10CTED)/AHR (DW10FD)	210416	Drive Shaft	28	37	59	91	955	
	2009.04.-	-	AT	-	F	Saloon Engine RHE(DW10CTED)/AHR (DW10FD)	810115	Outer Joint	28	26	58.5	92.5	61.5	M
	2009.04.-	-	MT	-	F	Saloon Engine RHE(DW10CTED)/AHR (DW10FD)	845074	Outer Joint	28	26	59	91	61.5	M
	2009.04.-	-	AT	R	F	Saloon Engine RHE(DW10CTED)/AHR (DW10FD)	210384	Drive Shaft	28	37	59	91	960	
	2009.04.-	-	MT	R	F	Saloon Engine RHE(DW10CTED)/AHR (DW10FD)	210302	Drive Shaft	28	37	58.6	94	969	
	2009.04.-	-	MT	L	F	Saloon Engine RHE(DW10CTED)/AHR (DW10FD)	210314	Drive Shaft	28	37	59	91	655	
	2009.04.-	-	-	-	F	Saloon Engine RHE(DW10CTED)/AHR (DW10FD)	810051	Outer Joint	28	39	58.6	94	63	I
2.0 HDi 165 (120 kW)	2009.04.-	-	AT	L	F	Saloon Engine RHH (DW10CTED4)	610161	Inner joint	37	26	40.5	65.5	100	
	2009.04.-	-	MT	R	F	Saloon Engine RHH (DW10CTED4)	610041	Inner Joint	37	39	32	399	95.5	
	2009.04.-	-	AT	L	F	Saloon Engine RHH (DW10CTED4)	245225	Drive Shaft	28	37	59	91	621	
	2009.04.-	-	AT	R	F	Saloon Engine RHH (DW10CTED4)	210416	Drive Shaft	28	37	59	91	955	
	2009.04.-	-	AT	-	F	Saloon Engine RHH (DW10CTED4)	810115	Outer Joint	28	26	58.5	92.5	61.5	M
	2009.04.-	-	MT	-	F	Saloon Engine RHH (DW10CTED4)	845074	Outer Joint	28	26	59	91	61.5	M
	2009.04.-	-	MT	L	F	Saloon Engine RHH (DW10CTED4)	645032	Inner Joint	37	39	40	68.5	100	
	2009.04.-	-	AT	R	F	Saloon Engine RHH (DW10CTED4)	210384	Drive Shaft	28	37	59	91	960	
	2009.04.-	-	MT	R	F	Saloon Engine RHH (DW10CTED4)	210302	Drive Shaft	28	37	58.6	94	969	
	2009.04.-	-	MT	L	F	Saloon Engine RHH (DW10CTED4)	210314	Drive Shaft	28	37	59	91	655	
	2009.04.-	-	-	-	F	Saloon Engine RHH (DW10CTED4)	810051	Outer Joint	28	39	58.6	94	63	I
2.2 HDi (125 kW)	2008.02.-	-	6MT	R	F	Saloon Engine 4HT (DW12BTED4)	210320	Drive Shaft	28	37	59	91	980	
2.2 HDi 165 (120 kW)	2008.02.-	-	-	R	F	Saloon Engine 4HP (DW12BTED4)	210320	Drive Shaft	28	37	59	91	980	
2.2 HDi 200 (150 kW)	2010.07.-	-	-	L	F	Saloon Engine 4HL (DW12C)	610161	Inner joint	37	26	40.5	65.5	100	
	2010.07.-	-	-	L	F	Saloon Engine 4HL (DW12C)	245225	Drive Shaft	28	37	59	91	621	
	2010.07.-	-	-	R	F	Saloon Engine 4HL (DW12C)	210416	Drive Shaft	28	37	59	91	955	
2.7 HDi (150 kW)	2008.02.-	-	-	L	F	Saloon Engine DT17ED4/UHZ(DT17BTED4)	210335	Drive Shaft	28	37	58.5	92.5	618	
	2008.02.-	-	-	L	F	Saloon Engine DT17ED4/UHZ(DT17BTED4)	610043	Inner Joint	37	26	40.5	67.5	104	
3.0 HDi 240 (177 kW)	2009.04.-	-	-	L	F	Saloon Engine DT20C	610161	Inner joint	37	26	40.5	65.5	100	
	2009.04.-	-	-	L	F	Saloon Engine DT20C	245225	Drive Shaft	28	37	59	91	621	
	2009.04.-	-	AT	R	F	Saloon Engine DT20C	210384	Drive Shaft	28	37	59	91	960	
3.0 V6 (155 kW)	2008.02.-	-	-	L	F	Saloon Engine XFU (ES9A)	210335	Drive Shaft	28	37	58.5	92.5	618	
	2008.02.-	-	-	L	F	Saloon Engine XFU (ES9A)	610043	Inner Joint	37	26	40.5	67.5	104	
C6 (TD_)														
2.2 HDi (120 kW)	2006.06.-	-	MT	R	F	Saloon Engine 4HP (DW12BTED4)	210320	Drive Shaft	28	37	59	91	980	
2.2 HDi (125 kW)	2006.06.-	-	-	R	F	Saloon Engine 4HT (DW12BTED4)	210320	Drive Shaft	28	37	59	91	980	
2.7 HDi (150 kW)	2005.09.-	-	-	L	F	Saloon Engine DT17ED4/UHZ(DT17BTED4)	210335	Drive Shaft	28	37	58.5	92.5	618	
	2005.09.-	-	-	L	F	Saloon Engine DT17ED4/UHZ(DT17BTED4)	610043	Inner Joint	37	26	40.5	67.5	104	
3.0 HDi (177 kW)	2009.04.-	-	-	L	F	Saloon Engine DT20C	610161	Inner joint	37	26	40.5	65.5	100	
	2009.04.-	-	-	L	F	Saloon Engine DT20C	245225	Drive Shaft	28	37	59	91	621	
3.0 V6 (155 kW)	2005.09.-	-	-	L	F	Saloon Engine XFX (ES9J4S)/XFX (ES9A)	210335	Drive Shaft	28	37	58.5	92.5	618	
	2005.09.-	-	-	L	F	Saloon Engine XFX (ES9J4S)/XFX (ES9A)	610043	Inner Joint	37	26	40.5	67.5	104	
C8 (EA_ EB_)														
2.0 (100 kW)	2002.07.-	-	-	-	F	MPV Engine RFN (EW10J4)	810016	Outer Joint	27	34	59	82	55	I
	2002.07.-	-	-	-	F	MPV Engine RFN (EW10J4)	845059	Outer Joint	27	34	58	81.5	55	I
	2002.07.-	-	MT	L	F	MPV Engine RFN (EW10J4)	210422	Drive Shaft	27	24	58	81.5	659	

	 YEAR	TRANSM	L/R	F/R	REMARKS	GSP Ref.	 PRODUCT	 ABS	Technical Specifications					
									A	B	C	H	L	P
CITROEN														
C8 (EA_ EB_)														
2.0 (100 kW)	2002.07-	-	MT	R	F	MPV Engine RFN (EW10J4)	210431	Drive Shaft	27	24	59	82	944	
	2002.07-	-	AT	R	F	MPV Engine RFN (EW10J4)	210425	Drive Shaft	27	26	59	82	855	
	2002.07-	-	-	L	F	MPV Engine RFN (EW10J4)	217220	Drive Shaft	27	26	58	81.5	648	
	2002.07-	-	-	R	F	MPV Engine RFN (EW10J4)	217218	Drive Shaft	27	26	58	81.5	855	
2.0 16V (103 kW)	2005.09-	-	-	-	F	MPV Engine RFJ (EW10A)	810016	Outer Joint	27	34	59	82	55	I
	2005.09-	-	MT	L	F	MPV Engine RFJ (EW10A)	210422	Drive Shaft	27	24	58	81.5	659	
	2005.09-	-	-	-	F	MPV Engine RFJ (EW10A)	845059	Outer Joint	27	34	58	81.5	55	I
	2005.09-	-	MT	R	F	MPV Engine RFJ (EW10A)	210431	Drive Shaft	27	24	59	82	944	
	2005.09-	-	AT	R	F	MPV Engine RFJ (EW10A)	210425	Drive Shaft	27	26	59	82	855	
	2005.09-	-	-	L	F	MPV Engine RFJ (EW10A)	217220	Drive Shaft	27	26	58	81.5	648	
2.0 16V (104 kW)	2005.09-	-	-	-	F	MPV Engine RFJ (EW10A)	810016	Outer Joint	27	34	59	82	55	I
	2005.09-	-	MT	L	F	MPV Engine RFJ (EW10A)	210422	Drive Shaft	27	24	58	81.5	659	
	2005.09-	-	MT	R	F	MPV Engine RFJ (EW10A)	210431	Drive Shaft	27	24	59	82	944	
2.0 HDi (79 kW)	2002.07-	-	AT	-	F	MPV Engine RHT (DW10ATED4)/RHM (DW10ATED4)	810016	Outer Joint	27	34	59	82	55	I
	2002.07-	-	AT	L	F	MPV Engine RHT (DW10ATED4)/RHM (DW10ATED4)	210423	Drive Shaft	27	26	58	81.5	635	
	2002.07-	-	AT	R	F	MPV Engine RHT (DW10ATED4)/RHM (DW10ATED4)	210425	Drive Shaft	27	26	59	82	855	
2.0 HDi (80 kW)	2002.07-	-	AT	-	F	MPV Engine RHW (DW10ATED4)	810016	Outer Joint	27	34	59	82	55	I
	2002.07-	-	-	R	F	MPV Engine RHW (DW10ATED4)	610160	Inner joint	37	28	32	399	95.5	
	2002.07-	-	-	R	F	MPV Engine RHW (DW10ATED4)	210440	Drive Shaft	27	37	58	81	973	
2.0 HDi (81 kW)	2002.07-	-	AT	L	F	MPV Engine RHT (DW10ATED4)	210423	Drive Shaft	27	26	58	81.5	635	
	2002.07-	-	AT	R	F	MPV Engine RHT (DW10ATED4)	210425	Drive Shaft	27	26	59	82	855	
2.0 HDi (88 kW)	2006.07-	-	-	R	F	MPV Engine RHK (DW10UTED4)	610160	Inner joint	37	28	32	399	95.5	
	2006.07-	-	-	R	F	MPV Engine RHK (DW10UTED4)	210440	Drive Shaft	27	37	58	81	973	
2.0 HDi 135 (100 kW)	2006.03-	-	-	R	F	MPV Engine RHD (DW10CB)/RHR(DW10BTED4)/RHD(DW10CTED4)	610160	Inner joint	37	28	32	399	95.5	
	2006.03-	-	-	R	F	MPV Engine RHD (DW10CB)/RHR(DW10BTED4)/RHD(DW10CTED4)	210440	Drive Shaft	27	37	58	81	973	
	2006.03-	-	MT	R	F	MPV Engine RHD (DW10CB)/RHR(DW10BTED4)/RHD(DW10CTED4)	210313	Drive Shaft	25	37	58.5	89	950	
2.0 HDi 165 (120 kW)	2006.03-	-	MT	L	F	MPV Engine RHE (DW10CTED4)/RHH (DW10CTED4)	210424	Drive Shaft	27	37	61.3	84	637	
	2006.03-	-	MT	L	F	MPV Engine RHE (DW10CTED4)/RHH (DW10CTED4)	610015	Inner Joint	37	39	40	68.5	104	
2.2 HDi (120 kW)	2007.06-	-	MT	L	F	MPV Engine 4HP (DW12BTED4)/4HR (DW12BTED4)	210424	Drive Shaft	27	37	61.3	84	637	
	2007.06-	-	MT	L	F	MPV Engine 4HP (DW12BTED4)/4HR (DW12BTED4)	610015	Inner Joint	37	39	40	68.5	104	
2.2 HDi (125 kW)	2006.06-	-	MT	L	F	MPV Engine 4HT (DW12BTED4)	210424	Drive Shaft	27	37	61.3	84	637	
	2006.06-	-	MT	L	F	MPV Engine 4HT (DW12BTED4)	610015	Inner Joint	37	39	40	68.5	104	
2.2 HDi (94 kW)	2002.07-	-	-	R	F	MPV Engine 4HW (DW12TED4)	218291	Drive Shaft	27	37	58	81	977	
	2002.07-	-	AT	R	F	MPV Engine 4HW (DW12TED4)	217217	Drive Shaft	27	37	58	81.5	924	
3.0 V6 (150 kW)	2002.07-	-	AT	L	F	MPV Engine XFX (ES9J4S)	217221	Drive Shaft	27	37	58	81.5	624	
	2002.07-	-	AT	R	F	MPV Engine XFX (ES9J4S)	250218	Drive Shaft	23	39	56.2	83.5	1001	
	2002.07-	-	AT	R	F	MPV Engine XFX (ES9J4S)	250218	Drive Shaft	23	39	56.2	83.5	1001	
	2002.07-	-	AT	R	F	MPV Engine XFX (ES9J4S)	250218	Drive Shaft	23	39	56.2	83.5	1001	
DS3														
1.2 THP 110 (81 kW)	2014.10-	2015.07	-	-	F	Convertible Engine HNZ (EB2DT)	845012	Outer Joint	21	34	48.5	86	55.5	I
	2014.10-	2015.07	MT	L	F	Convertible Engine HNZ (EB2DT)	210309	Drive Shaft	21	24	48.3	86.5	641	
	2014.10-	2015.07	MT	R	F	Convertible Engine HNZ (EB2DT)	210249	Drive Shaft	25	24	58.5	79	864	
1.2 VTi 82 (60 kW)	2013.01-	2015.07	5MT	-	-	Convertible Engine HMZ (EB2F)	810130	Outer Joint	21	34	48.3	86.5	55.5	I
	2013.01-	2015.07	MT	L	F	Convertible Engine HMZ (EB2F)	210306	Drive Shaft	21	22	49	86	652	
1.6 BlueHDi 100 (73 kW)	2014.07-	2015.07	MT	R	F	Convertible Engine BHY (DV6FD)	210249	Drive Shaft	25	24	58.5	79	864	
1.6 BlueHDi 115 (85 kW)	2013.10-	2015.07	MT	L	F	Convertible Engine BHX (DV6FC)	210253	Drive Shaft	25	24	58.5	79	626	
	2013.10-	2015.07	MT	L	F	Convertible Engine BHX (DV6FC)	810148	Outer Joint	25	34	58.5	79	55.5	I
	2013.10-	2015.07	MT	L	F	Convertible Engine BHX (DV6FC)	610057	Inner Joint	24	34	40	52.5	90	
1.6 BlueHDi 120 (88 kW)	2014.07-	2015.07	MT	L	F	Convertible Engine BHZ (DV6FC)	810148	Outer Joint	25	34	58.5	79	55.5	I
	2014.07-	2015.07	MT	L	F	Convertible Engine BHZ (DV6FC)	610057	Inner Joint	24	34	40	52.5	90	
	2014.07-	2015.07	MT	L	F	Convertible Engine BHZ (DV6FC)	210253	Drive Shaft	25	24	58.5	79	626	
1.6 HDi 90 (69 kW)	2013.01-	2015.07	MT	-	-	Convertible Engine 9HP (DV6DTEd)	899366	Outer Joint	25	34	58.5	79	55	I
	2013.01-	2015.07	-	-	F	Convertible Engine 9HP (DV6DTEd)	845012	Outer Joint	21	34	48.5	86	55.5	I
	2013.01-	2015.07	MT	-	-	Convertible Engine 9HP (DV6DTEd)	810130	Outer Joint	21	34	48.3	86.5	55.5	I
	2013.01-	2015.07	MT	L	F	Convertible Engine 9HP (DV6DTEd)	210309	Drive Shaft	21	24	48.3	86.5	641	
	2013.01-	2015.07	MT	-	F	Convertible Engine 9HP (DV6DTEd)	810028	Outer Joint	25	34	58	89	56	I
1.6 Racing (152 kW)	2014.03-	2015.07	-	L	F	Convertible Engine 5FD (EP6DTS)	210253	Drive Shaft	25	24	58.5	79	626	
	2014.03-	2015.07	-	L	F	Convertible Engine 5FD (EP6DTS)	810148	Outer Joint	25	34	58.5	79	55.5	I
	2014.03-	2015.07	-	-	F	Convertible Engine 5FD (EP6DTS)	845012	Outer Joint	21	34	48.5	86	55.5	I
	2014.03-	2015.07	MT	L	F	Convertible Engine 5FD (EP6DTS)	210309	Drive Shaft	21	24	48.3	86.5	641	
	2014.03-	2015.07	-	L	F	Convertible Engine 5FD (EP6DTS)	610057	Inner Joint	24	34	40	52.5	90	
1.6 Racing(149 kW)	2014.03-	2015.07	MT	L	F	Convertible Engine 5FF (EP6DTS)	210253	Drive Shaft	25	24	58.5	79	626	
	2014.03-	2015.07	MT	L	F	Convertible Engine 5FF (EP6DTS)	810148	Outer Joint	25	34	58.5	79	55.5	I
	2014.03-	2015.07	MT	L	F	Convertible Engine 5FF (EP6DTS)	610057	Inner Joint	24	34	40	52.5	90	
1.6 THP 150 (110 kW)	2013.01-	2015.07	MT	L	F	Convertible Engine 5FN (EP6CDT)	810148	Outer Joint	25	34	58.5	79	55.5	I
	2013.01-	2015.07	MT	L	F	Convertible Engine 5FN (EP6CDT)	610057	Inner Joint	24	34	40	52.5	90	



	 YEAR	TRANSM	L/R	F/R	REMARKS	GSP Ref.	 PRODUCT	 ABS	Technical Specifications					
									A	B	C	H	L	P
CITROEN														
DS3														
1.6 THP 150 (110 kW)	2013.01-2015.07	MT	L	F	Convertible Engine 5FN (EP6CDT)	210253	Drive Shaft		25	24	58.5	79	626	
1.6 THP 155 (115 kW)	2013.01-2015.07	-	L	F	Convertible Engine 5FV (EP6CDT)	210253	Drive Shaft		25	24	58.5	79	626	
	2013.01-2015.07	-	L	F	Convertible Engine 5FV (EP6CDT)	810148	Outer Joint		25	34	58.5	79	55.5	I
	2013.01-2015.07	MT	-	-	Convertible Engine 5FV (EP6CDT)	899366	Outer Joint		25	34	58.5	79	55	I
	2013.01-2015.07	5MT	-	-	Convertible Engine 5FV (EP6CDT)	810130	Outer Joint		21	34	48.3	86.5	55.5	I
	2013.01-2015.07	-	L	F	Convertible Engine 5FV (EP6CDT)	610057	Inner Joint		24	34	40	52.5	90	
	2013.01-2015.07	MT	-	F	Convertible Engine 5FV (EP6CDT)	810028	Outer Joint		25	34	58	89	56	I
1.6 THP 165 (121 kW)	2014.10-2015.07	MT	L	F	Convertible Engine 5GZ (EP6FDT)	810148	Outer Joint		25	34	58.5	79	55.5	I
	2014.10-2015.07	MT	L	F	Convertible Engine 5GZ (EP6FDT)	610057	Inner Joint		24	34	40	52.5	90	
	2014.10-2015.07	MT	L	F	Convertible Engine 5GZ (EP6FDT)	210253	Drive Shaft		25	24	58.5	79	626	
1.6 THP 165(120 kW)	2015.02-2015.07	MT	L	F	Convertible Engine 5FM (EP6DT)	210253	Drive Shaft		25	24	58.5	79	626	
	2015.02-2015.07	MT	L	F	Convertible Engine 5FM (EP6DT)	810148	Outer Joint		25	34	58.5	79	55.5	I
	2015.02-2015.07	MT	L	F	Convertible Engine 5FM (EP6DT)	610057	Inner Joint		24	34	40	52.5	90	
1.6 VTi 120 (88 kW)	2013.01-2015.07	5MT	-	-	Convertible Engine 5FS (EP6C)	810130	Outer Joint		21	34	48.3	86.5	55.5	I
	2013.01-2015.07	MT	L	F	Convertible Engine 5FS (EP6C)	210340	Drive Shaft		21	22	49	86	655	
DS3/DS 3														
1.2 THP 110 (81 kW)	2014.10-2015.03	-	-	F	Hatchback Engine HNZ (EB2DT)	845012	Outer Joint		21	34	48.5	86	55.5	I
	2014.10-2015.03	MT	L	F	Hatchback Engine HNZ (EB2DT)	210309	Drive Shaft		21	24	48.3	86.5	641	
	2014.10-2015.03	MT	R	F	Hatchback Engine HNZ (EB2DT)	210249	Drive Shaft		25	24	58.5	79	864	
1.2 VTi 82 (60 kW)	2013.01-2015.03	5MT	-	-	Hatchback Engine HMZ (EB2F)	810130	Outer Joint		21	34	48.3	86.5	55.5	I
	2013.01-2015.03	MT	L	F	Hatchback Engine HMZ (EB2F)	210306	Drive Shaft		21	22	49	86	652	
1.4 HDi 70 (50 kW)	2010.04-2015.07	-	L	F	Hatchback Engine 8HR (DV4C)	210311	Drive Shaft		21	22	48	86.5	647	
	2010.04-2015.07	MT	L	F	Hatchback Engine 8HR (DV4C)	210306	Drive Shaft		21	22	49	86	652	
1.4 VTi 95 (70 kW)	2010.04-2015.07	-	L	F	Hatchback Engine 8FP (EP3)	210311	Drive Shaft		21	22	48	86.5	647	
1.4 VTi 95 LPG (70 kW)	2012.08-2015.07	-	L	F	Hatchback Engine 8FN (EP3)	210311	Drive Shaft		21	22	48	86.5	647	
1.4 VTi 98 (72 kW)	2009.11-2015.07	-	L	F	Hatchback Engine 8FR (EP3)	210311	Drive Shaft		21	22	48	86.5	647	
	2009.11-2015.07	MT	L	F	Hatchback Engine 8FR (EP3)	210340	Drive Shaft		21	22	49	86	655	
1.6 (120 kW)	2012.01-2015.07	MT	L	F	Hatchback Engine 5FM (EP6DT)	810148	Outer Joint		25	34	58.5	79	55.5	I
	2012.01-2015.07	MT	L	F	Hatchback Engine 5FM (EP6DT)	610057	Inner Joint		24	34	40	52.5	90	
	2012.01-2015.07	MT	L	F	Hatchback Engine 5FM (EP6DT)	210253	Drive Shaft		25	24	58.5	79	626	
1.6 BlueHDi 100 (73 kW)	2014.07-2015.07	MT	R	F	Hatchback Engine BHY (DV6FD)	210249	Drive Shaft		25	24	58.5	79	864	
1.6 BlueHDi 120 (88 kW)	2013.10-2015.07	MT	L	F	Hatchback Engine BHZ (DV6FC)	810148	Outer Joint		25	34	58.5	79	55.5	I
	2013.10-2015.07	MT	L	F	Hatchback Engine BHZ (DV6FC)	610057	Inner Joint		24	34	40	52.5	90	
	2013.10-2015.07	MT	L	F	Hatchback Engine BHZ (DV6FC)	210253	Drive Shaft		25	24	58.5	79	626	
1.6 HDi 110 (82 kW)	2009.11-2015.07	-	L	F	Hatchback Engine 9HR (DV6C)	210253	Drive Shaft		25	24	58.5	79	626	
	2009.11-2015.07	-	L	F	Hatchback Engine 9HR (DV6C)	810148	Outer Joint		25	34	58.5	79	55.5	I
	2009.11-2015.07	MT	-	-	Hatchback Engine 9HR (DV6C)	899366	Outer Joint		25	34	58.5	79	55	I
	2009.11-2015.07	-	L	F	Hatchback Engine 9HR (DV6C)	610057	Inner Joint		24	34	40	52.5	90	
	2009.11-2015.07	MT	-	F	Hatchback Engine 9HR (DV6C)	810028	Outer Joint		25	34	58	89	56	I
1.6 HDi 115 (84 kW)	2012.08-2015.07	-	L	F	Hatchback Engine 9HL (DV6C)/9HD (DV6C)	210253	Drive Shaft		25	24	58.5	79	626	
	2012.08-2015.07	-	L	F	Hatchback Engine 9HL (DV6C)/9HD (DV6C)	810148	Outer Joint		25	34	58.5	79	55.5	I
	2012.08-2015.07	-	-	F	Hatchback Engine 9HL (DV6C)/9HD (DV6C)	810028	Outer Joint		25	34	58	89	56	I
	2012.08-2015.07	-	L	F	Hatchback Engine 9HL (DV6C)/9HD (DV6C)	610057	Inner Joint		24	34	40	52.5	90	
1.6 HDi 115 (85 kW)	2013.10-2015.07	MT	L	F	Hatchback Engine BHX (DV6FC)	810148	Outer Joint		25	34	58.5	79	55.5	I
	2013.10-2015.07	MT	L	F	Hatchback Engine BHX (DV6FC)	610057	Inner Joint		24	34	40	52.5	90	
	2013.10-2015.07	MT	L	F	Hatchback Engine BHX (DV6FC)	210253	Drive Shaft		25	24	58.5	79	626	
1.6 HDi 90 (68 kW)	2009.11-2015.07	-	-	F	Hatchback Engine 9HP (DV6DTED)	810028	Outer Joint		25	34	58	89	56	I
	2009.11-2015.07	MT	-	-	Hatchback Engine 9HP (DV6DTED)	899366	Outer Joint		25	34	58.5	79	55	I
	2009.11-2015.07	-	-	F	Hatchback Engine 9HP (DV6DTED)	845012	Outer Joint		21	34	48.5	86	55.5	I
	2009.11-2015.07	MT	-	-	Hatchback Engine 9HP (DV6DTED)	810130	Outer Joint		21	34	48.3	86.5	55.5	I
	2009.11-2015.07	MT	L	F	Hatchback Engine 9HP (DV6DTED)	210309	Drive Shaft		21	24	48.3	86.5	641	
1.6 Racing (147 kW)	2011.02-2015.07	-	L	F	Hatchback Engine 5FU (EP6CDTX)	210253	Drive Shaft		25	24	58.5	79	626	
	2011.02-2015.07	-	-	F	Hatchback Engine 5FU (EP6CDTX)	810028	Outer Joint		25	34	58	89	56	I
	2011.02-2015.07	-	L	F	Hatchback Engine 5FU (EP6CDTX)	810148	Outer Joint		25	34	58.5	79	55.5	I
	2011.02-2015.07	-	-	F	Hatchback Engine 5FU (EP6CDTX)	845012	Outer Joint		21	34	48.5	86	55.5	I
	2011.02-2015.07	MT	L	F	Hatchback Engine 5FU (EP6CDTX)	210309	Drive Shaft		21	24	48.3	86.5	641	
1.6 Racing (152 kW)	2011.02-2015.07	-	L	F	Hatchback Engine 5FD (EP6DTS)	210253	Drive Shaft		25	24	58.5	79	626	
	2011.02-2015.07	-	-	F	Hatchback Engine 5FD (EP6DTS)	810028	Outer Joint		25	34	58	89	56	I
	2011.02-2015.07	-	L	F	Hatchback Engine 5FD (EP6DTS)	810148	Outer Joint		25	34	58.5	79	55.5	I
	2011.02-2015.07	-	-	F	Hatchback Engine 5FD (EP6DTS)	845012	Outer Joint		21	34	48.5	86	55.5	I
	2011.02-2015.07	MT	L	F	Hatchback Engine 5FD (EP6DTS)	210309	Drive Shaft		21	24	48.3	86.5	641	
	2011.02-2015.07	-	L	F	Hatchback Engine 5FD (EP6DTS)	610057	Inner Joint		24	34	40	52.5	90	
1.6 THP 150 (110 kW)	2010.01-2015.07	-	L	F	Hatchback Engine 5FX (EP6DT)/5FN (EP6CDT)	210253	Drive Shaft		25	24	58.5	79	626	
	2010.01-2015.07	-	L	F	Hatchback Engine 5FX (EP6DT)/5FN (EP6CDT)	810148	Outer Joint		25	34	58.5	79	55.5	I
	2010.01-2015.07	-	L	F	Hatchback Engine 5FX (EP6DT)/5FN (EP6CDT)	610057	Inner Joint		24	34	40	52.5	90	

YEAR	TRANSM	L/R	F/R	REMARKS	GSP Ref.	PRODUCT	ABS	Technical Specifications										
								A	B	C	H	L	P					
CITROEN																		
DS3/DS 3																		
1.6 THP 155 (115 kW)	2010.04-2015.07	-	L	F	Hatchback Engine 5FR (EP6DT)/5FV (EP6CDT)	210253	Drive Shaft	25	24	58.5	79	626						
	2010.04-2015.07	-	L	F	Hatchback Engine 5FR (EP6DT)/5FV (EP6CDT)	810148	Outer Joint	25	34	58.5	79	55.5	I					
	2010.04-2015.07	MT	-	-	Hatchback Engine 5FR (EP6DT)/5FV (EP6CDT)	899366	Outer Joint	25	34	58.5	79	55	I					
	2010.04-2015.07	5MT	-	-	Hatchback Engine 5FR (EP6DT)/5FV (EP6CDT)	810130	Outer Joint	21	34	48.3	86.5	55.5	I					
	2010.04-2015.07	-	L	F	Hatchback Engine 5FR (EP6DT)/5FV (EP6CDT)	610057	Inner Joint	24	34	40	52.5	90						
	2010.04-2015.07	MT	-	F	Hatchback Engine 5FR (EP6DT)/5FV (EP6CDT)	810028	Outer Joint	25	34	58	89	56	I					
1.6 THP 165 (121 kW)	2014.10-2015.06	MT	L	F	Hatchback Engine 5GZ (EP6FDT)	810148	Outer Joint	25	34	58.5	79	55.5	I					
	2014.10-2015.06	MT	L	F	Hatchback Engine 5GZ (EP6FDT)	610057	Inner Joint	24	34	40	52.5	90						
	2014.10-2015.06	MT	L	F	Hatchback Engine 5GZ (EP6FDT)	210253	Drive Shaft	25	24	58.5	79	626						
1.6 VTi 120 (88 kW)	2010.04-2015.07	5MT	-	-	Hatchback Engine 5FS (EP6C)	810130	Outer Joint	21	34	48.3	86.5	55.5	I					
	2010.04-2015.07	MT	L	F	Hatchback Engine 5FS (EP6C)	210340	Drive Shaft	21	22	49	86	655						
DS4																		
1.6 BlueHDi 115 (85 kW)	2014.08-2015.07	AT/MT	-	-	Hatchback Engine BHX (DV6FC)	899366	Outer Joint	25	34	58.5	79	55	I					
1.6 BlueHDi 120 (88 kW)	2014.07-2015.07	MT	L	F	Hatchback Engine BHZ (DV6FC)	810148	Outer Joint	25	34	58.5	79	55.5	I					
	2014.07-2015.07	MT	R	F	Hatchback Engine BHZ (DV6FC)	210325	Drive Shaft	25	24	58.5	79	940						
	2014.07-2015.07	AT/MT	-	-	Hatchback Engine BHZ (DV6FC)	899366	Outer Joint	25	34	58.5	79	55	I					
	2014.07-2015.07	MT	L	F	Hatchback Engine BHZ (DV6FC)	610057	Inner Joint	24	34	40	52.5	90						
	2014.07-2015.07	MT	R	F	Hatchback Engine BHZ (DV6FC)	610058	Inner Joint	24	34	29.8	365	88						
	2014.07-2015.07	MT	L	F	Hatchback Engine BHZ (DV6FC)	210253	Drive Shaft	25	24	58.5	79	626						
1.6 HDi 110 (82 kW)	2011.04-2015.07	-	L	F	Hatchback Engine 9HR (DV6C)	210253	Drive Shaft	25	24	58.5	79	626						
	2011.04-2015.07	-	L	F	Hatchback Engine 9HR (DV6C)	810148	Outer Joint	25	34	58.5	79	55.5	I					
	2011.04-2015.07	-	R	F	Hatchback Engine 9HR (DV6C)	210325	Drive Shaft	25	24	58.5	79	940						
	2011.04-2015.07	-	L	F	Hatchback Engine 9HR (DV6C)	210312	Drive Shaft	25	37	58.5	89	625						
	2011.04-2015.07	-	L	F	Hatchback Engine 9HR (DV6C)	610057	Inner Joint	24	34	40	52.5	90						
	2011.04-2015.07	6MT	-	-	Hatchback Engine 9HR (DV6C)	810155	Outer Joint	25	39	58.5	89	63.5	I					
	2011.04-2015.07	-	R	F	Hatchback Engine 9HR (DV6C)	610058	Inner Joint	24	34	29.8	365	88						
1.6 HDi 115 (84 kW)	2012.08-2015.07	MT	L	F	Hatchback Engine 9HL (DV6C)/9HD (DV6C)	810148	Outer Joint	25	34	58.5	79	55.5	I					
	2012.08-2015.07	MT	R	F	Hatchback Engine 9HL (DV6C)/9HD (DV6C)	210325	Drive Shaft	25	24	58.5	79	940						
	2012.08-2015.07	MT	L	F	Hatchback Engine 9HL (DV6C)/9HD (DV6C)	610057	Inner Joint	24	34	40	52.5	90						
	2012.08-2015.07	-	L	F	Hatchback Engine 9HL (DV6C)/9HD (DV6C)	210312	Drive Shaft	25	37	58.5	89	625						
	2012.08-2015.07	MT	R	F	Hatchback Engine 9HL (DV6C)/9HD (DV6C)	610058	Inner Joint	24	34	29.8	365	88						
	2012.08-2015.07	MT	L	F	Hatchback Engine 9HL (DV6C)/9HD (DV6C)	210253	Drive Shaft	25	24	58.5	79	626						
1.6 HDi 90 (68 kW)	2011.05-2015.07	-	R	F	Hatchback Engine 9HP (DV6DTE)	210251	Drive Shaft	25	24	58.5	79	935						
1.6 THP 155 (115 kW)	2011.04-2015.07	-	L	F	Hatchback Engine 5FV (EP6CDT)	210253	Drive Shaft	25	24	58.5	79	626						
	2011.04-2015.07	MT/6MT	-	-	Hatchback Engine 5FV (EP6CDT)	899366	Outer Joint	25	34	58.5	79	55	I					
	2011.04-2015.07	-	L	F	Hatchback Engine 5FV (EP6CDT)	810148	Outer Joint	25	34	58.5	79	55.5	I					
	2011.04-2015.07	-	R	F	Hatchback Engine 5FV (EP6CDT)	210325	Drive Shaft	25	24	58.5	79	940						
	2011.04-2015.07	-	L	F	Hatchback Engine 5FV (EP6CDT)	610057	Inner Joint	24	34	40	52.5	90						
	2011.04-2015.07	6MT	-	-	Hatchback Engine 5FV (EP6CDT)	810155	Outer Joint	25	39	58.5	89	63.5	I					
	2011.04-2015.07	-	R	F	Hatchback Engine 5FV (EP6CDT)	610058	Inner Joint	24	34	29.8	365	88						
	2011.04-2015.07	MT	-	F	Hatchback Engine 5FV (EP6CDT)	810028	Outer Joint	25	34	58	89	56	I					
1.6 THP 160 (120 kW)	2012.04-2015.07	AT/MT	-	-	Hatchback Engine 5FM (EP6DT)	899366	Outer Joint	25	34	58.5	79	55	I					
1.6 THP 165 (121 kW)	2012.01-2015.07	AT/MT	-	-	Hatchback Engine 5FM (EP6DT)/5GZ (EP6FDT)	899366	Outer Joint	25	34	58.5	79	55	I					
1.6 THP 200 (147 kW)	2011.04-2015.07	6MT	-	-	Hatchback Engine 5FU (EP6DTX)	810155	Outer Joint	25	39	58.5	89	63.5	I					
1.6 VTi 120 (88 kW)	2011.04-2015.07	6AT	-	F	Hatchback Engine 5FS (EP6C)	810028	Outer Joint	25	34	58	89	56	I					
	2011.04-2015.07	6AT	-	-	Hatchback Engine 5FS (EP6C)	899366	Outer Joint	25	34	58.5	79	55	I					
	2011.04-2015.07	-	R	F	Hatchback Engine 5FS (EP6C)	210251	Drive Shaft	25	24	58.5	79	935						
	2011.04-2015.07	6MT	-	-	Hatchback Engine 5FS (EP6C)	810155	Outer Joint	25	39	58.5	89	63.5	I					
2.0 BlueHDi 150 (110 kW)	2014.07-2015.07	-	L	F	Hatchback Engine AHX (DW10FD)	810158	Outer Joint	25	26	58.5	89	61.5	M					
	2014.07-2015.07	-	L	F	Hatchback Engine AHX (DW10FD)	210427	Drive Shaft	25	37	58.5	89	638						
	2014.07-2015.07	-	R	F	Hatchback Engine AHX (DW10FD)	210421	Drive Shaft	25	37	58.5	89	972						
	2014.07-2015.07	-	L	F	Hatchback Engine AHX (DW10FD)	210312	Drive Shaft	25	37	58.5	89	625						
	2014.07-2015.07	MT	-	F	Hatchback Engine AHX (DW10FD)	810051	Outer Joint	28	39	58.6	94	63	I					
2.0 HDi / BlueHDi 135 (100 kW)	2011.09-2015.07	MT	L	F	Hatchback Engine RHD (DW10CTED4)/AHV(DW10FD)/AHS(DW10FD)/RHD(DW10CB)	810158	Outer Joint	25	26	58.5	89	61.5	M					
	2011.09-2015.07	MT	L	F	Hatchback Engine RHD (DW10CTED4)/AHV(DW10FD)/AHS(DW10FD)/RHD(DW10CB)	210427	Drive Shaft	25	37	58.5	89	638						
	2011.09-2015.07	MT	R	F	Hatchback Engine RHD (DW10CTED4)/AHV(DW10FD)/AHS(DW10FD)/RHD(DW10CB)	210421	Drive Shaft	25	37	58.5	89	972						
	2011.09-2015.07	MT	L	F	Hatchback Engine RHD (DW10CTED4)/AHV(DW10FD)/AHS(DW10FD)/RHD(DW10CB)	210312	Drive Shaft	25	37	58.5	89	625						
	2011.09-2015.07	MT	-	F	Hatchback Engine RHD (DW10CTED4)/AHV(DW10FD)/AHS(DW10FD)/RHD(DW10CB)	810051	Outer Joint	28	39	58.6	94	63	I					
2.0 HDi 165 (120 kW)	2011.04-2015.07	AT	L	F	Hatchback Engine RHH (DW10CTED4)	210375	Drive Shaft	25	37	58.4	89	619						
	2011.04-2015.07	6MT	-	-	Hatchback Engine RHH (DW10CTED4)	810155	Outer Joint	25	39	58.5	89	63.5	I					
DS5																		
1.6 HDi 110 (82 kW)	2011.11-2015.07	-	-	F	Hatchback Engine 9HR (DV6C)	810028	Outer Joint	25	34	58	89	56	I					
1.6 THP 155 (115 kW)	2011.11-2015.07	MT	-	-	Hatchback Engine 5FV (EP6CDT)	899366	Outer Joint	25	34	58.5	79	55	I					
	2011.11-2015.07	MT	-	F	Hatchback Engine 5FV (EP6CDT)	810028	Outer Joint	25	34	58	89	56	I					
1.6 THP 200 (147 kW)	2011.11-2015.07	-	-	F	Hatchback Engine 5FU (EP6DTX)	810028	Outer Joint	25	34	58	89	56	I					
	2011.11-2015.07	-	-	-	Hatchback Engine 5FU (EP6DTX)	899366	Outer Joint	25	34	58.5	79	55	I					





	 YEAR	TRANSM	L/R	F/R	REMARKS	GSP Ref.	 PRODUCT	 ABS	Technical Specifications						
									A	B	C	H	L	P	
CITROEN DS5															
2.0 BlueHDi 150 (110 kW)	2014.07-2015.07	MT	R	F	Hatchback Engine AHX (DW10FD)	610041	Inner Joint		37	39	32	399	95.5		
	2014.07-2015.07	MT	R	F	Hatchback Engine AHX (DW10FD)	210302	Drive Shaft		28	37	58.6	94	969		
2.0 HDi 165 (120 kW)	2011.11-2015.07	MT	R	F	Hatchback Engine RHH (DW10CTED4)	610041	Inner Joint		37	39	32	399	95.5		
	2011.11-2015.07	MT	-	F	Hatchback Engine RHH (DW10CTED4)	810051	Outer Joint		28	39	58.6	94	63	I	
	2011.11-2015.07	MT	R	F	Hatchback Engine RHH (DW10CTED4)	210302	Drive Shaft		28	37	58.6	94	969		
	2011.11-2015.07	6MT	-	-	Hatchback Engine RHH (DW10CTED4)	810155	Outer Joint		25	39	58.5	89	63.5	I	
2.0 HDi 165 Hybrid4 (120 kW)	2011.12-2015.07	MT	R	F	All-wheel Drive Hatchback Engine RHC (DW10CTED4)	610041	Inner Joint		37	39	32	399	95.5		
	2011.12-2015.07	MT	R	F	All-wheel Drive Hatchback Engine RHC (DW10CTED4)	210302	Drive Shaft		28	37	58.6	94	969		
EVASION (22 U6)/SYNERGIE															
1.8 (73 kW)	1997.05-2002.07	MT	L	F	MPV Engine LFZ (XU7JP)	210082	Drive Shaft	48T	27	24	59	82	648		
	1997.05-2002.07	MT	R	F	MPV Engine LFZ (XU7JP)	210012	Drive Shaft	48T	27	24	64	80.5	928		
	1997.05-2002.07	MT	L/R	F	MPV Engine LFZ (XU7JP)	810018	Outer Joint	48T	27	34	61	82	55	I	
	1997.05-2002.07	MT	L	F	MPV Engine LFZ (XU7JP)	210052	Drive Shaft		27	24	61	82	648		
	1997.05-2002.07	MT	R	F	MPV Engine LFZ (XU7JP)	210120	Drive Shaft		27	24	59	82	928		
1.9 TD (66 kW)	1994.11-2002.07	MT	L	F	MPV Engine DHX (XUD9TF/BTF)/D8B (XUD9TF)	610015	Inner Joint		37	39	40	68.5	104		
	1994.11-2002.07	MT	R	F	MPV Engine DHX (XUD9TF/BTF)/D8B (XUD9TF)	610034	Inner Joint		37	39	31.9	369.5	99		
	1994.11-2002.07	-	L	F	MPV Engine DHX (XUD9TF/BTF)/D8B (XUD9TF)	210073	Drive Shaft	48T	27	37	59	82	641		
	1994.11-2002.07	MT	L	F	MPV Engine DHX (XUD9TF/BTF)/D8B (XUD9TF)	210072	Drive Shaft		27	37	59	82	641		
	1994.11-2002.07	-	R	F	MPV Engine DHX (XUD9TF/BTF)/D8B (XUD9TF)	210108	Drive Shaft	48T	27	37	59	82	939		
	1994.11-2002.07	-	R	F	MPV Engine DHX (XUD9TF/BTF)/D8B (XUD9TF)	210074	Drive Shaft		27	37	59	82	939		
	1994.11-2002.07	MT	R	F	MPV Engine DHX (XUD9TF/BTF)/D8B (XUD9TF)	210155	Drive Shaft		27	37	59	82	947		
	1994.11-2002.07	-	L/R	F	MPV Engine DHX (XUD9TF/BTF)/D8B (XUD9TF)	810015	Outer Joint	48T	27	39	59	82	63	I	
	1994.11-2002.07	MT	L	F	MPV Engine DHX (XUD9TF/BTF)/D8B (XUD9TF)	210016	Drive Shaft	48T	27	37	59	82	641		
	1994.11-2002.07	MT	R	F	MPV Engine DHX (XUD9TF/BTF)/D8B (XUD9TF)	210014	Drive Shaft	48T	27	37	59	82	947		
1.9 TD (68 kW)	1995.10-1998.12	MT	L	F	MPV Engine D8B (XUD9TF)	610015	Inner Joint		37	39	40	68.5	104		
	1995.10-1998.12	MT	R	F	MPV Engine D8B (XUD9TF)	610034	Inner Joint		37	39	31.9	369.5	99		
	1995.10-1998.12	MT	L	F	MPV Engine D8B (XUD9TF)	210072	Drive Shaft		27	37	59	82	641		
	1995.10-1998.12	-	L	F	MPV Engine D8B (XUD9TF)	210073	Drive Shaft	48T	27	37	59	82	641		
	1995.10-1998.12	-	-	F	MPV Engine D8B (XUD9TF)	810014	Outer Joint		27	39	59	82	63	I	
	1995.10-1998.12	-	R	F	MPV Engine D8B (XUD9TF)	210108	Drive Shaft	48T	27	37	59	82	939		
	1995.10-1998.12	-	R	F	MPV Engine D8B (XUD9TF)	210074	Drive Shaft		27	37	59	82	939		
	1995.10-1998.12	-	L/R	F	MPV Engine D8B (XUD9TF)	810015	Outer Joint	48T	27	39	59	82	63	I	
	1995.10-1998.12	MT	R	F	MPV Engine D8B (XUD9TF)	210155	Drive Shaft		27	37	59	82	947		
	1995.10-1998.12	MT	L	F	MPV Engine D8B (XUD9TF)	210016	Drive Shaft	48T	27	37	59	82	641		
	1995.10-1998.12	MT	R	F	MPV Engine D8B (XUD9TF)	210014	Drive Shaft	48T	27	37	59	82	947		
	2.0 (89 kW)	1994.06-2002.07	-	-	F	MPV Engine RFU (XU10J2/C)	810016	Outer Joint		27	34	59	82	55	I
		1994.06-2002.07	MT	L	F	MPV Engine RFU (XU10J2/C)	210082	Drive Shaft	48T	27	24	59	82	648	
1994.06-2002.07		-	L	F	MPV Engine RFU (XU10J2/C)	610015	Inner Joint		37	39	40	68.5	104		
1994.06-2002.07		-	R	F	MPV Engine RFU (XU10J2/C)	210081	Drive Shaft	48T	27	24	59	82	935		
1994.06-2002.07		-	L	F	MPV Engine RFU (XU10J2/C)	210112	Drive Shaft		27	24	59	82	648		
1994.06-2002.07		MT	R	F	MPV Engine RFU (XU10J2/C)	210012	Drive Shaft	48T	27	24	64	80.5	928		
1994.06-2002.07		-	R	F	MPV Engine RFU (XU10J2/C)	610034	Inner Joint		37	39	31.9	369.5	99		
1994.06-2002.07		MT	L/R	F	MPV Engine RFU (XU10J2/C)	810018	Outer Joint	48T	27	34	61	82	55	I	
1994.06-2002.07		-	R	F	MPV Engine RFU (XU10J2/C)	210111	Drive Shaft		27	24	59	82	935		
1994.06-2002.07		-	L	F	MPV Engine RFU (XU10J2/C)	210072	Drive Shaft		27	37	59	82	641		
1994.06-2002.07		-	R	F	MPV Engine RFU (XU10J2/C)	210155	Drive Shaft		27	37	59	82	947		
1994.06-2002.07		MT	L	F	MPV Engine RFU (XU10J2/C)	210052	Drive Shaft		27	24	61	82	648		
1994.06-2002.07		-	L	F	MPV Engine RFU (XU10J2/C)	210016	Drive Shaft	48T	27	37	59	82	641		
1994.06-2002.07		MT	R	F	MPV Engine RFU (XU10J2/C)	210120	Drive Shaft		27	24	59	82	928		
1994.06-2002.07		-	R	F	MPV Engine RFU (XU10J2/C)	210014	Drive Shaft	48T	27	37	59	82	947		
1994.06-2002.07	-	-	F	MPV Engine RFU (XU10J2/C)	810059	Outer Joint	48T	27	34	59	82	55	I		
2.0 16V (100 kW)	2000.05-2002.07	-	-	F	MPV Engine RFN (EW10J4)	810016	Outer Joint		27	34	59	82	55	I	
	2000.05-2002.07	MT	L	F	MPV Engine RFN (EW10J4)	210082	Drive Shaft	48T	27	24	59	82	648		
	2000.05-2002.07	MT	R	F	MPV Engine RFN (EW10J4)	210081	Drive Shaft	48T	27	24	59	82	935		
	2000.05-2002.07	MT	R	F	MPV Engine RFN (EW10J4)	210012	Drive Shaft	48T	27	24	64	80.5	928		
	2000.05-2002.07	-	L	F	MPV Engine RFN (EW10J4)	210112	Drive Shaft		27	24	59	82	648		
	2000.05-2002.07	MT	L/R	F	MPV Engine RFN (EW10J4)	810018	Outer Joint	48T	27	34	61	82	55	I	
	2000.05-2002.07	-	R	F	MPV Engine RFN (EW10J4)	210111	Drive Shaft		27	24	59	82	935		
	2000.05-2002.07	MT	L	F	MPV Engine RFN (EW10J4)	210052	Drive Shaft		27	24	61	82	648		
	2000.05-2002.07	MT	R	F	MPV Engine RFN (EW10J4)	210120	Drive Shaft		27	24	59	82	928		
	2000.05-2002.07	-	-	F	MPV Engine RFN (EW10J4)	810059	Outer Joint	48T	27	34	59	82	55	I	
2.0 16V (97 kW)	1998.05-2000.04	MT	L	F	MPV Engine RFV (XU10J4R)	610015	Inner Joint		37	39	40	68.5	104		
	1998.05-2000.04	MT	R	F	MPV Engine RFV (XU10J4R)	610034	Inner Joint		37	39	31.9	369.5	99		
	1998.05-2000.04	MT	L/R	F	MPV Engine RFV (XU10J4R)	810018	Outer Joint	48T	27	34	61	82	55	I	
	1998.05-2000.04	MT	L	F	MPV Engine RFV (XU10J4R)	210072	Drive Shaft		27	37	59	82	641		
	1998.05-2000.04	MT	R	F	MPV Engine RFV (XU10J4R)	210155	Drive Shaft		27	37	59	82	947		





YEAR	TRANSM	L/R	F/R	REMARKS	GSP Ref.	PRODUCT	ABS	Technical Specifications										
								A	B	C	H	L	P					
CITROEN																		
EVASION (22 U6)/SYNERGIE																		
2.0 16V (97 kW)	1998.05-2000.04	MT	L	F	MPV Engine RFV (XU10J4R)	210016	Drive Shaft	48T	27	37	59	82	641					
	1998.05-2000.04	MT	R	F	MPV Engine RFV (XU10J4R)	210014	Drive Shaft	48T	27	37	59	82	947					
2.0 HDI (80 kW)	1999.08-2002.07	-	L	F	MPV Engine RHZ (DW10ATED)	210430	Drive Shaft		27	37	59	82	630					
	1999.08-2002.07	-	R	F	MPV Engine RHZ (DW10ATED)	210057	Drive Shaft		27	37	59	82	960					
	1999.08-2002.07	-	R	F	MPV Engine RHZ (DW10ATED)	210237	Drive Shaft	48T	27	37	59	82	953					
	1999.08-2002.07	-	L	F	MPV Engine RHZ (DW10ATED)	210264	Drive Shaft	48T	27	37	59	82	630					
	1999.08-2002.07	-	R	F	MPV Engine RHZ (DW10ATED)	245120	Drive Shaft	48T	27	37	59	82	960					
	1999.08-2002.07	-	-	F	MPV Engine RHZ (DW10ATED)	810014	Outer Joint		27	39	59	82	63	I				
	1999.08-2002.07	-	L	F	MPV Engine RHZ (DW10ATED)	610015	Inner Joint		37	39	40	68.5	104					
2.0 HDI 16V (80 kW)	1999.09-2002.07	-	L	F	MPV Engine RHW (DW10ATED4)	210430	Drive Shaft		27	37	59	82	630					
	1999.09-2002.07	-	R	F	MPV Engine RHW (DW10ATED4)	210057	Drive Shaft		27	37	59	82	960					
	1999.09-2002.07	-	R	F	MPV Engine RHW (DW10ATED4)	210237	Drive Shaft	48T	27	37	59	82	953					
	1999.09-2002.07	-	L	F	MPV Engine RHW (DW10ATED4)	210264	Drive Shaft	48T	27	37	59	82	630					
	1999.09-2002.07	-	R	F	MPV Engine RHW (DW10ATED4)	245120	Drive Shaft	48T	27	37	59	82	960					
	1999.09-2002.07	-	L	F	MPV Engine RHW (DW10ATED4)	610015	Inner Joint		37	39	40	68.5	104					
	1999.09-2002.07	-	R	F	MPV Engine RHW (DW10ATED4)	610034	Inner Joint		37	39	31.9	369.5	99					
2.0 Turbo C.T. (108 kW)	1994.06-2002.07	-	R	F	MPV Engine RGX (XU10J2TE)	210081	Drive Shaft	48T	27	24	59	82	935					
	1994.06-2002.07	MT	L	F	MPV Engine RGX (XU10J2TE)	610015	Inner Joint		37	39	40	68.5	104					
	1994.06-2002.07	-	L	F	MPV Engine RGX (XU10J2TE)	210112	Drive Shaft		27	24	59	82	648					
	1994.06-2002.07	MT	R	F	MPV Engine RGX (XU10J2TE)	610034	Inner Joint		37	39	31.9	369.5	99					
	1994.06-2002.07	-	R	F	MPV Engine RGX (XU10J2TE)	210111	Drive Shaft		27	24	59	82	935					
	1994.06-2002.07	-	-	F	MPV Engine RGX (XU10J2TE)	810014	Outer Joint		27	39	59	82	63	I				
	1994.06-2002.07	MT	L	F	MPV Engine RGX (XU10J2TE)	210072	Drive Shaft		27	37	59	82	641					
	1994.06-2002.07	MT	R	F	MPV Engine RGX (XU10J2TE)	210155	Drive Shaft		27	37	59	82	947					
	1994.06-2002.07	-	L/R	F	MPV Engine RGX (XU10J2TE)	810015	Outer Joint	48T	27	39	59	82	63	I				
	1994.06-2002.07	MT	L	F	MPV Engine RGX (XU10J2TE)	210016	Drive Shaft	48T	27	37	59	82	641					
	1994.06-2002.07	MT	R	F	MPV Engine RGX (XU10J2TE)	210014	Drive Shaft	48T	27	37	59	82	947					
2.1 TD (80 kW)	1996.05-2002.07	MT	L	F	MPV Engine P8C (XUD11BTE)	610015	Inner Joint		37	39	40	68.5	104					
	1996.05-2002.07	MT	R	F	MPV Engine P8C (XUD11BTE)	610034	Inner Joint		37	39	31.9	369.5	99					
	1996.05-2002.07	-	L	F	MPV Engine P8C (XUD11BTE)	210073	Drive Shaft	48T	27	37	59	82	641					
	1996.05-2002.07	MT	L	F	MPV Engine P8C (XUD11BTE)	210072	Drive Shaft		27	37	59	82	641					
	1996.05-2002.07	-	R	F	MPV Engine P8C (XUD11BTE)	210108	Drive Shaft	48T	27	37	59	82	939					
	1996.05-2002.07	-	R	F	MPV Engine P8C (XUD11BTE)	210074	Drive Shaft		27	37	59	82	939					
	1996.05-2002.07	MT	R	F	MPV Engine P8C (XUD11BTE)	210155	Drive Shaft		27	37	59	82	947					
	1996.05-2002.07	-	L/R	F	MPV Engine P8C (XUD11BTE)	810015	Outer Joint	48T	27	39	59	82	63	I				
	1996.05-2002.07	MT	L	F	MPV Engine P8C (XUD11BTE)	210016	Drive Shaft	48T	27	37	59	82	641					
	1996.05-2002.07	MT	R	F	MPV Engine P8C (XUD11BTE)	210014	Drive Shaft	48T	27	37	59	82	947					
FUKANG																		
1.6 (65 kW)	2005.05-2008.12	-	L	-	Hatchback Engine TU5JPK	210101	Drive Shaft	29T	25	22	59	79	598					
	2005.05-2008.12	-	R	-	Hatchback Engine TU5JPK	210245	Drive Shaft	29T	25	22	59	79	870					
	2005.05-2008.12	-	R	-	Hatchback Engine TU5JPK	210315	Drive Shaft	29T	25	22	59	79	866					
	2005.05-2008.12	-	L	-	Hatchback Engine TU5JPK	210316	Drive Shaft	29T	25	22	59	79	594					
1.6 (78 kW)	2005.05-2008.12	-	L	-	Hatchback Engine TU5JP4/N6A 10FX3A PSA	210101	Drive Shaft	29T	25	22	59	79	598					
	2005.05-2008.12	-	R	-	Hatchback Engine TU5JP4/N6A 10FX3A PSA	210245	Drive Shaft	29T	25	22	59	79	870					
	2005.05-2008.12	-	R	-	Hatchback Engine TU5JP4/N6A 10FX3A PSA	210315	Drive Shaft	29T	25	22	59	79	866					
	2005.05-2008.12	-	L	-	Hatchback Engine TU5JP4/N6A 10FX3A PSA	210316	Drive Shaft	29T	25	22	59	79	594					
JUMPER (230)/RELAY																		
1.9 TD (66 kW)	1994.03-2002.04	MT	L	F	Platform/Chassis Engine DHX (XUD9TF/BTF)	610015	Inner Joint		37	39	40	68.5	104					
	1994.03-2002.04	MT	L/R	F	Platform/Chassis Engine DHX (XUD9TF/BTF)	810012	Outer Joint		28	39	63	112.5	63	I				
	1994.03-2002.04	MT	L	F	Platform/Chassis Engine DHX (XUD9TF/BTF)	210102	Drive Shaft		28	41	63	112.5	757.5					
	1994.03-2002.04	MT	L	F	Platform/Chassis Engine DHX (XUD9TF/BTF)	210037	Drive Shaft	54T	28	37	63	112.5	771					
	1994.03-2002.04	MT	R	F	Platform/Chassis Engine DHX (XUD9TF/BTF)	210066	Drive Shaft		35	41	70	117	1085					
	1994.03-2002.04	MT	R	F	Platform/Chassis Engine DHX (XUD9TF/BTF)	210036	Drive Shaft	54T	28	41	63	112.5	1079					
	1994.03-2002.04	MT	R	F	Platform/Chassis Engine DHX (XUD9TF/BTF)	210032	Drive Shaft	54T	35	41	70	117	1085					
	1994.03-2002.04	-	-	-	Platform/Chassis Engine DHX (XUD9TF/BTF)	645013	Inner Joint		37	39	40	68.5	100					
	1994.03-2002.04	MT	L/R	F	Platform/Chassis Engine DHX (XUD9TF/BTF)	810011	Outer Joint	54T	35	45	70	117	73	I				
	1994.03-2002.04	MT	R	F	Platform/Chassis Engine DHX (XUD9TF/BTF)	610034	Inner Joint		37	39	31.9	369.5	99					
	1994.03-2002.04	MT	L	F	Platform/Chassis Engine DHX (XUD9TF/BTF)	210105	Drive Shaft		28	37	63	112.5	771					
	1994.03-2002.04	MT	R	F	Platform/Chassis Engine DHX (XUD9TF/BTF)	210103	Drive Shaft		28	41	63	112.5	1079					
	1994.03-2002.04	MT	L/R	F	Platform/Chassis Engine DHX (XUD9TF/BTF)	810013	Outer Joint	54T	28	39	63	112.5	63	I				
	1994.03-2002.04	MT	R	F	Platform/Chassis Engine DHX (XUD9TF/BTF)	210104	Drive Shaft	54T	28	37	63	112.5	1072					
	1994.03-2002.04	MT	L	F	Platform/Chassis Engine DHX (XUD9TF/BTF)	210067	Drive Shaft		35	41	70	117	762					
	1994.03-2002.04	MT	L	F	Platform/Chassis Engine DHX (XUD9TF/BTF)	210033	Drive Shaft	54T	35	41	70	117	762					
	1994.03-2002.04	MT	L/R	F	Platform/Chassis Engine DHX (XUD9TF/BTF)	810050	Outer Joint		35	45	70	117	73	I				
	1994.03-2002.04	MT	R	F	Platform/Chassis Engine DHX (XUD9TF/BTF)	210069	Drive Shaft		28	37	63	112.5	1072					

YEAR	TRANSM	L/R	F/R	REMARKS	GSP Ref.	PRODUCT	ABS	Technical Specifications							
								A	B	C	H	L	P		
CITROEN JUMPER (230)/RELAY															
1.9 TD (66 kW)	1994.03-2002.04	MT	R	F	Platform/Chassis Engine DHX (XUD9TF/BTF)	610009	Inner Joint		41	45	34.9	367.5	115.6		
	1994.03-2002.04	MT	L	F	Platform/Chassis Engine DHX (XUD9TF/BTF)	210035	Drive Shaft	54T	28	41	63	112.5	757.5		
1.9 TD (68 kW)	1994.03-2002.04	MT	L	F	Platform/Chassis Engine D8C (XUD9UTF)	610015	Inner Joint		37	39	40	68.5	104		
	1994.03-2002.04	MT	L/R	F	Platform/Chassis Engine D8C (XUD9UTF)	810012	Outer Joint		28	39	63	112.5	63	I	
	1994.03-2002.04	MT	L	F	Platform/Chassis Engine D8C (XUD9UTF)	210102	Drive Shaft		28	41	63	112.5	757.5		
	1994.03-2002.04	MT	L	F	Platform/Chassis Engine D8C (XUD9UTF)	210037	Drive Shaft	54T	28	37	63	112.5	771		
	1994.03-2002.04	MT	R	F	Platform/Chassis Engine D8C (XUD9UTF)	210066	Drive Shaft		35	41	70	117	1085		
	1994.03-2002.04	MT	R	F	Platform/Chassis Engine D8C (XUD9UTF)	210036	Drive Shaft	54T	28	41	63	112.5	1079		
	1994.03-2002.04	MT	R	F	Platform/Chassis Engine D8C (XUD9UTF)	210032	Drive Shaft	54T	35	41	70	117	1085		
	1994.03-2002.04	MT	L/R	F	Platform/Chassis Engine D8C (XUD9UTF)	810011	Outer Joint	54T	35	45	70	117	73	I	
	1994.03-2002.04	-	-	-	Platform/Chassis Engine D8C (XUD9UTF)	645013	Inner Joint		37	39	40	68.5	100		
	1994.03-2002.04	MT	R	F	Platform/Chassis Engine D8C (XUD9UTF)	610034	Inner Joint		37	39	31.9	369.5	99		
	1994.03-2002.04	MT	L	F	Platform/Chassis Engine D8C (XUD9UTF)	210105	Drive Shaft		28	37	63	112.5	771		
	1994.03-2002.04	MT	R	F	Platform/Chassis Engine D8C (XUD9UTF)	210103	Drive Shaft		28	41	63	112.5	1079		
	1994.03-2002.04	MT	L/R	F	Platform/Chassis Engine D8C (XUD9UTF)	810013	Outer Joint	54T	28	39	63	112.5	63	I	
	1994.03-2002.04	MT	R	F	Platform/Chassis Engine D8C (XUD9UTF)	210104	Drive Shaft	54T	28	37	63	112.5	1072		
	1994.03-2002.04	MT	L	F	Platform/Chassis Engine D8C (XUD9UTF)	210067	Drive Shaft		35	41	70	117	762		
	1994.03-2002.04	MT	L	F	Platform/Chassis Engine D8C (XUD9UTF)	210033	Drive Shaft	54T	35	41	70	117	762		
	1994.03-2002.04	MT	L/R	F	Platform/Chassis Engine D8C (XUD9UTF)	810050	Outer Joint		35	45	70	117	73	I	
	1994.03-2002.04	MT	R	F	Platform/Chassis Engine D8C (XUD9UTF)	210069	Drive Shaft		28	37	63	112.5	1072		
	1994.03-2002.04	MT	R	F	Platform/Chassis Engine D8C (XUD9UTF)	610009	Inner Joint		41	45	34.9	367.5	115.6		
	1994.03-2002.04	MT	L	F	Platform/Chassis Engine D8C (XUD9UTF)	210035	Drive Shaft	54T	28	41	63	112.5	757.5		
2.0 (80 kW)	1994.03-2002.04	MT	L	F	Platform/Chassis Engine RFW (XU10J2U)	210102	Drive Shaft		28	41	63	112.5	757.5		
	1994.03-2002.04	MT	L	F	Platform/Chassis Engine RFW (XU10J2U)	210037	Drive Shaft	54T	28	37	63	112.5	771		
	1994.03-2002.04	MT	R	F	Platform/Chassis Engine RFW (XU10J2U)	210066	Drive Shaft		35	41	70	117	1085		
	1994.03-2002.04	MT	R	F	Platform/Chassis Engine RFW (XU10J2U)	210036	Drive Shaft	54T	28	41	63	112.5	1079		
	1994.03-2002.04	MT	L/R	F	Platform/Chassis Engine RFW (XU10J2U)	810011	Outer Joint	54T	35	45	70	117	73	I	
	1994.03-2002.04	MT	R	F	Platform/Chassis Engine RFW (XU10J2U)	210032	Drive Shaft	54T	35	41	70	117	1085		
	1994.03-2002.04	MT	R	F	Platform/Chassis Engine RFW (XU10J2U)	610034	Inner Joint		37	39	31.9	369.5	99		
	1994.03-2002.04	MT	L	F	Platform/Chassis Engine RFW (XU10J2U)	210105	Drive Shaft		28	37	63	112.5	771		
	1994.03-2002.04	-	-	-	Platform/Chassis Engine RFW (XU10J2U)	645013	Inner Joint		37	39	40	68.5	100		
	1994.03-2002.04	MT	L/R	F	Platform/Chassis Engine RFW (XU10J2U)	810013	Outer Joint	54T	28	39	63	112.5	63	I	
	1994.03-2002.04	MT	R	F	Platform/Chassis Engine RFW (XU10J2U)	210103	Drive Shaft		28	41	63	112.5	1079		
	1994.03-2002.04	MT	R	F	Platform/Chassis Engine RFW (XU10J2U)	210104	Drive Shaft	54T	28	37	63	112.5	1072		
	1994.03-2002.04	MT	L	F	Platform/Chassis Engine RFW (XU10J2U)	210067	Drive Shaft		35	41	70	117	762		
	1994.03-2002.04	MT	L	F	Platform/Chassis Engine RFW (XU10J2U)	210033	Drive Shaft	54T	35	41	70	117	762		
	1994.03-2002.04	MT	L/R	F	Platform/Chassis Engine RFW (XU10J2U)	810050	Outer Joint		35	45	70	117	73	I	
	1994.03-2002.04	MT	R	F	Platform/Chassis Engine RFW (XU10J2U)	210069	Drive Shaft		28	37	63	112.5	1072		
	1994.03-2002.04	MT	R	F	Platform/Chassis Engine RFW (XU10J2U)	610009	Inner Joint		41	45	34.9	367.5	115.6		
	1994.03-2002.04	MT	L	F	Platform/Chassis Engine RFW (XU10J2U)	210035	Drive Shaft	54T	28	41	63	112.5	757.5		
	1994.03-2002.04	MT	L	F	Platform/Chassis Engine RFW (XU10J2U)	610015	Inner Joint		37	39	40	68.5	104		
	1994.03-2002.04	MT	L/R	F	Platform/Chassis Engine RFW (XU10J2U)	810012	Outer Joint		28	39	63	112.5	63	I	
2.5 D (63 kW)	1994.03-2002.04	MT	R	F	Platform/Chassis Engine T9A (DJ5)	210066	Drive Shaft		35	41	70	117	1085		
	1994.03-2002.04	MT	L	F	Platform/Chassis Engine T9A (DJ5)	210037	Drive Shaft	54T	28	37	63	112.5	771		
	1994.03-2002.04	MT	R	F	Platform/Chassis Engine T9A (DJ5)	210036	Drive Shaft	54T	28	41	63	112.5	1079		
	1994.03-2002.04	MT	L/R	F	Platform/Chassis Engine T9A (DJ5)	810011	Outer Joint	54T	35	45	70	117	73	I	
	1994.03-2002.04	MT	R	F	Platform/Chassis Engine T9A (DJ5)	210032	Drive Shaft	54T	35	41	70	117	1085		
	1994.03-2002.04	MT	R	F	Platform/Chassis Engine T9A (DJ5)	610034	Inner Joint		37	39	31.9	369.5	99		
	1994.03-2002.04	MT	L	F	Platform/Chassis Engine T9A (DJ5)	210105	Drive Shaft		28	37	63	112.5	771		
	1994.03-2002.04	MT	L/R	F	Platform/Chassis Engine T9A (DJ5)	810013	Outer Joint	54T	28	39	63	112.5	63	I	
	1994.03-2002.04	MT	R	F	Platform/Chassis Engine T9A (DJ5)	210103	Drive Shaft		28	41	63	112.5	1079		
	1994.03-2002.04	-	-	-	Platform/Chassis Engine T9A (DJ5)	645013	Inner Joint		37	39	40	68.5	100		
	1994.03-2002.04	MT	R	F	Platform/Chassis Engine T9A (DJ5)	210104	Drive Shaft	54T	28	37	63	112.5	1072		
	1994.03-2002.04	MT	L	F	Platform/Chassis Engine T9A (DJ5)	210067	Drive Shaft		35	41	70	117	762		
	1994.03-2002.04	MT	L	F	Platform/Chassis Engine T9A (DJ5)	210033	Drive Shaft	54T	35	41	70	117	762		
	1994.03-2002.04	MT	L/R	F	Platform/Chassis Engine T9A (DJ5)	810050	Outer Joint		35	45	70	117	73	I	
	1994.03-2002.04	MT	R	F	Platform/Chassis Engine T9A (DJ5)	610009	Inner Joint		41	45	34.9	367.5	115.6		
	1994.03-2002.04	MT	R	F	Platform/Chassis Engine T9A (DJ5)	210069	Drive Shaft		28	37	63	112.5	1072		
	1994.03-2002.04	MT	L	F	Platform/Chassis Engine T9A (DJ5)	210035	Drive Shaft	54T	28	41	63	112.5	757.5		
	1994.03-2002.04	MT	L	F	Platform/Chassis Engine T9A (DJ5)	610015	Inner Joint		37	39	40	68.5	104		
	1994.03-2002.04	MT	L/R	F	Platform/Chassis Engine T9A (DJ5)	810012	Outer Joint		28	39	63	112.5	63	I	
	1994.03-2002.04	MT	L	F	Platform/Chassis Engine T9A (DJ5)	210102	Drive Shaft		28	41	63	112.5	757.5		
	2000.03-2002.04	MT	L	F	All-wheel Drive Platform/Chassis Engine T9A (DJ5)	210102	Drive Shaft		28	41	63	112.5	757.5		
	2000.03-2002.04	MT	L	F	All-wheel Drive Platform/Chassis Engine T9A (DJ5)	210037	Drive Shaft	54T	28	37	63	112.5	771		
	2000.03-2002.04	MT	R	F	All-wheel Drive Platform/Chassis Engine T9A (DJ5)	210066	Drive Shaft		35	41	70	117	1085		
	2000.03-2002.04	MT	R	F	All-wheel Drive Platform/Chassis Engine T9A (DJ5)	210036	Drive Shaft	54T	28	41	63	112.5	1079		

				TRANSM		L/R F/R		REMARKS		GSP Ref.				ABS		Technical Specifications					
YEAR												PRODUCT		ABS		A	B	C	H	L	P
CITROEN																					
JUMPER (230)/RELAY																					
2.5 D (63 kW)																					
2000.03-	2002.04	MT	L/R	F	All-wheel Drive Platform/Chassis Engine T9A (DJ5)		810011	Outer Joint	54T	35	45	70	117	73	I						
2000.03-	2002.04	MT	R	F	All-wheel Drive Platform/Chassis Engine T9A (DJ5)		210032	Drive Shaft	54T	35	41	70	117	1085							
2000.03-	2002.04	MT	R	F	All-wheel Drive Platform/Chassis Engine T9A (DJ5)		610034	Inner Joint		37	39	31.9	369.5	99							
2000.03-	2002.04	MT	L	F	All-wheel Drive Platform/Chassis Engine T9A (DJ5)		210105	Drive Shaft		28	37	63	112.5	771							
2000.03-	2002.04	-	-	-	All-wheel Drive Platform/Chassis Engine T9A (DJ5)		645013	Inner Joint		37	39	40	68.5	100							
2000.03-	2002.04	MT	L/R	F	All-wheel Drive Platform/Chassis Engine T9A (DJ5)		810013	Outer Joint	54T	28	39	63	112.5	63	I						
2000.03-	2002.04	MT	R	F	All-wheel Drive Platform/Chassis Engine T9A (DJ5)		210103	Drive Shaft		28	41	63	112.5	1079							
2000.03-	2002.04	MT	R	F	All-wheel Drive Platform/Chassis Engine T9A (DJ5)		210104	Drive Shaft	54T	28	37	63	112.5	1072							
2000.03-	2002.04	MT	L	F	All-wheel Drive Platform/Chassis Engine T9A (DJ5)		210067	Drive Shaft		35	41	70	117	762							
2000.03-	2002.04	MT	L	F	All-wheel Drive Platform/Chassis Engine T9A (DJ5)		210033	Drive Shaft	54T	35	41	70	117	762							
2000.03-	2002.04	MT	L/R	F	All-wheel Drive Platform/Chassis Engine T9A (DJ5)		810050	Outer Joint		35	45	70	117	73	I						
2000.03-	2002.04	MT	R	F	All-wheel Drive Platform/Chassis Engine T9A (DJ5)		210069	Drive Shaft		28	37	63	112.5	1072							
2000.03-	2002.04	MT	R	F	All-wheel Drive Platform/Chassis Engine T9A (DJ5)		610009	Inner Joint		41	45	34.9	367.5	115.6							
2000.03-	2002.04	MT	L	F	All-wheel Drive Platform/Chassis Engine T9A (DJ5)		210035	Drive Shaft	54T	28	41	63	112.5	757.5							
2000.03-	2002.04	MT	L	F	All-wheel Drive Platform/Chassis Engine T9A (DJ5)		610015	Inner Joint		37	39	40	68.5	104							
2000.03-	2002.04	MT	L/R	F	All-wheel Drive Platform/Chassis Engine T9A (DJ5)		810012	Outer Joint		28	39	63	112.5	63	I						
2.5 TD (76 kW)																					
1994.03-	2002.04	MT	L	F	Platform/Chassis Engine T8A (DJ5T)		210102	Drive Shaft		28	41	63	112.5	757.5							
1994.03-	2002.04	MT	L	F	Platform/Chassis Engine T8A (DJ5T)		210037	Drive Shaft	54T	28	37	63	112.5	771							
1994.03-	2002.04	MT	R	F	Platform/Chassis Engine T8A (DJ5T)		210066	Drive Shaft		35	41	70	117	1085							
1994.03-	2002.04	MT	R	F	Platform/Chassis Engine T8A (DJ5T)		210036	Drive Shaft	54T	28	41	63	112.5	1079							
1994.03-	2002.04	MT	L/R	F	Platform/Chassis Engine T8A (DJ5T)		810011	Outer Joint	54T	35	45	70	117	73	I						
1994.03-	2002.04	MT	R	F	Platform/Chassis Engine T8A (DJ5T)		210032	Drive Shaft	54T	35	41	70	117	1085							
1994.03-	2002.04	MT	R	F	Platform/Chassis Engine T8A (DJ5T)		610034	Inner Joint		37	39	31.9	369.5	99							
1994.03-	2002.04	MT	L	F	Platform/Chassis Engine T8A (DJ5T)		210105	Drive Shaft		28	37	63	112.5	771							
1994.03-	2002.04	MT	L/R	F	Platform/Chassis Engine T8A (DJ5T)		810013	Outer Joint	54T	28	39	63	112.5	63	I						
1994.03-	2002.04	-	-	-	Platform/Chassis Engine T8A (DJ5T)		645013	Inner Joint		37	39	40	68.5	100							
1994.03-	2002.04	MT	R	F	Platform/Chassis Engine T8A (DJ5T)		210103	Drive Shaft		28	41	63	112.5	1079							
1994.03-	2002.04	MT	R	F	Platform/Chassis Engine T8A (DJ5T)		210104	Drive Shaft	54T	28	37	63	112.5	1072							
1994.03-	2002.04	MT	L	F	Platform/Chassis Engine T8A (DJ5T)		210067	Drive Shaft		35	41	70	117	762							
1994.03-	2002.04	MT	L	F	Platform/Chassis Engine T8A (DJ5T)		210033	Drive Shaft	54T	35	41	70	117	762							
1994.03-	2002.04	MT	L/R	F	Platform/Chassis Engine T8A (DJ5T)		810050	Outer Joint		35	45	70	117	73	I						
1994.03-	2002.04	MT	R	F	Platform/Chassis Engine T8A (DJ5T)		210069	Drive Shaft		28	37	63	112.5	1072							
1994.03-	2002.04	MT	R	F	Platform/Chassis Engine T8A (DJ5T)		610009	Inner Joint		41	45	34.9	367.5	115.6							
1994.03-	2002.04	MT	L	F	Platform/Chassis Engine T8A (DJ5T)		210035	Drive Shaft	54T	28	41	63	112.5	757.5							
1994.03-	2002.04	MT	L	F	Platform/Chassis Engine T8A (DJ5T)		610015	Inner Joint		37	39	40	68.5	104							
1994.03-	2002.04	MT	L/R	F	Platform/Chassis Engine T8A (DJ5T)		810012	Outer Joint		28	39	63	112.5	63	I						
2.5 TDi (79 kW)																					
1996.12-	2002.04	MT	L	F	Platform/Chassis Engine THX (DJ5TED)		210102	Drive Shaft		28	41	63	112.5	757.5							
1996.12-	2002.04	MT	L	F	Platform/Chassis Engine THX (DJ5TED)		210037	Drive Shaft	54T	28	37	63	112.5	771							
1996.12-	2002.04	MT	R	F	Platform/Chassis Engine THX (DJ5TED)		210066	Drive Shaft		35	41	70	117	1085							
1996.12-	2002.04	MT	R	F	Platform/Chassis Engine THX (DJ5TED)		210036	Drive Shaft	54T	28	41	63	112.5	1079							
1996.12-	2002.04	MT	L/R	F	Platform/Chassis Engine THX (DJ5TED)		810011	Outer Joint	54T	35	45	70	117	73	I						
1996.12-	2002.04	MT	R	F	Platform/Chassis Engine THX (DJ5TED)		210032	Drive Shaft	54T	35	41	70	117	1085							
1996.12-	2002.04	MT	R	F	Platform/Chassis Engine THX (DJ5TED)		610034	Inner Joint		37	39	31.9	369.5	99							
1996.12-	2002.04	MT	L	F	Platform/Chassis Engine THX (DJ5TED)		210105	Drive Shaft		28	37	63	112.5	771							
1996.12-	2002.04	MT	L/R	F	Platform/Chassis Engine THX (DJ5TED)		810013	Outer Joint	54T	28	39	63	112.5	63	I						
1996.12-	2002.04	-	-	-	Platform/Chassis Engine THX (DJ5TED)		645013	Inner Joint		37	39	40	68.5	100							
1996.12-	2002.04	MT	R	F	Platform/Chassis Engine THX (DJ5TED)		210103	Drive Shaft		28	41	63	112.5	1079							
1996.12-	2002.04	MT	R	F	Platform/Chassis Engine THX (DJ5TED)		210104	Drive Shaft	54T	28	37	63	112.5	1072							
1996.12-	2002.04	MT	L	F	Platform/Chassis Engine THX (DJ5TED)		210067	Drive Shaft		35	41	70	117	762							
1996.12-	2002.04	MT	L	F	Platform/Chassis Engine THX (DJ5TED)		210033	Drive Shaft	54T	35	41	70	117	762							
1996.12-	2002.04	MT	L/R	F	Platform/Chassis Engine THX (DJ5TED)		810050	Outer Joint		35	45	70	117	73	I						
1996.12-	2002.04	MT	R	F	Platform/Chassis Engine THX (DJ5TED)		210069	Drive Shaft		28	37	63	112.5	1072							
1996.12-	2002.04	MT	R	F	Platform/Chassis Engine THX (DJ5TED)		610009	Inner Joint		41	45	34.9	367.5	115.6							
1996.12-	2002.04	MT	L	F	Platform/Chassis Engine THX (DJ5TED)		210035	Drive Shaft	54T	28	41	63	112.5	757.5							
1996.12-	2002.04	MT	L	F	Platform/Chassis Engine THX (DJ5TED)		610015	Inner Joint		37	39	40	68.5	104							
1996.12-	2002.04	MT	L/R	F	Platform/Chassis Engine THX (DJ5TED)		810012	Outer Joint		28	39	63	112.5	63	I						
2000.03-	2002.04	MT	L	F	All-wheel Drive Platform/Chassis Engine THX (DJ5TED)		210102	Drive Shaft		28	41	63	112.5	757.5							
2000.03-	2002.04	MT	L	F	All-wheel Drive Platform/Chassis Engine THX (DJ5TED)		210037	Drive Shaft	54T	28	37	63	112.5	771							
2000.03-	2002.04	MT	R	F	All-wheel Drive Platform/Chassis Engine THX (DJ5TED)		210066	Drive Shaft		35	41	70	117	1085							
2000.03-	2002.04	MT	R	F	All-wheel Drive Platform/Chassis Engine THX (DJ5TED)		210036	Drive Shaft	54T	28	41	63	112.5	1079							
2000.03-	2002.04	MT	L/R	F	All-wheel Drive Platform/Chassis Engine THX (DJ5TED)		810011	Outer Joint	54T	35	45	70	117	73	I						
2000.03-	2002.04	MT	R	F	All-wheel Drive Platform/Chassis Engine THX (DJ5TED)		210032	Drive Shaft	54T	35	41	70	117	1085							
2000.03-	2002.04	MT	R	F	All-wheel Drive Platform/Chassis Engine THX (DJ5TED)		610034	Inner Joint		37	39	31.9	369.5	99							
2000.03-	2002.04	MT	L	F	All-wheel Drive Platform/Chassis Engine THX (DJ5TED)		210105	Drive Shaft		28	37	63	112.5	771							
2000.03-	2002.04	MT	L/R	F	All-wheel Drive Platform/Chassis Engine THX (DJ5TED)		810013	Outer Joint	54T	28	39	63	112.5	63	I						
2000.03-	20																				





YEAR	TRANSM	L/R	F/R	REMARKS	GSP Ref.	PRODUCT	ABS	Technical Specifications					
								A	B	C	H	L	P
CITROEN													
JUMPER (230)/RELAY													
2.5 TDi (79 kW)													
2000.03-2002.04	MT	R	F	All-wheel Drive Platform/Chassis Engine THX (DJ5TED)	210103	Drive Shaft		28	41	63	112.5	1079	
2000.03-2002.04	MT	R	F	All-wheel Drive Platform/Chassis Engine THX (DJ5TED)	210104	Drive Shaft	54T	28	37	63	112.5	1072	
2000.03-2002.04	MT	L	F	All-wheel Drive Platform/Chassis Engine THX (DJ5TED)	210067	Drive Shaft		35	41	70	117	762	
2000.03-2002.04	MT	L	F	All-wheel Drive Platform/Chassis Engine THX (DJ5TED)	210033	Drive Shaft	54T	35	41	70	117	762	
2000.03-2002.04	MT	L/R	F	All-wheel Drive Platform/Chassis Engine THX (DJ5TED)	810050	Outer Joint		35	45	70	117	73 I	
2000.03-2002.04	MT	R	F	All-wheel Drive Platform/Chassis Engine THX (DJ5TED)	210069	Drive Shaft		28	37	63	112.5	1072	
2000.03-2002.04	MT	R	F	All-wheel Drive Platform/Chassis Engine THX (DJ5TED)	610009	Inner Joint		41	45	34.9	367.5	115.6	
2000.03-2002.04	MT	L	F	All-wheel Drive Platform/Chassis Engine THX (DJ5TED)	210035	Drive Shaft	54T	28	41	63	112.5	757.5	
2000.03-2002.04	MT	L	F	All-wheel Drive Platform/Chassis Engine THX (DJ5TED)	610015	Inner Joint		37	39	40	68.5	104	
2000.03-2002.04	MT	L/R	F	All-wheel Drive Platform/Chassis Engine THX (DJ5TED)	810012	Outer Joint		28	39	63	112.5	63 I	
2.8 HDi (94 kW)													
2000.09-2002.04	MT	R	F	Platform/Chassis Engine 8140.43S	210066	Drive Shaft		35	41	70	117	1085	
2000.09-2002.04	MT	L/R	F	Platform/Chassis Engine 8140.43S	810011	Outer Joint	54T	35	45	70	117	73 I	
2000.09-2002.04	MT	R	F	Platform/Chassis Engine 8140.43S	210032	Drive Shaft	54T	35	41	70	117	1085	
2000.09-2002.04	MT	L	F	Platform/Chassis Engine 8140.43S	210067	Drive Shaft		35	41	70	117	762	
2000.09-2002.04	MT	L	F	Platform/Chassis Engine 8140.43S	210033	Drive Shaft	54T	35	41	70	117	762	
2000.09-2002.04	MT	L/R	F	Platform/Chassis Engine 8140.43S	810050	Outer Joint		35	45	70	117	73 I	
2000.09-2002.04	MT	R	F	Platform/Chassis Engine 8140.43S	610009	Inner Joint		41	45	34.9	367.5	115.6	
JUMPER (230L)/RELAY													
1.9 D (50 kW)													
1999.07-2002.04	MT	R	F	Box Engine DJY (XUD9A)	210066	Drive Shaft		35	41	70	117	1085	
1999.07-2002.04	MT	L	F	Box Engine DJY (XUD9A)	210037	Drive Shaft	54T	28	37	63	112.5	771	
1999.07-2002.04	MT	R	F	Box Engine DJY (XUD9A)	210036	Drive Shaft	54T	28	41	63	112.5	1079	
1999.07-2002.04	MT	L/R	F	Box Engine DJY (XUD9A)	810011	Outer Joint	54T	35	45	70	117	73 I	
1999.07-2002.04	MT	R	F	Box Engine DJY (XUD9A)	210032	Drive Shaft	54T	35	41	70	117	1085	
1999.07-2002.04	MT	R	F	Box Engine DJY (XUD9A)	610034	Inner Joint		37	39	31.9	369.5	99	
1999.07-2002.04	MT	L	F	Box Engine DJY (XUD9A)	210105	Drive Shaft		28	37	63	112.5	771	
1999.07-2002.04	-	-	-	Box Engine DJY (XUD9A)	645013	Inner Joint		37	39	40	68.5	100	
1999.07-2002.04	MT	L/R	F	Box Engine DJY (XUD9A)	810013	Outer Joint	54T	28	39	63	112.5	63 I	
1999.07-2002.04	MT	R	F	Box Engine DJY (XUD9A)	210103	Drive Shaft		28	41	63	112.5	1079	
1999.07-2002.04	MT	R	F	Box Engine DJY (XUD9A)	210104	Drive Shaft	54T	28	37	63	112.5	1072	
1999.07-2002.04	MT	L	F	Box Engine DJY (XUD9A)	210067	Drive Shaft		35	41	70	117	762	
1999.07-2002.04	MT	L	F	Box Engine DJY (XUD9A)	210033	Drive Shaft	54T	35	41	70	117	762	
1999.07-2002.04	MT	L/R	F	Box Engine DJY (XUD9A)	810050	Outer Joint		35	45	70	117	73 I	
1999.07-2002.04	MT	R	F	Box Engine DJY (XUD9A)	610009	Inner Joint		41	45	34.9	367.5	115.6	
1999.07-2002.04	MT	R	F	Box Engine DJY (XUD9A)	210069	Drive Shaft		28	37	63	112.5	1072	
1999.07-2002.04	MT	L	F	Box Engine DJY (XUD9A)	210035	Drive Shaft	54T	28	41	63	112.5	757.5	
1999.07-2002.04	MT	L	F	Box Engine DJY (XUD9A)	610015	Inner Joint		37	39	40	68.5	104	
1999.07-2002.04	MT	L/R	F	Box Engine DJY (XUD9A)	810012	Outer Joint		28	39	63	112.5	63 I	
1999.07-2002.04	MT	L	F	Box Engine DJY (XUD9A)	210102	Drive Shaft		28	41	63	112.5	757.5	
1.9 D (51 kW)													
1994.02-2002.04	MT	R	F	Box Engine D9B (XUD9A/U)	210066	Drive Shaft		35	41	70	117	1085	
1994.02-2002.04	MT	L	F	Box Engine D9B (XUD9A/U)	210037	Drive Shaft	54T	28	37	63	112.5	771	
1994.02-2002.04	MT	R	F	Box Engine D9B (XUD9A/U)	210036	Drive Shaft	54T	28	41	63	112.5	1079	
1994.02-2002.04	MT	L/R	F	Box Engine D9B (XUD9A/U)	810011	Outer Joint	54T	35	45	70	117	73 I	
1994.02-2002.04	MT	R	F	Box Engine D9B (XUD9A/U)	210032	Drive Shaft	54T	35	41	70	117	1085	
1994.02-2002.04	MT	R	F	Box Engine D9B (XUD9A/U)	610034	Inner Joint		37	39	31.9	369.5	99	
1994.02-2002.04	MT	L	F	Box Engine D9B (XUD9A/U)	210105	Drive Shaft		28	37	63	112.5	771	
1994.02-2002.04	-	-	-	Box Engine D9B (XUD9A/U)	645013	Inner Joint		37	39	40	68.5	100	
1994.02-2002.04	MT	L/R	F	Box Engine D9B (XUD9A/U)	810013	Outer Joint	54T	28	39	63	112.5	63 I	
1994.02-2002.04	MT	R	F	Box Engine D9B (XUD9A/U)	210103	Drive Shaft		28	41	63	112.5	1079	
1994.02-2002.04	MT	R	F	Box Engine D9B (XUD9A/U)	210104	Drive Shaft	54T	28	37	63	112.5	1072	
1994.02-2002.04	MT	L	F	Box Engine D9B (XUD9A/U)	210067	Drive Shaft		35	41	70	117	762	
1994.02-2002.04	MT	L	F	Box Engine D9B (XUD9A/U)	210033	Drive Shaft	54T	35	41	70	117	762	
1994.02-2002.04	MT	L/R	F	Box Engine D9B (XUD9A/U)	810050	Outer Joint		35	45	70	117	73 I	
1994.02-2002.04	MT	R	F	Box Engine D9B (XUD9A/U)	610009	Inner Joint		41	45	34.9	367.5	115.6	
1994.02-2002.04	MT	R	F	Box Engine D9B (XUD9A/U)	210069	Drive Shaft		28	37	63	112.5	1072	
1994.02-2002.04	MT	L	F	Box Engine D9B (XUD9A/U)	210035	Drive Shaft	54T	28	41	63	112.5	757.5	
1994.02-2002.04	MT	L	F	Box Engine D9B (XUD9A/U)	610015	Inner Joint		37	39	40	68.5	104	
1994.02-2002.04	MT	L/R	F	Box Engine D9B (XUD9A/U)	810012	Outer Joint		28	39	63	112.5	63 I	
1994.02-2002.04	MT	L	F	Box Engine D9B (XUD9A/U)	210102	Drive Shaft		28	41	63	112.5	757.5	
1.9 TD (66 kW)													
1994.03-2002.04	MT	L	F	Box Engine DHX (XUD9TF/BTF)	610015	Inner Joint		37	39	40	68.5	104	
1994.03-2002.04	MT	L/R	F	Box Engine DHX (XUD9TF/BTF)	810012	Outer Joint		28	39	63	112.5	63 I	
1994.03-2002.04	MT	L	F	Box Engine DHX (XUD9TF/BTF)	210102	Drive Shaft		28	41	63	112.5	757.5	
1994.03-2002.04	-	-	-	Box Engine DHX (XUD9TF/BTF)	645013	Inner Joint		37	39	40	68.5	100	
1994.03-2002.04	MT	L	F	Box Engine DHX (XUD9TF/BTF)	210037	Drive Shaft	54T	28	37	63	112.5	771	
1994.03-2002.04	MT	R	F	Box Engine DHX (XUD9TF/BTF)	210066	Drive Shaft		35	41	70	117	1085	
1994.03-2002.04	MT	R	F	Box Engine DHX (XUD9TF/BTF)	210036	Drive Shaft	54T	28	41	63	112.5	1079	
1994.03-2002.04	MT	R	F	Box Engine DHX (XUD9TF/BTF)	210032	Drive Shaft	54T	35	41	70	117	1085	

		 YEAR	TRANSM	L/R	F/R	REMARKS	GSP Ref.	 PRODUCT	 ABS	Technical Specifications					
										A	B	C	H	L	P
CITROEN JUMPER (230L)/RELAY															
1.9 TD (66 kW)		1994.03-2002.04	MT	L/R	F	Box Engine DHX (XUD9TF/BTF)	810011	Outer Joint	54T	35	45	70	117	73	I
		1994.03-2002.04	MT	R	F	Box Engine DHX (XUD9TF/BTF)	610034	Inner Joint		37	39	31.9	369.5	99	
		1994.03-2002.04	MT	L	F	Box Engine DHX (XUD9TF/BTF)	210105	Drive Shaft		28	37	63	112.5	771	
		1994.03-2002.04	MT	R	F	Box Engine DHX (XUD9TF/BTF)	210103	Drive Shaft		28	41	63	112.5	1079	
		1994.03-2002.04	MT	L/R	F	Box Engine DHX (XUD9TF/BTF)	810013	Outer Joint	54T	28	39	63	112.5	63	I
		1994.03-2002.04	MT	R	F	Box Engine DHX (XUD9TF/BTF)	210104	Drive Shaft	54T	28	37	63	112.5	1072	
		1994.03-2002.04	MT	L	F	Box Engine DHX (XUD9TF/BTF)	210067	Drive Shaft		35	41	70	117	762	
		1994.03-2002.04	MT	L	F	Box Engine DHX (XUD9TF/BTF)	210033	Drive Shaft	54T	35	41	70	117	762	
		1994.03-2002.04	MT	L/R	F	Box Engine DHX (XUD9TF/BTF)	810050	Outer Joint		35	45	70	117	73	I
		1994.03-2002.04	MT	R	F	Box Engine DHX (XUD9TF/BTF)	210069	Drive Shaft		28	37	63	112.5	1072	
1.9 TD (68 kW)		1994.03-2002.04	MT	R	F	Box Engine D8C (XUD9UTF)	210069	Drive Shaft		28	37	63	112.5	1072	
		1994.03-2002.04	MT	R	F	Box Engine D8C (XUD9UTF)	610009	Inner Joint		41	45	34.9	367.5	115.6	
		1994.03-2002.04	MT	L	F	Box Engine D8C (XUD9UTF)	210035	Drive Shaft	54T	28	41	63	112.5	757.5	
		1994.03-2002.04	MT	L	F	Box Engine D8C (XUD9UTF)	610015	Inner Joint		37	39	40	68.5	104	
		1994.03-2002.04	MT	L/R	F	Box Engine D8C (XUD9UTF)	810012	Outer Joint		28	39	63	112.5	63	I
		1994.03-2002.04	MT	L	F	Box Engine D8C (XUD9UTF)	210102	Drive Shaft		28	41	63	112.5	757.5	
		1994.03-2002.04	-	-	-	Box Engine D8C (XUD9UTF)	645013	Inner Joint		37	39	40	68.5	100	
		1994.03-2002.04	MT	L	F	Box Engine D8C (XUD9UTF)	210037	Drive Shaft	54T	28	37	63	112.5	771	
		1994.03-2002.04	MT	R	F	Box Engine D8C (XUD9UTF)	210066	Drive Shaft		35	41	70	117	1085	
		1994.03-2002.04	MT	R	F	Box Engine D8C (XUD9UTF)	210036	Drive Shaft	54T	28	41	63	112.5	1079	
		1994.03-2002.04	MT	R	F	Box Engine D8C (XUD9UTF)	210032	Drive Shaft	54T	35	41	70	117	1085	
		1994.03-2002.04	MT	L/R	F	Box Engine D8C (XUD9UTF)	810011	Outer Joint	54T	35	45	70	117	73	I
		1994.03-2002.04	MT	R	F	Box Engine D8C (XUD9UTF)	610034	Inner Joint		37	39	31.9	369.5	99	
		1994.03-2002.04	MT	L	F	Box Engine D8C (XUD9UTF)	210105	Drive Shaft		28	37	63	112.5	771	
		1994.03-2002.04	MT	R	F	Box Engine D8C (XUD9UTF)	210103	Drive Shaft		28	41	63	112.5	1079	
		1994.03-2002.04	MT	L/R	F	Box Engine D8C (XUD9UTF)	810013	Outer Joint	54T	28	39	63	112.5	63	I
1994.03-2002.04	MT	R	F	Box Engine D8C (XUD9UTF)	210104	Drive Shaft	54T	28	37	63	112.5	1072			
2.0 (80 kW)		1994.03-2002.04	MT	L	F	Box Engine RFW (XU10J2U)	210102	Drive Shaft		28	41	63	112.5	757.5	
		1994.03-2002.04	MT	L	F	Box Engine RFW (XU10J2U)	210037	Drive Shaft	54T	28	37	63	112.5	771	
		1994.03-2002.04	MT	R	F	Box Engine RFW (XU10J2U)	210066	Drive Shaft		35	41	70	117	1085	
		1994.03-2002.04	MT	R	F	Box Engine RFW (XU10J2U)	210036	Drive Shaft	54T	28	41	63	112.5	1079	
		1994.03-2002.04	MT	L/R	F	Box Engine RFW (XU10J2U)	810011	Outer Joint	54T	35	45	70	117	73	I
		1994.03-2002.04	MT	R	F	Box Engine RFW (XU10J2U)	210032	Drive Shaft	54T	35	41	70	117	1085	
		1994.03-2002.04	MT	R	F	Box Engine RFW (XU10J2U)	610034	Inner Joint		37	39	31.9	369.5	99	
		1994.03-2002.04	-	-	-	Box Engine RFW (XU10J2U)	645013	Inner Joint		37	39	40	68.5	100	
		1994.03-2002.04	MT	L	F	Box Engine RFW (XU10J2U)	210105	Drive Shaft		28	37	63	112.5	771	
		1994.03-2002.04	MT	L/R	F	Box Engine RFW (XU10J2U)	810013	Outer Joint	54T	28	39	63	112.5	63	I
		1994.03-2002.04	MT	R	F	Box Engine RFW (XU10J2U)	210103	Drive Shaft		28	41	63	112.5	1079	
		1994.03-2002.04	MT	R	F	Box Engine RFW (XU10J2U)	210104	Drive Shaft	54T	28	37	63	112.5	1072	
		1994.03-2002.04	MT	L	F	Box Engine RFW (XU10J2U)	210067	Drive Shaft		35	41	70	117	762	
		1994.03-2002.04	MT	L	F	Box Engine RFW (XU10J2U)	210033	Drive Shaft	54T	35	41	70	117	762	
		1994.03-2002.04	MT	L/R	F	Box Engine RFW (XU10J2U)	810050	Outer Joint		35	45	70	117	73	I
		1994.03-2002.04	MT	R	F	Box Engine RFW (XU10J2U)	210069	Drive Shaft		28	37	63	112.5	1072	
2.5 D (63 kW)		1994.03-2002.04	MT	R	F	Box Engine T9A (DJ5)	210066	Drive Shaft		35	41	70	117	1085	
		1994.03-2002.04	MT	L	F	Box Engine T9A (DJ5)	210037	Drive Shaft	54T	28	37	63	112.5	771	
		1994.03-2002.04	MT	R	F	Box Engine T9A (DJ5)	210036	Drive Shaft	54T	28	41	63	112.5	1079	
		1994.03-2002.04	MT	L/R	F	Box Engine T9A (DJ5)	810011	Outer Joint	54T	35	45	70	117	73	I
		1994.03-2002.04	MT	R	F	Box Engine T9A (DJ5)	210032	Drive Shaft	54T	35	41	70	117	1085	
		1994.03-2002.04	MT	R	F	Box Engine T9A (DJ5)	610034	Inner Joint		37	39	31.9	369.5	99	
		1994.03-2002.04	MT	L	F	Box Engine T9A (DJ5)	210105	Drive Shaft		28	37	63	112.5	771	
		1994.03-2002.04	MT	L/R	F	Box Engine T9A (DJ5)	810013	Outer Joint	54T	28	39	63	112.5	63	I
		1994.03-2002.04	-	-	-	Box Engine T9A (DJ5)	645013	Inner Joint		37	39	40	68.5	100	
		1994.03-2002.04	MT	R	F	Box Engine T9A (DJ5)	210103	Drive Shaft		28	41	63	112.5	1079	
		1994.03-2002.04	MT	R	F	Box Engine T9A (DJ5)	210104	Drive Shaft	54T	28	37	63	112.5	1072	
		1994.03-2002.04	MT	L	F	Box Engine T9A (DJ5)	210067	Drive Shaft		35	41	70	117	762	
		1994.03-2002.04	MT	L	F	Box Engine T9A (DJ5)	210033	Drive Shaft	54T	35	41	70	117	762	
		1994.03-2002.04	MT	L/R	F	Box Engine T9A (DJ5)	810050	Outer Joint		35	45	70	117	73	I





	 YEAR	TRANSM	L/R	F/R	REMARKS	GSP Ref.	 PRODUCT	 ABS	Technical Specifications					
									A	B	C	H	L	P
CITROEN														
JUMPER (230L)/RELAY														
2.5 D (63 kW)														
1994.03-	2002.04	MT	R	F	Box Engine T9A (DJ5)	610009	Inner Joint		41	45	34.9	367.5	115.6	
1994.03-	2002.04	MT	R	F	Box Engine T9A (DJ5)	210069	Drive Shaft		28	37	63	112.5	1072	
1994.03-	2002.04	MT	L	F	Box Engine T9A (DJ5)	210035	Drive Shaft	54T	28	41	63	112.5	757.5	
1994.03-	2002.04	MT	L	F	Box Engine T9A (DJ5)	610015	Inner Joint		37	39	40	68.5	104	
1994.03-	2002.04	MT	L/R	F	Box Engine T9A (DJ5)	810012	Outer Joint		28	39	63	112.5	63	I
1994.03-	2002.04	MT	L	F	Box Engine T9A (DJ5)	210102	Drive Shaft		28	41	63	112.5	757.5	
2000.03-	2002.04	MT	L	F	All-wheel Drive Box Engine T9A (DJ5)	210102	Drive Shaft		28	41	63	112.5	757.5	
2000.03-	2002.04	MT	L	F	All-wheel Drive Box Engine T9A (DJ5)	210037	Drive Shaft	54T	28	37	63	112.5	771	
2000.03-	2002.04	MT	R	F	All-wheel Drive Box Engine T9A (DJ5)	210066	Drive Shaft		35	41	70	117	1085	
2000.03-	2002.04	MT	R	F	All-wheel Drive Box Engine T9A (DJ5)	210036	Drive Shaft	54T	28	41	63	112.5	1079	
2000.03-	2002.04	MT	L/R	F	All-wheel Drive Box Engine T9A (DJ5)	810011	Outer Joint	54T	35	45	70	117	73	I
2000.03-	2002.04	MT	R	F	All-wheel Drive Box Engine T9A (DJ5)	210032	Drive Shaft	54T	35	41	70	117	1085	
2000.03-	2002.04	-	-	-	All-wheel Drive Box Engine T9A (DJ5)	645013	Inner Joint		37	39	40	68.5	100	
2000.03-	2002.04	MT	R	F	All-wheel Drive Box Engine T9A (DJ5)	610034	Inner Joint		37	39	31.9	369.5	99	
2000.03-	2002.04	MT	L	F	All-wheel Drive Box Engine T9A (DJ5)	210105	Drive Shaft		28	37	63	112.5	771	
2000.03-	2002.04	MT	L/R	F	All-wheel Drive Box Engine T9A (DJ5)	810013	Outer Joint	54T	28	39	63	112.5	63	I
2000.03-	2002.04	MT	R	F	All-wheel Drive Box Engine T9A (DJ5)	210103	Drive Shaft		28	41	63	112.5	1079	
2000.03-	2002.04	MT	R	F	All-wheel Drive Box Engine T9A (DJ5)	210104	Drive Shaft	54T	28	37	63	112.5	1072	
2000.03-	2002.04	MT	L	F	All-wheel Drive Box Engine T9A (DJ5)	210067	Drive Shaft		35	41	70	117	762	
2000.03-	2002.04	MT	L	F	All-wheel Drive Box Engine T9A (DJ5)	210033	Drive Shaft	54T	35	41	70	117	762	
2000.03-	2002.04	MT	L/R	F	All-wheel Drive Box Engine T9A (DJ5)	810050	Outer Joint		35	45	70	117	73	I
2000.03-	2002.04	MT	R	F	All-wheel Drive Box Engine T9A (DJ5)	210069	Drive Shaft		28	37	63	112.5	1072	
2000.03-	2002.04	MT	R	F	All-wheel Drive Box Engine T9A (DJ5)	610009	Inner Joint		41	45	34.9	367.5	115.6	
2000.03-	2002.04	MT	L	F	All-wheel Drive Box Engine T9A (DJ5)	210035	Drive Shaft	54T	28	41	63	112.5	757.5	
2000.03-	2002.04	MT	L	F	All-wheel Drive Box Engine T9A (DJ5)	610015	Inner Joint		37	39	40	68.5	104	
2000.03-	2002.04	MT	L/R	F	All-wheel Drive Box Engine T9A (DJ5)	810012	Outer Joint		28	39	63	112.5	63	I
2.5 TD (76 kW)														
1994.03-	2002.04	MT	L	F	Box Engine T8A (DJ5T)	210102	Drive Shaft		28	41	63	112.5	757.5	
1994.03-	2002.04	MT	L	F	Box Engine T8A (DJ5T)	210037	Drive Shaft	54T	28	37	63	112.5	771	
1994.03-	2002.04	MT	R	F	Box Engine T8A (DJ5T)	210066	Drive Shaft		35	41	70	117	1085	
1994.03-	2002.04	MT	R	F	Box Engine T8A (DJ5T)	210036	Drive Shaft	54T	28	41	63	112.5	1079	
1994.03-	2002.04	MT	L/R	F	Box Engine T8A (DJ5T)	810011	Outer Joint	54T	35	45	70	117	73	I
1994.03-	2002.04	MT	R	F	Box Engine T8A (DJ5T)	210032	Drive Shaft	54T	35	41	70	117	1085	
1994.03-	2002.04	MT	R	F	Box Engine T8A (DJ5T)	610034	Inner Joint		37	39	31.9	369.5	99	
1994.03-	2002.04	-	-	-	Box Engine T8A (DJ5T)	645013	Inner Joint		37	39	40	68.5	100	
1994.03-	2002.04	MT	L	F	Box Engine T8A (DJ5T)	210105	Drive Shaft		28	37	63	112.5	771	
1994.03-	2002.04	MT	L/R	F	Box Engine T8A (DJ5T)	810013	Outer Joint	54T	28	39	63	112.5	63	I
1994.03-	2002.04	MT	R	F	Box Engine T8A (DJ5T)	210103	Drive Shaft		28	41	63	112.5	1079	
1994.03-	2002.04	MT	R	F	Box Engine T8A (DJ5T)	210104	Drive Shaft	54T	28	37	63	112.5	1072	
1994.03-	2002.04	MT	L	F	Box Engine T8A (DJ5T)	210067	Drive Shaft		35	41	70	117	762	
1994.03-	2002.04	MT	L	F	Box Engine T8A (DJ5T)	210033	Drive Shaft	54T	35	41	70	117	762	
1994.03-	2002.04	MT	L/R	F	Box Engine T8A (DJ5T)	810050	Outer Joint		35	45	70	117	73	I
1994.03-	2002.04	MT	R	F	Box Engine T8A (DJ5T)	210069	Drive Shaft		28	37	63	112.5	1072	
1994.03-	2002.04	MT	R	F	Box Engine T8A (DJ5T)	610009	Inner Joint		41	45	34.9	367.5	115.6	
1994.03-	2002.04	MT	L	F	Box Engine T8A (DJ5T)	210035	Drive Shaft	54T	28	41	63	112.5	757.5	
1994.03-	2002.04	MT	L	F	Box Engine T8A (DJ5T)	610015	Inner Joint		37	39	40	68.5	104	
1994.03-	2002.04	MT	L/R	F	Box Engine T8A (DJ5T)	810012	Outer Joint		28	39	63	112.5	63	I
2.5 TDi (79 kW)														
1996.12-	2000.11	MT	R	F	Box Engine THX (DJ5TED)	210066	Drive Shaft		35	41	70	117	1085	
1996.12-	2000.11	MT	L	F	Box Engine THX (DJ5TED)	210037	Drive Shaft	54T	28	37	63	112.5	771	
1996.12-	2000.11	MT	R	F	Box Engine THX (DJ5TED)	210036	Drive Shaft	54T	28	41	63	112.5	1079	
1996.12-	2000.11	MT	L/R	F	Box Engine THX (DJ5TED)	810011	Outer Joint	54T	35	45	70	117	73	I
1996.12-	2000.11	MT	R	F	Box Engine THX (DJ5TED)	210032	Drive Shaft	54T	35	41	70	117	1085	
1996.12-	2000.11	MT	R	F	Box Engine THX (DJ5TED)	610034	Inner Joint		37	39	31.9	369.5	99	
1996.12-	2000.11	MT	L	F	Box Engine THX (DJ5TED)	210105	Drive Shaft		28	37	63	112.5	771	
1996.12-	2000.11	MT	L/R	F	Box Engine THX (DJ5TED)	810013	Outer Joint	54T	28	39	63	112.5	63	I
1996.12-	2000.11	-	-	-	Box Engine THX (DJ5TED)	645013	Inner Joint		37	39	40	68.5	100	
1996.12-	2000.11	MT	R	F	Box Engine THX (DJ5TED)	210103	Drive Shaft		28	41	63	112.5	1079	
1996.12-	2000.11	MT	R	F	Box Engine THX (DJ5TED)	210104	Drive Shaft	54T	28	37	63	112.5	1072	
1996.12-	2000.11	MT	L	F	Box Engine THX (DJ5TED)	210067	Drive Shaft		35	41	70	117	762	
1996.12-	2000.11	MT	L	F	Box Engine THX (DJ5TED)	210033	Drive Shaft	54T	35	41	70	117	762	
1996.12-	2000.11	MT	L/R	F	Box Engine THX (DJ5TED)	810050	Outer Joint		35	45	70	117	73	I
1996.12-	2000.11	MT	R	F	Box Engine THX (DJ5TED)	610009	Inner Joint		41	45	34.9	367.5	115.6	
1996.12-	2000.11	MT	R	F	Box Engine THX (DJ5TED)	210069	Drive Shaft		28	37	63	112.5	1072	
1996.12-	2000.11	MT	L	F	Box Engine THX (DJ5TED)	210035	Drive Shaft	54T	28	41	63	112.5	757.5	
1996.12-	2000.11	MT	L	F	Box Engine THX (DJ5TED)	610015	Inner Joint		37	39	40	68.5	104	
1996.12-	2000.11	MT	L/R	F	Box Engine THX (DJ5TED)	810012	Outer Joint		28	39	63	112.5	63	I
1996.12-	2000.11	MT	L	F	Box Engine THX (DJ5TED)	210102	Drive Shaft		28	41	63	112.5	757.5	

YEAR	TRANSM	L/R	F/R	REMARKS	GSP Ref.	PRODUCT	ABS	Technical Specifications									
								A	B	C	H	L	P				
CITROEN																	
JUMPER (230L)/RELAY																	
2.5 TDi (79 kW)																	
2000.03-2000.11	MT	R	F	All-wheel Drive Box Engine THX (DJ5TED)	210066	Drive Shaft		35	41	70	117	1085					
2000.03-2000.11	MT	L	F	All-wheel Drive Box Engine THX (DJ5TED)	210037	Drive Shaft	54T	28	37	63	112.5	771					
2000.03-2000.11	MT	R	F	All-wheel Drive Box Engine THX (DJ5TED)	210036	Drive Shaft	54T	28	41	63	112.5	1079					
2000.03-2000.11	MT	L/R	F	All-wheel Drive Box Engine THX (DJ5TED)	810011	Outer Joint	54T	35	45	70	117	73	I				
2000.03-2000.11	MT	R	F	All-wheel Drive Box Engine THX (DJ5TED)	210032	Drive Shaft	54T	35	41	70	117	1085					
2000.03-2000.11	MT	R	F	All-wheel Drive Box Engine THX (DJ5TED)	610034	Inner Joint		37	39	31.9	369.5	99					
2000.03-2000.11	MT	L	F	All-wheel Drive Box Engine THX (DJ5TED)	210105	Drive Shaft		28	37	63	112.5	771					
2000.03-2000.11	MT	L/R	F	All-wheel Drive Box Engine THX (DJ5TED)	810013	Outer Joint	54T	28	39	63	112.5	63	I				
2000.03-2000.11	-	-	-	All-wheel Drive Box Engine THX (DJ5TED)	645013	Inner Joint		37	39	40	68.5	100					
2000.03-2000.11	MT	R	F	All-wheel Drive Box Engine THX (DJ5TED)	210103	Drive Shaft		28	41	63	112.5	1079					
2000.03-2000.11	MT	R	F	All-wheel Drive Box Engine THX (DJ5TED)	210104	Drive Shaft	54T	28	37	63	112.5	1072					
2000.03-2000.11	MT	L	F	All-wheel Drive Box Engine THX (DJ5TED)	210067	Drive Shaft		35	41	70	117	762					
2000.03-2000.11	MT	L	F	All-wheel Drive Box Engine THX (DJ5TED)	210033	Drive Shaft	54T	35	41	70	117	762					
2000.03-2000.11	MT	L/R	F	All-wheel Drive Box Engine THX (DJ5TED)	810050	Outer Joint		35	45	70	117	73	I				
2000.03-2000.11	MT	R	F	All-wheel Drive Box Engine THX (DJ5TED)	610009	Inner Joint		41	45	34.9	367.5	115.6					
2000.03-2000.11	MT	R	F	All-wheel Drive Box Engine THX (DJ5TED)	210069	Drive Shaft		28	37	63	112.5	1072					
2000.03-2000.11	MT	L	F	All-wheel Drive Box Engine THX (DJ5TED)	210035	Drive Shaft	54T	28	41	63	112.5	757.5					
2000.03-2000.11	MT	L	F	All-wheel Drive Box Engine THX (DJ5TED)	610015	Inner Joint		37	39	40	68.5	104					
2000.03-2000.11	MT	L/R	F	All-wheel Drive Box Engine THX (DJ5TED)	810012	Outer Joint		28	39	63	112.5	63	I				
2000.03-2000.11	MT	L	F	All-wheel Drive Box Engine THX (DJ5TED)	210102	Drive Shaft		28	41	63	112.5	757.5					
2.8 HDi (94 kW)																	
2000.09-2002.04	MT	R	F	Box Engine 8140.43S	210066	Drive Shaft		35	41	70	117	1085					
2000.09-2002.04	MT	L/R	F	Box Engine 8140.43S	810011	Outer Joint	54T	35	45	70	117	73	I				
2000.09-2002.04	MT	R	F	Box Engine 8140.43S	210032	Drive Shaft	54T	35	41	70	117	1085					
2000.09-2002.04	MT	L	F	Box Engine 8140.43S	210067	Drive Shaft		35	41	70	117	762					
2000.09-2002.04	MT	L	F	Box Engine 8140.43S	210033	Drive Shaft	54T	35	41	70	117	762					
2000.09-2002.04	MT	L/R	F	Box Engine 8140.43S	810050	Outer Joint		35	45	70	117	73	I				
2000.09-2002.04	MT	R	F	Box Engine 8140.43S	610009	Inner Joint		41	45	34.9	367.5	115.6					
JUMPER (230P)/RELAY																	
1.9 D (51 kW)																	
1999.01-2002.04	MT	R	F	BUS Engine D9B (XUD9A/U)	210066	Drive Shaft		35	41	70	117	1085					
1999.01-2002.04	MT	L	F	BUS Engine D9B (XUD9A/U)	210037	Drive Shaft	54T	28	37	63	112.5	771					
1999.01-2002.04	MT	R	F	BUS Engine D9B (XUD9A/U)	210036	Drive Shaft	54T	28	41	63	112.5	1079					
1999.01-2002.04	MT	L/R	F	BUS Engine D9B (XUD9A/U)	810011	Outer Joint	54T	35	45	70	117	73	I				
1999.01-2002.04	MT	R	F	BUS Engine D9B (XUD9A/U)	210032	Drive Shaft	54T	35	41	70	117	1085					
1999.01-2002.04	MT	R	F	BUS Engine D9B (XUD9A/U)	610034	Inner Joint		37	39	31.9	369.5	99					
1999.01-2002.04	MT	L	F	BUS Engine D9B (XUD9A/U)	210105	Drive Shaft		28	37	63	112.5	771					
1999.01-2002.04	MT	L/R	F	BUS Engine D9B (XUD9A/U)	810013	Outer Joint	54T	28	39	63	112.5	63	I				
1999.01-2002.04	-	-	-	BUS Engine D9B (XUD9A/U)	645013	Inner Joint		37	39	40	68.5	100					
1999.01-2002.04	MT	R	F	BUS Engine D9B (XUD9A/U)	210103	Drive Shaft		28	41	63	112.5	1079					
1999.01-2002.04	MT	R	F	BUS Engine D9B (XUD9A/U)	210104	Drive Shaft	54T	28	37	63	112.5	1072					
1999.01-2002.04	MT	L	F	BUS Engine D9B (XUD9A/U)	210067	Drive Shaft		35	41	70	117	762					
1999.01-2002.04	MT	L	F	BUS Engine D9B (XUD9A/U)	210033	Drive Shaft	54T	35	41	70	117	762					
1999.01-2002.04	MT	L/R	F	BUS Engine D9B (XUD9A/U)	810050	Outer Joint		35	45	70	117	73	I				
1999.01-2002.04	MT	R	F	BUS Engine D9B (XUD9A/U)	610009	Inner Joint		41	45	34.9	367.5	115.6					
1999.01-2002.04	MT	R	F	BUS Engine D9B (XUD9A/U)	210069	Drive Shaft		28	37	63	112.5	1072					
1999.01-2002.04	MT	L	F	BUS Engine D9B (XUD9A/U)	210035	Drive Shaft	54T	28	41	63	112.5	757.5					
1999.01-2002.04	MT	L	F	BUS Engine D9B (XUD9A/U)	610015	Inner Joint		37	39	40	68.5	104					
1999.01-2002.04	MT	L/R	F	BUS Engine D9B (XUD9A/U)	810012	Outer Joint		28	39	63	112.5	63	I				
1999.01-2002.04	MT	L	F	BUS Engine D9B (XUD9A/U)	210102	Drive Shaft		28	41	63	112.5	757.5					
1.9 TD (66 kW)																	
1994.08-2002.04	MT	L	F	BUS Engine D8C (XUD9UTF)	210102	Drive Shaft		28	41	63	112.5	757.5					
1994.08-2002.04	MT	L	F	BUS Engine D8C (XUD9UTF)	210037	Drive Shaft	54T	28	37	63	112.5	771					
1994.08-2002.04	MT	R	F	BUS Engine D8C (XUD9UTF)	210066	Drive Shaft		35	41	70	117	1085					
1994.08-2002.04	MT	R	F	BUS Engine D8C (XUD9UTF)	210036	Drive Shaft	54T	28	41	63	112.5	1079					
1994.08-2002.04	MT	L/R	F	BUS Engine D8C (XUD9UTF)	810011	Outer Joint	54T	35	45	70	117	73	I				
1994.08-2002.04	MT	R	F	BUS Engine D8C (XUD9UTF)	210032	Drive Shaft	54T	35	41	70	117	1085					
1994.08-2002.04	MT	R	F	BUS Engine D8C (XUD9UTF)	610034	Inner Joint		37	39	31.9	369.5	99					
1994.08-2002.04	MT	L	F	BUS Engine D8C (XUD9UTF)	210105	Drive Shaft		28	37	63	112.5	771					
1994.08-2002.04	-	-	-	BUS Engine D8C (XUD9UTF)	645013	Inner Joint		37	39	40	68.5	100					
1994.08-2002.04	MT	L/R	F	BUS Engine D8C (XUD9UTF)	810013	Outer Joint	54T	28	39	63	112.5	63	I				
1994.08-2002.04	MT	R	F	BUS Engine D8C (XUD9UTF)	210103	Drive Shaft		28	41	63	112.5	1079					
1994.08-2002.04	MT	R	F	BUS Engine D8C (XUD9UTF)	210104	Drive Shaft	54T	28	37	63	112.5	1072					
1994.08-2002.04	MT	L	F	BUS Engine D8C (XUD9UTF)	210067	Drive Shaft		35	41	70	117	762					
1994.08-2002.04	MT	L	F	BUS Engine D8C (XUD9UTF)	210033	Drive Shaft	54T	35	41	70	117	762					
1994.08-2002.04	MT	L/R	F	BUS Engine D8C (XUD9UTF)	810050	Outer Joint		35	45	70	117	73	I				
1994.08-2002.04	MT	R	F	BUS Engine D8C (XUD9UTF)	210069	Drive Shaft		28	37	63	112.5	1072					
1994.08-2002.04	MT	R	F	BUS Engine D8C (XUD9UTF)	610009	Inner Joint		41	45	34.9	367.5	115.6					
1994.08-2002.04	MT	L	F	BUS Engine D8C (XUD9UTF)	210035	Drive Shaft	54T	28	41	63	112.5	757.5					

YEAR	TRANS	L/R	F/R	REMARKS	GSP Ref.	PRODUCT	ABS	Technical Specifications							
								A	B	C	H	L	P		
CITROEN JUMPER (230P)/RELAY															
1.9 TD (66 kW)	1994.08-2002.04	MT	L	F	BUS Engine D8C (XUD9UTF)	610015	Inner Joint		37	39	40	68.5	104		
	1994.08-2002.04	MT	L/R	F	BUS Engine D8C (XUD9UTF)	810012	Outer Joint		28	39	63	112.5	63	I	
1.9 TD (68 kW)	1994.02-2002.04	MT	L	F	BUS Engine D8C (XUD9UTF)	610015	Inner Joint		37	39	40	68.5	104		
	1994.02-2002.04	MT	L/R	F	BUS Engine D8C (XUD9UTF)	810012	Outer Joint		28	39	63	112.5	63	I	
	1994.02-2002.04	MT	L	F	BUS Engine D8C (XUD9UTF)	210102	Drive Shaft		28	41	63	112.5	757.5		
	1994.02-2002.04	MT	L	F	BUS Engine D8C (XUD9UTF)	210037	Drive Shaft	54T	28	37	63	112.5	771		
	1994.02-2002.04	MT	R	F	BUS Engine D8C (XUD9UTF)	210066	Drive Shaft		35	41	70	117	1085		
	1994.02-2002.04	-	-	-	BUS Engine D8C (XUD9UTF)	645013	Inner Joint		37	39	40	68.5	100		
	1994.02-2002.04	MT	R	F	BUS Engine D8C (XUD9UTF)	210036	Drive Shaft	54T	28	41	63	112.5	1079		
	1994.02-2002.04	MT	R	F	BUS Engine D8C (XUD9UTF)	210032	Drive Shaft	54T	35	41	70	117	1085		
	1994.02-2002.04	MT	L/R	F	BUS Engine D8C (XUD9UTF)	810011	Outer Joint	54T	35	45	70	117	73	I	
	1994.02-2002.04	MT	R	F	BUS Engine D8C (XUD9UTF)	610034	Inner Joint		37	39	31.9	369.5	99		
	1994.02-2002.04	MT	L	F	BUS Engine D8C (XUD9UTF)	210105	Drive Shaft		28	37	63	112.5	771		
	1994.02-2002.04	MT	R	F	BUS Engine D8C (XUD9UTF)	210103	Drive Shaft		28	41	63	112.5	1079		
	1994.02-2002.04	MT	L/R	F	BUS Engine D8C (XUD9UTF)	810013	Outer Joint	54T	28	39	63	112.5	63	I	
	1994.02-2002.04	MT	R	F	BUS Engine D8C (XUD9UTF)	210104	Drive Shaft	54T	28	37	63	112.5	1072		
	1994.02-2002.04	MT	L	F	BUS Engine D8C (XUD9UTF)	210067	Drive Shaft		35	41	70	117	762		
	1994.02-2002.04	MT	L	F	BUS Engine D8C (XUD9UTF)	210033	Drive Shaft	54T	35	41	70	117	762		
	1994.02-2002.04	MT	L/R	F	BUS Engine D8C (XUD9UTF)	810050	Outer Joint		35	45	70	117	73	I	
	1994.02-2002.04	MT	R	F	BUS Engine D8C (XUD9UTF)	210069	Drive Shaft		28	37	63	112.5	1072		
	1994.02-2002.04	MT	R	F	BUS Engine D8C (XUD9UTF)	610009	Inner Joint		41	45	34.9	367.5	115.6		
	1994.02-2002.04	MT	L	F	BUS Engine D8C (XUD9UTF)	210035	Drive Shaft	54T	28	41	63	112.5	757.5		
	1996.08-2002.04	MT	R	F	All-wheel Drive BUS Engine D8C (XUD9UTF)	210069	Drive Shaft		28	37	63	112.5	1072		
	1996.08-2002.04	MT	R	F	All-wheel Drive BUS Engine D8C (XUD9UTF)	610009	Inner Joint		41	45	34.9	367.5	115.6		
	1996.08-2002.04	MT	L	F	All-wheel Drive BUS Engine D8C (XUD9UTF)	210035	Drive Shaft	54T	28	41	63	112.5	757.5		
	1996.08-2002.04	MT	L	F	All-wheel Drive BUS Engine D8C (XUD9UTF)	610015	Inner Joint		37	39	40	68.5	104		
	1996.08-2002.04	MT	L/R	F	All-wheel Drive BUS Engine D8C (XUD9UTF)	810012	Outer Joint		28	39	63	112.5	63	I	
	1996.08-2002.04	MT	L	F	All-wheel Drive BUS Engine D8C (XUD9UTF)	210102	Drive Shaft		28	41	63	112.5	757.5		
	1996.08-2002.04	-	-	-	All-wheel Drive BUS Engine D8C (XUD9UTF)	645013	Inner Joint		37	39	40	68.5	100		
	1996.08-2002.04	MT	L	F	All-wheel Drive BUS Engine D8C (XUD9UTF)	210037	Drive Shaft	54T	28	37	63	112.5	771		
	1996.08-2002.04	MT	R	F	All-wheel Drive BUS Engine D8C (XUD9UTF)	210066	Drive Shaft		35	41	70	117	1085		
	1996.08-2002.04	MT	R	F	All-wheel Drive BUS Engine D8C (XUD9UTF)	210036	Drive Shaft	54T	28	41	63	112.5	1079		
	1996.08-2002.04	MT	R	F	All-wheel Drive BUS Engine D8C (XUD9UTF)	210032	Drive Shaft	54T	35	41	70	117	1085		
	1996.08-2002.04	MT	L/R	F	All-wheel Drive BUS Engine D8C (XUD9UTF)	810011	Outer Joint	54T	35	45	70	117	73	I	
	1996.08-2002.04	MT	R	F	All-wheel Drive BUS Engine D8C (XUD9UTF)	610034	Inner Joint		37	39	31.9	369.5	99		
	1996.08-2002.04	MT	L	F	All-wheel Drive BUS Engine D8C (XUD9UTF)	210105	Drive Shaft		28	37	63	112.5	771		
	1996.08-2002.04	MT	R	F	All-wheel Drive BUS Engine D8C (XUD9UTF)	210103	Drive Shaft		28	41	63	112.5	1079		
	1996.08-2002.04	MT	L/R	F	All-wheel Drive BUS Engine D8C (XUD9UTF)	810013	Outer Joint	54T	28	39	63	112.5	63	I	
	1996.08-2002.04	MT	R	F	All-wheel Drive BUS Engine D8C (XUD9UTF)	210104	Drive Shaft	54T	28	37	63	112.5	1072		
	1996.08-2002.04	MT	L	F	All-wheel Drive BUS Engine D8C (XUD9UTF)	210067	Drive Shaft		35	41	70	117	762		
	1996.08-2002.04	MT	L	F	All-wheel Drive BUS Engine D8C (XUD9UTF)	210033	Drive Shaft	54T	35	41	70	117	762		
	1996.08-2002.04	MT	L/R	F	All-wheel Drive BUS Engine D8C (XUD9UTF)	810050	Outer Joint		35	45	70	117	73	I	
2.0 (80 kW)	1994.02-2002.04	MT	L	F	BUS Engine RFW (XU10J2U)	210102	Drive Shaft		28	41	63	112.5	757.5		
	1994.02-2002.04	MT	L	F	BUS Engine RFW (XU10J2U)	210037	Drive Shaft	54T	28	37	63	112.5	771		
	1994.02-2002.04	MT	R	F	BUS Engine RFW (XU10J2U)	210066	Drive Shaft		35	41	70	117	1085		
	1994.02-2002.04	MT	R	F	BUS Engine RFW (XU10J2U)	210036	Drive Shaft	54T	28	41	63	112.5	1079		
	1994.02-2002.04	MT	L/R	F	BUS Engine RFW (XU10J2U)	810011	Outer Joint	54T	35	45	70	117	73	I	
	1994.02-2002.04	MT	R	F	BUS Engine RFW (XU10J2U)	210032	Drive Shaft	54T	35	41	70	117	1085		
	1994.02-2002.04	MT	R	F	BUS Engine RFW (XU10J2U)	610034	Inner Joint		37	39	31.9	369.5	99		
	1994.02-2002.04	MT	L	F	BUS Engine RFW (XU10J2U)	210105	Drive Shaft		28	37	63	112.5	771		
	1994.02-2002.04	-	-	-	BUS Engine RFW (XU10J2U)	645013	Inner Joint		37	39	40	68.5	100		
	1994.02-2002.04	MT	L/R	F	BUS Engine RFW (XU10J2U)	810013	Outer Joint	54T	28	39	63	112.5	63	I	
	1994.02-2002.04	MT	R	F	BUS Engine RFW (XU10J2U)	210103	Drive Shaft		28	41	63	112.5	1079		
	1994.02-2002.04	MT	R	F	BUS Engine RFW (XU10J2U)	210104	Drive Shaft	54T	28	37	63	112.5	1072		
	1994.02-2002.04	MT	L	F	BUS Engine RFW (XU10J2U)	210067	Drive Shaft		35	41	70	117	762		
	1994.02-2002.04	MT	L	F	BUS Engine RFW (XU10J2U)	210033	Drive Shaft	54T	35	41	70	117	762		
	1994.02-2002.04	MT	L/R	F	BUS Engine RFW (XU10J2U)	810050	Outer Joint		35	45	70	117	73	I	
	1994.02-2002.04	MT	R	F	BUS Engine RFW (XU10J2U)	210069	Drive Shaft		28	37	63	112.5	1072		
	1994.02-2002.04	MT	R	F	BUS Engine RFW (XU10J2U)	610009	Inner Joint		41	45	34.9	367.5	115.6		
	1994.02-2002.04	MT	L	F	BUS Engine RFW (XU10J2U)	210035	Drive Shaft	54T	28	41	63	112.5	757.5		
	1994.02-2002.04	MT	L	F	BUS Engine RFW (XU10J2U)	610015	Inner Joint		37	39	40	68.5	104		
	1994.02-2002.04	MT	L/R	F	BUS Engine RFW (XU10J2U)	810012	Outer Joint		28	39	63	112.5	63	I	
	1996.08-2002.04	MT	L	F	All-wheel Drive BUS Engine RFW (XU10J2U)	210102	Drive Shaft		28	41	63	112.5	757.5		
	1996.08-2002.04	MT	L	F	All-wheel Drive BUS Engine RFW (XU10J2U)	210037	Drive Shaft	54T	28	37	63	112.5	771		
	1996.08-2002.04	MT	R	F	All-wheel Drive BUS Engine RFW (XU10J2U)	210066	Drive Shaft		35	41	70	117	1085		

		 YEAR	TRANSM	L/R	F/R	REMARKS	GSP Ref.	 PRODUCT	 ABS	Technical Specifications					
										A	B	C	H	L	P
CITROEN															
JUMPER (230P)/RELAY															
2.0 (80 kW)															
1996.08-2002.04	2002.04	MT	L/R	F	All-wheel Drive BUS Engine RFW (XU10J2U)	810011	Outer Joint	54T	35	45	70	117	73	I	
1996.08-2002.04	2002.04	MT	R	F	All-wheel Drive BUS Engine RFW (XU10J2U)	210032	Drive Shaft	54T	35	41	70	117	1085		
1996.08-2002.04	2002.04	MT	R	F	All-wheel Drive BUS Engine RFW (XU10J2U)	610034	Inner Joint		37	39	31.9	369.5	99		
1996.08-2002.04	2002.04	MT	L	F	All-wheel Drive BUS Engine RFW (XU10J2U)	210105	Drive Shaft		28	37	63	112.5	771		
1996.08-2002.04	2002.04	-	-	-	All-wheel Drive BUS Engine RFW (XU10J2U)	645013	Inner Joint		37	39	40	68.5	100		
1996.08-2002.04	2002.04	MT	L/R	F	All-wheel Drive BUS Engine RFW (XU10J2U)	810013	Outer Joint	54T	28	39	63	112.5	63	I	
1996.08-2002.04	2002.04	MT	R	F	All-wheel Drive BUS Engine RFW (XU10J2U)	210103	Drive Shaft		28	41	63	112.5	1079		
1996.08-2002.04	2002.04	MT	R	F	All-wheel Drive BUS Engine RFW (XU10J2U)	210104	Drive Shaft	54T	28	37	63	112.5	1072		
1996.08-2002.04	2002.04	MT	L	F	All-wheel Drive BUS Engine RFW (XU10J2U)	210067	Drive Shaft		35	41	70	117	762		
1996.08-2002.04	2002.04	MT	L	F	All-wheel Drive BUS Engine RFW (XU10J2U)	210033	Drive Shaft	54T	35	41	70	117	762		
1996.08-2002.04	2002.04	MT	L/R	F	All-wheel Drive BUS Engine RFW (XU10J2U)	810050	Outer Joint		35	45	70	117	73	I	
1996.08-2002.04	2002.04	MT	R	F	All-wheel Drive BUS Engine RFW (XU10J2U)	210069	Drive Shaft		28	37	63	112.5	1072		
1996.08-2002.04	2002.04	MT	R	F	All-wheel Drive BUS Engine RFW (XU10J2U)	610009	Inner Joint		41	45	34.9	367.5	115.6		
1996.08-2002.04	2002.04	MT	L	F	All-wheel Drive BUS Engine RFW (XU10J2U)	210035	Drive Shaft	54T	28	41	63	112.5	757.5		
1996.08-2002.04	2002.04	MT	L	F	All-wheel Drive BUS Engine RFW (XU10J2U)	610015	Inner Joint		37	39	40	68.5	104		
1996.08-2002.04	2002.04	MT	L/R	F	All-wheel Drive BUS Engine RFW (XU10J2U)	810012	Outer Joint		28	39	63	112.5	63	I	
2.5 D (63 kW)															
1994.08-2002.04	2002.04	MT	R	F	BUS Engine T9A (DJ5)	210066	Drive Shaft		35	41	70	117	1085		
1994.08-2002.04	2002.04	MT	L	F	BUS Engine T9A (DJ5)	210037	Drive Shaft	54T	28	37	63	112.5	771		
1994.08-2002.04	2002.04	MT	R	F	BUS Engine T9A (DJ5)	210036	Drive Shaft	54T	28	41	63	112.5	1079		
1994.08-2002.04	2002.04	MT	L/R	F	BUS Engine T9A (DJ5)	810011	Outer Joint	54T	35	45	70	117	73	I	
1994.08-2002.04	2002.04	MT	R	F	BUS Engine T9A (DJ5)	210032	Drive Shaft	54T	35	41	70	117	1085		
1994.08-2002.04	2002.04	MT	R	F	BUS Engine T9A (DJ5)	610034	Inner Joint		37	39	31.9	369.5	99		
1994.08-2002.04	2002.04	MT	L	F	BUS Engine T9A (DJ5)	210105	Drive Shaft		28	37	63	112.5	771		
1994.08-2002.04	2002.04	MT	L/R	F	BUS Engine T9A (DJ5)	810013	Outer Joint	54T	28	39	63	112.5	63	I	
1994.08-2002.04	2002.04	MT	R	F	BUS Engine T9A (DJ5)	210103	Drive Shaft		28	41	63	112.5	1079		
1994.08-2002.04	2002.04	-	-	-	BUS Engine T9A (DJ5)	645013	Inner Joint		37	39	40	68.5	100		
1994.08-2002.04	2002.04	MT	R	F	BUS Engine T9A (DJ5)	210104	Drive Shaft	54T	28	37	63	112.5	1072		
1994.08-2002.04	2002.04	MT	L	F	BUS Engine T9A (DJ5)	210067	Drive Shaft		35	41	70	117	762		
1994.08-2002.04	2002.04	MT	L	F	BUS Engine T9A (DJ5)	210033	Drive Shaft	54T	35	41	70	117	762		
1994.08-2002.04	2002.04	MT	L/R	F	BUS Engine T9A (DJ5)	810050	Outer Joint		35	45	70	117	73	I	
1994.08-2002.04	2002.04	MT	R	F	BUS Engine T9A (DJ5)	610009	Inner Joint		41	45	34.9	367.5	115.6		
1994.08-2002.04	2002.04	MT	R	F	BUS Engine T9A (DJ5)	210069	Drive Shaft		28	37	63	112.5	1072		
1994.08-2002.04	2002.04	MT	L	F	BUS Engine T9A (DJ5)	210035	Drive Shaft	54T	28	41	63	112.5	757.5		
1994.08-2002.04	2002.04	MT	L	F	BUS Engine T9A (DJ5)	610015	Inner Joint		37	39	40	68.5	104		
1994.08-2002.04	2002.04	MT	L/R	F	BUS Engine T9A (DJ5)	810012	Outer Joint		28	39	63	112.5	63	I	
1994.08-2002.04	2002.04	MT	L	F	BUS Engine T9A (DJ5)	210102	Drive Shaft		28	41	63	112.5	757.5		
1996.08-2002.04	2002.04	MT	L	F	All-wheel Drive BUS Engine T9A (DJ5)	210102	Drive Shaft		28	41	63	112.5	757.5		
1996.08-2002.04	2002.04	MT	L	F	All-wheel Drive BUS Engine T9A (DJ5)	210037	Drive Shaft	54T	28	37	63	112.5	771		
1996.08-2002.04	2002.04	MT	R	F	All-wheel Drive BUS Engine T9A (DJ5)	210066	Drive Shaft		35	41	70	117	1085		
1996.08-2002.04	2002.04	MT	R	F	All-wheel Drive BUS Engine T9A (DJ5)	210036	Drive Shaft	54T	28	41	63	112.5	1079		
1996.08-2002.04	2002.04	MT	L/R	F	All-wheel Drive BUS Engine T9A (DJ5)	810011	Outer Joint	54T	35	45	70	117	73	I	
1996.08-2002.04	2002.04	MT	R	F	All-wheel Drive BUS Engine T9A (DJ5)	210032	Drive Shaft	54T	35	41	70	117	1085		
1996.08-2002.04	2002.04	MT	R	F	All-wheel Drive BUS Engine T9A (DJ5)	610034	Inner Joint		37	39	31.9	369.5	99		
1996.08-2002.04	2002.04	MT	L	F	All-wheel Drive BUS Engine T9A (DJ5)	210105	Drive Shaft		28	37	63	112.5	771		
1996.08-2002.04	2002.04	MT	L/R	F	All-wheel Drive BUS Engine T9A (DJ5)	810013	Outer Joint	54T	28	39	63	112.5	63	I	
1996.08-2002.04	2002.04	-	-	-	All-wheel Drive BUS Engine T9A (DJ5)	645013	Inner Joint		37	39	40	68.5	100		
1996.08-2002.04	2002.04	MT	R	F	All-wheel Drive BUS Engine T9A (DJ5)	210103	Drive Shaft		28	41	63	112.5	1079		
1996.08-2002.04	2002.04	MT	R	F	All-wheel Drive BUS Engine T9A (DJ5)	210104	Drive Shaft	54T	28	37	63	112.5	1072		
1996.08-2002.04	2002.04	MT	L	F	All-wheel Drive BUS Engine T9A (DJ5)	210067	Drive Shaft		35	41	70	117	762		
1996.08-2002.04	2002.04	MT	L	F	All-wheel Drive BUS Engine T9A (DJ5)	210033	Drive Shaft	54T	35	41	70	117	762		
1996.08-2002.04	2002.04	MT	L/R	F	All-wheel Drive BUS Engine T9A (DJ5)	810050	Outer Joint		35	45	70	117	73	I	
1996.08-2002.04	2002.04	MT	R	F	All-wheel Drive BUS Engine T9A (DJ5)	210069	Drive Shaft		28	37	63	112.5	1072		
1996.08-2002.04	2002.04	MT	R	F	All-wheel Drive BUS Engine T9A (DJ5)	610009	Inner Joint		41	45	34.9	367.5	115.6		
1996.08-2002.04	2002.04	MT	L	F	All-wheel Drive BUS Engine T9A (DJ5)	210035	Drive Shaft	54T	28	41	63	112.5	757.5		
1996.08-2002.04	2002.04	MT	L	F	All-wheel Drive BUS Engine T9A (DJ5)	610015	Inner Joint		37	39	40	68.5	104		
1996.08-2002.04	2002.04	MT	L/R	F	All-wheel Drive BUS Engine T9A (DJ5)	810012	Outer Joint		28	39	63	112.5	63	I	
2.5 TD (76 kW)															
1994.08-2002.04	2002.04	MT	L	F	BUS Engine T8A (DJ5T)	210102	Drive Shaft		28	41	63	112.5	757.5		
1994.08-2002.04	2002.04	MT	L	F	BUS Engine T8A (DJ5T)	210037	Drive Shaft	54T	28	37	63	112.5	771		
1994.08-2002.04	2002.04	MT	R	F	BUS Engine T8A (DJ5T)	210066	Drive Shaft		35	41	70	117	1085		
1994.08-2002.04	2002.04	MT	R	F	BUS Engine T8A (DJ5T)	210036	Drive Shaft	54T	28	41	63	112.5	1079		
1994.08-2002.04	2002.04	MT	L/R	F	BUS Engine T8A (DJ5T)	810011	Outer Joint	54T	35	45	70	117	73	I	
1994.08-2002.04	2002.04	MT	R	F	BUS Engine T8A (DJ5T)	210032	Drive Shaft	54T	35	41	70	117	1085		
1994.08-2002.04	2002.04	MT	R	F	BUS Engine T8A (DJ5T)	610034	Inner Joint		37	39	31.9	369.5	99		
1994.08-2002.04	2002.04	MT	L	F	BUS Engine T8A (DJ5T)	210105	Drive Shaft		28	37	63	112.5	771		
1994.08-2002.04	2002.04	MT	L	F	BUS Engine T8A (DJ5T)	210033	Drive Shaft	54T	35	41	70	117	762		
1994.08-2002.04	2002.04	MT	L/R	F	BUS Engine T8A (DJ5T)	810013	Outer Joint	54T	28	39	63	112.5	63	I	
1994.08-2002.04	2002.04	-	-	-	BUS Engine T8A (DJ5T)	645013	Inner Joint		37	39	40	68.5	100		

YEAR	TRANSM	L/R	F/R	REMARKS	GSP Ref.	PRODUCT	ABS	Technical Specifications									
								A	B	C	H	L	P				
CITROEN																	
JUMPER (230P)/RELAY																	
2.5 TD (76 kW)																	
1994.08-	2002.04	MT	R	F	BUS Engine T8A (DJ5T)	210103	Drive Shaft		28	41	63	112.5	1079				
1994.08-	2002.04	MT	R	F	BUS Engine T8A (DJ5T)	210104	Drive Shaft	54T	28	37	63	112.5	1072				
1994.08-	2002.04	MT	L	F	BUS Engine T8A (DJ5T)	210067	Drive Shaft		35	41	70	117	762				
1994.08-	2002.04	MT	L	F	BUS Engine T8A (DJ5T)	210033	Drive Shaft	54T	35	41	70	117	762				
1994.08-	2002.04	MT	L/R	F	BUS Engine T8A (DJ5T)	810050	Outer Joint		35	45	70	117	73	I			
1994.08-	2002.04	MT	R	F	BUS Engine T8A (DJ5T)	210069	Drive Shaft		28	37	63	112.5	1072				
1994.08-	2002.04	MT	R	F	BUS Engine T8A (DJ5T)	610009	Inner Joint		41	45	34.9	367.5	115.6				
1994.08-	2002.04	MT	L	F	BUS Engine T8A (DJ5T)	210035	Drive Shaft	54T	28	41	63	112.5	757.5				
1994.08-	2002.04	MT	L	F	BUS Engine T8A (DJ5T)	610015	Inner Joint		37	39	40	68.5	104				
1994.08-	2002.04	MT	L/R	F	BUS Engine T8A (DJ5T)	810012	Outer Joint		28	39	63	112.5	63	I			
1996.08-	2002.04	MT	L	F	All-wheel Drive BUS Engine T8A (DJ5T)	210102	Drive Shaft		28	41	63	112.5	757.5				
1996.08-	2002.04	MT	L	F	All-wheel Drive BUS Engine T8A (DJ5T)	210037	Drive Shaft	54T	28	37	63	112.5	771				
1996.08-	2002.04	MT	R	F	All-wheel Drive BUS Engine T8A (DJ5T)	210066	Drive Shaft		35	41	70	117	1085				
1996.08-	2002.04	MT	R	F	All-wheel Drive BUS Engine T8A (DJ5T)	210036	Drive Shaft	54T	28	41	63	112.5	1079				
1996.08-	2002.04	MT	L/R	F	All-wheel Drive BUS Engine T8A (DJ5T)	810011	Outer Joint	54T	35	45	70	117	73	I			
1996.08-	2002.04	MT	R	F	All-wheel Drive BUS Engine T8A (DJ5T)	210032	Drive Shaft	54T	35	41	70	117	1085				
1996.08-	2002.04	MT	R	F	All-wheel Drive BUS Engine T8A (DJ5T)	610034	Inner Joint		37	39	31.9	369.5	99				
1996.08-	2002.04	MT	L	F	All-wheel Drive BUS Engine T8A (DJ5T)	210105	Drive Shaft		28	37	63	112.5	771				
1996.08-	2002.04	MT	L/R	F	All-wheel Drive BUS Engine T8A (DJ5T)	810013	Outer Joint	54T	28	39	63	112.5	63	I			
1996.08-	2002.04	-	-	-	All-wheel Drive BUS Engine T8A (DJ5T)	645013	Inner Joint		37	39	40	68.5	100				
1996.08-	2002.04	MT	R	F	All-wheel Drive BUS Engine T8A (DJ5T)	210103	Drive Shaft		28	41	63	112.5	1079				
1996.08-	2002.04	MT	R	F	All-wheel Drive BUS Engine T8A (DJ5T)	210104	Drive Shaft	54T	28	37	63	112.5	1072				
1996.08-	2002.04	MT	L	F	All-wheel Drive BUS Engine T8A (DJ5T)	210067	Drive Shaft		35	41	70	117	762				
1996.08-	2002.04	MT	L	F	All-wheel Drive BUS Engine T8A (DJ5T)	210033	Drive Shaft	54T	35	41	70	117	762				
1996.08-	2002.04	MT	L/R	F	All-wheel Drive BUS Engine T8A (DJ5T)	810050	Outer Joint		35	45	70	117	73	I			
1996.08-	2002.04	MT	R	F	All-wheel Drive BUS Engine T8A (DJ5T)	210069	Drive Shaft		28	37	63	112.5	1072				
1996.08-	2002.04	MT	R	F	All-wheel Drive BUS Engine T8A (DJ5T)	610009	Inner Joint		41	45	34.9	367.5	115.6				
1996.08-	2002.04	MT	L	F	All-wheel Drive BUS Engine T8A (DJ5T)	210035	Drive Shaft	54T	28	41	63	112.5	757.5				
1996.08-	2002.04	MT	L	F	All-wheel Drive BUS Engine T8A (DJ5T)	610015	Inner Joint		37	39	40	68.5	104				
1996.08-	2002.04	MT	L/R	F	All-wheel Drive BUS Engine T8A (DJ5T)	810012	Outer Joint		28	39	63	112.5	63	I			
2.5 TDi (79 kW)																	
1996.12-	2000.11	MT	R	F	BUS Engine THX (DJ5TED)	210066	Drive Shaft		35	41	70	117	1085				
1996.12-	2000.11	MT	L	F	BUS Engine THX (DJ5TED)	210037	Drive Shaft	54T	28	37	63	112.5	771				
1996.12-	2000.11	MT	R	F	All-wheel Drive BUS Engine THX (DJ5TED)	210066	Drive Shaft		35	41	70	117	1085				
1996.12-	2000.11	MT	L	F	All-wheel Drive BUS Engine THX (DJ5TED)	210037	Drive Shaft	54T	28	37	63	112.5	771				
1996.12-	2000.11	MT	R	F	BUS Engine THX (DJ5TED)	210036	Drive Shaft	54T	28	41	63	112.5	1079				
1996.12-	2000.11	MT	R	F	All-wheel Drive BUS Engine THX (DJ5TED)	210036	Drive Shaft	54T	28	41	63	112.5	1079				
1996.12-	2000.11	MT	L/R	F	BUS Engine THX (DJ5TED)	810011	Outer Joint	54T	35	45	70	117	73	I			
1996.12-	2000.11	MT	L/R	F	All-wheel Drive BUS Engine THX (DJ5TED)	810011	Outer Joint	54T	35	45	70	117	73	I			
1996.12-	2000.11	MT	R	F	BUS Engine THX (DJ5TED)	210032	Drive Shaft	54T	35	41	70	117	1085				
1996.12-	2000.11	MT	R	F	All-wheel Drive BUS Engine THX (DJ5TED)	210032	Drive Shaft	54T	35	41	70	117	1085				
1996.12-	2000.11	MT	R	F	BUS Engine THX (DJ5TED)	610034	Inner Joint		37	39	31.9	369.5	99				
1996.12-	2000.11	MT	R	F	All-wheel Drive BUS Engine THX (DJ5TED)	610034	Inner Joint		37	39	31.9	369.5	99				
1996.12-	2000.11	MT	L	F	BUS Engine THX (DJ5TED)	210105	Drive Shaft		28	37	63	112.5	771				
1996.12-	2000.11	MT	L	F	All-wheel Drive BUS Engine THX (DJ5TED)	210105	Drive Shaft		28	37	63	112.5	771				
1996.12-	2000.11	MT	L/R	F	BUS Engine THX (DJ5TED)	810013	Outer Joint	54T	28	39	63	112.5	63	I			
1996.12-	2000.11	MT	L/R	F	All-wheel Drive BUS Engine THX (DJ5TED)	810013	Outer Joint	54T	28	39	63	112.5	63	I			
1996.12-	2000.11	MT	R	F	BUS Engine THX (DJ5TED)	210103	Drive Shaft		28	41	63	112.5	1079				
1996.12-	2000.11	MT	R	F	All-wheel Drive BUS Engine THX (DJ5TED)	210103	Drive Shaft		28	41	63	112.5	1079				
1996.12-	2000.11	-	-	-	BUS Engine THX (DJ5TED)	645013	Inner Joint		37	39	40	68.5	100				
1996.12-	2000.11	-	-	-	All-wheel Drive BUS Engine THX (DJ5TED)	645013	Inner Joint		37	39	40	68.5	100				
1996.12-	2000.11	MT	R	F	BUS Engine THX (DJ5TED)	210104	Drive Shaft	54T	28	37	63	112.5	1072				
1996.12-	2000.11	MT	R	F	All-wheel Drive BUS Engine THX (DJ5TED)	210104	Drive Shaft	54T	28	37	63	112.5	1072				
1996.12-	2000.11	MT	L	F	BUS Engine THX (DJ5TED)	210067	Drive Shaft		35	41	70	117	762				
1996.12-	2000.11	MT	L	F	All-wheel Drive BUS Engine THX (DJ5TED)	210067	Drive Shaft		35	41	70	117	762				
1996.12-	2000.11	MT	L	F	BUS Engine THX (DJ5TED)	210033	Drive Shaft	54T	35	41	70	117	762				
1996.12-	2000.11	MT	L	F	All-wheel Drive BUS Engine THX (DJ5TED)	210033	Drive Shaft	54T	35	41	70	117	762				
1996.12-	2000.11	MT	L/R	F	BUS Engine THX (DJ5TED)	810050	Outer Joint		35	45	70	117	73	I			
1996.12-	2000.11	MT	L/R	F	All-wheel Drive BUS Engine THX (DJ5TED)	810050	Outer Joint		35	45	70	117	73	I			
1996.12-	2000.11	MT	R	F	BUS Engine THX (DJ5TED)	610009	Inner Joint		41	45	34.9	367.5	115.6				
1996.12-	2000.11	MT	R	F	All-wheel Drive BUS Engine THX (DJ5TED)	610009	Inner Joint		41	45	34.9	367.5	115.6				
1996.12-	2000.11	MT	R	F	BUS Engine THX (DJ5TED)	210069	Drive Shaft		28	37	63	112.5	1072				
1996.12-	2000.11	MT	R	F	All-wheel Drive BUS Engine THX (DJ5TED)	210069	Drive Shaft		28	37	63	112.5	1072				
1996.12-	2000.11	MT	L	F	BUS Engine THX (DJ5TED)	210035	Drive Shaft	54T	28	41	63	112.5	757.5				
1996.12-	2000.11	MT	L	F	All-wheel Drive BUS Engine THX (DJ5TED)	210035	Drive Shaft	54T	28	41	63	112.5	757.5				
1996.12-	2000.11	MT	L	F	BUS Engine THX (DJ5TED)	610015	Inner Joint		37	39	40	68.5	104				
1996.12-	2000.11	MT	L	F	All-wheel Drive BUS Engine THX (DJ5TED)	610015	Inner Joint		37	39	40	68.5	104				

	 YEAR	TRANSM	L/R	F/R	REMARKS	GSP Ref.	 PRODUCT	 ABS	Technical Specifications					
									A	B	C	H	L	P
CITROEN														
JUMPER (230P)/RELAY														
2.5 TDi (79 kW)	1996.12-2000.11	MT	L/R	F	BUS Engine THX (DJ5TED)	810012	Outer Joint		28	39	63	112.5	63	I
	1996.12-2000.11	MT	L/R	F	All-wheel Drive BUS Engine THX (DJ5TED)	810012	Outer Joint		28	39	63	112.5	63	I
	1996.12-2000.11	MT	L	F	BUS Engine THX (DJ5TED)	210102	Drive Shaft		28	41	63	112.5	757.5	
	1996.12-2000.11	MT	L	F	All-wheel Drive BUS Engine THX (DJ5TED)	210102	Drive Shaft		28	41	63	112.5	757.5	
2.8 HDi (94 kW)	2000.09-2002.04	MT	R	F	BUS Engine 8140.43S	210066	Drive Shaft		35	41	70	117	1085	
	2000.09-2002.04	MT	L/R	F	BUS Engine 8140.43S	810011	Outer Joint	54T	35	45	70	117	73	I
	2000.09-2002.04	MT	R	F	BUS Engine 8140.43S	210032	Drive Shaft	54T	35	41	70	117	1085	
	2000.09-2002.04	MT	L	F	BUS Engine 8140.43S	210067	Drive Shaft		35	41	70	117	762	
	2000.09-2002.04	MT	L	F	BUS Engine 8140.43S	210033	Drive Shaft	54T	35	41	70	117	762	
	2000.09-2002.04	MT	L/R	F	BUS Engine 8140.43S	810050	Outer Joint		35	45	70	117	73	I
	2000.09-2002.04	MT	R	F	BUS Engine 8140.43S	610009	Inner Joint		41	45	34.9	367.5	115.6	
JUMPER (244 Z_)/RELAY														
2.0 (81 kW)	2002.04- -	-	R	F	BUS Engine XU10J2	610009	Inner Joint		41	45	34.9	367.5	115.6	
	2002.04- -	-	R	F	BUS Engine XU10J2	210036	Drive Shaft	54T	28	41	63	112.5	1079	
	2002.04- -	-	R	F	BUS Engine XU10J2	210066	Drive Shaft		35	41	70	117	1085	
	2002.04- -	-	R	F	BUS Engine XU10J2	210032	Drive Shaft	54T	35	41	70	117	1085	
	2002.04- -	MT	L/R	F	BUS Engine XU10J2	810011	Outer Joint	54T	35	45	70	117	73	I
	2002.04- -	MT	L/R	F	BUS Engine XU10J2	810013	Outer Joint	54T	28	39	63	112.5	63	I
2.0 bivalent (81 kW)	2003.02- -	-	R	F	BUS Engine XU10J2	610009	Inner Joint		41	45	34.9	367.5	115.6	
	2003.02- -	-	R	F	BUS Engine XU10J2	210036	Drive Shaft	54T	28	41	63	112.5	1079	
	2003.02- -	-	R	F	BUS Engine XU10J2	210066	Drive Shaft		35	41	70	117	1085	
	2003.02- -	-	R	F	BUS Engine XU10J2	210032	Drive Shaft	54T	35	41	70	117	1085	
2.0 HDi (62 kW)	2002.04- -	-	L	F	BUS Engine RHV (DW10UTD)	210037	Drive Shaft	54T	28	37	63	112.5	771	
	2002.04- -	-	R	F	BUS Engine RHV (DW10UTD)	610034	Inner Joint		37	39	31.9	369.5	99	
	2002.04- -	-	L	F	BUS Engine RHV (DW10UTD)	210105	Drive Shaft		28	37	63	112.5	771	
	2002.04- -	MT	L/R	F	BUS Engine RHV (DW10UTD)	810013	Outer Joint	54T	28	39	63	112.5	63	I
	2002.04- -	-	R	F	BUS Engine RHV (DW10UTD)	210104	Drive Shaft	54T	28	37	63	112.5	1072	
	2002.04- -	-	R	F	BUS Engine RHV (DW10UTD)	210069	Drive Shaft		28	37	63	112.5	1072	
	2002.04- -	-	L	F	BUS Engine RHV (DW10UTD)	610015	Inner Joint		37	39	40	68.5	104	
2.2 HDi (74 kW)	2002.04- -	-	R	F	BUS Engine 4HY (DW12UTED)	210066	Drive Shaft		35	41	70	117	1085	
	2002.04- -	-	R	F	BUS Engine 4HY (DW12UTED)	210036	Drive Shaft	54T	28	41	63	112.5	1079	
	2002.04- -	-	R	F	BUS Engine 4HY (DW12UTED)	210032	Drive Shaft	54T	35	41	70	117	1085	
	2002.04- -	-	R	F	BUS Engine 4HY (DW12UTED)	610009	Inner Joint		41	45	34.9	367.5	115.6	
2.8 HDi (94 kW)	2002.04- -	MT	L/R	F	BUS Engine 8140.43S	810011	Outer Joint	54T	35	45	70	117	73	I
	2002.04- -	MT	L/R	F	BUS Engine 8140.43S	810013	Outer Joint	54T	28	39	63	112.5	63	I
JUMPER (244)/RELAY														
2.0 (81 kW)	2002.04- -	-	R	F	Box Engine XU10J2	210066	Drive Shaft		35	41	70	117	1085	
	2002.04- -	-	R	F	Box Engine XU10J2	210036	Drive Shaft	54T	28	41	63	112.5	1079	
	2002.04- -	-	R	F	Box Engine XU10J2	210032	Drive Shaft	54T	35	41	70	117	1085	
	2002.04- -	MT	L/R	F	Box Engine XU10J2	810011	Outer Joint	54T	35	45	70	117	73	I
	2002.04- -	MT	L/R	F	Box Engine XU10J2	810013	Outer Joint	54T	28	39	63	112.5	63	I
	2002.04- -	-	R	F	Box Engine XU10J2	610009	Inner Joint		41	45	34.9	367.5	115.6	
2.0 bivalent (81 kW)	2003.02- -	-	R	F	Box Engine XU10J2	610009	Inner Joint		41	45	34.9	367.5	115.6	
	2003.02- -	-	R	F	Box Engine XU10J2	210036	Drive Shaft	54T	28	41	63	112.5	1079	
	2003.02- -	-	R	F	Box Engine XU10J2	210066	Drive Shaft		35	41	70	117	1085	
	2003.02- -	-	R	F	Box Engine XU10J2	210032	Drive Shaft	54T	35	41	70	117	1085	
2.0 HDi (62 kW)	2002.04- -	-	R	F	Platform/Chassis Engine RHV (DW10UTD)	210069	Drive Shaft		28	37	63	112.5	1072	
	2002.04- -	-	L	F	Box Engine RHV (DW10UTD)/RHV (DW10TD)	210037	Drive Shaft	54T	28	37	63	112.5	771	
	2002.04- -	-	L	F	Platform/Chassis Engine RHV (DW10UTD)	210037	Drive Shaft	54T	28	37	63	112.5	771	
	2002.04- -	-	L	F	Platform/Chassis Engine RHV (DW10UTD)	610015	Inner Joint		37	39	40	68.5	104	
	2002.04- -	-	R	F	Box Engine RHV (DW10UTD)/RHV (DW10TD)	610034	Inner Joint		37	39	31.9	369.5	99	
	2002.04- -	-	L	F	Box Engine RHV (DW10UTD)/RHV (DW10TD)	210105	Drive Shaft		28	37	63	112.5	771	
	2002.04- -	MT	L/R	F	Box Engine RHV (DW10UTD)/RHV (DW10TD)	810013	Outer Joint	54T	28	39	63	112.5	63	I
	2002.04- -	MT	L/R	F	Platform/Chassis Engine RHV (DW10UTD)	810013	Outer Joint	54T	28	39	63	112.5	63	I
	2002.04- -	-	R	F	Box Engine RHV (DW10UTD)/RHV (DW10TD)	210104	Drive Shaft	54T	28	37	63	112.5	1072	
	2002.04- -	-	R	F	Platform/Chassis Engine RHV (DW10UTD)	610034	Inner Joint		37	39	31.9	369.5	99	
	2002.04- -	-	L	F	Platform/Chassis Engine RHV (DW10UTD)	210105	Drive Shaft		28	37	63	112.5	771	
	2002.04- -	-	R	F	Box Engine RHV (DW10UTD)/RHV (DW10TD)	210069	Drive Shaft		28	37	63	112.5	1072	
	2002.04- -	-	L	F	Box Engine RHV (DW10UTD)/RHV (DW10TD)	610015	Inner Joint		37	39	40	68.5	104	
	2002.04- -	-	R	F	Platform/Chassis Engine RHV (DW10UTD)	210104	Drive Shaft	54T	28	37	63	112.5	1072	
2.2 HDi (74 kW)	2002.02-2006.06	-	R	F	Platform/Chassis Engine 4HY (DW12UTED)	610009	Inner Joint		41	45	34.9	367.5	115.6	
	2002.02-2006.06	-	R	F	Platform/Chassis Engine 4HY (DW12UTED)	210036	Drive Shaft	54T	28	41	63	112.5	1079	
	2002.02-2006.06	-	R	F	Platform/Chassis Engine 4HY (DW12UTED)	210066	Drive Shaft		35	41	70	117	1085	
	2002.02-2006.06	-	R	F	Platform/Chassis Engine 4HY (DW12UTED)	210032	Drive Shaft	54T	35	41	70	117	1085	
	2002.04- -	-	R	F	Platform/Chassis Engine 4HY (DW12UTED)	610009	Inner Joint		41	45	34.9	367.5	115.6	
	2002.04- -	-	R	F	Box Engine 4HY (DW12UTED)	210066	Drive Shaft		35	41	70	117	1085	





YEAR	TRANSM	L/R	F/R	REMARKS	GSP Ref.	PRODUCT	ABS	Technical Specifications						
								A	B	C	H	L	P	
CITROEN														
JUMPER (244)/RELAY														
2.2 HDi (74 kW)	2002.04-	-	-	R F	Box Engine 4HY (DW12UTED)	210036	Drive Shaft	54T	28	41	63	112.5	1079	
	2002.04-	-	-	R F	Box Engine 4HY (DW12UTED)	210032	Drive Shaft	54T	35	41	70	117	1085	
	2002.04-	-	-	R F	Platform/Chassis Engine 4HY (DW12UTED)	210036	Drive Shaft	54T	28	41	63	112.5	1079	
	2002.04-	-	-	R F	Platform/Chassis Engine 4HY (DW12UTED)	210066	Drive Shaft		35	41	70	117	1085	
	2002.04-	-	-	R F	Platform/Chassis Engine 4HY (DW12UTED)	210032	Drive Shaft	54T	35	41	70	117	1085	
	2002.04-	-	-	R F	Box Engine 4HY (DW12UTED)	610009	Inner Joint		41	45	34.9	367.5	115.6	
2.8 HDi (107 kW)	2004.05-	-	-	R F	Platform/Chassis Engine 8140.43N	210066	Drive Shaft		35	41	70	117	1085	
	2004.05-	-	-	R F	Box Engine 8140.43N	610009	Inner Joint		41	45	34.9	367.5	115.6	
	2004.05-	-	-	R F	Platform/Chassis Engine 8140.43N	210036	Drive Shaft	54T	28	41	63	112.5	1079	
	2004.05-	-	-	R F	Platform/Chassis Engine 8140.43N	210032	Drive Shaft	54T	35	41	70	117	1085	
	2004.05-	-	-	R F	Box Engine 8140.43N	210036	Drive Shaft	54T	28	41	63	112.5	1079	
	2004.05-	-	-	R F	Box Engine 8140.43N	210066	Drive Shaft		35	41	70	117	1085	
	2004.05-	-	-	R F	Box Engine 8140.43N	210032	Drive Shaft	54T	35	41	70	117	1085	
	2004.05-	-	-	R F	Platform/Chassis Engine 8140.43N	610009	Inner Joint		41	45	34.9	367.5	115.6	
2.8 HDi (94 kW)	2002.02-	2006.06	-	R F	All-wheel Drive Platform/Chassis Engine F28TDCR	610009	Inner Joint		41	45	34.9	367.5	115.6	
	2002.02-	2006.06	-	R F	All-wheel Drive Platform/Chassis Engine F28TDCR	210036	Drive Shaft	54T	28	41	63	112.5	1079	
	2002.02-	2006.06	-	R F	All-wheel Drive Platform/Chassis Engine F28TDCR	210066	Drive Shaft		35	41	70	117	1085	
	2002.02-	2006.06	-	R F	All-wheel Drive Platform/Chassis Engine F28TDCR	210032	Drive Shaft	54T	35	41	70	117	1085	
	2002.04-	-	-	R F	All-wheel Drive Box Engine 8140.43S	610009	Inner Joint		41	45	34.9	367.5	115.6	
	2002.04-	-	MT	L/R F	Box Engine 8140.43S	810011	Outer Joint	54T	35	45	70	117	73	I
	2002.04-	-	MT	L/R F	Platform/Chassis Engine 8140.43S	810011	Outer Joint	54T	35	45	70	117	73	I
	2002.04-	-	MT	L/R F	Box Engine 8140.43S	810013	Outer Joint	54T	28	39	63	112.5	63	I
	2002.04-	-	MT	L/R F	Platform/Chassis Engine 8140.43S	810013	Outer Joint	54T	28	39	63	112.5	63	I
	2002.04-	-	-	R F	All-wheel Drive Box Engine 8140.43S	210036	Drive Shaft	54T	28	41	63	112.5	1079	
	2002.04-	-	-	R F	All-wheel Drive Box Engine 8140.43S	210066	Drive Shaft		35	41	70	117	1085	
	2002.04-	-	-	R F	All-wheel Drive Box Engine 8140.43S	210032	Drive Shaft	54T	35	41	70	117	1085	
	2002.04-	-	MT	L/R F	All-wheel Drive Box Engine 8140.43S	810013	Outer Joint	54T	28	39	63	112.5	63	I
JUMPER I-II														
2.5 D	1994-	2006	-	L F	-	610010	Inner Joint		41	45	43	70	115.5	
2.8 HDI	1994-	2006	-	L F	-	610010	Inner Joint		41	45	43	70	115.5	
JUMPER III														
2.2 HDi (88 kW)	2011.07-	-	-	-	LCV	817054	Outer Joint		35	29	71.5	127	71	M
2.2 HDi (96 kW)	2011.07-	-	-	-	LCV	817054	Outer Joint		35	29	71.5	127	71	M
JUMPER/RELAY														
2.2 HDi 100 (74 kW)	2006.04-	-	5MT	L/R F	Box Engine 4HV (P22DTE)	817055	Outer Joint		35	27	71.5	127	66.5	I
	2006.04-	-	5MT	L/R F	Platform/Chassis Engine 4HV (P22DTE)	817055	Outer Joint		35	27	71.5	127	66.5	I
	2006.04-	-	5MT	L/R F	BUS Engine 4HV (P22DTE)	817055	Outer Joint		35	27	71.5	127	66.5	I
	2006.04-	-	5MT	L F	Box Engine 4HV (P22DTE)	617028	Inner Joint		41	29	43	69.5	109.5	
	2006.04-	-	5MT	L F	Platform/Chassis Engine 4HV (P22DTE)	617028	Inner Joint		41	29	43	69.5	109.5	
	2006.04-	-	5MT	L F	BUS Engine 4HV (P22DTE)	617028	Inner Joint		41	29	43	69.5	109.5	
	2006.04-	-	5MT	R F	Box Engine 4HV (P22DTE)	617020	Inner Joint		41	29	34.85	403	109	
	2006.04-	-	5MT	R F	Platform/Chassis Engine 4HV (P22DTE)	617020	Inner Joint		41	29	34.85	403	109	
	2006.04-	-	5MT	R F	BUS Engine 4HV (P22DTE)	617020	Inner Joint		41	29	34.85	403	109	
	2006.04-	-	5MT	L F	Box Engine 4HV (P22DTE)	617042	Inner Joint		41	27	43	70	102	
	2006.04-	-	5MT	L F	Platform/Chassis Engine 4HV (P22DTE)	617042	Inner Joint		41	27	43	70	102	
	2006.04-	-	5MT	L F	BUS Engine 4HV (P22DTE)	617042	Inner Joint		41	27	43	70	102	
	2006.04-	-	5MT	R F	Box Engine 4HV (P22DTE)	610038	Inner Joint		41	27	34.85	403	102	
	2006.04-	-	5MT	R F	Platform/Chassis Engine 4HV (P22DTE)	610038	Inner Joint		41	27	34.85	403	102	
	2006.04-	-	5MT	R F	BUS Engine 4HV (P22DTE)	610038	Inner Joint		41	27	34.85	403	102	
	2006.04-	-	5MT	L F	BUS Engine 4HV (P22DTE)	245176	Drive Shaft		35	41	71.5	127	808	
	2006.04-	-	5MT	L F	Box Engine 4HV (P22DTE)	245176	Drive Shaft		35	41	71.5	127	808	
	2006.04-	-	5MT	L F	Platform/Chassis Engine 4HV (P22DTE)	245176	Drive Shaft		35	41	71.5	127	808	
	2006.04-	-	5MT	L/R F	Box Engine 4HV (P22DTE)	817045	Outer Joint		35	29	71.5	127	71	M
	2006.04-	-	5MT	L/R F	Platform/Chassis Engine 4HV (P22DTE)	817045	Outer Joint		35	29	71.5	127	71	M
	2006.04-	-	5MT	L/R F	BUS Engine 4HV (P22DTE)	817045	Outer Joint		35	29	71.5	127	71	M
2.2 HDi 110 (81 kW)	2011.07-	-	-	L F	BUS Engine 4HG (P22DTE)	217053	Drive Shaft		35	41	71.5	127	806	
	2011.07-	-	MT	R F	Box Engine 4HG (P22DTE)	217050	Drive Shaft		35	41	71.5	127	1140	
	2011.07-	-	MT	R F	Platform/Chassis Engine 4HG (P22DTE)	217050	Drive Shaft		35	41	71.5	127	1140	
	2011.07-	-	-	R F	BUS Engine 4HG (P22DTE)	217050	Drive Shaft		35	41	71.5	127	1140	
	2011.07-	-	MT	L F	Platform/Chassis Engine 4HG (P22DTE)	217053	Drive Shaft		35	41	71.5	127	806	
	2011.07-	-	MT	L F	Box Engine 4HG (P22DTE)	217053	Drive Shaft		35	41	71.5	127	806	
2.2 HDi 120 (88 kW)	2006.04-	-	-	R F	Box Engine 4HU (P22DTE)	217050	Drive Shaft		35	41	71.5	127	1140	
	2006.04-	-	5MT	L/R F	Box Engine 4HU (P22DTE)	817055	Outer Joint		35	27	71.5	127	66.5	I
	2006.04-	-	5MT	L/R F	BUS Engine 4HU (P22DTE)	817055	Outer Joint		35	27	71.5	127	66.5	I
	2006.04-	-	5MT	L/R F	Platform/Chassis Engine 4HU (P22DTE)	817055	Outer Joint		35	27	71.5	127	66.5	I
	2006.04-	-	-	R F	BUS Engine 4HU (P22DTE)	217050	Drive Shaft		35	41	71.5	127	1140	

YEAR	TRANS	L/R	F/R	REMARKS	GSP Ref.	PRODUCT	ABS	Technical Specifications								
								A	B	C	H	L	P			
CITROEN																
JUMPER/RELAY																
2.2 HDi 120 (88 kW)	2006.04-	-	R	F	Platform/Chassis Engine 4HU (P22DTE)	217050	Drive Shaft	35	41	71.5	127	1140				
	2006.04-	5MT	L	F	Box Engine 4HU (P22DTE)	617028	Inner Joint	41	29	43	69.5	109.5				
	2006.04-	5MT	L	F	BUS Engine 4HU (P22DTE)	617028	Inner Joint	41	29	43	69.5	109.5				
	2006.04-	5MT	L	F	Platform/Chassis Engine 4HU (P22DTE)	617028	Inner Joint	41	29	43	69.5	109.5				
	2006.04-	5MT	R	F	Box Engine 4HU (P22DTE)	617020	Inner Joint	41	29	34.85	403	109				
	2006.04-	5MT	R	F	BUS Engine 4HU (P22DTE)	617020	Inner Joint	41	29	34.85	403	109				
	2006.04-	5MT	R	F	Platform/Chassis Engine 4HU (P22DTE)	617020	Inner Joint	41	29	34.85	403	109				
	2006.04-	5MT	L	F	Box Engine 4HU (P22DTE)	617042	Inner Joint	41	27	43	70	102				
	2006.04-	5MT	L	F	BUS Engine 4HU (P22DTE)	617042	Inner Joint	41	27	43	70	102				
	2006.04-	5MT	L	F	Platform/Chassis Engine 4HU (P22DTE)	617042	Inner Joint	41	27	43	70	102				
	2006.04-	5MT	R	F	Box Engine 4HU (P22DTE)	610038	Inner Joint	41	27	34.85	403	102				
	2006.04-	5MT	R	F	BUS Engine 4HU (P22DTE)	610038	Inner Joint	41	27	34.85	403	102				
	2006.04-	5MT	R	F	Platform/Chassis Engine 4HU (P22DTE)	610038	Inner Joint	41	27	34.85	403	102				
	2006.04-	5MT	L/R	F	Box Engine 4HU (P22DTE)	817045	Outer Joint	35	29	71.5	127	71	M			
	2006.04-	5MT	L/R	F	BUS Engine 4HU (P22DTE)	817045	Outer Joint	35	29	71.5	127	71	M			
	2006.04-	5MT	L/R	F	Platform/Chassis Engine 4HU (P22DTE)	817045	Outer Joint	35	29	71.5	127	71	M			
	2006.04-	-	L	F	Box Engine 4HU (P22DTE)	217053	Drive Shaft	35	41	71.5	127	806				
	2006.04-	-	L	F	BUS Engine 4HU (P22DTE)	217053	Drive Shaft	35	41	71.5	127	806				
	2006.04-	-	L	F	Platform/Chassis Engine 4HU (P22DTE)	217053	Drive Shaft	35	41	71.5	127	806				
2.2 HDi 130 (96 kW)	2011.07-	MT	R	F	Box Engine 4HH (P22DTE)	217050	Drive Shaft	35	41	71.5	127	1140				
	2011.07-	MT	R	F	Platform/Chassis Engine 4HH (P22DTE)	217050	Drive Shaft	35	41	71.5	127	1140				
	2011.07-	-	R	F	BUS Engine 4HH (P22DTE)	217050	Drive Shaft	35	41	71.5	127	1140				
	2011.07-	MT	L	F	Box Engine 4HH (P22DTE)	217053	Drive Shaft	35	41	71.5	127	806				
	2011.07-	MT	L	F	Platform/Chassis Engine 4HH (P22DTE)	217053	Drive Shaft	35	41	71.5	127	806				
	2011.07-	-	L	F	BUS Engine 4HH (P22DTE)	217053	Drive Shaft	35	41	71.5	127	806				
2.2 HDi 150 (110 kW)	2011.07-	MT	R	F	Box Engine 4HJ (P22DTE)	217050	Drive Shaft	35	41	71.5	127	1140				
	2011.07-	MT	R	F	Platform/Chassis Engine 4HJ (P22DTE)	217050	Drive Shaft	35	41	71.5	127	1140				
	2011.07-	MT	L	F	BUS Engine 4HJ (P22DTE)	245176	Drive Shaft	35	41	71.5	127	808				
	2011.07-	MT	L	F	Box Engine 4HJ (P22DTE)	245176	Drive Shaft	35	41	71.5	127	808				
	2011.07-	MT	L	F	Platform/Chassis Engine 4HJ (P22DTE)	245176	Drive Shaft	35	41	71.5	127	808				
	2011.07-	MT	L	F	Box Engine 4HJ (P22DTE)	217053	Drive Shaft	35	41	71.5	127	806				
	2011.07-	MT	L	F	Platform/Chassis Engine 4HJ (P22DTE)	217053	Drive Shaft	35	41	71.5	127	806				
3.0 HDi 145 (107 kW)	2010.07-	MT	L	F	Box Engine F1CE3481N (F30DTE)	245175	Drive Shaft	35	31	71.5	127	749.5				
	2010.07-	MT	L	F	Platform/Chassis Engine F1CE3481N (F30DTE)	245175	Drive Shaft	35	31	71.5	127	749.5				
	2010.07-	MT	R	F	Box Engine F1CE3481N (F30DTE)	245174	Drive Shaft	35	31	71.5	127	1199				
	2010.07-	MT	R	F	Platform/Chassis Engine F1CE3481N (F30DTE)	245174	Drive Shaft	35	31	71.5	127	1199				
3.0 HDi 155 (115 kW)	2010.07-	-	L	F	Box Engine F1CE0481D (F30DT)	245175	Drive Shaft	35	31	71.5	127	749.5				
	2010.07-	-	L	F	BUS Engine F1CE0481D (F30DT)	245175	Drive Shaft	35	31	71.5	127	749.5				
	2010.07-	-	R	F	Box Engine F1CE0481D (F30DT)	245174	Drive Shaft	35	31	71.5	127	1199				
	2010.07-	-	R	F	BUS Engine F1CE0481D (F30DT)	245174	Drive Shaft	35	31	71.5	127	1199				
3.0 HDi 160 (116 kW)	2006.09-	6MT	L/R	F	BUS Engine F1CE0481D (F30DT)	817060	Outer Joint	35	29	71.5	127	71	I			
	2006.09-	6MT	L/R	F	Box Engine F1CE0481D (F30DT)	817060	Outer Joint	35	29	71.5	127	71	I			
	2006.09-	6MT	L	F	Platform/Chassis Engine F1CE0481D (F30DT)	617022	Inner Joint	31	29	44.95	77	109.5				
	2006.09-	6MT	L	F	BUS Engine F1CE0481D (F30DT)	617022	Inner Joint	31	29	44.95	77	109.5				
	2006.09-	6MT	R	F	Platform/Chassis Engine F1CE0481D (F30DT)	617021	Inner Joint	31	29	34.85	530	109				
	2006.09-	6MT	R	F	BUS Engine F1CE0481D (F30DT)	617021	Inner Joint	31	29	34.85	530	109				
	2006.09-	-	L	F	Platform/Chassis Engine F1CE0481D (F30DT)	245175	Drive Shaft	35	31	71.5	127	749.5				
	2006.09-	-	L	F	Box Engine F1CE0481D (F30DT)	245175	Drive Shaft	35	31	71.5	127	749.5				
	2006.09-	-	L	F	BUS Engine F1CE0481D (F30DT)	245175	Drive Shaft	35	31	71.5	127	749.5				
	2006.09-	-	R	F	Box Engine F1CE0481D (F30DT)	245174	Drive Shaft	35	31	71.5	127	1199				
	2006.09-	-	R	F	BUS Engine F1CE0481D (F30DT)	245174	Drive Shaft	35	31	71.5	127	1199				
	2006.09-	-	R	F	Platform/Chassis Engine F1CE0481D (F30DT)	245174	Drive Shaft	35	31	71.5	127	1199				
	2006.09-	6MT	L/R	F	Platform/Chassis Engine F1CE0481D (F30DT)	817060	Outer Joint	35	29	71.5	127	71	I			
3.0 HDi 180 (130 kW)	2011.07-	MT	R	F	Box Engine F1CE3481E (F30DTE)	217050	Drive Shaft	35	41	71.5	127	1140				
	2011.07-	-	L	F	BUS Engine F1CE3481E (F30DTE)	245175	Drive Shaft	35	31	71.5	127	749.5				
	2011.07-	-	L	F	Box Engine F1CE3481E (F30DTE)	245175	Drive Shaft	35	31	71.5	127	749.5				
	2011.07-	-	L	F	Platform/Chassis Engine F1CE3481E (F30DTE)	245175	Drive Shaft	35	31	71.5	127	749.5				
	2011.07-	-	R	F	BUS Engine F1CE3481E (F30DTE)	245174	Drive Shaft	35	31	71.5	127	1199				
	2011.07-	-	R	F	Box Engine F1CE3481E (F30DTE)	245174	Drive Shaft	35	31	71.5	127	1199				
	2011.07-	-	R	F	Platform/Chassis Engine F1CE3481E (F30DTE)	245174	Drive Shaft	35	31	71.5	127	1199				
	2011.07-	MT	L	F	Box Engine F1CE3481E (F30DTE)	217053	Drive Shaft	35	41	71.5	127	806				
JUMPY																
1.6 HDi	2006-	-	L	F	-	699158	Inner Joint	24	34	40	62	89				
	2006-	-	L	F	-	810095	Outer Joint	28	34	58.5	92	55	I			





YEAR	TRANSM	L/R	F/R	REMARKS	GSP Ref.	PRODUCT	ABS	Technical Specifications							
								A	B	C	H	L	P		
CITROEN JUMPY															
1.6 MJT	2006-	-	-	L F -		699158	Inner Joint		24	34	40	62	89		
	2006-	-	-	R F -		699159	Inner Joint		24	34	29.8	350	87.5		
	2006-	-	-	L F -		699158	Inner Joint		24	34	40	62	89		
1.9 TD	1995-2005	-	-	R F -		210296	Drive Shaft	48T	27	37	59	82	947		
2.0 HDi	1995-2005	-	-	R F -		210296	Drive Shaft	48T	27	37	59	82	947		
JUMPY (BS_ BT_ BY_ BZ_)/DISPATCH															
1.6 i (58 kW)	1995.10-2000.08	MT	L	F	Box Engine 220A2.000/1580 SPI	210082	Drive Shaft	48T	27	24	59	82	648		
	1995.10-2000.08	MT	R	F	Box Engine 220A2.000/1580 SPI	210012	Drive Shaft	48T	27	24	64	80.5	928		
	1995.10-2000.08	MT	L/R	F	Box Engine 220A2.000/1580 SPI	810018	Outer Joint	48T	27	34	61	82	55	I	
	1995.10-2000.08	MT	L	F	Box Engine 220A2.000/1580 SPI	210052	Drive Shaft		27	24	61	82	648		
	1995.10-2000.08	MT	R	F	Box Engine 220A2.000/1580 SPI	210120	Drive Shaft		27	24	59	82	928		
1.9 D (51 kW)	1995.10-1998.08	-	-	L F	Box Engine D9B (XUD9A/U)	210082	Drive Shaft	48T	27	24	59	82	648		
	1995.10-1998.08	-	-	F	Box Engine D9B (XUD9A/U)	810016	Outer Joint		27	34	59	82	55	I	
	1995.10-1998.08	-	-	R F	Box Engine D9B (XUD9A/U)	210081	Drive Shaft	48T	27	24	59	82	935		
	1995.10-1998.08	-	-	R F	Box Engine D9B (XUD9A/U)	210012	Drive Shaft	48T	27	24	64	80.5	928		
	1995.10-1998.08	-	-	L F	Box Engine D9B (XUD9A/U)	210112	Drive Shaft		27	24	59	82	648		
	1995.10-1998.08	-	-	R F	Box Engine D9B (XUD9A/U)	210111	Drive Shaft		27	24	59	82	935		
	1995.10-1998.08	-	-	L F	Box Engine D9B (XUD9A/U)	210052	Drive Shaft		27	24	61	82	648		
	1995.10-1998.08	-	-	R F	Box Engine D9B (XUD9A/U)	210120	Drive Shaft		27	24	59	82	928		
	1995.10-1998.08	-	-	F	Box Engine D9B (XUD9A/U)	810059	Outer Joint	48T	27	34	59	82	55	I	
1.9 D 70 (51 kW)	1998.04-2006.10	-	-	F	Box Engine WJZ (DW8)/WJY (DW8B)	810016	Outer Joint		27	34	59	82	55	I	
	1998.04-2006.10	MT	L	F	Box Engine WJZ (DW8)/WJY (DW8B)	210082	Drive Shaft	48T	27	24	59	82	648		
	1998.04-2006.10	-	-	R F	Box Engine WJZ (DW8)/WJY (DW8B)	210081	Drive Shaft	48T	27	24	59	82	935		
	1998.04-2006.10	MT	R	F	Box Engine WJZ (DW8)/WJY (DW8B)	210012	Drive Shaft	48T	27	24	64	80.5	928		
	1998.04-2006.10	-	-	L F	Box Engine WJZ (DW8)/WJY (DW8B)	210112	Drive Shaft		27	24	59	82	648		
	1998.04-2006.10	MT	L/R	F	Box Engine WJZ (DW8)/WJY (DW8B)	810018	Outer Joint	48T	27	34	61	82	55	I	
	1998.04-2006.10	-	-	R F	Box Engine WJZ (DW8)/WJY (DW8B)	210111	Drive Shaft		27	24	59	82	935		
	1998.04-2006.10	MT	L	F	Box Engine WJZ (DW8)/WJY (DW8B)	210052	Drive Shaft		27	24	61	82	648		
	1998.04-2006.10	MT	R	F	Box Engine WJZ (DW8)/WJY (DW8B)	210120	Drive Shaft		27	24	59	82	928		
	1998.04-2006.10	-	-	F	Box Engine WJZ (DW8)/WJY (DW8B)	810059	Outer Joint	48T	27	34	59	82	55	I	
1.9 TD (66 kW)	1995.10-2000.08	MT	L	F	Box Engine DHX (XUD9TF/BTF)	610015	Inner Joint		37	39	40	68.5	104		
	1995.10-2000.08	MT	R	F	Box Engine DHX (XUD9TF/BTF)	610034	Inner Joint		37	39	31.9	369.5	99		
	1995.10-2000.08	MT	L	F	Box Engine DHX (XUD9TF/BTF)	210072	Drive Shaft		27	37	59	82	641		
	1995.10-2000.08	-	-	L F	Box Engine DHX (XUD9TF/BTF)	210073	Drive Shaft	48T	27	37	59	82	641		
	1995.10-2000.08	-	-	R F	Box Engine DHX (XUD9TF/BTF)	210108	Drive Shaft	48T	27	37	59	82	939		
	1995.10-2000.08	MT	R	F	Box Engine DHX (XUD9TF/BTF)	210155	Drive Shaft		27	37	59	82	947		
	1995.10-2000.08	-	-	L/R F	Box Engine DHX (XUD9TF/BTF)	810015	Outer Joint	48T	27	39	59	82	63	I	
	1995.10-2000.08	-	-	R F	Box Engine DHX (XUD9TF/BTF)	210074	Drive Shaft		27	37	59	82	939		
	1995.10-2000.08	MT	L	F	Box Engine DHX (XUD9TF/BTF)	210016	Drive Shaft	48T	27	37	59	82	641		
	1995.10-2000.08	MT	R	F	Box Engine DHX (XUD9TF/BTF)	210014	Drive Shaft	48T	27	37	59	82	947		
2.0 HDi 110 (80 kW)	2002.01-2006.10	MT	L	F	Box Engine RHW (DW10ATED4)	210430	Drive Shaft		27	37	59	82	630		
	2002.01-2006.10	-	-	L F	Box Engine RHW (DW10ATED4)	210430	Drive Shaft		27	37	59	82	630		
	2002.01-2006.10	MT	R	F	Box Engine RHW (DW10ATED4)	210057	Drive Shaft		27	37	59	82	960		
	2002.01-2006.10	-	-	R F	Box Engine RHW (DW10ATED4)	210057	Drive Shaft		27	37	59	82	960		
	2002.01-2006.10	-	-	L F	Box Engine RHW (DW10ATED4)	210264	Drive Shaft	48T	27	37	59	82	630		
	2002.01-2006.10	MT	L	F	Box Engine RHW (DW10ATED4)	210264	Drive Shaft	48T	27	37	59	82	630		
	2002.01-2006.10	-	-	R F	Box Engine RHW (DW10ATED4)	245120	Drive Shaft	48T	27	37	59	82	960		
	2002.01-2006.10	MT	R	F	Box Engine RHW (DW10ATED4)	245120	Drive Shaft	48T	27	37	59	82	960		
	2002.01-2006.10	MT	L	F	Box Engine RHW (DW10ATED4)	610015	Inner Joint		37	39	40	68.5	104		
	2002.01-2006.10	-	-	L F	Box Engine RHW (DW10ATED4)	610015	Inner Joint		37	39	40	68.5	104		
	2002.01-2006.10	MT	R	F	Box Engine RHW (DW10ATED4)	610034	Inner Joint		37	39	31.9	369.5	99		
	2002.01-2006.10	-	-	R F	Box Engine RHW (DW10ATED4)	610034	Inner Joint		37	39	31.9	369.5	99		
2.0 HDi 95 (69 kW)	1999.10-2006.10	-	-	L F	Box Engine RHX (DW10BTED)	210430	Drive Shaft		27	37	59	82	630		
	1999.10-2006.10	-	-	R F	Box Engine RHX (DW10BTED)	210057	Drive Shaft		27	37	59	82	960		
	1999.10-2006.10	-	-	R F	Box Engine RHX (DW10BTED)	210237	Drive Shaft	48T	27	37	59	82	953		
	1999.10-2006.10	-	-	L F	Box Engine RHX (DW10BTED)	210264	Drive Shaft	48T	27	37	59	82	630		
	1999.10-2006.10	-	-	R F	Box Engine RHX (DW10BTED)	245120	Drive Shaft	48T	27	37	59	82	960		
	1999.10-2006.10	-	-	L F	Box Engine RHX (DW10BTED)	610015	Inner Joint		37	39	40	68.5	104		
	1999.10-2006.10	-	-	R F	Box Engine RHX (DW10BTED)	610034	Inner Joint		37	39	31.9	369.5	99		
2.0 i 16V (102 kW)	2000.03-2006.10	MT	R	F	Box Engine RFN (EW10J4)	210120	Drive Shaft		27	24	59	82	928		
	2000.03-2006.10	MT	L	F	Box Engine RFN (EW10J4)	210082	Drive Shaft	48T	27	24	59	82	648		
	2000.03-2006.10	MT	R	F	Box Engine RFN (EW10J4)	210012	Drive Shaft	48T	27	24	64	80.5	928		
	2000.03-2006.10	MT	L/R	F	Box Engine RFN (EW10J4)	810018	Outer Joint	48T	27	34	61	82	55	I	
	2000.03-2006.10	MT	L	F	Box Engine RFN (EW10J4)	210052	Drive Shaft		27	24	61	82	648		
JUMPY (BU_ BV_ BW_ BX_)/DISPATCH															
1.9 TD (68 kW)	1999.10-2006.10	MT	L	F	Platform/Chassis Engine D8B (XUD9TF)	610015	Inner Joint		37	39	40	68.5	104		





YEAR	TRANS	L/R	F/R	REMARKS	GSP Ref.	PRODUCT	ABS	Technical Specifications						
								A	B	C	H	L	P	
CITROEN														
JUMPY (BU_BV_BW_BX_)/DISPATCH														
1.9 TD (68 kW)	1999.10-2006.10	MT	R	F	Platform/Chassis Engine D8B (XUD9TF)	610034	Inner Joint		37	39	31.9	369.5	99	
	1999.10-2006.10	-	L	F	Platform/Chassis Engine D8B (XUD9TF)	210073	Drive Shaft	48T	27	37	59	82	641	
	1999.10-2006.10	MT	L	F	Platform/Chassis Engine D8B (XUD9TF)	210072	Drive Shaft		27	37	59	82	641	
	1999.10-2006.10	-	R	F	Platform/Chassis Engine D8B (XUD9TF)	210108	Drive Shaft	48T	27	37	59	82	939	
	1999.10-2006.10	-	R	F	Platform/Chassis Engine D8B (XUD9TF)	210074	Drive Shaft		27	37	59	82	939	
	1999.10-2006.10	MT	R	F	Platform/Chassis Engine D8B (XUD9TF)	210155	Drive Shaft		27	37	59	82	947	
	1999.10-2006.10	MT	L	F	Platform/Chassis Engine D8B (XUD9TF)	210016	Drive Shaft	48T	27	37	59	82	641	
	1999.10-2006.10	MT	R	F	Platform/Chassis Engine D8B (XUD9TF)	210014	Drive Shaft	48T	27	37	59	82	947	
2.0 HDi 110 (80 kW)	2003.12-2006.10	-	L	F	Platform/Chassis Engine RHZ (DW10ATED4)	210430	Drive Shaft		27	37	59	82	630	
	2003.12-2006.10	-	R	F	Platform/Chassis Engine RHZ (DW10ATED4)	210057	Drive Shaft		27	37	59	82	960	
	2003.12-2006.10	-	L	F	Platform/Chassis Engine RHZ (DW10ATED4)	210264	Drive Shaft	48T	27	37	59	82	630	
	2003.12-2006.10	-	R	F	Platform/Chassis Engine RHZ (DW10ATED4)	245120	Drive Shaft	48T	27	37	59	82	960	
	2003.12-2006.10	-	L	F	Platform/Chassis Engine RHZ (DW10ATED4)	610015	Inner Joint		37	39	40	68.5	104	
	2003.12-2006.10	-	R	F	Platform/Chassis Engine RHZ (DW10ATED4)	610034	Inner Joint		37	39	31.9	369.5	99	
2.0 HDi 110 16V (80 kW)	2003.12-2006.10	-	L	F	Platform/Chassis Engine RHW (DW10ATED4)	210430	Drive Shaft		27	37	59	82	630	
	2003.12-2006.10	-	R	F	Platform/Chassis Engine RHW (DW10ATED4)	210057	Drive Shaft		27	37	59	82	960	
	2003.12-2006.10	-	L	F	Platform/Chassis Engine RHW (DW10ATED4)	210264	Drive Shaft	48T	27	37	59	82	630	
	2003.12-2006.10	-	R	F	Platform/Chassis Engine RHW (DW10ATED4)	245120	Drive Shaft	48T	27	37	59	82	960	
	2003.12-2006.10	-	L	F	Platform/Chassis Engine RHW (DW10ATED4)	610015	Inner Joint		37	39	40	68.5	104	
	2003.12-2006.10	-	R	F	Platform/Chassis Engine RHW (DW10ATED4)	610034	Inner Joint		37	39	31.9	369.5	99	
2.0 HDi 95 (69 kW)	1999.10-2006.10	-	L	F	Platform/Chassis Engine RHX (DW10BTED)	210430	Drive Shaft		27	37	59	82	630	
	1999.10-2006.10	-	R	F	Platform/Chassis Engine RHX (DW10BTED)	210057	Drive Shaft		27	37	59	82	960	
	1999.10-2006.10	-	L	F	Platform/Chassis Engine RHX (DW10BTED)	210264	Drive Shaft	48T	27	37	59	82	630	
	1999.10-2006.10	-	R	F	Platform/Chassis Engine RHX (DW10BTED)	245120	Drive Shaft	48T	27	37	59	82	960	
	1999.10-2006.10	-	L	F	Platform/Chassis Engine RHX (DW10BTED)	610015	Inner Joint		37	39	40	68.5	104	
	1999.10-2006.10	-	R	F	Platform/Chassis Engine RHX (DW10BTED)	610034	Inner Joint		37	39	31.9	369.5	99	
JUMPY (U6U)/DISPATCH														
1.6 (58 kW)	1995.10-2000.08	MT	L	F	MPV Engine 220 A2.000/1580 SPI	210082	Drive Shaft	48T	27	24	59	82	648	
	1995.10-2000.08	MT	R	F	MPV Engine 220 A2.000/1580 SPI	210012	Drive Shaft	48T	27	24	64	80.5	928	
	1995.10-2000.08	MT	L/R	F	MPV Engine 220 A2.000/1580 SPI	810018	Outer Joint	48T	27	34	61	82	55	I
	1995.10-2000.08	MT	L	F	MPV Engine 220 A2.000/1580 SPI	210052	Drive Shaft		27	24	61	82	648	
	1995.10-2000.08	MT	R	F	MPV Engine 220 A2.000/1580 SPI	210120	Drive Shaft		27	24	59	82	928	
1.9 D (51 kW)	1995.10-1998.08	-	-	F	MPV Engine D9B (XUD9A/U)	810016	Outer Joint		27	34	59	82	55	I
	1995.10-1998.08	MT	L	F	MPV Engine D9B (XUD9A/U)	210082	Drive Shaft	48T	27	24	59	82	648	
	1995.10-1998.08	-	R	F	MPV Engine D9B (XUD9A/U)	210081	Drive Shaft	48T	27	24	59	82	935	
	1995.10-1998.08	-	L	F	MPV Engine D9B (XUD9A/U)	210112	Drive Shaft		27	24	59	82	648	
	1995.10-1998.08	MT	R	F	MPV Engine D9B (XUD9A/U)	210012	Drive Shaft	48T	27	24	64	80.5	928	
	1995.10-1998.08	-	R	F	MPV Engine D9B (XUD9A/U)	210111	Drive Shaft		27	24	59	82	935	
	1995.10-1998.08	MT	L/R	F	MPV Engine D9B (XUD9A/U)	810018	Outer Joint	48T	27	34	61	82	55	I
	1995.10-1998.08	MT	L	F	MPV Engine D9B (XUD9A/U)	210052	Drive Shaft		27	24	61	82	648	
	1995.10-1998.08	MT	R	F	MPV Engine D9B (XUD9A/U)	210120	Drive Shaft		27	24	59	82	928	
	1995.10-1998.08	-	-	F	MPV Engine D9B (XUD9A/U)	810059	Outer Joint	48T	27	34	59	82	55	I
1.9 D 70 (51 kW)	1998.04-2003.11	-	-	F	MPV Engine WJZ (DW8)/WJZ (DW8B)	810016	Outer Joint		27	34	59	82	55	I
	1998.04-2003.11	MT	L	F	MPV Engine WJZ (DW8)/WJZ (DW8B)	210082	Drive Shaft	48T	27	24	59	82	648	
	1998.04-2003.11	-	R	F	MPV Engine WJZ (DW8)/WJZ (DW8B)	210081	Drive Shaft	48T	27	24	59	82	935	
	1998.04-2003.11	MT	R	F	MPV Engine WJZ (DW8)/WJZ (DW8B)	210012	Drive Shaft	48T	27	24	64	80.5	928	
	1998.04-2003.11	-	L	F	MPV Engine WJZ (DW8)/WJZ (DW8B)	210112	Drive Shaft		27	24	59	82	648	
	1998.04-2003.11	MT	L/R	F	MPV Engine WJZ (DW8)/WJZ (DW8B)	810018	Outer Joint	48T	27	34	61	82	55	I
	1998.04-2003.11	-	R	F	MPV Engine WJZ (DW8)/WJZ (DW8B)	210111	Drive Shaft		27	24	59	82	935	
	1998.04-2003.11	MT	L	F	MPV Engine WJZ (DW8)/WJZ (DW8B)	210052	Drive Shaft		27	24	61	82	648	
	1998.04-2003.11	MT	R	F	MPV Engine WJZ (DW8)/WJZ (DW8B)	210120	Drive Shaft		27	24	59	82	928	
	1998.04-2003.11	-	-	F	MPV Engine WJZ (DW8)/WJZ (DW8B)	810059	Outer Joint	48T	27	34	59	82	55	I
1.9 TD (66 kW)	1995.10-2000.08	MT	L	F	MPV Engine DHX (XUD9TF/BTF)	610015	Inner Joint		37	39	40	68.5	104	
	1995.10-2000.08	MT	R	F	MPV Engine DHX (XUD9TF/BTF)	610034	Inner Joint		37	39	31.9	369.5	99	
	1995.10-2000.08	-	L	F	MPV Engine DHX (XUD9TF/BTF)	210073	Drive Shaft	48T	27	37	59	82	641	
	1995.10-2000.08	-	R	F	MPV Engine DHX (XUD9TF/BTF)	210108	Drive Shaft	48T	27	37	59	82	939	
	1995.10-2000.08	-	-	F	MPV Engine DHX (XUD9TF/BTF)	810014	Outer Joint		27	39	59	82	63	I
	1995.10-2000.08	MT	L	F	MPV Engine DHX (XUD9TF/BTF)	210072	Drive Shaft		27	37	59	82	641	
	1995.10-2000.08	-	R	F	MPV Engine DHX (XUD9TF/BTF)	210074	Drive Shaft		27	37	59	82	939	
	1995.10-2000.08	MT	R	F	MPV Engine DHX (XUD9TF/BTF)	210155	Drive Shaft		27	37	59	82	947	
	1995.10-2000.08	-	L/R	F	MPV Engine DHX (XUD9TF/BTF)	810015	Outer Joint	48T	27	39	59	82	63	I
	1995.10-2000.08	MT	L	F	MPV Engine DHX (XUD9TF/BTF)	210016	Drive Shaft	48T	27	37	59	82	641	
	1995.10-2000.08	MT	R	F	MPV Engine DHX (XUD9TF/BTF)	210014	Drive Shaft	48T	27	37	59	82	947	
1.9 TD (68 kW)	1996.04-2003.11	MT	L	F	MPV Engine D8B (XUD9TF)	610015	Inner Joint		37	39	40	68.5	104	
	1996.04-2003.11	MT	R	F	MPV Engine D8B (XUD9TF)	610034	Inner Joint		37	39	31.9	369.5	99	
	1996.04-2003.11	-	L	F	MPV Engine D8B (XUD9TF)	210073	Drive Shaft	48T	27	37	59	82	641	

YEAR	TRANSM	L/R	F/R	REMARKS	GSP Ref.	PRODUCT	ABS	Technical Specifications									
								A	B	C	H	L	P				
CITROEN																	
JUMPY (U6U)/DISPATCH																	
1.9 TD (68 kW)	1996.04-2003.11	-	-	F	MPV Engine D8B (XUD9TF)	810014	Outer Joint		27	39	59	82	63	I			
	1996.04-2003.11	-	R	F	MPV Engine D8B (XUD9TF)	210108	Drive Shaft	48T	27	37	59	82	939				
	1996.04-2003.11	MT	L	F	MPV Engine D8B (XUD9TF)	210072	Drive Shaft		27	37	59	82	641				
	1996.04-2003.11	-	R	F	MPV Engine D8B (XUD9TF)	210074	Drive Shaft		27	37	59	82	939				
	1996.04-2003.11	MT	R	F	MPV Engine D8B (XUD9TF)	210155	Drive Shaft		27	37	59	82	947				
	1996.04-2003.11	-	L/R	F	MPV Engine D8B (XUD9TF)	810015	Outer Joint	48T	27	39	59	82	63	I			
	1996.04-2003.11	MT	L	F	MPV Engine D8B (XUD9TF)	210016	Drive Shaft	48T	27	37	59	82	641				
	1996.04-2003.11	MT	R	F	MPV Engine D8B (XUD9TF)	210014	Drive Shaft	48T	27	37	59	82	947				
2.0 (100 kW)	2000.04-2006.12	MT	R	F	MPV Engine RFN (EW10J4)	210120	Drive Shaft		27	24	59	82	928				
	2000.04-2006.12	MT	L	F	MPV Engine RFN (EW10J4)	210082	Drive Shaft	48T	27	24	59	82	648				
	2000.04-2006.12	MT	L/R	F	MPV Engine RFN (EW10J4)	810018	Outer Joint	48T	27	34	61	82	55	I			
	2000.04-2006.12	MT	R	F	MPV Engine RFN (EW10J4)	210012	Drive Shaft	48T	27	24	64	80.5	928				
	2000.04-2006.12	MT	L	F	MPV Engine RFN (EW10J4)	210052	Drive Shaft		27	24	61	82	648				
2.0 HDi 110 (80 kW)	2000.03-2006.10	-	L	F	MPV Engine RHW (DW10ATED4)	210430	Drive Shaft		27	37	59	82	630				
	2000.03-2006.10	-	L	F	MPV Engine RHZ(DW10ATED)RHZ(DW10CTED)RHZ(DW10BTED)RHZ(DW10CTED)RHZ(DW10BTED)	210430	Drive Shaft		27	37	59	82	630				
	2000.03-2006.10	-	R	F	MPV Engine RHZ(DW10ATED)RHZ(DW10CTED)RHZ(DW10BTED)RHZ(DW10CTED)RHZ(DW10BTED)	210057	Drive Shaft		27	37	59	82	960				
	2000.03-2006.10	-	R	F	MPV Engine RHW (DW10ATED4)	210057	Drive Shaft		27	37	59	82	960				
	2000.03-2006.10	-	L	F	MPV Engine RHZ(DW10ATED)RHZ(DW10CTED)RHZ(DW10BTED)RHZ(DW10CTED)RHZ(DW10BTED)	210264	Drive Shaft	48T	27	37	59	82	630				
	2000.03-2006.10	-	L	F	MPV Engine RHW (DW10ATED4)	210264	Drive Shaft	48T	27	37	59	82	630				
	2000.03-2006.10	-	R	F	MPV Engine RHZ(DW10ATED)RHZ(DW10CTED)RHZ(DW10BTED)RHZ(DW10CTED)RHZ(DW10BTED)	245120	Drive Shaft	48T	27	37	59	82	960				
	2000.03-2006.10	-	R	F	MPV Engine RHW (DW10ATED4)	245120	Drive Shaft	48T	27	37	59	82	960				
	2000.03-2006.10	-	L	F	MPV Engine RHW (DW10ATED4)	610015	Inner Joint		37	39	40	68.5	104				
	2000.03-2006.10	-	L	F	MPV Engine RHZ(DW10ATED)RHZ(DW10CTED)RHZ(DW10BTED)RHZ(DW10CTED)RHZ(DW10BTED)	610015	Inner Joint		37	39	40	68.5	104				
	2000.03-2006.10	-	R	F	MPV Engine RHZ(DW10ATED)RHZ(DW10CTED)RHZ(DW10BTED)RHZ(DW10CTED)RHZ(DW10BTED)	610034	Inner Joint		37	39	31.9	369.5	99				
	2000.03-2006.10	-	R	F	MPV Engine RHW (DW10ATED4)	610034	Inner Joint		37	39	31.9	369.5	99				
2.0 HDi 95 (69 kW)	1999.10-2006.10	-	L	F	MPV Engine RHX (DW10BTED)	210430	Drive Shaft		27	37	59	82	630				
	1999.10-2006.10	-	R	F	MPV Engine RHX (DW10BTED)	210057	Drive Shaft		27	37	59	82	960				
	1999.10-2006.10	-	R	F	MPV Engine RHX (DW10BTED)	210237	Drive Shaft	48T	27	37	59	82	953				
	1999.10-2006.10	-	L	F	MPV Engine RHX (DW10BTED)	210264	Drive Shaft	48T	27	37	59	82	630				
	1999.10-2006.10	-	R	F	MPV Engine RHX (DW10BTED)	245120	Drive Shaft	48T	27	37	59	82	960				
	1999.10-2006.10	-	L	F	MPV Engine RHX (DW10BTED)	610015	Inner Joint		37	39	40	68.5	104				
	1999.10-2006.10	-	R	F	MPV Engine RHX (DW10BTED)	610034	Inner Joint		37	39	31.9	369.5	99				
2.0 i 16V (102 kW)	2000.03-2006.10	MT	R	F	MPV Engine RFN (EW10J4)	210120	Drive Shaft		27	24	59	82	928				
	2000.03-2006.10	MT	L	F	MPV Engine RFN (EW10J4)	210082	Drive Shaft	48T	27	24	59	82	648				
	2000.03-2006.10	MT	R	F	MPV Engine RFN (EW10J4)	210012	Drive Shaft	48T	27	24	64	80.5	928				
	2000.03-2006.10	MT	L/R	F	MPV Engine RFN (EW10J4)	810018	Outer Joint	48T	27	34	61	82	55	I			
	2000.03-2006.10	MT	L	F	MPV Engine RFN (EW10J4)	210052	Drive Shaft		27	24	61	82	648				
JUMPY/DISPATCH																	
1.6 HDi 90 16V (66 kW)	2007.01--	-	-	R	F	MPV Engine 9HU (DV6UTED4)	210239	Drive Shaft		28	24	58.5	92	958			
	2007.01--	-	-	R	F	Box Engine 9HU (DV6UTED4)	210239	Drive Shaft		28	24	58.5	92	958			
	2007.01--	-	-	-	-	MPV Engine 9HU (DV6UTED4)	810124	Outer Joint		28	34	58.5	92	55	I		
	2007.01--	-	-	-	-	Box Engine 9HU (DV6UTED4)	810124	Outer Joint		28	34	58.5	92	55	I		
	2007.01--	MT	-	F	MPV Engine 9HU (DV6UTED4)	810052	Outer Joint		28	34	58.5	92	55	I			
	2007.01--	MT	-	F	Box Engine 9HU (DV6UTED4)	810052	Outer Joint		28	34	58.5	92	55	I			
	2007.01--	MT	-	F	MPV Engine 9HU (DV6UTED4)	810051	Outer Joint		28	39	58.6	94	63	I			
	2007.01--	MT	-	F	Box Engine 9HU (DV6UTED4)	810051	Outer Joint		28	39	58.6	94	63	I			
1.6 HDi 90 8V (66 kW)	2007.01--	MT	R	F	Box Engine 9HM (DV6UC)/9HH (DV6DUM)	210239	Drive Shaft		28	24	58.5	92	958				
	2007.01--	MT	R	F	MPV Engine 9HH (DV6DUM)/9HH (DV6DUC)	210239	Drive Shaft		28	24	58.5	92	958				
	2007.01--	-	-	-	-	Box Engine 9HM (DV6UC)/9HH (DV6DUM)	810124	Outer Joint		28	34	58.5	92	55	I		
	2007.01--	MT	-	F	MPV Engine 9HH (DV6DUM)/9HH (DV6DUC)	810052	Outer Joint		28	34	58.5	92	55	I			
	2007.01--	MT	-	F	Box Engine 9HM (DV6UC)/9HH (DV6DUM)	810052	Outer Joint		28	34	58.5	92	55	I			
	2007.01--	MT	-	F	MPV Engine 9HH (DV6DUM)/9HH (DV6DUC)	810051	Outer Joint		28	39	58.6	94	63	I			
	2007.01--	MT	-	F	Box Engine 9HM (DV6UC)/9HH (DV6DUM)	810051	Outer Joint		28	39	58.6	94	63	I			
2.0 BlueHDi 150 (110 kW)	2016.04--	-	-	F	MPV Engine AHR (DW10FD)/AHx (DW10FD)	810051	Outer Joint		28	39	58.6	94	63	I			
2.0 HDi 120 (88 kW)	2007.01--	MT	R	F	MPV Engine RHK (DW10UTED4)	210244	Drive Shaft		28	37	58.6	93	979				
	2007.01--	MT	R	F	Box Engine RHK (DW10UTED4)	210244	Drive Shaft		28	37	58.6	93	979				
	2007.01--	MT	L	F	MPV Engine RHK (DW10UTED4)	645032	Inner Joint		37	39	40	68.5	100				
	2007.01--	MT	L	F	Box Engine RHK (DW10UTED4)	645032	Inner Joint		37	39	40	68.5	100				
	2007.01--	MT	L	F	MPV Engine RHK (DW10UTED4)	245133	Drive Shaft		28	37	58.6	94	653				
	2007.01--	MT	L	F	Box Engine RHK (DW10UTED4)	245133	Drive Shaft		28	37	58.6	94	653				
	2007.01--	MT	R	F	MPV Engine RHK (DW10UTED4)	299214	Drive Shaft		28	37	58.6	94	978				
	2007.01--	MT	R	F	Box Engine RHK (DW10UTED4)	299214	Drive Shaft		28	37	58.6	94	978				
	2007.01--	-	-	F	MPV Engine RHK (DW10UTED4)	810098	Outer Joint		28	39	58.6	93	63	I			
	2007.01--	-	-	F	Box Engine RHK (DW10UTED4)	810098	Outer Joint		28	39	58.6	93	63	I			
	2007.01--	MT	L	F	MPV Engine RHK (DW10UTED4)	210234	Drive Shaft		28	37	58.6	93	648				
	2007.01--	MT	L	F	Box Engine RHK (DW10UTED4)	210234	Drive Shaft		28	37	58.6	93	648				





	 YEAR	TRANSM	L/R	F/R	REMARKS	GSP Ref.	 PRODUCT	 ABS	Technical Specifications						
									A	B	C	H	L	P	
CITROEN															
JUMPY/DISPATCH															
2.0 HDi 120 (88 kW)	2007.01.-	-	MT	-	F	Box Engine RHK (DW10UTED4)	810051	Outer Joint	28	39	58.6	94	63	I	
	2007.01.-	-	MT	R	F	MPV Engine RHK (DW10UTED4)	810159	Outer Joint	28	39	58.6	94	63	I	
	2007.01.-	-	MT	R	F	Box Engine RHK (DW10UTED4)	810159	Outer Joint	28	39	58.6	94	63	I	
	2007.01.-	-	-	-	F	MPV Engine RHK (DW10UTED4)	810051	Outer Joint	28	39	58.6	94	63	I	
	2007.01.-	-	MT	R	F	MPV Engine RHK (DW10UTED4)	610041	Inner Joint	37	39	32	399	95.5		
	2007.01.-	-	MT	R	F	Box Engine RHK (DW10UTED4)	610041	Inner Joint	37	39	32	399	95.5		
2.0 HDi 125 (94 kW)	2011.07.-	-	MT	R	F	MPV Engine AHZ (DW10CD)	210244	Drive Shaft	28	37	58.6	93	979		
	2011.07.-	-	MT	R	F	Box Engine AHZ (DW10CD)	210244	Drive Shaft	28	37	58.6	93	979		
	2011.07.-	-	MT	R	F	Platform/Chassis Engine AHZ (DW10CD)	210244	Drive Shaft	28	37	58.6	93	979		
	2011.07.-	-	MT	L	F	MPV Engine AHZ (DW10CD)	245133	Drive Shaft	28	37	58.6	94	653		
	2011.07.-	-	MT	L	F	Box Engine AHZ (DW10CD)	245133	Drive Shaft	28	37	58.6	94	653		
	2011.07.-	-	MT	L	F	Platform/Chassis Engine AHZ (DW10CD)	245133	Drive Shaft	28	37	58.6	94	653		
	2011.07.-	-	MT	R	F	MPV Engine AHZ (DW10CD)	299214	Drive Shaft	28	37	58.6	94	978		
	2011.07.-	-	MT	R	F	Box Engine AHZ (DW10CD)	299214	Drive Shaft	28	37	58.6	94	978		
	2011.07.-	-	MT	R	F	Platform/Chassis Engine AHZ (DW10CD)	299214	Drive Shaft	28	37	58.6	94	978		
	2011.07.-	-	MT	L	F	MPV Engine AHZ (DW10CD)	645032	Inner Joint	37	39	40	68.5	100		
	2011.07.-	-	MT	L	F	Box Engine AHZ (DW10CD)	210234	Drive Shaft	28	37	58.6	93	648		
	2011.07.-	-	MT	R	F	MPV Engine AHZ (DW10CD)	810159	Outer Joint	28	39	58.6	94	63	I	
	2011.07.-	-	MT	R	F	Box Engine AHZ (DW10CD)	810159	Outer Joint	28	39	58.6	94	63	I	
	2011.07.-	-	MT	R	F	Platform/Chassis Engine AHZ (DW10CD)	810159	Outer Joint	28	39	58.6	94	63	I	
	2011.07.-	-	-	-	F	MPV Engine AHZ (DW10CD)	810051	Outer Joint	28	39	58.6	94	63	I	
	2011.07.-	-	MT	R	F	MPV Engine AHZ (DW10CD)	610041	Inner Joint	37	39	32	399	95.5		
	2011.07.-	-	MT	R	F	Box Engine AHZ (DW10CD)	610041	Inner Joint	37	39	32	399	95.5		
	2011.07.-	-	MT	R	F	Platform/Chassis Engine AHZ (DW10CD)	610041	Inner Joint	37	39	32	399	95.5		
2.0 HDi 140 (100 kW)	2007.01.-	-	MT	R	F	MPV Engine RHR (DW10BTED4)	210244	Drive Shaft	28	37	58.6	93	979		
	2007.01.-	-	MT	R	F	Box Engine RHR (DW10BTED4)	210244	Drive Shaft	28	37	58.6	93	979		
	2007.01.-	-	MT	L	F	MPV Engine RHR (DW10BTED4)	645032	Inner Joint	37	39	40	68.5	100		
	2007.01.-	-	MT	L	F	Box Engine RHR (DW10BTED4)	645032	Inner Joint	37	39	40	68.5	100		
	2007.01.-	-	MT	L	F	MPV Engine RHR (DW10BTED4)	245133	Drive Shaft	28	37	58.6	94	653		
	2007.01.-	-	MT	L	F	Box Engine RHR (DW10BTED4)	245133	Drive Shaft	28	37	58.6	94	653		
	2007.01.-	-	MT	R	F	MPV Engine RHR (DW10BTED4)	299214	Drive Shaft	28	37	58.6	94	978		
	2007.01.-	-	MT	R	F	Box Engine RHR (DW10BTED4)	299214	Drive Shaft	28	37	58.6	94	978		
	2007.01.-	-	-	-	F	MPV Engine RHR (DW10BTED4)	810098	Outer Joint	28	39	58.6	93	63	I	
	2007.01.-	-	-	-	F	Box Engine RHR (DW10BTED4)	810098	Outer Joint	28	39	58.6	93	63	I	
	2007.01.-	-	MT	L	F	MPV Engine RHR (DW10BTED4)	210234	Drive Shaft	28	37	58.6	93	648		
	2007.01.-	-	MT	L	F	Box Engine RHR (DW10BTED4)	210234	Drive Shaft	28	37	58.6	93	648		
	2007.01.-	-	MT	-	F	Box Engine RHR (DW10BTED4)	810051	Outer Joint	28	39	58.6	94	63	I	
	2007.01.-	-	MT	R	F	MPV Engine RHR (DW10BTED4)	810159	Outer Joint	28	39	58.6	94	63	I	
	2007.01.-	-	MT	R	F	Box Engine RHR (DW10BTED4)	810159	Outer Joint	28	39	58.6	94	63	I	
	2007.01.-	-	-	-	F	MPV Engine RHR (DW10BTED4)	810051	Outer Joint	28	39	58.6	94	63	I	
	2007.01.-	-	MT	R	F	MPV Engine RHR (DW10BTED4)	610041	Inner Joint	37	39	32	399	95.5		
	2007.01.-	-	MT	R	F	Box Engine RHR (DW10BTED4)	610041	Inner Joint	37	39	32	399	95.5		
	2.0 HDi 165 (120 kW)	2010.07.-	-	MT	R	F	MPV Engine RHH (DW10CTED4)	210244	Drive Shaft	28	37	58.6	93	979	
		2010.07.-	-	MT	R	F	Box Engine RHH (DW10CTED4)	210244	Drive Shaft	28	37	58.6	93	979	
2010.07.-		-	MT	L	F	MPV Engine RHH (DW10CTED4)	245133	Drive Shaft	28	37	58.6	94	653		
2010.07.-		-	MT	L	F	Box Engine RHH (DW10CTED4)	245133	Drive Shaft	28	37	58.6	94	653		
2010.07.-		-	MT	R	F	MPV Engine RHH (DW10CTED4)	299214	Drive Shaft	28	37	58.6	94	978		
2010.07.-		-	MT	R	F	Box Engine RHH (DW10CTED4)	299214	Drive Shaft	28	37	58.6	94	978		
2010.07.-		-	MT	-	F	MPV Engine RHH (DW10CTED4)	810051	Outer Joint	28	39	58.6	94	63	I	
2010.07.-		-	MT	-	F	Box Engine RHH (DW10CTED4)	810051	Outer Joint	28	39	58.6	94	63	I	
2010.07.-		-	MT	R	F	MPV Engine RHH (DW10CTED4)	810159	Outer Joint	28	39	58.6	94	63	I	
2010.07.-		-	MT	R	F	Box Engine RHH (DW10CTED4)	810159	Outer Joint	28	39	58.6	94	63	I	
2010.07.-		-	MT	L	F	MPV Engine RHH (DW10CTED4)	645032	Inner Joint	37	39	40	68.5	100		
2010.07.-		-	MT	L	F	Box Engine RHH (DW10CTED4)	645032	Inner Joint	37	39	40	68.5	100		
2010.07.-		-	MT	R	F	MPV Engine RHH (DW10CTED4)	610041	Inner Joint	37	39	32	399	95.5		
2010.07.-		-	MT	R	F	Box Engine RHH (DW10CTED4)	610041	Inner Joint	37	39	32	399	95.5		
2.0 HDi 95 (72 kW)	2011.07.-	-	MT	L	F	MPV Engine AHY (DW10CE)	245133	Drive Shaft	28	37	58.6	94	653		
	2011.07.-	-	MT	L	F	Box Engine AHY (DW10CE)	245133	Drive Shaft	28	37	58.6	94	653		
	2011.07.-	-	MT	R	F	MPV Engine AHY (DW10CE)	299214	Drive Shaft	28	37	58.6	94	978		
	2011.07.-	-	MT	R	F	Box Engine AHY (DW10CE)	299214	Drive Shaft	28	37	58.6	94	978		
	2011.07.-	-	MT	L	F	MPV Engine AHY (DW10CE)	645032	Inner Joint	37	39	40	68.5	100		
	2011.07.-	-	MT	L	F	Box Engine AHY (DW10CE)	210234	Drive Shaft	28	37	58.6	93	648		
	2011.07.-	-	MT	R	F	MPV Engine AHY (DW10CE)	810159	Outer Joint	28	39	58.6	94	63	I	
	2011.07.-	-	MT	R	F	Box Engine AHY (DW10CE)	810159	Outer Joint	28	39	58.6	94	63	I	
	2011.07.-	-	-	-	F	MPV Engine AHY (DW10CE)	810051	Outer Joint	28	39	58.6	94	63	I	
2011.07.-	-	-	-	F	Box Engine AHY (DW10CE)	810051	Outer Joint	28	39	58.6	94	63	I		





YEAR	TRANSM	L/R	F/R	REMARKS	GSP Ref.	PRODUCT	ABS	Technical Specifications							
								A	B	C	H	L	P		
CITROEN															
JUMPY/DISPATCH															
2.0 HdI 95 (72 kW)	2011.07-	-	MT	R	F	MPV Engine AHY (DW10CE)	610041	Inner Joint		37	39	32	399	95.5	
	2011.07-	-	MT	R	F	Box Engine AHY (DW10CE)	610041	Inner Joint		37	39	32	399	95.5	
	2011.07-	-	MT	R	F	MPV Engine AHY (DW10CE)	210244	Drive Shaft		28	37	58.6	93	979	
	2011.07-	-	MT	R	F	Box Engine AHY (DW10CE)	210244	Drive Shaft		28	37	58.6	93	979	
2.0 i (103 kW)	2007.01-	-	-	R	F	MPV Engine RFH (EW10A)	210239	Drive Shaft		28	24	58.5	92	958	
	2007.01-	-	MT	R	F	Box Engine RFH (EW10A)	210239	Drive Shaft		28	24	58.5	92	958	
	2007.01-	-	-	-	-	MPV Engine RFH (EW10A)	810124	Outer Joint		28	34	58.5	92	55	I
	2007.01-	-	-	-	-	Box Engine RFH (EW10A)	810124	Outer Joint		28	34	58.5	92	55	I
	2007.01-	-	MT	-	F	MPV Engine RFH (EW10A)	810052	Outer Joint		28	34	58.5	92	55	I
	2007.01-	-	MT	-	F	Box Engine RFH (EW10A)	810052	Outer Joint		28	34	58.5	92	55	I
	2007.01-	-	MT	-	F	MPV Engine RFH (EW10A)	810051	Outer Joint		28	39	58.6	94	63	I
	2007.01-	-	MT	-	F	Box Engine RFH (EW10A)	810051	Outer Joint		28	39	58.6	94	63	I
NEMO															
1.3 HdI 75 (55 kW)	2010.10-	-	MT	L	F	Estate Engine FHZ (F13DTE5)	217166	Drive Shaft		25	24	51	84.5	605	
	2010.10-	-	MT	R	F	Estate Engine FHZ (F13DTE5)	217167	Drive Shaft		25	24	51	84.5	919	
1.4 (54 kW)	2009.04-	-	-	L/R	F	Estate Engine KFT (TU3A)/KFV (TU3A)	817070	Outer Joint		22	22	51	79	57.5	M
1.4 HDI	2007-	-	-	L	F	-	617029	Inner Joint		22	22	40	58.5	101	
1.4 HdI (50 kW)	2009.04-	-	MT	L	F	Estate Engine 8HS (DV4TED)	217151	Drive Shaft		25	22	51	84	656	
	2009.04-	-	MT	L	F	Estate Engine 8HS (DV4TED)	217051	Drive Shaft		25	22	51	84	648	
	2009.04-	-	MT	R	F	Estate Engine 8HS (DV4TED)	217052	Drive Shaft		25	22	51	84	879	
	2009.04-	-	-	-	F	Estate Engine 8HS (DV4TED)	817067	Outer Joint		25	22	51	84	57.5	M
	2009.04-	-	-	-	-	Estate Engine 8HS (DV4TED)	817068	Outer Joint		25	22	51	84	57.5	M
NEMO (AA_)															
1.3 HdI 75 (55 kW)	2010.10-	-	MT	L	F	Box Engine FHZ (F13DTE5)	217166	Drive Shaft		25	24	51	84.5	605	
	2010.10-	-	MT	R	F	Box Engine FHZ (F13DTE5)	217167	Drive Shaft		25	24	51	84.5	919	
1.4 (54 kW)	2008.02-	-	-	L/R	F	Box Engine KFV (TU3A)	817070	Outer Joint		22	22	51	79	57.5	M
1.4 HdI (50 kW)	2008.02-	-	MT	L	F	Box Engine 8HS (DV4TED)	217151	Drive Shaft		25	22	51	84	656	
	2008.02-	-	MT	L	F	Box Engine 8HS (DV4TED)	217051	Drive Shaft		25	22	51	84	648	
	2008.02-	-	MT	R	F	Box Engine 8HS (DV4TED)	217052	Drive Shaft		25	22	51	84	879	
	2008.02-	-	-	-	F	Box Engine 8HS (DV4TED)	817067	Outer Joint		25	22	51	84	57.5	M
	2008.02-	-	-	-	-	Box Engine 8HS (DV4TED)	817068	Outer Joint		25	22	51	84	57.5	M
SAXO															
-	-	-	-	L	-	-	210045	Drive Shaft	48T	21	22	50	86.5	625	
	-	-	-	-	-	-	610006	Inner Joint		22	22	40	58.5	87	
SAXO (S0 S1)/CHANSON															
1.0 X (33 kW)	1996.05-	1998.11	MT	R	F	Hatchback Engine CDZ (TU9M)	210062	Drive Shaft		21	22	49.9	81	798	
	1996.05-	1998.11	-	-	F	Hatchback Engine CDZ (TU9M)	808016	Outer Joint		22	22	52	96.5	53.5	O
	1996.05-	1998.11	MT	L	F	Hatchback Engine CDZ (TU9M)	210094	Drive Shaft		21	22	56.4	76	615	
	1996.05-	1998.11	MT	R	F	Hatchback Engine CDZ (TU9M)	210093	Drive Shaft		21	22	56.4	76	796	
	1996.05-	1998.11	-	R	F	Hatchback Engine CDZ (TU9M)	210085	Drive Shaft		21	22	56.4	76	798	
	1996.05-	1998.11	MT	L	F	Hatchback Engine CDZ (TU9M)	210061	Drive Shaft		21	22	49.9	81	620	
1.0 X (37 kW)	1998.05-	2003.06	MT	R	F	Hatchback Engine CDZ (TU9M)	210062	Drive Shaft		21	22	49.9	81	798	
	1998.05-	2003.06	MT	L	F	Hatchback Engine CDZ (TU9M)	210161	Drive Shaft		21	22	58.5	86	624	
	1998.05-	2003.06	-	-	-	Hatchback Engine CDZ (TU9M)	210089	Drive Shaft		21	22	56.4	76	790	
	1998.05-	2003.06	MT	R	F	Hatchback Engine CDZ (TU9M)	210156	Drive Shaft		21	22	58.5	86	807	
	1998.05-	2003.06	-	-	F	Hatchback Engine CDZ (TU9M)	808016	Outer Joint		22	22	52	96.5	53.5	O
	1998.05-	2003.06	MT	L	F	Hatchback Engine CDZ (TU9M)	810034	Outer Joint		21	20	50	81.5	54	O
	1998.05-	2003.06	MT	L	F	Hatchback Engine CDZ (TU9M)	210094	Drive Shaft		21	22	56.4	76	615	
	1998.05-	2003.06	MT	L	F	Hatchback Engine CDZ (TU9M)	245071	Drive Shaft		21	22	48	86.5	622	
	1998.05-	2003.06	MT	R	F	Hatchback Engine CDZ (TU9M)	245072	Drive Shaft		21	22	48	86.5	798.5	
	1998.05-	2003.06	MT	R	F	Hatchback Engine CDZ (TU9M)	210093	Drive Shaft		21	22	56.4	76	796	
	1998.05-	2003.06	MT	L	F	Hatchback Engine CDZ (TU9M)	210009	Drive Shaft		21	22	50	81.5	618	
	1998.05-	2003.06	-	R	F	Hatchback Engine CDZ (TU9M)	210085	Drive Shaft		21	22	56.4	76	798	
	1998.05-	2003.06	MT	L	F	Hatchback Engine CDZ (TU9M)	210061	Drive Shaft		21	22	49.9	81	620	
1.1 X,SX (40 kW)	1996.05-	2003.09	MT	R	F	Hatchback Engine HDZ (TU1M)	210062	Drive Shaft		21	22	49.9	81	798	
	1996.05-	2003.09	MT	L	F	Hatchback Engine HDZ (TU1M)	210161	Drive Shaft		21	22	58.5	86	624	
	1996.05-	2003.09	MT	R	F	Hatchback Engine HDZ (TU1M)	210156	Drive Shaft		21	22	58.5	86	807	
	1996.05-	2003.09	-	-	-	Hatchback Engine HDZ (TU1M)	210089	Drive Shaft		21	22	56.4	76	790	
	1996.05-	2003.09	MT	L	F	Hatchback Engine HDZ (TU1M)	299006	Drive Shaft	48T	21	22	58.5	86	624	
	1996.05-	2003.09	MT	L	F	Hatchback Engine HDZ (TU1M)	210094	Drive Shaft		21	22	56.4	76	615	
	1996.05-	2003.09	MT	R	F	Hatchback Engine HDZ (TU1M)	299010	Drive Shaft	48T	21	22	58.5	86	807	
	1996.05-	2003.09	-	-	F	Hatchback Engine HDZ (TU1M)	808016	Outer Joint		22	22	52	96.5	53.5	O
	1996.05-	2003.09	MT	L	F	Hatchback Engine HDZ (TU1M)	810034	Outer Joint		21	20	50	81.5	54	O
	1996.05-	2003.09	MT	L	F	Hatchback Engine HDZ (TU1M)	245071	Drive Shaft		21	22	48	86.5	622	
	1996.05-	2003.09	MT	R	F	Hatchback Engine HDZ (TU1M)	245072	Drive Shaft		21	22	48	86.5	798.5	
	1996.05-	2003.09	MT	R	F	Hatchback Engine HDZ (TU1M)	210093	Drive Shaft		21	22	56.4	76	796	
	1996.05-	2003.09	MT	R	F	Hatchback Engine HDZ (TU1M)	210092	Drive Shaft		21	22	56.4	76	796	





	 YEAR	TRANSM	L/R	F/R	REMARKS	GSP Ref.	 PRODUCT	 ABS	Technical Specifications						
									A	B	C	H	L	P	
CITROEN															
SAXO (S0 S1)/CHANSON															
1.1 X,SX (40 kW)	1996.05-2003.09	MT	L	F	Hatchback Engine HDZ (TU1M)	210164	Drive Shaft		21	22	58.5	76	614		
	1996.05-2003.09	MT	L	F	Hatchback Engine HDZ (TU1M)	210009	Drive Shaft		21	22	50	81.5	618		
	1996.05-2003.09	MT	R	F	Hatchback Engine HDZ (TU1M)	210085	Drive Shaft		21	22	56.4	76	798		
	1996.05-2003.09	MT	L	F	Hatchback Engine HDZ (TU1M)	210061	Drive Shaft		21	22	49.9	81	620		
	1996.05-2003.09	MT	L	F	Hatchback Engine HDZ (TU1M)	210038	Drive Shaft	48T	21	22	58.5	76	614		
	1996.05-2003.09	MT	R	F	Hatchback Engine HDZ (TU1M)	210042	Drive Shaft	48T	21	22	56.4	76	798		
1.1 X,SX (44 kW)	1996.05-2003.09	MT	L	F	Hatchback Engine HFX (TU1JP)/HDZ (TU1JM)	210161	Drive Shaft		21	22	58.5	86	624		
	1996.05-2003.09	MT	R	F	Hatchback Engine HFX (TU1JP)/HDZ (TU1JM)	210062	Drive Shaft		21	22	49.9	81	798		
	1996.05-2003.09	MT	R	F	Hatchback Engine HFX (TU1JP)/HDZ (TU1JM)	210156	Drive Shaft		21	22	58.5	86	807		
	1996.05-2003.09	-	-	-	Hatchback Engine HFX (TU1JP)/HDZ (TU1JM)	210089	Drive Shaft		21	22	56.4	76	790		
	1996.05-2003.09	MT	L	F	Hatchback Engine HFX (TU1JP)/HDZ (TU1JM)	299006	Drive Shaft	48T	21	22	58.5	86	624		
	1996.05-2003.09	MT	R	F	Hatchback Engine HFX (TU1JP)/HDZ (TU1JM)	299010	Drive Shaft	48T	21	22	58.5	86	807		
	1996.05-2003.09	-	-	F	Hatchback Engine HFX (TU1JP)/HDZ (TU1JM)	808016	Outer Joint		22	22	52	96.5	53.5	O	
	1996.05-2003.09	MT	L	F	Hatchback Engine HFX (TU1JP)/HDZ (TU1JM)	810034	Outer Joint		21	20	50	81.5	54	O	
	1996.05-2003.09	MT	L	F	Hatchback Engine HFX (TU1JP)/HDZ (TU1JM)	210094	Drive Shaft		21	22	56.4	76	615		
	1996.05-2003.09	MT	L	F	Hatchback Engine HFX (TU1JP)/HDZ (TU1JM)	245071	Drive Shaft		21	22	48	86.5	622		
	1996.05-2003.09	MT	R	F	Hatchback Engine HFX (TU1JP)/HDZ (TU1JM)	245072	Drive Shaft		21	22	48	86.5	798.5		
	1996.05-2003.09	MT	R	F	Hatchback Engine HFX (TU1JP)/HDZ (TU1JM)	210093	Drive Shaft		21	22	56.4	76	796		
	1996.05-2003.09	-	L	F	Hatchback Engine HFX (TU1JP)/HDZ (TU1JM)	210164	Drive Shaft		21	22	58.5	76	614		
	1996.05-2003.09	MT	L	F	Hatchback Engine HFX (TU1JP)/HDZ (TU1JM)	210009	Drive Shaft		21	22	50	81.5	618		
	1996.05-2003.09	MT	R	F	Hatchback Engine HFX (TU1JP)/HDZ (TU1JM)	210085	Drive Shaft		21	22	56.4	76	798		
	1996.05-2003.09	MT	L	F	Hatchback Engine HFX (TU1JP)/HDZ (TU1JM)	210061	Drive Shaft		21	22	49.9	81	620		
	1996.05-2003.09	-	L	F	Hatchback Engine HFX (TU1JP)/HDZ (TU1JM)	210038	Drive Shaft	48T	21	22	58.5	76	614		
	1996.05-2003.09	-	R	F	Hatchback Engine HFX (TU1JP)/HDZ (TU1JM)	210042	Drive Shaft	48T	21	22	56.4	76	798		
	1.4 VTS (55 kW)	1996.05-2003.06	MT	R	F	Hatchback Engine KFX (TU3JP)/KFW (TU3JP)	210062	Drive Shaft		21	22	49.9	81	798	
		1996.05-2003.06	MT	L	F	Hatchback Engine KFX (TU3JP)/KFW (TU3JP)	210161	Drive Shaft		21	22	58.5	86	624	
1996.05-2003.06		MT	R	F	Hatchback Engine KFX (TU3JP)/KFW (TU3JP)	210156	Drive Shaft		21	22	58.5	86	807		
1996.05-2003.06		MT	R	F	Hatchback Engine KFX (TU3JP)/KFW (TU3JP)	210089	Drive Shaft		21	22	56.4	76	790		
1996.05-2003.06		MT	L	F	Hatchback Engine KFX (TU3JP)/KFW (TU3JP)	299006	Drive Shaft	48T	21	22	58.5	86	624		
1996.05-2003.06		MT	L	F	Hatchback Engine KFX (TU3JP)/KFW (TU3JP)	210094	Drive Shaft		21	22	56.4	76	615		
1996.05-2003.06		MT	R	F	Hatchback Engine KFX (TU3JP)/KFW (TU3JP)	299010	Drive Shaft	48T	21	22	58.5	86	807		
1996.05-2003.06		-	-	F	Hatchback Engine KFX (TU3JP)/KFW (TU3JP)	808016	Outer Joint		22	22	52	96.5	53.5	O	
1996.05-2003.06		MT	L	F	Hatchback Engine KFX (TU3JP)/KFW (TU3JP)	245071	Drive Shaft		21	22	48	86.5	622		
1996.05-2003.06		MT	R	F	Hatchback Engine KFX (TU3JP)/KFW (TU3JP)	245072	Drive Shaft		21	22	48	86.5	798.5		
1996.05-2003.06		MT	R	F	Hatchback Engine KFX (TU3JP)/KFW (TU3JP)	210093	Drive Shaft		21	22	56.4	76	796		
1996.05-2003.06		MT	L	F	Hatchback Engine KFX (TU3JP)/KFW (TU3JP)	210164	Drive Shaft		21	22	58.5	76	614		
1996.05-2003.06		-	L	F	Hatchback Engine KFX (TU3JP)/KFW (TU3JP)	210200	Drive Shaft	48T	21	29.95	50.5	76.5	592		
1996.05-2003.06		AT	L	F	Hatchback Engine KFX (TU3JP)/KFW (TU3JP)	845030	Outer Joint		21	22	56	76	58	I	
1996.05-2003.06		AT	R	F	Hatchback Engine KFX (TU3JP)/KFW (TU3JP)	210028	Drive Shaft	48T	21	23	50.5	76.5	693.5		
1996.05-2003.06		AT	L	F	Hatchback Engine KFX (TU3JP)/KFW (TU3JP)	299079	Drive Shaft		21	29.95	56	76	603		
1996.05-2003.06		MT	R	F	Hatchback Engine KFX (TU3JP)/KFW (TU3JP)	210085	Drive Shaft		21	22	56.4	76	798		
1996.05-2003.06		AT	L	F	Hatchback Engine KFX (TU3JP)/KFW (TU3JP)	210138	Drive Shaft	48T	21	29.95	50	86	603.5		
1996.05-2003.06		MT	R	F	Hatchback Engine KFX (TU3JP)/KFW (TU3JP)	210186	Drive Shaft	48T	21	22	54	75.5	799		
1996.05-2003.06		MT	L	F	Hatchback Engine KFX (TU3JP)/KFW (TU3JP)	210061	Drive Shaft		21	22	49.9	81	620		
1996.05-2003.06		MT	L	F	Hatchback Engine KFX (TU3JP)/KFW (TU3JP)	210038	Drive Shaft	48T	21	22	58.5	76	614		
1996.05-2003.06		AT	R	F	Hatchback Engine KFX (TU3JP)/KFW (TU3JP)	299014	Drive Shaft		21	23	56	76	704.5		
1996.05-2003.06		MT	R	F	Hatchback Engine KFX (TU3JP)/KFW (TU3JP)	210042	Drive Shaft	48T	21	22	56.4	76	798		
1.5 D (40 kW)		1996.09-2003.09	MT	R	F	Hatchback Engine VJY (TUD5)	210062	Drive Shaft		21	22	49.9	81	798	
	1996.09-2003.09	MT	R	F	Hatchback Engine VJY (TUD5)	210089	Drive Shaft		21	22	56.4	76	790		
	1996.09-2003.09	MT	L	F	Hatchback Engine VJY (TUD5)	210094	Drive Shaft		21	22	56.4	76	615		
	1996.09-2003.09	-	-	F	Hatchback Engine VJY (TUD5)	808016	Outer Joint		22	22	52	96.5	53.5	O	
	1996.09-2003.09	MT	L	F	Hatchback Engine VJY (TUD5)	245071	Drive Shaft		21	22	48	86.5	622		
	1996.09-2003.09	MT	R	F	Hatchback Engine VJY (TUD5)	245072	Drive Shaft		21	22	48	86.5	798.5		
	1996.09-2003.09	MT	R	F	Hatchback Engine VJY (TUD5)	210093	Drive Shaft		21	22	56.4	76	796		
	1996.09-2003.09	MT	L	F	Hatchback Engine VJY (TUD5)	299007	Drive Shaft	48T	21	22	58.5	76	608		
	1996.09-2003.09	MT	R	F	Hatchback Engine VJY (TUD5)	210186	Drive Shaft	48T	21	22	54	75.5	799		
	1996.09-2003.09	-	R	F	Hatchback Engine VJY (TUD5)	210085	Drive Shaft		21	22	56.4	76	798		
	1996.09-2003.09	MT	L	F	Hatchback Engine VJY (TUD5)	210061	Drive Shaft		21	22	49.9	81	620		
	1996.09-2003.09	MT	R	F	Hatchback Engine VJY (TUD5)	299009	Drive Shaft	48T	21	22	58.5	76	797		
1.5 D (42 kW)	1996.09-2001.06	MT	R	F	Hatchback Engine VJZ (TUD5)	210062	Drive Shaft		21	22	49.9	81	798		
	1996.09-2001.06	MT	R	F	Hatchback Engine VJZ (TUD5)	210089	Drive Shaft		21	22	56.4	76	790		
	1996.09-2001.06	MT	L	F	Hatchback Engine VJZ (TUD5)	210094	Drive Shaft		21	22	56.4	76	615		
	1996.09-2001.06	-	-	F	Hatchback Engine VJZ (TUD5)	808016	Outer Joint		22	22	52	96.5	53.5	O	
	1996.09-2001.06	MT	L	F	Hatchback Engine VJZ (TUD5)	245071	Drive Shaft		21	22	48	86.5	622		
	1996.09-2001.06	MT	R	F	Hatchback Engine VJZ (TUD5)	245072	Drive Shaft		21	22	48	86.5	798.5		
	1996.09-2001.06	MT	R	F	Hatchback Engine VJZ (TUD5)	210093	Drive Shaft		21	22	56.4	76	796		





		 YEAR	TRANSM	L/R	F/R	REMARKS	GSP Ref.	 PRODUCT	 ABS	Technical Specifications					
										A	B	C	H	L	P
CITROEN															
SAXO (S0 S1)/CHANSON															
1.5 D (42 kW)	1996.09-2001.06	MT	L	F	Hatchback Engine VJZ (TUD5)	299007	Drive Shaft	48T	21	22	58.5	76	608		
	1996.09-2001.06	MT	R	F	Hatchback Engine VJZ (TUD5)	210186	Drive Shaft	48T	21	22	54	75.5	799		
	1996.09-2001.06	-	R	F	Hatchback Engine VJZ (TUD5)	210085	Drive Shaft		21	22	56.4	76	798		
	1996.09-2001.06	MT	L	F	Hatchback Engine VJZ (TUD5)	210061	Drive Shaft		21	22	49.9	81	620		
	1996.09-2001.06	MT	R	F	Hatchback Engine VJZ (TUD5)	299009	Drive Shaft	48T	21	22	58.5	76	797		
1.5 D (43 kW)	2001.07-2004.04	-	-	F	Hatchback Engine VJZ (TUD5)	808016	Outer Joint		22	22	52	96.5	53.5	O	
	2001.07-2004.04	MT	L	F	Hatchback Engine VJZ (TUD5)	245071	Drive Shaft		21	22	48	86.5	622		
	2001.07-2004.04	MT	R	F	Hatchback Engine VJZ (TUD5)	245072	Drive Shaft		21	22	48	86.5	798.5		
1.6 (66 kW)	1996.02-2003.06	MT	L	F	Hatchback Engine NFZ (TU5JP)	299160	Drive Shaft	48T	21	22	54	75.5	608		
	1996.02-2003.06	MT	R	F	Hatchback Engine NFZ (TU5JP)	299158	Drive Shaft	48T	21	22	54	75.5	801		
	1996.02-2003.06	MT	L	F	Hatchback Engine NFZ (TU5JP)	210054	Drive Shaft		21	22	56.4	76	610		
	1996.02-2003.06	-	-	F	Hatchback Engine NFZ (TU5JP)	808016	Outer Joint		22	22	52	96.5	53.5	O	
	1996.02-2003.06	MT	L	F	Hatchback Engine NFZ (TU5JP)	210157	Drive Shaft		21	22	58.5	86	616		
	1996.02-2003.06	MT	R	F	Hatchback Engine NFZ (TU5JP)	299203	Drive Shaft		21	22	54	75.5	801		
	1996.02-2003.06	MT	R	F	Hatchback Engine NFZ (TU5JP)	210152	Drive Shaft		21	22	50	85	812		
	1996.02-2003.06	MT	L	F	Hatchback Engine NFZ (TU5JP)	210048	Drive Shaft	48T	21	22	58.5	86	616		
	1996.02-2003.06	MT	R	F	Hatchback Engine NFZ (TU5JP)	210049	Drive Shaft	48T	21	22	58.5	86	811.5		
	1996.02-2003.06	MT	L	F	Hatchback Engine NFZ (TU5JP)	210159	Drive Shaft		21	22	58.5	76	615		
	1996.02-2003.06	MT	R	F	Hatchback Engine NFZ (TU5JP)	210118	Drive Shaft		21	22	56.4	76	800		
	1996.02-2003.06	-	L	F	Hatchback Engine NFZ (TU5JP)	210200	Drive Shaft	48T	21	29.95	50.5	76.5	592		
	1996.02-2003.06	MT	R	F	Hatchback Engine NFZ (TU5JP)	645003	Inner Joint		22	22	29.8	253.5	92		
	1996.02-2003.06	AT	L	F	Hatchback Engine NFZ (TU5JP)	845030	Outer Joint		21	22	56	76	58	I	
	1996.02-2003.06	AT	R	F	Hatchback Engine NFZ (TU5JP)	210028	Drive Shaft	48T	21	23	50.5	76.5	693.5		
	1996.02-2003.06	AT	L	F	Hatchback Engine NFZ (TU5JP)	299079	Drive Shaft		21	29.95	56	76	603		
	1996.02-2003.06	MT	L	F	Hatchback Engine NFZ (TU5JP)	210020	Drive Shaft	48T	21	22	58.5	76	615		
	1996.02-2003.06	AT	R	F	Hatchback Engine NFZ (TU5JP)	299014	Drive Shaft		21	23	56	76	704.5		
	1996.02-2003.06	MT	R	F	Hatchback Engine NFZ (TU5JP)	210174	Drive Shaft	48T	21	22	58.5	76	800		
1.6 (74 kW)	2001.02-2004.04	-	-	F	Hatchback Engine NFT (TU5JP)	808016	Outer Joint		22	22	52	96.5	53.5	O	
	2001.02-2004.04	-	L	F	Hatchback Engine NFT (TU5JP)	210157	Drive Shaft		21	22	58.5	86	616		
	2001.02-2004.04	-	R	F	Hatchback Engine NFT (TU5JP)	210152	Drive Shaft		21	22	50	85	812		
	2001.02-2004.04	-	L	F	Hatchback Engine NFT (TU5JP)	210048	Drive Shaft	48T	21	22	58.5	86	616		
	2001.02-2004.04	-	R	F	Hatchback Engine NFT (TU5JP)	210049	Drive Shaft	48T	21	22	58.5	86	811.5		
	2001.02-2004.04	MT	L	F	Hatchback Engine NFT (TU5JP)	299027	Drive Shaft		21	22	50	86	620		
	2001.02-2004.04	MT	R	F	Hatchback Engine NFT (TU5JP)	299026	Drive Shaft		21	22	50	86	815		
	2001.02-2004.04	-	R	F	Hatchback Engine NFT (TU5JP)	645003	Inner Joint		22	22	29.8	253.5	92		
1.6 (88 kW)	1996.02-2004.04	MT	R	F	Hatchback Engine NFX (TU5JP4)	299158	Drive Shaft	48T	21	22	54	75.5	801		
	1996.02-2004.04	MT	L	F	Hatchback Engine NFX (TU5JP4)	210054	Drive Shaft		21	22	56.4	76	610		
	1996.02-2004.04	MT	R	F	Hatchback Engine NFX (TU5JP4)	299203	Drive Shaft		21	22	54	75.5	801		
	1996.02-2004.04	-	-	F	Hatchback Engine NFX (TU5JP4)	808016	Outer Joint		22	22	52	96.5	53.5	O	
	1996.02-2004.04	-	L	F	Hatchback Engine NFX (TU5JP4)	210157	Drive Shaft		21	22	58.5	86	616		
	1996.02-2004.04	-	R	F	Hatchback Engine NFX (TU5JP4)	210152	Drive Shaft		21	22	50	85	812		
	1996.02-2004.04	-	L	F	Hatchback Engine NFX (TU5JP4)	210048	Drive Shaft	48T	21	22	58.5	86	616		
	1996.02-2004.04	-	R	F	Hatchback Engine NFX (TU5JP4)	210049	Drive Shaft	48T	21	22	58.5	86	811.5		
	1996.02-2004.04	-	L	F	Hatchback Engine NFX (TU5JP4)	210159	Drive Shaft		21	22	58.5	76	615		
	1996.02-2004.04	MT	L	F	Hatchback Engine NFX (TU5JP4)	299027	Drive Shaft		21	22	50	86	620		
	1996.02-2004.04	-	R	F	Hatchback Engine NFX (TU5JP4)	210118	Drive Shaft		21	22	56.4	76	800		
	1996.02-2004.04	MT	R	F	Hatchback Engine NFX (TU5JP4)	299026	Drive Shaft		21	22	50	86	815		
	1996.02-2004.04	-	R	F	Hatchback Engine NFX (TU5JP4)	645003	Inner Joint		22	22	29.8	253.5	92		
	1996.02-2004.04	AT	L	F	Hatchback Engine NFX (TU5JP4)	845030	Outer Joint		21	22	56	76	58	I	
	1996.02-2004.04	AT	R	F	Hatchback Engine NFX (TU5JP4)	210028	Drive Shaft	48T	21	23	50.5	76.5	693.5		
	1996.02-2004.04	AT	L	F	Hatchback Engine NFX (TU5JP4)	299079	Drive Shaft		21	29.95	56	76	603		
	1996.02-2004.04	-	L	F	Hatchback Engine NFX (TU5JP4)	210020	Drive Shaft	48T	21	22	58.5	76	615		
	1996.02-2004.04	AT	R	F	Hatchback Engine NFX (TU5JP4)	299014	Drive Shaft		21	23	56	76	704.5		
	1996.02-2004.04	-	R	F	Hatchback Engine NFX (TU5JP4)	210174	Drive Shaft	48T	21	22	58.5	76	800		
1996.02-2004.04	MT	L	F	Hatchback Engine NFX (TU5JP4)	299160	Drive Shaft	48T	21	22	54	75.5	608			
1.6 VTL,VTR (65 kW)	1996.05-2003.06	MT	R	F	Hatchback Engine NFZ (TU5JP)	299158	Drive Shaft	48T	21	22	54	75.5	801		
	1996.05-2003.06	MT	L	F	Hatchback Engine NFZ (TU5JP)	210054	Drive Shaft		21	22	56.4	76	610		
	1996.05-2003.06	MT	R	F	Hatchback Engine NFZ (TU5JP)	645003	Inner Joint		22	22	29.8	253.5	92		
	1996.05-2003.06	MT	R	F	Hatchback Engine NFZ (TU5JP)	299203	Drive Shaft		21	22	54	75.5	801		
	1996.05-2003.06	MT	L	F	Hatchback Engine NFZ (TU5JP)	210157	Drive Shaft		21	22	58.5	86	616		
	1996.05-2003.06	-	-	F	Hatchback Engine NFZ (TU5JP)	808016	Outer Joint		22	22	52	96.5	53.5	O	
	1996.05-2003.06	MT	R	F	Hatchback Engine NFZ (TU5JP)	210152	Drive Shaft		21	22	50	85	812		
	1996.05-2003.06	MT	L	F	Hatchback Engine NFZ (TU5JP)	210048	Drive Shaft	48T	21	22	58.5	86	616		
	1996.05-2003.06	MT	R	F	Hatchback Engine NFZ (TU5JP)	210049	Drive Shaft	48T	21	22	58.5	86	811.5		
1996.05-2003.06	MT	L	F	Hatchback Engine NFZ (TU5JP)	210159	Drive Shaft		21	22	58.5	76	615			





YEAR	TRANSM	L/R	F/R	REMARKS	GSP Ref.	PRODUCT	ABS	Technical Specifications							
								A	B	C	H	L	P		
CITROEN															
SAXO (S0 S1)/CHANSON															
1.6 VTL,VTR (65 kW)	1996.05-2003.06	MT	L	F	Hatchback Engine NFZ (TU5JP)	299027	Drive Shaft		21	22	50	86	620		
	1996.05-2003.06	MT	R	F	Hatchback Engine NFZ (TU5JP)	210118	Drive Shaft		21	22	56.4	76	800		
	1996.05-2003.06	MT	R	F	Hatchback Engine NFZ (TU5JP)	299026	Drive Shaft		21	22	50	86	815		
	1996.05-2003.06	-	L	F	Hatchback Engine NFZ (TU5JP)	210200	Drive Shaft	48T	21	29.95	50.5	76.5	592		
	1996.05-2003.06	MT	L	F	Hatchback Engine NFZ (TU5JP)	210020	Drive Shaft	48T	21	22	58.5	76	615		
	1996.05-2003.06	MT	R	F	Hatchback Engine NFZ (TU5JP)	210174	Drive Shaft	48T	21	22	58.5	76	800		
	1996.05-2003.06	MT	L	F	Hatchback Engine NFZ (TU5JP)	299160	Drive Shaft	48T	21	22	54	75.5	608		
1.6 VTS (72 kW)	2000.09-2003.09	-	-	F	Hatchback Engine NFT (TU5JP)	808016	Outer Joint		22	22	52	96.5	53.5	O	
	2000.09-2003.09	-	L	F	Hatchback Engine NFT (TU5JP)	210157	Drive Shaft		21	22	58.5	86	616		
	2000.09-2003.09	-	R	F	Hatchback Engine NFT (TU5JP)	210152	Drive Shaft		21	22	50	85	812		
	2000.09-2003.09	-	L	F	Hatchback Engine NFT (TU5JP)	210048	Drive Shaft	48T	21	22	58.5	86	616		
	2000.09-2003.09	-	R	F	Hatchback Engine NFT (TU5JP)	210049	Drive Shaft	48T	21	22	58.5	86	811.5		
	2000.09-2003.09	MT	L	F	Hatchback Engine NFT (TU5JP)	299027	Drive Shaft		21	22	50	86	620		
	2000.09-2003.09	MT	R	F	Hatchback Engine NFT (TU5JP)	299026	Drive Shaft		21	22	50	86	815		
	2000.09-2003.09	-	R	F	Hatchback Engine NFT (TU5JP)	645003	Inner Joint		22	22	29.8	253.5	92		
	2000.09-2003.09	-	R	F	Hatchback Engine NFT (TU5JP)	210119	Drive Shaft	48T	21	22	50	85	812		
1.6 VTS (87 kW)	1996.06-2003.09	MT	R	F	Hatchback Engine NFX (TU5JP4)	299158	Drive Shaft	48T	21	22	54	75.5	801		
	1996.06-2003.09	MT	L	F	Hatchback Engine NFX (TU5JP4)	210054	Drive Shaft		21	22	56.4	76	610		
	1996.06-2003.09	MT	R	F	Hatchback Engine NFX (TU5JP4)	645003	Inner Joint		22	22	29.8	253.5	92		
	1996.06-2003.09	MT	R	F	Hatchback Engine NFX (TU5JP4)	299203	Drive Shaft		21	22	54	75.5	801		
	1996.06-2003.09	MT	L	F	Hatchback Engine NFX (TU5JP4)	210157	Drive Shaft		21	22	58.5	86	616		
	1996.06-2003.09	-	-	F	Hatchback Engine NFX (TU5JP4)	808016	Outer Joint		22	22	52	96.5	53.5	O	
	1996.06-2003.09	MT	R	F	Hatchback Engine NFX (TU5JP4)	210152	Drive Shaft		21	22	50	85	812		
	1996.06-2003.09	MT	L	F	Hatchback Engine NFX (TU5JP4)	210048	Drive Shaft	48T	21	22	58.5	86	616		
	1996.06-2003.09	MT	R	F	Hatchback Engine NFX (TU5JP4)	210049	Drive Shaft	48T	21	22	58.5	86	811.5		
	1996.06-2003.09	MT	L	F	Hatchback Engine NFX (TU5JP4)	210159	Drive Shaft		21	22	58.5	76	615		
	1996.06-2003.09	MT	L	F	Hatchback Engine NFX (TU5JP4)	299027	Drive Shaft		21	22	50	86	620		
	1996.06-2003.09	MT	R	F	Hatchback Engine NFX (TU5JP4)	210118	Drive Shaft		21	22	56.4	76	800		
	1996.06-2003.09	MT	R	F	Hatchback Engine NFX (TU5JP4)	299026	Drive Shaft		21	22	50	86	815		
	1996.06-2003.09	-	R	F	Hatchback Engine NFX (TU5JP4)	210119	Drive Shaft	48T	21	22	50	85	812		
	1996.06-2003.09	MT	L	F	Hatchback Engine NFX (TU5JP4)	210020	Drive Shaft	48T	21	22	58.5	76	615		
	1996.06-2003.09	MT	R	F	Hatchback Engine NFX (TU5JP4)	210174	Drive Shaft	48T	21	22	58.5	76	800		
	1996.06-2003.09	MT	L	F	Hatchback Engine NFX (TU5JP4)	299160	Drive Shaft	48T	21	22	54	75.5	608		
Electric (20 kW)	1996.11-2003.06	-	-	F	Hatchback Engine SA13	808016	Outer Joint		22	22	52	96.5	53.5	O	
SAXO I															
1.6 16V	1997.01-1999.09	MT	R	F	-	245046	Drive Shaft	48T	21	22	58.5	76	800		
1.6 8V	1997.01-1999.09	MT	R	F	-	245046	Drive Shaft	48T	21	22	58.5	76	800		
SAXO II															
1.0/1.1	1999.10-	MT	R	F	-	210046	Drive Shaft		21	22	50	86.5	806		
1.4 D/1.5 D	1999.10-	-	-	-	-	610008	Inner Joint		22	22	40.4	94	81.5		
1.4/1.5 D	1999.10-	MT	R	F	-	210046	Drive Shaft		21	22	50	86.5	806		
VISA															
1.1 E (37 kW)	1982.07-1991.03	MT	L/R	F	Hatchback Engine 109/5F	210130	Drive Shaft		21	22	54	90	683		
1.1 E (42 kW)	1978.09-1991.03	MT	L/R	F	Hatchback Engine 109/5	210130	Drive Shaft		21	22	54	90	683		
1.4 (44 kW)	1984.07-1991.03	MT	L/R	F	Hatchback Engine 150D (XY7)	210130	Drive Shaft		21	22	54	90	683		
1.6 GTI (83 kW)	1986.06-1991.03	-	L	F	Hatchback Engine B6D	245068	Drive Shaft		21	24	56.4	76	563		
1.7 D (44 kW)	1984.04-1991.03	-	L	F	Hatchback Engine 161A (XUD7)	245068	Drive Shaft		21	24	56.4	76	563		
	1984.04-1991.03	MT	L	F	Hatchback Engine 161A (XUD7)	210039	Drive Shaft		21	24	56.4	76	567		
	1984.04-1991.03	MT	R	F	Hatchback Engine 161A (XUD7)	210007	Drive Shaft		21	24	48	75.5	845		
XANTIA															
-	-	-	L	-	-	210184	Drive Shaft	48T	25	24	58.5	79	612		
	-	-	R	-	-	210185	Drive Shaft	48T	25	24	58.5	79	887		
1.6	1993.07-1997.05	MT/AT	-	F	-	810065	Outer Joint	48T	25	34	58.5	80	55	I	
1.6 i	1993-	-	-	-	-	810174	Outer Joint	48T	25	23	55.7	79	55	I	
1.8	1993.07-1997.12	MT/AT	-	F	-	810065	Outer Joint	48T	25	34	58.5	80	55	I	
	1998.01-2001.04	-	-	F	-	845047	Outer Joint	48T	25	34	59	78.5	54	I	
1.9 D	1993.07-1996.10	MT/AT	-	F	-	810065	Outer Joint	48T	25	34	58.5	80	55	I	
1.9 TD	1994.01-1997.12	MT/AT	-	F	-	810065	Outer Joint	48T	25	34	58.5	80	55	I	
	1998.01-1999.06	MT	-	F	-	845047	Outer Joint	48T	25	34	59	78.5	54	I	
2.0 16V	1993.05-1997.12	MT/AT	-	F	-	810065	Outer Joint	48T	25	34	58.5	80	55	I	
	1998.01-2001.04	MT	-	F	-	845047	Outer Joint	48T	25	34	59	78.5	54	I	
2.0 8V	1993.05-2001.04	MT/AT	-	F	-	810065	Outer Joint	48T	25	34	58.5	80	55	I	
XANTIA (X1)															
1.6 i (65 kW)	1993.03-1998.01	MT	R	F	Hatchback Engine BFZ (XU5JP)	210195	Drive Shaft	48T	25	24	55.7	79	893		
	1993.03-1998.01	MT	L	F	Hatchback Engine BFZ (XU5JP)	210194	Drive Shaft	48T	25	24	55.7	79	620		
	1993.03-1998.01	-	-	-	Hatchback Engine BFZ (XU5JP)	210197	Drive Shaft		25	24	54.8	78.5	893		





	 YEAR	TRANSM	L/R	F/R	REMARKS	GSP Ref.	 PRODUCT	 ABS	Technical Specifications					
									A	B	C	H	L	P
CITROEN														
XANTIA (X1)														
1.6 i (65 kW)	1993.03-1998.01	MT	L/R	F	Hatchback Engine BFZ (XU5JP)	810002	Outer Joint		25	23	54.8	78.5	56	I
	1993.03-1998.01	MT	L/R	F	Hatchback Engine BFZ (XU5JP)	810004	Outer Joint	48T	25	23	54.8	78.5	56	I
	1993.03-1998.01	-	-	F	Hatchback Engine BFZ (XU5JP)	810027	Outer Joint	48T	25	34	55.7	79	55	I
	1993.03-1998.01	-	-	F	Hatchback Engine BFZ (XU5JP)	810042	Outer Joint		25	34	54.8	78.5	56	I
	1993.03-1998.01	MT	L/R	F	Hatchback Engine BFZ (XU5JP)	810043	Outer Joint		25	34	54.8	78.5	56	I
	1993.03-1998.01	-	-	F	Hatchback Engine BFZ (XU5JP)	845035	Outer Joint	48T	25	34	58	79	55.5	I
1.8 i (66 kW)	1997.04-1998.01	AT/MT	L/R	F	Hatchback Engine LFX (XU7JB)	810004	Outer Joint	48T	25	23	54.8	78.5	56	I
1.8 i (74 kW)	1993.03-1998.01	MT	R	F	Hatchback Engine LFZ (XU7JP)	210195	Drive Shaft	48T	25	24	55.7	79	893	
	1993.03-1998.01	MT	L	F	Hatchback Engine LFZ (XU7JP)	210194	Drive Shaft	48T	25	24	55.7	79	620	
	1993.03-1998.01	-	-	-	Hatchback Engine LFZ (XU7JP)	210197	Drive Shaft		25	24	54.8	78.5	893	
	1993.03-1998.01	MT	L/R	F	Hatchback Engine LFZ (XU7JP)	810002	Outer Joint		25	23	54.8	78.5	56	I
	1993.03-1998.01	AT/MT	L/R	F	Hatchback Engine LFZ (XU7JP)	810004	Outer Joint	48T	25	23	54.8	78.5	56	I
	1993.03-1998.01	-	-	F	Hatchback Engine LFZ (XU7JP)	810027	Outer Joint	48T	25	34	55.7	79	55	I
	1993.03-1998.01	-	-	F	Hatchback Engine LFZ (XU7JP)	810042	Outer Joint		25	34	54.8	78.5	56	I
	1993.03-1998.01	MT	L/R	F	Hatchback Engine LFZ (XU7JP)	810024	Outer Joint	48T	25	34	55.7	79	55	I
1.8 i 16V (81 kW)	1993.03-1998.01	-	-	F	Hatchback Engine LFZ (XU7JP)	845035	Outer Joint	48T	25	34	58	79	55.5	I
	1995.06-1998.01	MT	L/R	F	Hatchback Engine LFY (XU7JP4)	810002	Outer Joint		25	23	54.8	78.5	56	I
	1995.06-1998.01	-	-	F	Hatchback Engine LFY (XU7JP4)	810027	Outer Joint	48T	25	34	55.7	79	55	I
	1995.06-1998.01	MT	R	F	Hatchback Engine LFY (XU7JP4)	210202	Drive Shaft	48T	25	24	55.7	79	892	
	1995.06-1998.01	-	-	F	Hatchback Engine LFY (XU7JP4)	810042	Outer Joint		25	34	54.8	78.5	56	I
	1995.06-1998.01	MT	L/R	F	Hatchback Engine LFY (XU7JP4)	810024	Outer Joint	48T	25	34	55.7	79	55	I
1.9 D (50 kW)	1995.06-1998.01	-	-	F	Hatchback Engine LFY (XU7JP4)	845035	Outer Joint	48T	25	34	58	79	55.5	I
	1994.06-1998.01	MT	R	F	Hatchback Engine DJZ (XUD9Y)	210195	Drive Shaft	48T	25	24	55.7	79	893	
	1994.06-1998.01	MT	L	F	Hatchback Engine DJZ (XUD9Y)	210194	Drive Shaft	48T	25	24	55.7	79	620	
	1994.06-1998.01	MT	L/R	F	Hatchback Engine DJZ (XUD9Y)	810002	Outer Joint		25	23	54.8	78.5	56	I
	1994.06-1998.01	-	-	F	Hatchback Engine DJZ (XUD9Y)	810027	Outer Joint	48T	25	34	55.7	79	55	I
1.9 D (51 kW)	1994.06-1998.01	-	-	F	Hatchback Engine DJZ (XUD9Y)	810042	Outer Joint		25	34	54.8	78.5	56	I
	1994.06-1998.01	MT	R	F	Hatchback Engine D9B (XUD9A/L)	210195	Drive Shaft	48T	25	24	55.7	79	893	
	1994.06-1998.01	MT	L	F	Hatchback Engine D9B (XUD9A/L)	210194	Drive Shaft	48T	25	24	55.7	79	620	
	1994.06-1998.01	MT	L/R	F	Hatchback Engine D9B (XUD9A/L)	810002	Outer Joint		25	23	54.8	78.5	56	I
	1994.06-1998.01	-	-	F	Hatchback Engine D9B (XUD9A/L)	810027	Outer Joint	48T	25	34	55.7	79	55	I
1.9 SD (55 kW)	1994.06-1998.01	-	-	F	Hatchback Engine D9B (XUD9A/L)	810042	Outer Joint		25	34	54.8	78.5	56	I
	1996.02-1998.01	MT	L/R	F	Hatchback Engine DHW (XUD9SD)	810002	Outer Joint		25	23	54.8	78.5	56	I
	1996.02-1998.01	-	-	F	Hatchback Engine DHW (XUD9SD)	810027	Outer Joint	48T	25	34	55.7	79	55	I
	1996.02-1998.01	-	-	F	Hatchback Engine DHW (XUD9SD)	810042	Outer Joint		25	34	54.8	78.5	56	I
1.9 Turbo D (66 kW)	1994.10-1998.01	-	-	F	Hatchback Engine DHY (XUD9TE/Y)/DHX(XUD9TF/BTF)	845003	Outer Joint	29T	25	34	58	79	55.5	I
	1994.10-1998.01	MT	L	F	Hatchback Engine DHY (XUD9TE/Y)/DHX(XUD9TF/BTF)	210196	Drive Shaft		25	24	54.8	78.5	613	
	1994.10-1998.01	MT	R	F	Hatchback Engine DHY (XUD9TE/Y)/DHX(XUD9TF/BTF)	210199	Drive Shaft	48T	25	24	55.7	79	892	
	1994.10-1998.01	-	-	-	Hatchback Engine DHY (XUD9TE/Y)/DHX(XUD9TF/BTF)	210197	Drive Shaft		25	24	54.8	78.5	893	
	1994.10-1998.01	MT	L/R	F	Hatchback Engine DHY (XUD9TE/Y)/DHX(XUD9TF/BTF)	810002	Outer Joint		25	23	54.8	78.5	56	I
	1994.10-1998.01	AT/MT	L/R	F	Hatchback Engine DHY (XUD9TE/Y)/DHX(XUD9TF/BTF)	810004	Outer Joint	48T	25	23	54.8	78.5	56	I
	1994.10-1998.01	-	-	-	Hatchback Engine DHY (XUD9TE/Y)/DHX(XUD9TF/BTF)	810036	Outer Joint		25	34	55.7	79	55	I
	1994.10-1998.01	MT	R	F	Hatchback Engine DHY (XUD9TE/Y)/DHX(XUD9TF/BTF)	210202	Drive Shaft	48T	25	24	55.7	79	892	
	1994.10-1998.01	-	-	F	Hatchback Engine DHY (XUD9TE/Y)/DHX(XUD9TF/BTF)	810042	Outer Joint		25	34	54.8	78.5	56	I
	1994.10-1998.01	-	-	F	Hatchback Engine DHY (XUD9TE/Y)/DHX(XUD9TF/BTF)	845035	Outer Joint	48T	25	34	58	79	55.5	I
2.0 i (89 kW)	1994.10-1998.01	-	L	F	Hatchback Engine DHY (XUD9TE/Y)/DHX(XUD9TF/BTF)	210189	Drive Shaft	48T	25	24	54.8	78.5	610	
	1993.03-1998.01	MT	L	F	Hatchback Engine RFX (XU10J2C)	210196	Drive Shaft		25	24	54.8	78.5	613	
	1993.03-1998.01	MT	R	F	Hatchback Engine RFX (XU10J2C)	210199	Drive Shaft	48T	25	24	55.7	79	892	
	1993.03-1998.01	-	-	-	Hatchback Engine RFX (XU10J2C)	210197	Drive Shaft		25	24	54.8	78.5	893	
	1993.03-1998.01	MT	L/R	F	Hatchback Engine RFX (XU10J2C)	810002	Outer Joint		25	23	54.8	78.5	56	I
	1993.03-1998.01	-	-	F	Hatchback Engine RFX (XU10J2C)	810027	Outer Joint	48T	25	34	55.7	79	55	I
	1993.03-1998.01	-	-	F	Hatchback Engine RFX (XU10J2C)	810042	Outer Joint		25	34	54.8	78.5	56	I
	1993.03-1998.01	-	-	-	Hatchback Engine RFX (XU10J2C)	810036	Outer Joint		25	34	55.7	79	55	I
	1993.03-1998.01	MT	L/R	F	Hatchback Engine RFX (XU10J2C)	810024	Outer Joint	48T	25	34	55.7	79	55	I
2.0 i 16V (110 kW)	1993.03-1998.01	MT	R	F	Hatchback Engine RFX (XU10J2C)	210202	Drive Shaft	48T	25	24	55.7	79	892	
	1994.06-1998.01	-	-	F	Hatchback Engine RFT (XU10J4/Z)	845003	Outer Joint	29T	25	34	58	79	55.5	I
	1994.06-1998.01	MT	R	F	Hatchback Engine RFT (XU10J4/Z)	210199	Drive Shaft	48T	25	24	55.7	79	892	
	1994.06-1998.01	-	-	-	Hatchback Engine RFT (XU10J4/Z)	210197	Drive Shaft		25	24	54.8	78.5	893	
	1994.06-1998.01	MT	R	F	Hatchback Engine RFT (XU10J4/Z)	210202	Drive Shaft	48T	25	24	55.7	79	892	
	1994.06-1998.01	-	-	F	Hatchback Engine RFT (XU10J4/Z)	810042	Outer Joint		25	34	54.8	78.5	56	I
	1994.06-1998.01	-	-	F	Hatchback Engine RFT (XU10J4/Z)	845035	Outer Joint	48T	25	34	58	79	55.5	I
	1994.06-1998.01	-	L	F	Hatchback Engine RFT (XU10J4/Z)	210189	Drive Shaft	48T	25	24	54.8	78.5	610	
2.0 i 16V (112 kW)	1993.03-1998.01	-	-	F	Hatchback Engine RFY (XU10J4/Z)	845003	Outer Joint	29T	25	34	58	79	55.5	I
	1993.03-1998.01	MT	R	F	Hatchback Engine RFY (XU10J4/Z)	210199	Drive Shaft	48T	25	24	55.7	79	892	
	1993.03-1998.01	-	-	F	Hatchback Engine RFY (XU10J4/Z)	210197	Drive Shaft		25	24	54.8	78.5	893	
	1993.03-1998.01	-	-	F	Hatchback Engine RFY (XU10J4/Z)	810042	Outer Joint		25	34	54.8	78.5	56	I





	 YEAR	TRANSM	L/R	F/R	REMARKS	GSP Ref.	 PRODUCT	 ABS	Technical Specifications					
									A	B	C	H	L	P
CITROEN														
XANTIA (X1)														
2.0 i 16V (112 kW)	1993.03-1998.01	MT	R	F	Hatchback Engine RFY (XU10J4/Z)	210202	Drive Shaft	48T	25	24	55.7	79	892	
	1993.03-1998.01	-	-	F	Hatchback Engine RFY (XU10J4/Z)	845035	Outer Joint	48T	25	34	58	79	55.5	I
	1993.03-1998.01	-	L	F	Hatchback Engine RFY (XU10J4/Z)	210189	Drive Shaft	48T	25	24	54.8	78.5	610	
2.0 i 16V (97 kW)	1995.06-1998.01	-	-	F	Hatchback Engine RFV (XU10J4R)	845003	Outer Joint	29T	25	34	58	79	55.5	I
	1995.06-1998.01	-	-	-	Hatchback Engine RFV (XU10J4R)	210197	Drive Shaft		25	24	54.8	78.5	893	
	1995.06-1998.01	MT	L/R	F	Hatchback Engine RFV (XU10J4R)	810002	Outer Joint		25	23	54.8	78.5	56	I
	1995.06-1998.01	-	-	-	Hatchback Engine RFV (XU10J4R)	810036	Outer Joint		25	34	55.7	79	55	I
	1995.06-1998.01	MT	R	F	Hatchback Engine RFV (XU10J4R)	210202	Drive Shaft	48T	25	24	55.7	79	892	
	1995.06-1998.01	-	-	F	Hatchback Engine RFV (XU10J4R)	810042	Outer Joint		25	34	54.8	78.5	56	I
	1995.06-1998.01	MT	L/R	F	Hatchback Engine RFV (XU10J4R)	810024	Outer Joint	48T	25	34	55.7	79	55	I
	1995.06-1998.01	-	-	F	Hatchback Engine RFV (XU10J4R)	845035	Outer Joint	48T	25	34	58	79	55.5	I
2.0 Turbo (108 kW)	1995.06-1998.01	-	-	F	Hatchback Engine RGX (XU10J2TE)	810019	Outer Joint	48T	25	39	59	89	63.5	I
	1995.06-1998.01	MT	L/R	F	Hatchback Engine RGX (XU10J2TE)	810002	Outer Joint		25	23	54.8	78.5	56	I
	1995.06-1998.01	MT	L	F	Hatchback Engine RGX (XU10J2TE)	245178	Drive Shaft	48T	25	37	59	89	621	
	1995.06-1998.01	MT	R	F	Hatchback Engine RGX (XU10J2TE)	245179	Drive Shaft	48T	25	37	59	89	918	
	1995.06-1998.01	MT	L/R	F	Hatchback Engine RGX (XU10J2TE)	810024	Outer Joint	48T	25	34	55.7	79	55	I
2.1 Turbo D 12V (80 kW)	1995.06-1998.01	-	-	F	Hatchback Engine P8C (XUD11BTE)	810019	Outer Joint	48T	25	39	59	89	63.5	I
	1995.06-1998.01	MT	L	F	Hatchback Engine P8C (XUD11BTE)	245178	Drive Shaft	48T	25	37	59	89	621	
	1995.06-1998.01	MT	R	F	Hatchback Engine P8C (XUD11BTE)	245179	Drive Shaft	48T	25	37	59	89	918	
3.0 i 24V (140 kW)	1997.01-1998.01	-	-	F	Hatchback Engine XFZ (ES9J4)	810019	Outer Joint	48T	25	39	59	89	63.5	I
	1997.01-1998.01	AT/MT	L	F	Hatchback Engine XFZ (ES9J4)	245178	Drive Shaft	48T	25	37	59	89	621	
	1997.01-1998.01	AT/MT	R	F	Hatchback Engine XFZ (ES9J4)	245179	Drive Shaft	48T	25	37	59	89	918	
XANTIA (X2)														
2.0 HDI 109 (80 kW)	1999.02-2003.04	-	-	F	Hatchback Engine RHZ (DW10ATED)	810019	Outer Joint	48T	25	39	59	89	63.5	I
	1999.02-2003.04	MT	L	F	Hatchback Engine RHZ (DW10ATED)	245178	Drive Shaft	48T	25	37	59	89	621	
	1999.02-2003.04	MT	R	F	Hatchback Engine RHZ (DW10ATED)	245179	Drive Shaft	48T	25	37	59	89	918	
2.0 HDI 90 (66 kW)	1999.03-2003.04	-	-	-	Hatchback Engine RHY (DW10TD)	810036	Outer Joint		25	34	55.7	79	55	I
	1999.03-2003.04	-	-	F	Hatchback Engine RHY (DW10TD)	810042	Outer Joint		25	34	54.8	78.5	56	I
	1999.03-2003.04	-	-	F	Hatchback Engine RHY (DW10TD)	845035	Outer Joint	48T	25	34	58	79	55.5	I
XANTIA Break (X1)														
1.8 i (66 kW)	1997.04-1998.01	AT/MT	L/R	F	Estate Engine LFX (XU7JB)	810004	Outer Joint	48T	25	23	54.8	78.5	56	I
	1997.04-1998.01	-	-	F	Estate Engine LFX (XU7JB)	810027	Outer Joint	48T	25	34	55.7	79	55	I
	1997.04-1998.01	-	-	F	Estate Engine LFX (XU7JB)	810042	Outer Joint		25	34	54.8	78.5	56	I
	1997.04-1998.01	-	-	F	Estate Engine LFX (XU7JB)	845035	Outer Joint	48T	25	34	58	79	55.5	I
1.8 i (74 kW)	1995.06-1998.01	MT	R	F	Estate Engine LFZ (XU7JP)	210195	Drive Shaft	48T	25	24	55.7	79	893	
	1995.06-1998.01	MT	L	F	Estate Engine LFZ (XU7JP)	210194	Drive Shaft	48T	25	24	55.7	79	620	
	1995.06-1998.01	AT/MT	L/R	F	Estate Engine LFZ (XU7JP)	810004	Outer Joint	48T	25	23	54.8	78.5	56	I
	1995.06-1998.01	MT	L/R	F	Estate Engine LFZ (XU7JP)	810002	Outer Joint		25	23	54.8	78.5	56	I
	1995.06-1998.01	-	-	F	Estate Engine LFZ (XU7JP)	810027	Outer Joint	48T	25	34	55.7	79	55	I
	1995.06-1998.01	-	-	F	Estate Engine LFZ (XU7JP)	810042	Outer Joint		25	34	54.8	78.5	56	I
	1995.06-1998.01	MT	L/R	F	Estate Engine LFZ (XU7JP)	810024	Outer Joint	48T	25	34	55.7	79	55	I
	1995.06-1998.01	-	-	F	Estate Engine LFZ (XU7JP)	845035	Outer Joint	48T	25	34	58	79	55.5	I
1.8 i 16V (81 kW)	1995.06-1998.01	MT	L/R	F	Estate Engine LFY (XU7JP4)	810002	Outer Joint		25	23	54.8	78.5	56	I
	1995.06-1998.01	-	-	F	Estate Engine LFY (XU7JP4)	810027	Outer Joint	48T	25	34	55.7	79	55	I
	1995.06-1998.01	MT	L/R	F	Estate Engine LFY (XU7JP4)	810024	Outer Joint	48T	25	34	55.7	79	55	I
	1995.06-1998.01	-	-	F	Estate Engine LFY (XU7JP4)	810042	Outer Joint		25	34	54.8	78.5	56	I
	1995.06-1998.01	-	-	F	Estate Engine LFY (XU7JP4)	845035	Outer Joint	48T	25	34	58	79	55.5	I
1.9 SD (55 kW)	1997.04-1998.01	MT	L/R	F	Estate Engine DHW (XUD9SD)	810002	Outer Joint		25	23	54.8	78.5	56	I
	1997.04-1998.01	-	-	F	Estate Engine DHW (XUD9SD)	810027	Outer Joint	48T	25	34	55.7	79	55	I
	1997.04-1998.01	-	-	F	Estate Engine DHW (XUD9SD)	810042	Outer Joint		25	34	54.8	78.5	56	I
1.9 Turbo D (66 kW)	1995.06-1998.01	-	L	F	Estate Engine DHX (XUD9TF/BTF)/DHY(XUDE/Y)D88(XUD9TF)	210189	Drive Shaft	48T	25	24	54.8	78.5	610	
	1995.06-1998.01	MT	L	F	Estate Engine DHX (XUD9TF/BTF)/DHY(XUDE/Y)D88(XUD9TF)	210196	Drive Shaft		25	24	54.8	78.5	613	
	1995.06-1998.01	-	-	F	Estate Engine DHX (XUD9TF/BTF)/DHY(XUDE/Y)D88(XUD9TF)	845003	Outer Joint	29T	25	34	58	79	55.5	I
	1995.06-1998.01	MT	R	F	Estate Engine DHX (XUD9TF/BTF)/DHY(XUDE/Y)D88(XUD9TF)	210199	Drive Shaft	48T	25	24	55.7	79	892	
	1995.06-1998.01	-	-	-	Estate Engine DHX (XUD9TF/BTF)/DHY(XUDE/Y)D88(XUD9TF)	210197	Drive Shaft		25	24	54.8	78.5	893	
	1995.06-1998.01	MT	L/R	F	Estate Engine DHX (XUD9TF/BTF)/DHY(XUDE/Y)D88(XUD9TF)	810002	Outer Joint		25	23	54.8	78.5	56	I
	1995.06-1998.01	-	-	-	Estate Engine DHX (XUD9TF/BTF)/DHY(XUDE/Y)D88(XUD9TF)	810036	Outer Joint		25	34	55.7	79	55	I
	1995.06-1998.01	MT	R	F	Estate Engine DHX (XUD9TF/BTF)/DHY(XUDE/Y)D88(XUD9TF)	210202	Drive Shaft	48T	25	24	55.7	79	892	
	1995.06-1998.01	-	-	F	Estate Engine DHX (XUD9TF/BTF)/DHY(XUDE/Y)D88(XUD9TF)	810042	Outer Joint		25	34	54.8	78.5	56	I
	1995.06-1998.01	-	-	F	Estate Engine DHX (XUD9TF/BTF)/DHY(XUDE/Y)D88(XUD9TF)	845035	Outer Joint	48T	25	34	58	79	55.5	I
2.0 i (89 kW)	1995.06-1998.01	MT	L	F	Estate Engine RFX (XU10J2C)	210196	Drive Shaft		25	24	54.8	78.5	613	
	1995.06-1998.01	MT	R	F	Estate Engine RFX (XU10J2C)	210199	Drive Shaft	48T	25	24	55.7	79	892	
	1995.06-1998.01	-	-	-	Estate Engine RFX (XU10J2C)	210197	Drive Shaft		25	24	54.8	78.5	893	
	1995.06-1998.01	MT	L/R	F	Estate Engine RFX (XU10J2C)	810002	Outer Joint		25	23	54.8	78.5	56	I
	1995.06-1998.01	-	-	F	Estate Engine RFX (XU10J2C)	810027	Outer Joint	48T	25	34	55.7	79	55	I





	 YEAR	TRANSM	L/R	F/R	REMARKS	GSP Ref.	 PRODUCT	 ABS	Technical Specifications						
									A	B	C	H	L	P	
CITROEN															
XANTIA Break (X1)															
2.0 i (89 kW)	1995.06-1998.01	-	-	-	Estate Engine RFX (XU10J2C)	810036	Outer Joint		25	34	55.7	79	55	I	
	1995.06-1998.01	MT	R	F	Estate Engine RFX (XU10J2C)	210202	Drive Shaft	48T	25	24	55.7	79	892		
	1995.06-1998.01	-	-	F	Estate Engine RFX (XU10J2C)	810042	Outer Joint		25	34	54.8	78.5	56	I	
2.0 i 16V (97 kW)	1995.06-1998.01	-	L	F	Estate Engine RFV (XU10J4R)	210189	Drive Shaft	48T	25	24	54.8	78.5	610		
	1995.06-1998.01	-	-	F	Estate Engine RFV (XU10J4R)	845003	Outer Joint	29T	25	34	58	79	55.5	I	
	1995.06-1998.01	-	-	-	Estate Engine RFV (XU10J4R)	210197	Drive Shaft		25	24	54.8	78.5	893		
	1995.06-1998.01	MT	L/R	F	Estate Engine RFV (XU10J4R)	810002	Outer Joint		25	23	54.8	78.5	56	I	
	1995.06-1998.01	-	-	-	Estate Engine RFV (XU10J4R)	810036	Outer Joint		25	34	55.7	79	55	I	
	1995.06-1998.01	MT	R	F	Estate Engine RFV (XU10J4R)	210202	Drive Shaft	48T	25	24	55.7	79	892		
	1995.06-1998.01	-	-	F	Estate Engine RFV (XU10J4R)	810042	Outer Joint		25	34	54.8	78.5	56	I	
	1995.06-1998.01	MT	L/R	F	Estate Engine RFV (XU10J4R)	810024	Outer Joint	48T	25	34	55.7	79	55	I	
2.0 Turbo (108 kW)	1995.06-1998.01	-	-	F	Estate Engine RGX (XU10J2TE)	810019	Outer Joint	48T	25	39	59	89	63.5	I	
	1995.06-1998.01	MT	L/R	F	Estate Engine RGX (XU10J2TE)	810002	Outer Joint		25	23	54.8	78.5	56	I	
	1995.06-1998.01	MT	L	F	Estate Engine RGX (XU10J2TE)	245178	Drive Shaft	48T	25	37	59	89	621		
	1995.06-1998.01	MT	R	F	Estate Engine RGX (XU10J2TE)	245179	Drive Shaft	48T	25	37	59	89	918		
	1995.06-1998.01	MT	L/R	F	Estate Engine RGX (XU10J2TE)	810024	Outer Joint	48T	25	34	55.7	79	55	I	
2.1 Turbo D 12V (80 kW)	1996.06-1998.01	-	-	F	Estate Engine P8C (XUD11BTE)	810019	Outer Joint	48T	25	39	59	89	63.5	I	
	1996.06-1998.01	MT	L	F	Estate Engine P8C (XUD11BTE)	245178	Drive Shaft	48T	25	37	59	89	621		
	1996.06-1998.01	MT	R	F	Estate Engine P8C (XUD11BTE)	245179	Drive Shaft	48T	25	37	59	89	918		
XANTIA Break (X2)															
2.0 HDI 109 (80 kW)	1999.02-2003.04	-	-	F	Estate Engine RHZ (DW10ATED)	810019	Outer Joint	48T	25	39	59	89	63.5	I	
	1999.02-2003.04	MT	L	F	Estate Engine RHZ (DW10ATED)	245178	Drive Shaft	48T	25	37	59	89	621		
	1999.02-2003.04	MT	R	F	Estate Engine RHZ (DW10ATED)	245179	Drive Shaft	48T	25	37	59	89	918		
2.0 HDI 90 (66 kW)	1999.03-2003.04	-	L	F	Estate Engine RHY (DW10TD)	210189	Drive Shaft	48T	25	24	54.8	78.5	610		
	1999.03-2003.04	-	-	F	Estate Engine RHY (DW10TD)	810042	Outer Joint		25	34	54.8	78.5	56	I	
	1999.03-2003.04	-	-	F	Estate Engine RHY (DW10TD)	845035	Outer Joint	48T	25	34	58	79	55.5	I	
3.0 V6 (140 kW)	1998.01-2003.04	AT/MT	L	F	Estate Engine XFZ (ES9J4)	245178	Drive Shaft	48T	25	37	59	89	621		
	1998.01-2003.04	AT/MT	R	F	Estate Engine XFZ (ES9J4)	245179	Drive Shaft	48T	25	37	59	89	918		
XM (Y3)															
2.0 (84 kW)	1989.05-1994.04	-	-	F	Hatchback	810083	Outer Joint	48T	28	39	58	89	63	I	
	1989.05-1994.04	-	-	F	Hatchback	810008	Outer Joint	48T	28	27	58	89	63	I	
	1989.05-1994.04	MT	R	F	Hatchback	210084	Drive Shaft	48T	28	24	58	88.5	942.5		
	1989.05-1994.04	MT	L	F	Hatchback	210083	Drive Shaft	48T	28	24	58	88.5	651		
	1989.05-1994.04	-	R	F	Hatchback	210114	Drive Shaft		28	24	58	88.5	942.5		
	1989.05-1994.04	-	L	F	Hatchback	210113	Drive Shaft		28	24	58	88.5	651		
	1989.05-1994.04	-	-	F	Hatchback	810021	Outer Joint	29T	28	23	58	88.5	55	I	
	1989.05-1994.06	-	-	F	Hatchback Engine R6A	810083	Outer Joint	48T	28	39	58	89	63	I	
	1989.05-1994.06	-	-	F	Hatchback Engine R6A	810008	Outer Joint	48T	28	27	58	89	63	I	
2.0 (94 kW)	1989.05-1994.06	MT	R	F	Hatchback Engine R6A	210084	Drive Shaft	48T	28	24	58	88.5	942.5		
	1989.05-1994.06	MT	L	F	Hatchback Engine R6A	210083	Drive Shaft	48T	28	24	58	88.5	651		
	1989.05-1994.06	-	-	F	Hatchback Engine R6A	810021	Outer Joint	29T	28	23	58	88.5	55	I	
	2.0 i (79 kW)	1989.05-1994.04	-	-	F	Hatchback Engine RDZ (XU10MZ)	810008	Outer Joint	48T	28	27	58	89	63	I
		1989.05-1994.04	MT	R	F	Hatchback Engine RDZ (XU10MZ)	210084	Drive Shaft	48T	28	24	58	88.5	942.5	
		1989.05-1994.04	-	R	F	Hatchback Engine RDZ (XU10MZ)	210114	Drive Shaft		28	24	58	88.5	942.5	
		1989.05-1994.04	MT	L	F	Hatchback Engine RDZ (XU10MZ)	210083	Drive Shaft	48T	28	24	58	88.5	651	
		1989.05-1994.04	-	-	F	Hatchback Engine RDZ (XU10MZ)	810046	Outer Joint		28	23	58	88.5	55	I
		1989.05-1994.04	MT/AT	L	F	Hatchback Engine RDZ (XU10MZ)	610018	Inner Joint		24	29	40	62.5	99	
1989.05-1994.04		-	L	F	Hatchback Engine RDZ (XU10MZ)	210113	Drive Shaft		28	24	58	88.5	651		
1989.05-1994.04		-	-	F	Hatchback Engine RDZ (XU10MZ)	810021	Outer Joint	29T	28	23	58	88.5	55	I	
2.0 i (89 kW)		1989.05-1994.06	-	-	F	Hatchback Engine RFZ (XU10J2)	810083	Outer Joint	48T	28	39	58	89	63	I
	1989.05-1994.06	MT/AT	L	F	Hatchback Engine RFZ (XU10J2)	610018	Inner Joint		24	29	40	62.5	99		
	1989.05-1994.06	-	-	F	Hatchback Engine RFZ (XU10J2)	810008	Outer Joint	48T	28	27	58	89	63	I	
	1989.05-1994.06	-	L	F	Hatchback Engine RFZ (XU10J2)	210071	Drive Shaft	48T	28	37	58	89	641.5		
	1989.05-1994.06	MT	R	F	Hatchback Engine RFZ (XU10J2)	210084	Drive Shaft	48T	28	24	58	88.5	942.5		
	1989.05-1994.06	MT	L	F	Hatchback Engine RFZ (XU10J2)	210083	Drive Shaft	48T	28	24	58	88.5	651		
	1989.05-1994.06	-	R	F	Hatchback Engine RFZ (XU10J2)	210114	Drive Shaft		28	24	58	88.5	942.5		
	1989.05-1994.06	-	-	-	Hatchback Engine RFZ (XU10J2)	810046	Outer Joint		28	23	58	88.5	55	I	
	1989.05-1994.06	-	R	F	Hatchback Engine RFZ (XU10J2)	210070	Drive Shaft	48T	28	37	58	89	939		
	1989.05-1994.06	-	L	F	Hatchback Engine RFZ (XU10J2)	210113	Drive Shaft		28	24	58	88.5	651		
	1989.05-1994.06	-	-	F	Hatchback Engine RFZ (XU10J2)	810021	Outer Joint	29T	28	23	58	88.5	55	I	
	2.0 i (99 kW)	1989.05-1994.06	-	-	F	Hatchback Engine RFV (XU10J4R)	810083	Outer Joint	48T	28	39	58	89	63	I
		1989.05-1994.06	-	-	F	Hatchback Engine RFV (XU10J4R)	810008	Outer Joint	48T	28	27	58	89	63	I
1989.05-1994.06		MT	R	F	Hatchback Engine RFV (XU10J4R)	210084	Drive Shaft	48T	28	24	58	88.5	942.5		
1989.05-1994.06		MT	L	F	Hatchback Engine RFV (XU10J4R)	210083	Drive Shaft	48T	28	24	58	88.5	651		
1989.05-1994.06		-	-	F	Hatchback Engine RFV (XU10J4R)	810021	Outer Joint	29T	28	23	58	88.5	55	I	





	 YEAR	TRANSM	L/R	F/R	REMARKS	GSP Ref.	 PRODUCT	 ABS	Technical Specifications					
									A	B	C	H	L	P
CITROEN XM (Y3)														
2.0 i Turbo (104 kW)	1992.09-1994.06	-	-	F	Hatchback Engine RGY (XU10J2TE/Z)	810083	Outer Joint	48T	28	39	58	89	63	I
	1992.09-1994.06	-	-	F	Hatchback Engine RGY (XU10J2TE/Z)	810008	Outer Joint	48T	28	27	58	89	63	I
	1992.09-1994.06	-	L	F	Hatchback Engine RGY (XU10J2TE/Z)	210071	Drive Shaft	48T	28	37	58	89	641.5	
	1992.09-1994.06	AT/MT	L	F	Hatchback Engine RGY (XU10J2TE/Z)	210441	Drive Shaft	48T	28	37	58.5	88	623	
	1992.09-1994.06	AT/MT	R	F	Hatchback Engine RGY (XU10J2TE/Z)	210442	Drive Shaft	48T	28	37	58	89	920	
	1992.09-1994.06	-	-	F	Hatchback Engine RGY (XU10J2TE/Z)	810021	Outer Joint	29T	28	23	58	88.5	55	I
2.1 D 12V (60 kW)	1989.05-1994.06	-	-	F	Hatchback Engine P9A (XUD11A)	810083	Outer Joint	48T	28	39	58	89	63	I
	1989.05-1994.06	MT/AT	L	F	Hatchback Engine P9A (XUD11A)	610018	Inner Joint		24	29	40	62.5	99	
	1989.05-1994.06	-	-	F	Hatchback Engine P9A (XUD11A)	810008	Outer Joint	48T	28	27	58	89	63	I
	1989.05-1994.06	MT	R	F	Hatchback Engine P9A (XUD11A)	210084	Drive Shaft	48T	28	24	58	88.5	942.5	
	1989.05-1994.06	MT	L	F	Hatchback Engine P9A (XUD11A)	210083	Drive Shaft	48T	28	24	58	88.5	651	
	1989.05-1994.06	-	R	F	Hatchback Engine P9A (XUD11A)	210114	Drive Shaft		28	24	58	88.5	942.5	
	1989.05-1994.06	-	-	-	Hatchback Engine P9A (XUD11A)	810046	Outer Joint		28	23	58	88.5	55	I
	1989.05-1994.06	-	L	F	Hatchback Engine P9A (XUD11A)	210113	Drive Shaft		28	24	58	88.5	651	
2.1 TD 12V (80 kW)	1989.05-1994.06	-	-	F	Hatchback Engine P8A (XUD11ATE)/Phz (XUD11ATE)/Pjz (XUD11ATE)	810083	Outer Joint	48T	28	39	58	89	63	I
	1989.05-1994.06	-	-	F	Hatchback Engine P8A (XUD11ATE)/Phz (XUD11ATE)/Pjz (XUD11ATE)	810008	Outer Joint	48T	28	27	58	89	63	I
	1989.05-1994.06	-	L	F	Hatchback Engine P8A (XUD11ATE)/Phz (XUD11ATE)/Pjz (XUD11ATE)	210071	Drive Shaft	48T	28	37	58	89	641.5	
	1989.05-1994.06	AT/MT	L	F	Hatchback Engine P8A (XUD11ATE)/Phz (XUD11ATE)/Pjz (XUD11ATE)	210441	Drive Shaft	48T	28	37	58.5	88	623	
	1989.05-1994.06	AT/MT	R	F	Hatchback Engine P8A (XUD11ATE)/Phz (XUD11ATE)/Pjz (XUD11ATE)	210442	Drive Shaft	48T	28	37	58	89	920	
	1989.05-1994.06	-	R	F	Hatchback Engine P8A (XUD11ATE)/Phz (XUD11ATE)/Pjz (XUD11ATE)	210070	Drive Shaft	48T	28	37	58	89	939	
3.0 (147 kW)	1989.05-1994.06	-	-	F	Hatchback	810083	Outer Joint	48T	28	39	58	89	63	I
	1989.05-1994.06	-	-	F	Hatchback	810008	Outer Joint	48T	28	27	58	89	63	I
3.0 V6 (123 kW)	1989.05-1994.06	-	-	F	Hatchback Engine SFZ (ZPJ/Z)/UFZ (ZPJ/Z)	810083	Outer Joint	48T	28	39	58	89	63	I
	1989.05-1994.06	-	-	F	Hatchback Engine SFZ (ZPJ/Z)/UFZ (ZPJ/Z)	810008	Outer Joint	48T	28	27	58	89	63	I
	1989.05-1994.06	-	L	F	Hatchback Engine SFZ (ZPJ/Z)/UFZ (ZPJ/Z)	210071	Drive Shaft	48T	28	37	58	89	641.5	
	1989.05-1994.06	AT/MT	L	F	Hatchback Engine SFZ (ZPJ/Z)/UFZ (ZPJ/Z)	210441	Drive Shaft	48T	28	37	58.5	88	623	
	1989.05-1994.06	AT/MT	R	F	Hatchback Engine SFZ (ZPJ/Z)/UFZ (ZPJ/Z)	210442	Drive Shaft	48T	28	37	58	89	920	
	1989.05-1994.06	-	R	F	Hatchback Engine SFZ (ZPJ/Z)/UFZ (ZPJ/Z)	210070	Drive Shaft	48T	28	37	58	89	939	
3.0 V6 24V (147 kW)	1990.07-1994.06	-	-	F	Hatchback Engine SKZ (ZPJ/Z)/UKZ (ZPJ/Z)	810083	Outer Joint	48T	28	39	58	89	63	I
	1990.07-1994.06	-	-	F	Hatchback Engine SKZ (ZPJ/Z)/UKZ (ZPJ/Z)	810008	Outer Joint	48T	28	27	58	89	63	I
	1990.07-1994.06	-	L	F	Hatchback Engine SKZ (ZPJ/Z)/UKZ (ZPJ/Z)	210071	Drive Shaft	48T	28	37	58	89	641.5	
	1990.07-1994.06	AT/MT	L	F	Hatchback Engine SKZ (ZPJ/Z)/UKZ (ZPJ/Z)	210441	Drive Shaft	48T	28	37	58.5	88	623	
	1990.07-1994.06	AT/MT	R	F	Hatchback Engine SKZ (ZPJ/Z)/UKZ (ZPJ/Z)	210442	Drive Shaft	48T	28	37	58	89	920	
	1990.07-1994.06	-	R	F	Hatchback Engine SKZ (ZPJ/Z)/UKZ (ZPJ/Z)	210070	Drive Shaft	48T	28	37	58	89	939	
XM (Y4)														
2.0 i 16V (97 kW)	1994.05-2000.10	-	-	F	Hatchback Engine RFV (XU10J4R)	810083	Outer Joint	48T	28	39	58	89	63	I
	1994.05-2000.10	-	L	F	Hatchback Engine RFV (XU10J4R)	210071	Drive Shaft	48T	28	37	58	89	641.5	
	1994.05-2000.10	-	-	F	Hatchback Engine RFV (XU10J4R)	810008	Outer Joint	48T	28	27	58	89	63	I
	1994.05-2000.10	AT/MT	L	F	Hatchback Engine RFV (XU10J4R)	210441	Drive Shaft	48T	28	37	58.5	88	623	
	1994.05-2000.10	MT	R	F	Hatchback Engine RFV (XU10J4R)	210084	Drive Shaft	48T	28	24	58	88.5	942.5	
	1994.05-2000.10	-	R	F	Hatchback Engine RFV (XU10J4R)	210114	Drive Shaft		28	24	58	88.5	942.5	
	1994.05-2000.10	AT/MT	R	F	Hatchback Engine RFV (XU10J4R)	210442	Drive Shaft	48T	28	37	58	89	920	
	1994.05-2000.10	MT	L	F	Hatchback Engine RFV (XU10J4R)	210083	Drive Shaft	48T	28	24	58	88.5	651	
	1994.05-2000.10	-	R	F	Hatchback Engine RFV (XU10J4R)	210070	Drive Shaft	48T	28	37	58	89	939	
	1994.05-2000.10	-	L	F	Hatchback Engine RFV (XU10J4R)	210113	Drive Shaft		28	24	58	88.5	651	
	1994.05-2000.10	-	-	F	Hatchback Engine RFV (XU10J4R)	810021	Outer Joint	29T	28	23	58	88.5	55	I
	2.0 Turbo (108 kW)	1994.05-2000.10	-	-	F	Hatchback Engine RGX (XU10J2TE)	810083	Outer Joint	48T	28	39	58	89	63
1994.05-2000.10		-	L	F	Hatchback Engine RGX (XU10J2TE)	210071	Drive Shaft	48T	28	37	58	89	641.5	
1994.05-2000.10		-	-	F	Hatchback Engine RGX (XU10J2TE)	810008	Outer Joint	48T	28	27	58	89	63	I
1994.05-2000.10		AT/MT	L	F	Hatchback Engine RGX (XU10J2TE)	210441	Drive Shaft	48T	28	37	58.5	88	623	
1994.05-2000.10		-	R	F	Hatchback Engine RGX (XU10J2TE)	210114	Drive Shaft		28	24	58	88.5	942.5	
1994.05-2000.10		AT/MT	R	F	Hatchback Engine RGX (XU10J2TE)	210442	Drive Shaft	48T	28	37	58	89	920	
1994.05-2000.10		-	R	F	Hatchback Engine RGX (XU10J2TE)	210070	Drive Shaft	48T	28	37	58	89	939	
1994.05-2000.10		-	L	F	Hatchback Engine RGX (XU10J2TE)	210113	Drive Shaft		28	24	58	88.5	651	
2.1 TD 12V (80 kW)	1994.05-2000.10	-	-	F	Hatchback Engine P8A (XUD11ATE)/PHZ (XUD11ATE)/PJZ (XUD11ATE)/P8C (XUD11BTE)	810083	Outer Joint	48T	28	39	58	89	63	I
	1994.05-2000.10	-	L	F	Hatchback Engine P8A (XUD11ATE)/PHZ (XUD11ATE)/PJZ (XUD11ATE)/P8C (XUD11BTE)	210071	Drive Shaft	48T	28	37	58	89	641.5	
	1994.05-2000.10	-	-	F	Hatchback Engine P8A (XUD11ATE)/PHZ (XUD11ATE)/PJZ (XUD11ATE)/P8C (XUD11BTE)	810008	Outer Joint	48T	28	27	58	89	63	I
	1994.05-2000.10	AT/MT	L	F	Hatchback Engine P8A (XUD11ATE)/PHZ (XUD11ATE)/PJZ (XUD11ATE)/P8C (XUD11BTE)	210441	Drive Shaft	48T	28	37	58.5	88	623	
	1994.05-2000.10	-	R	F	Hatchback Engine P8A (XUD11ATE)/PHZ (XUD11ATE)/PJZ (XUD11ATE)/P8C (XUD11BTE)	210114	Drive Shaft		28	24	58	88.5	942.5	
	1994.05-2000.10	AT/MT	R	F	Hatchback Engine P8A (XUD11ATE)/PHZ (XUD11ATE)/PJZ (XUD11ATE)/P8C (XUD11BTE)	210442	Drive Shaft	48T	28	37	58	89	920	
	1994.05-2000.10	-	R	F	Hatchback Engine P8A (XUD11ATE)/PHZ (XUD11ATE)/PJZ (XUD11ATE)/P8C (XUD11BTE)	210070	Drive Shaft	48T	28	37	58	89	939	
	1994.05-2000.10	-	L	F	Hatchback Engine P8A (XUD11ATE)/PHZ (XUD11ATE)/PJZ (XUD11ATE)/P8C (XUD11BTE)	210113	Drive Shaft		28	24	58	88.5	651	
2.5 TD (95 kW)	1994.05-2000.10	-	-	F	Hatchback Engine THY (DK5ATE)	810008	Outer Joint	48T	28	27	58	89	63	I
3.0 V6 (123 kW)	1994.05-2000.10	-	-	F	Hatchback Engine SFZ (ZPJ/Z)/UFZ (ZPJ/Z)	810083	Outer Joint	48T	28	39	58	89	63	I
	1994.05-2000.10	-	-	F	Hatchback Engine SFZ (ZPJ/Z)/UFZ (ZPJ/Z)	810008	Outer Joint	48T	28	27	58	89	63	I





	 YEAR	TRANSM	L/R	F/R	REMARKS	GSP Ref.	 PRODUCT	 ABS	Technical Specifications					
									A	B	C	H	L	P
CITROEN XM (Y4)														
3.0 V6 (123 kW)	1994.05-2000.10	AT/MT	L	F	Hatchback Engine SFZ (ZPJ/Z)/UFZ (ZPJ/Z)	210441	Drive Shaft	48T	28	37	58.5	88	623	
	1994.05-2000.10	AT/MT	R	F	Hatchback Engine SFZ (ZPJ/Z)/UFZ (ZPJ/Z)	210442	Drive Shaft	48T	28	37	58	89	920	
3.0 V6 (140 kW)	1997.04-2000.10	-	-	F	Hatchback Engine XFZ (ES9J4)	810083	Outer Joint	48T	28	39	58	89	63	I
	1997.04-2000.10	-	-	F	Hatchback Engine XFZ (ES9J4)	810008	Outer Joint	48T	28	27	58	89	63	I
3.0 V6 24V (147 kW)	1994.05-2000.10	-	-	F	Hatchback Engine SKZ (ZPJ4/Z)/UKZ (ZPJ4/Z)	810083	Outer Joint	48T	28	39	58	89	63	I
	1994.05-2000.10	-	-	F	Hatchback Engine SKZ (ZPJ4/Z)/UKZ (ZPJ4/Z)	810008	Outer Joint	48T	28	27	58	89	63	I
	1994.05-2000.10	AT/MT	L	F	Hatchback Engine SKZ (ZPJ4/Z)/UKZ (ZPJ4/Z)	210441	Drive Shaft	48T	28	37	58.5	88	623	
	1994.05-2000.10	AT/MT	R	F	Hatchback Engine SKZ (ZPJ4/Z)/UKZ (ZPJ4/Z)	210442	Drive Shaft	48T	28	37	58	89	920	
XM Break (Y3)														
2.0 (94 kW)	1989.05-1994.06	-	-	F	Estate Engine R6A	810083	Outer Joint	48T	28	39	58	89	63	I
	1989.05-1994.06	-	-	F	Estate Engine R6A	810008	Outer Joint	48T	28	27	58	89	63	I
	1989.05-1994.06	MT	R	F	Estate Engine R6A	210084	Drive Shaft	48T	28	24	58	88.5	942.5	
	1989.05-1994.06	MT	L	F	Estate Engine R6A	210083	Drive Shaft	48T	28	24	58	88.5	651	
	1989.05-1994.06	-	-	F	Estate Engine R6A	810021	Outer Joint	29T	28	23	58	88.5	55	I
2.0 i (79 kW)	1991.11-1994.04	-	-	F	Estate Engine RDZ (XU10MZ)/XU102C	810083	Outer Joint	48T	28	39	58	89	63	I
	1991.11-1994.04	-	-	F	Estate Engine RDZ (XU10MZ)/XU102C	810008	Outer Joint	48T	28	27	58	89	63	I
	1991.11-1994.04	MT/AT	L	F	Estate Engine RDZ (XU10MZ)/XU102C	610018	Inner Joint		24	29	40	62.5	99	
	1991.11-1994.04	MT	R	F	Estate Engine RDZ (XU10MZ)/XU102C	210084	Drive Shaft	48T	28	24	58	88.5	942.5	
	1991.11-1994.04	MT	L	F	Estate Engine RDZ (XU10MZ)/XU102C	210083	Drive Shaft	48T	28	24	58	88.5	651	
	1991.11-1994.04	-	R	F	Estate Engine RDZ (XU10MZ)/XU102C	210114	Drive Shaft		28	24	58	88.5	942.5	
	1991.11-1994.04	-	-	-	Estate Engine RDZ (XU10MZ)/XU102C	810046	Outer Joint		28	23	58	88.5	55	I
	1991.11-1994.04	-	L	F	Estate Engine RDZ (XU10MZ)/XU102C	210113	Drive Shaft		28	24	58	88.5	651	
2.0 i (89 kW)	1991.11-1994.04	-	-	F	Estate Engine RFZ (XU10J2)	810083	Outer Joint	48T	28	39	58	89	63	I
	1991.11-1994.04	MT/AT	L	F	Estate Engine RFZ (XU10J2)	610018	Inner Joint		24	29	40	62.5	99	
	1991.11-1994.04	-	L	F	Estate Engine RFZ (XU10J2)	210071	Drive Shaft	48T	28	37	58	89	641.5	
	1991.11-1994.04	-	-	F	Estate Engine RFZ (XU10J2)	810008	Outer Joint	48T	28	27	58	89	63	I
	1991.11-1994.04	MT	R	F	Estate Engine RFZ (XU10J2)	210084	Drive Shaft	48T	28	24	58	88.5	942.5	
	1991.11-1994.04	MT	L	F	Estate Engine RFZ (XU10J2)	210083	Drive Shaft	48T	28	24	58	88.5	651	
	1991.11-1994.04	-	R	F	Estate Engine RFZ (XU10J2)	210114	Drive Shaft		28	24	58	88.5	942.5	
	1991.11-1994.04	-	-	-	Estate Engine RFZ (XU10J2)	810046	Outer Joint		28	23	58	88.5	55	I
	1991.11-1994.04	-	R	F	Estate Engine RFZ (XU10J2)	210070	Drive Shaft	48T	28	37	58	89	939	
	1991.11-1994.04	-	L	F	Estate Engine RFZ (XU10J2)	210113	Drive Shaft		28	24	58	88.5	651	
2.0 Turbo (104 kW)	1992.09-1994.04	-	-	F	Estate Engine RGY (XU10J2TE/Z)	810083	Outer Joint	48T	28	39	58	89	63	I
	1992.09-1994.04	-	-	F	Estate Engine RGY (XU10J2TE/Z)	810008	Outer Joint	48T	28	27	58	89	63	I
	1992.09-1994.04	-	L	F	Estate Engine RGY (XU10J2TE/Z)	210071	Drive Shaft	48T	28	37	58	89	641.5	
	1992.09-1994.04	AT/MT	L	F	Estate Engine RGY (XU10J2TE/Z)	210441	Drive Shaft	48T	28	37	58.5	88	623	
	1992.09-1994.04	AT/MT	R	F	Estate Engine RGY (XU10J2TE/Z)	210442	Drive Shaft	48T	28	37	58	89	920	
2.1 D 12V (60 kW)	1991.11-1994.04	-	-	F	Estate Engine P9A (XUD11A)	810083	Outer Joint	48T	28	39	58	89	63	I
	1991.11-1994.04	-	-	F	Estate Engine P9A (XUD11A)	810008	Outer Joint	48T	28	27	58	89	63	I
	1991.11-1994.04	MT	R	F	Estate Engine P9A (XUD11A)	210084	Drive Shaft	48T	28	24	58	88.5	942.5	
	1991.11-1994.04	-	R	F	Estate Engine P9A (XUD11A)	210114	Drive Shaft		28	24	58	88.5	942.5	
	1991.11-1994.04	MT	L	F	Estate Engine P9A (XUD11A)	210083	Drive Shaft	48T	28	24	58	88.5	651	
	1991.11-1994.04	MT/AT	L	F	Estate Engine P9A (XUD11A)	610018	Inner Joint		24	29	40	62.5	99	
	1991.11-1994.04	-	-	F	Estate Engine P9A (XUD11A)	810054	Outer Joint	48T	28	23	59	88.5	55	I
	1991.11-1994.04	-	L	F	Estate Engine P9A (XUD11A)	210113	Drive Shaft		28	24	58	88.5	651	
2.1 TD 12V (80 kW)	1991.11-1994.04	-	-	F	Estate Engine P8A (XUD11ATE)/PHZ (XUD11ATE)/PJZ (XUD11ATE)/P8C (XUD11BTE)	810083	Outer Joint	48T	28	39	58	89	63	I
	1991.11-1994.04	-	-	F	Estate Engine P8A (XUD11ATE)/PHZ (XUD11ATE)/PJZ (XUD11ATE)/P8C (XUD11BTE)	810008	Outer Joint	48T	28	27	58	89	63	I
	1991.11-1994.04	-	L	F	Estate Engine P8A (XUD11ATE)/PHZ (XUD11ATE)/PJZ (XUD11ATE)/P8C (XUD11BTE)	210071	Drive Shaft	48T	28	37	58	89	641.5	
	1991.11-1994.04	AT/MT	L	F	Estate Engine P8A (XUD11ATE)/PHZ (XUD11ATE)/PJZ (XUD11ATE)/P8C (XUD11BTE)	210441	Drive Shaft	48T	28	37	58.5	88	623	
	1991.11-1994.04	AT/MT	R	F	Estate Engine P8A (XUD11ATE)/PHZ (XUD11ATE)/PJZ (XUD11ATE)/P8C (XUD11BTE)	210442	Drive Shaft	48T	28	37	58	89	920	
3.0 V6 (123 kW)	1991.11-1994.04	-	-	F	Estate Engine SFZ (ZPJ/Z)/UFZ (ZPJ/Z)	810083	Outer Joint	48T	28	39	58	89	63	I
	1991.11-1994.04	-	-	F	Estate Engine SFZ (ZPJ/Z)/UFZ (ZPJ/Z)	810008	Outer Joint	48T	28	27	58	89	63	I
	1991.11-1994.04	-	L	F	Estate Engine SFZ (ZPJ/Z)/UFZ (ZPJ/Z)	210071	Drive Shaft	48T	28	37	58	89	641.5	
	1991.11-1994.04	AT/MT	L	F	Estate Engine SFZ (ZPJ/Z)/UFZ (ZPJ/Z)	210441	Drive Shaft	48T	28	37	58.5	88	623	
	1991.11-1994.04	AT/MT	R	F	Estate Engine SFZ (ZPJ/Z)/UFZ (ZPJ/Z)	210442	Drive Shaft	48T	28	37	58	89	920	
	1991.11-1994.04	-	R	F	Estate Engine SFZ (ZPJ/Z)/UFZ (ZPJ/Z)	210070	Drive Shaft	48T	28	37	58	89	939	
XM Break (Y4)														
2.0 i 16V (97 kW)	1994.05-2000.10	-	-	F	Estate Engine RFV (XU10J4R)	810083	Outer Joint	48T	28	39	58	89	63	I
	1994.05-2000.10	-	L	F	Estate Engine RFV (XU10J4R)	210071	Drive Shaft	48T	28	37	58	89	641.5	
	1994.05-2000.10	-	-	F	Estate Engine RFV (XU10J4R)	810008	Outer Joint	48T	28	27	58	89	63	I
	1994.05-2000.10	AT/MT	L	F	Estate Engine RFV (XU10J4R)	210441	Drive Shaft	48T	28	37	58.5	88	623	
	1994.05-2000.10	MT	R	F	Estate Engine RFV (XU10J4R)	210084	Drive Shaft	48T	28	24	58	88.5	942.5	





	 YEAR	TRANSM	L/R	F/R	REMARKS	GSP Ref.	 PRODUCT	 ABS	Technical Specifications					
									A	B	C	H	L	P
CITROEN														
XM Break (Y4)														
2.0 i 16V (97 kW)	1994.05-2000.10	-	R	F	Estate Engine RFV (XU10J4R)	210114	Drive Shaft		28	24	58	88.5	942.5	
	1994.05-2000.10	AT/MT	R	F	Estate Engine RFV (XU10J4R)	210442	Drive Shaft	48T	28	37	58	89	920	
	1994.05-2000.10	MT	L	F	Estate Engine RFV (XU10J4R)	210083	Drive Shaft	48T	28	24	58	88.5	651	
	1994.05-2000.10	-	R	F	Estate Engine RFV (XU10J4R)	210070	Drive Shaft	48T	28	37	58	89	939	
	1994.05-2000.10	-	L	F	Estate Engine RFV (XU10J4R)	210113	Drive Shaft		28	24	58	88.5	651	
	1994.05-2000.10	-	-	F	Estate Engine RFV (XU10J4R)	810021	Outer Joint	29T	28	23	58	88.5	55	I
2.0 Turbo (108 kW)	1994.05-2000.10	-	-	F	Estate Engine RGX (XU10J2TE)/RGY (XU10J2TE/Z)	810083	Outer Joint	48T	28	39	58	89	63	I
	1994.05-2000.10	-	L	F	Estate Engine RGX (XU10J2TE)/RGY (XU10J2TE/Z)	210071	Drive Shaft	48T	28	37	58	89	641.5	
	1994.05-2000.10	-	-	F	Estate Engine RGX (XU10J2TE)/RGY (XU10J2TE/Z)	810008	Outer Joint	48T	28	27	58	89	63	I
	1994.05-2000.10	AT/MT	L	F	Estate Engine RGX (XU10J2TE)/RGY (XU10J2TE/Z)	210441	Drive Shaft	48T	28	37	58.5	88	623	
	1994.05-2000.10	-	R	F	Estate Engine RGX (XU10J2TE)/RGY (XU10J2TE/Z)	210114	Drive Shaft		28	24	58	88.5	942.5	
	1994.05-2000.10	AT/MT	R	F	Estate Engine RGX (XU10J2TE)/RGY (XU10J2TE/Z)	210442	Drive Shaft	48T	28	37	58	89	920	
	1994.05-2000.10	-	R	F	Estate Engine RGX (XU10J2TE)/RGY (XU10J2TE/Z)	210070	Drive Shaft	48T	28	37	58	89	939	
	1994.05-2000.10	-	L	F	Estate Engine RGX (XU10J2TE)/RGY (XU10J2TE/Z)	210113	Drive Shaft		28	24	58	88.5	651	
	1994.05-2000.10	-	-	F	Estate Engine RGX (XU10J2TE)/RGY (XU10J2TE/Z)	810021	Outer Joint	29T	28	23	58	88.5	55	I
2.1 D12 (60 kW)	1994.07-1996.06	-	-	F	Estate Engine P9A (XUD11A)	810083	Outer Joint	48T	28	39	58	89	63	I
	1994.07-1996.06	-	L	F	Estate Engine P9A (XUD11A)	210071	Drive Shaft	48T	28	37	58	89	641.5	
	1994.07-1996.06	-	-	F	Estate Engine P9A (XUD11A)	810008	Outer Joint	48T	28	27	58	89	63	I
	1994.07-1996.06	MT	R	F	Estate Engine P9A (XUD11A)	210084	Drive Shaft	48T	28	24	58	88.5	942.5	
	1994.07-1996.06	-	R	F	Estate Engine P9A (XUD11A)	210114	Drive Shaft		28	24	58	88.5	942.5	
	1994.07-1996.06	MT	L	F	Estate Engine P9A (XUD11A)	210083	Drive Shaft	48T	28	24	58	88.5	651	
	1994.07-1996.06	MT/AT	L	F	Estate Engine P9A (XUD11A)	610018	Inner Joint		24	29	40	62.5	99	
	1994.07-1996.06	-	R	F	Estate Engine P9A (XUD11A)	210070	Drive Shaft	48T	28	37	58	89	939	
	1994.07-1996.06	-	L	F	Estate Engine P9A (XUD11A)	210113	Drive Shaft		28	24	58	88.5	651	
2.1 TD 12V (80 kW)	1994.05-2000.10	-	-	F	Estate Engine PHZ (XUD11ATE)/PJZ (XUD11ATE)/P8C (XUD11ATE)	810083	Outer Joint	48T	28	39	58	89	63	I
	1994.05-2000.10	-	L	F	Estate Engine PHZ (XUD11ATE)/PJZ (XUD11ATE)/P8C (XUD11ATE)	210071	Drive Shaft	48T	28	37	58	89	641.5	
	1994.05-2000.10	-	-	F	Estate Engine PHZ (XUD11ATE)/PJZ (XUD11ATE)/P8C (XUD11ATE)	810008	Outer Joint	48T	28	27	58	89	63	I
	1994.05-2000.10	AT/MT	L	F	Estate Engine PHZ (XUD11ATE)/PJZ (XUD11ATE)/P8C (XUD11ATE)	210441	Drive Shaft	48T	28	37	58.5	88	623	
	1994.05-2000.10	-	R	F	Estate Engine PHZ (XUD11ATE)/PJZ (XUD11ATE)/P8C (XUD11ATE)	210114	Drive Shaft		28	24	58	88.5	942.5	
	1994.05-2000.10	AT/MT	R	F	Estate Engine PHZ (XUD11ATE)/PJZ (XUD11ATE)/P8C (XUD11ATE)	210442	Drive Shaft	48T	28	37	58	89	920	
	1994.05-2000.10	-	R	F	Estate Engine PHZ (XUD11ATE)/PJZ (XUD11ATE)/P8C (XUD11ATE)	210070	Drive Shaft	48T	28	37	58	89	939	
	1994.05-2000.10	-	L	F	Estate Engine PHZ (XUD11ATE)/PJZ (XUD11ATE)/P8C (XUD11ATE)	210113	Drive Shaft		28	24	58	88.5	651	
2.5 TD (95 kW)	1994.05-2000.10	-	-	F	Estate Engine THY (DK5ATE)	810008	Outer Joint	48T	28	27	58	89	63	I
3.0 V6 (123 kW)	1994.05-2000.10	-	-	F	Estate Engine SFZ (ZPJ/Z)/UFZ (ZPJ/Z)	810083	Outer Joint	48T	28	39	58	89	63	I
	1994.05-2000.10	-	-	F	Estate Engine SFZ (ZPJ/Z)/UFZ (ZPJ/Z)	810008	Outer Joint	48T	28	27	58	89	63	I
	1994.05-2000.10	AT/MT	L	F	Estate Engine SFZ (ZPJ/Z)/UFZ (ZPJ/Z)	210441	Drive Shaft	48T	28	37	58.5	88	623	
	1994.05-2000.10	AT/MT	R	F	Estate Engine SFZ (ZPJ/Z)/UFZ (ZPJ/Z)	210442	Drive Shaft	48T	28	37	58	89	920	
3.0 V6 (140 kW)	1997.04-2000.10	-	-	F	Estate Engine XFZ (ES9J4)	810083	Outer Joint	48T	28	39	58	89	63	I
	1997.04-2000.10	-	-	F	Estate Engine XFZ (ES9J4)	810008	Outer Joint	48T	28	27	58	89	63	I
XSARA														
-	-	-	-	-	LADO ESQUERDO	645020	Inner Joint		24	34	40	69	89	
1.4 (55 kW)	2000.09-2005.03	-	R	F	Box Body/Estate Engine KFX (TU3JP)	210205	Drive Shaft		25	22	58.5	79	866	
2.0 HDI	1999.06-	-	R	-	-	210051	Drive Shaft	29T	25	24	55.7	79	865	
2.0 HDi (66 kW)	2000.09-2005.03	-	L	F	Box Engine RHY (DW10TD)	299195	Drive Shaft	48W	25	24	58.5	79	585	
	2000.09-2005.03	MT	L	F	Box Engine RHY (DW10TD)	210080	Drive Shaft	29W	25	24	55.7	79	597	
	2000.09-2005.03	MT	L	F	Box Engine RHY (DW10TD)	210128	Drive Shaft	29T	25	24	55.7	79	594	
	2000.09-2005.03	-	R	F	Box Engine RHY (DW10TD)	299196	Drive Shaft	48W	25	24	58.5	79	869	
	2000.09-2005.03	MT	L	F	Box Engine RHY (DW10TD)	210131	Drive Shaft	29T	25	24	54.8	78.5	583	
	2000.09-2005.03	MT	-	F	Box Engine RHY (DW10TD)	810022	Outer Joint	29W	25	34	55.7	79	55	I
XSARA (N0)														
1.4 HdI (50 kW)	2003.01-2005.03	-	L	F	Coupe Engine 8HX (DV4TD)	210128	Drive Shaft	29T	25	24	55.7	79	594	
	2003.01-2005.03	MT	L	F	Coupe Engine 8HX (DV4TD)	210080	Drive Shaft	29W	25	24	55.7	79	597	
	2003.01-2005.03	-	-	F	Coupe Engine 8HX (DV4TD)	810022	Outer Joint	29W	25	34	55.7	79	55	I
	2003.01-2005.03	-	L	F	Coupe Engine 8HX (DV4TD)	210131	Drive Shaft	29T	25	24	54.8	78.5	583	
1.4 i (55 kW)	1998.03-2005.03	MT	R	F	Coupe Engine KFW (TU3JP)/KFX (TU3JP)	210188	Drive Shaft	29T	25	22	54.5	79.5	860	
	1998.03-2005.03	MT	R	F	Coupe Engine KFW (TU3JP)/KFX (TU3JP)	210205	Drive Shaft		25	22	58.5	79	866	
	1998.03-2005.03	-	L	F	Coupe Engine KFW (TU3JP)/KFX (TU3JP)	245043	Drive Shaft		21	22	56.4	76	591	
	1998.03-2005.03	-	R	F	Coupe Engine KFW (TU3JP)/KFX (TU3JP)	210015	Drive Shaft		25	22	56.7	79	868	
	1998.03-2005.03	-	R	F	Coupe Engine KFW (TU3JP)/KFX (TU3JP)	210017	Drive Shaft		21	22	56.4	76	860	
	1998.03-2005.03	-	L	F	Coupe Engine KFW (TU3JP)/KFX (TU3JP)	210018	Drive Shaft	29T	25	22	60	80	603	
	1998.03-2005.03	-	R	F	Coupe Engine KFW (TU3JP)/KFX (TU3JP)	210019	Drive Shaft	29T	25	22	60	80	867	
	1998.03-2005.03	-	L	F	Coupe Engine KFW (TU3JP)/KFX (TU3JP)	210204	Drive Shaft		25	22	58.5	79	594	
	1998.03-2005.03	-	L	F	Coupe Engine KFW (TU3JP)/KFX (TU3JP)	210021	Drive Shaft	29T	25	22	60	80	593	
	1998.03-2005.03	-	-	F	Coupe Engine KFW (TU3JP)/KFX (TU3JP)	899221	Outer Joint	29T	25	22	60	78.7	54	M
	1998.03-2005.03	-	-	F	Coupe Engine KFW (TU3JP)/KFX (TU3JP)	899006	Outer Joint		25	22	60	78.7	54	M
	1998.03-2005.03	-	L	F	Coupe Engine KFW (TU3JP)/KFX (TU3JP)	210053	Drive Shaft	29T	25	22	54.5	79.5	592	





	 YEAR	TRANSM	L/R	F/R	REMARKS	GSP Ref.	 PRODUCT	 ABS	Technical Specifications					
									A	B	C	H	L	P
CITROEN XSARA (N0)														
1.4 i (55 kW)	1998.03-2005.03	-	R	F	Coupe Engine KFW (TU3JP)/KFX (TU3JP)	210076	Drive Shaft	29T	25	22	54.5	79.5	862	
1.6 16V (80 kW)	2000.09-2005.03	MT	R	F	Coupe Engine NFU (TU5JP4)	210076	Drive Shaft	29T	25	22	54.5	79.5	862	
	2000.09-2005.03	MT	R	F	Coupe Engine NFU (TU5JP4)	210188	Drive Shaft	29T	25	22	54.5	79.5	860	
	2000.09-2005.03	MT	R	F	Coupe Engine NFU (TU5JP4)	210205	Drive Shaft		25	22	58.5	79	866	
	2000.09-2005.03	MT	R	F	Coupe Engine NFU (TU5JP4)	210015	Drive Shaft		25	22	56.7	79	868	
	2000.09-2005.03	-	R	F	Coupe Engine NFU (TU5JP4)	210027	Drive Shaft		25	22	56.7	79	868	
	2000.09-2005.03	MT	R	F	Coupe Engine NFU (TU5JP4)	210019	Drive Shaft	29T	25	22	60	80	867	
	2000.09-2005.03	MT	L	F	Coupe Engine NFU (TU5JP4)	210204	Drive Shaft		25	22	58.5	79	594	
	2000.09-2005.03	MT	L	F	Coupe Engine NFU (TU5JP4)	210021	Drive Shaft	29T	25	22	60	80	593	
	2000.09-2005.03	-	-	F	Coupe Engine NFU (TU5JP4)	899221	Outer Joint	29T	25	22	60	78.7	54	M
	2000.09-2005.03	-	-	F	Coupe Engine NFU (TU5JP4)	899006	Outer Joint		25	22	60	78.7	54	M
2000.09-2005.03	MT	L	F	Coupe Engine NFU (TU5JP4)	210053	Drive Shaft	29T	25	22	54.5	79.5	592		
1.6 i (65 kW)	1998.02-2000.09	MT	R	F	Coupe Engine NFZ (TU5JP)	210076	Drive Shaft	29T	25	22	54.5	79.5	862	
	1998.02-2000.09	MT	R	F	Coupe Engine NFZ (TU5JP)	210188	Drive Shaft	29T	25	22	54.5	79.5	860	
	1998.02-2000.09	-	R	F	Coupe Engine NFZ (TU5JP)	210205	Drive Shaft		25	22	58.5	79	866	
	1998.02-2000.09	MT	R	F	Coupe Engine NFZ (TU5JP)	210015	Drive Shaft		25	22	56.7	79	868	
	1998.02-2000.09	MT	R	F	Coupe Engine NFZ (TU5JP)	210017	Drive Shaft		21	22	56.4	76	860	
	1998.02-2000.09	MT	L	F	Coupe Engine NFZ (TU5JP)	210018	Drive Shaft	29T	25	22	60	80	603	
	1998.02-2000.09	MT	R	F	Coupe Engine NFZ (TU5JP)	210019	Drive Shaft	29T	25	22	60	80	867	
	1998.02-2000.09	MT	L	F	Coupe Engine NFZ (TU5JP)	210204	Drive Shaft		25	22	58.5	79	594	
	1998.02-2000.09	MT	L	F	Coupe Engine NFZ (TU5JP)	210021	Drive Shaft	29T	25	22	60	80	593	
	1998.02-2000.09	MT	-	F	Coupe Engine NFZ (TU5JP)	899221	Outer Joint	29T	25	22	60	78.7	54	M
	1998.02-2000.09	MT	-	F	Coupe Engine NFZ (TU5JP)	899006	Outer Joint		25	22	60	78.7	54	M
	1998.02-2000.09	AT	-	F	Coupe Engine NFZ (TU5JP)	810022	Outer Joint	29W	25	34	55.7	79	55	I
	1998.02-2000.09	MT	L	F	Coupe Engine NFZ (TU5JP)	210053	Drive Shaft	29T	25	22	54.5	79.5	592	
1.8 i (66 kW)	1998.02-2000.09	-	-	F	Coupe Engine LFX (XU7JB)	810022	Outer Joint	29W	25	34	55.7	79	55	I
	1998.02-2000.09	-	L	F	Coupe Engine LFX (XU7JB)	210090	Drive Shaft		25	24	54.8	78.5	593	
	1998.02-2000.09	MT	L	F	Coupe Engine LFX (XU7JB)	210128	Drive Shaft	29T	25	24	55.7	79	594	
	1998.02-2000.09	MT	L/R	F	Coupe Engine LFX (XU7JB)	810003	Outer Joint	29T	25	23	54.8	78.5	56	I
	1998.02-2000.09	-	L	F	Coupe Engine LFX (XU7JB)	210131	Drive Shaft	29T	25	24	54.8	78.5	583	
	1998.02-2000.09	MT	L	F	Coupe Engine LFX (XU7JB)	299025	Drive Shaft	29W	25	24	55.7	79	597	
	1998.02-2000.09	MT	R	F	Coupe Engine LFX (XU7JB)	210078	Drive Shaft	29W	25	24	55.7	79	872	
	1998.02-2000.09	MT	R	F	Coupe Engine LFX (XU7JB)	210091	Drive Shaft		25	24	54.8	78.5	869.5	
	1998.02-2000.09	MT	L	F	Coupe Engine LFX (XU7JB)	210165	Drive Shaft		25	24	55.7	79	594	
1.8 i (74 kW)	1998.02-2000.09	-	L	F	Coupe Engine LFZ (XU7JP)	210090	Drive Shaft		25	24	54.8	78.5	593	
	1998.02-2000.09	-	L	F	Coupe Engine LFZ (XU7JP)	210128	Drive Shaft	29T	25	24	55.7	79	594	
	1998.02-2000.09	-	-	F	Coupe Engine LFZ (XU7JP)	810022	Outer Joint	29W	25	34	55.7	79	55	I
	1998.02-2000.09	-	L	F	Coupe Engine LFZ (XU7JP)	210131	Drive Shaft	29T	25	24	54.8	78.5	583	
1.8 i 16V (81 kW)	1998.02-2000.09	-	-	F	Coupe Engine LFY (XU7JP4)	810022	Outer Joint	29W	25	34	55.7	79	55	I
	1998.02-2000.09	-	L	F	Coupe Engine LFY (XU7JP4)	210090	Drive Shaft		25	24	54.8	78.5	593	
	1998.02-2000.09	MT	L	F	Coupe Engine LFY (XU7JP4)	210128	Drive Shaft	29T	25	24	55.7	79	594	
	1998.02-2000.09	MT	L/R	F	Coupe Engine LFY (XU7JP4)	810003	Outer Joint	29T	25	23	54.8	78.5	56	I
	1998.02-2000.09	-	L	F	Coupe Engine LFY (XU7JP4)	210131	Drive Shaft	29T	25	24	54.8	78.5	583	
	1998.02-2000.09	MT	L	F	Coupe Engine LFY (XU7JP4)	299025	Drive Shaft	29W	25	24	55.7	79	597	
	1998.02-2000.09	MT	R	F	Coupe Engine LFY (XU7JP4)	210078	Drive Shaft	29W	25	24	55.7	79	872	
	1998.02-2000.09	MT	R	F	Coupe Engine LFY (XU7JP4)	210091	Drive Shaft		25	24	54.8	78.5	869.5	
1998.02-2000.09	MT	L	F	Coupe Engine LFY (XU7JP4)	210165	Drive Shaft		25	24	55.7	79	594		
1.9 D (50 kW)	1998.02-2000.09	MT	L	F	Coupe Engine DJY (XUD9A)	210128	Drive Shaft	29T	25	24	55.7	79	594	
	1998.02-2000.09	-	-	F	Coupe Engine DJY (XUD9A)	810022	Outer Joint	29W	25	34	55.7	79	55	I
	1998.02-2000.09	-	L	F	Coupe Engine DJY (XUD9A)	210131	Drive Shaft	29T	25	24	54.8	78.5	583	
	1998.02-2000.09	MT	L	F	Coupe Engine DJY (XUD9A)	299025	Drive Shaft	29W	25	24	55.7	79	597	
	1998.02-2000.09	MT	R	F	Coupe Engine DJY (XUD9A)	210078	Drive Shaft	29W	25	24	55.7	79	872	
	1998.02-2000.09	MT	L	F	Coupe Engine DJY (XUD9A)	210165	Drive Shaft		25	24	55.7	79	594	
	1998.02-2000.09	-	R	F	Coupe Engine DJY (XUD9A)	210091	Drive Shaft		25	24	54.8	78.5	869.5	
1998.02-2000.09	MT	L	F	Coupe Engine DJY (XUD9A)	210090	Drive Shaft		25	24	54.8	78.5	593		
1.9 D (51 kW)	1999.02-2005.03	-	-	F	Coupe Engine WJY (DW8B)/WJZ (DW8)	810022	Outer Joint	29W	25	34	55.7	79	55	I
	1999.02-2005.03	MT	L/R	F	Coupe Engine WJY (DW8B)/WJZ (DW8)	810003	Outer Joint	29T	25	23	54.8	78.5	56	I
	1999.02-2005.03	-	L	F	Coupe Engine WJY (DW8B)/WJZ (DW8)	210131	Drive Shaft	29T	25	24	54.8	78.5	583	
	1999.02-2005.03	MT	L	F	Coupe Engine WJY (DW8B)/WJZ (DW8)	299025	Drive Shaft	29W	25	24	55.7	79	597	
	1999.02-2005.03	MT	R	F	Coupe Engine WJY (DW8B)/WJZ (DW8)	210078	Drive Shaft	29W	25	24	55.7	79	872	
	1999.02-2005.03	MT	L	F	Coupe Engine WJY (DW8B)/WJZ (DW8)	210165	Drive Shaft		25	24	55.7	79	594	
	1999.02-2005.03	-	R	F	Coupe Engine WJY (DW8B)/WJZ (DW8)	210091	Drive Shaft		25	24	54.8	78.5	869.5	
	1999.02-2005.03	MT	L	F	Coupe Engine WJY (DW8B)/WJZ (DW8)	210090	Drive Shaft		25	24	54.8	78.5	593	
1999.02-2005.03	MT	L	F	Coupe Engine WJY (DW8B)/WJZ (DW8)	210128	Drive Shaft	29T	25	24	55.7	79	594		
1.9 TD (66 kW)	1998.02-2000.09	MT	L	F	Coupe Engine DHY (XUD9TE/Y)	210080	Drive Shaft	29W	25	24	55.7	79	597	
	1998.02-2000.09	MT	L/R	F	Coupe Engine DHY (XUD9TE/Y)	810003	Outer Joint	29T	25	23	54.8	78.5	56	I





	 YEAR	TRANSM	L/R	F/R	REMARKS	GSP Ref.	 PRODUCT	 ABS	Technical Specifications					
									A	B	C	H	L	P
CITROEN XSARA (N0)														
1.9 TD (66 kW)	1998.02-2000.09	-	-	F	Coupe Engine DHY (XUD9TE/Y)	810022	Outer Joint	29W	25	34	55.7	79	55	I
	1998.02-2000.09	-	L	F	Coupe Engine DHY (XUD9TE/Y)	210128	Drive Shaft	29T	25	24	55.7	79	594	
	1998.02-2000.09	MT	L	F	Coupe Engine DHY (XUD9TE/Y)	210163	Drive Shaft		25	24	54.8	78.5	583	
	1998.02-2000.09	MT	L	F	Coupe Engine DHY (XUD9TE/Y)	210131	Drive Shaft	29T	25	24	54.8	78.5	583	
	1998.02-2000.09	-	-	-	Coupe Engine DHY (XUD9TE/Y)	810020	Outer Joint	29T	25	34	58	78.5	55	I
	1998.02-2000.09	MT	L	F	Coupe Engine DHY (XUD9TE/Y)	610018	Inner Joint		24	29	40	62.5	99	
1998.02-2000.09	MT	L	F	Coupe Engine DHY (XUD9TE/Y)	210090	Drive Shaft		25	24	54.8	78.5	593		
2.0 16V (100 kW)	2000.09-2005.03	MT	L	F	Coupe Engine RFN (EW10J4)	299195	Drive Shaft	48W	25	24	58.5	79	585	
	2000.09-2005.03	MT	L	F	Coupe Engine RFN (EW10J4)	210080	Drive Shaft	29W	25	24	55.7	79	597	
	2000.09-2005.03	-	-	F	Coupe Engine RFN (EW10J4)	810022	Outer Joint	29W	25	34	55.7	79	55	I
	2000.09-2005.03	MT	R	F	Coupe Engine RFN (EW10J4)	299196	Drive Shaft	48W	25	24	58.5	79	869	
2.0 HDi 109 (80 kW)	2001.05-2005.03	MT	L	F	Coupe Engine RHZ (DW10ATED)	299195	Drive Shaft	48W	25	24	58.5	79	585	
	2001.05-2005.03	MT	L	F	Coupe Engine RHZ (DW10ATED)	210080	Drive Shaft	29W	25	24	55.7	79	597	
	2001.05-2005.03	MT	L	F	Coupe Engine RHZ (DW10ATED)	210225	Drive Shaft	29T	25	24	55	79.5	585	
	2001.05-2005.03	MT	L	F	Coupe Engine RHZ (DW10ATED)	210128	Drive Shaft	29T	25	24	55.7	79	594	
	2001.05-2005.03	MT	R	F	Coupe Engine RHZ (DW10ATED)	210193	Drive Shaft	29T	25	24	55.7	79	867	
	2001.05-2005.03	MT	R	F	Coupe Engine RHZ (DW10ATED)	299196	Drive Shaft	48W	25	24	58.5	79	869	
	2001.05-2005.03	MT	L	F	Coupe Engine RHZ (DW10ATED)	210131	Drive Shaft	29T	25	24	54.8	78.5	583	
	2001.05-2005.03	MT	-	F	Coupe Engine RHZ (DW10ATED)	810022	Outer Joint	29W	25	34	55.7	79	55	I
2.0 HDi 90 (66 kW)	1999.02-2005.03	MT	L/R	F	Coupe Engine RHY (DW10TD)	810003	Outer Joint	29T	25	23	54.8	78.5	56	I
	1999.02-2005.03	MT	L	F	Coupe Engine RHY (DW10TD)	210080	Drive Shaft	29W	25	24	55.7	79	597	
	1999.02-2005.03	MT	L	F	Coupe Engine RHY (DW10TD)	210225	Drive Shaft	29T	25	24	55	79.5	585	
	1999.02-2005.03	-	R	F	Coupe Engine RHY (DW10TD)	299196	Drive Shaft	48W	25	24	58.5	79	869	
	1999.02-2005.03	MT	R	F	Coupe Engine RHY (DW10TD)	210193	Drive Shaft	29T	25	24	55.7	79	867	
	1999.02-2005.03	-	-	F	Coupe Engine RHY (DW10TD)	810022	Outer Joint	29W	25	34	55.7	79	55	I
	1999.02-2005.03	-	L	F	Coupe Engine RHY (DW10TD)	210131	Drive Shaft	29T	25	24	54.8	78.5	583	
	1999.02-2005.03	-	L	F	Coupe Engine RHY (DW10TD)	299195	Drive Shaft	48W	25	24	58.5	79	585	
2.0 i 16V (120 kW)	1999.02-2005.03	-	L	F	Coupe Engine RFS (XU10J4RS)	210128	Drive Shaft	29T	25	24	55.7	79	594	
	1998.02-2005.03	MT	L	F	Coupe Engine RFS (XU10J4RS)	210080	Drive Shaft	29W	25	24	55.7	79	597	
	1998.02-2005.03	-	-	F	Coupe Engine RFS (XU10J4RS)	810022	Outer Joint	29W	25	34	55.7	79	55	I
	1998.02-2005.03	MT	L/R	F	Coupe Engine RFS (XU10J4RS)	810003	Outer Joint	29T	25	23	54.8	78.5	56	I
	1998.02-2005.03	MT	L	F	Coupe Engine RFS (XU10J4RS)	210163	Drive Shaft		25	24	54.8	78.5	583	
	1998.02-2005.03	MT	L	F	Coupe Engine RFS (XU10J4RS)	210131	Drive Shaft	29T	25	24	54.8	78.5	583	
	1998.02-2005.03	MT	L	F	Coupe Engine RFS (XU10J4RS)	610018	Inner Joint		24	29	40	62.5	99	
	1998.02-2005.03	MT	L	F	Coupe Engine RFS (XU10J4RS)	210128	Drive Shaft	29T	25	24	55.7	79	594	
XSARA (N1)														
1.4 HDi (50 kW)	2003.01-2005.03	-	L	F	Hatchback Engine 8HX (DV4TD)	210128	Drive Shaft	29T	25	24	55.7	79	594	
	2003.01-2005.03	-	-	F	Hatchback Engine 8HX (DV4TD)	810022	Outer Joint	29W	25	34	55.7	79	55	I
	2003.01-2005.03	-	L	F	Hatchback Engine 8HX (DV4TD)	210131	Drive Shaft	29T	25	24	54.8	78.5	583	
	2003.01-2005.03	-	L	F	Hatchback Engine 8HX (DV4TD)	299025	Drive Shaft	29W	25	24	55.7	79	597	
	2003.01-2005.03	-	R	F	Hatchback Engine 8HX (DV4TD)	210078	Drive Shaft	29W	25	24	55.7	79	872	
1.4 i (55 kW)	1997.04-2005.03	MT	R	F	Hatchback Engine KFW (TU3JP)/KFX (TU3JP)	210076	Drive Shaft	29T	25	22	54.5	79.5	862	
	1997.04-2005.03	-	R	F	Hatchback Engine KFW (TU3JP)/KFX (TU3JP)	210205	Drive Shaft		25	22	58.5	79	866	
	1997.04-2005.03	MT	R	F	Hatchback Engine KFW (TU3JP)/KFX (TU3JP)	210188	Drive Shaft	29T	25	22	54.5	79.5	860	
	1997.04-2005.03	-	R	F	Hatchback Engine KFW (TU3JP)/KFX (TU3JP)	210015	Drive Shaft		25	22	56.7	79	868	
	1997.04-2005.03	-	L	F	Hatchback Engine KFW (TU3JP)/KFX (TU3JP)	245043	Drive Shaft		21	22	56.4	76	591	
	1997.04-2005.03	-	R	F	Hatchback Engine KFW (TU3JP)/KFX (TU3JP)	210017	Drive Shaft		21	22	56.4	76	860	
	1997.04-2005.03	-	L	F	Hatchback Engine KFW (TU3JP)/KFX (TU3JP)	210018	Drive Shaft	29T	25	22	60	80	603	
	1997.04-2005.03	-	R	F	Hatchback Engine KFW (TU3JP)/KFX (TU3JP)	210019	Drive Shaft	29T	25	22	60	80	867	
	1997.04-2005.03	-	L	F	Hatchback Engine KFW (TU3JP)/KFX (TU3JP)	210204	Drive Shaft		25	22	58.5	79	594	
	1997.04-2005.03	-	L	F	Hatchback Engine KFW (TU3JP)/KFX (TU3JP)	210021	Drive Shaft	29T	25	22	60	80	593	
	1997.04-2005.03	-	-	F	Hatchback Engine KFW (TU3JP)/KFX (TU3JP)	899221	Outer Joint	29T	25	22	60	78.7	54	M
	1997.04-2005.03	-	-	F	Hatchback Engine KFW (TU3JP)/KFX (TU3JP)	899006	Outer Joint		25	22	60	78.7	54	M
	1997.04-2005.03	MT	L	F	Hatchback Engine KFW (TU3JP)/KFX (TU3JP)	210053	Drive Shaft	29T	25	22	54.5	79.5	592	
1.4 LPG (55 kW)	1998.05-2000.08	-	R	F	Hatchback Engine KFW (TU3JP)	210205	Drive Shaft		25	22	58.5	79	866	
1.5 D (42 kW)	1997.04-2000.09	MT	R	F	Hatchback Engine VJZ (TUD5)	210205	Drive Shaft		25	22	58.5	79	866	
	1997.04-2000.09	-	R	F	Hatchback Engine VJZ (TUD5)	210188	Drive Shaft	29T	25	22	54.5	79.5	860	
	1997.04-2000.09	-	R	F	Hatchback Engine VJZ (TUD5)	210015	Drive Shaft		25	22	56.7	79	868	
	1997.04-2000.09	-	R	F	Hatchback Engine VJZ (TUD5)	210017	Drive Shaft		21	22	56.4	76	860	
	1997.04-2000.09	-	L	F	Hatchback Engine VJZ (TUD5)	210018	Drive Shaft	29T	25	22	60	80	603	
	1997.04-2000.09	-	R	F	Hatchback Engine VJZ (TUD5)	210019	Drive Shaft	29T	25	22	60	80	867	
	1997.04-2000.09	-	L	F	Hatchback Engine VJZ (TUD5)	210204	Drive Shaft		25	22	58.5	79	594	
	1997.04-2000.09	-	L	F	Hatchback Engine VJZ (TUD5)	210021	Drive Shaft	29T	25	22	60	80	593	
1.6 16V (80 kW)	2000.09-2005.03	MT	R	F	Hatchback Engine NFU (TU5JP4)	210076	Drive Shaft	29T	25	22	54.5	79.5	862	
	2000.09-2005.03	MT	R	F	Hatchback Engine NFU (TU5JP4)	210205	Drive Shaft		25	22	58.5	79	866	
	2000.09-2005.03	MT	R	F	Hatchback Engine NFU (TU5JP4)	210188	Drive Shaft	29T	25	22	54.5	79.5	860	
	2000.09-2005.03	MT	R	F	Hatchback Engine NFU (TU5JP4)	210188	Drive Shaft	29T	25	22	54.5	79.5	860	





	 YEAR	TRANSM	L/R	F/R	REMARKS	GSP Ref.	 PRODUCT	 ABS	Technical Specifications								
									A	B	C	H	L	P			
CITROEN XSARA (N1)																	
1.6 16V (80 kW)	2000.09-2005.03	MT	R	F	Hatchback Engine NFU (TU5JP4)	210015	Drive Shaft		25	22	56.7	79	868				
	2000.09-2005.03	-	R	F	Hatchback Engine NFU (TU5JP4)	210027	Drive Shaft		25	22	56.7	79	868				
	2000.09-2005.03	MT	R	F	Hatchback Engine NFU (TU5JP4)	210019	Drive Shaft	29T	25	22	60	80	867				
	2000.09-2005.03	MT	L	F	Hatchback Engine NFU (TU5JP4)	210204	Drive Shaft		25	22	58.5	79	594				
	2000.09-2005.03	MT	L	F	Hatchback Engine NFU (TU5JP4)	210021	Drive Shaft	29T	25	22	60	80	593				
	2000.09-2005.03	-	-	F	Hatchback Engine NFU (TU5JP4)	899221	Outer Joint	29T	25	22	60	78.7	54	M			
	2000.09-2005.03	-	-	F	Hatchback Engine NFU (TU5JP4)	899006	Outer Joint		25	22	60	78.7	54	M			
	2000.09-2005.03	MT	L	F	Hatchback Engine NFU (TU5JP4)	210053	Drive Shaft	29T	25	22	54.5	79.5	592				
1.6 i (65 kW)	1997.04-2000.09	MT	R	F	Hatchback Engine NFZ (TU5JP)	210076	Drive Shaft	29T	25	22	54.5	79.5	862				
	1997.04-2000.09	-	R	F	Hatchback Engine NFZ (TU5JP)	210205	Drive Shaft		25	22	58.5	79	866				
	1997.04-2000.09	MT	R	F	Hatchback Engine NFZ (TU5JP)	210188	Drive Shaft	29T	25	22	54.5	79.5	860				
	1997.04-2000.09	MT	L	F	Hatchback Engine NFZ (TU5JP)	210026	Drive Shaft		25	22	56.7	79	594				
	1997.04-2000.09	MT	R	F	Hatchback Engine NFZ (TU5JP)	210015	Drive Shaft		25	22	56.7	79	868				
	1997.04-2000.09	MT	R	F	Hatchback Engine NFZ (TU5JP)	210017	Drive Shaft		21	22	56.4	76	860				
	1997.04-2000.09	MT	L	F	Hatchback Engine NFZ (TU5JP)	210018	Drive Shaft	29T	25	22	60	80	603				
	1997.04-2000.09	-	R	F	Hatchback Engine NFZ (TU5JP)	210027	Drive Shaft		25	22	56.7	79	868				
	1997.04-2000.09	MT	R	F	Hatchback Engine NFZ (TU5JP)	210019	Drive Shaft	29T	25	22	60	80	867				
	1997.04-2000.09	MT	L	F	Hatchback Engine NFZ (TU5JP)	210204	Drive Shaft		25	22	58.5	79	594				
	1997.04-2000.09	MT	L	F	Hatchback Engine NFZ (TU5JP)	210021	Drive Shaft	29T	25	22	60	80	593				
	1997.04-2000.09	MT	-	F	Hatchback Engine NFZ (TU5JP)	899221	Outer Joint	29T	25	22	60	78.7	54	M			
	1997.04-2000.09	MT	-	F	Hatchback Engine NFZ (TU5JP)	899006	Outer Joint		25	22	60	78.7	54	M			
	1997.04-2000.09	AT	-	F	Hatchback Engine NFZ (TU5JP)	810022	Outer Joint	29W	25	34	55.7	79	55	I			
	1997.04-2000.09	MT	L	F	Hatchback Engine NFZ (TU5JP)	210053	Drive Shaft	29T	25	22	54.5	79.5	592				
1.8 D (43 kW)	1997.04-2000.09	MT	L	F	Hatchback Engine 161A (XUD7)/A9A (XUD7)	210128	Drive Shaft	29T	25	24	55.7	79	594				
	1997.04-2000.09	MT	L/R	F	Hatchback Engine 161A (XUD7)/A9A (XUD7)	810003	Outer Joint	29T	25	23	54.8	78.5	56	I			
	1997.04-2000.09	-	L	F	Hatchback Engine 161A (XUD7)/A9A (XUD7)	210131	Drive Shaft	29T	25	24	54.8	78.5	583				
	1997.04-2000.09	-	-	-	Hatchback Engine 161A (XUD7)/A9A (XUD7)	810020	Outer Joint	29T	25	34	58	78.5	55	I			
	1997.04-2000.09	MT	L	F	Hatchback Engine 161A (XUD7)/A9A (XUD7)	210165	Drive Shaft		25	24	55.7	79	594				
	1997.04-2000.09	MT	L	F	Hatchback Engine 161A (XUD7)/A9A (XUD7)	210090	Drive Shaft		25	24	54.8	78.5	593				
1.8 i (66 kW)	1997.04-2000.09	-	L	F	Hatchback Engine LFX (XU7JB)	210090	Drive Shaft		25	24	54.8	78.5	593				
	1997.04-2000.09	-	L	F	Hatchback Engine LFX (XU7JB)	210131	Drive Shaft	29T	25	24	54.8	78.5	583				
	1997.04-2000.09	MT	L	F	Hatchback Engine LFX (XU7JB)	299025	Drive Shaft	29W	25	24	55.7	79	597				
	1997.04-2000.09	MT	R	F	Hatchback Engine LFX (XU7JB)	210078	Drive Shaft	29W	25	24	55.7	79	872				
	1997.04-2000.09	-	-	-	Hatchback Engine LFX (XU7JB)	810020	Outer Joint	29T	25	34	58	78.5	55	I			
	1997.04-2000.09	MT	L	F	Hatchback Engine LFX (XU7JB)	210165	Drive Shaft		25	24	55.7	79	594				
	1997.04-2000.09	MT	L	F	Hatchback Engine LFX (XU7JB)	210128	Drive Shaft	29T	25	24	55.7	79	594				
	1997.04-2000.09	-	-	F	Hatchback Engine LFX (XU7JB)	810022	Outer Joint	29W	25	34	55.7	79	55	I			
1.8 i 16V (81 kW)	1997.04-2000.09	-	-	F	Hatchback Engine LFY (XU7JP4)	810022	Outer Joint	29W	25	34	55.7	79	55	I			
	1997.04-2000.09	-	L	F	Hatchback Engine LFY (XU7JP4)	210090	Drive Shaft		25	24	54.8	78.5	593				
	1997.04-2000.09	MT	L/R	F	Hatchback Engine LFY (XU7JP4)	810003	Outer Joint	29T	25	23	54.8	78.5	56	I			
	1997.04-2000.09	-	L	F	Hatchback Engine LFY (XU7JP4)	210131	Drive Shaft	29T	25	24	54.8	78.5	583				
	1997.04-2000.09	MT	L	F	Hatchback Engine LFY (XU7JP4)	299025	Drive Shaft	29W	25	24	55.7	79	597				
	1997.04-2000.09	MT	R	F	Hatchback Engine LFY (XU7JP4)	210078	Drive Shaft	29W	25	24	55.7	79	872				
	1997.04-2000.09	-	-	-	Hatchback Engine LFY (XU7JP4)	810020	Outer Joint	29T	25	34	58	78.5	55	I			
	1997.04-2000.09	MT	R	F	Hatchback Engine LFY (XU7JP4)	210091	Drive Shaft		25	24	54.8	78.5	869.5				
	1997.04-2000.09	MT	L	F	Hatchback Engine LFY (XU7JP4)	210165	Drive Shaft		25	24	55.7	79	594				
	1997.04-2000.09	MT	L	F	Hatchback Engine LFY (XU7JP4)	210128	Drive Shaft	29T	25	24	55.7	79	594				
1.8 i Aut. (74 kW)	1997.04-2000.09	-	-	F	Hatchback Engine LFZ (XU7JP)	810022	Outer Joint	29W	25	34	55.7	79	55	I			
	1997.04-2000.09	-	L	F	Hatchback Engine LFZ (XU7JP)	210090	Drive Shaft		25	24	54.8	78.5	593				
	1997.04-2000.09	AT	L/R	F	Hatchback Engine LFZ (XU7JP)	810003	Outer Joint	29T	25	23	54.8	78.5	56	I			
	1997.04-2000.09	-	L	F	Hatchback Engine LFZ (XU7JP)	210131	Drive Shaft	29T	25	24	54.8	78.5	583				
	1997.04-2000.09	AT	L	F	Hatchback Engine LFZ (XU7JP)	210165	Drive Shaft		25	24	55.7	79	594				
1.8 VTS (85 kW)	1997.04-2000.09	AT	L	F	Hatchback Engine LFZ (XU7JP)	210128	Drive Shaft	29T	25	24	55.7	79	594				
	2000.09-2004.10	-	-	F	Hatchback Engine 6FZ (EW7J4)	810022	Outer Joint	29W	25	34	55.7	79	55	I			
	2000.09-2004.10	MT	L	F	Hatchback Engine 6FZ (EW7J4)	299025	Drive Shaft	29W	25	24	55.7	79	597				
	2000.09-2004.10	MT	R	F	Hatchback Engine 6FZ (EW7J4)	210078	Drive Shaft	29W	25	24	55.7	79	872				
	1997.04-2000.09	-	-	F	Hatchback Engine DJY (XUD9A)	810022	Outer Joint	29W	25	34	55.7	79	55	I			
1.9 D (50 kW)	1997.04-2000.09	MT	L	F	Hatchback Engine DJY (XUD9A)	210128	Drive Shaft	29T	25	24	55.7	79	594				
	1997.04-2000.09	MT	L/R	F	Hatchback Engine DJY (XUD9A)	810003	Outer Joint	29T	25	23	54.8	78.5	56	I			
	1997.04-2000.09	-	L	F	Hatchback Engine DJY (XUD9A)	210131	Drive Shaft	29T	25	24	54.8	78.5	583				
	1997.04-2000.09	MT	L	F	Hatchback Engine DJY (XUD9A)	299025	Drive Shaft	29W	25	24	55.7	79	597				
	1997.04-2000.09	MT	R	F	Hatchback Engine DJY (XUD9A)	210078	Drive Shaft	29W	25	24	55.7	79	872				
	1997.04-2000.09	-	-	-	Hatchback Engine DJY (XUD9A)	810020	Outer Joint	29T	25	34	58	78.5	55	I			
	1997.04-2000.09	MT	L	F	Hatchback Engine DJY (XUD9A)	210165	Drive Shaft		25	24	55.7	79	594				
	1997.04-2000.09	-	R	F	Hatchback Engine DJY (XUD9A)	210091	Drive Shaft		25	24	54.8	78.5	869.5				
	1997.04-2000.09	MT	L	F	Hatchback Engine DJY (XUD9A)	210090	Drive Shaft		25	24	54.8	78.5	593				





		 YEAR	TRANSM	L/R	F/R	REMARKS	GSP Ref.	 PRODUCT	 ABS	Technical Specifications					
										A	B	C	H	L	P
CITROEN															
XSARA (N1)															
1.9 D (51 kW)	1998.07-2005.03	-	-	F	Hatchback Engine WJZ (DW8)/WJY (DW8B)	810022	Outer Joint	29W	25	34	55.7	79	55	I	
	1998.07-2005.03	MT	L	F	Hatchback Engine WJZ (DW8)/WJY (DW8B)	210128	Drive Shaft	29T	25	24	55.7	79	594		
	1998.07-2005.03	MT	L/R	F	Hatchback Engine WJZ (DW8)/WJY (DW8B)	810003	Outer Joint	29T	25	23	54.8	78.5	56	I	
	1998.07-2005.03	-	L	F	Hatchback Engine WJZ (DW8)/WJY (DW8B)	210131	Drive Shaft	29T	25	24	54.8	78.5	583		
	1998.07-2005.03	MT	L	F	Hatchback Engine WJZ (DW8)/WJY (DW8B)	299025	Drive Shaft	29W	25	24	55.7	79	597		
	1998.07-2005.03	MT	R	F	Hatchback Engine WJZ (DW8)/WJY (DW8B)	210078	Drive Shaft	29W	25	24	55.7	79	872		
	1998.07-2005.03	MT	L	F	Hatchback Engine WJZ (DW8)/WJY (DW8B)	210165	Drive Shaft		25	24	55.7	79	594		
	1998.07-2005.03	-	R	F	Hatchback Engine WJZ (DW8)/WJY (DW8B)	210091	Drive Shaft		25	24	54.8	78.5	869.5		
1.9 D (52 kW)	1998.07-2005.03	MT	L	F	Hatchback Engine WJZ (DW8)/WJY (DW8B)	210090	Drive Shaft		25	24	54.8	78.5	593		
	2000.04-2005.04	-	-	F	Hatchback Engine WJY (DW8B)	810022	Outer Joint	29W	25	34	55.7	79	55	I	
	2000.04-2005.04	MT	L	F	Hatchback Engine WJY (DW8B)	299025	Drive Shaft	29W	25	24	55.7	79	597		
	2000.04-2005.04	MT	R	F	Hatchback Engine WJY (DW8B)	210078	Drive Shaft	29W	25	24	55.7	79	872		
1.9 SD (55 kW)	2000.04-2005.04	-	-	-	Hatchback Engine WJY (DW8B)	810076	Outer Joint	29W	25	34	58.5	79	55	I	
	2000.04-2005.04	-	R	F	Hatchback Engine WJY (DW8B)	210091	Drive Shaft		25	24	54.8	78.5	869.5		
	1998.01-2000.09	-	-	F	Hatchback Engine DHV (XUD9BSD)	810022	Outer Joint	29W	25	34	55.7	79	55	I	
	1998.01-2000.09	MT	L	F	Hatchback Engine DHV (XUD9BSD)	210128	Drive Shaft	29T	25	24	55.7	79	594		
1.9 SD (55 kW)	1998.01-2000.09	MT	L/R	F	Hatchback Engine DHV (XUD9BSD)	810003	Outer Joint	29T	25	23	54.8	78.5	56	I	
	1998.01-2000.09	-	L	F	Hatchback Engine DHV (XUD9BSD)	210131	Drive Shaft	29T	25	24	54.8	78.5	583		
	1998.01-2000.09	MT	L	F	Hatchback Engine DHV (XUD9BSD)	299025	Drive Shaft	29W	25	24	55.7	79	597		
	1998.01-2000.09	MT	R	F	Hatchback Engine DHV (XUD9BSD)	210078	Drive Shaft	29W	25	24	55.7	79	872		
	1998.01-2000.09	-	-	-	Hatchback Engine DHV (XUD9BSD)	810020	Outer Joint	29T	25	34	58	78.5	55	I	
	1998.01-2000.09	MT	L	F	Hatchback Engine DHV (XUD9BSD)	210165	Drive Shaft		25	24	55.7	79	594		
	1998.01-2000.09	-	R	F	Hatchback Engine DHV (XUD9BSD)	210091	Drive Shaft		25	24	54.8	78.5	869.5		
	1998.01-2000.09	MT	L	F	Hatchback Engine DHV (XUD9BSD)	210090	Drive Shaft		25	24	54.8	78.5	593		
1.9 TD (66 kW)	1997.04-2000.09	-	-	F	Hatchback Engine DHY (XUD9TE/Y)	810022	Outer Joint	29W	25	34	55.7	79	55	I	
	1997.04-2000.09	MT	L	F	Hatchback Engine DHY (XUD9TE/Y)	210080	Drive Shaft	29W	25	24	55.7	79	597		
	1997.04-2000.09	MT	L/R	F	Hatchback Engine DHY (XUD9TE/Y)	810003	Outer Joint	29T	25	23	54.8	78.5	56	I	
	1997.04-2000.09	MT	L	F	Hatchback Engine DHY (XUD9TE/Y)	210163	Drive Shaft		25	24	54.8	78.5	583		
	1997.04-2000.09	MT	L	F	Hatchback Engine DHY (XUD9TE/Y)	210131	Drive Shaft	29T	25	24	54.8	78.5	583		
	1997.04-2000.09	MT	L	F	Hatchback Engine DHY (XUD9TE/Y)	610018	Inner Joint		24	29	40	62.5	99		
	1997.04-2000.09	-	-	-	Hatchback Engine DHY (XUD9TE/Y)	810020	Outer Joint	29T	25	34	58	78.5	55	I	
	1997.04-2000.09	MT	L	F	Hatchback Engine DHY (XUD9TE/Y)	210090	Drive Shaft		25	24	54.8	78.5	593		
2.0 16V (100 kW)	1997.04-2000.09	-	L	F	Hatchback Engine DHY (XUD9TE/Y)	210128	Drive Shaft	29T	25	24	55.7	79	594		
	2000.09-2005.03	MT	L	F	Hatchback Engine RFN (EW10J4)	299195	Drive Shaft	48W	25	24	58.5	79	869		
	2000.09-2005.03	MT	L	F	Hatchback Engine RFN (EW10J4)	210080	Drive Shaft	29W	25	24	55.7	79	597		
	2000.09-2005.03	MT	L/R	F	Hatchback Engine RFN (EW10J4)	810003	Outer Joint	29T	25	23	54.8	78.5	56	I	
	2000.09-2005.03	-	-	F	Hatchback Engine RFN (EW10J4)	810022	Outer Joint	29W	25	34	55.7	79	55	I	
	2000.09-2005.03	MT	R	F	Hatchback Engine RFN (EW10J4)	299196	Drive Shaft	48W	25	24	58.5	79	869		
	2000.09-2005.03	MT	L	F	Hatchback Engine RFN (EW10J4)	210163	Drive Shaft		25	24	54.8	78.5	583		
	2000.09-2005.03	MT	L	F	Hatchback Engine RFN (EW10J4)	210131	Drive Shaft	29T	25	24	54.8	78.5	583		
2.0 16V (120 kW)	2000.09-2005.03	MT	L	F	Hatchback Engine RFN (EW10J4)	610018	Inner Joint		24	29	40	62.5	99		
	1997.04-2000.09	-	-	F	Hatchback Engine RFS (XU10J4RS)	810022	Outer Joint	29W	25	34	55.7	79	55	I	
	1997.04-2000.09	MT	L	F	Hatchback Engine RFS (XU10J4RS)	210080	Drive Shaft	29W	25	24	55.7	79	597		
2.0 16V (97 kW)	1997.04-2000.09	MT	L	F	Hatchback Engine RFS (XU10J4RS)	610018	Inner Joint		24	29	40	62.5	99		
	1998.07-2000.09	MT	L	F	Hatchback Engine RFV (XU10J4R)	210080	Drive Shaft	29W	25	24	55.7	79	597		
	1998.07-2000.09	-	-	F	Hatchback Engine RFV (XU10J4R)	810022	Outer Joint	29W	25	34	55.7	79	55	I	
2.0 HDi 109 (80 kW)	1998.07-2000.09	-	L	F	Hatchback Engine RFV (XU10J4R)	210128	Drive Shaft	29T	25	24	55.7	79	594		
	1998.07-2000.09	MT	L	F	Hatchback Engine RFV (XU10J4R)	210163	Drive Shaft		25	24	54.8	78.5	583		
	1998.07-2000.09	MT	L	F	Hatchback Engine RFV (XU10J4R)	610018	Inner Joint		24	29	40	62.5	99		
	1998.07-2000.09	MT	L	F	Hatchback Engine RFV (XU10J4R)	210131	Drive Shaft	29T	25	24	54.8	78.5	583		
	2001.05-2005.03	MT	L	F	Hatchback Engine RHZ (DW10ATED)	299195	Drive Shaft	48W	25	24	58.5	79	869		
	2001.05-2005.03	MT	L	F	Hatchback Engine RHZ (DW10ATED)	210080	Drive Shaft	29W	25	24	55.7	79	597		
	2001.05-2005.03	MT	L	F	Hatchback Engine RHZ (DW10ATED)	210225	Drive Shaft	29T	25	24	55	79.5	585		
	2001.05-2005.03	MT	L	F	Hatchback Engine RHZ (DW10ATED)	210128	Drive Shaft	29T	25	24	55.7	79	594		
2.0 HDi 90 (66 kW)	2001.05-2005.03	MT	R	F	Hatchback Engine RHZ (DW10ATED)	210193	Drive Shaft	29T	25	24	55.7	79	867		
	2001.05-2005.03	MT	R	F	Hatchback Engine RHZ (DW10ATED)	299196	Drive Shaft	48W	25	24	58.5	79	869		
	2001.05-2005.03	MT	L	F	Hatchback Engine RHZ (DW10ATED)	210131	Drive Shaft	29T	25	24	54.8	78.5	583		
	2001.05-2005.03	MT	-	F	Hatchback Engine RHZ (DW10ATED)	810022	Outer Joint	29W	25	34	55.7	79	55	I	
	1999.02-2005.03	MT	L	F	Hatchback Engine RHY (DW10TD)	210080	Drive Shaft	29W	25	24	55.7	79	597		
	1999.02-2005.03	MT	L/R	F	Hatchback Engine RHY (DW10TD)	810003	Outer Joint	29T	25	23	54.8	78.5	56	I	
	1999.02-2005.03	-	R	F	Hatchback Engine RHY (DW10TD)	299196	Drive Shaft	48W	25	24	58.5	79	869		
	1999.02-2005.03	-	-	F	Hatchback Engine RHY (DW10TD)	810022	Outer Joint	29W	25	34	55.7	79	55	I	
2.0 HDi 90 (66 kW)	1999.02-2005.03	-	R	F	Hatchback Engine RHY (DW10TD)	210188	Drive Shaft	29T	25	22	54.5	79.5	860		
	1999.02-2005.03	-	L	F	Hatchback Engine RHY (DW10TD)	210131	Drive Shaft	29T	25	24	54.8	78.5	583		
	1999.02-2005.03	-	L	F	Hatchback Engine RHY (DW10TD)	299195	Drive Shaft	48W	25	24	58.5	79	869		
	1999.02-2005.03	-	L	F	Hatchback Engine RHY (DW10TD)	210128	Drive Shaft	29T	25	24	55.7	79	594		





	 YEAR	TRANSM	L/R	F/R	REMARKS	GSP Ref.	 PRODUCT	 ABS	Technical Specifications					
									A	B	C	H	L	P
CITROEN														
XSARA (N3_)														
1.4 (55 kW)	1998.05-2004.10	-	R	F	Box Body/Hatchback Engine KFX (TU3JP)	210205	Drive Shaft		25	22	58.5	79	866	
1.4 LPG (55 kW)	1999.06-2000.08	-	R	F	Box Body/Hatchback Engine KFX (TU3JP)	210205	Drive Shaft		25	22	58.5	79	866	
1.9 D (65 kW)	1998.05-2000.08	MT	L	F	Box Body/Hatchback Engine DHY (XUD9TE/Y)	210128	Drive Shaft	29T	25	24	55.7	79	594	
	1998.05-2000.08	-	-	F	Box Body/Hatchback Engine DHY (XUD9TE/Y)	810022	Outer Joint	29W	25	34	55.7	79	55	I
	1998.05-2000.08	MT	L	F	Box Body/Hatchback Engine DHY (XUD9TE/Y)	210131	Drive Shaft	29T	25	24	54.8	78.5	583	
	1998.05-2000.08	MT	L	F	Box Body/Hatchback Engine DHY (XUD9TE/Y)	299025	Drive Shaft	29W	25	24	55.7	79	597	
	1998.05-2000.08	MT	R	F	Box Body/Hatchback Engine DHY (XUD9TE/Y)	210078	Drive Shaft	29W	25	24	55.7	79	872	
	1998.05-2000.08	MT	R	F	Box Body/Hatchback Engine DHY (XUD9TE/Y)	210091	Drive Shaft		25	24	54.8	78.5	869.5	
2.0 HDi (66 kW)	2000.09-2005.03	-	L	F	Box Body/Hatchback Engine RHY(DW10TD)	299195	Drive Shaft	48W	25	24	58.5	79	585	
	2000.09-2005.03	MT	L	F	Box Body/Hatchback Engine RHY(DW10TD)	210080	Drive Shaft	29W	25	24	55.7	79	597	
	2000.09-2005.03	-	L	F	Box Body/Hatchback Engine RHY(DW10TD)	210128	Drive Shaft	29T	25	24	55.7	79	594	
	2000.09-2005.03	-	R	F	Box Body/Hatchback Engine RHY(DW10TD)	299196	Drive Shaft	48W	25	24	58.5	79	869	
	2000.09-2005.03	MT	L	F	Box Body/Hatchback Engine RHY(DW10TD)	210163	Drive Shaft		25	24	54.8	78.5	583	
	2000.09-2005.03	-	-	F	Box Body/Hatchback Engine RHY(DW10TD)	810022	Outer Joint	29W	25	34	55.7	79	55	I
	2000.09-2005.03	MT	L	F	Box Body/Hatchback Engine RHY(DW10TD)	210131	Drive Shaft	29T	25	24	54.8	78.5	583	
	2000.09-2005.03	-	L	F	Box Body/Hatchback Engine RHY(DW10TD)	210165	Drive Shaft		25	24	55.7	79	594	
XSARA Break (N2)														
1.4 HDi (50 kW)	2003.01-2005.08	MT	L	F	Estate Engine 8HX (DV4TD)	210080	Drive Shaft	29W	25	24	55.7	79	597	
	2003.01-2005.08	-	L	F	Estate Engine 8HX (DV4TD)	210128	Drive Shaft	29T	25	24	55.7	79	594	
	2003.01-2005.08	-	-	F	Estate Engine 8HX (DV4TD)	810022	Outer Joint	29W	25	34	55.7	79	55	I
	2003.01-2005.08	-	L	F	Estate Engine 8HX (DV4TD)	210131	Drive Shaft	29T	25	24	54.8	78.5	583	
1.4 i (55 kW)	1997.10-2005.08	MT	R	F	Estate Engine KFW (TU3JP)/KFX (TU3JP)	210188	Drive Shaft	29T	25	22	54.5	79.5	860	
	1997.10-2005.08	-	R	F	Estate Engine KFW (TU3JP)/KFX (TU3JP)	210205	Drive Shaft		25	22	58.5	79	866	
	1997.10-2005.08	-	L	F	Estate Engine KFW (TU3JP)/KFX (TU3JP)	245043	Drive Shaft		21	22	56.4	76	591	
	1997.10-2005.08	-	R	F	Estate Engine KFW (TU3JP)/KFX (TU3JP)	210015	Drive Shaft		25	22	56.7	79	868	
	1997.10-2005.08	-	L	F	Estate Engine KFW (TU3JP)/KFX (TU3JP)	210018	Drive Shaft	29T	25	22	60	80	603	
	1997.10-2005.08	-	R	F	Estate Engine KFW (TU3JP)/KFX (TU3JP)	210019	Drive Shaft	29T	25	22	60	80	867	
	1997.10-2005.08	-	L	F	Estate Engine KFW (TU3JP)/KFX (TU3JP)	210204	Drive Shaft		25	22	58.5	79	594	
	1997.10-2005.08	-	L	F	Estate Engine KFW (TU3JP)/KFX (TU3JP)	210021	Drive Shaft	29T	25	22	60	80	593	
	1997.10-2005.08	-	-	F	Estate Engine KFW (TU3JP)/KFX (TU3JP)	899221	Outer Joint	29T	25	22	60	78.7	54	M
	1997.10-2005.08	-	-	F	Estate Engine KFW (TU3JP)/KFX (TU3JP)	899006	Outer Joint		25	22	60	78.7	54	M
1.5 D (42 kW)	1997.10-2000.09	MT	R	F	Estate Engine VJZ (TUD5)	210203	Drive Shaft		21	22	48	86.5	877	
	1997.10-2000.09	MT	R	F	Estate Engine VJZ (TUD5)	210205	Drive Shaft		25	22	58.5	79	866	
	1997.10-2000.09	-	R	F	Estate Engine VJZ (TUD5)	210188	Drive Shaft	29T	25	22	54.5	79.5	860	
	1997.10-2000.09	MT	R	F	Estate Engine VJZ (TUD5)	210017	Drive Shaft		21	22	56.4	76	860	
	1997.10-2000.09	-	R	F	Estate Engine VJZ (TUD5)	210015	Drive Shaft		25	22	56.7	79	868	
	1997.10-2000.09	MT	L	F	Estate Engine VJZ (TUD5)	210018	Drive Shaft	29T	25	22	60	80	603	
	1997.10-2000.09	MT	R	F	Estate Engine VJZ (TUD5)	210019	Drive Shaft	29T	25	22	60	80	867	
	1997.10-2000.09	-	L	F	Estate Engine VJZ (TUD5)	210204	Drive Shaft		25	22	58.5	79	594	
	1997.10-2000.09	-	L	F	Estate Engine VJZ (TUD5)	210021	Drive Shaft	29T	25	22	60	80	593	
	1.6 16V (80 kW)	2000.09-2005.08	MT	R	F	Estate Engine NFU (TU5JP4)	210076	Drive Shaft	29T	25	22	54.5	79.5	862
2000.09-2005.08		MT	R	F	Estate Engine NFU (TU5JP4)	210188	Drive Shaft	29T	25	22	54.5	79.5	860	
2000.09-2005.08		-	R	F	Estate Engine NFU (TU5JP4)	210205	Drive Shaft		25	22	58.5	79	866	
2000.09-2005.08		MT	R	F	Estate Engine NFU (TU5JP4)	210015	Drive Shaft		25	22	56.7	79	868	
2000.09-2005.08		-	R	F	Estate Engine NFU (TU5JP4)	210027	Drive Shaft		25	22	56.7	79	868	
2000.09-2005.08		MT	R	F	Estate Engine NFU (TU5JP4)	210019	Drive Shaft	29T	25	22	60	80	867	
2000.09-2005.08		MT	L	F	Estate Engine NFU (TU5JP4)	210204	Drive Shaft		25	22	58.5	79	594	
2000.09-2005.08		MT	L	F	Estate Engine NFU (TU5JP4)	210021	Drive Shaft	29T	25	22	60	80	593	
2000.09-2005.08		-	-	F	Estate Engine NFU (TU5JP4)	899221	Outer Joint	29T	25	22	60	78.7	54	M
2000.09-2005.08		-	-	F	Estate Engine NFU (TU5JP4)	899006	Outer Joint		25	22	60	78.7	54	M
1.6 i (65 kW)	1997.10-2000.09	MT	R	F	Estate Engine NFZ (TU5JP)	210076	Drive Shaft	29T	25	22	54.5	79.5	862	
	1997.10-2000.09	MT	R	F	Estate Engine NFZ (TU5JP)	210188	Drive Shaft	29T	25	22	54.5	79.5	860	
	1997.10-2000.09	-	R	F	Estate Engine NFZ (TU5JP)	210205	Drive Shaft		25	22	58.5	79	866	
	1997.10-2000.09	-	R	F	Estate Engine NFZ (TU5JP)	210015	Drive Shaft		25	22	56.7	79	868	
	1997.10-2000.09	-	R	F	Estate Engine NFZ (TU5JP)	210027	Drive Shaft		25	22	56.7	79	868	
	1997.10-2000.09	MT	R	F	Estate Engine NFZ (TU5JP)	210019	Drive Shaft	29T	25	22	60	80	867	
	1997.10-2000.09	MT	L	F	Estate Engine NFZ (TU5JP)	210204	Drive Shaft		25	22	58.5	79	594	
	1997.10-2000.09	MT	L	F	Estate Engine NFZ (TU5JP)	210021	Drive Shaft	29T	25	22	60	80	593	
	1997.10-2000.09	MT	-	F	Estate Engine NFZ (TU5JP)	899221	Outer Joint	29T	25	22	60	78.7	54	M
	1997.10-2000.09	MT	-	F	Estate Engine NFZ (TU5JP)	899006	Outer Joint		25	22	60	78.7	54	M
1.8 D (43 kW)	1997.10-2000.09	AT	-	F	Estate Engine NFZ (TU5JP)	810022	Outer Joint	29W	25	34	55.7	79	55	I
	1997.10-2000.09	MT	L	F	Estate Engine NFZ (TU5JP)	210053	Drive Shaft	29T	25	22	54.5	79.5	592	
1.8 D (43 kW)	1997.10-2000.09	MT	L	F	Estate Engine A9A (XUD7)	210128	Drive Shaft	29T	25	24	55.7	79	594	





	 YEAR	TRANSM	L/R	F/R	REMARKS	GSP Ref.	 PRODUCT	 ABS	Technical Specifications								
									A	B	C	H	L	P			
CITROEN																	
XSARA Break (N2)																	
1.8 D (43 kW)	1997.10-2000.09	MT	L/R	F	Estate Engine A9A (XUD7)	810003	Outer Joint	29T	25	23	54.8	78.5	56	I			
	1997.10-2000.09	-	L	F	Estate Engine A9A (XUD7)	210131	Drive Shaft	29T	25	24	54.8	78.5	583				
	1997.10-2000.09	MT	L	F	Estate Engine A9A (XUD7)	210165	Drive Shaft		25	24	55.7	79	594				
	1997.10-2000.09	MT	L	F	Estate Engine A9A (XUD7)	210090	Drive Shaft		25	24	54.8	78.5	593				
1.8 i (66 kW)	1997.10-2000.09	-	-	F	Estate Engine LFX (XU7JB)	810022	Outer Joint	29W	25	34	55.7	79	55	I			
	1997.10-2000.09	-	L	F	Estate Engine LFX (XU7JB)	210090	Drive Shaft		25	24	54.8	78.5	593				
	1997.10-2000.09	MT	L/R	F	Estate Engine LFX (XU7JB)	810003	Outer Joint	29T	25	23	54.8	78.5	56	I			
	1997.10-2000.09	-	L	F	Estate Engine LFX (XU7JB)	210131	Drive Shaft	29T	25	24	54.8	78.5	583				
	1997.10-2000.09	MT	L	F	Estate Engine LFX (XU7JB)	299025	Drive Shaft	29W	25	24	55.7	79	597				
	1997.10-2000.09	MT	R	F	Estate Engine LFX (XU7JB)	210078	Drive Shaft	29W	25	24	55.7	79	872				
	1997.10-2000.09	-	-	-	Estate Engine LFX (XU7JB)	810020	Outer Joint	29T	25	34	58	78.5	55	I			
	1997.10-2000.09	MT	R	F	Estate Engine LFX (XU7JB)	210091	Drive Shaft		25	24	54.8	78.5	869.5				
	1997.10-2000.09	MT	L	F	Estate Engine LFX (XU7JB)	210165	Drive Shaft		25	24	55.7	79	594				
1.8 i 16V (81 kW)	1997.10-2000.09	MT	L	F	Estate Engine LFX (XU7JB)	210128	Drive Shaft	29T	25	24	55.7	79	594				
	1997.10-2000.09	-	-	F	Estate Engine LFY (XU7JP4)	810022	Outer Joint	29W	25	34	55.7	79	55	I			
	1997.10-2000.09	-	L	F	Estate Engine LFY (XU7JP4)	210090	Drive Shaft		25	24	54.8	78.5	593				
	1997.10-2000.09	MT	L/R	F	Estate Engine LFY (XU7JP4)	810003	Outer Joint	29T	25	23	54.8	78.5	56	I			
	1997.10-2000.09	-	L	F	Estate Engine LFY (XU7JP4)	210131	Drive Shaft	29T	25	24	54.8	78.5	583				
	1997.10-2000.09	MT	L	F	Estate Engine LFY (XU7JP4)	299025	Drive Shaft	29W	25	24	55.7	79	597				
	1997.10-2000.09	MT	R	F	Estate Engine LFY (XU7JP4)	210078	Drive Shaft	29W	25	24	55.7	79	872				
	1997.10-2000.09	-	-	-	Estate Engine LFY (XU7JP4)	810020	Outer Joint	29T	25	34	58	78.5	55	I			
	1997.10-2000.09	MT	R	F	Estate Engine LFY (XU7JP4)	210091	Drive Shaft		25	24	54.8	78.5	869.5				
1.8 i Aut. (74 kW)	1997.10-2000.09	MT	L	F	Estate Engine LFY (XU7JP4)	210165	Drive Shaft		25	24	55.7	79	594				
	1997.10-2000.09	MT	L	F	Estate Engine LFY (XU7JP4)	210128	Drive Shaft	29T	25	24	55.7	79	594				
	1997.10-2000.09	-	-	F	Estate Engine LFZ (XU7JP)	810022	Outer Joint	29W	25	34	55.7	79	55	I			
	1997.10-2000.09	-	L	F	Estate Engine LFZ (XU7JP)	210090	Drive Shaft		25	24	54.8	78.5	593				
	1997.10-2000.09	AT	L	F	Estate Engine LFZ (XU7JP)	210128	Drive Shaft	29T	25	24	55.7	79	594				
	1997.10-2000.09	-	L	F	Estate Engine LFZ (XU7JP)	210131	Drive Shaft	29T	25	24	54.8	78.5	583				
1.9 D (50 kW)	1997.10-2000.09	AT	L	F	Estate Engine LFZ (XU7JP)	210165	Drive Shaft		25	24	55.7	79	594				
	1997.10-2000.09	-	-	F	Estate Engine DJY (XUD9A)	810022	Outer Joint	29W	25	34	55.7	79	55	I			
	1997.10-2000.09	MT	L	F	Estate Engine DJY (XUD9A)	210128	Drive Shaft	29T	25	24	55.7	79	594				
	1997.10-2000.09	MT	L/R	F	Estate Engine DJY (XUD9A)	810003	Outer Joint	29T	25	23	54.8	78.5	56	I			
	1997.10-2000.09	MT	L	F	Estate Engine DJY (XUD9A)	299025	Drive Shaft	29W	25	24	55.7	79	597				
	1997.10-2000.09	-	L	F	Estate Engine DJY (XUD9A)	210131	Drive Shaft	29T	25	24	54.8	78.5	583				
	1997.10-2000.09	MT	R	F	Estate Engine DJY (XUD9A)	210078	Drive Shaft	29W	25	24	55.7	79	872				
	1997.10-2000.09	-	-	-	Estate Engine DJY (XUD9A)	810020	Outer Joint	29T	25	34	58	78.5	55	I			
	1997.10-2000.09	MT	L	F	Estate Engine DJY (XUD9A)	210165	Drive Shaft		25	24	55.7	79	594				
1.9 D (51 kW)	1997.10-2000.09	-	R	F	Estate Engine DJY (XUD9A)	210091	Drive Shaft		25	24	54.8	78.5	869.5				
	1997.10-2000.09	MT	L	F	Estate Engine DJY (XUD9A)	210090	Drive Shaft		25	24	54.8	78.5	593				
	1998.07-2005.08	-	-	F	Estate Engine WJY (DW8B)/WJZ (DW8)	810022	Outer Joint	29W	25	34	55.7	79	55	I			
	1998.07-2005.08	MT	L	F	Estate Engine WJY (DW8B)/WJZ (DW8)	210128	Drive Shaft	29T	25	24	55.7	79	594				
	1998.07-2005.08	MT	L/R	F	Estate Engine WJY (DW8B)/WJZ (DW8)	810003	Outer Joint	29T	25	23	54.8	78.5	56	I			
	1998.07-2005.08	-	L	F	Estate Engine WJY (DW8B)/WJZ (DW8)	210131	Drive Shaft	29T	25	24	54.8	78.5	583				
	1998.07-2005.08	MT	L	F	Estate Engine WJY (DW8B)/WJZ (DW8)	299025	Drive Shaft	29W	25	24	55.7	79	597				
	1998.07-2005.08	MT	R	F	Estate Engine WJY (DW8B)/WJZ (DW8)	210078	Drive Shaft	29W	25	24	55.7	79	872				
	1998.07-2005.08	MT	L	F	Estate Engine WJY (DW8B)/WJZ (DW8)	210165	Drive Shaft		25	24	55.7	79	594				
1.9 D (55 kW)	1998.07-2005.08	-	R	F	Estate Engine WJY (DW8B)/WJZ (DW8)	210091	Drive Shaft		25	24	54.8	78.5	869.5				
	1998.07-2005.08	MT	L	F	Estate Engine WJY (DW8B)/WJZ (DW8)	210090	Drive Shaft		25	24	54.8	78.5	593				
	1998.01-2000.09	-	-	F	Estate Engine DHV (XUD9BSD)	810022	Outer Joint	29W	25	34	55.7	79	55	I			
	1998.01-2000.09	MT	L	F	Estate Engine DHV (XUD9BSD)	210128	Drive Shaft	29T	25	24	55.7	79	594				
	1998.01-2000.09	MT	L/R	F	Estate Engine DHV (XUD9BSD)	810003	Outer Joint	29T	25	23	54.8	78.5	56	I			
	1998.01-2000.09	-	L	F	Estate Engine DHV (XUD9BSD)	210131	Drive Shaft	29T	25	24	54.8	78.5	583				
	1998.01-2000.09	MT	L	F	Estate Engine DHV (XUD9BSD)	299025	Drive Shaft	29W	25	24	55.7	79	597				
	1998.01-2000.09	MT	R	F	Estate Engine DHV (XUD9BSD)	210078	Drive Shaft	29W	25	24	55.7	79	872				
	1998.01-2000.09	MT	L	F	Estate Engine DHV (XUD9BSD)	210165	Drive Shaft		25	24	55.7	79	594				
1.9 TD (66 kW)	1998.01-2000.09	-	R	F	Estate Engine DHV (XUD9BSD)	210091	Drive Shaft		25	24	54.8	78.5	869.5				
	1998.01-2000.09	MT	L	F	Estate Engine DHV (XUD9BSD)	210090	Drive Shaft		25	24	54.8	78.5	593				
	1997.10-2000.09	-	-	F	Estate Engine DHY (XUD9TE/Y)	810022	Outer Joint	29W	25	34	55.7	79	55	I			
	1997.10-2000.09	MT	L	F	Estate Engine DHY (XUD9TE/Y)	210080	Drive Shaft	29W	25	24	55.7	79	597				
	1997.10-2000.09	MT	L	F	Estate Engine DHY (XUD9TE/Y)	210163	Drive Shaft		25	24	54.8	78.5	583				
	1997.10-2000.09	MT	L	F	Estate Engine DHY (XUD9TE/Y)	210131	Drive Shaft	29T	25	24	54.8	78.5	583				
	1997.10-2000.09	MT	L	F	Estate Engine DHY (XUD9TE/Y)	610018	Inner Joint		24	29	40	62.5	99				
	1997.10-2000.09	-	-	-	Estate Engine DHY (XUD9TE/Y)	810020	Outer Joint	29T	25	34	58	78.5	55	I			
	1997.10-2000.09	MT	L	F	Estate Engine DHY (XUD9TE/Y)	210090	Drive Shaft		25	24	54.8	78.5	593				
2.0 16V (100 kW)	2000.09-2005.08	MT	L	F	Estate Engine RFN (EW10J4)	299195	Drive Shaft	48W	25	24	58.5	79	585				





	 YEAR	TRANSM	L/R	F/R	REMARKS	GSP Ref.	 PRODUCT	 ABS	Technical Specifications						
									A	B	C	H	L	P	
CITROEN															
XSARA Break (N2)															
2.0 16V (100 kW)	2000.09-2005.08	MT	L	F	Estate Engine RFN (EW10J4)	210080	Drive Shaft	29W	25	24	55.7	79	597		
	2000.09-2005.08	MT	L	F	Estate Engine RFN (EW10J4)	210128	Drive Shaft	29T	25	24	55.7	79	594		
	2000.09-2005.08	-	-	F	Estate Engine RFN (EW10J4)	810022	Outer Joint	29W	25	34	55.7	79	55	I	
	2000.09-2005.08	MT	R	F	Estate Engine RFN (EW10J4)	299196	Drive Shaft	48W	25	24	58.5	79	869		
	2000.09-2005.08	MT	L	F	Estate Engine RFN (EW10J4)	210163	Drive Shaft		25	24	54.8	78.5	583		
	2000.09-2005.08	MT	L	F	Estate Engine RFN (EW10J4)	210131	Drive Shaft	29T	25	24	54.8	78.5	583		
	2000.09-2005.08	MT	L	F	Estate Engine RFN (EW10J4)	610018	Inner Joint		24	29	40	62.5	99		
2.0 16V (97 kW)	1998.07-2000.09	MT	L	F	Estate Engine RFV (XU10J4R)	210080	Drive Shaft	29W	25	24	55.7	79	597		
	1998.07-2000.09	-	-	F	Estate Engine RFV (XU10J4R)	810022	Outer Joint	29W	25	34	55.7	79	55	I	
	1998.07-2000.09	-	-	L	F	Estate Engine RFV (XU10J4R)	210128	Drive Shaft	29T	25	24	55.7	79	594	
	1998.07-2000.09	MT	L	F	Estate Engine RFV (XU10J4R)	210163	Drive Shaft		25	24	54.8	78.5	583		
	1998.07-2000.09	MT	L	F	Estate Engine RFV (XU10J4R)	610018	Inner Joint		24	29	40	62.5	99		
	1998.07-2000.09	MT	L	F	Estate Engine RFV (XU10J4R)	210131	Drive Shaft	29T	25	24	54.8	78.5	583		
2.0 HDi 109 (80 kW)	2001.05-2005.08	MT	L	F	Estate Engine RHZ (DW10ATED)	299195	Drive Shaft	48W	25	24	58.5	79	869		
	2001.05-2005.08	MT	L	F	Estate Engine RHZ (DW10ATED)	210080	Drive Shaft	29W	25	24	55.7	79	597		
	2001.05-2005.08	MT	L	F	Estate Engine RHZ (DW10ATED)	210225	Drive Shaft	29T	25	24	55	79.5	585		
	2001.05-2005.08	MT	L	F	Estate Engine RHZ (DW10ATED)	210128	Drive Shaft	29T	25	24	55.7	79	594		
	2001.05-2005.08	MT	R	F	Estate Engine RHZ (DW10ATED)	210193	Drive Shaft	29T	25	24	55.7	79	867		
	2001.05-2005.08	MT	R	F	Estate Engine RHZ (DW10ATED)	299196	Drive Shaft	48W	25	24	58.5	79	869		
	2001.05-2005.08	MT	L	F	Estate Engine RHZ (DW10ATED)	210131	Drive Shaft	29T	25	24	54.8	78.5	583		
	2001.05-2005.08	MT	-	F	Estate Engine RHZ (DW10ATED)	810022	Outer Joint	29W	25	34	55.7	79	55	I	
2.0 HDi 90 (66 kW)	1999.02-2005.08	MT	L	F	Estate Engine RHY (DW10TD)	210080	Drive Shaft	29W	25	24	55.7	79	597		
	1999.02-2005.08	MT	L	F	Estate Engine RHY (DW10TD)	210225	Drive Shaft	29T	25	24	55	79.5	585		
	1999.02-2005.08	-	R	F	Estate Engine RHY (DW10TD)	299196	Drive Shaft	48W	25	24	58.5	79	869		
	1999.02-2005.08	MT	R	F	Estate Engine RHY (DW10TD)	210193	Drive Shaft	29T	25	24	55.7	79	867		
	1999.02-2005.08	-	-	F	Estate Engine RHY (DW10TD)	810022	Outer Joint	29W	25	34	55.7	79	55	I	
	1999.02-2005.08	-	-	L	F	Estate Engine RHY (DW10TD)	210131	Drive Shaft	29T	25	24	54.8	78.5	583	
	1999.02-2005.08	-	-	L	F	Estate Engine RHY (DW10TD)	299195	Drive Shaft	48W	25	24	58.5	79	869	
	1999.02-2005.08	-	-	L	F	Estate Engine RHY (DW10TD)	210128	Drive Shaft	29T	25	24	55.7	79	594	
XSARA PICASSO															
1.6 HDi	2004.02-	-	MT/AT	-	F	-	845047	Outer Joint	48T	25	34	59	78.5	54	I
2.0 HDi	1999.06-	-	-	R	-	-	210051	Drive Shaft	29T	25	24	55.7	79	865	
XSARA PICASSO (N68)															
1.6 (65 kW)	1999.12-	-	MT	L	F	MPV Engine NFZ (TU5JP)	210128	Drive Shaft	29T	25	24	55.7	79	594	
	1999.12-	-	-	-	F	MPV Engine NFZ (TU5JP)	810022	Outer Joint	29W	25	34	55.7	79	55	I
	1999.12-	-	-	-	F	MPV Engine NFZ (TU5JP)	899293	Outer Joint	48W	25	34	58.5	79	55	I
	1999.12-	-	-	L	F	MPV Engine NFZ (TU5JP)	210080	Drive Shaft	29W	25	24	55.7	79	597	
	1999.12-	-	-	-	F	MPV Engine NFZ (TU5JP)	810067	Outer Joint	48W	25	34	58.5	79	55	I
	1999.12-	-	-	L	F	MPV Engine NFZ (TU5JP)	210165	Drive Shaft		25	24	55.7	79	594	
1.6 (67 kW)	2002.06-	-	-	R	F	MPV Engine NFZ (TU5JP)	210027	Drive Shaft		25	22	56.7	79	868	
1.6 (70 kW)	1999.12-	-	-	L	F	MPV Engine NFV (TU5JP)	210128	Drive Shaft	29T	25	24	55.7	79	594	
	1999.12-	-	MT	L/R	F	MPV Engine NFV (TU5JP)	810003	Outer Joint	29T	25	23	54.8	78.5	56	I
	1999.12-	-	MT	L	F	MPV Engine NFV (TU5JP)	210080	Drive Shaft	29W	25	24	55.7	79	597	
	1999.12-	-	-	R	F	MPV Engine NFV (TU5JP)	299196	Drive Shaft	48W	25	24	58.5	79	869	
	1999.12-	-	-	-	F	MPV Engine NFV (TU5JP)	899293	Outer Joint	48W	25	34	58.5	79	55	I
	1999.12-	-	-	-	F	MPV Engine NFV (TU5JP)	810022	Outer Joint	29W	25	34	55.7	79	55	I
	1999.12-	-	-	-	F	MPV Engine NFV (TU5JP)	810067	Outer Joint	48W	25	34	58.5	79	55	I
	1999.12-	-	-	R	F	MPV Engine NFV (TU5JP)	210027	Drive Shaft		25	22	56.7	79	868	
	1999.12-	-	-	L	F	MPV Engine NFV (TU5JP)	210165	Drive Shaft		25	24	55.7	79	594	
	1999.12-	-	-	L	F	MPV Engine NFV (TU5JP)	299195	Drive Shaft	48W	25	24	58.5	79	869	
1.6 16V (80 kW)	2005.09-	-	-	L	F	MPV Engine NFU (TU5JP4)	299195	Drive Shaft	48W	25	24	58.5	79	869	
	2005.09-	-	-	R	F	MPV Engine NFU (TU5JP4)	299196	Drive Shaft	48W	25	24	58.5	79	869	
	2005.09-	-	-	-	F	MPV Engine NFU (TU5JP4)	899293	Outer Joint	48W	25	34	58.5	79	55	I
	2005.09-	-	-	-	F	MPV Engine NFU (TU5JP4)	810067	Outer Joint	48W	25	34	58.5	79	55	I
1.6 16V (81 kW)	2005.06-2006.09	MT	L	F	MPV Engine NFU (TU5JP4)	299195	Drive Shaft	48W	25	24	58.5	79	869		
	2005.06-2006.09	MT	-	F	MPV Engine NFU (TU5JP4)	899293	Outer Joint	48W	25	34	58.5	79	55	I	
	2005.06-2006.09	MT	R	F	MPV Engine NFU (TU5JP4)	299196	Drive Shaft	48W	25	24	58.5	79	869		
1.6 Chrono (74 kW)	2001.04-2004.10	-	-	F	MPV Engine NFV (TU5JP)	808016	Outer Joint		22	22	52	96.5	53.5	O	
1.6 HDi (66 kW)	2005.09-	-	-	L	F	MPV Engine 9HX (DV6ATED4)	299195	Drive Shaft	48W	25	24	58.5	79	869	
	2005.09-	-	-	R	F	MPV Engine 9HX (DV6ATED4)	299196	Drive Shaft	48W	25	24	58.5	79	869	
	2005.09-	-	-	-	F	MPV Engine 9HX (DV6ATED4)	899293	Outer Joint	48W	25	34	58.5	79	55	I
	2005.09-	-	-	-	F	MPV Engine 9HX (DV6ATED4)	810067	Outer Joint	48W	25	34	58.5	79	55	I
1.6 HDi (80 kW)	2004.05-	-	-	L	F	MPV Engine 9HZ (DV6TED4)/9HY (DV6TED4)	299195	Drive Shaft	48W	25	24	58.5	79	869	
	2004.05-	-	-	-	F	MPV Engine 9HZ (DV6TED4)/9HY (DV6TED4)	899293	Outer Joint	48W	25	34	58.5	79	55	I
	2004.05-	-	-	R	F	MPV Engine 9HZ (DV6TED4)/9HY (DV6TED4)	299196	Drive Shaft	48W	25	24	58.5	79	869	
	2004.05-	-	-	-	F	MPV Engine 9HZ (DV6TED4)/9HY (DV6TED4)	810067	Outer Joint	48W	25	34	58.5	79	55	I





	 YEAR	TRANSM	L/R	F/R	REMARKS	GSP Ref.	 PRODUCT	 ABS	Technical Specifications						
									A	B	C	H	L	P	
CITROEN															
XSARA PICASSO (N68)															
1.8 16V (85 kW)	2000.02-	-	MT	L	F	MPV Engine 6FZ (EW7J4)	210128	Drive Shaft	29T	25	24	55.7	79	594	
	2000.02-	-	MT	L	F	MPV Engine 6FZ (EW7J4)	210080	Drive Shaft	29W	25	24	55.7	79	597	
	2000.02-	-	-	-	F	MPV Engine 6FZ (EW7J4)	810022	Outer Joint	29W	25	34	55.7	79	55	I
	2000.02-	-	-	-	F	MPV Engine 6FZ (EW7J4)	899293	Outer Joint	48W	25	34	58.5	79	55	I
	2000.02-	-	-	R	F	MPV Engine 6FZ (EW7J4)	299196	Drive Shaft	48W	25	24	58.5	79	869	
	2000.02-	-	MT	L/R	F	MPV Engine 6FZ (EW7J4)	810003	Outer Joint	29T	25	23	54.8	78.5	56	I
	2000.02-	-	-	L	F	MPV Engine 6FZ (EW7J4)	210165	Drive Shaft		25	24	55.7	79	594	
	2000.02-	-	-	L	F	MPV Engine 6FZ (EW7J4)	299195	Drive Shaft	48W	25	24	58.5	79	585	
1.8 SX (76 kW)	2000.06-	2005.08	-	-	F	MPV	808016	Outer Joint		22	22	52	96.5	53.5	O
	2003.01-	-	MT	L	F	MPV Engine RFN (EW10J4)	210128	Drive Shaft	29T	25	24	55.7	79	594	
2.0 16V (100 kW)	2003.01-	-	MT	R	F	MPV Engine RFN (EW10J4)	299196	Drive Shaft	48W	25	24	58.5	79	869	
	2003.01-	-	-	-	F	MPV Engine RFN (EW10J4)	899293	Outer Joint	48W	25	34	58.5	79	55	I
	2003.01-	-	MT	L	F	MPV Engine RFN (EW10J4)	210163	Drive Shaft		25	24	54.8	78.5	583	
	2003.01-	-	MT	L	F	MPV Engine RFN (EW10J4)	210131	Drive Shaft	29T	25	24	54.8	78.5	583	
	2003.01-	-	5MT	R	F	MPV Engine RFN (EW10J4)	210226	Drive Shaft	29T	25	24	58	78.5	867	
	2003.01-	-	MT	L	F	MPV Engine RFN (EW10J4)	610018	Inner Joint		24	29	40	62.5	99	
	2003.01-	-	MT	L	F	MPV Engine RFN (EW10J4)	299195	Drive Shaft	48W	25	24	58.5	79	585	
2.0 16V (101 kW)	1999.12-	2011.11	-	-	F	MPV Engine RFN (EW10A)	899293	Outer Joint	48W	25	34	58.5	79	55	I
2.0 HDi (66 kW)	1999.12-	-	MT	L/R	F	MPV Engine RHY (DW10TD)	810003	Outer Joint	29T	25	23	54.8	78.5	56	I
	1999.12-	-	MT	L	F	MPV Engine RHY (DW10TD)	210080	Drive Shaft	29W	25	24	55.7	79	597	
	1999.12-	-	-	-	F	MPV Engine RHY (DW10TD)	810022	Outer Joint	29W	25	34	55.7	79	55	I
	1999.12-	-	-	-	F	MPV Engine RHY (DW10TD)	899293	Outer Joint	48W	25	34	58.5	79	55	I
	1999.12-	-	-	R	F	MPV Engine RHY (DW10TD)	299196	Drive Shaft	48W	25	24	58.5	79	869	
	1999.12-	-	-	L	F	MPV Engine RHY (DW10TD)	210163	Drive Shaft		25	24	54.8	78.5	583	
	1999.12-	-	-	L	F	MPV Engine RHY (DW10TD)	210131	Drive Shaft	29T	25	24	54.8	78.5	583	
	1999.12-	-	MT	L	F	MPV Engine RHY (DW10TD)	610018	Inner Joint		24	29	40	62.5	99	
1999.12-	-	-	L	F	MPV Engine RHY (DW10TD)	299195	Drive Shaft	48W	25	24	58.5	79	585		
XSARA VAN															
2.0 HDi	2003.01-	-	-	R	-		210051	Drive Shaft	29T	25	24	55.7	79	865	
ZX															
-	-	-	-	-	-		645018	Inner Joint		24	34	40	62	88	
-	-	-	-	-	-	LADO ESQUERDO	645020	Inner Joint		24	34	40	69	89	
1.6 i	1991-	1996	-	-	-		810174	Outer Joint	48T	25	23	55.7	79	55	I
1.9 TD	1992.07-	1998.02	-	R	F		210150	Drive Shaft		25	24	54.8	78.5	866	
2.0 i	1992.10-	1996.06	MT/AT	-	F		810065	Outer Joint	48T	25	34	58.5	80	55	I
ZX (N2)															
1.1 (44 kW)	1991.03-	1997.06	MT	L	F	Hatchback Engine HDZ (TU1M)	210040	Drive Shaft		21	22	56.4	76	595	
	1991.03-	1997.06	MT	R	F	Hatchback Engine HDZ (TU1M)	210004	Drive Shaft		21	22	56.4	76	855.5	
1.4 (55 kW)	1991.03-	1997.06	-	R	F	Hatchback Engine KDZ (TU3M/Z)	210092	Drive Shaft		21	22	56.4	76	856.5	
	1991.03-	1997.06	-	R	F	Hatchback Engine KDZ (TU3M/Z)	210188	Drive Shaft	29T	25	22	54.5	79.5	860	
	1991.03-	1997.06	MT	L	F	Hatchback Engine KDZ (TU3M/Z)	210040	Drive Shaft		21	22	56.4	76	595	
	1991.03-	1997.06	-	L	F	Hatchback Engine KDZ (TU3M/Z)	210097	Drive Shaft		21	22	56.4	76	590.7	
	1991.03-	1997.06	MT	R	F	Hatchback Engine KDZ (TU3M/Z)	210004	Drive Shaft		21	22	56.4	76	855.5	
1.4 i (55 kW)	1991.03-	1997.06	-	R	F	Hatchback Engine KDX (TU3M/Z)/KDZ(TU3M/Z)/KFX(TU3JP)	210188	Drive Shaft	29T	25	22	54.5	79.5	860	
	1991.03-	1997.06	MT	L	F	Hatchback Engine KDX (TU3M/Z)/KDZ(TU3M/Z)/KFX(TU3JP)	210040	Drive Shaft		21	22	56.4	76	595	
	1991.03-	1997.06	MT	R	F	Hatchback Engine KDX (TU3M/Z)/KDZ(TU3M/Z)/KFX(TU3JP)	210004	Drive Shaft		21	22	56.4	76	855.5	
1.6 (66 kW)	1994.07-	1997.10	-	R	F	Hatchback Engine BDY(XU5M)/BFZ (XU5JP)	210091	Drive Shaft		25	24	54.8	78.5	869.5	
1.6 i (65 kW)	1991.03-	1997.06	MT	L	F	Hatchback Engine BDY (XU5M)/BFZ(XU5JP0)	210025	Drive Shaft	29T	25	24	54.8	78.5	593	
	1991.03-	1997.06	MT	L/R	F	Hatchback Engine BDY (XU5M)/BFZ(XU5JP0)	810003	Outer Joint	29T	25	23	54.8	78.5	56	I
	1991.03-	1997.06	-	L	F	Hatchback Engine BDY (XU5M)/BFZ(XU5JP0)	210117	Drive Shaft		25	24	54.8	79	592.5	
	1991.03-	1997.06	MT	R	F	Hatchback Engine BDY (XU5M)/BFZ(XU5JP0)	210167	Drive Shaft		25	24	55.7	79	868	
	1991.03-	1997.06	MT	L/R	F	Hatchback Engine BDY (XU5M)/BFZ(XU5JP0)	810002	Outer Joint		25	23	54.8	78.5	56	I
	1991.03-	1997.06	MT	R	F	Hatchback Engine BDY (XU5M)/BFZ(XU5JP0)	210023	Drive Shaft	29T	25	24	55.7	79	868	
	1991.03-	1997.06	-	R	F	Hatchback Engine BDY (XU5M)/BFZ(XU5JP0)	210091	Drive Shaft		25	24	54.8	78.5	869.5	
1.8 (76 kW)	1994.07-	1997.10	MT	L	F	Hatchback Engine LFZ (XU7JP)	210025	Drive Shaft	29T	25	24	54.8	78.5	593	
	1994.07-	1997.10	MT	R	F	Hatchback Engine LFZ (XU7JP)	210167	Drive Shaft		25	24	55.7	79	868	
	1994.07-	1997.10	MT	R	F	Hatchback Engine LFZ (XU7JP)	210023	Drive Shaft	29T	25	24	55.7	79	868	
	1994.07-	1997.10	MT	L/R	F	Hatchback Engine LFZ (XU7JP)	810002	Outer Joint		25	23	54.8	78.5	56	I
	1994.07-	1997.10	-	R	F	Hatchback Engine LFZ (XU7JP)	210091	Drive Shaft		25	24	54.8	78.5	869.5	
1.8 D (44 kW)	1993.06-	1997.06	-	L	F	Hatchback Engine 161A (XUD7)	210117	Drive Shaft		25	24	54.8	79	592.5	
1.8 i (74 kW)	1992.07-	1997.06	MT	L/R	F	Hatchback Engine LFZ (XU7JP)	810003	Outer Joint	29T	25	23	54.8	78.5	56	I
	1992.07-	1997.06	-	L	F	Hatchback Engine LFZ (XU7JP)	210117	Drive Shaft		25	24	54.8	79	592.5	
	1992.07-	1997.06	-	R	F	Hatchback Engine LFZ (XU7JP)	210091	Drive Shaft		25	24	54.8	78.5	869.5	
1.8 i 16V (81 kW)	1996.01-	1997.06	-	L	F	Hatchback Engine LFY (XU7JP4)	210117	Drive Shaft		25	24	54.8	79	592.5	
	1996.01-	1997.06	-	R	F	Hatchback Engine LFY (XU7JP4)	210091	Drive Shaft		25	24	54.8	78.5	869.5	

	 YEAR	TRANSM	L/R	F/R	REMARKS	GSP Ref.	 PRODUCT	 ABS	Technical Specifications					
									A	B	C	H	L	P
CITROEN ZX (N2)														
1.9 (93 kW)	1991.03-1997.06	-	-	F	Hatchback Engine D6E (XU9JA)	810027	Outer Joint	48T	25	34	55.7	79	55	I
	1991.03-1997.06	-	-	F	Hatchback Engine D6E (XU9JA)	810042	Outer Joint		25	34	54.8	78.5	56	I
1.9 (96 kW)	1991.03-1993.09	-	-	F	Hatchback Engine D6E (XU9JA)	810027	Outer Joint	48T	25	34	55.7	79	55	I
	1991.03-1993.09	-	-	F	Hatchback Engine D6E (XU9JA)	810042	Outer Joint		25	34	54.8	78.5	56	I
1.9 D (47 kW)	1991.03-1997.06	MT	L	F	Hatchback Engine DJZ (XUD9Y)	210025	Drive Shaft	29T	25	24	54.8	78.5	593	
	1991.03-1997.06	MT	L/R	F	Hatchback Engine DJZ (XUD9Y)	810003	Outer Joint	29T	25	23	54.8	78.5	56	I
	1991.03-1997.06	-	L	F	Hatchback Engine DJZ (XUD9Y)	210117	Drive Shaft		25	24	54.8	79	592.5	
	1991.03-1997.06	MT	R	F	Hatchback Engine DJZ (XUD9Y)	210167	Drive Shaft		25	24	55.7	79	868	
	1991.03-1997.06	MT	L/R	F	Hatchback Engine DJZ (XUD9Y)	810002	Outer Joint		25	23	54.8	78.5	56	I
	1991.03-1997.06	MT	R	F	Hatchback Engine DJZ (XUD9Y)	210023	Drive Shaft	29T	25	24	55.7	79	868	
	1991.03-1997.06	-	R	F	Hatchback Engine DJZ (XUD9Y)	210091	Drive Shaft		25	24	54.8	78.5	869.5	
1.9 D (50 kW)	1993.07-1997.06	MT	L	F	Hatchback Engine D9B (XUD9A/U)/DJY (XUD9A)	210025	Drive Shaft	29T	25	24	54.8	78.5	593	
	1993.07-1997.06	MT	L/R	F	Hatchback Engine D9B (XUD9A/U)/DJY (XUD9A)	810003	Outer Joint	29T	25	23	54.8	78.5	56	I
	1993.07-1997.06	-	L	F	Hatchback Engine D9B (XUD9A/U)/DJY (XUD9A)	210117	Drive Shaft		25	24	54.8	79	592.5	
	1993.07-1997.06	MT	R	F	Hatchback Engine D9B (XUD9A/U)/DJY (XUD9A)	210167	Drive Shaft		25	24	55.7	79	868	
	1993.07-1997.06	MT	L/R	F	Hatchback Engine D9B (XUD9A/U)/DJY (XUD9A)	810002	Outer Joint		25	23	54.8	78.5	56	I
	1993.07-1997.06	MT	R	F	Hatchback Engine D9B (XUD9A/U)/DJY (XUD9A)	210023	Drive Shaft	29T	25	24	55.7	79	868	
1.9 i (88 kW)	1991.03-1997.06	MT	L	F	Hatchback Engine DKZ (XU9JA)	210025	Drive Shaft	29T	25	24	54.8	78.5	593	
	1991.03-1997.06	AT/MT	L/R	F	Hatchback Engine DKZ (XU9JA)	810003	Outer Joint	29T	25	23	54.8	78.5	56	I
	1991.03-1997.06	-	L	F	Hatchback Engine DKZ (XU9JA)	210117	Drive Shaft		25	24	54.8	79	592.5	
	1991.03-1997.06	MT	R	F	Hatchback Engine DKZ (XU9JA)	210167	Drive Shaft		25	24	55.7	79	868	
	1991.03-1997.06	MT	L/R	F	Hatchback Engine DKZ (XU9JA)	810002	Outer Joint		25	23	54.8	78.5	56	I
	1991.03-1997.06	MT	R	F	Hatchback Engine DKZ (XU9JA)	210023	Drive Shaft	29T	25	24	55.7	79	868	
	1991.03-1997.06	-	-	F	Hatchback Engine DKZ (XU9JA)	810027	Outer Joint	48T	25	34	55.7	79	55	I
	1991.03-1997.06	-	-	F	Hatchback Engine DKZ (XU9JA)	810042	Outer Joint		25	34	54.8	78.5	56	I
	1992.07-1997.06	-	L	F	Hatchback Engine DHY (XUD9TE/Y)	210090	Drive Shaft		25	24	54.8	78.5	593	
	1992.07-1997.06	AT/MT	L/R	F	Hatchback Engine DHY (XUD9TE/Y)	810003	Outer Joint	29T	25	23	54.8	78.5	56	I
1.9 TD (66 kW)	1992.07-1997.06	MT	L	F	Hatchback Engine DHY (XUD9TE/Y)	210225	Drive Shaft	29T	25	24	55	79.5	585	
	1992.07-1997.06	MT	R	F	Hatchback Engine DHY (XUD9TE/Y)	210193	Drive Shaft	29T	25	24	55.7	79	867	
	1992.07-1997.06	MT	L	F	Hatchback Engine DHY (XUD9TE/Y)	210246	Drive Shaft		25	24	55	79.5	585	
	1992.07-1997.06	MT	L/R	F	Hatchback Engine DHY (XUD9TE/Y)	810002	Outer Joint		25	23	54.8	78.5	56	I
	1992.07-1997.06	AT/MT	L	F	Hatchback Engine DHY (XUD9TE/Y)	210149	Drive Shaft		25	24	54.8	78.5	588	
	1996.09-1997.10	MT	L/R	F	Hatchback Engine RFS (XU10J4RS)	810003	Outer Joint	29T	25	23	54.8	78.5	56	I
	1996.09-1997.10	-	-	F	Hatchback Engine RFS (XU10J4RS)	810027	Outer Joint	48T	25	34	55.7	79	55	I
2.0 (122 kW)	1996.09-1997.10	-	-	F	Hatchback Engine RFS (XU10J4RS)	810042	Outer Joint		25	34	54.8	78.5	56	I
	1992.07-1997.06	-	L	F	Hatchback Engine RFX (XU10J2C)	210090	Drive Shaft		25	24	54.8	78.5	593	
	1992.07-1997.06	AT/MT	L/R	F	Hatchback Engine RFX (XU10J2C)	810003	Outer Joint	29T	25	23	54.8	78.5	56	I
	1992.07-1997.06	MT	L	F	Hatchback Engine RFX (XU10J2C)	210225	Drive Shaft	29T	25	24	55	79.5	585	
	1992.07-1997.06	MT	R	F	Hatchback Engine RFX (XU10J2C)	210193	Drive Shaft	29T	25	24	55.7	79	867	
	1992.07-1997.06	MT	L	F	Hatchback Engine RFX (XU10J2C)	210246	Drive Shaft		25	24	55	79.5	585	
	1992.07-1997.06	-	-	F	Hatchback Engine RFX (XU10J2C)	810027	Outer Joint	48T	25	34	55.7	79	55	I
	1992.07-1997.06	-	-	F	Hatchback Engine RFX (XU10J2C)	810042	Outer Joint		25	34	54.8	78.5	56	I
2.0 i 16V (110 kW)	1994.06-1997.06	-	L	F	Hatchback Engine RFT (XU10J4/Z)	210090	Drive Shaft		25	24	54.8	78.5	593	
	1994.06-1997.06	MT	L/R	F	Hatchback Engine RFT (XU10J4/Z)	810003	Outer Joint	29T	25	23	54.8	78.5	56	I
	1994.06-1997.06	MT	L	F	Hatchback Engine RFT (XU10J4/Z)	210225	Drive Shaft	29T	25	24	55	79.5	585	
	1994.06-1997.06	MT	R	F	Hatchback Engine RFT (XU10J4/Z)	210193	Drive Shaft	29T	25	24	55.7	79	867	
	1994.06-1997.06	MT	L/R	F	Hatchback Engine RFT (XU10J4/Z)	810002	Outer Joint		25	23	54.8	78.5	56	I
	1994.06-1997.06	-	-	F	Hatchback Engine RFT (XU10J4/Z)	810027	Outer Joint	48T	25	34	55.7	79	55	I
	1994.06-1997.06	-	-	F	Hatchback Engine RFT (XU10J4/Z)	810042	Outer Joint		25	34	54.8	78.5	56	I
2.0 i 16V (112 kW)	1992.07-1994.10	-	L	F	Hatchback Engine RFY (XU10J4/Z)/RFT (XU10J4/Z)	210090	Drive Shaft		25	24	54.8	78.5	593	
	1992.07-1994.10	AT/MT	L/R	F	Hatchback Engine RFY (XU10J4/Z)/RFT (XU10J4/Z)	810003	Outer Joint	29T	25	23	54.8	78.5	56	I
	1992.07-1994.10	MT	L	F	Hatchback Engine RFY (XU10J4/Z)/RFT (XU10J4/Z)	210225	Drive Shaft	29T	25	24	55	79.5	585	
	1992.07-1994.10	MT	R	F	Hatchback Engine RFY (XU10J4/Z)/RFT (XU10J4/Z)	210193	Drive Shaft	29T	25	24	55.7	79	867	
	1992.07-1994.10	MT	L/R	F	Hatchback Engine RFY (XU10J4/Z)/RFT (XU10J4/Z)	810002	Outer Joint		25	23	54.8	78.5	56	I
	1992.07-1994.10	-	-	F	Hatchback Engine RFY (XU10J4/Z)/RFT (XU10J4/Z)	810027	Outer Joint	48T	25	34	55.7	79	55	I
	1992.07-1994.10	-	-	F	Hatchback Engine RFY (XU10J4/Z)/RFT (XU10J4/Z)	810042	Outer Joint		25	34	54.8	78.5	56	I
2.0 i 16V (114 kW)	1992.07-1997.10	-	-	F	Hatchback Engine RFY (XU10J4/Z)/RFT (XU10J4/Z)	810027	Outer Joint	48T	25	34	55.7	79	55	I
	1992.07-1997.10	-	-	F	Hatchback Engine RFY (XU10J4/Z)/RFT (XU10J4/Z)	810042	Outer Joint		25	34	54.8	78.5	56	I
2.0 i 16V (120 kW)	1996.05-1997.06	MT	L/R	F	Hatchback Engine RFS (XU10J4RS)	810003	Outer Joint	29T	25	23	54.8	78.5	56	I
	1996.05-1997.06	MT	L/R	F	Hatchback Engine RFS (XU10J4RS)	810002	Outer Joint		25	23	54.8	78.5	56	I
	1996.05-1997.06	-	-	F	Hatchback Engine RFS (XU10J4RS)	810027	Outer Joint	48T	25	34	55.7	79	55	I
	1996.05-1997.06	-	-	F	Hatchback Engine RFS (XU10J4RS)	810042	Outer Joint		25	34	54.8	78.5	56	I
ZX Break (N2)														
1.4 i (55 kW)	1993.10-1997.10	-	R	F	Estate Engine KDX(TU3M/Z)/KDY(TU3M)/KFX (TU3JP)	210092	Drive Shaft		21	22	56.4	76	856.5	
	1993.10-1997.10	MT	L	F	Estate Engine KDX(TU3M/Z)/KDY(TU3M)/KFX (TU3JP)	210040	Drive Shaft		21	22	56.4	76	595	





	 YEAR	TRANSM	L/R	F/R	REMARKS	GSP Ref.	 PRODUCT	 ABS	Technical Specifications					
									A	B	C	H	L	P
CITROEN														
ZX Break (N2)														
1.4 i (55 kW)	1993.10-1997.10	-	L	F	Estate Engine KDX(TU3M/Z)/KDY(TU3M)/KFX (TU3JP)	210097	Drive Shaft		21	22	56.4	76	590.7	
	1993.10-1997.10	MT	R	F	Estate Engine KDX(TU3M/Z)/KDY(TU3M)/KFX (TU3JP)	210004	Drive Shaft		21	22	56.4	76	855.5	
1.6 i (65 kW)	1993.10-1997.10	MT	L	F	Estate Engine BDY (XU5M)/BFZ (XU5M)	210025	Drive Shaft	29T	25	24	54.8	78.5	593	
	1993.10-1997.10	MT	L/R	F	Estate Engine BDY (XU5M)/BFZ (XU5M)	810003	Outer Joint	29T	25	23	54.8	78.5	56	I
	1993.10-1997.10	-	L	F	Estate Engine BDY (XU5M)/BFZ (XU5M)	210117	Drive Shaft		25	24	54.8	79	592.5	
	1993.10-1997.10	MT	R	F	Estate Engine BDY (XU5M)/BFZ (XU5M)	210167	Drive Shaft		25	24	55.7	79	868	
	1993.10-1997.10	MT	R	F	Estate Engine BDY (XU5M)/BFZ (XU5M)	210023	Drive Shaft	29T	25	24	55.7	79	868	
	1993.10-1997.10	MT	L/R	F	Estate Engine BDY (XU5M)/BFZ (XU5M)	810002	Outer Joint		25	23	54.8	78.5	56	I
1.8 D (44 kW)	1993.10-1997.10	-	R	F	Estate Engine BDY (XU5M)/BFZ (XU5M)	210091	Drive Shaft		25	24	54.8	78.5	869.5	
	1993.10-1997.10	MT	L	F	Estate Engine 161A (XUD7)	210025	Drive Shaft	29T	25	24	54.8	78.5	593	
	1993.10-1997.10	-	L	F	Estate Engine 161A (XUD7)	210117	Drive Shaft		25	24	54.8	79	592.5	
	1993.10-1997.10	MT	R	F	Estate Engine 161A (XUD7)	210167	Drive Shaft		25	24	55.7	79	868	
1.8 i (74 kW)	1993.10-1997.10	MT	R	F	Estate Engine 161A (XUD7)	210023	Drive Shaft	29T	25	24	55.7	79	868	
	1993.10-1997.10	MT	L	F	Estate Engine 161A (XUD7)	210025	Drive Shaft	29T	25	24	54.8	78.5	593	
	1993.10-1997.10	MT	L/R	F	Estate Engine LFZ (XU7JP)	810003	Outer Joint	29T	25	23	54.8	78.5	56	I
	1993.10-1997.10	-	L	F	Estate Engine LFZ (XU7JP)	210117	Drive Shaft		25	24	54.8	79	592.5	
	1993.10-1997.10	MT	R	F	Estate Engine LFZ (XU7JP)	210167	Drive Shaft		25	24	55.7	79	868	
	1993.10-1997.10	MT	R	F	Estate Engine LFZ (XU7JP)	210023	Drive Shaft	29T	25	24	55.7	79	868	
1.8 i 16V (81 kW)	1993.10-1997.10	MT	L/R	F	Estate Engine LFZ (XU7JP)	810002	Outer Joint		25	23	54.8	78.5	56	I
	1993.10-1997.10	-	R	F	Estate Engine LFZ (XU7JP)	210091	Drive Shaft		25	24	54.8	78.5	869.5	
	1996.01-1998.02	-	L	F	Estate Engine LFY (XU7JP4)	210117	Drive Shaft		25	24	54.8	79	592.5	
	1996.01-1998.02	-	R	F	Estate Engine LFY (XU7JP4)	210091	Drive Shaft		25	24	54.8	78.5	869.5	
	1993.10-1997.10	MT	L	F	Estate Engine DJZ (XUD9Y)	210025	Drive Shaft	29T	25	24	54.8	78.5	593	
	1993.10-1997.10	MT	L/R	F	Estate Engine DJZ (XUD9Y)	810003	Outer Joint	29T	25	23	54.8	78.5	56	I
1.9 D (47 kW)	1993.10-1997.10	-	L	F	Estate Engine DJZ (XUD9Y)	210117	Drive Shaft		25	24	54.8	79	592.5	
	1993.10-1997.10	MT	R	F	Estate Engine DJZ (XUD9Y)	210167	Drive Shaft		25	24	55.7	79	868	
	1993.10-1997.10	MT	R	F	Estate Engine DJZ (XUD9Y)	210023	Drive Shaft	29T	25	24	55.7	79	868	
	1993.10-1997.10	MT	L/R	F	Estate Engine DJZ (XUD9Y)	810002	Outer Joint		25	23	54.8	78.5	56	I
	1993.10-1997.10	-	R	F	Estate Engine DJZ (XUD9Y)	210091	Drive Shaft		25	24	54.8	78.5	869.5	
	1993.10-1997.10	MT	R	F	Estate Engine DJZ (XUD9Y)	210025	Drive Shaft	29T	25	24	54.8	78.5	593	
1.9 D (50 kW)	1994.06-1997.10	MT	L	F	Estate Engine D9B (XUD9A/U)	210025	Drive Shaft	29T	25	24	54.8	78.5	593	
	1994.06-1997.10	MT	L/R	F	Estate Engine D9B (XUD9A/U)	810003	Outer Joint	29T	25	23	54.8	78.5	56	I
	1994.06-1997.10	-	L	F	Estate Engine D9B (XUD9A/U)	210117	Drive Shaft		25	24	54.8	79	592.5	
	1994.06-1997.10	MT	R	F	Estate Engine D9B (XUD9A/U)	210167	Drive Shaft		25	24	55.7	79	868	
	1994.06-1997.10	MT	R	F	Estate Engine D9B (XUD9A/U)	210023	Drive Shaft	29T	25	24	55.7	79	868	
	1994.06-1997.10	MT	L/R	F	Estate Engine D9B (XUD9A/U)	810002	Outer Joint		25	23	54.8	78.5	56	I
1.9 TD (66 kW)	1994.06-1997.10	-	R	F	Estate Engine D9B (XUD9A/U)	210091	Drive Shaft		25	24	54.8	78.5	869.5	
	1993.10-1997.10	-	L	F	Estate Engine DHY (XUD9TE/Y)	210090	Drive Shaft		25	24	54.8	78.5	593	
	1993.10-1997.10	MT	L	F	Estate Engine DHY (XUD9TE/Y)	210225	Drive Shaft	29T	25	24	55	79.5	585	
	1993.10-1997.10	MT	L/R	F	Estate Engine DHY (XUD9TE/Y)	810003	Outer Joint	29T	25	23	54.8	78.5	56	I
	1993.10-1997.10	MT	R	F	Estate Engine DHY (XUD9TE/Y)	210193	Drive Shaft	29T	25	24	55.7	79	867	
	1993.10-1997.10	MT	L	F	Estate Engine DHY (XUD9TE/Y)	210246	Drive Shaft		25	24	55	79.5	585	
1993.10-1997.10	MT	L/R	F	Estate Engine DHY (XUD9TE/Y)	810002	Outer Joint		25	23	54.8	78.5	56	I	
CITROEN (DF-PSA)														
FUKANG														
1.4 (55 kW)	2007.12-2008.12	-	L	-	Saloon Engine TU3JPK	210101	Drive Shaft	29T	25	22	59	79	598	
	2007.12-2008.12	-	R	-	Saloon Engine TU3JPK	210245	Drive Shaft	29T	25	22	59	79	870	
	2007.12-2008.12	-	R	-	Saloon Engine TU3JPK	210315	Drive Shaft	29T	25	22	59	79	866	
	2007.12-2008.12	-	L	-	Saloon Engine TU3JPK	210316	Drive Shaft	29T	25	22	59	79	594	
1.6 (65 kW)	1997.02-2005.12	-	R	-	Hatchback Engine TU5JPK	210315	Drive Shaft	29T	25	22	59	79	866	
	1997.02-2005.12	-	L	-	Hatchback Engine TU5JPK	210316	Drive Shaft	29T	25	22	59	79	594	
	1998.09-2001.08	-	L	-	Saloon Engine TU5JPK	210101	Drive Shaft	29T	25	22	59	79	598	
	1998.09-2001.08	-	R	-	Saloon Engine TU5JPK	210245	Drive Shaft	29T	25	22	59	79	870	
	1998.09-2001.08	-	R	-	Saloon Engine TU5JPK	210315	Drive Shaft	29T	25	22	59	79	866	
	1998.09-2001.08	-	L	-	Saloon Engine TU5JPK	210316	Drive Shaft	29T	25	22	59	79	594	
1.6 (78 kW)	1997.02-2005.12	-	R	-	Hatchback Engine TU5JP4/N6A 10FX3A PSA	210315	Drive Shaft	29T	25	22	59	79	866	
	1997.02-2005.12	-	L	-	Hatchback Engine TU5JP4/N6A 10FX3A PSA	210316	Drive Shaft	29T	25	22	59	79	594	
XSARA														
2.0 (97 kW)	2003.05-2005.12	AT	L	-	Saloon Engine PSA RFN 10LH46	245127	Drive Shaft	29T	25	26	55.7	79	580	
	2003.05-2005.12	AT	R	-	Saloon Engine PSA RFN 10LH46	245128	Drive Shaft	29T	25	26	55.7	79	736	
CITROEN DF														
FUKANG														
1.4 (47 kW)	2002.02-2005.12	-	R	-	Hatchback Engine TU3JPK	210315	Drive Shaft	29T	25	22	59	79	866	
	2002.02-2005.12	-	L	-	Hatchback Engine TU3JPK	210316	Drive Shaft	29T	25	22	59	79	594	
DACIA														
1310														





	 YEAR	TRANSM	L/R	F/R	REMARKS	GSP Ref.	 PRODUCT	 ABS	Technical Specifications						
									A	B	C	H	L	P	
DACIA															
1310															
1.3 (40 kW)	1983.05-2004.07	-	-	F	Estate Engine 810-02/-99	211001	Drive Shaft		20	23	48	107	645		
	1983.05-2004.07	-	-	F	Estate Engine 810-02/-99	211001	Drive Shaft		20	23	48	107	645		
1310 (U X)															
1.3 (40 kW)	1983.05-2004.07	-	-	F	Saloon Engine 810-02/-99	211001	Drive Shaft		20	23	48	107	645		
	1983.05-2004.07	-	-	F	Saloon Engine 810-02/-99	211001	Drive Shaft		20	23	48	107	645		
DOKKER															
1.2 TCe (85 kW)	2012.11-	-	MT	L	F	Estate Engine H5F 402	650057	Inner Joint	26	22	40	64	104		
	2012.11-	-	MT	L	F	Estate Engine H5F 402	211024	Drive Shaft	25	26	52.5	88.5	653		
	2012.11-	-	MT	R	F	Estate Engine H5F 402	250501	Drive Shaft	25	26	52.4	88.5	898		
	2012.11-	-	-	-	R	Estate Engine H5F 402	812034	Outer Joint	24	20	44	113.5	48.5	I	
	2012.11-	-	MT	L/R	F	Estate Engine H5F 402	850162	Outer Joint	25	23	52.5	88.5	60.5	M	
1.5 dCi (55 kW)	2012.11-	-	MT	L	F	Estate Engine K9K 612	650057	Inner Joint	26	22	40	64	104		
	2012.11-	-	MT	L	F	Estate Engine K9K 612	211024	Drive Shaft	25	26	52.5	88.5	653		
	2012.11-	-	MT	R	F	Estate Engine K9K 612	250501	Drive Shaft	25	26	52.4	88.5	898		
	2012.11-	-	-	-	R	Estate Engine K9K 612	812034	Outer Joint	24	20	44	113.5	48.5	I	
	2012.11-	-	MT	L/R	F	Estate Engine K9K 612	850162	Outer Joint	25	23	52.5	88.5	60.5	M	
1.5 dCi (66 kW)	2012.11-	-	MT	L	F	Estate Engine K9K 612	650057	Inner Joint	26	22	40	64	104		
	2012.11-	-	MT	L	F	Estate Engine K9K 612	211024	Drive Shaft	25	26	52.5	88.5	653		
	2012.11-	-	MT	R	F	Estate Engine K9K 612	250501	Drive Shaft	25	26	52.4	88.5	898		
	2012.11-	-	-	-	R	Estate Engine K9K 612	812034	Outer Joint	24	20	44	113.5	48.5	I	
	2012.11-	-	MT	L/R	F	Estate Engine K9K 612	850162	Outer Joint	25	23	52.5	88.5	60.5	M	
1.6 (61 kW)	2012.11-	-	MT	L	F	Estate Engine K7M 812/K7M 828	650057	Inner Joint	26	22	40	64	104		
	2012.11-	-	MT	L	F	Estate Engine K7M 812/K7M 828	211024	Drive Shaft	25	26	52.5	88.5	653		
	2012.11-	-	MT	R	F	Estate Engine K7M 812/K7M 828	250501	Drive Shaft	25	26	52.4	88.5	898		
	2012.11-	-	-	-	R	Estate Engine K7M 812/K7M 828	812034	Outer Joint	24	20	44	113.5	48.5	I	
	2012.11-	-	MT	L/R	F	Estate Engine K7M 812/K7M 828	850162	Outer Joint	25	23	52.5	88.5	60.5	M	
1.6 (75 kW)	2015.04-	-	-	-	R	Estate	812034	Outer Joint	24	20	44	113.5	48.5	I	
1.6 LPG (61 kW)	2013.11-	-	-	-	R	Estate Engine K7M 812/K7M 828	812034	Outer Joint	24	20	44	113.5	48.5	I	
1.6 LPG (75 kW)	2015.04-	-	-	-	R	Estate	812034	Outer Joint	24	20	44	113.5	48.5	I	
DOKKER Express															
1.2 TCe 115 (84 kW)	2012.12-	-	MT	L	F	Box Engine H5F 402	211024	Drive Shaft	25	26	52.5	88.5	653		
	2012.12-	-	MT	L	F	Box Engine H5F 402	650057	Inner Joint	26	22	40	64	104		
	2012.12-	-	MT	R	F	Box Engine H5F 402	250501	Drive Shaft	25	26	52.4	88.5	898		
	2012.12-	-	-	-	R	Box Engine H5F 402	812034	Outer Joint	24	20	44	113.5	48.5	I	
	2012.12-	-	MT	L/R	F	Box Engine H5F 402	850162	Outer Joint	25	23	52.5	88.5	60.5	M	
1.2 TCe 115 (85 kW)	2015.07-	-	-	-	R	Box	812034	Outer Joint	24	20	44	113.5	48.5	I	
1.5 dCi (55 kW)	2012.12-	-	MT	L	F	Box Engine K9K 612	650057	Inner Joint	26	22	40	64	104		
	2012.12-	-	MT	L	F	Box Engine K9K 612	211024	Drive Shaft	25	26	52.5	88.5	653		
	2012.12-	-	MT	R	F	Box Engine K9K 612	250501	Drive Shaft	25	26	52.4	88.5	898		
	2012.12-	-	-	-	R	Box Engine K9K 612	812034	Outer Joint	24	20	44	113.5	48.5	I	
	2012.12-	-	MT	L/R	F	Box Engine K9K 612	850162	Outer Joint	25	23	52.5	88.5	60.5	M	
1.5 dCi (66 kW)	2012.12-	-	MT	L	F	Box Engine K9K 612	650057	Inner Joint	26	22	40	64	104		
	2012.12-	-	MT	L	F	Box Engine K9K 612	211024	Drive Shaft	25	26	52.5	88.5	653		
	2012.12-	-	MT	R	F	Box Engine K9K 612	250501	Drive Shaft	25	26	52.4	88.5	898		
	2012.12-	-	-	-	R	Box Engine K9K 612	812034	Outer Joint	24	20	44	113.5	48.5	I	
	2012.12-	-	MT	L/R	F	Box Engine K9K 612	850162	Outer Joint	25	23	52.5	88.5	60.5	M	
1.6 (61 kW)	2012.12-	-	MT	L	F	Box Engine K7M 812/K7M 828	650057	Inner Joint	26	22	40	64	104		
	2012.12-	-	MT	L	F	Box Engine K7M 812/K7M 828	211024	Drive Shaft	25	26	52.5	88.5	653		
	2012.12-	-	MT	R	F	Box Engine K7M 812/K7M 828	250501	Drive Shaft	25	26	52.4	88.5	898		
	2012.12-	-	-	-	R	Box Engine K7M 812/K7M 828	812034	Outer Joint	24	20	44	113.5	48.5	I	
	2012.12-	-	MT	L/R	F	Box Engine K7M 812/K7M 828	850162	Outer Joint	25	23	52.5	88.5	60.5	M	
1.6 (75 kW)	2015.04-	-	-	-	R	Box	812034	Outer Joint	24	20	44	113.5	48.5	I	
1.6 LPG (61 kW)	2013.11-	-	-	-	R	Box Engine K7M 812	812034	Outer Joint	24	20	44	113.5	48.5	I	
1.6 LPG (75 kW)	2015.04-	-	-	-	R	Box	812034	Outer Joint	24	20	44	113.5	48.5	I	
DUSTER															
1.2 TCe 125 (92 kW)	2013.10-	-	-	L	F	Closed Off-Road Vehicle Engine H5F 404	250498	Drive Shaft	25	26	52.6	89	702		
	2013.10-	-	-	R	F	Closed Off-Road Vehicle Engine H5F 404	211020	Drive Shaft	25	26	52.6	89	950		
	2013.10-	-	MT	L/R	R	All-wheel Drive Box Engine H5F 404	257265	Drive Shaft	48T	25	21	52.2	88.5	824	
	2013.10-	-	-	R	F	Closed Off-Road Vehicle Engine H5F 404	650138	Inner joint	26	33	33	346	100.5		
	2013.10-	-	MT	R	R	All-wheel Drive Box Engine H5F 404	857203	Outer Joint	48T	25	28	52.2	88.5	60	I
	2013.10-	-	MT	L	R	All-wheel Drive Box Engine H5F 404	657129	Inner Joint	21	28	38	55	96		
	2013.10-	-	-	L/R	F	Closed Off-Road Vehicle Engine H5F 404	850148	Outer Joint	25	35	52.6	89	60	I	
	2013.10-	-	-	-	-	Closed Off-Road Vehicle Engine H5F 404	650105	Inner Joint	27	33	40	70.5	111		
	2013.10-	-	-	-	-	All-wheel Drive Box Engine H5F 404	650105	Inner Joint	27	33	40	70.5	111		
	2013.10-	-	-	-	-	Closed Off-Road Vehicle Engine H5F 404	650106	Inner Joint	31	33	42	0	133.5		
	2013.10-	-	-	-	-	All-wheel Drive Box Engine H5F 404	650106	Inner Joint	31	33	42	0	133.5		





	 YEAR	TRANSM	L/R	F/R	REMARKS	GSP Ref.	 PRODUCT	 ABS	Technical Specifications					
									A	B	C	H	L	P
DACIA DUSTER														
1.2 TcE 125 (92 kW)	2015.06-	-	R	F	All-wheel Drive Closed Off-Road Vehicle Engine H5F 410	211020	Drive Shaft		25	26	52.6	89	950	
	2015.06-	MT	L/R	R	All-wheel Drive Closed Off-Road Vehicle Engine H5F 410	257265	Drive Shaft	48T	25	21	52.2	88.5	824	
	2015.06-	MT	R	R	All-wheel Drive Closed Off-Road Vehicle Engine H5F 410	857203	Outer Joint	48T	25	28	52.2	88.5	60	I
	2015.06-	MT	L	R	All-wheel Drive Closed Off-Road Vehicle Engine H5F 410	657129	Inner Joint		21	28	38	55	96	
	2015.06-	-	L/R	F	All-wheel Drive Closed Off-Road Vehicle Engine H5F 410	850148	Outer Joint		25	35	52.6	89	60	I
1.5 dCi (63 kW)	2010.04-	MT	L	F	Closed Off-Road Vehicle Engine K9K 796/K9K 830	250587	Drive Shaft		25	26	52.6	89	700	
	2010.04-	MT	R	F	Closed Off-Road Vehicle Engine K9K 796/K9K 830	228005	Drive Shaft		22	22	56	107.5	707	
	2010.04-	MT	R	F	Closed Off-Road Vehicle Engine K9K 796/K9K 830	228005	Drive Shaft		22	22	56	107.5	707	
	2010.04-	-	-	-	Closed Off-Road Vehicle Engine K9K 796/K9K 830	650105	Inner Joint		27	33	40	70.5	111	
	2010.04-	-	-	-	Closed Off-Road Vehicle Engine K9K 796/K9K 830	650106	Inner Joint		31	33	42	0	133.5	
1.5 dCi (66 kW)	2010.10-	MT	L	F	All-wheel Drive Closed Off-Road Vehicle Engine K9K 894/K9K 884	211017	Drive Shaft		25	27	52.6	89	655	
	2010.10-	-	L	F	Closed Off-Road Vehicle Engine K9K 884/K9K 892	250498	Drive Shaft		25	26	52.6	89	702	
	2010.10-	MT	R	F	All-wheel Drive Closed Off-Road Vehicle Engine K9K 894/K9K 884	211019	Drive Shaft		25	31	52.6	89	614	
	2010.10-	-	L	F	Closed Off-Road Vehicle Engine K9K 884/K9K 892	250587	Drive Shaft		25	26	52.6	89	700	
	2010.10-	-	L/R	R	All-wheel Drive Closed Off-Road Vehicle Engine K9K 894/K9K 884	257265	Drive Shaft	48T	25	21	52.2	88.5	824	
	2010.10-	-	R	F	Closed Off-Road Vehicle Engine K9K 884/K9K 892	250416	Drive Shaft		25	26	52.6	89	950	
	2010.10-	MT	R	F	Closed Off-Road Vehicle Engine K9K 884/K9K 892	228005	Drive Shaft		22	22	56	107.5	707	
	2010.10-	-	R	R	All-wheel Drive Closed Off-Road Vehicle Engine K9K 894/K9K 884	857203	Outer Joint	48T	25	28	52.2	88.5	60	I
	2010.10-	-	L	R	All-wheel Drive Closed Off-Road Vehicle Engine K9K 894/K9K 884	657129	Inner Joint		21	28	38	55	96	
	2010.10-	MT	R	F	Closed Off-Road Vehicle Engine K9K 884/K9K 892	228005	Drive Shaft		22	22	56	107.5	707	
	2010.10-	-	L/R	F	Closed Off-Road Vehicle Engine K9K 884/K9K 892	850148	Outer Joint		25	35	52.6	89	60	I
	2010.10-	-	L/R	F	All-wheel Drive Closed Off-Road Vehicle Engine K9K 894/K9K 884	850148	Outer Joint		25	35	52.6	89	60	I
	2010.10-	-	-	-	Closed Off-Road Vehicle Engine K9K 884/K9K 892	650105	Inner Joint		27	33	40	70.5	111	
	2010.10-	-	-	-	All-wheel Drive Closed Off-Road Vehicle Engine K9K 894/K9K 884	650105	Inner Joint		27	33	40	70.5	111	
	2010.10-	-	-	-	Closed Off-Road Vehicle Engine K9K 884/K9K 892	650106	Inner Joint		31	33	42	0	133.5	
	2010.10-	-	-	-	All-wheel Drive Closed Off-Road Vehicle Engine K9K 894/K9K 884	650106	Inner Joint		31	33	42	0	133.5	
	2010.10-	-	R	F	Closed Off-Road Vehicle Engine K9K 884/K9K 892	250463	Drive Shaft		25	31	52.6	89	611	
	2010.10-	-	R	F	All-wheel Drive Closed Off-Road Vehicle Engine K9K 894/K9K 884	250463	Drive Shaft		25	31	52.6	89	611	
	2010.10-	-	L	F	Closed Off-Road Vehicle Engine K9K 884/K9K 892	250464	Drive Shaft		25	27	52.6	89	652	
	2010.10-	-	L	F	All-wheel Drive Closed Off-Road Vehicle Engine K9K 894/K9K 884	250464	Drive Shaft		25	27	52.6	89	652	
	2010.10-	AT	L	F	All-wheel Drive Closed Off-Road Vehicle Engine K9K 894/K9K 884	641188	Inner Joint		26	33	42.9	46	100.5	
	2010.10-	-	L	F	Closed Off-Road Vehicle Engine K9K 884/K9K 892	250415	Drive Shaft		25	26	52.6	89	704	
	2011.04-	-	L	F	Box Engine K9K 892/K9K 884	250587	Drive Shaft		25	26	52.6	89	700	
	2011.04-	-	L/R	R	All-wheel Drive Box Engine K9K 892/K9K 884	257265	Drive Shaft	48T	25	21	52.2	88.5	824	
	2011.04-	-	R	R	All-wheel Drive Box Engine K9K 892/K9K 884	857203	Outer Joint	48T	25	28	52.2	88.5	60	I
	2011.04-	-	L	R	All-wheel Drive Box Engine K9K 892/K9K 884	657129	Inner Joint		21	28	38	55	96	
	2011.04-	MT	R	F	Box Engine K9K 892/K9K 884	228005	Drive Shaft		22	22	56	107.5	707	
2011.04-	MT	R	F	Box Engine K9K 892/K9K 884	228005	Drive Shaft		22	22	56	107.5	707		
2011.04-	-	-	-	Box Engine K9K 892/K9K 884	650105	Inner Joint		27	33	40	70.5	111		
2011.04-	-	-	-	All-wheel Drive Box Engine K9K 892/K9K 884	650105	Inner Joint		27	33	40	70.5	111		
2011.04-	-	-	-	Box Engine K9K 892/K9K 884	650106	Inner Joint		31	33	42	0	133.5		
2011.04-	-	-	-	All-wheel Drive Box Engine K9K 892/K9K 884	650106	Inner Joint		31	33	42	0	133.5		
1.5 dCi (79 kW)	2010.06-	MT	L	F	All-wheel Drive Closed Off-Road Vehicle Engine K9K 898	211017	Drive Shaft		25	27	52.6	89	655	
	2010.06-	-	L	F	Closed Off-Road Vehicle Engine K9K 896	250498	Drive Shaft		25	26	52.6	89	702	
	2010.06-	MT	R	F	All-wheel Drive Closed Off-Road Vehicle Engine K9K 898	211019	Drive Shaft		25	31	52.6	89	614	
	2010.06-	MT	L/R	R	All-wheel Drive Closed Off-Road Vehicle Engine K9K 898	257265	Drive Shaft	48T	25	21	52.2	88.5	824	
	2010.06-	-	R	F	Closed Off-Road Vehicle Engine K9K 896	250416	Drive Shaft		25	26	52.6	89	950	
	2010.06-	-	L/R	F	Closed Off-Road Vehicle Engine K9K 896	850148	Outer Joint		25	35	52.6	89	60	I
	2010.06-	-	L/R	F	All-wheel Drive Closed Off-Road Vehicle Engine K9K 898	850148	Outer Joint		25	35	52.6	89	60	I
	2010.06-	-	R	F	All-wheel Drive Closed Off-Road Vehicle Engine K9K 898	250463	Drive Shaft		25	31	52.6	89	611	
	2010.06-	-	L	F	All-wheel Drive Closed Off-Road Vehicle Engine K9K 898	250464	Drive Shaft		25	27	52.6	89	652	
	1.5 dCi (80 kW)	2013.04-	MT	L/R	R	All-wheel Drive Box Engine K9K 858/K9K 658	257265	Drive Shaft	48T	25	21	52.2	88.5	824
2013.04-		MT	R	R	All-wheel Drive Box Engine K9K 858/K9K 658	857203	Outer Joint	48T	25	28	52.2	88.5	60	I
2013.04-		MT	L	R	All-wheel Drive Box Engine K9K 858/K9K 658	657129	Inner Joint		21	28	38	55	96	
2013.04-		-	-	-	Box Engine K9K 856/K9K 666	650105	Inner Joint		27	33	40	70.5	111	
2013.04-		-	-	-	All-wheel Drive Box Engine K9K 858/K9K 658	650105	Inner Joint		27	33	40	70.5	111	
2013.04-		-	-	-	Box Engine K9K 856/K9K 666	650106	Inner Joint		31	33	42	0	133.5	
2013.04-		-	-	-	All-wheel Drive Box Engine K9K 858/K9K 658	650106	Inner Joint		31	33	42	0	133.5	
2013.04-		AT	L	F	All-wheel Drive Box Engine K9K 858/K9K 658	641188	Inner Joint		26	33	42.9	46	100.5	
2013.08-		-	L	F	Closed Off-Road Vehicle Engine K9K 856/K9K 658	250498	Drive Shaft		25	26	52.6	89	702	
2013.08-		MT	L/R	R	All-wheel Drive Closed Off-Road Vehicle Engine K9K 856/K9K 658	257265	Drive Shaft	48T	25	21	52.2	88.5	824	
2013.08-		MT	R	R	All-wheel Drive Closed Off-Road Vehicle Engine K9K 856/K9K 658	857203	Outer Joint	48T	25	28	52.2	88.5	60	I
2013.08-		MT	L	R	All-wheel Drive Closed Off-Road Vehicle Engine K9K 856/K9K 658	657129	Inner Joint		21	28	38	55	96	
2013.08-		-	L/R	F	Closed Off-Road Vehicle Engine K9K 856/K9K 658	850148	Outer Joint		25	35	52.6	89	60	I
2013.08-		-	L/R	F	All-wheel Drive Closed Off-Road Vehicle Engine K9K 856/K9K 658	850148	Outer Joint		25	35	52.6	89	60	I





	 YEAR	TRANSM	L/R	F/R	REMARKS	GSP Ref.	 PRODUCT	 ABS	Technical Specifications						
									A	B	C	H	L	P	
DACIA															
DUSTER															
1.5 dCi (80 kW)	2013.08	-	-	-	Closed Off-Road Vehicle Engine K9K 856/K9K 658	650105	Inner Joint		27	33	40	70.5	111		
	2013.08	-	-	-	All-wheel Drive Closed Off-Road Vehicle Engine K9K 856/K9K 658	650105	Inner Joint		27	33	40	70.5	111		
	2013.08	-	-	-	Closed Off-Road Vehicle Engine K9K 856/K9K 658	650106	Inner Joint		31	33	42	0	133.5		
	2013.08	-	-	-	All-wheel Drive Closed Off-Road Vehicle Engine K9K 856/K9K 658	650106	Inner Joint		31	33	42	0	133.5		
	2013.08	-	-	R	F	All-wheel Drive Closed Off-Road Vehicle Engine K9K 856/K9K 658	250463	Drive Shaft		25	31	52.6	89	611	
	2013.08	-	-	L	F	All-wheel Drive Closed Off-Road Vehicle Engine K9K 856/K9K 658	250464	Drive Shaft		25	27	52.6	89	652	
	2013.08	-	AT	L	F	All-wheel Drive Closed Off-Road Vehicle Engine K9K 856/K9K 658	641188	Inner Joint		26	33	42.9	46	100.5	
1.5 dCi (81 kW)	2010.10	-	-	L/R	R	All-wheel Drive Closed Off-Road Vehicle Engine K9K 898	257265	Drive Shaft	48T	25	21	52.2	88.5	824	
	2010.10	-	-	R	R	All-wheel Drive Closed Off-Road Vehicle Engine K9K 898	857203	Outer Joint	48T	25	28	52.2	88.5	60	I
	2010.10	-	-	L	R	All-wheel Drive Closed Off-Road Vehicle Engine K9K 898	657129	Inner Joint		21	28	38	55	96	
	2010.10	-	-	L/R	F	All-wheel Drive Closed Off-Road Vehicle Engine K9K 898	850148	Outer Joint		25	35	52.6	89	60	I
	2010.10	-	-	R	F	All-wheel Drive Closed Off-Road Vehicle Engine K9K 898	250463	Drive Shaft		25	31	52.6	89	611	
	2010.10	-	-	L	F	All-wheel Drive Closed Off-Road Vehicle Engine K9K 898	250464	Drive Shaft		25	27	52.6	89	652	
1.6 16V (77 kW)	2010.04	-	-	L	F	Closed Off-Road Vehicle Engine K4M 690/K4M 696	250587	Drive Shaft		25	26	52.6	89	700	
	2010.04	-	MT	R	F	Closed Off-Road Vehicle Engine K4M 690/K4M 696	250586	Drive Shaft		25	26	52.6	89	950	
	2010.04	-	-	R	F	Closed Off-Road Vehicle Engine K4M 690/K4M 696	250416	Drive Shaft		25	26	52.6	89	950	
	2010.04	-	MT	R	F	Closed Off-Road Vehicle Engine K4M 690/K4M 696	228005	Drive Shaft		22	22	56	107.5	707	
	2010.04	-	MT	R	F	Closed Off-Road Vehicle Engine K4M 690/K4M 696	228005	Drive Shaft		22	22	56	107.5	707	
	2010.04	-	-	R	F	Closed Off-Road Vehicle Engine K4M 690/K4M 696	850148	Outer Joint		25	35	52.6	89	60	I
	2010.04	-	-	-	-	Closed Off-Road Vehicle Engine K4M 690/K4M 696	650105	Inner Joint		27	33	40	70.5	111	
	2010.04	-	-	-	-	Closed Off-Road Vehicle Engine K4M 690/K4M 696	650106	Inner Joint		31	33	42	0	133.5	
	2010.04	-	-	R	F	Closed Off-Road Vehicle Engine K4M 690/K4M 696	641190	Inner Joint		26	33	33	329	101	
	2010.04	-	AT	L	F	Closed Off-Road Vehicle Engine K4M 690/K4M 696	641188	Inner Joint		26	33	42.9	46	100.5	
	2010.04	-	-	L	F	Closed Off-Road Vehicle Engine K4M 690/K4M 696	250415	Drive Shaft		25	26	52.6	89	704	
	2010.06	-	MT	L	F	All-wheel Drive Closed Off-Road Vehicle Engine K4M 606	211017	Drive Shaft		25	27	52.6	89	655	
	2010.06	-	MT	R	F	All-wheel Drive Closed Off-Road Vehicle Engine K4M 606	211019	Drive Shaft		25	31	52.6	89	614	
	2010.06	-	-	L/R	R	All-wheel Drive Closed Off-Road Vehicle Engine K4M 606	257265	Drive Shaft	48T	25	21	52.2	88.5	824	
	2010.06	-	-	R	R	All-wheel Drive Closed Off-Road Vehicle Engine K4M 606	857203	Outer Joint	48T	25	28	52.2	88.5	60	I
	2010.06	-	-	L	R	All-wheel Drive Closed Off-Road Vehicle Engine K4M 606	657129	Inner Joint		21	28	38	55	96	
	2010.06	-	-	-	-	All-wheel Drive Closed Off-Road Vehicle Engine K4M 606	650105	Inner Joint		27	33	40	70.5	111	
	2010.06	-	-	-	-	All-wheel Drive Closed Off-Road Vehicle Engine K4M 606	650106	Inner Joint		31	33	42	0	133.5	
	2011.04	-	-	L/R	R	All-wheel Drive Box Engine K4M 606	257265	Drive Shaft	48T	25	21	52.2	88.5	824	
	2011.04	-	-	R	R	All-wheel Drive Box Engine K4M 606	857203	Outer Joint	48T	25	28	52.2	88.5	60	I
	2011.04	-	-	L	R	All-wheel Drive Box Engine K4M 606	657129	Inner Joint		21	28	38	55	96	
	2011.04	-	-	-	-	All-wheel Drive Box Engine K4M 606	650105	Inner Joint		27	33	40	70.5	111	
	2011.04	-	-	-	-	All-wheel Drive Box Engine K4M 606	650106	Inner Joint		31	33	42	0	133.5	
1.6 16V Hi-Flex (77 kW)	2010.08	-	-	L	F	Closed Off-Road Vehicle Engine K4M 696	250587	Drive Shaft		25	26	52.6	89	700	
	2010.08	-	MT	R	F	Closed Off-Road Vehicle Engine K4M 696	228005	Drive Shaft		22	22	56	107.5	707	
	2010.08	-	MT	R	F	Closed Off-Road Vehicle Engine K4M 696	228005	Drive Shaft		22	22	56	107.5	707	
	2010.08	-	-	R	F	Closed Off-Road Vehicle Engine K4M 696	850148	Outer Joint		25	35	52.6	89	60	I
	2010.08	-	-	-	-	Closed Off-Road Vehicle Engine K4M 696	650105	Inner Joint		27	33	40	70.5	111	
	2010.08	-	-	-	-	Closed Off-Road Vehicle Engine K4M 696	650106	Inner Joint		31	33	42	0	133.5	
	2010.08	-	-	L	F	Closed Off-Road Vehicle Engine K4M 696	250415	Drive Shaft		25	26	52.6	89	704	
	2011.04	-	-	L	F	Box Engine K4M 696	250587	Drive Shaft		25	26	52.6	89	700	
	2011.04	-	MT	R	F	Box Engine K4M 696	228005	Drive Shaft		22	22	56	107.5	707	
	2011.04	-	MT	R	F	Box Engine K4M 696	228005	Drive Shaft		22	22	56	107.5	707	
	2011.04	-	-	-	-	Box Engine K4M 696	650105	Inner Joint		27	33	40	70.5	111	
1.6 16V LPG (77 kW)	2011.04	-	-	L	F	Closed Off-Road Vehicle Engine K4M 696	250587	Drive Shaft		25	26	52.6	89	700	
	2011.04	-	-	R	F	Closed Off-Road Vehicle Engine K4M 696	250586	Drive Shaft		25	26	52.6	89	950	
	2011.04	-	MT	R	F	Closed Off-Road Vehicle Engine K4M 696	228005	Drive Shaft		22	22	56	107.5	707	
	2011.04	-	MT	R	F	Closed Off-Road Vehicle Engine K4M 696	228005	Drive Shaft		22	22	56	107.5	707	
	2011.04	-	-	R	F	Closed Off-Road Vehicle Engine K4M 696	641190	Inner Joint		26	33	33	329	101	
	2011.04	-	-	R	F	Closed Off-Road Vehicle Engine K4M 696	850148	Outer Joint		25	35	52.6	89	60	I
	2011.04	-	-	-	-	Closed Off-Road Vehicle Engine K4M 696	650105	Inner Joint		27	33	40	70.5	111	
	2011.04	-	-	-	-	Closed Off-Road Vehicle Engine K4M 696	650106	Inner Joint		31	33	42	0	133.5	
	2011.04	-	-	L	F	Closed Off-Road Vehicle Engine K4M 696	250415	Drive Shaft		25	26	52.6	89	704	
	1.6 SCe 115 (84 kW)	2015.06	-	5MT	L	F	Closed Off-Road Vehicle Engine H4M 438/H4M 738	250587	Drive Shaft		25	26	52.6	89	700
2015.06		-	5MT	L	F	Box	250587	Drive Shaft		25	26	52.6	89	700	
2015.06		-	6MT	L/R	R	All-wheel Drive Closed Off-Road Vehicle Engine H4M 430/H4M 730/H4M 738	257265	Drive Shaft	48T	25	21	52.2	88.5	824	
2015.06		-	6MT	L/R	R	All-wheel Drive Box	257265	Drive Shaft	48T	25	21	52.2	88.5	824	
2015.06		-	5MT	R	F	Closed Off-Road Vehicle Engine H4M 438/H4M 738	250586	Drive Shaft		25	26	52.6	89	950	
2015.06		-	5MT	R	F	Box	250586	Drive Shaft		25	26	52.6	89	950	
2015.06		-	MT	R	F	Closed Off-Road Vehicle Engine H4M 438/H4M 738	228005	Drive Shaft		22	22	56	107.5	707	
2015.06		-	MT	R	F	Box	228005	Drive Shaft		22	22	56	107.5	707	
2015.06		-	MT	R	F	Closed Off-Road Vehicle Engine H4M 438/H4M 738	228005	Drive Shaft		22	22	56	107.5	707	





YEAR	TRANSM	L/R	F/R	REMARKS	GSP Ref.	PRODUCT	ABS	Technical Specifications							
								A	B	C	H	L	P		
DACIA															
DUSTER															
1.6 SCe 115 (84 kW)	2015.06-	-	MT	R	F	Box	228005	Drive Shaft		22	22	56	107.5	707	
	2015.06-	-	-	-	-	Closed Off-Road Vehicle Engine H4M 438/H4M 738	650105	Inner Joint		27	33	40	70.5	111	
	2015.06-	-	-	-	-	All-wheel Drive Closed Off-Road Vehicle Engine H4M 430/H4M 730/H4M 738	650105	Inner Joint		27	33	40	70.5	111	
	2015.06-	-	-	-	-	Closed Off-Road Vehicle Engine H4M 438/H4M 738	650106	Inner Joint		31	33	42	0	133.5	
	2015.06-	-	-	-	-	All-wheel Drive Closed Off-Road Vehicle Engine H4M 430/H4M 730/H4M 738	650106	Inner Joint		31	33	42	0	133.5	
	2017.1-	-	5MT	L	F	Closed Off-Road Vehicle Engine H4M 738	250587	Drive Shaft		25	26	52.6	89	700	
	2017.1-	-	6MT	L/R	R	All-wheel Drive Closed Off-Road Vehicle	257265	Drive Shaft	48T	25	21	52.2	88.5	824	
	2017.1-	-	5MT	R	F	Closed Off-Road Vehicle Engine H4M 738	250586	Drive Shaft		25	26	52.6	89	950	
1.6 SCe 115 LPG (84 kW)	2015.06-	-	5MT	L	F	Closed Off-Road Vehicle Engine H4M 740	250587	Drive Shaft		25	26	52.6	89	700	
	2015.06-	-	5MT	R	F	Closed Off-Road Vehicle Engine H4M 740	250586	Drive Shaft		25	26	52.6	89	950	
	2015.06-	-	MT	R	F	Closed Off-Road Vehicle Engine H4M 740	228005	Drive Shaft		22	22	56	107.5	707	
	2015.06-	-	MT	R	F	Closed Off-Road Vehicle Engine H4M 740	228005	Drive Shaft		22	22	56	107.5	707	
	2015.06-	-	-	-	-	Closed Off-Road Vehicle Engine H4M 740	650105	Inner Joint		27	33	40	70.5	111	
	2015.06-	-	-	-	-	Closed Off-Road Vehicle Engine H4M 740	650106	Inner Joint		31	33	42	0	133.5	
1.6 SCe 115 LPG(80 kW)	2017.1-	-	5MT	L	F	Closed Off-Road Vehicle	250587	Drive Shaft		25	26	52.6	89	700	
	2017.1-	-	5MT	R	F	Closed Off-Road Vehicle	250586	Drive Shaft		25	26	52.6	89	950	
LODGY															
1.2 TCe (85 kW)	2012.03-	-	MT	L	F	Estate Engine H5F 402	650057	Inner Joint		26	22	40	64	104	
	2012.03-	-	MT	L	F	Estate Engine H5F 402	211024	Drive Shaft		25	26	52.5	88.5	653	
	2012.03-	-	-	-	-	R Estate Engine H5F 402	812034	Outer Joint		24	20	44	113.5	48.5	I
	2012.03-	-	MT	L/R	F	Estate Engine H5F 402	850162	Outer Joint		25	23	52.5	88.5	60.5	M
1.5 dCi (66 kW)	2012.03-	-	-	-	-	R Estate Engine K9K 612	812034	Outer Joint		24	20	44	113.5	48.5	I
	2012.03-	-	MT	L/R	F	Estate Engine K9K 612	850162	Outer Joint		25	23	52.5	88.5	60.5	M
1.5 dCi (79 kW)	2013.01-	-	-	-	-	R Estate Engine K9K 846	812034	Outer Joint		24	20	44	113.5	48.5	I
	2013.01-	-	MT	L/R	F	Estate Engine K9K 846	850162	Outer Joint		25	23	52.5	88.5	60.5	M
1.5 dCi (80 kW)	2015.06-	-	-	-	-	R Estate	812034	Outer Joint		24	20	44	113.5	48.5	I
1.5 dCi (81 kW)	2012.03-	-	-	-	-	R Estate Engine K9K 846	812034	Outer Joint		24	20	44	113.5	48.5	I
1.6 (61 kW)	2012.03-	-	MT	L/R	F	Estate Engine K7M 812	850162	Outer Joint		25	23	52.5	88.5	60.5	M
	2012.03-	-	-	-	-	R Estate Engine K7M 812	812034	Outer Joint		24	20	44	113.5	48.5	I
1.6 LPG (61 kW)	2013.11-	-	-	-	-	R Estate Engine K7M 812/K7M 828	812034	Outer Joint		24	20	44	113.5	48.5	I
1.6 LPG (75 kW)	2015.04-	-	-	-	-	R Estate	812034	Outer Joint		24	20	44	113.5	48.5	I
1.6 SCe 115 (75 kW)	2015.06-	-	-	-	-	R Estate Engine H4M 740	812034	Outer Joint		24	20	44	113.5	48.5	I
LOGAN															
0.9	2015-	-	-	L	F	JH3336 5DR BENSIN ENGINE:H4B400	250512	Drive Shaft		23	26	49	86	658	
	2015-	-	5MT	L	F	5DR CBI BENSIN ENGINE:H4B400	250512	Drive Shaft		23	26	49	86	658	
	2015-	-	-	L	F	JH3336 5DR BENSIN ENGINE:H4B400	650118	Inner Joint		26	22	40	64	104	
	2015-	-	5MT	L	F	5DR CBI BENSIN ENGINE:H4B400	650118	Inner Joint		26	22	40	64	104	
LOGAN (LS_)															
1.2 16V (55 kW)	2006.02-	-	5MT	R	F	Estate Engine D4F 732	211023	Drive Shaft		21	23	49	84	761	
	2006.02-	-	5MT	R	F	Estate Engine D4F 732	650124	Inner joint		23	28	36.3		115	
	2006.02-	-	5MT	R	F	Estate Engine D4F 732	811004	Outer Joint		21	28	49	84	53.5	I
	2006.02-	-	-	R	F	Estate Engine D4F 732	650008	Inner Joint		23	30	36.3	52.2	68.5	
1.2 16V LPG (55 kW)	2006.02-	-	5MT	R	F	Estate Engine D4F 734	811004	Outer Joint		21	28	49	84	53.5	I
	2006.02-	-	5MT	R	F	Estate Engine D4F 734	211023	Drive Shaft		21	23	49	84	761	
	2006.02-	-	5MT	R	F	Estate Engine D4F 734	650124	Inner joint		23	28	36.3		115	
	2006.02-	-	MT	R	F	Estate Engine D4F 734	245085	Drive Shaft		21	23	49	84	763	
	2006.02-	-	MT	R	F	Estate Engine D4F 734	650008	Inner Joint		23	30	36.3	52.2	68.5	
1.4 (55 kW)	2004.09-	-	5MT	R	F	Estate Engine K7J 710	650124	Inner joint		23	28	36.3		115	
	2004.09-	-	5MT	R	F	Estate Engine K7J 710	211023	Drive Shaft		21	23	49	84	761	
	2004.09-	-	MT	L	F	Estate Engine K7J 710	245084	Drive Shaft		21	29.95	49	84	681	
	2004.09-	-	MT	R	F	Estate Engine K7J 710	245085	Drive Shaft		21	23	49	84	763	
	2004.09-	-	MT	R	F	Estate Engine K7J 710	650008	Inner Joint		23	30	36.3	52.2	68.5	
	2004.09-	-	-	-	-	R Estate Engine K7J 710	812034	Outer Joint		24	20	44	113.5	48.5	I
	2004.09-	-	5MT	R	F	Estate Engine K7J 710	811004	Outer Joint		21	28	49	84	53.5	I
1.4 MPI LPG (55 kW)	2006.02-	-	5MT	R	F	Estate Engine K7J 710/K7J 714	211023	Drive Shaft		21	23	49	84	761	
	2006.02-	-	-	L	F	Estate Engine K7J 710/K7J 714	245084	Drive Shaft		21	29.95	49	84	681	
	2006.02-	-	5MT	R	F	Estate Engine K7J 710/K7J 714	650124	Inner joint		23	28	36.3		115	
	2006.02-	-	-	R	F	Estate Engine K7J 710/K7J 714	245085	Drive Shaft		21	23	49	84	763	
	2006.02-	-	-	R	F	Estate Engine K7J 710/K7J 714	650008	Inner Joint		23	30	36.3	52.2	68.5	
	2006.02-	-	-	-	-	R Estate Engine K7J 710/K7J 714	812034	Outer Joint		24	20	44	113.5	48.5	I
	2006.02-	-	5MT	R	F	Estate Engine K7J 710/K7J 714	811004	Outer Joint		21	28	49	84	53.5	I
1.5 dCi (48 kW)	2005.09-	-	MT	L	F	Estate Engine K9K 790	211012	Drive Shaft		23	29.95	49	83.5	681	
	2005.09-	-	MT	R	F	Estate Engine K9K 790	211014	Drive Shaft		23	23	49	83.5	755	
1.5 dCi (50 kW)	2006.01-	-	-	R	F	Estate Engine K9K 792	699169	Inner Joint		26	30	33	326	95	
	2006.01-	-	MT	L	F	Estate Engine K9K 792	211012	Drive Shaft		23	29.95	49	83.5	681	
	2006.01-	-	MT	R	F	Estate Engine K9K 792	211014	Drive Shaft		23	23	49	83.5	755	

	 YEAR	TRANSM	L/R	F/R	REMARKS	GSP Ref.	 PRODUCT	 ABS	Technical Specifications					
									A	B	C	H	L	P
DACIA														
LOGAN (LS_)														
1.5 dCi (50 kW)	2006.01-	-	-	R	Estate Engine K9K 792	812034	Outer Joint		24	20	44	113.5	48.5	I
	2006.01-	-	-	F	Estate Engine K9K 792	899085	Outer Joint		23	30	49	86	59	I
	2006.01-	-	-	R	F Estate Engine K9K 792	250354	Drive Shaft		23	26	49	86	897	
	2006.01-	-	-	L	F Estate Engine K9K 792	250353	Drive Shaft		23	26	49	86	649	
1.5 dCi (55 kW)	2010.05-	-	-	L	F Estate Engine K9K 892	250570	Drive Shaft		23	26	49	83.5	647	
1.5 dCi (63 kW)	2007.09-	-	-	R	F Estate Engine K9K 796	699169	Inner Joint		26	30	33	326	95	
	2007.09-	-	-	L	F Estate Engine K9K 796	250570	Drive Shaft		23	26	49	83.5	647	
	2007.09-	-	-	R	F Estate Engine K9K 796	250593	Drive Shaft		23	26	49	83.5	890	
	2007.09-	-	-	R	F Estate Engine K9K 796	250354	Drive Shaft		23	26	49	86	897	
	2007.09-	-	-	L	F Estate Engine K9K 796	250353	Drive Shaft		23	26	49	86	649	
	2007.09-	-	-	-	F Estate Engine K9K 796	899085	Outer Joint		23	30	49	86	59	I
1.5 dCi (65 kW)	2010.05-	-	-	L	F Estate Engine K9K 892	250570	Drive Shaft		23	26	49	83.5	647	
1.6 (64 kW)	2004.09-	-	5MT	R	F Estate Engine K7M 710	650124	Inner joint		23	28	36.3		115	
	2004.09-	-	5MT	R	- Estate Engine K7M 710	211023	Drive Shaft		21	23	49	84	761	
	2004.09-	-	MT	L	F Estate Engine K7M 710	245084	Drive Shaft		21	29.95	49	84	681	
	2004.09-	-	MT	R	F Estate Engine K7M 710	245085	Drive Shaft		21	23	49	84	763	
	2004.09-	-	MT	R	F Estate Engine K7M 710	650008	Inner Joint		23	30	36.3	52.2	68.5	
	2004.09-	-	5MT	R	F Estate Engine K7M 710	811004	Outer Joint		21	28	49	84	53.5	I
1.6 16V (77 kW)	2006.02-	-	-	R	F Estate Engine K4M 696/K4M 690	699169	Inner Joint		26	30	33	326	95	
	2006.02-	-	MT	L	F Estate Engine K4M 696/K4M 690	211012	Drive Shaft		23	29.95	49	83.5	681	
	2006.02-	-	MT	R	F Estate Engine K4M 696/K4M 690	211014	Drive Shaft		23	23	49	83.5	755	
	2006.02-	-	-	R	Estate Engine K4M 696/K4M 690	812034	Outer Joint		24	20	44	113.5	48.5	I
	2006.02-	-	-	R	F Estate Engine K4M 696/K4M 690	250354	Drive Shaft		23	26	49	86	897	
	2006.02-	-	-	L	F Estate Engine K4M 696/K4M 690	250353	Drive Shaft		23	26	49	86	649	
	2006.02-	-	AT	L	F Estate Engine K4M 696/K4M 690	250574	Drive Shaft		23	26	49	86	652	
	2006.02-	-	AT	R	F Estate Engine K4M 696/K4M 690	250443	Drive Shaft		23	23	49	86	789	
1.6 16V Flexifuel (77 kW)	2010.07-	-	MT	L	F Estate Engine K4M 696	250570	Drive Shaft		23	26	49	83.5	647	
	2010.07-	-	MT	R	F Estate Engine K4M 696	250593	Drive Shaft		23	26	49	83.5	890	
1.6 Bifuel (62 kW)	2010.05-	-	5MT	R	F Estate Engine K7M 718	811004	Outer Joint		21	28	49	84	53.5	I
	2010.05-	-	5MT	R	F Estate Engine K7M 718	211023	Drive Shaft		21	23	49	84	761	
	2010.05-	-	5MT	R	F Estate Engine K7M 718	650124	Inner joint		23	28	36.3		115	
	2010.05-	-	MT	R	F Estate Engine K7M 718	245085	Drive Shaft		21	23	49	84	763	
	2010.05-	-	MT	R	F Estate Engine K7M 718	650008	Inner Joint		23	30	36.3	52.2	68.5	
	2010.05-	-	-	R	Estate Engine K7M 718	812034	Outer Joint		24	20	44	113.5	48.5	I
1.6 MPI 85 (62 kW)	2010.05-	-	5MT	R	F Estate Engine K7M 800	211023	Drive Shaft		21	23	49	84	761	
	2010.05-	-	5MT	R	F Estate Engine K7M 800	650124	Inner joint		23	28	36.3		115	
	2010.05-	-	-	R	F Estate Engine K7M 800	245085	Drive Shaft		21	23	49	84	763	
	2010.05-	-	5MT	R	F Estate Engine K7M 800	811004	Outer Joint		21	28	49	84	53.5	I
	2010.05-	-	-	R	F Estate Engine K7M 800	650008	Inner Joint		23	30	36.3	52.2	68.5	
	2010.05-	-	-	R	Estate Engine K7M 800	812034	Outer Joint		24	20	44	113.5	48.5	I
LOGAN (US_)														
1.4 (55 kW)	2009.01-	-	-	R	Pickup Engine K7J 710	812034	Outer Joint		24	20	44	113.5	48.5	I
1.5 dCi (50 kW)	2008.03-	-	-	L	F Pickup Engine K9K 792	250570	Drive Shaft		23	26	49	83.5	647	
	2008.03-	-	-	R	F Pickup Engine K9K 792	250593	Drive Shaft		23	26	49	83.5	890	
	2008.03-	-	-	R	Pickup Engine K9K 792	812034	Outer Joint		24	20	44	113.5	48.5	I
1.5 dCi (55 kW)	2010.05-	-	-	L	F Pickup Engine K9K 892	250570	Drive Shaft		23	26	49	83.5	647	
	2010.05-	-	-	R	F Pickup Engine K9K 892	250593	Drive Shaft		23	26	49	83.5	890	
	2010.05-	-	-	R	Pickup Engine K9K 892	812034	Outer Joint		24	20	44	113.5	48.5	I
1.5 dCi (63 kW)	2008.03-	-	-	L	F Pickup Engine K9K 796	250570	Drive Shaft		23	26	49	83.5	647	
	2008.03-	-	-	R	F Pickup Engine K9K 796	250593	Drive Shaft		23	26	49	83.5	890	
	2008.03-	-	-	R	Pickup Engine K9K 796	812034	Outer Joint		24	20	44	113.5	48.5	I
1.5 dCi (65 kW)	2010.05-	-	-	L	F Pickup Engine K9K 892	250570	Drive Shaft		23	26	49	83.5	647	
	2010.05-	-	-	R	F Pickup Engine K9K 892	250593	Drive Shaft		23	26	49	83.5	890	
	2010.05-	-	-	R	Pickup Engine K9K 892	812034	Outer Joint		24	20	44	113.5	48.5	I
1.6 (64 kW)	2008.03-	-	-	L	F Pickup Engine K7M 710	250570	Drive Shaft		23	26	49	83.5	647	
	2008.03-	-	-	R	F Pickup Engine K7M 710	250593	Drive Shaft		23	26	49	83.5	890	
	2008.03-	-	-	R	Pickup Engine K7M 710	812034	Outer Joint		24	20	44	113.5	48.5	I
1.6 Bifuel (62 kW)	2010.05-	-	-	L	F Pickup Engine K7M 800	250570	Drive Shaft		23	26	49	83.5	647	
	2010.05-	-	-	R	F Pickup Engine K7M 800	250593	Drive Shaft		23	26	49	83.5	890	
	2010.05-	-	-	R	Pickup Engine K7M 800	812034	Outer Joint		24	20	44	113.5	48.5	I
1.6 MPI 85 (62 kW)	2010.05-	-	-	L	F Pickup Engine K7M 800	250570	Drive Shaft		23	26	49	83.5	647	
	2010.05-	-	-	R	F Pickup Engine K7M 800	250593	Drive Shaft		23	26	49	83.5	890	
	2010.05-	-	-	R	Pickup Engine K7M 800	812034	Outer Joint		24	20	44	113.5	48.5	I
LOGAN EXPRESS (FS_)														
1.4 (55 kW)	2009.03-	-	-	R	F Box Engine K7J 710	699169	Inner Joint		26	30	33	326	95	
	2009.03-	-	-	R	Box Engine K7J 710	812034	Outer Joint		24	20	44	113.5	48.5	I

	 YEAR	TRANSM	L/R	F/R	REMARKS	GSP Ref.	 PRODUCT	 ABS	Technical Specifications					
									A	B	C	H	L	P
DACIA														
LOGAN EXPRESS (FS_)														
1.4 (55 kW)	2009.03-	-	-	R	F	Box Engine K7J 710	250354	Drive Shaft	23	26	49	86	897	
	2009.03-	-	-	L	F	Box Engine K7J 710	250353	Drive Shaft	23	26	49	86	649	
1.5 dCi (50 kW)	2009.03-	-	-	R	F	Box Engine K9K 792	699169	Inner Joint	26	30	33	326	95	
	2009.03-	-	-	L	F	Box Engine K9K 792	250570	Drive Shaft	23	26	49	83.5	647	
	2009.03-	-	-	R	F	Box Engine K9K 792	250593	Drive Shaft	23	26	49	83.5	890	
	2009.03-	-	-	R	F	Box Engine K9K 792	812034	Outer Joint	24	20	44	113.5	48.5	I
	2009.03-	-	-	R	F	Box Engine K9K 792	250354	Drive Shaft	23	26	49	86	897	
	2009.03-	-	-	L	F	Box Engine K9K 792	250353	Drive Shaft	23	26	49	86	649	
1.5 dCi (55 kW)	2010.05-	-	-	R	F	Box Engine K9K 892	699169	Inner Joint	26	30	33	326	95	
	2010.05-	-	-	L	F	Box Engine K9K 892	250570	Drive Shaft	23	26	49	83.5	647	
	2010.05-	-	-	R	F	Box Engine K9K 892	812034	Outer Joint	24	20	44	113.5	48.5	I
	2010.05-	-	-	L	F	Box Engine K9K 892	250353	Drive Shaft	23	26	49	86	649	
	2010.05-	-	-	R	F	Box Engine K9K 892	250354	Drive Shaft	23	26	49	86	897	
1.5 dCi (63 kW)	2009.03-	-	-	L	F	Box Engine K9K 796	250570	Drive Shaft	23	26	49	83.5	647	
	2009.03-	-	-	R	F	Box Engine K9K 796	250593	Drive Shaft	23	26	49	83.5	890	
	2009.03-	-	-	R	F	Box Engine K9K 796	812034	Outer Joint	24	20	44	113.5	48.5	I
1.5 dCi (65 kW)	2010.05-	-	-	R	F	Box Engine K9K 892	699169	Inner Joint	26	30	33	326	95	
	2010.05-	-	-	L	F	Box Engine K9K 892	250570	Drive Shaft	23	26	49	83.5	647	
	2010.05-	-	-	R	F	Box Engine K9K 892	812034	Outer Joint	24	20	44	113.5	48.5	I
	2010.05-	-	-	R	F	Box Engine K9K 892	250354	Drive Shaft	23	26	49	86	897	
	2010.05-	-	-	L	F	Box Engine K9K 892	250353	Drive Shaft	23	26	49	86	649	
1.6 (64 kW)	2009.03-	-	-	R	F	Box Engine K7M 710	699169	Inner Joint	26	30	33	326	95	
	2009.03-	-	-	L	F	Box Engine K7M 710	250570	Drive Shaft	23	26	49	83.5	647	
	2009.03-	-	-	R	F	Box Engine K7M 710	250593	Drive Shaft	23	26	49	83.5	890	
	2009.03-	-	-	R	F	Box Engine K7M 710	812034	Outer Joint	24	20	44	113.5	48.5	I
	2009.03-	-	-	R	F	Box Engine K7M 710	250354	Drive Shaft	23	26	49	86	897	
	2009.03-	-	-	L	F	Box Engine K7M 710	250353	Drive Shaft	23	26	49	86	649	
1.6 MPI 85 (62 kW)	2010.05-	-	-	R	F	Box Engine K7M 800	699169	Inner Joint	26	30	33	326	95	
	2010.05-	-	-	L	F	Box Engine K7M 800	250570	Drive Shaft	23	26	49	83.5	647	
	2010.05-	-	-	R	F	Box Engine K7M 800	812034	Outer Joint	24	20	44	113.5	48.5	I
	2010.05-	-	-	R	F	Box Engine K7M 800	250354	Drive Shaft	23	26	49	86	897	
	2010.05-	-	-	L	F	Box Engine K7M 800	250353	Drive Shaft	23	26	49	86	649	
LOGAN II														
0.9 (66 kW)	2012.10-	-	-	-	-	Saloon Engine H4B 400	850173	Outer Joint	23	22	49	86	57	M
1.2 (54 kW)	2015.05-	-	-	L/R	F	Saloon	850219	Outer Joint	23	28	49	86	52	I
1.2 (55 kW)	2012.10-	-	-	L	F	Saloon Engine D4F 732	211021	Drive Shaft	23	30	49	86	683	
	2012.10-	-	-	L/R	F	Saloon Engine D4F 732	850219	Outer Joint	23	28	49	86	52	I
1.2 LPG (55 kW)	2012.10-	-	-	L	F	Saloon Engine D4F 734	211021	Drive Shaft	23	30	49	86	683	
	2012.10-	-	-	L/R	F	Saloon Engine D4F 734	850219	Outer Joint	23	28	49	86	52	I
1.5 dCi (66 kW)	2012.10-	-	-	-	-	Saloon Engine K9K 612	850173	Outer Joint	23	22	49	86	57	M
TCe 90 LPG (66 kW)	2015.09-	-	-	-	-	Saloon	850173	Outer Joint	23	22	49	86	57	M
LOGAN MCV (KS_)														
1.4 (55 kW)	2007.02-	-	-	L	F	Estate Engine K7J 710	211012	Drive Shaft	23	29.95	49	83.5	681	
	2007.02-	-	-	R	F	Estate Engine K7J 710	211014	Drive Shaft	23	23	49	83.5	755	
	2007.02-	-	-	R	F	Estate Engine K7J 710	812034	Outer Joint	24	20	44	113.5	48.5	I
	2007.02-	-	-	F	F	Estate Engine K7J 710	899085	Outer Joint	23	30	49	86	59	I
1.5 dCi (50 kW)	2007.02-	-	-	R	F	Estate Engine K9K 792	699169	Inner Joint	26	30	33	326	95	
	2007.02-	-	-	L	F	Estate Engine K9K 792	250570	Drive Shaft	23	26	49	83.5	647	
	2007.02-	-	-	R	F	Estate Engine K9K 792	812034	Outer Joint	24	20	44	113.5	48.5	I
	2007.02-	-	-	R	F	Estate Engine K9K 792	250354	Drive Shaft	23	26	49	86	897	
	2007.02-	-	-	L	F	Estate Engine K9K 792	250353	Drive Shaft	23	26	49	86	649	
	2007.02-	-	-	F	F	Estate Engine K9K 792	899085	Outer Joint	23	30	49	86	59	I
1.5 dCi (55 kW)	2010.05-	-	-	L	F	Estate Engine K9K 892	250570	Drive Shaft	23	26	49	83.5	647	
	2010.05-	-	-	R	F	Estate Engine K9K 892	250593	Drive Shaft	23	26	49	83.5	890	
1.5 dCi (63 kW)	2007.09-	-	-	L	F	Estate Engine K9K 796	250570	Drive Shaft	23	26	49	83.5	647	
	2007.09-	-	-	R	F	Estate Engine K9K 796	250593	Drive Shaft	23	26	49	83.5	890	
	2007.09-	-	-	F	F	Estate Engine K9K 796	899085	Outer Joint	23	30	49	86	59	I
1.5 dCi (65 kW)	2010.05-	-	-	L	F	Estate Engine K9K 892	250570	Drive Shaft	23	26	49	83.5	647	
	2010.05-	-	-	R	F	Estate Engine K9K 892	250593	Drive Shaft	23	26	49	83.5	890	
1.6 (64 kW)	2007.02-	-	-	R	F	Estate Engine K7M 710	699169	Inner Joint	26	30	33	326	95	
	2007.02-	-	-	L	F	Estate Engine K7M 710	250570	Drive Shaft	23	26	49	83.5	647	
	2007.02-	-	-	L	F	Estate Engine K7M 710	211012	Drive Shaft	23	29.95	49	83.5	681	
	2007.02-	-	-	R	F	Estate Engine K7M 710	211014	Drive Shaft	23	23	49	83.5	755	
	2007.02-	-	-	R	F	Estate Engine K7M 710	250354	Drive Shaft	23	26	49	86	897	
	2007.02-	-	-	L	F	Estate Engine K7M 710	250353	Drive Shaft	23	26	49	86	649	
	2007.02-	-	-	F	F	Estate Engine K7M 710	899085	Outer Joint	23	30	49	86	59	I

	 YEAR	TRANSM	L/R	F/R	REMARKS	GSP Ref.	 PRODUCT	 ABS	Technical Specifications									
									A	B	C	H	L	P				
DACIA																		
LOGAN MCV (KS_)																		
1.6 16V (77 kW)	2007.02-	-	MT	R	F	Estate Engine K4M 690/K4M 696	699169	Inner Joint		26	30	33	326	95				
	2007.02-	-	MT	L	F	Estate Engine K4M 690/K4M 696	250570	Drive Shaft		23	26	49	83.5	647				
	2007.02-	-	-	-	R	Estate Engine K4M 690/K4M 696	812034	Outer Joint		24	20	44	113.5	48.5	I			
	2007.02-	-	MT	R	F	Estate Engine K4M 690/K4M 696	250354	Drive Shaft		23	26	49	86	897				
	2007.02-	-	MT	L	F	Estate Engine K4M 690/K4M 696	250353	Drive Shaft		23	26	49	86	649				
	2007.02-	-	-	-	F	Estate Engine K4M 690/K4M 696	899085	Outer Joint		23	30	49	86	59	I			
	2007.02-	-	AT	L	F	Estate Engine K4M 690/K4M 696	250574	Drive Shaft		23	26	49	86	652				
	2007.02-	-	AT	R	F	Estate Engine K4M 690/K4M 696	250443	Drive Shaft		23	23	49	86	789				
1.6 16V Hi-Flex (77 kW)	2009.11-	-	-	-	R	F	Estate Engine K4M 690	699169	Inner Joint		26	30	33	326	95			
	2009.11-	-	-	-	R	F	Estate Engine K4M 690	250354	Drive Shaft		23	26	49	86	897			
	2009.11-	-	-	-	L	F	Estate Engine K4M 690	250353	Drive Shaft		23	26	49	86	649			
1.6 Bifuel (62 kW)	2010.05-	-	-	-	L	F	Estate Engine K7M 718	211012	Drive Shaft		23	29.95	49	83.5	681			
	2010.05-	-	-	-	R	F	Estate Engine K7M 718	211014	Drive Shaft		23	23	49	83.5	755			
	2010.05-	-	-	-	R	F	Estate Engine K7M 718	812034	Outer Joint		24	20	44	113.5	48.5	I		
1.6 Bifuel (64 kW)	2008.11-	-	-	-	L	F	Estate Engine K7M 710	211012	Drive Shaft		23	29.95	49	83.5	681			
	2008.11-	-	-	-	R	F	Estate Engine K7M 710	211014	Drive Shaft		23	23	49	83.5	755			
	2008.11-	-	-	-	R	F	Estate Engine K7M 710	812034	Outer Joint		24	20	44	113.5	48.5	I		
1.6 MPI 85 (62 kW)	2010.05-	-	-	-	L	F	Estate Engine K7M 800	211012	Drive Shaft		23	29.95	49	83.5	681			
	2010.05-	-	-	-	R	F	Estate Engine K7M 800	211014	Drive Shaft		23	23	49	83.5	755			
	2010.05-	-	-	-	R	F	Estate Engine K7M 800	812034	Outer Joint		24	20	44	113.5	48.5	I		
LOGAN MCV II																		
0.9 (66 kW)	2013.02-	-	-	-	-	Estate Engine H4B 400	850173	Outer Joint		23	22	49	86	57	M			
0.9 LPG (66 kW)	2015.09-	-	-	-	-	Estate	850173	Outer Joint		23	22	49	86	57	M			
1.2 (54 kW)	2015.05-	-	-	-	L	F	Estate Engine D4F 732	211021	Drive Shaft		23	30	49	86	683			
	2015.05-	-	-	-	L/R	F	Estate Engine D4F 732	850219	Outer Joint		23	28	49	86	52	I		
1.2 (55 kW)	2013.02-	-	-	-	L	F	Estate Engine D4F 732	211021	Drive Shaft		23	30	49	86	683			
	2013.02-	-	-	-	L/R	F	Estate Engine D4F 732	850219	Outer Joint		23	28	49	86	52	I		
1.2 LPG (55 kW)	2013.02-	-	-	-	L	F	Estate Engine D4F 734	211021	Drive Shaft		23	30	49	86	683			
	2013.02-	-	-	-	L/R	F	Estate Engine D4F 734	850219	Outer Joint		23	28	49	86	52	I		
1.5 dCi (66 kW)	2013.02-	-	-	-	-	Estate Engine K9K 612	850173	Outer Joint		23	22	49	86	57	M			
1.6 (62 kW)	2013.06-	-	-	-	L/R	F	Estate Engine K7M 812	850219	Outer Joint		23	28	49	86	52	I		
PICK UP																		
1.4 i	2001-	-	-	-	R	F	-	650058	Inner Joint		23	22	36.3	40	64.5			
	2001-	-	-	-	R	F	-	250098	Drive Shaft		20	23	54	86	630			
1.5 DCi	2001-	-	-	-	R	F	-	650058	Inner Joint		23	22	36.3	40	64.5			
	2001-	-	-	-	R	F	-	250098	Drive Shaft		20	23	54	86	630			
1.9 D	2001-	-	-	-	R	F	-	650058	Inner Joint		23	22	36.3	40	64.5			
	2001-	-	-	-	R	F	-	250098	Drive Shaft		20	23	54	86	630			
SANDERO																		
0.9	2013-	-	-	-	L	F	5VXL 5DR MPV BENSIN ENGINE:H4B400	250512	Drive Shaft		23	26	49	86	658			
	2013-	-	-	-	L	F	5VXL 5DR MPV BENSIN ENGINE:H4B400	650118	Inner Joint		26	22	40	64	104			
	2013-	-	-	-	L	F	JH3336 5VXL 5DR SUV BENSIN ENGINE:H4B400	250508	Drive Shaft		23	26	49	86	660			
	2013-	-	-	-	L	F	JH3336 5VXL 5DR SUV BENSIN ENGINE:H4B400	850175	Outer Joint		23	22	49	86	58.5	I		
	2013-	-	-	-	L	F	JH3336 5VXL 5DR SUV BENSIN ENGINE:H4B400	650117	Inner Joint		26	22	40	64	106			
	2014-	-	-	-	R	F	U153246 JH3336 S054437 5DR CC BE ENGINE:H4B400	250507	Drive Shaft		23	26	49	86	898			
	2014-	-	-	-	R	F	U153246 JH3336 S054437 5DR CC BE ENGINE:H4B400	850175	Outer Joint		23	22	49	86	58.5	I		
	2014-	-	-	-	R	F	U153246 JH3336 S054437 5DR CC BE ENGINE:H4B400	650107	Inner Joint		26	21	40	64	105.5			
	2015-	-	5MT	-	R	F	3 CYL INSPR 0.9 5 VAX MAN 5DR CC BENSIN ENGINE:H4B400 D000659	250507	Drive Shaft		23	26	49	86	898			
	2015-	-	5MT	-	R	F	3 CYL INSPR 0.9 5 VAX MAN 5DR CC BENSIN ENGINE:H4B400 D000659	850175	Outer Joint		23	22	49	86	58.5	I		
	2015-	-	5MT	-	R	F	3 CYL INSPR 0.9 5 VAX MAN 5DR CC BENSIN ENGINE:H4B400 D000659	650107	Inner Joint		26	21	40	64	105.5			
	2015-	-	5MT	-	L	F	JH3336 S148557 5DR C ENGINE:H4B400 D212617	250508	Drive Shaft		23	26	49	86	660			
	2015-	-	5MT	-	L	F	JH3336 S148557 5DR C ENGINE:H4B400 D212617	850175	Outer Joint		23	22	49	86	58.5	I		
	2015-	-	5MT	-	L	F	JH3336 S148557 5DR C ENGINE:H4B400 D212617	650117	Inner Joint		26	22	40	64	106			
	2016-	-	5MT	-	L	F	CC BENSIN ; HatchbackENGINE:H4B 408	250512	Drive Shaft		23	26	49	86	658			
	2016-	-	5MT	-	L	F	CC BENSIN ; HatchbackENGINE:H4B 408	650118	Inner Joint		26	22	40	64	104			
	2016-	-	5MT	-	R	F	5 VXL 5DR SUV BENSIN	250507	Drive Shaft		23	26	49	86	898			
	2016-	-	5MT	-	R	F	5 VXL 5DR SUV BENSIN	850175	Outer Joint		23	22	49	86	58.5	I		
	2016-	-	5MT	-	R	F	5 VXL 5DR SUV BENSIN	650107	Inner Joint		26	21	40	64	105.5			
	2016-	-	-	-	L	F	JS3002 S003496 5DR SUV BE ENGINE:H4B408 U045143	250508	Drive Shaft		23	26	49	86	660			
	2016-	-	5MT	-	L	F	SUV BENSIN	250508	Drive Shaft		23	26	49	86	660			
	2016-	-	-	-	L	F	JS3002 S003496 5DR SUV BE ENGINE:H4B408 U045143	850175	Outer Joint		23	22	49	86	58.5	I		
	2016-	-	5MT	-	L	F	SUV BENSIN	850175	Outer Joint		23	22	49	86	58.5	I		
	2016-	-	-	-	L	F	JS3002 S003496 5DR SUV BE ENGINE:H4B408 U045143	650117	Inner Joint		26	22	40	64	106			
	2016-	-	5MT	-	L	F	SUV BENSIN	650117	Inner Joint		26	22	40	64	106			
1.2 16V (55 kW)	2008.11-	-	-	-	L	F	Hatchback Engine D4F 732	245084	Drive Shaft		21	29.95	49	84	681			
	2008.11-	-	5MT	-	R	F	Hatchback Engine D4F 732	211023	Drive Shaft		21	23	49	84	761			





	 YEAR	TRANSM	L/R	F/R	REMARKS	GSP Ref.	 PRODUCT	 ABS	Technical Specifications						
									A	B	C	H	L	P	
DACIA SANDERO															
1.2 16V (55 kW)	2008.11-	-	5MT	R	F	Hatchback Engine D4F 732	650124	Inner joint		23	28	36.3		115	
	2008.11-	-	-	R	F	Hatchback Engine D4F 732	245085	Drive Shaft		21	23	49	84	763	
	2008.11-	-	-	R	F	Hatchback Engine D4F 732	650008	Inner Joint		23	30	36.3	52.2	68.5	
	2008.11-	-	5MT	R	F	Hatchback Engine D4F 732	811004	Outer Joint		21	28	49	84	53.5	I
1.2 16V LPG (55 kW)	2008.11-	-	5MT	R	F	Hatchback Engine D4F 732	811004	Outer Joint		21	28	49	84	53.5	I
	2008.11-	-	5MT	R	F	Hatchback Engine D4F 732	211023	Drive Shaft		21	23	49	84	761	
	2008.11-	-	5MT	R	F	Hatchback Engine D4F 732	650124	Inner joint		23	28	36.3		115	
	2008.11-	-	-	R	F	Hatchback Engine D4F 732	650008	Inner Joint		23	30	36.3	52.2	68.5	
1.4 (55 kW)	2008.06-	-	-	L	F	Hatchback Engine K7J 710	245084	Drive Shaft		21	29.95	49	84	681	
	2008.06-	-	5MT	R	F	Hatchback Engine K7J 710	650124	Inner joint		23	28	36.3		115	
	2008.06-	-	-	R	F	Hatchback Engine K7J 710	211023	Drive Shaft		21	23	49	84	761	
	2008.06-	-	-	R	F	Hatchback Engine K7J 710	245085	Drive Shaft		21	23	49	84	763	
	2008.06-	-	5MT	R	F	Hatchback Engine K7J 710	811004	Outer Joint		21	28	49	84	53.5	I
	2008.06-	-	-	R	F	Hatchback Engine K7J 710	650008	Inner Joint		23	30	36.3	52.2	68.5	
1.4 MPI LPG (53 kW)	2009.01-	-	-	R	F	Hatchback Engine K7J 714	245085	Drive Shaft		21	23	49	84	763	
	2009.01-	-	-	R	F	Hatchback Engine K7J 714	650124	Inner joint		23	28	36.3		115	
	2009.01-	-	-	R	F	Hatchback Engine K7J 714	211023	Drive Shaft		21	23	49	84	761	
	2009.01-	-	-	R	F	Hatchback Engine K7J 714	811004	Outer Joint		21	28	49	84	53.5	I
	2009.01-	-	-	R	F	Hatchback Engine K7J 714	650008	Inner Joint		23	30	36.3	52.2	68.5	
1.5 dCi (50 kW)	2008.11-	-	MT	L	F	Hatchback Engine K9K 792	250570	Drive Shaft		23	26	49	83.5	647	
	2008.11-	-	MT	R	F	Hatchback Engine K9K 792	250593	Drive Shaft		23	26	49	83.5	890	
1.5 dCi (55 kW)	2010.05-	-	-	L	F	Hatchback Engine K9K 892	250570	Drive Shaft		23	26	49	83.5	647	
	2010.05-	-	-	R	F	Hatchback Engine K9K 892	250593	Drive Shaft		23	26	49	83.5	890	
1.5 dCi (63 kW)	2008.11-	-	-	L	F	Hatchback Engine K9K 796	250570	Drive Shaft		23	26	49	83.5	647	
	2008.11-	-	-	R	F	Hatchback Engine K9K 796	250593	Drive Shaft		23	26	49	83.5	890	
1.5 dCi (65 kW)	2010.05-	-	-	L	F	Hatchback Engine K9K 892	250570	Drive Shaft		23	26	49	83.5	647	
	2010.05-	-	-	R	F	Hatchback Engine K9K 892	250593	Drive Shaft		23	26	49	83.5	890	
1.6 (64 kW)	2008.06-	-	MT	L	F	Hatchback Engine K7M 710	245084	Drive Shaft		21	29.95	49	84	681	
	2008.06-	-	MT	R	F	Hatchback Engine K7M 710	245085	Drive Shaft		21	23	49	84	763	
	2008.06-	-	5MT	R	F	Hatchback Engine K7M 710	650124	Inner joint		23	28	36.3		115	
	2008.06-	-	-	R	F	Hatchback Engine K7M 710	211023	Drive Shaft		21	23	49	84	761	
	2008.06-	-	5MT	R	F	Hatchback Engine K7M 710	811004	Outer Joint		21	28	49	84	53.5	I
	2008.06-	-	MT	R	F	Hatchback Engine K7M 710	650008	Inner Joint		23	30	36.3	52.2	68.5	
1.6 16V (77 kW)	2011.07-	-	MT	R	F	Hatchback Engine K4M 690	211018	Drive Shaft		23	26	49	86	906	
	2011.07-	-	MT	L	F	Hatchback Engine K4M 690	211022	Drive Shaft		23	26	49	86	662	
	2011.07-	-	MT	L/R	F	Hatchback Engine K4M 690	650134	Inner joint		26	30	40	64	96	
	2011.07-	-	MT	L	F	Hatchback Engine K4M 690	211012	Drive Shaft		23	29.95	49	83.5	681	
	2011.07-	-	MT	R	F	Hatchback Engine K4M 690	211014	Drive Shaft		23	23	49	83.5	755	
1.6 16V Bifuel (77 kW)	2011.01-	-	MT	R	F	Hatchback Engine K4M 690/K4M 696/K4M 694	211018	Drive Shaft		23	26	49	86	906	
	2011.01-	-	MT	L	F	Hatchback Engine K4M 690/K4M 696/K4M 694	211022	Drive Shaft		23	26	49	86	662	
	2011.01-	-	MT	L/R	F	Hatchback Engine K4M 690/K4M 696/K4M 694	650134	Inner joint		26	30	40	64	96	
1.6 LPG (62 kW)	2010.05-	2012.10	MT	R	F	Hatchback Engine K7M 818	650008	Inner Joint		23	30	36.3	52.2	68.5	
1.6 MPI 85 (62 kW)	2010.05-	-	5MT	R	F	Hatchback Engine K7M 800	811004	Outer Joint		21	28	49	84	53.5	I
	2010.05-	-	5MT	R	F	Hatchback Engine K7M 800	211023	Drive Shaft		21	23	49	84	761	
	2010.05-	-	5MT	R	F	Hatchback Engine K7M 800	650124	Inner joint		23	28	36.3		115	
	2010.05-	-	MT	R	F	Hatchback Engine K7M 800	650008	Inner Joint		23	30	36.3	52.2	68.5	
SANDERO II															
0.9 (66 kW)	2012.10-	-	-	-	-	Hatchback Engine H4B 400	850173	Outer Joint		23	22	49	86	57	M
0.9 LPG (66 kW)	2015.09-	-	-	-	-	Hatchback	850173	Outer Joint		23	22	49	86	57	M
1.2 (54 kW)	2015.05-	-	-	L/R	F	Hatchback Engine D4F 732	850219	Outer Joint		23	28	49	86	52	I
1.2 (55 kW)	2012.10-	-	-	L	F	Hatchback Engine D4F 732	211021	Drive Shaft		23	30	49	86	683	
	2012.10-	-	-	L/R	F	Hatchback Engine D4F 732	850219	Outer Joint		23	28	49	86	52	I
1.2 LPG (55 kW)	2012.10-	-	-	L	F	Hatchback Engine D4F 732	211021	Drive Shaft		23	30	49	86	683	
	2012.10-	-	-	L/R	F	Hatchback Engine D4F 732	850219	Outer Joint		23	28	49	86	52	I
1.5 dCi (55 kW)	2012.10-	-	-	-	-	Hatchback Engine K9K 612	850173	Outer Joint		23	22	49	86	57	M
1.5 dCi (66 kW)	2012.10-	-	-	-	-	Hatchback Engine K9K 626	850173	Outer Joint		23	22	49	86	57	M
	2012.10-	-	-	-	-	Hatchback Engine K9K 626	899085	Outer Joint		23	30	49	86	59	I
1.6 (61 kW)	2012.11-	-	-	L	F	Hatchback Engine K7M 812	211021	Drive Shaft		23	30	49	86	683	
	2012.11-	-	-	L/R	F	Hatchback Engine K7M 812	850219	Outer Joint		23	28	49	86	52	I
SOLENZA															
1.4 MPI	2003-	-	-	L	F	-	850030	Outer Joint		20	25	54	86	58.5	O
SOLENZA (B41_)															
1.4 (55 kW)	2003.02-	-	MT	L	F	Hatchback Engine E7J 262	211006	Drive Shaft		20	29.95	54	86	616	
	2003.02-	-	MT	R	F	Hatchback Engine E7J 262	211007	Drive Shaft		20	23	54	86	744	
	2003.02-	-	MT	R	F	Hatchback Engine E7J 262	650008	Inner Joint		23	30	36.3	52.2	68.5	
1.9 D (46 kW)	2003.02-	-	MT	R	F	Hatchback Engine F8Q 636	250153	Drive Shaft		20	23	54	86	550	

	 YEAR	TRANSM	L/R	F/R	REMARKS	GSP Ref.	 PRODUCT	 ABS	Technical Specifications						
									A	B	C	H	L	P	
DACIA															
SUPER NOVA															
1.4 (55 kW)	1996.01-	-	MT	L	-	211002	Drive Shaft		20	29.95	54	86	613		
SUPERNOVA															
1.4 (55 kW)	2000.04-	2003.03	MT	R	F	Hatchback Engine E7J 262	211003	Drive Shaft		20	23	54	86	734	
DAEWOO															
-															
1.5	1994-	1995.10	AT	L	-		212023	Drive Shaft		22	34	52	95.5	510	
	1994-	1995.10	AT	R	-		212024	Drive Shaft		22	34	52	95.5	628	
1.5 i	1994.01-	1995.12	MT	L	-		212003	Drive Shaft		22	34	52	95	573	
	1994.01-	1995.12	MT	R	-		212004	Drive Shaft		22	34	52	95	906	
ARANOS/ESPERO															
1.8 (70 kW)	1995.01-	1997.11	-	L/R	F	Saloon Engine Y18L	808002	Outer Joint	47T	22	29	52	95.5	63	O
AVEO(GM)															
1.5	2006.01-	-	MT/AT	-	-	Engine	812049	Outer Joint		22	22	52	95.5	53.5	O
CIELO															
-	-	-	-	L	-		212007	Drive Shaft		22	34	52	95	576	
	-	-	-	R	-		212008	Drive Shaft		22	34	52	95	909	
	1995-	1997	AT	R	-		212016	Drive Shaft		33	34	52	95.5	505	
	1995-	1997	AT	-	-		612005	Inner Joint		34	24	36.7	39	90	
1.5	1995.01-	1998.04	MT	L	-	GL SOHC	212003	Drive Shaft		22	34	52	95	573	
	1995.01-	1998.04	MT	R	-		212004	Drive Shaft		22	34	52	95	906	
	1995.01-	1998.04	AT	L	-	GL 4 Speed	212017	Drive Shaft		22	34	52	95.5	473	
	1995.01-	1998.04	AT	-	-	GL 4 Speed	612002	Inner Joint		34	29	34.6	47	80	
	1995.01-	1998.04	AT	R	-		212018	Drive Shaft		22	34	52	95.5	490	
	1995.01-	1998.04	AT	-	-		812013	Outer Joint		22	22	52	96	56	I
	1995.10-	1998.04	AT	L	-		212023	Drive Shaft		22	34	52	95.5	510	
	1995.10-	1998.04	AT	R	-		212024	Drive Shaft		22	34	52	95.5	628	
1.5 (55 kW)	1995.04-	1997.07	-	-	F	Saloon Engine Y15L	812003	Outer Joint		22	29	52	95	62.5	O
1.5 (66 kW)	1994.06-	1998.07	-	-	-	Saloon Engine V15L	812030	Outer Joint		22	22	52	96	54	I
1.5 GLX DOHC 4 SPD	1995.01-	1997.12	AT	-	F		812014	Outer Joint		33	22	52	96	56	I
ESPERO															
-	-	-	-	-	-		612003	Inner Joint		34	29	35	56.5	119	
2.0	1995.04-	1997	MT/AT	L	-		212005	Drive Shaft		33	34	52	109	595	
	1995.04-	1997	MT/AT	R	-		212006	Drive Shaft		33	34	52	109	930	
	1995.04-	1997	MT/AT	-	-		608002	Inner Joint		34	29	35	56	125	
ESPERO (KLEJ)															
1.5 (55 kW)	1997.10-	1999.08	-	-	-	Saloon Engine A15F	812009	Outer Joint		33	29	52	109	63	O
1.5 16V (65 kW)	1993.10-	1994.09	-	-	F	Saloon Engine A15MF	812001	Outer Joint		33	29	52	95.5	63	O
	1993.10-	1994.09	-	-	F	Saloon Engine A15MF	812018	Outer Joint		33	29	52	95.5	62.5	O
	1993.10-	1994.09	-	-	-	Saloon Engine A15MF	812009	Outer Joint		33	29	52	109	63	O
	1993.10-	1994.09	-	-	F	Saloon Engine A15MF	812002	Outer Joint	47T	33	29	52	95.5	63	O
	1993.10-	1994.09	MT	-	F	Saloon Engine A15MF	644001	Inner Joint		34	22	35	56.2	76	
1.5 16V (66 kW)	1995.02-	1999.06	-	-	F	Saloon Engine A15MF	812001	Outer Joint		33	29	52	95.5	63	O
	1995.02-	1999.06	-	-	F	Saloon Engine A15MF	812008	Outer Joint	47T	33	29	52	108.5	63	O
	1995.02-	1999.06	-	-	F	Saloon Engine A15MF	812018	Outer Joint		33	29	52	95.5	62.5	O
	1995.02-	1999.06	-	-	-	Saloon Engine A15MF	812009	Outer Joint		33	29	52	109	63	O
	1995.02-	1999.06	-	-	F	Saloon Engine A15MF	812002	Outer Joint	47T	33	29	52	95.5	63	O
	1995.02-	1999.06	MT	-	F	Saloon Engine A15MF	644001	Inner Joint		34	22	35	56.2	76	
1.8 (66 kW)	1995.02-	1999.09	-	-	F	Saloon Engine C18LE	812001	Outer Joint		33	29	52	95.5	63	O
	1995.02-	1999.09	MT	-	F	Saloon Engine C18LE	812008	Outer Joint	47T	33	29	52	108.5	63	O
	1995.02-	1999.09	-	-	F	Saloon Engine C18LE	812004	Outer Joint		22	29	52	95.5	57	O
	1995.02-	1999.09	-	-	F	Saloon Engine C18LE	812018	Outer Joint		33	29	52	95.5	62.5	O
	1995.02-	1999.09	-	-	F	Saloon Engine C18LE	812002	Outer Joint	47T	33	29	52	95.5	63	O
	1995.02-	1999.09	MT	-	F	Saloon Engine C18LE	644001	Inner Joint		34	22	35	56.2	76	
1.8 (70 kW)	1995.02-	1999.06	-	-	F	Saloon Engine C18LE	812001	Outer Joint		33	29	52	95.5	63	O
	1995.02-	1999.06	MT	-	F	Saloon Engine C18LE	812008	Outer Joint	47T	33	29	52	108.5	63	O
	1995.02-	1999.06	-	-	F	Saloon Engine C18LE	812004	Outer Joint		22	29	52	95.5	57	O
	1995.02-	1999.06	-	-	F	Saloon Engine C18LE	812018	Outer Joint		33	29	52	95.5	62.5	O
	1995.02-	1999.06	-	-	-	Saloon Engine C18LE	812009	Outer Joint		33	29	52	109	63	O
	1995.02-	1999.06	-	-	F	Saloon Engine C18LE	812002	Outer Joint	47T	33	29	52	95.5	63	O
	1995.02-	1999.06	MT	-	F	Saloon Engine C18LE	644001	Inner Joint		34	22	35	56.2	76	
2.0 (74 kW)	1991.10-	1993.09	MT	L/R	F	Saloon Engine C20LZ	812039	Outer Joint		33	29	47.6	108.5	61.5	O
	1991.10-	1993.09	-	-	F	Saloon Engine C20LZ	812018	Outer Joint		33	29	52	95.5	62.5	O
	1991.10-	1993.09	-	-	-	Saloon Engine C20LZ	812009	Outer Joint		33	29	52	109	63	O
	1991.10-	1993.09	-	-	F	Saloon Engine C20LZ	812002	Outer Joint	47T	33	29	52	95.5	63	O
	1991.10-	1993.09	MT	-	F	Saloon Engine C20LZ	644001	Inner Joint		34	22	35	56.2	76	





YEAR	TRANS	L/R	F/R	REMARKS	GSP Ref.	PRODUCT	ABS	Technical Specifications								
								A	B	C	H	L	P			
DAEWOO																
ESPERO (KLEJ)																
2.0 (77 kW)	1995.02-1999.06	-	-	F	Saloon Engine C20LE	812001	Outer Joint		33	29	52	95.5	63	O		
	1995.02-1999.06	MT	-	F	Saloon Engine C20LE	812008	Outer Joint	47T	33	29	52	108.5	63	O		
	1995.02-1999.06	-	-	F	Saloon Engine C20LE	812018	Outer Joint		33	29	52	95.5	62.5	O		
	1995.02-1999.06	-	-	-	Saloon Engine C20LE	812009	Outer Joint		33	29	52	109	63	O		
	1995.02-1999.06	-	-	F	Saloon Engine C20LE	812002	Outer Joint	47T	33	29	52	95.5	63	O		
	1995.02-1999.06	-	-	F	Saloon Engine C20LE	644001	Inner Joint		34	22	35	56.2	76			
2.0 (81 kW)	1993.10-1994.09	-	-	F	Saloon Engine C20LE	812001	Outer Joint		33	29	52	95.5	63	O		
	1993.10-1994.09	-	-	F	Saloon Engine C20LE	812018	Outer Joint		33	29	52	95.5	62.5	O		
	1993.10-1994.09	-	-	F	Saloon Engine C20LE	812002	Outer Joint	47T	33	29	52	95.5	63	O		
	1993.10-1994.09	MT	-	F	Saloon Engine C20LE	644001	Inner Joint		34	22	35	56.2	76			
EVANDA (KLAL)																
2.0 (96 kW)	2002.08-		AT	L/R	F	Saloon Engine L88/X 20 SED	824021	Outer Joint		28	29	55.5	99	61	O	
	2002.08-		-	-	F	Saloon Engine L88/X 20 SED	812018	Outer Joint		33	29	52	95.5	62.5	O	
	2002.08-		-	-	-	Saloon Engine L88/X 20 SED	812009	Outer Joint		33	29	52	109	63	O	
	2002.08-		-	L/R	F	Saloon Engine L88/X 20 SED	814030	Outer Joint		28	32	55.5	99	61	O	
KALOS																
1.2	2003.04-		MT/AT	-	-	-	844099	Outer Joint		22	19	52	95.5	53	O	
KALOS (KLAS)																
1.2 (53 kW)	2003.04-		-	-	F	Hatchback Engine F12S3/B12S1	808034	Outer Joint	47T	22	19	52	95.5	53	O	
	2003.04-		MT	L	F	Hatchback Engine F12S3/B12S1	244071	Drive Shaft	47T	22	22	52	95.5	661		
	2003.04-		MT	R	F	Hatchback Engine F12S3/B12S1	244072	Drive Shaft	47T	22	22	52	95.5	880		
1.4 (61 kW)	2002.09-		MT	L	F	Hatchback Engine F14S3	208012	Drive Shaft	48T	22	22	52	95.5	602		
	2002.09-		MT	L	F	Hatchback Engine F14S3	212058	Drive Shaft	47T	22	34	52	96.5	606		
	2002.09-		MT	R	F	Hatchback Engine F14S3	208013	Drive Shaft	48T	22	22	52	95.5	930		
	2002.09-		MT	R	F	Hatchback Engine F14S3	212057	Drive Shaft	47T	22	34	52	96.5	923		
	2002.09-		-	-	F	Hatchback Engine F14S3	812042	Outer Joint	47T	22	22	52	96.5	53.5	O	
	2002.09-		-	L/R	F	Hatchback Engine F14S3	808021	Outer Joint	47T	22	22	52	96.5	53.5	O	
	2002.11-2004.12		MT	L	F	Saloon Engine F14S3	208012	Drive Shaft	48T	22	22	52	95.5	602		
	2002.11-2004.12		MT	R	F	Saloon Engine F14S3	208013	Drive Shaft	48T	22	22	52	95.5	930		
	2002.11-2004.12		MT	L	F	Saloon Engine F14S3	212058	Drive Shaft	47T	22	34	52	96.5	606		
	2002.11-2004.12		MT	R	F	Saloon Engine F14S3	212057	Drive Shaft	47T	22	34	52	96.5	923		
	2002.11-2004.12		-	-	F	Saloon Engine F14S3	812042	Outer Joint	47T	22	22	52	96.5	53.5	O	
	2002.11-2004.12		-	L/R	F	Saloon Engine F14S3	808021	Outer Joint	47T	22	22	52	96.5	53.5	O	
1.4 (69 kW)	2003.05-2004.12		MT	L	F	Saloon Engine F14D3	208012	Drive Shaft	48T	22	22	52	95.5	602		
	2003.05-2004.12		MT	R	F	Saloon Engine F14D3	208013	Drive Shaft	48T	22	22	52	95.5	930		
	2003.05-2004.12		MT	L	F	Saloon Engine F14D3	212058	Drive Shaft	47T	22	34	52	96.5	606		
	2003.05-2004.12		MT	R	F	Saloon Engine F14D3	212057	Drive Shaft	47T	22	34	52	96.5	923		
	2003.05-2004.12		-	-	F	Saloon Engine F14D3	812042	Outer Joint	47T	22	22	52	96.5	53.5	O	
	2003.05-2004.12		-	L/R	F	Saloon Engine F14D3	808021	Outer Joint	47T	22	22	52	96.5	53.5	O	
1.4 16V (69 kW)	2003.04-		MT	L	F	Hatchback Engine F14D3	208012	Drive Shaft	48T	22	22	52	95.5	602		
	2003.04-		MT	L	F	Hatchback Engine F14D3	212058	Drive Shaft	47T	22	34	52	96.5	606		
	2003.04-		MT	R	F	Hatchback Engine F14D3	208013	Drive Shaft	48T	22	22	52	95.5	930		
	2003.04-		MT	R	F	Hatchback Engine F14D3	212057	Drive Shaft	47T	22	34	52	96.5	923		
	2003.04-		-	-	F	Hatchback Engine F14D3	812042	Outer Joint	47T	22	22	52	96.5	53.5	O	
	2003.04-		-	L/R	F	Hatchback Engine F14D3	808021	Outer Joint	47T	22	22	52	96.5	53.5	O	
LACETTI (KLAN)																
1.4 (70 kW)	2004.02-		-	-	-	Hatchback Engine F14D3	808019	Outer Joint	47T	33	22	52	95.5	53	O	
	2004.02-		-	-	F	Hatchback Engine F14D3	812042	Outer Joint	47T	22	22	52	96.5	53.5	O	
	2004.02-		-	-	F	Hatchback Engine F14D3	644001	Inner Joint		34	22	35	56.2	76		
1.6 (80 kW)	2004.02-		-	-	-	Hatchback Engine F16D3	808019	Outer Joint	47T	33	22	52	95.5	53	O	
	2004.02-		-	-	F	Hatchback Engine F16D3	844086	Outer Joint	47T	33	22	52	96	56	O	
	2004.02-		MT	-	F	Hatchback Engine F16D3	644001	Inner Joint		34	22	35	56.2	76		
1.8 (90 kW)	2004.02-		-	-	-	Hatchback Engine T18SED	808019	Outer Joint	47T	33	22	52	95.5	53	O	
	2004.02-		-	-	L/R	F	Hatchback Engine T18SED	812027	Outer Joint	47T	33	29	52	95.5	63	O
LACETTI 16V																
1.4	2004.02-		MT/AT	-	-	Engine KLAN	817083	Outer Joint	47T	22	22	52	95.5	53	M	
	2004.02-		MT/AT	-	-	Engine KLAN	817083	Outer Joint	47T	22	22	52	95.5	53	M	
LANOS																
-	-		AT	R	-	-	212016	Drive Shaft		33	34	52	95.5	505		
1.5	1997.01-2000.07		MT	L	-	SOHC	212003	Drive Shaft		22	34	52	95	573		
	1997.01-2000.07		MT	R	-	SOHC	212004	Drive Shaft		22	34	52	95	906		
	1997.01-2000.07		AT	L	-	-	212017	Drive Shaft		22	34	52	95.5	473		
	1997.01-2000.07		AT	-	-	-	612002	Inner Joint		34	29	34.6	47	80		
	1997.01-2000.07		AT	R	-	-	212018	Drive Shaft		22	34	52	95.5	490		
	1997.01-2000.07		AT	-	-	-	812013	Outer Joint		22	22	52	96	56	I	
	1997.05-		MT/AT	-	-	Engine KLAT	817083	Outer Joint	47T	22	22	52	95.5	53	M	





YEAR	TRANSM	L/R	F/R	REMARKS	GSP Ref.	PRODUCT	ABS	Technical Specifications									
								A	B	C	H	L	P				
DAEWOO LANOS																	
1.5	1997.05-	-	MT/AT	-	-	Engine KLAT	817083	Outer Joint	47T	22	22	52	95.5	53	M		
	2000-	-	-	L	-	-	212007	Drive Shaft		22	34	52	95	576			
	2000-	-	-	R	-	-	212008	Drive Shaft		22	34	52	95	909			
1.6	1997.01-	2000.07	AT	-	F	-	812014	Outer Joint		33	22	52	96	56	I		
1500	1997.05-	-	MT/AT	-	-	Engine KLAT	817083	Outer Joint	47T	22	22	52	95.5	53	M		
	1997.05-	-	MT/AT	-	-	Engine KLAT	817083	Outer Joint	47T	22	22	52	95.5	53	M		
LANOS (KLAT)/LANOS/SENS																	
1.3 (55 kW)	1997.05-	-	-	L/R	F	Hatchback Engine A14SMS	808002	Outer Joint	47T	22	29	52	95.5	63	O		
	1997.05-	-	-	L/R	F	Saloon Engine A14SMS	808002	Outer Joint	47T	22	29	52	95.5	63	O		
	1997.05-	-	-	-	F	Hatchback Engine A14SMS	812020	Outer Joint		22	29	52	95.5	63	O		
	1997.05-	-	-	-	F	Saloon Engine A14SMS	812020	Outer Joint		22	29	52	95.5	63	O		
	1997.05-	-	-	-	F	Hatchback Engine A14SMS	644001	Inner Joint		34	22	35	56.2	76			
	1997.05-	-	-	-	F	Saloon Engine A14SMS	644001	Inner Joint		34	22	35	56.2	76			
	1997.05-	-	-	-	F	Hatchback Engine A14SMS	812003	Outer Joint		22	29	52	95	62.5	O		
	1997.05-	-	-	-	F	Saloon Engine A14SMS	812003	Outer Joint		22	29	52	95	62.5	O		
1.5 (63 kW)	1997.05-	-	-	L/R	F	Saloon Engine A15SMS	808002	Outer Joint	47T	22	29	52	95.5	63	O		
	1997.05-	-	-	L/R	F	Hatchback Engine A15SMS	808002	Outer Joint	47T	22	29	52	95.5	63	O		
	1997.05-	-	-	-	-	Hatchback Engine A15SMS	812005	Outer Joint	47T	22	22	52	96	56	I		
	1997.05-	-	-	-	-	Saloon Engine A15SMS	812005	Outer Joint	47T	22	22	52	96	56	I		
	1997.05-	-	-	-	F	Hatchback Engine A15SMS	699025	Inner Joint		34	22	35	80	58			
	1997.05-	-	-	-	F	Saloon Engine A15SMS	699025	Inner Joint		34	22	35	80	58			
	1997.05-	-	-	-	F	Hatchback Engine A15SMS	812020	Outer Joint		22	29	52	95.5	63	O		
1.5 (73 kW)	1997.10-	1999.06	MT	L/R	F	Saloon Engine Y15LS	808002	Outer Joint	47T	22	29	52	95.5	63	O		
	1997.10-	1999.06	-	L/R	F	Hatchback Engine A15DMS	808002	Outer Joint	47T	22	29	52	95.5	63	O		
	1997.10-	1999.06	-	-	F	Hatchback Engine A15DMS	644001	Inner Joint		34	22	35	56.2	76			
	1997.10-	1999.06	-	-	F	Saloon Engine Y15LS	644001	Inner Joint		34	22	35	56.2	76			
	1997.10-	1999.06	-	-	F	Hatchback Engine A15DMS	812003	Outer Joint		22	29	52	95	62.5	O		
	1997.10-	1999.06	-	-	F	Saloon Engine Y15LS	812003	Outer Joint		22	29	52	95	62.5	O		
	1997.10-	1999.06	-	-	F	Saloon Engine Y15LS	812020	Outer Joint		22	29	52	95.5	63	O		
1.6 16V (78 kW)	1997.02-	-	-	L/R	F	Saloon Engine A16DMS	808002	Outer Joint	47T	22	29	52	95.5	63	O		
	1997.02-	-	-	-	F	Saloon Engine A16DMS	812001	Outer Joint		33	29	52	95.5	63	O		
	1997.02-	-	-	-	F	Saloon Engine A16DMS	812008	Outer Joint	47T	33	29	52	108.5	63	O		
	1997.02-	-	-	-	F	Saloon Engine A16DMS	812018	Outer Joint		33	29	52	95.5	62.5	O		
	1997.02-	-	-	-	F	Saloon Engine A16DMS	812002	Outer Joint	47T	33	29	52	95.5	63	O		
	1997.02-	-	-	-	F	Saloon Engine A16DMS	812022	Outer Joint	47T	33	22	52	96	56	I		
	1997.02-	-	-	-	F	Saloon Engine A16DMS	644001	Inner Joint		34	22	35	56.2	76			
	1997.05-	-	-	L/R	F	Hatchback Engine A16DMS	808002	Outer Joint	47T	22	29	52	95.5	63	O		
	1997.05-	-	-	-	F	Hatchback Engine A16DMS	812001	Outer Joint		33	29	52	95.5	63	O		
	1997.05-	-	-	-	F	Hatchback Engine A16DMS	812008	Outer Joint	47T	33	29	52	108.5	63	O		
	1997.05-	-	-	-	F	Hatchback Engine A16DMS	812018	Outer Joint		33	29	52	95.5	62.5	O		
	1997.05-	-	-	-	-	Hatchback Engine A16DMS	812009	Outer Joint		33	29	52	109	63	O		
	1997.05-	-	-	-	F	Hatchback Engine A16DMS	812002	Outer Joint	47T	33	29	52	95.5	63	O		
	1997.05-	-	-	-	F	Hatchback Engine A16DMS	812022	Outer Joint	47T	33	22	52	96	56	I		
	1997.05-	-	-	-	F	Hatchback Engine A16DMS	644001	Inner Joint		34	22	35	56.2	76			
	LEGANZA																
	-	1997-	2001	-	-	-	-	612006	Inner Joint		24	29	40	95.5	146		
-	1998.02-	-	-	-	-	-	812024	Outer Joint	47T	33	23	52	96	64	I		
2.2	1991.01-	2001.12	AT	-	-	-	812016	Outer Joint		33	23	52	96	64	I		
	1999-	2001	AT	R	-	-	208019	Drive Shaft	47T	33	34	52	95.5	971			
LEGANZA (KLAV)/KONDOR																	
2.0 (133 kW)	2001.01-	2002.12	-	-	-	Saloon Engine T20SED	812009	Outer Joint		33	29	52	109	63	O		
2.0 16V (93 kW)	2000.07-	2004.04	-	L/R	F	Saloon Engine T20SED	808002	Outer Joint	47T	22	29	52	95.5	63	O		
	2000.07-	2004.04	-	-	F	Saloon Engine T20SED	812008	Outer Joint	47T	33	29	52	108.5	63	O		
	2000.07-	2004.04	-	-	F	Saloon Engine T20SED	812018	Outer Joint		33	29	52	95.5	62.5	O		
	2000.07-	2004.04	-	-	-	Saloon Engine T20SED	812009	Outer Joint		33	29	52	109	63	O		
	2000.07-	2004.04	-	-	F	Saloon Engine T20SED	812023	Outer Joint	47T	33	32	52	95.5	66	O		
	2000.07-	2004.04	-	-	F	Saloon Engine T20SED	812002	Outer Joint	47T	33	29	52	95.5	63	O		
2.0 16V (98 kW)	1997.06-	2002.12	-	L/R	F	Saloon Engine X 20 SED	808002	Outer Joint	47T	22	29	52	95.5	63	O		
	1997.06-	2002.12	-	-	F	Saloon Engine X 20 SED	812008	Outer Joint	47T	33	29	52	108.5	63	O		
	1997.06-	2002.12	-	-	F	Saloon Engine X 20 SED	812018	Outer Joint		33	29	52	95.5	62.5	O		
	1997.06-	2002.12	-	-	F	Saloon Engine X 20 SED	812023	Outer Joint	47T	33	32	52	95.5	66	O		
	1997.06-	2002.12	-	-	-	Saloon Engine X 20 SED	812009	Outer Joint		33	29	52	109	63	O		
	1997.06-	2002.12	-	-	F	Saloon Engine X 20 SED	812002	Outer Joint	47T	33	29	52	95.5	63	O		
2.2 16V (100 kW)	1999.04-	2002.12	-	-	F	Saloon Engine T22SED	812018	Outer Joint		33	29	52	95.5	62.5	O		
	1999.04-	2002.12	-	-	F	Saloon Engine T22SED	812018	Outer Joint		33	29	52	95.5	62.5	O		
	1999.04-	2002.12	-	-	-	Saloon Engine T22SED	812009	Outer Joint		33	29	52	109	63	O		

YEAR	TRANSM	L/R	F/R	REMARKS	GSP Ref.	PRODUCT	ABS	Technical Specifications								
								A	B	C	H	L	P			
DAEWOO																
MATIZ (KLYA)																
0.8 (38 kW)	1998.09-	-	-	R	F	Hatchback Engine F8CV	212044	Drive Shaft	40T	23	22	46	92	786		
	1998.09-	-	-	-	F	Hatchback Engine F8CV	812028	Outer Joint		23	19	46	92	56.5	O	
	1998.09-	-	-	L	F	Hatchback Engine F8CV	612001	Inner Joint		22	19	35	54.5	79		
	1998.09-	-	-	-	-	Hatchback Engine F8CV	812031	Outer Joint		23	19	44	89.5	54.5	O	
	1998.09-	-	-	MT	L/R	F	Hatchback Engine F8CV	812021	Outer Joint	40T	23	19	46	92	56.5	O
	1998.09-	-	-	-	F	Hatchback Engine F8CV	812007	Outer Joint		23	19	46	92	56.5	O	
	1998.09-	-	-	-	-	Hatchback Engine F8CV	812046	Outer Joint	40T	23	19	46	92	56.5	O	
	1998.09-	-	-	MT	R	F	Hatchback Engine F8CV	212012	Drive Shaft	40T	23	22	46	92	785	
	1998.09-	-	-	MT	R	F	Hatchback Engine F8CV	208059	Drive Shaft		23	22	46	92	785	
	1998.09-	-	-	-	L	F	Hatchback Engine F8CV	212011	Drive Shaft		23	22	46	92	616	
	1998.09-	-	-	-	L	F	Hatchback Engine F8CV	212025	Drive Shaft	40T	23	22	46	92	616	
1.0 (47 kW)	2003.01-	-	-	MT	L	F	Hatchback Engine B10S	257177	Drive Shaft	40T	23	22	46	92	562	
	2003.01-	-	-	MT	R	F	Hatchback Engine B10S	257176	Drive Shaft	40T	23	22	46	92	831	
	2003.01-	-	-	MT	L/R	F	Hatchback Engine B10S	812021	Outer Joint	40T	23	19	46	92	56.5	O
	2003.01-	-	-	-	-	Hatchback Engine B10S	812046	Outer Joint	40T	23	19	46	92	56.5	O	
NEXIA/CIELO																
1.5 (44 kW)	1996.08-	1997.08	-	-	F	Saloon Engine G15MF	812019	Outer Joint		22	29	52	95	62.5	O	
	1996.08-	1997.08	-	-	F	Hatchback Engine G15MF	812019	Outer Joint		22	29	52	95	62.5	O	
	1996.08-	1997.08	-	-	F	Saloon Engine G15MF	699025	Inner Joint		34	22	35	80	58		
	1996.08-	1997.08	-	-	F	Hatchback Engine G15MF	699025	Inner Joint		34	22	35	80	58		
	1996.08-	1997.08	-	-	F	Hatchback Engine G15MF	812004	Outer Joint		22	29	52	95.5	57	O	
	1996.08-	1997.08	-	-	F	Saloon Engine G15MF	812004	Outer Joint		22	29	52	95.5	57	O	
	1996.08-	1997.08	AT	-	F	Saloon Engine G15MF	812002	Outer Joint	47T	33	29	52	95.5	63	O	
	1996.08-	1997.08	AT	-	F	Hatchback Engine G15MF	812002	Outer Joint	47T	33	29	52	95.5	63	O	
1.5 (52 kW)	1995.02-	1997.08	-	-	F	Hatchback Engine G15MF	812019	Outer Joint		22	29	52	95	62.5	O	
	1995.02-	1997.08	-	-	F	Saloon Engine G15MF	812019	Outer Joint		22	29	52	95	62.5	O	
	1995.02-	1997.08	MT	L/R	F	Hatchback Engine G15MF	808002	Outer Joint	47T	22	29	52	95.5	63	O	
	1995.02-	1997.08	-	L/R	F	Saloon Engine G15MF	808002	Outer Joint	47T	22	29	52	95.5	63	O	
	1995.02-	1997.08	-	-	F	Hatchback Engine G15MF	699025	Inner Joint		34	22	35	80	58		
	1995.02-	1997.08	-	-	F	Saloon Engine G15MF	699025	Inner Joint		34	22	35	80	58		
	1995.02-	1997.08	-	-	F	Hatchback Engine G15MF	812004	Outer Joint		22	29	52	95.5	57	O	
	1995.02-	1997.08	-	-	F	Saloon Engine G15MF	812004	Outer Joint		22	29	52	95.5	57	O	
	1995.02-	1997.08	AT	-	F	Hatchback Engine G15MF	812002	Outer Joint	47T	33	29	52	95.5	63	O	
	1995.02-	1997.08	AT	-	F	Saloon Engine G15MF	812002	Outer Joint	47T	33	29	52	95.5	63	O	
1.5 (55 kW)	1995.02-	1997.08	-	-	F	Hatchback Engine G15MF	812019	Outer Joint		22	29	52	95	62.5	O	
	1995.02-	1997.08	-	-	F	Saloon Engine G15MF	812019	Outer Joint		22	29	52	95	62.5	O	
	1995.02-	1997.08	MT	L/R	F	Hatchback Engine G15MF	808002	Outer Joint	47T	22	29	52	95.5	63	O	
	1995.02-	1997.08	-	L/R	F	Saloon Engine G15MF	808002	Outer Joint	47T	22	29	52	95.5	63	O	
	1995.02-	1997.08	-	-	F	Hatchback Engine G15MF	699025	Inner Joint		34	22	35	80	58		
	1995.02-	1997.08	-	-	F	Saloon Engine G15MF	699025	Inner Joint		34	22	35	80	58		
	1995.02-	1997.08	-	-	F	Hatchback Engine G15MF	812004	Outer Joint		22	29	52	95.5	57	O	
	1995.02-	1997.08	-	-	F	Saloon Engine G15MF	812004	Outer Joint		22	29	52	95.5	57	O	
	1995.02-	1997.08	AT	-	F	Hatchback Engine G15MF	812002	Outer Joint	47T	33	29	52	95.5	63	O	
1.5 16V (66 kW)	1995.02-	1997.08	-	-	F	Hatchback Engine A15MF	812019	Outer Joint		22	29	52	95	62.5	O	
	1995.02-	1997.08	-	-	F	Saloon Engine A15MF	812019	Outer Joint		22	29	52	95	62.5	O	
	1995.02-	1997.08	-	L/R	F	Hatchback Engine A15MF	808002	Outer Joint	47T	22	29	52	95.5	63	O	
	1995.02-	1997.08	-	L/R	F	Saloon Engine A15MF	808002	Outer Joint	47T	22	29	52	95.5	63	O	
	1995.02-	1997.08	-	-	F	Hatchback Engine A15MF	699025	Inner Joint		34	22	35	80	58		
	1995.02-	1997.08	-	-	F	Saloon Engine A15MF	699025	Inner Joint		34	22	35	80	58		
	1995.02-	1997.08	-	-	F	Hatchback Engine A15MF	812004	Outer Joint		22	29	52	95.5	57	O	
	1995.02-	1997.08	-	-	F	Saloon Engine A15MF	812004	Outer Joint		22	29	52	95.5	57	O	
	1995.02-	1997.08	-	-	F	Hatchback Engine A15MF	812002	Outer Joint	47T	33	29	52	95.5	63	O	
	1995.02-	1997.08	-	-	F	Saloon Engine A15MF	812002	Outer Joint	47T	33	29	52	95.5	63	O	
NUBIRA																
-	-	-	-	-	-	-	899057	Outer Joint		33	22	52	109	56	I	
	1998-	1999	AT	L/R	-	-	212013	Drive Shaft		33	34	52	95.5	519		
	1998-	2002	AT	-	-	-	612005	Inner Joint		34	24	36.7	39	90		
	2000-	2002	AT	L/R	-	-	212013	Drive Shaft		33	34	52	95.5	519		
2.0	1998.01-	2002.12	AT	-	-	-	812015	Outer Joint		33	32	52	95.5	66	O	
	1998.01-	2002.12	MT	-	-	-	812015	Outer Joint		33	32	52	95.5	66	O	
NUBIRA (J100)																
1.6 16V (76 kW)	2000.07-	-	-	L/R	F	Saloon Engine A16DMS	808002	Outer Joint	47T	22	29	52	95.5	63	O	
	2000.07-	-	-	-	F	Saloon Engine A16DMS	812001	Outer Joint		33	29	52	95.5	63	O	
	2000.07-	-	-	L/R	F	Saloon Engine A16DMS	812027	Outer Joint	47T	33	29	52	95.5	63	O	
	2000.07-	-	-	-	F	Saloon Engine A16DMS	812018	Outer Joint		33	29	52	95.5	62.5	O	
	2000.07-	-	-	-	-	Saloon Engine A16DMS	812009	Outer Joint		33	29	52	109	63	O	

	 YEAR	TRANSM	L/R	F/R	REMARKS	GSP Ref.	 PRODUCT	 ABS	Technical Specifications						
									A	B	C	H	L	P	
DAEWOO															
NUBIRA (J100)															
1.6 16V (76 kW)	2000.07-	-	-	-	F Saloon Engine A16DMS	812002	Outer Joint	47T	33	29	52	95.5	63	O	
1.6 16V (78 kW)	1997.05-	-	-	-	F Saloon Engine A16DMS	812001	Outer Joint		33	29	52	95.5	63	O	
	1997.05-	-	-	L/R	F Saloon Engine A16DMS	808002	Outer Joint	47T	22	29	52	95.5	63	O	
	1997.05-	-	-	-	F Saloon Engine A16DMS	812018	Outer Joint		33	29	52	95.5	62.5	O	
	1997.05-	-	-	-	F Saloon Engine A16DMS	812002	Outer Joint	47T	33	29	52	95.5	63	O	
	1999.06-2003.07	2003.07	-	L/R	F Saloon Engine C20SED	808002	Outer Joint	47T	22	29	52	95.5	63	O	
2.0 (81 kW)	1999.06-2003.07	2003.07	-	-	F Saloon Engine C20SED	812002	Outer Joint	47T	33	29	52	95.5	63	O	
	2000.12-	-	-	-	F Saloon Engine T20SED	812001	Outer Joint		33	29	52	95.5	63	O	
2.0 16V (93 kW)	2000.12-	-	AT	L/R	F Saloon Engine T20SED	808002	Outer Joint	47T	22	29	52	95.5	63	O	
	2000.12-	-	-	L/R	F Saloon Engine T20SED	812027	Outer Joint	47T	33	29	52	95.5	63	O	
	2000.12-	-	-	-	F Saloon Engine T20SED	812018	Outer Joint		33	29	52	95.5	62.5	O	
	2000.12-	-	-	-	F Saloon Engine T20SED	812023	Outer Joint	47T	33	32	52	95.5	66	O	
	2000.12-	-	-	-	Saloon Engine T20SED	812009	Outer Joint		33	29	52	109	63	O	
	2000.12-	-	-	-	F Saloon Engine T20SED	812002	Outer Joint	47T	33	29	52	95.5	63	O	
	1997.05-	-	-	-	F Saloon Engine X 20 SED	812001	Outer Joint		33	29	52	95.5	63	O	
2.0 16V (98 kW)	1997.05-	-	MT	L/R	F Saloon Engine X 20 SED	808002	Outer Joint	47T	22	29	52	95.5	63	O	
	1997.05-	-	-	-	F Saloon Engine X 20 SED	812023	Outer Joint	47T	33	32	52	95.5	66	O	
	1997.05-	-	-	-	F Saloon Engine X 20 SED	812002	Outer Joint	47T	33	29	52	95.5	63	O	
NUBIRA (J100)/ORION															
1.6 16V (78 kW)	1997.05-	-	-	-	F Hatchback Engine A16DMS	812001	Outer Joint		33	29	52	95.5	63	O	
	1997.05-	-	-	L/R	F Hatchback Engine A16DMS	808002	Outer Joint	47T	22	29	52	95.5	63	O	
	1997.05-	-	-	-	F Hatchback Engine A16DMS	812018	Outer Joint		33	29	52	95.5	62.5	O	
	1997.05-	-	-	-	F Hatchback Engine A16DMS	812009	Outer Joint		33	29	52	109	63	O	
	1997.05-	-	-	-	F Hatchback Engine A16DMS	812002	Outer Joint	47T	33	29	52	95.5	63	O	
2.0 16V (98 kW)	1997.05-	-	MT	L/R	F Hatchback Engine X 20 SED/Z20L	808002	Outer Joint	47T	22	29	52	95.5	63	O	
	1997.05-	-	-	-	F Hatchback Engine X 20 SED/Z20L	812001	Outer Joint		33	29	52	95.5	63	O	
	1997.05-	-	-	-	F Hatchback Engine X 20 SED/Z20L	812023	Outer Joint	47T	33	32	52	95.5	66	O	
	1997.05-	-	-	-	F Hatchback Engine X 20 SED/Z20L	812002	Outer Joint	47T	33	29	52	95.5	63	O	
2.0 CDX (93 kW)	2002.08-2003.07	2003.07	AT	L/R	F Hatchback Engine T20SED	808002	Outer Joint	47T	22	29	52	95.5	63	O	
	2002.08-2003.07	2003.07	-	L/R	F Hatchback Engine T20SED	812027	Outer Joint	47T	33	29	52	95.5	63	O	
NUBIRA (J150)															
1.6 16V(78 kW)	1999.06-2002.07	2002.07	-	L/R	F Saloon Engine A16DMS	808002	Outer Joint	47T	22	29	52	95.5	63	O	
	1999.06-2002.07	2002.07	-	L/R	F Saloon Engine A16DMS	812027	Outer Joint	47T	33	29	52	95.5	63	O	
2.0 16V (98 kW)	1999.06-2002.07	2002.07	AT	L/R	F Estate Engine X 20 SED	808002	Outer Joint	47T	22	29	52	95.5	63	O	
	1999.06-2002.07	2002.07	AT	L/R	F Saloon Engine X 20 SED	808002	Outer Joint	47T	22	29	52	95.5	63	O	
	1999.06-2002.07	2002.07	-	L/R	F Estate Engine X 20 SED	812027	Outer Joint	47T	33	29	52	95.5	63	O	
	1999.06-2002.07	2002.07	-	L/R	F Saloon Engine X 20 SED	812027	Outer Joint	47T	33	29	52	95.5	63	O	
NUBIRA (J200)															
1.6 (80 kW)	2003.07-	-	-	-	F Saloon Engine F16D3	844086	Outer Joint	47T	33	22	52	96	56	O	
	2003.07-	-	-	-	F Saloon Engine F16D3	812022	Outer Joint	47T	33	22	52	96	56	I	
1.8 (90 kW)	2003.07-	-	-	-	Saloon Engine T18SED	808019	Outer Joint	47T	33	22	52	95.5	53	O	
	2003.07-	-	-	L/R	F Saloon Engine T18SED	812027	Outer Joint	47T	33	29	52	95.5	63	O	
	2003.07-	-	-	-	F Saloon Engine T18SED	844086	Outer Joint	47T	33	22	52	96	56	O	
	2003.07-	-	-	-	F Saloon Engine T18SED	812002	Outer Joint	47T	33	29	52	95.5	63	O	
	2003.07-	-	-	-	F Saloon Engine T18SED	812022	Outer Joint	47T	33	22	52	96	56	I	
NUBIRA Wagon (J100)/ORION															
1.6 16V (66 kW)	1997.06-	-	-	L/R	F Estate Engine A16SMS	808002	Outer Joint	47T	22	29	52	95.5	63	O	
	1997.06-	-	-	-	F Estate Engine A16SMS	812001	Outer Joint		33	29	52	95.5	63	O	
	1997.06-	-	-	-	F Estate Engine A16SMS	812018	Outer Joint		33	29	52	95.5	62.5	O	
	1997.06-	-	-	-	Estate Engine A16SMS	812009	Outer Joint		33	29	52	109	63	O	
	1997.06-	-	-	-	F Estate Engine A16SMS	812002	Outer Joint	47T	33	29	52	95.5	63	O	
1.6 16V (76 kW)	2000.12-	-	-	L/R	F Estate Engine A16DMS	808002	Outer Joint	47T	22	29	52	95.5	63	O	
	2000.12-	-	-	-	F Estate Engine A16DMS	812001	Outer Joint		33	29	52	95.5	63	O	
	2000.12-	-	-	L/R	F Estate Engine A16DMS	812027	Outer Joint	47T	33	29	52	95.5	63	O	
	2000.12-	-	-	-	F Estate Engine A16DMS	812018	Outer Joint		33	29	52	95.5	62.5	O	
	2000.12-	-	-	-	Estate Engine A16DMS	812009	Outer Joint		33	29	52	109	63	O	
	2000.12-	-	-	-	F Estate Engine A16DMS	812002	Outer Joint	47T	33	29	52	95.5	63	O	
1.6 16V (78 kW)	1997.05-	-	-	L/R	F Estate Engine A16DMS	808002	Outer Joint	47T	22	29	52	95.5	63	O	
	1997.05-	-	-	-	F Estate Engine A16DMS	812001	Outer Joint		33	29	52	95.5	63	O	
	1997.05-	-	-	-	F Estate Engine A16DMS	812018	Outer Joint		33	29	52	95.5	62.5	O	
	1997.05-	-	-	-	Estate Engine A16DMS	812009	Outer Joint		33	29	52	109	63	O	
	1997.05-	-	-	-	F Estate Engine A16DMS	812002	Outer Joint	47T	33	29	52	95.5	63	O	
2.0 16V (93 kW)	2000.12-	-	-	-	F Estate Engine T20SED	812001	Outer Joint		33	29	52	95.5	63	O	
	2000.12-	-	AT	L/R	F Estate Engine T20SED	808002	Outer Joint	47T	22	29	52	95.5	63	O	
	2000.12-	-	AT/MT	L/R	F Estate Engine T20SED	812027	Outer Joint	47T	33	29	52	95.5	63	O	
	2000.12-	-	-	-	F Estate Engine T20SED	812018	Outer Joint		33	29	52	95.5	62.5	O	

YEAR	TRANSM	L/R	F/R	REMARKS	GSP Ref.	PRODUCT	ABS	Technical Specifications							
								A	B	C	H	L	P		
DAEWOO															
NUBIRA Wagon (J100)/ORION															
2.0 16V (93 kW)	2000.12-	-	-	-	F	Estate Engine T20SED	812023	Outer Joint	47T	33	32	52	95.5	66	O
	2000.12-	-	-	-	-	Estate Engine T20SED	812009	Outer Joint		33	29	52	109	63	O
2.0 16V (98 kW)	1997.05-	-	MT	L/R	F	Estate Engine X 20 SED	808002	Outer Joint	47T	22	29	52	95.5	63	O
	1997.05-	-	-	-	F	Estate Engine X 20 SED	812001	Outer Joint		33	29	52	95.5	63	O
	1997.05-	-	-	-	F	Estate Engine X 20 SED	812023	Outer Joint	47T	33	32	52	95.5	66	O
	1997.05-	-	-	-	F	Estate Engine X 20 SED	812002	Outer Joint	47T	33	29	52	95.5	63	O
NUBIRA Wagon (J200)															
1.6 (80 kW)	2003.07-	-	-	-	F	Estate Engine F16D3	844086	Outer Joint	47T	33	22	52	96	56	O
	2003.07-	-	-	-	F	Estate Engine F16D3	812022	Outer Joint	47T	33	22	52	96	56	I
1.8 (90 kW)	2003.07-	-	-	-	-	Estate Engine T18SED	808019	Outer Joint	47T	33	22	52	95.5	63	O
	2003.07-	-	-	L/R	F	Estate Engine T18SED	812027	Outer Joint	47T	33	29	52	95.5	63	O
	2003.07-	-	-	-	F	Estate Engine T18SED	844086	Outer Joint	47T	33	22	52	96	56	O
	2003.07-	-	-	-	F	Estate Engine T18SED	812002	Outer Joint	47T	33	29	52	95.5	63	O
	2003.07-	-	-	-	F	Estate Engine T18SED	812022	Outer Joint	47T	33	22	52	96	56	I
RACER															
-	-	-	-	-	-	-	644006	Inner Joint		34	22	35	80	58	
	-	-	-	L	-	-	212003	Drive Shaft		22	34	52	95	573	
	-	-	-	R	-	-	212004	Drive Shaft		22	34	52	95	906	
1.5 (52 kW)	1995.03-	1997.12	-	L/R	F	Hatchback Engine G15MF	808002	Outer Joint	47T	22	29	52	95.5	63	O
RACER/CIELO															
-	-	-	-	-	-	-	699028	Inner Joint		34	22	35	79.5	58	O
	-	-	-	-	-	-	844029	Outer Joint		22	30	52	95.5	57.5	O
REZZO (KLAU)/TACUMA															
1.6 (77 kW)	2000.09-	-	MT	L/R	F	MPV Engine A16DMS	812027	Outer Joint	47T	33	29	52	95.5	63	O
	2000.09-	-	-	-	F	MPV Engine A16DMS	812002	Outer Joint	47T	33	29	52	95.5	63	O
1.6 SX (66 kW)	2001.08-	2004.12	-	L/R	F	MPV Engine A16SMS	812027	Outer Joint	47T	33	29	52	95.5	63	O
	2001.08-	2004.12	-	-	F	MPV Engine A16SMS	812002	Outer Joint	47T	33	29	52	95.5	63	O
1.8 (67 kW)	2000.09-	-	MT	L/R	F	MPV Engine F18D2	808002	Outer Joint	47T	22	29	52	95.5	63	O
	2000.09-	-	-	-	-	MPV Engine F18D2	812009	Outer Joint		33	29	52	109	63	O
1.8 (72 kW)	2000.09-	-	MT	L/R	F	MPV Engine A18DMS	812027	Outer Joint	47T	33	29	52	95.5	63	O
	2000.09-	-	-	-	F	MPV Engine A18DMS	812002	Outer Joint	47T	33	29	52	95.5	63	O
1.8 (74 kW)	2000.09-	-	MT	L/R	F	MPV Engine F18S2	808002	Outer Joint	47T	22	29	52	95.5	63	O
	2000.09-	-	MT	L/R	F	MPV Engine F18S2	812027	Outer Joint	47T	33	29	52	95.5	63	O
	2000.09-	-	-	-	-	MPV Engine F18S2	812009	Outer Joint		33	29	52	109	63	O
2.0 (89 kW)	2001.09-	-	-	L/R	F	MPV Engine X 20 SED	812027	Outer Joint	47T	33	29	52	95.5	63	O
	2001.09-	-	AT/MT	-	F	MPV Engine X 20 SED	812023	Outer Joint	47T	33	32	52	95.5	66	O
	2001.09-	-	AT	-	F	MPV Engine X 20 SED	812002	Outer Joint	47T	33	29	52	95.5	63	O
2.0 (94 kW)	2000.09-	-	-	-	F	MPV Engine T20SED	812023	Outer Joint	47T	33	32	52	95.5	66	O
	2000.09-	-	-	-	F	MPV Engine T20SED	812002	Outer Joint	47T	33	29	52	95.5	63	O
TICO															
0.8	1993-	-	-	L	-	-	212009	Drive Shaft		23	22	44	92	564	
	1993-	-	-	R	-	-	212010	Drive Shaft		23	22	44	92	748	
TICO (KLY3)															
0.8 (35 kW)	1995.02-	2000.12	-	-	-	Hatchback Engine F8C	812006	Outer Joint		23	19	44	92	56.5	O
	1995.02-	2000.12	-	-	-	Hatchback Engine F8C	812031	Outer Joint		23	19	44	89.5	54.5	O
	1995.02-	2000.12	AT/MT	L/R	F	Hatchback Engine F8C	808004	Outer Joint		23	19	44	89	54	M
	1995.02-	2000.12	-	-	F	Hatchback Engine F8C	812007	Outer Joint		23	19	46	92	56.5	O
0.8 (38 kW)	1996.01-	2000.12	-	-	-	Hatchback Engine F8CV	812006	Outer Joint		23	19	44	92	56.5	O
	1996.01-	2000.12	-	-	-	Hatchback Engine F8CV	812031	Outer Joint		23	19	44	89.5	54.5	O
WINSTORM															
-	2007-	-	-	-	-	-	821047	Outer Joint		30	22		105.5	53.5	O
DAIHATSU															
-	-	-	-	-	-	-	-	-	-	-	-	-	-	-	-
1.0	-	-	-	-	-	-	614009	Inner Joint		23	26	45	52	88.5	
	-	-	-	R	-	-	214028	Drive Shaft		24	23	47	91.5	879	
	-	-	-	L	-	-	214027	Drive Shaft		24	23	47	91.5	656	
1.3	-	-	-	R	-	-	214026	Drive Shaft		24	23	47	91.5	878	
	-	-	-	L	-	-	214025	Drive Shaft		24	23	47	91.5	657	
7100															
-	-	-	-	-	-	-	614001	Inner Joint		23	19	45	52	82	
APPLAUSE															
-	1989.10-	1997.09	AT	R	-	-	214015	Drive Shaft		24	23	54	92	883.5	
	1989.10-	1997.09	AT	-	-	-	614006	Inner Joint		23	22	34	60.2	89.8	
	1989.10-	1997.09	AT	L	-	-	214016	Drive Shaft		24	23	54	92	636.5	
	1989.10-	1997.09	MT	-	-	-	614007	Inner Joint		25	22	45	52	102	

	 YEAR	TRANSM	L/R	F/R	REMARKS	GSP Ref.	 PRODUCT	 ABS	Technical Specifications						
									A	B	C	H	L	P	
DAIHATSU															
APPLAUSE A101															
1.6	1989-	-	MT	-	-	614011	Inner Joint		25	22	45	52	102		
APPLAUSE I (A101 A111)															
1.6 16V (66 kW)	1989.06-	1997.07	-	R	F	Saloon Engine HD	214019	Drive Shaft	24	25	54	92	620		
	1989.06-	1997.07	-	L	F	Saloon Engine HD	214020	Drive Shaft	24	25	54	92	902		
1.6 16V (77 kW)	1989.06-	1997.07	-	R	F	Saloon Engine HD-E	214019	Drive Shaft	24	25	54	92	620		
	1989.06-	1997.07	-	R	F	All-wheel Drive Saloon Engine HD-E	214019	Drive Shaft	24	25	54	92	620		
	1989.06-	1997.07	-	L	F	Saloon Engine HD-E	214020	Drive Shaft	24	25	54	92	902		
	1989.06-	1997.07	-	L	F	All-wheel Drive Saloon Engine HD-E	214020	Drive Shaft	24	25	54	92	902		
	1989.06-	1997.07	-	-	F	Saloon Engine HD-E	814006	Outer Joint	24	22	54	92	53	M	
	1989.06-	1997.07	-	-	-	All-wheel Drive Saloon Engine HD-E	814006	Outer Joint	24	22	54	92	53	M	
ATRAI S230V															
660	1999.01-	1999.04	5MT/3AT	-	-	Allwheel Drive Engine EFVE	814052	Outer Joint	24	18	47	85	47	M	
BE-GO (J210G)															
1.5 4WD	2006.01-	-	4AT	-	-	Engine 3SZVE	899290	Outer Joint	24	22	52	89.8	81	M	
	2006.01-	-	5MT	-	F	Engine 3SZVE	899290	Outer Joint	24	22	52	89.8	81	M	
BOON (M300S)															
1.0	2004.05-	-	4AT	-	-	Engine 1KRFE	859461	Outer Joint	24	26	47	85.5	47.5	I	
BOON (M310S)															
1.0 4WD	2004.05-	-	4AT	-	-	Engine 1KRFE	859461	Outer Joint	24	26	47	85.5	47.5	I	
BOON M300S															
1.0	2004.05-	-	4AT	-	-	Engine 1KRFE	859461	Outer Joint	24	26	47	85.5	47.5	I	
1000	2004.05-	-	4AT	-	-	Engine 1KRFE	859461	Outer Joint	24	26	47	85.5	47.5	I	
BOON M310S															
1.0	2004.05-	-	4AT	-	-	Allwheel Drive Engine 1KRFE	859461	Outer Joint	24	26	47	85.5	47.5	I	
1000	2004.05-	-	4AT	-	-	Allwheel Drive Engine 1KRFE	859461	Outer Joint	24	26	47	85.5	47.5	I	
CHARADE															
-	-	-	-	-	-	-	614001	Inner Joint	23	19	45	52	82		
-	1993-	1996	AT	-	-	-	614010	Inner Joint	22	19	35	57.5	88		
CHARADE (G100)															
-	1989.01-	1993.06	-	R	-	-	214014	Drive Shaft	24	23	54	92	834		
-	1989.01-	1993.06	-	L	-	-	214013	Drive Shaft	24	23	54	92	638		
-	1989.01-	1993.06	AT	R	-	-	214012	Drive Shaft	24	23	54	92	866		
-	1989.01-	1993.06	AT	L	-	-	214011	Drive Shaft	24	23	54	92	618		
CHARADE (G102)															
-	1988.10-	1993.07	MT	L	-	-	214009	Drive Shaft	24	23	54	92	602		
-	1988.10-	1993.07	MT	R	-	-	214010	Drive Shaft	24	23	54	92	882		
-	1988.10-	1993.07	AT	L	-	-	214007	Drive Shaft	24	23	54	92	570		
-	1988.10-	1993.07	AT	R	-	-	214008	Drive Shaft	24	23	54	92	912		
-	1989.01-	1993.06	MT	L	-	-	214031	Drive Shaft	24	25	54	92	601		
-	1989.01-	1993.06	MT	R	-	-	214032	Drive Shaft	24	25	54	92	881		
-	1989.01-	1993.06	MT	-	-	-	614003	Inner Joint	25	19	45	51.6	82.5		
CHARADE (G200)															
-	1993.01-	1996.04	AT	L	-	-	214017	Drive Shaft	24	22	54	92	588		
-	1993.01-	1996.04	AT	R	-	-	214018	Drive Shaft	24	22	54	92	897		
1.3	1993.06-	1996.04	MT	L	-	-	214009	Drive Shaft	24	23	54	92	602		
	1993.06-	1996.04	MT	R	-	-	214010	Drive Shaft	24	23	54	92	882		
CHARADE (G202)															
1.0	1993.06-	1996.04	-	R	-	-	214014	Drive Shaft	24	23	54	92	834		
	1993.06-	1996.04	-	L	-	-	214013	Drive Shaft	24	23	54	92	638		
CHARADE (G203)															
-	1996.05-	1998.04	MT	L	-	-	214031	Drive Shaft	24	25	54	92	601		
-	1996.05-	1998.04	MT	R	-	-	214032	Drive Shaft	24	25	54	92	881		
-	1996.05-	1998.04	MT	-	-	-	614003	Inner Joint	25	19	45	51.6	82.5		
CHARADE (G203S)															
1.5	1996.08-	2000.05	4AT	-	-	Engine HEEG	814072	Outer Joint	48T	24	22	52	92	53	M
	1996.08-	2000.05	5MT	-	-	Engine HEEG	814072	Outer Joint	48T	24	22	52	92	53	M
CHARADE (L2_)															
1.0 (43 kW)	2003.03-	-	AT	-	F	Hatchback Engine EJ-VE	814042	Outer Joint	24	26	47	85.5	45	I	
	2003.03-	-	MT	-	F	Hatchback Engine EJ-VE	814028	Outer Joint	24	19	47	84.5	47.5	I	
	2003.03-	-	MT	L	F	Hatchback Engine EJ-VE	214035	Drive Shaft	24	23	47	84.5	581		
	2003.03-	-	MT	R	F	Hatchback Engine EJ-VE	214036	Drive Shaft	24	23	47	84.5	794		
CHARADE G100S															
1.0	1989.01-	1990.01	MT	-	-	Engine CB	814094	Outer Joint	24	19	54	93	47.5	M	
	1989.01-	1993.01	MT	-	-	Engine CB	814093	Outer Joint	24	21	54	93	47.5	M	
	1989.01-	1993.01	AT	-	-	Engine CB	814094	Outer Joint	24	19	54	93	47.5	M	

	 YEAR	TRANSM	L/R	F/R	REMARKS	GSP Ref.	 PRODUCT	 ABS	Technical Specifications						
									A	B	C	H	L	P	
DAIHATSU CHARADE G100S															
1000	1989.01-1990.01	MT	-	-	Engine CB	814094	Outer Joint		24	19	54	93	47.5	M	
	1989.01-1993.01	AT	-	-	Engine CB	814094	Outer Joint		24	19	54	93	47.5	M	
	1989.01-1993.01	MT	-	-	Engine CB	814093	Outer Joint		24	21	54	93	47.5	M	
CHARADE G101S															
1.0	1989.01-1993.01	MT	-	-	Engine CL	814093	Outer Joint		24	21	54	93	47.5	M	
	1989.01-1993.01	MT	-	-	Engine CL TBO	814093	Outer Joint		24	21	54	93	47.5	M	
	1989.01-1993.01	AT	-	-	Engine CL TBO	814094	Outer Joint		24	19	54	93	47.5	M	
1000	1989.01-1993.01	AT	-	-	Engine CL TBO	814094	Outer Joint		24	19	54	93	47.5	M	
	1989.01-1993.01	MT	-	-	Engine CL	814093	Outer Joint		24	21	54	93	47.5	M	
	1989.01-1993.01	MT	-	-	Engine CL TBO	814093	Outer Joint		24	21	54	93	47.5	M	
CHARADE G102S															
1.3	1989.01-1990.01	MT	-	-	Engine HC	814093	Outer Joint		24	21	54	93	47.5	M	
	1989.01-1990.01	MT	-	-	Engine HC	814093	Outer Joint		24	21	54	93	47.5	M	
	1989.01-1993.01	AT	-	-	Engine HC	814093	Outer Joint		24	21	54	93	47.5	M	
	1989.01-1993.01	MT	-	-	Engine HC	814093	Outer Joint		24	21	54	93	47.5	M	
	1989.01-1993.01	MT	-	-	Engine HC	814093	Outer Joint		24	21	54	93	47.5	M	
	1989.01-2009.11	MT	-	-	Engine HCF	814093	Outer Joint		24	21	54	93	47.5	M	
	1989.01-2009.11	AT	-	-	Engine HCF	814093	Outer Joint		24	21	54	93	47.5	M	
	1989.01-2009.11	MT	-	-	Engine HCE	814093	Outer Joint		24	21	54	93	47.5	M	
	1989.01-1993.01	AT	-	-	Engine HCE	814093	Outer Joint		24	21	54	93	47.5	M	
	1990.11-1993.01	MT	-	-	Engine HCE	814093	Outer Joint		24	21	54	93	47.5	M	
1300	1989.01-1990.01	MT	-	-	Engine HC	814093	Outer Joint		24	21	54	93	47.5	M	
	1989.01-1990.01	MT	-	-	Engine HC	814093	Outer Joint		24	21	54	93	47.5	M	
	1989.01-1993.01	AT	-	-	Engine HC	814093	Outer Joint		24	21	54	93	47.5	M	
	1989.01-1993.01	MT	-	-	Engine HC	814093	Outer Joint		24	21	54	93	47.5	M	
	1989.01-1993.01	MT	-	-	Engine HC	814093	Outer Joint		24	21	54	93	47.5	M	
	1989.01-1990.11	MT	-	-	Engine HCF	814093	Outer Joint		24	21	54	93	47.5	M	
	1989.01-1990.11	AT	-	-	Engine HCF	814093	Outer Joint		24	21	54	93	47.5	M	
	1989.01-1993.01	AT	-	-	Engine HCE	814093	Outer Joint		24	21	54	93	47.5	M	
	1989.01-1990.11	MT	-	-	Engine HCE	814093	Outer Joint		24	21	54	93	47.5	M	
	1990.11-1993.01	MT	-	-	Engine HCE	814093	Outer Joint		24	21	54	93	47.5	M	
CHARADE G112S															
1.3	1989.01-1993.01	MT	-	-	Allwheel Drive Engine HCE	814093	Outer Joint		24	21	54	93	47.5	M	
1300	1989.01-1993.01	MT	-	-	Allwheel Drive Engine HCE	814093	Outer Joint		24	21	54	93	47.5	M	
CHARADE G200S															
1.3	1993.01-2000.05	4AT	-	-	Engine HCE	814097	Outer Joint		24	20	52	93	53	M	
	1993.01-2000.05	4AT	-	-	Engine HCE	814097	Outer Joint		24	20	52	93	53	M	
1300	1993.01-2000.05	4AT	-	-	Engine HCE	814097	Outer Joint		24	20	52	93	53	M	
	1993.01-2000.05	4AT	-	-	Engine HCE	814097	Outer Joint		24	20	52	93	53	M	
CHARADE G203S															
1500	1996.08-2000.05	5MT	-	-	Engine HEEG	814072	Outer Joint	48T	24	22	52	92	53	M	
	1996.08-2000.05	5MT	-	-	Engine HEEG	814072	Outer Joint	48T	24	22	52	92	53	M	
	1996.08-2000.05	4AT	-	-	Engine HEEG	814072	Outer Joint	48T	24	22	52	92	53	M	
CHARADE III (G100 G101 G102)															
1.0 (38 kW)	1987.03-1992.12	-	-	F	Hatchback Engine CB 23	814012	Outer Joint		24	19	46	86.5	53.5	M	
	1987.03-1992.12	MT	-	F	Hatchback Engine CB 23	814005	Outer Joint		24	19	54	92	47.5	M	
	1990.11-1992.12	-	-	F	Hatchback Engine CB 90	814005	Outer Joint		24	19	54	92	47.5	M	
1.0 (40 kW)	1989.04-1992.12	-	-	F	Hatchback Engine CB 90	814005	Outer Joint		24	19	54	92	47.5	M	
1.0 (41 kW)	1989.04-1992.12	-	-	F	Hatchback Engine CB 90	814005	Outer Joint		24	19	54	92	47.5	M	
1.0 D (27 kW)	1987.03-1992.12	-	-	F	Hatchback Engine CL 11	814012	Outer Joint		24	19	46	86.5	53.5	M	
	1987.03-1992.12	AT	-	F	Hatchback Engine CL 11	814005	Outer Joint		24	19	54	92	47.5	M	
1.0 GTi (74 kW)	1987.03-1992.12	-	-	F	Hatchback Engine CB 80 T	814012	Outer Joint		24	19	46	86.5	53.5	M	
	1987.03-1992.12	-	-	F	Hatchback Engine CB 80 T	814017	Outer Joint		24	22	42	155	63	I	
1.0 TD (35 kW)	1987.03-1992.12	-	-	F	Hatchback Engine CL/CL 61	814012	Outer Joint		24	19	46	86.5	53.5	M	
	1987.03-1992.12	-	-	F	Hatchback Engine CL/CL 61	814005	Outer Joint		24	19	54	92	47.5	M	
1.0 Turbo (50 kW)	1987.03-1990.10	-	-	F	Hatchback Engine CB 61	814012	Outer Joint		24	19	46	86.5	53.5	M	
1.3 (56 kW)	1988.09-1992.01	-	-	R	Hatchback Engine HC-C	814013	Outer Joint		24	21	54	92	50	M	
	1988.09-1992.01	-	L	F	Hatchback Engine HC-C	814016	Outer Joint		24	21	46	86.5	54.5	M	
	1988.09-1992.01	-	-	-	Hatchback Engine HC-C	814014	Outer Joint		24	21	54	92	47.5	M	
1.3 i (66 kW)	1988.06-1992.12	-	-	F	Hatchback Engine HCE	814012	Outer Joint		24	19	46	86.5	53.5	M	
	1988.06-1993.01	-	-	F	All-wheel Drive Hatchback Engine HCE	814012	Outer Joint		24	19	46	86.5	53.5	M	
	1988.06-1992.12	-	-	-	Hatchback Engine HCE	814014	Outer Joint		24	21	54	92	47.5	M	
	1988.06-1992.12	AT/MT	L	F	Hatchback Engine HCE	814034	Outer Joint		24	21	46	86	53	M	
	1988.06-1993.01	AT/MT	L	F	All-wheel Drive Hatchback Engine HCE	814034	Outer Joint		24	21	46	86	53	M	
CHARADE III (G102)															
1.3 (66 kW)	1990.11-1993.02	-	-	-	Saloon Engine HCE	814014	Outer Joint		24	21	54	92	47.5	M	
CHARADE IV (G200 G202)															

YEAR	TRANSM	L/R	F/R	REMARKS	GSP Ref.	PRODUCT	ABS	Technical Specifications						
								A	B	C	H	L	P	
DAIHATSU														
CHARADE IV (G200 G202)														
1.3 (44 kW)	1996.09-1999.11	-	-	-	Hatchback Engine HC	814001	Outer Joint	48T	24	22	52	93	54	I
	1996.09-1999.11	MT/AT	L/R	F	Hatchback Engine HC	814046	Outer Joint		24	22	52	93	53	I
	1996.09-1999.11	MT	L/R	F	Hatchback Engine HC	814073	Outer Joint	48T	24	21	52	93	53	M
	1996.09-1999.11	-	-	F	Hatchback Engine HC	814096	Outer Joint		24	19	52	93	53	M
	1996.09-1999.11	-	-	F	Hatchback Engine HC	8141323	Outer Joint		24	22	52	92	53	M
1.3 16V (55 kW)	1996.05-1999.11	-	-	-	Hatchback Engine HCE	814001	Outer Joint	48T	24	22	52	93	54	I
	1996.05-1999.11	MT/AT	L/R	F	Hatchback Engine HCE	814046	Outer Joint		24	22	52	93	53	I
	1996.05-1999.11	MT	L/R	F	Hatchback Engine HCE	814073	Outer Joint	48T	24	21	52	93	53	M
	1996.05-1999.11	-	-	F	Hatchback Engine HCE	814096	Outer Joint		24	19	52	93	53	M
	1996.05-1999.11	-	-	F	Hatchback Engine HCE	8141323	Outer Joint		24	22	52	92	53	M
1.3 i 16V (62 kW)	1996.05-1999.11	-	-	F	Hatchback Engine HCE	814019	Outer Joint		24	20	52	92	47.5	M
	1993.01-2000.09	-	-	-	Hatchback Engine HCE/HC	814001	Outer Joint	48T	24	22	52	93	54	I
	1993.01-2000.09	MT/AT	L/R	F	Hatchback Engine HCE/HC	814046	Outer Joint		24	22	52	93	53	I
	1993.01-2000.09	AT	L/R	F	Hatchback Engine HCE/HC	814033	Outer Joint	48T	24	22	52	93	53	I
	1993.01-2000.09	MT	L/R	F	Hatchback Engine HCE/HC	814073	Outer Joint	48T	24	21	52	93	53	M
1.5 HG (55 kW)	1993.01-2000.09	-	-	F	Hatchback Engine HCE/HC	814096	Outer Joint		24	19	52	93	53	M
	1993.01-2000.09	-	-	F	Hatchback Engine HCE/HC	814019	Outer Joint		24	20	52	92	47.5	M
	1994.06-1996.03	-	-	-	Hatchback Engine HEEG/HEE	814001	Outer Joint	48T	24	22	52	93	54	I
	1997.01-1999.11	-	-	-	Hatchback Engine HEEG/HEE	814001	Outer Joint	48T	24	22	52	93	54	I
	1997.01-1999.11	-	-	F	Hatchback Engine HEEG/HEE	814096	Outer Joint		24	19	52	93	53	M
1.6 GTi (77 kW)	1997.01-1999.11	-	-	F	Hatchback Engine HEEG/HEE	8141323	Outer Joint		24	22	52	92	53	M
	1993.03-1999.11	-	-	-	Hatchback Engine HD-E	814001	Outer Joint	48T	24	22	52	93	54	I
	1993.03-1999.11	MT/AT	L/R	F	Hatchback Engine HD-E	814046	Outer Joint		24	22	52	93	53	I
	1993.03-1999.11	-	-	F	Hatchback Engine HD-E	814006	Outer Joint		24	22	54	92	53	M
	1993.03-1999.11	-	-	F	Hatchback Engine HD-E	814096	Outer Joint		24	19	52	93	53	M
1993.03-1999.11	-	-	F	Hatchback Engine HD-E	8141323	Outer Joint		24	22	52	92	53	M	
CHARADE IV (G203)/VALERA														
1.5 16V (55 kW)	1994.10-2001.01	-	-	-	Saloon Engine HEE	814001	Outer Joint	48T	24	22	52	93	54	I
	1994.10-2001.01	MT/AT	L/R	F	Saloon Engine HEE	814046	Outer Joint		24	22	52	93	53	I
	1994.10-2001.01	-	-	F	Saloon Engine HEE	814096	Outer Joint		24	19	52	93	53	M
	1994.10-2001.01	-	-	F	Saloon Engine HEE	8141323	Outer Joint		24	22	52	92	53	M
1.5 i 16V (66 kW)	1994.06-1999.11	-	-	-	Saloon Engine HEE	814001	Outer Joint	48T	24	22	52	93	54	I
	1994.06-1999.11	MT/AT	L	F	Saloon Engine HEE	814046	Outer Joint		24	22	52	93	53	I
	1994.06-1999.11	AT/MT	L/R	F	Saloon Engine HEE	814033	Outer Joint	48T	24	22	52	93	53	I
	1994.06-1999.11	-	-	F	Saloon Engine HEE	814096	Outer Joint		24	19	52	93	53	M
CUORE														
-	2000.01-2001.12	MT/AT	L	-	-	214006	Drive Shaft		24	23	47	93	584.4	
	2000.01-2001.12	MT/AT	R	-	-	214005	Drive Shaft		24	23	47	93	802	
	2000.01-2001.12	MT/AT	R	-	-	814024	Outer Joint		24	20	47	93	47	I
	2000.01-2001.12	MT/AT	R	-	-	614005	Inner Joint		23	20	45	52	88.5	
0.6 660	2003.05-	MT/AT	-	-	Engine EJVE	814078	Outer Joint		24	19	47	85.5	47.5	M
	2003.05-	MT/AT	-	-	Engine EJVE	814078	Outer Joint		24	19	47	85.5	47.5	M
	2003.05-	MT/AT	-	-	Engine EJVE	814078	Outer Joint		24	19	47	85.5	47.5	M
	2003.05-	MT/AT	-	-	Engine EJVE	814078	Outer Joint		24	19	47	85.5	47.5	M
	2003.05-	MT/AT	-	-	Engine EJVE	814078	Outer Joint		24	19	47	85.5	47.5	M
CUORE (M401)														
0.6	2006.01-	MT/AT	-	-	Engine K3VE	814098	Outer Joint		24	29	47	85.5	47.5	M
CUORE II (L80 L81)/MIRA														
0.8 (29 kW)	1989.11-1990.12	-	-	-	Hatchback Engine ED 10	814009	Outer Joint		24	20	44	113.5	48.5	M
	1989.11-1990.12	-	-	F	Hatchback Engine ED 10	814018	Outer Joint		24	19	44	111.5	48.5	M
0.8 (32 kW)	1985.09-1990.06	-	-	-	Hatchback Engine ED 10	814036	Outer Joint		24	18	44	111.5	49.5	M
	1985.09-1990.06	-	-	F	Hatchback Engine ED 10	814018	Outer Joint		24	19	44	111.5	48.5	M
CUORE III (L201)/MIRA														
0.8 (30 kW)	1990.10-1994.12	-	-	-	Hatchback Engine ED 10 K	814053	Outer Joint		24	20	44	112	49.5	I
	1990.10-1994.12	-	-	-	Hatchback Engine ED 10 K	814009	Outer Joint		24	20	44	113.5	48.5	M
	1990.10-1994.12	-	-	F	Hatchback Engine ED 10 K	814018	Outer Joint		24	19	44	111.5	48.5	M
CUORE IV (L501)/MIRA														
0.8 (31 kW)	1996.11-1998.10	-	-	-	Hatchback Engine ED 20	814009	Outer Joint		24	20	44	113.5	48.5	M
	1996.11-1998.10	-	-	F	Hatchback Engine ED 20	814018	Outer Joint		24	19	44	111.5	48.5	M
0.8 (32 kW)	1995.01-1998.08	-	-	-	Hatchback Engine ED 20	814009	Outer Joint		24	20	44	113.5	48.5	M
	1995.01-1998.08	-	-	F	Hatchback Engine ED 20	814018	Outer Joint		24	19	44	111.5	48.5	M
CUORE M401														
660	2006.01-	MT/AT	-	-	Engine K3VE	814098	Outer Joint		24	29	47	85.5	47.5	M
	2006.01-	MT/AT	-	-	Engine K3VE	814098	Outer Joint		24	29	47	85.5	47.5	M
CUORE V (L7_)/MIRA														
1.0 (40 kW)	1998.11-2000.09	AT/MT	L	F	Hatchback Engine EJ-DE	214035	Drive Shaft		24	23	47	84.5	581	





YEAR	TRANSM	L/R	F/R	REMARKS	GSP Ref.	PRODUCT	ABS	Technical Specifications						
								A	B	C	H	L	P	
DAIHATSU														
CUORE V (L7_)/MIRA														
1.0 (40 kW)	1998.11-2000.09	-	-	F	Hatchback Engine EJ-DE	814029	Outer Joint		24	19	47	84.5	47.5	I
	1998.11-2000.09	AT/MT	R	F	Hatchback Engine EJ-DE	214036	Drive Shaft		24	23	47	84.5	794	
	1998.11-2000.09	-	-	-	Hatchback Engine EJ-DE	814040	Outer Joint		24	18	47	85.5	45.5	I
1.0 i (41 kW)	1998.10-2003.05	-	-	F	Hatchback Engine EJ-DE/EJ-VE	814029	Outer Joint		24	19	47	84.5	47.5	I
	1998.10-2003.05	-	-	-	Hatchback Engine EJ-DE/EJ-VE	814040	Outer Joint		24	18	47	85.5	45.5	I
	1998.10-2003.05	-	-	F	Hatchback Engine EJ-DE/EJ-VE	814061	Outer Joint		24	19	47	85.5	47	M
CUORE VI (L251 L250_ L260_)/MIRA														
1.0 (43 kW)	2003.05-	-	-	-	Hatchback Engine EJ-VE	814063	Outer Joint		24	26	47	85.5	45.5	I
	2003.05-	-	-	F	Hatchback Engine EJ-VE	859268	Outer Joint		24	26	47	85.5	47.5	I
EXTOL (S22_ S23_)/Atrai														
1.3 (63 kW)	2000.07-2011.11	-	-	F	BUS Engine K3-VE	859268	Outer Joint		24	26	47	85.5	47.5	I
1.3 (66 kW)	2000.07-2003.09	-	-	F	All-wheel Drive BUS Engine K3-VE	859268	Outer Joint		24	26	47	85.5	47.5	I
1.3 (68 kW)	2003.10-2005.12	-	-	F	All-wheel Drive BUS Engine K3-VE	859268	Outer Joint		24	26	47	85.5	47.5	I
FEROZA Hard Top (F300)/SPORTRAK														
1.6 16V (63 kW)	1988.10-1999.12	-	-	-	All-wheel Drive Closed Off-Road Vehicle Engine HDC	814001	Outer Joint	48T	24	22	52	93	54	I
1.6 i 16V (70 kW)	1988.10-1999.12	-	-	-	All-wheel Drive Closed Off-Road Vehicle Engine HD-E	814001	Outer Joint	48T	24	22	52	93	54	I
	1988.10-1999.12	-	-	F	All-wheel Drive Closed Off-Road Vehicle Engine HD-E	814017	Outer Joint		24	22	42	155	63	I
FEROZA Soft Top (F300)/SPORTRAK														
1.6 16V (63 kW)	1988.10-1999.12	-	-	-	All-wheel Drive Open Off-Road Vehicle Engine HDC	814001	Outer Joint	48T	24	22	52	93	54	I
1.6 i 16V (70 kW)	1988.10-1999.12	-	-	-	All-wheel Drive Open Off-Road Vehicle Engine HD-E	814001	Outer Joint	48T	24	22	52	93	54	I
	1988.10-1999.12	-	-	F	All-wheel Drive Open Off-Road Vehicle Engine HD-E	814017	Outer Joint		24	22	42	155	63	I
GRAN MOVE (G3)/PYZAR														
1.5 16V (66 kW)	1996.10-1998.07	-	-	-	MPV Engine HEEG	814001	Outer Joint	48T	24	22	52	93	54	I
	1996.10-1998.07	AT	-	F	MPV Engine HEEG	814006	Outer Joint		24	22	54	92	53	M
	1996.10-1998.07	-	-	F	MPV Engine HEEG	841323	Outer Joint		24	22	52	92	53	M
1.5 GLX (71 kW)	1996.10-1998.08	-	-	-	MPV Engine HEEG	814001	Outer Joint	48T	24	22	52	93	54	I
1.5 GX (55 kW)	1996.10-1998.08	-	-	-	MPV Engine HEE/HEEG	814001	Outer Joint	48T	24	22	52	93	54	I
1.6 16V (67 kW)	1998.05-	-	-	-	MPV Engine HDEP	814001	Outer Joint	48T	24	22	52	93	54	I
	1998.05-	-	-	F	MPV Engine HDEP	814006	Outer Joint		24	22	54	92	53	M
1.6 GX (67 kW)	1998.06-2002.07	-	-	-	MPV Engine HDEP	814001	Outer Joint	48T	24	22	52	93	54	I
HANDIVAN														
-	1999.01-2001.12	MT/AT	L	-	-	214006	Drive Shaft		24	23	47	93	584.4	
	1999.01-2001.12	MT/AT	R	-	-	214005	Drive Shaft		24	23	47	93	802	
	1999.01-2001.12	MT/AT	R	-	-	814024	Outer Joint		24	20	47	93	47	I
	1999.01-2001.12	MT/AT	R	-	-	614005	Inner Joint		23	20	45	52	88.5	
HIJET														
-	-	-	-	-	-	814051	Outer Joint		24	18	44	115	49.5	M
HIJET (S210P)														
660	1999.01-	5MT	-	-	Engine EFVE	814052	Outer Joint		24	18	47	85	47	M
	1999.01-	MT/AT	-	-	Engine EFVE	814052	Outer Joint		24	18	47	85	47	M
660 4WD	1999.01-	MT/AT	-	-	Engine EFVE	814052	Outer Joint		24	18	47	85	47	M
HIJET CARGO (S210V)														
660 4WD	1999.01-	5MT	-	-	Engine EFSE	814052	Outer Joint		24	18	47	85	47	M
	1999.01-	MT/AT	-	-	Engine EFVE	814052	Outer Joint		24	18	47	85	47	M
HIJET CARGO S210V														
660	1999.01-	MT/AT	-	-	Allwheel Drive Engine EFVE	814052	Outer Joint		24	18	47	85	47	M
	1999.01-	MT/AT	-	-	Allwheel Drive Engine EFVE	814052	Outer Joint		24	18	47	85	47	M
	1999.01-	5MT	-	-	Allwheel Drive Engine EFSE	814052	Outer Joint		24	18	47	85	47	M
	1999.01-	5MT	-	-	Allwheel Drive Engine EFSE	814052	Outer Joint		24	18	47	85	47	M
	1999.01-	MT/AT	-	-	Allwheel Drive Engine EFVE	814052	Outer Joint		24	18	47	85	47	M
	1999.01-	MT/AT	-	-	Allwheel Drive Engine EFVE	814052	Outer Joint		24	18	47	85	47	M
	1999.01-	5MT	-	-	Allwheel Drive Engine EFSE	814052	Outer Joint		24	18	47	85	47	M
	1999.01-	5MT	-	-	Allwheel Drive Engine EFSE	814052	Outer Joint		24	18	47	85	47	M
	1999.01-2004.11	5MT/3AT	-	-	Allwheel Drive Engine EFVE	814052	Outer Joint		24	18	47	85	47	M
	1999.01-2004.11	5MT	-	-	Allwheel Drive Engine EFSE	814052	Outer Joint		24	18	47	85	47	M
HIJET S210P														
660	1999.01-	MT/AT	-	-	Engine EFVE	814052	Outer Joint		24	18	47	85	47	M
	1999.01-	5MT	-	-	Engine EFVE	814052	Outer Joint		24	18	47	85	47	M
	1999.01-	MT/AT	-	-	Allwheel Drive Engine EFVE	814052	Outer Joint		24	18	47	85	47	M
	1999.01-	MT/AT	-	-	Engine EFVE	814052	Outer Joint		24	18	47	85	47	M
	1999.01-	5MT	-	-	Engine EFVE	814052	Outer Joint		24	18	47	85	47	M
	1999.01-	MT/AT	-	-	Allwheel Drive Engine EFVE	814052	Outer Joint		24	18	47	85	47	M
MIRA														
0.9	1998-2003	-	R	-	-	214024	Drive Shaft		24	23	44	113.5	758.5	
660	1995-2002	-	L	-	-	214003	Drive Shaft		24	23	44	111.5	600	





YEAR	TRANSM	L/R	F/R	REMARKS	GSP Ref.	PRODUCT	ABS	Technical Specifications					
								A	B	C	H	L	P
DAIHATSU													
MIRA													
660	1995-2002	-	R	-	214004	Drive Shaft		24	23	44	111.5	746.5	
	1995-2002	-	L	-	614004	Inner Joint		23	20	39	49.7	82	
	1998.10-	MT/AT	-	EG CAR Model: L700SL700V	814039	Outer Joint		24	18	47	85.5	45	M
	1998.10-	MT/AT	-	EG CAR Model: L900SL902S	814041	Outer Joint		24	24	47	85.5	45	I
MIRA CUORE (L500S)													
0.6	1994.08-	5MT/3AT	-	Engine EFKL	814107	Outer Joint	38T	24	19	44	111.5	48.5	M
	1994.08-	5MT/4AT	-	Engine EFJL	814107	Outer Joint	38T	24	19	44	111.5	48.5	M
	1994.10-	4MT/3AT	-	Engine EFFL	814107	Outer Joint	38T	24	19	44	111.5	48.5	M
	1995.10-	5MT/3AT	-	Engine EFGL	814107	Outer Joint	38T	24	19	44	111.5	48.5	M
	1995.10-	5MT/4AT	-	Engine EFRL	814107	Outer Joint	38T	24	19	44	111.5	48.5	M
	1995.10-	5MT/4AT	-	Engine EFZL	814107	Outer Joint	38T	24	19	44	111.5	48.5	M
MIRA CUORE (L500V)													
0.6	1994.08-	4MT/3AT	-	Engine EFCL	814107	Outer Joint	38T	24	19	44	111.5	48.5	M
MIRA CUORE (L502S)													
0.6	1995.10-	5MT/4AT	-	Engine JBEL	814107	Outer Joint	38T	24	19	44	111.5	48.5	M
MIRA CUORE (L510S)													
0.6 4WD	1995.10-	5MT	-	Engine EFZL	814107	Outer Joint	38T	24	19	44	111.5	48.5	M
MIRA CUORE (L510V)													
0.6 4WD	1994.08-	5MT	-	Engine EFCL	814107	Outer Joint	38T	24	19	44	111.5	48.5	M
MIRA CUORE L500S													
660	1994.08-1995.10	5MT/4AT	-	Engine EFJL	814107	Outer Joint	38T	24	19	44	111.5	48.5	M
	1994.08-1995.10	5MT/3AT	-	Engine EFKL	814107	Outer Joint	38T	24	19	44	111.5	48.5	M
	1994.08-1995.10	5MT/4AT	-	Engine EFJL	814107	Outer Joint	38T	24	19	44	111.5	48.5	M
	1994.08-1995.10	5MT/3AT	-	Engine EFKL	814107	Outer Joint	38T	24	19	44	111.5	48.5	M
	1994.10-1997.05	4MT/3AT	-	Engine EFFL	814107	Outer Joint	38T	24	19	44	111.5	48.5	M
	1994.10-1997.05	4MT/3AT	-	Engine EFFL	814107	Outer Joint	38T	24	19	44	111.5	48.5	M
	1995.10-1998.08	5MT/4AT	-	Engine EFRL	814107	Outer Joint	38T	24	19	44	111.5	48.5	M
	1995.10-1997.05	5MT/3AT	-	Engine EFGL	814107	Outer Joint	38T	24	19	44	111.5	48.5	M
	1995.10-1997.05	5MT/4AT	-	Engine EFZL	814107	Outer Joint	38T	24	19	44	111.5	48.5	M
	1995.10-1997.05	5MT/4AT	-	Engine EFZL	814107	Outer Joint	38T	24	19	44	111.5	48.5	M
	1995.10-1998.08	5MT/4AT	-	Engine EFRL	814107	Outer Joint	38T	24	19	44	111.5	48.5	M
	1995.10-1997.05	5MT/3AT	-	Engine EFGL	814107	Outer Joint	38T	24	19	44	111.5	48.5	M
	1995.10-1997.05	5MT/4AT	-	Engine EFZL	814107	Outer Joint	38T	24	19	44	111.5	48.5	M
	1997.05-1998.08	5MT/4AT	-	Engine EFZL	814107	Outer Joint	38T	24	19	44	111.5	48.5	M
	1997.05-1998.08	4MT/3AT	-	Engine EFFL	814107	Outer Joint	38T	24	19	44	111.5	48.5	M
	1997.05-1998.08	5MT/4AT	-	Engine EFZL	814107	Outer Joint	38T	24	19	44	111.5	48.5	M
	1997.05-1998.08	4MT/3AT	-	Engine EFFL	814107	Outer Joint	38T	24	19	44	111.5	48.5	M
MIRA CUORE L500V													
660	1994.08-1998.08	4MT/3AT	-	Engine EFCL	814107	Outer Joint	38T	24	19	44	111.5	48.5	M
	1994.08-1998.08	4MT/3AT	-	Engine EFCL	814107	Outer Joint	38T	24	19	44	111.5	48.5	M
MIRA CUORE L502S													
660	1995.10-1997.05	5MT/4AT	-	Engine JBEL	814107	Outer Joint	38T	24	19	44	111.5	48.5	M
	1995.10-1997.05	5MT/4AT	-	Engine JBEL	814107	Outer Joint	38T	24	19	44	111.5	48.5	M
MIRA CUORE L510S													
660	1995.10-1998.08	5MT	-	Allwheel Drive Engine EFZL	814107	Outer Joint	38T	24	19	44	111.5	48.5	M
	1995.10-1997.05	5MT	-	Allwheel Drive Engine EFZL	814107	Outer Joint	38T	24	19	44	111.5	48.5	M
	1995.10-1998.08	5MT	-	Allwheel Drive Engine EFZL	814107	Outer Joint	38T	24	19	44	111.5	48.5	M
	1995.10-1997.05	5MT	-	Allwheel Drive Engine EFZL	814107	Outer Joint	38T	24	19	44	111.5	48.5	M
	1995.10-1998.08	5MT	-	Allwheel Drive Engine EFZL	814107	Outer Joint	38T	24	19	44	111.5	48.5	M
MIRA CUORE L510V													
660	1994.08-1998.08	5MT	-	Allwheel Drive Engine EFCL	814107	Outer Joint	38T	24	19	44	111.5	48.5	M
	1994.08-1998.08	5MT	-	Allwheel Drive Engine EFCL	814107	Outer Joint	38T	24	19	44	111.5	48.5	M
MIRA GINO L650S													
660	2005.12-	4AT	-	Engine EFVE	814052	Outer Joint		24	18	47	85	47	M
MOVE													
-	1997-1999	MT	L	-	214003	Drive Shaft		24	23	44	111.5	600	
	1997-1999	MT	R	-	214004	Drive Shaft		24	23	44	111.5	746.5	
	1997-1999	MT	L	-	614004	Inner Joint		23	20	39	49.7	82	
MOVE (L6_)													
0.8 (31 kW)	1996.10-2002.09	-	R	MPV Engine ED 20	814020	Outer Joint		24	19	44	113.5	48.5	M
	1996.10-2002.09	-	F	MPV Engine ED 20	814008	Outer Joint		24	20	44	111.5	48.5	M
	1996.10-2002.09	-	-	MPV Engine ED 20	814009	Outer Joint		24	20	44	113.5	48.5	M
	1996.10-2002.09	-	F	MPV Engine ED 20	814018	Outer Joint		24	19	44	111.5	48.5	M
	1996.10-2002.09	MT/AT	-	MPV Engine ED 20	814074	Outer Joint		24	18	44	111.5	48.5	M
MOVE (L900)													
-	-	-	R	-	214039	Drive Shaft		24	23	47	85.5	799	

DAIHATSU MOVE (L900)	YEAR	TRANSM	L/R	F/R	REMARKS	GSP Ref.	PRODUCT	ABS	Technical Specifications						
									A	B	C	H	L	P	
MOVE (L910S)	-	-	-	L	-	214040	Drive Shaft		24	23	47	85.5	579		
660 4WD	1998.10	1999.11	MT/AT	-	-	Engine EFD/EFVE	814052	Outer Joint	24	18	47	85	47	M	
MOVE (L9_)															
1.0 i (41 kW)	1998.10	2002.09	-	-	-	MPV Engine EJ-DE	814009	Outer Joint	24	20	44	113.5	48.5	M	
	1998.10	2002.09	-	-	F	MPV Engine EJ-DE	814018	Outer Joint	24	19	44	111.5	48.5	M	
	1998.10	2002.09	MT/AT	-	F	MPV Engine EJ-DE	814074	Outer Joint	24	18	44	111.5	48.5	M	
MOVE L160S															
660	2002.10	2003.06	MT/ATV	-	-	Allwheel Drive Engine EFVE	814078	Outer Joint	24	19	47	85.5	47.5	M	
	2002.10	2003.06	MT/ATV	-	-	Allwheel Drive Engine EFVE	814078	Outer Joint	24	19	47	85.5	47.5	M	
	2002.10	2003.06	MT/ATV	-	-	Allwheel Drive Engine EFVE	814078	Outer Joint	24	19	47	85.5	47.5	M	
MOVE L900S															
660	1998.01	1999.11	MT/AT	-	-	Engine EFSE	814052	Outer Joint	24	18	47	85	47	M	
	1998.01	1999.11	MT/AT	-	-	Engine EFSE	814052	Outer Joint	24	18	47	85	47	M	
	1998.10	1999.11	MT/AT	-	-	Engine EFVE	814052	Outer Joint	24	18	47	85	47	M	
	1998.10	1999.11	MT/AT	-	-	Engine EFVE	814052	Outer Joint	24	18	47	85	47	M	
	1999.12	-	MT/ATV	-	-	Engine EFSE /VE	814052	Outer Joint	24	18	47	85	47	M	
MOVE L902S															
660	1998.10	1999.11	MT/AT	-	-	Engine JBDET	814052	Outer Joint	24	18	47	85	47	M	
	1998.10	1999.11	MT/AT	-	-	Engine JBDET	814052	Outer Joint	24	18	47	85	47	M	
MYVI (MS300S)															
1.0	2004.05	-	4AT	-	-	Engine 1KRFE	859461	Outer Joint	24	26	47	85.5	47.5	I	
MYVI MS300S															
1.0	2004.05	-	4AT	-	-	Engine 1KRFE	859461	Outer Joint	24	26	47	85.5	47.5	I	
1000	2004.05	-	4AT	-	-	Engine 1KRFE	859461	Outer Joint	24	26	47	85.5	47.5	I	
NEW G100															
-	-	-	-	-	-	-	614001	Inner Joint	23	19	45	52	82		
OPTI (L800S)															
660	1998.11	1999.07	MT/AT	-	-	Engine EFSE /VE	814052	Outer Joint	24	18	47	85	47	M	
	1998.11	-	MT/CVT	-	-	Engine EFVE	814052	Outer Joint	24	18	47	85	47	M	
OPTI L800S															
660	1998.11	2000.02	MT/ATV	-	-	Engine EFSE /VE	814052	Outer Joint	24	18	47	85	47	M	
	1998.11	2000.02	MT/ATV	-	-	Engine EFSE /VE	814052	Outer Joint	24	18	47	85	47	M	
	2000.02	-	MT/ATV	-	-	Engine EFSE /VE	814052	Outer Joint	24	18	47	85	47	M	
	2000.02	-	MT/ATV	-	-	Engine EFSE /VE	814052	Outer Joint	24	18	47	85	47	M	
OPTI L810S															
660	1998.11	1999.10	MT/ATV	-	-	Allwheel Drive Engine EFSE /VE	814052	Outer Joint	24	18	47	85	47	M	
	1998.11	1999.10	MT/ATV	-	-	Allwheel Drive Engine EFSE /VE	814052	Outer Joint	24	18	47	85	47	M	
PYZAR															
-	1997	2001.01	MT	L	-	-	214031	Drive Shaft	24	25	54	92	601		
	1997	2001.01	MT	R	-	-	214032	Drive Shaft	24	25	54	92	881		
	1997	2001.01	MT	-	-	-	614003	Inner Joint	25	19	45	51.6	82.5		
PYZAR GRAN MOVE G301G															
1600	1996.08	2002.07	4AT	-	-	Engine HDEP	814072	Outer Joint	48T	24	22	52	92	53	M
	1996.08	2002.07	4AT	-	-	Engine HDEP	814072	Outer Joint	48T	24	22	52	92	53	M
	1996.08	2002.07	4AT	-	-	Engine HDEP	814072	Outer Joint	48T	24	22	52	92	53	M
	1996.08	2002.07	5MT	-	-	Engine HDEP	814072	Outer Joint	48T	24	22	52	92	53	M
	1996.08	2002.07	5MT	-	-	Engine HDEP	814072	Outer Joint	48T	24	22	52	92	53	M
	1996.08	2002.07	5MT	-	-	Engine HDEP	814072	Outer Joint	48T	24	22	52	92	53	M
PYZAR GRAN MOVE G303G															
1500	1996.08	2002.07	4AT	-	-	Engine HEEG	814072	Outer Joint	48T	24	22	52	92	53	M
	1996.08	2002.07	4AT	-	-	Engine HEEG	814072	Outer Joint	48T	24	22	52	92	53	M
	1996.08	2002.07	4AT	-	-	Engine HEEP	814072	Outer Joint	48T	24	22	52	92	53	M
	1996.08	2002.07	5MT	-	-	Engine HEEG	814072	Outer Joint	48T	24	22	52	92	53	M
	1996.08	2002.07	5MT	-	-	Engine HEEG	814072	Outer Joint	48T	24	22	52	92	53	M
	1996.08	2002.07	5MT	-	-	Engine HEEG	814072	Outer Joint	48T	24	22	52	92	53	M
PYZAR GRANMOVE (G301G)															
1.6	1996.08	2002.07	4AT	-	F	Engine HDEP	814072	Outer Joint	48T	24	22	52	92	53	M
	1996.08	2002.07	5MT	-	F	Engine HDEP	814072	Outer Joint	48T	24	22	52	92	53	M
PYZAR GRANMOVE (G303G)															
1.5	1996.08	2002.07	4AT	-	F	Engine HEEG/HEEP	814072	Outer Joint	48T	24	22	52	92	53	M
	1996.08	2002.07	5MT	-	F	Engine HEEG	814072	Outer Joint	48T	24	22	52	92	53	M
PYZAR GRANMOVE G301G															
1.6	1996.08	2002.07	4AT	-	-	Engine HDEP	814072	Outer Joint	48T	24	22	52	92	53	M
	1996.08	2002.07	4AT	-	-	Engine HDEP	814072	Outer Joint	48T	24	22	52	92	53	M





YEAR	TRANSM	L/R	F/R	REMARKS	GSP Ref.	PRODUCT	ABS	Technical Specifications								
								A	B	C	H	L	P			
DAIHATSU																
PYZAR GRANMOVE G301G																
1.6	1996.08-2002.07	4AT	-	-	Engine HDEP	814072	Outer Joint	48T	24	22	52	92	53	M		
	1996.08-2002.07	5MT	-	-	Engine HDEP	814072	Outer Joint	48T	24	22	52	92	53	M		
	1996.08-2002.07	5MT	-	-	Engine HDEP	814072	Outer Joint	48T	24	22	52	92	53	M		
	1996.08-2002.07	5MT	-	-	Engine HDEP	814072	Outer Joint	48T	24	22	52	92	53	M		
PYZAR GRANMOVE G303G																
1.5	1996.08-2002.07	4AT	-	-	Engine HEEG	814072	Outer Joint	48T	24	22	52	92	53	M		
	1996.08-2002.07	4AT	-	-	Engine HEEG	814072	Outer Joint	48T	24	22	52	92	53	M		
	1996.08-2002.07	4AT	-	-	Engine HEEP	814072	Outer Joint	48T	24	22	52	92	53	M		
	1996.08-2002.07	5MT	-	-	Engine HEEG	814072	Outer Joint	48T	24	22	52	92	53	M		
	1996.08-2002.07	5MT	-	-	Engine HEEG	814072	Outer Joint	48T	24	22	52	92	53	M		
	1996.08-2002.07	5MT	-	-	Engine HEEG	814072	Outer Joint	48T	24	22	52	92	53	M		
ROCKY (F70)																
2.7 4WD	1990.11-	-	MT	-	-	Engine DL	814065	Outer Joint		26	30	42	165.5	56	M	
ROCKY Hard Top (F7 F8)/FOURTRAK																
2.0 (65 kW)	1985.02-1993.04	MT	-	F	All-wheel Drive Open Off-Road Vehicle Engine 3Y	814004	Outer Joint		26	23	42	165.5	56	I		
2.8 D (54 kW)	1985.02-1998.12	MT	-	F	All-wheel Drive Open Off-Road Vehicle Engine DL	814004	Outer Joint		26	23	42	165.5	56	I		
2.8 TD (67 kW)	1987.12-1993.04	MT	-	F	All-wheel Drive Open Off-Road Vehicle Engine DL 51	814004	Outer Joint		26	23	42	165.5	56	I		
2.8 TD (72 kW)	1993.05-1998.12	-	-	F	All-wheel Drive Open Off-Road Vehicle Engine DL 52/DLC-C	814010	Outer Joint		26	26	61.95	161	65	M		
2.8 TD (75 kW)	1991.09-1998.12	-	-	F	All-wheel Drive Open Off-Road Vehicle Engine DL 52/DLT	814010	Outer Joint		26	26	61.95	161	65	M		
ROCKY Soft Top (F7 F8)/FOURTRAK																
2.0 (65 kW)	1985.02-1993.04	MT	-	F	All-wheel Drive Open Off-Road Vehicle Engine 3Y	814004	Outer Joint		26	23	42	165.5	56	I		
2.8 D (54 kW)	1985.02-1998.12	MT	-	F	All-wheel Drive Open Off-Road Vehicle Engine DL	814004	Outer Joint		26	23	42	165.5	56	I		
2.8 TD (67 kW)	1987.12-1993.04	MT	-	F	All-wheel Drive Open Off-Road Vehicle Engine DL 51	814004	Outer Joint		26	23	42	165.5	56	I		
2.8 TD (75 kW)	1991.09-1998.12	-	-	F	All-wheel Drive Open Off-Road Vehicle Engine DL 52	814010	Outer Joint		26	26	61.95	161	65	M		
RUGGER (F70)																
2.7 4WD	1990.11-	-	MT	-	-	Engine DL	814065	Outer Joint		26	30	42	165.5	56	M	
RUGGER/FOURTRAK																
2.8 D (54 kW)	1984.04-1993.04	MT	-	F	All-wheel Drive Open Off-Road Vehicle Engine DL	814004	Outer Joint		26	23	42	165.5	56	I		
	1993.05-1994.09	-	-	F	All-wheel Drive Open Off-Road Vehicle Engine DL	814010	Outer Joint		26	26	61.95	161	65	M		
2.8 TDiC (72 kW)	1996.07-1999.12	-	-	F	All-wheel Drive Open Off-Road Vehicle Engine DLT	814010	Outer Joint		26	26	61.95	161	65	M		
2.8 TDiC (75 kW)	1993.05-1996.06	-	-	F	All-wheel Drive Open Off-Road Vehicle Engine DLT	814010	Outer Joint		26	26	61.95	161	65	M		
SIRION																
-	1998-2001	-	L	-	-		218077	Drive Shaft		24	23	47	93	616		
	1998-2001	-	R	-	-		218078	Drive Shaft		24	23	47	93	833		
SIRION (M1)/STORIA																
1.0 i (41 kW)	1998.04-2000.09	-	-	-	Hatchback Engine EJ-DE	814040	Outer Joint		24	18	47	85.5	45.5	I		
	1998.04-2000.09	-	-	F	Hatchback Engine EJ-DE	814061	Outer Joint		24	19	47	85.5	47	M		
	1999.04-2000.09	-	-	-	All-wheel Drive Hatchback Engine EJ-DE	814040	Outer Joint		24	18	47	85.5	45.5	I		
1.0 i (43 kW)	2000.09-2005.01	-	-	-	Hatchback Engine EJ-VE	814040	Outer Joint		24	18	47	85.5	45.5	I		
	2000.09-2005.01	-	-	-	All-wheel Drive Hatchback Engine EJ-VE	814040	Outer Joint		24	18	47	85.5	45.5	I		
1.3 Sport (75 kW)	2000.08-2005.01	-	-	F	Hatchback Engine K3-VE2	859268	Outer Joint		24	26	47	85.5	47.5	I		
	2000.08-2005.03	-	-	F	All-wheel Drive Hatchback Engine K3-VE2	859268	Outer Joint		24	26	47	85.5	47.5	I		
	2000.08-2005.01	AT/MT	L/R	F	Hatchback Engine K3-VE2	814034	Outer Joint		24	21	46	86	53	M		
	2000.08-2005.03	AT/MT	L/R	F	All-wheel Drive Hatchback Engine K3-VE2	814034	Outer Joint		24	21	46	86	53	M		
SIRION (M3)/BOON																
1.0 (51 kW)	2005.01-	-	-	-	Hatchback Engine 1KR-FE	814042	Outer Joint		24	26	47	85.5	45	I		
	2005.01-	-	-	-	Hatchback Engine 1KR-FE	814063	Outer Joint		24	26	47	85.5	45.5	I		
	2005.01-	-	-	-	Hatchback Engine 1KR-FE	614017	Inner Joint		23	26	45	52	83			
	2005.01-	-	-	F	Hatchback Engine 1KR-FE	859268	Outer Joint		24	26	47	85.5	47.5	I		
1.3 (64 kW)	2005.01-	-	-	F	Hatchback Engine K3-VE	859268	Outer Joint		24	26	47	85.5	47.5	I		
	2005.01-	-	-	F	Hatchback Engine K3-VE	859266	Outer Joint		24	29	47	85.5	51	I		
	2005.04-	-	-	-	All-wheel Drive Hatchback Engine K3-VE	814063	Outer Joint		24	26	47	85.5	45.5	I		
	2005.04-	-	-	-	All-wheel Drive Hatchback Engine K3-VE	614017	Inner Joint		23	26	45	52	83			
	2005.04-	-	-	F	All-wheel Drive Hatchback Engine K3-VE	859268	Outer Joint		24	26	47	85.5	47.5	I		
1.3 (67 kW)	2008.03-	-	-	-	Hatchback Engine K3-VE	814025	Outer Joint		24	29	47	91.5	51	I		
	2008.03-	-	-	-	All-wheel Drive Hatchback Engine K3-VE	814025	Outer Joint		24	29	47	91.5	51	I		
SIRION II (M3)																
1.3 (64 kW)	2005.01-	-	-	-	-	814055	Outer Joint		24	29	47	85.5	51	I		
1.3 (67 kW)	2008.03-	-	-	-	-	814055	Outer Joint		24	29	47	85.5	51	I		
1.3 4WD (64 kW)	2005.04-	-	-	-	-	814055	Outer Joint		24	29	47	85.5	51	I		
1.3 4WD (67 kW)	2008.03-	-	-	-	-	814055	Outer Joint		24	29	47	85.5	51	I		
1.5 (76 kW)	2008.03-	-	-	-	-	814055	Outer Joint		24	29	47	85.5	51	I		
SOCIAL																
1.3	1990-1994	-	-	-	-	614001	Inner Joint		23	19	45	52	82			
TAFT (F70)																

YEAR	TRANSM	L/R	F/R	REMARKS	GSP Ref.	PRODUCT	ABS	Technical Specifications							
								A	B	C	H	L	P		
DAIHATSU															
TAFT (F70)															
2.7	1990.11-	-	MT/AT	-	-	Engine DL	814065	Outer Joint		26	30	42	165.5	56	M
TERIOS															
-	-	-	-	L	-	-	214029	Drive Shaft	48T	24	23	52	94	539	
1997-2000	-	-	-	L	-	4WD	214021	Drive Shaft		24	23	52	94	540.5	
1997-2000	-	-	-	R	-	4WD	214022	Drive Shaft		24	23	52	94	849.5	
1997-2000	-	-	-	L	-	4WD	614008	Inner Joint		23	19	35	55.5	86	
TERIOS (J100)															
1.3	1997.03-	-	MT/AT	-	-	Engine HCEJ	844103	Outer Joint		22	22	52	95.5	53.5	M
TERIOS (J1_)															
1.3 (61 kW)	1997.10-	2000.10	-	-	F	All-wheel Drive Closed Off-Road Vehicle Engine HC-EJ	814037	Outer Joint	48T	24	19	52	94	81.5	M
	1997.10-	2000.10	AT/MT	-	F	All-wheel Drive Closed Off-Road Vehicle Engine HC-EJ	814011	Outer Joint		24	19	52	94	81.5	M
	1997.10-	2000.10	MT	-	F	All-wheel Drive Closed Off-Road Vehicle Engine HC-EJ	814027	Outer Joint		24	19	52	94	81.5	I
	1997.10-	2000.10	MT	-	F	All-wheel Drive Closed Off-Road Vehicle Engine HC-EJ	814002	Outer Joint	48T	24	19	52	94	81.5	I
1.3 (63 kW)	2000.10-	2005.10	-	-	F	All-wheel Drive Closed Off-Road Vehicle Engine K3-VE	814037	Outer Joint	48T	24	19	52	94	81.5	M
	2000.10-	2005.10	AT/MT	-	F	All-wheel Drive Closed Off-Road Vehicle Engine K3-VE	814011	Outer Joint		24	19	52	94	81.5	M
	2001.09-	2005.10	AT/MT	-	F	Closed Off-Road Vehicle Engine K3-VE	814011	Outer Joint		24	19	52	94	81.5	M
TERIOS KID (J111)															
6.6 4WD	1998.10-	-	MT/AT	-	-	Engine EFDTE/EFDEM	844103	Outer Joint		22	22	52	95.5	53.5	M
VIVA															
1.0	-	-	-	-	-	-	814043	Outer Joint		24	19	47	84.5	47.5	M
VIVA (L250)															
660	2007.05-	-	MT/AT	-	-	Engine EFVE	899299	Outer Joint		24	19	47	85.5	47.5	M
VIVA (L251)															
1.0	2007.05-	-	MT/AT	-	-	Engine EJVE	899299	Outer Joint		24	19	47	85.5	47.5	M
VIVA (L252)															
850	2007.05-	-	MT/AT	-	-	Engine EDVE	899299	Outer Joint		24	19	47	85.5	47.5	M
VIVA L250															
660	2007.05-	-	MT/AT	-	-	Engine EFVE	899299	Outer Joint		24	19	47	85.5	47.5	M
	2007.05-	-	MT/AT	-	-	Engine EFVE	899299	Outer Joint		24	19	47	85.5	47.5	M
VIVA L251															
1.0	2007.05-	-	MT/AT	-	-	Engine EJVE	899299	Outer Joint		24	19	47	85.5	47.5	M
1000	2007.05-	-	MT/AT	-	-	Engine EJVE	899299	Outer Joint		24	19	47	85.5	47.5	M
VIVA L252															
850	2007.05-	-	MT/AT	-	-	Engine EDVE	899299	Outer Joint		24	19	47	85.5	47.5	M
	2007.05-	-	MT/AT	-	-	Engine EDVE	899299	Outer Joint		24	19	47	85.5	47.5	M
YRV (M2)															
1.3 (64 kW)	2001.02-	-	-	-	F	Estate Engine K3-VE	814038	Outer Joint		24	21	47	85	47	M
	2001.02-	-	-	-	F	Estate Engine K3-VE	859268	Outer Joint		24	26	47	85.5	47.5	I
	2001.02-	-	-	-	F	All-wheel Drive Estate Engine K3-VE	859268	Outer Joint		24	26	47	85.5	47.5	I
	2001.02-	-	-	-	F	Estate Engine K3-VE	814062	Outer Joint		24	20	47	86.5	48	M
1.3 GTi (95 kW)	2002.07-	-	-	-	F	Estate Engine K3-VET	814028	Outer Joint		24	19	47	84.5	47.5	I
YRV (M201)															
1.3	2000.08-	-	MT/AT	-	-	Engine K3VE	814077	Outer Joint		24	20	47	85.5	47	M
YRV M201															
1.3	2000.08-	-	MT/AT	-	-	Engine K3VE	814077	Outer Joint		24	20	47	85.5	47	M
1300	2000.08-	-	MT/AT	-	-	Engine K3VE	814077	Outer Joint		24	20	47	85.5	47	M
DODGE															
400															
-	1983-	-	-	-	-	-	615002	Inner Joint		23	23	40	57	105.5	
ARIES															
-	1986-	1989	-	-	-	Saginaw	809010	Outer Joint		26	29	54	99.5	62.5	O
ATOS															
-	2006-	2011	MT/AT	L/R	-	-	639072	Inner Joint		25	30	35	62.5	95	
AVENGER															
-	1995-	1999	-	-	-	-	839041	Outer Joint		25	25	54	95.5	65	M
2.0	2008-	2010	MT	R	-	-	635037	Inner Joint		28	24	42.5		126	
	2008-	2010	MT	L/R	-	-	899327	Outer Joint		32	32	56.7	104.5	62	I
2.4	2008-	2014	AT	L	-	-	609033	Inner Joint		25	24	40	74	113	
	2008-	2014	AT	R	-	-	635037	Inner Joint		28	24	42.5		126	
	2008-	2014	AT	L/R	-	-	899327	Outer Joint		32	32	56.7	104.5	62	I
2.4L 4 Cyl DOHC 16V Dual VVT	2008-	-	-	-	-	SE	235042	Propshaft					30	745	
	2008-	-	-	-	-	SXT	235042	Propshaft					30	745	
	2008-	-	-	-	-	SE	235041	Propshaft					30	770	
	2008-	-	-	-	-	SXT	235041	Propshaft					30	770	
2.4L I4 16V Dual VVT	2008-	-	-	-	-	Engine PZEV SE	235041	Propshaft					30	770	

	 YEAR	TRANSM	L/R	F/R	REMARKS	GSP Ref.	 PRODUCT	 ABS	Technical Specifications					
									A	B	C	H	L	P
DODGE AVENGER														
2.4L I4 16V Dual VVT	2008-	-	-	-	Engine PZEV SXT	235041	Propshaft					30	770	
2.4L I4 PZEV 16V Dual VVT	2008-	-	-	-	Engine SE	235042	Propshaft					30	745	
	2008-	-	-	-	Engine SXT	235042	Propshaft					30	745	
2.7L V6 DOHC 24 Valve MPI	2008-	-	-	-	SE	235042	Propshaft					30	745	
	2008-	-	-	-	SXT	235042	Propshaft					30	745	
	2008-	-	-	-	SE	235041	Propshaft					30	770	
	2008-	-	-	-	SXT	235041	Propshaft					30	770	
3.5	2008-2009		AT	L	-	635035	Inner Joint	29	26	40	81	108.5		
	2008-2009		AT	R	-	635036	Inner Joint	28	26	42.5		126		
3.5L High Output V6 24V MPI	2008-	-	6AT	-	R/T	235042	Propshaft					30	745	
	2008-	-	6AT	-	AWD R/T	235042	Propshaft					30	745	
	2008-	-	6AT	-	62TE R/T	235041	Propshaft					30	770	
	2008-	-	6AT	-	62TE R/T AWD	235041	Propshaft					30	770	
CALIBER														
-	2007-2012		MT/AT	L/R	-	851032	Outer Joint	28	33	59.5	95	63.5	I	
	2007-2010		MT/AT	-	-	618167	Inner Joint	26	26	40	69	116.5		
	2007-2012		MT/AT	L	-	641056	Inner Joint	27	33	40	62	112		
	2007-2012		MT	R	-	615014	Inner Joint	28	33	42	40	82		
1.8 (110 kW)	2006.06-2009.12		5MT	-	F Hatchback Engine EBA	839113	Outer Joint	28	33	59.5	95	61.5	I	
2.0 (115 kW)	2006.06-	-	5MT	-	F Hatchback Engine ECN	839113	Outer Joint	28	33	59.5	95	61.5	I	
	2006.06-	-	CVT	L	F Hatchback Engine ECN	215053	Drive Shaft	28	27	59.5	95	638		
2.0 CRD (103 kW)	2006.06-	-	-	-	F Hatchback Engine ECE	815010	Outer Joint	28	36	59.5	95	68	I	
	2006.06-	-	5MT	-	F Hatchback Engine ECE	839113	Outer Joint	28	33	59.5	95	61.5	I	
2.0 CRD(100 kW)	2006.06-2011.11		-	-	F Hatchback Engine ECD	815010	Outer Joint	28	36	59.5	95	68	I	
	2006.06-2011.11		5MT	-	F Hatchback Engine ECD	839113	Outer Joint	28	33	59.5	95	61.5	I	
2.2 CRD (120 kW)	2010.07-	-	-	-	F Hatchback Engine ENE	815010	Outer Joint	28	36	59.5	95	68	I	
	2010.07-	-	5MT	-	F Hatchback Engine ENE	839113	Outer Joint	28	33	59.5	95	61.5	I	
2.4 (125 kW)	2006.10-	-	5MT	-	F Hatchback Engine ED3	839113	Outer Joint	28	33	59.5	95	61.5	I	
2.4 Turbo (217 kW)	2007.12-	-	5MT	-	F Hatchback Engine ED4	839113	Outer Joint	28	33	59.5	95	61.5	I	
CALIBER (PM)														
1.8 i 16V DOHC	2006.04-	-	5MT	R	F Hatchback Engine EBA	215051	Drive Shaft	28	28	59.5	95	586		
2.0 D 16V DOHC	2006.04-	-	6MT	L	F Hatchback Engine ECN	215054	Drive Shaft	28	24	59.5	95	622		
	2006.04-	-	6MT	R	F Hatchback Engine ECN	215052	Drive Shaft	28	28	59.5	95	613		
2.0 i 16V DOHC	2006.04-	-	6MT/AT	R	F Hatchback Engine ECN	215051	Drive Shaft	28	28	59.5	95	586		
CARAVAN														
-	1991-1995		-	-	-	609026	Inner Joint	25	32	40	71	124		
	1991-1995		-	-	SUV/Truck/VAN GKN PASSENGER	609027	Inner Joint	25	32	28	172	137		
	1996-1997		-	-	TRUCK	609011	Inner Joint	25	32	40	71.5	107		
	1996-2001		-	R	TRUCK	609012	Inner Joint	25	32	28	173	107		
	1996-2000		-	-	SUV/Truck/VAN	609021	Inner Joint	25	32	28	173	107		
	1996-2004		-	-	SUV/Truck/VAN	699059	Inner Joint	25	32	40	71.5	107		
-AWD	2001-2004		-	-	-	609034	Propshaft CV Joint		25		32			
2.0 i (98 kW)	1995.01-2001.03		-	-	MPV	809013	Outer Joint	26	32	54	98.5	61.5	I	
	1995.01-2001.03		4AT	-	MPV	809029	Outer Joint	47T	26	32	54	98.5	61.5	I
2.4 i (111 kW)	1995.01-2001.03		-	-	MPV Engine EDZ	809013	Outer Joint	26	32	54	98.5	61.5	I	
	1995.01-2001.03		4AT	-	MPV Engine EDZ	809029	Outer Joint	47T	26	32	54	98.5	61.5	I
2.5 TD (85 kW)	1995.01-2001.03		-	-	MPV Engine ENC	809013	Outer Joint	26	32	54	98.5	61.5	I	
	1995.01-2001.03		4AT	-	MPV Engine ENC	809029	Outer Joint	47T	26	32	54	98.5	61.5	I
2.8 CRD (120 kW)	2009.01-	-	4AT	-	MPV Engine ENS	809029	Outer Joint	47T	26	32	54	98.5	61.5	I
3.0 (112 kW)	1995.01-2001.03		-	-	MPV Engine EFA	809013	Outer Joint	26	32	54	98.5	61.5	I	
	1995.01-2001.03		4AT	-	MPV Engine EFA	809029	Outer Joint	47T	26	32	54	98.5	61.5	I
3.3 i (116 kW)	1995.01-2001.03		-	-	MPV Engine EGP	809013	Outer Joint	26	32	54	98.5	61.5	I	
	1995.01-2001.03		4AT	-	MPV Engine EGP	809029	Outer Joint	47T	26	32	54	98.5	61.5	I
3.8 (142 kW)	2008.01-	-	4AT	-	MPV	809029	Outer Joint	47T	26	32	54	98.5	61.5	I
3.8 i (122 kW)	1995.01-2001.03		-	-	MPV Engine EGH	809013	Outer Joint	26	32	54	98.5	61.5	I	
	1995.01-2001.03		4AT	-	MPV Engine EGH	809029	Outer Joint	47T	26	32	54	98.5	61.5	I
3.8 i (131 kW)	1995.01-2001.03		-	-	MPV Engine EGH	809013	Outer Joint	26	32	54	98.5	61.5	I	
	1995.01-2001.03		4AT	-	MPV Engine EGH	809029	Outer Joint	47T	26	32	54	98.5	61.5	I
3.8 i AWD (122 kW)	1995.01-2001.03		-	-	All-wheel Drive MPV Engine EGH	809013	Outer Joint	26	32	54	98.5	61.5	I	
	1995.01-2001.03		4AT	-	All-wheel Drive MPV Engine EGH	809029	Outer Joint	47T	26	32	54	98.5	61.5	I
3.8 i AWD (131 kW)	1995.01-2001.03		-	-	All-wheel Drive MPV Engine EGH	809013	Outer Joint	26	32	54	98.5	61.5	I	
	1995.01-2001.03		4AT	-	All-wheel Drive MPV Engine EGH	809029	Outer Joint	47T	26	32	54	98.5	61.5	I
4.0 (189 kW)	2009.01-	-	4AT	-	MPV	809029	Outer Joint	47T	26	32	54	98.5	61.5	I
CARAVAN (RG_)														
2.4 (111 kW)	2000.02-2007.12		4AT	-	MPV Engine EDZ	809029	Outer Joint	47T	26	32	54	98.5	61.5	I
3.3 (128 kW)	2000.02-2007.12		4AT	-	MPV Engine EGA	809029	Outer Joint	47T	26	32	54	98.5	61.5	I





	 YEAR	TRANSM	L/R	F/R	REMARKS	GSP Ref.	 PRODUCT	 ABS	Technical Specifications						
									A	B	C	H	L	P	
DODGE CARAVAN (RG_)															
3.3 AWD (128 kW)	2000.02-2007.12	4AT	-	F	All-wheel Drive MPV Engine EGA	809029	Outer Joint	47T	26	32	54	98.5	61.5	I	
3.8 (160 kW)	2000.02-2007.12	4AT	-	F	MPV Engine EGH	809029	Outer Joint	47T	26	32	54	98.5	61.5	I	
3.8 AWD (160 kW)	2000.02-2007.12	4AT	-	F	All-wheel Drive MPV Engine EGH	809029	Outer Joint	47T	26	32	54	98.5	61.5	I	
3.8 Turbo AWD (153 kW)	2001.04-2007.12	4AT	-	F	All-wheel Drive MPV Engine EGH	809029	Outer Joint	47T	26	32	54	98.5	61.5	I	
CHARGER															
6.4 SRT8 (351 kW)	2011.09-	AT	R	R	Saloon Engine ESG	235130	Drive Shaft	48NS	32	31	63	105.5	822		
	2011.09-	AT	L	R	Saloon Engine ESG	235131	Drive Shaft	48NS	32	31	63	105.5	797		
COLT VISTA FWD															
2.4	1992-1994	AT	-	-	-	839041	Outer Joint		25	25	54	95.5	65	M	
DAKOTA															
-	1991-1996	-	-	-	4WD	815009	Outer Joint	56T	31	34	61	115.5	64	O	
	2000-	-	-	-	-	615010	Inner Joint		29	35	47	53	90		
2.5 AWD (73 kW)	1989.10-1995.09	-	-	-	All-wheel Drive Pickup Engine EDM	815005	Outer Joint		31	34	61	115.5	64	O	
2.5L L4	2000-	-	L	-	-	215061	Stub Axle		29	29	34.9		158.5		
	2001-	-	L	-	-	215061	Stub Axle		29	29	34.9		158.5		
2.5L POWER TECH I-4 Cyl.	1999-	5MT	-	-	HD CLUB CAB	216024	Propshaft					30	868		
	1999-	5MT	-	-	HD REGULAR CAB	216024	Propshaft					30	868		
3.9L V6	2000-	-	L	-	-	215061	Stub Axle		29	29	34.9		158.5		
	2001-	-	L	-	-	215061	Stub Axle		29	29	34.9		158.5		
5.2L V8 MPI	1999-	4AT	-	-	44RE CAB	216024	Propshaft					30	868		
	1999-	4AT	-	-	44RE CAB	216024	Propshaft					30	868		
	1999-	5MT	-	-	CLUB CAB	216024	Propshaft					30	868		
	1999-	5MT	-	-	REGULAR CAB	216024	Propshaft					30	868		
5.9L V8	2000-	-	L	-	-	215061	Stub Axle		29	29	34.9		158.5		
	2001-	-	L	-	-	215061	Stub Axle		29	29	34.9		158.5		
5.9L V8 MPI	1999-	4AT	-	-	46RE CLUB CAB	216024	Propshaft					30	868		
	1999-	4AT	-	-	46RE REGULAR CAB	216024	Propshaft					30	868		
DAKOTA "MAGNUM"															
3.9L SMPI V6	1999-	4AT	-	-	42RE CLUB CAB	216024	Propshaft					30	868		
	1999-	4AT	-	-	42RE REGULAR CAB	216024	Propshaft					30	868		
	1999-	5MT	-	-	CLUB CAB	216024	Propshaft					30	868		
	1999-	5MT	-	-	REGULAR CAB	216024	Propshaft					30	868		
DAYTONA															
-	1986-1993	-	-	-	SAGINAW	809010	Outer Joint		26	29	54	99.5	62.5	O	
	1987-1993	-	-	-	-	809008	Outer Joint		26	28	54	98	58	I	
DURANGO															
-	2000-	-	-	-	-	615010	Inner Joint		29	35	47	53	90		
5.2L V8	2000-	-	L	-	-	215061	Stub Axle		29	29	34.9		158.5		
5.9L V8	2000-	-	L	-	-	215061	Stub Axle		29	29	34.9		158.5		
	2001-	-	L	-	-	215061	Stub Axle		29	29	34.9		158.5		
DYNASTY															
-	1989-1990	-	-	-	Saginaw	809010	Outer Joint		26	29	54	99.5	62.5	O	
I10															
-	2012-2014	MT	L	-	-	639073	Inner Joint		25	20	35	54	91		
INTREPID															
-	1993-1995	-	-	-	-	809038	Outer Joint	50W	33	32	49.6	102.5	60	O	
	1993-2004	-	-	-	-	699062	Inner Joint		27	32	39.5	49	76		
	1996-1997	-	R	-	-	209013	Drive Shaft	50T	33	27	49.6	102.5	537		
	1996-1997	-	-	-	-	808022	Outer Joint	50T	33	32	49.6	102.5	60	O	
	1996-1997	-	-	-	-	609009	Inner Joint		27	32	39.8	47.5	77.5		
	1998-2004	-	-	-	-	809039	Outer Joint	50T	33	32	49.6	102.5	57	O	
JOURNEY															
2.4	2009-	AT	L	-	-	609033	Inner Joint		25	24	40	74	113		
	2009-	AT	R	-	-	635038	Inner Joint		27	24	40	62	115.5		
	2009-	AT	L/R	-	-	899327	Outer Joint		32	32	56.7	104.5	62	I	
3.5	2009-2010	AT	L	-	-	635035	Inner Joint		29	26	40	81	108.5		
	2009-2010	AT	R	-	-	635036	Inner Joint		28	26	42.5		126		
JOURNEY/JC															
2.0 CRD (103 kW)	2008.06-	-	L	F	MPV Engine ECE	209079	Drive Shaft		32	29	56.7	104.5	643		
	2008.06-	-	R	F	MPV Engine ECE	209080	Drive Shaft		32	28	56.7	104.5	521		
2.4 (125 kW)	2009.01-	-	L	F	MPV Engine ED3	209079	Drive Shaft		32	29	56.7	104.5	643		
	2009.01-	-	R	F	MPV Engine ED3	209080	Drive Shaft		32	28	56.7	104.5	521		
2.4 ECO+ (125 kW)	2009.03-	-	L	-	MPV Engine EDG	209079	Drive Shaft		32	29	56.7	104.5	643		
	2009.03-	-	R	-	MPV Engine EDG	209080	Drive Shaft		32	28	56.7	104.5	521		
3.5 (173 kW)	2008.06-	-	L	-	MPV Engine EGF	209079	Drive Shaft		32	29	56.7	104.5	643		

YEAR	TRANSM	L/R	F/R	REMARKS	GSP Ref.	PRODUCT	ABS	Technical Specifications						
								A	B	C	H	L	P	
DODGE JOURNEY/JC														
3.5 (173 kW)	2008.06-	-	-	R -	MPV Engine EGF	209080	Drive Shaft		32	28	56.7	104.5	521	
3.5 AWD (173 kW)	2008.06-	-	-	L -	All-wheel Drive MPV Engine EGF	209079	Drive Shaft		32	29	56.7	104.5	643	
	2008.06-	-	-	R -	All-wheel Drive MPV Engine EGF	209080	Drive Shaft		32	28	56.7	104.5	521	
3.6 (211 kW)	2012.01-	-	-	L -	MPV Engine ERB	209079	Drive Shaft		32	29	56.7	104.5	643	
	2012.01-	-	-	R -	MPV Engine ERB	209080	Drive Shaft		32	28	56.7	104.5	521	
3.6 AWD (206 kW)	2013.05-	-	-	L F	All-wheel Drive MPV Engine ERB	209079	Drive Shaft		32	29	56.7	104.5	643	
	2013.05-	-	-	R F	All-wheel Drive MPV Engine ERB	209080	Drive Shaft		32	28	56.7	104.5	521	
LANCER														
-	1986-	1989	-	-	SAGINAW	809010	Outer Joint		26	29	54	99.5	62.5	O
NEON														
-	1995-	1996	AT	R -	-	215009	Drive Shaft		23	25	57.7	91.8	942	
	1995-	1996	MT/AT	L -	-	215006	Drive Shaft		23	25	57.7	91.8	582	
	1995-	1996	MT/AT	-	-	609020	Inner Joint		25	28	40	71.5	109.5	
2.0	1995-	1997	AT	L -	-	609004	Inner Joint		25	28	40	74	103.5	
	1995-	1997	MT	L/R -	-	609004	Inner Joint		25	28	40	74	103.5	
	1995-	1999	MT	L -	-	609004	Inner Joint		25	28	40	74	103.5	
	1995-	1999	MT	L/R -	-	609004	Inner Joint		25	28	40	74	103.5	
	1998-	1999	AT	L -	-	609004	Inner Joint		25	28	40	74	103.5	
	1998-	1999	MT	L/R -	-	609004	Inner Joint		25	28	40	74	103.5	
2.0 16V (107 kW)	1994.06-	1999.08	-	-	Saloon Engine ECC	809011	Outer Joint		23	28	57.7	91.8	58	I
	1994.06-	1999.08	AT/MT	L/R F	Saloon Engine ECC	809036	Outer Joint	56T	23	28	57.7	91.8	58	I
2.0 16V (109 kW)	1996.04-	1999.08	-	-	Saloon Engine ECC	809011	Outer Joint		23	28	57.7	91.8	58	I
	1996.04-	1999.08	AT/MT	L/R F	Saloon Engine ECC	809036	Outer Joint	56T	23	28	57.7	91.8	58	I
2.0 16V (112 kW)	1996.04-	1999.08	-	-	Saloon Engine ECC	809011	Outer Joint		23	28	57.7	91.8	58	I
2.0 16V (98 kW)	1994.05-	1999.08	-	-	Saloon Engine ECB	809011	Outer Joint		23	28	57.7	91.8	58	I
	1994.05-	1999.08	AT/MT	L/R F	Saloon Engine ECB	809036	Outer Joint	56T	23	28	57.7	91.8	58	I
NEON II														
2.0 16V (112 kW)	1999.08-	-	-	-	Saloon Engine ECH	809011	Outer Joint		23	28	57.7	91.8	58	I
2.0 16V (98 kW)	1999.08-	-	-	-	Saloon Engine ECB	809011	Outer Joint		23	28	57.7	91.8	58	I
RAM 1500														
-	2002-	2006	-	-	F 4WD/PROPELLER SHAFT	808078	Propshaft CV Joint		30	28	50	102	63	M
RAM 50														
-	1982-	1993	-	-	4WD	639044	Inner Joint			25		62.5		
SHADOW														
-	1987-	1994	-	-	Saginaw	809010	Outer Joint		26	29	54	99.5	62.5	O
-	1987-	1994	-	-	-	809008	Outer Joint		26	28	54	98	58	I
SPIRIT														
-	1989-	1990	-	-	Saginaw	809010	Outer Joint		26	29	54	99.5	62.5	O
-	1991-	1993	-	-	-	609026	Inner Joint		25	32	40	71	124	
-	1991-	1993	-	-	Turbo GKN Passenger	609027	Inner Joint		25	32	28	172	137	
STEALTH (FWD)														
-	1993-	1996	-	-	-	615006	Inner Joint		26	26	42	39.5	78.5	
STRATUS														
2.0 16V (98 kW)	1995.12-	2001.04	-	-	Saloon Engine ECB	841146	Outer Joint	46T	26	32	54.1	95	64	O
2.4 16 V (103 kW)	1995.12-	2001.04	-	-	Saloon Engine EDZ	841146	Outer Joint	46T	26	32	54.1	95	64	O
2.4 16V (112 kW)	1995.12-	2001.04	-	-	Saloon Engine EDZ	841146	Outer Joint	46T	26	32	54.1	95	64	O
2.5 V6 (125 kW)	1995.12-	2001.04	-	-	Saloon Engine EEB	841146	Outer Joint	46T	26	32	54.1	95	64	O
2.7L V6 24V FFV	2004-	-	4AT	-	ES	216024	Propshaft					30	868	
	2004-	-	4AT	-	SE	216024	Propshaft					30	868	
2.7L V6 DOHC 24 Valve MPI	2004-	-	4AT	-	ES	216024	Propshaft					30	868	
	2004-	-	4AT	-	R/T	216024	Propshaft					30	868	
	2004-	-	4AT	-	SE	216024	Propshaft					30	868	
	2004-	-	4AT	-	SXT	216024	Propshaft					30	868	
	2004-	-	5MT	-	R/T	216024	Propshaft					30	868	
STRATUS SEDAN														
-	1995-	1999	-	-	-	609010	Inner Joint		25	32	40	74	113	
DONGNAN (SOUEAST) GRAND VOYAGER														
3.3 (128 kW)	2007.11-	2012.12	AT	R F	MPV Engine EGA	209003	Drive Shaft		26	25	54	98.5	1001	
LIONCEL														
1.6 (74 kW)	2003.03-	2008.12	MT	L -	Saloon Engine 4 G 18	239126	Drive Shaft	43T	25	25	54	95	610	
	2003.03-	2008.12	MT	R -	Saloon Engine 4 G 18	239127	Drive Shaft	43T	25	25	54	95	929	
DS DS 3														
1.2 THP 110 (81 kW)	2015.04-	-	MT	L F	Hatchback Engine HNZ (EB2DT)	210414	Drive Shaft		25	24	58.5	78.5	632	

	 YEAR	TRANSM	L/R	F/R	REMARKS	GSP Ref.	 PRODUCT	 ABS	Technical Specifications					
									A	B	C	H	L	P
DS														
DS 3														
1.2 THP 110 (81 kW)	2015.04 -	MT	-	F	Hatchback Engine HNZ (EB2DT)	845012	Outer Joint		21	34	48.5	86	55.5	I
	2015.04 -	MT	R	F	Hatchback Engine HNZ (EB2DT)	210249	Drive Shaft		25	24	58.5	79	864	
	2015.04 -	MT	L	F	Hatchback Engine HNZ (EB2DT)	210309	Drive Shaft		21	24	48.3	86.5	641	
	2015.07 -	MT	L	F	Convertible Engine HNZ (EB2DT)	210414	Drive Shaft		25	24	58.5	78.5	632	
	2015.07 -	MT	-	F	Convertible Engine HNZ (EB2DT)	845012	Outer Joint		21	34	48.5	86	55.5	I
	2015.07 -	MT	L	F	Convertible Engine HNZ (EB2DT)	210309	Drive Shaft		21	24	48.3	86.5	641	
1.2 THP 130 (96 kW)	2015.09 -	6MT	L	F	Hatchback Engine HNY (EB2DTS)	210253	Drive Shaft		25	24	58.5	79	626	
	2015.09 -	6MT	L	F	Convertible Engine HNY (EB2DTS)	210253	Drive Shaft		25	24	58.5	79	626	
	2015.09 -	6MT	L	F	Hatchback Engine HNY (EB2DTS)	810148	Outer Joint		25	34	58.5	79	55.5	I
	2015.09 -	6MT	L	F	Convertible Engine HNY (EB2DTS)	810148	Outer Joint		25	34	58.5	79	55.5	I
	2015.09 -	6MT	L	F	Hatchback Engine HNY (EB2DTS)	610057	Inner Joint		24	34	40	52.5	90	
1.2 VTi 82 (60 kW)	2015.04 -	MT	-	-	Hatchback Engine HMZ (EB2F)	810130	Outer Joint		21	34	48.3	86.5	55.5	I
	2015.07 -	MT	-	-	Convertible Engine HMZ (EB2F)	810130	Outer Joint		21	34	48.3	86.5	55.5	I
1.6 BlueHDi 100 (73 kW)	2015.04 -	MT	L	F	Hatchback Engine BHY (DV6FD)	210414	Drive Shaft		25	24	58.5	78.5	632	
	2015.04 -	MT	R	F	Hatchback Engine BHY (DV6FD)	210249	Drive Shaft		25	24	58.5	79	864	
	2015.07 -	MT	L	F	Convertible Engine BHY (DV6FD)	210414	Drive Shaft		25	24	58.5	78.5	632	
	2015.07 -	MT	R	F	Convertible Engine BHY (DV6FD)	210249	Drive Shaft		25	24	58.5	79	864	
1.6 BlueHDi 120 (88 kW)	2015.07 -	MT	L	F	Hatchback Engine BHZ (DV6FC)	210253	Drive Shaft		25	24	58.5	79	626	
	2015.07 -	MT	L	F	Convertible Engine BHZ (DV6FC)	210253	Drive Shaft		25	24	58.5	79	626	
	2015.07 -	MT	L	F	Hatchback Engine BHZ (DV6FC)	810148	Outer Joint		25	34	58.5	79	55.5	I
	2015.07 -	MT	L	F	Convertible Engine BHZ (DV6FC)	810148	Outer Joint		25	34	58.5	79	55.5	I
	2015.07 -	MT	L	F	Hatchback Engine BHZ (DV6FC)	610057	Inner Joint		24	34	40	52.5	90	
	2015.07 -	MT	L	F	Convertible Engine BHZ (DV6FC)	610057	Inner Joint		24	34	40	52.5	90	
1.6 BlueHDi 75 (55 kW)	2015.07 -	MT	L	F	Hatchback Engine BHW (DV6FE)	210414	Drive Shaft		25	24	58.5	78.5	632	
	2015.07 -	MT	R	F	Hatchback Engine BHW (DV6FE)	210249	Drive Shaft		25	24	58.5	79	864	
1.6 THP 165 (121 kW)	2015.07 -	6MT	L	F	Hatchback Engine 5GZ (EP6FDT)	210253	Drive Shaft		25	24	58.5	79	626	
	2015.07 -	6MT	L	F	Convertible Engine 5GZ (EP6FDT)	210253	Drive Shaft		25	24	58.5	79	626	
	2015.07 -	6MT	L	F	Hatchback Engine 5GZ (EP6FDT)	810148	Outer Joint		25	34	58.5	79	55.5	I
	2015.07 -	6MT	L	F	Convertible Engine 5GZ (EP6FDT)	810148	Outer Joint		25	34	58.5	79	55.5	I
	2015.07 -	6MT	L	F	Hatchback Engine 5GZ (EP6FDT)	610057	Inner Joint		24	34	40	52.5	90	
	2015.07 -	6MT	L	F	Convertible Engine 5GZ (EP6FDT)	610057	Inner Joint		24	34	40	52.5	90	
1.6 THP 208 (153 kW)	2015.09 -	6MT	L	F	Hatchback Engine 5GR (EP6FDTX)	210253	Drive Shaft		25	24	58.5	79	626	
	2015.09 -	6MT	L	F	Convertible Engine 5GM (EP6FDTX)	210253	Drive Shaft		25	24	58.5	79	626	
	2015.09 -	6MT	L	F	Hatchback Engine 5GR (EP6FDTX)	810148	Outer Joint		25	34	58.5	79	55.5	I
	2015.09 -	6MT	L	F	Convertible Engine 5GM (EP6FDTX)	810148	Outer Joint		25	34	58.5	79	55.5	I
	2015.09 -	6MT	L	F	Hatchback Engine 5GR (EP6FDTX)	610057	Inner Joint		24	34	40	52.5	90	
	2015.09 -	6MT	L	F	Convertible Engine 5GM (EP6FDTX)	610057	Inner Joint		24	34	40	52.5	90	
1.6 THP(120 kW)	2015.07 -	MT	L	F	Hatchback Engine 5GZ (EP6FDT)	210253	Drive Shaft		25	24	58.5	79	626	
	2015.07 -	MT	L	F	Convertible Engine 5GZ (EP6FDT)	210253	Drive Shaft		25	24	58.5	79	626	
	2015.07 -	MT	L	F	Hatchback Engine 5GZ (EP6FDT)	810148	Outer Joint		25	34	58.5	79	55.5	I
	2015.07 -	MT	L	F	Convertible Engine 5GZ (EP6FDT)	810148	Outer Joint		25	34	58.5	79	55.5	I
	2015.07 -	MT	L	F	Hatchback Engine 5GZ (EP6FDT)	610057	Inner Joint		24	34	40	52.5	90	
2015.07 -	MT	L	F	Convertible Engine 5GZ (EP6FDT)	610057	Inner Joint		24	34	40	52.5	90		
DS 4/DS 4 CROSSBACK														
1.2 THP 130 (96 kW)	2015.07 -	MT	L	F	Hatchback Engine HNY (EB2DTS)	810158	Outer Joint		25	26	58.5	89	61.5	M
	2015.07 -	MT	L	F	Hatchback Engine HNY (EB2DTS)	210427	Drive Shaft		25	37	58.5	89	638	
	2015.07 -	MT	R	F	Hatchback Engine HNY (EB2DTS)	210421	Drive Shaft		25	37	58.5	89	972	
1.6 BlueHDi 100 (73 kW)	2016.04 -	5MT	R	F	Hatchback Engine BHY (DV6FD)	210251	Drive Shaft		25	24	58.5	79	935	
	2016.04 -	5MT	L	F	Hatchback Engine BHY (DV6FD)	210414	Drive Shaft		25	24	58.5	78.5	632	
1.6 BlueHDi 120 (88 kW)	2015.07 -	MT	R	F	Hatchback Engine BHZ (DV6FC)	210325	Drive Shaft		25	24	58.5	79	940	
	2015.07 -	MT	L	F	Hatchback Engine BHZ (DV6FC)	610057	Inner Joint		24	34	40	52.5	90	
	2015.07 -	AT/MT	-	-	Hatchback Engine BHZ (DV6FC)	899366	Outer Joint		25	34	58.5	79	55	I
	2015.07 -	MT	R	F	Hatchback Engine BHZ (DV6FC)	610058	Inner Joint		24	34	29.8	365	88	
	2015.07 -	MT	L	F	Hatchback Engine BHZ (DV6FC)	210253	Drive Shaft		25	24	58.5	79	626	
	2015.07 -	MT	L	F	Hatchback Engine BHZ (DV6FC)	810148	Outer Joint		25	34	58.5	79	55.5	I
1.6 THP 165 (121 kW)	2015.07 -	AT/MT	-	-	Hatchback Engine 5GZ (EP6FDT)	899366	Outer Joint		25	34	58.5	79	55	I
2.0 BlueHDi 150 (110 kW)	2015.07 -	-	L	F	Hatchback Engine AHR (DW10FD)	810158	Outer Joint		25	26	58.5	89	61.5	M
	2015.07 -	-	L	F	Hatchback Engine AHR (DW10FD)	210427	Drive Shaft		25	37	58.5	89	638	
	2015.07 -	-	R	F	Hatchback Engine AHR (DW10FD)	210421	Drive Shaft		25	37	58.5	89	972	
	2015.07 -	-	L	F	Hatchback Engine AHR (DW10FD)	210312	Drive Shaft		25	37	58.5	89	625	
	2015.07 -	MT	-	F	Hatchback Engine AHR (DW10FD)	810051	Outer Joint		28	39	58.6	94	63	I
DS5														
2.0 BlueHDi 150 (110 kW)	2015.04 -	MT	R	F	Hatchback Engine AHR (DW10FD)	610041	Inner Joint		37	39	32	399	95.5	
	2015.04 -	MT	R	F	Hatchback Engine AHR (DW10FD)	210302	Drive Shaft		28	37	58.6	94	969	





YEAR	TRANS	L/R	F/R	REMARKS	GSP Ref.	PRODUCT	ABS	Technical Specifications							
								A	B	C	H	L	P		
EAGLE SUMMIT															
2.4	1992-	1996	-	-	-	-	839041	Outer Joint		25	25	54	95.5	65	M
VISION															
-	1993-	1995	-	-	-	-	809038	Outer Joint	50W	33	32	49.6	102.5	60	O
-	1993-	1997	-	-	-	-	699062	Inner Joint		27	32	39.5	49	76	
-	1996-	1997	-	R	-	-	209013	Drive Shaft	50T	33	27	49.6	102.5	537	
-	1996-	1997	-	-	-	-	808022	Outer Joint	50T	33	32	49.6	102.5	60	O
-	1996-	1997	-	-	-	-	609009	Inner Joint		27	32	39.8	47.5	77.5	
ENGLON (GEELY) KINGKONG															
1.5 (69 kW)	2006.05-	2013.12	MT	L	F	Saloon Engine MR479QA	265001	Drive Shaft	40T	24	25	59	93.5	601	
	2006.05-	2013.12	MT	R	F	Saloon Engine MR479QA	265002	Drive Shaft	40T	24	25	59	93.5	935	
1.5 (75 kW)	2009.05-	2013.12	MT	L	F	Saloon Engine MR479QN	265001	Drive Shaft	40T	24	25	59	93.5	601	
	2009.05-	2013.12	MT	R	F	Saloon Engine MR479QN	265002	Drive Shaft	40T	24	25	59	93.5	935	
1.6 (78 kW)	2006.05-	2008.12	MT	L	F	Saloon Engine MR481QA	265001	Drive Shaft	40T	24	25	59	93.5	601	
	2006.05-	2008.12	MT	R	F	Saloon Engine MR481QA	265002	Drive Shaft	40T	24	25	59	93.5	935	
1.8 (80 kW)	2007.05-	2008.12	MT	L	-	Saloon Engine JL481Q	265001	Drive Shaft	40T	24	25	59	93.5	601	
	2007.05-	2008.12	MT	R	-	Saloon Engine JL481Q	265002	Drive Shaft	40T	24	25	59	93.5	935	
FAW XIALI															
1.3 (64 kW)	2007.01-	-	-	R	-	Hatchback Engine 8A-FE	214047	Drive Shaft		24	23	54	92	838	
	2007.01-	-	-	L	-	Hatchback Engine 8A-FE	214048	Drive Shaft		24	23	54	92	638	
	2007.01-	-	-	R	-	Hatchback Engine 8A-FE	214049	Drive Shaft		24	25	54	91.5	914	
	2007.01-	-	-	L	-	Hatchback Engine 8A-FE	214050	Drive Shaft		24	25	54	91.5	561	
1.4 (63 kW)	1997.01-	2009.12	-	R	-	Saloon Engine CA4GB1	214047	Drive Shaft		24	23	54	92	838	
	1997.01-	2009.12	-	L	-	Saloon Engine CA4GB1	214048	Drive Shaft		24	23	54	92	638	
	1997.01-	2009.12	AT	R	-	Saloon Engine CA4GB1	259263	Drive Shaft							
1.4 (65 kW)	2007.01-	2010.01	-	R	-	Hatchback Engine CA4GB1	214047	Drive Shaft		24	23	54	92	838	
	2007.01-	2010.01	-	L	-	Hatchback Engine CA4GB1	214048	Drive Shaft		24	23	54	92	638	
	2007.01-	2010.01	-	R	-	Hatchback Engine CA4GB1	214049	Drive Shaft		24	25	54	91.5	914	
	2007.01-	2010.01	-	L	-	Hatchback Engine CA4GB1	214050	Drive Shaft		24	25	54	91.5	561	
FAW TIANJIN N5															
1.0 (48 kW)	2009.11-	-	MT	L	-	Saloon Engine CA3GA2/CA3GA2+/CA3GA5	275005	Drive Shaft		24	25	54	91.5	607	
1.3 (67 kW)	2009.11-	-	MT	L	-	Saloon Engine CA4GA1/CA4GA13	275005	Drive Shaft		24	25	54	91.5	607	
XIALI															
1.0 (38 kW)	1997.01-	2009.12	-	R	-	Hatchback Engine CE36/37	214047	Drive Shaft		24	23	54	92	838	
	1997.01-	2009.12	-	L	-	Hatchback Engine CE36/37	214048	Drive Shaft		24	23	54	92	638	
	1997.01-	2009.12	AT	R	-	Hatchback Engine CE36/37	259263	Drive Shaft							
FENGSHEN S30															
1.5 (85 kW)	2013.03-	-	MT	L	-	Saloon Engine DFMA15	210331	Drive Shaft	45T	25	22	59.1	78.5	605	
	2013.03-	-	MT	R	-	Saloon Engine DFMA15	210332	Drive Shaft	45T	25	22	59.1	78.5	882	
	2013.03-	-	AT	L	-	Saloon Engine DFMA15	210333	Drive Shaft	45T	25	23	59.1	78.5	608	
	2013.03-	-	AT	R	-	Saloon Engine DFMA15	210334	Drive Shaft	45T	25	23	59.1	78.5	880	
1.6 (78 kW)	2009.07-	2014.12	MT	L	-	Saloon Engine N6A 10FX3A PSA	210327	Drive Shaft	45T	25	22	59.1	78.5	600	
	2009.07-	2014.12	MT	R	-	Saloon Engine N6A 10FX3A PSA	210328	Drive Shaft	45T	25	22	59.1	78.5	877	
	2009.07-	2014.12	AT	L	-	Saloon Engine N6A 10FX3A PSA	210329	Drive Shaft	45T	25	22	59.1	78.5	595	
	2009.07-	2014.12	AT	R	-	Saloon Engine N6A 10FX3A PSA	210330	Drive Shaft	45T	25	22	59.1	78.5	894	
FENGXING (DONGFENG) JOYEAR															
1.8 (105 kW)	2013.08-	-	MT	R	F	MPV Engine 4 G 93 M	275017	Drive Shaft	33T	25	25	52	88	943	
	2013.08-	-	MT	L	F	MPV Engine 4 G 93 M	275019	Drive Shaft	33T	25	25	52	94	640.5	
FIAT 500 (312_)															
0.9 (44 kW)	2013.12-	-	MT	L	F	Hatchback Engine 312 A4.000/312 A6.000	817026	Outer Joint		25	22	51	84	57	M
0.9 (48 kW)	2012.09-	-	MT	L	F	Hatchback Engine 312 A4.000	817026	Outer Joint		25	22	51	84	57	M
0.9 (59 kW)	2013.12-	-	AT/MT	L/R	F	Hatchback Engine 312 A5.000	817026	Outer Joint		25	22	51	84	57	M
0.9 (63 kW)	2010.07-	-	-	R	F	Hatchback Engine 312 A2.000	617004	Inner Joint		22	21	36	61	93.5	
	2010.07-	-	-	R	F	Hatchback Engine 312 A2.000	217120	Drive Shaft		25	22	51	84	846	
	2010.07-	-	-	L	F	Hatchback Engine 312 A2.000	217119	Drive Shaft		25	22	51	84	615	
0.9 (77 kW)	2013.10-	-	MT	L/R	F	Hatchback Engine 199 B6.000	817026	Outer Joint		25	22	51	84	57	M
1.2 (51 kW)	2007.10-	-	-	L	F	Hatchback Engine 169 A4.000	217101	Drive Shaft		22	22	47	75.5	613	
	2007.10-	-	-	R	F	Hatchback Engine 169 A4.000	217112	Drive Shaft		22	22	47	75.5	846	





YEAR	TRANSM	L/R	F/R	REMARKS	GSP Ref.	PRODUCT	ABS	Technical Specifications									
								A	B	C	H	L	P				
FIAT																	
500 (312_)																	
1.2 (51 kW)	2007.10-	-	-	L F	Hatchback Engine 169 A4.000	217170	Drive Shaft	22	29.2	47	75.5	524					
	2007.10-	-	-	R F	Hatchback Engine 169 A4.000	217171	Drive Shaft	22	29.2	47	75.5	758					
	2007.10-	-	-	L/R F	Hatchback Engine 169 A4.000	817043	Outer Joint	22	20	47	75.5	54.5	M				
1.2 LPG (51 kW)	2010.12-	-	-	L F	Hatchback Engine 169 A4.000	217101	Drive Shaft	22	22	47	75.5	613					
	2010.12-	-	-	R F	Hatchback Engine 169 A4.000	217112	Drive Shaft	22	22	47	75.5	846					
	2010.12-	-	-	L F	Hatchback Engine 169 A4.000	217170	Drive Shaft	22	29.2	47	75.5	524					
	2010.12-	-	-	R F	Hatchback Engine 169 A4.000	217171	Drive Shaft	22	29.2	47	75.5	758					
1.3 D Multijet (55 kW)	2007.10-	-	-	R F	Hatchback Engine 169 A1.000	617004	Inner Joint	22	21	36	61	93.5					
	2007.10-	-	-	R F	Hatchback Engine 169 A1.000	217120	Drive Shaft	25	22	51	84	846					
	2007.10-	-	-	L F	Hatchback Engine 169 A1.000	217119	Drive Shaft	25	22	51	84	615					
1.4 (74 kW)	2007.10-	-	-	L F	Hatchback Engine 169 A3.000	617004	Inner Joint	22	21	36	61	93.5					
	2007.10-	-	-	L F	Hatchback Engine 169 A3.000	217119	Drive Shaft	25	22	51	84	615					
500 C (312_)																	
0.9 (44 kW)	2013.12-	-	-	MT L F	Convertible Engine 312 A6.000	817026	Outer Joint	25	22	51	84	57	M				
0.9 (48 kW)	2012.09-	-	-	MT L F	Convertible Engine 312 A4.000	817026	Outer Joint	25	22	51	84	57	M				
	2012.09-	-	-	R F	Convertible Engine 312 A4.000	617004	Inner Joint	22	21	36	61	93.5					
	2012.09-	-	-	R F	Convertible Engine 312 A4.000	217120	Drive Shaft	25	22	51	84	846					
	2012.09-	-	-	L F	Convertible Engine 312 A4.000	217119	Drive Shaft	25	22	51	84	615					
0.9 (59 kW)	2013.12-	-	-	AT/MT L/R F	Convertible Engine 312 A5.000	817026	Outer Joint	25	22	51	84	57	M				
0.9 (63 kW)	2009.09-	-	-	R F	Convertible Engine 312 A2.000	617004	Inner Joint	22	21	36	61	93.5					
	2009.09-	-	-	R F	Convertible Engine 312 A2.000	217120	Drive Shaft	25	22	51	84	846					
	2009.09-	-	-	L F	Convertible Engine 312 A2.000	217119	Drive Shaft	25	22	51	84	615					
0.9 (77 kW)	2013.12-	-	-	MT L/R F	Convertible Engine 199 B6.000	817026	Outer Joint	25	22	51	84	57	M				
	2013.12-	-	-	R F	Convertible Engine 199 B6.000	617004	Inner Joint	22	21	36	61	93.5					
	2013.12-	-	-	R F	Convertible Engine 199 B6.000	217120	Drive Shaft	25	22	51	84	846					
	2013.12-	-	-	L F	Convertible Engine 199 B6.000	217119	Drive Shaft	25	22	51	84	615					
1.2 (51 kW)	2009.09-	-	-	R F	Convertible Engine 169 A4.000	617004	Inner Joint	22	21	36	61	93.5					
	2009.09-	-	-	R F	Convertible Engine 169 A4.000	217120	Drive Shaft	25	22	51	84	846					
	2009.09-	-	-	L F	Convertible Engine 169 A4.000	217119	Drive Shaft	25	22	51	84	615					
1.3 D Multijet (55 kW)	2009.09-	-	-	R F	Convertible Engine 169 A1.000	617004	Inner Joint	22	21	36	61	93.5					
	2009.09-	-	-	R F	Convertible Engine 169 A1.000	217120	Drive Shaft	25	22	51	84	846					
	2009.09-	-	-	L F	Convertible Engine 169 A1.000	217119	Drive Shaft	25	22	51	84	615					
1.3 D Multijet (70 kW)	2009.09-	-	-	MT - F	Convertible Engine 199 B1.000	817027	Outer Joint	25	23	51	84.5	60	M				
1.4 (74 kW)	2009.09-	-	-	L F	Convertible Engine 169 A3.000	617004	Inner Joint	22	21	36	61	93.5					
	2009.09-	-	-	L F	Convertible Engine 169 A3.000	217119	Drive Shaft	25	22	51	84	615					
1.4 (75 kW)	2011.09-	-	-	L F	Convertible Engine 169 A3.000/EAB	617004	Inner Joint	22	21	36	61	93.5					
	2011.09-	-	-	L F	Convertible Engine 169 A3.000/EAB	217119	Drive Shaft	25	22	51	84	615					
500 L																	
0.9 (70 kW)	2012-	-	-	- - -		617027	Inner Joint	22	22	36	61.5	93.5					
1.3 DS (62 kW)	2012-	-	-	R - -		617015	Inner Joint	24	24	29.7	379	100.5					
	2012-	-	-	L - -		699008	Inner Joint	24	24	29.7	86.5	93					
500, 500 C, ABARTH																	
0.9 (48 kW)	2012.07-	-	-	- - -		617027	Inner Joint	22	22	36	61.5	93.5					
0.9 (63 kW)	2012.07-	-	-	- - -		617027	Inner Joint	22	22	36	61.5	93.5					
0.9 (77 kW)	2012.07-	-	-	- - -		617027	Inner Joint	22	22	36	61.5	93.5					
1.2 (51 kW)	2007.10-	-	-	- - -		617001	Inner Joint	22	19	36	61.5	88.5					
1.3 D Multijet (55 kW)	2007.10-	-	-	- - -		617027	Inner Joint	22	22	36	61.5	93.5					
1.4 (70 kW)	2007.10-	-	-	- - -		617027	Inner Joint	22	22	36	61.5	93.5					
ABARTH 500																	
1.3 D Multijet (74 kW)	2009.12-	-	-	L - -		617011	Inner Joint	24	23	29.7	86.5	93					
1.4 (103 kW)	2008.08-	-	-	L - -		699008	Inner Joint	24	24	29.7	86.5	93					
1.4 (132 kW)	2008.08-	-	-	L - -		699008	Inner Joint	24	24	29.7	86.5	93					
1.4 (99 kW)	2008.08-	-	-	L - -		699008	Inner Joint	24	24	29.7	86.5	93					
ABARTH 500 C																	
1.3 D Multijet (74 kW)	2009.12-	-	-	L - -		617011	Inner Joint	24	23	29.7	86.5	93					
1.4 (103 kW)	2008.08-	-	-	L - -		699008	Inner Joint	24	24	29.7	86.5	93					
1.4 (132 kW)	2008.08-	-	-	L - -		699008	Inner Joint	24	24	29.7	86.5	93					
1.4 (99 kW)	2008.08-	-	-	L - -		699008	Inner Joint	24	24	29.7	86.5	93					
ALBEA																	
1.2	2002-	-	-	- - -		617027	Inner Joint	22	22	36	61.5	93.5					
1.2 16V	2002-	-	-	R F -		217030	Drive Shaft	22	31.95	47	89	809					
	2002-	-	-	L F -		217029	Drive Shaft	22	31.95	47	89	504					
1.3 MJT	2003-2006	-	-	R F -		217202	Stub Axle	24	101			415					
	2003-2006	-	-	L F -		217203	Stub Axle	24	101			118.5					
	2006-	-	-	L F -		217056	Drive Shaft	25	24	51	90	557					
	2006-	-	-	F -		699008	Inner Joint	24	24	29.7	86.5	93					

	 YEAR	TRANSM	L/R	F/R	REMARKS	GSP Ref.	 PRODUCT	 ABS	Technical Specifications						
									A	B	C	H	L	P	
FIAT															
ALBEA															
1.3 MJT	2006-	-	-	R	F	-	217014	Drive Shaft		25	35.6	51	90	524	
1.3 MJTD	2006-	-	-	L	-	-	217034	Drive Shaft		25	35.6	51	90	447	
1.4	2002-	-	-	-	-	-	617027	Inner Joint		22	22	36	61.5	93.5	
1.4 16V	2002-	-	-	R	F	-	217030	Drive Shaft		22	31.95	47	89	809	
	2002-	-	-	L	F	-	217029	Drive Shaft		22	31.95	47	89	504	
1.6	2002-	-	-	-	-	-	617027	Inner Joint		22	22	36	61.5	93.5	
1.6 16V	2002-	-	-	R	F	-	217030	Drive Shaft		22	31.95	47	89	809	
	2002-	-	-	L	F	-	217029	Drive Shaft		22	31.95	47	89	504	
1.9 JTD (59 kW)	2003-	2005	MT	R	-	-	617009	Inner Joint			25		32		
BARCETTA (183)															
1.8 16V (96 kW)	1995.04-	1999.04	-	-	-	-	617009	Inner Joint			25		32		
BARCETTA (183_)															
1.8 16V (96 kW)	1995.04-	2005.05	-	L	F	Convertible Engine 183 A1.000/188 A6.000	299048	Drive Shaft		25		52	85	467	
	1995.04-	2005.05	-	-	F	Convertible Engine 183 A1.000/188 A6.000	802006	Outer Joint	44T	25	25	52	85	58	O
	1995.04-	2005.05	MT	L/R	F	Convertible Engine 183 A1.000/188 A6.000	817042	Outer Joint		25	25	51	85	58	O
	1995.04-	2005.05	MT	L/R	F	Convertible Engine 183 A1.000/188 A6.000	817004	Outer Joint		25	25	52	85	58	I
	1995.04-	2005.05	-	-	F	Convertible Engine 183 A1.000/188 A6.000	802004	Outer Joint	44T	25	25	52	85	58	I
	1995.04-	2005.05	AT/MT	L/R	F	Convertible Engine 183 A1.000/188 A6.000	618070	Inner Joint			25		32		
	1995.04-	2005.05	-	-	F	Convertible Engine 183 A1.000/188 A6.000	602005	Inner Joint			25		32		
1995.04-	2005.05	-	R	F	Convertible Engine 183 A1.000/188 A6.000	299049	Drive Shaft		25		52	85	493		
BRAVA (182_)															
1.2 16V (64 kW)	1998.12-	2002.12	MT	R	F	Hatchback Engine 182 B2.000	217025	Drive Shaft		22	22	46.8	75.5	913	
	1998.12-	2002.12	-	-	F	Hatchback Engine 182 B2.000	817008	Outer Joint		22	20	51	79.5	51.5	O
1.2 16V 80 (59 kW)	2000.10-	2001.10	MT	R	F	Hatchback Engine 188 A5.000	217025	Drive Shaft		22	22	46.8	75.5	913	
	2000.10-	2001.10	-	-	F	Hatchback Engine 188 A5.000	817008	Outer Joint		22	20	51	79.5	51.5	O
1.2 16V 80 (60 kW)	1998.12-	2002.12	MT	R	F	Hatchback Engine 182 B2.000	217011	Drive Shaft		22	31.95	46.8	75.5	928.5	
	1998.12-	2002.12	MT	R	F	Hatchback Engine 182 B2.000	217025	Drive Shaft		22	22	46.8	75.5	913	
	1998.12-	2002.12	-	-	F	Hatchback Engine 182 B2.000	817008	Outer Joint		22	20	51	79.5	51.5	O
	1998.12-	2002.12	AT/MT	L/R	F	Hatchback Engine 182 B2.000	618070	Inner Joint			25		32		
	1998.12-	2002.12	MT	L	F	Hatchback Engine 182 B2.000	217010	Drive Shaft		22	31.95	46.8	75.5	569	
1.4 (55 kW)	1995.10-	2001.10	MT	R	F	Hatchback Engine 182 A5.000	217011	Drive Shaft		22	31.95	46.8	75.5	928.5	
	1995.10-	2001.10	AT/MT	L/R	F	Hatchback Engine 182 A5.000	817001	Outer Joint		22	20	46.8	75.5	52	O
	1995.10-	2001.10	AT/MT	L/R	F	Hatchback Engine 182 A5.000	817039	Outer Joint	44T	22	20	46.8	75.5	52	O
	1995.10-	2001.10	-	L	F	Hatchback Engine 182 A5.000	217197	Drive Shaft		22	22	46.8	75.5	591	
	1995.10-	2001.10	MT	R	F	Hatchback Engine 182 A5.000	217041	Drive Shaft	44T	22	22	46.8	75.5	913	
	1995.10-	2001.10	MT	L	F	Hatchback Engine 182 A5.000	217114	Drive Shaft	44T	22	22	46.8	75.5	591	
1.4 12 V (59 kW)	1995.10-	1998.08	MT	R	F	Hatchback Engine 182 A3.000	217011	Drive Shaft		22	31.95	46.8	75.5	569	
	1995.10-	1998.08	AT/MT	L/R	F	Hatchback Engine 182 A3.000	817001	Outer Joint		22	20	46.8	75.5	52	O
	1995.10-	1998.08	AT/MT	L/R	F	Hatchback Engine 182 A3.000	817039	Outer Joint	44T	22	20	46.8	75.5	52	O
	1995.10-	1998.08	-	L	F	Hatchback Engine 182 A3.000	217197	Drive Shaft		22	22	46.8	75.5	591	
	1995.10-	1998.08	MT	R	F	Hatchback Engine 182 A3.000	217041	Drive Shaft	44T	22	22	46.8	75.5	913	
	1995.10-	1998.08	MT	L	F	Hatchback Engine 182 A3.000	217114	Drive Shaft	44T	22	22	46.8	75.5	591	
	1995.10-	1998.08	MT	L	F	Hatchback Engine 182 A3.000	217010	Drive Shaft		22	31.95	46.8	75.5	569	
	1995.10-	2001.10	AT/MT	-	F	Hatchback Engine 182 A6.000	817015	Outer Joint		22	22	51	79.5	54	O
	1995.10-	2001.10	MT	R	F	Hatchback Engine 182 A6.000	217011	Drive Shaft		22	31.95	46.8	75.5	928.5	
1995.10-	2001.10	MT	L	F	Hatchback Engine 182 A6.000	217010	Drive Shaft		22	31.95	46.8	75.5	569		
1.6 16V (76 kW)	1996.02-	2001.10	AT/MT	-	F	Hatchback Engine 182 A4.000	817015	Outer Joint		22	22	51	79.5	54	O
	1996.02-	2001.10	-	-	F	Hatchback Engine 182 A4.000	817022	Outer Joint	44T	22	22	46.8	75.5	52	O
	1996.02-	2001.10	-	-	F	Hatchback Engine 182 A4.000	817021	Outer Joint		22	22	46.8	75.5	52	O
1.8 GT 16V (83 kW)	1995.10-	2001.10	-	-	F	Hatchback Engine 182 A2.000	602006	Inner Joint			25		32		
	1995.10-	2001.10	AT/MT	L/R	F	Hatchback Engine 182 A2.000	817004	Outer Joint		25	25	52	85	58	I
	1995.10-	2001.10	-	-	F	Hatchback Engine 182 A2.000	802004	Outer Joint	44T	25	25	52	85	58	I
	1995.10-	2001.10	MT	L/R	F	Hatchback Engine 182 A2.000	602011	Inner Joint			25		32		
	1995.10-	2001.10	-	-	F	Hatchback Engine 182 A2.000	802020	Outer Joint		25	25	51	85	58	O
	1995.10-	2001.10	-	-	F	Hatchback Engine 182 A2.000	602005	Inner Joint			25		32		
	1995.10-	2001.10	AT/MT	L/R	F	Hatchback Engine 182 A2.000	618070	Inner Joint			25		32		
1.9 D (48 kW)	1995.10-	2001.10	MT	R	F	Hatchback Engine 160 A7.000	217011	Drive Shaft		22	31.95	46.8	75.5	928.5	
	1995.10-	2001.10	AT/MT	L/R	F	Hatchback Engine 160 A7.000	817001	Outer Joint		22	20	46.8	75.5	52	O
	1995.10-	2001.10	AT/MT	L/R	F	Hatchback Engine 160 A7.000	817039	Outer Joint	44T	22	20	46.8	75.5	52	O
	1995.10-	2001.10	MT	L	F	Hatchback Engine 160 A7.000	217010	Drive Shaft		22	31.95	46.8	75.5	569	
1.9 JTD (74 kW)	2000.09-	2001.10	AT/MT	L/R	F	Hatchback Engine 182 B9.000	802003	Outer Joint		25	25	52	85	58	O
	2000.09-	2001.10	-	-	F	Hatchback Engine 182 B9.000	602005	Inner Joint			25		32		
	2000.09-	2001.10	MT	L/R	F	Hatchback Engine 182 B9.000	817042	Outer Joint		25	25	51	85	58	O
	2000.09-	2001.10	-	-	F	Hatchback Engine 182 B9.000	802020	Outer Joint		25	25	51	85	58	O
1.9 JTD (79 kW)	2001.01-	2002.12	-	-	F	Hatchback Engine 182 B4.000	602006	Inner Joint			25		32		





YEAR	TRANS	L/R	F/R	REMARKS	GSP Ref.	PRODUCT	ABS	Technical Specifications							
								A	B	C	H	L	P		
FIAT															
BRAVA (182_)															
1.9 JTD (79 kW)	2001.01-2002.12	-	-	F	Hatchback Engine 182 B4.000	802020	Outer Joint		25	25	51	85	58	O	
1.9 JTD 105 (77 kW)	1998.12-2001.10	AT/MT	L/R	F	Hatchback Engine 182 B4.000	618070	Inner Joint			25		32			
	1998.12-2001.10	MT	L/R	F	Hatchback Engine 182 B4.000	817042	Outer Joint		25	25	51	85	58	O	
	1998.12-2001.10	MT	L/R	F	Hatchback Engine 182 B4.000	602011	Inner Joint			25		32			
	1998.12-2001.10	-	-	F	Hatchback Engine 182 B4.000	602005	Inner Joint			25		32			
	1998.12-2001.10	MT	-	F	Hatchback Engine 182 B4.000	802020	Outer Joint		25	25	51	85	58	O	
1.9 TD 100 S (74 kW)	1996.03-2001.10	-	L/R	F	Hatchback Engine 182 A7.000	217001	Drive Shaft	44T	25		52	85	452		
	1996.03-2001.10	AT/MT	L/R	F	Hatchback Engine 182 A7.000	802003	Outer Joint		25	25	52	85	58	O	
	1996.03-2001.10	-	-	F	Hatchback Engine 182 A7.000	802006	Outer Joint	44T	25	25	52	85	58	O	
	1996.03-2001.10	MT	L/R	F	Hatchback Engine 182 A7.000	817042	Outer Joint		25	25	51	85	58	O	
	1996.03-2001.10	MT	-	F	Hatchback Engine 182 A7.000	802020	Outer Joint		25	25	51	85	58	O	
	1996.03-2001.10	AT/MT	L/R	F	Hatchback Engine 182 A7.000	618070	Inner Joint			25		32			
	1996.03-2001.10	-	L/R	F	Hatchback Engine 182 A7.000	217038	Drive Shaft		25		52	85	452		
1.9 TD 75 S (55 kW)	1996.03-2001.10	AT/MT	L/R	F	Hatchback Engine 182 A8.000	618070	Inner Joint			25		32			
	1996.03-2001.10	-	L/R	F	Hatchback Engine 182 A8.000	217001	Drive Shaft	44T	25		52	85	452		
	1996.03-2001.10	AT/MT	L/R	F	Hatchback Engine 182 A8.000	802003	Outer Joint		25	25	52	85	58	O	
	1996.03-2001.10	-	-	F	Hatchback Engine 182 A8.000	802006	Outer Joint	44T	25	25	52	85	58	O	
	1996.03-2001.10	-	-	F	Hatchback Engine 182 A8.000	602005	Inner Joint			25		32			
	1996.03-2001.10	-	-	F	Hatchback Engine 182 A8.000	802020	Outer Joint		25	25	51	85	58	O	
	1996.03-2001.10	-	L/R	F	Hatchback Engine 182 A8.000	217038	Drive Shaft		25		52	85	452		
BRAVA,BRAVO (182)															
1.2 16V (59 kW)	1998.12-2001.10	-	-	-	-	617027	Inner Joint		22	22	36	61.5	93.5		
1.4 (55 kW)	1995.10-2001.10	MT	-	-	-	617027	Inner Joint		22	22	36	61.5	93.5		
1.6 16V (66 kW)	1995.10-2001.10	-	-	-	Inch Brazil/TurkeyConverte	617009	Inner Joint			25		32			
1.6 16V (76 kW)	1995.10-2001.10	-	-	-	Inch Brazil/TurkeyConverte	617009	Inner Joint			25		32			
1.8 GT (83 kW)	1995.10-2001.10	MT	-	-	-	617009	Inner Joint			25		32			
1.9 JTD 105 (77 kW)	1998.12-2001.10	MT	-	-	-	617009	Inner Joint			25		32			
1.9 TD 100 S (74 kW)	1996.03-2001.10	MT	-	-	-	617009	Inner Joint			25		32			
1.9 TD 75 S (55 kW)	1996.03-2001.10	MT	-	-	-	617009	Inner Joint			25		32			
2.0 HGT 20V (108 kW)	1995.09-2001.10	-	-	-	Exc Brava	617009	Inner Joint			25		32			
2.0 HGT 20V (113 kW)	1995.09-2001.10	-	-	-	Exc Brava	617009	Inner Joint			25		32			
BRAVO (198)															
1.4 T-JET (110 kW)	2007.09-2007.09	-	-	R	-	617058	Inner Joint		25	26	34.9	367	108.5		
	2007.09-2007.09	-	-	L	-	617035	Inner Joint		25	26	34.9	57.5	114.5		
1.4 T-JET (88 kW)	2007.09-2007.09	-	-	R	-	617058	Inner Joint		25	26	34.9	367	108.5		
	2007.09-2007.09	-	-	L	-	617035	Inner Joint		25	26	34.9	57.5	114.5		
1.6 D Multijet (88 kW)	2009.07-2009.07	-	-	L	-	617035	Inner Joint		25	26	34.9	57.5	114.5		
1.9 D Multijet (110 kW)	2007.04-2007.04	-	-	R	-	617006	Inner Joint		25	26	29.8	377	108		
	2007.04-2007.04	-	-	L	-	617005	Inner Joint		25	26	32	91	95		
1.9 D Multijet (66 kW)	2007.04-2007.04	-	-	L	-	617035	Inner Joint		25	26	34.9	57.5	114.5		
1.9 D Multijet (88 kW)	2007.04-2007.04	-	-	L	-	617035	Inner Joint		25	26	34.9	57.5	114.5		
	2007.04-2007.04	-	-	R	-	617006	Inner Joint		25	26	29.8	377	108		
	2007.04-2007.04	-	-	L	-	617005	Inner Joint		25	26	32	91	95		
2.0 D Multijet (121 kW)	2008.09-2008.09	-	-	L	-	621017	Inner Joint		27	27	35	78.5	112		
BRAVO I (182_)															
1.2 16V 80 (59 kW)	2000.10-2001.10	MT	R	F	Hatchback Engine 188 A5.000	217011	Drive Shaft		22	31.95	46.8	75.5	928.5		
	2000.10-2001.10	MT	R	F	Hatchback Engine 188 A5.000	217025	Drive Shaft		22	22	46.8	75.5	913		
	2000.10-2001.10	-	-	F	Hatchback Engine 188 A5.000	817008	Outer Joint		22	20	51	79.5	51.5	O	
	2000.10-2001.10	MT	L	F	Hatchback Engine 188 A5.000	217010	Drive Shaft		22	31.95	46.8	75.5	569		
1.2 16V 80 (60 kW)	1998.12-2000.10	MT	R	F	Hatchback Engine 182 B2.000	217011	Drive Shaft		22	31.95	46.8	75.5	928.5		
	1998.12-2000.10	AT/MT	L/R	F	Hatchback Engine 182 B2.000	618070	Inner Joint			25		32			
	1998.12-2000.10	MT	R	F	Hatchback Engine 182 B2.000	217025	Drive Shaft		22	22	46.8	75.5	913		
	1998.12-2000.10	-	-	F	Hatchback Engine 182 B2.000	817008	Outer Joint		22	20	51	79.5	51.5	O	
	1998.12-2000.10	MT	L	F	Hatchback Engine 182 B2.000	217010	Drive Shaft		22	31.95	46.8	75.5	569		
1.2 16V 80 (64 kW)	1998.12-2001.10	MT	R	F	Hatchback Engine 182 B2.000	217025	Drive Shaft		22	22	46.8	75.5	913		
	1998.12-2001.10	-	-	F	Hatchback Engine 182 B2.000	817008	Outer Joint		22	20	51	79.5	51.5	O	
1.4 (55 kW)	1995.10-2001.10	AT/MT	L/R	F	Hatchback Engine 182 A5.000	817001	Outer Joint		22	20	46.8	75.5	52	O	
	1995.10-2001.10	AT/MT	L/R	F	Hatchback Engine 182 A5.000	817039	Outer Joint	44T	22	20	46.8	75.5	52	O	
	1995.10-2001.10	MT	R	F	Hatchback Engine 182 A5.000	217011	Drive Shaft		22	31.95	46.8	75.5	928.5		
	1995.10-2001.10	-	L	F	Hatchback Engine 182 A5.000	217197	Drive Shaft		22	22	46.8	75.5	591		
	1995.10-2001.10	MT	R	F	Hatchback Engine 182 A5.000	217041	Drive Shaft	44T	22	22	46.8	75.5	913		
	1995.10-2001.10	MT	L	F	Hatchback Engine 182 A5.000	217114	Drive Shaft	44T	22	22	46.8	75.5	591		
	1995.10-2001.10	MT	L	F	Hatchback Engine 182 A5.000	217010	Drive Shaft		22	31.95	46.8	75.5	569		
1.4 (59 kW)	1995.10-2001.10	MT	R	F	Hatchback Engine 182 A3.000	217011	Drive Shaft		22	31.95	46.8	75.5	928.5		
	1995.10-2001.10	AT/MT	L/R	F	Hatchback Engine 182 A3.000	817001	Outer Joint		22	20	46.8	75.5	52	O	

YEAR	TRANSM	L/R	F/R	REMARKS	GSP Ref.	PRODUCT	ABS	Technical Specifications						
								A	B	C	H	L	P	
FIAT														
BRAVO I (182_)														
1.4 (59 kW)	1995.10-2001.10	AT/MT	L/R	F	Hatchback Engine 182 A3.000	817039	Outer Joint	44T	22	20	46.8	75.5	52	O
	1995.10-2001.10	-	L	F	Hatchback Engine 182 A3.000	217197	Drive Shaft		22	22	46.8	75.5	591	
	1995.10-2001.10	MT	R	F	Hatchback Engine 182 A3.000	217041	Drive Shaft	44T	22	22	46.8	75.5	913	
	1995.10-2001.10	MT	L	F	Hatchback Engine 182 A3.000	217114	Drive Shaft	44T	22	22	46.8	75.5	591	
	1995.10-2001.10	MT	L	F	Hatchback Engine 182 A3.000	217010	Drive Shaft		22	31.95	46.8	75.5	569	
1.6 16V (66 kW)	1995.10-2001.10	AT/MT	-	F	Hatchback Engine 182 A6.000	817015	Outer Joint		22	22	51	79.5	54	O
	1995.10-2001.10	MT	R	F	Hatchback Engine 182 A6.000	217011	Drive Shaft		22	31.95	46.8	75.5	928.5	
	1995.10-2001.10	MT	L	F	Hatchback Engine 182 A6.000	217010	Drive Shaft		22	31.95	46.8	75.5	569	
1.6 16V (76 kW)	1996.03-2001.10	AT/MT	-	F	Hatchback Engine 182 A4.000	817015	Outer Joint		22	22	51	79.5	54	O
	1996.03-2001.10	MT	-	F	Hatchback Engine 182 A4.000	817022	Outer Joint	44T	22	22	46.8	75.5	52	O
	1996.03-2001.10	MT	-	F	Hatchback Engine 182 A4.000	817021	Outer Joint		22	22	46.8	75.5	52	O
1.8 GT (83 kW)	1995.10-2001.10	-	-	F	Hatchback Engine 182 A2.000	602006	Inner Joint			25		32		
	1995.10-2001.10	AT/MT	L/R	F	Hatchback Engine 182 A2.000	817004	Outer Joint		25	25	52	85	58	I
	1995.10-2001.10	-	-	F	Hatchback Engine 182 A2.000	802004	Outer Joint	44T	25	25	52	85	58	I
	1995.10-2001.10	MT	L/R	F	Hatchback Engine 182 A2.000	602011	Inner Joint			25		32		
	1995.10-2001.10	-	-	F	Hatchback Engine 182 A2.000	802020	Outer Joint		25	25	51	85	58	O
	1995.10-2001.10	-	-	F	Hatchback Engine 182 A2.000	602005	Inner Joint			25		32		
1.9 D (48 kW)	1995.10-2001.10	AT/MT	L/R	F	Hatchback Engine 160 A7.000	817001	Outer Joint		22	20	46.8	75.5	52	O
	1995.10-2001.10	MT	R	F	Hatchback Engine 160 A7.000	217011	Drive Shaft		22	31.95	46.8	75.5	928.5	
	1995.10-2001.10	AT/MT	L/R	F	Hatchback Engine 160 A7.000	817039	Outer Joint	44T	22	20	46.8	75.5	52	O
	1995.10-2001.10	MT	L	F	Hatchback Engine 160 A7.000	217010	Drive Shaft		22	31.95	46.8	75.5	569	
1.9 JTD (74 kW)	2000.09-2001.10	AT/MT	L/R	F	Hatchback Engine 182 B9.000	802003	Outer Joint		25	25	52	85	58	O
	2000.09-2001.10	-	-	F	Hatchback Engine 182 B9.000	602005	Inner Joint			25		32		
	2000.09-2001.10	MT	L/R	F	Hatchback Engine 182 B9.000	817042	Outer Joint		25	25	51	85	58	O
	2000.09-2001.10	-	-	F	Hatchback Engine 182 B9.000	802020	Outer Joint		25	25	51	85	58	O
1.9 JTD 105 (77 kW)	1998.12-2001.10	AT/MT	L/R	F	Hatchback Engine 182 B4.000	618070	Inner Joint			25		32		
	1998.12-2001.10	MT	L/R	F	Hatchback Engine 182 B4.000	817042	Outer Joint		25	25	51	85	58	O
	1998.12-2001.10	-	-	F	Hatchback Engine 182 B4.000	602006	Inner Joint			25		32		
	1998.12-2001.10	-	-	F	Hatchback Engine 182 B4.000	602005	Inner Joint			25		32		
	1998.12-2001.10	-	-	F	Hatchback Engine 182 B4.000	802020	Outer Joint		25	25	51	85	58	O
1.9 TD 100 S (74 kW)	1996.03-2001.10	-	L/R	F	Hatchback Engine 182 A7.000	217001	Drive Shaft	44T	25		52	85	452	
	1996.03-2001.10	AT/MT	L/R	F	Hatchback Engine 182 A7.000	802003	Outer Joint		25	25	52	85	58	O
	1996.03-2001.10	-	-	F	Hatchback Engine 182 A7.000	802006	Outer Joint	44T	25	25	52	85	58	O
	1996.03-2001.10	MT	L/R	F	Hatchback Engine 182 A7.000	817042	Outer Joint		25	25	51	85	58	O
	1996.03-2001.10	-	-	F	Hatchback Engine 182 A7.000	602005	Inner Joint			25		32		
	1996.03-2001.10	AT/MT	L/R	F	Hatchback Engine 182 A7.000	618070	Inner Joint			25		32		
	1996.03-2001.10	-	-	F	Hatchback Engine 182 A7.000	802020	Outer Joint		25	25	51	85	58	O
	1996.03-2001.10	-	L/R	F	Hatchback Engine 182 A7.000	217038	Drive Shaft		25		52	85	452	
1.9 TD 75 S (55 kW)	1996.03-2001.10	AT/MT	L/R	F	Hatchback Engine 182 A8.000	618070	Inner Joint			25		32		
	1996.03-2001.10	-	L/R	F	Hatchback Engine 182 A8.000	217001	Drive Shaft	44T	25		52	85	452	
	1996.03-2001.10	AT/MT	L/R	F	Hatchback Engine 182 A8.000	802003	Outer Joint		25	25	52	85	58	O
	1996.03-2001.10	-	-	F	Hatchback Engine 182 A8.000	802006	Outer Joint	44T	25	25	52	85	58	O
	1996.03-2001.10	-	-	F	Hatchback Engine 182 A8.000	602005	Inner Joint			25		32		
	1996.03-2001.10	-	-	F	Hatchback Engine 182 A8.000	802020	Outer Joint		25	25	51	85	58	O
	1996.03-2001.10	-	L/R	F	Hatchback Engine 182 A8.000	217038	Drive Shaft		25		52	85	452	
2.0 HGT 20V (108 kW)	1995.10-1998.07	-	-	F	Hatchback Engine 182 A1.000	817032	Outer Joint	44T	25	25	59	85	58	O
	1995.10-1998.07	-	-	F	Hatchback Engine 182 A1.000	602006	Inner Joint			25		32		
	1995.10-1998.07	AT/MT	L/R	F	Hatchback Engine 182 A1.000	602011	Inner Joint			25		32		
	1995.10-1998.07	-	-	F	Hatchback Engine 182 A1.000	602005	Inner Joint			25		32		
	1995.10-1998.07	AT/MT	L/R	F	Hatchback Engine 182 A1.000	618070	Inner Joint			25		32		
2.0 HGT 20V (113 kW)	1998.07-2001.10	-	-	F	Hatchback Engine 182 B7.000	602005	Inner Joint			25		32		
	1998.07-2001.10	MT	L/R	F	Hatchback Engine 182 B7.000	817004	Outer Joint		25	25	52	85	58	I
	1998.07-2001.10	-	-	F	Hatchback Engine 182 B7.000	602006	Inner Joint			25		32		
	1998.07-2001.10	MT	L/R	F	Hatchback Engine 182 B7.000	602011	Inner Joint			25		32		
BRAVO II														
1.4 16V (66 kW)	2010.01-	-	-	-	-	617027	Inner Joint		22	22	36	61.5	93.5	
1.4 Multiair Turbo 16V (103 kW)	2010.03-	-	-	L	-	617031	Inner Joint		25	26	32	59	110.5	
1.4 Multiair Turbo 16V (88 kW)	2010.03-	-	-	L	-	617031	Inner Joint		25	26	32	59	110.5	
1.4 T-JET 16V (110 kW)	2010.01-	-	-	R	-	617058	Inner Joint		25	26	34.9	367	108.5	
	2010.01-	-	-	L	-	617035	Inner Joint		25	26	34.9	57.5	114.5	
1.4 T-JET 16V (88 kW)	2010.01-	-	-	R	-	617058	Inner Joint		25	26	34.9	367	108.5	
	2010.01-	-	-	L	-	617035	Inner Joint		25	26	34.9	57.5	114.5	
1.6 JTD 16V (66 kW)	2010.01-	-	-	L	-	617031	Inner Joint		25	26	32	59	110.5	
1.6 JTD 16V (77 kW)	2010.01-	-	-	L	-	617031	Inner Joint		25	26	32	59	110.5	
1.6 JTD 16V (88 kW)	2010.01-	-	-	L	-	617035	Inner Joint		25	26	34.9	57.5	114.5	
	2010.01-	-	-	L	-	617031	Inner Joint		25	26	32	59	110.5	

	 YEAR	TRANSM	L/R	F/R	REMARKS	GSP Ref.	 PRODUCT	 ABS	Technical Specifications								
									A	B	C	H	L	P			
FIAT																	
BRAVO II																	
1.9 JTD (110 kW)	2010.01-	-	-	R	-	-	617006	Inner Joint		25	26	29.8	377	108			
	2010.01-	-	-	L	-	-	617005	Inner Joint		25	26	32	91	95			
2.0 JTDM 16V (121 kW)	2010.01-	-	-	L	-	-	621017	Inner Joint		27	27	35	78.5	112			
BRAVO II (198_)																	
1.4 T-Jet (110 kW)	2007.09-	-	-	L/R	F	Hatchback Engine 198 A1.000	817030	Outer Joint		25	26	51	84.5	64.5	M		
	2007.09-	-	MT	L	F	Hatchback Engine 198 A1.000	217180	Drive Shaft		25	25	51	84.5	628			
	2007.09-	-	MT	R	F	Hatchback Engine 198 A1.000	217178	Drive Shaft		25	25	51	84.5	931			
1.4 T-Jet (88 kW)	2007.09-	-	MT	L	F	Hatchback Engine 198 A4.000	217180	Drive Shaft		25	25	51	84.5	628			
	2007.09-	-	MT	R	F	Hatchback Engine 198 A4.000	217178	Drive Shaft		25	25	51	84.5	931			
	2007.09-	-	-	L/R	F	Hatchback Engine 198 A4.000	817030	Outer Joint		25	26	51	84.5	64.5	M		
1.6 D Multijet (66 kW)	2008.03-	-	-	L/R	F	Hatchback Engine 198 A6.000	217194	Drive Shaft		25	39.2	51	84.5	523			
	2008.03-	-	-	L/R	F	Hatchback Engine 198 A6.000	817030	Outer Joint		25	26	51	84.5	64.5	M		
1.6 D Multijet (77 kW)	2007.09-	-	-	L	F	Hatchback Engine 198 A3.000, 844 A3.000	217179	Drive Shaft		25	25	51	84.5	632			
	2007.09-	-	-	L/R	F	Hatchback Engine 198 A3.000, 844 A3.000	217194	Drive Shaft		25	39.2	51	84.5	523			
	2007.09-	-	-	L/R	F	Hatchback Engine 198 A3.000, 844 A3.000	817030	Outer Joint		25	26	51	84.5	64.5	M		
1.6 D Multijet (88 kW)	2008.03-	-	-	L	F	Hatchback Engine 198 A2.000	217179	Drive Shaft		25	25	51	84.5	632			
	2008.03-	-	MT	L/R	F	Hatchback Engine 198 A2.000	217194	Drive Shaft		25	39.2	51	84.5	523			
	2008.03-	-	-	L/R	F	Hatchback Engine 198 A2.000	817030	Outer Joint		25	26	51	84.5	64.5	M		
1.6 D Multijet(85 kW)	2008.11-	-	-	L	F	Hatchback Engine 955 A4.000	217179	Drive Shaft		25	25	51	84.5	632			
1.9 D Multijet (110 kW)	2007.04-	-	-	L	F	Hatchback Engine 937 A5.000	217121	Drive Shaft		25	25	59	84	630			
	2007.04-	-	-	R	F	Hatchback Engine 937 A5.000	217136	Drive Shaft		25	25	51	84.5	931			
	2007.04-	-	-	R	F	Hatchback Engine 937 A5.000	617073	Inner Joint		25	24	29.7	377.5	94.5			
1.9 D Multijet (66 kW)	2007.04-2008.12	-	-	L/R	F	Hatchback Engine 192 B5.000	817030	Outer Joint		25	26	51	84.5	64.5	M		
	2007.04-2008.12	-	-	L/R	F	Hatchback Engine 192 B5.000	217194	Drive Shaft		25	39.2	51	84.5	523			
1.9 D Multijet (88 kW)	2007.04-	-	-	L	F	Hatchback Engine 192 A8.000	217179	Drive Shaft		25	25	51	84.5	632			
	2007.04-	-	5MT	L/R	F	Hatchback Engine 192 A8.000	217194	Drive Shaft		25	39.2	51	84.5	523			
	2007.04-	-	-	L/R	F	Hatchback Engine 192 A8.000	817030	Outer Joint		25	26	51	84.5	64.5	M		
2.0 D Multijet (120 kW)	2008.09-	-	-	-	F	Hatchback Engine 198 A8.000	817064	Outer Joint		27	27	59	84.5	64	M		
2.0 D Multijet (121 kW)	2008.09-	-	-	-	F	Hatchback Engine 198 A5.000	817064	Outer Joint		27	27	59	84.5	64	M		
BRAVO,BRAVA (182)																	
2.0 HGT 20V (113 kW)	1998.07-2001.10	-	-	-	-	Exc Brava	802008	Outer Joint		25	25	59	85	58	O		
CINQUECENTO (170_)																	
0.7 (23 kW)	1991.12-1996.01	MT	L/R	F	Hatchback Engine 170 A.000	817010	Outer Joint		22	20	46.8	75.5	48	O			
0.7 i (22 kW)	1994.07-1998.01	MT	L/R	F	Hatchback Engine 170 A.046	817010	Outer Joint		22	20	46.8	75.5	48	O			
0.9 (30 kW)	1991.07-1993.12	MT	L/R	F	Hatchback Engine 170 A1.000	817010	Outer Joint		22	20	46.8	75.5	48	O			
	1991.07-1993.12	MT	L	F	Hatchback Engine 170 A1.000	217187	Drive Shaft		22	29.2	46.8	75.5	534				
	1991.07-1993.12	MT	R	F	Hatchback Engine 170 A1.000	217048	Drive Shaft		22	29.2	46.8	75.5	795				
0.9 i.e. (30 kW)	1991.07-1993.12	MT	L/R	F	Hatchback Engine 170 A1.046	817010	Outer Joint		22	20	46.8	75.5	48	O			
	1991.07-1993.12	MT	L	F	Hatchback Engine 170 A1.046	217187	Drive Shaft		22	29.2	46.8	75.5	534				
	1991.07-1993.12	MT	R	F	Hatchback Engine 170 A1.046	217048	Drive Shaft		22	29.2	46.8	75.5	795				
0.9 i.e. S (29 kW)	1991.07-1999.07	MT	L/R	F	Hatchback Engine 1170 A1.000/1170 A1.046	817010	Outer Joint		22	20	46.8	75.5	48	O			
	1991.07-1999.07	MT	L	F	Hatchback Engine 1170 A1.000/1170 A1.046	217187	Drive Shaft		22	29.2	46.8	75.5	534				
	1991.07-1999.07	MT	R	F	Hatchback Engine 1170 A1.000/1170 A1.046	217048	Drive Shaft		22	29.2	46.8	75.5	795				
1.1 Sporting (40 kW)	1994.10-1998.01	MT	L/R	F	Hatchback Engine 176 B2.000	817010	Outer Joint		22	20	46.8	75.5	48	O			
	1994.10-1998.01	MT	L	F	Hatchback Engine 176 B2.000	217188	Drive Shaft		22	22	46.8	75.5	552				
	1994.10-1998.01	-	R	F	Hatchback Engine 176 B2.000	217189	Drive Shaft		22	22	46.8	75.5	774				
COUPE (175_)																	
1.8 16V (96 kW)	1996.03-2000.08	-	-	F	Coupe Engine 183 A1.000	802006	Outer Joint	44T	25	25	52	85	58	O			
	1996.03-2000.08	-	-	F	Coupe Engine 183 A1.000	602005	Inner Joint			25		32					
2.0 16V (102 kW)	1993.11-1996.08	-	-	F	Coupe Engine 836 A3.000	602006	Inner Joint			25		32					
	1993.11-1996.08	MT	L/R	F	Coupe Engine 836 A3.000	817004	Outer Joint		25	25	52	85	58	I			
	1993.11-1996.08	-	-	F	Coupe Engine 836 A3.000	802006	Outer Joint	44T	25	25	52	85	58	O			
	1993.11-1996.08	-	-	F	Coupe Engine 836 A3.000	602005	Inner Joint			25		32					
2.0 16V Turbo (140 kW)	1993.11-1996.08	-	-	F	Coupe Engine 175 A1.000	602006	Inner Joint			25		32					
	1993.11-1996.08	MT	L/R	F	Coupe Engine 175 A1.000	802009	Outer Joint	44T	25	28	56	85	63.5	O			
	1993.11-1996.08	-	-	F	Coupe Engine 175 A1.000	602005	Inner Joint			25		32					
2.0 20V (108 kW)	1996.08-1998.04	-	-	F	Coupe Engine 182 A1.000	602005	Inner Joint			25		32					
	1996.08-1998.04	AT/MT	L/R	F	Coupe Engine 182 A1.000	618070	Inner Joint			25		32					
	1996.08-1998.04	-	-	F	Coupe Engine 182 A1.000	602006	Inner Joint			25		32					
	1996.08-1998.04	-	-	F	Coupe Engine 182 A1.000	802006	Outer Joint	44T	25	25	52	85	58	O			
2.0 20V (113 kW)	1998.04-2000.08	-	-	F	Coupe Engine 182 B3.000	602005	Inner Joint			25		32					
	1998.04-2000.08	AT/MT	L/R	F	Coupe Engine 182 B3.000	618070	Inner Joint			25		32					
	1998.04-2000.08	-	-	F	Coupe Engine 182 B3.000	802006	Outer Joint	44T	25	25	52	85	58	O			
2.0 20V Turbo (162 kW)	1996.08-2000.08	MT	L/R	F	Coupe Engine 175 A3.000	802009	Outer Joint	44T	25	28	56	85	63.5	O			
COUPE (FA/175)																	
1.8 16V (96 kW)	1996.03-2000.08	-	-	-	-	-	617009	Inner Joint			25		32				





	 YEAR	TRANSM	L/R	F/R	REMARKS	GSP Ref.	 PRODUCT	 ABS	Technical Specifications						
									A	B	C	H	L	P	
FIAT															
COUPE (FA/175)															
2.0 16V (102 kW)	1993.11-1996.08	-	-	-	-	617009	Inner Joint			25	32				
2.0 20V (108 kW)	1996.08-2008.08	-	-	-	-	617009	Inner Joint			25	32				
2.0 20V (113 kW)	1996.08-2008.08	-	-	-	-	617009	Inner Joint			25	32				
CROMA (154_)															
1.6 (61 kW)	1985.12-1990.12	MT	L/R	F	Hatchback Engine 154 A.048	648004	Inner Joint			25	32				
1.9 Turbo D i.d. (66 kW)	1989.05-1992.10	MT	L/R	F	Hatchback Engine 154 C6.000	648004	Inner Joint			25	32				
	1989.05-1992.10	-	-	F	Hatchback Engine 154 C6.000	602006	Inner Joint			25	32				
1.9 Turbo D i.d. (69 kW)	1992.11-1996.12	-	-	F	Hatchback Engine 154 D1.000	602006	Inner Joint			25	32				
	1992.11-1996.12	-	-	-	Hatchback Engine 154 D1.000	817033	Outer Joint			27	25	56	85	58	I
	1992.11-1996.12	MT	L/R	F	Hatchback Engine 154 D1.000	817013	Outer Joint	44T		27	25	56	85	58	I
2.0 16V (101 kW)	1992.08-1996.08	MT	L/R	F	Hatchback Engine 154 E1.000	817004	Outer Joint			25	25	52	85	58	I
	1992.08-1996.08	-	-	F	Hatchback Engine 154 E1.000	602006	Inner Joint			25	32				
	1992.08-1996.08	-	-	-	Hatchback Engine 154 E1.000	817033	Outer Joint		27	25	56	85	58	I	
2.0 CHT (66 kW)	1985.12-1989.02	MT	L/R	F	Hatchback Engine 154 A1.000	648004	Inner Joint			25	32				
	1985.12-1989.02	-	-	F	Hatchback Engine 154 A1.000	602006	Inner Joint			25	32				
2.0 CHT (74 kW)	1991.01-1992.09	MT	L/R	F	Hatchback Engine 154 A1.000/154 C5.000	648004	Inner Joint			25	32				
	1991.01-1992.09	-	-	F	Hatchback Engine 154 A1.000/154 C5.000	602006	Inner Joint			25	32				
2.0 i.e. (83 kW)	1986.03-1990.09	-	-	F	Hatchback Engine 834 B.048	602006	Inner Joint			25	32				
2.0 i.e. (85 kW)	1986.03-1990.09	MT	L/R	F	Hatchback Engine 834 B.048	648004	Inner Joint			25	32				
	1987.10-1996.08	-	-	F	Hatchback Engine 154 C3.046/834 B.146	602006	Inner Joint			25	32				
	1987.10-1996.08	MT	L/R	F	Hatchback Engine 154 C3.046/834 B.146	648004	Inner Joint			25	32				
	1987.10-1996.08	-	-	-	Hatchback Engine 154 C3.046/834 B.146	817033	Outer Joint		27	25	56	85	58	I	
2.0 i.e. (88 kW)	1987.10-1996.08	MT	L/R	F	Hatchback Engine 154 C3.046/834 B.146	817013	Outer Joint	44T		27	25	56	85	58	I
	1987.03-1992.09	-	-	F	Hatchback Engine 154 C3.000/834 B.000	602006	Inner Joint			25	32				
	1987.03-1992.09	MT	L/R	F	Hatchback Engine 154 C3.000/834 B.000	648004	Inner Joint			25	32				
2.0 i.e. Turbo (110 kW)	1987.06-1996.08	-	-	F	Hatchback Engine 154 C4.046/834 C.146	602006	Inner Joint			25	32				
	1987.06-1996.08	MT	L/R	F	Hatchback Engine 154 C4.046/834 C.146	648004	Inner Joint			25	32				
	1987.06-1996.08	-	-	-	Hatchback Engine 154 C4.046/834 C.146	817033	Outer Joint		27	25	56	85	58	I	
2.0 i.e. Turbo (114 kW)	1985.12-1990.06	-	-	F	Hatchback Engine 154 A2.000	602006	Inner Joint			25	32				
	1985.12-1990.06	MT	L/R	F	Hatchback Engine 154 A2.000	648004	Inner Joint			25	32				
2.5 D (55 kW)	1985.12-1989.12	MT	L/R	F	Hatchback Engine 8144.67	648004	Inner Joint			25	32				
	1985.12-1989.12	-	-	F	Hatchback Engine 8144.67	602006	Inner Joint			25	32				
2.5 TD (74 kW)	1985.12-1989.08	MT	L/R	F	Hatchback Engine 8144.91.2000	648004	Inner Joint			25	32				
	1985.12-1989.08	-	-	F	Hatchback Engine 8144.91.2000	602006	Inner Joint			25	32				
2.5 TD (85 kW)	1989.05-1996.08	-	-	F	Hatchback Engine 8144.97/8144.97 Y/8144.97.2400	602006	Inner Joint			25	32				
	1989.05-1996.08	MT	L/R	F	Hatchback Engine 8144.97/8144.97 Y/8144.97.2400	648004	Inner Joint			25	32				
	1989.05-1996.08	-	-	-	Hatchback Engine 8144.97/8144.97 Y/8144.97.2400	817033	Outer Joint		27	25	56	85	58	I	
2.5 TDE (77 kW)	1991.12-1996.08	MT	L/R	F	Hatchback Engine 8144.97 S	648004	Inner Joint			25	32				
	1991.12-1996.08	-	-	F	Hatchback Engine 8144.97 S	602006	Inner Joint			25	32				
	1991.12-1996.08	-	-	-	Hatchback Engine 8144.97 S	817033	Outer Joint		27	25	56	85	58	I	
2.5 V6 (119 kW)	1993.06-1996.08	-	-	F	Hatchback Engine 834 G.000	602006	Inner Joint			25	32				
	1993.06-1996.08	MT	L/R	F	Hatchback Engine 834 G.000	817013	Outer Joint	44T		27	25	56	85	58	I
CROMA (194)															
1.9 D Multijet (100 kW)	2005.06-	-	-	L	-	617035	Inner Joint			25	26	34.9	57.5	114.5	
	2005.06-	-	-	R	-	617036	Inner Joint			25	26	34.9	434.5	108.5	
1.9 D Multijet (110 kW)	2005.06-	-	AT	R	-	617043	Inner Joint			27	26	35	448.5	107	
	2005.06-	-	AT	L	-	621016	Inner Joint			27	26	35	78.5	112	
	2005.06-	-	-	L	-	617035	Inner Joint			25	26	34.9	57.5	114.5	
	2005.06-	-	-	R	-	617036	Inner Joint			25	26	34.9	434.5	108.5	
1.9 D Multijet (85 kW)	2005.06-	-	-	L	-	617035	Inner Joint			25	26	34.9	57.5	114.5	
	2005.06-	-	-	R	-	617036	Inner Joint			25	26	34.9	434.5	108.5	
1.9 D Multijet (88 kW)	2005.06-	-	-	L	-	617035	Inner Joint			25	26	34.9	57.5	114.5	
	2005.06-	-	-	R	-	617036	Inner Joint			25	26	34.9	434.5	108.5	
2.4 D Multijet (147 kW)	2005.06-	-	-	L	-	621016	Inner Joint			27	26	35	78.5	112	
CROMA (194_)															
1.8 16V (103 kW)	2005.12-	-	MT	L	F	Estate Engine 939 A4.000	699026	Inner Joint		22	25	35	57	82.5	
	2005.12-	-	MT	L	F	Estate Engine 939 A4.000	244020	Drive Shaft		30	22	52.5	105	617.5	
	2005.12-	-	MT	R	F	Estate Engine 939 A4.000	217040	Drive Shaft		30	22	52.5	105	987	
	2005.12-	-	-	L/R	F	Estate Engine 939 A4.000	817007	Outer Joint		30	25	52.5	105	62	O
	2005.12-	-	-	R	-	Estate Engine 939 A4.000	201124	Drive Shaft		30	34	52.5	105	971	
1.9 D Multijet (100 kW)	2005.12-	-	-	R	-	Estate Engine 939 A8.000	201124	Drive Shaft		30	34	52.5	105	971	
	2005.12-	-	MT	L	F	Estate Engine 939 A8.000	221102	Drive Shaft		30	25	53.8	94.5	602	
	2005.12-	-	AT/MT	R	F	Estate Engine 939 A8.000	221103	Drive Shaft		30	25	53.8	94.5	972	
	2005.12-	-	-	-	F	Estate Engine 939 A8.000	899023	Outer Joint		30	26	53.8	94.5	65.5	M
1.9 D Multijet (110 kW)	2005.06-	-	-	R	-	Estate Engine 939 A2.000	201124	Drive Shaft		30	34	52.5	105	971	
	2005.06-	-	MT	L	F	Estate Engine 939 A2.000	221102	Drive Shaft		30	25	53.8	94.5	602	





YEAR	TRANSM	L/R	F/R	REMARKS	GSP Ref.	PRODUCT	ABS	Technical Specifications						
								A	B	C	H	L	P	
FIAT														
CROMA (194_)														
1.9 D Multijet (110 kW)	2005.06-	-	MT	R	F	Estate Engine 939 A2.000	221103	Drive Shaft	30	25	53.8	94.5	972	
	2005.06-	-	-	-	F	Estate Engine 939 A2.000	899023	Outer Joint	30	26	53.8	94.5	65.5	M
1.9 D Multijet (85 kW)	2005.06-	-	-	-	F	Estate Engine 939 A7.000	899023	Outer Joint	30	26	53.8	94.5	65.5	M
	2005.06-	-	-	R	-	Estate Engine 939 A7.000	201124	Drive Shaft	30	34	52.5	105	971	
	2005.06-	-	MT	L	F	Estate Engine 939 A7.000	221102	Drive Shaft	30	25	53.8	94.5	602	
	2005.06-	-	MT	R	F	Estate Engine 939 A7.000	221103	Drive Shaft	30	25	53.8	94.5	972	
1.9 D Multijet (88 kW)	2005.06-	-	-	R	-	Estate Engine 939 A1.000	201124	Drive Shaft	30	34	52.5	105	971	
	2005.06-	-	MT	L	F	Estate Engine 939 A1.000	221102	Drive Shaft	30	25	53.8	94.5	602	
	2005.06-	-	MT	R	F	Estate Engine 939 A1.000	221103	Drive Shaft	30	25	53.8	94.5	972	
	2005.06-	-	-	-	F	Estate Engine 939 A1.000	899023	Outer Joint	30	26	53.8	94.5	65.5	M
2.2 16V (108 kW)	2005.06-	-	MT	L	F	Estate Engine 194 A1.000	621011	Inner Joint	34	25	35	78	64	
	2005.06-	-	MT	L/R	F	Estate Engine 194 A1.000	817007	Outer Joint	30	25	52.5	105	62	O
	2005.06-	-	-	R	-	Estate Engine 194 A1.000	201124	Drive Shaft	30	34	52.5	105	971	
2.4 D Multijet (147 kW)	2005.06-	-	-	R	-	Estate Engine 939 A3.000	201124	Drive Shaft	30	34	52.5	105	971	
DELTA III (844)														
1.6 D Multijet (88 kW)	2008.09-	-	-	R	-	w/o Selespeed	617006	Inner Joint	25	26	29.8	377	108	
DOBLO														
1.3 MJT	2005-	-	-	-	F	-	699008	Inner Joint	24	24	29.7	86.5	93	
	2005-	-	-	R	F	-	217014	Drive Shaft	25	35.6	51	90	524	
	2010-	-	-	L	F	-	617025	Inner Joint	24	24	29.7	86.5	93	
	2010-	-	-	R	F	-	617026	Inner Joint	24	24	29.7	379	100.5	
	2010-	-	-	L	F	-	217068	Drive Shaft	25	39.2	51	84.5	492	
	2010-	-	-	L	F	-	217078	Drive Shaft	25	24	51	84.5	602	
	2010-	-	-	R	F	-	217069	Drive Shaft	25	39.2	51	84.5	559	
	2010-	-	-	R	F	-	217079	Drive Shaft	25	24	51	84.5	970	
	2010-	-	-	L/R	F	-	899316	Outer Joint	25	25	51	84.5	61	M
1.4	2005-	-	-	R	F	-	217113	Drive Shaft	22	22	51	89.5	930.5	
	2005-	-	-	L	F	-	217102	Drive Shaft	22	22	51	89.5	636	
1.6 MJT	2010-	-	-	L	F	-	217067	Drive Shaft	25	27.35	51	84.5	500	
	2010-	-	-	R	F	-	618100	Inner Joint	25	26	29.7	434	108	
	2010-	-	-	L	F	-	617031	Inner Joint	25	26	32	59	110.5	
1.8 8V	-	-	-	-	-	-	617018	Inner Joint		25		32		
	2002-	2006	-	-	-	-	217031	Drive Shaft					336	
	2002-	2006	-	-	-	-	617018	Inner Joint		25		32		
1.9 JTD	2001-	-	-	R	F	-	217014	Drive Shaft	25	35.6	51	90	524	
	2005-	-	-	-	F	-	699008	Inner Joint	24	24	29.7	86.5	93	
DOBLO (119_ 223_)														
1.2 (48 kW)	2001.03-	-	-	L	F	MPV Engine 223 A5.000	241006	Drive Shaft	22	31.95	51	89.5	618	
	2001.03-	-	-	L/R	F	MPV Engine 223 A5.000	802018	Outer Joint	22	22	51	89.5	57	M
1.3 D Multijet (62 kW)	2005.10-	-	-	R	F	MPV Engine 223 A9.000	217019	Drive Shaft	25	24	51	90	928	
	2005.10-	-	-	L	F	MPV Engine 223 A9.000	217017	Drive Shaft	25	24	51	90	611	
	2005.10-	-	-	L	F	MPV Engine 223 A9.000	217013	Drive Shaft	25	35.6	51	90	501	
	2005.10-	-	-	L/R	F	MPV Engine 223 A9.000	817031	Outer Joint	25	24	51	90	62	M
1.4 (57 kW)	2005.10-	-	-	L/R	F	MPV Engine 350 A1.000	802018	Outer Joint	22	22	51	89.5	57	M
1.6 16V (76 kW)	2001.10-	-	-	L/R	F	MPV Engine 182 B6.000	802018	Outer Joint	22	22	51	89.5	57	M
1.6 Natural Power (76 kW)	2002.09-	-	-	L/R	F	MPV Engine 182 B6.000	802018	Outer Joint	22	22	51	89.5	57	M
1.9 D (46 kW)	2001.03-	-	-	L	F	MPV Engine 223 A6.000	241006	Drive Shaft	22	31.95	51	89.5	618	
	2001.03-	-	-	R	F	MPV Engine 223 A6.000	241007	Drive Shaft	22	31.95	51	89.5	932	
	2001.03-	-	-	L/R	F	MPV Engine 223 A6.000	802018	Outer Joint	22	22	51	89.5	57	M
1.9 D Multijet (88 kW)	2005.10-	-	-	R	F	MPV Engine 186 A9.000	217019	Drive Shaft	25	24	51	90	928	
	2005.10-	-	-	L	F	MPV Engine 186 A9.000	217017	Drive Shaft	25	24	51	90	611	
	2005.10-	-	-	L	F	MPV Engine 186 A9.000	217013	Drive Shaft	25	35.6	51	90	501	
	2005.10-	-	-	L/R	F	MPV Engine 186 A9.000	817031	Outer Joint	25	24	51	90	62	M
1.9 JTD (74 kW)	2001.10-	-	-	R	F	MPV Engine 182 B9.000/223 B2.000	217019	Drive Shaft	25	24	51	90	928	
	2001.10-	-	-	L	F	MPV Engine 182 B9.000/223 B2.000	217017	Drive Shaft	25	24	51	90	611	
	2001.10-	-	-	L	F	MPV Engine 182 B9.000/223 B2.000	217013	Drive Shaft	25	35.6	51	90	501	
	2001.10-	-	-	L/R	F	MPV Engine 182 B9.000/223 B2.000	817031	Outer Joint	25	24	51	90	62	M
1.9 JTD (77 kW)	2003.07-	-	-	R	F	MPV Engine 223 A7.000/223 B1.000	217019	Drive Shaft	25	24	51	90	928	
	2003.07-	-	-	L	F	MPV Engine 223 A7.000/223 B1.000	217017	Drive Shaft	25	24	51	90	611	
	2003.07-	-	-	L	F	MPV Engine 223 A7.000/223 B1.000	217013	Drive Shaft	25	35.6	51	90	501	
	2003.07-	-	-	L/R	F	MPV Engine 223 A7.000/223 B1.000	817031	Outer Joint	25	24	51	90	62	M
DOBLO (263_)														
1.3 D Multijet (66 kW)	2010.02-	-	AT	-	F	MPV Engine 199 A3.000/263 A2.000	899298	Outer Joint	27	26	59	84.5	63	M
1.4 (70 kW)	2010.02-	-	-	L/R	F	MPV Engine 843 A1.000	817026	Outer Joint	25	22	51	84	57	M
	2010.02-	-	-	L/R	F	Box Body/Estate Engine 843 A1.000	817026	Outer Joint	25	22	51	84	57	M
	2010.02-	-	AT	-	F	MPV Engine 843 A1.000	899298	Outer Joint	27	26	59	84.5	63	M





	 YEAR	TRANSM	L/R	F/R	REMARKS	GSP Ref.	 PRODUCT	 ABS	Technical Specifications							
									A	B	C	H	L	P		
FIAT																
DOBLO (263_)																
1.4 (70 kW)	2010.02-	-	AT	-	F	Box Body/Estate Engine 843 A1.000	899298	Outer Joint		27	26	59	84.5	63	M	
1.4 (88 kW)	2011.10-	-	-	-	F	Box Body/Estate Engine 198 A4.000	899298	Outer Joint		27	26	59	84.5	63	M	
	2011.10-	-	-	-	F	MPV Engine 198 A4.000	899298	Outer Joint		27	26	59	84.5	63	M	
	2011.10-	-	MT	L	F	Box Body/Estate Engine 198 A4.000	217076	Drive Shaft		25	25	51	84.5	596		
	2011.10-	-	MT	R	F	Box Body/Estate Engine 198 A4.000	217081	Drive Shaft		25	25	51	84.5	966.5		
1.4 Natural Power (88 kW)	2010.02-	-	-	-	F	MPV Engine 198 A4.000	899298	Outer Joint		27	26	59	84.5	63	M	
	2010.06-	-	-	-	F	Box Body/Estate Engine 198 A4.000	899298	Outer Joint		27	26	59	84.5	63	M	
	2010.06-	-	MT	L	F	Box Body/Estate Engine 198 A4.000	217076	Drive Shaft		25	25	51	84.5	596		
1.6 D Multijet (66 kW)	2010.02-	-	-	-	L/R	F	MPV Engine 263 A4.000	817030	Outer Joint		25	26	51	84.5	64.5	M
	2010.02-	-	-	-	L/R	F	Box Body/Estate Engine 263 A4.000/263 A5.000	817030	Outer Joint		25	26	51	84.5	64.5	M
	2010.02-	-	MT	-	F	Box Body/Estate Engine 263 A4.000/263 A5.000	899298	Outer Joint		27	26	59	84.5	63	M	
	2010.02-	-	-	-	F	MPV Engine 263 A4.000	899298	Outer Joint		27	26	59	84.5	63	M	
	2010.02-	-	MT	L	F	Box Body/Estate Engine 263 A4.000/263 A5.000	217076	Drive Shaft		25	25	51	84.5	596		
	2010.02-	-	MT	R	F	Box Body/Estate Engine 263 A4.000/263 A5.000	217081	Drive Shaft		25	25	51	84.5	966.5		
	2010.02-	-	MT	L	F	MPV Engine 263 A4.000	217152	Drive Shaft		27	25	59	84.5	596		
	2010.02-	-	MT	L	F	Box Body/Estate Engine 263 A4.000/263 A5.000	217152	Drive Shaft		27	25	59	84.5	596		
	2010.02-	-	MT	R	F	MPV Engine 263 A4.000	217153	Drive Shaft		27	25	59	84.5	967		
	2010.02-	-	MT	R	F	Box Body/Estate Engine 263 A4.000/263 A5.000	217153	Drive Shaft		27	25	59	84.5	967		
1.6 D Multijet (74 kW)	2010.02-	-	-	-	L/R	F	Box Body/Estate Engine 263 A3.000/263 A9.000	817030	Outer Joint		25	26	51	84.5	64.5	M
	2010.02-	-	MT	L	F	Box Body/Estate Engine 263 A3.000/263 A9.000	217076	Drive Shaft		25	25	51	84.5	596		
	2010.02-	-	MT	R	F	Box Body/Estate Engine 263 A3.000/263 A9.000	217081	Drive Shaft		25	25	51	84.5	966.5		
	2010.02-	-	MT	L	F	Box Body/Estate Engine 263 A3.000/263 A9.000	217152	Drive Shaft		27	25	59	84.5	596		
	2010.02-	-	MT	R	F	Box Body/Estate Engine 263 A3.000/263 A9.000	217153	Drive Shaft		27	25	59	84.5	967		
1.6 D Multijet (77 kW)	2010.02-	-	-	-	L/R	F	Box Body/Estate Engine 198 A3.000/263 A8.000	817030	Outer Joint		25	26	51	84.5	64.5	M
	2010.02-	-	-	-	L/R	F	MPV Engine 198 A3.000/263 A8.000	817030	Outer Joint		25	26	51	84.5	64.5	M
	2010.02-	-	MT	L	F	Box Body/Estate Engine 198 A3.000/263 A8.000	217076	Drive Shaft		25	25	51	84.5	596		
	2010.02-	-	MT	R	F	Box Body/Estate Engine 198 A3.000/263 A8.000	217081	Drive Shaft		25	25	51	84.5	966.5		
	2010.02-	-	MT	L	F	Box Body/Estate Engine 198 A3.000/263 A8.000	217152	Drive Shaft		27	25	59	84.5	596		
	2010.02-	-	MT	L	F	MPV Engine 198 A3.000/263 A8.000	217152	Drive Shaft		27	25	59	84.5	596		
	2010.02-	-	MT	R	F	Box Body/Estate Engine 198 A3.000/263 A8.000	217153	Drive Shaft		27	25	59	84.5	967		
	2010.02-	-	MT	R	F	MPV Engine 198 A3.000/263 A8.000	217153	Drive Shaft		27	25	59	84.5	967		
2.0 D Multijet (99 kW)	2010.02-	-	MT	L/R	F	MPV Engine 263 A1.000	617114	Inner Joint		25	27	29.7	433	110		
	2010.02-	-	MT	L/R	F	Box Body/Estate Engine 263 A1.000	617114	Inner Joint		25	27	29.7	433	110		
	2010.02-	-	-	-	F	MPV Engine 263 A1.000	899298	Outer Joint		27	26	59	84.5	63	M	
	2010.02-	-	-	-	F	Box Body/Estate Engine 263 A1.000	899298	Outer Joint		27	26	59	84.5	63	M	
DOBLO (263_)/PRATICO																
1.4 (70 kW)	2010.04-	-	-	-	L/R	F	Platform/Chassis Engine 843 A1.000	817026	Outer Joint		25	22	51	84	57	M
	2010.04-	-	AT	-	F	Platform/Chassis Engine 843 A1.000	899298	Outer Joint		27	26	59	84.5	63	M	
1.4 (88 kW)	2011.10-	-	MT	L	F	Platform/Chassis Engine 198 A4.000	217076	Drive Shaft		25	25	51	84.5	596		
	2011.10-	-	MT	R	F	Platform/Chassis Engine 198 A4.000	217081	Drive Shaft		25	25	51	84.5	966.5		
1.6 D Multijet (66 kW)	2010.02-	-	-	-	L/R	F	Platform/Chassis Engine 263 A4.000/263 A5.000	817030	Outer Joint		25	26	51	84.5	64.5	M
	2010.02-	-	MT	-	F	Platform/Chassis Engine 263 A4.000/263 A5.000	899298	Outer Joint		27	26	59	84.5	63	M	
	2010.02-	-	MT	L	F	Platform/Chassis Engine 263 A4.000/263 A5.000	217076	Drive Shaft		25	25	51	84.5	596		
	2010.02-	-	MT	R	F	Platform/Chassis Engine 263 A4.000/263 A5.000	217081	Drive Shaft		25	25	51	84.5	966.5		
	2010.02-	-	MT	L	F	Platform/Chassis Engine 263 A4.000/263 A5.000	217152	Drive Shaft		27	25	59	84.5	596		
	2010.02-	-	MT	R	F	Platform/Chassis Engine 263 A4.000/263 A5.000	217153	Drive Shaft		27	25	59	84.5	967		
1.6 D Multijet (74 kW)	2011.02-	-	-	-	L/R	F	Platform/Chassis Engine 263 A3.000/263 A9.000	817030	Outer Joint		25	26	51	84.5	64.5	M
	2011.02-	-	MT	L	F	Platform/Chassis Engine 263 A3.000/263 A9.000	217152	Drive Shaft		27	25	59	84.5	596		
	2011.02-	-	MT	R	F	Platform/Chassis Engine 263 A3.000/263 A9.000	217153	Drive Shaft		27	25	59	84.5	967		
1.6 D Multijet (77 kW)	2010.02-	-	-	-	L/R	F	Platform/Chassis Engine 198 A3.000/263 A8.000	817030	Outer Joint		25	26	51	84.5	64.5	M
	2010.02-	-	MT	L	F	Platform/Chassis Engine 198 A3.000/263 A8.000	217076	Drive Shaft		25	25	51	84.5	596		
	2010.02-	-	MT	R	F	Platform/Chassis Engine 198 A3.000/263 A8.000	217081	Drive Shaft		25	25	51	84.5	966.5		
	2010.02-	-	MT	L	F	Platform/Chassis Engine 198 A3.000/263 A8.000	217152	Drive Shaft		27	25	59	84.5	596		
	2010.02-	-	MT	R	F	Platform/Chassis Engine 198 A3.000/263 A8.000	217153	Drive Shaft		27	25	59	84.5	967		
2.0 D Multijet (99 kW)	2010.02-	-	MT	L/R	F	Platform/Chassis Engine 263 A1.000	617114	Inner Joint		25	27	29.7	433	110		
	2010.02-	-	-	-	F	Platform/Chassis Engine 263 A1.000	899298	Outer Joint		27	26	59	84.5	63	M	
DOBLO ADVENTURE																
1.8 8V	-	-	-	-	-	-	617018	Inner Joint			25		32			
DOBLO CARGO (223)																
1.3 D Multijet (55 kW)	2005.10-	-	-	-	L	-	LCV	699008	Inner Joint		24	24	29.7	86.5	93	
1.3 JTD 16V (51 kW)	2004.05-	-	-	-	L	-	LCV	699008	Inner Joint		24	24	29.7	86.5	93	
1.9 JTD (74 kW)	2001.09-	2004.01	-	-	L	-	LCV	699008	Inner Joint		24	24	29.7	86.5	93	
1.9 JTD (77 kW)	2001.09-	2006.12	-	-	L	-	LCV	699008	Inner Joint		24	24	29.7	86.5	93	
1.9 JTD (88 kW)	2005.11-	2006.12	-	-	L	-	LCV	699008	Inner Joint		24	24	29.7	86.5	93	
DOBLO Cargo (223_)																





YEAR	TRANSM	L/R	F/R	REMARKS	GSP Ref.	PRODUCT	ABS	Technical Specifications									
								A	B	C	H	L	P				
FIAT																	
DOBLO Cargo (223_)																	
1.2 (48 kW)	2001.03-	-	-	L F	Box Body/Estate Engine 223 A5.000	241006	Drive Shaft		22	31.95	51	89.5	618				
	2001.03-	-	-	L/R F	Box Body/Estate Engine 223 A5.000	802018	Outer Joint		22	22	51	89.5	57	M			
1.3 D Multijet (55 kW)	2005.10-	2010.01	-	R F	Box Body/Estate Engine 199 A2.000	217019	Drive Shaft		25	24	51	90	928				
	2005.10-	2010.01	-	L F	Box Body/Estate Engine 199 A2.000	217017	Drive Shaft		25	24	51	90	611				
	2005.10-	2010.01	-	L F	Box Body/Estate Engine 199 A2.000	217013	Drive Shaft		25	35.6	51	90	501				
	2005.10-	2010.01	-	L/R F	Box Body/Estate Engine 199 A2.000	817031	Outer Joint		25	24	51	90	62	M			
1.3 JTD 16V (51 kW)	2004.05-	2006.12	-	R F	Box Body/Estate Engine 188 A8.000/188 A9.000	217019	Drive Shaft		25	24	51	90	928				
	2004.05-	2006.12	-	L F	Box Body/Estate Engine 188 A8.000/188 A9.000	217017	Drive Shaft		25	24	51	90	611				
	2004.05-	2006.12	-	L/R F	Box Body/Estate Engine 188 A8.000/188 A9.000	817031	Outer Joint		25	24	51	90	62	M			
1.3 JTD 16V Multijet (62 kW)	2006.08-	-	-	L F	Box Body/Estate Engine 223 A9.000	217013	Drive Shaft		25	35.6	51	90	501				
	2006.08-	-	-	L/R F	Box Body/Estate Engine 223 A9.000	817031	Outer Joint		25	24	51	90	62	M			
1.4 (57 kW)	2005.10-	-	-	L/R F	Box Body/Estate Engine 350 A1.000	802018	Outer Joint		22	22	51	89.5	57	M			
1.6 16V (76 kW)	2001.10-	-	-	L/R F	Box Body/Estate Engine 182 B6.000	802018	Outer Joint		22	22	51	89.5	57	M			
1.6 Natural Power (76 kW)	2002.09-	-	-	L/R F	Box Body/Estate Engine 182 B6.000	802018	Outer Joint		22	22	51	89.5	57	M			
1.9 D (46 kW)	2001.03-	-	-	L F	Box Body/Estate Engine 223 A6.000	241006	Drive Shaft		22	31.95	51	89.5	618				
	2001.03-	-	-	R F	Box Body/Estate Engine 223 A6.000	241007	Drive Shaft		22	31.95	51	89.5	932				
	2001.03-	-	-	L/R F	Box Body/Estate Engine 223 A6.000	802018	Outer Joint		22	22	51	89.5	57	M			
1.9 JTD (74 kW)	2001.10-	-	-	R F	Box Body/Estate Engine 182 B9.000	217019	Drive Shaft		25	24	51	90	928				
	2001.10-	-	-	L F	Box Body/Estate Engine 182 B9.000	217017	Drive Shaft		25	24	51	90	611				
	2001.10-	-	-	L F	Box Body/Estate Engine 182 B9.000	217013	Drive Shaft		25	35.6	51	90	501				
	2001.10-	-	-	L/R F	Box Body/Estate Engine 182 B9.000	817031	Outer Joint		25	24	51	90	62	M			
1.9 JTD (77 kW)	2003.07-	-	-	R F	Box Body/Estate Engine 223 A7.000/223 B1.000	217019	Drive Shaft		25	24	51	90	928				
	2003.07-	-	-	L F	Box Body/Estate Engine 223 A7.000/223 B1.000	217017	Drive Shaft		25	24	51	90	611				
	2003.07-	-	-	L F	Box Body/Estate Engine 223 A7.000/223 B1.000	217013	Drive Shaft		25	35.6	51	90	501				
	2003.07-	-	-	L/R F	Box Body/Estate Engine 223 A7.000/223 B1.000	817031	Outer Joint		25	24	51	90	62	M			
1.9 JTD Multijet (88 kW)	2006.12-	-	-	L F	Box Body/Estate Engine 186 A9.000	217013	Drive Shaft		25	35.6	51	90	501				
	2006.12-	-	-	L/R F	Box Body/Estate Engine 186 A9.000	817031	Outer Joint		25	24	51	90	62	M			
DOBLO CARGO I (223)																	
1.3 D Multijet (55 kW)	2005.10-	-	-	R -	LCV	617015	Inner Joint		24	24	29.7	379	100.5				
1.3 JTD 16V (51 kW)	2004.05-	-	-	R -	LCV	617015	Inner Joint		24	24	29.7	379	100.5				
1.9 JTD (74 kW)	2001.09-	2006.12	-	R -	LCV	617015	Inner Joint		24	24	29.7	379	100.5				
1.9 JTD (77 kW)	2001.09-	2006.12	-	R -	LCV	617015	Inner Joint		24	24	29.7	379	100.5				
1.9 JTD (88 kW)	2005.11-	2006.12	-	R -	LCV	617015	Inner Joint		24	24	29.7	379	100.5				
DOBLO CARGO II (223)																	
1.3 D Multijet (55 kW)	2005.10-	-	-	R -	LCV	617015	Inner Joint		24	24	29.7	379	100.5				
1.3 JTD 16V (51 kW)	2004.05-	-	-	R -	LCV	617015	Inner Joint		24	24	29.7	379	100.5				
1.4 (57 kW)	2005.10-	-	-	- -	-	617027	Inner Joint		22	22	36	61.5	93.5				
1.9 JTD (74 kW)	2001.09-	2006.12	-	R -	LCV	617015	Inner Joint		24	24	29.7	379	100.5				
1.9 JTD (77 kW)	2001.09-	2006.12	-	R -	LCV	617015	Inner Joint		24	24	29.7	379	100.5				
1.9 JTD (88 kW)	2005.11-	2006.12	-	R -	LCV	617015	Inner Joint		24	24	29.7	379	100.5				
DOBLO CARGO III (263)																	
1.3 D Multijet (66 kW)	2010.02-	-	-	L -	LCV	617025	Inner Joint		24	24	29.7	86.5	93				
	2010.02-	-	-	R -	LCV	617026	Inner Joint		24	24	29.7	379	100.5				
1.4 (88 kW)	2011.10-	-	-	L -	LCV	617031	Inner Joint		25	26	32	59	110.5				
1.4 Natural Power (88 kW)	2010.06-	-	-	L -	LCV	617031	Inner Joint		25	26	32	59	110.5				
1.6 D Multijet (66 kW)	2010.02-	-	-	L -	LCV	617031	Inner Joint		25	26	32	59	110.5				
1.6 D Multijet (74 kW)	2010.02-	-	-	L -	LCV	617031	Inner Joint		25	26	32	59	110.5				
1.6 D Multijet (77 kW)	2010.02-	-	-	L -	LCV	617031	Inner Joint		25	26	32	59	110.5				
DOBLO I (119)																	
1.9 JTD (74 kW)	2005-	-	-	L -	-	699008	Inner Joint		24	24	29.7	86.5	93				
1.9 JTD (77 kW)	2005-	-	-	L -	-	699008	Inner Joint		24	24	29.7	86.5	93				
13 MTJ (62 kW)	2005-	-	-	L -	-	699008	Inner Joint		24	24	29.7	86.5	93				
13 MTJ 16V (55 kW)	2005-	-	-	L -	-	699008	Inner Joint		24	24	29.7	86.5	93				
DOBLO I (223)																	
1.3 D Multijet (62 kW)	2005.10-	-	-	R -	-	617015	Inner Joint		24	24	29.7	379	100.5				
	2005.10-	-	-	L -	-	699008	Inner Joint		24	24	29.7	86.5	93				
1.9 D Multijet (88 kW)	2005.10-	-	-	R -	-	617015	Inner Joint		24	24	29.7	379	100.5				
	2005.10-	-	-	L -	-	699008	Inner Joint		24	24	29.7	86.5	93				
1.9 JTD (74 kW)	2001.03-	2003.10	-	R -	-	617015	Inner Joint		24	24	29.7	379	100.5				
	2001.03-	2003.10	-	L -	-	699008	Inner Joint		24	24	29.7	86.5	93				
1.9 JTD (77 kW)	2001.03-	2003.10	-	R -	-	617015	Inner Joint		24	24	29.7	379	100.5				
	2001.03-	2003.10	-	L -	-	699008	Inner Joint		24	24	29.7	86.5	93				
DOBLO II (119)																	
1.3 MTJ (62 kW)	2005-	-	-	R -	-	617015	Inner Joint		24	24	29.7	379	100.5				
1.3 MTJ 16V (55 kW)	2005-	-	-	R -	-	617015	Inner Joint		24	24	29.7	379	100.5				
1.9 JTD (74 kW)	2005-	-	-	R -	-	617015	Inner Joint		24	24	29.7	379	100.5				





YEAR	TRANSM	L/R	F/R	REMARKS	GSP Ref.	PRODUCT	ABS	Technical Specifications							
								A	B	C	H	L	P		
FIAT															
DOBLO II (119)															
1.9 JTD (77 kW)	2005-	-	-	R	-	617015	Inner Joint		24	24	29.7	379	100.5		
DOBLO III (152)															
1.3 D Multijet (66 kW)	2010.02-	-	-	L	-	617025	Inner Joint		24	24	29.7	86.5	93		
	2010.02-	-	-	R	-	617026	Inner Joint		24	24	29.7	379	100.5		
1.4 (70 kW)	2010.02-	-	-	-	-	617027	Inner Joint		22	22	36	61.5	93.5		
1.4 Natural Power (88 kW)	2010.02-	-	-	L	-	617031	Inner Joint		25	26	32	59	110.5		
1.6 D Multijet (66 kW)	2010.01-	-	-	L	-	617031	Inner Joint		25	26	32	59	110.5		
1.6 D Multijet (77 kW)	2010.01-	-	-	L	-	617031	Inner Joint		25	26	32	59	110.5		
DOBLO MAXI															
1.6 MJT	2010-	-	-	L	F	217106	Drive Shaft		27	43.2	59	84.5	499.5		
DOBLOII (119)															
1.4 MPI (55 kW)	2005-	-	-	-	-	617027	Inner Joint		22	22	36	61.5	93.5		
1.6 16V (76 kW)	2005-	-	-	-	-	617027	Inner Joint		22	22	36	61.5	93.5		
DUCATO															
2.0 D Multijet (85 kW)	2011.06-	-	-	-	-	817054	Outer Joint		35	29	71.5	127	71	M	
2.2 JTD (88 kW)	2006.07-	-	-	-	-	817054	Outer Joint		35	29	71.5	127	71	M	
2.3 D Multijet (109 kW)	2011.06-	-	-	-	-	817054	Outer Joint		35	29	71.5	127	71	M	
2.3 D Multijet (88 kW)	2006.07-	-	-	-	-	817054	Outer Joint		35	29	71.5	127	71	M	
2.3 D Multijet (93 kW)	2006.07-	-	-	-	-	817054	Outer Joint		35	29	71.5	127	71	M	
2.3 D Multijet (96 kW)	2011.06-	-	-	-	-	817054	Outer Joint		35	29	71.5	127	71	M	
DUCATO (230_)															
1.9 D (50 kW)	1998.04-	2002.04	MT	L	F	Bus Engine DJY/D9B/D9B(XUD9A)	610015	Inner Joint		37	39	40	68.5	104	
	1998.04-	2002.04	MT	L	F	Box Engine DJY	610015	Inner Joint		37	39	40	68.5	104	
	1998.04-	2002.04	MT	L	F	Platform/Chassis Engine DJY	610015	Inner Joint		37	39	40	68.5	104	
	1998.04-	2002.04	MT	L/R	F	Bus Engine DJY/D9B/D9B(XUD9A)	810012	Outer Joint		28	39	63	112.5	63	I
	1998.04-	2002.04	MT	L/R	F	Box Engine DJY	810012	Outer Joint		28	39	63	112.5	63	I
	1998.04-	2002.04	MT	L/R	F	Platform/Chassis Engine DJY	810012	Outer Joint		28	39	63	112.5	63	I
	1998.04-	2002.04	MT	L	F	Bus Engine DJY/D9B/D9B(XUD9A)	210102	Drive Shaft		28	41	63	112.5	757.5	
	1998.04-	2002.04	MT	L	F	Box Engine DJY	210102	Drive Shaft		28	41	63	112.5	757.5	
	1998.04-	2002.04	MT	L	F	Platform/Chassis Engine DJY	210102	Drive Shaft		28	41	63	112.5	757.5	
	1998.04-	2002.04	MT	L	F	Bus Engine DJY/D9B/D9B(XUD9A)	210037	Drive Shaft	54T	28	37	63	112.5	771	
	1998.04-	2002.04	MT	L	F	Box Engine DJY	210037	Drive Shaft	54T	28	37	63	112.5	771	
	1998.04-	2002.04	MT	L	F	Platform/Chassis Engine DJY	210037	Drive Shaft	54T	28	37	63	112.5	771	
	1998.04-	2002.04	MT	R	F	Bus Engine DJY/D9B/D9B(XUD9A)	210066	Drive Shaft		35	41	70	117	1085	
	1998.04-	2002.04	MT	R	F	Box Engine DJY	210066	Drive Shaft		35	41	70	117	1085	
	1998.04-	2002.04	MT	R	F	Platform/Chassis Engine DJY	210066	Drive Shaft		35	41	70	117	1085	
	1998.04-	2002.04	MT	R	F	Bus Engine DJY/D9B/D9B(XUD9A)	210036	Drive Shaft	54T	28	41	63	112.5	1079	
	1998.04-	2002.04	MT	R	F	Box Engine DJY	210036	Drive Shaft	54T	28	41	63	112.5	1079	
	1998.04-	2002.04	MT	R	F	Platform/Chassis Engine DJY	210036	Drive Shaft	54T	28	41	63	112.5	1079	
	1998.04-	2002.04	-	-	-	Box Engine DJY	645013	Inner Joint		37	39	40	68.5	100	
	1998.04-	2002.04	MT	R	F	Bus Engine DJY/D9B/D9B(XUD9A)	210032	Drive Shaft	54T	35	41	70	117	1085	
	1998.04-	2002.04	MT	R	F	Box Engine DJY	210032	Drive Shaft	54T	35	41	70	117	1085	
	1998.04-	2002.04	MT	R	F	Platform/Chassis Engine DJY	210032	Drive Shaft	54T	35	41	70	117	1085	
	1998.04-	2002.04	MT	L/R	F	Bus Engine DJY/D9B/D9B(XUD9A)	810011	Outer Joint	54T	35	45	70	117	73	I
	1998.04-	2002.04	MT	L/R	F	Box Engine DJY	810011	Outer Joint	54T	35	45	70	117	73	I
	1998.04-	2002.04	MT	L/R	F	Platform/Chassis Engine DJY	810011	Outer Joint	54T	35	45	70	117	73	I
	1998.04-	2002.04	-	-	-	Bus Engine DJY/D9B/D9B(XUD9A)	645013	Inner Joint		37	39	40	68.5	100	
	1998.04-	2002.04	MT	R	F	Bus Engine DJY/D9B/D9B(XUD9A)	610034	Inner Joint		37	39	31.9	369.5	99	
	1998.04-	2002.04	MT	R	F	Box Engine DJY	610034	Inner Joint		37	39	31.9	369.5	99	
	1998.04-	2002.04	MT	R	F	Platform/Chassis Engine DJY	610034	Inner Joint		37	39	31.9	369.5	99	
	1998.04-	2002.04	MT	L	F	Bus Engine DJY/D9B/D9B(XUD9A)	210105	Drive Shaft		28	37	63	112.5	771	
	1998.04-	2002.04	MT	L	F	Box Engine DJY	210105	Drive Shaft		28	37	63	112.5	771	
	1998.04-	2002.04	-	-	-	Platform/Chassis Engine DJY	645013	Inner Joint		37	39	40	68.5	100	
	1998.04-	2002.04	MT	L	F	Platform/Chassis Engine DJY	210105	Drive Shaft		28	37	63	112.5	771	
	1998.04-	2002.04	MT	R	F	Bus Engine DJY/D9B/D9B(XUD9A)	210103	Drive Shaft		28	41	63	112.5	1079	
	1998.04-	2002.04	MT	R	F	Box Engine DJY	210103	Drive Shaft		28	41	63	112.5	1079	
	1998.04-	2002.04	MT	R	F	Platform/Chassis Engine DJY	210103	Drive Shaft		28	41	63	112.5	1079	
	1998.04-	2002.04	MT	L/R	F	Bus Engine DJY/D9B/D9B(XUD9A)	810013	Outer Joint	54T	28	39	63	112.5	63	I
	1998.04-	2002.04	MT	L/R	F	Box Engine DJY	810013	Outer Joint	54T	28	39	63	112.5	63	I
	1998.04-	2002.04	MT	L/R	F	Platform/Chassis Engine DJY	810013	Outer Joint	54T	28	39	63	112.5	63	I
	1998.04-	2002.04	MT	R	F	Bus Engine DJY/D9B/D9B(XUD9A)	210104	Drive Shaft	54T	28	37	63	112.5	1072	
	1998.04-	2002.04	MT	R	F	Box Engine DJY	210104	Drive Shaft	54T	28	37	63	112.5	1072	
	1998.04-	2002.04	MT	R	F	Platform/Chassis Engine DJY	210104	Drive Shaft	54T	28	37	63	112.5	1072	
	1998.04-	2002.04	MT	L	F	Bus Engine DJY/D9B/D9B(XUD9A)	210067	Drive Shaft		35	41	70	117	762	
	1998.04-	2002.04	MT	L	F	Box Engine DJY	210067	Drive Shaft		35	41	70	117	762	
	1998.04-	2002.04	MT	L	F	Platform/Chassis Engine DJY	210067	Drive Shaft		35	41	70	117	762	

		 YEAR	TRANSM	L/R	F/R	REMARKS	GSP Ref.	 PRODUCT	 ABS	Technical Specifications						
										A	B	C	H	L	P	
FIAT																
DUCATO (230_)																
1.9 D (50 kW)		1998.04-2002.04	MT	L	F	Bus Engine DJY/D9B/D9B(XUD9A)	210033	Drive Shaft	54T	35	41	70	117	762		
		1998.04-2002.04	MT	L	F	Box Engine DJY	210033	Drive Shaft	54T	35	41	70	117	762		
		1998.04-2002.04	MT	L	F	Platform/Chassis Engine DJY	210033	Drive Shaft	54T	35	41	70	117	762		
		1998.04-2002.04	MT	L/R	F	Bus Engine DJY/D9B/D9B(XUD9A)	810050	Outer Joint		35	45	70	117	73	I	
		1998.04-2002.04	MT	L/R	F	Box Engine DJY	810050	Outer Joint		35	45	70	117	73	I	
		1998.04-2002.04	MT	L/R	F	Platform/Chassis Engine DJY	810050	Outer Joint		35	45	70	117	73	I	
		1998.04-2002.04	MT	R	F	Bus Engine DJY/D9B/D9B(XUD9A)	210069	Drive Shaft		28	37	63	112.5	1072		
		1998.04-2002.04	MT	R	F	Box Engine DJY	210069	Drive Shaft		28	37	63	112.5	1072		
		1998.04-2002.04	MT	R	F	Bus Engine DJY/D9B/D9B(XUD9A)	610009	Inner Joint		41	45	34.9	367.5	115.6		
		1998.04-2002.04	MT	R	F	Platform/Chassis Engine DJY	210069	Drive Shaft		28	37	63	112.5	1072		
		1998.04-2002.04	MT	R	F	Box Engine DJY	610009	Inner Joint		41	45	34.9	367.5	115.6		
		1998.04-2002.04	MT	R	F	Platform/Chassis Engine DJY	610009	Inner Joint		41	45	34.9	367.5	115.6		
		1998.04-2002.04	MT	L	F	Bus Engine DJY/D9B/D9B(XUD9A)	210035	Drive Shaft	54T	28	41	63	112.5	757.5		
		1998.04-2002.04	MT	L	F	Box Engine DJY	210035	Drive Shaft	54T	28	41	63	112.5	757.5		
		1998.04-2002.04	MT	L	F	Platform/Chassis Engine DJY	210035	Drive Shaft	54T	28	41	63	112.5	757.5		
1.9 D (51 kW)		1994.03-2002.04	MT	L/R	F	Box Engine 230 A2.000	810012	Outer Joint		28	39	63	112.5	63	I	
		1994.03-2002.04	MT	L/R	F	Platform/Chassis Engine 230 A2.000	810012	Outer Joint		28	39	63	112.5	63	I	
		1994.03-2002.04	MT	L	F	Box Engine 230 A2.000	210102	Drive Shaft		28	41	63	112.5	757.5		
		1994.03-2002.04	MT	L	F	Platform/Chassis Engine 230 A2.000	210102	Drive Shaft		28	41	63	112.5	757.5		
		1994.03-2002.04	MT	L	F	Box Engine 230 A2.000	210037	Drive Shaft	54T	28	37	63	112.5	771		
		1994.03-2002.04	MT	L	F	Platform/Chassis Engine 230 A2.000	210037	Drive Shaft	54T	28	37	63	112.5	771		
		1994.03-2002.04	MT	R	F	Box Engine 230 A2.000	210066	Drive Shaft		35	41	70	117	1085		
		1994.03-2002.04	MT	R	F	Platform/Chassis Engine 230 A2.000	210066	Drive Shaft		35	41	70	117	1085		
		1994.03-2002.04	MT	R	F	Box Engine 230 A2.000	210036	Drive Shaft	54T	28	41	63	112.5	1079		
		1994.03-2002.04	MT	R	F	Platform/Chassis Engine 230 A2.000	210036	Drive Shaft	54T	28	41	63	112.5	1079		
		1994.03-2002.04	MT	R	F	Box Engine 230 A2.000	210032	Drive Shaft	54T	35	41	70	117	1085		
		1994.03-2002.04	MT	R	F	Platform/Chassis Engine 230 A2.000	210032	Drive Shaft	54T	35	41	70	117	1085		
		1994.03-2002.04	MT	L/R	F	Box Engine 230 A2.000	810011	Outer Joint	54T	35	45	70	117	73	I	
		1994.03-2002.04	MT	L/R	F	Platform/Chassis Engine 230 A2.000	810011	Outer Joint	54T	35	45	70	117	73	I	
		1994.03-2002.04	MT	R	F	Box Engine 230 A2.000	610034	Inner Joint		37	39	31.9	369.5	99		
		1994.03-2002.04	MT	R	F	Platform/Chassis Engine 230 A2.000	610034	Inner Joint		37	39	31.9	369.5	99		
		1994.03-2002.04	-	-	-	Box Engine 230 A2.000	645013	Inner Joint		37	39	40	68.5	100		
		1994.03-2002.04	MT	L	F	Box Engine 230 A2.000	210105	Drive Shaft		28	37	63	112.5	771		
		1994.03-2002.04	MT	L	F	Platform/Chassis Engine 230 A2.000	210105	Drive Shaft		28	37	63	112.5	771		
		1994.03-2002.04	MT	R	F	Box Engine 230 A2.000	210103	Drive Shaft		28	41	63	112.5	1079		
		1994.03-2002.04	MT	R	F	Platform/Chassis Engine 230 A2.000	210103	Drive Shaft		28	41	63	112.5	1079		
		1994.03-2002.04	MT	L/R	F	Box Engine 230 A2.000	810013	Outer Joint	54T	28	39	63	112.5	63	I	
		1994.03-2002.04	-	-	-	Platform/Chassis Engine 230 A2.000	645013	Inner Joint		37	39	40	68.5	100		
		1994.03-2002.04	MT	L/R	F	Platform/Chassis Engine 230 A2.000	810013	Outer Joint	54T	28	39	63	112.5	63	I	
		1994.03-2002.04	MT	R	F	Box Engine 230 A2.000	210104	Drive Shaft	54T	28	37	63	112.5	1072		
		1994.03-2002.04	MT	R	F	Platform/Chassis Engine 230 A2.000	210104	Drive Shaft	54T	28	37	63	112.5	1072		
		1994.03-2002.04	MT	L	F	Box Engine 230 A2.000	210067	Drive Shaft		35	41	70	117	762		
		1994.03-2002.04	MT	L	F	Platform/Chassis Engine 230 A2.000	210067	Drive Shaft		35	41	70	117	762		
		1994.03-2002.04	MT	L	F	Box Engine 230 A2.000	210033	Drive Shaft	54T	35	41	70	117	762		
		1994.03-2002.04	MT	L	F	Platform/Chassis Engine 230 A2.000	210033	Drive Shaft	54T	35	41	70	117	762		
		1994.03-2002.04	MT	L/R	F	Box Engine 230 A2.000	810050	Outer Joint		35	45	70	117	73	I	
		1994.03-2002.04	MT	L/R	F	Platform/Chassis Engine 230 A2.000	810050	Outer Joint		35	45	70	117	73	I	
		1994.03-2002.04	MT	R	F	Box Engine 230 A2.000	210069	Drive Shaft		28	37	63	112.5	1072		
		1994.03-2002.04	MT	R	F	Platform/Chassis Engine 230 A2.000	210069	Drive Shaft		28	37	63	112.5	1072		
		1994.03-2002.04	MT	R	F	Box Engine 230 A2.000	610009	Inner Joint		41	45	34.9	367.5	115.6		
		1994.03-2002.04	MT	R	F	Platform/Chassis Engine 230 A2.000	610009	Inner Joint		41	45	34.9	367.5	115.6		
		1994.03-2002.04	MT	L	F	Box Engine 230 A2.000	210035	Drive Shaft	54T	28	41	63	112.5	757.5		
		1994.03-2002.04	MT	L	F	Platform/Chassis Engine 230 A2.000	210035	Drive Shaft	54T	28	41	63	112.5	757.5		
		1994.03-2002.04	MT	L	F	Box Engine 230 A2.000	610015	Inner Joint		37	39	40	68.5	104		
		1994.03-2002.04	MT	L	F	Platform/Chassis Engine 230 A2.000	610015	Inner Joint		37	39	40	68.5	104		
1.9 D Combinato (51 kW)		1995.06-2002.04	MT	L	F	Bus Engine 230 A2.000	610015	Inner Joint		37	39	40	68.5	104		
		1995.06-2002.04	MT	L/R	F	Bus Engine 230 A2.000	810012	Outer Joint		28	39	63	112.5	63	I	
		1995.06-2002.04	MT	L	F	Bus Engine 230 A2.000	210102	Drive Shaft		28	41	63	112.5	757.5		
		1995.06-2002.04	MT	L	F	Bus Engine 230 A2.000	210037	Drive Shaft	54T	28	37	63	112.5	771		
		1995.06-2002.04	MT	R	F	Bus Engine 230 A2.000	210066	Drive Shaft		35	41	70	117	1085		
		1995.06-2002.04	MT	R	F	Bus Engine 230 A2.000	210036	Drive Shaft	54T	28	41	63	112.5	1079		
		1995.06-2002.04	MT	R	F	Bus Engine 230 A2.000	210032	Drive Shaft	54T	35	41	70	117	1085		
		1995.06-2002.04	MT	L/R	F	Bus Engine 230 A2.000	810011	Outer Joint	54T	35	45	70	117	73	I	
		1995.06-2002.04	MT	R	F	Bus Engine 230 A2.000	610034	Inner Joint		37	39	31.9	369.5	99		
		1995.06-2002.04	-	-	-	Bus Engine 230 A2.000	645013	Inner Joint		37	39	40	68.5	100		
		1995.06-2002.04	MT	L	F	Bus Engine 230 A2.000	210105	Drive Shaft		28	37	63	112.5	771		

	 YEAR	TRANSM	L/R	F/R	REMARKS	GSP Ref.	 PRODUCT	 ABS	Technical Specifications					
									A	B	C	H	L	P
FIAT														
DUCATO (230_)														
1.9 D Combinato (51 kW)	1995.06-2002.04	MT	R	F	Bus Engine 230 A2.000	210103	Drive Shaft		28	41	63	112.5	1079	
	1995.06-2002.04	MT	L/R	F	Bus Engine 230 A2.000	810013	Outer Joint	54T	28	39	63	112.5	63	I
	1995.06-2002.04	MT	R	F	Bus Engine 230 A2.000	210104	Drive Shaft	54T	28	37	63	112.5	1072	
	1995.06-2002.04	MT	L	F	Bus Engine 230 A2.000	210067	Drive Shaft		35	41	70	117	762	
	1995.06-2002.04	MT	L	F	Bus Engine 230 A2.000	210033	Drive Shaft	54T	35	41	70	117	762	
	1995.06-2002.04	MT	L/R	F	Bus Engine 230 A2.000	810050	Outer Joint		35	45	70	117	73	I
	1995.06-2002.04	MT	R	F	Bus Engine 230 A2.000	210069	Drive Shaft		28	37	63	112.5	1072	
	1995.06-2002.04	MT	R	F	Bus Engine 230 A2.000	610009	Inner Joint		41	45	34.9	367.5	115.6	
	1995.06-2002.04	MT	L	F	Bus Engine 230 A2.000	210035	Drive Shaft	54T	28	41	63	112.5	757.5	
1.9 TD (60 kW)	1994.03-2002.04	MT	L	F	Box Engine 230 A3.000	210102	Drive Shaft		28	41	63	112.5	757.5	
	1994.03-2002.04	MT	L	F	Platform/Chassis Engine 230 A3.000	210102	Drive Shaft		28	41	63	112.5	757.5	
	1994.03-2002.04	MT	L	F	Box Engine 230 A3.000	210037	Drive Shaft	54T	28	37	63	112.5	771	
	1994.03-2002.04	MT	L	F	Platform/Chassis Engine 230 A3.000	210037	Drive Shaft	54T	28	37	63	112.5	771	
	1994.03-2002.04	MT	R	F	Box Engine 230 A3.000	210066	Drive Shaft		35	41	70	117	1085	
	1994.03-2002.04	MT	R	F	Platform/Chassis Engine 230 A3.000	210066	Drive Shaft		35	41	70	117	1085	
	1994.03-2002.04	MT	R	F	Box Engine 230 A3.000	210036	Drive Shaft	54T	28	41	63	112.5	1079	
	1994.03-2002.04	MT	R	F	Platform/Chassis Engine 230 A3.000	210036	Drive Shaft	54T	28	41	63	112.5	1079	
	1994.03-2002.04	MT	R	F	Box Engine 230 A3.000	210032	Drive Shaft	54T	35	41	70	117	1085	
	1994.03-2002.04	MT	R	F	Platform/Chassis Engine 230 A3.000	210032	Drive Shaft	54T	35	41	70	117	1085	
	1994.03-2002.04	MT	L/R	F	Box Engine 230 A3.000	810011	Outer Joint	54T	35	45	70	117	73	I
	1994.03-2002.04	MT	L/R	F	Platform/Chassis Engine 230 A3.000	810011	Outer Joint	54T	35	45	70	117	73	I
	1994.03-2002.04	MT	R	F	Box Engine 230 A3.000	610034	Inner Joint		37	39	31.9	369.5	99	
	1994.03-2002.04	MT	R	F	Platform/Chassis Engine 230 A3.000	610034	Inner Joint		37	39	31.9	369.5	99	
	1994.03-2002.04	MT	L	F	Box Engine 230 A3.000	210105	Drive Shaft		28	37	63	112.5	771	
	1994.03-2002.04	MT	L	F	Platform/Chassis Engine 230 A3.000	210105	Drive Shaft		28	37	63	112.5	771	
	1994.03-2002.04	-	-	-	Box Engine 230 A3.000	645013	Inner Joint		37	39	40	68.5	100	
	1994.03-2002.04	MT	R	F	Box Engine 230 A3.000	210103	Drive Shaft		28	41	63	112.5	1079	
	1994.03-2002.04	MT	R	F	Platform/Chassis Engine 230 A3.000	210103	Drive Shaft		28	41	63	112.5	1079	
	1994.03-2002.04	MT	L/R	F	Box Engine 230 A3.000	810013	Outer Joint	54T	28	39	63	112.5	63	I
	1994.03-2002.04	MT	L/R	F	Platform/Chassis Engine 230 A3.000	810013	Outer Joint	54T	28	39	63	112.5	63	I
	1994.03-2002.04	-	-	-	Platform/Chassis Engine 230 A3.000	645013	Inner Joint		37	39	40	68.5	100	
	1994.03-2002.04	MT	R	F	Box Engine 230 A3.000	210104	Drive Shaft	54T	28	37	63	112.5	1072	
	1994.03-2002.04	MT	R	F	Platform/Chassis Engine 230 A3.000	210104	Drive Shaft	54T	28	37	63	112.5	1072	
	1994.03-2002.04	MT	L	F	Box Engine 230 A3.000	210067	Drive Shaft		35	41	70	117	762	
	1994.03-2002.04	MT	L	F	Platform/Chassis Engine 230 A3.000	210067	Drive Shaft		35	41	70	117	762	
	1994.03-2002.04	MT	L	F	Box Engine 230 A3.000	210033	Drive Shaft	54T	35	41	70	117	762	
	1994.03-2002.04	MT	L	F	Platform/Chassis Engine 230 A3.000	210033	Drive Shaft	54T	35	41	70	117	762	
	1994.03-2002.04	MT	L/R	F	Box Engine 230 A3.000	810050	Outer Joint		35	45	70	117	73	I
	1994.03-2002.04	MT	L/R	F	Platform/Chassis Engine 230 A3.000	810050	Outer Joint		35	45	70	117	73	I
	1994.03-2002.04	MT	R	F	Box Engine 230 A3.000	210069	Drive Shaft		28	37	63	112.5	1072	
	1994.03-2002.04	MT	R	F	Platform/Chassis Engine 230 A3.000	210069	Drive Shaft		28	37	63	112.5	1072	
	1994.03-2002.04	MT	R	F	Box Engine 230 A3.000	610009	Inner Joint		41	45	34.9	367.5	115.6	
	1994.03-2002.04	MT	R	F	Platform/Chassis Engine 230 A3.000	610009	Inner Joint		41	45	34.9	367.5	115.6	
	1994.03-2002.04	MT	L	F	Box Engine 230 A3.000	210035	Drive Shaft	54T	28	41	63	112.5	757.5	
	1994.03-2002.04	MT	L	F	Platform/Chassis Engine 230 A3.000	210035	Drive Shaft	54T	28	41	63	112.5	757.5	
1994.03-2002.04	MT	L	F	Box Engine 230 A3.000	610015	Inner Joint		37	39	40	68.5	104		
1994.03-2002.04	MT	L	F	Platform/Chassis Engine 230 A3.000	610015	Inner Joint		37	39	40	68.5	104		
1994.03-2002.04	MT	L/R	F	Box Engine 230 A3.000	810012	Outer Joint		28	39	63	112.5	63	I	
1994.03-2002.04	MT	L/R	F	Platform/Chassis Engine 230 A3.000	810012	Outer Joint		28	39	63	112.5	63	I	
1.9 TD (66 kW)	1998.04-2002.04	MT	L	F	Bus Engine DHX (XUD9TF/L)	210035	Drive Shaft	54T	28	41	63	112.5	757.5	
	1998.04-2002.04	MT	L	F	Box Engine DHX (XUD9TF/L)	210035	Drive Shaft	54T	28	41	63	112.5	757.5	
	1998.04-2002.04	MT	L	F	Platform/Chassis Engine DHX (XUD9TF/L)	210035	Drive Shaft	54T	28	41	63	112.5	757.5	
	1998.04-2002.04	MT	L	F	Bus Engine DHX (XUD9TF/L)	610015	Inner Joint		37	39	40	68.5	104	
	1998.04-2002.04	MT	L	F	Box Engine DHX (XUD9TF/L)	610015	Inner Joint		37	39	40	68.5	104	
	1998.04-2002.04	MT	L	F	Platform/Chassis Engine DHX (XUD9TF/L)	610015	Inner Joint		37	39	40	68.5	104	
	1998.04-2002.04	MT	L/R	F	Bus Engine DHX (XUD9TF/L)	810012	Outer Joint		28	39	63	112.5	63	I
	1998.04-2002.04	MT	L/R	F	Box Engine DHX (XUD9TF/L)	810012	Outer Joint		28	39	63	112.5	63	I
	1998.04-2002.04	MT	L/R	F	Platform/Chassis Engine DHX (XUD9TF/L)	810012	Outer Joint		28	39	63	112.5	63	I
	1998.04-2002.04	MT	L	F	Bus Engine DHX (XUD9TF/L)	210102	Drive Shaft		28	41	63	112.5	757.5	
	1998.04-2002.04	MT	L	F	Box Engine DHX (XUD9TF/L)	210102	Drive Shaft		28	41	63	112.5	757.5	
	1998.04-2002.04	MT	L	F	Platform/Chassis Engine DHX (XUD9TF/L)	210102	Drive Shaft		28	41	63	112.5	757.5	
	1998.04-2002.04	MT	L	F	Bus Engine DHX (XUD9TF/L)	210037	Drive Shaft	54T	28	37	63	112.5	771	
	1998.04-2002.04	MT	L	F	Box Engine DHX (XUD9TF/L)	210037	Drive Shaft	54T	28	37	63	112.5	771	
	1998.04-2002.04	MT	R	F	Bus Engine DHX (XUD9TF/L)	210066	Drive Shaft		35	41	70	117	1085	
	1998.04-2002.04	MT	L	F	Platform/Chassis Engine DHX (XUD9TF/L)	210037	Drive Shaft	54T	28	37	63	112.5	771	
	1998.04-2002.04	MT	R	F	Box Engine DHX (XUD9TF/L)	210066	Drive Shaft		35	41	70	117	1085	

		 YEAR	TRANSM	L/R	F/R	REMARKS	GSP Ref.	 PRODUCT	 ABS	Technical Specifications					
										A	B	C	H	L	P
FIAT															
DUCATO (230_)															
1.9 TD (66 kW)															
1998.04	2002.04	MT	R	F	Bus Engine DHX (XUD9TF/L)	210036	Drive Shaft	54T		28	41	63	112.5	1079	
1998.04	2002.04	MT	R	F	Platform/Chassis Engine DHX (XUD9TF/L)	210066	Drive Shaft			35	41	70	117	1085	
1998.04	2002.04	MT	R	F	Box Engine DHX (XUD9TF/L)	210036	Drive Shaft	54T		28	41	63	112.5	1079	
1998.04	2002.04	MT	R	F	Platform/Chassis Engine DHX (XUD9TF/L)	210036	Drive Shaft	54T		28	41	63	112.5	1079	
1998.04	2002.04	-	-	-	Box Engine DHX (XUD9TF/L)	645013	Inner Joint			37	39	40	68.5	100	
1998.04	2002.04	MT	R	F	Bus Engine DHX (XUD9TF/L)	210032	Drive Shaft	54T		35	41	70	117	1085	
1998.04	2002.04	MT	R	F	Box Engine DHX (XUD9TF/L)	210032	Drive Shaft	54T		35	41	70	117	1085	
1998.04	2002.04	MT	R	F	Platform/Chassis Engine DHX (XUD9TF/L)	210032	Drive Shaft	54T		35	41	70	117	1085	
1998.04	2002.04	MT	L/R	F	Bus Engine DHX (XUD9TF/L)	810011	Outer Joint	54T		35	45	70	117	73	I
1998.04	2002.04	MT	L/R	F	Box Engine DHX (XUD9TF/L)	810011	Outer Joint	54T		35	45	70	117	73	I
1998.04	2002.04	MT	L/R	F	Platform/Chassis Engine DHX (XUD9TF/L)	810011	Outer Joint	54T		35	45	70	117	73	I
1998.04	2002.04	-	-	-	Bus Engine DHX (XUD9TF/L)	645013	Inner Joint			37	39	40	68.5	100	
1998.04	2002.04	MT	R	F	Bus Engine DHX (XUD9TF/L)	610034	Inner Joint			37	39	31.9	369.5	99	
1998.04	2002.04	MT	R	F	Box Engine DHX (XUD9TF/L)	610034	Inner Joint			37	39	31.9	369.5	99	
1998.04	2002.04	MT	R	F	Platform/Chassis Engine DHX (XUD9TF/L)	610034	Inner Joint			37	39	31.9	369.5	99	
1998.04	2002.04	-	-	-	Platform/Chassis Engine DHX (XUD9TF/L)	645013	Inner Joint			37	39	40	68.5	100	
1998.04	2002.04	MT	L	F	Bus Engine DHX (XUD9TF/L)	210105	Drive Shaft			28	37	63	112.5	771	
1998.04	2002.04	MT	L	F	Box Engine DHX (XUD9TF/L)	210105	Drive Shaft			28	37	63	112.5	771	
1998.04	2002.04	MT	L	F	Platform/Chassis Engine DHX (XUD9TF/L)	210105	Drive Shaft			28	37	63	112.5	771	
1998.04	2002.04	MT	R	F	Bus Engine DHX (XUD9TF/L)	210103	Drive Shaft			28	41	63	112.5	1079	
1998.04	2002.04	MT	R	F	Box Engine DHX (XUD9TF/L)	210103	Drive Shaft			28	41	63	112.5	1079	
1998.04	2002.04	MT	R	F	Platform/Chassis Engine DHX (XUD9TF/L)	210103	Drive Shaft			28	41	63	112.5	1079	
1998.04	2002.04	MT	L/R	F	Bus Engine DHX (XUD9TF/L)	810013	Outer Joint	54T		28	39	63	112.5	63	I
1998.04	2002.04	MT	L/R	F	Box Engine DHX (XUD9TF/L)	810013	Outer Joint	54T		28	39	63	112.5	63	I
1998.04	2002.04	MT	L/R	F	Platform/Chassis Engine DHX (XUD9TF/L)	810013	Outer Joint	54T		28	39	63	112.5	63	I
1998.04	2002.04	MT	R	F	Bus Engine DHX (XUD9TF/L)	210104	Drive Shaft	54T		28	37	63	112.5	1072	
1998.04	2002.04	MT	R	F	Box Engine DHX (XUD9TF/L)	210104	Drive Shaft	54T		28	37	63	112.5	1072	
1998.04	2002.04	MT	R	F	Platform/Chassis Engine DHX (XUD9TF/L)	210104	Drive Shaft	54T		28	37	63	112.5	1072	
1998.04	2002.04	MT	L	F	Bus Engine DHX (XUD9TF/L)	210067	Drive Shaft			35	41	70	117	762	
1998.04	2002.04	MT	L	F	Box Engine DHX (XUD9TF/L)	210067	Drive Shaft			35	41	70	117	762	
1998.04	2002.04	MT	L	F	Platform/Chassis Engine DHX (XUD9TF/L)	210067	Drive Shaft			35	41	70	117	762	
1998.04	2002.04	MT	L	F	Bus Engine DHX (XUD9TF/L)	210033	Drive Shaft	54T		35	41	70	117	762	
1998.04	2002.04	MT	L	F	Box Engine DHX (XUD9TF/L)	210033	Drive Shaft	54T		35	41	70	117	762	
1998.04	2002.04	MT	L/R	F	Bus Engine DHX (XUD9TF/L)	810050	Outer Joint			35	45	70	117	73	I
1998.04	2002.04	MT	L	F	Platform/Chassis Engine DHX (XUD9TF/L)	210033	Drive Shaft	54T		35	41	70	117	762	
1998.04	2002.04	MT	L/R	F	Box Engine DHX (XUD9TF/L)	810050	Outer Joint			35	45	70	117	73	I
1998.04	2002.04	MT	L/R	F	Platform/Chassis Engine DHX (XUD9TF/L)	810050	Outer Joint			35	45	70	117	73	I
1998.04	2002.04	MT	R	F	Bus Engine DHX (XUD9TF/L)	210069	Drive Shaft			28	37	63	112.5	1072	
1998.04	2002.04	MT	R	F	Box Engine DHX (XUD9TF/L)	210069	Drive Shaft			28	37	63	112.5	1072	
1998.04	2002.04	MT	R	F	Bus Engine DHX (XUD9TF/L)	610009	Inner Joint			41	45	34.9	367.5	115.6	
1998.04	2002.04	MT	R	F	Box Engine DHX (XUD9TF/L)	610009	Inner Joint			41	45	34.9	367.5	115.6	
1998.04	2002.04	MT	R	F	Platform/Chassis Engine DHX (XUD9TF/L)	210069	Drive Shaft			28	37	63	112.5	1072	
1998.04	2002.04	MT	R	F	Platform/Chassis Engine DHX (XUD9TF/L)	610009	Inner Joint			41	45	34.9	367.5	115.6	
1.9 TD CAT (59 kW)															
1994.08	2002.04	MT	L	F	Box Engine 230 A4.000	210102	Drive Shaft			28	41	63	112.5	757.5	
1994.08	2002.04	MT	L	F	Platform/Chassis Engine 230 A4.000	210102	Drive Shaft			28	41	63	112.5	757.5	
1994.08	2002.04	MT	L	F	Box Engine 230 A4.000	210037	Drive Shaft	54T		28	37	63	112.5	771	
1994.08	2002.04	MT	R	F	Box Engine 230 A4.000	210066	Drive Shaft			35	41	70	117	1085	
1994.08	2002.04	MT	L	F	Platform/Chassis Engine 230 A4.000	210037	Drive Shaft	54T		28	37	63	112.5	771	
1994.08	2002.04	MT	R	F	Box Engine 230 A4.000	210036	Drive Shaft	54T		28	41	63	112.5	1079	
1994.08	2002.04	MT	R	F	Platform/Chassis Engine 230 A4.000	210066	Drive Shaft			35	41	70	117	1085	
1994.08	2002.04	MT	R	F	Platform/Chassis Engine 230 A4.000	210036	Drive Shaft	54T		28	41	63	112.5	1079	
1994.08	2002.04	MT	L/R	F	Box Engine 230 A4.000	810011	Outer Joint	54T		35	45	70	117	73	I
1994.08	2002.04	MT	R	F	Box Engine 230 A4.000	210032	Drive Shaft	54T		35	41	70	117	1085	
1994.08	2002.04	MT	L/R	F	Platform/Chassis Engine 230 A4.000	810011	Outer Joint	54T		35	45	70	117	73	I
1994.08	2002.04	MT	R	F	Platform/Chassis Engine 230 A4.000	210032	Drive Shaft	54T		35	41	70	117	1085	
1994.08	2002.04	MT	R	F	Box Engine 230 A4.000	610034	Inner Joint			37	39	31.9	369.5	99	
1994.08	2002.04	MT	R	F	Platform/Chassis Engine 230 A4.000	610034	Inner Joint			37	39	31.9	369.5	99	
1994.08	2002.04	MT	L	F	Box Engine 230 A4.000	210105	Drive Shaft			28	37	63	112.5	771	
1994.08	2002.04	MT	L	F	Platform/Chassis Engine 230 A4.000	210105	Drive Shaft			28	37	63	112.5	771	
1994.08	2002.04	MT	L/R	F	Box Engine 230 A4.000	810013	Outer Joint	54T		28	39	63	112.5	63	I
1994.08	2002.04	MT	L/R	F	Platform/Chassis Engine 230 A4.000	810013	Outer Joint	54T		28	39	63	112.5	63	I
1994.08	2002.04	MT	R	F	Box Engine 230 A4.000	210103	Drive Shaft			28	41	63	112.5	1079	
1994.08	2002.04	MT	R	F	Platform/Chassis Engine 230 A4.000	210103	Drive Shaft			28	41	63	112.5	1079	
1994.08	2002.04	-	-	-	Box Engine 230 A4.000	645013	Inner Joint			37	39	40	68.5	100	
1994.08	2002.04	-	-	-	Platform/Chassis Engine 230 A4.000	645013	Inner Joint			37	39	40	68.5	100	
1994.08	2002.04	MT	R	F	Box Engine 230 A4.000	210104	Drive Shaft	54T		28	37	63	112.5	1072	





	 YEAR	TRANSM	L/R	F/R	REMARKS	GSP Ref.	 PRODUCT	 ABS	Technical Specifications						
									A	B	C	H	L	P	
FIAT															
DUCATO (230_)															
1.9 TD CAT (59 kW)	1994.08-2002.04	MT	R	F	Platform/Chassis Engine 230 A4.000	210104	Drive Shaft	54T	28	37	63	112.5	1072		
	1994.08-2002.04	MT	L	F	Box Engine 230 A4.000	210067	Drive Shaft		35	41	70	117	762		
	1994.08-2002.04	MT	L	F	Platform/Chassis Engine 230 A4.000	210067	Drive Shaft		35	41	70	117	762		
	1994.08-2002.04	MT	L	F	Box Engine 230 A4.000	210033	Drive Shaft	54T	35	41	70	117	762		
	1994.08-2002.04	MT	L/R	F	Box Engine 230 A4.000	810050	Outer Joint		35	45	70	117	73	I	
	1994.08-2002.04	MT	L	F	Platform/Chassis Engine 230 A4.000	210033	Drive Shaft	54T	35	41	70	117	762		
	1994.08-2002.04	MT	L/R	F	Platform/Chassis Engine 230 A4.000	810050	Outer Joint		35	45	70	117	73	I	
	1994.08-2002.04	MT	R	F	Box Engine 230 A4.000	210069	Drive Shaft		28	37	63	112.5	1072		
	1994.08-2002.04	MT	R	F	Box Engine 230 A4.000	610009	Inner Joint		41	45	34.9	367.5	115.6		
	1994.08-2002.04	MT	R	F	Platform/Chassis Engine 230 A4.000	210069	Drive Shaft		28	37	63	112.5	1072		
	1994.08-2002.04	MT	R	F	Platform/Chassis Engine 230 A4.000	610009	Inner Joint		41	45	34.9	367.5	115.6		
	1994.08-2002.04	MT	L	F	Box Engine 230 A4.000	210035	Drive Shaft	54T	28	41	63	112.5	757.5		
	1994.08-2002.04	MT	L	F	Platform/Chassis Engine 230 A4.000	210035	Drive Shaft	54T	28	41	63	112.5	757.5		
	1994.08-2002.04	MT	L	F	Box Engine 230 A4.000	610015	Inner Joint		37	39	40	68.5	104		
	1994.08-2002.04	MT	L	F	Platform/Chassis Engine 230 A4.000	610015	Inner Joint		37	39	40	68.5	104		
	1994.08-2002.04	MT	L/R	F	Box Engine 230 A4.000	810012	Outer Joint		28	39	63	112.5	63	I	
	1994.08-2002.04	MT	L/R	F	Platform/Chassis Engine 230 A4.000	810012	Outer Joint		28	39	63	112.5	63	I	
1.9 TD Combinato (59 kW)	1994.08-2002.04	MT	L	F	Bus Engine 230 A4.000	210037	Drive Shaft	54T	28	37	63	112.5	771		
	1994.08-2002.04	MT	R	F	Bus Engine 230 A4.000	210066	Drive Shaft		35	41	70	117	1085		
	1994.08-2002.04	MT	R	F	Bus Engine 230 A4.000	210036	Drive Shaft	54T	28	41	63	112.5	1079		
	1994.08-2002.04	MT	L/R	F	Bus Engine 230 A4.000	810011	Outer Joint	54T	35	45	70	117	73	I	
	1994.08-2002.04	MT	R	F	Bus Engine 230 A4.000	210032	Drive Shaft	54T	35	41	70	117	1085		
	1994.08-2002.04	MT	R	F	Bus Engine 230 A4.000	610034	Inner Joint		37	39	31.9	369.5	99		
	1994.08-2002.04	MT	L	F	Bus Engine 230 A4.000	210105	Drive Shaft		28	37	63	112.5	771		
	1994.08-2002.04	MT	L/R	F	Bus Engine 230 A4.000	810013	Outer Joint	54T	28	39	63	112.5	63	I	
	1994.08-2002.04	MT	R	F	Bus Engine 230 A4.000	210103	Drive Shaft		28	41	63	112.5	1079		
	1994.08-2002.04	-	-	-	Bus Engine 230 A4.000	645013	Inner Joint		37	39	40	68.5	100		
	1994.08-2002.04	MT	R	F	Bus Engine 230 A4.000	210104	Drive Shaft	54T	28	37	63	112.5	1072		
	1994.08-2002.04	MT	L	F	Bus Engine 230 A4.000	210067	Drive Shaft		35	41	70	117	762		
	1994.08-2002.04	MT	L	F	Bus Engine 230 A4.000	210033	Drive Shaft	54T	35	41	70	117	762		
	1994.08-2002.04	MT	L/R	F	Bus Engine 230 A4.000	810050	Outer Joint		35	45	70	117	73	I	
	1994.08-2002.04	MT	R	F	Bus Engine 230 A4.000	210069	Drive Shaft		28	37	63	112.5	1072		
	1994.08-2002.04	MT	R	F	Bus Engine 230 A4.000	610009	Inner Joint		41	45	34.9	367.5	115.6		
	1994.08-2002.04	MT	L	F	Bus Engine 230 A4.000	210035	Drive Shaft	54T	28	41	63	112.5	757.5		
1994.08-2002.04	MT	L	F	Bus Engine 230 A4.000	610015	Inner Joint		37	39	40	68.5	104			
1994.08-2002.04	MT	L/R	F	Bus Engine 230 A4.000	810012	Outer Joint		28	39	63	112.5	63	I		
1994.08-2002.04	MT	L	F	Bus Engine 230 A4.000	210102	Drive Shaft		28	41	63	112.5	757.5			
1.9 TD Panorama/Combinato (60 kW)	1994.03-2002.04	MT	L	F	Bus Engine 230 A3.000	610015	Inner Joint		37	39	40	68.5	104		
	1994.03-2002.04	MT	L/R	F	Bus Engine 230 A3.000	810012	Outer Joint		28	39	63	112.5	63	I	
	1994.03-2002.04	MT	L	F	Bus Engine 230 A3.000	210102	Drive Shaft		28	41	63	112.5	757.5		
	1994.03-2002.04	MT	L	F	Bus Engine 230 A3.000	210037	Drive Shaft	54T	28	37	63	112.5	771		
	1994.03-2002.04	MT	R	F	Bus Engine 230 A3.000	210066	Drive Shaft		35	41	70	117	1085		
	1994.03-2002.04	MT	R	F	Bus Engine 230 A3.000	210036	Drive Shaft	54T	28	41	63	112.5	1079		
	1994.03-2002.04	MT	R	F	Bus Engine 230 A3.000	210032	Drive Shaft	54T	35	41	70	117	1085		
	1994.03-2002.04	MT	L/R	F	Bus Engine 230 A3.000	810011	Outer Joint	54T	35	45	70	117	73	I	
	1994.03-2002.04	MT	R	F	Bus Engine 230 A3.000	610034	Inner Joint		37	39	31.9	369.5	99		
	1994.03-2002.04	MT	L	F	Bus Engine 230 A3.000	210105	Drive Shaft		28	37	63	112.5	771		
	1994.03-2002.04	MT	R	F	Bus Engine 230 A3.000	210103	Drive Shaft		28	41	63	112.5	1079		
	1994.03-2002.04	MT	L/R	F	Bus Engine 230 A3.000	810013	Outer Joint	54T	28	39	63	112.5	63	I	
	1994.03-2002.04	MT	R	F	Bus Engine 230 A3.000	210104	Drive Shaft	54T	28	37	63	112.5	1072		
	1994.03-2002.04	MT	L	F	Bus Engine 230 A3.000	210067	Drive Shaft		35	41	70	117	762		
	1994.03-2002.04	MT	L	F	Bus Engine 230 A3.000	210033	Drive Shaft	54T	35	41	70	117	762		
	1994.03-2002.04	MT	L/R	F	Bus Engine 230 A3.000	810050	Outer Joint		35	45	70	117	73	I	
	1994.03-2002.04	MT	R	F	Bus Engine 230 A3.000	210069	Drive Shaft		28	37	63	112.5	1072		
1994.03-2002.04	MT	R	F	Bus Engine 230 A3.000	610009	Inner Joint		41	45	34.9	367.5	115.6			
1994.03-2002.04	MT	L	F	Bus Engine 230 A3.000	210035	Drive Shaft	54T	28	41	63	112.5	757.5			
2.0 (80 kW)	1994.03-2002.04	MT	L	F	Box Engine RFW	210102	Drive Shaft		28	41	63	112.5	757.5		
	1994.03-2002.04	MT	L	F	Platform/Chassis Engine RFW	210102	Drive Shaft		28	41	63	112.5	757.5		
	1994.03-2002.04	MT	L	F	Box Engine RFW	210037	Drive Shaft	54T	28	37	63	112.5	771		
	1994.03-2002.04	MT	L	F	Platform/Chassis Engine RFW	210037	Drive Shaft	54T	28	37	63	112.5	771		
	1994.03-2002.04	MT	R	F	Box Engine RFW	210066	Drive Shaft		35	41	70	117	1085		
	1994.03-2002.04	MT	R	F	Platform/Chassis Engine RFW	210066	Drive Shaft		35	41	70	117	1085		
	1994.03-2002.04	MT	R	F	Box Engine RFW	210036	Drive Shaft	54T	28	41	63	112.5	1079		
	1994.03-2002.04	MT	R	F	Platform/Chassis Engine RFW	210036	Drive Shaft	54T	28	41	63	112.5	1079		
	1994.03-2002.04	MT	R	F	Box Engine RFW	210032	Drive Shaft	54T	35	41	70	117	1085		
	1994.03-2002.04	MT	R	F	Platform/Chassis Engine RFW	210032	Drive Shaft	54T	35	41	70	117	1085		

	 YEAR	TRANSM	L/R	F/R	REMARKS	GSP Ref.	 PRODUCT	 ABS	Technical Specifications					
									A	B	C	H	L	P
FIAT														
DUCATO (230_)														
2.0 (80 kW)														
1994.03-2002.04	2002.04	MT	L/R	F	Box Engine RFW	810011	Outer Joint	54T	35	45	70	117	73	I
1994.03-2002.04	2002.04	MT	L/R	F	Platform/Chassis Engine RFW	810011	Outer Joint	54T	35	45	70	117	73	I
1994.03-2002.04	2002.04	MT	R	F	Box Engine RFW	610034	Inner Joint		37	39	31.9	369.5	99	
1994.03-2002.04	2002.04	MT	R	F	Platform/Chassis Engine RFW	610034	Inner Joint		37	39	31.9	369.5	99	
1994.03-2002.04	2002.04	MT	L	F	Box Engine RFW	210105	Drive Shaft		28	37	63	112.5	771	
1994.03-2002.04	2002.04	MT	L	F	Platform/Chassis Engine RFW	210105	Drive Shaft		28	37	63	112.5	771	
1994.03-2002.04	2002.04	-	-	-	Box Engine RFW	645013	Inner Joint		37	39	40	68.5	100	
1994.03-2002.04	2002.04	MT	R	F	Box Engine RFW	210103	Drive Shaft		28	41	63	112.5	1079	
1994.03-2002.04	2002.04	MT	R	F	Platform/Chassis Engine RFW	210103	Drive Shaft		28	41	63	112.5	1079	
1994.03-2002.04	2002.04	MT	L/R	F	Box Engine RFW	810013	Outer Joint	54T	28	39	63	112.5	63	I
1994.03-2002.04	2002.04	MT	L/R	F	Platform/Chassis Engine RFW	810013	Outer Joint	54T	28	39	63	112.5	63	I
1994.03-2002.04	2002.04	-	-	-	Platform/Chassis Engine RFW	645013	Inner Joint		37	39	40	68.5	100	
1994.03-2002.04	2002.04	MT	R	F	Box Engine RFW	210104	Drive Shaft	54T	28	37	63	112.5	1072	
1994.03-2002.04	2002.04	MT	R	F	Platform/Chassis Engine RFW	210104	Drive Shaft	54T	28	37	63	112.5	1072	
1994.03-2002.04	2002.04	MT	L	F	Box Engine RFW	210067	Drive Shaft		35	41	70	117	762	
1994.03-2002.04	2002.04	MT	L	F	Platform/Chassis Engine RFW	210067	Drive Shaft		35	41	70	117	762	
1994.03-2002.04	2002.04	MT	L	F	Box Engine RFW	210033	Drive Shaft	54T	35	41	70	117	762	
1994.03-2002.04	2002.04	MT	L	F	Platform/Chassis Engine RFW	210033	Drive Shaft	54T	35	41	70	117	762	
1994.03-2002.04	2002.04	MT	L/R	F	Box Engine RFW	810050	Outer Joint		35	45	70	117	73	I
1994.03-2002.04	2002.04	MT	L/R	F	Platform/Chassis Engine RFW	810050	Outer Joint		35	45	70	117	73	I
1994.03-2002.04	2002.04	MT	R	F	Box Engine RFW	210069	Drive Shaft		28	37	63	112.5	1072	
1994.03-2002.04	2002.04	MT	R	F	Box Engine RFW	610009	Inner Joint		41	45	34.9	367.5	115.6	
1994.03-2002.04	2002.04	MT	R	F	Platform/Chassis Engine RFW	210069	Drive Shaft		28	37	63	112.5	1072	
1994.03-2002.04	2002.04	MT	R	F	Platform/Chassis Engine RFW	610009	Inner Joint		41	45	34.9	367.5	115.6	
1994.03-2002.04	2002.04	MT	L	F	Box Engine RFW	210035	Drive Shaft	54T	28	41	63	112.5	757.5	
1994.03-2002.04	2002.04	MT	L	F	Platform/Chassis Engine RFW	210035	Drive Shaft	54T	28	41	63	112.5	757.5	
1994.03-2002.04	2002.04	MT	L	F	Box Engine RFW	610015	Inner Joint		37	39	40	68.5	104	
1994.03-2002.04	2002.04	MT	L	F	Platform/Chassis Engine RFW	610015	Inner Joint		37	39	40	68.5	104	
1994.03-2002.04	2002.04	MT	L/R	F	Box Engine RFW	810012	Outer Joint		28	39	63	112.5	63	I
1994.03-2002.04	2002.04	MT	L/R	F	Platform/Chassis Engine RFW	810012	Outer Joint		28	39	63	112.5	63	I
2.0 Panorama/Combinato (80 kW)														
1994.03-2002.04	2002.04	MT	L	F	Bus Engine RFW	210035	Drive Shaft	54T	28	41	63	112.5	757.5	
1994.03-2002.04	2002.04	MT	L	F	Bus Engine RFW	610015	Inner Joint		37	39	40	68.5	104	
1994.03-2002.04	2002.04	MT	L/R	F	Bus Engine RFW	810012	Outer Joint		28	39	63	112.5	63	I
1994.03-2002.04	2002.04	MT	L	F	Bus Engine RFW	210102	Drive Shaft		28	41	63	112.5	757.5	
1994.03-2002.04	2002.04	MT	L	F	Bus Engine RFW	210037	Drive Shaft	54T	28	37	63	112.5	771	
1994.03-2002.04	2002.04	MT	R	F	Bus Engine RFW	210066	Drive Shaft		35	41	70	117	1085	
1994.03-2002.04	2002.04	MT	R	F	Bus Engine RFW	210036	Drive Shaft	54T	28	41	63	112.5	1079	
1994.03-2002.04	2002.04	MT	R	F	Bus Engine RFW	210032	Drive Shaft	54T	35	41	70	117	1085	
1994.03-2002.04	2002.04	MT	L/R	F	Bus Engine RFW	810011	Outer Joint	54T	35	45	70	117	73	I
1994.03-2002.04	2002.04	-	-	-	Bus Engine RFW	645013	Inner Joint		37	39	40	68.5	100	
1994.03-2002.04	2002.04	MT	R	F	Bus Engine RFW	610034	Inner Joint		37	39	31.9	369.5	99	
1994.03-2002.04	2002.04	MT	L	F	Bus Engine RFW	210105	Drive Shaft		28	37	63	112.5	771	
1994.03-2002.04	2002.04	MT	R	F	Bus Engine RFW	210103	Drive Shaft		28	41	63	112.5	1079	
1994.03-2002.04	2002.04	MT	L/R	F	Bus Engine RFW	810013	Outer Joint	54T	28	39	63	112.5	63	I
1994.03-2002.04	2002.04	MT	R	F	Bus Engine RFW	210104	Drive Shaft	54T	28	37	63	112.5	1072	
1994.03-2002.04	2002.04	MT	L	F	Bus Engine RFW	210067	Drive Shaft		35	41	70	117	762	
1994.03-2002.04	2002.04	MT	L	F	Bus Engine RFW	210033	Drive Shaft	54T	35	41	70	117	762	
1994.03-2002.04	2002.04	MT	L/R	F	Bus Engine RFW	810050	Outer Joint		35	45	70	117	73	I
1994.03-2002.04	2002.04	MT	R	F	Bus Engine RFW	210069	Drive Shaft		28	37	63	112.5	1072	
1994.03-2002.04	2002.04	MT	R	F	Bus Engine RFW	610009	Inner Joint		41	45	34.9	367.5	115.6	
2.5 D (62 kW)														
1994.03-2002.04	2002.04	MT	L/R	F	All-wheel Drive Platform/Chassis Engine 8140.67	810012	Outer Joint		28	39	63	112.5	63	I
1994.03-2002.04	2002.04	MT	L	F	Box Engine 8140.67	210102	Drive Shaft		28	41	63	112.5	757.5	
1994.03-2002.04	2002.04	MT	L	F	Platform/Chassis Engine 8140.67	210102	Drive Shaft		28	41	63	112.5	757.5	
1994.03-2002.04	2002.04	MT	L	F	All-wheel Drive Platform/Chassis Engine 8140.67	210102	Drive Shaft		28	41	63	112.5	757.5	
1994.03-2002.04	2002.04	MT	L	F	Box Engine 8140.67	210037	Drive Shaft	54T	28	37	63	112.5	771	
1994.03-2002.04	2002.04	MT	R	F	Box Engine 8140.67	210066	Drive Shaft		35	41	70	117	1085	
1994.03-2002.04	2002.04	MT	R	F	Box Engine 8140.67	210036	Drive Shaft	54T	28	41	63	112.5	1079	
1994.03-2002.04	2002.04	MT	L	F	Platform/Chassis Engine 8140.67	210037	Drive Shaft	54T	28	37	63	112.5	771	
1994.03-2002.04	2002.04	MT	L	F	All-wheel Drive Platform/Chassis Engine 8140.67	210037	Drive Shaft	54T	28	37	63	112.5	771	
1994.03-2002.04	2002.04	MT	R	F	Platform/Chassis Engine 8140.67	210066	Drive Shaft		35	41	70	117	1085	
1994.03-2002.04	2002.04	MT	R	F	All-wheel Drive Platform/Chassis Engine 8140.67	210066	Drive Shaft		35	41	70	117	1085	
1994.03-2002.04	2002.04	MT	R	F	Platform/Chassis Engine 8140.67	210036	Drive Shaft	54T	28	41	63	112.5	1079	
1994.03-2002.04	2002.04	MT	R	F	Box Engine 8140.67	210032	Drive Shaft	54T	35	41	70	117	1085	
1994.03-2002.04	2002.04	MT	R	F	All-wheel Drive Platform/Chassis Engine 8140.67	210036	Drive Shaft	54T	28	41	63	112.5	1079	
1994.03-2002.04	2002.04	MT	L/R	F	Box Engine 8140.67	810011	Outer Joint	54T	35	45	70	117	73	I
1994.03-2002.04	2002.04	MT	R	F	Platform/Chassis Engine 8140.67	210032	Drive Shaft	54T	35	41	70	117	1085	

YEAR	TRANSM	L/R	F/R	REMARKS	GSP Ref.	PRODUCT	ABS	Technical Specifications							
								A	B	C	H	L	P		
FIAT															
DUCATO (230_)															
2.5 D (62 kW)															
1994.03-2002.04	2002.04	MT	R	F	All-wheel Drive Platform/Chassis Engine 8140.67	210032	Drive Shaft	54T	35	41	70	117	1085		
1994.03-2002.04	2002.04	MT	R	F	Box Engine 8140.67	610034	Inner Joint		37	39	31.9	369.5	99		
1994.03-2002.04	2002.04	MT	L/R	F	Platform/Chassis Engine 8140.67	810011	Outer Joint	54T	35	45	70	117	73	I	
1994.03-2002.04	2002.04	MT	L/R	F	All-wheel Drive Platform/Chassis Engine 8140.67	810011	Outer Joint	54T	35	45	70	117	73	I	
1994.03-2002.04	2002.04	MT	L	F	Box Engine 8140.67	210105	Drive Shaft		28	37	63	112.5	771		
1994.03-2002.04	2002.04	MT	R	F	Platform/Chassis Engine 8140.67	610034	Inner Joint		37	39	31.9	369.5	99		
1994.03-2002.04	2002.04	MT	R	F	All-wheel Drive Platform/Chassis Engine 8140.67	610034	Inner Joint		37	39	31.9	369.5	99		
1994.03-2002.04	2002.04	MT	L	F	Platform/Chassis Engine 8140.67	210105	Drive Shaft		28	37	63	112.5	771		
1994.03-2002.04	2002.04	MT	L	F	All-wheel Drive Platform/Chassis Engine 8140.67	210105	Drive Shaft		28	37	63	112.5	771		
1994.03-2002.04	2002.04	-	-	-	Box Engine 8140.67	645013	Inner Joint		37	39	40	68.5	100		
1994.03-2002.04	2002.04	MT	R	F	Box Engine 8140.67	210103	Drive Shaft		28	41	63	112.5	1079		
1994.03-2002.04	2002.04	MT	L/R	F	Box Engine 8140.67	810013	Outer Joint	54T	28	39	63	112.5	63	I	
1994.03-2002.04	2002.04	MT	R	F	Platform/Chassis Engine 8140.67	210103	Drive Shaft		28	41	63	112.5	1079		
1994.03-2002.04	2002.04	MT	R	F	All-wheel Drive Platform/Chassis Engine 8140.67	210103	Drive Shaft		28	41	63	112.5	1079		
1994.03-2002.04	2002.04	MT	L/R	F	Platform/Chassis Engine 8140.67	810013	Outer Joint	54T	28	39	63	112.5	63	I	
1994.03-2002.04	2002.04	MT	L/R	F	All-wheel Drive Platform/Chassis Engine 8140.67	810013	Outer Joint	54T	28	39	63	112.5	63	I	
1994.03-2002.04	2002.04	-	-	-	Platform/Chassis Engine 8140.67	645013	Inner Joint		37	39	40	68.5	100		
1994.03-2002.04	2002.04	-	-	-	All-wheel Drive Platform/Chassis Engine 8140.67	645013	Inner Joint		37	39	40	68.5	100		
1994.03-2002.04	2002.04	MT	R	F	Box Engine 8140.67	210104	Drive Shaft	54T	28	37	63	112.5	1072		
1994.03-2002.04	2002.04	MT	R	F	Platform/Chassis Engine 8140.67	210104	Drive Shaft	54T	28	37	63	112.5	1072		
1994.03-2002.04	2002.04	MT	R	F	All-wheel Drive Platform/Chassis Engine 8140.67	210104	Drive Shaft	54T	28	37	63	112.5	1072		
1994.03-2002.04	2002.04	MT	L	F	Box Engine 8140.67	210067	Drive Shaft		35	41	70	117	762		
1994.03-2002.04	2002.04	MT	L	F	Box Engine 8140.67	210033	Drive Shaft	54T	35	41	70	117	762		
1994.03-2002.04	2002.04	MT	L	F	Platform/Chassis Engine 8140.67	210067	Drive Shaft		35	41	70	117	762		
1994.03-2002.04	2002.04	MT	L/R	F	Box Engine 8140.67	810050	Outer Joint		35	45	70	117	73	I	
1994.03-2002.04	2002.04	MT	L	F	All-wheel Drive Platform/Chassis Engine 8140.67	210067	Drive Shaft		35	41	70	117	762		
1994.03-2002.04	2002.04	MT	R	F	Box Engine 8140.67	210069	Drive Shaft		28	37	63	112.5	1072		
1994.03-2002.04	2002.04	MT	L	F	Platform/Chassis Engine 8140.67	210033	Drive Shaft	54T	35	41	70	117	762		
1994.03-2002.04	2002.04	MT	R	F	All-wheel Drive Platform/Chassis Engine 8140.67	610009	Inner Joint		41	45	34.9	367.5	115.6		
1994.03-2002.04	2002.04	MT	L	F	All-wheel Drive Platform/Chassis Engine 8140.67	210033	Drive Shaft	54T	35	41	70	117	762		
1994.03-2002.04	2002.04	MT	L/R	F	Platform/Chassis Engine 8140.67	810050	Outer Joint		35	45	70	117	73	I	
1994.03-2002.04	2002.04	MT	L/R	F	All-wheel Drive Platform/Chassis Engine 8140.67	810050	Outer Joint		35	45	70	117	73	I	
1994.03-2002.04	2002.04	MT	R	F	Platform/Chassis Engine 8140.67	210069	Drive Shaft		28	37	63	112.5	1072		
1994.03-2002.04	2002.04	MT	R	F	Platform/Chassis Engine 8140.67	610009	Inner Joint		41	45	34.9	367.5	115.6		
1994.03-2002.04	2002.04	MT	R	F	All-wheel Drive Platform/Chassis Engine 8140.67	210069	Drive Shaft		28	37	63	112.5	1072		
1994.03-2002.04	2002.04	MT	L	F	Box Engine 8140.67	210035	Drive Shaft	54T	28	41	63	112.5	757.5		
1994.03-2002.04	2002.04	MT	R	F	All-wheel Drive Platform/Chassis Engine 8140.67	610009	Inner Joint		41	45	34.9	367.5	115.6		
1994.03-2002.04	2002.04	MT	L	F	Platform/Chassis Engine 8140.67	210035	Drive Shaft	54T	28	41	63	112.5	757.5		
1994.03-2002.04	2002.04	MT	L	F	All-wheel Drive Platform/Chassis Engine 8140.67	210035	Drive Shaft	54T	28	41	63	112.5	757.5		
1994.03-2002.04	2002.04	MT	L	F	Box Engine 8140.67	610015	Inner Joint		37	39	40	68.5	104		
1994.03-2002.04	2002.04	MT	L/R	F	Box Engine 8140.67	810012	Outer Joint		28	39	63	112.5	63	I	
1994.03-2002.04	2002.04	MT	L	F	Platform/Chassis Engine 8140.67	610015	Inner Joint		37	39	40	68.5	104		
1994.03-2002.04	2002.04	MT	L	F	All-wheel Drive Platform/Chassis Engine 8140.67	610015	Inner Joint		37	39	40	68.5	104		
1994.03-2002.04	2002.04	MT	L/R	F	Platform/Chassis Engine 8140.67	810012	Outer Joint		28	39	63	112.5	63	I	
2.5 D Combinato (62 kW)															
1994.08-2002.04	2002.04	MT	L	F	Bus Engine 8140.67	210037	Drive Shaft	54T	28	37	63	112.5	771		
1994.08-2002.04	2002.04	MT	R	F	Bus Engine 8140.67	210066	Drive Shaft		35	41	70	117	1085		
1994.08-2002.04	2002.04	MT	R	F	Bus Engine 8140.67	210036	Drive Shaft	54T	28	41	63	112.5	1079		
1994.08-2002.04	2002.04	MT	L/R	F	Bus Engine 8140.67	810011	Outer Joint	54T	35	45	70	117	73	I	
1994.08-2002.04	2002.04	MT	R	F	Bus Engine 8140.67	210032	Drive Shaft	54T	35	41	70	117	1085		
1994.08-2002.04	2002.04	MT	R	F	Bus Engine 8140.67	610034	Inner Joint		37	39	31.9	369.5	99		
1994.08-2002.04	2002.04	MT	L	F	Bus Engine 8140.67	210105	Drive Shaft		28	37	63	112.5	771		
1994.08-2002.04	2002.04	MT	L/R	F	Bus Engine 8140.67	810013	Outer Joint	54T	28	39	63	112.5	63	I	
1994.08-2002.04	2002.04	MT	R	F	Bus Engine 8140.67	210103	Drive Shaft		28	41	63	112.5	1079		
1994.08-2002.04	2002.04	-	-	-	Bus Engine 8140.67	645013	Inner Joint		37	39	40	68.5	100		
1994.08-2002.04	2002.04	MT	R	F	Bus Engine 8140.67	210104	Drive Shaft	54T	28	37	63	112.5	1072		
1994.08-2002.04	2002.04	MT	L	F	Bus Engine 8140.67	210067	Drive Shaft		35	41	70	117	762		
1994.08-2002.04	2002.04	MT	L	F	Bus Engine 8140.67	210033	Drive Shaft	54T	35	41	70	117	762		
1994.08-2002.04	2002.04	MT	L/R	F	Bus Engine 8140.67	810050	Outer Joint		35	45	70	117	73	I	
1994.08-2002.04	2002.04	MT	R	F	Bus Engine 8140.67	210069	Drive Shaft		28	37	63	112.5	1072		
1994.08-2002.04	2002.04	MT	R	F	Bus Engine 8140.67	610009	Inner Joint		41	45	34.9	367.5	115.6		
1994.08-2002.04	2002.04	MT	L	F	Bus Engine 8140.67	210035	Drive Shaft	54T	28	41	63	112.5	757.5		
1994.08-2002.04	2002.04	MT	L	F	Bus Engine 8140.67	610015	Inner Joint		37	39	40	68.5	104		
1994.08-2002.04	2002.04	MT	L/R	F	Bus Engine 8140.67	810012	Outer Joint		28	39	63	112.5	63	I	
1994.08-2002.04	2002.04	MT	L	F	Bus Engine 8140.67	210102	Drive Shaft		28	41	63	112.5	757.5		
2.5 TDI (80 kW)															
1994.03-2002.04	2002.04	MT	L	F	Platform/Chassis Engine 8140.47R	210067	Drive Shaft		35	41	70	117	762		
1994.03-2002.04	2002.04	MT	L	F	Platform/Chassis Engine 8140.47R	210033	Drive Shaft	54T	35	41	70	117	762		

YEAR	TRANSM	L/R	F/R	REMARKS	GSP Ref.	PRODUCT	ABS	Technical Specifications							
								A	B	C	H	L	P		
FIAT															
DUCATO (230_)															
2.5 TDI (80 kW)															
1994.03-2002.04	MT	R	F	Platform/Chassis Engine 8140.47R	210069	Drive Shaft		28	37	63	112.5	1072			
1994.03-2002.04	MT	L/R	F	Platform/Chassis Engine 8140.47R	810050	Outer Joint		35	45	70	117	73	I		
1994.03-2002.04	MT	L	F	Box Engine 8140.47R	210102	Drive Shaft		28	41	63	112.5	757.5			
1994.03-2002.04	MT	L	F	Platform/Chassis Engine 8140.47R	210035	Drive Shaft	54T	28	41	63	112.5	757.5			
1994.03-2002.04	MT	R	F	Platform/Chassis Engine 8140.47R	610009	Inner Joint		41	45	34.9	367.5	115.6			
1994.03-2002.04	MT	L	F	Platform/Chassis Engine 8140.47R	610015	Inner Joint		37	39	40	68.5	104			
1994.03-2002.04	MT	L/R	F	Platform/Chassis Engine 8140.47R	810012	Outer Joint		28	39	63	112.5	63	I		
1994.03-2002.04	MT	L	F	Box Engine 8140.47R	210037	Drive Shaft	54T	28	37	63	112.5	771			
1994.03-2002.04	MT	R	F	Box Engine 8140.47R	210066	Drive Shaft		35	41	70	117	1085			
1994.03-2002.04	MT	R	F	Box Engine 8140.47R	210036	Drive Shaft	54T	28	41	63	112.5	1079			
1994.03-2002.04	MT	L	F	Platform/Chassis Engine 8140.47R	210102	Drive Shaft		28	41	63	112.5	757.5			
1994.03-2002.04	MT	R	F	Box Engine 8140.47R	210032	Drive Shaft	54T	35	41	70	117	1085			
1994.03-2002.04	MT	L/R	F	Box Engine 8140.47R	810011	Outer Joint	54T	35	45	70	117	73	I		
1994.03-2002.04	MT	R	F	Box Engine 8140.47R	610034	Inner Joint		37	39	31.9	369.5	99			
1994.03-2002.04	MT	L	F	Box Engine 8140.47R	210105	Drive Shaft		28	37	63	112.5	771			
1994.03-2002.04	-	-	-	Box Engine 8140.47R	645013	Inner Joint		37	39	40	68.5	100			
1994.03-2002.04	MT	R	F	Box Engine 8140.47R	210103	Drive Shaft		28	41	63	112.5	1079			
1994.03-2002.04	MT	L	F	Platform/Chassis Engine 8140.47R	210037	Drive Shaft	54T	28	37	63	112.5	771			
1994.03-2002.04	MT	L/R	F	Box Engine 8140.47R	810013	Outer Joint	54T	28	39	63	112.5	63	I		
1994.03-2002.04	-	-	-	Platform/Chassis Engine 8140.47R	645013	Inner Joint		37	39	40	68.5	100			
1994.03-2002.04	MT	R	F	Platform/Chassis Engine 8140.47R	210036	Drive Shaft	54T	28	41	63	112.5	1079			
1994.03-2002.04	MT	R	F	Platform/Chassis Engine 8140.47R	210066	Drive Shaft		35	41	70	117	1085			
1994.03-2002.04	MT	R	F	Platform/Chassis Engine 8140.47R	610034	Inner Joint		37	39	31.9	369.5	99			
1994.03-2002.04	MT	R	F	Platform/Chassis Engine 8140.47R	210032	Drive Shaft	54T	35	41	70	117	1085			
1994.03-2002.04	MT	L/R	F	Platform/Chassis Engine 8140.47R	810011	Outer Joint	54T	35	45	70	117	73	I		
1994.03-2002.04	MT	L	F	Platform/Chassis Engine 8140.47R	210105	Drive Shaft		28	37	63	112.5	771			
1994.03-2002.04	MT	R	F	Box Engine 8140.47R	210104	Drive Shaft	54T	28	37	63	112.5	1072			
1994.03-2002.04	MT	R	F	Platform/Chassis Engine 8140.47R	210103	Drive Shaft		28	41	63	112.5	1079			
1994.03-2002.04	MT	L	F	Box Engine 8140.47R	210067	Drive Shaft		35	41	70	117	762			
1994.03-2002.04	MT	L	F	Box Engine 8140.47R	210033	Drive Shaft	54T	35	41	70	117	762			
1994.03-2002.04	MT	L/R	F	Platform/Chassis Engine 8140.47R	810013	Outer Joint	54T	28	39	63	112.5	63	I		
1994.03-2002.04	MT	L/R	F	Box Engine 8140.47R	810050	Outer Joint		35	45	70	117	73	I		
1994.03-2002.04	MT	R	F	Box Engine 8140.47R	210069	Drive Shaft		28	37	63	112.5	1072			
1994.03-2002.04	MT	R	F	Box Engine 8140.47R	610009	Inner Joint		41	45	34.9	367.5	115.6			
1994.03-2002.04	MT	L	F	Box Engine 8140.47R	210035	Drive Shaft	54T	28	41	63	112.5	757.5			
1994.03-2002.04	MT	R	F	Platform/Chassis Engine 8140.47R	210104	Drive Shaft	54T	28	37	63	112.5	1072			
1994.03-2002.04	MT	L	F	Box Engine 8140.47R	610015	Inner Joint		37	39	40	68.5	104			
1994.03-2002.04	MT	L/R	F	Box Engine 8140.47R	810012	Outer Joint		28	39	63	112.5	63	I		
2.5 TDI (85 kW)															
1994.03-2002.04	MT	L	F	Platform/Chassis Engine 8140.47	210067	Drive Shaft		35	41	70	117	762			
1994.03-2002.04	MT	L	F	Box Engine 8140.47	210102	Drive Shaft		28	41	63	112.5	757.5			
1994.03-2002.04	MT	L	F	Platform/Chassis Engine 8140.47	210033	Drive Shaft	54T	35	41	70	117	762			
1994.03-2002.04	MT	R	F	Platform/Chassis Engine 8140.47	210069	Drive Shaft		28	37	63	112.5	1072			
1994.03-2002.04	MT	L/R	F	Platform/Chassis Engine 8140.47	810050	Outer Joint		35	45	70	117	73	I		
1994.03-2002.04	MT	L	F	Platform/Chassis Engine 8140.47	210035	Drive Shaft	54T	28	41	63	112.5	757.5			
1994.03-2002.04	MT	R	F	Platform/Chassis Engine 8140.47	610009	Inner Joint		41	45	34.9	367.5	115.6			
1994.03-2002.04	MT	L	F	Platform/Chassis Engine 8140.47	610015	Inner Joint		37	39	40	68.5	104			
1994.03-2002.04	MT	L/R	F	Platform/Chassis Engine 8140.47	810012	Outer Joint		28	39	63	112.5	63	I		
1994.03-2002.04	MT	L	F	Box Engine 8140.47	210037	Drive Shaft	54T	28	37	63	112.5	771			
1994.03-2002.04	MT	R	F	Box Engine 8140.47	210066	Drive Shaft		35	41	70	117	1085			
1994.03-2002.04	MT	R	F	Box Engine 8140.47	210036	Drive Shaft	54T	28	41	63	112.5	1079			
1994.03-2002.04	MT	R	F	Box Engine 8140.47	210032	Drive Shaft	54T	35	41	70	117	1085			
1994.03-2002.04	MT	L/R	F	Box Engine 8140.47	810011	Outer Joint	54T	35	45	70	117	73	I		
1994.03-2002.04	MT	L	F	Platform/Chassis Engine 8140.47	210102	Drive Shaft		28	41	63	112.5	757.5			
1994.03-2002.04	MT	R	F	Box Engine 8140.47	610034	Inner Joint		37	39	31.9	369.5	99			
1994.03-2002.04	MT	L	F	Box Engine 8140.47	210105	Drive Shaft		28	37	63	112.5	771			
1994.03-2002.04	MT	R	F	Box Engine 8140.47	210103	Drive Shaft		28	41	63	112.5	1079			
1994.03-2002.04	-	-	-	Box Engine 8140.47	645013	Inner Joint		37	39	40	68.5	100			
1994.03-2002.04	MT	L/R	F	Box Engine 8140.47	810013	Outer Joint	54T	28	39	63	112.5	63	I		
1994.03-2002.04	MT	L	F	Platform/Chassis Engine 8140.47	210037	Drive Shaft	54T	28	37	63	112.5	771			
1994.03-2002.04	-	-	-	Platform/Chassis Engine 8140.47	645013	Inner Joint		37	39	40	68.5	100			
1994.03-2002.04	MT	R	F	Platform/Chassis Engine 8140.47	210036	Drive Shaft	54T	28	41	63	112.5	1079			
1994.03-2002.04	MT	R	F	Platform/Chassis Engine 8140.47	210066	Drive Shaft		35	41	70	117	1085			
1994.03-2002.04	MT	R	F	Platform/Chassis Engine 8140.47	610034	Inner Joint		37	39	31.9	369.5	99			
1994.03-2002.04	MT	R	F	Platform/Chassis Engine 8140.47	210032	Drive Shaft	54T	35	41	70	117	1085			
1994.03-2002.04	MT	L/R	F	Platform/Chassis Engine 8140.47	810011	Outer Joint	54T	35	45	70	117	73	I		
1994.03-2002.04	MT	L	F	Platform/Chassis Engine 8140.47	210105	Drive Shaft		28	37	63	112.5	771			

YEAR	TRANSM	L/R	F/R	REMARKS	GSP Ref.	PRODUCT	ABS	Technical Specifications										
								A	B	C	H	L	P					
FIAT																		
DUCATO (230_)																		
2.5 TDI (85 kW)																		
1994.03-	2002.04	MT	R	F	Box Engine 8140.47	210104	Drive Shaft	54T	28	37	63	112.5	1072					
1994.03-	2002.04	MT	R	F	Platform/Chassis Engine 8140.47	210103	Drive Shaft		28	41	63	112.5	1079					
1994.03-	2002.04	MT	L	F	Box Engine 8140.47	210067	Drive Shaft		35	41	70	117	762					
1994.03-	2002.04	MT	L	F	Box Engine 8140.47	210033	Drive Shaft	54T	35	41	70	117	762					
1994.03-	2002.04	MT	L/R	F	Box Engine 8140.47	810050	Outer Joint		35	45	70	117	73	I				
1994.03-	2002.04	MT	L/R	F	Platform/Chassis Engine 8140.47	810013	Outer Joint	54T	28	39	63	112.5	63	I				
1994.03-	2002.04	MT	R	F	Box Engine 8140.47	210069	Drive Shaft		28	37	63	112.5	1072					
1994.03-	2002.04	MT	R	F	Box Engine 8140.47	610009	Inner Joint		41	45	34.9	367.5	115.6					
1994.03-	2002.04	MT	L	F	Box Engine 8140.47	210035	Drive Shaft	54T	28	41	63	112.5	757.5					
1994.03-	2002.04	MT	R	F	Platform/Chassis Engine 8140.47	210104	Drive Shaft	54T	28	37	63	112.5	1072					
1994.03-	2002.04	MT	L	F	Box Engine 8140.47	610015	Inner Joint		37	39	40	68.5	104					
1994.03-	2002.04	MT	L/R	F	Box Engine 8140.47	810012	Outer Joint		28	39	63	112.5	63	I				
1997.04-	2002.04	MT	L	F	All-wheel Drive Bus Engine 8140.47	210067	Drive Shaft		35	41	70	117	762					
1997.04-	2002.04	MT	L	F	All-wheel Drive Bus Engine 8140.47	210033	Drive Shaft	54T	35	41	70	117	762					
1997.04-	2002.04	MT	R	F	All-wheel Drive Bus Engine 8140.47	210069	Drive Shaft		28	37	63	112.5	1072					
1997.04-	2002.04	MT	L/R	F	All-wheel Drive Bus Engine 8140.47	810050	Outer Joint		35	45	70	117	73	I				
1997.04-	2002.04	MT	L	F	All-wheel Drive Bus Engine 8140.47	210035	Drive Shaft	54T	28	41	63	112.5	757.5					
1997.04-	2002.04	MT	R	F	All-wheel Drive Bus Engine 8140.47	610009	Inner Joint		41	45	34.9	367.5	115.6					
1997.04-	2002.04	MT	L	F	All-wheel Drive Bus Engine 8140.47	610015	Inner Joint		37	39	40	68.5	104					
1997.04-	2002.04	MT	L/R	F	All-wheel Drive Bus Engine 8140.47	810012	Outer Joint		28	39	63	112.5	63	I				
1997.04-	2002.04	MT	L	F	All-wheel Drive Bus Engine 8140.47	210102	Drive Shaft		28	41	63	112.5	757.5					
1997.04-	2002.04	MT	L	F	All-wheel Drive Bus Engine 8140.47	210037	Drive Shaft	54T	28	37	63	112.5	771					
1997.04-	2002.04	-	-	-	All-wheel Drive Bus Engine 8140.47	645013	Inner Joint		37	39	40	68.5	100					
1997.04-	2002.04	MT	R	F	All-wheel Drive Bus Engine 8140.47	210036	Drive Shaft	54T	28	41	63	112.5	1079					
1997.04-	2002.04	MT	R	F	All-wheel Drive Bus Engine 8140.47	210066	Drive Shaft		35	41	70	117	1085					
1997.04-	2002.04	MT	R	F	All-wheel Drive Bus Engine 8140.47	610034	Inner Joint		37	39	31.9	369.5	99					
1997.04-	2002.04	MT	L/R	F	All-wheel Drive Bus Engine 8140.47	810011	Outer Joint	54T	35	45	70	117	73	I				
1997.04-	2002.04	MT	R	F	All-wheel Drive Bus Engine 8140.47	210032	Drive Shaft	54T	35	41	70	117	1085					
1997.04-	2002.04	MT	L	F	All-wheel Drive Bus Engine 8140.47	210105	Drive Shaft		28	37	63	112.5	771					
1997.04-	2002.04	MT	R	F	All-wheel Drive Bus Engine 8140.47	210103	Drive Shaft		28	41	63	112.5	1079					
1997.04-	2002.04	MT	L/R	F	All-wheel Drive Bus Engine 8140.47	810013	Outer Joint	54T	28	39	63	112.5	63	I				
1997.04-	2002.04	MT	R	F	All-wheel Drive Bus Engine 8140.47	210104	Drive Shaft	54T	28	37	63	112.5	1072					
1998.05-	2002.04	-	-	-	All-wheel Drive Box Engine 8140.47	645013	Inner Joint		37	39	40	68.5	100					
1998.06-	2002.04	MT	L	F	All-wheel Drive Platform/Chassis Engine 8140.47	210067	Drive Shaft		35	41	70	117	762					
1998.06-	2002.04	MT	L	F	All-wheel Drive Platform/Chassis Engine 8140.47	210033	Drive Shaft	54T	35	41	70	117	762					
1998.06-	2002.04	MT	R	F	All-wheel Drive Platform/Chassis Engine 8140.47	210069	Drive Shaft		28	37	63	112.5	1072					
1998.06-	2002.04	MT	L/R	F	All-wheel Drive Platform/Chassis Engine 8140.47	810050	Outer Joint		35	45	70	117	73	I				
1998.06-	2002.04	MT	L	F	All-wheel Drive Platform/Chassis Engine 8140.47	210035	Drive Shaft	54T	28	41	63	112.5	757.5					
1998.06-	2002.04	MT	R	F	All-wheel Drive Platform/Chassis Engine 8140.47	610009	Inner Joint		41	45	34.9	367.5	115.6					
1998.06-	2002.04	MT	L	F	All-wheel Drive Platform/Chassis Engine 8140.47	610015	Inner Joint		37	39	40	68.5	104					
1998.06-	2002.04	MT	L/R	F	All-wheel Drive Platform/Chassis Engine 8140.47	810012	Outer Joint		28	39	63	112.5	63	I				
1998.06-	2002.04	MT	L	F	All-wheel Drive Platform/Chassis Engine 8140.47	210102	Drive Shaft		28	41	63	112.5	757.5					
1998.06-	2002.04	MT	L	F	All-wheel Drive Platform/Chassis Engine 8140.47	210037	Drive Shaft	54T	28	37	63	112.5	771					
1998.06-	2002.04	MT	R	F	All-wheel Drive Platform/Chassis Engine 8140.47	210036	Drive Shaft	54T	28	41	63	112.5	1079					
1998.06-	2002.04	-	-	-	All-wheel Drive Platform/Chassis Engine 8140.47	645013	Inner Joint		37	39	40	68.5	100					
1998.06-	2002.04	MT	R	F	All-wheel Drive Platform/Chassis Engine 8140.47	210066	Drive Shaft		35	41	70	117	1085					
1998.06-	2002.04	MT	R	F	All-wheel Drive Platform/Chassis Engine 8140.47	610034	Inner Joint		37	39	31.9	369.5	99					
1998.06-	2002.04	MT	L/R	F	All-wheel Drive Platform/Chassis Engine 8140.47	810011	Outer Joint	54T	35	45	70	117	73	I				
1998.06-	2002.04	MT	R	F	All-wheel Drive Platform/Chassis Engine 8140.47	210032	Drive Shaft	54T	35	41	70	117	1085					
1998.06-	2002.04	MT	L	F	All-wheel Drive Platform/Chassis Engine 8140.47	210105	Drive Shaft		28	37	63	112.5	771					
1998.06-	2002.04	MT	R	F	All-wheel Drive Platform/Chassis Engine 8140.47	210103	Drive Shaft		28	41	63	112.5	1079					
1998.06-	2002.04	MT	L/R	F	All-wheel Drive Platform/Chassis Engine 8140.47	810013	Outer Joint	54T	28	39	63	112.5	63	I				
1998.06-	2002.04	MT	R	F	All-wheel Drive Platform/Chassis Engine 8140.47	210104	Drive Shaft	54T	28	37	63	112.5	1072					
2.5 TDI Panorama/Combinato (80 kw)																		
1994.07-	2002.04	MT	L	F	Bus Engine 8140.47R	210067	Drive Shaft		35	41	70	117	762					
1994.07-	2002.04	MT	L	F	Bus Engine 8140.47R	210033	Drive Shaft	54T	35	41	70	117	762					
1994.07-	2002.04	MT	R	F	Bus Engine 8140.47R	210069	Drive Shaft		28	37	63	112.5	1072					
1994.07-	2002.04	MT	L/R	F	Bus Engine 8140.47R	810050	Outer Joint		35	45	70	117	73	I				
1994.07-	2002.04	MT	L	F	Bus Engine 8140.47R	210035	Drive Shaft	54T	28	41	63	112.5	757.5					
1994.07-	2002.04	MT	R	F	Bus Engine 8140.47R	610009	Inner Joint		41	45	34.9	367.5	115.6					
1994.07-	2002.04	MT	L	F	Bus Engine 8140.47R	210105	Drive Shaft		28	37	63	112.5	771					
1994.07-	2002.04	MT	L	F	Bus Engine 8140.47R	210102	Drive Shaft		28	41	63	112.5	757.5					
1994.07-	2002.04	MT	L	F	Bus Engine 8140.47R	210037	Drive Shaft	54T	28	37	63	112.5	771					
1994.07-	2002.04	-	-	-	Bus Engine 8140.47R	645013	Inner Joint		37	39	40	68.5	100					
1994.07-	2002.04	MT	R	F	Bus Engine 8140.47R	210036	Drive Shaft	54T	28	41	63	112.5	1079					
1994.07-	2002.04	MT	R	F	Bus Engine 8140.47R	210066	Drive Shaft		35	41	70	117	1085					
1994.07-	2002.04	MT	R	F	Bus Engine 8140.47R	610034	Inner Joint		37	39	31.9	369.5	99					

	 YEAR	TRANSM	L/R	F/R	REMARKS	GSP Ref.	 PRODUCT	 ABS	Technical Specifications					
									A	B	C	H	L	P
FIAT														
DUCATO (230_)														
2.5 TDI Panorama/Combinato (80 kv)	1994.07-2002.04	MT	R	F	Bus Engine 8140.47R	210032	Drive Shaft	54T	35	41	70	117	1085	
	1994.07-2002.04	MT	L/R	F	Bus Engine 8140.47R	810011	Outer Joint	54T	35	45	70	117	73	I
	1994.07-2002.04	MT	R	F	Bus Engine 8140.47R	210103	Drive Shaft		28	41	63	112.5	1079	
	1994.07-2002.04	MT	L/R	F	Bus Engine 8140.47R	810013	Outer Joint	54T	28	39	63	112.5	63	I
	1994.07-2002.04	MT	L	F	Bus Engine 8140.47R	610015	Inner Joint		37	39	40	68.5	104	
	1994.07-2002.04	MT	L/R	F	Bus Engine 8140.47R	810012	Outer Joint		28	39	63	112.5	63	I
	1994.07-2002.04	MT	R	F	Bus Engine 8140.47R	210104	Drive Shaft	54T	28	37	63	112.5	1072	
2.5 TDI Panorama/Combinato (85 kv)	1994.03-2002.04	MT	R	F	Bus Engine 8140.47	210066	Drive Shaft		35	41	70	117	1085	
	1994.03-2002.04	MT	L	F	Bus Engine 8140.47	210037	Drive Shaft	54T	28	37	63	112.5	771	
	1994.03-2002.04	MT	R	F	Bus Engine 8140.47	210036	Drive Shaft	54T	28	41	63	112.5	1079	
	1994.03-2002.04	MT	L/R	F	Bus Engine 8140.47	810011	Outer Joint	54T	35	45	70	117	73	I
	1994.03-2002.04	MT	R	F	Bus Engine 8140.47	210032	Drive Shaft	54T	35	41	70	117	1085	
	1994.03-2002.04	MT	R	F	Bus Engine 8140.47	610034	Inner Joint		37	39	31.9	369.5	99	
	1994.03-2002.04	MT	L	F	Bus Engine 8140.47	210105	Drive Shaft		28	37	63	112.5	771	
	1994.03-2002.04	MT	L/R	F	Bus Engine 8140.47	810013	Outer Joint	54T	28	39	63	112.5	63	I
	1994.03-2002.04	MT	R	F	Bus Engine 8140.47	210103	Drive Shaft		28	41	63	112.5	1079	
	1994.03-2002.04	-	-	-	Bus Engine 8140.47	645013	Inner Joint		37	39	40	68.5	100	
	1994.03-2002.04	MT	R	F	Bus Engine 8140.47	210104	Drive Shaft	54T	28	37	63	112.5	1072	
	1994.03-2002.04	MT	L	F	Bus Engine 8140.47	210067	Drive Shaft		35	41	70	117	762	
	1994.03-2002.04	MT	L	F	Bus Engine 8140.47	210033	Drive Shaft	54T	35	41	70	117	762	
	1994.03-2002.04	MT	L/R	F	Bus Engine 8140.47	810050	Outer Joint		35	45	70	117	73	I
	1994.03-2002.04	MT	R	F	Bus Engine 8140.47	610009	Inner Joint		41	45	34.9	367.5	115.6	
	1994.03-2002.04	MT	R	F	Bus Engine 8140.47	210069	Drive Shaft		28	37	63	112.5	1072	
	1994.03-2002.04	MT	L	F	Bus Engine 8140.47	210035	Drive Shaft	54T	28	41	63	112.5	757.5	
	1994.03-2002.04	MT	L	F	Bus Engine 8140.47	610015	Inner Joint		37	39	40	68.5	104	
	1994.03-2002.04	MT	L/R	F	Bus Engine 8140.47	810012	Outer Joint		28	39	63	112.5	63	I
	2.8 D (64 kW)	1998.02-2002.04	MT	L	F	Bus Engine 8140.63	210102	Drive Shaft		28	41	63	112.5	757.5
1998.02-2002.04		MT	L	F	Platform/Chassis Engine 8140.63	210102	Drive Shaft		28	41	63	112.5	757.5	
1998.02-2002.04		MT	L	F	Platform/Chassis Engine 8140.63	210037	Drive Shaft	54T	28	37	63	112.5	771	
1998.02-2002.04		MT	L	F	Platform/Chassis Engine 8140.63	210037	Drive Shaft	54T	28	37	63	112.5	771	
1998.02-2002.04		MT	R	F	Bus Engine 8140.63	210066	Drive Shaft		35	41	70	117	1085	
1998.02-2002.04		MT	R	F	Platform/Chassis Engine 8140.63	210066	Drive Shaft		35	41	70	117	1085	
1998.02-2002.04		MT	R	F	Bus Engine 8140.63	210036	Drive Shaft	54T	28	41	63	112.5	1079	
1998.02-2002.04		MT	R	F	Platform/Chassis Engine 8140.63	210036	Drive Shaft	54T	28	41	63	112.5	1079	
1998.02-2002.04		MT	R	F	Bus Engine 8140.63	210032	Drive Shaft	54T	35	41	70	117	1085	
1998.02-2002.04		MT	R	F	Platform/Chassis Engine 8140.63	210032	Drive Shaft	54T	35	41	70	117	1085	
1998.02-2002.04		MT	L/R	F	Bus Engine 8140.63	810011	Outer Joint	54T	35	45	70	117	73	I
1998.02-2002.04		MT	L/R	F	Platform/Chassis Engine 8140.63	810011	Outer Joint	54T	35	45	70	117	73	I
1998.02-2002.04		MT	R	F	Bus Engine 8140.63	610034	Inner Joint		37	39	31.9	369.5	99	
1998.02-2002.04		MT	R	F	Platform/Chassis Engine 8140.63	610034	Inner Joint		37	39	31.9	369.5	99	
1998.02-2002.04		MT	L	F	Bus Engine 8140.63	210105	Drive Shaft		28	37	63	112.5	771	
1998.02-2002.04		MT	L	F	Platform/Chassis Engine 8140.63	210105	Drive Shaft		28	37	63	112.5	771	
1998.02-2002.04		MT	R	F	Bus Engine 8140.63	210103	Drive Shaft		28	41	63	112.5	1079	
1998.02-2002.04		MT	R	F	Platform/Chassis Engine 8140.63	210103	Drive Shaft		28	41	63	112.5	1079	
1998.02-2002.04		MT	L/R	F	Bus Engine 8140.63	810013	Outer Joint	54T	28	39	63	112.5	63	I
1998.02-2002.04		MT	L/R	F	Platform/Chassis Engine 8140.63	810013	Outer Joint	54T	28	39	63	112.5	63	I
1998.02-2002.04		-	-	-	Bus Engine 8140.63	645013	Inner Joint		37	39	40	68.5	100	
1998.02-2002.04		-	-	-	Platform/Chassis Engine 8140.63	645013	Inner Joint		37	39	40	68.5	100	
1998.02-2002.04		MT	R	F	Bus Engine 8140.63	210104	Drive Shaft	54T	28	37	63	112.5	1072	
1998.02-2002.04		MT	R	F	Platform/Chassis Engine 8140.63	210104	Drive Shaft	54T	28	37	63	112.5	1072	
1998.02-2002.04		MT	L	F	Bus Engine 8140.63	210067	Drive Shaft		35	41	70	117	762	
1998.02-2002.04		MT	L	F	Platform/Chassis Engine 8140.63	210067	Drive Shaft		35	41	70	117	762	
1998.02-2002.04		MT	L	F	Bus Engine 8140.63	210033	Drive Shaft	54T	35	41	70	117	762	
1998.02-2002.04		MT	L	F	Platform/Chassis Engine 8140.63	210033	Drive Shaft	54T	35	41	70	117	762	
1998.02-2002.04		MT	L/R	F	Bus Engine 8140.63	810050	Outer Joint		35	45	70	117	73	I
1998.02-2002.04		MT	L/R	F	Platform/Chassis Engine 8140.63	810050	Outer Joint		35	45	70	117	73	I
1998.02-2002.04		MT	R	F	Bus Engine 8140.63	210069	Drive Shaft		28	37	63	112.5	1072	
1998.02-2002.04		MT	R	F	Platform/Chassis Engine 8140.63	210069	Drive Shaft		28	37	63	112.5	1072	
1998.02-2002.04		MT	R	F	Bus Engine 8140.63	610009	Inner Joint		41	45	34.9	367.5	115.6	
1998.02-2002.04		MT	R	F	Platform/Chassis Engine 8140.63	610009	Inner Joint		41	45	34.9	367.5	115.6	
1998.02-2002.04		MT	L	F	Bus Engine 8140.63	210035	Drive Shaft	54T	28	41	63	112.5	757.5	
1998.02-2002.04		MT	L	F	Platform/Chassis Engine 8140.63	210035	Drive Shaft	54T	28	41	63	112.5	757.5	
1998.02-2002.04		MT	L	F	Bus Engine 8140.63	610015	Inner Joint		37	39	40	68.5	104	
1998.02-2002.04		MT	L	F	Platform/Chassis Engine 8140.63	610015	Inner Joint		37	39	40	68.5	104	
1998.02-2002.04		MT	L/R	F	Bus Engine 8140.63	810012	Outer Joint		28	39	63	112.5	63	I

YEAR	TRANS	L/R	F/R	REMARKS	GSP Ref.	PRODUCT	ABS	Technical Specifications										
								A	B	C	H	L	P					
FIAT																		
DUCATO (230_)																		
2.8 D (64 kW)																		
1998.02-2002.04	MT	L/R	F	Platform/Chassis Engine 8140.63	810012	Outer Joint		28	39	63	112.5	63	I					
1998.05-2002.04	MT	L	F	Box Engine 8140.63	210102	Drive Shaft		28	41	63	112.5	757.5						
1998.05-2002.04	MT	L	F	Box Engine 8140.63	210037	Drive Shaft	54T	28	37	63	112.5	771						
1998.05-2002.04	MT	R	F	Box Engine 8140.63	210066	Drive Shaft		35	41	70	117	1085						
1998.05-2002.04	MT	R	F	Box Engine 8140.63	210036	Drive Shaft	54T	28	41	63	112.5	1079						
1998.05-2002.04	MT	L/R	F	Box Engine 8140.63	810011	Outer Joint	54T	35	45	70	117	73	I					
1998.05-2002.04	MT	R	F	Box Engine 8140.63	210032	Drive Shaft	54T	35	41	70	117	1085						
1998.05-2002.04	MT	R	F	Box Engine 8140.63	610034	Inner Joint		37	39	31.9	369.5	99						
1998.05-2002.04	MT	L	F	Box Engine 8140.63	210105	Drive Shaft		28	37	63	112.5	771						
1998.05-2002.04	MT	L/R	F	Box Engine 8140.63	810013	Outer Joint	54T	28	39	63	112.5	63	I					
1998.05-2002.04	MT	R	F	Box Engine 8140.63	210103	Drive Shaft		28	41	63	112.5	1079						
1998.05-2002.04	-	-	-	Box Engine 8140.63	645013	Inner Joint		37	39	40	68.5	100						
1998.05-2002.04	MT	R	F	Box Engine 8140.63	210104	Drive Shaft	54T	28	37	63	112.5	1072						
1998.05-2002.04	MT	L	F	Box Engine 8140.63	210067	Drive Shaft		35	41	70	117	762						
1998.05-2002.04	MT	L	F	Box Engine 8140.63	210033	Drive Shaft	54T	35	41	70	117	762						
1998.05-2002.04	MT	L/R	F	Box Engine 8140.63	810050	Outer Joint		35	45	70	117	73	I					
1998.05-2002.04	MT	R	F	Box Engine 8140.63	210069	Drive Shaft		28	37	63	112.5	1072						
1998.05-2002.04	MT	R	F	Box Engine 8140.63	610009	Inner Joint		41	45	34.9	367.5	115.6						
1998.05-2002.04	MT	L	F	Box Engine 8140.63	210035	Drive Shaft	54T	28	41	63	112.5	757.5						
1998.05-2002.04	MT	L	F	Box Engine 8140.63	610015	Inner Joint		37	39	40	68.5	104						
1998.05-2002.04	MT	L/R	F	Box Engine 8140.63	810012	Outer Joint		28	39	63	112.5	63	I					
1998.08-2002.04	MT	L	F	All-wheel Drive Box Engine 8140.63	210035	Drive Shaft	54T	28	41	63	112.5	757.5						
1998.08-2002.04	MT	L	F	All-wheel Drive Box Engine 8140.63	610015	Inner Joint		37	39	40	68.5	104						
1998.08-2002.04	MT	L/R	F	All-wheel Drive Box Engine 8140.63	810012	Outer Joint		28	39	63	112.5	63	I					
1998.08-2002.04	MT	L	F	All-wheel Drive Box Engine 8140.63	210102	Drive Shaft		28	41	63	112.5	757.5						
1998.08-2002.04	MT	L	F	All-wheel Drive Box Engine 8140.63	210037	Drive Shaft	54T	28	37	63	112.5	771						
1998.08-2002.04	MT	R	F	All-wheel Drive Box Engine 8140.63	210066	Drive Shaft		35	41	70	117	1085						
1998.08-2002.04	MT	R	F	All-wheel Drive Box Engine 8140.63	210036	Drive Shaft	54T	28	41	63	112.5	1079						
1998.08-2002.04	MT	R	F	All-wheel Drive Box Engine 8140.63	210032	Drive Shaft	54T	35	41	70	117	1085						
1998.08-2002.04	-	-	-	All-wheel Drive Box Engine 8140.63	645013	Inner Joint		37	39	40	68.5	100						
1998.08-2002.04	MT	L/R	F	All-wheel Drive Box Engine 8140.63	810011	Outer Joint	54T	35	45	70	117	73	I					
1998.08-2002.04	MT	R	F	All-wheel Drive Box Engine 8140.63	610034	Inner Joint		37	39	31.9	369.5	99						
1998.08-2002.04	MT	L	F	All-wheel Drive Box Engine 8140.63	210105	Drive Shaft		28	37	63	112.5	771						
1998.08-2002.04	MT	R	F	All-wheel Drive Box Engine 8140.63	210103	Drive Shaft		28	41	63	112.5	1079						
1998.08-2002.04	MT	L/R	F	All-wheel Drive Box Engine 8140.63	810013	Outer Joint	54T	28	39	63	112.5	63	I					
1998.08-2002.04	MT	R	F	All-wheel Drive Box Engine 8140.63	210104	Drive Shaft	54T	28	37	63	112.5	1072						
1998.08-2002.04	MT	L	F	All-wheel Drive Box Engine 8140.63	210067	Drive Shaft		35	41	70	117	762						
1998.08-2002.04	MT	L	F	All-wheel Drive Box Engine 8140.63	210033	Drive Shaft	54T	35	41	70	117	762						
1998.08-2002.04	MT	L/R	F	All-wheel Drive Box Engine 8140.63	810050	Outer Joint		35	45	70	117	73	I					
1998.08-2002.04	MT	R	F	All-wheel Drive Box Engine 8140.63	210069	Drive Shaft		28	37	63	112.5	1072						
1998.08-2002.04	MT	R	F	All-wheel Drive Box Engine 8140.63	610009	Inner Joint		41	45	34.9	367.5	115.6						
2.8 JTD (94 kW)																		
2000.11-2002.04	MT	R	F	Box Engine 8140.43S	210066	Drive Shaft		35	41	70	117	1085						
2000.11-2002.04	MT	L	F	Box Engine 8140.43S	210037	Drive Shaft	54T	28	37	63	112.5	771						
2000.11-2002.04	MT	R	F	Platform/Chassis Engine 8140.43S	210066	Drive Shaft		35	41	70	117	1085						
2000.11-2002.04	MT	L	F	Platform/Chassis Engine 8140.43S	210037	Drive Shaft	54T	28	37	63	112.5	771						
2000.11-2002.04	MT	R	F	Box Engine 8140.43S	210036	Drive Shaft	54T	28	41	63	112.5	1079						
2000.11-2002.04	MT	R	F	Platform/Chassis Engine 8140.43S	210036	Drive Shaft	54T	28	41	63	112.5	1079						
2000.11-2002.04	MT	L/R	F	Box Engine 8140.43S	810011	Outer Joint	54T	35	45	70	117	73	I					
2000.11-2002.04	MT	L/R	F	Platform/Chassis Engine 8140.43S	810011	Outer Joint	54T	35	45	70	117	73	I					
2000.11-2002.04	MT	R	F	Box Engine 8140.43S	210032	Drive Shaft	54T	35	41	70	117	1085						
2000.11-2002.04	MT	R	F	Platform/Chassis Engine 8140.43S	210032	Drive Shaft	54T	35	41	70	117	1085						
2000.11-2002.04	MT	R	F	Box Engine 8140.43S	610034	Inner Joint		37	39	31.9	369.5	99						
2000.11-2002.04	MT	R	F	Platform/Chassis Engine 8140.43S	610034	Inner Joint		37	39	31.9	369.5	99						
2000.11-2002.04	MT	L	F	Box Engine 8140.43S	210105	Drive Shaft		28	37	63	112.5	771						
2000.11-2002.04	MT	L	F	Platform/Chassis Engine 8140.43S	210105	Drive Shaft		28	37	63	112.5	771						
2000.11-2002.04	MT	L/R	F	Box Engine 8140.43S	810013	Outer Joint	54T	28	39	63	112.5	63	I					
2000.11-2002.04	MT	L/R	F	Platform/Chassis Engine 8140.43S	810013	Outer Joint	54T	28	39	63	112.5	63	I					
2000.11-2002.04	MT	R	F	Box Engine 8140.43S	210103	Drive Shaft		28	41	63	112.5	1079						
2000.11-2002.04	MT	R	F	Platform/Chassis Engine 8140.43S	210103	Drive Shaft		28	41	63	112.5	1079						
2000.11-2002.04	MT	R	F	Box Engine 8140.43S	210104	Drive Shaft	54T	28	37	63	112.5	1072						
2000.11-2002.04	MT	R	F	Platform/Chassis Engine 8140.43S	210104	Drive Shaft	54T	28	37	63	112.5	1072						
2000.11-2002.04	MT	L	F	Box Engine 8140.43S	210067	Drive Shaft		35	41	70	117	762						
2000.11-2002.04	MT	L	F	Platform/Chassis Engine 8140.43S	210067	Drive Shaft		35	41	70	117	762						
2000.11-2002.04	MT	L	F	Box Engine 8140.43S	210033	Drive Shaft	54T	35	41	70	117	762						
2000.11-2002.04	MT	L	F	Platform/Chassis Engine 8140.43S	210033	Drive Shaft	54T	35	41	70	117	762						
2000.11-2002.04	MT	L/R	F	Box Engine 8140.43S	810050	Outer Joint		35	45	70	117	73	I					

YEAR	TRANSM	L/R	F/R	REMARKS	GSP Ref.	PRODUCT	ABS	Technical Specifications							
								A	B	C	H	L	P		
FIAT															
DUCATO (230_)															
2.8 JTD (94 kW)															
2000.11-2002.04	MT	L/R	F	Platform/Chassis Engine 8140.43S	810050	Outer Joint		35	45	70	117	73	I		
2000.11-2002.04	MT	R	F	Box Engine 8140.43S	610009	Inner Joint		41	45	34.9	367.5	115.6			
2000.11-2002.04	MT	R	F	Platform/Chassis Engine 8140.43S	610009	Inner Joint		41	45	34.9	367.5	115.6			
2000.11-2002.04	MT	R	F	Box Engine 8140.43S	210069	Drive Shaft		28	37	63	112.5	1072			
2000.11-2002.04	MT	R	F	Platform/Chassis Engine 8140.43S	210069	Drive Shaft		28	37	63	112.5	1072			
2000.11-2002.04	MT	L	F	Box Engine 8140.43S	210035	Drive Shaft	54T	28	41	63	112.5	757.5			
2000.11-2002.04	MT	L	F	Platform/Chassis Engine 8140.43S	210035	Drive Shaft	54T	28	41	63	112.5	757.5			
2000.11-2002.04	MT	L	F	Box Engine 8140.43S	610015	Inner Joint		37	39	40	68.5	104			
2000.11-2002.04	MT	L	F	Platform/Chassis Engine 8140.43S	610015	Inner Joint		37	39	40	68.5	104			
2000.11-2002.04	MT	L/R	F	Box Engine 8140.43S	810012	Outer Joint		28	39	63	112.5	63	I		
2000.11-2002.04	MT	L/R	F	Platform/Chassis Engine 8140.43S	810012	Outer Joint		28	39	63	112.5	63	I		
2000.11-2002.04	MT	L	F	Box Engine 8140.43S	210102	Drive Shaft		28	41	63	112.5	757.5			
2000.11-2002.04	MT	L	F	Platform/Chassis Engine 8140.43S	210102	Drive Shaft		28	41	63	112.5	757.5			
2001.03-2002.04	MT	L	F	Platform/Chassis Engine 8140.43S	210037	Drive Shaft	54T	28	37	63	112.5	771			
2001.03-2002.04	MT	R	F	Platform/Chassis Engine 8140.43S	210066	Drive Shaft		35	41	70	117	1085			
2001.03-2002.04	MT	R	F	Platform/Chassis Engine 8140.43S	210036	Drive Shaft	54T	28	41	63	112.5	1079			
2001.03-2002.04	MT	L/R	F	Platform/Chassis Engine 8140.43S	810011	Outer Joint	54T	35	45	70	117	73	I		
2001.03-2002.04	MT	R	F	Platform/Chassis Engine 8140.43S	210032	Drive Shaft	54T	35	41	70	117	1085			
2001.03-2002.04	MT	R	F	Platform/Chassis Engine 8140.43S	610034	Inner Joint		37	39	31.9	369.5	99			
2001.03-2002.04	MT	L	F	Platform/Chassis Engine 8140.43S	210105	Drive Shaft		28	37	63	112.5	771			
2001.03-2002.04	MT	L/R	F	Platform/Chassis Engine 8140.43S	810013	Outer Joint	54T	28	39	63	112.5	63	I		
2001.03-2002.04	MT	R	F	Platform/Chassis Engine 8140.43S	210103	Drive Shaft		28	41	63	112.5	1079			
2001.03-2002.04	MT	R	F	Platform/Chassis Engine 8140.43S	210104	Drive Shaft	54T	28	37	63	112.5	1072			
2001.03-2002.04	MT	L	F	Platform/Chassis Engine 8140.43S	210067	Drive Shaft		35	41	70	117	762			
2001.03-2002.04	MT	L	F	Platform/Chassis Engine 8140.43S	210033	Drive Shaft	54T	35	41	70	117	762			
2001.03-2002.04	MT	L/R	F	Platform/Chassis Engine 8140.43S	810050	Outer Joint		35	45	70	117	73	I		
2001.03-2002.04	MT	R	F	Platform/Chassis Engine 8140.43S	210069	Drive Shaft		28	37	63	112.5	1072			
2001.03-2002.04	MT	R	F	Platform/Chassis Engine 8140.43S	610009	Inner Joint		41	45	34.9	367.5	115.6			
2001.03-2002.04	MT	L	F	Platform/Chassis Engine 8140.43S	210035	Drive Shaft	54T	28	41	63	112.5	757.5			
2001.03-2002.04	MT	L	F	Platform/Chassis Engine 8140.43S	610015	Inner Joint		37	39	40	68.5	104			
2001.03-2002.04	MT	L/R	F	Platform/Chassis Engine 8140.43S	810012	Outer Joint		28	39	63	112.5	63	I		
2001.03-2002.04	MT	L	F	Platform/Chassis Engine 8140.43S	210102	Drive Shaft		28	41	63	112.5	757.5			
2.8 TDI (90 kW)															
1997.10-2002.04	MT	L	F	Bus Engine 8140.43	210102	Drive Shaft		28	41	63	112.5	757.5			
1997.10-2002.04	MT	L	F	Box Engine 8140.43	210102	Drive Shaft		28	41	63	112.5	757.5			
1997.10-2002.04	MT	L	F	Bus Engine 8140.43	210037	Drive Shaft	54T	28	37	63	112.5	771			
1997.10-2002.04	MT	L	F	Box Engine 8140.43	210037	Drive Shaft	54T	28	37	63	112.5	771			
1997.10-2002.04	MT	R	F	Bus Engine 8140.43	210066	Drive Shaft		35	41	70	117	1085			
1997.10-2002.04	MT	R	F	Box Engine 8140.43	210066	Drive Shaft		35	41	70	117	1085			
1997.10-2002.04	MT	R	F	Bus Engine 8140.43	210036	Drive Shaft	54T	28	41	63	112.5	1079			
1997.10-2002.04	MT	R	F	Box Engine 8140.43	210036	Drive Shaft	54T	28	41	63	112.5	1079			
1997.10-2002.04	MT	R	F	Bus Engine 8140.43	210032	Drive Shaft	54T	35	41	70	117	1085			
1997.10-2002.04	MT	R	F	Box Engine 8140.43	210032	Drive Shaft	54T	35	41	70	117	1085			
1997.10-2002.04	MT	L/R	F	Bus Engine 8140.43	810011	Outer Joint	54T	35	45	70	117	73	I		
1997.10-2002.04	MT	L/R	F	Box Engine 8140.43	810011	Outer Joint	54T	35	45	70	117	73	I		
1997.10-2002.04	MT	R	F	Bus Engine 8140.43	610034	Inner Joint		37	39	31.9	369.5	99			
1997.10-2002.04	MT	R	F	Box Engine 8140.43	610034	Inner Joint		37	39	31.9	369.5	99			
1997.10-2002.04	MT	L	F	Bus Engine 8140.43	210105	Drive Shaft		28	37	63	112.5	771			
1997.10-2002.04	MT	L	F	Box Engine 8140.43	210105	Drive Shaft		28	37	63	112.5	771			
1997.10-2002.04	MT	R	F	Bus Engine 8140.43	210103	Drive Shaft		28	41	63	112.5	1079			
1997.10-2002.04	MT	R	F	Box Engine 8140.43	210103	Drive Shaft		28	41	63	112.5	1079			
1997.10-2002.04	-	-	-	Box Engine 8140.43	645013	Inner Joint		37	39	40	68.5	100			
1997.10-2002.04	MT	L/R	F	Bus Engine 8140.43	810013	Outer Joint	54T	28	39	63	112.5	63	I		
1997.10-2002.04	MT	L/R	F	Box Engine 8140.43	810013	Outer Joint	54T	28	39	63	112.5	63	I		
1997.10-2002.04	-	-	-	Bus Engine 8140.43	645013	Inner Joint		37	39	40	68.5	100			
1997.10-2002.04	MT	R	F	Bus Engine 8140.43	210104	Drive Shaft	54T	28	37	63	112.5	1072			
1997.10-2002.04	MT	R	F	Box Engine 8140.43	210104	Drive Shaft	54T	28	37	63	112.5	1072			
1997.10-2002.04	MT	L	F	Bus Engine 8140.43	210067	Drive Shaft		35	41	70	117	762			
1997.10-2002.04	MT	L	F	Box Engine 8140.43	210067	Drive Shaft		35	41	70	117	762			
1997.10-2002.04	MT	L	F	Bus Engine 8140.43	210033	Drive Shaft	54T	35	41	70	117	762			
1997.10-2002.04	MT	L	F	Box Engine 8140.43	210033	Drive Shaft	54T	35	41	70	117	762			
1997.10-2002.04	MT	L/R	F	Bus Engine 8140.43	810050	Outer Joint		35	45	70	117	73	I		
1997.10-2002.04	MT	L/R	F	Box Engine 8140.43	810050	Outer Joint		35	45	70	117	73	I		
1997.10-2002.04	MT	R	F	Bus Engine 8140.43	210069	Drive Shaft		28	37	63	112.5	1072			
1997.10-2002.04	MT	R	F	Box Engine 8140.43	210069	Drive Shaft		28	37	63	112.5	1072			
1997.10-2002.04	MT	R	F	Bus Engine 8140.43	610009	Inner Joint		41	45	34.9	367.5	115.6			
1997.10-2002.04	MT	R	F	Box Engine 8140.43	610009	Inner Joint		41	45	34.9	367.5	115.6			

YEAR	TRANSM	L/R	F/R	REMARKS	GSP Ref.	PRODUCT	ABS	Technical Specifications										
								A	B	C	H	L	P					
FIAT																		
DUCATO (230_)																		
2.8 TDI (90 kW)																		
1997.10-	2002.04	MT	L	F	Bus Engine 8140.43	210035	Drive Shaft	54T	28	41	63	112.5	757.5					
1997.10-	2002.04	MT	L	F	Box Engine 8140.43	210035	Drive Shaft	54T	28	41	63	112.5	757.5					
1997.10-	2002.04	MT	L	F	Bus Engine 8140.43	610015	Inner Joint		37	39	40	68.5	104					
1997.10-	2002.04	MT	L	F	Box Engine 8140.43	610015	Inner Joint		37	39	40	68.5	104					
1997.10-	2002.04	MT	L/R	F	Bus Engine 8140.43	810012	Outer Joint		28	39	63	112.5	63	I				
1997.10-	2002.04	MT	L/R	F	Box Engine 8140.43	810012	Outer Joint		28	39	63	112.5	63	I				
1998.12-	2002.04	MT	L	F	Platform/Chassis Engine 8140.43	210035	Drive Shaft	54T	28	41	63	112.5	757.5					
1998.12-	2002.04	MT	L	F	Platform/Chassis Engine 8140.43	610015	Inner Joint		37	39	40	68.5	104					
1998.12-	2002.04	MT	L/R	F	Platform/Chassis Engine 8140.43	810012	Outer Joint		28	39	63	112.5	63	I				
1998.12-	2002.04	MT	L	F	Platform/Chassis Engine 8140.43	210102	Drive Shaft		28	41	63	112.5	757.5					
1998.12-	2002.04	MT	L	F	Platform/Chassis Engine 8140.43	210037	Drive Shaft	54T	28	37	63	112.5	771					
1998.12-	2002.04	MT	R	F	Platform/Chassis Engine 8140.43	210066	Drive Shaft		35	41	70	117	1085					
1998.12-	2002.04	MT	R	F	Platform/Chassis Engine 8140.43	210036	Drive Shaft	54T	28	41	63	112.5	1079					
1998.12-	2002.04	MT	R	F	Platform/Chassis Engine 8140.43	210032	Drive Shaft	54T	35	41	70	117	1085					
1998.12-	2002.04	MT	L/R	F	Platform/Chassis Engine 8140.43	810011	Outer Joint	54T	35	45	70	117	73	I				
1998.12-	2002.04	MT	R	F	Platform/Chassis Engine 8140.43	610034	Inner Joint		37	39	31.9	369.5	99					
1998.12-	2002.04	MT	L	F	Platform/Chassis Engine 8140.43	210105	Drive Shaft		28	37	63	112.5	771					
1998.12-	2002.04	-	-	-	Platform/Chassis Engine 8140.43	645013	Inner Joint		37	39	40	68.5	100					
1998.12-	2002.04	MT	R	F	Platform/Chassis Engine 8140.43	210103	Drive Shaft		28	41	63	112.5	1079					
1998.12-	2002.04	MT	L/R	F	Platform/Chassis Engine 8140.43	810013	Outer Joint	54T	28	39	63	112.5	63	I				
1998.12-	2002.04	MT	R	F	Platform/Chassis Engine 8140.43	210104	Drive Shaft	54T	28	37	63	112.5	1072					
1998.12-	2002.04	MT	L	F	Platform/Chassis Engine 8140.43	210067	Drive Shaft		35	41	70	117	762					
1998.12-	2002.04	MT	L	F	Platform/Chassis Engine 8140.43	210033	Drive Shaft	54T	35	41	70	117	762					
1998.12-	2002.04	MT	L/R	F	Platform/Chassis Engine 8140.43	810050	Outer Joint		35	45	70	117	73	I				
1998.12-	2002.04	MT	R	F	Platform/Chassis Engine 8140.43	210069	Drive Shaft		28	37	63	112.5	1072					
1998.12-	2002.04	MT	R	F	Platform/Chassis Engine 8140.43	610009	Inner Joint		41	45	34.9	367.5	115.6					
1999.06-	2002.04	-	-	-	All-wheel Drive Box Engine 8140.43	645013	Inner Joint		37	39	40	68.5	100					
1999.07-	2002.04	MT	L	F	All-wheel Drive Bus Engine 8140.43	210067	Drive Shaft		35	41	70	117	762					
1999.07-	2002.04	MT	L	F	All-wheel Drive Bus Engine 8140.43	210033	Drive Shaft	54T	35	41	70	117	762					
1999.07-	2002.04	MT	R	F	All-wheel Drive Bus Engine 8140.43	210069	Drive Shaft		28	37	63	112.5	1072					
1999.07-	2002.04	MT	L/R	F	All-wheel Drive Bus Engine 8140.43	810050	Outer Joint		35	45	70	117	73	I				
1999.07-	2002.04	MT	L	F	All-wheel Drive Bus Engine 8140.43	210035	Drive Shaft	54T	28	41	63	112.5	757.5					
1999.07-	2002.04	MT	R	F	All-wheel Drive Bus Engine 8140.43	610009	Inner Joint		41	45	34.9	367.5	115.6					
1999.07-	2002.04	MT	L	F	All-wheel Drive Bus Engine 8140.43	610015	Inner Joint		37	39	40	68.5	104					
1999.07-	2002.04	MT	L/R	F	All-wheel Drive Bus Engine 8140.43	810012	Outer Joint		28	39	63	112.5	63	I				
1999.07-	2002.04	MT	L	F	All-wheel Drive Bus Engine 8140.43	210102	Drive Shaft		28	41	63	112.5	757.5					
1999.07-	2002.04	MT	L	F	All-wheel Drive Bus Engine 8140.43	210037	Drive Shaft	54T	28	37	63	112.5	771					
1999.07-	2002.04	-	-	-	All-wheel Drive Bus Engine 8140.43	645013	Inner Joint		37	39	40	68.5	100					
1999.07-	2002.04	MT	R	F	All-wheel Drive Bus Engine 8140.43	210036	Drive Shaft	54T	28	41	63	112.5	1079					
1999.07-	2002.04	MT	R	F	All-wheel Drive Bus Engine 8140.43	210066	Drive Shaft		35	41	70	117	1085					
1999.07-	2002.04	MT	R	F	All-wheel Drive Bus Engine 8140.43	610034	Inner Joint		37	39	31.9	369.5	99					
1999.07-	2002.04	MT	L/R	F	All-wheel Drive Bus Engine 8140.43	810011	Outer Joint	54T	35	45	70	117	73	I				
1999.07-	2002.04	MT	R	F	All-wheel Drive Bus Engine 8140.43	210032	Drive Shaft	54T	35	41	70	117	1085					
1999.07-	2002.04	MT	L	F	All-wheel Drive Bus Engine 8140.43	210105	Drive Shaft		28	37	63	112.5	771					
1999.07-	2002.04	MT	R	F	All-wheel Drive Bus Engine 8140.43	210103	Drive Shaft		28	41	63	112.5	1079					
1999.07-	2002.04	MT	L/R	F	All-wheel Drive Bus Engine 8140.43	810013	Outer Joint	54T	28	39	63	112.5	63	I				
1999.07-	2002.04	MT	R	F	All-wheel Drive Bus Engine 8140.43	210104	Drive Shaft	54T	28	37	63	112.5	1072					
DUCATO (244_)																		
2.0 (81 kW)																		
2002.04-	-	-	L/R	F	Bus Engine RFL	810050	Outer Joint		35	45	70	117	73	I				
2002.04-	-	-	R	F	Box Engine RFL	210066	Drive Shaft		35	41	70	117	1085					
2002.04-	-	-	R	F	Bus Engine RFL	210066	Drive Shaft		35	41	70	117	1085					
2002.04-	-	-	R	F	Box Engine RFL	210032	Drive Shaft	54T	35	41	70	117	1085					
2002.04-	-	-	R	F	Bus Engine RFL	210032	Drive Shaft	54T	35	41	70	117	1085					
2002.04-	-	MT	L/R	F	Bus Engine RFL	810011	Outer Joint	54T	35	45	70	117	73	I				
2002.04-	-	-	L/R	F	Box Engine RFL	817061	Outer Joint	54T	35	29	71.5	127	71	I				
2002.04-	-	-	L/R	F	Bus Engine RFL	817061	Outer Joint	54T	35	29	71.5	127	71	I				
2002.04-	-	-	-	F	Box Engine RFL	810094	Outer Joint	54T	28	27	63.3	116	66.5	I				
2002.04-	-	MT	L/R	F	Box Engine RFL	810011	Outer Joint	54T	35	45	70	117	73	I				
2002.04-	-	-	-	F	Bus Engine RFL	810094	Outer Joint	54T	28	27	63.3	116	66.5	I				
2002.04-	-	-	-	F	Bus Engine RFL	824119	Outer Joint	54T	35	29	71.5	127	71	I				
2002.04-	-	MT	L/R	F	Box Engine RFL	810013	Outer Joint	54T	28	39	63	112.5	63	I				
2002.04-	-	MT	L/R	F	Bus Engine RFL	810013	Outer Joint	54T	28	39	63	112.5	63	I				
2002.04-	2006.07	MT	R	F	Platform/Chassis Engine RFL	210036	Drive Shaft	54T	28	41	63	112.5	1079					
2002.04-	-	-	R	F	Box Engine RFL	610009	Inner Joint		41	45	34.9	367.5	115.6					
2002.04-	-	-	R	F	Bus Engine RFL	610009	Inner Joint		41	45	34.9	367.5	115.6					
2002.04-	-	-	L	F	Box Engine RFL	210067	Drive Shaft		35	41	70	117	762					





YEAR	TRANSM	L/R	F/R	REMARKS	GSP Ref.	PRODUCT	ABS	Technical Specifications										
								A	B	C	H	L	P					
FIAT																		
DUCATO (244_)																		
2.0 (81 kW)	2002.04-	-	-	L F	Bus Engine RFL	210067	Drive Shaft		35	41	70	117	762					
	2002.04-	-	-	L F	Box Engine RFL	210033	Drive Shaft	54T	35	41	70	117	762					
	2002.04-	-	-	L/R F	Box Engine RFL	810050	Outer Joint		35	45	70	117	73	I				
	2002.04-	-	-	L F	Bus Engine RFL	210033	Drive Shaft	54T	35	41	70	117	762					
	2002.05-2006.07	-	-	L F	All-wheel Drive Bus Engine RFL	210033	Drive Shaft	54T	35	41	70	117	762					
	2002.05-2006.07	-	-	L/R F	All-wheel Drive Bus Engine RFL	810050	Outer Joint		35	45	70	117	73	I				
	2002.05-2006.07	-	-	R F	All-wheel Drive Bus Engine RFL	610009	Inner Joint		41	45	34.9	367.5	115.6					
	2002.05-2006.07	-	-	R F	All-wheel Drive Bus Engine RFL	210032	Drive Shaft	54T	35	41	70	117	1085					
	2002.05-2006.07	-	-	L/R F	All-wheel Drive Bus Engine RFL	817061	Outer Joint	54T	35	29	71.5	127	71	I				
	2002.05-2006.07	-	-	R F	All-wheel Drive Bus Engine RFL	210066	Drive Shaft		35	41	70	117	1085					
	2002.05-2006.07	-	-	L/R F	All-wheel Drive Bus Engine RFL	810011	Outer Joint	54T	35	45	70	117	73	I				
	2002.05-2006.07	-	-	L F	All-wheel Drive Bus Engine RFL	210067	Drive Shaft		35	41	70	117	762					
2.0 Bipower (81 kW)	2002.11-	-	-	-	Box Engine RFL	817061	Outer Joint	54T	35	29	71.5	127	71	I				
	2002.11-	-	-	-	Bus Engine RFL	817061	Outer Joint	54T	35	29	71.5	127	71	I				
	2002.11-	-	-	-	Box Engine RFL	810094	Outer Joint	54T	28	27	63.3	116	66.5	I				
	2002.11-	-	-	-	Bus Engine RFL	810094	Outer Joint	54T	28	27	63.3	116	66.5	I				
	2002.11-	-	-	-	Bus Engine RFL	824119	Outer Joint	54T	35	29	71.5	127	71	I				
2.0 JTD (62 kW)	2002.04-2006.07	-	-	R F	Platform/Chassis Engine RHV (DW10)	210069	Drive Shaft		28	37	63	112.5	1072					
	2002.04-	-	-	L F	Box Engine RHV (DW10)	210037	Drive Shaft	54T	28	37	63	112.5	771					
	2002.04-	-	-	L F	Bus Engine RHV (DW10)	210037	Drive Shaft	54T	28	37	63	112.5	771					
	2002.04-2006.07	-	-	L F	Platform/Chassis Engine RHV (DW10)	610015	Inner Joint		37	39	40	68.5	104					
	2002.04-	-	-	R F	Box Engine RHV (DW10)	610034	Inner Joint		37	39	31.9	369.5	99					
	2002.04-	-	-	R F	Bus Engine RHV (DW10)	610034	Inner Joint		37	39	31.9	369.5	99					
	2002.04-	-	-	L F	Box Engine RHV (DW10)	210105	Drive Shaft		28	37	63	112.5	771					
	2002.04-	-	-	L F	Bus Engine RHV (DW10)	210105	Drive Shaft		28	37	63	112.5	771					
	2002.04-	-	-	-	Box Engine RHV (DW10)	817061	Outer Joint	54T	35	29	71.5	127	71	I				
	2002.04-	-	-	-	Bus Engine RHV (DW10)	817061	Outer Joint	54T	35	29	71.5	127	71	I				
	2002.04-	-	-	-	Box Engine RHV (DW10)	810094	Outer Joint	54T	28	27	63.3	116	66.5	I				
	2002.04-	-	-	-	Bus Engine RHV (DW10)	810094	Outer Joint	54T	28	27	63.3	116	66.5	I				
	2002.04-	-	-	-	Box Engine RHV (DW10)	824119	Outer Joint	54T	35	29	71.5	127	71	I				
	2002.04-	-	-	-	Bus Engine RHV (DW10)	824119	Outer Joint	54T	35	29	71.5	127	71	I				
	2002.04-	-	-	MT L/R	Box Engine RHV (DW10)	810013	Outer Joint	54T	28	39	63	112.5	63	I				
	2002.04-2006.07	-	-	L F	Platform/Chassis Engine RHV (DW10)	210037	Drive Shaft	54T	28	37	63	112.5	771					
	2002.04-	-	-	R F	Box Engine RHV (DW10)	210104	Drive Shaft	54T	28	37	63	112.5	1072					
	2002.04-	-	-	R F	Bus Engine RHV (DW10)	210104	Drive Shaft	54T	28	37	63	112.5	1072					
	2002.04-2006.07	-	-	R F	Platform/Chassis Engine RHV (DW10)	610034	Inner Joint		37	39	31.9	369.5	99					
	2002.04-2006.07	-	-	L F	Platform/Chassis Engine RHV (DW10)	210105	Drive Shaft		28	37	63	112.5	771					
	2002.04-	-	-	R F	Box Engine RHV (DW10)	210069	Drive Shaft		28	37	63	112.5	1072					
	2002.04-	-	-	R F	Bus Engine RHV (DW10)	210069	Drive Shaft		28	37	63	112.5	1072					
	2002.04-	-	-	MT L/R	Bus Engine RHV (DW10)	810013	Outer Joint	54T	28	39	63	112.5	63	I				
	2002.04-	-	-	L F	Box Engine RHV (DW10)	610015	Inner Joint		37	39	40	68.5	104					
	2002.04-	-	-	L F	Bus Engine RHV (DW10)	610015	Inner Joint		37	39	40	68.5	104					
	2002.04-2006.07	MT	-	L/R F	Platform/Chassis Engine RHV (DW10)	810013	Outer Joint	54T	28	39	63	112.5	63	I				
	2002.04-2006.07	-	-	R F	Platform/Chassis Engine RHV (DW10)	210104	Drive Shaft	54T	28	37	63	112.5	1072					
2.3 JTD (81 kW)	2002.04-2006.07	-	-	L F	Platform/Chassis Engine F1AE0481C	210033	Drive Shaft	54T	35	41	70	117	762					
	2002.04-	-	-	L/R F	Bus Engine F1AE0481C	810050	Outer Joint		35	45	70	117	73	I				
	2002.04-2006.07	-	-	L/R F	Platform/Chassis Engine F1AE0481C	810050	Outer Joint		35	45	70	117	73	I				
	2002.04-2006.07	-	-	R F	Platform/Chassis Engine F1AE0481C	610009	Inner Joint		41	45	34.9	367.5	115.6					
	2002.04-	-	-	R F	Box Engine F1AE0481C	210066	Drive Shaft		35	41	70	117	1085					
	2002.04-	-	-	R F	Bus Engine F1AE0481C	210066	Drive Shaft		35	41	70	117	1085					
	2002.04-	-	-	R F	Box Engine F1AE0481C	210032	Drive Shaft	54T	35	41	70	117	1085					
	2002.04-	-	-	R F	Bus Engine F1AE0481C	210032	Drive Shaft	54T	35	41	70	117	1085					
	2002.04-2006.07	-	-	R F	Platform/Chassis Engine F1AE0481C	210032	Drive Shaft	54T	35	41	70	117	1085					
	2002.04-2006.07	-	-	L/R F	Platform/Chassis Engine F1AE0481C	817061	Outer Joint	54T	35	29	71.5	127	71	I				
	2002.04-	-	-	L/R F	Box Engine F1AE0481C	817061	Outer Joint	54T	35	29	71.5	127	71	I				
	2002.04-	-	-	L/R F	Bus Engine F1AE0481C	817061	Outer Joint	54T	35	29	71.5	127	71	I				
	2002.04-	-	-	MT R	Bus Engine F1AE0481C	217098	Drive Shaft	54T	35	41	71.5	127	1095					
	2002.04-	-	-	-	Box Engine F1AE0481C	810094	Outer Joint	54T	28	27	63.3	116	66.5	I				
	2002.04-	-	-	MT L/R	Box Engine F1AE0481C	810011	Outer Joint	54T	35	45	70	117	73	I				
	2002.04-	-	-	MT L/R	Bus Engine F1AE0481C	810011	Outer Joint	54T	35	45	70	117	73	I				
	2002.04-	-	-	-	Bus Engine F1AE0481C	810094	Outer Joint	54T	28	27	63.3	116	66.5	I				
	2002.04-	-	-	-	Box Engine F1AE0481C	824119	Outer Joint	54T	35	29	71.5	127	71	I				
	2002.04-	-	-	MT L/R	Box Engine F1AE0481C	810013	Outer Joint	54T	28	39	63	112.5	63	I				
	2002.04-	-	-	MT L/R	Bus Engine F1AE0481C	810013	Outer Joint	54T	28	39	63	112.5	63	I				
	2002.04-2006.07	-	-	R F	Platform/Chassis Engine F1AE0481C	210066	Drive Shaft		35	41	70	117	1085					
	2002.04-2006.07	MT	-	L/R F	Platform/Chassis Engine F1AE0481C	810011	Outer Joint	54T	35	45	70	117	73	I				





YEAR	TRANSM	L/R	F/R	REMARKS	GSP Ref.	PRODUCT	ABS	Technical Specifications										
								A	B	C	H	L	P					
FIAT																		
DUCATO (244_)																		
2.3 JTD (81 kW)	2002.04-	-	-	R F	Box Engine F1AE0481C	610009	Inner Joint		41	45	34.9	367.5	115.6					
	2002.04-	-	-	R F	Bus Engine F1AE0481C	610009	Inner Joint		41	45	34.9	367.5	115.6					
	2002.04-	2006.07	MT	L/R	F Platform/Chassis Engine F1AE0481C	810013	Outer Joint	54T	28	39	63	112.5	63	I				
	2002.04-	-	-	L F	Box Engine F1AE0481C	210067	Drive Shaft		35	41	70	117	762					
	2002.04-	-	-	L F	Bus Engine F1AE0481C	210067	Drive Shaft		35	41	70	117	762					
	2002.04-	2006.07	-	L F	Platform/Chassis Engine F1AE0481C	210067	Drive Shaft		35	41	70	117	762					
	2002.04-	-	-	L F	Box Engine F1AE0481C	210033	Drive Shaft	54T	35	41	70	117	762					
	2002.04-	-	-	L/R	F Box Engine F1AE0481C	810050	Outer Joint		35	45	70	117	73	I				
	2002.04-	-	-	L F	Bus Engine F1AE0481C	210033	Drive Shaft	54T	35	41	70	117	762					
2.8 JTD (107 kW)	2004.04-	2006.07	-	L/R	F Bus Engine 8140.43N	817061	Outer Joint	54T	35	29	71.5	127	71	I				
2.8 JTD (94 kW)	2002.04-	2006.07	MT	L F	Platform/Chassis Engine 8140.43S	210033	Drive Shaft	54T	35	41	70	117	762					
	2002.04-	-	-	L/R	F Bus Engine 8140.43S	810050	Outer Joint		35	45	70	117	73	I				
	2002.04-	2006.07	-	L/R	F Platform/Chassis Engine 8140.43S	810050	Outer Joint		35	45	70	117	73	I				
	2002.04-	-	-	AT/MT	R F Bus Engine 8140.43S	610009	Inner Joint		41	45	34.9	367.5	115.6					
	2002.04-	2006.07	AT/MT	R F	Platform/Chassis Engine 8140.43S	610009	Inner Joint		41	45	34.9	367.5	115.6					
	2002.04-	-	-	AT/MT	R F Box Engine 8140.43S	210066	Drive Shaft		35	41	70	117	1085					
	2002.04-	-	-	AT/MT	R F Box Engine 8140.43S	210032	Drive Shaft	54T	35	41	70	117	1085					
	2002.04-	-	-	AT/MT	R F Bus Engine 8140.43S	210032	Drive Shaft	54T	35	41	70	117	1085					
	2002.04-	2006.07	AT/MT	R F	Platform/Chassis Engine 8140.43S	210032	Drive Shaft	54T	35	41	70	117	1085					
	2002.04-	2006.07	-	L/R	F Platform/Chassis Engine 8140.43S	817061	Outer Joint	54T	35	29	71.5	127	71	I				
	2002.04-	-	-	L/R	F Box Engine 8140.43S	817061	Outer Joint	54T	35	29	71.5	127	71	I				
	2002.04-	-	-	L/R	F Bus Engine 8140.43S	817061	Outer Joint	54T	35	29	71.5	127	71	I				
	2002.04-	-	-	MT	R F Bus Engine 8140.43S	217098	Drive Shaft	54T	35	41	71.5	127	1095					
	2002.04-	-	-	-	F Box Engine 8140.43S	810094	Outer Joint	54T	28	27	63.3	116	66.5	I				
	2002.04-	-	-	MT	L/R F Box Engine 8140.43S	810011	Outer Joint	54T	35	45	70	117	73	I				
	2002.04-	-	-	-	F Bus Engine 8140.43S	810094	Outer Joint	54T	28	27	63.3	116	66.5	I				
	2002.04-	-	-	MT	L/R F Box Engine 8140.43S	810013	Outer Joint	54T	28	39	63	112.5	63	I				
	2002.04-	-	-	AT/MT	R F Bus Engine 8140.43S	210066	Drive Shaft		35	41	70	117	1085					
	2002.04-	2006.07	AT/MT	R F	Platform/Chassis Engine 8140.43S	210066	Drive Shaft		35	41	70	117	1085					
	2002.04-	-	-	MT	L/R F Bus Engine 8140.43S	810011	Outer Joint	54T	35	45	70	117	73	I				
	2002.04-	2006.07	MT	L/R	F Platform/Chassis Engine 8140.43S	810011	Outer Joint	54T	35	45	70	117	73	I				
	2002.04-	-	-	AT/MT	R F Box Engine 8140.43S	610009	Inner Joint		41	45	34.9	367.5	115.6					
	2002.04-	-	-	MT	L/R F Bus Engine 8140.43S	810013	Outer Joint	54T	28	39	63	112.5	63	I				
	2002.04-	2006.07	MT	L/R	F Platform/Chassis Engine 8140.43S	810013	Outer Joint	54T	28	39	63	112.5	63	I				
	2002.04-	-	-	MT	L F Box Engine 8140.43S	210067	Drive Shaft		35	41	70	117	762					
	2002.04-	-	-	MT	L F Bus Engine 8140.43S	210067	Drive Shaft		35	41	70	117	762					
	2002.04-	2006.07	MT	L F	Platform/Chassis Engine 8140.43S	210067	Drive Shaft		35	41	70	117	762					
	2002.04-	-	-	MT	L F Box Engine 8140.43S	210033	Drive Shaft	54T	35	41	70	117	762					
	2002.04-	-	-	L/R	F Box Engine 8140.43S	810050	Outer Joint		35	45	70	117	73	I				
	2002.04-	-	-	MT	L F Bus Engine 8140.43S	210033	Drive Shaft	54T	35	41	70	117	762					
	2002.07-	-	-	L F	All-wheel Drive Bus Engine 8140.43S	210033	Drive Shaft	54T	35	41	70	117	762					
	2002.07-	-	-	L F	All-wheel Drive Box Engine 8140.43S	210033	Drive Shaft	54T	35	41	70	117	762					
	2002.07-	-	-	L/R	F All-wheel Drive Bus Engine 8140.43S	810050	Outer Joint		35	45	70	117	73	I				
	2002.07-	-	-	L/R	F All-wheel Drive Box Engine 8140.43S	810050	Outer Joint		35	45	70	117	73	I				
	2002.07-	-	-	R F	All-wheel Drive Bus Engine 8140.43S	610009	Inner Joint		41	45	34.9	367.5	115.6					
	2002.07-	-	-	R F	All-wheel Drive Box Engine 8140.43S	610009	Inner Joint		41	45	34.9	367.5	115.6					
	2002.07-	-	-	R F	All-wheel Drive Box Engine 8140.43S	210032	Drive Shaft	54T	35	41	70	117	1085					
	2002.07-	-	-	L/R	F All-wheel Drive Bus Engine 8140.43S	817061	Outer Joint	54T	35	29	71.5	127	71	I				
	2002.07-	-	-	L/R	F All-wheel Drive Box Engine 8140.43S	817061	Outer Joint	54T	35	29	71.5	127	71	I				
	2002.07-	-	-	R F	All-wheel Drive Bus Engine 8140.43S	210066	Drive Shaft		35	41	70	117	1085					
	2002.07-	-	-	R F	All-wheel Drive Box Engine 8140.43S	210066	Drive Shaft		35	41	70	117	1085					
	2002.07-	-	-	R F	All-wheel Drive Bus Engine 8140.43S	210032	Drive Shaft	54T	35	41	70	117	1085					
	2002.07-	-	-	L/R	F All-wheel Drive Bus Engine 8140.43S	810011	Outer Joint	54T	35	45	70	117	73	I				
	2002.07-	-	-	L/R	F All-wheel Drive Box Engine 8140.43S	810011	Outer Joint	54T	35	45	70	117	73	I				
	2002.07-	-	-	MT	L/R F All-wheel Drive Box Engine 8140.43S	810013	Outer Joint	54T	28	39	63	112.5	63	I				
	2002.07-	-	-	L F	All-wheel Drive Bus Engine 8140.43S	210067	Drive Shaft		35	41	70	117	762					
	2002.07-	-	-	L F	All-wheel Drive Box Engine 8140.43S	210067	Drive Shaft		35	41	70	117	762					
	2002.10-	2006.07	-	L F	All-wheel Drive Platform/Chassis Engine 8140.43S	210033	Drive Shaft	54T	35	41	70	117	762					
	2002.10-	2006.07	-	L/R	F All-wheel Drive Platform/Chassis Engine 8140.43S	810050	Outer Joint		35	45	70	117	73	I				
	2002.10-	2006.07	-	R F	All-wheel Drive Platform/Chassis Engine 8140.43S	610009	Inner Joint		41	45	34.9	367.5	115.6					
	2002.10-	2006.07	-	R F	All-wheel Drive Platform/Chassis Engine 8140.43S	210032	Drive Shaft	54T	35	41	70	117	1085					
	2002.10-	2006.07	-	L/R	F All-wheel Drive Platform/Chassis Engine 8140.43S	817061	Outer Joint	54T	35	29	71.5	127	71	I				
	2002.10-	2006.07	-	R F	All-wheel Drive Platform/Chassis Engine 8140.43S	210066	Drive Shaft		35	41	70	117	1085					
	2002.10-	2006.07	-	L/R	F All-wheel Drive Platform/Chassis Engine 8140.43S	810011	Outer Joint	54T	35	45	70	117	73	I				
	2002.10-	2006.07	MT	L/R	F All-wheel Drive Platform/Chassis Engine 8140.43S	810013	Outer Joint	54T	28	39	63	112.5	63	I				
	2002.10-	2006.07	-	L F	All-wheel Drive Platform/Chassis Engine 8140.43S	210067	Drive Shaft		35	41	70	117	762					





YEAR	TRANSM	L/R	F/R	REMARKS	GSP Ref.	PRODUCT	ABS	Technical Specifications									
								A	B	C	H	L	P				
FIAT																	
DUCATO (244_)																	
2.8 JTD Power (107 kW)	2004.05-	-	-	L/R	F	Box Engine 8140.43N	817061	Outer Joint	54T	35	29	71.5	127	71	I		
	2004.05-	-	-	-	F	Box Engine 8140.43N	810094	Outer Joint	54T	28	27	63.3	116	66.5	I		
DUCATO (250_ 290_)																	
115 Multijet 2,0 D (85 kW)	2011.06-	-	-	AT	R	F	Bus Engine 250 A1.000/250 A2.000	217050	Drive Shaft		35	41	71.5	127	1140		
	2011.06-	-	-	AT	R	F	Box Engine 250 A1.000/250 A2.000	217050	Drive Shaft		35	41	71.5	127	1140		
	2011.06-	-	-	AT	L/R	F	Bus Engine 250 A1.000/250 A2.000	817045	Outer Joint		35	29	71.5	127	71	M	
	2011.06-	-	-	AT	L/R	F	Box Engine 250 A1.000/250 A2.000	817045	Outer Joint		35	29	71.5	127	71	M	
	2011.06-	-	-	AT	L	F	Bus Engine 250 A1.000/250 A2.000	217053	Drive Shaft		35	41	71.5	127	806		
	2011.06-	-	-	AT	L	F	Box Engine 250 A1.000/250 A2.000	217053	Drive Shaft		35	41	71.5	127	806		
	2011.06-	-	-	MT	L/R	F	Bus Engine 250 A1.000/250 A2.000	817060	Outer Joint		35	29	71.5	127	71	I	
	2011.06-	-	-	MT	L/R	F	Box Engine 250 A1.000/250 A2.000	817060	Outer Joint		35	29	71.5	127	71	I	
130 Multijet 2,3 D (93 kW)	2010.01-	-	-	MT	L	F	Bus Engine F1AE0481T	245176	Drive Shaft		35	41	71.5	127	808		
140 Natural Power (100 kW)	2009.04-	-	-	MT	L/R	F	Box Engine F1CFA401A/F1CF0441A	817060	Outer Joint		35	29	71.5	127	71	I	
	2009.04-	-	-	-	L/R	F	Bus Engine F1CE0441A/F1CFA401A	817060	Outer Joint		35	29	71.5	127	71	I	
150 Multijet 2,3 D (109 kW)	2011.06-	-	-	-	R	F	Bus Engine F1AE3481E	217050	Drive Shaft		35	41	71.5	127	1140		
	2011.06-	-	-	MT	L	F	Bus Engine F1AE3481E	617042	Inner Joint		41	27	43	70	102		
	2011.06-	-	-	MT	R	F	Bus Engine F1AE3481E	610038	Inner Joint		41	27	34.85	403	102		
	2011.06-	-	-	MT	L	F	Bus Engine F1AE3481E	245176	Drive Shaft		35	41	71.5	127	808		
	2011.06-	-	-	MT	L	F	Box Engine F1AE3481E	245176	Drive Shaft		35	41	71.5	127	808		
	2011.06-	-	-	-	L/R	F	Bus Engine F1AE3481E	817045	Outer Joint		35	29	71.5	127	71	M	
	2011.06-	-	-	AT/MT	L/R	F	Bus Engine F1AE3481E	817060	Outer Joint		35	29	71.5	127	71	I	
	2011.06-	-	-	-	L	F	Bus Engine F1AE3481E	217053	Drive Shaft		35	41	71.5	127	806		
	2011.06-	-	-	AT/MT	L/R	F	Box Engine F1AE3481E	817060	Outer Joint		35	29	71.5	127	71	I	
150 Multijet 2,3 D (110 kW)	2015.04-	-	-	6MT	R	F	Bus Engine F1AGL411A/F1AGL411C	217050	Drive Shaft		35	41	71.5	127	1140		
	2015.04-	-	-	6MT	L/R	F	Bus Engine F1AGL411A/F1AGL411C	817045	Outer Joint		35	29	71.5	127	71	M	
	2015.04-	-	-	6MT	L/R	F	Bus Engine F1AGL411A/F1AGL411C	817060	Outer Joint		35	29	71.5	127	71	I	
	2015.04-	-	-	6MT	L	F	Bus Engine F1AGL411A/F1AGL411C	217053	Drive Shaft		35	41	71.5	127	806		
	2015.12-	-	-	-	L/R	F	Box Engine F1AGL411C/F1AGL411A	817060	Outer Joint		35	29	71.5	127	71	I	
	2015.12-	-	-	-	L/R	F	Platform/Chassis Engine F1AGL411C	817060	Outer Joint		35	29	71.5	127	71	I	
150 Multijet 3.0 D (107 kW)	2010.04-	-	-	MT	L	F	Box Engine F1CE3481N	245175	Drive Shaft		35	31	71.5	127	749.5		
	2010.04-	-	-	MT	L	F	Platform/Chassis Engine F1CE3481N	245175	Drive Shaft		35	31	71.5	127	749.5		
	2010.04-	-	-	MT	R	F	Box Engine F1CE3481N	245174	Drive Shaft		35	31	71.5	127	1199		
	2010.04-	-	-	MT	R	F	Platform/Chassis Engine F1CE3481N	245174	Drive Shaft		35	31	71.5	127	1199		
	2010.04-	-	-	-	L/R	F	Box Engine F1CE3481N	817060	Outer Joint		35	29	71.5	127	71	I	
	2010.04-	-	-	-	L/R	F	Bus Engine F1CE3481N	817060	Outer Joint		35	29	71.5	127	71	I	
	2010.04-	-	-	-	L/R	F	Platform/Chassis Engine F1CE3481N	817060	Outer Joint		35	29	71.5	127	71	I	
180 Multijet 2,3 D (130 kW)	2015.12-	-	-	-	L/R	F	Platform/Chassis Engine F1AGL411B	817060	Outer Joint		35	29	71.5	127	71	I	
	2015.12-	-	-	-	L/R	F	Box Engine F1AGL411B	817060	Outer Joint		35	29	71.5	127	71	I	
180 Multijet 3.0 D (130 kW)	2011.06-	-	-	MT	L	F	Box Engine F1CE3481E	245175	Drive Shaft		35	31	71.5	127	749.5		
	2011.06-	-	-	-	L	F	Platform/Chassis Engine F1CE3481E	245175	Drive Shaft		35	31	71.5	127	749.5		
	2011.06-	-	-	AT/MT	L/R	F	Bus Engine F1CE3481E	817060	Outer Joint		35	29	71.5	127	71	I	
	2011.06-	-	-	AT/MT	L/R	F	Platform/Chassis Engine F1CE3481E	817060	Outer Joint		35	29	71.5	127	71	I	
	2011.06-	-	-	MT	R	F	Bus Engine F1CE3481E	245174	Drive Shaft		35	31	71.5	127	1199		
	2011.06-	-	-	-	R	F	Platform/Chassis Engine F1CE3481E	245174	Drive Shaft		35	31	71.5	127	1199		
2.0 D (85 kW)	2011.06-	-	-	AT	R	F	Platform/Chassis Engine 250 A1.000/250 A2.000	217050	Drive Shaft		35	41	71.5	127	1140		
	2011.06-	-	-	AT	L/R	F	Platform/Chassis Engine 250 A1.000/250 A2.000	817045	Outer Joint		35	29	71.5	127	71	M	
	2011.06-	-	-	AT	L	F	Platform/Chassis Engine 250 A1.000/250 A2.000	217053	Drive Shaft		35	41	71.5	127	806		
	2011.06-	-	-	AT/MT	L/R	F	Platform/Chassis Engine 250 A1.000/250 A2.000	817060	Outer Joint		35	29	71.5	127	71	I	
2.2 D (74 kW)	2006.07-	-	-	-	L/R	F	Bus Engine 4HV	817060	Outer Joint		35	29	71.5	127	71	I	
	2006.07-	-	-	5MT	L/R	F	Bus Engine 4HV	817055	Outer Joint		35	27	71.5	127	66.5	I	
	2006.07-	-	-	5MT	L/R	F	Box Engine 4HV	817055	Outer Joint		35	27	71.5	127	66.5	I	
	2006.07-	-	-	5MT	L/R	F	Platform/Chassis Engine 4HV	817055	Outer Joint		35	27	71.5	127	66.5	I	
	2006.07-	-	-	-	R	F	Box Engine 4HV	217050	Drive Shaft		35	41	71.5	127	1140		
	2006.07-	-	-	-	R	F	Platform/Chassis Engine 4HV	217050	Drive Shaft		35	41	71.5	127	1140		
	2006.07-	-	-	5MT	L	F	Bus Engine 4HV	617028	Inner Joint		41	29	43	69.5	109.5		
	2006.07-	-	-	5MT	L	F	Box Engine 4HV	617028	Inner Joint		41	29	43	69.5	109.5		
	2006.07-	-	-	-	R	F	Bus Engine 4HV	217050	Drive Shaft		35	41	71.5	127	1140		
	2006.07-	-	-	5MT	L	F	Platform/Chassis Engine 4HV	617028	Inner Joint		41	29	43	69.5	109.5		
	2006.07-	-	-	5MT	R	F	Bus Engine 4HV	617020	Inner Joint		41	29	34.85	403	109		
	2006.07-	-	-	5MT	R	F	Box Engine 4HV	617020	Inner Joint		41	29	34.85	403	109		
	2006.07-	-	-	5MT	R	F	Platform/Chassis Engine 4HV	617020	Inner Joint		41	29	34.85	403	109		
	2006.07-	-	-	5MT	L	F	Bus Engine 4HV	617042	Inner Joint		41	27	43	70	102		
	2006.07-	-	-	5MT	L/R	F	Box Engine 4HV	617042	Inner Joint		41	27	43	70	102		
	2006.07-	-	-	5MT	L/R	F	Platform/Chassis Engine 4HV	617042	Inner Joint		41	27	43	70	102		
	2006.07-	-	-	5MT	R	F	Bus Engine 4HV	610038	Inner Joint		41	27	34.85	403	102		
	2006.07-	-	-	5MT	L/R	F	Box Engine 4HV	610038	Inner Joint		41	27	34.85	403	102		





YEAR	TRANSM	L/R	F/R	REMARKS	GSP Ref.	PRODUCT	ABS	Technical Specifications							
								A	B	C	H	L	P		
FIAT															
DUCATO (250_290_)															
2.2 D (74 kW)	2006.07-	-	5MT	L/R	F	Platform/Chassis Engine 4HV	610038	Inner Joint	41	27	34.85	403	102		
	2006.07-	-	-	L	F	Bus Engine 4HV	617022	Inner Joint	31	29	44.95	77	109.5		
	2006.07-	-	MT	L	F	Bus Engine 4HV	245176	Drive Shaft	35	41	71.5	127	808		
	2006.07-	-	MT	L	F	Box Engine 4HV	245176	Drive Shaft	35	41	71.5	127	808		
	2006.07-	-	MT	L	F	Platform/Chassis Engine 4HV	245176	Drive Shaft	35	41	71.5	127	808		
	2006.07-	-	5MT	L/R	F	Bus Engine 4HV	817045	Outer Joint	35	29	71.5	127	71	M	
	2006.07-	-	5MT	L/R	F	Box Engine 4HV	817045	Outer Joint	35	29	71.5	127	71	M	
	2006.07-	-	5MT	L/R	F	Platform/Chassis Engine 4HV	817045	Outer Joint	35	29	71.5	127	71	M	
	2006.07-	-	-	L	F	Box Engine 4HV	217053	Drive Shaft	35	41	71.5	127	806		
	2006.07-	-	-	L	F	Platform/Chassis Engine 4HV	217053	Drive Shaft	35	41	71.5	127	806		
	2006.07-	-	-	L	F	Bus Engine 4HV	217053	Drive Shaft	35	41	71.5	127	806		
2.3 D (109 kW)	2011.06-	-	AT/MT	L/R	F	Platform/Chassis Engine F1AE3481E	817060	Outer Joint	35	29	71.5	127	71	I	
2.3 D (115 kW)	2006.07-	2011.12	6MT	L	F	Box Engine F1CE3481M	617022	Inner Joint	31	29	44.95	77	109.5		
	2006.07-	2011.12	6MT	R	F	Box Engine F1CE3481M	617021	Inner Joint	31	29	34.85	530	109		
	2006.07-	2011.12	MT	L	F	Box Engine F1CE3481M	245175	Drive Shaft	35	31	71.5	127	749.5		
	2006.07-	2011.12	MT	R	F	Box Engine F1CE3481M	245174	Drive Shaft	35	31	71.5	127	1199		
	2006.07-	2011.12	MT	L/R	F	Box Engine F1CE3481M	817060	Outer Joint	35	29	71.5	127	71	I	
2.3 D (83 kW)	2011.10-	-	-	L	F	Bus Engine F1AE3481G	617042	Inner Joint	41	27	43	70	102		
	2011.10-	-	-	L	F	Box Engine F1AE3481G	617042	Inner Joint	41	27	43	70	102		
	2011.10-	-	-	L	F	Platform/Chassis Engine F1AE3481G	617042	Inner Joint	41	27	43	70	102		
	2011.10-	-	-	R	F	Bus Engine F1AE3481G	610038	Inner Joint	41	27	34.85	403	102		
	2011.10-	-	-	R	F	Box Engine F1AE3481G	610038	Inner Joint	41	27	34.85	403	102		
	2011.10-	-	-	R	F	Platform/Chassis Engine F1AE3481G	610038	Inner Joint	41	27	34.85	403	102		
	2011.10-	-	MT	L	F	Bus Engine F1AE3481G	245176	Drive Shaft	35	41	71.5	127	808		
	2011.10-	-	MT	L	F	Box Engine F1AE3481G	245176	Drive Shaft	35	41	71.5	127	808		
	2011.10-	-	MT	L	F	Platform/Chassis Engine F1AE3481G	245176	Drive Shaft	35	41	71.5	127	808		
2.3 D (88 kW)	2006.07-	-	5MT	L/R	F	Box Engine FPT/F1AE0481D	817055	Outer Joint	35	27	71.5	127	66.5	I	
	2006.07-	-	5MT	L/R	F	Bus Engine F1AE0481D	817055	Outer Joint	35	27	71.5	127	66.5	I	
	2006.07-	-	-	R	F	Bus Engine F1AE0481D	217050	Drive Shaft	35	41	71.5	127	1140		
	2006.07-	-	5MT	L/R	F	Platform/Chassis Engine F1AE0481D	817055	Outer Joint	35	27	71.5	127	66.5	I	
	2006.07-	-	-	R	F	Box Engine FPT/F1AE0481D	217050	Drive Shaft	35	41	71.5	127	1140		
	2006.07-	-	-	R	F	Platform/Chassis Engine F1AE0481D	217050	Drive Shaft	35	41	71.5	127	1140		
	2006.07-	-	5MT	L	F	Box Engine FPT/F1AE0481D	617028	Inner Joint	41	29	43	69.5	109.5		
	2006.07-	-	5MT	L	F	Bus Engine F1AE0481D	617028	Inner Joint	41	29	43	69.5	109.5		
	2006.07-	-	5MT	L	F	Platform/Chassis Engine F1AE0481D	617028	Inner Joint	41	29	43	69.5	109.5		
	2006.07-	-	5MT	R	F	Box Engine FPT/F1AE0481D	617020	Inner Joint	41	29	34.85	403	109		
	2006.07-	-	5MT	R	F	Bus Engine F1AE0481D	617020	Inner Joint	41	29	34.85	403	109		
	2006.07-	-	5MT	R	F	Platform/Chassis Engine F1AE0481D	617020	Inner Joint	41	29	34.85	403	109		
	2006.07-	-	5MT	L/R	F	Platform/Chassis Engine F1AE0481D	617042	Inner Joint	41	27	43	70	102		
	2006.07-	-	5MT	L	F	Box Engine FPT/F1AE0481D	617042	Inner Joint	41	27	43	70	102		
	2006.07-	-	5MT	L	F	Bus Engine F1AE0481D	617042	Inner Joint	41	27	43	70	102		
	2006.07-	-	5MT	R	F	Box Engine FPT/F1AE0481D	610038	Inner Joint	41	27	34.85	403	102		
	2006.07-	-	5MT	R	F	Bus Engine F1AE0481D	610038	Inner Joint	41	27	34.85	403	102		
	2006.07-	-	5MT	L/R	F	Platform/Chassis Engine F1AE0481D	610038	Inner Joint	41	27	34.85	403	102		
	2006.07-	-	MT	L	F	Bus Engine F1AE0481D	245176	Drive Shaft	35	41	71.5	127	808		
	2006.07-	-	MT	L	F	Box Engine FPT/F1AE0481D	245176	Drive Shaft	35	41	71.5	127	808		
	2006.07-	-	-	L	F	Platform/Chassis Engine F1AE0481D	245176	Drive Shaft	35	41	71.5	127	808		
	2006.07-	-	5MT	L/R	F	Box Engine FPT/F1AE0481D	817045	Outer Joint	35	29	71.5	127	71	M	
	2006.07-	-	5MT	L/R	F	Bus Engine F1AE0481D	817045	Outer Joint	35	29	71.5	127	71	M	
	2006.07-	-	5MT	L/R	F	Platform/Chassis Engine F1AE0481D	817045	Outer Joint	35	29	71.5	127	71	M	
	2006.07-	-	-	L	F	Box Engine FPT/F1AE0481D	217053	Drive Shaft	35	41	71.5	127	806		
	2006.07-	-	-	L	F	Bus Engine F1AE0481D	217053	Drive Shaft	35	41	71.5	127	806		
	2006.07-	-	-	L	F	Platform/Chassis Engine F1AE0481D	217053	Drive Shaft	35	41	71.5	127	806		
	2010.03-	-	MT	L	F	All-wheel Drive Platform/Chassis Engine F1AE0481D	245176	Drive Shaft	35	41	71.5	127	808		
2.3 D (93 kW)	2006.08-	-	-	R	F	Platform/Chassis Engine F1AE0481T	217050	Drive Shaft	35	41	71.5	127	1140		
	2006.08-	-	-	R	F	Box Engine F1AE0481T	217050	Drive Shaft	35	41	71.5	127	1140		
	2006.08-	-	MT	L	F	Platform/Chassis Engine F1AE0481T	245176	Drive Shaft	35	41	71.5	127	808		
	2006.08-	-	-	L/R	F	Platform/Chassis Engine F1AE0481T	817045	Outer Joint	35	29	71.5	127	71	M	
	2006.08-	-	-	L/R	F	Box Engine F1AE0481T	817045	Outer Joint	35	29	71.5	127	71	M	
	2006.08-	-	-	L	F	Platform/Chassis Engine F1AE0481T	217053	Drive Shaft	35	41	71.5	127	806		
	2006.08-	-	-	L	F	Box Engine F1AE0481T	217053	Drive Shaft	35	41	71.5	127	806		
2.3 D (96 kW)	2011.03-	-	AT/MT	R	F	Bus Engine F1AGL411M/F1AE3481D/F1AE0481D/F1AGL411M	217050	Drive Shaft	35	41	71.5	127	1140		
	2011.03-	-	AT/MT	R	F	Box Engine F1AGL411D/F1AE0481N/F1AGL411D	217050	Drive Shaft	35	41	71.5	127	1140		
	2011.03-	-	AT/MT	R	F	Platform/Chassis Engine F1AE0481N/F1AE3481D/F1AGL411D	217050	Drive Shaft	35	41	71.5	127	1140		
	2011.03-	-	MT	L	F	Bus Engine F1AGL411M/F1AE3481D/F1AE0481D/F1AGL411M	617042	Inner Joint	41	27	43	70	102		
	2011.03-	-	MT	L	F	Box Engine F1AGL411D/F1AE0481N/F1AGL411D	617042	Inner Joint	41	27	43	70	102		

YEAR	TRANSM	L/R	F/R	REMARKS	GSP Ref.	PRODUCT	ABS	Technical Specifications						
								A	B	C	H	L	P	
FIAT														
DUCATO (250_ 290_)														
2.3 D (96 kW)	2011.03.-	-	MT	L F	Platform/Chassis Engine F1AE0481N/F1AE3481D/F1AGL411D	617042	Inner Joint	41	27	43	70	102		
	2011.03.-	-	MT	R F	Bus Engine F1AGL411M/F1AE3481D/F1AE0481D/F1AGL411M	610038	Inner Joint	41	27	34.85	403	102		
	2011.03.-	-	MT	R F	Box Engine F1AGL411D/F1AE0481N/F1AGL411D	610038	Inner Joint	41	27	34.85	403	102		
	2011.03.-	-	MT	R F	Platform/Chassis Engine F1AE0481N/F1AE3481D/F1AGL411D	610038	Inner Joint	41	27	34.85	403	102		
	2011.03.-	-	-	L F	Platform/Chassis Engine F1AE0481N/F1AE3481D/F1AGL411D	245176	Drive Shaft	35	41	71.5	127	808		
	2011.03.-	-	MT	L F	Bus Engine F1AGL411M/F1AE3481D/F1AE0481D/F1AGL411M	245176	Drive Shaft	35	41	71.5	127	808		
	2011.03.-	-	MT	L F	Box Engine F1AGL411D/F1AE0481N/F1AGL411D	245176	Drive Shaft	35	41	71.5	127	808		
	2011.03.-	-	AT/MT	L/R F	Bus Engine F1AGL411M/F1AE3481D/F1AE0481D/F1AGL411M	817045	Outer Joint	35	29	71.5	127	71	M	
	2011.03.-	-	AT/MT	L/R F	Box Engine F1AGL411D/F1AE0481N/F1AGL411D	817045	Outer Joint	35	29	71.5	127	71	M	
	2011.03.-	-	AT/MT	L/R F	Platform/Chassis Engine F1AE0481N/F1AE3481D/F1AGL411D	817045	Outer Joint	35	29	71.5	127	71	M	
	2011.03.-	-	AT/MT	L F	Bus Engine F1AGL411M/F1AE3481D/F1AE0481D/F1AGL411M	217053	Drive Shaft	35	41	71.5	127	806		
	2011.03.-	-	AT/MT	L F	Box Engine F1AGL411D/F1AE0481N/F1AGL411D	217053	Drive Shaft	35	41	71.5	127	806		
	2011.03.-	-	AT/MT	L F	Platform/Chassis Engine F1AE0481N/F1AE3481D/F1AGL411D	217053	Drive Shaft	35	41	71.5	127	806		
	2011.03.-	-	AT	L/R F	Bus Engine F1AGL411M/F1AE3481D/F1AE0481D/F1AGL411M	817060	Outer Joint	35	29	71.5	127	71	I	
	2011.03.-	-	AT	L/R F	Box Engine F1AGL411D/F1AE0481N/F1AGL411D	817060	Outer Joint	35	29	71.5	127	71	I	
	2011.03.-	-	AT	L/R F	Platform/Chassis Engine F1AE0481N/F1AE3481D/F1AGL411D	817060	Outer Joint	35	29	71.5	127	71	I	
3.0 D (115 kW)	2006.07.-	2011.12	6MT	L F	Platform/Chassis Engine F1CE3481M	617022	Inner Joint	31	29	44.95	77	109.5		
	2006.07.-	2011.12	6MT	R F	Platform/Chassis Engine F1CE3481M	617021	Inner Joint	31	29	34.85	530	109		
	2006.07.-	2011.12	MT	L F	Platform/Chassis Engine F1CE3481M	245175	Drive Shaft	35	31	71.5	127	749.5		
	2006.07.-	2011.12	MT	R F	Platform/Chassis Engine F1CE3481M	245174	Drive Shaft	35	31	71.5	127	1199		
	2006.07.-	2011.12	MT	L/R F	Platform/Chassis Engine F1CE3481M	817060	Outer Joint	35	29	71.5	127	71	I	
	2006.10.-	-	6MT	L F	Bus Engine F1CE0481D	617022	Inner Joint	31	29	44.95	77	109.5		
	2006.10.-	-	6MT	R F	Bus Engine F1CE0481D	617021	Inner Joint	31	29	34.85	530	109		
	2006.10.-	-	6MT	L/R F	Bus Engine F1CE0481D	817060	Outer Joint	35	29	71.5	127	71	I	
3.0 D (116 kW)	2006.07.-	-	MT	L/R F	Bus Engine F1CE3481M/F1CE0481D	817060	Outer Joint	35	29	71.5	127	71	I	
	2006.07.-	-	MT	L F	Bus Engine F1CE3481M/F1CE0481D	617022	Inner Joint	31	29	44.95	77	109.5		
	2006.07.-	-	MT	L F	Bus Engine F1CE3481M/F1CE0481D	245175	Drive Shaft	35	31	71.5	127	749.5		
	2006.07.-	-	MT	L F	Box Engine F1CE0481D	245175	Drive Shaft	35	31	71.5	127	749.5		
	2006.07.-	-	MT	L F	Platform/Chassis Engine F1CE0481D	245175	Drive Shaft	35	31	71.5	127	749.5		
	2006.07.-	-	-	R F	Bus Engine F1CE3481M/F1CE0481D	245174	Drive Shaft	35	31	71.5	127	1199		
	2006.07.-	-	-	R F	Box Engine F1CE0481D	245174	Drive Shaft	35	31	71.5	127	1199		
	2006.07.-	-	-	R F	Platform/Chassis Engine F1CE0481D	245174	Drive Shaft	35	31	71.5	127	1199		
	2006.07.-	-	MT	L/R F	Box Engine F1CE0481D	817060	Outer Joint	35	29	71.5	127	71	I	
	2006.07.-	-	MT	L/R F	Platform/Chassis Engine F1CE0481D	817060	Outer Joint	35	29	71.5	127	71	I	
3.0 D (130 kW)	2011.06.-	-	MT	L F	Box Engine F1CE3481E	245175	Drive Shaft	35	31	71.5	127	749.5		
	2011.06.-	-	MT	R F	Box Engine F1CE3481E	245174	Drive Shaft	35	31	71.5	127	1199		
	2011.06.-	-	AT/MT	L/R F	Box Engine F1CE3481E	817060	Outer Joint	35	29	71.5	127	71	I	
DUCATO (250_ 290_)														
110 Multijet 2,3 D(82 kW)	2006.08.-	-	6MT	R F	Platform/Chassis Engine F1AE3481G	217050	Drive Shaft	35	41	71.5	127	1140		
	2006.08.-	-	6MT	L/R F	Platform/Chassis Engine F1AE3481G	817045	Outer Joint	35	29	71.5	127	71	M	
	2006.08.-	-	6MT	L F	Platform/Chassis Engine F1AE3481G	217053	Drive Shaft	35	41	71.5	127	806		
	2014.05.-	-	6MT	R F	Bus Engine F1AE3481G	217050	Drive Shaft	35	41	71.5	127	1140		
	2014.05.-	-	6MT	R F	Box Engine F1AE3481G	217050	Drive Shaft	35	41	71.5	127	1140		
	2014.05.-	-	6MT	L/R F	Bus Engine F1AE3481G	817045	Outer Joint	35	29	71.5	127	71	M	
	2014.05.-	-	6MT	L/R F	Box Engine F1AE3481G	817045	Outer Joint	35	29	71.5	127	71	M	
	2014.05.-	-	6MT	L F	Bus Engine F1AE3481G	217053	Drive Shaft	35	41	71.5	127	806		
	2014.05.-	-	6MT	L F	Box Engine F1AE3481G	217053	Drive Shaft	35	41	71.5	127	806		
DUCATO (280)														
-	-	-	-	-	-	810104	Outer Joint	54T	28	27	63	112.5	63	I
DUCATO (280_)														
1.9 D (52 kW)	1988.01.-	1990.08	MT	R F	Platform/Chassis Engine 149 B1.000	210013	Drive Shaft	28	25	63	112.5	1072		
	1988.01.-	1990.08	MT	R F	Box Engine 149 B1.000	210013	Drive Shaft	28	25	63	112.5	1072		
	1988.01.-	1990.08	MT	L/R F	Platform/Chassis Engine 149 B1.000	810010	Outer Joint	28	27	63	112.5	63	I	
	1988.01.-	1990.08	MT	L/R F	Box Engine 149 B1.000	810010	Outer Joint	28	27	63	112.5	63	I	
	1988.01.-	1990.08	MT	L F	Platform/Chassis Engine 149 B1.000	210034	Drive Shaft	28	25	63	112.5	701		
	1988.01.-	1990.08	MT	L F	Box Engine 149 B1.000	210034	Drive Shaft	28	25	63	112.5	701		
1.9 TD (60 kW)	1989.03.-	1990.08	MT	R F	Box Engine 280 A1.000	210013	Drive Shaft	28	25	63	112.5	1072		
	1989.03.-	1990.08	MT	R F	Platform/Chassis Engine 280 A1.000	210013	Drive Shaft	28	25	63	112.5	1072		
	1989.03.-	1990.08	MT	L/R F	Box Engine 280 A1.000	810010	Outer Joint	28	27	63	112.5	63	I	
	1989.03.-	1990.08	MT	L/R F	Platform/Chassis Engine 280 A1.000	810010	Outer Joint	28	27	63	112.5	63	I	
	1989.03.-	1990.08	MT	L F	Box Engine 280 A1.000	210034	Drive Shaft	28	25	63	112.5	701		
	1989.03.-	1990.08	MT	L F	Platform/Chassis Engine 280 A1.000	210034	Drive Shaft	28	25	63	112.5	701		
2.0 (55 kW)	1985.07.-	1990.08	MT	L/R F	Platform/Chassis Engine 170 B/XN 1T	810010	Outer Joint	28	27	63	112.5	63	I	
	1985.07.-	1990.08	MT	L/R F	Box Engine 170 B	810010	Outer Joint	28	27	63	112.5	63	I	
	1985.07.-	1990.08	MT	R F	Platform/Chassis Engine 170 B/XN 1T	210068	Drive Shaft	28	25	63	112.5	1068		
	1985.07.-	1990.08	MT	R F	Box Engine 170 B	210068	Drive Shaft	28	25	63	112.5	1068		





	 YEAR	TRANSM	L/R	F/R	REMARKS	GSP Ref.	 PRODUCT	 ABS	Technical Specifications					
									A	B	C	H	L	P
FIAT														
DUCATO (280_)														
2.0 (55 kW)	1985.07-1990.08	MT	L	F	Platform/Chassis Engine 170 B/XN 1T	210034	Drive Shaft		28	25	63	112.5	701	
	1985.07-1990.08	MT	L	F	Box Engine 170 B	210034	Drive Shaft		28	25	63	112.5	701	
2.0 (58 kW)	1982.01-1990.08	MT	L/R	F	Box Engine XN 1T	810010	Outer Joint		28	27	63	112.5	63	I
	1982.01-1990.08	MT	R	F	Box Engine XN 1T	210068	Drive Shaft		28	25	63	112.5	1068	
	1982.01-1990.08	MT	L	F	Box Engine XN 1T	210034	Drive Shaft		28	25	63	112.5	701	
2.0 (62 kW)	1988.08-1990.08	MT	L/R	F	Platform/Chassis Engine 170 D	810010	Outer Joint		28	27	63	112.5	63	I
	1988.08-1990.08	MT	R	F	Platform/Chassis Engine 170 D	210068	Drive Shaft		28	25	63	112.5	1068	
	1988.08-1990.08	MT	L	F	Platform/Chassis Engine 170 D	210034	Drive Shaft		28	25	63	112.5	701	
	1989.03-1990.08	MT	L/R	F	Box Engine 170 D	810010	Outer Joint		28	27	63	112.5	63	I
	1989.03-1990.08	MT	R	F	Box Engine 170 D	210068	Drive Shaft		28	25	63	112.5	1068	
	1989.03-1990.08	MT	L	F	Box Engine 170 D	210034	Drive Shaft		28	25	63	112.5	701	
2.4 D (53 kW)	1982.01-1990.08	MT	L/R	F	Box Engine 8144.61	810010	Outer Joint		28	27	63	112.5	63	I
2.5 D (55 kW)	1982.01-1990.08	MT	R	F	Box Engine 8144.67/CRD93L (U25-661)	210013	Drive Shaft		28	25	63	112.5	1072	
	1982.01-1990.08	MT	L/R	F	Box Engine 8144.67/CRD93L (U25-661)	810010	Outer Joint		28	27	63	112.5	63	I
	1982.01-1990.08	MT	R	F	Box Engine 8144.67/CRD93L (U25-661)	210068	Drive Shaft		28	25	63	112.5	1068	
	1982.01-1990.08	MT	L	F	Box Engine 8144.67/CRD93L (U25-661)	210034	Drive Shaft		28	25	63	112.5	701	
	1982.07-1990.08	MT	R	F	Platform/Chassis Engine 8144.67/CRD93L(U25-661)	210013	Drive Shaft		28	25	63	112.5	1072	
	1982.07-1990.08	MT	L/R	F	Platform/Chassis Engine 8144.67/CRD93L(U25-661)	810010	Outer Joint		28	27	63	112.5	63	I
	1982.07-1990.08	MT	R	F	Platform/Chassis Engine 8144.67/CRD93L(U25-661)	210068	Drive Shaft		28	25	63	112.5	1068	
	1982.07-1990.08	MT	L	F	Platform/Chassis Engine 8144.67/CRD93L(U25-661)	210034	Drive Shaft		28	25	63	112.5	701	
	1986.09-1990.05	MT	L/R	F	Box Engine 8140.61	810010	Outer Joint		28	27	63	112.5	63	I
	1989.03-1990.08	MT	L	F	All-wheel Drive Box Engine 8144.67	210034	Drive Shaft		28	25	63	112.5	701	
	1989.03-1990.08	MT	R	F	All-wheel Drive Platform/Chassis Engine 8144.67	210013	Drive Shaft		28	25	63	112.5	1072	
	1989.03-1990.08	MT	R	F	All-wheel Drive Box Engine 8144.67	210013	Drive Shaft		28	25	63	112.5	1072	
	1989.03-1990.08	MT	L/R	F	All-wheel Drive Platform/Chassis Engine 8144.67	810010	Outer Joint		28	27	63	112.5	63	I
	1989.03-1990.08	MT	R	F	All-wheel Drive Platform/Chassis Engine 8144.67	210068	Drive Shaft		28	25	63	112.5	1068	
	1989.03-1990.08	MT	L/R	F	All-wheel Drive Box Engine 8144.67	810010	Outer Joint		28	27	63	112.5	63	I
	1989.03-1990.08	MT	R	F	All-wheel Drive Box Engine 8144.67	210068	Drive Shaft		28	25	63	112.5	1068	
	1989.03-1990.08	MT	L	F	All-wheel Drive Platform/Chassis Engine 8144.67	210034	Drive Shaft		28	25	63	112.5	701	
2.5 TD (68 kW)	1986.01-1990.08	MT	R	F	Platform/Chassis Engine 8144.21	210013	Drive Shaft		28	25	63	112.5	1072	
	1986.01-1990.08	MT	L/R	F	Platform/Chassis Engine 8144.21	810010	Outer Joint		28	27	63	112.5	63	I
	1986.01-1990.08	MT	R	F	Platform/Chassis Engine 8144.21	210068	Drive Shaft		28	25	63	112.5	1068	
	1986.01-1990.08	MT	L	F	Platform/Chassis Engine 8144.21	210034	Drive Shaft		28	25	63	112.5	701	
DUCATO (290)														
-	-	-	-	-	-	810104	Outer Joint	54T	28	27	63	112.5	63	I
DUCATO (290_)														
1.9 D (52 kW)	1990.07-1994.03	MT	L	F	Box Engine 149 B1.000	210034	Drive Shaft		28	25	63	112.5	701	
	1990.07-1994.03	MT	R	F	Box Engine 149 B1.000	210013	Drive Shaft		28	25	63	112.5	1072	
	1990.07-1994.03	MT	L/R	F	Box Engine 149 B1.000	810010	Outer Joint		28	27	63	112.5	63	I
1.9 TD (60 kW)	1989.03-1994.03	MT	R	F	Box Engine 280 A1.000	210013	Drive Shaft		28	25	63	112.5	1072	
	1989.03-1994.03	MT	R	F	Platform/Chassis Engine 280 A1.000	210013	Drive Shaft		28	25	63	112.5	1072	
	1989.03-1994.03	MT	L/R	F	Box Engine 280 A1.000	810010	Outer Joint		28	27	63	112.5	63	I
	1989.03-1994.03	MT	L/R	F	Platform/Chassis Engine 280 A1.000	810010	Outer Joint		28	27	63	112.5	63	I
	1989.03-1994.03	MT	R	F	Box Engine 280 A1.000	210068	Drive Shaft		28	25	63	112.5	1068	
	1989.03-1994.03	MT	R	F	Platform/Chassis Engine 280 A1.000	210068	Drive Shaft		28	25	63	112.5	1068	
	1989.03-1994.03	MT	L	F	Box Engine 280 A1.000	210034	Drive Shaft		28	25	63	112.5	701	
	1989.03-1994.03	MT	L	F	Platform/Chassis Engine 280 A1.000	210034	Drive Shaft		28	25	63	112.5	701	
2.0 (62 kW)	1990.07-1994.03	MT	L	F	Platform/Chassis Engine 170 D	210034	Drive Shaft		28	25	63	112.5	701	
	1990.07-1994.03	MT	L/R	F	Platform/Chassis Engine 170 D	810010	Outer Joint		28	27	63	112.5	63	I
	1990.07-1994.03	MT	R	F	Platform/Chassis Engine 170 D	210068	Drive Shaft		28	25	63	112.5	1068	
2.5 D (55 kW)	1989.03-1994.03	MT	R	F	Platform/Chassis Engine 8144.67	210013	Drive Shaft		28	25	63	112.5	1072	
	1989.03-1994.03	MT	L/R	F	Platform/Chassis Engine 8144.67	810010	Outer Joint		28	27	63	112.5	63	I
	1989.03-1994.03	MT	R	F	Platform/Chassis Engine 8144.67	210068	Drive Shaft		28	25	63	112.5	1068	
	1989.03-1994.03	MT	L	F	Platform/Chassis Engine 8144.67	210034	Drive Shaft		28	25	63	112.5	701	
	1990.07-1994.03	MT	L	F	All-wheel Drive Platform/Chassis Engine 8144.67	210034	Drive Shaft		28	25	63	112.5	701	
	1990.07-1994.03	MT	R	F	All-wheel Drive Platform/Chassis Engine 8144.67	210013	Drive Shaft		28	25	63	112.5	1072	
	1990.07-1994.03	MT	R	F	All-wheel Drive Box Engine 8144.67	210013	Drive Shaft		28	25	63	112.5	1072	
	1990.07-1994.03	MT	L/R	F	All-wheel Drive Platform/Chassis Engine 8144.67	810010	Outer Joint		28	27	63	112.5	63	I
	1990.07-1994.03	MT	L/R	F	All-wheel Drive Box Engine 8144.67	810010	Outer Joint		28	27	63	112.5	63	I
	1990.07-1994.03	MT	R	F	All-wheel Drive Platform/Chassis Engine 8144.67	210068	Drive Shaft		28	25	63	112.5	1068	
	1990.07-1994.03	MT	R	F	All-wheel Drive Box Engine 8144.67	210068	Drive Shaft		28	25	63	112.5	1068	
2.5 TD (70 kW)	1990.07-1994.03	MT	L	F	All-wheel Drive Box Engine 8140.27	210034	Drive Shaft		28	25	63	112.5	701	
	1990.07-1994.03	MT	L	F	All-wheel Drive Platform/Chassis Engine 8140.27	210034	Drive Shaft		28	25	63	112.5	701	
	1990.07-1994.03	MT	R	F	Box Engine 8140.27	210013	Drive Shaft		28	25	63	112.5	1072	
	1990.07-1994.03	MT	R	F	Platform/Chassis Engine 8140.27	210013	Drive Shaft		28	25	63	112.5	1072	





	 YEAR	TRANSM	L/R	F/R	REMARKS	GSP Ref.	 PRODUCT	 ABS	Technical Specifications								
									A	B	C	H	L	P			
FIAT																	
DUCATO (290_)																	
2.5 TD (70 kW)	1990.07-1994.03	MT	L/R	F	Box Engine 8140.27	810010	Outer Joint		28	27	63	112.5	63	I			
	1990.07-1994.03	MT	L/R	F	Platform/Chassis Engine 8140.27	810010	Outer Joint		28	27	63	112.5	63	I			
	1990.07-1994.03	MT	R	F	All-wheel Drive Box Engine 8140.27	210013	Drive Shaft		28	25	63	112.5	1072				
	1990.07-1994.03	MT	R	F	All-wheel Drive Platform/Chassis Engine 8140.27	210013	Drive Shaft		28	25	63	112.5	1072				
	1990.07-1994.03	MT	R	F	Box Engine 8140.27	210068	Drive Shaft		28	25	63	112.5	1068				
	1990.07-1994.03	MT	R	F	Platform/Chassis Engine 8140.27	210068	Drive Shaft		28	25	63	112.5	1068				
	1990.07-1994.03	MT	L/R	F	All-wheel Drive Box Engine 8140.27	810010	Outer Joint		28	27	63	112.5	63	I			
	1990.07-1994.03	MT	L/R	F	All-wheel Drive Platform/Chassis Engine 8140.27	810010	Outer Joint		28	27	63	112.5	63	I			
	1990.07-1994.03	MT	R	F	All-wheel Drive Box Engine 8140.27	210068	Drive Shaft		28	25	63	112.5	1068				
	1990.07-1994.03	MT	R	F	All-wheel Drive Platform/Chassis Engine 8140.27	210068	Drive Shaft		28	25	63	112.5	1068				
1990.07-1994.03	MT	L	F	Box Engine 8140.27	210034	Drive Shaft		28	25	63	112.5	701					
1990.07-1994.03	MT	L	F	Platform/Chassis Engine 8140.27	210034	Drive Shaft		28	25	63	112.5	701					
DUCATO III-IV																	
2.5 D	1994-2006	-	L	F	-	610010	Inner Joint		41	45	43	70	115.5				
2.8 TDI	1994-2006	-	L	F	-	610010	Inner Joint		41	45	43	70	115.5				
DUCATO Panorama (280_)																	
1.9 D (52 kW)	1987.02-1990.08	MT	R	F	Bus Engine 149 B1.000	210013	Drive Shaft		28	25	63	112.5	1072				
	1987.02-1990.08	MT	L/R	F	Bus Engine 149 B1.000	810010	Outer Joint		28	27	63	112.5	63	I			
	1987.02-1990.08	MT	L	F	Bus Engine 149 B1.000	210034	Drive Shaft		28	25	63	112.5	701				
1.9 TD (60 kW)	1989.03-1990.08	MT	R	F	Bus Engine 280 A1.000	210013	Drive Shaft		28	25	63	112.5	1072				
	1989.03-1990.08	MT	L/R	F	Bus Engine 280 A1.000	810010	Outer Joint		28	27	63	112.5	63	I			
	1989.03-1990.08	MT	L	F	Bus Engine 280 A1.000	210034	Drive Shaft		28	25	63	112.5	701				
2.0 (55 kW)	1986.01-1990.08	MT	L/R	F	Bus Engine 170 B	810010	Outer Joint		28	27	63	112.5	63	I			
	1986.01-1990.08	MT	R	F	Bus Engine 170 B	210068	Drive Shaft		28	25	63	112.5	1068				
	1986.01-1990.08	MT	L	F	Bus Engine 170 B	210034	Drive Shaft		28	25	63	112.5	701				
2.0 (62 kW)	1988.09-1990.08	MT	L/R	F	Bus Engine 170 D	810010	Outer Joint		28	27	63	112.5	63	I			
	1988.09-1990.08	MT	R	F	Bus Engine 170 D	210068	Drive Shaft		28	25	63	112.5	1068				
	1988.09-1990.08	MT	L	F	Bus Engine 170 D	210034	Drive Shaft		28	25	63	112.5	701				
2.5 D (55 kW)	1986.01-1990.08	MT	R	F	Bus Engine 8144.67/CRD93L (U25-661)	210013	Drive Shaft		28	25	63	112.5	1072				
	1986.01-1990.08	MT	L/R	F	Bus Engine 8144.67/CRD93L (U25-661)	810010	Outer Joint		28	27	63	112.5	63	I			
	1986.01-1990.08	MT	R	F	Bus Engine 8144.67/CRD93L (U25-661)	210068	Drive Shaft		28	25	63	112.5	1068				
	1986.01-1990.08	MT	L	F	Bus Engine 8144.67/CRD93L (U25-661)	210034	Drive Shaft		28	25	63	112.5	701				
	1987.01-1990.08	MT	R	F	All-wheel Drive Bus Engine 8144.67	210013	Drive Shaft		28	25	63	112.5	1072				
	1987.01-1990.08	MT	L/R	F	All-wheel Drive Bus Engine 8144.67	810010	Outer Joint		28	27	63	112.5	63	I			
	1987.01-1990.08	MT	R	F	All-wheel Drive Bus Engine 8144.67	210068	Drive Shaft		28	25	63	112.5	1068				
	1987.01-1990.08	MT	L	F	All-wheel Drive Bus Engine 8144.67	210034	Drive Shaft		28	25	63	112.5	701				
	1987.01-1990.08	MT	R	F	All-wheel Drive Bus Engine 8144.67	210013	Drive Shaft		28	25	63	112.5	1072				
2.5 TD (68 kW)	1986.01-1990.08	MT	L	F	All-wheel Drive Bus Engine 8144.21	210034	Drive Shaft		28	25	63	112.5	701				
	1986.01-1990.08	MT	R	F	All-wheel Drive Bus Engine 8144.21	210013	Drive Shaft		28	25	63	112.5	1072				
	1986.01-1990.08	MT	L/R	F	All-wheel Drive Bus Engine 8144.21	810010	Outer Joint		28	27	63	112.5	63	I			
	1986.01-1990.08	MT	R	F	All-wheel Drive Bus Engine 8144.21	210068	Drive Shaft		28	25	63	112.5	1068				
	1987.01-1990.08	MT	L	F	Bus Engine 8144.21/8144.21.220	210034	Drive Shaft		28	25	63	112.5	701				
	1987.01-1990.08	MT	R	F	Bus Engine 8144.21/8144.21.220	210013	Drive Shaft		28	25	63	112.5	1072				
	1987.01-1990.08	MT	L/R	F	Bus Engine 8144.21/8144.21.220	810010	Outer Joint		28	27	63	112.5	63	I			
	1987.01-1990.08	MT	R	F	Bus Engine 8144.21/8144.21.220	210068	Drive Shaft		28	25	63	112.5	1068				
DUCATO Panorama (290_)																	
1.9 D (52 kW)	1990.07-1994.03	MT	L	F	Bus Engine 149 B1.000	210034	Drive Shaft		28	25	63	112.5	701				
	1990.07-1994.03	MT	R	F	Bus Engine 149 B1.000	210013	Drive Shaft		28	25	63	112.5	1072				
	1990.07-1994.03	MT	L/R	F	Bus Engine 149 B1.000	810010	Outer Joint		28	27	63	112.5	63	I			
1.9 TD (60 kW)	1990.07-1994.03	MT	R	F	Bus Engine 280 A1.000	210013	Drive Shaft		28	25	63	112.5	1072				
	1990.07-1994.03	MT	L/R	F	Bus Engine 280 A1.000	810010	Outer Joint		28	27	63	112.5	63	I			
	1990.07-1994.03	MT	R	F	Bus Engine 280 A1.000	210068	Drive Shaft		28	25	63	112.5	1068				
	1990.07-1994.03	MT	L	F	Bus Engine 280 A1.000	210034	Drive Shaft		28	25	63	112.5	701				
2.0 (62 kW)	1990.07-1994.03	MT	L/R	F	Bus Engine 170 D	810010	Outer Joint		28	27	63	112.5	63	I			
	1990.07-1994.03	MT	R	F	Bus Engine 170 D	210068	Drive Shaft		28	25	63	112.5	1068				
	1990.07-1994.03	MT	L	F	Bus Engine 170 D	210034	Drive Shaft		28	25	63	112.5	701				
2.5 D (55 kW)	1990.07-1994.03	MT	L	F	Bus Engine 8144.67	210034	Drive Shaft		28	25	63	112.5	701				
	1990.07-1994.03	MT	L	F	All-wheel Drive Bus Engine 8144.67	210034	Drive Shaft		28	25	63	112.5	701				
	1990.07-1994.03	MT	R	F	Bus Engine 8144.67	210013	Drive Shaft		28	25	63	112.5	1072				
	1990.07-1994.03	MT	R	F	All-wheel Drive Bus Engine 8144.67	210013	Drive Shaft		28	25	63	112.5	1072				
	1990.07-1994.03	MT	L/R	F	Bus Engine 8144.67	810010	Outer Joint		28	27	63	112.5	63	I			
	1990.07-1994.03	MT	L/R	F	All-wheel Drive Bus Engine 8144.67	810010	Outer Joint		28	27	63	112.5	63	I			
	1990.07-1994.03	MT	R	F	Bus Engine 8144.67	210068	Drive Shaft		28	25	63	112.5	1068				
	1990.07-1994.03	MT	R	F	All-wheel Drive Bus Engine 8144.67	210068	Drive Shaft		28	25	63	112.5	1068				
	1990.07-1994.03	MT	L	F	Bus Engine 8140.27	210034	Drive Shaft		28	25	63	112.5	701				
2.5 TD (70 kW)	1990.08-1994.03	MT	R	F	Bus Engine 8140.27	210013	Drive Shaft		28	25	63	112.5	1072				
	1990.08-1994.03	MT	R	F	Bus Engine 8140.27	210013	Drive Shaft		28	25	63	112.5	1072				
	1990.08-1994.03	MT	L/R	F	Bus Engine 8140.27	810010	Outer Joint		28	27	63	112.5	63	I			

	 YEAR	TRANSM	L/R	F/R	REMARKS	GSP Ref.	 PRODUCT	 ABS	Technical Specifications					
									A	B	C	H	L	P
FIAT														
DUCATO Panorama (290_)														
2.5 TD (70 kW)	1990.08-1994.03	MT	R	F	Bus Engine 8140.27	210068	Drive Shaft		28	25	63	112.5	1068	
	1991.01-1994.03	MT	R	F	All-wheel Drive Bus Engine 8140.27	210013	Drive Shaft		28	25	63	112.5	1072	
	1991.01-1994.03	MT	L/R	F	All-wheel Drive Bus Engine 8140.27	810010	Outer Joint		28	27	63	112.5	63	I
	1991.01-1994.03	MT	R	F	All-wheel Drive Bus Engine 8140.27	210068	Drive Shaft		28	25	63	112.5	1068	
	1991.01-1994.03	MT	L	F	All-wheel Drive Bus Engine 8140.27	210034	Drive Shaft		28	25	63	112.5	701	
DUNA (146_)														
1.7 DS (44 kW)	1987.01-1991.12	-	-	F	Saloon Engine 149 B3.000	817005	Outer Joint		22	20	48.1	90.5	59.5	O
60 1.1 (43 kW)	1987.01-1991.12	-	-	F	Saloon Engine 146 A6.000	817005	Outer Joint		22	20	48.1	90.5	59.5	O
70 1.3 (49 kW)	1987.01-1991.12	-	-	F	Saloon Engine 146 A5.000	817005	Outer Joint		22	20	48.1	90.5	59.5	O
DUNA Weekend (146_)														
1.7 DS (44 kW)	1987.01-1991.12	-	-	F	Estate Engine 149 B3.000/146 B2.000	817005	Outer Joint		22	20	48.1	90.5	59.5	O
60 1.1 (43 kW)	1987.01-1991.12	-	-	F	Estate Engine 146 A6.000	817005	Outer Joint		22	20	48.1	90.5	59.5	O
70 1.3 (49 kW)	1987.01-1991.12	-	-	F	Estate Engine 146 A5.000	817005	Outer Joint		22	20	48.1	90.5	59.5	O
ELBA (146_)/ELBA CSL														
1.3 (43 kW)	1986.04-1993.12	-	-	F	Estate Engine 127 A2.011	817005	Outer Joint		22	20	48.1	90.5	59.5	O
1.5 (49 kW)	1992.01-1996.12	-	-	F	Estate Engine 149 C1.000	817005	Outer Joint		22	20	48.1	90.5	59.5	O
1.5 (52 kW)	1986.04-1992.10	-	-	F	Estate Engine 149 C1.000	817005	Outer Joint		22	20	48.1	90.5	59.5	O
1.7 D (43 kW)	1989.04-1996.12	-	-	F	Estate Engine 146 B2.000	817005	Outer Joint		22	20	48.1	90.5	59.5	O
FIORINO														
1.3 16V	2000-2009	-	-	-	-	817041	Outer Joint		22	20	52	91	60.5	O
1.3 8V	2000-2009	-	-	-	-	817041	Outer Joint		22	20	52	91	60.5	O
1.3 MJT	2007-	-	-	F	-	699008	Inner Joint		24	24	29.7	86.5	93	
	2007-	-	L	F	-	699008	Inner Joint		24	24	29.7	86.5	93	
	2007-	-	L	F	-	217062	Drive Shaft		25	24	51	84.5	582	
1.6 8V	1994-1995	-	-	-	-	817041	Outer Joint		22	20	52	91	60.5	O
FIORINO (146_)														
1.7 TD (46 kW)	1996.11-2000.05	MT	L/R	F	Box Engine 146 D7.000	817019	Outer Joint		22	22	52	91	60.5	O
	1996.11-2000.05	AT/MT	L/R	F	Box Engine 146 D7.000	817020	Outer Joint	44T	22	22	52	91	60.5	O
60 1.1 (40 kW)	1988.05-1993.12	-	-	-	Box Engine 146 A9.000	817017	Outer Joint		22	20	52	91	60.5	O
60 1.7 D (42 kW)	1988.05-1996.10	-	-	-	Box Engine 146 B2.000	817017	Outer Joint		22	20	52	91	60.5	O
60 1.7 D (44 kW)	1988.05-2000.05	-	-	-	Box Engine 149 B3.000	817017	Outer Joint		22	20	52	91	60.5	O
65 1.7 TD (46 kW)	1997.01-2001.05	MT	L/R	F	Box Engine 146 D7.000	817019	Outer Joint		22	22	52	91	60.5	O
	1997.01-2001.05	AT/MT	L/R	F	Box Engine 146 D7.000	817020	Outer Joint	44T	22	22	52	91	60.5	O
70 1.3 (49 kW)	1988.01-1994.12	-	-	-	Box Engine 146 A5.000	817017	Outer Joint		22	20	52	91	60.5	O
75 i.e. 1.5 (55 kW)	1988.05-1993.12	-	-	-	Box Engine 149 C1.000	817017	Outer Joint		22	20	52	91	60.5	O
FIORINO (225_)														
1.3 D Multijet (55 kW)	2007.11-	MT	R	F	Box Body/Estate Engine 199 A2.000/199 A9.000	217061	Drive Shaft		25	24	51	84.5	953	
	2007.11-	MT	R	F	Box Body/Estate Engine 199 A2.000/199 A9.000	217055	Drive Shaft		25	35.45	51	84.5	543	
	2007.11-	AT	L/R	F	Box Body/Estate Engine 199 A2.000/199 A9.000	817053	Outer Joint		25	23	51	84.5	60	M
	2007.11-	-	R	F	Box Body/Estate Engine 199 A2.000/199 A9.000	217157	Drive Shaft		25	24	51	84.5	919	
	2007.11-	MT	L/R	F	Box Body/Estate Engine 199 A2.000/199 A9.000	817028	Outer Joint		25	24	51	84.5	62	M
	2007.11-	-	L	F	Box Body/Estate Engine 199 A2.000/199 A9.000	217165	Drive Shaft		25	24	51	84.5	603	
	2007.11-	AT	R	F	Box Body/Estate Engine 199 A2.000/199 A9.000	217146	Drive Shaft		25		51	84.5	522	
	2007.11-	AT	L	F	Box Body/Estate Engine 199 A2.000/199 A9.000	217147	Drive Shaft		25		51	84.5	480	
1.3 D Multijet (70 kW)	2009.07-	-	R	F	Box Body/Estate Engine 199 B1.000/330 A1.000	217157	Drive Shaft		25	24	51	84.5	919	
	2009.07-	-	L	F	Box Body/Estate Engine 199 B1.000/330 A1.000	217165	Drive Shaft		25	24	51	84.5	603	
1.4 (54 kW)	2007.11-	-	L/R	F	Box Body/Estate Engine KFT/KFV	817070	Outer Joint		22	22	51	79	57.5	M
1.4 Natural Power (57 kW)	2008.06-	-	L/R	F	Box Body/Estate Engine 350 A1.000	817070	Outer Joint		22	22	51	79	57.5	M
FIORINO IV (225)														
1.3 D Multijet (55 kW)	2008.02-2009.07	-	R	-	LCV	617059	Inner Joint		24	24	29.8	394	100	
	2008.02-2009.07	-	R	-	w/o Seiespeed	617015	Inner Joint		24	24	29.7	379	100.5	
	2008.02-2009.07	-	L	-	LCV	699008	Inner Joint		24	24	29.7	86.5	93	
	2009.07-	-	R	-	LCV	617056	Inner Joint		25	23	34.9	400	97	
	2009.07-	-	L	-	LCV	644014	Inner Joint		25	23	34.9	57.5	102	
1.3 D Multijet (70 kW)	2008.02-2009.07	-	R	-	LCV	617059	Inner Joint		24	24	29.8	394	100	
	2008.02-2009.07	-	R	-	w/o Seiespeed	617015	Inner Joint		24	24	29.7	379	100.5	
	2008.02-2009.07	-	L	-	LCV	699008	Inner Joint		24	24	29.7	86.5	93	
1.4 (51 kW)	2008.02-	-	-	-	-	617027	Inner Joint		22	22	36	61.5	93.5	
1.6 16V (76 kW)	2010.01-	-	-	-	-	617027	Inner Joint		22	22	36	61.5	93.5	
1.6 Natural Power (76 kW)	2009.02-	-	-	-	-	617027	Inner Joint		22	22	36	61.5	93.5	
1.9 D (46 kW)	2003.01-	-	-	-	-	617027	Inner Joint		22	22	36	61.5	93.5	
FIORINO Pick up (146_)														
1.3 (49 kW)	1988.01-1994.12	-	-	-	Pickup Engine 146 A5.000	817017	Outer Joint		22	20	52	91	60.5	O
1.7 D (44 kW)	1988.05-1999.10	-	-	-	Pickup Engine 149 B3.000	817017	Outer Joint		22	20	52	91	60.5	O
1.7 TD (46 kW)	1997.01-2001.05	MT	L/R	F	Pickup Engine 146 D7.000	817019	Outer Joint		22	22	52	91	60.5	O
	1997.01-2001.05	AT/MT	L/R	F	Pickup Engine 146 D7.000	817020	Outer Joint	44T	22	22	52	91	60.5	O

	 YEAR	TRANSM	L/R	F/R	REMARKS	GSP Ref.	 PRODUCT	 ABS	Technical Specifications						
									A	B	C	H	L	P	
FIAT															
FIORINO(225_)															
1.4 Natural Power(51 kW)	2008.06-	-	-	L/R	F	Box Body/Estate Engine 350 A1.000	817070	Outer Joint		22	22	51	79	57.5	M
FREEMONT (345_)															
2.0 JTD (103 kW)	2011.08-	-	-	-	-	Estate Engine 939 B5.000/940 A5.000	809054	Outer Joint		32	26	56.7	105	62	M
2.0 JTD (125 kW)	2011.08-	-	AT	L	F	All-wheel Drive Estate Engine 939 B5.000	217229	Drive Shaft		32	29	56.7	105	640	
	2011.08-	-	AT	R	F	All-wheel Drive Estate Engine 939 B5.000	217228	Drive Shaft		32	28	56.7	105	524	
	2011.08-	-	-	-	-	Estate Engine 939 B5.000	809054	Outer Joint		32	26	56.7	105	62	M
2011.08-	-	-	-	-	-	All-wheel Drive Estate Engine 939 B5.000	809054	Outer Joint		32	26	56.7	105	62	M
FREEMONT (JC)															
2.0 JTD (100 kW)	2011.08-	-	MT	L	-	-	617031	Inner Joint		25	26	32	59	110.5	
2.0 JTD (103 kW)	2011.08-	-	MT	L	-	-	617031	Inner Joint		25	26	32	59	110.5	
	2011.08-	-	AT	L	-	-	617031	Inner Joint		25	26	32	59	110.5	
2.0 JTD (125 kW)	2011.08-	-	AT	L	-	-	617031	Inner Joint		25	26	32	59	110.5	
2.0 JTD 4x4 (103 kW)	2011.08-	-	-	L	-	-	617031	Inner Joint		25	26	32	59	110.5	
2.0 JTD 4x4 (125 kW)	2011.08-	-	-	L	-	-	617031	Inner Joint		25	26	32	59	110.5	
FULLBACK (502_ 503_)															
2.4 D (110 kW)	2016.01-	-	AT/MT	R	F	All-wheel Drive Pickup Engine 4N15	239164	Drive Shaft	47T	30		69	98	492	
	2016.01-	-	AT/MT	L/R	F	All-wheel Drive Pickup Engine 4N15	839294	Outer Joint		30	33	69	98	66.5	I
2.4 D (113 kW)	2016.01-	-	AT/MT	R	F	All-wheel Drive Pickup Engine 4N15	239164	Drive Shaft	47T	30		69	98	492	
	2016.01-	-	AT/MT	L/R	F	All-wheel Drive Pickup Engine 4N15	839294	Outer Joint		30	33	69	98	66.5	I
2.4 D (133 kW)	2016.01-	-	AT/MT	R	F	All-wheel Drive Pickup Engine 4N15	239164	Drive Shaft	47T	30		69	98	492	
	2016.01-	-	AT/MT	L/R	F	All-wheel Drive Pickup Engine 4N15	839294	Outer Joint		30	33	69	98	66.5	I
GRANDE PUNTO															
1.3 MJT	2005-	-	-	L	F	-	617011	Inner Joint		24	23	29.7	86.5	93	
	2005-	-	-	R	F	-	617012	Inner Joint		24	23	29.7	379	100.5	
	2005-	-	-	R	F	-	617012	Inner Joint		24	23	29.7	379	100.5	
	2005-	-	-	L	F	-	217135	Drive Shaft		25	24	51	84.5	626	
GRANDE PUNTO (199)															
1.2 (48 kW)	2005.10-	-	-	-	-	Type GKN	617027	Inner Joint		22	22	36	61.5	93.5	
1.3 D Multijet (51 kW)	2005.10-	-	-	R	-	-	617012	Inner Joint		24	23	29.7	379	100.5	
	2005.10-	-	-	L	-	-	617011	Inner Joint		24	23	29.7	86.5	93	
1.3 D Multijet (55 kW)	2005.10-	-	-	R	-	-	617012	Inner Joint		24	23	29.7	379	100.5	
	2005.10-	-	-	L	-	-	617011	Inner Joint		24	23	29.7	86.5	93	
1.3 D Multijet (61 kW)	2005.10-	-	-	L	-	-	617025	Inner Joint		24	24	29.7	86.5	93	
	2005.10-	-	-	R	-	-	617026	Inner Joint		24	24	29.7	379	100.5	
1.3 D Multijet (62 kW)	2005.10-	-	-	R	-	-	617012	Inner Joint		24	23	29.7	379	100.5	
	2005.10-	-	-	L	-	-	617011	Inner Joint		24	23	29.7	86.5	93	
1.3 D Multijet (66 kW)	2005.10-	-	-	R	-	-	617056	Inner Joint		25	23	34.9	400	97	
	2005.10-	-	-	L	-	-	699008	Inner Joint		24	24	29.7	86.5	93	
	2005.10-	-	-	L	-	-	644014	Inner Joint		25	23	34.9	57.5	102	
1.4 16V (70 kW)	2005.10-	-	-	-	-	-	617027	Inner Joint		22	22	36	61.5	93.5	
1.4 LPG Natural Power (57 kW)	2005.10-	-	-	-	-	-	617027	Inner Joint		22	22	36	61.5	93.5	
1.4 T-Jet (88 kW)	2007.09-	-	-	L	-	-	617025	Inner Joint		24	24	29.7	86.5	93	
GRANDE PUNTO (199), VAN															
1.4 (55 kW)	2009.03-	-	-	-	-	-	617027	Inner Joint		22	22	36	61.5	93.5	
1.4 (57 kW)	2009.03-	-	-	-	-	-	617027	Inner Joint		22	22	36	61.5	93.5	
1.4 LPG, Natural Power (57 kW)	2009.03-	-	-	-	-	-	617027	Inner Joint		22	22	36	61.5	93.5	
GRANDE PUNTO (199_)															
1.2 (48 kW)	2005.10-	-	-	L	F	Hatchback Engine 199 A4.000	617103	Inner Joint		22	27	36	61.5	93.5	
	2005.10-	-	-	-	F	Hatchback Engine 199 A4.000	899018	Outer Joint		22	27	51	79.5	54	O
	2005.10-	-	-	-	-	Hatchback Engine 199 A4.000	817034	Outer Joint		22	21	51	79.5	54	M
	2005.10-	-	-	L	F	Hatchback Engine 199 A4.000	217222	Drive Shaft		22	22	51	79.5	646	
	2005.10-	-	-	L/R	F	Hatchback Engine 199 A4.000	817052	Outer Joint		22	21	51.2	79.5	54	M
	2005.10-	-	-	L	F	Hatchback Engine 199 A4.000	899325	Outer Joint		22	27	51	79.5	54	O
	2005.10-	-	-	L	F	Hatchback Engine 199 A4.000	617004	Inner Joint		22	21	36	61	93.5	
1.2 (51 kW)	2010.09-	-	-	L	F	Hatchback Engine 169 A4.000	217222	Drive Shaft		22	22	51	79.5	646	
	2010.09-	-	-	L	F	Hatchback Engine 169 A4.000	899325	Outer Joint		22	27	51	79.5	54	O
	2010.09-	-	-	L	F	Hatchback Engine 169 A4.000	617004	Inner Joint		22	21	36	61	93.5	
	2010.09-	-	-	L	F	Hatchback Engine 169 A4.000	617103	Inner Joint		22	27	36	61.5	93.5	
1.3 D Multijet (51 kW)	2008.07-	-	-	R	F	Hatchback Engine 199 B2.000	217109	Drive Shaft		25	24	51	84.5	908	
	2008.07-	-	CVT	L/R	F	Hatchback Engine 199 B2.000	817053	Outer Joint		25	23	51	84.5	60	M
	2008.07-	-	-	R	F	Hatchback Engine 199 B2.000	217066	Drive Shaft		25	33.9	51	84.5	497	
	2008.07-	-	-	L	F	Hatchback Engine 199 B2.000	217182	Drive Shaft		25	24	51	84.5	624	
	2008.07-	-	-	-	F	Hatchback Engine 199 B2.000	817027	Outer Joint		25	23	51	84.5	60	M
	2008.07-	-	-	L	F	Hatchback Engine 199 B2.000	217082	Drive Shaft		25	33.9	51	84.5	514	
1.3 D Multijet (55 kW)	2005.10-	-	-	R	F	Hatchback Engine 199 A2.000	217109	Drive Shaft		25	24	51	84.5	908	
	2005.10-	-	6MT	L/R	F	Hatchback Engine 199 A2.000	817053	Outer Joint		25	23	51	84.5	60	M

YEAR	TRANSM	L/R	F/R	REMARKS	GSP Ref.	PRODUCT	ABS	Technical Specifications					
								A	B	C	H	L	P
FIAT													
GRANDE PUNTO (199_)													
1.3 D Multijet (55 kW)	2005.10-	-	-	R F	Hatchback Engine 199 A2.000	217066	Drive Shaft	25	33.9	51	84.5	497	
	2005.10-	-	-	L F	Hatchback Engine 199 A2.000	217182	Drive Shaft	25	24	51	84.5	624	
	2005.10-	-	-	L F	Hatchback Engine 199 A2.000	217082	Drive Shaft	25	33.9	51	84.5	514	
	2005.10-	-	-	- F	Hatchback Engine 199 A2.000	817027	Outer Joint	25	23	51	84.5	60	M
1.3 D Multijet (56 kW)	2009.06-	-	MT	R F	Hatchback Engine 199 A2.000	217109	Drive Shaft	25	24	51	84.5	908	
	2009.06-	-	MT	L F	Hatchback Engine 199 A2.000	217182	Drive Shaft	25	24	51	84.5	624	
	2009.06-	-	MT	- F	Hatchback Engine 199 A2.000	817027	Outer Joint	25	23	51	84.5	60	M
1.3 D Multijet (62 kW)	2010.04-	-	-	L/R F	Hatchback Engine 199 B4.000/223 A9.000	817063	Outer Joint	25	25	51.1	84.5	61	M
	2010.04-	-	-	R F	Hatchback Engine 199 B4.000/223 A9.000	217109	Drive Shaft	25	24	51	84.5	908	
	2010.04-	-	-	L F	Hatchback Engine 199 B4.000/223 A9.000	217182	Drive Shaft	25	24	51	84.5	624	
1.3 D Multijet (66 kW)	2005.10-	-	5AT	L F	Hatchback Engine 199 A3.000	217148	Drive Shaft	25	24	51.1	84.5	614	
	2005.10-	-	5AT	R F	Hatchback Engine 199 A3.000	217144	Drive Shaft	25	24	51.1	84.5	908	
	2005.10-	-	-	R F	Hatchback Engine 199 A3.000	217059	Drive Shaft	25	24	51	84.5	925	
	2005.10-	-	6MT	L/R F	Hatchback Engine 199 A3.000	817053	Outer Joint	25	23	51	84.5	60	M
	2005.10-	-	5MT	L/R F	Hatchback Engine 199 A3.000	817028	Outer Joint	25	24	51	84.5	62	M
	2005.10-	-	6MT	L F	Hatchback Engine 199 A3.000	217172	Drive Shaft	25	33.9	51	84.5	486	
	2005.10-	-	-	- F	Hatchback Engine 199 A3.000	817027	Outer Joint	25	23	51	84.5	60	M
	2005.10-	-	6MT	R F	Hatchback Engine 199 A3.000	217146	Drive Shaft	25		51	84.5	522	
1.3 JTD Multijet(55 kW)	2006.02-2013.06	-	-	R F	Box Body/Hatchback/Van Engine 199 A2.000	217066	Drive Shaft	25	33.9	51	84.5	497	
	2006.02-2013.06	CVT	-	R F	Box Body/Hatchback/Van Engine 199 A2.000	817053	Outer Joint	25	23	51	84.5	60	M
	2006.02-2013.06	-	-	L F	Box Body/Hatchback/Van Engine 199 A2.000	217082	Drive Shaft	25	33.9	51	84.5	514	
1.4 (55 kW)	2006.06-	-	-	L F	Hatchback Engine 199 A7.000	217222	Drive Shaft	22	22	51	79.5	646	
	2006.06-	-	MT	L F	Hatchback Engine 199 A7.000	899325	Outer Joint	22	27	51	79.5	54	O
	2006.06-	-	-	L F	Hatchback Engine 199 A7.000	617004	Inner Joint	22	21	36	61	93.5	
	2006.06-	-	MT	L F	Hatchback Engine 199 A7.000	617103	Inner Joint	22	27	36	61.5	93.5	
1.4 (57 kW)	2005.10-	-	-	L F	Hatchback Engine 350 A1.000	217222	Drive Shaft	22	22	51	79.5	646	
	2005.10-	-	-	L/R F	Hatchback Engine 350 A1.000	817052	Outer Joint	22	21	51.2	79.5	54	M
	2005.10-	-	MT	L F	Hatchback Engine 350 A1.000	899325	Outer Joint	22	27	51	79.5	54	O
	2005.10-	-	MT	L F	Hatchback Engine 350 A1.000	617103	Inner Joint	22	27	36	61.5	93.5	
	2005.10-	-	-	L F	Hatchback Engine 350 A1.000	617004	Inner Joint	22	21	36	61	93.5	
1.4 16V (70 kW)	2005.10-	-	-	L F	Hatchback Engine 199 A6.000	217222	Drive Shaft	22	22	51	79.5	646	
	2005.10-	-	-	L/R F	Hatchback Engine 199 A6.000	817052	Outer Joint	22	21	51.2	79.5	54	M
	2005.10-	-	-	L F	Hatchback Engine 199 A6.000	617004	Inner Joint	22	21	36	61	93.5	
1.4 LPG (57 kW)	2008.12-	-	-	L F	Hatchback Engine 350 A1.000	217222	Drive Shaft	22	22	51	79.5	646	
	2008.12-	-	MT	L F	Hatchback Engine 350 A1.000	899325	Outer Joint	22	27	51	79.5	54	O
	2008.12-	-	-	L F	Hatchback Engine 350 A1.000	617004	Inner Joint	22	21	36	61	93.5	
	2008.12-	-	MT	L F	Hatchback Engine 350 A1.000	617103	Inner Joint	22	27	36	61.5	93.5	
1.4 Natural Power (57 kW)	2008.07-	-	-	L F	Hatchback Engine 350 A1.000	217222	Drive Shaft	22	22	51	79.5	646	
	2008.07-	-	MT	L F	Hatchback Engine 350 A1.000	899325	Outer Joint	22	27	51	79.5	54	O
	2008.07-	-	-	L F	Hatchback Engine 350 A1.000	617004	Inner Joint	22	21	36	61	93.5	
	2008.07-	-	MT	L F	Hatchback Engine 350 A1.000	617103	Inner Joint	22	27	36	61.5	93.5	
1.4 T-Jet (88 kW)	2007.09-	-	-	L/R F	Hatchback Engine 198 A4.000	817063	Outer Joint	25	25	51.1	84.5	61	M
1.6 D Multijet (88 kW)	2008.07-	-	MT	L F	Hatchback Engine 955 A3.000	617085	Inner Joint	25	33	34.9	57.5	97.5	
	2008.07-	-	MT	R F	Hatchback Engine 955 A3.000	617072	Inner Joint	25	33	34.9	431.5	93	
	2008.07-	-	MT	L F	Hatchback Engine 955 A3.000	217142	Drive Shaft	25	25	51.1	84.5	588	
	2008.07-	-	MT	R F	Hatchback Engine 955 A3.000	217143	Drive Shaft	25	25	51.1	84.5	953	
1.9 D Multijet (85 kW)	2006.06-2009.12	MT	L F	F	Hatchback Engine 939 A7.000	617085	Inner Joint	25	33	34.9	57.5	97.5	
	2006.06-2009.12	MT	R F	F	Hatchback Engine 939 A7.000	617072	Inner Joint	25	33	34.9	431.5	93	
	2006.06-2009.12	MT	L F	F	Hatchback Engine 939 A7.000	217142	Drive Shaft	25	25	51.1	84.5	588	
	2006.06-2009.12	MT	R F	F	Hatchback Engine 939 A7.000	217143	Drive Shaft	25	25	51.1	84.5	953	
1.9 D Multijet (88 kW)	2005.10-	-	MT	L F	Hatchback Engine 939 A1.000	617085	Inner Joint	25	33	34.9	57.5	97.5	
	2005.10-	-	MT	R F	Hatchback Engine 939 A1.000	617072	Inner Joint	25	33	34.9	431.5	93	
	2005.10-	-	-	- F	Hatchback Engine 939 A1.000	817065	Outer Joint	25	33	51.1	84.5	61	I
	2005.10-	-	MT	L F	Hatchback Engine 939 A1.000	217142	Drive Shaft	25	25	51.1	84.5	588	
	2005.10-	-	MT	R F	Hatchback Engine 939 A1.000	217143	Drive Shaft	25	25	51.1	84.5	953	
1.9 D Multijet (96 kW)	2005.10-	-	MT	L F	Hatchback Engine 199 A5.000	617085	Inner Joint	25	33	34.9	57.5	97.5	
	2005.10-	-	MT	R F	Hatchback Engine 199 A5.000	617072	Inner Joint	25	33	34.9	431.5	93	
	2005.10-	-	-	- F	Hatchback Engine 199 A5.000	817065	Outer Joint	25	33	51.1	84.5	61	I
	2005.10-	-	MT	L F	Hatchback Engine 199 A5.000	217142	Drive Shaft	25	25	51.1	84.5	588	
	2005.10-	-	MT	R F	Hatchback Engine 199 A5.000	217143	Drive Shaft	25	25	51.1	84.5	953	
GRANDE PUNTO IV													
1.4	2005-	-	-	- -		844081	Outer Joint	22	21	51	79.5	54	M
IDEA													
1.3 D Multijet (66 kW)	2005.10-	2008.05	-	L -		699008	Inner Joint	24	24	29.7	86.5	93	
1.3 D Multijet (66kW)	2005.10-	2008.05	-	R -		617015	Inner Joint	24	24	29.7	379	100.5	
1.3 D Multijet (70 kW)	2005.10-	2008.05	-	R -		617015	Inner Joint	24	24	29.7	379	100.5	





	 YEAR	TRANSM	L/R	F/R	REMARKS	GSP Ref.	 PRODUCT	 ABS	Technical Specifications						
									A	B	C	H	L	P	
FIAT															
IDEA															
1.3 D Multijet (70 kW)	2005.10-2008.05	-	L	-		699008	Inner Joint		24	24	29.7	86.5	93		
1.3 JTD (51 kW)	2004.01-	-	R	-		617012	Inner Joint		24	23	29.7	379	100.5		
	2004.01-	-	L	-		617011	Inner Joint		24	23	29.7	86.5	93		
	2004.01-	-	-	-		617009	Inner Joint			25		32			
1.4 (57 kW)	2003.12-2005.10	-	-	-		617027	Inner Joint		22	22	36	61.5	93.5		
1.4 8V	2003.01-2010.12	-	-	-		817059	Outer Joint		22	21	47	89	54	M	
1.6 D Multijet (88 kW)	2008.05-	-	R	-		617006	Inner Joint		25	26	29.8	377	108		
	2008.05-	-	L	-		617005	Inner Joint		25	26	32	91	95		
1.8 8V	-	-	-	-		617018	Inner Joint			25		32			
	-	-	-	-		217031	Drive Shaft						336		
	-	-	-	-		617018	Inner Joint			25		32			
1.9 JTD (74 kW)	2004.01-	-	R	-		617062	Inner Joint		34	24	34.9	300	102.5		
IDEA (350_)															
1.2 16V (59 kW)	2004.01-	-	MT	R	F	MPV Engine 188 A5.000	617004	Inner Joint		22	21	36	61	93.5	
	2004.01-	-	MT	R	F	MPV Engine 188 A5.000	217227	Drive Shaft		22	22	51	79.5	863	
	2004.01-	-	-	-	-	MPV Engine 188 A5.000	817034	Outer Joint		22	21	51	79.5	54	M
1.3 D Multijet (51 kW)	2004.01-	-	5MT	L	F	MPV Engine 188 A9.000	217147	Drive Shaft		25		51	84.5	480	
	2004.01-	-	-	L/R	F	MPV Engine 188 A9.000	817053	Outer Joint		25	23	51	84.5	60	M
	2004.01-	-	5MT	R	F	MPV Engine 188 A9.000	217066	Drive Shaft		25	33.9	51	84.5	497	
	2004.01-	-	MT	L/R	F	MPV Engine 188 A9.000	602011	Inner Joint			25		32		
	2004.01-	-	-	-	F	MPV Engine 188 A9.000	602005	Inner Joint			25		32		
	2004.01-	-	MT	-	F	MPV Engine 188 A9.000	817027	Outer Joint		25	23	51	84.5	60	M
1.3 D Multijet (66 kW)	2005.10-	-	MT	L/R	F	MPV Engine 199 A3.000	817028	Outer Joint		25	24	51	84.5	62	M
	2005.10-	-	-	L	F	MPV Engine 199 A3.000	217054	Drive Shaft		25	35.45	51	84.5	472	
1.4 16V (70 kW)	2004.01-	-	MT	R	F	MPV Engine 843 A1.000	617004	Inner Joint		22	21	36	61	93.5	
	2004.01-	-	MT	R	F	MPV Engine 843 A1.000	217227	Drive Shaft		22	22	51	79.5	863	
	2004.01-	-	MT	L/R	F	MPV Engine 843 A1.000	817014	Outer Joint		22	21	51	79.5	54	M
	2004.01-	-	-	-	-	MPV Engine 843 A1.000	817034	Outer Joint		22	21	51	79.5	54	M
1.9 JTD (74 kW)	2004.01-	-	MT	L/R	F	MPV Engine 188 B2.000	817028	Outer Joint		25	24	51	84.5	62	M
LINEA															
1.3 JTD (63 kW)	2007.06-	-	-	L	-		617025	Inner Joint		24	24	29.7	86.5	93	
	2007.06-	-	-	R	-		617026	Inner Joint		24	24	29.7	379	100.5	
1.3 MJT	2007-	-	-	L	F		617025	Inner Joint		24	24	29.7	86.5	93	
	2007-	-	-	R	F		617026	Inner Joint		24	24	29.7	379	100.5	
	2007-	-	-	R	F		217057	Drive Shaft		25	24	51.1	84.5	949	
	2007-	-	-	L	F		217058	Drive Shaft		25	24	51.1	84.5	582	
	2007-	-	-	R	F		217063	Drive Shaft		25	39.2	51.1	84.5	538	
1.4	2007-	-	-	L	F		217088	Drive Shaft		22	31.95	51	79	552	
	2007-	-	-	R	F		217089	Drive Shaft		22	31.95	51	79	793	
1.4 T-Jet (88 kW)	2007.09-	-	-	L	-		617025	Inner Joint		24	24	29.7	86.5	93	
1.6 D Multijet (77 kW)	2009.06-	-	-	L	-		617031	Inner Joint		25	26	32	59	110.5	
LINEA (323_110_)															
1.3 D Multijet (66 kW)	2007.06-	-	MT	L	F	Saloon Engine 199 A3.000	217064	Drive Shaft		25	39.2	51.1	84.5	471	
	2007.06-	-	MT	L/R	F	Saloon Engine 199 A3.000	817063	Outer Joint		25	25	51.1	84.5	61	M
	2007.06-	-	Semi-AT	L/R	F	Saloon Engine 199 A3.000	817028	Outer Joint		25	24	51	84.5	62	M
1.4 (57 kW)	2007.06-	-	-	L/R	F	Saloon Engine 350 A1.000	817070	Outer Joint		22	22	51	79	57.5	M
1.4 T-Jet (88 kW)	2007.09-	-	-	L/R	F	Saloon Engine 198 A4.000	817063	Outer Joint		25	25	51.1	84.5	61	M
1.6 D Multijet (77 kW)	2009.06-	-	-	L/R	F	Saloon Engine 198 A3.000	817063	Outer Joint		25	25	51.1	84.5	61	M
LYBRA (839AX, BX), SW															
2.0 20V (110 kW)	2000.09-	-	-	-	-		802008	Outer Joint		25	25	59	85	58	O
MAREA (185)															
2.0 20V (110 kW)	2001-	-	-	-	-		802008	Outer Joint		25	25	59	85	58	O
2.0 20V (113 kW)	1999-	-	-	-	-		802008	Outer Joint		25	25	59	85	58	O
MAREA (185), WEEKEND															
1.8 16V (83 kW)	1999.04-	-	-	R	-		617009	Inner Joint			25		32		
1.9 JTD (81 kW)	2001.01-	-	-	R	-		617009	Inner Joint			25		32		
1.9 TD (55 kW)	1996.09-1999.03	-	-	R	-		617009	Inner Joint			25		32		
2.0 20V (108 kW)	1996.09-2001.01	-	-	-	-		617009	Inner Joint			25		32		
2.0 20V (110 kW)	1996.09-2001.01	-	-	-	-		617009	Inner Joint			25		32		
2.0 20V (113 kW)	1999.04-2001.01	-	-	-	-		617009	Inner Joint			25		32		
2.4 JTD (96 kW)	1999.02-	-	-	L	-		602007	Inner Joint			34		47.5		
2.4 TD (91 kW)	1996.09-1999.04	-	-	L	-		602007	Inner Joint			34		47.5		
MAREA (185_)															
1.2 16V (60 kW)	1998.10-2002.05	-	-	F	Saloon Engine 182 B2.000	817015	Outer Joint		22	22	51	79.5	54	O	
1.4 80 12V (59 kW)	1996.09-2002.05	-	-	F	Saloon Engine 182 A3.000	817015	Outer Joint		22	22	51	79.5	54	O	
	1996.09-2002.05	-	MT	R	F	Saloon Engine 182 A3.000	217011	Drive Shaft		22	31.95	46.8	75.5	928.5	





	 YEAR	TRANSM	L/R	F/R	REMARKS	GSP Ref.	 PRODUCT	 ABS	Technical Specifications					
									A	B	C	H	L	P
FIAT														
MAREA (185_)														
1.4 80 12V (59 kW)	1996.09-2002.05	AT/MT	L/R	F	Saloon Engine 182 A3.000	817001	Outer Joint		22	20	46.8	75.5	52	O
	1996.09-2002.05	AT/MT	L/R	F	Saloon Engine 182 A3.000	817039	Outer Joint	44T	22	20	46.8	75.5	52	O
	1996.09-2002.05	MT	L	F	Saloon Engine 182 A3.000	217010	Drive Shaft		22	31.95	46.8	75.5	569	
1.6 100 16V (76 kW)	1996.09-2002.05	AT/MT	-	F	Saloon Engine 182 A4.000	817015	Outer Joint		22	22	51	79.5	54	O
	1996.09-2002.05	AT/MT	L/R	F	Saloon Engine 182 A4.000	817023	Outer Joint		25	22	52	84	57	O
1.6 100 16V Bipower (76 kW)	1999.04-2002.05	MT	-	F	Saloon Engine 185 A3.000/186 A4.000	817015	Outer Joint		22	22	51	79.5	54	O
	1999.04-2002.05	AT/MT	L/R	F	Saloon Engine 185 A3.000/186 A4.000	817011	Outer Joint		25	22	51	84.5	57	O
1.8 115 16V (83 kW)	1996.09-2002.05	AT/MT	L/R	F	Saloon Engine 182 A2.000	618070	Inner Joint			25		32		
	1996.09-2002.05	-	-	F	Saloon Engine 182 A2.000	802006	Outer Joint	44T	25	25	52	85	58	O
	1996.09-2002.05	AT/MT	R	F	Saloon Engine 182 A2.000	602011	Inner Joint			25		32		
	1996.09-2002.05	-	-	F	Saloon Engine 182 A2.000	802020	Outer Joint		25	25	51	85	58	O
1.9 JTD (79 kW)	2001.01-2007.12	-	-	F	Saloon Engine 182 B4.000/182 B9.000	802020	Outer Joint		25	25	51	85	58	O
1.9 JTD 105 (77 kW)	1999.04-2001.01	MT	L/R	F	Saloon Engine 182 B4.000	817042	Outer Joint		25	25	51	85	58	O
1.9 JTD 110 (81 kW)	2001.01-2002.05	-	-	F	Saloon Engine 186 A6.000	602005	Inner Joint			25		32		
	2001.01-2002.05	MT	R	F	Saloon Engine 186 A6.000	602011	Inner Joint			25		32		
	2001.01-2002.05	-	-	F	Saloon Engine 186 A6.000	802020	Outer Joint		25	25	51	85	58	O
1.9 TD 100 (74 kW)	1996.09-2002.05	-	-	F	Saloon Engine 182 A7.000	802006	Outer Joint	44T	25	25	52	85	58	O
	1996.09-2002.05	-	-	F	Saloon Engine 182 A7.000	802020	Outer Joint		25	25	51	85	58	O
1.9 TD 75 (55 kW)	1996.09-2002.05	-	-	F	Saloon Engine 182 A8.000	802006	Outer Joint	44T	25	25	52	85	58	O
	1996.09-2002.05	-	-	F	Saloon Engine 182 A8.000	802020	Outer Joint		25	25	51	85	58	O
2.0 150 20V (108 kW)	1996.09-1999.04	-	-	F	Saloon Engine 182 A1.000	817032	Outer Joint	44T	25	25	59	85	58	O
	1996.09-1999.04	AT/MT	L/R	F	Saloon Engine 182 A1.000	618070	Inner Joint			25		32		
	1996.09-1999.04	-	-	F	Saloon Engine 182 A1.000	602006	Inner Joint			25		32		
	1996.09-1999.04	AT/MT	L/R	F	Saloon Engine 182 A1.000	602011	Inner Joint			25		32		
	1996.09-1999.04	-	-	F	Saloon Engine 182 A1.000	602005	Inner Joint			25		32		
2.0 150 20V (110 kW)	2001.01-2002.05	-	-	F	Saloon Engine 185 A8.000	602005	Inner Joint			25		32		
	2001.01-2002.05	MT	L/R	F	Saloon Engine 185 A8.000	602011	Inner Joint			25		32		
	2001.01-2002.05	-	-	F	Saloon Engine 185 A8.000	802020	Outer Joint		25	25	51	85	58	O
2.0 155 20V (113 kW)	1999.04-2001.01	-	-	F	Saloon Engine 182 B7.000	602005	Inner Joint			25		32		
	1999.04-2001.01	MT	L/R	F	Saloon Engine 182 B7.000	802003	Outer Joint		25	25	52	85	58	O
	1999.04-2001.01	MT	L/R	F	Saloon Engine 182 B7.000	602011	Inner Joint			25		32		
	1999.04-2001.01	MT	-	F	Saloon Engine 182 B7.000	802020	Outer Joint		25	25	51	85	58	O
	1999.04-2001.01	MT	L/R	F	Saloon Engine 182 B7.000	618070	Inner Joint			25		32		
2.4 JTD 130 (96 kW)	1999.04-2002.05	-	-	F	Saloon Engine 185 A6.000/839 A5.000	602005	Inner Joint			25		32		
	1999.04-2002.05	MT	L/R	F	Saloon Engine 185 A6.000/839 A5.000	802012	Outer Joint		25	28	59	85	63	O
	1999.04-2002.05	MT	L/R	F	Saloon Engine 185 A6.000/839 A5.000	618070	Inner Joint			25		32		
2.4 TD 125 (91 kW)	1996.09-1999.04	AT/MT	L/R	F	Saloon Engine 185 A2.000	802009	Outer Joint	44T	25	28	56	85	63.5	O
	1996.09-1999.04	MT	L/R	F	Saloon Engine 185 A2.000	618070	Inner Joint			25		32		
	1996.09-1999.04	-	-	F	Saloon Engine 185 A2.000	602005	Inner Joint			25		32		
MAREA Weekend (185_)														
1.2 16V (60 kW)	1998.10-2002.05	-	-	F	Estate Engine 182 B2.000	817015	Outer Joint		22	22	51	79.5	54	O
1.4 80 12V (59 kW)	1996.09-2002.05	-	-	F	Estate Engine 182 A3.000	817015	Outer Joint		22	22	51	79.5	54	O
	1996.09-2002.05	MT	R	F	Estate Engine 182 A3.000	217011	Drive Shaft		22	31.95	46.8	75.5	928.5	
	1996.09-2002.05	AT/MT	L/R	F	Estate Engine 182 A3.000	817001	Outer Joint		22	20	46.8	75.5	52	O
	1996.09-2002.05	AT/MT	L/R	F	Estate Engine 182 A3.000	817039	Outer Joint	44T	22	20	46.8	75.5	52	O
	1996.09-2002.05	-	-	F	Estate Engine 182 A3.000	602005	Inner Joint			25		32		
	1996.09-2002.05	MT	L/R	F	Estate Engine 182 A3.000	618070	Inner Joint			25		32		
	1996.09-2002.05	MT	L	F	Estate Engine 182 A3.000	217010	Drive Shaft		22	31.95	46.8	75.5	569	
1.6 100 16V (76 kW)	1996.09-2002.05	AT/MT	-	F	Estate Engine 182 A4.000	817015	Outer Joint		22	22	51	79.5	54	O
	1996.09-2002.05	AT/MT	L/R	F	Estate Engine 182 A4.000	817023	Outer Joint		25	22	52	84	57	O
1.8 115 16V (83 kW)	1996.09-2002.05	AT/MT	L/R	F	Estate Engine 182 A2.000	618070	Inner Joint			25		32		
	1996.09-2002.05	AT/MT	R	F	Estate Engine 182 A2.000	602011	Inner Joint			25		32		
1.9 JTD (79 kW)	2001.01-2007.12	-	-	F	Estate Engine 182 B4.000/182 B9.000	802020	Outer Joint		25	25	51	85	58	O
1.9 JTD 105 (77 kW)	1999.04-2002.05	MT	L/R	F	Estate Engine 182 B4.000	817042	Outer Joint		25	25	51	85	58	O
1.9 JTD 110 (81 kW)	2001.01-2002.05	-	-	F	Estate Engine 186 A6.000	602005	Inner Joint			25		32		
	2001.01-2002.05	MT	R	F	Estate Engine 186 A6.000	602011	Inner Joint			25		32		
	2001.01-2002.05	-	-	F	Estate Engine 186 A6.000	802020	Outer Joint		25	25	51	85	58	O
1.9 TD 100 (74 kW)	1996.09-2002.05	-	-	F	Estate Engine 182 A7.000/182 B9.000	802006	Outer Joint	44T	25	25	52	85	58	O
1.9 TD 75 (55 kW)	1996.09-2002.05	-	-	F	Estate Engine 182 A8.000	802006	Outer Joint	44T	25	25	52	85	58	O
2.0 150 20V (108 kW)	1996.09-1999.04	-	-	F	Estate Engine 182 A1.000	602005	Inner Joint			25		32		
	1996.09-1999.04	-	-	F	Estate Engine 182 A1.000	817032	Outer Joint	44T	25	25	59	85	58	O
	1996.09-1999.04	AT/MT	L/R	F	Estate Engine 182 A1.000	618070	Inner Joint			25		32		
	1996.09-1999.04	-	-	F	Estate Engine 182 A1.000	602006	Inner Joint			25		32		
	1996.09-1999.04	AT/MT	L/R	F	Estate Engine 182 A1.000	602011	Inner Joint			25		32		
2.0 150 20V (110 kW)	2001.01-2002.05	-	-	F	Estate Engine 185 A8.000	602005	Inner Joint			25		32		
	2001.01-2002.05	MT	L/R	F	Estate Engine 185 A8.000	602011	Inner Joint			25		32		





YEAR	TRANSM	L/R	F/R	REMARKS	GSP Ref.	PRODUCT	ABS	Technical Specifications							
								A	B	C	H	L	P		
FIAT															
MAREA Weekend (185_)															
2.0 150 20V (110 kW)	2001.01-	2002.05	-	-	F	Estate Engine 185 A8.000	802020	Outer Joint		25	25	51	85	58	O
2.0 155 20V (113 kW)	1999.04-	2003.02	-	-	F	Estate Engine 182 B7.000	602005	Inner Joint			25		32		
	1999.04-	2003.02	MT	L/R	F	Estate Engine 182 B7.000	802003	Outer Joint		25	25	52	85	58	O
	1999.04-	2003.02	MT	L/R	F	Estate Engine 182 B7.000	602011	Inner Joint			25		32		
	1999.04-	2003.02	MT	L/R	F	Estate Engine 182 B7.000	618070	Inner Joint			25		32		
2.4 JTD 130 (96 kW)	1999.04-	2002.05	-	-	F	Estate Engine 185 A6.000/839 A5.000	602005	Inner Joint			25		32		
	1999.04-	2002.05	MT	L/R	F	Estate Engine 185 A6.000/839 A5.000	802012	Outer Joint		25	28	59	85	63	O
	1999.04-	2002.05	MT	L/R	F	Estate Engine 185 A6.000/839 A5.000	618070	Inner Joint			25		32		
2.4 TD 125 (91 kW)	1996.09-	1999.04	-	-	F	Estate Engine 185 A2.000	602005	Inner Joint			25		32		
	1996.09-	1999.04	AT/MT	L/R	F	Estate Engine 185 A2.000	802009	Outer Joint	44T	25	28	56	85	63.5	O
	1996.09-	1999.04	MT	L/R	F	Estate Engine 185 A2.000	618070	Inner Joint			25		32		
MARENGO															
2.4 TD (91 kW)	1997-	-	-	-	L	LCV	602007	Inner Joint			34		47.5		
MÚTIPLA (186)															
1.9 JTD (77 kW)	1999.04-	-	-	-	R	-	617009	Inner Joint			25		32		
1.9 JTD (81 kW)	2001.03-	2002.07	-	-	R	-	617009	Inner Joint			25		32		
1.9 JTD (85 kW)	2002.07-	-	-	-	-	-	617009	Inner Joint			25		32		
1.9 JTD (88 kW)	2002.04-	-	-	-	R	-	617009	Inner Joint			25		32		
MULTIPLA (186_)															
1.6 100 16V (76 kW)	1999.04-	2010.06	MT	L/R	F	MPV Engine 182 A4.000	817011	Outer Joint		25	22	51	84.5	57	O
1.6 16V Bipower (76 kW)	1999.04-	2010.06	MT	L/R	F	MPV Engine 186 A4.000	817011	Outer Joint		25	22	51	84.5	57	O
	1999.04-	2010.06	MT	L/R	F	MPV Engine 186 A4.000	618070	Inner Joint			25		32		
1.6 16V Blupower (70 kW)	1999.04-	2010.06	-	-	F	MPV Engine 186 A3.000	602005	Inner Joint			25		32		
	1999.04-	2010.06	MT	L/R	F	MPV Engine 186 A3.000	817011	Outer Joint		25	22	51	84.5	57	O
	1999.04-	2010.06	MT	L/R	F	MPV Engine 186 A3.000	618070	Inner Joint			25		32		
1.9 JTD (88 kW)	2002.04-	2010.06	-	-	F	MPV Engine 186 A9.000	602005	Inner Joint			25		32		
	2002.04-	2010.06	-	-	F	MPV Engine 186 A9.000	602006	Inner Joint			25		32		
	2002.04-	2010.06	-	-	F	MPV Engine 186 A9.000	802020	Outer Joint		25	25	51	85	58	O
1.9 JTD 105 (77 kW)	1999.04-	2010.06	-	-	F	MPV Engine 182 B4.000	602005	Inner Joint			25		32		
	1999.04-	2010.06	AT/MT	L/R	F	MPV Engine 182 B4.000	618070	Inner Joint			25		32		
	1999.04-	2010.06	MT	L/R	F	MPV Engine 182 B4.000	817042	Outer Joint		25	25	51	85	58	O
	1999.04-	2010.06	-	-	F	MPV Engine 182 B4.000	602006	Inner Joint			25		32		
	1999.04-	2010.06	MT	R	F	MPV Engine 182 B4.000	602011	Inner Joint			25		32		
	1999.04-	2010.06	-	-	F	MPV Engine 182 B4.000	802020	Outer Joint		25	25	51	85	58	O
1.9 JTD 110 (81 kW)	2001.03-	2002.07	AT/MT	L/R	F	MPV Engine 186 A6.000	618070	Inner Joint			25		32		
	2001.03-	2002.07	-	-	F	MPV Engine 186 A6.000	602005	Inner Joint			25		32		
	2001.03-	2002.07	-	-	F	MPV Engine 186 A6.000	602006	Inner Joint			25		32		
	2001.03-	2002.07	MT	R	F	MPV Engine 186 A6.000	602011	Inner Joint			25		32		
	2001.03-	2002.07	-	-	F	MPV Engine 186 A6.000	802020	Outer Joint		25	25	51	85	58	O
1.9 JTD 115 (85 kW)	2002.07-	2010.06	AT/MT	L/R	F	MPV Engine 186 A8.000	618070	Inner Joint			25		32		
	2002.07-	2010.06	-	-	F	MPV Engine 186 A8.000	602005	Inner Joint			25		32		
	2002.07-	2010.06	-	-	F	MPV Engine 186 A8.000	602006	Inner Joint			25		32		
	2002.07-	2010.06	MT	R	F	MPV Engine 186 A8.000	602011	Inner Joint			25		32		
	2002.07-	2010.06	-	-	F	MPV Engine 186 A8.000	802020	Outer Joint		25	25	51	85	58	O
PALIO															
1.0 8V	1996-	2000	-	-	-	-	817041	Outer Joint		22	20	52	91	60.5	O
	2008-	2006	-	-	-	-	817093	Outer Joint		22	28	47	89	57	O
1.2	2002-	-	-	-	-	-	617027	Inner Joint		22	22	36	61.5	93.5	
1.2 16V	2002-	-	-	R	F	-	217030	Drive Shaft		22	31.95	47	89	809	
	2002-	-	-	L	F	-	217029	Drive Shaft		22	31.95	47	89	504	
1.2/1.4	1997-	2002	-	R	F	-	216001	Drive Shaft		22	31.95	47	89	918.5	
	1997-	2002	-	L	F	-	216002	Drive Shaft		22	31.95	47	89	571.5	
1.3	1996-	2008	-	-	-	-	817041	Outer Joint		22	20	52	91	60.5	O
1.3 MJT	2003-	2006	-	R	F	-	217202	Stub Axle		24	101			415	
	2003-	2006	-	L	F	-	217203	Stub Axle		24	101			118.5	
	2005-	-	-	L	F	-	217056	Drive Shaft		25	24	51	90	557	
	2005-	-	-	R	F	-	217014	Drive Shaft		25	35.6	51	90	524	
1.4	2002-	-	-	-	-	-	617027	Inner Joint		22	22	36	61.5	93.5	
1.4 16V	2002-	-	-	R	F	-	217030	Drive Shaft		22	31.95	47	89	809	
	2002-	-	-	L	F	-	217029	Drive Shaft		22	31.95	47	89	504	
1.4 8V	2008-	-	-	-	-	-	817093	Outer Joint		22	28	47	89	57	O
1.4/1.6	-	-	-	L	-	-	217029	Drive Shaft		22	31.95	47	89	504	
	-	-	-	R	-	-	217030	Drive Shaft		22	31.95	47	89	809	
1.6	1996-	-	-	R	F	-	217008	Drive Shaft	44T	22	31.95	52	91	904.5	
1.6 16V	2002-	-	-	R	F	-	217030	Drive Shaft		22	31.95	47	89	809	
	2002-	-	-	L	F	-	217029	Drive Shaft		22	31.95	47	89	504	

YEAR	TRANS	L/R	F/R	REMARKS	GSP Ref.	PRODUCT	ABS	Technical Specifications							
								A	B	C	H	L	P		
FIAT															
PALIO															
1.8 8V	-	-	-	-	-	617018	Inner Joint		25		32				
PALIO (178BX, 178DX)															
1.3 MJT (55 kW)	2005.11-	-	-	L	-	699008	Inner Joint		24	24	29.7	86.5	93		
PALIO (178BX, 178DX), WEEKEND															
1.2 (59 kW)	1997.07-	2002.08	-	-	-	617027	Inner Joint		22	22	36	61.5	93.5		
1.2 (70 kW)	1997.07-	2002.08	-	-	-	617027	Inner Joint		22	22	36	61.5	93.5		
1.3 MJT (51 kW)	2002-	-	-	R	-	617009	Inner Joint		25		32				
1.3 MJT (55 kW)	2005-	2011	-	R	-	617015	Inner Joint		24	24	29.7	379	100.5		
1.4 (51 kW)	2002-	-	-	-	-	617027	Inner Joint		22	22	36	61.5	93.5		
1.4 Kat (51 kW)	2002.07-	-	-	-	-	617027	Inner Joint		22	22	36	61.5	93.5		
1.9 JTD (59 kW)	2001.09-	-	-	R	-	617009	Inner Joint		25		32				
PALIO (178_)															
1.2 (54 kW)	1998.06-	-	-	L	F	Hatchback Engine 176 A8.000/178 B5.000/178 E2.000	217005	Drive Shaft		22	31.95	52	91	554	
	1998.06-	-	-	R	F	Hatchback Engine 176 A8.000/178 B5.000/178 E2.000	217007	Drive Shaft		22	31.95	52	91	904.5	
1.6 16V (74 kW)	1996.04-	2002.10	MT	L/R	F	Hatchback Engine 178 B3.000	817019	Outer Joint		22	22	52	91	60.5	O
	1996.04-	2002.10	-	L	F	Hatchback Engine 178 B3.000	217005	Drive Shaft		22	31.95	52	91	554	
	1996.04-	2002.10	-	R	F	Hatchback Engine 178 B3.000	217007	Drive Shaft		22	31.95	52	91	904.5	
	1996.04-	2002.10	AT/MT	L/R	F	Hatchback Engine 178 B3.000	817020	Outer Joint	44T	22	22	52	91	60.5	O
PALIO WEEKEND															
1.0 8V	1998-	2008	-	-	-	817041	Outer Joint		22	20	52	91	60.5	O	
1.3 MJT (55 kW)	2005.11-	-	-	L	-	699008	Inner Joint		24	24	29.7	86.5	93		
1.8 8V	-	-	-	-	-	617018	Inner Joint		25		32				
PALIO Weekend (178_)															
1.2 (44 kW)	2001.02-	-	-	-	F	Estate Engine 178 C4.066 188 A4.000	817029	Outer Joint		22	20	47	89	61	O
	2001.02-	-	AT/MT	L/R	F	Estate Engine 178 C4.066 188 A4.000	817016	Outer Joint		22	22	47	89	61	O
1.2 (54 kW)	1996.04-	2001.02	-	-	-	Estate Engine 178 B5.000	817056	Outer Joint		22	22	52	90	59.5	O
1.6 16V (74 kW)	1996.04-	2001.02	MT	L/R	F	Estate Engine 178 B3.000	817019	Outer Joint		22	22	52	91	60.5	O
	1996.04-	2001.02	AT/MT	L/R	F	Estate Engine 178 B3.000	817020	Outer Joint	44T	22	22	52	91	60.5	O
1.6 16V (76 kW)	2001.02-	-	AT/MT	L/R	F	Estate Engine 182 B6.000	817016	Outer Joint		22	22	47	89	61	O
1.7 TD (51 kW)	1996.04-	2001.03	MT	L/R	F	Estate Engine 176 A3.000	817019	Outer Joint		22	22	52	91	60.5	O
	1996.04-	2001.03	AT/MT	L/R	F	Estate Engine 176 A3.000	817020	Outer Joint	44T	22	22	52	91	60.5	O
1.9 D (46 kW)	2001.03-	-	AT/MT	L/R	F	Estate Engine 223 A6.000	817020	Outer Joint	44T	22	22	52	91	60.5	O
	2001.03-	-	AT/MT	L/R	F	Estate Engine 223 A6.000	817016	Outer Joint		22	22	47	89	61	O
PANDA (141_)															
1.0 (32 kW)	1986.01-	1989.07	MT	-	R	All-wheel Drive Hatchback Engine 156 A2.100/156 A3.100	602006	Inner Joint		25		32			
1.0 (33 kW)	1986.05-	1994.12	AT	-	-	All-wheel Drive Hatchback Engine 141 C2.000/156 A2.246	602006	Inner Joint		25		32			
1.0 (37 kW)	1986.01-	1992.12	-	-	R	All-wheel Drive Hatchback Engine 156 A3.000	602006	Inner Joint		25		32			
PANDA (169_)															
1.1 (40 kW)	2003.09-	-	MT	L	F	Hatchback Engine 187 A1.000	217181	Drive Shaft		22	22	47	75.5	595	
	2003.09-	-	MT	R	F	Hatchback Engine 187 A1.000	217137	Drive Shaft		22	22	47	75.5	827	
	2003.09-	-	-	L/R	F	Hatchback Engine 187 A1.000	817043	Outer Joint		22	20	47	75.5	54.5	M
1.2 (44 kW)	2003.09-	-	MT	L	F	Hatchback Engine 188 A4.000	217181	Drive Shaft		22	22	47	75.5	595	
	2003.09-	-	MT	R	F	Hatchback Engine 188 A4.000	217137	Drive Shaft		22	22	47	75.5	827	
	2003.09-	-	-	L/R	F	Hatchback Engine 188 A4.000	817043	Outer Joint		22	20	47	75.5	54.5	M
	2004.10-	-	MT	L/R	F	All-wheel Drive Hatchback Engine 188 A4.000	817026	Outer Joint		25	22	51	84	57	M
	2004.10-	-	-	L/R	R	All-wheel Drive Hatchback Engine 188 A4.000	817043	Outer Joint		22	20	47	75.5	54.5	M
1.2 (51 kW)	2010.03-	-	-	L	F	Hatchback Engine 169 A4.000	217181	Drive Shaft		22	22	47	75.5	595	
	2010.03-	-	-	R	F	Hatchback Engine 169 A4.000	217137	Drive Shaft		22	22	47	75.5	827	
1.2 LPG (44 kW)	2009.04-	-	-	L	F	Hatchback Engine 188 A4.000	217181	Drive Shaft		22	22	47	75.5	595	
	2009.04-	-	-	R	F	Hatchback Engine 188 A4.000	217137	Drive Shaft		22	22	47	75.5	827	
1.2 LPG (51 kW)	2010.11-	-	-	L	F	Hatchback Engine 169 A4.000	217181	Drive Shaft		22	22	47	75.5	595	
	2010.11-	-	-	R	F	Hatchback Engine 169 A4.000	217137	Drive Shaft		22	22	47	75.5	827	
1.2 Natural Power (44 kW)	2007.01-	2011.12	-	L/R	F	Hatchback Engine 188 A4.000	817043	Outer Joint		22	20	47	75.5	54.5	M
1.3 D Multijet (51 kW)	2003.09-	-	MT	L/R	F	Hatchback Engine 188 A8.000/188 A9.000	817026	Outer Joint		25	22	51	84	57	M
	2003.09-	-	MT	L	F	Hatchback Engine 188 A8.000/188 A9.000	617004	Inner Joint		22	21	36	61	93.5	
	2003.09-	-	MT	L	F	Hatchback Engine 188 A8.000/188 A9.000	217141	Drive Shaft		25	22	51	84	593	
	2003.09-	-	MT	R	F	Hatchback Engine 188 A8.000/188 A9.000	217149	Drive Shaft		25	22	51	84	828	
	2004.10-	-	MT	L/R	F	All-wheel Drive Hatchback Engine 188 A8.000/188 A9.000	817026	Outer Joint		25	22	51	84	57	M
	2004.10-	-	-	L/R	R	All-wheel Drive Hatchback Engine 188 A8.000/188 A9.000	817043	Outer Joint		22	20	47	75.5	54.5	M
1.3 D Multijet (55 kW)	2006.06-	-	MT	L	F	Hatchback Engine 169 A1.000/169 A5.000	617004	Inner Joint		22	21	36	61	93.5	
	2006.06-	-	MT	L	F	Hatchback Engine 169 A1.000/169 A5.000	217141	Drive Shaft		25	22	51	84	593	
	2006.06-	-	MT	R	F	Hatchback Engine 169 A1.000/169 A5.000	217149	Drive Shaft		25	22	51	84	828	
1.4 (74 kW)	2006.10-	-	MT	L/R	F	Hatchback Engine 169 A3.000	817026	Outer Joint		25	22	51	84	57	M
PANDA (312_ , 319)															
0.9 4x4 (63 kW)	2012.09-	-	-	-	-	635064	Propshaft CV Joint			20		21			
0.9 4x4 (66 kW)	2014.06-	-	-	-	-	635064	Propshaft CV Joint			20		21			

YEAR	TRANS	L/R	F/R	REMARKS	GSP Ref.	PRODUCT	ABS	Technical Specifications							
								A	B	C	H	L	P		
FIAT															
PANDA (312_ , 319)															
1.3D MULTIJET 4x4 (55 kW)	2012.06-	-	-	-	-	635064	Propshaft CV Joint			20		21			
1.3D MULTIJET 4x4 (59 kW)	2014.06-	-	-	-	-	635064	Propshaft CV Joint			20		21			
PANDA II (169) VAN															
1.1 (40 kW)	2003.09-	-	-	-	-	617001	Inner Joint		22	19	36	61.5	88.5		
1.2 (44 kW)	2003.09-	2010.03	-	-	-	617001	Inner Joint		22	19	36	61.5	88.5		
1.2 (51 kW)	2003.09-	2010.03	-	-	-	617001	Inner Joint		22	19	36	61.5	88.5		
1.2 Bi-Power/Natural Power (44 kW)	2007.01-	-	-	-	-	617001	Inner Joint		22	19	36	61.5	88.5		
1.2 LPG (51 kW)	2010.11-	-	-	-	-	617001	Inner Joint		22	19	36	61.5	88.5		
1.3 D Multijet (44 kW)	2003.09-	2006.09	-	-	-	617027	Inner Joint		22	22	36	61.5	93.5		
1.3 D Multijet (51 kW)	2003.09-	2006.09	-	-	-	617027	Inner Joint		22	22	36	61.5	93.5		
1.4 (74 kW)	2000.10-	-	-	-	-	617027	Inner Joint		22	22	36	61.5	93.5		
1.4 8V Natural Power (51 kW)	2010.01-	-	-	-	-	617027	Inner Joint		22	22	36	61.5	93.5		
1.4 Bi-Power-Natural Power (57 kW)	2010.09-	-	-	-	-	617001	Inner Joint		22	19	36	61.5	88.5		
PANDA III (312)															
0.9 4x4 (63 kW)	2012.02-	-	-	-	Type NTN	617027	Inner Joint		22	22	36	61.5	93.5		
0.9 T-ASP (57 kW)	2012.02-	-	-	-	-	617001	Inner Joint		22	19	36	61.5	88.5		
1.2 4x2 (51 kW)	2012.02-	-	-	-	-	617001	Inner Joint		22	19	36	61.5	88.5		
1.3 JTD 4x2 (55 kW)	2012.02-	-	-	L	-	617011	Inner Joint		24	23	29.7	86.5	93		
1.3 JTD 4x4 (55 kW)	2013.02-	-	-	L	-	699008	Inner Joint		24	24	29.7	86.5	93		
PANDA VAN (169)															
1.2 4x4 (4x4 kW)	2004.10-	2012.12	-	-	-	635064	Propshaft CV Joint			20		21			
1.2 4x4 (51 kW)	2010.04-	2012.12	-	-	-	635064	Propshaft CV Joint			20		21			
1.3D MULTIJET 4x4 (51 kW)	2004.10-	-	-	-	-	635064	Propshaft CV Joint			20		21			
1.3D MULTIJET 4x4 (55 kW)	2010.09-	-	-	-	-	635064	Propshaft CV Joint			20		21			
PANDA Van (169_)															
1.2 (44 kW)	2004.09-	-	-	L/R	F	All-wheel Drive Box Engine 188 A4.000	817043	Outer Joint	22	20	47	75.5	54.5	M	
1.2 LPG (44 kW)	2009.04-	-	-	L	F	Box Engine 188 A4.000	217181	Drive Shaft	22	22	47	75.5	595		
	2009.04-	-	-	R	F	Box Engine 188 A4.000	217137	Drive Shaft	22	22	47	75.5	827		
1.3 D Multijet (51 kW)	2004.03-	-	-	MT	L	F	Box Engine 188 A8.000/188 A9.000	617004	Inner Joint	22	21	36	61	93.5	
	2004.03-	-	-	MT	L	F	Box Engine 188 A8.000/188 A9.000	217141	Drive Shaft	25	22	51	84	593	
	2004.03-	-	-	MT	R	F	Box Engine 188 A8.000/188 A9.000	217149	Drive Shaft	25	22	51	84	828	
1.3 D Multijet (55 kW)	2006.01-	-	-	MT	L	F	Box Engine 169 A1.000	617004	Inner Joint	22	21	36	61	93.5	
	2006.01-	-	-	MT	L	F	Box Engine 169 A1.000	217141	Drive Shaft	25	22	51	84	593	
	2006.01-	-	-	MT	R	F	Box Engine 169 A1.000	217149	Drive Shaft	25	22	51	84	828	
PANDA VAN (312)															
0.9 4x4 (63 kW)	2012.09-	2013.01	-	-	-	635064	Propshaft CV Joint			20		21			
1.3D MULTIJET 4x4 (55 kW)	2012.06-	-	-	-	-	635064	Propshaft CV Joint			20		21			
PUNTO (176_)															
1.2 16V (63 kW)	1997.04-	1999.09	MT	L/R	F	Hatchback Engine 176 B9.000	817001	Outer Joint		22	20	46.8	75.5	52	O
	1997.04-	1999.09	MT	L/R	F	Hatchback Engine 176 B9.000	817039	Outer Joint	44T	22	20	46.8	75.5	52	O
	1997.04-	1999.09	MT	L	F	Hatchback Engine 176 B9.000	217037	Drive Shaft	44T	22	22	46.8	75.5	581	
	1997.04-	1999.09	-	R	F	Hatchback Engine 176 B9.000	217039	Drive Shaft	44T	22	22	46.8	75.5	874	
1.4 GT Turbo (96 kW)	1996.09-	1999.09	-	-	F	Hatchback Engine 176 B6.000	602005	Inner Joint		25		32			
	1996.09-	1999.09	AT/MT	L/R	F	Hatchback Engine 176 B6.000	618070	Inner Joint		25		32			
	1996.09-	1999.09	-	L	F	Hatchback Engine 176 B6.000	299048	Drive Shaft		25		52	85	467	
	1996.09-	1999.09	-	-	F	Hatchback Engine 176 B6.000	602006	Inner Joint		25		32			
	1996.09-	1999.09	AT/MT	L/R	F	Hatchback Engine 176 B6.000	602011	Inner Joint		25		32			
	1996.09-	1999.09	-	-	F	Hatchback Engine 176 B6.000	802004	Outer Joint	44T	25	25	52	85	58	I
	1996.09-	1999.09	MT	R	F	Hatchback Engine 176 B6.000	299049	Drive Shaft		25		52	85	493	
1.4 GT Turbo (98 kW)	1994.01-	1996.09	MT	R	F	Hatchback Engine 176 A4.000	299049	Drive Shaft		25		52	85	493	
	1994.01-	1996.09	-	L	F	Hatchback Engine 176 A4.000	299048	Drive Shaft		25		52	85	467	
	1994.01-	1996.09	-	-	F	Hatchback Engine 176 A4.000	602006	Inner Joint		25		32			
	1994.01-	1996.09	MT	L/R	F	Hatchback Engine 176 A4.000	817004	Outer Joint		25	25	52	85	58	I
	1994.01-	1996.09	-	-	F	Hatchback Engine 176 A4.000	802004	Outer Joint	44T	25	25	52	85	58	I
	1994.01-	1996.09	MT	L/R	F	Hatchback Engine 176 A4.000	602011	Inner Joint		25		32			
	1994.01-	1996.09	-	-	F	Hatchback Engine 176 A4.000	602005	Inner Joint		25		32			
1.6 (65 kW)	1994.01-	1997.04	MT	L/R	F	Hatchback Engine 176 A9.000	817001	Outer Joint		22	20	46.8	75.5	52	O
	1994.01-	1997.04	MT	L/R	F	Hatchback Engine 176 A9.000	817039	Outer Joint	44T	22	20	46.8	75.5	52	O
	1994.01-	1997.04	MT	R	F	Hatchback Engine 176 A9.000	217011	Drive Shaft		22	31.95	46.8	75.5	928.5	
	1994.01-	1997.04	MT	L	F	Hatchback Engine 176 A9.000	217037	Drive Shaft	44T	22	22	46.8	75.5	581	
	1994.01-	1997.04	MT	L	F	Hatchback Engine 176 A9.000	217018	Drive Shaft		22	22	46.8	75.5	581	
	1994.01-	1997.04	MT	R	F	Hatchback Engine 176 A9.000	217022	Drive Shaft		22	22	46.8	75.5	874	
1.7 D (42 kW)	1994.01-	1997.04	MT	L	F	Hatchback Engine 176 A9.000	217010	Drive Shaft		22	31.95	46.8	75.5	569	
	1994.04-	1997.09	MT	R	F	Hatchback Engine 176 B3.000	217011	Drive Shaft		22	31.95	46.8	75.5	928.5	
	1994.04-	1997.09	MT	L	F	Hatchback Engine 176 B3.000	217037	Drive Shaft	44T	22	22	46.8	75.5	581	

	 YEAR	TRANSM	L/R	F/R	REMARKS	GSP Ref.	 PRODUCT	 ABS	Technical Specifications					
									A	B	C	H	L	P
FIAT														
PUNTO (176_)														
1.7 D (42 kW)	1994.04-1997.09	MT	L	F	Hatchback Engine 176 B3.000	217018	Drive Shaft		22	22	46.8	75.5	581	
	1994.04-1997.09	MT	L	F	Hatchback Engine 176 B3.000	217010	Drive Shaft		22	31.95	46.8	75.5	569	
	1994.04-1997.09	MT	R	F	Hatchback Engine 176 B3.000	217022	Drive Shaft		22	22	46.8	75.5	874	
1.7 TD (46 kW)	1996.09-1999.09	AT/MT	L/R	F	Hatchback Engine 176 B7.000	618070	Inner Joint			25		32		
	1996.09-1999.09	-	-	F	Hatchback Engine 176 B7.000	817022	Outer Joint	44T	22	22	46.8	75.5	52	O
	1996.09-1999.09	-	-	F	Hatchback Engine 176 B7.000	817021	Outer Joint		22	22	46.8	75.5	52	O
1.7 TD (51 kW)	1994.01-1999.09	MT	R	F	Hatchback Engine 176 A3.000	299049	Drive Shaft		25		52	85	493	
	1994.01-1999.09	-	L	F	Hatchback Engine 176 A3.000	299048	Drive Shaft		25		52	85	467	
	1994.01-1999.09	-	-	F	Hatchback Engine 176 A3.000	602006	Inner Joint			25		32		
	1994.01-1999.09	MT	L/R	F	Hatchback Engine 176 A3.000	817004	Outer Joint		25	25	52	85	58	I
	1994.01-1999.09	-	-	F	Hatchback Engine 176 A3.000	802005	Outer Joint	44T	25	22	52	84	57	O
	1994.01-1999.09	-	-	F	Hatchback Engine 176 A3.000	802004	Outer Joint	44T	25	25	52	85	58	I
	1994.01-1999.09	MT	L/R	F	Hatchback Engine 176 A3.000	602011	Inner Joint			25		32		
	1994.01-1999.09	-	-	F	Hatchback Engine 176 A3.000	602005	Inner Joint			25		32		
1.7 TD (52 kW)	1994.01-1999.09	MT	R	F	Hatchback Engine 176 A5.000	299049	Drive Shaft		25		52	85	493	
	1994.01-1999.09	-	L	F	Hatchback Engine 176 A5.000	299048	Drive Shaft		25		52	85	467	
	1994.01-1999.09	-	-	F	Hatchback Engine 176 A5.000	602006	Inner Joint			25		32		
	1994.01-1999.09	MT	L/R	F	Hatchback Engine 176 A5.000	817004	Outer Joint		25	25	52	85	58	I
	1994.01-1999.09	-	-	F	Hatchback Engine 176 A5.000	802005	Outer Joint	44T	25	22	52	84	57	O
	1994.01-1999.09	-	-	F	Hatchback Engine 176 A5.000	802004	Outer Joint	44T	25	25	52	85	58	I
	1994.01-1999.09	MT	L/R	F	Hatchback Engine 176 A5.000	602011	Inner Joint			25		32		
	1994.01-1999.09	AT/MT	L/R	F	Hatchback Engine 176 A5.000	618070	Inner Joint			25		32		
1994.01-1999.09	-	-	F	Hatchback Engine 176 A5.000	602005	Inner Joint			25		32			
55 1.1 (40 kW)	1993.09-1999.09	MT	R	F	Hatchback Engine 176 A6.000/176 B2.000	217011	Drive Shaft		22	31.95	46.8	75.5	928.5	
	1993.09-1999.09	MT	L/R	F	Hatchback Engine 176 A6.000/176 B2.000	817001	Outer Joint		22	20	46.8	75.5	52	O
	1993.09-1999.09	MT	L/R	F	Hatchback Engine 176 A6.000/176 B2.000	817039	Outer Joint	44T	22	20	46.8	75.5	52	O
	1993.09-1999.09	MT	L	F	Hatchback Engine 176 A6.000/176 B2.000	217037	Drive Shaft	44T	22	22	46.8	75.5	581	
	1993.09-1999.09	-	R	F	Hatchback Engine 176 A6.000/176 B2.000	217039	Drive Shaft	44T	22	22	46.8	75.5	874	
	1993.09-1999.09	5MT	L	F	Hatchback Engine 176 A6.000/176 B2.000	217018	Drive Shaft		22	22	46.8	75.5	581	
	1993.09-1999.09	MT	L	F	Hatchback Engine 176 A6.000/176 B2.000	217010	Drive Shaft		22	31.95	46.8	75.5	569	
	1993.09-1999.09	5MT	R	F	Hatchback Engine 176 A6.000/176 B2.000	217022	Drive Shaft		22	22	46.8	75.5	874	
60 1.2 (43 kW)	1994.01-1999.09	MT	L/R	F	Hatchback Engine 176 A7.000	817001	Outer Joint		22	20	46.8	75.5	52	O
	1994.01-1999.09	MT	L/R	F	Hatchback Engine 176 A7.000	817039	Outer Joint	44T	22	20	46.8	75.5	52	O
	1994.01-1999.09	MT	R	F	Hatchback Engine 176 A7.000	217011	Drive Shaft		22	31.95	46.8	75.5	928.5	
	1994.01-1999.09	MT	L	F	Hatchback Engine 176 A7.000	217018	Drive Shaft		22	22	46.8	75.5	581	
	1994.01-1999.09	MT	R	F	Hatchback Engine 176 A7.000	217022	Drive Shaft		22	22	46.8	75.5	874	
	1994.01-1999.09	MT	L	F	Hatchback Engine 176 A7.000	217010	Drive Shaft		22	31.95	46.8	75.5	569	
	1994.04-2000.06	MT	L/R	F	Convertible Engine 176 A7.000	817001	Outer Joint		22	20	46.8	75.5	52	O
	1994.04-2000.06	MT	L/R	F	Convertible Engine 176 A7.000	817039	Outer Joint	44T	22	20	46.8	75.5	52	O
1994.04-2000.06	MT	L	F	Convertible Engine 176 A7.000	217018	Drive Shaft		22	22	46.8	75.5	581		
1994.04-2000.06	MT	R	F	Convertible Engine 176 A7.000	217022	Drive Shaft		22	22	46.8	75.5	874		
60 1.2 (44 kW)	1993.09-1999.09	MT	R	F	Hatchback Engine 176 B1.000/176 B4.000	217011	Drive Shaft		22	31.95	46.8	75.5	928.5	
	1993.09-1999.09	MT	L/R	F	Hatchback Engine 176 B1.000/176 B4.000	817001	Outer Joint		22	20	46.8	75.5	52	O
	1993.09-1999.09	MT	L/R	F	Hatchback Engine 176 B1.000/176 B4.000	817039	Outer Joint	44T	22	20	46.8	75.5	52	O
	1993.09-1999.09	MT	L	F	Hatchback Engine 176 B1.000/176 B4.000	217037	Drive Shaft	44T	22	22	46.8	75.5	581	
	1993.09-1999.09	MT	L	F	Hatchback Engine 176 B1.000/176 B4.000	217018	Drive Shaft		22	22	46.8	75.5	581	
	1993.09-1999.09	MT	R	F	Hatchback Engine 176 B1.000/176 B4.000	217022	Drive Shaft		22	22	46.8	75.5	874	
	1993.09-1999.09	MT	L	F	Hatchback Engine 176 B1.000/176 B4.000	217010	Drive Shaft		22	31.95	46.8	75.5	569	
	1995.05-2000.06	MT	L/R	F	Convertible Engine 176 B1.000/176 B4.000	817001	Outer Joint		22	20	46.8	75.5	52	O
1995.05-2000.06	MT	L/R	F	Convertible Engine 176 B1.000/176 B4.000	817039	Outer Joint	44T	22	20	46.8	75.5	52	O	
1995.05-2000.06	MT	L	F	Convertible Engine 176 B1.000/176 B4.000	217018	Drive Shaft		22	22	46.8	75.5	581		
1995.05-2000.06	MT	R	F	Convertible Engine 176 B1.000/176 B4.000	217022	Drive Shaft		22	22	46.8	75.5	874		
75 1.2 (54 kW)	1993.10-1999.09	MT	L/R	F	Hatchback Engine 176 A8.000	817001	Outer Joint		22	20	46.8	75.5	52	O
	1993.10-1999.09	MT	L/R	F	Hatchback Engine 176 A8.000	817039	Outer Joint	44T	22	20	46.8	75.5	52	O
	1993.10-1999.09	MT	R	F	Hatchback Engine 176 A8.000	217011	Drive Shaft		22	31.95	46.8	75.5	928.5	
	1993.10-1999.09	MT	L	F	Hatchback Engine 176 A8.000	217037	Drive Shaft	44T	22	22	46.8	75.5	581	
	1993.10-1999.09	MT	L	F	Hatchback Engine 176 A8.000	217018	Drive Shaft		22	22	46.8	75.5	581	
	1993.10-1999.09	MT	R	F	Hatchback Engine 176 A8.000	217022	Drive Shaft		22	22	46.8	75.5	874	
85 16V 1.2 (63 kW)	1997.04-2000.06	MT	L/R	F	Convertible Engine 176 B9.000	817001	Outer Joint		22	20	46.8	75.5	52	O
	1997.04-2000.06	MT	L/R	F	Convertible Engine 176 B9.000	817039	Outer Joint	44T	22	20	46.8	75.5	52	O
	1997.04-2000.06	-	R	F	Convertible Engine 176 B9.000	217039	Drive Shaft	44T	22	22	46.8	75.5	874	
90 1.6 (65 kW)	1994.04-1997.04	MT	L/R	F	Convertible Engine 176 A9.000	817001	Outer Joint		22	20	46.8	75.5	52	O
	1994.04-1997.04	MT	L/R	F	Convertible Engine 176 A9.000	817039	Outer Joint	44T	22	20	46.8	75.5	52	O
	1994.04-1997.04	MT	L	F	Convertible Engine 176 A9.000	217018	Drive Shaft		22	22	46.8	75.5	581	
	1994.04-1997.04	MT	R	F	Convertible Engine 176 A9.000	217022	Drive Shaft		22	22	46.8	75.5	874	





	 YEAR	TRANSM	L/R	F/R	REMARKS	GSP Ref.	 PRODUCT	 ABS	Technical Specifications					
									A	B	C	H	L	P
FIAT														
PUNTO (188_)														
1.2 16V 80 (59 kW)	1999.09-2006.12	AT/MT	L/R	F	Hatchback Engine 188 A5.000	817014	Outer Joint		22	21	51	79.5	54	M
	1999.09-2006.12	-	-	-	Hatchback Engine 188 A5.000	817034	Outer Joint		22	21	51	79.5	54	M
	1999.09-2006.12	MT	L	F	Hatchback Engine 188 A5.000	217023	Drive Shaft		22	22	46.8	75.5	606	
	1999.09-2006.12	MT	R	F	Hatchback Engine 188 A5.000	217046	Drive Shaft		22	22	51	79.5	844	
	1999.09-2006.12	MT	L	F	Hatchback Engine 188 A5.000	217032	Drive Shaft		22	22	51	79.5	612	
	1999.09-2006.12	MT	R	F	Hatchback Engine 188 A5.000	217033	Drive Shaft		22	22	51	79.5	841	
	1999.09-2006.12	CVT	L	F	Hatchback Engine 188 A5.000	217158	Drive Shaft		22	23	51	79.5	512	
	1999.09-2006.12	MT	R	F	Hatchback Engine 188 A5.000	899325	Outer Joint		22	27	51	79.5	54	O
	1999.09-2006.12	MT	L	F	Hatchback Engine 188 A5.000	617004	Inner Joint		22	21	36	61	93.5	
1999.09-2006.12	MT	R	F	Hatchback Engine 188 A5.000	617103	Inner Joint		22	27	36	61.5	93.5		
1.2 60 (44 kW)	1999.09-2010.12	MT	L/R	F	Hatchback Engine 188 A4.000	817014	Outer Joint		22	21	51	79.5	54	M
	1999.09-2010.12	-	-	-	Hatchback Engine 188 A4.000	817034	Outer Joint		22	21	51	79.5	54	M
	1999.09-2010.12	MT	L	F	Hatchback Engine 188 A4.000	217023	Drive Shaft		22	22	46.8	75.5	606	
	1999.09-2010.12	MT	R	F	Hatchback Engine 188 A4.000	217046	Drive Shaft		22	22	51	79.5	844	
	1999.09-2010.12	MT	L	F	Hatchback Engine 188 A4.000	217032	Drive Shaft		22	22	51	79.5	612	
	1999.09-2010.12	MT	R	F	Hatchback Engine 188 A4.000	217033	Drive Shaft		22	22	51	79.5	841	
	1999.09-2010.12	MT	R	F	Hatchback Engine 188 A4.000	899325	Outer Joint		22	27	51	79.5	54	O
	1999.09-2010.12	MT	L	F	Hatchback Engine 188 A4.000	617004	Inner Joint		22	21	36	61	93.5	
	1999.09-2010.12	MT	R	F	Hatchback Engine 188 A4.000	617103	Inner Joint		22	27	36	61.5	93.5	
1.2 Natural Power (44 kW)	2003.09-2012.03	-	-	F	Hatchback Engine 188 A4.000	899018	Outer Joint		22	27	51	79.5	54	O
	2003.09-2012.03	MT	L/R	F	Hatchback Engine 188 A4.000	817014	Outer Joint		22	21	51	79.5	54	M
	2003.09-2012.03	MT	L	F	Hatchback Engine 188 A4.000	217023	Drive Shaft		22	22	46.8	75.5	606	
	2003.09-2012.03	MT	R	F	Hatchback Engine 188 A4.000	217046	Drive Shaft		22	22	51	79.5	844	
	2003.09-2012.03	MT	L	F	Hatchback Engine 188 A4.000	217032	Drive Shaft		22	22	51	79.5	612	
	2003.09-2012.03	MT	R	F	Hatchback Engine 188 A4.000	217033	Drive Shaft		22	22	51	79.5	841	
	2003.09-2012.03	AT	L	F	Hatchback Engine 188 A4.000	217158	Drive Shaft		22	23	51	79.5	512	
	2003.09-2012.03	MT	R	F	Hatchback Engine 188 A4.000	899325	Outer Joint		22	27	51	79.5	54	O
	2003.09-2012.03	MT	L	F	Hatchback Engine 188 A4.000	617004	Inner Joint		22	21	36	61	93.5	
2003.09-2012.03	MT	R	F	Hatchback Engine 188 A4.000	617103	Inner Joint		22	27	36	61.5	93.5		
1.3 JTD 16V (51 kW)	2003.06-2012.03	MT	L	F	Hatchback Engine 188 A9.000	217192	Drive Shaft		25	33.9	51	84.5	452	
	2003.06-2012.03	MT	R	F	Hatchback Engine 188 A9.000	217193	Drive Shaft		25	33.9	51	84.5	469	
	2003.06-2012.03	MT	L/R	F	Hatchback Engine 188 A9.000	817042	Outer Joint		25	25	51	85	58	O
	2003.06-2012.03	MT	L	F	Hatchback Engine 188 A9.000	202005	Drive Shaft		25		51	85	450	
	2003.06-2012.03	MT	R	F	Hatchback Engine 188 A9.000	602011	Inner Joint			25		32		
	2003.06-2012.03	-	-	F	Hatchback Engine 188 A9.000	602005	Inner Joint			25		32		
	2003.06-2012.03	MT	-	F	Hatchback Engine 188 A9.000	802020	Outer Joint		25	25	51	85	58	O
	2003.06-2012.03	MT	L/R	F	Hatchback Engine 188 A9.000	618070	Inner Joint			25		32		
	2003.06-2012.03	MT	L	F	Hatchback Engine 188 A9.000	817014	Outer Joint		22	21	51	79.5	54	M
1.4 (70 kW)	2003.09-2012.03	-	L	F	Hatchback Engine 843 A1.000	217023	Drive Shaft		22	22	46.8	75.5	606	
	2003.09-2012.03	-	L	F	Hatchback Engine 843 A1.000	217032	Drive Shaft		22	22	51	79.5	612	
	2003.09-2012.03	-	R	F	Hatchback Engine 843 A1.000	217046	Drive Shaft		22	22	51	79.5	844	
	2003.09-2012.03	-	R	F	Hatchback Engine 843 A1.000	899325	Outer Joint		22	27	51	79.5	54	O
	2003.09-2012.03	-	L	F	Hatchback Engine 843 A1.000	617004	Inner Joint		22	21	36	61	93.5	
	2003.09-2012.03	-	R	F	Hatchback Engine 843 A1.000	617103	Inner Joint		22	27	36	61.5	93.5	
	2003.09-2012.03	MT	L	F	Hatchback Engine 199 A6.000	217023	Drive Shaft		22	22	46.8	75.5	606	
	2003.09-2012.03	MT	R	F	Hatchback Engine 199 A6.000	217046	Drive Shaft		22	22	51	79.5	844	
	2003.09-2012.03	-	L	F	Hatchback Engine 199 A6.000	217032	Drive Shaft		22	22	51	79.5	612	
1.4 (71 kW)	2005.11-2012.03	-	L/R	F	Hatchback Engine 199 A6.000	817052	Outer Joint		22	21	51.2	79.5	54	M
	2005.11-2012.03	MT	R	F	Hatchback Engine 199 A6.000	899325	Outer Joint		22	27	51	79.5	54	O
	2005.11-2012.03	-	L	F	Hatchback Engine 199 A6.000	617004	Inner Joint		22	21	36	61	93.5	
	2005.11-2012.03	MT	R	F	Hatchback Engine 199 A6.000	617103	Inner Joint		22	27	36	61.5	93.5	
	1999.09-2012.03	-	-	F	Hatchback Engine 183 A1.000/188 A6.000	602005	Inner Joint			25		32		
	1999.09-2012.03	MT	L/R	F	Hatchback Engine 183 A1.000/188 A6.000	817042	Outer Joint		25	25	51	85	58	O
	1999.09-2012.03	MT	L	F	Hatchback Engine 183 A1.000/188 A6.000	202005	Drive Shaft		25		51	85	450	
	1999.09-2012.03	MT	L/R	F	Hatchback Engine 183 A1.000/188 A6.000	602011	Inner Joint			25		32		
	1999.09-2012.03	-	-	F	Hatchback Engine 183 A1.000/188 A6.000	802020	Outer Joint		25	25	51	85	58	O
1.9 DS 60 (44 kW)	1999.09-2012.03	MT	L/R	F	Hatchback Engine 188 A3.000	817014	Outer Joint		22	21	51	79.5	54	M
	1999.09-2012.03	-	-	-	Hatchback Engine 188 A3.000	817034	Outer Joint		22	21	51	79.5	54	M
	2001.10-2012.03	-	-	F	Hatchback Engine 188 A7.000	602005	Inner Joint			25		32		
	2001.10-2012.03	MT	L/R	F	Hatchback Engine 188 A7.000	817042	Outer Joint		25	25	51	85	58	O
	2001.10-2012.03	MT	L	F	Hatchback Engine 188 A7.000	202005	Drive Shaft		25		51	85	450	
	2001.10-2012.03	MT	R	F	Hatchback Engine 188 A7.000	602011	Inner Joint			25		32		
	2001.10-2012.03	-	-	F	Hatchback Engine 188 A7.000	802020	Outer Joint		25	25	51	85	58	O
	2001.10-2012.03	MT	L/R	F	Hatchback Engine 188 A7.000	618070	Inner Joint			25		32		
	2001.10-2012.03	MT	L/R	F	Hatchback Engine 188 B2.000	817028	Outer Joint		25	24	51	84.5	62	M

	 YEAR	TRANSM	L/R	F/R	REMARKS	GSP Ref.	 PRODUCT	 ABS	Technical Specifications						
									A	B	C	H	L	P	
FIAT															
PUNTO (188_)															
1.9 JTD (74 kW)	2003.06-	2012.03	MT	L/R	F	Hatchback Engine 188 B2.000	618070	Inner Joint			25		32		
1.9 JTD 80 (59 kW)	1999.09-	2012.03	-	-	F	Hatchback Engine 188 A2.000	602005	Inner Joint			25		32		
	1999.09-	2012.03	MT	L/R	F	Hatchback Engine 188 A2.000	817042	Outer Joint	25	25	51	85	58	O	
	1999.09-	2012.03	MT	L	F	Hatchback Engine 188 A2.000	202005	Drive Shaft	25		51	85	450		
	1999.09-	2012.03	MT	R	F	Hatchback Engine 188 A2.000	602011	Inner Joint			25		32		
	1999.09-	2012.03	-	-	F	Hatchback Engine 188 A2.000	802020	Outer Joint	25	25	51	85	58	O	
	1999.09-	2012.03	MT	L/R	F	Hatchback Engine 188 A2.000	618070	Inner Joint			25		32		
PUNTO (199_)															
0.9 Bifuel (63 kW)	2012.03-	-	-	R	-	Hatchback Engine 312 A2.000	217225	Drive Shaft	22	22	51	79	860		
	2012.03-	-	-	L	-	Hatchback Engine 312 A2.000	217224	Drive Shaft	22	22	51	79	670		
0.9 Twinair Turbo (63 kW)	2012.03-	-	-	R	-	Hatchback Engine 312 A2.000	217225	Drive Shaft	22	22	51	79	860		
	2012.03-	-	-	L	-	Hatchback Engine 312 A2.000	217224	Drive Shaft	22	22	51	79	670		
1.2 (49 kW)	2014.02-	-	-	L	F	Hatchback Engine 199 B9.000	617004	Inner Joint	22	21	36	61	93.5		
	2014.02-	-	-	L	F	Hatchback Engine 199 B9.000	617103	Inner Joint	22	27	36	61.5	93.5		
	2014.02-	-	-	L	F	Hatchback Engine 199 B9.000	217222	Drive Shaft	22	22	51	79.5	646		
	2014.02-	-	-	L	F	Hatchback Engine 199 B9.000	899325	Outer Joint	22	27	51	79.5	54	O	
1.2 (51 kW)	2012.03-	-	-	L	F	Hatchback Engine 169 A4.000	617103	Inner Joint	22	27	36	61.5	93.5		
	2012.03-	-	-	L	F	Hatchback Engine 169 A4.000	217222	Drive Shaft	22	22	51	79.5	646		
	2012.03-	-	-	L	F	Hatchback Engine 169 A4.000	899325	Outer Joint	22	27	51	79.5	54	O	
	2012.03-	-	-	L	F	Hatchback Engine 169 A4.000	617004	Inner Joint	22	21	36	61	93.5		
1.3 D Multijet (55 kW)	2012.03-	-	-	R	F	Hatchback Engine 199 A2.000/199 A9.000	217066	Drive Shaft	25	33.9	51	84.5	497		
	2012.03-	-	-	L	F	Hatchback Engine 199 A2.000/199 A9.000	217082	Drive Shaft	25	33.9	51	84.5	514		
1.3 D Multijet (62 kW)	2012.03-	-	-	L/R	F	Hatchback Engine 199 B4.000	817063	Outer Joint	25	25	51.1	84.5	61	M	
1.3 D Multijet (70 kW)	2012.03-	-	-	L/R	F	Hatchback Engine 199 B1.000/330 A1.000	817063	Outer Joint	25	25	51.1	84.5	61	M	
1.4 (55 kW)	2012.03-	-	-	R	F	Hatchback Engine 199 A7.000	217066	Drive Shaft	25	33.9	51	84.5	497		
	2012.03-	-	-	L	F	Hatchback Engine 199 A7.000	217082	Drive Shaft	25	33.9	51	84.5	514		
1.4 Bifuel (57 kW)	2012.03-	-	-	L	F	Hatchback Engine 350 A1.000	217222	Drive Shaft	22	22	51	79.5	646		
	2012.03-	-	-	L	F	Hatchback Engine 350 A1.000	617004	Inner Joint	22	21	36	61	93.5		
1.4 Natural Power (57 kW)	2012.03-	-	-	L	F	Hatchback Engine 350 A1.000	217222	Drive Shaft	22	22	51	79.5	646		
	2012.03-	-	-	L	F	Hatchback Engine 350 A1.000	617004	Inner Joint	22	21	36	61	93.5		
1.4 Turbo Multi Air (99 kW)	2012.03-	-	-	L/R	F	Hatchback Engine 955 A2.000	817063	Outer Joint	25	25	51.1	84.5	61	M	
PUNTO 1 (176, 176C), CABRIO															
1.1 (40 kW)	1993.09-	1999.09	-	-	-	-	617001	Inner Joint	22	19	36	61.5	88.5		
1.2 (43 kW)	1994.01-	1999.09	-	-	-	-	617001	Inner Joint	22	19	36	61.5	88.5		
1.2 (44 kW)	1994.01-	1999.09	-	-	-	-	617001	Inner Joint	22	19	36	61.5	88.5		
1.4 GT Turbo (96 kW)	1994.01-	1996.09	-	-	-	-	617009	Inner Joint		25		32			
1.4 GT Turbo (98 kW)	1994.01-	1996.09	-	-	-	-	617009	Inner Joint		25		32			
12 85 16V Cabrio (63 kW)	1997.04-	1999.09	-	-	-	-	617027	Inner Joint	22	22	36	61.5	93.5		
17 TD (51 kW)	1994.01-	1999.09	-	-	-	-	617009	Inner Joint		25		32			
17 TD (52 kW)	1994.01-	1999.09	-	-	-	-	617009	Inner Joint		25		32			
PUNTO EVO															
1.3 D Multijet (51 kW)	2008.07-	2012.02	-	R	-	-	617012	Inner Joint	24	23	29.7	379	100.5		
	2008.07-	2012.02	-	L	-	-	617011	Inner Joint	24	23	29.7	86.5	93		
1.3 D Multijet (55 kW)	2008.07-	2012.02	-	R	-	-	617012	Inner Joint	24	23	29.7	379	100.5		
	2008.07-	2012.02	-	L	-	-	617011	Inner Joint	24	23	29.7	86.5	93		
1.3 D Multijet (61 kW)	2009.10-	2012.02	-	R	-	-	617026	Inner Joint	24	24	29.7	379	100.5		
1.3 D Multijet (66 kW)	2009.10-	2012.02	-	L	-	-	699008	Inner Joint	24	24	29.7	86.5	93		
1.3 D Multijet (70 kW)	2009.10-	2012.02	-	R	-	-	617026	Inner Joint	24	24	29.7	379	100.5		
PUNTO EVO (199_)															
1.2 (48 kW)	2009.10-	2012.02	-	R	F	Hatchback Engine 199 A4.000	617004	Inner Joint	22	21	36	61	93.5		
	2009.10-	2012.02	-	L	F	Hatchback Engine 199 A4.000	617103	Inner Joint	22	27	36	61.5	93.5		
	2009.10-	2012.02	-	R	F	Hatchback Engine 199 A4.000	217222	Drive Shaft	22	22	51	79.5	646		
	2009.10-	2012.02	-	L	F	Hatchback Engine 199 A4.000	899325	Outer Joint	22	27	51	79.5	54	O	
1.2 (51 kW)	2009.10-	2012.02	-	L	F	Hatchback Engine 169 A4.000	217222	Drive Shaft	22	22	51	79.5	646		
	2009.10-	2012.02	-	L	F	Hatchback Engine 169 A4.000	899325	Outer Joint	22	27	51	79.5	54	O	
	2009.10-	2012.02	-	L	F	Hatchback Engine 169 A4.000	617004	Inner Joint	22	21	36	61	93.5		
	2009.10-	2012.02	-	L	F	Hatchback Engine 169 A4.000	617103	Inner Joint	22	27	36	61.5	93.5		
1.3 D Multijet (51 kW)	2008.07-	2012.02	CVT	L/R	F	Hatchback Engine 199 B2.000	817053	Outer Joint	25	23	51	84.5	60	M	
	2008.07-	2012.02	-	R	F	Hatchback Engine 199 B2.000	217066	Drive Shaft	25	33.9	51	84.5	497		
	2008.07-	2012.02	MT	L	F	Hatchback Engine 199 B2.000	217182	Drive Shaft	25	24	51	84.5	624		
	2008.07-	2012.02	-	-	F	Hatchback Engine 199 B2.000	817027	Outer Joint	25	23	51	84.5	60	M	
	2008.07-	2012.02	-	L	F	Hatchback Engine 199 B2.000	217082	Drive Shaft	25	33.9	51	84.5	514		
1.3 D Multijet (55 kW)	2009.10-	2012.02	CVT	L/R	F	Hatchback Engine 199 A2.000/199 A9.000	817053	Outer Joint	25	23	51	84.5	60	M	
	2009.10-	2012.02	-	R	F	Hatchback Engine 199 A2.000/199 A9.000	217066	Drive Shaft	25	33.9	51	84.5	497		
	2009.10-	2012.02	MT	L	F	Hatchback Engine 199 A2.000/199 A9.000	217182	Drive Shaft	25	24	51	84.5	624		
	2009.10-	2012.02	-	L	F	Hatchback Engine 199 A2.000/199 A9.000	217082	Drive Shaft	25	33.9	51	84.5	514		

YEAR	TRANS	L/R	F/R	REMARKS	GSP Ref.	PRODUCT	ABS	Technical Specifications						
								A	B	C	H	L	P	
FIAT														
PUNTO EVO (199_)														
1.3 D Multijet (55 kW)	2009.10-	2012.02	-	-	F	Hatchback Engine 199 A2.000/199 A9.000	817027	Outer Joint	25	23	51	84.5	60	M
1.3 D Multijet (62 kW)	2009.10-	2012.02	-	L/R	F	Hatchback Engine 199 B4.000/223 A9.000	817063	Outer Joint	25	25	51.1	84.5	61	M
1.3 D Multijet (66 kW)	2009.10-	-	CVT	L/R	F	Hatchback Engine 199 A3.000	817053	Outer Joint	25	23	51	84.5	60	M
	2009.10-	-	-	L	F	Hatchback Engine 199 A3.000	217172	Drive Shaft	25	33.9	51	84.5	486	
	2009.10-	-	-	R	F	Hatchback Engine 199 A3.000	217146	Drive Shaft	25		51	84.5	522	
1.3 D Multijet (70 kW)	2009.03-	2012.02	-	L/R	F	Box/Van Engine 199 B1.000	817063	Outer Joint	25	25	51.1	84.5	61	M
	2009.10-	2012.02	CVT	L/R	F	Hatchback Engine 199 B1.000	817053	Outer Joint	25	23	51	84.5	60	M
	2009.10-	2012.02	-	L	F	Hatchback Engine 199 B1.000	217172	Drive Shaft	25	33.9	51	84.5	486	
	2009.10-	2012.02	-	R	F	Hatchback Engine 199 B1.000	217146	Drive Shaft	25		51	84.5	522	
1.4 (55 kW)	2009.07-	2012.02	-	L	F	Hatchback Engine 199 A7.000	899325	Outer Joint	22	27	51	79.5	54	O
	2009.07-	2012.02	-	L	F	Hatchback Engine 199 A7.000	617103	Inner Joint	22	27	36	61.5	93.5	
1.4 (57 kW)	2009.10-	2012.02	-	L	F	Hatchback Engine 350 A1.000	617004	Inner Joint	22	21	36	61	93.5	
	2009.10-	2012.02	-	L	F	Hatchback Engine 350 A1.000	617103	Inner Joint	22	27	36	61.5	93.5	
	2009.10-	2012.02	-	L	F	Hatchback Engine 350 A1.000	217222	Drive Shaft	22	22	51	79.5	646	
	2009.10-	2012.02	-	L	F	Hatchback Engine 350 A1.000	899325	Outer Joint	22	27	51	79.5	54	O
1.4 16V (77 kW)	2009.10-	2012.02	-	L/R	F	Hatchback Engine 955 A6.000	817070	Outer Joint	22	22	51	79	57.5	M
1.4 16V (99 kW)	2009.10-	2012.02	-	L/R	F	Hatchback Engine 955 A2.000	817063	Outer Joint	25	25	51.1	84.5	61	M
1.4 LPG (57 kW)	2009.06-	2012.02	-	L	F	Hatchback Engine 350 A1.000	617103	Inner Joint	22	27	36	61.5	93.5	
	2009.06-	2012.02	-	L	F	Hatchback Engine 350 A1.000	217222	Drive Shaft	22	22	51	79.5	646	
	2009.06-	2012.02	-	L	F	Hatchback Engine 350 A1.000	899325	Outer Joint	22	27	51	79.5	54	O
	2009.06-	2012.02	-	L	F	Hatchback Engine 350 A1.000	617004	Inner Joint	22	21	36	61	93.5	
1.4 Natural Power (57 kW)	2009.10-	2012.02	-	L	F	Hatchback Engine 350 A1.000	899325	Outer Joint	22	27	51	79.5	54	O
	2009.10-	2012.02	-	L	F	Hatchback Engine 350 A1.000	617103	Inner Joint	22	27	36	61.5	93.5	
1.6 D Multijet (88 kW)	2009.10-	2012.02	MT	L	F	Hatchback Engine 955 A3.000	617085	Inner Joint	25	33	34.9	57.5	97.5	
	2009.10-	2012.02	MT	R	F	Hatchback Engine 955 A3.000	617072	Inner Joint	25	33	34.9	431.5	93	
	2009.10-	2012.02	-	L/R	F	Hatchback Engine 955 A3.000	817063	Outer Joint	25	25	51.1	84.5	61	M
	2009.10-	2012.02	MT	L	F	Hatchback Engine 955 A3.000	217142	Drive Shaft	25	25	51.1	84.5	588	
	2009.10-	2012.02	MT	R	F	Hatchback Engine 955 A3.000	217143	Drive Shaft	25	25	51.1	84.5	953	
PUNTO EVO, VAN														
1.3 D Multijet (66 kW)	2009.10-	2012.02	-	R	-		617015	Inner Joint	24	24	29.7	379	100.5	
	2009.10-	2012.02	-	R	-		617056	Inner Joint	25	23	34.9	400	97	
	2009.10-	2012.02	-	L	-		644014	Inner Joint	25	23	34.9	57.5	102	
1.3 D Multijet (70 kW)	2009.10-	2012.02	-	R	-		617056	Inner Joint	25	23	34.9	400	97	
	2009.10-	2012.02	-	L	-		644014	Inner Joint	25	23	34.9	57.5	102	
1.3 Multijet (61 kW)	2009.10-	2012.02	-	L	-		617025	Inner Joint	24	24	29.7	86.5	93	
1.3 Multijet (70 kW)	2009.10-	2012.02	-	L	-		617025	Inner Joint	24	24	29.7	86.5	93	
1.4 16V (77 kW)	2009.10-	2012.02	-	L	-		617025	Inner Joint	24	24	29.7	86.5	93	
1.4 16V (99 kW)	2009.10-	2012.02	-	L	-		617025	Inner Joint	24	24	29.7	86.5	93	
1.4 Natural Power (55 kW)	2009.07-	2012.02	-	-	-		617027	Inner Joint	22	22	36	61.5	93.5	
1.4 Natural Power (57 kW)	2009.07-	2012.02	-	-	-		617027	Inner Joint	22	22	36	61.5	93.5	
1.4 TB (99 kW)	2009.10-	2012.02	-	L	-		617031	Inner Joint	25	26	32	59	110.5	
PUNTO II														
1.2	1999.10-	-	MT	L	F	-	617001	Inner Joint	22	19	36	61.5	88.5	
1.9 D	1999.10-	-	MT	L	F	-	617001	Inner Joint	22	19	36	61.5	88.5	
PUNTO II (188)														
1.8 HGT (96 kW)	1999.09-	-	-	R	-		617009	Inner Joint			25		32	
1.9 JTD (59 kW)	1999.09-	-	-	R	-		617009	Inner Joint			25		32	
1.9 JTD (63 kW)	1999.09-	-	-	R	-		617009	Inner Joint			25		32	
1.9 JTD (74 kW)	2003.06-	-	-	R	-		617062	Inner Joint	34	24	34.9	300	102.5	
13 JTD 16V (51 kW)	2003.06-	-	-	R	-		617009	Inner Joint			25		32	
PUNTO III (199)														
0.9 Bifuel (63 kW)	2012.03-	-	-	-	-		617027	Inner Joint	22	22	36	61.5	93.5	
1.2 (51 kW)	2012.03-	-	-	-	-		617027	Inner Joint	22	22	36	61.5	93.5	
1.3 D Multijet (55 kW)	2012.03-	-	-	R	-		617012	Inner Joint	24	23	29.7	379	100.5	
1.3 D Multijet (62 kW)	2012.03-	-	-	R	-		617026	Inner Joint	24	24	29.7	379	100.5	
1.3 D Multijet (70 kW)	2012.03-	-	-	R	-		617026	Inner Joint	24	24	29.7	379	100.5	
1.3 Multijet (55 kW)	2012.03-	-	-	L	-		617011	Inner Joint	24	23	29.7	86.5	93	
1.3 Multijet (62 kW)	2012.03-	-	-	L	-		617025	Inner Joint	24	24	29.7	86.5	93	
1.3 Multijet (66 kW)	2005.10-	2010.06	-	R	-		617056	Inner Joint	25	23	34.9	400	97	
	2005.10-	2010.06	-	L	-		644014	Inner Joint	25	23	34.9	57.5	102	
1.3 Multijet (70 kW)	2012.03-	-	-	L	-		617025	Inner Joint	24	24	29.7	86.5	93	
1.4 (55 kW)	2012.03-	-	-	-	-		617027	Inner Joint	22	22	36	61.5	93.5	
1.4 (57 kW)	2012.03-	-	-	-	-		617027	Inner Joint	22	22	36	61.5	93.5	
1.4 Multi Air (77 kW)	2012.03-	-	-	-	-		617027	Inner Joint	22	22	36	61.5	93.5	
1.4 Multi Air Turbo (99 kW)	2012.03-	-	-	L	-		617031	Inner Joint	25	26	32	59	110.5	
1.4 Natural Power (57 kW)	2012.03-	-	-	-	-		617027	Inner Joint	22	22	36	61.5	93.5	





YEAR	TRANS	L/R	F/R	REMARKS	GSP Ref.	PRODUCT	ABS	Technical Specifications							
								A	B	C	H	L	P		
FIAT															
PUNTO VAN															
1.3 D Multijet (51 kW)	2008.07-	2012.02	-	R	-	617012	Inner Joint		24	23	29.7	379	100.5		
	2008.07-	2012.02	-	L	-	617011	Inner Joint		24	23	29.7	86.5	93		
1.3 D Multijet (55 kW)	2008.07-	2012.02	-	R	-	617012	Inner Joint		24	23	29.7	379	100.5		
	2008.07-	2012.02	-	L	-	617011	Inner Joint		24	23	29.7	86.5	93		
1.3 D Multijet (61 kW)	2009.10-	2012.02	-	R	-	617026	Inner Joint		24	24	29.7	379	100.5		
1.3 D Multijet (66 kW)	2009.10-	2012.02	-	L	-	699008	Inner Joint		24	24	29.7	86.5	93		
1.3 D Multijet (70 kW)	2009.10-	2012.02	-	R	-	617026	Inner Joint		24	24	29.7	379	100.5		
PUNTO Van (176_)															
1.1 (40 kW)	1996.04-	2000.02	MT	L/R	F	Box Engine 176 B2.000	817001	Outer Joint		22	20	46.8	75.5	52	O
	1996.04-	2000.02	MT	L/R	F	Box Engine 176 B2.000	817039	Outer Joint	44T	22	20	46.8	75.5	52	O
	1996.04-	2000.02	MT	L	F	Box Engine 176 B2.000	217037	Drive Shaft	44T	22	22	46.8	75.5	581	
1.7 D (42 kW)	1996.04-	2000.02	MT	L	F	Box Engine 176 B3.000	217037	Drive Shaft	44T	22	22	46.8	75.5	581	
1.7 TD (46 kW)	1996.09-	1999.09	-	-	F	Box Engine 176 B7.000	817022	Outer Joint	44T	22	22	46.8	75.5	52	O
	1996.09-	1999.09	-	-	F	Box Engine 176 B7.000	817021	Outer Joint		22	22	46.8	75.5	52	O
1.7 TD (52 kW)	1996.04-	2000.02	-	-	F	Box Engine 176 A5.000	602005	Inner Joint			25		32		
	1996.04-	2000.02	-	L	F	Box Engine 176 A5.000	299048	Drive Shaft		25		52	85	467	
	1996.04-	2000.02	MT	L/R	F	Box Engine 176 A5.000	817023	Outer Joint		25	22	52	84	57	O
	1996.04-	2000.02	-	-	F	Box Engine 176 A5.000	802005	Outer Joint	44T	25	22	52	84	57	O
	1996.04-	2000.02	-	-	F	Box Engine 176 A5.000	802004	Outer Joint	44T	25	25	52	85	58	I
PUNTO Van (188_)															
1.2 60 (44 kW)	2000.02-	2009.10	MT	L	F	Box Engine 188 A4.000	217023	Drive Shaft		22	22	46.8	75.5	606	
	2000.02-	2009.10	MT	R	F	Box Engine 188 A4.000	217046	Drive Shaft		22	22	51	79.5	844	
	2000.02-	2009.10	MT	L	F	Box Engine 188 A4.000	217032	Drive Shaft		22	22	51	79.5	612	
	2000.02-	2009.10	MT	R	F	Box Engine 188 A4.000	217033	Drive Shaft		22	22	51	79.5	841	
	2000.02-	2009.10	MT	R	F	Box Engine 188 A4.000	899325	Outer Joint		22	27	51	79.5	54	O
	2000.02-	2009.10	MT	L	F	Box Engine 188 A4.000	617004	Inner Joint		22	21	36	61	93.5	
	2000.02-	2009.10	MT	R	F	Box Engine 188 A4.000	617103	Inner Joint		22	27	36	61.5	93.5	
1.3 D Multijet (55 kW)	2005.02-	2009.10	MT	L	F	Box Engine 188 A9.000	217182	Drive Shaft		25	24	51	84.5	624	
	2005.02-	2009.10	-	-	F	Box Engine 188 A9.000	817027	Outer Joint		25	23	51	84.5	60	M
1.3 JTD (51 kW)	2003.06-	2005.10	-	L	F	Box Engine 188 A9.000	202005	Drive Shaft		25		51	85	450	
	2003.06-	2005.10	-	-	F	Box Engine 188 A9.000	802020	Outer Joint		25	25	51	85	58	O
1.9 D 60 (44 kW)	2000.02-	2009.10	-	-	F	Box Engine 188 A3.000	602005	Inner Joint			25		32		
1.9 JTD (63 kW)	2000.02-	2009.10	-	-	F	Box Engine 188 A7.000	602005	Inner Joint			25		32		
	2000.02-	2009.10	MT	L	F	Box Engine 188 A7.000	202005	Drive Shaft		25		51	85	450	
	2000.02-	2009.10	MT	R	F	Box Engine 188 A7.000	602011	Inner Joint			25		32		
	2000.02-	2009.10	-	-	F	Box Engine 188 A7.000	802020	Outer Joint		25	25	51	85	58	O
	2000.02-	2009.10	MT	L/R	F	Box Engine 188 A7.000	618070	Inner Joint			25		32		
PUNTO Van (199_)															
1.3 D Multijet (55 kW)	2008.04-	-	-	R	F	Box Engine 199 A2.000/199 A9.000	217109	Drive Shaft		25	24	51	84.5	908	
	2008.04-	-	-	R	F	Box Engine 199 A2.000/199 A9.000	217066	Drive Shaft		25	33.9	51	84.5	497	
	2008.04-	-	-	L	F	Box Engine 199 A2.000/199 A9.000	217182	Drive Shaft		25	24	51	84.5	624	
	2008.04-	-	-	L	F	Box Engine 199 A2.000/199 A9.000	217082	Drive Shaft		25	33.9	51	84.5	514	
	2008.04-	-	-	-	F	Box Engine 199 A2.000/199 A9.000	817027	Outer Joint		25	23	51	84.5	60	M
1.3 D Multijet (62 kW)	2012.03-	-	-	L/R	F	Box Engine 199 B4.000	817063	Outer Joint		25	25	51.1	84.5	61	M
1.3 D Multijet (70 kW)	2009.03-	-	-	L/R	F	Box Engine 199 B1.000	817063	Outer Joint		25	25	51.1	84.5	61	M
1.4 (57 kW)	2006.02-	-	-	L	F	Box Engine 350 A1.000	617103	Inner Joint		22	27	36	61.5	93.5	
	2006.02-	-	-	R	F	Box Engine 350 A1.000	617004	Inner Joint		22	21	36	61	93.5	
	2006.02-	-	-	L	F	Box Engine 350 A1.000	899325	Outer Joint		22	27	51	79.5	54	O
1.4 LPG (57 kW)	2009.03-	-	-	L	F	Box Engine 350 A1.000	617103	Inner Joint		22	27	36	61.5	93.5	
	2009.03-	-	-	R	F	Box Engine 350 A1.000	617004	Inner Joint		22	21	36	61	93.5	
	2009.03-	-	-	L	F	Box Engine 350 A1.000	899325	Outer Joint		22	27	51	79.5	54	O
1.4 Natural Power (57 kW)	2009.03-	-	-	L	F	Box Engine 350 A1.000	617103	Inner Joint		22	27	36	61.5	93.5	
	2009.03-	-	-	R	F	Box Engine 350 A1.000	617004	Inner Joint		22	21	36	61	93.5	
	2009.03-	-	-	L	F	Box Engine 350 A1.000	899325	Outer Joint		22	27	51	79.5	54	O
PUNTO VAN I (176L)															
1.7 D (52 kW)	1996.04-	2000.02	-	-	-	LCV	617009	Inner Joint			25		32		
PUNTO VAN II															
1.2	2001.01-	-	MT	L	F	LCV	617001	Inner Joint		22	19	36	61.5	88.5	
1.9 D	2001.01-	-	MT	L	F	LCV	617001	Inner Joint		22	19	36	61.5	88.5	
PUNTO VAN II (188AX)															
1.3 JTD (51 kW)	2003.06-	2005.10	-	R	-	LCV	617012	Inner Joint		24	23	29.7	379	100.5	
	2003.06-	2015.10	-	L	-	LCV	617011	Inner Joint		24	23	29.7	86.5	93	
QUBO (225)															
1.3 D Multijet (55 kW)	2008.09-	-	-	R	-	w/o Selespeed	617015	Inner Joint		24	24	29.7	379	100.5	
	2008.09-	-	-	L	-	LCV	699008	Inner Joint		24	24	29.7	86.5	93	
	2009.09-	-	-	R	-	LCV	617059	Inner Joint		24	24	29.8	394	100	

YEAR	TRANSM	L/R	F/R	REMARKS	GSP Ref.	PRODUCT	ABS	Technical Specifications									
								A	B	C	H	L	P				
FIAT																	
QUBO (225)																	
1.3 D Multijet (55 kW)	2010.07-	-	-	R	-	LCV	617056	Inner Joint		25	23	34.9	400	97			
	2010.07-	-	-	L	-	LCV	644014	Inner Joint		25	23	34.9	57.5	102			
1.3 D Multijet (70 kW)	2008.09-	-	-	R	-	w/o Selespeed	617015	Inner Joint		24	24	29.7	379	100.5			
	2009.09-	-	-	R	-	LCV	617059	Inner Joint		24	24	29.8	394	100			
	2009.09-	-	-	L	-	LCV	699008	Inner Joint		24	24	29.7	86.5	93			
1.4 (51 kW)	2008.09-	-	-	-	-	-	617027	Inner Joint		22	22	36	61.5	93.5			
QUBO (225_)																	
1.3 D Multijet (55 kW)	2008.02-	-	-	MT	R	F	MPV Engine 199 A2.000/199 A9.000	217061	Drive Shaft		25	24	51	84.5	953		
	2008.02-	-	-	-	R	F	MPV Engine 199 A2.000/199 A9.000	217055	Drive Shaft		25	35.45	51	84.5	543		
	2008.02-	-	-	MT	R	F	MPV Engine 199 A2.000/199 A9.000	217157	Drive Shaft		25	24	51	84.5	919		
	2008.02-	-	-	CVT	L/R	F	MPV Engine 199 A2.000/199 A9.000	817053	Outer Joint		25	23	51	84.5	60	M	
	2008.02-	-	-	MT	L/R	F	MPV Engine 199 A2.000/199 A9.000	817028	Outer Joint		25	24	51	84.5	62	M	
	2008.02-	-	-	MT	L	F	MPV Engine 199 A2.000/199 A9.000	217165	Drive Shaft		25	24	51	84.5	603		
	2008.02-	-	-	AT	R	F	MPV Engine 199 A2.000/199 A9.000	217146	Drive Shaft		25		51	84.5	522		
	2008.02-	-	-	AT	L	F	MPV Engine 199 A2.000/199 A9.000	217147	Drive Shaft		25		51	84.5	480		
1.3 D Multijet (70 kW)	2010.07-	-	-	MT	R	F	MPV Engine 199 B1.000	217157	Drive Shaft		25	24	51	84.5	919		
	2010.07-	-	-	MT	L	F	MPV Engine 199 B1.000	217165	Drive Shaft		25	24	51	84.5	603		
1.4 (54 kW)	2008.02-	-	-	L/R	F	F	MPV Engine KFT/KFV	817070	Outer Joint		22	22	51	79	57.5	M	
1.4 Natural Power (57 kW)	2009.10-	-	-	L/R	F	F	MPV Engine 350 A1.000	817070	Outer Joint		22	22	51	79	57.5	M	
REGATA (138_)																	
1.6 (70 kW)	1983.10-	1989.07	-	MT	L/R	F	Saloon Engine 149 C3.000	817006	Outer Joint		22	25	48.1	93.5	60.5	I	
	1983.10-	1989.07	-	MT	L/R	F	Saloon Engine 149 C3.000	648004	Inner Joint			25		32			
	1983.10-	1989.07	-	-	-	F	Saloon Engine 149 C3.000	602006	Inner Joint			25		32			
1.6 (74 kW)	1983.10-	1990.12	-	-	-	F	Saloon Engine 149 A2.000/149 A4.000	602006	Inner Joint			25		32			
	1983.10-	1990.12	-	MT	L/R	F	Saloon Engine 149 A2.000/149 A4.000	648004	Inner Joint			25		32			
	1983.10-	1990.12	-	MT	L/R	F	Saloon Engine 149 A2.000/149 A4.000	817006	Outer Joint		22	25	48.1	93.5	60.5	I	
75 1.5 (55 kW)	1983.12-	1989.07	-	AT	L/R	F	Saloon Engine 138 B3.048/138 C2.048/138 C3.048 1/49 C1.000	603005	Inner Joint			33		32			
	1983.12-	1989.07	-	AT/MT	L/R	F	Saloon Engine 138 B3.048/138 C2.048/138 C3.048 1/49 C1.000	817006	Outer Joint		22	25	48.1	93.5	60.5	I	
80 Turbo Diesel 1.9 (59 kW)	1986.05-	1989.07	-	MT	L/R	F	Saloon Engine 831 D1.000	817006	Outer Joint		22	25	48.1	93.5	60.5	I	
	1986.05-	1989.07	-	MT	L/R	F	Saloon Engine 831 D1.000	648004	Inner Joint			25		32			
	1986.05-	1989.07	-	-	-	F	Saloon Engine 831 D1.000	602006	Inner Joint			25		32			
85 1.6 (60 kW)	1983.10-	1990.06	-	AT	L/R	F	Saloon Engine 149 A.000	603005	Inner Joint			33		32			
	1983.10-	1990.06	-	AT/MT	L/R	F	Saloon Engine 149 A.000	817006	Outer Joint		22	25	48.1	93.5	60.5	I	
90 i.e. 1.6 (66 kW)	1987.01-	1989.07	-	MT	L/R	F	Saloon Engine 149 C2.000	817006	Outer Joint		22	25	48.1	93.5	60.5	I	
	1987.01-	1989.07	-	MT	L/R	F	Saloon Engine 149 C2.000	648004	Inner Joint			25		32			
REGATA Weekend (138_)																	
1.6 (74 kW)	1984.09-	1990.12	-	-	-	F	Estate Engine 149 A4.000/149 C3.000	602006	Inner Joint			25		32			
	1984.09-	1990.12	-	MT	L/R	F	Estate Engine 149 A4.000/149 C3.000	648004	Inner Joint			25		32			
	1984.09-	1990.12	-	MT	L/R	F	Estate Engine 149 A4.000/149 C3.000	817006	Outer Joint		22	25	48.1	93.5	60.5	I	
75 1.5 (55 kW)	1984.09-	1989.07	-	AT	L/R	F	Estate Engine 138 B3.048/138 C2.048/138 C3.048	603005	Inner Joint			33		32			
	1984.09-	1989.07	-	AT/MT	L/R	F	Estate Engine 138 B3.048/138 C2.048/138 C3.048	817006	Outer Joint		22	25	48.1	93.5	60.5	I	
80 Turbo Diesel 1.9 (59 kW)	1986.05-	1989.07	-	MT	L/R	F	Estate Engine 831 D1.000	817006	Outer Joint		22	25	48.1	93.5	60.5	I	
	1986.05-	1989.07	-	MT	L/R	F	Estate Engine 831 D1.000	648004	Inner Joint			25		32			
	1986.05-	1989.07	-	-	-	F	Estate Engine 831 D1.000	602006	Inner Joint			25		32			
85 1.5 (60 kW)	1984.01-	1989.04	-	AT/MT	L/R	F	Estate Engine 138 B3.000	817006	Outer Joint		22	25	48.1	93.5	60.5	I	
	1984.01-	1989.04	-	AT	-	F	Estate Engine 138 B3.000	602006	Inner Joint			25		32			
	1984.01-	1989.04	-	AT	L/R	F	Estate Engine 138 B3.000	603005	Inner Joint			33		32			
90 i.e. 1.6 (66 kW)	1987.01-	1989.07	-	MT	L/R	F	Estate Engine 149 C2.000	817006	Outer Joint		22	25	48.1	93.5	60.5	I	
	1987.01-	1989.07	-	MT	L/R	F	Estate Engine 149 C2.000	648004	Inner Joint			25		32			
RITMO (138_)/STRADA																	
85 1.5 (63 kW)	1980.01-	1989.07	-	MT	L/R	F	Convertible Engine 138 A4.000	817006	Outer Joint		22	25	48.1	93.5	60.5	I	
SCUDO																	
1.6 MJT	2006-	-	-	L	F	-		699158	Inner Joint		24	34	40	62	89		
	2006-	-	-	L	F	-		699158	Inner Joint		24	34	40	62	89		
	2006-	-	-	R	F	-		699159	Inner Joint		24	34	29.8	350	87.5		
	2006-	-	-	L	F	-		810095	Outer Joint		28	34	58.5	92	55	I	
	2006-	-	-	L	F	-		699158	Inner Joint		24	34	40	62	89		
1.9 TD	1995-	2006	-	R	F	-		210296	Drive Shaft	48T	27	37	59	82	947		
2.0 JTD	1995-	2006	-	R	F	-		210296	Drive Shaft	48T	27	37	59	82	947		
SCUDO (220_)																	
1.6 (58 kW)	1996.02-	2006.12	-	MT	L	F	Box Engine 220 A 2.000	210082	Drive Shaft	48T	27	24	59	82	648		
	1996.02-	2006.12	-	MT	R	F	Box Engine 220 A 2.000	210012	Drive Shaft	48T	27	24	64	80.5	928		
	1996.02-	2006.12	-	MT	L/R	F	Box Engine 220 A 2.000	810018	Outer Joint	48T	27	34	61	82	55	I	
	1996.02-	2006.12	-	MT	L	F	Box Engine 220 A 2.000	210052	Drive Shaft		27	24	61	82	648		
	1996.02-	2006.12	-	MT	R	F	Box Engine 220 A 2.000	210120	Drive Shaft		27	24	59	82	928		
1.9 D (51 kW)	1996.02-	2006.12	-	-	-	F	Box Engine D9B	810016	Outer Joint		27	34	59	82	55	I	

	 YEAR	TRANSM	L/R	F/R	REMARKS	GSP Ref.	 PRODUCT	 ABS	Technical Specifications					
									A	B	C	H	L	P
FIAT														
SCUDO (220_)														
1.9 D (51 kW)	1996.02-2006.12	MT	L	F	Box Engine D9B	210082	Drive Shaft	48T	27	24	59	82	648	
	1996.02-2006.12	-	R	F	Box Engine D9B	210081	Drive Shaft	48T	27	24	59	82	935	
	1996.02-2006.12	-	L	F	Box Engine D9B	210112	Drive Shaft		27	24	59	82	648	
	1996.02-2006.12	MT	R	F	Box Engine D9B	210012	Drive Shaft	48T	27	24	64	80.5	928	
	1996.02-2006.12	MT	L/R	F	Box Engine D9B	810018	Outer Joint	48T	27	34	61	82	55	I
	1996.02-2006.12	-	R	F	Box Engine D9B	210111	Drive Shaft		27	24	59	82	935	
	1996.02-2006.12	MT	L	F	Box Engine D9B	210052	Drive Shaft		27	24	61	82	648	
	1996.02-2006.12	MT	R	F	Box Engine D9B	210120	Drive Shaft		27	24	59	82	928	
	1996.02-2006.12	-	-	F	Box Engine D9B	810059	Outer Joint	48T	27	34	59	82	55	I
	1998.04-2006.12	-	R	F	Platform/Chassis Engine WJY (DW8)	210120	Drive Shaft		27	24	59	82	928	
	1998.04-2006.12	-	-	F	Box Engine WJY (DW8B)/WJZ (DW8)	810016	Outer Joint		27	34	59	82	55	I
	1998.04-2006.12	MT	L	F	Box Engine WJY (DW8B)/WJZ (DW8)	210082	Drive Shaft	48T	27	24	59	82	648	
	1998.04-2006.12	-	R	F	Box Engine WJY (DW8B)/WJZ (DW8)	210081	Drive Shaft	48T	27	24	59	82	935	
	1998.04-2006.12	-	L	F	Platform/Chassis Engine WJY (DW8)	210082	Drive Shaft	48T	27	24	59	82	648	
	1998.04-2006.12	-	L	F	Box Engine WJY (DW8B)/WJZ (DW8)	210112	Drive Shaft		27	24	59	82	648	
	1998.04-2006.12	MT	R	F	Box Engine WJY (DW8B)/WJZ (DW8)	210012	Drive Shaft	48T	27	24	64	80.5	928	
	1998.04-2006.12	-	R	F	Box Engine WJY (DW8B)/WJZ (DW8)	210111	Drive Shaft		27	24	59	82	935	
	1998.04-2006.12	MT	L/R	F	Box Engine WJY (DW8B)/WJZ (DW8)	810018	Outer Joint	48T	27	34	61	82	55	I
	1998.04-2006.12	-	R	F	Platform/Chassis Engine WJY (DW8)	210012	Drive Shaft	48T	27	24	64	80.5	928	
	1998.04-2006.12	MT	L	F	Box Engine WJY (DW8B)/WJZ (DW8)	210052	Drive Shaft		27	24	61	82	648	
1998.04-2006.12	MT	R	F	Box Engine WJY (DW8B)/WJZ (DW8)	210120	Drive Shaft		27	24	59	82	928		
1998.04-2006.12	-	-	F	Box Engine WJY (DW8B)/WJZ (DW8)	810059	Outer Joint	48T	27	34	59	82	55	I	
1.9 TD (66 kW)	1996.02-2006.12	MT	L	F	Box Engine DHX (XUD9TF/L)	610015	Inner Joint		37	39	40	68.5	104	
	1996.02-2006.12	MT	R	F	Box Engine DHX (XUD9TF/L)	610034	Inner Joint		37	39	31.9	369.5	99	
	1996.02-2006.12	MT	L	F	Box Engine DHX (XUD9TF/L)	210073	Drive Shaft	48T	27	37	59	82	641	
	1996.02-2006.12	MT	R	F	Box Engine DHX (XUD9TF/L)	210108	Drive Shaft	48T	27	37	59	82	939	
	1996.02-2006.12	MT	L	F	Box Engine DHX (XUD9TF/L)	210072	Drive Shaft		27	37	59	82	641	
	1996.02-2006.12	MT	R	F	Box Engine DHX (XUD9TF/L)	210074	Drive Shaft		27	37	59	82	939	
	1996.02-2006.12	MT	R	F	Box Engine DHX (XUD9TF/L)	210155	Drive Shaft		27	37	59	82	947	
	1996.02-2006.12	-	L/R	F	Box Engine DHX (XUD9TF/L)	810015	Outer Joint	48T	27	39	59	82	63	I
	1996.02-2006.12	MT	L	F	Box Engine DHX (XUD9TF/L)	210016	Drive Shaft	48T	27	37	59	82	641	
	1996.02-2006.12	MT	R	F	Box Engine DHX (XUD9TF/L)	210014	Drive Shaft	48T	27	37	59	82	947	
1.9 TD (68 kW)	1996.09-2006.12	-	L	F	Platform/Chassis Engine D8B/DHX (XUD9TF/L)	610015	Inner Joint		37	39	40	68.5	104	
	1996.09-2006.12	-	R	F	Platform/Chassis Engine D8B/DHX (XUD9TF/L)	610034	Inner Joint		37	39	31.9	369.5	99	
	1996.09-2006.12	MT	L	F	Platform/Chassis Engine D8B/DHX (XUD9TF/L)	210073	Drive Shaft	48T	27	37	59	82	641	
	1996.09-2006.12	-	L	F	Platform/Chassis Engine D8B/DHX (XUD9TF/L)	210072	Drive Shaft		27	37	59	82	641	
	1996.09-2006.12	MT	R	F	Platform/Chassis Engine D8B/DHX (XUD9TF/L)	210108	Drive Shaft	48T	27	37	59	82	939	
	1996.09-2006.12	MT	R	F	Platform/Chassis Engine D8B/DHX (XUD9TF/L)	210074	Drive Shaft		27	37	59	82	939	
	1996.09-2006.12	-	R	F	Platform/Chassis Engine D8B/DHX (XUD9TF/L)	210155	Drive Shaft		27	37	59	82	947	
	1996.09-2006.12	-	L	F	Platform/Chassis Engine D8B/DHX (XUD9TF/L)	210016	Drive Shaft	48T	27	37	59	82	641	
	1996.09-2006.12	-	R	F	Platform/Chassis Engine D8B/DHX (XUD9TF/L)	210014	Drive Shaft	48T	27	37	59	82	947	
	1998.02-2006.12	MT	L	F	Box Engine D8B	610015	Inner Joint		37	39	40	68.5	104	
	1998.02-2006.12	MT	R	F	Box Engine D8B	610034	Inner Joint		37	39	31.9	369.5	99	
	1998.02-2006.12	MT	L	F	Box Engine D8B	210073	Drive Shaft	48T	27	37	59	82	641	
	1998.02-2006.12	MT	R	F	Box Engine D8B	210108	Drive Shaft	48T	27	37	59	82	939	
	1998.02-2006.12	MT	L	F	Box Engine D8B	210072	Drive Shaft		27	37	59	82	641	
	1998.02-2006.12	-	-	F	Box Engine D8B	810014	Outer Joint		27	39	59	82	63	I
	1998.02-2006.12	MT	R	F	Box Engine D8B	210074	Drive Shaft		27	37	59	82	939	
	1998.02-2006.12	MT	R	F	Box Engine D8B	210155	Drive Shaft		27	37	59	82	947	
	1998.02-2006.12	-	L/R	F	Box Engine D8B	810015	Outer Joint	48T	27	39	59	82	63	I
	1998.02-2006.12	MT	L	F	Box Engine D8B	210016	Drive Shaft	48T	27	37	59	82	641	
	1998.02-2006.12	MT	R	F	Box Engine D8B	210014	Drive Shaft	48T	27	37	59	82	947	
2.0 (100 kW)	2000.05-2006.12	-	R	F	Box Engine RFN (EW10J4)	210120	Drive Shaft		27	24	59	82	928	
	2000.05-2006.12	-	L	F	Box Engine RFN (EW10J4)	210082	Drive Shaft	48T	27	24	59	82	648	
	2000.05-2006.12	-	R	F	Box Engine RFN (EW10J4)	210012	Drive Shaft	48T	27	24	64	80.5	928	
	2000.05-2006.12	MT	L/R	F	Box Engine RFN (EW10J4)	810018	Outer Joint	48T	27	34	61	82	55	I
	2000.05-2006.12	-	L	F	Box Engine RFN (EW10J4)	210052	Drive Shaft		27	24	61	82	648	
2.0 JTD (69 kW)	1999.10-2006.12	MT	L	F	Box Engine RHX	210430	Drive Shaft		27	37	59	82	630	
	1999.10-2006.12	-	R	F	Box Engine RHX	210237	Drive Shaft	48T	27	37	59	82	953	
	1999.10-2006.12	MT	R	F	Box Engine RHX	210057	Drive Shaft		27	37	59	82	960	
	1999.10-2006.12	MT	L	F	Box Engine RHX	210264	Drive Shaft	48T	27	37	59	82	630	
	1999.10-2006.12	MT	R	F	Box Engine RHX	245120	Drive Shaft	48T	27	37	59	82	960	
	1999.10-2006.12	MT	L	F	Box Engine RHX	610015	Inner Joint		37	39	40	68.5	104	
	1999.10-2006.12	MT	R	F	Box Engine RHX	610034	Inner Joint		37	39	31.9	369.5	99	
2.0 JTD (80 kW)	2002.12-2006.12	5MT	L	F	Platform/Chassis Engine RHZ	210430	Drive Shaft		27	37	59	82	630	

YEAR	TRANSM	L/R	F/R	REMARKS	GSP Ref.	PRODUCT	ABS	Technical Specifications									
								A	B	C	H	L	P				
FIAT																	
SCUDO (220_)																	
2.0 JTD (80 kW)	2002.12-	2006.12	-	L F	Box Engine RHZ	210430	Drive Shaft		27	37	59	82	630				
	2002.12-	2006.12	5MT	R F	Platform/Chassis Engine RHZ	210057	Drive Shaft		27	37	59	82	960				
	2002.12-	2006.12	-	R F	Box Engine RHZ	210057	Drive Shaft		27	37	59	82	960				
	2002.12-	2006.12	5MT	L F	Platform/Chassis Engine RHZ	210264	Drive Shaft	48T	27	37	59	82	630				
	2002.12-	2006.12	-	L F	Box Engine RHZ	210264	Drive Shaft	48T	27	37	59	82	630				
	2002.12-	2006.12	5MT	R F	Platform/Chassis Engine RHZ	245120	Drive Shaft	48T	27	37	59	82	960				
	2002.12-	2006.12	-	R F	Box Engine RHZ	245120	Drive Shaft	48T	27	37	59	82	960				
	2002.12-	2006.12	5MT	L F	Platform/Chassis Engine RHZ	610015	Inner Joint		37	39	40	68.5	104				
	2002.12-	2006.12	-	L F	Box Engine RHZ	610015	Inner Joint		37	39	40	68.5	104				
	2002.12-	2006.12	5MT	R F	Platform/Chassis Engine RHZ	610034	Inner Joint		37	39	31.9	369.5	99				
	2002.12-	2006.12	-	R F	Box Engine RHZ	610034	Inner Joint		37	39	31.9	369.5	99				
2.0 JTD 16V (80 kW)	1999.05-	2006.12	-	L F	Box Engine RHK (DW10UTED4)/RHM (DW10ATED4)/RHW (DW10ATED4)	210430	Drive Shaft		27	37	59	82	630				
	1999.05-	2006.12	-	R F	Box Engine RHK (DW10UTED4)/RHM (DW10ATED4)/RHW (DW10ATED4)	210057	Drive Shaft		27	37	59	82	960				
	1999.05-	2006.12	-	L F	Box Engine RHK (DW10UTED4)/RHM (DW10ATED4)/RHW (DW10ATED4)	210264	Drive Shaft	48T	27	37	59	82	630				
	1999.05-	2006.12	-	R F	Box Engine RHK (DW10UTED4)/RHM (DW10ATED4)/RHW (DW10ATED4)	245120	Drive Shaft	48T	27	37	59	82	960				
	1999.05-	2006.12	-	L F	Box Engine RHK (DW10UTED4)/RHM (DW10ATED4)/RHW (DW10ATED4)	610015	Inner Joint		37	39	40	68.5	104				
	1999.05-	2006.12	-	R F	Box Engine RHK (DW10UTED4)/RHM (DW10ATED4)/RHW (DW10ATED4)	610034	Inner Joint		37	39	31.9	369.5	99				
SCUDO (270_ 272_)																	
1.6 D Multijet (66 kW)	2007.01-	-	MT	-	F	Platform/Chassis Engine 9HU	810052	Outer Joint		28	34	58.5	92	55	I		
2.0 D Multijet (100 kW)	2007.01-	-	MT	R	F	MPV Engine RHR	210244	Drive Shaft		28	37	58.6	93	979			
	2007.01-	-	MT	R	F	Box Engine RHR	210244	Drive Shaft		28	37	58.6	93	979			
	2007.01-	-	MT	R	F	Platform/Chassis Engine DW10BTED4/RHR	210244	Drive Shaft		28	37	58.6	93	979			
	2007.01-	-	MT	L	F	MPV Engine RHR	645032	Inner Joint		37	39	40	68.5	100			
	2007.01-	-	-	L	F	Box Engine RHR	645032	Inner Joint		37	39	40	68.5	100			
	2007.01-	-	-	L	F	Platform/Chassis Engine DW10BTED4/RHR	645032	Inner Joint		37	39	40	68.5	100			
	2007.01-	-	MT	L	F	MPV Engine RHR	245133	Drive Shaft		28	37	58.6	94	653			
	2007.01-	-	MT	L	F	Box Engine RHR	245133	Drive Shaft		28	37	58.6	94	653			
	2007.01-	-	MT	L	F	Platform/Chassis Engine DW10BTED4/RHR	245133	Drive Shaft		28	37	58.6	94	653			
	2007.01-	-	MT	R	F	MPV Engine RHR	299214	Drive Shaft		28	37	58.6	94	978			
	2007.01-	-	MT	R	F	Box Engine RHR	299214	Drive Shaft		28	37	58.6	94	978			
	2007.01-	-	MT	R	F	Platform/Chassis Engine DW10BTED4/RHR	299214	Drive Shaft		28	37	58.6	94	978			
	2007.01-	-	-	-	F	MPV Engine RHR	810098	Outer Joint		28	39	58.6	93	63	I		
	2007.01-	-	-	-	F	Box Engine RHR	810098	Outer Joint		28	39	58.6	93	63	I		
	2007.01-	-	-	-	F	Platform/Chassis Engine DW10BTED4/RHR	810098	Outer Joint		28	39	58.6	93	63	I		
	2007.01-	-	MT	-	F	Platform/Chassis Engine DW10BTED4/RHR	810051	Outer Joint		28	39	58.6	94	63	I		
	2007.01-	-	MT	L	F	MPV Engine RHR	210234	Drive Shaft		28	37	58.6	93	648			
	2007.01-	-	MT	L	F	Box Engine RHR	210234	Drive Shaft		28	37	58.6	93	648			
	2007.01-	-	MT	L	F	Platform/Chassis Engine DW10BTED4/RHR	210234	Drive Shaft		28	37	58.6	93	648			
	2007.01-	-	MT	R	F	MPV Engine RHR	810159	Outer Joint		28	39	58.6	94	63	I		
	2007.01-	-	MT	R	F	Box Engine RHR	810159	Outer Joint		28	39	58.6	94	63	I		
	2007.01-	-	MT	R	F	Platform/Chassis Engine DW10BTED4/RHR	810159	Outer Joint		28	39	58.6	94	63	I		
	2007.01-	-	-	-	F	MPV Engine RHR	810051	Outer Joint		28	39	58.6	94	63	I		
	2007.01-	-	-	-	F	Box Engine RHR	810051	Outer Joint		28	39	58.6	94	63	I		
	2007.01-	-	MT	R	F	MPV Engine RHR	610041	Inner Joint		37	39	32	399	95.5			
	2007.01-	-	MT	R	F	Box Engine RHR	610041	Inner Joint		37	39	32	399	95.5			
	2007.01-	-	MT	R	F	Platform/Chassis Engine DW10BTED4/RHR	610041	Inner Joint		37	39	32	399	95.5			
2.0 D Multijet (120 kW)	2010.07-	-	-	R	F	Box Engine RH02/RHH	610041	Inner Joint		37	39	32	399	95.5			
	2010.07-	-	-	R	F	MPV Engine RH02/RHH	610041	Inner Joint		37	39	32	399	95.5			
	2010.07-	-	MT	L	F	MPV Engine RH02/RHH	645032	Inner Joint		37	39	40	68.5	100			
	2010.07-	-	-	L	F	Box Engine RH02/RHH	245133	Drive Shaft		28	37	58.6	94	653			
	2010.07-	-	-	L	F	MPV Engine RH02/RHH	245133	Drive Shaft		28	37	58.6	94	653			
	2010.07-	-	-	R	F	Box Engine RH02/RHH	299214	Drive Shaft		28	37	58.6	94	978			
	2010.07-	-	-	R	F	MPV Engine RH02/RHH	299214	Drive Shaft		28	37	58.6	94	978			
	2010.07-	-	-	-	F	Box Engine RH02/RHH	810051	Outer Joint		28	39	58.6	94	63	I		
	2010.07-	-	-	-	F	MPV Engine RH02/RHH	810051	Outer Joint		28	39	58.6	94	63	I		
	2010.07-	-	-	R	F	Box Engine RH02/RHH	810159	Outer Joint		28	39	58.6	94	63	I		
	2010.07-	-	-	R	F	MPV Engine RH02/RHH	810159	Outer Joint		28	39	58.6	94	63	I		
	2010.07-	-	-	L	F	Box Engine RH02/RHH	645032	Inner Joint		37	39	40	68.5	100			
	2010.07-	-	MT	R	F	Box Engine RH02/RHH	210244	Drive Shaft		28	37	58.6	93	979			
	2010.07-	-	MT	R	F	MPV Engine RH02/RHH	210244	Drive Shaft		28	37	58.6	93	979			
2.0 D Multijet (88 kW)	2007.01-	-	MT	R	F	MPV Engine RHK	210244	Drive Shaft		28	37	58.6	93	979			
	2007.01-	-	MT	R	F	Box Engine RHK	210244	Drive Shaft		28	37	58.6	93	979			
	2007.01-	-	MT	R	F	Platform/Chassis Engine RHK	210244	Drive Shaft		28	37	58.6	93	979			
	2007.01-	-	MT	L	F	MPV Engine RHK	645032	Inner Joint		37	39	40	68.5	100			
	2007.01-	-	-	L	F	Box Engine RHK	645032	Inner Joint		37	39	40	68.5	100			
	2007.01-	-	-	L	F	Platform/Chassis Engine RHK	645032	Inner Joint		37	39	40	68.5	100			





YEAR	TRANSM	L/R	F/R	REMARKS	GSP Ref.	PRODUCT	ABS	Technical Specifications						
								A	B	C	H	L	P	
FIAT														
SCUDO (270_ 272_)														
2.0 D Multijet (88 kW)														
2007.01-	-	MT	L	F	MPV Engine RHK	245133	Drive Shaft		28	37	58.6	94	653	
2007.01-	-	MT	L	F	Box Engine RHK	245133	Drive Shaft		28	37	58.6	94	653	
2007.01-	-	MT	L	F	Platform/Chassis Engine RHK	245133	Drive Shaft		28	37	58.6	94	653	
2007.01-	-	MT	R	F	MPV Engine RHK	299214	Drive Shaft		28	37	58.6	94	978	
2007.01-	-	MT	R	F	Box Engine RHK	299214	Drive Shaft		28	37	58.6	94	978	
2007.01-	-	MT	R	F	Platform/Chassis Engine RHK	299214	Drive Shaft		28	37	58.6	94	978	
2007.01-	-	-	-	F	MPV Engine RHK	810098	Outer Joint		28	39	58.6	93	63	I
2007.01-	-	-	-	F	Box Engine RHK	810098	Outer Joint		28	39	58.6	93	63	I
2007.01-	-	-	-	F	Platform/Chassis Engine RHK	810098	Outer Joint		28	39	58.6	93	63	I
2007.01-	-	MT	-	F	Box Engine RHK	810051	Outer Joint		28	39	58.6	94	63	I
2007.01-	-	MT	L	F	MPV Engine RHK	210234	Drive Shaft		28	37	58.6	93	648	
2007.01-	-	MT	L	F	Box Engine RHK	210234	Drive Shaft		28	37	58.6	93	648	
2007.01-	-	MT	R	F	MPV Engine RHK	810159	Outer Joint		28	39	58.6	94	63	I
2007.01-	-	MT	R	F	Box Engine RHK	810159	Outer Joint		28	39	58.6	94	63	I
2007.01-	-	MT	R	F	Platform/Chassis Engine RHK	810159	Outer Joint		28	39	58.6	94	63	I
2007.01-	-	-	-	F	MPV Engine RHK	810051	Outer Joint		28	39	58.6	94	63	I
2007.01-	-	-	-	F	Platform/Chassis Engine RHK	810051	Outer Joint		28	39	58.6	94	63	I
2007.01-	-	MT	R	F	MPV Engine RHK	610041	Inner Joint		37	39	32	399	95.5	
2007.01-	-	MT	R	F	Box Engine RHK	610041	Inner Joint		37	39	32	399	95.5	
2007.01-	-	MT	R	F	Platform/Chassis Engine RHK	610041	Inner Joint		37	39	32	399	95.5	
2.0 D Multijet (94 kW)														
2011.04-	-	-	R	F	MPV Engine RH02	610041	Inner Joint		37	39	32	399	95.5	
2011.04-	-	-	L	F	MPV Engine RH02	245133	Drive Shaft		28	37	58.6	94	653	
2011.04-	-	-	R	F	MPV Engine RH02	299214	Drive Shaft		28	37	58.6	94	978	
2011.04-	-	-	R	F	MPV Engine RH02	810159	Outer Joint		28	39	58.6	94	63	I
2011.04-	-	MT	R	F	MPV Engine RH02	210244	Drive Shaft		28	37	58.6	93	979	
2011.05-	-	-	R	F	Box Engine RH02	610041	Inner Joint		37	39	32	399	95.5	
2011.05-	-	MT	R	F	Box Engine RH02	210244	Drive Shaft		28	37	58.6	93	979	
2011.05-	-	-	R	F	Platform/Chassis Engine RH02	610041	Inner Joint		37	39	32	399	95.5	
2011.05-	-	MT	R	F	Platform/Chassis Engine RH02	210244	Drive Shaft		28	37	58.6	93	979	
2011.05-	-	-	L	F	Platform/Chassis Engine RH02	645032	Inner Joint		37	39	40	68.5	100	
2011.05-	-	-	L	F	Box Engine RH02	245133	Drive Shaft		28	37	58.6	94	653	
2011.05-	-	-	L	F	Platform/Chassis Engine RH02	245133	Drive Shaft		28	37	58.6	94	653	
2011.05-	-	-	R	F	Box Engine RH02	299214	Drive Shaft		28	37	58.6	94	978	
2011.05-	-	-	R	F	Platform/Chassis Engine RH02	299214	Drive Shaft		28	37	58.6	94	978	
2011.05-	-	-	L	F	Box Engine RH02	645032	Inner Joint		37	39	40	68.5	100	
2011.05-	-	MT	L	F	Box Engine RH02	210234	Drive Shaft		28	37	58.6	93	648	
2011.05-	-	-	-	F	Box Engine RH02	810051	Outer Joint		28	39	58.6	94	63	I
2011.05-	-	-	R	F	Box Engine RH02	810159	Outer Joint		28	39	58.6	94	63	I
2011.05-	-	-	R	F	Platform/Chassis Engine RH02	810159	Outer Joint		28	39	58.6	94	63	I
2011.05-	-	-	-	F	Platform/Chassis Engine RH02	810051	Outer Joint		28	39	58.6	94	63	I
SCUDO Combinato (220_)														
1.6 (58 kW)														
1996.02-	2006.12	MT	L	F	Estate Engine 220 A 2.000	210082	Drive Shaft	48T	27	24	59	82	648	
1996.02-	2006.12	MT	R	F	Estate Engine 220 A 2.000	210012	Drive Shaft	48T	27	24	64	80.5	928	
1996.02-	2006.12	MT	L/R	F	Estate Engine 220 A 2.000	810018	Outer Joint	48T	27	34	61	82	55	I
1996.02-	2006.12	MT	L	F	Estate Engine 220 A 2.000	210052	Drive Shaft		27	24	61	82	648	
1996.02-	2006.12	MT	R	F	Estate Engine 220 A 2.000	210120	Drive Shaft		27	24	59	82	928	
1.9 D (51 kW)														
1996.02-	1998.04	-	-	F	Estate Engine D9B	810016	Outer Joint		27	34	59	82	55	I
1996.02-	1998.04	MT	L	F	Estate Engine D9B	210082	Drive Shaft	48T	27	24	59	82	648	
1996.02-	1998.04	-	R	F	Estate Engine D9B	210081	Drive Shaft	48T	27	24	59	82	935	
1996.02-	1998.04	-	L	F	Estate Engine D9B	210112	Drive Shaft		27	24	59	82	648	
1996.02-	1998.04	MT	R	F	Estate Engine D9B	210012	Drive Shaft	48T	27	24	64	80.5	928	
1996.02-	1998.04	-	R	F	Estate Engine D9B	210111	Drive Shaft		27	24	59	82	935	
1996.02-	1998.04	MT	L/R	F	Estate Engine D9B	810018	Outer Joint	48T	27	34	61	82	55	I
1996.02-	1998.04	MT	L	F	Estate Engine D9B	210052	Drive Shaft		27	24	61	82	648	
1996.02-	1998.04	MT	R	F	Estate Engine D9B	210120	Drive Shaft		27	24	59	82	928	
1996.02-	1998.04	-	-	F	Estate Engine D9B	810059	Outer Joint	48T	27	34	59	82	55	I
1998.04-	2006.12	-	-	F	Estate Engine WJZ (DW8)	810016	Outer Joint		27	34	59	82	55	I
1998.04-	2006.12	MT	L	F	Estate Engine WJZ (DW8)	210082	Drive Shaft	48T	27	24	59	82	648	
1998.04-	2006.12	-	R	F	Estate Engine WJZ (DW8)	210081	Drive Shaft	48T	27	24	59	82	935	
1998.04-	2006.12	MT	R	F	Estate Engine WJZ (DW8)	210012	Drive Shaft	48T	27	24	64	80.5	928	
1998.04-	2006.12	-	L	F	Estate Engine WJZ (DW8)	210112	Drive Shaft		27	24	59	82	648	
1998.04-	2006.12	MT	L/R	F	Estate Engine WJZ (DW8)	810018	Outer Joint	48T	27	34	61	82	55	I
1998.04-	2006.12	-	R	F	Estate Engine WJZ (DW8)	210111	Drive Shaft		27	24	59	82	935	
1998.04-	2006.12	MT	L	F	Estate Engine WJZ (DW8)	210052	Drive Shaft		27	24	61	82	648	
1998.04-	2006.12	MT	R	F	Estate Engine WJZ (DW8)	210120	Drive Shaft		27	24	59	82	928	
1998.04-	2006.12	-	-	F	Estate Engine WJZ (DW8)	810059	Outer Joint	48T	27	34	59	82	55	I

	 YEAR	TRANSM	L/R	F/R	REMARKS	GSP Ref.	 PRODUCT	 ABS	Technical Specifications					
									A	B	C	H	L	P
FIAT														
SCUDO Combinato (220_)														
1.9 TD (68 kW)	1996.02-2006.12	MT	L	F	Estate Engine D8B	610015	Inner Joint		37	39	40	68.5	104	
	1996.02-2006.12	MT	R	F	Estate Engine D8B	610034	Inner Joint		37	39	31.9	369.5	99	
	1996.02-2006.12	MT	L	F	Estate Engine D8B	210073	Drive Shaft	48T	27	37	59	82	641	
	1996.02-2006.12	MT	R	F	Estate Engine D8B	210108	Drive Shaft	48T	27	37	59	82	939	
	1996.02-2006.12	MT	L	F	Estate Engine D8B	210072	Drive Shaft		27	37	59	82	641	
	1996.02-2006.12	-	-	F	Estate Engine D8B	810014	Outer Joint		27	39	59	82	63	I
	1996.02-2006.12	MT	R	F	Estate Engine D8B	210074	Drive Shaft		27	37	59	82	939	
	1996.02-2006.12	MT	R	F	Estate Engine D8B	210155	Drive Shaft		27	37	59	82	947	
	1996.02-2006.12	-	L/R	F	Estate Engine D8B	810015	Outer Joint	48T	27	39	59	82	63	I
	1996.02-2006.12	MT	L	F	Estate Engine D8B	210016	Drive Shaft	48T	27	37	59	82	641	
1996.02-2006.12	MT	R	F	Estate Engine D8B	210014	Drive Shaft	48T	27	37	59	82	947		
1.9 TD Eco (66 kW)	1996.02-2006.12	MT	L	F	Estate Engine DHX (XUD9TF/L)	610015	Inner Joint		37	39	40	68.5	104	
	1996.02-2006.12	MT	R	F	Estate Engine DHX (XUD9TF/L)	610034	Inner Joint		37	39	31.9	369.5	99	
	1996.02-2006.12	MT	L	F	Estate Engine DHX (XUD9TF/L)	210073	Drive Shaft	48T	27	37	59	82	641	
	1996.02-2006.12	MT	L	F	Estate Engine DHX (XUD9TF/L)	210072	Drive Shaft		27	37	59	82	641	
	1996.02-2006.12	MT	R	F	Estate Engine DHX (XUD9TF/L)	210108	Drive Shaft	48T	27	37	59	82	939	
	1996.02-2006.12	MT	R	F	Estate Engine DHX (XUD9TF/L)	210074	Drive Shaft		27	37	59	82	939	
	1996.02-2006.12	MT	R	F	Estate Engine DHX (XUD9TF/L)	210155	Drive Shaft		27	37	59	82	947	
	1996.02-2006.12	-	L/R	F	Estate Engine DHX (XUD9TF/L)	810015	Outer Joint	48T	27	39	59	82	63	I
	1996.02-2006.12	MT	L	F	Estate Engine DHX (XUD9TF/L)	210016	Drive Shaft	48T	27	37	59	82	641	
	1996.02-2006.12	MT	R	F	Estate Engine DHX (XUD9TF/L)	210014	Drive Shaft	48T	27	37	59	82	947	
2.0 16V (100 kW)	2000.06-2006.12	-	L	F	Estate Engine RFN (EW10J4)	210082	Drive Shaft	48T	27	24	59	82	648	
	2000.06-2006.12	-	R	F	Estate Engine RFN (EW10J4)	210012	Drive Shaft	48T	27	24	64	80.5	928	
	2000.06-2006.12	MT	L/R	F	Estate Engine RFN (EW10J4)	810018	Outer Joint	48T	27	34	61	82	55	I
	2000.06-2006.12	-	L	F	Estate Engine RFN (EW10J4)	210052	Drive Shaft		27	24	61	82	648	
	2000.06-2006.12	-	R	F	Estate Engine RFN (EW10J4)	210120	Drive Shaft		27	24	59	82	928	
2.0 JTD (69 kW)	2004.01-2006.12	MT	L	F	Estate Engine RHX	210430	Drive Shaft		27	37	59	82	630	
	2004.01-2006.12	MT	R	F	Estate Engine RHX	210057	Drive Shaft		27	37	59	82	960	
	2004.01-2006.12	MT	L	F	Estate Engine RHX	210264	Drive Shaft	48T	27	37	59	82	630	
	2004.01-2006.12	MT	R	F	Estate Engine RHX	245120	Drive Shaft	48T	27	37	59	82	960	
	2004.01-2006.12	MT	L	F	Estate Engine RHX	610015	Inner Joint		37	39	40	68.5	104	
	2004.01-2006.12	MT	R	F	Estate Engine RHX	610034	Inner Joint		37	39	31.9	369.5	99	
2.0 JTD (80 kW)	1999.12-2006.12	MT	L	F	Estate Engine RHZ	210430	Drive Shaft		27	37	59	82	630	
	1999.12-2006.12	MT	R	F	Estate Engine RHZ	210057	Drive Shaft		27	37	59	82	960	
	1999.12-2006.12	-	R	F	Estate Engine RHZ	210237	Drive Shaft	48T	27	37	59	82	953	
	1999.12-2006.12	MT	L	F	Estate Engine RHZ	210264	Drive Shaft	48T	27	37	59	82	630	
	1999.12-2006.12	MT	R	F	Estate Engine RHZ	245120	Drive Shaft	48T	27	37	59	82	960	
	1999.12-2006.12	MT	L	F	Estate Engine RHZ	610015	Inner Joint		37	39	40	68.5	104	
	1999.12-2006.12	MT	R	F	Estate Engine RHZ	610034	Inner Joint		37	39	31.9	369.5	99	
2.0 JTD 16V (80 kW)	1999.05-2006.12	-	L	F	Estate Engine RHW (DW10ATED4)	210430	Drive Shaft		27	37	59	82	630	
	1999.05-2006.12	-	R	F	Estate Engine RHW (DW10ATED4)	210057	Drive Shaft		27	37	59	82	960	
	1999.05-2006.12	-	L	F	Estate Engine RHW (DW10ATED4)	210264	Drive Shaft	48T	27	37	59	82	630	
	1999.05-2006.12	-	R	F	Estate Engine RHW (DW10ATED4)	245120	Drive Shaft	48T	27	37	59	82	960	
	1999.05-2006.12	-	L	F	Estate Engine RHW (DW10ATED4)	610015	Inner Joint		37	39	40	68.5	104	
	1999.05-2006.12	-	R	F	Estate Engine RHW (DW10ATED4)	610034	Inner Joint		37	39	31.9	369.5	99	
SEDICI (FY_)														
1.6 16V (79 kW)	2006.06-2014.10	MT	R	F	All-wheel Drive Closed Off-Road Vehicle Engine M16A	257290	Drive Shaft		28	26	58	85	698	
	2006.06-2014.10	-	-	F	All-wheel Drive Closed Off-Road Vehicle Engine M16A	857078	Outer Joint		28	29	58	85	62	I
	2006.06-2014.10	-	-	F	Closed Off-Road Vehicle Engine M16A	857078	Outer Joint		28	29	58	85	62	I
	2006.06-2014.10	-	R	R	All-wheel Drive Closed Off-Road Vehicle Engine M16A	214073	Drive Shaft		24		45	89	731	
	2006.06-2014.10	-	L	R	All-wheel Drive Closed Off-Road Vehicle Engine M16A	214074	Drive Shaft		24		45	89	637	
	2006.06-2014.10	MT	R	F	All-wheel Drive Closed Off-Road Vehicle Engine M16A	657137	Inner Joint		26	29	40		116.5	
	2006.06-2014.10	-	L	F	All-wheel Drive Closed Off-Road Vehicle Engine M16A	257247	Drive Shaft		28	26	58	85	612	
	2006.06-2014.10	-	L	F	Closed Off-Road Vehicle Engine M16A	257247	Drive Shaft		28	26	58	85	612	
	2006.06-2014.10	-	R	F	All-wheel Drive Closed Off-Road Vehicle Engine M16A	257074	Drive Shaft		28	26	58	85	699.5	
	2006.06-2014.10	-	R	F	Closed Off-Road Vehicle Engine M16A	257074	Drive Shaft		28	26	58	85	699.5	
	2006.06-2014.10	AT/MT	L/R	F	Closed Off-Road Vehicle Engine M16A	857092	Outer Joint		28	29	58	86.5	63	I
	2006.06-2014.10	AT/MT	L/R	F	All-wheel Drive Closed Off-Road Vehicle Engine M16A	857092	Outer Joint		28	29	58	86.5	63	I
	2006.06-2014.10	-	-	F	All-wheel Drive Closed Off-Road Vehicle Engine M16A	857140	Outer Joint		28	29	58	85	62.5	I
	1.6 16V (88 kW)	2006.06-2014.10	-	-	F	Closed Off-Road Vehicle Engine M16A	857078	Outer Joint		28	29	58	85	62
2006.06-2014.10		-	-	F	All-wheel Drive Closed Off-Road Vehicle Engine M16A	857078	Outer Joint		28	29	58	85	62	I
2006.06-2014.10		-	L	F	Closed Off-Road Vehicle Engine M16A	257247	Drive Shaft		28	26	58	85	612	
2006.06-2014.10		-	L	F	All-wheel Drive Closed Off-Road Vehicle Engine M16A	257247	Drive Shaft		28	26	58	85	612	
2006.06-2014.10		-	R	F	Closed Off-Road Vehicle Engine M16A	257074	Drive Shaft		28	26	58	85	699.5	
2006.06-2014.10		-	R	F	All-wheel Drive Closed Off-Road Vehicle Engine M16A	257074	Drive Shaft		28	26	58	85	699.5	
2006.06-2014.10		AT/MT	L/R	F	Closed Off-Road Vehicle Engine M16A	857092	Outer Joint		28	29	58	86.5	63	I

YEAR	TRANSM	L/R	F/R	REMARKS	GSP Ref.	PRODUCT	ABS	Technical Specifications								
								A	B	C	H	L	P			
FIAT																
SIATIC (FY_)																
1.6 16V (88 kW)	2006.06-	2014.10	AT/MT	L/R	F	All-wheel Drive Closed Off-Road Vehicle Engine M16A	857092	Outer Joint		28	29	58	86.5	63	I	
1.9 D Multijet (88 kW)	2006.06-	2014.10	-	R	F	All-wheel Drive Closed Off-Road Vehicle Engine D19AA	257281	Drive Shaft		28	26	58	85	567		
	2006.06-	2014.10	-	-	F	All-wheel Drive Closed Off-Road Vehicle Engine D19AA	857078	Outer Joint		28	29	58	85	62	I	
	2006.06-	2014.10	-	R	F	Closed Off-Road Vehicle Engine D19AA	257281	Drive Shaft		28	26	58	85	567		
	2006.06-	2014.10	-	-	F	Closed Off-Road Vehicle Engine D19AA	857078	Outer Joint		28	29	58	85	62	I	
	2006.06-	2014.10	-	R	R	All-wheel Drive Closed Off-Road Vehicle Engine D19AA	214073	Drive Shaft		24		45	89	731		
	2006.06-	2014.10	-	L	R	All-wheel Drive Closed Off-Road Vehicle Engine D19AA	214074	Drive Shaft		24		45	89	637		
	2006.06-	2014.10	-	R	F	All-wheel Drive Closed Off-Road Vehicle Engine D19AA	657168	Inner joint		26	33	40		125		
	2006.06-	2014.10	-	-	F	All-wheel Drive Closed Off-Road Vehicle Engine D19AA	899310	Outer Joint		28	35	58	85	65	I	
	2006.06-	2014.10	-	-	F	All-wheel Drive Closed Off-Road Vehicle Engine D19AA	857140	Outer Joint		28	29	58	85	62.5	I	
2.0 D Multijet (99 kW)	2006.06-	2014.10	-	-	F	Closed Off-Road Vehicle Engine D20AA	857078	Outer Joint		28	29	58	85	62	I	
	2006.06-	2014.10	-	-	F	All-wheel Drive Closed Off-Road Vehicle Engine D20AA	857078	Outer Joint		28	29	58	85	62	I	
	2006.06-	2014.10	-	L	F	Closed Off-Road Vehicle Engine D20AA	657164	Inner joint		28	33	42	70.5	102.5		
	2006.06-	2014.10	-	L	F	Closed Off-Road Vehicle Engine D20AA	657163	Inner joint		28	33	42		122.5		
	2006.06-	2014.10	-	L	F	All-wheel Drive Closed Off-Road Vehicle Engine D20AA	657164	Inner joint		28	33	42	70.5	102.5		
	2006.06-	2014.10	-	L	F	All-wheel Drive Closed Off-Road Vehicle Engine D20AA	657163	Inner joint		28	33	42		122.5		
	2006.06-	2014.10	-	L	F	Closed Off-Road Vehicle Engine D20AA	857205	Outer Joint		28	33	58	85	64.5	I	
	2006.06-	2014.10	-	L	F	All-wheel Drive Closed Off-Road Vehicle Engine D20AA	857205	Outer Joint		28	33	58	85	64.5	I	
	2006.06-	2014.10	-	L	F	Closed Off-Road Vehicle Engine D20AA	257299	Drive Shaft		28	28	58	85	598		
	2006.06-	2014.10	-	L	F	All-wheel Drive Closed Off-Road Vehicle Engine D20AA	257299	Drive Shaft		28	28	58	85	598		
	2006.06-	2014.10	-	R	F	Closed Off-Road Vehicle Engine D20AA	257300	Drive Shaft		28	28	58	85	710		
	2006.06-	2014.10	-	R	F	All-wheel Drive Closed Off-Road Vehicle Engine D20AA	257300	Drive Shaft		28	28	58	85	710		
	2006.06-	2014.10	MT	L/R	F	Closed Off-Road Vehicle Engine D20AA	857092	Outer Joint		28	29	58	86.5	63	I	
	2006.06-	2014.10	MT	L/R	F	All-wheel Drive Closed Off-Road Vehicle Engine D20AA	857092	Outer Joint		28	29	58	86.5	63	I	
	SEICENTO/600 (187_)															
	0.9 (29 kW)	1998.01-	2010.01	MT	L/R	F	Hatchback Engine 1170 A1.046	817010	Outer Joint		22	20	46.8	75.5	48	O
		1998.01-	2010.01	MT	L/R	F	Hatchback Engine 1170 A1.046	817024	Outer Joint		22	20	47	75.5	51.5	O
		1998.01-	2010.01	MT	L	F	Hatchback Engine 1170 A1.046	217201	Drive Shaft		22	29.2	47	75.5	533	
		1998.01-	2010.01	MT	R	F	Hatchback Engine 1170 A1.046	217206	Drive Shaft		22	29.2	47	75.5	795	
1998.01-		2010.01	MT	L	F	Hatchback Engine 1170 A1.046	217187	Drive Shaft		22	29.2	46.8	75.5	534		
1998.01-		2010.01	MT	R	F	Hatchback Engine 1170 A1.046	217048	Drive Shaft		22	29.2	46.8	75.5	795		
1.1 (40 kW)	1998.01-	2010.01	MT	L/R	F	Hatchback Engine 176 B2.000/187 A1.000	817010	Outer Joint		22	20	46.8	75.5	48	O	
	1998.01-	2010.01	MT	L/R	F	Hatchback Engine 176 B2.000/187 A1.000	817024	Outer Joint		22	20	47	75.5	51.5	O	
	1998.01-	2010.01	MT	L	F	Hatchback Engine 176 B2.000/187 A1.000	217201	Drive Shaft		22	29.2	47	75.5	533		
	1998.01-	2010.01	MT	R	F	Hatchback Engine 176 B2.000/187 A1.000	217206	Drive Shaft		22	29.2	47	75.5	795		
	1998.01-	2010.01	-	-	F	Hatchback Engine 176 B2.000/187 A1.000	817008	Outer Joint		22	20	51	79.5	51.5	O	
	1998.01-	2010.01	MT	L	F	Hatchback Engine 176 B2.000/187 A1.000	217190	Drive Shaft		22	22	47	75.5	553		
	1998.01-	2010.01	MT	R	F	Hatchback Engine 176 B2.000/187 A1.000	217191	Drive Shaft		22	22	47	75.5	776		
	1998.01-	2010.01	MT	L	F	Hatchback Engine 176 B2.000/187 A1.000	217188	Drive Shaft		22	22	46.8	75.5	552		
	1998.01-	2010.01	-	R	F	Hatchback Engine 176 B2.000/187 A1.000	217189	Drive Shaft		22	22	46.8	75.5	774		
SIENA																
-	2002-	-	-	-	-	VNVS / VS II	217031	Drive Shaft						336		
	2002-	-	-	-	-	VNVS / VS II	617018	Inner Joint			25		32			
1.0	2008-	2012	-	-	-	-	817093	Outer Joint		22	28	47	89	57	O	
1.0 8V	1998-	2008	-	-	-	-	817041	Outer Joint		22	20	52	91	60.5	O	
1.2/1.4	1997-	2002	-	R	F	-	216001	Drive Shaft		22	31.95	47	89	918.5		
	1997-	2002	-	L	F	-	216002	Drive Shaft		22	31.95	47	89	571.5		
1.4 8V	2008-	2012	-	-	-	-	817093	Outer Joint		22	28	47	89	57	O	
SIENA (178_ 172_)/ALBEA																
1.2 (54 kW)	1998.09-	2009.12	-	-	F	Saloon Engine 178 B5.000 (09.98-)	817029	Outer Joint		22	20	47	89	61	O	
	1998.09-	2009.12	MT	L/R	F	Saloon Engine 178 B5.000 (09.98-)	817019	Outer Joint		22	22	52	91	60.5	O	
1.4 (51 kW)	1996.04-	2009.12	MT	L/R	F	Saloon Engine 178 B2.000 (04.96-)	817019	Outer Joint		22	22	52	91	60.5	O	
	1996.04-	2009.12	AT/MT	L/R	F	Saloon Engine 178 B2.000 (04.96-)	817020	Outer Joint	44T	22	22	52	91	60.5	O	
1.4 Cat (51 kW)	1996.04-	2009.12	MT	L/R	F	Saloon Engine 178 B2.016	817019	Outer Joint		22	22	52	91	60.5	O	
1.6 16V (78 kW)	1998.09-	2009.12	MT	L/R	F	Saloon Engine 178 B3.000	817019	Outer Joint		22	22	52	91	60.5	O	
	1998.09-	2009.12	AT/MT	L/R	F	Saloon Engine 178 B3.000	817020	Outer Joint	44T	22	22	52	91	60.5	O	
1.7 TD (51 kW)	2006.02-	2009.12	AT/MT	L/R	F	Saloon Engine 176 A3.000	817020	Outer Joint	44T	22	22	52	91	60.5	O	
STILO																
1.9	2001-	2005	-	-	R	-	617014	Inner Joint		34	24	34.9	411	102.5		
STILO (192),MULTI WAGON																
1.2 16V(59 kW)	2002.02-	-	-	-	-	-	617027	Inner Joint		22	22	36	61.5	93.5		
1.4 16V (76 kW)	2005.05-	2010.01	-	-	-	-	617027	Inner Joint		22	22	36	61.5	93.5		
1.4 16V (77 kW)	2005.05-	2010.01	-	-	-	-	617027	Inner Joint		22	22	36	61.5	93.5		
1.6 16V(76 kW)	2001.10-	2005.05	-	-	-	-	617027	Inner Joint		22	22	36	61.5	93.5		
1.6 16V(77 kW)	2001.10-	2005.05	-	-	-	-	617027	Inner Joint		22	22	36	61.5	93.5		





YEAR	TRANSM	L/R	F/R	REMARKS	GSP Ref.	PRODUCT	ABS	Technical Specifications									
								A	B	C	H	L	P				
FIAT																	
STILO (192),MULTI WAGON																	
1.8 16V (98 kW)	2001.1-2008.08	-	-	-	-	617009	Inner Joint			25		32					
	2001.10-	-	-	-	Ch0276610	802008	Outer Joint		25	25	59	85	58	O			
1.9 D Multijet (110 kW)	2005.09-	-	R	-	-	617006	Inner Joint		25	26	29.8	377	108				
	2005.09-	-	L	-	-	617005	Inner Joint		25	26	32	91	95				
1.9 D Multijet (74 kW)	2005.09-	-	-	-	-	617009	Inner Joint			25		32					
1.9 D Multijet (88 kW)	2005.09-	-	-	-	-	617009	Inner Joint			25		32					
1.9 JTD (100 kW)	2004.01-	-	-	-	-	617009	Inner Joint			25		32					
1.9 JTD (103 kW)	2004.01-	-	-	-	-	617009	Inner Joint			25		32					
1.9 JTD (110 kW)	2003-2007	-	R	-	-	617006	Inner Joint		25	26	29.8	377	108				
	2003-2007	-	L	-	-	617005	Inner Joint		25	26	32	91	95				
1.9 JTD (59 kW)	2002.02-	-	-	-	Ch6276610	802008	Outer Joint		25	25	59	85	58	O			
	2002.02-2008.02	-	-	-	-	617009	Inner Joint			25		32					
1.9 JTD (74 kW)	2002.02-2008.02	-	-	-	-	617009	Inner Joint			25		32					
1.9 JTD (88 kW)	2003-2007	-	R	-	-	617006	Inner Joint		25	26	29.8	377	108				
	2003-2007	-	L	-	-	617005	Inner Joint		25	26	32	91	95				
1.9 JTD (93 kW)	2004.01-	-	-	-	-	617009	Inner Joint			25		32					
2.4 20V (125 kW)	2001.10-	-	R	-	-	699130	Inner Joint		25	26	29.8	469	108				
	2001.10-	-	L	-	-	617005	Inner Joint		25	26	32	91	95				
STILO (192_)																	
1.2 16V (59 kW)	2002.02-2006.11	-	L/R	F	Hatchback Engine 188 A5.000	817014	Outer Joint		22	21	51	79.5	54	M			
	2002.02-2006.11	-	-	-	Hatchback Engine 188 A5.000	817034	Outer Joint		22	21	51	79.5	54	M			
	2002.02-2006.11	MT	L	F	Hatchback Engine 188 A5.000	217140	Drive Shaft		25	22	51	84	660				
	2002.02-2006.11	MT	L	F	Hatchback Engine 188 A5.000	617004	Inner Joint		22	21	36	61	93.5				
1.4 16V (70 kW)	2004.01-2006.11	-	L/R	F	Hatchback Engine 843 A1.000	817026	Outer Joint		25	22	51	84	57	M			
1.6 16V (76 kW)	2001.10-2006.11	-	L/R	F	Hatchback Engine 182 B6.000	817026	Outer Joint		25	22	51	84	57	M			
	2001.10-2006.11	-	L	F	Hatchback Engine 182 B6.000	217099	Drive Shaft		25	22	51	84	638				
	2001.10-2006.11	-	R	F	Hatchback Engine 182 B6.000	217080	Drive Shaft		25	22	51	84	938				
	2001.10-2006.11	-	L	F	Hatchback Engine 182 B6.000	617004	Inner Joint		22	21	36	61	93.5				
1.8 16V (98 kW)	2001.10-2006.11	-	-	F	Hatchback Engine 192 A4.000	602005	Inner Joint			25		32					
	2001.10-2006.11	-	-	F	Hatchback Engine 192 A4.000	602006	Inner Joint			25		32					
	2001.10-2006.11	MT	L/R	F	Hatchback Engine 192 A4.000	618070	Inner Joint			25		32					
1.9 D Multijet (74 kW)	2005.09-2006.11	AT/MT	L/R	F	Hatchback Engine 192 A9.000	618070	Inner Joint			25		32					
	2005.09-2006.11	-	-	F	Hatchback Engine 192 A9.000	602005	Inner Joint			25		32					
	2005.09-2006.11	-	-	F	Hatchback Engine 192 A9.000	602006	Inner Joint			25		32					
	2005.09-2006.11	MT	L/R	F	Hatchback Engine 192 A9.000	602011	Inner Joint			25		32					
1.9 D Multijet (88 kW)	2005.09-2006.11	AT/MT	L/R	F	Hatchback Engine 192 A8.000	618070	Inner Joint			25		32					
	2005.09-2006.11	-	L/R	F	Hatchback Engine 192 A8.000	217194	Drive Shaft		25	39.2	51	84.5	523				
1.9 JTD (59 kW)	2002.02-2006.11	-	-	F	Hatchback Engine 192 A3.000	602005	Inner Joint			25		32					
	2002.02-2006.11	-	-	F	Hatchback Engine 192 A3.000	602006	Inner Joint			25		32					
1.9 JTD (66 kW)	2004.09-2006.11	-	-	F	Hatchback Engine 192 B5.000	602006	Inner Joint			25		32					
1.9 JTD (85 kW)	2001.10-2006.11	-	R	F	Hatchback Engine 192 A1.000/937 A7.000	217077	Drive Shaft		25	34	51	84.5	928				
	2001.10-2006.11	-	R	F	Hatchback Engine 192 A1.000/937 A7.000	817057	Outer Joint		25	24	51	84.5	62	M			
	2001.10-2006.11	-	L	F	Hatchback Engine 192 A1.000/937 A7.000	617013	Inner Joint		34	24	35	56.5	115				
	2001.10-2006.11	-	L/R	F	Hatchback Engine 192 A1.000/937 A7.000	817030	Outer Joint		25	26	51	84.5	64.5	M			
2.4 20V (125 kW)	2001.10-2006.11	-	R	F	Hatchback Engine 192 A2.000	217118	Drive Shaft		25	25	59	84	985				
STILO ABARTH																	
2.4	-	-	R	-	-	617019	Inner Joint		25	26	29.8	405	108				
STILO Multi Wagon (192_)																	
1.4 16V (70 kW)	2004.01-2008.08	-	L/R	F	Estate Engine 843 A1.000	817026	Outer Joint		25	22	51	84	57	M			
1.6 16V (76 kW)	2003.01-2008.08	-	L/R	F	Estate Engine 182 B6.000	817026	Outer Joint		25	22	51	84	57	M			
	2003.01-2008.08	-	L	F	Estate Engine 182 B6.000	217099	Drive Shaft		25	22	51	84	638				
	2003.01-2008.08	-	R	F	Estate Engine 182 B6.000	217080	Drive Shaft		25	22	51	84	938				
	2003.01-2008.08	-	L	F	Estate Engine 182 B6.000	617004	Inner Joint		22	21	36	61	93.5				
1.8 16V (98 kW)	2003.01-2008.08	-	-	F	Estate Engine 192 A4.000	602005	Inner Joint			25		32					
	2003.01-2008.08	-	-	F	Estate Engine 192 A4.000	602006	Inner Joint			25		32					
	2003.01-2008.08	MT	L/R	F	Estate Engine 192 A4.000	602011	Inner Joint			25		32					
	2003.01-2008.08	MT	L/R	F	Estate Engine 192 A4.000	618070	Inner Joint			25		32					
1.9 D Multijet (74 kW)	2005.09-2008.08	-	-	F	Estate Engine 192 A9.000	602005	Inner Joint			25		32					
	2005.09-2008.08	-	-	F	Estate Engine 192 A9.000	602006	Inner Joint			25		32					
	2005.09-2008.08	AT/MT	L/R	F	Estate Engine 192 A9.000	618070	Inner Joint			25		32					
1.9 D Multijet (88 kW)	2005.09-2008.08	MT	L	F	Estate Engine 192 A8.000	217108	Drive Shaft		25	34	51	84.5	631				
	2005.09-2008.08	-	L/R	F	Estate Engine 192 A8.000	217194	Drive Shaft		25	39.2	51	84.5	523				
	2005.09-2008.08	AT/MT	L/R	F	Estate Engine 192 A8.000	618070	Inner Joint			25		32					
1.9 JTD (59 kW)	2003.01-2008.08	-	-	F	Estate Engine 192 A3.000	602005	Inner Joint			25		32					
	2003.01-2008.08	-	-	F	Estate Engine 192 A3.000	602006	Inner Joint			25		32					
	2003.01-2008.08	MT	L/R	F	Estate Engine 192 A3.000	602011	Inner Joint			25		32					

YEAR	TRANSM	L/R	F/R	REMARKS	GSP Ref.	PRODUCT	ABS	Technical Specifications									
								A	B	C	H	L	P				
FIAT																	
STILO Multi Wagon (192_)																	
1.9 JTD (85 kW)	2003.01-2008.08	-	L/R	F	Estate Engine 192 A1.000/937 A7.000	817030	Outer Joint		25	26	51	84.5	64.5		M		
	2003.01-2008.08	MT	L	F	Estate Engine 192 A1.000/937 A7.000	217108	Drive Shaft		25	34	51	84.5	631				
	2003.01-2008.08	-	R	F	Estate Engine 192 A1.000/937 A7.000	217077	Drive Shaft		25	34	51	84.5	928				
	2003.01-2008.08	-	R	F	Estate Engine 192 A1.000/937 A7.000	817057	Outer Joint		25	24	51	84.5	62		M		
	2003.01-2008.08	-	L	F	Estate Engine 192 A1.000/937 A7.000	617013	Inner Joint		34	24	35	56.5	115				
STRADA																	
-	2002-	-	-	-	-		217031	Drive Shaft							336		
	2002-	-	-	-	-		617018	Inner Joint		25		32					
1.3 16V	2011-2012	-	-	-	-		817093	Outer Joint		22	28	47	89	57		O	
1.4 8V	2009-	-	-	-	-		817093	Outer Joint		22	28	47	89	57		O	
STRADA (178E)																	
1.3 D Multijet (62 kW)	2006.05-	-	-	-	LCV		617009	Inner Joint		25		32					
1.9 JTD (59 kW)	2003.04-	-	-	-	LCV		617009	Inner Joint		25		32					
STRADA (178_)																	
1.2 (44 kW)	2003.04-	-	-	-	F Pickup Engine 188 A4.000		817037	Outer Joint		22	22	51	89	61		O	
1.2 (54 kW)	1999.06-2006.12	-	-	-	F Pickup Engine 178 B5.000		817037	Outer Joint		22	22	51	89	61		O	
1.3 D Multijet (62 kW)	2006.05-	-	-	-	F Pickup Engine 223 A9.000		602005	Inner Joint		25		32					
1.7 TD (51 kW)	1999.06-2006.12	-	-	-	F Pickup Engine 176 A3.000		817037	Outer Joint		22	22	51	89	61		O	
1.9 D (46 kW)	2000.12-	-	-	-	F Pickup Engine 223 A6.000		817037	Outer Joint		22	22	51	89	61		O	
1.9 JTD (59 kW)	2003.04-	-	MT	R	F Pickup Engine 188 A2.000		217002	Drive Shaft		25		51	90	533			
	2003.04-	-	MT	L	F Pickup Engine 188 A2.000		217003	Drive Shaft		25		51	90	455			
	2003.04-	-	-	-	F Pickup Engine 188 A2.000		602005	Inner Joint		25		32					
	2003.04-	-	-	L/R	F Pickup Engine 188 A2.000		817031	Outer Joint		25	24	51	90	62		M	
TALENTO																	
2.1	-	-	-	-	-		810104	Outer Joint	54T	28	27	63	112.5	63		I	
TALENTO (290_)																	
1.9 D (52 kW)	1989.03-1994.03	MT	R	F	Box Engine 149 B1.000		210013	Drive Shaft		28	25	63	112.5	1072			
	1989.03-1994.03	MT	R	F	Platform/Chassis Engine 149 B1.000		210013	Drive Shaft		28	25	63	112.5	1072			
	1989.03-1994.03	MT	R	F	Bus Engine 149 B1.000		210013	Drive Shaft		28	25	63	112.5	1072			
	1989.03-1994.03	MT	L/R	F	Box Engine 149 B1.000		810010	Outer Joint		28	27	63	112.5	63		I	
	1989.03-1994.03	MT	L/R	F	Platform/Chassis Engine 149 B1.000		810010	Outer Joint		28	27	63	112.5	63		I	
	1989.03-1994.03	MT	L/R	F	Bus Engine 149 B1.000		810010	Outer Joint		28	27	63	112.5	63		I	
	1989.03-1994.03	MT	L	F	Box Engine 149 B1.000		210034	Drive Shaft		28	25	63	112.5	701			
	1989.03-1994.03	MT	L	F	Platform/Chassis Engine 149 B1.000		210034	Drive Shaft		28	25	63	112.5	701			
	1989.03-1994.03	MT	L	F	Bus Engine 149 B1.000		210034	Drive Shaft		28	25	63	112.5	701			
2.0 (55 kW)	1989.03-1994.03	MT	L/R	F	Bus Engine 170 B		810010	Outer Joint		28	27	63	112.5	63		I	
	1989.03-1994.03	MT	L/R	F	Platform/Chassis Engine 170 B		810010	Outer Joint		28	27	63	112.5	63		I	
	1989.03-1994.03	MT	L/R	F	Bus Engine 170 B		810010	Outer Joint		28	27	63	112.5	63		I	
	1989.03-1994.03	MT	R	F	Bus Engine 170 B		210068	Drive Shaft		28	25	63	112.5	1068			
	1989.03-1994.03	MT	R	F	Platform/Chassis Engine 170 B		210068	Drive Shaft		28	25	63	112.5	1068			
	1989.03-1994.03	MT	R	F	Bus Engine 170 B		210068	Drive Shaft		28	25	63	112.5	1068			
	1989.03-1994.03	MT	L	F	Bus Engine 170 B		210034	Drive Shaft		28	25	63	112.5	701			
	1989.03-1994.03	MT	L	F	Platform/Chassis Engine 170 B		210034	Drive Shaft		28	25	63	112.5	701			
	1989.03-1994.03	MT	L	F	Bus Engine 170 B		210034	Drive Shaft		28	25	63	112.5	701			
TEMPRA (159_)																	
1.4 i.e. (51 kW)	1990.04-1996.08	AT	L/R	F	Saloon Engine 159 A2.000/160 A1.046/836 A4.000		648004	Inner Joint			25		32				
	1990.04-1996.08	MT	R	F	Saloon Engine 159 A2.000/160 A1.046/836 A4.000		217011	Drive Shaft		22	31.95	46.8	75.5	928.5			
	1990.04-1996.08	MT	L	F	Saloon Engine 159 A2.000/160 A1.046/836 A4.000		217010	Drive Shaft		22	31.95	46.8	75.5	569			
1.4 i.e. (57 kW)	1991.03-1996.08	AT	L/R	F	Saloon Engine 159 A2.000		648004	Inner Joint			25		32				
1.6 (63 kW)	1990.03-1996.08	AT	L/R	F	Saloon Engine 159 A3.000/159 B9.000		648004	Inner Joint			25		32				
1.6 i.e. (55 kW)	1992.06-1996.08	-	-	-	F Saloon Engine 159 A3.048/835 C1.000		602006	Inner Joint			25		32				
	1992.06-1996.08	MT	R	F	Saloon Engine 159 A3.048/835 C1.000		217011	Drive Shaft		22	31.95	46.8	75.5	928.5			
	1992.06-1996.08	AT	L/R	F	Saloon Engine 159 A3.048/835 C1.000		648004	Inner Joint			25		32				
	1992.06-1996.08	MT	L	F	Saloon Engine 159 A3.048/835 C1.000		217010	Drive Shaft		22	31.95	46.8	75.5	569			
1.6 i.e. (57 kW)	1990.06-1992.07	-	-	-	F Saloon Engine 159 A3.046		602006	Inner Joint			25		32				
	1990.06-1992.07	AT	L/R	F	Saloon Engine 159 A3.046		648004	Inner Joint			25		32				
1.6 i.e. (63 kW)	1994.06-1996.08	MT	R	F	Saloon Engine 159 B9.000		217011	Drive Shaft		22	31.95	46.8	75.5	928.5			
	1994.06-1996.08	AT	L/R	F	Saloon Engine 159 B9.000		648004	Inner Joint			25		32				
	1994.06-1996.08	MT	L	F	Saloon Engine 159 B9.000		217010	Drive Shaft		22	31.95	46.8	75.5	569			
1.6 i.e. (66 kW)	1994.06-1996.08	MT	R	F	Saloon Engine 159 B9.000		217011	Drive Shaft		22	31.95	46.8	75.5	928.5			
	1994.06-1996.08	AT	L/R	F	Saloon Engine 159 B9.000		648004	Inner Joint			25		32				
	1994.06-1996.08	MT	L	F	Saloon Engine 159 B9.000		217010	Drive Shaft		22	31.95	46.8	75.5	569			
1.8 i.e. (66 kW)	1993.09-1996.08	-	-	-	F Saloon Engine 835 C4.000		602006	Inner Joint			25		32				
	1993.09-1996.08	MT	L/R	F	Saloon Engine 835 C4.000		648004	Inner Joint			25		32				
	1993.09-1996.08	MT	L/R	F	Saloon Engine 835 C4.000		817012	Outer Joint		25	25	52	84.5	56		I	
1.8 i.e. (74 kW)	1994.10-1996.08	-	-	-	F Saloon Engine 836 A5.000		602006	Inner Joint			25		32				





	 YEAR	TRANSM	L/R	F/R	REMARKS	GSP Ref.	 PRODUCT	 ABS	Technical Specifications						
									A	B	C	H	L	P	
FIAT															
TEMPRA (159_)															
1.8 i.e. (74 kW)	1994.10-1996.08	MT	L/R	F	Saloon Engine 836 A5.000	648004	Inner Joint			25		32			
	1994.10-1996.08	MT	L/R	F	Saloon Engine 836 A5.000	817012	Outer Joint		25	25	52	84.5	56	I	
1.8 i.e. (76 kW)	1993.09-1996.08	-	-	F	Saloon Engine 835 C2.000	602006	Inner Joint			25		32			
	1993.09-1996.08	MT	L/R	F	Saloon Engine 835 C2.000	648004	Inner Joint			25		32			
	1993.09-1996.08	MT	L/R	F	Saloon Engine 835 C2.000	817012	Outer Joint		25	25	52	84.5	56	I	
1.8 i.e. (77 kW)	1992.03-1996.08	-	-	F	Saloon Engine 159 A4.046	602006	Inner Joint			25		32			
	1992.03-1996.08	MT	L/R	F	Saloon Engine 159 A4.046	648004	Inner Joint			25		32			
	1992.03-1996.08	MT	L/R	F	Saloon Engine 159 A4.046	817012	Outer Joint		25	25	52	84.5	56	I	
1.8 i.e. (81 kW)	1990.03-1996.08	MT	L/R	F	Saloon Engine 159 A4.000	648004	Inner Joint			25		32			
	1990.03-1996.08	-	-	F	Saloon Engine 159 A4.000	602006	Inner Joint			25		32			
	1990.03-1996.08	MT	L/R	F	Saloon Engine 159 A4.000	817012	Outer Joint		25	25	52	84.5	56	I	
1.9 D (48 kW)	1991.07-1996.08	MT	R	F	Saloon Engine 149 A1.000/160 A7.000	217011	Drive Shaft		22	31.95	46.8	75.5	928.5		
	1991.07-1996.08	MT	L	F	Saloon Engine 149 A1.000/160 A7.000	217010	Drive Shaft		22	31.95	46.8	75.5	569		
1.9 TD (59 kW)	1992.07-1996.08	-	-	F	Saloon Engine 160 B6.046	602006	Inner Joint			25		32			
	1992.07-1996.08	MT	L/R	F	Saloon Engine 160 B6.046	648004	Inner Joint			25		32			
	1992.07-1996.08	MT	L/R	F	Saloon Engine 160 B6.046	817012	Outer Joint		25	25	52	84.5	56	I	
	1992.07-1996.08	-	-	F	Saloon Engine 160 B6.046	802004	Outer Joint	44T	25	25	52	85	58	I	
	1992.07-1996.08	-	-	F	Saloon Engine 160 B6.046	602005	Inner Joint			25		32			
1.9 TD (66 kW)	1990.05-1996.08	-	-	F	Saloon Engine 160 A6.000/160 D1.000	602006	Inner Joint			25		32			
	1990.05-1996.08	MT	L/R	F	Saloon Engine 160 A6.000/160 D1.000	648004	Inner Joint			25		32			
	1990.05-1996.08	MT	L/R	F	Saloon Engine 160 A6.000/160 D1.000	817012	Outer Joint		25	25	52	84.5	56	I	
	1990.05-1996.08	-	-	F	Saloon Engine 160 A6.000/160 D1.000	802004	Outer Joint	44T	25	25	52	85	58	I	
	1990.05-1996.08	-	-	F	Saloon Engine 160 A6.000/160 D1.000	602005	Inner Joint			25		32			
2.0 i.e. (83 kW)	1990.10-1996.08	-	-	F	Saloon Engine 159 A6.046	602006	Inner Joint			25		32			
	1990.10-1996.08	MT	L/R	F	Saloon Engine 159 A6.046	648004	Inner Joint			25		32			
TEMPRA S.W. (159_)															
1.4 i.e. (51 kW)	1992.10-1996.08	MT	L	F	Estate Engine 159 A2.000/160 A1.046/836 A4.000	217010	Drive Shaft		22	31.95	46.8	75.5	569		
	1992.10-1996.08	AT	L/R	F	Estate Engine 159 A2.000/160 A1.046/836 A4.000	648004	Inner Joint			25		32			
	1992.10-1996.08	MT	R	F	Estate Engine 159 A2.000/160 A1.046/836 A4.000	217011	Drive Shaft		22	31.95	46.8	75.5	928.5		
1.6 (63 kW)	1990.12-1993.04	MT	L	F	Estate Engine 159 A3.000	217010	Drive Shaft		22	31.95	46.8	75.5	569		
	1990.12-1993.04	MT	R	F	Estate Engine 159 A3.000	217011	Drive Shaft		22	31.95	46.8	75.5	928.5		
	1990.12-1993.04	AT	L/R	F	Estate Engine 159 A3.000	648004	Inner Joint			25		32			
1.6 i.e. (55 kW)	1992.10-1996.08	MT	L	F	Estate Engine 159 A3.048/835 C1.000	217010	Drive Shaft		22	31.95	46.8	75.5	569		
	1992.10-1996.08	-	-	F	Estate Engine 159 A3.048/835 C1.000	602006	Inner Joint			25		32			
	1992.10-1996.08	MT	R	F	Estate Engine 159 A3.048/835 C1.000	217011	Drive Shaft		22	31.95	46.8	75.5	928.5		
	1992.10-1996.08	AT	L/R	F	Estate Engine 159 A3.048/835 C1.000	648004	Inner Joint			25		32			
1.6 i.e. (57 kW)	1990.10-1996.08	AT	L/R	F	Estate Engine 159 A3.046/835 C1.000	648004	Inner Joint			25		32			
	1990.10-1996.08	MT	-	F	Estate Engine 159 A3.046/835 C1.000	602006	Inner Joint			25		32			
1.6 i.e. (66 kW)	1994.06-1996.08	MT	L	F	Estate Engine 159 B9.000	217010	Drive Shaft		22	31.95	46.8	75.5	569		
	1994.06-1996.08	MT	R	F	Estate Engine 159 B9.000	217011	Drive Shaft		22	31.95	46.8	75.5	928.5		
	1994.06-1996.08	AT	L/R	F	Estate Engine 159 B9.000	648004	Inner Joint			25		32			
1.8 i.e. (66 kW)	1993.09-1996.08	-	-	F	Estate Engine 835 C4.000	602006	Inner Joint			25		32			
	1993.09-1996.08	MT	L/R	F	Estate Engine 835 C4.000	648004	Inner Joint			25		32			
	1993.09-1996.08	MT	L/R	F	Estate Engine 835 C4.000	817012	Outer Joint		25	25	52	84.5	56	I	
1.8 i.e. (74 kW)	1994.10-1996.08	-	-	F	Estate Engine 836 A5.000	602006	Inner Joint			25		32			
	1994.10-1996.08	MT	L/R	F	Estate Engine 836 A5.000	648004	Inner Joint			25		32			
	1994.10-1996.08	MT	L/R	F	Estate Engine 836 A5.000	817012	Outer Joint		25	25	52	84.5	56	I	
1.8 i.e. (76 kW)	1993.09-1996.08	-	-	F	Estate Engine 835 C2.000	602006	Inner Joint			25		32			
	1993.09-1996.08	MT	L/R	F	Estate Engine 835 C2.000	648004	Inner Joint			25		32			
	1993.09-1996.08	MT	L/R	F	Estate Engine 835 C2.000	817012	Outer Joint		25	25	52	84.5	56	I	
1.8 i.e. (77 kW)	1992.03-1993.12	-	-	F	Estate Engine 159 A4.046	602006	Inner Joint			25		32			
	1992.03-1993.12	MT	L/R	F	Estate Engine 159 A4.046	648004	Inner Joint			25		32			
	1992.03-1993.12	MT	L/R	F	Estate Engine 159 A4.046	817012	Outer Joint		25	25	52	84.5	56	I	
1.8 i.e. (81 kW)	1990.03-1996.08	MT	L/R	F	Estate Engine 159 A4.000	648004	Inner Joint			25		32			
	1990.03-1996.08	-	-	F	Estate Engine 159 A4.000	602006	Inner Joint			25		32			
	1990.03-1996.08	MT	L/R	F	Estate Engine 159 A4.000	817012	Outer Joint		25	25	52	84.5	56	I	
1.9 D (48 kW)	1991.07-1996.08	MT	L	F	Estate Engine 149 A1.000/160 A7.000	217010	Drive Shaft		22	31.95	46.8	75.5	569		
	1991.07-1996.08	MT	R	F	Estate Engine 149 A1.000/160 A7.000	217011	Drive Shaft		22	31.95	46.8	75.5	928.5		
1.9 TD (59 kW)	1992.03-1993.06	-	-	F	Estate Engine 160 B6.046	602006	Inner Joint			25		32			
	1992.03-1993.06	MT	L/R	F	Estate Engine 160 B6.046	648004	Inner Joint			25		32			
	1992.03-1993.06	MT	L/R	F	Estate Engine 160 B6.046	817012	Outer Joint		25	25	52	84.5	56	I	
	1992.03-1993.06	-	-	F	Estate Engine 160 B6.046	802004	Outer Joint	44T	25	25	52	85	58	I	
	1992.03-1993.06	-	-	F	Estate Engine 160 B6.046	602005	Inner Joint			25		32			
1.9 TD (66 kW)	1991.07-1995.02	-	-	F	Estate Engine 160 A6.000/160 D1.000	602006	Inner Joint			25		32			
	1991.07-1995.02	MT	L/R	F	Estate Engine 160 A6.000/160 D1.000	648004	Inner Joint			25		32			
	1991.07-1995.02	MT	L/R	F	Estate Engine 160 A6.000/160 D1.000	817012	Outer Joint		25	25	52	84.5	56	I	

YEAR	TRANSM	L/R	F/R	REMARKS	GSP Ref.	PRODUCT	ABS	Technical Specifications						
								A	B	C	H	L	P	
FIAT														
TEMPRA S.W. (159_)														
1.9 TD (66 kW)	1991.07-1995.02	-	-	F	Estate Engine 160 A6.000/160 D1.000	802004	Outer Joint	44T	25	25	52	85	58	I
	1991.07-1995.02	-	-	F	Estate Engine 160 A6.000/160 D1.000	602005	Inner Joint		25		32			
2.0 i.e. (83 kW)	1991.01-1995.03	-	-	F	Estate Engine 159 A6.046	602006	Inner Joint		25		32			
	1991.01-1995.03	MT	L/R	F	Estate Engine 159 A6.046	648004	Inner Joint		25		32			
	1992.03-1995.03	-	-	-	All-wheel Drive Estate Engine 159 A6.046	602006	Inner Joint		25		32			
	1992.03-1995.03	MT	L/R	F	All-wheel Drive Estate Engine 159 A6.046	648004	Inner Joint		25		32			
TIPO														
1.6	1994.01-1997.12	MT	-	-	-	817046	Outer Joint		22	20	46	79.5	51	O
TIPO (160_)														
1.1 (41 kW)	1988.01-1991.10	MT	L	F	Hatchback Engine 160 A3.000	217010	Drive Shaft		22	31.95	46.8	75.5	569	
	1988.01-1991.10	MT	R	F	Hatchback Engine 160 A3.000	217011	Drive Shaft		22	31.95	46.8	75.5	928.5	
	1988.01-1991.10	AT	L/R	F	Hatchback Engine 160 A3.000	648004	Inner Joint		25		32			
1.4 (52 kW)	1987.07-1989.12	AT	L/R	F	Hatchback Engine 160 A1.000/160 A1.048	648004	Inner Joint		25		32			
	1987.07-1989.12	MT	L	F	Hatchback Engine 160 A1.000/160 A1.048	217010	Drive Shaft		22	31.95	46.8	75.5	569	
	1987.07-1989.12	MT	R	F	Hatchback Engine 160 A1.000/160 A1.048	217011	Drive Shaft		22	31.95	46.8	75.5	928.5	
1.4 i.e. (51 kW)	1989.05-1995.04	MT	L	F	Hatchback Engine 160 A1.046/836 A4.000	217010	Drive Shaft		22	31.95	46.8	75.5	569	
	1989.05-1995.04	MT	R	F	Hatchback Engine 160 A1.046/836 A4.000	217011	Drive Shaft		22	31.95	46.8	75.5	928.5	
	1989.05-1995.04	AT	L/R	F	Hatchback Engine 160 A1.046/836 A4.000	648004	Inner Joint		25		32			
1.4 i.e. (57 kW)	1989.05-1995.04	MT	L	F	Hatchback Engine 159 A2.000	217010	Drive Shaft		22	31.95	46.8	75.5	569	
	1989.05-1995.04	MT	R	F	Hatchback Engine 159 A2.000	217011	Drive Shaft		22	31.95	46.8	75.5	928.5	
	1989.05-1995.04	AT	L/R	F	Hatchback Engine 159 A2.000	648004	Inner Joint		25		32			
1.6 (61 kW)	1988.01-1991.10	AT	L/R	F	Hatchback Engine 160 A2.000	648004	Inner Joint		25		32			
1.6 i.e. (55 kW)	1992.10-1995.04	MT	L	F	Hatchback Engine 159 A3.048/835 C1.000	217010	Drive Shaft		22	31.95	46.8	75.5	569	
	1992.10-1995.04	MT	R	F	Hatchback Engine 159 A3.048/835 C1.000	217011	Drive Shaft		22	31.95	46.8	75.5	928.5	
	1992.10-1995.04	AT	L/R	F	Hatchback Engine 159 A3.048/835 C1.000	648004	Inner Joint		25		32			
1.6 i.e. (57 kW)	1990.07-1993.01	AT	L/R	F	Hatchback Engine 159 A3.046	648004	Inner Joint		25		32			
1.6 i.e. (66 kW)	1988.02-1991.05	MT	L	F	Hatchback Engine 149 C2.046	217010	Drive Shaft		22	31.95	46.8	75.5	569	
	1988.02-1991.05	MT	L/R	F	Hatchback Engine 149 C2.046	648004	Inner Joint		25		32			
	1988.02-1991.05	MT	R	F	Hatchback Engine 149 C2.046	217011	Drive Shaft		22	31.95	46.8	75.5	928.5	
	1988.02-1991.05	MT	L/R	F	Hatchback Engine 149 C2.046	817012	Outer Joint		25	25	52	84.5	56	I
1.7 D (43 kW)	1988.01-1994.10	MT	L	F	Hatchback Engine 149 B4.000	217010	Drive Shaft		22	31.95	46.8	75.5	569	
	1988.01-1994.10	MT	R	F	Hatchback Engine 149 B4.000	217011	Drive Shaft		22	31.95	46.8	75.5	928.5	
1.8 i.e. (71 kW)	1993.03-1995.04	-	-	F	Hatchback Engine 836 A5.000	602006	Inner Joint		25		32			
1.8 i.e. (66 kW)	1993.09-1995.04	-	-	F	Hatchback Engine 835 C4.000	602006	Inner Joint		25		32			
	1993.09-1995.04	MT	L/R	F	Hatchback Engine 835 C4.000	648004	Inner Joint		25		32			
	1993.09-1995.04	MT	L/R	F	Hatchback Engine 835 C4.000	817012	Outer Joint		25	25	52	84.5	56	I
1.8 i.e. (74 kW)	1994.10-1995.10	MT	L/R	F	Hatchback Engine 159 A4.000/836 A5.000	648004	Inner Joint		25		32			
	1994.10-1995.10	-	-	F	Hatchback Engine 159 A4.000/836 A5.000	602006	Inner Joint		25		32			
	1994.10-1995.10	MT	L/R	F	Hatchback Engine 159 A4.000/836 A5.000	817012	Outer Joint		25	25	52	84.5	56	I
1.8 i.e. (76 kW)	1993.04-1995.04	-	-	F	Hatchback Engine 835 C2.000	602006	Inner Joint		25		32			
	1993.04-1995.04	MT	L/R	F	Hatchback Engine 835 C2.000	648004	Inner Joint		25		32			
	1993.04-1995.04	MT	L/R	F	Hatchback Engine 835 C2.000	817012	Outer Joint		25	25	52	84.5	56	I
1.8 i.e. (77 kW)	1990.10-1993.06	-	-	F	Hatchback Engine 159 A4.046	602006	Inner Joint		25		32			
	1990.10-1993.06	MT	L/R	F	Hatchback Engine 159 A4.046	648004	Inner Joint		25		32			
	1990.10-1993.06	MT	L/R	F	Hatchback Engine 159 A4.046	817012	Outer Joint		25	25	52	84.5	56	I
1.8 i.e. (81 kW)	1990.10-1993.06	MT	L/R	F	Hatchback Engine 159 A4.000	648004	Inner Joint		25		32			
	1990.10-1993.06	-	-	F	Hatchback Engine 159 A4.000	602006	Inner Joint		25		32			
	1990.10-1993.06	MT	L/R	F	Hatchback Engine 159 A4.000	817012	Outer Joint		25	25	52	84.5	56	I
1.8 i.e.16V Sport (100 kW)	1989.11-1992.06	-	-	F	Hatchback Engine 160 A5.000	602005	Inner Joint		25		32			
	1989.11-1992.06	-	-	F	Hatchback Engine 160 A5.000	602006	Inner Joint		25		32			
1.9 D (48 kW)	1991.07-1995.08	MT	L	F	Hatchback Engine 149 A1.000/160 A7.000	217010	Drive Shaft		22	31.95	46.8	75.5	569	
	1991.07-1995.08	MT	R	F	Hatchback Engine 149 A1.000/160 A7.000	217011	Drive Shaft		22	31.95	46.8	75.5	928.5	
1.9 TD (59 kW)	1992.03-1993.06	MT	L/R	F	Hatchback Engine 160 B6.046	648004	Inner Joint		25		32			
	1992.03-1993.06	MT	L/R	F	Hatchback Engine 160 B6.046	817012	Outer Joint		25	25	52	84.5	56	I
	1992.03-1993.06	-	-	F	Hatchback Engine 160 B6.046	802004	Outer Joint	44T	25	25	52	85	58	I
	1992.03-1993.06	-	-	F	Hatchback Engine 160 B6.046	602005	Inner Joint		25		32			
1.9 TD (66 kW)	1990.09-1995.04	-	-	F	Hatchback Engine 160 A6.000/160 A6.046/160 D1.000	602006	Inner Joint		25		32			
	1990.09-1995.04	MT	L/R	F	Hatchback Engine 160 A6.000/160 A6.046/160 D1.000	648004	Inner Joint		25		32			
	1990.09-1995.04	MT	L/R	F	Hatchback Engine 160 A6.000/160 A6.046/160 D1.000	817012	Outer Joint		25	25	52	84.5	56	I
	1990.09-1995.04	-	-	F	Hatchback Engine 160 A6.000/160 A6.046/160 D1.000	802004	Outer Joint	44T	25	25	52	85	58	I
	1990.09-1995.04	-	-	F	Hatchback Engine 160 A6.000/160 A6.046/160 D1.000	602005	Inner Joint		25		32			
2.0 (104 kW)	1993.03-1995.04	-	-	F	Hatchback Engine 836 A3.011	602006	Inner Joint		25		32			
2.0 (85 kW)	1990.10-1992.10	-	-	F	Hatchback Engine 159 A5.046/159 A6.046	602006	Inner Joint		25		32			
2.0 16V (107 kW)	1991.07-1995.04	-	-	F	Hatchback Engine 160 A8.046	602006	Inner Joint		25		32			
	1991.07-1995.04	MT	L/R	F	Hatchback Engine 160 A8.046	602011	Inner Joint		25		32			
2.0 i.e. (80 kW)	1990.06-1992.03	-	-	F	Hatchback Engine 159 A5.046	602006	Inner Joint		25		32			

YEAR	TRANSM	L/R	F/R	REMARKS	GSP Ref.	PRODUCT	ABS	Technical Specifications										
								A	B	C	H	L	P					
FIAT																		
TIPO (160_)																		
2.0 i.e. (80 kW)	1990.06-1992.03	MT	L/R	F	Hatchback Engine 159 A5.046	648004	Inner Joint			25		32						
2.0 i.e. (83 kW)	1990.03-1995.04	-	-	F	Hatchback Engine 159 A6.046	602006	Inner Joint			25		32						
	1990.03-1995.04	MT	L/R	F	Hatchback Engine 159 A6.046	648004	Inner Joint			25		32						
2.0 i.e. 16V Sport (102 kW)	1993.03-1995.04	-	-	F	Hatchback Engine 836 A3.000	602006	Inner Joint			25		32						
ULYSSE (179_)																		
2.0 (100 kW)	2002.08-2011.06	-	-	F	MPV Engine RFN (EW10J4)	810016	Outer Joint		27	34	59	82	55		I			
	2002.08-2011.06	-	-	F	MPV Engine RFN (EW10J4)	845059	Outer Joint		27	34	58	81.5	55		I			
	2002.08-2011.06	MT	L	F	MPV Engine RFN (EW10J4)	210422	Drive Shaft		27	24	58	81.5	659					
	2002.08-2011.06	-	L	F	MPV Engine RFN (EW10J4)	217220	Drive Shaft		27	26	58	81.5	648					
	2002.08-2011.06	AT	-	F	MPV Engine RFN (EW10J4)	817044	Outer Joint		27	28	58	81.5	62		M			
	2002.08-2011.06	-	R	F	MPV Engine RFN (EW10J4)	217218	Drive Shaft		27	26	58	81.5	855					
2.0 JTD (79 kW)	2003.05-2006.08	AT	-	F	MPV Engine RHM (DW10ATED4)	810016	Outer Joint		27	34	59	82	55		I			
	2003.05-2006.08	-	-	F	MPV Engine RHM (DW10ATED4)	817044	Outer Joint		27	28	58	81.5	62		M			
2.0 JTD (80 kW)	2002.08-2006.08	AT	-	F	MPV Engine RHW (DW10ATED4)	810016	Outer Joint		27	34	59	82	55		I			
	2002.08-2006.08	-	-	F	MPV Engine RHW (DW10ATED4)	817044	Outer Joint		27	28	58	81.5	62		M			
2.2 JTD (94 kW)	2002.08-2006.08	-	-	F	MPV Engine 4HW (DW12ATED4)	817044	Outer Joint		27	28	58	81.5	62		M			
	2002.08-2006.08	-	-	F	MPV Engine 4HW (DW12ATED4)	818098	Outer Joint		27	29	58	81	71		M			
3.0 (150 kW)	2002.08-2011.06	AT	R	F	MPV Engine XFW	217217	Drive Shaft		27	37	58	81.5	924					
	2002.08-2011.06	AT	L	F	MPV Engine XFW	217221	Drive Shaft		27	37	58	81.5	624					
	2002.08-2011.06	AT	R	F	MPV Engine XFW	250218	Drive Shaft		23	39	56.2	83.5	1001					
	2002.08-2011.06	AT	R	F	MPV Engine XFW	250218	Drive Shaft		23	39	56.2	83.5	1001					
ULYSSE (220_)																		
1.8 (73 kW)	1997.05-2002.08	MT	L	F	MPV Engine LFW	210082	Drive Shaft	48T	27	24	59	82	648					
	1997.05-2002.08	MT	R	F	MPV Engine LFW	210012	Drive Shaft	48T	27	24	64	80.5	928					
	1997.05-2002.08	MT	L/R	F	MPV Engine LFW	810018	Outer Joint	48T	27	34	61	82	55		I			
	1997.05-2002.08	MT	L	F	MPV Engine LFW	210052	Drive Shaft		27	24	61	82	648					
	1997.05-2002.08	MT	R	F	MPV Engine LFW	210120	Drive Shaft		27	24	59	82	928					
1.9 TD (66 kW)	1995.02-2002.08	MT	L	F	MPV Engine DHX (XUD9TF/L)	610015	Inner Joint		37	39	40	68.5	104					
	1995.02-2002.08	MT	R	F	MPV Engine DHX (XUD9TF/L)	610034	Inner Joint		37	39	31.9	369.5	99					
	1995.02-2002.08	-	L	F	MPV Engine DHX (XUD9TF/L)	210073	Drive Shaft	48T	27	37	59	82	641					
	1995.02-2002.08	MT	L	F	MPV Engine DHX (XUD9TF/L)	210072	Drive Shaft		27	37	59	82	641					
	1995.02-2002.08	-	-	F	MPV Engine DHX (XUD9TF/L)	810014	Outer Joint		27	39	59	82	63		I			
	1995.02-2002.08	-	R	F	MPV Engine DHX (XUD9TF/L)	210108	Drive Shaft	48T	27	37	59	82	939					
	1995.02-2002.08	-	R	F	MPV Engine DHX (XUD9TF/L)	210074	Drive Shaft		27	37	59	82	939					
	1995.02-2002.08	MT	R	F	MPV Engine DHX (XUD9TF/L)	210155	Drive Shaft		27	37	59	82	947					
	1995.02-2002.08	-	L/R	F	MPV Engine DHX (XUD9TF/L)	810015	Outer Joint	48T	27	39	59	82	63		I			
	1995.02-2002.08	MT	L	F	MPV Engine DHX (XUD9TF/L)	210016	Drive Shaft	48T	27	37	59	82	641					
2.0 (89 kW)	1995.02-2002.08	MT	R	F	MPV Engine DHX (XUD9TF/L)	210014	Drive Shaft	48T	27	37	59	82	947					
	1994.06-2002.08	-	-	F	MPV Engine RFU (XU10J2C)	810016	Outer Joint		27	34	59	82	55		I			
	1994.06-2002.08	MT	L	F	MPV Engine RFU (XU10J2C)	210082	Drive Shaft	48T	27	24	59	82	648					
	1994.06-2002.08	-	R	F	MPV Engine RFU (XU10J2C)	210081	Drive Shaft	48T	27	24	59	82	935					
	1994.06-2002.08	-	L	F	MPV Engine RFU (XU10J2C)	210112	Drive Shaft		27	24	59	82	648					
	1994.06-2002.08	MT	R	F	MPV Engine RFU (XU10J2C)	210012	Drive Shaft	48T	27	24	64	80.5	928					
	1994.06-2002.08	-	R	F	MPV Engine RFU (XU10J2C)	210111	Drive Shaft		27	24	59	82	935					
	1994.06-2002.08	MT	L/R	F	MPV Engine RFU (XU10J2C)	810018	Outer Joint	48T	27	34	61	82	55		I			
	1994.06-2002.08	MT	L	F	MPV Engine RFU (XU10J2C)	210052	Drive Shaft		27	24	61	82	648					
	1994.06-2002.08	MT	R	F	MPV Engine RFU (XU10J2C)	210120	Drive Shaft		27	24	59	82	928					
2.0 16V (100 kW)	1994.06-2002.08	-	-	F	MPV Engine RFU (XU10J2C)	810059	Outer Joint	48T	27	34	59	82	55		I			
	2000.09-2002.08	-	-	F	MPV Engine RFN (EW10J4)	810016	Outer Joint		27	34	59	82	55		I			
	2000.09-2002.08	MT	R	F	MPV Engine RFN (EW10J4)	210081	Drive Shaft	48T	27	24	59	82	935					
	2000.09-2002.08	MT	L	F	MPV Engine RFN (EW10J4)	210112	Drive Shaft		27	24	59	82	648					
	2000.09-2002.08	MT	R	F	MPV Engine RFN (EW10J4)	210111	Drive Shaft		27	24	59	82	935					
	2000.09-2002.08	MT	L/R	F	MPV Engine RFN (EW10J4)	810018	Outer Joint	48T	27	34	61	82	55		I			
2.0 16V (97 kW)	2000.09-2002.08	-	-	F	MPV Engine RFN (EW10J4)	810059	Outer Joint	48T	27	34	59	82	55		I			
	1998.05-2000.09	MT	L/R	F	MPV Engine RFV	810018	Outer Joint	48T	27	34	61	82	55		I			
2.0 JTD (80 kW)	1999.10-2002.08	MT	L	F	MPV Engine RHZ	210430	Drive Shaft		27	37	59	82	630					
	1999.10-2002.08	MT	R	F	MPV Engine RHZ	210057	Drive Shaft		27	37	59	82	960					
	1999.10-2002.08	-	R	F	MPV Engine RHZ	210237	Drive Shaft	48T	27	37	59	82	953					
	1999.10-2002.08	MT	L	F	MPV Engine RHZ	210264	Drive Shaft	48T	27	37	59	82	630					
	1999.10-2002.08	MT	R	F	MPV Engine RHZ	245120	Drive Shaft	48T	27	37	59	82	960					
	1999.10-2002.08	MT	L	F	MPV Engine RHZ	610015	Inner Joint		37	39	40	68.5	104					
	1999.10-2002.08	MT	R	F	MPV Engine RHZ	610034	Inner Joint		37	39	31.9	369.5	99					
	1999.10-2002.08	MT	R	F	MPV Engine RHZ	610015	Inner Joint		37	39	40	68.5	104					
2.0 Turbo (108 kW)	1994.06-2002.08	MT	L	F	MPV Engine RGX (XU10J2CTE)	610015	Inner Joint		37	39	40	68.5	104					
	1994.06-2002.08	MT	R	F	MPV Engine RGX (XU10J2CTE)	610034	Inner Joint		37	39	31.9	369.5	99					
	1994.06-2002.08	MT	L	F	MPV Engine RGX (XU10J2CTE)	210072	Drive Shaft		27	37	59	82	641					
	1994.06-2002.08	MT	R	F	MPV Engine RGX (XU10J2CTE)	210155	Drive Shaft		27	37	59	82	947					

	 YEAR	TRANSM	L/R	F/R	REMARKS	GSP Ref.	 PRODUCT	 ABS	Technical Specifications					
									A	B	C	H	L	P
FIAT														
ULYSSE (220_)														
2.0 Turbo (108 kW)	1994.06-2002.08	-	L/R	F	MPV Engine RGX (XU10J2CTE)	810015	Outer Joint	48T	27	39	59	82	63	I
	1994.06-2002.08	MT	L	F	MPV Engine RGX (XU10J2CTE)	210016	Drive Shaft	48T	27	37	59	82	641	
	1994.06-2002.08	MT	R	F	MPV Engine RGX (XU10J2CTE)	210014	Drive Shaft	48T	27	37	59	82	947	
2.1 TD (80 kW)	1996.03-1999.10	-	-	F	MPV Engine P8C	810014	Outer Joint		27	39	59	82	63	I
	1996.03-1999.10	-	L/R	F	MPV Engine P8C	810015	Outer Joint	48T	27	39	59	82	63	I
UNO														
1.0 8V	1991-2012	-	-	-	-	817041	Outer Joint		22	20	52	91	60.5	O
UNO (146A/E)														
1.4 i.e. (51 kW)	1989.09-1993.12	-	-	-	-	617001	Inner Joint		22	19	36	61.5	88.5	
1.4 i.e. (53 kW)	1989.09-1993.12	-	-	-	-	617001	Inner Joint		22	19	36	61.5	88.5	
UNO (146_)														
1.0(41 kW)	1993.05-2000.08	MT	L	F	Hatchback	217015	Drive Shaft		20	31.95	43.1	90.5	552	
	1993.05-2000.08	MT	R	F	Hatchback	217016	Drive Shaft		20	31.95	43.1	90.5	861.5	
1.3 Turbo i.e. (74 kW)	1989.09-1991.03	-	-	F	Hatchback Engine 146 A2.246	602006	Inner Joint			25		32		
	1989.09-1991.03	MT	L/R	F	Hatchback Engine 146 A2.246	602011	Inner Joint			25		32		
	1989.09-1991.03	MT	L/R	F	Hatchback Engine 146 A2.246	817006	Outer Joint		22	25	48.1	93.5	60.5	I
1.3 Turbo i.e. (77 kW)	1985.04-1989.08	MT	L/R	F	Hatchback Engine 146 A2.000	817006	Outer Joint		22	25	48.1	93.5	60.5	I
	1985.04-1989.08	-	-	F	Hatchback Engine 146 A2.000	602006	Inner Joint			25		32		
1.4 Turbo i.e. (82 kW)	1989.09-1993.09	MT	L/R	F	Hatchback Engine 146 A8.046	817006	Outer Joint		22	25	48.1	93.5	60.5	I
1.4 Turbo i.e. (87 kW)	1989.12-1996.12	MT	L/R	F	Hatchback Engine 146 A8.000	817006	Outer Joint		22	25	48.1	93.5	60.5	I
1.7 D (43 kW)	1988.02-1992.02	MT	L/R	F	Box Engine 146 B2.000/149 B4.046	648004	Inner Joint			25		32		
	1988.02-1992.02	MT	R	F	Box Engine 146 B2.000/149 B4.046	217021	Drive Shaft		22	31.95	48	92	877	
1.9 D (44 kW)	1989.09-1994.03	-	-	F	Hatchback Engine 149 B5.046	817005	Outer Joint		22	20	48.1	90.5	59.5	O
45 0.9 (33 kW)	1983.03-1992.09	MT	L	F	Hatchback Engine 146 A.000/146 A1.000	217185	Drive Shaft		20	29.2	43.1	90.5	553	
	1983.03-1992.09	MT	R	F	Hatchback Engine 146 A.000/146 A1.000	217186	Drive Shaft		20	29.2	43.1	90.5	870	
45 i.e. 1.0 (33 kW)	1984.04-1995.10	MT	L	F	Hatchback Engine 156 A2.246	217185	Drive Shaft		20	29.2	43.1	90.5	553	
	1984.04-1995.10	MT	R	F	Hatchback Engine 156 A2.246	217186	Drive Shaft		20	29.2	43.1	90.5	870	
50 1.1 (37 kW)	1986.01-1989.12	-	-	F	Hatchback Engine 146 A4.044	817005	Outer Joint		22	20	48.1	90.5	59.5	O
55 1.1 (40 kW)	1983.01-1989.08	-	-	F	Hatchback Engine 138 B.000	817005	Outer Joint		22	20	48.1	90.5	59.5	O
	1983.01-1989.08	MT	L	F	Hatchback Engine 138 B.000	217185	Drive Shaft		20	29.2	43.1	90.5	553	
	1983.01-1989.08	MT	R	F	Hatchback Engine 138 B.000	217186	Drive Shaft		20	29.2	43.1	90.5	870	
60 Diesel 1.7 (42 kW)	1989.09-1993.12	MT	L	F	Hatchback Engine 146 B2.000	217020	Drive Shaft		22	31.95	48	92	539.5	
	1989.09-1993.12	MT	L/R	F	Hatchback Engine 146 B2.000	648004	Inner Joint			25		32		
	1989.09-1993.12	MT	R	F	Hatchback Engine 146 B2.000	217021	Drive Shaft		22	31.95	48	92	877	
	1989.09-1993.12	-	-	F	Hatchback Engine 146 B2.000	817005	Outer Joint		22	20	48.1	90.5	59.5	O
60 Diesel 1.7 (44 kW)	1986.07-1989.08	-	-	F	Hatchback Engine 149 B3.000	817005	Outer Joint		22	20	48.1	90.5	59.5	O
	1986.07-1989.08	MT	L	F	Hatchback Engine 149 B3.000	217020	Drive Shaft		22	31.95	48	92	539.5	
70 TD 1.4 (52 kW)	1986.10-1990.10	MT	L	F	Hatchback Engine 146 B.000/146 B3.000	217020	Drive Shaft		22	31.95	48	92	539.5	
	1986.10-1990.10	MT	R	F	Hatchback Engine 146 B.000/146 B3.000	217021	Drive Shaft		22	31.95	48	92	877	
	1986.10-1990.10	-	-	F	Hatchback Engine 146 B.000/146 B3.000	817005	Outer Joint		22	20	48.1	90.5	59.5	O
WEEKEND														
-	2003-	-	-	-	-	217031	Drive Shaft							336
	2003-	-	-	-	-	617018	Inner Joint			25		32		
X 1/9 (128_)														
1.5 (56 kW)	1985.06-1989.12	MT	L/R	R	Convertible Engine 138 BS.031	648004	Inner Joint			25		32		
	1985.06-1989.12	-	-	R	Convertible Engine 138 BS.031	602006	Inner Joint			25		32		
1.5 (63 kW)	1978.11-1989.12	MT	L/R	R	Convertible Engine 138 AS.000	648004	Inner Joint			25		32		
	1978.11-1989.12	-	-	R	Convertible Engine 138 AS.000	602006	Inner Joint			25		32		
FIAT (NANJING)														
PALIO														
1.5 (63 kW)	2002.01-	-	AT	L	-	Hatchback Engine 178 E5.027	217092	Drive Shaft		22	23	47	89	503.5
	2002.01-	-	AT	R	-	Hatchback Engine 178 E5.027	217100	Drive Shaft		22	23	47	89	858.5
PERLA														
1.7 (70 kW)	2006.07-2007.12	MT	-	-	Saloon Engine 311A1027	217012	Drive Shaft		25	24	51	90	911.5	
FORD														
-	-	-	-	F	-	218519	Stub Axle							
	-	-	-	F	-	218520	Stub Axle		35	35			461	
	-	-	-	F	-	218522	Stub Axle		35	35			435.5	
323														
-	1990-1994	-	-	-	-	618039	Inner Joint		24	28	35	64.1	91.5	
AEROSTAR														
-	1990-1997	-	-	-	4WD	818050	Outer Joint		26	30	58	119	71	I
ASPIRE														
-	1994-1997	AT	-	-	-	618010	Inner Joint		24	21	35	64	95	



YEAR	TRANS	L/R	F/R	REMARKS	GSP Ref.	PRODUCT	ABS	Technical Specifications						
								A	B	C	H	L	P	
FORD														
B-MAX (JK)														
1.5 TDCi (55 kW)	2012.10-	-	MT	L F	MPV Engine UGJC	218405	Drive Shaft	25	23	53.2	88.5	622		
1.6 TDCi (70 kW)	2012.10-	-	MT	L F	MPV Engine T3JB	218405	Drive Shaft	25	23	53.2	88.5	622		
1.6 Ti (77 kW)	2012.10-	-	AT	R F	MPV Engine IQJA	218406	Drive Shaft	25	34	53.3	87	974		
	2012.10-	-	-	F	MPV Engine IQJA	818222	Outer Joint	25	23	53.3	87	56	M	
BELINA														
1.8	1989-	1991	-	-	-	818043	Outer Joint	24	30	46	109	62.5	I	
BELINA II														
1.8	1989.08-	1991.04	MT	-	-	818103	Outer Joint	24	30	46	109	62	I	
C-MAX (DM2)														
1.6 (74 kW)	2007.02-	2010.09	MT	R F	MPV Engine HWDA/HWDB/SHDA/SHDB/SHDC	218337	Drive Shaft	36	23	51.6	48	908		
	2007.02-	2010.09	-	-	MPV Engine HWDA/HWDB/SHDA/SHDB/SHDC	862039	Outer Joint	36	24	55.8	48	57	M	
	2007.02-	2010.09	MT	L F	MPV Engine HWDA/HWDB/SHDA/SHDB/SHDC	218189	Drive Shaft	36	23	56	48	601		
	2007.02-	2010.09	-	R F	MPV Engine HWDA/HWDB/SHDA/SHDB/SHDC	618045	Inner Joint	26	23	40	389	92		
	2007.02-	2010.09	MT	R F	MPV Engine HWDA/HWDB/SHDA/SHDB/SHDC	218206	Drive Shaft	36	23	56	48	906		
	2007.02-	2010.09	-	R F	MPV Engine HWDA/HWDB/SHDA/SHDB/SHDC	618161	Inner Joint	26	23	40	389	86		
	2007.02-	2010.09	-	L F	MPV Engine HWDA/HWDB/SHDA/SHDB/SHDC	618044	Inner Joint	26	23	40	68.5	99.5		
	2007.02-	2010.09	MT	L/R	F	MPV Engine HWDA/HWDB/SHDA/SHDB/SHDC	899129	Outer Joint	36	24	56	48	57	M
	2007.02-	2010.09	MT	L F	MPV Engine HWDA/HWDB/SHDA/SHDB/SHDC	818264	Outer Joint	36	25	51.6	48	58	O	
	2007.02-	2010.09	MT	L F	MPV Engine HWDA/HWDB/SHDA/SHDB/SHDC	618168	Inner Joint	23	22	40	61	90		
1.6 (85 kW)	2007.04-	2010.09	MT	R F	MPV Engine HXDA/HXDB/SIDA	218337	Drive Shaft	36	23	51.6	48	908		
	2007.04-	2010.09	-	-	MPV Engine HXDA/HXDB/SIDA	862039	Outer Joint	36	24	55.8	48	57	M	
	2007.04-	2010.09	MT	L F	MPV Engine HXDA/HXDB/SIDA	218189	Drive Shaft	36	23	56	48	601		
	2007.04-	2010.09	-	R F	MPV Engine HXDA/HXDB/SIDA	618045	Inner Joint	26	23	40	389	92		
	2007.04-	2010.09	MT	R F	MPV Engine HXDA/HXDB/SIDA	218206	Drive Shaft	36	23	56	48	906		
	2007.04-	2010.09	-	R F	MPV Engine HXDA/HXDB/SIDA	618161	Inner Joint	26	23	40	389	86		
	2007.04-	2010.09	-	L F	MPV Engine HXDA/HXDB/SIDA	618044	Inner Joint	26	23	40	68.5	99.5		
	2007.04-	2010.09	MT	L F	MPV Engine HXDA/HXDB/SIDA	818264	Outer Joint	36	25	51.6	48	58	O	
	2007.04-	2010.09	MT	L F	MPV Engine HXDA/HXDB/SIDA	618168	Inner Joint	23	22	40	61	90		
	2007.04-	2010.09	-	R F	MPV Engine HXDA/HXDB/SIDA	818230	Outer Joint	36	26	56.3	48	61	M	
1.6 TDCi (66 kW)	2007.02-	2010.09	-	-	MPV Engine HHDA	862039	Outer Joint	36	24	55.8	48	57	M	
	2007.02-	2010.09	-	R F	MPV Engine HHDA	618045	Inner Joint	26	23	40	389	92		
	2007.02-	2010.09	-	R F	MPV Engine HHDA	618161	Inner Joint	26	23	40	389	86		
	2007.02-	2010.09	-	L F	MPV Engine HHDA	618044	Inner Joint	26	23	40	68.5	99.5		
	2007.02-	2010.09	-	L F	MPV Engine HHDA	899288	Outer Joint	36	26	56.3	48	61	M	
	2007.02-	2010.09	-	L F	MPV Engine HHDA	218218	Drive Shaft	36	26	56	48	582		
	2007.02-	2010.09	-	R F	MPV Engine HHDA	218219	Drive Shaft	36	26	56.3	48	921		
	2007.02-	2010.09	MT	R F	MPV Engine HHDA	899130	Outer Joint	36	26	56.3	48	61	M	
	2007.02-	2010.09	-	-	MPV Engine G8DC	862039	Outer Joint	36	24	55.8	48	57	M	
	2007.02-	2010.09	-	R F	MPV Engine G8DC	618045	Inner Joint	26	23	40	389	92		
1.6 TDCi (74 kW)	2007.02-	2010.09	-	R F	MPV Engine G8DC	618161	Inner Joint	26	23	40	389	86		
	2007.02-	2010.09	-	L F	MPV Engine G8DC	618044	Inner Joint	26	23	40	68.5	99.5		
	2007.02-	2010.09	-	L F	MPV Engine G8DC	218218	Drive Shaft	36	26	56	48	582		
	2007.02-	2010.09	-	R F	MPV Engine G8DC	218219	Drive Shaft	36	26	56.3	48	921		
	2007.02-	2010.09	-	-	MPV Engine G8DA/G8DB/G8DD	862039	Outer Joint	36	24	55.8	48	57	M	
	2007.02-	2010.09	-	R F	MPV Engine G8DA/G8DB/G8DD	618045	Inner Joint	26	23	40	389	92		
1.8 (90 kW)	2007.02-	2010.09	-	R F	MPV Engine G8DA/G8DB/G8DD	618161	Inner Joint	26	23	40	389	86		
	2007.02-	2010.09	-	L F	MPV Engine G8DA/G8DB/G8DD	618044	Inner Joint	26	23	40	68.5	99.5		
	2007.02-	2010.09	-	L F	MPV Engine G8DA/G8DB/G8DD	218218	Drive Shaft	36	26	56	48	582		
	2007.02-	2010.09	-	R F	MPV Engine G8DA/G8DB/G8DD	218219	Drive Shaft	36	26	56.3	48	921		
	2007.02-	2010.09	MT	R F	MPV Engine G8DA/G8DB/G8DD	899130	Outer Joint	36	26	56.3	48	61	M	
	2007.02-	2010.09	-	-	MPV Engine QQDC	862039	Outer Joint	36	24	55.8	48	57	M	
	2007.02-	2010.09	MT	L F	MPV Engine QQDC	218189	Drive Shaft	36	23	56	48	601		
	2007.02-	2010.09	-	R F	MPV Engine QQDC	618045	Inner Joint	26	23	40	389	92		
	2007.02-	2010.09	MT	R F	MPV Engine QQDC	218206	Drive Shaft	36	23	56	48	906		
	2007.02-	2010.09	-	R F	MPV Engine QQDC	618161	Inner Joint	26	23	40	389	86		
1.8 (92 kW)	2007.02-	2010.09	-	L F	MPV Engine QQDC	618044	Inner Joint	26	23	40	68.5	99.5		
	2007.02-	2010.09	-	R F	MPV Engine QQDC	218358	Drive Shaft	36	23	56	48	899		
	2007.02-	2010.09	-	L F	MPV Engine QQDC	218359	Drive Shaft	36	23	56	48	594		
	2007.02-	2010.09	-	-	MPV Engine QQDA/QQDB	862039	Outer Joint	36	24	55.8	48	57	M	
	2007.02-	2010.09	MT	L F	MPV Engine QQDA/QQDB	218189	Drive Shaft	36	23	56	48	601		
	2007.02-	2010.09	-	R F	MPV Engine QQDA/QQDB	618045	Inner Joint	26	23	40	389	92		
	2007.02-	2010.09	MT	R F	MPV Engine QQDA/QQDB	218206	Drive Shaft	36	23	56	48	906		
	2007.02-	2010.09	-	R F	MPV Engine QQDA/QQDB	618161	Inner Joint	26	23	40	389	86		
	2007.02-	2010.09	-	L F	MPV Engine QQDA/QQDB	618044	Inner Joint	26	23	40	68.5	99.5		
	2007.02-	2010.09	5MT	R F	MPV Engine QQDA/QQDB	218358	Drive Shaft	36	23	56	48	899		
2007.02-	2010.09	5MT	L F	MPV Engine QQDA/QQDB	218359	Drive Shaft	36	23	56	48	594			





	 YEAR	TRANSM	L/R	F/R	REMARKS	GSP Ref.	 PRODUCT	 ABS	Technical Specifications					
									A	B	C	H	L	P
FORD														
C-MAX (DM2)														
1.8 (92 kW)	2007.02-2010.09	-	L/R	F	MPV Engine QQDA/QQDB	818203	Outer Joint		36	23	56	48	57	I
1.8 Flexifuel (92 kW)	2007.02-2010.09	-	-	-	MPV Engine Q7DA	862039	Outer Joint		36	24	55.8	48	57	M
	2007.02-2010.09	MT	L	F	MPV Engine Q7DA	218189	Drive Shaft		36	23	56	48	601	
	2007.02-2010.09	-	R	F	MPV Engine Q7DA	618045	Inner Joint		26	23	40	389	92	
	2007.02-2010.09	MT	R	F	MPV Engine Q7DA	218206	Drive Shaft		36	23	56	48	906	
	2007.02-2010.09	-	R	F	MPV Engine Q7DA	618161	Inner Joint		26	23	40	389	86	
	2007.02-2010.09	-	L	F	MPV Engine Q7DA	618044	Inner Joint		26	23	40	68.5	99.5	
	2007.02-2010.09	5MT	R	F	MPV Engine Q7DA	218358	Drive Shaft		36	23	56	48	899	
	2007.02-2010.09	5MT	L	F	MPV Engine Q7DA	218359	Drive Shaft		36	23	56	48	594	
1.8 TDCi (85 kW)	2007.02-2010.09	-	L/R	F	MPV Engine KKDA	818230	Outer Joint		36	26	56.3	48	61	M
	2007.02-2010.09	-	-	-	MPV Engine KKDA	862039	Outer Joint		36	24	55.8	48	57	M
	2007.02-2010.09	-	R	F	MPV Engine KKDA	618045	Inner Joint		26	23	40	389	92	
	2007.02-2010.09	-	R	F	MPV Engine KKDA	618161	Inner Joint		26	23	40	389	86	
	2007.02-2010.09	-	L	F	MPV Engine KKDA	618044	Inner Joint		26	23	40	68.5	99.5	
	2007.02-2010.09	-	L	F	MPV Engine KKDA	899288	Outer Joint		36	26	56.3	48	61	M
	2007.02-2010.09	-	L	F	MPV Engine KKDA	218218	Drive Shaft		36	26	56	48	582	
	2007.02-2010.09	-	R	F	MPV Engine KKDA	218219	Drive Shaft		36	26	56.3	48	921	
2.0 (107 kW)	2007.02-2010.09	MT	R	F	MPV Engine KKDA	899130	Outer Joint		36	26	56.3	48	61	M
	2007.02-2010.09	5MT	R	F	MPV Engine AODA/AODB/SYDA/AODE	218329	Drive Shaft		36	26	55.3	48	920	
	2007.02-2010.09	AT	L	F	MPV Engine AODA/AODB/SYDA/AODE	262074	Drive Shaft		36	26	56	48	585	
	2007.02-2010.09	-	-	-	MPV Engine AODA/AODB/SYDA/AODE	862039	Outer Joint		36	24	55.8	48	57	M
	2007.02-2010.09	-	R	F	MPV Engine AODA/AODB/SYDA/AODE	618045	Inner Joint		26	23	40	389	92	
	2007.02-2010.09	-	R	F	MPV Engine AODA/AODB/SYDA/AODE	618161	Inner Joint		26	23	40	389	86	
	2007.02-2010.09	AT	R	F	MPV Engine AODA/AODB/SYDA/AODE	218190	Drive Shaft		36	26	56.3	48	919	
	2007.02-2010.09	-	L	F	MPV Engine AODA/AODB/SYDA/AODE	618044	Inner Joint		26	23	40	68.5	99.5	
2.0 CNG (107 kW)	2007.02-2010.09	AT/MT	L/R	F	MPV Engine AODA/AODB/SYDA/AODE	818203	Outer Joint		36	23	56	48	57	I
	2007.02-2010.09	AT	R	F	MPV Engine AODA/AODB/SYDA/AODE	899130	Outer Joint		36	26	56.3	48	61	M
	2007.02-2010.09	5AT	R	F	MPV Engine AODA/AODB/SYDA/AODE	234163	Drive Shaft		36	26	56	48	926	
	2007.02-2010.09	5AT	L	F	MPV Engine AODA/AODB/SYDA/AODE	218327	Drive Shaft		36	26	55.3	48	585	
	2007.02-2010.09	5MT	L	F	MPV Engine AODA/AODB/SYDA/AODE	218328	Drive Shaft		36	26	55.3	48	580	
	2009.04-2010.09	5MT	R	F	MPV Engine SYDA	218329	Drive Shaft		36	26	55.3	48	920	
	2009.04-2010.09	AT	L	F	MPV Engine SYDA	262074	Drive Shaft		36	26	56	48	585	
	2009.04-2010.09	-	-	-	MPV Engine SYDA	862039	Outer Joint		36	24	55.8	48	57	M
	2009.04-2010.09	-	R	F	MPV Engine SYDA	618045	Inner Joint		26	23	40	389	92	
	2009.04-2010.09	-	R	F	MPV Engine SYDA	618161	Inner Joint		26	23	40	389	86	
	2009.04-2010.09	AT	R	F	MPV Engine SYDA	218190	Drive Shaft		36	26	56.3	48	919	
	2009.04-2010.09	-	L	F	MPV Engine SYDA	618044	Inner Joint		26	23	40	68.5	99.5	
2.0 LPG (107 kW)	2009.04-2010.09	5AT	R	F	MPV Engine SYDA	234163	Drive Shaft		36	26	56	48	926	
	2009.04-2010.09	AT	R	F	MPV Engine SYDA	899130	Outer Joint		36	26	56.3	48	61	M
	2009.04-2010.09	5AT	L	F	MPV Engine SYDA	218327	Drive Shaft		36	26	55.3	48	585	
	2009.04-2010.09	5MT	L	F	MPV Engine SYDA	218328	Drive Shaft		36	26	55.3	48	580	
	2008.06-2010.09	-	R	F	MPV Engine SYDA	218329	Drive Shaft		36	26	55.3	48	920	
	2008.06-2010.09	AT	L	F	MPV Engine SYDA	262074	Drive Shaft		36	26	56	48	585	
	2008.06-2010.09	-	-	-	MPV Engine SYDA	862039	Outer Joint		36	24	55.8	48	57	M
	2008.06-2010.09	-	R	F	MPV Engine SYDA	618045	Inner Joint		26	23	40	389	92	
	2008.06-2010.09	-	R	F	MPV Engine SYDA	618161	Inner Joint		26	23	40	389	86	
	2008.06-2010.09	-	R	F	MPV Engine SYDA	618045	Inner Joint		26	23	40	389	92	
	2008.06-2010.09	AT	R	F	MPV Engine SYDA	218190	Drive Shaft		36	26	56.3	48	919	
	2008.06-2010.09	-	L	F	MPV Engine SYDA	618044	Inner Joint		26	23	40	68.5	99.5	
2.0 TDCi (100 kW)	2008.06-2010.09	AT	R	F	MPV Engine SYDA	899130	Outer Joint		36	26	56.3	48	61	M
	2008.06-2010.09	-	L	F	MPV Engine SYDA	218328	Drive Shaft		36	26	55.3	48	580	
	2007.02-2010.09	-	-	-	MPV Engine G6DA/G6DB/G6DD/G6DG	862039	Outer Joint		36	24	55.8	48	57	M
	2007.02-2010.09	-	R	F	MPV Engine G6DA/G6DB/G6DD/G6DG	618045	Inner Joint		26	23	40	389	92	
	2007.02-2010.09	-	R	F	MPV Engine G6DA/G6DB/G6DD/G6DG	618161	Inner Joint		26	23	40	389	86	
	2007.02-2010.09	-	L	F	MPV Engine G6DA/G6DB/G6DD/G6DG	618044	Inner Joint		26	23	40	68.5	99.5	
	2007.02-2010.09	MT	L	F	MPV Engine G6DA/G6DB/G6DD/G6DG	218194	Drive Shaft		36	26	56	48	568	
	2007.02-2010.09	MT	R	F	MPV Engine G6DA/G6DB/G6DD/G6DG	218280	Drive Shaft		36	26	56	48	918	
2.0 TDCi (81 kW)	2007.02-2010.09	-	L	F	MPV Engine G6DA/G6DB/G6DD/G6DG	818203	Outer Joint		36	23	56	48	57	I
	2007.02-2010.09	AT	R	F	MPV Engine G6DA/G6DB/G6DD/G6DG	262024	Drive Shaft		36	28	56	48	908	
	2007.02-2010.09	MT	R	F	MPV Engine G6DA/G6DB/G6DD/G6DG	899130	Outer Joint		36	26	56.3	48	61	M
	2008.02-2010.09	-	-	-	MPV Engine IXDA	862039	Outer Joint		36	24	55.8	48	57	M
	2008.02-2010.09	-	R	F	MPV Engine IXDA	618045	Inner Joint		26	23	40	389	92	
	2008.02-2010.09	-	R	F	MPV Engine IXDA	618161	Inner Joint		26	23	40	389	86	
	2008.02-2010.09	-	L	F	MPV Engine IXDA	618044	Inner Joint		26	23	40	68.5	99.5	
	2008.02-2010.09	MT	L	F	MPV Engine IXDA	218194	Drive Shaft		36	26	56	48	568	
2008.02-2010.09	MT	R	F	MPV Engine IXDA	218280	Drive Shaft		36	26	56	48	918		





YEAR	TRANS	L/R	F/R	REMARKS	GSP Ref.	PRODUCT	ABS	Technical Specifications						
								A	B	C	H	L	P	
FORD														
C-MAX (DM2)														
2.0 TDCi (81 kW)	2008.02-	2010.09	-	L F	MPV Engine IXDA	818203	Outer Joint		36	23	56	48	57	I
2.0 TDCi (98 kW)	2007.02-	2010.09	-	-	MPV Engine G6DC/G6DE/G6DF	862039	Outer Joint		36	24	55.8	48	57	M
	2007.02-	2010.09	-	R F	MPV Engine G6DC/G6DE/G6DF	618045	Inner Joint		26	23	40	389	92	
	2007.02-	2010.09	-	R F	MPV Engine G6DC/G6DE/G6DF	618161	Inner Joint		26	23	40	389	86	
	2007.02-	2010.09	-	L F	MPV Engine G6DC/G6DE/G6DF	618044	Inner Joint		26	23	40	68.5	99.5	
	2007.02-	2010.09	MT	L F	MPV Engine G6DC/G6DE/G6DF	218194	Drive Shaft		36	26	56	48	568	
	2007.02-	2010.09	MT	R F	MPV Engine G6DC/G6DE/G6DF	218280	Drive Shaft		36	26	56	48	918	
	2007.02-	2010.09	MT	R F	MPV Engine G6DC/G6DE/G6DF	899130	Outer Joint		36	26	56.3	48	61	M
C-MAX II (DXA/CB7 DXA/CEU)														
1.5 EcoBoost (110 kW)	2015.03-	-	MT	R F	MPV Engine M8DB	218294	Drive Shaft		27	26	63	96	972	
	2015.03-	-	MT	L F	MPV Engine M8DB	218295	Drive Shaft		27	26	63	96	637	
1.5 TDCi (70 kW)	2015.03-	-	-	-	MPV Engine XXDA	818240	Outer Joint		27	26	63	96	62.5	M
1.5 TDCi (88 kW)	2015.03-	-	-	-	MPV Engine XWDA/XWDB	818240	Outer Joint		27	26	63	96	62.5	M
1.5 TDCi ECOnetic (77 kW)	2015.03-	-	-	-	MPV Engine AEDA	818240	Outer Joint		27	26	63	96	62.5	M
1.6 EcoBoost (110 kW)	2010.12-	-	MT	R F	MPV Engine JQDA/JQDB	218294	Drive Shaft		27	26	63	96	972	
	2010.12-	-	MT	R F	MPV Engine JQDA/JQDB	818239	Outer Joint		27	26	63	96	62.5	M
	2010.12-	-	MT	L F	MPV Engine JQDA/JQDB	218295	Drive Shaft		27	26	63	96	637	
1.6 EcoBoost (134 kW)	2010.12-	-	MT	R F	MPV Engine JTDA/JTDB	218294	Drive Shaft		27	26	63	96	972	
	2010.12-	-	MT	R F	MPV Engine JTDA/JTDB	818239	Outer Joint		27	26	63	96	62.5	M
	2010.12-	-	MT	L F	MPV Engine JTDA/JTDB	218295	Drive Shaft		27	26	63	96	637	
1.6 Flexifuel (88 kW)	2011.02-	-	MT	L F	MPV Engine MUDA	218322	Drive Shaft		27	23	62.8	95.5	657	
	2011.02-	-	MT	R F	MPV Engine MUDA	218323	Drive Shaft		27	23	62.8	95.5	961	
1.6 LPG (86 kW)	2012.02-	-	MT	L F	MPV Engine MUDA	218322	Drive Shaft		27	23	62.8	95.5	657	
	2012.02-	-	MT	R F	MPV Engine MUDA	218323	Drive Shaft		27	23	62.8	95.5	961	
1.6 LPG (88 kW)	2012.02-	-	MT	L F	MPV Engine MUDA	218322	Drive Shaft		27	23	62.8	95.5	657	
	2012.02-	-	MT	R F	MPV Engine MUDA	218323	Drive Shaft		27	23	62.8	95.5	961	
1.6 TDCi (70 kW)	2010.12-	-	-	-	MPV Engine T3DA/T3DB	818240	Outer Joint		27	26	63	96	62.5	M
1.6 TDCi (85 kW)	2010.12-	-	-	-	MPV Engine T1DA/T1DB	818240	Outer Joint		27	26	63	96	62.5	M
1.6 Ti (63 kW)	2010.12-	-	MT	L F	MPV Engine XTDA	218322	Drive Shaft		27	23	62.8	95.5	657	
	2010.12-	-	MT	R F	MPV Engine XTDA	218323	Drive Shaft		27	23	62.8	95.5	961	
1.6 Ti (77 kW)	2010.12-	-	MT	L F	MPV Engine IQDA/IQDB	218322	Drive Shaft		27	23	62.8	95.5	657	
	2010.12-	-	MT	R F	MPV Engine IQDA/IQDB	218323	Drive Shaft		27	23	62.8	95.5	961	
1.6 Ti (88 kW)	2012.02-	-	MT	L F	MPV Engine MUDA	218322	Drive Shaft		27	23	62.8	95.5	657	
	2012.02-	-	MT	R F	MPV Engine MUDA	218323	Drive Shaft		27	23	62.8	95.5	961	
1.6 Ti (92 kW)	2010.12-	-	MT	L F	MPV Engine PNDA	218322	Drive Shaft		27	23	62.8	95.5	657	
	2010.12-	-	MT	R F	MPV Engine PNDA	218323	Drive Shaft		27	23	62.8	95.5	961	
2.0 TDCi (100 kW)	2011.02-	-	MT	L/R F	MPV Engine UKDB	818270	Outer Joint		27	26	62.8	91	64	M
	2011.02-	-	AT	R F	MPV Engine UKDB	218343	Drive Shaft		27	28	63.1	96	967	
2.0 TDCi (103 kW)	2011.02-	-	MT	L/R F	MPV Engine UFDB	818270	Outer Joint		27	26	62.8	91	64	M
	2011.02-	-	AT	R F	MPV Engine UFDB	218343	Drive Shaft		27	28	63.1	96	967	
2.0 TDCi (120 kW)	2010.12-	-	MT	L/R F	MPV Engine TXDB	818270	Outer Joint		27	26	62.8	91	64	M
	2010.12-	-	AT	R F	MPV Engine TXDB	218343	Drive Shaft		27	28	63.1	96	967	
2.0 TDCi (85 kW)	2011.02-	-	MT	L/R F	MPV Engine TYDA	818270	Outer Joint		27	26	62.8	91	64	M
	2011.02-	-	AT	R F	MPV Engine TYDA	218343	Drive Shaft		27	28	63.1	96	967	
CAPRI														
-	1989.01-	1994.12	MT/AT	L F	-	234076	Drive Shaft		24	26	52	86	595	
-	1989.01-	1994.12	MT/AT	R F	-	234077	Drive Shaft		24	26	52	86	541	
CONTOUR														
-	1995-	2001	-	-	-	818080	Outer Joint	44T	27	30	57	91	56	I
2.5	1995-	2000	-	-	-	818056	Outer Joint		27	32	54.3	91	62	I
	1995-	-	-	-	-	618067	Inner Joint		35	32	42	50	67.5	
COUGAR (EC)														
2.5 ST (151 kW)	2000.06-	2001.12	-	-	-	818225	Outer Joint	44W	27	32	57.2	91.5	62	I
2.5 V6 24V (125 kW)	2000.06-	2001.12	-	-	-	818225	Outer Joint	44W	27	32	57.2	91.5	62	I
COUGAR (EC_)														
2.0 16V (96 kW)	1998.08-	2001.12	MT	L F	Coupe Engine EDDBA/EDBB/EDBC/EDBD	636001	Inner Joint		26	33	40	68.6	100	
	1998.08-	2001.12	MT	L F	Coupe Engine EDDBA/EDBB/EDBC/EDBD	218001	Drive Shaft		27	26	54.3	91	615	
	1998.08-	2001.12	MT	L F	Coupe Engine EDDBA/EDBB/EDBC/EDBD	218017	Drive Shaft	44T	27	26	57	91	618.5	
2.5 ST 200 (151 kW)	2000.01-	2001.12	MT	L F	Coupe Engine SGA	636001	Inner Joint		26	33	40	68.6	100	
	2000.01-	2001.12	MT	L F	Coupe Engine SGA	218017	Drive Shaft	44T	27	26	57	91	618.5	
	2000.01-	2001.12	-	-	F Coupe Engine SGA	818081	Outer Joint	44W	27	32	54.3	91	62	I
2.5 V6 24V (125 kW)	1998.08-	2001.12	MT	L F	Coupe Engine LCBA	636001	Inner Joint		26	33	40	68.6	100	
	1998.08-	2001.12	MT	L F	Coupe Engine LCBA	218017	Drive Shaft	44T	27	26	57	91	618.5	
	1998.08-	2001.12	-	-	F Coupe Engine LCBA	818081	Outer Joint	44W	27	32	54.3	91	62	I
	2000.06-	2001.12	MT	L F	Coupe Engine LCBB/LCBC/LCBE	636001	Inner Joint		26	33	40	68.6	100	
	2000.06-	2001.12	MT	L F	Coupe Engine LCBB/LCBC/LCBE	218017	Drive Shaft	44T	27	26	57	91	618.5	





YEAR	TRANS	L/R	F/R	REMARKS	GSP Ref.	PRODUCT	ABS	Technical Specifications							
								A	B	C	H	L	P		
FORD															
COUGAR (EC_)															
2.5 V6 24V (125 kW)	2000.06-	2001.12	-	-	F	Coupe Engine LCBB/LCBC/LCBE	818081	Outer Joint	44W	27	32	54.3	91	62	I
COURIER															
-	1987.01-	1996.12	-	R	-	-	234019	Drive Shaft		26	26	65	143.5	606	
1.3	1997.01-	1999.12	MT	-	-	-	899015	Outer Joint		25	20	56.5	88	49	O
COURIER II															
1.3	1995.10-	1997.01	MT	R	F	LCV	299043	Drive Shaft		25	25	56.5	88.5	813	
1.8 D	1995.10-	1997.01	MT	R	F	LCV	299043	Drive Shaft		25	25	56.5	88.5	813	
DEL REY															
1.6	1989-	1991	-	-	-	-	818043	Outer Joint		24	30	46	109	62.5	I
	1989.08-	1991.04	MT	-	-	-	818103	Outer Joint		24	30	46	109	62	I
1.8	1989-	1991	-	-	-	-	818043	Outer Joint		24	30	46	109	62.5	I
	1989.08-	1991.04	MT	-	-	-	818103	Outer Joint		24	30	46	109	62	I
ECOSPORT															
2.0 16V	2003-	2012	-	-	-	-	218303	Drive Shaft		25	26	53.3	88	941	
EDGE															
3.5 AWD	2014.09-	-	-	R	F	-	201477	Drive Shaft		27	27	55	105	1074	
	2014.09-	-	-	L	F	-	201478	Drive Shaft		27	27	55	105	658	
ESCAPE															
-	2001-	2007	-	-	R	4WD	635047	Propshaft CV Joint				26		42	
	2001-	2004	-	-	-	Truck/VAN	834039	Outer Joint		28	24	56	94	62	M
2.3	2004-	-	-	-	-	-	834107	Outer Joint		28	33	56.5	94	59	I
2.5L L4	2009-	-	-	-	F	-	218521	Stub Axle		35	35			437	
	2010-	-	-	-	F	-	218521	Stub Axle		35	35			437	
	2011-	-	-	-	F	-	218521	Stub Axle		35	35			437	
	2012-	-	-	-	F	-	218521	Stub Axle		35	35			437	
3.0	2005-	2007	AT	R	-	-	618118	Inner Joint		35	24	42	54	76	
	2005-	2007	AT	L	-	-	635034	Inner Joint		30	24	39	73.5	110.5	
3.0L V6	2009-	-	-	-	F	-	218521	Stub Axle		35	35			437	
	2010-	-	-	-	F	-	218521	Stub Axle		35	35			437	
	2011-	-	-	-	F	-	218521	Stub Axle		35	35			437	
	2012-	-	-	-	F	-	218521	Stub Axle		35	35			437	
ESCORT															
-	1991-	2001	-	-	-	-	818048	Outer Joint		26	28	56	93	61	I
	1991-	2001	-	-	-	-	818079	Outer Joint	44T	26	28	56	93	61	I
1.6	1992.01-	1996.12	MT	-	-	-	899154	Outer Joint		25	30	56.5	89	52	I
1.8	1989.05-	1992.11	MT	-	-	-	818044	Outer Joint		23	30	55	91.5	54.5	I
	1992.12-	1996.12	MT	-	-	-	818100	Outer Joint		25	30	56.5	89	56.5	I
	1992.12-	1996.12	MT	-	-	-	618018	Inner Joint			33		32		
2.0	1992.12-	1996.12	MT	-	-	-	818100	Outer Joint		25	30	56.5	89	56.5	I
	1992.12-	1996.12	MT	-	-	-	618018	Inner Joint			33		32		
2.0 Turbo	1992.06-	1996.07	MT	L/R	F	4WD	218139	Drive Shaft	94T	23	23	55	91	576	
ESCORT '86 Express (AVF)															
1.1 (37 kW)	1986.05-	1990.07	-	-	F	Box Engine GSG	818018	Outer Joint		23	20	50	91.5	52	O
	1986.05-	1990.07	MT	R	F	Box Engine GSG	218127	Drive Shaft		23	23	55	91.5	860	
	1986.05-	1990.07	MT	L/R	F	Box Engine GSG	618002	Inner Joint		23	20	40	61.5	62.5	
1.3 (44 kW)	1986.02-	1990.07	-	-	F	Box Engine JBB/JLA/JLB	818018	Outer Joint		23	20	50	91.5	52	O
	1986.02-	1990.07	MT	R	F	Box Engine JBB/JLA/JLB	218127	Drive Shaft		23	23	55	91.5	860	
1.3 (46 kW)	1988.07-	1990.07	-	-	F	Box Engine JBA	818018	Outer Joint		23	20	50	91.5	52	O
	1988.07-	1990.07	MT	R	F	Box Engine JBA	218127	Drive Shaft		23	23	55	91.5	860	
1.4 i (54 kW)	1986.02-	1990.07	MT	R	F	Box Engine F6B/F6D/FUC	218127	Drive Shaft		23	23	55	91.5	860	
	1986.02-	1990.07	-	-	F	Box Engine F6B/F6D/FUC	818019	Outer Joint		23	22	55	91.5	54.5	O
	1986.02-	1990.07	-	-	F	Box Engine F6B/F6D/FUC	618053	Inner Joint		23	22	40	61	91.5	
1.6 (60 kW)	1986.02-	1990.07	MT	-	F	Box Engine LUC	618053	Inner Joint		23	22	40	61	91.5	
	1986.02-	1990.07	MT	R	F	Box Engine LUC	218127	Drive Shaft		23	23	55	91.5	860	
	1986.02-	1990.07	-	-	F	Box Engine LUC	818019	Outer Joint		23	22	55	91.5	54.5	O
1.6 D (40 kW)	1986.02-	1990.07	MT	R	F	Box Engine LTA	218127	Drive Shaft		23	23	55	91.5	860	
	1986.02-	1990.07	-	-	F	Box Engine LTA	818019	Outer Joint		23	22	55	91.5	54.5	O
	1986.02-	1990.07	-	-	F	Box Engine LTA	618053	Inner Joint		23	22	40	61	91.5	
1.8 D (44 kW)	1988.07-	1990.07	MT	R	F	Box Engine RTA/RTB	218127	Drive Shaft		23	23	55	91.5	860	
	1988.07-	1990.07	-	-	F	Box Engine RTA/RTB	818019	Outer Joint		23	22	55	91.5	54.5	O
	1988.07-	1990.07	-	-	F	Box Engine RTA/RTB	618053	Inner Joint		23	22	40	61	91.5	
ESCORT '91 Express (AVL)															
1.3 (46 kW)	1990.07-	1994.12	MT	L/R	F	Box Engine JBD	818017	Outer Joint		23	20	48	80.5	49	O
	1990.07-	1994.12	MT	L/R	F	Box Engine JBD	818015	Outer Joint		23	22	48	80	52.5	O
1.4 (52 kW)	1990.07-	1994.12	MT	L/R	F	Box Engine F6F/F6G	818015	Outer Joint		23	22	48	80	52.5	O
	1990.07-	1994.12	MT	R	F	Box Engine F6F/F6G	218039	Drive Shaft		25	23	56.5	88.5	903	

YEAR	TRANS	L/R	F/R	REMARKS	GSP Ref.	PRODUCT	ABS	Technical Specifications							
								A	B	C	H	L	P		
FORD															
ESCORT '91 Express (AVL)															
1.4 (52 kW)	1990.07-	1994.12	-	-	F	Box Engine F6F/F6G	618053	Inner Joint		23	22	40	61	91.5	
1.8 D (44 kW)	1990.07-	1994.12	-	L	F	Box Engine RTH	218040	Drive Shaft		25	23	56.5	88.5	608	
	1990.07-	1994.12	-	-	F	Box Engine RTH	618053	Inner Joint		23	22	40	61	91.5	
ESCORT '95 (AVL)															
1.3(44 kW)	1995.01-	1997.08	-	L/R	F	Box/Courier/Express Engine J6A	818021	Outer Joint		25	25	56.5	89	56.5	O
	1995.01-	1997.08	-	L/R	F	Box/Courier/Express Engine J6A	818004	Outer Joint		25	22	56.5	88.5	53.5	O
1.4 (54 kW)	1995.01-	2000.08	-	L	F	Box Engine F4B	218040	Drive Shaft		25	23	56.5	88.5	608	
	1995.01-	2000.08	-	-	F	Box Engine F4B	618053	Inner Joint		23	22	40	61	91.5	
1.8 D (44 kW)	1995.01-	2000.08	-	L/R	F	Box Engine RTF/RTH	818021	Outer Joint		25	25	56.5	89	56.5	O
	1995.01-	2000.08	-	L/R	F	Box Engine RTF/RTH	818004	Outer Joint		25	22	56.5	88.5	53.5	O
	1995.01-	2000.08	-	L	F	Box Engine RTF/RTH	218040	Drive Shaft		25	23	56.5	88.5	608	
	1995.01-	2000.08	-	-	F	Box Engine RTF/RTH	618053	Inner Joint		23	22	40	61	91.5	
1.8 TD (66 kW)	1995.01-	2000.08	-	L/R	F	Box Engine RFD/RFK/RFS	818021	Outer Joint		25	25	56.5	89	56.5	O
	1995.01-	2000.08	-	L/R	F	Box Engine RFD/RFK/RFS	818004	Outer Joint		25	22	56.5	88.5	53.5	O
	1995.01-	2000.08	-	R	F	Box Engine RFD/RFK/RFS	218103	Drive Shaft		25	25	56.5	89	816.5	
	1995.01-	2000.08	-	R	F	Box Engine RFD/RFK/RFS	218015	Drive Shaft		25	26	56.5	89	906	
1.8 Turbo D (51 kW)	1995.12-	2001.06	MT	L	F	Box Engine RVA	218044	Drive Shaft		25	26	56.5	89	594	
	1995.12-	2001.06	-	R	F	Box Engine RVA	218103	Drive Shaft		25	25	56.5	89	816.5	
	1995.12-	2001.06	-	R	F	Box Engine RVA	218015	Drive Shaft		25	26	56.5	89	906	
ESCORT CLASSIC (AAL ABL)															
1.6 16V (66 kW)	1998.10-	2000.07	MT	L/R	F	Hatchback Engine L1E	818021	Outer Joint		25	25	56.5	89	56.5	O
	1998.10-	2000.07	AT	L/R	F	Hatchback Engine L1E	818004	Outer Joint		25	22	56.5	88.5	53.5	O
1.8 TD (66 kW)	1998.10-	2000.07	MT	L	F	Hatchback Engine RFD/RFK	218019	Drive Shaft		25	26	56.5	89	591.5	
ESCORT CLASSIC Turnier (ANL)															
1.6 16V (66 kW)	1999.02-	2000.07	MT	L/R	F	Estate Engine L1E	818021	Outer Joint		25	25	56.5	89	56.5	O
	1999.02-	2000.07	AT	L/R	F	Estate Engine L1E	818004	Outer Joint		25	22	56.5	88.5	53.5	O
1.8 TD (66 kW)	1999.02-	2000.07	-	R	F	Estate Engine RFD/RFK	218015	Drive Shaft		25	26	56.5	89	906	
	1999.02-	2000.07	-	-	F	Estate Engine RFD/RFK	818016	Outer Joint		25	30	56.5	89	56.5	I
	1999.02-	2000.07	MT	L	F	Estate Engine RFD/RFK	218019	Drive Shaft		25	26	56.5	89	591.5	
ESCORT EXPRESS															
-	1983-	1990	-	R	-	-	218081	Drive Shaft		26	23	51	88.5	892	
	1983.06-	1990	AT	L	-	-	218148	Drive Shaft		26	23	51	88.5	562	
	1983.06-	1990	MT	L	-	-	218153	Drive Shaft		26	23	51	88.5	560	
	1991-	1996	AT	-	-	-	618039	Inner Joint		24	28	35	64.1	91.5	
1.8	1991-	1996	AT	-	-	-	618068	Inner Joint		24	28	35	63.9	89.5	
1.9	1986.01-	1990.12	-	-	-	-	818042	Outer Joint		26	23	51	88.5	60	I
	1991-	1996	-	-	-	-	618068	Inner Joint		24	28	35	63.9	89.5	
2.0	1997-	2001	AT	-	-	-	618068	Inner Joint		24	28	35	63.9	89.5	
ESCORT HOBBY															
1.0	1993.08-	1996.05	MT	-	-	-	618019	Inner Joint			33		32		
	1993.08-	1996.05	MT	-	-	-	818044	Outer Joint		23	30	55	91.5	54.5	I
1.6	1993.08-	1996.05	MT	-	-	-	618019	Inner Joint			33		32		
	1993.08-	1996.05	MT	-	-	-	818044	Outer Joint		23	30	55	91.5	54.5	I
ESCORT IV (ALF)															
1.4 (54 kW)	1987.02-	1990.07	MT	-	F	Convertible Engine F6B/F6D/FUC	618053	Inner Joint		23	22	40	61	91.5	
	1987.02-	1990.07	-	-	F	Convertible Engine F6B/F6D/FUC	818019	Outer Joint		23	22	55	91.5	54.5	O
1.4 (55 kW)	1986.01-	1990.07	MT	R	F	Convertible Engine FUA	218127	Drive Shaft		23	23	55	91.5	860	
	1986.01-	1990.07	MT	-	F	Convertible Engine FUA	618053	Inner Joint		23	22	40	61	91.5	
	1986.01-	1990.07	-	-	F	Convertible Engine FUA	818019	Outer Joint		23	22	55	91.5	54.5	O
	1986.01-	1990.07	MT	R	F	Convertible Engine L4B	218127	Drive Shaft		23	23	55	91.5	860	
1.6 i (66 kW)	1986.01-	1990.07	MT	-	F	Convertible Engine L4B	618053	Inner Joint		23	22	40	61	91.5	
	1986.01-	1990.07	-	-	F	Convertible Engine L4B	818019	Outer Joint		23	22	55	91.5	54.5	O
	1989.08-	1990.07	MT	-	F	Convertible Engine LJB	618053	Inner Joint		23	22	40	61	91.5	
1.6 i (75 kW)	1989.08-	1990.07	-	-	F	Convertible Engine LJB	818019	Outer Joint		23	22	55	91.5	54.5	O
	1986.01-	1990.07	MT	R	F	Convertible Engine LR2/LRB	218127	Drive Shaft		23	23	55	91.5	860	
	1986.01-	1990.07	-	-	F	Convertible Engine LR2/LRB	818019	Outer Joint		23	22	55	91.5	54.5	O
1.6 XR3i (77 kW)	1986.01-	1990.07	-	-	F	Convertible Engine LR2/LRB	618053	Inner Joint		23	22	40	61	91.5	
ESCORT IV (GAF AWF ABFT)															
1.1 (37 kW)	1985.12-	1990.07	MT	R	F	Hatchback Engine GSG	218127	Drive Shaft		23	23	55	91.5	860	
	1985.12-	1990.07	MT	L/R	F	Hatchback Engine GSG	618002	Inner Joint		23	20	40	61.5	62.5	
	1985.12-	1990.07	-	-	F	Hatchback Engine GSG	818018	Outer Joint		23	20	50	91.5	52	O
1.3 (44 kW)	1986.01-	1990.07	MT	L/R	F	Hatchback Engine JBB/JLA/JLB	618002	Inner Joint		23	20	40	61.5	62.5	
	1986.01-	1990.07	-	-	F	Hatchback Engine JBB/JLA/JLB	818018	Outer Joint		23	20	50	91.5	52	O
1.3 (46 kW)	1988.07-	1990.10	-	-	F	Hatchback Engine JBA	818018	Outer Joint		23	20	50	91.5	52	O
	1988.07-	1990.10	MT	L/R	F	Hatchback Engine JBA	618002	Inner Joint		23	20	40	61.5	62.5	
1.4 (51 kW)	1985.10-	1990.10	MT	R	F	Hatchback Engine FUAA	218127	Drive Shaft		23	23	55	91.5	860	

				TRANSM		L/R F/R		REMARKS		GSP Ref.				ABS		Technical Specifications					
YEAR																A	B	C	H	L	P
FORD																					
ESCORT IV (GAF AWF ABFT)																					
1.4 (51 kW)		1985.10-1990.10	-	-	F	Hatchback Engine FUAA		818019	Outer Joint		23	22	55	91.5	54.5						
		1985.10-1990.10	-	-	F	Hatchback Engine FUAA		618053	Inner Joint		23	22	40	61	91.5						
1.4 (54 kW)		1986.01-1990.07	MT	R	F	Hatchback Engine F6B/F6D/FUC		218127	Drive Shaft		23	23	55	91.5	860						
		1986.01-1990.07	-	-	F	Hatchback Engine F6B/F6D/FUC		818019	Outer Joint		23	22	55	91.5	54.5						
		1986.01-1990.07	-	-	F	Hatchback Engine F6B/F6D/FUC		618053	Inner Joint		23	22	40	61	91.5						
1.4 (55 kW)		1986.01-1990.07	MT	R	F	Hatchback Engine FUA		218127	Drive Shaft		23	23	55	91.5	860						
		1986.01-1990.07	MT	-	F	Hatchback Engine FUA		618053	Inner Joint		23	22	40	61	91.5						
		1986.01-1990.07	-	-	F	Hatchback Engine FUA		818019	Outer Joint		23	22	55	91.5	54.5						
1.6 D (40 kW)		1986.01-1989.01	MT	R	F	Hatchback Engine LTC		218127	Drive Shaft		23	23	55	91.5	860						
		1986.01-1989.01	-	-	F	Hatchback Engine LTC		818019	Outer Joint		23	22	55	91.5	54.5						
1.6 i (66 kW)		1986.01-1990.05	MT	R	F	Hatchback Engine L4B		218127	Drive Shaft		23	23	55	91.5	860						
		1986.01-1990.05	MT	-	F	Hatchback Engine L4B		618053	Inner Joint		23	22	40	61	91.5						
		1986.01-1990.05	-	-	F	Hatchback Engine L4B		818019	Outer Joint		23	22	55	91.5	54.5						
1.6 i (75 kW)		1989.08-1990.07	MT	-	F	Hatchback Engine LJB		618053	Inner Joint		23	22	40	61	91.5						
		1989.08-1990.07	-	-	F	Hatchback Engine LJB		818019	Outer Joint		23	22	55	91.5	54.5						
1.6 Turbo RS (97 kW)		1986.01-1990.07	MT	R	F	Hatchback Engine LNB		218127	Drive Shaft		23	23	55	91.5	860						
		1986.01-1990.07	-	-	F	Hatchback Engine LNB		818019	Outer Joint		23	22	55	91.5	54.5						
		1986.01-1990.07	-	-	F	Hatchback Engine LNB		618053	Inner Joint		23	22	40	61	91.5						
1.6 XR3i (77 kW)		1986.01-1989.08	MT	R	F	Hatchback Engine LR2/LRB		218127	Drive Shaft		23	23	55	91.5	860						
		1986.01-1989.08	-	-	F	Hatchback Engine LR2/LRB		818019	Outer Joint		23	22	55	91.5	54.5						
		1986.01-1989.08	-	-	F	Hatchback Engine LR2/LRB		618053	Inner Joint		23	22	40	61	91.5						
1.8 D (44 kW)		1989.01-1990.07	-	-	F	Hatchback Engine RTA/RTB		818019	Outer Joint		23	22	55	91.5	54.5						
		1989.01-1990.07	MT	R	F	Hatchback Engine RTA/RTB		218127	Drive Shaft		23	23	55	91.5	860						
		1989.01-1990.07	-	-	F	Hatchback Engine RTA/RTB		618053	Inner Joint		23	22	40	61	91.5						
ESCORT IV Turnier (AWF AVF)																					
1.1 (37 kW)		1985.10-1990.09	-	-	F	Estate Engine GSG		818018	Outer Joint		23	20	50	91.5	52						
		1985.10-1990.09	MT	R	F	Estate Engine GSG		218127	Drive Shaft		23	23	55	91.5	860						
		1985.10-1990.09	MT	L/R	F	Estate Engine GSG		618002	Inner Joint		23	20	40	61.5	62.5						
1.3 (44 kW)		1986.01-1990.07	-	-	F	Estate Engine JBB/JLA/JLB		818018	Outer Joint		23	20	50	91.5	52						
1.4 (51 kW)		1985.10-1990.10	AT/MT	-	F	Estate Engine FUAA		818019	Outer Joint		23	22	55	91.5	54.5						
		1985.10-1990.10	MT	R	F	Estate Engine FUAA		218127	Drive Shaft		23	23	55	91.5	860						
		1985.10-1990.10	MT	-	F	Estate Engine FUAA		618053	Inner Joint		23	22	40	61	91.5						
1.4 (54 kW)		1986.01-1990.07	AT/MT	-	F	Estate Engine F6B/F6D/FUC		818019	Outer Joint		23	22	55	91.5	54.5						
		1986.01-1990.07	MT	R	F	Estate Engine F6B/F6D/FUC		218127	Drive Shaft		23	23	55	91.5	860						
		1986.01-1990.07	MT	-	F	Estate Engine F6B/F6D/FUC		618053	Inner Joint		23	22	40	61	91.5						
1.4 (55 kW)		1986.01-1990.07	MT	R	F	Estate Engine FUA		218127	Drive Shaft		23	23	55	91.5	860						
		1986.01-1990.07	MT	-	F	Estate Engine FUA		618053	Inner Joint		23	22	40	61	91.5						
		1986.01-1990.07	-	-	F	Estate Engine FUA		818019	Outer Joint		23	22	55	91.5	54.5						
1.6 D (40 kW)		1986.01-1989.01	MT	R	F	Estate Engine LTC		218127	Drive Shaft		23	23	55	91.5	860						
		1986.01-1989.01	-	-	F	Estate Engine LTC		818019	Outer Joint		23	22	55	91.5	54.5						
1.6 i (66 kW)		1986.01-1990.07	MT	R	F	Estate Engine L4B		218127	Drive Shaft		23	23	55	91.5	860						
		1986.01-1990.07	MT	-	F	Estate Engine L4B		618053	Inner Joint		23	22	40	61	91.5						
		1986.01-1990.07	-	-	F	Estate Engine L4B		818019	Outer Joint		23	22	55	91.5	54.5						
1.8 D (44 kW)		1989.01-1990.07	MT	R	F	Estate Engine RTA/RTB		218127	Drive Shaft		23	23	55	91.5	860						
		1989.01-1990.07	-	-	F	Estate Engine RTA/RTB		818019	Outer Joint		23	22	55	91.5	54.5						
		1989.01-1990.07	-	-	F	Estate Engine RTA/RTB		618053	Inner Joint		23	22	40	61	91.5						
ESCORT V (ALL)																					
1.4 (52 kW)		1990.07-1992.12	MT	L/R	F	Convertible Engine F6F/F6G		818015	Outer Joint		23	22	48	80	52.5						
		1990.07-1992.12	-	-	F	Convertible Engine F6F/F6G		618053	Inner Joint		23	22	40	61	91.5						
1.6 (77 kW)		1990.07-1992.12	MT	R	F	Convertible Engine LJF		218039	Drive Shaft		25	23	56.5	88.5	903						
		1990.07-1992.12	-	-	F	Convertible Engine LJF		618053	Inner Joint		23	22	40	61	91.5						
1.8 16V XR3i (77 kW)		1992.02-1992.12	MT	L/R	F	Convertible Engine RDA		818021	Outer Joint		25	25	56.5	89	56.5						
		1992.02-1992.12	MT	L	F	Convertible Engine RDA		218044	Drive Shaft		25	26	56.5	89	594						
1.8 16V XR3i (96 kW)		1992.02-1992.12	MT	L/R	F	Convertible Engine RQB		818021	Outer Joint		25	25	56.5	89	56.5						
		1992.02-1992.12	MT	L	F	Convertible Engine RQB		218044	Drive Shaft		25	26	56.5	89	594						
		1992.02-1992.12	-	-	F	Convertible Engine RQB		218040	Drive Shaft		25	23	56.5	88.5	608						
		1992.02-1992.12	-	-	F	Convertible Engine RQB		618053	Inner Joint		23	22	40	61	91.5						
ESCORT V (GAL)																					
1.3 (44 kW)		1990.07-1992.09	MT	L/R	F	Hatchback Engine J4B/J6A		818017	Outer Joint		23	20	48	80.5	49						
		1990.07-1992.09	MT	L/R	F	Hatchback Engine J4B/J6A		818015	Outer Joint		23	22	48	80	52.5						
		1990.07-1992.09	-	-	F	Hatchback Engine J4B/J6A		618053	Inner Joint		23	22	40	61	91.5						
1.4 (52 kW)		1990.07-1992.09	MT	L/R	F	Hatchback Engine F6F/F6G		818015	Outer Joint		23	22	48	80	52.5						
		1990.07-1992.09	MT	R	F	Hatchback Engine F6F/F6G		218039	Drive Shaft		25	23	56.5	88.5	903						
		1990.07-1992.09	-	-	F	Hatchback Engine F6F/F6G		618053	Inner Joint		23	22	40	61	91.5						
1.6 (66 kW)		1990.07-1992.08	MT	R	F	Hatchback Engine LUJ/LUK		218039	Drive Shaft		25	23	56.5	88.5	903						
		1990.07-1992.08	-	-	F	Hatchback Engine LUJ/LUK		618053	Inner Joint		23	22	40	61	91.5						

	 YEAR	TRANSM	L/R	F/R	REMARKS	GSP Ref.	 PRODUCT	 ABS	Technical Specifications					
									A	B	C	H	L	P
FORD														
ESCORT V (GAL)														
1.6 (77 kW)	1990.07-1992.12	-	-	F	Hatchback Engine LJF	618053	Inner Joint		23	22	40	61	91.5	
1.8 16V XR3i (77 kW)	1992.02-1992.12	MT	L/R	F	Hatchback Engine RDA	818021	Outer Joint		25	25	56.5	89	56.5	O
	1992.02-1992.12	MT	L	F	Hatchback Engine RDA	218044	Drive Shaft		25	26	56.5	89	594	
1.8 16V XR3i (96 kW)	1992.02-1992.12	MT	L/R	F	Hatchback Engine RQB	818021	Outer Joint		25	25	56.5	89	56.5	O
	1992.02-1992.12	MT	L	F	Hatchback Engine RQB	218044	Drive Shaft		25	26	56.5	89	594	
1.8 D (44 kW)	1990.07-1992.12	MT	R	F	Hatchback Engine RTE/RTF/RTH	218039	Drive Shaft		25	23	56.5	88.5	903	
	1990.07-1992.12	-	L	F	Hatchback Engine RTE/RTF/RTH	218040	Drive Shaft		25	23	56.5	88.5	608	
	1990.07-1992.12	-	-	F	Hatchback Engine RTE/RTF/RTH	618053	Inner Joint		23	22	40	61	91.5	
RS 2.0 (110 kW)	1991.05-1992.12	MT	L/R	F	Hatchback Engine N7A	818021	Outer Joint		25	25	56.5	89	56.5	O
	1991.05-1992.12	MT	L	F	Hatchback Engine N7A	218044	Drive Shaft		25	26	56.5	89	594	
ESCORT V Turnier (GAL AVL)														
1.3 (44 kW)	1991.09-1992.09	MT	L/R	F	Estate Engine J4B/J6A	818017	Outer Joint		23	20	48	80.5	49	O
	1991.09-1992.09	-	-	F	Estate Engine J4B/J6A	618053	Inner Joint		23	22	40	61	91.5	
1.4 (52 kW)	1990.07-1992.09	MT	L/R	F	Estate Engine F6F/F6G	818015	Outer Joint		23	22	48	80	52.5	O
	1990.07-1992.09	MT	R	F	Estate Engine F6F/F6G	218039	Drive Shaft		25	23	56.5	88.5	903	
	1990.07-1992.09	-	-	F	Estate Engine F6F/F6G	618053	Inner Joint		23	22	40	61	91.5	
1.6 (66 kW)	1990.07-1992.08	MT	R	F	Estate Engine LUJ/LUK	218039	Drive Shaft		25	23	56.5	88.5	903	
	1990.07-1992.08	-	-	F	Estate Engine LUJ/LUK	618053	Inner Joint		23	22	40	61	91.5	
1.6 (77 kW)	1990.07-1992.09	-	-	F	Estate Engine LJF	618053	Inner Joint		23	22	40	61	91.5	
1.8 16V (77 kW)	1992.02-1992.12	MT	L/R	F	Estate Engine RDA	818021	Outer Joint		25	25	56.5	89	56.5	O
	1992.02-1992.12	-	L	F	Estate Engine RDA	218040	Drive Shaft		25	23	56.5	88.5	608	
	1992.02-1992.12	-	-	F	Estate Engine RDA	618053	Inner Joint		23	22	40	61	91.5	
1.8 D (44 kW)	1990.07-1992.12	MT	R	F	Estate Engine RTE/RTF/RTH	218039	Drive Shaft		25	23	56.5	88.5	903	
	1990.07-1992.12	-	L	F	Estate Engine RTE/RTF/RTH	218040	Drive Shaft		25	23	56.5	88.5	608	
	1990.07-1992.12	-	-	F	Estate Engine RTE/RTF/RTH	618053	Inner Joint		23	22	40	61	91.5	
ESCORT VI (ALL)														
1.4 (52 kW)	1992.12-1994.04	-	L	F	Convertible Engine F6F/F6G	218040	Drive Shaft		25	23	56.5	88.5	608	
	1992.12-1994.04	-	-	F	Convertible Engine F6F/F6G	618053	Inner Joint		23	22	40	61	91.5	
1.4 i (55 kW)	1993.07-1995.01	MT	R	F	Convertible Engine F4B	218039	Drive Shaft		25	23	56.5	88.5	903	
	1993.07-1995.01	-	L	F	Convertible Engine F4B	218040	Drive Shaft		25	23	56.5	88.5	608	
	1993.07-1995.01	-	-	F	Convertible Engine F4B	618053	Inner Joint		23	22	40	61	91.5	
1.6 16V XR3i (66 kW)	1992.12-1995.01	MT	R	F	Convertible Engine L1E	218039	Drive Shaft		25	23	56.5	88.5	903	
	1992.12-1995.01	-	L	F	Convertible Engine L1E	218040	Drive Shaft		25	23	56.5	88.5	608	
	1992.12-1995.01	-	-	F	Convertible Engine L1E	618053	Inner Joint		23	22	40	61	91.5	
1.6 i 16V (65 kW)	1994.02-1995.01	MT	R	F	Convertible Engine L1H	218039	Drive Shaft		25	23	56.5	88.5	903	
	1994.02-1995.01	-	L	F	Convertible Engine L1H	218040	Drive Shaft		25	23	56.5	88.5	608	
	1994.02-1995.01	-	-	F	Convertible Engine L1H	618053	Inner Joint		23	22	40	61	91.5	
1.8 16V XR3i (77 kW)	1992.12-1995.01	MT	L/R	F	Convertible Engine RDA	818021	Outer Joint		25	25	56.5	89	56.5	O
	1992.12-1995.01	-	L	F	Convertible Engine RDA	218040	Drive Shaft		25	23	56.5	88.5	608	
	1992.12-1995.01	-	-	F	Convertible Engine RDA	618053	Inner Joint		23	22	40	61	91.5	
1.8 16V XR3i (96 kW)	1992.12-1995.01	MT	L/R	F	Convertible Engine RQB	818021	Outer Joint		25	25	56.5	89	56.5	O
	1992.12-1995.01	MT	L	F	Convertible Engine RQB	218044	Drive Shaft		25	26	56.5	89	594	
ESCORT VI (GAL)														
1.3 (44 kW)	1992.09-1995.01	MT	L/R	F	Hatchback Engine J4B/J6A	818017	Outer Joint		23	20	48	80.5	49	O
	1992.09-1995.01	MT	L/R	F	Hatchback Engine J4B/J6A	818015	Outer Joint		23	22	48	80	52.5	O
	1992.09-1995.01	-	-	F	Hatchback Engine J4B/J6A	618053	Inner Joint		23	22	40	61	91.5	
	1993.08-1995.01	MT	L/R	F	Saloon Engine J4B/J6A	818017	Outer Joint		23	20	48	80.5	49	O
	1993.08-1995.01	-	-	F	Saloon Engine J4B/J6A	618053	Inner Joint		23	22	40	61	91.5	
1.4 (52 kW)	1992.09-1995.01	MT	R	F	Hatchback Engine F6F/F6G	218039	Drive Shaft		25	23	56.5	88.5	903	
	1992.09-1995.01	-	L	F	Hatchback Engine F6F/F6G	218040	Drive Shaft		25	23	56.5	88.5	608	
	1992.09-1995.01	-	-	F	Hatchback Engine F6F/F6G	618053	Inner Joint		23	22	40	61	91.5	
	1993.08-1994.04	-	L	F	Saloon Engine F6F/F6G	218040	Drive Shaft		25	23	56.5	88.5	608	
	1993.08-1994.04	-	-	F	Saloon Engine F6F/F6G	618053	Inner Joint		23	22	40	61	91.5	
1.4 (55 kW)	1993.08-1995.01	-	L	F	Saloon Engine F4B/FUH	218040	Drive Shaft		25	23	56.5	88.5	608	
	1993.08-1995.01	-	-	F	Saloon Engine F4B/FUH	618053	Inner Joint		23	22	40	61	91.5	
1.6 i 16V (65 kW)	1994.01-1995.01	MT	R	F	Hatchback Engine L1H	218039	Drive Shaft		25	23	56.5	88.5	903	
	1994.01-1995.01	MT	R	F	Saloon Engine L1H	218039	Drive Shaft		25	23	56.5	88.5	903	
	1994.01-1995.01	-	L	F	Hatchback Engine L1H	218040	Drive Shaft		25	23	56.5	88.5	608	
	1994.01-1995.01	-	L	F	Saloon Engine L1H	218040	Drive Shaft		25	23	56.5	88.5	608	
	1994.01-1995.01	-	-	F	Hatchback Engine L1H	618053	Inner Joint		23	22	40	61	91.5	
	1994.01-1995.01	-	-	F	Saloon Engine L1H	618053	Inner Joint		23	22	40	61	91.5	
1.6 i 16V (66 kW)	1992.09-1995.01	MT	R	F	Hatchback Engine L1E	218039	Drive Shaft		25	23	56.5	88.5	903	
	1992.09-1995.01	-	L	F	Hatchback Engine L1E	218040	Drive Shaft		25	23	56.5	88.5	608	
	1992.09-1995.01	-	-	F	Hatchback Engine L1E	618053	Inner Joint		23	22	40	61	91.5	
	1993.08-1995.01	MT	R	F	Saloon Engine L1E/L1K	218039	Drive Shaft		25	23	56.5	88.5	903	
	1993.08-1995.01	-	L	F	Saloon Engine L1E/L1K	218040	Drive Shaft		25	23	56.5	88.5	608	
	1993.08-1995.01	-	-	F	Saloon Engine L1E/L1K	618053	Inner Joint		23	22	40	61	91.5	





	 YEAR	TRANSM	L/R	F/R	REMARKS	GSP Ref.	 PRODUCT	 ABS	Technical Specifications					
									A	B	C	H	L	P
FORD														
ESCORT VI (GAL)														
1.6 i 16V (66 kW)	1993.08-1995.01	-	-	F	Saloon Engine L1E/L1K	618053	Inner Joint		23	22	40	61	91.5	
1.8 16V XR3i (96 kW)	1992.09-1995.01	MT	L/R	F	Hatchback Engine RQB	818021	Outer Joint		25	25	56.5	89	56.5	O
	1992.09-1995.01	MT	L	F	Hatchback Engine RQB	218044	Drive Shaft		25	26	56.5	89	594	
	1992.09-1995.01	-	L	F	Hatchback Engine RQB	218040	Drive Shaft		25	23	56.5	88.5	608	
	1992.09-1995.01	-	-	F	Hatchback Engine RQB	618053	Inner Joint		23	22	40	61	91.5	
1.8 D (44 kW)	1992.09-1995.01	MT	R	F	Hatchback Engine RTE/RTF/RTH	218039	Drive Shaft		25	23	56.5	88.5	903	
	1992.09-1995.01	-	L	F	Hatchback Engine RTE/RTF/RTH	218040	Drive Shaft		25	23	56.5	88.5	608	
	1992.09-1995.01	-	-	F	Hatchback Engine RTE/RTF/RTH	618053	Inner Joint		23	22	40	61	91.5	
	1993.08-1995.01	MT	R	F	Saloon Engine RTE/RTF/RTH	218039	Drive Shaft		25	23	56.5	88.5	903	
	1993.08-1995.01	-	L	F	Saloon Engine RTE/RTF/RTH	218040	Drive Shaft		25	23	56.5	88.5	608	
1.8 i 16V (77 kW)	1993.08-1995.01	-	-	F	Saloon Engine RTE/RTF/RTH	618053	Inner Joint		23	22	40	61	91.5	
	1992.09-1995.01	MT	L/R	F	Hatchback Engine RDA	818021	Outer Joint		25	25	56.5	89	56.5	O
	1992.09-1995.01	MT	L	F	Hatchback Engine RDA	218044	Drive Shaft		25	26	56.5	89	594	
	1992.09-1995.01	-	L	F	Hatchback Engine RDA	218040	Drive Shaft		25	23	56.5	88.5	608	
	1992.09-1995.01	-	-	F	Hatchback Engine RDA	618053	Inner Joint		23	22	40	61	91.5	
	1993.08-1995.01	MT	L	F	Saloon Engine RDA	218044	Drive Shaft		25	26	56.5	89	594	
1.8 TD (66 kW)	1993.08-1995.01	-	L	F	Saloon Engine RDA	218040	Drive Shaft		25	23	56.5	88.5	608	
	1993.08-1995.01	-	-	F	Saloon Engine RDA	618053	Inner Joint		23	22	40	61	91.5	
	1993.02-1995.01	MT	L/R	F	Hatchback Engine RFD/RFK/RFS	818021	Outer Joint		25	25	56.5	89	56.5	O
	1993.02-1995.01	MT	L	F	Hatchback Engine RFD/RFK/RFS	218044	Drive Shaft		25	26	56.5	89	594	
	1993.02-1995.01	-	R	F	Hatchback Engine RFD/RFK/RFS	218103	Drive Shaft		25	25	56.5	89	816.5	
	1993.02-1995.01	MT	L	F	Hatchback Engine RFD/RFK/RFS	218019	Drive Shaft		25	26	56.5	89	591.5	
	1993.02-1995.01	-	R	F	Hatchback Engine RFD/RFK/RFS	218015	Drive Shaft		25	26	56.5	89	906	
	1993.08-1995.01	MT	L/R	F	Saloon Engine RFD/RFK	818021	Outer Joint		25	25	56.5	89	56.5	O
	1993.08-1995.01	MT	L	F	Saloon Engine RFD/RFK	218044	Drive Shaft		25	26	56.5	89	594	
	1993.08-1995.01	-	R	F	Saloon Engine RFD/RFK	218103	Drive Shaft		25	25	56.5	89	816.5	
RS 2.0 (110 kW)	1993.08-1995.01	MT	L	F	Saloon Engine RFD/RFK	218019	Drive Shaft		25	26	56.5	89	591.5	
	1993.08-1995.01	-	R	F	Saloon Engine RFD/RFK	218103	Drive Shaft		25	25	56.5	89	816.5	
	1993.08-1995.01	MT	L	F	Saloon Engine RFD/RFK	218015	Drive Shaft		25	26	56.5	89	906	
	1993.08-1995.01	-	R	F	Saloon Engine RFD/RFK	218015	Drive Shaft		25	26	56.5	89	906	
	1992.09-1995.01	MT	L/R	F	Hatchback Engine N7A	818021	Outer Joint		25	25	56.5	89	56.5	O
	1992.09-1995.01	MT	L	F	Hatchback Engine N7A	218044	Drive Shaft		25	26	56.5	89	594	
	1992.09-1995.01	MT	L	F	Hatchback Engine N7A	218019	Drive Shaft		25	26	56.5	89	591.5	
RS Cosworth (162 kW)	1993.08-1995.01	-	-	F	All-wheel Drive Hatchback Engine N7A	218033	Drive Shaft	94T	23	23	55	91	583	
	1993.08-1995.01	MT	L	F	All-wheel Drive Hatchback Engine N7A	218044	Drive Shaft		25	26	56.5	89	594	
	1993.08-1995.01	-	-	-	All-wheel Drive Hatchback Engine N7A	818077	Outer Joint	94T	23	22	55	91	64	O
	1993.08-1995.01	MT	L	F	All-wheel Drive Hatchback Engine N7A	218019	Drive Shaft		25	26	56.5	89	591.5	
RS Cosworth (162 kW)	1992.09-1995.01	-	-	F	All-wheel Drive Hatchback Engine N5F	218033	Drive Shaft	94T	23	23	55	91	583	
	1992.09-1995.01	-	-	-	All-wheel Drive Hatchback Engine N5F	818077	Outer Joint	94T	23	22	55	91	64	O
ESCORT VI Turnier (GAL)/ESCORT NOMADE														
1.3 (44 kW)	1992.09-1995.01	MT	L/R	F	Estate Engine J4B/J6A	818017	Outer Joint		23	20	48	80.5	49	O
	1992.09-1995.01	-	-	F	Estate Engine J4B/J6A	618053	Inner Joint		23	22	40	61	91.5	
1.4 (52 kW)	1992.09-1995.01	MT	R	F	Estate Engine F6F/F6G	218039	Drive Shaft		25	23	56.5	88.5	903	
	1992.09-1995.01	-	L	F	Estate Engine F6F/F6G	218040	Drive Shaft		25	23	56.5	88.5	608	
	1992.09-1995.01	-	-	F	Estate Engine F6F/F6G	618053	Inner Joint		23	22	40	61	91.5	
1.4 (55 kW)	1994.01-1995.01	-	L	F	Estate Engine F4B/FUH	218040	Drive Shaft		25	23	56.5	88.5	608	
	1994.01-1995.01	-	-	F	Estate Engine F4B/FUH	618053	Inner Joint		23	22	40	61	91.5	
1.6 i 16V (65 kW)	1994.01-1995.01	MT	R	F	Estate Engine L1H	218039	Drive Shaft		25	23	56.5	88.5	903	
	1994.01-1995.01	-	L	F	Estate Engine L1H	218040	Drive Shaft		25	23	56.5	88.5	608	
	1994.01-1995.01	-	-	F	Estate Engine L1H	618053	Inner Joint		23	22	40	61	91.5	
1.6 i 16V (66 kW)	1992.09-1995.01	MT	R	F	Estate Engine L1E	218039	Drive Shaft		25	23	56.5	88.5	903	
	1992.09-1995.01	-	L	F	Estate Engine L1E	218040	Drive Shaft		25	23	56.5	88.5	608	
	1992.09-1995.01	-	-	F	Estate Engine L1E	618053	Inner Joint		23	22	40	61	91.5	
1.8 D (44 kW)	1992.09-1995.01	MT	R	F	Estate Engine RTH	218039	Drive Shaft		25	23	56.5	88.5	903	
	1992.09-1995.01	-	L	F	Estate Engine RTH	218040	Drive Shaft		25	23	56.5	88.5	608	
	1992.09-1995.01	-	-	F	Estate Engine RTH	618053	Inner Joint		23	22	40	61	91.5	
1.8 i 16V (77 kW)	1993.01-1995.01	MT	L/R	F	Estate Engine RDA	818021	Outer Joint		25	25	56.5	89	56.5	O
	1993.01-1995.01	MT	L	F	Estate Engine RDA	218044	Drive Shaft		25	26	56.5	89	594	
	1993.01-1995.01	-	L	F	Estate Engine RDA	218040	Drive Shaft		25	23	56.5	88.5	608	
	1993.01-1995.01	-	-	F	Estate Engine RDA	618053	Inner Joint		23	22	40	61	91.5	
1.8 i 16V (96 kW)	1993.02-1995.01	MT	L/R	F	Estate Engine RQB	818021	Outer Joint		25	25	56.5	89	56.5	O
	1993.02-1995.01	-	L	F	Estate Engine RQB	218040	Drive Shaft		25	23	56.5	88.5	608	
	1993.02-1995.01	-	-	F	Estate Engine RQB	618053	Inner Joint		23	22	40	61	91.5	
1.8 TD (66 kW)	1993.02-1995.01	MT	L/R	F	Estate Engine RFD/RFK	818021	Outer Joint		25	25	56.5	89	56.5	O
	1993.02-1995.01	MT	L	F	Estate Engine RFD/RFK	218044	Drive Shaft		25	26	56.5	89	594	
	1993.02-1995.01	-	R	F	Estate Engine RFD/RFK	218103	Drive Shaft		25	25	56.5	89	816.5	
	1993.02-1995.01	MT	L	F	Estate Engine RFD/RFK	218019	Drive Shaft		25	26	56.5	89	591.5	
	1993.02-1995.01	-	R	F	Estate Engine RFD/RFK	218015	Drive Shaft		25	26	56.5	89	906	





	 YEAR	TRANSM	L/R	F/R	REMARKS	GSP Ref.	 PRODUCT	 ABS	Technical Specifications					
									A	B	C	H	L	P
FORD														
ESCORT VII (ALL)														
1.4 (55 kW)	1995.02-1998.08	MT	R	F	Convertible Engine F4B	218039	Drive Shaft		25	23	56.5	88.5	903	
	1995.02-1998.08	-	L	F	Convertible Engine F4B	218040	Drive Shaft		25	23	56.5	88.5	608	
	1995.02-1998.08	-	-	F	Convertible Engine F4B	618053	Inner Joint		23	22	40	61	91.5	
1.6 16V XR3i (65 kW)	1995.02-1996.12	MT	R	F	Convertible Engine L1H	218039	Drive Shaft		25	23	56.5	88.5	903	
	1995.02-1996.12	-	L	F	Convertible Engine L1H	218040	Drive Shaft		25	23	56.5	88.5	608	
	1995.02-1996.12	-	-	F	Convertible Engine L1H	618053	Inner Joint		23	22	40	61	91.5	
1.6 16V XR3i (66 kW)	1995.02-1999.09	MT	L/R	F	Convertible Engine L1E	818021	Outer Joint		25	25	56.5	89	56.5	O
	1995.02-1999.09	MT	R	F	Convertible Engine L1E	218039	Drive Shaft		25	23	56.5	88.5	903	
	1995.02-1999.09	-	L	F	Convertible Engine L1E	218040	Drive Shaft		25	23	56.5	88.5	608	
	1995.02-1999.09	-	-	F	Convertible Engine L1E	618053	Inner Joint		23	22	40	61	91.5	
1.8 16V XR3i (77 kW)	1995.02-1998.08	-	L/R	F	Convertible Engine RDA	818021	Outer Joint		25	25	56.5	89	56.5	O
	1995.02-1998.08	MT	L	F	Convertible Engine RDA	218044	Drive Shaft		25	26	56.5	89	594	
	1995.02-1998.08	-	L/R	F	Convertible Engine RDA	818004	Outer Joint		25	22	56.5	88.5	53.5	O
	1995.02-1998.08	-	L	F	Convertible Engine RDA	218040	Drive Shaft		25	23	56.5	88.5	608	
1.8 16V XR3i (85 kW)	1995.02-1998.08	-	-	F	Convertible Engine RDA	618053	Inner Joint		23	22	40	61	91.5	
	1995.10-1998.08	MT	L	F	Convertible Engine RKC	218044	Drive Shaft		25	26	56.5	89	594	
	1995.10-1998.08	-	L	F	Convertible Engine RKC	218040	Drive Shaft		25	23	56.5	88.5	608	
	1995.10-1998.08	-	-	F	Convertible Engine RKC	618053	Inner Joint		23	22	40	61	91.5	
1.8 16V XR3i (96 kW)	1995.02-2000.08	-	L/R	F	Convertible Engine RQB	818021	Outer Joint		25	25	56.5	89	56.5	O
	1995.02-2000.08	-	L/R	F	Convertible Engine RQB	818004	Outer Joint		25	22	56.5	88.5	53.5	O
	1995.10-1998.08	MT	L	F	Convertible Engine RKC	218044	Drive Shaft		25	26	56.5	89	594	
	1995.10-1998.08	-	L	F	Convertible Engine RKC	218040	Drive Shaft		25	23	56.5	88.5	608	
1.8 TD (66 kW)	1995.09-1998.08	MT	L/R	F	Convertible Engine RFD/RFK	218019	Drive Shaft		25	26	56.5	89	591.5	
	1995.09-1998.08	-	R	F	Convertible Engine RFD/RFK	218015	Drive Shaft		25	26	56.5	89	906	
	1995.09-1998.08	MT	L	F	Convertible Engine RFD/RFK	218044	Drive Shaft		25	26	56.5	89	594	
	1995.09-1998.08	MT	R	F	Convertible Engine RFD/RFK	218103	Drive Shaft		25	25	56.5	89	816.5	
	1995.09-1998.08	MT	L	F	Convertible Engine RFD/RFK	218019	Drive Shaft		25	26	56.5	89	591.5	
	1995.09-1998.08	-	R	F	Convertible Engine RFD/RFK	218015	Drive Shaft		25	26	56.5	89	906	
1.8 Turbo D (51 kW)	1996.10-1999.08	MT	L/R	F	Convertible Engine RVA	818021	Outer Joint		25	25	56.5	89	56.5	O
	1996.10-1999.08	MT	L	F	Convertible Engine RVA	218044	Drive Shaft		25	26	56.5	89	594	
	1996.10-1999.08	-	L	F	Convertible Engine RVA	218038	Drive Shaft		25	26	56.5	89	596	
	1996.10-1999.08	-	R	F	Convertible Engine RVA	218103	Drive Shaft		25	25	56.5	89	816.5	
	1996.10-1999.08	-	R	F	Convertible Engine RVA	218015	Drive Shaft		25	26	56.5	89	906	
ESCORT VII (GAL AAL ABL)														
1.3 (44 kW)	1995.01-1998.10	MT	L/R	F	Hatchback Engine J4B/J6A	818017	Outer Joint		23	20	48	80.5	49	O
	1995.01-1998.10	-	-	F	Hatchback Engine J4B/J6A	618053	Inner Joint		23	22	40	61	91.5	
1.4 (54 kW)	1995.01-1999.12	-	L/R	F	Hatchback Engine F4B	818021	Outer Joint		25	25	56.5	89	56.5	O
	1995.01-1999.12	-	L	F	Hatchback Engine F4B	818004	Outer Joint		25	22	56.5	88.5	53.5	O
1.4 (55 kW)	1995.01-1998.10	MT	R	F	Hatchback Engine F4B	218039	Drive Shaft		25	23	56.5	88.5	903	
	1995.01-1998.10	-	L	F	Hatchback Engine F4B	218040	Drive Shaft		25	23	56.5	88.5	608	
	1995.01-1998.10	-	-	F	Hatchback Engine F4B	618053	Inner Joint		23	22	40	61	91.5	
1.6 16V (66 kW)	1995.01-1998.10	MT	R	F	Hatchback Engine L1E	218039	Drive Shaft		25	23	56.5	88.5	903	
	1995.01-1998.10	-	L	F	All-wheel Drive Hatchback Engine L1E	218040	Drive Shaft		25	23	56.5	88.5	608	
	1995.01-1998.10	-	L/R	F	All-wheel Drive Hatchback Engine L1E	818004	Outer Joint		25	22	56.5	88.5	53.5	O
	1995.01-1998.10	-	L	F	Hatchback Engine L1E	218040	Drive Shaft		25	23	56.5	88.5	608	
	1995.01-1998.10	-	-	-	All-wheel Drive Hatchback Engine L1E	618053	Inner Joint		23	22	40	61	91.5	
1.6 i 16V (65 kW)	1995.01-1995.08	-	L/R	F	Hatchback Engine L1H	818021	Outer Joint		25	25	56.5	89	56.5	O
	1995.01-1995.08	MT	R	F	Hatchback Engine L1H	218039	Drive Shaft		25	23	56.5	88.5	903	
	1995.01-1995.08	-	L	F	Hatchback Engine L1H	218040	Drive Shaft		25	23	56.5	88.5	608	
	1995.01-1995.08	-	-	F	Hatchback Engine L1H	618053	Inner Joint		23	22	40	61	91.5	
1.8 16V (77 kW)	1995.01-1995.08	MT	L	F	Hatchback Engine RDA	218044	Drive Shaft		25	26	56.5	89	594	
	1995.01-1995.08	-	L	F	Hatchback Engine RDA	218040	Drive Shaft		25	23	56.5	88.5	608	
	1995.01-1995.08	-	-	F	Hatchback Engine RDA	618053	Inner Joint		23	22	40	61	91.5	
1.8 16V (85 kW)	1995.01-1998.10	MT	L	F	Hatchback Engine RKC	218044	Drive Shaft		25	26	56.5	89	594	
	1995.01-1998.10	-	L	F	Hatchback Engine RKC	218040	Drive Shaft		25	23	56.5	88.5	608	
	1995.01-1998.10	-	-	F	Hatchback Engine RKC	618053	Inner Joint		23	22	40	61	91.5	
	1995.01-1998.10	MT	L	F	Hatchback Engine RKC	218019	Drive Shaft		25	26	56.5	89	591.5	
1.8 D (44 kW)	1995.01-1996.12	MT	R	F	Hatchback Engine RTE/RTF/RTH	218039	Drive Shaft		25	23	56.5	88.5	903	
	1995.01-1996.12	-	L	F	Hatchback Engine RTE/RTF/RTH	218040	Drive Shaft		25	23	56.5	88.5	608	
	1995.01-1996.12	-	-	F	Hatchback Engine RTE/RTF/RTH	618053	Inner Joint		23	22	40	61	91.5	
1.8 TD (66 kW)	1995.01-1998.10	MT	L/R	F	Hatchback Engine RFD/RFK	818021	Outer Joint		25	25	56.5	89	56.5	O
	1995.01-1998.10	MT	L	F	Hatchback Engine RFD/RFK	218044	Drive Shaft		25	26	56.5	89	594	
	1995.01-1998.10	-	R	F	Hatchback Engine RFD/RFK	218103	Drive Shaft		25	25	56.5	89	816.5	
	1995.01-1998.10	MT	L	F	Hatchback Engine RFD/RFK	218019	Drive Shaft		25	26	56.5	89	591.5	
	1995.01-1998.10	-	R	F	Hatchback Engine RFD/RFK	218015	Drive Shaft		25	26	56.5	89	906	
1.8 Turbo D (51 kW)	1995.12-1998.10	MT	L/R	F	Hatchback Engine RVA	818021	Outer Joint		25	25	56.5	89	56.5	O

YEAR	TRANSM	L/R	F/R	REMARKS	GSP Ref.	PRODUCT	ABS	Technical Specifications						
								A	B	C	H	L	P	
FORD														
ESCORT VII (GAL AAL ABL)														
1.8 Turbo D (51 kW)	1995.12-1998.10	MT	L	F	Hatchback Engine RVA	218044	Drive Shaft		25	26	56.5	89	594	
	1995.12-1998.10	-	L	F	Hatchback Engine RVA	218038	Drive Shaft		25	26	56.5	89	596	
	1995.12-1998.10	-	R	F	Hatchback Engine RVA	218103	Drive Shaft		25	25	56.5	89	816.5	
	1995.12-1998.10	-	R	F	Hatchback Engine RVA	218015	Drive Shaft		25	26	56.5	89	906	
RS 2.0 (110 kW)	1995.02-1998.02	-	L/R	F	Hatchback Engine N7A	818021	Outer Joint		25	25	56.5	89	56.5	O
	1995.02-1998.02	MT	L	F	Hatchback Engine N7A	218044	Drive Shaft		25	26	56.5	89	594	
	1995.02-1998.10	MT	L	F	All-wheel Drive Hatchback Engine N7A	218044	Drive Shaft		25	26	56.5	89	594	
	1995.02-1998.10	-	L/R	F	All-wheel Drive Hatchback Engine N7A	818004	Outer Joint		25	22	56.5	88.5	53.5	O
	1995.02-1998.02	-	L/R	F	Hatchback Engine N7A	818004	Outer Joint		25	22	56.5	88.5	53.5	O
	1995.02-1998.02	MT	R	F	Hatchback Engine N7A	636001	Inner Joint		26	33	40	68.6	100	
	1995.02-1998.02	MT	R	F	Hatchback Engine N7A	218179	Drive Shaft		25	26	56.5	89	908	
	1995.02-1998.02	MT	L	F	Hatchback Engine N7A	218019	Drive Shaft		25	26	56.5	89	591.5	
	1995.02-1998.10	MT	L	F	All-wheel Drive Hatchback Engine N7A	218019	Drive Shaft		25	26	56.5	89	591.5	
RS Cosworth (162 kW)	1995.02-1998.10	-	-	F	All-wheel Drive Hatchback Engine N5F	218033	Drive Shaft	94T	23	23	55	91	583	
	1995.02-1998.10	-	-	-	All-wheel Drive Hatchback Engine N5F	818077	Outer Joint	94T	23	22	55	91	64	O
ESCORT VII (GAL AFL)														
1.3 (44 kW)	1995.01-1999.02	MT	L/R	F	Saloon Engine J4B/J6A	818017	Outer Joint		23	20	48	80.5	49	O
	1995.01-1999.02	-	-	F	Saloon Engine J4B/J6A	618053	Inner Joint		23	22	40	61	91.5	
1.4 (55 kW)	1995.01-1999.02	MT	R	F	Saloon Engine F4B/FUH	218039	Drive Shaft		25	23	56.5	88.5	903	
	1995.01-1999.02	-	L	F	Saloon Engine F4B/FUH	218040	Drive Shaft		25	23	56.5	88.5	608	
	1995.01-1999.02	-	-	F	Saloon Engine F4B/FUH	618053	Inner Joint		23	22	40	61	91.5	
1.6 i 16V (65 kW)	1995.01-1995.08	-	L/R	F	Saloon Engine L1H	818021	Outer Joint		25	25	56.5	89	56.5	O
	1995.01-1995.08	MT	R	F	Saloon Engine L1H	218039	Drive Shaft		25	23	56.5	88.5	903	
	1995.01-1995.08	-	L	F	Saloon Engine L1H	218040	Drive Shaft		25	23	56.5	88.5	608	
	1995.01-1995.08	-	-	F	Saloon Engine L1H	618053	Inner Joint		23	22	40	61	91.5	
1.6 i 16V (66 kW)	1995.01-1999.02	MT	-	F	Saloon Engine L1E/L1K	618053	Inner Joint		23	22	40	61	91.5	
	1995.01-1999.02	MT	R	F	Saloon Engine L1E/L1K	218039	Drive Shaft		25	23	56.5	88.5	903	
	1995.01-1999.02	-	L	F	Saloon Engine L1E/L1K	218040	Drive Shaft		25	23	56.5	88.5	608	
1.8 16V (77 kW)	1995.01-1995.08	MT	L	F	Saloon Engine RDA	218044	Drive Shaft		25	26	56.5	89	594	
	1995.01-1995.08	-	L	F	Saloon Engine RDA	218040	Drive Shaft		25	23	56.5	88.5	608	
	1995.01-1995.08	-	-	F	Saloon Engine RDA	618053	Inner Joint		23	22	40	61	91.5	
1.8 16V (85 kW)	1995.01-1999.02	MT	L	F	Saloon Engine RKC	218044	Drive Shaft		25	26	56.5	89	594	
	1995.01-1999.02	-	L	F	Saloon Engine RKC	218040	Drive Shaft		25	23	56.5	88.5	608	
	1995.01-1999.02	-	-	F	Saloon Engine RKC	618053	Inner Joint		23	22	40	61	91.5	
	1995.01-1999.02	MT	L	F	Saloon Engine RKC	218019	Drive Shaft		25	26	56.5	89	591.5	
1.8 D (44 kW)	1995.01-1996.12	MT	R	F	Saloon Engine RTE/RTF/RTH	218039	Drive Shaft		25	23	56.5	88.5	903	
	1995.01-1996.12	-	L	F	Saloon Engine RTE/RTF/RTH	218040	Drive Shaft		25	23	56.5	88.5	608	
	1995.01-1996.12	-	-	F	Saloon Engine RTE/RTF/RTH	618053	Inner Joint		23	22	40	61	91.5	
1.8 TD (66 kW)	1995.01-1999.02	MT	L/R	F	Saloon Engine RFD/RFK	818021	Outer Joint		25	25	56.5	89	56.5	O
	1995.01-1999.02	-	-	F	Saloon Engine RFD/RFK	818016	Outer Joint		25	30	56.5	89	56.5	I
	1995.01-1999.02	MT	R	F	Saloon Engine RFD/RFK	218103	Drive Shaft		25	25	56.5	89	816.5	
	1995.01-1999.02	MT	R	F	Saloon Engine RFD/RFK	218015	Drive Shaft		25	26	56.5	89	906	
	1995.01-1999.02	MT	L	F	Saloon Engine RFD/RFK	218019	Drive Shaft		25	26	56.5	89	591.5	
1.8 Turbo D (51 kW)	1995.12-1999.02	MT	L/R	F	Saloon Engine RVA	818021	Outer Joint		25	25	56.5	89	56.5	O
	1995.12-1999.02	MT	L	F	Saloon Engine RVA	218044	Drive Shaft		25	26	56.5	89	594	
	1995.12-1999.02	-	L	F	Saloon Engine RVA	218038	Drive Shaft		25	26	56.5	89	596	
	1995.12-1999.02	-	R	F	Saloon Engine RVA	218103	Drive Shaft		25	25	56.5	89	816.5	
	1995.12-1999.02	-	R	F	Saloon Engine RVA	218015	Drive Shaft		25	26	56.5	89	906	
ESCORT VII (GAL, ANL)/ESCORT NOMADE														
1.4(54 kW)	1995.01-1996.12	-	L/R	F	Estate/Clipper/Turnier Engine F4B	818021	Outer Joint		25	25	56.5	89	56.5	O
	1995.01-1996.12	-	L/R	F	Estate/Clipper/Turnier Engine F4B	818004	Outer Joint		25	22	56.5	88.5	53.5	O
ESCORT VII Turnier (GAL ANL)/ESCORT NOMADE														
1.3 (44 kW)	1995.01-1999.01	MT	L/R	F	Estate Engine J4B/J6A	818017	Outer Joint		23	20	48	80.5	49	O
	1995.01-1999.01	-	-	F	Estate Engine J4B/J6A	618053	Inner Joint		23	22	40	61	91.5	
1.4 (55 kW)	1995.01-1999.02	MT	L	F	Estate Engine F4B/FUH	218040	Drive Shaft		25	23	56.5	88.5	608	
	1995.01-1999.02	MT	R	F	Estate Engine F4B/FUH	218039	Drive Shaft		25	23	56.5	88.5	903	
	1995.01-1999.02	-	-	F	Estate Engine F4B/FUH	618053	Inner Joint		23	22	40	61	91.5	
1.6 16V (66 kW)	1995.01-1999.02	MT	R	F	Estate Engine L1E	218039	Drive Shaft		25	23	56.5	88.5	903	
	1995.01-1999.02	-	L	F	Estate Engine L1E	218040	Drive Shaft		25	23	56.5	88.5	608	
	1995.01-1999.02	-	-	F	Estate Engine L1E	618053	Inner Joint		23	22	40	61	91.5	
1.6 i 16V (65 kW)	1995.01-1995.08	MT	R	F	Estate Engine L1H	218039	Drive Shaft		25	23	56.5	88.5	903	
	1995.01-1995.08	-	L	F	Estate Engine L1H	218040	Drive Shaft		25	23	56.5	88.5	608	
	1995.01-1995.08	-	-	F	Estate Engine L1H	618053	Inner Joint		23	22	40	61	91.5	
1.8 16V (77 kW)	1995.01-1995.08	MT	L	F	Estate Engine RDA	218044	Drive Shaft		25	26	56.5	89	594	
	1995.01-1995.08	-	L	F	Estate Engine RDA	218040	Drive Shaft		25	23	56.5	88.5	608	
	1995.01-1995.08	-	-	F	Estate Engine RDA	618053	Inner Joint		23	22	40	61	91.5	

YEAR	TRANSM	L/R	F/R	REMARKS	GSP Ref.	PRODUCT	ABS	Technical Specifications						
								A	B	C	H	L	P	
FORD														
ESCORT VII Turnier (GAL ANL)/ESCORT NOMADE														
1.8 16V (85 kW)	1995.01-1999.02	MT	L	F	Estate Engine RKC	218044	Drive Shaft		25	26	56.5	89	594	
	1995.01-1999.02	-	L	F	Estate Engine RKC	218040	Drive Shaft		25	23	56.5	88.5	608	
	1995.01-1999.02	-	-	F	Estate Engine RKC	618053	Inner Joint		23	22	40	61	91.5	
	1995.01-1999.02	MT	L	F	Estate Engine RKC	218019	Drive Shaft		25	26	56.5	89	591.5	
1.8 D (44 kW)	1995.01-1999.02	MT	R	F	Estate Engine RTE/RTF/RTH	218039	Drive Shaft		25	23	56.5	88.5	903	
	1995.01-1999.02	-	L	F	Estate Engine RTE/RTF/RTH	218040	Drive Shaft		25	23	56.5	88.5	608	
	1995.01-1999.02	-	-	F	Estate Engine RTE/RTF/RTH	618053	Inner Joint		23	22	40	61	91.5	
1.8 TD (66 kW)	1995.01-1999.02	MT	L/R	F	Estate Engine RFD/RFK	818021	Outer Joint		25	25	56.5	89	56.5	O
	1995.01-1999.02	MT	L	F	Estate Engine RFD/RFK	218044	Drive Shaft		25	26	56.5	89	594	
	1995.01-1999.02	-	R	F	Estate Engine RFD/RFK	218103	Drive Shaft		25	25	56.5	89	816.5	
	1995.01-1999.02	MT	L	F	Estate Engine RFD/RFK	218019	Drive Shaft		25	26	56.5	89	591.5	
	1995.01-1999.02	-	R	F	Estate Engine RFD/RFK	218015	Drive Shaft		25	26	56.5	89	906	
1.8 Turbo D (51 kW)	1995.12-1999.02	MT	R	F	Estate Engine RVA	818021	Outer Joint		25	25	56.5	89	56.5	O
	1995.12-1999.02	-	-	F	Estate Engine RVA	818016	Outer Joint		25	30	56.5	89	56.5	I
	1995.12-1999.02	MT	L	F	Estate Engine RVA	218044	Drive Shaft		25	26	56.5	89	594	
	1995.12-1999.02	-	L	F	Estate Engine RVA	218038	Drive Shaft		25	26	56.5	89	596	
	1995.12-1999.02	MT	R	F	Estate Engine RVA	218103	Drive Shaft		25	25	56.5	89	816.5	
	1995.12-1999.02	MT	R	F	Estate Engine RVA	218015	Drive Shaft		25	26	56.5	89	906	
ESCORT VIII														
1.8 TD	1998-2000	-	-	-	-	618041	Inner Joint		26	25	40	389	92	
ESCORT ZX2														
-	1998-2001	AT	-	-	-	618068	Inner Joint		24	28	35	63.9	89.5	
EXPEDITION														
-	2007-2012	-	-	-	-	818279	Propshaft CV Joint			28		38		I
-	2008-2015	-	-	-	-	299302	DRIVE SHAFT					38	804	
4X4	2001-2002	AT	L/R	-	-	618040	Inner Joint			28		97.5		
EXPEDITION/F150														
-	1997-2002	-	-	-	4WD	818057	Outer Joint		33	28	75.6	113.2	76	I
EXPLORER														
-	1995-2001	-	-	F	-	818055	Outer Joint		27	34	59.7	112	80	I
-	1995-2001	-	-	-	Truck	618037	Inner Joint		27	34	35.55	117.3	76	
-	1995-2001	-	L	-	Truck 4WD	218093	Drive Shaft		27	27	59.7	112	597.4	
-	2006-2008	-	-	-	-	818267	Outer Joint		27	24	66.3	110	58.5	M
-	2006-2010	-	-	-	-	618218	Propshaft CV Joint			26		35		
4.6	2006-2010	AT	L	-	-	618169	Inner Joint		27	24	35.55	117	81	
-	2006-2010	AT	R	-	-	618170	Inner Joint		27	24	44	58.5	69.5	
EXPLORER SPORT/SPORT TRAC														
-	2002-2005	-	-	-	Truck	618037	Inner Joint		27	34	35.55	117.3	76	
-	2002-2005	-	L	-	Truck 4WD	218093	Drive Shaft		27	27	59.7	112	597.4	
F-150														
-	2004-2014	-	-	-	-	618189	Inner Joint		31	39	46	130	98	
-	2009-2014	-	-	-	-	299302	DRIVE SHAFT					38	804	
4X4	1997-2002	-	L/R	-	-	618040	Inner Joint			28		97.5		
F-250														
-	1997-1999	-	-	-	4WD	818057	Outer Joint		33	28	75.6	113.2	76	I
-	2004-2014	-	-	-	-	618189	Inner Joint		31	39	46	130	98	
4X4	1997-2000	-	L/R	-	-	618040	Inner Joint			28		97.5		
F-350														
-	2004-2014	-	-	-	-	618189	Inner Joint		31	39	46	130	98	
F150 6														
-	-	-	-	-	-	818279	Propshaft CV Joint			28		38		I
FALCON														
-	1998.09-2002.08	-	L	-	6 Cyl	218138	Drive Shaft	50T	28	28	60	110.5	771	
-	1998.09-2002.08	-	R	-	6 Cyl	218137	Drive Shaft	50T	28	28	60	110.5	868	
FESTIVA														
-	-	-	-	-	-	618008	Inner Joint		22	19	35	59	82	
1.5	1997-2001	MT	L	-	WF	227024	Drive Shaft		24	26	52	86	605	
-	1997-2001	MT	R	-	WF	227026	Drive Shaft		24	26	52	86	888	
-	1997-2001	MT	L/R	-	WF	627008	Inner Joint		26	22	35	66.5	95	
FIESTA														
-	1999-	-	-	-	-	618072	Inner Joint		23	22	40	61	86	
FIESTA (F3L F5L)/COURIER														
1.3 (44 kW)	1991.09-1996.02	MT	L/R	F	Box Engine J6B	818015	Outer Joint		23	22	48	80	52.5	O
-	1991.09-1996.02	-	-	F	Box Engine J6B	618053	Inner Joint		23	22	40	61	91.5	
-	1991.09-1996.02	-	L	F	Box Engine J6B	218118	Drive Shaft		23	23	48	80	583.5	





YEAR	TRANS	L/R	F/R	REMARKS	GSP Ref.	PRODUCT	ABS	Technical Specifications									
								A	B	C	H	L	P				
FORD																	
FIESTA (F3L F5L)/COURIER																	
1.3 (44 kW)	1991.09-1996.02	-	-	R	Box Engine J6B	899012	Outer Joint	20	19	42	90	47	M				
	1991.09-1996.02	-	-	R	F Box Engine J6B	218289	Drive Shaft	23	23	48	80	857					
1.8 D (44 kW)	1991.09-1996.02	MT	L/R	F	Box Engine RTD/RTG/RTC	818015	Outer Joint	23	22	48	80	52.5	O				
	1991.09-1996.02	-	-	F	Box Engine RTD/RTG/RTC	618053	Inner Joint	23	22	40	61	91.5					
	1991.09-1996.02	-	-	L	F Box Engine RTD/RTG/RTC	218118	Drive Shaft	23	23	48	80	583.5					
	1991.09-1996.02	-	-	R	Box Engine RTD/RTG/RTC	899012	Outer Joint	20	19	42	90	47	M				
	1991.09-1996.02	-	-	R	F Box Engine RTD/RTG/RTC	218289	Drive Shaft	23	23	48	80	857					
FIESTA (FVD)																	
1.0 (33 kW)	1983.08-1989.11	MT	L/R	F	Box Engine TKB	618002	Inner Joint	23	20	40	61.5	62.5					
	1983.08-1989.11	MT	L/R	F	Box Engine TKB	818017	Outer Joint	23	20	48	80.5	49	O				
1.4 (52 kW)	1986.09-1989.09	-	-	F	Box Engine F6A	818019	Outer Joint	23	22	55	91.5	54.5	O				
	1986.09-1989.09	MT	L	F	Box Engine F6A	699075	Inner Joint	23	22	40	61	93	O				
1.6 D (40 kW)	1983.09-1989.09	-	-	F	Box Engine LTB	699075	Inner Joint	23	22	40	61	93	O				
1.8 D (43 kW)	1989.03-1995.12	MT	L	F	Box Engine RTD/RTG/RTC	218118	Drive Shaft	23	23	48	80	583.5					
	1989.03-1995.12	-	-	R	Box Engine RTD/RTG/RTC	899012	Outer Joint	20	19	42	90	47	M				
	1989.03-1995.12	MT	R	F	Box Engine RTD/RTG/RTC	218289	Drive Shaft	23	23	48	80	857					
	1989.03-1995.12	-	-	F	Box Engine RTD/RTG/RTC	618053	Inner Joint	23	22	40	61	91.5					
FIESTA (J5_J3)/COURIER																	
1.3 (44 kW)	1996.02-2003.08	-	-	R	F Box Engine J4C	618047	Inner Joint	25	22	30	283	81					
	1996.02-2003.08	-	-	F	Box Engine J4C	818022	Outer Joint	25	22	56.5	88.5	53.5	O				
	1996.02-2003.08	MT	L	F	Box Engine J4C	218141	Drive Shaft	25	23	55.5	88.5	606					
	1996.02-2003.08	MT	R	F	Box Engine J4C	218175	Drive Shaft	25	23	56.5	88.5	898					
	1996.02-2003.08	-	-	R	F Box Engine J4C	218011	Drive Shaft	25	25	55.5	88.5	813.5					
	1996.02-2003.08	MT	L/R	F	Box Engine J4C	818012	Outer Joint	25	20	56.5	88.5	49	O				
	1996.02-2003.08	-	-	R	F Box Engine J4C	218032	Drive Shaft	25	23	56.5	88.5	900					
1.4 i (66 kW)	1996.04-1999.10	-	-	R	F Box Engine FHA	618047	Inner Joint	25	22	30	283	81					
	1996.04-1999.10	-	-	F	Box Engine FHA	818022	Outer Joint	25	22	56.5	88.5	53.5	O				
	1996.04-1999.10	MT	L	F	Box Engine FHA	218141	Drive Shaft	25	23	55.5	88.5	606					
	1996.04-1999.10	MT	R	F	Box Engine FHA	218175	Drive Shaft	25	23	56.5	88.5	898					
	1996.04-1999.10	-	-	R	F Box Engine FHA	218011	Drive Shaft	25	25	55.5	88.5	813.5					
	1996.04-1999.10	MT	L/R	F	Box Engine FHA	818004	Outer Joint	25	22	56.5	88.5	53.5	O				
	1996.04-1999.10	-	-	R	F Box Engine FHA	218032	Drive Shaft	25	23	56.5	88.5	900					
1.8 D (44 kW)	1996.02-2002.04	-	-	R	F Box Engine RTK	618047	Inner Joint	25	22	30	283	81					
	1996.02-2002.04	-	-	F	Box Engine RTK	818022	Outer Joint	25	22	56.5	88.5	53.5	O				
	1996.02-2002.04	MT	L	F	Box Engine RTK	218141	Drive Shaft	25	23	55.5	88.5	606					
	1996.02-2002.04	-	-	L	F Box Engine RTK	299047	Drive Shaft	25	23	56.5	88.5	601.5					
	1996.02-2002.04	MT	R	F	Box Engine RTK	218175	Drive Shaft	25	23	56.5	88.5	898					
	1996.02-2002.04	-	-	R	F Box Engine RTK	218011	Drive Shaft	25	25	55.5	88.5	813.5					
	1996.02-2002.04	MT	L/R	F	Box Engine RTK	818004	Outer Joint	25	22	56.5	88.5	53.5	O				
	1996.02-2002.04	-	-	L/R	F Box Engine RTK	818012	Outer Joint	25	20	56.5	88.5	49	O				
	1996.02-2002.04	-	-	R	F Box Engine RTK	218032	Drive Shaft	25	23	56.5	88.5	900					
1.8 DI (55 kW)	2000.09-2003.08	-	-	F	Box Engine RTP/RTN	818022	Outer Joint	25	22	56.5	88.5	53.5	O				
	2000.09-2003.08	MT	L	F	Box Engine RTP/RTN	218141	Drive Shaft	25	23	55.5	88.5	606					
	2000.09-2003.08	-	-	L	F Box Engine RTP/RTN	299047	Drive Shaft	25	23	56.5	88.5	601.5					
	2000.09-2003.08	MT	R	F	Box Engine RTP/RTN	218175	Drive Shaft	25	23	56.5	88.5	898					
	2000.09-2003.08	-	-	L/R	F Box Engine RTP/RTN	818004	Outer Joint	25	22	56.5	88.5	53.5	O				
	2000.09-2003.08	-	-	R	F Box Engine RTP/RTN	218032	Drive Shaft	25	23	56.5	88.5	900					
FIESTA (JV)/COURIER																	
D 1.8 (44 kW)	1998.05-2002.04	-	-	F	Box Engine RTK/RTJ	818022	Outer Joint	25	22	56.5	88.5	53.5	O				
	1998.05-2002.04	MT	L/R	F	Box Engine RTK/RTJ	818004	Outer Joint	25	22	56.5	88.5	53.5	O				
	1998.05-2002.04	-	-	L/R	F Box Engine RTK/RTJ	818012	Outer Joint	25	20	56.5	88.5	49	O				
	1998.05-2002.04	-	-	R	F Box Engine RTK/RTJ	218032	Drive Shaft	25	23	56.5	88.5	900					
TD 1.8 (55 kW)	2000.03-2003.08	-	-	F	Box Engine RTP/RTN/RTQ	818022	Outer Joint	25	22	56.5	88.5	53.5	O				
	2000.03-2003.08	-	-	L/R	F Box Engine RTP/RTN/RTQ	818004	Outer Joint	25	22	56.5	88.5	53.5	O				
FIESTA GII																	
1.0	1996.01-1998.12	MT	-	-	-	899015	Outer Joint	25	20	56.5	88	49	O				
1.0 Zetec Rocan	1999.01-2006.12	MT	-	-	-	818099	Outer Joint	25	20	55	88	52	M				
1.3	1996.01-1998.12	MT	-	-	-	899015	Outer Joint	25	20	56.5	88	49	O				
FIESTA II (FBD)																	
1.0 (33 kW)	1983.09-1989.02	MT	L/R	F	Hatchback Engine TKB	618002	Inner Joint	23	20	40	61.5	62.5					
1.1 (36 kW)	1986.05-1989.02	MT	L/R	F	Hatchback Engine GSH	618002	Inner Joint	23	20	40	61.5	62.5					
1.1 (37 kW)	1983.09-1989.02	-	-	F	Hatchback Engine GLC/GSF	818018	Outer Joint	23	20	50	91.5	52	O				
	1983.09-1989.02	MT	L/R	F	Hatchback Engine GLC/GSF	618002	Inner Joint	23	20	40	61.5	62.5					
1.4 (52 kW)	1986.10-1989.02	MT	-	F	Hatchback Engine F6A/F6C	818019	Outer Joint	23	22	55	91.5	54.5	O				
	1986.10-1989.02	MT	L	F	Hatchback Engine F6A/F6C	699075	Inner Joint	23	22	40	61	93	O				
1.4 (54 kW)	1987.02-1989.02	MT	-	F	Hatchback Engine FUD	818019	Outer Joint	23	22	55	91.5	54.5	O				

	 YEAR	TRANSM	L/R	F/R	REMARKS	GSP Ref.	 PRODUCT	 ABS	Technical Specifications						
									A	B	C	H	L	P	
FORD															
FIESTA II (FBD)															
1.4 (54 kW)	1987.02-1989.02	MT	L	F	Hatchback Engine FUD	699075	Inner Joint		23	22	40	61	93	O	
1.4 (55 kW)	1985.10-1989.11	-	-	F	Hatchback Engine FUB	699121	Inner Joint			22		29			
	1985.10-1989.11	-	-	F	Hatchback Engine FUB	818019	Outer Joint		23	22	55	91.5	54.5	O	
	1985.10-1989.11	MT	L	F	Hatchback Engine FUB	699075	Inner Joint		23	22	40	61	93	O	
1.6 D (40 kW)	1984.04-1989.02	-	-	F	Hatchback Engine LTB	818018	Outer Joint		23	20	50	91.5	52	O	
	1984.04-1989.02	MT	L/R	F	Hatchback Engine LTB	618002	Inner Joint		23	20	40	61.5	62.5		
1.6 XR2 (70 kW)	1984.03-1989.02	-	-	F	Hatchback Engine LUD	699075	Inner Joint		23	22	40	61	93	O	
1.6 XR2 (71 kW)	1984.04-1989.02	-	-	F	Hatchback Engine LUB	699075	Inner Joint		23	22	40	61	93	O	
FIESTA III (GFJ)															
1.0 (33 kW)	1989.03-1995.12	MT	L/R	F	Hatchback Engine TLB	818017	Outer Joint		23	20	48	80.5	49	O	
	1989.03-1995.12	-	-	-	Hatchback Engine TLB	899012	Outer Joint		20	19	42	90	47	M	
	1989.03-1995.12	-	-	F	Hatchback Engine TLB	618053	Inner Joint		23	22	40	61	91.5		
	1989.03-1995.12	MT	L/R	F	Hatchback Engine TLB	618002	Inner Joint		23	20	40	61.5	62.5		
1.1 (37 kW)	1989.03-1995.12	MT	L/R	F	Hatchback Engine G6A	818017	Outer Joint		23	20	48	80.5	49	O	
	1989.03-1995.12	-	-	F	Hatchback Engine G6A	618053	Inner Joint		23	22	40	61	91.5		
	1989.03-1995.12	-	-	-	Hatchback Engine G6A	899012	Outer Joint		20	19	42	90	47	M	
	1989.03-1995.12	-	R	F	Hatchback Engine G6A	299044	Drive Shaft		25	23	56.5	88.5	866		
	1989.03-1995.12	MT	L/R	F	Hatchback Engine G6A	618002	Inner Joint		23	20	40	61.5	62.5		
1.1 (40 kW)	1989.03-1995.12	-	L	F	Hatchback Engine GUE/GUD	218007	Drive Shaft		25	23	56.5	88.5	590		
	1989.03-1995.12	MT	L/R	F	Hatchback Engine GUE/GUD	818017	Outer Joint		23	20	48	80.5	49	O	
	1989.03-1995.12	-	-	F	Hatchback Engine GUE/GUD	618053	Inner Joint		23	22	40	61	91.5		
	1989.03-1995.12	-	-	-	Hatchback Engine GUE/GUD	899012	Outer Joint		20	19	42	90	47	M	
	1989.03-1995.12	-	R	F	Hatchback Engine GUE/GUD	299044	Drive Shaft		25	23	56.5	88.5	866		
	1989.03-1995.12	MT	L/R	F	Hatchback Engine GUE/GUD	618002	Inner Joint		23	20	40	61.5	62.5		
	1989.03-1995.12	-	R	F	Hatchback Engine GUE/GUD	218140	Drive Shaft		25	23	56.5	88.5	868		
	1989.03-1995.12	MT	L/R	F	Hatchback Engine JBB/JBC	818015	Outer Joint		23	22	48	80	52.5	O	
1.3 (44 kW)	1989.03-1992.12	MT	L/R	F	Hatchback Engine JBC	818015	Outer Joint		23	22	48	80	52.5	O	
	1989.03-1995.12	MT	L	F	Hatchback Engine JBB/JBC	218284	Drive Shaft		25	23	56.5	88.5	585		
	1989.03-1995.12	-	L	F	Hatchback Engine JBB/JBC	218118	Drive Shaft		23	23	48	80	583.5		
	1989.03-1995.12	-	R	F	Hatchback Engine JBB/JBC	218289	Drive Shaft		23	23	48	80	857		
	1989.03-1995.12	-	-	-	Hatchback Engine JBB/JBC	899012	Outer Joint		20	19	42	90	47	M	
	1989.03-1992.12	-	-	-	Hatchback Engine JBC	899012	Outer Joint		20	19	42	90	47	M	
	1989.03-1992.12	-	-	F	Hatchback Engine JBC	618053	Inner Joint		23	22	40	61	91.5		
	1989.03-1995.12	-	-	F	Hatchback Engine JBB/JBC	618053	Inner Joint		23	22	40	61	91.5		
	1.3 Cat (44 kW)	1991.05-1997.01	MT	L/R	F	Hatchback Engine J6B	818015	Outer Joint		23	22	48	80	52.5	O
		1991.05-1997.01	MT	L	F	Hatchback Engine J6B	218284	Drive Shaft		25	23	56.5	88.5	585	
1991.05-1997.01		-	-	F	Hatchback Engine J6B	618053	Inner Joint		23	22	40	61	91.5		
1991.05-1997.01		-	L	F	Hatchback Engine J6B	218118	Drive Shaft		23	23	48	80	583.5		
1991.05-1997.01		-	R	F	Hatchback Engine J6B	218289	Drive Shaft		23	23	48	80	857		
1991.05-1997.01		-	-	-	Hatchback Engine J6B	899012	Outer Joint		20	19	42	90	47	M	
1.4 (52 kW)	1989.03-1995.12	MT	L/R	F	Hatchback Engine F6E	818015	Outer Joint		23	22	48	80	52.5	O	
	1989.03-1995.12	-	-	F	Hatchback Engine F6E	618053	Inner Joint		23	22	40	61	91.5		
	1989.03-1995.12	-	L	F	Hatchback Engine F6E	218118	Drive Shaft		23	23	48	80	583.5		
	1989.03-1995.12	-	R	F	Hatchback Engine F6E	218289	Drive Shaft		23	23	48	80	857		
	1989.03-1995.12	-	-	-	Hatchback Engine F6E	899012	Outer Joint		20	19	42	90	47	M	
1.4 (54 kW)	1989.03-1995.12	MT	L/R	F	Hatchback Engine FUG/FUJ	818015	Outer Joint		23	22	48	80	52.5	O	
	1989.03-1995.12	-	-	F	Hatchback Engine FUG/FUJ	618053	Inner Joint		23	22	40	61	91.5		
	1989.03-1995.12	-	L	F	Hatchback Engine FUG/FUJ	218118	Drive Shaft		23	23	48	80	583.5		
	1989.03-1995.12	-	R	F	Hatchback Engine FUG/FUJ	218289	Drive Shaft		23	23	48	80	857		
	1989.03-1995.12	-	-	-	Hatchback Engine FUG/FUJ	899012	Outer Joint		20	19	42	90	47	M	
1.4 (55 kW)	1992.11-1996.12	-	-	-	Hatchback Engine FUF	899012	Outer Joint		20	19	42	90	47	M	
	1992.11-1996.12	-	-	F	Hatchback Engine FUF	618053	Inner Joint		23	22	40	61	91.5		
1.4 Cat (54 kW)	1989.03-1995.12	MT	L/R	F	Hatchback Engine F4A	818015	Outer Joint		23	22	48	80	52.5	O	
	1989.03-1995.12	-	L	F	Hatchback Engine F4A	218118	Drive Shaft		23	23	48	80	583.5		
	1989.03-1995.12	-	-	F	Hatchback Engine F4A	618053	Inner Joint		23	22	40	61	91.5		
	1989.03-1995.12	-	R	F	Hatchback Engine F4A	218289	Drive Shaft		23	23	48	80	857		
	1989.03-1995.12	-	-	-	Hatchback Engine F4A	899012	Outer Joint		20	19	42	90	47	M	
1.6 (65 kW)	1989.01-1994.01	MT	L/R	F	Hatchback Engine LUH	818015	Outer Joint		23	22	48	80	52.5	O	
	1989.01-1994.01	-	-	F	Hatchback Engine LUH	618053	Inner Joint		23	22	40	61	91.5		
	1989.01-1994.01	-	-	-	Hatchback Engine LUH	899012	Outer Joint		20	19	42	90	47	M	
1.6 (66 kW)	1989.03-1992.12	-	-	-	Hatchback Engine LUH	899012	Outer Joint		20	19	42	90	47	M	
	1989.03-1992.12	-	-	F	Hatchback Engine LUH	618053	Inner Joint		23	22	40	61	91.5		
1.6 i 16V (65 kW)	1994.01-1995.12	MT	L	F	Hatchback Engine L1G	218284	Drive Shaft		25	23	56.5	88.5	585		
	1994.01-1995.12	-	-	-	Hatchback Engine L1G	899012	Outer Joint		20	19	42	90	47	M	
	1994.01-1995.12	-	-	F	Hatchback Engine L1G	618053	Inner Joint		23	22	40	61	91.5		
1.6 Turbo (96 kW)	1990.03-1992.10	-	-	-	Hatchback Engine LHA	899012	Outer Joint		20	19	42	90	47	M	

	 YEAR	TRANSM	L/R	F/R	REMARKS	GSP Ref.	 PRODUCT	 ABS	Technical Specifications						
									A	B	C	H	L	P	
FORD															
FIESTA III (GFJ)															
1.6 Turbo (96 kW)	1990.03-1992.10	-	-	F	Hatchback Engine LHA	618053	Inner Joint		23	22	40	61	91.5		
1.6 XR2i (76 kW)	1989.03-1993.03	MT	L/R	F	Hatchback Engine LJD	818015	Outer Joint		23	22	48	80	52.5	O	
	1989.03-1993.03	-	-	F	Hatchback Engine LJD	618053	Inner Joint		23	22	40	61	91.5		
	1989.03-1993.03	-	-	-	Hatchback Engine LJD	899012	Outer Joint		20	19	42	90	47	M	
1.6 XR2i (81 kW)	1989.03-1994.01	MT	L/R	F	Hatchback Engine LJC	818015	Outer Joint		23	22	48	80	52.5	O	
	1989.03-1994.01	-	-	-	Hatchback Engine LJC	899012	Outer Joint		20	19	42	90	47	M	
	1989.03-1994.01	-	-	F	Hatchback Engine LJC	618053	Inner Joint		23	22	40	61	91.5		
1.8 16V (77 kW)	1992.02-1995.12	MT	L/R	F	Hatchback Engine RDB	818015	Outer Joint		23	22	48	80	52.5	O	
	1992.02-1995.12	-	-	F	Hatchback Engine RDB	618053	Inner Joint		23	22	40	61	91.5		
	1992.02-1995.12	-	L	F	Hatchback Engine RDB	218118	Drive Shaft		23	23	48	80	583.5		
	1992.02-1995.12	-	R	F	Hatchback Engine RDB	218289	Drive Shaft		23	23	48	80	857		
	1992.02-1995.12	-	-	-	Hatchback Engine RDB	899012	Outer Joint		20	19	42	90	47	M	
1.8 D (44 kW)	1989.03-1995.12	MT	L/R	F	Hatchback Engine RTC/RTD/RTG	818015	Outer Joint		23	22	48	80	52.5	O	
	1989.03-1995.12	MT	L	F	Hatchback Engine RTC/RTD/RTG	218284	Drive Shaft		25	23	56.5	88.5	585		
	1989.03-1995.12	-	-	F	Hatchback Engine RTC/RTD/RTG	618053	Inner Joint		23	22	40	61	91.5		
	1989.03-1995.12	-	L	F	Hatchback Engine RTC/RTD/RTG	218118	Drive Shaft		23	23	48	80	583.5		
	1989.03-1995.12	-	R	F	Hatchback Engine RTC/RTD/RTG	218289	Drive Shaft		23	23	48	80	857		
	1989.03-1995.12	-	-	-	Hatchback Engine RTC/RTD/RTG	899012	Outer Joint		20	19	42	90	47	M	
1.8 TD (55 kW)	1993.03-1995.12	-	-	F	Hatchback Engine RFL	618053	Inner Joint		23	22	40	61	91.5		
1.8 XR2i 16V (96 kW)	1992.02-1995.12	MT	L/R	F	Hatchback Engine RQC	818015	Outer Joint		23	22	48	80	52.5	O	
	1992.02-1995.12	-	-	F	Hatchback Engine RQC	618053	Inner Joint		23	22	40	61	91.5		
	1992.02-1995.12	-	L	F	Hatchback Engine RQC	218118	Drive Shaft		23	23	48	80	583.5		
	1992.02-1995.12	-	R	F	Hatchback Engine RQC	218289	Drive Shaft		23	23	48	80	857		
	1992.02-1995.12	-	-	-	Hatchback Engine RQC	899012	Outer Joint		20	19	42	90	47	M	
FIESTA IV															
1.3	1995.10-1997.01	MT	R	F	-	299043	Drive Shaft		25	25	56.5	88.5	813		
1.4	1996.02-1997.01	MT	R	F	-	299043	Drive Shaft		25	25	56.5	88.5	813		
1.8 D	1995.10-1997.01	MT	R	F	-	299043	Drive Shaft		25	25	56.5	88.5	813		
FIESTA IV (JA_ JB_)															
1.0 i (48 kW)	1999.09-2002.01	MT	L	F	Hatchback	218141	Drive Shaft		25	23	55.5	88.5	606		
	1999.09-2002.01	MT	R	F	Hatchback	218175	Drive Shaft		25	23	56.5	88.5	898		
1.1 (37 kW)	1995.09-1996.12	-	-	-	Hatchback	899012	Outer Joint		20	19	42	90	47	M	
1.25 i 16V (55 kW)	1995.08-2002.01	-	-	F	Hatchback Engine DHE/DHF/DHG/DHA/DHB/DHC/DHD	818022	Outer Joint		25	22	56.5	88.5	53.5	O	
	1995.08-2002.01	MT	L	F	Hatchback Engine DHE/DHF/DHG/DHA/DHB/DHC/DHD	218141	Drive Shaft		25	23	55.5	88.5	606		
	1995.08-2002.01	MT	R	F	Hatchback Engine DHE/DHF/DHG/DHA/DHB/DHC/DHD	218175	Drive Shaft		25	23	56.5	88.5	898		
	1995.08-2002.01	MT	L/R	F	Hatchback Engine DHE/DHF/DHG/DHA/DHB/DHC/DHD	818004	Outer Joint		25	22	56.5	88.5	53.5	O	
	1995.08-2002.01	-	R	F	Hatchback Engine DHE/DHF/DHG/DHA/DHB/DHC/DHD	218032	Drive Shaft		25	23	56.5	88.5	900		
1.3 (42 kW)	1996.04-1999.08	-	-	F	Hatchback	818022	Outer Joint		25	22	56.5	88.5	53.5	O	
	1996.04-1999.08	-	R	F	Hatchback	218032	Drive Shaft		25	23	56.5	88.5	900		
1.3 i (37 kW)	1995.08-2002.01	-	R	F	Hatchback Engine JJA/JJC/JJE/JJJ/JJK/JJM	618047	Inner Joint		25	22	30	283	81		
	1995.08-2002.01	-	-	F	Hatchback Engine JJA/JJC/JJE/JJJ/JJK/JJM	818022	Outer Joint		25	22	56.5	88.5	53.5	O	
	1995.08-2002.01	MT	L	F	Hatchback Engine JJA/JJC/JJE/JJJ/JJK/JJM	218141	Drive Shaft		25	23	55.5	88.5	606		
	1995.08-2002.01	MT	R	F	Hatchback Engine JJA/JJC/JJE/JJJ/JJK/JJM	218175	Drive Shaft		25	23	56.5	88.5	898		
	1995.08-2002.01	-	R	F	Hatchback Engine JJA/JJC/JJE/JJJ/JJK/JJM	218011	Drive Shaft		25	25	55.5	88.5	813.5		
	1995.08-2002.01	MT	L/R	F	Hatchback Engine JJA/JJC/JJE/JJJ/JJK/JJM	818012	Outer Joint		25	20	56.5	88.5	49	O	
	1995.08-2002.01	-	R	F	Hatchback Engine JJA/JJC/JJE/JJJ/JJK/JJM	218032	Drive Shaft		25	23	56.5	88.5	900		
	1995.08-2002.01	-	R	F	Hatchback Engine J4L/JBC/J4C/J4J/J4Q/J4R/J4T	618047	Inner Joint		25	22	30	283	81		
1.3 i (44 kW)	1995.08-2002.01	MT	L	F	Hatchback Engine J4L/JBC/J4C/J4J/J4Q/J4R/J4T	218284	Drive Shaft		25	23	56.5	88.5	585		
	1995.08-2002.01	-	-	F	Hatchback Engine J4L/JBC/J4C/J4J/J4Q/J4R/J4T	818022	Outer Joint		25	22	56.5	88.5	53.5	O	
	1995.08-2002.01	MT	L	F	Hatchback Engine J4L/JBC/J4C/J4J/J4Q/J4R/J4T	218141	Drive Shaft		25	23	55.5	88.5	606		
	1995.08-2002.01	MT	R	F	Hatchback Engine J4L/JBC/J4C/J4J/J4Q/J4R/J4T	218175	Drive Shaft		25	23	56.5	88.5	898		
	1995.08-2002.01	-	R	F	Hatchback Engine J4L/JBC/J4C/J4J/J4Q/J4R/J4T	218011	Drive Shaft		25	25	55.5	88.5	813.5		
	1995.08-2002.01	MT	L/R	F	Hatchback Engine J4L/JBC/J4C/J4J/J4Q/J4R/J4T	818012	Outer Joint		25	20	56.5	88.5	49	O	
	1995.08-2002.01	-	R	F	Hatchback Engine J4L/JBC/J4C/J4J/J4Q/J4R/J4T	218032	Drive Shaft		25	23	56.5	88.5	900		
	1995.08-2002.01	-	-	F	Hatchback Engine J4L/J4J/J4C/J4Q/J4R/J4T	818022	Outer Joint		25	22	56.5	88.5	53.5	O	
	1996.04-1999.08	MT	L/R	F	Hatchback Engine J4L/J4J/J4C/J4Q/J4R/J4T	818012	Outer Joint		25	20	56.5	88.5	49	O	
	1996.04-1999.08	-	R	F	Hatchback Engine J4L/J4J/J4C/J4Q/J4R/J4T	218032	Drive Shaft		25	23	56.5	88.5	900		
	1.4 i 16V (66 kW)	1996.04-2002.01	-	-	F	Hatchback Engine FHA/FHE	818022	Outer Joint		25	22	56.5	88.5	53.5	O
		1996.04-2002.01	MT	L	F	Hatchback Engine FHA/FHE	218141	Drive Shaft		25	23	55.5	88.5	606	
		1996.04-2002.01	MT	R	F	Hatchback Engine FHA/FHE	218175	Drive Shaft		25	23	56.5	88.5	898	
1996.04-2002.01		MT	L/R	F	Hatchback Engine FHA/FHE	818004	Outer Joint		25	22	56.5	88.5	53.5	O	
1996.04-2002.01		-	R	F	Hatchback Engine FHA/FHE	218032	Drive Shaft		25	23	56.5	88.5	900		
1.6 (65 kW)		2000.02-2002.01	-	-	F	Hatchback	818022	Outer Joint		25	22	56.5	88.5	53.5	O
1.6 16V Sport (76 kW)	2000.02-2002.01	-	L/R	F	Hatchback Engine L1T/L1V	818006	Outer Joint		25	22	55.5	88.5	53	O	
	2000.02-2002.01	-	-	F	Hatchback Engine L1T/L1V	818022	Outer Joint		25	22	56.5	88.5	53.5	O	
	2000.02-2002.01	MT	L	F	Hatchback Engine L1T/L1V	218141	Drive Shaft		25	23	55.5	88.5	606		

YEAR	TRANSM	L/R	F/R	REMARKS	GSP Ref.	PRODUCT	ABS	Technical Specifications							
								A	B	C	H	L	P		
FORD															
FIESTA IV (JA_ JB_)															
1.6 16V Sport (76 kW)	2000.02-2002.01		MT	R	F	Hatchback Engine L1T/L1V	218175	Drive Shaft		25	23	56.5	88.5	898	
1.8 D (44 kW)	1995.08-2000.04		-	-	F	Hatchback Engine RTJ/RTK	818022	Outer Joint		25	22	56.5	88.5	53.5	O
	1995.08-2000.04		MT	L	F	Hatchback Engine RTJ/RTK	218141	Drive Shaft		25	23	55.5	88.5	606	
	1995.08-2000.04		MT	R	F	Hatchback Engine RTJ/RTK	218175	Drive Shaft		25	23	56.5	88.5	898	
	1995.08-2000.04		MT	L/R	F	Hatchback Engine RTJ/RTK	818004	Outer Joint		25	22	56.5	88.5	53.5	O
	1995.08-2000.04		-	R	F	Hatchback Engine RTJ/RTK	218032	Drive Shaft		25	23	56.5	88.5	900	
1.8 DI (55 kW)	2000.04-2002.01		-	-	F	Hatchback Engine RTN/RTP/RTQ	818022	Outer Joint		25	22	56.5	88.5	53.5	O
	2000.04-2002.01		MT	L	F	Hatchback Engine RTN/RTP/RTQ	218141	Drive Shaft		25	23	55.5	88.5	606	
	2000.04-2002.01		MT	R	F	Hatchback Engine RTN/RTP/RTQ	218175	Drive Shaft		25	23	56.5	88.5	898	
	2000.04-2002.01		-	L/R	F	Hatchback Engine RTN/RTP/RTQ	818004	Outer Joint		25	22	56.5	88.5	53.5	O
FIESTA V (JH_ JD)															
1.2 16V (51 kW)	2003.03-		-	-	-		818092	Outer Joint		25	22	53	88	51	M
1.3 (44 kW)	2001.11-		-	-	-		818092	Outer Joint		25	22	53	88	51	M
1.3 (51 kW)	2001.11-		-	-	-		818092	Outer Joint		25	22	53	88	51	M
1.4 16V (59 kW)	2001.11-		-	-	-		818092	Outer Joint		25	22	53	88	51	M
FIESTA V (JH_ JD_)															
1.25 16V (51 kW)	2003.03-2008.06		MT	-	F	Hatchback Engine M7JA/M7JB	818009	Outer Joint		25	22	53.3	90	51	M
1.25 16V (55 kW)	2002.05-2008.06		MT	-	F	Hatchback Engine FUJB/FUJA	818009	Outer Joint		25	22	53.3	90	51	M
1.3 (44 kW)	2001.11-2008.06		AT	-	F	Hatchback Engine BAJA	818014	Outer Joint		25	21	53.2	89	54	M
	2001.11-2008.06		MT	-	F	Hatchback Engine BAJA	818009	Outer Joint		25	22	53.3	90	51	M
1.3 (51 kW)	2001.11-2008.06		AT	-	F	Hatchback Engine A9JA/A9JB	818014	Outer Joint		25	21	53.2	89	54	M
	2001.11-2008.06		MT	-	F	Hatchback Engine A9JA/A9JB	818009	Outer Joint		25	22	53.3	90	51	M
1.4 16V (59 kW)	2001.11-2008.06		AMT	L	F	Hatchback Engine FXJA/FXJB	218202	Drive Shaft		25	23	53	88	620	
	2001.11-2008.06		AMT	R	F	Hatchback Engine FXJA/FXJB	218201	Drive Shaft		25	23	53.3	90	919	
	2001.11-2008.06		MT	-	F	Hatchback Engine FXJA/FXJB	818014	Outer Joint		25	21	53.2	89	54	M
	2001.11-2008.06		MT	-	F	Hatchback Engine FXJA/FXJB	818009	Outer Joint		25	22	53.3	90	51	M
1.4 TDCi (50 kW)	2001.11-2008.06		MT	-	F	Hatchback Engine F6JB/F6JA	818014	Outer Joint		25	21	53.2	89	54	M
	2001.11-2008.06		-	R	F	Hatchback Engine F6JB/F6JA	218217	Drive Shaft		25	23	52.9	89	916	
	2001.11-2008.06		-	L	F	Hatchback Engine F6JB/F6JA	218216	Drive Shaft		25	23	53.3	90	621	
	2001.11-2008.06		MT	L	F	Hatchback Engine F6JB/F6JA	618085	Inner Joint		23	22	40	61	90	
	2001.11-2008.06		MT	-	F	Hatchback Engine F6JB/F6JA	818001	Outer Joint		25	20	52.9	89	52	M
	2001.11-2008.06		MT	-	F	Hatchback Engine F6JB/F6JA	818009	Outer Joint		25	22	53.3	90	51	M
1.6 16V (74 kW)	2001.11-2008.06		MT	L	F	Hatchback Engine FYJA/FYJB	218202	Drive Shaft		25	23	53	88	620	
	2001.11-2008.06		AT/MT	-	F	Hatchback Engine FYJA/FYJB	818014	Outer Joint		25	21	53.2	89	54	M
	2001.11-2008.06		MT	R	F	Hatchback Engine FYJA/FYJB	218201	Drive Shaft		25	23	53.3	90	919	
	2001.11-2008.06		AT	L	F	Hatchback Engine FYJA/FYJB	218351	Drive Shaft		25	22	53.3	89	606	
	2001.11-2008.06		AT	R	F	Hatchback Engine FYJA/FYJB	218333	Drive Shaft		25	22	53.3	89	930	
	2001.11-2008.06		AT	L	F	Hatchback Engine FYJA/FYJB	657115	Inner Joint		22	21	38	59.5	97.5	
	2001.11-2008.06		AT	R	F	Hatchback Engine FYJA/FYJB	618103	Inner Joint		22	21	38	403.5	84.5	
	2001.11-2008.06		-	-	F	Hatchback Engine FYJA/FYJB	818222	Outer Joint		25	23	53.3	87	56	M
1.6 TDCi (66 kW)	2004.11-2008.06		AT/MT	-	F	Hatchback Engine HHJA/HHJB	818014	Outer Joint		25	21	53.2	89	54	M
	2004.11-2008.06		MT	L	F	Hatchback Engine HHJA/HHJB	218309	Drive Shaft		25	23	52.9	89	615	
	2004.11-2008.06		MT	R	F	Hatchback Engine HHJA/HHJB	218326	Drive Shaft		25	23	53.38	88.5	915	
	2004.11-2008.06		AT	L	F	Hatchback Engine HHJA/HHJB	657115	Inner Joint		22	21	38	59.5	97.5	
	2004.11-2008.06		AT	R	F	Hatchback Engine HHJA/HHJB	618103	Inner Joint		22	21	38	403.5	84.5	
	2004.11-2008.06		-	-	F	Hatchback Engine HHJA/HHJB	818222	Outer Joint		25	23	53.3	87	56	M
ST150 (110 kW)	2005.03-2008.06		AT	-	F	Hatchback Engine N4JB	818014	Outer Joint		25	21	53.2	89	54	M
	2005.03-2008.06		MT	L	F	Hatchback Engine N4JB	218309	Drive Shaft		25	23	52.9	89	615	
	2005.03-2008.06		MT	R	F	Hatchback Engine N4JB	218326	Drive Shaft		25	23	53.38	88.5	915	
	2005.03-2008.06		MT	R	F	Hatchback Engine N4JB	218018	Drive Shaft		25	23	53.2	89	930	
FIESTA V Van															
1.4 TDCi (50 kW)	2003.10-2010.12		-	R	F	Box Engine F6JB/F6JA	218217	Drive Shaft		25	23	52.9	89	916	
	2003.10-2010.12		-	L	F	Box Engine F6JB/F6JA	218216	Drive Shaft		25	23	53.3	90	621	
	2003.10-2010.12		-	-	F	Box Engine F6JB/F6JA	818001	Outer Joint		25	20	52.9	89	52	M
1.6 TDCi (66 kW)	2007.04-2009.09		MT	L	F	Box Engine HHJB/HHJA	218309	Drive Shaft		25	23	52.9	89	615	
	2007.04-2009.09		MT	R	F	Box Engine HHJB/HHJA	218326	Drive Shaft		25	23	53.38	88.5	915	
FIESTA VI															
1.0 (48 kW)	2013.01-		MT	-	F	Hatchback Engine XMJA/XMJB	818222	Outer Joint		25	23	53.3	87	56	M
1.0 (59 kW)	2012.10-		MT	-	F	Hatchback Engine P4JA/P4JB/P4JC/P4JD	818222	Outer Joint		25	23	53.3	87	56	M
1.0 EcoBoost (74 kW)	2013.01-		Semi-AT	R	F	Hatchback Engine SFJD/SFJC/SFJB/SFJA	218406	Drive Shaft		25	34	53.3	87	974	
	2013.01-		Semi-AT	-	F	Hatchback Engine SFJD/SFJC/SFJB/SFJA	818222	Outer Joint		25	23	53.3	87	56	M
1.25 (44 kW)	2008.06-		-	-	F	Hatchback Engine STJA/STJB	818222	Outer Joint		25	23	53.3	87	56	M
1.25 (60 kW)	2008.06-		-	-	F	Hatchback Engine SNJA/SNJB/SNJC/SNJD	818222	Outer Joint		25	23	53.3	87	56	M
1.4 (71 kW)	2008.06-		-	-	F	Hatchback Engine SPJC/SPJA	818222	Outer Joint		25	23	53.3	87	56	M
1.4 LPG (68 kW)	2009.01-		-	-	F	Hatchback Engine RTJB/RTJA	818222	Outer Joint		25	23	53.3	87	56	M
1.4 LPG (71 kW)	2009.01-		-	-	F	Hatchback Engine RTJA/RTJB	818222	Outer Joint		25	23	53.3	87	56	M

YEAR	TRANSM	L/R	F/R	REMARKS	GSP Ref.	PRODUCT	ABS	Technical Specifications							
								A	B	C	H	L	P		
FORD															
FIESTA VI															
1.5 TDCi (55 kW)	2012.09-	-	MT	R	F	Hatchback Engine UGJC/XUJA/XUJB	218407	Drive Shaft		25	23	53.3	87	922	
	2012.09-	-	-	-	F	Hatchback Engine UGJC/XUJA/XUJB	818222	Outer Joint		25	23	53.3	87	56	M
1.5 TDCi (70 kW)	2015.05-	-	MT	R	F	Hatchback Engine XVJB/XVJC	218407	Drive Shaft		25	23	53.3	87	922	
	2015.05-	-	-	-	F	Hatchback Engine XVJB/XVJC	818222	Outer Joint		25	23	53.3	87	56	M
1.6 TDCi (66 kW)	2008.06-	-	-	-	F	Hatchback Engine HHJD/HHJC/HHJE	818222	Outer Joint		25	23	53.3	87	56	M
1.6 TDCi (70 kW)	2010.02-	-	-	-	F	Hatchback Engine T3JA/TZJA/TZJB	818222	Outer Joint		25	23	53.3	87	56	M
1.6 Ti (77 kW)	2012.09-	-	AT	R	F	Hatchback Engine IQJA	218406	Drive Shaft		25	34	53.3	87	974	
	2012.09-	-	-	-	F	Hatchback Engine IQJA	818222	Outer Joint		25	23	53.3	87	56	M
1.6 Ti (88 kW)	2008.06-	-	-	-	F	Hatchback Engine HXJB/HXJA	818222	Outer Joint		25	23	53.3	87	56	M
1.6 Ti (99 kW)	2010.12-	-	-	-	F	Hatchback Engine U5JA	818222	Outer Joint		25	23	53.3	87	56	M
FIESTA VI Van															
1.0 (59 kW)	2012.10-	-	MT	-	F	Box Engine P4JD/P4JC/P4JB/P4JA	818222	Outer Joint		25	23	53.3	87	56	M
1.5 TDCi (55 kW)	2012.10-	-	MT	R	F	Box Engine UGJC	218407	Drive Shaft		25	23	53.3	87	922	
	2012.10-	-	-	-	F	Box Engine UGJC	818222	Outer Joint		25	23	53.3	87	56	M
1.5 TDCi (70 kW)	2015.05-	-	MT	R	F	Box Engine XVJC/XVJB	218407	Drive Shaft		25	23	53.3	87	922	
	2015.05-	-	-	-	F	Box Engine XVJC/XVJB	818222	Outer Joint		25	23	53.3	87	56	M
1.6 TDCi (66 kW)	2009.01-	-	-	-	F	Box Engine HHJC/HHJD/HHJE	818222	Outer Joint		25	23	53.3	87	56	M
1.6 TDCi (70 kW)	2010.02-	-	-	-	F	Box Engine T3JA/TZJA/TZJB	818222	Outer Joint		25	23	53.3	87	56	M
FOCUS															
-	2000-	2005	MT/AT	-	-	-	618148	Inner Joint		26	23	40	389	92	
	2000-	2005	MT/AT	-	-	-	618147	Inner Joint		26	23	40	69	99	
1.6 16V	2009.11-	-	-	-	-	-	834151	Outer Joint		36	21	53	48.5	55.5	M
2.0	2002.02-	2004.12	AT	L	-	-	218138	Drive Shaft	50T	28	28	60	110.5	771	
	2002.02-	2004.12	AT	R	-	-	218137	Drive Shaft	50T	28	28	60	110.5	868	
FOCUS (DAW DBW)															
1.4 16V (55 kW)	1998.10-	2004.11	5MT	L	F	Hatchback Engine FXDA/FXDC/FXDB/FXDD	218042	Drive Shaft		25	23	53.38	88.5	633	
	1998.10-	2004.11	5MT	R	F	Hatchback Engine FXDA/FXDC/FXDB/FXDD	218046	Drive Shaft		25	23	53.38	88.5	934	
	1998.10-	1999.09	MT	L	F	Hatchback Engine FXDA	618162	Inner Joint		23	21	40	61	87.5	
	1998.10-	2004.11	AT/MT	L/R	F	Hatchback Engine FXDA/FXDC/FXDB/FXDD	818013	Outer Joint		25	23	53.4	88.5	57	M
	1998.10-	2004.11	AT/MT	L/R	F	Hatchback Engine FXDA/FXDC/FXDB/FXDD	818003	Outer Joint		25	21	53.3	89	53	M
	1998.10-	2004.11	MT	R	F	Hatchback Engine FXDA/FXDC/FXDB/FXDD	218018	Drive Shaft		25	23	53.2	89	930	
1.6 16V (74 kW)	1998.10-	2004.11	5MT	L	F	Hatchback Engine FYDD/FYDA/FYDC/FYDB/FYDH	218042	Drive Shaft		25	23	53.38	88.5	633	
	1998.10-	2004.11	5MT	R	F	Hatchback Engine FYDD/FYDA/FYDC/FYDB/FYDH	218046	Drive Shaft		25	23	53.38	88.5	934	
	1998.10-	2004.11	AT/MT	L/R	F	Hatchback Engine FYDD/FYDA/FYDC/FYDB/FYDH	818013	Outer Joint		25	23	53.4	88.5	57	M
	1998.10-	2004.11	AT/MT	L/R	F	Hatchback Engine FYDD/FYDA/FYDC/FYDB/FYDH	818003	Outer Joint		25	21	53.3	89	53	M
	1998.10-	2004.11	MT	R	F	Hatchback Engine FYDD/FYDA/FYDC/FYDB/FYDH	218018	Drive Shaft		25	23	53.2	89	930	
1.8 16V (85 kW)	1998.10-	2004.11	5MT	L	F	Hatchback Engine EYDF/EYDC/EYDB/EYDD/EYDE/EYDG/EYDI/EYDJ/EYDL	218042	Drive Shaft		25	23	53.38	88.5	633	
	1998.10-	2004.11	5MT	R	F	Hatchback Engine EYDF/EYDC/EYDB/EYDD/EYDE/EYDG/EYDI/EYDJ/EYDL	218046	Drive Shaft		25	23	53.38	88.5	934	
	1998.10-	2004.11	AT/MT	L/R	F	Hatchback Engine EYDF/EYDC/EYDB/EYDD/EYDE/EYDG/EYDI/EYDJ/EYDL	818013	Outer Joint		25	23	53.4	88.5	57	M
	1998.10-	2004.11	AT/MT	L/R	F	Hatchback Engine EYDF/EYDC/EYDB/EYDD/EYDE/EYDG/EYDI/EYDJ/EYDL	818003	Outer Joint		25	21	53.3	89	53	M
	1998.10-	2004.11	MT	R	F	Hatchback Engine EYDF/EYDC/EYDB/EYDD/EYDE/EYDG/EYDI/EYDJ/EYDL	218018	Drive Shaft		25	23	53.2	89	930	
1.8 DI / TDDi (55 kW)	1999.08-	2004.11	AT/MT	L	F	Hatchback Engine BHDB/BHDA	218101	Drive Shaft		25	26	53.38	88.5	613	
	1999.08-	2004.11	AT/MT	R	F	Hatchback Engine BHDB/BHDA	218102	Drive Shaft		25	26	53.38	88.5	944.5	
	1999.08-	2004.11	MT	L	F	Hatchback Engine BHDB/BHDA	618162	Inner Joint		23	21	40	61	87.5	
	1999.08-	2004.11	AT/MT	L/R	F	Hatchback Engine BHDB/BHDA	818003	Outer Joint		25	21	53.3	89	53	M
	1999.08-	2004.11	AT/MT	L/R	F	Hatchback Engine BHDB/BHDA	818013	Outer Joint		25	23	53.4	88.5	57	M
1.8 TDCi (74 kW)	2002.08-	2004.11	5MT	R	F	Hatchback Engine FFDA	218454	Drive Shaft		25	26	53.38	88.5	949	
	2002.08-	2004.11	-	-	F	Hatchback Engine FFDA	818069	Outer Joint		25	24	52.6	88	59	M
	2002.08-	2004.11	MT	L	F	Hatchback Engine FFDA	618162	Inner Joint		23	21	40	61	87.5	
1.8 TDCi (85 kW)	2001.03-	2004.11	5MT	R	F	Hatchback Engine F9DB/F9DA	218454	Drive Shaft		25	26	53.38	88.5	949	
	2001.03-	2004.11	-	-	F	Hatchback Engine F9DB/F9DA	818069	Outer Joint		25	24	52.6	88	59	M
	2001.03-	2004.11	MT	L	F	Hatchback Engine F9DB/F9DA	618162	Inner Joint		23	21	40	61	87.5	
1.8 Turbo DI / TDDi (66 kW)	1998.10-	2004.11	AT/MT	L	F	Hatchback Engine C9DB/C9DA/C9DC	218101	Drive Shaft		25	26	53.38	88.5	613	
	1998.10-	2004.11	AT/MT	R	F	Hatchback Engine C9DB/C9DA/C9DC	218102	Drive Shaft		25	26	53.38	88.5	944.5	
	1998.10-	2004.11	MT	L	F	Hatchback Engine C9DB/C9DA/C9DC	618162	Inner Joint		23	21	40	61	87.5	
	1998.10-	2004.11	AT/MT	L/R	F	Hatchback Engine C9DB/C9DA/C9DC	818013	Outer Joint		25	23	53.4	88.5	57	M
2.0 16V (96 kW)	1998.10-	2004.11	MT	R	F	Hatchback Engine EDDC/EDDB/EDDD/EDDF	218046	Drive Shaft		25	23	53.38	88.5	934	
	1998.10-	2004.11	5MT	L	F	Hatchback Engine EDDC/EDDB/EDDD/EDDF	218101	Drive Shaft		25	26	53.38	88.5	613	
	1998.10-	2004.11	5MT	R	F	Hatchback Engine EDDC/EDDB/EDDD/EDDF	218102	Drive Shaft		25	26	53.38	88.5	944.5	
	1998.10-	2004.11	AT/MT	L/R	F	Hatchback Engine EDDC/EDDB/EDDD/EDDF	818013	Outer Joint		25	23	53.4	88.5	57	M
RS (158 kW)	2002.10-	2004.11	MT	R	F	Hatchback Engine HMDA	218043	Drive Shaft		27	35	56.5	92	579	
	2002.10-	2004.11	MT	R	F	Hatchback Engine HMDA	618061	Inner Joint		35	34	42	50	67.5	
ST170 (127 kW)	2002.03-	2004.11	MT	R	F	Hatchback Engine ALDA	618182	Inner Joint		34	24	36	390	91.5	
	2002.03-	2004.11	MT	L	F	Hatchback Engine ALDA	218195	Drive Shaft		25	34	52.6	88	603	
	2002.03-	2004.11	MT	R	F	Hatchback Engine ALDA	299175	Drive Shaft		25	34	52.6	88	948	
FOCUS (DAW, DBW)															

	 YEAR	TRANSM	L/R	F/R	REMARKS	GSP Ref.	 PRODUCT	 ABS	Technical Specifications						
									A	B	C	H	L	P	
FORD															
FOCUS (DAW, DBW)															
2.0 ST170 (127 kW)	2002.03-	2004.11	MT	L	F	Hatchback Engine ALDA	618126	Inner Joint		34	24	40	54	97	
FOCUS (DFW)															
1.4 16V (55 kW)	1999.02-	2004.11	5MT	L	F	Saloon Engine FXDA/FXDC/FXDB/FXDD	218042	Drive Shaft		25	23	53.38	88.5	633	
	1999.02-	2004.11	5MT	R	F	Saloon Engine FXDA/FXDC/FXDB/FXDD	218046	Drive Shaft		25	23	53.38	88.5	934	
	1999.02-	2004.11	MT	L	F	Saloon Engine FXDA/FXDC/FXDB/FXDD	618162	Inner Joint		23	21	40	61	87.5	
	1999.02-	2004.11	AT/MT	L/R	F	Saloon Engine FXDA/FXDC/FXDB/FXDD	818013	Outer Joint		25	23	53.4	88.5	57	M
	1999.02-	2004.11	AT/MT	L/R	F	Saloon Engine FXDA/FXDC/FXDB/FXDD	818003	Outer Joint		25	21	53.3	89	53	M
1.6 16V (74 kW)	1999.02-	2004.11	5MT	L	F	Saloon Engine FYDH/FYDA/FYDC/FYDB/FYDD	218042	Drive Shaft		25	23	53.38	88.5	633	
	1999.02-	2004.11	5MT	R	F	Saloon Engine FYDH/FYDA/FYDC/FYDB/FYDD	218046	Drive Shaft		25	23	53.38	88.5	934	
	1999.02-	2004.11	MT	L	F	Saloon Engine FYDH/FYDA/FYDC/FYDB/FYDD	618162	Inner Joint		23	21	40	61	87.5	
	1999.02-	2004.11	AT/MT	L/R	F	Saloon Engine FYDH/FYDA/FYDC/FYDB/FYDD	818013	Outer Joint		25	23	53.4	88.5	57	M
	1999.02-	2004.11	AT/MT	L/R	F	Saloon Engine FYDH/FYDA/FYDC/FYDB/FYDD	818003	Outer Joint		25	21	53.3	89	53	M
	1999.02-	2004.11	MT	R	F	Saloon Engine FYDH/FYDA/FYDC/FYDB/FYDD	218018	Drive Shaft		25	23	53.2	89	930	
1.8 16V (85 kW)	1999.02-	2004.11	5MT	L	F	Saloon Engine EYDJ/EYDL/EYDI/EYDG/EYDF/EYDE/EYDD/EYDB/EYDC	218042	Drive Shaft		25	23	53.38	88.5	633	
	1999.02-	2004.11	5MT	R	F	Saloon Engine EYDJ/EYDL/EYDI/EYDG/EYDF/EYDE/EYDD/EYDB/EYDC	218046	Drive Shaft		25	23	53.38	88.5	934	
	1999.02-	2004.11	MT	L	F	Saloon Engine EYDJ/EYDL/EYDI/EYDG/EYDF/EYDE/EYDD/EYDB/EYDC	618162	Inner Joint		23	21	40	61	87.5	
	1999.02-	2004.11	AT/MT	L/R	F	Saloon Engine EYDJ/EYDL/EYDI/EYDG/EYDF/EYDE/EYDD/EYDB/EYDC	818013	Outer Joint		25	23	53.4	88.5	57	M
	1999.02-	2004.11	AT/MT	L/R	F	Saloon Engine EYDJ/EYDL/EYDI/EYDG/EYDF/EYDE/EYDD/EYDB/EYDC	818003	Outer Joint		25	21	53.3	89	53	M
	1999.02-	2004.11	MT	R	F	Saloon Engine EYDJ/EYDL/EYDI/EYDG/EYDF/EYDE/EYDD/EYDB/EYDC	218018	Drive Shaft		25	23	53.2	89	930	
1.8 TDCi (74 kW)	2002.08-	2004.11	5MT	R	F	Saloon Engine FFDA	218454	Drive Shaft		25	26	53.38	88.5	949	
	2002.08-	2004.11	-	-	F	Saloon Engine FFDA	818069	Outer Joint		25	24	52.6	88	59	M
	2002.08-	2004.11	MT	L	F	Saloon Engine FFDA	618162	Inner Joint		23	21	40	61	87.5	
1.8 TDCi (85 kW)	2001.03-	2004.11	5MT	R	F	Saloon Engine F9DB/F9DA	218454	Drive Shaft		25	26	53.38	88.5	949	
	2001.03-	2004.11	-	-	F	Saloon Engine F9DB/F9DA	818069	Outer Joint		25	24	52.6	88	59	M
	2001.03-	2004.11	MT	L	F	Saloon Engine F9DB/F9DA	618162	Inner Joint		23	21	40	61	87.5	
1.8 Turbo DI / TDDi (55 kW)	2001.08-	2005.03	-	L	F	Saloon Engine BHDA/BHDB	218101	Drive Shaft		25	26	53.38	88.5	613	
	2001.08-	2005.03	-	R	F	Saloon Engine BHDA/BHDB	218102	Drive Shaft		25	26	53.38	88.5	944.5	
	2001.08-	2005.03	MT	L	F	Saloon Engine BHDA/BHDB	618162	Inner Joint		23	21	40	61	87.5	
1.8 Turbo DI / TDDi (66 kW)	1999.02-	2004.11	AT/MT	L	F	Saloon Engine C9DB/C9DA/C9DC	218101	Drive Shaft		25	26	53.38	88.5	613	
	1999.02-	2004.11	AT/MT	R	F	Saloon Engine C9DB/C9DA/C9DC	218102	Drive Shaft		25	26	53.38	88.5	944.5	
	1999.02-	2004.11	MT	L	F	Saloon Engine C9DB/C9DA/C9DC	618162	Inner Joint		23	21	40	61	87.5	
	1999.02-	2004.11	AT/MT	L/R	F	Saloon Engine C9DB/C9DA/C9DC	818013	Outer Joint		25	23	53.4	88.5	57	M
2.0 16V (96 kW)	1999.02-	2004.11	AT/MT	L	F	Saloon Engine EDDF/EDDD/EDDB/EDDC	218101	Drive Shaft		25	26	53.38	88.5	613	
	1999.02-	2004.11	AT/MT	R	F	Saloon Engine EDDF/EDDD/EDDB/EDDC	218102	Drive Shaft		25	26	53.38	88.5	944.5	
	1999.02-	2004.11	AT/MT	L/R	F	Saloon Engine EDDF/EDDD/EDDB/EDDC	818013	Outer Joint		25	23	53.4	88.5	57	M
FOCUS (DNW)															
2.0 ST170 (127 kW)	2002.08-	2004.11	MT	L	F	Estate Engine ALDA	618126	Inner Joint		34	24	40	54	97	
FOCUS C-MAX															
1.6 (74 kW)	2003.10-	2007.03	MT	R	F	MPV Engine HWDA/HWDB	218337	Drive Shaft		36	23	51.6	48	908	
	2003.10-	2007.03	MT	L	F	MPV Engine HWDA/HWDB	218189	Drive Shaft		36	23	56	48	601	
	2003.10-	2007.03	-	R	F	MPV Engine HWDA/HWDB	618045	Inner Joint		26	23	40	389	92	
	2003.10-	2007.03	MT	R	F	MPV Engine HWDA/HWDB	218206	Drive Shaft		36	23	56	48	906	
	2003.10-	2007.03	MT	L/R	F	MPV Engine HWDA/HWDB	899129	Outer Joint		36	24	56	48	57	M
	2003.10-	2007.03	MT	L	F	MPV Engine HWDA/HWDB	818264	Outer Joint		36	25	51.6	48	58	O
	2003.10-	2007.03	MT	L	F	MPV Engine HWDA/HWDB	618168	Inner Joint		23	22	40	61	90	
	2003.10-	2007.03	MT	L	F	MPV Engine HWDA/HWDB	218336	Drive Shaft		36	23	51.6	48	600	
1.6 TDCi (66 kW)	2005.02-	2007.03	-	R	F	MPV Engine HHDA/HHDB	818230	Outer Joint		36	26	56.3	48	61	M
	2005.02-	2007.03	-	L/R	F	MPV Engine HHDA/HHDB	899288	Outer Joint		36	26	56.3	48	61	M
	2005.02-	2007.03	-	L	F	MPV Engine HHDA/HHDB	218218	Drive Shaft		36	26	56	48	582	
	2005.02-	2007.03	MT	R	F	MPV Engine HHDA/HHDB	899130	Outer Joint		36	26	56.3	48	61	M
	2005.02-	2007.03	-	R	F	MPV Engine HHDA/HHDB	218219	Drive Shaft		36	26	56.3	48	921	
1.6 TDCi (80 kW)	2003.10-	2007.03	CVT	L	F	MPV Engine G8DA/G8DB	899132	Outer Joint		36	24	56	48	57	I
	2003.10-	2007.03	-	R	F	MPV Engine G8DA/G8DB	818230	Outer Joint		36	26	56.3	48	61	M
	2003.10-	2007.03	-	R	F	MPV Engine G8DA/G8DB	618045	Inner Joint		26	23	40	389	92	
	2003.10-	2007.03	CVT	L	F	MPV Engine G8DA/G8DB	618172	Inner Joint		34	24	39	61	89.5	
	2003.10-	2007.03	CVT	R	F	MPV Engine G8DA/G8DB	618124	Inner Joint		34	24	40	353	91	
	2003.10-	2007.03	CVT	L	F	MPV Engine G8DA/G8DB	218193	Drive Shaft		36	34	56	48	568	
	2003.10-	2007.03	CVT	R	F	MPV Engine G8DA/G8DB	218191	Drive Shaft		36	34	56	48	890	
	2003.10-	2007.03	-	L	F	MPV Engine G8DA/G8DB	899288	Outer Joint		36	26	56.3	48	61	M
	2003.10-	2007.03	-	L	F	MPV Engine G8DA/G8DB	218218	Drive Shaft		36	26	56	48	582	
	2003.10-	2007.03	MT	R	F	MPV Engine G8DA/G8DB	899130	Outer Joint		36	26	56.3	48	61	M
	2003.10-	2007.03	-	R	F	MPV Engine G8DA/G8DB	218219	Drive Shaft		36	26	56.3	48	921	
1.6 Ti (85 kW)	2004.08-	2007.03	MT	R	F	MPV Engine HXDA/SIDA	218337	Drive Shaft		36	23	51.6	48	908	
	2004.08-	2007.03	MT	L	F	MPV Engine HXDA/SIDA	218189	Drive Shaft		36	23	56	48	601	
	2004.08-	2007.03	-	R	F	MPV Engine HXDA/SIDA	618045	Inner Joint		26	23	40	389	92	
	2004.08-	2007.03	MT	R	F	MPV Engine HXDA/SIDA	218206	Drive Shaft		36	23	56	48	906	

YEAR	TRANSM	L/R	F/R	REMARKS	GSP Ref.	PRODUCT	ABS	Technical Specifications								
								A	B	C	H	L	P			
FORD																
FOCUS C-MAX																
1.6 Ti (85 kW)	2004.08-2007.03	MT	L/R	F	MPV Engine HXDA/SIDA	899129	Outer Joint	36	24	56	48	57	M			
	2004.08-2007.03	MT	L	F	MPV Engine HXDA/SIDA	818264	Outer Joint	36	25	51.6	48	58	O			
	2004.08-2007.03	MT	L	F	MPV Engine HXDA/SIDA	618168	Inner Joint	23	22	40	61	90				
	2004.08-2007.03	MT	L	F	MPV Engine HXDA/SIDA	218336	Drive Shaft	36	23	51.6	48	600				
1.8 (88 kW)	2003.10-2007.03	MT	L	F	MPV Engine CSDB/CSDA	218189	Drive Shaft	36	23	56	48	601				
	2003.10-2007.03	-	R	F	MPV Engine CSDB/CSDA	618045	Inner Joint	26	23	40	389	92				
	2003.10-2007.03	MT	R	F	MPV Engine CSDB/CSDA	218206	Drive Shaft	36	23	56	48	906				
	2003.10-2007.03	-	L/R	F	MPV Engine CSDB/CSDA	818203	Outer Joint	36	23	56	48	57	I			
	2003.10-2007.03	MT	R	F	MPV Engine CSDB/CSDA	899130	Outer Joint	36	26	56.3	48	61	M			
	2003.10-2007.03	-	L	F	MPV Engine CSDB/CSDA	218328	Drive Shaft	36	26	55.3	48	580				
	2003.10-2007.03	-	R	F	MPV Engine CSDB/CSDA	218329	Drive Shaft	36	26	55.3	48	920				
1.8 (90 kW)	2005.09-2007.03	MT	L	F	MPV Engine QQDC	218189	Drive Shaft	36	23	56	48	601				
	2005.09-2007.03	MT	R	F	MPV Engine QQDC	218206	Drive Shaft	36	23	56	48	906				
	2005.09-2007.03	MT	R	F	MPV Engine QQDC	218358	Drive Shaft	36	23	56	48	899				
	2005.09-2007.03	MT	L	F	MPV Engine QQDC	218359	Drive Shaft	36	23	56	48	594				
	2005.09-2007.03	MT	R	F	MPV Engine QQDC	899130	Outer Joint	36	26	56.3	48	61	M			
1.8 (92 kW)	2004.04-2007.03	MT	L	F	MPV Engine QQDA/QQDB/Q7DA	218189	Drive Shaft	36	23	56	48	601				
	2004.04-2007.03	-	R	F	MPV Engine QQDA/QQDB/Q7DA	618045	Inner Joint	26	23	40	389	92				
	2004.04-2007.03	MT	R	F	MPV Engine QQDA/QQDB/Q7DA	218206	Drive Shaft	36	23	56	48	906				
	2004.04-2007.03	5MT	R	F	MPV Engine QQDA/QQDB/Q7DA	218358	Drive Shaft	36	23	56	48	899				
	2004.04-2007.03	MT	L/R	F	MPV Engine QQDA/QQDB/Q7DA	818203	Outer Joint	36	23	56	48	57	I			
	2004.04-2007.03	5MT	L	F	MPV Engine QQDA/QQDB/Q7DA	218359	Drive Shaft	36	23	56	48	594				
	2004.04-2007.03	MT	R	F	MPV Engine QQDA/QQDB/Q7DA	899130	Outer Joint	36	26	56.3	48	61	M			
1.8 Flexifuel (92 kW)	2006.01-2007.03	MT	L	F	MPV Engine Q7DA	218189	Drive Shaft	36	23	56	48	601				
	2006.01-2007.03	MT	R	F	MPV Engine Q7DA	218206	Drive Shaft	36	23	56	48	906				
	2006.01-2007.03	5MT	R	F	MPV Engine Q7DA	218358	Drive Shaft	36	23	56	48	899				
	2006.01-2007.03	MT	L/R	F	MPV Engine Q7DA	818203	Outer Joint	36	23	56	48	57	I			
	2006.01-2007.03	5MT	L	F	MPV Engine Q7DA	218359	Drive Shaft	36	23	56	48	594				
	2006.01-2007.03	MT	R	F	MPV Engine Q7DA	899130	Outer Joint	36	26	56.3	48	61	M			
1.8 TDCi (85 kW)	2005.01-2007.03	-	R	F	MPV Engine KKDA	618045	Inner Joint	26	23	40	389	92				
	2005.01-2007.03	-	L	F	MPV Engine KKDA	218218	Drive Shaft	36	26	56	48	582				
	2005.01-2007.03	-	R	F	MPV Engine KKDA	218219	Drive Shaft	36	26	56.3	48	921				
	2005.01-2007.03	MT	R	F	MPV Engine KKDA	899130	Outer Joint	36	26	56.3	48	61	M			
2.0 (107 kW)	2004.03-2007.03	MT	R	F	MPV Engine AODA/AODB/SYDA	218329	Drive Shaft	36	26	55.3	48	920				
	2004.03-2007.03	AT	L	F	MPV Engine AODA/AODB/SYDA	262074	Drive Shaft	36	26	56	48	585				
	2004.03-2007.03	-	R	F	MPV Engine AODA/AODB/SYDA	618045	Inner Joint	26	23	40	389	92				
	2004.03-2007.03	AT	R	F	MPV Engine AODA/AODB/SYDA	218190	Drive Shaft	36	26	56.3	48	919				
	2004.03-2007.03	AT/MT	L/R	F	MPV Engine AODA/AODB/SYDA	818203	Outer Joint	36	23	56	48	57	I			
	2004.03-2007.03	AT	R	F	MPV Engine AODA/AODB/SYDA	899130	Outer Joint	36	26	56.3	48	61	M			
	2004.03-2007.03	5AT	R	F	MPV Engine AODA/AODB/SYDA	234163	Drive Shaft	36	26	56	48	926				
	2004.03-2007.03	5AT	L	F	MPV Engine AODA/AODB/SYDA	218327	Drive Shaft	36	26	55.3	48	585				
	2004.03-2007.03	5MT	L	F	MPV Engine AODA/AODB/SYDA	218328	Drive Shaft	36	26	55.3	48	580				
2.0 TDCi (100 kW)	2003.10-2007.03	-	R	F	MPV Engine G6DA/G6DB/G6DD/G6DG	618045	Inner Joint	26	23	40	389	92				
	2003.10-2007.03	6MT	-	F	MPV Engine G6DA/G6DB/G6DD/G6DG	862048	Outer Joint	36	26	56	48	64	I			
	2003.10-2007.03	MT	L	F	MPV Engine G6DA/G6DB/G6DD/G6DG	218194	Drive Shaft	36	26	56	48	568				
	2003.10-2007.03	MT	R	F	MPV Engine G6DA/G6DB/G6DD/G6DG	218280	Drive Shaft	36	26	56	48	918				
	2003.10-2007.03	MT	L	F	MPV Engine G6DA/G6DB/G6DD/G6DG	218198	Drive Shaft	36	26	56	48	580				
	2003.10-2007.03	-	L/R	F	MPV Engine G6DA/G6DB/G6DD/G6DG	818203	Outer Joint	36	23	56	48	57	I			
	2003.10-2007.03	MT	R	F	MPV Engine G6DA/G6DB/G6DD/G6DG	899130	Outer Joint	36	26	56.3	48	61	M			
	2003.10-2007.03	AT	R	F	MPV Engine G6DA/G6DB/G6DD/G6DG	262024	Drive Shaft	36	28	56	48	908				
2.0 TDCi (98 kW)	2003.10-2007.03	-	R	F	MPV Engine G6DF/G6DC/G6DE	618045	Inner Joint	26	23	40	389	92				
	2003.10-2007.03	-	L	F	MPV Engine G6DF/G6DC/G6DE	218194	Drive Shaft	36	26	56	48	568				
	2003.10-2007.03	MT	L	F	MPV Engine G6DF/G6DC/G6DE	218198	Drive Shaft	36	26	56	48	580				
	2003.10-2007.03	-	R	F	MPV Engine G6DF/G6DC/G6DE	218280	Drive Shaft	36	26	56	48	918				
	2003.10-2007.03	MT	R	F	MPV Engine G6DF/G6DC/G6DE	899130	Outer Joint	36	26	56.3	48	61	M			
FOCUS II																
1.6	2004-2011	-	R	F	-	218262	Drive Shaft	36	23	55.8	48	905				
	2004-2011	-	L	F	-	218261	Drive Shaft	36	23	55.8	48	600				
	2004-2011	-	L	F	-	618086	Inner Joint	23	22	40	61	90				
	2004-2011	-	R	F	-	618087	Inner Joint	23	22	40	371	78.5				
1.6 (74 kW)	2006.10-2011.07	-	-	F	Convertible Engine SHDB/SHDC/SHDA/HWDA/HWDB	818238	Outer Joint	27	23	63	96	57	M			
	2006.10-2011.07	MT	R	F	Convertible Engine SHDB/SHDC/SHDA/HWDA/HWDB	218337	Drive Shaft	36	23	51.6	48	908				
	2006.10-2011.07	MT	L	F	Convertible Engine SHDB/SHDC/SHDA/HWDA/HWDB	218189	Drive Shaft	36	23	56	48	601				
	2006.10-2011.07	MT	R	F	Convertible Engine SHDB/SHDC/SHDA/HWDA/HWDB	218206	Drive Shaft	36	23	56	48	906				
	2006.10-2011.07	MT	L/R	F	Convertible Engine SHDB/SHDC/SHDA/HWDA/HWDB	899129	Outer Joint	36	24	56	48	57	M			
	2006.10-2011.07	MT	L	F	Convertible Engine SHDB/SHDC/SHDA/HWDA/HWDB	818264	Outer Joint	36	25	51.6	48	58	O			

YEAR	TRANS	L/R	F/R	REMARKS	GSP Ref.	PRODUCT	ABS	Technical Specifications							
								A	B	C	H	L	P		
FORD															
FOCUS II															
1.6 (74 kW)	2006.10-2011.07	AT	L/R	F	Convertible Engine SHDB/SHDC/SHDA/HWDA/HWDB	818203	Outer Joint	36	23	56	48	57	I		
	2006.10-2011.07	MT	L	F	Convertible Engine SHDB/SHDC/SHDA/HWDA/HWDB	618168	Inner Joint	23	22	40	61	90			
	2006.10-2011.07	-	-	F	Convertible Engine SHDB/SHDC/SHDA/HWDA/HWDB	818244	Outer Joint	27	24	62.8	95.5	59	M		
2.0 (107 kW)	2006.10-2011.07	5MT	R	F	Convertible Engine AODB/AODA	218329	Drive Shaft	36	26	55.3	48	920			
	2006.10-2011.07	-	-	F	Convertible Engine AODB/AODA	818238	Outer Joint	27	23	63	96	57	M		
	2006.10-2011.07	AT	L	F	Convertible Engine AODB/AODA	262074	Drive Shaft	36	26	56	48	585			
	2006.10-2011.07	AT	R	F	Convertible Engine AODB/AODA	218190	Drive Shaft	36	26	56.3	48	919			
	2006.10-2011.07	-	L/R	F	Convertible Engine AODB/AODA	818203	Outer Joint	36	23	56	48	57	I		
	2006.10-2011.07	AT	R	F	Convertible Engine AODB/AODA	899130	Outer Joint	36	26	56.3	48	61	M		
	2006.10-2011.07	-	-	F	Convertible Engine AODB/AODA	818244	Outer Joint	27	24	62.8	95.5	59	M		
2.0 TDCi (100 kW)	2006.10-2011.07	5MT	L	F	Convertible Engine AODB/AODA	218328	Drive Shaft	36	26	55.3	48	580			
	2006.10-2011.07	-	-	F	Convertible Engine G6DA/G6DB/G6DD	818238	Outer Joint	27	23	63	96	57	M		
	2006.10-2011.07	MT	L	F	Convertible Engine G6DA/G6DB/G6DD	218194	Drive Shaft	36	26	56	48	568			
	2006.10-2011.07	MT	R	F	Convertible Engine G6DA/G6DB/G6DD	218280	Drive Shaft	36	26	56	48	918			
	2006.10-2011.07	MT	L	F	Convertible Engine G6DA/G6DB/G6DD	218198	Drive Shaft	36	26	56	48	580			
	2006.10-2011.07	-	L	F	Convertible Engine G6DA/G6DB/G6DD	818203	Outer Joint	36	23	56	48	57	I		
	2006.10-2011.07	AT	R	F	Convertible Engine G6DA/G6DB/G6DD	262024	Drive Shaft	36	28	56	48	908			
FOCUS II (DA_HCP)	2006.10-2011.07	-	-	F	Convertible Engine G6DA/G6DB/G6DD	818244	Outer Joint	27	24	62.8	95.5	59	M		
	2006.10-2011.07	MT	R	F	Convertible Engine G6DA/G6DB/G6DD	899130	Outer Joint	36	26	56.3	48	61	M		
	1.4 (59 kW)														
	2004.07-2012.09	MT	R	F	Hatchback Engine ASDA/ASDB	218337	Drive Shaft	36	23	51.6	48	908			
	2004.07-2012.09	MT	L	F	Hatchback Engine ASDA/ASDB	218189	Drive Shaft	36	23	56	48	601			
	2004.07-2012.09	-	R	F	Hatchback Engine ASDA/ASDB	618045	Inner Joint	26	23	40	389	92			
	2004.07-2012.09	-	-	-	Hatchback Engine ASDA/ASDB	862039	Outer Joint	36	24	55.8	48	57	M		
2004.07-2012.09	MT	R	F	Hatchback Engine ASDA/ASDB	218206	Drive Shaft	36	23	56	48	906				
2004.07-2012.09	-	R	F	Hatchback Engine ASDA/ASDB	618161	Inner Joint	26	23	40	389	86				
2004.07-2012.09	MT	L/R	F	Hatchback Engine ASDA/ASDB	899129	Outer Joint	36	24	56	48	57	M			
2004.07-2012.09	-	L	F	Hatchback Engine ASDA/ASDB	618044	Inner Joint	26	23	40	68.5	99.5				
2004.07-2012.09	MT	L	F	Hatchback Engine ASDA/ASDB	818264	Outer Joint	36	25	51.6	48	58	O			
2004.07-2012.09	MT	L	F	Hatchback Engine ASDA/ASDB	618168	Inner Joint	23	22	40	61	90				
2004.07-2012.09	MT	L	F	Hatchback Engine ASDA/ASDB	218336	Drive Shaft	36	23	51.6	48	600				
1.6 (74 kW)	2004.07-2012.09	MT	R	F	Hatchback Engine HWDA/HWDB/SHDA/SHDB/SHDC	218337	Drive Shaft	36	23	51.6	48	908			
	2004.07-2012.09	MT	L	F	Hatchback Engine HWDA/HWDB/SHDA/SHDB/SHDC	218189	Drive Shaft	36	23	56	48	601			
	2004.07-2012.09	-	R	F	Hatchback Engine HWDA/HWDB/SHDA/SHDB/SHDC	618045	Inner Joint	26	23	40	389	92			
	2004.07-2012.09	-	-	-	Hatchback Engine HWDA/HWDB/SHDA/SHDB/SHDC	862039	Outer Joint	36	24	55.8	48	57	M		
	2004.07-2012.09	MT	R	F	Hatchback Engine HWDA/HWDB/SHDA/SHDB/SHDC	218206	Drive Shaft	36	23	56	48	906			
	2004.07-2012.09	AT	R	F	Hatchback Engine HWDA/HWDB/SHDA/SHDB/SHDC	218190	Drive Shaft	36	26	56.3	48	919			
	2004.07-2012.09	-	R	F	Hatchback Engine HWDA/HWDB/SHDA/SHDB/SHDC	618161	Inner Joint	26	23	40	389	86			
	2004.07-2012.09	MT	L/R	F	Hatchback Engine HWDA/HWDB/SHDA/SHDB/SHDC	899129	Outer Joint	36	24	56	48	57	M		
	2004.07-2012.09	-	L	F	Hatchback Engine HWDA/HWDB/SHDA/SHDB/SHDC	618044	Inner Joint	26	23	40	68.5	99.5			
	2004.07-2012.09	AT	L/R	F	Hatchback Engine HWDA/HWDB/SHDA/SHDB/SHDC	818203	Outer Joint	36	23	56	48	57	I		
	2004.07-2012.09	MT	L	F	Hatchback Engine HWDA/HWDB/SHDA/SHDB/SHDC	818264	Outer Joint	36	25	51.6	48	58	O		
	2004.07-2012.09	AT	R	F	Hatchback Engine HWDA/HWDB/SHDA/SHDB/SHDC	899130	Outer Joint	36	26	56.3	48	61	M		
	2004.07-2012.09	MT	L	F	Hatchback Engine HWDA/HWDB/SHDA/SHDB/SHDC	618168	Inner Joint	23	22	40	61	90			
	2004.07-2012.09	MT	L	F	Hatchback Engine HWDA/HWDB/SHDA/SHDB/SHDC	218336	Drive Shaft	36	23	51.6	48	600			
	1.6 LPG (85 kW)	2009.10-2011.07	MT	R	F	Hatchback Engine SIDA	218337	Drive Shaft	36	23	51.6	48	908		
2009.10-2011.07		MT	L	F	Hatchback Engine SIDA	218189	Drive Shaft	36	23	56	48	601			
2009.10-2011.07		MT	R	F	Hatchback Engine SIDA	218206	Drive Shaft	36	23	56	48	906			
2009.10-2011.07		MT	L/R	F	Hatchback Engine SIDA	899129	Outer Joint	36	24	56	48	57	M		
2009.10-2011.07		MT	L	F	Hatchback Engine SIDA	818264	Outer Joint	36	25	51.6	48	58	O		
2009.10-2011.07		MT	L	F	Hatchback Engine SIDA	618168	Inner Joint	23	22	40	61	90			
1.6 TDCi (66 kW)	2005.01-2012.09	-	R	F	Hatchback Engine HHDA/HHDB/GPDA/GPDC/GPDB	818230	Outer Joint	36	26	56.3	48	61	M		
	2005.01-2012.09	-	R	F	Hatchback Engine HHDA/HHDB/GPDA/GPDC/GPDB	618045	Inner Joint	26	23	40	389	92			
	2005.01-2012.09	-	-	-	Hatchback Engine HHDA/HHDB/GPDA/GPDC/GPDB	862039	Outer Joint	36	24	55.8	48	57	M		
	2005.01-2012.09	-	R	F	Hatchback Engine HHDA/HHDB/GPDA/GPDC/GPDB	618161	Inner Joint	26	23	40	389	86			
	2005.01-2012.09	-	L	F	Hatchback Engine HHDA/HHDB/GPDA/GPDC/GPDB	618044	Inner Joint	26	23	40	68.5	99.5			
	2005.01-2012.09	-	L	F	Hatchback Engine HHDA/HHDB/GPDA/GPDC/GPDB	899288	Outer Joint	36	26	56.3	48	61	M		
	2005.01-2012.09	-	L	F	Hatchback Engine HHDA/HHDB/GPDA/GPDC/GPDB	218218	Drive Shaft	36	26	56	48	582			
	2005.01-2012.09	-	R	F	Hatchback Engine HHDA/HHDB/GPDA/GPDC/GPDB	218219	Drive Shaft	36	26	56.3	48	921			
	2005.01-2012.09	MT	R	F	Hatchback Engine HHDA/HHDB/GPDA/GPDC/GPDB	899130	Outer Joint	36	26	56.3	48	61	M		
1.6 TDCi (74 kW)	2004.07-2012.09	-	R	F	Hatchback Engine G8DC/MTDA	618045	Inner Joint	26	23	40	389	92			
	2004.07-2012.09	-	-	-	Hatchback Engine G8DC/MTDA	862039	Outer Joint	36	24	55.8	48	57	M		
	2004.07-2012.09	-	R	F	Hatchback Engine G8DC/MTDA	618161	Inner Joint	26	23	40	389	86			
	2004.07-2012.09	-	L	F	Hatchback Engine G8DC/MTDA	618044	Inner Joint	26	23	40	68.5	99.5			
	2004.07-2012.09	-	R	F	Hatchback Engine G8DC/MTDA	218358	Drive Shaft	36	23	56	48	899			
	2004.07-2012.09	-	L	F	Hatchback Engine G8DC/MTDA	218359	Drive Shaft	36	23	56	48	594			

YEAR	TRANSM	L/R	F/R	REMARKS	GSP Ref.	PRODUCT	ABS	Technical Specifications									
								A	B	C	H	L	P				
FORD																	
FOCUS II (DA_HCP)																	
1.6 TDCi (80 kW)																	
2004.07-2012.09	-	R	F	Hatchback Engine G8DB/G8DA/G8DD/G8DE/G8DF	818230	Outer Joint		36	26	56.3	48	61	M				
2004.07-2012.09	-	R	F	Hatchback Engine G8DB/G8DA/G8DD/G8DE/G8DF	618045	Inner Joint		26	23	40	389	92					
2004.07-2012.09	-	-	-	Hatchback Engine G8DB/G8DA/G8DD/G8DE/G8DF	862039	Outer Joint		36	24	55.8	48	57	M				
2004.07-2012.09	-	R	F	Hatchback Engine G8DB/G8DA/G8DD/G8DE/G8DF	618161	Inner Joint		26	23	40	389	86					
2004.07-2012.09	-	L	F	Hatchback Engine G8DB/G8DA/G8DD/G8DE/G8DF	618044	Inner Joint		26	23	40	68.5	99.5					
2004.07-2012.09	-	L	F	Hatchback Engine G8DB/G8DA/G8DD/G8DE/G8DF	899288	Outer Joint		36	26	56.3	48	61	M				
2004.07-2012.09	-	L	F	Hatchback Engine G8DB/G8DA/G8DD/G8DE/G8DF	218218	Drive Shaft		36	26	56	48	582					
2004.07-2012.09	MT	R	F	Hatchback Engine G8DB/G8DA/G8DD/G8DE/G8DF	899130	Outer Joint		36	26	56.3	48	61	M				
2004.07-2012.09	-	R	F	Hatchback Engine G8DB/G8DA/G8DD/G8DE/G8DF	218219	Drive Shaft		36	26	56.3	48	921					
1.6 Ti (85 kW)																	
2004.07-2012.09	MT	R	F	Hatchback Engine HXDA/HXDB/SIDA	218337	Drive Shaft		36	23	51.6	48	908					
2004.07-2012.09	MT	L	F	Hatchback Engine HXDA/HXDB/SIDA	218189	Drive Shaft		36	23	56	48	601					
2004.07-2012.09	-	R	F	Hatchback Engine HXDA/HXDB/SIDA	618045	Inner Joint		26	23	40	389	92					
2004.07-2012.09	-	-	-	Hatchback Engine HXDA/HXDB/SIDA	862039	Outer Joint		36	24	55.8	48	57	M				
2004.07-2012.09	MT	R	F	Hatchback Engine HXDA/HXDB/SIDA	218206	Drive Shaft		36	23	56	48	906					
2004.07-2012.09	-	R	F	Hatchback Engine HXDA/HXDB/SIDA	618161	Inner Joint		26	23	40	389	86					
2004.07-2012.09	MT	L/R	F	Hatchback Engine HXDA/HXDB/SIDA	899129	Outer Joint		36	24	56	48	57	M				
2004.07-2012.09	-	L	F	Hatchback Engine HXDA/HXDB/SIDA	618044	Inner Joint		26	23	40	68.5	99.5					
2004.07-2012.09	MT	L	F	Hatchback Engine HXDA/HXDB/SIDA	818264	Outer Joint		36	25	51.6	48	58	O				
2004.07-2012.09	AT	L/R	F	Hatchback Engine HXDA/HXDB/SIDA	818203	Outer Joint		36	23	56	48	57	I				
2004.07-2012.09	MT	L	F	Hatchback Engine HXDA/HXDB/SIDA	618168	Inner Joint		23	22	40	61	90					
2004.07-2012.09	MT	L	F	Hatchback Engine HXDA/HXDB/SIDA	218336	Drive Shaft		36	23	51.6	48	600					
1.8 (92 kW)																	
2006.03-2012.09	MT	L	F	Hatchback Engine QQDB	218189	Drive Shaft		36	23	56	48	601					
2006.03-2012.09	-	-	-	Hatchback Engine QQDB	862039	Outer Joint		36	24	55.8	48	57	M				
2006.03-2012.09	-	R	F	Hatchback Engine QQDB	618045	Inner Joint		26	23	40	389	92					
2006.03-2012.09	MT	R	F	Hatchback Engine QQDB	218206	Drive Shaft		36	23	56	48	906					
2006.03-2012.09	-	R	F	Hatchback Engine QQDB	618161	Inner Joint		26	23	40	389	86					
2006.03-2012.09	-	L	F	Hatchback Engine QQDB	618044	Inner Joint		26	23	40	68.5	99.5					
2006.03-2012.09	-	R	F	Hatchback Engine QQDB	218358	Drive Shaft		36	23	56	48	899					
2006.03-2012.09	-	L	F	Hatchback Engine QQDB	218359	Drive Shaft		36	23	56	48	594					
2006.03-2012.09	-	L/R	F	Hatchback Engine QQDB	818203	Outer Joint		36	23	56	48	57	I				
2006.03-2012.09	MT	R	F	Hatchback Engine QQDB	899130	Outer Joint		36	26	56.3	48	61	M				
1.8 Flexifuel (92 kW)																	
2006.01-2012.09	MT	L	F	Hatchback Engine Q7DA	218189	Drive Shaft		36	23	56	48	601					
2006.01-2012.09	-	-	-	Hatchback Engine Q7DA	862039	Outer Joint		36	24	55.8	48	57	M				
2006.01-2012.09	MT	R	F	Hatchback Engine Q7DA	218206	Drive Shaft		36	23	56	48	906					
2006.01-2012.09	-	R	F	Hatchback Engine Q7DA	618045	Inner Joint		26	23	40	389	92					
2006.01-2012.09	-	R	F	Hatchback Engine Q7DA	618161	Inner Joint		26	23	40	389	86					
2006.01-2012.09	-	L/R	F	Hatchback Engine Q7DA	818203	Outer Joint		36	23	56	48	57	I				
2006.01-2012.09	-	L	F	Hatchback Engine Q7DA	618044	Inner Joint		26	23	40	68.5	99.5					
2006.01-2012.09	-	R	F	Hatchback Engine Q7DA	218358	Drive Shaft		36	23	56	48	899					
2006.01-2012.09	-	L	F	Hatchback Engine Q7DA	218359	Drive Shaft		36	23	56	48	594					
2006.01-2012.09	MT	R	F	Hatchback Engine Q7DA	899130	Outer Joint		36	26	56.3	48	61	M				
1.8 TDCi (85 kW)																	
2005.01-2012.09	-	R	F	Hatchback Engine KKDA/KKDB	818230	Outer Joint		36	26	56.3	48	61	M				
2005.01-2012.09	-	R	F	Hatchback Engine KKDA/KKDB	618045	Inner Joint		26	23	40	389	92					
2005.01-2012.09	-	-	-	Hatchback Engine KKDA/KKDB	862039	Outer Joint		36	24	55.8	48	57	M				
2005.01-2012.09	-	R	F	Hatchback Engine KKDA/KKDB	618161	Inner Joint		26	23	40	389	86					
2005.01-2012.09	-	L	F	Hatchback Engine KKDA/KKDB	618044	Inner Joint		26	23	40	68.5	99.5					
2005.01-2012.09	-	L	F	Hatchback Engine KKDA/KKDB	899288	Outer Joint		36	26	56.3	48	61	M				
2005.01-2012.09	-	L	F	Hatchback Engine KKDA/KKDB	218218	Drive Shaft		36	26	56	48	582					
2005.01-2012.09	-	R	F	Hatchback Engine KKDA/KKDB	218219	Drive Shaft		36	26	56.3	48	921					
2005.01-2012.09	MT	R	F	Hatchback Engine KKDA/KKDB	899130	Outer Joint		36	26	56.3	48	61	M				
2.0 (104 kW)																	
2005.06-2008.09	AT	L	F	Hatchback	262074	Drive Shaft		36	26	56	48	585					
2005.06-2008.09	AT	R	F	Hatchback	218190	Drive Shaft		36	26	56.3	48	919					
2005.06-2008.09	AT	R	F	Hatchback	899130	Outer Joint		36	26	56.3	48	61	M				
2.0 (105 kW)																	
2010.04-2012.09	AT	L	F	Hatchback Engine SYDA	262074	Drive Shaft		36	26	56	48	585					
2010.04-2012.09	-	-	-	Hatchback Engine SYDA	862039	Outer Joint		36	24	55.8	48	57	M				
2010.04-2012.09	-	R	F	Hatchback Engine SYDA	618045	Inner Joint		26	23	40	389	92					
2010.04-2012.09	AT	R	F	Hatchback Engine SYDA	218190	Drive Shaft		36	26	56.3	48	919					
2010.04-2012.09	-	R	F	Hatchback Engine SYDA	618161	Inner Joint		26	23	40	389	86					
2010.04-2012.09	-	L	F	Hatchback Engine SYDA	618044	Inner Joint		26	23	40	68.5	99.5					
2010.04-2012.09	AT	R	F	Hatchback Engine SYDA	899130	Outer Joint		36	26	56.3	48	61	M				
2.0 (107 kW)																	
2004.07-2012.09	AT	L	F	Hatchback Engine AODA/AODB/AODE	262074	Drive Shaft		36	26	56	48	585					
2004.07-2012.09	-	R	F	Hatchback Engine AODA/AODB/AODE	618045	Inner Joint		26	23	40	389	92					
2004.07-2012.09	-	-	-	Hatchback Engine AODA/AODB/AODE	862039	Outer Joint		36	24	55.8	48	57	M				
2004.07-2012.09	AT	R	F	Hatchback Engine AODA/AODB/AODE	218190	Drive Shaft		36	26	56.3	48	919					
2004.07-2012.09	-	R	F	Hatchback Engine AODA/AODB/AODE	618161	Inner Joint		26	23	40	389	86					
2004.07-2012.09	-	L	F	Hatchback Engine AODA/AODB/AODE	618044	Inner Joint		26	23	40	68.5	99.5					





YEAR	TRANS	L/R	F/R	REMARKS	GSP Ref.	PRODUCT	ABS	Technical Specifications							
								A	B	C	H	L	P		
FORD															
FOCUS II (DA_HCP)															
2.0 (107 kW)															
2004.07-2012.09	AT/MT	L/R	F	Hatchback Engine AODA/AODB/AODE	818203	Outer Joint		36	23	56	48	57	I		
2004.07-2012.09	AT	R	F	Hatchback Engine AODA/AODB/AODE	899130	Outer Joint		36	26	56.3	48	61	M		
2004.07-2012.09	5AT	R	F	Hatchback Engine AODA/AODB/AODE	234163	Drive Shaft		36	26	56	48	926			
2004.07-2012.09	5AT	L	F	Hatchback Engine AODA/AODB/AODE	218327	Drive Shaft		36	26	55.3	48	585			
2004.07-2012.09	5MT	L	F	Hatchback Engine AODA/AODB/AODE	218328	Drive Shaft		36	26	55.3	48	580			
2004.07-2012.09	5MT	R	F	Hatchback Engine AODA/AODB/AODE	218329	Drive Shaft		36	26	55.3	48	920			
2.0 CNG (107 kW)															
2009.04-2011.07	MT	R	F	Hatchback Engine SYDA	218329	Drive Shaft		36	26	55.3	48	920			
2009.04-2011.07	AT	L	F	Hatchback Engine SYDA	262074	Drive Shaft		36	26	56	48	585			
2009.04-2011.07	AT	R	F	Hatchback Engine SYDA	234163	Drive Shaft		36	26	56	48	926			
2009.04-2011.07	AT	L	F	Hatchback Engine SYDA	218327	Drive Shaft		36	26	55.3	48	585			
2009.04-2011.07	MT	L	F	Hatchback Engine SYDA	218328	Drive Shaft		36	26	55.3	48	580			
2.0 LPG (107 kW)															
2008.06-2011.07	5MT	R	F	Hatchback Engine SYDA	218329	Drive Shaft		36	26	55.3	48	920			
2008.06-2011.07	AT	L	F	Hatchback Engine SYDA	262074	Drive Shaft		36	26	56	48	585			
2008.06-2011.07	AT	R	F	Hatchback Engine SYDA	218190	Drive Shaft		36	26	56.3	48	919			
2008.06-2011.07	AT	R	F	Hatchback Engine SYDA	899130	Outer Joint		36	26	56.3	48	61	M		
2008.06-2011.07	5AT	R	F	Hatchback Engine SYDA	234163	Drive Shaft		36	26	56	48	926			
2008.06-2011.07	5AT	L	F	Hatchback Engine SYDA	218327	Drive Shaft		36	26	55.3	48	585			
2008.06-2011.07	5MT	L	F	Hatchback Engine SYDA	218328	Drive Shaft		36	26	55.3	48	580			
2.0 TDCi (100 kW)															
2004.07-2012.09	-	R	F	Hatchback Engine G6DD/G6DA/G6DB	618045	Inner Joint		26	23	40	389	92			
2004.07-2012.09	-	-	-	Hatchback Engine G6DD/G6DA/G6DB	862039	Outer Joint		36	24	55.8	48	57	M		
2004.07-2012.09	-	R	F	Hatchback Engine G6DD/G6DA/G6DB	618161	Inner Joint		26	23	40	389	86			
2004.07-2012.09	MT	L	F	Hatchback Engine G6DD/G6DA/G6DB	218194	Drive Shaft		36	26	56	48	568			
2004.07-2012.09	-	L	F	Hatchback Engine G6DD/G6DA/G6DB	618044	Inner Joint		26	23	40	68.5	99.5			
2004.07-2012.09	-	L	F	Hatchback Engine G6DD/G6DA/G6DB	818203	Outer Joint		36	23	56	48	57	I		
2004.07-2012.09	MT	R	F	Hatchback Engine G6DD/G6DA/G6DB	218280	Drive Shaft		36	26	56	48	918			
2004.07-2012.09	MT	L	F	Hatchback Engine G6DD/G6DA/G6DB	218198	Drive Shaft		36	26	56	48	580			
2004.07-2012.09	MT	R	F	Hatchback Engine G6DD/G6DA/G6DB	899130	Outer Joint		36	26	56.3	48	61	M		
2004.07-2012.09	AT	R	F	Hatchback Engine G6DD/G6DA/G6DB	262024	Drive Shaft		36	28	56	48	908			
2.0 TDCi (81 kW)															
2008.02-2011.07	MT	L	F	Hatchback Engine IXDA	218194	Drive Shaft		36	26	56	48	568			
2008.02-2011.07	MT	R	F	Hatchback Engine IXDA	218280	Drive Shaft		36	26	56	48	918			
2008.02-2011.07	-	L	F	Hatchback Engine IXDA	818203	Outer Joint		36	23	56	48	57	I		
2.0 TDCi (98 kW)															
2004.07-2008.01	-	R	F	Hatchback Engine G6DE/G6DF	618045	Inner Joint		26	23	40	389	92			
2004.07-2008.01	-	L	F	Hatchback Engine G6DE/G6DF	218194	Drive Shaft		36	26	56	48	568			
2004.07-2008.01	-	R	F	Hatchback Engine G6DE/G6DF	218280	Drive Shaft		36	26	56	48	918			
2004.07-2008.01	MT	L	F	Hatchback Engine G6DE/G6DF	218198	Drive Shaft		36	26	56	48	580			
2004.07-2008.01	MT	R	F	Hatchback Engine G6DE/G6DF	899130	Outer Joint		36	26	56.3	48	61	M		
2.5 ST (166 kW)															
2005.10-2012.09	-	-	-	Hatchback Engine HYDA	862039	Outer Joint		36	24	55.8	48	57	M		
2005.10-2012.09	-	R	F	Hatchback Engine HYDA	618045	Inner Joint		26	23	40	389	92			
2005.10-2012.09	-	F	F	Hatchback Engine HYDA	899155	Outer Joint		36	26	56	48	64	I		
2005.10-2012.09	-	R	F	Hatchback Engine HYDA	618161	Inner Joint		26	23	40	389	86			
2005.10-2012.09	MT	L	F	Hatchback Engine HYDA	218290	Drive Shaft		36	26	56	48	530			
2005.10-2012.09	MT	R	F	Hatchback Engine HYDA	218251	Drive Shaft		36	26	56	48	960			
2005.10-2012.09	-	L	F	Hatchback Engine HYDA	618044	Inner Joint		26	23	40	68.5	99.5			
FOCUS II (DB_FCH)															
1.4 (59 kW)															
2005.04-2012.09	MT	R	F	Saloon Engine ASDA/ASDB	218337	Drive Shaft		36	23	51.6	48	908			
2005.04-2012.09	MT	L	F	Saloon Engine ASDA/ASDB	218189	Drive Shaft		36	23	56	48	601			
2005.04-2012.09	-	-	-	Saloon Engine ASDA/ASDB	862039	Outer Joint		36	24	55.8	48	57	M		
2005.04-2012.09	-	R	F	Saloon Engine ASDA/ASDB	618045	Inner Joint		26	23	40	389	92			
2005.04-2012.09	MT	R	F	Saloon Engine ASDA/ASDB	218206	Drive Shaft		36	23	56	48	906			
2005.04-2012.09	-	R	F	Saloon Engine ASDA/ASDB	618161	Inner Joint		26	23	40	389	86			
2005.04-2012.09	MT	L/R	F	Saloon Engine ASDA/ASDB	899129	Outer Joint		36	24	56	48	57	M		
2005.04-2012.09	MT	L	F	Saloon Engine ASDA/ASDB	818264	Outer Joint		36	25	51.6	48	58	O		
2005.04-2012.09	-	L	F	Saloon Engine ASDA/ASDB	618044	Inner Joint		26	23	40	68.5	99.5			
2005.04-2012.09	MT	L	F	Saloon Engine ASDA/ASDB	618168	Inner Joint		23	22	40	61	90			
2005.04-2012.09	MT	L	F	Saloon Engine ASDA/ASDB	218336	Drive Shaft		36	23	51.6	48	600			
1.6 (74 kW)															
2005.04-2012.09	MT	R	F	Saloon Engine SHDA/SHDB/SHDC/HWDA/HWDB	218337	Drive Shaft		36	23	51.6	48	908			
2005.04-2012.09	MT	L	F	Saloon Engine SHDA/SHDB/SHDC/HWDA/HWDB	218189	Drive Shaft		36	23	56	48	601			
2005.04-2012.09	-	-	-	Saloon Engine SHDA/SHDB/SHDC/HWDA/HWDB	862039	Outer Joint		36	24	55.8	48	57	M		
2005.04-2012.09	-	R	F	Saloon Engine SHDA/SHDB/SHDC/HWDA/HWDB	618045	Inner Joint		26	23	40	389	92			
2005.04-2012.09	MT	R	F	Saloon Engine SHDA/SHDB/SHDC/HWDA/HWDB	218206	Drive Shaft		36	23	56	48	906			
2005.04-2012.09	AT	R	F	Saloon Engine SHDA/SHDB/SHDC/HWDA/HWDB	218190	Drive Shaft		36	26	56.3	48	919			
2005.04-2012.09	-	R	F	Saloon Engine SHDA/SHDB/SHDC/HWDA/HWDB	618161	Inner Joint		26	23	40	389	86			
2005.04-2012.09	MT	L/R	F	Saloon Engine SHDA/SHDB/SHDC/HWDA/HWDB	899129	Outer Joint		36	24	56	48	57	M		
2005.04-2012.09	MT	L	F	Saloon Engine SHDA/SHDB/SHDC/HWDA/HWDB	818264	Outer Joint		36	25	51.6	48	58	O		
2005.04-2012.09	-	L	F	Saloon Engine SHDA/SHDB/SHDC/HWDA/HWDB	618044	Inner Joint		26	23	40	68.5	99.5			
2005.04-2012.09	AT	L/R	F	Saloon Engine SHDA/SHDB/SHDC/HWDA/HWDB	818203	Outer Joint		36	23	56	48	57	I		





YEAR	TRANSM	L/R	F/R	REMARKS	GSP Ref.	PRODUCT	ABS	Technical Specifications							
								A	B	C	H	L	P		
FORD															
FOCUS II (DB_FCH)															
1.6 (74 kW)	2005.04-2012.09	AT	R	F	Saloon Engine SHDA/SHDB/SHDC/HWDA/HWDB	899130	Outer Joint	36	26	56.3	48	61	M		
	2005.04-2012.09	MT	L	F	Saloon Engine SHDA/SHDB/SHDC/HWDA/HWDB	618168	Inner Joint	23	22	40	61	90			
	2005.04-2012.09	MT	L	F	Saloon Engine SHDA/SHDB/SHDC/HWDA/HWDB	218336	Drive Shaft	36	23	51.6	48	600			
1.6 TDCi (66 kW)	2005.04-2012.09	-	R	F	Saloon Engine HHDA/HHDB	818230	Outer Joint	36	26	56.3	48	61	M		
	2005.04-2012.09	-	-	-	Saloon Engine HHDA/HHDB	862039	Outer Joint	36	24	55.8	48	57	M		
	2005.04-2012.09	-	R	F	Saloon Engine HHDA/HHDB	618045	Inner Joint	26	23	40	389	92			
	2005.04-2012.09	-	R	F	Saloon Engine HHDA/HHDB	618161	Inner Joint	26	23	40	389	86			
	2005.04-2012.09	-	L	F	Saloon Engine HHDA/HHDB	618044	Inner Joint	26	23	40	68.5	99.5			
	2005.04-2012.09	-	L	F	Saloon Engine HHDA/HHDB	899288	Outer Joint	36	26	56.3	48	61	M		
	2005.04-2012.09	-	L	F	Saloon Engine HHDA/HHDB	218218	Drive Shaft	36	26	56	48	582			
	2005.04-2012.09	-	R	F	Saloon Engine HHDA/HHDB	218219	Drive Shaft	36	26	56.3	48	921			
	2005.04-2012.09	MT	R	F	Saloon Engine HHDA/HHDB	899130	Outer Joint	36	26	56.3	48	61	M		
1.6 TDCi (74 kW)	2005.04-2012.09	-	-	-	Saloon Engine MTDA/G8DC	862039	Outer Joint	36	24	55.8	48	57	M		
	2005.04-2012.09	-	R	F	Saloon Engine MTDA/G8DC	618045	Inner Joint	26	23	40	389	92			
	2005.04-2012.09	-	R	F	Saloon Engine MTDA/G8DC	618161	Inner Joint	26	23	40	389	86			
	2005.04-2012.09	-	L	F	Saloon Engine MTDA/G8DC	618044	Inner Joint	26	23	40	68.5	99.5			
	2005.04-2012.09	-	L	F	Saloon Engine MTDA/G8DC	218218	Drive Shaft	36	26	56	48	582			
	2005.04-2012.09	-	R	F	Saloon Engine MTDA/G8DC	218219	Drive Shaft	36	26	56.3	48	921			
1.6 TDCi (80 kW)	2005.04-2012.09	-	R	F	Saloon Engine G8DA/G8DB/G8DD/G8DE/G8DF	818230	Outer Joint	36	26	56.3	48	61	M		
	2005.04-2012.09	-	-	-	Saloon Engine G8DA/G8DB/G8DD/G8DE/G8DF	862039	Outer Joint	36	24	55.8	48	57	M		
	2005.04-2012.09	-	R	F	Saloon Engine G8DA/G8DB/G8DD/G8DE/G8DF	618045	Inner Joint	26	23	40	389	92			
	2005.04-2012.09	-	R	F	Saloon Engine G8DA/G8DB/G8DD/G8DE/G8DF	618161	Inner Joint	26	23	40	389	86			
	2005.04-2012.09	-	L	F	Saloon Engine G8DA/G8DB/G8DD/G8DE/G8DF	618044	Inner Joint	26	23	40	68.5	99.5			
	2005.04-2012.09	-	L	F	Saloon Engine G8DA/G8DB/G8DD/G8DE/G8DF	899288	Outer Joint	36	26	56.3	48	61	M		
	2005.04-2012.09	-	L	F	Saloon Engine G8DA/G8DB/G8DD/G8DE/G8DF	218218	Drive Shaft	36	26	56	48	582			
	2005.04-2012.09	-	R	F	Saloon Engine G8DA/G8DB/G8DD/G8DE/G8DF	218219	Drive Shaft	36	26	56.3	48	921			
	2005.04-2012.09	MT	R	F	Saloon Engine G8DA/G8DB/G8DD/G8DE/G8DF	899130	Outer Joint	36	26	56.3	48	61	M		
1.6 Ti (85 kW)	2005.04-2012.09	MT	R	F	Saloon Engine HXDB/HXDA/SIDA	218337	Drive Shaft	36	23	51.6	48	908			
	2005.04-2012.09	MT	L	F	Saloon Engine HXDB/HXDA/SIDA	218189	Drive Shaft	36	23	56	48	601			
	2005.04-2012.09	-	-	-	Saloon Engine HXDB/HXDA/SIDA	862039	Outer Joint	36	24	55.8	48	57	M		
	2005.04-2012.09	-	R	F	Saloon Engine HXDB/HXDA/SIDA	618045	Inner Joint	26	23	40	389	92			
	2005.04-2012.09	MT	R	F	Saloon Engine HXDB/HXDA/SIDA	218206	Drive Shaft	36	23	56	48	906			
	2005.04-2012.09	-	R	F	Saloon Engine HXDB/HXDA/SIDA	618161	Inner Joint	26	23	40	389	86			
	2005.04-2012.09	MT	L/R	F	Saloon Engine HXDB/HXDA/SIDA	899129	Outer Joint	36	24	56	48	57	M		
	2005.04-2012.09	MT	L	F	Saloon Engine HXDB/HXDA/SIDA	818264	Outer Joint	36	25	51.6	48	58	O		
	2005.04-2012.09	-	L	F	Saloon Engine HXDB/HXDA/SIDA	618044	Inner Joint	26	23	40	68.5	99.5			
	2005.04-2012.09	AT	L/R	F	Saloon Engine HXDB/HXDA/SIDA	818203	Outer Joint	36	23	56	48	57	I		
	2005.04-2012.09	MT	L	F	Saloon Engine HXDB/HXDA/SIDA	618168	Inner Joint	23	22	40	61	90			
	2005.04-2012.09	MT	L	F	Saloon Engine HXDB/HXDA/SIDA	218336	Drive Shaft	36	23	51.6	48	600			
1.8 (92 kW)	2006.03-2012.09	MT	L	F	Saloon Engine QQDB	218189	Drive Shaft	36	23	56	48	601			
	2006.03-2012.09	-	-	-	Saloon Engine QQDB	862039	Outer Joint	36	24	55.8	48	57	M		
	2006.03-2012.09	-	R	F	Saloon Engine QQDB	618045	Inner Joint	26	23	40	389	92			
	2006.03-2012.09	MT	R	F	Saloon Engine QQDB	218206	Drive Shaft	36	23	56	48	906			
	2006.03-2012.09	-	R	F	Saloon Engine QQDB	618161	Inner Joint	26	23	40	389	86			
	2006.03-2012.09	5MT	R	F	Saloon Engine QQDB	218358	Drive Shaft	36	23	56	48	899			
	2006.03-2012.09	-	L	F	Saloon Engine QQDB	618044	Inner Joint	26	23	40	68.5	99.5			
	2006.03-2012.09	5MT	L	F	Saloon Engine QQDB	218359	Drive Shaft	36	23	56	48	594			
	2006.03-2012.09	-	L/R	F	Saloon Engine QQDB	818203	Outer Joint	36	23	56	48	57	I		
	2006.03-2012.09	5MT	L	F	Saloon Engine QQDB	218328	Drive Shaft	36	26	55.3	48	580			
	2006.03-2012.09	MT	R	F	Saloon Engine QQDB	899130	Outer Joint	36	26	56.3	48	61	M		
	2006.03-2012.09	5MT	R	F	Saloon Engine QQDB	218329	Drive Shaft	36	26	55.3	48	920			
1.8 Flexifuel (92 kW)	2006.06-2011.07	MT	L	F	Saloon Engine Q7DA	218189	Drive Shaft	36	23	56	48	601			
	2006.06-2011.07	MT	R	F	Saloon Engine Q7DA	218206	Drive Shaft	36	23	56	48	906			
	2006.06-2011.07	-	R	F	Saloon Engine Q7DA	218358	Drive Shaft	36	23	56	48	899			
	2006.06-2011.07	-	L/R	F	Saloon Engine Q7DA	818203	Outer Joint	36	23	56	48	57	I		
	2006.06-2011.07	-	L	F	Saloon Engine Q7DA	218359	Drive Shaft	36	23	56	48	594			
	2006.06-2011.07	MT	R	F	Saloon Engine Q7DA	899130	Outer Joint	36	26	56.3	48	61	M		
1.8 TDCi (85 kW)	2005.04-2012.09	-	R	F	Saloon Engine KKDA/KKDB	818230	Outer Joint	36	26	56.3	48	61	M		
	2005.04-2012.09	-	-	-	Saloon Engine KKDA/KKDB	862039	Outer Joint	36	24	55.8	48	57	M		
	2005.04-2012.09	-	R	F	Saloon Engine KKDA/KKDB	618045	Inner Joint	26	23	40	389	92			
	2005.04-2012.09	-	R	F	Saloon Engine KKDA/KKDB	618161	Inner Joint	26	23	40	389	86			
	2005.04-2012.09	-	L	F	Saloon Engine KKDA/KKDB	618044	Inner Joint	26	23	40	68.5	99.5			
	2005.04-2012.09	-	L	F	Saloon Engine KKDA/KKDB	899288	Outer Joint	36	26	56.3	48	61	M		
	2005.04-2012.09	-	L	F	Saloon Engine KKDA/KKDB	218218	Drive Shaft	36	26	56	48	582			
	2005.04-2012.09	-	R	F	Saloon Engine KKDA/KKDB	218219	Drive Shaft	36	26	56.3	48	921			
	2005.04-2012.09	MT	R	F	Saloon Engine KKDA/KKDB	899130	Outer Joint	36	26	56.3	48	61	M		





YEAR	TRANSM	L/R	F/R	REMARKS	GSP Ref.	PRODUCT	ABS	Technical Specifications						
								A	B	C	H	L	P	
FORD														
FOCUS II (DB_FCH)														
2.0 (104 kW)	2008.02-	-	AT	L F	Saloon	262074	Drive Shaft		36	26	56	48	585	
	2008.02-	-	-	-	Saloon	862039	Outer Joint		36	24	55.8	48	57	M
	2008.02-	-	-	R F	Saloon	618045	Inner Joint		26	23	40	389	92	
	2008.02-	-	AT	R F	Saloon	218190	Drive Shaft		36	26	56.3	48	919	
	2008.02-	-	-	R F	Saloon	618161	Inner Joint		26	23	40	389	86	
	2008.02-	-	-	L F	Saloon	618044	Inner Joint		26	23	40	68.5	99.5	
	2008.02-	-	AT	R F	Saloon	899130	Outer Joint		36	26	56.3	48	61	M
2.0 (107 kW)	2005.04-2011.07	5MT	R F	F	Saloon Engine AODB/AODA	218329	Drive Shaft		36	26	55.3	48	920	
	2005.04-2011.07	AT	L F	F	Saloon Engine AODB/AODA	262074	Drive Shaft		36	26	56	48	585	
	2005.04-2011.07	AT	R F	F	Saloon Engine AODB/AODA	218190	Drive Shaft		36	26	56.3	48	919	
	2005.04-2011.07	AT/MT	L/R	F	Saloon Engine AODB/AODA	818203	Outer Joint		36	23	56	48	57	I
	2005.04-2011.07	5AT	R F	F	Saloon Engine AODB/AODA	234163	Drive Shaft		36	26	56	48	926	
	2005.04-2011.07	AT	R F	F	Saloon Engine AODB/AODA	899130	Outer Joint		36	26	56.3	48	61	M
	2005.04-2011.07	5AT	L F	F	Saloon Engine AODB/AODA	218327	Drive Shaft		36	26	55.3	48	585	
	2005.04-2011.07	5MT	L F	F	Saloon Engine AODB/AODA	218328	Drive Shaft		36	26	55.3	48	580	
2.0 TDCi (100 kW)	2005.04-2012.09	-	-	-	Saloon Engine G6DD/G6DB/G6DA	862039	Outer Joint		36	24	55.8	48	57	M
	2005.04-2012.09	-	R F	F	Saloon Engine G6DD/G6DB/G6DA	618045	Inner Joint		26	23	40	389	92	
	2005.04-2012.09	-	R F	F	Saloon Engine G6DD/G6DB/G6DA	618161	Inner Joint		26	23	40	389	86	
	2005.04-2012.09	MT	L F	F	Saloon Engine G6DD/G6DB/G6DA	218194	Drive Shaft		36	26	56	48	568	
	2005.04-2012.09	-	L F	F	Saloon Engine G6DD/G6DB/G6DA	818203	Outer Joint		36	23	56	48	57	I
	2005.04-2012.09	-	L F	F	Saloon Engine G6DD/G6DB/G6DA	618044	Inner Joint		26	23	40	68.5	99.5	
	2005.04-2012.09	MT	R F	F	Saloon Engine G6DD/G6DB/G6DA	218280	Drive Shaft		36	26	56	48	918	
	2005.04-2012.09	MT	L F	F	Saloon Engine G6DD/G6DB/G6DA	218198	Drive Shaft		36	26	56	48	580	
	2005.04-2012.09	AT	R F	F	Saloon Engine G6DD/G6DB/G6DA	262024	Drive Shaft		36	28	56	48	908	
	2005.04-2012.09	MT	R F	F	Saloon Engine G6DD/G6DB/G6DA	899130	Outer Joint		36	26	56.3	48	61	M
2.0 TDCi (81 kW)	2008.02-2011.07	-	L F	F	Saloon Engine IXDA	218194	Drive Shaft		36	26	56	48	568	
	2008.02-2011.07	MT	R F	F	Saloon Engine IXDA	218280	Drive Shaft		36	26	56	48	918	
	2008.02-2011.07	-	L F	F	Saloon Engine IXDA	818203	Outer Joint		36	23	56	48	57	I
FOCUS II Turnier (DA_FFS)														
1.4 (59 kW)	2004.07-2012.09	MT	R F	F	Estate Engine ASDA/ASDB	218337	Drive Shaft		36	23	51.6	48	908	
	2004.07-2012.09	MT	L F	F	Estate Engine ASDA/ASDB	218189	Drive Shaft		36	23	56	48	601	
	2004.07-2012.09	-	R F	F	Estate Engine ASDA/ASDB	618045	Inner Joint		26	23	40	389	92	
	2004.07-2012.09	-	-	-	Estate Engine ASDA/ASDB	862039	Outer Joint		36	24	55.8	48	57	M
	2004.07-2012.09	MT	R F	F	Estate Engine ASDA/ASDB	218206	Drive Shaft		36	23	56	48	906	
	2004.07-2012.09	-	R F	F	Estate Engine ASDA/ASDB	618161	Inner Joint		26	23	40	389	86	
	2004.07-2012.09	MT	L/R	F	Estate Engine ASDA/ASDB	899129	Outer Joint		36	24	56	48	57	M
	2004.07-2012.09	-	L F	F	Estate Engine ASDA/ASDB	618044	Inner Joint		26	23	40	68.5	99.5	
	2004.07-2012.09	MT	L F	F	Estate Engine ASDA/ASDB	818264	Outer Joint		36	25	51.6	48	58	O
	2004.07-2012.09	MT	L F	F	Estate Engine ASDA/ASDB	618168	Inner Joint		23	22	40	61	90	
	2004.07-2012.09	MT	L F	F	Estate Engine ASDA/ASDB	218336	Drive Shaft		36	23	51.6	48	600	
1.6 (74 kW)	2004.07-2011.07	MT	R F	F	Estate Engine SHDA/SHDB/SHDC/HWDA/HWDB	218337	Drive Shaft		36	23	51.6	48	908	
	2004.07-2011.07	MT	L F	F	Estate Engine SHDA/SHDB/SHDC/HWDA/HWDB	218189	Drive Shaft		36	23	56	48	601	
	2004.07-2011.07	-	R F	F	Estate Engine SHDA/SHDB/SHDC/HWDA/HWDB	618045	Inner Joint		26	23	40	389	92	
	2004.07-2011.07	MT	R F	F	Estate Engine SHDA/SHDB/SHDC/HWDA/HWDB	218206	Drive Shaft		36	23	56	48	906	
	2004.07-2011.07	AT	R F	F	Estate Engine SHDA/SHDB/SHDC/HWDA/HWDB	218190	Drive Shaft		36	26	56.3	48	919	
	2004.07-2011.07	AT/MT	L/R	F	Estate Engine SHDA/SHDB/SHDC/HWDA/HWDB	899129	Outer Joint		36	24	56	48	57	M
	2004.07-2011.07	MT	L F	F	Estate Engine SHDA/SHDB/SHDC/HWDA/HWDB	818264	Outer Joint		36	25	51.6	48	58	O
	2004.07-2011.07	AT	L/R	F	Estate Engine SHDA/SHDB/SHDC/HWDA/HWDB	818203	Outer Joint		36	23	56	48	57	I
	2004.07-2011.07	AT	R F	F	Estate Engine SHDA/SHDB/SHDC/HWDA/HWDB	899130	Outer Joint		36	26	56.3	48	61	M
	2004.07-2011.07	MT	L F	F	Estate Engine SHDA/SHDB/SHDC/HWDA/HWDB	618168	Inner Joint		23	22	40	61	90	
	2004.07-2011.07	MT	L F	F	Estate Engine SHDA/SHDB/SHDC/HWDA/HWDB	218336	Drive Shaft		36	23	51.6	48	600	
1.6 LPG (85 kW)	2009.10-2012.09	MT	L F	F	Estate Engine SIDA	218189	Drive Shaft		36	23	56	48	601	
	2009.10-2012.09	-	-	-	Estate Engine SIDA	862039	Outer Joint		36	24	55.8	48	57	M
	2009.10-2012.09	-	R F	F	Estate Engine SIDA	618045	Inner Joint		26	23	40	389	92	
	2009.10-2012.09	MT	R F	F	Estate Engine SIDA	218206	Drive Shaft		36	23	56	48	906	
	2009.10-2012.09	AT	R F	F	Estate Engine SIDA	218190	Drive Shaft		36	26	56.3	48	919	
	2009.10-2012.09	-	R F	F	Estate Engine SIDA	618161	Inner Joint		26	23	40	389	86	
	2009.10-2012.09	MT	L F	F	Estate Engine SIDA	818264	Outer Joint		36	25	51.6	48	58	O
	2009.10-2012.09	-	L F	F	Estate Engine SIDA	618044	Inner Joint		26	23	40	68.5	99.5	
	2009.10-2012.09	AT	R F	F	Estate Engine SIDA	899130	Outer Joint		36	26	56.3	48	61	M
	2009.10-2012.09	MT	L F	F	Estate Engine SIDA	618168	Inner Joint		23	22	40	61	90	
1.6 TDCi (66 kW)	2004.07-2012.09	-	R F	F	Estate Engine HHDA	818230	Outer Joint		36	26	56.3	48	61	M
	2004.07-2012.09	-	R F	F	Estate Engine HHDA	618045	Inner Joint		26	23	40	389	92	
	2004.07-2012.09	-	-	-	Estate Engine HHDA	862039	Outer Joint		36	24	55.8	48	57	M
	2004.07-2012.09	-	R F	F	Estate Engine HHDA	618161	Inner Joint		26	23	40	389	86	
	2004.07-2012.09	-	L F	F	Estate Engine HHDA	618044	Inner Joint		26	23	40	68.5	99.5	

YEAR	TRANSM	L/R	F/R	REMARKS	GSP Ref.	PRODUCT	ABS	Technical Specifications									
								A	B	C	H	L	P				
FORD																	
FOCUS II Turnier (DA_ FFS)																	
1.6 TDCi (66 kW)	2004.07-2012.09	-	L	F	Estate Engine HHDA	899288	Outer Joint	36	26	56.3	48	61	M				
	2004.07-2012.09	-	L	F	Estate Engine HHDA	218218	Drive Shaft	36	26	56	48	582					
	2004.07-2012.09	MT	R	F	Estate Engine HHDA	899130	Outer Joint	36	26	56.3	48	61	M				
	2004.07-2012.09	-	R	F	Estate Engine HHDA	218219	Drive Shaft	36	26	56.3	48	921					
1.6 TDCi (74 kW)	2004.07-2012.09	-	R	F	Estate Engine HHDA/HHDB/GPDA/GPDC	618045	Inner Joint	26	23	40	389	92					
	2004.07-2012.09	-	-	-	Estate Engine HHDA/HHDB/GPDA/GPDC	862039	Outer Joint	36	24	55.8	48	57	M				
	2004.07-2012.09	-	R	F	Estate Engine HHDA/HHDB/GPDA/GPDC	618161	Inner Joint	26	23	40	389	86					
	2004.07-2012.09	-	L	F	Estate Engine HHDA/HHDB/GPDA/GPDC	618044	Inner Joint	26	23	40	68.5	99.5					
	2004.07-2012.09	-	L	F	Estate Engine HHDA/HHDB/GPDA/GPDC	218218	Drive Shaft	36	26	56	48	582					
	2004.07-2012.09	MT	R	F	Estate Engine HHDA/HHDB/GPDA/GPDC	899130	Outer Joint	36	26	56.3	48	61	M				
	2004.07-2012.09	-	R	F	Estate Engine HHDA/HHDB/GPDA/GPDC	218219	Drive Shaft	36	26	56.3	48	921					
1.6 TDCi (80 kW)	2004.07-2012.09	-	R	F	Estate Engine G8DA/G8DB/G8DD/G8DE/G8DF	818230	Outer Joint	36	26	56.3	48	61	M				
	2004.07-2012.09	-	R	F	Estate Engine G8DA/G8DB/G8DD/G8DE/G8DF	618045	Inner Joint	26	23	40	389	92					
	2004.07-2012.09	-	-	-	Estate Engine G8DA/G8DB/G8DD/G8DE/G8DF	862039	Outer Joint	36	24	55.8	48	57	M				
	2004.07-2012.09	-	R	F	Estate Engine G8DA/G8DB/G8DD/G8DE/G8DF	618161	Inner Joint	26	23	40	389	86					
	2004.07-2012.09	-	L	F	Estate Engine G8DA/G8DB/G8DD/G8DE/G8DF	618044	Inner Joint	26	23	40	68.5	99.5					
	2004.07-2012.09	-	L	F	Estate Engine G8DA/G8DB/G8DD/G8DE/G8DF	899288	Outer Joint	36	26	56.3	48	61	M				
	2004.07-2012.09	-	L	F	Estate Engine G8DA/G8DB/G8DD/G8DE/G8DF	218218	Drive Shaft	36	26	56	48	582					
	2004.07-2012.09	MT	R	F	Estate Engine G8DA/G8DB/G8DD/G8DE/G8DF	899130	Outer Joint	36	26	56.3	48	61	M				
1.6 TDCi (81 kW)	2004.07-2012.09	-	R	F	Estate Engine G8DA/G8DB/G8DD/G8DE/G8DF	218219	Drive Shaft	36	26	56.3	48	921					
	2007.12-2012.09	-	-	-	Estate Engine G8DA	862039	Outer Joint	36	24	55.8	48	57	M				
	2007.12-2012.09	-	R	F	Estate Engine G8DA	618045	Inner Joint	26	23	40	389	92					
	2007.12-2012.09	-	R	F	Estate Engine G8DA	618161	Inner Joint	26	23	40	389	86					
	2007.12-2012.09	-	L	F	Estate Engine G8DA	618044	Inner Joint	26	23	40	68.5	99.5					
	2007.12-2012.09	MT	L	F	Estate Engine G8DA	218218	Drive Shaft	36	26	56	48	582					
	2007.12-2012.09	MT	R	F	Estate Engine G8DA	899130	Outer Joint	36	26	56.3	48	61	M				
1.6 Ti (85 kW)	2004.07-2012.09	MT	R	F	Estate Engine SIDA/HXDA/HXDB	218337	Drive Shaft	36	23	51.6	48	908					
	2004.07-2012.09	MT	L	F	Estate Engine SIDA/HXDA/HXDB	218189	Drive Shaft	36	23	56	48	601					
	2004.07-2012.09	-	R	F	Estate Engine SIDA/HXDA/HXDB	618045	Inner Joint	26	23	40	389	92					
	2004.07-2012.09	-	-	-	Estate Engine SIDA/HXDA/HXDB	862039	Outer Joint	36	24	55.8	48	57	M				
	2004.07-2012.09	MT	R	F	Estate Engine SIDA/HXDA/HXDB	218206	Drive Shaft	36	23	56	48	906					
	2004.07-2012.09	-	R	F	Estate Engine SIDA/HXDA/HXDB	618161	Inner Joint	26	23	40	389	86					
	2004.07-2012.09	MT	L/R	F	Estate Engine SIDA/HXDA/HXDB	899129	Outer Joint	36	24	56	48	57	M				
	2004.07-2012.09	-	L	F	Estate Engine SIDA/HXDA/HXDB	618044	Inner Joint	26	23	40	68.5	99.5					
	2004.07-2012.09	MT	L	F	Estate Engine SIDA/HXDA/HXDB	818264	Outer Joint	36	25	51.6	48	58	O				
	2004.07-2012.09	AT	L/R	F	Estate Engine SIDA/HXDA/HXDB	818203	Outer Joint	36	23	56	48	57	I				
	2004.07-2012.09	MT	L	F	Estate Engine SIDA/HXDA/HXDB	618168	Inner Joint	23	22	40	61	90					
1.8 (92 kW)	2006.03-2012.09	5MT	R	F	Estate Engine QQDB/Q7DA	218329	Drive Shaft	36	26	55.3	48	920					
	2006.03-2012.09	MT	L	F	Estate Engine QQDB/Q7DA	218189	Drive Shaft	36	23	56	48	601					
	2006.03-2012.09	-	-	-	Estate Engine QQDB/Q7DA	862039	Outer Joint	36	24	55.8	48	57	M				
	2006.03-2012.09	-	R	F	Estate Engine QQDB/Q7DA	618045	Inner Joint	26	23	40	389	92					
	2006.03-2012.09	MT	R	F	Estate Engine QQDB/Q7DA	218206	Drive Shaft	36	23	56	48	906					
	2006.03-2012.09	-	R	F	Estate Engine QQDB/Q7DA	618161	Inner Joint	26	23	40	389	86					
	2006.03-2012.09	5MT	R	F	Estate Engine QQDB/Q7DA	218358	Drive Shaft	36	23	56	48	899					
	2006.03-2012.09	-	L	F	Estate Engine QQDB/Q7DA	618044	Inner Joint	26	23	40	68.5	99.5					
	2006.03-2012.09	5MT	L	F	Estate Engine QQDB/Q7DA	218359	Drive Shaft	36	23	56	48	594					
	2006.03-2012.09	-	L/R	F	Estate Engine QQDB/Q7DA	818203	Outer Joint	36	23	56	48	57	I				
	2006.03-2012.09	5MT	L	F	Estate Engine QQDB/Q7DA	218328	Drive Shaft	36	26	55.3	48	580					
	2006.03-2012.09	MT	R	F	Estate Engine QQDB/Q7DA	899130	Outer Joint	36	26	56.3	48	61	M				
	1.8 Flexifuel (92 kW)	2006.01-2012.09	MT	L	F	Estate Engine Q7DA	218189	Drive Shaft	36	23	56	48	601				
2006.01-2012.09		-	-	-	Estate Engine Q7DA	862039	Outer Joint	36	24	55.8	48	57	M				
2006.01-2012.09		MT	R	F	Estate Engine Q7DA	218206	Drive Shaft	36	23	56	48	906					
2006.01-2012.09		-	R	F	Estate Engine Q7DA	618045	Inner Joint	26	23	40	389	92					
2006.01-2012.09		-	R	F	Estate Engine Q7DA	618161	Inner Joint	26	23	40	389	86					
2006.01-2012.09		-	L	F	Estate Engine Q7DA	618044	Inner Joint	26	23	40	68.5	99.5					
2006.01-2012.09		-	R	F	Estate Engine Q7DA	218358	Drive Shaft	36	23	56	48	899					
2006.01-2012.09		-	L/R	F	Estate Engine Q7DA	818203	Outer Joint	36	23	56	48	57	I				
2006.01-2012.09		-	L	F	Estate Engine Q7DA	218359	Drive Shaft	36	23	56	48	594					
2006.01-2012.09		MT	R	F	Estate Engine Q7DA	899130	Outer Joint	36	26	56.3	48	61	M				
1.8 TDCi (85 kW)	2004.07-2012.09	-	R	F	Estate Engine KKDB/KKDA	818230	Outer Joint	36	26	56.3	48	61	M				
	2004.07-2012.09	-	R	F	Estate Engine KKDB/KKDA	618045	Inner Joint	26	23	40	389	92					
	2004.07-2012.09	-	-	-	Estate Engine KKDB/KKDA	862039	Outer Joint	36	24	55.8	48	57	M				
	2004.07-2012.09	-	R	F	Estate Engine KKDB/KKDA	618161	Inner Joint	26	23	40	389	86					
	2004.07-2012.09	-	L	F	Estate Engine KKDB/KKDA	618044	Inner Joint	26	23	40	68.5	99.5					

YEAR	TRANSM	L/R	F/R	REMARKS	GSP Ref.	PRODUCT	ABS	Technical Specifications							
								A	B	C	H	L	P		
FORD															
FOCUS II Turnier (DA_ FFS)															
1.8 TDCi (85 kW)	2004.07-2012.09	-	L	F	Estate Engine KKDB/KKDA	899288	Outer Joint	36	26	56.3	48	61	M		
	2004.07-2012.09	-	L	F	Estate Engine KKDB/KKDA	218218	Drive Shaft	36	26	56	48	582			
	2004.07-2012.09	-	R	F	Estate Engine KKDB/KKDA	218219	Drive Shaft	36	26	56.3	48	921			
	2004.07-2012.09	MT	R	F	Estate Engine KKDB/KKDA	899130	Outer Joint	36	26	56.3	48	61	M		
2.0 (107 kW)	2004.07-2012.09	5MT	R	F	Estate Engine AODA/AODB/AODE	218329	Drive Shaft	36	26	55.3	48	920			
	2004.07-2012.09	4AT	L	F	Estate Engine AODA/AODB/AODE	262074	Drive Shaft	36	26	56	48	585			
	2004.07-2012.09	-	R	F	Estate Engine AODA/AODB/AODE	618045	Inner Joint	26	23	40	389	92			
	2004.07-2012.09	-	-	-	Estate Engine AODA/AODB/AODE	862039	Outer Joint	36	24	55.8	48	57	M		
	2004.07-2012.09	4AT	R	F	Estate Engine AODA/AODB/AODE	218190	Drive Shaft	36	26	56.3	48	919			
	2004.07-2012.09	-	R	F	Estate Engine AODA/AODB/AODE	618161	Inner Joint	26	23	40	389	86			
	2004.07-2012.09	AT/MT	L/R	F	Estate Engine AODA/AODB/AODE	818203	Outer Joint	36	23	56	48	57	I		
	2004.07-2012.09	-	L	F	Estate Engine AODA/AODB/AODE	618044	Inner Joint	26	23	40	68.5	99.5			
	2004.07-2012.09	5AT	R	F	Estate Engine AODA/AODB/AODE	234163	Drive Shaft	36	26	56	48	926			
	2004.07-2012.09	5AT	L	F	Estate Engine AODA/AODB/AODE	218327	Drive Shaft	36	26	55.3	48	585			
	2004.07-2012.09	4AT	R	F	Estate Engine AODA/AODB/AODE	899130	Outer Joint	36	26	56.3	48	61	M		
	2004.07-2012.09	5MT	L	F	Estate Engine AODA/AODB/AODE	218328	Drive Shaft	36	26	55.3	48	580			
2.0 LPG (107 kW)	2008.06-2011.07	5MT	R	F	Estate Engine SYDA	218329	Drive Shaft	36	26	55.3	48	920			
	2008.06-2011.07	AT	L	F	Estate Engine SYDA	262074	Drive Shaft	36	26	56	48	585			
	2008.06-2011.07	AT	R	F	Estate Engine SYDA	218190	Drive Shaft	36	26	56.3	48	919			
	2008.06-2011.07	5AT	R	F	Estate Engine SYDA	234163	Drive Shaft	36	26	56	48	926			
	2008.06-2011.07	AT	R	F	Estate Engine SYDA	899130	Outer Joint	36	26	56.3	48	61	M		
	2008.06-2011.07	5AT	L	F	Estate Engine SYDA	218327	Drive Shaft	36	26	55.3	48	585			
	2008.06-2011.07	5MT	L	F	Estate Engine SYDA	218328	Drive Shaft	36	26	55.3	48	580			
2.0 TDCi (100 kW)	2004.07-2012.09	-	R	F	Estate Engine G6DD/G6DB/G6DA	618045	Inner Joint	26	23	40	389	92			
	2004.07-2012.09	-	-	-	Estate Engine G6DD/G6DB/G6DA	862039	Outer Joint	36	24	55.8	48	57	M		
	2004.07-2012.09	-	R	F	Estate Engine G6DD/G6DB/G6DA	618161	Inner Joint	26	23	40	389	86			
	2004.07-2012.09	-	L	F	Estate Engine G6DD/G6DB/G6DA	618044	Inner Joint	26	23	40	68.5	99.5			
	2004.07-2012.09	-	L	F	Estate Engine G6DD/G6DB/G6DA	218194	Drive Shaft	36	26	56	48	568			
	2004.07-2012.09	MT	L	F	Estate Engine G6DD/G6DB/G6DA	218198	Drive Shaft	36	26	56	48	580			
	2004.07-2012.09	-	L/R	F	Estate Engine G6DD/G6DB/G6DA	818203	Outer Joint	36	23	56	48	57	I		
	2004.07-2012.09	-	R	F	Estate Engine G6DD/G6DB/G6DA	218280	Drive Shaft	36	26	56	48	918			
	2004.07-2012.09	MT	R	F	Estate Engine G6DD/G6DB/G6DA	899130	Outer Joint	36	26	56.3	48	61	M		
	2004.07-2012.09	AT	R	F	Estate Engine G6DD/G6DB/G6DA	262024	Drive Shaft	36	28	56	48	908			
2.0 TDCi (81 kW)	2008.02-2011.07	-	L	F	Estate Engine IXDA	218194	Drive Shaft	36	26	56	48	568			
	2008.02-2011.07	MT	R	F	Estate Engine IXDA	218280	Drive Shaft	36	26	56	48	918			
	2008.02-2011.07	-	L	F	Estate Engine IXDA	818203	Outer Joint	36	23	56	48	57	I		
2.0 TDCi (98 kW)	2004.07-2008.01	-	R	F	Estate Engine G6DF/G6DE	618045	Inner Joint	26	23	40	389	92			
	2004.07-2008.01	-	L	F	Estate Engine G6DF/G6DE	218194	Drive Shaft	36	26	56	48	568			
	2004.07-2008.01	-	R	F	Estate Engine G6DF/G6DE	218280	Drive Shaft	36	26	56	48	918			
	2004.07-2008.01	MT	L	F	Estate Engine G6DF/G6DE	218198	Drive Shaft	36	26	56	48	580			
	2004.07-2008.01	MT	R	F	Estate Engine G6DF/G6DE	899130	Outer Joint	36	26	56.3	48	61	M		
FOCUS III															
1.5 EcoBoost (110 kW)	2014.09-	-	-	F	Hatchback Engine M8DA/M8DB	818238	Outer Joint	27	23	63	96	57	M		
	2014.09-	MT	R	F	Hatchback Engine M8DA/M8DB	218294	Drive Shaft	27	26	63	96	972			
	2014.09-	MT	L	F	Hatchback Engine M8DA/M8DB	218295	Drive Shaft	27	26	63	96	637			
	2014.09-	-	-	F	Hatchback Engine M8DA/M8DB	818240	Outer Joint	27	26	63	96	62.5	M		
	2014.11-	MT	R	F	Saloon Engine M8DA/M8DB	218294	Drive Shaft	27	26	63	96	972			
	2014.11-	MT	L	F	Saloon Engine M8DA/M8DB	218295	Drive Shaft	27	26	63	96	637			
	2014.11-	-	-	F	Saloon Engine M8DA/M8DB	818240	Outer Joint	27	26	63	96	62.5	M		
1.5 EcoBoost (134 kW)	2014.09-	-	-	F	Hatchback Engine M9DB/M9DA	818238	Outer Joint	27	23	63	96	57	M		
	2014.09-	MT	R	F	Hatchback Engine M9DB/M9DA	218294	Drive Shaft	27	26	63	96	972			
	2014.09-	MT	L	F	Hatchback Engine M9DB/M9DA	218295	Drive Shaft	27	26	63	96	637			
	2014.09-	-	-	F	Hatchback Engine M9DB/M9DA	818240	Outer Joint	27	26	63	96	62.5	M		
	2014.11-	MT	R	F	Saloon Engine M9DA/M9DB	218294	Drive Shaft	27	26	63	96	972			
	2014.11-	MT	L	F	Saloon Engine M9DA/M9DB	218295	Drive Shaft	27	26	63	96	637			
	2014.11-	-	-	F	Saloon Engine M9DA/M9DB	818240	Outer Joint	27	26	63	96	62.5	M		
1.5 TDCi (70 kW)	2014.09-	-	-	F	Hatchback Engine XXDC/XXDA	818238	Outer Joint	27	23	63	96	57	M		
	2014.09-	-	-	F	Hatchback Engine XXDC/XXDA	818240	Outer Joint	27	26	63	96	62.5	M		
	2014.11-	-	-	F	Saloon Engine XXDA/XXDC	818240	Outer Joint	27	26	63	96	62.5	M		
1.5 TDCi (88 kW)	2014.09-	-	-	F	Hatchback Engine XWDA/XWDB/XWDC/XWDD	818238	Outer Joint	27	23	63	96	57	M		
	2014.09-	-	-	F	Hatchback Engine XWDA/XWDB/XWDC/XWDD	818240	Outer Joint	27	26	63	96	62.5	M		
	2014.11-	-	-	F	Saloon Engine XWDD/XWDA/XWDB/XWDC	818240	Outer Joint	27	26	63	96	62.5	M		
1.5 TDCi ECONetic (77 kW)	2014.09-	-	-	F	Hatchback Engine XXDB	818238	Outer Joint	27	23	63	96	57	M		
	2014.09-	-	-	F	Hatchback Engine XXDB	818240	Outer Joint	27	26	63	96	62.5	M		
	2014.11-	-	-	F	Saloon Engine XXDB	818240	Outer Joint	27	26	63	96	62.5	M		
1.6 EcoBoost (110 kW)	2010.07-	MT	R	F	Saloon Engine JQDA/JQDB/YUDA	218294	Drive Shaft	27	26	63	96	972			

	 YEAR	TRANSM	L/R	F/R	REMARKS	GSP Ref.	 PRODUCT	 ABS	Technical Specifications						
									A	B	C	H	L	P	
FORD															
FOCUS III															
1.6 EcoBoost (110 kW)	2010.07.-	-	MT	R	F	Hatchback Engine JQDA/JQDB/YUDA	218294	Drive Shaft		27	26	63	96	972	
	2010.07.-	-	MT	R	F	Saloon Engine JQDA/JQDB/YUDA	818239	Outer Joint		27	26	63	96	62.5	M
	2010.07.-	-	MT	L	F	Saloon Engine JQDA/JQDB/YUDA	218295	Drive Shaft		27	26	63	96	637	
	2010.07.-	-	MT	R	F	Hatchback Engine JQDA/JQDB/YUDA	818239	Outer Joint		27	26	63	96	62.5	M
	2010.07.-	-	MT	L	F	Hatchback Engine JQDA/JQDB/YUDA	218295	Drive Shaft		27	26	63	96	637	
	2010.07.-	-	-	-	-	F Saloon Engine JQDA/JQDB/YUDA	818240	Outer Joint		27	26	63	96	62.5	M
	2010.07.-	-	-	-	-	F Hatchback Engine JQDA/JQDB/YUDA	818240	Outer Joint		27	26	63	96	62.5	M
	2010.07.-	-	-	-	-	F Saloon Engine JQDA/JQDB/YUDA	818244	Outer Joint		27	24	62.8	95.5	59	M
	2010.07.-	-	-	-	-	F Hatchback Engine JQDA/JQDB/YUDA	818244	Outer Joint		27	24	62.8	95.5	59	M
	2010.07.-	-	-	-	-	F Saloon Engine JQDA/JQDB/YUDA	818238	Outer Joint		27	23	63	96	57	M
2010.07.-	-	-	-	-	F Hatchback Engine JQDA/JQDB/YUDA	818238	Outer Joint		27	23	63	96	57	M	
1.6 EcoBoost (134 kW)	2010.07.-	-	MT	R	F	Saloon Engine JTDA/JTDB	218294	Drive Shaft		27	26	63	96	972	
	2010.07.-	-	MT	R	F	Hatchback Engine JTDA/JTDB	218294	Drive Shaft		27	26	63	96	972	
	2010.07.-	-	MT	R	F	Saloon Engine JTDA/JTDB	818239	Outer Joint		27	26	63	96	62.5	M
	2010.07.-	-	MT	L	F	Saloon Engine JTDA/JTDB	218295	Drive Shaft		27	26	63	96	637	
	2010.07.-	-	MT	R	F	Hatchback Engine JTDA/JTDB	818239	Outer Joint		27	26	63	96	62.5	M
	2010.07.-	-	MT	L	F	Hatchback Engine JTDA/JTDB	218295	Drive Shaft		27	26	63	96	637	
	2010.07.-	-	-	-	-	F Saloon Engine JTDA/JTDB	818240	Outer Joint		27	26	63	96	62.5	M
	2010.07.-	-	-	-	-	F Hatchback Engine JTDA/JTDB	818240	Outer Joint		27	26	63	96	62.5	M
	2010.07.-	-	-	-	-	F Saloon Engine JTDA/JTDB	818244	Outer Joint		27	24	62.8	95.5	59	M
	2010.07.-	-	-	-	-	F Hatchback Engine JTDA/JTDB	818244	Outer Joint		27	24	62.8	95.5	59	M
2010.07.-	-	-	-	-	F Saloon Engine JTDA/JTDB	818238	Outer Joint		27	23	63	96	57	M	
2010.07.-	-	-	-	-	F Hatchback Engine JTDA/JTDB	818238	Outer Joint		27	23	63	96	57	M	
1.6 Flexifuel (110 kW)	2013.07.-	-	MT	R	F	Saloon Engine YUDA	218294	Drive Shaft		27	26	63	96	972	
	2013.07.-	-	MT	R	F	Hatchback Engine YUDA	218294	Drive Shaft		27	26	63	96	972	
	2013.07.-	-	MT	L	F	Saloon Engine YUDA	218295	Drive Shaft		27	26	63	96	637	
	2013.07.-	-	MT	L	F	Hatchback Engine YUDA	218295	Drive Shaft		27	26	63	96	637	
	2013.07.-	-	-	-	-	F Saloon Engine YUDA	818240	Outer Joint		27	26	63	96	62.5	M
	2013.07.-	-	-	-	-	F Hatchback Engine YUDA	818240	Outer Joint		27	26	63	96	62.5	M
	2013.07.-	-	MT	R	F	Saloon Engine YUDA	818239	Outer Joint		27	26	63	96	62.5	M
1.6 Flexifuel (88 kW)	2010.07.-	-	MT	L	F	Saloon Engine MUDA	218322	Drive Shaft		27	23	62.8	95.5	657	
	2010.07.-	-	MT	L	F	Hatchback Engine MUDA	218322	Drive Shaft		27	23	62.8	95.5	657	
	2010.07.-	-	MT	R	F	Saloon Engine MUDA	218323	Drive Shaft		27	23	62.8	95.5	961	
	2010.07.-	-	MT	R	F	Hatchback Engine MUDA	218323	Drive Shaft		27	23	62.8	95.5	961	
	2010.07.-	-	AT	L	F	Saloon Engine MUDA	218296	Drive Shaft		27	34	63	96	606	
	2010.07.-	-	AT	L	F	Hatchback Engine MUDA	218296	Drive Shaft		27	34	63	96	606	
	2010.07.-	-	-	-	-	F Saloon Engine MUDA	818244	Outer Joint		27	24	62.8	95.5	59	M
	2010.07.-	-	-	-	-	F Hatchback Engine MUDA	818244	Outer Joint		27	24	62.8	95.5	59	M
	2010.07.-	-	-	-	-	F Saloon Engine MUDA	818238	Outer Joint		27	23	63	96	57	M
	2010.07.-	-	-	-	-	F Hatchback Engine MUDA	818238	Outer Joint		27	23	63	96	57	M
1.6 LPG (86 kW)	2012.02.-	-	MT	L	F	Hatchback Engine MUDA	218322	Drive Shaft		27	23	62.8	95.5	657	
	2012.02.-	-	MT	R	F	Hatchback Engine MUDA	218323	Drive Shaft		27	23	62.8	95.5	961	
	2012.02.-	-	AT	L	F	Hatchback Engine MUDA	218296	Drive Shaft		27	34	63	96	606	
1.6 LPG (88 kW)	2012.02.-	-	MT	L	F	Hatchback Engine MUDA	218322	Drive Shaft		27	23	62.8	95.5	657	
	2012.02.-	-	MT	R	F	Hatchback Engine MUDA	218323	Drive Shaft		27	23	62.8	95.5	961	
	2012.02.-	-	AT	L	F	Hatchback Engine MUDA	218296	Drive Shaft		27	34	63	96	606	
1.6 TDCi (70 kW)	2010.07.-	-	-	-	-	F Saloon Engine T3DA/T3DB	818240	Outer Joint		27	26	63	96	62.5	M
	2010.07.-	-	-	-	-	F Hatchback Engine T3DA/T3DB	818240	Outer Joint		27	26	63	96	62.5	M
	2010.07.-	-	-	-	-	F Saloon Engine T3DA/T3DB	818244	Outer Joint		27	24	62.8	95.5	59	M
	2010.07.-	-	-	-	-	F Hatchback Engine T3DA/T3DB	818244	Outer Joint		27	24	62.8	95.5	59	M
	2010.07.-	-	-	-	-	F Saloon Engine T3DA/T3DB	818238	Outer Joint		27	23	63	96	57	M
	2010.07.-	-	-	-	-	F Hatchback Engine T3DA/T3DB	818238	Outer Joint		27	23	63	96	57	M
1.6 TDCi (77 kW)	2012.05.-	-	-	-	-	F Saloon Engine NGDA/NGDB	818240	Outer Joint		27	26	63	96	62.5	M
1.6 TDCi (85 kW)	2010.07.-	-	-	-	-	F Saloon Engine T1DA/T1DB	818240	Outer Joint		27	26	63	96	62.5	M
	2010.07.-	-	-	-	-	F Hatchback Engine T1DA/T1DB	818240	Outer Joint		27	26	63	96	62.5	M
	2010.07.-	-	-	-	-	F Saloon Engine T1DA/T1DB	818244	Outer Joint		27	24	62.8	95.5	59	M
	2010.07.-	-	-	-	-	F Hatchback Engine T1DA/T1DB	818244	Outer Joint		27	24	62.8	95.5	59	M
	2010.07.-	-	-	-	-	F Saloon Engine T1DA/T1DB	818238	Outer Joint		27	23	63	96	57	M
	2010.07.-	-	-	-	-	F Hatchback Engine T1DA/T1DB	818238	Outer Joint		27	23	63	96	57	M
1.6 TDCi ECONetic (77 kW)	2012.05.-	-	-	-	-	F Hatchback Engine NGDA/NGDB	818240	Outer Joint		27	26	63	96	62.5	M
1.6 Ti (63 kW)	2011.08.-	-	MT	L	F	Hatchback Engine XTDA	218322	Drive Shaft		27	23	62.8	95.5	657	
	2011.08.-	-	MT	L	F	Saloon Engine XTDA	218322	Drive Shaft		27	23	62.8	95.5	657	
	2011.08.-	-	MT	R	F	Hatchback Engine XTDA	218323	Drive Shaft		27	23	62.8	95.5	961	
	2011.08.-	-	MT	R	F	Saloon Engine XTDA	218323	Drive Shaft		27	23	62.8	95.5	961	
1.6 Ti (77 kW)	2010.07.-	-	MT	L	F	Saloon Engine IQDB	218322	Drive Shaft		27	23	62.8	95.5	657	
	2010.07.-	-	MT	L	F	Hatchback Engine IQDB	218322	Drive Shaft		27	23	62.8	95.5	657	

	 YEAR	TRANSM	L/R	F/R	REMARKS	GSP Ref.	 PRODUCT	 ABS	Technical Specifications						
									A	B	C	H	L	P	
FORD															
FOCUS III															
1.6 Ti (77 kW)	2010.07-	-	MT	R	F	Saloon Engine IQDB	218323	Drive Shaft		27	23	62.8	95.5	961	
	2010.07-	-	MT	R	F	Hatchback Engine IQDB	218323	Drive Shaft		27	23	62.8	95.5	961	
	2010.07-	-	AT	L	F	Saloon Engine IQDB	218296	Drive Shaft		27	34	63	96	606	
	2010.07-	-	-	-	F	Saloon Engine IQDB	818244	Outer Joint		27	24	62.8	95.5	59	M
	2010.07-	-	-	-	F	Hatchback Engine IQDB	818244	Outer Joint		27	24	62.8	95.5	59	M
	2010.07-	-	-	-	F	Saloon Engine IQDB	818238	Outer Joint		27	23	63	96	57	M
	2010.07-	-	-	-	F	Hatchback Engine IQDB	818238	Outer Joint		27	23	63	96	57	M
1.6 Ti (92 kW)	2010.07-	-	MT	L	F	Saloon Engine PNDA	218322	Drive Shaft		27	23	62.8	95.5	657	
	2010.07-	-	MT	L	F	Hatchback Engine PNDA	218322	Drive Shaft		27	23	62.8	95.5	657	
	2010.07-	-	MT	R	F	Saloon Engine PNDA	218323	Drive Shaft		27	23	62.8	95.5	961	
	2010.07-	-	MT	R	F	Hatchback Engine PNDA	218323	Drive Shaft		27	23	62.8	95.5	961	
	2010.07-	-	AT	L	F	Saloon Engine PNDA	218296	Drive Shaft		27	34	63	96	606	
	2010.07-	-	AT	L	F	Hatchback Engine PNDA	218296	Drive Shaft		27	34	63	96	606	
	2010.07-	-	AT	-	F	Saloon Engine PNDA	818222	Outer Joint		25	23	53.3	87	56	M
	2010.07-	-	-	-	F	Hatchback Engine PNDA	818222	Outer Joint		25	23	53.3	87	56	M
	2010.07-	-	-	-	F	Saloon Engine PNDA	818244	Outer Joint		27	24	62.8	95.5	59	M
	2010.07-	-	-	-	F	Hatchback Engine PNDA	818244	Outer Joint		27	24	62.8	95.5	59	M
2.0 ST (184 kW)	2012.07-	-	MT	L	F	Hatchback Engine R9DA	218382	Drive Shaft		27	26	63.1	96	638	
	2012.07-	-	MT	R	F	Hatchback Engine R9DA	218381	Drive Shaft		27	26	63.1	96	977	
2.0 TDCi (100 kW)	2010.07-	-	-	-	F	Hatchback Engine UKDB	818238	Outer Joint		27	23	63	96	57	M
	2010.07-	-	-	-	F	Saloon Engine UKDB	818238	Outer Joint		27	23	63	96	57	M
	2010.07-	-	MT	L/R	F	Hatchback Engine UKDB	818270	Outer Joint		27	26	62.8	91	64	M
	2010.07-	-	MT	L/R	F	Saloon Engine UKDB	818270	Outer Joint		27	26	62.8	91	64	M
	2010.07-	-	AT	R	F	Hatchback Engine UKDB	218343	Drive Shaft		27	28	63.1	96	967	
	2010.07-	-	AT	R	F	Saloon Engine UKDB	218343	Drive Shaft		27	28	63.1	96	967	
	2010.07-	-	-	-	F	Hatchback Engine UKDB	818244	Outer Joint		27	24	62.8	95.5	59	M
	2010.07-	-	-	-	F	Saloon Engine UKDB	818244	Outer Joint		27	24	62.8	95.5	59	M
2.0 TDCi (103 kW)	2010.07-	-	MT	L/R	F	Saloon Engine UFDB	818270	Outer Joint		27	26	62.8	91	64	M
	2010.07-	-	MT	L/R	F	Hatchback Engine UFDB	818270	Outer Joint		27	26	62.8	91	64	M
	2010.07-	-	AT	R	F	Saloon Engine UFDB	218343	Drive Shaft		27	28	63.1	96	967	
	2010.07-	-	AT	R	F	Hatchback Engine UFDB	218343	Drive Shaft		27	28	63.1	96	967	
	2010.07-	-	-	-	F	Saloon Engine UFDB	818244	Outer Joint		27	24	62.8	95.5	59	M
	2010.07-	-	-	-	F	Hatchback Engine UFDB	818244	Outer Joint		27	24	62.8	95.5	59	M
	2010.07-	-	-	-	F	Saloon Engine UFDB	818238	Outer Joint		27	23	63	96	57	M
	2010.07-	-	-	-	F	Hatchback Engine UFDB	818238	Outer Joint		27	23	63	96	57	M
2.0 TDCi (110 kW)	2014.11-	-	AT	R	F	Saloon Engine T7DB	218343	Drive Shaft		27	28	63.1	96	967	
	2014.11-	-	AT	R	F	Hatchback Engine T7DB	218343	Drive Shaft		27	28	63.1	96	967	
2.0 TDCi (120 kW)	2010.07-	-	MT	L/R	F	Saloon Engine TXDB	818270	Outer Joint		27	26	62.8	91	64	M
	2010.07-	-	MT	L/R	F	Hatchback Engine TXDB	818270	Outer Joint		27	26	62.8	91	64	M
	2010.07-	-	AT	R	F	Saloon Engine TXDB	218343	Drive Shaft		27	28	63.1	96	967	
	2010.07-	-	AT	R	F	Hatchback Engine TXDB	218343	Drive Shaft		27	28	63.1	96	967	
	2010.07-	-	-	-	F	Saloon Engine TXDB	818244	Outer Joint		27	24	62.8	95.5	59	M
	2010.07-	-	-	-	F	Hatchback Engine TXDB	818244	Outer Joint		27	24	62.8	95.5	59	M
	2010.07-	-	-	-	F	Saloon Engine TXDB	818238	Outer Joint		27	23	63	96	57	M
	2010.07-	-	-	-	F	Hatchback Engine TXDB	818238	Outer Joint		27	23	63	96	57	M
2.0 TDCi (85 kW)	2010.07-	-	MT	L/R	F	Saloon Engine TYDA	818270	Outer Joint		27	26	62.8	91	64	M
	2010.07-	-	MT	L/R	F	Hatchback Engine TYDA	818270	Outer Joint		27	26	62.8	91	64	M
	2010.07-	-	AT	R	F	Saloon Engine TYDA	218343	Drive Shaft		27	28	63.1	96	967	
	2010.07-	-	AT	R	F	Hatchback Engine TYDA	218343	Drive Shaft		27	28	63.1	96	967	
	2010.07-	-	-	-	F	Saloon Engine TYDA	818244	Outer Joint		27	24	62.8	95.5	59	M
	2010.07-	-	-	-	F	Hatchback Engine TYDA	818244	Outer Joint		27	24	62.8	95.5	59	M
	2010.07-	-	-	-	F	Saloon Engine TYDA	818238	Outer Joint		27	23	63	96	57	M
	2010.07-	-	-	-	F	Hatchback Engine TYDA	818238	Outer Joint		27	23	63	96	57	M
2.0 TDCi ST (136 kW)	2014.11-	-	AT	R	F	Hatchback Engine T8DA	218343	Drive Shaft		27	28	63.1	96	967	
FOCUS III Turnier															
1.5 EcoBoost (110 kW)	2014.09-	-	-	-	F	Estate Engine M8DA/M8DB	818238	Outer Joint		27	23	63	96	57	M
	2014.09-	-	MT	R	F	Estate Engine M8DA/M8DB	218294	Drive Shaft		27	26	63	96	972	
	2014.09-	-	MT	L	F	Estate Engine M8DA/M8DB	218295	Drive Shaft		27	26	63	96	637	
	2014.09-	-	-	-	F	Estate Engine M8DA/M8DB	818240	Outer Joint		27	26	63	96	62.5	M
1.5 EcoBoost (134 kW)	2014.09-	-	-	-	F	Estate Engine M9DA/M9DB	818238	Outer Joint		27	23	63	96	57	M
	2014.09-	-	MT	R	F	Estate Engine M9DA/M9DB	218294	Drive Shaft		27	26	63	96	972	
	2014.09-	-	MT	L	F	Estate Engine M9DA/M9DB	218295	Drive Shaft		27	26	63	96	637	
	2014.09-	-	-	-	F	Estate Engine M9DA/M9DB	818240	Outer Joint		27	26	63	96	62.5	M
1.5 TDCi (70 kW)	2014.09-	-	-	-	F	Estate Engine XXDA/XXDC	818238	Outer Joint		27	23	63	96	57	M

	 YEAR	TRANSM	L/R	F/R	REMARKS	GSP Ref.	 PRODUCT	 ABS	Technical Specifications					
									A	B	C	H	L	P
FORD														
FOCUS III Turnier														
1.5 TDCi (70 kW)	2014.09-	-	-	-	F Estate Engine XXDA/XXDC	818240	Outer Joint		27	26	63	96	62.5	M
1.5 TDCi (88 kW)	2014.09-	-	-	-	F Estate Engine XWDA/XWDB/XWDC/XWDD	818238	Outer Joint		27	23	63	96	57	M
	2014.09-	-	-	-	F Estate Engine XWDA/XWDB/XWDC/XWDD	818240	Outer Joint		27	26	63	96	62.5	M
1.5 TDCi ECOnetic (77 kW)	2014.09-	-	-	-	F Estate Engine XXDB	818238	Outer Joint		27	23	63	96	57	M
	2014.09-	-	-	-	F Estate Engine XXDB	818240	Outer Joint		27	26	63	96	62.5	M
1.6 EcoBoost (110 kW)	2010.07-	-	MT	R	F Estate Engine JQDA/JQDB/YUDA	218294	Drive Shaft		27	26	63	96	972	
	2010.07-	-	MT	R	F Estate Engine JQDA/JQDB/YUDA	818239	Outer Joint		27	26	63	96	62.5	M
	2010.07-	-	MT	L	F Estate Engine JQDA/JQDB/YUDA	218295	Drive Shaft		27	26	63	96	637	
	2010.07-	-	-	-	F Estate Engine JQDA/JQDB/YUDA	818240	Outer Joint		27	26	63	96	62.5	M
	2010.07-	-	-	-	F Estate Engine JQDA/JQDB/YUDA	818244	Outer Joint		27	24	62.8	95.5	59	M
	2010.07-	-	-	-	F Estate Engine JQDA/JQDB/YUDA	818238	Outer Joint		27	23	63	96	57	M
1.6 EcoBoost (134 kW)	2010.07-	-	MT	R	F Estate Engine JTDA/JTDB	218294	Drive Shaft		27	26	63	96	972	
	2010.07-	-	MT	R	F Estate Engine JTDA/JTDB	818239	Outer Joint		27	26	63	96	62.5	M
	2010.07-	-	MT	L	F Estate Engine JTDA/JTDB	218295	Drive Shaft		27	26	63	96	637	
	2010.07-	-	-	-	F Estate Engine JTDA/JTDB	818240	Outer Joint		27	26	63	96	62.5	M
	2010.07-	-	-	-	F Estate Engine JTDA/JTDB	818244	Outer Joint		27	24	62.8	95.5	59	M
	2010.07-	-	-	-	F Estate Engine JTDA/JTDB	818238	Outer Joint		27	23	63	96	57	M
1.6 Flexifuel (110 kW)	2013.07-	-	MT	R	F Estate Engine YUDA	218294	Drive Shaft		27	26	63	96	972	
	2013.07-	-	MT	L	F Estate Engine YUDA	218295	Drive Shaft		27	26	63	96	637	
	2013.07-	-	-	-	F Estate Engine YUDA	818240	Outer Joint		27	26	63	96	62.5	M
	2013.07-	-	MT	R	F Estate Engine YUDA	818239	Outer Joint		27	26	63	96	62.5	M
1.6 Flexifuel (88 kW)	2010.07-	-	MT	L	F Estate Engine MUDA	218322	Drive Shaft		27	23	62.8	95.5	657	
	2010.07-	-	MT	R	F Estate Engine MUDA	218323	Drive Shaft		27	23	62.8	95.5	961	
	2010.07-	-	AT	L	F Estate Engine MUDA	218296	Drive Shaft		27	34	63	96	606	
	2010.07-	-	-	-	F Estate Engine MUDA	818244	Outer Joint		27	24	62.8	95.5	59	M
	2010.07-	-	-	-	F Estate Engine MUDA	818238	Outer Joint		27	23	63	96	57	M
1.6 LPG (86 kW)	2012.02-	-	MT	L	F Estate Engine MUDA	218322	Drive Shaft		27	23	62.8	95.5	657	
	2012.02-	-	MT	R	F Estate Engine MUDA	218323	Drive Shaft		27	23	62.8	95.5	961	
	2012.02-	-	AT	L	F Estate Engine MUDA	218296	Drive Shaft		27	34	63	96	606	
1.6 LPG (88 kW)	2012.02-	-	MT	L	F Estate Engine MUDA	218322	Drive Shaft		27	23	62.8	95.5	657	
	2012.02-	-	MT	R	F Estate Engine MUDA	218323	Drive Shaft		27	23	62.8	95.5	961	
	2012.02-	-	AT	L	F Estate Engine MUDA	218296	Drive Shaft		27	34	63	96	606	
1.6 TDCi (70 kW)	2010.07-	-	-	-	F Estate Engine T3DA/T3DB	818238	Outer Joint		27	23	63	96	57	M
	2010.07-	-	-	-	F Estate Engine T3DA/T3DB	818240	Outer Joint		27	26	63	96	62.5	M
	2010.07-	-	-	-	F Estate Engine T3DA/T3DB	818244	Outer Joint		27	24	62.8	95.5	59	M
1.6 TDCi (85 kW)	2010.07-	-	-	-	F Estate Engine T1DA/T1DB	818238	Outer Joint		27	23	63	96	57	M
	2010.07-	-	-	-	F Estate Engine T1DA/T1DB	818240	Outer Joint		27	26	63	96	62.5	M
	2010.07-	-	-	-	F Estate Engine T1DA/T1DB	818244	Outer Joint		27	24	62.8	95.5	59	M
1.6 TDCi ECOnetic (77 kW)	2012.05-	-	-	-	F Estate Engine NGDA/NGDB	818240	Outer Joint		27	26	63	96	62.5	M
1.6 Ti (63 kW)	2011.08-	-	MT	L	F Estate Engine XTDA	218322	Drive Shaft		27	23	62.8	95.5	657	
	2011.08-	-	MT	R	F Estate Engine XTDA	218323	Drive Shaft		27	23	62.8	95.5	961	
1.6 Ti (77 kW)	2010.07-	-	MT	L	F Estate Engine IQDB	218322	Drive Shaft		27	23	62.8	95.5	657	
	2010.07-	-	MT	R	F Estate Engine IQDB	218323	Drive Shaft		27	23	62.8	95.5	961	
	2010.07-	-	-	-	F Estate Engine IQDB	818244	Outer Joint		27	24	62.8	95.5	59	M
	2010.07-	-	-	-	F Estate Engine IQDB	818238	Outer Joint		27	23	63	96	57	M
1.6 Ti (92 kW)	2010.07-	-	MT	L	F Estate Engine PNDA	218322	Drive Shaft		27	23	62.8	95.5	657	
	2010.07-	-	MT	R	F Estate Engine PNDA	218323	Drive Shaft		27	23	62.8	95.5	961	
	2010.07-	-	AT	L	F Estate Engine PNDA	218296	Drive Shaft		27	34	63	96	606	
	2010.07-	-	-	-	F Estate Engine PNDA	818222	Outer Joint		25	23	53.3	87	56	M
	2010.07-	-	-	-	F Estate Engine PNDA	818244	Outer Joint		27	24	62.8	95.5	59	M
	2010.07-	-	-	-	F Estate Engine PNDA	818238	Outer Joint		27	23	63	96	57	M
2.0 ST (184 kW)	2012.07-	-	MT	L	F Estate Engine R9DA	218382	Drive Shaft		27	26	63.1	96	638	
	2012.07-	-	MT	R	F Estate Engine R9DA	218381	Drive Shaft		27	26	63.1	96	977	
2.0 TDCi (100 kW)	2010.07-	-	-	-	F Estate Engine UKDB	818238	Outer Joint		27	23	63	96	57	M
	2010.07-	-	MT	L/R	F Estate Engine UKDB	818270	Outer Joint		27	26	62.8	91	64	M
	2010.07-	-	AT	R	F Estate Engine UKDB	218343	Drive Shaft		27	28	63.1	96	967	
	2010.07-	-	-	-	F Estate Engine UKDB	818244	Outer Joint		27	24	62.8	95.5	59	M
2.0 TDCi (103 kW)	2010.07-	-	-	-	F Estate Engine UFDB	818238	Outer Joint		27	23	63	96	57	M
	2010.07-	-	MT	L/R	F Estate Engine UFDB	818270	Outer Joint		27	26	62.8	91	64	M
	2010.07-	-	AT	R	F Estate Engine UFDB	218343	Drive Shaft		27	28	63.1	96	967	
	2010.07-	-	-	-	F Estate Engine UFDB	818244	Outer Joint		27	24	62.8	95.5	59	M
2.0 TDCi (110 kW)	2014.11-	-	AT	R	F Estate Engine T7DB	218343	Drive Shaft		27	28	63.1	96	967	
2.0 TDCi (120 kW)	2010.07-	-	-	-	F Estate Engine TXDB	818238	Outer Joint		27	23	63	96	57	M
	2010.07-	-	MT	L/R	F Estate Engine TXDB	818270	Outer Joint		27	26	62.8	91	64	M
	2010.07-	-	AT	R	F Estate Engine TXDB	218343	Drive Shaft		27	28	63.1	96	967	
	2010.07-	-	-	-	F Estate Engine TXDB	818244	Outer Joint		27	24	62.8	95.5	59	M

YEAR	TRANSM	L/R	F/R	REMARKS	GSP Ref.	PRODUCT	ABS	Technical Specifications							
								A	B	C	H	L	P		
FORD															
FOCUS III Turnier															
2.0 TDCi (85 kW)	2010.07-	-	-	F	Estate Engine TYDA	818238	Outer Joint		27	23	63	96	57	M	
	2010.07-	-	MT	L/R	F	Estate Engine TYDA	818270	Outer Joint	27	26	62.8	91	64	M	
	2010.07-	-	AT	R	F	Estate Engine TYDA	218343	Drive Shaft	27	28	63.1	96	967		
	2010.07-	-	-	-	F	Estate Engine TYDA	818244	Outer Joint	27	24	62.8	95.5	59	M	
2.0 TDCi ST (136 kW)	2014.11-	-	AT	R	F	Estate Engine T8DA	218343	Drive Shaft	27	28	63.1	96	967		
2.0 Ti-GDi (125 kW)	2010.07-	-	-	-	F	Estate Engine MGDA	818238	Outer Joint	27	23	63	96	57	M	
	2010.07-	-	-	-	F	Estate Engine MGDA	818244	Outer Joint	27	24	62.8	95.5	59	M	
FOCUS Turnier (DNW)															
1.4 16V (55 kW)	1999.02-	2004.11	5MT	L	F	Estate Engine FXDA/FXDC/FXDB/FXDD	218042	Drive Shaft	25	23	53.38	88.5	633		
	1999.02-	2004.11	5MT	R	F	Estate Engine FXDA/FXDC/FXDB/FXDD	218046	Drive Shaft	25	23	53.38	88.5	934		
	1999.02-	2004.11	MT	L	F	Estate Engine FXDA/FXDC/FXDB/FXDD	618162	Inner Joint	23	21	40	61	87.5		
	1999.02-	2004.11	AT/MT	L/R	F	Estate Engine FXDA/FXDC/FXDB/FXDD	818013	Outer Joint	25	23	53.4	88.5	57	M	
	1999.02-	2004.11	AT/MT	L/R	F	Estate Engine FXDA/FXDC/FXDB/FXDD	818003	Outer Joint	25	21	53.3	89	53	M	
1.6 16V (74 kW)	1999.02-	2004.11	5MT	L	F	Estate Engine FYDB/FYDA/FYDC/FYDD/FYDH	218042	Drive Shaft	25	23	53.38	88.5	633		
	1999.02-	2004.11	5MT	R	F	Estate Engine FYDB/FYDA/FYDC/FYDD/FYDH	218046	Drive Shaft	25	23	53.38	88.5	934		
	1999.02-	2004.11	MT	L	F	Estate Engine FYDB/FYDA/FYDC/FYDD/FYDH	618162	Inner Joint	23	21	40	61	87.5		
	1999.02-	2004.11	AT/MT	L/R	F	Estate Engine FYDB/FYDA/FYDC/FYDD/FYDH	818013	Outer Joint	25	23	53.4	88.5	57	M	
	1999.02-	2004.11	AT/MT	L/R	F	Estate Engine FYDB/FYDA/FYDC/FYDD/FYDH	818003	Outer Joint	25	21	53.3	89	53	M	
	1999.02-	2004.11	MT	R	F	Estate Engine FYDB/FYDA/FYDC/FYDD/FYDH	218018	Drive Shaft	25	23	53.2	89	930		
1.8 16V (85 kW)	1999.02-	2004.11	5MT	L	F	Estate Engine EYDF/EYDC/EYDB/EYDD/EYDE/EYDG/EYDI/EYDJ/EYDL	218042	Drive Shaft	25	23	53.38	88.5	633		
	1999.02-	2004.11	5MT	R	F	Estate Engine EYDF/EYDC/EYDB/EYDD/EYDE/EYDG/EYDI/EYDJ/EYDL	218046	Drive Shaft	25	23	53.38	88.5	934		
	1999.02-	2004.11	MT	L	F	Estate Engine EYDF/EYDC/EYDB/EYDD/EYDE/EYDG/EYDI/EYDJ/EYDL	618162	Inner Joint	23	21	40	61	87.5		
	1999.02-	2004.11	AT/MT	L/R	F	Estate Engine EYDF/EYDC/EYDB/EYDD/EYDE/EYDG/EYDI/EYDJ/EYDL	818013	Outer Joint	25	23	53.4	88.5	57	M	
	1999.02-	2004.11	AT/MT	L/R	F	Estate Engine EYDF/EYDC/EYDB/EYDD/EYDE/EYDG/EYDI/EYDJ/EYDL	818003	Outer Joint	25	21	53.3	89	53	M	
	1999.02-	2004.11	MT	R	F	Estate Engine EYDF/EYDC/EYDB/EYDD/EYDE/EYDG/EYDI/EYDJ/EYDL	218018	Drive Shaft	25	23	53.2	89	930		
1.8 BiFuel (82 kW)	2003.02-	2005.01	-	L	F	Estate Engine EYDL	218042	Drive Shaft	25	23	53.38	88.5	633		
	2003.02-	2005.01	-	R	F	Estate Engine EYDL	218046	Drive Shaft	25	23	53.38	88.5	934		
	2003.02-	2005.01	MT	L	F	Estate Engine EYDL	618162	Inner Joint	23	21	40	61	87.5		
	2003.02-	2005.01	MT	R	F	Estate Engine EYDL	218018	Drive Shaft	25	23	53.2	89	930		
1.8 DI / TDDi (55 kW)	1999.08-	2004.11	AT/MT	L	F	Estate Engine BHDA/BHDB	218101	Drive Shaft	25	26	53.38	88.5	613		
	1999.08-	2004.11	AT/MT	R	F	Estate Engine BHDA/BHDB	218102	Drive Shaft	25	26	53.38	88.5	944.5		
	1999.08-	2004.11	MT	L	F	Estate Engine BHDA/BHDB	618162	Inner Joint	23	21	40	61	87.5		
	1999.08-	2004.11	AT/MT	L/R	F	Estate Engine BHDA/BHDB	818003	Outer Joint	25	21	53.3	89	53	M	
	1999.08-	2004.11	AT/MT	L/R	F	Estate Engine BHDA/BHDB	818013	Outer Joint	25	23	53.4	88.5	57	M	
1.8 TDCi (74 kW)	2002.08-	2004.11	5MT	R	F	Estate Engine FFDA	218454	Drive Shaft	25	26	53.38	88.5	949		
	2002.08-	2004.11	-	-	F	Estate Engine FFDA	818069	Outer Joint	25	24	52.6	88	59	M	
	2002.08-	2004.11	MT	L	F	Estate Engine FFDA	618162	Inner Joint	23	21	40	61	87.5		
1.8 TDCi (85 kW)	2001.03-	2004.11	5MT	R	F	Estate Engine F9DA/F9DB	218454	Drive Shaft	25	26	53.38	88.5	949		
	2001.03-	2004.11	-	-	F	Estate Engine F9DA/F9DB	818069	Outer Joint	25	24	52.6	88	59	M	
	2001.03-	2004.11	MT	L	F	Estate Engine F9DA/F9DB	618162	Inner Joint	23	21	40	61	87.5		
1.8 Turbo DI / TDDi (66 kW)	1999.02-	2004.11	MT	R	F	Estate Engine C9DC/C9DA/C9DB	218046	Drive Shaft	25	23	53.38	88.5	934		
	1999.02-	2004.11	AT/MT	L	F	Estate Engine C9DC/C9DA/C9DB	218101	Drive Shaft	25	26	53.38	88.5	613		
	1999.02-	2004.11	AT/MT	R	F	Estate Engine C9DC/C9DA/C9DB	218102	Drive Shaft	25	26	53.38	88.5	944.5		
	1999.02-	2004.11	MT	L	F	Estate Engine C9DC/C9DA/C9DB	618162	Inner Joint	23	21	40	61	87.5		
	1999.02-	2004.11	AT/MT	L/R	F	Estate Engine C9DC/C9DA/C9DB	818013	Outer Joint	25	23	53.4	88.5	57	M	
2.0 16V (96 kW)	1999.02-	2004.11	MT	R	F	Estate Engine EDDB/EDDC/EDDD/EDDF	218046	Drive Shaft	25	23	53.38	88.5	934		
	1999.02-	2004.11	MT	L	F	Estate Engine EDDB/EDDC/EDDD/EDDF	218101	Drive Shaft	25	26	53.38	88.5	613		
	1999.02-	2004.11	MT	R	F	Estate Engine EDDB/EDDC/EDDD/EDDF	218102	Drive Shaft	25	26	53.38	88.5	944.5		
	1999.02-	2004.11	AT/MT	L/R	F	Estate Engine EDDB/EDDC/EDDD/EDDF	818013	Outer Joint	25	23	53.4	88.5	57	M	
ST170 (127 kW)	2002.08-	2004.11	MT	R	F	Estate Engine ALDA	618182	Inner Joint	34	24	36	390	91.5		
	2002.08-	2004.11	MT	L	F	Estate Engine ALDA	218195	Drive Shaft	25	34	52.6	88	603		
	2002.08-	2004.11	MT	R	F	Estate Engine ALDA	299175	Drive Shaft	25	34	52.6	88	948		
FREESTAR															
-	2004-	2007	AT	L	-	-	618118	Inner Joint	35	24	42	54	76		
	2004-	2007	AT	R	-	-	618166	Inner Joint	35	24	42	60	118.5		
	2004-	2007	AT	L/R	-	-	899295	Outer Joint	26	24	55	108	66	M	
FUSION															
2.3	2006-	-	-	-	-	-	834201	Outer Joint	44T	28	32	62	89.5	57.5	I
2.5	2006-	-	-	-	-	-	834201	Outer Joint	44T	28	32	62	89.5	57.5	I
	2009.02-	-	-	-	-	-	634096	Inner Joint		28	32	43	48	84	
3.0 V6	2009-	-	-	R	-	-	218306	Drive Shaft	44T	28	28	62	90	523	
	2009-	-	-	L	-	-	218305	Drive Shaft	44T	28	35	62	90	666	
3.0 V6 4X4	2009-	-	-	R	-	-	218306	Drive Shaft	44T	28	28	62	90	523	
	2009-	-	-	L	-	-	218305	Drive Shaft	44T	28	35	62	90	666	
FUSION (JU)															
1.4 16V (59 kW)	2002.08-	-	-	-	-	-	818092	Outer Joint		25	22	53	88	51	M





YEAR	TRANS	L/R	F/R	REMARKS	GSP Ref.	PRODUCT	ABS	Technical Specifications					
								A	B	C	H	L	P
FORD													
FUSION (JU_)													
1.25 (55 kW)	2004.08-2012.12	-	L	F	Estate Engine FUJA/FUJB	218202	Drive Shaft	25	23	53	88	620	
	2004.08-2012.12	-	R	F	Estate Engine FUJA/FUJB	218201	Drive Shaft	25	23	53.3	90	919	
	2004.08-2012.12	-	-	F	Estate Engine FUJA/FUJB	818009	Outer Joint	25	22	53.3	90	51	M
1.4 (59 kW)	2002.08-2012.12	AMT	L	F	Estate Engine FXJC/FXJB/FXJA	218202	Drive Shaft	25	23	53	88	620	
	2002.08-2012.12	AMT	R	F	Estate Engine FXJC/FXJB/FXJA	218201	Drive Shaft	25	23	53.3	90	919	
	2002.08-2012.12	MT	-	F	Estate Engine FXJC/FXJB/FXJA	818014	Outer Joint	25	21	53.2	89	54	M
	2002.08-2012.12	-	-	F	Estate Engine FXJC/FXJB/FXJA	818009	Outer Joint	25	22	53.3	90	51	M
1.4 LPG (59 kW)	2010.01-2012.12	-	L	F	Estate Engine UTJA	218202	Drive Shaft	25	23	53	88	620	
	2010.01-2012.12	MT	-	F	Estate Engine UTJA	818014	Outer Joint	25	21	53.2	89	54	M
1.4 TDCi (50 kW)	2002.08-2012.12	MT	-	F	Estate Engine F6JA/F6JB	818014	Outer Joint	25	21	53.2	89	54	M
	2002.08-2012.12	MT	R	F	Estate Engine F6JA/F6JB	218217	Drive Shaft	25	23	52.9	89	916	
	2002.08-2012.12	MT	L	F	Estate Engine F6JA/F6JB	218216	Drive Shaft	25	23	53.3	90	621	
	2002.08-2012.12	MT	L	F	Estate Engine F6JA/F6JB	618085	Inner Joint	23	22	40	61	90	
	2002.08-2012.12	-	-	F	Estate Engine F6JA/F6JB	818001	Outer Joint	25	20	52.9	89	52	M
1.6 (74 kW)	2002.08-2008.11	MT	L	F	Estate Engine FYJC/FYJB/FYJA	218202	Drive Shaft	25	23	53	88	620	
	2002.08-2008.11	AT/MT	-	F	Estate Engine FYJC/FYJB/FYJA	818014	Outer Joint	25	21	53.2	89	54	M
	2002.08-2008.11	MT	R	F	Estate Engine FYJC/FYJB/FYJA	218201	Drive Shaft	25	23	53.3	90	919	
	2002.08-2008.11	AT	L	F	Estate Engine FYJC/FYJB/FYJA	218351	Drive Shaft	25	22	53.3	89	606	
	2002.08-2008.11	AT	R	F	Estate Engine FYJC/FYJB/FYJA	218333	Drive Shaft	25	22	53.3	89	930	
	2002.08-2008.11	AT	L	F	Estate Engine FYJC/FYJB/FYJA	657115	Inner Joint	22	21	38	59.5	97.5	
	2002.08-2008.11	AT	R	F	Estate Engine FYJC/FYJB/FYJA	618103	Inner Joint	22	21	38	403.5	84.5	
1.6 TDCi (66 kW)	2004.11-2012.12	AT/MT	-	F	Estate Engine HHJA/HHJB	818014	Outer Joint	25	21	53.2	89	54	M
	2004.11-2012.12	MT	L	F	Estate Engine HHJA/HHJB	218309	Drive Shaft	25	23	52.9	89	615	
	2004.11-2012.12	MT	R	F	Estate Engine HHJA/HHJB	218326	Drive Shaft	25	23	53.38	88.5	915	
	2004.11-2012.12	AT	L	F	Estate Engine HHJA/HHJB	657115	Inner Joint	22	21	38	59.5	97.5	
	2004.11-2012.12	AT	R	F	Estate Engine HHJA/HHJB	618103	Inner Joint	22	21	38	403.5	84.5	
	2004.11-2012.12	5AT	-	F	Estate Engine HHJA/HHJB	818222	Outer Joint	25	23	53.3	87	56	M
GALAXY													
1.9 Tdi (110 KW)	2005-	-	R	F	MPV (Diesel)	261255	Stub Axle	37	113.5			381	
	2006-	-	R	F	MPV (Diesel)	261255	Stub Axle	37	113.5			381	
1.9 Tdi (66 KW)	1995-	-	R	F	MPV (Diesel)	261255	Stub Axle	37	113.5			381	
	1996-	-	R	F	MPV (Diesel)	261255	Stub Axle	37	113.5			381	
	1997-	-	R	F	MPV (Diesel)	261255	Stub Axle	37	113.5			381	
	1998-	-	R	F	MPV (Diesel)	261255	Stub Axle	37	113.5			381	
	1999-	-	R	F	MPV (Diesel)	261255	Stub Axle	37	113.5			381	
	2000-	-	R	F	MPV (Diesel)	261255	Stub Axle	37	113.5			381	
	2001-	-	R	F	MPV (Diesel)	261255	Stub Axle	37	113.5			381	
	2002-	-	R	F	MPV (Diesel)	261255	Stub Axle	37	113.5			381	
	2003-	-	R	F	MPV (Diesel)	261255	Stub Axle	37	113.5			381	
	2004-	-	R	F	MPV (Diesel)	261255	Stub Axle	37	113.5			381	
	2005-	-	R	F	MPV (Diesel)	261255	Stub Axle	37	113.5			381	
	2006-	-	R	F	MPV (Diesel)	261255	Stub Axle	37	113.5			381	
1.9 Tdi (81 KW)	1997-	-	R	F	MPV (Diesel)	261255	Stub Axle	37	113.5			381	
	1998-	-	R	F	MPV (Diesel)	261255	Stub Axle	37	113.5			381	
	1999-	-	R	F	MPV (Diesel)	261255	Stub Axle	37	113.5			381	
	2000-	-	R	F	MPV (Diesel)	261255	Stub Axle	37	113.5			381	
1.9 Tdi (85 KW)	2000-	-	R	F	MPV (Diesel)	261255	Stub Axle	37	113.5			381	
	2001-	-	R	F	MPV (Diesel)	261255	Stub Axle	37	113.5			381	
	2002-	-	R	F	MPV (Diesel)	261255	Stub Axle	37	113.5			381	
	2003-	-	R	F	MPV (Diesel)	261255	Stub Axle	37	113.5			381	
	2004-	-	R	F	MPV (Diesel)	261255	Stub Axle	37	113.5			381	
	2005-	-	R	F	MPV (Diesel)	261255	Stub Axle	37	113.5			381	
	2006-	-	R	F	MPV (Diesel)	261255	Stub Axle	37	113.5			381	
1.9 Tdi (96 KW)	2003-	-	R	F	MPV (Diesel)	261255	Stub Axle	37	113.5			381	
	2004-	-	R	F	MPV (Diesel)	261255	Stub Axle	37	113.5			381	
	2005-	-	R	F	MPV (Diesel)	261255	Stub Axle	37	113.5			381	
	2006-	-	R	F	MPV (Diesel)	261255	Stub Axle	37	113.5			381	
GALAXY (WA6)													
1.6 TDCi (85 kW)	2011.02-2015.06	MT	L	F	MPV Engine T1WA/T1WB	299211	Drive Shaft	40	26	57.4	51	603	
	2011.02-2015.06	MT	R	F	MPV Engine T1WA/T1WB	299212	Drive Shaft	40	26	57.4	51	945	
1.8 TDCi (74 kW)	2006.05-2015.06	MT	L	F	MPV Engine FFWA	299211	Drive Shaft	40	26	57.4	51	603	
	2006.05-2015.06	MT	R	F	MPV Engine FFWA	299212	Drive Shaft	40	26	57.4	51	945	
1.8 TDCi (92 kW)	2006.05-2015.06	MT	L	F	MPV Engine QYWA	299211	Drive Shaft	40	26	57.4	51	603	
	2006.05-2015.06	MT	R	F	MPV Engine QYWA	299212	Drive Shaft	40	26	57.4	51	945	
2.0 (107 kW)	2006.05-2015.06	MT	L	F	MPV Engine AOWA/AOWB	299211	Drive Shaft	40	26	57.4	51	603	
2.0 EcoBoost (149 kW)	2010.03-2015.06	Semi-AT	R	F	MPV Engine TNWA	218341	Drive Shaft	40	28	57.4	52	952	

YEAR	TRANSM	L/R	F/R	REMARKS	GSP Ref.	PRODUCT	ABS	Technical Specifications						
								A	B	C	H	L	P	
FORD														
GALAXY (WA6)														
2.0 EcoBoost (149 kW)	2010.03-2015.06	Semi-AT	-	F	MPV Engine TNWA	859344	Outer Joint		40	26	57.4	52	63.5	M
2.0 TDCi (100 kW)	2006.05-2015.06	AT	-	F	MPV Engine UKWA/AZWC	859344	Outer Joint		40	26	57.4	52	63.5	M
	2006.05-2015.06	AT	L	F	MPV Engine UKWA/AZWC	218340	Drive Shaft		40	28	57.4	52	592	
	2006.05-2015.06	MT	L	F	MPV Engine UKWA/AZWC	299211	Drive Shaft		40	26	57.4	51	603	
	2006.05-2015.06	MT	R	F	MPV Engine UKWA/AZWC	299212	Drive Shaft		40	26	57.4	51	945	
	2006.05-2015.06	AT	L	F	MPV Engine UKWA/AZWC	203288	Drive Shaft		40	31	57.4	51	582	
	2006.05-2015.06	AT	R	F	MPV Engine UKWA/AZWC	203289	Drive Shaft		40	28	57.4	51	932	
2.0 TDCi (103 kW)	2006.05-2015.06	AT	-	F	MPV Engine QXWC/QXWA/QXWB/UFWA	859344	Outer Joint		40	26	57.4	52	63.5	M
	2006.05-2015.06	AT	L	F	MPV Engine QXWC/QXWA/QXWB/UFWA	218340	Drive Shaft		40	28	57.4	52	592	
	2006.05-2015.06	MT	L	F	MPV Engine QXWC/QXWA/QXWB/UFWA	299211	Drive Shaft		40	26	57.4	51	603	
	2006.05-2015.06	MT	R	F	MPV Engine QXWC/QXWA/QXWB/UFWA	299212	Drive Shaft		40	26	57.4	51	945	
	2006.05-2015.06	AT	L	F	MPV Engine QXWC/QXWA/QXWB/UFWA	203288	Drive Shaft		40	31	57.4	51	582	
	2006.05-2015.06	AT	R	F	MPV Engine QXWC/QXWA/QXWB/UFWA	203289	Drive Shaft		40	28	57.4	51	932	
2.0 TDCi (120 kW)	2010.03-2015.06	AT	-	F	MPV Engine TXWA	859344	Outer Joint		40	26	57.4	52	63.5	M
	2010.03-2015.06	AT	L	F	MPV Engine TXWA	218340	Drive Shaft		40	28	57.4	52	592	
	2010.03-2015.06	MT	L	F	MPV Engine TXWA	299211	Drive Shaft		40	26	57.4	51	603	
	2010.03-2015.06	MT	R	F	MPV Engine TXWA	299212	Drive Shaft		40	26	57.4	51	945	
	2010.03-2015.06	AT	L	F	MPV Engine TXWA	203288	Drive Shaft		40	31	57.4	51	582	
	2010.03-2015.06	AT	R	F	MPV Engine TXWA	203289	Drive Shaft		40	28	57.4	51	932	
2.0 TDCi (85 kW)	2007.11-2015.06	MT	L	F	MPV Engine TYWA/KLWA	299211	Drive Shaft		40	26	57.4	51	603	
	2007.11-2015.06	MT	R	F	MPV Engine TYWA/KLWA	299212	Drive Shaft		40	26	57.4	51	945	
2.0 TDCi (96 kW)	2006.05-2015.06	AT	-	F	MPV Engine AZWA	859344	Outer Joint		40	26	57.4	52	63.5	M
	2006.05-2015.06	AT	L	F	MPV Engine AZWA	218340	Drive Shaft		40	28	57.4	52	592	
	2006.05-2015.06	MT	L	F	MPV Engine AZWA	299211	Drive Shaft		40	26	57.4	51	603	
	2006.05-2015.06	MT	R	F	MPV Engine AZWA	299212	Drive Shaft		40	26	57.4	51	945	
	2006.05-2015.06	AT	L	F	MPV Engine AZWA	203288	Drive Shaft		40	31	57.4	51	582	
	2006.05-2015.06	AT	R	F	MPV Engine AZWA	203289	Drive Shaft		40	28	57.4	51	932	
2.2 TDCi (129 kW)	2008.03-2012.12	MT	L	F	MPV Engine Q4WA/Q4BA	218363	Drive Shaft		40	31	57.4	52	588.5	
	2008.03-2012.12	MT	R	F	MPV Engine Q4WA/Q4BA	218350	Drive Shaft		40	28	57.4	52	963	
2.2 TDCi (147 kW)	2010.11-2015.06	MT	L	F	MPV Engine KNWA	218363	Drive Shaft		40	31	57.4	52	588.5	
	2010.11-2015.06	MT	R	F	MPV Engine KNWA	218350	Drive Shaft		40	28	57.4	52	963	
2.3 (118 kW)	2007.09-2015.06	AT	R	F	MPV Engine SEWA	261106	Drive Shaft		40	31	57.4	51	945	
GALAXY (WGR)														
1.9 TDI (110 kW)	2005.05-2006.05	-	R	F	MPV Engine BTB	261193	Stub Axle		37		60		322	
	2005.05-2006.05	-	R	F	MPV Engine BTB	261192	Stub Axle		26	37	60		129.5	
	2005.05-2006.05	-	L/R	F	MPV Engine BTB	203023	Drive Shaft	48W	38		60	34	507	
	2005.05-2006.05	-	L/R	F	MPV Engine BTB	818025	Outer Joint	48W	38	36	60	34	72.5	I
	2005.05-2006.05	-	L/R	F	MPV Engine BTB	261087	Drive Shaft	48W	38		60	34.5	506	
1.9 TDI (66 kW)	1995.03-2006.05	-	L/R	F	MPV Engine AHU/ANU/1Z	261192	Stub Axle		26	37	60		129.5	
	1995.03-2006.05	MT	L	F	MPV Engine AHU/ANU/1Z	861022	Outer Joint		38	27	60	34.5	65	M
	1995.03-2006.05	-	L/R	F	MPV Engine AHU/ANU/1Z	661032	Inner Joint			27		34		
	1995.03-2006.05	MT	-	F	MPV Engine AHU/ANU/1Z	659006	Inner Joint			34		33.2		
	1995.03-2006.05	MT	-	F	MPV Engine AHU/ANU/1Z	818040	Outer Joint		38	27	60	34.5	65	I
	1995.03-2006.05	MT	L/R	F	MPV Engine AHU/ANU/1Z	203023	Drive Shaft	48W	38		60	34	507	
	1995.03-2006.05	MT	L	F	MPV Engine AHU/ANU/1Z	203024	Drive Shaft	48W	38	26	60	34.5	617	
	1995.03-2006.05	MT	R	F	MPV Engine AHU/ANU/1Z	203027	Drive Shaft	48W	38	35	60	34.5	561	
	1995.03-2006.05	AT/MT	L/R	F	MPV Engine AHU/ANU/1Z	818026	Outer Joint	48W	38	27	60	34.5	65	I
	1995.03-2006.05	MT	L	F	MPV Engine AHU/ANU/1Z	203064	Drive Shaft		38	26	60	34.5	617	
	1995.03-2006.05	MT	R	F	MPV Engine AHU/ANU/1Z	203065	Drive Shaft		38	35	60	34.5	561	
	1995.03-2006.05	AT/MT	L/R	F	MPV Engine AHU/ANU/1Z	818025	Outer Joint	48W	38	36	60	34	72.5	I
	1995.03-2006.05	MT	R	F	MPV Engine AHU/ANU/1Z	261245	Stub Axle		26	113.5			290	
	1995.03-2006.05	-	R	F	MPV Engine AHU/ANU/1Z	261193	Stub Axle		37		60		322	
1.9 TDI (81 kW)	1997.08-2000.04	AT	L/R	F	MPV Engine AFN/AVG	661033	Inner Joint			34		85		
	1997.08-2000.04	MT	R	F	MPV Engine AFN/AVG	218008	Drive Shaft	48W	38	35	60	34.5	559	
	1997.08-2000.04	AT	L	F	MPV Engine AFN/AVG	261085	Drive Shaft	48W	38		60	34.5	513	
	1997.08-2000.04	AT	R	F	MPV Engine AFN/AVG	261065	Drive Shaft	48W	38		60	34.5	544	
	1997.08-2000.04	MT	L	F	MPV Engine AFN/AVG	861022	Outer Joint		38	27	60	34.5	65	M
	1997.08-2000.04	-	-	F	MPV Engine AFN/AVG	818040	Outer Joint		38	27	60	34.5	65	I
	1997.08-2000.04	MT	L	F	MPV Engine AFN/AVG	203024	Drive Shaft	48W	38	26	60	34.5	617	
	1997.08-2000.04	MT	R	F	MPV Engine AFN/AVG	203027	Drive Shaft	48W	38	35	60	34.5	561	
	1997.08-2000.04	AT/MT	L/R	F	MPV Engine AFN/AVG	818026	Outer Joint	48W	38	27	60	34.5	65	I
	1997.08-2000.04	MT	L	F	MPV Engine AFN/AVG	203064	Drive Shaft		38	26	60	34.5	617	
	1997.08-2000.04	MT	R	F	MPV Engine AFN/AVG	203065	Drive Shaft		38	35	60	34.5	561	
	1997.08-2000.04	-	L/R	F	MPV Engine AFN/AVG	818025	Outer Joint	48W	38	36	60	34	72.5	I
	1997.08-2000.04	AT	R	F	MPV Engine AFN/AVG	261104	Drive Shaft	48W	38		60	34	544	
	1.9 TDI (85 kW)	2000.04-2006.05	-	R	F	MPV Engine AUJ	261193	Stub Axle		37		60		322





YEAR	TRANSM	L/R	F/R	REMARKS	GSP Ref.	PRODUCT	ABS	Technical Specifications						
								A	B	C	H	L	P	
FORD														
GALAXY (WGR)														
1.9 TDI (85 kW)	2000.04-2006.05	5AT	L/R	F	MPV Engine AUJ	203022	Drive Shaft	48W	38		60	34	486	
	2000.04-2006.05	-	R	F	MPV Engine AUJ	261192	Stub Axle		26	37	60		129.5	
	2000.04-2006.05	MT	L/R	F	MPV Engine AUJ	203023	Drive Shaft	48W	38		60	34	507	
	2000.04-2006.05	AT/MT	L/R	F	MPV Engine AUJ	818025	Outer Joint	48W	38	36	60	34	72.5	I
	2000.04-2006.05	5AT	L/R	F	MPV Engine AUJ	818039	Outer Joint		38	36	60	34	72.5	I
1.9 TDI (96 kW)	2003.02-2006.05	-	R	F	MPV Engine ASZ	261193	Stub Axle		37		60		322	
	2003.02-2006.05	-	R	F	MPV Engine ASZ	261192	Stub Axle		26	37	60		129.5	
	2003.02-2006.05	MT	L/R	F	MPV Engine ASZ	203023	Drive Shaft	48W	38		60	34	507	
	2003.02-2006.05	-	L/R	F	MPV Engine ASZ	818025	Outer Joint	48W	38	36	60	34	72.5	I
2.0 i (85 kW)	1995.11-2006.05	AT	L/R	F	MPV Engine ZVSA/NSE	661033	Inner Joint			34			85	
	1995.11-2006.05	MT	R	F	MPV Engine ZVSA/NSE	218008	Drive Shaft	48W	38	35	60	34.5	559	
	1995.11-2006.05	AT	L	F	MPV Engine ZVSA/NSE	261085	Drive Shaft	48W	38		60	34.5	513	
	1995.11-2006.05	AT	R	F	MPV Engine ZVSA/NSE	261065	Drive Shaft	48W	38		60	34.5	544	
	1995.11-2006.05	-	-	F	MPV Engine ZVSA/NSE	818040	Outer Joint		38	27	60	34.5	65	I
	1995.11-2006.05	MT	L	F	MPV Engine ZVSA/NSE	203024	Drive Shaft	48W	38	26	60	34.5	617	
	1995.11-2006.05	AT/MT	L/R	F	MPV Engine ZVSA/NSE	818026	Outer Joint	48W	38	27	60	34.5	65	I
	1995.11-2006.05	MT	R	F	MPV Engine ZVSA/NSE	203027	Drive Shaft	48W	38	35	60	34.5	561	
	1995.11-2006.05	-	L/R	F	MPV Engine ZVSA/NSE	818025	Outer Joint	48W	38	36	60	34	72.5	I
	1995.11-2006.05	AT	R	F	MPV Engine ZVSA/NSE	261104	Drive Shaft	48W	38		60	34	544	
2.3 16V (103 kW)	2001.09-2006.05	Semi-AT	L	F	MPV Engine E5SB	261085	Drive Shaft	48W	38		60	34.5	513	
	2001.09-2006.05	MT	L	F	MPV Engine E5SB	203024	Drive Shaft	48W	38	26	60	34.5	617	
	2001.09-2006.05	MT	R	F	MPV Engine E5SB	203027	Drive Shaft	48W	38	35	60	34.5	561	
	2001.09-2006.05	-	L/R	F	MPV Engine E5SB	818025	Outer Joint	48W	38	36	60	34	72.5	I
	2001.09-2006.05	AT	R	F	MPV Engine E5SB	261104	Drive Shaft	48W	38		60	34	544	
2.3 16V (107 kW)	1997.01-2006.05	-	R	F	MPV Engine Y5B/ESSA	218008	Drive Shaft	48W	38	35	60	34.5	559	
	1997.01-2006.05	-	L	F	MPV Engine Y5B/ESSA	261085	Drive Shaft	48W	38		60	34.5	513	
	1997.01-2006.05	-	R	F	MPV Engine Y5B/ESSA	261065	Drive Shaft	48W	38		60	34.5	544	
	1997.01-2006.05	MT	L	F	MPV Engine Y5B/ESSA	861022	Outer Joint		38	27	60	34.5	65	M
	1997.01-2006.05	-	-	F	MPV Engine Y5B/ESSA	818040	Outer Joint		38	27	60	34.5	65	I
	1997.01-2006.05	MT	L	F	MPV Engine Y5B/ESSA	203024	Drive Shaft	48W	38	26	60	34.5	617	
	1997.01-2006.05	MT	R	F	MPV Engine Y5B/ESSA	203027	Drive Shaft	48W	38	35	60	34.5	561	
	1997.01-2006.05	AT/MT	L/R	F	MPV Engine Y5B/ESSA	818026	Outer Joint	48W	38	27	60	34.5	65	I
	1997.01-2006.05	MT	L	F	MPV Engine Y5B/ESSA	203064	Drive Shaft		38	26	60	34.5	617	
	1997.01-2006.05	MT	R	F	MPV Engine Y5B/ESSA	203065	Drive Shaft		38	35	60	34.5	561	
	1997.01-2006.05	AT	R	F	MPV Engine Y5B/ESSA	261104	Drive Shaft	48W	38		60	34	544	
	1997.01-2006.05	AT/MT	L/R	F	MPV Engine Y5B/ESSA	818025	Outer Joint	48W	38	36	60	34	72.5	I
2.8 i V6 (128 kW)	1995.11-2000.04	MT	L	F	MPV Engine AMY/AAA	218009	Drive Shaft	48W	38	26	60	34.5	620	
	1995.11-2000.04	MT	R	F	MPV Engine AMY/AAA	218106	Drive Shaft	48W	38	35	60	34.5	634	
	1995.11-2000.04	AT	L/R	F	MPV Engine AMY/AAA	218010	Drive Shaft	48W	38		60	34.5	550	
	1995.11-2000.04	-	-	F	MPV Engine AMY/AAA	818040	Outer Joint		38	27	60	34.5	65	I
	1995.11-2000.04	AT/MT	L/R	F	MPV Engine AMY/AAA	818026	Outer Joint	48W	38	27	60	34.5	65	I
	1995.11-2000.04	-	L/R	F	MPV Engine AMY/AAA	818025	Outer Joint	48W	38	36	60	34	72.5	I
	1996.04-2000.04	MT	L	F	All-wheel Drive MPV Engine AAA/AMY	218009	Drive Shaft	48W	38	26	60	34.5	620	
	1996.04-2000.04	MT	R	F	All-wheel Drive MPV Engine AAA/AMY	218106	Drive Shaft	48W	38	35	60	34.5	634	
	1996.04-2000.04	AT	L/R	F	All-wheel Drive MPV Engine AAA/AMY	218010	Drive Shaft	48W	38		60	34.5	550	
	1996.04-2000.04	AT/MT	L/R	F	All-wheel Drive MPV Engine AAA/AMY	818026	Outer Joint	48W	38	27	60	34.5	65	I
	1996.04-2000.04	-	L/R	F	All-wheel Drive MPV Engine AAA/AMY	818025	Outer Joint	48W	38	36	60	34	72.5	I
2.8 V6 (150 kW)	2000.04-2006.05	-	R	F	MPV Engine AYL	261193	Stub Axle		37		60		322	
	2000.04-2006.05	5AT	L	F	MPV Engine AYL	203022	Drive Shaft	48W	38		60	34	486	
	2000.04-2006.05	5AT	R	F	MPV Engine AYL	299120	Drive Shaft	48W	38	30	60	34	561	
	2000.04-2006.05	-	R	F	MPV Engine AYL	261192	Stub Axle		26	37	60		129.5	
	2000.04-2006.05	MT	L/R	F	MPV Engine AYL	203023	Drive Shaft	48W	38		60	34	507	
	2000.04-2006.05	AT/MT	L/R	F	MPV Engine AYL	818025	Outer Joint	48W	38	36	60	34	72.5	I
	2000.04-2006.05	5AT	L	F	MPV Engine AYL	818039	Outer Joint		38	36	60	34	72.5	I
GALAXY I (VX, WGR, VY)														
1.9 TDi (66 kW)	1995.02-2000.04	-	L	-	Europe	699053	Inner Joint		26	28	40	77.5	82.5	
	1995.02-2000.04	-	R	-	-	661028	Inner Joint		35	28	42	48	52	
1.9 TDi (81 kW)	1995.02-2000.04	-	L	-	Europe	699053	Inner Joint		26	28	40	77.5	82.5	
	1995.02-2000.04	-	R	-	-	661028	Inner Joint		35	28	42	48	52	
2.0 (85 kW)	1995.02-2000.04	-	L	-	Europe	699053	Inner Joint		26	28	40	77.5	82.5	
	1995.02-2000.04	-	R	-	-	661028	Inner Joint		35	28	42	48	52	
2.3 16V (107 kW)	1996.09-2000.04	-	L	-	Europe	699053	Inner Joint		26	28	40	77.5	82.5	
	1996.09-2000.04	-	R	-	-	661028	Inner Joint		35	28	42	48	52	
GHIA														
-	1994-1996	AT	-	-	-	818063	Outer Joint		26	32	51	105	64.5	I
GRAND C-MAX (DXA/CB7 DXA/CEU)														

YEAR	TRANSM	L/R	F/R	REMARKS	GSP Ref.	PRODUCT	ABS	Technical Specifications						
								A	B	C	H	L	P	
FORD														
GRAND C-MAX (DXA/CB7 DXA/CEU)														
1.5 TDCi (70 kW)	2015.03-	-	-	F	MPV Engine XXDA/XXDC	818240	Outer Joint	27	26	63	96	62.5	M	
1.5 TDCi (88 kW)	2015.03-	-	-	F	MPV Engine XWDA/XWDB	818240	Outer Joint	27	26	63	96	62.5	M	
1.6 EcoBoost (110 kW)	2010.12-	MT	R	F	MPV Engine JQDA/JQDB	218294	Drive Shaft	27	26	63	96	972		
	2010.12-	MT	R	F	MPV Engine JQDA/JQDB	818239	Outer Joint	27	26	63	96	62.5	M	
	2010.12-	MT	L	F	MPV Engine JQDA/JQDB	218295	Drive Shaft	27	26	63	96	637		
1.6 EcoBoost (134 kW)	2010.12-	MT	R	F	MPV Engine JTDA/JTDB	218294	Drive Shaft	27	26	63	96	972		
	2010.12-	MT	R	F	MPV Engine JTDA/JTDB	818239	Outer Joint	27	26	63	96	62.5	M	
	2010.12-	MT	L	F	MPV Engine JTDA/JTDB	218295	Drive Shaft	27	26	63	96	637		
1.6 TDCi (70 kW)	2010.12-	-	-	F	MPV Engine T3DA/T3DB	818240	Outer Joint	27	26	63	96	62.5	M	
1.6 TDCi (85 kW)	2010.12-	-	-	F	MPV Engine T1DA/T1DB	818240	Outer Joint	27	26	63	96	62.5	M	
1.6 Ti (77 kW)	2010.12-	MT	L	F	MPV Engine IQDA/IQDB	218322	Drive Shaft	27	23	62.8	95.5	657		
	2010.12-	MT	R	F	MPV Engine IQDA/IQDB	218323	Drive Shaft	27	23	62.8	95.5	961		
1.6 Ti (92 kW)	2010.12-	MT	L	F	MPV Engine PNDA	218322	Drive Shaft	27	23	62.8	95.5	657		
	2010.12-	MT	R	F	MPV Engine PNDA	218323	Drive Shaft	27	23	62.8	95.5	961		
2.0 TDCi (100 kW)	2011.02-	MT	L/R	F	MPV Engine UKDB	818270	Outer Joint	27	26	62.8	91	64	M	
	2011.02-	AT	R	F	MPV Engine UKDB	218343	Drive Shaft	27	28	63.1	96	967		
2.0 TDCi (103 kW)	2011.02-	MT	L/R	F	MPV Engine UFDB	818270	Outer Joint	27	26	62.8	91	64	M	
	2011.02-	AT	R	F	MPV Engine UFDB	218343	Drive Shaft	27	28	63.1	96	967		
2.0 TDCi (120 kW)	2010.12-	MT	L/R	F	MPV Engine TXDB	818270	Outer Joint	27	26	62.8	91	64	M	
	2010.12-	AT	R	F	MPV Engine TXDB	218343	Drive Shaft	27	28	63.1	96	967		
2.0 TDCi (85 kW)	2011.02-	MT	L/R	F	MPV Engine TYDA	818270	Outer Joint	27	26	62.8	91	64	M	
	2011.02-	AT	R	F	MPV Engine TYDA	218343	Drive Shaft	27	28	63.1	96	967		
IKON/FIESTA														
-	2001-2005	MT	-	-	-	618022	Inner Joint	23	21	40	61	88		
-	2001-2005	MT	-	-	-	699072	Inner Joint	23	21	40	370.5	75.5		
KA														
-	1999-	-	-	-	-	618072	Inner Joint	23	22	40	61	86		
1.0	1997.01-1999.12	MT	-	-	-	899015	Outer Joint	25	20	56.5	88	49	O	
1.0 Zetec Rocan	2000.01-2006.12	MT	-	-	-	818099	Outer Joint	25	20	55	88	52	M	
1.3	1997.01-1999.12	MT	-	-	-	899015	Outer Joint	25	20	56.5	88	49	O	
KA (RB_)														
1.3 i (36 kW)	1998.06-2008.11	MT	R	F	Hatchback Engine JJD/JJF/JJG/JJH/JJL	218140	Drive Shaft	25	23	56.5	88.5	868		
	1998.06-2008.11	MT	L	F	Hatchback Engine JJD/JJF/JJG/JJH/JJL	218007	Drive Shaft	25	23	56.5	88.5	590		
	1998.06-2008.11	MT	L/R	F	Hatchback Engine JJD/JJF/JJG/JJH/JJL	818012	Outer Joint	25	20	56.5	88.5	49	O	
	1998.06-2008.11	MT	R	F	Hatchback Engine JJD/JJF/JJG/JJH/JJL	299044	Drive Shaft	25	23	56.5	88.5	866		
	1998.06-2008.11	-	-	F	Hatchback Engine JJD/JJF/JJG/JJH/JJL	618053	Inner Joint	23	22	40	61	91.5		
1.3 i (37 kW)	1996.09-2002.10	MT	L	F	Hatchback Engine JJB	218007	Drive Shaft	25	23	56.5	88.5	590		
	1996.09-2002.10	MT	L/R	F	Hatchback Engine JJB	818012	Outer Joint	25	20	56.5	88.5	49	O	
	1996.09-2002.10	-	-	F	Hatchback Engine JJB	618053	Inner Joint	23	22	40	61	91.5		
	1996.09-2002.10	MT	R	F	Hatchback Engine JJB	299044	Drive Shaft	25	23	56.5	88.5	866		
	1996.09-2002.10	MT	R	F	Hatchback Engine JJB	218140	Drive Shaft	25	23	56.5	88.5	868		
1.3 i (44 kW)	1996.09-2008.11	MT	L	F	Hatchback Engine J4K/J4D/J4M/J4N/J4P/J4S/BAA	218007	Drive Shaft	25	23	56.5	88.5	590		
	1996.09-2008.11	MT	L/R	F	Hatchback Engine J4K/J4D/J4M/J4N/J4P/J4S/BAA	818012	Outer Joint	25	20	56.5	88.5	49	O	
	1996.09-2008.11	-	-	F	Hatchback Engine J4K/J4D/J4M/J4N/J4P/J4S/BAA	618053	Inner Joint	23	22	40	61	91.5		
	1996.09-2008.11	MT	R	F	Hatchback Engine J4K/J4D/J4M/J4N/J4P/J4S/BAA	299044	Drive Shaft	25	23	56.5	88.5	866		
	1996.09-2008.11	MT	R	F	Hatchback Engine J4K/J4D/J4M/J4N/J4P/J4S/BAA	218140	Drive Shaft	25	23	56.5	88.5	868		
1.3 i (51 kW)	2002.08-2008.11	MT	R	F	Hatchback Engine A9A/A9B	299044	Drive Shaft	25	23	56.5	88.5	866		
	2002.08-2008.11	-	-	F	Hatchback Engine A9A/A9B	618053	Inner Joint	23	22	40	61	91.5		
1.6 (68 kW)	2006.10-2007.12	-	-	F	Hatchback	818222	Outer Joint	25	23	53.3	87	56	M	
	2006.10-2007.12	MT	R	F	Hatchback	299044	Drive Shaft	25	23	56.5	88.5	866		
1.6 i (70 kW)	2003.07-2008.11	-	-	F	Hatchback Engine CDB/CDC	818222	Outer Joint	25	23	53.3	87	56	M	
	2003.07-2008.11	MT	R	F	Hatchback Engine CDB/CDC	299044	Drive Shaft	25	23	56.5	88.5	866		
	2003.07-2008.11	-	-	F	Hatchback Engine CDB/CDC	818009	Outer Joint	25	22	53.3	90	51	M	
1.6 i (71 kW)	2005.11-2008.09	-	-	F	Hatchback	818222	Outer Joint	25	23	53.3	87	56	M	
	2005.11-2008.09	MT	R	F	Hatchback	299044	Drive Shaft	25	23	56.5	88.5	866		
KA (RU8)														
1.2 (51 kW)	2008.10-	-	-	L	F	Hatchback Engine FP4	217170	Drive Shaft	22	29.2	47	75.5	524	
	2008.10-	-	-	R	F	Hatchback Engine FP4	217171	Drive Shaft	22	29.2	47	75.5	758	
	2008.10-	MT	L/R	F	Hatchback Engine FP4	817043	Outer Joint	22	20	47	75.5	54.5	M	
1.3 TDCi (55 kW)	2008.10-	-	-	L/R	F	Hatchback Engine FD4	817026	Outer Joint	25	22	51	84	57	M
KA Van (RB)														
1.3 i (44 kW)	2002.05-2005.05	-	R	F	Box Engine J4K/J4D/J4M/J4N/J4P/J4S/BAA	218007	Drive Shaft	25	23	56.5	88.5	590		
	2002.05-2005.05	MT	R	F	Box Engine J4K/J4D/J4M/J4N/J4P/J4S/BAA	299044	Drive Shaft	25	23	56.5	88.5	866		
	2002.05-2005.05	-	L	F	Box Engine J4K/J4D/J4M/J4N/J4P/J4S/BAA	218140	Drive Shaft	25	23	56.5	88.5	868		
KUGA I														
2.0 TDCi (100 kW)	2008.03-2012.11	MT	L	F	All-wheel Drive Closed Off-Road Vehicle Engine G6DG/UKDA	250466	Drive Shaft	27	26	63	91	657		

YEAR	TRANSM	L/R	F/R	REMARKS	GSP Ref.	PRODUCT	ABS	Technical Specifications							
								A	B	C	H	L	P		
FORD															
KUGA I															
2.0 TDCi (100 kW)	2008.03-2012.11	-	L/R	R	All-wheel Drive Closed Off-Road Vehicle Engine G6DG/UKDA	201129	Drive Shaft		36	26	56.5	49.5	756		
	2008.03-2012.11	6MT	R	F	All-wheel Drive Closed Off-Road Vehicle Engine G6DG/UKDA	650083	Inner Joint		26	27	30	388.5	96		
	2008.03-2012.11	6MT	R	F	All-wheel Drive Closed Off-Road Vehicle Engine G6DG/UKDA	250465	Drive Shaft		27	26	63	91	994		
	2008.03-2012.11	-	L/R	F	Closed Off-Road Vehicle Engine G6DG/UKDA	899318	Outer Joint		27	36	63	91	68	I	
	2008.03-2012.11	-	L/R	F	All-wheel Drive Closed Off-Road Vehicle Engine G6DG/UKDA	899318	Outer Joint		27	36	63	91	68	I	
2.0 TDCi (103 kW)	2010.03-2012.11	MT	L	F	All-wheel Drive Closed Off-Road Vehicle Engine UFDA	250466	Drive Shaft		27	26	63	91	657		
	2010.03-2012.11	6AT/6MT	L/R	R	All-wheel Drive Closed Off-Road Vehicle Engine UFDA	201129	Drive Shaft		36	26	56.5	49.5	756		
	2010.03-2012.11	-	R	F	Closed Off-Road Vehicle Engine UFDA	650083	Inner Joint		26	27	30	388.5	96		
	2010.03-2012.11	-	R	F	All-wheel Drive Closed Off-Road Vehicle Engine UFDA	650083	Inner Joint		26	27	30	388.5	96		
	2010.03-2012.11	-	R	F	Closed Off-Road Vehicle Engine UFDA	250465	Drive Shaft		27	26	63	91	994		
	2010.03-2012.11	-	R	F	All-wheel Drive Closed Off-Road Vehicle Engine UFDA	250465	Drive Shaft		27	26	63	91	994		
	2010.03-2012.11	-	L	F	Closed Off-Road Vehicle Engine UFDA	899318	Outer Joint		27	36	63	91	68	I	
	2010.03-2012.11	-	L	F	All-wheel Drive Closed Off-Road Vehicle Engine UFDA	899318	Outer Joint		27	36	63	91	68	I	
2.0 TDCi (120 kW)	2010.03-2012.11	MT	L	F	All-wheel Drive Closed Off-Road Vehicle Engine TXDA	250466	Drive Shaft		27	26	63	91	657		
	2010.03-2012.11	6AT/6MT	L/R	R	All-wheel Drive Closed Off-Road Vehicle Engine TXDA	201129	Drive Shaft		36	26	56.5	49.5	756		
	2010.03-2012.11	-	R	F	All-wheel Drive Closed Off-Road Vehicle Engine TXDA	650083	Inner Joint		26	27	30	388.5	96		
	2010.03-2012.11	-	R	F	All-wheel Drive Closed Off-Road Vehicle Engine TXDA	250465	Drive Shaft		27	26	63	91	994		
	2010.03-2012.11	-	L	F	All-wheel Drive Closed Off-Road Vehicle Engine TXDA	899318	Outer Joint		27	36	63	91	68	I	
2.0 TDCi 4x4 (100 kW)	2008.03-	MT	L	F	Closed Off-Road Vehicle Engine G6DG/UKDA	650061	Inner Joint		26	27	40	69	111		
2.0 TDCi 4x4 (103 kW)	2010.03-	MT	L	F	Closed Off-Road Vehicle Engine UFDA	650061	Inner Joint		26	27	40	69	111		
2.0 TDCi 4x4 (120 kW)	2010.03-	MT	L	F	Closed Off-Road Vehicle Engine TXDA	650061	Inner Joint		26	27	40	69	111		
2.5 (147 kW)	2009.03-	-	-	R	All-wheel Drive Closed Off-Road Vehicle Engine HYDB	818290	Outer Joint		36	29	56.5	49.5	64	I	
	2009.03-	-	-	L/R	R	All-wheel Drive Closed Off-Road Vehicle Engine HYDB	201129	Drive Shaft		36	26	56.5	49.5	756	
	2009.03-	-	-	L/R	F	All-wheel Drive Closed Off-Road Vehicle Engine HYDB	899318	Outer Joint		27	36	63	91	68	I
	2009.03-2012.11	MT	L/R	F	Closed Off-Road Vehicle Engine HYDC/HYDB	899318	Outer Joint		27	36	63	91	68	I	
	2009.03-	-	-	R	All-wheel Drive Closed Off-Road Vehicle Engine HYDB	618187	Inner Joint		26	29	35	69.5	107.5		
KUGA II (DM2)															
1.5 EcoBoost (134 kW)	2014.09-	MT	L/R	F	All-wheel Drive Closed Off-Road Vehicle Engine M9MA	818270	Outer Joint		27	26	62.8	91	64	M	
1.6 EcoBoost (110 kW)	2013.03-	MT	L/R	F	Closed Off-Road Vehicle Engine JQMA/JQMB	818270	Outer Joint		27	26	62.8	91	64	M	
	2013.03-	MT	L/R	F	All-wheel Drive Closed Off-Road Vehicle Engine JQMA/JQMB	818270	Outer Joint		27	26	62.8	91	64	M	
1.6 EcoBoost (134 kW)	2013.03-	MT	L/R	F	All-wheel Drive Closed Off-Road Vehicle Engine JTMA	818270	Outer Joint		27	26	62.8	91	64	M	
2.0 TDCi (120 kW)	2013.03-	-	-	F	All-wheel Drive Closed Off-Road Vehicle Engine TXMA/TXDA	218509	Drive Shaft		27	28	63.1	96	990		
LASER															
1.6 SOHC KF KH	1990.01-1994.09	-	-	-	-	618009	Inner Joint		24	23	35	64	98.5		
	1990.01-1994.09	MT/AT	R	-	-	218057	Drive Shaft		26	24	56	93	905		
1.8	1994-1999	MT	L	-	DOHC KL KJ	227049	Drive Shaft		26	28	56	92	615.5		
	1994-1999	AT	-	-	DOHC KJ KL	634010	Inner Joint		24	30	35	64	99		
1.8 DOHC	1994-1999	-	-	-	-	608014	Inner Joint		28	30	43	47	72		
	1994-1999	-	R	-	-	259001	Drive Shaft	44T	26	28	56	93	625		
	1994-1999	AT	L	-	-	234011	Drive Shaft		26	24	56	93	627		
	1994-1999	AT	L	F	-	234080	Drive Shaft	44T	26	24	56	93	627		
LASER (METEOR)															
-	1985.01-1990.03	MT/AT	L	-	KC (GC) KE TX 3 2WD	234076	Drive Shaft		24	26	52	86	595		
	1985.01-1990.03	MT/AT	R	-	KC (GC) KE TX 3 2WD	234077	Drive Shaft		24	26	52	86	541		
LYNX															
-	-	AT	-	-	-	608014	Inner Joint		28	30	43	47	72		
	-	MT	L	-	-	227049	Drive Shaft		26	28	56	92	615.5		
	-	AT	R	-	-	259001	Drive Shaft	44T	26	28	56	93	625		
	-	AT	L	-	-	234011	Drive Shaft		26	24	56	93	627		
	-	AT	L	-	-	234080	Drive Shaft	44T	26	24	56	93	627		
	-	AT	-	-	-	634010	Inner Joint		24	30	35	64	99		
MAVERICK															
2.0 16V (91 kW)	2001.02-	AT/MT	L/R	F	All-wheel Drive Closed Off-Road Vehicle Engine YF	834090	Outer Joint	44T	28	24	56	89.1	59.5	M	
	2001.02-	-	-	R	All-wheel Drive Closed Off-Road Vehicle Engine YF	818204	Outer Joint	44T	26	30	56	114	58	I	
	2001.02-	MT	L	F	All-wheel Drive Closed Off-Road Vehicle Engine YF	634071	Inner Joint		28	32	35	66.5	112		
	2001.02-	MT	L	F	All-wheel Drive Closed Off-Road Vehicle Engine YF	234096	Drive Shaft	44T	28	28	56	94	635		
	2001.02-	MT	R	F	All-wheel Drive Closed Off-Road Vehicle Engine YF	234196	Drive Shaft	44T	28	35	56	94	570		
	2001.02-	-	-	F	All-wheel Drive Closed Off-Road Vehicle Engine YF	834064	Outer Joint	44T	28	24	56	94	62	M	
2.3 16V (110 kW)	2004.03-	AT/MT	L/R	F	All-wheel Drive Closed Off-Road Vehicle Engine GZ	834090	Outer Joint	44T	28	24	56	89.1	59.5	M	
3.0 V6 24V (145 kW)	2001.02-	AT/MT	L/R	F	All-wheel Drive Closed Off-Road Vehicle Engine AJ	834090	Outer Joint	44T	28	24	56	89.1	59.5	M	
	2001.02-	-	-	R	All-wheel Drive Closed Off-Road Vehicle Engine AJ	818204	Outer Joint	44T	26	30	56	114	58	I	
	2001.02-	AT	L	F	All-wheel Drive Closed Off-Road Vehicle Engine AJ	218083	Drive Shaft	44T	28	35	56	91.5	670		
	2001.02-	AT	R	F	All-wheel Drive Closed Off-Road Vehicle Engine AJ	234087	Drive Shaft	44T	28	35	56	94	545		
	2001.02-	-	-	F	All-wheel Drive Closed Off-Road Vehicle Engine AJ	834064	Outer Joint	44T	28	24	56	94	62	M	
3.0 V6 24V (149 kW)	2004.03-	AT/MT	L/R	F	All-wheel Drive Closed Off-Road Vehicle Engine AJ	834090	Outer Joint	44T	28	24	56	89.1	59.5	M	
	2004.03-	-	-	R	All-wheel Drive Closed Off-Road Vehicle Engine AJ	818204	Outer Joint	44T	26	30	56	114	58	I	

		 YEAR	TRANSM	L/R	F/R	REMARKS	GSP Ref.	 PRODUCT	 ABS	Technical Specifications						
										A	B	C	H	L	P	
FORD MAVERICK																
3.0 V6 24V (149 kW)		2004.03-	-	AT	L	F	All-wheel Drive Closed Off-Road Vehicle Engine AJ	218083	Drive Shaft	44T	28	35	56	91.5	670	
		2004.03-	-	AT	R	F	All-wheel Drive Closed Off-Road Vehicle Engine AJ	234087	Drive Shaft	44T	28	35	56	94	545	
		2004.03-	-	-	-	F	All-wheel Drive Closed Off-Road Vehicle Engine AJ	834064	Outer Joint	44T	28	24	56	94	62	M
MONDEO																
-		1995-	1998	AT	-	-	-	818051	Outer Joint		27	30	54.3	91	56	I
2.0		-	-	-	-	-	-	218178	Drive Shaft		27	35	56.5	92	573	
		-	-	-	L	-	-	218186	Drive Shaft		27	26	56.1	91.5	626	
2.0 (105 kW)		2007.09-	-	AT	L	-	Saloon Engine LF-DE	218225	Drive Shaft		27	35	56.1	91.5	675	
		2007.09-	-	AT	R	-	Saloon Engine LF-DE	218226	Drive Shaft		27	35	56.1	91.5	571.5	
2.0 (149 kW)		2011.03-	-	AT	L	-	Saloon Engine GTDIQ0	218225	Drive Shaft		27	35	56.1	91.5	675	
		2011.03-	-	AT	L	-	Saloon Engine GTDIQ0	218226	Drive Shaft		27	35	56.1	91.5	571.5	
2.0 (176 kW)		2011.03-	-	AT	L	-	Saloon Engine GTDIQ1	218225	Drive Shaft		27	35	56.1	91.5	675	
		2011.03-	-	AT	R	-	Saloon Engine GTDIQ1	218226	Drive Shaft		27	35	56.1	91.5	571.5	
MONDEO (GE)																
-		2000-	2007	-	-	-	-	699076	Inner Joint		35	33	42	50	65	
MONDEO I (GBP)																
1.6 i 16V (65 kW)		1994.07-	1996.08	MT	L/R	F	Hatchback Engine L1J	818024	Outer Joint	44T	27	30	57	91	56	M
		1994.07-	1996.08	MT	L/R	F	Saloon Engine L1J	818024	Outer Joint	44T	27	30	57	91	56	M
		1994.07-	1996.08	MT	L	F	Hatchback Engine L1J	636001	Inner Joint		26	33	40	68.6	100	
		1994.07-	1996.08	MT	L	F	Saloon Engine L1J	636001	Inner Joint		26	33	40	68.6	100	
		1994.07-	1996.08	MT	L	F	Hatchback Engine L1J	218001	Drive Shaft		27	26	54.3	91	615	
		1994.07-	1996.08	MT	L	F	Saloon Engine L1J	218001	Drive Shaft		27	26	54.3	91	615	
		1994.07-	1996.08	MT	L	F	Hatchback Engine L1J	218002	Drive Shaft	44T	27	26	54.3	91	615	
		1994.07-	1996.08	MT	L	F	Saloon Engine L1J	218002	Drive Shaft	44T	27	26	54.3	91	615	
		1994.07-	1996.08	MT	L	F	Hatchback Engine L1J	218017	Drive Shaft	44T	27	26	57	91	618.5	
		1994.07-	1996.08	MT	L	F	Saloon Engine L1J	218017	Drive Shaft	44T	27	26	57	91	618.5	
		1994.07-	1996.08	MT	L	F	Hatchback Engine L1J	218027	Drive Shaft		27	26	57	91	627.5	
		1994.07-	1996.08	MT	L	F	Saloon Engine L1J	218027	Drive Shaft		27	26	57	91	627.5	
		1994.07-	1996.08	MT	R	F	Hatchback Engine L1J	218028	Drive Shaft		27	35	57	91	576.5	
		1994.07-	1996.08	MT	R	F	Saloon Engine L1J	218028	Drive Shaft		27	35	57	91	576.5	
		1994.07-	1996.08	MT	R	F	Hatchback Engine L1J	218012	Drive Shaft	44T	27	35	54.3	91	568	
		1994.07-	1996.08	MT	R	F	Saloon Engine L1J	218012	Drive Shaft	44T	27	35	54.3	91	568	
		1994.07-	1996.08	MT	R	F	Hatchback Engine L1J	218006	Drive Shaft	44T	27	35	57	91	566	
		1994.07-	1996.08	MT	R	F	Saloon Engine L1J	218006	Drive Shaft	44T	27	35	57	91	566	
		1994.07-	1996.08	AT	R	F	Hatchback Engine L1J	218005	Drive Shaft		27	35	57	91	566	
		1994.07-	1996.08	AT	R	F	Saloon Engine L1J	218005	Drive Shaft		27	35	57	91	566	
		1994.07-	1996.08	-	-	F	Hatchback Engine L1J	818052	Outer Joint		27	30	57	91	56	I
		1994.07-	1996.08	-	-	F	Saloon Engine L1J	818052	Outer Joint		27	30	57	91	56	I
		1994.07-	1996.08	-	-	F	Hatchback Engine L1J	818023	Outer Joint	44T	27	30	57	91	56	I
		1994.07-	1996.08	-	-	F	Saloon Engine L1J	818023	Outer Joint	44T	27	30	57	91	56	I
1.6 i 16V (66 kW)		1993.02-	1996.08	MT	L/R	F	Hatchback Engine L1F	818024	Outer Joint	44T	27	30	57	91	56	M
		1993.02-	1996.08	MT	L/R	F	Saloon Engine L1F	818024	Outer Joint	44T	27	30	57	91	56	M
		1993.02-	1996.08	MT	L	F	Hatchback Engine L1F	636001	Inner Joint		26	33	40	68.6	100	
		1993.02-	1996.08	MT	L	F	Saloon Engine L1F	636001	Inner Joint		26	33	40	68.6	100	
		1993.02-	1996.08	MT	L	F	Hatchback Engine L1F	218001	Drive Shaft		27	26	54.3	91	615	
		1993.02-	1996.08	MT	L	F	Saloon Engine L1F	218001	Drive Shaft		27	26	54.3	91	615	
		1993.02-	1996.08	MT	L	F	Hatchback Engine L1F	218002	Drive Shaft	44T	27	26	54.3	91	615	
		1993.02-	1996.08	MT	L	F	Saloon Engine L1F	218002	Drive Shaft	44T	27	26	54.3	91	615	
		1993.02-	1996.08	MT	L	F	Hatchback Engine L1F	218017	Drive Shaft	44T	27	26	57	91	618.5	
		1993.02-	1996.08	MT	L	F	Saloon Engine L1F	218017	Drive Shaft	44T	27	26	57	91	618.5	
		1993.02-	1996.08	MT	L	F	Hatchback Engine L1F	218027	Drive Shaft		27	26	57	91	627.5	
		1993.02-	1996.08	MT	L	F	Saloon Engine L1F	218027	Drive Shaft		27	26	57	91	627.5	
		1993.02-	1996.08	MT	R	F	Hatchback Engine L1F	218028	Drive Shaft		27	35	57	91	576.5	
		1993.02-	1996.08	MT	R	F	Saloon Engine L1F	218028	Drive Shaft		27	35	57	91	576.5	
		1993.02-	1996.08	MT	R	F	Hatchback Engine L1F	218012	Drive Shaft	44T	27	35	54.3	91	568	
		1993.02-	1996.08	MT	R	F	Saloon Engine L1F	218012	Drive Shaft	44T	27	35	54.3	91	568	
		1993.02-	1996.08	MT	R	F	Hatchback Engine L1F	218006	Drive Shaft	44T	27	35	57	91	566	
		1993.02-	1996.08	MT	R	F	Saloon Engine L1F	218006	Drive Shaft	44T	27	35	57	91	566	
		1993.02-	1996.08	AT	R	F	Hatchback Engine L1F	218005	Drive Shaft		27	35	57	91	566	
		1993.02-	1996.08	AT	R	F	Saloon Engine L1F	218005	Drive Shaft		27	35	57	91	566	
		1993.02-	1996.08	-	-	F	Hatchback Engine L1F	818052	Outer Joint		27	30	57	91	56	I
		1993.02-	1996.08	-	-	F	Saloon Engine L1F	818052	Outer Joint		27	30	57	91	56	I
		1993.02-	1996.08	-	-	F	Hatchback Engine L1F	818023	Outer Joint	44T	27	30	57	91	56	I
		1993.02-	1996.08	-	-	F	Saloon Engine L1F	818023	Outer Joint	44T	27	30	57	91	56	I
1.8 i 16V (82 kW)		1994.01-	1996.08	AT	R	F	Saloon Engine RKB	218004	Drive Shaft	44T	27	35	54.3	91	566	
		1994.01-	1996.08	AT/MT	L/R	F	Saloon Engine RKB	818024	Outer Joint	44T	27	30	57	91	56	M





YEAR	TRANSM	L/R	F/R	REMARKS	GSP Ref.	PRODUCT	ABS	Technical Specifications							
								A	B	C	H	L	P		
FORD															
MONDEO I (GBP)															
1.8 i 16V (82 kW)															
1994.01-1996.08	AT	-	F	Saloon Engine RKB	818010	Outer Joint		27	25	57	91	61	I		
1994.01-1996.08	AT	L/R	F	Saloon Engine RKB	818011	Outer Joint	44T	27	25	57	91	61	I		
1994.01-1996.08	MT	L	F	Saloon Engine RKB	636001	Inner Joint		26	33	40	68.6	100			
1994.01-1996.08	MT	L	F	Saloon Engine RKB	218001	Drive Shaft		27	26	54.3	91	615			
1994.01-1996.08	MT	L	F	Saloon Engine RKB	218002	Drive Shaft	44T	27	26	54.3	91	615			
1994.01-1996.08	MT	L	F	Saloon Engine RKB	218017	Drive Shaft	44T	27	26	57	91	618.5			
1994.01-1996.08	MT	L	F	Saloon Engine RKB	218027	Drive Shaft		27	26	57	91	627.5			
1994.01-1996.08	AT/MT	R	F	Saloon Engine RKB	218028	Drive Shaft		27	35	57	91	576.5			
1994.01-1996.08	-	R	F	Saloon Engine RKB	218012	Drive Shaft	44T	27	35	54.3	91	568			
1994.01-1996.08	AT/MT	R	F	Saloon Engine RKB	218006	Drive Shaft	44T	27	35	57	91	566			
1994.01-1996.08	AT/MT	-	F	Saloon Engine RKB	818052	Outer Joint		27	30	57	91	56	I		
1994.01-1996.08	AT/MT	-	F	Saloon Engine RKB	818023	Outer Joint	44T	27	30	57	91	56	I		
1994.07-1996.08	AT	R	F	Hatchback Engine RKB	218004	Drive Shaft	44T	27	35	54.3	91	566			
1994.07-1996.08	AT/MT	L/R	F	Hatchback Engine RKB	818024	Outer Joint	44T	27	30	57	91	56	M		
1994.07-1996.08	-	-	F	Hatchback Engine RKB	818010	Outer Joint		27	25	57	91	61	I		
1994.07-1996.08	AT	L/R	F	Hatchback Engine RKB	818011	Outer Joint	44T	27	25	57	91	61	I		
1994.07-1996.08	MT	L	F	Hatchback Engine RKB	636001	Inner Joint		26	33	40	68.6	100			
1994.07-1996.08	MT	L	F	Hatchback Engine RKB	218001	Drive Shaft		27	26	54.3	91	615			
1994.07-1996.08	MT	L	F	Hatchback Engine RKB	218002	Drive Shaft	44T	27	26	54.3	91	615			
1994.07-1996.08	MT	L	F	Hatchback Engine RKB	218017	Drive Shaft	44T	27	26	57	91	618.5			
1994.07-1996.08	MT	L	F	Hatchback Engine RKB	218027	Drive Shaft		27	26	57	91	627.5			
1994.07-1996.08	AT/MT	R	F	Hatchback Engine RKB	218028	Drive Shaft		27	35	57	91	576.5			
1994.07-1996.08	-	R	F	Hatchback Engine RKB	218012	Drive Shaft	44T	27	35	54.3	91	568			
1994.07-1996.08	AT/MT	R	F	Hatchback Engine RKB	218006	Drive Shaft	44T	27	35	57	91	566			
1994.07-1996.08	AT/MT	-	F	Hatchback Engine RKB	818023	Outer Joint	44T	27	30	57	91	56	I		
1994.07-1996.08	-	-	F	Hatchback Engine RKB	818052	Outer Joint		27	30	57	91	56	I		
1.8 i 16V (85 kW)															
1993.02-1996.08	AT/MT	L/R	F	Hatchback Engine RKA	818024	Outer Joint	44T	27	30	57	91	56	M		
1993.02-1996.08	AT/MT	L/R	F	Saloon Engine RKA	818024	Outer Joint	44T	27	30	57	91	56	M		
1993.02-1996.08	AT	R	F	All-wheel Drive Hatchback Engine RKA	218004	Drive Shaft	44T	27	35	54.3	91	566			
1993.02-1996.08	AT/MT	L/R	F	All-wheel Drive Hatchback Engine RKA	818024	Outer Joint	44T	27	30	57	91	56	M		
1993.02-1996.08	-	-	F	Hatchback Engine RKA	818010	Outer Joint		27	25	57	91	61	I		
1993.02-1996.08	-	-	F	Saloon Engine RKA	818010	Outer Joint		27	25	57	91	61	I		
1993.02-1996.08	-	-	-	All-wheel Drive Hatchback Engine RKA	818010	Outer Joint		27	25	57	91	61	I		
1993.02-1996.08	AT	L/R	F	Hatchback Engine RKA	818011	Outer Joint	44T	27	25	57	91	61	I		
1993.02-1996.08	MT	L	F	Hatchback Engine RKA	636001	Inner Joint		26	33	40	68.6	100			
1993.02-1996.08	AT	L/R	F	Saloon Engine RKA	818011	Outer Joint	44T	27	25	57	91	61	I		
1993.02-1996.08	MT	L	F	Saloon Engine RKA	636001	Inner Joint		26	33	40	68.6	100			
1993.02-1996.08	MT	L	F	Hatchback Engine RKA	218001	Drive Shaft		27	26	54.3	91	615			
1993.02-1996.08	MT	L	F	Saloon Engine RKA	218001	Drive Shaft		27	26	54.3	91	615			
1993.02-1996.08	AT	L/R	F	All-wheel Drive Hatchback Engine RKA	818011	Outer Joint	44T	27	25	57	91	61	I		
1993.02-1996.08	MT	L	F	Hatchback Engine RKA	218002	Drive Shaft	44T	27	26	54.3	91	615			
1993.02-1996.08	MT	L	F	Saloon Engine RKA	218002	Drive Shaft	44T	27	26	54.3	91	615			
1993.02-1996.08	MT	L	F	Hatchback Engine RKA	218017	Drive Shaft	44T	27	26	57	91	618.5			
1993.02-1996.08	MT	L	F	Saloon Engine RKA	218017	Drive Shaft	44T	27	26	57	91	618.5			
1993.02-1996.08	MT	L	F	All-wheel Drive Hatchback Engine RKA	636001	Inner Joint		26	33	40	68.6	100			
1993.02-1996.08	MT	L	F	All-wheel Drive Hatchback Engine RKA	218001	Drive Shaft		27	26	54.3	91	615			
1993.02-1996.08	MT	L	F	All-wheel Drive Hatchback Engine RKA	218002	Drive Shaft	44T	27	26	54.3	91	615			
1993.02-1996.08	MT	L	F	All-wheel Drive Hatchback Engine RKA	218017	Drive Shaft	44T	27	26	57	91	618.5			
1993.02-1996.08	MT	L	F	Hatchback Engine RKA	218027	Drive Shaft		27	26	57	91	627.5			
1993.02-1996.08	MT	L	F	Saloon Engine RKA	218027	Drive Shaft		27	26	57	91	627.5			
1993.02-1996.08	MT	L	F	All-wheel Drive Hatchback Engine RKA	218027	Drive Shaft		27	26	57	91	627.5			
1993.02-1996.08	AT/MT	R	F	Hatchback Engine RKA	218028	Drive Shaft		27	35	57	91	576.5			
1993.02-1996.08	AT/MT	R	F	Saloon Engine RKA	218028	Drive Shaft		27	35	57	91	576.5			
1993.02-1996.08	-	R	F	Hatchback Engine RKA	218012	Drive Shaft	44T	27	35	54.3	91	568			
1993.02-1996.08	-	R	F	Saloon Engine RKA	218012	Drive Shaft	44T	27	35	54.3	91	568			
1993.02-1996.08	AT/MT	R	F	All-wheel Drive Hatchback Engine RKA	218028	Drive Shaft		27	35	57	91	576.5			
1993.02-1996.08	-	R	F	All-wheel Drive Hatchback Engine RKA	218012	Drive Shaft	44T	27	35	54.3	91	568			
1993.02-1996.08	AT/MT	R	F	Hatchback Engine RKA	218006	Drive Shaft	44T	27	35	57	91	566			
1993.02-1996.08	AT/MT	R	F	Saloon Engine RKA	218006	Drive Shaft	44T	27	35	57	91	566			
1993.02-1996.08	AT/MT	R	F	All-wheel Drive Hatchback Engine RKA	218006	Drive Shaft	44T	27	35	57	91	566			
1993.02-1996.08	AT/MT	-	F	Hatchback Engine RKA	818023	Outer Joint	44T	27	30	57	91	56	I		
1993.02-1996.08	AT/MT	-	F	Saloon Engine RKA	818023	Outer Joint	44T	27	30	57	91	56	I		
1993.02-1996.08	AT	R	F	Hatchback Engine RKA	218005	Drive Shaft		27	35	57	91	566			
1993.02-1996.08	AT	R	F	Saloon Engine RKA	218005	Drive Shaft		27	35	57	91	566			
1993.02-1996.08	-	-	F/R	All-wheel Drive Hatchback Engine RKA	818023	Outer Joint	44T	27	30	57	91	56	I		
1993.02-1996.08	-	-	F	Hatchback Engine RKA	818052	Outer Joint		27	30	57	91	56	I		





	 YEAR	TRANSM	L/R	F/R	REMARKS	GSP Ref.	 PRODUCT	 ABS	Technical Specifications						
									A	B	C	H	L	P	
FORD															
MONDEO I (GBP)															
1.8 i 16V (85 kW)	1993.02-1996.08	-	-	F	Saloon Engine RKA	818052	Outer Joint		27	30	57	91	56	I	
	1993.02-1996.08	AT	R	F	All-wheel Drive Hatchback Engine RKA	218005	Drive Shaft		27	35	57	91	566		
	1993.02-1996.08	-	-	-	All-wheel Drive Hatchback Engine RKA	818052	Outer Joint		27	30	57	91	56	I	
	1993.02-1996.08	AT	R	F	Hatchback Engine RKA	218004	Drive Shaft	44T	27	35	54.3	91	566		
	1993.02-1996.08	AT	R	F	Saloon Engine RKA	218004	Drive Shaft	44T	27	35	54.3	91	566		
1.8 TD (65 kW)	1993.06-1996.08	MT	R	F	Hatchback Engine RFM/RFN	218004	Drive Shaft	44T	27	35	54.3	91	566		
	1993.06-1996.08	MT	R	F	Saloon Engine RFM/RFN	218004	Drive Shaft	44T	27	35	54.3	91	566		
	1993.06-1996.08	-	-	F	Hatchback Engine RFM/RFN	818010	Outer Joint		27	25	57	91	61	I	
	1993.06-1996.08	MT	L	F	Hatchback Engine RFM/RFN	636001	Inner Joint		26	33	40	68.6	100		
	1993.06-1996.08	MT	L	F	Saloon Engine RFM/RFN	636001	Inner Joint		26	33	40	68.6	100		
	1993.06-1996.08	MT	L	F	Hatchback Engine RFM/RFN	218001	Drive Shaft		27	26	54.3	91	615		
	1993.06-1996.08	MT	L	F	Saloon Engine RFM/RFN	218001	Drive Shaft		27	26	54.3	91	615		
	1993.06-1996.08	MT	L/R	F	Hatchback Engine RFM/RFN	818011	Outer Joint	44T	27	25	57	91	61	I	
	1993.06-1996.08	MT	L/R	F	Saloon Engine RFM/RFN	818011	Outer Joint	44T	27	25	57	91	61	I	
	1993.06-1996.08	MT	L	F	Hatchback Engine RFM/RFN	218017	Drive Shaft	44T	27	26	57	91	618.5		
	1993.06-1996.08	MT	L	F	Saloon Engine RFM/RFN	218017	Drive Shaft	44T	27	26	57	91	618.5		
	1993.06-1996.08	-	R	F	Hatchback Engine RFM/RFN	218003	Drive Shaft		27	35	54.3	91	566		
	1993.06-1996.08	-	R	F	Saloon Engine RFM/RFN	218003	Drive Shaft		27	35	54.3	91	566		
	1993.06-1996.08	MT	L	F	Hatchback Engine RFM/RFN	218027	Drive Shaft		27	26	57	91	627.5		
	1993.06-1996.08	MT	L	F	Saloon Engine RFM/RFN	218027	Drive Shaft		27	26	57	91	627.5		
	1993.06-1996.08	MT	R	F	Saloon Engine RFM/RFN	218028	Drive Shaft		27	35	57	91	576.5		
	1993.06-1996.08	AT/MT	R	F	Hatchback Engine RFM/RFN	218028	Drive Shaft		27	35	57	91	576.5		
	1993.06-1996.08	MT	-	F	Saloon Engine RFM/RFN	818010	Outer Joint		27	25	57	91	61	I	
	1.8 TD (66 kW)	1995.10-1996.08	AT/MT	-	F	Saloon Engine RFM/RFN	818010	Outer Joint		27	25	57	91	61	I
1995.10-1996.08		MT	R	F	Hatchback Engine RFM/RFN	218004	Drive Shaft	44T	27	35	54.3	91	566		
1995.10-1996.08		MT	R	F	Saloon Engine RFM/RFN	218004	Drive Shaft	44T	27	35	54.3	91	566		
1995.10-1996.08		-	-	F	Hatchback Engine RFM/RFN	818010	Outer Joint		27	25	57	91	61	I	
1995.10-1996.08		MT	L/R	F	Hatchback Engine RFM/RFN	818011	Outer Joint	44T	27	25	57	91	61	I	
1995.10-1996.08		MT	L/R	F	Saloon Engine RFM/RFN	818011	Outer Joint	44T	27	25	57	91	61	I	
1995.10-1996.08		MT	L	F	Hatchback Engine RFM/RFN	636001	Inner Joint		26	33	40	68.6	100		
1995.10-1996.08		MT	L	F	Saloon Engine RFM/RFN	636001	Inner Joint		26	33	40	68.6	100		
1995.10-1996.08		MT	L	F	Hatchback Engine RFM/RFN	218001	Drive Shaft		27	26	54.3	91	615		
1995.10-1996.08		MT	L	F	Saloon Engine RFM/RFN	218001	Drive Shaft		27	26	54.3	91	615		
1995.10-1996.08		MT	L	F	Hatchback Engine RFM/RFN	218017	Drive Shaft	44T	27	26	57	91	618.5		
1995.10-1996.08		MT	L	F	Saloon Engine RFM/RFN	218017	Drive Shaft	44T	27	26	57	91	618.5		
1995.10-1996.08		-	R	F	Hatchback Engine RFM/RFN	218003	Drive Shaft		27	35	54.3	91	566		
1995.10-1996.08		-	R	F	Saloon Engine RFM/RFN	218003	Drive Shaft		27	35	54.3	91	566		
1995.10-1996.08		MT	L	F	Hatchback Engine RFM/RFN	218027	Drive Shaft		27	26	57	91	627.5		
1995.10-1996.08		MT	L	F	Saloon Engine RFM/RFN	218027	Drive Shaft		27	26	57	91	627.5		
1995.10-1996.08		AT/MT	R	F	Hatchback Engine RFM/RFN	218028	Drive Shaft		27	35	57	91	576.5		
1995.10-1996.08		AT/MT	R	F	Saloon Engine RFM/RFN	218028	Drive Shaft		27	35	57	91	576.5		
2.0 i 16V (100 kW)		1993.02-1996.08	AT/MT	L/R	F	Hatchback Engine NGA	818024	Outer Joint	44T	27	30	57	91	56	M
		1993.02-1996.08	AT/MT	L/R	F	Saloon Engine NGA	818024	Outer Joint	44T	27	30	57	91	56	M
	1993.02-1996.08	AT	-	F	Hatchback Engine NGA	818010	Outer Joint		27	25	57	91	61	I	
	1993.02-1996.08	-	-	F	Saloon Engine NGA	818010	Outer Joint		27	25	57	91	61	I	
	1993.02-1996.08	-	-	F	All-wheel Drive Saloon Engine NGA	818010	Outer Joint		27	25	57	91	61	I	
	1993.02-1996.08	AT	L/R	F	Hatchback Engine NGA	818011	Outer Joint	44T	27	25	57	91	61	I	
	1993.02-1996.08	MT	L	F	Hatchback Engine NGA	636001	Inner Joint		26	33	40	68.6	100		
	1993.02-1996.08	AT	L/R	F	Saloon Engine NGA	818011	Outer Joint	44T	27	25	57	91	61	I	
	1993.02-1996.08	MT	L	F	Saloon Engine NGA	636001	Inner Joint		26	33	40	68.6	100		
	1993.02-1996.08	MT	L	F	Hatchback Engine NGA	218001	Drive Shaft		27	26	54.3	91	615		
	1993.02-1996.08	MT	L	F	Saloon Engine NGA	218001	Drive Shaft		27	26	54.3	91	615		
	1993.02-1996.08	MT	L	F	Hatchback Engine NGA	218002	Drive Shaft	44T	27	26	54.3	91	615		
	1993.02-1996.08	MT	L	F	Saloon Engine NGA	218002	Drive Shaft	44T	27	26	54.3	91	615		
	1993.02-1996.08	MT	L	F	Hatchback Engine NGA	218017	Drive Shaft	44T	27	26	57	91	618.5		
	1993.02-1996.08	MT	L	F	Saloon Engine NGA	218017	Drive Shaft	44T	27	26	57	91	618.5		
	1993.02-1996.08	MT	L	F	All-wheel Drive Saloon Engine NGA	636001	Inner Joint		26	33	40	68.6	100		
	1993.02-1996.08	MT	L	F	All-wheel Drive Saloon Engine NGA	218017	Drive Shaft	44T	27	26	57	91	618.5		
	1993.02-1996.08	MT	L	F	Hatchback Engine NGA	218027	Drive Shaft		27	26	57	91	627.5		
	1993.02-1996.08	MT	L	F	Saloon Engine NGA	218027	Drive Shaft		27	26	57	91	627.5		
	1993.02-1996.08	MT	L	F	All-wheel Drive Saloon Engine NGA	218027	Drive Shaft		27	26	57	91	627.5		
	1993.02-1996.08	AT/MT	R	F	Hatchback Engine NGA	218028	Drive Shaft		27	35	57	91	576.5		
	1993.02-1996.08	AT/MT	R	F	Saloon Engine NGA	218028	Drive Shaft		27	35	57	91	576.5		
	1993.02-1996.08	-	R	F	Hatchback Engine NGA	218012	Drive Shaft	44T	27	35	54.3	91	568		
	1993.02-1996.08	-	R	F	Saloon Engine NGA	218012	Drive Shaft	44T	27	35	54.3	91	568		
	1993.02-1996.08	-	R	F	All-wheel Drive Saloon Engine NGA	218028	Drive Shaft		27	35	57	91	576.5		

YEAR	TRANSM	L/R	F/R	REMARKS	GSP Ref.	PRODUCT	ABS	Technical Specifications							
								A	B	C	H	L	P		
FORD															
MONDEO I (GBP)															
2.0 i 16V (100 kW)															
1993.02-1996.08	AT/MT	R	F	Hatchback Engine NGA	218006	Drive Shaft	44T	27	35	57	91	566			
1993.02-1996.08	AT/MT	R	F	Saloon Engine NGA	218006	Drive Shaft	44T	27	35	57	91	566			
1993.02-1996.08	AT/MT	-	F	Hatchback Engine NGA	818052	Outer Joint		27	30	57	91	56	I		
1993.02-1996.08	-	L	F	All-wheel Drive Saloon Engine NGA	218016	Drive Shaft		27	26	57	91	618.5			
1993.02-1996.08	AT/MT	-	F	Hatchback Engine NGA	818023	Outer Joint	44T	27	30	57	91	56	I		
1993.02-1996.08	AT/MT	-	F	Saloon Engine NGA	818023	Outer Joint	44T	27	30	57	91	56	I		
1993.02-1996.08	AT	R	F	Hatchback Engine NGA	218005	Drive Shaft		27	35	57	91	566			
1993.02-1996.08	AT	R	F	Saloon Engine NGA	218005	Drive Shaft		27	35	57	91	566			
1993.02-1996.08	-	-	F	Saloon Engine NGA	818052	Outer Joint		27	30	57	91	56	I		
1993.02-1996.08	-	R	F	All-wheel Drive Saloon Engine NGA	218005	Drive Shaft		27	35	57	91	566			
1993.02-1996.08	-	-	F	All-wheel Drive Saloon Engine NGA	818052	Outer Joint		27	30	57	91	56	I		
1993.02-1996.08	AT	R	F	Hatchback Engine NGA	218004	Drive Shaft	44T	27	35	54.3	91	566			
1993.02-1996.08	AT	R	F	Saloon Engine NGA	218004	Drive Shaft	44T	27	35	54.3	91	566			
1993.04-1996.08	-	L	F	All-wheel Drive Hatchback Engine NGA	636001	Inner Joint		26	33	40	68.6	100			
1993.04-1996.08	-	L	F	All-wheel Drive Hatchback Engine NGA	218016	Drive Shaft		27	26	57	91	618.5			
1993.04-1996.08	-	R	F	All-wheel Drive Hatchback Engine NGA	218005	Drive Shaft		27	35	57	91	566			
2.0 i 16V (97 kW)															
1994.12-1996.08	MT	L/R	F	All-wheel Drive Saloon Engine NGA	818024	Outer Joint	44T	27	30	57	91	56	M		
1994.12-1996.08	MT	L/R	F	All-wheel Drive Hatchback Engine NGA	818024	Outer Joint	44T	27	30	57	91	56	M		
1994.12-1996.08	-	-	-	All-wheel Drive Saloon Engine NGA	818010	Outer Joint		27	25	57	91	61	I		
1994.12-1996.08	MT	L	F	All-wheel Drive Saloon Engine NGA	636001	Inner Joint		26	33	40	68.6	100			
1994.12-1996.08	MT	L	F	All-wheel Drive Saloon Engine NGA	218001	Drive Shaft		27	26	54.3	91	615			
1994.12-1996.08	MT	L	F	All-wheel Drive Hatchback Engine NGA	218001	Drive Shaft		27	26	54.3	91	615			
1994.12-1996.08	MT	L	F	All-wheel Drive Saloon Engine NGA	218002	Drive Shaft	44T	27	26	54.3	91	615			
1994.12-1996.08	MT	L	F	All-wheel Drive Hatchback Engine NGA	218002	Drive Shaft	44T	27	26	54.3	91	615			
1994.12-1996.08	MT	L	F	All-wheel Drive Saloon Engine NGA	218017	Drive Shaft	44T	27	26	57	91	618.5			
1994.12-1996.08	MT	L	F	All-wheel Drive Saloon Engine NGA	218027	Drive Shaft		27	26	57	91	627.5			
1994.12-1996.08	-	R	F	All-wheel Drive Saloon Engine NGA	218012	Drive Shaft	44T	27	35	54.3	91	568			
1994.12-1996.08	-	R	F	All-wheel Drive Hatchback Engine NGA	218012	Drive Shaft	44T	27	35	54.3	91	568			
1994.12-1996.08	AT/MT	R	F	All-wheel Drive Saloon Engine NGA	218028	Drive Shaft		27	35	57	91	576.5			
1994.12-1996.08	MT	R	F	All-wheel Drive Saloon Engine NGA	218006	Drive Shaft	44T	27	35	57	91	566			
1994.12-1996.08	MT	R	F	All-wheel Drive Hatchback Engine NGA	218006	Drive Shaft	44T	27	35	57	91	566			
1994.12-1996.08	-	-	F/R	All-wheel Drive Saloon Engine NGA	818023	Outer Joint	44T	27	30	57	91	56	I		
1994.12-1996.08	AT	R	F	All-wheel Drive Saloon Engine NGA	218005	Drive Shaft		27	35	57	91	566			
1994.12-1996.08	AT	R	F	All-wheel Drive Hatchback Engine NGA	218005	Drive Shaft		27	35	57	91	566			
1994.12-1996.08	-	-	F/R	All-wheel Drive Hatchback Engine NGA	818023	Outer Joint	44T	27	30	57	91	56	I		
1994.12-1996.08	-	-	-	All-wheel Drive Saloon Engine NGA	818052	Outer Joint		27	30	57	91	56	I		
2.5 i 24V (125 kW)															
1994.07-1996.08	AT/MT	R	F	Hatchback Engine SEA	218004	Drive Shaft	44T	27	35	54.3	91	566			
1994.07-1996.08	AT/MT	R	F	Saloon Engine SEA	218004	Drive Shaft	44T	27	35	54.3	91	566			
1994.07-1996.08	-	-	F	Hatchback Engine SEA	818010	Outer Joint		27	25	57	91	61	I		
1994.07-1996.08	-	-	F	Saloon Engine SEA	818010	Outer Joint		27	25	57	91	61	I		
1994.07-1996.08	MT	L	F	Hatchback Engine SEA	636001	Inner Joint		26	33	40	68.6	100			
1994.07-1996.08	MT	L	F	Saloon Engine SEA	636001	Inner Joint		26	33	40	68.6	100			
1994.07-1996.08	AT/MT	L/R	F	Hatchback Engine SEA	818011	Outer Joint	44T	27	25	57	91	61	I		
1994.07-1996.08	AT/MT	L/R	F	Saloon Engine SEA	818011	Outer Joint	44T	27	25	57	91	61	I		
1994.07-1996.08	MT	L	F	Hatchback Engine SEA	218001	Drive Shaft		27	26	54.3	91	615			
1994.07-1996.08	MT	L	F	Saloon Engine SEA	218001	Drive Shaft		27	26	54.3	91	615			
1994.07-1996.08	MT	L	F	Hatchback Engine SEA	218017	Drive Shaft	44T	27	26	57	91	618.5			
1994.07-1996.08	MT	L	F	Saloon Engine SEA	218017	Drive Shaft	44T	27	26	57	91	618.5			
1994.07-1996.08	-	R	F	Hatchback Engine SEA	218003	Drive Shaft		27	35	54.3	91	566			
1994.07-1996.08	-	R	F	Saloon Engine SEA	218003	Drive Shaft		27	35	54.3	91	566			
1994.07-1996.08	MT	L	F	Hatchback Engine SEA	218027	Drive Shaft		27	26	57	91	627.5			
1994.07-1996.08	MT	L	F	Saloon Engine SEA	218027	Drive Shaft		27	26	57	91	627.5			
1994.07-1996.08	AT/MT	R	F	Hatchback Engine SEA	218028	Drive Shaft		27	35	57	91	576.5			
1994.07-1996.08	AT/MT	R	F	Saloon Engine SEA	218028	Drive Shaft		27	35	57	91	576.5			
MONDEO I Turnier (BNP)															
1.6 i 16V (65 kW)															
1994.07-1996.08	MT	L/R	F	Estate Engine L1J	818024	Outer Joint	44T	27	30	57	91	56	M		
1994.07-1996.08	MT	L	F	Estate Engine L1J	636001	Inner Joint		26	33	40	68.6	100			
1994.07-1996.08	MT	L	F	Estate Engine L1J	218001	Drive Shaft		27	26	54.3	91	615			
1994.07-1996.08	MT	L	F	Estate Engine L1J	218002	Drive Shaft	44T	27	26	54.3	91	615			
1994.07-1996.08	MT	L	F	Estate Engine L1J	218017	Drive Shaft	44T	27	26	57	91	618.5			
1994.07-1996.08	MT	L	F	Estate Engine L1J	218027	Drive Shaft		27	26	57	91	627.5			
1994.07-1996.08	MT	R	F	Estate Engine L1J	218028	Drive Shaft		27	35	57	91	576.5			
1994.07-1996.08	MT	R	F	Estate Engine L1J	218012	Drive Shaft	44T	27	35	54.3	91	568			
1994.07-1996.08	MT	-	F	Estate Engine L1J	818052	Outer Joint		27	30	57	91	56	I		
1994.07-1996.08	MT	R	F	Estate Engine L1J	218006	Drive Shaft	44T	27	35	57	91	566			
1994.07-1996.08	AT	R	F	Estate Engine L1J	218005	Drive Shaft		27	35	57	91	566			

YEAR	TRANSM	L/R	F/R	REMARKS	GSP Ref.	PRODUCT	ABS	Technical Specifications													
								A	B	C	H	L	P								
FORD																					
MONDEO I Turnier (BNP)																					
1.6 i 16V (65 kW)								1994.07-1996.08	-	-	F	Estate Engine L1J	818023	Outer Joint	44T	27	30	57	91	56	I
1.6 i 16V (66 kW)								1993.04-1996.08	MT	L/R	F	Estate Engine L1F	818024	Outer Joint	44T	27	30	57	91	56	M
								1993.04-1996.08	MT	L	F	Estate Engine L1F	636001	Inner Joint		26	33	40	68.6	100	
								1993.04-1996.08	MT	L	F	Estate Engine L1F	218001	Drive Shaft		27	26	54.3	91	615	
								1993.04-1996.08	MT	L	F	Estate Engine L1F	218002	Drive Shaft	44T	27	26	54.3	91	615	
								1993.04-1996.08	MT	L	F	Estate Engine L1F	218017	Drive Shaft	44T	27	26	57	91	618.5	
								1993.04-1996.08	MT	L	F	Estate Engine L1F	218027	Drive Shaft		27	26	57	91	627.5	
								1993.04-1996.08	MT	R	F	Estate Engine L1F	218028	Drive Shaft		27	35	57	91	576.5	
								1993.04-1996.08	MT	R	F	Estate Engine L1F	218012	Drive Shaft	44T	27	35	54.3	91	568	
								1993.04-1996.08	MT	-	F	Estate Engine L1F	818052	Outer Joint		27	30	57	91	56	I
								1993.04-1996.08	MT	R	F	Estate Engine L1F	218006	Drive Shaft	44T	27	35	57	91	566	
								1993.04-1996.08	AT	R	F	Estate Engine L1F	218005	Drive Shaft		27	35	57	91	566	
								1993.04-1996.08	-	-	F	Estate Engine L1F	818023	Outer Joint	44T	27	30	57	91	56	I
1.8 i 16V (82 kW)								1994.07-1996.08	AT	R	F	Estate Engine RKB	218004	Drive Shaft	44T	27	35	54.3	91	566	
								1994.07-1996.08	AT/MT	L/R	F	Estate Engine RKB	818024	Outer Joint	44T	27	30	57	91	56	M
								1994.07-1996.08	AT	-	F	Estate Engine RKB	818010	Outer Joint		27	25	57	91	61	I
								1994.07-1996.08	AT	L/R	F	Estate Engine RKB	818011	Outer Joint	44T	27	25	57	91	61	I
								1994.07-1996.08	MT	L	F	Estate Engine RKB	636001	Inner Joint		26	33	40	68.6	100	
								1994.07-1996.08	MT	L	F	Estate Engine RKB	218001	Drive Shaft		27	26	54.3	91	615	
								1994.07-1996.08	MT	L	F	Estate Engine RKB	218002	Drive Shaft	44T	27	26	54.3	91	615	
								1994.07-1996.08	MT	L	F	Estate Engine RKB	218017	Drive Shaft	44T	27	26	57	91	618.5	
								1994.07-1996.08	MT	L	F	Estate Engine RKB	218027	Drive Shaft		27	26	57	91	627.5	
								1994.07-1996.08	AT/MT	R	F	Estate Engine RKB	218028	Drive Shaft		27	35	57	91	576.5	
								1994.07-1996.08	-	R	F	Estate Engine RKB	218012	Drive Shaft	44T	27	35	54.3	91	568	
								1994.07-1996.08	AT/MT	R	F	Estate Engine RKB	218006	Drive Shaft	44T	27	35	57	91	566	
								1994.07-1996.08	AT/MT	-	F	Estate Engine RKB	818052	Outer Joint		27	30	57	91	56	I
								1994.07-1996.08	AT/MT	-	F	Estate Engine RKB	818023	Outer Joint	44T	27	30	57	91	56	I
1.8 i 16V (85 kW)								1993.04-1996.08	AT	R	F	Estate Engine RKA	218004	Drive Shaft	44T	27	35	54.3	91	566	
								1993.04-1996.08	AT/MT	L/R	F	All-wheel Drive Estate Engine RKA	818024	Outer Joint	44T	27	30	57	91	56	M
								1993.04-1996.08	AT/MT	L/R	F	Estate Engine RKA	818024	Outer Joint	44T	27	30	57	91	56	M
								1993.04-1996.08	AT	-	-	All-wheel Drive Estate Engine RKA	818010	Outer Joint		27	25	57	91	61	I
								1993.04-1996.08	AT	-	F	Estate Engine RKA	818010	Outer Joint		27	25	57	91	61	I
								1993.04-1996.08	AT	L/R	F	All-wheel Drive Estate Engine RKA	818011	Outer Joint	44T	27	25	57	91	61	I
								1993.04-1996.08	AT	L/R	F	Estate Engine RKA	818011	Outer Joint	44T	27	25	57	91	61	I
								1993.04-1996.08	MT	L	F	Estate Engine RKA	636001	Inner Joint		26	33	40	68.6	100	
								1993.04-1996.08	MT	L	F	Estate Engine RKA	218001	Drive Shaft		27	26	54.3	91	615	
								1993.04-1996.08	MT	L	F	All-wheel Drive Estate Engine RKA	218002	Drive Shaft	44T	27	26	54.3	91	615	
								1993.04-1996.08	MT	L	F	Estate Engine RKA	218002	Drive Shaft	44T	27	26	54.3	91	615	
								1993.04-1996.08	MT	L	F	Estate Engine RKA	218017	Drive Shaft	44T	27	26	57	91	618.5	
								1993.04-1996.08	MT	L	F	All-wheel Drive Estate Engine RKA	636001	Inner Joint		26	33	40	68.6	100	
								1993.04-1996.08	MT	L	F	All-wheel Drive Estate Engine RKA	218001	Drive Shaft		27	26	54.3	91	615	
								1993.04-1996.08	MT	L	F	All-wheel Drive Estate Engine RKA	218017	Drive Shaft	44T	27	26	57	91	618.5	
								1993.04-1996.08	MT	L	F	Estate Engine RKA	218027	Drive Shaft		27	26	57	91	627.5	
								1993.04-1996.08	MT	L	F	All-wheel Drive Estate Engine RKA	218027	Drive Shaft		27	26	57	91	627.5	
								1993.04-1996.08	AT/MT	R	F	Estate Engine RKA	218028	Drive Shaft		27	35	57	91	576.5	
								1993.04-1996.08	-	R	F	Estate Engine RKA	218012	Drive Shaft	44T	27	35	54.3	91	568	
								1993.04-1996.08	AT/MT	R	F	All-wheel Drive Estate Engine RKA	218028	Drive Shaft		27	35	57	91	576.5	
								1993.04-1996.08	-	R	F	All-wheel Drive Estate Engine RKA	218012	Drive Shaft	44T	27	35	54.3	91	568	
								1993.04-1996.08	AT/MT	R	F	All-wheel Drive Estate Engine RKA	218006	Drive Shaft	44T	27	35	57	91	566	
								1993.04-1996.08	AT/MT	R	F	Estate Engine RKA	218006	Drive Shaft	44T	27	35	57	91	566	
								1993.04-1996.08	AT/MT	-	-	All-wheel Drive Estate Engine RKA	818052	Outer Joint		27	30	57	91	56	I
								1993.04-1996.08	AT/MT	-	F	Estate Engine RKA	818052	Outer Joint		27	30	57	91	56	I
								1993.04-1996.08	AT/MT	-	F	Estate Engine RKA	818023	Outer Joint	44T	27	30	57	91	56	I
								1993.04-1996.08	-	-	F/R	All-wheel Drive Estate Engine RKA	818023	Outer Joint	44T	27	30	57	91	56	I
								1993.04-1996.08	AT	R	F	Estate Engine RKA	218005	Drive Shaft		27	35	57	91	566	
								1993.04-1996.08	AT	R	F	All-wheel Drive Estate Engine RKA	218005	Drive Shaft		27	35	57	91	566	
								1993.04-1996.08	AT	R	F	All-wheel Drive Estate Engine RKA	218004	Drive Shaft	44T	27	35	54.3	91	566	
1.8 TD (65 kW)								1993.06-1996.08	MT	R	F	Estate Engine RFM/RFN	218004	Drive Shaft	44T	27	35	54.3	91	566	
								1993.06-1996.08	MT	L	F	Estate Engine RFM/RFN	636001	Inner Joint		26	33	40	68.6	100	
								1993.06-1996.08	MT	L	F	Estate Engine RFM/RFN	218001	Drive Shaft		27	26	54.3	91	615	
								1993.06-1996.08	MT	L/R	F	Estate Engine RFM/RFN	818011	Outer Joint	44T	27	25	57	91	61	I
								1993.06-1996.08	MT	L	F	Estate Engine RFM/RFN	218017	Drive Shaft	44T	27	26	57	91	618.5	
								1993.06-1996.08	-	R	F	Estate Engine RFM/RFN	218003	Drive Shaft		27	35	54.3	91	566	
								1993.06-1996.08	MT	L	F	Estate Engine RFM/RFN	218027	Drive Shaft		27	26	57	91	627.5	
								1993.06-1996.08	MT	R	F	Estate Engine RFM/RFN	218028	Drive Shaft		27	35	57	91	576.5	
								1993.06-1996.08	MT	-	F	Estate Engine RFM/RFN	818010	Outer Joint		27	25	57	91	61	I

YEAR		TRANSM	L/R	F/R	REMARKS	GSP Ref.	PRODUCT	ABS	Technical Specifications								
									A	B	C	H	L	P			
FORD																	
MONDEO I Turnier (BNP)																	
1.8 TD (66 kW)		1995.11-1996.08	AT/MT	-	F	Estate Engine RFM/RFN	818010	Outer Joint		27	25	57	91	61	I		
		1995.11-1996.08	MT	R	F	Estate Engine RFM/RFN	218004	Drive Shaft	44T	27	35	54.3	91	566			
		1995.11-1996.08	MT	L/R	F	Estate Engine RFM/RFN	818011	Outer Joint	44T	27	25	57	91	61	I		
		1995.11-1996.08	MT	L	F	Estate Engine RFM/RFN	636001	Inner Joint		26	33	40	68.6	100			
		1995.11-1996.08	MT	L	F	Estate Engine RFM/RFN	218001	Drive Shaft		27	26	54.3	91	615			
		1995.11-1996.08	MT	L	F	Estate Engine RFM/RFN	218017	Drive Shaft	44T	27	26	57	91	618.5			
		1995.11-1996.08	-	R	F	Estate Engine RFM/RFN	218003	Drive Shaft		27	35	54.3	91	566			
		1995.11-1996.08	MT	L	F	Estate Engine RFM/RFN	218027	Drive Shaft		27	26	57	91	627.5			
		1995.11-1996.08	AT/MT	R	F	Estate Engine RFM/RFN	218028	Drive Shaft		27	35	57	91	576.5			
2.0 i 16V (100 kW)		1993.04-1996.08	AT/MT	L/R	F	All-wheel Drive Estate Engine NGA	818024	Outer Joint	44T	27	30	57	91	56	M		
		1993.04-1996.08	AT	R	F	Estate Engine NGA	218004	Drive Shaft	44T	27	35	54.3	91	566			
		1993.04-1996.08	AT/MT	L/R	F	Estate Engine NGA	818024	Outer Joint	44T	27	30	57	91	56	M		
		1993.04-1996.08	AT	-	F	Estate Engine NGA	818010	Outer Joint		27	25	57	91	61	I		
		1993.04-1996.08	-	-	F	All-wheel Drive Estate Engine NGA	818010	Outer Joint		27	25	57	91	61	I		
		1993.04-1996.08	AT	L/R	F	All-wheel Drive Estate Engine NGA	818011	Outer Joint	44T	27	25	57	91	61	I		
		1993.04-1996.08	AT	L/R	F	Estate Engine NGA	818011	Outer Joint	44T	27	25	57	91	61	I		
		1993.04-1996.08	MT	L	F	Estate Engine NGA	636001	Inner Joint		26	33	40	68.6	100			
		1993.04-1996.08	MT	L	F	Estate Engine NGA	218001	Drive Shaft		27	26	54.3	91	615			
		1993.04-1996.08	MT	L	F	All-wheel Drive Estate Engine NGA	218002	Drive Shaft	44T	27	26	54.3	91	615			
		1993.04-1996.08	MT	L	F	Estate Engine NGA	218002	Drive Shaft	44T	27	26	54.3	91	615			
		1993.04-1996.08	MT	L	F	Estate Engine NGA	218017	Drive Shaft	44T	27	26	57	91	618.5			
		1993.04-1996.08	MT	L	F	All-wheel Drive Estate Engine NGA	636001	Inner Joint		26	33	40	68.6	100			
		1993.04-1996.08	MT	L	F	All-wheel Drive Estate Engine NGA	218001	Drive Shaft		27	26	54.3	91	615			
		1993.04-1996.08	MT	L	F	All-wheel Drive Estate Engine NGA	218017	Drive Shaft	44T	27	26	57	91	618.5			
		1993.04-1996.08	MT	L	F	Estate Engine NGA	218027	Drive Shaft		27	26	57	91	627.5			
		1993.04-1996.08	MT	L	F	All-wheel Drive Estate Engine NGA	218027	Drive Shaft		27	26	57	91	627.5			
		1993.04-1996.08	-	R	F	All-wheel Drive Estate Engine NGA	218012	Drive Shaft	44T	27	35	54.3	91	568			
		1993.04-1996.08	AT/MT	R	F	Estate Engine NGA	218028	Drive Shaft		27	35	57	91	576.5			
		1993.04-1996.08	-	R	F	Estate Engine NGA	218012	Drive Shaft	44T	27	35	54.3	91	568			
		1993.04-1996.08	-	R	F	All-wheel Drive Estate Engine NGA	218028	Drive Shaft		27	35	57	91	576.5			
		1993.04-1996.08	AT/MT	R	F	All-wheel Drive Estate Engine NGA	218006	Drive Shaft	44T	27	35	57	91	566			
		1993.04-1996.08	AT/MT	R	F	Estate Engine NGA	218006	Drive Shaft	44T	27	35	57	91	566			
		1993.04-1996.08	AT/MT	-	F	Estate Engine NGA	818052	Outer Joint		27	30	57	91	56	I		
		1993.04-1996.08	AT/MT	-	F	Estate Engine NGA	818023	Outer Joint	44T	27	30	57	91	56	I		
		1993.04-1996.08	-	-	F/R	All-wheel Drive Estate Engine NGA	818023	Outer Joint	44T	27	30	57	91	56	I		
		1993.04-1996.08	AT	R	F	Estate Engine NGA	218005	Drive Shaft		27	35	57	91	566			
		1993.04-1996.08	AT	R	F	All-wheel Drive Estate Engine NGA	218004	Drive Shaft	44T	27	35	54.3	91	566			
		1993.04-1996.08	AT	R	F	All-wheel Drive Estate Engine NGA	218005	Drive Shaft		27	35	57	91	566			
		1993.04-1996.08	-	-	F	All-wheel Drive Estate Engine NGA	818052	Outer Joint		27	30	57	91	56	I		
2.0 i 16V (97 kW)		1994.12-1996.08	MT	L/R	F	All-wheel Drive Estate Engine NGA	818024	Outer Joint	44T	27	30	57	91	56	M		
		1994.12-1996.08	MT	L	F	All-wheel Drive Estate Engine NGA	218001	Drive Shaft		27	26	54.3	91	615			
		1994.12-1996.08	MT	L	F	All-wheel Drive Estate Engine NGA	218002	Drive Shaft	44T	27	26	54.3	91	615			
		1994.12-1996.08	-	R	F	All-wheel Drive Estate Engine NGA	218012	Drive Shaft	44T	27	35	54.3	91	568			
		1994.12-1996.08	AT	R	F	All-wheel Drive Estate Engine NGA	218005	Drive Shaft		27	35	57	91	566			
		1994.12-1996.08	MT	R	F	All-wheel Drive Estate Engine NGA	218006	Drive Shaft	44T	27	35	57	91	566			
		1994.12-1996.08	-	-	F/R	All-wheel Drive Estate Engine NGA	818023	Outer Joint	44T	27	30	57	91	56	I		
2.5 i 24V (125 kW)		1994.07-1996.08	AT/MT	R	F	Estate Engine SEA	218004	Drive Shaft	44T	27	35	54.3	91	566			
		1994.07-1996.08	AT/MT	L/R	F	Estate Engine SEA	818011	Outer Joint	44T	27	25	57	91	61	I		
		1994.07-1996.08	MT	L	F	Estate Engine SEA	636001	Inner Joint		26	33	40	68.6	100			
		1994.07-1996.08	MT	L	F	Estate Engine SEA	218001	Drive Shaft		27	26	54.3	91	615			
		1994.07-1996.08	MT	L	F	Estate Engine SEA	218017	Drive Shaft	44T	27	26	57	91	618.5			
		1994.07-1996.08	-	R	F	Estate Engine SEA	218003	Drive Shaft		27	35	54.3	91	566			
		1994.07-1996.08	MT	L	F	Estate Engine SEA	218027	Drive Shaft		27	26	57	91	627.5			
		1994.07-1996.08	AT/MT	R	F	Estate Engine SEA	218028	Drive Shaft		27	35	57	91	576.5			
		1994.07-1996.08	AT/MT	-	F	Estate Engine SEA	818010	Outer Joint		27	25	57	91	61	I		
MONDEO II (BAP)																	
1.6 i (66 kW)		1996.08-2000.09	MT	L/R	F	Hatchback Engine L1J	818024	Outer Joint	44T	27	30	57	91	56	M		
		1996.08-2000.09	MT	L	F	Hatchback Engine L1J	636001	Inner Joint		26	33	40	68.6	100			
		1996.08-2000.09	MT	L	F	Hatchback Engine L1J	218001	Drive Shaft		27	26	54.3	91	615			
		1996.08-2000.09	MT	L	F	Hatchback Engine L1J	218002	Drive Shaft	44T	27	26	54.3	91	615			
		1996.08-2000.09	MT	L	F	Hatchback Engine L1J	218017	Drive Shaft	44T	27	26	57	91	618.5			
		1996.08-2000.09	MT	L	F	Hatchback Engine L1J	218027	Drive Shaft		27	26	57	91	627.5			
		1996.08-2000.09	MT	R	F	Hatchback Engine L1J	218028	Drive Shaft		27	35	57	91	576.5			
		1996.08-2000.09	-	R	F	Hatchback Engine L1J	218012	Drive Shaft	44T	27	35	54.3	91	568			
		1996.08-2000.09	MT	-	F	Hatchback Engine L1J	818052	Outer Joint		27	30	57	91	56	I		
		1996.08-2000.09	MT	R	F	Hatchback Engine L1J	218006	Drive Shaft	44T	27	35	57	91	566			

	 YEAR	TRANSM	L/R	F/R	REMARKS	GSP Ref.	 PRODUCT	 ABS	Technical Specifications						
									A	B	C	H	L	P	
FORD															
MONDEO II (BAP)															
1.6 i (66 kW)	1996.08-2000.09	-	-	F	Hatchback Engine L1J	818023	Outer Joint	44T	27	30	57	91	56	I	
1.6 i 16V (70 kW)	1998.05-2000.09	-	-	F	Hatchback Engine L1L/L1N/L1Q	818023	Outer Joint	44T	27	30	57	91	56	I	
	1998.05-2000.09	MT	L/R	F	Hatchback Engine L1L/L1N/L1Q	818024	Outer Joint	44T	27	30	57	91	56	M	
	1998.05-2000.09	MT	L	F	Hatchback Engine L1L/L1N/L1Q	636001	Inner Joint		26	33	40	68.6	100		
	1998.05-2000.09	MT	L	F	Hatchback Engine L1L/L1N/L1Q	218001	Drive Shaft		27	26	54.3	91	615		
	1998.05-2000.09	MT	L	F	Hatchback Engine L1L/L1N/L1Q	218002	Drive Shaft	44T	27	26	54.3	91	615		
	1998.05-2000.09	MT	L	F	Hatchback Engine L1L/L1N/L1Q	218017	Drive Shaft	44T	27	26	57	91	618.5		
	1998.05-2000.09	MT	L	F	Hatchback Engine L1L/L1N/L1Q	218027	Drive Shaft		27	26	57	91	627.5		
	1998.05-2000.09	MT	R	F	Hatchback Engine L1L/L1N/L1Q	218028	Drive Shaft		27	35	57	91	576.5		
	1998.05-2000.09	-	R	F	Hatchback Engine L1L/L1N/L1Q	218012	Drive Shaft	44T	27	35	54.3	91	568		
	1998.05-2000.09	MT	-	F	Hatchback Engine L1L/L1N/L1Q	818052	Outer Joint		27	30	57	91	56	I	
1998.05-2000.09	MT	R	F	Hatchback Engine L1L/L1N/L1Q	218006	Drive Shaft	44T	27	35	57	91	566			
1.8 i (85 kW)	1996.08-2000.09	-	-	F	Hatchback Engine RKF/RKJ/RKB/RKH/RKK	818023	Outer Joint	44T	27	30	57	91	56	I	
	1996.08-2000.09	AT/MT	L/R	F	Hatchback Engine RKF/RKJ/RKB/RKH/RKK	818024	Outer Joint	44T	27	30	57	91	56	M	
	1996.08-2000.09	MT	L	F	Hatchback Engine RKF/RKJ/RKB/RKH/RKK	636001	Inner Joint		26	33	40	68.6	100		
	1996.08-2000.09	MT	L	F	Hatchback Engine RKF/RKJ/RKB/RKH/RKK	218001	Drive Shaft		27	26	54.3	91	615		
	1996.08-2000.09	MT	L	F	Hatchback Engine RKF/RKJ/RKB/RKH/RKK	218002	Drive Shaft	44T	27	26	54.3	91	615		
	1996.08-2000.09	MT	L	F	Hatchback Engine RKF/RKJ/RKB/RKH/RKK	218017	Drive Shaft	44T	27	26	57	91	618.5		
	1996.08-2000.09	MT	L	F	Hatchback Engine RKF/RKJ/RKB/RKH/RKK	218027	Drive Shaft		27	26	57	91	627.5		
	1996.08-2000.09	MT	R	F	Hatchback Engine RKF/RKJ/RKB/RKH/RKK	218012	Drive Shaft	44T	27	35	54.3	91	568		
	1996.08-2000.09	AT/MT	R	F	Hatchback Engine RKF/RKJ/RKB/RKH/RKK	218028	Drive Shaft		27	35	57	91	576.5		
	1996.08-2000.09	AT/MT	-	F	Hatchback Engine RKF/RKJ/RKB/RKH/RKK	818052	Outer Joint		27	30	57	91	56	I	
1996.08-2000.09	MT	R	F	Hatchback Engine RKF/RKJ/RKB/RKH/RKK	218006	Drive Shaft	44T	27	35	57	91	566			
1.8 TD (66 kW)	1996.08-2000.09	AT/MT	-	F	Hatchback Engine RFN	818010	Outer Joint		27	25	57	91	61	I	
	1996.08-2000.09	MT	R	F	Hatchback Engine RFN	218004	Drive Shaft	44T	27	35	54.3	91	566		
	1996.08-2000.09	MT	L/R	F	Hatchback Engine RFN	818011	Outer Joint	44T	27	25	57	91	61	I	
	1996.08-2000.09	MT	L	F	Hatchback Engine RFN	218001	Drive Shaft		27	26	54.3	91	615		
	1996.08-2000.09	-	R	F	Hatchback Engine RFN	218003	Drive Shaft		27	35	54.3	91	566		
	1996.08-2000.09	MT	L	F	Hatchback Engine RFN	218027	Drive Shaft		27	26	57	91	627.5		
	1996.08-2000.09	AT/MT	R	F	Hatchback Engine RFN	218028	Drive Shaft		27	35	57	91	576.5		
2.0 i (96 kW)	1996.08-2000.09	-	-	F	Hatchback Engine NGA/NGB/NGC/NGD	818023	Outer Joint	44T	27	30	57	91	56	I	
	1996.08-2000.09	AT/MT	L/R	F	Hatchback Engine NGA/NGB/NGC/NGD	818024	Outer Joint	44T	27	30	57	91	56	M	
	1996.08-2000.09	MT	L	F	Hatchback Engine NGA/NGB/NGC/NGD	636001	Inner Joint		26	33	40	68.6	100		
	1996.08-2000.09	MT	L	F	Hatchback Engine NGA/NGB/NGC/NGD	218001	Drive Shaft		27	26	54.3	91	615		
	1996.08-2000.09	MT	L	F	Hatchback Engine NGA/NGB/NGC/NGD	218002	Drive Shaft	44T	27	26	54.3	91	615		
	1996.08-2000.09	MT	L	F	Hatchback Engine NGA/NGB/NGC/NGD	218017	Drive Shaft	44T	27	26	57	91	618.5		
	1996.08-2000.09	MT	L	F	Hatchback Engine NGA/NGB/NGC/NGD	218027	Drive Shaft		27	26	57	91	627.5		
	1996.08-2000.09	AT/MT	R	F	Hatchback Engine NGA/NGB/NGC/NGD	218028	Drive Shaft		27	35	57	91	576.5		
	1996.08-2000.09	-	R	F	Hatchback Engine NGA/NGB/NGC/NGD	218012	Drive Shaft	44T	27	35	54.3	91	568		
	1996.08-2000.09	AT/MT	-	F	Hatchback Engine NGA/NGB/NGC/NGD	818052	Outer Joint		27	30	57	91	56	I	
1996.08-2000.09	MT	R	F	Hatchback Engine NGA/NGB/NGC/NGD	218006	Drive Shaft	44T	27	35	57	91	566			
2.5 24V (125 kW)	1996.08-2000.09	AT/MT	-	F	Hatchback Engine SEA	818010	Outer Joint		27	25	57	91	61	I	
	1996.08-2000.09	MT	R	F	Hatchback Engine SEA	218004	Drive Shaft	44T	27	35	54.3	91	566		
	1996.08-2000.09	AT/MT	L/R	F	Hatchback Engine SEA	818011	Outer Joint	44T	27	25	57	91	61	I	
	1996.08-2000.09	MT	L	F	Hatchback Engine SEA	636001	Inner Joint		26	33	40	68.6	100		
	1996.08-2000.09	MT	L	F	Hatchback Engine SEA	218001	Drive Shaft		27	26	54.3	91	615		
	1996.08-2000.09	-	R	F	Hatchback Engine SEA	218003	Drive Shaft		27	35	54.3	91	566		
	1996.08-2000.09	MT	L	F	Hatchback Engine SEA	218017	Drive Shaft	44T	27	26	57	91	618.5		
	1996.08-2000.09	MT	L	F	Hatchback Engine SEA	218027	Drive Shaft		27	26	57	91	627.5		
	1996.08-2000.09	AT/MT	R	F	Hatchback Engine SEA	218028	Drive Shaft		27	35	57	91	576.5		
	1996.08-2000.09	MT	-	F	Hatchback Engine SEA	818023	Outer Joint	44T	27	30	57	91	56	I	
	2000.06-2000.09	MT	-	F	Hatchback Engine SEC/SEB	818010	Outer Joint		27	25	57	91	61	I	
	2000.06-2000.09	-	R	F	Hatchback Engine SEC/SEB	218004	Drive Shaft	44T	27	35	54.3	91	566		
	2000.06-2000.09	-	L/R	F	Hatchback Engine SEC/SEB	818011	Outer Joint	44T	27	25	57	91	61	I	
	2000.06-2000.09	-	R	F	Hatchback Engine SEC/SEB	218003	Drive Shaft		27	35	54.3	91	566		
	2000.06-2000.09	AT/MT	R	F	Hatchback Engine SEC/SEB	218028	Drive Shaft		27	35	57	91	576.5		
2000.06-2000.09	AT	-	F	Hatchback Engine SEC/SEB	818052	Outer Joint		27	30	57	91	56	I		
2000.06-2000.09	MT	-	F	Hatchback Engine SEC/SEB	818023	Outer Joint	44T	27	30	57	91	56	I		
2.5 ST 200 (151 kW)	1999.05-2000.09	-	R	F	Hatchback Engine SGA	218004	Drive Shaft	44T	27	35	54.3	91	566		
	1999.05-2000.09	-	L/R	F	Hatchback Engine SGA	818011	Outer Joint	44T	27	25	57	91	61	I	
	1999.05-2000.09	MT	L	F	Hatchback Engine SGA	636001	Inner Joint		26	33	40	68.6	100		
	1999.05-2000.09	-	R	F	Hatchback Engine SGA	218003	Drive Shaft		27	35	54.3	91	566		
	1999.05-2000.09	MT	L	F	Hatchback Engine SGA	218017	Drive Shaft	44T	27	26	57	91	618.5		
	1999.05-2000.09	MT	-	F	Hatchback Engine SGA	818023	Outer Joint	44T	27	30	57	91	56	I	
MONDEO II (BFP)															
1.6 i (66 kW)	1996.08-2000.09	-	-	F	Saloon Engine L1J	818023	Outer Joint	44T	27	30	57	91	56	I	





	 YEAR	TRANSM	L/R	F/R	REMARKS	GSP Ref.	 PRODUCT	 ABS	Technical Specifications					
									A	B	C	H	L	P
FORD														
MONDEO II (BFP)														
1.6 i (66 kW)	1996.08-2000.09	MT	L/R	F	Saloon Engine L1J	818024	Outer Joint	44T	27	30	57	91	56	M
	1996.08-2000.09	MT	L	F	Saloon Engine L1J	636001	Inner Joint		26	33	40	68.6	100	
	1996.08-2000.09	MT	L	F	Saloon Engine L1J	218001	Drive Shaft		27	26	54.3	91	615	
	1996.08-2000.09	MT	L	F	Saloon Engine L1J	218002	Drive Shaft	44T	27	26	54.3	91	615	
	1996.08-2000.09	MT	L	F	Saloon Engine L1J	218017	Drive Shaft	44T	27	26	57	91	618.5	
	1996.08-2000.09	MT	L	F	Saloon Engine L1J	218027	Drive Shaft		27	26	57	91	627.5	
	1996.08-2000.09	MT	R	F	Saloon Engine L1J	218028	Drive Shaft		27	35	57	91	576.5	
	1996.08-2000.09	-	R	F	Saloon Engine L1J	218012	Drive Shaft	44T	27	35	54.3	91	568	
	1996.08-2000.09	MT	-	F	Saloon Engine L1J	818052	Outer Joint		27	30	57	91	56	I
1.6 i 16V (70 kW)	1998.05-2000.09	-	-	F	Saloon Engine L1L/L1N/L1Q	818023	Outer Joint	44T	27	30	57	91	56	I
	1998.05-2000.09	MT	L/R	F	Saloon Engine L1L/L1N/L1Q	818024	Outer Joint	44T	27	30	57	91	56	M
	1998.05-2000.09	MT	L	F	Saloon Engine L1L/L1N/L1Q	636001	Inner Joint		26	33	40	68.6	100	
	1998.05-2000.09	MT	L	F	Saloon Engine L1L/L1N/L1Q	218001	Drive Shaft		27	26	54.3	91	615	
	1998.05-2000.09	MT	L	F	Saloon Engine L1L/L1N/L1Q	218002	Drive Shaft	44T	27	26	54.3	91	615	
	1998.05-2000.09	MT	L	F	Saloon Engine L1L/L1N/L1Q	218017	Drive Shaft	44T	27	26	57	91	618.5	
	1998.05-2000.09	MT	L	F	Saloon Engine L1L/L1N/L1Q	218027	Drive Shaft		27	26	57	91	627.5	
	1998.05-2000.09	MT	R	F	Saloon Engine L1L/L1N/L1Q	218028	Drive Shaft		27	35	57	91	576.5	
	1998.05-2000.09	-	R	F	Saloon Engine L1L/L1N/L1Q	218012	Drive Shaft	44T	27	35	54.3	91	568	
1.8 i (85 kW)	1998.05-2000.09	MT	-	F	Saloon Engine L1L/L1N/L1Q	818052	Outer Joint		27	30	57	91	56	I
	1998.05-2000.09	MT	R	F	Saloon Engine L1L/L1N/L1Q	218006	Drive Shaft	44T	27	35	57	91	566	
	1996.08-2000.09	-	-	F	Saloon Engine RKF/RKJ/RKB/RKH/RKK	818023	Outer Joint	44T	27	30	57	91	56	I
	1996.08-2000.09	AT/MT	L/R	F	Saloon Engine RKF/RKJ/RKB/RKH/RKK	818024	Outer Joint	44T	27	30	57	91	56	M
	1996.08-2000.09	MT	L	F	Saloon Engine RKF/RKJ/RKB/RKH/RKK	636001	Inner Joint		26	33	40	68.6	100	
	1996.08-2000.09	MT	L	F	Saloon Engine RKF/RKJ/RKB/RKH/RKK	218001	Drive Shaft		27	26	54.3	91	615	
	1996.08-2000.09	MT	L	F	Saloon Engine RKF/RKJ/RKB/RKH/RKK	218002	Drive Shaft	44T	27	26	54.3	91	615	
	1996.08-2000.09	MT	L	F	Saloon Engine RKF/RKJ/RKB/RKH/RKK	218017	Drive Shaft	44T	27	26	57	91	618.5	
	1996.08-2000.09	MT	L	F	Saloon Engine RKF/RKJ/RKB/RKH/RKK	218027	Drive Shaft		27	26	57	91	627.5	
1.8 TD (66 kW)	1996.08-2000.09	AT/MT	-	F	Saloon Engine RKF/RKJ/RKB/RKH/RKK	218028	Drive Shaft		27	35	57	91	576.5	
	1996.08-2000.09	-	R	F	Saloon Engine RKF/RKJ/RKB/RKH/RKK	218012	Drive Shaft	44T	27	35	54.3	91	568	
	1996.08-2000.09	MT	R	F	Saloon Engine RKF/RKJ/RKB/RKH/RKK	218006	Drive Shaft	44T	27	35	57	91	566	
	1996.08-2000.09	-	-	F	Saloon Engine RKF/RKJ/RKB/RKH/RKK	818052	Outer Joint		27	30	57	91	56	I
	1996.08-2000.09	AT/MT	-	F	Saloon Engine RFN	818010	Outer Joint		27	25	57	91	61	I
	1996.08-2000.09	MT	R	F	Saloon Engine RFN	218004	Drive Shaft	44T	27	35	54.3	91	566	
	1996.08-2000.09	MT	L/R	F	Saloon Engine RFN	818011	Outer Joint	44T	27	25	57	91	61	I
	1996.08-2000.09	MT	L	F	Saloon Engine RFN	636001	Inner Joint		26	33	40	68.6	100	
	1996.08-2000.09	MT	L	F	Saloon Engine RFN	218001	Drive Shaft		27	26	54.3	91	615	
2.0 i (96 kW)	1996.08-2000.09	-	R	F	Saloon Engine RFN	218003	Drive Shaft		27	35	54.3	91	566	
	1996.08-2000.09	MT	L	F	Saloon Engine RFN	218017	Drive Shaft	44T	27	26	57	91	618.5	
	1996.08-2000.09	MT	L	F	Saloon Engine RFN	218027	Drive Shaft		27	26	57	91	627.5	
	1996.08-2000.09	AT/MT	R	F	Saloon Engine RFN	218028	Drive Shaft		27	35	57	91	576.5	
	1996.08-2000.09	-	-	F	Saloon Engine NGA/NGB/NGC/NGD	818023	Outer Joint	44T	27	30	57	91	56	I
	1996.08-2000.09	AT/MT	L/R	F	Saloon Engine NGA/NGB/NGC/NGD	818024	Outer Joint	44T	27	30	57	91	56	M
	1996.08-2000.09	MT	L	F	Saloon Engine NGA/NGB/NGC/NGD	636001	Inner Joint		26	33	40	68.6	100	
	1996.08-2000.09	MT	L	F	Saloon Engine NGA/NGB/NGC/NGD	218001	Drive Shaft		27	26	54.3	91	615	
	1996.08-2000.09	MT	L	F	Saloon Engine NGA/NGB/NGC/NGD	218002	Drive Shaft	44T	27	26	54.3	91	615	
2.5 24V (125 kW)	1996.08-2000.09	MT	L	F	Saloon Engine NGA/NGB/NGC/NGD	218017	Drive Shaft	44T	27	26	57	91	618.5	
	1996.08-2000.09	MT	L	F	Saloon Engine NGA/NGB/NGC/NGD	218027	Drive Shaft		27	26	57	91	627.5	
	1996.08-2000.09	AT/MT	R	F	Saloon Engine NGA/NGB/NGC/NGD	218028	Drive Shaft		27	35	57	91	576.5	
	1996.08-2000.09	-	R	F	Saloon Engine NGA/NGB/NGC/NGD	218012	Drive Shaft	44T	27	35	54.3	91	568	
	1996.08-2000.09	AT/MT	-	F	Saloon Engine NGA/NGB/NGC/NGD	818052	Outer Joint		27	30	57	91	56	I
	1996.08-2000.09	MT	R	F	Saloon Engine NGA/NGB/NGC/NGD	218006	Drive Shaft	44T	27	35	57	91	566	
	1996.08-2000.09	MT	-	F	Saloon Engine SEA	818010	Outer Joint		27	25	57	91	61	I
	1996.08-2000.09	MT	R	F	Saloon Engine SEA	218004	Drive Shaft	44T	27	35	54.3	91	566	
	1996.08-2000.09	AT/MT	L/R	F	Saloon Engine SEA	818011	Outer Joint	44T	27	25	57	91	61	I
2.5 24V (125 kW)	1996.08-2000.09	MT	L	F	Saloon Engine SEA	636001	Inner Joint		26	33	40	68.6	100	
	1996.08-2000.09	MT	L	F	Saloon Engine SEA	218001	Drive Shaft		27	26	54.3	91	615	
	1996.08-2000.09	-	R	F	Saloon Engine SEA	218003	Drive Shaft		27	35	54.3	91	566	
	1996.08-2000.09	MT	L	F	Saloon Engine SEA	218017	Drive Shaft	44T	27	26	57	91	618.5	
	1996.08-2000.09	MT	L	F	Saloon Engine SEA	218027	Drive Shaft		27	26	57	91	627.5	
	1996.08-2000.09	AT/MT	R	F	Saloon Engine SEA	218028	Drive Shaft		27	35	57	91	576.5	
	1996.08-2000.09	AT	-	F	Saloon Engine SEA	818052	Outer Joint		27	30	57	91	56	I
	2000.06-2000.09	MT	-	F	Saloon Engine SEC/SEB/LCBD	818010	Outer Joint		27	25	57	91	61	I
	2000.06-2000.09	-	R	F	Saloon Engine SEC/SEB/LCBD	218004	Drive Shaft	44T	27	35	54.3	91	566	
	2000.06-2000.09	-	L/R	F	Saloon Engine SEC/SEB/LCBD	818011	Outer Joint	44T	27	25	57	91	61	I
	2000.06-2000.09	MT	L	F	Saloon Engine SEC/SEB/LCBD	636001	Inner Joint		26	33	40	68.6	100	





YEAR	TRANSM	L/R	F/R	REMARKS	GSP Ref.	PRODUCT	ABS	Technical Specifications							
								A	B	C	H	L	P		
FORD															
MONDEO II (BFP)															
2.5 24V (125 kW)	2000.06-2000.09	-	R	F	Saloon Engine SEC/SEB/LCBD	218003	Drive Shaft		27	35	54.3	91	566		
	2000.06-2000.09	MT	L	F	Saloon Engine SEC/SEB/LCBD	218017	Drive Shaft	44T	27	26	57	91	618.5		
	2000.06-2000.09	AT/MT	R	F	Saloon Engine SEC/SEB/LCBD	218028	Drive Shaft		27	35	57	91	576.5		
	2000.06-2000.09	AT	-	F	Saloon Engine SEC/SEB/LCBD	818052	Outer Joint		27	30	57	91	56	I	
2.5 ST 200 (151 kW)	1999.05-2000.09	-	R	F	Saloon Engine SGA	218004	Drive Shaft	44T	27	35	54.3	91	566		
	1999.05-2000.09	-	L/R	F	Saloon Engine SGA	818011	Outer Joint	44T	27	25	57	91	61	I	
	1999.05-2000.09	MT	L	F	Saloon Engine SGA	636001	Inner Joint		26	33	40	68.6	100		
	1999.05-2000.09	-	R	F	Saloon Engine SGA	218003	Drive Shaft		27	35	54.3	91	566		
	1999.05-2000.09	MT	L	F	Saloon Engine SGA	218017	Drive Shaft	44T	27	26	57	91	618.5		
MONDEO II Turnier (BNP)															
1.6 i (66 kW)	1996.08-2000.09	-	-	F	Estate Engine L1J	818023	Outer Joint	44T	27	30	57	91	56	I	
	1996.08-2000.09	MT	L/R	F	Estate Engine L1J	818024	Outer Joint	44T	27	30	57	91	56	M	
	1996.08-2000.09	MT	L	F	Estate Engine L1J	636001	Inner Joint		26	33	40	68.6	100		
	1996.08-2000.09	MT	L	F	Estate Engine L1J	218001	Drive Shaft		27	26	54.3	91	615		
	1996.08-2000.09	MT	L	F	Estate Engine L1J	218002	Drive Shaft	44T	27	26	54.3	91	615		
	1996.08-2000.09	MT	L	F	Estate Engine L1J	218017	Drive Shaft	44T	27	26	57	91	618.5		
	1996.08-2000.09	MT	L	F	Estate Engine L1J	218027	Drive Shaft		27	26	57	91	627.5		
	1996.08-2000.09	MT	R	F	Estate Engine L1J	218028	Drive Shaft		27	35	57	91	576.5		
	1996.08-2000.09	-	R	F	Estate Engine L1J	218012	Drive Shaft	44T	27	35	54.3	91	568		
	1996.08-2000.09	MT	-	F	Estate Engine L1J	818052	Outer Joint		27	30	57	91	56	I	
1.6 i 16V (70 kW)	1998.05-2000.09	-	-	F	Estate Engine L1L/L1N/L1Q	818023	Outer Joint	44T	27	30	57	91	56	I	
	1998.05-2000.09	MT	L/R	F	Estate Engine L1L/L1N/L1Q	818024	Outer Joint	44T	27	30	57	91	56	M	
	1998.05-2000.09	MT	L	F	Estate Engine L1L/L1N/L1Q	636001	Inner Joint		26	33	40	68.6	100		
	1998.05-2000.09	MT	L	F	Estate Engine L1L/L1N/L1Q	218001	Drive Shaft		27	26	54.3	91	615		
	1998.05-2000.09	MT	L	F	Estate Engine L1L/L1N/L1Q	218002	Drive Shaft	44T	27	26	54.3	91	615		
	1998.05-2000.09	MT	L	F	Estate Engine L1L/L1N/L1Q	218017	Drive Shaft	44T	27	26	57	91	618.5		
	1998.05-2000.09	MT	L	F	Estate Engine L1L/L1N/L1Q	218027	Drive Shaft		27	26	57	91	627.5		
	1998.05-2000.09	MT	L	F	Estate Engine L1L/L1N/L1Q	218028	Drive Shaft		27	26	57	91	615		
	1998.05-2000.09	MT	R	F	Estate Engine L1L/L1N/L1Q	218028	Drive Shaft		27	35	57	91	576.5		
	1998.05-2000.09	-	R	F	Estate Engine L1L/L1N/L1Q	218012	Drive Shaft	44T	27	35	54.3	91	568		
1.8 i (85 kW)	1996.08-2000.09	MT	-	F	Estate Engine RKF/RKJ/RKB/RKH/RKK	818010	Outer Joint		27	25	57	91	61	I	
	1996.08-2000.09	-	-	F	Estate Engine RKF/RKJ/RKB/RKH/RKK	818023	Outer Joint	44T	27	30	57	91	56	I	
	1996.08-2000.09	AT/MT	L/R	F	Estate Engine RKF/RKJ/RKB/RKH/RKK	818024	Outer Joint	44T	27	30	57	91	56	M	
	1996.08-2000.09	MT	L	F	Estate Engine RKF/RKJ/RKB/RKH/RKK	636001	Inner Joint		26	33	40	68.6	100		
	1996.08-2000.09	MT	L	F	Estate Engine RKF/RKJ/RKB/RKH/RKK	218001	Drive Shaft		27	26	54.3	91	615		
	1996.08-2000.09	MT	L	F	Estate Engine RKF/RKJ/RKB/RKH/RKK	218002	Drive Shaft	44T	27	26	54.3	91	615		
	1996.08-2000.09	MT	L	F	Estate Engine RKF/RKJ/RKB/RKH/RKK	218017	Drive Shaft	44T	27	26	57	91	618.5		
	1996.08-2000.09	MT	L	F	Estate Engine RKF/RKJ/RKB/RKH/RKK	218027	Drive Shaft		27	26	57	91	627.5		
	1996.08-2000.09	AT/MT	R	F	Estate Engine RKF/RKJ/RKB/RKH/RKK	218028	Drive Shaft		27	35	57	91	576.5		
	1996.08-2000.09	-	R	F	Estate Engine RKF/RKJ/RKB/RKH/RKK	218012	Drive Shaft	44T	27	35	54.3	91	568		
1.8 TD (66 kW)	1996.08-2000.09	AT/MT	-	F	Estate Engine RKF/RKJ/RKB/RKH/RKK	818052	Outer Joint		27	30	57	91	56	I	
	1996.08-2000.09	MT	R	F	Estate Engine RKF/RKJ/RKB/RKH/RKK	218006	Drive Shaft	44T	27	35	57	91	566		
	1996.08-2000.09	MT	R	F	Estate Engine RFN	218004	Drive Shaft	44T	27	35	54.3	91	566		
	1996.08-2000.09	-	-	F	Estate Engine RFN	818010	Outer Joint		27	25	57	91	61	I	
	1996.08-2000.09	MT	L/R	F	Estate Engine RFN	818011	Outer Joint	44T	27	25	57	91	61	I	
	1996.08-2000.09	MT	L	F	Estate Engine RFN	636001	Inner Joint		26	33	40	68.6	100		
	1996.08-2000.09	MT	L	F	Estate Engine RFN	218001	Drive Shaft		27	26	54.3	91	615		
	1996.08-2000.09	-	R	F	Estate Engine RFN	218003	Drive Shaft		27	35	54.3	91	566		
	1996.08-2000.09	MT	L	F	Estate Engine RFN	218017	Drive Shaft	44T	27	26	57	91	618.5		
	1996.08-2000.09	MT	L	F	Estate Engine RFN	218027	Drive Shaft		27	26	57	91	627.5		
2.0 i (96 kW)	1996.08-2000.09	AT/MT	R	F	Estate Engine RFN	218028	Drive Shaft		27	35	57	91	576.5		
	1996.08-2000.09	-	-	F	Estate Engine NGA/NGB/NGC/NGD	818023	Outer Joint	44T	27	30	57	91	56	I	
	1996.08-2000.09	AT/MT	L/R	F	Estate Engine NGA/NGB/NGC/NGD	818024	Outer Joint	44T	27	30	57	91	56	M	
	1996.08-2000.09	MT	L	F	Estate Engine NGA/NGB/NGC/NGD	636001	Inner Joint		26	33	40	68.6	100		
	1996.08-2000.09	MT	L	F	Estate Engine NGA/NGB/NGC/NGD	218001	Drive Shaft		27	26	54.3	91	615		
	1996.08-2000.09	MT	L	F	Estate Engine NGA/NGB/NGC/NGD	218002	Drive Shaft	44T	27	26	54.3	91	615		
	1996.08-2000.09	MT	L	F	Estate Engine NGA/NGB/NGC/NGD	218017	Drive Shaft	44T	27	26	57	91	618.5		
	1996.08-2000.09	MT	L	F	Estate Engine NGA/NGB/NGC/NGD	218027	Drive Shaft		27	26	57	91	627.5		
	1996.08-2000.09	AT/MT	R	F	Estate Engine NGA/NGB/NGC/NGD	218028	Drive Shaft		27	35	57	91	576.5		
	1996.08-2000.09	-	R	F	Estate Engine NGA/NGB/NGC/NGD	218012	Drive Shaft	44T	27	35	54.3	91	568		
2.5 24V (125 kW)	1996.08-2000.09	AT/MT	-	F	Estate Engine NGA/NGB/NGC/NGD	818052	Outer Joint		27	30	57	91	56	I	
	1996.08-2000.09	MT	R	F	Estate Engine NGA/NGB/NGC/NGD	218006	Drive Shaft	44T	27	35	57	91	566		
	1996.08-2000.09	MT	R	F	Estate Engine SEA	818010	Outer Joint		27	25	57	91	61	I	
1996.08-2000.09	MT	R	F	Estate Engine SEA	218004	Drive Shaft	44T	27	35	54.3	91	566			

YEAR	TRANSM	L/R	F/R	REMARKS	GSP Ref.	PRODUCT	ABS	Technical Specifications									
								A	B	C	H	L	P				
FORD																	
MONDEO II Turnier (BNP)																	
2.5 24V (125 kW)	1996.08-2000.09	AT/MT	L/R	F	Estate Engine SEA	818011	Outer Joint	44T	27	25	57	91	61	I			
	1996.08-2000.09	MT	L	F	Estate Engine SEA	218001	Drive Shaft		27	26	54.3	91	615				
	1996.08-2000.09	-	R	F	Estate Engine SEA	218003	Drive Shaft		27	35	54.3	91	566				
	1996.08-2000.09	AT/MT	R	F	Estate Engine SEA	218028	Drive Shaft		27	35	57	91	576.5				
	1996.08-2000.09	AT	-	F	Estate Engine SEA	818052	Outer Joint		27	30	57	91	56	I			
	1999.10-2000.09	MT	-	F	Estate Engine SEC/SEB	818010	Outer Joint		27	25	57	91	61	I			
	1999.10-2000.09	-	R	F	Estate Engine SEC/SEB	218004	Drive Shaft	44T	27	35	54.3	91	566				
	1999.10-2000.09	-	L/R	F	Estate Engine SEC/SEB	818011	Outer Joint	44T	27	25	57	91	61	I			
	1999.10-2000.09	-	R	F	Estate Engine SEC/SEB	218003	Drive Shaft		27	35	54.3	91	566				
	1999.10-2000.09	AT/MT	R	F	Estate Engine SEC/SEB	218028	Drive Shaft		27	35	57	91	576.5				
	1999.10-2000.09	AT	-	F	Estate Engine SEC/SEB	818052	Outer Joint		27	30	57	91	56	I			
2.5 ST 200 (151 kW)	1999.05-2000.09	-	R	F	Estate Engine SGA	218004	Drive Shaft	44T	27	35	54.3	91	566				
	1999.05-2000.09	-	L/R	F	Estate Engine SGA	818011	Outer Joint	44T	27	25	57	91	61	I			
	1999.05-2000.09	MT	L	F	Estate Engine SGA	636001	Inner Joint		26	33	40	68.6	100				
	1999.05-2000.09	-	R	F	Estate Engine SGA	218003	Drive Shaft		27	35	54.3	91	566				
	1999.05-2000.09	MT	L	F	Estate Engine SGA	218017	Drive Shaft	44T	27	26	57	91	618.5				
MONDEO III																	
1.8	2000.10-	-	MT	L	F	-	218143	Drive Shaft		27	26	57	91	626			
2.0	2000.10-	-	MT	L	F	-	218143	Drive Shaft		27	26	57	91	626			
MONDEO III (B4Y)																	
1.8 16V (81 kW)	2000.10-2007.03	-	L/R	F	Saloon Engine CGBB/CGBA	818007	Outer Joint		27	23	56.1	91.5	58.5	M			
	2000.10-2007.03	-	L	F	Saloon Engine CGBB/CGBA	218220	Drive Shaft		27	26	56.5	92	633				
	2000.10-2007.03	AT/MT	R	F	Saloon Engine CGBB/CGBA	618061	Inner Joint		35	34	42	50	67.5				
1.8 16V (92 kW)	2000.10-2007.03	-	L/R	F	Saloon Engine CHBA/CHBB	818007	Outer Joint		27	23	56.1	91.5	58.5	M			
	2000.10-2007.03	-	L	F	Saloon Engine CHBA/CHBB	218220	Drive Shaft		27	26	56.5	92	633				
	2000.10-2007.03	AT/MT	R	F	Saloon Engine CHBA/CHBB	618061	Inner Joint		35	34	42	50	67.5				
1.8 SCi (96 kW)	2003.06-2007.03	-	L/R	F	Saloon Engine CFBA	818007	Outer Joint		27	23	56.1	91.5	58.5	M			
	2003.06-2007.03	AT/MT	R	F	Saloon Engine CFBA	618061	Inner Joint		35	34	42	50	67.5				
2.0 16V (107 kW)	2000.10-2007.03	AT	L	F	Saloon Engine CJBA/CJBB	218297	Drive Shaft		27	35	56.1	91.5	67.5				
	2000.10-2007.03	-	L/R	F	Saloon Engine CJBA/CJBB	818007	Outer Joint		27	23	56.1	91.5	58.5	M			
	2000.10-2007.03	-	L	F	Saloon Engine CJBA/CJBB	218220	Drive Shaft		27	26	56.5	92	633				
	2000.10-2007.03	AT/MT	R	F	Saloon Engine CJBA/CJBB	618061	Inner Joint		35	34	42	50	67.5				
2.0 16V DI / TDDi / TDCi (66 kW)	2000.10-2007.03	-	L	F	Saloon Engine SDBA/D5BA	218220	Drive Shaft		27	26	56.5	92	633				
	2000.10-2007.03	-	L/R	F	Saloon Engine SDBA/D5BA	818002	Outer Joint		27	26	56	91	64	M			
	2000.10-2007.03	AT/MT	R	F	Saloon Engine SDBA/D5BA	218043	Drive Shaft		27	35	56.5	92	579				
	2000.10-2007.03	AT/MT	R	F	Saloon Engine SDBA/D5BA	618061	Inner Joint		35	34	42	50	67.5				
	2000.10-2007.03	MT	-	-	Saloon Engine SDBA/D5BA	818008	Outer Joint		27	26	56.5	92	64	M			
2.0 16V TDDi / TDCi (85 kW)	2000.10-2007.03	-	L	F	Saloon Engine HJBC/HJBB/HJBA/D6BA	218220	Drive Shaft		27	26	56.5	92	633				
	2000.10-2007.03	-	L/R	F	Saloon Engine HJBC/HJBB/HJBA/D6BA	818002	Outer Joint		27	26	56	91	64	M			
	2000.10-2007.03	AT/MT	R	F	Saloon Engine HJBC/HJBB/HJBA/D6BA	218043	Drive Shaft		27	35	56.5	92	579				
	2000.10-2007.03	AT/MT	R	F	Saloon Engine HJBC/HJBB/HJBA/D6BA	618061	Inner Joint		35	34	42	50	67.5				
	2000.10-2007.03	MT	-	-	Saloon Engine HJBC/HJBB/HJBA/D6BA	818008	Outer Joint		27	26	56.5	92	64	M			
2.0 TDCi (96 kW)	2001.10-2007.03	-	L/R	F	Saloon Engine FMBA/N7BA	818002	Outer Joint		27	26	56	91	64	M			
	2001.10-2007.03	AT	L	F	Saloon Engine FMBA/N7BA	218252	Drive Shaft		27	30	62.8	91	617				
	2001.10-2007.03	AT/MT	R	F	Saloon Engine FMBA/N7BA	218043	Drive Shaft		27	35	56.5	92	579				
	2001.10-2007.03	MT	-	-	Saloon Engine FMBA/N7BA	818008	Outer Joint		27	26	56.5	92	64	M			
	2001.10-2007.03	AT/MT	R	F	Saloon Engine FMBA/N7BA	618061	Inner Joint		35	34	42	50	67.5				
2.2 (166 kW)	2002.04-2007.03	-	L/R	F	Saloon Engine MEBA	818002	Outer Joint		27	26	56	91	64	M			
	2002.04-2007.03	MT	R	F	Saloon Engine MEBA	218043	Drive Shaft		27	35	56.5	92	579				
	2002.04-2007.03	MT	R	F	Saloon Engine MEBA	618061	Inner Joint		35	34	42	50	67.5				
2.2 TDCi (110 kW)	2004.09-2007.03	MT	R	F	Saloon Engine QJBC/QJBD	218043	Drive Shaft		27	35	56.5	92	579				
	2004.09-2007.03	MT	R	F	Saloon Engine QJBC/QJBD	618061	Inner Joint		35	34	42	50	67.5				
2.2 TDCi (114 kW)	2004.09-2007.03	MT	R	F	Saloon Engine QJBA/QJBB	218043	Drive Shaft		27	35	56.5	92	579				
	2004.09-2007.03	MT	R	F	Saloon Engine QJBA/QJBB	618061	Inner Joint		35	34	42	50	67.5				
2.5 V6 24V (125 kW)	2000.10-2007.03	-	L/R	F	Saloon Engine LCB D	818002	Outer Joint		27	26	56	91	64	M			
	2000.10-2007.03	AT	L	F	Saloon Engine LCB D	218252	Drive Shaft		27	30	62.8	91	617				
	2000.10-2007.03	AT/MT	R	F	Saloon Engine LCB D	218043	Drive Shaft		27	35	56.5	92	579				
	2000.10-2007.03	AT/MT	R	F	Saloon Engine LCB D	618061	Inner Joint		35	34	42	50	67.5				
	2000.10-2007.03	MT	-	-	Saloon Engine LCB D	818008	Outer Joint		27	26	56.5	92	64	M			
3.0 V6 24V (150 kW)	2004.09-2007.03	MT	R	F	Saloon Engine REBA	218043	Drive Shaft		27	35	56.5	92	579				
	2004.09-2007.03	MT	R	F	Saloon Engine REBA	618061	Inner Joint		35	34	42	50	67.5				
MONDEO III (B5Y)																	
1.8 16V (81 kW)	2000.10-2007.03	-	L/R	F	Hatchback Engine CGBB/CGBB	818007	Outer Joint		27	23	56.1	91.5	58.5	M			
	2000.10-2007.03	-	L	F	Hatchback Engine CGBB/CGBB	218220	Drive Shaft		27	26	56.5	92	633				
	2000.10-2007.03	AT/MT	R	F	Hatchback Engine CGBB/CGBB	618061	Inner Joint		35	34	42	50	67.5				
1.8 16V (92 kW)	2000.10-2007.03	-	L/R	F	Hatchback Engine CHBA/CHBB	818007	Outer Joint		27	23	56.1	91.5	58.5	M			

YEAR	TRANS	L/R	F/R	REMARKS	GSP Ref.	PRODUCT	ABS	Technical Specifications							
								A	B	C	H	L	P		
FORD															
MONDEO III (B5Y)															
1.8 16V (92 kW)	2000.10-2007.03	-	L	F	Hatchback Engine CHBA/CHBB	218220	Drive Shaft	27	26	56.5	92	633			
	2000.10-2007.03	AT/MT	R	F	Hatchback Engine CHBA/CHBB	618061	Inner Joint	35	34	42	50	67.5			
1.8 SCi (96 kW)	2003.06-2007.03	-	L/R	F	Hatchback Engine CFBA	818007	Outer Joint	27	23	56.1	91.5	58.5	M		
	2003.06-2007.03	AT/MT	R	F	Hatchback Engine CFBA	618061	Inner Joint	35	34	42	50	67.5			
2.0 16V (107 kW)	2000.10-2007.03	AT	L	F	Hatchback Engine CJBA/CJBB	218297	Drive Shaft	27	35	56.1	91.5	676			
	2000.10-2007.03	-	L/R	F	Hatchback Engine CJBA/CJBB	818007	Outer Joint	27	23	56.1	91.5	58.5	M		
	2000.10-2007.03	-	L	F	Hatchback Engine CJBA/CJBB	218220	Drive Shaft	27	26	56.5	92	633			
	2000.10-2007.03	AT/MT	R	F	Hatchback Engine CJBA/CJBB	618061	Inner Joint	35	34	42	50	67.5			
2.0 16V DI / TDDi / TDCi (66 kW)	2000.10-2007.03	-	L	F	Hatchback Engine D5BA/SDBA	218220	Drive Shaft	27	26	56.5	92	633			
	2000.10-2007.03	-	L/R	F	Hatchback Engine D5BA/SDBA	818002	Outer Joint	27	26	56	91	64	M		
	2000.10-2007.03	AT/MT	R	F	Hatchback Engine D5BA/SDBA	218043	Drive Shaft	27	35	56.5	92	579			
	2000.10-2007.03	MT	-	-	Hatchback Engine D5BA/SDBA	818008	Outer Joint	27	26	56.5	92	64	M		
2.0 16V TDDi / TDCi (85 kW)	2000.10-2007.03	-	L	F	Hatchback Engine D6BA/HJBA/HJBB/HJBC	218220	Drive Shaft	27	26	56.5	92	633			
	2000.10-2007.03	-	L/R	F	Hatchback Engine D6BA/HJBA/HJBB/HJBC	818002	Outer Joint	27	26	56	91	64	M		
	2000.10-2007.03	AT/MT	R	F	Hatchback Engine D6BA/HJBA/HJBB/HJBC	218043	Drive Shaft	27	35	56.5	92	579			
	2000.10-2007.03	MT	-	-	Hatchback Engine D6BA/HJBA/HJBB/HJBC	818008	Outer Joint	27	26	56.5	92	64	M		
2.0 TDCi (96 kW)	2000.10-2007.03	-	L	F	Hatchback Engine FMBA/N7BA	218220	Drive Shaft	27	26	56.5	92	633			
	2001.10-2007.03	-	L/R	F	Hatchback Engine FMBA/N7BA	818002	Outer Joint	27	26	56	91	64	M		
	2001.10-2007.03	AT	L	F	Hatchback Engine FMBA/N7BA	218252	Drive Shaft	27	30	62.8	91	617			
	2001.10-2007.03	AT/MT	R	F	Hatchback Engine FMBA/N7BA	218043	Drive Shaft	27	35	56.5	92	579			
	2001.10-2007.03	MT	-	-	Hatchback Engine FMBA/N7BA	818008	Outer Joint	27	26	56.5	92	64	M		
2.2 (166 kW)	2001.10-2007.03	AT/MT	R	F	Hatchback Engine FMBA/N7BA	618061	Inner Joint	35	34	42	50	67.5			
	2002.04-2007.03	-	L/R	F	Hatchback Engine MEBA	818002	Outer Joint	27	26	56	91	64	M		
	2002.04-2007.03	MT	R	F	Hatchback Engine MEBA	218043	Drive Shaft	27	35	56.5	92	579			
2.2 TDCi (110 kW)	2002.04-2007.03	MT	R	F	Hatchback Engine MEBA	618061	Inner Joint	35	34	42	50	67.5			
	2004.09-2007.03	MT	R	F	Hatchback Engine QJBD/QJBC	218043	Drive Shaft	27	35	56.5	92	579			
	2004.09-2007.03	MT	R	F	Hatchback Engine QJBD/QJBC	618061	Inner Joint	35	34	42	50	67.5			
2.2 TDCi (114 kW)	2004.09-2007.03	MT	R	F	Hatchback Engine QJBA/QJBB	218043	Drive Shaft	27	35	56.5	92	579			
	2004.09-2007.03	MT	R	F	Hatchback Engine QJBA/QJBB	618061	Inner Joint	35	34	42	50	67.5			
2.5 V6 24V (125 kW)	2000.10-2007.03	-	L	F	Hatchback Engine LCBBD	218220	Drive Shaft	27	26	56.5	92	633			
	2000.10-2007.03	-	L/R	F	Hatchback Engine LCBBD	818002	Outer Joint	27	26	56	91	64	M		
	2000.10-2007.03	AT	L	F	Hatchback Engine LCBBD	218252	Drive Shaft	27	30	62.8	91	617			
	2000.10-2007.03	AT/MT	R	F	Hatchback Engine LCBBD	218043	Drive Shaft	27	35	56.5	92	579			
	2000.10-2007.03	AT/MT	R	F	Hatchback Engine LCBBD	618061	Inner Joint	35	34	42	50	67.5			
3.0 V6 24V (150 kW)	2000.10-2007.03	MT	-	-	Hatchback Engine LCBBD	818008	Outer Joint	27	26	56.5	92	64	M		
	2004.09-2007.03	MT	R	F	Hatchback Engine REBA	218043	Drive Shaft	27	35	56.5	92	579			
2004.09-2007.03	MT	R	F	Hatchback Engine REBA	618061	Inner Joint	35	34	42	50	67.5				
MONDEO III (B5Y), SW															
2.0 16V Di (66 kW)	2000.11-	-	-	-	-	818095	Outer Joint	27	26	56.5	92	64	M		
2.0 16V Di (85 kW)	2000.11-	-	-	-	-	818095	Outer Joint	27	26	56.5	92	64	M		
2.0 16V TDCi (85 kW)	2000.11-	-	-	-	-	818095	Outer Joint	27	26	56.5	92	64	M		
2.0 16V TDCi (66 kW)	2000.11-	-	-	-	-	818095	Outer Joint	27	26	56.5	92	64	M		
2.0 16V TDDi (66 kW)	2000.11-	-	-	-	-	818095	Outer Joint	27	26	56.5	92	64	M		
2.0 16V TDDi (85 kW)	2000.11-	-	-	-	-	818095	Outer Joint	27	26	56.5	92	64	M		
2.0 TDCi (96 kW)	2001.11-2007	-	-	-	-	818095	Outer Joint	27	26	56.5	92	64	M		
2.2 TDCi (114 kW)	2004.09-2007	-	-	-	-	818095	Outer Joint	27	26	56.5	92	64	M		
2.5 V6 24V (125 kW)	2000.11-	-	-	-	-	818095	Outer Joint	27	26	56.5	92	64	M		
3.0 ST200 (166 kW)	2002.04-	-	-	-	-	818095	Outer Joint	27	26	56.5	92	64	M		
3.0 V6 24V (150 kW)	2004.09-	-	-	-	-	818095	Outer Joint	27	26	56.5	92	64	M		
MONDEO III Turnier (BWY)															
1.8 16V (81 kW)	2000.10-2007.03	-	L/R	F	Estate Engine CGBA/CGBB	818007	Outer Joint	27	23	56.1	91.5	58.5	M		
	2000.10-2007.03	-	L	F	Estate Engine CGBA/CGBB	218220	Drive Shaft	27	26	56.5	92	633			
	2000.10-2007.03	AT/MT	R	F	Estate Engine CGBA/CGBB	618061	Inner Joint	35	34	42	50	67.5			
1.8 16V (92 kW)	2000.10-2007.03	-	L/R	F	Estate Engine CHBA/CHBB	818007	Outer Joint	27	23	56.1	91.5	58.5	M		
	2000.10-2007.03	-	L	F	Estate Engine CHBA/CHBB	218220	Drive Shaft	27	26	56.5	92	633			
1.8 SCi (96 kW)	2000.10-2007.03	AT/MT	R	F	Estate Engine CHBA/CHBB	618061	Inner Joint	35	34	42	50	67.5			
	2003.06-2007.03	-	L/R	F	Estate Engine CFBA	818007	Outer Joint	27	23	56.1	91.5	58.5	M		
2.0 16V (107 kW)	2003.06-2007.03	AT/MT	R	F	Estate Engine CFBA	618061	Inner Joint	35	34	42	50	67.5			
	2000.10-2007.03	AT	L	F	Estate Engine CJBA/CJBB	218297	Drive Shaft	27	35	56.1	91.5	676			
2.0 16V DI / TDDi / TDCi (66 kW)	2000.10-2007.03	-	L/R	F	Estate Engine CJBA/CJBB	818007	Outer Joint	27	23	56.1	91.5	58.5	M		
	2000.10-2007.03	-	L	F	Estate Engine CJBA/CJBB	218220	Drive Shaft	27	26	56.5	92	633			
	2000.10-2007.03	AT/MT	R	F	Estate Engine CJBA/CJBB	618061	Inner Joint	35	34	42	50	67.5			
	2000.10-2007.03	-	L	F	Estate Engine D5BA/SDBA	218220	Drive Shaft	27	26	56.5	92	633			
2000.10-2007.03	-	L/R	F	Estate Engine D5BA/SDBA	818002	Outer Joint	27	26	56	91	64	M			

YEAR	TRANSM	L/R	F/R	REMARKS	GSP Ref.	PRODUCT	ABS	Technical Specifications							
								A	B	C	H	L	P		
FORD															
MONDEO III Turnier (BWY)															
2.0 16V DI / TDDi / TDCi (66 kW)	2000.10-2007.03	AT/MT	R	F	Estate Engine D5BA/SDBA	218043	Drive Shaft	27	35	56.5	92	579			
	2000.10-2007.03	AT/MT	R	F	Estate Engine D5BA/SDBA	618061	Inner Joint	35	34	42	50	67.5			
	2000.10-2007.03	MT	-	-	Estate Engine D5BA/SDBA	818008	Outer Joint	27	26	56.5	92	64	M		
2.0 16V TDDi / TDCi (85 kW)	2000.10-2007.03	-	L	F	Estate Engine HJBC/HJBB/HJBA/D6BA	218220	Drive Shaft	27	26	56.5	92	633			
	2000.10-2007.03	-	L/R	F	Estate Engine HJBC/HJBB/HJBA/D6BA	818002	Outer Joint	27	26	56	91	64	M		
	2000.10-2007.03	AT/MT	R	F	Estate Engine HJBC/HJBB/HJBA/D6BA	218043	Drive Shaft	27	35	56.5	92	579			
	2000.10-2007.03	AT/MT	R	F	Estate Engine HJBC/HJBB/HJBA/D6BA	618061	Inner Joint	35	34	42	50	67.5			
	2000.10-2007.03	MT	-	-	Estate Engine HJBC/HJBB/HJBA/D6BA	818008	Outer Joint	27	26	56.5	92	64	M		
2.0 TDCi (96 kW)	2001.10-2007.03	-	L/R	F	Estate Engine FMBA/N7BA	818002	Outer Joint	27	26	56	91	64	M		
	2001.10-2007.03	AT	L	F	Estate Engine FMBA/N7BA	218252	Drive Shaft	27	30	62.8	91	617			
	2001.10-2007.03	AT/MT	R	F	Estate Engine FMBA/N7BA	218043	Drive Shaft	27	35	56.5	92	579			
	2001.10-2007.03	AT/MT	R	F	Estate Engine FMBA/N7BA	618061	Inner Joint	35	34	42	50	67.5			
	2001.10-2007.03	MT	-	-	Estate Engine FMBA/N7BA	818008	Outer Joint	27	26	56.5	92	64	M		
2.2 (166 kW)	2002.04-2007.03	-	L/R	F	Estate Engine MEBA	818002	Outer Joint	27	26	56	91	64	M		
	2002.04-2007.03	MT	R	F	Estate Engine MEBA	218043	Drive Shaft	27	35	56.5	92	579			
	2002.04-2007.03	MT	R	F	Estate Engine MEBA	618061	Inner Joint	35	34	42	50	67.5			
2.2 TDCi (110 kW)	2004.09-2007.03	MT	R	F	Estate Engine QJBC/QJBD	218043	Drive Shaft	27	35	56.5	92	579			
	2004.09-2007.03	MT	R	F	Estate Engine QJBC/QJBD	618061	Inner Joint	35	34	42	50	67.5			
2.2 TDCi (114 kW)	2004.09-2007.03	MT	R	F	Estate Engine QJBA/QJBB	218043	Drive Shaft	27	35	56.5	92	579			
	2004.09-2007.03	MT	R	F	Estate Engine QJBA/QJBB	618061	Inner Joint	35	34	42	50	67.5			
2.5 V6 24V (125 kW)	2000.10-2007.03	AT	L	F	Estate Engine LCBD	218252	Drive Shaft	27	30	62.8	91	617			
	2000.10-2007.03	AT/MT	R	F	Estate Engine LCBD	218043	Drive Shaft	27	35	56.5	92	579			
	2000.10-2007.03	AT/MT	R	F	Estate Engine LCBD	618061	Inner Joint	35	34	42	50	67.5			
	2000.10-2007.03	MT	-	-	Estate Engine LCBD	818008	Outer Joint	27	26	56.5	92	64	M		
3.0 V6 24V (150 kW)	2004.09-2007.03	MT	R	F	Estate Engine REBA	218043	Drive Shaft	27	35	56.5	92	579			
	2004.09-2007.03	MT	R	F	Estate Engine REBA	618061	Inner Joint	35	34	42	50	67.5			
	2004.09-2007.03	-	-	-	Estate Engine REBA	899012	Outer Joint	20	19	42	90	47	M		
MONDEO IV (BA7)															
1.6 EcoBoost (118 kW)	2010.11-2015.01	AT/MT	-	F	Saloon Engine JTBB/JTBA	899271	Outer Joint	40	28	57.4	51	63	M		
	2010.11-2015.01	AT	-	F	Saloon Engine JTBB/JTBA	862045	Outer Joint	40	26	57.4	52	62.5	M		
	2010.11-2015.01	MT	L	F	Saloon Engine JTBB/JTBA	618128	Inner Joint	26	28	40	68.5	111			
	2010.11-2015.01	MT	R	F	Saloon Engine JTBB/JTBA	618129	Inner Joint	26	28	40	389	96.5			
	2011.02-2015.01	AT/MT	-	F	Hatchback Engine JTBB/JTBA	899271	Outer Joint	40	28	57.4	51	63	M		
	2011.02-2015.01	AT	-	F	Hatchback Engine JTBB/JTBA	862045	Outer Joint	40	26	57.4	52	62.5	M		
	2011.02-2015.01	MT	L	F	Hatchback Engine JTBB/JTBA	618128	Inner Joint	26	28	40	68.5	111			
	2011.02-2015.01	MT	R	F	Hatchback Engine JTBB/JTBA	618129	Inner Joint	26	28	40	389	96.5			
1.6 TDCi (85 kW)	2010.12-2015.01	AT/MT	-	F	Saloon Engine T1BC/T1BB/T1BA	899271	Outer Joint	40	28	57.4	51	63	M		
	2010.12-2015.01	AT	-	F	Saloon Engine T1BC/T1BB/T1BA	862045	Outer Joint	40	26	57.4	52	62.5	M		
	2010.12-2015.01	MT	L	F	Saloon Engine T1BC/T1BB/T1BA	618128	Inner Joint	26	28	40	68.5	111			
	2010.12-2015.01	MT	R	F	Saloon Engine T1BC/T1BB/T1BA	618129	Inner Joint	26	28	40	389	96.5			
	2011.02-2015.01	AT/MT	-	F	Hatchback Engine T1BB/T1BA/T1BC	899271	Outer Joint	40	28	57.4	51	63	M		
	2011.02-2015.01	AT	-	F	Hatchback Engine T1BB/T1BA/T1BC	862045	Outer Joint	40	26	57.4	52	62.5	M		
	2011.02-2015.01	MT	L	F	Hatchback Engine T1BB/T1BA/T1BC	618128	Inner Joint	26	28	40	68.5	111			
	2011.02-2015.01	MT	L	F	Hatchback Engine T1BB/T1BA/T1BC	299211	Drive Shaft	40	26	57.4	51	603			
	2011.02-2015.01	MT	R	F	Hatchback Engine T1BB/T1BA/T1BC	299212	Drive Shaft	40	26	57.4	51	945			
	2011.02-2015.01	MT	R	F	Hatchback Engine T1BB/T1BA/T1BC	618129	Inner Joint	26	28	40	389	96.5			
1.6 Ti (81 kW)	2007.03-2015.01	-	L	F	Saloon Engine RHBA	618267	Inner Joint	31	26	36.2	68	93			
	2007.03-2015.01	AT/MT	-	F	Hatchback Engine RHBA	899271	Outer Joint	40	28	57.4	51	63	M		
	2007.03-2015.01	AT/MT	-	F	Saloon Engine RHBA	899271	Outer Joint	40	28	57.4	51	63	M		
	2007.03-2015.01	AT	-	F	Hatchback Engine RHBA	862045	Outer Joint	40	26	57.4	52	62.5	M		
	2007.03-2015.01	AT	-	F	Saloon Engine RHBA	862045	Outer Joint	40	26	57.4	52	62.5	M		
	2007.03-2015.01	MT	L	F	Hatchback Engine RHBA	618128	Inner Joint	26	28	40	68.5	111			
	2007.03-2015.01	MT	L	F	Saloon Engine RHBA	618128	Inner Joint	26	28	40	68.5	111			
	2007.03-2015.01	MT	R	F	Hatchback Engine RHBA	618129	Inner Joint	26	28	40	389	96.5			
	2007.03-2015.01	MT	R	F	Saloon Engine RHBA	618129	Inner Joint	26	28	40	389	96.5			
	2007.03-2015.01	-	L	F	Hatchback Engine RHBA	618267	Inner Joint	31	26	36.2	68	93			
1.6 Ti (88 kW)	2010.03-2015.01	-	L	F	Saloon Engine KGBA	618267	Inner Joint	31	26	36.2	68	93			
	2010.03-2015.01	AT/MT	-	F	Saloon Engine KGBA	899271	Outer Joint	40	28	57.4	51	63	M		
	2010.03-2015.01	AT	-	F	Saloon Engine KGBA	862045	Outer Joint	40	26	57.4	52	62.5	M		
	2010.03-2015.01	-	-	-	Saloon Engine KGBA	859285	Outer Joint	40	27	57.4	52	63.5	M		
	2010.03-2015.01	MT	L	F	Saloon Engine KGBA	618128	Inner Joint	26	28	40	68.5	111			
	2010.03-2015.01	-	-	-	Saloon Engine KGBA	834202	Outer Joint	40	24	57.5	52	56.5	M		
	2010.03-2015.01	MT	R	F	Saloon Engine KGBA	618129	Inner Joint	26	28	40	389	96.5			
	2010.07-2015.01	AT/MT	-	F	Hatchback Engine KGBA	899271	Outer Joint	40	28	57.4	51	63	M		
	2010.07-2015.01	AT	-	F	Hatchback Engine KGBA	862045	Outer Joint	40	26	57.4	52	62.5	M		
2010.07-2015.01	MT	L	F	Hatchback Engine KGBA	618128	Inner Joint	26	28	40	68.5	111				

	 YEAR	TRANSM	L/R	F/R	REMARKS	GSP Ref.	 PRODUCT	 ABS	Technical Specifications						
									A	B	C	H	L	P	
FORD															
MONDEO IV (BA7)															
1.6 Ti (88 kW)	2010.07-2015.01	MT	R	F	Hatchback Engine KGBA	618129	Inner Joint		26	28	40	389	96.5		
1.6 Ti (92 kW)	2007.03-2015.01	-	L	F	Hatchback Engine PNBA	618267	Inner Joint		31	26	36.2	68	93		
	2007.03-2015.01	AT/MT	-	F	Saloon Engine PNBA	899271	Outer Joint		40	28	57.4	51	63	M	
	2007.03-2015.01	AT/MT	-	F	Hatchback Engine PNBA	899271	Outer Joint		40	28	57.4	51	63	M	
	2007.03-2015.01	AT	-	F	Saloon Engine PNBA	862045	Outer Joint		40	26	57.4	52	62.5	M	
	2007.03-2015.01	AT	-	F	Hatchback Engine PNBA	862045	Outer Joint		40	26	57.4	52	62.5	M	
	2007.03-2015.01	MT	L	F	Saloon Engine PNBA	618128	Inner Joint		26	28	40	68.5	111		
	2007.03-2015.01	MT	L	F	Hatchback Engine PNBA	618128	Inner Joint		26	28	40	68.5	111		
	2007.03-2015.01	MT	R	F	Saloon Engine PNBA	618129	Inner Joint		26	28	40	389	96.5		
	2007.03-2015.01	MT	R	F	Hatchback Engine PNBA	618129	Inner Joint		26	28	40	389	96.5		
2007.03-2015.01	-	L	F	Saloon Engine PNBA	618267	Inner Joint		31	26	36.2	68	93			
1.8 TDCi (74 kW)	2007.03-2015.01	-	L	F	Hatchback Engine FFBA	618267	Inner Joint		31	26	36.2	68	93		
	2007.03-2015.01	-	L	F	Saloon Engine FFBA	618267	Inner Joint		31	26	36.2	68	93		
	2007.03-2015.01	AT/MT	-	F	Hatchback Engine FFBA	899271	Outer Joint		40	28	57.4	51	63	M	
	2007.03-2015.01	AT/MT	-	F	Saloon Engine FFBA	899271	Outer Joint		40	28	57.4	51	63	M	
	2007.03-2015.01	AT	-	F	Hatchback Engine FFBA	862045	Outer Joint		40	26	57.4	52	62.5	M	
	2007.03-2015.01	AT	-	F	Saloon Engine FFBA	862045	Outer Joint		40	26	57.4	52	62.5	M	
	2007.03-2015.01	MT	L	F	Hatchback Engine FFBA	618128	Inner Joint		26	28	40	68.5	111		
	2007.03-2015.01	MT	L	F	Hatchback Engine FFBA	299211	Drive Shaft		40	26	57.4	51	603		
	2007.03-2015.01	MT	L	F	Saloon Engine FFBA	299211	Drive Shaft		40	26	57.4	51	603		
	2007.03-2015.01	MT	L	F	Saloon Engine FFBA	618128	Inner Joint		26	28	40	68.5	111		
	2007.03-2015.01	MT	R	F	Hatchback Engine FFBA	299212	Drive Shaft		40	26	57.4	51	945		
	2007.03-2015.01	MT	R	F	Hatchback Engine FFBA	618129	Inner Joint		26	28	40	389	96.5		
	2007.03-2015.01	MT	R	F	Saloon Engine FFBA	299212	Drive Shaft		40	26	57.4	51	945		
	2007.03-2015.01	MT	R	F	Saloon Engine FFBA	618129	Inner Joint		26	28	40	389	96.5		
	1.8 TDCi (92 kW)	2007.06-2015.01	-	L	F	Hatchback Engine QYBA/KHBA	618267	Inner Joint		31	26	36.2	68	93	
2007.06-2015.01		-	L	F	Saloon Engine QYBA/KHBA	618267	Inner Joint		31	26	36.2	68	93		
2007.06-2015.01		AT/MT	-	F	Saloon Engine QYBA/KHBA	899271	Outer Joint		40	28	57.4	51	63	M	
2007.06-2015.01		AT/MT	-	F	Hatchback Engine QYBA/KHBA	899271	Outer Joint		40	28	57.4	51	63	M	
2007.06-2015.01		AT	-	F	Saloon Engine QYBA/KHBA	862045	Outer Joint		40	26	57.4	52	62.5	M	
2007.06-2015.01		AT	-	F	Hatchback Engine QYBA/KHBA	862045	Outer Joint		40	26	57.4	52	62.5	M	
2007.06-2015.01		-	-	F	Hatchback Engine QYBA/KHBA	859285	Outer Joint		40	27	57.4	52	63.5	M	
2007.06-2015.01		MT	L	F	Hatchback Engine QYBA/KHBA	299211	Drive Shaft		40	26	57.4	51	603		
2007.06-2015.01		MT	L	F	Saloon Engine QYBA/KHBA	299211	Drive Shaft		40	26	57.4	51	603		
2007.06-2015.01		MT	L	F	Saloon Engine QYBA/KHBA	618128	Inner Joint		26	28	40	68.5	111		
2007.06-2015.01		MT	L	F	Hatchback Engine QYBA/KHBA	618128	Inner Joint		26	28	40	68.5	111		
2007.06-2015.01		-	-	F	Hatchback Engine QYBA/KHBA	834202	Outer Joint		40	24	57.5	52	56.5	M	
2007.06-2015.01		MT	R	F	Hatchback Engine QYBA/KHBA	299212	Drive Shaft		40	26	57.4	51	945		
2007.06-2015.01		MT	R	F	Saloon Engine QYBA/KHBA	299212	Drive Shaft		40	26	57.4	51	945		
2007.06-2015.01		MT	R	F	Saloon Engine QYBA/KHBA	618129	Inner Joint		26	28	40	389	96.5		
2007.06-2015.01		MT	R	F	Hatchback Engine QYBA/KHBA	618129	Inner Joint		26	28	40	389	96.5		
2.0 (107 kW)		2007.03-2015.01	-	L	F	Hatchback Engine AOBTA/TBBA/AOBC	618267	Inner Joint		31	26	36.2	68	93	
		2007.03-2015.01	-	L	F	Saloon Engine TBBA/AOBA/AOBC	618267	Inner Joint		31	26	36.2	68	93	
	2007.03-2015.01	AT/MT	-	F	Hatchback Engine AOBTA/TBBA/AOBC	899271	Outer Joint		40	28	57.4	51	63	M	
	2007.03-2015.01	AT/MT	-	F	Saloon Engine TBBA/AOBA/AOBC	899271	Outer Joint		40	28	57.4	51	63	M	
	2007.03-2015.01	AT	-	F	Hatchback Engine AOBTA/TBBA/AOBC	862045	Outer Joint		40	26	57.4	52	62.5	M	
	2007.03-2015.01	AT	-	F	Saloon Engine TBBA/AOBA/AOBC	862045	Outer Joint		40	26	57.4	52	62.5	M	
	2007.03-2015.01	MT	L	F	Hatchback Engine AOBTA/TBBA/AOBC	618128	Inner Joint		26	28	40	68.5	111		
	2007.03-2015.01	MT	L	F	Hatchback Engine AOBTA/TBBA/AOBC	299211	Drive Shaft		40	26	57.4	51	603		
	2007.03-2015.01	MT	L	F	Saloon Engine TBBA/AOBA/AOBC	618128	Inner Joint		26	28	40	68.5	111		
	2007.03-2015.01	MT	L	F	Saloon Engine TBBA/AOBA/AOBC	299211	Drive Shaft		40	26	57.4	51	603		
	2007.03-2015.01	MT	R	F	Hatchback Engine AOBTA/TBBA/AOBC	618129	Inner Joint		26	28	40	389	96.5		
	2007.03-2015.01	MT	R	F	Saloon Engine TBBA/AOBA/AOBC	618129	Inner Joint		26	28	40	389	96.5		
2.0 EcoBoost (176 kW)	2010.07-2015.01	Semi-AT	R	F	Hatchback Engine TPBA	218341	Drive Shaft		40	28	57.4	52	952		
	2010.07-2015.01	AT/MT	-	F	Hatchback Engine TPBA	899271	Outer Joint		40	28	57.4	51	63	M	
	2010.07-2015.01	Semi-AT	-	F	Hatchback Engine TPBA	859344	Outer Joint		40	26	57.4	52	63.5	M	
	2010.07-2015.01	AT	-	F	Hatchback Engine TPBA	862045	Outer Joint		40	26	57.4	52	62.5	M	
	2010.07-2015.01	MT	L	F	Hatchback Engine TPBA	618128	Inner Joint		26	28	40	68.5	111		
	2010.07-2015.01	MT	R	F	Hatchback Engine TPBA	618129	Inner Joint		26	28	40	389	96.5		
2.0 Flexifuel (107 kW)	2009.03-2015.01	AT/MT	-	F	Hatchback Engine TBBA/TBBB	899271	Outer Joint		40	28	57.4	51	63	M	
	2009.03-2015.01	AT/MT	-	F	Saloon Engine TBBA/TBBB	899271	Outer Joint		40	28	57.4	51	63	M	
	2009.03-2015.01	AT	-	F	Hatchback Engine TBBA/TBBB	862045	Outer Joint		40	26	57.4	52	62.5	M	
	2009.03-2015.01	AT	-	F	Saloon Engine TBBA/TBBB	862045	Outer Joint		40	26	57.4	52	62.5	M	
	2009.03-2015.01	MT	L	F	Hatchback Engine TBBA/TBBB	299211	Drive Shaft		40	26	57.4	51	603		
	2009.03-2015.01	MT	L	F	Hatchback Engine TBBA/TBBB	618128	Inner Joint		26	28	40	68.5	111		
	2009.03-2015.01	MT	L	F	Saloon Engine TBBA/TBBB	299211	Drive Shaft		40	26	57.4	51	603		

	 YEAR	TRANSM	L/R	F/R	REMARKS	GSP Ref.	 PRODUCT	 ABS	Technical Specifications					
									A	B	C	H	L	P
FORD														
MONDEO IV (BA7)														
2.0 Flexifuel (107 kW)	2009.03-2015.01	MT	L	F	Saloon Engine TBBA/TBBB	618128	Inner Joint		26	28	40	68.5	111	
	2009.03-2015.01	MT	R	F	Hatchback Engine TBBA/TBBB	618129	Inner Joint		26	28	40	389	96.5	
	2009.03-2015.01	MT	R	F	Saloon Engine TBBA/TBBB	618129	Inner Joint		26	28	40	389	96.5	
2.0 LPG (107 kW)	2009.07-2015.01	AT/MT	-	F	Hatchback Engine TBBA	899271	Outer Joint		40	28	57.4	51	63	M
	2009.07-2015.01	AT/MT	-	F	Saloon Engine TBBA	899271	Outer Joint		40	28	57.4	51	63	M
	2009.07-2015.01	AT	-	F	Hatchback Engine TBBA	862045	Outer Joint		40	26	57.4	52	62.5	M
	2009.07-2015.01	AT	-	F	Saloon Engine TBBA	862045	Outer Joint		40	26	57.4	52	62.5	M
	2009.07-2015.01	MT	L	F	Hatchback Engine TBBA	618128	Inner Joint		26	28	40	68.5	111	
	2009.07-2015.01	MT	L	F	Saloon Engine TBBA	618128	Inner Joint		26	28	40	68.5	111	
	2009.07-2015.01	MT	L	F	Hatchback Engine TBBA	299211	Drive Shaft		40	26	57.4	51	603	
	2009.07-2015.01	MT	L	F	Saloon Engine TBBA	299211	Drive Shaft		40	26	57.4	51	603	
	2009.07-2015.01	MT	R	F	Hatchback Engine TBBA	618129	Inner Joint		26	28	40	389	96.5	
2.0 SCTi (149 kW)	2010.03-2015.01	-	L	F	Saloon	618267	Inner Joint		31	26	36.2	68	93	
	2010.03-2015.01	AT	R	F	Hatchback Engine TNBA	218341	Drive Shaft		40	28	57.4	52	952	
	2010.03-2015.01	AT	-	F	Hatchback Engine TNBA	859344	Outer Joint		40	26	57.4	52	63.5	M
	2010.03-2015.01	AT/MT	-	F	Hatchback Engine TNBA	899271	Outer Joint		40	28	57.4	51	63	M
	2010.03-2015.01	AT/MT	-	F	Saloon	899271	Outer Joint		40	28	57.4	51	63	M
	2010.03-2015.01	AT	-	F	Hatchback Engine TNBA	862045	Outer Joint		40	26	57.4	52	62.5	M
	2010.03-2015.01	AT	-	F	Saloon	862045	Outer Joint		40	26	57.4	52	62.5	M
	2010.03-2015.01	-	-	F	Saloon	859285	Outer Joint		40	27	57.4	52	63.5	M
	2010.03-2015.01	MT	L	F	Hatchback Engine TNBA	618128	Inner Joint		26	28	40	68.5	111	
	2010.03-2015.01	MT	L	F	Saloon	618128	Inner Joint		26	28	40	68.5	111	
	2010.03-2015.01	-	-	F	Saloon	834202	Outer Joint		40	24	57.5	52	56.5	M
	2010.03-2015.01	MT	R	F	Hatchback Engine TNBA	618129	Inner Joint		26	28	40	389	96.5	
2.0 TDCi (100 kW)	2007.03-2015.01	AT	-	F	Hatchback Engine AZBC/UKBA/UKBB	859344	Outer Joint		40	26	57.4	52	63.5	M
	2007.03-2015.01	AT/MT	-	F	Hatchback Engine AZBC/UKBA/UKBB	899271	Outer Joint		40	28	57.4	51	63	M
	2007.03-2015.01	AT	L	F	Hatchback Engine AZBC/UKBA/UKBB	218340	Drive Shaft		40	28	57.4	52	592	
	2007.03-2015.01	AT	-	F	Hatchback Engine AZBC/UKBA/UKBB	862045	Outer Joint		40	26	57.4	52	62.5	M
	2007.03-2015.01	MT	L	F	Hatchback Engine AZBC/UKBA/UKBB	618128	Inner Joint		26	28	40	68.5	111	
	2007.03-2015.01	MT	L	F	Hatchback Engine AZBC/UKBA/UKBB	299211	Drive Shaft		40	26	57.4	51	603	
	2007.03-2015.01	MT	R	F	Hatchback Engine AZBC/UKBA/UKBB	299212	Drive Shaft		40	26	57.4	51	945	
	2007.03-2015.01	MT	R	F	Hatchback Engine AZBC/UKBA/UKBB	618129	Inner Joint		26	28	40	389	96.5	
	2007.03-2015.01	AT	L	F	Hatchback Engine AZBC/UKBA/UKBB	203288	Drive Shaft		40	31	57.4	51	582	
	2007.03-2015.01	AT	R	F	Hatchback Engine AZBC/UKBA/UKBB	203289	Drive Shaft		40	28	57.4	51	932	
	2007.03-2015.01	-	L	F	Hatchback Engine AZBC/UKBA/UKBB	618267	Inner Joint		31	26	36.2	68	93	
	2008.08-2015.01	-	L	F	Saloon Engine AZBC, UKBA, UKBB	618267	Inner Joint		31	26	36.2	68	93	
	2008.08-2015.01	AT/MT	-	F	Saloon Engine AZBC, UKBA, UKBB	899271	Outer Joint		40	28	57.4	51	63	M
	2008.08-2015.01	AT	-	F	Saloon Engine AZBC, UKBA, UKBB	862045	Outer Joint		40	26	57.4	52	62.5	M
	2008.08-2015.01	-	-	F	Saloon Engine AZBC, UKBA, UKBB	859285	Outer Joint		40	27	57.4	52	63.5	M
	2008.08-2015.01	MT	L	F	Saloon Engine AZBC, UKBA, UKBB	618128	Inner Joint		26	28	40	68.5	111	
	2008.08-2015.01	-	-	F	Saloon Engine AZBC, UKBA, UKBB	834202	Outer Joint		40	24	57.5	52	56.5	M
2008.08-2015.01	MT	R	F	Saloon Engine AZBC, UKBA, UKBB	618129	Inner Joint		26	28	40	389	96.5		
2.0 TDCi (103 kW)	2007.03-2015.01	-	L	F	Hatchback Engine UFBB/UFBA/QXBB/QXBA	618267	Inner Joint		31	26	36.2	68	93	
	2007.03-2015.01	-	L	F	Saloon Engine UFBB/UFBA/QXBB/QXBA	618267	Inner Joint		31	26	36.2	68	93	
	2007.03-2015.01	AT	-	F	Hatchback Engine UFBB/UFBA/QXBB/QXBA	859344	Outer Joint		40	26	57.4	52	63.5	M
	2007.03-2015.01	AT	-	F	Saloon Engine UFBB/UFBA/QXBB/QXBA	859344	Outer Joint		40	26	57.4	52	63.5	M
	2007.03-2015.01	AT/MT	-	F	Hatchback Engine UFBB/UFBA/QXBB/QXBA	899271	Outer Joint		40	28	57.4	51	63	M
	2007.03-2015.01	AT/MT	-	F	Saloon Engine UFBB/UFBA/QXBB/QXBA	899271	Outer Joint		40	28	57.4	51	63	M
	2007.03-2015.01	AT	L	F	Hatchback Engine UFBB/UFBA/QXBB/QXBA	218340	Drive Shaft		40	28	57.4	52	592	
	2007.03-2015.01	AT	L	F	Saloon Engine UFBB/UFBA/QXBB/QXBA	218340	Drive Shaft		40	28	57.4	52	592	
	2007.03-2015.01	AT	-	F	Hatchback Engine UFBB/UFBA/QXBB/QXBA	862045	Outer Joint		40	26	57.4	52	62.5	M
	2007.03-2015.01	AT	-	F	Saloon Engine UFBB/UFBA/QXBB/QXBA	862045	Outer Joint		40	26	57.4	52	62.5	M
	2007.03-2015.01	MT	L	F	Hatchback Engine UFBB/UFBA/QXBB/QXBA	299211	Drive Shaft		40	26	57.4	51	603	
	2007.03-2015.01	MT	L	F	Hatchback Engine UFBB/UFBA/QXBB/QXBA	618128	Inner Joint		26	28	40	68.5	111	
	2007.03-2015.01	MT	L	F	Saloon Engine UFBB/UFBA/QXBB/QXBA	618128	Inner Joint		26	28	40	68.5	111	
	2007.03-2015.01	MT	L	F	Saloon Engine UFBB/UFBA/QXBB/QXBA	299211	Drive Shaft		40	26	57.4	51	603	
	2007.03-2015.01	MT	R	F	Hatchback Engine UFBB/UFBA/QXBB/QXBA	299212	Drive Shaft		40	26	57.4	51	945	
	2007.03-2015.01	MT	R	F	Saloon Engine UFBB/UFBA/QXBB/QXBA	299212	Drive Shaft		40	26	57.4	51	945	
	2007.03-2015.01	MT	R	F	Hatchback Engine UFBB/UFBA/QXBB/QXBA	618129	Inner Joint		26	28	40	389	96.5	
	2007.03-2015.01	MT	R	F	Saloon Engine UFBB/UFBA/QXBB/QXBA	618129	Inner Joint		26	28	40	389	96.5	
	2007.03-2015.01	AT	L	F	Hatchback Engine UFBB/UFBA/QXBB/QXBA	203288	Drive Shaft		40	31	57.4	51	582	
	2007.03-2015.01	AT	L	F	Saloon Engine UFBB/UFBA/QXBB/QXBA	203288	Drive Shaft		40	31	57.4	51	582	
	2007.03-2015.01	AT	R	F	Hatchback Engine UFBB/UFBA/QXBB/QXBA	203289	Drive Shaft		40	28	57.4	51	932	
2007.03-2015.01	AT	R	F	Saloon Engine UFBB/UFBA/QXBB/QXBA	203289	Drive Shaft		40	28	57.4	51	932		





YEAR	TRANSM	L/R	F/R	REMARKS	GSP Ref.	PRODUCT	ABS	Technical Specifications						
								A	B	C	H	L	P	
FORD														
MONDEO IV (BA7)														
2.0 TDCi (120 kW)														
2010.03-2015.01	AT	-	F	Hatchback Engine TXBA/TXBB	859344	Outer Joint		40	26	57.4	52	63.5	M	
2010.03-2015.01	AT	-	F	Saloon Engine TXBA/TXBB	859344	Outer Joint		40	26	57.4	52	63.5	M	
2010.03-2015.01	AT/MT	-	F	Hatchback Engine TXBA/TXBB	899271	Outer Joint		40	28	57.4	51	63	M	
2010.03-2015.01	AT/MT	-	F	Saloon Engine TXBA/TXBB	899271	Outer Joint		40	28	57.4	51	63	M	
2010.03-2015.01	AT	L	F	Hatchback Engine TXBA/TXBB	218340	Drive Shaft		40	28	57.4	52	592		
2010.03-2015.01	AT	L	F	Saloon Engine TXBA/TXBB	218340	Drive Shaft		40	28	57.4	52	592		
2010.03-2015.01	AT	-	F	Hatchback Engine TXBA/TXBB	862045	Outer Joint		40	26	57.4	52	62.5	M	
2010.03-2015.01	AT	-	F	Saloon Engine TXBA/TXBB	862045	Outer Joint		40	26	57.4	52	62.5	M	
2010.03-2015.01	MT	L	F	Hatchback Engine TXBA/TXBB	299211	Drive Shaft		40	26	57.4	51	603		
2010.03-2015.01	MT	L	F	Saloon Engine TXBA/TXBB	299211	Drive Shaft		40	26	57.4	51	603		
2010.03-2015.01	MT	L	F	Hatchback Engine TXBA/TXBB	618128	Inner Joint		26	28	40	68.5	111		
2010.03-2015.01	MT	L	F	Saloon Engine TXBA/TXBB	618128	Inner Joint		26	28	40	68.5	111		
2010.03-2015.01	MT	R	F	Hatchback Engine TXBA/TXBB	299212	Drive Shaft		40	26	57.4	51	945		
2010.03-2015.01	MT	R	F	Saloon Engine TXBA/TXBB	299212	Drive Shaft		40	26	57.4	51	945		
2010.03-2015.01	MT	R	F	Hatchback Engine TXBA/TXBB	618129	Inner Joint		26	28	40	389	96.5		
2010.03-2015.01	MT	R	F	Saloon Engine TXBA/TXBB	618129	Inner Joint		26	28	40	389	96.5		
2010.03-2015.01	AT	L	F	Hatchback Engine TXBA/TXBB	203288	Drive Shaft		40	31	57.4	51	582		
2010.03-2015.01	AT	L	F	Saloon Engine TXBA/TXBB	203288	Drive Shaft		40	31	57.4	51	582		
2010.03-2015.01	AT	R	F	Hatchback Engine TXBA/TXBB	203289	Drive Shaft		40	28	57.4	51	932		
2010.03-2015.01	AT	R	F	Saloon Engine TXBA/TXBB	203289	Drive Shaft		40	28	57.4	51	932		
2.0 TDCi (85 kW)														
2007.11-2015.01	AT/MT	-	F	Hatchback Engine KLBA/LPBA/TYBA	899271	Outer Joint		40	28	57.4	51	63	M	
2007.11-2015.01	AT/MT	-	F	Saloon Engine LPBA/KLBA/TYBA	899271	Outer Joint		40	28	57.4	51	63	M	
2007.11-2015.01	AT	L	F	Hatchback Engine KLBA/LPBA/TYBA	218340	Drive Shaft		40	28	57.4	52	592		
2007.11-2015.01	AT	-	F	Hatchback Engine KLBA/LPBA/TYBA	862045	Outer Joint		40	26	57.4	52	62.5	M	
2007.11-2015.01	AT	-	F	Saloon Engine LPBA/KLBA/TYBA	862045	Outer Joint		40	26	57.4	52	62.5	M	
2007.11-2015.01	MT	L	F	Hatchback Engine KLBA/LPBA/TYBA	299211	Drive Shaft		40	26	57.4	51	603		
2007.11-2015.01	MT	L	F	Hatchback Engine KLBA/LPBA/TYBA	618128	Inner Joint		26	28	40	68.5	111		
2007.11-2015.01	MT	L	F	Saloon Engine LPBA/KLBA/TYBA	299211	Drive Shaft		40	26	57.4	51	603		
2007.11-2015.01	MT	L	F	Saloon Engine LPBA/KLBA/TYBA	618128	Inner Joint		26	28	40	68.5	111		
2007.11-2015.01	MT	R	F	Hatchback Engine KLBA/LPBA/TYBA	299212	Drive Shaft		40	26	57.4	51	945		
2007.11-2015.01	MT	R	F	Saloon Engine LPBA/KLBA/TYBA	299212	Drive Shaft		40	26	57.4	51	945		
2007.11-2015.01	MT	R	F	Hatchback Engine KLBA/LPBA/TYBA	618129	Inner Joint		26	28	40	389	96.5		
2007.11-2015.01	MT	R	F	Saloon Engine LPBA/KLBA/TYBA	618129	Inner Joint		26	28	40	389	96.5		
2007.11-2015.01	AT	L	F	Hatchback Engine KLBA/LPBA/TYBA	203288	Drive Shaft		40	31	57.4	51	582		
2007.11-2015.01	AT	R	F	Hatchback Engine KLBA/LPBA/TYBA	203289	Drive Shaft		40	28	57.4	51	932		
2.0 TDCi (96 kW)														
2007.03-2015.01	-	L	F	Hatchback Engine AZBA	618267	Inner Joint		31	26	36.2	68	93		
2007.03-2015.01	-	L	F	Saloon Engine AZBA	618267	Inner Joint		31	26	36.2	68	93		
2007.03-2015.01	Semi-AT	-	F	Hatchback Engine AZBA	859344	Outer Joint		40	26	57.4	52	63.5	M	
2007.03-2015.01	Semi-AT	-	F	Saloon Engine AZBA	859344	Outer Joint		40	26	57.4	52	63.5	M	
2007.03-2015.01	AT/MT	-	F	Hatchback Engine AZBA	899271	Outer Joint		40	28	57.4	51	63	M	
2007.03-2015.01	AT/MT	-	F	Saloon Engine AZBA	899271	Outer Joint		40	28	57.4	51	63	M	
2007.03-2015.01	AT	L	F	Hatchback Engine AZBA	218340	Drive Shaft		40	28	57.4	52	592		
2007.03-2015.01	AT	L	F	Saloon Engine AZBA	218340	Drive Shaft		40	28	57.4	52	592		
2007.03-2015.01	AT	-	F	Hatchback Engine AZBA	862045	Outer Joint		40	26	57.4	52	62.5	M	
2007.03-2015.01	AT	-	F	Saloon Engine AZBA	862045	Outer Joint		40	26	57.4	52	62.5	M	
2007.03-2015.01	MT	L	F	Hatchback Engine AZBA	618128	Inner Joint		26	28	40	68.5	111		
2007.03-2015.01	MT	L	F	Saloon Engine AZBA	618128	Inner Joint		26	28	40	68.5	111		
2007.03-2015.01	MT	R	F	Hatchback Engine AZBA	618129	Inner Joint		26	28	40	389	96.5		
2007.03-2015.01	MT	R	F	Saloon Engine AZBA	618129	Inner Joint		26	28	40	389	96.5		
2007.03-2015.01	AT	L	F	Hatchback Engine AZBA	203288	Drive Shaft		40	31	57.4	51	582		
2007.03-2015.01	AT	L	F	Saloon Engine AZBA	203288	Drive Shaft		40	31	57.4	51	582		
2007.03-2015.01	AT	R	F	Hatchback Engine AZBA	203289	Drive Shaft		40	28	57.4	51	932		
2007.03-2015.01	AT	R	F	Saloon Engine AZBA	203289	Drive Shaft		40	28	57.4	51	932		
2.2 TDCi (129 kW)														
2008.03-2010.10	MT	L	F	Hatchback Engine Q4BA	218363	Drive Shaft		40	31	57.4	52	588.5		
2008.03-2010.10	MT	L	F	Saloon Engine Q4BA	218363	Drive Shaft		40	31	57.4	52	588.5		
2008.03-2010.10	MT	R	F	Hatchback Engine Q4BA	218350	Drive Shaft		40	28	57.4	52	963		
2008.03-2010.10	MT	R	F	Saloon Engine Q4BA	218350	Drive Shaft		40	28	57.4	52	963		
2008.03-2010.10	AT/MT	-	F	Hatchback Engine Q4BA	899271	Outer Joint		40	28	57.4	51	63	M	
2008.03-2010.10	AT/MT	-	F	Saloon Engine Q4BA	899271	Outer Joint		40	28	57.4	51	63	M	
2008.03-2010.10	-	-	F	Hatchback Engine Q4BA	859344	Outer Joint		40	26	57.4	52	63.5	M	
2008.03-2010.10	-	-	F	Saloon Engine Q4BA	859344	Outer Joint		40	26	57.4	52	63.5	M	
2008.03-2010.10	AT	-	F	Hatchback Engine Q4BA	862045	Outer Joint		40	26	57.4	52	62.5	M	
2008.03-2010.10	AT	-	F	Saloon Engine Q4BA	862045	Outer Joint		40	26	57.4	52	62.5	M	
2008.03-2010.10	MT	L	F	Hatchback Engine Q4BA	618128	Inner Joint		26	28	40	68.5	111		
2008.03-2010.10	MT	L	F	Saloon Engine Q4BA	618128	Inner Joint		26	28	40	68.5	111		
2008.03-2010.10	MT	R	F	Hatchback Engine Q4BA	618129	Inner Joint		26	28	40	389	96.5		

YEAR	TRANSM	L/R	F/R	REMARKS	GSP Ref.	PRODUCT	ABS	Technical Specifications						
								A	B	C	H	L	P	
FORD														
MONDEO IV (BA7)														
2.2 TDCi (129 kW)	2008.03-2010.10	MT	R	F	Saloon Engine Q4BA	618129	Inner Joint	26	28	40	389	96.5		
2.2 TDCi (147 kW)	2010.07-2015.01	MT	L	F	Hatchback Engine KNBA	218363	Drive Shaft	40	31	57.4	52	588.5		
	2010.07-2015.01	MT	R	F	Hatchback Engine KNBA	218350	Drive Shaft	40	28	57.4	52	963		
	2010.07-2015.01	AT/MT	-	F	Hatchback Engine KNBA	899271	Outer Joint	40	28	57.4	51	63	M	
	2010.07-2015.01	-	-	F	Hatchback Engine KNBA	859344	Outer Joint	40	26	57.4	52	63.5	M	
	2010.07-2015.01	AT	-	F	Hatchback Engine KNBA	862045	Outer Joint	40	26	57.4	52	62.5	M	
	2010.07-2015.01	MT	L	F	Hatchback Engine KNBA	618128	Inner Joint	26	28	40	68.5	111		
	2010.07-2015.01	MT	R	F	Hatchback Engine KNBA	618129	Inner Joint	26	28	40	389	96.5		
	2010.10-2015.01	-	L	F	Saloon Engine KNBA	618267	Inner Joint	31	26	36.2	68	93		
	2010.10-2015.01	AT/MT	-	F	Saloon Engine KNBA	899271	Outer Joint	40	28	57.4	51	63	M	
	2010.10-2015.01	AT	-	F	Saloon Engine KNBA	862045	Outer Joint	40	26	57.4	52	62.5	M	
	2010.10-2015.01	-	-	F	Saloon Engine KNBA	859285	Outer Joint	40	27	57.4	52	63.5	M	
	2010.10-2015.01	MT	L	F	Saloon Engine KNBA	618128	Inner Joint	26	28	40	68.5	111		
	2010.10-2015.01	-	-	F	Saloon Engine KNBA	834202	Outer Joint	40	24	57.5	52	56.5	M	
	2010.10-2015.01	MT	R	F	Saloon Engine KNBA	618129	Inner Joint	26	28	40	389	96.5		
2.3 (118 kW)	2007.07-2015.01	-	L	F	Hatchback Engine SEBA	618267	Inner Joint	31	26	36.2	68	93		
	2007.07-2015.01	-	L	F	Saloon Engine SEBA	618267	Inner Joint	31	26	36.2	68	93		
	2007.07-2015.01	AT	R	F	Hatchback Engine SEBA	261106	Drive Shaft	40	31	57.4	51	945		
	2007.07-2015.01	AT	R	F	Saloon Engine SEBA	261106	Drive Shaft	40	31	57.4	51	945		
	2007.07-2015.01	AT/MT	-	F	Hatchback Engine SEBA	899271	Outer Joint	40	28	57.4	51	63	M	
	2007.07-2015.01	AT/MT	-	F	Saloon Engine SEBA	899271	Outer Joint	40	28	57.4	51	63	M	
	2007.07-2015.01	AT	-	F	Hatchback Engine SEBA	862045	Outer Joint	40	26	57.4	52	62.5	M	
	2007.07-2015.01	AT	-	F	Saloon Engine SEBA	862045	Outer Joint	40	26	57.4	52	62.5	M	
	2007.07-2015.01	MT	L	F	Hatchback Engine SEBA	618128	Inner Joint	26	28	40	68.5	111		
	2007.07-2015.01	MT	L	F	Saloon Engine SEBA	618128	Inner Joint	26	28	40	68.5	111		
	2007.07-2015.01	MT	R	F	Hatchback Engine SEBA	618129	Inner Joint	26	28	40	389	96.5		
	2007.07-2015.01	MT	R	F	Saloon Engine SEBA	618129	Inner Joint	26	28	40	389	96.5		
	2.5 (162 kW)	2007.03-2015.01	-	L	F	Hatchback Engine HUBA	618267	Inner Joint	31	26	36.2	68	93	
		2007.03-2015.01	-	L	F	Saloon Engine HUBA	618267	Inner Joint	31	26	36.2	68	93	
2007.03-2015.01		AT/MT	-	F	Hatchback Engine HUBA	899271	Outer Joint	40	28	57.4	51	63	M	
2007.03-2015.01		AT/MT	-	F	Saloon Engine HUBA	899271	Outer Joint	40	28	57.4	51	63	M	
2007.03-2015.01		AT	-	F	Hatchback Engine HUBA	862045	Outer Joint	40	26	57.4	52	62.5	M	
2007.03-2015.01		AT	-	F	Saloon Engine HUBA	862045	Outer Joint	40	26	57.4	52	62.5	M	
2007.03-2015.01		MT	L	F	Hatchback Engine HUBA	618128	Inner Joint	26	28	40	68.5	111		
2007.03-2015.01		MT	L	F	Saloon Engine HUBA	618128	Inner Joint	26	28	40	68.5	111		
2007.03-2015.01		MT	R	F	Hatchback Engine HUBA	618129	Inner Joint	26	28	40	389	96.5		
2007.03-2015.01		MT	R	F	Saloon Engine HUBA	618129	Inner Joint	26	28	40	389	96.5		
2007.03-2015.01		MT	L/R	F	Hatchback Engine HUBA	862042	Outer Joint	40	27	57.4	52	63.5	M	
2007.03-2015.01		MT	L/R	F	Saloon Engine HUBA	862042	Outer Joint	40	27	57.4	52	63.5	M	
2007.03-2015.01		MT	L	F	Hatchback Engine HUBA	221070	Drive Shaft	40	26	57.4	52	556		
2007.03-2015.01		MT	L	F	Saloon Engine HUBA	221070	Drive Shaft	40	26	57.4	52	556		
MONDEO IV Turnier (BA7)														
1.6 TDCi (85 kW)	2011.02-2015.01	MT	L	F	Estate Engine T1BC/T1BB/T1BA	299211	Drive Shaft	40	26	57.4	51	603		
	2011.02-2015.01	MT	R	F	Estate Engine T1BC/T1BB/T1BA	299212	Drive Shaft	40	26	57.4	51	945		
1.8 TDCi (74 kW)	2007.03-2012.12	MT	L	F	Estate Engine FFBA	299211	Drive Shaft	40	26	57.4	51	603		
	2007.03-2012.12	MT	R	F	Estate Engine FFBA	299212	Drive Shaft	40	26	57.4	51	945		
1.8 TDCi (92 kW)	2007.06-2012.12	MT	L	F	Estate Engine QYBA/KHBA	299211	Drive Shaft	40	26	57.4	51	603		
	2007.06-2012.12	MT	R	F	Estate Engine QYBA/KHBA	299212	Drive Shaft	40	26	57.4	51	945		
2.0 (107 kW)	2007.03-2015.01	MT	L	F	Estate Engine TBBA/AOBA/AOBC	299211	Drive Shaft	40	26	57.4	51	603		
2.0 EcoBoost (176 kW)	2010.07-2015.01	Semi-AT	R	F	Estate Engine TPBA	218341	Drive Shaft	40	28	57.4	52	952		
	2010.07-2015.01	Semi-AT	-	F	Estate Engine TPBA	859344	Outer Joint	40	26	57.4	52	63.5	M	
2.0 Flexifuel (107 kW)	2009.03-2015.01	MT	L	F	Estate Engine TBBA/TBBB	299211	Drive Shaft	40	26	57.4	51	603		
2.0 LPG (107 kW)	2009.07-2015.01	MT	L	F	Estate Engine TBBA	299211	Drive Shaft	40	26	57.4	51	603		
2.0 SCTi (149 kW)	2010.03-2015.01	AT	R	F	Estate Engine TNBA	218341	Drive Shaft	40	28	57.4	52	952		
	2010.03-2015.01	AT	-	F	Estate Engine TNBA	859344	Outer Joint	40	26	57.4	52	63.5	M	
2.0 TDCi (100 kW)	2007.03-2015.01	AT	-	F	Estate Engine AZBC/UKBA/UKBB	859344	Outer Joint	40	26	57.4	52	63.5	M	
	2007.03-2015.01	AT	L	F	Estate Engine AZBC/UKBA/UKBB	218340	Drive Shaft	40	28	57.4	52	592		
	2007.03-2015.01	MT	L	F	Estate Engine AZBC/UKBA/UKBB	299211	Drive Shaft	40	26	57.4	51	603		
	2007.03-2015.01	MT	R	F	Estate Engine AZBC/UKBA/UKBB	299212	Drive Shaft	40	26	57.4	51	945		
	2007.03-2015.01	AT	L	F	Estate Engine AZBC/UKBA/UKBB	203288	Drive Shaft	40	31	57.4	51	582		
	2007.03-2015.01	AT	R	F	Estate Engine AZBC/UKBA/UKBB	203289	Drive Shaft	40	28	57.4	51	932		
	2.0 TDCi (103 kW)	2007.03-2015.01	AT	-	F	Estate Engine UFBB/UFBA/QXBB/QXBA	859344	Outer Joint	40	26	57.4	52	63.5	M
2007.03-2015.01		AT	L	F	Estate Engine UFBB/UFBA/QXBB/QXBA	218340	Drive Shaft	40	28	57.4	52	592		
2007.03-2015.01		MT	L	F	Estate Engine UFBB/UFBA/QXBB/QXBA	299211	Drive Shaft	40	26	57.4	51	603		
2007.03-2015.01		MT	R	F	Estate Engine UFBB/UFBA/QXBB/QXBA	299212	Drive Shaft	40	26	57.4	51	945		
2007.03-2015.01		AT	L	F	Estate Engine UFBB/UFBA/QXBB/QXBA	203288	Drive Shaft	40	31	57.4	51	582		

YEAR	TRANSM	L/R	F/R	REMARKS	GSP Ref.	PRODUCT	ABS	Technical Specifications						
								A	B	C	H	L	P	
FORD														
MONDEO IV Turnier (BA7)														
2.0 TDCi (103 kW)	2007.03-2015.01	AT	R	F	Estate Engine UFBB/UFBA/QXBB/QXBA	203289	Drive Shaft		40	28	57.4	51	932	
2.0 TDCi (120 kW)	2010.03-2015.01	AT	L	F	Estate Engine TXBA/TXBB	218340	Drive Shaft		40	28	57.4	52	592	
	2010.03-2015.01	MT	L	F	Estate Engine TXBA/TXBB	299211	Drive Shaft		40	26	57.4	51	603	
	2010.03-2015.01	MT	R	F	Estate Engine TXBA/TXBB	299212	Drive Shaft		40	26	57.4	51	945	
	2010.03-2015.01	AT	L	F	Estate Engine TXBA/TXBB	203288	Drive Shaft		40	31	57.4	51	582	
	2010.03-2015.01	AT	R	F	Estate Engine TXBA/TXBB	203289	Drive Shaft		40	28	57.4	51	932	
2.0 TDCi (85 kW)	2007.11-2015.01	MT	L	F	Estate Engine LPBA/KLBA/TYBA	299211	Drive Shaft		40	26	57.4	51	603	
2.0 TDCi (96 kW)	2007.03-2012.12	Semi-AT	-	F	Estate Engine AZBA	859344	Outer Joint		40	26	57.4	52	63.5	M
	2007.03-2012.12	AT	L	F	Estate Engine AZBA	218340	Drive Shaft		40	28	57.4	52	592	
	2007.03-2012.12	AT	L	F	Estate Engine AZBA	203288	Drive Shaft		40	31	57.4	51	582	
	2007.03-2012.12	AT	R	F	Estate Engine AZBA	203289	Drive Shaft		40	28	57.4	51	932	
2.2 TDCi (129 kW)	2008.03-2010.10	MT	L	F	Estate Engine Q4BA	218363	Drive Shaft		40	31	57.4	52	588.5	
	2008.03-2010.10	MT	R	F	Estate Engine Q4BA	218350	Drive Shaft		40	28	57.4	52	963	
	2008.03-2010.10	-	-	F	Estate Engine Q4BA	859344	Outer Joint		40	26	57.4	52	63.5	M
2.2 TDCi (147 kW)	2010.07-2015.01	MT	L	F	Estate Engine KNBA	218363	Drive Shaft		40	31	57.4	52	588.5	
	2010.07-2015.01	-	R	F	Estate Engine KNBA	218350	Drive Shaft		40	28	57.4	52	963	
	2010.07-2015.01	-	-	F	Estate Engine KNBA	859344	Outer Joint		40	26	57.4	52	63.5	M
2.3 (118 kW)	2007.07-2015.01	AT	R	F	Estate Engine SEBA	261106	Drive Shaft		40	31	57.4	51	945	
2.5 (162 kW)	2007.03-2012.12	MT	L/R	F	Estate Engine HUBA	862042	Outer Joint		40	27	57.4	52	63.5	M
	2007.03-2012.12	MT	L	F	Estate Engine HUBA	221070	Drive Shaft		40	26	57.4	52	556	
MONDEO IV, SW														
1.6 Ti (81 kW)	2007.03-	-	-	-	-	818072	Outer Joint		27	23	56.1	91.5	56.5	M
1.6 Ti (92 kW)	2007.03-	-	-	-	-	818072	Outer Joint		27	23	56.1	91.5	56.5	M
MUSTANG														
V8 281 4.6	2005-2010	-	-	R	-	699240	Propshaft CV Joint			30		33		
	2005-2010	-	-	R	Rear DriveshaftCV at Fixed End Rear axle	835056	Propshaft CV Joint			30		34.5		
MYSTIQUE														
-	1995-2001	-	-	-	-	818080	Outer Joint	44T	27	30	57	91	56	I
ORION II (AFF)														
1.3 (44 kW)	1985.12-1990.07	-	-	F	Saloon Engine JLA/JLB/JBB	618053	Inner Joint		23	22	40	61	91.5	
	1985.12-1990.07	MT	L/R	F	Saloon Engine JLA/JLB/JBB	618002	Inner Joint		23	20	40	61.5	62.5	
1.4 (52 kW)	1986.03-1990.07	-	-	F	Saloon Engine FUAA	699075	Inner Joint		23	22	40	61	93	O
	1986.03-1990.07	-	-	F	Saloon Engine FUAA	818019	Outer Joint		23	22	55	91.5	54.5	O
1.4 (54 kW)	1986.01-1990.07	-	-	F	Saloon Engine FUC	699075	Inner Joint		23	22	40	61	93	O
	1986.01-1990.07	MT	R	F	Saloon Engine FUC	218127	Drive Shaft		23	23	55	91.5	860	
	1986.01-1990.07	-	-	F	Saloon Engine FUC	818019	Outer Joint		23	22	55	91.5	54.5	O
1.4 (55 kW)	1985.12-1990.07	MT	-	F	Saloon Engine FUA	699075	Inner Joint		23	22	40	61	93	O
	1985.12-1990.07	-	-	F	Saloon Engine FUA	818019	Outer Joint		23	22	55	91.5	54.5	O
	1985.12-1990.07	MT	R	F	Saloon Engine FUA	218127	Drive Shaft		23	23	55	91.5	860	
1.4 Cat (54 kW)	1987.02-1990.07	MT	-	F	Saloon Engine F6B/F6D	699075	Inner Joint		23	22	40	61	93	O
	1987.02-1990.07	-	-	F	Saloon Engine F6B/F6D	818019	Outer Joint		23	22	55	91.5	54.5	O
1.6 (65 kW)	1986.03-1990.07	AT	-	F	Saloon Engine LUG	818019	Outer Joint		23	22	55	91.5	54.5	O
1.6 (66 kW)	1985.12-1990.07	AT	-	F	Saloon Engine LUC	818019	Outer Joint		23	22	55	91.5	54.5	O
	1985.12-1990.07	MT	R	F	Saloon Engine LUC	218127	Drive Shaft		23	23	55	91.5	860	
1.6 D (40 kW)	1985.12-1989.01	MT	R	F	Saloon Engine LTC	218127	Drive Shaft		23	23	55	91.5	860	
	1985.12-1989.01	-	-	F	Saloon Engine LTC	818019	Outer Joint		23	22	55	91.5	54.5	O
1.6 i (75 kW)	1989.08-1990.07	AT	-	F	Saloon Engine LJB	818019	Outer Joint		23	22	55	91.5	54.5	O
1.6 i (77 kW)	1986.03-1990.07	-	-	F	Saloon Engine LRB	818019	Outer Joint		23	22	55	91.5	54.5	O
1.6 i Cat (66 kW)	1986.03-1990.07	-	-	F	Saloon Engine L4B	818019	Outer Joint		23	22	55	91.5	54.5	O
1.8 D (44 kW)	1989.01-1990.07	MT	R	F	Saloon Engine RTA/RTB	218127	Drive Shaft		23	23	55	91.5	860	
	1989.01-1990.07	-	-	F	Saloon Engine RTA/RTB	818019	Outer Joint		23	22	55	91.5	54.5	O
ORION III (GAL)														
1.3 (44 kW)	1990.07-1993.12	MT	L/R	F	Saloon Engine J6A/J4B	818017	Outer Joint		23	20	48	80.5	49	O
	1990.07-1993.12	MT	L/R	F	Saloon Engine J6A/J4B	818015	Outer Joint		23	22	48	80	52.5	O
	1990.07-1993.12	-	-	F	Saloon Engine J6A/J4B	618053	Inner Joint		23	22	40	61	91.5	
1.4 (52 kW)	1990.07-1993.12	MT	L/R	F	Saloon Engine F6F/F6G	818015	Outer Joint		23	22	48	80	52.5	O
	1990.07-1993.12	-	-	F	Saloon Engine F6F/F6G	618053	Inner Joint		23	22	40	61	91.5	
1.4 (54 kW)	1990.07-1993.12	MT	L/R	F	Saloon Engine FUH	818015	Outer Joint		23	22	48	80	52.5	O
	1990.07-1993.12	-	-	F	Saloon Engine FUH	618053	Inner Joint		23	22	40	61	91.5	
1.6 (66 kW)	1990.07-1992.12	-	-	F	Saloon Engine LUJ/LUK	618053	Inner Joint		23	22	40	61	91.5	
1.6 i (77 kW)	1990.07-1992.09	-	-	F	Saloon Engine LJF	618053	Inner Joint		23	22	40	61	91.5	
1.6 i 16V (66 kW)	1992.07-1993.12	-	L	F	Saloon Engine L1E/L1K	218040	Drive Shaft		25	23	56.5	88.5	608	
	1992.07-1993.12	-	-	F	Saloon Engine L1E/L1K	618053	Inner Joint		23	22	40	61	91.5	
1.8 D (44 kW)	1990.11-1993.12	-	L	F	Saloon Engine RTE/RTF/RTH	218040	Drive Shaft		25	23	56.5	88.5	608	
	1990.11-1993.12	-	-	F	Saloon Engine RTE/RTF/RTH	618053	Inner Joint		23	22	40	61	91.5	
1.8 i 16V (77 kW)	1992.02-1993.12	MT	L/R	F	Saloon Engine RDA	818021	Outer Joint		25	25	56.5	89	56.5	O

YEAR	TRANSM	L/R	F/R	REMARKS	GSP Ref.	PRODUCT	ABS	Technical Specifications						
								A	B	C	H	L	P	
FORD														
ORION III (GAL)														
1.8 i 16V (96 kW)	1992.01-1993.12	MT	L/R	F	Saloon Engine RQB	818021	Outer Joint		25	25	56.5	89	56.5	O
1.8 TD (66 kW)	1992.03-1993.12	MT	L/R	F	Saloon Engine RFD/RFK	818021	Outer Joint		25	25	56.5	89	56.5	O
	1992.03-1993.12	-	L	F	Saloon Engine RFD/RFK	218040	Drive Shaft		25	23	56.5	88.5	608	
	1992.03-1993.12	-	-	F	Saloon Engine RFD/RFK	618053	Inner Joint		23	22	40	61	91.5	
	1992.03-1993.12	MT	L	F	Saloon Engine RFD/RFK	218019	Drive Shaft		25	26	56.5	89	591.5	
PAMPA														
1.6	1981.01-1989.07	MT	-	-	-	818020	Outer Joint		24	30	46	109	62.5	O
	1989.08-1997.12	MT	-	-	-	818103	Outer Joint		24	30	46	109	62	I
1.8	1989.08-1997.12	MT	-	-	-	818103	Outer Joint		24	30	46	109	62	I
	1989.09-1997	-	-	-	-	818043	Outer Joint		24	30	46	109	62.5	I
PROBE														
-	1993-1997	AT	-	-	4 Cyl	618015	Inner Joint		28	23	43	42	76.5	
	1993-1997	MT	-	-	4 Cyl / 6 Cyl	618015	Inner Joint		28	23	43	42	76.5	
2.0	1993-1996	AT	-	-	-	818045	Outer Joint		28	32	56	91.5	65	I
	1993-1997	MT	-	-	-	834036	Outer Joint		28	32	56	90	59	I
2.5	1993-1996	AT	-	-	-	818045	Outer Joint		28	32	56	91.5	65	I
	1993-1997	MT	-	-	-	834036	Outer Joint		28	32	56	90	59	I
PUMA (EC_)														
1.4 16V (66 kW)	1997.11-2000.10	-	-	F	Coupe Engine FHF/FHD	818022	Outer Joint		25	22	56.5	88.5	53.5	O
	1997.11-2000.10	-	L	F	Coupe Engine FHF/FHD	299047	Drive Shaft		25	23	56.5	88.5	601.5	
	1997.11-2000.10	MT	L/R	F	Coupe Engine FHF/FHD	818004	Outer Joint		25	22	56.5	88.5	53.5	O
1.6 16V (76 kW)	2000.08-2002.06	-	L/R	F	Coupe Engine L1W	818006	Outer Joint		25	22	55.5	88.5	53	O
	2000.08-2002.06	-	-	F	Coupe Engine L1W	818022	Outer Joint		25	22	56.5	88.5	53.5	O
	2000.08-2002.06	-	L	F	Coupe Engine L1W	299047	Drive Shaft		25	23	56.5	88.5	601.5	
1.7 16V (92 kW)	1997.03-2002.06	MT	L/R	F	Coupe Engine MHB/MHA	818006	Outer Joint		25	22	55.5	88.5	53	O
	1997.03-2002.06	-	-	F	Coupe Engine MHB/MHA	818022	Outer Joint		25	22	56.5	88.5	53.5	O
	1997.03-2002.06	-	L	F	Coupe Engine MHB/MHA	299047	Drive Shaft		25	23	56.5	88.5	601.5	
ST 160 (118 kW)	1999.06-2002.06	-	L/R	F	Coupe	818006	Outer Joint		25	22	55.5	88.5	53	O
RAIDER														
-	1987.01-1996.12	-	R	-	-	234019	Drive Shaft		26	26	65	143.5	606	
RANGER														
-	1998-2011	-	-	F	4WD/PROPELLER SHAFT	661100	Propshaft CV Joint			26		35		
	1998-1999	-	-	-	SUV/Truck/VAN 4WD	818037	Outer Joint		27	34	66.8	115	66	I
	2000-2001	-	-	F	-	818055	Outer Joint		27	34	59.7	112	80	I
	2000-2005	-	-	-	Truck	618037	Inner Joint		27	34	35.55	117.3	76	
	2000-2005	-	L	-	Truck 4WD	218093	Drive Shaft		27	27	59.7	112	597.4	
2.5 D 4WD	2002-2006	-	R	F	-	234133	Drive Shaft 44W		26	26	61	103.5	579	
	2002-2006	-	L	F	-	234132	Drive Shaft 44W		26	26	61	103.5	510	
3.0	2007-	MT	-	-	-	618076	Inner Joint		28	36	42	41.5	70.5	
	2007-	MT	-	-	-	618077	Inner Joint		30	36	38	94.5	101	
RANGER (ER EQ)														
2.5 D (57 kW)	1999.10-2002.04	MT	L	F	Pickup Engine WL	239001	Drive Shaft		26	26	65	143.5	527	
	1999.10-2002.04	MT	L	F	All-wheel Drive Pickup Engine WL	239001	Drive Shaft		26	26	65	143.5	527	
	1999.10-2002.04	MT	R	F	Pickup Engine WL	234012	Drive Shaft		26	26	65	143.5	606	
	1999.10-2002.04	MT	R	F	All-wheel Drive Pickup Engine WL	234012	Drive Shaft		26	26	65	143.5	606	
	1999.10-2002.04	-	L	F	Pickup Engine WL	227063	Drive Shaft 44W		26	26	61	103.5	509	
	1999.10-2002.04	-	L	F	All-wheel Drive Pickup Engine WL	227063	Drive Shaft 44W		26	26	61	103.5	509	
	1999.10-2002.04	-	R	F	Pickup Engine WL	227062	Drive Shaft 44W		26	26	61	103.5	579.5	
	1999.10-2002.04	-	R	F	All-wheel Drive Pickup Engine WL	227062	Drive Shaft 44W		26	26	61	103.5	579.5	
	1999.10-2002.04	MT	L	F	Pickup Engine WL	634011	Inner Joint		26	25	40	39	81	
	1999.10-2002.04	MT	L	F	All-wheel Drive Pickup Engine WL	634011	Inner Joint		26	25	40	39	81	
2.5 TD (62 kW)	2002.04-2006.06	MT	L	F	All-wheel Drive Pickup Engine WL-T	227063	Drive Shaft 44W		26	26	61	103.5	509	
	2002.04-2006.06	-	L	F	Pickup Engine WL-T	227063	Drive Shaft 44W		26	26	61	103.5	509	
	2002.04-2006.06	MT	R	F	All-wheel Drive Pickup Engine WL-T	227062	Drive Shaft 44W		26	26	61	103.5	579.5	
	2002.04-2006.06	-	R	F	Pickup Engine WL-T	227062	Drive Shaft 44W		26	26	61	103.5	579.5	
	2002.04-2006.06	-	-	F	Pickup Engine WL-T	827017	Outer Joint		26	25	61	103.5	75.5	M
	2002.04-2006.06	-	-	F	All-wheel Drive Pickup Engine WL-T	827017	Outer Joint		26	25	61	103.5	75.5	M
	2002.04-2006.06	-	-	F	Pickup Engine WL-T	834067	Outer Joint 44W		26	25	61	103.5	75.5	M
	2002.04-2006.06	-	-	F	All-wheel Drive Pickup Engine WL-T	834067	Outer Joint 44W		26	25	61	103.5	75.5	M
2.5 TD (80 kW)	1999.10-2006.06	MT	L	F	All-wheel Drive Pickup Engine WL-T	239001	Drive Shaft		26	26	65	143.5	527	
	1999.10-2006.06	MT	R	F	All-wheel Drive Pickup Engine WL-T	234012	Drive Shaft		26	26	65	143.5	606	
	1999.10-2006.06	-	L	F	All-wheel Drive Pickup Engine WL-T	227063	Drive Shaft 44W		26	26	61	103.5	509	
	1999.10-2006.06	-	R	F	All-wheel Drive Pickup Engine WL-T	227062	Drive Shaft 44W		26	26	61	103.5	579.5	
	1999.10-2006.06	MT	L	F	All-wheel Drive Pickup Engine WL-T	634011	Inner Joint		26	25	40	39	81	
	1999.10-2006.06	-	-	F	All-wheel Drive Pickup Engine WL-T	827017	Outer Joint		26	25	61	103.5	75.5	M
	1999.10-2006.06	-	-	F	All-wheel Drive Pickup Engine WL-T	834067	Outer Joint 44W		26	25	61	103.5	75.5	M

YEAR	TRANSM	L/R	F/R	REMARKS	GSP Ref.	PRODUCT	ABS	Technical Specifications							
								A	B	C	H	L	P		
FORD															
RANGER (ET)															
2.5 TDCi (105 kW)	2006.05-2012.07	-	L	F	All-wheel Drive Pickup Engine WLAA	218210	Drive Shaft	44W	28	28	61	104.5	492		
	2006.05-2012.07	-	R	F	All-wheel Drive Pickup Engine WLAA	218211	Drive Shaft	44W	28	30	61	104.5	577		
	2006.05-2012.07	-	-	F	All-wheel Drive Pickup Engine WLAA	818206	Outer Joint	44W	28	36	61	104.5	78.5	I	
3.0 TDCi (115 kW)	2006.05-2012.07	-	L	F	All-wheel Drive Pickup	218210	Drive Shaft	44W	28	28	61	104.5	492		
	2006.05-2012.07	-	R	F	All-wheel Drive Pickup	218211	Drive Shaft	44W	28	30	61	104.5	577		
	2006.05-2012.07	-	-	F	All-wheel Drive Pickup	818206	Outer Joint	44W	28	36	61	104.5	78.5	I	
RANGER (TKE)															
2.2 TDCi (110 kW)	2011.04-	-	AT/MT	L/R	F	All-wheel Drive Pickup Engine GBVAJQJ	834248	Outer Joint		28	26	61	104	70.5	I
	2011.04-	-	AT/MT	L	F	All-wheel Drive Pickup Engine GBVAJQJ	234228	Drive Shaft		28	29	61	104	608	
	2011.04-	-	MT	L	F	All-wheel Drive Pickup Engine GBVAJQJ	234221	Drive Shaft		28	29	61	104	608	
	2011.04-	-	MT	R	F	All-wheel Drive Pickup Engine GBVAJQJ	234220	Drive Shaft		28	29	61	104	566	
	2011.04-	-	AT/MT	R	F	All-wheel Drive Pickup Engine GBVAJQJ	234227	Drive Shaft		28	29	61	104	566	
	2011.04-	-	-	-	F	All-wheel Drive Pickup Engine GBVAJQJ	634117	Inner Joint		29	27	56		149	
	2011.11-	-	MT	L	F	Pickup Engine GBVAJQJ	234221	Drive Shaft		28	29	61	104	608	
	2011.11-	-	MT	R	F	Pickup Engine GBVAJQJ	234220	Drive Shaft		28	29	61	104	566	
2.2 TDCi (118 kW)	2015.05-	-	AT/MT	L/R	F	All-wheel Drive Pickup	834248	Outer Joint		28	26	61	104	70.5	I
	2015.05-	-	AT/MT	L	F	All-wheel Drive Pickup	234228	Drive Shaft		28	29	61	104	608	
	2015.05-	-	AT/MT	R	F	All-wheel Drive Pickup	234227	Drive Shaft		28	29	61	104	566	
2.2 TDCi (88 kW)	2011.04-	-	MT	L	F	Pickup Engine GBVAJPF	234221	Drive Shaft		28	29	61	104	608	
	2011.04-	-	MT	R	F	Pickup Engine GBVAJPF	234220	Drive Shaft		28	29	61	104	566	
	2011.04-	-	-	-	F	Pickup Engine GBVAJPF	634117	Inner Joint		29	27	56		149	
2.2 TDCi (92 kW)	2011.04-	-	AT/MT	L/R	F	All-wheel Drive Pickup Engine GBVAJQW	834248	Outer Joint		28	26	61	104	70.5	I
	2011.04-	-	AT/MT	L	F	All-wheel Drive Pickup Engine GBVAJQW	234228	Drive Shaft		28	29	61	104	608	
	2011.04-	-	MT	L	F	Pickup Engine GBVAJQW	234221	Drive Shaft		28	29	61	104	608	
	2011.04-	-	MT	L	F	All-wheel Drive Pickup Engine GBVAJQW	234221	Drive Shaft		28	29	61	104	608	
	2011.04-	-	MT	R	F	Pickup Engine GBVAJQW	234220	Drive Shaft		28	29	61	104	566	
	2011.04-	-	MT	R	F	All-wheel Drive Pickup Engine GBVAJQW	234220	Drive Shaft		28	29	61	104	566	
	2011.04-	-	AT/MT	R	F	All-wheel Drive Pickup Engine GBVAJQW	234227	Drive Shaft		28	29	61	104	566	
	2011.04-	-	-	-	F	Pickup Engine GBVAJQW	634117	Inner Joint		29	27	56		149	
	2011.04-	-	-	-	F	All-wheel Drive Pickup Engine GBVAJQW	634117	Inner Joint		29	27	56		149	
2.2 TDCi (96 kW)	2015.05-	-	AT/MT	L/R	F	All-wheel Drive Pickup	834248	Outer Joint		28	26	61	104	70.5	I
	2015.05-	-	AT/MT	L	F	All-wheel Drive Pickup	234228	Drive Shaft		28	29	61	104	608	
	2015.05-	-	AT/MT	R	F	All-wheel Drive Pickup	234227	Drive Shaft		28	29	61	104	566	
3.2 TDCi (147 kW)	2011.04-	-	AT/MT	L/R	F	All-wheel Drive Pickup Engine SAFA	834248	Outer Joint		28	26	61	104	70.5	I
	2011.04-	-	AT/MT	L	F	All-wheel Drive Pickup Engine SAFA	234228	Drive Shaft		28	29	61	104	608	
	2011.04-	-	MT	L	F	All-wheel Drive Pickup Engine SAFA	234221	Drive Shaft		28	29	61	104	608	
	2011.04-	-	MT	R	F	All-wheel Drive Pickup Engine SAFA	234220	Drive Shaft		28	29	61	104	566	
	2011.04-	-	AT/MT	R	F	All-wheel Drive Pickup Engine SAFA	234227	Drive Shaft		28	29	61	104	566	
	2011.04-	-	-	-	F	All-wheel Drive Pickup Engine SAFA	634117	Inner Joint		29	27	56		149	
RANGER (TU_)															
2.5 D (57 kW)	1999.10-2002.04	-	L	F	Pickup Engine WL	634018	Inner Joint		26	25	40	39	68		
2.5 D 4x4 (57 kW)	1999.10-2002.04	-	L	F	Pickup Engine WL	634018	Inner Joint		26	25	40	39	68		
2.5 TD (62 kW)	2002.04-2006.06	-	L	F	Pickup Engine eWLT	634018	Inner Joint		26	25	40	39	68		
2.5 TD 4x4 (62 kW)	2002.04-2006.06	-	L	F	Pickup Engine WLT	634018	Inner Joint		26	25	40	39	68		
2.5 TD 4x4 (80 kW)	1999.10-2006.06	-	L	F	Pickup Engine WLT	634018	Inner Joint		26	25	40	39	68		
ROYALE															
1.8	1991.02-1992.11	MT	-	-	-	861024	Outer Joint	43T	22	30	64	78	51	I	
	1992.01-1995.12	MT/AT	-	-	-	899134	Outer Joint	43T	22	30	51	78	61	I	
	1992.01-1995.12	MT/AT	-	-	-	618018	Inner Joint			33		32			
	1993.01-1995.12	MT/AT	-	-	-	861028	Outer Joint		22	30	51	78	61	I	
	1993.01-1995.12	MT/AT	-	-	-	618018	Inner Joint			33		32			
	1996.01-1996.12	MT/AT	-	-	-	899134	Outer Joint	43T	22	30	51	78	61	I	
	1996.01-1996.12	MT/AT	-	-	-	861028	Outer Joint		22	30	51	78	61	I	
2.0	1991.01-1992.11	MT	-	-	-	861024	Outer Joint	43T	22	30	64	78	51	I	
	1992.02-1995.12	MT/AT	-	-	-	899134	Outer Joint	43T	22	30	51	78	61	I	
	1992.02-1995.12	MT/AT	-	-	-	618018	Inner Joint			33		32			
	1992.11-1995.12	MT/AT	-	-	-	861028	Outer Joint		22	30	51	78	61	I	
	1992.11-1995.12	MT/AT	-	-	-	618018	Inner Joint			33		32			
	1992.12-1995.12	MT/AT	-	-	-	861028	Outer Joint		22	30	51	78	61	I	
	1992.12-1995.12	MT/AT	-	-	-	618018	Inner Joint			33		32			
	1996.01-1996.12	MT/AT	-	-	-	899134	Outer Joint	43T	22	30	51	78	61	I	
	1996.01-1996.12	MT/AT	-	-	-	861028	Outer Joint		22	30	51	78	61	I	
S-MAX (WA6)															
1.6 EcoBoost (118 kW)	2011.02-2014.12	AT/MT	-	F	MPV Engine JTWB/JTWA	899271	Outer Joint		40	28	57.4	51	63	M	
	2011.02-2014.12	AT	-	F	MPV Engine JTWB/JTWA	862045	Outer Joint		40	26	57.4	52	62.5	M	
	2011.02-2014.12	MT	L	F	MPV Engine JTWB/JTWA	618128	Inner Joint		26	28	40	68.5	111		

	 YEAR	TRANSM	L/R	F/R	REMARKS	GSP Ref.	 PRODUCT	 ABS	Technical Specifications					
									A	B	C	H	L	P
FORD														
S-MAX (WA6)														
1.6 EcoBoost (118 kW)	2011.02-2014.12	MT	R	F	MPV Engine JTWB/JTWA	618129	Inner Joint		26	28	40	389	96.5	
1.6 TDCi (85 kW)	2011.02-2014.12	AT/MT	-	F	MPV Engine T1WB/T1WA	899271	Outer Joint		40	28	57.4	51	63	M
	2011.02-2014.12	AT	-	F	MPV Engine T1WB/T1WA	862045	Outer Joint		40	26	57.4	52	62.5	M
	2011.02-2014.12	MT	L	F	MPV Engine T1WB/T1WA	618128	Inner Joint		26	28	40	68.5	111	
	2011.02-2014.12	MT	L	F	MPV Engine T1WB/T1WA	299211	Drive Shaft		40	26	57.4	51	603	
	2011.02-2014.12	MT	R	F	MPV Engine T1WB/T1WA	299212	Drive Shaft		40	26	57.4	51	945	
	2011.02-2014.12	MT	R	F	MPV Engine T1WB/T1WA	618129	Inner Joint		26	28	40	389	96.5	
1.8 TDCi (74 kW)	2007.01-2010.12	-	L	F	MPV Engine FFWA	618267	Inner Joint		31	26	36.2	68	93	
	2007.01-2010.12	AT/MT	-	F	MPV Engine FFWA	899271	Outer Joint		40	28	57.4	51	63	M
	2007.01-2010.12	AT	-	F	MPV Engine FFWA	862045	Outer Joint		40	26	57.4	52	62.5	M
	2007.01-2010.12	MT	L	F	MPV Engine FFWA	299211	Drive Shaft		40	26	57.4	51	603	
	2007.01-2010.12	MT	L	F	MPV Engine FFWA	618128	Inner Joint		26	28	40	68.5	111	
	2007.01-2010.12	-	R	F	MPV Engine FFWA	299212	Drive Shaft		40	26	57.4	51	945	
	2007.01-2010.12	MT	R	F	MPV Engine FFWA	618129	Inner Joint		26	28	40	389	96.5	
1.8 TDCi (92 kW)	2006.05-2014.12	AT/MT	-	F	MPV Engine QYWA	899271	Outer Joint		40	28	57.4	51	63	M
	2006.05-2014.12	AT	-	F	MPV Engine QYWA	862045	Outer Joint		40	26	57.4	52	62.5	M
	2006.05-2014.12	MT	L	F	MPV Engine QYWA	618128	Inner Joint		26	28	40	68.5	111	
	2006.05-2014.12	MT	L	F	MPV Engine QYWA	299211	Drive Shaft		40	26	57.4	51	603	
	2006.05-2014.12	MT	R	F	MPV Engine QYWA	299212	Drive Shaft		40	26	57.4	51	945	
	2006.05-2014.12	MT	R	F	MPV Engine QYWA	618129	Inner Joint		26	28	40	389	96.5	
	2006.05-2014.12	-	L	F	MPV Engine QYWA	618267	Inner Joint		31	26	36.2	68	93	
2.0 (107 kW)	2006.05-2014.12	AT/MT	-	F	MPV Engine AOWB/AOWA	899271	Outer Joint		40	28	57.4	51	63	M
	2006.05-2014.12	AT	-	F	MPV Engine AOWB/AOWA	862045	Outer Joint		40	26	57.4	52	62.5	M
	2006.05-2014.12	MT	L	F	MPV Engine AOWB/AOWA	618128	Inner Joint		26	28	40	68.5	111	
	2006.05-2014.12	MT	L	F	MPV Engine AOWB/AOWA	299211	Drive Shaft		40	26	57.4	51	603	
	2006.05-2014.12	MT	R	F	MPV Engine AOWB/AOWA	618129	Inner Joint		26	28	40	389	96.5	
	2006.05-2014.12	-	L	F	MPV Engine AOWB/AOWA	618267	Inner Joint		31	26	36.2	68	93	
2.0 EcoBoost (146 kW)	2010.07-2014.12	AT/MT	-	F	MPV Engine TNWB	899271	Outer Joint		40	28	57.4	51	63	M
	2010.07-2014.12	AT	-	F	MPV Engine TNWB	862045	Outer Joint		40	26	57.4	52	62.5	M
	2010.07-2014.12	MT	L	F	MPV Engine TNWB	618128	Inner Joint		26	28	40	68.5	111	
	2010.07-2014.12	MT	R	F	MPV Engine TNWB	618129	Inner Joint		26	28	40	389	96.5	
2.0 EcoBoost (149 kW)	2010.03-2014.12	Semi-AT	R	F	MPV Engine TNWA	218341	Drive Shaft		40	28	57.4	52	952	
	2010.03-2014.12	Semi-AT	-	F	MPV Engine TNWA	859344	Outer Joint		40	26	57.4	52	63.5	M
	2010.03-2014.12	AT/MT	-	F	MPV Engine TNWA	899271	Outer Joint		40	28	57.4	51	63	M
	2010.03-2014.12	AT	-	F	MPV Engine TNWA	862045	Outer Joint		40	26	57.4	52	62.5	M
	2010.03-2014.12	MT	L	F	MPV Engine TNWA	618128	Inner Joint		26	28	40	68.5	111	
	2010.03-2014.12	MT	R	F	MPV Engine TNWA	618129	Inner Joint		26	28	40	389	96.5	
2.0 EcoBoost (176 kW)	2010.07-2014.12	Semi-AT	R	F	MPV Engine TPWA	218341	Drive Shaft		40	28	57.4	52	952	
	2010.07-2014.12	AT/MT	-	F	MPV Engine TPWA	899271	Outer Joint		40	28	57.4	51	63	M
	2010.07-2014.12	Semi-AT	-	F	MPV Engine TPWA	859344	Outer Joint		40	26	57.4	52	63.5	M
	2010.07-2014.12	AT	-	F	MPV Engine TPWA	862045	Outer Joint		40	26	57.4	52	62.5	M
	2010.07-2014.12	MT	L	F	MPV Engine TPWA	618128	Inner Joint		26	28	40	68.5	111	
	2010.07-2014.12	MT	R	F	MPV Engine TPWA	618129	Inner Joint		26	28	40	389	96.5	
2.0 Flexifuel (107 kW)	2006.05-2014.12	-	L	F	MPV Engine TBWA/TBWB	618267	Inner Joint		31	26	36.2	68	93	
	2006.05-2014.12	AT/MT	-	F	MPV Engine TBWA/TBWB	899271	Outer Joint		40	28	57.4	51	63	M
	2006.05-2014.12	AT	-	F	MPV Engine TBWA/TBWB	862045	Outer Joint		40	26	57.4	52	62.5	M
	2006.05-2014.12	MT	L	F	MPV Engine TBWA/TBWB	299211	Drive Shaft		40	26	57.4	51	603	
	2006.05-2014.12	MT	L	F	MPV Engine TBWA/TBWB	618128	Inner Joint		26	28	40	68.5	111	
	2006.05-2014.12	MT	R	F	MPV Engine TBWA/TBWB	618129	Inner Joint		26	28	40	389	96.5	
2.0 TDCi (100 kW)	2006.05-2014.12	AT	-	F	MPV Engine UKWA/AZWC	859344	Outer Joint		40	26	57.4	52	63.5	M
	2006.05-2014.12	AT/MT	-	F	MPV Engine UKWA/AZWC	899271	Outer Joint		40	28	57.4	51	63	M
	2006.05-2014.12	AT	L	F	MPV Engine UKWA/AZWC	218340	Drive Shaft		40	28	57.4	52	592	
	2006.05-2014.12	AT	-	F	MPV Engine UKWA/AZWC	862045	Outer Joint		40	26	57.4	52	62.5	M
	2006.05-2014.12	MT	L	F	MPV Engine UKWA/AZWC	618128	Inner Joint		26	28	40	68.5	111	
	2006.05-2014.12	MT	L	F	MPV Engine UKWA/AZWC	299211	Drive Shaft		40	26	57.4	51	603	
	2006.05-2014.12	MT	R	F	MPV Engine UKWA/AZWC	299212	Drive Shaft		40	26	57.4	51	945	
	2006.05-2014.12	AT	L	F	MPV Engine UKWA/AZWC	203288	Drive Shaft		40	31	57.4	51	582	
	2006.05-2014.12	MT	R	F	MPV Engine UKWA/AZWC	618129	Inner Joint		26	28	40	389	96.5	
	2006.05-2014.12	AT	R	F	MPV Engine UKWA/AZWC	203289	Drive Shaft		40	28	57.4	51	932	
	2006.05-2014.12	-	L	F	MPV Engine UKWA/AZWC	618267	Inner Joint		31	26	36.2	68	93	
	2.0 TDCi (103 kW)	2006.05-2014.12	AT	-	F	MPV Engine QXWA/QXWB/QXWC/UFWA	859344	Outer Joint		40	26	57.4	52	63.5
2006.05-2014.12		AT/MT	-	F	MPV Engine QXWA/QXWB/QXWC/UFWA	899271	Outer Joint		40	28	57.4	51	63	M
2006.05-2014.12		AT	L	F	MPV Engine QXWA/QXWB/QXWC/UFWA	218340	Drive Shaft		40	28	57.4	52	592	
2006.05-2014.12		AT	-	F	MPV Engine QXWA/QXWB/QXWC/UFWA	862045	Outer Joint		40	26	57.4	52	62.5	M
2006.05-2014.12		MT	L	F	MPV Engine QXWA/QXWB/QXWC/UFWA	618128	Inner Joint		26	28	40	68.5	111	
2006.05-2014.12		MT	L	F	MPV Engine QXWA/QXWB/QXWC/UFWA	299211	Drive Shaft		40	26	57.4	51	603	

YEAR	TRANSM	L/R	F/R	REMARKS	GSP Ref.	PRODUCT	ABS	Technical Specifications										
								A	B	C	H	L	P					
FORD																		
S-MAX (WA6)																		
2.0 TDCi (103 kW)	2006.05-2014.12	MT	R	F	MPV Engine QXWA/QXWB/QXWC/UFWA	299212	Drive Shaft	40	26	57.4	51	945						
	2006.05-2014.12	AT	L	F	MPV Engine QXWA/QXWB/QXWC/UFWA	203288	Drive Shaft	40	31	57.4	51	582						
	2006.05-2014.12	MT	R	F	MPV Engine QXWA/QXWB/QXWC/UFWA	618129	Inner Joint	26	28	40	389	96.5						
	2006.05-2014.12	AT	R	F	MPV Engine QXWA/QXWB/QXWC/UFWA	203289	Drive Shaft	40	28	57.4	51	932						
	2006.05-2014.12	-	L	F	MPV Engine QXWA/QXWB/QXWC/UFWA	618267	Inner Joint	31	26	36.2	68	93						
2.0 TDCi (120 kW)	2010.03-2014.12	AT	-	F	MPV Engine TXWA	859344	Outer Joint	40	26	57.4	52	63.5	M					
	2010.03-2014.12	AT/MT	-	F	MPV Engine TXWA	899271	Outer Joint	40	28	57.4	51	63	M					
	2010.03-2014.12	AT	L	F	MPV Engine TXWA	218340	Drive Shaft	40	28	57.4	52	592						
	2010.03-2014.12	AT	-	F	MPV Engine TXWA	862045	Outer Joint	40	26	57.4	52	62.5	M					
	2010.03-2014.12	MT	L	F	MPV Engine TXWA	299211	Drive Shaft	40	26	57.4	51	603						
	2010.03-2014.12	MT	L	F	MPV Engine TXWA	618128	Inner Joint	26	28	40	68.5	111						
	2010.03-2014.12	MT	R	F	MPV Engine TXWA	299212	Drive Shaft	40	26	57.4	51	945						
	2010.03-2014.12	AT	L	F	MPV Engine TXWA	203288	Drive Shaft	40	31	57.4	51	582						
	2010.03-2014.12	MT	R	F	MPV Engine TXWA	618129	Inner Joint	26	28	40	389	96.5						
	2010.03-2014.12	AT	R	F	MPV Engine TXWA	203289	Drive Shaft	40	28	57.4	51	932						
2.0 TDCi (85 kW)	2007.11-2014.12	AT	-	F	MPV Engine KLWA/TYWA	859344	Outer Joint	40	26	57.4	52	63.5	M					
	2007.11-2014.12	AT/MT	-	F	MPV Engine KLWA/TYWA	899271	Outer Joint	40	28	57.4	51	63	M					
	2007.11-2014.12	MT	L	F	MPV Engine KLWA/TYWA	299211	Drive Shaft	40	26	57.4	51	603						
	2007.11-2014.12	MT	L	F	MPV Engine KLWA/TYWA	618128	Inner Joint	26	28	40	68.5	111						
	2007.11-2014.12	MT	R	F	MPV Engine KLWA/TYWA	299212	Drive Shaft	40	26	57.4	51	945						
	2007.11-2014.12	MT	R	F	MPV Engine KLWA/TYWA	618129	Inner Joint	26	28	40	389	96.5						
2.0 TDCi (96 kW)	2006.05-2014.12	AT	-	F	MPV Engine AZWA	859344	Outer Joint	40	26	57.4	52	63.5	M					
	2006.05-2014.12	AT/MT	-	F	MPV Engine AZWA	899271	Outer Joint	40	28	57.4	51	63	M					
	2006.05-2014.12	AT	-	F	MPV Engine AZWA	862045	Outer Joint	40	26	57.4	52	62.5	M					
	2006.05-2014.12	MT	L	F	MPV Engine AZWA	618128	Inner Joint	26	28	40	68.5	111						
	2006.05-2014.12	MT	R	F	MPV Engine AZWA	618129	Inner Joint	26	28	40	389	96.5						
	2006.05-2014.12	-	L	F	MPV Engine AZWA	618267	Inner Joint	31	26	36.2	68	93						
2.2 TDCi (129 kW)	2008.03-2012.12	MT	L	F	MPV Engine Q4WA	218363	Drive Shaft	40	31	57.4	52	588.5						
	2008.03-2012.12	MT	R	F	MPV Engine Q4WA	218350	Drive Shaft	40	28	57.4	52	963						
	2008.03-2012.12	AT/MT	-	F	MPV Engine Q4WA	899271	Outer Joint	40	28	57.4	51	63	M					
	2008.03-2012.12	AT	-	F	MPV Engine Q4WA	862045	Outer Joint	40	26	57.4	52	62.5	M					
	2008.03-2012.12	MT	L	F	MPV Engine Q4WA	618128	Inner Joint	26	28	40	68.5	111						
	2008.03-2012.12	MT	R	F	MPV Engine Q4WA	618129	Inner Joint	26	28	40	389	96.5						
2.2 TDCi (147 kW)	2010.07-2014.12	MT	L	F	MPV Engine KNWA	218363	Drive Shaft	40	31	57.4	52	588.5						
	2010.07-2014.12	MT	R	F	MPV Engine KNWA	218350	Drive Shaft	40	28	57.4	52	963						
	2010.07-2014.12	AT	-	F	MPV Engine KNWA	859344	Outer Joint	40	26	57.4	52	63.5	M					
	2010.07-2014.12	AT/MT	-	F	MPV Engine KNWA	899271	Outer Joint	40	28	57.4	51	63	M					
	2010.07-2014.12	AT	-	F	MPV Engine KNWA	862045	Outer Joint	40	26	57.4	52	62.5	M					
	2010.07-2014.12	MT	L	F	MPV Engine KNWA	618128	Inner Joint	26	28	40	68.5	111						
	2010.07-2014.12	MT	R	F	MPV Engine KNWA	618129	Inner Joint	26	28	40	389	96.5						
2.3 (118 kW)	2007.07-2014.12	-	L	F	MPV Engine SEWA	618267	Inner Joint	31	26	36.2	68	93						
	2007.07-2014.12	AT	R	F	MPV Engine SEWA	261106	Drive Shaft	40	31	57.4	51	945						
	2007.07-2014.12	AT/MT	-	F	MPV Engine SEWA	899271	Outer Joint	40	28	57.4	51	63	M					
	2007.07-2014.12	AT	-	F	MPV Engine SEWA	862045	Outer Joint	40	26	57.4	52	62.5	M					
	2007.07-2014.12	MT	L	F	MPV Engine SEWA	618128	Inner Joint	26	28	40	68.5	111						
	2007.07-2014.12	MT	R	F	MPV Engine SEWA	618129	Inner Joint	26	28	40	389	96.5						
2.5 ST (162 kW)	2006.05-2014.12	AT/MT	-	F	MPV Engine HUWA	899271	Outer Joint	40	28	57.4	51	63	M					
	2006.05-2014.12	AT	-	F	MPV Engine HUWA	862045	Outer Joint	40	26	57.4	52	62.5	M					
	2006.05-2014.12	MT	L	F	MPV Engine HUWA	618128	Inner Joint	26	28	40	68.5	111						
	2006.05-2014.12	AT/MT	L/R	F	MPV Engine HUWA	862042	Outer Joint	40	27	57.4	52	63.5	M					
	2006.05-2014.12	MT	R	F	MPV Engine HUWA	618129	Inner Joint	26	28	40	389	96.5						
	2006.05-2014.12	-	L	F	MPV Engine HUWA	618267	Inner Joint	31	26	36.2	68	93						
	2006.05-2014.12	MT	L	F	MPV Engine HUWA	221070	Drive Shaft	40	26	57.4	52	556						
SCALA																		
1.6	1981.01-1989.07	MT	-	-	-	818020	Outer Joint	24	30	46	109	62.5	O					
1.8	1989-1997	-	-	-	-	818043	Outer Joint	24	30	46	109	62.5	I					
	1989.08-1991.04	MT	-	-	-	818103	Outer Joint	24	30	46	109	62	I					
SCORPIO I (GAE GGE)/GRANADA																		
1.8 (66 kW)	1985.04-1992.02	-	R	R	Hatchback Engine REC	218128	Drive Shaft					32	519					
	1985.04-1992.02	MT	L/R	R	Hatchback Engine REC	618001	Inner Joint		25			32						
	1985.04-1992.02	-	-	R	Hatchback Engine REC	602006	Inner Joint		25			32						
	1985.04-1992.02	-	L	R	Hatchback Engine REC	218129	Drive Shaft					32	478					
2.0 (77 kW)	1985.04-1989.08	AT/MT	L/R	R	Hatchback Engine N8D/NEL	618001	Inner Joint		25			32	478					
	1985.04-1989.08	-	L	R	Hatchback Engine N8D/NEL	218129	Drive Shaft					32	478					
	1985.04-1989.08	-	R	R	Hatchback Engine N8D/NEL	218128	Drive Shaft					32	519					
	1985.04-1989.08	-	-	R	Hatchback Engine N8D/NEL	602006	Inner Joint		25			32						

YEAR	TRANSM	L/R	F/R	REMARKS	GSP Ref.	PRODUCT	ABS	Technical Specifications						
								A	B	C	H	L	P	
FORD														
SCORPIO I (GAE GGE)/GRANADA														
2.0 (80 kW)	1988.11-1992.10	-	R	R	Hatchback Engine N8A	218128	Drive Shaft					32	519	
	1988.11-1992.10	-	-	R	Hatchback Engine N8A	602006	Inner Joint		25			32		
	1988.11-1992.10	-	L	R	Hatchback Engine N8A	218129	Drive Shaft					32	478	
2.0 i (74 kW)	1985.10-1990.12	-	R	R	Hatchback Engine NRC	218128	Drive Shaft					32	519	
	1985.10-1990.12	AT/MT	L/R	R	Hatchback Engine NRC	618001	Inner Joint		25			32		
	1985.10-1990.12	-	-	R	Hatchback Engine NRC	602006	Inner Joint		25			32		
	1985.10-1990.12	-	L	R	Hatchback Engine NRC	218129	Drive Shaft					32	478	
2.0 i (85 kW)	1985.04-1992.02	AT/MT	L/R	R	Hatchback Engine NRA/NRI	618001	Inner Joint		25			32		
	1985.04-1992.02	-	R	R	Hatchback Engine NRA/NRI	218128	Drive Shaft					32	519	
	1985.04-1992.02	-	-	R	Hatchback Engine NRA/NRI	602006	Inner Joint		25			32		
	1985.04-1992.02	-	L	R	Hatchback Engine NRA/NRI	218129	Drive Shaft					32	478	
	1992.02-1994.09	-	R	R	Hatchback Engine NRA/NRI	218128	Drive Shaft					32	519	
	1992.02-1994.09	AT/MT	L/R	R	Hatchback Engine NRA/NRI	618001	Inner Joint		25			32		
	1992.02-1994.09	-	-	R	Hatchback Engine NRA/NRI	602006	Inner Joint		25			32		
	1992.02-1994.09	-	L	R	Hatchback Engine NRA/NRI	218129	Drive Shaft					32	478	
2.0 i (88 kW)	1989.05-1994.09	AT/MT	L/R	R	Hatchback Engine N9D	618001	Inner Joint		25			32		
	1989.05-1994.09	-	R	R	Hatchback Engine N9D	218128	Drive Shaft					32	519	
	1989.05-1994.09	-	-	F/R	Hatchback Engine N9D	602006	Inner Joint		25			32		
	1989.05-1994.09	-	L	R	Hatchback Engine N9D	218129	Drive Shaft					32	478	
2.4 i (92 kW)	1988.10-1992.02	-	R	R	Hatchback Engine ARD	218128	Drive Shaft					32	519	
	1988.10-1992.02	AT/MT	L/R	R	Hatchback Engine ARD	618001	Inner Joint		25			32		
	1988.10-1992.02	-	-	R	Hatchback Engine ARD	602006	Inner Joint		25			32		
	1988.10-1992.02	-	L	R	Hatchback Engine ARD	218129	Drive Shaft					32	478	
2.4 i Cat (92 kW)	1988.10-1994.09	AT/MT	L/R	R	Hatchback Engine ARD	618001	Inner Joint		25			32		
	1988.10-1994.09	-	R	R	Hatchback Engine ARD	218128	Drive Shaft					32	519	
	1988.10-1994.09	-	-	R	Hatchback Engine ARD	602006	Inner Joint		25			32		
	1988.10-1994.09	-	L	R	Hatchback Engine ARD	218129	Drive Shaft					32	478	
2.5 D (51 kW)	1985.12-1992.02	-	R	R	Hatchback Engine STR	218128	Drive Shaft					32	519	
	1985.12-1992.02	MT	L/R	R	Hatchback Engine STR	618001	Inner Joint		25			32		
	1985.12-1992.02	-	-	R	Hatchback Engine STR	602006	Inner Joint		25			32		
	1985.12-1992.02	-	L	R	Hatchback Engine STR	218129	Drive Shaft					32	478	
2.5 TD (68 kW)	1988.06-1993.07	-	R	R	Hatchback Engine SFA/SFB	218128	Drive Shaft					32	519	
	1988.06-1993.07	MT	L/R	R	Hatchback Engine SFA/SFB	618001	Inner Joint		25			32		
	1988.06-1993.07	-	-	R	Hatchback Engine SFA/SFB	602006	Inner Joint		25			32		
	1988.06-1993.07	-	L	R	Hatchback Engine SFA/SFB	218129	Drive Shaft					32	478	
2.5 TD (85 kW)	1993.08-1994.09	MT	L/R	R	Hatchback Engine SCB	618001	Inner Joint		25			32		
	1993.08-1994.09	-	R	R	Hatchback Engine SCB	218128	Drive Shaft					32	519	
	1993.08-1994.09	-	-	R	Hatchback Engine SCB	602006	Inner Joint		25			32		
	1993.08-1994.09	-	L	R	Hatchback Engine SCB	218129	Drive Shaft					32	478	
2.9 i (107 kW)	1986.09-1994.09	-	R	R	Hatchback Engine BRF/BRE/BRD	218128	Drive Shaft					32	519	
	1986.09-1994.09	AT/MT	L/R	R	Hatchback Engine BRF/BRE/BRD	618001	Inner Joint		25			32		
	1986.09-1994.09	-	-	R	Hatchback Engine BRF/BRE/BRD	602006	Inner Joint		25			32		
	1986.09-1994.09	-	L	R	Hatchback Engine BRF/BRE/BRD	218129	Drive Shaft					32	478	
	1988.05-1993.02	AT/MT	L/R	R	All-wheel Drive Hatchback Engine BRF/BRE/BRD	618001	Inner Joint		25			32		
	1988.05-1993.02	-	R	R	All-wheel Drive Hatchback Engine BRF/BRE/BRD	218128	Drive Shaft					32	519	
	1988.05-1993.02	-	-	F/R	All-wheel Drive Hatchback Engine BRF/BRE/BRD	602006	Inner Joint		25			32		
	1988.05-1993.02	-	-	F	All-wheel Drive Hatchback Engine BRF/BRE/BRD	818077	Outer Joint	94T	23	22	55	91	64	O
	1988.05-1993.02	-	L	R	All-wheel Drive Hatchback Engine BRF/BRE/BRD	218129	Drive Shaft					32	478	
2.9 i (110 kW)	1986.09-1994.09	AT/MT	L/R	R	All-wheel Drive Hatchback Engine BRC	618001	Inner Joint		25			32		
	1986.09-1994.09	-	R	R	All-wheel Drive Hatchback Engine BRC	218128	Drive Shaft					32	519	
	1986.09-1994.09	-	R	R	Hatchback Engine BRC	218128	Drive Shaft					32	519	
	1986.09-1994.09	AT/MT	L/R	R	Hatchback Engine BRC	618001	Inner Joint		25			32		
	1986.09-1994.09	-	-	R	All-wheel Drive Hatchback Engine BRC	602006	Inner Joint		25			32		
	1986.09-1994.09	-	-	R	Hatchback Engine BRC	602006	Inner Joint		25			32		
	1986.09-1994.09	-	-	F	All-wheel Drive Hatchback Engine BRC	818077	Outer Joint	94T	23	22	55	91	64	O
	1986.09-1994.09	-	L	R	All-wheel Drive Hatchback Engine BRC	218129	Drive Shaft					32	478	
	1986.09-1994.09	-	L	R	Hatchback Engine BRC	218129	Drive Shaft					32	478	
2.9 i 24V (143 kW)	1991.04-1994.09	-	R	R	Hatchback Engine BOA	218128	Drive Shaft					32	519	
	1991.04-1994.09	AT/MT	L/R	R	Hatchback Engine BOA	618001	Inner Joint		25			32		
	1991.04-1994.09	-	-	R	Hatchback Engine BOA	602006	Inner Joint		25			32		
	1991.04-1994.09	-	L	R	Hatchback Engine BOA	218129	Drive Shaft					32	478	
2.9 i Cat (107 kW)	1987.10-1994.09	-	R	R	Hatchback Engine BRE	218128	Drive Shaft					32	519	
	1987.10-1994.09	AT/MT	L/R	R	Hatchback Engine BRE	618001	Inner Joint		25			32		
	1987.10-1994.09	-	-	R	Hatchback Engine BRE	602006	Inner Joint		25			32		
	1987.10-1994.09	-	L	R	Hatchback Engine BRE	218129	Drive Shaft					32	478	
SCORPIO I (GGE)/GRANADA														

YEAR	TRANSM	L/R	F/R	REMARKS	GSP Ref.	PRODUCT	ABS	Technical Specifications						
								A	B	C	H	L	P	
FORD														
SCORPIO I (GGE)/GRANADA														
1.9 (85 kW)	1992.11-1993.09	-	L	R	Saloon Engine NRA	218129	Drive Shaft					32	478	
	1992.11-1993.09	-	R	R	Saloon Engine NRA	218128	Drive Shaft					32	519	
	1992.11-1993.09	-	-	R	Saloon Engine NRA	602006	Inner Joint			25		32		
	1992.11-1993.09	-	-	F	Saloon Engine NRA	818077	Outer Joint	94T	23	22	55	91	64	O
2.0 i (85 kW)	1992.02-1994.09	AT/MT	L/R	R	Saloon Engine N9F	618001	Inner Joint			25		32		
2.0 i (88 kW)	1989.05-1994.09	AT/MT	L/R	R	Saloon Engine N9D	618001	Inner Joint			25		32		
	1989.05-1994.09	-	R	R	Saloon Engine N9D	218128	Drive Shaft					32	519	
	1989.05-1994.09	-	-	R	Saloon Engine N9D	602006	Inner Joint			25		32		
	1989.05-1994.09	-	-	F	Saloon Engine N9D	818077	Outer Joint	94T	23	22	55	91	64	O
	1989.05-1994.09	-	L	R	Saloon Engine N9D	218129	Drive Shaft					32	478	
2.0 i (92 kW)	1989.05-1992.02	MT	L/R	R	Saloon Engine N9B	618001	Inner Joint			25		32		
	1989.05-1992.02	-	R	R	Saloon Engine N9B	218128	Drive Shaft					32	519	
	1989.05-1992.02	-	-	R	Saloon Engine N9B	602006	Inner Joint			25		32		
	1989.05-1992.02	-	-	F	Saloon Engine N9B	818077	Outer Joint	94T	23	22	55	91	64	O
	1989.05-1992.02	-	L	R	Saloon Engine N9B	218129	Drive Shaft					32	478	
2.4 i (92 kW)	1988.10-1994.10	MT	L/R	R	Saloon Engine ARD	618001	Inner Joint			25		32		
	1988.10-1994.10	-	R	R	Saloon Engine ARD	218128	Drive Shaft					32	519	
	1988.10-1994.10	-	-	R	Saloon Engine ARD	602006	Inner Joint			25		32		
	1988.10-1994.10	-	-	F	Saloon Engine ARD	818077	Outer Joint	94T	23	22	55	91	64	O
	1988.10-1994.10	-	L	R	Saloon Engine ARD	218129	Drive Shaft					32	478	
2.5 D (51 kW)	1989.12-1994.12	-	R	R	Saloon Engine STR	218128	Drive Shaft					32	519	
	1989.12-1994.12	-	-	R	Saloon Engine STR	602006	Inner Joint			25		32		
	1989.12-1994.12	-	L	R	Saloon Engine STR	218129	Drive Shaft					32	478	
2.5 TD (68 kW)	1988.06-1993.07	-	R	R	Saloon Engine SFA/SFB	218128	Drive Shaft					32	519	
	1988.06-1993.07	MT	L/R	R	Saloon Engine SFA/SFB	618001	Inner Joint			25		32		
	1988.06-1993.07	-	-	R	Saloon Engine SFA/SFB	602006	Inner Joint			25		32		
	1988.06-1993.07	-	-	F	Saloon Engine SFA/SFB	818077	Outer Joint	94T	23	22	55	91	64	O
	1988.06-1993.07	-	L	R	Saloon Engine SFA/SFB	218129	Drive Shaft					32	478	
2.5 TD (85 kW)	1993.08-1994.09	MT	L/R	R	Saloon Engine SCB	618001	Inner Joint			25		32		
	1993.08-1994.09	-	R	R	Saloon Engine SCB	218128	Drive Shaft					32	519	
	1993.08-1994.09	-	-	R	Saloon Engine SCB	602006	Inner Joint			25		32		
	1993.08-1994.09	-	-	F	Saloon Engine SCB	818077	Outer Joint	94T	23	22	55	91	64	O
	1993.08-1994.09	-	L	R	Saloon Engine SCB	218129	Drive Shaft					32	478	
2.9 i (107 kW)	1986.09-1994.12	AT/MT	L/R	R	Saloon Engine BRF/BRE/BRD	618001	Inner Joint			25		32		
	1986.09-1994.12	-	R	R	Saloon Engine BRF/BRE/BRD	218128	Drive Shaft					32	519	
	1986.09-1994.12	-	-	R	Saloon Engine BRF/BRE/BRD	602006	Inner Joint			25		32		
	1986.09-1994.12	-	L	R	Saloon Engine BRF/BRE/BRD	218129	Drive Shaft					32	478	
	1989.12-1994.10	-	R	R	All-wheel Drive Saloon Engine BRF/BRE/BRD	218128	Drive Shaft					32	519	
	1989.12-1994.10	AT/MT	L/R	R	All-wheel Drive Saloon Engine BRF/BRE/BRD	618001	Inner Joint			25		32		
	1989.12-1994.10	-	-	R	All-wheel Drive Saloon Engine BRF/BRE/BRD	602006	Inner Joint			25		32		
	1989.12-1994.10	-	-	F	All-wheel Drive Saloon Engine BRF/BRE/BRD	818077	Outer Joint	94T	23	22	55	91	64	O
2.9 i 24V (143 kW)	1991.04-1994.09	-	R	R	Saloon Engine BOA	218128	Drive Shaft					32	519	
	1991.04-1994.09	AT/MT	L/R	R	Saloon Engine BOA	618001	Inner Joint			25		32		
	1991.04-1994.09	-	-	R	Saloon Engine BOA	602006	Inner Joint			25		32		
	1991.04-1994.09	-	L	R	Saloon Engine BOA	218129	Drive Shaft					32	478	
SCORPIO I Turnier (GGE)/GRANADA														
2.0 i (85 kW)	1991.09-1994.09	AT/MT	L/R	R	Estate Engine N9F	618001	Inner Joint			25		32		
	1991.09-1994.09	-	R	R	Estate Engine N9F	218128	Drive Shaft					32	519	
	1991.09-1994.09	-	-	R	Estate Engine N9F	602006	Inner Joint			25		32		
	1991.09-1994.09	-	L	R	Estate Engine N9F	218129	Drive Shaft					32	478	
2.0 i (88 kW)	1991.09-1994.09	-	R	R	Estate Engine N9D	218128	Drive Shaft					32	519	
	1991.09-1994.09	AT/MT	L/R	R	Estate Engine N9D	618001	Inner Joint			25		32		
	1991.09-1994.09	-	-	R	Estate Engine N9D	602006	Inner Joint			25		32		
	1991.09-1994.09	-	L	R	Estate Engine N9D	218129	Drive Shaft					32	478	
2.0 i (90 kW)	1990.10-1992.10	-	L	R	Estate Engine N9A	218129	Drive Shaft					32	478	
	1990.10-1992.10	-	R	R	Estate Engine N9A	218128	Drive Shaft					32	519	
	1990.10-1992.10	-	-	R	Estate Engine N9A	602006	Inner Joint			25		32		
2.4 i (92 kW)	1991.09-1994.09	-	R	R	Estate Engine ARD	218128	Drive Shaft					32	519	
	1991.09-1994.09	MT	L/R	R	Estate Engine ARD	618001	Inner Joint			25		32		
	1991.09-1994.09	-	-	R	Estate Engine ARD	602006	Inner Joint			25		32		
	1991.09-1994.09	-	L	R	Estate Engine ARD	218129	Drive Shaft					32	478	
2.5 D (51 kW)	1990.10-1992.08	-	R	R	Estate Engine STR	218128	Drive Shaft					32	519	
	1990.10-1992.08	-	-	R	Estate Engine STR	602006	Inner Joint			25		32		
	1990.10-1992.08	-	L	R	Estate Engine STR	218129	Drive Shaft					32	478	
2.5 TD (68 kW)	1991.09-1993.07	MT	L/R	R	Estate Engine SFA/SFB	618001	Inner Joint			25		32		

YEAR	TRANSM	L/R	F/R	REMARKS	GSP Ref.	PRODUCT	ABS	Technical Specifications						
								A	B	C	H	L	P	
FORD														
SCORPIO I Turnier (GGE)/GRANADA														
2.5 TD (85 kW)	1993.08-1994.09	MT	L/R	R	Estate Engine SCB	618001	Inner Joint			25		32		
	1993.08-1994.09	-	R	R	Estate Engine SCB	218128	Drive Shaft					32	519	
	1993.08-1994.09	-	-	R	Estate Engine SCB	602006	Inner Joint			25		32		
	1993.08-1994.09	-	L	R	Estate Engine SCB	218129	Drive Shaft					32	478	
2.9 24V (143 kW)	1993.08-1994.09	-	R	R	Estate Engine BOA	218128	Drive Shaft					32	519	
	1993.08-1994.09	AT/MT	L/R	R	Estate Engine BOA	618001	Inner Joint			25		32		
	1993.08-1994.09	-	-	R	Estate Engine BOA	602006	Inner Joint			25		32		
	1993.08-1994.09	-	L	R	Estate Engine BOA	218129	Drive Shaft					32	478	
2.9 i (107 kW)	1988.05-1993.02	AT/MT	L/R	R	All-wheel Drive Estate Engine BRF/BRE/BRD	618001	Inner Joint			25		32		
	1988.05-1993.02	-	R	R	All-wheel Drive Estate Engine BRF/BRE/BRD	218128	Drive Shaft					32	519	
	1988.05-1993.02	-	-	R	All-wheel Drive Estate Engine BRF/BRE/BRD	602006	Inner Joint			25		32		
	1988.05-1993.02	-	-	F	All-wheel Drive Estate Engine BRF/BRE/BRD	818077	Outer Joint	94T	23	22	55	91	64	O
	1988.05-1993.02	-	L	R	All-wheel Drive Estate Engine BRF/BRE/BRD	218129	Drive Shaft					32	478	
	1991.09-1994.09	-	R	R	Estate Engine BRF/BRE/BRD	218128	Drive Shaft					32	519	
	1991.09-1994.09	AT/MT	L/R	R	Estate Engine BRF/BRE/BRD	618001	Inner Joint			25		32		
	1991.09-1994.09	-	-	R	Estate Engine BRF/BRE/BRD	602006	Inner Joint			25		32		
	1991.09-1994.09	-	L	R	Estate Engine BRF/BRE/BRD	218129	Drive Shaft					32	478	
SCORPIO II (GFR GGR)														
2.0 i (85 kW)	1994.10-1998.08	AT/MT	L/R	R	Saloon Engine NSD	618001	Inner Joint			25		32		
	1994.10-1998.08	-	-	R	Saloon Engine NSD	602006	Inner Joint			25		32		
2.0 i 16V (100 kW)	1994.10-1998.08	-	-	R	Saloon Engine N3A	602006	Inner Joint			25		32		
2.3 i 16V (108 kW)	1996.06-1998.08	-	-	R	Saloon Engine Y5A	602006	Inner Joint			25		32		
2.5 TD (85 kW)	1994.10-1998.08	-	-	R	Saloon Engine SCC	602006	Inner Joint			25		32		
2.5 TD (92 kW)	1996.09-1998.08	-	-	R	Saloon Engine VM	602006	Inner Joint			25		32		
SCORPIO II Turnier (GNR GGR)														
2.0 i (85 kW)	1994.10-1998.08	AT/MT	L/R	R	Estate Engine NSD	618001	Inner Joint			25		32		
	1994.10-1998.08	-	-	R	Estate Engine NSD	602006	Inner Joint			25		32		
2.0 i 16V (100 kW)	1994.10-1998.08	-	-	R	Estate Engine N3A	602006	Inner Joint			25		32		
2.3 i 16V (108 kW)	1996.06-1998.08	-	-	R	Estate Engine Y5A	602006	Inner Joint			25		32		
2.5 TD (85 kW)	1994.10-1998.08	-	-	R	Estate Engine SCC	602006	Inner Joint			25		32		
2.5 TD (92 kW)	1996.09-1998.08	-	-	R	Estate Engine VM	602006	Inner Joint			25		32		
SIERRA														
2.0 Turbo	1986.07-1993.04	MT	L/R	F	4WD	218139	Drive Shaft	94T	23	23	55	91	576	
SIERRA (GBC GBG)														
1.6 (53 kW)	1988.01-1993.02	-	-	-	Hatchback Engine LSF	602006	Inner Joint			25		32		
1.6 (55 kW)	1987.01-1993.02	-	-	-	Hatchback Engine LSE	602006	Inner Joint			25		32		
1.6 i (59 kW)	1989.10-1993.02	-	-	-	Hatchback Engine L6B	602006	Inner Joint			25		32		
1.8 (64 kW)	1988.05-1993.02	-	-	-	Hatchback Engine R6A/R2C	602006	Inner Joint			25		32		
2.0 (88 kW)	1991.10-1993.03	MT	-	F	All-wheel Drive Hatchback Engine N9C	218033	Drive Shaft	94T	23	23	55	91	583	
	1991.10-1993.03	-	-	F	All-wheel Drive Hatchback Engine N9C	818077	Outer Joint	94T	23	22	55	91	64	O
2.0 16V Cosworth (162 kW)	1990.01-1993.02	-	L/R	F	All-wheel Drive Hatchback Engine N5D	218033	Drive Shaft	94T	23	23	55	91	583	
	1990.01-1993.02	-	-	F	All-wheel Drive Hatchback Engine N5D	818077	Outer Joint	94T	23	22	55	91	64	O
2.0 16V Cosworth Cat (162 kW)	1990.01-1993.02	-	L/R	F	All-wheel Drive Hatchback Engine N5C	218033	Drive Shaft	94T	23	23	55	91	583	
	1990.01-1993.02	-	-	F	All-wheel Drive Hatchback Engine N5C	818077	Outer Joint	94T	23	22	55	91	64	O
2.0 RS Cosworth (150 kW)	1987.11-1990.01	-	L/R	F	Hatchback Engine N5B	218033	Drive Shaft	94T	23	23	55	91	583	
	1987.11-1990.01	-	-	F	Hatchback Engine N5B	818077	Outer Joint	94T	23	22	55	91	64	O
2.8 (110 kW)	1987.03-1989.09	-	L	R	Hatchback Engine PRG	218129	Drive Shaft					32	478	
	1987.03-1989.09	-	R	R	Hatchback Engine PRG	218128	Drive Shaft					32	519	
	1987.03-1989.09	-	-	R	Hatchback Engine PRG	602006	Inner Joint			25		32		
2.9 i XR (107 kW)	1988.08-1993.02	-	R	R	All-wheel Drive Hatchback Engine B4B/B4C	218128	Drive Shaft					32	519	
	1988.08-1993.02	-	-	R	All-wheel Drive Hatchback Engine B4B/B4C	602006	Inner Joint			25		32		
	1988.08-1993.02	-	L	R	All-wheel Drive Hatchback Engine B4B/B4C	218129	Drive Shaft					32	478	
2.9 i XR (110 kW)	1988.08-1993.02	MT	R	R	All-wheel Drive Hatchback Engine B4A	218128	Drive Shaft					32	519	
	1988.08-1993.02	-	-	R	All-wheel Drive Hatchback Engine B4A	602006	Inner Joint			25		32		
	1988.08-1993.02	-	-	-	All-wheel Drive Hatchback Engine B4A	818077	Outer Joint	94T	23	22	55	91	64	O
	1988.08-1993.02	MT	L	R	All-wheel Drive Hatchback Engine B4A	218129	Drive Shaft					32	478	
SIERRA (GBG GB4)														
1.6 (53 kW)	1988.01-1993.02	-	-	-	Saloon Engine LSF	602006	Inner Joint			25		32		
1.6 (55 kW)	1987.01-1993.02	-	-	-	Saloon Engine LSE	602006	Inner Joint			25		32		
1.6 i (59 kW)	1989.10-1993.02	-	-	F	Saloon Engine L6B	602006	Inner Joint			25		32		
1.8 (59 kW)	1987.10-1989.09	-	-	R	Saloon Engine RED/REF	602006	Inner Joint			25		32		
1.8 (64 kW)	1988.05-1993.02	-	-	-	Saloon Engine R2C/R6A	602006	Inner Joint			25		32		
2.0 (88 kW)	1990.01-1993.02	MT	-	F	All-wheel Drive Saloon Engine N9C	218033	Drive Shaft	94T	23	23	55	91	583	
	1990.01-1993.02	-	-	F	All-wheel Drive Saloon Engine N9C	818077	Outer Joint	94T	23	22	55	91	64	O
2.0 (92 kW)	1990.01-1993.02	MT	-	F	All-wheel Drive Saloon Engine N9C	218033	Drive Shaft	94T	23	23	55	91	583	
	1990.01-1993.02	-	-	F	All-wheel Drive Saloon Engine N9C	818077	Outer Joint	94T	23	22	55	91	64	O



YEAR	TRANSM	L/R	F/R	REMARKS	GSP Ref.	PRODUCT	ABS	Technical Specifications									
								A	B	C	H	L	P				
FORD																	
SIERRA (GBG GB4)																	
2.0 16V Cosworth (162 kW)	1990.01-1993.02	-	L/R	F	All-wheel Drive Saloon Engine N5C	218033	Drive Shaft	94T	23	23	55	91	583				
	1990.01-1993.02	-	-	F	All-wheel Drive Saloon Engine N5C	818077	Outer Joint	94T	23	22	55	91	64	O			
2.0 RS Cosworth (150 kW)	1987.01-1990.12	-	L/R	F	Saloon Engine N5B	218033	Drive Shaft	94T	23	23	55	91	583				
	1987.01-1990.12	-	-	F	Saloon Engine N5B	818077	Outer Joint	94T	23	22	55	91	64	O			
2.9 (110 kW)	1988.08-1993.02	-	R	R	All-wheel Drive Saloon Engine B4B/B4C	218128	Drive Shaft					32	519				
	1988.08-1993.02	-	-	F	All-wheel Drive Saloon Engine B4B/B4C	818077	Outer Joint	94T	23	22	55	91	64	O			
	1988.08-1993.02	-	-	R	All-wheel Drive Saloon Engine B4B/B4C	602006	Inner Joint			25		32					
	1988.08-1993.02	MT	L	R	All-wheel Drive Saloon Engine B4B/B4C	218129	Drive Shaft					32	478				
2.9 i (107 kW)	1988.08-1993.02	MT	R	R	Saloon Engine B4B/B4C	218128	Drive Shaft					32	519				
	1988.08-1993.02	-	-	R	Saloon Engine B4B/B4C	602006	Inner Joint			25		32					
	1988.08-1993.02	-	-	-	Saloon Engine B4B/B4C	818077	Outer Joint	94T	23	22	55	91	64	O			
	1988.08-1993.02	MT	L	R	Saloon Engine B4B/B4C	218129	Drive Shaft					32	478				
2.9 i (110 kW)	1988.08-1993.02	MT	R	R	Saloon Engine B4B/B4C	218128	Drive Shaft					32	519				
	1988.08-1993.02	-	-	R	Saloon Engine B4B/B4C	602006	Inner Joint			25		32					
	1988.08-1993.02	-	-	-	Saloon Engine B4B/B4C	818077	Outer Joint	94T	23	22	55	91	64	O			
	1988.08-1993.02	MT	L	R	Saloon Engine B4B/B4C	218129	Drive Shaft					32	478				
SIERRA Turnier (BNG)																	
1.6 (55 kW)	1987.01-1993.02	-	-	R	Estate Engine LSE	602006	Inner Joint			25		32					
1.6 i (59 kW)	1989.10-1993.02	-	-	-	Estate Engine L6B	602006	Inner Joint			25		32					
1.8 (64 kW)	1988.05-1993.02	-	-	-	Estate Engine R2C/R6A	602006	Inner Joint			25		32					
2.0 (88 kW)	1990.02-1993.02	MT	-	F	All-wheel Drive Estate Engine N9C	218033	Drive Shaft	94T	23	23	55	91	583				
	1990.02-1993.02	-	-	F	All-wheel Drive Estate Engine N9C	818077	Outer Joint	94T	23	22	55	91	64	O			
2.0 (92 kW)	1989.05-1993.02	-	R	R	All-wheel Drive Estate Engine N9C	218128	Drive Shaft					32	519				
	1989.05-1993.02	-	-	R	All-wheel Drive Estate Engine N9C	602006	Inner Joint			25		32					
	1989.05-1993.02	-	L	R	All-wheel Drive Estate Engine N9C	218129	Drive Shaft					32	478				
2.9 (107 kW)	1988.08-1993.02	MT	R	R	Estate Engine B4B/B4C	218128	Drive Shaft					32	519				
	1988.08-1993.02	-	-	R	Estate Engine B4B/B4C	602006	Inner Joint			25		32					
	1988.08-1993.02	-	-	-	Estate Engine B4B/B4C	818077	Outer Joint	94T	23	22	55	91	64	O			
	1988.08-1993.02	MT	L	R	Estate Engine B4B/B4C	218129	Drive Shaft					32	478				
2.9 (110 kW)	1988.08-1993.02	MT	R	R	All-wheel Drive Estate Engine B4B/B4C	218128	Drive Shaft					32	519				
	1988.08-1993.02	-	-	R	All-wheel Drive Estate Engine B4B/B4C	602006	Inner Joint			25		32					
	1988.08-1993.02	-	-	-	All-wheel Drive Estate Engine B4B/B4C	818077	Outer Joint	94T	23	22	55	91	64	O			
	1988.08-1993.02	MT	L	R	All-wheel Drive Estate Engine B4B/B4C	218129	Drive Shaft					32	478				
STREET KA (RL2)																	
1.6 (70 kW)	2003.05-2005.07	-	-	F	Convertible Engine CDRA/CDRB	818222	Outer Joint		25	23	53.3	87	56	M			
	2003.05-2005.07	MT	R	F	Convertible Engine CDRA/CDRB	299044	Drive Shaft		25	23	56.5	88.5	866				
TAURUS																	
-	1986-1993	-	-	-	W/O SHO PKG 6 Cyl	818041	Outer Joint		26	30	56	106	61	I			
	1994-1999	-	-	-	W/O SHO PKG	818041	Outer Joint		26	30	56	106	61	I			
3.0 6V 12V	1994-1995	-	-	-	-	818065	Outer Joint		26	33	55.8	105	64	I			
3.0 SHO	1986-1989	-	-	-	6 Cyl	818046	Outer Joint		26	32	55.9	105.5	64.5	I			
	1986-1989	-	-	-	-	818085	Outer Joint	50T	26	32	55.9	105.5	64.5	I			
	1990-1995	MT	-	-	6 Cyl	818046	Outer Joint		26	32	55.9	105.5	64.5	I			
	1990-1995	MT	-	-	-	818085	Outer Joint	50T	26	32	55.9	105.5	64.5	I			
3.8	1986-1995	-	-	-	6 Cyl	818046	Outer Joint		26	32	55.9	105.5	64.5	I			
	1986-1995	-	-	-	6 Cyl	818085	Outer Joint	50T	26	32	55.9	105.5	64.5	I			
TELSTAR																	
1.8 (GE8P)	1991.09-	-	MT/AT	-	Engine K8	634032	Inner Joint		28	23	35	66	105				
2.0	-	-	-	-	-	627006	Inner Joint		28	23	35	66.5	104				
2.0 (GEEP)	1991.09-	-	MT/AT	-	Engine KF	634032	Inner Joint		28	23	35	66	105				
TELSTAR (GD/GE)																	
1.8 (GE8P)	1991.09-	-	MT/AT	-	USA Engine K8	634032	Inner Joint		28	23	35	66	105				
2.0 (GEEP)	1991.08-	-	MT/AT	-	USA Engine KF	634032	Inner Joint		28	23	35	66	105				
TEMPO																	
-	1984-1991	AT	L	-	-	218148	Drive Shaft		26	23	51	88.5	562				
	1984-1991	MT	L	-	-	218153	Drive Shaft		26	23	51	88.5	560				
	1986-1991	-	R	-	-	218081	Drive Shaft		26	23	51	88.5	892				
	1992-1994	-	-	-	-	618026	Inner Joint		25	28	42	89.5	110				
	1992-1994	-	-	-	4 Cyl	618027	Inner Joint		25	28	42	66.5	108.8				
2.3	1992-1994	-	-	-	-	818047	Outer Joint		26	28	51	107.5	58	I			
All Models	1984.01-1991.12	AT	-	-	-	818042	Outer Joint		26	23	51	88.5	60	I			
	1985.01-1991.12	MT	-	-	-	818042	Outer Joint		26	23	51	88.5	60	I			
THUNDERBIRD																	
-	-	-	R	-	-	218058	Drive Shaft		24	24	52	86.5	900				
	-	-	-	-	-	618010	Inner Joint		24	21	35	64	95				
	1989-1997	-	-	-	-	899146	Outer Joint		28	32	55.9	95.5	64	I			

YEAR	TRANSM	L/R	F/R	REMARKS	GSP Ref.	PRODUCT	ABS	Technical Specifications									
								A	B	C	H	L	P				
FORD																	
TOPAZ																	
-	1987-1991	1991	AT	-	-	-		618054	Inner Joint		23	24	42	90	108		
-	1988-1991	1991	MT	-	-	-		618021	Inner Joint		23	24	42	67	113		
-	1992-1994	1994	AT	-	-	-		818063	Outer Joint		26	32	51	105	64.5	I	
TOURNEO CONNECT																	
1.8 16V (85 kW)	2002.06-2013.12	2013.12	-	L	F	MPV Engine EYPA/EYPC/EYPD		218041	Drive Shaft		25	26	53.3	94.5	632		
	2002.06-2013.12	2013.12	-	R	F	MPV Engine EYPA/EYPC/EYPD		299042	Drive Shaft		25	26	53.3	94.5	963		
	2002.06-2013.12	2013.12	-	L	F	MPV Engine EYPA/EYPC/EYPD		618269	Inner Joint		26	24	40	77.5	104		
	2002.06-2013.12	2013.12	-	L/R	F	MPV Engine EYPA/EYPC/EYPD		818067	Outer Joint		25	26	53.3	94.5	64.5	M	
	2002.06-2013.12	2013.12	-	R	F	MPV Engine EYPA/EYPC/EYPD		618058	Inner Joint		26	26	40	389	99.5		
1.8 TDCi (66 kW)	2002.06-2013.12	2013.12	-	L	F	MPV Engine RWPF/RWPE/R3PA/P9PD/P9PC/P9PB/P9PA/HCPA/HCPB		218041	Drive Shaft		25	26	53.3	94.5	632		
	2002.06-2013.12	2013.12	-	R	F	MPV Engine RWPF/RWPE/R3PA/P9PD/P9PC/P9PB/P9PA/HCPA/HCPB		299042	Drive Shaft		25	26	53.3	94.5	963		
	2002.06-2013.12	2013.12	-	L	F	MPV Engine RWPF/RWPE/R3PA/P9PD/P9PC/P9PB/P9PA/HCPA/HCPB		618269	Inner Joint		26	24	40	77.5	104		
	2002.06-2013.12	2013.12	-	L/R	F	MPV Engine RWPF/RWPE/R3PA/P9PD/P9PC/P9PB/P9PA/HCPA/HCPB		818067	Outer Joint		25	26	53.3	94.5	64.5	M	
	2002.06-2013.12	2013.12	-	R	F	MPV Engine RWPF/RWPE/R3PA/P9PD/P9PC/P9PB/P9PA/HCPA/HCPB		618058	Inner Joint		26	26	40	389	99.5		
1.8 TDCi (81 kW)	2006.08-2013.12	2013.12	-	L	F	MPV Engine RWPA/RWPC/RWPD		218041	Drive Shaft		25	26	53.3	94.5	632		
	2006.08-2013.12	2013.12	-	R	F	MPV Engine RWPA/RWPC/RWPD		299042	Drive Shaft		25	26	53.3	94.5	963		
	2006.08-2013.12	2013.12	-	L/R	F	MPV Engine RWPA/RWPC/RWPD		818067	Outer Joint		25	26	53.3	94.5	64.5	M	
	2006.08-2013.12	2013.12	-	R	F	MPV Engine RWPA/RWPC/RWPD		618058	Inner Joint		26	26	40	389	99.5		
1.8 TDCi /TDDi /DI (55 kW)	2002.06-2013.12	2013.12	-	L	F	MPV Engine BHPA/P7PA/P7PB/R2PA		218263	Drive Shaft		25	26	53.5	94.5	628		
	2002.06-2013.12	2013.12	-	R	F	MPV Engine BHPA/P7PA/P7PB/R2PA		218264	Drive Shaft		25	26	53.5	94.5	962		
	2002.06-2013.12	2013.12	-	R	F	MPV Engine BHPA/P7PA/P7PB/R2PA		299042	Drive Shaft		25	26	53.3	94.5	963		
	2002.06-2013.12	2013.12	-	L	F	MPV Engine BHPA/P7PA/P7PB/R2PA		618269	Inner Joint		26	24	40	77.5	104		
	2002.06-2013.12	2013.12	-	L/R	F	MPV Engine BHPA/P7PA/P7PB/R2PA		818067	Outer Joint		25	26	53.3	94.5	64.5	M	
	2002.06-2013.12	2013.12	-	L/R	F	MPV Engine BHPA/P7PA/P7PB/R2PA		818207	Outer Joint		25	24	53.5	94.5	62	M	
	2002.06-2013.12	2013.12	-	R	F	MPV Engine BHPA/P7PA/P7PB/R2PA		618058	Inner Joint		26	26	40	389	99.5		
TOURNEO CONNECT I																	
1.8 16V (85 kW)	2003.03-2009.04	2009.04	-	-	-	LCV		818102	Outer Joint		25	24	53.5	94.5	62	M	
1.8 Di (55 kW)	2002.06-	-	-	-	-	LCV		818102	Outer Joint		25	24	53.5	94.5	62	M	
1.8 TDCi (55 kW)	2003.03-2010.07	2010.07	-	-	-	LCV		818102	Outer Joint		25	24	53.5	94.5	62	M	
1.8 TDCi (66 kW)	2003.03-2009.04	2009.04	-	-	-	LCV		818102	Outer Joint		25	24	53.5	94.5	62	M	
1.8 TDCi (81 kW)	2006.08-	-	-	-	-	LCV		818102	Outer Joint		25	24	53.5	94.5	62	M	
TOURNEO CUSTOM																	
2.0 TDCi (125 kW)	2015.12-	-	MT	L/R	F	Bus Engine YNF6/YNFS		818286	Outer Joint		31	28	57.7	121	68	I	
	2015.12-	-	MT	L	F	Bus Engine YNF6/YNFS		218334	Drive Shaft		31	41	57.7	121	752		
	2015.12-	-	MT	R	F	Bus Engine YNF6/YNFS		218335	Drive Shaft		31	41	57.7	121	1092		
2.0 TDCi (77 kW)	2015.12-	-	MT	L/R	F	Bus Engine YLFS/YLF6		818286	Outer Joint		31	28	57.7	121	68	I	
	2015.12-	-	MT	L	F	Bus Engine YLFS/YLF6		218334	Drive Shaft		31	41	57.7	121	752		
	2015.12-	-	MT	R	F	Bus Engine YLFS/YLF6		218335	Drive Shaft		31	41	57.7	121	1092		
2.0 TDCi (96 kW)	2015.12-	-	MT	L/R	F	Bus Engine YMFS		818286	Outer Joint		31	28	57.7	121	68	I	
	2015.12-	-	MT	L	F	Bus Engine YMFS		218334	Drive Shaft		31	41	57.7	121	752		
	2015.12-	-	MT	R	F	Bus Engine YMFS		218335	Drive Shaft		31	41	57.7	121	1092		
2.2 TDCi (114 kW)	2012.04-	-	MT	L/R	F	Bus Engine CVFF		818286	Outer Joint		31	28	57.7	121	68	I	
	2012.04-	-	MT	L	F	Bus Engine CVFF		218334	Drive Shaft		31	41	57.7	121	752		
	2012.04-	-	MT	R	F	Bus Engine CVFF		218335	Drive Shaft		31	41	57.7	121	1092		
2.2 TDCi (74 kW)	2012.04-	-	MT	L/R	F	Bus Engine DRFG/DRFF/DRF4		818286	Outer Joint		31	28	57.7	121	68	I	
	2012.04-	-	MT	L	F	Bus Engine DRFG/DRFF/DRF4		218334	Drive Shaft		31	41	57.7	121	752		
	2012.04-	-	MT	R	F	Bus Engine DRFG/DRFF/DRF4		218335	Drive Shaft		31	41	57.7	121	1092		
2.2 TDCi (92 kW)	2012.04-	-	MT	L/R	F	Bus Engine CYF4/CYFF		818286	Outer Joint		31	28	57.7	121	68	I	
	2012.04-	-	MT	L	F	Bus Engine CYF4/CYFF		218334	Drive Shaft		31	41	57.7	121	752		
	2012.04-	-	MT	R	F	Bus Engine CYF4/CYFF		218335	Drive Shaft		31	41	57.7	121	1092		
TRANSIT																	
-	1986.01-2000.03	2000.03	AT	-	-	Propshaft		699050	Inner Joint			24		32			
2.0 TDCi (125 kW)	2016.03-	-	MT	R	F	Box Engine YNF6/YNFS		218335	Drive Shaft		31	41	57.7	121	1092		
	2016.03-	-	MT	R	F	Platform/Chassis Engine YNF6/YNFS		218335	Drive Shaft		31	41	57.7	121	1092		
	2016.03-	-	MT	R	F	Bus Engine YNF6/YNFS		218335	Drive Shaft		31	41	57.7	121	1092		
	2016.03-	-	MT	L/R	F	Box Engine YNF6/YNFS		818286	Outer Joint		31	28	57.7	121	68	I	
	2016.03-	-	MT	L/R	F	Bus Engine YNF6/YNFS		818286	Outer Joint		31	28	57.7	121	68	I	
	2016.03-	-	MT	L	F	Box Engine YNF6/YNFS		218334	Drive Shaft		31	41	57.7	121	752		
	2016.03-	-	MT	L	F	Platform/Chassis Engine YNF6/YNFS		218334	Drive Shaft		31	41	57.7	121	752		
	2016.03-	-	MT	L	F	Bus Engine YNF6/YNFS		218334	Drive Shaft		31	41	57.7	121	752		
2.0 TDCi (77 kW)	2016.03-	-	MT	R	F	Box Engine YLFS/YLF6		218335	Drive Shaft		31	41	57.7	121	1092		
	2016.03-	-	MT	R	F	Platform/Chassis Engine YLFS/YLF6		218335	Drive Shaft		31	41	57.7	121	1092		
	2016.03-	-	MT	R	F	Bus Engine YLFS/YLF6		218335	Drive Shaft		31	41	57.7	121	1092		
	2016.03-	-	MT	L/R	F	Box Engine YLFS/YLF6		818286	Outer Joint		31	28	57.7	121	68	I	
	2016.03-	-	MT	L/R	F	Bus Engine YLFS/YLF6		818286	Outer Joint		31	28	57.7	121	68	I	
	2016.03-	-	MT	L	F	Box Engine YLFS/YLF6		218334	Drive Shaft		31	41	57.7	121	752		





YEAR	TRANSM	L/R	F/R	REMARKS	GSP Ref.	PRODUCT	ABS	Technical Specifications							
								A	B	C	H	L	P		
FORD															
TRANSIT															
2.0 TDCi (77 kW)	2016.03-	-	MT	L F	Platform/Chassis Engine YLFS/YLF6	218334	Drive Shaft		31	41	57.7	121	752		
	2016.03-	-	MT	L F	Bus Engine YLFS/YLF6	218334	Drive Shaft		31	41	57.7	121	752		
2.0 TDCi (96 kW)	2016.03-	-	MT	R F	Platform/Chassis Engine YMFS/YMF6	218335	Drive Shaft		31	41	57.7	121	1092		
	2016.03-	-	MT	R F	Bus Engine YMFS/YMF6	218335	Drive Shaft		31	41	57.7	121	1092		
	2016.03-	-	MT	L/R F	Box Engine YMFS/YMF6	818286	Outer Joint		31	28	57.7	121	68	I	
	2016.03-	-	MT	L/R F	Bus Engine YMFS/YMF6	818286	Outer Joint		31	28	57.7	121	68	I	
	2016.03-	-	MT	L F	Box Engine YMFS/YMF6	218334	Drive Shaft		31	41	57.7	121	752		
	2016.03-	-	MT	L F	Platform/Chassis Engine YMFS/YMF6	218334	Drive Shaft		31	41	57.7	121	752		
	2016.03-	-	MT	L F	Bus Engine YMFS/YMF6	218334	Drive Shaft		31	41	57.7	121	752		
	2016.03-	-	MT	R F	Box Engine YMFS/YMF6	218335	Drive Shaft		31	41	57.7	121	1092		
2.2 TDCi (114 kW)	2013.08-	-	MT	L/R F	Box Engine CVF5	818286	Outer Joint		31	28	57.7	121	68	I	
	2013.08-	-	MT	L F	Box Engine CVF5	218334	Drive Shaft		31	41	57.7	121	752		
	2013.08-	-	MT	L F	Platform/Chassis Engine CVF5	218334	Drive Shaft		31	41	57.7	121	752		
	2013.08-	-	MT	R F	Box Engine CVF5	218335	Drive Shaft		31	41	57.7	121	1092		
	2013.08-	-	MT	R F	Platform/Chassis Engine CVF5	218335	Drive Shaft		31	41	57.7	121	1092		
	2014.12-	-	MT	L F	Bus Engine CVF5	218334	Drive Shaft		31	41	57.7	121	752		
	2014.12-	-	MT	R F	Bus Engine CVF5	218335	Drive Shaft		31	41	57.7	121	1092		
2.2 TDCi (63 kW)	2006.04-	2011.10	6MT	- -	-	818237	Outer Joint	48T	28	31	65	124	78	M	
2.2 TDCi (74 kW)	2013.08-	-	6MT	L F	Box Engine DRF5/DRFG/DRFF	218293	Drive Shaft	48T	28	41	65	124	754		
	2013.08-	-	MT	L/R F	Box Engine DRF5/DRFG/DRFF	818286	Outer Joint		31	28	57.7	121	68	I	
	2013.08-	-	MT	L/R F	Bus Engine DRF5/DRFG/DRFF	818286	Outer Joint		31	28	57.7	121	68	I	
	2013.08-	-	6MT	R F	Box Engine DRF5/DRFG/DRFF	218292	Drive Shaft	48T	28	41	65	124	1093		
	2013.08-	-	MT	L F	Box Engine DRF5/DRFG/DRFF	218334	Drive Shaft		31	41	57.7	121	752		
	2013.08-	-	MT	L F	Platform/Chassis Engine DRF5/DRFG/DRFF	218334	Drive Shaft		31	41	57.7	121	752		
	2013.08-	-	MT	L F	Bus Engine DRF5/DRFG/DRFF	218334	Drive Shaft		31	41	57.7	121	752		
	2013.08-	-	MT	R F	Box Engine DRF5/DRFG/DRFF	218335	Drive Shaft		31	41	57.7	121	1092		
	2013.08-	-	MT	R F	Platform/Chassis Engine DRF5/DRFG/DRFF	218335	Drive Shaft		31	41	57.7	121	1092		
	2013.08-	-	MT	R F	Bus Engine DRF5/DRFG/DRFF	218335	Drive Shaft		31	41	57.7	121	1092		
2.2 TDCi (81 kW)	2006.04-	2011.10	6MT	- -	-	818237	Outer Joint	48T	28	31	65	124	78	M	
2.2 TDCi (92 kW)	2013.08-	-	6MT	L F	Box Engine CYF5/CYFG/CY14/USF6	218293	Drive Shaft	48T	28	41	65	124	754		
	2013.08-	-	MT	L/R F	Box Engine CYF5/CYFG/CY14/USF6	818286	Outer Joint		31	28	57.7	121	68	I	
	2013.08-	-	MT	L/R F	Bus Engine CYF5/CYFG/CY14	818286	Outer Joint		31	28	57.7	121	68	I	
	2013.08-	-	6MT	R F	Box Engine CYF5/CYFG/CY14/USF6	218292	Drive Shaft	48T	28	41	65	124	1093		
	2013.08-	-	MT	L F	Box Engine CYF5/CYFG/CY14/USF6	218334	Drive Shaft		31	41	57.7	121	752		
	2013.08-	-	MT	L F	Platform/Chassis Engine CYF5	218334	Drive Shaft		31	41	57.7	121	752		
	2013.08-	-	MT	L F	Bus Engine CYF5/CYFG/CY14	218334	Drive Shaft		31	41	57.7	121	752		
	2013.08-	-	MT	R F	Box Engine CYF5/CYFG/CY14/USF6	218335	Drive Shaft		31	41	57.7	121	1092		
	2013.08-	-	MT	R F	Platform/Chassis Engine CYF5	218335	Drive Shaft		31	41	57.7	121	1092		
	2013.08-	-	MT	R F	Bus Engine CYF5/CYFG/CY14	218335	Drive Shaft		31	41	57.7	121	1092		
2.2 TDCi (96 kW)	2006.04-	2011.10	6MT	- -	-	818237	Outer Joint	48T	28	31	65	124	78	M	
TRANSIT (FA_)															
2.0 DI (55 kW)	2000.08-	2006.05	5AT	R F	Box Engine D3FA	218034	Drive Shaft	48T	28	26	57	120.5	1056		
	2000.08-	2006.05	-	L F	Box Engine D3FA	218036	Drive Shaft	48T	28	26	57	120.5	797		
	2000.08-	2006.05	5AT	L F	Box Engine D3FA	218035	Drive Shaft		28	26	57	120.5	797		
	2000.08-	2006.05	-	R F	Box Engine D3FA	218242	Drive Shaft	48T	28	26	57	120.5	1056		
	2000.08-	2006.05	-	L F	Box Engine D3FA	218209	Drive Shaft	48T	28	36	57	120.5	794.5		
	2000.08-	2006.05	-	R F	Box Engine D3FA	218213	Drive Shaft	48T	28	36	57	120.5	1056		
	2000.08-	2006.05	-	- F	Box Engine D3FA	818005	Outer Joint	48T	28	26	57	120.5	64	M	
	2000.08-	2006.05	-	- F	Box Engine D3FA	899270	Outer Joint	48T	28	28	59	128	61.5	M	
	2000.08-	2006.05	MT	R F	Box Engine D3FA	218142	Drive Shaft		28	26	57	120.5	1056		
	2000.08-	2006.05	-	L F	Box Engine D3FA	618055	Inner Joint		26	26	40	77.5	104		
	2000.08-	2006.05	-	- F	Box Engine D3FA	899349	Outer Joint	48T	28	36	57	120.5	72	I	
	2000.08-	2006.05	-	L F	Box Engine D3FA	618173	Inner Joint		36	28	40	77	111.5		
	2000.08-	2006.05	-	R F	Box Engine D3FA	618120	Inner Joint		36	28	40	330	120		
	2000.08-	2006.05	-	- F	Box Engine D3FA	818061	Outer Joint		28	26	57	120.5	64	M	
	2000.08-	2006.05	-	- F	Box Engine D3FA	618274	Inner Joint		36	26	40	330	110		
	2000.08-	2006.05	-	R F	Box Engine D3FA	218265	Drive Shaft	48T	28	36	57	120.5	1053		
	2000.08-	2006.05	-	R F	Box Engine D3FA	299178	Drive Shaft	48T	28	36	59	128	1057		
	2000.08-	2006.05	MT	L F	Box Engine D3FA	228006	Drive Shaft		22	22	56	107.5	831		
	2000.08-	2006.05	MT	L F	Box Engine D3FA	228006	Drive Shaft		22	22	56	107.5	831		
2.0 DI (63 kW)	2000.08-	2006.05	5AT	R F	Box Engine F3FA	218034	Drive Shaft	48T	28	26	57	120.5	1056		
	2000.08-	2006.05	-	L F	Box Engine F3FA	218036	Drive Shaft	48T	28	26	57	120.5	797		
	2000.08-	2006.05	5AT	L F	Box Engine F3FA	218035	Drive Shaft		28	26	57	120.5	797		
	2000.08-	2006.05	-	R F	Box Engine F3FA	218242	Drive Shaft	48T	28	26	57	120.5	1056		
	2000.08-	2006.05	-	L F	Box Engine F3FA	218209	Drive Shaft	48T	28	36	57	120.5	794.5		
	2000.08-	2006.05	-	R F	Box Engine F3FA	218213	Drive Shaft	48T	28	36	57	120.5	1056		





YEAR	TRANSM	L/R	F/R	REMARKS	GSP Ref.	PRODUCT	ABS	Technical Specifications										
								A	B	C	H	L	P					
FORD																		
TRANSIT (FA_)																		
2.0 DI (63 kW)																		
2000.08-	2006.05	-	-	F	Box Engine F3FA	818005	Outer Joint	48T	28	26	57	120.5	64	M				
2000.08-	2006.05	-	-	F	Box Engine F3FA	899270	Outer Joint	48T	28	28	59	128	61.5	M				
2000.08-	2006.05	MT	R	F	Box Engine F3FA	218142	Drive Shaft		28	26	57	120.5	1056					
2000.08-	2006.05	-	L	F	Box Engine F3FA	618055	Inner Joint		26	26	40	77.5	104					
2000.08-	2006.05	-	L	F	Box Engine F3FA	618173	Inner Joint		36	28	40	77	111.5					
2000.08-	2006.05	-	-	F	Box Engine F3FA	899349	Outer Joint	48T	28	36	57	120.5	72	I				
2000.08-	2006.05	-	R	F	Box Engine F3FA	618120	Inner Joint		36	28	40	330	120					
2000.08-	2006.05	-	-	F	Box Engine F3FA	818061	Outer Joint		28	26	57	120.5	64	M				
2000.08-	2006.05	-	-	F	Box Engine F3FA	618274	Inner Joint		36	26	40	330	110					
2000.08-	2006.05	-	R	F	Box Engine F3FA	218265	Drive Shaft	48T	28	36	57	120.5	1053					
2000.08-	2006.05	-	R	F	Box Engine F3FA	299178	Drive Shaft	48T	28	36	59	128	1057					
2000.08-	2006.05	MT	L	F	Box Engine F3FA	228006	Drive Shaft		22	22	56	107.5	831					
2000.08-	2006.05	MT	L	F	Box Engine F3FA	228006	Drive Shaft		22	22	56	107.5	831					
2.0 DI (74 kW)																		
2000.08-	2006.05	5AT	R	F	Box Engine ABFA	218034	Drive Shaft	48T	28	26	57	120.5	1056					
2000.08-	2006.05	-	L	F	Box Engine ABFA	218036	Drive Shaft	48T	28	26	57	120.5	797					
2000.08-	2006.05	5AT	L	F	Box Engine ABFA	218035	Drive Shaft		28	26	57	120.5	797					
2000.08-	2006.05	-	L	F	Box Engine ABFA	218259	Drive Shaft	48T	28	36	57	120.5	798.5					
2000.08-	2006.05	-	R	F	Box Engine ABFA	218260	Drive Shaft	48T	28	36	57	120.5	059.5					
2000.08-	2006.05	MT	R	F	Box Engine ABFA	218435	Drive Shaft		28	36	57	120.5	059.5					
2000.08-	2006.05	-	R	F	Box Engine ABFA	218242	Drive Shaft	48T	28	26	57	120.5	1056					
2000.08-	2006.05	MT	L	F	Box Engine ABFA	218209	Drive Shaft	48T	28	36	57	120.5	794.5					
2000.08-	2006.05	MT	R	F	Box Engine ABFA	218213	Drive Shaft	48T	28	36	57	120.5	1056					
2000.08-	2006.05	-	-	F	Box Engine ABFA	818005	Outer Joint	48T	28	26	57	120.5	64	M				
2000.08-	2006.05	-	-	F	Box Engine ABFA	899270	Outer Joint	48T	28	28	59	128	61.5	M				
2000.08-	2006.05	-	L	F	Box Engine ABFA	618180	Inner Joint		36	27	40	77.5	111					
2000.08-	2006.05	MT	R	F	Box Engine ABFA	218142	Drive Shaft		28	26	57	120.5	1056					
2000.08-	2006.05	-	L	F	Box Engine ABFA	218434	Drive Shaft		28	36	57	120.5	798.5					
2000.08-	2006.05	MT	L	F	Box Engine ABFA	618173	Inner Joint		36	28	40	77	111.5					
2000.08-	2006.05	-	L	F	Box Engine ABFA	618055	Inner Joint		26	26	40	77.5	104					
2000.08-	2006.05	-	-	F	Box Engine ABFA	899349	Outer Joint	48T	28	36	57	120.5	72	I				
2000.08-	2006.05	MT	R	F	Box Engine ABFA	618120	Inner Joint		36	28	40	330	120					
2000.08-	2006.05	-	-	F	Box Engine ABFA	818061	Outer Joint		28	26	57	120.5	64	M				
2000.08-	2006.05	-	-	F	Box Engine ABFA	618274	Inner Joint		36	26	40	330	110					
2000.08-	2006.05	MT	R	F	Box Engine ABFA	218265	Drive Shaft	48T	28	36	57	120.5	1053					
2000.08-	2006.05	MT	L	F	Box Engine ABFA	228006	Drive Shaft		22	22	56	107.5	831					
2000.08-	2006.05	-	R	F	Box Engine ABFA	299178	Drive Shaft	48T	28	36	59	128	1057					
2000.08-	2006.05	MT	L	F	Box Engine ABFA	228006	Drive Shaft		22	22	56	107.5	831					
2.0 TDCi (92 kW)																		
2002.08-	2006.05	5AT	R	F	Box Engine F1FA	218034	Drive Shaft	48T	28	26	57	120.5	1056					
2002.08-	2006.05	MT	L	F	Box Engine F1FA	218036	Drive Shaft	48T	28	26	57	120.5	797					
2002.08-	2006.05	-	L	F	Box Engine F1FA	218259	Drive Shaft	48T	28	36	57	120.5	798.5					
2002.08-	2006.05	-	R	F	Box Engine F1FA	218260	Drive Shaft	48T	28	36	57	120.5	059.5					
2002.08-	2006.05	5AT	L	F	Box Engine F1FA	218035	Drive Shaft		28	26	57	120.5	797					
2002.08-	2006.05	-	R	F	Box Engine F1FA	218435	Drive Shaft		28	36	57	120.5	059.5					
2002.08-	2006.05	-	R	F	Box Engine F1FA	218242	Drive Shaft	48T	28	26	57	120.5	1056					
2002.08-	2006.05	MT	L	F	Box Engine F1FA	218209	Drive Shaft	48T	28	36	57	120.5	794.5					
2002.08-	2006.05	MT	R	F	Box Engine F1FA	218213	Drive Shaft	48T	28	36	57	120.5	1056					
2002.08-	2006.05	-	-	F	Box Engine F1FA	899270	Outer Joint	48T	28	28	59	128	61.5	M				
2002.08-	2006.05	-	L	F	Box Engine F1FA	618180	Inner Joint		36	27	40	77.5	111					
2002.08-	2006.05	MT	R	F	Box Engine F1FA	218142	Drive Shaft		28	26	57	120.5	1056					
2002.08-	2006.05	-	L	F	Box Engine F1FA	218434	Drive Shaft		28	36	57	120.5	798.5					
2002.08-	2006.05	MT	L	F	Box Engine F1FA	618055	Inner Joint		26	26	40	77.5	104					
2002.08-	2006.05	MT	L	F	Box Engine F1FA	618173	Inner Joint		36	28	40	77	111.5					
2002.08-	2006.05	-	-	F	Box Engine F1FA	899349	Outer Joint	48T	28	36	57	120.5	72	I				
2002.08-	2006.05	MT	R	F	Box Engine F1FA	618120	Inner Joint		36	28	40	330	120					
2002.08-	2006.05	-	-	F	Box Engine F1FA	818061	Outer Joint		28	26	57	120.5	64	M				
2002.08-	2006.05	-	-	F	Box Engine F1FA	618274	Inner Joint		36	26	40	330	110					
2002.08-	2006.05	-	R	F	Box Engine F1FA	218265	Drive Shaft	48T	28	36	57	120.5	1053					
2002.08-	2006.05	-	R	F	Box Engine F1FA	299178	Drive Shaft	48T	28	36	59	128	1057					
2002.08-	2006.05	MT	L	F	Box Engine F1FA	228006	Drive Shaft		22	22	56	107.5	831					
2002.08-	2006.05	MT	L	F	Box Engine F1FA	228006	Drive Shaft		22	22	56	107.5	831					
2.2 TDCi (103 kW)																		
2007.10-	2014.08	6MT	L	F	Box Engine PGFB/PGFA/UHFA/UHFB/UHFC	218293	Drive Shaft	48T	28	41	65	124	754					
2007.10-	2014.08	6MT	R	F	Box Engine PGFB/PGFA/UHFA/UHFB/UHFC	218292	Drive Shaft	48T	28	41	65	124	1093					
2007.10-	2014.08	-	-	F	Box Engine PGFB/PGFA/UHFA/UHFB/UHFC	899284	Outer Joint	48T	28	29	60	126.5	72	M				
2007.10-	2014.08	MT	L	F	Box Engine PGFB/PGFA/UHFA/UHFB/UHFC	218472	Drive Shaft	48T	28	41	57	124.5	761					
2007.10-	2014.08	MT	L	F	Box Engine PGFB/PGFA/UHFA/UHFB/UHFC	218334	Drive Shaft		31	41	57.7	121	752					
2007.10-	2014.08	MT	R	F	Box Engine PGFB/PGFA/UHFA/UHFB/UHFC	218335	Drive Shaft		31	41	57.7	121	1092					

YEAR	TRANSM	L/R	F/R	REMARKS	GSP Ref.	PRODUCT	ABS	Technical Specifications							
								A	B	C	H	L	P		
FORD															
TRANSIT (FA_ _)															
2.2 TDCi (63 kW)	2006.04-2014.08	5AT	-	F	Box Engine P8FA/P8FB	899270	Outer Joint	48T	28	28	59	128	61.5	M	
	2006.04-2014.08	5AT	L	F	Box Engine P8FA/P8FB	618173	Inner Joint		36	28	40	77	111.5		
	2006.04-2014.08	-	-	F	Box Engine P8FA/P8FB	899284	Outer Joint	48T	28	29	60	126.5	72	M	
	2006.04-2014.08	5AT	L	F	Box Engine P8FA/P8FB	299179	Drive Shaft	48T	28	36	59	128	796		
	2006.04-2014.08	5AT	-	F	Box Engine P8FA/P8FB	899349	Outer Joint	48T	28	36	57	120.5	72	I	
2.2 TDCi (74 kW)	2011.10-2014.08	6MT	L	F	Box Engine DRFE/DRFD/DRFC/DRFB/DRFA	218293	Drive Shaft	48T	28	41	65	124	754		
	2011.10-2014.08	6MT	R	F	Box Engine DRFE/DRFD/DRFC/DRFB/DRFA	218292	Drive Shaft	48T	28	41	65	124	1093		
	2011.10-2014.08	MT	L/R	F	Box Engine DRFE/DRFD/DRFC/DRFB/DRFA	818298	Outer Joint	48T	28	29	57	124.5	79.5	I	
	2011.10-2014.08	-	L	F	Box Engine DRFE/DRFD/DRFC/DRFB/DRFA	218472	Drive Shaft	48T	28	41	57	124.5	761		
	2011.10-2014.08	MT	L	F	Box Engine DRFE/DRFD/DRFC/DRFB/DRFA	218334	Drive Shaft		31	41	57.7	121	752		
	2011.10-2014.08	MT	R	F	Box Engine DRFE/DRFD/DRFC/DRFB/DRFA	218335	Drive Shaft		31	41	57.7	121	1092		
2.2 TDCi (81 kW)	2006.04-2014.08	-	R	F	Box Engine QVFA	618120	Inner Joint		36	28	40	330	120		
	2006.04-2014.08	5AT	-	F	Box Engine QVFA	899270	Outer Joint	48T	28	28	59	128	61.5	M	
	2006.04-2014.08	5AT	L	F	Box Engine QVFA	618173	Inner Joint		36	28	40	77	111.5		
	2006.04-2014.08	-	-	F	Box Engine QVFA	899284	Outer Joint	48T	28	29	60	126.5	72	M	
	2006.04-2014.08	5AT	L	F	Box Engine QVFA	299179	Drive Shaft	48T	28	36	59	128	796		
	2006.04-2014.08	5AT	-	F	Box Engine QVFA	899349	Outer Joint	48T	28	36	57	120.5	72	I	
	2006.04-2014.08	-	L	F	Box Engine QVFA	218455	Drive Shaft	48T	28	36	60	126.5	797		
	2006.04-2014.08	-	R	F	Box Engine QVFA	299194	Drive Shaft	48T	28	36	59	128	1057		
2.2 TDCi (85 kW)	2008.10-2014.08	-	R	F	Box Engine SRFA/SRFB/SRFC/SRFD/SRFE	618120	Inner Joint		36	28	40	330	120		
	2008.10-2014.08	6MT	L	F	Box Engine SRFA/SRFB/SRFC/SRFD/SRFE	218293	Drive Shaft	48T	28	41	65	124	754		
	2008.10-2014.08	6MT	R	F	Box Engine SRFA/SRFB/SRFC/SRFD/SRFE	218292	Drive Shaft	48T	28	41	65	124	1093		
	2008.10-2014.08	-	-	F	Box Engine SRFA/SRFB/SRFC/SRFD/SRFE	899284	Outer Joint	48T	28	29	60	126.5	72	M	
	2008.10-2014.08	MT	L	F	Box Engine SRFA/SRFB/SRFC/SRFD/SRFE	218472	Drive Shaft	48T	28	41	57	124.5	761		
	2008.10-2014.08	MT	L	F	Box Engine SRFA/SRFB/SRFC/SRFD/SRFE	218334	Drive Shaft		31	41	57.7	121	752		
	2008.10-2014.08	-	R	F	Box Engine SRFA/SRFB/SRFC/SRFD/SRFE	299178	Drive Shaft	48T	28	36	59	128	1057		
	2008.10-2014.08	MT	R	F	Box Engine SRFA/SRFB/SRFC/SRFD/SRFE	218335	Drive Shaft		31	41	57.7	121	1092		
2.2 TDCi (92 kW)	2011.10-2014.08	6MT	L	F	Box Engine CYFA/CYFB/CYFC/CYFD	218293	Drive Shaft	48T	28	41	65	124	754		
	2011.10-2014.08	6MT	R	F	Box Engine CYFA/CYFB/CYFC/CYFD	218292	Drive Shaft	48T	28	41	65	124	1093		
	2011.10-2014.08	MT	L/R	F	Box Engine CYFA/CYFB/CYFC/CYFD	818298	Outer Joint	48T	28	29	57	124.5	79.5	I	
	2011.10-2014.08	-	L	F	Box Engine CYFA/CYFB/CYFC/CYFD	218472	Drive Shaft	48T	28	41	57	124.5	761		
	2011.10-2014.08	MT	L	F	Box Engine CYFA/CYFB/CYFC/CYFD	218334	Drive Shaft		31	41	57.7	121	752		
	2011.10-2014.08	MT	R	F	Box Engine CYFA/CYFB/CYFC/CYFD	218335	Drive Shaft		31	41	57.7	121	1092		
2.2 TDCi (96 kW)	2006.04-2014.08	MT	R	F	Box Engine QWFA	618120	Inner Joint		36	28	40	330	120		
	2006.04-2014.08	5AT	-	F	Box Engine QWFA	899270	Outer Joint	48T	28	28	59	128	61.5	M	
	2006.04-2014.08	5AT	L	F	Box Engine QWFA	618173	Inner Joint		36	28	40	77	111.5		
	2006.04-2014.08	-	-	F	Box Engine QWFA	899284	Outer Joint	48T	28	29	60	126.5	72	M	
	2006.04-2014.08	5AT	L	F	Box Engine QWFA	299179	Drive Shaft	48T	28	36	59	128	796		
	2006.04-2014.08	5AT	-	F	Box Engine QWFA	899349	Outer Joint	48T	28	36	57	120.5	72	I	
	2006.04-2014.08	MT	L	F	Box Engine QWFA	218455	Drive Shaft	48T	28	36	60	126.5	797		
	2006.04-2014.08	MT	R	F	Box Engine QWFA	299194	Drive Shaft	48T	28	36	59	128	1057		
2.3 16V RWD (107 kW)	2001.04-2006.05	-	-	F	Box Engine E5FA/E5FC	818005	Outer Joint	48T	28	26	57	120.5	64	M	
2.4 DI (66 kW)	2000.01-2006.05	-	-	F	Box Engine D2FB/D2FE/D2FA	818005	Outer Joint	48T	28	26	57	120.5	64	M	
2.4 DI RWD (55 kW)	2000.01-2006.05	-	-	F	Box Engine F4FA	818005	Outer Joint	48T	28	26	57	120.5	64	M	
2.4 DI RWD (88 kW)	2000.01-2006.05	-	-	F	Box Engine D4FA	818005	Outer Joint	48T	28	26	57	120.5	64	M	
2.4 TDCi (101 kW)	2004.03-2006.05	6MT	L	F	Box Engine H9FA	218293	Drive Shaft	48T	28	41	65	124	754		
	2004.03-2006.05	6MT	R	F	Box Engine H9FA	218292	Drive Shaft	48T	28	41	65	124	1093		
	2004.03-2006.05	-	-	F	Box Engine H9FA	818005	Outer Joint	48T	28	26	57	120.5	64	M	
2.4 TDE (85 kW)	2004.03-2006.05	-	-	F	Box Engine FXFA	818005	Outer Joint	48T	28	26	57	120.5	64	M	
	2004.03-2006.05	-	-	-	Box Engine FXFA	899270	Outer Joint	48T	28	28	59	128	61.5	M	
	2004.03-2006.05	-	-	-	Box Engine FXFA	899349	Outer Joint	48T	28	36	57	120.5	72	I	
2.4 TDE (92 kW)	2001.07-2006.05	-	-	F	Box Engine DOFA	818005	Outer Joint	48T	28	26	57	120.5	64	M	
TRANSIT (FD_ _ FB_ _ FS_ _ FZ_ _ FC_ _)															
2.0 DI (55 kW)	2000.08-2006.05	5AT	R	F	Bus Engine D3FA	218034	Drive Shaft	48T	28	26	57	120.5	1056		
	2000.08-2006.05	-	L	F	Bus Engine D3FA	218036	Drive Shaft	48T	28	26	57	120.5	797		
	2000.08-2006.05	5AT	L	F	Bus Engine D3FA	218035	Drive Shaft		28	26	57	120.5	797		
	2000.08-2006.05	-	R	F	Bus Engine D3FA	618120	Inner Joint		36	28	40	330	120		
	2000.08-2006.05	-	R	F	Bus Engine D3FA	218242	Drive Shaft	48T	28	26	57	120.5	1056		
	2000.08-2006.05	-	-	F	Bus Engine D3FA	818005	Outer Joint	48T	28	26	57	120.5	64	M	
	2000.08-2006.05	-	-	F	Bus Engine D3FA	899270	Outer Joint	48T	28	28	59	128	61.5	M	
	2000.08-2006.05	MT	R	F	Bus Engine D3FA	218142	Drive Shaft		28	26	57	120.5	1056		
	2000.08-2006.05	-	L	F	Bus Engine D3FA	618055	Inner Joint		26	26	40	77.5	104		
	2000.08-2006.05	-	-	F	Bus Engine D3FA	899349	Outer Joint	48T	28	36	57	120.5	72	I	
	2000.08-2006.05	-	-	F	Bus Engine D3FA	818061	Outer Joint		28	26	57	120.5	64	M	
	2000.08-2006.05	-	-	F	Bus Engine D3FA	618274	Inner Joint		36	26	40	330	110		
	2000.08-2006.05	MT	L	F	Bus Engine D3FA	228006	Drive Shaft		22	22	56	107.5	831		

		 YEAR		TRANSM	L/R	F/R	REMARKS	GSP Ref.	 PRODUCT	 ABS	Technical Specifications					
											A	B	C	H	L	P
FORD																
TRANSIT (FD _ FB _ FS _ FZ _ FC _)																
2.0 DI (55 kW)		2000.08-2006.05	-	R	F	Bus Engine D3FA		299178	Drive Shaft	48T	28	36	59	128	1057	
		2000.08-2006.05	MT	L	F	Bus Engine D3FA		228006	Drive Shaft		22	22	56	107.5	831	
2.0 DI (63 kW)		2000.08-2006.05	-	L	F	Bus Engine F3FA		218036	Drive Shaft	48T	28	26	57	120.5	797	
		2000.08-2006.05	5AT	R	F	Bus Engine F3FA		218034	Drive Shaft	48T	28	26	57	120.5	1056	
		2000.08-2006.05	5AT	L	F	Bus Engine F3FA		218035	Drive Shaft		28	26	57	120.5	797	
		2000.08-2006.05	-	R	F	Bus Engine F3FA		218242	Drive Shaft	48T	28	26	57	120.5	1056	
		2000.08-2006.05	-	L	F	Bus Engine F3FA		218209	Drive Shaft	48T	28	36	57	120.5	794.5	
		2000.08-2006.05	-	R	F	Bus Engine F3FA		218213	Drive Shaft	48T	28	36	57	120.5	1056	
		2000.08-2006.05	-	-	F	Bus Engine F3FA		818005	Outer Joint	48T	28	26	57	120.5	64	M
		2000.08-2006.05	-	-	F	Bus Engine F3FA		899270	Outer Joint	48T	28	28	59	128	61.5	M
		2000.08-2006.05	MT	R	F	Bus Engine F3FA		218142	Drive Shaft		28	26	57	120.5	1056	
		2000.08-2006.05	-	L	F	Bus Engine F3FA		618055	Inner Joint		26	26	40	77.5	104	
		2000.08-2006.05	-	L	F	Bus Engine F3FA		618173	Inner Joint		36	28	40	77	111.5	
		2000.08-2006.05	-	-	F	Bus Engine F3FA		899349	Outer Joint	48T	28	36	57	120.5	72	I
		2000.08-2006.05	-	R	F	Bus Engine F3FA		618120	Inner Joint		36	28	40	330	120	
		2000.08-2006.05	-	-	F	Bus Engine F3FA		818061	Outer Joint		28	26	57	120.5	64	M
		2000.08-2006.05	-	-	F	Bus Engine F3FA		618274	Inner Joint		36	26	40	330	110	
		2000.08-2006.05	-	R	F	Bus Engine F3FA		218265	Drive Shaft	48T	28	36	57	120.5	1053	
		2000.08-2006.05	MT	L	F	Bus Engine F3FA		228006	Drive Shaft		22	22	56	107.5	831	
		2000.08-2006.05	-	R	F	Bus Engine F3FA		299178	Drive Shaft	48T	28	36	59	128	1057	
		2000.08-2006.05	MT	L	F	Bus Engine F3FA		228006	Drive Shaft		22	22	56	107.5	831	
2.0 DI (74 kW)		2000.08-2006.05	5AT	R	F	Bus Engine ABFA		218034	Drive Shaft	48T	28	26	57	120.5	1056	
		2000.08-2006.05	-	L	F	Bus Engine ABFA		218036	Drive Shaft	48T	28	26	57	120.5	797	
		2000.08-2006.05	5AT	L	F	Bus Engine ABFA		218035	Drive Shaft		28	26	57	120.5	797	
		2000.08-2006.05	-	R	F	Bus Engine ABFA		218242	Drive Shaft	48T	28	26	57	120.5	1056	
		2000.08-2006.05	-	L	F	Bus Engine ABFA		218209	Drive Shaft	48T	28	36	57	120.5	794.5	
		2000.08-2006.05	-	R	F	Bus Engine ABFA		218213	Drive Shaft	48T	28	36	57	120.5	1056	
		2000.08-2006.05	-	-	F	Bus Engine ABFA		818005	Outer Joint	48T	28	26	57	120.5	64	M
		2000.08-2006.05	-	-	F	Bus Engine ABFA		899270	Outer Joint	48T	28	28	59	128	61.5	M
		2000.08-2006.05	MT	R	F	Bus Engine ABFA		218142	Drive Shaft		28	26	57	120.5	1056	
		2000.08-2006.05	-	L	F	Bus Engine ABFA		618055	Inner Joint		26	26	40	77.5	104	
		2000.08-2006.05	-	-	F	Bus Engine ABFA		899349	Outer Joint	48T	28	36	57	120.5	72	I
		2000.08-2006.05	-	L	F	Bus Engine ABFA		618173	Inner Joint		36	28	40	77	111.5	
		2000.08-2006.05	-	R	F	Bus Engine ABFA		618120	Inner Joint		36	28	40	330	120	
		2000.08-2006.05	-	-	F	Bus Engine ABFA		818061	Outer Joint		28	26	57	120.5	64	M
		2000.08-2006.05	-	-	F	Bus Engine ABFA		618274	Inner Joint		36	26	40	330	110	
		2000.08-2006.05	-	R	F	Bus Engine ABFA		218265	Drive Shaft	48T	28	36	57	120.5	1053	
		2000.08-2006.05	MT	L	F	Bus Engine ABFA		228006	Drive Shaft		22	22	56	107.5	831	
		2000.08-2006.05	-	R	F	Bus Engine ABFA		299178	Drive Shaft	48T	28	36	59	128	1057	
		2000.08-2006.05	MT	L	F	Bus Engine ABFA		228006	Drive Shaft		22	22	56	107.5	831	
2.0 TDCi (92 kW)		2002.08-2006.05	5AT	R	F	Bus Engine FIFA		218034	Drive Shaft	48T	28	26	57	120.5	1056	
		2002.08-2006.05	-	L	F	Bus Engine FIFA		218036	Drive Shaft	48T	28	26	57	120.5	797	
		2002.08-2006.05	-	R	F	Bus Engine FIFA		218260	Drive Shaft	48T	28	36	57	120.5	059.5	
		2002.08-2006.05	5AT	L	F	Bus Engine FIFA		218035	Drive Shaft		28	26	57	120.5	797	
		2002.08-2006.05	-	R	F	Bus Engine FIFA		218242	Drive Shaft	48T	28	26	57	120.5	1056	
		2002.08-2006.05	-	L	F	Bus Engine FIFA		218209	Drive Shaft	48T	28	36	57	120.5	794.5	
		2002.08-2006.05	MT	R	F	Bus Engine FIFA		218213	Drive Shaft	48T	28	36	57	120.5	1056	
		2002.08-2006.05	-	-	F	Bus Engine FIFA		899270	Outer Joint	48T	28	28	59	128	61.5	M
		2002.08-2006.05	MT	R	F	Bus Engine FIFA		218142	Drive Shaft		28	26	57	120.5	1056	
		2002.08-2006.05	-	L	F	Bus Engine FIFA		618055	Inner Joint		26	26	40	77.5	104	
		2002.08-2006.05	-	L	F	Bus Engine FIFA		618173	Inner Joint		36	28	40	77	111.5	
		2002.08-2006.05	-	-	F	Bus Engine FIFA		899349	Outer Joint	48T	28	36	57	120.5	72	I
		2002.08-2006.05	MT	R	F	Bus Engine FIFA		618120	Inner Joint		36	28	40	330	120	
		2002.08-2006.05	-	-	F	Bus Engine FIFA		818061	Outer Joint		28	26	57	120.5	64	M
		2002.08-2006.05	-	-	F	Bus Engine FIFA		618274	Inner Joint		36	26	40	330	110	
		2002.08-2006.05	-	R	F	Bus Engine FIFA		218265	Drive Shaft	48T	28	36	57	120.5	1053	
		2002.08-2006.05	MT	L	F	Bus Engine FIFA		228006	Drive Shaft		22	22	56	107.5	831	
		2002.08-2006.05	-	R	F	Bus Engine FIFA		299178	Drive Shaft	48T	28	36	59	128	1057	
		2002.08-2006.05	MT	L	F	Bus Engine FIFA		228006	Drive Shaft		22	22	56	107.5	831	
2.2 TDCi (103 kW)		2007.10-2014.08	6MT	L	F	Bus Engine PGFB/PGFA/UHFA/UHFB/UHFC		218293	Drive Shaft	48T	28	41	65	124	754	
		2007.10-2014.08	6MT	R	F	Bus Engine PGFB/PGFA/UHFA/UHFB/UHFC		218292	Drive Shaft	48T	28	41	65	124	1093	
		2007.10-2014.08	-	-	F	Bus Engine PGFB/PGFA/UHFA/UHFB/UHFC		899284	Outer Joint	48T	28	29	60	126.5	72	M
		2007.10-2014.08	MT	L	F	Bus Engine PGFB/PGFA/UHFA/UHFB/UHFC		218472	Drive Shaft	48T	28	41	57	124.5	761	
		2007.10-2014.08	MT	L	F	Bus Engine PGFB/PGFA/UHFA/UHFB/UHFC		218334	Drive Shaft		31	41	57.7	121	752	
		2007.10-2014.08	MT	R	F	Bus Engine PGFB/PGFA/UHFA/UHFB/UHFC		218335	Drive Shaft		31	41	57.7	121	1092	
2.2 TDCi (63 kW)		2006.04-2014.08	5AT	-	F	Bus Engine P8FA/P8FB		899270	Outer Joint	48T	28	28	59	128	61.5	M





YEAR	TRANSM	L/R	F/R	REMARKS	GSP Ref.	PRODUCT	ABS	Technical Specifications								
								A	B	C	H	L	P			
FORD																
TRANSIT (FD _ FB _ FS _ FZ _ FC _)																
2.2 TDCi (63 kW)	2006.04-2014.08	5AT	L	F	Bus Engine P8FA/P8FB	618173	Inner Joint		36	28	40	77	111.5			
	2006.04-2014.08	-	-	F	Bus Engine P8FA/P8FB	899284	Outer Joint	48T	28	29	60	126.5	72	M		
	2006.04-2014.08	5AT	L	F	Bus Engine P8FA/P8FB	299179	Drive Shaft	48T	28	36	59	128	796			
	2006.04-2014.08	5AT	-	F	Bus Engine P8FA/P8FB	899349	Outer Joint	48T	28	36	57	120.5	72	I		
2.2 TDCi (74 kW)	2011.10-2014.08	6MT	L	F	Bus Engine DRFE/DRFD/DRFC/DRFB/DRFA	218293	Drive Shaft	48T	28	41	65	124	754			
	2011.10-2014.08	6MT	R	F	Bus Engine DRFE/DRFD/DRFC/DRFB/DRFA	218292	Drive Shaft	48T	28	41	65	124	1093			
	2011.10-2014.08	MT	L/R	F	Bus Engine DRFE/DRFD/DRFC/DRFB/DRFA	818298	Outer Joint	48T	28	29	57	124.5	79.5	I		
	2011.10-2014.08	-	L	F	Bus Engine DRFE/DRFD/DRFC/DRFB/DRFA	218472	Drive Shaft	48T	28	41	57	124.5	761			
	2011.10-2014.08	MT	L	F	Bus Engine DRFE/DRFD/DRFC/DRFB/DRFA	218334	Drive Shaft		31	41	57.7	121	752			
	2011.10-2014.08	MT	R	F	Bus Engine DRFE/DRFD/DRFC/DRFB/DRFA	218335	Drive Shaft		31	41	57.7	121	1092			
2.2 TDCi (81 kW)	2006.04-2014.08	-	R	F	Bus Engine QVFA	618120	Inner Joint		36	28	40	330	120			
	2006.04-2014.08	5AT	-	F	Bus Engine QVFA	899270	Outer Joint	48T	28	28	59	128	61.5	M		
	2006.04-2014.08	5AT	L	F	Bus Engine QVFA	618173	Inner Joint		36	28	40	77	111.5			
	2006.04-2014.08	-	-	F	Bus Engine QVFA	899284	Outer Joint	48T	28	29	60	126.5	72	M		
	2006.04-2014.08	5AT	L	F	Bus Engine QVFA	299179	Drive Shaft	48T	28	36	59	128	796			
	2006.04-2014.08	5AT	-	F	Bus Engine QVFA	899349	Outer Joint	48T	28	36	57	120.5	72	I		
	2006.04-2014.08	-	L	F	Bus Engine QVFA	218455	Drive Shaft	48T	28	36	60	126.5	797			
	2006.04-2014.08	-	R	F	Bus Engine QVFA	299194	Drive Shaft	48T	28	36	59	128	1057			
2.2 TDCi (85 kW)	2008.10-2014.08	6MT	L	F	Bus Engine SRFA/SRFB/SRFC/SRFD/SRFE	218293	Drive Shaft	48T	28	41	65	124	754			
	2008.10-2014.08	6MT	R	F	Bus Engine SRFA/SRFB/SRFC/SRFD/SRFE	218292	Drive Shaft	48T	28	41	65	124	1093			
	2008.10-2014.08	5AT	-	F	Bus Engine SRFA/SRFB/SRFC/SRFD/SRFE	899270	Outer Joint	48T	28	28	59	128	61.5	M		
	2008.10-2014.08	5AT	L	F	Bus Engine SRFA/SRFB/SRFC/SRFD/SRFE	618173	Inner Joint		36	28	40	77	111.5			
	2008.10-2014.08	-	-	F	Bus Engine SRFA/SRFB/SRFC/SRFD/SRFE	899284	Outer Joint	48T	28	29	60	126.5	72	M		
	2008.10-2014.08	MT	L	F	Bus Engine SRFA/SRFB/SRFC/SRFD/SRFE	218472	Drive Shaft	48T	28	41	57	124.5	761			
	2008.10-2014.08	5AT	L	F	Bus Engine SRFA/SRFB/SRFC/SRFD/SRFE	299179	Drive Shaft	48T	28	36	59	128	796			
	2008.10-2014.08	5AT	-	F	Bus Engine SRFA/SRFB/SRFC/SRFD/SRFE	899349	Outer Joint	48T	28	36	57	120.5	72	I		
2.2 TDCi (92 kW)	2011.10-2014.08	6MT	L	F	Bus Engine CYFA/CYFB/CYFC/CYFD	218293	Drive Shaft	48T	28	41	65	124	754			
	2011.10-2014.08	6MT	R	F	Bus Engine CYFA/CYFB/CYFC/CYFD	218292	Drive Shaft	48T	28	41	65	124	1093			
	2011.10-2014.08	MT	L/R	F	Bus Engine CYFA/CYFB/CYFC/CYFD	818298	Outer Joint	48T	28	29	57	124.5	79.5	I		
	2011.10-2014.08	-	L	F	Bus Engine CYFA/CYFB/CYFC/CYFD	218472	Drive Shaft	48T	28	41	57	124.5	761			
	2011.10-2014.08	MT	L	F	Bus Engine CYFA/CYFB/CYFC/CYFD	218334	Drive Shaft		31	41	57.7	121	752			
	2011.10-2014.08	MT	R	F	Bus Engine CYFA/CYFB/CYFC/CYFD	218335	Drive Shaft		31	41	57.7	121	1092			
2.2 TDCi (96 kW)	2006.04-2014.08	MT	R	F	Bus Engine QWFA	618120	Inner Joint		36	28	40	330	120			
	2006.04-2014.08	5AT	-	F	Bus Engine QWFA	899270	Outer Joint	48T	28	28	59	128	61.5	M		
	2006.04-2014.08	5AT	L	F	Bus Engine QWFA	618173	Inner Joint		36	28	40	77	111.5			
	2006.04-2014.08	-	-	F	Bus Engine QWFA	899284	Outer Joint	48T	28	29	60	126.5	72	M		
	2006.04-2014.08	5AT	L	F	Bus Engine QWFA	299179	Drive Shaft	48T	28	36	59	128	796			
	2006.04-2014.08	5AT	-	F	Bus Engine QWFA	899349	Outer Joint	48T	28	36	57	120.5	72	I		
	2006.04-2014.08	MT	L	F	Bus Engine QWFA	218455	Drive Shaft	48T	28	36	60	126.5	797			
	2006.04-2014.08	MT	R	F	Bus Engine QWFA	299194	Drive Shaft	48T	28	36	59	128	1057			
2.2 TDCi RWD (100 kW)	2011.09-2014.08	-	-	F	Bus Engine USRB/USRA	899284	Outer Joint	48T	28	29	60	126.5	72	M		
2.3 16V RWD (107 kW)	2000.08-2006.05	-	-	F	Bus Engine E5FA/E5FC	818005	Outer Joint	48T	28	26	57	120.5	64	M		
2.4 DI (66 kW)	2000.01-2006.05	-	-	F	Bus Engine D2FB/D2FE/D2FA	818005	Outer Joint	48T	28	26	57	120.5	64	M		
2.4 DI RWD (55 kW)	2000.01-2006.05	-	-	F	Bus Engine F4FA	818005	Outer Joint	48T	28	26	57	120.5	64	M		
2.4 DI RWD (88 kW)	2000.01-2006.05	-	-	F	Bus Engine D4FA	818005	Outer Joint	48T	28	26	57	120.5	64	M		
2.4 TDCi (101 kW)	2004.03-2006.05	-	-	F	Bus Engine H9FA	818005	Outer Joint	48T	28	26	57	120.5	64	M		
	2004.03-2006.05	-	-	-	Bus Engine H9FA	899270	Outer Joint	48T	28	28	59	128	61.5	M		
	2004.03-2006.05	MT	-	-	Bus Engine H9FA	899349	Outer Joint	48T	28	36	57	120.5	72	I		
2.4 TDE (85 kW)	2004.03-2006.05	-	-	F	Bus Engine FXFA	818005	Outer Joint	48T	28	26	57	120.5	64	M		
	2004.03-2006.05	-	-	-	Bus Engine FXFA	899270	Outer Joint	48T	28	28	59	128	61.5	M		
	2004.03-2006.05	MT	-	-	Bus Engine FXFA	899349	Outer Joint	48T	28	36	57	120.5	72	I		
2.4 TDE (92 kW)	2001.07-2006.05	-	-	F	Bus Engine DOFA	818005	Outer Joint	48T	28	26	57	120.5	64	M		
TRANSIT (FM _ FN _)																
2.0 DI (55 kW)	2000.08-2006.05	5AT	R	F	Platform/Chassis Engine D3FA	218034	Drive Shaft	48T	28	26	57	120.5	1056			
	2000.08-2006.05	-	L	F	Platform/Chassis Engine D3FA	218036	Drive Shaft	48T	28	26	57	120.5	797			
	2000.08-2006.05	5AT	L	F	Platform/Chassis Engine D3FA	218035	Drive Shaft		28	26	57	120.5	797			
	2000.08-2006.05	-	R	F	Platform/Chassis Engine D3FA	218242	Drive Shaft	48T	28	26	57	120.5	1056			
	2000.08-2006.05	-	L	F	Platform/Chassis Engine D3FA	218209	Drive Shaft	48T	28	36	57	120.5	794.5			
	2000.08-2006.05	-	R	F	Platform/Chassis Engine D3FA	218213	Drive Shaft	48T	28	36	57	120.5	1056			
	2000.08-2006.05	-	-	F	Platform/Chassis Engine D3FA	818005	Outer Joint	48T	28	26	57	120.5	64	M		
	2000.08-2006.05	-	-	F	Platform/Chassis Engine D3FA	899270	Outer Joint	48T	28	28	59	128	61.5	M		
	2000.08-2006.05	-	L	F	Platform/Chassis Engine D3FA	618055	Inner Joint		26	26	40	77.5	104			
	2000.08-2006.05	-	L	F	Platform/Chassis Engine D3FA	618173	Inner Joint		36	28	40	77	111.5			
	2000.08-2006.05	-	-	F	Platform/Chassis Engine D3FA	899349	Outer Joint	48T	28	36	57	120.5	72	I		
	2000.08-2006.05	-	R	F	Platform/Chassis Engine D3FA	618120	Inner Joint		36	28	40	330	120			
	2000.08-2006.05	-	-	F	Platform/Chassis Engine D3FA	818061	Outer Joint		28	26	57	120.5	64	M		

		 YEAR	TRANSM	L/R	F/R	REMARKS	GSP Ref.	 PRODUCT	 ABS	Technical Specifications					
										A	B	C	H	L	P
FORD															
TRANSIT (FM__FN__)															
2.0 DI (55 kW)	2000.08-2006.05	-	-	F	Platform/Chassis Engine D3FA	618274	Inner Joint		36	26	40	330	110		
	2000.08-2006.05	-	R	F	Platform/Chassis Engine D3FA	218265	Drive Shaft	48T	28	36	57	120.5	1053		
	2000.08-2006.05	MT	L	F	Platform/Chassis Engine D3FA	228006	Drive Shaft		22	22	56	107.5	831		
	2000.08-2006.05	-	R	F	Platform/Chassis Engine D3FA	299178	Drive Shaft	48T	28	36	59	128	1057		
	2000.08-2006.05	MT	L	F	Platform/Chassis Engine D3FA	228006	Drive Shaft		22	22	56	107.5	831		
2.0 DI (63 kW)	2000.08-2006.05	5AT	R	F	Platform/Chassis Engine F3FA	218034	Drive Shaft	48T	28	26	57	120.5	1056		
	2000.08-2006.05	-	L	F	Platform/Chassis Engine F3FA	218036	Drive Shaft	48T	28	26	57	120.5	797		
	2000.08-2006.05	5AT	L	F	Platform/Chassis Engine F3FA	218035	Drive Shaft		28	26	57	120.5	797		
	2000.08-2006.05	-	R	F	Platform/Chassis Engine F3FA	218242	Drive Shaft	48T	28	26	57	120.5	1056		
	2000.08-2006.05	-	L	F	Platform/Chassis Engine F3FA	218209	Drive Shaft	48T	28	36	57	120.5	794.5		
	2000.08-2006.05	-	R	F	Platform/Chassis Engine F3FA	218213	Drive Shaft	48T	28	36	57	120.5	1056		
	2000.08-2006.05	-	-	F	Platform/Chassis Engine F3FA	818005	Outer Joint	48T	28	26	57	120.5	64	M	
	2000.08-2006.05	-	-	F	Platform/Chassis Engine F3FA	899270	Outer Joint	48T	28	28	59	128	61.5	M	
	2000.08-2006.05	-	L	F	Platform/Chassis Engine F3FA	618055	Inner Joint		26	26	40	77.5	104		
	2000.08-2006.05	-	L	F	Platform/Chassis Engine F3FA	618173	Inner Joint		36	28	40	77	111.5		
	2000.08-2006.05	-	-	F	Platform/Chassis Engine F3FA	899349	Outer Joint	48T	28	36	57	120.5	72	I	
	2000.08-2006.05	-	R	F	Platform/Chassis Engine F3FA	618120	Inner Joint		36	28	40	330	120		
	2000.08-2006.05	-	-	F	Platform/Chassis Engine F3FA	818061	Outer Joint		28	26	57	120.5	64	M	
	2000.08-2006.05	-	-	F	Platform/Chassis Engine F3FA	618274	Inner Joint		36	26	40	330	110		
	2000.08-2006.05	-	R	F	Platform/Chassis Engine F3FA	218265	Drive Shaft	48T	28	36	57	120.5	1053		
	2000.08-2006.05	MT	L	F	Platform/Chassis Engine F3FA	228006	Drive Shaft		22	22	56	107.5	831		
	2000.08-2006.05	-	R	F	Platform/Chassis Engine F3FA	299178	Drive Shaft	48T	28	36	59	128	1057		
2000.08-2006.05	MT	L	F	Platform/Chassis Engine F3FA	228006	Drive Shaft		22	22	56	107.5	831			
2.0 DI (74 kW)	2000.08-2006.05	5AT	R	F	Platform/Chassis Engine ABFA	218034	Drive Shaft	48T	28	26	57	120.5	1056		
	2000.08-2006.05	-	L	F	Platform/Chassis Engine ABFA	218036	Drive Shaft	48T	28	26	57	120.5	797		
	2000.08-2006.05	5AT	L	F	Platform/Chassis Engine ABFA	218035	Drive Shaft		28	26	57	120.5	797		
	2000.08-2006.05	-	L	F	Platform/Chassis Engine ABFA	218259	Drive Shaft	48T	28	36	57	120.5	798.5		
	2000.08-2006.05	-	R	F	Platform/Chassis Engine ABFA	218260	Drive Shaft	48T	28	36	57	120.5	059.5		
	2000.08-2006.05	MT	R	F	Platform/Chassis Engine ABFA	218435	Drive Shaft		28	36	57	120.5	059.5		
	2000.08-2006.05	-	R	F	Platform/Chassis Engine ABFA	218242	Drive Shaft	48T	28	26	57	120.5	1056		
	2000.08-2006.05	MT	L	F	Platform/Chassis Engine ABFA	218209	Drive Shaft	48T	28	36	57	120.5	794.5		
	2000.08-2006.05	-	R	F	Platform/Chassis Engine ABFA	218213	Drive Shaft	48T	28	36	57	120.5	1056		
	2000.08-2006.05	-	-	F	Platform/Chassis Engine ABFA	818005	Outer Joint	48T	28	26	57	120.5	64	M	
	2000.08-2006.05	-	-	F	Platform/Chassis Engine ABFA	899270	Outer Joint	48T	28	28	59	128	61.5	M	
	2000.08-2006.05	-	L	F	Platform/Chassis Engine ABFA	618180	Inner Joint		36	27	40	77.5	111		
	2000.08-2006.05	-	L	F	Platform/Chassis Engine ABFA	218434	Drive Shaft		28	36	57	120.5	798.5		
	2000.08-2006.05	MT	L	F	Platform/Chassis Engine ABFA	618173	Inner Joint		36	28	40	77	111.5		
	2000.08-2006.05	-	L	F	Platform/Chassis Engine ABFA	618055	Inner Joint		26	26	40	77.5	104		
	2000.08-2006.05	-	-	F	Platform/Chassis Engine ABFA	899349	Outer Joint	48T	28	36	57	120.5	72	I	
	2000.08-2006.05	-	R	F	Platform/Chassis Engine ABFA	618120	Inner Joint		36	28	40	330	120		
	2000.08-2006.05	-	-	F	Platform/Chassis Engine ABFA	818061	Outer Joint		28	26	57	120.5	64	M	
	2000.08-2006.05	-	-	F	Platform/Chassis Engine ABFA	618274	Inner Joint		36	26	40	330	110		
	2000.08-2006.05	-	R	F	Platform/Chassis Engine ABFA	218265	Drive Shaft	48T	28	36	57	120.5	1053		
	2000.08-2006.05	MT	L	F	Platform/Chassis Engine ABFA	228006	Drive Shaft		22	22	56	107.5	831		
	2000.08-2006.05	-	R	F	Platform/Chassis Engine ABFA	299178	Drive Shaft	48T	28	36	59	128	1057		
	2000.08-2006.05	MT	L	F	Platform/Chassis Engine ABFA	228006	Drive Shaft		22	22	56	107.5	831		
2.0 TDCi (92 kW)	2002.08-2006.05	5AT	R	F	Platform/Chassis Engine F1FA	218034	Drive Shaft	48T	28	26	57	120.5	1056		
	2002.08-2006.05	MT	L	F	Platform/Chassis Engine F1FA	218036	Drive Shaft	48T	28	26	57	120.5	797		
	2002.08-2006.05	-	L	F	Platform/Chassis Engine F1FA	218259	Drive Shaft	48T	28	36	57	120.5	798.5		
	2002.08-2006.05	-	R	F	Platform/Chassis Engine F1FA	218260	Drive Shaft	48T	28	36	57	120.5	059.5		
	2002.08-2006.05	5AT	L	F	Platform/Chassis Engine F1FA	218035	Drive Shaft		28	26	57	120.5	797		
	2002.08-2006.05	-	R	F	Platform/Chassis Engine F1FA	218435	Drive Shaft		28	36	57	120.5	059.5		
	2002.08-2006.05	-	R	F	Platform/Chassis Engine F1FA	218242	Drive Shaft	48T	28	26	57	120.5	1056		
	2002.08-2006.05	MT	L	F	Platform/Chassis Engine F1FA	218209	Drive Shaft	48T	28	36	57	120.5	794.5		
	2002.08-2006.05	MT	R	F	Platform/Chassis Engine F1FA	218213	Drive Shaft	48T	28	36	57	120.5	1056		
	2002.08-2006.05	-	-	F	Platform/Chassis Engine F1FA	899270	Outer Joint	48T	28	28	59	128	61.5	M	
	2002.08-2006.05	-	L	F	Platform/Chassis Engine F1FA	618180	Inner Joint		36	27	40	77.5	111		
	2002.08-2006.05	-	L	F	Platform/Chassis Engine F1FA	218434	Drive Shaft		28	36	57	120.5	798.5		
	2002.08-2006.05	MT	L	F	Platform/Chassis Engine F1FA	618055	Inner Joint		26	26	40	77.5	104		
	2002.08-2006.05	MT	L	F	Platform/Chassis Engine F1FA	618173	Inner Joint		36	28	40	77	111.5		
	2002.08-2006.05	-	-	F	Platform/Chassis Engine F1FA	899349	Outer Joint	48T	28	36	57	120.5	72	I	
	2002.08-2006.05	MT	R	F	Platform/Chassis Engine F1FA	618120	Inner Joint		36	28	40	330	120		
	2002.08-2006.05	-	-	F	Platform/Chassis Engine F1FA	818061	Outer Joint		28	26	57	120.5	64	M	
	2002.08-2006.05	-	-	F	Platform/Chassis Engine F1FA	618274	Inner Joint		36	26	40	330	110		
	2002.08-2006.05	-	R	F	Platform/Chassis Engine F1FA	218265	Drive Shaft	48T	28	36	57	120.5	1053		
	2002.08-2006.05	MT	L	F	Platform/Chassis Engine F1FA	228006	Drive Shaft		22	22	56	107.5	831		

	 YEAR	TRANSM	L/R	F/R	REMARKS	GSP Ref.	 PRODUCT	 ABS	Technical Specifications					
									A	B	C	H	L	P
FORD														
TRANSIT (FM_ _ FN_ _)														
2.0 TDCi (92 kW)	2002.08-2006.05	-	R	F	Platform/Chassis Engine FIFA	299178	Drive Shaft	48T	28	36	59	128	1057	
	2002.08-2006.05	MT	L	F	Platform/Chassis Engine FIFA	228006	Drive Shaft		22	22	56	107.5	831	
2.2 TDCi (103 kW)	2007.10-2011.09	6MT	L	F	Platform/Chassis Engine PGFB/PGFA/UHFA/UHFB/UHFC	218293	Drive Shaft	48T	28	41	65	124	754	
	2007.10-2011.09	6MT	R	F	Platform/Chassis Engine PGFB/PGFA/UHFA/UHFB/UHFC	218292	Drive Shaft	48T	28	41	65	124	1093	
	2007.10-2011.09	-	L	F	Platform/Chassis Engine PGFB/PGFA/UHFA/UHFB/UHFC	218472	Drive Shaft	48T	28	41	57	124.5	761	
2.2 TDCi (63 kW)	2006.04-2014.08	5AT	-	F	Platform/Chassis Engine P8FA/P8FB	899270	Outer Joint	48T	28	28	59	128	61.5	M
	2006.04-2014.08	5AT	L	F	Platform/Chassis Engine P8FA/P8FB	618173	Inner Joint		36	28	40	77	111.5	
	2006.04-2014.08	-	-	F	Platform/Chassis Engine P8FA/P8FB	899284	Outer Joint	48T	28	29	60	126.5	72	M
	2006.04-2014.08	5AT	L	F	Platform/Chassis Engine P8FA/P8FB	299179	Drive Shaft	48T	28	36	59	128	796	
	2006.04-2014.08	5AT	-	F	Platform/Chassis Engine P8FA/P8FB	899349	Outer Joint	48T	28	36	57	120.5	72	I
2.2 TDCi (74 kW)	2011.10-2014.08	MT	L/R	F	Platform/Chassis Engine DRFE/DRFD/DRFC/DRFB/DRFA	818298	Outer Joint	48T	28	29	57	124.5	79.5	I
	2011.10-2014.08	MT	L	F	Platform/Chassis Engine DRFE/DRFD/DRFC/DRFB/DRFA	218472	Drive Shaft	48T	28	41	57	124.5	761	
	2011.10-2014.08	MT	L	F	Platform/Chassis Engine DRFE/DRFD/DRFC/DRFB/DRFA	218334	Drive Shaft		31	41	57.7	121	752	
	2011.10-2014.08	MT	R	F	Platform/Chassis Engine DRFE/DRFD/DRFC/DRFB/DRFA	218335	Drive Shaft		31	41	57.7	121	1092	
2.2 TDCi (81 kW)	2006.04-2014.08	-	R	F	Platform/Chassis Engine QVFA	618120	Inner Joint		36	28	40	330	120	
	2006.04-2014.08	5AT	-	F	Platform/Chassis Engine QVFA	899270	Outer Joint	48T	28	28	59	128	61.5	M
	2006.04-2014.08	5AT	L	F	Platform/Chassis Engine QVFA	618173	Inner Joint		36	28	40	77	111.5	
	2006.04-2014.08	-	-	F	Platform/Chassis Engine QVFA	899284	Outer Joint	48T	28	29	60	126.5	72	M
	2006.04-2014.08	5AT	L	F	Platform/Chassis Engine QVFA	299179	Drive Shaft	48T	28	36	59	128	796	
	2006.04-2014.08	5AT	-	F	Platform/Chassis Engine QVFA	899349	Outer Joint	48T	28	36	57	120.5	72	I
	2006.04-2014.08	-	L	F	Platform/Chassis Engine QVFA	218455	Drive Shaft	48T	28	36	60	126.5	797	
	2006.04-2014.08	-	R	F	Platform/Chassis Engine QVFA	299194	Drive Shaft	48T	28	36	59	128	1057	
2.2 TDCi (85 kW)	2008.10-2014.08	6MT	L	F	Platform/Chassis Engine SRFA/SRFB/SRFC/SRFD/SRFE	218293	Drive Shaft	48T	28	41	65	124	754	
	2008.10-2014.08	6MT	R	F	Platform/Chassis Engine SRFA/SRFB/SRFC/SRFD/SRFE	218292	Drive Shaft	48T	28	41	65	124	1093	
	2008.10-2014.08	-	-	F	Platform/Chassis Engine SRFA/SRFB/SRFC/SRFD/SRFE	899284	Outer Joint	48T	28	29	60	126.5	72	M
	2008.10-2014.08	MT	L	F	Platform/Chassis Engine SRFA/SRFB/SRFC/SRFD/SRFE	218472	Drive Shaft	48T	28	41	57	124.5	761	
	2008.10-2014.08	MT	L	F	Platform/Chassis Engine SRFA/SRFB/SRFC/SRFD/SRFE	218334	Drive Shaft		31	41	57.7	121	752	
	2008.10-2014.08	MT	R	F	Platform/Chassis Engine SRFA/SRFB/SRFC/SRFD/SRFE	218335	Drive Shaft		31	41	57.7	121	1092	
2.2 TDCi (92 kW)	2011.10-2014.08	MT	L/R	F	Platform/Chassis Engine CYFA/CYFB/CYFC/CYFD	818298	Outer Joint	48T	28	29	57	124.5	79.5	I
	2011.10-2014.08	-	L	F	Platform/Chassis Engine CYFA/CYFB/CYFC/CYFD	218472	Drive Shaft	48T	28	41	57	124.5	761	
	2011.10-2014.08	MT	L	F	Platform/Chassis Engine CYFA/CYFB/CYFC/CYFD	218334	Drive Shaft		31	41	57.7	121	752	
	2011.10-2014.08	MT	R	F	Platform/Chassis Engine CYFA/CYFB/CYFC/CYFD	218335	Drive Shaft		31	41	57.7	121	1092	
2.2 TDCi (96 kW)	2006.04-2014.08	MT	R	F	Platform/Chassis Engine QWFA	618120	Inner Joint		36	28	40	330	120	
	2006.04-2014.08	5AT	-	F	Platform/Chassis Engine QWFA	899270	Outer Joint	48T	28	28	59	128	61.5	M
	2006.04-2014.08	5AT	L	F	Platform/Chassis Engine QWFA	618173	Inner Joint		36	28	40	77	111.5	
	2006.04-2014.08	-	-	F	Platform/Chassis Engine QWFA	899284	Outer Joint	48T	28	29	60	126.5	72	M
	2006.04-2014.08	5AT	L	F	Platform/Chassis Engine QWFA	299179	Drive Shaft	48T	28	36	59	128	796	
	2006.04-2014.08	5AT	-	F	Platform/Chassis Engine QWFA	899349	Outer Joint	48T	28	36	57	120.5	72	I
	2006.04-2014.08	MT	L	F	Platform/Chassis Engine QWFA	218455	Drive Shaft	48T	28	36	60	126.5	797	
	2006.04-2014.08	MT	R	F	Platform/Chassis Engine QWFA	299194	Drive Shaft	48T	28	36	59	128	1057	
2.2 TDCi RWD (74 kW)	2011.10-2014.08	MT	L/R	F	Platform/Chassis Engine DRRA/DRRB/DRRC	818298	Outer Joint	48T	28	29	57	124.5	79.5	I
2.2 TDCi RWD (92 kW)	2011.10-2014.08	MT	L/R	F	Platform/Chassis Engine CYRB/CYRA	818298	Outer Joint	48T	28	29	57	124.5	79.5	I
2.3 16V (107 kW)	2001.04-2006.05	-	-	F	Platform/Chassis Engine E5FA/E5FC	818005	Outer Joint	48T	28	26	57	120.5	64	M
2.4 DI (55 kW)	2000.01-2006.05	-	-	F	Platform/Chassis Engine F4FA	818005	Outer Joint	48T	28	26	57	120.5	64	M
2.4 DI (66 kW)	2000.01-2006.05	-	-	F	Platform/Chassis Engine D2FB/D2FE/D2FA	818005	Outer Joint	48T	28	26	57	120.5	64	M
2.4 DI (88 kW)	2000.01-2006.05	-	-	F	Platform/Chassis Engine D4FA	818005	Outer Joint	48T	28	26	57	120.5	64	M
2.4 TDCi (101 kW)	2004.03-2006.05	6MT	L	F	Platform/Chassis Engine H9FA	218293	Drive Shaft	48T	28	41	65	124	754	
	2004.03-2006.05	6MT	R	F	Platform/Chassis Engine H9FA	218292	Drive Shaft	48T	28	41	65	124	1093	
	2004.03-2006.05	-	-	F	Platform/Chassis Engine H9FA	818005	Outer Joint	48T	28	26	57	120.5	64	M
2.4 TDE (85 kW)	2004.03-2006.05	-	-	F	Platform/Chassis Engine FXFA	818005	Outer Joint	48T	28	26	57	120.5	64	M
	2004.03-2006.05	-	-	-	Platform/Chassis Engine FXFA	899270	Outer Joint	48T	28	28	59	128	61.5	M
	2004.03-2006.05	MT	-	-	Platform/Chassis Engine FXFA	899349	Outer Joint	48T	28	36	57	120.5	72	I
2.4 TDE (92 kW)	2001.07-2006.05	-	-	F	Platform/Chassis Engine DOFA	818005	Outer Joint	48T	28	26	57	120.5	64	M
TRANSIT (FM_ _ FN_ _)														
2.0 Di (74 kW)	2000.08-2006.05	-	R	F	Platform/Chassis Engine ABFA	618181	Inner Joint		36	27	40	330	120	
TRANSIT CONNECT (P65_ P70_ P80_)														
1.8 16V (85 kW)	2002.06-2013.12	MT	L	F	Box Engine EYPA/EYPC/EYPD	218263	Drive Shaft		25	26	53.5	94.5	628	
	2002.06-2013.12	MT	R	F	Box Engine EYPA/EYPC/EYPD	218264	Drive Shaft		25	26	53.5	94.5	962	
	2002.06-2013.12	MT	L	F	Box Engine EYPA/EYPC/EYPD	218041	Drive Shaft		25	26	53.3	94.5	632	
	2002.06-2013.12	-	R	F	Box Engine EYPA/EYPC/EYPD	299042	Drive Shaft		25	26	53.3	94.5	963	
	2002.06-2013.12	-	L/R	F	Box Engine EYPA/EYPC/EYPD	818067	Outer Joint		25	26	53.3	94.5	64.5	M
	2002.06-2013.12	-	R	F	Box Engine EYPA/EYPC/EYPD	618058	Inner Joint		26	26	40	389	99.5	
1.8 16V LPG (85 kW)	2002.06-2013.12	-	L	F	Box Engine EYPC	218263	Drive Shaft		25	26	53.5	94.5	628	
	2002.06-2013.12	-	R	F	Box Engine EYPC	218264	Drive Shaft		25	26	53.5	94.5	962	
	2002.06-2013.12	-	L	F	Box Engine EYPC	218041	Drive Shaft		25	26	53.3	94.5	632	
	2002.06-2013.12	-	R	F	Box Engine EYPC	299042	Drive Shaft		25	26	53.3	94.5	963	





YEAR	TRANSM	L/R	F/R	REMARKS	GSP Ref.	PRODUCT	ABS	Technical Specifications						
								A	B	C	H	L	P	
FORD														
TRANSIT CONNECT (P65_ P70_ P80_)														
1.8 16V LPG (85 kW)	2002.06-2013.12	-	L/R	F	Box Engine EYPC	818067	Outer Joint	25	26	53.3	94.5	64.5	M	
	2002.06-2013.12	-	R	F	Box Engine EYPC	818207	Outer Joint	25	24	53.5	94.5	62	M	
	2002.06-2013.12	-	R	F	Box Engine EYPC	618058	Inner Joint	26	26	40	389	99.5		
1.8 Di (55 kW)	2002.06-2013.12	MT	L	F	Box Engine BHPA/P7PA/P7PB/R2PA	218263	Drive Shaft	25	26	53.5	94.5	628		
	2002.06-2013.12	MT	R	F	Box Engine BHPA/P7PA/P7PB/R2PA	218264	Drive Shaft	25	26	53.5	94.5	962		
	2002.06-2013.12	MT	R	F	Box Engine BHPA/P7PA/P7PB/R2PA	299042	Drive Shaft	25	26	53.3	94.5	963		
	2002.06-2013.12	MT	R	F	Box Engine BHPA/P7PA/P7PB/R2PA	618102	Inner Joint	26	24	40	390	97		
	2002.06-2013.12	-	L/R	F	Box Engine BHPA/P7PA/P7PB/R2PA	818067	Outer Joint	25	26	53.3	94.5	64.5	M	
	2002.06-2013.12	-	L/R	F	Box Engine BHPA/P7PA/P7PB/R2PA	818207	Outer Joint	25	24	53.5	94.5	62	M	
	2002.06-2013.12	MT	R	F	Box Engine BHPA/P7PA/P7PB/R2PA	618058	Inner Joint	26	26	40	389	99.5		
1.8 TDCi (66 kW)	2002.06-2013.12	MT	L	F	Box Engine RWPF/RWPE/R3PA/P9PD/P9PC/P9PB/P9PA/HCPA/HCPB	218263	Drive Shaft	25	26	53.5	94.5	628		
	2002.06-2013.12	MT	R	F	Box Engine RWPF/RWPE/R3PA/P9PD/P9PC/P9PB/P9PA/HCPA/HCPB	218264	Drive Shaft	25	26	53.5	94.5	962		
	2002.06-2013.12	MT	L	F	Box Engine RWPF/RWPE/R3PA/P9PD/P9PC/P9PB/P9PA/HCPA/HCPB	218041	Drive Shaft	25	26	53.3	94.5	632		
	2002.06-2013.12	MT	R	F	Box Engine RWPF/RWPE/R3PA/P9PD/P9PC/P9PB/P9PA/HCPA/HCPB	299042	Drive Shaft	25	26	53.3	94.5	963		
	2002.06-2013.12	-	L/R	F	Box Engine RWPF/RWPE/R3PA/P9PD/P9PC/P9PB/P9PA/HCPA/HCPB	818067	Outer Joint	25	26	53.3	94.5	64.5	M	
	2002.06-2013.12	MT	R	F	Box Engine RWPF/RWPE/R3PA/P9PD/P9PC/P9PB/P9PA/HCPA/HCPB	618058	Inner Joint	26	26	40	389	99.5		
1.8 TDCi (81 kW)	2006.08-2013.12	MT	L	F	Box Engine RWPA/RWPC/RWPD	218263	Drive Shaft	25	26	53.5	94.5	628		
	2006.08-2013.12	MT	R	F	Box Engine RWPA/RWPC/RWPD	218264	Drive Shaft	25	26	53.5	94.5	962		
	2006.08-2013.12	-	L	F	Box Engine RWPA/RWPC/RWPD	218041	Drive Shaft	25	26	53.3	94.5	632		
	2006.08-2013.12	MT	R	F	Box Engine RWPA/RWPC/RWPD	299042	Drive Shaft	25	26	53.3	94.5	963		
	2006.08-2013.12	-	L/R	F	Box Engine RWPA/RWPC/RWPD	818067	Outer Joint	25	26	53.3	94.5	64.5	M	
	2006.08-2013.12	MT	R	F	Box Engine RWPA/RWPC/RWPD	618058	Inner Joint	26	26	40	389	99.5		
TRANSIT CONNECT I														
1.8 Di (55 kW)	2002.06-	-	-	-	LCV	818102	Outer Joint	25	24	53.5	94.5	62	M	
1.8 TDCi (55 kW)	2003.03-2009.04	-	-	-	LCV	818102	Outer Joint	25	24	53.5	94.5	62	M	
1.8 TDCi (66 kW)	2003.03-2009.04	-	-	-	LCV	818102	Outer Joint	25	24	53.5	94.5	62	M	
1.8 TDCi (81 kW)	2003.03-2009.04	-	-	-	LCV	818102	Outer Joint	25	24	53.5	94.5	62	M	
TRANSIT CONNECT II														
1.8 TDCi (55 kW)	2009.04-2010.07	-	-	-	LCV	818102	Outer Joint	25	24	53.5	94.5	62	M	
TRANSIT CUSTOM														
2.0 TDCi (125 kW)	2015.12-	-	MT	L/R	F	Box Engine YNF6/YNFS	818286	Outer Joint	31	28	57.7	121	68	I
	2015.12-	-	MT	L/R	F	Bus Engine YNFS/YNF6	818286	Outer Joint	31	28	57.7	121	68	I
	2015.12-	-	MT	L	F	Box Engine YNF6/YNFS	218334	Drive Shaft	31	41	57.7	121	752	
	2015.12-	-	MT	L	F	Bus Engine YNFS/YNF6	218334	Drive Shaft	31	41	57.7	121	752	
	2015.12-	-	MT	R	F	Box Engine YNF6/YNFS	218335	Drive Shaft	31	41	57.7	121	1092	
	2015.12-	-	MT	R	F	Bus Engine YNFS/YNF6	218335	Drive Shaft	31	41	57.7	121	1092	
2.0 TDCi (77 kW)	2015.12-	-	MT	L/R	F	Box Engine YLFS/YLF6	818286	Outer Joint	31	28	57.7	121	68	I
	2015.12-	-	MT	L/R	F	Bus Engine YLFS/YLF6	818286	Outer Joint	31	28	57.7	121	68	I
	2015.12-	-	MT	L	F	Box Engine YLFS/YLF6	218334	Drive Shaft	31	41	57.7	121	752	
	2015.12-	-	MT	L	F	Bus Engine YLFS/YLF6	218334	Drive Shaft	31	41	57.7	121	752	
	2015.12-	-	MT	R	F	Box Engine YLFS/YLF6	218335	Drive Shaft	31	41	57.7	121	1092	
	2015.12-	-	MT	R	F	Bus Engine YLFS/YLF6	218335	Drive Shaft	31	41	57.7	121	1092	
2.0 TDCi (96 kW)	2015.12-	-	MT	L/R	F	Box Engine YMFS/YMF6	818286	Outer Joint	31	28	57.7	121	68	I
	2015.12-	-	MT	L/R	F	Bus Engine YMFS/YMF6	818286	Outer Joint	31	28	57.7	121	68	I
	2015.12-	-	MT	L	F	Box Engine YMFS/YMF6	218334	Drive Shaft	31	41	57.7	121	752	
	2015.12-	-	MT	L	F	Bus Engine YMFS/YMF6	218334	Drive Shaft	31	41	57.7	121	752	
	2015.12-	-	MT	R	F	Box Engine YMFS/YMF6	218335	Drive Shaft	31	41	57.7	121	1092	
	2015.12-	-	MT	R	F	Bus Engine YMFS/YMF6	218335	Drive Shaft	31	41	57.7	121	1092	
2.2 TDCi (114 kW)	2012.04-	-	MT	L/R	F	Bus Engine CVFF	818286	Outer Joint	31	28	57.7	121	68	I
	2012.04-	-	MT	L/R	F	Box Engine CVFF	818286	Outer Joint	31	28	57.7	121	68	I
	2012.04-	-	MT	L	F	Bus Engine CVFF	218334	Drive Shaft	31	41	57.7	121	752	
	2012.04-	-	MT	L	F	Box Engine CVFF	218334	Drive Shaft	31	41	57.7	121	752	
	2012.04-	-	MT	R	F	Bus Engine CVFF	218413	Drive Shaft	31	41	57.7	121	753	
	2012.04-	-	MT	R	F	Box Engine CVFF	218413	Drive Shaft	31	41	57.7	121	753	
	2012.04-	-	MT	R	F	Bus Engine CVFF	218335	Drive Shaft	31	41	57.7	121	1092	
	2012.04-	-	MT	R	F	Box Engine CVFF	218335	Drive Shaft	31	41	57.7	121	1092	
2.2 TDCi (74 kW)	2012.04-	-	MT	L/R	F	Bus Engine DRFG/DRFF/DRF4	818286	Outer Joint	31	28	57.7	121	68	I
	2012.04-	-	MT	L/R	F	Box Engine DRFG/DRFF/DRF4	818286	Outer Joint	31	28	57.7	121	68	I
	2012.04-	-	MT	L	F	Bus Engine DRFG/DRFF/DRF4	218334	Drive Shaft	31	41	57.7	121	752	
	2012.04-	-	MT	L	F	Box Engine DRFG/DRFF/DRF4	218334	Drive Shaft	31	41	57.7	121	752	
	2012.04-	-	MT	R	F	Bus Engine DRFG/DRFF/DRF4	218413	Drive Shaft	31	41	57.7	121	753	
	2012.04-	-	MT	R	F	Box Engine DRFG/DRFF/DRF4	218413	Drive Shaft	31	41	57.7	121	753	
	2012.04-	-	MT	R	F	Bus Engine DRFG/DRFF/DRF4	218335	Drive Shaft	31	41	57.7	121	1092	
	2012.04-	-	MT	R	F	Box Engine DRFG/DRFF/DRF4	218335	Drive Shaft	31	41	57.7	121	1092	
2.2 TDCi (92 kW)	2012.04-	-	MT	L/R	F	Bus Engine CYF4/CYFF	818286	Outer Joint	31	28	57.7	121	68	I
	2012.04-	-	MT	L/R	F	Box Engine CYF4/CYFF	818286	Outer Joint	31	28	57.7	121	68	I





YEAR	TRANSM	L/R	F/R	REMARKS	GSP Ref.	PRODUCT	ABS	Technical Specifications						
								A	B	C	H	L	P	
FORD														
TRANSIT CUSTOM														
2.2 TDCi (92 kW)	2012.04-	-	MT	L F	Bus Engine CYF4/CYFF	218334	Drive Shaft		31	41	57.7	121	752	
	2012.04-	-	MT	L F	Box Engine CYF4/CYFF	218334	Drive Shaft		31	41	57.7	121	752	
	2012.04-	-	MT	R F	Bus Engine CYF4/CYFF	218413	Drive Shaft		31	41	57.7	121	753	
	2012.04-	-	MT	R F	Box Engine CYF4/CYFF	218413	Drive Shaft		31	41	57.7	121	753	
	2012.04-	-	MT	R F	Bus Engine CYF4/CYFF	218335	Drive Shaft		31	41	57.7	121	1092	
	2012.04-	-	MT	R F	Box Engine CYF4/CYFF	218335	Drive Shaft		31	41	57.7	121	1092	
TRANSIT TOURNEO														
2.2 TDCi (103 kW)	2007.10-	2014.08	6MT	L F	Bus Engine UHFB/UHFA/PGFA/PGFB	218293	Drive Shaft	48T	28	41	65	124	754	
	2007.10-	2014.08	6MT	R F	Bus Engine UHFB/UHFA/PGFA/PGFB	218292	Drive Shaft	48T	28	41	65	124	1093	
	2007.10-	2014.08	MT	L F	Bus Engine UHFB/UHFA/PGFA/PGFB	218472	Drive Shaft	48T	28	41	57	124.5	761	
	2007.10-	2014.08	MT	L F	Bus Engine UHFB/UHFA/PGFA/PGFB	218334	Drive Shaft		31	41	57.7	121	752	
	2007.10-	2014.08	MT	R F	Bus Engine UHFB/UHFA/PGFA/PGFB	218335	Drive Shaft		31	41	57.7	121	1092	
2.2 TDCi (81 kW)	2006.07-	2014.08	-	R F	Bus Engine QVFA	618120	Inner Joint		36	28	40	330	120	
	2006.07-	2014.08	5AT	- F	Bus Engine QVFA	899270	Outer Joint	48T	28	28	59	128	61.5	M
	2006.07-	2014.08	5AT	L F	Bus Engine QVFA	618173	Inner Joint		36	28	40	77	111.5	
	2006.07-	2014.08	5AT	L F	Bus Engine QVFA	299179	Drive Shaft	48T	28	36	59	128	796	
	2006.07-	2014.08	5AT	- F	Bus Engine QVFA	899349	Outer Joint	48T	28	36	57	120.5	72	I
	2006.07-	2014.08	-	L F	Bus Engine QVFA	218455	Drive Shaft	48T	28	36	60	126.5	797	
	2006.07-	2014.08	-	R F	Bus Engine QVFA	299194	Drive Shaft	48T	28	36	59	128	1057	
2.2 TDCi (85 kW)	2008.10-	2014.08	6MT	L F	Bus Engine SRFA/SRFB/SRFC/SRFD/SRFE	218293	Drive Shaft	48T	28	41	65	124	754	
	2008.10-	2014.08	6MT	R F	Bus Engine SRFA/SRFB/SRFC/SRFD/SRFE	218292	Drive Shaft	48T	28	41	65	124	1093	
	2008.10-	2014.08	MT	L F	Bus Engine SRFA/SRFB/SRFC/SRFD/SRFE	218472	Drive Shaft	48T	28	41	57	124.5	761	
	2008.10-	2014.08	MT	L F	Bus Engine SRFA/SRFB/SRFC/SRFD/SRFE	218334	Drive Shaft		31	41	57.7	121	752	
	2008.10-	2014.08	MT	R F	Bus Engine SRFA/SRFB/SRFC/SRFD/SRFE	218335	Drive Shaft		31	41	57.7	121	1092	
2.2 TDCi (96 kW)	2006.07-	2014.08	MT	R F	Bus Engine QWFA	618120	Inner Joint		36	28	40	330	120	
	2006.07-	2014.08	5AT	- F	Bus Engine QWFA	899270	Outer Joint	48T	28	28	59	128	61.5	M
	2006.07-	2014.08	5AT	L F	Bus Engine QWFA	618173	Inner Joint		36	28	40	77	111.5	
	2006.07-	2014.08	5AT	L F	Bus Engine QWFA	299179	Drive Shaft	48T	28	36	59	128	796	
	2006.07-	2014.08	5AT	- F	Bus Engine QWFA	899349	Outer Joint	48T	28	36	57	120.5	72	I
	2006.07-	2014.08	MT	L F	Bus Engine QWFA	218455	Drive Shaft	48T	28	36	60	126.5	797	
	2006.07-	2014.08	MT	R F	Bus Engine QWFA	299194	Drive Shaft	48T	28	36	59	128	1057	
TRANSIT V347														
2.2 TDCi	2006-	-	-	R F	-	299244	Drive Shaft	48T	28	36	59	128	1060	
TRANSIT VAN (FA_ _)														
2.0 Di (74 kW)	2000.08-	2006.05	-	R F	Box Engine ABFA	618181	Inner Joint		36	27	40	330	120	
TRANSIT VII (FA, FD, FM)														
2.4 Di (55 kW)	2000.01-	-	-	-	LCV	818220	Outer Joint		28	36	57	120.5	72	I
2.4 Di (66 kW)	2000.01-	-	-	-	LCV	818220	Outer Joint		28	36	57	120.5	72	I
2.4 Di (88 kW)	2000.01-	-	-	-	LCV	818220	Outer Joint		28	36	57	120.5	72	I
TRUCK EXPEDITION														
-	1995-	2001	-	R -	-	218094	Drive Shaft		27	27	59.7	112	527.4	
	1995-	2001	-	R -	-	618038	Inner Joint		27	34	44	57.8	65.5	
TRUCK EXPLORER														
-	1995-	2000	-	R -	-	218094	Drive Shaft		27	27	59.7	112	527.4	
	1995-	2000	-	R -	-	618038	Inner Joint		27	34	44	57.8	65.5	
VERONA														
1.8	1990.01-	1993.09	MT	- -	-	818044	Outer Joint		23	30	55	91.5	54.5	I
	1993.10-	1997.12	MT	- -	-	818100	Outer Joint		25	30	56.5	89	56.5	I
	1993.10-	1997.12	MT	- -	-	618018	Inner Joint			33		32		
2.0	1993.10-	1997.12	MT	- -	-	818100	Outer Joint		25	30	56.5	89	56.5	I
	1993.10-	1997.12	MT	- -	-	618018	Inner Joint			33		32		
VERSAILLES														
1.8	1991.01-	1992.11	MT	- -	-	861024	Outer Joint	43T	22	30	64	78	51	I
	1992.12-	1995.12	MT/AT	- -	-	899134	Outer Joint	43T	22	30	51	78	61	I
	1992.12-	1995.12	MT/AT	- -	-	861028	Outer Joint		22	30	51	78	61	I
	1992.12-	1995.12	MT/AT	- -	-	618018	Inner Joint			33		32		
	1996.01-	1996.12	MT/AT	- -	-	899134	Outer Joint	43T	22	30	51	78	61	I
	1996.01-	1996.12	MT/AT	- -	-	861028	Outer Joint		22	30	51	78	61	I
2.0	1991.01-	1992.11	MT	- -	-	861024	Outer Joint	43T	22	30	64	78	51	I
	1992.12-	1995.12	MT/AT	- -	-	899134	Outer Joint	43T	22	30	51	78	61	I
	1992.12-	1995.12	MT/AT	- -	-	861028	Outer Joint		22	30	51	78	61	I
	1992.12-	1995.12	MT/AT	- -	-	618018	Inner Joint			33		32		
	1996.01-	1996.12	MT/AT	- -	-	899134	Outer Joint	43T	22	30	51	78	61	I
	1996.01-	1996.12	MT/AT	- -	-	861028	Outer Joint		22	30	51	78	61	I
VILLAGER														
-	1993-	2000	AT	- -	-	641109	Inner Joint		29	34	39	65.5	120.7	

	 YEAR	TRANSM	L/R	F/R	REMARKS	GSP Ref.	 PRODUCT	 ABS	Technical Specifications						
									A	B	C	H	L	P	
FORD															
WINDSTAR															
3.8	1996-	2003	AT	-	-	618056	Inner Joint		35	32	42	50.5	78		
FORD (CHANGAN)															
FIESTA															
1.5 (76 kW)	2009.02-	2013.12	AT	-	-	Hatchback Engine ZY-VE	218239	Drive Shaft		25	28	53.3	89	562	
	2009.02-	2013.12	AT	-	-	Saloon Engine ZY	218239	Drive Shaft		25	28	53.3	89	562	
1.5 (81 kW)	2013.03-	-	AT	-	-	Hatchback Engine CT	218239	Drive Shaft		25	28	53.3	89	562	
FIESTA (GAF)															
1.6 (68 kW)	2003.03-	2006.06	AT	R	-	Saloon Engine JL482QA	218182	Drive Shaft		25	22	53.3	89	897	
	2003.03-	2006.06	MT	L	-	Saloon Engine JL482QA	218183	Drive Shaft		25	23	53	89	595	
	2003.03-	2006.06	MT	R	-	Saloon Engine JL482QA	218246	Drive Shaft		25	23	53	89	898	
	2003.03-	2006.06	AT	L	-	Saloon Engine JL482QA	299192	Drive Shaft		25	22	53.3	89	607	
MONDEO															
2.0 (149 kW)	2013.08-	-	AT	L	F	Saloon Engine CAF488Q0	218225	Drive Shaft		27	35	56.1	91.5	675	
	2013.08-	-	AT	R	F	Saloon Engine CAF488Q0	218226	Drive Shaft		27	35	56.1	91.5	571.5	
2.5 (127 kW)	2003.05-	2007.12	AT	L	-	Saloon Engine MP25LCBD	218233	Drive Shaft		27	30	56.5	92	614	
	2003.05-	2007.12	AT	R	-	Saloon Engine MP25LCBD	218234	Drive Shaft		27	35	56.5	92	579	
FORD USA															
PROBE II (ECP)															
2.0 16V (85 kW)	1993.10-	1998.03	MT	L/R	F	Coupe Engine FS	818035	Outer Joint		28	23	56	90	59	I
	1993.10-	1998.03	-	R	F	Coupe Engine FS	634033	Inner Joint		28	23	43	46	77	
	1993.10-	1998.03	-	-	-	Coupe Engine FS	834082	Outer Joint	44T	28	26	56	94	63	M
	1993.10-	1998.03	MT	L/R	F	Coupe Engine FS	834080	Outer Joint	44T	28	23	56	90	59	M
	1993.10-	1998.03	AT	L/R	F	Coupe Engine FS	834117	Outer Joint	44T	28	32	56	89	59	M
2.5 V6 24V (119 kW)	1993.10-	1998.03	MT	L	F	Coupe Engine KL	250269	Drive Shaft		27	37.1	56.5	91.5	595	
	1993.10-	1998.03	MT	L	F	Coupe Engine KL	250269	Drive Shaft		27	37.1	56.5	91.5	595	
	1993.10-	1998.03	-	R	F	Coupe Engine KL	634033	Inner Joint		28	23	43	46	77	
	1993.10-	1998.03	-	-	-	Coupe Engine KL	834071	Outer Joint	44T	28	26	56	89	65	M
	1993.10-	1998.03	MT	-	-	Coupe Engine KL	834082	Outer Joint	44T	28	26	56	94	63	M
	1993.10-	1998.03	AT	L/R	F	Coupe Engine KL	834117	Outer Joint	44T	28	32	56	89	59	M
	1993.10-	1998.03	-	-	-	Coupe Engine KL	834071	Outer Joint	44T	28	26	56	89	65	M
2.5 V6 24V (120 kW)	1994.12-	1998.03	-	R	F	Coupe Engine KL	634033	Inner Joint		28	23	43	46	77	
	1994.12-	1998.03	MT	-	-	Coupe Engine KL	834082	Outer Joint	44T	28	26	56	94	63	M
GAC															
GA5															
2.0 (108 kW)	2012.03-	-	AT	L	-	Saloon Engine 4B20K2	275047	Drive Shaft		27	27	58.5	85	633	
	2012.03-	-	AT	R	-	Saloon Engine 4B20K2	275048	Drive Shaft		27	27	58.5	85	967	
	2012.03-	-	MT	L	-	Saloon Engine 4B20K2	275049	Drive Shaft		27	24	58.5	85	634	
	2012.03-	-	MT	R	-	Saloon Engine 4B20K2	275050	Drive Shaft		27	24	58.5	85	964	
GEELY															
HAOQING															
1.0 (37 kW)	1998.05-	2001.08	-	R	-	Hatchback Engine TJ376Q/JL376QF	214047	Drive Shaft		24	23	54	92	838	
	1998.05-	2001.08	-	L	-	Hatchback Engine TJ376Q/JL376QF	214048	Drive Shaft		24	23	54	92	638	
1.0 (38 kW)	2000.01-	2003.04	-	R	-	Hatchback Engine JL376QE	214047	Drive Shaft		24	23	54	92	838	
	2000.01-	2003.04	-	L	-	Hatchback Engine JL376QE	214048	Drive Shaft		24	23	54	92	638	
1.0 (40 kW)	2000.01-	2003.04	-	R	-	Hatchback Engine JL378QE	214047	Drive Shaft		24	23	54	92	838	
	2000.01-	2003.04	-	L	-	Hatchback Engine JL378QE	214048	Drive Shaft		24	23	54	92	638	
HAOQING SRV															
1.3 (63 kW)	2005.07-	2007.12	-	R	-	Estate Engine MR479Q	214049	Drive Shaft		24	25	54	91.5	914	
	2005.07-	2007.12	-	L	-	Estate Engine MR479Q	214050	Drive Shaft		24	25	54	91.5	561	
ULIO															
1.0 (38 kW)	2002.04-	2008.12	MT	L	-	Saloon Engine JL376QE	265003	Drive Shaft		24	25	54	91.5	564	
	2002.04-	2008.12	MT	R	-	Saloon Engine JL376QE	265004	Drive Shaft		24	25	54	91.5	917	
1.0 (40 kW)	2005.01-	2009.12	MT	L	-	Saloon Engine JL378QE	265003	Drive Shaft		24	25	54	91.5	564	
	2005.01-	2009.12	MT	R	-	Saloon Engine JL378QE	265004	Drive Shaft		24	25	54	91.5	917	
GEO															
AVALANCHE															
-	2002-	2005	-	-	-	4WD SUV/Truck/VAN	839029	Outer Joint		33	41	80	112	88.5	O
BLAZER/K1500/K2500/K3500															
-	1992-	1994	-	-	-	4WD Suv/Truck/Van	821022	Outer Joint	55T	33	29	80	112	88.5	O
	1998-	2000	-	-	-	4WD SUV/Truck/VAN	839029	Outer Joint		33	41	80	112	88.5	O
METRO															
-	1995-	2000	-	-	-	-	857043	Outer Joint	42T	23	19	46	92	56.5	I
	1995-	2000	-	-	-	Housing Stamped 75 LAC	808018	Outer Joint		23	19	46	92	56.5	I

GEO	YEAR	TRANSM	L/R	F/R	REMARKS	GSP Ref.	PRODUCT	ABS	Technical Specifications								
									A	B	C	H	L	P			
GEO																	
PRIZM																	
-	1993-2000	-	-	-		859163	Outer Joint	48T	26	29	56	99.5	62.5	O			
S10/S10 BLAZER																	
-	1997-2005	-	-	-	SUV/Truck/VAN 4WD	808011	Outer Joint		27	34	55.8	127.5	64	O			
-	1997-2005	-	-	-	4WD	608009	Inner Joint		26	34	40	55	85				
SILVERADO PICK UP																	
-	1999-2005	-	-	-	SUV/Truck/VAN	839029	Outer Joint		33	41	80	112	88.5	O			
STORM																	
1.6 i (67 kW)	1991.04-1993.12	-	L	F	Hatchback	826001	Outer Joint		22	22	50	91	54	I			
	1991.04-1993.12	-	-	-	F Coupe	826001	Outer Joint		22	22	50	91	54	I			
1.6 i (71 kW)	1989.01-1991.03	-	L	F	Coupe	826001	Outer Joint		22	22	50	91	54	I			
	1989.01-1991.03	-	L	F	Hatchback	826001	Outer Joint		22	22	50	91	54	I			
SUBURBAN/TAHOE																	
-	1992-1994	-	-	-	Suv/Truck/Van	821022	Outer Joint	55T	33	29	80	112	88.5	O			
-	1998-2005	-	-	-	SUV/Truck/VAN	839029	Outer Joint		33	41	80	112	88.5	O			
GM																	
-																	
4.5	1992-1996	-	-	-	C/H/E Body	806003	Outer Joint		33	32	50	105	62.5	O			
	1992-	-	-	-	E Body	806003	Outer Joint		33	32	50	105	62.5	O			
	1994-1996	-	-	-	A Body	806003	Outer Joint		33	32	50	105	62.5	O			
ASTRA																	
1.8 8V	1999.01-2006.12	MT	-	-	-	844032	Outer Joint		33	25	52	103.5	61	O			
1.8/2.0/2.2Y/2.4 LTS	2000-2003	MT	L/R	-	-	844087	Outer Joint		33	25	52	103.5	61	O			
	2000-2003	MT	L/R	-	-	844087	Outer Joint		33	25	52	103.5	61	O			
2.0 16V	1999.01-2006.12	MT	-	-	-	844032	Outer Joint		33	25	52	103.5	61	O			
2.0 8V	1999.01-2006.12	MT	-	-	-	844032	Outer Joint		33	25	52	103.5	61	O			
CAVALIER																	
-	1990-1993	MT	-	-	-	821006	Outer Joint		33	32	47.7	109	66	I			
	1990-1993	MT	-	-	-	621007	Inner Joint		34	25	35	55.5	118				
	1991-1993	AT	-	-	-	821006	Outer Joint		33	32	47.7	109	66	I			
	1991-1998	AT	-	-	-	621006	Inner Joint		34	25	35	58	73				
	1992-1993	MT	-	-	-	621006	Inner Joint		34	25	35	58	73				
	1994-	AT	-	-	-	621007	Inner Joint		34	25	35	55.5	118				
	1994-	-	-	-	-	821017	Outer Joint	48T	33	32	47.7	109	66	I			
	1995-1998	MT	-	-	-	621007	Inner Joint		34	25	35	55.5	118				
	1995-1998	AT	-	-	-	821017	Outer Joint	48T	33	32	47.7	109	66	I			
	1995-1998	MT	-	-	-	821017	Outer Joint	48T	33	32	47.7	109	66	I			
CAVALIER Z-24																	
-	1995-1998	MT	-	-	-	621007	Inner Joint		34	25	35	55.5	118				
	1995-1998	MT	-	-	-	821017	Outer Joint	48T	33	32	47.7	109	66	I			
CAVALIER/CAVALIER Z-24																	
-	1994-	MT	-	-	-	621006	Inner Joint		34	25	35	58	73				
	1994-	MT	-	-	-	821017	Outer Joint	48T	33	32	47.7	109	66	I			
CELTA																	
1.0	2000.06-2006.12	MT	-	-	-	699023	Inner Joint		22	28	34.95	57.5	72.5				
	2000.06-2006.12	MT	-	-	-	821025	Outer Joint		22	28	52	90	54	O			
1.0 VHC	2000.06-2006.12	MT	-	-	-	699023	Inner Joint		22	28	34.95	57.5	72.5				
	2000.06-2006.12	MT	-	-	-	821025	Outer Joint		22	28	52	90	54	O			
1.4	2000.06-2006.12	MT	-	-	-	699023	Inner Joint		22	28	34.95	57.5	72.5				
	2000.06-2006.12	MT	-	-	-	821025	Outer Joint		22	28	52	90	54	O			
CENTURY																	
-	1994-1997	AT	-	-	-	821010	Outer Joint		33	32	50	105	61	I			
CENTURY/CUTLASS																	
-	1990-	AT	-	-	-	821006	Outer Joint		33	32	47.7	109	66	I			
	1990-	MT	-	-	-	821006	Outer Joint		33	32	47.7	109	66	I			
	1990-	AT	-	-	-	621007	Inner Joint		34	25	35	55.5	118				
	1990-	MT	-	-	-	621007	Inner Joint		34	25	35	55.5	118				
	1990-	AT	-	-	-	621006	Inner Joint		34	25	35	58	73				
CENTURY/CUTLASS EUROSPORT																	
-	1991-1993	AT	-	-	-	621007	Inner Joint		34	25	35	55.5	118				
	1991-1997	AT	-	-	-	621006	Inner Joint		34	25	35	58	73				
CENTURY/CUTLASS/CUTLASS EUROSPORT																	
-	1994-1997	AT	-	-	-	621007	Inner Joint		34	25	35	55.5	118				
CHEVY/MONZA																	
-	1996-2003	MT/AT	-	-	-	699027	Inner Joint		22	28	35	57.5	93				
CORSA																	





YEAR	TRANS	L/R	F/R	REMARKS	GSP Ref.	PRODUCT	ABS	Technical Specifications						
								A	B	C	H	L	P	
GM														
CORSA														
-	-	-	L	-	India	244009	Drive Shaft		22	22	52	90	549	
-	-	-	R	-	India	244010	Drive Shaft		22	22	52	90	898	
1.0	1994-	-	MT	-	-	821026	Outer Joint		22	22	52	97.5	55	O
	1994.01-	2003.12	MT	L	-	221040	Drive Shaft		22	22	52.1	97	568	
	1994.01-	2003.12	MT	R	-	244041	Drive Shaft		22	22	52.1	97	917	
	1994.01-	2003.12	MT	-	-	699023	Inner Joint		22	28	34.95	57.5	72.5	
	1994.01-	2003.12	MT	-	-	821025	Outer Joint		22	28	52	90	54	O
	1994.01-	2003.12	MT	-	-	821032	Outer Joint		22	22	52	97	50	O
1.4	1994-	-	MT	-	-	821026	Outer Joint		22	22	52	97.5	55	O
	1994.01-	2003.12	MT	L	-	221040	Drive Shaft		22	22	52.1	97	568	
	1994.01-	2003.12	MT	R	-	244041	Drive Shaft		22	22	52.1	97	917	
	1994.01-	2003.12	MT	-	-	699023	Inner Joint		22	28	34.95	57.5	72.5	
	1994.01-	2003.12	MT	-	-	821025	Outer Joint		22	28	52	90	54	O
	1994.01-	2003.12	MT	-	-	821032	Outer Joint		22	22	52	97	50	O
1.6	1994-	-	MT	-	-	821026	Outer Joint		22	22	52	97.5	55	O
	1994.01-	2003.12	MT	L	-	221040	Drive Shaft		22	22	52.1	97	568	
	1994.01-	2003.12	MT	R	-	244041	Drive Shaft		22	22	52.1	97	917	
	1994.01-	2003.12	MT	-	-	699023	Inner Joint		22	28	34.95	57.5	72.5	
	1994.01-	2003.12	MT	-	-	821025	Outer Joint		22	28	52	90	54	O
	1994.01-	2003.12	MT	-	-	821032	Outer Joint		22	22	52	97	50	O
1.8 8V	2002-	-	-	L/R	-	844066	Outer Joint		22	23	52	97.5	61	M
	2002-	-	-	R	-	244035	Drive Shaft		22	22	52	97.5	929	
	2002-	-	-	L	-	244034	Drive Shaft		22	22	52	97.5	580	
	2002-	-	-	L/R	-	644015	Inner Joint		22	23	35	57.5	82	
CORSA CLASSIC														
1.0 VHC	2004.01-	2006.12	MT	L	-	221040	Drive Shaft		22	22	52.1	97	568	
	2004.01-	2006.12	MT	R	-	244041	Drive Shaft		22	22	52.1	97	917	
	2004.01-	2006.12	MT	-	-	699023	Inner Joint		22	28	34.95	57.5	72.5	
	2004.01-	2006.12	MT	-	-	821025	Outer Joint		22	28	52	90	54	O
1.6	2004.01-	2006.12	MT	L	-	221040	Drive Shaft		22	22	52.1	97	568	
	2004.01-	2006.12	MT	R	-	244041	Drive Shaft		22	22	52.1	97	917	
	2004.01-	2006.12	MT	-	-	699023	Inner Joint		22	28	34.95	57.5	72.5	
	2004.01-	2006.12	MT	-	-	821025	Outer Joint		22	28	52	90	54	O
CORSA NOVO														
1.0	2002.03-	2006.12	MT	-	-	699023	Inner Joint		22	28	34.95	57.5	72.5	
	2002.03-	2006.12	MT	-	-	821025	Outer Joint		22	28	52	90	54	O
1.0 8V VHC	2002-	2007	MT	-	-	821032	Outer Joint		22	22	52	97	50	O
1.0 VHC	2002.03-	2006.12	MT	-	-	699023	Inner Joint		22	28	34.95	57.5	72.5	
	2002.03-	2006.12	MT	-	-	821025	Outer Joint		22	28	52	90	54	O
CORSA PICK UP														
1.6	1994.01-	2006.12	MT	L	-	221040	Drive Shaft		22	22	52.1	97	568	
	1994.01-	2006.12	MT	R	-	244041	Drive Shaft		22	22	52.1	97	917	
	1994.01-	2006.12	MT	-	-	699023	Inner Joint		22	28	34.95	57.5	72.5	
	1994.01-	2006.12	MT	-	-	821025	Outer Joint		22	28	52	90	54	O
1.6 8V	1995.01-	2003.12	MT	-	-	821032	Outer Joint		22	22	52	97	50	O
CORSA SEDAN														
1.0	1994.01-	2003.12	MT	L	-	221040	Drive Shaft		22	22	52.1	97	568	
	1994.01-	2003.12	MT	R	-	244041	Drive Shaft		22	22	52.1	97	917	
	1994.01-	2003.12	MT	-	-	699023	Inner Joint		22	28	34.95	57.5	72.5	
	1994.01-	2003.12	MT	-	-	821025	Outer Joint		22	28	52	90	54	O
	1994.01-	2003.12	MT	-	-	821032	Outer Joint		22	22	52	97	50	O
1.6	1994.01-	2003.12	MT	L	-	221040	Drive Shaft		22	22	52.1	97	568	
	1994.01-	2003.12	MT	R	-	244041	Drive Shaft		22	22	52.1	97	917	
	1994.01-	2003.12	MT	-	-	699023	Inner Joint		22	28	34.95	57.5	72.5	
	1994.01-	2003.12	MT	-	-	821025	Outer Joint		22	28	52	90	54	O
	1994.01-	2003.12	MT	-	-	821032	Outer Joint		22	22	52	97	50	O
CORSA WAGON														
1.0	1994.01-	2003.12	MT	L	-	221040	Drive Shaft		22	22	52.1	97	568	
	1994.01-	2003.12	MT	R	-	244041	Drive Shaft		22	22	52.1	97	917	
	1994.01-	2003.12	MT	-	-	699023	Inner Joint		22	28	34.95	57.5	72.5	
	1994.01-	2003.12	MT	-	-	821025	Outer Joint		22	28	52	90	54	O
	1994.01-	2003.12	MT	-	-	821032	Outer Joint		22	22	52	97	50	O
1.6	1994.01-	2003.12	MT	L	-	221040	Drive Shaft		22	22	52.1	97	568	
	1994.01-	2003.12	MT	R	-	244041	Drive Shaft		22	22	52.1	97	917	
	1994.01-	2003.12	MT	-	-	699023	Inner Joint		22	28	34.95	57.5	72.5	
	1994.01-	2003.12	MT	-	-	821025	Outer Joint		22	28	52	90	54	O





	 YEAR	TRANSM	L/R	F/R	REMARKS	GSP Ref.	 PRODUCT	 ABS	Technical Specifications								
									A	B	C	H	L	P			
GM																	
CORSA WAGON																	
1.6	1994.01-	2003.12	MT	-	-	-	821032	Outer Joint		22	22	52	97	50	O		
CUTLASS																	
-	1994-	1997	AT	-	-	-	821010	Outer Joint		33	32	50	105	61	I		
CUTLASS EUROSPORT																	
-	1991-	1997	MT	-	-	-	621007	Inner Joint		34	25	35	55.5	118			
-	1994-	1997	MT	-	-	-	821010	Outer Joint		33	32	50	105	61	I		
EQUINOX																	
3.4	2001-	2008	MT	-	-	-	808014	Outer Joint		33	24	60	105	63	M		
MERIVA																	
1.8 16V	2002.01-	2006.12	MT	-	-	-	644015	Inner Joint		22	23	35	57.5	82			
-	2002.09-	2006.12	MT	-	-	-	844066	Outer Joint		22	23	52	97.5	61	M		
1.8 8V	2002.01-	2006.12	MT	-	-	-	644015	Inner Joint		22	23	35	57.5	82			
-	2002.01-	2006.12	MT	-	-	-	844066	Outer Joint		22	23	52	97.5	61	M		
OPTRA																	
2.0	2006-	2009	MT	-	-	-	821013	Outer Joint		33	29	52	96.5	59	O		
PICK UP																	
1.6	1994-	-	MT	-	-	-	821026	Outer Joint		22	22	52	97.5	55	O		
PONTIAC MATIZ																	
1.0	2004-	2014	MT	-	-	-	657108	Inner Joint		22	19	35	50	85			
SPACE VAN																	
2.2	1991.01-	1999.12	MT	-	-	-	899076	Outer Joint		25	27	56.3	110.5	62	I		
TORRENT																	
3.4	2001-	2008	MT	-	-	-	808014	Outer Joint		33	24	60	105	63	M		
VECTRA																	
1.8	1994.01-	1996.12	MT	-	-	-	844069	Outer Joint	29T	33	25	52	109	61	O		
2.0	1994.01-	1996.12	MT	-	-	-	844069	Outer Joint	29T	33	25	52	109	61	O		
-	1997.01-	2006.12	MT	-	-	-	821031	Outer Joint		33	25	52	103.5	61	O		
2.2	1997.01-	2006.12	MT	-	-	-	821031	Outer Joint		33	25	52	103.5	61	O		
ZAFIRA																	
1.8/2.0/2.2Y/2.4 LTS	2000-	2003	MT	L/R	-	-	844087	Outer Joint		33	25	52	103.5	61	O		
-	2000-	2003	MT	L/R	-	-	844087	Outer Joint		33	25	52	103.5	61	O		
2.0 16V	2002.01-	2006.12	MT	-	-	-	844032	Outer Joint		33	25	52	103.5	61	O		
2.0 8V	2002.01-	2006.12	MT	-	-	-	844032	Outer Joint		33	25	52	103.5	61	O		
GMC																	
CANYON																	
-	2004-	2009	-	-	F	AWD/PROPELLER SHAFT	608074	Propshaft CV Joint			34		57				
ENVOY																	
-	2002-	2009	-	-	F	4WD/PROPELLER SHAFT	608073	Propshaft CV Joint		17	22	44		119			
ENVOY/ENVOY XL																	
-	1997-	2001	-	-	-	4WD	608009	Inner Joint		26	34	40	55	85			
-	1998-	2005	-	-	-	SUV/Truck/VAN 4WD	808011	Outer Joint		27	34	55.8	127.5	64	O		
-	1998-	2004	-	-	-	-	608008	Inner Joint		26	34	40	92	98			
JIMMY (AWD)																	
-	1995-	1997	-	-	-	-	699117	Inner Joint			22		88.5				
SAFARI VAN (AWD)																	
-	1992-	1998	-	-	-	-	699117	Inner Joint			22		88.5				
JIMMY																	
-	2000-	2005	-	-	F	4WD/PROPELLER SHAFT	608072	Propshaft CV Joint		17	22	44		119			
AWD	1995-	1997	-	-	-	-	699117	Propshaft CV Joint			22		88.5				
-	1995-	1997	-	-	-	-	699117	Inner Joint			22		88.5				
JIMMY (AWD)																	
-	1995-	1997	-	-	-	-	699117	Propshaft CV Joint			22		88.5				
JIMMY/K1500/K2500/K3500																	
-	1988-	1997	-	-	-	-	808009	Outer Joint		33	29	80	112	88.5	O		
-	1992-	1994	-	-	-	4WD SUV/Truck/Van	821022	Outer Joint	55T	33	29	80	112	88.5	O		
-	1998-	2000	-	-	-	4WD SUV/Truck/VAN	839029	Outer Joint		33	41	80	112	88.5	O		
S15/JIMMY/SONOMA/PICK UP																	
All Models	1985.01-	1990.12	-	-	-	-	808005	Outer Joint		27	34	56	109	63	O		
S15/JIMMY/SONOMA/SYCLONE/TYPHOON																	
-	1997-	2005	-	-	-	SUV/Truck/VAN 4WD	808011	Outer Joint		27	34	55.8	127.5	64	O		
-	1997-	2004	-	-	-	-	608008	Inner Joint		26	34	40	92	98			
-	1997-	2004	-	-	-	4WD	608009	Inner Joint		26	34	40	55	85			
SAFARI																	
-	1990-	1996	-	-	-	VAN MBody 4WD	808006	Outer Joint		33	35	77	112.5	73.5	O		
-	1997-	2000	-	-	-	VAN MBody 4WD	808006	Outer Joint		33	35	77	112.5	73.5	O		





	 YEAR	TRANSM	L/R	F/R	REMARKS	GSP Ref.	 PRODUCT	 ABS	Technical Specifications									
									A	B	C	H	L	P				
GMC SAFARI																		
-	1997-2000	-	-	-	VAN MBody 4WD	821019	Outer Joint	55T	33	35	77	112.5	73.5	O				
SAFARI VAN																		
AWD	1992-1998	-	-	-	-	699117	Propshaft CV Joint			22		88.5						
	1992-1998	-	-	-	-	699117	Inner Joint			22		88.5						
SAFARI VAN (AWD)																		
-	1992-1998	-	-	-	-	699117	Propshaft CV Joint			22		88.5						
SIERRA 1500																		
4.3L V6 - Gas	2013-	-	-	-	Denali, Hybrid, SL, SLE, SLT, WT, XFE	207007	Drive Shaft		33		72.8	112.5	583					
4.8L V8 - Flex	2013-	-	-	-	Denali, Hybrid, SL, SLE, SLT, WT, XFE	207007	Drive Shaft		33		72.8	112.5	583					
5.3L V8 - Flex	2013-	-	-	-	Denali, Hybrid, SL, SLE, SLT, WT, XFE	207007	Drive Shaft		33		72.8	112.5	583					
6.0L V8 - Electric/Flex	2013-	-	-	-	Denali, Hybrid, SL, SLE, SLT, WT, XFE	207007	Drive Shaft		33		72.8	112.5	583					
6.2L V8 - Flex	2013-	-	-	-	Denali, Hybrid, SL, SLE, SLT, WT, XFE	207007	Drive Shaft		33		72.8	112.5	583					
SIERRA PICK UP																		
-	2001-2005	-	-	-	4WD SUV/Truck/VAN	839029	Outer Joint		33	41	80	112	88.5	O				
SUBURBAN/YUKON XL																		
-	1988-1997	-	-	-	-	808009	Outer Joint		33	29	80	112	88.5	O				
	1992-1994	-	-	-	4WD Suv/Truck/Van	821022	Outer Joint	55T	33	29	80	112	88.5	O				
	1998-2005	-	-	-	4WD SUV/Truck/VAN	839029	Outer Joint		33	41	80	112	88.5	O				
YUKON																		
5.3L V8 - Flex	2013-	-	-	-	Denali, Denali Hybrid, Hybrid, SLE, SLT	207007	Drive Shaft		33		72.8	112.5	583					
5.3L V8 - Flex, 6.2L V8 - Flex	2014-	-	-	-	Denali, SLE, SLT	207007	Drive Shaft		33		72.8	112.5	583					
6.0L V8 - Electric/Flex	2013-	-	-	-	Denali, Denali Hybrid, Hybrid, SLE, SLT	207007	Drive Shaft		33		72.8	112.5	583					
6.2L V8 - Flex	2013-	-	-	-	Denali, Denali Hybrid, Hybrid, SLE, SLT	207007	Drive Shaft		33		72.8	112.5	583					
YUKON (GMT900)																		
6.2 (301 kW)	2010.09-2014.07	-	-	F	All-wheel Drive Closed Off-Road Vehicle Engine L92	807001	Outer Joint		33	41	80	112	88.5	O				
YUKON XL 1500																		
5.3L V8 - Flex, 6.2L V8 - Flex	2013-	-	-	-	Denali, SLE, SLT	207007	Drive Shaft		33		72.8	112.5	583					
	2014-	-	-	-	Denali, SLE, SLT	207007	Drive Shaft		33		72.8	112.5	583					
YUKON XL 2500																		
6.0L V8 - Flex	2013-	-	-	-	SLE, SLT	207007	Drive Shaft		33		72.8	112.5	583					
GREAT WALL H6																		
1.5	2012-	-	MT	-	-	675027	Inner Joint		37	26	42	75	97.5					
	2012-	-	MT	-	-	675050	Inner Joint		37	26	30.5	385	93.5					
2.0	2011-	-	MT	-	-	675026	Inner Joint		25	24	28.5	383	96					
HOVER H3/HAVAL H3																		
2.0 (90 kW)	2009.05-	-	-	-	Closed Off-Road Vehicle Engine 4G63S4M	226008	Drive Shaft		17	17	53	136.5	608					
2.4 (100 kW)	2010.07-2013.12	-	-	-	Closed Off-Road Vehicle Engine 4G69S4N	226008	Drive Shaft		17	17	53	136.5	608					
	2010.07-2013.12	-	-	-	All-wheel Drive Closed Off-Road Vehicle Engine 4G69S4N	226008	Drive Shaft		17	17	53	136.5	608					
2.5 TCI (80 kW)	2010.01-2013.12	-	-	-	Closed Off-Road Vehicle Engine GW25TCI	226008	Drive Shaft		17	17	53	136.5	608					
	2010.01-2013.12	-	-	-	All-wheel Drive Closed Off-Road Vehicle Engine GW25TCI	226008	Drive Shaft		17	17	53	136.5	608					
HOVER M1																		
1.3 (68 kW)	2009.09-2013.12	-	L	-	Closed Off-Road Vehicle Engine GW4G13	275011	Drive Shaft	48T	24	23	56	87	570					
	2009.09-2013.12	-	R	-	Closed Off-Road Vehicle Engine GW4G13	275012	Drive Shaft	48T	24	23	56	87	843					
	2009.09-2013.12	-	L	-	All-wheel Drive Closed Off-Road Vehicle Engine GW4G13	275011	Drive Shaft	48T	24	23	56	87	570					
	2009.09-2013.12	-	R	-	All-wheel Drive Closed Off-Road Vehicle Engine GW4G13	275012	Drive Shaft	48T	24	23	56	87	843					
PERI																		
1.3 (65 kW)	2008.03-2010.01	-	R	-	Hatchback Engine GW413EF	275044	Drive Shaft	48T	24	25	56	87	914					
	2008.03-2010.01	-	L	-	Hatchback Engine GW413EF	275045	Drive Shaft	48T	24	25	56	87	514					
GW VOLEEX C30																		
-	-	-	-	-	-	201155	Drive Shaft	48T	28	27	65	89.5	990					
	-	-	-	-	-	201154	Drive Shaft	48T	28	27	65	89.5	650					
HAFEI LOBO/LUBAO																		
1.0 (34 kW)	2003.05-2010.12	MT	-	-	Hatchback Engine DA465Q2	270001	Drive Shaft	48T	23	22	49	78	832					
LOBO/LUBAO/BRIO																		
1.0 (34 kW)	2003.10-	MT	-	-	Hatchback Engine DA465Q2	270001	Drive Shaft	48T	23	22	49	78	832					
1.1 (48 kW)	2003.06-	MT	-	-	Hatchback Engine DA468Q	270001	Drive Shaft	48T	23	22	49	78	832					
1.3 (58 kW)	2003.06-2010.12	MT	-	-	Hatchback Engine DA471QL	270001	Drive Shaft	48T	23	22	49	78	832					
HAIMA (FAW) FAMILY III																		
1.6 (88 kW)	2010.11-2015.12	MT	L	-	Saloon Engine HM479Q-A	234107	Drive Shaft	44T	26	24	56	93.5	626.8					
	2010.11-2015.12	MT	R	-	Saloon Engine HM479Q-A	234109	Drive Shaft	44T	26	28	56	93.5	592					





YEAR	TRANS	L/R	F/R	REMARKS	GSP Ref.	PRODUCT	ABS	Technical Specifications									
								A	B	C	H	L	P				
HAIMA (FAW)																	
FREEMA																	
1.8 (90 kW)	2010.09-	-	AT/MT	R	-	MPV Engine HM483Q	234109	Drive Shaft	44T	26	28	56	93.5	592			
	2010.09-	-	AT/MT	L	-	MPV Engine HM483Q	234119	Drive Shaft	44T	26	24	56	93.5	634.5			
HAPPIN																	
1.6 (74 kW)	2007.06-	2009.05	MT	L	F	Saloon Engine 4G18	234074	Drive Shaft	44T	26	25	56	93.5	633			
	2007.06-	2009.05	MT	R	F	Saloon Engine 4G18	234075	Drive Shaft	44T	26	25	56	93.5	906			
1.6 (89 kW)	2009.05-	2009.12	MT	L	-	Saloon Engine HM479Q-B	234074	Drive Shaft	44T	26	25	56	93.5	633			
	2009.05-	2009.12	MT	R	-	Saloon Engine HM479Q-B	234075	Drive Shaft	44T	26	25	56	93.5	906			
PREMACY																	
1.8 (90 kW)	2007.03-	2009.10	MT/AT	R	-	MPV Engine HM483Q/HM483Q	234109	Drive Shaft	44T	26	28	56	93.5	592			
	2007.03-	2009.10	MT/AT	L	-	MPV Engine HM483Q/HM483Q	234119	Drive Shaft	44T	26	24	56	93.5	634.5			
HAVAL																	
H5																	
2.0 (140 kW)	2013.03-	-	-	-	-	Closed Off-Road Vehicle Engine 4G63 T	226008	Drive Shaft		17	17	53	136.5	608			
	2013.03-	-	-	-	-	All-wheel Drive Closed Off-Road Vehicle Engine 4G63 T	226008	Drive Shaft		17	17	53	136.5	608			
2.0 (90 kW)	2010.08-	-	-	-	-	All-wheel Drive Closed Off-Road Vehicle Engine 4G63S4M	226008	Drive Shaft		17	17	53	136.5	608			
	2011.03-	-	-	-	-	Closed Off-Road Vehicle Engine 4G63	226008	Drive Shaft		17	17	53	136.5	608			
2.0 D (100 kW)	2011.03-	-	-	-	-	Closed Off-Road Vehicle Engine GW4D20	226008	Drive Shaft		17	17	53	136.5	608			
	2011.03-	-	-	-	-	All-wheel Drive Closed Off-Road Vehicle Engine GW4D20	226008	Drive Shaft		17	17	53	136.5	608			
2.0 D (110 kW)	2013.03-	-	-	-	-	Closed Off-Road Vehicle Engine GW4D20	226008	Drive Shaft		17	17	53	136.5	608			
	2013.03-	-	-	-	-	All-wheel Drive Closed Off-Road Vehicle Engine GW4D20	226008	Drive Shaft		17	17	53	136.5	608			
2.4 (100 kW)	2011.03-	-	-	-	-	Closed Off-Road Vehicle Engine 4G69	226008	Drive Shaft		17	17	53	136.5	608			
	2011.03-	-	-	-	-	All-wheel Drive Closed Off-Road Vehicle Engine 4G69	226008	Drive Shaft		17	17	53	136.5	608			
HAWTAI																	
TERRACAN T9																	
2.4 (93 kW)	2009.11-	2011.12	-	-	-	Closed Off-Road Vehicle Engine 4G69S4N	224334	Drive Shaft		28		56	154	569			
	2009.11-	2011.12	-	-	-	All-wheel Drive Closed Off-Road Vehicle Engine 4G69S4N	224334	Drive Shaft		28		56	154	569			
HOLDEN																	
APOLLO																	
-	1990.01-	1993.04	MT/AT	R	-	JK	259032	Drive Shaft		26	20	56	95.5	913.5			
	1993.01-	1997.12	MT/AT	L	-	4 Cyl JM JP	222005	Drive Shaft	48T	26	20	56	99.5	676.5			
	1993.01-	1997.12	MT/AT	R	-	4 Cyl JM JP	222006	Drive Shaft	48T	26	20	56	99.5	940			
ASTRA																	
1.8/2.6	1998.01-	2002.11	MT/AT	-	-	-	822004	Outer Joint		33	25	52	109	61	M		
ASTRA TS																	
-	1998.02-	-	-	-	-	-	822006	Outer Joint		33	25	52	104	64	I		
	2003-	-	-	-	-	-	822005	Outer Joint		33	24	52	104	64	M		
BARINA																	
1.3	1989.01-	1994.03	AT	L	-	-	257009	Drive Shaft		23	22	49	92	565			
	1989.01-	1994.03	AT	R	-	-	257010	Drive Shaft		23	22	49	92	555			
COMMODORE																	
-	1997.09-	-	-	L/R	-	-	299155	Drive Shaft					32	468			
COMMODORE/STATSMAN																	
-	-	-	-	L/R	-	VX VY	221015	Drive Shaft					32	505			
JACKAROO																	
-	1998.01-	2002.11	MT/AT	L	-	-	201001	Drive Shaft		17	17	53	144	1004			
	1998.01-	2002.11	MT/AT	-	-	-	626003	Inner Joint		17	33	30	517	90.5			
2.6 Petrol/2.8/Diesel Turbo	1988.01-	1992.04	MT/AT	L	-	-	226004	Drive Shaft		17	17	53	144	966			
	1988.01-	1992.04	MT/AT	R	-	-	223004	Drive Shaft		17	17	53	144	547			
	1988.01-	1992.04	MT/AT	-	-	-	626001	Inner Joint		17	26	30	517	97.5			
	1988.01-	1992.04	MT/AT	-	-	-	626002	Inner Joint		17	26	30	98	98.5			
NOVA																	
-	1989.01-	-	-	L	-	-	259035	Drive Shaft		26	23	56	96.5	605			
RODEO																	
2.6 Petrol/2.8 Diesel Turbo	1988.01-	1995.05	MT/AT	L	-	-	226004	Drive Shaft		17	17	53	144	966			
	1988.01-	1995.05	MT/AT	R	-	-	223004	Drive Shaft		17	17	53	144	547			
	1988.01-	1995.05	MT/AT	-	-	-	626001	Inner Joint		17	26	30	517	97.5			
	1988.01-	1995.05	MT/AT	-	-	-	626002	Inner Joint		17	26	30	98	98.5			
2.8 DT	1995.01-	1997.12	MT/AT	L	-	-	226004	Drive Shaft		17	17	53	144	966			
	1995.01-	1997.12	MT/AT	R	-	TFG6 TFG7 JAFS17HP7	223004	Drive Shaft		17	17	53	144	547			
	1995.01-	1997.12	MT/AT	-	-	-	626001	Inner Joint		17	26	30	517	97.5			
	1995.01-	1997.12	MT/AT	-	-	-	626002	Inner Joint		17	26	30	98	98.5			
HONDA																	
-																	
1.4	2006-	2012	6MT	R	-	Engine L13A7	823176	Outer Joint		26	30	58	78	59	M		

YEAR	TRANSM	L/R	F/R	REMARKS	GSP Ref.	PRODUCT	ABS	Technical Specifications							
								A	B	C	H	L	P		
HONDA ACCORD															
-	-	-	R	-	201027	Drive Shaft		26	27	63	79	961			
1984-1989	MT/AT	-	-	-	823043	Outer Joint		26	32	49	79	56	M		
1994-1997	-	L	-	4 Cyl	201015	Drive Shaft	50T	28	27	60	88	977			
1995-1997	-	L	-	6 Cyl	201039	Drive Shaft	50T	28	29	60	88	634			
1997-	AT	L	-	4 Cyl	223031	Drive Shaft		28	27	60	88	005.1			
1998-2002	-	-	-	-	823085	Outer Joint	50T	28	32	60	89	60	M		
1998-2002	MT/AT	R	F	4 Cyl	223061	Drive Shaft		28	27	60	88	631			
1998-2000	MT	L	-	4 Cyl	201028	Drive Shaft		28	27	60	88	651.5			
1998.02-	AT	L	-	4 Cyl	223032	Drive Shaft	50T	28	27	60	88	005.1			
2003-2007	AT	L	-	-	201026	Drive Shaft		26	27	63	79	661			
2008-	-	-	-	-	823103	Outer Joint		30	30	68	89	59	M		
2.0	2012-	5AT	L	F	223331	Drive Shaft		30	27	68.1	88	680			
	2012-	5AT	L	F	823221	Outer Joint		30	30	68.1	88	58	M		
	2012-	5AT	L	F	623086	Inner Joint		27	30	40	58	97.5			
	2012-	5AT	R	F	223332	Drive Shaft		30	27	68.1	88	645			
	2012-	5AT	R	F	823221	Outer Joint		30	30	68.1	88	58	M		
	2012-	5AT	R	F	623106	Inner Joint		27	30	40		120.5			
2.2	1989.01-1994.12	AT	L	-	201003	Drive Shaft		28	27	60	88	958			
2.2 CD	1993.01-1997.12	-	L	-	201006	Drive Shaft		28	27	60	88	982			
	1993.01-1997.12	-	R	-	201004	Drive Shaft		28	27	60	88	618			
2.4	2008-2012	-	R	F	Engine: K24Z2	223177	Drive Shaft	30	27	68	89	574.5			
	2008-2012	-	L	F	Engine: K24Z2	223178	Drive Shaft	30	27	68	89	677			
	2010-	5AT	L	F	2DOOR	623044	Inner Joint	27	32	40	58.5	97			
	2010-	6MT	L	F	-	223311	Drive Shaft	30	27	68	88	685			
	2010-	6MT	L	F	-	623077	Inner Joint	27	34	40	58.5	97			
3.5	2009.01-	AT	-	-	823153	Outer Joint		30	32	68	88.5	59.5	M		
ACCORD (CB1)															
1.8	1989.01-1993.09	MT/AT	-	-	Engine F18A	823015	Outer Joint	28	32	60	89	60	M		
ACCORD (CB2)															
1.8 4WS	1989.01-1993.09	MT/AT	-	-	Engine F18A	823015	Outer Joint	28	32	60	89	60	M		
ACCORD (CB3)															
2.0	1989.01-1993.09	MT/AT	-	-	Engine F20A	823015	Outer Joint	28	32	60	89	60	M		
ACCORD (CB4)															
2.0 4WS	1989.01-1993.09	MT/AT	-	-	Engine F20A	823015	Outer Joint	28	32	60	89	60	M		
ACCORD (CD3)															
1.8	1993.09-1997.09	MT/AT	-	-	Engine F18B	823015	Outer Joint	28	32	60	89	60	M		
ACCORD (CD4)															
2.0	1993.09-1997.09	AT	-	-	Engine F20B	823015	Outer Joint	28	32	60	89	60	M		
ACCORD (CD5)															
2.2	1993.09-1997.09	AT	-	-	Engine F22B	823015	Outer Joint	28	32	60	89	60	M		
ACCORD (CD6)															
2.2	1993.09-1997.09	MT/AT	-	-	Engine H22A	823015	Outer Joint	28	32	60	89	60	M		
ACCORD (CD7)															
2.2	1994.03-1994.11	AT	-	-	Engine F22B	823015	Outer Joint	28	32	60	89	60	M		
ACCORD (CD8)															
2.2	1994.03-1994.11	AT	-	-	Engine H22A	823015	Outer Joint	28	32	60	89	60	M		
ACCORD (CE1)															
2.2	1994.03-1994.11	AT	-	-	Engine F22B	823015	Outer Joint	28	32	60	89	60	M		
ACCORD CB1															
1.8	1989.01-1993.09	MT	-	-	Engine F18A	823015	Outer Joint	28	32	60	89	60	M		
	1989.01-1993.09	MT	-	-	Engine F18A	823015	Outer Joint	28	32	60	89	60	M		
	1989.01-1993.09	AT	-	-	Engine F18A	823015	Outer Joint	28	32	60	89	60	M		
	1989.01-1993.09	AT	-	-	Engine F18A	823015	Outer Joint	28	32	60	89	60	M		
1800	1989.01-1993.09	MT	-	-	Engine F18A	823015	Outer Joint	28	32	60	89	60	M		
	1989.01-1993.09	AT	-	-	Engine F18A	823015	Outer Joint	28	32	60	89	60	M		
	1989.01-1993.09	AT	-	-	Engine F18A	823015	Outer Joint	28	32	60	89	60	M		
	1989.01-1993.09	MT	-	-	Engine F18A	823015	Outer Joint	28	32	60	89	60	M		
ACCORD CB2 4WS															
1.8	1989.01-1993.09	MT	-	-	Engine F18A	823015	Outer Joint	28	32	60	89	60	M		
	1989.01-1993.09	MT	-	-	Engine F18A	823015	Outer Joint	28	32	60	89	60	M		
	1989.01-1993.09	AT	-	-	Engine F18A	823015	Outer Joint	28	32	60	89	60	M		
	1989.01-1993.09	AT	-	-	Engine F18A	823015	Outer Joint	28	32	60	89	60	M		
1800	1989.01-1993.09	MT	-	-	Engine F18A	823015	Outer Joint	28	32	60	89	60	M		
	1989.01-1993.09	MT	-	-	Engine F18A	823015	Outer Joint	28	32	60	89	60	M		
	1989.01-1993.09	AT	-	-	Engine F18A	823015	Outer Joint	28	32	60	89	60	M		





	 YEAR	TRANSM	L/R	F/R	REMARKS	GSP Ref.	 PRODUCT	 ABS	Technical Specifications					
									A	B	C	H	L	P
HONDA														
ACCORD CB2 4WS														
1800	1989.01-1993.09	AT	-	-	Engine F18A	823015	Outer Joint		28	32	60	89	60	M
ACCORD CB3														
2.0	1989.01-1993.09	MT	-	-	Engine F20A	823015	Outer Joint		28	32	60	89	60	M
	1989.01-1993.09	MT	-	-	Engine F20A	823015	Outer Joint		28	32	60	89	60	M
	1989.01-1993.09	AT	-	-	Engine F20A	823015	Outer Joint		28	32	60	89	60	M
2000	1989.01-1993.09	MT	-	-	Engine F20A	823015	Outer Joint		28	32	60	89	60	M
	1989.01-1993.09	MT	-	-	Engine F20A	823015	Outer Joint		28	32	60	89	60	M
	1989.01-1993.09	AT	-	-	Engine F20A	823015	Outer Joint		28	32	60	89	60	M
ACCORD CB4 4WS														
2.0	1989.01-1993.09	MT	-	-	Engine F20A	823015	Outer Joint		28	32	60	89	60	M
	1989.01-1993.09	MT	-	-	Engine F20A	823015	Outer Joint		28	32	60	89	60	M
	1989.01-1993.09	AT	-	-	Engine F20A	823015	Outer Joint		28	32	60	89	60	M
	1989.09-1993.09	AT	-	-	Engine F20A	823015	Outer Joint		28	32	60	89	60	M
2000	1989.01-1993.09	MT	-	-	Engine F20A	823015	Outer Joint		28	32	60	89	60	M
	1989.01-1993.09	MT	-	-	Engine F20A	823015	Outer Joint		28	32	60	89	60	M
	1989.01-1993.09	AT	-	-	Engine F20A	823015	Outer Joint		28	32	60	89	60	M
	1989.09-1993.09	AT	-	-	Engine F20A	823015	Outer Joint		28	32	60	89	60	M
ACCORD CD3														
1.8	1993.09-1997.09	MT	-	-	Engine F18B	823015	Outer Joint		28	32	60	89	60	M
	1993.09-1997.09	AT	-	-	Engine F18B	823015	Outer Joint		28	32	60	89	60	M
	1993.09-1997.09	AT	-	-	Engine F18B	823015	Outer Joint		28	32	60	89	60	M
	1993.09-1997.09	AT	-	-	Engine F18B	823015	Outer Joint		28	32	60	89	60	M
1800	1993.09-1997.09	MT	-	-	Engine F18B	823015	Outer Joint		28	32	60	89	60	M
	1993.09-1997.09	AT	-	-	Engine F18B	823015	Outer Joint		28	32	60	89	60	M
	1993.09-1997.09	AT	-	-	Engine F18B	823015	Outer Joint		28	32	60	89	60	M
	1993.09-1997.09	AT	-	-	Engine F18B	823015	Outer Joint		28	32	60	89	60	M
ACCORD CD4														
2.0	1993.09-1997.09	AT	-	-	Engine F20B	823015	Outer Joint		28	32	60	89	60	M
	1993.09-1997.09	AT	-	-	Engine F20B	823015	Outer Joint		28	32	60	89	60	M
	1993.09-1997.09	AT	-	-	Engine F20B	823015	Outer Joint		28	32	60	89	60	M
2000	1993.09-1997.09	AT	-	-	Engine F20B	823015	Outer Joint		28	32	60	89	60	M
	1993.09-1997.09	AT	-	-	Engine F20B	823015	Outer Joint		28	32	60	89	60	M
	1993.09-1997.09	AT	-	-	Engine F20B	823015	Outer Joint		28	32	60	89	60	M
ACCORD CD5														
2.2	1993.09-1997.09	AT	-	-	Engine F22B	823015	Outer Joint		28	32	60	89	60	M
	1993.09-1997.09	AT	-	-	Engine F22B	823015	Outer Joint		28	32	60	89	60	M
	1993.09-1997.09	AT	-	-	Engine F22B	823015	Outer Joint		28	32	60	89	60	M
	1993.09-1997.09	AT	-	-	Engine F22B	823015	Outer Joint		28	32	60	89	60	M
	1993.09-1997.09	AT	-	-	Engine F22B	823015	Outer Joint		28	32	60	89	60	M
	1993.09-1997.09	AT	-	-	Engine F22B	823015	Outer Joint		28	32	60	89	60	M
ACCORD CD6														
2.2	1993.09-1997.09	AT	-	-	Engine H22A	823015	Outer Joint		28	32	60	89	60	M
	1993.09-1997.09	AT	-	-	Engine H22A	823015	Outer Joint		28	32	60	89	60	M
	1993.09-1997.09	MT	-	-	Engine H22A	823015	Outer Joint		28	32	60	89	60	M
	1993.09-1997.09	AT	-	-	Engine H22A	823015	Outer Joint		28	32	60	89	60	M
	1993.09-1997.09	AT	-	-	Engine H22A	823015	Outer Joint		28	32	60	89	60	M
	1993.09-1997.09	MT	-	-	Engine H22A	823015	Outer Joint		28	32	60	89	60	M
ACCORD CD7														
2.2	1994.03-1994.11	AT	-	-	Engine F22B	823015	Outer Joint		28	32	60	89	60	M
	1994.03-1994.11	AT	-	-	Engine F22B	823015	Outer Joint		28	32	60	89	60	M
ACCORD CD8														
2.2	1994.03-1994.11	AT	-	-	Engine H22A	823015	Outer Joint		28	32	60	89	60	M
	1994.03-1994.11	AT	-	-	Engine H22A	823015	Outer Joint		28	32	60	89	60	M
ACCORD CE1														
2.2	1994.03-1994.11	AT	-	-	Engine F22B	823015	Outer Joint		28	32	60	89	60	M
	1994.03-1994.11	AT	-	-	Engine F22B	823015	Outer Joint		28	32	60	89	60	M
ACCORD III														
2.0 i	1985-1990	-	L/R	F	-	623007	Inner Joint		25	30	35	62	98.5	
ACCORD III (CA)														
1.6 L (65 kW)	1985.11-1989.12	AT/MT	L/R	F	Saloon Engine A16A1	823011	Outer Joint		26	30	49	79	53	M
	1985.11-1989.12	-	R	F	Saloon Engine A16A1	823012	Outer Joint	100T	26	30	49	78.5	55.5	M
2.0 EX (75 kW)	1985.11-1989.12	AT/MT	L/R	F	Saloon Engine A20A1	823021	Outer Joint		26	32	49	78.5	56.5	M
	1985.11-1989.12	-	-	F	Saloon Engine A20A1	823071	Outer Joint	50T	26	32	49	78.5	56.5	M
	1985.11-1989.12	AT/MT	L/R	F	Saloon Engine A20A1	823026	Outer Joint	100T	26	32	49	78.5	54.5	M
	1985.11-1989.12	-	-	-	Saloon Engine A20A1	801001	Outer Joint		26	32	49	78.5	54.5	M

	 YEAR	TRANSM	L/R	F/R	REMARKS	GSP Ref.	 PRODUCT	 ABS	Technical Specifications					
									A	B	C	H	L	P
HONDA														
ACCORD III (CA)														
2.0 EX (76 kW)	1985.11-1989.12	AT/MT	L/R	F	Saloon Engine A20A1	823021	Outer Joint		26	32	49	78.5	56.5	M
	1985.11-1989.12	-	-	F	Saloon Engine A20A1	823071	Outer Joint	50T	26	32	49	78.5	56.5	M
	1985.11-1989.12	AT/MT	L/R	F	Saloon Engine A20A1	823026	Outer Joint	100T	26	32	49	78.5	54.5	M
2.0 EX (78 kW)	1985.11-1989.05	AT/MT	L/R	F	Saloon Engine A20A2	823021	Outer Joint		26	32	49	78.5	56.5	M
	1985.11-1989.05	-	-	F	Saloon Engine A20A2	823071	Outer Joint	50T	26	32	49	78.5	56.5	M
2.0 EXi (85 kW)	1986.01-1989.12	AT/MT	L/R	F	Saloon Engine A20A3	823021	Outer Joint		26	32	49	78.5	56.5	M
	1986.01-1989.12	-	-	F	Saloon Engine A20A3	823071	Outer Joint	50T	26	32	49	78.5	56.5	M
	1986.01-1989.12	AT/MT	L/R	F	Saloon Engine A20A3	823026	Outer Joint	100T	26	32	49	78.5	54.5	M
	1986.01-1989.12	-	-	-	Saloon Engine A20A3	801001	Outer Joint		26	32	49	78.5	54.5	M
2.0 i 16V (98 kW)	1987.10-1989.12	-	-	F	Saloon Engine B20A8	823016	Outer Joint		26	32	55	78.5	56.5	M
	1987.10-1989.12	-	-	F	Saloon Engine B20A8	823071	Outer Joint	50T	26	32	49	78.5	56.5	M
	1987.10-1989.12	AT/MT	L/R	F	Saloon Engine B20A8	823017	Outer Joint	50T	26	32	55	78.5	56.5	M
	1987.10-1989.12	AT/MT	L/R	F	Saloon Engine B20A8	823026	Outer Joint	100T	26	32	49	78.5	54.5	M
	1987.10-1989.12	-	-	-	Saloon Engine B20A8	801001	Outer Joint		26	32	49	78.5	54.5	M
ACCORD III Aerodeck (CA)														
1.6 L (65 kW)	1985.11-1989.12	AT/MT	L/R	F	Estate Engine A16A1	823011	Outer Joint		26	30	49	79	53	M
	1985.11-1989.12	-	-	-	Estate Engine A16A1	801001	Outer Joint		26	32	49	78.5	54.5	M
2.0 EX (75 kW)	1987.10-1989.12	AT/MT	L/R	F	Estate Engine A20A1	823021	Outer Joint		26	32	49	78.5	56.5	M
	1987.10-1989.12	-	-	F	Estate Engine A20A1	823071	Outer Joint	50T	26	32	49	78.5	56.5	M
	1987.10-1989.12	AT/MT	L/R	F	Estate Engine A20A1	823026	Outer Joint	100T	26	32	49	78.5	54.5	M
	1987.10-1989.12	-	-	-	Estate Engine A20A1	801001	Outer Joint		26	32	49	78.5	54.5	M
2.0 EX (76 kW)	1987.10-1989.12	AT/MT	L/R	F	Estate Engine A20A1	823021	Outer Joint		26	32	49	78.5	56.5	M
	1987.10-1989.12	-	-	F	Estate Engine A20A1	823071	Outer Joint	50T	26	32	49	78.5	56.5	M
	1987.10-1989.12	AT/MT	L/R	F	Estate Engine A20A1	823026	Outer Joint	100T	26	32	49	78.5	54.5	M
	1987.10-1989.12	-	-	-	Estate Engine A20A1	801001	Outer Joint		26	32	49	78.5	54.5	M
2.0 EX (78 kW)	1985.11-1989.05	AT/MT	L/R	F	Estate Engine A20A2	823021	Outer Joint		26	32	49	78.5	56.5	M
	1985.11-1989.05	-	-	F	Estate Engine A20A2	823071	Outer Joint	50T	26	32	49	78.5	56.5	M
	1985.11-1989.05	-	-	-	Estate Engine A20A2	801001	Outer Joint		26	32	49	78.5	54.5	M
2.0 EXi (85 kW)	1987.10-1989.12	AT/MT	L/R	F	Estate Engine A20A3	823021	Outer Joint		26	32	49	78.5	56.5	M
	1987.10-1989.12	-	-	F	Estate Engine A20A3	823071	Outer Joint	50T	26	32	49	78.5	56.5	M
	1987.10-1989.12	AT/MT	L/R	F	Estate Engine A20A3	823026	Outer Joint	100T	26	32	49	78.5	54.5	M
	1987.10-1989.12	-	-	-	Estate Engine A20A3	801001	Outer Joint		26	32	49	78.5	54.5	M
ACCORD IV														
1.8	1996.03-1998.09	MT	L	F	-	223134	Drive Shaft	50T	28	27	60	89	615	
2.0	1993.05-1998.09	MT	L	F	-	223134	Drive Shaft	50T	28	27	60	89	615	
2.2	1994.06-1998.09	MT	L	F	-	223134	Drive Shaft	50T	28	27	60	89	615	
ACCORD IV (CB CC)														
2.0 i 16V (98 kW)	1992.01-1993.09	AT/MT	L	F	Coupe Engine F20A7	223008	Drive Shaft		28	27	60	88	597	
	1992.01-1993.09	AT/MT	R	F	Coupe Engine F20A7	223084	Drive Shaft		28	27	60	88	600	
	1992.01-1993.09	AT/MT	L	F	Coupe Engine F20A7	223009	Drive Shaft	50T	28	27	60	88	597	
	1992.01-1993.09	AT/MT	R	F	Coupe Engine F20A7	201002	Drive Shaft	50T	28	27	60	88	600	
	1992.01-1993.09	AT/MT	L	F	Coupe Engine F20A7	601003	Inner Joint		27	32	40	55	97.5	
	1992.01-1993.09	AT/MT	R	F	Coupe Engine F20A7	623009	Inner Joint		27	32	40	58.5	97	
	1992.01-1993.09	AT/MT	L/R	F	Coupe Engine F20A7	823014	Outer Joint	50T	28	32	60	88	59	M
	1992.01-1993.09	AT/MT	L/R	F	Coupe Engine F20A7	823013	Outer Joint		28	32	60	88	59	M
ACCORD IV (CB)														
2.0 16V (66 kW)	1990.01-1993.03	AT/MT	L	F	Saloon Engine F20A6	223008	Drive Shaft		28	27	60	88	597	
	1990.01-1993.03	AT/MT	R	F	Saloon Engine F20A6	223084	Drive Shaft		28	27	60	88	600	
	1990.01-1993.03	AT/MT	L	F	Saloon Engine F20A6	223009	Drive Shaft	50T	28	27	60	88	597	
	1990.01-1993.03	AT/MT	R	F	Saloon Engine F20A6	201002	Drive Shaft	50T	28	27	60	88	600	
	1990.01-1993.03	AT/MT	L	F	Saloon Engine F20A6	601003	Inner Joint		27	32	40	55	97.5	
	1990.01-1993.03	AT/MT	R	F	Saloon Engine F20A6	623009	Inner Joint		27	32	40	58.5	97	
	1990.01-1993.03	AT/MT	L/R	F	Saloon Engine F20A6	823014	Outer Joint	50T	28	32	60	88	59	M
	1990.01-1993.03	AT/MT	L/R	F	Saloon Engine F20A6	823013	Outer Joint		28	32	60	88	59	M
2.0 16V (81 kW)	1990.01-1993.03	AT/MT	L	F	Saloon Engine F20A2/F20A3	223008	Drive Shaft		28	27	60	88	597	
	1990.01-1993.03	AT/MT	R	F	Saloon Engine F20A2/F20A3	223084	Drive Shaft		28	27	60	88	600	
	1990.01-1993.03	AT/MT	L	F	Saloon Engine F20A2/F20A3	223009	Drive Shaft	50T	28	27	60	88	597	
	1990.01-1993.03	AT/MT	R	F	Saloon Engine F20A2/F20A3	201002	Drive Shaft	50T	28	27	60	88	600	
	1990.01-1993.03	AT/MT	L	F	Saloon Engine F20A2/F20A3	601003	Inner Joint		27	32	40	55	97.5	
	1990.01-1993.03	AT/MT	R	F	Saloon Engine F20A2/F20A3	623009	Inner Joint		27	32	40	58.5	97	
	1990.01-1993.03	AT/MT	L/R	F	Saloon Engine F20A2/F20A3	823014	Outer Joint	50T	28	32	60	88	59	M
	1990.01-1993.03	AT/MT	L/R	F	Saloon Engine F20A2/F20A3	823013	Outer Joint		28	32	60	88	59	M
2.0 i 16V (98 kW)	1990.01-1993.03	AT/MT	L	F	Saloon Engine F20A4/F20A8	223008	Drive Shaft		28	27	60	88	597	
	1990.01-1993.03	AT/MT	R	F	Saloon Engine F20A4/F20A8	223084	Drive Shaft		28	27	60	88	600	
	1990.01-1993.03	AT/MT	L	F	Saloon Engine F20A4/F20A8	223009	Drive Shaft	50T	28	27	60	88	597	
	1990.01-1993.03	AT/MT	R	F	Saloon Engine F20A4/F20A8	201002	Drive Shaft	50T	28	27	60	88	600	

	 YEAR	TRANSM	L/R	F/R	REMARKS	GSP Ref.	 PRODUCT	 ABS	Technical Specifications					
									A	B	C	H	L	P
HONDA														
ACCORD IV (CB)														
2.0 i 16V (98 kW)	1990.01-1993.03	AT/MT	L	F	Saloon Engine F20A4/F20A8	601003	Inner Joint		27	32	40	55	97.5	
	1990.01-1993.03	AT/MT	R	F	Saloon Engine F20A4/F20A8	623009	Inner Joint		27	32	40	58.5	97	
	1990.01-1993.03	AT/MT	L/R	F	Saloon Engine F20A4/F20A8	823014	Outer Joint	50T	28	32	60	88	59	M
	1990.01-1993.03	AT/MT	L/R	F	Saloon Engine F20A4/F20A8	823013	Outer Joint		28	32	60	88	59	M
2.2 i 16V (110 kW)	1990.01-1993.03	AT/MT	L	F	Saloon Engine F22A3	223008	Drive Shaft		28	27	60	88	597	
	1990.01-1993.03	AT/MT	R	F	Saloon Engine F22A3	223084	Drive Shaft		28	27	60	88	600	
	1990.01-1993.03	AT/MT	L	F	Saloon Engine F22A3	223009	Drive Shaft	50T	28	27	60	88	597	
	1990.01-1993.03	AT/MT	R	F	Saloon Engine F22A3	201002	Drive Shaft	50T	28	27	60	88	600	
	1990.01-1993.03	AT/MT	L	F	Saloon Engine F22A3	601003	Inner Joint		27	32	40	55	97.5	
	1990.01-1993.03	AT/MT	R	F	Saloon Engine F22A3	623009	Inner Joint		27	32	40	58.5	97	
	1990.01-1993.03	AT/MT	L/R	F	Saloon Engine F22A3	823014	Outer Joint	50T	28	32	60	88	59	M
	1990.01-1993.03	AT/MT	L/R	F	Saloon Engine F22A3	823013	Outer Joint		28	32	60	88	59	M
2.2 i 16V Automatik (108 kW)	1990.01-1993.03	AT	L/R	F	Saloon Engine F22A3	823013	Outer Joint		28	32	60	88	59	M
	1990.01-1993.03	AT	L/R	F	Saloon Engine F22A3	823014	Outer Joint	50T	28	32	60	88	59	M
ACCORD IV (CB,CB3,CB7,CB8,CC,CC1,SM4)														
2.5 (CC2)	1992.01-1995.02	AT	-	-	Engine G25A	823028	Outer Joint		28	34	60	89	60	M
ACCORD IV Aerodeck (CB)														
2.0 i 16V (98 kW)	1993.03-1993.12	AT/MT	L/R	F	Estate Engine F20Z3	823013	Outer Joint		28	32	60	88	59	M
	1993.03-1993.12	AT/MT	L	F	Estate Engine F20Z3	223008	Drive Shaft		28	27	60	88	597	
	1993.03-1993.12	AT/MT	R	F	Estate Engine F20Z3	223084	Drive Shaft		28	27	60	88	600	
	1993.03-1993.12	AT/MT	L	F	Estate Engine F20Z3	223009	Drive Shaft	50T	28	27	60	88	597	
	1993.03-1993.12	AT/MT	R	F	Estate Engine F20Z3	201002	Drive Shaft	50T	28	27	60	88	600	
	1993.03-1993.12	AT/MT	L	F	Estate Engine F20Z3	601003	Inner Joint		27	32	40	55	97.5	
	1993.03-1993.12	AT/MT	R	F	Estate Engine F20Z3	623009	Inner Joint		27	32	40	58.5	97	
	1993.03-1993.12	AT/MT	L/R	F	Estate Engine F20Z3	823014	Outer Joint	50T	28	32	60	88	59	M
2.2 i 16V (108 kW)	1991.01-1993.12	AT/MT	L/R	F	Estate Engine F22A8	823014	Outer Joint	50T	28	32	60	88	59	M
	1991.01-1993.12	AT/MT	L/R	F	Estate Engine F22A8	823013	Outer Joint		28	32	60	88	59	M
2.2 i 16V (110 kW)	1991.01-1993.12	AT/MT	L/R	F	Estate Engine F22A7	823013	Outer Joint		28	32	60	88	59	M
	1991.01-1993.12	AT/MT	L	F	Estate Engine F22A7	223008	Drive Shaft		28	27	60	88	597	
	1991.01-1993.12	AT/MT	R	F	Estate Engine F22A7	223084	Drive Shaft		28	27	60	88	600	
	1991.01-1993.12	AT/MT	L	F	Estate Engine F22A7	223009	Drive Shaft	50T	28	27	60	88	597	
	1991.01-1993.12	AT/MT	R	F	Estate Engine F22A7	201002	Drive Shaft	50T	28	27	60	88	600	
	1991.01-1993.12	AT/MT	L	F	Estate Engine F22A7	601003	Inner Joint		27	32	40	55	97.5	
	1991.01-1993.12	AT/MT	R	F	Estate Engine F22A7	623009	Inner Joint		27	32	40	58.5	97	
	1991.01-1993.12	AT/MT	L/R	F	Estate Engine F22A7	823014	Outer Joint	50T	28	32	60	88	59	M
ACCORD V (CC CD)														
2.0 i (85 kW)	1993.03-1996.01	-	-	F	Saloon Engine F20Z2	823009	Outer Joint	50T	28	32	60	89	61	I
	1993.03-1996.01	AT/MT	L/R	F	Saloon Engine F20Z2	823014	Outer Joint	50T	28	32	60	88	59	M
	1993.03-1996.01	AT/MT	L/R	F	Saloon Engine F20Z2	823013	Outer Joint		28	32	60	88	59	M
	1993.03-1996.01	MT	-	-	Saloon Engine F20Z2	623013	Inner Joint		27	32	40	45.5	75	
2.0 i S (96 kW)	1993.03-1996.01	-	-	F	Saloon Engine F20Z1	823009	Outer Joint	50T	28	32	60	89	61	I
	1993.03-1996.01	AT/MT	L/R	F	Saloon Engine F20Z1	851001	Outer Joint	50T	28	32	60	89	61	I
	1993.03-1996.01	AT/MT	L/R	F	Saloon Engine F20Z1	823014	Outer Joint	50T	28	32	60	88	59	M
	1993.03-1996.01	AT/MT	L/R	F	Saloon Engine F20Z1	823013	Outer Joint		28	32	60	88	59	M
	1993.03-1996.01	MT	-	-	Saloon Engine F20Z1	623013	Inner Joint		27	32	40	45.5	75	
2.3 i SR (116 kW)	1993.03-1996.01	MT	-	-	Saloon Engine H23A3	623013	Inner Joint		27	32	40	45.5	75	
ACCORD V (CD)														
2.2 i ES (110 kW)	1993.09-1998.02	AT/MT	L/R	F	Coupe Engine F22B5	823013	Outer Joint		28	32	60	88	59	M
	1993.09-1998.02	AT/MT	L/R	F	Coupe Engine F22B5	823014	Outer Joint	50T	28	32	60	88	59	M
ACCORD V (CE CF_)														
1.9 i (85 kW)	1996.02-1998.10	-	-	F	Saloon Engine F18A3	823009	Outer Joint	50T	28	32	60	89	61	I
	1996.02-1998.10	AT/MT	L/R	F	Saloon Engine F18A3	851001	Outer Joint	50T	28	32	60	89	61	I
2.0 i LS (96 kW)	1996.02-1998.10	AT/MT	L/R	F	Saloon Engine F20Z1	823013	Outer Joint		28	32	60	88	59	M
	1996.02-1998.10	-	-	F	Saloon Engine F20Z1	823009	Outer Joint	50T	28	32	60	89	61	I
	1996.02-1998.10	AT/MT	L/R	F	Saloon Engine F20Z1	851001	Outer Joint	50T	28	32	60	89	61	I
	1996.02-1998.10	AT/MT	L/R	F	Saloon Engine F20Z1	823014	Outer Joint	50T	28	32	60	88	59	M
2.0 TDi (77 kW)	1996.04-1998.10	-	-	F	Saloon Engine 20T2N	823009	Outer Joint	50T	28	32	60	89	61	I
	1996.04-1998.10	AT/MT	L/R	F	Saloon Engine 20T2N	851001	Outer Joint	50T	28	32	60	89	61	I
2.2 i VTEC (110 kW)	1996.02-1998.10	AT/MT	L/R	F	Saloon Engine F22Z2	851001	Outer Joint	50T	28	32	60	89	61	I
ACCORD V Aerodeck (CE)														
2.0 i LS 16V (100 kW)	1993.09-1998.02	AT/MT	L/R	F	Estate Engine F20B3	823013	Outer Joint		28	32	60	88	59	M
	1993.09-1998.02	AT/MT	L/R	F	Estate Engine F20B3	823014	Outer Joint	50T	28	32	60	88	59	M
2.2 i ES (110 kW)	1993.09-1998.02	AT/MT	L/R	F	Estate Engine F22B5	823014	Outer Joint	50T	28	32	60	88	59	M
	1993.09-1998.02	AT/MT	L/R	F	Estate Engine F22B5	823013	Outer Joint		28	32	60	88	59	M
ACCORD VI (CG)														
2.0 (107 kW)	1999.11-2002.10	MT	-	-	Coupe Engine F20B7	623013	Inner Joint		27	32	40	45.5	75	

	 YEAR	TRANSM	L/R	F/R	REMARKS	GSP Ref.	 PRODUCT	 ABS	Technical Specifications					
									A	B	C	H	L	P
HONDA														
ACCORD VI (CG)														
2.0 i 16V (108 kW)	1998.02-2003.06	MT	-	-	Coupe Engine F20B5/F20B7	623013	Inner Joint		27	32	40	45.5	75	
	1998.02-2003.06	-	-	F	Coupe Engine F20B5/F20B7	823059	Outer Joint		28	32	64	88.5	62	M
	1998.02-2003.06	-	-	F	Coupe Engine F20B5/F20B7	823029	Outer Joint	50T	28	32	64	89	60	M
	1998.02-2003.06	-	-	-	Coupe Engine F20B5/F20B7	823031	Outer Joint	50T	28	32	60	88	59	M
3.0 V6 24V (147 kW)	1998.02-2003.06	4AT/5MT	-	-	Coupe Engine J30A1	623013	Inner Joint		27	32	40	45.5	75	
	1998.02-2003.06	-	-	F	Coupe Engine J30A1	823059	Outer Joint		28	32	64	88.5	62	M
	1998.02-2003.06	4AT/5MT	-	F	Coupe Engine J30A1	823035	Outer Joint		28	32	64	89	60	M
	1998.02-2003.06	4AT	-	F	Coupe Engine J30A1	823029	Outer Joint	50T	28	32	64	89	60	M
	1998.02-2003.06	-	-	-	Coupe Engine J30A1	823031	Outer Joint	50T	28	32	60	88	59	M
ACCORD VI (CH CL)														
2.0 (108 kW)	1999.12-2002.12	-	-	F	Hatchback Engine F20B6	823080	Outer Joint	50T	28	32	64	88.5	62	M
2.3 (113 kW)	2000.11-2002.12	-	-	-	Hatchback Engine F23Z5	823163	Outer Joint	50T	28	32	64	88	58.5	M
	2000.11-2002.12	AT/MT	L/R	F	Hatchback Engine F23Z5	823118	Outer Joint	50T	28	32	64	88.5	62	M
	2000.11-2002.12	MT	-	F	Hatchback Engine F23Z5	823029	Outer Joint	50T	28	32	64	89	60	M
	2000.11-2002.12	AT	-	F	Hatchback Engine F23Z5	823036	Outer Joint	50T	28	32	64	88.5	60.5	I
	2000.11-2002.12	-	-	F	Hatchback Engine F23Z5	823080	Outer Joint	50T	28	32	64	88.5	62	M
ACCORD VI (CK CG CH CF8)														
1.8 i (100 kW)	1998.10-2002.12	-	-	F	Saloon Engine F18B2	823036	Outer Joint	50T	28	32	64	88.5	60.5	I
	1998.10-2002.12	-	-	F	Saloon Engine F18B2	823080	Outer Joint	50T	28	32	64	88.5	62	M
2.0 i (108 kW)	1998.10-2001.01	AT	L/R	F	Saloon Engine F20B6	823118	Outer Joint	50T	28	32	64	88.5	62	M
	1998.10-2001.01	MT	-	F	Saloon Engine F20B6	823080	Outer Joint	50T	28	32	64	88.5	62	M
	1998.10-2001.01	-	-	F	Saloon Engine F20B6	823036	Outer Joint	50T	28	32	64	88.5	60.5	I
2.2 Type-R (156 kW)	1999.02-2002.12	-	-	-	Saloon Engine H22A7	823163	Outer Joint	50T	28	32	64	88	58.5	M
	1999.02-2002.12	MT	-	F	Saloon Engine H22A7	823029	Outer Joint	50T	28	32	64	89	60	M
	1999.02-2002.12	MT	-	F	Saloon Engine H22A7	823080	Outer Joint	50T	28	32	64	88.5	62	M
2.3 (110 kW)	1997.03-1999.01	4AT/MT	-	-	Saloon Engine F23A1	623013	Inner Joint		27	32	40	45.5	75	
	1997.03-1999.01	-	-	F	Saloon Engine F23A1	823009	Outer Joint	50T	28	32	60	89	61	I
	1997.03-1999.01	4AT/5MT	-	F	Saloon Engine F23A1	823035	Outer Joint		28	32	64	89	60	M
	1997.03-1999.01	4AT/5MT	-	F	Saloon Engine F23A1	823029	Outer Joint	50T	28	32	64	89	60	M
	1997.03-1999.01	-	-	F	Saloon Engine F23A1	823080	Outer Joint	50T	28	32	64	88.5	62	M
2.3 (112 kW)	1997.03-2003.03	MT	-	-	Saloon Engine F23A1/F23Z5	623013	Inner Joint		27	32	40	45.5	75	
	1997.03-2003.03	-	-	F	Saloon Engine F23A1/F23Z5	823035	Outer Joint		28	32	64	89	60	M
2.3 (113 kW)	2001.01-2003.06	-	-	-	Saloon Engine F23Z5/F23A1	823163	Outer Joint	50T	28	32	64	88	58.5	M
	2001.01-2003.06	AT/MT	L/R	F	Saloon Engine F23Z5/F23A1	823118	Outer Joint	50T	28	32	64	88.5	62	M
	2001.01-2003.06	MT	-	F	Saloon Engine F23Z5/F23A1	823029	Outer Joint	50T	28	32	64	89	60	M
	2001.01-2003.06	AT	-	F	Saloon Engine F23Z5/F23A1	823036	Outer Joint	50T	28	32	64	88.5	60.5	I
	2001.01-2003.06	-	-	F	Saloon Engine F23Z5/F23A1	823080	Outer Joint	50T	28	32	64	88.5	62	M
ACCORD VII (CL CN)														
2.0 (114 kW)	2003.02-2008.05	-	-	-	Saloon Engine K20A6	623013	Inner Joint		27	32	40	45.5	75	
	2003.02-2008.05	MT	R	F	Saloon Engine K20A6	223250	Drive Shaft		28	27	63	88.5	550	
	2003.02-2008.05	-	-	-	All-wheel Drive Saloon Engine K20A6	623013	Inner Joint		27	32	40	45.5	75	
	2003.02-2008.05	MT	R	F	All-wheel Drive Saloon Engine K20A6	223250	Drive Shaft		28	27	63	88.5	550	
	2003.02-2008.05	-	-	-	Saloon Engine K20A6	823056	Outer Joint		26	30	63	79	59	M
	2003.02-2008.05	-	-	-	All-wheel Drive Saloon Engine K20A6	823056	Outer Joint		26	30	63	79	59	M
	2003.02-2008.05	MT	L	F	Saloon Engine K20A6	623009	Inner Joint		27	32	40	58.5	97	
	2003.02-2008.05	MT	L	F	All-wheel Drive Saloon Engine K20A6	623009	Inner Joint		27	32	40	58.5	97	
	2003.02-2008.05	-	-	L/R	F Saloon Engine K20A6	823034	Outer Joint		28	32	63	88.5	59.5	M
	2003.02-2008.05	-	-	L/R	F Saloon Engine K20A6	623037	Inner Joint		29	34	40	57	97	
2.2 i-CTDi (103 kW)	2004.01-2008.05	MT	L	F	Saloon Engine N22A1	823034	Inner Joint		29	34	40	57	97	
	2004.01-2008.05	-	-	F	Saloon Engine N22A1	823117	Outer Joint		28	34	63	88.5	59.5	M
	2004.01-2008.05	MT	-	F	Saloon Engine N22A1	823146	Outer Joint		28	34	63	88.5	59.5	M
	2004.01-2008.05	MT	R	F	Saloon Engine N22A1	623038	Inner Joint		29	34	42	47.5	74.5	
	2004.01-2008.05	MT	L	F	Saloon Engine N22A1	223026	Drive Shaft		28	29	63	88.5	620	
	2004.01-2008.05	MT	R	F	Saloon Engine N22A1	223027	Drive Shaft		28	29	63	88.5	557	
	2004.01-2008.05	MT	R	F	Saloon Engine N22A1	223027	Drive Shaft		28	29	63	88.5	557	
2.4 (140 kW)	2003.02-2008.05	-	-	-	Saloon Engine K24A/K24A3	823056	Outer Joint		26	30	63	79	59	M
	2003.02-2008.05	MT	L	F	Saloon Engine K24A/K24A3	623009	Inner Joint		27	32	40	58.5	97	
	2003.02-2008.05	-	-	L/R	F Saloon Engine K24A/K24A3	823034	Outer Joint		28	32	63	88.5	59.5	M
	2003.02-2008.05	MT	L	F	Saloon Engine K24A/K24A3	201047	Drive Shaft		28	27	63	88.5	655	
	2003.02-2008.05	MT	R	F	Saloon Engine K24A/K24A3	222019	Drive Shaft		28	27	63	88.5	548	
3.0 (182 kW)	2006.04-2008.05	AT	L	R	Saloon Engine J30A5	605086	Inner Joint		28	28	57	71	64	
	2006.04-2008.05	AT	L	R	Saloon Engine J30A5	605087	Inner Joint		32	28	50	85	72.5	
ACCORD VII (CL, CN)														
2.0 R(160 kW)	2003.06-2008.12	MT	-	-	Saloon	823136	Outer Joint	50T	26	30	60	78.5	57	M
ACCORD VII (CM)														
2.4 Vtec E (118 kW)	2002.09-2005.12	-	-	-	Saloon Engine K24A4/K24A2	823056	Outer Joint		26	30	63	79	59	M
ACCORD VII Tourer (CM CN)														
2.0 (114 kW)	2003.04-2008.05	-	-	-	Estate Engine K20A6	623013	Inner Joint		27	32	40	45.5	75	





YEAR	TRANSM	L/R	F/R	REMARKS	GSP Ref.	PRODUCT	ABS	Technical Specifications								
								A	B	C	H	L	P			
HONDA																
ACCORD VII Tourer (CM CN)																
2.0 (114 kW)	2003.04-2008.05	MT	R	F	Estate Engine K20A6	223250	Drive Shaft		28	27	63	88.5	550			
	2003.04-2008.05	MT	L	F	Estate Engine K20A6	623009	Inner Joint		27	32	40	58.5	97			
	2003.04-2008.05	-	L/R	F	Estate Engine K20A6	823034	Outer Joint		28	32	63	88.5	59.5	M		
2.2 i-CTDi (103 kW)	2004.01-2008.05	MT	L	F	Estate Engine N22A1	623037	Inner Joint		29	34	40	57	97			
	2004.01-2008.05	-	-	F	Estate Engine N22A1	823117	Outer Joint		28	34	63	88.5	59.5	M		
	2004.01-2008.05	MT	-	F	Estate Engine N22A1	823146	Outer Joint		28	34	63	88.5	59.5	M		
	2004.01-2008.05	MT	R	F	Estate Engine N22A1	623038	Inner Joint		29	34	42	47.5	74.5			
	2004.01-2008.05	MT	L	F	Estate Engine N22A1	223026	Drive Shaft		28	29	63	88.5	620			
	2004.01-2008.05	MT	R	F	Estate Engine N22A1	223027	Drive Shaft		28	29	63	88.5	557			
2.4 (140 kW)	2003.04-2008.05	AT	-	-	Estate Engine K24A	623013	Inner Joint		27	32	40	45.5	75			
	2003.04-2008.05	AT	-	R	Estate Engine K24A	623069	Inner Joint		23	25	35	60	94.5			
	2003.04-2008.05	-	-	-	Estate Engine K24A	823056	Outer Joint		26	30	63	79	59	M		
	2003.04-2008.05	MT	L	F	Estate Engine K24A	623009	Inner Joint		27	32	40	58.5	97			
	2003.04-2008.05	AT	R	F	Estate Engine K24A	623023	Inner Joint		27	30	40	45.5	75			
	2003.04-2008.05	AT	-	R	Estate Engine K24A	623054	Inner Joint		23	25	55	78	85			
	2003.04-2008.05	AT	R	F	Estate Engine K24A	699079	Inner Joint		27	30	40	55.5	97			
	2003.04-2008.05	-	L/R	F	Estate Engine K24A	823034	Outer Joint		28	32	63	88.5	59.5	M		
	2003.04-2008.05	MT	L	F	Estate Engine K24A	201047	Drive Shaft		28	27	63	88.5	655			
	2003.04-2008.05	MT	R	F	Estate Engine K24A	222019	Drive Shaft		28	27	63	88.5	548			
2.4 Vtec T (147 kW)	2003.09-2008.05	-	-	-	Estate Engine K24A1	823056	Outer Joint		26	30	63	79	59	M		
ACCORD VIII (CU)																
2.0 i (115 kW)	2008.06-2015.06	MT	-	F	Saloon Engine R20A3	823145	Outer Joint		30	34	68	88	59.5	M		
	2008.06-2015.06	AT	-	F	Saloon Engine R20A3	823135	Outer Joint		30	30	68	89	59	M		
	2008.06-2015.06	AT	R	F	Saloon Engine R20A3	623023	Inner Joint		27	30	40	45.5	75			
	2008.06-2015.06	AT	-	F	Saloon Engine R20A3	823168	Outer Joint		30	30	68	88.5	59.5	M		
	2008.06-2015.06	AT	R	F	Saloon Engine R20A3	699079	Inner Joint		27	30	40	55.5	97			
	2008.06-2015.06	MT	L	F	Saloon Engine R20A3	623053	Inner Joint		27	34	40	58	97.5			
	2008.06-2015.06	MT	R	F	Saloon Engine R20A3	623052	Inner Joint		27	34	40	46	74.5			
2.2 i-DTEC (110 kW)	2008.07-2015.06	AT	L	F	Saloon Engine N22B1	223270	Drive Shaft		30	29	68	88	651			
	2008.07-2015.06	MT	L	F	Saloon Engine N22B1	623037	Inner Joint		29	34	40	57	97			
	2008.07-2015.06	-	-	F	Saloon Engine N22B1	823145	Outer Joint		30	34	68	88	59.5	M		
	2008.07-2015.06	-	R	F	Saloon Engine N22B1	623038	Inner Joint		29	34	42	47.5	74.5			
2.2 i-DTEC (132 kW)	2008.07-2015.06	MT	L	F	Saloon Engine N22B2	623037	Inner Joint		29	34	40	57	97			
	2008.07-2015.06	MT	-	F	Saloon Engine N22B2	823145	Outer Joint		30	34	68	88	59.5	M		
	2008.07-2015.06	MT	R	F	Saloon Engine N22B2	623038	Inner Joint		29	34	42	47.5	74.5			
2.4 i (148 kW)	2008.07-2015.06	AT	-	-	Saloon Engine K24Z3	623013	Inner Joint		27	32	40	45.5	75			
	2008.07-2015.06	MT	-	F	Saloon Engine K24Z3	823145	Outer Joint		30	34	68	88	59.5	M		
	2008.07-2015.06	AT	-	F	Saloon Engine K24Z3	823124	Outer Joint		30	32	68	88	59.5	M		
	2008.07-2015.06	MT	L	F	Saloon Engine K24Z3	623053	Inner Joint		27	34	40	58	97.5			
	2008.07-2015.06	MT	R	F	Saloon Engine K24Z3	623052	Inner Joint		27	34	40	46	74.5			
ACCORD VIII (CW)																
2.0 i (115 kW)	2008.07-2015.06	MT	-	F	Estate Engine R20A3	823145	Outer Joint		30	34	68	88	59.5	M		
	2008.07-2015.06	AT	-	F	Estate Engine R20A3	823135	Outer Joint		30	30	68	89	59	M		
	2008.07-2015.06	AT	R	F	Estate Engine R20A3	623023	Inner Joint		27	30	40	45.5	75			
	2008.07-2015.06	AT	-	F	Estate Engine R20A3	823168	Outer Joint		30	30	68	88.5	59.5	M		
	2008.07-2015.06	AT	R	F	Estate Engine R20A3	699079	Inner Joint		27	30	40	55.5	97			
	2008.07-2015.06	MT	L	F	Estate Engine R20A3	623053	Inner Joint		27	34	40	58	97.5			
	2008.07-2015.06	MT	R	F	Estate Engine R20A3	623052	Inner Joint		27	34	40	46	74.5			
2.2 i-DTEC (110 kW)	2008.07-2015.06	AT/MT	L	F	Estate Engine N22B1	223270	Drive Shaft		30	29	68	88	651			
	2008.07-2015.06	MT	L	F	Estate Engine N22B1	623037	Inner Joint		29	34	40	57	97			
	2008.07-2015.06	-	-	F	Estate Engine N22B1	823145	Outer Joint		30	34	68	88	59.5	M		
	2008.07-2015.06	-	R	F	Estate Engine N22B1	623038	Inner Joint		29	34	42	47.5	74.5			
2.2 i-DTEC (132 kW)	2008.07-2015.06	MT	L	F	Estate Engine N22B2	623037	Inner Joint		29	34	40	57	97			
	2008.07-2015.06	MT	-	F	Estate Engine N22B2	823145	Outer Joint		30	34	68	88	59.5	M		
	2008.07-2015.06	MT	R	F	Estate Engine N22B2	623038	Inner Joint		29	34	42	47.5	74.5			
2.4 i (148 kW)	2008.07-2015.06	AT	-	-	Estate Engine K24Z3	623013	Inner Joint		27	32	40	45.5	75			
	2008.07-2015.06	MT	-	F	Estate Engine K24Z3	823145	Outer Joint		30	34	68	88	59.5	M		
	2008.07-2015.06	AT	-	F	Estate Engine K24Z3	823124	Outer Joint		30	32	68	88	59.5	M		
	2008.07-2015.06	MT	L	F	Estate Engine K24Z3	623053	Inner Joint		27	34	40	58	97.5			
	2008.07-2015.06	MT	R	F	Estate Engine K24Z3	623052	Inner Joint		27	34	40	46	74.5			
ACCORD VIII (CU)																
2.0 i (115 kW)	2010-2015.06	-	-	R	F	-	223334	Drive Shaft		30	27	68	88	647		
ACCORD(CU2)																
-	2008-2015.06	-	-	-	-	-	823111	Outer Joint		23	25	49	78	50.5	M	
ACTY HA2																
550	1988.05-1990.02	MT	-	-	Allwheel Drive Engine E05A	823112	Outer Joint		23	18	47	77.5	61.5	M		





	 YEAR	TRANSM	L/R	F/R	REMARKS	GSP Ref.	 PRODUCT	 ABS	Technical Specifications					
									A	B	C	H	L	P
HONDA														
ACTY HA2														
550	1988.05-1990.02	MT	-	-	Allwheel Drive Engine E05A	823112	Outer Joint		23	18	47	77.5	61.5	M
ACTY HA4														
660	1990.02-1999.07	MT	-	-	Allwheel Drive Engine E07A	823112	Outer Joint		23	18	47	77.5	61.5	M
	1990.02-1999.07	MT	-	-	Allwheel Drive Engine E07A	823112	Outer Joint		23	18	47	77.5	61.5	M
	1990.02-1999.07	MT	-	-	Allwheel Drive Engine E07A	823112	Outer Joint		23	18	47	77.5	61.5	M
	1990.02-1999.07	MT	-	-	Allwheel Drive Engine E07A	823112	Outer Joint		23	18	47	77.5	61.5	M
ACTY HH2														
550	1988.05-1990.02	MT	-	-	Allwheel Drive Engine E05A	823112	Outer Joint		23	18	47	77.5	61.5	M
	1988.05-1990.02	MT	-	-	Allwheel Drive Engine E05A	823112	Outer Joint		23	18	47	77.5	61.5	M
ACTY HH4														
660	1990.02-1999.06	MT	-	-	Allwheel Drive Engine E07A	823112	Outer Joint		23	18	47	77.5	61.5	M
	1990.02-1999.06	5MT	-	-	Allwheel Drive Engine E07A	823112	Outer Joint		23	18	47	77.5	61.5	M
	1990.02-1999.06	5MT	-	-	Allwheel Drive Engine E07A	823112	Outer Joint		23	18	47	77.5	61.5	M
	1990.02-1999.06	5MT	-	-	Allwheel Drive Engine E07A	823112	Outer Joint		23	18	47	77.5	61.5	M
	1990.02-1999.06	5MT	-	-	Allwheel Drive Engine E07A	823112	Outer Joint		23	18	47	77.5	61.5	M
	1990.02-1999.06	MT	-	-	Allwheel Drive Engine E07A	823112	Outer Joint		23	18	47	77.5	61.5	M
	1990.02-1999.06	5MT	-	-	Allwheel Drive Engine E07A	823112	Outer Joint		23	18	47	77.5	61.5	M
	1990.02-1999.06	5MT	-	-	Allwheel Drive Engine E07A	823112	Outer Joint		23	18	47	77.5	61.5	M
ACTY VAN														
0.7 Ha7	1999-	MT	-	-	-	823231	Outer Joint		23	23	49	78	49	I
0.7 Hh6	1999-2003	MT/AT	-	-	-	823231	Outer Joint		23	23	49	78	49	I
0.7 Hh6,Hm2	2003-	-	-	-	-	823231	Outer Joint		23	23	49	78	49	I
ASCOT (CB1)														
1.8	1989.09-1992.04	MT	-	-	Engine F18A	823015	Outer Joint		28	32	60	89	60	M
	1989.09-1993.10	AT	-	-	Engine F18A	823015	Outer Joint		28	32	60	89	60	M
ASCOT (CB2)														
1.8 4WD	1989.09-1991.07	MT/AT	-	-	Engine F18A	823015	Outer Joint		28	32	60	89	60	M
ASCOT (CB3)														
2.0	1989.09-1992.04	MT	-	-	Engine F20A	823015	Outer Joint		28	32	60	89	60	M
	1989.09-1993.10	AT	-	-	Engine F20A	823015	Outer Joint		28	32	60	89	60	M
ASCOT (CB4)														
2.0 4WS	1989.09-1991.07	MT	-	-	Engine F20A	823015	Outer Joint		28	32	60	89	60	M
	1989.09-1993.10	AT	-	-	Engine F20A	823015	Outer Joint		28	32	60	89	60	M
ASCOT (CE4)														
2.0	1993.10-1997.09	MT/AT	-	-	Engine G20A	823015	Outer Joint		28	32	60	89	60	M
ASCOT (CE5)														
2.5	1993.10-1997.09	AT	-	-	Engine G25A	823015	Outer Joint		28	32	60	89	60	M
ASCOT CB1														
1.8	1989.09-1992.04	MT	-	-	Engine F18A	823015	Outer Joint		28	32	60	89	60	M
	1989.09-1992.04	AT	-	-	Engine F18A	823015	Outer Joint		28	32	60	89	60	M
	1992.04-1993.10	AT	-	-	Engine F18A	823015	Outer Joint		28	32	60	89	60	M
1800	1989.09-1992.04	AT	-	-	Engine F18A	823015	Outer Joint		28	32	60	89	60	M
	1989.09-1992.04	MT	-	-	Engine F18A	823015	Outer Joint		28	32	60	89	60	M
	1992.04-1993.10	AT	-	-	Engine F18A	823015	Outer Joint		28	32	60	89	60	M
ASCOT CB2														
1.8	1989.09-1991.07	AT	-	-	Allwheel Drive Engine F18A	823015	Outer Joint		28	32	60	89	60	M
	1989.09-1991.07	MT	-	-	Allwheel Drive Engine F18A	823015	Outer Joint		28	32	60	89	60	M
1800	1989.09-1991.07	AT	-	-	Allwheel Drive Engine F18A	823015	Outer Joint		28	32	60	89	60	M
	1989.09-1991.07	MT	-	-	Allwheel Drive Engine F18A	823015	Outer Joint		28	32	60	89	60	M
ASCOT CB3														
2.0	1989.09-1992.04	MT	-	-	Engine F20A	823015	Outer Joint		28	32	60	89	60	M
	1989.09-1992.04	AT	-	-	Engine F20A	823015	Outer Joint		28	32	60	89	60	M
	1992.04-1993.10	AT	-	-	Engine F20A	823015	Outer Joint		28	32	60	89	60	M
2000	1989.09-1992.04	MT	-	-	Engine F20A	823015	Outer Joint		28	32	60	89	60	M
	1989.09-1992.04	AT	-	-	Engine F20A	823015	Outer Joint		28	32	60	89	60	M
	1992.04-1993.10	AT	-	-	Engine F20A	823015	Outer Joint		28	32	60	89	60	M
ASCOT CB4 4WS														
2.0	1989.09-1992.04	AT	-	-	Engine F20A	823015	Outer Joint		28	32	60	89	60	M
	1989.09-1991.07	MT	-	-	Engine F20A	823015	Outer Joint		28	32	60	89	60	M
	1992.04-1993.10	AT	-	-	Engine F20A	823015	Outer Joint		28	32	60	89	60	M
2000	1989.09-1992.04	AT	-	-	Engine F20A	823015	Outer Joint		28	32	60	89	60	M
	1989.09-1991.07	MT	-	-	Engine F20A	823015	Outer Joint		28	32	60	89	60	M
	1992.04-1993.10	AT	-	-	Engine F20A	823015	Outer Joint		28	32	60	89	60	M
ASCOT CE4														
2.0	1993.10-1997.09	MT/AT	-	-	Engine G20A	823015	Outer Joint		28	32	60	89	60	M

YEAR	TRANS	L/R	F/R	REMARKS	GSP Ref.	PRODUCT	ABS	Technical Specifications							
								A	B	C	H	L	P		
HONDA															
ASCOT CE4															
2000	1993.10-	1997.09	MT/AT	-	-	Engine G20A	823015	Outer Joint		28	32	60	89	60	M
ASCOT CE5															
2.5	1993.10-	1997.09	AT	-	-	Engine G25A	823015	Outer Joint		28	32	60	89	60	M
	1993.10-	1997.09	AT	-	-	Engine G25A	823015	Outer Joint		28	32	60	89	60	M
AVANCIER															
2.3 (110 kW)	1999.09-	2003.09	MT	-	-	All-wheel Drive Estate Engine F23A	623013	Inner Joint		27	32	40	45.5	75	
BALLADE															
1.5	2011-	-	AT	R	F	Engine: L15A7	223173	Drive Shaft		26	27	52	78.5	570	
	2011-	-	AT	L	F	Engine: L15A7	223174	Drive Shaft		26	25	52	78.5	641	
BRIO															
1.2	2014-	-	5MT	R	F	S 5MT OYW4300	223326	Drive Shaft		26	25	52	78.5	895	
	2014-	-	CVT	R	F	S CVT GG7A200	223326	Drive Shaft		26	25	52	78.5	895	
	2014-	-	5MT	R	F	S 5MT OYW4300	823138	Outer Joint		26	27	52	78.5	52.5	M
	2014-	-	CVT	R	F	S CVT GG7A200	823138	Outer Joint		26	27	52	78.5	52.5	M
	2014-	-	5MT	R	F	S 5MT OYW4300	623050	Inner Joint		25	27	35	58	94.5	
	2014-	-	CVT	R	F	S CVT GG7A200	623050	Inner Joint		25	27	35	58	94.5	
	2015-	-	CVT	R	F	S CVT GG7A300	223326	Drive Shaft		26	25	52	78.5	895	
	2015-	-	CVT	R	F	S CVT GG7A300	823138	Outer Joint		26	27	52	78.5	52.5	M
	2015-	-	CVT	R	F	S CVT GG7A300	623050	Inner Joint		25	27	35	58	94.5	
BRIO AMAZE															
1.2	2014-	-	5MT	R	F	S	223326	Drive Shaft		26	25	52	78.5	895	
	2014-	-	5MT	R	F	S	823138	Outer Joint		26	27	52	78.5	52.5	M
	2014-	-	5MT	R	F	S	623050	Inner Joint		25	27	35	58	94.5	
	2015-	-	5MT	R	F	S	223326	Drive Shaft		26	25	52	78.5	895	
	2015-	-	5MT	R	F	S	823138	Outer Joint		26	27	52	78.5	52.5	M
	2015-	-	5MT	R	F	S	623050	Inner Joint		25	27	35	58	94.5	
CITY															
-	-	-	-	R	-	-	823061	Outer Joint		26	22	52	79	56	M
	-	-	-	R	-	-	223014	Drive Shaft		26	25	52	79	899	
	-	-	-	L	-	-	823051	Outer Joint		26	22	55	77.5	53	I
	-	-	-	L	-	-	223015	Drive Shaft		26	25	55	77.5	600	
	-	-	-	L	-	-	201009	Drive Shaft		26	25	52	79	616	
1.5	2009-	2011	AT	R	F	Engine: L15A7	223173	Drive Shaft		26	27	52	78.5	570	
	2009-	2011	AT	L	F	Engine: L15A7	223174	Drive Shaft		26	25	52	78.5	641	
CITY (GM2 GM3)															
1.5 (88 kW)	2009.02-	-	5AT	L	-	Saloon Engine L15A7	223350	Drive Shaft		26	25	58	78.5	641	
CIVIC															
-	-	2006.12	AT	R	-	-	623032	Inner Joint		25	22	35	61.5	97	
	1992-	1995	-	R	-	-	223119	Drive Shaft		26	25	55	78.5	622	
	1992-	1995	-	L	-	-	223120	Drive Shaft		26	25	55	78.5	904.5	
	1996-	-	-	R	-	-	623028	Inner Joint		25	30	35	54.5	98.5	
	1997-	2000	MT/AT	R	-	-	623029	Inner Joint		25	30	35	62	97.5	
	2001-	2005	AT	L	-	-	223128	Drive Shaft	50T	26	25	60	78	903	
	2001-	2005	AT	R	-	-	223127	Drive Shaft	50T	26	25	60	78	606	
	2001-	2005	AT	L	-	-	223087	Drive Shaft	50T	26	25	60	78	905	
	2001-	2005	-	-	-	-	823053	Outer Joint		26	23	60	78	61	M
	2001.04-	-	AT	R	-	-	201035	Drive Shaft		26	25	60	78	606	
	2001.04-	-	AT	L	-	-	223069	Drive Shaft		26	25	60	78	903	
	2001.04-	2005	AT	R	-	-	623008	Inner Joint		25	30	35	54.5	92	
1.3/1.5	1995-	-	MT/AT	-	-	-	623021	Inner Joint		25	28	35	61.5	97.5	
1.6	1995-	2000	-	L	-	-	223051	Drive Shaft	50T	26	25	55	77.5	901.5	
	1995-	2000	-	R	-	-	201025	Drive Shaft	50T	26	25	55	77.5	619.5	
1.6 16V	1997.01-	2000.12	MT/AT	-	-	-	823109	Outer Joint		26	32	55	78	58.5	I
	1997.01-	2000.12	MT/AT	-	-	-	823108	Outer Joint	50T	26	32	55	78	58.5	I
1.7	-	-	-	R	-	-	223066	Drive Shaft		26	25	60	78	611	
	-	-	-	L	-	-	223068	Drive Shaft		26	25	60	78	895.5	
	2000.01-	2002.12	MT/AT	-	-	Engine D17	823105	Outer Joint	50T	26	23	60	78.5	59.5	M
	2000.01-	2002.12	MT/AT	-	-	Engine D17	823105	Outer Joint	50T	26	23	60	78.5	59.5	M
1.8	2002-	2010	MT	-	-	-	823107	Outer Joint		26	24	58	79.5	60.5	M
	2002-	2010	AT	-	-	-	823110	Outer Joint		26	22	58	78.5	56	M
	2006-	2011	MT	L	-	-	623030	Inner Joint		27	23	40	58.5	97	
	2006-	2011	AT	L	-	-	623031	Inner Joint		25	22	35	58	96	
	2006-	2011	MT	R	-	-	623033	Inner Joint		27	23	40	48.5	74	
	2006-	2011	AT	R	-	-	623067	Inner Joint		25	22	35	58	96	
	2006-	-	-	R	-	-	223023	Drive Shaft		26	25	58	78.5	912	
	2006-	-	-	L	-	-	223022	Drive Shaft		26	25	58	78.5	623	





YEAR	TRANSM	L/R	F/R	REMARKS	GSP Ref.	PRODUCT	ABS	Technical Specifications						
								A	B	C	H	L	P	
HONDA CIVIC														
16V	1988-1990	-	-	-	-	623008	Inner Joint		25	30	35	54.5	92	
1700	2000.01-2002.12	MT/AT	-	-	Engine D17	823105	Outer Joint	50T	26	23	60	78.5	59.5	M
2.0	2006-	-	R	-	-	223024	Drive Shaft		26	27	63	79	585	
	2006-	-	L	-	-	223025	Drive Shaft		26	27	63	79	620	
	2007-2010	MT	-	-	-	823111	Outer Joint		23	25	49	78	50.5	M
CIVIC (FD1)														
1.8	2005.09-	5AT	-	F	Engine R18A	823155	Outer Joint		26	28	58	78	51.5	M
	2005.09-	5AT	-	-	Engine R18A	823155	Outer Joint		26	28	58	78	51.5	M
	2005.09-	5MT	-	F	Engine R18A	823155	Outer Joint		26	28	58	78	51.5	M
	2005.09-	5MT	-	-	Engine R18A	823155	Outer Joint		26	28	58	78	51.5	M
CIVIC (FD2)														
2.0	2007.03-	6MT	-	-	Engine K20A	823153	Outer Joint		30	32	68	88.5	59.5	M
CIVIC CRX														
-	1988-1991	-	-	-	-	623010	Inner Joint		25	27	35	54.5	90	
	1988-1991	-	R	-	-	223044	Drive Shaft		23	25	49	79.5	600	
	1988-1991	-	L	-	-	223045	Drive Shaft		23	25	49	79.5	905	
CIVIC DEL SOL														
1.5	1994-1996	-	L	-	-	201022	Drive Shaft		26	27	55	78.5	566.5	
	1993-	-	R	-	-	223119	Drive Shaft		26	25	55	78.5	622	
	1993-	-	L	-	-	223120	Drive Shaft		26	25	55	78.5	904.5	
	1994-1996	-	R	-	-	223119	Drive Shaft		26	25	55	78.5	622	
	1994-1996	-	L	-	-	223120	Drive Shaft		26	25	55	78.5	904.5	
1.6	1993-	-	L	-	-	223120	Drive Shaft		26	25	55	78.5	904.5	
	1994-1996	-	L	-	-	223120	Drive Shaft		26	25	55	78.5	904.5	
CIVIC EF8														
1.6	1989.08-1992.02	5MT	-	-	Engine B16A	823207	Outer Joint		26	32	55	78.1	55	M
1600	1989.08-1992.02	5MT	-	-	Engine B16A	823207	Outer Joint		26	32	55	78.1	55	M
CIVIC EF9														
1.6	1989.09-1991.09	5MT	-	-	Engine B16A	823207	Outer Joint		26	32	55	78.1	55	M
1600	1989.09-1991.09	5MT	-	-	Engine B16A	823207	Outer Joint		26	32	55	78.1	55	M
CIVIC EG2														
1.6	1992.02-1993.07	MT/AT	-	-	Engine B16A	823207	Outer Joint		26	32	55	78.1	55	M
	1993.07-1997.08	MT/AT	-	-	Engine B16A	823207	Outer Joint		26	32	55	78.1	55	M
1600	1992.02-1993.07	MT/AT	-	-	Engine B16A	823207	Outer Joint		26	32	55	78.1	55	M
	1993.07-1997.08	MT/AT	-	-	Engine B16A	823207	Outer Joint		26	32	55	78.1	55	M
CIVIC EG5														
1.6	1992.05-1995.09	MT/AT	-	-	Engine ZC	823207	Outer Joint		26	32	55	78.1	55	M
1600	1992.05-1995.09	MT/AT	-	-	Engine ZC	823207	Outer Joint		26	32	55	78.1	55	M
CIVIC EG6														
1.6	1991.09-1993.09	MT/AT	-	-	Engine B16A	823207	Outer Joint		26	32	55	78.1	55	M
	1991.09-1992.09	MT/AT	-	-	Engine B16A	823207	Outer Joint		26	32	55	78.1	55	M
	1993.09-1995.09	MT/AT	-	-	Engine B16A	823207	Outer Joint		26	32	55	78.1	55	M
1600	1991.09-1993.09	MT/AT	-	-	Engine B16A	823207	Outer Joint		26	32	55	78.1	55	M
	1991.09-1992.09	MT/AT	-	-	Engine B16A	823207	Outer Joint		26	32	55	78.1	55	M
	1993.09-1995.09	MT/AT	-	-	Engine B16A	823207	Outer Joint		26	32	55	78.1	55	M
CIVIC EG9														
1.6	1991.09-1993.09	MT/AT	-	-	Engine B16A	823207	Outer Joint		26	32	55	78.1	55	M
	1993.09-1995.09	MT/AT	-	-	Engine B16A	823207	Outer Joint		26	32	55	78.1	55	M
1600	1991.09-1993.09	MT/AT	-	-	Engine B16A	823207	Outer Joint		26	32	55	78.1	55	M
	1993.09-1995.09	MT/AT	-	-	Engine B16A	823207	Outer Joint		26	32	55	78.1	55	M
CIVIC EH1														
1.6	1991.09-1995.09	MT/AT	-	-	Allwheel Drive Engine ZC	823207	Outer Joint		26	32	55	78.1	55	M
1600	1991.09-1995.09	MT/AT	-	-	Allwheel Drive Engine ZC	823207	Outer Joint		26	32	55	78.1	55	M
CIVIC EK5														
1.6	1995.09-2000.09	MT/AT	-	-	Allwheel Drive Engine D16A	823207	Outer Joint		26	32	55	78.1	55	M
1600	1995.09-2000.09	MT/AT	-	-	Allwheel Drive Engine D16A	823207	Outer Joint		26	32	55	78.1	55	M
CIVIC FD1														
1.8	2005.09-	5AT	-	-	Engine R18A	823155	Outer Joint		26	28	58	78	51.5	M
	2005.09-	5MT	-	-	Engine R18A	823155	Outer Joint		26	28	58	78	51.5	M
1800	2005.09-	5MT	-	-	Engine R18A	823155	Outer Joint		26	28	58	78	51.5	M
	2005.09-	5AT	-	-	Engine R18A	823155	Outer Joint		26	28	58	78	51.5	M
	2005.09-	5AT	-	-	Engine R18A	823155	Outer Joint		26	28	58	78	51.5	M
	2005.09-	5MT	-	-	Engine R18A	823155	Outer Joint		26	28	58	78	51.5	M
	2005.09-	5MT	-	-	Engine R18A	823155	Outer Joint		26	28	58	78	51.5	M
	2005.09-	5AT	-	-	Engine R18A	823155	Outer Joint		26	28	58	78	51.5	M





YEAR	TRANS	L/R	F/R	REMARKS	GSP Ref.	PRODUCT	ABS	Technical Specifications							
								A	B	C	H	L	P		
HONDA															
CIVIC FD1															
1800	2005.09-	-	5MT	-	-	Engine R18A	823155	Outer Joint		26	28	58	78	51.5	M
CIVIC FD2															
2.0	2007.03-	-	6MT	-	-	Engine K20A	823153	Outer Joint		30	32	68	88.5	59.5	M
2000	2007.03-	-	6MT	-	-	Engine K20A	823153	Outer Joint		30	32	68	88.5	59.5	M
CIVIC FERIO EG9															
1.6	1991.01-1992.09		MT/AT	-	-	Engine B16A	823207	Outer Joint		26	32	55	78.1	55	M
	1992.09-1993.09		MT/AT	-	-	Engine B16A	823207	Outer Joint		26	32	55	78.1	55	M
	1993.09-1995.09		MT/AT	-	-	Engine B16A	823207	Outer Joint		26	32	55	78.1	55	M
1600	1991.01-1992.09		MT/AT	-	-	Engine B16A	823207	Outer Joint		26	32	55	78.1	55	M
	1992.09-1993.09		MT/AT	-	-	Engine B16A	823207	Outer Joint		26	32	55	78.1	55	M
	1993.09-1995.09		MT/AT	-	-	Engine B16A	823207	Outer Joint		26	32	55	78.1	55	M
CIVIC FERIO EH1															
1.6	1991.01-1992.09		MT/AT	-	-	Allwheel Drive Engine ZC	823207	Outer Joint		26	32	55	78.1	55	M
	1992.09-1993.09		MT/AT	-	-	Allwheel Drive Engine ZC	823207	Outer Joint		26	32	55	78.1	55	M
	1993.09-1995.09		MT/AT	-	-	Allwheel Drive Engine ZC	823207	Outer Joint		26	32	55	78.1	55	M
1600	1991.01-1992.09		MT/AT	-	-	Allwheel Drive Engine ZC	823207	Outer Joint		26	32	55	78.1	55	M
	1992.09-1993.09		MT/AT	-	-	Allwheel Drive Engine ZC	823207	Outer Joint		26	32	55	78.1	55	M
	1993.09-1995.09		MT/AT	-	-	Allwheel Drive Engine ZC	823207	Outer Joint		26	32	55	78.1	55	M
CIVIC FERIO EK5															
1.6	1995.09-	2000.09	MT/AT	-	-	Allwheel Drive Engine D16A	823207	Outer Joint		26	32	55	78.1	55	M
1600	1995.09-	2000.09	MT/AT	-	-	Allwheel Drive Engine D16A	823207	Outer Joint		26	32	55	78.1	55	M
CIVIC II															
1.4 i	1988-	1995	-	L/R	F	-	623007	Inner Joint		25	30	35	62	98.5	
1.6 i	1988-	1995	-	R	F	-	623043	Inner Joint		25	30	35	54.5	97	
CIVIC II Shuttle (EE)															
1.4 i 16V (66 kW)	1988.01-1992.12		AT/MT	R	F	Estate Engine D14A1	223225	Drive Shaft		26	25	49	79	599	
	1988.01-1992.12		-	L	F	Estate Engine D14A1	623004	Inner Joint		25	30	35	62	97.5	
	1988.01-1992.12		MT	R	F	Estate Engine D14A1	223030	Drive Shaft		26	25	49	79	599	
	1988.01-1992.12		-	R	F	Estate Engine D14A1	623005	Inner Joint		25	30	35	54.5	97	
	1988.01-1992.12		-	L	F	Estate Engine D14A1	201013	Drive Shaft		26	25	49	79	903	
1.5 i 16V (69 kW)	1988.01-1991.11		AT/MT	R	F	Estate Engine D15B2	223225	Drive Shaft		26	25	49	79	599	
	1988.01-1991.11		5MT	L	F	Estate Engine D15B2	623004	Inner Joint		25	30	35	62	97.5	
	1988.01-1991.11		MT	R	F	Estate Engine D15B2	223030	Drive Shaft		26	25	49	79	599	
	1988.01-1991.11		5MT	R	F	Estate Engine D15B2	623005	Inner Joint		25	30	35	54.5	97	
	1988.01-1991.11		5MT	R	F	Estate Engine D15B2	601001	Inner Joint		27	32	40	55.5	97	
1.6 (85 kW)	1988.01-1992.12		MT	L	F	All-wheel Drive Estate Engine D16A7/D16A	623004	Inner Joint		25	30	35	62	97.5	
	1988.01-1992.12		-	L	F	All-wheel Drive Estate Engine D16A7/D16A	201013	Drive Shaft		26	25	49	79	903	
	1988.01-1992.12		MT	R	F	All-wheel Drive Estate Engine D16A7/D16A	601001	Inner Joint		27	32	40	55.5	97	
1.6 i 16V (80 kW)	1988.01-1989.12		AT/MT	L	F	All-wheel Drive Estate Engine D16A6	823021	Outer Joint		26	32	49	78.5	56.5	M
	1988.01-1989.12		-	L	F	All-wheel Drive Estate Engine D16A6	201013	Drive Shaft		26	25	49	79	903	
	1988.01-1989.12		5MT	R	F	All-wheel Drive Estate Engine D16A6	601001	Inner Joint		27	32	40	55.5	97	
	1988.01-1989.12		MT	L	F	All-wheel Drive Estate Engine D16A6	623004	Inner Joint		25	30	35	62	97.5	
	1988.01-1989.12		5MT	R	F	All-wheel Drive Estate Engine D16A6	623005	Inner Joint		25	30	35	54.5	97	
1.6 i 16V (81 kW)	1988.01-1995.02		MT	L	F	All-wheel Drive Estate Engine D16A6	623004	Inner Joint		25	30	35	62	97.5	
	1988.01-1995.02		AT/MT	L	F	All-wheel Drive Estate Engine D16A6	823021	Outer Joint		26	32	49	78.5	56.5	M
	1988.01-1995.02		-	L	F	All-wheel Drive Estate Engine D16A6	201013	Drive Shaft		26	25	49	79	903	
	1988.01-1995.02		5MT	R	F	All-wheel Drive Estate Engine D16A6	623005	Inner Joint		25	30	35	54.5	97	
	1988.01-1995.02		5MT	R	F	All-wheel Drive Estate Engine D16A6	601001	Inner Joint		27	32	40	55.5	97	
CIVIC III															
1.3	1987.08-	1991.11	-	R	F	-	223150	Drive Shaft		26	25	55	78.5	610	
1.4	1987.08-	1991.11	-	R	F	-	223150	Drive Shaft		26	25	55	78.5	610	
1.6	1990.07-	1991.11	-	R	F	-	223150	Drive Shaft		26	25	55	78.5	610	
CIVIC IV															
1.4	1991.11-	1996.03	MT/AT	R	F	-	223135	Drive Shaft		26	25	55	78.5	627	
1.5	1991.11-	1996.03	MT/AT	R	F	-	223135	Drive Shaft		26	25	55	78.5	627	
1.6 SOHC	1991.11-	1996.03	MT/AT	R	F	-	223135	Drive Shaft		26	25	55	78.5	627	
CIVIC IV (EC ED EE)															
1.3 (55 kW)	1987.10-1989.12		MT	R	F	Hatchback Engine D13B1	223030	Drive Shaft		26	25	49	79	599	
	1987.10-1989.12		AT/MT	R	F	Hatchback Engine D13B1	823011	Outer Joint		26	30	49	79	53	M
	1987.10-1989.12		-	L/R	F	Hatchback Engine D13B1	823012	Outer Joint	100T	26	30	49	78.5	55.5	M
	1987.10-1989.12		-	L	F	Hatchback Engine D13B1	623004	Inner Joint		25	30	35	62	97.5	
	1987.10-1989.12		AT/MT	R	F	Hatchback Engine D13B1	223225	Drive Shaft		26	25	49	79	599	
	1987.10-1989.12		-	R	F	Hatchback Engine D13B1	623005	Inner Joint		25	30	35	54.5	97	
1.3 16V Cat (55 kW)	1989.09-1991.09		AT/MT	R	F	Hatchback Engine D13B2	823011	Outer Joint		26	30	49	79	53	M
	1989.09-1991.09		MT	L	F	Hatchback Engine D13B2	623004	Inner Joint		25	30	35	62	97.5	
	1989.09-1991.09		MT	R	F	Hatchback Engine D13B2	223030	Drive Shaft		26	25	49	79	599	

	 YEAR	TRANSM	L/R	F/R	REMARKS	GSP Ref.	 PRODUCT	 ABS	Technical Specifications					
									A	B	C	H	L	P
HONDA														
CIVIC IV (EC ED EE)														
1.3 16V Cat (55 kW)	1989.09-1991.09	MT	R	F	Hatchback Engine D13B2	623005	Inner Joint		25	30	35	54.5	97	
	1989.09-1991.09	-	L/R	F	Hatchback Engine D13B2	823012	Outer Joint	100T	26	30	49	78.5	55.5	M
1.4 L (66 kW)	1987.10-1989.12	MT	R	F	Hatchback Engine D14A1	223030	Drive Shaft		26	25	49	79	599	
	1987.10-1989.12	-	L	F	Hatchback Engine D14A1	201013	Drive Shaft		26	25	49	79	903	
	1987.10-1989.12	AT/MT	R	F	Hatchback Engine D14A1	823011	Outer Joint		26	30	49	79	53	M
	1987.10-1989.12	-	L/R	F	Hatchback Engine D14A1	823012	Outer Joint	100T	26	30	49	78.5	55.5	M
	1987.10-1989.12	-	L	F	Hatchback Engine D14A1	623004	Inner Joint		25	30	35	62	97.5	
	1987.10-1989.12	-	R	F	Hatchback Engine D14A1	623005	Inner Joint		25	30	35	54.5	97	
	1987.10-1989.12	AT/MT	R	F	Hatchback Engine D14A1	223225	Drive Shaft		26	25	49	79	599	
1.5 i 16V (66 kW)	1988.10-1991.09	AT/MT	L/R	F	Hatchback Engine D15B2	823011	Outer Joint		26	30	49	79	53	M
	1988.10-1991.09	AT/MT	R	F	Hatchback Engine D15B2	223225	Drive Shaft		26	25	49	79	599	
	1988.10-1991.09	-	L	F/R	Hatchback Engine D15B2	823020	Outer Joint		26	23	49	78.5	54.5	M
	1988.10-1991.09	MT	R	F	Hatchback Engine D15B2	223030	Drive Shaft		26	25	49	79	599	
1.5 i 16V (69 kW)	1988.10-1991.09	AT/MT	L/R	F	Hatchback Engine D15B2	823011	Outer Joint		26	30	49	79	53	M
	1988.10-1991.09	AT/MT	R	F	Hatchback Engine D15B2	223225	Drive Shaft		26	25	49	79	599	
	1988.10-1991.09	-	R	F	Hatchback Engine D15B2	823020	Outer Joint		26	23	49	78.5	54.5	M
	1988.10-1991.09	MT	R	F	Hatchback Engine D15B2	223030	Drive Shaft		26	25	49	79	599	
	1988.10-1991.09	5MT	L	F	Hatchback Engine D15B2	623004	Inner Joint		25	30	35	62	97.5	
	1988.10-1991.09	5MT	R	F	Hatchback Engine D15B2	623005	Inner Joint		25	30	35	54.5	97	
1.6 i 16V (80 kW)	1987.10-1991.09	AT/MT	L/R	F	Hatchback Engine D16A6	823011	Outer Joint		26	30	49	79	53	M
	1987.10-1991.09	AT/MT	R	F	Hatchback Engine D16A6	223225	Drive Shaft		26	25	49	79	599	
	1987.10-1991.09	MT	L	F	Hatchback Engine D16A6	623004	Inner Joint		25	30	35	62	97.5	
	1987.10-1991.09	MT	R	F	Hatchback Engine D16A6	223030	Drive Shaft		26	25	49	79	599	
	1987.10-1991.09	MT	R	F	Hatchback Engine D16A6	623005	Inner Joint		25	30	35	54.5	97	
	1987.10-1991.09	-	L	F	Hatchback Engine D16A6	201013	Drive Shaft		26	25	49	79	903	
	1987.10-1991.09	-	L/R	F	Hatchback Engine D16A6	823012	Outer Joint	100T	26	30	49	78.5	55.5	M
1.6 i 16V (81 kW)	1987.10-1991.09	AT/MT	L/R	F	Hatchback Engine D16Z2	823011	Outer Joint		26	30	49	79	53	M
	1987.10-1991.09	AT/MT	R	F	Hatchback Engine D16Z2	223225	Drive Shaft		26	25	49	79	599	
	1987.10-1991.09	MT	L	F	Hatchback Engine D16Z2	623004	Inner Joint		25	30	35	62	97.5	
	1987.10-1991.09	MT	R	F	Hatchback Engine D16Z2	223030	Drive Shaft		26	25	49	79	599	
	1987.10-1991.09	MT	R	F	Hatchback Engine D16Z2	623005	Inner Joint		25	30	35	54.5	97	
	1987.10-1991.09	-	L	F	Hatchback Engine D16Z2	201013	Drive Shaft		26	25	49	79	903	
	1987.10-1991.09	-	L/R	F	Hatchback Engine D16Z2	823012	Outer Joint		26	30	49	79	53	M
1.6 i 16V (96 kW)	1987.09-1991.09	-	L	F	Hatchback Engine D16A7/D16A9	623004	Inner Joint		25	30	35	62	97.5	
	1987.09-1991.09	AT/MT	L/R	F	Hatchback Engine D16A7/D16A9	823021	Outer Joint		26	32	49	78.5	56.5	M
	1987.09-1991.09	-	R	F	Hatchback Engine D16A7/D16A9	623005	Inner Joint		25	30	35	54.5	97	
	1987.09-1991.09	-	L	F	Hatchback Engine D16A7/D16A9	201013	Drive Shaft		26	25	49	79	903	
	1987.09-1991.09	-	L/R	F	Hatchback Engine D16A7/D16A9	823012	Outer Joint	100T	26	30	49	78.5	55.5	M
	1987.09-1991.09	MT	R	F	Hatchback Engine D16A7/D16A9	601001	Inner Joint		27	32	40	55.5	97	
1.6 i 16V Vtec (110 kW)	1989.10-1991.09	MT	L/R	F	Hatchback Engine B16A1	823021	Outer Joint		26	32	49	78.5	56.5	M
	1989.10-1991.09	MT	L/R	F	Hatchback Engine B16A1	823026	Outer Joint	100T	26	32	49	78.5	54.5	M
	1989.10-1991.09	MT	R	F	Hatchback Engine B16A1	601001	Inner Joint		27	32	40	55.5	97	
CIVIC IV (ED)														
1.3 (55 kW)	1987.10-1989.12	MT	R	F	Saloon Engine D13B1	223030	Drive Shaft		26	25	49	79	599	
	1987.10-1989.12	AT/MT	R	F	Saloon Engine D13B1	223225	Drive Shaft		26	25	49	79	599	
1.4 L (66 kW)	1987.10-1989.12	MT	R	F	Saloon Engine D14A1	223030	Drive Shaft		26	25	49	79	599	
	1987.10-1989.12	-	L	F	Saloon Engine D14A1	201013	Drive Shaft		26	25	49	79	903	
	1987.10-1989.12	AT/MT	R	F	Saloon Engine D14A1	823011	Outer Joint		26	30	49	79	53	M
	1987.10-1989.12	-	L/R	F	Saloon Engine D14A1	823012	Outer Joint	100T	26	30	49	78.5	55.5	M
	1987.10-1989.12	-	L	F	Saloon Engine D14A1	623004	Inner Joint		25	30	35	62	97.5	
	1987.10-1989.12	-	R	F	Saloon Engine D14A1	623005	Inner Joint		25	30	35	54.5	97	
	1987.10-1989.12	AT/MT	R	F	Saloon Engine D14A1	223225	Drive Shaft		26	25	49	79	599	
1.5 i 16V (66 kW)	1987.10-1991.09	-	L	F	Saloon Engine D15B2	623004	Inner Joint		25	30	35	62	97.5	
	1987.10-1991.09	-	R	F	Saloon Engine D15B2	823020	Outer Joint		26	23	49	78.5	54.5	M
	1987.10-1991.09	MT	R	F	Saloon Engine D15B2	223030	Drive Shaft		26	25	49	79	599	
	1987.10-1991.09	-	R	F	Saloon Engine D15B2	623005	Inner Joint		25	30	35	54.5	97	
1.5 i 16V (69 kW)	1987.10-1991.09	AT/MT	L/R	F	Saloon Engine D15B2	823011	Outer Joint		26	30	49	79	53	M
	1987.10-1991.09	5MT	L	F	Saloon Engine D15B2	623004	Inner Joint		25	30	35	62	97.5	
	1987.10-1991.09	-	R	F	Saloon Engine D15B2	823020	Outer Joint		26	23	49	78.5	54.5	M
	1987.10-1991.09	MT	R	F	Saloon Engine D15B2	223030	Drive Shaft		26	25	49	79	599	
	1987.10-1991.09	5MT	R	F	Saloon Engine D15B2	623005	Inner Joint		25	30	35	54.5	97	
1.6 i 16V (80 kW)	1987.11-1991.09	-	L	F	Saloon Engine D16A6	623004	Inner Joint		25	30	35	62	97.5	
	1987.11-1991.09	MT	R	F	Saloon Engine D16A6	223030	Drive Shaft		26	25	49	79	599	
	1987.11-1991.09	AT/MT	L/R	F	Saloon Engine D16A6	823021	Outer Joint		26	32	49	78.5	56.5	M
	1987.11-1991.09	-	R	F	Saloon Engine D16A6	623005	Inner Joint		25	30	35	54.5	97	
	1987.11-1991.09	-	L	F	Saloon Engine D16A6	201013	Drive Shaft		26	25	49	79	903	
	1987.11-1991.09	-	L/R	F	Saloon Engine D16A6	823012	Outer Joint	100T	26	30	49	78.5	55.5	M

	 YEAR	TRANSM	L/R	F/R	REMARKS	GSP Ref.	 PRODUCT	 ABS	Technical Specifications						
									A	B	C	H	L	P	
HONDA															
CIVIC IV (ED)															
1.6 i 16V (80 kW)	1989.10-1991.09	AT/MT	R	F	All-wheel Drive Saloon Engine D16A6	223225	Drive Shaft		26	25	49	79	599		
	1989.10-1991.09	AT/MT	R	F	All-wheel Drive Saloon Engine D16A6	823020	Outer Joint		26	23	49	78.5	54.5	M	
	1989.10-1991.09	-	L	F	All-wheel Drive Saloon Engine D16A6	201013	Drive Shaft		26	25	49	79	903		
1.6 i 16V (81 kW)	1987.10-1991.09	AT/MT	R	F	Saloon Engine D16Z2	223225	Drive Shaft		26	25	49	79	599		
	1987.10-1991.09	MT	L	F	Saloon Engine D16Z2	623004	Inner Joint		25	30	35	62	97.5		
	1987.10-1991.09	MT	R	F	Saloon Engine D16Z2	223030	Drive Shaft		26	25	49	79	599		
	1987.10-1991.09	AT/MT	L/R	F	Saloon Engine D16Z2	823021	Outer Joint		26	32	49	78.5	56.5	M	
	1987.10-1991.09	MT	R	F	Saloon Engine D16Z2	623005	Inner Joint		25	30	35	54.5	97		
	1987.10-1991.09	-	L	F	Saloon Engine D16Z2	201013	Drive Shaft		26	25	49	79	903		
	1989.01-1991.12	MT	L	F	All-wheel Drive Saloon Engine D16Z2	623004	Inner Joint		25	30	35	62	97.5		
	1989.01-1991.12	MT	R	F	All-wheel Drive Saloon Engine D16Z2	623005	Inner Joint		25	30	35	54.5	97		
1.6 i 16V (96 kW)	1987.09-1991.09	-	L	F	Saloon Engine D16A7	623004	Inner Joint		25	30	35	62	97.5		
	1987.09-1991.09	AT/MT	L/R	F	Saloon Engine D16A7	823021	Outer Joint		26	32	49	78.5	56.5	M	
	1987.09-1991.09	-	R	F	Saloon Engine D16A7	623005	Inner Joint		25	30	35	54.5	97		
	1987.09-1991.09	-	L/R	F	Saloon Engine D16A7	823012	Outer Joint	100T	26	30	49	78.5	55.5	M	
CIVIC IX (FK)															
1.8 i-VTEC (104 kW)	2012.02-	5AT	L	F	Hatchback Engine R18Z4	223345	Drive Shaft		26	25	58	78.5	617		
	2012.02-	5AT	R	F	Hatchback Engine R18Z4	223349	Drive Shaft		26	25	52	78.5	911		
	2012.02-	5AT	L/R	F	Hatchback Engine R18Z4	623100	Inner Joint		25	27	35	58	94.5		
CIVIC NACIONAL															
1.6	1997.01-2000.12	MT/AT	-	-	-	823109	Outer Joint		26	32	55	78	58.5	I	
	1997.01-2000.12	MT/AT	-	-	-	823108	Outer Joint	50T	26	32	55	78	58.5	I	
CIVIC SHUTTLE II															
1.4	1988.04-1991.11	-	R	F	-	223150	Drive Shaft		26	25	55	78.5	610		
CIVIC V															
1.4	1991-1995	-	R	F	-	223202	Drive Shaft	50T	26	25	55	78.5	622		
	1995.03-2000.12	-	R	F	Hatchbackback 5 DR	223149	Drive Shaft	50T	26	25	55	78.5	627		
1.5	1995.03-2000.12	-	R	F	Hatchbackback 5 DR	223149	Drive Shaft	50T	26	25	55	78.5	627		
1.6	1995.03-2000.12	-	R	F	Hatchbackback 5 DR	223149	Drive Shaft	50T	26	25	55	78.5	627		
CIVIC V (EG EH)															
1.3 (55 kW)	1992.01-1992.12	MT	L	F	Saloon Engine D13B2	623004	Inner Joint		25	30	35	62	97.5		
	1992.01-1992.12	MT	-	F	Saloon Engine D13B2	823023	Outer Joint		26	30	55	78.5	56.5	M	
	1992.01-1992.12	MT	R	F	Saloon Engine D13B2	623005	Inner Joint		25	30	35	54.5	97		
	1992.01-1992.12	AT/MT	L	F	Saloon Engine D13B2	223020	Drive Shaft	50T	26	25	49	78.8	909		
	1992.01-1992.12	AT/MT	R	F	Saloon Engine D13B2	201010	Drive Shaft	50T	26	25	55	78.5	627		
1.5 (66 kW)	1993.10-1995.12	AT/MT	L	F	Saloon Engine D15B2	223020	Drive Shaft	50T	26	25	49	78.8	909		
	1993.10-1995.12	AT/MT	R	F	Saloon Engine D15B2	201010	Drive Shaft	50T	26	25	55	78.5	627		
1.5 (67 kW)	1993.10-1995.12	-	-	F	Saloon Engine D15B7	823086	Outer Joint	50T	26	30	55	78.5	56.5	M	
	1993.10-1995.12	AT/MT	L	F	Saloon Engine D15B7	223020	Drive Shaft	50T	26	25	49	78.8	909		
	1993.10-1995.12	AT/MT	R	F	Saloon Engine D15B7	201010	Drive Shaft	50T	26	25	55	78.5	627		
1.5 i 16V (69 kW)	1991.10-1995.11	MT/AT	L/R	F	Saloon Engine D15B2/D15Z1	823083	Outer Joint	50T	26	30	55	78.5	56	M	
	1991.10-1995.11	-	-	F	Saloon Engine D15B2/D15Z1	823016	Outer Joint		26	32	55	78.5	56.5	M	
	1991.10-1995.11	-	L	F	Saloon Engine D15B2/D15Z1	623004	Inner Joint		25	30	35	62	97.5		
	1991.10-1995.11	-	-	F	Saloon Engine D15B2/D15Z1	823023	Outer Joint		26	30	55	78.5	56.5	M	
	1991.10-1995.11	-	R	F	Saloon Engine D15B2/D15Z1	623005	Inner Joint		25	30	35	54.5	97		
	1991.10-1995.11	AT/MT	L/R	F	Saloon Engine D15B2/D15Z1	823022	Outer Joint		26	30	55	79	56	M	
1.6 16V Vtec (92 kW)	1991.10-1995.11	MT/AT	L/R	F	Saloon Engine D16Z6/D16Z7	823083	Outer Joint	50T	26	30	55	78.5	56	M	
	1991.10-1995.11	-	L	F	Saloon Engine D16Z6/D16Z7	623004	Inner Joint		25	30	35	62	97.5		
	1991.10-1995.11	-	-	F	Saloon Engine D16Z6/D16Z7	823023	Outer Joint		26	30	55	78.5	56.5	M	
	1991.10-1995.11	-	R	F	Saloon Engine D16Z6/D16Z7	623005	Inner Joint		25	30	35	54.5	97		
	1991.10-1995.11	-	-	F	Saloon Engine D16Z6/D16Z7	823086	Outer Joint	50T	26	30	55	78.5	56.5	M	
	1991.10-1995.11	AT/MT	L	F	Saloon Engine D16Z6/D16Z7	223020	Drive Shaft	50T	26	25	49	78.8	909		
	1991.10-1995.11	AT/MT	R	F	Saloon Engine D16Z6/D16Z7	201010	Drive Shaft	50T	26	25	55	78.5	627		
	1991.10-1995.11	AT/MT	L/R	F	Saloon Engine D16Z6/D16Z7	823022	Outer Joint		26	30	55	79	56	M	
	1991.10-1995.11	-	-	-	Saloon Engine D16Z6/D16Z7	823096	Outer Joint		26	30	55	79.5	57	I	
	1991.10-1995.11	-	-	-	Saloon Engine D16Z6/D16Z7	823097	Outer Joint	50T	26	30	55	77.5	53	I	
	1.6 si 16V (90 kW)	1991.10-1993.10	-	R	F	Saloon Engine D16A8	623005	Inner Joint		25	30	35	54.5	97	
		1991.10-1993.10	AT/MT	L	F	Saloon Engine D16A8	223020	Drive Shaft	50T	26	25	49	78.8	909	
1991.10-1993.10		AT/MT	R	F	Saloon Engine D16A8	201010	Drive Shaft	50T	26	25	55	78.5	627		
1991.10-1993.10		-	-	-	Saloon Engine D16A8	623013	Inner Joint		27	32	40	45.5	75		
1.6 VTi (118 kW)	1991.10-1995.11	-	-	F	Saloon Engine B16A2	823019	Outer Joint		26	30	55	78.5	56	M	
	1991.10-1995.11	-	-	F	Saloon Engine B16A2	823016	Outer Joint		26	32	55	78.5	56.5	M	
	1991.10-1995.11	MT	R	F	Saloon Engine B16A2	623005	Inner Joint		25	30	35	54.5	97		
	1991.10-1995.11	AT/MT	L/R	F	Saloon Engine B16A2	823017	Outer Joint	50T	26	32	55	78.5	56.5	M	
	1991.10-1995.11	MT	L	F	Saloon Engine B16A2	223155	Drive Shaft	50T	26	27	55	78.5	557		
	1991.10-1995.11	MT	-	-	Saloon Engine B16A2	623013	Inner Joint		27	32	40	45.5	75		

YEAR	TRANSM	L/R	F/R	REMARKS	GSP Ref.	PRODUCT	ABS	Technical Specifications						
								A	B	C	H	L	P	
HONDA														
CIVIC V (EG)														
1.3 16V (55 kW)	1991.10-1995.11	MT/AT	L/R	F	Hatchback Engine D13B2	823083	Outer Joint	50T	26	30	55	78.5	56	M
	1991.10-1995.11	-	-	F	Hatchback Engine D13B2	823006	Outer Joint		23	30	49	79.5	56	M
	1991.10-1995.11	MT	L	F	Hatchback Engine D13B2	623004	Inner Joint		25	30	35	62	97.5	
	1991.10-1995.11	MT	-	F	Hatchback Engine D13B2	823023	Outer Joint		26	30	55	78.5	56.5	M
	1991.10-1995.11	MT	R	F	Hatchback Engine D13B2	623005	Inner Joint		25	30	35	54.5	97	
	1991.10-1995.11	MT	R	F	Hatchback Engine D13B2	201054	Drive Shaft		26	25	55	78.5	627	
	1991.10-1995.11	AT/MT	L	F	Hatchback Engine D13B2	223020	Drive Shaft	50T	26	25	49	78.8	909	
	1991.10-1995.11	AT/MT	R	F	Hatchback Engine D13B2	201010	Drive Shaft	50T	26	25	55	78.5	627	
	1991.10-1995.11	AT/MT	L/R	F	Hatchback Engine D13B2	823022	Outer Joint		26	30	55	79	56	M
	1991.10-1995.11	-	-	-	Hatchback Engine D13B2	823096	Outer Joint		26	30	55	79.5	57	I
	1991.10-1995.11	-	-	-	Hatchback Engine D13B2	823097	Outer Joint	50T	26	30	55	77.5	53	I
1.5 i 16V (66 kW)	1991.10-1995.11	MT/AT	L/R	F	Hatchback Engine D15B2/D15Z2	823083	Outer Joint	50T	26	30	55	78.5	56	M
	1991.10-1995.11	-	L	F	Hatchback Engine D15B2/D15Z2	623004	Inner Joint		25	30	35	62	97.5	
	1991.10-1995.11	-	-	-	Hatchback Engine D15B2/D15Z2	823093	Outer Joint		26	30	55	78	56	I
	1991.10-1995.11	-	-	F	Hatchback Engine D15B2/D15Z2	823023	Outer Joint		26	30	55	78.5	56.5	M
	1991.10-1995.11	-	R	F	Hatchback Engine D15B2/D15Z2	623005	Inner Joint		25	30	35	54.5	97	
	1991.10-1995.11	MT	R	F	Hatchback Engine D15B2/D15Z2	201054	Drive Shaft		26	25	55	78.5	627	
	1991.10-1995.11	AT/MT	L	F	Hatchback Engine D15B2/D15Z2	223020	Drive Shaft	50T	26	25	49	78.8	909	
	1991.10-1995.11	AT/MT	R	F	Hatchback Engine D15B2/D15Z2	201010	Drive Shaft	50T	26	25	55	78.5	627	
	1991.10-1995.11	-	-	-	Hatchback Engine D15B2/D15Z2	823096	Outer Joint		26	30	55	79.5	57	I
	1991.10-1995.11	AT/MT	L/R	F	Hatchback Engine D15B2/D15Z2	823022	Outer Joint		26	30	55	79	56	M
	1991.10-1995.11	-	-	-	Hatchback Engine D15B2/D15Z2	823097	Outer Joint	50T	26	30	55	77.5	53	I
1.5 i 16V (69 kW)	1991.10-1995.11	-	L	F	Hatchback Engine D15Z1/D15B2	623004	Inner Joint		25	30	35	62	97.5	
	1991.10-1995.11	-	-	F	Hatchback Engine D15Z1/D15B2	823023	Outer Joint		26	30	55	78.5	56.5	M
	1991.10-1995.11	-	R	F	Hatchback Engine D15Z1/D15B2	623005	Inner Joint		25	30	35	54.5	97	
	1991.10-1995.11	MT	R	F	Hatchback Engine D15Z1/D15B2	201054	Drive Shaft		26	25	55	78.5	627	
1.6 16V Vtec (92 kW)	1991.10-1995.11	MT/AT	L/R	F	Hatchback Engine D16Z6	823083	Outer Joint	50T	26	30	55	78.5	56	M
	1991.10-1995.11	-	-	F	Hatchback Engine D16Z6	823016	Outer Joint		26	32	55	78.5	56.5	M
	1991.10-1995.11	-	-	F	Hatchback Engine D16Z6	851021	Outer Joint	50T	26	32	55	78.5	56.5	I
	1991.10-1995.11	-	L	F	Hatchback Engine D16Z6	623004	Inner Joint		25	30	35	62	97.5	
	1991.10-1995.11	-	-	F	Hatchback Engine D16Z6	823023	Outer Joint		26	30	55	78.5	56.5	M
	1991.10-1995.11	-	R	F	Hatchback Engine D16Z6	623005	Inner Joint		25	30	35	54.5	97	
	1991.10-1995.11	-	-	F	Hatchback Engine D16Z6	823086	Outer Joint	50T	26	30	55	78.5	56.5	M
	1991.10-1995.11	MT	R	F	Hatchback Engine D16Z6	201054	Drive Shaft		26	25	55	78.5	627	
	1991.10-1995.11	AT/MT	L	F	Hatchback Engine D16Z6	223020	Drive Shaft	50T	26	25	49	78.8	909	
	1991.10-1995.11	AT/MT	R	F	Hatchback Engine D16Z6	201010	Drive Shaft	50T	26	25	55	78.5	627	
	1991.10-1995.11	-	-	-	Hatchback Engine D16Z6	823096	Outer Joint		26	30	55	79.5	57	I
	1991.10-1995.11	AT/MT	L/R	F	Hatchback Engine D16Z6	823022	Outer Joint		26	30	55	79	56	M
	1991.10-1995.11	-	-	-	Hatchback Engine D16Z6	823097	Outer Joint	50T	26	30	55	77.5	53	I
1.6 si 16V (90 kW)	1991.10-1993.10	-	R	F	Hatchback Engine D16A8	623005	Inner Joint		25	30	35	54.5	97	
	1991.10-1993.10	AT/MT	L	F	Hatchback Engine D16A8	223020	Drive Shaft	50T	26	25	49	78.8	909	
	1991.10-1993.10	AT/MT	R	F	Hatchback Engine D16A8	201010	Drive Shaft	50T	26	25	55	78.5	627	
	1991.10-1993.10	-	-	-	Hatchback Engine D16A8	623013	Inner Joint		27	32	40	45.5	75	
1.6 VTi 16V (118 kW)	1991.10-1995.11	-	-	F	Hatchback Engine B16A2	823019	Outer Joint		26	30	55	78.5	56	M
	1991.10-1995.11	-	-	F	Hatchback Engine B16A2	823016	Outer Joint		26	32	55	78.5	56.5	M
	1991.10-1995.11	MT	R	F	Hatchback Engine B16A2	623005	Inner Joint		25	30	35	54.5	97	
	1991.10-1995.11	AT/MT	L/R	F	Hatchback Engine B16A2	823017	Outer Joint	50T	26	32	55	78.5	56.5	M
	1991.10-1995.11	MT	L	F	Hatchback Engine B16A2	223155	Drive Shaft	50T	26	27	55	78.5	557	
	1991.10-1995.11	-	-	-	Hatchback Engine B16A2	823097	Outer Joint	50T	26	30	55	77.5	53	I
	1991.10-1995.11	MT	-	-	Hatchback Engine B16A2	623013	Inner Joint		27	32	40	45.5	75	
CIVIC V (EJ)														
1.5 i LSi (74 kW)	1993.08-1995.11	MT/AT	L/R	F	Coupe Engine D15B7	823083	Outer Joint	50T	26	30	55	78.5	56	M
	1993.08-1995.11	MT	-	F	Coupe Engine D15B7	823050	Outer Joint		26	28	55	78.5	56.5	M
	1993.08-1995.11	5MT	L	F	Coupe Engine D15B7	623004	Inner Joint		25	30	35	62	97.5	
	1993.08-1995.11	5MT	-	F	Coupe Engine D15B7	823023	Outer Joint		26	30	55	78.5	56.5	M
	1993.08-1995.11	5MT	R	F	Coupe Engine D15B7	623005	Inner Joint		25	30	35	54.5	97	
	1993.08-1995.11	5MT	-	F	Coupe Engine D15B7	823086	Outer Joint	50T	26	30	55	78.5	56.5	M
	1993.08-1995.11	AT/MT	L	F	Coupe Engine D15B7	223020	Drive Shaft	50T	26	25	49	78.8	909	
	1993.08-1995.11	AT/MT	R	F	Coupe Engine D15B7	201010	Drive Shaft	50T	26	25	55	78.5	627	
	1993.08-1995.11	MT	L/R	F	Coupe Engine D15B7	823022	Outer Joint		26	30	55	79	56	M
	1993.08-1995.11	MT	-	F	Coupe Engine D15B7	823073	Outer Joint	50T	26	28	55	78.5	56.5	M
1.6 i (77 kW)	1994.01-1995.11	MT	-	F	Coupe Engine D16Y7	823050	Outer Joint		26	28	55	78.5	56.5	M
	1994.01-1995.11	AT/MT	L	F	Coupe Engine D16Y7	223020	Drive Shaft	50T	26	25	49	78.8	909	
	1994.01-1995.11	AT/MT	R	F	Coupe Engine D16Y7	201010	Drive Shaft	50T	26	25	55	78.5	627	
	1994.01-1995.11	MT	-	F	Coupe Engine D16Y7	823073	Outer Joint	50T	26	28	55	78.5	56.5	M
1.6 i Vtec (118 kW)	1994.01-1995.11	MT	-	F	Coupe Engine B16A2	823073	Outer Joint	50T	26	28	55	78.5	56.5	M

	 YEAR	TRANSM	L/R	F/R	REMARKS	GSP Ref.	 PRODUCT	 ABS	Technical Specifications					
									A	B	C	H	L	P
HONDA														
CIVIC V (EJ)														
1.6 i Vtec (118 kW)	1994.01-1995.11	-	-	F	Coupe Engine B16A2	823019	Outer Joint		26	30	55	78.5	56	M
	1994.01-1995.11	MT	-	F	Coupe Engine B16A2	823050	Outer Joint		26	28	55	78.5	56.5	M
	1994.01-1995.11	MT	L	F	Coupe Engine B16A2	223020	Drive Shaft	50T	26	25	49	78.8	909	
	1994.01-1995.11	MT	R	F	Coupe Engine B16A2	201010	Drive Shaft	50T	26	25	55	78.5	627	
1.6 i Vtec (92 kW)	1994.01-1996.03	-	-	F	Coupe Engine D16Y6/D16Z9	823019	Outer Joint		26	30	55	78.5	56	M
	1994.01-1996.03	MT	-	F	Coupe Engine D16Y6/D16Z9	823050	Outer Joint		26	28	55	78.5	56.5	M
	1994.01-1996.03	MT/AT	L/R	F	Coupe Engine D16Y6/D16Z9	823083	Outer Joint	50T	26	30	55	78.5	56	M
	1994.01-1996.03	-	L	F	Coupe Engine D16Y6/D16Z9	623004	Inner Joint		25	30	35	62	97.5	
	1994.01-1996.03	-	-	F	Coupe Engine D16Y6/D16Z9	823023	Outer Joint		26	30	55	78.5	56.5	M
	1994.01-1996.03	-	R	F	Coupe Engine D16Y6/D16Z9	623005	Inner Joint		25	30	35	54.5	97	
	1994.01-1996.03	AT/MT	L	F	Coupe Engine D16Y6/D16Z9	223020	Drive Shaft	50T	26	25	49	78.8	909	
	1994.01-1996.03	AT/MT	R	F	Coupe Engine D16Y6/D16Z9	201010	Drive Shaft	50T	26	25	55	78.5	627	
	1994.01-1996.03	MT	L/R	F	Coupe Engine D16Y6/D16Z9	823022	Outer Joint		26	30	55	79	56	M
1994.01-1996.03	MT	-	F	Coupe Engine D16Y6/D16Z9	823073	Outer Joint	50T	26	28	55	78.5	56.5	M	
CIVIC VI														
1.6	1995-2001	-	L/R	F	-	623014	Inner Joint		25	28	35	61.5	97.5	
1.6 i	1995-2001	-	L/R	F	-	623011	Inner Joint		27	32	40	45.5	85	
CIVIC VI (EJ EK)														
1.4 i (55 kW)	1995.11-2001.02	-	-	F	Hatchback Engine D14A3/D14Z1	823073	Outer Joint	50T	26	28	55	78.5	56.5	M
	1995.11-2001.02	-	-	F	Hatchback Engine D14A3/D14Z1	823019	Outer Joint		26	30	55	78.5	56	M
	1995.11-2001.02	AT/MT	L/R	F	Hatchback Engine D14A3/D14Z1	823047	Outer Joint		26	28	55	77.5	53	M
	1995.11-2001.02	-	-	F	Hatchback Engine D14A3/D14Z1	823050	Outer Joint		26	28	55	78.5	56.5	M
	1995.11-2001.02	-	-	-	Hatchback Engine D14A3/D14Z1	823038	Outer Joint		26	28	55	78	55	M
	1995.11-2001.02	AT/MT	L/R	F	Hatchback Engine D14A3/D14Z1	823063	Outer Joint		26	32	55	78.5	56.5	I
	1995.11-2001.02	AT/MT	L/R	F	Hatchback Engine D14A3/D14Z1	899225	Outer Joint	50T	26	32	55	78.5	56.5	I
	1995.11-2001.02	AT/MT	L/R	F	Hatchback Engine D14A3/D14Z1	823024	Outer Joint	50T	26	28	55	77.5	53	M
	1995.11-2001.02	MT	-	F	Hatchback Engine D14A3/D14Z1	823086	Outer Joint	50T	26	30	55	78.5	56.5	M
	1995.11-2001.02	AT/MT	L	F	Hatchback Engine D14A3/D14Z1	223020	Drive Shaft	50T	26	25	49	78.8	909	
	1995.11-2001.02	MT	R	F	Hatchback Engine D14A3/D14Z1	623017	Inner Joint		27	30	40	58.5	97	
	1995.11-2001.02	MT	R	F	Hatchback Engine D14A3/D14Z1	623023	Inner Joint		27	30	40	45.5	75	
	1995.11-2001.02	AT/MT	R	F	Hatchback Engine D14A3/D14Z1	201010	Drive Shaft	50T	26	25	55	78.5	627	
	1995.11-2001.02	MT	R	F	Hatchback Engine D14A3/D14Z1	623020	Inner Joint		25	28	35	54.5	96.5	
1.4 i S (66 kW)	1995.11-2001.02	-	-	F	Hatchback Engine D14A4/S14Z4/D14Z2	823073	Outer Joint	50T	26	28	55	78.5	56.5	M
	1995.11-2001.02	-	-	F	Hatchback Engine D14A4/S14Z4/D14Z2	823019	Outer Joint		26	30	55	78.5	56	M
	1995.11-2001.02	AT/MT	L	F	Hatchback Engine D14A4/S14Z4/D14Z2	223083	Drive Shaft		26	25	55	77.5	901.5	
	1995.11-2001.02	AT/MT	L/R	F	Hatchback Engine D14A4/S14Z4/D14Z2	823047	Outer Joint		26	28	55	77.5	53	M
	1995.11-2001.02	AT/MT	R	F	Hatchback Engine D14A4/S14Z4/D14Z2	223082	Drive Shaft		26	25	55	77.5	619.5	
	1995.11-2001.02	-	-	F	Hatchback Engine D14A4/S14Z4/D14Z2	823050	Outer Joint		26	28	55	78.5	56.5	M
	1995.11-2001.02	-	-	-	Hatchback Engine D14A4/S14Z4/D14Z2	823038	Outer Joint		26	28	55	78	55	M
	1995.11-2001.02	AT/MT	L/R	F	Hatchback Engine D14A4/S14Z4/D14Z2	823063	Outer Joint		26	32	55	78.5	56.5	I
	1995.11-2001.02	AT/MT	L/R	F	Hatchback Engine D14A4/S14Z4/D14Z2	899225	Outer Joint	50T	26	32	55	78.5	56.5	I
	1995.11-2001.02	-	L/R	F	Hatchback Engine D14A4/S14Z4/D14Z2	823156	Outer Joint	50T	26	28	55	78	52	M
	1995.11-2001.02	AT/MT	L/R	F	Hatchback Engine D14A4/S14Z4/D14Z2	823024	Outer Joint	50T	26	28	55	77.5	53	M
	1995.11-2001.02	AT	-	F	Hatchback Engine D14A4/S14Z4/D14Z2	823086	Outer Joint	50T	26	30	55	78.5	56.5	M
	1995.11-2001.02	AT/MT	L	F	Hatchback Engine D14A4/S14Z4/D14Z2	223020	Drive Shaft	50T	26	25	49	78.8	909	
	1995.11-2001.02	AT	R	F	Hatchback Engine D14A4/S14Z4/D14Z2	623017	Inner Joint		27	30	40	58.5	97	
	1995.11-2001.02	AT	R	F	Hatchback Engine D14A4/S14Z4/D14Z2	623023	Inner Joint		27	30	40	45.5	75	
	1995.11-2001.02	AT/MT	R	F	Hatchback Engine D14A4/S14Z4/D14Z2	201010	Drive Shaft	50T	26	25	55	78.5	627	
	1995.11-2001.02	-	R	F	Hatchback Engine D14A4/S14Z4/D14Z2	623020	Inner Joint		25	28	35	54.5	96.5	
1.4 LPG (66 kW)	1997.01-2001.02	-	-	F	Hatchback Engine D14Z4	823073	Outer Joint	50T	26	28	55	78.5	56.5	M
	1997.01-2001.02	-	-	F	Hatchback Engine D14Z4	823050	Outer Joint		26	28	55	78.5	56.5	M
	1997.01-2001.02	-	-	F	Hatchback Engine D14Z4	851021	Outer Joint	50T	26	32	55	78.5	56.5	I
	1997.01-2001.02	-	-	F	Hatchback Engine D14Z4	899210	Outer Joint		26	32	55	78.5	56.5	I
	1997.01-2001.02	-	L/R	F	Hatchback Engine D14Z4	899225	Outer Joint	50T	26	32	55	78.5	56.5	I
	1997.01-2001.02	AT/MT	L	F	Hatchback Engine D14Z4	223020	Drive Shaft	50T	26	25	49	78.8	909	
	1997.01-2001.02	AT/MT	R	F	Hatchback Engine D14Z4	201010	Drive Shaft	50T	26	25	55	78.5	627	
1.5 (66 kW)	1995.11-1996.12	-	-	-	Hatchback Engine D15Z3	823038	Outer Joint		26	28	55	78	55	M
	1995.11-1996.12	MT	L	F	Hatchback Engine D15Z3	223020	Drive Shaft	50T	26	25	49	78.8	909	
	1995.11-1996.12	MT	R	F	Hatchback Engine D15Z3	201010	Drive Shaft	50T	26	25	55	78.5	627	
1.5 i (84 kW)	1995.11-2001.02	-	-	F	Hatchback Engine D15Z6	823073	Outer Joint	50T	26	28	55	78.5	56.5	M
	1995.11-2001.02	AT/MT	L	F	Hatchback Engine D15Z6	223083	Drive Shaft		26	25	55	77.5	901.5	
	1995.11-2001.02	AT/MT	L/R	F	Hatchback Engine D15Z6	823047	Outer Joint		26	28	55	77.5	53	M
	1995.11-2001.02	AT/MT	R	F	Hatchback Engine D15Z6	223082	Drive Shaft		26	25	55	77.5	619.5	
	1995.11-2001.02	-	-	F	Hatchback Engine D15Z6	823050	Outer Joint		26	28	55	78.5	56.5	M
	1995.11-2001.02	-	-	-	Hatchback Engine D15Z6	823038	Outer Joint		26	28	55	78	55	M
	1995.11-2001.02	AT/MT	L/R	F	Hatchback Engine D15Z6	823063	Outer Joint		26	32	55	78.5	56.5	I

	 YEAR	TRANSM	L/R	F/R	REMARKS	GSP Ref.	 PRODUCT	 ABS	Technical Specifications						
									A	B	C	H	L	P	
HONDA															
CIVIC VI (EJ EK)															
1.5 i (84 kW)	1995.11-2001.02	AT/MT	L/R	F	Hatchback Engine D15Z6	899225	Outer Joint	50T	26	32	55	78.5	56.5	I	
	1995.11-2001.02	AT/MT	L/R	F	Hatchback Engine D15Z6	823024	Outer Joint	50T	26	28	55	77.5	53	M	
	1995.11-2001.02	AT/MT	L	F	Hatchback Engine D15Z6	223020	Drive Shaft	50T	26	25	49	78.8	909		
	1995.11-2001.02	AT/MT	R	F	Hatchback Engine D15Z6	201010	Drive Shaft	50T	26	25	55	78.5	627		
	1995.11-2001.02	-	R	F	Hatchback Engine D15Z6	623020	Inner Joint		25	28	35	54.5	96.5		
1.6 (92 kW)	1998.11-2000.10	MT	-	F	Hatchback Engine D16W4	823073	Outer Joint	50T	26	28	55	78.5	56.5	M	
	1998.11-2000.10	MT	-	F	Hatchback Engine D16W4	823050	Outer Joint		26	28	55	78.5	56.5	M	
	1998.11-2000.10	-	-	-	Hatchback Engine D16W4	823038	Outer Joint		26	28	55	78	55	M	
	1998.11-2000.10	-	L/R	F	Hatchback Engine D16W4	899225	Outer Joint	50T	26	32	55	78.5	56.5	I	
	1998.11-2000.10	AT/MT	L	F	Hatchback Engine D16W4	223020	Drive Shaft	50T	26	25	49	78.8	909		
	1998.11-2000.10	AT/MT	R	F	Hatchback Engine D16W4	201010	Drive Shaft	50T	26	25	55	78.5	627		
1.6 (93 kW)	1995.10-2000.09	MT	-	F	Hatchback Engine D16Y2	823073	Outer Joint	50T	26	28	55	78.5	56.5	M	
	1995.10-2000.09	MT	-	F	Hatchback Engine D16Y2	823050	Outer Joint		26	28	55	78.5	56.5	M	
	1995.10-2000.09	-	-	-	Hatchback Engine D16Y2	823038	Outer Joint		26	28	55	78	55	M	
	1995.10-2000.09	AT/MT	L	F	Hatchback Engine D16Y2	223020	Drive Shaft	50T	26	25	49	78.8	909		
	1995.10-2000.09	AT/MT	R	F	Hatchback Engine D16Y2	201010	Drive Shaft	50T	26	25	55	78.5	627		
1.6 i (84 kW)	1995.11-2001.02	MT	-	F	Hatchback Engine D16Y5	823050	Outer Joint		26	28	55	78.5	56.5	M	
	1995.11-2001.02	-	-	-	Hatchback Engine D16Y5	823038	Outer Joint		26	28	55	78	55	M	
	1995.11-2001.02	AT/MT	L	F	Hatchback Engine D16Y5	223020	Drive Shaft	50T	26	25	49	78.8	909		
	1995.11-2001.02	AT/MT	R	F	Hatchback Engine D16Y5	201010	Drive Shaft	50T	26	25	55	78.5	627		
	1995.11-2001.02	-	R	F	Hatchback Engine D16Y5	623020	Inner Joint		25	28	35	54.5	96.5		
	1995.11-2001.02	MT	-	F	Hatchback Engine D16Y5	823073	Outer Joint	50T	26	28	55	78.5	56.5	M	
1.6 VTi (118 kW)	1995.11-2001.02	AT/MT	L	F	Hatchback Engine B16A2	223083	Drive Shaft		26	25	55	77.5	901.5		
	1995.11-2001.02	AT/MT	R	F	Hatchback Engine B16A2	223082	Drive Shaft		26	25	55	77.5	619.5		
	1995.11-2001.02	-	-	F	Hatchback Engine B16A2	851021	Outer Joint	50T	26	32	55	78.5	56.5	I	
	1995.11-2001.02	MT	-	F	Hatchback Engine B16A2	823086	Outer Joint	50T	26	30	55	78.5	56.5	M	
	1995.11-2001.02	MT	-	F	Hatchback Engine B16A2	823033	Outer Joint	50T	26	30	60	78.5	57	M	
	1995.11-2001.02	MT	R	F	Hatchback Engine B16A2	623017	Inner Joint		27	30	40	58.5	97		
	1995.11-2001.02	MT	R	F	Hatchback Engine B16A2	623023	Inner Joint		27	30	40	45.5	75		
	1995.11-2001.02	-	R	F	Hatchback Engine B16A2	201016	Drive Shaft	50T	26	27	55	78.5	596		
CIVIC VI (EJ EK)/INTEGRA SJ															
1.4 (55 kW)	1995.11-1998.10	-	-	F	Saloon Engine D14A4	823019	Outer Joint		26	30	55	78.5	56	M	
	1995.11-1998.10	-	-	-	Saloon Engine D14A4	823038	Outer Joint		26	28	55	78	55	M	
1.4 i (66 kW)	1995.11-2001.02	-	-	F	Saloon Engine D14A4/S14Z4/D14Z2	823073	Outer Joint	50T	26	28	55	78.5	56.5	M	
	1995.11-2001.02	-	-	F	Saloon Engine D14A4/S14Z4/D14Z2	823019	Outer Joint		26	30	55	78.5	56	M	
	1995.11-2001.02	AT/MT	L	F	Saloon Engine D14A4/S14Z4/D14Z2	223083	Drive Shaft		26	25	55	77.5	901.5		
	1995.11-2001.02	AT/MT	R	F	Saloon Engine D14A4/S14Z4/D14Z2	223082	Drive Shaft		26	25	55	77.5	619.5		
	1995.11-2001.02	-	-	F	Saloon Engine D14A4/S14Z4/D14Z2	823050	Outer Joint		26	28	55	78.5	56.5	M	
	1995.11-2001.02	-	-	-	Saloon Engine D14A4/S14Z4/D14Z2	823038	Outer Joint		26	28	55	78	55	M	
	1995.11-2001.02	AT/MT	L/R	F	Saloon Engine D14A4/S14Z4/D14Z2	823063	Outer Joint		26	32	55	78.5	56.5	I	
	1995.11-2001.02	-	L/R	F	Saloon Engine D14A4/S14Z4/D14Z2	823156	Outer Joint	50T	26	28	55	78	52	M	
	1995.11-2001.02	AT/MT	L/R	F	Saloon Engine D14A4/S14Z4/D14Z2	899225	Outer Joint	50T	26	32	55	78.5	56.5	I	
	1995.11-2001.02	AT/MT	L/R	F	Saloon Engine D14A4/S14Z4/D14Z2	823024	Outer Joint	50T	26	28	55	77.5	53	M	
	1995.11-2001.02	AT	-	F	Saloon Engine D14A4/S14Z4/D14Z2	823086	Outer Joint	50T	26	30	55	78.5	56.5	M	
	1995.11-2001.02	AT/MT	L	F	Saloon Engine D14A4/S14Z4/D14Z2	223020	Drive Shaft	50T	26	25	49	78.8	909		
	1995.11-2001.02	AT	R	F	Saloon Engine D14A4/S14Z4/D14Z2	623017	Inner Joint		27	30	40	58.5	97		
	1995.11-2001.02	AT	R	F	Saloon Engine D14A4/S14Z4/D14Z2	623023	Inner Joint		27	30	40	45.5	75		
	1995.11-2001.02	AT/MT	R	F	Saloon Engine D14A4/S14Z4/D14Z2	201010	Drive Shaft	50T	26	25	55	78.5	627		
1995.11-2001.02	-	R	F	Saloon Engine D14A4/S14Z4/D14Z2	623020	Inner Joint		25	28	35	54.5	96.5			
1.5 i (84 kW)	1995.11-2001.02	-	-	F	Saloon Engine D15Z6	823073	Outer Joint	50T	26	28	55	78.5	56.5	M	
	1995.11-2001.02	AT/MT	L	F	Saloon Engine D15Z6	223083	Drive Shaft		26	25	55	77.5	901.5		
	1995.11-2001.02	AT/MT	R	F	Saloon Engine D15Z6	223082	Drive Shaft		26	25	55	77.5	619.5		
	1995.11-2001.02	-	-	F	Saloon Engine D15Z6	823050	Outer Joint		26	28	55	78.5	56.5	M	
	1995.11-2001.02	AT/MT	L/R	F	Saloon Engine D15Z6	823063	Outer Joint		26	32	55	78.5	56.5	I	
	1995.11-2001.02	-	-	-	Saloon Engine D15Z6	823038	Outer Joint		26	28	55	78	55	M	
	1995.11-2001.02	AT/MT	L/R	F	Saloon Engine D15Z6	899225	Outer Joint	50T	26	32	55	78.5	56.5	I	
	1995.11-2001.02	AT/MT	L/R	F	Saloon Engine D15Z6	823024	Outer Joint	50T	26	28	55	77.5	53	M	
	1995.11-2001.02	AT/MT	L	F	Saloon Engine D15Z6	223020	Drive Shaft	50T	26	25	49	78.8	909		
	1995.11-2001.02	AT/MT	R	F	Saloon Engine D15Z6	201010	Drive Shaft	50T	26	25	55	78.5	627		
1995.11-2001.02	-	R	F	Saloon Engine D15Z6	623020	Inner Joint		25	28	35	54.5	96.5			
1.6 i Vtec (92 kW)	1995.11-2001.02	MT	-	F	Saloon Engine D16Y6/D16V6	823073	Outer Joint	50T	26	28	55	78.5	56.5	M	
	1995.11-2001.02	-	-	F	Saloon Engine D16Y6/D16V6	823019	Outer Joint		26	30	55	78.5	56	M	
	1995.11-2001.02	AT/MT	L	F	Saloon Engine D16Y6/D16V6	223083	Drive Shaft		26	25	55	77.5	901.5		
	1995.11-2001.02	MT	-	F	Saloon Engine D16Y6/D16V6	823050	Outer Joint		26	28	55	78.5	56.5	M	
	1995.11-2001.02	AT/MT	R	F	Saloon Engine D16Y6/D16V6	223082	Drive Shaft		26	25	55	77.5	619.5		
	1995.11-2001.02	-	-	-	Saloon Engine D16Y6/D16V6	823038	Outer Joint		26	28	55	78	55	M	





YEAR	TRANS	L/R	F/R	REMARKS	GSP Ref.	PRODUCT	ABS	Technical Specifications					
								A	B	C	H	L	P
HONDA													
CIVIC VI (EJ EK)/INTEGRA SJ													
1.6 i Vtec (92 kW)													
1995.11-2001.02	-	L	F	Saloon Engine D16Y6/D16V6	623004	Inner Joint		25	30	35	62	97.5	
1995.11-2001.02	-	R	F	Saloon Engine D16Y6/D16V6	623005	Inner Joint		25	30	35	54.5	97	
1995.11-2001.02	-	-	F	Saloon Engine D16Y6/D16V6	823086	Outer Joint	50T	26	30	55	78.5	56.5 M	
1995.11-2001.02	AT/MT	L	F	Saloon Engine D16Y6/D16V6	223020	Drive Shaft	50T	26	25	49	78.8	909	
1995.11-2001.02	AT/MT	R	F	Saloon Engine D16Y6/D16V6	201010	Drive Shaft	50T	26	25	55	78.5	627	
1995.11-2001.02	-	R	F	Saloon Engine D16Y6/D16V6	623020	Inner Joint		25	28	35	54.5	96.5	
1995.11-2001.02	-	-	-	Saloon Engine D16Y6/D16V6	823159	Outer Joint	50T	26	32	55	78.1	55 M	
1.6 VTi (118 kW)													
1995.11-2001.02	AT/MT	L	F	Saloon Engine B16A2	223083	Drive Shaft		26	25	55	77.5	901.5	
1995.11-2001.02	AT/MT	R	F	Saloon Engine B16A2	223082	Drive Shaft		26	25	55	77.5	619.5	
1995.11-2001.02	-	-	F	Saloon Engine B16A2	851021	Outer Joint	50T	26	32	55	78.5	56.5 I	
1995.11-2001.02	MT	-	F	Saloon Engine B16A2	823086	Outer Joint	50T	26	30	55	78.5	56.5 M	
1995.11-2001.02	MT	-	F	Saloon Engine B16A2	823033	Outer Joint	50T	26	30	60	78.5	57 M	
1995.11-2001.02	MT	R	F	Saloon Engine B16A2	623017	Inner Joint		27	30	40	58.5	97	
1995.11-2001.02	MT	R	F	Saloon Engine B16A2	623023	Inner Joint		27	30	40	45.5	75	
1995.11-2001.02	MT	R	F	Saloon Engine B16A2	201016	Drive Shaft	50T	26	27	55	78.5	596	
CIVIC VI (EJ EM1)													
1.6 (79 kW)													
1996.05-1999.04	-	-	F	Coupe Engine D16Y7	823073	Outer Joint	50T	26	28	55	78.5	56.5 M	
1996.05-1999.04	-	-	F	Coupe Engine D16Y7	823050	Outer Joint		26	28	55	78.5	56.5 M	
1996.05-1999.04	4AT/5MT	L	F	Coupe Engine D16Y7	623004	Inner Joint		25	30	35	62	97.5	
1996.05-1999.04	4AT/5MT	-	F	Coupe Engine D16Y7	823023	Outer Joint		26	30	55	78.5	56.5 M	
1996.05-1999.04	4AT/5MT	-	F	Coupe Engine D16Y7	823086	Outer Joint	50T	26	30	55	78.5	56.5 M	
1996.05-1999.04	4AT/5MT/CVT	R	F	Coupe Engine D16Y7	623005	Inner Joint		25	30	35	54.5	97	
1996.05-1999.04	AT/MT	L	F	Coupe Engine D16Y7	223020	Drive Shaft	50T	26	25	49	78.8	909	
1996.05-1999.04	5MT	-	F	Coupe Engine D16Y7	823033	Outer Joint	50T	26	30	60	78.5	57 M	
1996.05-1999.04	5MT	R	F	Coupe Engine D16Y7	623017	Inner Joint		27	30	40	58.5	97	
1996.05-1999.04	AT/MT	R	F	Coupe Engine D16Y7	201010	Drive Shaft	50T	26	25	55	78.5	627	
1996.05-1999.04	CVT/5MT	R	F	Coupe Engine D16Y7	623023	Inner Joint		27	30	40	45.5	75	
1996.05-1999.04	CVT	R	F	Coupe Engine D16Y7	623020	Inner Joint		25	28	35	54.5	96.5	
1.6 i (77 kW)													
1996.03-2000.03	4AT/5MT	L	F	Coupe Engine D16Y7	623004	Inner Joint		25	30	35	62	97.5	
1996.03-2000.03	4AT/5MT	-	F	Coupe Engine D16Y7	823023	Outer Joint		26	30	55	78.5	56.5 M	
1996.03-2000.03	4AT/5MT	-	F	Coupe Engine D16Y7	823086	Outer Joint	50T	26	30	55	78.5	56.5 M	
1996.03-2000.03	4AT/5MT/CVT	R	F	Coupe Engine D16Y7	623005	Inner Joint		25	30	35	54.5	97	
1996.03-2000.03	5MT	-	F	Coupe Engine D16Y7	823033	Outer Joint	50T	26	30	60	78.5	57 M	
1996.03-2000.03	5MT	R	F	Coupe Engine D16Y7	623017	Inner Joint		27	30	40	58.5	97	
1996.03-2000.03	CVT/5MT	R	F	Coupe Engine D16Y7	623023	Inner Joint		27	30	40	45.5	75	
1996.03-2000.03	CVT	R	F	Coupe Engine D16Y7	623020	Inner Joint		25	28	35	54.5	96.5	
1.6 i Vtec (118 kW)													
1999.04-2000.12	-	-	F	Coupe Engine B16A2	823019	Outer Joint		26	30	55	78.5	56 M	
1999.04-2000.12	AT/MT	L	F	Coupe Engine B16A2	223083	Drive Shaft		26	25	55	77.5	901.5	
1999.04-2000.12	AT/MT	R	F	Coupe Engine B16A2	223082	Drive Shaft		26	25	55	77.5	619.5	
1999.04-2000.12	-	-	-	Coupe Engine B16A2	823038	Outer Joint		26	28	55	78	55 M	
1999.04-2000.12	4AT/5MT	L	F	Coupe Engine B16A2	623004	Inner Joint		25	30	35	62	97.5	
1999.04-2000.12	4AT/MT	-	F	Coupe Engine B16A2	823023	Outer Joint		26	30	55	78.5	56.5 M	
1999.04-2000.12	4AT/MT	-	F	Coupe Engine B16A2	823086	Outer Joint	50T	26	30	55	78.5	56.5 M	
1999.04-2000.12	4AT/5MT/CVT	R	F	Coupe Engine B16A2	623005	Inner Joint		25	30	35	54.5	97	
1999.04-2000.12	MT	-	F	Coupe Engine B16A2	823033	Outer Joint	50T	26	30	60	78.5	57 M	
1999.04-2000.12	MT	R	F	Coupe Engine B16A2	623017	Inner Joint		27	30	40	58.5	97	
1999.04-2000.12	CVT/MT	R	F	Coupe Engine B16A2	623023	Inner Joint		27	30	40	45.5	75	
1999.04-2000.12	CVT	R	F	Coupe Engine B16A2	623020	Inner Joint		25	28	35	54.5	96.5	
1.6 i Vtec (92 kW)													
1996.03-2000.03	-	-	F	Coupe Engine D16Y8	823019	Outer Joint		26	30	55	78.5	56 M	
1996.03-2000.03	MT	R	F	Coupe Engine D16Y8	623020	Inner Joint		25	28	35	54.5	96.5	
CIVIC VI Aerodeck (MB MC)													
1.4 16V (55 kW)													
1998.04-2001.02	-	-	F	Estate Engine D14A7	823073	Outer Joint	50T	26	28	55	78.5	56.5 M	
1998.04-2001.02	AT/MT	L/R	F	Estate Engine D14A7	823047	Outer Joint		26	28	55	77.5	53 M	
1998.04-2001.02	-	-	F	Estate Engine D14A7	823050	Outer Joint		26	28	55	78.5	56.5 M	
1998.04-2001.02	-	-	F	Estate Engine D14A7	851021	Outer Joint	50T	26	32	55	78.5	56.5 I	
1998.04-2001.02	-	L/R	F	Estate Engine D14A7	899225	Outer Joint	50T	26	32	55	78.5	56.5 I	
1998.04-2001.02	-	-	F	Estate Engine D14A7	899210	Outer Joint		26	32	55	78.5	56.5 I	
1998.04-2001.02	-	R	F	Estate Engine D14A7	623005	Inner Joint		25	30	35	54.5	97	
1998.04-2001.02	AT/MT	L	F	Estate Engine D14A7	223020	Drive Shaft	50T	26	25	49	78.8	909	
1998.04-2001.02	AT/MT	R	F	Estate Engine D14A7	201010	Drive Shaft	50T	26	25	55	78.5	627	
1.4 16V (66 kW)													
1998.04-2001.02	-	-	F	Estate Engine D14A8	823073	Outer Joint	50T	26	28	55	78.5	56.5 M	
1998.04-2001.02	AT/MT	L/R	F	Estate Engine D14A8	823047	Outer Joint		26	28	55	77.5	53 M	
1998.04-2001.02	-	-	F	Estate Engine D14A8	823050	Outer Joint		26	28	55	78.5	56.5 M	
1998.04-2001.02	-	-	F	Estate Engine D14A8	851021	Outer Joint	50T	26	32	55	78.5	56.5 I	
1998.04-2001.02	-	-	F	Estate Engine D14A8	899210	Outer Joint		26	32	55	78.5	56.5 I	
1998.04-2001.02	-	L/R	F	Estate Engine D14A8	899225	Outer Joint	50T	26	32	55	78.5	56.5 I	

YEAR	TRANSM	L/R	F/R	REMARKS	GSP Ref.	PRODUCT	ABS	Technical Specifications										
								A	B	C	H	L	P					
HONDA																		
CIVIC VI Aerodeck (MB MC)																		
1.4 16V (66 kW)	1998.04-2001.02	-	R	F	Estate Engine D14A8	623005	Inner Joint		25	30	35	54.5	97					
	1998.04-2001.02	AT/MT	L	F	Estate Engine D14A8	223020	Drive Shaft	50T	26	25	49	78.8	909					
	1998.04-2001.02	AT/MT	R	F	Estate Engine D14A8	201010	Drive Shaft	50T	26	25	55	78.5	627					
1.5 16V (84 kW)	1998.04-2001.02	AT/MT	L/R	F	Estate Engine D15Z8	823047	Outer Joint		26	28	55	77.5	53	M				
	1998.04-2001.02	AT/MT	L/R	F	Estate Engine D15Z8	823063	Outer Joint		26	32	55	78.5	56.5	I				
	1998.04-2001.02	-	-	F	Estate Engine D15Z8	851021	Outer Joint	50T	26	32	55	78.5	56.5	I				
	1998.04-2001.02	-	L/R	F	Estate Engine D15Z8	899225	Outer Joint	50T	26	32	55	78.5	56.5	I				
	1998.04-2001.02	-	L	F	Estate Engine D15Z8	623004	Inner Joint		25	30	35	62	97.5					
	1998.04-2001.02	-	R	F	Estate Engine D15Z8	623005	Inner Joint		25	30	35	54.5	97					
	1998.04-2001.02	AT/MT	L	F	Estate Engine D15Z8	223020	Drive Shaft	50T	26	25	49	78.8	909					
1.6 16V (85 kW)	1998.04-2001.02	AT/MT	R	F	Estate Engine D15Z8	201010	Drive Shaft	50T	26	25	55	78.5	627					
	1998.04-2001.02	-	-	F	Estate Engine D16B2	823073	Outer Joint	50T	26	28	55	78.5	56.5	M				
	1998.04-2001.02	AT/MT	L/R	F	Estate Engine D16B2	823047	Outer Joint		26	28	55	77.5	53	M				
	1998.04-2001.02	-	-	F	Estate Engine D16B2	823050	Outer Joint		26	28	55	78.5	56.5	M				
	1998.04-2001.02	MT	L	F	Estate Engine D16B2	623004	Inner Joint		25	30	35	62	97.5					
	1998.04-2001.02	-	R	F	Estate Engine D16B2	623005	Inner Joint		25	30	35	54.5	97					
	1998.04-2001.02	AT/MT	L	F	Estate Engine D16B2	223020	Drive Shaft	50T	26	25	49	78.8	909					
1.6 16V (92 kW)	1998.04-2001.02	AT/MT	R	F	Estate Engine D16B2	201010	Drive Shaft	50T	26	25	55	78.5	627					
	1998.04-2001.02	-	-	F	Estate Engine D16W4	823073	Outer Joint	50T	26	28	55	78.5	56.5	M				
	1998.04-2001.02	-	-	F	Estate Engine D16W4	823050	Outer Joint		26	28	55	78.5	56.5	M				
	1998.04-2001.02	MT	L	F	Estate Engine D16W4	623004	Inner Joint		25	30	35	62	97.5					
	1998.04-2001.02	-	L/R	F	Estate Engine D16W4	899225	Outer Joint	50T	26	32	55	78.5	56.5	I				
	1998.04-2001.02	MT	R	F	Estate Engine D16W4	623005	Inner Joint		25	30	35	54.5	97					
	1998.04-2001.02	AT/MT	L	F	Estate Engine D16W4	223020	Drive Shaft	50T	26	25	49	78.8	909					
1.8 16V (124 kW)	1998.04-2001.02	AT/MT	R	F	Estate Engine D16W4	201010	Drive Shaft	50T	26	25	55	78.5	627					
	1998.04-2001.02	MT	R	F	Estate Engine B18C4	201056	Drive Shaft	50T	26	27	55	78.5	591.5					
2.0 i D (77 kW)	1998.04-2001.02	-	R	F	Estate Engine B18C4	623005	Inner Joint		25	30	35	54.5	97					
	1998.04-2001.02	AT/MT	L/R	F	Estate Engine 20T2N	823002	Outer Joint	43T	26	32	55	78	68.5	I				
CIVIC VI Fastback (MA MB)																		
1.4 i (55 kW)	1995.09-2001.02	-	-	F	Hatchback Engine D14A7/D14Z5/D14Z3	823073	Outer Joint	50T	26	28	55	78.5	56.5	M				
	1995.09-2001.02	AT/MT	L/R	F	Hatchback Engine D14A7/D14Z5/D14Z3	823047	Outer Joint		26	28	55	77.5	53	M				
	1995.09-2001.02	-	-	F	Hatchback Engine D14A7/D14Z5/D14Z3	823050	Outer Joint		26	28	55	78.5	56.5	M				
	1995.09-2001.02	MT	-	F	Hatchback Engine D14A7/D14Z5/D14Z3	851021	Outer Joint	50T	26	32	55	78.5	56.5	I				
	1995.09-2001.02	AT/MT	L/R	F	Hatchback Engine D14A7/D14Z5/D14Z3	823063	Outer Joint		26	32	55	78.5	56.5	I				
	1995.09-2001.02	MT	L	F	Hatchback Engine D14A7/D14Z5/D14Z3	623004	Inner Joint		25	30	35	62	97.5					
	1995.09-2001.02	AT/MT	L/R	F	Hatchback Engine D14A7/D14Z5/D14Z3	899225	Outer Joint	50T	26	32	55	78.5	56.5	I				
	1995.09-2001.02	-	-	-	Hatchback Engine D14A7/D14Z5/D14Z3	823179	Outer Joint	50T	26	32	55	78.5	56.5	I				
	1995.09-2001.02	AT/MT	L/R	F	Hatchback Engine D14A7/D14Z5/D14Z3	823024	Outer Joint	50T	26	28	55	77.5	53	M				
	1995.09-2001.02	MT	R	F	Hatchback Engine D14A7/D14Z5/D14Z3	623005	Inner Joint		25	30	35	54.5	97					
	1995.09-2001.02	-	L	F	Hatchback Engine D14A7/D14Z5/D14Z3	223020	Drive Shaft	50T	26	25	49	78.8	909					
	1995.09-2001.02	-	R	F	Hatchback Engine D14A7/D14Z5/D14Z3	201010	Drive Shaft	50T	26	25	55	78.5	627					
	1.4 i (66 kW)	1994.09-2001.02	AT/MT	L/R	F	Hatchback Engine D14Z4/D14A2/D14A8/D14A6	823047	Outer Joint		26	28	55	77.5	53	M			
1994.09-2001.02		MT	-	F	Hatchback Engine D14Z4/D14A2/D14A8/D14A6	851021	Outer Joint	50T	26	32	55	78.5	56.5	I				
1994.09-2001.02		AT/MT	L/R	F	Hatchback Engine D14Z4/D14A2/D14A8/D14A6	823063	Outer Joint		26	32	55	78.5	56.5	I				
1994.09-2001.02		AT/MT	L/R	F	Hatchback Engine D14Z4/D14A2/D14A8/D14A6	899225	Outer Joint	50T	26	32	55	78.5	56.5	I				
1994.09-2001.02		-	L	F	Hatchback Engine D14Z4/D14A2/D14A8/D14A6	623004	Inner Joint		25	30	35	62	97.5					
1994.09-2001.02		-	-	-	Hatchback Engine D14Z4/D14A2/D14A8/D14A6	823179	Outer Joint	50T	26	32	55	78.5	56.5	I				
1994.09-2001.02		AT/MT	L/R	F	Hatchback Engine D14Z4/D14A2/D14A8/D14A6	823024	Outer Joint	50T	26	28	55	77.5	53	M				
1994.09-2001.02		-	R	F	Hatchback Engine D14Z4/D14A2/D14A8/D14A6	623005	Inner Joint		25	30	35	54.5	97					
1.5 16V (84 kW)	1997.01-2001.02	-	-	F	Hatchback Engine D15Z8	823073	Outer Joint	50T	26	28	55	78.5	56.5	M				
	1997.01-2001.02	AT/MT	L/R	F	Hatchback Engine D15Z8	823047	Outer Joint		26	28	55	77.5	53	M				
	1997.01-2001.02	-	-	F	Hatchback Engine D15Z8	823050	Outer Joint		26	28	55	78.5	56.5	M				
	1997.01-2001.02	-	-	-	Hatchback Engine D15Z8	823038	Outer Joint		26	28	55	78	55	M				
	1997.01-2001.02	-	-	F	Hatchback Engine D15Z8	851021	Outer Joint	50T	26	32	55	78.5	56.5	I				
	1997.01-2001.02	AT/MT	L/R	F	Hatchback Engine D15Z8	823063	Outer Joint		26	32	55	78.5	56.5	I				
	1997.01-2001.02	-	-	F	Hatchback Engine D15Z8	899210	Outer Joint		26	32	55	78.5	56.5	I				
	1997.01-2001.02	MT	L	F	Hatchback Engine D15Z8	623004	Inner Joint		25	30	35	62	97.5					
	1997.01-2001.02	AT/MT	L/R	F	Hatchback Engine D15Z8	899225	Outer Joint	50T	26	32	55	78.5	56.5	I				
	1997.01-2001.02	AT/MT	L/R	F	Hatchback Engine D15Z8	823024	Outer Joint	50T	26	28	55	77.5	53	M				
	1997.01-2001.02	MT	R	F	Hatchback Engine D15Z8	623005	Inner Joint		25	30	35	54.5	97					
	1997.01-2001.02	AT/MT	L	F	Hatchback Engine D15Z8	223020	Drive Shaft	50T	26	25	49	78.8	909					
1.5 i Vtec-E (66 kW)	1994.09-1997.01	AT/MT	R	F	Hatchback Engine D15Z8	201010	Drive Shaft	50T	26	25	55	78.5	627					
	1994.09-1997.01	MT	-	F	Hatchback Engine D15Z3	823050	Outer Joint		26	28	55	78.5	56.5	M				
	1994.09-1997.01	MT	L	F	Hatchback Engine D15Z3	623004	Inner Joint		25	30	35	62	97.5					
	1994.09-1997.01	-	-	-	Hatchback Engine D15Z3	823179	Outer Joint	50T	26	32	55	78.5	56.5	I				
1994.09-1997.01	MT	R	F	Hatchback Engine D15Z3	623005	Inner Joint		25	30	35	54.5	97						





YEAR	TRANSM	L/R	F/R	REMARKS	GSP Ref.	PRODUCT	ABS	Technical Specifications						
								A	B	C	H	L	P	
HONDA														
CIVIC VI Fastback (MA MB)														
1.5 i Vtec-E (66 kW)	1994.09-1997.01	MT	L	F	Hatchback Engine D15Z3	223020	Drive Shaft	50T	26	25	49	78.8	909	
	1994.09-1997.01	MT	R	F	Hatchback Engine D15Z3	201010	Drive Shaft	50T	26	25	55	78.5	627	
	1994.09-1997.01	MT	-	F	Hatchback Engine D15Z3	823073	Outer Joint	50T	26	28	55	78.5	56.5	M
1.6 (92 kW)	1998.11-2000.10	-	-	-	Hatchback Engine D16W4	823038	Outer Joint		26	28	55	78	55	M
	1998.11-2000.10	-	L	F	Hatchback Engine D16W4	623004	Inner Joint		25	30	35	62	97.5	
	1998.11-2000.10	-	L/R	F	Hatchback Engine D16W4	899225	Outer Joint	50T	26	32	55	78.5	56.5	I
	1998.11-2000.10	-	R	F	Hatchback Engine D16W4	623005	Inner Joint		25	30	35	54.5	97	
	1998.11-2000.10	-	L	F	Hatchback Engine D16W4	223020	Drive Shaft	50T	26	25	49	78.8	909	
	1998.11-2000.10	-	R	F	Hatchback Engine D16W4	201010	Drive Shaft	50T	26	25	55	78.5	627	
1.6 16V (85 kW)	1997.01-2001.02	AT/MT	L/R	F	Hatchback Engine D16B2	823047	Outer Joint		26	28	55	77.5	53	M
	1997.01-2001.02	-	-	-	Hatchback Engine D16B2	823038	Outer Joint		26	28	55	78	55	M
	1997.01-2001.02	-	L/R	F	Hatchback Engine D16B2	899225	Outer Joint	50T	26	32	55	78.5	56.5	I
	1997.01-2001.02	AT	L	F	Hatchback Engine D16B2	623004	Inner Joint		25	30	35	62	97.5	
	1997.01-2001.02	-	R	F	Hatchback Engine D16B2	623005	Inner Joint		25	30	35	54.5	97	
1.6 i (83 kW)	1994.09-1997.01	-	L	F	Hatchback Engine D16Y3	623004	Inner Joint		25	30	35	62	97.5	
	1994.09-1997.01	-	-	-	Hatchback Engine D16Y3	823179	Outer Joint	50T	26	32	55	78.5	56.5	I
	1994.09-1997.01	-	R	F	Hatchback Engine D16Y3	623005	Inner Joint		25	30	35	54.5	97	
	1994.09-1997.01	-	L	F	Hatchback Engine D16Y3	223020	Drive Shaft	50T	26	25	49	78.8	909	
	1994.09-1997.01	-	R	F	Hatchback Engine D16Y3	201010	Drive Shaft	50T	26	25	55	78.5	627	
1.6 i Vtec (93 kW)	1994.09-1997.01	MT	L	F	Hatchback Engine D16Y2	623004	Inner Joint		25	30	35	62	97.5	
	1994.09-1997.01	MT	R	F	Hatchback Engine D16Y2	623005	Inner Joint		25	30	35	54.5	97	
	1994.09-1997.01	-	L	F	Hatchback Engine D16Y2	223020	Drive Shaft	50T	26	25	49	78.8	909	
	1994.09-1997.01	-	R	F	Hatchback Engine D16Y2	201010	Drive Shaft	50T	26	25	55	78.5	627	
1.6 VTi (118 kW)	1997.01-2001.02	-	R	F	Hatchback Engine B16A2	201016	Drive Shaft	50T	26	27	55	78.5	596	
	1997.01-2001.02	AT/MT	L	F	Hatchback Engine B16A2	223083	Drive Shaft		26	25	55	77.5	901.5	
	1997.01-2001.02	AT/MT	R	F	Hatchback Engine B16A2	223082	Drive Shaft		26	25	55	77.5	619.5	
1.8 16V (124 kW)	1997.01-2001.02	MT	R	F	Hatchback Engine B18C4	201056	Drive Shaft	50T	26	27	55	78.5	591.5	
	1997.01-2001.02	MT	R	F	Hatchback Engine B18C4	623005	Inner Joint		25	30	35	54.5	97	
2.0 i TD (63 kW)	1997.01-2001.02	AT/MT	L/R	F	Hatchback Engine 20T2R	823002	Outer Joint	43T	26	32	55	78	68.5	I
CIVIC VII (EM2)														
1.6 i (81 kW)	2001.02-2005.12	-	L	F	Coupe Engine D16V1	223192	Drive Shaft	50T	26	25	55	77.5	893	
	2001.02-2005.12	-	R	F	Coupe Engine D16V1	223259	Drive Shaft	50T	26	25	60	77.5	622	
	2001.02-2005.12	MT	L	F	Coupe Engine D16V1	223089	Drive Shaft	50T	26	25	60	78	895	
	2001.02-2005.12	MT	R	F	Coupe Engine D16V1	223097	Drive Shaft	50T	26	25	60	78	610	
1.7 i (88 kW)	2001.05-2005.12	MT	-	F	Coupe Engine D17A8	823087	Outer Joint	50T	26	23	60	78	61	M
	2001.05-2005.12	MT	L	F	Coupe Engine D17A8	223089	Drive Shaft	50T	26	25	60	78	895	
	2001.05-2005.12	MT	R	F	Coupe Engine D17A8	223097	Drive Shaft	50T	26	25	60	78	610	
1.7 i VTEC (92 kW)	2001.05-2005.12	MT	-	F	Coupe Engine D17A9/D17A5	823087	Outer Joint	50T	26	23	60	78	61	M
	2001.05-2005.12	MT	L	F	Coupe Engine D17A9/D17A5	223089	Drive Shaft	50T	26	25	60	78	895	
	2001.05-2005.12	MT	R	F	Coupe Engine D17A9/D17A5	223097	Drive Shaft	50T	26	25	60	78	610	
CIVIC VII (ES ET)/CIVIC FERIO														
1.3 Hybrid (69 kW)	2002.09-2005.12	MT	L	F	Saloon Engine LDA1	623018	Inner Joint		25	28	35	58	95.5	
	2002.09-2005.12	MT	-	F	Saloon Engine LDA1	823039	Outer Joint	50T	26	28	60	77.5	53	M
1.3 IMA (61 kW)	2003.10-2005.09	MT	L	F	Saloon Engine LDA1	623018	Inner Joint		25	28	35	58	95.5	
1.4 (66 kW)	2000.12-2005.09	MT	L	F	Saloon Engine D14Z5	223192	Drive Shaft	50T	26	25	55	77.5	893	
	2000.12-2005.09	MT	R	F	Saloon Engine D14Z5	223259	Drive Shaft	50T	26	25	60	77.5	622	
	2000.12-2005.09	-	L	F	Saloon Engine D14Z5	623018	Inner Joint		25	28	35	58	95.5	
	2000.12-2005.09	-	-	F	Saloon Engine D14Z5	823039	Outer Joint	50T	26	28	60	77.5	53	M
	2000.12-2005.09	MT	L	F	Saloon Engine D14Z5	223089	Drive Shaft	50T	26	25	60	78	895	
	2000.12-2005.09	MT	R	F	Saloon Engine D14Z5	223097	Drive Shaft	50T	26	25	60	78	610	
1.6 (81 kW)	2001.02-2005.09	-	L	F	Saloon Engine D16V1	223192	Drive Shaft	50T	26	25	55	77.5	893	
	2001.02-2005.09	-	R	F	Saloon Engine D16V1	223259	Drive Shaft	50T	26	25	60	77.5	622	
	2001.02-2005.09	MT	L	F	Saloon Engine D16V1	223089	Drive Shaft	50T	26	25	60	78	895	
	2001.02-2005.09	MT	R	F	Saloon Engine D16V1	223097	Drive Shaft	50T	26	25	60	78	610	
CIVIC VII (EU EP EV)														
1.4 i (55 kW)	2001.02-2005.09	MT	L	F	Hatchback Engine D14Z6	223192	Drive Shaft	50T	26	25	55	77.5	893	
	2001.02-2005.09	MT	R	F	Hatchback Engine D14Z6	223259	Drive Shaft	50T	26	25	60	77.5	622	
	2001.02-2005.09	MT	L	F	Hatchback Engine D14Z6	623018	Inner Joint		25	28	35	58	95.5	
	2001.02-2005.09	MT	-	F	Hatchback Engine D14Z6	823039	Outer Joint	50T	26	28	60	77.5	53	M
1.4 iS (66 kW)	2001.02-2005.09	MT	L	F	Hatchback Engine D14Z5/D14Z6	223192	Drive Shaft	50T	26	25	55	77.5	893	
	2001.02-2005.09	MT	R	F	Hatchback Engine D14Z5/D14Z6	223259	Drive Shaft	50T	26	25	60	77.5	622	
	2001.02-2005.09	-	-	F	Hatchback Engine D14Z5/D14Z6	823095	Outer Joint	50T	26	22	60	79	56	M
	2001.02-2005.09	-	L	F	Hatchback Engine D14Z5/D14Z6	623018	Inner Joint		25	28	35	58	95.5	
	2001.02-2005.09	-	-	F	Hatchback Engine D14Z5/D14Z6	823039	Outer Joint	50T	26	28	60	77.5	53	M
	2001.02-2005.09	MT	L	F	Hatchback Engine D14Z5/D14Z6	223089	Drive Shaft	50T	26	25	60	78	895	
	2001.02-2005.09	MT	R	F	Hatchback Engine D14Z5/D14Z6	223097	Drive Shaft	50T	26	25	60	78	610	





YEAR	TRANS	L/R	F/R	REMARKS	GSP Ref.	PRODUCT	ABS	Technical Specifications							
								A	B	C	H	L	P		
HONDA															
CIVIC VII (EU EP EV)															
1.6 i (81 kW)	2001.02-2005.09	-	L	F	Hatchback Engine D16V1	223192	Drive Shaft	50T	26	25	55	77.5	893		
	2001.02-2005.09	-	R	F	Hatchback Engine D16V1	223259	Drive Shaft	50T	26	25	60	77.5	622		
	2001.02-2005.09	MT	L	F	Hatchback Engine D16V1	223089	Drive Shaft	50T	26	25	60	78	895		
	2001.02-2005.09	MT	R	F	Hatchback Engine D16V1	223097	Drive Shaft	50T	26	25	60	78	610		
1.7 CTDi (74 kW)	2002.01-2005.09	-	-	F	Hatchback Engine 4EE-2	823001	Outer Joint	50T	26	32	60	79	62.5	I	
2.0 i Sport (118 kW)	2001.09-2005.09	MT	-	F	Hatchback Engine K20A3	823033	Outer Joint	50T	26	30	60	78.5	57	M	
	2001.09-2005.09	MT	R	F	Hatchback Engine K20A3	623023	Inner Joint		27	30	40	45.5	75		
	2001.09-2005.09	MT	R	F	Hatchback Engine K20A3	699079	Inner Joint		27	30	40	55.5	97		
2.0 Type-R (147 kW)	2001.09-2005.09	-	L	F	Hatchback Engine K20A2	223266	Drive Shaft	50T	28	27	64	88	624		
	2001.09-2005.09	-	R	F	Hatchback Engine K20A2	223284	Drive Shaft	50T	28	27	64	88	581		
	2001.09-2005.09	AT/MT	L/R	F	Hatchback Engine K20A2	823118	Outer Joint	50T	28	32	64	88.5	62	M	
	2001.09-2005.09	-	-	F	Hatchback Engine K20A2	823080	Outer Joint	50T	28	32	64	88.5	62	M	
CIVIC VIII (FD FA)															
1.3 Hybrid (70 kW)	2006.01-	-	CVT	L	F	Saloon Engine LDA2	623018	Inner Joint		25	28	35	58	95.5	
	2006.01-	-	CVT	-	F	Saloon Engine LDA2	823066	Outer Joint		26	28	58	78.5	51	M
1.3 Hybrid (85 kW)	2010.01-2012.02	CVT	L	F	Saloon Engine LDA2	623018	Inner Joint		25	28	35	58	95.5		
	2010.01-2012.02	CVT	-	F	Saloon Engine LDA2	823066	Outer Joint		26	28	58	78.5	51	M	
1.8 (103 kW)	2005.09-2012.02	MT	L	F	Saloon Engine R18A1	223164	Drive Shaft		26	27	58	79	633		
	2005.09-2012.02	MT	R	F	Saloon Engine R18A1	223165	Drive Shaft		26	27	58	79	590		
	2005.09-2012.02	AT	L	F	Saloon Engine R18A1	623018	Inner Joint		25	28	35	58	95.5		
	2005.09-2012.02	MT	R	F	Saloon Engine R18A1	623023	Inner Joint		27	30	40	45.5	75		
	2005.09-2012.02	MT	-	F	Saloon Engine R18A1	823125	Outer Joint		26	30	58	79	59	M	
	2005.09-2012.02	-	-	F	Saloon Engine R18A1	823066	Outer Joint		26	28	58	78.5	51	M	
	2005.09-2012.02	MT	R	F	Saloon Engine R18A1	699079	Inner Joint		27	30	40	55.5	97		
2.0 i-VTEC Type R (165 kW)	2007.08-2010.09	MT	-	-	Saloon	623013	Inner Joint		27	32	40	45.5	75		
	2007.08-2010.09	AT	L	F	Saloon	623018	Inner Joint		25	28	35	58	95.5		
	2007.08-2010.09	MT	R	F	Saloon	623023	Inner Joint		27	30	40	45.5	75		
	2007.08-2010.09	AT	-	F	Saloon	823066	Outer Joint		26	28	58	78.5	51	M	
	2007.08-2010.09	MT	R	F	Saloon	699079	Inner Joint		27	30	40	55.5	97		
	2007.08-2010.09	MT	-	F	Saloon	823124	Outer Joint		30	32	68	88	59.5	M	
CIVIC VIII (FN FK)															
1.4 (61 kW)	2005.09-	-	MT	-	F	Hatchback Engine L13A7	823125	Outer Joint		26	30	58	79	59	M
	2005.09-	-	MT	R	F	Hatchback Engine L13A7	699079	Inner Joint		27	30	40	55.5	97	
1.4 (73 kW)	2008.10-	-	MT	-	F	Hatchback Engine L13Z1	823125	Outer Joint		26	30	58	79	59	M
	2008.10-	-	MT	R	F	Hatchback Engine L13Z1	699079	Inner Joint		27	30	40	55.5	97	
1.8 (103 kW)	2005.09-	-	MT	L	F	Hatchback Engine R18A2	223164	Drive Shaft		26	27	58	79	633	
	2005.09-	-	MT	R	F	Hatchback Engine R18A2	223165	Drive Shaft		26	27	58	79	590	
	2005.09-	-	AT	L	F	Hatchback Engine R18A2	623018	Inner Joint		25	28	35	58	95.5	
	2005.09-	-	-	R	F	Hatchback Engine R18A2	623023	Inner Joint		27	30	40	45.5	75	
	2005.09-	-	AT	-	F	Hatchback Engine R18A2	823125	Outer Joint		26	30	58	79	59	M
	2005.09-	-	AT	-	F	Hatchback Engine R18A2	823066	Outer Joint		26	28	58	78.5	51	M
	2005.09-	-	-	R	F	Hatchback Engine R18A2	699079	Inner Joint		27	30	40	55.5	97	
2.0 Type R (148 kW)	2006.09-	-	MT	-	-	Hatchback Engine K20Z4	623013	Inner Joint		27	32	40	45.5	75	
	2006.09-	-	MT	L	F	Hatchback Engine K20Z4	223291	Drive Shaft		28	27	63	88.5	639	
	2006.09-	-	MT	R	F	Hatchback Engine K20Z4	223287	Drive Shaft		28	27	63	88.5	602	
	2006.09-	-	MT	L	F	Hatchback Engine K20Z4	623009	Inner Joint		27	32	40	58.5	97	
2.2 CTDi (103 kW)	2005.09-	-	MT	R	F	Hatchback Engine N22A2	223191	Drive Shaft		28	29	63	89	616	
	2005.09-	-	MT	-	F	Hatchback Engine N22A2	823147	Outer Joint		28	35	63	89	60	I
	2005.09-	-	-	-	-	Hatchback Engine N22A2	223194	Drive Shaft		28	29	63	89	615	
CIVIC VIII (FN, FK)															
2.0 i-VTEC Type R (177 kW)	2010.03-2010.12	MT	-	-	Hatchback/掀背式	623013	Inner Joint		27	32	40	45.5	75		
CONCERTO (HW MA)															
1.4 (66 kW)	1989.08-1991.10	AT/MT	L/R	F	Hatchback Engine D14A8/D14A1	823010	Outer Joint		26	22	49	78.8	55	I	
1.5 i 16V (66 kW)	1989.08-1995.03	AT/MT	L/R	F	Hatchback Engine D15B2	823010	Outer Joint		26	22	49	78.8	55	I	
1.6 (96 kW)	1989.10-1992.10	MT	L	F	Hatchback Engine D16A9	623004	Inner Joint		25	30	35	62	97.5		
1.6 16V (78 kW)	1989.08-1995.03	-	L	F	Hatchback Engine D16Z2	623004	Inner Joint		25	30	35	62	97.5		
	1989.08-1995.03	-	R	F	Hatchback Engine D16Z2	623005	Inner Joint		25	30	35	54.5	97		
	1989.08-1995.03	AT/MT	L/R	F	Hatchback Engine D16Z2	823010	Outer Joint		26	22	49	78.8	55	I	
	1989.08-1995.03	AT	-	F	Hatchback Engine D16Z2	823008	Outer Joint	50T	26	23	49	78.8	55	I	
1.6 i 16V (82 kW)	1989.08-1995.03	-	L	F	Hatchback Engine D16Z2	623004	Inner Joint		25	30	35	62	97.5		
	1989.08-1995.03	-	R	F	Hatchback Engine D16Z2	623005	Inner Joint		25	30	35	54.5	97		
	1989.08-1995.03	AT	-	F	Hatchback Engine D16Z2	823008	Outer Joint	50T	26	23	49	78.8	55	I	
1.6 i 16V (90 kW)	1989.08-1995.03	-	L	F	Hatchback Engine D16A8	623004	Inner Joint		25	30	35	62	97.5		
	1989.08-1995.03	AT	-	F	Hatchback Engine D16A8	823008	Outer Joint	50T	26	23	49	78.8	55	I	
CONCERTO (HWW)															
1.4 (66 kW)	1989.08-1991.10	AT/MT	L/R	F	Saloon Engine D14A1/D14A8	823010	Outer Joint		26	22	49	78.8	55	I	

YEAR	TRANSM	L/R	F/R	REMARKS	GSP Ref.	PRODUCT	ABS	Technical Specifications										
								A	B	C	H	L	P					
HONDA																		
CONCERTO (HWW)																		
1.5 i 16V (66 kW)	1989.08-1995.05	AT/MT	L/R	F	Saloon Engine D15B2	823010	Outer Joint		26	22	49	78.8	55	I				
1.6 (96 kW)	1989.10-1992.10	MT	L/R	F	Saloon Engine D16A9	623004	Inner Joint		25	30	35	62	97.5					
1.6 16V (78 kW)	1989.08-1995.03	AT/MT	L/R	F	Saloon Engine D16Z2	823010	Outer Joint		26	22	49	78.8	55	I				
1.6 i 16V (90 kW)	1989.08-1995.03	MT	L	F	Saloon Engine D16A8	623004	Inner Joint		25	30	35	62	97.5					
CR-V																		
-	1997-1998	-	L	-	Truck	223124	Drive Shaft		28	27	64	88.5	601.7					
2.0	2007-2008	AT	R	F	Engine: R20A2	223175	Drive Shaft		30	27	68	88	564					
	2007-2008	AT	L	F	Engine: R20A2	223176	Drive Shaft		30	27	68	88	668					
	2015-	6MT/5AT	L	F	KR;GBR	223306	Drive Shaft		30	27	68.1	88	663					
	2015-	6MT/5AT	L	F	KR;GBR	823221	Outer Joint		30	30	68.1	88	58	M				
	2015-	6MT/5AT	L	F	KR;GBR	623072	Inner Joint		27	30	40	58	97.5					
2.0 Re3	2006-2011	AT	-	-		823111	Outer Joint		23	25	49	78	50.5	M				
2.4 Re4	2006-2011	AT	-	-		823111	Outer Joint		23	25	49	78	50.5	M				
CR-V (RE3)																		
2.4	2006.10-	5AT	-	-	Engine K24A	823153	Outer Joint		30	32	68	88.5	59.5	M				
CR-V (RE4)																		
2.4 4WD	2006.10-	5AT	-	-	Engine K24A	823153	Outer Joint		30	32	68	88.5	59.5	M				
CR-V I (RD)																		
2.0 16V (108 kW)	1999.01-2002.02	-	R	F	All-wheel Drive Closed Off-Road Vehicle Engine B20Z1	823197	Outer Joint	50T	28	32	64	88.5	62	M				
	1999.01-2002.02	-	-	-	All-wheel Drive Closed Off-Road Vehicle Engine B20Z1	623013	Inner Joint		27	32	40	45.5	75					
	1999.01-2002.02	-	-	R	All-wheel Drive Closed Off-Road Vehicle Engine B20Z1	623069	Inner Joint		23	25	35	60	94.5					
	1999.01-2002.02	-	-	-	All-wheel Drive Closed Off-Road Vehicle Engine B20Z1	801006	Outer Joint		28	32	64	88.5	62	M				
	1999.01-2002.02	-	L/R	F	All-wheel Drive Closed Off-Road Vehicle Engine B20Z1	823139	Outer Joint	50T	28	32	64	88	58.5	M				
	1999.01-2002.02	AT/MT	L/R	F	All-wheel Drive Closed Off-Road Vehicle Engine B20Z1	823118	Outer Joint	50T	28	32	64	88.5	62	M				
	1999.01-2002.02	-	-	F	All-wheel Drive Closed Off-Road Vehicle Engine B20Z1	823029	Outer Joint	50T	28	32	64	89	60	M				
	1999.01-2002.02	-	-	F	All-wheel Drive Closed Off-Road Vehicle Engine B20Z1	823080	Outer Joint	50T	28	32	64	88.5	62	M				
	1999.01-2002.02	-	-	R	All-wheel Drive Closed Off-Road Vehicle Engine B20Z1	623054	Inner Joint		23	25	55	78	85					
	1999.01-2002.02	-	L	F	All-wheel Drive Closed Off-Road Vehicle Engine B20Z1	223042	Drive Shaft	50T	28	27	64	88.5	601.7					
	1999.01-2002.02	-	R	F	All-wheel Drive Closed Off-Road Vehicle Engine B20Z1	299146	Drive Shaft	50T	28	27	64	88.5	640					
	1999.01-2002.02	AT	R	F	All-wheel Drive Closed Off-Road Vehicle Engine B20Z1	601001	Inner Joint		27	32	40	55.5	97					
	2.0 16V (94 kW)	1995.10-2001.12	AT/MT	R	F	All-wheel Drive Closed Off-Road Vehicle Engine B20B	823197	Outer Joint	50T	28	32	64	88.5	62	M			
1995.10-2001.12		4AT/5MT	-	-	All-wheel Drive Closed Off-Road Vehicle Engine B20B	623013	Inner Joint		27	32	40	45.5	75					
1995.10-2001.12		-	-	F	All-wheel Drive Closed Off-Road Vehicle Engine B20B	899248	Outer Joint	50T	26	32	60	78	56	M				
1995.10-2001.12		4AT/5MT	-	R	All-wheel Drive Closed Off-Road Vehicle Engine B20B	623069	Inner Joint		23	25	35	60	94.5					
1995.10-2001.12		-	-	-	All-wheel Drive Closed Off-Road Vehicle Engine B20B	801006	Outer Joint		28	32	64	88.5	62	M				
1995.10-2001.12		AT/MT	L/R	F	All-wheel Drive Closed Off-Road Vehicle Engine B20B	823118	Outer Joint	50T	28	32	64	88.5	62	M				
1995.10-2001.12		4AT/5MT	-	F	All-wheel Drive Closed Off-Road Vehicle Engine B20B	823035	Outer Joint		28	32	64	89	60	M				
1995.10-2001.12		4AT/5MT	-	F	All-wheel Drive Closed Off-Road Vehicle Engine B20B	823029	Outer Joint	50T	28	32	64	89	60	M				
1995.10-2001.12		-	-	F	All-wheel Drive Closed Off-Road Vehicle Engine B20B	823080	Outer Joint	50T	28	32	64	88.5	62	M				
1995.10-2001.12		4AT/5MT	-	R	All-wheel Drive Closed Off-Road Vehicle Engine B20B	623054	Inner Joint		23	25	55	78	85					
1995.10-2001.12		AT/MT	L	F	All-wheel Drive Closed Off-Road Vehicle Engine B20B	223042	Drive Shaft	50T	28	27	64	88.5	601.7					
1995.10-2001.12		AT/MT	R	F	All-wheel Drive Closed Off-Road Vehicle Engine B20B	299146	Drive Shaft	50T	28	27	64	88.5	640					
1995.10-2001.12		4AT	R	F	All-wheel Drive Closed Off-Road Vehicle Engine B20B	601001	Inner Joint		27	32	40	55.5	97					
CR-V II (RD_)																		
2.0 (110 kW)	2001.09-2006.09	AT	-	-	All-wheel Drive Closed Off-Road Vehicle Engine K20A4	623013	Inner Joint		27	32	40	45.5	75					
	2001.09-2006.09	AT/MT	L	F	All-wheel Drive Closed Off-Road Vehicle Engine K20A4	223011	Drive Shaft		28	27	63	88.5	663					
	2001.09-2006.09	AT/MT	R	F	All-wheel Drive Closed Off-Road Vehicle Engine K20A4	223074	Drive Shaft		28	27	63	88.5	618					
	2001.09-2006.09	AT/MT	L	F	All-wheel Drive Closed Off-Road Vehicle Engine K20A4	623009	Inner Joint		27	32	40	58.5	97					
	2001.09-2006.09	-	-	-	All-wheel Drive Closed Off-Road Vehicle Engine K20A4	823032	Outer Joint	50T	28	32	64	88.5	62	M				
	2001.09-2006.09	-	-	-	All-wheel Drive Closed Off-Road Vehicle Engine K20A4	899159	Outer Joint		28	32	60	87	61	M				
2.2 CTDi (103 kW)	2005.02-2006.09	MT	L	F	All-wheel Drive Closed Off-Road Vehicle Engine N22A2	223188	Drive Shaft		28	29	63	88.5	640					
	2005.02-2006.09	MT	R	F	All-wheel Drive Closed Off-Road Vehicle Engine N22A2	223190	Drive Shaft		28	29	63	88.5	627					
	2005.02-2006.09	MT	L	F	All-wheel Drive Closed Off-Road Vehicle Engine N22A2	623037	Inner Joint		29	34	40	57	97					
	2005.02-2006.09	-	-	F	All-wheel Drive Closed Off-Road Vehicle Engine N22A2	823117	Outer Joint		28	34	63	88.5	59.5	M				
	2005.02-2006.09	MT	R	F	All-wheel Drive Closed Off-Road Vehicle Engine N22A2	623038	Inner Joint		29	34	42	47.5	74.5					
	2005.02-2006.09	MT	-	R	All-wheel Drive Closed Off-Road Vehicle Engine N22A2	623045	Inner Joint		23	20	35	58.5	104.5					
2.4 Vtec (118 kW)	2001.09-2006.09	-	R	-	All-wheel Drive Closed Off-Road Vehicle Engine K24A1	223021	Drive Shaft		28	27	63	88.5	575					
	2001.09-2006.09	-	L	-	All-wheel Drive Closed Off-Road Vehicle Engine K24A1	223224	Drive Shaft		28	27	63	88.5	663					
CR-V III (RE_)																		
2.0 i (110 kW)	2007.01-	-	-	-	All-wheel Drive Closed Off-Road Vehicle Engine R20A2	623013	Inner Joint		27	32	40	45.5	75					
	2007.01-	-	AT/MT	L	F	All-wheel Drive Closed Off-Road Vehicle Engine R20A2	223324	Drive Shaft		30	27	68	88	677				
	2007.01-	-	AT/MT	R	F	All-wheel Drive Closed Off-Road Vehicle Engine R20A2	223325	Drive Shaft		30	27	68	88	579				
	2007.01-	-	AT/MT	-	F	All-wheel Drive Closed Off-Road Vehicle Engine R20A2	823131	Outer Joint		30	32	68	90	63	M			
	2007.01-	-	-	L	R	All-wheel Drive Closed Off-Road Vehicle Engine R20A2	223199	Drive Shaft		28	23	55	91	770				
	2007.01-	-	-	R	R	All-wheel Drive Closed Off-Road Vehicle Engine R20A2	223198	Drive Shaft		28	23	55	91	820				
	2007.01-	-	-	-	F	All-wheel Drive Closed Off-Road Vehicle Engine R20A2	823124	Outer Joint		30	32	68	88	59.5	M			

	 YEAR	TRANSM	L/R	F/R	REMARKS	GSP Ref.	 PRODUCT	 ABS	Technical Specifications						
									A	B	C	H	L	P	
HONDA															
CR-V III (RE_)															
2.0 i (110 kW)	2007.01-	-	-	R	All-wheel Drive Closed Off-Road Vehicle Engine R20A2	823160	Outer Joint		28	20	55	91	52.5	M	
	2007.01-	-	-	R	All-wheel Drive Closed Off-Road Vehicle Engine R20A2	623045	Inner Joint		23	20	35	58.5	104.5		
2.2 i-CTDi (103 kW)	2007.01-	-	MT	L	F	All-wheel Drive Closed Off-Road Vehicle Engine N22A2	223216	Drive Shaft	30	29	68	88	640		
	2007.01-	-	MT	R	F	All-wheel Drive Closed Off-Road Vehicle Engine N22A2	223189	Drive Shaft	30	29	68	88	557		
	2007.01-	-	MT	L	F	All-wheel Drive Closed Off-Road Vehicle Engine N22A2	623037	Inner Joint	29	34	40	57	97		
	2007.01-	-	-	L	R	All-wheel Drive Closed Off-Road Vehicle Engine N22A2	223199	Drive Shaft	28	23	55	91	770		
	2007.01-	-	MT	-	F	All-wheel Drive Closed Off-Road Vehicle Engine N22A2	823145	Outer Joint	30	34	68	88	59.5	M	
	2007.01-	-	-	R	R	All-wheel Drive Closed Off-Road Vehicle Engine N22A2	223198	Drive Shaft	28	23	55	91	820		
	2007.01-	-	MT	-	R	All-wheel Drive Closed Off-Road Vehicle Engine N22A2	823160	Outer Joint	28	20	55	91	52.5	M	
	2007.01-	-	MT	R	F	All-wheel Drive Closed Off-Road Vehicle Engine N22A2	623038	Inner Joint	29	34	42	47.5	74.5		
	2007.01-	-	MT	-	R	All-wheel Drive Closed Off-Road Vehicle Engine N22A2	623045	Inner Joint	23	20	35	58.5	104.5		
2.2 i-DTEC (110 kW)	2007.01-	-	6MT	L	F	All-wheel Drive Closed Off-Road Vehicle Engine N22B3	223216	Drive Shaft	30	29	68	88	640		
	2007.01-	-	6MT	R	F	All-wheel Drive Closed Off-Road Vehicle Engine N22B3	223189	Drive Shaft	30	29	68	88	557		
	2007.01-	-	MT	L	F	All-wheel Drive Closed Off-Road Vehicle Engine N22B3	623037	Inner Joint	29	34	40	57	97		
	2007.01-	-	-	L	R	All-wheel Drive Closed Off-Road Vehicle Engine N22B3	223199	Drive Shaft	28	23	55	91	770		
	2007.01-	-	-	-	F	All-wheel Drive Closed Off-Road Vehicle Engine N22B3	823145	Outer Joint	30	34	68	88	59.5	M	
	2007.01-	-	-	R	R	All-wheel Drive Closed Off-Road Vehicle Engine N22B3	223198	Drive Shaft	28	23	55	91	820		
	2007.01-	-	-	-	R	All-wheel Drive Closed Off-Road Vehicle Engine N22B3	823160	Outer Joint	28	20	55	91	52.5	M	
	2007.01-	-	-	R	F	All-wheel Drive Closed Off-Road Vehicle Engine N22B3	623038	Inner Joint	29	34	42	47.5	74.5		
	2007.01-	-	-	-	R	All-wheel Drive Closed Off-Road Vehicle Engine N22B3	623045	Inner Joint	23	20	35	58.5	104.5		
2.4 (124 kW)	2006.09-	-	5AT/6MT	R	R	All-wheel Drive Closed Off-Road Vehicle Engine K24A/K24Z1	223329	Drive Shaft	28	23	55	90.5	820		
	2006.09-	-	5AT/6MT	L	R	All-wheel Drive Closed Off-Road Vehicle Engine K24A/K24Z1	223330	Drive Shaft	28	23	55	90.5	769		
2.4 i-VTEC (122 kW)	2009.09-	-	-	-	-	All-wheel Drive Closed Off-Road Vehicle Engine K24Z4/K24Z1	623013	Inner Joint	27	32	40	45.5	75		
	2009.09-	-	-	L	R	All-wheel Drive Closed Off-Road Vehicle Engine K24Z4/K24Z1	223199	Drive Shaft	28	23	55	91	770		
	2009.09-	-	-	R	R	All-wheel Drive Closed Off-Road Vehicle Engine K24Z4/K24Z1	223198	Drive Shaft	28	23	55	91	820		
	2009.09-	-	-	-	F	All-wheel Drive Closed Off-Road Vehicle Engine K24Z4/K24Z1	823124	Outer Joint	30	32	68	88	59.5	M	
	2009.09-	-	-	-	R	All-wheel Drive Closed Off-Road Vehicle Engine K24Z4/K24Z1	823160	Outer Joint	28	20	55	91	52.5	M	
	2009.09-	-	-	-	R	All-wheel Drive Closed Off-Road Vehicle Engine K24Z4/K24Z1	623045	Inner Joint	23	20	35	58.5	104.5		
CR-V IV (RE)															
2.4 (127 kW)	2012.09-	-	-	R	-	Closed Off-Road Vehicle Engine K24A	223021	Drive Shaft	28	27	63	88.5	575		
	2012.09-	-	-	L	-	Closed Off-Road Vehicle Engine K24A	223224	Drive Shaft	28	27	63	88.5	663		
CR-V RD1															
2.0	1995.10-	2001.09	4AT	-	-	Allwheel Drive Engine B20B	823207	Outer Joint	26	32	55	78.1	55	M	
CR-V RE3															
2400	2006.10-	-	5AT	-	-	Engine K24A	823153	Outer Joint	30	32	68	88.5	59.5	M	
	2006.10-	-	5AT	-	-	Engine K24A	823153	Outer Joint	30	32	68	88.5	59.5	M	
CR-V RE4															
2400	2006.10-	-	5AT	-	-	Allwheel Drive Engine K24A	823153	Outer Joint	30	32	68	88.5	59.5	M	
	2006.10-	-	5AT	-	-	Allwheel Drive Engine K24A	823153	Outer Joint	30	32	68	88.5	59.5	M	
CR-Z (ZF)															
1.5 Hybrid (84 kW)	2010.06-	-	-	-	-	Coupe Engine LEA1	823260	Outer Joint	26	29	58	78	52	M	
1.5 Hybrid (89 kW)	2012.11-	-	-	-	-	Coupe Engine LEA1/LEA3	823260	Outer Joint	26	29	58	78	52	M	
1.5 Hybrid (91 kW)	2010.09-	2013.12	6MT	L	F	Coupe Engine LEA1/LEA3	223333	Drive Shaft	26	27	58	78.5	624		
	2010.09-	2013.12	6MT	L	F	Coupe Engine LEA1/LEA3	823253	Outer Joint	26	29	58	78.5	51	M	
	2010.09-	2013.12	6MT	L	F	Coupe Engine LEA1/LEA3	623079	Inner Joint	27	29	40	58	95.5		
CRV															
2.4	2002-	2006	AT	-	-	-	623044	Inner Joint	27	32	40	58.5	97		
CRX II (ED EE)															
1.6 i 16V (91 kW)	1987.10-	1992.02	MT	L	F	Coupe Engine D16Z5	623004	Inner Joint	25	30	35	62	97.5		
	1987.10-	1992.02	AT/MT	L/R	F	Coupe Engine D16Z5	823021	Outer Joint	26	32	49	78.5	56.5	M	
	1987.10-	1992.02	MT	R	F	Coupe Engine D16Z5	623005	Inner Joint	25	30	35	54.5	97		
1.6 i 16V (96 kW)	1987.10-	1989.12	AT/MT	L/R	F	Coupe Engine D16A9/D16A8	823021	Outer Joint	26	32	49	78.5	56.5	M	
	1987.10-	1989.12	-	-	F	Coupe Engine D16A9/D16A8	823071	Outer Joint	50T	26	32	49	78.5	56.5	M
	1987.10-	1989.12	MT	L	F	Coupe Engine D16A9/D16A8	623004	Inner Joint	25	30	35	62	97.5		
	1987.10-	1989.12	MT	R	F	Coupe Engine D16A9/D16A8	623005	Inner Joint	25	30	35	54.5	97		
1.6 i 16V Vtec (110 kW)	1989.10-	1992.02	MT	L/R	F	Coupe Engine B16A1	823021	Outer Joint	26	32	49	78.5	56.5	M	
	1989.10-	1992.02	MT	R	F	Coupe Engine B16A1	601001	Inner Joint	27	32	40	55.5	97		
CRX III (EH EG)/CIVIC del Sol															
1.6 ESi (92 kW)	1992.03-	1998.12	-	L	F	Targa Engine D16Y8/D16Z6	623004	Inner Joint	25	30	35	62	97.5		
	1992.03-	1998.12	-	-	F	Targa Engine D16Y8/D16Z6	823023	Outer Joint	26	30	55	78.5	56.5	M	
	1992.03-	1998.12	-	-	F	Targa Engine D16Y8/D16Z6	823086	Outer Joint	50T	26	30	55	78.5	56.5	M
	1992.03-	1998.12	-	R	F	Targa Engine D16Y8/D16Z6	623005	Inner Joint	25	30	35	54.5	97		
	1992.03-	1998.12	AT/MT	L/R	F	Targa Engine D16Y8/D16Z6	823017	Outer Joint	50T	26	32	55	78.5	56.5	M
	1992.03-	1998.12	-	R	F	Targa Engine D16Y8/D16Z6	623020	Inner Joint	25	28	35	54.5	96.5		
	1992.03-	1998.12	-	L	F	Targa Engine D16Y8/D16Z6	223155	Drive Shaft	50T	26	27	55	78.5	557	
	1992.03-	1998.12	-	-	-	Targa Engine D16Y8/D16Z6	823159	Outer Joint	50T	26	32	55	78.1	55	M

YEAR	TRANS	L/R	F/R	REMARKS	GSP Ref.	PRODUCT	ABS	Technical Specifications						
								A	B	C	H	L	P	
HONDA														
CRX III (EH EG)/CIVIC del Sol														
1.6 i VTi (118 kW)	1992.03-1998.12	5MT	L	F	Targa Engine B16A2	623004	Inner Joint		25	30	35	62	97.5	
	1992.03-1998.12	MT	R	F	Targa Engine B16A2	623005	Inner Joint		25	30	35	54.5	97	
	1992.03-1998.12	5MT	-	F	Targa Engine B16A2	823023	Outer Joint		26	30	55	78.5	56.5	M
	1992.03-1998.12	MT	-	F	Targa Engine B16A2	823086	Outer Joint	50T	26	30	55	78.5	56.5	M
	1992.03-1998.12	MT	R	F	Targa Engine B16A2	623017	Inner Joint		27	30	40	58.5	97	
	1992.03-1998.12	AT/MT	L/R	F	Targa Engine B16A2	823017	Outer Joint	50T	26	32	55	78.5	56.5	M
	1992.03-1998.12	5MT	R	F	Targa Engine B16A2	623020	Inner Joint		25	28	35	54.5	96.5	
	1992.03-1998.12	-	L	F	Targa Engine B16A2	223155	Drive Shaft	50T	26	27	55	78.5	557	
	1992.03-1998.12	-	-	-	Targa Engine B16A2	823159	Outer Joint	50T	26	32	55	78.1	55	M
	1992.03-1998.12	MT	-	-	Targa Engine B16A2	623013	Inner Joint		27	32	40	45.5	75	
DOMANI (MA_)														
1.5 (69 kW)	1992.10-2000.09	-	-	-	Saloon Engine D15B3	823038	Outer Joint		26	28	55	78	55	M
DOMANI (MJ_)														
1.6 (88 kW)	1995.10-1999.09	-	-	-	Saloon Engine D16A	823038	Outer Joint		26	28	55	78	55	M
DOMANI MA5														
1.8	1992.10-1997.01	MT/AT	-	-	Engine B18B	823207	Outer Joint		26	32	55	78.1	55	M
1800	1992.10-1997.01	MT/AT	-	-	Engine B18B	823207	Outer Joint		26	32	55	78.1	55	M
DOMANI MA6														
1.6	1992.10-1997.01	MT/AT	-	-	Allwheel Drive Engine ZC	823207	Outer Joint		26	32	55	78.1	55	M
1600	1992.10-1997.01	MT/AT	-	-	Allwheel Drive Engine ZC	823207	Outer Joint		26	32	55	78.1	55	M
DOMANI MB5														
1.6	1997.01-	MT/AT	-	-	Allwheel Drive Engine D16A	823207	Outer Joint		26	32	55	78.1	55	M
1600	1997.01-	MT/AT	-	-	Allwheel Drive Engine D16A	823207	Outer Joint		26	32	55	78.1	55	M
ELYSION														
2.4 i-VTEC (118 kW)	2004.05-	-	-	-	MPV Engine K24A1	823255	Outer Joint		30	32	68.1	88	59.5	M
	2004.05-	-	-	-	MPV Engine K24A1	623013	Inner Joint		27	32	40	45.5	75	
	2004.05-	-	-	R	MPV Engine K24A1	623069	Inner Joint		23	25	35	60	94.5	
	2004.05-	-	-	R	MPV Engine K24A1	623046	Inner Joint		23	25	55	78	85	
3.0 i-VTEC(184 kW)	2004.05-	AT	R	F	MPV Engine J30A4	223296	Drive Shaft		30	29	68.1	88	619	
	2004.05-	AT	L	F	MPV Engine J30A4	223297	Drive Shaft		30	29	68.1	88	686	
FIT														
1.4	-	MT/AT	R	-	-	623027	Inner Joint		25	22	35	58	97	
	-	MT/AT	L	-	-	623036	Inner Joint		25	28	35	58	95	
1.5	-	MT/AT	R	-	-	623027	Inner Joint		25	22	35	58	97	
	-	MT/AT	L	-	-	623036	Inner Joint		25	28	35	58	95	
FIT JAZZ CITY GE7														
1.3	2007.10-	5AT	-	-	Allwheel Drive Engine L13A	823184	Outer Joint		26	27	52	78.5	54	M
1300	2007.10-	5AT	-	-	Allwheel Drive Engine L13A	823184	Outer Joint		26	27	52	78.5	54	M
FIT JAZZ CITY GE9														
1.5	2007.10-	5AT	-	-	Allwheel Drive Engine L15A	823184	Outer Joint		26	27	52	78.5	54	M
1500	2007.10-	5AT	-	-	Allwheel Drive Engine L15A	823184	Outer Joint		26	27	52	78.5	54	M
FIT/JAZZ/CITY (GD1)														
1.3	2001.06-	MT/AT	-	-	Engine L13A	823104	Outer Joint		23	25	52	79	50	M
FIT/JAZZ/CITY (GE6)														
1.3	2007.10-	CVT	-	F	Engine L13A	823165	Outer Joint		26	27	52	78.6	54.3	M
FIT/JAZZ/CITY (GE7) 4WD														
1.3	2007.10-	5AT	-	F	Engine L13A	823165	Outer Joint		26	27	52	78.6	54.3	M
FIT/JAZZ/CITY (GE8)														
1.5	2007.10-	CVT	-	F	Engine L15A	823165	Outer Joint		26	27	52	78.6	54.3	M
	2007.10-	5MT	-	F	Engine L15A	823165	Outer Joint		26	27	52	78.6	54.3	M
FIT/JAZZ/CITY (GE9) 4WD														
1.5	2007.10-	5AT	-	F	Engine L15A	823165	Outer Joint		26	27	52	78.6	54.3	M
FR-V (BE)/EDIX														
1.7 (92 kW)	2004.08-	-	-	-	Hatchback Engine D17A2	899159	Outer Joint		28	32	60	87	61	M
1.8 (103 kW)	2007.01-	MT	-	-	Hatchback Engine R18A1	623013	Inner Joint		27	32	40	45.5	75	
	2007.01-	-	-	-	Hatchback Engine R18A1	823056	Outer Joint		26	30	63	79	59	M
	2007.01-	AT	R	F	Hatchback Engine R18A1	699079	Inner Joint		27	30	40	55.5	97	
	2007.01-	-	-	-	Hatchback Engine R18A1	899159	Outer Joint		28	32	60	87	61	M
2.0 (110 kW)	2005.02-	MT	-	-	Hatchback Engine K20A9	623013	Inner Joint		27	32	40	45.5	75	
	2005.02-	-	-	-	Hatchback Engine K20A9	823056	Outer Joint		26	30	63	79	59	M
	2005.02-	-	-	-	Hatchback Engine K20A9	899159	Outer Joint		28	32	60	87	61	M
2.2 i CTDi (103 kW)	2005.07-	MT	L	F	Hatchback Engine N22A1	623037	Inner Joint		29	34	40	57	97	
	2005.07-	-	-	F	Hatchback Engine N22A1	823117	Outer Joint		28	34	63	88.5	59.5	M
	2005.07-	MT	R	F	Hatchback Engine N22A1	623038	Inner Joint		29	34	42	47.5	74.5	
FREED (GB3)														





	 YEAR	TRANSM	L/R	F/R	REMARKS	GSP Ref.	 PRODUCT	 ABS	Technical Specifications						
									A	B	C	H	L	P	
HONDA															
FREED (GB3)															
1.5	2008.05-	-	CVT	-	-	Engine L15A	823173	Outer Joint		26	27	58	78	51.5	M
FREED GB3															
1500	2008.05-	-	CVT	-	-	Engine L15A	823173	Outer Joint		26	27	58	78	51.5	M
FREED GB4															
1500	2008.05-	-	5AT	-	-	Allwheel Drive Engine L15A	823155	Outer Joint		26	28	58	78	51.5	M
FREED I (GB3 GB4 GP3)															
1.5 (73 kW)	2011.10-	2016.08	AT	-	F	MPV	823208	Outer Joint		26	27	58	78.5	53	M
1.5 (87 kW)	2010.10-	-	AT	-	F	All-wheel Drive MPV Engine L15A	823208	Outer Joint		26	27	58	78.5	53	M
GJ2															
1.5	2005.04-	2008.04	CVT	R	-	Allwheel Drive Engine L15A	823176	Outer Joint		26	30	58	78	59	M
	2008.04-	2010.08	CVT	R	-	Allwheel Drive Engine L15A	823176	Outer Joint		26	30	58	78	59	M
 GK3 L13B															
-	2013.09-	-	CVT	-	-	-	823185	Outer Joint		26	26	52	78.5	54	M
GP4															
1.5	2012.05-	2013.09	CVT	R	-	Engine LEA	823176	Outer Joint		26	30	58	78	59	M
GP5															
1.5	2013.09-	-	7MT	R	-	Engine LEB	823206	Outer Joint		26	29	52	78.5	54	M
HR-V (GH)															
1.6 16V (77 kW)	1999.03-	-	MT	L/R	F	All-wheel Drive Closed Off-Road Vehicle Engine D16W1	823060	Outer Joint		26	30	60	78.5	57	M
	1999.03-	-	-	-	R	All-wheel Drive Closed Off-Road Vehicle Engine D16W1	623083	Inner Joint		23	23	35	58.5	89.5	
	1999.03-	-	-	-	F	All-wheel Drive Closed Off-Road Vehicle Engine D16W1	823033	Outer Joint	50T	26	30	60	78.5	57	M
	1999.03-	-	-	-	F	Closed Off-Road Vehicle Engine D16W1	823033	Outer Joint	50T	26	30	60	78.5	57	M
	1999.03-	-	CVT	R	F	Closed Off-Road Vehicle Engine D16W1	623017	Inner Joint		27	30	40	58.5	97	
	1999.03-	-	-	-	R	All-wheel Drive Closed Off-Road Vehicle Engine D16W1	623023	Inner Joint		27	30	40	45.5	75	
	1999.03-	-	-	-	R	Closed Off-Road Vehicle Engine D16W1	623023	Inner Joint		27	30	40	45.5	75	
	1999.03-	-	-	-	R	All-wheel Drive Closed Off-Road Vehicle Engine D16W1	699079	Inner Joint		27	30	40	55.5	97	
	1999.03-	-	MT	R	F	Closed Off-Road Vehicle Engine D16W1	699079	Inner Joint		27	30	40	55.5	97	
	1999.03-	-	-	-	L	All-wheel Drive Closed Off-Road Vehicle Engine D16W1	223251	Drive Shaft	50T	26	27	60	78.5	593	
	1999.03-	-	-	-	L	Closed Off-Road Vehicle Engine D16W1	223251	Drive Shaft	50T	26	27	60	78.5	593	
	1999.03-	-	-	-	R	All-wheel Drive Closed Off-Road Vehicle Engine D16W1	223249	Drive Shaft	50T	26	27	60	78.5	595	
	1999.03-	-	-	-	R	Closed Off-Road Vehicle Engine D16W1	223249	Drive Shaft	50T	26	27	60	78.5	595	
1.6 16V (91 kW)	1999.10-	-	MT	L/R	F	All-wheel Drive Closed Off-Road Vehicle Engine D16W5	823060	Outer Joint		26	30	60	78.5	57	M
	1999.10-	-	-	-	R	All-wheel Drive Closed Off-Road Vehicle Engine D16W5	623083	Inner Joint		23	23	35	58.5	89.5	
	1999.10-	-	-	-	F	All-wheel Drive Closed Off-Road Vehicle Engine D16W5	823033	Outer Joint	50T	26	30	60	78.5	57	M
	1999.10-	-	-	-	R	All-wheel Drive Closed Off-Road Vehicle Engine D16W5	623023	Inner Joint		27	30	40	45.5	75	
	1999.10-	-	-	-	R	All-wheel Drive Closed Off-Road Vehicle Engine D16W5	699079	Inner Joint		27	30	40	55.5	97	
	1999.10-	-	-	-	L	All-wheel Drive Closed Off-Road Vehicle Engine D16W5	223251	Drive Shaft	50T	26	27	60	78.5	593	
	1999.10-	-	-	-	R	All-wheel Drive Closed Off-Road Vehicle Engine D16W5	223249	Drive Shaft	50T	26	27	60	78.5	595	
INSPIRE															
2.4	2010-	-	AT	-	-	-	823111	Outer Joint		23	25	49	78	50.5	M
2.5 (CC2)	1992.01-	1995.02	AT	-	-	Engine G25A	823028	Outer Joint		28	34	60	89	60	M
INSPIRE (CB5)															
2.0	1989.10-	1995.02	MT/AT	-	-	Engine G20A	823015	Outer Joint		28	32	60	89	60	M
INSPIRE (CC3)															
2.0	1992.01-	1995.02	AT	-	-	Engine G20A	823015	Outer Joint		28	32	60	89	60	M
INSPIRE (UA4 UA5)/SABER															
2.5 GX (147 kW)	1998.09-	2003.08	AT	-	-	Saloon Engine J25A	623013	Inner Joint		27	32	40	45.5	75	
3.2 (191 kW)	1998.09-	2003.08	AT	-	-	Saloon Engine J32A	623013	Inner Joint		27	32	40	45.5	75	
INSPIRE CB5															
2.0	1989.10-	1995.02	MT/AT	-	-	Engine G20A	823015	Outer Joint		28	32	60	89	60	M
2000	1989.10-	1995.02	MT/AT	-	-	Engine G20A	823015	Outer Joint		28	32	60	89	60	M
INSPIRE CC3															
2.0	1992.01-	1995.02	AT	-	-	Engine G20A	823015	Outer Joint		28	32	60	89	60	M
2000	1992.01-	1995.02	AT	-	-	Engine G20A	823015	Outer Joint		28	32	60	89	60	M
INTEGRA															
-	1985-	1989	-	-	-	-	823043	Outer Joint		26	32	49	79	56	M
	1989.06-	1993.06	MT	R	-	-	223117	Drive Shaft		26	27	55	78.5	603	
	1990-	1993	-	L	-	-	201036	Drive Shaft		26	27	55	78.5	597	
INTEGRA (DA5, DA6, DA7, DA8, DA9, DB1, DB2)															
1.6(88 kW)	1989.06-	1993.07	AT/MT	L	F	Saloon Engine ZC	623004	Inner Joint		25	30	35	62	97.5	
	1989.06-	1993.07	AT/MT	R	F	Saloon Engine ZC	623005	Inner Joint		25	30	35	54.5	97	
	1989.06-	1993.07	AT/MT	R	F	Saloon Engine ZC	601001	Inner Joint		27	32	40	55.5	97	
INTEGRA (DC2 DC4)															
1.8 (107 kW)	1993.07-	2001.11	-	-	F	Coupe Engine B18B2	823023	Outer Joint		26	30	55	78.5	56.5	M
	1993.07-	2001.11	-	-	R	Coupe Engine B18B2	623005	Inner Joint		25	30	35	54.5	97	





	 YEAR	TRANSM	L/R	F/R	REMARKS	GSP Ref.	 PRODUCT	 ABS	Technical Specifications					
									A	B	C	H	L	P
HONDA														
INTEGRA (DC2 DC4)														
1.8 (107 kW)	1993.07-2001.11	-	-	F	Coupe Engine B18B2	823086	Outer Joint	50T	26	30	55	78.5	56.5	M
	1993.07-2001.11	-	R	F	Coupe Engine B18B2	623017	Inner Joint		27	30	40	58.5	97	
	1993.07-2001.11	-	-	-	Coupe Engine B18B2	623013	Inner Joint		27	32	40	45.5	75	
1.8 Type-R (140 kW)	1997.11-2001.10	MT	R	F	Coupe Engine B18C6	623005	Inner Joint		25	30	35	54.5	97	
	1997.11-2001.10	MT	L/R	F	Coupe Engine B18C6	823017	Outer Joint	50T	26	32	55	78.5	56.5	M
INTEGRA (DC5)														
2.0 (118 kW)	2002.02-	-	-	F	Coupe Engine K20A3	823033	Outer Joint	50T	26	30	60	78.5	57	M
	2002.02-	-	R	F	Coupe Engine K20A3	623023	Inner Joint		27	30	40	45.5	75	
	2002.02-	-	R	F	Coupe Engine K20A3	699079	Inner Joint		27	30	40	55.5	97	
2.0 16V Type-R (162 kW)	2002.02-	-	-	-	Coupe Engine K20Z1	623013	Inner Joint		27	32	40	45.5	75	
	2002.02-	-	-	F	Coupe Engine K20Z1	823029	Outer Joint	50T	28	32	64	89	60	M
INTEGRA DA6														
1.6	1989.04-1993.05	AT	-	-	Engine B16A	823207	Outer Joint		26	32	55	78.1	55	M
	1989.04-1993.05	MT	-	-	Engine B16A	823207	Outer Joint		26	32	55	78.1	55	M
1600	1989.04-1993.05	AT	-	-	Engine B16A	823207	Outer Joint		26	32	55	78.1	55	M
	1989.04-1993.05	MT	-	-	Engine B16A	823207	Outer Joint		26	32	55	78.1	55	M
INTEGRA DA8														
1.6	1989.04-1993.07	AT	-	-	Engine B16A	823207	Outer Joint		26	32	55	78.1	55	M
	1989.04-1993.07	MT	-	-	Engine B16A	823207	Outer Joint		26	32	55	78.1	55	M
1600	1989.04-1993.07	AT	-	-	Engine B16A	823207	Outer Joint		26	32	55	78.1	55	M
	1989.04-1993.07	MT	-	-	Engine B16A	823207	Outer Joint		26	32	55	78.1	55	M
INTEGRA DB1														
1.8	1991.10-1993.07	AT	-	-	Engine B18B	823207	Outer Joint		26	32	55	78.1	55	M
	1991.10-1993.07	AT	-	-	Engine B18B	823207	Outer Joint		26	32	55	78.1	55	M
1800	1991.10-1993.07	AT	-	-	Engine B18B	823207	Outer Joint		26	32	55	78.1	55	M
	1991.10-1993.07	AT	-	-	Engine B18B	823207	Outer Joint		26	32	55	78.1	55	M
INTEGRA DB7														
1.8	1993.07-1995.08	MT/AT	-	-	Engine B18B	823207	Outer Joint		26	32	55	78.1	55	M
1800	1993.07-1995.08	MT/AT	-	-	Engine B18B	823207	Outer Joint		26	32	55	78.1	55	M
INTEGRA DB8														
1.8	1993.07-1995.08	MT/AT	-	-	Engine B18C	823207	Outer Joint		26	32	55	78.1	55	M
1800	1993.07-1995.08	MT/AT	-	-	Engine B18C	823207	Outer Joint		26	32	55	78.1	55	M
INTEGRA DB9														
1.6	1993.07-1995.08	MT/AT	-	-	Allwheel Drive Engine ZC	823207	Outer Joint		26	32	55	78.1	55	M
1600	1993.07-1995.08	MT/AT	-	-	Allwheel Drive Engine ZC	823207	Outer Joint		26	32	55	78.1	55	M
INTEGRA DC2														
1.8	1993.05-1995.08	MT/AT	-	-	Engine B18C	823207	Outer Joint		26	32	55	78.1	55	M
1800	1993.05-1995.08	MT/AT	-	-	Engine B18C	823207	Outer Joint		26	32	55	78.1	55	M
JAZZ														
1.2 L 16V	2009.06-2012.08	MT	-	F	-	223328	Drive Shaft		26	25	52	78.5	642	
1.4	2009-2012	AT	R	F	Engine:L13Z1 ; AREA:KN	223173	Drive Shaft		26	27	52	78.5	570	
	2009-2012	AT	L	F	Engine:L13Z1 ; AREA:KN	223174	Drive Shaft		26	25	52	78.5	641	
1.5	2009-2012	AT	R	F	Engine: L15A7 ; AREA:KY	223173	Drive Shaft		26	27	52	78.5	570	
	2009-2012	AT	L	F	Engine: L15A7 ; AREA:KY	223174	Drive Shaft		26	25	52	78.5	641	
JAZZ II (GD_ GE3 GE2)/FIT														
1.2 i-DSI (57 kW)	2002.03-2008.07	-	L/R	F	Hatchback Engine L12A1	823030	Outer Joint		26	28	52	79	56	M
	2002.03-2008.07	-	L/R	F	Hatchback Engine L12A1	823094	Outer Joint		26	28	52	78.5	56	M
	2002.03-2008.07	MT	L	F	Hatchback Engine L12A1	623018	Inner Joint		25	28	35	58	95.5	
	2002.03-2008.07	MT	-	F	Hatchback Engine L12A1	823106	Outer Joint		26	28	52	79	54	M
	2002.03-2008.07	MT	L	F	Hatchback Engine L12A1	223070	Drive Shaft		26	25	52	79	612.5	
	2002.03-2008.07	MT	R	F	Hatchback Engine L12A1	223071	Drive Shaft		26	25	52	79	899	
1.3 (61 kW)	2002.03-2008.07	-	L/R	F	Hatchback Engine L13A1	823030	Outer Joint		26	28	52	79	56	M
	2002.03-2008.07	-	L/R	F	Hatchback Engine L13A1	823094	Outer Joint		26	28	52	78.5	56	M
	2002.03-2008.07	-	L	F	Hatchback Engine L13A1	223070	Drive Shaft		26	25	52	79	612.5	
	2002.03-2008.07	-	R	F	Hatchback Engine L13A1	223071	Drive Shaft		26	25	52	79	899	
1.4 iDSI (61 kW)	2006.12-2008.10	-	L/R	F	Hatchback Engine L13A6	823030	Outer Joint		26	28	52	79	56	M
	2006.12-2008.10	-	L/R	F	Hatchback Engine L13A6	823094	Outer Joint		26	28	52	78.5	56	M
	2006.12-2008.10	-	L	F	Hatchback Engine L13A6	623018	Inner Joint		25	28	35	58	95.5	
	2006.12-2008.10	-	-	F	Hatchback Engine L13A6	823106	Outer Joint		26	28	52	79	54	M
JAZZ III (GE_ GG_ GP_)/FIT														
1.2 (66 kW)	2008.07-	MT	L	F	Hatchback Engine L12B1	623018	Inner Joint		25	28	35	58	95.5	
	2008.07-	MT	-	F	Hatchback Engine L12B1	823106	Outer Joint		26	28	52	79	54	M
1.3 i (73 kW)	2008.07-	-	L	F	Hatchback Engine L13Z1	623018	Inner Joint		25	28	35	58	95.5	
	2008.07-	-	-	F	Hatchback Engine L13Z1	823106	Outer Joint		26	28	52	79	54	M
	2008.07-	AMT	L/R	F	Hatchback Engine L13Z1	823030	Outer Joint		26	28	52	79	56	M

YEAR	TRANSM	L/R	F/R	REMARKS	GSP Ref.	PRODUCT	ABS	Technical Specifications							
								A	B	C	H	L	P		
HONDA															
JAZZ III (GE_GG_GP_)/FIT															
1.4 (74 kW)	2008.11-	-	MT	R	F	Hatchback Engine L13Z1	223327	Drive Shaft		26	25	52	78.5	898	
	2008.11-	-	-	L	F	Hatchback Engine L13Z1	623018	Inner Joint		25	28	35	58	95.5	
	2008.11-	-	-	-	F	Hatchback Engine L13Z1	823106	Outer Joint		26	28	52	79	54	M
LEGEND															
3.2 V6	1991.01-	1996.04	-	L	-		201018	Drive Shaft	50T	30	31	64	89	671	
	1991.01-	1996.04	-	R	-		201017	Drive Shaft	50T	30	31	64	89	639.5	
	1991.01-	1996.04	-	-	-		601006	Inner Joint		31	36	42	64.1	106.2	
	1991.03-	1996.04	-	-	-		601007	Inner Joint		31	36	43	44.5	81.5	
LEGEND I (HS KA)															
2.7 i 24V (124 kW)	1988.01-	1990.12	-	-	F	Saloon Engine C27A1	823081	Outer Joint	50T	28	34	60	83.5	59	M
LEGEND I (KA_)															
2.7 i 24V (124 kW)	1987.10-	1990.12	-	-	F	Coupe Engine C27A1	823081	Outer Joint	50T	28	34	60	83.5	59	M
	1987.10-	1990.12	AT	L/R	F	Coupe Engine C27A1	823044	Outer Joint		28	34	60	88	57.5	M
LEGEND II (CC,KA7,KA8)															
2.5 (CC2)	1992.01-	1995.02	AT	-	-	Engine G25A	823028	Outer Joint		28	34	60	89	60	M
LEGEND II (KA)															
3.2 i 24V (151 kW)	1991.01-	1996.02	AT	L/R	F	Saloon Engine C32A2	801005	Outer Joint		30	36	64	89	65.5	M
	1991.01-	1996.02	AT	L/R	F	Coupe Engine C32A2	801005	Outer Joint		30	36	64	89	65.5	M
	1991.01-	1996.02	-	-	F	Saloon Engine C32A2	823084	Outer Joint	50T	30	36	64	89	65.5	M
	1991.01-	1996.02	-	-	F	Coupe Engine C32A2	823084	Outer Joint	50T	30	36	64	89	65.5	M
LEGEND IV (KB_)															
3.5 V6 (217 kW)	2006.05-	2012.12	AT	-	F	All-wheel Drive Saloon Engine C35A8/J35A8	823124	Outer Joint		30	32	68	88	59.5	M
3.7 VTEC V6 (217 kW)	2008.07-	2012.12	AT	R	F	All-wheel Drive Saloon Engine J37A2/J37A3	623038	Inner Joint		29	34	42	47.5	74.5	
LIFE (JA4)															
660	1993.01-	1996.02	MT/AT	-	-	Engine E07A	823099	Outer Joint		23	21	49	72	49	I
LIFE (JB1)															
0.7	1998.10-	-	MT/AT	-	-	Engine E07Z	823182	Outer Joint	50T	23	25	49	78	50.5	M
	1998.10-	2003.09	5MT	-	-	Engine E07Z	823182	Outer Joint	50T	23	25	49	78	50.5	M
	1998.10-	2003.09	3AT	-	-	Engine E07Z	823182	Outer Joint	50T	23	25	49	78	50.5	M
LIFE (JB2)															
0.7 4WD	1998.10-	-	5MT	-	-	Engine E07E	823182	Outer Joint	50T	23	25	49	78	50.5	M
	1998.10-	-	3AT	-	-	Engine E07E	823182	Outer Joint	50T	23	25	49	78	50.5	M
	1998.10-	2003.09	5MT	-	-	Engine E07Z	823182	Outer Joint	50T	23	25	49	78	50.5	M
	1998.10-	2003.09	3AT	-	-	Engine E07Z	823182	Outer Joint	50T	23	25	49	78	50.5	M
LIFE (JB3)															
0.7	2000.12-	-	3AT	-	-	Engine E07Z TBO	823182	Outer Joint	50T	23	25	49	78	50.5	M
LIFE (JB4)															
0.7 4WD	2000.12-	-	3AT	-	-	Engine E07Z TBO	823182	Outer Joint	50T	23	25	49	78	50.5	M
LIFE (JD1)															
0.7	2002.02-	-	3AT	-	-	Engine E07Z TBO	823182	Outer Joint	50T	23	25	49	78	50.5	M
LIFE (JD2)															
0.7 4WD	2002.02-	-	3AT	-	-	Engine E07Z TBO	823182	Outer Joint	50T	23	25	49	78	50.5	M
LIFE DUNK (JB3)															
0.7	2000.12-	2003.09	3AT	-	-	Engine E07Z TBO	823182	Outer Joint	50T	23	25	49	78	50.5	M
LIFE DUNK (JB4)															
0.7 4WD	2000.12-	2003.09	3AT	-	-	Engine E07Z TBO	823182	Outer Joint	50T	23	25	49	78	50.5	M
LIFE DUNK JB3															
660 3AT	2000.12-	2003.09	-	-	-	Engine E07Z TBO	823182	Outer Joint	50T	23	25	49	78	50.5	M
LIFE DUNK JB4															
660 3AT	2000.12-	2003.09	-	-	-	Allwheel Drive Engine E07Z TBO	823182	Outer Joint	50T	23	25	49	78	50.5	M
LIFE JB1															
660	1998.10-	-	MT/AT	-	-	Engine E07Z	823182	Outer Joint	50T	23	25	49	78	50.5	M
	1998.10-	2003.09	5MT	-	-	Engine E07Z	823182	Outer Joint	50T	23	25	49	78	50.5	M
	1998.10-	2003.09	5MT	-	-	Engine E07Z	823182	Outer Joint	50T	23	25	49	78	50.5	M
	1998.10-	2003.09	3AT	-	-	Engine E07Z	823182	Outer Joint	50T	23	25	49	78	50.5	M
	1998.10-	2003.09	3AT	-	-	Engine E07Z	823182	Outer Joint	50T	23	25	49	78	50.5	M
LIFE JB2															
660	1998.10-	-	5MT	-	-	Allwheel Drive Engine E07E	823182	Outer Joint	50T	23	25	49	78	50.5	M
	1998.10-	-	3AT	-	-	Allwheel Drive Engine E07E	823182	Outer Joint	50T	23	25	49	78	50.5	M
	1998.10-	2003.09	5MT	-	-	Allwheel Drive Engine E07Z	823182	Outer Joint	50T	23	25	49	78	50.5	M
	1998.10-	2003.09	3AT	-	-	Allwheel Drive Engine E07Z	823182	Outer Joint	50T	23	25	49	78	50.5	M
	1998.10-	2003.09	3AT	-	-	Allwheel Drive Engine E07Z	823182	Outer Joint	50T	23	25	49	78	50.5	M
LIFE JB3															
660	2000.12-	-	3AT	-	-	Engine E07Z TBO	823182	Outer Joint	50T	23	25	49	78	50.5	M
LIFE JB4															

YEAR	TRANS	L/R	F/R	REMARKS	GSP Ref.	PRODUCT	ABS	Technical Specifications							
								A	B	C	H	L	P		
HONDA															
LIFE JB4															
660	2000.12-	-	3AT	-	-	Allwheel Drive Engine E07Z TBO	823182	Outer Joint	50T	23	25	49	78	50.5	M
LIFE JB5															
660	2004.01-	2004.10	4AT	-	-	Engine P07A TBO	823193	Outer Joint		23	29	52	78.5	54	I
	2004.01-	2004.10	4AT	-	-	Allwheel Drive Engine P07A TBO	823193	Outer Joint		23	29	52	78.5	54	I
LIFE JB7															
660	2003.10-	-	4AT	-	-	Engine P07A TBO	823193	Outer Joint		23	29	52	78.5	54	I
	2005.10-	-	4AT	-	-	Engine P07A TBO	823193	Outer Joint		23	29	52	78.5	54	I
LIFE JB8															
660	2003.10-	-	4AT	-	-	Allwheel Drive Engine P07A TBO	823193	Outer Joint		23	29	52	78.5	54	I
	2005.10-	-	4AT	-	-	Allwheel Drive Engine P07A TBO	823193	Outer Joint		23	29	52	78.5	54	I
LOGO (GA)															
1.3 (48 kW)	1999.03-	2002.03	-	-	F	Hatchback Engine D13B7	823126	Outer Joint	50T	23	26	49	78	50.5	M
	1999.03-	2002.03	-	R	F	Hatchback Engine D13B7	623020	Inner Joint		25	28	35	54.5	96.5	
LOGO (GA3)															
1.3	1990-	2001	-	-	-	Engine D13B	899162	Outer Joint		23	26	49	78	50.5	M
ODYSSEY															
-	1995-	1998	-	L	-	Truck/VAN	223090	Drive Shaft		28	27	64	88.5	569	
	1995-	1998	-	R	-	Truck	223013	Drive Shaft	50T	28	27	64	88.5	613.5	
	1995-	1998	-	L	-	Truck	223091	Drive Shaft	50T	28	27	64	88.5	569	
	2005-	2010	-	-	-	-	823120	Outer Joint		30	35	68	89	59	I
3.5 V6	2011-	2016	-	-	F	-	223351	Drive Shaft		30	31	64	89	1041	
3.5L V6	2011-	-	-	L	F	Touring Elite Mini Passenger Van 4-Door	223348	Drive Shaft		30	31	64	89	723	
	2011-	-	-	L	F	Touring Mini Passenger Van 4-Door	223348	Drive Shaft		30	31	64	89	723	
	2012-	-	-	L	F	Touring Elite Mini Passenger Van 4-Door	223348	Drive Shaft		30	31	64	89	723	
	2012-	-	-	L	F	Touring Mini Passenger Van 4-Door	223348	Drive Shaft		30	31	64	89	723	
	2013-	-	-	L	F	Touring Elite Mini Passenger Van 4-Door	223348	Drive Shaft		30	31	64	89	723	
	2013-	-	-	L	F	Touring Mini Passenger Van 4-Door	223348	Drive Shaft		30	31	64	89	723	
	2014-	-	-	L	F	EX Mini Passenger Van 4-Door	223348	Drive Shaft		30	31	64	89	723	
	2014-	-	-	L	F	EX-L Mini Passenger Van 4-Door	223348	Drive Shaft		30	31	64	89	723	
	2014-	-	-	L	F	LX Mini Passenger Van 4-Door	223348	Drive Shaft		30	31	64	89	723	
	2014-	-	-	L	F	Touring Elite Mini Passenger Van 4-Door	223348	Drive Shaft		30	31	64	89	723	
	2014-	-	-	L	F	Touring Mini Passenger Van 4-Door	223348	Drive Shaft		30	31	64	89	723	
	2015-	-	-	L	F	EX Mini Passenger Van 4-Door	223348	Drive Shaft		30	31	64	89	723	
	2015-	-	-	L	F	EX-L Mini Passenger Van 4-Door	223348	Drive Shaft		30	31	64	89	723	
	2015-	-	-	L	F	LX Mini Passenger Van 4-Door	223348	Drive Shaft		30	31	64	89	723	
	2015-	-	-	L	F	Touring Elite Mini Passenger Van 4-Door	223348	Drive Shaft		30	31	64	89	723	
	2015-	-	-	L	F	Touring Mini Passenger Van 4-Door	223348	Drive Shaft		30	31	64	89	723	
	2016-	-	-	L	F	EX Mini Passenger Van 4-Door	223348	Drive Shaft		30	31	64	89	723	
	2016-	-	-	L	F	EX-L Mini Passenger Van 4-Door	223348	Drive Shaft		30	31	64	89	723	
	2016-	-	-	L	F	LX Mini Passenger Van 4-Door	223348	Drive Shaft		30	31	64	89	723	
	2016-	-	-	L	F	SE Mini Passenger Van 4-Door	223348	Drive Shaft		30	31	64	89	723	
	2016-	-	-	L	F	Touring Elite Mini Passenger Van 4-Door	223348	Drive Shaft		30	31	64	89	723	
	2016-	-	-	L	F	Touring Mini Passenger Van 4-Door	223348	Drive Shaft		30	31	64	89	723	
	2017-	-	-	L	F	EX Mini Passenger Van 4-Door	223348	Drive Shaft		30	31	64	89	723	
2017-	-	-	L	F	EX-L Mini Passenger Van 4-Door	223348	Drive Shaft		30	31	64	89	723		
2017-	-	-	L	F	LX Mini Passenger Van 4-Door	223348	Drive Shaft		30	31	64	89	723		
2017-	-	-	L	F	SE Mini Passenger Van 4-Door	223348	Drive Shaft		30	31	64	89	723		
2017-	-	-	L	F	Touring Elite Mini Passenger Van 4-Door	223348	Drive Shaft		30	31	64	89	723		
2017-	-	-	L	F	Touring Mini Passenger Van 4-Door	223348	Drive Shaft		30	31	64	89	723		
ODYSSEY (RA)															
2.3 (110 kW)	1997.10-	1999.12	AT	-	-	MPV Engine F23A7	623013	Inner Joint		27	32	40	45.5	75	
	1997.10-	1999.12	AT	-	F	MPV Engine F23A7	823029	Outer Joint	50T	28	32	64	89	60	M
	1997.10-	1999.12	-	-	F	MPV Engine F23A7	823080	Outer Joint	50T	28	32	64	88.5	62	M
PASSPORT															
-	1994-	1995	-	-	-	-	626001	Inner Joint		17	26	30	517	97.5	
	1994-	1995	-	-	-	-	626002	Inner Joint		17	26	30	98	98.5	
	1996-	1997	-	L/R	-	Truck/VAN 4WD	223129	Drive Shaft		17	17	53	144	606.5	
	1998-	2002	-	L/R	-	-	823055	Outer Joint		17	33	53	136.5	69.5	I
	1998-	2002	-	L/R	-	-	223005	Drive Shaft		17	17	53	136.5	609	
PILOT															
3.5 (183 kW)	2011.01-	-	-	L	-	All-wheel Drive Closed Off-Road Vehicle Engine J35Z4	823251	Outer Joint		30	36	64	106	70	I
	2011.01-	-	-	L	-	All-wheel Drive Closed Off-Road Vehicle Engine J35Z4	623101	Inner Joint		29	35	40	61.5	101	
	2011.01-	-	-	L	-	All-wheel Drive Closed Off-Road Vehicle Engine J35Z4	223346	Drive Shaft		30	29	64	106	733	
3.5 (186 kW)	2008.09-	-	AT	-	F	Closed Off-Road Vehicle Engine J35Z4	823148	Outer Joint		30	36	64	106	64	I
	2008.09-	-	AT	-	F	All-wheel Drive Closed Off-Road Vehicle Engine J35Z4	823148	Outer Joint		30	36	64	106	64	I
3.5(189 kW)	2010.01-	2015.06	AT	-	F	All-wheel Drive Closed Off-Road Vehicle	823148	Outer Joint		30	36	64	106	64	I

YEAR	TRANSM	L/R	F/R	REMARKS	GSP Ref.	PRODUCT	ABS	Technical Specifications							
								A	B	C	H	L	P		
HONDA															
PILOT															
3.5L V6	2012-	-	-	R F	EX Sport Utility 4-Door	223347	Drive Shaft		30	29	64	106	1039		
	2012-	-	-	R F	EX-L Sport Utility 4-Door	223347	Drive Shaft		30	29	64	106	1039		
	2012-	-	-	R F	LX Sport Utility 4-Door	223347	Drive Shaft		30	29	64	106	1039		
	2012-	-	-	R F	Touring Sport Utility 4-Door	223347	Drive Shaft		30	29	64	106	1039		
	2013-	-	-	R F	EX Sport Utility 4-Door	223347	Drive Shaft		30	29	64	106	1039		
	2013-	-	-	R F	EX-L Sport Utility 4-Door	223347	Drive Shaft		30	29	64	106	1039		
	2013-	-	-	R F	LX Sport Utility 4-Door	223347	Drive Shaft		30	29	64	106	1039		
	2013-	-	-	R F	Touring Sport Utility 4-Door	223347	Drive Shaft		30	29	64	106	1039		
	2014-	-	-	R F	EX Sport Utility 4-Door	223347	Drive Shaft		30	29	64	106	1039		
	2014-	-	-	R F	EX-L Sport Utility 4-Door	223347	Drive Shaft		30	29	64	106	1039		
	2014-	-	-	R F	LX Sport Utility 4-Door	223347	Drive Shaft		30	29	64	106	1039		
	2014-	-	-	R F	Touring Sport Utility 4-Door	223347	Drive Shaft		30	29	64	106	1039		
	2015-	-	-	R F	EX Sport Utility 4-Door	223347	Drive Shaft		30	29	64	106	1039		
	2015-	-	-	R F	EX-L Sport Utility 4-Door	223347	Drive Shaft		30	29	64	106	1039		
	2015-	-	-	R F	LX Sport Utility 4-Door	223347	Drive Shaft		30	29	64	106	1039		
	2015-	-	-	R F	SE Sport Utility 4-Door	223347	Drive Shaft		30	29	64	106	1039		
	2015-	-	-	R F	Touring Sport Utility 4-Door	223347	Drive Shaft		30	29	64	106	1039		
PRELUDE															
-	1991.01-	1993.09	AT	L -	-	223016	Drive Shaft		28	27	60	93	979		
	1992-	2001	-	- -	-	623012	Inner Joint		27	32	40	58.3	107.3		
	1992-	1996	-	- -	-	823072	Outer Joint	50T	28	32	60	93	59	M	
	1993.10-	1996	-	R -	BB	223079	Drive Shaft		28	27	60	93	628.8		
	1993.10-	1996	-	R -	BB	623012	Inner Joint		27	32	40	58.3	107.3		
2.0	1995-	2000	-	- -	-	823074	Outer Joint		26	23	55	78.5	56.5	M	
	1995-	2000	-	- -	-	823075	Outer Joint	50T	26	23	55	78.5	56.5	M	
	1995-	2000	-	R -	-	223080	Drive Shaft		26	27	55	78.5	618.5		
	1995-	2000	-	R -	-	223049	Drive Shaft	50T	26	27	55	78.5	618.5		
	1995-	2000	-	L -	-	223081	Drive Shaft		26	27	55	78.5	594		
	1995-	2000	-	L -	-	223050	Drive Shaft	50T	26	27	55	78.5	594		
2.0 4WS BA	1987.10-	1991.11	-	L -	-	223116	Drive Shaft		26	27	55	78.5	608		
PRELUDE (BA4)															
2.0	1987.04-	1991.09	MT/AT	- -	Engine B20A	823015	Outer Joint		28	32	60	89	60	M	
PRELUDE (BA5)															
2.0 4WS	1987.04-	1991.09	MT/AT	- -	Engine B20A	823015	Outer Joint		28	32	60	89	60	M	
PRELUDE (BA7)															
2.1	1990.10-	1991.09	AT	- -	Engine B21A	823015	Outer Joint		28	32	60	89	60	M	
PRELUDE (BA8)															
2.2	1991.09-	1994.09	4AT	- -	Engine F22B	823015	Outer Joint		28	32	60	89	60	M	
	1991.09-	1996.11	5MT	- -	Engine F22B	823015	Outer Joint		28	32	60	89	60	M	
	1991.09-	1996.11	AT	- -	Engine F22B	823015	Outer Joint		28	32	60	89	60	M	
PRELUDE (BA9)															
2.2 4WS	1991.09-	1994.09	MT/AT	- -	Engine F22B	823015	Outer Joint		28	32	60	89	60	M	
	1991.09-	1996.11	4AT	- -	Engine F22B	823015	Outer Joint		28	32	60	89	60	M	
	1991.09-	1996.11	5MT	- -	Engine F22B	823015	Outer Joint		28	32	60	89	60	M	
PRELUDE (BB1)															
2.2 4WS	1991.09-	1994.09	4AT	- -	Engine H22A	823015	Outer Joint		28	32	60	89	60	M	
	1991.09-	1994.09	5MT	- -	Engine H22A	823015	Outer Joint		28	32	60	89	60	M	
	1991.09-	1996.11	AT	- -	Engine H22A	823015	Outer Joint		28	32	60	89	60	M	
	1994.09-	1996.11	MT	- -	Engine H22A	823015	Outer Joint		28	32	60	89	60	M	
PRELUDE (BB4)															
2.2	1991.09-	1994.09	AT	- -	Engine H22A	823015	Outer Joint		28	32	60	89	60	M	
	1991.09-	1996.11	4AT	- -	Engine H22A	823015	Outer Joint		28	32	60	89	60	M	
	1991.09-	1996.11	5MT	- -	Engine H22A	823015	Outer Joint		28	32	60	89	60	M	
PRELUDE BA4															
2.0	1987.01-	1989.01	MT/AT	- -	Engine B20A	823207	Outer Joint		26	32	55	78.1	55	M	
	1987.01-	1989.01	MT/AT	- -	Engine B20A	823207	Outer Joint		26	32	55	78.1	55	M	
	1987.01-	1989.01	MT/AT	- -	Engine B20A	823207	Outer Joint		26	32	55	78.1	55	M	
	1987.01-	1989.01	MT/AT	- -	Engine B20A	823207	Outer Joint		26	32	55	78.1	55	M	
	1987.01-	1989.01	MT/AT	- -	Engine B20A	823207	Outer Joint		26	32	55	78.1	55	M	
	1987.01-	1989.01	MT/AT	- -	Engine B20A	823207	Outer Joint		26	32	55	78.1	55	M	
	1987.01-	1989.01	MT/AT	- -	Engine B20A	823207	Outer Joint		26	32	55	78.1	55	M	
	1987.04-	1991.09	MT/AT	- -	Engine B20A	823207	Outer Joint		26	32	55	78.1	55	M	
	1987.04-	1991.09	MT/AT	- -	Engine B20A	823015	Outer Joint		28	32	60	89	60	M	
2000	1987.01-	1989.01	MT/AT	- -	Engine B20A	823207	Outer Joint		26	32	55	78.1	55	M	
	1987.01-	1989.01	MT/AT	- -	Engine B20A	823207	Outer Joint		26	32	55	78.1	55	M	
	1987.01-	1989.01	MT/AT	- -	Engine B20A	823207	Outer Joint		26	32	55	78.1	55	M	

	 YEAR	TRANSM	L/R	F/R	REMARKS	GSP Ref.	 PRODUCT	 ABS	Technical Specifications					
									A	B	C	H	L	P
HONDA														
PRELUDE BB4														
2.2	1991.09-1994.09	5MT	-	-	Engine H22A	823015	Outer Joint		28	32	60	89	60	M
	1991.09-1994.09	4AT	-	-	Engine H22A	823015	Outer Joint		28	32	60	89	60	M
	1991.09-1994.09	AT	-	-	Engine H22A	823015	Outer Joint		28	32	60	89	60	M
	1994.09-1996.11	5MT	-	-	Engine H22A	823015	Outer Joint		28	32	60	89	60	M
	1994.09-1996.11	4AT	-	-	Engine H22A	823015	Outer Joint		28	32	60	89	60	M
	1994.09-1996.11	5MT	-	-	Engine H22A	823015	Outer Joint		28	32	60	89	60	M
	1994.09-1996.11	4AT	-	-	Engine H22A	823015	Outer Joint		28	32	60	89	60	M
PRELUDE III (BA)														
2.0 (84 kW)	1987.08-1992.01	-	-	F	Coupe Engine B20A4	823016	Outer Joint		26	32	55	78.5	56.5	M
	1987.08-1992.01	AT	L	F	Coupe Engine B20A4	224035	Drive Shaft	50T	26	27	60	78.5	615	
	1987.08-1992.01	AT/MT	L/R	F	Coupe Engine B20A4	823017	Outer Joint	50T	26	32	55	78.5	56.5	M
	1987.08-1992.01	AT/MT	L/R	F	Coupe Engine B20A4	823014	Outer Joint	50T	28	32	60	88	59	M
	1987.08-1992.01	AT/MT	L/R	F	Coupe Engine B20A4	823013	Outer Joint		28	32	60	88	59	M
2.0 EX (80 kW)	1987.04-1992.01	AT	L	F	Coupe Engine B20A3	224035	Drive Shaft	50T	26	27	60	78.5	615	
	1987.04-1992.01	AT/MT	L/R	F	Coupe Engine B20A3	823017	Outer Joint	50T	26	32	55	78.5	56.5	M
	1987.04-1992.01	AT/MT	L/R	F	Coupe Engine B20A3	823014	Outer Joint	50T	28	32	60	88	59	M
	1987.04-1992.01	AT/MT	L/R	F	Coupe Engine B20A3	823013	Outer Joint		28	32	60	88	59	M
2.0 i EX 16V (103 kW)	1987.10-1992.01	MT	L	F	Coupe Engine B20A9	224035	Drive Shaft	50T	26	27	60	78.5	615	
	1987.10-1992.01	AT/MT	L/R	F	Coupe Engine B20A9	823014	Outer Joint	50T	28	32	60	88	59	M
	1987.10-1992.01	AT/MT	L/R	F	Coupe Engine B20A9	823013	Outer Joint		28	32	60	88	59	M
2.0 i EX 16V (110 kW)	1987.10-1990.12	-	-	F	Coupe Engine B20A7	823016	Outer Joint		26	32	55	78.5	56.5	M
	1987.10-1990.12	AT/MT	L/R	F	Coupe Engine B20A7	823014	Outer Joint	50T	28	32	60	88	59	M
	1987.10-1990.12	AT/MT	L/R	F	Coupe Engine B20A7	823013	Outer Joint		28	32	60	88	59	M
2.0 i EX 16V Cat (101 kW)	1987.04-1992.01	-	-	F	Coupe Engine B20A5	823016	Outer Joint		26	32	55	78.5	56.5	M
	1987.04-1992.01	MT	L	F	Coupe Engine B20A5	224035	Drive Shaft	50T	26	27	60	78.5	615	
	1987.04-1992.01	AT/MT	L/R	F	Coupe Engine B20A5	823014	Outer Joint	50T	28	32	60	88	59	M
	1987.04-1992.01	AT/MT	L/R	F	Coupe Engine B20A5	823013	Outer Joint		28	32	60	88	59	M
PRELUDE IV (BB_)														
2.0 i 16V (98 kW)	1992.02-1996.09	-	-	-	Coupe Engine F20A4	823046	Outer Joint		28	32	60	93	59	M
	1992.02-1996.09	AT/MT	L/R	F	Coupe Engine F20A4	823014	Outer Joint	50T	28	32	60	88	59	M
	1992.02-1996.09	MT	L	F	Coupe Engine F20A4	223017	Drive Shaft	50T	28	27	64	88.5	578.5	
	1992.02-1996.09	AT/MT	L/R	F	Coupe Engine F20A4	823013	Outer Joint		28	32	60	88	59	M
2.2 i 16V Vtec (136 kW)	1993.02-1996.09	AT/MT	L/R	F	Coupe Engine H22A2	823013	Outer Joint		28	32	60	88	59	M
	1993.02-1996.09	MT	L	F	Coupe Engine H22A2	223017	Drive Shaft	50T	28	27	64	88.5	578.5	
	1993.02-1996.09	AT/MT	L/R	F	Coupe Engine H22A2	823014	Outer Joint	50T	28	32	60	88	59	M
2.3 i 16V (118 kW)	1992.02-1996.09	MT	L	F	Coupe Engine H23A2	223017	Drive Shaft	50T	28	27	64	88.5	578.5	
PRELUDE V (BB_)														
2.0 16V (98 kW)	1996.10-2000.10	-	-	F	Coupe Engine F20A4	823035	Outer Joint		28	32	64	89	60	M
	1996.10-2000.10	-	-	F	Coupe Engine F20A4	823029	Outer Joint	50T	28	32	64	89	60	M
	1996.10-2000.10	-	-	F	Coupe Engine F20A4	823080	Outer Joint	50T	28	32	64	88.5	62	M
2.2 16V (136 kW)	1996.10-2000.10	-	-	F	Coupe Engine H22A2/H22A5	823035	Outer Joint		28	32	64	89	60	M
	1996.10-2000.10	-	-	F	Coupe Engine H22A2/H22A5	823029	Outer Joint	50T	28	32	64	89	60	M
	1996.10-2000.10	-	-	F	Coupe Engine H22A2/H22A5	823080	Outer Joint	50T	28	32	64	88.5	62	M
2.2 16V (147 kW)	1996.10-2000.10	-	-	F	Coupe Engine H22A5	823035	Outer Joint		28	32	64	89	60	M
	1996.10-2000.10	-	-	F	Coupe Engine H22A5	823029	Outer Joint	50T	28	32	64	89	60	M
RAFAGA (CE4)														
2.0	1993.10-1997.09	MT/AT	-	-	Engine G20A	823015	Outer Joint		28	32	60	89	60	M
RAFAGA (CE5)														
2.5	1993.10-1997.09	AT	-	-	Engine G25A	823015	Outer Joint		28	32	60	89	60	M
RAFAGA CE4														
2.0	1993.10-1997.09	MT/AT	-	-	Engine G20A	823015	Outer Joint		28	32	60	89	60	M
2000	1993.10-1997.09	MT/AT	-	-	Engine G20A	823015	Outer Joint		28	32	60	89	60	M
RAFAGA CE5														
2.5	1993.10-1997.09	AT	-	-	Engine G25A	823015	Outer Joint		28	32	60	89	60	M
	1993.10-1997.09	AT	-	-	Engine G25A	823015	Outer Joint		28	32	60	89	60	M
S2000 (AP)														
2.0 (177 kW)	1999.06-	-	-	-	Convertible Engine F20C VTEC	823122	Outer Joint	50T	28	32	64	88.5	58.5	M
SHUTTLE (RA)/ODYSSEY														
2.2 16V (110 kW)	1994.10-1998.02	-	-	-	MPV Engine F22B8	801006	Outer Joint		28	32	64	88.5	62	M
	1994.10-1998.02	-	-	F	MPV Engine F22B8	823059	Outer Joint		28	32	64	88.5	62	M
	1994.10-1998.02	AT	-	F	MPV Engine F22B8	823029	Outer Joint	50T	28	32	64	89	60	M
	1994.10-1998.02	-	-	F	MPV Engine F22B8	823080	Outer Joint	50T	28	32	64	88.5	62	M
	1994.10-1998.02	-	-	-	MPV Engine F22B8	823032	Outer Joint	50T	28	32	64	88.5	62	M
	1994.10-1998.02	AT	-	-	MPV Engine F22B8	623013	Inner Joint		27	32	40	45.5	75	
2.3 16V (110 kW)	1997.10-2004.06	AT	-	-	MPV Engine F23A7	623013	Inner Joint		27	32	40	45.5	75	
	1997.10-2004.06	AT	-	F	MPV Engine F23A7	823029	Outer Joint	50T	28	32	64	89	60	M





	 YEAR	TRANSM	L/R	F/R	REMARKS	GSP Ref.	 PRODUCT	 ABS	Technical Specifications						
									A	B	C	H	L	P	
HONDA															
SHUTTLE (RA)/ODYSSEY															
2.3 16V (110 kW)	1997.10-2004.06	-	-	F	MPV Engine F23A7	823080	Outer Joint	50T	28	32	64	88.5	62	M	
	1997.10-2004.06	-	-	-	MPV Engine F23A7	823032	Outer Joint	50T	28	32	64	88.5	62	M	
3.0 (154 kW)	1997.10-2004.06	AT	-	-	MPV Engine J30A	623013	Inner Joint		27	32	40	45.5	75		
	1997.10-2002.06	AT	-	-	All-wheel Drive MPV Engine J30A	623013	Inner Joint		27	32	40	45.5	75		
	1997.10-2004.06	AT	-	R	MPV Engine J30A	623069	Inner Joint		23	25	35	60	94.5		
	1997.10-2002.06	AT	-	R	All-wheel Drive MPV Engine J30A	623069	Inner Joint		23	25	35	60	94.5		
	1997.10-2004.06	AT	-	F	MPV Engine J30A	823029	Outer Joint	50T	28	32	64	89	60	M	
	1997.10-2002.06	AT	-	F	All-wheel Drive MPV Engine J30A	823029	Outer Joint	50T	28	32	64	89	60	M	
	1997.10-2004.06	-	-	F	MPV Engine J30A	823080	Outer Joint	50T	28	32	64	88.5	62	M	
	1997.10-2004.06	AT	-	R	MPV Engine J30A	623054	Inner Joint		23	25	55	78	85		
	1997.10-2002.06	AT	-	R	All-wheel Drive MPV Engine J30A	623054	Inner Joint		23	25	55	78	85		
SMX															
2.0 Lowdown (103 kW)	1999.10-2002.09	-	-	F	Hatchback Engine B20B1	823059	Outer Joint		28	32	64	88.5	62	M	
STEPWGN (E-RF_GF-RF_)															
2.0 (99 kW)	1996.05-2000.09	-	-	F	MPV Engine B20B	823059	Outer Joint		28	32	64	88.5	62	M	
STREAM															
1.7	-	-	-	R	-	223073	Drive Shaft	50T	26	25	60	78.5	906		
	-	-	-	L	-	223072	Drive Shaft	50T	26	25	60	78.5	610		
2.0	-	-	-	R	-	623019	Inner Joint		27	30	28.5	398.5	124.5		
	-	-	-	R	-	224036	Drive Shaft	50T	26	27	60	78.5	905		
STREAM (RN)															
1.7 16V (92 kW)	2001.05-	-	-	-	MPV Engine D17A2	823163	Outer Joint	50T	28	32	64	88	58.5	M	
	2001.05-	MT	L/R	F	MPV Engine D17A2	823118	Outer Joint	50T	28	32	64	88.5	62	M	
	2001.05-	MT	-	F	MPV Engine D17A2	823029	Outer Joint	50T	28	32	64	89	60	M	
	2001.05-	AT	-	F	MPV Engine D17A2	823033	Outer Joint	50T	26	30	60	78.5	57	M	
	2001.05-	-	-	F	MPV Engine D17A2	823080	Outer Joint	50T	28	32	64	88.5	62	M	
2.0 16V (115 kW)	2001.05-	-	-	-	MPV Engine K20A1	823163	Outer Joint	50T	28	32	64	88	58.5	M	
	2001.05-	MT	-	-	MPV Engine K20A1	623013	Inner Joint		27	32	40	45.5	75		
	2001.05-	MT	L/R	F	MPV Engine K20A1	823118	Outer Joint	50T	28	32	64	88.5	62	M	
	2001.05-	MT	-	F	MPV Engine K20A1	823029	Outer Joint	50T	28	32	64	89	60	M	
	2001.05-	AT	-	F	MPV Engine K20A1	823033	Outer Joint	50T	26	30	60	78.5	57	M	
	2001.05-	MT	-	F	MPV Engine K20A1	823080	Outer Joint	50T	28	32	64	88.5	62	M	
	2001.05-	AT	R	F	MPV Engine K20A1	623023	Inner Joint		27	30	40	45.5	75		
	2001.05-	AT	R	F	MPV Engine K20A1	699079	Inner Joint		27	30	40	55.5	97		
STREAM RN6															
1800	2006.07-2009.06	5AT	-	-	Engine R18A	823192	Outer Joint		26	29	63	78.5	57	M	
	2006.07-2009.06	5AT	-	-	Engine R18A	823192	Outer Joint		26	29	63	78.5	57	M	
	2006.07-2009.06	5AT	-	-	Engine R18A	823192	Outer Joint		26	29	63	78.5	57	M	
	2009.06-	5AT	-	-	Engine R18A	823192	Outer Joint		26	29	63	78.5	57	M	
	2009.06-	5AT	-	-	Engine R18A	823192	Outer Joint		26	29	63	78.5	57	M	
	2009.06-	5AT	-	-	Engine R18A	823192	Outer Joint		26	29	63	78.5	57	M	
STREAM RN7															
1800	2006.07-2009.06	5AT	-	-	Allwheel Drive Engine R18A	823192	Outer Joint		26	29	63	78.5	57	M	
	2006.07-2009.06	5AT	-	-	Allwheel Drive Engine R18A	823192	Outer Joint		26	29	63	78.5	57	M	
	2006.07-2009.06	5AT	-	-	Allwheel Drive Engine R18A	823192	Outer Joint		26	29	63	78.5	57	M	
	2009.06-	5AT	-	-	Allwheel Drive Engine R18A	823192	Outer Joint		26	29	63	78.5	57	M	
	2009.06-	5AT	-	-	Allwheel Drive Engine R18A	823192	Outer Joint		26	29	63	78.5	57	M	
STREAM RN8															
2000	2006.07-2009.06	CVT	-	-	Engine R20A	823192	Outer Joint		26	29	63	78.5	57	M	
	2006.07-2009.06	CVT	-	-	Engine R20A	823192	Outer Joint		26	29	63	78.5	57	M	
	2006.07-2009.06	CVT	-	-	Engine R20A	823192	Outer Joint		26	29	63	78.5	57	M	
	2009.06-	CVT	-	-	Engine R20A	823192	Outer Joint		26	29	63	78.5	57	M	
	2009.06-	CVT	-	-	Engine R20A	823192	Outer Joint		26	29	63	78.5	57	M	
STREAM RN9															
2000	2006.07-2009.06	5AT	-	-	Allwheel Drive Engine R20A	823192	Outer Joint		26	29	63	78.5	57	M	
	2006.07-2009.06	5AT	-	-	Allwheel Drive Engine R20A	823192	Outer Joint		26	29	63	78.5	57	M	
	2006.07-2009.06	5AT	-	-	Allwheel Drive Engine R20A	823192	Outer Joint		26	29	63	78.5	57	M	
	2009.06-	5AT	-	-	Allwheel Drive Engine R20A	823192	Outer Joint		26	29	63	78.5	57	M	
	2009.06-	5AT	-	-	Allwheel Drive Engine R20A	823192	Outer Joint		26	29	63	78.5	57	M	
THATS JD1															
660	2002.02-	3AT	-	-	Engine E07Z TBO	823182	Outer Joint	50T	23	25	49	78	50.5	M	
	2002.02-	3AT	-	-	Engine E07Z	823182	Outer Joint	50T	23	25	49	78	50.5	M	
THATS JD2															
660	2002.02-	3AT	-	-	Allwheel Drive Engine E07Z TBO	823182	Outer Joint	50T	23	25	49	78	50.5	M	
	2002.02-	3AT	-	-	Allwheel Drive Engine E07Z	823182	Outer Joint	50T	23	25	49	78	50.5	M	
TODAY															

	YEAR	TRANS	L/R	F/R	REMARKS	GSP Ref.	PRODUCT	ABS	Technical Specifications											
									A	B	C	H	L	P						
HONDA TODAY																				
-	-	-	-	-	-	823231	Outer Joint		23	23	49	78	49	I						
1988.03-	-	-	-	-	-	823098	Outer Joint		23	19	49	73	47.5	I						
1990.03-	-	-	-	-	-	823098	Outer Joint		23	19	49	73	47.5	I						
TODAY (JA1)																				
550	1988.03-	1990.03	MT/AT	-	-	Engine E05A	823099	Outer Joint	23	21	49	72	49	I						
TODAY (JA2)																				
660	1990.03-	1992.12	MT/AT	-	-	Engine E07A	823099	Outer Joint	23	21	49	72	49	I						
TODAY (JA3)																				
660 4WD	1990.03-	1992.12	MT/AT	-	-	Engine E07A	823099	Outer Joint	23	21	49	72	49	I						
TODAY (JA4)																				
660	1993.01-	1996.02	MT/AT	-	-	Engine E07A	823099	Outer Joint	23	21	49	72	49	I						
TODAY (JA5)																				
660 4WD	1993.01-	1996.02	MT/AT	-	-	Engine E07A	823099	Outer Joint	23	21	49	72	49	I						
TODAY (JW2)																				
550	1988.02-	1990.03	MT/AT	-	-	Engine E05A	823099	Outer Joint	23	21	49	72	49	I						
TODAY (JW3)																				
660	1990.03-	-	MT/AT	-	-	Engine E07A	823099	Outer Joint	23	21	49	72	49	I						
TODAY (JW4)																				
660 4WD	1990.03-	-	MT/AT	-	-	Engine E07A	823099	Outer Joint	23	21	49	72	49	I						
VAMOS																				
0.7 Hm2	1999-	2003	MT/AT	-	-	-	823231	Outer Joint	23	23	49	78	49	I						
VAMOS HOBIO																				
0.7 Hm4	1999-	2003	AT	-	-	-	823231	Outer Joint	23	23	49	78	49	I						
VIGOR																				
2.5 (CC2)	1992.01-	1995.02	AT	-	-	Engine G25A	823028	Outer Joint	28	34	60	89	60	M						
VIGOR (CB5)																				
2.0	1989.10-	1995.02	MT/AT	-	-	Engine G20A	823015	Outer Joint	28	32	60	89	60	M						
VIGOR (CC3)																				
2.0	1992.01-	1995.02	AT	-	-	Engine G20A	823015	Outer Joint	28	32	60	89	60	M						
VIGOR CB5																				
2.0	1989.10-	1995.02	MT/AT	-	-	Engine G20A	823015	Outer Joint	28	32	60	89	60	M						
2000	1989.10-	1995.02	MT/AT	-	-	Engine G20A	823015	Outer Joint	28	32	60	89	60	M						
VIGOR CC3																				
2.0	1992.01-	1995.02	AT	-	-	Engine G20A	823015	Outer Joint	28	32	60	89	60	M						
2000	1992.01-	1995.02	AT	-	-	Engine G20A	823015	Outer Joint	28	32	60	89	60	M						
ZEST JE1																				
660	2006.02-	-	4AT	-	-	Engine P07A TBO	823193	Outer Joint	23	29	52	78.5	54	I						
ZEST JE2																				
660	2006.02-	-	4AT	-	-	Allwheel Drive Engine P07A	823193	Outer Joint	23	29	52	78.5	54	I						
HONDA (DONGFENG) CIVIC VIII (FA_)																				
1.8 (103 kW)	2006.04-	2012.12	MT	-	-	Saloon Engine R18A1	223156	Drive Shaft	26	27	58	79.5	582							
1.8 (104 kW)	2011.10-	-	MT	-	-	Saloon Engine R18Z2	223156	Drive Shaft	26	27	58	79.5	582							
HONDA (GAC) ACCORD IX (CR_)																				
2.0 (114 kW)	2013.09-	-	-	-	-	Saloon Engine R20Z4	223245	Drive Shaft	50T	28	27	60	88	618						
	2013.09-	-	-	-	-	Saloon Engine R20Z4	223246	Drive Shaft	50T	28	27	60	88	982						
	2013.09-	-	-	-	-	Saloon Engine R20Z4	201063	Drive Shaft	50T	28	27	60	88	620						
ACCORD VI (CF_ CG_)																				
2.3 Vtec (110 kW)	2000.06-	2002.12	AT	L	F	Saloon Engine F23Z5/F23A3/F23Z4	223243	Drive Shaft	50T	28	27	64	88.5	012.5						
	2000.06-	2002.12	AT	R	F	Saloon Engine F23Z5/F23A3/F23Z4	223244	Drive Shaft	50T	28	27	64	88.5	640						
ACCORD VII (CM_)																				
2.0 (110 kW)	2003.01-	2007.12	-	-	-	Saloon Engine K20A7	223245	Drive Shaft	50T	28	27	60	88	618						
	2003.01-	2007.12	-	-	-	Saloon Engine K20A7	223246	Drive Shaft	50T	28	27	60	88	982						
	2003.01-	2007.12	-	-	-	Saloon Engine K20A7	201063	Drive Shaft	50T	28	27	60	88	620						
ACCORD VIII (CP_)																				
2.0 (115 kW)	2008.03-	2013.12	-	-	-	Saloon Engine R20A3	223179	Drive Shaft		30	27	68	88	640						
	2008.03-	2013.12	-	-	-	Saloon Engine R20A3	223245	Drive Shaft	50T	28	27	60	88	618						
	2008.03-	2013.12	-	-	-	Saloon Engine R20A3	201063	Drive Shaft	50T	28	27	60	88	620						
2.4 (132 kW)	2008.01-	2013.12	AT	R	-	Saloon Engine K24Z2	223162	Drive Shaft		30	27	68	89	579						
	2008.01-	2013.12	AT	L	-	Saloon Engine K24Z2	223241	Drive Shaft		30	27	68	88	668						
	2008.01-	2013.12	-	-	-	Saloon Engine K24Z2	223161	Drive Shaft		30	27	68	89	653						
ODYSSEY (RA_)																				
2.3 (110 kW)	2002.04-	2004.12	-	L	-	MPV Engine F23Z4	223171	Drive Shaft	50T	28	27	64	88.5	618						

YEAR	TRANSM	L/R	F/R	REMARKS	GSP Ref.	PRODUCT	ABS	Technical Specifications					
								A	B	C	H	L	P
HONDA (GAC)													
ODYSSEY (RA_)													
2.3 (110 kW)	2002.04-2004.12	AT	L	-	MPV Engine F23Z4	223243	Drive Shaft	50T	28	27	64	88.5	1012.1
	2002.04-2004.12	AT	R	-	MPV Engine F23Z4	223244	Drive Shaft	50T	28	27	64	88.5	640
2.4 (118 kW)	2005.03-2009.08	-	R	-	MPV Engine K24A6	223021	Drive Shaft		28	27	63	88.5	575
	2005.03-2009.08	-	L	-	MPV Engine K24A6	223224	Drive Shaft		28	27	63	88.5	663
ODYSSEY (RB_)													
2.4 (133 kW)	2009.08-2014.12	-	R	F	MPV Engine K24Z2	223021	Drive Shaft		28	27	63	88.5	575
	2009.08-2014.12	-	L	F	MPV Engine K24Z2	223224	Drive Shaft		28	27	63	88.5	663
HUMMER													
H2													
-	2003-2005	-	-	-	-	839029	Outer Joint		33	41	80	112	88.5 O
H3													
-	2006-2010	-	-	-	-	299303	DRIVE SHAFT					57	760
	2006-2009	-	-	F	4WD/PROPELLER SHAFT	608074	Propshaft CV Joint		34			57	
H3T													
-	2009-2010	-	-	F	PROPELLER SHAFT	608074	Propshaft CV Joint		34			57	
HYUNDAI													
-													
-	-	-	-	-	-	699258	Propshaft CV Joint			26		42	
2.7	2003.01-2006.01	MT/AT	R	-	-	824185	Outer Joint	47T	27	26	60	96.5	68.5 M
ACCENT													
-	-	-	L	-	-	224028	Drive Shaft		25	25	50	95	617.5
	-	-	R	-	-	224029	Drive Shaft		25	25	50	95	902
	-	-	-	-	-	899164	Outer Joint		25	30	49.9	94.5	56 O
	1995-1999	-	L	-	-	224009	Drive Shaft		25	25	50	95	613
	1995-1999	-	L	-	-	639001	Inner Joint		25	22	35	55	91
	2006-	4AT	L	F	2WD	224412	Drive Shaft	48T	25	25	52.5	95	639
	2006-	4AT	L	F	2WD	224412	Drive Shaft	48T	25	25	52.5	95	639
	2006-	4AT	L	F	2WD	224412	Drive Shaft	48T	25	25	52.5	95	639
1.4 2WD	2010-2013	4AT	R	-	GAMMA > DOHC MPI	224259	Drive Shaft		25	25	52.5	93.5	927
	2010-2013	5MT	R	-	GAMMA > DOHC MPI	224259	Drive Shaft		25	25	52.5	93.5	927
	2010-2013	4AT	L	-	GAMMA > DOHC MPI	224260	Drive Shaft		25	25	52.5	93.5	652
	2010-2013	5MT	L	-	GAMMA > DOHC MPI	224260	Drive Shaft		25	25	52.5	93.5	652
	2010-2013	5MT/4AT	R	-	GAMMA	224247	Drive Shaft	48T	25	25	52.5	93.5	927
	2010-2013	5MT/4AT	L	-	GAMMA	224246	Drive Shaft	48T	25	25	52.5	93.5	652
	2011-2013	6MT	L	-	U2 > DOHC TCI	627043	Inner Joint		27	24	41	61.5	91
	2011-2013	6MT	R	-	U2 > DOHC TCI	224291	Drive Shaft	48T	25	27	52.5	94.5	930
	2011-2013	6MT	L	-	U2 > DOHC TCI	224290	Drive Shaft	48T	25	27	52.5	94.5	647
	2011-2013	6MT	L	-	U2 > DOHC TCI	824163	Outer Joint	48T	25	24	52.5	94.5	64 M
1.4/1.6	2006-	-	L	-	-	224043	Drive Shaft		25	25	52.5	95	640
	2006-	-	R	-	-	224044	Drive Shaft	48T	25	25	52.5	95	924
1.5	1994-	-	L	-	-	224018	Drive Shaft		25	25	50	95	614
	1994-	-	R	-	-	224019	Drive Shaft		25	25	50	95	909
	2005.10-2006.03	4AT	R	F	-	224482	Drive Shaft		25	25	52.5	95	911
	2005.10-2006.03	4AT	R	F	-	899172	Outer Joint		25	22	52.5	95	58 M
1.5 CRDi	2006-	-	L/R	-	-	824026	Outer Joint		25	23	50	94.5	63.5 M
	2006-	-	L	-	-	224045	Drive Shaft		25	27	50	94.5	633
	2006-	-	R	-	-	224046	Drive Shaft	48T	25	26	50	94.5	588
1.5/1.6 2WD	1999-2001	5MT	R	-	MPISOHC	239214	Drive Shaft	44T	25	25	52.5	95	912
	1999-2001	5MT	L	-	MPISOHC	239211	Drive Shaft	44T	25	25	52.5	95	622
	1999-2001	4AT	R	-	MPISOHC	239212	Drive Shaft	44T	25	25	52.5	95	911
	1999-2001	4AT	L	-	MPISOHC	239213	Drive Shaft	44T	25	25	52.5	95	625
1.6 2WD	2010-2013	4AT	R	-	GAMMA > DOHC MPI	224259	Drive Shaft		25	25	52.5	93.5	927
	2010-2013	5MT	R	-	GAMMA > DOHC MPI	224259	Drive Shaft		25	25	52.5	93.5	927
	2010-2013	4AT	L	-	GAMMA > DOHC MPI	224260	Drive Shaft		25	25	52.5	93.5	652
	2010-2014	5MT	L	-	GAMMA > DOHC MPI	224260	Drive Shaft		25	25	52.5	93.5	652
	2010-2013	5MT/4AT	R	-	GAMMA	224247	Drive Shaft	48T	25	25	52.5	93.5	927
	2010-2013	5MT/4AT	L	-	GAMMA	224246	Drive Shaft	48T	25	25	52.5	93.5	652
	2011-2013	6MT	L	-	U2 > DOHC TCI	627043	Inner Joint		27	24	41	61.5	91
	2011-2013	6MT	R	-	U2 > DOHC TCI	224291	Drive Shaft	48T	25	27	52.5	94.5	930
	2011-2013	6MT	L	-	U2 > DOHC TCI	224290	Drive Shaft	48T	25	27	52.5	94.5	647
	2011-2012	4AT	L	-	U2 > DOHC TCI	224294	Drive Shaft	48T	25	27	52.5	94.5	646
	2011-2012	4AT	R	-	U2 > DOHC TCI	224293	Drive Shaft	48T	25	27	52.5	94.5	929
	2011-2013	6MT	L	-	U2 > DOHC TCI	824163	Outer Joint	48T	25	24	52.5	94.5	64 M
ACCENT (X-3)/VERNA/PONY/EXCEL													
1.3 (44 kW)	1994.10-2000.01	AT/MT	R	F	Saloon Engine G4EH	224023	Drive Shaft		25	25	50	95	904

YEAR	TRANSM	L/R	F/R	REMARKS	GSP Ref.	PRODUCT	ABS	Technical Specifications						
								A	B	C	H	L	P	
HYUNDAI														
ACCENT (X-3)/VERNA/PONY/EXCEL														
1.3 (44 kW)	1994.10-2000.01	-	L/R	F	Saloon Engine G4EH	824002	Outer Joint	29T	25	22	50	95	58	M
	1994.10-2000.01	AT	-	F	Saloon Engine G4EH	824065	Outer Joint	44T	25	22	52.5	95	58	M
	1994.10-2000.01	MT	-	-	Saloon Engine G4EH	624009	Inner Joint		25	22	35	54.5	87	
	1994.10-2000.01	AT/MT	L	F	Saloon Engine G4EH	224022	Drive Shaft		25	25	50	95	610	
1.3 (55 kW)	1994.10-2000.01	AT/MT	R	F	Saloon Engine G4EH	224023	Drive Shaft		25	25	50	95	904	
	1994.10-2000.01	MT	L/R	F	Saloon Engine G4EH	824002	Outer Joint	29T	25	22	50	95	58	M
	1994.10-2000.01	AT	-	F	Saloon Engine G4EH	824065	Outer Joint	44T	25	22	52.5	95	58	M
	1994.10-2000.01	MT	-	-	Saloon Engine G4EH	624009	Inner Joint		25	22	35	54.5	87	
	1994.10-2000.01	AT/MT	L	F	Saloon Engine G4EH	224022	Drive Shaft		25	25	50	95	610	
1.3 i 12V (62 kW)	1994.10-2000.01	AT/MT	R	F	Saloon Engine G4EH	224022	Drive Shaft		25	25	50	95	610	
	1994.10-2000.01	AT/MT	L	F	Saloon Engine G4EH	224023	Drive Shaft		25	25	50	95	904	
	1994.10-2000.01	-	L/R	F	Saloon Engine G4EH	824002	Outer Joint	29T	25	22	50	95	58	M
	1994.10-2000.01	AT	-	F	Saloon Engine G4EH	824065	Outer Joint	44T	25	22	52.5	95	58	M
	1994.10-2000.01	MT	-	-	Saloon Engine G4EH	624009	Inner Joint		25	22	35	54.5	87	
1.5 (63 kW)	1994.10-1999.07	4AT	-	F	Saloon Engine G4EK	824065	Outer Joint	44T	25	22	52.5	95	58	M
	1994.10-1999.07	5MT	-	-	Saloon Engine G4EK	624009	Inner Joint		25	22	35	54.5	87	
1.5 i 12V (65 kW)	1994.10-2000.01	AT/MT	L	F	Saloon Engine G4EK	224022	Drive Shaft		25	25	50	95	610	
	1994.10-2000.01	AT/MT	R	F	Saloon Engine G4EK	224023	Drive Shaft		25	25	50	95	904	
	1994.10-2000.01	AT	-	F	Saloon Engine G4EK	824065	Outer Joint	44T	25	22	52.5	95	58	M
	1994.10-2000.01	MT	-	-	Saloon Engine G4EK	624009	Inner Joint		25	22	35	54.5	87	
1.5 i 16V (73 kW)	1995.10-2000.01	AT	-	F	Saloon Engine G4ER	824065	Outer Joint	44T	25	22	52.5	95	58	M
	1995.10-2000.01	MT	-	-	Saloon Engine G4ER	624009	Inner Joint		25	22	35	54.5	87	
ACCENT 11														
-	2011.03--	6AT	L	F	ABS (ANTI LOCK BRK SYS)/2WD	224409	Drive Shaft	48T	25	27	52.5	93.5	634	
	2011.03--	6AT	R	F	ABS (ANTI LOCK BRK SYS)/2WD	224408	Drive Shaft	48T	25	27	52.5	93.5	923	
	2011.03--	6AT	L	F	ABS (ANTI LOCK BRK SYS)/2WD	624065	Inner Joint		27	22	30	68	77	
	2011.03--	6AT	R	F	ABS (ANTI LOCK BRK SYS)/2WD	624065	Inner Joint		27	22	30	68	77	
	2011.03--	6AT	L	F	ABS (ANTI LOCK BRK SYS)/2WD	824183	Outer Joint		25	22	52.5	93.5	59.5	M
	2011.03--	6AT	R	F	ABS (ANTI LOCK BRK SYS)/2WD	824183	Outer Joint		25	22	52.5	93.5	59.5	M
	2011.04--	6AT	L	F	ABS (ANTI LOCK BRK SYS)/2WD	224409	Drive Shaft	48T	25	27	52.5	93.5	634	
	2011.04--	6AT	R	F	ABS (ANTI LOCK BRK SYS)/2WD	224408	Drive Shaft	48T	25	27	52.5	93.5	923	
	2011.04--	6AT	L	F	ABS (ANTI LOCK BRK SYS)/2WD	624065	Inner Joint		27	22	30	68	77	
	2011.04--	6AT	L	F	ABS (ANTI LOCK BRK SYS)/2WD	824183	Outer Joint		25	22	52.5	93.5	59.5	M
	2013.07--	6AT	R	F	GAMMA DOHC GDI AUTO 6 SPEED 2WD	624065	Inner Joint		27	22	30	68	77	
1.6	2013.07--	6AT	L	F	GAMMA DOHC GDI AUTO 6 SPEED 2WD EMISSION REGULATION EURO 4/ABS (ANTI LOCK BRK SYS)	224409	Drive Shaft	48T	25	27	52.5	93.5	634	
	2013.07--	6AT	R	F	GAMMA DOHC GDI AUTO 6 SPEED 2WD EMISSION REGULATION EURO 4/ABS (ANTI LOCK BRK SYS)	224408	Drive Shaft	48T	25	27	52.5	93.5	923	
	2013.07--	6AT	L	F	GAMMA DOHC GDI AUTO 6 SPEED 2WD	624065	Inner Joint		27	22	30	68	77	
	2013.07--	6AT	L	F	GAMMA DOHC GDI AUTO 6 SPEED 2WD	824183	Outer Joint		25	22	52.5	93.5	59.5	M
	2013.07--	6AT	L	F	GAMMA DOHC GDI AUTO 6 SPEED 2WD	224409	Drive Shaft	48T	25	27	52.5	93.5	634	
	2013.07--	6AT	R	F	GAMMA DOHC GDI AUTO 6 SPEED 2WD	824183	Outer Joint		25	22	52.5	93.5	59.5	M
	2013.07--	6AT	R	F	GAMMA DOHC GDI AUTO 6 SPEED 2WD	224408	Drive Shaft	48T	25	27	52.5	93.5	923	
	2013.07--	6AT	L	F	GAMMA DOHC GDI AUTO 6 SPEED 2WD	224409	Drive Shaft	48T	25	27	52.5	93.5	634	
	2013.07--	6AT	R	F	GAMMA DOHC GDI AUTO 6 SPEED 2WD	224408	Drive Shaft	48T	25	27	52.5	93.5	923	
ACCENT ADMIRE														
1.3	2003-2006	-	R	F	-	224002	Drive Shaft		25	25	50	95	908	
1.5	2003-2006	-	R	F	-	224002	Drive Shaft		25	25	50	95	908	
1.5 CRDi	2003-2006	-	L/R	F	-	839063	Outer Joint	47T	25	23	50	94.5	63.5	M
	2003-2006	-	L	F	-	839128	Outer Joint	44T	25	23	50	94.5	63.5	M
	2003-2006	-	R	F	-	839128	Outer Joint	44T	25	23	50	94.5	63.5	M
	2003-2006	-	R	F	-	624031	Inner Joint		26	23	42	40	68	
	2003-2006	-	L	F	-	239122	Drive Shaft	44T	25	25	50	94.5	618	
	2003-2006	-	R	F	-	239123	Drive Shaft	44T	25	26	50	94.5	572	
1.6	2003-2006	-	R	F	-	224002	Drive Shaft		25	25	50	95	908	
ACCENT BLUE														
-	2011--	-	-	F	-	224409	Drive Shaft	48T	25	27	52.5	93.5	634	
	2011--	-	-	F	-	624065	Inner Joint		27	22	30	68	77	
	2011--	-	-	F	-	824183	Outer Joint		25	22	52.5	93.5	59.5	M
ACCENT ERA														
1.4	2006--	-	L	F	-	224188	Drive Shaft	48T	25	25	52.5	95	640	
	2006--	-	L	F	-	624012	Inner Joint		25	22	41	63	86.5	
1.4/1.6	2006--	-	-	-	-	624012	Inner Joint		25	22	41	63	86.5	
1.5 CRDi	2006--	-	L/R	F	-	824026	Outer Joint		25	23	50	94.5	63.5	M
1.6	2006--	-	L	F	-	224188	Drive Shaft	48T	25	25	52.5	95	640	
	2006--	-	L	F	-	624012	Inner Joint		25	22	41	63	86.5	
ACCENT GETZ														
1.3	2002-2005	-	R	F	-	224002	Drive Shaft		25	25	50	95	908	

YEAR	TRANS	L/R	F/R	REMARKS	GSP Ref.	PRODUCT	ABS	Technical Specifications							
								A	B	C	H	L	P		
HYUNDAI															
ACCENT I (X-3)/VERNA/PONY/EXCEL															
1.3 (44 kW)	1994.10-2000.01	AT/MT	R	F	Hatchback Engine G4EH	224023	Drive Shaft		25	25	50	95	904		
	1994.10-2000.01	MT	L/R	F	Hatchback Engine G4EH	824002	Outer Joint	29T	25	22	50	95	58	M	
	1994.10-2000.01	AT	-	F	Hatchback Engine G4EH	824065	Outer Joint	44T	25	22	52.5	95	58	M	
	1994.10-2000.01	MT	-	-	Hatchback Engine G4EH	624009	Inner Joint		25	22	35	54.5	87		
	1994.10-2000.01	AT/MT	L	F	Hatchback Engine G4EH	224022	Drive Shaft		25	25	50	95	610		
1.3 (55 kW)	1994.10-2000.01	AT/MT	R	F	Hatchback Engine G4EH	224023	Drive Shaft		25	25	50	95	904		
	1994.10-2000.01	MT	L/R	F	Hatchback Engine G4EH	824002	Outer Joint	29T	25	22	50	95	58	M	
	1994.10-2000.01	AT	-	F	Hatchback Engine G4EH	824065	Outer Joint	44T	25	22	52.5	95	58	M	
	1994.10-2000.01	MT	-	-	Hatchback Engine G4EH	624009	Inner Joint		25	22	35	54.5	87		
	1994.10-2000.01	AT/MT	L	F	Hatchback Engine G4EH	224022	Drive Shaft		25	25	50	95	610		
1.3 i 12V (62 kW)	1994.10-2000.01	AT/MT	R	F	Hatchback Engine G4EH	224023	Drive Shaft		25	25	50	95	904		
	1994.10-2000.01	-	L/R	F	Hatchback Engine G4EH	824002	Outer Joint	29T	25	22	50	95	58	M	
	1994.10-2000.01	AT	-	F	Hatchback Engine G4EH	824065	Outer Joint	44T	25	22	52.5	95	58	M	
	1994.10-2000.01	MT	-	-	Hatchback Engine G4EH	624009	Inner Joint		25	22	35	54.5	87		
	1994.10-2000.01	AT/MT	L	F	Hatchback Engine G4EH	224022	Drive Shaft		25	25	50	95	610		
1.5 16V (76 kW)	1994.10-2000.01	AT	-	F	Hatchback Engine G4FK	824065	Outer Joint	44T	25	22	52.5	95	58	M	
	1994.10-2000.01	MT	-	-	Hatchback Engine G4FK	624009	Inner Joint		25	22	35	54.5	87		
1.5 i 12V (65 kW)	1994.10-2000.01	AT/MT	R	F	Hatchback Engine G4EK	224023	Drive Shaft		25	25	50	95	904		
	1994.10-2000.01	-	L/R	F	Hatchback Engine G4EK	809004	Outer Joint		25	22	50	95	58	M	
	1994.10-2000.01	AT	-	F	Hatchback Engine G4EK	824065	Outer Joint	44T	25	22	52.5	95	58	M	
	1994.10-2000.01	MT	-	-	Hatchback Engine G4EK	624009	Inner Joint		25	22	35	54.5	87		
1.5 i 16V (73 kW)	1994.10-2000.01	AT/MT	L	F	Hatchback Engine G4EK	224022	Drive Shaft		25	25	50	95	610		
	1995.12-2000.01	-	L/R	F	Hatchback Engine G4ER	809004	Outer Joint		25	22	50	95	58	M	
	1995.12-2000.01	AT	-	F	Hatchback Engine G4ER	824065	Outer Joint	44T	25	22	52.5	95	58	M	
1995.12-2000.01	MT	-	-	Hatchback Engine G4ER	624009	Inner Joint		25	22	35	54.5	87			
ACCENT II															
-	-	-	6AT	R	F	2WD	224408	Drive Shaft	48T	25	27	52.5	93.5	923	
	-	-	6AT	L	F	2WD	224409	Drive Shaft	48T	25	27	52.5	93.5	634	
	-	-	6AT	R	F	2WD	624065	Inner Joint		27	22	30	68	77	
	-	-	6AT	L	F	2WD	624065	Inner Joint		27	22	30	68	77	
	-	-	6AT	R	F	2WD	824183	Outer Joint		25	22	52.5	93.5	59.5	M
	-	-	6AT	L	F	2WD	824183	Outer Joint		25	22	52.5	93.5	59.5	M
	-	-	6AT	L	F	GLS Hatchback 4Door	624065	Inner Joint		27	22	30	68	77	
1.3	2000.01-	-	L	-	-	899172	Outer Joint		25	22	52.5	95	58	M	
	2000.01-	MT	-	F	-	824016	Outer Joint		25	22	50	95	58	M	
1.4	2011-	-	R	-	-	227202	Drive Shaft	48T	25	25	52.5	93.5	917		
	2011-	-	L	-	-	227201	Drive Shaft	48T	25	25	52.5	93.5	636		
	2011-	-	R	-	-	224383	Drive Shaft		25	25	52.5	93.5	915		
	2011-	-	L	-	-	224384	Drive Shaft		25	25	52.5	93.5	637		
	2011-	-	MT	R	-	-	224386	Drive Shaft		25	27	52.5	94.5	932	
	2011-	-	MT	L	-	-	224368	Drive Shaft		25	27	52.5	94.5	648	
1.5	2000.01-	-	L	-	-	899172	Outer Joint		25	22	52.5	95	58	M	
1.6	2011-	-	6AT	R	F	GLS Hatchback 4Door/1.6L 1591CC 97Cu. In. I4 GAS DOHC Naturally Aspirated	224408	Drive Shaft	48T	25	27	52.5	93.5	923	
	2011-	-	6AT	L	F	GLS Hatchback 4Door/1.6L 1591CC 97Cu. In. I4 GAS DOHC Naturally Aspirated	224409	Drive Shaft	48T	25	27	52.5	93.5	634	
	2011-	-	6AT	R	F	GLS Hatchback 4Door	624065	Inner Joint		27	22	30	68	77	
	2011-	-	6AT	R	F	GLS Hatchback 4Door	824183	Outer Joint		25	22	52.5	93.5	59.5	M
	2011-	-	6AT	L	F	GLS Hatchback 4Door	824183	Outer Joint		25	22	52.5	93.5	59.5	M
	2011-	-	AT	L	-	-	224385	Drive Shaft		25	27	52.5	94.5	647	
	2011-	-	MT	R	-	-	224386	Drive Shaft		25	27	52.5	94.5	932	
2011-	-	MT	L	-	-	224368	Drive Shaft		25	27	52.5	94.5	648		
ACCENT II (LC)/VERNA															
1.3 (55 kW)	2000.01-2005.11	-	L/R	F	Saloon Engine G4EA	824033	Outer Joint	44T	25	22	50	95	58	M	
	2000.01-2005.11	-	L	F	Saloon Engine G4EA	224147	Drive Shaft	44T	25	25	50	95	627		
	2000.01-2005.11	-	R	F	Saloon Engine G4EA	224148	Drive Shaft	44T	25	25	50	95	908		
	2000.01-2005.11	-	-	-	Saloon Engine G4EA	824075	Outer Joint		25	22	52.5	95	58	M	
	2000.01-2005.11	-	L	F	Saloon Engine G4EA	224038	Drive Shaft		25	25	52.5	95	622		
	2000.01-2005.11	-	R	F	Saloon Engine G4EA	224129	Drive Shaft		25	25	52.5	95	908.5		
	2000.01-2005.11	4AT	-	F	Saloon Engine G4EA	824065	Outer Joint	44T	25	22	52.5	95	58	M	
1.3 (63 kW)	2000.01-2005.11	AT	L	F	Saloon Engine G4EA	224558	Drive Shaft	44T	25	25	52.5	95	622		
	2000.01-2005.11	-	L/R	F	Saloon Engine G4EA	824033	Outer Joint	44T	25	22	50	95	58	M	
	2000.01-2005.11	-	L	F	Saloon Engine G4EA	224147	Drive Shaft	44T	25	25	50	95	627		
	2000.01-2005.11	-	R	F	Saloon Engine G4EA	224148	Drive Shaft	44T	25	25	50	95	908		
	2000.01-2005.11	-	-	-	Saloon Engine G4EA	824075	Outer Joint		25	22	52.5	95	58	M	
	2000.01-2005.11	-	L	F	Saloon Engine G4EA	224038	Drive Shaft		25	25	52.5	95	622		
	2000.01-2005.11	-	R	F	Saloon Engine G4EA	224129	Drive Shaft		25	25	52.5	95	908.5		
	2000.01-2005.11	MT	L/R	F	Saloon Engine G4EA	824002	Outer Joint	29T	25	22	50	95	58	M	

	 YEAR	TRANSM	L/R	F/R	REMARKS	GSP Ref.	 PRODUCT	 ABS	Technical Specifications					
									A	B	C	H	L	P
HYUNDAI														
ACCENT II (LC)/VERNA														
1.3 (63 kW)	2000.01-2005.11	5MT	-	-	Saloon Engine G4EA	624009	Inner Joint		25	22	35	54.5	87	
1.5 (66 kW)	2000.01-2005.11	AT	L	F	Saloon Engine G4EB	224558	Drive Shaft	44T	25	25	52.5	95	622	
	2000.01-2005.11	-	L/R	F	Saloon Engine G4EB	824033	Outer Joint	44T	25	22	50	95	58	M
	2000.01-2005.11	-	L	F	Saloon Engine G4EB	224147	Drive Shaft	44T	25	25	50	95	627	
	2000.01-2005.11	-	R	F	Saloon Engine G4EB	224148	Drive Shaft	44T	25	25	50	95	908	
	2000.01-2005.11	-	-	-	Saloon Engine G4EB	824075	Outer Joint		25	22	52.5	95	58	M
	2000.01-2005.11	-	L	F	Saloon Engine G4EB	224038	Drive Shaft		25	25	52.5	95	622	
	2000.01-2005.11	-	R	F	Saloon Engine G4EB	224129	Drive Shaft		25	25	52.5	95	908.5	
	2000.01-2005.11	AT	-	F	Saloon Engine G4EB	824065	Outer Joint	44T	25	22	52.5	95	58	M
1.5 CRDi (60 kW)	2002.01-2005.11	4AT	-	F	Saloon Engine D3EA	824065	Outer Joint	44T	25	22	52.5	95	58	M
	2002.01-2005.11	MT	-	-	Saloon Engine D3EA	624009	Inner Joint		25	22	35	54.5	87	
1.6 (77 kW)	2002.12-2005.11	MT	R	F	Saloon Engine G4ED-G	224507	Drive Shaft	44T	25	25	52.5	95	908.5	
	2002.12-2005.11	4AT/5MT	-	R	Saloon Engine G4ED-G	624010	Inner Joint		25	22	35	63	87	
	2002.12-2005.11	5MT	-	-	Saloon Engine G4ED-G	624093	Inner Joint		25	22	41	63	86.5	
	2002.12-2005.11	5MT	-	F	Saloon Engine G4ED-G	824101	Outer Joint	48T	25	22	52.5	95	58	M
	2002.12-2005.11	MT	L/R	F	Saloon Engine G4ED-G	824002	Outer Joint	29T	25	22	50	95	58	M
	2002.12-2005.11	AT	-	F	Saloon Engine G4ED-G	824065	Outer Joint	44T	25	22	52.5	95	58	M
	2002.12-2005.11	MT	-	-	Saloon Engine G4ED-G	624009	Inner Joint		25	22	35	54.5	87	
ACCENT II (LC)/VERNA/EXCEL														
1.3 (55 kW)	2000.01-2005.11	-	L/R	F	Hatchback Engine G4EA	824033	Outer Joint	44T	25	22	50	95	58	M
	2000.01-2005.11	-	L	F	Hatchback Engine G4EA	224147	Drive Shaft	44T	25	25	50	95	627	
	2000.01-2005.11	-	R	F	Hatchback Engine G4EA	224148	Drive Shaft	44T	25	25	50	95	908	
	2000.01-2005.11	-	-	-	Hatchback Engine G4EA	824075	Outer Joint		25	22	52.5	95	58	M
	2000.01-2005.11	-	L	F	Hatchback Engine G4EA	224038	Drive Shaft		25	25	52.5	95	622	
	2000.01-2005.11	-	R	F	Hatchback Engine G4EA	224129	Drive Shaft		25	25	52.5	95	908.5	
	2000.01-2005.11	MT	L/R	F	Hatchback Engine G4EA	824002	Outer Joint	29T	25	22	50	95	58	M
1.3 (61 kW)	2000.01-2005.11	AT	L	F	Hatchback Engine G4EA	224558	Drive Shaft	44T	25	25	52.5	95	622	
	2000.01-2005.11	-	L/R	F	Hatchback Engine G4EA	824033	Outer Joint	44T	25	22	50	95	58	M
	2000.01-2005.11	-	L	F	Hatchback Engine G4EA	224147	Drive Shaft	44T	25	25	50	95	627	
	2000.01-2005.11	-	R	F	Hatchback Engine G4EA	224148	Drive Shaft	44T	25	25	50	95	908	
	2000.01-2005.11	-	L	F	Hatchback Engine G4EA	224038	Drive Shaft		25	25	52.5	95	622	
	2000.01-2005.11	-	R	F	Hatchback Engine G4EA	224129	Drive Shaft		25	25	52.5	95	908.5	
	2000.01-2005.11	AT	-	F	Hatchback Engine G4EA	824065	Outer Joint	44T	25	22	52.5	95	58	M
	2000.01-2005.11	MT	-	-	Hatchback Engine G4EA	624009	Inner Joint		25	22	35	54.5	87	
1.3 (62 kW)	2002.08-2005.11	AT	L	F	Hatchback Engine G4EH	224558	Drive Shaft	44T	25	25	52.5	95	622	
	2002.08-2005.11	-	-	-	Hatchback Engine G4EH	824075	Outer Joint		25	22	52.5	95	58	M
	2002.08-2005.11	-	L	F	Hatchback Engine G4EH	224038	Drive Shaft		25	25	52.5	95	622	
	2002.08-2005.11	-	R	F	Hatchback Engine G4EH	224129	Drive Shaft		25	25	52.5	95	908.5	
	2002.08-2005.11	AT	-	F	Hatchback Engine G4EH	824065	Outer Joint	44T	25	22	52.5	95	58	M
	2002.08-2005.11	MT	-	-	Hatchback Engine G4EH	624009	Inner Joint		25	22	35	54.5	87	
	2002.08-2005.11	-	-	-	Hatchback Engine G4EH	824075	Outer Joint		25	22	52.5	95	58	M
1.3 (63 kW)	2000.01-2005.11	AT	L	F	Hatchback Engine G4EA	224558	Drive Shaft	44T	25	25	52.5	95	622	
	2000.01-2005.11	-	L/R	F	Hatchback Engine G4EA	824033	Outer Joint	44T	25	22	50	95	58	M
	2000.01-2005.11	-	L	F	Hatchback Engine G4EA	224147	Drive Shaft	44T	25	25	50	95	627	
	2000.01-2005.11	-	R	F	Hatchback Engine G4EA	224148	Drive Shaft	44T	25	25	50	95	908	
	2000.01-2005.11	-	-	-	Hatchback Engine G4EA	824075	Outer Joint		25	22	52.5	95	58	M
	2000.01-2005.11	-	L	F	Hatchback Engine G4EA	224038	Drive Shaft		25	25	52.5	95	622	
	2000.01-2005.11	-	R	F	Hatchback Engine G4EA	224129	Drive Shaft		25	25	52.5	95	908.5	
	2000.01-2005.11	MT	L/R	F	Hatchback Engine G4EA	824002	Outer Joint	29T	25	22	50	95	58	M
1.5 (65 kW)	1999.09-2002.10	-	L	F	Hatchback Engine G4EK	224147	Drive Shaft	44T	25	25	50	95	627	
	1999.09-2002.10	-	R	F	Hatchback Engine G4EK	224148	Drive Shaft	44T	25	25	50	95	908	
	1999.09-2002.10	AT	-	F	Hatchback Engine G4EK	824065	Outer Joint	44T	25	22	52.5	95	58	M
1.5 (66 kW)	2000.01-2005.11	AT	L	F	Hatchback Engine G4EB	224558	Drive Shaft	44T	25	25	52.5	95	622	
	2000.01-2005.11	-	L/R	F	Hatchback Engine G4EB	824033	Outer Joint	44T	25	22	50	95	58	M
	2000.01-2005.11	-	L	F	Hatchback Engine G4EB	224147	Drive Shaft	44T	25	25	50	95	627	
	2000.01-2005.11	-	R	F	Hatchback Engine G4EB	224148	Drive Shaft	44T	25	25	50	95	908	
	2000.01-2005.11	-	-	-	Hatchback Engine G4EB	824075	Outer Joint		25	22	52.5	95	58	M
	2000.01-2005.11	-	L	F	Hatchback Engine G4EB	224038	Drive Shaft		25	25	52.5	95	622	
	2000.01-2005.11	-	R	F	Hatchback Engine G4EB	224129	Drive Shaft		25	25	52.5	95	908.5	
	2000.01-2005.11	MT	L/R	F	Hatchback Engine G4EB	824002	Outer Joint	29T	25	22	50	95	58	M
2000.01-2005.11	AT	-	F	Hatchback Engine G4EB	824065	Outer Joint	44T	25	22	52.5	95	58	M	
1.5 (75 kW)	2000.09-2005.11	AT	L	F	Hatchback Engine G4EC-G	224558	Drive Shaft	44T	25	25	52.5	95	622	
	2000.09-2005.11	-	L/R	F	Hatchback Engine G4EC-G	824033	Outer Joint	44T	25	22	50	95	58	M
	2000.09-2005.11	-	L	F	Hatchback Engine G4EC-G	224147	Drive Shaft	44T	25	25	50	95	627	
	2000.09-2005.11	-	R	F	Hatchback Engine G4EC-G	224148	Drive Shaft	44T	25	25	50	95	908	
	2000.09-2005.11	-	-	-	Hatchback Engine G4EC-G	824075	Outer Joint		25	22	52.5	95	58	M
	2000.09-2005.11	-	L	F	Hatchback Engine G4EC-G	224038	Drive Shaft		25	25	52.5	95	622	

		YEAR		TRANSM	L/R	F/R	REMARKS	GSP Ref.	PRODUCT	ABS	Technical Specifications					
											A	B	C	H	L	P
HYUNDAI																
ACCENT II (LC)/VERNA/EXCEL																
1.5 (75 kW)	2000.09-2005.11	2005.11	-	R	F		Hatchback Engine G4EC-G	224129	Drive Shaft		25	25	52.5	95	908.5	
	2000.09-2005.11	2005.11	MT	L/R	F		Hatchback Engine G4EC-G	824002	Outer Joint	29T	25	22	50	95	58	M
1.5 CRDi (60 kW)	2002.04-2005.11	2005.11	MT	-	-		Hatchback Engine D3EA	624009	Inner Joint		25	22	35	54.5	87	
1.6 (77 kW)	2002.12-2005.11	2005.11	MT	R	F		Hatchback Engine G4ED-G	224507	Drive Shaft	44T	25	25	52.5	95	908.5	
	2002.12-2005.11	2005.11	MT	L/R	F		Hatchback Engine G4ED-G	824002	Outer Joint	29T	25	22	50	95	58	M
	2002.12-2005.11	2005.11	AT	-	F		Hatchback Engine G4ED-G	824065	Outer Joint	44T	25	22	52.5	95	58	M
	2002.12-2005.11	2005.11	MT	-	-		Hatchback Engine G4ED-G	624009	Inner Joint		25	22	35	54.5	87	
ACCENT III (MC)																
1.4 GL (71 kW)	2005.11-2010.11	2010.11	MT	-	-		Hatchback Engine G4EE	624093	Inner Joint		25	22	41	63	86.5	
	2005.11-2010.11	2010.11	MT	-	-		Saloon Engine G4EE	624093	Inner Joint		25	22	41	63	86.5	
	2005.11-2010.11	2010.11	MT	-	F		Hatchback Engine G4EE	824101	Outer Joint	48T	25	22	52.5	95	58	M
	2005.11-2010.11	2010.11	MT	-	F		Saloon Engine G4EE	824101	Outer Joint	48T	25	22	52.5	95	58	M
	2005.11-2010.11	2010.11	4AT/5MT	L	F		Hatchback Engine G4EE	639052	Inner Joint		25	22	41	63	86	
	2005.11-2010.11	2010.11	4AT/5MT	L	F		Saloon Engine G4EE	639052	Inner Joint		25	22	41	63	86	
	2005.11-2010.11	2010.11	4AT/5MT	-	F		Hatchback Engine G4EE	824136	Outer Joint		25	22	52.5	93.5	59.5	M
	2005.11-2010.11	2010.11	4AT/5MT	-	F		Saloon Engine G4EE	824136	Outer Joint		25	22	52.5	93.5	59.5	M
	2005.11-2010.11	2010.11	4AT/5MT	-	F		Hatchback Engine G4EE	824131	Outer Joint	48T	25	22	52.5	93.5	59.5	M
	2005.11-2010.11	2010.11	4AT/5MT	-	F		Saloon Engine G4EE	824131	Outer Joint	48T	25	22	52.5	93.5	59.5	M
1.6 GLS (82 kW)	2005.11-2010.11	2010.11	MT	-	-		Hatchback Engine G4ED	624093	Inner Joint		25	22	41	63	86.5	
	2005.11-2010.11	2010.11	MT	-	-		Saloon Engine G4ED	624093	Inner Joint		25	22	41	63	86.5	
	2005.11-2010.11	2010.11	MT	-	F		Hatchback Engine G4ED	824101	Outer Joint	48T	25	22	52.5	95	58	M
	2005.11-2010.11	2010.11	MT	-	F		Saloon Engine G4ED	824101	Outer Joint	48T	25	22	52.5	95	58	M
	2005.11-2010.11	2010.11	AT	-	F		Hatchback Engine G4ED	824065	Outer Joint	44T	25	22	52.5	95	58	M
	2005.11-2010.11	2010.11	AT	-	F		Saloon Engine G4ED	824065	Outer Joint	44T	25	22	52.5	95	58	M
	2005.11-2010.11	2010.11	MT	-	-		Hatchback Engine G4ED	624009	Inner Joint		25	22	35	54.5	87	
	2005.11-2010.11	2010.11	MT	-	-		Saloon Engine G4ED	624009	Inner Joint		25	22	35	54.5	87	
	2005.11-2010.11	2010.11	6MT	L	F		Hatchback Engine G4ED	639052	Inner Joint		25	22	41	63	86	
	2005.11-2010.11	2010.11	6MT	L	F		Saloon Engine G4ED	639052	Inner Joint		25	22	41	63	86	
	2005.11-2010.11	2010.11	6AT/6MT	-	F		Hatchback Engine G4ED	824131	Outer Joint	48T	25	22	52.5	93.5	59.5	M
	2005.11-2010.11	2010.11	6AT/6MT	-	F		Saloon Engine G4ED	824131	Outer Joint	48T	25	22	52.5	93.5	59.5	M
ACCENT IV (RB)/SOLARIS/ACCENT i25																
1.4 (74 kW)	2010.11-2016.12	2016.12	-	-	R		Saloon Engine G4LC	624010	Inner Joint		25	22	35	63	87	
	2010.11-2016.12	2016.12	MT	-	-		Saloon Engine G4LC	624093	Inner Joint		25	22	41	63	86.5	
	2010.11-2016.12	2016.12	MT	-	F		Saloon Engine G4LC	824101	Outer Joint	48T	25	22	52.5	95	58	M
1.4 (80 kW)	2010.11-2014.12	2014.12	-	-	R		Saloon Engine G4FA	624010	Inner Joint		25	22	35	63	87	
	2010.11-2014.12	2014.12	MT	-	-		Saloon Engine G4FA	624093	Inner Joint		25	22	41	63	86.5	
	2010.11-2014.12	2014.12	MT	-	F		Saloon Engine G4FA	824101	Outer Joint	48T	25	22	52.5	95	58	M
1.6 (91 kW)	2010.11-	-	-	-	R		Saloon Engine G4FC	624010	Inner Joint		25	22	35	63	87	
	2010.11-	-	MT	-	-		Saloon Engine G4FC	624093	Inner Joint		25	22	41	63	86.5	
	2010.11-	-	MT	-	F		Saloon Engine G4FC	824101	Outer Joint	48T	25	22	52.5	95	58	M
1.6 CRDi (100 kW)	2011.04-	-	6MT	L	F		Saloon Engine D4FB	639052	Inner Joint		25	22	41	63	86	
	2011.04-	-	6AT/6MT	-	F		Saloon Engine D4FB	824131	Outer Joint	48T	25	22	52.5	93.5	59.5	M
1.6 CRDi (94 kW)	2010.11-2015.12	2015.12	6MT	L	F		Saloon Engine D4FB	639052	Inner Joint		25	22	41	63	86	
	2010.11-2015.12	2015.12	6AT/6MT	-	F		Saloon Engine D4FB	824131	Outer Joint	48T	25	22	52.5	93.5	59.5	M
ACCENT MILENIUM																
1.3	2000-	2003	-	R	F		-	224002	Drive Shaft		25	25	50	95	908	
1.5	2000-	2003	-	R	F		-	224002	Drive Shaft		25	25	50	95	908	
1.6	2000-	2003	-	R	F		-	224002	Drive Shaft		25	25	50	95	908	
ACCENT/VERNA																
-	2006-	-	4AT	L	F		2WD	224412	Drive Shaft	48T	25	25	52.5	95	639	
1.5	-	-	MT	L	F		-	224120	Drive Shaft	48T	25	27	50	94.5	633	
	2006-	-	5MT	L	F		2WD	224120	Drive Shaft	48T	25	27	50	94.5	633	
	2006-	-	-	L	F		-	224120	Drive Shaft	48T	25	27	50	94.5	633	
	2006-	-	5MT	L	F		2WD	824026	Outer Joint		25	23	50	94.5	63.5	M
1.6	2006-	-	4AT	L	F		2WD	224412	Drive Shaft	48T	25	25	52.5	95	639	
	2009-	2011	AT	L	F		-	224412	Drive Shaft	48T	25	25	52.5	95	639	
ATTITUDE 1																
4 Lts	2011-	2013	MT	L/R	-	-	-	824243	Outer Joint		25	22	52.6	93	61	M
ATOS																
-	-	-	-	-	-	-	-	824018	Outer Joint		25	19	52.5	95	52	M
1.0	2000-	2004	MT	-	-	-	-	624002	Inner Joint		22	19	35	52	86	
ATOS (MX)/AMICA/ATOZ																
1.0 i (40 kW)	1998.02-2014.12	2014.12	-	-	-		Hatchback Engine G4HC	899025	Outer Joint		25	20	50	94.5	52.5	I
	1998.02-2014.12	2014.12	AT	L	F		Hatchback Engine G4HC	227017	Drive Shaft	38T	25	22	50	94.5	570	
	1998.02-2014.12	2014.12	MT	R	F		Hatchback Engine G4HC	224104	Drive Shaft		25	22	50	94.5	809	
	1998.02-2014.12	2014.12	AT	R	F		Hatchback Engine G4HC	224033	Drive Shaft	38T	25	22	50	94.5	844	

YEAR	TRANSM	L/R	F/R	REMARKS	GSP Ref.	PRODUCT	ABS	Technical Specifications						
								A	B	C	H	L	P	
HYUNDAI														
ATOS (MX)/AMICA/ATOZ														
1.0 i (40 kW)	1998.02-2014.12	-	L	F	Hatchback Engine G4HC	224105	Drive Shaft		25	22	50	94.5	596	
	1998.02-2014.12	AT/MT	L/R	F	Hatchback Engine G4HC	824004	Outer Joint	38T	25	19	50	94.5	52.5	M
	1998.02-2014.12	-	L	F	Hatchback Engine G4HC	224034	Drive Shaft	38T	25	22	50	94.5	596	
	1998.02-2014.12	-	-	F	Hatchback Engine G4HC	824005	Outer Joint		25	19	50	96	52	M
	1998.02-2014.12	AT/MT	L/R	F	Hatchback Engine G4HC	824011	Outer Joint		25	19	50	94.5	52.5	M
1.0 i (41 kW)	1998.02-2002.03	MT	R	F	Hatchback Engine G4HC	224104	Drive Shaft		25	22	50	94.5	809	
	1998.02-2002.03	-	L	F	Hatchback Engine G4HC	224034	Drive Shaft	38T	25	22	50	94.5	596	
1.0 i (43 kW)	2001.03-2003.07	-	-	-	Hatchback Engine G4HC-E	899025	Outer Joint		25	20	50	94.5	52.5	I
	2001.03-2003.07	AT	L	F	Hatchback Engine G4HC-E	227017	Drive Shaft	38T	25	22	50	94.5	570	
	2001.03-2003.07	MT	R	F	Hatchback Engine G4HC-E	224104	Drive Shaft		25	22	50	94.5	809	
	2001.03-2003.07	AT	R	F	Hatchback Engine G4HC-E	224033	Drive Shaft	38T	25	22	50	94.5	844	
	2001.03-2003.07	AT/MT	L/R	F	Hatchback Engine G4HC-E	824004	Outer Joint	38T	25	19	50	94.5	52.5	M
	2001.03-2003.07	-	L	F	Hatchback Engine G4HC-E	224034	Drive Shaft	38T	25	22	50	94.5	596	
	2001.03-2003.07	-	-	F	Hatchback Engine G4HC-E	824005	Outer Joint		25	19	50	96	52	M
	2001.03-2003.07	AT/MT	L/R	F	Hatchback Engine G4HC-E	824011	Outer Joint		25	19	50	94.5	52.5	M
1.1 (43 kW)	2003.08-2005.05	-	-	F	Hatchback Engine G4HD	824159	Outer Joint	38T	25	20	50	94.5	56	I
	2003.08-2005.05	AT/MT	L/R	F	Hatchback Engine G4HD	824004	Outer Joint	38T	25	19	50	94.5	52.5	M
	2003.08-2005.05	AT/MT	L/R	F	Hatchback Engine G4HD	824011	Outer Joint		25	19	50	94.5	52.5	M
1.1 (45 kW)	2003.06-2010.12	-	-	F	Hatchback Engine G4HG	824159	Outer Joint	38T	25	20	50	94.5	56	I
	2003.06-2010.12	MT	L/R	F	Hatchback Engine G4HG	699106	Inner Joint		22	20	35	52	86	
	2003.06-2010.12	MT	R	F	Hatchback Engine G4HG	224547	Drive Shaft	38T	25	22	50	94.5	591	
	2003.06-2010.12	MT	L	F	Hatchback Engine G4HG	224544	Drive Shaft	38T	25	22	50	94.5	804	
1.1 (46 kW)	1997.01-2014.12	-	-	F	Hatchback Engine G4HG	824159	Outer Joint	38T	25	20	50	94.5	56	I
	1997.01-2014.12	MT	L/R	F	Hatchback Engine G4HG	824004	Outer Joint	38T	25	19	50	94.5	52.5	M
	1997.01-2014.12	MT	L/R	F	Hatchback Engine G4HG	699106	Inner Joint		22	20	35	52	86	
	1997.01-2014.12	MT	R	F	Hatchback Engine G4HG	224547	Drive Shaft	38T	25	22	50	94.5	591	
	1997.01-2014.12	MT	L	F	Hatchback Engine G4HG	224544	Drive Shaft	38T	25	22	50	94.5	804	
ATOS PRIME I (MX)														
1.1 12V (46 kW)	2004.03-	-	-	-	-	824014	Outer Joint		25	20	50	94.5	56	I
	2004.03-	-	-	-	-	824099	Outer Joint	38T	25	20	50	94.5	56	I
ATTITUDE														
1.6	2011-	2013	-	-	-	839263	Outer Joint	48T	25	22	52.5	92.5	60	M
AVEO														
1.5	2006.01-	-	MT/AT	-	-	812049	Outer Joint		22	22	52	95.5	53.5	O
AZERA														
-	2006-	-	-	L	-	224127	Drive Shaft	47T	30	28	65	95	662	
	2006-	-	-	R	-	224128	Drive Shaft	47T	30	28	65	95	981.5	
2.4 2WD	2010-2014	6AT	R	-	THETA 2	224261	Drive Shaft	48T	27	27	62	92.5	970	
	2010-2014	6AT	L	-	THETA 2	224262	Drive Shaft	48T	27	27	62	92.5	672	
2.7 2WD	2006-2010	5AT	R	-	MU > DOHC MPI	224142	Drive Shaft	47T	27	28	62	94.5	974	
	2006-2010	5AT	L	-	MU > DOHC MPI	224143	Drive Shaft	47T	27	27	62	94.5	666	
2.7 V6	2007-	-	AT	L	-	224143	Drive Shaft	47T	27	27	62	94.5	666	
	2007-	-	AT	R	-	224142	Drive Shaft	47T	27	28	62	94.5	974	
3.0	-	-	-	R	F	224320	Drive Shaft	48T	30	28	65	93	982	
	2011-	2014	-	R	F	224320	Drive Shaft	48T	30	28	65	93	982	
3.3	2005-2010	5AT	R	-	LAMBDA	224128	Drive Shaft	47T	30	28	65	95	981.5	
	2005-2010	5AT	L	-	LAMBDA	224127	Drive Shaft	47T	30	28	65	95	662	
AZERA	2011-2014	-	R	F	-	624079	Inner Joint		28	35	33	343.5	164.5	
	2011-2014	-	R	F	-	824195	Outer Joint		30	36	65	93	67.5	I
AZERA 11														
-	2011.12-2013.08	-	R	F	-	624079	Inner Joint		28	35	33	343.5	164.5	
	2011.12-2013.08	-	R	F	-	224320	Drive Shaft	48T	30	28	65	93	982	
	2011.12-2013.08	-	R	F	-	824195	Outer Joint		30	36	65	93	67.5	I
3.0	2011-	2014	-	L	-	224270	Drive Shaft	48T	30	28	65	93	654	
	2011-	2014	-	R	-	224394	Drive Shaft	48T	30	28	65	93	985	
	2011-	2014	-	L	-	224395	Drive Shaft	48T	30	28	65	93	654	
	2011.01-2013.08	-	R	F	LAMBDA 2	624079	Inner Joint		28	35	33	343.5	164.5	
	2011.01-2013.08	-	R	F	LAMBDA 2	224320	Drive Shaft	48T	30	28	65	93	982	
	2011.01-2013.08	-	R	F	LAMBDA 2	224320	Drive Shaft	48T	30	28	65	93	982	
	2011.01-2013.08	-	R	F	LAMBDA 2	824195	Outer Joint		30	36	65	93	67.5	I
	2011.03-2013.08	-	R	F	LAMBDA 2	624079	Inner Joint		28	35	33	343.5	164.5	
	2011.03-2013.08	-	R	F	LAMBDA 2	224320	Drive Shaft	48T	30	28	65	93	982	
	2011.03-2013.08	-	R	F	LAMBDA 2	824195	Outer Joint		30	36	65	93	67.5	I
CARNIVAL I (UP)														
2.5 (121kW)	1999.08-2001.10	AT	-	-	RH	227019	Drive Shaft	54T	28	28	56	102	657	

YEAR	TRANSM	L/R	F/R	REMARKS	GSP Ref.	PRODUCT	ABS	Technical Specifications								
								A	B	C	H	L	P			
HYUNDAI COUPE																
1.6	2003-2004	-	L	-		224364	Drive Shaft	44T	25	25	50	95.5	655			
	2003-2004	5MT/4AT	R	-		224363	Drive Shaft	44T	25	25	50	95.5	936			
	2003-2004	-	L	-		839190	Outer Joint	44T	25	23	50	95.5	60.5	M		
	2003-2004	-	L	-		624032	Inner Joint		25	23	35	63	88			
2.7	2003.04-2004.09	4AT	L	F		624043	Inner Joint		27	25	41	62.8	92.5			
	2003.04-2004.09	4AT	L	F		224508	Drive Shaft	44T	27	27	60	95	650			
	2007.09-2008.09	6MT	R	F		224543	Drive Shaft	44T	27	26	60	95	582			
COUPE (GK)																
1.6 16V (77 kW)	2002.03-2009.08	MT	-	F	Coupe Engine G4ED-G	824038	Outer Joint	44T	25	25	50	94.5	65	M		
	2002.03-2009.08	AT	L	F	Coupe Engine G4ED-G	224203	Drive Shaft	44T	25	25	50	94.5	652			
	2002.03-2009.08	MT	L	F	Coupe Engine G4ED-G	224162	Drive Shaft	44T	25	25	50	94.5	643			
	2002.03-2009.08	MT	R	F	Coupe Engine G4ED-G	224163	Drive Shaft	44T	25	25	50	94.5	928			
	2002.03-2009.08	MT	R	F	Coupe Engine G4ED-G	224502	Drive Shaft	44T	25	25	50	94.5	938			
	2002.03-2009.08	MT	-	F	Coupe Engine G4ED-G	839245	Outer Joint		25	23	50	96	59	M		
	2002.03-2009.08	AT	R	F	Coupe Engine G4ED-G	224204	Drive Shaft	44T	25	25	50	94.5	936			
	2002.03-2009.08	-	-	F	Coupe Engine G4ED-G	824120	Outer Joint	44T	25	23	50	95.5	60.5	M		
	2002.03-2009.08	-	-	-	Coupe Engine G4ED-G	839276	Outer Joint		25	23	50	95.5	60.5	M		
	2002.03-2009.08	-	-	F	Coupe Engine G4ED-G	839140	Outer Joint	44T	25	23	50	95	60.5	M		
	2002.03-2009.08	-	-	F	Coupe Engine G4ED-G	839185	Outer Joint	44T	25	23	50	94.5	63.5	M		
	2002.03-2009.08	-	L	-	Coupe Engine G4ED-G	224095	Drive Shaft	44T	25	25	50	94.5	652			
	2002.03-2009.08	MT	-	-	Coupe Engine G4ED-G	639041	Inner Joint		25	23	35	63	92.5			
	2002.03-2009.08	MT	L/R	F	Coupe Engine G4ED-G	824024	Outer Joint		25	25	50	94.5	65	M		
1.6 16V (79 kW)	2002.03-2009.08	MT	-	F	Coupe Engine G4ED-G	824038	Outer Joint	44T	25	25	50	94.5	65	M		
	2002.03-2009.08	AT	L	F	Coupe Engine G4ED-G	224203	Drive Shaft	44T	25	25	50	94.5	652			
	2002.03-2009.08	MT	L	F	Coupe Engine G4ED-G	224162	Drive Shaft	44T	25	25	50	94.5	643			
	2002.03-2009.08	MT	R	F	Coupe Engine G4ED-G	224163	Drive Shaft	44T	25	25	50	94.5	928			
	2002.03-2009.08	MT	-	F	Coupe Engine G4ED-G	839245	Outer Joint		25	23	50	96	59	M		
	2002.03-2009.08	AT	R	F	Coupe Engine G4ED-G	224204	Drive Shaft	44T	25	25	50	94.5	936			
	2002.03-2009.08	-	-	F	Coupe Engine G4ED-G	824120	Outer Joint	44T	25	23	50	95.5	60.5	M		
	2002.03-2009.08	-	-	-	Coupe Engine G4ED-G	839276	Outer Joint		25	23	50	95.5	60.5	M		
	2002.03-2009.08	-	-	F	Coupe Engine G4ED-G	839140	Outer Joint	44T	25	23	50	95	60.5	M		
	2002.03-2009.08	-	-	F	Coupe Engine G4ED-G	839185	Outer Joint	44T	25	23	50	94.5	63.5	M		
	2002.03-2009.08	-	L	-	Coupe Engine G4ED-G	224095	Drive Shaft	44T	25	25	50	94.5	652			
	2002.03-2009.08	MT	-	-	Coupe Engine G4ED-G	639041	Inner Joint		25	23	35	63	92.5			
	2002.03-2009.08	MT	L/R	F	Coupe Engine G4ED-G	824024	Outer Joint		25	25	50	94.5	65	M		
	2002.03-2009.08	MT	-	F	Coupe Engine G4ED-G	809002	Outer Joint		25	23	50	94.5	63.5	M		
2.0 (100 kW)	2001.08-2009.08	MT	-	F	Coupe Engine G4GC-G	824038	Outer Joint	44T	25	25	50	94.5	65	M		
	2001.08-2009.08	AT	L	F	Coupe Engine G4GC-G	224203	Drive Shaft	44T	25	25	50	94.5	652			
	2001.08-2009.08	MT	L	F	Coupe Engine G4GC-G	224162	Drive Shaft	44T	25	25	50	94.5	643			
	2001.08-2009.08	MT	R	F	Coupe Engine G4GC-G	224163	Drive Shaft	44T	25	25	50	94.5	928			
	2001.08-2009.08	MT	R	F	Coupe Engine G4GC-G	224502	Drive Shaft	44T	25	25	50	94.5	938			
	2001.08-2009.08	AT	R	F	Coupe Engine G4GC-G	224204	Drive Shaft	44T	25	25	50	94.5	936			
	2001.08-2009.08	-	-	F	Coupe Engine G4GC-G	839185	Outer Joint	44T	25	23	50	94.5	63.5	M		
	2001.08-2009.08	5MT	-	F	Coupe Engine G4GC-G	824061	Outer Joint	44T	25	23	50	94.5	63.5	M		
	2001.08-2009.08	-	-	-	Coupe Engine G4GC-G	824038	Outer Joint	44T	25	23	50	94.5	63.5	M		
	2001.08-2009.08	AT	L	F	Coupe Engine G4GC-G	224203	Drive Shaft	44T	25	25	50	94.5	652			
	2001.08-2009.08	MT	L	F	Coupe Engine G4GC-G	224162	Drive Shaft	44T	25	25	50	94.5	643			
2.0 (102 kW)	2002.03-2009.08	MT	-	F	Coupe Engine G4GC-G	824038	Outer Joint	44T	25	25	50	94.5	65	M		
	2002.03-2009.08	AT	L	F	Coupe Engine G4GC-G	224203	Drive Shaft	44T	25	25	50	94.5	652			
	2002.03-2009.08	MT	L	F	Coupe Engine G4GC-G	224162	Drive Shaft	44T	25	25	50	94.5	643			
	2002.03-2009.08	MT	R	F	Coupe Engine G4GC-G	224163	Drive Shaft	44T	25	25	50	94.5	928			
	2002.03-2009.08	MT	R	F	Coupe Engine G4GC-G	224502	Drive Shaft	44T	25	25	50	94.5	938			
	2002.03-2009.08	AT	R	F	Coupe Engine G4GC-G	224204	Drive Shaft	44T	25	25	50	94.5	936			
	2002.03-2009.08	-	-	F	Coupe Engine G4GC-G	839185	Outer Joint	44T	25	23	50	94.5	63.5	M		
	2002.03-2009.08	-	L	-	Coupe Engine G4GC-G	224095	Drive Shaft	44T	25	25	50	94.5	652			
2.0 GLS (105 kW)	2003.02-2009.08	MT	-	F	Coupe Engine G4GC-G	824038	Outer Joint	44T	25	25	50	94.5	65	M		
	2003.02-2009.08	AT	L	F	Coupe Engine G4GC-G	224203	Drive Shaft	44T	25	25	50	94.5	652			
	2003.02-2009.08	MT	L	F	Coupe Engine G4GC-G	224162	Drive Shaft	44T	25	25	50	94.5	643			
	2003.02-2009.08	MT	R	F	Coupe Engine G4GC-G	224163	Drive Shaft	44T	25	25	50	94.5	928			
	2003.02-2009.08	MT	R	F	Coupe Engine G4GC-G	224502	Drive Shaft	44T	25	25	50	94.5	938			
	2003.02-2009.08	AT	R	F	Coupe Engine G4GC-G	224204	Drive Shaft	44T	25	25	50	94.5	936			
	2003.02-2009.08	-	-	F	Coupe Engine G4GC-G	839185	Outer Joint	44T	25	23	50	94.5	63.5	M		
2.7 V6 (121 kW)	2007.01-2009.08	-	-	F	Coupe Engine G6BA-G	824060	Outer Joint	44T	27	26	60	95	69	M		
	2002.03-2009.08	-	-	F	Coupe Engine G6BA-G	824060	Outer Joint	44T	27	26	60	95	69	M		
COUPE (RD)/TIBURON																
1.6 16V (85 kW)	1998.03-2002.04	-	R	F	Coupe Engine G4GR	824044	Outer Joint	29T	25	25	50	94.5	65	M		
	1998.03-2002.04	MT	L	F	Coupe Engine G4GR	224162	Drive Shaft	44T	25	25	50	94.5	643			
	1998.03-2002.04	MT	R	F	Coupe Engine G4GR	224163	Drive Shaft	44T	25	25	50	94.5	928			

YEAR	TRANSM	L/R	F/R	REMARKS	GSP Ref.	PRODUCT	ABS	Technical Specifications							
								A	B	C	H	L	P		
HYUNDAI															
COUPE (RD)/TIBURON															
1.6 16V (85 kW)	1998.03-	2002.04	-	R	F	Coupe Engine G4GR	839033	Outer Joint		25	25	50	95	65	M
	1998.03-	2002.04	-	L	F	Coupe Engine G4GR	839032	Outer Joint		25	23	50	95	60.5	M
	1998.03-	2002.04	-	-	-	Coupe Engine G4GR	624072	Inner Joint		25	30	35	62.5	88	
	1998.03-	2002.04	MT	-	-	Coupe Engine G4GR	639041	Inner Joint		25	23	35	63	92.5	
	1998.03-	2002.04	MT	-	F	Coupe Engine G4GR	224113	Drive Shaft	44T	25		50	95.5	554	
	1998.03-	2002.04	MT	L/R	F	Coupe Engine G4GR	824024	Outer Joint		25	25	50	94.5	65	M
1.6 i 16V (79 kW)	2000.08-	2002.01	-	-	-	Coupe Engine G4ED-G	624072	Inner Joint		25	30	35	62.5	88	
	2000.08-	2002.01	MT	-	-	Coupe Engine G4ED-G	639041	Inner Joint		25	23	35	63	92.5	
1.6 i 16V (84 kW)	1996.12-	2002.04	-	R	F	Coupe Engine G4ED	824044	Outer Joint	29T	25	25	50	94.5	65	M
	1996.12-	2002.04	MT	L	F	Coupe Engine G4ED	224162	Drive Shaft	44T	25	25	50	94.5	643	
	1996.12-	2002.04	MT	R	F	Coupe Engine G4ED	224163	Drive Shaft	44T	25	25	50	94.5	928	
	1996.12-	2002.04	-	R	F	Coupe Engine G4ED	839033	Outer Joint		25	25	50	95	65	M
	1996.12-	2002.04	-	L	F	Coupe Engine G4ED	839032	Outer Joint		25	23	50	95	60.5	M
	1996.12-	2002.04	-	-	-	Coupe Engine G4ED	624072	Inner Joint		25	30	35	62.5	88	
	1996.12-	2002.04	MT	-	-	Coupe Engine G4ED	639041	Inner Joint		25	23	35	63	92.5	
	1996.12-	2002.04	MT	-	F	Coupe Engine G4ED	224113	Drive Shaft	44T	25		50	95.5	554	
	1996.12-	2002.04	MT	L/R	F	Coupe Engine G4ED	824024	Outer Joint		25	25	50	94.5	65	M
2.0 (101 kW)	1999.08-	2002.01	-	-	F	Coupe Engine G4DF	824038	Outer Joint	44T	25	25	50	94.5	65	M
	1999.08-	2002.01	MT	L	F	Coupe Engine G4DF	224162	Drive Shaft	44T	25	25	50	94.5	643	
	1999.08-	2002.01	MT	R	F	Coupe Engine G4DF	224163	Drive Shaft	44T	25	25	50	94.5	928	
	1999.08-	2002.01	-	-	F	Coupe Engine G4DF	839185	Outer Joint	44T	25	23	50	94.5	63.5	M
	1999.08-	2002.01	MT	L/R	F	Coupe Engine G4DF	824024	Outer Joint		25	25	50	94.5	65	M
2.0 16V (102 kW)	1996.08-	2002.04	-	-	F	Coupe Engine G4GF	824038	Outer Joint	44T	25	25	50	94.5	65	M
	1996.08-	2002.04	MT	-	F	Coupe Engine G4GF	824044	Outer Joint	29T	25	25	50	94.5	65	M
	1996.08-	2002.04	MT	L	F	Coupe Engine G4GF	224162	Drive Shaft	44T	25	25	50	94.5	643	
	1996.08-	2002.04	MT	R	F	Coupe Engine G4GF	224163	Drive Shaft	44T	25	25	50	94.5	928	
	1996.08-	2002.04	-	-	F	Coupe Engine G4GF	839185	Outer Joint	44T	25	23	50	94.5	63.5	M
	1996.08-	2002.04	MT	L/R	F	Coupe Engine G4GF	824024	Outer Joint		25	25	50	94.5	65	M
F2 Evolution (115 kW)	1999.01-	1999.05	-	-	F	Coupe Engine G4GF	824038	Outer Joint	44T	25	25	50	94.5	65	M
	1999.01-	1999.05	MT	L	F	Coupe Engine G4GF	224162	Drive Shaft	44T	25	25	50	94.5	643	
	1999.01-	1999.05	MT	R	F	Coupe Engine G4GF	224163	Drive Shaft	44T	25	25	50	94.5	928	
	1999.01-	1999.05	-	-	F	Coupe Engine G4GF	839185	Outer Joint	44T	25	23	50	94.5	63.5	M
	1999.01-	1999.05	MT	L/R	F	Coupe Engine G4GF	824024	Outer Joint		25	25	50	94.5	65	M
DF 12															
-	2011-	-	-	-	F	-	624043	Inner Joint		27	25	41	62.8	92.5	
	2011-	-	-	-	F	-	224389	Drive Shaft	48T	27	27	62	92.5	983	
	2011-	-	-	-	F	-	824194	Outer Joint		27	25	62	92.5	61	M
ELANTRA															
-	-	-	-	L	F	-	224077	Drive Shaft	46T	27	27	60	94.5	671	
	-	-	-	R	F	-	224076	Drive Shaft	46T	27	27	60	94.5	940	
	-	-	-	L	F	-	824055	Outer Joint	46T	27	30	60	94.5	57	M
	-	-	-	R	F	-	824055	Outer Joint	46T	27	30	60	94.5	57	M
	1993-	1995	-	-	-	-	839063	Outer Joint	47T	25	23	50	94.5	63.5	M
	2003.04-	2006.08	-	L	F	-	624043	Inner Joint		27	25	41	62.8	92.5	
	2003.04-	2006.08	-	L	F	-	224508	Drive Shaft	44T	27	27	60	95	650	
	2006-	-	-	L	F	-	224077	Drive Shaft	46T	27	27	60	94.5	671	
	2006-	-	-	L	F	-	624015	Inner Joint		27	30	41	62	90	
	2006-	-	-	L	F	-	824068	Outer Joint		27	30	60	94.5	57	M
	2006-	-	-	L	F	-	824055	Outer Joint	46T	27	30	60	94.5	57	M
	2007-	-	-	R	-	-	224076	Drive Shaft	46T	27	27	60	94.5	940	
	2007-	-	-	L	-	-	224077	Drive Shaft	46T	27	27	60	94.5	671	
	2007-	-	-	R	-	-	624015	Inner Joint		27	30	41	62	90	
	2007-	-	-	L	-	-	624015	Inner Joint		27	30	41	62	90	
	2007-	-	-	R	-	-	824055	Outer Joint	46T	27	30	60	94.5	57	M
	2007-	-	-	L	-	-	824055	Outer Joint	46T	27	30	60	94.5	57	M
	2007-	-	-	R	-	-	824068	Outer Joint		27	30	60	94.5	57	M
	2007-	-	-	L	-	-	824068	Outer Joint		27	30	60	94.5	57	M
	2010-	2013	6AT	L	F	2WD	224416	Drive Shaft	46T	27	27	60	95.5	667	
	2010-	2013	6AT	L	F	2WD	624089	Inner Joint		27	22	30	67.5	81	
	2010-	2013	6AT	L	F	2WD	824334	Outer Joint		27	30	60	95.5	56.5	M
	2013-	-	6AT	L	F	2WD	224416	Drive Shaft	46T	27	27	60	95.5	667	
	2013-	-	6AT	L	F	2WD	624089	Inner Joint		27	22	30	67.5	81	
	2013-	-	6AT	L	F	2WD	824334	Outer Joint		27	30	60	95.5	56.5	M
1.5	1990-	-	-	L	-	-	224020	Drive Shaft		25	25	50	95	596.5	
	1990-	-	-	R	-	-	224021	Drive Shaft		25	25	50	95	923.5	
1.6	-	-	-	-	-	-	824031	Outer Joint	44T	27	23	60	95	60	M

YEAR	TRANSM	L/R	F/R	REMARKS	GSP Ref.	PRODUCT	ABS	Technical Specifications								
								A	B	C	H	L	P			
HYUNDAI ELANTRA																
1.6	-	-	-	L	-											
	-	-	-	R	-											
	-	-	4AT	-	-											M
	-	-	4AT	-	-	Engine										M
	-	-	4AT	-	-	Engine										M
2000-	2006	-	R	F	-											
2000-	-	4AT	R	F	2WD											
2000-	2006	-	L	F	-											
2000-	-	4AT	R	F	2WD											
2000-	2006	-	R	F	-											
2000-	2006	-	L	F	-											M
2000-	2006	-	L	F	-											M
2000-	-	4AT	R	F	2WD											M
2005.05-	2006.08	5MT	L	F	-											
2005.05-	2006.08	5MT	L	F	-											
2006.11-	2006.11	-	L	F	-											
2006.11-	2006.11	-	L	F	-											M
2007.04-	2008.03	5MT	R	F	-											
2007.04-	2008.03	5MT	L	F	-											
2007.04-	2008.03	5MT	R	F	-											M
2007.04-	2008.03	5MT	L	F	-											M
2007.04-	2008.03	5MT	R	F	-											
2008.03-	2008.12	5MT	L	F	-											
2008.03-	2008.12	5MT	R	F	-											M
2008.03-	2008.12	5MT	L	F	-											M
2008.03-	2008.12	5MT	R	F	-											
2008.03-	2008.12	5MT	R	F	-											
2008.06-	2011.05	5MT	L	F	-											
2008.06-	2011.05	4AT	L	F	-											
2008.06-	2011.05	5MT	R	F	-											
2008.06-	2011.05	4AT	R	F	-											
2008.06-	2010.01	-	R	F	-											
2008.07-	2009.05	-	R	F	-											
2008.12-	2009.02	5MT	L	F	-											
2008.12-	2009.02	5MT	R	F	-											M
2008.12-	2009.02	5MT	L	F	-											M
2008.12-	2009.02	5MT	R	F	-											
2008.12-	2009.02	5MT	R	F	-											
2009.05-	2011.05	4AT	L	F	-											
2009.05-	2011.05	5MT	L	F	-											
2009.05-	2011.05	4AT	R	F	-											
2009.05-	2011.05	5MT	R	F	-											
2009.05-	2010.01	-	R	F	-											
2011.01-	2013.10	6MT	L	F	-											
2011.01-	2013.10	6MT	L	F	-											
2011.01-	2013.10	6MT	L	F	-											M
1.6 16V	2006-	2010	-	L	-											
	2006-	2010	-	R	-											
1.6 2WD	2003-	2005	5MT	L	-											
	2003-	2005	5MT	R	-											
	2003-	2005	5MT	L	-											M
	2003-	2005	5MT	L	-											
	2011-	2013	6AT	R	-	GAMMA										
	2011-	2013	6AT	R	-	GAMMA										
	2011-	2013	6AT	R	-	GAMMA										M
1.8	2000.01-	2002.12	MT	L	-											
	2000.01-	2002.12	MT	L	-											
	2000.01-	2002.12	MT	R	-											
	2000.01-	2002.12	MT	R	-											
	2003.04-	2003.06	4AT	R	F	-										M
	2003.04-	2003.06	4AT	L	F	-										M
	2003.04-	2003.06	4AT	R	F	-										
	2003.04-	2003.06	4AT	L	F	-										
	2003.04-	2003.06	4AT	R	F	-										
	2003.04-	2003.06	4AT	L	F	-										
	2003.06-	2005.05	5MT	L	F	-										
	2003.06-	2005.05	5MT	R	F	-										

YEAR	TRANS	L/R	F/R	REMARKS	GSP Ref.	PRODUCT	ABS	Technical Specifications							
								A	B	C	H	L	P		
HYUNDAI ELANTRA															
1.8	2003.06-2005.05	5MT	L	F	-	668001	Inner Joint		25	23	35	63	88		
	2003.06-2005.05	5MT	R	F	-	668001	Inner Joint		25	23	35	63	88		
1.8 2WD	2011-2013	6AT	R	-	NU	624065	Inner Joint		27	22	30	68	77		
	2011-2013	6AT	R	-	NU	224265	Drive Shaft		27	27	60	95	957		
	2011-2013	6AT	R	-	NU	824144	Outer Joint		27	24	60	95	59	M	
	2012-	6MT	R	-	NU	224249	Drive Shaft	46T	27	27	60	94.5	964		
	2012-	6MT	L	-	NU	224248	Drive Shaft	46T	27	27	60	94.5	681		
	2012-	6MT	R	-	NU	624061	Inner Joint		27	22	41	62	86		
1600	-	4AT	-	-	Engine	839147	Outer Joint		25	30	50	96	59	M	
	-	4AT	-	-	Engine	839147	Outer Joint		25	30	50	96	59	M	
2.0	2001-2006	AT	L	F	GT Hatchback 5Door	639069	Inner Joint		25	23	41	63	92.5		
	2001-2006	AT	L	F	GT Hatchback 5Door	824023	Outer Joint		25	23	50	94.5	63.5	M	
	2005.05-2006.08	5MT	L	F	-	239291	Drive Shaft	44T	25	25	50	94.5	657		
	2005.05-2006.08	5MT	L	F	-	239291	Drive Shaft	44T	25	25	50	94.5	657		
	2005.05-2006.08	5MT	R	F	-	624049	Inner Joint		25	25	35	63	87.5		
	2005.05-2006.08	5MT	L	F	-	624049	Inner Joint		25	25	35	63	87.5		
	2005.05-2006.08	5MT	L	F	-	624049	Inner Joint		25	25	35	63	87.5		
	2005.05-2006.08	4AT	R	F	-	639069	Inner Joint		25	23	41	63	92.5		
	2006-	MT	R	F	-	224076	Drive Shaft	46T	27	27	60	94.5	940		
	2006-	-	R	F	-	224076	Drive Shaft	46T	27	27	60	94.5	940		
	2006-	5MT	R	F	2WD	224076	Drive Shaft	46T	27	27	60	94.5	940		
	2006-	5MT	L	F	2WD	224077	Drive Shaft	46T	27	27	60	94.5	671		
	2006-	-	L	F	-	224077	Drive Shaft	46T	27	27	60	94.5	671		
	2006-	MT	R	F	-	624015	Inner Joint		27	30	41	62	90		
	2006-	-	R	F	-	624015	Inner Joint		27	30	41	62	90		
	2006-	5MT	R	F	2WD	624015	Inner Joint		27	30	41	62	90		
	2006-	5MT	L	F	2WD	624015	Inner Joint		27	30	41	62	90		
	2006-	MT	R	F	-	824068	Outer Joint		27	30	60	94.5	57	M	
	2006-	-	R	F	-	824068	Outer Joint		27	30	60	94.5	57	M	
	2006-	5MT	R	F	2WD	824068	Outer Joint		27	30	60	94.5	57	M	
	2006-	MT	R	F	-	824055	Outer Joint	46T	27	30	60	94.5	57	M	
	2006-	5MT	L	F	2WD	824068	Outer Joint		27	30	60	94.5	57	M	
	2006-	-	R	F	-	824055	Outer Joint	46T	27	30	60	94.5	57	M	
	2006-	5MT	R	F	2WD	824055	Outer Joint	46T	27	30	60	94.5	57	M	
	2006-	5MT	L	F	2WD	824055	Outer Joint	46T	27	30	60	94.5	57	M	
	2006-	-	L	F	-	824055	Outer Joint	46T	27	30	60	94.5	57	M	
2.0 2WD	2012-2013	6AT	R	-	-	624065	Inner Joint		27	22	30	68	77		
	2012-2013	6AT	R	-	-	224265	Drive Shaft		27	27	60	95	957		
	2012-2013	6AT	R	-	-	824144	Outer Joint		27	24	60	95	59	M	
ELANTRA (AD)/AVANTE															
2.0 (112 kW)	2015.1-	AT	-	F	Saloon Engine G4NA	824227	Outer Joint	46T	27	24	60	92.5	58	M	
ELANTRA (HD)/AVANTE															
1.6 CRDi (85 kW)	2005.11-2011.12	6AT	-	F	Saloon Engine D4FB	824227	Outer Joint	46T	27	24	60	92.5	58	M	
	2005.11-2011.12	MT	-	-	Saloon Engine D4FB	624093	Inner Joint		25	22	41	63	86.5		
	2005.11-2011.12	4AT	-	-	Saloon Engine D4FB	624072	Inner Joint		25	30	35	62.5	88		
	2005.11-2011.12	5MT	-	-	Saloon Engine D4FB	639041	Inner Joint		25	23	35	63	92.5		
	2005.11-2011.12	5MT	-	F	Saloon Engine D4FB	824120	Outer Joint	44T	25	23	50	95.5	60.5	M	
1.6 CVVT (90 kW)	2006.06-2011.06	5MT	-	F	Saloon Engine G4FC	824120	Outer Joint	44T	25	23	50	95.5	60.5	M	
ELANTRA (JK)/AVANTE															
2.0 (129 kW)	2013.09-2015.12	6MT	R	F	Coupe Engine G4NA	224509	Drive Shaft		27	27	60	95	967		
ELANTRA (MD UD)/i35/AVANTE															
1.6 (94 kW)	2011.06-	AT	-	F	Saloon Engine G4FG	824227	Outer Joint	46T	27	24	60	92.5	58	M	
1.6 (97 kW)	2011.06-2015.12	AT	-	F	Saloon Engine G4FG	824227	Outer Joint	46T	27	24	60	92.5	58	M	
1.6 CRDi (100 kW)	2015.10-	6AT	-	F	Saloon Engine D4FB	824227	Outer Joint	46T	27	24	60	92.5	58	M	
1.6 CRDi (94 kW)	2011.02-2015.12	AT	-	F	Saloon Engine D4FB	824227	Outer Joint	46T	27	24	60	92.5	58	M	
1.6 Hybrid (84 kW)	2010.09-2015.08	AT	-	F	Saloon Engine G4FC	824305	Outer Joint	46T	27	30	60	95.5	56.5	M	
2.0 GDI (112 kW)	2015.10-	AT	-	F	Saloon Engine G4NA	824227	Outer Joint	46T	27	24	60	92.5	58	M	
ELANTRA (MD, UD)/i35/AVANTE															
1.8 (110 kW)	2010.09-	AT	-	F	Saloon Engine G4NB	824305	Outer Joint	46T	27	30	60	95.5	56.5	M	
ELANTRA (XD)/AVANTE															
1.5 16V (75 kW)	2000.09-2006.07	4AT	-	F	Saloon Engine G4EC-G	839014	Outer Joint		25	30	50	95	60.5	M	
	2000.09-2006.07	5MT	-	F	Saloon Engine G4EC-G	839245	Outer Joint		25	23	50	96	59	M	
	2000.09-2006.07	4AT	-	-	Saloon Engine G4EC-G	624072	Inner Joint		25	30	35	62.5	88		
	2000.09-2006.07	5MT	-	-	Saloon Engine G4EC-G	639041	Inner Joint		25	23	35	63	92.5		
	2000.09-2006.07	5MT	-	F	Saloon Engine G4EC-G	824120	Outer Joint	44T	25	23	50	95.5	60.5	M	
	2000.09-2006.07	5MT	-	F	Saloon Engine G4EC-G	809002	Outer Joint		25	23	50	94.5	63.5	M	

YEAR	TRANSM	L/R	F/R	REMARKS	GSP Ref.	PRODUCT	ABS	Technical Specifications						
								A	B	C	H	L	P	
HYUNDAI ELANTRA (XD)/AVANTE														
1.5 D (82 kW)	2000.06-2006.07	4AT	-	F Saloon Engine D4FA	839014	Outer Joint		25	30	50	95	60.5	M	
	2000.06-2006.07	5MT	-	F Saloon Engine D4FA	839245	Outer Joint		25	23	50	96	59	M	
	2000.06-2006.07	4AT	-	- Saloon Engine D4FA	624072	Inner Joint		25	30	35	62.5	88		
	2000.06-2006.07	5MT	-	- Saloon Engine D4FA	639041	Inner Joint		25	23	35	63	92.5		
	2000.06-2006.07	5MT	-	F Saloon Engine D4FA	824120	Outer Joint	44T	25	23	50	95.5	60.5	M	
	2000.06-2006.07	5MT	-	F Saloon Engine D4FA	809002	Outer Joint		25	23	50	94.5	63.5	M	
1.5 VVTi (77 kW)	2003.08-2006.05	5MT	-	F Hatchback	824120	Outer Joint	44T	25	23	50	95.5	60.5	M	
	2003.08-2006.05	5MT	-	F Saloon	824120	Outer Joint	44T	25	23	50	95.5	60.5	M	
1.6 (66 kW)	2000.06-2006.07	AT	-	F Saloon Engine G4GR	839014	Outer Joint		25	30	50	95	60.5	M	
	2000.06-2006.07	AT	-	F Hatchback Engine G4GR	839014	Outer Joint		25	30	50	95	60.5	M	
	2000.06-2006.07	4AT/5MT	-	- Saloon Engine G4GR	624093	Inner Joint		25	22	41	63	86.5		
	2000.06-2006.07	4AT/5MT	-	- Hatchback Engine G4GR	624093	Inner Joint		25	22	41	63	86.5		
	2000.06-2006.07	MT	-	F Saloon Engine G4GR	839245	Outer Joint		25	23	50	96	59	M	
	2000.06-2006.07	MT	-	F Hatchback Engine G4GR	839245	Outer Joint		25	23	50	96	59	M	
	2000.06-2006.07	-	-	F Saloon Engine G4GR	824120	Outer Joint	44T	25	23	50	95.5	60.5	M	
	2000.06-2006.07	AT	-	- Saloon Engine G4GR	624072	Inner Joint		25	30	35	62.5	88		
	2000.06-2006.07	-	-	F Hatchback Engine G4GR	824120	Outer Joint	44T	25	23	50	95.5	60.5	M	
	2000.06-2006.07	AT	-	- Hatchback Engine G4GR	624072	Inner Joint		25	30	35	62.5	88		
	2000.06-2006.07	MT	-	- Saloon Engine G4GR	639041	Inner Joint		25	23	35	63	92.5		
	2000.06-2006.07	MT	-	- Hatchback Engine G4GR	639041	Inner Joint		25	23	35	63	92.5		
	2000.06-2006.07	MT	-	F Saloon Engine G4GR	809002	Outer Joint		25	23	50	94.5	63.5	M	
	2000.06-2006.07	MT	-	F Hatchback Engine G4GR	809002	Outer Joint		25	23	50	94.5	63.5	M	
1.6 (77 kW)	2003.05-2006.07	AT	L	F Saloon Engine G4ED-G	224203	Drive Shaft	44T	25	25	50	94.5	652		
	2003.05-2006.07	AT	L	F Hatchback Engine G4ED-G	224203	Drive Shaft	44T	25	25	50	94.5	652		
	2003.05-2006.07	AT	-	F Saloon Engine G4ED-G	839014	Outer Joint		25	30	50	95	60.5	M	
	2003.05-2006.07	AT	-	F Hatchback Engine G4ED-G	839014	Outer Joint		25	30	50	95	60.5	M	
	2003.05-2006.07	MT	R	F Saloon Engine G4ED-G	224502	Drive Shaft	44T	25	25	50	94.5	938		
	2003.05-2006.07	MT	R	F Hatchback Engine G4ED-G	224502	Drive Shaft	44T	25	25	50	94.5	938		
	2003.05-2006.07	4AT/5MT	-	- Saloon Engine G4ED-G	624093	Inner Joint		25	22	41	63	86.5		
	2003.05-2006.07	4AT/5MT	-	- Hatchback Engine G4ED-G	624093	Inner Joint		25	22	41	63	86.5		
	2003.05-2006.07	AT	R	F Saloon Engine G4ED-G	224204	Drive Shaft	44T	25	25	50	94.5	936		
	2003.05-2006.07	AT	R	F Hatchback Engine G4ED-G	224204	Drive Shaft	44T	25	25	50	94.5	936		
	2003.05-2006.07	MT	-	F Saloon Engine G4ED-G	839245	Outer Joint		25	23	50	96	59	M	
	2003.05-2006.07	MT	-	F Hatchback Engine G4ED-G	839245	Outer Joint		25	23	50	96	59	M	
	2003.05-2006.07	-	-	F Saloon Engine G4ED-G	824120	Outer Joint	44T	25	23	50	95.5	60.5	M	
	2003.05-2006.07	-	-	F Hatchback Engine G4ED-G	824120	Outer Joint	44T	25	23	50	95.5	60.5	M	
	2003.05-2006.07	-	-	- Saloon Engine G4ED-G	839276	Outer Joint		25	23	50	95.5	60.5	M	
	2003.05-2006.07	-	-	- Hatchback Engine G4ED-G	839276	Outer Joint		25	23	50	95.5	60.5	M	
	2003.05-2006.07	-	-	F Saloon Engine G4ED-G	839140	Outer Joint	44T	25	23	50	95	60.5	M	
	2003.05-2006.07	-	-	F Hatchback Engine G4ED-G	839140	Outer Joint	44T	25	23	50	95	60.5	M	
	2003.05-2006.07	AT	-	- Saloon Engine G4ED-G	624072	Inner Joint		25	30	35	62.5	88		
	2003.05-2006.07	AT	-	- Hatchback Engine G4ED-G	624072	Inner Joint		25	30	35	62.5	88		
	2003.05-2006.07	-	-	F Saloon Engine G4ED-G	839185	Outer Joint	44T	25	23	50	94.5	63.5	M	
	2003.05-2006.07	-	-	F Hatchback Engine G4ED-G	839185	Outer Joint	44T	25	23	50	94.5	63.5	M	
	2003.05-2006.07	MT	-	- Saloon Engine G4ED-G	639041	Inner Joint		25	23	35	63	92.5		
	2003.05-2006.07	MT	-	- Hatchback Engine G4ED-G	639041	Inner Joint		25	23	35	63	92.5		
	2003.05-2006.07	MT	-	F Saloon Engine G4ED-G	809002	Outer Joint		25	23	50	94.5	63.5	M	
	2003.05-2006.07	MT	-	F Hatchback Engine G4ED-G	809002	Outer Joint		25	23	50	94.5	63.5	M	
1.6 (79 kW)	2000.06-2006.07	-	-	F Hatchback Engine G4ED-G	839014	Outer Joint		25	30	50	95	60.5	M	
	2000.06-2006.07	-	-	F Saloon Engine G4ED-G	839014	Outer Joint		25	30	50	95	60.5	M	
	2000.06-2006.07	-	-	F Hatchback Engine G4ED-G	824120	Outer Joint	44T	25	23	50	95.5	60.5	M	
	2000.06-2006.07	-	-	F Saloon Engine G4ED-G	824120	Outer Joint	44T	25	23	50	95.5	60.5	M	
	2000.06-2006.07	4AT/5MT	-	- Hatchback Engine G4ED-G	624093	Inner Joint		25	22	41	63	86.5		
	2000.06-2006.07	4AT/5MT	-	- Saloon Engine G4ED-G	624093	Inner Joint		25	22	41	63	86.5		
	2000.06-2006.07	MT	R	F Hatchback Engine G4ED-G	224502	Drive Shaft	44T	25	25	50	94.5	938		
	2000.06-2006.07	-	-	F Hatchback Engine G4ED-G	839245	Outer Joint		25	23	50	96	59	M	
	2000.06-2006.07	-	-	F Saloon Engine G4ED-G	839245	Outer Joint		25	23	50	96	59	M	
	2000.06-2006.07	-	-	- Hatchback Engine G4ED-G	839276	Outer Joint		25	23	50	95.5	60.5	M	
	2000.06-2006.07	-	-	- Saloon Engine G4ED-G	839276	Outer Joint		25	23	50	95.5	60.5	M	
	2000.06-2006.07	-	-	F Hatchback Engine G4ED-G	839140	Outer Joint	44T	25	23	50	95	60.5	M	
	2000.06-2006.07	-	-	F Saloon Engine G4ED-G	839140	Outer Joint	44T	25	23	50	95	60.5	M	
	2000.06-2006.07	-	-	F Hatchback Engine G4ED-G	839185	Outer Joint	44T	25	23	50	94.5	63.5	M	
	2000.06-2006.07	-	-	F Saloon Engine G4ED-G	839185	Outer Joint	44T	25	23	50	94.5	63.5	M	
	2000.06-2006.07	-	-	F Hatchback Engine G4ED-G	809002	Outer Joint		25	23	50	94.5	63.5	M	
	2000.06-2006.07	-	-	F Saloon Engine G4ED-G	809002	Outer Joint		25	23	50	94.5	63.5	M	
1.6 (82 kW)	2003.09-2006.07	-	-	F Hatchback Engine G4GA	824120	Outer Joint	44T	25	23	50	95.5	60.5	M	





YEAR	TRANSM	L/R	F/R	REMARKS	GSP Ref.	PRODUCT	ABS	Technical Specifications								
								A	B	C	H	L	P			
HYUNDAI ELANTRA (XD)/AVANTE																
1.8 (97 kW)	2000.06-2006.07	AT	-	-	Saloon Engine G4BB/G4BB	624072	Inner Joint		25	30	35	62.5	88			
	2000.06-2006.07	AT	-	-	Hatchback Engine G4BB/G4GB	624072	Inner Joint		25	30	35	62.5	88			
	2000.06-2006.07	AT	-	F	Saloon Engine G4GB/G4BB	824061	Outer Joint	44T	25	23	50	94.5	63.5	M		
	2000.06-2006.07	AT	-	F	Hatchback Engine G4BB/G4GB	824061	Outer Joint	44T	25	23	50	94.5	63.5	M		
2.0 (102 kW)	2000.06-2006.07	AT	L	F	Saloon Engine G4GC-G	224203	Drive Shaft	44T	25	25	50	94.5	652			
	2000.06-2006.07	AT	L	F	Hatchback Engine G4GC-G	224203	Drive Shaft	44T	25	25	50	94.5	652			
	2000.06-2006.07	-	-	F	Saloon Engine G4GC-G	824038	Outer Joint	44T	25	25	50	94.5	65	M		
	2000.06-2006.07	-	-	F	Hatchback Engine G4GC-G	824038	Outer Joint	44T	25	25	50	94.5	65	M		
	2000.06-2006.07	AT	-	F	Saloon Engine G4GC-G	839014	Outer Joint		25	30	50	95	60.5	M		
	2000.06-2006.07	AT	-	F	Hatchback Engine G4GC-G	839014	Outer Joint		25	30	50	95	60.5	M		
	2000.06-2006.07	MT	R	F	Saloon Engine G4GC-G	224502	Drive Shaft	44T	25	25	50	94.5	938			
	2000.06-2006.07	MT	R	F	Hatchback Engine G4GC-G	224502	Drive Shaft	44T	25	25	50	94.5	938			
	2000.06-2006.07	AT	R	F	Saloon Engine G4GC-G	224204	Drive Shaft	44T	25	25	50	94.5	936			
	2000.06-2006.07	AT	R	F	Hatchback Engine G4GC-G	224204	Drive Shaft	44T	25	25	50	94.5	936			
	2000.06-2006.07	AT	-	-	Saloon Engine G4GC-G	624072	Inner Joint		25	30	35	62.5	88			
	2000.06-2006.07	AT	-	-	Hatchback Engine G4GC-G	624072	Inner Joint		25	30	35	62.5	88			
	2000.06-2006.07	-	-	F	Saloon Engine G4GC-G	824061	Outer Joint	44T	25	23	50	94.5	63.5	M		
	2000.06-2006.07	-	-	F	Hatchback Engine G4GC-G	824061	Outer Joint	44T	25	23	50	94.5	63.5	M		
2.0 (104 kW)	2000.06-2006.07	AT	L	F	Hatchback Engine G4GC	224203	Drive Shaft	44T	25	25	50	94.5	652			
	2000.06-2006.07	AT	L	F	Saloon Engine G4GC	224203	Drive Shaft	44T	25	25	50	94.5	652			
	2000.06-2006.07	-	-	F	Hatchback Engine G4GC	824038	Outer Joint	44T	25	25	50	94.5	65	M		
	2000.06-2006.07	-	-	F	Saloon Engine G4GC	824038	Outer Joint	44T	25	25	50	94.5	65	M		
	2000.06-2006.07	-	-	F	Hatchback Engine G4GC	839014	Outer Joint		25	30	50	95	60.5	M		
	2000.06-2006.07	-	-	F	Saloon Engine G4GC	839014	Outer Joint		25	30	50	95	60.5	M		
	2000.06-2006.07	MT	R	F	Hatchback Engine G4GC	224502	Drive Shaft	44T	25	25	50	94.5	938			
	2000.06-2006.07	MT	R	F	Saloon Engine G4GC	224502	Drive Shaft	44T	25	25	50	94.5	938			
	2000.06-2006.07	AT	R	F	Hatchback Engine G4GC	224204	Drive Shaft	44T	25	25	50	94.5	936			
	2000.06-2006.07	AT	R	F	Saloon Engine G4GC	224204	Drive Shaft	44T	25	25	50	94.5	936			
	2000.06-2006.07	-	-	-	Hatchback Engine G4GC	624072	Inner Joint		25	30	35	62.5	88			
	2000.06-2006.07	-	-	-	Saloon Engine G4GC	624072	Inner Joint		25	30	35	62.5	88			
	2000.06-2006.07	-	-	F	Hatchback Engine G4GC	824061	Outer Joint	44T	25	23	50	94.5	63.5	M		
	2000.06-2006.07	-	-	F	Saloon Engine G4GC	824061	Outer Joint	44T	25	23	50	94.5	63.5	M		
2.0 (105 kW)	2003.10-2006.07	-	-	F	Saloon Engine G4GC	824038	Outer Joint	44T	25	25	50	94.5	65	M		
	2003.10-2006.07	-	-	F	Hatchback Engine G4GC	824038	Outer Joint	44T	25	25	50	94.5	65	M		
	2003.10-2006.07	AT	-	F	Saloon Engine G4GC	824061	Outer Joint	44T	25	23	50	94.5	63.5	M		
	2003.10-2006.07	AT	-	F	Hatchback Engine G4GC	824061	Outer Joint	44T	25	23	50	94.5	63.5	M		
	2001.04-2006.07	-	-	F	Hatchback Engine D4EA	824120	Outer Joint	44T	25	23	50	95.5	60.5	M		
2.0 CRDi (83 kW)	2001.04-2006.07	-	-	F	Saloon Engine D4EA	824120	Outer Joint	44T	25	23	50	95.5	60.5	M		
	2001.04-2006.07	-	-	F	Hatchback Engine D4EA	839245	Outer Joint		25	23	50	96	59	M		
	2001.04-2006.07	-	-	F	Saloon Engine D4EA	839245	Outer Joint		25	23	50	96	59	M		
	2001.04-2006.07	-	-	F	Hatchback Engine D4EA	824060	Outer Joint	44T	27	26	60	95	69	M		
	2001.04-2006.07	-	-	F	Saloon Engine D4EA	824060	Outer Joint	44T	27	26	60	95	69	M		
	2001.04-2006.07	-	-	F	Hatchback Engine D4EA	824061	Outer Joint	44T	25	23	50	94.5	63.5	M		
	2001.04-2006.07	-	-	F	Saloon Engine D4EA	824061	Outer Joint	44T	25	23	50	94.5	63.5	M		
	2001.04-2006.07	-	-	-	Hatchback Engine D4EA	639041	Inner Joint		25	23	35	63	92.5			
	2001.04-2006.07	-	-	-	Saloon Engine D4EA	639041	Inner Joint		25	23	35	63	92.5			
	2001.04-2006.07	-	-	F	Hatchback Engine D4EA	809002	Outer Joint		25	23	50	94.5	63.5	M		
	2001.04-2006.07	-	-	F	Saloon Engine D4EA	809002	Outer Joint		25	23	50	94.5	63.5	M		
	ELANTRA 06															
	1.6	2006-	-	-	R	F	ENGINE:G4FC/L4FC/G4FD	224481	Drive Shaft	46T	27	25	60	94.5	942	
		2006-	-	-	R	F	ENGINE:G4FC/L4FC/G4FD	824121	Outer Joint		27	22	60	94.5	54.5	M
ELANTRA 11																
-	2010.10-2013.12	6AT	L	F	ALABAMA PLANTCAN /2WD	624089	Inner Joint		27	22	30	67.5	81			
	2010.10-2013.12	6AT	L	F	ALABAMA PLANTCAN ABS (ANTI LOCK BRK SYS)/2WD	224416	Drive Shaft	46T	27	27	60	95.5	667			
	2010.10-2013.12	6AT	L	F	ALABAMA PLANTUSA ABS (ANTI LOCK BRK SYS)/2WD	224416	Drive Shaft	46T	27	27	60	95.5	667			
	2010.10-2013.12	6AT	L	F	ALABAMA PLANTCAN /2WD	824334	Outer Joint		27	30	60	94.5	56.5	M		
1.6	2011-2013	6MT	R	F	2WD	824267	Outer Joint		27	22	60	94.5	54.5	M		
2.0	2011-2013	6MT	L	F	ENGINE:G4NA/G4NE/G4NC/G4ND/G4NB;2WD	224472	Drive Shaft		27	27	60	95	681			
	2011-2013	6MT	L	F	ENGINE:G4NA/G4NE/G4NC/G4ND/G4NB;2WD	824302	Outer Joint		27	23	60	95	57	M		
	2011-2013	6MT	L	F	ENGINE:G4NA/G4NE/G4NC/G4ND/G4NB;2WD	624115	Inner Joint		27	23	41	62.5	88			
ELANTRA 14																
-	2010.10-2013.12	6AT	L	F	ALABAMA PLANTCAN /2WD	624089	Inner Joint		27	22	30	67.5	81			
	2010.10-2013.12	6AT	L	F	ALABAMA PLANTCAN ABS (ANTI LOCK BRK SYS)/2WD	224416	Drive Shaft	46T	27	27	60	95.5	667			
	2010.10-2013.12	6AT	L	F	ALABAMA PLANTUSA ABS (ANTI LOCK BRK SYS)/2WD	224416	Drive Shaft	46T	27	27	60	95.5	667			
	2010.10-2013.12	6AT	L	F	ALABAMA PLANTCAN /2WD	824334	Outer Joint		27	30	60	94.5	56.5	M		
1.6	2013-	-	-	6MT	R	F	2WD	824267	Outer Joint		27	22	60	94.5	54.5	M





YEAR	TRANS	L/R	F/R	REMARKS	GSP Ref.	PRODUCT	ABS	Technical Specifications							
								A	B	C	H	L	P		
HYUNDAI ELANTRA 14															
1.6	2013-	-	6MT	L F	ENGINE:G4NA/G4NE/G4NC/G4ND/G4NB;2WD	224472	Drive Shaft		27	27	60	95	681		
	2013-	-	6MT	L F	ENGINE:G4NA/G4NE/G4NC/G4ND/G4NB;2WD	824302	Outer Joint		27	23	60	95	57	M	
	2013-	-	6MT	L F	ENGINE:G4NA/G4NE/G4NC/G4ND/G4NB;2WD	624115	Inner Joint		27	23	41	62.5	88		
ELANTRA GT															
2.0	2012-	-	MT	R -		224387	Drive Shaft	46T	27	27	60	95	966		
	2012-	-	MT	L -		224388	Drive Shaft	46T	27	27	60	95	681		
ELANTRA TOURING															
-	2007-	-	-	R F	-	224440	Drive Shaft	46T	27	27	60	94.5	941		
	2007-	-	-	R F	-	224440	Drive Shaft	46T	27	27	60	94.5	941		
	2007-	-	-	R F	-	224306	Drive Shaft	46T	27	27	60	94.5	940		
	2007-	-	-	R F	-	624134	Inner Joint		27	22	41	62	86		
	2007-	-	-	R F	-	624061	Inner Joint		27	22	41	62	86		
	2007-	-	4AT	L F	2WD	624097	Inner Joint		27	22	41	62.5	94		
	2007-	-	-	R F	-	824121	Outer Joint		27	22	60	94.5	54.5	M	
	2007-	-	4AT	L F	2WD	824184	Outer Joint		27	24	60	95	59	M	
	2007-	-	-	R F	-	824292	Outer Joint		27	22	60	94.5	54.5	M	
ELANTRA/AVANTE															
2.0	2006-	-	MT	L F	-	224077	Drive Shaft	46T	27	27	60	94.5	671		
	2006-	-	5MT	L F	2WD	224077	Drive Shaft	46T	27	27	60	94.5	671		
	2006-	-	MT	L F	-	824055	Outer Joint	46T	27	30	60	94.5	57	M	
	2006-	-	5MT	L F	2WD	824055	Outer Joint	46T	27	30	60	94.5	57	M	
ELANTRA/AVANTE															
	2006-	-	5MT	L F	2WD	624015	Inner Joint		27	30	41	62	90		
	2006-	-	5MT	L F	2WD	824068	Outer Joint		27	30	60	94.5	57	M	
ELANTRA/LANTRA															
1.6	2000-	-	4AT	R F	2WD	224149	Drive Shaft	44T	25	25	50	95.5	934		
	2000-	-	4AT	L F	2WD	224150	Drive Shaft	44T	25	25	50	95.5	652		
	2000-	-	4AT	R F	2WD	624027	Inner Joint		25	30	35	63	92.5		
	2000-	-	4AT	L F	2WD	624027	Inner Joint		25	30	35	63	92.5		
	2000-	-	4AT	R F	2WD	839053	Outer Joint		25	30	50	95.5	60.5	M	
	2000-	-	4AT	L F	2WD	839053	Outer Joint		25	30	50	95.5	60.5	M	
EON															
0.8	2011-	-	-	R -	-	624112	Inner Joint		22	19	35	52	82		
	2011-	-	-	R -	-	224432	Drive Shaft		24	22	52.5	86	832		
	2011-	-	-	R -	-	824198	Outer Joint		24	19	52.5	86	57	M	
EON 11															
0.8	2011-	-	-	L F	-	224433	Drive Shaft		24	22	52.5	86.5	615		
	2011-	-	-	R F	-	224432	Drive Shaft		24	22	52.5	86	832		
	2011-	-	-	L F	-	624113	Inner Joint		22	18	35	51.5	79.5		
	2011-	-	-	R F	-	624112	Inner Joint		22	19	35	52	82		
	2011-	-	-	L F	-	824199	Outer Joint		24	18	52.5	86.5	52	M	
	2011-	-	-	R F	-	824198	Outer Joint		24	19	52.5	86	57	M	
EON II															
0.8	2011-	-	-	R -	-	224382	Drive Shaft		24	22	52.5	86.5	830		
	2011-	-	-	L -	-	224381	Drive Shaft		24	22	52.5	86	620		
EXCEL															
-	-	-	-	-	-	899164	Outer Joint		25	30	49.9	94.5	56	O	
EXCEL/SCOUPE															
-	1994-	1999	-	R -	X3	224010	Drive Shaft		25	25	50	95	913		
	1994-	1999	-	L -	X3	224009	Drive Shaft		25	25	50	95	613		
	1994-	1999	-	R -	X3	639001	Inner Joint		25	22	35	55	91		
	1994-	1999	-	L -	X3	639001	Inner Joint		25	22	35	55	91		
GALLOPER II (JK-01)															
2.5 TD intercooler (73 kW)	1998.08-	2003.12	-	L/R	F	All-wheel Drive Closed Off-Road Vehicle Engine D4BH	839027	Outer Joint		28	25	56	154.1	62	M
GENESIS															
3.0	2013-	-	AT	L -	-	224393	Drive Shaft	47T	30		65	97.5	700		
3.8	2013-	-	AT	L -	-	224393	Drive Shaft	47T	30		65	97.5	700		
GENESIS (BH)/Rohens															
3.8 V6 (213 kW)	2008.01-	2014.12	5AT	L/R	R	Saloon Engine G6DA	824313	Outer Joint	47T	30	25	65	96	69.5	M
GENESIS/ROHENS															
2.0 T (157 kW)	2008.01-	2012.12	5AT/6AT	L	R	Coupe Engine G4KF	624152	Inner Joint		28	25	43	67.5	105.5	
GETZ															
-	2005.08-	2006.12	4AT	L F	-	224552	Drive Shaft	48T	25	25	52.5	95	626		
1.1	2002.05-	2006.12	-	L F	-	224520	Drive Shaft	48T	25	25	52.5	95	649		
	2006.11-	2011.01	5MT	L F	-	224520	Drive Shaft	48T	25	25	52.5	95	649		
	2007.01-	2007.07	5MT	L F	-	224520	Drive Shaft	48T	25	25	52.5	95	649		

	YEAR	TRANSM	L/R	F/R	REMARKS	GSP Ref.	PRODUCT	ABS	Technical Specifications									
									A	B	C	H	L	P				
HYUNDAI GETZ																		
1.3	2002.05-	-	5MT	L	F	-	224553	Drive Shaft	48T	25	25	52.5	95	630				
1.4	2005.08-	2005.08	5MT	L	F	-	224553	Drive Shaft	48T	25	25	52.5	95	630				
	2006.11-	2011.01	4AT	L	F	-	224552	Drive Shaft	48T	25	25	52.5	95	626				
	2007.01-	2007.07	4AT	L	F	-	224552	Drive Shaft	48T	25	25	52.5	95	626				
	2007.4.-	2008.12	5MT	L	F	-	824112	Outer Joint	48T	25	22	52.5	95	58	I			
	2007.4.-	2008.12	5MT	L	F	-	639020	Inner Joint		25	28	35	54.5	87.5				
1.5 CRDi	2003-	2009	-	L/R	F	-	824026	Outer Joint		25	23	50	94.5	63.5	M			
	2003-	2009	-	R	F	-	224141	Drive Shaft		25	26	50	94.5	579				
	2003-	2009	-	R	F	-	624031	Inner Joint		26	23	42	40	68				
	2003-	2009	-	L	F	-	224140	Drive Shaft	48T	25	27	50	94.5	631				
	2003-	2009	-	R	F	-	624031	Inner Joint		26	23	42	40	68				
	2003-	2009	-	R	F	-	824026	Outer Joint		25	23	50	94.5	63.5	M			
1.6	2002.05-	-	5MT	L	F	-	224553	Drive Shaft	48T	25	25	52.5	95	630				
	2006.11-	2011.01	4AT	L	F	-	224552	Drive Shaft	48T	25	25	52.5	95	626				
	2007.01-	2007.07	4AT	L	F	-	224552	Drive Shaft	48T	25	25	52.5	95	626				
	2007.4.-	2008.12	5MT	L	F	-	824112	Outer Joint	48T	25	22	52.5	95	58	I			
	2007.4.-	2008.12	5MT	L	F	-	639020	Inner Joint		25	28	35	54.5	87.5				
GETZ (TB)/CLICK																		
1.1 (46 kW)	2002.09-	2005.09	MT	L/R	F	Hatchback Engine G4HD	824041	Outer Joint	48T	25	19	52.5	95	52.5	M			
	2002.09-	2005.09	AT	-	F	Hatchback Engine G4HD	824025	Outer Joint		25	22	52.5	95	58	M			
	2002.09-	2005.09	MT	-	-	Hatchback Engine G4HD	624045	Inner Joint		25	19	35	54	85.5				
	2002.09-	2005.09	MT	-	F	Hatchback Engine G4HD	839232	Outer Joint		25	22	52.5	95	58	M			
	2002.09-	2005.09	-	L/R	F	Hatchback Engine G4HD	824151	Outer Joint	48T	25	20	52.5	94.5	63	M			
1.1 (49 kW)	2005.09-	2009.06	MT	L/R	F	Hatchback Engine G4HD/G4HG	824041	Outer Joint	48T	25	19	52.5	95	52.5	M			
	2005.09-	2009.06	AT	-	F	Hatchback Engine G4HD/G4HG	824025	Outer Joint		25	22	52.5	95	58	M			
	2005.09-	2009.06	MT	-	-	Hatchback Engine G4HD/G4HG	624045	Inner Joint		25	19	35	54	85.5				
	2005.09-	2009.06	MT	-	F	Hatchback Engine G4HD/G4HG	839232	Outer Joint		25	22	52.5	95	58	M			
	2005.09-	2009.06	-	-	F	Hatchback Engine G4HD/G4HG	824098	Outer Joint	48T	25	22	52.5	95	58	M			
	2005.09-	2009.06	-	L/R	F	Hatchback Engine G4HD/G4HG	824151	Outer Joint	48T	25	20	52.5	94.5	63	M			
1.3 (61 kW)	2004.09-	2009.06	AT	-	F	Hatchback Engine G4EA	824025	Outer Joint		25	22	52.5	95	58	M			
	2004.09-	2009.06	MT	L	F	Hatchback Engine G4EA	224200	Drive Shaft	48T	25	25	52.5	95	626				
	2004.09-	2009.06	MT	R	F	Hatchback Engine G4EA	224194	Drive Shaft	48T	25	25	52.5	95	914				
	2004.09-	2009.06	MT	-	F	Hatchback Engine G4EA	839232	Outer Joint		25	22	52.5	95	58	M			
	2004.09-	2009.06	-	-	F	Hatchback Engine G4EA	824098	Outer Joint	48T	25	22	52.5	95	58	M			
	2004.09-	2009.06	-	-	F	Hatchback Engine G4EA	824101	Outer Joint	48T	25	22	52.5	95	58	M			
1.3 (63 kW)	2003.09-	2005.09	AT/MT	L	F	Hatchback Engine G4EA	224531	Drive Shaft	48T	25	25	52.5	95	625				
	2003.09-	2005.09	AT	-	F	Hatchback Engine G4EA	824025	Outer Joint		25	22	52.5	95	58	M			
	2003.09-	2005.09	MT	L	F	Hatchback Engine G4EA	224200	Drive Shaft	48T	25	25	52.5	95	626				
	2003.09-	2005.09	MT	R	F	Hatchback Engine G4EA	224194	Drive Shaft	48T	25	25	52.5	95	914				
	2003.09-	2005.09	-	-	F	Hatchback Engine G4EA	824098	Outer Joint	48T	25	22	52.5	95	58	M			
	2003.09-	2005.09	-	-	F	Hatchback Engine G4EA	824101	Outer Joint	48T	25	22	52.5	95	58	M			
	2003.09-	2005.09	MT	L/R	F	Hatchback Engine G4EA	824046	Outer Joint	48T	25	22	52.5	95	58	M			
1.3 i (60 kW)	2002.09-	2004.03	AT/MT	L	F	Hatchback Engine G4EA	224531	Drive Shaft	48T	25	25	52.5	95	625				
	2002.09-	2004.03	AT	-	F	Hatchback Engine G4EA	824025	Outer Joint		25	22	52.5	95	58	M			
	2002.09-	2004.03	MT	L	F	Hatchback Engine G4EA	224200	Drive Shaft	48T	25	25	52.5	95	626				
	2002.09-	2004.03	MT	R	F	Hatchback Engine G4EA	224194	Drive Shaft	48T	25	25	52.5	95	914				
	2002.09-	2004.03	MT	-	F	Hatchback Engine G4EA	839232	Outer Joint		25	22	52.5	95	58	M			
	2002.09-	2004.03	-	-	F	Hatchback Engine G4EA	824098	Outer Joint	48T	25	22	52.5	95	58	M			
	2002.09-	2004.03	MT	L/R	F	Hatchback Engine G4EA	824046	Outer Joint	48T	25	22	52.5	95	58	M			
	2002.09-	2004.03	MT	L	F	Hatchback Engine G4EA	224200	Drive Shaft	48T	25	25	52.5	95	626				
1.4 i (71 kW)	2005.08-	2010.12	AT/MT	L	F	Hatchback Engine G4EE	224531	Drive Shaft	48T	25	25	52.5	95	625				
	2005.08-	2010.12	AT	-	F	Hatchback Engine G4EE	824025	Outer Joint		25	22	52.5	95	58	M			
	2005.08-	2010.12	MT	L	F	Hatchback Engine G4EE	224200	Drive Shaft	48T	25	25	52.5	95	626				
	2005.08-	2010.12	MT	R	F	Hatchback Engine G4EE	224194	Drive Shaft	48T	25	25	52.5	95	914				
	2005.08-	2010.12	MT	-	F	Hatchback Engine G4EE	839232	Outer Joint		25	22	52.5	95	58	M			
	2005.08-	2010.12	-	-	F	Hatchback Engine G4EE	824098	Outer Joint	48T	25	22	52.5	95	58	M			
	2005.08-	2010.12	5MT	R	F	Hatchback Engine G4EE	224533	Drive Shaft	48T	25	25	52.5	95	913				
	2005.08-	2010.12	-	L/R	F	Hatchback Engine G4EE	824046	Outer Joint	48T	25	22	52.5	95	58	M			
1.5 CRDi (60 kW)	2003.03-	2005.09	AT	-	F	Hatchback Engine D3EA	824025	Outer Joint		25	22	52.5	95	58	M			
	2003.03-	2005.09	MT	R	F	Hatchback Engine D3EA	224211	Drive Shaft	48T	25	26	50	94.5	579				
	2003.03-	2005.09	-	-	F	Hatchback Engine D3EA	824047	Outer Joint	48T	25	23	50	94.5	63.5	M			
	2003.03-	2005.09	MT	L/R	F	Hatchback Engine D3EA	839017	Outer Joint	43T	25	23	54	95.5	63.5	I			
1.5 CRDi (65 kW)	2005.08-	2009.06	AT	-	F	Hatchback Engine D4FA	824025	Outer Joint		25	22	52.5	95	58	M			
	2005.08-	2009.06	MT	R	F	Hatchback Engine D4FA	224211	Drive Shaft	48T	25	26	50	94.5	579				
	2005.08-	2009.06	-	-	F	Hatchback Engine D4FA	824047	Outer Joint	48T	25	23	50	94.5	63.5	M			
	2005.08-	2009.06	MT	L/R	F	Hatchback Engine D4FA	839017	Outer Joint	43T	25	23	54	95.5	63.5	I			
1.5 CRDi GLS (81 kW)	2005.08-	2009.06	AT	-	F	Hatchback Engine D4FA	824025	Outer Joint		25	22	52.5	95	58	M			

YEAR	TRANS	L/R	F/R	REMARKS	GSP Ref.	PRODUCT	ABS	Technical Specifications							
								A	B	C	H	L	P		
HYUNDAI															
GETZ (TB)/CLICK															
1.5 CRDi GLS (81 kW)	2005.08-2009.06	MT	R	F	Hatchback Engine D4FA	224211	Drive Shaft	48T	25	26	50	94.5	579		
	2005.08-2009.06	-	-	F	Hatchback Engine D4FA	824047	Outer Joint	48T	25	23	50	94.5	63.5	M	
	2005.08-2009.06	MT	L/R	F	Hatchback Engine D4FA	839017	Outer Joint	43T	25	23	54	95.5	63.5	I	
1.6 (77 kW)	2002.09-2005.09	AT/MT	L	F	Hatchback Engine G4ED-G	224531	Drive Shaft	48T	25	25	52.5	95	625		
	2002.09-2005.09	AT	-	F	Hatchback Engine G4ED-G	824025	Outer Joint		25	22	52.5	95	58	M	
	2002.09-2005.09	-	-	F	Hatchback Engine G4ED-G	824098	Outer Joint	48T	25	22	52.5	95	58	M	
	2002.09-2005.09	-	-	-	Hatchback Engine G4ED-G	224533	Drive Shaft	48T	25	25	52.5	95	913		
	2002.09-2005.09	MT	L/R	F	Hatchback Engine G4ED-G	824046	Outer Joint	48T	25	22	52.5	95	58	M	
1.6 (78 kW)	2005.06-2006.12	AT	-	F	Hatchback Engine G4ED-G	824025	Outer Joint		25	22	52.5	95	58	M	
	2005.06-2006.12	-	-	F	Hatchback Engine G4ED-G	824098	Outer Joint	48T	25	22	52.5	95	58	M	
	2005.06-2006.12	5MT	R	F	Hatchback Engine G4ED-G	224533	Drive Shaft	48T	25	25	52.5	95	913		
GRAND I10															
1.2	2013-	-	MT	L	-	224366	Drive Shaft	48T	25	25	52.2	92.5	640		
GRAND I10 14															
-	2013-	-	-	L	F	-	224571	Drive Shaft		25	25	52.6	93	634	
	2013-	-	-	R	F	-	224570	Drive Shaft		25	25	52.6	93	907	
GRAND SANTA F?/MAXCRUZ															
2.2 CRDi (145 kW)	2013.06-	-	AT	R	F	All-wheel Drive Closed Off-Road Vehicle Engine D4HB	261352	Stub Axle		28	28			430	
	2013.06-	-	-	L	-	All-wheel Drive Closed Off-Road Vehicle Engine D4HB	624160	Inner joint		31	35	36	67	104.5	
2.2 CRDi (147 kW)	2015.10-	-	AT	R	F	All-wheel Drive Closed Off-Road Vehicle Engine D4HB	261352	Stub Axle		28	28			430	
3.4 (199 kW)	2014.02-	-	AT	-	-	All-wheel Drive Closed Off-Road Vehicle Engine G6DF	639041	Inner Joint		25	23	35	63	92.5	
	2014.02-	-	AT	-	R	All-wheel Drive Closed Off-Road Vehicle Engine G6DF	824321	Outer Joint	52T	30	20	57	93.5	61	M
GRAND SANTA FE															
2.2	2013.05-2016.01	-	L	R	-	224555	Drive Shaft	52T	30	25	57	93.5	848		
	2013.05-2016.01	-	L	R	-	624032	Inner Joint		25	23	35	63	88		
	2016.01-	-	L	R	-	224555	Drive Shaft	52T	30	25	57	93.5	848		
	2016.01-	-	L	R	-	624032	Inner Joint		25	23	35	63	88		
3.0	2016.01-	-	L	R	-	224555	Drive Shaft	52T	30	25	57	93.5	848		
	2016.01-	-	L	R	-	624032	Inner Joint		25	23	35	63	88		
3.3	2013.05-2015.10	-	L	R	-	224555	Drive Shaft	52T	30	25	57	93.5	848		
	2013.05-2015.10	-	L	R	-	624032	Inner Joint		25	23	35	63	88		
	2017.03-	-	L	R	-	224555	Drive Shaft	52T	30	25	57	93.5	848		
	2017.03-	-	L	R	-	624032	Inner Joint		25	23	35	63	88		
GRAND SANTA FE 13															
3.3	2013-2015	-	L	F	ENGINE:G6DB/G6DH	224448	Drive Shaft	52T	30	28	73	94.5	664		
	2013-2015	-	L	F	ENGINE:G6DB/G6DH	824300	Outer Joint		30	35	73	94.5	67	M	
	2013-2015	-	L	F	ENGINE:G6DB/G6DH	624145	Inner Joint		28	35	33	67	105.5		
	2013-2015	-	R	F	ENGINE:G6DB/G6DH	224451	Drive Shaft	52T	30	28	73	94.5	608		
	2013-2015	-	R	F	ENGINE:G6DB/G6DH	824300	Outer Joint		30	35	73	94.5	67	M	
	2013-2015	-	R	F	ENGINE:G6DB/G6DH	624143	Inner Joint		28	35	42		129.5		
GRANDEUR															
3.0 V6	1999.01-2003.12	MT/AT	-	-	-	824034	Outer Joint		27	34	60	95	69	I	
3.3	2005-2010	5AT	R	-	LAMBDA	224128	Drive Shaft	47T	30	28	65	95	981.5		
	2005-2010	5AT	L	-	LAMBDA	224127	Drive Shaft	47T	30	28	65	95	662		
GRANDEUR (HG)/AZERA															
2.4 16V (148 kW)	2011.01-	-	AT	-	F	Saloon Engine G4KJ	824090	Outer Joint	48T	27	25	61.9	95	61	M
	2011.01-	-	AT	L	F	Saloon Engine G4KJ	624056	Inner Joint		27	25	30	67	83.5	
GRANDEUR (TG)															
2.4 (121 kW)	2006.09-2008.12	AT	-	F	Saloon Engine G4KC	824062	Outer Joint	47T	27	25	62.2	95	60	M	
3.3 (173 kW)	2005.04-2010.12	-	-	-	Saloon Engine G6DB	824063	Outer Joint	47T	30	36	65	95	68	I	
HB20															
1.0	-	-	-	R	F	-	224438	Drive Shaft	48T	25	25	52.4	94.5	920	
	-	-	-	R	F	-	824294	Outer Joint		25	20	52.4	94.5	55	M
	2012-	-	5MT	L	F	ENGINE:G3LA/G4LA/B3LA	224427	Drive Shaft	48T	25	25	52.4	94.5	645	
	2012-	-	5MT	L	F	ENGINE:G3LA/G4LA/B3LA	824294	Outer Joint		25	20	52.4	94.5	55	M
	2012-	-	5MT	L	F	ENGINE:G3LA/G4LA/B3LA	624136	Inner Joint		25	20	35	55	84	
1.0 12V	2012-	-	-	R	F	DOHC L3	224438	Drive Shaft	48T	25	25	52.4	94.5	920	
	2012-	-	-	R	F	DOHC L3	624136	Inner Joint		25	20	35	55	84	
	2012-	-	-	R	F	DOHC L3	824294	Outer Joint		25	20	52.4	94.5	55	M
1.6	-	-	-	R	F	-	224439	Drive Shaft	48T	25	25	52.5	93.5	922	
	-	-	-	R	F	-	824222	Outer Joint		25	22	52.5	93.5	59.5	M
	2012-	-	-	L	F	ENGINE:G4FC/L4FC/G4FD	224428	Drive Shaft	48T	25	25	52.5	93.5	645	
	2012-	-	-	L	F	ENGINE:G4FC/L4FC/G4FD	824222	Outer Joint		25	22	52.5	93.5	59.5	M
	2012-	-	-	L	F	ENGINE:G4FC/L4FC/G4FD	624137	Inner Joint		25	22	41	62.5	86	
1.6 16V	-	-	AT	-	-	824223	Outer Joint	48T	25	22	52.5	93.5	59.5	M	
	2012-	-	-	R	F	DOHC L4	224439	Drive Shaft	48T	25	25	52.5	93.5	922	

YEAR	TRANSM	L/R	F/R	REMARKS	GSP Ref.	PRODUCT	ABS	Technical Specifications						
								A	B	C	H	L	P	
HYUNDAI														
HB20														
1.6 16V	2012-	-	-	R F	DOHC L4	624137	Inner Joint		25	22	41	62.5	86	
	2012-	-	-	R F	DOHC L4	824222	Outer Joint		25	22	52.5	93.5	59.5	M
	2012-	-	-	-	-	824223	Outer Joint	48T	25	22	52.5	93.5	59.5	M
I10														
1.1 2WD	2007-	2010	5MT	L -	EPSILON > SOHC MPI	624048	Inner Joint		25	20	35	54	91	
	2007-	2010	5MT	L -	EPSILON > SOHC MPI	224156	Drive Shaft		24	25	52.5	86.5	624	
	2007-	-	5MT	R -	EPSILON > SOHC MPI	224157	Drive Shaft		24	25	52.5	86.5	845	
	2007-	-	5MT	L -	EPSILON > SOHC MPI	239191	Drive Shaft	48T	24	25	52.5	86.5	624	
	2007-	2010	4AT	L -	EPSILON > SOHC MPI	224240	Drive Shaft	48T	24	25	52.5	86.5	601	
	2007-	2010	4AT	R -	EPSILON > SOHC MPI	224241	Drive Shaft	48T	24	25	52.5	86.5	870	
	2007-	-	5MT	L -	EPSILON > SOHC MPI	824129	Outer Joint	48T	24	20	52.5	86.5	63	M
	2007-	2010	5MT	L -	EPSILON > SOHC MPI	824087	Outer Joint		24	20	52.5	86.5	63	M
i10 (PA)														
1.2 (57 kW)	2008.11-	2011.12	MT	L F	Hatchback Engine G4LA	257145	Drive Shaft	48T	24	25	52.5	86	597	
	2008.11-	2011.12	MT	R F	Hatchback Engine G4LA	239192	Drive Shaft	48T	24	25	52.5	86.5	845	
	2008.11-	2011.12	MT	R F	Hatchback Engine G4LA	257195	Drive Shaft	48T	24	25	52.5	86	871	
	2008.11-	2011.12	MT	R F	Hatchback Engine G4LA	657109	Inner Joint		25	21	35	54	93.5	
1.2 (63 kW)	2011.04-	2013.12	-	L F	Hatchback Engine G4LA	257145	Drive Shaft	48T	24	25	52.5	86	597	
	2011.04-	2013.12	-	R F	Hatchback Engine G4LA	239192	Drive Shaft	48T	24	25	52.5	86.5	845	
	2011.04-	2013.12	-	L F	Hatchback Engine G4LA	257195	Drive Shaft	48T	24	25	52.5	86	871	
	2011.04-	2013.12	MT	R F	Hatchback Engine G4LA	657109	Inner Joint		25	21	35	54	93.5	
I20														
1.4 2WD	2007-	2012	5MT	R -	U/U2	239190	Drive Shaft	48T	25	27	52.6	94.5	938	
	2007-	2014	6MT	R -	U2	239190	Drive Shaft	48T	25	27	52.6	94.5	938	
	2007-	2012	5MT	L -	U/U2	839192	Outer Joint	48T	25	24	52.6	94.5	63.5	M
	2007-	2012	5MT	L -	U/U2	627037	Inner Joint		27	24	41	61.5	91	
	2008-	2014	6MT	L -	U2	839192	Outer Joint	48T	25	24	52.6	94.5	63.5	M
	2008-	2014	6MT	L -	U2	627037	Inner Joint		27	24	41	61.5	91	
1.6 2WD	2008-	2012	6MT	R -	U2	239190	Drive Shaft	48T	25	27	52.6	94.5	938	
	2008-	2012	6MT	L -	U2	839192	Outer Joint	48T	25	24	52.6	94.5	63.5	M
	2008-	2012	6MT	L -	U2	627037	Inner Joint		27	24	41	61.5	91	
i20 (GB IB)														
1.2 (55 kW)	2014.11-	-	5MT	L -	Hatchback Engine G4LA	624151	Inner Joint		25	21	35	55.5	85.5	
	2014.11-	-	5MT	L -	Hatchback Engine G4LA	827110	Outer Joint	48T	25	21	52.5	92.5	56	M
1.4 (74 kW)	2014.11-	-	6MT	L/R F	Hatchback Engine G4LC	839261	Outer Joint	48T	25	22	52.5	92.5	54.5	M
i20 (PB PBT)														
1.4 (74 kW)	2008.09-	2015.12	MT	R F	Hatchback Engine G4FA	224153	Drive Shaft	48T	25	25	52.5	94.5	930	
	2008.09-	2015.12	AT	R F	Hatchback Engine G4FA	239167	Drive Shaft	48T	25	25	52.5	93.5	933	
	2008.09-	2015.12	MT	L F	Hatchback Engine G4FA	224304	Drive Shaft	48T	25	25	52.5	93.5	656	
	2008.09-	2015.12	MT	- F	Hatchback Engine G4FA	839181	Outer Joint	48T	25	22	52.5	93.5	59	M
1.4 CRDi (55 kW)	2008.09-	2012.12	MT	L F	Hatchback Engine D4FC	239189	Drive Shaft	48T	25	27	52.6	94.5	646	
1.4 CRDi (66 kW)	2008.08-	2015.12	-	L F	Hatchback Engine D4FC	239189	Drive Shaft	48T	25	27	52.6	94.5	646	
I30														
-	2011-	2014	-	R F	-	824267	Outer Joint		27	22	60	94.5	54.5	M
1.4	2011.12-	2015.01	6MT	L F	-	224548	Drive Shaft	46T	27	25	60	94.5	687	
	2014.12-	-	6MT	L F	-	224548	Drive Shaft	46T	27	25	60	94.5	687	
i30														
1.4 (73 kW)	2013.05-	-	MT	- F	Coupe Engine G4FA	824132	Outer Joint	46T	27	22	60	94.5	54.5	M
	2013.05-	-	MT	L F	Coupe Engine G4FA	639052	Inner Joint		25	22	41	63	86	
1.4 (74 kW)	2014.12-	-	MT	L F	Coupe Engine G4LC	639052	Inner Joint		25	22	41	63	86	
	2014.12-	-	MT	- F	Coupe Engine G4LC	824132	Outer Joint	46T	27	22	60	94.5	54.5	M
I30														
1.6	2011.10-	2012.02	4AT	R F	-	224505	Drive Shaft	46T	27	27	60	95	946	
	2011.10-	2012.02	4AT	R F	-	624061	Inner Joint		27	22	41	62	86	
	2011.10-	2012.02	4AT	L F	-	624097	Inner Joint		27	22	41	62.5	94	
	2011.12-	2015.01	6MT	L F	-	224548	Drive Shaft	46T	27	25	60	94.5	687	
	2012-	-	6AT	L F	ENGINE:D4FB/D4FD	227219	Drive Shaft	46T	27	27	60	95	666	
	2012-	-	6AT	L F	ENGINE:D4FB/D4FD	824184	Outer Joint		27	24	60	95	59	M
	2012-	-	6AT	L F	ENGINE:D4FB/D4FD	624053	Inner Joint		27	24	30	67.5	88.5	
	2012-	-	6AT	R F	ENGINE:D4FB/D4FD	227218	Drive Shaft	46T	27	27	60	95	956	
	2012-	-	6AT	R F	ENGINE:D4FB/D4FD	824184	Outer Joint		27	24	60	95	59	M
	2012-	-	6AT	R F	ENGINE:D4FB/D4FD	624053	Inner Joint		27	24	30	67.5	88.5	
	2012-	-	6MT	R F	2WD	824267	Outer Joint		27	22	60	94.5	54.5	M
	2012.03-	2012.05	4AT	R F	-	224505	Drive Shaft	46T	27	27	60	95	946	
	2012.03-	2012.05	4AT	R F	-	624061	Inner Joint		27	22	41	62	86	
	2012.03-	2012.05	4AT	L F	-	624097	Inner Joint		27	22	41	62.5	94	

	 YEAR	TRANSM	L/R	F/R	REMARKS	GSP Ref.	 PRODUCT	 ABS	Technical Specifications						
									A	B	C	H	L	P	
HYUNDAI															
i30															
1.6	2014.11-	-	6MT	L	F	-	224548	Drive Shaft	46T	27	25	60	94.5	687	
	2015.01-	-	6MT	L	F	-	224548	Drive Shaft	46T	27	25	60	94.5	687	
1.6 2WD	2011-	-	6AT	R	-	GAMMA/NU	224321	Drive Shaft	46T	27	27	60	95	957	
	2011-	-	6AT	-	-	GAMMA/NU	224272	Drive Shaft		27	27	60	95	668	
i30															
1.6 CRDi (100 kW)	2014.12-	-	6AT	-	F	Coupe Engine D4FB	824227	Outer Joint	46T	27	24	60	92.5	58	M
1.6 CRDi (94 kW)	2013.05-	-	AT	-	F	Coupe Engine D4FB	824227	Outer Joint	46T	27	24	60	92.5	58	M
1.6 GDI (99 kW)	2013.05-	-	MT	L	F	Coupe Engine G4FD	639052	Inner Joint		25	22	41	63	86	
	2013.05-	-	AT	-	F	Coupe Engine G4FD	824227	Outer Joint	46T	27	24	60	92.5	58	M
	2013.05-	-	MT	-	F	Coupe Engine G4FD	824132	Outer Joint	46T	27	22	60	94.5	54.5	M
1.6 MPI (88 kW)	2016.11-	-	MT	L	F	Coupe Engine G4FC	639052	Inner Joint		25	22	41	63	86	
	2016.11-	-	AT	-	F	Coupe Engine G4FC	824227	Outer Joint	46T	27	24	60	92.5	58	M
	2016.11-	-	MT	-	F	Coupe Engine G4FC	824132	Outer Joint	46T	27	22	60	94.5	54.5	M
1.6 T-GDI (137 kW)	2015.01-	-	MT	L	F	Coupe Engine G4FJ	639052	Inner Joint		25	22	41	63	86	
	2015.01-	-	AT	-	F	Coupe Engine G4FJ	824227	Outer Joint	46T	27	24	60	92.5	58	M
	2015.01-	-	MT	-	F	Coupe Engine G4FJ	824132	Outer Joint	46T	27	22	60	94.5	54.5	M
i30															
1.6/1.8 2WD	2011-	-	6AT	R	-	GAMMA/NU	624065	Inner Joint		27	22	30	68	77	
	2011-	-	6AT	R	-	GAMMA/NU	224265	Drive Shaft		27	27	60	95	957	
	2011-	-	6AT	L	-	GAMMA/NU	224264	Drive Shaft	46T	27	27	60	95	668	
	2011-	-	6AT	R	-	GAMMA/NU	824144	Outer Joint		27	24	60	95	59	M
1.8 2WD	2011-	-	6AT	R	-	GAMMA/NU	224321	Drive Shaft	46T	27	27	60	95	957	
	2011-	-	6AT	-	-	GAMMA/NU	224272	Drive Shaft		27	27	60	95	668	
	2012-	-	6MT	R	-	NU	224249	Drive Shaft	46T	27	27	60	94.5	964	
	2012-	-	6MT	L	-	NU	224248	Drive Shaft	46T	27	27	60	94.5	681	
	2012-	-	6MT	R	-	NU	624061	Inner Joint		27	22	41	62	86	
2.0	2011.10-	2012.02	4AT	R	F	-	224505	Drive Shaft	46T	27	27	60	95	946	
	2011.10-	2012.02	4AT	R	F	-	624061	Inner Joint		27	22	41	62	86	
	2011.10-	2012.02	4AT	L	F	-	624097	Inner Joint		27	22	41	62.5	94	
	2012-	-	MT	R	-	-	224387	Drive Shaft	46T	27	27	60	95	966	
	2012-	-	MT	L	-	-	224388	Drive Shaft	46T	27	27	60	95	681	
i30 (FD)															
1.4 (77 kW)	2007.10-	2012.06	MT	R	F	Estate Engine G4FA	224282	Drive Shaft	46T	27	25	60	94.5	941	
	2007.10-	2011.11	MT	R	F	Hatchback Engine G4FA	224282	Drive Shaft	46T	27	25	60	94.5	941	
	2007.10-	2012.06	-	-	F	Estate Engine G4FA	824077	Outer Joint	46T	27	22	60	94.5	54.5	M
	2007.10-	2011.11	-	-	F	Hatchback Engine G4FA	824077	Outer Joint	46T	27	22	60	94.5	54.5	M
	2007.10-	2011.11	5MT	L/R	F	Hatchback Engine G4FA	824095	Outer Joint	46T	27	22	60	94.5	58.5	M
	2007.10-	2012.06	MT	-	F	Estate Engine G4FA	824132	Outer Joint	46T	27	22	60	94.5	54.5	M
	2007.10-	2011.11	MT	-	F	Hatchback Engine G4FA	824132	Outer Joint	46T	27	22	60	94.5	54.5	M
1.4 (80 kW)	2007.10-	2011.11	MT	R	F	Hatchback Engine G4FA	224282	Drive Shaft	46T	27	25	60	94.5	941	
	2007.10-	2011.11	-	-	F	Hatchback Engine G4FA	824077	Outer Joint	46T	27	22	60	94.5	54.5	M
	2007.10-	2011.11	5MT	L/R	F	Hatchback Engine G4FA	824095	Outer Joint	46T	27	22	60	94.5	58.5	M
	2007.10-	2011.11	MT	-	F	Hatchback Engine G4FA	824132	Outer Joint	46T	27	22	60	94.5	54.5	M
	2009.11-	2012.06	MT	R	F	Estate Engine G4FA	224282	Drive Shaft	46T	27	25	60	94.5	941	
	2009.11-	2012.06	-	-	F	Estate Engine G4FA	824077	Outer Joint	46T	27	22	60	94.5	54.5	M
	2009.11-	2012.06	MT	-	F	Estate Engine G4FA	824132	Outer Joint	46T	27	22	60	94.5	54.5	M
1.6 (85 kW)	2007.10-	2011.11	6AT	-	F	Hatchback Engine G4FC	824227	Outer Joint	46T	27	24	60	92.5	58	M
	2007.10-	2011.11	MT	R	F	Hatchback Engine G4FC	224282	Drive Shaft	46T	27	25	60	94.5	941	
	2007.10-	2011.11	-	-	F	Hatchback Engine G4FC	824077	Outer Joint	46T	27	22	60	94.5	54.5	M
	2007.10-	2011.11	5MT	L/R	F	Hatchback Engine G4FC	824095	Outer Joint	46T	27	22	60	94.5	58.5	M
	2008.02-	2012.06	6AT	-	F	Estate Engine G4FC	824227	Outer Joint	46T	27	24	60	92.5	58	M
	2008.02-	2012.06	MT	R	F	Estate Engine G4FC	224282	Drive Shaft	46T	27	25	60	94.5	941	
	2008.02-	2012.06	-	-	F	Estate Engine G4FC	824077	Outer Joint	46T	27	22	60	94.5	54.5	M
	2008.02-	2012.06	5MT	L/R	F	Estate Engine G4FC	824095	Outer Joint	46T	27	22	60	94.5	58.5	M
1.6 (90 kW)	2007.10-	2011.11	6AT	-	F	Hatchback Engine G4FC	824227	Outer Joint	46T	27	24	60	92.5	58	M
	2007.10-	2011.11	MT	R	F	Hatchback Engine G4FC	224282	Drive Shaft	46T	27	25	60	94.5	941	
	2007.10-	2011.11	-	-	F	Hatchback Engine G4FC	824077	Outer Joint	46T	27	22	60	94.5	54.5	M
	2007.10-	2011.11	5MT	L/R	F	Hatchback Engine G4FC	824095	Outer Joint	46T	27	22	60	94.5	58.5	M
	2008.02-	2012.06	6AT	-	F	Estate Engine G4FC	824227	Outer Joint	46T	27	24	60	92.5	58	M
	2008.02-	2012.06	MT	R	F	Estate Engine G4FC	224282	Drive Shaft	46T	27	25	60	94.5	941	
	2008.02-	2012.06	-	-	F	Estate Engine G4FC	824077	Outer Joint	46T	27	22	60	94.5	54.5	M
	2008.02-	2012.06	5MT	L/R	F	Estate Engine G4FC	824095	Outer Joint	46T	27	22	60	94.5	58.5	M
1.6 (93 kW)	2008.02-	2012.06	6AT	-	F	Estate Engine G4FC	824227	Outer Joint	46T	27	24	60	92.5	58	M
	2008.02-	2011.11	6AT	-	F	Hatchback Engine G4FC	824227	Outer Joint	46T	27	24	60	92.5	58	M
	2008.02-	2012.06	MT	R	F	Estate Engine G4FC	224282	Drive Shaft	46T	27	25	60	94.5	941	
	2008.02-	2011.11	MT	R	F	Hatchback Engine G4FC	224282	Drive Shaft	46T	27	25	60	94.5	941	

	 YEAR	TRANSM	L/R	F/R	REMARKS	GSP Ref.	 PRODUCT	 ABS	Technical Specifications						
									A	B	C	H	L	P	
HYUNDAI															
i30 (FD)															
1.6 (93 kW)	2008.02-2012.06	-	-	F	Estate Engine G4FC	824077	Outer Joint	46T	27	22	60	94.5	54.5	M	
	2008.02-2011.11	-	-	F	Hatchback Engine G4FC	824077	Outer Joint	46T	27	22	60	94.5	54.5	M	
	2008.02-2012.06	5MT	L/R	F	Estate Engine G4FC	824095	Outer Joint	46T	27	22	60	94.5	58.5	M	
1.6 CRDi (66 kW)	2007.10-2011.11	6AT	-	F	Hatchback Engine D4FB	824227	Outer Joint	46T	27	24	60	92.5	58	M	
	2007.10-2011.11	MT	L	F	Hatchback Engine D4FB	224181	Drive Shaft	46T	27	25	60	94.5	679		
	2007.10-2011.11	MT	R	F	Hatchback Engine D4FB	224297	Drive Shaft	46T	27	27	60	95	954		
	2007.10-2011.11	5MT/6MT	L/R	F	Hatchback Engine D4FB	824339	Outer Joint	46T	27	25	68	95	64	M	
	2007.10-2011.11	MT	-	-	Hatchback Engine D4FB	824126	Outer Joint	46T	27	25	60	95	63	M	
	2007.10-2011.11	5MT	L/R	F	Hatchback Engine D4FB	824152	Outer Joint	46T	27	26	60	94	67	M	
	2007.10-2011.11	4AT/5MT	-	F	Hatchback Engine D4FB	824132	Outer Joint	46T	27	22	60	94.5	54.5	M	
	2008.02-2012.06	6AT	-	F	Estate Engine D4FB	824227	Outer Joint	46T	27	24	60	92.5	58	M	
	2008.02-2012.06	MT	L	F	Estate Engine D4FB	224181	Drive Shaft	46T	27	25	60	94.5	679		
	2008.02-2012.06	MT	R	F	Estate Engine D4FB	224297	Drive Shaft	46T	27	27	60	95	954		
	2008.02-2012.06	MT	-	-	Estate Engine D4FB	824126	Outer Joint	46T	27	25	60	95	63	M	
	2008.02-2012.06	5MT	L/R	F	Estate Engine D4FB	824152	Outer Joint	46T	27	26	60	94	67	M	
	2008.02-2012.06	4AT/5MT	-	F	Estate Engine D4FB	824132	Outer Joint	46T	27	22	60	94.5	54.5	M	
1.6 CRDi (85 kW)	2007.10-2011.11	6AT	-	F	Hatchback Engine D4FB	824227	Outer Joint	46T	27	24	60	92.5	58	M	
	2007.10-2011.11	MT	L	F	Hatchback Engine D4FB	224181	Drive Shaft	46T	27	25	60	94.5	679		
	2007.10-2011.11	MT	R	F	Hatchback Engine D4FB	224297	Drive Shaft	46T	27	27	60	95	954		
	2007.10-2011.11	MT	-	-	Hatchback Engine D4FB	824126	Outer Joint	46T	27	25	60	95	63	M	
	2007.10-2011.11	5MT/6MT	L/R	F	Hatchback Engine D4FB	824339	Outer Joint	46T	27	25	68	95	64	M	
	2007.10-2011.11	5MT	L/R	F	Hatchback Engine D4FB	824152	Outer Joint	46T	27	26	60	94	67	M	
	2007.10-2011.11	4AT/5MT	-	F	Hatchback Engine D4FB	824132	Outer Joint	46T	27	22	60	94.5	54.5	M	
	2008.02-2012.06	6AT	-	F	Estate Engine D4FB	824227	Outer Joint	46T	27	24	60	92.5	58	M	
	2008.02-2012.06	MT	L	F	Estate Engine D4FB	224181	Drive Shaft	46T	27	25	60	94.5	679		
	2008.02-2012.06	MT	R	F	Estate Engine D4FB	224297	Drive Shaft	46T	27	27	60	95	954		
	2008.02-2012.06	MT	-	-	Estate Engine D4FB	824126	Outer Joint	46T	27	25	60	95	63	M	
	2008.02-2012.06	5MT	L/R	F	Estate Engine D4FB	824152	Outer Joint	46T	27	26	60	94	67	M	
	2008.02-2012.06	4AT/5MT	-	F	Estate Engine D4FB	824132	Outer Joint	46T	27	22	60	94.5	54.5	M	
1.6 CRDi (94 kW)	2010.01-2011.11	6AT	-	F	Hatchback Engine D4FB	824227	Outer Joint	46T	27	24	60	92.5	58	M	
	2010.01-2012.06	6AT	-	F	Estate Engine D4FB	824227	Outer Joint	46T	27	24	60	92.5	58	M	
	2010.01-2012.06	MT	L	F	Estate Engine D4FB	224181	Drive Shaft	46T	27	25	60	94.5	679		
	2010.01-2011.11	MT	R	F	Hatchback Engine D4FB	224297	Drive Shaft	46T	27	27	60	95	954		
	2010.01-2012.06	MT	R	F	Estate Engine D4FB	224297	Drive Shaft	46T	27	27	60	95	954		
	2010.01-2011.11	-	-	-	Hatchback Engine D4FB	824077	Outer Joint	46T	27	22	60	94.5	54.5	M	
	2010.01-2012.06	-	-	-	Estate Engine D4FB	824077	Outer Joint	46T	27	22	60	94.5	54.5	M	
	2010.01-2011.11	4AT/5MT	-	F	Hatchback Engine D4FB	824132	Outer Joint	46T	27	22	60	94.5	54.5	M	
	2010.01-2012.06	4AT/5MT	-	F	Estate Engine D4FB	824132	Outer Joint	46T	27	22	60	94.5	54.5	M	
	2.0 (105 kW)	2007.10-2011.11	4AT/5MT	L/R	F	Hatchback Engine G4GC-G/G4GC	827080	Outer Joint	46T	27	23	60	95	58	M
2008.02-2012.06	4AT/5MT	L/R	F	Estate Engine G4GC-G/G4GC	827080	Outer Joint	46T	27	23	60	95	58	M		
2.0 CRDi (103 kW)	2007.10-2011.11	6MT	L/R	F	Hatchback Engine D4EA	824152	Outer Joint	46T	27	26	60	94	67	M	
	2008.02-2012.06	6MT	L/R	F	Estate Engine D4EA	824152	Outer Joint	46T	27	26	60	94	67	M	
i30 (GD)															
1.4 (73 kW)	2011.12-2015.12	MT	-	F	Hatchback Engine G4FA	824132	Outer Joint	46T	27	22	60	94.5	54.5	M	
	2011.12-2015.12	MT	L	F	Hatchback Engine G4FA	639052	Inner Joint		25	22	41	63	86		
	2012.06-2015.12	MT	-	F	Estate Engine G4FA	824132	Outer Joint	46T	27	22	60	94.5	54.5	M	
	2012.06-2015.12	MT	L	F	Estate Engine G4FA	639052	Inner Joint		25	22	41	63	86		
1.4 (74 kW)	2014.12-2016.12	MT	L	F	Hatchback Engine G4LC	639052	Inner Joint		25	22	41	63	86		
	2014.12-2016.12	MT	-	F	Hatchback Engine G4LC	824132	Outer Joint	46T	27	22	60	94.5	54.5	M	
	2015.01-	MT	L	F	Estate Engine G4LC	639052	Inner Joint		25	22	41	63	86		
	2015.01-	MT	-	F	Estate Engine G4LC	824132	Outer Joint	46T	27	22	60	94.5	54.5	M	
1.6 (88 kW)	2012.01-2016.12	AT	-	F	Hatchback Engine G4FC	824227	Outer Joint	46T	27	24	60	92.5	58	M	
	2012.01-2016.12	MT	-	F	Hatchback Engine G4FC	824132	Outer Joint	46T	27	22	60	94.5	54.5	M	
	2012.01-2016.12	MT	L	F	Hatchback Engine G4FC	639052	Inner Joint		25	22	41	63	86		
	2012.06-	AT	-	F	Estate Engine G4FG	824227	Outer Joint	46T	27	24	60	92.5	58	M	
	2012.06-	MT	-	F	Estate Engine G4FG	824132	Outer Joint	46T	27	22	60	94.5	54.5	M	
	2012.06-	MT	L	F	Estate Engine G4FG	639052	Inner Joint		25	22	41	63	86		
1.6 (95 kW)	2012.06-2015.12	AT	-	F	Estate Engine G4FG	824227	Outer Joint	46T	27	24	60	92.5	58	M	
	2012.06-2015.12	MT	-	F	Estate Engine G4FG	824132	Outer Joint	46T	27	22	60	94.5	54.5	M	
	2012.06-2015.12	MT	L	F	Estate Engine G4FG	639052	Inner Joint		25	22	41	63	86		
1.6 CRDi (100 kW)	2011.11-2016.12	AT	-	F	Hatchback Engine D4FB	824227	Outer Joint	46T	27	24	60	92.5	58	M	
	2011.11-2016.12	4AT	L	F	Hatchback Engine D4FB	224305	Drive Shaft	46T	27	27	60	95	675		
1.6 CRDi (81 kW)	2011.12-2016.12	AT	-	F	Hatchback Engine D4FB	824227	Outer Joint	46T	27	24	60	92.5	58	M	
	2011.12-2016.12	4AT	L	F	Hatchback Engine D4FB	224305	Drive Shaft	46T	27	27	60	95	675		
	2012.06-	AT	-	F	Estate Engine D4FB	824227	Outer Joint	46T	27	24	60	92.5	58	M	
1.6 CRDi (94 kW)	2011.12-2015.12	AT	-	F	Hatchback Engine D4FB	824227	Outer Joint	46T	27	24	60	92.5	58	M	

YEAR	TRANSM	L/R	F/R	REMARKS	GSP Ref.	PRODUCT	ABS	Technical Specifications						
								A	B	C	H	L	P	
HYUNDAI														
i30 (GD)														
1.6 CRDi (94 kW)	2011.12-2015.12	4AT	L	F	Hatchback Engine D4FB	224305	Drive Shaft	46T	27	27	60	95	675	
	2012.06-2015.12	AT	-	F	Estate Engine D4FB-5P	824227	Outer Joint	46T	27	24	60	92.5	58	M
1.6 GDI (95 kW)	2011.12-2015.12	AT	-	F	Hatchback Engine G4FG	824227	Outer Joint	46T	27	24	60	92.5	58	M
	2011.12-2015.12	-	-	F	Hatchback Engine G4FG	824132	Outer Joint	46T	27	22	60	94.5	54.5	M
	2011.12-2015.12	MT	L	F	Hatchback Engine G4FG	639052	Inner Joint		25	22	41	63	86	
1.6 GDI (99 kW)	2011.12-2016.12	AT	-	F	Hatchback Engine G4FD	824227	Outer Joint	46T	27	24	60	92.5	58	M
	2011.12-2016.12	MT	L	F	Hatchback Engine G4FD	639052	Inner Joint		25	22	41	63	86	
	2012.06-	AT	-	F	Estate Engine G4FD	824227	Outer Joint	46T	27	24	60	92.5	58	M
	2012.06-	MT	-	F	Estate Engine G4FD	824132	Outer Joint	46T	27	22	60	94.5	54.5	M
	2012.06-	MT	L	F	Estate Engine G4FD	639052	Inner Joint		25	22	41	63	86	
1.6 T-GDI (137 kW)	2015.01-	MT	L	F	Hatchback Engine G4FJ	639052	Inner Joint		25	22	41	63	86	
	2015.01-	AT	-	F	Hatchback Engine G4FJ	824227	Outer Joint	46T	27	24	60	92.5	58	M
	2015.01-	MT	-	F	Hatchback Engine G4FJ	824132	Outer Joint	46T	27	22	60	94.5	54.5	M
i30 (PDE PD)														
1.4 MPI (73 kW)	2016.11-	MT	L	F	Hatchback Engine	639052	Inner Joint		25	22	41	63	86	
	2016.11-	-	-	F	Hatchback Engine	824077	Outer Joint	46T	27	22	60	94.5	54.5	M
	2016.11-	MT	-	F	Hatchback Engine	824132	Outer Joint	46T	27	22	60	94.5	54.5	M
1.4 T-GDI (103 kW)	2016.11-	MT	L	F	Hatchback Engine G4LD	639052	Inner Joint		25	22	41	63	86	
	2016.11-	MT	-	F	Hatchback Engine G4LD	824132	Outer Joint	46T	27	22	60	94.5	54.5	M
i30 (PDE)														
1.4 MPI(73 kW)	2017.05-	MT	L	F	Estate	639052	Inner Joint		25	22	41	63	86	
	2017.05-	-	-	F	Estate	824077	Outer Joint	46T	27	22	60	94.5	54.5	M
	2017.05-	MT	-	F	Estate	824132	Outer Joint	46T	27	22	60	94.5	54.5	M
1.4 MPI(74 kW)	2017.03-	MT	L	F	Estate	639052	Inner Joint		25	22	41	63	86	
	2017.03-	-	-	F	Estate	824077	Outer Joint	46T	27	22	60	94.5	54.5	M
	2017.03-	MT	-	F	Estate	824132	Outer Joint	46T	27	22	60	94.5	54.5	M
1.4 T-GDI(103 kW)	2017.03-	MT	L	F	Estate Engine G4LD	639052	Inner Joint		25	22	41	63	86	
	2017.03-	MT	-	F	Estate Engine G4LD	824132	Outer Joint	46T	27	22	60	94.5	54.5	M
	2017.06-	MT	L	F	Hatchback/FASTBACK Engine G4LD	639052	Inner Joint		25	22	41	63	86	
	2017.06-	MT	-	F	Hatchback/FASTBACK Engine G4LD	824132	Outer Joint	46T	27	22	60	94.5	54.5	M
i30 (PDE, PD)														
1.4 MPI(74 kW)	2016.11-	MT	L	F	Hatchback Engine G4LC	639052	Inner Joint		25	22	41	63	86	
	2016.11-	-	-	F	Hatchback Engine G4LC	824077	Outer Joint	46T	27	22	60	94.5	54.5	M
	2016.11-	MT	-	F	Hatchback Engine G4LC	824132	Outer Joint	46T	27	22	60	94.5	54.5	M
2.0 N(184 kW)	2017.07-	AT	-	F	Hatchback Engine G4KH	824227	Outer Joint	46T	27	24	60	92.5	58	M
2.0 N(202 kW)	2017.07-	AT	-	F	Hatchback Engine G4KH	824227	Outer Joint	46T	27	24	60	92.5	58	M
I30/ELANTRA														
1.6	2012-	6MT	R	F	2WD	824267	Outer Joint		27	22	60	94.5	54.5	M
I30/I30 CW														
1.4 2WD	2010-2012	5MT/6MT	L	-	GAMMA	224283	Drive Shaft	46T	27	25	60	94.5	674	
	2010-2012	5MT/6MT	L	-	GAMMA	627019	Inner Joint		25	22	41	62	93.5	
1.6 2WD	2007-2012	5MT/6MT	L	-	U2 > DOHC TCI	224296	Drive Shaft	46T	27	27	60	95	663	
	2007-2012	4AT	L	-	U2 > DOHC TCI	624097	Inner Joint		27	22	41	62.5	94	
	2007-2012	4AT	L	-	U2 > DOHC TCI	824184	Outer Joint		27	24	60	95	59	M
	2007-2012	4AT	L	-	U2 > DOHC TCI	624097	Inner Joint		27	22	41	62.5	94	
	2007-2012	5MT/6MT	L	-	U2 > DOHC TCI	624098	Inner Joint		27	25	41	61.5	100.5	
	2008-2012	5MT/6MT/4AT	L	-	GAMMA	224283	Drive Shaft	46T	27	25	60	94.5	674	
	2008-2012	5MT/6MT/4AT	L	-	GAMMA	627019	Inner Joint		25	22	41	62	93.5	
I30/I30CW														
-	2007-	-	L	F	2WD	624097	Inner Joint		27	22	41	62.5	94	
	2007-	-	L	F	2WD	824184	Outer Joint		27	24	60	95	59	M
	2008-	4AT	L	F	2WD	624097	Inner Joint		27	22	41	62.5	94	
	2008-	4AT	L	F	2WD	824184	Outer Joint		27	24	60	95	59	M
	2009-	4AT	L	F	2WD	624097	Inner Joint		27	22	41	62.5	94	
	2009-	4AT	L	F	2WD	824184	Outer Joint		27	24	60	95	59	M
1.6	2007-	4AT	L	F	2WD	624097	Inner Joint		27	22	41	62.5	94	
	2007-	4AT	L	F	2WD	824184	Outer Joint		27	24	60	95	59	M
2.0	2007-	-	L	F	-	224429	Drive Shaft	46T	27	27	60	94.5	675	
	2007-	5MT	L	F	2WD	224429	Drive Shaft	46T	27	27	60	94.5	675	
	2007-	4AT	L	F	2WD	224429	Drive Shaft	46T	27	27	60	94.5	675	
	2007-	-	R	F	-	224440	Drive Shaft	46T	27	27	60	94.5	941	
	2007-	5MT	R	F	2WD	224440	Drive Shaft	46T	27	27	60	94.5	941	
	2007-	4AT	R	F	2WD	224440	Drive Shaft	46T	27	27	60	94.5	941	
	2007-	5MT	L	F	2WD	624138	Inner Joint		27	22	41	62	94	
	2007-	4AT	L	F	2WD	624138	Inner Joint		27	22	41	62	94	
	2007-	5MT	R	F	2WD	624134	Inner Joint		27	22	41	62	86	

YEAR	TRANSM	L/R	F/R	REMARKS	GSP Ref.	PRODUCT	ABS	Technical Specifications							
								A	B	C	H	L	P		
HYUNDAI															
I30/I30CW															
2.0	2007-	-	4AT	R	F	2WD	624134	Inner Joint		27	22	41	62	86	
	2007-	-	5MT	L	F	2WD	824292	Outer Joint		27	22	60	94.5	54.5	M
	2007-	-	4AT	L	F	2WD	824292	Outer Joint		27	22	60	94.5	54.5	M
	2007-	-	5MT	R	F	2WD	824292	Outer Joint		27	22	60	94.5	54.5	M
	2007-	-	4AT	R	F	2WD	824292	Outer Joint		27	22	60	94.5	54.5	M
	2008-	-	5MT	R	F	2WD	224440	Drive Shaft	46T	27	27	60	94.5	941	
	2008-	-	4AT	R	F	2WD	224440	Drive Shaft	46T	27	27	60	94.5	941	
	2008-	-	5MT	R	F	2WD	624134	Inner Joint		27	22	41	62	86	
	2008-	-	4AT	R	F	2WD	624134	Inner Joint		27	22	41	62	86	
	2008-	-	5MT	R	F	2WD	824292	Outer Joint		27	22	60	94.5	54.5	M
	2008-	-	4AT	R	F	2WD	824292	Outer Joint		27	22	60	94.5	54.5	M
	2009-	-	5MT	L	F	2WD	224429	Drive Shaft	46T	27	27	60	94.5	675	
	2009-	-	4AT	L	F	2WD	224429	Drive Shaft	46T	27	27	60	94.5	675	
	2009-	-	5MT	R	F	2WD	224440	Drive Shaft	46T	27	27	60	94.5	941	
	2009-	-	4AT	R	F	2WD	224440	Drive Shaft	46T	27	27	60	94.5	941	
	2009-	-	5MT	L	F	2WD	624138	Inner Joint		27	22	41	62	94	
	2009-	-	4AT	L	F	2WD	624138	Inner Joint		27	22	41	62	94	
	2009-	-	5MT	R	F	2WD	624134	Inner Joint		27	22	41	62	86	
	2009-	-	4AT	R	F	2WD	624134	Inner Joint		27	22	41	62	86	
	2009-	-	5MT	L	F	2WD	824292	Outer Joint		27	22	60	94.5	54.5	M
	2009-	-	4AT	L	F	2WD	824292	Outer Joint		27	22	60	94.5	54.5	M
	2009-	-	5MT	R	F	2WD	824292	Outer Joint		27	22	60	94.5	54.5	M
	2009-	-	4AT	R	F	2WD	824292	Outer Joint		27	22	60	94.5	54.5	M
I40															
-	2011-	-	-	-	F	-	624043	Inner Joint		27	25	41	62.8	92.5	
	2011-	-	-	-	F	-	224389	Drive Shaft	48T	27	27	62	92.5	983	
	2011-	-	-	-	F	-	824194	Outer Joint		27	25	62	92.5	61	M
2.0	2011-	-	AT	R	-	-	224391	Drive Shaft	48T	27	27	62	92.5	959	
i40 (VF)															
1.7 CRDi (100 kW)	2012.03-	-	AT	R	F	Saloon Engine D4FD	224563	Drive Shaft	48T	27	28	62	92.5	960	
	2012.03-	-	MT	R	F	Saloon Engine D4FD	224347	Drive Shaft	48T	27	28	62	92.5	988	
	2012.03-	-	AT	R	F	Saloon Engine D4FD	624159	Inner joint		28	25	33	67	84	
	2012.03-	-	6AT	L	F	Saloon Engine D4FD	624100	Inner Joint		28	25	33	67.5	83.5	
	2012.03-	-	-	-	F	Saloon Engine D4FD	824138	Outer Joint	48T	27	25	62	92.5	61	M
2.0 GDi (121 kW)	2014.12-	-	AT	L	F	Saloon Engine G4NC	624056	Inner Joint		27	25	30	67	83.5	
2.0 GDI (131 kW)	2012.03-	-	AT	L	F	Saloon Engine G4NC	624056	Inner Joint		27	25	30	67	83.5	
2.0 GDI(130 kW)	2012.03-	-	AT	L	F	Saloon Engine G4NC	624056	Inner Joint		27	25	30	67	83.5	
I40 12															
1.7	2011-	-	6MT	L	F	2WD	224392	Drive Shaft	48T	27	28	62	92.5	664	
	2011-	-	6MT	L	F	2WD	624092	Inner Joint		28	25	41	61.5	93	
	2011-	-	6MT	L	F	2WD	824194	Outer Joint		27	25	62	92.5	61	M
	2011.04-	-	MT	L	F	U2 DOHC TCI DIESEL DIESEL /2WD	224392	Drive Shaft	48T	27	28	62	92.5	664	
	2011.04-	-	MT	L	F	U2 DOHC TCI DIESEL DIESEL ENGINE PACKAGE VGT HIGH POWER ENG/2WD	224392	Drive Shaft	48T	27	28	62	92.5	664	
	2011.12-	2014.03	MT	L	F	U2 DOHC TCI DIESEL DIESEL ENGINE PACKAGE VGT HIGH POWER ENG/2WD	224392	Drive Shaft	48T	27	28	62	92.5	664	
	2011.12-	2013.04	MT	L	F	U2 DOHC TCI DIESEL DIESEL ENGINE PACKAGE VGT HIGH POWER ENG/2WD	224392	Drive Shaft	48T	27	28	62	92.5	664	
	2012.03-	-	MT	L	F	U2 DOHC TCI DIESEL DIESEL ENGINE PACKAGE VGT HIGH POWER ENG/2WD	224392	Drive Shaft	48T	27	28	62	92.5	664	
2.0	2011-	-	6MT	R	F	2WD	824194	Outer Joint		27	25	62	92.5	61	M
	2011-	-	6MT	L	F	2WD	824194	Outer Joint		27	25	62	92.5	61	M
	2011-	-	6MT	R	F	2WD	224389	Drive Shaft	48T	27	27	62	92.5	983	
	2011-	-	6MT	L	F	2WD	224390	Drive Shaft	48T	27	27	62	92.5	669	
	2011-	-	6MT	R	F	2WD	624043	Inner Joint		27	25	41	62.8	92.5	
	2011-	-	6MT	L	F	2WD	624043	Inner Joint		27	25	41	62.8	92.5	
	2011.04-	-	6MT	R	F	NU DOHC GDI GASOLINE UNLEADED/2WD	824194	Outer Joint		27	25	62	92.5	61	M
	2011.04-	-	6MT	L	F	NU DOHC GDI GASOLINE UNLEADED /2WD	824194	Outer Joint		27	25	62	92.5	61	M
	2011.04-	-	6MT	R	F	NU DOHC GDI GASOLINE UNLEADED/2WD	224389	Drive Shaft	48T	27	27	62	92.5	983	
	2011.04-	-	6MT	L	F	NU DOHC GDI GASOLINE UNLEADED /2WD	224390	Drive Shaft	48T	27	27	62	92.5	669	
	2011.04-	-	6MT	R	F	NU DOHC GDI GASOLINE UNLEADED/2WD	624043	Inner Joint		27	25	41	62.8	92.5	
	2011.04-	-	6MT	L	F	NU DOHC GDI GASOLINE UNLEADED /2WD	624043	Inner Joint		27	25	41	62.8	92.5	
	2011.11-	2013.07	6MT	R	F	NU DOHC GDI GASOLINE UNLEADED/2WD	824194	Outer Joint		27	25	62	92.5	61	M
	2011.11-	2013.07	6MT	L	F	NU DOHC GDI GASOLINE UNLEADED /2WD	824194	Outer Joint		27	25	62	92.5	61	M
	2011.11-	2013.07	6MT	R	F	NU DOHC GDI GASOLINE UNLEADED/2WD	224389	Drive Shaft	48T	27	27	62	92.5	983	
	2011.11-	2013.07	6MT	L	F	NU DOHC GDI GASOLINE UNLEADED /2WD	224390	Drive Shaft	48T	27	27	62	92.5	669	
	2011.11-	2013.07	6MT	R	F	NU DOHC GDI GASOLINE UNLEADED/2WD	624043	Inner Joint		27	25	41	62.8	92.5	
	2011.11-	2013.07	6MT	L	F	NU DOHC GDI GASOLINE UNLEADED /2WD	624043	Inner Joint		27	25	41	62.8	92.5	
	2011.12-	-	6MT	R	F	NU DOHC MPI GASOLINE UNLEADED/2WD	824194	Outer Joint		27	25	62	92.5	61	M
	2011.12-	-	6MT	L	F	NU DOHC MPI GASOLINE UNLEADED /2WD	824194	Outer Joint		27	25	62	92.5	61	M

YEAR	TRANSM	L/R	F/R	REMARKS	GSP Ref.	PRODUCT	ABS	Technical Specifications							
								A	B	C	H	L	P		
HYUNDAI															
i40 12															
2.0	2011.12-	-	6MT	R	F	NU DOHC MPI GASOLINE UNLEADED/2WD	224389	Drive Shaft	48T	27	27	62	92.5	983	
	2011.12-	-	6MT	L	F	NU DOHC MPI GASOLINE UNLEADED /2WD	224390	Drive Shaft	48T	27	27	62	92.5	669	
	2011.12-	-	6MT	R	F	NU DOHC MPI GASOLINE UNLEADED/2WD	624043	Inner Joint		27	25	41	62.8	92.5	
	2011.12-	-	6MT	L	F	NU DOHC MPI GASOLINE UNLEADED /2WD	624043	Inner Joint		27	25	41	62.8	92.5	
	2013.03-	-	6MT	R	F	NU DOHC MPI GASOLINE UNLEADED/2WD	824194	Outer Joint		27	25	62	92.5	61	M
	2013.03-	-	6MT	L	F	NU DOHC MPI GASOLINE UNLEADED /2WD	824194	Outer Joint		27	25	62	92.5	61	M
	2013.03-	-	6MT	R	F	NU DOHC MPI GASOLINE UNLEADED/2WD	224389	Drive Shaft	48T	27	27	62	92.5	983	
	2013.03-	-	6MT	L	F	NU DOHC MPI GASOLINE UNLEADED /2WD	224390	Drive Shaft	48T	27	27	62	92.5	669	
	2013.03-	-	6MT	R	F	NU DOHC MPI GASOLINE UNLEADED/2WD	624043	Inner Joint		27	25	41	62.8	92.5	
i40	2011.04-	-	MT	L	F	U2 DOHC TCI DIESEL /2WD	624092	Inner Joint		28	25	41	61.5	93	
	2011.04-	-	MT	L	F	U2 DOHC TCI/2WD	624092	Inner Joint		28	25	41	61.5	93	
	2011.12-	2014.03	MT	L	F	U2 DOHC TCI/2WD	624092	Inner Joint		28	25	41	61.5	93	
	2011.12-	2013.04	MT	L	F	U2 DOHC TCI/2WD	624092	Inner Joint		28	25	41	61.5	93	
	2012.03-	-	MT	L	F	U2 DOHC TCI/2WD	624092	Inner Joint		28	25	41	61.5	93	
i40 12	2011.04-	-	MT	L	F	U2 DOHC TCI DIESEL DIESEL /2WD	824194	Outer Joint		27	25	62	92.5	61	M
	2011.04-	-	MT	L	F	U2 DOHC TCI/2WD	824194	Outer Joint		27	25	62	92.5	61	M
	2011.12-	2014.03	MT	L	F	U2 DOHC TCI/2WD	824194	Outer Joint		27	25	62	92.5	61	M
	2011.12-	2013.04	MT	L	F	U2 DOHC TCI/2WD	824194	Outer Joint		27	25	62	92.5	61	M
	2012.03-	-	MT	L	F	U2 DOHC TCI/2WD	824194	Outer Joint		27	25	62	92.5	61	M
i40 CW (VF)															
1.7 CRDi (100 kW)	2011.07-	-	AT	R	F	Estate Engine D4FD	224563	Drive Shaft	48T	27	28	62	92.5	960	
	2011.07-	-	MT	R	F	Estate Engine D4FD	224347	Drive Shaft	48T	27	28	62	92.5	988	
	2011.07-	-	AT	R	F	Estate Engine D4FD	624159	Inner joint		28	25	33	67	84	
	2011.07-	-	-	-	F	Estate Engine D4FD	824138	Outer Joint	48T	27	25	62	92.5	61	M
2.0 GDi (121 kW)	2014.12-	-	AT	L	F	Estate Engine G4NC	624056	Inner Joint		27	25	30	67	83.5	
2.0 GDi (130 kW)	2011.07-	-	AT	L	F	Estate Engine G4NC	624056	Inner Joint		27	25	30	67	83.5	
I45															
2.4 2WD	2010-	2014	6AT	R	-	THETA 2	224261	Drive Shaft	48T	27	27	62	92.5	970	
	2010-	2014	6AT	L	-	THETA 2	224262	Drive Shaft	48T	27	27	62	92.5	672	
ix20 (JC)															
1.4 (66 kW)	2010.11-	-	-	R	F	Hatchback Engine G4FA	239237	Drive Shaft	46T	27	25	60	94.5	959	
	2010.11-	-	-	-	F	Hatchback Engine G4FA	827088	Outer Joint	46T	27	22	60	94.5	54.5	M
1.4 CRDi (57 kW)	2011.06-	-	MT	L	F	Hatchback Engine D4FC-M	224318	Drive Shaft	46T	27	27	60	95	672	
	2011.06-	-	MT	R	F	Hatchback Engine D4FC-M	224400	Drive Shaft	46T	27	27	60	95	967	
1.4 CRDi (66 kW)	2010.11-	-	MT	L	F	Hatchback Engine D4FC	224318	Drive Shaft	46T	27	27	60	95	672	
	2010.11-	-	MT	R	F	Hatchback Engine D4FC	224400	Drive Shaft	46T	27	27	60	95	967	
1.6 (92 kW)	2010.11-	-	AT	R	F	Hatchback Engine G4FC	239237	Drive Shaft	46T	27	25	60	94.5	959	
	2010.11-	-	-	-	F	Hatchback Engine G4FC	827088	Outer Joint	46T	27	22	60	94.5	54.5	M
1.6 CRDi (85 kW)	2011.06-	-	MT	L	F	Hatchback Engine D4FB	224318	Drive Shaft	46T	27	27	60	95	672	
	2011.06-	-	MT	R	F	Hatchback Engine D4FB	224400	Drive Shaft	46T	27	27	60	95	967	
IX35															
2.0	2010.01-	2011.06	6AT	L	F	-	627056	Inner Joint		28	25	33	67	103.5	
	2010.01-	2011.06	6AT	R	F	-	624064	Inner Joint		28	25	44.1	43.5	76.5	
	2010.01-	2011.06	6MT	R	F	-	624064	Inner Joint		28	25	44.1	43.5	76.5	
	2010.01-	2011.06	6MT	L	F	-	627057	Inner Joint		28	25	41	61.5	107	
	2010.01-	2011.06	6MT	R	F	-	627057	Inner Joint		28	25	41	61.5	107	
	2010.01-	2011.06	6AT	L	F	-	224550	Drive Shaft	48T	30	28	62	95	671	
	2010.01-	2011.06	6AT	R	F	-	224522	Drive Shaft	48T	30	28	62	95	585	
	2010.01-	2011.06	6MT	R	F	-	224522	Drive Shaft	48T	30	28	62	95	585	
	2010.01-	2011.06	6MT	L	F	-	224523	Drive Shaft	48T	30	28	62	95	680	
	2010.01-	2011.06	6MT	R	F	-	224551	Drive Shaft	48T	30	28	62	95	989	
	2010.01-	2011.06	6AT	L	F	-	824221	Outer Joint	48T	30	25	62	95	63	M
	2010.01-	2011.06	6AT	R	F	-	824221	Outer Joint	48T	30	25	62	95	63	M
	2010.01-	2011.06	6MT	R	F	-	824221	Outer Joint	48T	30	25	62	95	63	M
	2010.01-	2011.06	6MT	L	F	-	824221	Outer Joint	48T	30	25	62	95	63	M
	2010.01-	2011.06	6MT	R	F	-	824221	Outer Joint	48T	30	25	62	95	63	M
	2011.06-	2013.08	6AT	L	F	-	627056	Inner Joint		28	25	33	67	103.5	
	2011.06-	2013.08	6AT	R	F	-	624064	Inner Joint		28	25	44.1	43.5	76.5	
	2011.06-	2013.08	6MT	R	F	-	624064	Inner Joint		28	25	44.1	43.5	76.5	
	2011.06-	2013.08	6AT	L	F	-	224550	Drive Shaft	48T	30	28	62	95	671	
	2011.06-	2013.08	6AT	R	F	-	224522	Drive Shaft	48T	30	28	62	95	585	
	2011.06-	2013.08	6MT	R	F	-	224522	Drive Shaft	48T	30	28	62	95	585	
	2011.06-	2013.08	6AT	L	F	-	824221	Outer Joint	48T	30	25	62	95	63	M
	2011.06-	2013.08	6AT	R	F	-	824221	Outer Joint	48T	30	25	62	95	63	M
	2011.06-	2013.08	6MT	R	F	-	824221	Outer Joint	48T	30	25	62	95	63	M

YEAR	TRANSM	L/R	F/R	REMARKS	GSP Ref.	PRODUCT	ABS	Technical Specifications									
								A	B	C	H	L	P				
HYUNDAI IX35																	
2.0	2012.12-2013.08	2013.08	6AT	L	F	-		627056	Inner Joint		28	25	33	67	103.5		
	2012.12-2013.08	2013.08	6AT	R	F	-		624064	Inner Joint		28	25	44.1	43.5	76.5		
	2012.12-2013.08	2013.08	6MT	L	F	-		627057	Inner Joint		28	25	41	61.5	107		
	2012.12-2013.08	2013.08	6AT	L	F	-		224550	Drive Shaft	48T	30	28	62	95	671		
	2012.12-2013.08	2013.08	6AT	R	F	-		224522	Drive Shaft	48T	30	28	62	95	585		
	2012.12-2013.08	2013.08	6MT	L	F	-		224523	Drive Shaft	48T	30	28	62	95	680		
	2012.12-2013.08	2013.08	6AT	L	F	-		824221	Outer Joint	48T	30	25	62	95	63	M	
	2012.12-2013.08	2013.08	6AT	R	F	-		824221	Outer Joint	48T	30	25	62	95	63	M	
	2012.12-2013.08	2013.08	6MT	L	F	-		824221	Outer Joint	48T	30	25	62	95	63	M	
ix35 (LM EL ELH)/TUCSON																	
1.6 (99 kW)	2010.11-	-	MT	R	F	Closed Off-Road Vehicle Engine G4FD		824284	Outer Joint	48T	27	24	62	95	59	M	
	2010.11-	-	MT	R	F	Closed Off-Road Vehicle Engine G4FD		224317	Drive Shaft	48T	27	25	62	95	691		
	2010.11-	-	6MT	L	-	Closed Off-Road Vehicle Engine G4FD		624128	Inner Joint		25	23	41	63	98.5		
1.7 CRDi (85 kW)	2010.11-	-	MT	R	F	Closed Off-Road Vehicle Engine D4FD		224362	Drive Shaft	48T	30	27	62	95	979		
2.0 (116 kW)	2014.09-	-	AT	R	F	All-wheel Drive Closed Off-Road Vehicle Engine G4NA		624158	Inner Joint		27	24	30	67	88.5		
	2014.09-	-	-	R	F	All-wheel Drive Closed Off-Road Vehicle Engine G4NA		627032	Inner Joint		26	24	44.1	42	73		
	2014.09-	-	MT	-	-	All-wheel Drive Closed Off-Road Vehicle Engine G4NA		627058	Inner Joint		27	24	41	61.5	100		
	2014.09-	-	-	-	F	All-wheel Drive Closed Off-Road Vehicle Engine G4NA		824124	Outer Joint	48T	27	24	62	95	58	M	
2.0 (120 kW)	2010.01-	-	MT	L	F	Closed Off-Road Vehicle Engine G4KD		224299	Drive Shaft	48T	30	27	62	95	690		
	2010.01-	-	MT	L	F	All-wheel Drive Closed Off-Road Vehicle Engine G4KD		224299	Drive Shaft	48T	30	27	62	95	690		
	2010.01-	-	AT	R	F	Closed Off-Road Vehicle Engine G4KD		624158	Inner Joint		27	24	30	67	88.5		
	2010.01-	-	AT	R	F	All-wheel Drive Closed Off-Road Vehicle Engine G4KD		624158	Inner Joint		27	24	30	67	88.5		
	2010.01-	-	-	R	F	Closed Off-Road Vehicle Engine G4KD		627032	Inner Joint		26	24	44.1	42	73		
	2010.01-	-	-	R	F	All-wheel Drive Closed Off-Road Vehicle Engine G4KD		627032	Inner Joint		26	24	44.1	42	73		
	2010.01-	-	MT	-	-	Closed Off-Road Vehicle Engine G4KD		627058	Inner Joint		27	24	41	61.5	100		
	2010.01-	-	MT	-	-	All-wheel Drive Closed Off-Road Vehicle Engine G4KD		627058	Inner Joint		27	24	41	61.5	100		
	2010.01-	-	-	-	F	Closed Off-Road Vehicle Engine G4KD		824124	Outer Joint	48T	27	24	62	95	58	M	
	2010.01-	-	-	-	F	All-wheel Drive Closed Off-Road Vehicle Engine G4KD		824124	Outer Joint	48T	27	24	62	95	58	M	
2.0 CRDi (100 kW)	2010.01-	-	MT	L	F	Closed Off-Road Vehicle Engine D4HA		224299	Drive Shaft	48T	30	27	62	95	690		
	2010.01-	-	AT	R	F	All-wheel Drive Closed Off-Road Vehicle Engine D4HA		624158	Inner Joint		27	24	30	67	88.5		
	2010.01-	-	6AT	R	F	Closed Off-Road Vehicle Engine D4HA		624158	Inner Joint		27	24	30	67	88.5		
	2010.01-	-	AT	-	F	All-wheel Drive Closed Off-Road Vehicle Engine D4HA		824124	Outer Joint	48T	27	24	62	95	58	M	
	2010.01-	-	6AT	-	F	Closed Off-Road Vehicle Engine D4HA		824124	Outer Joint	48T	27	24	62	95	58	M	
2.0 CRDi (135 kW)	2010.01-	-	AT	R	F	All-wheel Drive Closed Off-Road Vehicle Engine D4HA		624158	Inner Joint		27	24	30	67	88.5		
	2010.01-	-	AT	-	F	All-wheel Drive Closed Off-Road Vehicle Engine D4HA		824124	Outer Joint	48T	27	24	62	95	58	M	
	2012.01-	-	MT	L	F	Closed Off-Road Vehicle Engine D4HA		224299	Drive Shaft	48T	30	27	62	95	690		
	2012.01-	-	6AT	R	F	Closed Off-Road Vehicle Engine D4HA		624158	Inner Joint		27	24	30	67	88.5		
	2012.01-	-	AT	R	F	Closed Off-Road Vehicle Engine D4HA		224362	Drive Shaft	48T	30	27	62	95	979		
	2012.01-	-	6AT	-	F	Closed Off-Road Vehicle Engine D4HA		824124	Outer Joint	48T	27	24	62	95	58	M	
2.0 GDi (122 kW)	2013.08-	-	AT	R	F	All-wheel Drive Closed Off-Road Vehicle Engine G4NC		624158	Inner Joint		27	24	30	67	88.5		
	2013.08-	-	AT	R	F	Closed Off-Road Vehicle Engine G4NC		624158	Inner Joint		27	24	30	67	88.5		
	2013.08-	-	-	R	F	All-wheel Drive Closed Off-Road Vehicle Engine G4NC		627032	Inner Joint		26	24	44.1	42	73		
	2013.08-	-	-	R	F	Closed Off-Road Vehicle Engine G4NC		627032	Inner Joint		26	24	44.1	42	73		
	2013.08-	-	MT	-	-	All-wheel Drive Closed Off-Road Vehicle Engine G4NC		627058	Inner Joint		27	24	41	61.5	100		
	2013.08-	-	MT	-	-	Closed Off-Road Vehicle Engine G4NC		627058	Inner Joint		27	24	41	61.5	100		
	2013.08-	-	-	-	F	All-wheel Drive Closed Off-Road Vehicle Engine G4NC		824124	Outer Joint	48T	27	24	62	95	58	M	
	2013.08-	-	-	-	F	Closed Off-Road Vehicle Engine G4NC		824124	Outer Joint	48T	27	24	62	95	58	M	
2.4 DCVVT-I (128 kW)	2010.07-2013.12	2013.12	AT	R	F	All-wheel Drive Closed Off-Road Vehicle Engine G4KE		624158	Inner Joint		27	24	30	67	88.5		
	2010.07-2013.12	2013.12	AT	R	F	All-wheel Drive Closed Off-Road Vehicle Engine G4KE		627032	Inner Joint		26	24	44.1	42	73		
	2010.07-2013.12	2013.12	AT	-	F	All-wheel Drive Closed Off-Road Vehicle Engine G4KE		824124	Outer Joint	48T	27	24	62	95	58	M	
IX35 14																	
-	2013.08-	2015.05	-	-	F	-		227229	Stub Axle		26	27			445		
IX35 LM																	
2.0 (120kW)	2009-	2013	-	L	F	2WD		224535	Drive Shaft	48T	27	27	62	95	966		
IX35/TUCSON 10																	
-	2010-	-	-	L	F	SLOVAKIA PLANTEUR		224525	Drive Shaft	48T	27	27	62	95	696		
2.0	2010-	2011	6AT	L	F	ENGINE:G4KD/G4KF/G4KH;2WD		227217	Drive Shaft	48T	27	27	62	95	678		
	2010-	2011	6AT	L	F	ENGINE:G4KD/G4KF/G4KH;4WD		227217	Drive Shaft	48T	27	27	62	95	678		
	2010-	2011	6AT	L	F	ENGINE:G4KD/G4KF/G4KH;2WD		824333	Outer Joint		27	24	62	95	59	M	
	2010-	2011	6AT	L	F	ENGINE:G4KD/G4KF/G4KH;4WD		824333	Outer Joint		27	24	62	95	59	M	
IX35/TUCSON 11																	
-	2011-	2013	-	L	F	CZECH PLANTEUR		224525	Drive Shaft	48T	27	27	62	95	696		
2.0	2012-	2013	6AT	L	F	ENGINE:G4KD/G4KF/G4KH;2WD		227217	Drive Shaft	48T	27	27	62	95	678		
	2012-	2013	6AT	L	F	ENGINE:G4KD/G4KF/G4KH;4WD		227217	Drive Shaft	48T	27	27	62	95	678		
	2012-	2013	6AT	L	F	ENGINE:G4KD/G4KF/G4KH;2WD		824333	Outer Joint		27	24	62	95	59	M	
	2012-	2013	6AT	L	F	ENGINE:G4KD/G4KF/G4KH;4WD		824333	Outer Joint		27	24	62	95	59	M	

YEAR	TRANSM	L/R	F/R	REMARKS	GSP Ref.	PRODUCT	ABS	Technical Specifications						
								A	B	C	H	L	P	
HYUNDAI ix55/VERACRUZ														
3.0 V6 CRDi (176 kW)	2008.09-2011.12	-	L	F	All-wheel Drive Closed Off-Road Vehicle Engine D6EA	624057	Inner Joint		31	36	43	65	118.5	
3.0 V6 CRDi (184 kW)	2011.09-2012.12	-	L	F	All-wheel Drive Closed Off-Road Vehicle Engine D6EB	624057	Inner Joint		31	36	43	65	118.5	
3.8 V6 (191 kW)	2007.01-	6AT	L	F	All-wheel Drive Closed Off-Road Vehicle Engine G6DA	624057	Inner Joint		31	36	43	65	118.5	
3.8 V6 (194 kW)	2011.01-	-	L	F	Closed Off-Road Vehicle Engine G6DA	624057	Inner Joint		31	36	43	65	118.5	
	2011.01-	6AT	L	F	All-wheel Drive Closed Off-Road Vehicle Engine G6DA	624057	Inner Joint		31	36	43	65	118.5	
LANTRA														
1.6 2WD	2003-2005	5MT	L	-	-	224364	Drive Shaft	44T	25	25	50	95.5	655	
	2003-2005	5MT	R	-	-	224363	Drive Shaft	44T	25	25	50	95.5	936	
	2003-2005	5MT	L	-	-	839190	Outer Joint	44T	25	23	50	95.5	60.5	M
	2003-2005	5MT	L	-	-	624032	Inner Joint		25	23	35	63	88	
1.8	1993.01-1995.08	MT/AT	L	-	-	224107	Drive Shaft	44T	25	25	50	94.5	940	
	1993.07-1995.08	-	L	-	-	215001	Drive Shaft		25	25	50	94.5	940	
	1995.01-	MT/AT	L	-	-	215002	Drive Shaft		25	25	50	94.5	643	
	1995.01-	MT/AT	L	-	-	224059	Drive Shaft	47T	25	25	50	94.5	643	
	1995.01-2000.12	MT/AT	R	-	-	224013	Drive Shaft		25	25	50	94.5	927	
	1995.01-2000.12	MT/AT	R	-	-	224060	Drive Shaft	47T	25	25	50	94.5	927	
LANTRA I (J-1)/ELANTRA														
1.5 i.e. (63 kW)	1990.10-1995.11	-	-	-	Saloon Engine G15B/G4DJ	839034	Outer Joint		25	25	50	94.5	65	M
	1990.10-1995.11	-	-	F	Saloon Engine G15B/G4DJ	809003	Outer Joint		25	25	50	95	64.5	M
	1990.10-1995.11	MT	L/R	F	Saloon Engine G15B/G4DJ	824001	Outer Joint		25	23	50	95.5	60.5	M
	1990.10-1995.11	MT	L/R	F	Saloon Engine G15B/G4DJ	809004	Outer Joint		25	22	50	95	58	M
	1990.10-1995.11	-	-	F	Saloon Engine G15B/G4DJ	809002	Outer Joint		25	23	50	94.5	63.5	M
1.6 i.e. 16V (78 kW)	1990.10-1995.11	-	-	F	Saloon Engine G4CR	809003	Outer Joint		25	25	50	95	64.5	M
	1990.10-1995.11	-	-	F	Saloon Engine G4CR	824009	Outer Joint		25	30	50	95	56.5	M
	1990.10-1995.11	-	-	F	Saloon Engine G4CR	809002	Outer Joint		25	23	50	94.5	63.5	M
1.6 i.e. 16V (84 kW)	1990.10-1995.11	-	-	F	Saloon Engine G4CR	809003	Outer Joint		25	25	50	95	64.5	M
	1990.10-1995.11	-	-	F	Saloon Engine G4CR	824009	Outer Joint		25	30	50	95	56.5	M
	1990.10-1995.11	-	-	F	Saloon Engine G4CR	809002	Outer Joint		25	23	50	94.5	63.5	M
1.8 i.e. 16V (93 kW)	1990.10-1995.11	-	-	F	Saloon Engine G4CN	809003	Outer Joint		25	25	50	95	64.5	M
	1990.10-1995.11	MT	L/R	F	Saloon Engine G4CN	839054	Outer Joint		25	23	50	96	59	M
	1990.10-1995.11	-	R	F	Saloon Engine G4CN	839033	Outer Joint		25	25	50	95	65	M
	1990.10-1995.11	-	-	F	Saloon Engine G4CN	824008	Outer Joint	44T	25	23	50	94.5	63.5	M
	1990.10-1995.11	-	-	F	Saloon Engine G4CN	839032	Outer Joint		25	23	50	95	60.5	M
	1990.10-1995.11	-	-	F	Saloon Engine G4CN	809002	Outer Joint		25	23	50	94.5	63.5	M
LANTRA II (J-2), SW														
1.9 D (50 kW)	1998-2000.09	-	-	-	-	824074	Outer Joint	44T	25	30	50	95.5	60.5	I
LANTRA II (J-2)/ELANTRA														
1.5 12V (65 kW)	1996.12-2000.09	4AT	-	F	Saloon Engine G4EK	839014	Outer Joint		25	30	50	95	60.5	M
	1996.12-2000.09	-	-	-	Saloon Engine G4EK	624072	Inner Joint		25	30	35	62.5	88	
	1996.12-2000.09	MT	-	F	Saloon Engine G4EK	224113	Drive Shaft	44T	25		50	95.5	554	
	1996.12-2000.09	5MT	-	F	Saloon Engine G4EK	809002	Outer Joint		25	23	50	94.5	63.5	M
	1997.04-2000.10	-	-	-	Estate Engine G4EK	624072	Inner Joint		25	30	35	62.5	88	
	1997.04-2000.10	MT	-	F	Estate Engine G4EK	224113	Drive Shaft	44T	25		50	95.5	554	
1.5 16V (76 kW)	1995.11-2000.10	4AT	-	F	Saloon Engine G4FK	839014	Outer Joint		25	30	50	95	60.5	M
	1995.11-2000.10	-	-	-	Saloon Engine G4FK	624072	Inner Joint		25	30	35	62.5	88	
	1995.11-2000.10	5MT	-	-	Saloon Engine G4FK	639041	Inner Joint		25	23	35	63	92.5	
	1995.11-2000.10	5MT	-	F	Saloon Engine G4FK	824120	Outer Joint	44T	25	23	50	95.5	60.5	M
	1995.11-2000.10	5MT	-	F	Saloon Engine G4FK	809002	Outer Joint		25	23	50	94.5	63.5	M
1.6 16V (76 kW)	1995.11-2000.10	4AT	-	F	Saloon Engine G4ED	839014	Outer Joint		25	30	50	95	60.5	M
	1995.11-2000.10	-	-	F	Saloon Engine G4ED	839064	Outer Joint	43T	25	30	54	95	60.5	M
	1995.11-2000.10	-	-	-	Saloon Engine G4ED	624072	Inner Joint		25	30	35	62.5	88	
	1995.11-2000.10	5MT	-	F	Saloon Engine G4ED	809002	Outer Joint		25	23	50	94.5	63.5	M
1.6 16V (84 kW)	1995.11-2000.09	4AT	-	F	Saloon Engine G4GR	839014	Outer Joint		25	30	50	95	60.5	M
	1995.11-2000.09	-	R	F	Saloon Engine G4GR	839067	Outer Joint	29T	25	30	50	95	60.5	M
	1995.11-2000.09	-	-	F	Saloon Engine G4GR	839064	Outer Joint	43T	25	30	54	95	60.5	M
	1995.11-2000.09	-	-	-	Saloon Engine G4GR	624072	Inner Joint		25	30	35	62.5	88	
	1995.11-2000.09	MT	-	F	Saloon Engine G4GR	824006	Outer Joint	44T	25	25	50	94.5	65	M
	1995.11-2000.09	MT	-	F	Saloon Engine G4GR	224113	Drive Shaft	44T	25		50	95.5	554	
	1995.11-2000.09	5MT	-	F	Saloon Engine G4GR	809002	Outer Joint		25	23	50	94.5	63.5	M
	1996.02-2000.10	-	R	F	Estate Engine G4GR	839067	Outer Joint	29T	25	30	50	95	60.5	M
	1996.02-2000.10	-	-	F	Estate Engine G4GR	839064	Outer Joint	43T	25	30	54	95	60.5	M
	1996.02-2000.10	-	-	-	Estate Engine G4GR	624072	Inner Joint		25	30	35	62.5	88	
	1996.02-2000.10	-	-	F	Estate Engine G4GR	824006	Outer Joint	44T	25	25	50	94.5	65	M
	1996.02-2000.10	MT	-	F	Estate Engine G4GR	224113	Drive Shaft	44T	25		50	95.5	554	
1.6 i (66 kW)	1995.11-2000.09	4AT	-	F	Saloon Engine G4GR	839014	Outer Joint		25	30	50	95	60.5	M
	1995.11-2000.09	-	-	-	Saloon Engine G4GR	899181	Outer Joint		25	30	50	97	57	M

YEAR	TRANSM	L/R	F/R	REMARKS	GSP Ref.	PRODUCT	ABS	Technical Specifications									
								A	B	C	H	L	P				
HYUNDAI																	
LANTRA II (J-2)/ELANTRA																	
1.6 i (66 kW)	1995.11-2000.09	-	-	F	Saloon Engine G4GR	839064	Outer Joint	43T	25	30	54	95	60.5	M			
	1995.11-2000.09	-	-	-	Saloon Engine G4GR	624072	Inner Joint		25	30	35	62.5	88				
	1995.11-2000.09	-	-	F	Saloon Engine G4GR	824006	Outer Joint	44T	25	25	50	94.5	65	M			
	1995.11-2000.09	MT	-	F	Saloon Engine G4GR	224113	Drive Shaft	44T	25		50	95.5	554				
	1995.11-2000.09	5MT	-	F	Saloon Engine G4GR	809002	Outer Joint		25	23	50	94.5	63.5	M			
	1996.02-2000.10	-	-	-	Estate Engine G4GR	899181	Outer Joint		25	30	50	97	57	M			
	1996.02-2000.10	-	-	-	Estate Engine G4GR	624072	Inner Joint		25	30	35	62.5	88				
	1996.02-2000.10	MT	-	F	Estate Engine G4GR	224113	Drive Shaft	44T	25		50	95.5	554				
1.8 16V (94 kW)	1995.11-2000.09	-	-	F	Saloon Engine G4GM	824042	Outer Joint	29T	25	25	50	94.5	65	M			
	1995.11-2000.09	-	-	F	Saloon Engine G4GM	824039	Outer Joint	29T	25	23	50	95	60.5	M			
	1995.11-2000.09	-	-	F	Saloon Engine G4GM	839033	Outer Joint		25	25	50	95	65	M			
	1995.11-2000.09	-	-	F	Saloon Engine G4GM	839032	Outer Joint		25	23	50	95	60.5	M			
	1995.11-2000.09	-	R	F	Saloon Engine G4GM	839067	Outer Joint	29T	25	30	50	95	60.5	M			
	1996.02-2000.10	-	R	F	Estate Engine G4GM	839067	Outer Joint	29T	25	30	50	95	60.5	M			
1.9 D (50 kW)	1998.03-2000.09	-	-	-	Saloon Engine DJY	624072	Inner Joint		25	30	35	62.5	88				
	1998.03-2000.10	-	-	-	Estate Engine DJY	624072	Inner Joint		25	30	35	62.5	88				
2.0 16V (102 kW)	1996.08-2000.09	5MT	-	F	Saloon Engine G4GF	824061	Outer Joint	44T	25	23	50	94.5	63.5	M			
MATRIX																	
1.8	-	-	-	-	-	624016	Inner Joint		25	30	41	62.5	92				
	-	-	-	L	-	224053	Drive Shaft	44T	25	25	50	95.5	651				
MATRIX (FC)																	
1.5	2003-	-	MT	-	Engine D3EA	899331	Outer Joint	44T	25	23	50	95.1	64.5	M			
1.8 (90 kW)	2001.06-	-	-	-	-	824074	Outer Joint	44T	25	30	50	95.5	60.5	I			
MATRIX (FC)/LAVITA																	
1.5 (75 kW)	2001.06-2010.08	-	-	F	MPV Engine G4EC-G	824038	Outer Joint	44T	25	25	50	94.5	65	M			
	2001.06-2010.08	-	-	-	MPV Engine G4EC-G	624072	Inner Joint		25	30	35	62.5	88				
1.5 CRDi (60 kW)	2001.10-2010.08	-	-	F	MPV Engine D3EA	824038	Outer Joint	44T	25	25	50	94.5	65	M			
	2001.10-2010.08	MT	L	F	MPV Engine D3EA	239262	Drive Shaft	44T	25	25	50	94.5	657				
	2001.10-2010.08	MT	R	F	MPV Engine D3EA	239249	Drive Shaft	44T	25	26	50	94.5	585				
	2001.10-2010.08	-	-	F	MPV Engine D3EA	839140	Outer Joint	44T	25	23	50	95	60.5	M			
	2001.10-2010.08	-	-	-	MPV Engine D3EA	624072	Inner Joint		25	30	35	62.5	88				
	2001.10-2010.08	MT	-	F	MPV Engine D3EA	824061	Outer Joint	44T	25	23	50	94.5	63.5	M			
1.5 CRDi (75 kW)	2004.12-2010.08	-	-	F	MPV Engine D4FA	824038	Outer Joint	44T	25	25	50	94.5	65	M			
	2004.12-2010.08	-	-	F	MPV Engine D4FA	839140	Outer Joint	44T	25	23	50	95	60.5	M			
	2004.12-2010.08	-	-	-	MPV Engine D4FA	624072	Inner Joint		25	30	35	62.5	88				
	2004.12-2010.08	MT	-	F	MPV Engine D4FA	824061	Outer Joint	44T	25	23	50	94.5	63.5	M			
1.5 CRDi VGT (81 kW)	2005.08-2010.08	-	-	F	MPV Engine D4FA	824038	Outer Joint	44T	25	25	50	94.5	65	M			
	2005.08-2010.08	-	-	F	MPV Engine D4FA	839140	Outer Joint	44T	25	23	50	95	60.5	M			
1.6 (76 kW)	2001.06-2010.08	MT	R	F	MPV Engine G4ED-G	224054	Drive Shaft	44T	25	25	50	95.5	936				
	2001.06-2010.08	MT	R	F	MPV Engine G4ED-G	224102	Drive Shaft		25	25	50	95.5	939.5				
	2001.06-2010.08	-	-	F	MPV Engine G4ED-G	839140	Outer Joint	44T	25	23	50	95	60.5	M			
	2001.06-2010.08	-	-	-	MPV Engine G4ED-G	624072	Inner Joint		25	30	35	62.5	88				
	2001.06-2010.08	-	L/R	F	MPV Engine G4ED-G	824036	Outer Joint	44T	25	30	50	95.5	60.5	M			
1.8 (90 kW)	2001.06-2010.08	MT	-	F	MPV Engine G4GB-G	824100	Outer Joint	44T	25	24	50	94.5	63.5	M			
	2001.06-2010.08	5MT	-	-	MPV Engine G4GB-G	624072	Inner Joint		25	30	35	62.5	88				
	2001.06-2010.08	-	-	F	MPV Engine G4GB-G	839140	Outer Joint	44T	25	23	50	95	60.5	M			
MAXCRUZ																	
-	2013.01-2015.12	-	L	F	-	224567	Drive Shaft	52T	30	31	73	94.5	674				
OPIRUS																	
2.7	200301	200601	MT/AT	R	-	824185	Outer Joint	47T	27	26	60	96.5	68.5	M			
PONY (X-1)																	
1.3 (50 kW)	1985.10-1989.09	MT	R	F	Hatchback Engine G13B	824284	Outer Joint	48T	27	24	62	95	59	M			
	1985.10-1989.09	MT	L/R	F	Hatchback Engine G13B	809004	Outer Joint		25	22	50	95	58	M			
	1985.10-1989.09	AT/MT	L	F	Hatchback Engine G13B	224022	Drive Shaft		25	25	50	95	610				
	1985.10-1989.09	AT/MT	R	F	Hatchback Engine G13B	224023	Drive Shaft		25	25	50	95	904				
1.5 (53 kW)	1985.10-1989.09	MT	L/R	F	Hatchback Engine G15B/G4DJ	809004	Outer Joint		25	22	50	95	58	M			
	1985.10-1989.09	AT/MT	L	F	Hatchback Engine G15B/G4DJ	224022	Drive Shaft		25	25	50	95	610				
	1985.10-1989.09	AT/MT	R	F	Hatchback Engine G15B/G4DJ	224023	Drive Shaft		25	25	50	95	904				
PONY (X-1)/PRESTO																	
1.3 (50 kW)	1985.10-1989.09	MT	L/R	F	Saloon Engine G13B	809004	Outer Joint		25	22	50	95	58	M			
	1985.10-1989.09	AT/MT	L	F	Saloon Engine G13B	224022	Drive Shaft		25	25	50	95	610				
	1985.10-1989.09	AT/MT	R	F	Saloon Engine G13B	224023	Drive Shaft		25	25	50	95	904				
1.5 (53 kW)	1985.10-1989.09	MT	L/R	F	Saloon Engine G15B/G4DJ	809004	Outer Joint		25	22	50	95	58	M			
	1985.10-1989.09	AT/MT	L	F	Saloon Engine G15B/G4DJ	224022	Drive Shaft		25	25	50	95	610				
	1985.10-1989.09	AT/MT	R	F	Saloon Engine G15B/G4DJ	224023	Drive Shaft		25	25	50	95	904				
PONY (X-2)																	

YEAR	TRANSM	L/R	F/R	REMARKS	GSP Ref.	PRODUCT	ABS	Technical Specifications									
								A	B	C	H	L	P				
HYUNDAI																	
PONY (X-2)																	
1.3 (43 kW)	1989.10-1995.01	MT	L/R	F	Hatchback Engine G4DG	809004	Outer Joint		25	22	50	95	58	M			
1.5 (53 kW)	1989.10-1995.01	AT/MT	L	F	Hatchback Engine G15B/G4DJ	224022	Drive Shaft		25	25	50	95	610				
	1989.10-1995.01	AT/MT	R	F	Hatchback Engine G15B/G4DJ	224023	Drive Shaft		25	25	50	95	904				
	1989.10-1995.01	MT	L/R	F	Hatchback Engine G15B/G4DJ	809004	Outer Joint		25	22	50	95	58	M			
1.5 i (61 kW)	1989.10-1995.01	MT	L/R	F	Hatchback Engine G15B/G4DJ	809004	Outer Joint		25	22	50	95	58	M			
1.5 i (62 kW)	1989.10-1995.01	AT/MT	L	F	Hatchback Engine G15B/G4DJ	224022	Drive Shaft		25	25	50	95	610				
	1989.10-1995.01	AT/MT	R	F	Hatchback Engine G15B/G4DJ	224023	Drive Shaft		25	25	50	95	904				
	1989.10-1995.01	MT	L/R	F	Hatchback Engine G15B/G4DJ	809004	Outer Joint		25	22	50	95	58	M			
PONY/EXCEL (X-2)																	
1.5 (53 kW)	1990.01-1995.01	AT/MT	L	F	Saloon Engine G15B/G4DJ	224022	Drive Shaft		25	25	50	95	610				
	1990.01-1995.01	AT/MT	R	F	Saloon Engine G15B/G4DJ	224023	Drive Shaft		25	25	50	95	904				
	1990.01-1995.01	MT	L/R	F	Saloon Engine G15B/G4DJ	809004	Outer Joint		25	22	50	95	58	M			
1.5 i (61 kW)	1990.01-1995.01	MT	L/R	F	Saloon Engine G15B/G4DJ	809004	Outer Joint		25	22	50	95	58	M			
1.5 i (62 kW)	1990.01-1995.01	AT/MT	L	F	Saloon Engine G15B/G4DJ	224022	Drive Shaft		25	25	50	95	610				
	1990.01-1995.01	AT/MT	R	F	Saloon Engine G15B/G4DJ	224023	Drive Shaft		25	25	50	95	904				
	1990.01-1995.01	MT	L/R	F	Saloon Engine G15B/G4DJ	809004	Outer Joint		25	22	50	95	58	M			
S COUPE																	
2.0	1996.01-2002.03	MT/AT	L	-	FX	215002	Drive Shaft		25	25	50	94.5	643				
	1996.01-2002.03	MT/AT	L	-	FX	224059	Drive Shaft	47T	25	25	50	94.5	643				
	1996.01-2002.03	MT/AT	R	-	FX	224013	Drive Shaft		25	25	50	94.5	927				
	1996.01-2002.03	MT/AT	R	-	FX	224060	Drive Shaft	47T	25	25	50	94.5	927				
S COUPE (SLC)																	
1.5 i (62 kW)	1990.02-1996.05	AT/MT	L/R	F	Coupe Engine G15B/G4DJ	809004	Outer Joint		25	22	50	95	58	M			
1.5 i (65 kW)	1992.04-1996.05	AT/MT	L/R	F	Coupe Engine G4EK	809004	Outer Joint		25	22	50	95	58	M			
	1992.04-1996.05	-	R	F	Coupe Engine G4EK	839033	Outer Joint		25	25	50	95	65	M			
	1992.04-1996.05	-	-	F	Coupe Engine G4EK	839032	Outer Joint		25	23	50	95	60.5	M			
1.5 i Turbo (85 kW)	1991.04-1996.05	-	-	-	Coupe Engine G4EK-TC	839034	Outer Joint		25	25	50	94.5	65	M			
	1991.04-1996.05	AT/MT	L/R	F	Coupe Engine G4EK-TC	809004	Outer Joint		25	22	50	95	58	M			
	1991.04-1996.05	-	R	F	Coupe Engine G4EK-TC	839033	Outer Joint		25	25	50	95	65	M			
	1991.04-1996.05	-	-	F	Coupe Engine G4EK-TC	839032	Outer Joint		25	23	50	95	60.5	M			
SANTA																	
2.7	2006.09-	4AT	R	F	ENGINE:G6EA/L6EA;2WD	224473	Drive Shaft	52T	30	28	73	97	611				
	2006.09-	4AT	R	F	ENGINE:G6EA/L6EA;2WD	824071	Outer Joint		30	36	73	97	67.5	I			
	2006.09-	4AT	R	F	ENGINE:G6EA/L6EA;2WD	624146	Inner Joint		28	35	42		129.5				
3.3	2006.09-	5AT	R	F	ENGINE:G6DB/G6DH;4WD	224473	Drive Shaft	52T	30	28	73	97	611				
	2006.09-	5AT	R	F	ENGINE:G6DB/G6DH;4WD	824071	Outer Joint		30	36	73	97	67.5	I			
	2006.09-	5AT	R	F	ENGINE:G6DB/G6DH;4WD	624146	Inner Joint		28	35	42		129.5				
SANTA FE																	
-	2001.07-	-	L/R	R	-	224556	Drive Shaft	52T	27	27	60	95	823				
	2001.10-2005.12	-	L/R	R	-	224556	Drive Shaft	52T	27	27	60	95	823				
	2013-2016	-	R	R	Closed OffRoad Vehicle	224554	Drive Shaft	52T	30	25	57	93.5	829				
	2015-	-	R	R	Closed OffRoad Vehicle	224554	Drive Shaft	52T	30	25	57	93.5	829				
	2015.05-	6AT	L	R	-	624032	Inner Joint		25	23	35	63	88				
	2015.05-	6MT	L	R	-	624032	Inner Joint		25	23	35	63	88				
	2015.05-	6AT	L	R	-	224555	Drive Shaft	52T	30	25	57	93.5	848				
	2015.05-	6MT	L	R	-	224555	Drive Shaft	52T	30	25	57	93.5	848				
2.0	2001.07-	4AT	L/R	R	-	224556	Drive Shaft	52T	27	27	60	95	823				
	2001.07-	5MT	L/R	R	-	224556	Drive Shaft	52T	27	27	60	95	823				
	2001.10-2005.12	4AT	L/R	R	-	224556	Drive Shaft	52T	27	27	60	95	823				
	2001.10-2005.12	5MT	L/R	R	-	224556	Drive Shaft	52T	27	27	60	95	823				
	2009.12-2010.01	6MT	L	F	-	224470	Drive Shaft	52T	30	28	73	97	655				
	2009.12-2010.01	6MT	L	F	-	624147	Inner Joint		28	36	41	71.5	119.5				
	2009.12-2010.01	6MT	L	F	-	824327	Outer Joint	52T	30	36	73	97	67.5	I			
	2013.04-2015.03	6AT	L	R	-	224555	Drive Shaft	52T	30	25	57	93.5	848				
	2013.04-2015.03	6AT	L	R	-	624032	Inner Joint		25	23	35	63	88				
	2013.06-2015.04	6MT	L	R	-	224555	Drive Shaft	52T	30	25	57	93.5	848				
	2013.06-2015.04	6MT	L	R	-	624032	Inner Joint		25	23	35	63	88				
	2.0 (93 kW)	2010.11-	AT/MT	L	-	Closed Off-Road Vehicle Engine 4G63S4M	224322	Drive Shaft	52T	27	25	60	95	666			
		2010.11-	AT/MT	R	-	Closed Off-Road Vehicle Engine 4G63S4M	224323	Drive Shaft	52T	27	28	60	95	577			
2.2	2006-2012	-	R	-	-	239250	Drive Shaft	52T	30	28	73	97	611				
	2006.01-2006.12	5AT	L/R	R	-	224549	Drive Shaft	52T	30	27	60	97.5	831				
	2006.01-2006.12	5MT	L/R	R	-	224549	Drive Shaft	52T	30	27	60	97.5	831				
	2006.01-2006.12	4AT	L/R	R	-	224549	Drive Shaft	52T	30	27	60	97.5	831				
	2006.01-2006.12	-	L/R	R	-	224549	Drive Shaft	52T	30	27	60	97.5	831				
	2009.09-2010.01	6MT	L	F	-	224470	Drive Shaft	52T	30	28	73	97	655				
	2009.09-2010.01	6MT	L	F	-	624147	Inner Joint		28	36	41	71.5	119.5				

	YEAR		TRANSM	L/R	F/R	REMARKS	GSP Ref.	PRODUCT	ABS	Technical Specifications										
										A	B	C	H	L	P					
HYUNDAI SANTA FE																				
2.2	2009.09-2010.01	2010.01	6MT	L	F	-	824327	Outer Joint	52T	30	36	73	97	67.5	I					
	2010.01-2012.05	2012.05	6AT	L	F	-	627052	Inner Joint		31	36	36	66.5	106						
	2010.01-2012.06	2012.06	6AT	L	F	-	627052	Inner Joint		31	36	36	66.5	106						
	2010.01-2012.05	2012.05	6AT	L	F	-	824327	Outer Joint	52T	30	36	73	97	67.5	I					
	2010.01-2012.06	2012.06	6AT	L	F	-	824327	Outer Joint	52T	30	36	73	97	67.5	I					
	2010.01-2012.05	2012.05	6AT	L	F	-	224464	Drive Shaft	52T	30	31	73	97	654						
	2010.01-2012.06	2012.06	6AT	L	F	-	224464	Drive Shaft	52T	30	31	73	97	654						
	2013.06-2015.05	2015.05	6MT	L	R	-	624032	Inner Joint		25	23	35	63	88						
	2013.06-2015.06	2015.06	6AT	L	R	-	224555	Drive Shaft	52T	30	25	57	93.5	848						
	2013.06-2015.05	2015.05	6MT	L	R	-	224555	Drive Shaft	52T	30	25	57	93.5	848						
	2013.06-2015.06	2015.06	6AT	L	R	-	624032	Inner Joint		25	23	35	63	88						
2.4	2001.07-	-	5MT	L/R	R	-	224557	Drive Shaft	52T	27	27	60	95	822						
	2001.07-	-	5MT	L/R	R	-	824325	Outer Joint	52T	27	23	60	95	65	M					
	2009.09-2010.02	2010.02	6AT	R	F	-	224477	Drive Shaft	52T	30	28	73	97	599						
	2009.09-2010.02	2010.02	6MT	R	F	-	224477	Drive Shaft	52T	30	28	73	97	599						
	2010.02-2012.06	2012.06	6MT	L	F	-	624157	Inner Joint		28	35	41	61.5	120						
	2010.02-2012.04	2012.04	6MT	L	F	-	624157	Inner Joint		28	35	41	61.5	120						
	2010.02-2012.06	2012.06	6AT	L	F	-	824327	Outer Joint	52T	30	36	73	97	67.5	I					
	2010.02-2012.06	2012.06	6AT	R	F	-	824327	Outer Joint	52T	30	36	73	97	67.5	I					
	2010.02-2012.06	2012.06	6MT	L	F	-	824327	Outer Joint	52T	30	36	73	97	67.5	I					
	2010.02-2012.04	2012.04	6MT	L	F	-	824327	Outer Joint	52T	30	36	73	97	67.5	I					
	2010.02-2012.06	2012.06	6AT	L	F	-	224466	Drive Shaft	52T	30	28	73	97	658						
	2010.02-2012.06	2012.06	6AT	R	F	-	224474	Drive Shaft	52T	30	28	73	97	597						
	2010.02-2012.06	2012.06	6MT	L	F	-	224467	Drive Shaft	52T	30	28	73	97	667						
	2010.02-2012.04	2012.04	6MT	L	F	-	224467	Drive Shaft	52T	30	28	73	97	667						
	2013.06-2015.06	2015.06	6AT	L	R	-	224555	Drive Shaft	52T	30	25	57	93.5	848						
	2013.06-2015.04	2015.04	6MT	L	R	-	224555	Drive Shaft	52T	30	25	57	93.5	848						
	2013.06-2015.06	2015.06	6AT	L	R	-	624032	Inner Joint		25	23	35	63	88						
	2013.06-2015.04	2015.04	6MT	L	R	-	624032	Inner Joint		25	23	35	63	88						
2.4 2WD	2009-2010	2010	6AT	R	-	THETA 2	224232	Drive Shaft	52T	30	28	73	97	597						
	2009-2010	2010	6AT	L	-	THETA 2	224233	Drive Shaft	52T	30	28	73	97	659						
	2009-2010	2010	6AT	L	-	THETA 2	624066	Inner Joint		28	35	33	67.5	100						
	2009-2010	2010	6AT	R	-	THETA 2	624054	Inner Joint		28	35	42	42	83						
2.4L	2010-	-	-	-	-	GL Sport Utility 4Door	224585	Stub Axle												
	2010-	-	-	-	-	GLS Sport Utility 4Door	224585	Stub Axle												
	2010-	-	-	-	-	Limited Sport Utility 4Door	224585	Stub Axle												
	2011-	-	-	-	-	GL Premium Sport Utility 4Door	224585	Stub Axle												
	2011-	-	-	-	-	GL Sport Utility 4Door	224585	Stub Axle												
	2011-	-	-	-	-	GLS Sport Utility 4Door	224585	Stub Axle												
	2011-	-	-	-	-	Limited Sport Utility 4Door	224585	Stub Axle												
	2012-	-	-	-	-	GL Premium Sport Utility 4Door	224585	Stub Axle												
	2012-	-	-	-	-	GL Sport Utility 4Door	224585	Stub Axle												
	2012-	-	-	-	-	GLS Sport Utility 4Door	224585	Stub Axle												
	2012-	-	-	-	-	Limited Sport Utility 4Door	224585	Stub Axle												
2.7	-	-	AT	L	F	-	224116	Drive Shaft	52T	30	27	73	97	667						
	2001.07-	-	4AT	L/R	R	-	224556	Drive Shaft	52T	27	27	60	95	823						
	2006-2012	2012	AT	R	-	-	239250	Drive Shaft	52T	30	28	73	97	611						
3.3	2006-2012	2012	AT	R	-	-	239250	Drive Shaft	52T	30	28	73	97	611						
3.5	2009.09-2010.01	2010.01	6AT	R	F	-	224477	Drive Shaft	52T	30	28	73	97	599						
	2010.01-2012.04	2012.04	6AT	L	F	-	824327	Outer Joint	52T	30	36	73	97	67.5	I					
	2010.01-2012.04	2012.04	6AT	L	F	-	224468	Drive Shaft	52T	30	28	73	97	655						
SANTA FE 12																				
-	2012.06-2016.01	2016.01	-	-	F	-	224517	Stub Axle		28	28			420.5						
2.0	2012-2015	2015	6MT	L	F	ENGINE:D4HA/D4HB;2WD	224447	Drive Shaft	52T	30	28	73	94.5	674						
	2012-2015	2015	6MT	L	F	ENGINE:D4HA/D4HB;4WD	224447	Drive Shaft	52T	30	28	73	94.5	674						
	2012-2015	2015	6MT	L	F	ENGINE:D4HA/D4HB;2WD	824300	Outer Joint		30	35	73	94.5	67	M					
	2012-2015	2015	6MT	L	F	ENGINE:D4HA/D4HB;4WD	824300	Outer Joint		30	35	73	94.5	67	M					
	2012-2015	2015	6MT	L	F	ENGINE:D4HA/D4HB;2WD	624144	Inner Joint		28	35	41	61.5	120						
	2012-2015	2015	6MT	L	F	ENGINE:D4HA/D4HB;4WD	624144	Inner Joint		28	35	41	61.5	120						
2.2	2012-2015	2015	6MT	L	F	ENGINE:D4HA/D4HB;2WD	224447	Drive Shaft	52T	30	28	73	94.5	674						
	2012-2015	2015	6MT	L	F	ENGINE:D4HA/D4HB;4WD	224447	Drive Shaft	52T	30	28	73	94.5	674						
	2012-2015	2015	6MT	L	F	ENGINE:D4HA/D4HB;2WD	824300	Outer Joint		30	35	73	94.5	67	M					
	2012-2015	2015	6MT	L	F	ENGINE:D4HA/D4HB;4WD	824300	Outer Joint		30	35	73	94.5	67	M					
	2012-2015	2015	6MT	L	F	ENGINE:D4HA/D4HB;2WD	624144	Inner Joint		28	35	41	61.5	120						
	2012-2015	2015	6MT	L	F	ENGINE:D4HA/D4HB;4WD	624144	Inner Joint		28	35	41	61.5	120						
2.4	2012-2015	2015	6AT	L	F	ENGINE:G4KC/G4KE/G4KG/G4KJ/G4KK;4WD	224449	Drive Shaft	52T	30	28	73	94.5	681						

	YEAR		TRANSM	L/R	F/R	REMARKS	GSP Ref.	PRODUCT	ABS	Technical Specifications										
	A	B								C	H	L	P							
HYUNDAI SANTA FE 12																				
2.4	2012-	2015	6AT	L	F	ENGINE:G4KC/G4KE/G4KG/G4KJ/G4KK;4WD	824297	Outer Joint		30	25	73	94.5	67	M					
	2012-	2015	6AT	L	F	ENGINE:G4KC/G4KE/G4KG/G4KJ/G4KK;4WD	624140	Inner Joint		28	33	33	67	105.5						
	2012-	2015	6MT	R	F	ENGINE:G4KC/G4KE/G4KG/G4KJ/G4KK;2WD	224479	Drive Shaft	52T	30	28	73	94.5	596						
	2012-	2015	6MT	R	F	ENGINE:G4KC/G4KE/G4KG/G4KJ/G4KK;2WD	824297	Outer Joint		30	25	73	94.5	67	M					
	2012-	2015	6MT	R	F	ENGINE:G4KC/G4KE/G4KG/G4KJ/G4KK;2WD	624139	Inner Joint		28	33	42		129.5						
	2012-	2015	6AT	L	F	ENGINE:G4KC/G4KE/G4KG/G4KJ/G4KK;4WD	824296	Outer Joint	52T	30	25	73	94.5	67	M					
2012-	2015	6MT	R	F	ENGINE:G4KC/G4KE/G4KG/G4KJ/G4KK;2WD	824296	Outer Joint	52T	30	25	73	94.5	67	M						
SANTA FE I (SM)																				
2.0 (99 kW)	2001.08-	2006.03	MT	L/R	F	Closed Off-Road Vehicle Engine G4BP	824066	Outer Joint	47T	27	26	60	95	69	M					
	2001.08-	2006.03	MT	-	F	Closed Off-Road Vehicle Engine G4BP	824091	Outer Joint	52T	27	26	60	95	69	M					
2.0 CRDi (107 kW)	2003.11-	2006.02	-	-	R	All-wheel Drive Closed Off-Road Vehicle Engine D4EA	824319	Outer Joint	52T	27	25	60	95	65	M					
	2003.11-	2006.02	-	L	F	All-wheel Drive Closed Off-Road Vehicle Engine D4EA	624025	Inner Joint		27	26	41	62.5	89						
	2003.11-	2006.02	-	-	R	All-wheel Drive Closed Off-Road Vehicle Engine D4EA	624088	Inner Joint		27	25	41	62.8	92.5						
	2003.11-	2006.02	5MT/4AT	L	F	All-wheel Drive Closed Off-Road Vehicle Engine D4EA	639016	Inner Joint		27	26	41	63	100						
2.0 CRDi (83 kW)	2003.11-	2006.02	-	-	F	All-wheel Drive Closed Off-Road Vehicle Engine D4EA	824091	Outer Joint	52T	27	26	60	95	69	M					
	2001.04-	2006.03	-	-	R	All-wheel Drive Closed Off-Road Vehicle Engine D4EA	824319	Outer Joint	52T	27	25	60	95	65	M					
	2001.04-	2006.03	-	L	F	All-wheel Drive Closed Off-Road Vehicle Engine D4EA	624025	Inner Joint		27	26	41	62.5	89						
	2001.04-	2006.03	5MT/4AT	R	-	All-wheel Drive Closed Off-Road Vehicle Engine D4EA	824102	Outer Joint	52T	27	25	60	95	69	M					
	2001.04-	2006.03	5MT/4AT	L	F	All-wheel Drive Closed Off-Road Vehicle Engine D4EA	639016	Inner Joint		27	26	41	63	100						
	2001.04-	2006.03	-	-	R	All-wheel Drive Closed Off-Road Vehicle Engine D4EA	624088	Inner Joint		27	25	41	62.8	92.5						
	2001.04-	2006.03	-	L	F	All-wheel Drive Closed Off-Road Vehicle Engine D4EA	224218	Drive Shaft	52T	27	27	60	95	648						
	2001.04-	2006.03	-	R	F	All-wheel Drive Closed Off-Road Vehicle Engine D4EA	224217	Drive Shaft	52T	27	26	60	95	609						
	2001.04-	2006.03	-	-	F	All-wheel Drive Closed Off-Road Vehicle Engine D4EA	824056	Outer Joint	52T	27	26	60	95	69.5	M					
	2001.04-	2006.03	-	R	F	All-wheel Drive Closed Off-Road Vehicle Engine D4EA	639075	Inner Joint		26	34	42	43	64						
	2001.04-	2006.03	-	R	F	All-wheel Drive Closed Off-Road Vehicle Engine D4EA	824022	Outer Joint		27	34	60	96.5	71	I					
	2001.04-	2006.03	-	-	F	All-wheel Drive Closed Off-Road Vehicle Engine D4EA	824091	Outer Joint	52T	27	26	60	95	69	M					
	2001.08-	2006.03	MT	L/R	F	Closed Off-Road Vehicle Engine D4EA	824066	Outer Joint	47T	27	26	60	95	69	M					
	2001.08-	2006.03	-	L	F	Closed Off-Road Vehicle Engine D4EA	224218	Drive Shaft	52T	27	27	60	95	648						
	2001.08-	2006.03	-	R	F	Closed Off-Road Vehicle Engine D4EA	224217	Drive Shaft	52T	27	26	60	95	609						
	2001.08-	2006.03	-	-	F	Closed Off-Road Vehicle Engine D4EA	824056	Outer Joint	52T	27	26	60	95	69.5	M					
	2001.08-	2006.03	-	R	F	Closed Off-Road Vehicle Engine D4EA	639075	Inner Joint		26	34	42	43	64						
	2001.08-	2006.03	-	R	F	Closed Off-Road Vehicle Engine D4EA	824022	Outer Joint		27	34	60	96.5	71	I					
	2001.08-	2006.03	-	-	F	Closed Off-Road Vehicle Engine D4EA	824091	Outer Joint	52T	27	26	60	95	69	M					
	2.0 CRDi (92 kW)	2003.08-	2006.03	-	-	R	All-wheel Drive Closed Off-Road Vehicle Engine D4EA	824319	Outer Joint	52T	27	25	60	95	65	M				
2003.08-		2006.03	-	L	F	All-wheel Drive Closed Off-Road Vehicle Engine D4EA	624025	Inner Joint		27	26	41	62.5	89						
2003.08-		2006.03	-	-	R	All-wheel Drive Closed Off-Road Vehicle Engine D4EA	624088	Inner Joint		27	25	41	62.8	92.5						
2003.08-		2006.03	-	R	-	All-wheel Drive Closed Off-Road Vehicle Engine D4EA	824102	Outer Joint	52T	27	25	60	95	69	M					
2003.08-		2006.03	5MT/4AT	L	F	All-wheel Drive Closed Off-Road Vehicle Engine D4EA	639016	Inner Joint		27	26	41	63	100						
2003.08-		2006.03	-	-	F	All-wheel Drive Closed Off-Road Vehicle Engine D4EA	824091	Outer Joint	52T	27	26	60	95	69	M					
2.4 16V (100 kW)	2001.02-	2006.03	MT	-	R	All-wheel Drive Closed Off-Road Vehicle Engine G4JS-G	624088	Inner Joint		27	25	41	62.8	92.5						
	2001.02-	2006.03	MT	L	F	All-wheel Drive Closed Off-Road Vehicle Engine G4JS-G	224218	Drive Shaft	52T	27	27	60	95	648						
	2001.02-	2006.03	MT	R	F	All-wheel Drive Closed Off-Road Vehicle Engine G4JS-G	224217	Drive Shaft	52T	27	26	60	95	609						
	2001.02-	2006.03	-	-	F	All-wheel Drive Closed Off-Road Vehicle Engine G4JS-G	824056	Outer Joint	52T	27	26	60	95	69.5	M					
	2001.02-	2006.03	MT	R	F	All-wheel Drive Closed Off-Road Vehicle Engine G4JS-G	639075	Inner Joint		26	34	42	43	64						
	2001.02-	2006.03	MT	R	F	All-wheel Drive Closed Off-Road Vehicle Engine G4JS-G	824022	Outer Joint		27	34	60	96.5	71	I					
	2001.02-	2006.03	MT	-	F	All-wheel Drive Closed Off-Road Vehicle Engine G4JS-G	824091	Outer Joint	52T	27	26	60	95	69	M					
	2001.02-	2006.03	MT	-	R	All-wheel Drive Closed Off-Road Vehicle Engine G4JS-G	624088	Inner Joint		27	25	41	62.8	92.5						
2.4 16V (107 kW)	2001.02-	2006.03	MT	L	F	All-wheel Drive Closed Off-Road Vehicle Engine G4JS-G	224218	Drive Shaft	52T	27	27	60	95	648						
	2001.02-	2006.03	MT	R	F	All-wheel Drive Closed Off-Road Vehicle Engine G4JS-G	224217	Drive Shaft	52T	27	26	60	95	609						
	2001.02-	2006.03	-	-	F	All-wheel Drive Closed Off-Road Vehicle Engine G4JS-G	824056	Outer Joint	52T	27	26	60	95	69.5	M					
	2001.02-	2006.03	MT	R	F	All-wheel Drive Closed Off-Road Vehicle Engine G4JS-G	639075	Inner Joint		26	34	42	43	64						
	2001.02-	2006.03	MT	R	F	All-wheel Drive Closed Off-Road Vehicle Engine G4JS-G	824022	Outer Joint		27	34	60	96.5	71	I					
	2001.02-	2006.03	MT	-	F	All-wheel Drive Closed Off-Road Vehicle Engine G4JS-G	824091	Outer Joint	52T	27	26	60	95	69	M					
	2001.02-	2006.03	MT	-	R	All-wheel Drive Closed Off-Road Vehicle Engine G4JS-G	624088	Inner Joint		27	25	41	62.8	92.5						
	2001.02-	2006.03	MT	L	F	All-wheel Drive Closed Off-Road Vehicle Engine G4JS-G	224218	Drive Shaft	52T	27	27	60	95	648						
2.7 (129 kW)	2001.02-	2006.03	MT	R	F	All-wheel Drive Closed Off-Road Vehicle Engine G4JS-G	224217	Drive Shaft	52T	27	26	60	95	609						
	2001.02-	2006.03	-	-	F	All-wheel Drive Closed Off-Road Vehicle Engine G4JS-G	824056	Outer Joint	52T	27	26	60	95	69.5	M					
	2001.02-	2006.03	MT	R	F	All-wheel Drive Closed Off-Road Vehicle Engine G4JS-G	639075	Inner Joint		26	34	42	43	64						
	2001.02-	2006.03	MT	R	F	All-wheel Drive Closed Off-Road Vehicle Engine G4JS-G	824022	Outer Joint		27	34	60	96.5	71	I					
	2001.02-	2006.03	MT	-	F	All-wheel Drive Closed Off-Road Vehicle Engine G4JS-G	824091	Outer Joint	52T	27	26	60	95	69	M					
	2002.09-	2004.12	AT	-	R	All-wheel Drive Closed Off-Road Vehicle Engine G6BA-G	824319	Outer Joint	52T	27	25	60	95	65	M					
	2002.09-	2004.12	AT	L	F	All-wheel Drive Closed Off-Road Vehicle Engine G6BA-G	624025	Inner Joint		27	26	41	62.5	89						
	2002.09-	2004.12	AT	-	R	All-wheel Drive Closed Off-Road Vehicle Engine G6BA-G	624088	Inner Joint		27	25	41	62.8	92.5						
2.7 (132 kW)	2002.09-	2004.12	4AT	R	-	All-wheel Drive Closed Off-Road Vehicle Engine G6BA-G	824102	Outer Joint	52T	27	25	60	95	69	M					
	2002.09-	2004.12	5MT/4AT	L	F	All-wheel Drive Closed Off-Road Vehicle Engine G6BA-G	639016	Inner Joint		27	26	41	63	100						
	2002.09-	2004.12	AT	-	F	All-wheel Drive Closed Off-Road Vehicle Engine G6BA-G	824091	Outer Joint	52T	27	26	60	95	69	M					
	2004.08-	2006.03	AT	R	F	Closed Off-Road Vehicle Engine G6EA	224117	Drive Shaft	52T	30	28	73	97	611						
	2004.08-	2006.03	AT	R	F	Closed Off-Road Vehicle Engine G6EA	624022	Inner Joint		28	35	42	39.5	78.5						
	2000.11-	2006.03	AT	-	R	All-wheel Drive Closed Off-Road Vehicle Engine G6EA	824319	Outer Joint	52T	27	25	60	95	65	M					
2000.11-	2006.03	AT	L	F	All-wheel Drive Closed Off-Road Vehicle Engine G6EA	624025	Inner Joint		27	26	41	62.5	89							
2000.11-	2006.03	AT	-	R	All-wheel Drive Closed Off-Road Vehicle Engine G6EA	624088	Inner Joint		27	25	41	62.8	92.5							
2000.11-	2006.03	AT	R	F	All-wheel Drive Closed Off-Road Vehicle Engine G6EA	224217	Drive Shaft	52T	27	26	60	95	609							
2000.11-	2006.03	-	-	F	All-wheel Drive Closed Off-Road Vehicle Engine G6EA	824056	Outer Joint	52T	27	26	60	95	69.5	M						

	YEAR	TRANSM	L/R	F/R	REMARKS	GSP Ref.	PRODUCT	ABS	Technical Specifications									
									A	B	C	H	L	P				
HYUNDAI SANTA FE I (SM)																		
2.7 (132 kW)	2000.11-2006.03	AT	R	F	All-wheel Drive Closed Off-Road Vehicle Engine G6EA	639075	Inner Joint		26	34	42	43	64					
	2000.11-2006.03	AT	R	F	All-wheel Drive Closed Off-Road Vehicle Engine G6EA	824022	Outer Joint		27	34	60	96.5	71	I				
	2000.11-2006.03	4AT	R	-	All-wheel Drive Closed Off-Road Vehicle Engine G6EA	824102	Outer Joint	52T	27	25	60	95	69	M				
	2000.11-2006.03	4AT	L	F	All-wheel Drive Closed Off-Road Vehicle Engine G6EA	639016	Inner Joint		27	26	41	63	100					
	2000.11-2006.03	AT	-	F	All-wheel Drive Closed Off-Road Vehicle Engine G6EA	824091	Outer Joint	52T	27	26	60	95	69	M				
2.7 V6 (127 kW)	2001.02-2006.03	-	-	R	All-wheel Drive Closed Off-Road Vehicle Engine G6BA-G	824319	Outer Joint	52T	27	25	60	95	65	M				
	2001.02-2006.03	4AT	R	-	All-wheel Drive Closed Off-Road Vehicle Engine G6BA-G	824102	Outer Joint	52T	27	25	60	95	69	M				
	2001.02-2006.03	4AT	L	F	All-wheel Drive Closed Off-Road Vehicle Engine G6BA-G	639016	Inner Joint		27	26	41	63	100					
	2001.02-2006.03	-	L	F	All-wheel Drive Closed Off-Road Vehicle Engine G6BA-G	624025	Inner Joint		27	26	41	62.5	89					
	2001.02-2006.03	-	-	R	All-wheel Drive Closed Off-Road Vehicle Engine G6BA-G	624088	Inner Joint		27	25	41	62.8	92.5					
	2001.02-2006.03	AT	R	F	All-wheel Drive Closed Off-Road Vehicle Engine G6BA-G	224217	Drive Shaft	52T	27	26	60	95	609					
	2001.02-2006.03	-	-	F	All-wheel Drive Closed Off-Road Vehicle Engine G6BA-G	824056	Outer Joint	52T	27	26	60	95	69.5	M				
	2001.02-2006.03	AT	R	F	All-wheel Drive Closed Off-Road Vehicle Engine G6BA-G	639075	Inner Joint		26	34	42	43	64					
	2001.02-2006.03	AT	R	F	All-wheel Drive Closed Off-Road Vehicle Engine G6BA-G	824022	Outer Joint		27	34	60	96.5	71	I				
	2001.02-2006.03	-	-	F	All-wheel Drive Closed Off-Road Vehicle Engine G6BA-G	824091	Outer Joint	52T	27	26	60	95	69	M				
	SANTA FE II (CM)																	
2.0 CRDi (110 kW)	2010.12-2012.12	6AT	R	F	All-wheel Drive Closed Off-Road Vehicle Engine D4HA	261352	Stub Axle		28	28			430					
	2010.12-2012.12	MT	-	R	All-wheel Drive Closed Off-Road Vehicle Engine D4HA	624076	Inner Joint		25	22	35	63	87					
	2010.12-2012.12	AT	L	F	Closed Off-Road Vehicle Engine D4HA	624155	Inner Joint		28	35	33	67	105.5					
	2010.12-2012.12	AT	-	F	Closed Off-Road Vehicle Engine D4HA	624156	Inner Joint		28	35	42		129.5					
	2010.12-2012.12	-	R	F	Closed Off-Road Vehicle Engine D4HA	224117	Drive Shaft	52T	30	28	73	97	611					
	2010.12-2012.12	-	R	F	All-wheel Drive Closed Off-Road Vehicle Engine D4HA	224117	Drive Shaft	52T	30	28	73	97	611					
	2010.12-2012.12	-	L	F	Closed Off-Road Vehicle Engine D4HA	224195	Drive Shaft	52T	30	28	73	97	659					
	2010.12-2012.12	-	L	F	All-wheel Drive Closed Off-Road Vehicle Engine D4HA	224195	Drive Shaft	52T	30	28	73	97	659					
	2010.12-2012.12	-	R	F	Closed Off-Road Vehicle Engine D4HA	624022	Inner Joint		28	35	42	39.5	78.5					
	2010.12-2012.12	-	R	F	All-wheel Drive Closed Off-Road Vehicle Engine D4HA	624022	Inner Joint		28	35	42	39.5	78.5					
	2010.12-2012.12	6AT	-	-	All-wheel Drive Closed Off-Road Vehicle Engine D4HA	639041	Inner Joint		25	23	35	63	92.5					
2.0 CRDi (135 kW)	2006.03-2012.12	6AT	R	F	All-wheel Drive Closed Off-Road Vehicle Engine D4HA	261352	Stub Axle		28	28			430					
	2006.03-2012.12	MT	-	R	All-wheel Drive Closed Off-Road Vehicle Engine D4HA	624076	Inner Joint		25	22	35	63	87					
	2006.03-2012.12	-	R	F	All-wheel Drive Closed Off-Road Vehicle Engine D4HA	224117	Drive Shaft	52T	30	28	73	97	611					
	2006.03-2012.12	-	L	F	All-wheel Drive Closed Off-Road Vehicle Engine D4HA	224195	Drive Shaft	52T	30	28	73	97	659					
	2006.03-2012.12	-	R	F	All-wheel Drive Closed Off-Road Vehicle Engine D4HA	624022	Inner Joint		28	35	42	39.5	78.5					
	2006.03-2012.12	-	-	F	All-wheel Drive Closed Off-Road Vehicle Engine D4HA	824072	Outer Joint	52T	30	36	73	97	67.5	I				
	2006.03-2012.12	6AT	-	-	All-wheel Drive Closed Off-Road Vehicle Engine D4HA	639041	Inner Joint		25	23	35	63	92.5					
	2006.03-2012.12	6AT	-	R	All-wheel Drive Closed Off-Road Vehicle Engine D4HA	824321	Outer Joint	52T	30	20	57	93.5	61	M				
	2.0 CRDi (85 kW)	2006.03-2012.12	6AT	R	F	All-wheel Drive Closed Off-Road Vehicle Engine D4EA	261352	Stub Axle		28	28			430				
		2006.03-2012.12	MT	-	R	All-wheel Drive Closed Off-Road Vehicle Engine D4EA	624076	Inner Joint		25	22	35	63	87				
		2006.03-2012.12	-	R	F	All-wheel Drive Closed Off-Road Vehicle Engine D4EA	224117	Drive Shaft	52T	30	28	73	97	611				
2006.03-2012.12		-	L	F	All-wheel Drive Closed Off-Road Vehicle Engine D4EA	224195	Drive Shaft	52T	30	28	73	97	659					
2006.03-2012.12		-	R	F	All-wheel Drive Closed Off-Road Vehicle Engine D4EA	624022	Inner Joint		28	35	42	39.5	78.5					
2006.03-2012.12		-	-	F	All-wheel Drive Closed Off-Road Vehicle Engine D4EA	824072	Outer Joint	52T	30	36	73	97	67.5	I				
2006.03-2012.12		6AT	-	-	All-wheel Drive Closed Off-Road Vehicle Engine D4EA	639041	Inner Joint		25	23	35	63	92.5					
2006.03-2012.12		6AT	-	R	All-wheel Drive Closed Off-Road Vehicle Engine D4EA	824321	Outer Joint	52T	30	20	57	93.5	61	M				
2.2 CRDi (102 kW)	2006.03-2012.12	-	-	R	All-wheel Drive Closed Off-Road Vehicle Engine D4EB	824323	Outer Joint	52T	30	23	60	97.5	63.5	M				
	2006.03-2012.12	-	-	-	Closed Off-Road Vehicle Engine D4EB	899314	Outer Joint	52T	30	36	65	95	67.5	I				
	2006.03-2012.12	AT	R	F	All-wheel Drive Closed Off-Road Vehicle Engine D4EB	261352	Stub Axle		28	28			430					
	2006.03-2012.12	-	-	R	All-wheel Drive Closed Off-Road Vehicle Engine D4EB	624076	Inner Joint		25	22	35	63	87					
	2006.03-2012.12	AT	L	F	Closed Off-Road Vehicle Engine D4EB	224462	Drive Shaft	52T	30	28	73	97	668					
	2006.03-2012.12	AT	L	F	All-wheel Drive Closed Off-Road Vehicle Engine D4EB	224462	Drive Shaft	52T	30	28	73	97	668					
	2006.03-2012.12	-	R	F	Closed Off-Road Vehicle Engine D4EB	624058	Inner Joint		28	36	42.1	43.5	88					
	2006.03-2012.12	-	R	F	All-wheel Drive Closed Off-Road Vehicle Engine D4EB	624058	Inner Joint		28	36	42.1	43.5	88					
	2006.03-2012.12	-	-	R	All-wheel Drive Closed Off-Road Vehicle Engine D4EB	624129	Inner Joint		27	23	41	62	87					
	2006.03-2012.12	-	R	F	Closed Off-Road Vehicle Engine D4EB	224117	Drive Shaft	52T	30	28	73	97	611					
	2006.03-2012.12	-	R	F	All-wheel Drive Closed Off-Road Vehicle Engine D4EB	224117	Drive Shaft	52T	30	28	73	97	611					
	2006.03-2012.12	AT	R	F	Closed Off-Road Vehicle Engine D4EB	224463	Drive Shaft	52T	30	28	73	97	610					
	2006.03-2012.12	AT	R	F	All-wheel Drive Closed Off-Road Vehicle Engine D4EB	224463	Drive Shaft	52T	30	28	73	97	610					
	2006.03-2012.12	-	L	F	Closed Off-Road Vehicle Engine D4EB	224195	Drive Shaft	52T	30	28	73	97	659					
	2006.03-2012.12	-	L	F	All-wheel Drive Closed Off-Road Vehicle Engine D4EB	224195	Drive Shaft	52T	30	28	73	97	659					
	2006.03-2012.12	-	R	F	Closed Off-Road Vehicle Engine D4EB	624022	Inner Joint		28	35	42	39.5	78.5					
	2006.03-2012.12	-	R	F	All-wheel Drive Closed Off-Road Vehicle Engine D4EB	624022	Inner Joint		28	35	42	39.5	78.5					
	2006.03-2012.12	-	-	F	Closed Off-Road Vehicle Engine D4EB	824072	Outer Joint	52T	30	36	73	97	67.5	I				
	2006.03-2012.12	-	-	F	All-wheel Drive Closed Off-Road Vehicle Engine D4EB	824072	Outer Joint	52T	30	36	73	97	67.5	I				
	2006.03-2012.12	AT	L	F	Closed Off-Road Vehicle Engine D4EB	624095	Inner Joint		28	35	41	71	116.5					

YEAR	TRANSM	L/R	F/R	REMARKS	GSP Ref.	PRODUCT	ABS	Technical Specifications								
								A	B	C	H	L	P			
HYUNDAI SANTA FE II (CM)																
2.2 CRDi (102 kW)																
2006.03-2012.12	-	L	F	All-wheel Drive Closed Off-Road Vehicle Engine D4EB	224465	Drive Shaft	52T	30	28	73	97	656				
2006.03-2012.12	AT	L	F	All-wheel Drive Closed Off-Road Vehicle Engine D4EB	624095	Inner Joint		28	35	41	71	116.5				
2006.03-2012.12	6MT	L	F	Closed Off-Road Vehicle Engine D4EB	224465	Drive Shaft	52T	30	28	73	97	656				
2006.03-2012.12	5MT	L	F	Closed Off-Road Vehicle Engine D4EB	224459	Drive Shaft	52T	30	28	65	95	657				
2006.03-2012.12	6AT/6MT	-	-	All-wheel Drive Closed Off-Road Vehicle Engine D4EB	639041	Inner Joint		25	23	35	63	92.5				
2006.03-2012.12	6AT/6MT	-	R	All-wheel Drive Closed Off-Road Vehicle Engine D4EB	824321	Outer Joint	52T	30	20	57	93.5	61	M			
2006.03-2012.12	-	R	F	Closed Off-Road Vehicle Engine D4EB	624094	Inner Joint		28	35	42		129.5				
2006.03-2012.12	-	R	F	All-wheel Drive Closed Off-Road Vehicle Engine D4EB	624094	Inner Joint		28	35	42		129.5				
2.2 CRDi (114 kW)																
2006.03-2009.12	-	-	R	All-wheel Drive Closed Off-Road Vehicle Engine D4EB	824323	Outer Joint	52T	30	23	60	97.5	63.5	M			
2006.03-2009.12	6AT	R	F	All-wheel Drive Closed Off-Road Vehicle Engine D4EB	261352	Stub Axle		28	28			430				
2006.03-2009.12	6AT/6MT	-	R	All-wheel Drive Closed Off-Road Vehicle Engine D4EB	624076	Inner Joint		25	22	35	63	87				
2006.03-2009.12	AT	L	F	Closed Off-Road Vehicle Engine D4EB	224462	Drive Shaft	52T	30	28	73	97	668				
2006.03-2009.12	AT	L	F	All-wheel Drive Closed Off-Road Vehicle Engine D4EB	224462	Drive Shaft	52T	30	28	73	97	668				
2006.03-2009.12	-	R	F	Closed Off-Road Vehicle Engine D4EB	624058	Inner Joint		28	36	42.1	43.5	88				
2006.03-2009.12	-	R	F	All-wheel Drive Closed Off-Road Vehicle Engine D4EB	624058	Inner Joint		28	36	42.1	43.5	88				
2006.03-2009.12	AT/MT	R	F	All-wheel Drive Closed Off-Road Vehicle Engine D4EB	224117	Drive Shaft	52T	30	28	73	97	611				
2006.03-2009.12	-	-	R	All-wheel Drive Closed Off-Road Vehicle Engine D4EB	624129	Inner Joint		27	23	41	62	87				
2006.03-2009.12	-	R	F	Closed Off-Road Vehicle Engine D4EB	224117	Drive Shaft	52T	30	28	73	97	611				
2006.03-2009.12	AT	R	F	Closed Off-Road Vehicle Engine D4EB	224463	Drive Shaft	52T	30	28	73	97	610				
2006.03-2009.12	AT	R	F	All-wheel Drive Closed Off-Road Vehicle Engine D4EB	224463	Drive Shaft	52T	30	28	73	97	610				
2006.03-2009.12	AT/MT	L	F	All-wheel Drive Closed Off-Road Vehicle Engine D4EB	224195	Drive Shaft	52T	30	28	73	97	659				
2006.03-2009.12	AT/MT	R	F	All-wheel Drive Closed Off-Road Vehicle Engine D4EB	624022	Inner Joint		28	35	42	39.5	78.5				
2006.03-2009.12	-	L	F	Closed Off-Road Vehicle Engine D4EB	224195	Drive Shaft	52T	30	28	73	97	659				
2006.03-2009.12	-	R	F	Closed Off-Road Vehicle Engine D4EB	624022	Inner Joint		28	35	42	39.5	78.5				
2006.03-2009.12	-	-	F	Closed Off-Road Vehicle Engine D4EB	824072	Outer Joint	52T	30	36	73	97	67.5	I			
2006.03-2009.12	-	-	F	All-wheel Drive Closed Off-Road Vehicle Engine D4EB	824072	Outer Joint	52T	30	36	73	97	67.5	I			
2006.03-2009.12	AT	L	F	Closed Off-Road Vehicle Engine D4EB	624095	Inner Joint		28	35	41	71	116.5				
2006.03-2009.12	AT	L	F	All-wheel Drive Closed Off-Road Vehicle Engine D4EB	624095	Inner Joint		28	35	41	71	116.5				
2006.03-2009.12	-	L	F	Closed Off-Road Vehicle Engine D4EB	224465	Drive Shaft	52T	30	28	73	97	656				
2006.03-2009.12	-	L	F	All-wheel Drive Closed Off-Road Vehicle Engine D4EB	224465	Drive Shaft	52T	30	28	73	97	656				
2006.03-2009.12	-	L	F	Closed Off-Road Vehicle Engine D4EB	224460	Drive Shaft	52T	30	28	73	97	658				
2006.03-2009.12	-	R	F	Closed Off-Road Vehicle Engine D4EB	624094	Inner Joint		28	35	42		129.5				
2006.03-2009.12	-	R	F	All-wheel Drive Closed Off-Road Vehicle Engine D4EB	624094	Inner Joint		28	35	42		129.5				
2.2 CRDi (145 kW)																
2009.01-2012.12	-	-	R	All-wheel Drive Closed Off-Road Vehicle Engine D4HB	824323	Outer Joint	52T	30	23	60	97.5	63.5	M			
2009.01-2012.12	AT	R	F	All-wheel Drive Closed Off-Road Vehicle Engine D4HB	261352	Stub Axle		28	28			430				
2009.01-2012.12	-	-	R	All-wheel Drive Closed Off-Road Vehicle Engine D4HB	624076	Inner Joint		25	22	35	63	87				
2009.01-2012.12	-	R	F	Closed Off-Road Vehicle Engine D4HB	624058	Inner Joint		28	36	42.1	43.5	88				
2009.01-2012.12	-	R	F	All-wheel Drive Closed Off-Road Vehicle Engine D4HB	624058	Inner Joint		28	36	42.1	43.5	88				
2009.01-2012.12	-	-	R	All-wheel Drive Closed Off-Road Vehicle Engine D4HB	624129	Inner Joint		27	23	41	62	87				
2009.01-2012.12	-	-	F	Closed Off-Road Vehicle Engine D4HB	824072	Outer Joint	52T	30	36	73	97	67.5	I			
2009.01-2012.12	-	-	F	All-wheel Drive Closed Off-Road Vehicle Engine D4HB	824072	Outer Joint	52T	30	36	73	97	67.5	I			
2009.01-2012.12	-	R	F	All-wheel Drive Closed Off-Road Vehicle Engine D4HB	224561	Drive Shaft	52T	30	28	73	97	590				
2009.01-2012.12	6AT/6MT	-	-	All-wheel Drive Closed Off-Road Vehicle Engine D4HB	639041	Inner Joint		25	23	35	63	92.5				
2009.01-2012.12	6AT/6MT	-	R	All-wheel Drive Closed Off-Road Vehicle Engine D4HB	824321	Outer Joint	52T	30	20	57	93.5	61	M			
2.2 CRDi GLS (110 kW)																
2006.03-2009.12	-	-	R	All-wheel Drive Closed Off-Road Vehicle Engine D4EB	824323	Outer Joint	52T	30	23	60	97.5	63.5	M			
2006.03-2009.12	6AT	R	F	All-wheel Drive Closed Off-Road Vehicle Engine D4EB	261352	Stub Axle		28	28			430				
2006.03-2009.12	6AT/6MT	-	R	All-wheel Drive Closed Off-Road Vehicle Engine D4EB	624076	Inner Joint		25	22	35	63	87				
2006.03-2009.12	AT	L	F	Closed Off-Road Vehicle Engine D4EB	224462	Drive Shaft	52T	30	28	73	97	668				
2006.03-2009.12	AT	L	F	All-wheel Drive Closed Off-Road Vehicle Engine D4EB	224462	Drive Shaft	52T	30	28	73	97	668				
2006.03-2009.12	-	R	F	Closed Off-Road Vehicle Engine D4EB	624058	Inner Joint		28	36	42.1	43.5	88				
2006.03-2009.12	-	R	F	All-wheel Drive Closed Off-Road Vehicle Engine D4EB	624058	Inner Joint		28	36	42.1	43.5	88				
2006.03-2009.12	AT/MT	R	F	All-wheel Drive Closed Off-Road Vehicle Engine D4EB	224117	Drive Shaft	52T	30	28	73	97	611				
2006.03-2009.12	-	-	R	All-wheel Drive Closed Off-Road Vehicle Engine D4EB	624129	Inner Joint		27	23	41	62	87				
2006.03-2009.12	-	R	F	Closed Off-Road Vehicle Engine D4EB	224117	Drive Shaft	52T	30	28	73	97	611				
2006.03-2009.12	AT	R	F	Closed Off-Road Vehicle Engine D4EB	224463	Drive Shaft	52T	30	28	73	97	610				
2006.03-2009.12	AT	R	F	All-wheel Drive Closed Off-Road Vehicle Engine D4EB	224463	Drive Shaft	52T	30	28	73	97	610				
2006.03-2009.12	AT/MT	L	F	All-wheel Drive Closed Off-Road Vehicle Engine D4EB	224195	Drive Shaft	52T	30	28	73	97	659				
2006.03-2009.12	AT/MT	R	F	All-wheel Drive Closed Off-Road Vehicle Engine D4EB	624022	Inner Joint		28	35	42	39.5	78.5				
2006.03-2009.12	-	L	F	Closed Off-Road Vehicle Engine D4EB	224195	Drive Shaft	52T	30	28	73	97	659				
2006.03-2009.12	-	R	F	Closed Off-Road Vehicle Engine D4EB	624022	Inner Joint		28	35	42	39.5	78.5				
2006.03-2009.12	-	-	F	Closed Off-Road Vehicle Engine D4EB	824072	Outer Joint	52T	30	36	73	97	67.5	I			
2006.03-2009.12	-	-	F	All-wheel Drive Closed Off-Road Vehicle Engine D4EB	824072	Outer Joint	52T	30	36	73	97	67.5	I			
2006.03-2009.12	AT	L	F	Closed Off-Road Vehicle Engine D4EB	624095	Inner Joint		28	35	41	71	116.5				
2006.03-2009.12	AT	L	F	All-wheel Drive Closed Off-Road Vehicle Engine D4EB	624095	Inner Joint		28	35	41	71	116.5				

YEAR	TRANSM	L/R	F/R	REMARKS	GSP Ref.	PRODUCT	ABS	Technical Specifications							
								A	B	C	H	L	P		
HYUNDAI															
SANTA FE II (CM)															
2.2 CRDi GLS (110 kW)	2006.03-2009.12	-	L	F	Closed Off-Road Vehicle Engine D4EB	224460	Drive Shaft	52T	30	28	73	97	658		
	2006.03-2009.12	-	L	F	All-wheel Drive Closed Off-Road Vehicle Engine D4EB	224460	Drive Shaft	52T	30	28	73	97	658		
	2006.03-2009.12	AT	L	F	Closed Off-Road Vehicle Engine D4EB	239247	Drive Shaft	52T	30	28	73	97	670		
	2006.03-2009.12	AT	L	F	All-wheel Drive Closed Off-Road Vehicle Engine D4EB	239247	Drive Shaft	52T	30	28	73	97	670		
	2006.03-2009.12	-	R	F	Closed Off-Road Vehicle Engine D4EB	624094	Inner Joint		28	35	42		129.5		
	2006.03-2009.12	-	R	F	All-wheel Drive Closed Off-Road Vehicle Engine D4EB	624094	Inner Joint		28	35	42		129.5		
2.4 (128 kW)	2010.07-2012.12	-	-	R	All-wheel Drive Closed Off-Road Vehicle Engine G4KE	624076	Inner Joint		25	22	35	63	87		
	2010.07-2012.12	AT	L	F	All-wheel Drive Closed Off-Road Vehicle Engine G4KE	624155	Inner Joint		28	35	33	67	105.5		
	2010.07-2012.12	-	-	F	All-wheel Drive Closed Off-Road Vehicle Engine G4KE	624156	Inner Joint		28	35	42		129.5		
	2010.11-2012.12	AT	L	F	Closed Off-Road Vehicle Engine G4KE	624155	Inner Joint		28	35	33	67	105.5		
	2010.11-2012.12	MT	-	F	Closed Off-Road Vehicle Engine G4KE	624156	Inner Joint		28	35	42		129.5		
2.7 (125 kW)	2006.03-2012.12	-	-	R	All-wheel Drive Closed Off-Road Vehicle Engine G6BA	824323	Outer Joint	52T	30	23	60	97.5	63.5	M	
	2006.03-2012.12	AT	R	F	All-wheel Drive Closed Off-Road Vehicle Engine G6BA	261351	Stub Axle		28	27			422		
	2006.03-2012.12	6AT	L	F	Closed Off-Road Vehicle Engine G6BA	624155	Inner Joint		28	35	33	67	105.5		
	2006.03-2012.12	6AT	-	F	Closed Off-Road Vehicle Engine G6BA	624156	Inner Joint		28	35	42		129.5		
	2006.03-2012.12	-	-	R	All-wheel Drive Closed Off-Road Vehicle Engine G6BA	624129	Inner Joint		27	23	41	62	87		
	2006.03-2012.12	AT	R	F	All-wheel Drive Closed Off-Road Vehicle Engine G6BA	224117	Drive Shaft	52T	30	28	73	97	611		
	2006.03-2012.12	AT	R	F	Closed Off-Road Vehicle Engine G6BA	224117	Drive Shaft	52T	30	28	73	97	611		
	2006.03-2012.12	AT	R	F	All-wheel Drive Closed Off-Road Vehicle Engine G6BA	624022	Inner Joint		28	35	42	39.5	78.5		
	2006.03-2012.12	AT	R	F	Closed Off-Road Vehicle Engine G6BA	624022	Inner Joint		28	35	42	39.5	78.5		
	2006.03-2012.12	-	-	F	All-wheel Drive Closed Off-Road Vehicle Engine G6BA	824072	Outer Joint	52T	30	36	73	97	67.5	I	
	2006.03-2012.12	-	-	F	Closed Off-Road Vehicle Engine G6BA	824072	Outer Joint	52T	30	36	73	97	67.5	I	
2.7 V6 GLS (139 kW)	2006.03-2009.12	-	-	R	All-wheel Drive Closed Off-Road Vehicle Engine G6EA	824323	Outer Joint	52T	30	23	60	97.5	63.5	M	
	2006.03-2009.12	AT	R	F	All-wheel Drive Closed Off-Road Vehicle Engine G6EA	261351	Stub Axle		28	27			422		
	2006.03-2009.12	6AT	L	F	Closed Off-Road Vehicle Engine G6EA	624155	Inner Joint		28	35	33	67	105.5		
	2006.03-2009.12	6AT	-	F	Closed Off-Road Vehicle Engine G6EA	624156	Inner Joint		28	35	42		129.5		
	2006.03-2009.12	-	-	R	All-wheel Drive Closed Off-Road Vehicle Engine G6EA	624129	Inner Joint		27	23	41	62	87		
	2006.03-2009.12	AT	R	F	Closed Off-Road Vehicle Engine G6EA	224117	Drive Shaft	52T	30	28	73	97	611		
	2006.03-2009.12	AT	R	F	All-wheel Drive Closed Off-Road Vehicle Engine G6EA	224117	Drive Shaft	52T	30	28	73	97	611		
	2006.03-2009.12	AT	R	F	Closed Off-Road Vehicle Engine G6EA	624022	Inner Joint		28	35	42	39.5	78.5		
	2006.03-2009.12	AT	R	F	All-wheel Drive Closed Off-Road Vehicle Engine G6EA	624022	Inner Joint		28	35	42	39.5	78.5		
	2006.03-2009.12	-	-	F	Closed Off-Road Vehicle Engine G6EA	824072	Outer Joint	52T	30	36	73	97	67.5	I	
	2006.03-2009.12	-	-	F	All-wheel Drive Closed Off-Road Vehicle Engine G6EA	824072	Outer Joint	52T	30	36	73	97	67.5	I	
SANTA FE III (DM)															
2.0 CRDi (110 kW)	2012.09-	-	AT	R	F	All-wheel Drive Closed Off-Road Vehicle Engine D4HA	261352	Stub Axle		28	28			430	
	2012.09-	-	-	-	F	Closed Off-Road Vehicle Engine D4HA	824301	Outer Joint	52T	30	35	73	94.5	67	M
	2012.09-	-	-	-	F	All-wheel Drive Closed Off-Road Vehicle Engine D4HA	824301	Outer Joint	52T	30	35	73	94.5	67	M
2.2 CRDi (145 kW)	2012.09-2015.12	AT	R	F	All-wheel Drive Closed Off-Road Vehicle Engine D4HB	261352	Stub Axle		28	28			430		
	2012.09-2015.12	-	-	-	F	Closed Off-Road Vehicle Engine D4HB	824301	Outer Joint	52T	30	35	73	94.5	67	M
	2012.09-2015.12	-	-	-	F	All-wheel Drive Closed Off-Road Vehicle Engine D4HB	824301	Outer Joint	52T	30	35	73	94.5	67	M
	2012.09-2015.12	-	-	R	All-wheel Drive Closed Off-Road Vehicle Engine D4HB	624076	Inner Joint		25	22	35	63	87		
2.2 CRDi (147 kW)	2015.10-	-	AT	R	F	All-wheel Drive Closed Off-Road Vehicle Engine D4HB	261352	Stub Axle		28	28			430	
2.4 (141 kW)	2012.09-2015.12	-	-	-	All-wheel Drive Closed Off-Road Vehicle Engine G4KJ	639041	Inner Joint		25	23	35	63	92.5		
	2012.09-2015.12	-	-	R	All-wheel Drive Closed Off-Road Vehicle Engine G4KJ	824321	Outer Joint	52T	30	20	57	93.5	61	M	
SANTA FÉ (DM)															
-	2013.01-2015.12	-	L	F	-	224567	Drive Shaft	52T	30	31	73	94.5	674		
SANTRO															
-	-	-	-	-	-	824014	Outer Joint		25	20	50	94.5	56	I	
	-	-	-	L	-	224016	Drive Shaft		25	22	50	94.5	589.5		
	-	-	-	R	-	224017	Drive Shaft		25	22	50	94.5	805		
SONATA															
-	-	-	L	-	6 Cyl (BEIJING)	824012	Outer Joint		27	26	60	95	69.5	M	
	-	-	L	-	6 Cyl (BEIJING)	224003	Drive Shaft		27	27	60	95	663		
	-	-	R	-	6 Cyl (BEIJING)	824013	Outer Joint		27	26	60	95	69	M	
	-	-	R	-	6 Cyl (BEIJING)	224004	Drive Shaft		27	27	60	95	976.5		
	-	-	L	-	-	224063	Drive Shaft		27	27	60	95	660		
	-	-	R	-	6 Cyl (BEIJING)	824013	Outer Joint		27	26	60	95	69	M	
	2001-	-	AT	-	4 Cyl	624008	Inner Joint		25	23	41	63	92.5		
	2001-2005	AT	L	-	4 Cyl	224124	Drive Shaft		27	25	60	95	661		
	2001-2005	AT	R	-	4 Cyl	224123	Drive Shaft		27	25	60	95	974		
	2001-	-	L	-	6 Cyl	224126	Drive Shaft	47T	27	27	60	95	662		
	2001-	-	R	-	6 Cyl	224125	Drive Shaft	47T	27	26	60	95	619		
2.0	1993-1996	-	L	-	-	224011	Drive Shaft		25	25	50	94.5	982		
	1993-1996	-	R	-	-	224012	Drive Shaft		25	25	50	94.5	639		
2.4 2WD	2010-2014	6AT	L	-	THETA 2	224261	Drive Shaft	48T	27	27	62	92.5	970		
	2010-2014	6AT	R	-	THETA 2	224262	Drive Shaft	48T	27	27	62	92.5	672		

YEAR	TRANSM	L/R	F/R	REMARKS	GSP Ref.	PRODUCT	ABS	Technical Specifications								
								A	B	C	H	L	P			
HYUNDAI SONATA																
2.4	1999-2001	AT	R	F	-	227002	Drive Shaft		27	27	60	95	974			
	1999-2001	AT	L	-	-	224014	Drive Shaft	47T	27	27	60	95	659			
	1999-2001	AT	R	-	-	224015	Drive Shaft	47T	27	27	60	95	974			
	1999-2001	AT	-	-	-	627001	Inner Joint		27	25	41	62.5	93			
	1999-2001	AT	L	F	-	227001	Drive Shaft		27	27	60	95	659			
	2006.01-2006.01	MT/AT	-	-	-	824170	Outer Joint	47T	27	25	62.2	95	61.5	M		
2.4 2WD	2009-2014	6AT	R	-	THETA 2	224228	Drive Shaft		27	27	62	94.5	972			
	2009-2014	6AT	L	-	THETA 2	224229	Drive Shaft		27	27	62	94.5	674			
	2009-2014	6AT	L	-	THETA 2	824125	Outer Joint		27	25	62	94.5	61	M		
2.5	1999-2001	AT	L	-	-	224094	Drive Shaft	47T	27	27	60	96.5	661			
2.7	2002-	-	L	-	6 Cyl	224094	Drive Shaft	47T	27	27	60	96.5	661			
2400	2006.01-	-	MT/AT	-	Engine	824170	Outer Joint	47T	27	25	62.2	95	61.5	M		
3.0 V6	1989-1991	-	-	-	-	824019	Outer Joint		25	26	50	95	69	M		
	1998.01-2001.10	MT/AT	-	-	-	824034	Outer Joint		27	34	60	95	69	I		
3.3	2005-2010	5AT	R	-	LAMBDA	224128	Drive Shaft	47T	30	28	65	95	981.5			
	2005-2010	5AT	L	-	LAMBDA	224127	Drive Shaft	47T	30	28	65	95	662			
SONATA (NF)																
-	-	-	L	-	-	224031	Drive Shaft	47T	27	28	62	94.5	660			
	-	-	R	-	-	224032	Drive Shaft	47T	27	28	62	94.5	986			
2.4	2007-	-	AT	L	-	224145	Drive Shaft	47T	27	27	62.2	95	671			
	2007-	-	AT	R	-	224144	Drive Shaft	47T	27	27	62.2	95	979			
SONATA II (Y-2)																
1.8 i (70 kW)	1988.09-1993.10	-	-	F	Coupe Engine 4G62	809003	Outer Joint		25	25	50	95	64.5	M		
	1988.09-1993.10	-	R	F	Coupe Engine 4G62	839034	Outer Joint		25	25	50	94.5	65	M		
	1988.09-1993.10	-	-	F	Coupe Engine 4G62	839032	Outer Joint		25	23	50	95	60.5	M		
2.0 i (74 kW)	1988.09-1991.08	-	-	F	Saloon Engine G4CP	809003	Outer Joint		25	25	50	95	64.5	M		
	1988.09-1991.08	-	R	F	Saloon Engine G4CP	839034	Outer Joint		25	25	50	94.5	65	M		
	1988.09-1991.08	AT	R	F	Saloon Engine G4CP	839033	Outer Joint		25	25	50	95	65	M		
	1988.09-1991.08	MT	R	F	Saloon Engine G4CP	839032	Outer Joint		25	23	50	95	60.5	M		
2.0 i (80 kW)	1991.01-1993.10	-	R	F	Saloon Engine G4CP-U	839034	Outer Joint		25	25	50	94.5	65	M		
	1991.01-1993.10	-	-	F	Saloon Engine G4CP-U	809003	Outer Joint		25	25	50	95	64.5	M		
	1991.01-1993.10	AT	R	F	Saloon Engine G4CP-U	839033	Outer Joint		25	25	50	95	65	M		
	1991.01-1993.10	MT	R	F	Saloon Engine G4CP-U	839032	Outer Joint		25	23	50	95	60.5	M		
	1991.01-1993.10	-	R	F	Saloon Engine G4CP-U	899038	Outer Joint	47T	25	25	50	94.5	65	M		
2.0 i 16V (96 kW)	1991.01-1993.10	-	R	F	Saloon Engine G4CP-D	839034	Outer Joint		25	25	50	94.5	65	M		
	1991.01-1993.10	-	-	F	Saloon Engine G4CP-D	809003	Outer Joint		25	25	50	95	64.5	M		
	1991.01-1993.10	AT	R	F	Saloon Engine G4CP-D	839033	Outer Joint		25	25	50	95	65	M		
	1991.01-1993.10	MT	R	F	Saloon Engine G4CP-D	839032	Outer Joint		25	23	50	95	60.5	M		
	1991.01-1993.10	-	R	F	Saloon Engine G4CP-D	899038	Outer Joint	47T	25	25	50	94.5	65	M		
2.4 i (83 kW)	1988.09-1991.08	-	-	F	Saloon Engine G4CS	809003	Outer Joint		25	25	50	95	64.5	M		
	1988.09-1991.08	-	R	F	Saloon Engine G4CS	839034	Outer Joint		25	25	50	94.5	65	M		
	1988.09-1991.08	-	-	F	Saloon Engine G4CS	839032	Outer Joint		25	23	50	95	60.5	M		
3.0 i V6 (107 kW)	1991.01-1993.10	-	-	-	Saloon Engine G6AT	839034	Outer Joint		25	25	50	94.5	65	M		
	1991.01-1993.10	-	-	F	Saloon Engine G6AT	809003	Outer Joint		25	25	50	95	64.5	M		
SONATA III (Y-3)/SONICA																
1.8 i (72 kW)	1993.05-1998.06	-	R	F	Saloon Engine G4CM	839034	Outer Joint		25	25	50	94.5	65	M		
	1993.05-1998.06	-	-	F	Saloon Engine G4CM	824027	Outer Joint	47T	27	23	60	95	63.5	M		
	1993.05-1998.06	-	R	F	Saloon Engine G4CM	899038	Outer Joint	47T	25	25	50	94.5	65	M		
2.0 i (70 kW)	1996.08-1998.06	-	R	F	Saloon Engine G4EP	839034	Outer Joint		25	25	50	94.5	65	M		
	1996.08-1998.06	-	R	F	Saloon Engine G4EP	839033	Outer Joint		25	25	50	95	65	M		
	1996.08-1998.06	-	-	F	Saloon Engine G4EP	839032	Outer Joint		25	23	50	95	60.5	M		
	1996.08-1998.06	MT	-	F	Saloon Engine G4EP	839104	Outer Joint		27	25	60	97	63.5	I		
	1996.08-1998.06	-	-	F	Saloon Engine G4EP	824027	Outer Joint	47T	27	23	60	95	63.5	M		
	1996.08-1998.06	-	R	F	Saloon Engine G4EP	899038	Outer Joint	47T	25	25	50	94.5	65	M		
2.0 i (77 kW)	1994.06-1996.08	-	-	-	Saloon Engine G4CP	839034	Outer Joint		25	25	50	94.5	65	M		
	1994.06-1996.08	-	R	F	Saloon Engine G4CP	839033	Outer Joint		25	25	50	95	65	M		
	1994.06-1996.08	-	-	F	Saloon Engine G4CP	839032	Outer Joint		25	23	50	95	60.5	M		
	1994.06-1996.08	-	R	F	Saloon Engine G4CP	899038	Outer Joint	47T	25	25	50	94.5	65	M		
2.0 i 16V (102 kW)	1993.05-1998.06	-	R	F	Saloon Engine G4CP-D	839034	Outer Joint		25	25	50	94.5	65	M		
	1993.05-1998.06	-	R	F	Saloon Engine G4CP-D	839033	Outer Joint		25	25	50	95	65	M		
	1993.05-1998.06	-	-	F	Saloon Engine G4CP-D	839032	Outer Joint		25	23	50	95	60.5	M		
	1993.05-1998.06	MT	-	F	Saloon Engine G4CP-D	839104	Outer Joint		27	25	60	97	63.5	I		
	1993.05-1998.06	-	-	F	Saloon Engine G4CP-D	824027	Outer Joint	47T	27	23	60	95	63.5	M		
	1993.05-1998.06	-	R	F	Saloon Engine G4CP-D	899038	Outer Joint	47T	25	25	50	94.5	65	M		
2.0 i 16V (92 kW)	1996.06-1998.06	AT	R	F	Saloon Engine G4CP-DM	839033	Outer Joint		25	25	50	95	65	M		
	1996.06-1998.06	AT/MT	-	F	Saloon Engine G4CP-DM	839032	Outer Joint		25	23	50	95	60.5	M		

YEAR	TRANSM	L/R	F/R	REMARKS	GSP Ref.	PRODUCT	ABS	Technical Specifications							
								A	B	C	H	L	P		
HYUNDAI SONATA III (Y-3)/SONICA															
2.0 i 16V (92 kW)	1996.06-1998.06	MT	-	F	Saloon Engine G4CP-DM	839104	Outer Joint		27	25	60	97	63.5	I	
	1996.06-1998.06	-	-	F	Saloon Engine G4CP-DM	824027	Outer Joint	47T	27	23	60	95	63.5	M	
	1996.06-1998.06	-	R	F	Saloon Engine G4CP-DM	899038	Outer Joint	47T	25	25	50	94.5	65	M	
3.0 i V6 (107 kW)	1993.05-1998.06	-	R	F	Saloon Engine G6AT	839034	Outer Joint		25	25	50	94.5	65	M	
	1993.05-1998.06	-	-	F	Saloon Engine G6AT	839069	Outer Joint	47T	25	26	50	95	69	M	
SONATA IV (EF)/SONICA															
2.0 (100 kW)	2001.04-2004.11	MT	-	-	Saloon Engine G4JP	624001	Inner Joint		27	25	41	62.8	92.5		
	2001.04-2004.11	MT	-	F	Saloon Engine G4JP	839104	Outer Joint		27	25	60	97	63.5	I	
	2001.04-2004.11	MT	-	F	Saloon Engine G4JP	824029	Outer Joint	47T	27	25	60	95	63.5	M	
	2001.04-2004.11	AT	-	F	Saloon Engine G4JP	824027	Outer Joint	47T	27	23	60	95	63.5	M	
	2001.04-2004.11	4AT/5MT	-	F	Saloon Engine G4JP	824062	Outer Joint	47T	27	25	62.2	95	60	M	
	2001.04-2004.11	5MT	-	F	Saloon Engine G4JP	824028	Outer Joint	47T	27	26	60	95	69	M	
2.0 16V (100 kW)	1998.06-2001.10	-	-	-	Saloon Engine G4JP-G	624001	Inner Joint		27	25	41	62.8	92.5		
	1998.06-2001.10	-	-	F	Saloon Engine G4JP-G	839104	Outer Joint		27	25	60	97	63.5	I	
	1998.06-2001.10	-	-	F	Saloon Engine G4JP-G	824029	Outer Joint	47T	27	25	60	95	63.5	M	
	1998.06-2001.10	-	-	F	Saloon Engine G4JP-G	824027	Outer Joint	47T	27	23	60	95	63.5	M	
2.0 16V (96 kW)	2001.10-2004.11	4AT/5MT	-	F	Saloon Engine G4JP-EG	824062	Outer Joint	47T	27	25	62.2	95	60	M	
	2001.10-2004.11	5MT	-	F	Saloon Engine G4JP-EG	824028	Outer Joint	47T	27	26	60	95	69	M	
2.4 16V (105 kW)	1998.03-2001.10	-	-	-	Saloon Engine G4BS	624001	Inner Joint		27	25	41	62.8	92.5		
	1998.03-2001.10	-	-	F	Saloon Engine G4BS	839104	Outer Joint		27	25	60	97	63.5	I	
	1998.03-2001.10	-	-	F	Saloon Engine G4BS	824029	Outer Joint	47T	27	25	60	95	63.5	M	
2.5 V6 24V (118 kW)	1998.06-2001.10	-	-	F	Saloon Engine G6BV-G	824073	Outer Joint	47T	27	26	60	95	69	M	
	1998.06-2001.10	-	L	F	Saloon Engine G6BV-G	627020	Inner Joint		27	25	41	62	100.5		
	1998.06-2001.10	MT	L/R	F	Saloon Engine G6BV-G	824066	Outer Joint	47T	27	26	60	95	69	M	
2.7 i V6 (132 kW)	2001.10-2005.05	MT	-	F	Saloon Engine G6BA-Y	824073	Outer Joint	47T	27	26	60	95	69	M	
	2001.10-2005.05	AT	L	F	Saloon Engine G6BA-Y	627020	Inner Joint		27	25	41	62	100.5		
2.7 V6 (127 kW)	2001.10-2004.11	MT	L/R	F	Saloon Engine G6BA-G	824066	Outer Joint	47T	27	26	60	95	69	M	
2.7 V6 (129 kW)	2002.11-2004.11	MT	-	F	Saloon Engine G6BA	824073	Outer Joint	47T	27	26	60	95	69	M	
	2002.11-2004.11	AT	L	F	Saloon Engine G6BA	627020	Inner Joint		27	25	41	62	100.5		
SONATA V (NF)/SONICA															
2.0 CRDi (100 kW)	2006.02-2010.12	5MT	-	F	Saloon Engine D4EA	824028	Outer Joint	47T	27	26	60	95	69	M	
	2006.02-2010.12	MT	-	-	Saloon Engine D4EA	824058	Outer Joint	47T	27	26	62	94.5	65	M	
	2006.02-2010.12	AT	L	F	Saloon Engine D4EA	224220	Stub Axle	47T	27	28	62	94.5	664		
	2006.02-2010.12	AT	R	F	Saloon Engine D4EA	224545	Drive Shaft	47T	27	28	62	94.5	986		
	2006.02-2010.12	5MT	-	-	Saloon Engine D4EA	624001	Inner Joint		27	25	41	62.8	92.5		
	2006.02-2010.12	4AT/5MT	-	F	Saloon Engine D4EA	824062	Outer Joint	47T	27	25	62.2	95	60	M	
	2006.02-2010.12	5MT	-	F	Saloon Engine D4EA	824028	Outer Joint	47T	27	26	60	95	69	M	
2.0 CRDi (103 kW)	2006.02-2010.12	MT	-	-	Saloon Engine D4EA	824058	Outer Joint	47T	27	26	62	94.5	65	M	
	2006.02-2010.12	AT	L	F	Saloon Engine D4EA	224220	Stub Axle	47T	27	28	62	94.5	664		
	2006.02-2010.12	AT	R	F	Saloon Engine D4EA	224545	Drive Shaft	47T	27	28	62	94.5	986		
	2006.02-2010.12	5MT	-	-	Saloon Engine D4EA	624001	Inner Joint		27	25	41	62.8	92.5		
	2006.02-2010.12	4AT/5MT	-	F	Saloon Engine D4EA	824062	Outer Joint	47T	27	25	62.2	95	60	M	
	2009.03-2010.12	MT	-	-	Saloon Engine D4EA	824058	Outer Joint	47T	27	26	62	94.5	65	M	
	2009.03-2010.12	AT	L	F	Saloon Engine D4EA	224220	Stub Axle	47T	27	28	62	94.5	664		
2.0 CRDi (110 kW)	2009.03-2010.12	AT	R	F	Saloon Engine D4EA	224545	Drive Shaft	47T	27	28	62	94.5	986		
	2009.03-2010.12	4AT/5MT	-	F	Saloon Engine D4EA	824062	Outer Joint	47T	27	25	62.2	95	60	M	
	2008.07-2010.12	6AT	-	F	Saloon Engine G4KD	824090	Outer Joint	48T	27	25	61.9	95	61	M	
	2008.07-2010.12	6AT	L	F	Saloon Engine G4KD	624056	Inner Joint		27	25	30	67	83.5		
2.0 VVTi GLS (106 kW)	2005.05-2010.12	6AT	-	F	Saloon Engine G4KA	824090	Outer Joint	48T	27	25	61.9	95	61	M	
	2005.05-2010.12	-	-	-	Saloon Engine G4KA	624001	Inner Joint		27	25	41	62.8	92.5		
	2005.05-2010.12	6AT	L	F	Saloon Engine G4KA	624056	Inner Joint		27	25	30	67	83.5		
	2005.05-2010.12	MT	-	F	Saloon Engine G4KA	839104	Outer Joint		27	25	60	97	63.5	I	
	2005.05-2010.12	MT	-	F	Saloon Engine G4KA	824029	Outer Joint	47T	27	25	60	95	63.5	M	
	2005.05-2010.12	AT	-	F	Saloon Engine G4KA	824027	Outer Joint	47T	27	23	60	95	63.5	M	
	2005.05-2010.12	-	-	F	Saloon Engine G4KA	824062	Outer Joint	47T	27	25	62.2	95	60	M	
	2005.05-2010.12	MT	-	F	Saloon Engine G4KA	824028	Outer Joint	47T	27	26	60	95	69	M	
2.0 VVTi GLS (121 kW)	2008.01-2010.12	6AT	-	F	Saloon Engine G4KD	824090	Outer Joint	48T	27	25	61.9	95	61	M	
	2008.01-2010.12	6AT	L	F	Saloon Engine G4KD	624056	Inner Joint		27	25	30	67	83.5		
	2008.01-2010.12	-	-	F	Saloon Engine G4KD	824062	Outer Joint	47T	27	25	62.2	95	60	M	
2.4 (119 kW)	2005.01-2010.12	AT	L	F	Saloon Engine G4KC	224220	Stub Axle	47T	27	28	62	94.5	664		
	2005.01-2010.12	AT	R	F	Saloon Engine G4KC	224545	Drive Shaft	47T	27	28	62	94.5	986		
	2005.01-2010.12	-	-	F	Saloon Engine G4KC	824062	Outer Joint	47T	27	25	62.2	95	60	M	
2.4 (128 kW)	2008.06-2010.12	AT	L	F	Saloon Engine G4KE	224220	Stub Axle	47T	27	28	62	94.5	664		
	2008.06-2010.12	AT	R	F	Saloon Engine G4KE	224545	Drive Shaft	47T	27	28	62	94.5	986		
	2008.06-2010.12	-	-	F	Saloon Engine G4KE	824062	Outer Joint	47T	27	25	62.2	95	60	M	

YEAR	TRANSM	L/R	F/R	REMARKS	GSP Ref.	PRODUCT	ABS	Technical Specifications							
								A	B	C	H	L	P		
HYUNDAI SONATA V (NF)/SONICA															
3.3 (171 kW)	2005.01-	2010.12	-	-	-	Saloon Engine G6DB	824063	Outer Joint	47T	30	36	65	95	68	I
3.3 (173 kW)	2005.06-	2010.12	-	-	-	Saloon Engine G6DB	824063	Outer Joint	47T	30	36	65	95	68	I
3.3 (184 kW)	2008.01-	2010.12	-	-	-	Saloon Engine G6DB	824063	Outer Joint	47T	30	36	65	95	68	I
SONATA VI (YF)															
2.0 (110 kW)	2009.01-	2014.06	6MT	L	F	Saloon Engine G4KD	201176	Drive Shaft	48T	27	27	62	92.5	690	
2.0 Hybrid (110 kW)	2011.01-	2014.06	AT	-	F	Saloon Engine G4NA	824090	Outer Joint	48T	27	25	61.9	95	61	M
	2011.01-	2014.06	AT	L	F	Saloon Engine G4NA	624056	Inner Joint		27	25	30	67	83.5	
2.0 i (121 kW)	2011.01-	2014.06	AT	-	F	Saloon Engine G4KD	824090	Outer Joint	48T	27	25	61.9	95	61	M
	2011.01-	2014.06	AT	L	F	Saloon Engine G4KD	624056	Inner Joint		27	25	30	67	83.5	
2.4 (128 kW)	2009.01-	2010.11	-	-	F	Saloon Engine G4KC	824062	Outer Joint	47T	27	25	62.2	95	60	M
SONATA VII (LF)															
2.4 (138 kW)	2014.09-	-	6AT	L	F	Saloon Engine G4KJ	224497	Drive Shaft	48T	30	27	73	95	672	
	2014.09-	-	6AT	R	F	Saloon Engine G4KJ	224496	Drive Shaft	48T	30	27	73	95	976	
	2014.09-	-	6AT	L	F	Saloon Engine G4KJ	224497	Drive Shaft	48T	30	27	73	95	672	
	2014.09-	-	6AT	R	F	Saloon Engine G4KJ	224496	Drive Shaft	48T	30	27	73	95	976	
2.4(138 kW)	2014.09-	-	6AT	L/R	-	Saloon Engine G4KJ	824299	Outer Joint	48T	30	25	73	95	61.5	M
	2014.09-	-	6AT	L/R	F	Saloon Engine G4KJ	624141	Inner Joint		27	33	30	67	95.5	
SONICA															
2.0	-	-	-	-	-	-	224108	Drive Shaft	47T	25	25	50	94.5	637	
STELLAR (F31_ SF2_)															
2.0 GSL (61 kW)	1986.09-	1989.12	-	-	-	Saloon Engine 4G63	839034	Outer Joint		25	25	50	94.5	65	M
TERRACAN (HP)															
2.9 CRDi (110 kW)	2001.12-	2006.12	-	L/R	F	All-wheel Drive Closed Off-Road Vehicle Engine J3	824173	Outer Joint		28	34	56	152	68	I
2.9 CRDi (120 kW)	2003.11-	2006.12	-	L/R	F	All-wheel Drive Closed Off-Road Vehicle Engine J3	824173	Outer Joint		28	34	56	152	68	I
3.5 i V6 (143 kW)	2001.12-	2006.12	-	L/R	F	All-wheel Drive Closed Off-Road Vehicle Engine G6CU	824173	Outer Joint		28	34	56	152	68	I
TRAJET (FO)															
2.0 (100 kW)	2000.03-	2008.07	-	L	F	MPV Engine G4JP-G	627020	Inner Joint		27	25	41	62	100.5	
	2000.03-	2008.07	-	-	-	MPV Engine G4JP-G	824130	Outer Joint	47T	27	25	60	95	65	M
	2000.03-	2008.07	-	-	-	MPV Engine G4JP-G	624001	Inner Joint		27	25	41	62.8	92.5	
	2000.03-	2008.07	MT	L	F	MPV Engine G4JP-G	224158	Drive Shaft	47T	27	27	60	95	660	
	2000.03-	2008.07	MT	R	F	MPV Engine G4JP-G	224058	Drive Shaft	47T	27	27	60	95	976.5	
	2000.03-	2008.07	MT	-	F	MPV Engine G4JP-G	824037	Outer Joint	47T	27	34	60	96.5	71	I
	2000.03-	2008.07	-	-	F	MPV Engine G4JP-G	839104	Outer Joint		27	25	60	97	63.5	I
	2000.03-	2008.07	-	-	F	MPV Engine G4JP-G	824029	Outer Joint	47T	27	25	60	95	63.5	M
	2000.03-	2008.07	-	-	-	MPV Engine G4JP-G	827009	Outer Joint		27	25	60	95	63.5	M
	2000.03-	2008.07	-	-	F	MPV Engine G4JP-G	824028	Outer Joint	47T	27	26	60	95	69	M
2.0 (103 kW)	2001.03-	2003.10	-	-	-	MPV Engine G4CP-D	827009	Outer Joint		27	25	60	95	63.5	M
	2004.01-	2008.07	-	-	-	MPV Engine G4GC-G	824130	Outer Joint	47T	27	25	60	95	65	M
	2004.01-	2008.07	-	-	-	MPV Engine G4GC-G	624001	Inner Joint		27	25	41	62.8	92.5	
	2004.01-	2008.07	MT	L	F	MPV Engine G4GC-G	224158	Drive Shaft	47T	27	27	60	95	660	
	2004.01-	2008.07	MT	-	F	MPV Engine G4GC-G	824037	Outer Joint	47T	27	34	60	96.5	71	I
	2004.01-	2008.07	-	-	F	MPV Engine G4GC-G	824029	Outer Joint	47T	27	25	60	95	63.5	M
2.0 (104 kW)	2004.01-	2008.07	-	-	-	MPV Engine G4GC-G	827009	Outer Joint		27	25	60	95	63.5	M
	2003.11-	2008.07	-	-	-	MPV Engine G4GC	824130	Outer Joint	47T	27	25	60	95	65	M
	2003.11-	2008.07	-	-	-	MPV Engine G4GC	624001	Inner Joint		27	25	41	62.8	92.5	
	2003.11-	2008.07	-	-	F	MPV Engine G4GC	824029	Outer Joint	47T	27	25	60	95	63.5	M
2.0 CRDi (83 kW)	2001.04-	2008.07	-	-	F	MPV Engine D4EA	824073	Outer Joint	47T	27	26	60	95	69	M
	2001.04-	2008.07	-	L	F	MPV Engine D4EA	627020	Inner Joint		27	25	41	62	100.5	
	2001.04-	2008.07	4AT/5MT	-	-	MPV Engine D4EA	624001	Inner Joint		27	25	41	62.8	92.5	
	2001.04-	2008.07	MT	L/R	F	MPV Engine D4EA	824066	Outer Joint	47T	27	26	60	95	69	M
	2001.04-	2008.07	AT/MT	L	F	MPV Engine D4EA	224158	Drive Shaft	47T	27	27	60	95	660	
	2001.04-	2008.07	AT/MT	R	F	MPV Engine D4EA	224058	Drive Shaft	47T	27	27	60	95	976.5	
	2001.04-	2008.07	4AT/5MT	-	F	MPV Engine D4EA	839104	Outer Joint		27	25	60	97	63.5	I
	2001.04-	2008.07	4AT/5MT	-	F	MPV Engine D4EA	824029	Outer Joint	47T	27	25	60	95	63.5	M
	2001.04-	2008.07	-	-	F	MPV Engine D4EA	824028	Outer Joint	47T	27	26	60	95	69	M
	2001.04-	2008.07	-	-	F	MPV Engine D4EA	627020	Inner Joint		27	25	41	62	100.5	
2.7 V6 (127 kW)	2000.09-	2008.07	-	L	F	MPV Engine G6BA-G	627020	Inner Joint		27	25	41	62	100.5	
	2000.09-	2008.07	MT	L/R	F	MPV Engine G6BA-G	824066	Outer Joint	47T	27	26	60	95	69	M
	2000.09-	2008.07	AT	L	F	MPV Engine G6BA-G	224158	Drive Shaft	47T	27	27	60	95	660	
	2000.09-	2008.07	AT	R	F	MPV Engine G6BA-G	224058	Drive Shaft	47T	27	27	60	95	976.5	
TUCSON															
-	2004-	-	-	R	F	2WD	224441	Drive Shaft	48T	27	27	62.2	95	956	
-	2004-	-	4AT	R	F	2WD	824059	Outer Joint		27	25	62.2	95	60	M
-	2004-	-	5MT	R	F	2WD	824059	Outer Joint		27	25	62.2	95	60	M
-	2005-	2009	-	-	-	-	899249	Outer Joint		27	23	62.2	95	60	M
-	2005-	-	-	-	-	-	824059	Outer Joint		27	25	62.2	95	60	M





YEAR	TRANSM	L/R	F/R	REMARKS	GSP Ref.	PRODUCT	ABS	Technical Specifications							
								A	B	C	H	L	P		
HYUNDAI TUCSON															
-	2005-2007	AT	L/R	-	-	899249	Outer Joint		27	23	62.2	95	60	M	
	2005-2007	MT	L/R	-	-	824059	Outer Joint		27	25	62.2	95	60	M	
	2005-2007	AT	L	-	-	299053	Drive Shaft	48T	27	27	62.2	95	668		
	2005-2007	MT	R	-	-	224111	Drive Shaft	48T	27	27	62.2	95	956		
	2005-2007	AT	R	-	-	224112	Drive Shaft	48T	27	27	62.2	95	955		
2.0	2004-	4AT	R	F	2WD	224441	Drive Shaft	48T	27	27	62.2	95	956		
	2004-	5MT	R	F	2WD	224441	Drive Shaft	48T	27	27	62.2	95	956		
	2004-	4AT	R	F	2WD	624135	Inner Joint		27	25	41	62	90.5		
	2004-	5MT	R	F	2WD	624135	Inner Joint		27	25	41	62	90.5		
2.0 2WD	2006-2009	5MT	L/R	-	BETA	824059	Outer Joint		27	25	62.2	95	60	M	
	2006-2009	5MT	R	-	BETA	224111	Drive Shaft	48T	27	27	62.2	95	956		
	2006-2009	5MT	L	-	BETA	224216	Drive Shaft	48T	27	27	62.2	95	673		
TUCSON (JM)															
2.0 (104 kW)	2004.08-2010.03	AT	-	F	Closed Off-Road Vehicle Engine G4GC	824103	Outer Joint	48T	27	23	62.2	95	60	I	
	2004.08-2010.03	AT	-	F	All-wheel Drive Closed Off-Road Vehicle Engine G4GC	824103	Outer Joint	48T	27	23	62.2	95	60	I	
	2004.08-2010.03	4AT/5MT	L	F	All-wheel Drive Closed Off-Road Vehicle Engine G4GC	624013	Inner Joint		27	33	41	61.5	107		
	2004.08-2010.03	4AT/5MT	L	F	Closed Off-Road Vehicle Engine G4GC	624013	Inner Joint		27	33	41	61.5	107		
	2004.08-2010.03	MT	-	F	Closed Off-Road Vehicle Engine G4GC	824090	Outer Joint	48T	27	25	61.9	95	61	M	
	2004.08-2010.03	MT	L	F	Closed Off-Road Vehicle Engine G4GC	224110	Drive Shaft	48T	27	27	62.2	95	673		
	2004.08-2010.03	MT	L	F	All-wheel Drive Closed Off-Road Vehicle Engine G4GC	224110	Drive Shaft	48T	27	27	62.2	95	673		
	2004.08-2010.03	6MT	-	F	Closed Off-Road Vehicle Engine G4GC	824148	Outer Joint	48T	30	36	65	93	67.5	I	
	2004.08-2010.03	MT	R	F	All-wheel Drive Closed Off-Road Vehicle Engine G4GC	224221	Drive Shaft	48T	27	26	61.9	95	610		
	2004.08-2010.03	6MT	-	F	All-wheel Drive Closed Off-Road Vehicle Engine G4GC	824148	Outer Joint	48T	30	36	65	93	67.5	I	
	2004.08-2010.03	AT/MT	L/R	R	All-wheel Drive Closed Off-Road Vehicle Engine G4GC	224287	Drive Shaft	48T	27	27	60	94	800		
	2004.08-2010.03	AT	R	F	Closed Off-Road Vehicle Engine G4GC	624158	Inner Joint		27	24	30	67	88.5		
	2004.08-2010.03	AT	R	F	All-wheel Drive Closed Off-Road Vehicle Engine G4GC	624158	Inner Joint		27	24	30	67	88.5		
	2004.08-2010.03	AT/MT	L	F	Closed Off-Road Vehicle Engine G4GC	224172	Drive Shaft	48T	27	27	62.2	95	668		
	2004.08-2010.03	-	R	F	All-wheel Drive Closed Off-Road Vehicle Engine G4GC	627032	Inner Joint		26	24	44.1	42	73		
	2004.08-2010.03	AT/MT	L	F	All-wheel Drive Closed Off-Road Vehicle Engine G4GC	224172	Drive Shaft	48T	27	27	62.2	95	668		
	2004.08-2010.03	-	R	F	Closed Off-Road Vehicle Engine G4GC	627032	Inner Joint		26	24	44.1	42	73		
	2004.08-2010.03	AT/MT	R	F	All-wheel Drive Closed Off-Road Vehicle Engine G4GC	224173	Drive Shaft	48T	27	26	62.2	95	609		
	2004.08-2010.03	-	-	F	Closed Off-Road Vehicle Engine G4GC	824049	Outer Joint	48T	27	25	62.2	95	60	M	
	2004.08-2010.03	-	-	F	All-wheel Drive Closed Off-Road Vehicle Engine G4GC	824049	Outer Joint	48T	27	25	62.2	95	60	M	
	2004.08-2010.03	MT	L	F	Closed Off-Road Vehicle Engine G4GC	624044	Inner Joint		27	25	41	62	87		
	2004.08-2010.03	MT	L	F	All-wheel Drive Closed Off-Road Vehicle Engine G4GC	624044	Inner Joint		27	25	41	62	87		
	2004.08-2010.03	MT	-	-	Closed Off-Road Vehicle Engine G4GC	627058	Inner Joint		27	24	41	61.5	100		
	2004.08-2010.03	MT	-	-	All-wheel Drive Closed Off-Road Vehicle Engine G4GC	627058	Inner Joint		27	24	41	61.5	100		
	2004.08-2010.03	-	-	F	Closed Off-Road Vehicle Engine G4GC	824124	Outer Joint	48T	27	24	62	95	58	M	
	2004.08-2010.03	-	-	F	All-wheel Drive Closed Off-Road Vehicle Engine G4GC	824124	Outer Joint	48T	27	24	62	95	58	M	
	2004.08-2010.03	MT	R	F	All-wheel Drive Closed Off-Road Vehicle Engine G4GC	639063	Inner Joint		26	25	42	39.5	68.5		
	2004.08-2010.03	MT	R	F	Closed Off-Road Vehicle Engine G4GC	624030	Inner Joint		26	25	42	40	68		
	2004.08-2010.03	MT	R	F	All-wheel Drive Closed Off-Road Vehicle Engine G4GC	624030	Inner Joint		26	25	42	40	68		
2.0 (105 kW)	2005.07-2010.11	AT	-	F	All-wheel Drive Closed Off-Road Vehicle Engine G4GC	824103	Outer Joint	48T	27	23	62.2	95	60	I	
	2005.07-2010.11	4AT/5MT	L	F	All-wheel Drive Closed Off-Road Vehicle Engine G4GC	624013	Inner Joint		27	33	41	61.5	107		
	2005.07-2010.11	-	-	F	All-wheel Drive Closed Off-Road Vehicle Engine G4GC	824090	Outer Joint	48T	27	25	61.9	95	61	M	
	2005.07-2010.11	MT	L	F	All-wheel Drive Closed Off-Road Vehicle Engine G4GC	224110	Drive Shaft	48T	27	27	62.2	95	673		
	2005.07-2010.11	6MT	-	F	All-wheel Drive Closed Off-Road Vehicle Engine G4GC	824148	Outer Joint	48T	30	36	65	93	67.5	I	
	2005.07-2010.11	-	-	R	All-wheel Drive Closed Off-Road Vehicle Engine G4GC	824178	Outer Joint	48T	27	23	60	94	60	M	
	2005.07-2010.11	MT	R	F	All-wheel Drive Closed Off-Road Vehicle Engine G4GC	224221	Drive Shaft	48T	27	26	61.9	95	610		
	2005.07-2010.11	AT	R	F	All-wheel Drive Closed Off-Road Vehicle Engine G4GC	624158	Inner Joint		27	24	30	67	88.5		
	2005.07-2010.11	-	R	F	All-wheel Drive Closed Off-Road Vehicle Engine G4GC	627032	Inner Joint		26	24	44.1	42	73		
	2005.07-2010.11	MT	L	F	All-wheel Drive Closed Off-Road Vehicle Engine G4GC	624044	Inner Joint		27	25	41	62	87		
	2005.07-2010.11	MT	-	-	All-wheel Drive Closed Off-Road Vehicle Engine G4GC	627058	Inner Joint		27	24	41	61.5	100		
	2005.07-2010.11	-	-	F	All-wheel Drive Closed Off-Road Vehicle Engine G4GC	824049	Outer Joint	48T	27	25	62.2	95	60	M	
	2005.07-2010.11	-	-	F	All-wheel Drive Closed Off-Road Vehicle Engine G4GC	824124	Outer Joint	48T	27	24	62	95	58	M	
	2005.07-2010.11	MT	R	F	All-wheel Drive Closed Off-Road Vehicle Engine G4GC	639063	Inner Joint		26	25	42	39.5	68.5		
	2005.07-2010.11	MT	R	F	All-wheel Drive Closed Off-Road Vehicle Engine G4GC	624030	Inner Joint		26	25	42	40	68		
	2005.07-2010.11	-	-	-	All-wheel Drive Closed Off-Road Vehicle Engine G4GC	639041	Inner Joint		25	23	35	63	92.5		
	2010.01-2010.03	AT	-	F	Closed Off-Road Vehicle Engine G4GC	824103	Outer Joint	48T	27	23	62.2	95	60	I	
	2010.01-2010.03	MT	-	F	Closed Off-Road Vehicle Engine G4GC	824090	Outer Joint	48T	27	25	61.9	95	61	M	
	2010.01-2010.03	MT	L	F	Closed Off-Road Vehicle Engine G4GC	224110	Drive Shaft	48T	27	27	62.2	95	673		
	2010.01-2010.03	AT	R	F	Closed Off-Road Vehicle Engine G4GC	624158	Inner Joint		27	24	30	67	88.5		
	2010.01-2010.03	-	-	F	Closed Off-Road Vehicle Engine G4GC	824049	Outer Joint	48T	27	25	62.2	95	60	M	
	2010.01-2010.03	MT	L	F	Closed Off-Road Vehicle Engine G4GC	624044	Inner Joint		27	25	41	62	87		
	2010.01-2010.03	MT	-	-	Closed Off-Road Vehicle Engine G4GC	627058	Inner Joint		27	24	41	61.5	100		
	2010.01-2010.03	-	-	F	Closed Off-Road Vehicle Engine G4GC	824124	Outer Joint	48T	27	24	62	95	58	M	

YEAR	TRANSM	L/R	F/R	REMARKS	GSP Ref.	PRODUCT	ABS	Technical Specifications								
								A	B	C	H	L	P			
HYUNDAI TUCSON (JM)																
2.0 (105 kW)																
2010.01-2010.03	MT	R	F	Closed Off-Road Vehicle Engine G4GC	624030	Inner Joint		26	25	42	40	68				
2.0 CRDi (100 kW)																
2006.01-2010.03	AT	-	F	Closed Off-Road Vehicle Engine D4EA	824103	Outer Joint	48T	27	23	62.2	95	60	I			
2006.01-2010.03	-	-	F	Closed Off-Road Vehicle Engine D4EA	824090	Outer Joint	48T	27	25	61.9	95	61	M			
2006.01-2010.03	-	-	F	All-wheel Drive Closed Off-Road Vehicle Engine D4EA	824090	Outer Joint	48T	27	25	61.9	95	61	M			
2006.01-2010.03	-	L	F	Closed Off-Road Vehicle Engine D4EA	624013	Inner Joint		27	33	41	61.5	107				
2006.01-2010.03	-	L	F	All-wheel Drive Closed Off-Road Vehicle Engine D4EA	624013	Inner Joint		27	33	41	61.5	107				
2006.01-2010.03	MT	-	F	Closed Off-Road Vehicle Engine D4EA	824148	Outer Joint	48T	30	36	65	93	67.5	I			
2006.01-2010.03	MT	-	F	All-wheel Drive Closed Off-Road Vehicle Engine D4EA	824148	Outer Joint	48T	30	36	65	93	67.5	I			
2006.01-2010.03	-	-	R	All-wheel Drive Closed Off-Road Vehicle Engine D4EA	824178	Outer Joint	48T	27	23	60	94	60	M			
2006.01-2010.03	AT/MT	R	F	Closed Off-Road Vehicle Engine D4EA	224221	Drive Shaft	48T	27	26	61.9	95	610				
2006.01-2010.03	MT	R	F	All-wheel Drive Closed Off-Road Vehicle Engine D4EA	224221	Drive Shaft	48T	27	26	61.9	95	610				
2006.01-2010.03	MT	L	F	Closed Off-Road Vehicle Engine D4EA	224300	Drive Shaft	48T	30	28	65	95	653				
2006.01-2010.03	MT	L	F	All-wheel Drive Closed Off-Road Vehicle Engine D4EA	224300	Drive Shaft	48T	30	28	65	95	653				
2006.01-2010.03	6AT	R	F	Closed Off-Road Vehicle Engine D4EA	624158	Inner Joint		27	24	30	67	88.5				
2006.01-2010.03	MT	R	F	Closed Off-Road Vehicle Engine D4EA	224301	Drive Shaft	48T	30	28	65	95	605				
2006.01-2010.03	MT	R	F	All-wheel Drive Closed Off-Road Vehicle Engine D4EA	224301	Drive Shaft	48T	30	28	65	95	605				
2006.01-2010.03	MT	L	F	Closed Off-Road Vehicle Engine D4EA	224352	Drive Shaft	48T	27	27	62	94.5	671				
2006.01-2010.03	MT	L	F	All-wheel Drive Closed Off-Road Vehicle Engine D4EA	224352	Drive Shaft	48T	27	27	62	94.5	671				
2006.01-2010.03	-	L	F	Closed Off-Road Vehicle Engine D4EA	624044	Inner Joint		27	25	41	62	87				
2006.01-2010.03	-	-	F	Closed Off-Road Vehicle Engine D4EA	824049	Outer Joint	48T	27	25	62.2	95	60	M			
2006.01-2010.03	-	-	F	All-wheel Drive Closed Off-Road Vehicle Engine D4EA	824049	Outer Joint	48T	27	25	62.2	95	60	M			
2006.01-2010.03	6AT	-	F	Closed Off-Road Vehicle Engine D4EA	824124	Outer Joint	48T	27	24	62	95	58	M			
2006.01-2010.03	-	-	F	Closed Off-Road Vehicle Engine D4EA	824048	Outer Joint	48T	27	23	62.2	95	60	M			
2006.01-2010.03	-	-	F	All-wheel Drive Closed Off-Road Vehicle Engine D4EA	824048	Outer Joint	48T	27	23	62.2	95	60	M			
2006.01-2010.03	AT/MT	R	F	Closed Off-Road Vehicle Engine D4EA	639063	Inner Joint		26	25	42	39.5	68.5				
2006.01-2010.03	MT	R	F	All-wheel Drive Closed Off-Road Vehicle Engine D4EA	639063	Inner Joint		26	25	42	39.5	68.5				
2006.01-2010.03	-	R	F	Closed Off-Road Vehicle Engine D4EA	624030	Inner Joint		26	25	42	40	68				
2006.01-2010.03	AT	R	F	All-wheel Drive Closed Off-Road Vehicle Engine D4EA	624030	Inner Joint		26	25	42	40	68				
2006.01-2010.03	-	-	-	All-wheel Drive Closed Off-Road Vehicle Engine D4EA	639041	Inner Joint		25	23	35	63	92.5				
2006.01-2010.03	-	-	F	Closed Off-Road Vehicle Engine D4EA	824153	Outer Joint	48T	30	25	65	95	69.5	M			
2006.01-2010.03	-	-	F	All-wheel Drive Closed Off-Road Vehicle Engine D4EA	824153	Outer Joint	48T	30	25	65	95	69.5	M			
2006.01-2010.03	MT	-	F	All-wheel Drive Closed Off-Road Vehicle Engine D4EA	827067	Outer Joint	48T	27	24	62.1	95	63	M			
2.0 CRDi (103 kW)																
2006.01-2010.03	AT	-	F	Closed Off-Road Vehicle Engine D4EA-V	824103	Outer Joint	48T	27	23	62.2	95	60	I			
2006.01-2010.03	-	-	F	Closed Off-Road Vehicle Engine D4EA-V	824090	Outer Joint	48T	27	25	61.9	95	61	M			
2006.01-2010.03	-	-	F	All-wheel Drive Closed Off-Road Vehicle Engine D4EA-F/D4EA-V	824090	Outer Joint	48T	27	25	61.9	95	61	M			
2006.01-2010.03	-	L	F	Closed Off-Road Vehicle Engine D4EA-V	624013	Inner Joint		27	33	41	61.5	107				
2006.01-2010.03	-	L	F	All-wheel Drive Closed Off-Road Vehicle Engine D4EA-F/D4EA-V	624013	Inner Joint		27	33	41	61.5	107				
2006.01-2010.03	MT	-	F	Closed Off-Road Vehicle Engine D4EA-V	824148	Outer Joint	48T	30	36	65	93	67.5	I			
2006.01-2010.03	MT	-	F	All-wheel Drive Closed Off-Road Vehicle Engine D4EA-F/D4EA-V	824148	Outer Joint	48T	30	36	65	93	67.5	I			
2006.01-2010.03	AT/MT	R	F	Closed Off-Road Vehicle Engine D4EA-V	224221	Drive Shaft	48T	27	26	61.9	95	610				
2006.01-2010.03	AT/MT	R	F	All-wheel Drive Closed Off-Road Vehicle Engine D4EA-F/D4EA-V	224221	Drive Shaft	48T	27	26	61.9	95	610				
2006.01-2010.03	-	-	R	All-wheel Drive Closed Off-Road Vehicle Engine D4EA-F/D4EA-V	824178	Outer Joint	48T	27	23	60	94	60	M			
2006.01-2010.03	MT	L	F	Closed Off-Road Vehicle Engine D4EA-V	224300	Drive Shaft	48T	30	28	65	95	653				
2006.01-2010.03	MT	L	F	All-wheel Drive Closed Off-Road Vehicle Engine D4EA-F/D4EA-V	224300	Drive Shaft	48T	30	28	65	95	653				
2006.01-2010.03	6AT	R	F	Closed Off-Road Vehicle Engine D4EA-V	624158	Inner Joint		27	24	30	67	88.5				
2006.01-2010.03	MT	R	F	Closed Off-Road Vehicle Engine D4EA-V	224301	Drive Shaft	48T	30	28	65	95	605				
2006.01-2010.03	MT	R	F	All-wheel Drive Closed Off-Road Vehicle Engine D4EA-F/D4EA-V	224301	Drive Shaft	48T	30	28	65	95	605				
2006.01-2010.03	MT	L	F	Closed Off-Road Vehicle Engine D4EA-V	224352	Drive Shaft	48T	27	27	62	94.5	671				
2006.01-2010.03	MT	L	F	All-wheel Drive Closed Off-Road Vehicle Engine D4EA-F/D4EA-V	224352	Drive Shaft	48T	27	27	62	94.5	671				
2006.01-2010.03	-	-	F	All-wheel Drive Closed Off-Road Vehicle Engine D4EA-F/D4EA-V	824049	Outer Joint	48T	27	25	62.2	95	60	M			
2006.01-2010.03	-	L	F	Closed Off-Road Vehicle Engine D4EA-V	624044	Inner Joint		27	25	41	62	87				
2006.01-2010.03	-	-	F	Closed Off-Road Vehicle Engine D4EA-V	824049	Outer Joint	48T	27	25	62.2	95	60	M			
2006.01-2010.03	6AT	-	F	Closed Off-Road Vehicle Engine D4EA-V	824124	Outer Joint	48T	27	24	62	95	58	M			
2006.01-2010.03	-	-	F	Closed Off-Road Vehicle Engine D4EA-V	824048	Outer Joint	48T	27	23	62.2	95	60	M			
2006.01-2010.03	-	-	F	All-wheel Drive Closed Off-Road Vehicle Engine D4EA-F/D4EA-V	824048	Outer Joint	48T	27	23	62.2	95	60	M			
2006.01-2010.03	AT/MT	R	F	Closed Off-Road Vehicle Engine D4EA-V	639063	Inner Joint		26	25	42	39.5	68.5				
2006.01-2010.03	AT/MT	R	F	All-wheel Drive Closed Off-Road Vehicle Engine D4EA-F/D4EA-V	639063	Inner Joint		26	25	42	39.5	68.5				
2006.01-2010.03	-	R	F	Closed Off-Road Vehicle Engine D4EA-V	624030	Inner Joint		26	25	42	40	68				
2006.01-2010.03	AT	R	F	All-wheel Drive Closed Off-Road Vehicle Engine D4EA-F/D4EA-V	624030	Inner Joint		26	25	42	40	68				
2006.01-2010.03	-	-	-	All-wheel Drive Closed Off-Road Vehicle Engine D4EA-F/D4EA-V	639041	Inner Joint		25	23	35	63	92.5				
2006.01-2010.03	-	-	F	Closed Off-Road Vehicle Engine D4EA-V	824153	Outer Joint	48T	30	25	65	95	69.5	M			
2006.01-2010.03	-	-	F	All-wheel Drive Closed Off-Road Vehicle Engine D4EA-F/D4EA-V	824153	Outer Joint	48T	30	25	65	95	69.5	M			
2006.01-2010.03	MT	-	F	All-wheel Drive Closed Off-Road Vehicle Engine D4EA-F/D4EA-V	827067	Outer Joint	48T	27	24	62.1	95	63	M			
2.0 CRDi (110 kW)																
2009.01-2010.03	MT	-	F	All-wheel Drive Closed Off-Road Vehicle Engine D4EA	827067	Outer Joint	48T	27	24	62.1	95	63	M			
2009.01-2010.03	AT	-	F	Closed Off-Road Vehicle Engine D4EA	824103	Outer Joint	48T	27	23	62.2	95	60	I			
2009.01-2010.03	MT	-	F	Closed Off-Road Vehicle Engine D4EA	824148	Outer Joint	48T	30	36	65	93	67.5	I			





YEAR	TRANSM	L/R	F/R	REMARKS	GSP Ref.	PRODUCT	ABS	Technical Specifications							
								A	B	C	H	L	P		
HYUNDAI TUCSON (JM)															
2.0 CRDi (110 kW)	2009.01-2010.03	MT	-	F	All-wheel Drive Closed Off-Road Vehicle Engine D4EA	824148	Outer Joint	48T	30	36	65	93	67.5	I	
	2009.01-2010.03	MT	L	F	Closed Off-Road Vehicle Engine D4EA	224300	Drive Shaft	48T	30	28	65	95	653		
	2009.01-2010.03	MT	L	F	All-wheel Drive Closed Off-Road Vehicle Engine D4EA	224300	Drive Shaft	48T	30	28	65	95	653		
	2009.01-2010.03	6AT	R	F	Closed Off-Road Vehicle Engine D4EA	624158	Inner Joint		27	24	30	67	88.5		
	2009.01-2010.03	MT/5MT	-	-	Closed Off-Road Vehicle Engine D4EA	824094	Outer Joint	48T	27	26	62	94.5	65	M	
	2009.01-2010.03	MT/5MT	-	-	All-wheel Drive Closed Off-Road Vehicle Engine D4EA	824094	Outer Joint	48T	27	26	62	94.5	65	M	
	2009.01-2010.03	MT	R	F	Closed Off-Road Vehicle Engine D4EA	224301	Drive Shaft	48T	30	28	65	95	605		
	2009.01-2010.03	MT	R	F	All-wheel Drive Closed Off-Road Vehicle Engine D4EA	224301	Drive Shaft	48T	30	28	65	95	605		
	2009.01-2010.03	6AT	-	F	Closed Off-Road Vehicle Engine D4EA	824124	Outer Joint	48T	27	24	62	95	58	M	
	2009.01-2010.03	AT	R	F	All-wheel Drive Closed Off-Road Vehicle Engine D4EA	624030	Inner Joint		26	25	42	40	68		
	2009.01-2010.03	AT/MT	-	F	Closed Off-Road Vehicle Engine D4EA	824153	Outer Joint	48T	30	25	65	95	69.5	M	
	2009.01-2010.03	-	-	F	All-wheel Drive Closed Off-Road Vehicle Engine D4EA	824153	Outer Joint	48T	30	25	65	95	69.5	M	
2.0 CRDi (83 kW)	2004.08-2010.03	AT	-	F	Closed Off-Road Vehicle Engine D4EA	824103	Outer Joint	48T	27	23	62.2	95	60	I	
	2004.08-2010.03	MT	-	F	Closed Off-Road Vehicle Engine D4EA	824148	Outer Joint	48T	30	36	65	93	67.5	I	
	2004.08-2010.03	MT	-	F	All-wheel Drive Closed Off-Road Vehicle Engine D4EA	824148	Outer Joint	48T	30	36	65	93	67.5	I	
	2004.08-2010.03	AT/MT	R	F	Closed Off-Road Vehicle Engine D4EA	224221	Drive Shaft	48T	27	26	61.9	95	610		
	2004.08-2010.03	AT/MT	R	F	All-wheel Drive Closed Off-Road Vehicle Engine D4EA	224221	Drive Shaft	48T	27	26	61.9	95	610		
	2004.08-2010.03	MT	L	F	All-wheel Drive Closed Off-Road Vehicle Engine D4EA	224300	Drive Shaft	48T	30	28	65	95	653		
	2004.08-2010.03	6AT	R	F	Closed Off-Road Vehicle Engine D4EA	624158	Inner Joint		27	24	30	67	88.5		
	2004.08-2010.03	MT	R	F	All-wheel Drive Closed Off-Road Vehicle Engine D4EA	224301	Drive Shaft	48T	30	28	65	95	605		
	2004.08-2010.03	MT	L	F	All-wheel Drive Closed Off-Road Vehicle Engine D4EA	224352	Drive Shaft	48T	27	27	62	94.5	671		
	2004.08-2010.03	-	-	F	Closed Off-Road Vehicle Engine D4EA	824049	Outer Joint	48T	27	25	62.2	95	60	M	
	2004.08-2010.03	-	-	F	All-wheel Drive Closed Off-Road Vehicle Engine D4EA	824049	Outer Joint	48T	27	25	62.2	95	60	M	
	2004.08-2010.03	6AT	-	F	Closed Off-Road Vehicle Engine D4EA	824124	Outer Joint	48T	27	24	62	95	58	M	
	2004.08-2010.03	-	-	F	Closed Off-Road Vehicle Engine D4EA	824048	Outer Joint	48T	27	23	62.2	95	60	M	
	2004.08-2010.03	-	-	F	All-wheel Drive Closed Off-Road Vehicle Engine D4EA	824048	Outer Joint	48T	27	23	62.2	95	60	M	
	2004.08-2010.03	AT/MT	R	F	Closed Off-Road Vehicle Engine D4EA	639063	Inner Joint		26	25	42	39.5	68.5		
	2004.08-2010.03	AT/MT	R	F	All-wheel Drive Closed Off-Road Vehicle Engine D4EA	639063	Inner Joint		26	25	42	39.5	68.5		
	2004.08-2010.03	AT	R	F	All-wheel Drive Closed Off-Road Vehicle Engine D4EA	624030	Inner Joint		26	25	42	40	68		
	2004.08-2010.03	AT/MT	-	F	Closed Off-Road Vehicle Engine D4EA	824153	Outer Joint	48T	30	25	65	95	69.5	M	
	2004.08-2010.03	-	-	F	All-wheel Drive Closed Off-Road Vehicle Engine D4EA	824153	Outer Joint	48T	30	25	65	95	69.5	M	
	2004.08-2010.03	MT	-	F	All-wheel Drive Closed Off-Road Vehicle Engine D4EA	827067	Outer Joint	48T	27	24	62.1	95	63	M	
2.0 CRDi 4WD (100 kW)	2006.01-	-	-	-	-	899289	Outer Joint	48T	27	26	62	94.5	65	M	
2.0 CRDi 4WD (83 kW)	2004.08-	-	-	-	-	899289	Outer Joint	48T	27	26	62	94.5	65	M	
2.7 (129 kW)	2004.08-2010.03	AT	L	F	All-wheel Drive Closed Off-Road Vehicle Engine G6BA-G	624013	Inner Joint		27	33	41	61.5	107		
	2004.08-2010.03	AT	-	F	All-wheel Drive Closed Off-Road Vehicle Engine G6BA-G	824090	Outer Joint	48T	27	25	61.9	95	61	M	
	2004.08-2010.03	AT	-	R	All-wheel Drive Closed Off-Road Vehicle Engine G6BA-G	824178	Outer Joint	48T	27	23	60	94	60	M	
	2004.08-2010.03	AT/MT	L/R	R	All-wheel Drive Closed Off-Road Vehicle Engine G6BA-G	224287	Drive Shaft	48T	27	27	60	94	800		
	2004.08-2010.03	AT/MT	L	F	All-wheel Drive Closed Off-Road Vehicle Engine G6BA-G	224172	Drive Shaft	48T	27	27	62.2	95	668		
	2004.08-2010.03	AT/MT	R	F	All-wheel Drive Closed Off-Road Vehicle Engine G6BA-G	224173	Drive Shaft	48T	27	26	62.2	95	609		
	2004.08-2010.03	-	-	F	All-wheel Drive Closed Off-Road Vehicle Engine G6BA-G	824049	Outer Joint	48T	27	25	62.2	95	60	M	
	2004.08-2010.03	AT	R	F	All-wheel Drive Closed Off-Road Vehicle Engine G6BA-G	624014	Inner Joint		26	33	42	42	82		
	2004.08-2010.03	AT	-	-	All-wheel Drive Closed Off-Road Vehicle Engine G6BA-G	639041	Inner Joint		25	23	35	63	92.5		
TUCSON (TL)															
1.6 GDi (97 kW)	2015.06-	6AT	L	F	Closed Off-Road Vehicle Engine G4FD	201245	Drive Shaft	48T	30	27	73	95	683		
	2015.06-	6AT	R	F	Closed Off-Road Vehicle Engine G4FD	201254	Drive Shaft	48T	30	27	73	95	967		
1.6 T-GDi (130 kW)	2015.06-	6AT	L	F	Closed Off-Road Vehicle Engine G4FJ	201245	Drive Shaft	48T	30	27	73	95	683		
	2015.06-	6AT	R	F	Closed Off-Road Vehicle Engine G4FJ	201254	Drive Shaft	48T	30	27	73	95	967		
2.0 (114 kW)	2015.05-	6MT	L	F	All-wheel Drive Closed Off-Road Vehicle	201247	Drive Shaft	48T	30	27	73	95	695		
TUCSON 14															
-	2013.08-2015.05	-	-	F	-	227229	Stub Axle		26	27			445		
TUCSON 16															
-	2016-2018	-	L	F	-	201248	Drive Shaft	48T	30	27	73	95	674		
	2016-2018	-	R	F	-	601150	Inner Joint		28	32	44.1		116		
	2016-2018	-	R	F	-	201255	Drive Shaft	48T	30	28	73	95	577		
VELOSTER															
2WD	2011-	6AT	R	-	DOHC MPI	224288	Drive Shaft	46T	27	27	60	95	669		
	2011-	6AT	L	-	DOHC MPI	224289	Drive Shaft	46T	27	27	60	95	956		
	2011-	6AT	L	-	DOHC MPI	824161	Outer Joint	46T	27	23	60	95	57	M	
VELOSTER (FS)															
1.6 GDI (103 kW)	2011.03-	MT	R	F	Coupe Engine G4FD	224398	Drive Shaft	46T	27	25	60	94.5	965		
VERNA															
-	-	-	-	-	-	899164	Outer Joint		25	30	49.9	94.5	56	O	
	2006-	-	L	F	2WD	224120	Drive Shaft	48T	25	27	50	94.5	633		
	2006-	-	L	F	2WD	824026	Outer Joint		25	23	50	94.5	63.5	M	
1.5	1999-	-	L	-	-	224024	Drive Shaft	44T	25	25	50	95	625.5		

YEAR	TRANSM	L/R	F/R	REMARKS	GSP Ref.	PRODUCT	ABS	Technical Specifications							
								A	B	C	H	L	P		
HYUNDAI															
VERNA															
1.5	2000.06-	-	MT/AT	-	-	-	899172	Outer Joint		25	22	52.5	95	58	M
	2006-	-	-	L	F	-	224120	Drive Shaft	48T	25	27	50	94.5	633	
	2006-	-	-	L	F	-	824026	Outer Joint		25	23	50	94.5	63.5	M
1.5/1.6 2WD	1999-	2001	5MT	R	-	MPISOHC	239214	Drive Shaft	44T	25	25	52.5	95	912	
	1999-	2001	5MT	L	-	MPISOHC	239211	Drive Shaft	44T	25	25	52.5	95	622	
	1999-	2001	4AT	R	-	MPISOHC	239212	Drive Shaft	44T	25	25	52.5	95	911	
	1999-	2001	4AT	L	-	MPISOHC	239213	Drive Shaft	44T	25	25	52.5	95	625	
VERNA BLUE															
-	2011-	-	-	-	F	-	824183	Outer Joint		25	22	52.5	93.5	59.5	M
	2011-	-	-	-	F	-	224409	Drive Shaft	48T	25	27	52.5	93.5	634	
	2011-	-	-	-	F	-	624065	Inner Joint		27	22	30	68	77	
VERNA C/ABS															
-	2004-	2007	MT	L/R	-	-	824142	Outer Joint	44T	25	22	50	95	58	M
XG															
250 (123 kW)	2003.10-	2005.09	AT	L	F	Saloon Engine G6BV	627020	Inner Joint		27	25	41	62	100.5	
XG (XG)/GRANDEUR XG															
2.5 (120 kW)	1998.12-	2005.12	MT	-	F	Saloon Engine G6BV	824073	Outer Joint	47T	27	26	60	95	69	M
	1998.12-	2005.12	AT	L	F	Saloon Engine G6BV	627020	Inner Joint		27	25	41	62	100.5	
3.0 (138 kW)	1998.12-	2005.12	AT	-	F	Saloon Engine G6CT-G	824073	Outer Joint	47T	27	26	60	95	69	M
350 (145 kW)	2002.10-	2005.12	AT	-	F	Saloon Engine G6CU	824073	Outer Joint	47T	27	26	60	95	69	M
HYUNDAI (BEIJING)															
ELANTRA															
1.6 (81 kW)	2003.12-	2010.12	AT	R	-	Hatchback Engine G4GR	224169	Drive Shaft	44T	27	27	60	95	937	
	2003.12-	2010.12	AT	L	-	Hatchback Engine G4GR	224170	Drive Shaft	44T	27	27	60	95	652.5	
	2003.12-	2010.12	CVT	L	-	Hatchback Engine G4GR	224197	Drive Shaft	44T	27	25	60	95	652.5	
	2003.12-	2010.12	CVT	R	-	Hatchback Engine G4GR	224198	Drive Shaft	44T	27	25	60	95	937	
1.6 (82 kW)	2003.12-	2014.12	AT	R	-	Saloon Engine G4ED-G/G4GA	224169	Drive Shaft	44T	27	27	60	95	937	
	2003.12-	2014.12	AT	L	-	Saloon Engine G4ED-G/G4GA	224170	Drive Shaft	44T	27	27	60	95	652.5	
	2003.12-	2014.12	CVT	L	-	Saloon Engine G4ED-G/G4GA	224197	Drive Shaft	44T	27	25	60	95	652.5	
	2003.12-	2014.12	CVT	R	-	Saloon Engine G4ED-G/G4GA	224198	Drive Shaft	44T	27	25	60	95	937	
1.6 LPG (81 kW)	2003.12-	-	AT	R	-	Saloon Engine G4GR	224169	Drive Shaft	44T	27	27	60	95	937	
	2003.12-	-	AT	L	-	Saloon Engine G4GR	224170	Drive Shaft	44T	27	27	60	95	652.5	
	2003.12-	-	CVT	L	-	Saloon Engine G4GR	224197	Drive Shaft	44T	27	25	60	95	652.5	
	2003.12-	-	CVT	R	-	Saloon Engine G4GR	224198	Drive Shaft	44T	27	25	60	95	937	
1.8 (96 kW)	2003.12-	2008.12	AT	R	-	Saloon Engine G4GB	224169	Drive Shaft	44T	27	27	60	95	937	
	2003.12-	2008.12	AT	L	-	Saloon Engine G4GB	224170	Drive Shaft	44T	27	27	60	95	652.5	
	2003.12-	2008.12	CVT	L	-	Saloon Engine G4GB	224197	Drive Shaft	44T	27	25	60	95	652.5	
	2003.12-	2008.12	CVT	R	-	Saloon Engine G4GB	224198	Drive Shaft	44T	27	25	60	95	937	
SANTA FE (DM)															
2.0 (180 kW)	2012.12-	-	-	-	-	All-wheel Drive Closed Off-Road Vehicle Engine G4KH	224308	Drive Shaft	52T	27	27	60	95	821	
	2012.12-	-	-	-	-	All-wheel Drive Closed Off-Road Vehicle Engine G4KH	224309	Drive Shaft	52T	27	27	60	95	657	
	2012.12-	-	-	-	-	All-wheel Drive Closed Off-Road Vehicle Engine G4KH	224310	Drive Shaft	52T	27	28	60	95	589	
	2012.12-	-	-	-	-	All-wheel Drive Closed Off-Road Vehicle Engine G4KH	299238	Drive Shaft	52T	27	28	60	95	651.5	
	2012.12-	-	-	-	-	All-wheel Drive Closed Off-Road Vehicle Engine G4KH	299239	Drive Shaft	52T	27	28	60	95	604.5	
2.4 (139 kW)	2012.12-	-	-	-	-	Closed Off-Road Vehicle Engine G4KJ	224336	Drive Shaft	52T	30	27	60	97.5	830	
	2012.12-	-	-	-	-	All-wheel Drive Closed Off-Road Vehicle Engine G4KJ	224336	Drive Shaft	52T	30	27	60	97.5	830	
SONATA (EF)															
2.0 (101 kW)	2002.12-	2010.12	MT/AT	L	-	Saloon Engine G4GC	224254	Drive Shaft	47T	27	27	60	95	663	
SONATA (NF)															
2.0 (107 kW)	2005.09-	2010.12	MT/AT	L	-	Saloon Engine G4KA	224254	Drive Shaft	47T	27	27	60	95	663	
SONATA (NFC)															
2.0 (121 kW)	2008.12-	2012.12	AT/MT	L	F	Saloon Engine G4KD	224254	Drive Shaft	47T	27	27	60	95	663	
SONATA (YF)															
2.0 (119 kW)	2012.12-	-	-	L	F	Saloon Engine G4NA	224254	Drive Shaft	47T	27	27	60	95	663	
2.0 (121 kW)	2011.04-	-	AT/MT	L	-	Saloon Engine G4KD	224254	Drive Shaft	47T	27	27	60	95	663	
2.0 (162 kW)	2012.06-	-	-	L	F	Saloon Engine G4NA	224254	Drive Shaft	47T	27	27	60	95	663	
TUCSON (JM)															
2.7 (129 kW)	2005.05-	-	-	R	-	All-wheel Drive Closed Off-Road Vehicle Engine G6BA	224187	Drive Shaft	48T	27	26	62.2	95	604.5	
VERNA															
1.4 (79 kW)	2010.08-	2012.12	MT	L	F	Saloon Engine G4FA	224285	Drive Shaft	48T	25	25	52.5	94.5	648	
	2010.08-	2012.12	MT	R	F	Saloon Engine G4FA	224286	Drive Shaft	48T	25	25	52.5	94.5	925	
	2010.12-	-	MT	L	F	Hatchback Engine G4FA	224285	Drive Shaft	48T	25	25	52.5	94.5	648	
	2010.12-	-	MT	R	F	Hatchback Engine G4FA	224286	Drive Shaft	48T	25	25	52.5	94.5	925	
YUE DONG															
1.6 (82 kW)	2008.04-	2009.12	AT	R	-	Saloon Engine G4ED	224182	Drive Shaft	46T	27	25	60	94.5	947	

YEAR	TRANSM	L/R	F/R	REMARKS	GSP Ref.	PRODUCT	ABS	Technical Specifications							
								A	B	C	H	L	P		
HYUNDAI (BEIJING)															
YUE DONG															
1.6 (90 kW)	2009.11-	-	AT	R	-	Saloon Engine G4FC	224182	Drive Shaft	46T	27	25	60	94.5	947	
1.8 (96 kW)	2008.04-	2015.12	AT	R	-	Saloon Engine G4GB	224182	Drive Shaft	46T	27	25	60	94.5	947	
HYUNDAI (HUATAI)															
TERRACAN															
3.5 (147 kW)	2003.03-	2008.12	-	-	-	All-wheel Drive Closed Off-Road Vehicle Engine G6CU	224339	Drive Shaft		28	28	56	154	648	
INFINITI															
EX															
30d (175 kW)	2010.04-	-	AT	-	-	All-wheel Drive Hatchback Engine V9X	641014	Inner Joint			27		81.2		
37 (235 kW)	2010.09-	-	-	L/R	F	All-wheel Drive Hatchback Engine VQ37VHR	841227	Outer Joint		27	22	59	107	61.5	M
FX															
30d AWD (175 kW)	2010.04-	-	AT	-	-	All-wheel Drive Closed Off-Road Vehicle Engine V9X	641014	Inner Joint			27		81.2		
35 (206 kW)	2003.01-	2008.12	AT	-	-	All-wheel Drive Closed Off-Road Vehicle Engine VQ35DE	641014	Inner Joint			27		81.2		
	2003.01-	2008.12	-	L/R	F	All-wheel Drive Closed Off-Road Vehicle Engine VQ35DE	841227	Outer Joint		27	22	59	107	61.5	M
37 AWD (235 kW)	2008.10-	-	-	L/R	F	All-wheel Drive Closed Off-Road Vehicle Engine VQ37VHR	841227	Outer Joint		27	22	59	107	61.5	M
45 (232 kW)	2003.01-	2008.12	AT	-	-	All-wheel Drive Closed Off-Road Vehicle Engine VK45DE	641014	Inner Joint			27		81.2		
	2003.01-	2008.12	-	L/R	F	All-wheel Drive Closed Off-Road Vehicle Engine VK45DE	841227	Outer Joint		27	22	59	107	61.5	M
50 AWD (287 kW)	2008.10-	-	-	L/R	F	All-wheel Drive Closed Off-Road Vehicle Engine VK50VE	841227	Outer Joint		27	22	59	107	61.5	M
50 AWD (309 kW)	2013.06-	-	AT	-	-	All-wheel Drive Closed Off-Road Vehicle Engine VK50VE	641014	Inner Joint			27		81.2		
G															
37 (235 kW)	2010.09-	-	-	L/R	F	Coupe Engine VQ37VHR	841227	Outer Joint		27	22	59	107	61.5	M
37 X (235 kW)	2008.10-	-	-	L/R	F	All-wheel Drive Saloon Engine VQ37VHR	841227	Outer Joint		27	22	59	107	61.5	M
G20															
-	1991-	1993	-	-	-	-	641013	Inner Joint		25	25	33	345	102.5	
2.0 (85 kW)	1990.01-	1997.12	-	L	F	Saloon Engine SR20DE	650065	Inner Joint		25	25	40	63	101	
I30															
-	1996-	1999	-	-	-	-	641008	Inner Joint		29/31	27	46	86.8	124	
3.0 (142 kW)	1997.01-	-	-	R	F	Saloon Engine VQ30DE	641019	Inner Joint		29	27	33	437.5	101	
	1997.01-	-	AT	-	F	Saloon Engine VQ30DE	841185	Outer Joint	44T	29	25	56	101	68	M
	1997.01-	-	AT	L	F	Saloon Engine VQ30DE	641062	Inner Joint		29	27	39	65.5	114.5	
	1997.01-	-	AT	R	F	Saloon Engine VQ30DE	641104	Inner Joint		29	27	33	436	99	
	1997.01-	-	AT	-	F	Saloon Engine VQ30DE	841314	Outer Joint	46T	29	27	56	101	68	M
Q60															
3.7 (235 kW)	2013.10-	-	-	L/R	F	Coupe Engine VQ37VHR	841227	Outer Joint		27	22	59	107	61.5	M
QX4															
3.3 (125 kW)	1997.01-	-	AT	-	F	All-wheel Drive Closed Off-Road Vehicle Engine VG33E	841016	Outer Joint		28	27	50	150	71	I
	1997.01-	-	AT	-	-	All-wheel Drive Closed Off-Road Vehicle Engine VG33E	641014	Inner Joint			27		81.2		
QX50															
37 AWD (235 kW)	2013.08-	-	-	L/R	F	All-wheel Drive Closed Off-Road Vehicle Engine VQ37VHR	841227	Outer Joint		27	22	59	107	61.5	M
QX70															
3.7 AWD (235 kW)	2013.08-	-	-	L/R	F	All-wheel Drive Closed Off-Road Vehicle Engine VQ37VHR	841227	Outer Joint		27	22	59	107	61.5	M
50 AWD (287 kW)	2013.08-	-	-	L/R	F	All-wheel Drive Closed Off-Road Vehicle Engine VK50VE	841227	Outer Joint		27	22	59	107	61.5	M
ISUZU															
AMIGO															
-	1989-	1995	-	-	-	-	626001	Inner Joint		17	26	30	517	97.5	
	1989-	1995	-	-	-	-	626002	Inner Joint		17	26	30	98	98.5	
	1998-	2000	-	L/R	-	Truck	823055	Outer Joint		17	33	53	136.5	69.5	I
	1998-	2000	-	L/R	-	Truck	223005	Drive Shaft		17	17	53	136.5	609	
ASCENDER															
-	2003-	2008	-	-	F	4WD/PROPELLER SHAFT	608073	Propshaft CV Joint		17	22	44		119	
AXIOM															
-	2002-	-	-	L/R	F	-	223129	Drive Shaft		17	17	53	144	606.5	
D-MAX I (TFR TFS)/RODEO															
2.5 DiTD (100 kW)	2006.10-	2012.06	AT/MT	-	F	Pickup Engine 4JK1-TC	826004	Outer Joint		17	33	53	144	69.5	I
	2007.01-	2012.06	AT/MT	-	F	All-wheel Drive Pickup Engine 4JK1-TC	826004	Outer Joint		17	33	53	144	69.5	I
2.5 DiTD (74 kW)	2002.05-	2012.06	AT/MT	-	F	All-wheel Drive Pickup Engine 4JA1-TC	826004	Outer Joint		17	33	53	144	69.5	I
	2002.10-	2012.06	AT/MT	-	F	Pickup Engine 4JA1-TC	826004	Outer Joint		17	33	53	144	69.5	I
FASTER RODEO (TFSIS)															
2.2	1988-	-	-	-	-	Engine C223	626005	Inner Joint		23	23	28	97	90	
	1988-	-	-	-	-	Engine C223	626004	Inner Joint		23	23	28	487	90	
GEMINI (JT)															
1.5 (52 kW)	1988.02-	1989.12	-	-	-	Saloon Engine 4XC1U Kat.	826001	Outer Joint		22	22	50	91	54	I
	1988.02-	1990.12	AT/MT	R	F	Hatchback Engine 4XC1U Kat.	821002	Outer Joint		22	21	50	94.5	54	M
	1988.02-	1990.12	-	-	F	Hatchback Engine 4XC1U Kat.	826001	Outer Joint		22	22	50	91	54	I
1.5 D (37 kW)	1988.02-	1989.12	AT/MT	L	F	Saloon Engine 4EC1	826001	Outer Joint		22	22	50	91	54	I

	 YEAR	TRANSM	L/R	F/R	REMARKS	GSP Ref.	 PRODUCT	 ABS	Technical Specifications						
									A	B	C	H	L	P	
ISUZU															
GEMINI (JT)															
1.5 D (37 kW)	1988.02-1990.12	MT	L/R	F	Hatchback Engine 4EC1	821002	Outer Joint		22	21	50	94.5	54	M	
	1988.02-1990.12	AT/MT	L	F	Hatchback Engine 4EC1	826001	Outer Joint		22	22	50	91	54	I	
1.5 TD (49 kW)	1988.02-1990.12	-	R	F	Hatchback Engine 4EC1T	826005	Outer Joint		24	21	50	90.5	55	M	
	1988.02-1990.12	-	L	F	Hatchback Engine 4EC1T	826006	Outer Joint		24	22	50	90.5	55	I	
	1988.02-1989.12	AT/MT	L	F	Saloon Engine 4EC1T	826001	Outer Joint		22	22	50	91	54	I	
	1988.02-1989.12	-	R	F	Saloon Engine 4EC1T	826005	Outer Joint		24	21	50	90.5	55	M	
	1988.02-1989.12	-	L	F	Saloon Engine 4EC1T	826006	Outer Joint		24	22	50	90.5	55	I	
	1988.02-1990.12	AT/MT	L	F	Hatchback Engine 4EC1T	826001	Outer Joint		22	22	50	91	54	I	
1.6 GTI 16V (84 kW)	1988.08-1990.12	AT/MT	L	F	Hatchback Engine 4XE1	826001	Outer Joint		22	22	50	91	54	I	
HOMBRE															
-	2000-	-	-	-	F 4WD/PROPELLER SHAFT	608072	Propshaft CV Joint		17	22	44		119		
I-350															
-	2006-	-	-	-	F PROPELLER SHAFT	608074	Propshaft CV Joint			34		57			
I-370															
-	2007-	2008	-	-	F 4WD/PROPELLER SHAFT	608074	Propshaft CV Joint			34		57			
IMPULSE															
-	1990-	1992	MT/AT	L	-	-	226006	Drive Shaft	42T	24	34	50	87.5	613	
	1990-	1992	MT	R	-	-	208034	Drive Shaft	42T	24	26	50	87.5	565	
	1990-	1992	MT	-	-	2WD	808015	Outer Joint		24	30	50	87.5	55 M	
1.8	1990-	1992	-	-	-	-	808020	Outer Joint	42T	24	30	50	87.5	55 M	
	1990-	1992	-	R	-	4WD	208035	Drive Shaft	42T	24	34	50	87.5	924	
PICK UP															
-	1988-	1995	-	-	-	-	626001	Inner Joint		17	26	30	517	97.5	
	1988-	1995	-	-	-	-	626002	Inner Joint		17	26	30	98	98.5	
PICK UP HOMBRE															
-	1998-	2000	-	-	-	SUV/Truck/VAN 4WD	808011	Outer Joint		27	34	55.8	127.5	64 O	
RODEO															
-	1987-	1995	-	-	-	Pick up	826009	Outer Joint		17	25	53	144	69.5 M	
	1991-	1995	-	-	-	-	626001	Inner Joint		17	26	30	517	97.5	
	1991-	1995	-	-	-	-	626002	Inner Joint		17	26	30	98	98.5	
	1992-	2002	-	R	-	Truck	223002	Drive Shaft		17	17	53	144	550	
	1992-	2002	-	L	-	Truck	223003	Drive Shaft		17	17	53	144	970	
	1992-	2002	-	-	-	Truck	626003	Inner Joint		17	33	30	517	90.5	
	1998-	2001	-	L/R	-	Truck	823055	Outer Joint		17	33	53	136.5	69.5 I	
	1998-	2001	-	L/R	-	Truck	223005	Drive Shaft		17	17	53	136.5	609	
	1998-	2002	-	-	-	4WD	623001	Inner Joint		17	33	30	97.5	91.5	
STYLUS															
-	1991-	1993	-	-	-	DOHC	808015	Outer Joint		24	30	50	87.5	55 M	
TROOPER															
-	1987-	1995	-	-	-	-	826009	Outer Joint		17	25	53	144	69.5 M	
3.5 V6 24V (158 kW)	2000.04-	-	-	-	-	-	826009	Outer Joint		17	25	53	144	69.5 M	
TROOPER & TROOPER II															
-	1988-	1991	-	-	-	-	626001	Inner Joint		17	26	30	517	97.5	
	1988-	1991	-	-	-	-	626002	Inner Joint		17	26	30	98	98.5	
	1998-	2002	-	-	F	-	623001	Inner Joint		17	33	30	97.5	91.5	
TROOPER I (UBS)/BIGHORN															
2.2 D (39 kW)	1984.05-	1989.07	AT/MT	L/R	F	All-wheel Drive Open Off-Road Vehicle Engine C223	822002	Outer Joint		24	23	47.9	149	56 M	
2.2 TD (53 kW)	1984.03-	1991.12	AT/MT	L/R	F	All-wheel Drive Open Off-Road Vehicle Engine C223T	822002	Outer Joint		24	23	47.9	149	56 M	
2.3 (66 kW)	1985.11-	1991.12	MT	L/R	F	All-wheel Drive Open Off-Road Vehicle Engine 4ZD1	826002	Outer Joint		17	23	53	144	62.5 M	
2.6 i (85 kW)	1987.10-	1991.12	AT/MT	L/R	F	All-wheel Drive Open Off-Road Vehicle Engine 4ZE1	826003	Outer Joint		17	26	53	144	70.5 M	
2.8 TD (71 kW)	1987.10-	1991.12	AT/MT	L/R	F	All-wheel Drive Closed Off-Road Vehicle Engine 4JB1T	826003	Outer Joint		17	26	53	144	70.5 M	
2.8 TD (78 kW)	1988.10-	1991.12	AT/MT	L/R	F	All-wheel Drive Closed Off-Road Vehicle Engine 4JB1-TC	826003	Outer Joint		17	26	53	144	70.5 M	
TROOPER II (UB)/BIGHORN															
3.1 TD (84 kW)	1991.08-	1998.07	-	-	F	All-wheel Drive Closed Off-Road Vehicle Engine 4JG2 T	826004	Outer Joint		17	33	53	144	69.5 I	
	1991.08-	1998.07	-	-	F	All-wheel Drive Open Off-Road Vehicle Engine 4JG2 T	826004	Outer Joint		17	33	53	144	69.5 I	
TROOPER III/BIGHORN															
3.0 DTI (117 kW)	1998.05-	2004.08	-	-	-	All-wheel Drive Closed Off-Road Vehicle Engine 4JX1	826007	Outer Joint		17	25	53	144	70.5 M	
3.5 V6 24V (158 kW)	2000.04-	2004.08	-	-	-	All-wheel Drive Closed Off-Road Vehicle Engine 6VE1	826007	Outer Joint		17	25	53	144	70.5 M	
IVECO															
DAILY II															
1940/10/1 (76 kW)	1997.01-	1999.05	MT	L/R	F	All-wheel Drive Box Body/Estate Engine 8140.23.	210444	Drive Shaft		25	26	58	89	843	
40-10 W (76 kW)	1997.01-	1999.05	MT	L/R	F	All-wheel Drive Platform/Chassis Engine 8140.23.	210444	Drive Shaft		25	26	58	89	843	
JAC															
BIN YUE															
1.8 (97 kW)	2011.04-	-	-	-	L	Saloon Engine HFC4GA4.C	274001	Drive Shaft	29T	25	27	54	95	672	

YEAR	TRANSM	L/R	F/R	REMARKS	GSP Ref.	PRODUCT	ABS	Technical Specifications						
								A	B	C	H	L	P	
JAC														
BIN YUE														
1.8 (97 kW)	2011.04-	-	-	R -	Saloon Engine HFC4GA4.C	274002	Drive Shaft	29T	25	25	54	95	979	
2.0 (108 kW)	2008.09-2014.12	-	-	L -	Saloon Engine 4G63S4N	274001	Drive Shaft	29T	25	27	54	95	672	
	2008.09-2014.12	-	-	R -	Saloon Engine 4G63S4N	274002	Drive Shaft	29T	25	25	54	95	979	
	2008.09-2014.12	-	-	L -	Saloon Engine 4G63S4N	275066	Drive Shaft	29T	25	37	53.8	95	1024	
HE YUE														
1.5 (78 kW)	2009.10-2012.12	MT	L	F	Saloon Engine 4G15S	274003	Drive Shaft	52T	27	25	60	95	643	
	2009.10-2012.12	MT	R	F	Saloon Engine 4G15S	274004	Drive Shaft	52T	27	25	60	95	931	
1.5 (83 kW)	2010.09-	MT	L	-	Saloon Engine HFC4GB2.3C	274003	Drive Shaft	52T	27	25	60	95	643	
	2010.09-	MT	R	-	Saloon Engine HFC4GB2.3C	274004	Drive Shaft	52T	27	25	60	95	931	
1.8 (105 kW)	2011.09-	MT	L	-	Saloon Engine 4G93D	274003	Drive Shaft	52T	27	25	60	95	643	
	2011.09-	MT	R	-	Saloon Engine 4G93D	274004	Drive Shaft	52T	27	25	60	95	931	
TONG YUE														
1.3 (73 kW)	2010.03-2014.12	-	L	-	Saloon Engine HFC4GB1.3C	274009	Drive Shaft	44T	25	25	52.5	94.5	607	
	2010.03-2014.12	-	R	-	Saloon Engine HFC4GB1.3C	274010	Drive Shaft	44T	25	28	52.5	94.5	551	
	2010.03-2014.12	MT	L	-	Saloon Engine HFC4GB1.3C	274005	Drive Shaft	44T	25	23	52.5	95	605.5	
	2010.03-2014.12	MT	R	-	Saloon Engine HFC4GB1.3C	274006	Drive Shaft	44T	25	23	52.5	95	916	
	2010.03-2014.12	MT	L	-	Saloon Engine HFC4GB1.3C	274007	Drive Shaft	44T	25	25	52.5	95	615.5	
	2010.03-2014.12	MT	R	-	Saloon Engine HFC4GB1.3C	274008	Drive Shaft	44T	25	28	52.5	95	556	
1.5 (76 kW)	2008.11-2010.12	-	L	-	Saloon Engine 4G15	274009	Drive Shaft	44T	25	25	52.5	94.5	607	
	2008.11-2010.12	-	R	-	Saloon Engine 4G15	274010	Drive Shaft	44T	25	28	52.5	94.5	551	
JAGUAR														
S-TYPE (X200)														
2.5 V6 (147 kW)	2002.04-2007.10	MT	R	R	Saloon Engine JB (AJ-V6)/AJ25	818271	Outer Joint	46T	28	24	55	106	59	M
	2002.04-2007.10	-	R	R	Saloon Engine JB (AJ-V6)/AJ25	218342	Drive Shaft	46W	28	28	54.9	105.5	830	
	2002.04-2007.10	MT	R	R	Saloon Engine JB (AJ-V6)/AJ25	618179	Inner Joint		28	28	46	101	78.5	
	2002.04-2007.10	MT	R	R	Saloon Engine JB (AJ-V6)/AJ25	218230	Drive Shaft	46T	28	28	55	106	831	
2.7 D (152 kW)	2004.06-2007.10	-	R	R	Saloon Engine AJD	218342	Drive Shaft	46W	28	28	54.9	105.5	830	
	2004.06-2007.10	-	R	R	Saloon Engine AJD	618179	Inner Joint		28	28	46	101	78.5	
3.0 V6 (175 kW)	1999.01-2007.10	-	R	R	Saloon Engine AJ-V6/FB	218342	Drive Shaft	46W	28	28	54.9	105.5	830	
	1999.01-2007.10	-	R	R	Saloon Engine AJ-V6/FB	618179	Inner Joint		28	28	46	101	78.5	
4.2 V8 (219 kW)	2002.04-2007.10	-	R	R	Saloon Engine AJ8FT	218342	Drive Shaft	46W	28	28	54.9	105.5	830	
	2002.04-2007.10	-	R	R	Saloon Engine AJ8FT	618179	Inner Joint		28	28	46	101	78.5	
R 4.2 V8 (291 kW)	2002.04-2007.10	-	R	R	Saloon Engine AJ8FT	218342	Drive Shaft	46W	28	28	54.9	105.5	830	
	2002.04-2007.10	-	R	R	Saloon Engine AJ8FT	618179	Inner Joint		28	28	46	101	78.5	
X-TYPE (X400)														
2.0 D (96 kW)	2003.07-2009.11	-	-	R	Saloon Engine R4-X404/FMBA/FMBB	635007	Inner Joint		26	24	58	83	83	
	2003.07-2009.11	-	L	F	Saloon Engine R4-X404/FMBA/FMBB	699147	Inner Joint		26	24	40	68.5	159.5	
	2003.07-2009.11	-	R	F	Saloon Engine R4-X404/FMBA/FMBB	699146	Inner Joint		26	24	40	469	91	
	2003.07-2009.11	-	-	F	Saloon Engine R4-X404/FMBA/FMBB	899147	Outer Joint		27	24	56.1	91.5	58.5	M
	2003.07-2009.11	-	L	F	Saloon Engine R4-X404/FMBA/FMBB	299177	Drive Shaft		27	26	56.1	91.5	624	
	2003.07-2009.11	-	R	F	Saloon Engine R4-X404/FMBA/FMBB	299176	Drive Shaft		27	26	56.1	91.5	956	
	2003.07-2009.11	-	L	R	Saloon Engine R4-X404/FMBA/FMBB	235030	Drive Shaft	32W	28	26	46	85	791	
	2003.07-2009.11	-	R	R	Saloon Engine R4-X404/FMBA/FMBB	235029	Drive Shaft	32W	28	26	46	85	826	
	2004.02-2009.12	-	-	R	Estate Engine R4-X404/FMBA/FMBB	635007	Inner Joint		26	24	58	83	83	
	2004.02-2009.12	-	L	F	Estate Engine R4-X404/FMBA/FMBB	699147	Inner Joint		26	24	40	68.5	159.5	
	2004.02-2009.12	-	R	F	Estate Engine R4-X404/FMBA/FMBB	699146	Inner Joint		26	24	40	469	91	
	2004.02-2009.12	-	-	F	Estate Engine R4-X404/FMBA/FMBB	899147	Outer Joint		27	24	56.1	91.5	58.5	M
	2004.02-2009.12	-	L	F	Estate Engine R4-X404/FMBA/FMBB	299177	Drive Shaft		27	26	56.1	91.5	624	
	2004.02-2009.12	-	R	F	Estate Engine R4-X404/FMBA/FMBB	299176	Drive Shaft		27	26	56.1	91.5	956	
	2004.02-2009.12	-	L	R	Estate Engine R4-X404/FMBA/FMBB	235030	Drive Shaft	32W	28	26	46	85	791	
	2004.02-2009.12	-	R	R	Estate Engine R4-X404/FMBA/FMBB	235029	Drive Shaft	32W	28	26	46	85	826	
	2.1 V6 (115 kW)	2002.03-2009.11	-	-	R	Saloon Engine YB (AJ-V6)	635007	Inner Joint		26	24	58	83	83
2002.03-2009.11		-	L	F	Saloon Engine YB (AJ-V6)	699147	Inner Joint		26	24	40	68.5	159.5	
2002.03-2009.11		-	R	F	Saloon Engine YB (AJ-V6)	699146	Inner Joint		26	24	40	469	91	
2002.03-2009.11		-	-	F	Saloon Engine YB (AJ-V6)	899147	Outer Joint		27	24	56.1	91.5	58.5	M
2002.03-2009.11		-	L	F	Saloon Engine YB (AJ-V6)	299177	Drive Shaft		27	26	56.1	91.5	624	
2002.03-2009.11		-	R	F	Saloon Engine YB (AJ-V6)	299176	Drive Shaft		27	26	56.1	91.5	956	
2002.03-2009.11		-	L	R	Saloon Engine YB (AJ-V6)	235030	Drive Shaft	32W	28	26	46	85	791	
2002.03-2009.11		-	R	R	Saloon Engine YB (AJ-V6)	235029	Drive Shaft	32W	28	26	46	85	826	
2003.11-2009.03		-	-	R	Estate Engine YB (AJ-V6)	635007	Inner Joint		26	24	58	83	83	
2003.11-2009.03		-	L	F	Estate Engine YB (AJ-V6)	699147	Inner Joint		26	24	40	68.5	159.5	
2003.11-2009.03		-	R	F	Estate Engine YB (AJ-V6)	699146	Inner Joint		26	24	40	469	91	
2003.11-2009.03		-	-	F	Estate Engine YB (AJ-V6)	899147	Outer Joint		27	24	56.1	91.5	58.5	M
2003.11-2009.03		-	L	F	Estate Engine YB (AJ-V6)	299177	Drive Shaft		27	26	56.1	91.5	624	
2003.11-2009.03	-	R	F	Estate Engine YB (AJ-V6)	299176	Drive Shaft		27	26	56.1	91.5	956		





	 YEAR	TRANSM	L/R	F/R	REMARKS	GSP Ref.	 PRODUCT	 ABS	Technical Specifications					
									A	B	C	H	L	P
JAGUAR														
X-TYPE (X400)														
2.1 V6 (115 kW)	2003.11-2009.03	-	L	R	Estate Engine YB (AJ-V6)	235030	Drive Shaft	32W	28	26	46	85	791	
	2003.11-2009.03	-	R	R	Estate Engine YB (AJ-V6)	235029	Drive Shaft	32W	28	26	46	85	826	
2.2 D (110 kW)	2005.10-2009.11	-	-	R	Saloon Engine LJ46G	635007	Inner Joint		26	24	58	83	83	
	2005.10-2009.12	-	-	R	Estate Engine LJ46G	635007	Inner Joint		26	24	58	83	83	
	2005.10-2009.11	-	L	R	Saloon Engine LJ46G	235030	Drive Shaft	32W	28	26	46	85	791	
	2005.10-2009.12	-	L	R	Estate Engine LJ46G	235030	Drive Shaft	32W	28	26	46	85	791	
	2005.10-2009.11	-	R	R	Saloon Engine LJ46G	235029	Drive Shaft	32W	28	26	46	85	826	
	2005.10-2009.12	-	R	R	Estate Engine LJ46G	235029	Drive Shaft	32W	28	26	46	85	826	
2.2 D (114 kW)	2005.10-2009.12	MT	L	F	Estate Engine LJ46G	699147	Inner Joint		26	24	40	68.5	159.5	
	2005.10-2009.11	MT	L	F	Saloon Engine LJ46G	699147	Inner Joint		26	24	40	68.5	159.5	
	2005.10-2009.12	MT	R	F	Estate Engine LJ46G	699146	Inner Joint		26	24	40	469	91	
	2005.10-2009.11	MT	R	F	Saloon Engine LJ46G	699146	Inner Joint		26	24	40	469	91	
	2005.10-2009.12	MT	L	F	Estate Engine LJ46G	299177	Drive Shaft		27	26	56.1	91.5	624	
	2005.10-2009.11	MT	L	F	Saloon Engine LJ46G	299177	Drive Shaft		27	26	56.1	91.5	624	
	2005.10-2009.12	MT	R	F	Estate Engine LJ46G	299176	Drive Shaft		27	26	56.1	91.5	956	
	2005.10-2009.11	MT	R	F	Saloon Engine LJ46G	299176	Drive Shaft		27	26	56.1	91.5	956	
2.5 (144 kW)	2004.02-2009.12	-	-	R	All-wheel Drive Estate Engine XB (AJ-V6)	635007	Inner Joint		26	24	58	83	83	
	2004.02-2009.12	-	-	F	All-wheel Drive Estate Engine XB (AJ-V6)	899147	Outer Joint		27	24	56.1	91.5	58.5	M
	2004.02-2009.12	-	L	R	All-wheel Drive Estate Engine XB (AJ-V6)	235030	Drive Shaft	32W	28	26	46	85	791	
	2004.02-2009.12	-	R	R	All-wheel Drive Estate Engine XB (AJ-V6)	235029	Drive Shaft	32W	28	26	46	85	826	
	2004.02-2009.12	-	R	F	All-wheel Drive Estate Engine XB (AJ-V6)	218240	Drive Shaft		27	23	56.1	91.5	970	
2.5 V6 (144 kW)	2001.06-2009.11	-	-	R	All-wheel Drive Saloon Engine XB (AJ-V6)	635007	Inner Joint		26	24	58	83	83	
	2001.06-2009.11	-	-	F	All-wheel Drive Saloon Engine XB (AJ-V6)	899147	Outer Joint		27	24	56.1	91.5	58.5	M
	2001.06-2009.11	-	L	R	All-wheel Drive Saloon Engine XB (AJ-V6)	235030	Drive Shaft	32W	28	26	46	85	791	
	2001.06-2009.11	-	R	R	All-wheel Drive Saloon Engine XB (AJ-V6)	235029	Drive Shaft	32W	28	26	46	85	826	
	2001.06-2009.11	-	R	F	All-wheel Drive Saloon Engine XB (AJ-V6)	218240	Drive Shaft		27	23	56.1	91.5	970	
3.0 (169 kW)	2004.02-2009.12	-	-	R	All-wheel Drive Estate Engine AJ-V6	635007	Inner Joint		26	24	58	83	83	
	2004.02-2009.12	-	-	F	All-wheel Drive Estate Engine AJ-V6	899147	Outer Joint		27	24	56.1	91.5	58.5	M
	2004.02-2009.12	-	L	R	All-wheel Drive Estate Engine AJ-V6	235030	Drive Shaft	32W	28	26	46	85	791	
	2004.02-2009.12	-	R	R	All-wheel Drive Estate Engine AJ-V6	235029	Drive Shaft	32W	28	26	46	85	826	
	2004.02-2009.12	-	R	F	All-wheel Drive Estate Engine AJ-V6	218240	Drive Shaft		27	23	56.1	91.5	970	
3.0 V6 (169 kW)	2001.06-2007.11	-	-	R	All-wheel Drive Saloon Engine AJ-V6	635007	Inner Joint		26	24	58	83	83	
	2001.06-2007.11	-	-	F	All-wheel Drive Saloon Engine AJ-V6	899147	Outer Joint		27	24	56.1	91.5	58.5	M
	2001.06-2007.11	-	L	R	All-wheel Drive Saloon Engine AJ-V6	235030	Drive Shaft	32W	28	26	46	85	791	
	2001.06-2007.11	-	R	R	All-wheel Drive Saloon Engine AJ-V6	235029	Drive Shaft	32W	28	26	46	85	826	
	2001.06-2007.11	-	R	F	All-wheel Drive Saloon Engine AJ-V6	218240	Drive Shaft		27	23	56.1	91.5	970	
JEEP														
CHEROKEE (KJ)														
2.4 (108 kW)	2001.09-2008.01	MT	L	F	All-wheel Drive Closed Off-Road Vehicle Engine ED1	216010	Drive Shaft		27	27	57.9	126	605	
	2001.09-2008.01	MT	R	F	All-wheel Drive Closed Off-Road Vehicle Engine ED1	209018	Drive Shaft		27	29	57.9	126	582.5	
	2001.09-2008.01	MT	-	R	All-wheel Drive Closed Off-Road Vehicle Engine ED1	899032	Outer Joint		25	30			I	
	2001.09-2008.01	-	-	F	All-wheel Drive Closed Off-Road Vehicle Engine ED1	809049	Outer Joint		27	35	57.9	126	64	O
2.4 Laredo (108 kW)	2001.10-2004.09	MT	L	F	Closed Off-Road Vehicle Engine ED1	216010	Drive Shaft		27	27	57.9	126	605	
	2001.10-2004.09	MT	R	F	Closed Off-Road Vehicle Engine ED1	209018	Drive Shaft		27	29	57.9	126	582.5	
	2001.10-2004.09	-	-	F	Closed Off-Road Vehicle Engine ED1	809049	Outer Joint		27	35	57.9	126	64	O
2.5 CRD (105 kW)	2001.09-2008.01	MT	L	F	All-wheel Drive Closed Off-Road Vehicle Engine R 425 DOHC	216010	Drive Shaft		27	27	57.9	126	605	
	2001.09-2008.01	MT	R	F	All-wheel Drive Closed Off-Road Vehicle Engine R 425 DOHC	209018	Drive Shaft		27	29	57.9	126	582.5	
	2001.09-2008.01	MT	-	R	All-wheel Drive Closed Off-Road Vehicle Engine R 425 DOHC	899032	Outer Joint		25	30			I	
	2001.09-2008.01	-	-	F	All-wheel Drive Closed Off-Road Vehicle Engine R 425 DOHC	809049	Outer Joint		27	35	57.9	126	64	O
2.8 CRD (110 kW)	2002.11-2008.01	AT/MT	L	F	All-wheel Drive Closed Off-Road Vehicle Engine ENR	216010	Drive Shaft		27	27	57.9	126	605	
	2002.11-2008.01	AT/MT	R	F	All-wheel Drive Closed Off-Road Vehicle Engine ENR	209018	Drive Shaft		27	29	57.9	126	582.5	
	2002.11-2008.01	AT/MT	-	R	All-wheel Drive Closed Off-Road Vehicle Engine ENR	899032	Outer Joint		25	30			I	
	2002.11-2008.01	-	-	F	All-wheel Drive Closed Off-Road Vehicle Engine ENR	809049	Outer Joint		27	35	57.9	126	64	O
2.8 CRD (120 kW)	2004.11-2008.01	AT/MT	L	F	All-wheel Drive Closed Off-Road Vehicle Engine ENR	216010	Drive Shaft		27	27	57.9	126	605	
	2004.11-2008.01	AT/MT	R	F	All-wheel Drive Closed Off-Road Vehicle Engine ENR	209018	Drive Shaft		27	29	57.9	126	582.5	
	2004.11-2008.01	AT/MT	-	R	All-wheel Drive Closed Off-Road Vehicle Engine ENR	899032	Outer Joint		25	30			I	
	2004.11-2008.01	-	-	F	All-wheel Drive Closed Off-Road Vehicle Engine ENR	809049	Outer Joint		27	35	57.9	126	64	O
3.7 (150 kW)	2003.08-2008.01	AT/MT	L	F	All-wheel Drive Closed Off-Road Vehicle Engine EKG	216010	Drive Shaft		27	27	57.9	126	605	
	2003.08-2008.01	AT/MT	R	F	All-wheel Drive Closed Off-Road Vehicle Engine EKG	209018	Drive Shaft		27	29	57.9	126	582.5	
	2003.08-2008.01	AT	-	R	All-wheel Drive Closed Off-Road Vehicle Engine EKG	899032	Outer Joint		25	30			I	
	2003.08-2008.01	-	-	F	All-wheel Drive Closed Off-Road Vehicle Engine EKG	809049	Outer Joint		27	35	57.9	126	64	O
3.7 (155 kW)	2001.09-2008.01	AT/MT	L	F	All-wheel Drive Closed Off-Road Vehicle Engine EKG	216010	Drive Shaft		27	27	57.9	126	605	
	2001.09-2008.01	AT/MT	R	F	All-wheel Drive Closed Off-Road Vehicle Engine EKG	209018	Drive Shaft		27	29	57.9	126	582.5	
	2001.09-2008.01	AT	-	R	All-wheel Drive Closed Off-Road Vehicle Engine EKG	899032	Outer Joint		25	30			I	
	2001.09-2008.01	-	-	F	All-wheel Drive Closed Off-Road Vehicle Engine EKG	809049	Outer Joint		27	35	57.9	126	64	O

YEAR	TRANSM	L/R	F/R	REMARKS	GSP Ref.	PRODUCT	ABS	Technical Specifications							
								A	B	C	H	L	P		
JEEP															
CHEROKEE (KJ)															
3.7 Laredo (150 kW)	2001.10-2004.09	AT/MT	L	F	Closed Off-Road Vehicle Engine EKG	216010	Drive Shaft		27	27	57.9	126	605		
	2001.10-2004.09	AT/MT	R	F	Closed Off-Road Vehicle Engine EKG	209018	Drive Shaft		27	29	57.9	126	582.5		
	2001.10-2004.09	-	-	F	Closed Off-Road Vehicle Engine EKG	809049	Outer Joint		27	35	57.9	126	64	O	
CHEROKEE (XJ)															
2.1 TD (59 kW)	1989.06-1992.03	AT/MT	L	F	Closed Off-Road Vehicle Engine J8S	216003	Drive Shaft	54T	27		60	102.5	576		
	1989.06-1992.03	AT/MT	R	F	Closed Off-Road Vehicle Engine J8S	216004	Drive Shaft	54T	27		60	102.5	575.5		
2.5 (89 kW)	1995.10-2001.09	-	-	F	All-wheel Drive Closed Off-Road Vehicle Engine EPE	816004	Outer Joint	54T	27	32	60	102.5	77.5	I	
	1995.10-2001.09	-	L	F	All-wheel Drive Closed Off-Road Vehicle Engine EPE	216012	Drive Shaft		27		60	102.5	576		
	1995.10-2001.09	-	L	F	All-wheel Drive Closed Off-Road Vehicle Engine EPE	216013	Drive Shaft		27		60	102.5	575.5		
	1995.10-2001.09	-	L	F	All-wheel Drive Closed Off-Road Vehicle Engine EPE	299167	Drive Shaft	54T	27		60	102.5	576		
	1995.10-2001.09	-	-	-	All-wheel Drive Closed Off-Road Vehicle Engine EPE	816001	Outer Joint		27	32	60	102.5	77.5	I	
	1995.10-2001.09	-	R	F	All-wheel Drive Closed Off-Road Vehicle Engine EPE	299168	Drive Shaft	54T	27		60	102.5	979		
2.5 (90 kW)	1986.10-1990.09	-	-	F	All-wheel Drive Closed Off-Road Vehicle Engine EPE	816004	Outer Joint	54T	27	32	60	102.5	77.5	I	
	1986.10-1990.09	-	L	F	All-wheel Drive Closed Off-Road Vehicle Engine EPE	299167	Drive Shaft	54T	27		60	102.5	576		
	1986.10-1990.09	-	R	F	All-wheel Drive Closed Off-Road Vehicle Engine EPE	299168	Drive Shaft	54T	27		60	102.5	979		
2.5 i (87 kW)	1984.10-2001.09	-	-	F	All-wheel Drive Closed Off-Road Vehicle Engine EPE	816004	Outer Joint	54T	27	32	60	102.5	77.5	I	
	1984.10-2001.09	-	L	F	All-wheel Drive Closed Off-Road Vehicle Engine EPE	216012	Drive Shaft		27		60	102.5	576		
	1984.10-2001.09	-	L	F	All-wheel Drive Closed Off-Road Vehicle Engine EPE	216013	Drive Shaft		27		60	102.5	575.5		
	1984.10-2001.09	-	L	F	All-wheel Drive Closed Off-Road Vehicle Engine EPE	299167	Drive Shaft	54T	27		60	102.5	576		
	1984.10-2001.09	-	-	-	All-wheel Drive Closed Off-Road Vehicle Engine EPE	816001	Outer Joint		27	32	60	102.5	77.5	I	
	1984.10-2001.09	-	R	F	All-wheel Drive Closed Off-Road Vehicle Engine EPE	299168	Drive Shaft	54T	27		60	102.5	979		
2.5 i (90 kW)	1991.12-2001.09	AT/MT	R	F	All-wheel Drive Closed Off-Road Vehicle Engine EPE/HX	216004	Drive Shaft	54T	27		60	102.5	575.5		
	1991.12-2001.09	-	-	F	All-wheel Drive Closed Off-Road Vehicle Engine EPE/HX	816004	Outer Joint	54T	27	32	60	102.5	77.5	I	
	1991.12-2001.09	-	L	F	All-wheel Drive Closed Off-Road Vehicle Engine EPE/HX	216012	Drive Shaft		27		60	102.5	576		
	1991.12-2001.09	-	L	F	All-wheel Drive Closed Off-Road Vehicle Engine EPE/HX	216013	Drive Shaft		27		60	102.5	575.5		
	1991.12-2001.09	-	L	F	All-wheel Drive Closed Off-Road Vehicle Engine EPE/HX	299167	Drive Shaft	54T	27		60	102.5	576		
	1991.12-2001.09	-	-	-	All-wheel Drive Closed Off-Road Vehicle Engine EPE/HX	816001	Outer Joint		27	32	60	102.5	77.5	I	
	1991.12-2001.09	-	R	F	All-wheel Drive Closed Off-Road Vehicle Engine EPE/HX	299168	Drive Shaft	54T	27		60	102.5	979		
	1991.12-2001.09	AT/MT	L	F	All-wheel Drive Closed Off-Road Vehicle Engine EPE/HX	216003	Drive Shaft	54T	27		60	102.5	576		
2.5 TD (85 kW)	1988.01-2001.09	AT/MT	R	F	All-wheel Drive Closed Off-Road Vehicle Engine ENC	216004	Drive Shaft	54T	27		60	102.5	575.5		
	1988.01-2001.09	-	-	F	All-wheel Drive Closed Off-Road Vehicle Engine ENC	816004	Outer Joint	54T	27	32	60	102.5	77.5	I	
	1988.01-2001.09	-	L	F	All-wheel Drive Closed Off-Road Vehicle Engine ENC	216012	Drive Shaft		27		60	102.5	576		
	1988.01-2001.09	-	L	F	All-wheel Drive Closed Off-Road Vehicle Engine ENC	216013	Drive Shaft		27		60	102.5	575.5		
	1988.01-2001.09	-	L	F	All-wheel Drive Closed Off-Road Vehicle Engine ENC	299167	Drive Shaft	54T	27		60	102.5	576		
	1988.01-2001.09	-	-	-	All-wheel Drive Closed Off-Road Vehicle Engine ENC	816001	Outer Joint		27	32	60	102.5	77.5	I	
	1988.01-2001.09	-	R	F	All-wheel Drive Closed Off-Road Vehicle Engine ENC	299168	Drive Shaft	54T	27		60	102.5	979		
	1988.01-2001.09	AT/MT	L	F	All-wheel Drive Closed Off-Road Vehicle Engine ENC	216003	Drive Shaft	54T	27		60	102.5	576		
2.5 Tdi (85 kW)	1996.10-2001.09	AT/MT	L	F	All-wheel Drive Closed Off-Road Vehicle Engine ENC	216003	Drive Shaft	54T	27		60	102.5	576		
	1996.10-2001.09	AT/MT	R	F	All-wheel Drive Closed Off-Road Vehicle Engine ENC	216004	Drive Shaft	54T	27		60	102.5	575.5		
	1996.10-2001.09	-	-	F	All-wheel Drive Closed Off-Road Vehicle Engine ENC	816004	Outer Joint	54T	27	32	60	102.5	77.5	I	
	1996.10-2001.09	-	L	F	All-wheel Drive Closed Off-Road Vehicle Engine ENC	299167	Drive Shaft	54T	27		60	102.5	576		
	1996.10-2001.09	-	R	F	All-wheel Drive Closed Off-Road Vehicle Engine ENC	299168	Drive Shaft	54T	27		60	102.5	979		
4.0 i (127 kW)	1998.07-2001.09	AT/MT	L	F	All-wheel Drive Closed Off-Road Vehicle Engine ERH	216003	Drive Shaft	54T	27		60	102.5	576		
	1998.07-2001.09	AT/MT	R	F	All-wheel Drive Closed Off-Road Vehicle Engine ERH	216004	Drive Shaft	54T	27		60	102.5	575.5		
	1998.07-2001.09	-	-	F	All-wheel Drive Closed Off-Road Vehicle Engine ERH	816004	Outer Joint	54T	27	32	60	102.5	77.5	I	
	1998.07-2001.09	-	L	F	All-wheel Drive Closed Off-Road Vehicle Engine ERH	216012	Drive Shaft		27		60	102.5	576		
	1998.07-2001.09	-	L	F	All-wheel Drive Closed Off-Road Vehicle Engine ERH	216013	Drive Shaft		27		60	102.5	575.5		
	1998.07-2001.09	-	L	F	All-wheel Drive Closed Off-Road Vehicle Engine ERH	299167	Drive Shaft	54T	27		60	102.5	576		
	1998.07-2001.09	-	-	-	All-wheel Drive Closed Off-Road Vehicle Engine ERH	816001	Outer Joint		27	32	60	102.5	77.5	I	
	1998.07-2001.09	-	R	F	All-wheel Drive Closed Off-Road Vehicle Engine ERH	299168	Drive Shaft	54T	27		60	102.5	979		
4.0 i (131 kW)	1995.01-2001.09	-	-	F	All-wheel Drive Closed Off-Road Vehicle Engine ERH	816004	Outer Joint	54T	27	32	60	102.5	77.5	I	
	1995.01-2001.09	-	L	F	All-wheel Drive Closed Off-Road Vehicle Engine ERH	216012	Drive Shaft		27		60	102.5	576		
	1995.01-2001.09	-	L	F	All-wheel Drive Closed Off-Road Vehicle Engine ERH	216013	Drive Shaft		27		60	102.5	575.5		
	1995.01-2001.09	-	L	F	All-wheel Drive Closed Off-Road Vehicle Engine ERH	299167	Drive Shaft	54T	27		60	102.5	576		
	1995.01-2001.09	-	-	-	All-wheel Drive Closed Off-Road Vehicle Engine ERH	816001	Outer Joint		27	32	60	102.5	77.5	I	
	1995.01-2001.09	-	R	F	All-wheel Drive Closed Off-Road Vehicle Engine ERH	299168	Drive Shaft	54T	27		60	102.5	979		
4.0 i (135 kW)	1991.12-2001.09	AT/MT	R	F	All-wheel Drive Closed Off-Road Vehicle Engine MX	216004	Drive Shaft	54T	27		60	102.5	575.5		
	1991.12-2001.09	-	-	F	All-wheel Drive Closed Off-Road Vehicle Engine MX	816004	Outer Joint	54T	27	32	60	102.5	77.5	I	
	1991.12-2001.09	-	L	F	All-wheel Drive Closed Off-Road Vehicle Engine MX	216012	Drive Shaft		27		60	102.5	576		
	1991.12-2001.09	-	L	F	All-wheel Drive Closed Off-Road Vehicle Engine MX	216013	Drive Shaft		27		60	102.5	575.5		
	1991.12-2001.09	-	L	F	All-wheel Drive Closed Off-Road Vehicle Engine MX	299167	Drive Shaft	54T	27		60	102.5	576		
	1991.12-2001.09	-	-	-	All-wheel Drive Closed Off-Road Vehicle Engine MX	816001	Outer Joint		27	32	60	102.5	77.5	I	
	1991.12-2001.09	-	R	F	All-wheel Drive Closed Off-Road Vehicle Engine MX	299168	Drive Shaft	54T	27		60	102.5	979		
	1991.12-2001.09	AT/MT	L	F	All-wheel Drive Closed Off-Road Vehicle Engine MX	216003	Drive Shaft	54T	27		60	102.5	576		
	1999.02-2001.09	-	-	F	All-wheel Drive Closed Off-Road Vehicle Engine MX	816004	Outer Joint	54T	27	32	60	102.5	77.5	I	
	1999.02-2001.09	-	L	F	All-wheel Drive Closed Off-Road Vehicle Engine MX	216012	Drive Shaft		27		60	102.5	576		





YEAR	TRANSM	L/R	F/R	REMARKS	GSP Ref.	PRODUCT	ABS	Technical Specifications							
								A	B	C	H	L	P		
JEEP															
CHEROKEE (XJ)															
4.0 i (135 kW)	1999.02-2001.09	-	L	F	All-wheel Drive Closed Off-Road Vehicle Engine MX	216013	Drive Shaft		27		60	102.5	975.5		
	1999.02-2001.09	-	L	F	All-wheel Drive Closed Off-Road Vehicle Engine MX	299167	Drive Shaft	54T	27		60	102.5	576		
	1999.02-2001.09	-	-	-	All-wheel Drive Closed Off-Road Vehicle Engine MX	816001	Outer Joint		27	32	60	102.5	77.5	I	
	1999.02-2001.09	-	R	F	All-wheel Drive Closed Off-Road Vehicle Engine MX	299168	Drive Shaft	54T	27		60	102.5	979		
4.0 i (136 kW)	1988.01-2001.09	-	-	F	All-wheel Drive Closed Off-Road Vehicle Engine ERH	816004	Outer Joint	54T	27	32	60	102.5	77.5	I	
	1988.01-2001.09	-	L	F	All-wheel Drive Closed Off-Road Vehicle Engine ERH	216012	Drive Shaft		27		60	102.5	576		
	1988.01-2001.09	-	L	F	All-wheel Drive Closed Off-Road Vehicle Engine ERH	216013	Drive Shaft		27		60	102.5	975.5		
	1988.01-2001.09	-	L	F	All-wheel Drive Closed Off-Road Vehicle Engine ERH	299167	Drive Shaft	54T	27		60	102.5	576		
	1988.01-2001.09	-	-	-	All-wheel Drive Closed Off-Road Vehicle Engine ERH	816001	Outer Joint		27	32	60	102.5	77.5	I	
	1988.01-2001.09	-	R	F	All-wheel Drive Closed Off-Road Vehicle Engine ERH	299168	Drive Shaft	54T	27		60	102.5	979		
CHEROKEE/COMANCHE/GRAND CHEROKEE/GRAND WAGONEER/WAGONEER															
-	1988-1992	-	-	-	4WD SUV/Truck/VAN	816003	Outer Joint	48T	27	32	60	104	70	I	
COMMANDER (XK XH)															
3.7 V6 (157 kW)	2005.09-2010.12	-	-	-	All-wheel Drive Closed Off-Road Vehicle Engine EKG	809056	Outer Joint		29	36	70	112	59.5	I	
4.7 V8 (170 kW)	2005.09-2010.12	-	-	-	All-wheel Drive Closed Off-Road Vehicle Engine EVA	809056	Outer Joint		29	36	70	112	59.5	I	
5.7 V8 (240 kW)	2005.09-2010.12	-	-	-	All-wheel Drive Closed Off-Road Vehicle Engine EZB	809056	Outer Joint		29	36	70	112	59.5	I	
	2005.09-2010.12	AT	R	F	All-wheel Drive Closed Off-Road Vehicle Engine EZB	208150	Drive Shaft		29	29	70	112	607		
	2005.09-2010.12	AT	L	F	All-wheel Drive Closed Off-Road Vehicle Engine EZB	208115	Drive Shaft		29	29	70	112	653		
COMPASS															
-	2007-	-	MT/AT	L/R	-	851032	Outer Joint		28	33	59.5	95	63.5	I	
-	2007-	-	MT/AT	L	-	641056	Inner Joint		27	33	40	62	112		
-	2007-	-	MT	R	-	615014	Inner Joint		28	33	42	40	82		
COMPASS (MK49)															
2.0 (115 kW)	2011.05-	-	-	-	Closed Off-Road Vehicle Engine ECN	239121	Drive Shaft		28	27	59.5	95	649.5		
	2011.05-	-	-	-	Closed Off-Road Vehicle Engine ECN	251045	Drive Shaft		28	27	59.5	95	962		
2.0 CRD (103 kW)	2006.08-	-	-	F	Closed Off-Road Vehicle Engine ECD/ECE	815010	Outer Joint		28	36	59.5	95	68	I	
	2006.08-	-	MT	R	F	Closed Off-Road Vehicle Engine ECD/ECE	251041	Drive Shaft		28	24	59.5	95	977.5	
	2006.09-	-	-	F	All-wheel Drive Closed Off-Road Vehicle Engine ECE	815010	Outer Joint		28	36	59.5	95	68	I	
	2006.09-	-	MT	R	F	All-wheel Drive Closed Off-Road Vehicle Engine ECE	251041	Drive Shaft		28	24	59.5	95	977.5	
2.2 CRD (120 kW)	2010.12-	-	-	F	All-wheel Drive Closed Off-Road Vehicle Engine OM 651.925	839137	Outer Joint		28	37	59.5	94.5	71.5	I	
2.4 (125 kW)	2006.08-	-	-	L	Closed Off-Road Vehicle Engine ERZ/ED3	239121	Drive Shaft		28	27	59.5	95	649.5		
	2006.08-	-	AT	L	F	Closed Off-Road Vehicle Engine ERZ/ED3	215053	Drive Shaft		28	27	59.5	95	638	
	2006.09-	-	-	R	-	All-wheel Drive Closed Off-Road Vehicle Engine ERZ/ED3	251045	Drive Shaft		28	27	59.5	95	962	
	2006.09-	-	-	L	-	All-wheel Drive Closed Off-Road Vehicle Engine ERZ/ED3	239121	Drive Shaft		28	27	59.5	95	649.5	
	2006.09-	-	AT	L	F	All-wheel Drive Closed Off-Road Vehicle Engine ERZ/ED3	215053	Drive Shaft		28	27	59.5	95	638	
GRAND CHEROKEE															
-	1999.06-	-	-	-	-	816002	Outer Joint		27	32	65.4	108	70	I	
-	2000-	-	4AT	-	-	216024	Propshaft						30	868	
4.0L Power Tech I-6	1999-	-	4AT	-	42RE	216024	Propshaft						30	868	
	2000-2001	-	4AT	-	42RE LAREDO	216024	Propshaft						30	868	
	2000-2001	-	4AT	-	42RE Limited	216024	Propshaft						30	868	
4.7L HO V8 MPI	2001-	-	5MT	-	545RFE Limited	216024	Propshaft						30	868	
4.7L V8 MPI	1999-	-	MULTISPEED AUTO	-	45RFE	216024	Propshaft						30	868	
	2000-	-	MULTISPEED AUTO	-	45RFE LAREDO	216024	Propshaft						30	868	
	2000-	-	MULTISPEED AUTO	-	45RFE Limited	216024	Propshaft						30	868	
	2001-	-	5MT	-	545RFE LAREDO	216024	Propshaft						30	868	
	2001-	-	5MT	-	545RFE Limited	216024	Propshaft						30	868	
4.7L V8 Power Tech	1999-	-	MULTISPEED AUTO	-	45RFE	216024	Propshaft						30	868	
GRAND CHEROKEE 1998-93															
-	1993-1998	-	-	F	4WD/PROPELLER SHAFT	616011	Propshaft CV Joint			25		32			
GRAND CHEROKEE I (ZJ)															
2.5 TD (85 kW)	1995.10-1999.04	AT/MT	R	F	All-wheel Drive Closed Off-Road Vehicle Engine M51/M52	216004	Drive Shaft	54T	27		60	102.5	975.5		
	1995.10-1999.04	-	-	F	All-wheel Drive Closed Off-Road Vehicle Engine M51/M52	816004	Outer Joint	54T	27	32	60	102.5	77.5	I	
	1995.10-1999.04	-	L	F	All-wheel Drive Closed Off-Road Vehicle Engine M51/M52	216012	Drive Shaft		27		60	102.5	576		
	1995.10-1999.04	-	L	F	All-wheel Drive Closed Off-Road Vehicle Engine M51/M52	216013	Drive Shaft		27		60	102.5	975.5		
	1995.10-1999.04	-	-	-	All-wheel Drive Closed Off-Road Vehicle Engine M51/M52	816007	Outer Joint	54T	27	32	60	104	70	I	
	1995.10-1999.04	-	-	-	All-wheel Drive Closed Off-Road Vehicle Engine M51/M52	816001	Outer Joint		27	32	60	102.5	77.5	I	
	1995.10-1999.04	-	L	F	All-wheel Drive Closed Off-Road Vehicle Engine M51/M52	299167	Drive Shaft	54T	27		60	102.5	576		
	1995.10-1999.04	-	-	-	All-wheel Drive Closed Off-Road Vehicle Engine M51/M52	816006	Outer Joint		27	32	60	104	70	I	
	1995.10-1999.04	-	R	F	All-wheel Drive Closed Off-Road Vehicle Engine M51/M52	299168	Drive Shaft	54T	27		60	102.5	979		
	1995.10-1999.04	AT/MT	L	F	All-wheel Drive Closed Off-Road Vehicle Engine M51/M52	216003	Drive Shaft	54T	27		60	102.5	576		
2.5 TD Laredo (85 kW)	1996.10-1998.09	-	-	F	Closed Off-Road Vehicle	816004	Outer Joint	54T	27	32	60	102.5	77.5	I	
	1996.10-1998.09	-	L	F	Closed Off-Road Vehicle	216012	Drive Shaft		27		60	102.5	576		
	1996.10-1998.09	-	L	F	Closed Off-Road Vehicle	216013	Drive Shaft		27		60	102.5	975.5		
	1996.10-1998.09	-	-	-	Closed Off-Road Vehicle	816001	Outer Joint		27	32	60	102.5	77.5	I	
	1996.10-1998.09	-	L	F	Closed Off-Road Vehicle	299167	Drive Shaft	54T	27		60	102.5	576		

YEAR	TRANSM	L/R	F/R	REMARKS	GSP Ref.	PRODUCT	ABS	Technical Specifications						
								A	B	C	H	L	P	
JEEP														
GRAND CHEROKEE I (ZJ)														
2.5 TD Laredo (85 kW)	1996.10-1998.09	-	R	F	Closed Off-Road Vehicle	299168	Drive Shaft	54T	27		60	102.5	979	
4.0 i (130 kW)	1995.10-1999.04	AT/MT	L	F	All-wheel Drive Closed Off-Road Vehicle Engine S01	216003	Drive Shaft	54T	27		60	102.5	576	
	1995.10-1999.04	AT/MT	R	F	All-wheel Drive Closed Off-Road Vehicle Engine S01	216004	Drive Shaft	54T	27		60	102.5	975.5	
	1995.10-1999.04	-	-	F	All-wheel Drive Closed Off-Road Vehicle Engine S01	816004	Outer Joint	54T	27	32	60	102.5	77.5	I
	1995.10-1999.04	-	L	F	All-wheel Drive Closed Off-Road Vehicle Engine S01	216012	Drive Shaft		27		60	102.5	576	
	1995.10-1999.04	-	L	F	All-wheel Drive Closed Off-Road Vehicle Engine S01	216013	Drive Shaft		27		60	102.5	975.5	
	1995.10-1999.04	-	-	-	All-wheel Drive Closed Off-Road Vehicle Engine S01	816007	Outer Joint	54T	27	32	60	104	70	I
	1995.10-1999.04	-	L	F	All-wheel Drive Closed Off-Road Vehicle Engine S01	299167	Drive Shaft	54T	27		60	102.5	576	
	1995.10-1999.04	-	-	-	All-wheel Drive Closed Off-Road Vehicle Engine S01	816001	Outer Joint		27	32	60	102.5	77.5	I
	1995.10-1999.04	-	-	-	All-wheel Drive Closed Off-Road Vehicle Engine S01	816006	Outer Joint		27	32	60	104	70	I
4.0 i (132 kW)	1991.09-1999.04	-	-	F	All-wheel Drive Closed Off-Road Vehicle Engine ERH	816004	Outer Joint	54T	27	32	60	102.5	77.5	I
	1991.09-1999.04	-	L	F	All-wheel Drive Closed Off-Road Vehicle Engine ERH	216012	Drive Shaft		27		60	102.5	576	
	1991.09-1999.04	-	L	F	All-wheel Drive Closed Off-Road Vehicle Engine ERH	216013	Drive Shaft		27		60	102.5	975.5	
	1991.09-1999.04	-	-	-	All-wheel Drive Closed Off-Road Vehicle Engine ERH	816007	Outer Joint	54T	27	32	60	104	70	I
	1991.09-1999.04	-	L	F	All-wheel Drive Closed Off-Road Vehicle Engine ERH	299167	Drive Shaft	54T	27		60	102.5	576	
	1991.09-1999.04	-	-	-	All-wheel Drive Closed Off-Road Vehicle Engine ERH	816001	Outer Joint		27	32	60	102.5	77.5	I
	1991.09-1999.04	-	R	F	All-wheel Drive Closed Off-Road Vehicle Engine ERH	299168	Drive Shaft	54T	27		60	102.5	979	
4.0 i (135 kW)	1991.09-1999.04	AT/MT	L	F	All-wheel Drive Closed Off-Road Vehicle Engine MX	216003	Drive Shaft	54T	27		60	102.5	576	
	1991.09-1999.04	AT/MT	R	F	All-wheel Drive Closed Off-Road Vehicle Engine MX	216004	Drive Shaft	54T	27		60	102.5	975.5	
	1991.09-1999.04	-	-	F	All-wheel Drive Closed Off-Road Vehicle Engine MX	816004	Outer Joint	54T	27	32	60	102.5	77.5	I
	1991.09-1999.04	-	L	F	All-wheel Drive Closed Off-Road Vehicle Engine MX	216012	Drive Shaft		27		60	102.5	576	
	1991.09-1999.04	-	L	F	All-wheel Drive Closed Off-Road Vehicle Engine MX	216013	Drive Shaft		27		60	102.5	975.5	
	1991.09-1999.04	-	-	-	All-wheel Drive Closed Off-Road Vehicle Engine MX	816007	Outer Joint	54T	27	32	60	104	70	I
	1991.09-1999.04	-	L	F	All-wheel Drive Closed Off-Road Vehicle Engine MX	299167	Drive Shaft	54T	27		60	102.5	576	
	1991.09-1999.04	-	-	-	All-wheel Drive Closed Off-Road Vehicle Engine MX	816001	Outer Joint		27	32	60	102.5	77.5	I
	1991.09-1999.04	-	R	F	All-wheel Drive Closed Off-Road Vehicle Engine MX	299168	Drive Shaft	54T	27		60	102.5	979	
4.0 Laredo (131 kW)	1996.10-1998.09	-	-	F	Closed Off-Road Vehicle Engine ERH	816004	Outer Joint	54T	27	32	60	102.5	77.5	I
	1996.10-1998.09	-	L	F	Closed Off-Road Vehicle Engine ERH	216012	Drive Shaft		27		60	102.5	576	
	1996.10-1998.09	-	L	F	Closed Off-Road Vehicle Engine ERH	216013	Drive Shaft		27		60	102.5	975.5	
	1996.10-1998.09	-	-	-	Closed Off-Road Vehicle Engine ERH	816001	Outer Joint		27	32	60	102.5	77.5	I
	1996.10-1998.09	-	L	F	Closed Off-Road Vehicle Engine ERH	299167	Drive Shaft	54T	27		60	102.5	576	
	1996.10-1998.09	-	R	F	Closed Off-Road Vehicle Engine ERH	299168	Drive Shaft	54T	27		60	102.5	979	
5.2 (156 kW)	1995.10-1999.04	-	-	F	All-wheel Drive Closed Off-Road Vehicle Engine Y01	816004	Outer Joint	54T	27	32	60	102.5	77.5	I
	1995.10-1999.04	-	-	-	All-wheel Drive Closed Off-Road Vehicle Engine Y01	816007	Outer Joint	54T	27	32	60	104	70	I
	1995.10-1999.04	-	L	F	All-wheel Drive Closed Off-Road Vehicle Engine Y01	299167	Drive Shaft	54T	27		60	102.5	576	
	1995.10-1999.04	-	-	-	All-wheel Drive Closed Off-Road Vehicle Engine Y01	816006	Outer Joint		27	32	60	104	70	I
	1995.10-1999.04	-	R	F	All-wheel Drive Closed Off-Road Vehicle Engine Y01	299168	Drive Shaft	54T	27		60	102.5	979	
5.2 (164 kW)	1996.10-1998.09	-	-	F	All-wheel Drive Closed Off-Road Vehicle Engine ELF	816004	Outer Joint	54T	27	32	60	102.5	77.5	I
	1996.10-1998.09	-	L	F	All-wheel Drive Closed Off-Road Vehicle Engine ELF	299167	Drive Shaft	54T	27		60	102.5	576	
	1996.10-1998.09	-	R	F	All-wheel Drive Closed Off-Road Vehicle Engine ELF	299168	Drive Shaft	54T	27		60	102.5	979	
5.2 i (155 kW)	1992.01-1999.04	-	-	F	All-wheel Drive Closed Off-Road Vehicle Engine ELF	816004	Outer Joint	54T	27	32	60	102.5	77.5	I
	1992.01-1999.04	-	-	-	All-wheel Drive Closed Off-Road Vehicle Engine ELF	816007	Outer Joint	54T	27	32	60	104	70	I
	1992.01-1999.04	-	L	F	All-wheel Drive Closed Off-Road Vehicle Engine ELF	299167	Drive Shaft	54T	27		60	102.5	576	
	1992.01-1999.04	-	R	F	All-wheel Drive Closed Off-Road Vehicle Engine ELF	299168	Drive Shaft	54T	27		60	102.5	979	
	1992.01-1999.04	-	-	-	All-wheel Drive Closed Off-Road Vehicle Engine ELF	816006	Outer Joint		27	32	60	104	70	I
5.2 i (158 kW)	1992.09-1999.04	AT/MT	L	F	All-wheel Drive Closed Off-Road Vehicle Engine Y	216003	Drive Shaft	54T	27		60	102.5	576	
	1992.09-1999.04	AT/MT	R	F	All-wheel Drive Closed Off-Road Vehicle Engine Y	216004	Drive Shaft	54T	27		60	102.5	975.5	
	1992.09-1999.04	-	-	F	All-wheel Drive Closed Off-Road Vehicle Engine Y	816004	Outer Joint	54T	27	32	60	102.5	77.5	I
	1992.09-1999.04	-	-	-	All-wheel Drive Closed Off-Road Vehicle Engine Y	816007	Outer Joint	54T	27	32	60	104	70	I
	1992.09-1999.04	-	L	F	All-wheel Drive Closed Off-Road Vehicle Engine Y	299167	Drive Shaft	54T	27		60	102.5	576	
	1992.09-1999.04	-	R	F	All-wheel Drive Closed Off-Road Vehicle Engine Y	299168	Drive Shaft	54T	27		60	102.5	979	
	1992.09-1999.04	-	-	-	All-wheel Drive Closed Off-Road Vehicle Engine Y	816006	Outer Joint		27	32	60	104	70	I
5.2 Limited (136 kW)	1996.10-1998.09	-	-	F	All-wheel Drive Closed Off-Road Vehicle Engine ELF	816004	Outer Joint	54T	27	32	60	102.5	77.5	I
	1996.10-1998.09	-	L	F	All-wheel Drive Closed Off-Road Vehicle Engine ELF	299167	Drive Shaft	54T	27		60	102.5	576	
	1996.10-1998.09	-	R	F	All-wheel Drive Closed Off-Road Vehicle Engine ELF	299168	Drive Shaft	54T	27		60	102.5	979	
5.9 i (177 kW)	1997.08-1999.04	AT/MT	L	F	All-wheel Drive Closed Off-Road Vehicle	216003	Drive Shaft	54T	27		60	102.5	576	
	1997.08-1999.04	AT/MT	R	F	All-wheel Drive Closed Off-Road Vehicle	216004	Drive Shaft	54T	27		60	102.5	975.5	
	1997.08-1999.04	-	-	F	All-wheel Drive Closed Off-Road Vehicle	816004	Outer Joint	54T	27	32	60	102.5	77.5	I
	1997.08-1999.04	-	L	F	All-wheel Drive Closed Off-Road Vehicle	299167	Drive Shaft	54T	27		60	102.5	576	
	1997.08-1999.04	-	R	F	All-wheel Drive Closed Off-Road Vehicle	299168	Drive Shaft	54T	27		60	102.5	979	
GRAND CHEROKEE II (WJ WG)														
2.7 CRD (120 kW)	2001.10-2005.09	-	-	F	All-wheel Drive Closed Off-Road Vehicle Engine ENF	816005	Outer Joint	48T	27	32	65.4	108	70	I
	2001.10-2005.09	AT/MT	-	R	All-wheel Drive Closed Off-Road Vehicle Engine ENF	899032	Outer Joint			25		30		I

YEAR	TRANSM	L/R	F/R	REMARKS	GSP Ref.	PRODUCT	ABS	Technical Specifications							
								A	B	C	H	L	P		
JEEP															
GRAND CHEROKEE II (WJ WG)															
2.7 CRD (120 kW)	2001.10-2005.09	AT	L	F	All-wheel Drive Closed Off-Road Vehicle Engine ENF	209016	Drive Shaft	48T	27		65.4	108	620		
	2001.10-2005.09	AT	R	F	All-wheel Drive Closed Off-Road Vehicle Engine ENF	215020	Drive Shaft	48T	27		65.4	108	1017.5		
	2001.10-2005.09	-	-	F	All-wheel Drive Closed Off-Road Vehicle Engine ENF	235040	Drive Shaft					30	795		
	2001.10-2005.09	-	-	F	All-wheel Drive Closed Off-Road Vehicle Engine ENF	616005	Inner Joint			25		40			
	2001.10-2005.09	AT	L	F	All-wheel Drive Closed Off-Road Vehicle Engine ENF	216009	Drive Shaft	48T	27		65.4	108	589		
	2001.10-2005.09	AT	R	F	All-wheel Drive Closed Off-Road Vehicle Engine ENF	216006	Drive Shaft	48T	27		65.4	108	1045		
3.1 TD (103 kW)	1999.04-2001.12	-	-	F	All-wheel Drive Closed Off-Road Vehicle Engine EXA	816005	Outer Joint	48T	27	32	65.4	108	70	I	
	1999.04-2001.12	AT/MT	-	R	All-wheel Drive Closed Off-Road Vehicle Engine EXA	899032	Outer Joint			25		30		I	
	1999.04-2001.12	AT	L	F	All-wheel Drive Closed Off-Road Vehicle Engine EXA	209016	Drive Shaft	48T	27		65.4	108	620		
	1999.04-2001.12	AT	R	F	All-wheel Drive Closed Off-Road Vehicle Engine EXA	215020	Drive Shaft	48T	27		65.4	108	1017.5		
	1999.04-2001.12	MT	L	F	All-wheel Drive Closed Off-Road Vehicle Engine EXA	216009	Drive Shaft	48T	27		65.4	108	589		
	1999.04-2001.12	MT	R	F	All-wheel Drive Closed Off-Road Vehicle Engine EXA	216006	Drive Shaft	48T	27		65.4	108	1045		
4.0 (140 kW)	1999.04-2005.09	AT/MT	-	R	All-wheel Drive Closed Off-Road Vehicle Engine ERH	899032	Outer Joint			25		30		I	
	1999.04-2005.09	-	-	F	All-wheel Drive Closed Off-Road Vehicle Engine ERH	216021	Propshaft					30	826		
	1999.04-2005.09	-	-	F	All-wheel Drive Closed Off-Road Vehicle Engine ERH	616005	Inner Joint			25		40			
4.7 V8 (162 kW)	1999.04-2000.08	AT/MT	-	R	All-wheel Drive Closed Off-Road Vehicle Engine EVA	899032	Outer Joint			25		30		I	
4.7 V8 (164 kW)	1999.04-2005.09	-	-	F	All-wheel Drive Closed Off-Road Vehicle Engine EVA	816005	Outer Joint	48T	27	32	65.4	108	70	I	
	1999.04-2005.09	AT/MT	-	R	All-wheel Drive Closed Off-Road Vehicle Engine EVA	899032	Outer Joint			25		30		I	
	1999.04-2005.09	AT	L	F	All-wheel Drive Closed Off-Road Vehicle Engine EVA	209016	Drive Shaft	48T	27		65.4	108	620		
	1999.04-2005.09	AT	R	F	All-wheel Drive Closed Off-Road Vehicle Engine EVA	215020	Drive Shaft	48T	27		65.4	108	1017.5		
	1999.04-2005.09	-	-	F	All-wheel Drive Closed Off-Road Vehicle Engine EVA	216021	Propshaft					30	826		
	1999.04-2005.09	-	-	F	All-wheel Drive Closed Off-Road Vehicle Engine EVA	616005	Inner Joint			25		40			
	1999.04-2005.09	AT	L	F	All-wheel Drive Closed Off-Road Vehicle Engine EVA	216009	Drive Shaft	48T	27		65.4	108	589		
	1999.04-2005.09	AT	R	F	All-wheel Drive Closed Off-Road Vehicle Engine EVA	216006	Drive Shaft	48T	27		65.4	108	1045		
4.7 V8 (167 kW)	2003.06-2005.09	AT	R	F	All-wheel Drive Closed Off-Road Vehicle Engine EVA	216006	Drive Shaft	48T	27		65.4	108	1045		
	2003.06-2005.09	-	-	F	All-wheel Drive Closed Off-Road Vehicle Engine EVA	816005	Outer Joint	48T	27	32	65.4	108	70	I	
	2003.06-2005.09	-	-	F	All-wheel Drive Closed Off-Road Vehicle Engine EVA	216021	Propshaft					30	826		
	2003.06-2005.09	-	-	F	All-wheel Drive Closed Off-Road Vehicle Engine EVA	616005	Inner Joint			25		40			
	2003.06-2005.09	AT	L	F	All-wheel Drive Closed Off-Road Vehicle Engine EVA	216009	Drive Shaft	48T	27		65.4	108	589		
4.7 V8 (190 kW)	2001.10-2005.09	-	-	F	All-wheel Drive Closed Off-Road Vehicle Engine EVC	816005	Outer Joint	48T	27	32	65.4	108	70	I	
	2001.10-2005.09	AT/MT	-	R	All-wheel Drive Closed Off-Road Vehicle Engine EVC	899032	Outer Joint			25		30		I	
	2001.10-2005.09	-	-	F	All-wheel Drive Closed Off-Road Vehicle Engine EVC	216021	Propshaft					30	826		
	2001.10-2005.09	-	-	F	All-wheel Drive Closed Off-Road Vehicle Engine EVC	616005	Inner Joint			25		40			
	2001.10-2005.09	AT	L	F	All-wheel Drive Closed Off-Road Vehicle Engine EVC	216009	Drive Shaft	48T	27		65.4	108	589		
	2001.10-2005.09	AT	R	F	All-wheel Drive Closed Off-Road Vehicle Engine EVC	216006	Drive Shaft	48T	27		65.4	108	1045		
GRAND CHEROKEE III (WH WK)															
3.0 CRD (155 kW)	2006.05-2010.12	AT	R	F	All-wheel Drive Closed Off-Road Vehicle Engine EXL	208150	Drive Shaft			29	29	70	112	607	
	2006.05-2010.12	AT	L	F	All-wheel Drive Closed Off-Road Vehicle Engine EXL	208115	Drive Shaft			29	29	70	112	653	
3.0 CRD (160 kW)	2005.06-2010.12	AT	-	R	All-wheel Drive Closed Off-Road Vehicle Engine EXL	899297	Outer Joint			25		30		I	
	2005.06-2010.12	AT	R	F	All-wheel Drive Closed Off-Road Vehicle Engine EXL	208150	Drive Shaft			29	29	70	112	607	
	2005.06-2010.12	AT	L	F	All-wheel Drive Closed Off-Road Vehicle Engine EXL	208115	Drive Shaft			29	29	70	112	653	
3.7 V6 (157 kW)	2005.06-2010.12	AT	-	R	All-wheel Drive Closed Off-Road Vehicle Engine EKG	899297	Outer Joint			25		30		I	
4.7 V8 (170 kW)	2005.06-2010.12	AT	-	R	All-wheel Drive Closed Off-Road Vehicle Engine EVA	899297	Outer Joint			25		30		I	
5.7 V8 (240 kW)	2005.06-2010.12	AT	-	R	All-wheel Drive Closed Off-Road Vehicle Engine EZB	899297	Outer Joint			25		30		I	
	2005.06-2010.12	AT	R	F	All-wheel Drive Closed Off-Road Vehicle Engine EZB	208150	Drive Shaft			29	29	70	112	607	
	2005.06-2010.12	AT	L	F	All-wheel Drive Closed Off-Road Vehicle Engine EZB	208115	Drive Shaft			29	29	70	112	653	
6.1 SRT8 (313 kW)	2006.03-2010.12	AT	-	R	All-wheel Drive Closed Off-Road Vehicle Engine ESF	899297	Outer Joint			25		30		I	
GRAND CHEROKEE III (WH, WK)															
4.7 V8 FLEX (167 kW)	2004.10-2010.05	-	-	-	Closed Off-Road Vehicle Engine EVA, EVD, EVE	809056	Outer Joint			29	36	70	112	59.5	I
4.7 V8(167 kW)	2004.1-2010.05	-	-	-	Closed Off-Road Vehicle Engine EVA, EVE	809056	Outer Joint			29	36	70	112	59.5	I
GRAND CHEROKEE IV (WK WK2)															
3.0 CRD V6 (177 kW)	2011.02--	AT	L	R	All-wheel Drive Closed Off-Road Vehicle Engine EXF	201133	Drive Shaft			32	32	72	114.5	876	
3.6 V6 (210 kW)	2010.11--	-	-	-	All-wheel Drive Closed Off-Road Vehicle Engine ERB	809056	Outer Joint			29	36	70	112	59.5	I
3.6 V6 FlexFuel (210 kW)	2010.11--	-	-	-	All-wheel Drive Closed Off-Road Vehicle Engine ERB	809056	Outer Joint			29	36	70	112	59.5	I
5.7 V8 (259 kW)	2010.11--	-	-	-	All-wheel Drive Closed Off-Road Vehicle Engine EZH	809056	Outer Joint			29	36	70	112	59.5	I
GRAND WAGONEER															
-	1993--	-	-	-	F PROPELLER SHAFT	616011	Propshaft CV Joint				25		32		
LIBERTY															
2.4L 4 Cyl DOHC 16v SMPI	2004--	-	5MT	-	HD SPORT 4x4	235042	Propshaft					30	745		
	2004--	-	5MT	-	HD SPORT 4x4	235041	Propshaft					30	770		
	2005--	-	6MT	-	NSG370 SPORT 4x4	235041	Propshaft					30	770		
2.4L Power Tech DOHC I-4	2002--	-	5MT	-	HD Manual SPORT	235042	Propshaft					30	745		
	2002--	-	5MT	-	HD SPORT	235041	Propshaft					30	770		
	2003--	-	5MT	-	HD SPORT 4x4	235042	Propshaft					30	745		
	2003--	-	5MT	-	HD SPORT 4x4	235041	Propshaft					30	770		
2.8L 4 Cyl Turbo Diesel	2005--	-	5AT	-	545RFE EDITION Limited	235041	Propshaft					30	770		





	 YEAR	TRANSM	L/R	F/R	REMARKS	GSP Ref.	 PRODUCT	 ABS	Technical Specifications					
									A	B	C	H	L	P
JEEP LIBERTY														
2.8L 4 Cyl Turbo Diesel	2005-2006	5AT	-	-	545RFE SPORT	235041	Propshaft					30	770	
	2006-	5AT	-	-	545RFE EDTION Limited	235041	Propshaft					30	770	
3.7	2002-2005	-	-	-	-	616004	Inner Joint	27	35	34.9	114	113		
3.7L V6	2002-	5MT	-	-	HD Manual RENEGADE	235042	Propshaft					30	745	
	2002-	5MT	-	-	HD Manual SPORT	235042	Propshaft					30	745	
	2002-	MULTISPEED AUTO	-	-	45RFE EDITION Limited	235042	Propshaft					30	745	
	2002-	MULTISPEED AUTO	-	-	45RFE RENEGADE	235042	Propshaft					30	745	
	2002-	MULTISPEED AUTO	-	-	45RFE SPORT	235042	Propshaft					30	745	
	2002-	5MT	-	-	HD RENEGADE	235041	Propshaft					30	770	
	2002-	5MT	-	-	HD SPORT	235041	Propshaft					30	770	
	2002-	MULTISPEED AUTO	-	-	45RFE EDITION Limited	235041	Propshaft					30	770	
	2002-	MULTISPEED AUTO	-	-	45RFE RENEGADE	235041	Propshaft					30	770	
	2002-	MULTISPEED AUTO	-	-	45RFE SPORT	235041	Propshaft					30	770	
	2003-2004	4AT	-	-	42RLE EDITION Limited 4x4	235042	Propshaft					30	745	
	2003-2004	4AT	-	-	42RLE RENEGADE 4x4	235042	Propshaft					30	745	
	2003-2004	4AT	-	-	42RLE SPORT 4x4	235042	Propshaft					30	745	
	2003-2004	5MT	-	-	HD RENEGADE 4x4	235042	Propshaft					30	745	
	2003-2004	5MT	-	-	HD SPORT 4x4	235042	Propshaft					30	745	
	2003-	MULTISPEED AUTO	-	-	45RFE EDITION Limited 4x4	235042	Propshaft					30	745	
	2003-	MULTISPEED AUTO	-	-	45RFE RENEGADE 4x4	235042	Propshaft					30	745	
	2003-2004	MULTISPEED AUTO	-	-	45RFE SPORT 4x4	235042	Propshaft					30	745	
	2003-2005	4AT	-	-	-	235041	Propshaft					30	770	
	2003-2005	4AT	-	-	-	235041	Propshaft					30	770	
	2003-2005	4AT	-	-	-	235041	Propshaft					30	770	
	2003-2004	5MT	-	-	HD RENEGADE 4x4	235041	Propshaft					30	770	
	2003-2004	5MT	-	-	HD SPORT 4x4	235041	Propshaft					30	770	
	2003-	MULTISPEED AUTO	-	-	45RFE EDITION Limited 4x4	235041	Propshaft					30	770	
	2003-	MULTISPEED AUTO	-	-	45RFE RENEGADE 4x4	235041	Propshaft					30	770	
	2003-2004	MULTISPEED AUTO	-	-	45RFE SPORT 4x4	235041	Propshaft					30	770	
	2005-	6MT	-	-	NSG370 RENEGADE 4x4	235041	Propshaft					30	770	
	2005-	6MT	-	-	NSG370 SPORT 4x4	235041	Propshaft					30	770	
	2006-	4AT	-	-	42RLE EDTION Limited	235041	Propshaft					30	770	
	2006-	4AT	-	-	42RLE RENEGADE	235041	Propshaft					30	770	
	2006-	4AT	-	-	42RLE SPORT	235041	Propshaft					30	770	
	2006-	4AT	-	-	VLP EDTION Limited	235041	Propshaft					30	770	
	2006-	4AT	-	-	VLP RENEGADE	235041	Propshaft					30	770	
	2006-	4AT	-	-	VLP SPORT	235041	Propshaft					30	770	
	2006-	6MT	-	-	NSG370 RENEGADE 4x4	235041	Propshaft					30	770	
	2006-2007	6MT	-	-	NSG370 SPORT 4x4	235041	Propshaft					30	770	
	2007-	4AT	-	-	VLP 42RLE Trans EDITION Limited	235041	Propshaft					30	770	
	2007-	4AT	-	-	VLP 42RLE Trans SPORT	235041	Propshaft					30	770	
PATRIOT														
-	2007-	MT/AT	L/R	-	-	851032	Outer Joint	28	33	59.5	95	63.5	I	
	2007-	MT/AT	L	-	-	641056	Inner Joint	27	33	40	62	112		
	2007-	MT	R	-	-	615014	Inner Joint	28	33	42	40	82		
PATRIOT (MK74)														
2.0 CRD (103 kW)	2007.02-	-	-	F	All-wheel Drive Closed Off-Road Vehicle Engine ECD/ECE	815010	Outer Joint	28	36	59.5	95	68	I	
2.4 (125 kW)	2008.01-	CVT	L	F	All-wheel Drive Closed Off-Road Vehicle Engine ED3	215053	Drive Shaft	28	27	59.5	95	638		
2.4 Eco + (125 kW)	2008.07-	AT	L	F	All-wheel Drive Closed Off-Road Vehicle Engine ED3	215053	Drive Shaft	28	27	59.5	95	638		
WRANGLER														
-	2007-2008	AT	-	F	-	816011	Propshaft CV Joint			35		28.5		
	2007-2008	MT	-	F	LIGHT DUTY DANA AXLE	816011	Propshaft CV Joint			35		28.5		
	2007-2008	-	-	R	-	816011	Propshaft CV Joint			35		28.5		
	2009-2013	-	-	F	DANA 216 MM AXLE	816011	Propshaft CV Joint			35		28.5		
WRANGLER I (YJ SJ_)														
2.5 (76 kW)	1988.01-1991.12	-	L	F	All-wheel Drive Closed Off-Road Vehicle	216012	Drive Shaft	27		60	102.5	576		
	1988.01-1991.12	-	L	F	All-wheel Drive Closed Off-Road Vehicle	216013	Drive Shaft	27		60	102.5	975.5		
	1988.01-1991.12	-	-	-	All-wheel Drive Closed Off-Road Vehicle	816001	Outer Joint	27	32	60	102.5	77.5	I	
2.5 (89 kW)	1991.12-1996.08	-	L	F	All-wheel Drive Closed Off-Road Vehicle Engine EPE	216012	Drive Shaft	27		60	102.5	576		
	1991.12-1996.08	-	L	F	All-wheel Drive Closed Off-Road Vehicle Engine EPE	216013	Drive Shaft	27		60	102.5	975.5		
	1991.12-1996.08	-	-	-	All-wheel Drive Closed Off-Road Vehicle Engine EPE	816001	Outer Joint	27	32	60	102.5	77.5	I	
4.0 (131 kW)	1991.12-1996.08	-	F	F	All-wheel Drive Closed Off-Road Vehicle Engine ERH	816004	Outer Joint	54T	27	32	60	102.5	77.5	I
	1991.12-1996.08	-	L	F	All-wheel Drive Closed Off-Road Vehicle Engine ERH	216012	Drive Shaft		27		60	102.5	576	
	1991.12-1996.08	-	L	F	All-wheel Drive Closed Off-Road Vehicle Engine ERH	216013	Drive Shaft		27		60	102.5	975.5	
	1991.12-1996.08	-	L	F	All-wheel Drive Closed Off-Road Vehicle Engine ERH	299167	Drive Shaft	54T	27		60	102.5	576	
	1991.12-1996.08	-	R	F	All-wheel Drive Closed Off-Road Vehicle Engine ERH	299168	Drive Shaft	54T	27		60	102.5	979	





YEAR	TRANSM	L/R	F/R	REMARKS	GSP Ref.	PRODUCT	ABS	Technical Specifications							
								A	B	C	H	L	P		
JEEP															
WRANGLER I (YJ SJ_)															
4.0 (131 kW)	1991.12-1996.08	-	-	-	All-wheel Drive Closed Off-Road Vehicle Engine ERH	816001	Outer Joint		27	32	60	102.5	77.5	I	
WRANGLER II (TJ)															
2.5 (87 kW)	1996.08-2007.04	AT/MT	R	F	All-wheel Drive Open Off-Road Vehicle Engine P00	216004	Drive Shaft	54T	27		60	102.5	975.5		
	1996.08-2007.04	-	L	F	All-wheel Drive Open Off-Road Vehicle Engine P00	216012	Drive Shaft		27		60	102.5	576		
	1996.08-2007.04	-	L	F	All-wheel Drive Open Off-Road Vehicle Engine P00	216013	Drive Shaft		27		60	102.5	975.5		
	1996.08-2007.04	-	-	-	All-wheel Drive Open Off-Road Vehicle Engine P00	816001	Outer Joint		27	32	60	102.5	77.5	I	
	1996.08-2007.04	AT/MT	L	F	All-wheel Drive Open Off-Road Vehicle Engine P00	216003	Drive Shaft	54T	27		60	102.5	576		
4.0 (124 kW)	1998.06-2007.04	AT/MT	R	F	All-wheel Drive Open Off-Road Vehicle	216004	Drive Shaft	54T	27		60	102.5	975.5		
	1998.06-2007.04	-	-	F	All-wheel Drive Open Off-Road Vehicle	816004	Outer Joint	54T	27	32	60	102.5	77.5	I	
	1998.06-2007.04	-	L	F	All-wheel Drive Open Off-Road Vehicle	216012	Drive Shaft		27		60	102.5	576		
	1998.06-2007.04	-	L	F	All-wheel Drive Open Off-Road Vehicle	216013	Drive Shaft		27		60	102.5	975.5		
	1998.06-2007.04	-	L	F	All-wheel Drive Open Off-Road Vehicle	299167	Drive Shaft	54T	27		60	102.5	576		
	1998.06-2007.04	-	-	-	All-wheel Drive Open Off-Road Vehicle	816001	Outer Joint		27	32	60	102.5	77.5	I	
	1998.06-2007.04	-	R	F	All-wheel Drive Open Off-Road Vehicle	299168	Drive Shaft	54T	27		60	102.5	979		
	1998.06-2007.04	AT/MT	L	F	All-wheel Drive Open Off-Road Vehicle	216003	Drive Shaft	54T	27		60	102.5	576		
4.0 (130 kW)	1996.08-2007.04	-	-	F	All-wheel Drive Open Off-Road Vehicle Engine S01	816004	Outer Joint	54T	27	32	60	102.5	77.5	I	
	1996.08-2007.04	-	L	F	All-wheel Drive Open Off-Road Vehicle Engine S01	216012	Drive Shaft		27		60	102.5	576		
	1996.08-2007.04	-	L	F	All-wheel Drive Open Off-Road Vehicle Engine S01	216013	Drive Shaft		27		60	102.5	975.5		
	1996.08-2007.04	-	L	F	All-wheel Drive Open Off-Road Vehicle Engine S01	299167	Drive Shaft	54T	27		60	102.5	576		
	1996.08-2007.04	-	-	-	All-wheel Drive Open Off-Road Vehicle Engine S01	816001	Outer Joint		27	32	60	102.5	77.5	I	
	1996.08-2007.04	-	R	F	All-wheel Drive Open Off-Road Vehicle Engine S01	299168	Drive Shaft	54T	27		60	102.5	979		
4.0 Rubicon (128 kW)	2003.08-2007.04	-	-	F	All-wheel Drive Open Off-Road Vehicle Engine ERH	816004	Outer Joint	54T	27	32	60	102.5	77.5	I	
	2003.08-2007.04	-	L	F	All-wheel Drive Open Off-Road Vehicle Engine ERH	299167	Drive Shaft	54T	27		60	102.5	576		
	2003.08-2007.04	-	R	F	All-wheel Drive Open Off-Road Vehicle Engine ERH	299168	Drive Shaft	54T	27		60	102.5	979		
KIA															
-															
2.0	2004.08-2010	MT	R	-	-		824188	Outer Joint	48T	27	24	62.2	95	61.5	M
BONGO															
2.9 TDiC (90 kW)	2003.10-	5MT	R	F	All-wheel Drive MPV Engine HJ3		624123	Inner Joint		28	25	42		118	
BONGO/BONGO/K-SERIES/BONGO III															
2.9 TDiC (90 kW)	2003.10-	5MT	R	F	All-wheel Drive Platform/Chassis Engine HJ3		624123	Inner Joint		28	25	42		118	
CADENZA															
3.3 L	2013-2016	-	L	F	-		201146	Drive Shaft	48T	30	28	65	92	658	
CANIVAL															
2.0	2001.01-2003.12	MT/AT	-	-	Engine		827013	Outer Joint		28	24	56	102	60	M
2000	2001.01-2003.12	MT/AT	-	-	Engine		827013	Outer Joint		28	24	56	102	60	M
3.0	1998.01-	MT/AT	-	-	Engine		834195	Outer Joint		28	26	56	102.3	66	M
	1998.01-	MT/AT	-	-	Engine		834195	Outer Joint		28	26	56	102.3	66	M
3000	1998.01-	MT/AT	-	-	Engine		834195	Outer Joint		28	26	56	102.3	66	M
	1998.01-	MT/AT	-	-	Engine		834195	Outer Joint		28	26	56	102.3	66	M
CARENS															
1.8	-	-	-	-	-		627003	Inner Joint		27	24	41	64.7	105	
2.0 2WD	2006-2008	5MT/4AT	L	-	DOHC MPI		227111	Drive Shaft	48T	27	27	62.1	95	688	
	2006-2008	5MT/4AT	R	-	DOHC MPI		227102	Drive Shaft	48T	27	27	62.2	95	957	
CARENS I (FC)															
1.8 i (81 kW)	2000.11-2002.07	-	-	F	MPV Engine T8		827029	Outer Joint	46T	28	24	56	90	60	M
	2000.11-2002.07	MT	L	F	MPV Engine T8		227071	Drive Shaft	46T	28	24	56	90	624	
	2000.11-2002.07	MT	R	F	MPV Engine T8		227070	Drive Shaft	46T	28	28	56	90	618.5	
CARENS II															
1.8	-	-	-	R	-		227034	Drive Shaft	46T	28	28	56	90	584.5	
	-	-	-	L	-		227035	Drive Shaft	46T	28	27	56	90	630.5	
CARENS II (FJ)/X-TREK															
1.8 (93 kW)	2002.07-	-	-	F	MPV Engine TB		827029	Outer Joint	46T	28	24	56	90	60	M
	2002.07-	MT	L	F	MPV Engine TB		227071	Drive Shaft	46T	28	24	56	90	624	
	2002.07-	MT	R	F	MPV Engine TB		227070	Drive Shaft	46T	28	28	56	90	618.5	
2.0 CRDi (103 kW)	2005.11-	-	-	F	MPV Engine D4EA		827029	Outer Joint	46T	28	24	56	90	60	M
2.0 CRDi (83 kW)	2002.07-	-	-	F	MPV Engine D4EA		827029	Outer Joint	46T	28	24	56	90	60	M
2.0 CVVT (102 kW)	2004.08-	-	-	F	MPV Engine G4GC		827029	Outer Joint	46T	28	24	56	90	60	M
	2004.08-	MT	L	F	MPV Engine G4GC		227071	Drive Shaft	46T	28	24	56	90	624	
	2004.08-	MT	R	F	MPV Engine G4GC		227070	Drive Shaft	46T	28	28	56	90	618.5	
CARENS IV															
1.6 GDi (99 kW)	2013.03-	6AT	L	F	MPV Engine G4FD		201206	Drive Shaft	48T	27	27	62	92.5	668	
	2013.03-	6AT	R	F	MPV Engine G4FD		201209	Drive Shaft	48T	27	27	62	92.5	956	
	2013.03-	6MT	L	F	MPV Engine G4FD		201210	Drive Shaft	48T	27	27	62	92.5	682	
	2013.03-	6AT	L	F	MPV Engine G4FD		801069	Outer Joint	48T	27	23	62	92.5	59.5	M





	 YEAR	TRANSM	L/R	F/R	REMARKS	GSP Ref.	 PRODUCT	 ABS	Technical Specifications						
									A	B	C	H	L	P	
KIA															
CARENS IV															
1.6 GDi (99 kW)	2013.03-	-	6MT/6AT	L	F	MPV Engine G4FD	601112	Inner Joint		27	23	30	67	84	
	2013.03-	-	6MT	L	F	MPV Engine G4FD	601103	Inner Joint		27	25	41	61.5	91.5	
1.7 CRDi (100 kW)	2013.03-	-	6MT/6AT	R	F	MPV Engine D4FD-L	201207	Drive Shaft	48T	27	27	62	92.5	968	
	2013.03-	-	6MT/6AT	R	F	MPV Engine D4FD-L	601103	Inner Joint		27	25	41	61.5	91.5	
1.7 CRDi (85 kW)	2013.03-	-	6MT/6AT	R	F	MPV Engine D4FD-L	201208	Drive Shaft	48T	27	28	62	92.5	956	
CARNIVAL															
-	-	-	-	-	-	-	827013	Outer Joint		28	24	56	102	60	M
	-	-	-	-	-	-	827031	Outer Joint	54T	28	24	56	102	60	M
	1999-	2001	AT	L	-	-	227037	Drive Shaft	54T	28	34	56	102	732	
	1999-	2001	AT	-	-	-	827015	Outer Joint		28	24	56	102	60	M
	2001-	-	-	-	-	-	627003	Inner Joint		27	24	41	64.7	105	
2.5	2001-	-	AT	R	-	-	227018	Drive Shaft		28	28	56	102	657	
	2001-	-	AT	L	-	-	227020	Drive Shaft		28	27	56	102	715	
	2001-	-	AT	-	-	-	627002	Inner Joint		28	24	43	40.1	83.5	
2.5 V6	-	-	MT	-	-	-	627014	Inner Joint		28	26	35	68	102	
	-	-	MT	R	-	-	227078	Drive Shaft		28	28	56	102.5	668	
	-	-	MT	L	-	-	227079	Drive Shaft		28	28	56	102.5	722	
CARNIVAL (VQ)															
2.7	2006-	2010	4AT	R	-	MU > DOHC MPI	227115	Drive Shaft	54T	31	28	56	102	663	
	2006-	2010	4AT	L	-	MU > DOHC MPI	227114	Drive Shaft	54T	31	27	56	102	720	
	2006-	2010	4AT	R	-	MU > DOHC MPI	627023	Inner Joint		28	25	42	43.5	77.5	
3.5 2WD	2011-	-	6AT	L	-	LAMBDA 2	227152	Drive Shaft	54T	31	28	56	102	701	
	2011-	-	6AT	L	-	LAMBDA 2	827091	Outer Joint	54T	31	25	56	102	63	M
	2011-	-	6AT	L	-	LAMBDA 2	627033	Inner Joint		28	25	43	67	103.5	
3.8 2WD	2006-	2010	5AT	L	-	LAMBDA > DOHC MPI	227151	Drive Shaft	54T	31	28	56	102	708.5	
	2006-	2010	5AT	L	-	LAMBDA > DOHC MPI	627034	Inner Joint		28	25	41	72.5	104	
CARNIVAL I (UP)															
2.5 (121kW)	1999.08-	2001.10	AT	-	-	RH	227019	Drive Shaft	54T	28	28	56	102	657	
CARNIVAL I (UP)/SEDONA															
2.5 V6 (121 kW)	1999.08-	2001.10	MT	-	F	MPV Engine KRV6	827053	Outer Joint		28	26	56	102.5	66	M
	1999.08-	2001.10	-	-	F	MPV Engine KRV6	827062	Outer Joint	54T	28	24	56	102	60	M
	1999.08-	2001.10	MT	R	F	MPV Engine KRV6	627013	Inner Joint		28	26	43	41	75	
	1999.08-	2001.10	-	-	F	MPV Engine KRV6	827059	Outer Joint	54T	28	26	56	102.5	66	M
	1999.08-	2001.10	-	-	F	MPV Engine KRV6	827030	Outer Joint	54T	28	26	56	102.5	66	M
2.9 TD (93 kW)	1999.08-	2001.10	MT	-	F	MPV Engine J3	827030	Outer Joint	54T	28	26	56	102.5	66	M
	1999.08-	2001.10	MT	R	F	MPV Engine J3	627013	Inner Joint		28	26	43	41	75	
	1999.08-	2001.10	-	-	F	MPV Engine J3	827059	Outer Joint	54T	28	26	56	102.5	66	M
	1999.08-	2001.10	AT	L	F	MPV Engine J3	627036	Inner Joint		28	25	35	79	113.5	
	1999.08-	2001.10	AT	R	F	MPV Engine J3	634075	Inner Joint		28	25	43	40.3	76	
	1999.08-	2001.10	MT	L	F	MPV Engine J3	227097	Drive Shaft	54T	28	28	56	102.5	650	
	1999.08-	2001.10	MT	R	F	MPV Engine J3	234166	Drive Shaft	54T	28	28	56	102.5	596	
	1999.08-	2001.10	AT	L	F	MPV Engine J3	227099	Drive Shaft	54T	28	28	56	102.5	624	
	1999.08-	2001.10	AT	R	F	MPV Engine J3	227096	Drive Shaft	54T	28	28	56	102.5	549	
	1999.08-	2001.10	AT	R	F	MPV Engine J3	227096	Drive Shaft	54T	28	28	56	102.5	549	
CARNIVAL II (GQ)/SEDONA/CARNIVAL/SEDONA															
2.5 V6 (110 kW)	2001.10-	2006.06	MT	-	F	MPV Engine K5	827053	Outer Joint		28	26	56	102.5	66	M
	2001.10-	2006.06	-	-	F	MPV Engine K5	827062	Outer Joint	54T	28	24	56	102	60	M
	2001.10-	2006.06	-	R	F	MPV Engine K5	627013	Inner Joint		28	26	43	41	75	
	2001.10-	2006.06	-	-	F	MPV Engine K5	827059	Outer Joint	54T	28	26	56	102.5	66	M
2.9 CRDi (106 kW)	2001.10-	2006.06	-	-	F	MPV Engine J3	827030	Outer Joint	54T	28	26	56	102.5	66	M
	2001.10-	2006.06	-	R	F	MPV Engine J3	627013	Inner Joint		28	26	43	41	75	
	2001.10-	2006.06	-	-	F	MPV Engine J3	827059	Outer Joint	54T	28	26	56	102.5	66	M
	2001.10-	2006.06	AT	L	F	MPV Engine J3	627036	Inner Joint		28	25	35	79	113.5	
	2001.10-	2006.06	AT	R	F	MPV Engine J3	634075	Inner Joint		28	25	43	40.3	76	
	2001.10-	2006.06	MT	L	F	MPV Engine J3	227097	Drive Shaft	54T	28	28	56	102.5	650	
	2001.10-	2006.06	MT	R	F	MPV Engine J3	234166	Drive Shaft	54T	28	28	56	102.5	596	
	2001.10-	2006.06	AT	L	F	MPV Engine J3	227099	Drive Shaft	54T	28	28	56	102.5	624	
	2001.10-	2006.06	AT	R	F	MPV Engine J3	227096	Drive Shaft	54T	28	28	56	102.5	549	
	2001.10-	2006.06	AT	R	F	MPV Engine J3	227096	Drive Shaft	54T	28	28	56	102.5	549	
2.9 TD (93 kW)	1999.01-	2007.09	MT	-	F	MPV Engine J3	827030	Outer Joint	54T	28	26	56	102.5	66	M
	1999.01-	2007.09	MT	R	F	MPV Engine J3	627013	Inner Joint		28	26	43	41	75	
	1999.01-	2007.09	-	-	F	MPV Engine J3	827059	Outer Joint	54T	28	26	56	102.5	66	M
	1999.01-	2007.09	AT	L	F	MPV Engine J3	627036	Inner Joint		28	25	35	79	113.5	
	1999.01-	2007.09	AT	R	F	MPV Engine J3	634075	Inner Joint		28	25	43	40.3	76	
	1999.01-	2007.09	MT	L	F	MPV Engine J3	227097	Drive Shaft	54T	28	28	56	102.5	650	
	1999.01-	2007.09	MT	R	F	MPV Engine J3	234166	Drive Shaft	54T	28	28	56	102.5	596	
	1999.01-	2007.09	AT	L	F	MPV Engine J3	227099	Drive Shaft	54T	28	28	56	102.5	624	
	1999.01-	2007.09	AT	R	F	MPV Engine J3	227096	Drive Shaft	54T	28	28	56	102.5	549	

YEAR	TRANSM	L/R	F/R	REMARKS	GSP Ref.	PRODUCT	ABS	Technical Specifications							
								A	B	C	H	L	P		
KIA															
CARNIVAL/GRAND CARNIVAL III (VQ)/SEDONA															
2.7 V6 (139 kW)	2006.06-	-	AT	-	F	MPV Engine G6EA	827075	Outer Joint	54T	31	26	56	102	66	M
	2006.06-	-	MT	R	F	MPV Engine G6EA	299278	Drive Shaft	54T	31	28	56	102	554	
	2006.06-	-	AT	L	F	MPV Engine G6EA	627020	Inner Joint		27	25	41	62	100.5	
	2006.06-	-	-	-	F	MPV Engine G6EA	834128	Outer Joint	54T	31	28	56	102	69.5	M
	2006.06-	-	MT	L	F	MPV Engine G6EA	299279	Drive Shaft	54T	31	28	56	102	663	
2.9 CRDi (136 kW)	2006.06-	-	AT	-	F	MPV Engine J3	827075	Outer Joint	54T	31	26	56	102	66	M
	2006.06-	-	MT	R	F	MPV Engine J3	299278	Drive Shaft	54T	31	28	56	102	554	
	2006.06-	-	AT	L	F	MPV Engine J3	234210	Drive Shaft	54T	31	28	56	102	661	
	2006.06-	-	MT	-	F	MPV Engine J3	834128	Outer Joint	54T	31	28	56	102	69.5	M
	2006.06-	-	MT	L	F	MPV Engine J3	299279	Drive Shaft	54T	31	28	56	102	663	
CEE'D (ED)															
1.4 (77 kW)	2006.12-	2012.12	-	-	F	Hatchback Engine G4FA	824077	Outer Joint	46T	27	22	60	94.5	54.5	M
	2006.12-	2012.12	MT	L	F	Hatchback Engine G4FA	624039	Inner Joint		25	22	41	61	100	
	2006.12-	2012.12	MT	R	F	Hatchback Engine G4FA	224399	Drive Shaft	46T	27	25	60	94.5	939	
1.4 (80 kW)	2006.12-	2012.12	-	-	F	Hatchback Engine G4FA	824077	Outer Joint	46T	27	22	60	94.5	54.5	M
	2006.12-	2012.12	MT	L	F	Hatchback Engine G4FA	624039	Inner Joint		25	22	41	61	100	
	2006.12-	2012.12	5MT	L/R	F	Hatchback Engine G4FA	824095	Outer Joint	46T	27	22	60	94.5	58.5	M
2006.12-	2012.12	MT	R	F	Hatchback Engine G4FA	224399	Drive Shaft	46T	27	25	60	94.5	939		
1.4 CVVT (66 kW)	2010.06-	2012.12	MT	L	F	Hatchback Engine G4FA-L	624039	Inner Joint		25	22	41	61	100	
1.6 (85 kW)	2007.09-	2012.12	-	-	F	Hatchback Engine G4FC	824077	Outer Joint	46T	27	22	60	94.5	54.5	M
	2007.09-	2012.12	-	L	F	Hatchback Engine G4FC	624039	Inner Joint		25	22	41	61	100	
	2007.09-	2012.12	MT	R	F	Hatchback Engine G4FC	224399	Drive Shaft	46T	27	25	60	94.5	939	
1.6 (90 kW)	2006.12-	2012.12	MT	R	F	Hatchback Engine G4FC	224399	Drive Shaft	46T	27	25	60	94.5	939	
	2006.12-	2012.12	-	-	F	Hatchback Engine G4FC	824077	Outer Joint	46T	27	22	60	94.5	54.5	M
	2006.12-	2012.12	-	L	F	Hatchback Engine G4FC	624039	Inner Joint		25	22	41	61	100	
	2006.12-	2012.12	-	L/R	F	Hatchback Engine G4FC	824095	Outer Joint	46T	27	22	60	94.5	58.5	M
1.6 (93 kW)	2008.02-	2012.12	MT	R	F	Hatchback Engine G4FC	224399	Drive Shaft	46T	27	25	60	94.5	939	
	2008.02-	2012.12	-	L	F	Hatchback Engine G4FC	624039	Inner Joint		25	22	41	61	100	
	2008.02-	2012.12	-	-	F	Hatchback Engine G4FC	824077	Outer Joint	46T	27	22	60	94.5	54.5	M
	2008.02-	2012.12	-	L/R	F	Hatchback Engine G4FC	824095	Outer Joint	46T	27	22	60	94.5	58.5	M
1.6 CRDi 115 (85 kW)	2006.12-	2012.12	MT	R	F	Hatchback Engine D4FB	239210	Drive Shaft	46T	27	27	60	94	945	
	2006.12-	2012.12	MT	L	F	Hatchback Engine D4FB	239263	Drive Shaft	46T	27	27	60	94	658	
	2006.12-	2012.12	AT	-	F	Hatchback Engine D4FB	824132	Outer Joint	46T	27	22	60	94.5	54.5	M
	2006.12-	2012.12	5MT	L/R	F	Hatchback Engine D4FB	824152	Outer Joint	46T	27	26	60	94	67	M
1.6 CRDi 128 (94 kW)	2010.10-	2012.12	MT	R	F	Hatchback Engine D4FB	239210	Drive Shaft	46T	27	27	60	94	945	
	2010.10-	2012.12	MT	L	F	Hatchback Engine D4FB	239263	Drive Shaft	46T	27	27	60	94	658	
	2010.10-	2012.12	AT	-	F	Hatchback Engine D4FB	824132	Outer Joint	46T	27	22	60	94.5	54.5	M
1.6 CRDi 90 (66 kW)	2006.12-	2012.12	MT	R	F	Hatchback Engine D4FB-L	239210	Drive Shaft	46T	27	27	60	94	945	
	2006.12-	2012.12	MT	L	F	Hatchback Engine D4FB-L	239263	Drive Shaft	46T	27	27	60	94	658	
	2006.12-	2012.12	AT	-	F	Hatchback Engine D4FB-L	824132	Outer Joint	46T	27	22	60	94.5	54.5	M
	2006.12-	2012.12	5MT	L/R	F	Hatchback Engine D4FB-L	824152	Outer Joint	46T	27	26	60	94	67	M
1.6 CVVT (92 kW)	2010.10-	2012.12	-	-	F	Hatchback Engine G4FC	824077	Outer Joint	46T	27	22	60	94.5	54.5	M
	2010.10-	2012.12	-	L	F	Hatchback Engine G4FC	624039	Inner Joint		25	22	41	61	100	
	2010.10-	2012.12	MT	R	F	Hatchback Engine G4FC	224399	Drive Shaft	46T	27	25	60	94.5	939	
2.0 (105 kW)	2006.12-	2012.12	MT	R	F	Hatchback Engine G4GC	239210	Drive Shaft	46T	27	27	60	94	945	
	2006.12-	2012.12	MT	L	F	Hatchback Engine G4GC	239263	Drive Shaft	46T	27	27	60	94	658	
	2006.12-	2012.12	-	-	F	Hatchback Engine G4GC	824132	Outer Joint	46T	27	22	60	94.5	54.5	M
	2006.12-	2012.12	-	L/R	F	Hatchback Engine G4GC	827080	Outer Joint	46T	27	23	60	95	58	M
2.0 CRDi (100 kW)	2007.06-	2012.12	-	L/R	F	Hatchback Engine D4EA	824152	Outer Joint	46T	27	26	60	94	67	M
2.0 CRDi 140 (103 kW)	2007.09-	2012.12	6MT	L/R	F	Hatchback Engine D4EA-F	824152	Outer Joint	46T	27	26	60	94	67	M
CEE'D (JD)															
1.4 CVVT (66 kW)	2012.05-	-	-	-	F	Hatchback Engine G4FA-L	824077	Outer Joint	46T	27	22	60	94.5	54.5	M
	2012.05-	-	MT	-	F	Hatchback Engine G4FA-L	824132	Outer Joint	46T	27	22	60	94.5	54.5	M
	2012.05-	-	MT	L	F	Hatchback Engine G4FA-L	639052	Inner Joint		25	22	41	63	86	
1.4 CVVT (73 kW)	2012.05-	-	-	-	F	Hatchback Engine G4FA	824077	Outer Joint	46T	27	22	60	94.5	54.5	M
	2012.05-	-	MT	-	F	Hatchback Engine G4FA	824132	Outer Joint	46T	27	22	60	94.5	54.5	M
	2012.05-	-	MT	L	F	Hatchback Engine G4FA	639052	Inner Joint		25	22	41	63	86	
1.4 MPI (74 kW)	2015.04-	-	-	-	F	Hatchback Engine G4LC	824077	Outer Joint	46T	27	22	60	94.5	54.5	M
	2015.04-	-	MT	-	F	Hatchback Engine G4LC	824132	Outer Joint	46T	27	22	60	94.5	54.5	M
	2015.04-	-	MT	L	F	Hatchback Engine G4LC	639052	Inner Joint		25	22	41	63	86	
1.6 CVVT (92 kW)	2012.05-	-	AT	-	F	Hatchback Engine G4FC	824227	Outer Joint	46T	27	24	60	92.5	58	M
	2012.05-	-	-	-	F	Hatchback Engine G4FC	824077	Outer Joint	46T	27	22	60	94.5	54.5	M
	2012.05-	-	MT	-	F	Hatchback Engine G4FC	824132	Outer Joint	46T	27	22	60	94.5	54.5	M
	2012.05-	-	MT	L	F	Hatchback Engine G4FC	639052	Inner Joint		25	22	41	63	86	
1.6 GDI (99 kW)	2012.05-	-	AT	-	F	Hatchback Engine G4FD	824227	Outer Joint	46T	27	24	60	92.5	58	M
	2012.05-	-	MT	-	F	Hatchback Engine G4FD	824132	Outer Joint	46T	27	22	60	94.5	54.5	M

YEAR	TRANSM	L/R	F/R	REMARKS	GSP Ref.	PRODUCT	ABS	Technical Specifications							
								A	B	C	H	L	P		
KIA															
CEE'D (JD)															
1.6 GDI (99 kW)	2012.05-	-	MT	L	F	Hatchback Engine G4FD	639052	Inner Joint		25	22	41	63	86	
1.6 GT (150 kW)	2013.06-	-	AT	-	F	Hatchback Engine G4FJ	824227	Outer Joint	46T	27	24	60	92.5	58	M
	2013.06-	-	MT	-	F	Hatchback Engine G4FJ	824132	Outer Joint	46T	27	22	60	94.5	54.5	M
	2013.06-	-	MT	L	F	Hatchback Engine G4FJ	639052	Inner Joint		25	22	41	63	86	
CEE'D Sportswagon (JD)															
1.4 CVVT (73 kW)	2012.09-	-	-	-	F	Estate Engine G4FA	824077	Outer Joint	46T	27	22	60	94.5	54.5	M
	2012.09-	-	MT	-	F	Estate Engine G4FA	824132	Outer Joint	46T	27	22	60	94.5	54.5	M
	2012.09-	-	MT	L	F	Estate Engine G4FA	639052	Inner Joint		25	22	41	63	86	
1.4 MPI (74 kW)	2015.04-	-	-	-	F	Estate Engine G4LC	824077	Outer Joint	46T	27	22	60	94.5	54.5	M
	2015.04-	-	MT	-	F	Estate Engine G4LC	824132	Outer Joint	46T	27	22	60	94.5	54.5	M
	2015.04-	-	MT	L	F	Estate Engine G4LC	639052	Inner Joint		25	22	41	63	86	
1.6 GDI (99 kW)	2012.09-	-	AT	-	F	Estate Engine G4FD	824227	Outer Joint	46T	27	24	60	92.5	58	M
	2012.09-	-	MT	-	F	Estate Engine G4FD	824132	Outer Joint	46T	27	22	60	94.5	54.5	M
	2012.09-	-	MT	L	F	Estate Engine G4FD	639052	Inner Joint		25	22	41	63	86	
CEE'D SW (ED)															
1.4 (77 kW)	2010.10-	2012.12	-	-	F	Estate Engine G4FA	824077	Outer Joint	46T	27	22	60	94.5	54.5	M
	2010.10-	2012.12	MT	L	F	Estate Engine G4FA	624039	Inner Joint		25	22	41	61	100	
	2010.10-	2012.12	MT	R	F	Estate Engine G4FA	224399	Drive Shaft	46T	27	25	60	94.5	939	
1.4 (80 kW)	2007.09-	2012.12	MT	R	F	Estate Engine G4FA	224399	Drive Shaft	46T	27	25	60	94.5	939	
	2007.09-	2012.12	-	-	F	Estate Engine G4FA	824077	Outer Joint	46T	27	22	60	94.5	54.5	M
	2007.09-	2012.12	MT	L	F	Estate Engine G4FA	624039	Inner Joint		25	22	41	61	100	
	2007.09-	2012.12	5MT	L/R	F	Estate Engine G4FA	824095	Outer Joint	46T	27	22	60	94.5	58.5	M
1.4 CVVT (66 kW)	2009.07-	2012.12	-	-	F	Estate Engine G4FA-L	824077	Outer Joint	46T	27	22	60	94.5	54.5	M
	2009.07-	2012.12	MT	L	F	Estate Engine G4FA-L	624039	Inner Joint		25	22	41	61	100	
	2009.07-	2012.12	MT	R	F	Estate Engine G4FA-L	224399	Drive Shaft	46T	27	25	60	94.5	939	
1.6 (85 kW)	2007.09-	2012.11	-	-	F	Estate Engine G4FC	824077	Outer Joint	46T	27	22	60	94.5	54.5	M
	2007.09-	2012.11	-	L	F	Estate Engine G4FC	624039	Inner Joint		25	22	41	61	100	
	2007.09-	2012.11	MT	R	F	Estate Engine G4FC	224399	Drive Shaft	46T	27	25	60	94.5	939	
1.6 (90 kW)	2007.09-	2012.12	MT	R	F	Estate Engine G4FC	224399	Drive Shaft	46T	27	25	60	94.5	939	
	2007.09-	2012.12	-	-	F	Estate Engine G4FC	824077	Outer Joint	46T	27	22	60	94.5	54.5	M
	2007.09-	2012.12	-	L	F	Estate Engine G4FC	624039	Inner Joint		25	22	41	61	100	
	2007.09-	2012.12	-	L/R	F	Estate Engine G4FC	824095	Outer Joint	46T	27	22	60	94.5	58.5	M
1.6 (93 kW)	2007.09-	2012.12	MT	R	F	Estate Engine G4FC	224399	Drive Shaft	46T	27	25	60	94.5	939	
	2007.09-	2012.12	-	L	F	Estate Engine G4FC	624039	Inner Joint		25	22	41	61	100	
	2007.09-	2012.12	-	-	F	Estate Engine G4FC	824077	Outer Joint	46T	27	22	60	94.5	54.5	M
	2007.09-	2012.12	-	L/R	F	Estate Engine G4FC	824095	Outer Joint	46T	27	22	60	94.5	58.5	M
1.6 CRDi 115 (85 kW)	2007.09-	2012.12	MT	R	F	Estate Engine D4FB	239210	Drive Shaft	46T	27	27	60	94	945	
	2007.09-	2012.12	MT	L	F	Estate Engine D4FB	239263	Drive Shaft	46T	27	27	60	94	658	
	2007.09-	2012.12	AT	-	F	Estate Engine D4FB	824132	Outer Joint	46T	27	22	60	94.5	54.5	M
	2007.09-	2012.12	5MT	L/R	F	Estate Engine D4FB	824152	Outer Joint	46T	27	26	60	94	67	M
1.6 CRDi 128 (94 kW)	2010.10-	2012.12	MT	R	F	Estate Engine D4FB	239210	Drive Shaft	46T	27	27	60	94	945	
	2010.10-	2012.12	MT	L	F	Estate Engine D4FB	239263	Drive Shaft	46T	27	27	60	94	658	
	2010.10-	2012.12	AT	-	F	Estate Engine D4FB	824132	Outer Joint	46T	27	22	60	94.5	54.5	M
1.6 CRDi 90 (66 kW)	2007.09-	2012.12	MT	R	F	Estate Engine D4FB-L	239210	Drive Shaft	46T	27	27	60	94	945	
	2007.09-	2012.12	MT	L	F	Estate Engine D4FB-L	239263	Drive Shaft	46T	27	27	60	94	658	
	2007.09-	2012.12	AT	-	F	Estate Engine D4FB-L	824132	Outer Joint	46T	27	22	60	94.5	54.5	M
	2007.09-	2012.12	5MT	L/R	F	Estate Engine D4FB-L	824152	Outer Joint	46T	27	26	60	94	67	M
1.6 CVVT (92 kW)	2009.06-	2012.12	-	-	F	Estate Engine G4FC	824077	Outer Joint	46T	27	22	60	94.5	54.5	M
	2009.06-	2012.12	-	L	F	Estate Engine G4FC	624039	Inner Joint		25	22	41	61	100	
	2009.06-	2012.12	MT	R	F	Estate Engine G4FC	224399	Drive Shaft	46T	27	25	60	94.5	939	
2.0 (105 kW)	2007.09-	2012.12	-	L/R	F	Estate Engine G4GC	827080	Outer Joint	46T	27	23	60	95	58	M
	2007.09-	2012.12	-	-	F	Estate Engine G4GC	824132	Outer Joint	46T	27	22	60	94.5	54.5	M
2.0 CRDi 140 (103 kW)	2007.09-	2012.12	6MT	L/R	F	Estate Engine D4EA-F	824152	Outer Joint	46T	27	26	60	94	67	M
CEED (CD)															
1.4 T-GDI(103 kW)	2018.03-	-	MT	L	F	Hatchback Engine G4LD	639052	Inner Joint		25	22	41	63	86	
	2018.03-	-	MT	-	F	Hatchback Engine G4LD	824132	Outer Joint	46T	27	22	60	94.5	54.5	M
1.4(73 kW)	2018.03-	-	MT	L	F	Hatchback Engine G4LC	639052	Inner Joint		25	22	41	63	86	
	2018.03-	-	MT	-	F	Hatchback Engine G4LC	824132	Outer Joint	46T	27	22	60	94.5	54.5	M
CERATO															
1.6 2WD	2008-	2009	5MT/6AT	L	-	GAMMA DOHC MPI	227143	Drive Shaft	46T	27	25	60	94.5	671	
	2008-	2009	5MT/6AT	R	-	GAMMA DOHC MPI	227142	Drive Shaft	46T	27	25	60	94.5	943	
CERATO (LD)															
1.5 CRDi (75 kW)	2005.07-	-	-	-	F	Hatchback Engine D4FA	824139	Outer Joint	44T	27	24	60	90	63	M
	2005.07-	-	-	-	-	Hatchback Engine D4FA	827055	Outer Joint	44T	27	24	60	90	63	M
	2005.07-	-	MT	L	F	Hatchback Engine D4FA	627018	Inner Joint		27	24	41	61.5	100.5	
1.6 (77 kW)	2004.07-	-	-	-	-	Hatchback Engine G4ED	827063	Outer Joint		25	22	50	89	60	M





	 YEAR	TRANSM	L/R	F/R	REMARKS	GSP Ref.	 PRODUCT	 ABS	Technical Specifications					
									A	B	C	H	L	P
KIA														
CERATO (LD)														
1.6 (77 kW)	2004.07-	-	AT	-	F Hatchback Engine G4ED	824227	Outer Joint	46T	27	24	60	92.5	58	M
	2004.07-	-	-	-	Hatchback Engine G4ED	824089	Outer Joint	44T	25	22	50	91	57	M
	2004.07-	-	AT/MT	-	F Hatchback Engine G4ED	899294	Outer Joint	44T	25	22	50	90	60	M
	2004.07-	-	4AT	L	F Hatchback Engine G4ED	627018	Inner Joint		27	24	41	61.5	100.5	
	2004.07-	-	-	-	F Hatchback Engine G4ED	827066	Outer Joint	44T	25	22	50	89	60	M
	2004.07-	-	-	-	F Hatchback Engine G4ED	824132	Outer Joint	46T	27	22	60	94.5	54.5	M
	2004.07-	-	AT	L	F Hatchback Engine G4ED	227168	Drive Shaft	44T	25	25	50	89	645	
	2004.07-	-	AT	R	F Hatchback Engine G4ED	227169	Drive Shaft	44T	25	25	50	89	931	
1.6 CRDi (85 kW)	2005.06-	-	-	-	F Hatchback Engine D4FB	824139	Outer Joint	44T	27	24	60	90	63	M
	2005.06-	-	-	-	Hatchback Engine D4FB	827055	Outer Joint	44T	27	24	60	90	63	M
	2005.06-	-	4AT	L	F Hatchback Engine D4FB	627018	Inner Joint		27	24	41	61.5	100.5	
	2005.06-	-	-	-	F Hatchback Engine D4FB	827066	Outer Joint	44T	25	22	50	89	60	M
2.0 (105 kW)	2004.04-	-	MT	R	F Hatchback Engine G4GC	627025	Inner Joint		25	24	35	62	100	
	2004.04-	-	AT	-	F Hatchback Engine G4GC	824227	Outer Joint	46T	27	24	60	92.5	58	M
	2004.04-	-	MT	L	F Hatchback Engine G4GC	227131	Drive Shaft	44T	25	25	50	90	647	
	2004.04-	-	AT	L	F Hatchback Engine G4GC	627018	Inner Joint		27	24	41	61.5	100.5	
	2004.04-	-	MT	R	F Hatchback Engine G4GC	227130	Drive Shaft	44T	25	25	50	90	928	
	2004.04-	-	AT	-	F Hatchback Engine G4GC	827073	Outer Joint	44T	25	24	50	90	63	M
	2004.04-	-	-	-	F Hatchback Engine G4GC	824132	Outer Joint	46T	27	22	60	94.5	54.5	M
2.0 CRDi (83 kW)	2004.04-	-	4AT	L	F Hatchback Engine D4EA	627018	Inner Joint		27	24	41	61.5	100.5	
CERATO (LD)/SPECTRA														
1.5 CRDi (75 kW)	2005.07-	-	-	-	F Saloon Engine D4FA	824139	Outer Joint	44T	27	24	60	90	63	M
	2005.07-	-	-	-	Saloon Engine D4FA	827055	Outer Joint	44T	27	24	60	90	63	M
	2005.07-	-	MT	L	F Saloon Engine D4FA	627018	Inner Joint		27	24	41	61.5	100.5	
1.6 (77 kW)	2004.04-	-	-	-	Saloon Engine G4ED	827063	Outer Joint		25	22	50	89	60	M
	2004.04-	-	AT	-	F Saloon Engine G4ED	824227	Outer Joint	46T	27	24	60	92.5	58	M
	2004.04-	-	-	-	Saloon Engine G4ED	824089	Outer Joint	44T	25	22	50	91	57	M
	2004.04-	-	-	-	F Saloon Engine G4ED	899294	Outer Joint	44T	25	22	50	90	60	M
	2004.04-	-	4AT	L	F Saloon Engine G4ED	627018	Inner Joint		27	24	41	61.5	100.5	
	2004.04-	-	-	-	F Saloon Engine G4ED	827066	Outer Joint	44T	25	22	50	89	60	M
	2004.04-	-	-	-	F Saloon Engine G4ED	824132	Outer Joint	46T	27	22	60	94.5	54.5	M
	2004.04-	-	AT	L	F Saloon Engine G4ED	227168	Drive Shaft	44T	25	25	50	89	645	
	2004.04-	-	AT	R	F Saloon Engine G4ED	227169	Drive Shaft	44T	25	25	50	89	931	
	2004.04-	-	MT	L	F Saloon Engine G4ED	639052	Inner Joint		25	22	41	63	86	
1.6 (90 kW)	2006.05-	-	AT	-	F Saloon Engine G4FC	824227	Outer Joint	46T	27	24	60	92.5	58	M
	2006.05-	-	4AT	L	F Saloon Engine G4FC	627018	Inner Joint		27	24	41	61.5	100.5	
	2006.05-	-	-	-	F Saloon Engine G4FC	827066	Outer Joint	44T	25	22	50	89	60	M
	2006.05-	-	-	-	F Saloon Engine G4FC	824132	Outer Joint	46T	27	22	60	94.5	54.5	M
	2006.05-	-	MT	L	F Saloon Engine G4FC	639052	Inner Joint		25	22	41	63	86	
1.6 CRDi (85 kW)	2005.06-	-	-	-	F Saloon Engine D4FB	824139	Outer Joint	44T	27	24	60	90	63	M
	2005.06-	-	-	-	Saloon Engine D4FB	827055	Outer Joint	44T	27	24	60	90	63	M
	2005.06-	-	4AT	L	F Saloon Engine D4FB	627018	Inner Joint		27	24	41	61.5	100.5	
	2005.06-	-	-	-	F Saloon Engine D4FB	827066	Outer Joint	44T	25	22	50	89	60	M
2.0 (105 kW)	2004.04-	-	AT	-	F Saloon Engine G4GC	824227	Outer Joint	46T	27	24	60	92.5	58	M
	2004.04-	-	AT	L	F Saloon Engine G4GC	627018	Inner Joint		27	24	41	61.5	100.5	
	2004.04-	-	MT	L	F Saloon Engine G4GC	227131	Drive Shaft	44T	25	25	50	90	647	
	2004.04-	-	MT	R	F Saloon Engine G4GC	227130	Drive Shaft	44T	25	25	50	90	928	
	2004.04-	-	AT	-	F Saloon Engine G4GC	827073	Outer Joint	44T	25	24	50	90	63	M
	2004.04-	-	-	-	F Saloon Engine G4GC	824132	Outer Joint	46T	27	22	60	94.5	54.5	M
	2004.04-	-	MT	R	F Saloon Engine G4GC	627025	Inner Joint		25	24	35	62	100	
2.0 CRDi (83 kW)	2004.04-	-	4AT	L	F Saloon Engine D4EA	627018	Inner Joint		27	24	41	61.5	100.5	
CERATO II (TD)/K3														
1.6 (93 kW)	2010.01-	-	AT	-	F Saloon Engine G4FC	824227	Outer Joint	46T	27	24	60	92.5	58	M
	2010.01-	-	-	-	F Saloon Engine G4FC	824132	Outer Joint	46T	27	22	60	94.5	54.5	M
	2010.01-	-	MT	L	F Saloon Engine G4FC	639052	Inner Joint		25	22	41	63	86	
CERATO KOUP (TD)/K3														
1.6 CVVT (150 kW)	2013.09-	-	MT	L	F Coupe Engine G4FJ	639052	Inner Joint		25	22	41	63	86	
	2013.09-	-	AT	-	F Coupe Engine G4FJ	824227	Outer Joint	46T	27	24	60	92.5	58	M
CERATO KOUP/K3 KOUP														
1.6 GDI (103 kW)	2013.12-	-	6AT	L	F Coupe Engine G4FD	201148	Drive Shaft	46T	27	28	60	95	666	
	2013.12-	-	6AT	R	F Coupe Engine G4FD	201152	Drive Shaft	46T	27	28	60	95	616	
	2013.12-	-	6MT	L	F Coupe Engine G4FD	224559	Drive Shaft		27	25	60	94.5	689	
CERATO/K3 EURO														
1.6 GDI (103 kW)	2012.09-	-	6MT	L	F Hatchback Engine G4FD	224559	Drive Shaft		27	25	60	94.5	689	
CLARUS														

	 YEAR	TRANSM	L/R	F/R	REMARKS	GSP Ref.	 PRODUCT	 ABS	Technical Specifications						
									A	B	C	H	L	P	
KIA															
CLARUS															
1.0	2001.01-	2003.12	MT/AT	-	-	Engine	827013	Outer Joint		28	24	56	102	60	M
1000	2001.01-	2003.12	MT/AT	-	-	Engine	827013	Outer Joint		28	24	56	102	60	M
CLARUS (GC)/CREDOS															
1.8 i 16V (85 kW)	1998.05-	-	-	-	F	Estate Engine T8	827029	Outer Joint	46T	28	24	56	90	60	M
	1998.05-	-	MT	L/R	F	Estate Engine T8	827010	Outer Joint		28	24	56	90	60	M
	1998.05-	-	MT	L	F	Estate Engine T8	227071	Drive Shaft	46T	28	24	56	90	624	
	1998.05-	-	MT	R	F	Estate Engine T8	227070	Drive Shaft	46T	28	28	56	90	618.5	
2.0 i 16V (98 kW)	1998.05-	-	-	-	F	Estate Engine FE (16V)	827029	Outer Joint	46T	28	24	56	90	60	M
	1998.05-	-	MT	L/R	F	Estate Engine FE (16V)	827010	Outer Joint		28	24	56	90	60	M
	1998.05-	-	-	L	F	Estate Engine FE (16V)	227071	Drive Shaft	46T	28	24	56	90	624	
	1998.05-	-	-	R	F	Estate Engine FE (16V)	227070	Drive Shaft	46T	28	28	56	90	618.5	
CLARUS (K9A)/CREDOS															
1.8 i 16V (85 kW)	1996.07-	2001.08	MT	L/R	F	Saloon Engine T8	827010	Outer Joint		28	24	56	90	60	M
2.0 i 16V (98 kW)	1996.07-	2001.11	MT	L/R	F	Saloon Engine FE (16V)	827010	Outer Joint		28	24	56	90	60	M
CREDOS															
1.8	1995-	-	-	R	-	-	227033	Drive Shaft		28	28	56	90	635.5	
K5															
2.0 L	2015-	2018	-	R	F	-	201175	Drive Shaft	48T	30	27	73	95	955	
MAGENTIS															
-	2001-	2005	-	-	F	6 Cyl	627001	Inner Joint		27	25	41	62.5	93	
	2001-	2005	-	L	-	6 Cyl	224094	Drive Shaft	47T	27	27	60	96.5	661	
MAGENTIS (GD MS)/OPTIMA/REGAL															
2.0 (100 kW)	2001.05-	2005.09	MT	L	F	Saloon Engine G4JP	224158	Drive Shaft	47T	27	27	60	95	660	
	2001.05-	2005.09	MT	R	F	Saloon Engine G4JP	224058	Drive Shaft	47T	27	27	60	95	976.5	
2.5 V6 (124 kW)	2001.05-	-	-	L	F	Saloon Engine G6BV	627020	Inner Joint		27	25	41	62	100.5	
	2001.05-	-	MT	L/R	F	Saloon Engine G6BV	824066	Outer Joint	47T	27	26	60	95	69	M
	2001.05-	-	MT	L	F	Saloon Engine G6BV	224158	Drive Shaft	47T	27	27	60	95	660	
	2001.05-	-	MT	R	F	Saloon Engine G6BV	224058	Drive Shaft	47T	27	27	60	95	976.5	
	2001.05-	-	4AT	-	F	Saloon Engine G6BV	824027	Outer Joint	47T	27	23	60	95	63.5	M
MAGENTIS (MG)/LOTZE															
2.0 (106 kW)	2005.11-	-	-	-	F	Saloon Engine G4KA	827067	Outer Joint	48T	27	24	62.1	95	63	M
	2005.11-	-	-	-	-	Saloon Engine G4KA	824206	Outer Joint	48T	27	24	62	90.5	64	M
	2005.11-	-	-	-	F	Saloon Engine G4KA	824049	Outer Joint	48T	27	25	62.2	95	60	M
2.0 (121 kW)	2009.07-	-	-	-	F	Saloon Engine G4KD	827067	Outer Joint	48T	27	24	62.1	95	63	M
	2009.07-	-	-	-	-	Saloon Engine G4KD	824206	Outer Joint	48T	27	24	62	90.5	64	M
2.0 CRDi (100 kW)	2005.11-	2008.12	4AT/5MT	-	F	Saloon Engine D4EA	827067	Outer Joint	48T	27	24	62.1	95	63	M
	2005.11-	2008.12	-	-	F	Saloon Engine D4EA	824049	Outer Joint	48T	27	25	62.2	95	60	M
2.0 CRDi (103 kW)	2006.04-	-	4AT/5MT	-	F	Saloon Engine D4EA	827067	Outer Joint	48T	27	24	62.1	95	63	M
	2006.04-	-	-	-	F	Saloon Engine D4EA	824049	Outer Joint	48T	27	25	62.2	95	60	M
2.0 CRDi (110 kW)	2006.04-	-	4AT/5MT	-	F	Saloon Engine D4EA	827067	Outer Joint	48T	27	24	62.1	95	63	M
	2006.04-	-	-	-	F	Saloon Engine D4EA	824049	Outer Joint	48T	27	25	62.2	95	60	M
2.7 (138 kW)	2005.11-	-	AT	R	F	Saloon Engine G6EA	624041	Inner Joint		28	25	42	43	75	
2.7 V6 (142 kW)	2009.07-	-	AT	R	F	Saloon Engine G6EA	624041	Inner Joint		28	25	42	43	75	
MENTOR															
-	1998.05-	2001.05	MT	L	-	-	227049	Drive Shaft		26	28	56	92	615.5	
OPIRUS															
3.8	2007-	2010	-	L	F	-	227203	Drive Shaft	47T	30	28	65	94.5	655	
	2007-	2010	-	R	F	-	227204	Drive Shaft	47T	30	28	65	94.5	595	
OPIRUS (GH)															
3.5 (149 kW)	2003.09-	-	AT	-	F	Saloon Engine G6CU	827056	Outer Joint	47T	27	26	60	97	69	M
	2003.09-	-	AT	L	-	Saloon Engine G6CU	227074	Drive Shaft	47T	27	28	60	97	652	
	2003.09-	-	AT	R	-	Saloon Engine G6CU	227136	Drive Shaft	47T	27	28	60	97	609	
OPTIMA															
-	2000-	2004	AT	-	-	-	624008	Inner Joint		25	23	41	63	92.5	
	2001-	-	-	L	-	-	227001	Drive Shaft		27	27	60	95	659	
	2001-	-	-	R	-	-	227002	Drive Shaft		27	27	60	95	974	
	2001-	2002	-	L	-	-	224094	Drive Shaft	47T	27	27	60	96.5	661	
2.0 L	2015-	2018	-	R	F	-	201175	Drive Shaft	48T	30	27	73	95	955	
2.7	2003-	2006	AT	-	-	6 Cyl	627001	Inner Joint		27	25	41	62.5	93	
	2003-	2006	AT	L	-	6 Cyl	224094	Drive Shaft	47T	27	27	60	96.5	661	
OPTIMA/K5															
1.7 CRDi (100 kW)	2012.03-	-	-	-	-	Saloon Engine D4FD-L	827069	Outer Joint	47T	27	24	62.1	95	63	M
2.0 (125 kW)	2012.03-	-	AT	-	F	Saloon Engine G4KD	824090	Outer Joint	48T	27	25	61.9	95	61	M
	2012.03-	-	AT	L	F	Saloon Engine G4KD	624056	Inner Joint		27	25	30	67	83.5	
2.0 CVVL (121 kW)	2012.03-	-	AT	-	F	Saloon Engine G4KD	824090	Outer Joint	48T	27	25	61.9	95	61	M
	2012.03-	-	AT	L	F	Saloon Engine G4KD	624056	Inner Joint		27	25	30	67	83.5	

	 YEAR	TRANSM	L/R	F/R	REMARKS	GSP Ref.	 PRODUCT	 ABS	Technical Specifications					
									A	B	C	H	L	P
KIA														
OPTIMA/K5														
2.0 CVVT Hybrid (140 kW)	2012.12-	-	AT	-	F Saloon	824090	Outer Joint	48T	27	25	61.9	95	61	M
	2012.12-	-	AT	L	F Saloon	624056	Inner Joint		27	25	30	67	83.5	
2.0 GDI Hybrid (115 kW)	2016.09-	-	-	L	F Saloon Engine G4NG	801064	Outer Joint	48T	30	36	73	94.5	67.5	I
	2016.09-	-	-	L	F Saloon Engine G4NG	201167	Drive Shaft	48T	30	28	73	94.5	656	
2.0 GDI Hybrid (151 kW)	2016.09-	-	-	L	F Saloon Engine G4NG	801064	Outer Joint	48T	30	36	73	94.5	67.5	I
	2016.09-	-	-	L	F Saloon Engine G4NG	201167	Drive Shaft	48T	30	28	73	94.5	656	
2.0 Hybrid (110 kW)	2012.03-	-	AT	-	F Saloon Engine G4NE	824090	Outer Joint	48T	27	25	61.9	95	61	M
	2012.03-	-	AT	L	F Saloon Engine G4NE	624056	Inner Joint		27	25	30	67	83.5	
2.0 LPI (106 kW)	2010.04-2015.12		6AT	R	F Saloon Engine G4KD	201171	Drive Shaft	48T	30	28	65	93	588	
	2010.04-2015.12		6AT	L	F Saloon Engine G4KD	201172	Drive Shaft	48T	30	28	65	93	663	
2.0 T-GDi (180 kW)	2015.09-	-	-	R	F Saloon Engine G4KH	601096	Inner Joint		28	33	42		129	
	2015.09-	-	-	R	F Saloon Engine G4KH	201168	Drive Shaft	48T	30	28	73	94.5	594	
2.4 GDI (138 kW)	2015.09-	-	6AT	L	F Saloon Engine G4KJ	824299	Outer Joint	48T	30	25	73	95	61.5	M
	2015.09-	-	6AT	L	F Saloon Engine G4KJ	201174	Drive Shaft	48T	30	27	73	95	690	
2.4 Hybrid (154 kW)	2011.09-	-	-	L	F Saloon	624100	Inner Joint		28	25	33	67.5	83.5	
	2011.09-	-	-	L	F Saloon	201173	Drive Shaft	48T	27	28	62	92.5	639	
PICANTO														
1.0 2WD	2004-2007		5MT	L	- SOHC MPI	234169	Drive Shaft	48T	24		52.5	86.5	557	
	2004-2007		4AT	R	- SOHC MPI	234167	Drive Shaft	48T	24		52.5	86.5	807	
	2004-2007		4AT	L	- SOHC MPI	234168	Drive Shaft	48T	24		52.5	86.5	533	
1.1 CRDi	2005-	-	-	-	-	827107	Outer Joint		24	20	52.5	86.5	52	M
1.2	2011-	-	MT	L	F -	834157	Outer Joint		24	20	52.5	86.5	52	M
PICANTO (BA)/MORNING														
1.0 (45 kW)	2004.04-	-	-	-	F Hatchback Engine G4HE	827072	Outer Joint	48T	24	20	52.5	85.5	51	M
	2004.04-	-	MT	L	F Hatchback Engine G4HE	227132	Drive Shaft	48T	24	25	52.5	86.5	631	
	2004.04-	-	MT	R	F Hatchback Engine G4HE	299216	Drive Shaft	48T	24	25	52.5	86.5	853	
	2004.04-	-	MT	L	F Hatchback Engine G4HE	624019	Inner Joint		25	20	35	54.5	82.5	
	2004.04-	-	-	-	F Hatchback Engine G4HE	899300	Outer Joint	48T	24	20	52.5	86.5	52	M
	2004.04-	-	-	-	F Hatchback Engine G4HE	827077	Outer Joint		24	20	52.5	85.5	51	M
	2004.04-	-	-	-	F Hatchback Engine G4HE	827019	Outer Joint		24	20	52.5	86.5	52	M
	2004.04-	-	AT	L	F Hatchback Engine G4HE	227207	Drive Shaft	48T	24	25	52.5	86.5	606	
	2004.04-	-	AT	R	F Hatchback Engine G4HE	227206	Drive Shaft	48T	24	25	52.5	86.5	876	
	2004.04-	-	-	L/R	F Hatchback Engine G4HE	834156	Outer Joint	48T	24	20	52.5	86.5	52	M
	2004.04-	-	MT	R	F Hatchback Engine G4HE	827074	Outer Joint		24	20	52.5	86.5	52	M
	1.0 (46 kW)	2007.09-	-	-	-	F Hatchback Engine G4HE	827072	Outer Joint	48T	24	20	52.5	85.5	51
2007.09-		-	MT	L	F Hatchback Engine G4HE	227132	Drive Shaft	48T	24	25	52.5	86.5	631	
2007.09-		-	MT	R	F Hatchback Engine G4HE	299216	Drive Shaft	48T	24	25	52.5	86.5	853	
2007.09-		-	MT	L	F Hatchback Engine G4HE	624019	Inner Joint		25	20	35	54.5	82.5	
2007.09-		-	-	-	F Hatchback Engine G4HE	899300	Outer Joint	48T	24	20	52.5	86.5	52	M
2007.09-		-	-	-	F Hatchback Engine G4HE	827019	Outer Joint		24	20	52.5	86.5	52	M
2007.09-		-	-	L/R	F Hatchback Engine G4HE	834156	Outer Joint	48T	24	20	52.5	86.5	52	M
1.0 (53 kW)	2004.04-2011.04		-	-	F Hatchback Engine G4HC	827077	Outer Joint		24	20	52.5	85.5	51	M
1.1 (48 kW)	2004.04-	-	-	-	F Hatchback Engine G4HG	827072	Outer Joint	48T	24	20	52.5	85.5	51	M
	2004.04-	-	MT	L	F Hatchback Engine G4HG	227132	Drive Shaft	48T	24	25	52.5	86.5	631	
	2004.04-	-	MT	R	F Hatchback Engine G4HG	299216	Drive Shaft	48T	24	25	52.5	86.5	853	
	2004.04-	-	MT	L	F Hatchback Engine G4HG	624019	Inner Joint		25	20	35	54.5	82.5	
	2004.04-	-	-	-	F Hatchback Engine G4HG	899300	Outer Joint	48T	24	20	52.5	86.5	52	M
	2004.04-	-	-	-	F Hatchback Engine G4HG	827077	Outer Joint		24	20	52.5	85.5	51	M
	2004.04-	-	-	-	F Hatchback Engine G4HG	827019	Outer Joint		24	20	52.5	86.5	52	M
	2004.04-	-	AT	L	F Hatchback Engine G4HG	227207	Drive Shaft	48T	24	25	52.5	86.5	606	
	2004.04-	-	AT	R	F Hatchback Engine G4HG	227206	Drive Shaft	48T	24	25	52.5	86.5	876	
	2004.04-	-	-	L/R	F Hatchback Engine G4HG	834156	Outer Joint	48T	24	20	52.5	86.5	52	M
	2004.04-	-	MT	R	F Hatchback Engine G4HG	827074	Outer Joint		24	20	52.5	86.5	52	M
1.1 CRDi (55 kW)	2005.11-	-	-	-	F Hatchback Engine D3FA	834094	Outer Joint	48T	24	21	52.5	86.5	54.5	M
	2005.11-	-	-	-	F Hatchback Engine D3FA	827077	Outer Joint		24	20	52.5	85.5	51	M
	2005.11-	-	-	-	F Hatchback Engine D3FA	827019	Outer Joint		24	20	52.5	86.5	52	M
	2005.11-	-	-	-	F Hatchback Engine D3FA	834146	Outer Joint	48T	24	21	52.5	86	63.5	M
PICANTO (TA)/MORNING														
1.0 (51 kW)	2011.05-	-	MT	L	F Hatchback Engine G3LA	234257	Drive Shaft	48T	24	25	52.5	86.5	609	
1.0 Bi-Fuel (60 kW)	2011.05-	-	MT	L	F Hatchback Engine B3LA	234257	Drive Shaft	48T	24	25	52.5	86.5	609	
1.2 (63 kW)	2011.09-	-	MT	L	F Hatchback Engine G4LA	234257	Drive Shaft	48T	24	25	52.5	86.5	609	
	2011.09-	-	MT	R	F Hatchback Engine G4LA	234171	Drive Shaft	48T	24	25	52.5	86.5	882	
PICANTO 11														
1.0	2011-	-	4AT	L	F ENGINE:G3LA/G4LA/B3LA	227227	Drive Shaft	48T	24	25	52.5	86.5	603	
	2011-	-	4AT	L	F ENGINE:G3LA/G4LA/B3LA	834157	Outer Joint		24	20	52.5	86.5	52	M
PICANTO/MORNING														

YEAR	TRANSM	L/R	F/R	REMARKS	GSP Ref.	PRODUCT	ABS	Technical Specifications							
								A	B	C	H	L	P		
KIA															
PICANTO/MORNING															
1.0	2015-	-	4AT	R	F	2WD	227225	Drive Shaft	48T	24	25	52.5	86.5	890	
	2015-	-	4AT	R	F	2WD	834157	Outer Joint		24	20	52.5	86.5	52	M
1.2	2011-	2016	4AT	L	F	2WD	827111	Outer Joint		24	21	52.5	86.5	54.5	M
	2011-	2016	4AT	R	F	2WD	834141	Outer Joint		24	21	52.5	86.5	54.5	M
	2011-	2016	4AT	L	F	2WD	227208	Drive Shaft		24	25	52.5	86.5	604	
	2011-	2016	4AT	R	F	2WD	227191	Drive Shaft	48T	24	25	52.5	86.5	893	
	2011-	2016	4AT	L	F	2WD	624050	Inner Joint		25	21	35	54	83.5	
	2011-	2016	4AT	R	F	2WD	624050	Inner Joint		25	21	35	54	83.5	
	2015-	-	4AT	L	F	2WD	827125	Outer Joint		24	21	52.5	86	56	M
	2015-	-	4AT	R	F	2WD	827125	Outer Joint		24	21	52.5	86	56	M
	2015-	-	4AT	L	F	2WD	227226	Drive Shaft	48T	24	25	52.5	86	602	
2015-	-	4AT	R	F	2WD	227224	Drive Shaft	48T	24	25	52.5	86	890		
PRIDE															
-	-	-	AT	R	-	Hatchbackback Engine B1	227108	Drive Shaft		24	24	52	86.5	881	
	-	-	AT	L	-	Hatchbackback Engine B1	227109	Drive Shaft		24	24	52	86.5	597	
1.3 (47 kW)	1999.08-	2001.05	MT	R	F	Estate Engine B3A5	227042	Drive Shaft		24	22	52	86	880	
	1999.08-	2001.05	MT	L	F	Estate Engine B3A5	618007	Inner Joint		22	20	35	59	82	
	1999.08-	2001.05	MT	-	F	Estate Engine B3A5	818030	Outer Joint		24	19	52	86	50.5	M
	1999.08-	2001.05	MT	L	F	Estate Engine B3A5	227040	Drive Shaft		24	22	52	86	605.4	
	1999.08-	2001.05	-	-	F	Estate Engine B3A5	834018	Outer Joint		24	21	52	86	50	M
PRIDE (DA)															
1.1 i (38 kW)	1991.01-	2000.10	MT	R	F	Hatchback Engine B1	227042	Drive Shaft		24	22	52	86	880	
	1991.01-	2000.10	MT	-	F	Hatchback Engine B1	827005	Outer Joint		24	19	52	86	50.5	O
	1991.01-	2000.10	MT	L	F	Hatchback Engine B1	618007	Inner Joint		22	20	35	59	82	
	1991.01-	2000.10	MT	-	F	Hatchback Engine B1	818030	Outer Joint		24	19	52	86	50.5	M
	1991.01-	2000.10	MT	L	F	Hatchback Engine B1	227040	Drive Shaft		24	22	52	86	605.4	
	1991.01-	2000.10	-	-	F	Hatchback Engine B1	834018	Outer Joint		24	21	52	86	50	M
1.3 (54 kW)	1994.05-	1997.05	-	-	-	Hatchback	827003	Outer Joint		24	21	52	86	54.5	I
	1994.05-	1997.05	-	-	F	Hatchback	834018	Outer Joint		24	21	52	86	50	M
1.3 16V (44 kW)	1990.01-	2000.10	-	-	-	Hatchback Engine B3	827003	Outer Joint		24	21	52	86	54.5	I
	1990.01-	2000.10	MT	R	F	Hatchback Engine B3	227042	Drive Shaft		24	22	52	86	880	
	1990.01-	2000.10	MT	-	F	Hatchback Engine B3	827005	Outer Joint		24	19	52	86	50.5	O
	1990.01-	2000.10	MT	L	F	Hatchback Engine B3	618007	Inner Joint		22	20	35	59	82	
	1990.01-	2000.10	MT	-	F	Hatchback Engine B3	818030	Outer Joint		24	19	52	86	50.5	M
	1990.01-	2000.10	MT	L	F	Hatchback Engine B3	227040	Drive Shaft		24	22	52	86	605.4	
	1990.01-	2000.10	-	-	F	Hatchback Engine B3	834018	Outer Joint		24	21	52	86	50	M
	1990.01-	2000.10	-	-	F	Hatchback Engine B3	818033	Outer Joint		24	20	52	86	50.5	M
1.3 16V (47 kW)	1996.10-	2001.05	-	-	-	Hatchback Engine B3	827003	Outer Joint		24	21	52	86	54.5	I
	1996.10-	2001.05	MT	R	F	Hatchback Engine B3	227042	Drive Shaft		24	22	52	86	880	
	1996.10-	2001.05	MT	L	F	Hatchback Engine B3	618007	Inner Joint		22	20	35	59	82	
	1996.10-	2001.05	MT	-	F	Hatchback Engine B3	818030	Outer Joint		24	19	52	86	50.5	M
	1996.10-	2001.05	MT	L	F	Hatchback Engine B3	227040	Drive Shaft		24	22	52	86	605.4	
	1996.10-	2001.05	-	-	F	Hatchback Engine B3	834018	Outer Joint		24	21	52	86	50	M
1.3 16V (53 kW)	1990.01-	2001.09	-	-	-	Hatchback Engine B3	827003	Outer Joint		24	21	52	86	54.5	I
	1990.01-	2001.09	MT	R	F	Hatchback Engine B3	227042	Drive Shaft		24	22	52	86	880	
	1990.01-	2001.09	MT	-	F	Hatchback Engine B3	827005	Outer Joint		24	19	52	86	50.5	O
	1990.01-	2001.09	MT	L	F	Hatchback Engine B3	618007	Inner Joint		22	20	35	59	82	
	1990.01-	2001.09	MT	-	F	Hatchback Engine B3	818030	Outer Joint		24	19	52	86	50.5	M
	1990.01-	2001.09	MT	L	F	Hatchback Engine B3	227040	Drive Shaft		24	22	52	86	605.4	
	1990.01-	2001.09	-	-	F	Hatchback Engine B3	834018	Outer Joint		24	21	52	86	50	M
	1990.01-	2001.09	-	-	F	Hatchback Engine B3	818033	Outer Joint		24	20	52	86	50.5	M
1.3 i (51 kW)	1990.01-	1997.05	-	-	-	Hatchback	827003	Outer Joint		24	21	52	86	54.5	I
	1990.01-	1997.05	MT	R	F	Hatchback	227042	Drive Shaft		24	22	52	86	880	
	1990.01-	1997.05	MT	-	F	Hatchback	827005	Outer Joint		24	19	52	86	50.5	O
	1990.01-	1997.05	MT	L	F	Hatchback	618007	Inner Joint		22	20	35	59	82	
	1990.01-	1997.05	4AT/5MT	-	F	Hatchback	818030	Outer Joint		24	19	52	86	50.5	M
	1990.01-	1997.05	MT	L	F	Hatchback	227040	Drive Shaft		24	22	52	86	605.4	
	1990.01-	1997.05	-	-	F	Hatchback	834018	Outer Joint		24	21	52	86	50	M
1990.01-	1997.05	-	-	F	Hatchback	818033	Outer Joint		24	20	52	86	50.5	M	
PRIDE Van (DA)															
1.3 16V (44 kW)	1992.04-	1996.10	MT	R	F	Box Engine B3	227042	Drive Shaft		24	22	52	86	880	
	1992.04-	1996.10	MT	L	F	Box Engine B3	618007	Inner Joint		22	20	35	59	82	
	1992.04-	1996.10	4AT/MT	-	F	Box Engine B3	818030	Outer Joint		24	19	52	86	50.5	M
	1992.04-	1996.10	MT	L	F	Box Engine B3	227040	Drive Shaft		24	22	52	86	605.4	
	1992.04-	1996.10	-	-	F	Box Engine B3	818033	Outer Joint		24	20	52	86	50.5	M
1.3 16V (47 kW)	1996.10-	1999.06	MT	R	F	Box Engine B3	227042	Drive Shaft		24	22	52	86	880	

YEAR	TRANSM	L/R	F/R	REMARKS	GSP Ref.	PRODUCT	ABS	Technical Specifications									
								A	B	C	H	L	P				
KIA																	
PRIDE Van (DA)																	
1.3 16V (47 kW)	1996.10-1999.06	MT	L	F	Box Engine B3	618007	Inner Joint		22	20	35	59	82				
	1996.10-1999.06	MT	L	F	Box Engine B3	227040	Drive Shaft		24	22	52	86	605.4				
PRO CEE'D (ED)																	
1.4 (77 kW)	2008.02-2012.09	-	-	F	Hatchback Engine G4FA	824077	Outer Joint	46T	27	22	60	94.5	54.5	M			
	2008.02-2012.09	MT	L	F	Hatchback Engine G4FA	624039	Inner Joint		25	22	41	61	100				
	2008.02-2012.09	MT	R	F	Hatchback Engine G4FA	224399	Drive Shaft	46T	27	25	60	94.5	939				
1.4 (80 kW)	2008.02-2012.09	MT	R	F	Hatchback Engine G4FA	224399	Drive Shaft	46T	27	25	60	94.5	939				
	2008.02-2012.09	MT	L	F	Hatchback Engine G4FA	624039	Inner Joint		25	22	41	61	100				
	2008.02-2012.09	-	-	F	Hatchback Engine G4FA	824077	Outer Joint	46T	27	22	60	94.5	54.5	M			
1.4 CVVT (66 kW)	2010.06-2012.09	MT	R	F	Hatchback Engine G4FA-L	224399	Drive Shaft	46T	27	25	60	94.5	939				
	2010.06-2012.09	MT	L	F	Hatchback Engine G4FA-L	624039	Inner Joint		25	22	41	61	100				
	2010.06-2012.09	-	-	F	Hatchback Engine G4FA-L	824077	Outer Joint	46T	27	22	60	94.5	54.5	M			
1.6 (90 kW)	2008.02-2012.09	MT	R	F	Hatchback Engine G4FC	224399	Drive Shaft	46T	27	25	60	94.5	939				
	2008.02-2012.09	-	L	F	Hatchback Engine G4FC	624039	Inner Joint		25	22	41	61	100				
	2008.02-2012.09	-	-	F	Hatchback Engine G4FC	824077	Outer Joint	46T	27	22	60	94.5	54.5	M			
1.6 (93 kW)	2008.02-2012.09	MT	R	F	Hatchback Engine G4FC	224399	Drive Shaft	46T	27	25	60	94.5	939				
	2008.02-2012.09	-	L	F	Hatchback Engine G4FC	624039	Inner Joint		25	22	41	61	100				
	2008.02-2012.09	-	-	F	Hatchback Engine G4FC	824077	Outer Joint	46T	27	22	60	94.5	54.5	M			
1.6 CRDi 115 (85 kW)	2008.02-2012.09	MT	R	F	Hatchback Engine D4FB	239210	Drive Shaft	46T	27	27	60	94	945				
	2008.02-2012.09	MT	L	F	Hatchback Engine D4FB	239263	Drive Shaft	46T	27	27	60	94	658				
	2008.02-2012.09	MT	L/R	F	Hatchback Engine D4FB	824152	Outer Joint	46T	27	26	60	94	67	M			
1.6 CRDi 128 (94 kW)	2010.10-2012.09	MT	R	F	Hatchback Engine D4FB	239210	Drive Shaft	46T	27	27	60	94	945				
	2010.10-2012.09	MT	L	F	Hatchback Engine D4FB	239263	Drive Shaft	46T	27	27	60	94	658				
	2010.10-2012.09	MT	L/R	F	Hatchback Engine D4FB	824152	Outer Joint	46T	27	26	60	94	67	M			
1.6 CRDi 90 (66 kW)	2008.02-2012.09	MT	R	F	Hatchback Engine D4FB-L	239210	Drive Shaft	46T	27	27	60	94	945				
	2008.02-2012.09	MT	L	F	Hatchback Engine D4FB-L	239263	Drive Shaft	46T	27	27	60	94	658				
	2008.02-2012.09	MT	L/R	F	Hatchback Engine D4FB-L	824152	Outer Joint	46T	27	26	60	94	67	M			
1.6 CVVT (92 kW)	2010.10-2013.02	-	-	F	Hatchback Engine G4FC	824077	Outer Joint	46T	27	22	60	94.5	54.5	M			
	2010.10-2013.02	-	L	F	Hatchback Engine G4FC	624039	Inner Joint		25	22	41	61	100				
	2010.10-2013.02	MT	R	F	Hatchback Engine G4FC	224399	Drive Shaft	46T	27	25	60	94.5	939				
2.0 CRDi 140 (103 kW)	2008.02-2012.09	MT	L/R	F	Hatchback Engine D4EA-F	824152	Outer Joint	46T	27	26	60	94	67	M			
PRO CEE'D (JD)																	
1.4 CVVT (73 kW)	2013.03-	-	-	F	Hatchback Engine G4FA	824077	Outer Joint	46T	27	22	60	94.5	54.5	M			
1.4 MPI (73 kW)	2013.07-	-	-	F	Hatchback	824077	Outer Joint	46T	27	22	60	94.5	54.5	M			
1.4 MPI (74 kW)	2015.04-	-	-	F	Hatchback Engine G4LC	824077	Outer Joint	46T	27	22	60	94.5	54.5	M			
QUORIS/K9																	
5.0 GDI (312 kW)	2015.05-	-	-	L	R	Saloon Engine G8BE	201179	Drive Shaft	47T	30	30	65	96	798			
	2015.05-	-	-	R	R	Saloon Engine G8BE	201180	Drive Shaft	47T	30	30	65	96	844			
RETONA (CE)																	
2.0 TD (61 kW)	1999.06-	-	-	F	All-wheel Drive Closed Off-Road Vehicle Engine RF	827002	Outer Joint		26	24	65	122	62	M			
RIO																	
-	2000-	2001	MT	L	-	-	227024	Drive Shaft		24	26	52	86	605			
	2000-	2001	MT	R	-	-	227026	Drive Shaft		24	26	52	86	888			
	2000-	2004	-	-	-	-	627008	Inner Joint		26	22	35	66.5	95			
	2000-	2005	MT	L/R	F	-	627008	Inner Joint		26	22	35	66.5	95			
	2000-	2001	MT	L/R	-	-	627008	Inner Joint		26	22	35	66.5	95			
	2001-	2004	-	-	-	-	834127	Outer Joint		24	22	52	86	58.5	M		
1.4 2WD	2007-	2009	5MT	L	-	ALPHA DOHC> DOHC MPI	227155	Drive Shaft	48T	25	25	52.5	93.5	637			
	2007-	2009	5MT	R	-	ALPHA DOHC> DOHC MPI	227156	Drive Shaft	48T	25	25	52.5	93.5	925			
	2007-	2009	4AT	L	-	ALPHA DOHC> DOHC MPI	227186	Drive Shaft	48T	25	25	52.5	95	638			
	2007-	2009	4AT	R	-	ALPHA DOHC> DOHC MPI	227185	Drive Shaft	48T	25	25	52.5	95	926			
	2007-	2009	5MT	L	-	ALPHA DOHC> DOHC MPI	827097	Outer Joint	48T	25	22	52.5	93.5	59.5	M		
	2007-	2009	4AT	L	-	ALPHA DOHC> DOHC MPI	627038	Inner Joint		25	22	35	62	94			
RIO (BC)																	
1.5 2WD	2000-	2005	5MT	R	-	DOHC MPI	227107	Drive Shaft		24	26	52	86	888			
	2000-	2005	5MT	L	-	DOHC MPI	227106	Drive Shaft		24	26	52	86	606			
	2000-	2005	5MT	L	-	DOHC MPI	834127	Outer Joint		24	22	52	86	58.5	M		
RIO (DC)																	
1.3 (55 kW)	2000.08-2005.02	AT/MT	-	F	Estate Engine A3E	827070	Outer Joint		24	21	52	86	55	M			
	2000.08-2005.02	MT	L	F	Estate Engine A3E	227077	Drive Shaft	44T	24	26	52	86	606				
	2000.08-2005.02	MT	-	-	Estate Engine A3E	827078	Outer Joint	44T	24	21	52	86	55	M			
	2000.08-2005.02	-	-	F	Estate Engine A3E	834095	Outer Joint	44T	24	21	52	86.5	53	M			
	2000.08-2005.02	-	-	F	Estate Engine A3E	899232	Outer Joint	44T	24	21	52	86.5	53	I			
	2000.08-2005.02	-	-	F	Estate Engine A3E	818074	Outer Joint		24	21	52	86.5	53	I			
	2000.08-2005.02	MT	L	F	Estate Engine A3E	227025	Drive Shaft	44T	24	26	52	86	605				
	2000.08-2005.02	MT	R	F	Estate Engine A3E	227027	Drive Shaft	44T	24	26	52	86	888				

	 YEAR	TRANSM	L/R	F/R	REMARKS	GSP Ref.	 PRODUCT	 ABS	Technical Specifications							
									A	B	C	H	L	P		
KIA																
RIO (DC)																
1.3 (55 kW)	2000.08-	2005.02	AT	R	F	Estate Engine A3E	257036	Drive Shaft	44T	24	26	52	86	888		
1.3 (60 kW)	2000.08-	2005.02	AT/MT	-	F	Estate Engine A3E	827070	Outer Joint		24	21	52	86	55	M	
	2000.08-	2005.02	MT	L	F	Estate Engine A3E	227077	Drive Shaft	44T	24	26	52	86	606		
	2000.08-	2005.02	MT	-	-	Estate Engine A3E	827078	Outer Joint	44T	24	21	52	86	55	M	
	2000.08-	2005.02	-	-	F	Estate Engine A3E	834095	Outer Joint	44T	24	21	52	86.5	53	M	
	2000.08-	2005.02	-	-	F	Estate Engine A3E	899232	Outer Joint	44T	24	21	52	86.5	53	I	
	2000.08-	2005.02	-	-	F	Estate Engine A3E	818074	Outer Joint		24	21	52	86.5	53	I	
	2000.08-	2005.02	MT	L	F	Estate Engine A3E	227025	Drive Shaft	44T	24	26	52	86	605		
	2000.08-	2005.02	MT	R	F	Estate Engine A3E	227027	Drive Shaft	44T	24	26	52	86	888		
1.5 16V (71 kW)	2000.08-	2005.02	AT	R	F	Estate Engine A3E	257036	Drive Shaft	44T	24	26	52	86	888		
	2002.09-	2005.02	-	-	F	Estate Engine A5D	827033	Outer Joint	44T	24	22	52	86	58.5	M	
	2002.09-	2005.02	-	-	F	Estate Engine A5D	899232	Outer Joint	44T	24	21	52	86.5	53	I	
	2002.09-	2005.02	MT	L	F	Estate Engine A5D	634008	Inner Joint		26	22	35	66.7	92		
	2002.09-	2005.02	MT	-	F	Estate Engine A5D	818027	Outer Joint		24	22	52	86.5	55	M	
	2002.09-	2005.02	MT	L	F	Estate Engine A5D	227025	Drive Shaft	44T	24	26	52	86	605		
	2002.09-	2005.02	MT	R	F	Estate Engine A5D	227027	Drive Shaft	44T	24	26	52	86	888		
	2002.09-	2005.02	AT	R	F	Estate Engine A5D	257036	Drive Shaft	44T	24	26	52	86	888		
1.5 16V (72 kW)	2000.08-	2005.02	AT	-	F	Estate Engine A5D	827070	Outer Joint		24	21	52	86	55	M	
	2000.08-	2005.02	MT	-	F	Estate Engine A5D	827016	Outer Joint		24	22	52	86	58.5	M	
	2000.08-	2005.02	-	-	F	Estate Engine A5D	827033	Outer Joint	44T	24	22	52	86	58.5	M	
	2000.08-	2005.02	-	-	F	Estate Engine A5D	899232	Outer Joint	44T	24	21	52	86.5	53	I	
	2000.08-	2005.02	-	-	F	Estate Engine A5D	818074	Outer Joint		24	21	52	86.5	53	I	
	2000.08-	2005.02	MT	L	F	Estate Engine A5D	634008	Inner Joint		26	22	35	66.7	92		
	2000.08-	2005.02	MT	-	F	Estate Engine A5D	818027	Outer Joint		24	22	52	86.5	55	M	
	2000.08-	2005.02	MT	L	F	Estate Engine A5D	227025	Drive Shaft	44T	24	26	52	86	605		
	2000.08-	2005.02	MT	R	F	Estate Engine A5D	227027	Drive Shaft	44T	24	26	52	86	888		
	2000.08-	2005.02	AT	R	F	Estate Engine A5D	257036	Drive Shaft	44T	24	26	52	86	888		
RIO (DC_)																
1.3 (55 kW)	2000.09-	2005.02	AT/MT	-	F	Saloon Engine A3E	827070	Outer Joint		24	21	52	86	55	M	
	2000.09-	2005.02	MT	L	F	Saloon Engine A3E	227077	Drive Shaft	44T	24	26	52	86	606		
	2000.09-	2005.02	MT	-	-	Saloon Engine A3E	827078	Outer Joint	44T	24	21	52	86	55	M	
	2000.09-	2005.02	-	-	F	Saloon Engine A3E	834095	Outer Joint	44T	24	21	52	86.5	53	M	
	2000.09-	2005.02	-	-	F	Saloon Engine A3E	899232	Outer Joint	44T	24	21	52	86.5	53	I	
	2000.09-	2005.02	-	-	F	Saloon Engine A3E	818074	Outer Joint		24	21	52	86.5	53	I	
	2000.09-	2005.02	MT	L	F	Saloon Engine A3E	227025	Drive Shaft	44T	24	26	52	86	605		
	2000.09-	2005.02	MT	R	F	Saloon Engine A3E	227027	Drive Shaft	44T	24	26	52	86	888		
	2000.09-	2005.02	AT	R	F	Saloon Engine A3E	257036	Drive Shaft	44T	24	26	52	86	888		
	1.3 (60 kW)	2002.08-	2005.02	MT	L	F	Saloon Engine A3E	227077	Drive Shaft	44T	24	26	52	86	606	
2002.08-		2005.02	MT	-	-	Saloon Engine A3E	827078	Outer Joint	44T	24	21	52	86	55	M	
2002.08-		2005.02	-	-	F	Saloon Engine A3E	834095	Outer Joint	44T	24	21	52	86.5	53	M	
2002.08-		2005.02	-	-	F	Saloon Engine A3E	899232	Outer Joint	44T	24	21	52	86.5	53	I	
2002.08-		2005.02	-	-	F	Saloon Engine A3E	818074	Outer Joint		24	21	52	86.5	53	I	
2002.08-		2005.02	MT	L	F	Saloon Engine A3E	227025	Drive Shaft	44T	24	26	52	86	605		
2002.08-		2005.02	MT	R	F	Saloon Engine A3E	227027	Drive Shaft	44T	24	26	52	86	888		
2002.08-		2005.02	AT	R	F	Saloon Engine A3E	257036	Drive Shaft	44T	24	26	52	86	888		
1.5 16V (71 kW)		2002.09-	2005.02	MT	L	F	Saloon Engine A5D	634008	Inner Joint		26	22	35	66.7	92	
		2002.09-	2005.02	MT	-	F	Saloon Engine A5D	818027	Outer Joint		24	22	52	86.5	55	M
1.5 16V (72 kW)	2000.09-	2005.02	AT	-	F	Saloon Engine A5D	827070	Outer Joint		24	21	52	86	55	M	
	2000.09-	2005.02	MT	-	F	Saloon Engine A5D	827016	Outer Joint		24	22	52	86	58.5	M	
	2000.09-	2005.02	-	-	F	Saloon Engine A5D	827033	Outer Joint	44T	24	22	52	86	58.5	M	
	2000.09-	2005.02	MT	L	F	Saloon Engine A5D	634008	Inner Joint		26	22	35	66.7	92		
	2000.09-	2005.02	MT	-	F	Saloon Engine A5D	818027	Outer Joint		24	22	52	86.5	55	M	
	2000.09-	2005.02	MT	L	F	Saloon Engine A5D	227025	Drive Shaft	44T	24	26	52	86	605		
	2000.09-	2005.02	MT	R	F	Saloon Engine A5D	227027	Drive Shaft	44T	24	26	52	86	888		
	2000.09-	2005.02	AT	R	F	Saloon Engine A5D	257036	Drive Shaft	44T	24	26	52	86	888		
RIO I																
1.3	2000-	-	-	-	-	-	827108	Outer Joint		24	21	52	86	58.5	M	
RIO II (JB)/PRIDE																
1.4 16V (71 kW)	2005.03-	-	-	-	F	Hatchback Engine G4EE	827070	Outer Joint		24	21	52	86	55	M	
	2005.03-	-	-	-	F	Saloon Engine G4EE	827070	Outer Joint		24	21	52	86	55	M	
	2005.03-	-	-	-	F	Hatchback Engine G4EE	827076	Outer Joint	44T	25	22	50	95	58	M	
	2005.03-	-	-	-	F	Saloon Engine G4EE	827076	Outer Joint	44T	25	22	50	95	58	M	
	2005.03-	-	MT	-	F	Hatchback Engine G4EE	824101	Outer Joint	48T	25	22	52.5	95	58	M	
	2005.03-	-	MT	-	F	Saloon Engine G4EE	824101	Outer Joint	48T	25	22	52.5	95	58	M	
	2005.03-	-	-	L	F	Hatchback Engine G4EE	639052	Inner Joint		25	22	41	63	86		
	2005.03-	-	-	L	F	Saloon Engine G4EE	639052	Inner Joint		25	22	41	63	86		

YEAR	TRANSM	L/R	F/R	REMARKS	GSP Ref.	PRODUCT	ABS	Technical Specifications							
								A	B	C	H	L	P		
KIA															
RIO II (JB)/PRIDE															
1.4 16V (71 kW)	2005.03-	-	-	F	Hatchback Engine G4EE	824136	Outer Joint		25	22	52.5	93.5	59.5	M	
	2005.03-	-	-	F	Saloon Engine G4EE	824136	Outer Joint		25	22	52.5	93.5	59.5	M	
	2005.03-	-	-	F	Hatchback Engine G4EE	824131	Outer Joint	48T	25	22	52.5	93.5	59.5	M	
	2005.03-	-	-	F	Saloon Engine G4EE	824131	Outer Joint	48T	25	22	52.5	93.5	59.5	M	
1.5 CRDi (81 kW)	2005.03-	-	-	F	Hatchback Engine D4FA	824114	Outer Joint	48T	25	24	50	94.5	63.5	M	
	2005.03-	-	-	F	Saloon Engine D4FA	824114	Outer Joint	48T	25	24	50	94.5	63.5	M	
	2005.03-	-	MT	L	F	Hatchback Engine D4FA	224401	Drive Shaft	48T	25	27	50	93.5	637	
	2005.03-	-	MT	L	F	Saloon Engine D4FA	224401	Drive Shaft	48T	25	27	50	93.5	637	
	2005.03-	-	AT/MT	L/R	F	Hatchback Engine D4FA	827068	Outer Joint	48T	25	24	50	94.5	63.5	M
	2005.03-	-	AT/MT	L/R	F	Saloon Engine D4FA	827068	Outer Joint	48T	25	24	50	94.5	63.5	M
1.6 16V (82 kW)	2005.03-	-	MT	L	F	Saloon Engine G4ED	827070	Outer Joint		24	21	52	86	55	M
	2005.03-	-	-	-	F	Saloon Engine G4ED	824114	Outer Joint	48T	25	24	50	94.5	63.5	M
	2005.03-	-	MT	-	F	Saloon Engine G4ED	824101	Outer Joint	48T	25	22	52.5	95	58	M
	2005.03-	-	-	L	F	Saloon Engine G4ED	639052	Inner Joint		25	22	41	63	86	
	2005.03-	-	-	-	F	Saloon Engine G4ED	824136	Outer Joint		25	22	52.5	93.5	59.5	M
	2005.03-	-	-	-	F	Saloon Engine G4ED	824131	Outer Joint	48T	25	22	52.5	93.5	59.5	M
1.6 CVVT (82 kW)	2005.03-	-	MT	L	F	Hatchback Engine G4ED	827070	Outer Joint		24	21	52	86	55	M
	2005.03-	-	-	-	F	Hatchback Engine G4ED	824114	Outer Joint	48T	25	24	50	94.5	63.5	M
	2005.03-	-	MT	-	F	Hatchback Engine G4ED	824101	Outer Joint	48T	25	22	52.5	95	58	M
	2005.03-	-	-	L	F	Hatchback Engine G4ED	639052	Inner Joint		25	22	41	63	86	
	2005.03-	-	-	-	F	Hatchback Engine G4ED	824136	Outer Joint		25	22	52.5	93.5	59.5	M
	2005.03-	-	-	-	F	Hatchback Engine G4ED	824131	Outer Joint	48T	25	22	52.5	93.5	59.5	M
RIO III (UB)/PRIDE															
1.4 CVVT (80 kW)	2011.09-	-	-	-	F	Hatchback Engine G4FA	824136	Outer Joint		25	22	52.5	93.5	59.5	M
	2011.10-	-	-	-	F	Saloon Engine G4FA	824136	Outer Joint		25	22	52.5	93.5	59.5	M
RIO12															
1.2	2011-	2014	-	-	-	-	201565	Drive Shaft	48T	25	25	52.6	94.5	654	
	2011-	2014	-	-	-	-	201566	Drive Shaft	48T	25	25	52.6	94.5	931	
RIO15															
1.2	2014-	-	-	-	-	-	201565	Drive Shaft	48T	25	25	52.6	94.5	654	
	2014-	-	-	-	-	-	201566	Drive Shaft	48T	25	25	52.6	94.5	931	
SEDONA															
3.3 L	2015-	2018	-	R	F	-	201151	Drive Shaft	52T	30	28	73	95	727	
3.5 2WD	2011-	-	6AT	L	-	LAMBDA 2	227152	Drive Shaft	54T	31	28	56	102	701	
	2011-	-	6AT	L	-	LAMBDA 2	827091	Outer Joint	54T	31	25	56	102	63	M
	2011-	-	6AT	L	-	LAMBDA 2	627033	Inner Joint		28	25	43	67	103.5	
SEPHIA															
-	1994-	1997	MT/AT	-	-	-	627007	Inner Joint		28	23	43	40.8	75.5	
	1995-	1997	-	-	-	-	618039	Inner Joint		24	28	35	64.1	91.5	
	1996-	-	MT	L	-	S15	227005	Drive Shaft		26	26	56	93	629	
	1996-	-	MT	R	-	S15	227006	Drive Shaft		26	26	56	93	898	
	1998-	2001	MT/AT	-	F	-	627015	Inner Joint		28	23	43	40.8	75	
	1998-	1999	-	-	-	-	827022	Outer Joint		26	24	56	92	60	M
	1998-	2001	-	R	F	-	227066	Drive Shaft		26	28	56	93	625.5	
	1998-	2001	AT	L	F	-	227053	Drive Shaft	44T	26	24	56	92	626	
1.5	1994-	-	-	L	-	-	227061	Drive Shaft		26	24	56	93.5	635	
1.6	1994-	1998	-	-	-	-	827028	Outer Joint	44T	26	22	56	93	55	M
1.6 DOHC	1994-	1997	-	R	-	-	227050	Drive Shaft		26	28	56	93	615.5	
1.8	1994-	1997	MT	-	-	-	627006	Inner Joint		28	23	35	66.5	104	
	1994-	1997	MT	L	-	-	227054	Drive Shaft	44T	26	28	56	93	617.5	
	1994-	1997	MT	R	-	-	227055	Drive Shaft	44T	26	28	56	93	617.5	
	1995-	1998	-	-	-	-	827024	Outer Joint	44T	26	23	56	93	56.5	M
SEPHIA (FA)/MENTOR															
1.5 i (59 kW)	1996.02-	1997.10	MT	R	F	Saloon Engine B5	250227	Drive Shaft		23	37.1	56	84	619	
	1996.02-	1997.10	MT	R	F	Hatchback Engine B5	250227	Drive Shaft		23	37.1	56	84	619	
	1996.02-	1997.10	MT	L/R	F	Hatchback Engine B5	827001	Outer Joint		26	22	56	93.5	55.5	M
	1996.02-	1997.10	MT	R	F	Saloon Engine B5	250227	Drive Shaft		23	37.1	56	84	619	
	1996.02-	1997.10	MT	R	F	Hatchback Engine B5	250227	Drive Shaft		23	37.1	56	84	619	
	1996.02-	1997.10	MT	L/R	F	Saloon Engine B5	827001	Outer Joint		26	22	56	93.5	55.5	M
	1996.02-	1997.10	-	-	F	Hatchback Engine B5	834144	Outer Joint		28	22	56	89.1	59.5	M
	1996.02-	1997.10	-	-	F	Saloon Engine B5	834144	Outer Joint		28	22	56	89.1	59.5	M
	1996.02-	1997.10	MT	L	F	Hatchback Engine B5	218087	Drive Shaft		26	24	56	93	626.5	
	1996.02-	1997.10	MT	L	F	Saloon Engine B5	218087	Drive Shaft		26	24	56	93	626.5	
	1996.02-	1997.10	MT	R	F	Hatchback Engine B5	227031	Drive Shaft		26	24	56	93.5	895	
	1996.02-	1997.10	MT	R	F	Saloon Engine B5	227031	Drive Shaft		26	24	56	93.5	895	
	1996.02-	1997.10	-	-	-	Saloon Engine B5	827006	Outer Joint		26	22	56	93	55	M

KIA SEPHIA (FA)/MENTOR	YEAR	TRANSM	L/R	F/R	REMARKS	GSP Ref.	PRODUCT	ABS	Technical Specifications					
									A	B	C	H	L	P
1.5 i (59 kW)	1996.02-1997.10	MT	L	F	Saloon Engine B5	227060	Drive Shaft		26	26	56	93.5	630	
1.6 i (59 kW)	1993.09-1997.10	AT/MT	R	F	Saloon Engine B6	250227	Drive Shaft		23	37.1	56	84	619	
	1993.09-1997.10	AT/MT	R	F	Saloon Engine B6	250227	Drive Shaft		23	37.1	56	84	619	
	1993.09-1997.10	MT	L/R	F	Saloon Engine B6	827001	Outer Joint		26	22	56	93.5	55.5	M
	1993.09-1997.10	AT/MT	R	F	Saloon Engine B6	250227	Drive Shaft		23	37.1	56	84	619	
	1993.09-1997.10	-	-	F	Saloon Engine B6	834144	Outer Joint		28	22	56	89.1	59.5	M
	1993.09-1997.10	MT/AT	L	F	Saloon Engine B6	218087	Drive Shaft		26	24	56	93	626.5	
	1993.09-1997.10	MT/AT	R	F	Saloon Engine B6	227031	Drive Shaft		26	24	56	93.5	895	
	1993.09-1997.10	-	-	-	Saloon Engine B6	827006	Outer Joint		26	22	56	93	55	M
	1995.01-1997.10	AT/MT	R	F	Hatchback Engine B6	250227	Drive Shaft		23	37.1	56	84	619	
	1995.01-1997.10	AT/MT	R	F	Hatchback Engine B6	250227	Drive Shaft		23	37.1	56	84	619	
	1995.01-1997.10	AT/MT	R	F	Hatchback Engine B6	250227	Drive Shaft		23	37.1	56	84	619	
	1995.01-1997.10	-	-	F	Hatchback Engine B6	834144	Outer Joint		28	22	56	89.1	59.5	M
	1995.01-1997.10	MT/AT	L	F	Hatchback Engine B6	218087	Drive Shaft		26	24	56	93	626.5	
	1995.01-1997.10	MT/AT	R	F	Hatchback Engine B6	227031	Drive Shaft		26	24	56	93.5	895	
1.8 i 16V (82 kW)	1995.01-1997.10	MT	L/R	F	Saloon Engine OK26Y/OK24N	827001	Outer Joint		26	22	56	93.5	55.5	M
	1995.01-1997.10	MT	L/R	F	Hatchback Engine OK26Y/OK24N	827001	Outer Joint		26	22	56	93.5	55.5	M
	1995.01-1997.10	-	-	F	Hatchback Engine OK26Y/OK24N	834144	Outer Joint		28	22	56	89.1	59.5	M
	1995.01-1997.10	-	-	F	Saloon Engine OK26Y/OK24N	834144	Outer Joint		28	22	56	89.1	59.5	M
	1995.01-1997.10	-	-	-	Hatchback Engine OK26Y/OK24N	827006	Outer Joint		26	22	56	93	55	M
SHUMA	-	-	MT	L	-	227049	Drive Shaft		26	28	56	92	615.5	
SHUMA (FB)/SEPHIA														
1.5 (59 kW)	1996.03-1998.12	MT	L/R	F	Saloon Engine OK280	827001	Outer Joint		26	22	56	93.5	55.5	M
	1996.03-1998.12	-	-	F	Saloon Engine OK280	834144	Outer Joint		28	22	56	89.1	59.5	M
	1996.03-1998.12	-	-	F	Saloon Engine OK280	834022	Outer Joint	44T	26	22	56	94	59	I
	1996.03-1998.12	-	-	-	Saloon Engine OK280	827006	Outer Joint		26	22	56	93	55	M
1.5 i 16V (65 kW)	1997.10-2001.03	MT	L/R	F	Hatchback Engine ZYVE/BFD	827001	Outer Joint		26	22	56	93.5	55.5	M
	1997.10-2001.03	-	-	F	Hatchback Engine ZYVE/BFD	834144	Outer Joint		28	22	56	89.1	59.5	M
	1997.10-2001.10	-	-	F	Saloon Engine BFD/ZYVE	834144	Outer Joint		28	22	56	89.1	59.5	M
	1997.10-2001.10	4AT	L	F	Saloon Engine BFD/ZYVE	627005	Inner Joint		24	22	35	64	91	
	1997.10-2001.03	4AT	L	F	Hatchback Engine ZYVE/BFD	627005	Inner Joint		24	22	35	64	91	
	1997.10-2001.10	5MT	L	F	Saloon Engine BFD/ZYVE	634008	Inner Joint		26	22	35	66.7	92	
	1997.10-2001.03	5MT	L	F	Hatchback Engine ZYVE/BFD	634008	Inner Joint		26	22	35	66.7	92	
	1997.10-2001.10	-	-	F	Saloon Engine BFD/ZYVE	834022	Outer Joint	44T	26	22	56	94	59	I
	1997.10-2001.03	-	-	F	Hatchback Engine ZYVE/BFD	834022	Outer Joint	44T	26	22	56	94	59	I
	1997.10-2001.10	-	-	-	Saloon Engine BFD/ZYVE	827006	Outer Joint		26	22	56	93	55	M
	1997.10-2001.03	-	-	-	Hatchback Engine ZYVE/BFD	827006	Outer Joint		26	22	56	93	55	M
	1997.10-2001.10	4AT/5MT	-	F	Saloon Engine BFD/ZYVE	834120	Outer Joint	44T	28	22	56	89.1	59.5	M
1997.10-2001.03	4AT/5MT	-	F	Hatchback Engine ZYVE/BFD	834120	Outer Joint	44T	28	22	56	89.1	59.5	M	
1.6 (75 kW)	2001.01-2001.12	-	-	F	Hatchback Engine GA6D	827032	Outer Joint	46T	28	22	56	89.7	55.5	M
	2001.01-2001.12	-	-	F	Hatchback Engine GA6D	834144	Outer Joint		28	22	56	89.1	59.5	M
	2001.01-2001.12	MT	R	F	Hatchback Engine GA6D	218050	Drive Shaft		28	28	56	90	575	
1.8 i 16V (81 kW)	1997.10-2001.03	-	-	F	Hatchback Engine T8	834144	Outer Joint		28	22	56	89.1	59.5	M
	1997.10-2001.03	AT	L	F	Hatchback Engine T8	627005	Inner Joint		24	22	35	64	91	
	1997.10-2001.03	MT	L	F	Hatchback Engine T8	634008	Inner Joint		26	22	35	66.7	92	
	1997.10-2001.03	-	-	F	Hatchback Engine T8	834120	Outer Joint	44T	28	22	56	89.1	59.5	M
SHUMA II (FB)														
1.6 (75 kW)	2001.05-2004.08	-	-	F	Hatchback Engine GA6D	834144	Outer Joint		28	22	56	89.1	59.5	M
	2001.05-2004.05	-	-	F	Saloon Engine GA6D	834144	Outer Joint		28	22	56	89.1	59.5	M
	2001.05-2004.08	-	L	F	Hatchback Engine GA6D	627005	Inner Joint		24	22	35	64	91	
	2001.05-2004.05	-	L	F	Saloon Engine GA6D	627005	Inner Joint		24	22	35	64	91	
	2001.05-2004.08	-	L	F	Hatchback Engine GA6D	634008	Inner Joint		26	22	35	66.7	92	
	2001.05-2004.05	-	L	F	Saloon Engine GA6D	634008	Inner Joint		26	22	35	66.7	92	
	2001.05-2004.05	MT	R	F	Saloon Engine GA6D	218050	Drive Shaft		28	28	56	90	575	
	2001.05-2004.08	-	-	F	Hatchback Engine GA6D	834120	Outer Joint	44T	28	22	56	89.1	59.5	M
	2001.05-2004.05	-	-	F	Saloon Engine GA6D	834120	Outer Joint	44T	28	22	56	89.1	59.5	M
1.8 (81 kW)	2001.05-2004.06	-	-	F	Hatchback Engine T8	834144	Outer Joint		28	22	56	89.1	59.5	M
1.8 (84 kW)	2003.04-2004.08	-	-	F	Hatchback Engine T8	834144	Outer Joint		28	22	56	89.1	59.5	M
	2003.04-2004.08	-	-	F	Hatchback Engine T8	827029	Outer Joint	46T	28	24	56	90	60	M
	2003.04-2004.08	AT	L	F	Hatchback Engine T8	627005	Inner Joint		24	22	35	64	91	
	2003.04-2004.08	MT	L	F	Hatchback Engine T8	634008	Inner Joint		26	22	35	66.7	92	
	2003.04-2004.08	-	-	F	Hatchback Engine T8	834120	Outer Joint	44T	28	22	56	89.1	59.5	M
SORENTO														
-	2004-2006	5MT	-	F	-	635045	Propshaft CV Joint			24		32		
-	2005-2006	5AT	-	F	-	635045	Propshaft CV Joint			24		32		

KIA SORENTO	YEAR	TRANSM	L/R	F/R	REMARKS	GSP Ref.	PRODUCT	ABS	Technical Specifications					
									A	B	C	H	L	P
2.4	2011.03-2012.09	6MT	L	F	-	224471	Drive Shaft	52T	30	28	73	93.5	662	
	2011.03-2012.09	6MT	L	F	-	824331	Outer Joint	52T	30	36	73	93.5	67.5	I
	2011.03-2012.09	6MT	L	F	-	624157	Inner Joint		28	35	41	61.5	120	
2.4L	2011-	-	-	-	Base Sport Utility 4Door	224585	Stub Axle							
	2011-	-	-	-	EX Sport Utility 4Door	224585	Stub Axle							
	2011-	-	-	-	LX Sport Utility 4Door	224585	Stub Axle							
	2012-	-	-	-	Base Sport Utility 4Door	224585	Stub Axle							
	2012-	-	-	-	EX Sport Utility 4Door	224585	Stub Axle							
	2012-	-	-	-	LX Sport Utility 4Door	224585	Stub Axle							
	2013-	-	-	-	F EX Sport Utility 4Door	224585	Stub Axle							
	2013-	-	-	-	LX Sport Utility 4Door	224585	Stub Axle							
SORENTO I (JC)														
2.4 (102 kW)	2002.08-	-	MT	-	F All-wheel Drive Closed Off-Road Vehicle Engine G4JS	827014	Outer Joint		28	25	56	102	63	M
	2002.08-	-	AT	L	F All-wheel Drive Closed Off-Road Vehicle Engine G4JS	624155	Inner Joint		28	35	33	67	105.5	
	2002.08-	-	-	-	F All-wheel Drive Closed Off-Road Vehicle Engine G4JS	624156	Inner Joint		28	35	42		129.5	
	2002.08-	-	MT	-	R All-wheel Drive Closed Off-Road Vehicle Engine G4JS	624010	Inner Joint		25	22	35	63	87	
	2002.08-	-	-	-	R All-wheel Drive Closed Off-Road Vehicle Engine G4JS	624123	Inner Joint		28	25	42		118	
	2002.08-	-	MT	L	F All-wheel Drive Closed Off-Road Vehicle Engine G4JS	634079	Inner Joint		30	25	38	77.5	108	
	2002.08-	-	MT	R	F All-wheel Drive Closed Off-Road Vehicle Engine G4JS	634078	Inner Joint		28	25	43	41	78	
	2002.08-	-	-	-	- All-wheel Drive Closed Off-Road Vehicle Engine G4JS	227221	Stub Axle		28	28			420.5	
	2002.08-	-	-	-	- All-wheel Drive Closed Off-Road Vehicle Engine G4JS	639041	Inner Joint		25	23	35	63	92.5	
	2002.08-	-	-	-	R All-wheel Drive Closed Off-Road Vehicle Engine G4JS	824321	Outer Joint	52T	30	20	57	93.5	61	M
2.5 CRDi (103 kW)	2002.08-	-	-	-	F All-wheel Drive Closed Off-Road Vehicle Engine D4CB	827014	Outer Joint		28	25	56	102	63	M
	2002.08-	-	MT	L	F All-wheel Drive Closed Off-Road Vehicle Engine D4CB	227065	Drive Shaft		28	30	56	102	635	
	2002.08-	-	MT	R	F All-wheel Drive Closed Off-Road Vehicle Engine D4CB	227064	Drive Shaft		28	28	56	102	567	
	2002.08-	-	-	-	R All-wheel Drive Closed Off-Road Vehicle Engine D4CB	624123	Inner Joint		28	25	42		118	
	2002.08-	-	-	-	L F All-wheel Drive Closed Off-Road Vehicle Engine D4CB	634079	Inner Joint		30	25	38	77.5	108	
	2002.08-	-	-	-	R F All-wheel Drive Closed Off-Road Vehicle Engine D4CB	634078	Inner Joint		28	25	43	41	78	
	2002.08-	-	AT	-	F All-wheel Drive Closed Off-Road Vehicle Engine D4CB	827012	Outer Joint		28	26	56	102.5	66	M
2.5 CRDi (120 kW)	2006.05-	-	-	-	F All-wheel Drive Closed Off-Road Vehicle Engine D4CB	827014	Outer Joint		28	25	56	102	63	M
	2006.05-	-	-	-	L F All-wheel Drive Closed Off-Road Vehicle Engine D4CB	634079	Inner Joint		30	25	38	77.5	108	
	2006.05-	-	-	-	R F All-wheel Drive Closed Off-Road Vehicle Engine D4CB	634078	Inner Joint		28	25	43	41	78	
	2006.05-	-	AT	-	F All-wheel Drive Closed Off-Road Vehicle Engine D4CB	827012	Outer Joint		28	26	56	102.5	66	M
	2006.05-	-	-	-	R F All-wheel Drive Closed Off-Road Vehicle Engine D4CB	624123	Inner Joint		28	25	42		118	
2.5 CRDi (125 kW)	2006.12-	-	-	-	F All-wheel Drive Closed Off-Road Vehicle Engine D4CB	827014	Outer Joint		28	25	56	102	63	M
	2006.12-	-	-	-	R F All-wheel Drive Closed Off-Road Vehicle Engine D4CB	624123	Inner Joint		28	25	42		118	
	2006.12-	-	-	-	L F All-wheel Drive Closed Off-Road Vehicle Engine D4CB	634079	Inner Joint		30	25	38	77.5	108	
	2006.12-	-	-	-	R F All-wheel Drive Closed Off-Road Vehicle Engine D4CB	634078	Inner Joint		28	25	43	41	78	
	2006.12-	-	AT	-	F All-wheel Drive Closed Off-Road Vehicle Engine D4CB	827012	Outer Joint		28	26	56	102.5	66	M
2.5 CRDi (131 kW)	2006.09-	-	-	-	R F Closed Off-Road Vehicle Engine D4CB	624123	Inner Joint		28	25	42		118	
3.3 V6 (177 kW)	2006.12-	-	AT	-	F All-wheel Drive Closed Off-Road Vehicle	827014	Outer Joint		28	25	56	102	63	M
	2006.12-	-	-	-	R F All-wheel Drive Closed Off-Road Vehicle	624123	Inner Joint		28	25	42		118	
	2006.12-	-	AT	L	F All-wheel Drive Closed Off-Road Vehicle	634079	Inner Joint		30	25	38	77.5	108	
	2006.12-	-	AT	R	F All-wheel Drive Closed Off-Road Vehicle	634078	Inner Joint		28	25	43	41	78	
3.3 V6 (182 kW)	2007.02-	-	AT	-	F All-wheel Drive Closed Off-Road Vehicle Engine G6DB	827014	Outer Joint		28	25	56	102	63	M
	2007.02-	-	AT	L	F All-wheel Drive Closed Off-Road Vehicle Engine G6DB	634079	Inner Joint		30	25	38	77.5	108	
	2007.02-	-	AT	R	F All-wheel Drive Closed Off-Road Vehicle Engine G6DB	634078	Inner Joint		28	25	43	41	78	
	2007.02-	-	-	-	R F All-wheel Drive Closed Off-Road Vehicle Engine G6DB	624123	Inner Joint		28	25	42		118	
3.5 V6 (143 kW)	2002.08-	-	-	-	L - All-wheel Drive Closed Off-Road Vehicle Engine G6CU	227125	Drive Shaft		28	30	56	102.5	633	
	2002.08-	-	-	-	R - All-wheel Drive Closed Off-Road Vehicle Engine G6CU	227126	Drive Shaft		28	28	56	102.5	569.5	
	2002.08-	-	-	-	F All-wheel Drive Closed Off-Road Vehicle Engine G6CU	827014	Outer Joint		28	25	56	102	63	M
	2002.08-	-	AT	L	F All-wheel Drive Closed Off-Road Vehicle Engine G6CU	624155	Inner Joint		28	35	33	67	105.5	
	2002.08-	-	AT	-	F All-wheel Drive Closed Off-Road Vehicle Engine G6CU	624156	Inner Joint		28	35	42		129.5	
	2002.08-	-	AT	-	R All-wheel Drive Closed Off-Road Vehicle Engine G6CU	624010	Inner Joint		25	22	35	63	87	
	2002.08-	-	-	-	R F All-wheel Drive Closed Off-Road Vehicle Engine G6CU	624123	Inner Joint		28	25	42		118	
	2002.08-	-	-	-	L F All-wheel Drive Closed Off-Road Vehicle Engine G6CU	634079	Inner Joint		30	25	38	77.5	108	
	2002.08-	-	-	-	R F All-wheel Drive Closed Off-Road Vehicle Engine G6CU	634078	Inner Joint		28	25	43	41	78	
	2002.08-	-	AT	-	- All-wheel Drive Closed Off-Road Vehicle Engine G6CU	639041	Inner Joint		25	23	35	63	92.5	
	2002.08-	-	AT	-	R All-wheel Drive Closed Off-Road Vehicle Engine G6CU	824321	Outer Joint	52T	30	20	57	93.5	61	M
SORENTO II (XM)														
2.0 CRDi (110 kW)	2010.11-	-	6AT	R	F All-wheel Drive Closed Off-Road Vehicle Engine D4HA	261352	Stub Axle		28	28			430	
	2010.11-	-	-	-	F Closed Off-Road Vehicle Engine D4HA	824301	Outer Joint	52T	30	35	73	94.5	67	M
	2010.11-	-	-	-	F All-wheel Drive Closed Off-Road Vehicle Engine D4HA	824301	Outer Joint	52T	30	35	73	94.5	67	M
	2010.11-	-	AT	L	F Closed Off-Road Vehicle Engine D4HA	224462	Drive Shaft	52T	30	28	73	97	668	
	2010.11-	-	AT	L	F All-wheel Drive Closed Off-Road Vehicle Engine D4HA	224462	Drive Shaft	52T	30	28	73	97	668	
	2010.11-	-	6AT	L	F Closed Off-Road Vehicle Engine D4HA	624155	Inner Joint		28	35	33	67	105.5	

YEAR	TRANSM	L/R	F/R	REMARKS	GSP Ref.	PRODUCT	ABS	Technical Specifications									
								A	B	C	H	L	P				
KIA																	
SORENTO II (XM)																	
2.0 CRDi (110 kW)	2010.11.-	6AT	-	F	Closed Off-Road Vehicle Engine D4HA	624156	Inner Joint		28	35	42		129.5				
	2010.11.-	MT	R	F	Closed Off-Road Vehicle Engine D4HA	624058	Inner Joint		28	36	42.1	43.5	88				
	2010.11.-	MT	R	F	All-wheel Drive Closed Off-Road Vehicle Engine D4HA	624058	Inner Joint		28	36	42.1	43.5	88				
	2010.11.-	MT	-	R	All-wheel Drive Closed Off-Road Vehicle Engine D4HA	624010	Inner Joint		25	22	35	63	87				
	2010.11.-	MT	R	F	Closed Off-Road Vehicle Engine D4HA	224117	Drive Shaft	52T	30	28	73	97	611				
	2010.11.-	MT	R	F	All-wheel Drive Closed Off-Road Vehicle Engine D4HA	224117	Drive Shaft	52T	30	28	73	97	611				
	2010.11.-	AT	R	F	Closed Off-Road Vehicle Engine D4HA	224463	Drive Shaft	52T	30	28	73	97	610				
	2010.11.-	AT	R	F	All-wheel Drive Closed Off-Road Vehicle Engine D4HA	224463	Drive Shaft	52T	30	28	73	97	610				
	2010.11.-	MT	L	F	Closed Off-Road Vehicle Engine D4HA	224195	Drive Shaft	52T	30	28	73	97	659				
	2010.11.-	MT	L	F	All-wheel Drive Closed Off-Road Vehicle Engine D4HA	224195	Drive Shaft	52T	30	28	73	97	659				
	2010.11.-	MT	R	F	Closed Off-Road Vehicle Engine D4HA	624022	Inner Joint		28	35	42	39.5	78.5				
	2010.11.-	MT	R	F	All-wheel Drive Closed Off-Road Vehicle Engine D4HA	624022	Inner Joint		28	35	42	39.5	78.5				
	2010.11.-	MT	-	-	All-wheel Drive Closed Off-Road Vehicle Engine D4HA	639041	Inner Joint		25	23	35	63	92.5				
	2010.11.-	MT	L	F	Closed Off-Road Vehicle Engine D4HA	224465	Drive Shaft	52T	30	28	73	97	656				
	2010.11.-	MT	L	F	All-wheel Drive Closed Off-Road Vehicle Engine D4HA	224465	Drive Shaft	52T	30	28	73	97	656				
	2010.11.-	MT	-	R	All-wheel Drive Closed Off-Road Vehicle Engine D4HA	824321	Outer Joint	52T	30	20	57	93.5	61	M			
	2010.11.-	MT	R	F	Closed Off-Road Vehicle Engine D4HA	624094	Inner Joint		28	35	42		129.5				
	2010.11.-	MT	R	F	All-wheel Drive Closed Off-Road Vehicle Engine D4HA	624094	Inner Joint		28	35	42		129.5				
2.2 CRDi (145 kW)	2009.11.-	AT	R	F	All-wheel Drive Closed Off-Road Vehicle Engine D4HB	261352	Stub Axle		28	28			430				
	2009.11.-	-	-	F	Closed Off-Road Vehicle Engine D4HB	824301	Outer Joint	52T	30	35	73	94.5	67	M			
	2009.11.-	-	-	F	All-wheel Drive Closed Off-Road Vehicle Engine D4HB	824301	Outer Joint	52T	30	35	73	94.5	67	M			
	2009.11.-	AT	L	F	All-wheel Drive Closed Off-Road Vehicle Engine D4HB	224462	Drive Shaft	52T	30	28	73	97	668				
	2009.11.-	-	R	F	Closed Off-Road Vehicle Engine D4HB	624058	Inner Joint		28	36	42.1	43.5	88				
	2009.11.-	-	R	F	All-wheel Drive Closed Off-Road Vehicle Engine D4HB	624058	Inner Joint		28	36	42.1	43.5	88				
	2009.11.-	-	-	R	All-wheel Drive Closed Off-Road Vehicle Engine D4HB	624010	Inner Joint		25	22	35	63	87				
	2009.11.-	6AT/6MT	R	F	Closed Off-Road Vehicle Engine D4HB	224117	Drive Shaft	52T	30	28	73	97	611				
	2009.11.-	6AT/6MT	R	F	All-wheel Drive Closed Off-Road Vehicle Engine D4HB	224117	Drive Shaft	52T	30	28	73	97	611				
	2009.11.-	AT	R	F	All-wheel Drive Closed Off-Road Vehicle Engine D4HB	224463	Drive Shaft	52T	30	28	73	97	610				
	2009.11.-	MT	L	F	Closed Off-Road Vehicle Engine D4HB	224195	Drive Shaft	52T	30	28	73	97	659				
	2009.11.-	6MT	L	F	All-wheel Drive Closed Off-Road Vehicle Engine D4HB	224195	Drive Shaft	52T	30	28	73	97	659				
	2009.11.-	6AT/6MT	R	F	Closed Off-Road Vehicle Engine D4HB	624022	Inner Joint		28	35	42	39.5	78.5				
	2009.11.-	6AT/6MT	R	F	All-wheel Drive Closed Off-Road Vehicle Engine D4HB	624022	Inner Joint		28	35	42	39.5	78.5				
	2009.11.-	-	-	-	All-wheel Drive Closed Off-Road Vehicle Engine D4HB	639041	Inner Joint		25	23	35	63	92.5				
	2009.11.-	AT	L	F	Closed Off-Road Vehicle Engine D4HB	239247	Drive Shaft	52T	30	28	73	97	670				
	2009.11.-	AT	L	F	Closed Off-Road Vehicle Engine D4HB	624095	Inner Joint		28	35	41	71	116.5				
	2009.11.-	AT	L	F	All-wheel Drive Closed Off-Road Vehicle Engine D4HB	239247	Drive Shaft	52T	30	28	73	97	670				
	2009.11.-	AT	L	F	All-wheel Drive Closed Off-Road Vehicle Engine D4HB	624095	Inner Joint		28	35	41	71	116.5				
	2009.11.-	MT	L	F	All-wheel Drive Closed Off-Road Vehicle Engine D4HB	224465	Drive Shaft	52T	30	28	73	97	656				
	2009.11.-	-	L	-	Closed Off-Road Vehicle Engine D4HB	624160	Inner joint		31	35	36	67	104.5				
	2009.11.-	-	R	-	All-wheel Drive Closed Off-Road Vehicle Engine D4HB	824321	Outer Joint	52T	30	20	57	93.5	61	M			
	2009.11.-	-	R	F	All-wheel Drive Closed Off-Road Vehicle Engine D4HB	624094	Inner Joint		28	35	42		129.5				
	2009.11.-	-	R	F	Closed Off-Road Vehicle Engine D4HB	624094	Inner Joint		28	35	42		129.5				
2.2 CRDi (147 kW)	2009.11.-	-	R	F	Closed Off-Road Vehicle Engine D4HB	624058	Inner Joint		28	36	42.1	43.5	88				
2.4 CVVT (128 kW)	2009.11.-	AT	L	F	Closed Off-Road Vehicle Engine G4KE	624155	Inner Joint		28	35	33	67	105.5				
	2009.11.-	AT	L	F	All-wheel Drive Closed Off-Road Vehicle Engine G4KE	624155	Inner Joint		28	35	33	67	105.5				
	2009.11.-	-	-	F	Closed Off-Road Vehicle Engine G4KE	624156	Inner Joint		28	35	42		129.5				
	2009.11.-	-	-	F	All-wheel Drive Closed Off-Road Vehicle Engine G4KE	624156	Inner Joint		28	35	42		129.5				
	2009.11.-	-	-	R	All-wheel Drive Closed Off-Road Vehicle Engine G4KE	624010	Inner Joint		25	22	35	63	87				
	2009.11.-	-	-	-	Closed Off-Road Vehicle Engine G4KE	227221	Stub Axle		28	28			420.5				
	2009.11.-	-	-	-	All-wheel Drive Closed Off-Road Vehicle Engine G4KE	227221	Stub Axle		28	28			420.5				
	2009.11.-	-	-	-	All-wheel Drive Closed Off-Road Vehicle Engine G4KE	639041	Inner Joint		25	23	35	63	92.5				
	2009.11.-	-	-	R	All-wheel Drive Closed Off-Road Vehicle Engine G4KE	824321	Outer Joint	52T	30	20	57	93.5	61	M			
2.4 CVVT (141 kW)	2012.10.-	-	-	-	All-wheel Drive Closed Off-Road Vehicle	639041	Inner Joint		25	23	35	63	92.5				
	2012.10.-	-	-	R	All-wheel Drive Closed Off-Road Vehicle	824321	Outer Joint	52T	30	20	57	93.5	61	M			
2.4 GDI (141 kW)	2012.10.-	-	-	-	Closed Off-Road Vehicle Engine G4KJ	227221	Stub Axle		28	28			420.5				
	2012.10.-	-	-	-	All-wheel Drive Closed Off-Road Vehicle Engine G4KJ	227221	Stub Axle		28	28			420.5				
	2012.10.-	-	-	-	All-wheel Drive Closed Off-Road Vehicle Engine G4KJ	639041	Inner Joint		25	23	35	63	92.5				
	2012.10.-	-	-	R	All-wheel Drive Closed Off-Road Vehicle Engine G4KJ	824321	Outer Joint	52T	30	20	57	93.5	61	M			
3.5 (204 kW)	2013.05.-	AT	-	-	All-wheel Drive Closed Off-Road Vehicle Engine G6DC	639041	Inner Joint		25	23	35	63	92.5				
	2013.05.-	AT	-	R	All-wheel Drive Closed Off-Road Vehicle Engine G6DC	824321	Outer Joint	52T	30	20	57	93.5	61	M			
SORENTO III (UM)																	
2.4 (126 kW)	2015.01.-	6AT	R	F	Closed Off-Road Vehicle Engine G4KE	801089	Outer Joint	52T	30	26	55	94.5	65.5	M			
	2015.01.-	6AT	R	F	All-wheel Drive Closed Off-Road Vehicle Engine G4KE	801089	Outer Joint	52T	30	26	55	94.5	65.5	M			
	2015.01.-	6AT	R	F	Closed Off-Road Vehicle Engine G4KE	601096	Inner Joint		28	33	42		129				
	2015.01.-	6AT	R	F	All-wheel Drive Closed Off-Road Vehicle Engine G4KE	601096	Inner Joint		28	33	42		129				
	2015.01.-	6AT	L	F	Closed Off-Road Vehicle Engine G4KE	201243	Drive Shaft	52T	30	28	55	94.5	679				





YEAR	TRANSM	L/R	F/R	REMARKS	GSP Ref.	PRODUCT	ABS	Technical Specifications						
								A	B	C	H	L	P	
KIA														
SORENTO III (UM)														
2.4 (126 kW)	2015.01-	-	6AT	L F	All-wheel Drive Closed Off-Road Vehicle Engine G4KE	201243	Drive Shaft	52T	30	28	55	94.5	679	
	2015.01-	-	6AT	R F	Closed Off-Road Vehicle Engine G4KE	201251	Drive Shaft	52T	30	28	55	94.5	602	
	2015.01-	-	6AT	R F	All-wheel Drive Closed Off-Road Vehicle Engine G4KE	201251	Drive Shaft	52T	30	28	55	94.5	602	
2.4 (129 kW)	2015.01-	-	6AT	R F	Closed Off-Road Vehicle Engine G4KE	801089	Outer Joint	52T	30	26	55	94.5	65.5	M
	2015.01-	-	6AT	R F	All-wheel Drive Closed Off-Road Vehicle Engine G4KE	801089	Outer Joint	52T	30	26	55	94.5	65.5	M
	2015.01-	-	6AT	R F	Closed Off-Road Vehicle Engine G4KE	601096	Inner Joint		28	33	42		129	
	2015.01-	-	6AT	R F	All-wheel Drive Closed Off-Road Vehicle Engine G4KE	601096	Inner Joint		28	33	42		129	
	2015.01-	-	-	R F	Closed Off-Road Vehicle Engine G4KE	201147	Drive Shaft	52T	30	28	54	94.5	612	
	2015.01-	-	6MT	L F	Closed Off-Road Vehicle Engine G4KE	201153	Drive Shaft	52T	30	28	54	94.5	683	
	2015.01-	-	6MT	L F	All-wheel Drive Closed Off-Road Vehicle Engine G4KE	201153	Drive Shaft	52T	30	28	54	94.5	683	
	2015.01-	-	6AT	L F	Closed Off-Road Vehicle Engine G4KE	201243	Drive Shaft	52T	30	28	55	94.5	679	
	2015.01-	-	6AT	L F	All-wheel Drive Closed Off-Road Vehicle Engine G4KE	201243	Drive Shaft	52T	30	28	55	94.5	679	
	2015.01-	-	6AT	R F	Closed Off-Road Vehicle Engine G4KE	201251	Drive Shaft	52T	30	28	55	94.5	602	
	2015.01-	-	6AT	R F	All-wheel Drive Closed Off-Road Vehicle Engine G4KE	201251	Drive Shaft	52T	30	28	55	94.5	602	
	2015.01-	-	6MT	L F	Closed Off-Road Vehicle Engine G4KE	801038	Outer Joint	52T	30	36	54	94.5	67.5	I
	2015.01-	-	6MT	L F	All-wheel Drive Closed Off-Road Vehicle Engine G4KE	801038	Outer Joint	52T	30	36	54	94.5	67.5	I
2.4 GDI (138 kW)	2015.01-	-	6AT	R F	Closed Off-Road Vehicle	801089	Outer Joint	52T	30	26	55	94.5	65.5	M
	2015.01-	-	6AT	R F	All-wheel Drive Closed Off-Road Vehicle Engine G4KJ	801089	Outer Joint	52T	30	26	55	94.5	65.5	M
	2015.01-	-	6AT	R F	Closed Off-Road Vehicle	601096	Inner Joint		28	33	42		129	
	2015.01-	-	6AT	R F	All-wheel Drive Closed Off-Road Vehicle Engine G4KJ	601096	Inner Joint		28	33	42		129	
	2015.01-	-	6AT	L F	Closed Off-Road Vehicle	201243	Drive Shaft	52T	30	28	55	94.5	679	
	2015.01-	-	6AT	L F	All-wheel Drive Closed Off-Road Vehicle Engine G4KJ	201243	Drive Shaft	52T	30	28	55	94.5	679	
	2015.01-	-	6AT	R F	Closed Off-Road Vehicle	201251	Drive Shaft	52T	30	28	55	94.5	602	
	2015.01-	-	6AT	R F	All-wheel Drive Closed Off-Road Vehicle Engine G4KJ	201251	Drive Shaft	52T	30	28	55	94.5	602	
3.3 (199 kW)	2015.04-	-	6AT	L F	Closed Off-Road Vehicle	201149	Drive Shaft	52T	30	28	54	94.5	667	
	2015.04-	-	6AT	L F	All-wheel Drive Closed Off-Road Vehicle	201149	Drive Shaft	52T	30	28	54	94.5	667	
	2015.04-	-	6AT	R F	Closed Off-Road Vehicle	201147	Drive Shaft	52T	30	28	54	94.5	612	
	2015.04-	-	6AT	R F	All-wheel Drive Closed Off-Road Vehicle	201147	Drive Shaft	52T	30	28	54	94.5	612	
SOUL (AM)														
1.6 CRDi 115 (85 kW)	2009.02-	-	AT	- F	Hatchback Engine D4FB	824227	Outer Joint	46T	27	24	60	92.5	58	M
	2009.02-	-	-	L F	Hatchback Engine D4FB	627044	Inner Joint		27	24	41	62.5	88.5	
1.6 CRDi 128 (94 kW)	2009.02-	-	AT	- F	Hatchback Engine D4FB	824227	Outer Joint	46T	27	24	60	92.5	58	M
	2009.02-	-	AT/MT	- -	Hatchback Engine D4FB	824137	Outer Joint	46T	27	24	60	95	59	M
	2009.02-	-	-	L F	Hatchback Engine D4FB	627044	Inner Joint		27	24	41	62.5	88.5	
1.6 CVVT (77 kW)	2009.02-	-	-	- F	Hatchback Engine G4FC	824227	Outer Joint	46T	27	24	60	92.5	58	M
	2009.02-	-	4AT	L F	Hatchback Engine G4FC	627044	Inner Joint		27	24	41	62.5	88.5	
	2009.02-	-	-	L F	Hatchback Engine G4FC	639052	Inner Joint		25	22	41	63	86	
1.6 CVVT (93 kW)	2009.02-	-	-	- F	Hatchback Engine G4FC	824227	Outer Joint	46T	27	24	60	92.5	58	M
	2009.02-	-	4AT	L F	Hatchback Engine G4FC	627044	Inner Joint		27	24	41	62.5	88.5	
	2009.02-	-	-	L F	Hatchback Engine G4FC	639052	Inner Joint		25	22	41	63	86	
1.6 GDI (103 kW)	2011.06-	-	-	- F	Hatchback Engine G4FD	824227	Outer Joint	46T	27	24	60	92.5	58	M
	2011.06-	-	-	L F	Hatchback Engine G4FD	639052	Inner Joint		25	22	41	63	86	
SOUL II (PS)														
EV Electric (25 kW)	2014.09-	-	6MT	L F	Hatchback	201241	Drive Shaft	46T	27	27	60	92.5	686	
	2014.09-	-	6MT	L F	Hatchback	201250	Drive Shaft	46T	27	27	60	92.5	967	
	2014.09-	-	6AT	L F	Hatchback	201242	Drive Shaft	46T	27	27	60	92.5	670	
	2014.09-	-	6AT	L F	Hatchback	201249	Drive Shaft	46T	27	27	60	92.5	958	
EV Electric (81 kW)	2014.09-	-	6MT	L F	Hatchback	201241	Drive Shaft	46T	27	27	60	92.5	686	
	2014.09-	-	6MT	L F	Hatchback	201250	Drive Shaft	46T	27	27	60	92.5	967	
	2014.09-	-	6AT	L F	Hatchback	201242	Drive Shaft	46T	27	27	60	92.5	670	
	2014.09-	-	6AT	L F	Hatchback	201249	Drive Shaft	46T	27	27	60	92.5	958	
SPECTRA														
-	2000-	2001	MT/AT	- F	-	627015	Inner Joint		28	23	43	40.8	75	
	2000-	2001	-	R F	-	227066	Drive Shaft		26	28	56	93	625.5	
	2000-	2001	AT	L F	-	227053	Drive Shaft	44T	26	24	56	92	626	
1.5	1991-	-	AT	R	- BFD (RHD)	227012	Drive Shaft	46T	28	24	56	89.7	907.5	
	1991-	-	AT	L	- BFD (RHD)	227011	Drive Shaft	46T	28	24	56	89.7	635	
	2000-	-	-	L	-	227059	Drive Shaft		28	26	56	89.7	633	
1.6	2002-	2003	-	-	-	627004	Inner Joint		28	22	43	40	67	
	2002-	2003	-	R	-	227030	Drive Shaft	46T	28	28	56	89.7	574	
2.0L	2003-	2009	-	-	F 4 Door Sedan,5 Door Sedan,Sedan4Door 5P	239185	Drive Shaft	44T	25	27	50	90	640	
	2003-	2009	-	-	F 4 Door Sedan,5 Door Sedan,Sedan4Door 5P	239185	Drive Shaft	44T	25	27	50	90	640	
SPECTRA (BFD)														
1.5	1991.01-	-	4AT	- -	-	827004	Outer Joint		28	22	56	90	55.5	M
SPECTRA BFD														
1.5	1991.01-	-	4AT	- -	Engine	827004	Outer Joint		28	22	56	90	55.5	M

KIA	YEAR	TRANSM	L/R	F/R	REMARKS	GSP Ref.	PRODUCT	ABS	Technical Specifications								
									A	B	C	H	L	P			
KIA SPECTRA BFD																	
1.5	1991.01-	-	4AT	-	-	Engine	827004	Outer Joint		28	22	56	90	55.5	M		
1500	1991.01-	-	4AT	-	-	Engine	827004	Outer Joint		28	22	56	90	55.5	M		
	1991.01-	-	4AT	-	-	Engine	827004	Outer Joint		28	22	56	90	55.5	M		
SPECTRA SX																	
2.0L	2007-	2009	-	-	F	4 Door Sedan,5 Door Sedan,Sedan4Door 5P	239185	Drive Shaft	44T	25	27	50	90	640			
	2007-	2009	-	-	F	4 Door Sedan,5 Door Sedan,Sedan4Door 5P	239185	Drive Shaft	44T	25	27	50	90	640			
SPECTRA5 SX																	
2.0L	2007-	2009	-	-	F	Sedan4Door 5P,Sedan5Door 5P	239185	Drive Shaft	44T	25	27	50	90	640			
	2007-	2009	-	-	F	Sedan4Door 5P,Sedan5Door 5P	239185	Drive Shaft	44T	25	27	50	90	640			
	2007-	2009	-	-	F	Sedan4Door 5P,Sedan5Door 5P	239186	Drive Shaft	44T	25	27	50	90	926.5			
SPORTAGE																	
-	-	-	-	-	-	-	227069	Drive Shaft		26	26	65	136	504			
	-	-	-	-	-	-	827011	Outer Joint		26	24	65	136	64	M		
	1995-	2000	-	-	-	-	627016	Inner Joint		26	24	35	82.5	100			
	1995-	2000	-	-	-	-	227067	Drive Shaft		26	26	65	122	577.5			
	2001-	2002	-	-	F	Truck/VAN	634037	Inner Joint		26	25	35	82.5	100			
	2001-	2002	-	R	F	Truck/VAN	227084	Drive Shaft		26	26	66.8	125	582			
2.0	2005-	-	-	-	-	-	227105	Drive Shaft	48T	27	26	62.2	95	608			
	2007-	-	4AT	R	F	-	227231	Drive Shaft	48T	27	27	62.1	95	955			
	2007-	-	4AT	L	F	-	227232	Drive Shaft	48T	27	27	62.1	95	670			
	2010.03-	2013.10	6AT	L	F	-	827128	Outer Joint	48T	30	25	62	95	63	M		
	2010.03-	2013.10	6MT	L	F	-	827128	Outer Joint	48T	30	25	62	95	63	M		
	2010.03-	2013.10	6MT	R	F	-	624064	Inner Joint		28	25	44.1	43.5	76.5			
	2010.03-	2013.10	6AT	R	F	-	624064	Inner Joint		28	25	44.1	43.5	76.5			
	2010.03-	2013.10	6AT	L	F	-	227233	Drive Shaft	48T	30	28	62	95	672			
	2010.03-	2013.10	6AT	R	F	-	227234	Drive Shaft	48T	30	28	62	95	976			
	2010.03-	2013.10	6MT	R	F	-	227237	Drive Shaft	48T	30	28	62	95	989			
	2010.03-	2013.10	6MT	L	F	-	227236	Drive Shaft	48T	30	28	62	95	680			
	2010.03-	2013.10	6MT	R	F	-	227235	Drive Shaft	48T	30	28	62	95	585			
	2010.03-	2013.10	6AT	R	F	-	227235	Drive Shaft	48T	30	28	62	95	585			
	2010.03-	2013.10	6AT	L	F	-	627056	Inner Joint		28	25	33	67	103.5			
	2010.03-	2013.10	6AT	R	F	-	627056	Inner Joint		28	25	33	67	103.5			
	2010.03-	2013.10	6MT	R	F	-	627057	Inner Joint		28	25	41	61.5	107			
	2010.03-	2013.10	6MT	L	F	-	627057	Inner Joint		28	25	41	61.5	107			
	2010.03-	2013.10	6MT	R	F	-	827128	Outer Joint	48T	30	25	62	95	63	M		
	2010.03-	2013.10	6AT	R	F	-	827128	Outer Joint	48T	30	25	62	95	63	M		
	2.4	2010-	-	6MT	L	F	2WD	824123	Outer Joint		27	24	62	95	58	M	
2010-		-	6MT	L	F	2WD	224231	Drive Shaft	48T	27	27	62	95	676			
2010-		-	6MT	L	F	2WD	624053	Inner Joint		27	24	30	67.5	88.5			
2.4 L	2016-	2018	-	L	F	-	201248	Drive Shaft	48T	30	27	73	95	674			
	2016-	2018	-	R	F	-	601150	Inner Joint		28	32	44.1		116			
	2016-	2018	-	R	F	-	201255	Drive Shaft	48T	30	28	73	95	577			
2.7	2004-	-	5MT	R	F	4WD	824180	Outer Joint		27	25	62	94.5	70	M		
	2004-	-	5MT	R	F	4WD	224348	Drive Shaft	48T	27	26	62	94.5	611			
	2004-	-	5MT	R	F	4WD	624033	Inner Joint		26	25	42	43	75			
SPORTAGE (JE)																	
2.0 CRDi (103 kW)	2006.01-	-	-	-	-	-	899289	Outer Joint	48T	27	26	62	94.5	65	M		
2.0 CRDi (110 kW)	2008.09-	-	-	-	-	-	899289	Outer Joint	48T	27	26	62	94.5	65	M		
2.0 CRDi (83 kW)	2005.02-	-	-	-	-	-	899289	Outer Joint	48T	27	26	62	94.5	65	M		
2.0 CRDi 4WD (103 kW)	2006.01-	-	-	-	-	-	899289	Outer Joint	48T	27	26	62	94.5	65	M		
2.0 CRDi 4WD (110 kW)	2008.09-	-	-	-	-	-	899289	Outer Joint	48T	27	26	62	94.5	65	M		
2.0 CRDi 4WD (83 kW)	2004.09-	-	-	-	-	-	899289	Outer Joint	48T	27	26	62	94.5	65	M		
SPORTAGE (JE_KM_)																	
2.0 16V (104 kW)	2004.09-	-	-	-	F	All-wheel Drive Closed Off-Road Vehicle Engine G4GC	827067	Outer Joint	48T	27	24	62.1	95	63	M		
	2004.09-	-	-	-	R	All-wheel Drive Closed Off-Road Vehicle Engine G4GC	824111	Outer Joint	48T	27	22	60	95	59.5	M		
	2004.09-	-	MT	L	F	All-wheel Drive Closed Off-Road Vehicle Engine G4GC	224110	Drive Shaft	48T	27	27	62.2	95	673			
	2004.09-	-	5MT	L	F	All-wheel Drive Closed Off-Road Vehicle Engine G4GC	627020	Inner Joint		27	25	41	62	100.5			
	2004.09-	-	MT	R	F	All-wheel Drive Closed Off-Road Vehicle Engine G4GC	224221	Drive Shaft	48T	27	26	61.9	95	610			
	2004.09-	-	AT	R	F	All-wheel Drive Closed Off-Road Vehicle Engine G4GC	624158	Inner Joint		27	24	30	67	88.5			
	2004.09-	-	-	R	F	All-wheel Drive Closed Off-Road Vehicle Engine G4GC	627032	Inner Joint		26	24	44.1	42	73			
	2004.09-	-	AT/MT	L	F	All-wheel Drive Closed Off-Road Vehicle Engine G4GC	224172	Drive Shaft	48T	27	27	62.2	95	668			
	2004.09-	-	AT/MT	R	F	All-wheel Drive Closed Off-Road Vehicle Engine G4GC	224173	Drive Shaft	48T	27	26	62.2	95	609			
	2004.09-	-	-	L	F	All-wheel Drive Closed Off-Road Vehicle Engine G4GC	627018	Inner Joint		27	24	41	61.5	100.5			
	2004.09-	-	-	-	F	All-wheel Drive Closed Off-Road Vehicle Engine G4GC	824049	Outer Joint	48T	27	25	62.2	95	60	M		
	2004.09-	-	-	R	F	All-wheel Drive Closed Off-Road Vehicle Engine G4GC	627024	Inner Joint		26	24	42	43.5	71.5			
	2004.09-	-	MT	-	-	All-wheel Drive Closed Off-Road Vehicle Engine G4GC	627058	Inner Joint		27	24	41	61.5	100			

KIA SPORTAGE (JE_KM_)	YEAR	TRANSM	L/R	F/R	REMARKS	GSP Ref.	PRODUCT	ABS	Technical Specifications						
									A	B	C	H	L	P	
2.0 16V (104 kW)	2004.09-	-	MT	R	F	All-wheel Drive Closed Off-Road Vehicle Engine G4GC	639063	Inner Joint		26	25	42	39.5	68.5	
	2004.09-	-	-	-	F	All-wheel Drive Closed Off-Road Vehicle Engine G4GC	824124	Outer Joint	48T	27	24	62	95	58	M
2.0 CRDi (100 kW)	2006.01-	-	-	-	R	All-wheel Drive Closed Off-Road Vehicle Engine D4EA	824111	Outer Joint	48T	27	22	60	95	59.5	M
	2006.01-	-	MT	L	F	All-wheel Drive Closed Off-Road Vehicle Engine D4EA	627020	Inner Joint		27	25	41	62	100.5	
	2006.01-	-	MT	L	F	Closed Off-Road Vehicle Engine D4EA	627020	Inner Joint		27	25	41	62	100.5	
	2006.01-	-	MT	R	F	All-wheel Drive Closed Off-Road Vehicle Engine D4EA	224221	Drive Shaft	48T	27	26	61.9	95	610	
	2006.01-	-	MT	R	F	Closed Off-Road Vehicle Engine D4EA	224221	Drive Shaft	48T	27	26	61.9	95	610	
	2006.01-	-	AT/MT	L	F	All-wheel Drive Closed Off-Road Vehicle Engine D4EA	224300	Drive Shaft	48T	30	28	65	95	653	
	2006.01-	-	AT/MT	R	F	Closed Off-Road Vehicle Engine D4EA	224300	Drive Shaft	48T	30	28	65	95	653	
	2006.01-	-	6AT	R	F	Closed Off-Road Vehicle Engine D4EA	624158	Inner Joint		27	24	30	67	88.5	
	2006.01-	-	-	L	F	All-wheel Drive Closed Off-Road Vehicle Engine D4EA	627018	Inner Joint		27	24	41	61.5	100.5	
	2006.01-	-	AT	L	F	Closed Off-Road Vehicle Engine D4EA	627018	Inner Joint		27	24	41	61.5	100.5	
	2006.01-	-	MT	L	F	All-wheel Drive Closed Off-Road Vehicle Engine D4EA	224352	Drive Shaft	48T	27	27	62	94.5	671	
	2006.01-	-	MT	L	F	Closed Off-Road Vehicle Engine D4EA	224352	Drive Shaft	48T	27	27	62	94.5	671	
	2006.01-	-	AT/MT	R	F	All-wheel Drive Closed Off-Road Vehicle Engine D4EA	224301	Drive Shaft	48T	30	28	65	95	605	
	2006.01-	-	AT/MT	R	F	Closed Off-Road Vehicle Engine D4EA	224301	Drive Shaft	48T	30	28	65	95	605	
	2006.01-	-	-	-	F	All-wheel Drive Closed Off-Road Vehicle Engine D4EA	824049	Outer Joint	48T	27	25	62.2	95	60	M
	2006.01-	-	-	-	F	Closed Off-Road Vehicle Engine D4EA	824049	Outer Joint	48T	27	25	62.2	95	60	M
	2006.01-	-	-	R	F	Closed Off-Road Vehicle Engine D4EA	627024	Inner Joint		26	24	42	43.5	71.5	
	2006.01-	-	-	R	F	All-wheel Drive Closed Off-Road Vehicle Engine D4EA	627024	Inner Joint		26	24	42	43.5	71.5	
	2006.01-	-	MT	R	F	All-wheel Drive Closed Off-Road Vehicle Engine D4EA	639063	Inner Joint		26	25	42	39.5	68.5	
	2006.01-	-	6AT	-	F	Closed Off-Road Vehicle Engine D4EA	824124	Outer Joint	48T	27	24	62	95	58	M
	2006.01-	-	MT	R	F	Closed Off-Road Vehicle Engine D4EA	639063	Inner Joint		26	25	42	39.5	68.5	
	2006.01-	-	-	-	F	All-wheel Drive Closed Off-Road Vehicle Engine D4EA	824153	Outer Joint	48T	30	25	65	95	69.5	M
	2006.01-	-	-	-	F	Closed Off-Road Vehicle Engine D4EA	824153	Outer Joint	48T	30	25	65	95	69.5	M
	2006.01-	-	AT	-	F	All-wheel Drive Closed Off-Road Vehicle Engine D4EA	827067	Outer Joint	48T	27	24	62.1	95	63	M
	2006.01-	-	AT	-	F	Closed Off-Road Vehicle Engine D4EA	827067	Outer Joint	48T	27	24	62.1	95	63	M
2.0 CRDi (103 kW)	2006.01-	-	-	-	R	All-wheel Drive Closed Off-Road Vehicle Engine D4EA-F/D4EA-F	824111	Outer Joint	48T	27	22	60	95	59.5	M
	2006.01-	-	MT	L	F	All-wheel Drive Closed Off-Road Vehicle Engine D4EA-F/D4EA-F	627020	Inner Joint		27	25	41	62	100.5	
	2006.01-	-	MT	L	F	Closed Off-Road Vehicle Engine D4EA-V	627020	Inner Joint		27	25	41	62	100.5	
	2006.01-	-	MT	R	F	All-wheel Drive Closed Off-Road Vehicle Engine D4EA-F/D4EA-F	224221	Drive Shaft	48T	27	26	61.9	95	610	
	2006.01-	-	MT	R	F	Closed Off-Road Vehicle Engine D4EA-V	224221	Drive Shaft	48T	27	26	61.9	95	610	
	2006.01-	-	AT/MT	L	F	All-wheel Drive Closed Off-Road Vehicle Engine D4EA-F/D4EA-F	224300	Drive Shaft	48T	30	28	65	95	653	
	2006.01-	-	AT/MT	L	F	Closed Off-Road Vehicle Engine D4EA-V	224300	Drive Shaft	48T	30	28	65	95	653	
	2006.01-	-	6AT	R	F	Closed Off-Road Vehicle Engine D4EA-V	624158	Inner Joint		27	24	30	67	88.5	
	2006.01-	-	-	L	F	All-wheel Drive Closed Off-Road Vehicle Engine D4EA-F/D4EA-F	627018	Inner Joint		27	24	41	61.5	100.5	
	2006.01-	-	AT	L	F	Closed Off-Road Vehicle Engine D4EA-V	627018	Inner Joint		27	24	41	61.5	100.5	
	2006.01-	-	MT	L	F	All-wheel Drive Closed Off-Road Vehicle Engine D4EA-F/D4EA-F	224352	Drive Shaft	48T	27	27	62	94.5	671	
	2006.01-	-	MT	L	F	Closed Off-Road Vehicle Engine D4EA-V	224352	Drive Shaft	48T	27	27	62	94.5	671	
	2006.01-	-	AT/MT	R	F	All-wheel Drive Closed Off-Road Vehicle Engine D4EA-F/D4EA-F	224301	Drive Shaft	48T	30	28	65	95	605	
	2006.01-	-	AT/MT	R	F	Closed Off-Road Vehicle Engine D4EA-V	224301	Drive Shaft	48T	30	28	65	95	605	
	2006.01-	-	-	-	F	All-wheel Drive Closed Off-Road Vehicle Engine D4EA-F/D4EA-F	824049	Outer Joint	48T	27	25	62.2	95	60	M
	2006.01-	-	-	-	F	Closed Off-Road Vehicle Engine D4EA-V	627024	Inner Joint		26	24	42	43.5	71.5	
	2006.01-	-	-	-	F	Closed Off-Road Vehicle Engine D4EA-V	824049	Outer Joint	48T	27	25	62.2	95	60	M
	2006.01-	-	-	R	F	All-wheel Drive Closed Off-Road Vehicle Engine D4EA-F/D4EA-F	627024	Inner Joint		26	24	42	43.5	71.5	
	2006.01-	-	6AT	-	F	Closed Off-Road Vehicle Engine D4EA-V	824124	Outer Joint	48T	27	24	62	95	58	M
	2006.01-	-	MT	R	F	All-wheel Drive Closed Off-Road Vehicle Engine D4EA-F/D4EA-F	639063	Inner Joint		26	25	42	39.5	68.5	
	2006.01-	-	MT	R	F	Closed Off-Road Vehicle Engine D4EA-V	639063	Inner Joint		26	25	42	39.5	68.5	
	2006.01-	-	-	-	F	All-wheel Drive Closed Off-Road Vehicle Engine D4EA-F/D4EA-F	824153	Outer Joint	48T	30	25	65	95	69.5	M
	2006.01-	-	-	-	F	Closed Off-Road Vehicle Engine D4EA-V	824153	Outer Joint	48T	30	25	65	95	69.5	M
	2006.01-	-	AT	-	F	All-wheel Drive Closed Off-Road Vehicle Engine D4EA-F/D4EA-F	827067	Outer Joint	48T	27	24	62.1	95	63	M
	2006.01-	-	AT	-	F	Closed Off-Road Vehicle Engine D4EA-V	827067	Outer Joint	48T	27	24	62.1	95	63	M
2.0 CRDi (110 kW)	2008.09-	-	AT	-	F	Closed Off-Road Vehicle Engine D4EA	827067	Outer Joint	48T	27	24	62.1	95	63	M
	2008.09-	-	AT	-	F	All-wheel Drive Closed Off-Road Vehicle Engine D4EA	827067	Outer Joint	48T	27	24	62.1	95	63	M
	2008.09-	-	-	-	R	All-wheel Drive Closed Off-Road Vehicle Engine D4EA	824111	Outer Joint	48T	27	22	60	95	59.5	M
	2008.09-	-	MT	L	F	Closed Off-Road Vehicle Engine D4EA	627020	Inner Joint		27	25	41	62	100.5	
	2008.09-	-	MT	L	F	All-wheel Drive Closed Off-Road Vehicle Engine D4EA	627020	Inner Joint		27	25	41	62	100.5	
	2008.09-	-	MT	R	F	Closed Off-Road Vehicle Engine D4EA	224221	Drive Shaft	48T	27	26	61.9	95	610	
	2008.09-	-	MT	R	F	All-wheel Drive Closed Off-Road Vehicle Engine D4EA	224221	Drive Shaft	48T	27	26	61.9	95	610	
	2008.09-	-	AT/MT	L	F	Closed Off-Road Vehicle Engine D4EA	224300	Drive Shaft	48T	30	28	65	95	653	
	2008.09-	-	AT/MT	L	F	All-wheel Drive Closed Off-Road Vehicle Engine D4EA	224300	Drive Shaft	48T	30	28	65	95	653	
	2008.09-	-	6AT	R	F	Closed Off-Road Vehicle Engine D4EA	624158	Inner Joint		27	24	30	67	88.5	
	2008.09-	-	AT	L	F	Closed Off-Road Vehicle Engine D4EA	627018	Inner Joint		27	24	41	61.5	100.5	
	2008.09-	-	-	L	F	All-wheel Drive Closed Off-Road Vehicle Engine D4EA	627018	Inner Joint		27	24	41	61.5	100.5	
	2008.09-	-	MT	L	F	Closed Off-Road Vehicle Engine D4EA	224352	Drive Shaft	48T	27	27	62	94.5	671	
	2008.09-	-	MT	L	F	All-wheel Drive Closed Off-Road Vehicle Engine D4EA	224352	Drive Shaft	48T	27	27	62	94.5	671	

KIA SPORTAGE (JE_KM_)	YEAR	TRANSM	L/R	F/R	REMARKS	GSP Ref.	PRODUCT	ABS	Technical Specifications							
									A	B	C	H	L	P		
2.0 CRDi (110 kW)	2008.09.-	AT/MT	R	F	Closed Off-Road Vehicle Engine D4EA	224301	Drive Shaft	48T	30	28	65	95	605			
	2008.09.-	AT/MT	R	F	All-wheel Drive Closed Off-Road Vehicle Engine D4EA	224301	Drive Shaft	48T	30	28	65	95	605			
	2008.09.-	-	R	F	Closed Off-Road Vehicle Engine D4EA	627024	Inner Joint		26	24	42	43.5	71.5			
	2008.09.-	-	R	F	All-wheel Drive Closed Off-Road Vehicle Engine D4EA	627024	Inner Joint		26	24	42	43.5	71.5			
	2008.09.-	-	-	F	Closed Off-Road Vehicle Engine D4EA	824049	Outer Joint	48T	27	25	62.2	95	60	M		
	2008.09.-	-	-	F	All-wheel Drive Closed Off-Road Vehicle Engine D4EA	824049	Outer Joint	48T	27	25	62.2	95	60	M		
	2008.09.-	6AT	-	F	Closed Off-Road Vehicle Engine D4EA	824124	Outer Joint	48T	27	24	62	95	58	M		
	2008.09.-	MT	R	F	Closed Off-Road Vehicle Engine D4EA	639063	Inner Joint		26	25	42	39.5	68.5			
	2008.09.-	MT	R	F	All-wheel Drive Closed Off-Road Vehicle Engine D4EA	639063	Inner Joint		26	25	42	39.5	68.5			
	2008.09.-	-	-	F	Closed Off-Road Vehicle Engine D4EA	824153	Outer Joint	48T	30	25	65	95	69.5	M		
2.0 CRDi (83 kW)	2004.09.-	AT	-	F	All-wheel Drive Closed Off-Road Vehicle Engine D4EA	827067	Outer Joint	48T	27	24	62.1	95	63	M		
	2004.09.-	-	R	F	All-wheel Drive Closed Off-Road Vehicle Engine D4EA	824111	Outer Joint	48T	27	22	60	95	59.5	M		
	2004.09.-	MT	L	F	All-wheel Drive Closed Off-Road Vehicle Engine D4EA	627020	Inner Joint		27	25	41	62	100.5			
	2004.09.-	MT	R	F	All-wheel Drive Closed Off-Road Vehicle Engine D4EA	224221	Drive Shaft	48T	27	26	61.9	95	610			
	2004.09.-	AT/MT	L	F	All-wheel Drive Closed Off-Road Vehicle Engine D4EA	224300	Drive Shaft	48T	30	28	65	95	653			
	2004.09.-	MT	L	F	All-wheel Drive Closed Off-Road Vehicle Engine D4EA	224352	Drive Shaft	48T	27	27	62	94.5	671			
	2004.09.-	-	L	F	All-wheel Drive Closed Off-Road Vehicle Engine D4EA	627018	Inner Joint		27	24	41	61.5	100.5			
	2004.09.-	AT/MT	R	F	All-wheel Drive Closed Off-Road Vehicle Engine D4EA	224301	Drive Shaft	48T	30	28	65	95	605			
	2004.09.-	-	-	F	All-wheel Drive Closed Off-Road Vehicle Engine D4EA	824049	Outer Joint	48T	27	25	62.2	95	60	M		
	2004.09.-	-	R	F	All-wheel Drive Closed Off-Road Vehicle Engine D4EA	627024	Inner Joint		26	24	42	43.5	71.5			
	2004.09.-	MT	R	F	All-wheel Drive Closed Off-Road Vehicle Engine D4EA	639063	Inner Joint		26	25	42	39.5	68.5			
	2004.09.-	-	-	F	All-wheel Drive Closed Off-Road Vehicle Engine D4EA	824153	Outer Joint	48T	30	25	65	95	69.5	M		
	2005.02.-	MT	L	F	Closed Off-Road Vehicle Engine D4EA	627020	Inner Joint		27	25	41	62	100.5			
	2005.02.-	MT	R	F	Closed Off-Road Vehicle Engine D4EA	224221	Drive Shaft	48T	27	26	61.9	95	610			
	2005.02.-	AT/MT	L	F	Closed Off-Road Vehicle Engine D4EA	224300	Drive Shaft	48T	30	28	65	95	653			
	2005.02.-	6AT	R	F	Closed Off-Road Vehicle Engine D4EA	624158	Inner Joint		27	24	30	67	88.5			
	2005.02.-	AT	L	F	Closed Off-Road Vehicle Engine D4EA	627018	Inner Joint		27	24	41	61.5	100.5			
	2005.02.-	MT	L	F	Closed Off-Road Vehicle Engine D4EA	224352	Drive Shaft	48T	27	27	62	94.5	671			
	2005.02.-	-	R	F	Closed Off-Road Vehicle Engine D4EA	627024	Inner Joint		26	24	42	43.5	71.5			
	2005.02.-	-	-	F	Closed Off-Road Vehicle Engine D4EA	824049	Outer Joint	48T	27	25	62.2	95	60	M		
2005.02.-	6AT	-	F	Closed Off-Road Vehicle Engine D4EA	824124	Outer Joint	48T	27	24	62	95	58	M			
2.0 i 16V (104 kW)	2005.02.-	MT	R	F	Closed Off-Road Vehicle Engine D4EA	639063	Inner Joint		26	25	42	39.5	68.5			
	2005.02.-	-	-	F	Closed Off-Road Vehicle Engine D4EA	824153	Outer Joint	48T	30	25	65	95	69.5	M		
	2005.02.-	AT	-	F	Closed Off-Road Vehicle Engine D4EA	827067	Outer Joint	48T	27	24	62.1	95	63	M		
	2004.09.-	-	-	F	Closed Off-Road Vehicle Engine G4GC	827067	Outer Joint	48T	27	24	62.1	95	63	M		
	2004.09.-	-	R	F	Closed Off-Road Vehicle Engine G4GC	824111	Outer Joint	48T	27	22	60	95	59.5	M		
	2004.09.-	MT	L	F	Closed Off-Road Vehicle Engine G4GC	224110	Drive Shaft	48T	27	27	62.2	95	673			
	2004.09.-	5MT	L	F	Closed Off-Road Vehicle Engine G4GC	627020	Inner Joint		27	25	41	62	100.5			
	2004.09.-	AT	R	F	Closed Off-Road Vehicle Engine G4GC	624158	Inner Joint		27	24	30	67	88.5			
	2004.09.-	AT/MT	L	F	Closed Off-Road Vehicle Engine G4GC	224172	Drive Shaft	48T	27	27	62.2	95	668			
	2004.09.-	-	R	F	Closed Off-Road Vehicle Engine G4GC	627032	Inner Joint		26	24	44.1	42	73			
2.7 V6 (129 kW)	2004.09.-	-	L	F	Closed Off-Road Vehicle Engine G4GC	627018	Inner Joint		27	24	41	61.5	100.5			
	2004.09.-	-	-	F	Closed Off-Road Vehicle Engine G4GC	824049	Outer Joint	48T	27	25	62.2	95	60	M		
	2004.09.-	MT	-	-	Closed Off-Road Vehicle Engine G4GC	627058	Inner Joint		27	24	41	61.5	100			
	2004.09.-	-	-	F	Closed Off-Road Vehicle Engine G4GC	824124	Outer Joint	48T	27	24	62	95	58	M		
	2004.09.-	AT	-	R	All-wheel Drive Closed Off-Road Vehicle Engine G6BA	824111	Outer Joint	48T	27	22	60	95	59.5	M		
	2004.09.-	AT	-	F	All-wheel Drive Closed Off-Road Vehicle Engine G6BA	824090	Outer Joint	48T	27	25	61.9	95	61	M		
	2004.09.-	AT	L	F	All-wheel Drive Closed Off-Road Vehicle Engine G6BA	624013	Inner Joint		27	33	41	61.5	107			
	2004.09.-	AT	L	F	All-wheel Drive Closed Off-Road Vehicle Engine G6BA	627020	Inner Joint		27	25	41	62	100.5			
SPORTAGE (K00)	2004.09.-	AT/MT	L	F	All-wheel Drive Closed Off-Road Vehicle Engine G6BA	224172	Drive Shaft	48T	27	27	62.2	95	668			
	2004.09.-	AT/MT	R	F	All-wheel Drive Closed Off-Road Vehicle Engine G6BA	224173	Drive Shaft	48T	27	26	62.2	95	609			
	2004.09.-	AT	L	F	All-wheel Drive Closed Off-Road Vehicle Engine G6BA	627018	Inner Joint		27	24	41	61.5	100.5			
	2004.09.-	AT	R	F	All-wheel Drive Closed Off-Road Vehicle Engine G6BA	624014	Inner Joint		26	33	42	42	82			
	2.0 (87 kW)	2000.10.-	2003.08	-	-	F	All-wheel Drive Closed Off-Road Vehicle Engine FE (16V)	827002	Outer Joint		26	24	65	122	62	M
	2.0 (70 kW)	2000.10.-	2003.08	-	-	F	Closed Off-Road Vehicle Engine FE (16V)	827002	Outer Joint		26	24	65	122	62	M
2.0 i (70 kW)	1994.04.-	1999.08	-	-	-	All-wheel Drive Closed Off-Road Vehicle Engine FE (8V)	899053	Outer Joint		26	25	65	122	63	M	
2.0 i 16V (94 kW)	1994.04.-	2003.08	-	-	F	All-wheel Drive Closed Off-Road Vehicle Engine FE (16V)	827002	Outer Joint		26	24	65	122	62	M	
	1994.04.-	2003.08	-	-	-	All-wheel Drive Closed Off-Road Vehicle Engine FE (16V)	899053	Outer Joint		26	25	65	122	63	M	
	1999.10.-	2003.08	-	-	F	Closed Off-Road Vehicle Engine FE (16V)	827002	Outer Joint		26	24	65	122	62	M	
	1999.10.-	2003.08	-	-	-	Closed Off-Road Vehicle Engine FE (16V)	899053	Outer Joint		26	25	65	122	63	M	
2.0 i 16V (95 kW)	1998.11.-	2004.08	-	-	R	All-wheel Drive Closed Off-Road Vehicle	824111	Outer Joint	48T	27	22	60	95	59.5	M	
	1998.11.-	2004.08	5MT	L	F	All-wheel Drive Closed Off-Road Vehicle	627020	Inner Joint		27	25	41	62	100.5		
	1998.11.-	2004.08	-	-	F	All-wheel Drive Closed Off-Road Vehicle	827002	Outer Joint		26	24	65	122	62	M	

KIA	YEAR	TRANSM	L/R	F/R	REMARKS	GSP Ref.	PRODUCT	ABS	Technical Specifications								
									A	B	C	H	L	P			
KIA SPORTAGE (K00)																	
2.0 i 16V (95 kW)	1998.11-2004.08	4AT	L	F	All-wheel Drive Closed Off-Road Vehicle	627018	Inner Joint		27	24	41	61.5	100.5				
	1998.11-2004.08	4AT	-	F	All-wheel Drive Closed Off-Road Vehicle	827067	Outer Joint	48T	27	24	62.1	95	63	M			
2.0 TD (61 kW)	1997.10-2003.08	-	-	F	All-wheel Drive Closed Off-Road Vehicle Engine RF	827002	Outer Joint		26	24	65	122	62	M			
KIA SPORTAGE (QL)																	
2.0 (114 kW)	2015.12-	6AT	L	F	Closed Off-Road Vehicle	801091	Outer Joint	48T	30	24	73	95	59	M			
	2015.12-	6AT	L	F	Closed Off-Road Vehicle	624126	Inner Joint		27	32	30	67	88.5				
	2015.12-	6MT	R	F	Closed Off-Road Vehicle	801093	Outer Joint	48T	30	25	73	95	64	M			
	2015.12-	6MT	R	F	Closed Off-Road Vehicle	601149	Inner Joint		27	33	41	61.5	105				
	2015.12-	6AT	L	F	Closed Off-Road Vehicle	201244	Drive Shaft	48T	30	27	73	95	693				
	2015.12-	6MT	L	F	Closed Off-Road Vehicle	201246	Drive Shaft	48T	30	27	73	95	692				
	2015.12-	6MT	R	F	Closed Off-Road Vehicle	201253	Drive Shaft	48T	30	27	73	95	982				
2.0 (115 kW)	2015.12-	6AT	L	F	Closed Off-Road Vehicle Engine G4NA	801091	Outer Joint	48T	30	24	73	95	59	M			
	2015.12-	6AT	L	F	Closed Off-Road Vehicle Engine G4NA	624126	Inner Joint		27	32	30	67	88.5				
	2015.12-	6MT	R	F	Closed Off-Road Vehicle Engine G4NA	801093	Outer Joint	48T	30	25	73	95	64	M			
	2015.12-	6MT	R	F	Closed Off-Road Vehicle Engine G4NA	601149	Inner Joint		27	33	41	61.5	105				
	2015.12-	6AT	L	F	Closed Off-Road Vehicle Engine G4NA	201244	Drive Shaft	48T	30	27	73	95	693				
	2015.12-	6MT	L	F	Closed Off-Road Vehicle Engine G4NA	201246	Drive Shaft	48T	30	27	73	95	692				
	2015.12-	6MT	R	F	Closed Off-Road Vehicle Engine G4NA	201253	Drive Shaft	48T	30	27	73	95	982				
2.0 AWD (114 kW)	2015.12-	6AT	R	F	All-wheel Drive Closed Off-Road Vehicle	201252	Drive Shaft	48T	30	28	73	95	571				
2.0 AWD (131 kW)	2015.09-	6AT	R	F	All-wheel Drive Closed Off-Road Vehicle	201252	Drive Shaft	48T	30	28	73	95	571				
KIA SPORTAGE (SL)																	
1.6 GDI (99 kW)	2011.02-	6AT	L	F	Closed Off-Road Vehicle Engine G4FD	201240	Drive Shaft	48T	27	27	62	95	676				
	2011.02-	MT	R	F	Closed Off-Road Vehicle Engine G4FD	224317	Drive Shaft	48T	27	25	62	95	691				
	2011.02-	6AT	R	F	Closed Off-Road Vehicle Engine G4FD	201996	Drive Shaft	48T	27	27	62	95	963				
1.7 CRDi (85 kW)	2010.12-	MT	R	F	Closed Off-Road Vehicle Engine D4FD-L	224362	Drive Shaft	48T	30	27	62	95	979				
2.0 CRDi (100 kW)	2010.07-	MT	L	F	Closed Off-Road Vehicle Engine D4HA	224299	Drive Shaft	48T	30	27	62	95	690				
	2010.07-	6AT	R	F	Closed Off-Road Vehicle Engine D4HA	624158	Inner Joint		27	24	30	67	88.5				
	2010.07-	6AT	-	F	Closed Off-Road Vehicle Engine D4HA	824124	Outer Joint	48T	27	24	62	95	58	M			
2.0 CRDi (135 kW)	2010.08-	6AT	R	F	Closed Off-Road Vehicle Engine D4HA	624158	Inner Joint		27	24	30	67	88.5				
	2010.08-	6AT	-	F	Closed Off-Road Vehicle Engine D4HA	824124	Outer Joint	48T	27	24	62	95	58	M			
2.0 CRDi AWD (135 kW)	2010.08-	MT	L	F	All-wheel Drive Closed Off-Road Vehicle Engine D4HA	224299	Drive Shaft	48T	30	27	62	95	690				
2.0 CVVT (120 kW)	2010.07-	6AT	R	F	Closed Off-Road Vehicle Engine G4KD	824284	Outer Joint	48T	27	24	62	95	59	M			
	2010.07-	AT	R	F	Closed Off-Road Vehicle Engine G4KD	624158	Inner Joint		27	24	30	67	88.5				
	2010.07-	-	R	F	Closed Off-Road Vehicle Engine G4KD	627032	Inner Joint		26	24	44.1	42	73				
	2010.07-	MT	-	-	Closed Off-Road Vehicle Engine G4KD	627058	Inner Joint		27	24	41	61.5	100				
	2010.07-	-	-	F	Closed Off-Road Vehicle Engine G4KD	824124	Outer Joint	48T	27	24	62	95	58	M			
2.0 CVVT (122 kW)	2010.07-	6AT	R	F	Closed Off-Road Vehicle Engine G4KD	824284	Outer Joint	48T	27	24	62	95	59	M			
	2010.07-	AT	R	F	Closed Off-Road Vehicle Engine G4KD	624158	Inner Joint		27	24	30	67	88.5				
	2010.07-	-	R	F	Closed Off-Road Vehicle Engine G4KD	627032	Inner Joint		26	24	44.1	42	73				
	2010.07-	MT	-	-	Closed Off-Road Vehicle Engine G4KD	627058	Inner Joint		27	24	41	61.5	100				
	2010.07-	-	-	F	Closed Off-Road Vehicle Engine G4KD	824124	Outer Joint	48T	27	24	62	95	58	M			
2.0 CVVT AWD (120 kW)	2010.07-	AT	R	F	All-wheel Drive Closed Off-Road Vehicle Engine G4KD	624158	Inner Joint		27	24	30	67	88.5				
	2010.07-	MT	-	-	All-wheel Drive Closed Off-Road Vehicle Engine G4KD	627058	Inner Joint		27	24	41	61.5	100				
	2010.07-	-	-	F	All-wheel Drive Closed Off-Road Vehicle Engine G4KD	824124	Outer Joint	48T	27	24	62	95	58	M			
2.0 CVVT AWD (122 kW)	2010.07-	AT	R	F	All-wheel Drive Closed Off-Road Vehicle Engine G4KD	624158	Inner Joint		27	24	30	67	88.5				
	2010.07-	MT	-	-	All-wheel Drive Closed Off-Road Vehicle Engine G4KD	627058	Inner Joint		27	24	41	61.5	100				
	2010.07-	-	-	F	All-wheel Drive Closed Off-Road Vehicle Engine G4KD	824124	Outer Joint	48T	27	24	62	95	58	M			
2.0 GDI (122 kW)	2014.02-	6AT	L	F	Closed Off-Road Vehicle Engine G4NC	601106	Inner Joint		27	24	30	67.5	88.5				
	2014.02-	6AT	L	F	Closed Off-Road Vehicle Engine G4NC	201239	Drive Shaft	48T	27	27	62	95	682				
	2014.02-	AT	R	F	Closed Off-Road Vehicle Engine G4NC	624158	Inner Joint		27	24	30	67	88.5				
	2014.02-	MT	-	-	Closed Off-Road Vehicle Engine G4NC	627058	Inner Joint		27	24	41	61.5	100				
	2014.02-	-	-	F	Closed Off-Road Vehicle Engine G4NC	824124	Outer Joint	48T	27	24	62	95	58	M			
2.0 GDI AWD (122 kW)	2014.02-	AT	R	F	All-wheel Drive Closed Off-Road Vehicle Engine G4NC	624158	Inner Joint		27	24	30	67	88.5				
	2014.02-	MT	-	-	All-wheel Drive Closed Off-Road Vehicle Engine G4NC	627058	Inner Joint		27	24	41	61.5	100				
	2014.02-	-	-	F	All-wheel Drive Closed Off-Road Vehicle Engine G4NC	824124	Outer Joint	48T	27	24	62	95	58	M			
KIA SPORTAGE 10																	
2.0	2010.03-2013.10	6AT	R	F	-	224230	Drive Shaft	48T	27	27	62	95	961				
	2010.03-2013.10	6AT	R	F	-	624053	Inner Joint		27	24	30	67.5	88.5				
KIA VENGA (YN)																	
1.4 CRDi 75 (55 kW)	2010.02-	MT	L	F	Hatchback Engine D4FC	224318	Drive Shaft	46T	27	27	60	95	672				
	2010.02-	MT	R	F	Hatchback Engine D4FC	224400	Drive Shaft	46T	27	27	60	95	967				
1.4 CRDi 75 (57 kW)	2010.02-	MT	L	F	Hatchback Engine D4FC	224318	Drive Shaft	46T	27	27	60	95	672				
	2010.02-	MT	R	F	Hatchback Engine D4FC	224400	Drive Shaft	46T	27	27	60	95	967				
1.4 CRDi 90 (66 kW)	2010.02-	MT	L	F	Hatchback Engine D4FC	224318	Drive Shaft	46T	27	27	60	95	672				
	2010.02-	MT	R	F	Hatchback Engine D4FC	224400	Drive Shaft	46T	27	27	60	95	967				
1.4 CVVT (66 kW)	2010.02-	MT	R	F	Hatchback Engine G4FA-L	239237	Drive Shaft	46T	27	25	60	94.5	959				

	 YEAR	TRANSM	L/R	F/R	REMARKS	GSP Ref.	 PRODUCT	 ABS	Technical Specifications						
									A	B	C	H	L	P	
KIA															
VENGA (YN)															
1.6 CRDi 115 (85 kW)	2010.02-	-	MT	L	F	Hatchback Engine D4FB	224318	Drive Shaft	46T	27	27	60	95	672	
	2010.02-	-	MT	R	F	Hatchback Engine D4FB	224400	Drive Shaft	46T	27	27	60	95	967	
1.6 CRDi 128 (94 kW)	2010.02-	-	MT	L	F	Hatchback Engine D4FB	224318	Drive Shaft	46T	27	27	60	95	672	
	2010.02-	-	MT	R	F	Hatchback Engine D4FB	224400	Drive Shaft	46T	27	27	60	95	967	
1.6 CVVT (92 kW)	2010.02-	-	4AT/MT	R	F	Hatchback Engine G4FC	239237	Drive Shaft	46T	27	25	60	94.5	959	
KIA (DYK)															
CARNIVAL															
3.5 (140 kW)	2004.07-	2010.12	AT	L	-	MPV Engine G6CU	227081	Drive Shaft	54T	28	28	56	102.5	673	
	2004.07-	2010.12	AT	R	-	MPV Engine G6CU	227083	Drive Shaft	54T	28	28	56	102.5	666	
FORTE															
1.6 (90 kW)	2009.06-	-	MT	R	F	Saloon Engine G4FC	227144	Drive Shaft	46T	27	25	60	94.5	966	
QIANLIMA															
1.3 CNG (61 kW)	2002.12-	2007.04	AT	L	-	Saloon Engine G4EA	227123	Drive Shaft	44T	25	25	50	95	627	
	2002.12-	2007.04	AT	R	-	Saloon Engine G4EA	227124	Drive Shaft	44T	25	25	50	95	913	
LADA															
110 (2110)/VEGA															
1.5 (52 kW)	1995.01-	2005.12	-	-	F	Saloon Engine BA3 2111	828005	Outer Joint		22	22	50	77	53.5	I
	1995.01-	2005.12	-	-	-	Saloon Engine BA3 2111	828001	Outer Joint		22	22	50	77	53.5	I
1.5 (54 kW)	1995.01-	2012.12	-	L	F	Saloon	228001	Drive Shaft		22	24	50	77	600	
1.5 (56 kW)	2000.10-	2005.12	-	-	F	Saloon Engine VAZ-2111	828005	Outer Joint		22	22	50	77	53.5	I
	2000.10-	2005.12	-	L	F	Saloon Engine VAZ-2111	228001	Drive Shaft		22	24	50	77	600	
1.5 (57 kW)	1995.01-	2005.12	-	-	F	Saloon Engine VAZ-2111	828005	Outer Joint		22	22	50	77	53.5	I
	1995.01-	2005.12	-	-	-	Saloon Engine VAZ-2111	828001	Outer Joint		22	22	50	77	53.5	I
	1995.01-	2005.12	-	L	F	Saloon Engine VAZ-2111	228001	Drive Shaft		22	24	50	77	600	
1.5 16V (67 kW)	2000.10-	2010.12	-	-	F	Saloon Engine VAZ-2112	828005	Outer Joint		22	22	50	77	53.5	I
	2000.10-	2010.12	-	L	F	Saloon Engine VAZ-2112	228001	Drive Shaft		22	24	50	77	600	
1.5 16V (70 kW)	1995.01-	2005.12	-	-	F	Saloon Engine VAZ-2112	828005	Outer Joint		22	22	50	77	53.5	I
	1995.01-	2005.12	-	-	-	Saloon Engine VAZ-2112	828001	Outer Joint		22	22	50	77	53.5	I
	1995.01-	2005.12	-	L	F	Saloon Engine VAZ-2112	228001	Drive Shaft		22	24	50	77	600	
1.6 (60 kW)	2000.01-	2012.12	-	-	F	Saloon Engine VAZ-21114	828005	Outer Joint		22	22	50	77	53.5	I
	2000.01-	2012.12	-	L	F	Saloon Engine VAZ-21114	228001	Drive Shaft		22	24	50	77	600	
1.6 (66 kW)	2000.01-	2007.04	-	L	F	Saloon Engine VAZ-21124	228001	Drive Shaft		22	24	50	77	600	
1.6 (72 kW)	1995.01-	2007.12	-	L	F	Saloon Engine VAZ-21114	228001	Drive Shaft		22	24	50	77	600	
1.6 16V (67 kW)	2004.10-	2010.12	-	L	F	Saloon Engine VAZ-21124	228001	Drive Shaft		22	24	50	77	600	
1.6 LPG (60 kW)	2004.10-	2007.03	-	L	F	Saloon Engine VAZ-21114	228001	Drive Shaft		22	24	50	77	600	
2.0 i (110 kW)	1996.08-	2000.07	-	-	F	Saloon Engine C 20 XE	828005	Outer Joint		22	22	50	77	53.5	I
	1996.08-	2000.07	-	-	-	Saloon Engine C 20 XE	828001	Outer Joint		22	22	50	77	53.5	I
	1996.08-	2000.07	-	L	F	Saloon Engine C 20 XE	228001	Drive Shaft		22	24	50	77	600	
2.6 (88 kW)	1997.06-	2004.09	-	-	F	Saloon Engine VAZ-415	828005	Outer Joint		22	22	50	77	53.5	I
	1997.06-	2004.09	-	-	-	Saloon Engine VAZ-415	828001	Outer Joint		22	22	50	77	53.5	I
	1997.06-	2004.09	-	L	F	Saloon Engine VAZ-415	228001	Drive Shaft		22	24	50	77	600	
111 (2111)															
1.5 (52 kW)	1997.01-	2003.12	-	L	F	Estate Engine BA3 2111	228001	Drive Shaft		22	24	50	77	600	
1.5 (56 kW)	2000.10-	2005.12	-	-	F	Estate Engine VAZ-2111	828005	Outer Joint		22	22	50	77	53.5	I
	2000.10-	2005.12	-	L	F	Estate Engine VAZ-2111	228001	Drive Shaft		22	24	50	77	600	
1.5 (57 kW)	1996.01-	2005.12	-	-	F	Estate Engine VAZ-2111	828005	Outer Joint		22	22	50	77	53.5	I
	1996.01-	2005.12	-	-	-	Estate Engine VAZ-2111	828001	Outer Joint		22	22	50	77	53.5	I
	1996.01-	2005.12	-	L	F	Estate Engine VAZ-2111	228001	Drive Shaft		22	24	50	77	600	
1.5 (58 kW)	2000.10-	2004.09	-	L	F	Estate Engine VAZ-2111	228001	Drive Shaft		22	24	50	77	600	
1.5 16V (67 kW)	2000.10-	2005.12	-	-	F	Estate Engine VAZ-2112	828005	Outer Joint		22	22	50	77	53.5	I
	2000.10-	2005.12	-	L	F	Estate Engine VAZ-2112	228001	Drive Shaft		22	24	50	77	600	
1.5 16V (70 kW)	1995.01-	2002.08	-	-	F	Estate Engine VAZ-2112	828005	Outer Joint		22	22	50	77	53.5	I
	1995.01-	2002.08	-	-	-	Estate Engine VAZ-2112	828001	Outer Joint		22	22	50	77	53.5	I
	1995.01-	2002.08	-	L	F	Estate Engine VAZ-2112	228001	Drive Shaft		22	24	50	77	600	
112 (2112)															
1.5 (54 kW)	1995.01-	2000.10	-	-	F	Hatchback Engine VAZ-2111	828005	Outer Joint		22	22	50	77	53.5	I
	1995.01-	2000.10	-	-	-	Hatchback Engine VAZ-2111	828001	Outer Joint		22	22	50	77	53.5	I
1.5 (56 kW)	2000.10-	2005.12	-	-	F	Hatchback Engine VAZ-2111	828005	Outer Joint		22	22	50	77	53.5	I
	2000.10-	2005.12	-	L	F	Hatchback Engine VAZ-2111	228001	Drive Shaft		22	24	50	77	600	
1.5 (57 kW)	1995.01-	2004.09	-	-	F	Hatchback Engine VAZ-2111	828005	Outer Joint		22	22	50	77	53.5	I
	1995.01-	2004.09	-	-	-	Hatchback Engine VAZ-2111	828001	Outer Joint		22	22	50	77	53.5	I
	1995.01-	2004.09	-	L	F	Hatchback Engine VAZ-2111	228001	Drive Shaft		22	24	50	77	600	
1.5 16V (67 kW)	2000.10-	2005.12	-	-	F	Hatchback Engine VAZ-2112	828005	Outer Joint		22	22	50	77	53.5	I
	2000.10-	2005.12	-	L	F	Hatchback Engine VAZ-2112	228001	Drive Shaft		22	24	50	77	600	
1.5 16V (70 kW)	1995.01-	2000.09	-	-	F	Hatchback Engine VAZ-2112	828005	Outer Joint		22	22	50	77	53.5	I

YEAR	TRANSM	L/R	F/R	REMARKS	GSP Ref.	PRODUCT	ABS	Technical Specifications										
								A	B	C	H	L	P					
LADA																		
112 (2112)																		
1.5 16V (70 kW)	1995.01-2000.09	-	-	-	Hatchback Engine VAZ-2112	828001	Outer Joint		22	22	50	77	53.5	I				
	1995.01-2000.09	-	L	F	Hatchback Engine VAZ-2112	228001	Drive Shaft		22	24	50	77	600					
1.6 (60 kW)	2005.01-2011.12	-	L	F	Hatchback Engine VAZ-21114	228001	Drive Shaft		22	24	50	77	600					
1.6 (66 kW)	2006.03-2008.12	-	-	F	Hatchback Engine VAZ-21124	828005	Outer Joint		22	22	50	77	53.5	I				
	2006.03-2008.12	-	L	F	Hatchback Engine VAZ-21124	228001	Drive Shaft		22	24	50	77	600					
2170 KALINA/ PRIORA																		
-	-	-	-	-	-	828010	Outer Joint	43T	22	22	50	77	53.5	I				
GRANTA (2190)																		
1.6 (60 kW)	2011.10-	-	-	R	F	Saloon Engine VAZ-11183	201290	Drive Shaft	43T	22	25	50	77	887				
	2011.10-	-	-	L	F	Saloon Engine VAZ-11183	201292	Drive Shaft	43T	22	25	50	77	568				
1.6 (64 kW)	2011.10-	-	-	R	F	Saloon Engine VAZ-11186	201290	Drive Shaft	43T	22	25	50	77	887				
	2011.10-	-	-	L	F	Saloon Engine VAZ-11186	201292	Drive Shaft	43T	22	25	50	77	568				
1.6 (72 kW)	2011.10-	-	-	R	F	Saloon Engine VAZ-21126	201290	Drive Shaft	43T	22	25	50	77	887				
	2011.10-	-	-	L	F	Saloon Engine VAZ-21126	201292	Drive Shaft	43T	22	25	50	77	568				
1.6 (78 kW)	2013.07-	-	-	R	F	Saloon Engine VAZ-21127	201290	Drive Shaft	43T	22	25	50	77	887				
	2013.07-	-	-	L	F	Saloon Engine VAZ-21127	201292	Drive Shaft	43T	22	25	50	77	568				
GRANTA (2349)																		
1.6 (64 kW)	2011.10-	-	-	R	F	Pickup Engine VAZ-11186	201290	Drive Shaft	43T	22	25	50	77	887				
	2011.10-	-	-	L	F	Pickup Engine VAZ-11186	201292	Drive Shaft	43T	22	25	50	77	568				
KALINA (1117)																		
1.6 (60 kW)	2004.10-	2013.12	-	-	F	Estate Engine VAZ-21114	828005	Outer Joint		22	22	50	77	53.5	I			
KALINA (1118)																		
1.6 (60 kW)	2004.10-	2009.12	-	-	F	Saloon Engine VAZ-21124/VAZ-21114	828005	Outer Joint		22	22	50	77	53.5	I			
1.6 (66 kW)	2004.10-	-	-	-	F	Saloon Engine VAZ-11186	828005	Outer Joint		22	22	50	77	53.5	I			
KALINA (1119)																		
1.6 (60 kW)	2004.10-	2013.12	-	-	F	Hatchback Engine VAZ-21114	828005	Outer Joint		22	22	50	77	53.5	I			
1.6 (66 kW)	2004.10-	2013.12	-	-	F	Hatchback Engine VAZ-11186	828005	Outer Joint		22	22	50	77	53.5	I			
LARGUS																		
1.6 (62 kW)	2012.03-	-	-	-	R	Box Engine VAZ-K7M	812034	Outer Joint		24	20	44	113.5	48.5	I			
	2012.03-	-	-	-	R	Estate Engine VAZ-K7M	812034	Outer Joint		24	20	44	113.5	48.5	I			
1.6 (77 kW)	2012.03-	-	-	-	R	Box Engine VAZ- K4M	812034	Outer Joint		24	20	44	113.5	48.5	I			
	2012.03-	-	-	-	R	Estate Engine VAZ- K4M	812034	Outer Joint		24	20	44	113.5	48.5	I			
NADESHDA (2120)																		
1.7	1997.12-	-	-	L	-	-	628003	Inner Joint		22	22	40	93.5	116				
1.7 i	1997.12-	-	-	L	-	-	628003	Inner Joint		22	22	40	93.5	116				
1.8	1997.12-	-	-	L	-	-	628003	Inner Joint		22	22	40	93.5	116				
1.8 i	1997.12-	-	-	L	-	-	628003	Inner Joint		22	22	40	93.5	116				
NIVA (2121 2131)/TAIGA																		
1.6 (54 kW)	1987.01-	1995.03	AT/MT	L/R	F	All-wheel Drive Closed Off-Road Vehicle Engine BA3 2121	828002	Outer Joint		22	22	56	107.5	66.5	I			
1.6 (56 kW)	1976.12-	1993.12	AT/MT	L/R	F	All-wheel Drive Closed Off-Road Vehicle Engine BA3 2121	828002	Outer Joint		22	22	56	107.5	66.5	I			
1700 i (59 kW)	1996.06-	2006.12	AT/MT	L/R	F	All-wheel Drive Closed Off-Road Vehicle Engine BA3 21214	828002	Outer Joint		22	22	56	107.5	66.5	I			
1700 i (60 kW)	2000.10-	2010.12	AT/MT	L/R	F	All-wheel Drive Closed Off-Road Vehicle Engine BA3 21214	828002	Outer Joint		22	22	56	107.5	66.5	I			
NIVA (2121)																		
1.7 i	1996.06-	-	-	L	-	-	628003	Inner Joint		22	22	40	93.5	116				
	200.10-	-	-	L	-	-	628003	Inner Joint		22	22	40	93.5	116				
	2000.10-	-	-	L	-	-	628003	Inner Joint		22	22	40	93.5	116				
1.9	1999.01-	-	-	L	-	-	628003	Inner Joint		22	22	40	93.5	116				
1.9 D	1993.01-	-	-	L	-	-	628003	Inner Joint		22	22	40	93.5	116				
NIVA (2123)																		
-	2000-	-	-	-	-	TRIPOD TYPE	628007	Inner Joint		24	22	40	215.5	116				
	2000-	-	-	-	-	TRIPOD TYPE	628006	Inner Joint		24	22	40	93.5	116				
	2000-	-	-	-	-	-	828004	Outer Joint		24	22	46	107.5	66.5	I			
	2000-	-	-	L	-	-	228011	Drive Shaft		24	24	46	107.5	707				
	2000-	-	-	R	-	-	228012	Drive Shaft		24	24	46	107.5	829				
OKA																		
0.6 (22 kW)	1987-	1995	-	R	-	-	228007	Drive Shaft		20	20	42	90	696				
	1987-	1995	-	L	-	-	228008	Drive Shaft		20	20	42	90	606				
	1987-	1995	-	-	-	-	628005	Inner Joint		20	19	35	53.5	88				
0.8 (26 kW)	1987-	1995	-	R	-	-	228007	Drive Shaft		20	20	42	90	696				
	1987-	1995	-	L	-	-	228008	Drive Shaft		20	20	42	90	606				
	1987-	1995	-	-	-	-	628005	Inner Joint		20	19	35	53.5	88				
SAMARA (2108210921152113 2114)																		
1.1 (39 kW)	1988.02-	1994.12	-	-	F	Hatchback Engine BA3 21081	828005	Outer Joint		22	22	50	77	53.5	I			
	1988.02-	1994.12	-	-	-	Hatchback Engine BA3 21081	828001	Outer Joint		22	22	50	77	53.5	I			
	1988.02-	1994.12	-	-	-	Hatchback Engine BA3 21081	628001	Inner Joint		24	22	35	60.8	97				

YEAR	TRANSM	L/R	F/R	REMARKS	GSP Ref.	PRODUCT	ABS	Technical Specifications										
								A	B	C	H	L	P					
LADA																		
SAMARA (2108210921152113 2114)																		
1.1 (39 kW)	1988.02-1994.12	MT	L	F	Hatchback Engine BA3 21081	228001	Drive Shaft		22	24	50	77	600					
	1988.02-1994.12	-	-	-	Hatchback Engine BA3 21081	628002	Inner Joint		24	22	35	60.8	97					
	1988.02-1994.12	-	R	F	Hatchback Engine BA3 21081	228002	Drive Shaft		22	24	50	77	848					
1.1 (43 kW)	1996.02-1999.08	-	-	F	Hatchback Engine BA3 21081	828005	Outer Joint		22	22	50	77	53.5	I				
	1996.02-1999.08	-	-	-	Hatchback Engine BA3 21081	828001	Outer Joint		22	22	50	77	53.5	I				
	1996.02-1999.08	-	-	-	Hatchback Engine BA3 21081	628002	Inner Joint		24	22	35	60.8	97					
	1996.02-1999.08	-	R	F	Hatchback Engine BA3 21081	228002	Drive Shaft		22	24	50	77	848					
1.3 (45 kW)	1991.09-1999.08	-	-	F	Hatchback Engine BA3 2108	828005	Outer Joint		22	22	50	77	53.5	I				
	1991.09-1999.08	-	-	-	Hatchback Engine BA3 2108	828001	Outer Joint		22	22	50	77	53.5	I				
	1991.09-1999.08	-	-	-	Hatchback Engine BA3 2108	628001	Inner Joint		24	22	35	60.8	97					
	1991.09-1999.08	MT	L	F	Hatchback Engine BA3 2108	228001	Drive Shaft		22	24	50	77	600					
	1991.09-1999.08	-	-	-	Hatchback Engine BA3 2108	628002	Inner Joint		24	22	35	60.8	97					
1.3 (46 kW)	1987.06-1996.12	-	-	F	Hatchback Engine BA3 2108	828005	Outer Joint		22	22	50	77	53.5	I				
	1987.06-1996.12	-	-	-	Hatchback Engine BA3 2108	828001	Outer Joint		22	22	50	77	53.5	I				
	1987.06-1996.12	-	-	-	Hatchback Engine BA3 2108	628001	Inner Joint		24	22	35	60.8	97					
	1987.06-1996.12	MT	L	F	Hatchback Engine BA3 2108	228001	Drive Shaft		22	24	50	77	600					
	1987.06-1996.12	-	-	-	Hatchback Engine BA3 2108	628002	Inner Joint		24	22	35	60.8	97					
1.3 (48 kW)	1986.01-1994.12	-	-	F	Hatchback Engine BA3 2108	828005	Outer Joint		22	22	50	77	53.5	I				
	1986.01-1994.12	-	-	-	Hatchback Engine BA3 2108	828001	Outer Joint		22	22	50	77	53.5	I				
	1986.01-1994.12	-	-	-	Hatchback Engine BA3 2108	628001	Inner Joint		24	22	35	60.8	97					
	1986.01-1994.12	MT	L	F	Hatchback Engine BA3 2108	228001	Drive Shaft		22	24	50	77	600					
	1986.01-1994.12	-	-	-	Hatchback Engine BA3 2108	628002	Inner Joint		24	22	35	60.8	97					
1.3 (50 kW)	1996.02-1996.12	-	-	F	Hatchback Engine BA3 21115	828005	Outer Joint		22	22	50	77	53.5	I				
	1996.02-1996.12	-	-	-	Hatchback Engine BA3 21115	828001	Outer Joint		22	22	50	77	53.5	I				
	1996.02-1996.12	-	-	-	Hatchback Engine BA3 21115	628002	Inner Joint		24	22	35	60.8	97					
	1996.02-1996.12	-	R	F	Hatchback Engine BA3 21115	228002	Drive Shaft		22	24	50	77	848					
	1996.02-1996.12	-	-	-	Hatchback Engine BA3 21115	828005	Outer Joint		22	22	50	77	53.5	I				
1.5 (50 kW)	1991.09-1996.12	-	-	F	Hatchback Engine BA3 21083	828005	Outer Joint		22	22	50	77	53.5	I				
	1991.09-1996.12	-	-	-	Hatchback Engine BA3 21083	828001	Outer Joint		22	22	50	77	53.5	I				
	1991.09-1996.12	-	-	-	Hatchback Engine BA3 21083	628001	Inner Joint		24	22	35	60.8	97					
	1991.09-1996.12	MT	L	F	Hatchback Engine BA3 21083	228001	Drive Shaft		22	24	50	77	600					
	1991.09-1996.12	-	-	-	Hatchback Engine BA3 21083	628002	Inner Joint		24	22	35	60.8	97					
1.5 (52 kW)	1995.02-2006.12	-	-	F	Hatchback Engine BA3 2111	828005	Outer Joint		22	22	50	77	53.5	I				
	1995.02-2006.12	-	-	-	Hatchback Engine BA3 2111	828001	Outer Joint		22	22	50	77	53.5	I				
	1995.02-2006.12	-	-	-	Hatchback Engine BA3 2111	628001	Inner Joint		24	22	35	60.8	97					
	1995.02-2006.12	MT	L	F	Hatchback Engine BA3 2111	228001	Drive Shaft		22	24	50	77	600					
	1995.02-2006.12	-	-	-	Hatchback Engine BA3 2111	628002	Inner Joint		24	22	35	60.8	97					
1.5 (53 kW)	1987.09-1996.12	-	-	F	Hatchback Engine BA3 21083	828005	Outer Joint		22	22	50	77	53.5	I				
	1987.09-1996.12	-	-	-	Hatchback Engine BA3 21083	828001	Outer Joint		22	22	50	77	53.5	I				
	1987.09-1996.12	-	-	-	Hatchback Engine BA3 21083	628001	Inner Joint		24	22	35	60.8	97					
	1987.09-1996.12	MT	L	F	Hatchback Engine BA3 21083	228001	Drive Shaft		22	24	50	77	600					
	1987.09-1996.12	-	-	-	Hatchback Engine BA3 21083	628002	Inner Joint		24	22	35	60.8	97					
1.5 (56 kW)	1996.04-2006.12	-	-	F	Hatchback Engine VAZ-2111	828005	Outer Joint		22	22	50	77	53.5	I				
	1996.04-2006.12	MT	L	F	Hatchback Engine VAZ-2111	228001	Drive Shaft		22	24	50	77	600					
1.5 (59 kW)	2003.08-2006.12	-	L	F	Hatchback	228001	Drive Shaft		22	24	50	77	600					
SAMARA (21099 2115)/VOLUMES/SAMARA FORMA/DIVA/SAGONA																		
1.1 (39 kW)	1991.07-1999.08	-	-	F	Saloon Engine BA3 21081	828005	Outer Joint		22	22	50	77	53.5	I				
	1991.07-1999.08	-	-	-	Saloon Engine BA3 21081	828001	Outer Joint		22	22	50	77	53.5	I				
	1991.07-1999.08	-	-	-	Saloon Engine BA3 21081	628001	Inner Joint		24	22	35	60.8	97					
	1991.07-1999.08	MT	L	F	Saloon Engine BA3 21081	228001	Drive Shaft		22	24	50	77	600					
	1991.07-1999.08	-	-	-	Saloon Engine BA3 21081	628002	Inner Joint		24	22	35	60.8	97					
	1991.07-1999.08	-	R	F	Saloon Engine BA3 21081	228002	Drive Shaft		22	24	50	77	848					
1.3 (45 kW)	1991.07-1999.08	-	-	F	Saloon Engine BA3 2108	828005	Outer Joint		22	22	50	77	53.5	I				
	1991.07-1999.08	-	-	-	Saloon Engine BA3 2108	628001	Inner Joint		24	22	35	60.8	97					
	1991.07-1999.08	MT	L	F	Saloon Engine BA3 2108	228001	Drive Shaft		22	24	50	77	600					
	1991.07-1999.08	-	-	-	Saloon Engine BA3 2108	628002	Inner Joint		24	22	35	60.8	97					
	1991.07-1999.08	-	R	F	Saloon Engine BA3 2108	228002	Drive Shaft		22	24	50	77	848					
1.3 (46 kW)	1990.05-1999.08	-	-	F	Saloon Engine BA3 2108	828005	Outer Joint		22	22	50	77	53.5	I				
	1990.05-1999.08	-	-	-	Saloon Engine BA3 2108	628001	Inner Joint		24	22	35	60.8	97					
	1990.05-1999.08	MT	L	F	Saloon Engine BA3 2108	228001	Drive Shaft		22	24	50	77	600					
	1990.05-1999.08	-	-	-	Saloon Engine BA3 2108	628002	Inner Joint		24	22	35	60.8	97					





	YEAR		TRANSM	L/R	F/R	REMARKS	GSP Ref.	PRODUCT	ABS	Technical Specifications						
										A	B	C	H	L	P	
LADA																
SAMARA (21099 2115)/VOLUMES/SAMARA FORMA/DIVA/SAGONA																
1.3 (46 kW)	1990.05-	1999.08	-	R	F	Saloon Engine BA3 2108	228002	Drive Shaft		22	24	50	77	848		
1.3 (48 kW)	1989.05-	1997.07	-	R	F	Saloon Engine BA3 2108	228002	Drive Shaft		22	24	50	77	848		
	1989.05-	1997.07	-	-	F	Saloon Engine BA3 2108	828005	Outer Joint		22	22	50	77	53.5	I	
	1989.05-	1997.07	-	-	-	Saloon Engine BA3 2108	828001	Outer Joint		22	22	50	77	53.5	I	
	1989.05-	1997.07	-	-	-	Saloon Engine BA3 2108	628001	Inner Joint		24	22	35	60.8	97		
	1989.05-	1997.07	MT	L	F	Saloon Engine BA3 2108	228001	Drive Shaft		22	24	50	77	600		
	1989.05-	1997.07	-	-	-	Saloon Engine BA3 2108	628002	Inner Joint		24	22	35	60.8	97		
1.3 (50 kW)	1996.02-	2006.12	-	R	F	Saloon Engine BA3 21115	228002	Drive Shaft		22	24	50	77	848		
	1996.02-	2006.12	-	-	F	Saloon Engine BA3 21115	828005	Outer Joint		22	22	50	77	53.5	I	
	1996.02-	2006.12	-	-	-	Saloon Engine BA3 21115	628002	Inner Joint		24	22	35	60.8	97		
1.5 (50 kW)	1991.07-	1996.12	-	R	F	Saloon Engine BA3 21083	228002	Drive Shaft		22	24	50	77	848		
	1991.07-	1996.12	-	-	F	Saloon Engine BA3 21083	828005	Outer Joint		22	22	50	77	53.5	I	
	1991.07-	1996.12	-	-	-	Saloon Engine BA3 21083	628001	Inner Joint		24	22	35	60.8	97		
	1991.07-	1996.12	MT	L	F	Saloon Engine BA3 21083	228001	Drive Shaft		22	24	50	77	600		
	1991.07-	1996.12	-	-	-	Saloon Engine BA3 21083	628002	Inner Joint		24	22	35	60.8	97		
1.5 (53 kW)	1991.09-	1996.12	-	R	F	Saloon Engine BA3 21083	228002	Drive Shaft		22	24	50	77	848		
	1991.09-	1996.12	-	-	F	Saloon Engine BA3 21083	828005	Outer Joint		22	22	50	77	53.5	I	
	1991.09-	1996.12	-	-	-	Saloon Engine BA3 21083	628001	Inner Joint		24	22	35	60.8	97		
	1991.09-	1996.12	MT	L	F	Saloon Engine BA3 21083	228001	Drive Shaft		22	24	50	77	600		
	1991.09-	1996.12	-	-	-	Saloon Engine BA3 21083	628002	Inner Joint		24	22	35	60.8	97		
1500 (52 kW)	1994.11-	2006.12	-	R	F	Saloon Engine BA3 2111	228002	Drive Shaft		22	24	50	77	848		
	1994.11-	2006.12	-	-	F	Saloon Engine BA3 2111	828005	Outer Joint		22	22	50	77	53.5	I	
	1994.11-	2006.12	-	-	-	Saloon Engine BA3 2111	628001	Inner Joint		24	22	35	60.8	97		
	1994.11-	2006.12	-	-	-	Saloon Engine BA3 2111	628002	Inner Joint		24	22	35	60.8	97		
SAMARA (2113, 2114, 2115)																
1.5(53 kW)	2003.08-	2013.12	-	-	F	Hatchback Engine BA3 21083	828005	Outer Joint		22	22	50	77	53.5	I	
	2003.08-	2013.12	-	-	-	Hatchback Engine BA3 21083	628001	Inner Joint		24	22	35	60.8	97		
	2003.08-	2013.12	-	L	F	Hatchback Engine BA3 21083	228001	Drive Shaft		22	24	50	77	600		
SAMARA 2110																
-	-	-	MT	R	-	-	228004	Drive Shaft		22	24	50	77	856.2		
-	-	-	MT	L	-	-	228003	Drive Shaft		22	24	50	77	594		
LANCIA																
DEDRA (835_)																
1.6 16V (76 kW)	1996.01-	1999.07	-	-	F	Saloon Engine 182 A4.000	802005	Outer Joint	44T	25	22	52	84	57	O	
1.6 i.e. (55 kW)	1993.04-	1999.07	MT	L	F	Saloon Engine 835 C1.000	217010	Drive Shaft		22	31.95	46.8	75.5	569		
	1993.04-	1999.07	MT	L/R	F	Saloon Engine 835 C1.000	817001	Outer Joint		22	20	46.8	75.5	52	O	
	1993.04-	1999.07	MT	L/R	F	Saloon Engine 835 C1.000	817039	Outer Joint	44T	22	20	46.8	75.5	52	O	
	1993.04-	1999.07	MT	R	F	Saloon Engine 835 C1.000	217011	Drive Shaft		22	31.95	46.8	75.5	928.5		
1.6 i.e. (57 kW)	1989.08-	1993.03	MT	L	F	Saloon Engine 835 A1.046	217010	Drive Shaft		22	31.95	46.8	75.5	569		
	1989.08-	1993.03	MT	R	F	Saloon Engine 835 A1.046	217011	Drive Shaft		22	31.95	46.8	75.5	928.5		
1.6 i.e. (66 kW)	1989.08-	1994.06	MT	L/R	F	Saloon Engine 835 A1.000	817001	Outer Joint		22	20	46.8	75.5	52	O	
	1989.08-	1994.06	MT	L/R	F	Saloon Engine 835 A1.000	817039	Outer Joint	44T	22	20	46.8	75.5	52	O	
1.6 LE Cat (66 kW)	1994.07-	1999.07	MT	L/R	F	Saloon Engine 159 B9.000	817001	Outer Joint		22	20	46.8	75.5	52	O	
	1994.07-	1999.07	MT	L/R	F	Saloon Engine 159 B9.000	817039	Outer Joint	44T	22	20	46.8	75.5	52	O	
1.8 16V LE (83 kW)	1996.03-	1999.07	MT	L/R	F	Saloon Engine 182 A2.000	817004	Outer Joint		25	25	52	85	58	I	
	1996.03-	1999.07	-	-	F	Saloon Engine 182 A2.000	802004	Outer Joint	44T	25	25	52	85	58	I	
	1996.03-	1999.07	-	-	F	Saloon Engine 182 A2.000	602005	Inner Joint		25		32				
1.8 GT 16V (96 kW)	1996.03-	1999.07	-	-	F	Saloon Engine 183 A1.000	802006	Outer Joint	44T	25	25	52	85	58	O	
	1996.03-	1999.07	-	-	F	Saloon Engine 183 A1.000	602005	Inner Joint		25		32				
1.8 i.e. (66 kW)	1993.08-	1999.07	MT	L/R	F	Saloon Engine 835 C5.000	648004	Inner Joint		25		32				
	1993.08-	1999.07	MT	L/R	F	Saloon Engine 835 C5.000	817004	Outer Joint		25	25	52	85	58	I	
	1993.08-	1999.07	-	-	F	Saloon Engine 835 C5.000	802004	Outer Joint	44T	25	25	52	85	58	I	
	1993.08-	1999.07	-	-	F	Saloon Engine 835 C5.000	602005	Inner Joint		25		32				
1.8 i.e. (74 kW)	1994.07-	1999.07	MT	L/R	F	Saloon Engine 836 A5.000	817004	Outer Joint		25	25	52	85	58	I	
	1994.07-	1999.07	-	-	F	Saloon Engine 836 A5.000	802004	Outer Joint	44T	25	25	52	85	58	I	
	1994.07-	1999.07	-	-	F	Saloon Engine 836 A5.000	602005	Inner Joint		25		32				
1.8 i.e. (77 kW)	1989.09-	1999.07	-	-	F	Saloon Engine 835 A2.046	602006	Inner Joint		25		32				
	1989.09-	1999.07	MT	L/R	F	Saloon Engine 835 A2.046	648004	Inner Joint		25		32				
	1989.09-	1999.07	MT	L/R	F	Saloon Engine 835 A2.046	817004	Outer Joint		25	25	52	85	58	I	
1.8 i.e. (80 kW)	1989.09-	1994.06	-	-	F	Saloon Engine 835 A2.000	602005	Inner Joint		25		32				
	1989.09-	1994.06	MT	L/R	F	Saloon Engine 835 A2.000	648004	Inner Joint		25		32				
	1989.09-	1994.06	-	-	F	Saloon Engine 835 A2.000	602006	Inner Joint		25		32				
	1989.09-	1994.06	-	-	F	Saloon Engine 835 A2.000	802004	Outer Joint	44T	25	25	52	85	58	I	
	1989.09-	1994.06	-	-	F	Saloon Engine 835 A2.000	802006	Outer Joint	44T	25	25	52	85	58	O	
1.9 TDS (66 kW)	1989.04-	1999.07	MT	L/R	F	Saloon Engine 835 A4.000/160 D1.000/835 A4.046	648004	Inner Joint		25		32				
	1989.04-	1999.07	-	-	F	Saloon Engine 835 A4.000/160 D1.000/835 A4.046	802006	Outer Joint	44T	25	25	52	85	58	O	

YEAR	TRANSM	L/R	F/R	REMARKS	GSP Ref.	PRODUCT	ABS	Technical Specifications									
								A	B	C	H	L	P				
LANCIA																	
DEDRA (835_)																	
1.9 TDS (66 kW)	1989.04-1999.07	-	-	F	Saloon Engine 835 A4.000/160 D1.000/835 A4.046	802004	Outer Joint	44T	25	25	52	85	58	I			
	1989.04-1999.07	-	-	F	Saloon Engine 835 A4.000/160 D1.000/835 A4.046	602005	Inner Joint			25		32					
2.0 16V (102 kW)	1994.07-1999.07	MT	L/R	F	Saloon Engine 836 A3.000	817004	Outer Joint		25	25	52	85	58	I			
	1994.07-1999.07	-	-	F	Saloon Engine 836 A3.000	802004	Outer Joint	44T	25	25	52	85	58	I			
	1994.07-1999.07	-	-	F	Saloon Engine 836 A3.000	602005	Inner Joint			25		32					
2.0 HF Integrale (124 kW)	1990.11-1994.07	-	-	-	All-wheel Drive Saloon Engine 835 A7.046	602006	Inner Joint			25		32					
	1990.11-1994.07	-	-	F/R	All-wheel Drive Saloon Engine 835 A7.046	802004	Outer Joint	44T	25	25	52	85	58	I			
2.0 i.e. (83 kW)	1989.09-1999.07	-	-	F	Saloon Engine 835 A5.046	602006	Inner Joint			25		32					
	1989.09-1999.07	MT	L/R	F	Saloon Engine 835 A5.046	648004	Inner Joint			25		32					
	1989.09-1999.07	MT	L/R	F	Saloon Engine 835 A5.046	817004	Outer Joint		25	25	52	85	58	I			
	1989.09-1999.07	MT	-	F	Saloon Engine 835 A5.046	802004	Outer Joint	44T	25	25	52	85	58	I			
	1989.09-1999.07	MT	-	F	Saloon Engine 835 A5.046	602005	Inner Joint			25		32					
2.0 i.e. (86 kW)	1989.09-1992.07	-	-	F	Saloon Engine 835 A5.000	602005	Inner Joint			25		32					
	1989.09-1992.07	MT	L/R	F	Saloon Engine 835 A5.000	648004	Inner Joint			25		32					
	1989.09-1992.07	-	-	F	Saloon Engine 835 A5.000	602006	Inner Joint			25		32					
	1989.09-1992.07	-	-	F	Saloon Engine 835 A5.000	802004	Outer Joint	44T	25	25	52	85	58	I			
2.0 i.e. Turbo (119 kW)	1991.04-1999.07	-	-	F	Saloon Engine 835 A8.046	602006	Inner Joint			25		32					
2.0 i.e. Turbo Integrale (121 kW)	1990.05-1994.07	-	-	F	All-wheel Drive Saloon Engine 835 A7.000	602005	Inner Joint			25		32					
	1990.05-1994.07	-	-	-	All-wheel Drive Saloon Engine 835 A7.000	602006	Inner Joint			25		32					
	1990.05-1994.07	-	-	F/R	All-wheel Drive Saloon Engine 835 A7.000	802004	Outer Joint	44T	25	25	52	85	58	I			
2.0 Turbo (130 kW)	1990.11-1994.06	-	-	F	Saloon Engine 835 A8.000	602006	Inner Joint			25		32					
DEDRA SW (835_)																	
1.6 (66 kW)	1994.10-1999.07	MT	L/R	F	Estate Engine 159 B9.000	817004	Outer Joint		25	25	52	85	58	I			
1.6 16V (76 kW)	1996.01-1999.07	-	-	F	Estate Engine 182 A4.000	802005	Outer Joint	44T	25	22	52	84	57	O			
1.8 16V LE (83 kW)	1996.03-1999.07	MT	L/R	F	Estate Engine 182 A2.000	817004	Outer Joint		25	25	52	85	58	I			
	1996.03-1999.07	-	-	F	Estate Engine 182 A2.000	802004	Outer Joint	44T	25	25	52	85	58	I			
	1996.03-1999.07	-	-	F	Estate Engine 182 A2.000	602005	Inner Joint			25		32					
1.8 GT 16V (96 kW)	1996.03-1999.07	-	-	F	Estate Engine 183 A1.000	802006	Outer Joint	44T	25	25	52	85	58	O			
	1996.03-1999.07	-	-	F	Estate Engine 183 A1.000	602005	Inner Joint			25		32					
1.8 i.e. (74 kW)	1994.07-1999.07	MT	L/R	F	Estate Engine 836 A5.000	817004	Outer Joint		25	25	52	85	58	I			
	1994.07-1999.07	-	-	F	Estate Engine 836 A5.000	802004	Outer Joint	44T	25	25	52	85	58	I			
	1994.07-1999.07	-	-	F	Estate Engine 836 A5.000	602005	Inner Joint			25		32					
1.9 TDS (66 kW)	1994.07-1999.07	-	-	F	Estate Engine 160 D1.000/835 A4.000	802006	Outer Joint	44T	25	25	52	85	58	O			
	1994.07-1999.07	-	-	F	Estate Engine 160 D1.000/835 A4.000	802004	Outer Joint	44T	25	25	52	85	58	I			
	1994.07-1999.07	-	-	F	Estate Engine 160 D1.000/835 A4.000	602005	Inner Joint			25		32					
2.0 16V (102 kW)	1994.07-1999.07	MT	L/R	F	Estate Engine 836 A3.000	817004	Outer Joint		25	25	52	85	58	I			
	1994.07-1999.07	-	-	F	Estate Engine 836 A3.000	802004	Outer Joint	44T	25	25	52	85	58	I			
	1994.07-1999.07	-	-	F	Estate Engine 836 A3.000	602005	Inner Joint			25		32					
2.0 Integrale (102 kW)	1994.07-1999.07	MT	L/R	F	All-wheel Drive Estate Engine 836 A3.000	817004	Outer Joint		25	25	52	85	58	I			
	1994.07-1999.07	-	-	F	All-wheel Drive Estate Engine 836 A3.000	802004	Outer Joint	44T	25	25	52	85	58	I			
	1994.07-1999.07	-	-	F	All-wheel Drive Estate Engine 836 A3.000	602005	Inner Joint			25		32					
DELTA I (831_)																	
1.5 (63 kW)	1979.09-1992.12	MT	L/R	F	Hatchback Engine 831 A1.000/831 B1.000	817006	Outer Joint		22	25	48.1	93.5	60.5	I			
	1979.09-1992.12	AT	-	F	Hatchback Engine 831 A1.000/831 B1.000	602006	Inner Joint			25		32					
1.6 GT i.e. (66 kW)	1987.05-1992.08	MT	L/R	F	Hatchback Engine 149 C2.000	817006	Outer Joint		22	25	48.1	93.5	60.5	I			
2.0 HF Integrale (130 kW)	1986.12-1992.12	-	-	-	All-wheel Drive Hatchback Engine 831 C5.046	602006	Inner Joint			25		32					
DELTA II (836_)																	
1.4 i.e. (51 kW)	1994.10-1999.08	MT	L	F	Hatchback Engine 160 A1.046/836.A4.000	217010	Drive Shaft		22	31.95	46.8	75.5	569				
	1994.10-1999.08	MT	L/R	F	Hatchback Engine 160 A1.046/836.A4.000	817001	Outer Joint		22	20	46.8	75.5	52	O			
	1994.10-1999.08	MT	L/R	F	Hatchback Engine 160 A1.046/836.A4.000	817039	Outer Joint	44T	22	20	46.8	75.5	52	O			
	1994.10-1999.08	MT	R	F	Hatchback Engine 160 A1.046/836.A4.000	217011	Drive Shaft		22	31.95	46.8	75.5	928.5				
1.6 i.e. (55 kW)	1993.06-1999.08	MT	L	F	Hatchback Engine 835 C1.000	217010	Drive Shaft		22	31.95	46.8	75.5	569				
	1993.06-1999.08	MT	L/R	F	Hatchback Engine 835 C1.000	817001	Outer Joint		22	20	46.8	75.5	52	O			
	1993.06-1999.08	MT	L/R	F	Hatchback Engine 835 C1.000	817039	Outer Joint	44T	22	20	46.8	75.5	52	O			
	1993.06-1999.08	MT	R	F	Hatchback Engine 835 C1.000	217011	Drive Shaft		22	31.95	46.8	75.5	928.5				
1.6 i.e. (66 kW)	1996.03-1999.08	MT	L/R	F	Hatchback Engine 182 A6.000	817004	Outer Joint		25	25	52	85	58	I			
1.8 i.e. (66 kW)	1994.07-1999.08	MT	L/R	F	Hatchback Engine 835 C4.000/836 C4.000/836 A6.000	817004	Outer Joint		25	25	52	85	58	I			
	1994.07-1999.08	-	-	F	Hatchback Engine 835 C4.000/836 C4.000/836 A6.000	802004	Outer Joint	44T	25	25	52	85	58	I			
	1994.07-1999.08	-	-	F	Hatchback Engine 835 C4.000/836 C4.000/836 A6.000	602005	Inner Joint			25		32					
1.8 i.e. (76 kW)	1993.06-1999.08	MT	L/R	F	Hatchback Engine 835 C2.000	817004	Outer Joint		25	25	52	85	58	I			
	1993.06-1999.08	-	-	F	Hatchback Engine 835 C2.000	802004	Outer Joint	44T	25	25	52	85	58	I			
	1993.06-1999.08	-	-	F	Hatchback Engine 835 C2.000	602005	Inner Joint			25		32					
1.8 i.e. 16V (83 kW)	1996.03-1999.08	-	-	F	Hatchback Engine 182 A2.000	802004	Outer Joint	44T	25	25	52	85	58	I			
	1996.03-1999.08	-	-	F	Hatchback Engine 182 A2.000	602005	Inner Joint			25		32					
1.8 i.e. 16V GT (96 kW)	1996.03-1999.08	-	-	F	Hatchback Engine 183 A1.000	802006	Outer Joint	44T	25	25	52	85	58	O			
	1996.03-1999.08	-	-	F	Hatchback Engine 183 A1.000	602005	Inner Joint			25		32					





YEAR	TRANSM	L/R	F/R	REMARKS	GSP Ref.	PRODUCT	ABS	Technical Specifications									
								A	B	C	H	L	P				
LANCIA																	
DELTA II (836_)																	
1.9 TD (66 kW)	1994.10-1999.08	MT	L/R	F	Hatchback Engine 160 D1.000/835 A4.000	817004	Outer Joint		25	25	52	85	58	I			
	1994.10-1999.08	-	-	F	Hatchback Engine 160 D1.000/835 A4.000	802006	Outer Joint	44T	25	25	52	85	58	O			
	1994.10-1999.08	-	-	F	Hatchback Engine 160 D1.000/835 A4.000	602005	Inner Joint		25		32						
2.0 16V (102 kW)	1993.06-1999.08	MT	L/R	F	Hatchback Engine 836 A3.000	817004	Outer Joint		25	25	52	85	58	I			
	1993.06-1999.08	-	-	F	Hatchback Engine 836 A3.000	802006	Outer Joint	44T	25	25	52	85	58	O			
	1993.06-1999.08	-	-	F	Hatchback Engine 836 A3.000	602005	Inner Joint		25		32						
2.0 16V Turbo (137 kW)	1993.06-1999.08	MT	L/R	F	Hatchback Engine 836 A2.000	817004	Outer Joint		25	25	52	85	58	I			
	1993.06-1999.08	-	-	F	Hatchback Engine 836 A2.000	602005	Inner Joint		25		32						
2.0 16V Turbo (142 kW)	1996.07-1999.08	-	-	F	Hatchback Engine 175 A4.000	602005	Inner Joint		25		32						
DELTA III (844)																	
1.4 (110 kW)	2008.09-	-	-	R	-	617058	Inner Joint		25	26	34.9	367	108.5				
	2008.09-	-	-	L	-	617035	Inner Joint		25	26	34.9	57.5	114.5				
1.4 (88 kW)	2008.09-	-	-	R	-	617058	Inner Joint		25	26	34.9	367	108.5				
1.4 16V (103 kW)	2010.07-	-	-	L	-	617031	Inner Joint		25	26	32	59	110.5				
1.4 16V (88 kW)	2010.07-	-	-	L	-	617031	Inner Joint		25	26	32	59	110.5				
1.6 D Multijet (77 kW)	2008.09-2011.04	-	-	L	-	617031	Inner Joint		25	26	32	59	110.5				
1.6 D Multijet (88 kW)	2008.09-	-	-	L	-	617005	Inner Joint		25	26	32	91	95				
	2008.09-2011.04	-	-	L	-	617031	Inner Joint		25	26	32	59	110.5				
1.8 (147 kW)	2009.01-	-	-	L	-	621017	Inner Joint		27	27	35	78.5	112				
1.9 D Multijet (140 kW)	2009.01-	-	-	L	-	621017	Inner Joint		27	27	35	78.5	112				
2.0 D Multijet (121 kW)	2008.09-	-	-	L	-	621017	Inner Joint		27	27	35	78.5	112				
DELTA III (844_)																	
1.4 (110 kW)	2008.09-2014.08	-	L/R	F	Hatchback Engine 198 A1.000	817030	Outer Joint		25	26	51	84.5	64.5	M			
1.4 (88 kW)	2008.09-2014.08	-	L/R	F	Hatchback Engine 198 A4.000	817030	Outer Joint		25	26	51	84.5	64.5	M			
1.6 D Multijet (85 kW)	2008.08-2014.08	MT	L/R	F	Hatchback Engine 955 A4.000	217194	Drive Shaft		25	39.2	51	84.5	523				
KAPPA (838A, B), SW																	
2.0 20V (107 kW)	1994.10-2001.10	-	-	-	-	617009	Inner Joint		25		32						
2.0 20V (114 kW)	1994.10-2001.10	-	-	-	-	617009	Inner Joint		25		32						
2.0 20V Turbo (162 kW)	1998.06-2001.10	-	-	L	-	602007	Inner Joint		34		47.5						
2.4 20V (129 kW)	1994.08-2001.10	-	-	L	-	602007	Inner Joint		34		47.5						
2.4 JTD (100 kW)	1998.06-2001.10	-	-	L	-	602007	Inner Joint		34		47.5						
3.0 24V (150 kW)	1994.08-2001.10	-	-	L	-	602007	Inner Joint		34		47.5						
KAPPA (838_)																	
2.0 16V Turbo (151 kW)	1995.02-2001.10	-	-	F	Saloon Engine 838 A4.000	802011	Outer Joint	44T	27	28	56	85	63.5	O			
	1996.11-2001.03	-	-	F	Coupe Engine 838 A4.000	802011	Outer Joint	44T	27	28	56	85	63.5	O			
2.0 20V (107 kW)	1994.10-2001.10	-	-	-	Saloon Engine 838 A1.000	829003	Outer Joint	44T	27	25	60	85	58	I			
	1994.10-2001.10	-	-	F	Saloon Engine 838 A1.000	829001	Outer Joint	44T	27	25	60	84.5	57.5	O			
	1994.10-2001.10	MT	L/R	F	Saloon Engine 838 A1.000	602011	Inner Joint		25		32						
2.0 20V (114 kW)	1996.07-2001.10	-	-	-	Saloon Engine 838 A6.000	829003	Outer Joint	44T	27	25	60	85	58	I			
	1996.07-2001.03	-	-	-	Coupe Engine 838 A6.000	829003	Outer Joint	44T	27	25	60	85	58	I			
	1996.07-2001.10	-	-	F	Saloon Engine 838 A6.000	829001	Outer Joint	44T	27	25	60	84.5	57.5	O			
	1996.07-2001.03	-	-	F	Coupe Engine 838 A6.000	829001	Outer Joint	44T	27	25	60	84.5	57.5	O			
	1996.07-2001.10	AT/MT	L/R	F	Saloon Engine 838 A6.000	602011	Inner Joint		25		32						
2.4 20V (129 kW)	1994.08-2001.10	-	-	F	Saloon Engine 838 A2.000/838 A2.027	802011	Outer Joint	44T	27	28	56	85	63.5	O			
	1996.11-2001.03	-	-	F	Coupe Engine 838 A2.000	802011	Outer Joint	44T	27	28	56	85	63.5	O			
2.4 T.DS (91 kW)	1994.08-2001.10	-	-	F	Saloon Engine 838 A7.000/838 A3.000	802011	Outer Joint	44T	27	28	56	85	63.5	O			
3.0 24V (150 kW)	1994.08-2001.10	-	-	F	Saloon Engine 838 B.000	802011	Outer Joint	44T	27	28	56	85	63.5	O			
	1996.11-2001.03	-	-	F	Coupe Engine 838 B.000	802011	Outer Joint	44T	27	28	56	85	63.5	O			
KAPPA SW (838_)																	
2.0 16V Turbo (151 kW)	1996.07-2001.10	-	-	F	Estate Engine 838 A4.000	802011	Outer Joint	44T	27	28	56	85	63.5	O			
2.0 20V (114 kW)	1996.07-2001.10	-	-	-	Estate Engine 838 A6.000	829003	Outer Joint	44T	27	25	60	85	58	I			
	1996.07-2001.10	-	-	F	Estate Engine 838 A6.000	829001	Outer Joint	44T	27	25	60	84.5	57.5	O			
2.4 20V (129 kW)	1996.07-2001.10	-	-	F	Estate Engine 838 A2.000	802011	Outer Joint	44T	27	28	56	85	63.5	O			
2.4 T.DS (91 kW)	1996.07-2001.10	-	-	F	Estate Engine 838 A3.000/838 A7.000	802011	Outer Joint	44T	27	28	56	85	63.5	O			
3.0 24V (150 kW)	1996.07-2001.10	-	-	F	Estate Engine 838 B.000	802011	Outer Joint	44T	27	28	56	85	63.5	O			
LYBRA (839AX, BX), SW																	
1.9 JTD (77 kW)	1999.07-2001.05	-	-	L	-	602007	Inner Joint		34		47.5						
1.9 JTD (81 kW)	1999.07-2001.05	-	-	L	-	602007	Inner Joint		34		47.5						
1.9 JTD (85 kW)	1999.07-2001.05	-	-	L	-	602007	Inner Joint		34		47.5						
	2001.05-	-	-	R	-	617006	Inner Joint		25	26	29.8	377	108				
	2001.05-	-	-	L	-	617005	Inner Joint		25	26	32	91	95				
2.0 20V (113 kW)	1999.07-2000.09	-	-	-	-	617009	Inner Joint		25		32						
2.4 JTD (103 kW)	1999.07-2002.05	-	-	R	-	699130	Inner Joint		25	26	29.8	469	108				
	1999.07-2002.05	-	-	L	-	617005	Inner Joint		25	26	32	91	95				
2.4 JTD (110 kW)	1999.07-2002.05	-	-	R	-	699130	Inner Joint		25	26	29.8	469	108				
	1999.07-2002.05	-	-	L	-	617005	Inner Joint		25	26	32	91	95				

YEAR	TRANSM	L/R	F/R	REMARKS	GSP Ref.	PRODUCT	ABS	Technical Specifications							
								A	B	C	H	L	P		
LANCIA															
LYBRA (839AX, BX), SW															
2.4 JTD (99 kW)	1999.07-	2002.05	-	L	-		617005	Inner Joint		25	26	32	91	95	
LYBRA (839_)															
1.6 16V (76 kW)	1999.07-	2005.10	MT	L/R	F	Saloon Engine 182 A4.000	817011	Outer Joint		25	22	51	84.5	57	O
1.8 16V (96 kW)	1999.07-	2005.10	-	-	F	Saloon Engine 839 A9.000/839 A7.000/839 A4.000	602005	Inner Joint		25		32			
	1999.07-	2005.10	MT	L/R	F	Saloon Engine 839 A9.000/839 A7.000/839 A4.000	817042	Outer Joint		25	25	51	85	58	O
	1999.07-	2005.10	MT	L/R	F	Saloon Engine 839 A9.000/839 A7.000/839 A4.000	602011	Inner Joint		25		32			
1.9 JTD (77 kW)	1999.07-	2000.09	MT	L/R	F	Saloon Engine AR 32302	802012	Outer Joint		25	28	59	85	63	O
	1999.07-	2000.09	MT	L/R	F	Saloon Engine AR 32302	602011	Inner Joint		25		32			
1.9 JTD (85 kW)	2001.05-	2005.10	-	L/R	F	Saloon Engine 937 A2.000	817009	Outer Joint		25	26	59	84	63	M
	2001.05-	2005.10	-	L/R	F	Saloon Engine 937 A2.000	802012	Outer Joint		25	28	59	85	63	O
	2001.05-	2005.10	-	L	F	Saloon Engine 937 A2.000	217107	Drive Shaft		25	25	59	84	615	
	2001.05-	2005.10	-	L	F	Saloon Engine 937 A2.000	202003	Drive Shaft		25	26.65	59	84	502	
2.0 20V (110 kW)	2000.09-	2005.10	MT	-	F	Saloon Engine 185 A8.000	602005	Inner Joint		25		32			
	2000.09-	2005.10	MT	L/R	F	Saloon Engine 185 A8.000	602011	Inner Joint		25		32			
2.0 20V (113 kW)	1999.07-	2000.09	AT/MT	L/R	F	Saloon Engine 182 B7.000	802017	Outer Joint		25	25	58.8	85	58.3	O
	1999.07-	2000.09	MT	-	F	Saloon Engine 182 B7.000	602005	Inner Joint		25		32			
	1999.07-	2000.09	MT	L/R	F	Saloon Engine 182 B7.000	602011	Inner Joint		25		32			
	1999.07-	2000.09	MT	L/R	F	Saloon Engine 182 B7.000	618070	Inner Joint		25		32			
2.4 JTD (103 kW)	2000.09-	2002.05	-	L/R	F	Saloon Engine 839 A6.000	817009	Outer Joint		25	26	59	84	63	M
	2000.09-	2002.05	MT	L/R	F	Saloon Engine 839 A6.000	618070	Inner Joint		25		32			
2.4 JTD (110 kW)	2002.05-	2005.10	-	L/R	F	Saloon Engine 841 C.000	817009	Outer Joint		25	26	59	84	63	M
2.4 JTD (99 kW)	1999.07-	2001.02	MT	L/R	F	Saloon Engine 839 A5.000/AR 32501	817009	Outer Joint		25	26	59	84	63	M
	1999.07-	2001.02	MT	L/R	F	Saloon Engine 839 A5.000/AR 32501	618070	Inner Joint		25		32			
LYBRA SW (839_)															
1.6 16V (76 kW)	1999.07-	2005.10	MT	L/R	F	Estate Engine 182 A4.000	817011	Outer Joint		25	22	51	84.5	57	O
1.8 16V (96 kW)	1999.07-	2005.10	-	-	F	Estate Engine 839 A4.000/839 A7.000	602005	Inner Joint		25		32			
	1999.07-	2005.10	MT	L/R	F	Estate Engine 839 A4.000/839 A7.000	817042	Outer Joint		25	25	51	85	58	O
1.9 JTD (77 kW)	1999.07-	2000.09	MT	L/R	F	Estate Engine AR 32302	802012	Outer Joint		25	28	59	85	63	O
1.9 JTD (85 kW)	2001.05-	2005.10	-	L/R	F	Estate Engine 937 A2.000	817009	Outer Joint		25	26	59	84	63	M
	2001.05-	2005.10	-	L/R	F	Estate Engine 937 A2.000	802012	Outer Joint		25	28	59	85	63	O
	2001.05-	2005.10	-	L	F	Estate Engine 937 A2.000	217107	Drive Shaft		25	25	59	84	615	
	2001.05-	2005.10	-	L	F	Estate Engine 937 A2.000	202003	Drive Shaft		25	26.65	59	84	502	
	2001.05-	2005.10	-	R	F	Estate Engine 937 A2.000	202004	Drive Shaft		25	26.65	59	84	521	
2.0 20V (110 kW)	2000.09-	2005.10	MT	-	F	Estate Engine 185 A8.000	602005	Inner Joint		25		32			
2.0 20V (113 kW)	1999.07-	2000.09	AT/MT	L/R	F	Estate Engine 182 B7.000	802017	Outer Joint		25	25	58.8	85	58.3	O
	1999.07-	2000.09	MT	-	F	Estate Engine 182 B7.000	602005	Inner Joint		25		32			
	1999.07-	2000.09	MT	L/R	F	Estate Engine 182 B7.000	602011	Inner Joint		25		32			
	1999.07-	2000.09	MT	L/R	F	Estate Engine 182 B7.000	618070	Inner Joint		25		32			
2.4 JTD (103 kW)	2000.09-	2005.10	-	L/R	F	Estate Engine 839 A6.000	817009	Outer Joint		25	26	59	84	63	M
2.4 JTD (110 kW)	2002.05-	2005.10	-	L/R	F	Estate Engine 841 C.000	817009	Outer Joint		25	26	59	84	63	M
2.4 JTD (99 kW)	1999.10-	2000.09	MT	L/R	F	Estate Engine 839 A5.000/AR 32501	817009	Outer Joint		25	26	59	84	63	M
MUSA															
-	2004-	-	-	-	-	-	217238	Stub Axle		24	101			379	
MUSA (350)															
1.3 D Multijet (51 kW)	2004.10-	-	-	R	-	-	617012	Inner Joint		24	23	29.7	379	100.5	
	2004.10-	-	-	L	-	-	617011	Inner Joint		24	23	29.7	86.5	93	
	2004.10-	-	-	-	-	-	617009	Inner Joint		25		32			
1.3 D Multijet (66 kW)	2006.09-	2009.03	-	R	-	-	617015	Inner Joint		24	24	29.7	379	100.5	
	2006.09-	2009.03	-	L	-	-	699008	Inner Joint		24	24	29.7	86.5	93	
1.3 D Multijet (68 kW)	2006.09-	2009.03	-	R	-	-	617015	Inner Joint		24	24	29.7	379	100.5	
	2006.09-	2009.03	-	L	-	-	699008	Inner Joint		24	24	29.7	86.5	93	
1.3 D Multijet (70 kW)	2006.09-	2009.03	-	R	-	-	617015	Inner Joint		24	24	29.7	379	100.5	
	2006.09-	2009.03	-	L	-	-	699008	Inner Joint		24	24	29.7	86.5	93	
1.4 (57 kW)	2004.10-	2010	-	-	-	-	617027	Inner Joint		22	22	36	61.5	93.5	
1.4 (66 kW)	2004.10-	2010	-	-	-	-	617027	Inner Joint		22	22	36	61.5	93.5	
1.4 (70 kW)	2004.10-	2010	-	-	-	-	617027	Inner Joint		22	22	36	61.5	93.5	
1.6 D Multijet (85 kW)	2008.07-	-	-	R	-	-	617006	Inner Joint		25	26	29.8	377	108	
	2008.07-	2010	-	L	-	-	617005	Inner Joint		25	26	32	91	95	
1.6 D Multijet (88 kW)	2008.07-	2010	-	L	-	-	617005	Inner Joint		25	26	32	91	95	
	2010-	-	-	R	-	-	617006	Inner Joint		25	26	29.8	377	108	
1.9 D Multijet (74 kW)	2004.10-	-	-	R	-	-	617062	Inner Joint		34	24	34.9	300	102.5	
MUSA (350_)															
1.3 D Multijet (51 kW)	2004.10-	2012.09	5MT	L	F	MPV Engine 188 A9.000	217147	Drive Shaft		25		51	84.5	480	
	2004.10-	2012.09	5MT	R	F	MPV Engine 188 A9.000	217066	Drive Shaft		25	33.9	51	84.5	497	
	2004.10-	2012.09	-	L/R	F	MPV Engine 188 A9.000	817053	Outer Joint		25	23	51	84.5	60	M

YEAR	TRANSM	L/R	F/R	REMARKS	GSP Ref.	PRODUCT	ABS	Technical Specifications										
								A	B	C	H	L	P					
LANCIA																		
MUSA (350_)																		
1.3 D Multijet (51 kW)	2004.10-2012.09	-	-	F	MPV Engine 188 A9.000	602005	Inner Joint		25		32							
	2004.10-2012.09	MT	L/R	F	MPV Engine 188 A9.000	602011	Inner Joint		25		32							
1.3 D Multijet (66 kW)	2006.09-2012.09	MT	L/R	F	MPV Engine 199 A3.000	817028	Outer Joint	25	24	51	84.5	62	M					
	2006.09-2012.09	-	L	F	MPV Engine 199 A3.000	217054	Drive Shaft	25	35.45	51	84.5	472						
1.4 (70 kW)	2004.10-2012.09	MT	L/R	F	MPV Engine 843 A 1.000	817014	Outer Joint	22	21	51	79.5	54	M					
1.9 D Multijet (74 kW)	2004.10-2012.09	MT	L/R	F	MPV Engine 188 B2.000	817028	Outer Joint	25	24	51	84.5	62	M					
PHEDRA (179_)																		
2.0 (100 kW)	2002.09-2010.11	-	-	F	MPV Engine RFN (EW10J4)	845059	Outer Joint	27	34	58	81.5	55	I					
	2002.09-2010.11	MT	L	F	MPV Engine RFN (EW10J4)	210422	Drive Shaft	27	24	58	81.5	659						
	2002.09-2010.11	-	L	F	MPV Engine RFN (EW10J4)	217220	Drive Shaft	27	26	58	81.5	648						
	2002.09-2010.11	-	R	F	MPV Engine RFN (EW10J4)	217218	Drive Shaft	27	26	58	81.5	855						
	2002.09-2010.11	-	-	F	MPV Engine RFN (EW10J4)	817044	Outer Joint	27	28	58	81.5	62	M					
2.0 JTD (79 kW)	2003.07-2010.11	-	-	F	MPV Engine RHM (DW10ATED4)	817044	Outer Joint	27	28	58	81.5	62	M					
2.0 JTD (80 kW)	2002.09-2010.11	-	-	F	MPV Engine RHW (DW10ATED4)	817044	Outer Joint	27	28	58	81.5	62	M					
2.2 JTD (94 kW)	2002.09-2010.11	-	-	F	MPV Engine 4HW (DW12ATED4)	845059	Outer Joint	27	34	58	81.5	55	I					
	2002.09-2010.11	-	L	F	MPV Engine 4HW (DW12ATED4)	217220	Drive Shaft	27	26	58	81.5	648						
	2002.09-2010.11	-	-	F	MPV Engine 4HW (DW12ATED4)	817044	Outer Joint	27	28	58	81.5	62	M					
	2002.09-2010.11	-	R	F	MPV Engine 4HW (DW12ATED4)	217218	Drive Shaft	27	26	58	81.5	855						
	2002.09-2010.11	-	-	F	MPV Engine 4HW (DW12ATED4)	818098	Outer Joint	27	29	58	81	71	M					
3.0 V6 (150 kW)	2002.09-2010.11	AT	R	F	MPV Engine ES9 J4S	217217	Drive Shaft	27	37	58	81.5	924						
	2002.09-2010.11	-	-	-	MPV Engine ES9 J4S	217221	Drive Shaft	27	37	58	81.5	624						
	2002.09-2010.11	AT	R	F	MPV Engine ES9 J4S	250218	Drive Shaft	23	39	56.2	83.5	1001						
	2002.09-2010.11	AT	R	F	MPV Engine ES9 J4S	250218	Drive Shaft	23	39	56.2	83.5	1001						
PRISMA (831_)																		
1.5 (55 kW)	1985.09-1992.02	AT	L/R	F	Saloon Engine 138 C2.048/831 B1.048	817006	Outer Joint	22	25	48.1	93.5	60.5	I					
1.5 (59 kW)	1986.08-1992.02	AT	L/R	F	Saloon Engine 831 B1.000	817006	Outer Joint	22	25	48.1	93.5	60.5	I					
1.6 (73 kW)	1986.08-1992.02	-	-	F	Saloon Engine 831 B6.000	602006	Inner Joint		25		32							
	1986.08-1992.02	MT	L/R	F	Saloon Engine 831 B6.000	817006	Outer Joint	22	25	48.1	93.5	60.5	I					
1.6 i.e. (80 kW)	1986.05-1989.12	MT	L/R	F	Saloon Engine 831 B7.000	817006	Outer Joint	22	25	48.1	93.5	60.5	I					
	1986.05-1989.12	-	-	F	Saloon Engine 831 B7.000	602006	Inner Joint		25		32							
1.6 i.e. Super (66 kW)	1987.05-1989.12	-	-	F	Saloon Engine 149 C2.000	602006	Inner Joint		25		32							
1.9 Diesel (48 kW)	1983.01-1992.02	MT	L/R	F	Saloon Engine 831 D.000	817006	Outer Joint	22	25	48.1	93.5	60.5	I					
1.9 Turbo Diesel (59 kW)	1985.05-1989.12	MT	L/R	F	Saloon Engine 831 D1.000	817006	Outer Joint	22	25	48.1	93.5	60.5	I					
THEMA (834_)																		
2.0 16V (112 kW)	1992.08-1993.12	-	-	F	Saloon Engine 834 F1.000	602006	Inner Joint		25		32							
	1992.08-1993.12	AT/MT	L/R	F	Saloon Engine 834 F1.000	817004	Outer Joint	25	25	52	85	58	I					
2.0 16V Turbo (133 kW)	1988.12-1990.06	-	-	F	Saloon Engine 834 C1.000	602006	Inner Joint		25		32							
2.0 16V Turbo (148 kW)	1992.10-1994.07	-	-	F	Saloon Engine 834 F2.000	602006	Inner Joint		25		32							
2.0 i.e. (86 kW)	1988.09-1992.05	-	-	F	Saloon Engine 834 B1.000	602006	Inner Joint		25		32							
2.0 i.e. (85 kW)	1987.09-1992.05	-	-	F	Saloon Engine 834 B.146	602006	Inner Joint		25		32							
2.0 i.e. 16V (104 kW)	1989.02-1992.05	-	-	F	Saloon Engine 834 B2.246	602006	Inner Joint		25		32							
2.0 i.e. 16V (108 kW)	1988.05-1992.08	-	-	F	Saloon Engine 834 B2.000	602006	Inner Joint		25		32							
2.0 i.e. 16V Turbo (130 kW)	1989.04-1992.05	-	-	F	Saloon Engine 834 C1.246	602006	Inner Joint		25		32							
2.0 i.e. Turbo (122 kW)	1984.11-1989.12	-	-	F	Saloon Engine 834 C.000	602006	Inner Joint		25		32							
	1984.11-1989.12	-	-	-	Saloon Engine 834 C.000	817003	Outer Joint	90T	25	25	54.5	77	58	I				
	1984.11-1989.12	-	-	-	Saloon Engine 834 C.000	817018	Outer Joint	90T	25	25	52	85	58	I				
2.0 i.e. Turbo (110 kW)	1986.07-1990.05	-	-	F	Saloon Engine 834 C.146	602006	Inner Joint		25		32							
2.5 Turbo DS (85 kW)	1988.06-1992.05	AT/MT	L/R	F	Saloon Engine 8144.97	817004	Outer Joint	25	25	52	85	58	I					
	1992.05-1994.07	AT/MT	L/R	F	Saloon Engine 8144.97 Y	817004	Outer Joint	25	25	52	85	58	I					
THEMA SW (834_)																		
2.0 16V (112 kW)	1992.05-1994.07	AT/MT	L/R	F	Estate Engine 834 F1.000	817004	Outer Joint	25	25	52	85	58	I					
	1992.05-1994.07	-	-	F	Estate Engine 834 F1.000	602006	Inner Joint		25		32							
2.0 i.e. 16V (104 kW)	1989.02-1992.05	-	-	F	Estate Engine 834 B2.246	602006	Inner Joint		25		32							
2.0 i.e. 16V (108 kW)	1989.05-1992.08	-	-	F	Estate Engine 834 B2.000	602006	Inner Joint		25		32							
2.0 i.e. 16V Turbo (130 kW)	1989.04-1993.03	-	-	F	Estate Engine 834 C1.246	602006	Inner Joint		25		32							
	1989.04-1993.03	AT/MT	L/R	F	Estate Engine 834 C1.246	817004	Outer Joint	25	25	52	85	58	I					
2.0 i.e. 16V Turbo (133 kW)	1988.12-1990.06	-	-	F	Estate Engine 834 C1.000	602006	Inner Joint		25		32							
2.0 Turbo (110 kW)	1988.12-1992.03	-	-	F	Estate Engine 834 C.146	602006	Inner Joint		25		32							
2.0 Turbo 16V (148 kW)	1992.11-1994.07	-	-	F	Estate Engine 834 F2.000	602006	Inner Joint		25		32							
2.5 Turbo DS (74 kW)	1987.03-1990.09	-	-	-	Estate Engine 8144.91	817003	Outer Joint	90T	25	25	54.5	77	58	I				
	1987.03-1990.09	-	-	-	Estate Engine 8144.91	817018	Outer Joint	90T	25	25	52	85	58	I				
2.5 Turbo DS (85 kW)	1988.06-1992.05	AT/MT	L/R	F	Estate Engine 8144.97	817004	Outer Joint	25	25	52	85	58	I					
	1992.09-1994.07	AT/MT	L/R	F	Estate Engine 8144.97 Y	817004	Outer Joint	25	25	52	85	58	I					
THEESIS (841AX)																		
2.0 T (136 kW)	2002.07-	-	-	-	-	817047	Outer Joint	27	26	59	83.5	63	M					
2.0 Turbo (136 kW)	2002.07-	-	L	-	-	817005	Inner Joint	25	26	32	91	95						

	 YEAR	TRANSM	L/R	F/R	REMARKS	GSP Ref.	 PRODUCT	 ABS	Technical Specifications							
									A	B	C	H	L	P		
LANCIA																
THEISIS (841AX)																
2.4 (125 kW)	2002.07-	-	-	-	-	817047	Outer Joint		27	26	59	83.5	63	M		
2.4 Bz (125 kW)	2002.07-	-	-	L	-	617005	Inner Joint		25	26	32	91	95			
2.4 D Multijet (136 kW)	2006.04-	-	-	-	-	817047	Outer Joint		27	26	59	83.5	63	M		
2.4 JTD (110 kW)	2002.07-	-	-	-	-	817047	Outer Joint		27	26	59	83.5	63	M		
	2006.04-	-	-	L	-	617005	Inner Joint		25	26	32	91	95			
2.4 JTD (120 kW)	2006.04-	-	AT	L	-	617048	Inner Joint		26	26	31	68	94.5			
	2006.04-	-	AT	R	-	617069	Inner Joint		26	26	31	418.5	108.5			
	2006.04-	-	MT	L	-	621016	Inner Joint		27	26	35	78.5	112			
	2006.04-	-	MT	R	-	617076	Inner Joint		27	26	35	428	108.5			
2.4 JTD (129 kW)	2003.05-	-	-	-	-	817047	Outer Joint		27	26	59	83.5	63	M		
	2006.04-	-	AT	L	-	617048	Inner Joint		26	26	31	68	94.5			
	2006.04-	-	AT	R	-	617069	Inner Joint		26	26	31	418.5	108.5			
	2006.04-	-	MT	L	-	621016	Inner Joint		27	26	35	78.5	112			
3.0 V6 (158 kW)	2002.07-	-	AT	L	-	617048	Inner Joint		26	26	31	68	94.5			
	2002.07-	-	AT	R	-	617069	Inner Joint		26	26	31	418.5	108.5			
3.2 V6 (169 kW)	2003.05-	-	AT	L	-	617048	Inner Joint		26	26	31	68	94.5			
	2003.05-	-	AT	R	-	617069	Inner Joint		26	26	31	418.5	108.5			
Y (840A)																
1.1 (40 kW)	1995.11-	2003.09	-	-	-	617001	Inner Joint		22	19	36	61.5	88.5			
1.2 (44 kW)	1996.03-	2003.09	-	-	-	617001	Inner Joint		22	19	36	61.5	88.5			
1.2 16V (59 kW)	1997.04-	2003.09	-	-	-	617027	Inner Joint		22	22	36	61.5	93.5			
1.2 16V (63 kW)	1997.04-	2003.09	-	-	-	617027	Inner Joint		22	22	36	61.5	93.5			
Y (840_)																
1.1 (40 kW)	1995.11-	2003.09	MT	L	F	Hatchback Engine 176 B2.000	217010	Drive Shaft		22	31.95	46.8	75.5	569		
	1995.11-	2003.09	MT	L/R	F	Hatchback Engine 176 B2.000	817001	Outer Joint		22	20	46.8	75.5	52	O	
	1995.11-	2003.09	MT	L/R	F	Hatchback Engine 176 B2.000	817039	Outer Joint	44T	22	20	46.8	75.5	52	O	
	1995.11-	2003.09	MT	R	F	Hatchback Engine 176 B2.000	217011	Drive Shaft		22	31.95	46.8	75.5	928.5		
	1995.11-	2003.09	-	R	F	Hatchback Engine 176 B2.000	217039	Drive Shaft	44T	22	22	46.8	75.5	874		
	1995.11-	2003.09	MT	L	F	Hatchback Engine 176 B2.000	217018	Drive Shaft		22	22	46.8	75.5	581		
1.2 (44 kW)	1995.11-	2003.09	MT	R	F	Hatchback Engine 176 B2.000	217022	Drive Shaft		22	22	46.8	75.5	874		
	1996.03-	2003.09	MT	L	F	Hatchback Engine 188 A4.000/840 A3.000	217010	Drive Shaft		22	31.95	46.8	75.5	569		
	1996.03-	2003.09	MT	L/R	F	Hatchback Engine 188 A4.000/840 A3.000	817001	Outer Joint		22	20	46.8	75.5	52	O	
	1996.03-	2003.09	MT	L/R	F	Hatchback Engine 188 A4.000/840 A3.000	817039	Outer Joint	44T	22	20	46.8	75.5	52	O	
	1996.03-	2003.09	MT	R	F	Hatchback Engine 188 A4.000/840 A3.000	217011	Drive Shaft		22	31.95	46.8	75.5	928.5		
	1996.03-	2003.09	-	R	F	Hatchback Engine 188 A4.000/840 A3.000	217039	Drive Shaft	44T	22	22	46.8	75.5	874		
1.2 16V (59 kW)	1996.03-	2003.09	MT	L	F	Hatchback Engine 188 A4.000/840 A3.000	217018	Drive Shaft		22	22	46.8	75.5	581		
	1996.03-	2003.09	MT	R	F	Hatchback Engine 188 A4.000/840 A3.000	217022	Drive Shaft		22	22	46.8	75.5	874		
	2000.10-	2003.09	MT	L/R	F	Hatchback Engine 188 A5.000	817014	Outer Joint		22	21	51	79.5	54	M	
	2000.10-	2003.09	-	-	-	Hatchback Engine 188 A5.000	817034	Outer Joint		22	21	51	79.5	54	M	
	1.2 16V (63 kW)	1997.04-	2003.09	AT/MT	L/R	F	Hatchback Engine 176 B9.000	817001	Outer Joint		22	20	46.8	75.5	52	O
		1997.04-	2003.09	AT/MT	L/R	F	Hatchback Engine 176 B9.000	817039	Outer Joint	44T	22	20	46.8	75.5	52	O
1.4 12V (55 kW)	1996.03-	2003.09	MT	L	F	Hatchback Engine 840 A4.000	217010	Drive Shaft		22	31.95	46.8	75.5	569		
	1996.03-	2003.09	AT/MT	L/R	F	Hatchback Engine 840 A4.000	817001	Outer Joint		22	20	46.8	75.5	52	O	
	1996.03-	2003.09	AT/MT	L/R	F	Hatchback Engine 840 A4.000	817039	Outer Joint	44T	22	20	46.8	75.5	52	O	
	1996.03-	2003.09	MT	R	F	Hatchback Engine 840 A4.000	217011	Drive Shaft		22	31.95	46.8	75.5	928.5		
1.4 12V (59 kW)	1996.10-	2003.09	MT	L	F	Hatchback Engine 840 A2.000	217010	Drive Shaft		22	31.95	46.8	75.5	569		
	1996.10-	2003.09	AT/MT	L/R	F	Hatchback Engine 840 A2.000	817001	Outer Joint		22	20	46.8	75.5	52	O	
	1996.10-	2003.09	AT/MT	L/R	F	Hatchback Engine 840 A2.000	817039	Outer Joint	44T	22	20	46.8	75.5	52	O	
	1996.10-	2003.09	MT	R	F	Hatchback Engine 840 A2.000	217011	Drive Shaft		22	31.95	46.8	75.5	928.5		
YPSILON (843_)																
1.2 (44 kW)	2003.10-	2011.12	MT	R	F	Hatchback Engine 188 A4.000	617004	Inner Joint		22	21	36	61	93.5		
	2003.10-	2011.12	MT	L/R	F	Hatchback Engine 188 A4.000	817014	Outer Joint		22	21	51	79.5	54	M	
	2003.10-	2011.12	MT	R	F	Hatchback Engine 188 A4.000	217230	Drive Shaft		22	22	51	79.5	636		
1.2 (59 kW)	2003.10-	2011.12	MT	R	F	Hatchback Engine 188 A5.000	617004	Inner Joint		22	21	36	61	93.5		
	2003.10-	2011.12	MT	L/R	F	Hatchback Engine 188 A5.000	817014	Outer Joint		22	21	51	79.5	54	M	
	2003.10-	2011.12	MT	R	F	Hatchback Engine 188 A5.000	217230	Drive Shaft		22	22	51	79.5	636		
	2003.10-	2011.12	-	-	-	Hatchback Engine 188 A5.000	817034	Outer Joint		22	21	51	79.5	54	M	
1.3 D Multijet (55 kW)	2006.09-	2011.12	5MT	L	F	Hatchback Engine 199 A2.000	217147	Drive Shaft		25		51	84.5	480		
	2006.09-	2011.12	5MT	R	F	Hatchback Engine 199 A2.000	217066	Drive Shaft		25	33.9	51	84.5	497		
	2006.09-	2011.12	CVT	L/R	F	Hatchback Engine 199 A2.000	817053	Outer Joint		25	23	51	84.5	60	M	
	2006.09-	2011.12	AT/MT	L/R	F	Hatchback Engine 199 A2.000	829002	Outer Joint		25	28	51	84	58.5	O	
	2006.09-	2011.12	5MT	L	F	Hatchback Engine 199 A2.000	217082	Drive Shaft		25	33.9	51	84.5	514		
1.3 D Multijet (66 kW)	2006.09-	2011.12	MT	L/R	F	Hatchback Engine 199 A3.000	817028	Outer Joint		25	24	51	84.5	62	M	
	2006.09-	2011.12	6MT	L	F	Hatchback Engine 199 A3.000	217172	Drive Shaft		25	33.9	51	84.5	486		
	2006.09-	2011.12	6MT	R	F	Hatchback Engine 199 A3.000	217146	Drive Shaft		25		51	84.5	522		

YEAR	TRANSM	L/R	F/R	REMARKS	GSP Ref.	PRODUCT	ABS	Technical Specifications						
								A	B	C	H	L	P	
LANCIA														
YPSILON (843_)														
1.3 D Multijet (77 kW)	2007.05-2011.12	MT	L/R	F	Hatchback Engine 199 A3.000	817028	Outer Joint	25	24	51	84.5	62	M	
	2007.05-2011.12	-	L	F	Hatchback Engine 199 A3.000	217054	Drive Shaft	25	35.45	51	84.5	472		
1.3 JTD (51 kW)	2003.10-2011.12	-	L	F	Hatchback Engine 188 A9.000	217147	Drive Shaft	25		51	84.5	480		
	2003.10-2011.12	CVT	L/R	F	Hatchback Engine 188 A9.000	817053	Outer Joint	25	23	51	84.5	60	M	
	2003.10-2011.12	-	R	F	Hatchback Engine 188 A9.000	217066	Drive Shaft	25	33.9	51	84.5	497		
	2003.10-2011.12	AT/MT	L/R	F	Hatchback Engine 188 A9.000	829002	Outer Joint	25	28	51	84	58.5	O	
1.4 16V (70 kW)	2003.10-2011.12	MT	R	F	Hatchback Engine 843 A 1.000	617004	Inner Joint	22	21	36	61	93.5		
	2003.10-2011.12	MT	L/R	F	Hatchback Engine 843 A 1.000	817014	Outer Joint	22	21	51	79.5	54	M	
	2003.10-2011.12	MT	R	F	Hatchback Engine 843 A 1.000	217230	Drive Shaft	22	22	51	79.5	636		
	2003.10-2011.12	-	-	-	Hatchback Engine 843 A 1.000	817034	Outer Joint	22	21	51	79.5	54	M	
YPSILON I (843)														
0.9 (62 kW)	2011.05-	-	-	-	-	617027	Inner Joint	22	22	36	61.5	93.5		
1.2 (51 kW)	2003.10-2010.08	-	-	-	-	617027	Inner Joint	22	22	36	61.5	93.5		
1.2 (59 kW)	2003.10-2010.08	-	-	-	-	617027	Inner Joint	22	22	36	61.5	93.5		
1.2 8V (50 kW)	2011.05-	-	-	-	-	617001	Inner Joint	22	19	36	61.5	88.5		
1.3 D Multijet (51 kW)	2003.10-2006.03	-	R	-	-	617012	Inner Joint	24	23	29.7	379	100.5		
	2003.10-2006.03	-	L	-	-	617011	Inner Joint	24	23	29.7	86.5	93		
	2006.09-	-	-	-	-	617016	Inner Joint		28		48.5			
1.3 D Multijet (55 kW)	2006.09-	-	-	-	-	617016	Inner Joint		28		48.5			
1.3 D Multijet (56 kW)	2003.10-2006.03	-	R	-	-	617012	Inner Joint	24	23	29.7	379	100.5		
	2003.10-2006.03	-	L	-	-	617011	Inner Joint	24	23	29.7	86.5	93		
1.3 D Multijet (66 kW)	2007.05-	-	R	-	-	617015	Inner Joint	24	24	29.7	379	100.5		
	2007.05-	-	L	-	-	699008	Inner Joint	24	24	29.7	86.5	93		
1.3 D Multijet (77 kW)	2007.05-	-	R	-	-	617015	Inner Joint	24	24	29.7	379	100.5		
	2007.05-	-	L	-	-	699008	Inner Joint	24	24	29.7	86.5	93		
1.3 DS (70 kW)	2011.05-	-	L	-	-	617011	Inner Joint	24	23	29.7	86.5	93		
1.4 (57 kW)	2006.02-	-	-	-	-	617027	Inner Joint	22	22	36	61.5	93.5		
1.4 16V (70 kW)	2003.10-	-	-	-	-	617027	Inner Joint	22	22	36	61.5	93.5		
1.4 LPG (57 kW)	2010.11-	-	-	-	-	617027	Inner Joint	22	22	36	61.5	93.5		
ZETA (22_)														
2.0 16V (100 kW)	2000.07-2002.09	MT	R	F	MPV Engine RFN	210120	Drive Shaft	27	24	59	82	928		
	2000.07-2002.09	MT	L	F	MPV Engine RFN	210082	Drive Shaft	48T	27	24	59	82	648	
	2000.07-2002.09	-	L	F	MPV Engine RFN	610015	Inner Joint	37	39	40	68.5	104		
	2000.07-2002.09	-	R	F	MPV Engine RFN	610034	Inner Joint	37	39	31.9	369.5	99		
	2000.07-2002.09	MT	R	F	MPV Engine RFN	210012	Drive Shaft	48T	27	24	64	80.5	928	
	2000.07-2002.09	MT	L/R	F	MPV Engine RFN	810018	Outer Joint	48T	27	34	61	82	55	I
	2000.07-2002.09	-	L	F	MPV Engine RFN	210072	Drive Shaft	27	37	59	82	641		
	2000.07-2002.09	-	R	F	MPV Engine RFN	210155	Drive Shaft	27	37	59	82	947		
	2000.07-2002.09	MT	L	F	MPV Engine RFN	210052	Drive Shaft	27	24	61	82	648		
	2000.07-2002.09	-	L	F	MPV Engine RFN	210016	Drive Shaft	48T	27	37	59	82	641	
	2000.07-2002.09	MT	R	F	MPV Engine RFN	210014	Drive Shaft	48T	27	37	59	82	947	
2.0 16V (97 kW)	1998.05-2000.07	-	R	F	MPV Engine RFV (XU10J4R)	210120	Drive Shaft	27	24	59	82	928		
	1998.05-2000.07	-	L	F	MPV Engine RFV (XU10J4R)	210082	Drive Shaft	48T	27	24	59	82	648	
	1998.05-2000.07	-	L	F	MPV Engine RFV (XU10J4R)	610015	Inner Joint	37	39	40	68.5	104		
	1998.05-2000.07	-	R	F	MPV Engine RFV (XU10J4R)	610034	Inner Joint	37	39	31.9	369.5	99		
	1998.05-2000.07	MT	L/R	F	MPV Engine RFV (XU10J4R)	810018	Outer Joint	48T	27	34	61	82	55	I
	1998.05-2000.07	-	R	F	MPV Engine RFV (XU10J4R)	210012	Drive Shaft	48T	27	24	64	80.5	928	
	1998.05-2000.07	-	L	F	MPV Engine RFV (XU10J4R)	210072	Drive Shaft	27	37	59	82	641		
	1998.05-2000.07	-	R	F	MPV Engine RFV (XU10J4R)	210155	Drive Shaft	27	37	59	82	947		
	1998.05-2000.07	-	L	F	MPV Engine RFV (XU10J4R)	210052	Drive Shaft	27	24	61	82	648		
	1998.05-2000.07	-	L	F	MPV Engine RFV (XU10J4R)	210016	Drive Shaft	48T	27	37	59	82	641	
	1998.05-2000.07	-	R	F	MPV Engine RFV (XU10J4R)	210014	Drive Shaft	48T	27	37	59	82	947	
2.0 JTD (80 kW)	2000.04-2002.09	MT	L	F	MPV Engine RHZ (DW10ATED)	210430	Drive Shaft	27	37	59	82	630		
	2000.04-2002.09	MT	R	F	MPV Engine RHZ (DW10ATED)	210057	Drive Shaft	27	37	59	82	960		
	2000.04-2002.09	MT	L	F	MPV Engine RHZ (DW10ATED)	210264	Drive Shaft	48T	27	37	59	82	630	
	2000.04-2002.09	MT	R	F	MPV Engine RHZ (DW10ATED)	245120	Drive Shaft	48T	27	37	59	82	960	
	2000.04-2002.09	MT	L	F	MPV Engine RHZ (DW10ATED)	610015	Inner Joint	37	39	40	68.5	104		
	2000.04-2002.09	MT	R	F	MPV Engine RHZ (DW10ATED)	610034	Inner Joint	37	39	31.9	369.5	99		
2.0 JTD 16V (80 kW)	1999.09-2002.09	MT	L	F	MPV Engine RHW (DW10ATED4)	210430	Drive Shaft	27	37	59	82	630		
	1999.09-2002.09	MT	R	F	MPV Engine RHW (DW10ATED4)	210057	Drive Shaft	27	37	59	82	960		
	1999.09-2002.09	-	R	F	MPV Engine RHW (DW10ATED4)	210237	Drive Shaft	48T	27	37	59	82	953	
	1999.09-2002.09	MT	L	F	MPV Engine RHW (DW10ATED4)	210264	Drive Shaft	48T	27	37	59	82	630	
	1999.09-2002.09	MT	R	F	MPV Engine RHW (DW10ATED4)	245120	Drive Shaft	48T	27	37	59	82	960	
	1999.09-2002.09	MT	L	F	MPV Engine RHW (DW10ATED4)	610015	Inner Joint	37	39	40	68.5	104		
	1999.09-2002.09	MT	R	F	MPV Engine RHW (DW10ATED4)	610034	Inner Joint	37	39	31.9	369.5	99		
2.0 Turbo (108 kW)	1995.05-2002.09	-	L	F	MPV Engine RGX (XU10J2TE)	610015	Inner Joint	37	39	40	68.5	104		

	 YEAR	TRANSM	L/R	F/R	REMARKS	GSP Ref.	 PRODUCT	 ABS	Technical Specifications					
									A	B	C	H	L	P
LANCIA														
ZETA (22_)														
2.0 Turbo (108 kW)	1995.05-2002.09	-	R	F	MPV Engine RGX (XU10J2TE)	610034	Inner Joint		37	39	31.9	369.5	99	
	1995.05-2002.09	-	L	F	MPV Engine RGX (XU10J2TE)	210072	Drive Shaft		27	37	59	82	641	
	1995.05-2002.09	-	R	F	MPV Engine RGX (XU10J2TE)	210155	Drive Shaft		27	37	59	82	947	
	1995.05-2002.09	-	L/R	F	MPV Engine RGX (XU10J2TE)	810015	Outer Joint	48T	27	39	59	82	63	I
	1995.05-2002.09	-	L	F	MPV Engine RGX (XU10J2TE)	210016	Drive Shaft	48T	27	37	59	82	641	
	1995.05-2002.09	-	R	F	MPV Engine RGX (XU10J2TE)	210014	Drive Shaft	48T	27	37	59	82	947	
2.1 TD (80 kW)	1996.05-1999.09	AT/MT	L	F	MPV Engine P 8 C	610015	Inner Joint		37	39	40	68.5	104	
	1996.05-1999.09	AT/MT	R	F	MPV Engine P 8 C	610034	Inner Joint		37	39	31.9	369.5	99	
	1996.05-1999.09	AT/MT	L	F	MPV Engine P 8 C	210072	Drive Shaft		27	37	59	82	641	
	1996.05-1999.09	-	L/R	F	MPV Engine P 8 C	810015	Outer Joint	48T	27	39	59	82	63	I
	1996.05-1999.09	AT/MT	R	F	MPV Engine P 8 C	210155	Drive Shaft		27	37	59	82	947	
	1996.05-1999.09	AT/MT	L	F	MPV Engine P 8 C	210016	Drive Shaft	48T	27	37	59	82	641	
	1996.05-1999.09	AT/MT	R	F	MPV Engine P 8 C	210014	Drive Shaft	48T	27	37	59	82	947	
LAND ROVER														
DISCOVERY II (L318)														
2.5 Td5 (102 kW)	1999.01-2004.06	-	L/R	F	All-wheel Drive Closed Off-Road Vehicle Engine 10 P/15 P	899211	Outer Joint		24	32	62	100	95	I
DISCOVERY III (L319)														
2.7 TD (140 kW)	2004.07-2009.09	MT	-	F	All-wheel Drive Closed Off-Road Vehicle Engine 276DT	830012	Outer Joint	48T	29	27	74	96	67.5	M
	2004.07-2009.09	-	R	R	All-wheel Drive Closed Off-Road Vehicle Engine 276DT	830014	Outer Joint	48T	31	29	74	96.5	75.5	M
	2004.07-2009.09	6MT	L	F	All-wheel Drive Closed Off-Road Vehicle Engine 276DT	230002	Drive Shaft	48T	29	29	74	96	638	
	2004.07-2009.09	6MT	R	F	All-wheel Drive Closed Off-Road Vehicle Engine 276DT	259480	Drive Shaft	48T	29	29	74	96	999	
4.0 (160 kW)	2005.02-2009.09	-	-	F	All-wheel Drive Closed Off-Road Vehicle	830012	Outer Joint	48T	29	27	74	96	67.5	M
	2005.02-2009.09	-	L/R	R	All-wheel Drive Closed Off-Road Vehicle	830014	Outer Joint	48T	31	29	74	96.5	75.5	M
	2005.02-2009.09	AT	L	F	All-wheel Drive Closed Off-Road Vehicle	230002	Drive Shaft	48T	29	29	74	96	638	
	2005.02-2009.09	AT	R	F	All-wheel Drive Closed Off-Road Vehicle	259480	Drive Shaft	48T	29	29	74	96	999	
4.0 V6 (160 kW)	2004.10-2009.09	-	-	F	All-wheel Drive Closed Off-Road Vehicle Engine 406PN	830012	Outer Joint	48T	29	27	74	96	67.5	M
	2004.10-2009.09	AT	L/R	R	All-wheel Drive Closed Off-Road Vehicle Engine 406PN	830014	Outer Joint	48T	31	29	74	96.5	75.5	M
	2004.10-2009.09	AT	L	F	All-wheel Drive Closed Off-Road Vehicle Engine 406PN	230002	Drive Shaft	48T	29	29	74	96	638	
	2004.10-2009.09	AT	R	F	All-wheel Drive Closed Off-Road Vehicle Engine 406PN	259480	Drive Shaft	48T	29	29	74	96	999	
4.4 (220 kW)	2004.07-2009.09	-	-	F	All-wheel Drive Closed Off-Road Vehicle Engine 448PN	830012	Outer Joint	48T	29	27	74	96	67.5	M
	2004.07-2009.09	-	L/R	R	All-wheel Drive Closed Off-Road Vehicle Engine 448PN	830014	Outer Joint	48T	31	29	74	96.5	75.5	M
	2004.07-2009.09	AT	L	F	All-wheel Drive Closed Off-Road Vehicle Engine 448PN	230002	Drive Shaft	48T	29	29	74	96	638	
	2004.07-2009.09	AT	R	F	All-wheel Drive Closed Off-Road Vehicle Engine 448PN	259480	Drive Shaft	48T	29	29	74	96	999	
DISCOVERY IV (L319)														
2.7 TD (140 kW)	2009.09-2013.08	MT	-	F	All-wheel Drive Closed Off-Road Vehicle Engine 276DT	830012	Outer Joint	48T	29	27	74	96	67.5	M
	2009.09-2013.08	6MT	L	F	All-wheel Drive Closed Off-Road Vehicle Engine 276DT	230002	Drive Shaft	48T	29	29	74	96	638	
	2009.09-2013.08	6MT	R	F	All-wheel Drive Closed Off-Road Vehicle Engine 276DT	259480	Drive Shaft	48T	29	29	74	96	999	
3.0 (250 kW)	2013.08-2018.08	AT	L/R	R	All-wheel Drive Closed Off-Road Vehicle Engine 30HD0D/306PS	830014	Outer Joint	48T	31	29	74	96.5	75.5	M
3.0 SDV6 (188 kW)	2009.11-2013.08	8AT	L/R	R	All-wheel Drive Closed Off-Road Vehicle Engine 30DDTX	830014	Outer Joint	48T	31	29	74	96.5	75.5	M
3.0 TD (155 kW)	2010.05-2012.07	-	L/R	R	All-wheel Drive Closed Off-Road Vehicle Engine 306DT/30DDTX	830014	Outer Joint	48T	31	29	74	96.5	75.5	M
3.0 TD (183 kW)	2012.07-2018.08	AT	L/R	R	All-wheel Drive Closed Off-Road Vehicle Engine 306DT	830014	Outer Joint	48T	31	29	74	96.5	75.5	M
4.0 V6 HSE (160 kW)	2009.09-2013.08	-	-	F	All-wheel Drive Closed Off-Road Vehicle	830012	Outer Joint	48T	29	27	74	96	67.5	M
	2009.09-2013.08	AT	L	F	All-wheel Drive Closed Off-Road Vehicle	230002	Drive Shaft	48T	29	29	74	96	638	
	2009.09-2013.08	AT	R	F	All-wheel Drive Closed Off-Road Vehicle	259480	Drive Shaft	48T	29	29	74	96	999	
5.0 V8 HSE (276 kW)	2009.09-2013.08	-	-	F	All-wheel Drive Closed Off-Road Vehicle Engine 508PN	830012	Outer Joint	48T	29	27	74	96	67.5	M
	2009.09-2013.08	AT	L	F	All-wheel Drive Closed Off-Road Vehicle Engine 508PN	230002	Drive Shaft	48T	29	29	74	96	638	
	2009.09-2013.08	AT	R	F	All-wheel Drive Closed Off-Road Vehicle Engine 508PN	259480	Drive Shaft	48T	29	29	74	96	999	
FREELANDER														
1.8	1998.01-2000.12	MT/AT	-	-	-	630001	Inner Joint		25	32	40	57.5	101.5	
1.8 i	1997.12-2000.08	-	-	F	Ch.No A999999	651007	Inner Joint		25	25	40	57.5	93	
2.0 TD 8V	1997.12-2000.08	-	-	F	-	651007	Inner Joint		25	25	40	57.5	93	
2.0 TD4	2000-2005.09	-	L	F	-	299133	Drive Shaft		28	25	57.7	85	631	
	2000-2005.09	-	R	F	-	299134	Drive Shaft		28	25	57.7	85	596	
FREELANDER (L314)														
1.8 16V (86 kW)	2000.11-2006.10	-	L/R	F	All-wheel Drive Closed Off-Road Vehicle Engine 18 K4F	851020	Outer Joint	60W	28	32	55.6	85	61	I
	2000.11-2006.10	-	-	R	All-wheel Drive Closed Off-Road Vehicle Engine 18 K4F	851015	Outer Joint		28	32	55.6	85	61	I
	2000.11-2006.10	-	-	F	All-wheel Drive Closed Off-Road Vehicle Engine 18 K4F	251008	Drive Shaft	60W	28	25	57.7	85	613	
	2000.11-2006.10	-	-	F	All-wheel Drive Closed Off-Road Vehicle Engine 18 K4F	830009	Outer Joint		28	32	56	83.5	61	I
	2000.11-2006.10	-	-	F	All-wheel Drive Closed Off-Road Vehicle Engine 18 K4F	251009	Drive Shaft	60W	28	25	55.6	85	611	
	2000.11-2006.10	-	-	R	All-wheel Drive Closed Off-Road Vehicle Engine 18 K4F	251025	Drive Shaft	60W	28	23	55.6	85	808	
	2000.11-2006.10	-	-	R	All-wheel Drive Closed Off-Road Vehicle Engine 18 K4F	651012	Inner Joint		23	32	35.7	85.5	124.5	
	2000.11-2006.10	-	-	R	All-wheel Drive Closed Off-Road Vehicle Engine 18 K4F	830016	Outer Joint		28	21	57.7	85	61	M
	2000.11-2006.10	-	L/R	F	All-wheel Drive Closed Off-Road Vehicle Engine 18 K4F	230005	Drive Shaft		28	25	56	83.5	610.5	
	2000.11-2006.10	-	L/R	R	All-wheel Drive Closed Off-Road Vehicle Engine 18 K4F	251030	Drive Shaft	60W	28	23	57.7	85	806	
	2000.11-2006.10	-	-	R	All-wheel Drive Closed Off-Road Vehicle Engine 18 K4F	818200	Outer Joint	60W	28	21	57.7	85	61	M





YEAR	TRANSM	L/R	F/R	REMARKS	GSP Ref.	PRODUCT	ABS	Technical Specifications										
								A	B	C	H	L	P					
LAND ROVER																		
FREELANDER (L314)																		
1.8 16V (86 kW)	2000.11-2006.10	-	L/R	R	All-wheel Drive Closed Off-Road Vehicle Engine 18 K4F	251037	Drive Shaft		28	23	57.7	85	806					
	2000.11-2006.10	-	-	R	All-wheel Drive Closed Off-Road Vehicle Engine 18 K4F	818280	Outer Joint		28	21	57.7	85	61	M				
1.8 i 16V (88 kW)	1998.02-2000.11	MT	L/R	F/R	All-wheel Drive Closed Off-Road Vehicle Engine 18 K4F	851020	Outer Joint	60W	28	32	55.6	85	61	I				
	1998.02-2000.11	-	-	F/R	All-wheel Drive Closed Off-Road Vehicle Engine 18 K4F	851015	Outer Joint		28	32	55.6	85	61	I				
	1998.02-2000.11	-	-	F	All-wheel Drive Closed Off-Road Vehicle Engine 18 K4F	251008	Drive Shaft	60W	28	25	57.7	85	613					
	1998.02-2000.11	-	-	F	All-wheel Drive Closed Off-Road Vehicle Engine 18 K4F	830009	Outer Joint		28	32	56	83.5	61	I				
	1998.02-2000.11	-	-	F	All-wheel Drive Closed Off-Road Vehicle Engine 18 K4F	251009	Drive Shaft	60W	28	25	55.6	85	611					
	1998.02-2000.11	-	-	R	All-wheel Drive Closed Off-Road Vehicle Engine 18 K4F	251025	Drive Shaft	60W	28	23	55.6	85	808					
	1998.02-2000.11	-	-	R	All-wheel Drive Closed Off-Road Vehicle Engine 18 K4F	651012	Inner Joint		23	32	35.7	85.5	124.5					
	1998.02-2000.11	-	-	F	All-wheel Drive Closed Off-Road Vehicle Engine 18 K4F	230005	Drive Shaft		28	25	56	83.5	610.5					
	1998.02-2000.11	-	-	R	All-wheel Drive Closed Off-Road Vehicle Engine 18 K4F	251030	Drive Shaft	60W	28	23	57.7	85	806					
	1998.02-2000.11	-	-	R	All-wheel Drive Closed Off-Road Vehicle Engine 18 K4F	818200	Outer Joint	60W	28	21	57.7	85	61	M				
	1998.02-2000.11	-	-	R	All-wheel Drive Closed Off-Road Vehicle Engine 18 K4F	251037	Drive Shaft		28	23	57.7	85	806					
	1998.02-2000.11	-	-	F	All-wheel Drive Closed Off-Road Vehicle Engine 18 K4F	818280	Outer Joint		28	21	57.7	85	61	M				
2.0 DI (72 kW)	1998.02-2000.11	-	-	F/R	All-wheel Drive Closed Off-Road Vehicle Engine 20 T2N	851015	Outer Joint		28	32	55.6	85	61	I				
	1998.02-2000.11	MT	L/R	F/R	All-wheel Drive Closed Off-Road Vehicle Engine 20 T2N	851020	Outer Joint	60W	28	32	55.6	85	61	I				
	1998.02-2000.11	-	-	F	All-wheel Drive Closed Off-Road Vehicle Engine 20 T2N	251009	Drive Shaft	60W	28	25	55.6	85	611					
	1998.02-2000.11	-	-	R	All-wheel Drive Closed Off-Road Vehicle Engine 20 T2N	251025	Drive Shaft	60W	28	23	55.6	85	808					
	1998.02-2000.11	-	-	R	All-wheel Drive Closed Off-Road Vehicle Engine 20 T2N	651012	Inner Joint		23	32	35.7	85.5	124.5					
	1998.02-2000.11	-	-	L/R	All-wheel Drive Closed Off-Road Vehicle Engine 20 T2N	251030	Drive Shaft	60W	28	23	57.7	85	806					
	1998.02-2000.11	-	-	L/R	All-wheel Drive Closed Off-Road Vehicle Engine 20 T2N	251037	Drive Shaft		28	23	57.7	85	806					
	1998.02-2000.11	-	-	R	All-wheel Drive Closed Off-Road Vehicle Engine 20 T2N	818200	Outer Joint	60W	28	21	57.7	85	61	M				
	1998.02-2000.11	-	-	R	All-wheel Drive Closed Off-Road Vehicle Engine 20 T2N	818280	Outer Joint		28	21	57.7	85	61	M				
2.0 Td4 (80 kW)	2001.03-2006.10	-	-	F/R	All-wheel Drive Closed Off-Road Vehicle Engine 204D3	851015	Outer Joint		28	32	55.6	85	61	I				
	2001.03-2006.10	AT/MT	L	F	All-wheel Drive Closed Off-Road Vehicle Engine 204D3	251003	Drive Shaft	60W	28	25	55.6	85	629					
	2001.03-2006.10	-	-	F	All-wheel Drive Closed Off-Road Vehicle Engine 204D3	251008	Drive Shaft	60W	28	25	57.7	85	613					
	2001.03-2006.10	-	-	F	All-wheel Drive Closed Off-Road Vehicle Engine 204D3	830009	Outer Joint		28	32	56	83.5	61	I				
	2001.03-2006.10	-	-	R	All-wheel Drive Closed Off-Road Vehicle Engine 204D3	230004	Drive Shaft		28	25	56	83.5	589					
	2001.03-2006.10	-	-	L	All-wheel Drive Closed Off-Road Vehicle Engine 204D3	230003	Drive Shaft		28	25	56	83.5	629.5					
	2001.03-2006.10	-	-	R	All-wheel Drive Closed Off-Road Vehicle Engine 204D3	851019	Outer Joint		28	32	57.7	85	61	I				
	2001.03-2006.10	-	-	F	All-wheel Drive Closed Off-Road Vehicle Engine 204D3	251009	Drive Shaft	60W	28	25	55.6	85	611					
	2001.03-2006.10	-	-	R	All-wheel Drive Closed Off-Road Vehicle Engine 204D3	251025	Drive Shaft	60W	28	23	55.6	85	808					
	2001.03-2006.10	-	-	R	All-wheel Drive Closed Off-Road Vehicle Engine 204D3	251013	Drive Shaft		28	25	57.7	85	631					
	2001.03-2006.10	-	-	L	All-wheel Drive Closed Off-Road Vehicle Engine 204D3	251024	Drive Shaft	60W	28	25	57.7	85	631					
	2001.03-2006.10	-	-	R	All-wheel Drive Closed Off-Road Vehicle Engine 204D3	251002	Drive Shaft	60W	28	25	55.6	85	592					
	2001.03-2006.10	-	-	R	All-wheel Drive Closed Off-Road Vehicle Engine 204D3	651012	Inner Joint		23	32	35.7	85.5	124.5					
	2001.03-2006.10	-	-	L/R	All-wheel Drive Closed Off-Road Vehicle Engine 204D3	251030	Drive Shaft	60W	28	23	57.7	85	806					
	2001.03-2006.10	-	-	L/R	All-wheel Drive Closed Off-Road Vehicle Engine 204D3	251037	Drive Shaft		28	23	57.7	85	806					
	2001.03-2006.10	-	-	R	All-wheel Drive Closed Off-Road Vehicle Engine 204D3	818200	Outer Joint	60W	28	21	57.7	85	61	M				
	2001.03-2006.10	-	-	R	All-wheel Drive Closed Off-Road Vehicle Engine 204D3	818280	Outer Joint		28	21	57.7	85	61	M				
2.0 Td4 (82 kW)	2000.11-2006.10	-	-	F/R	All-wheel Drive Closed Off-Road Vehicle Engine M 47/204D3	851015	Outer Joint		28	32	55.6	85	61	I				
	2000.11-2006.10	AT/MT	L	F	All-wheel Drive Closed Off-Road Vehicle Engine M 47/204D3	251003	Drive Shaft	60W	28	25	55.6	85	629					
	2000.11-2006.10	-	-	F	All-wheel Drive Closed Off-Road Vehicle Engine M 47/204D3	830009	Outer Joint		28	32	56	83.5	61	I				
	2000.11-2006.10	-	-	R	All-wheel Drive Closed Off-Road Vehicle Engine M 47/204D3	230004	Drive Shaft		28	25	56	83.5	589					
	2000.11-2006.10	-	-	R	All-wheel Drive Closed Off-Road Vehicle Engine M 47/204D3	851019	Outer Joint		28	32	57.7	85	61	I				
	2000.11-2006.10	-	-	F	All-wheel Drive Closed Off-Road Vehicle Engine M 47/204D3	251009	Drive Shaft	60W	28	25	55.6	85	611					
	2000.11-2006.10	-	-	L	All-wheel Drive Closed Off-Road Vehicle Engine M 47/204D3	230003	Drive Shaft		28	25	56	83.5	629.5					
	2000.11-2006.10	-	-	R	All-wheel Drive Closed Off-Road Vehicle Engine M 47/204D3	251025	Drive Shaft	60W	28	23	55.6	85	808					
	2000.11-2006.10	-	-	R	All-wheel Drive Closed Off-Road Vehicle Engine M 47/204D3	251013	Drive Shaft		28	25	57.7	85	631					
	2000.11-2006.10	-	-	L	All-wheel Drive Closed Off-Road Vehicle Engine M 47/204D3	251024	Drive Shaft	60W	28	25	57.7	85	631					
	2000.11-2006.10	-	-	R	All-wheel Drive Closed Off-Road Vehicle Engine M 47/204D3	251002	Drive Shaft	60W	28	25	55.6	85	592					
	2000.11-2006.10	-	-	R	All-wheel Drive Closed Off-Road Vehicle Engine M 47/204D3	651012	Inner Joint		23	32	35.7	85.5	124.5					
	2000.11-2006.10	-	-	L/R	All-wheel Drive Closed Off-Road Vehicle Engine M 47/204D3	251030	Drive Shaft	60W	28	23	57.7	85	806					
	2000.11-2006.10	-	-	L/R	All-wheel Drive Closed Off-Road Vehicle Engine M 47/204D3	251037	Drive Shaft		28	23	57.7	85	806					
	2000.11-2006.10	-	-	R	All-wheel Drive Closed Off-Road Vehicle Engine M 47/204D3	818200	Outer Joint	60W	28	21	57.7	85	61	M				
	2000.11-2006.10	-	-	R	All-wheel Drive Closed Off-Road Vehicle Engine M 47/204D3	818280	Outer Joint		28	21	57.7	85	61	M				
2.5 V6 (130 kW)	2000.11-2006.10	AT/MT	L	F	All-wheel Drive Closed Off-Road Vehicle Engine 25 K4F	251003	Drive Shaft	60W	28	25	55.6	85	629					
	2000.11-2006.10	-	-	F	All-wheel Drive Closed Off-Road Vehicle Engine 25 K4F	830009	Outer Joint		28	32	56	83.5	61	I				
	2000.11-2006.10	-	-	R	All-wheel Drive Closed Off-Road Vehicle Engine 25 K4F	230004	Drive Shaft		28	25	56	83.5	589					
	2000.11-2006.10	-	-	R	All-wheel Drive Closed Off-Road Vehicle Engine 25 K4F	851019	Outer Joint		28	32	57.7	85	61	I				
	2000.11-2006.10	-	-	L	All-wheel Drive Closed Off-Road Vehicle Engine 25 K4F	230003	Drive Shaft		28	25	56	83.5	629.5					
	2000.11-2006.10	-	-	R	All-wheel Drive Closed Off-Road Vehicle Engine 25 K4F	251013	Drive Shaft		28	25	57.7	85	631					
	2000.11-2006.10	-	-	L	All-wheel Drive Closed Off-Road Vehicle Engine 25 K4F	251024	Drive Shaft	60W	28	25	57.7	85	631					
	2000.11-2006.10	-	-	R	All-wheel Drive Closed Off-Road Vehicle Engine 25 K4F	251002	Drive Shaft	60W	28	25	55.6	85	592					
	2000.11-2006.10	-	-	R	All-wheel Drive Closed Off-Road Vehicle Engine 25 K4F	830016	Outer Joint		28	21	57.7	85	61	M				
	2000.11-2006.10	-	-	R	All-wheel Drive Closed Off-Road Vehicle Engine 25 K4F	657071	Inner Joint		26	22	35	69.5	95					





YEAR	TRANSM	L/R	F/R	REMARKS	GSP Ref.	PRODUCT	ABS	Technical Specifications						
								A	B	C	H	L	P	
LAND ROVER														
FREELANDER (L314)														
2.5 V6 (130 kW)	2000.11-2006.10	-	-	R	All-wheel Drive Closed Off-Road Vehicle Engine 25 K4F	618187	Inner Joint		26	29	35	69.5	107.5	
	2000.11-2006.10	-	L/R	R	All-wheel Drive Closed Off-Road Vehicle Engine 25 K4F	251030	Drive Shaft	60W	28	23	57.7	85	806	
	2000.11-2006.10	-	-	R	All-wheel Drive Closed Off-Road Vehicle Engine 25 K4F	818200	Outer Joint	60W	28	21	57.7	85	61	M
	2000.11-2006.10	-	L/R	R	All-wheel Drive Closed Off-Road Vehicle Engine 25 K4F	251037	Drive Shaft		28	23	57.7	85	806	
	2000.11-2006.10	-	-	R	All-wheel Drive Closed Off-Road Vehicle Engine 25 K4F	818280	Outer Joint		28	21	57.7	85	61	M
FREELANDER 2 (L359)														
2.0 Si4 (177 kW)	2011.10-2014.10	-	-	R	All-wheel Drive Closed Off-Road Vehicle Engine 204PT	857132	Outer Joint		28	22	57.7	84	61.5	M
	2011.10-2014.10	-	L/R	R	All-wheel Drive Closed Off-Road Vehicle Engine 204PT	257165	Drive Shaft		28	26	57.7	84	819.5	
2.2 eD4 (110 kW)	2010.08-2014.10	AT	L	F	Closed Off-Road Vehicle Engine 224DT/DW12BTED4	251038	Drive Shaft		40	31	57.4	52	538	
	2010.08-2014.10	AT	R	F	Closed Off-Road Vehicle Engine 224DT/DW12BTED4	251039	Drive Shaft		40	28	57.4	52	1000	
	2010.08-2014.10	MT	L	F	Closed Off-Road Vehicle Engine 224DT/DW12BTED4	259344	Drive Shaft		40	31	57.4	52	554.5	
2.2 SD4 (140 kW)	2010.08-2014.10	-	-	R	All-wheel Drive Closed Off-Road Vehicle Engine 224DT	857132	Outer Joint		28	22	57.7	84	61.5	M
	2010.08-2014.10	-	L/R	R	All-wheel Drive Closed Off-Road Vehicle Engine 224DT	257165	Drive Shaft		28	26	57.7	84	819.5	
	2010.08-2014.10	AT	L	F	All-wheel Drive Closed Off-Road Vehicle Engine 224DT	251038	Drive Shaft		40	31	57.4	52	538	
	2010.08-2014.10	AT	R	F	All-wheel Drive Closed Off-Road Vehicle Engine 224DT	251039	Drive Shaft		40	28	57.4	52	1000	
	2010.08-2014.10	MT	L	F	All-wheel Drive Closed Off-Road Vehicle Engine 224DT	259344	Drive Shaft		40	31	57.4	52	554.5	
	2010.08-2014.10	MT	R	F	All-wheel Drive Closed Off-Road Vehicle Engine 224DT	259346	Drive Shaft		40	28	57.4	52	1022.5	
2.2 TD4 (110 kW)	2006.10-2014.10	-	-	R	All-wheel Drive Closed Off-Road Vehicle Engine DW12BTED4/224DT	857132	Outer Joint		28	22	57.7	84	61.5	M
	2006.10-2014.10	-	L/R	R	All-wheel Drive Closed Off-Road Vehicle Engine DW12BTED4/224DT	257165	Drive Shaft		28	26	57.7	84	819.5	
	2006.10-2014.10	AT	L	F	All-wheel Drive Closed Off-Road Vehicle Engine DW12BTED4/224DT	251038	Drive Shaft		40	31	57.4	52	538	
	2006.10-2014.10	AT	R	F	All-wheel Drive Closed Off-Road Vehicle Engine DW12BTED4/224DT	251039	Drive Shaft		40	28	57.4	52	1000	
	2006.10-2014.10	MT	L	F	All-wheel Drive Closed Off-Road Vehicle Engine DW12BTED4/224DT	259344	Drive Shaft		40	31	57.4	52	554.5	
	2006.10-2014.10	MT	R	F	All-wheel Drive Closed Off-Road Vehicle Engine DW12BTED4/224DT	259346	Drive Shaft		40	28	57.4	52	1022.5	
2.2 TD4 (112 kW)	2007.01-2014.10	-	-	R	All-wheel Drive Closed Off-Road Vehicle Engine 224DT	857132	Outer Joint		28	22	57.7	84	61.5	M
	2007.01-2014.10	-	L/R	R	All-wheel Drive Closed Off-Road Vehicle Engine 224DT	257165	Drive Shaft		28	26	57.7	84	819.5	
	2007.01-2014.10	AT	L	F	All-wheel Drive Closed Off-Road Vehicle Engine 224DT	251038	Drive Shaft		40	31	57.4	52	538	
	2007.01-2014.10	AT	R	F	All-wheel Drive Closed Off-Road Vehicle Engine 224DT	251039	Drive Shaft		40	28	57.4	52	1000	
	2007.01-2014.10	MT	L	F	All-wheel Drive Closed Off-Road Vehicle Engine 224DT	259344	Drive Shaft		40	31	57.4	52	554.5	
	2007.01-2014.10	MT	R	F	All-wheel Drive Closed Off-Road Vehicle Engine 224DT	259346	Drive Shaft		40	28	57.4	52	1022.5	
2.2 TD4 (115 kW)	2006.10-2014.10	-	-	R	All-wheel Drive Closed Off-Road Vehicle Engine 224DT	857132	Outer Joint		28	22	57.7	84	61.5	M
	2006.10-2014.10	-	L/R	R	All-wheel Drive Closed Off-Road Vehicle Engine 224DT	257165	Drive Shaft		28	26	57.7	84	819.5	
	2006.10-2014.10	AT	L	F	All-wheel Drive Closed Off-Road Vehicle Engine 224DT	251038	Drive Shaft		40	31	57.4	52	538	
	2006.10-2014.10	AT	R	F	All-wheel Drive Closed Off-Road Vehicle Engine 224DT	251039	Drive Shaft		40	28	57.4	52	1000	
	2006.10-2014.10	MT	L	F	All-wheel Drive Closed Off-Road Vehicle Engine 224DT	259344	Drive Shaft		40	31	57.4	52	554.5	
	2006.10-2014.10	MT	R	F	All-wheel Drive Closed Off-Road Vehicle Engine 224DT	259346	Drive Shaft		40	28	57.4	52	1022.5	
2.2 TD4 (118 kW)	2006.10-2014.10	-	-	R	All-wheel Drive Closed Off-Road Vehicle Engine DW12BTED4/224DT	857132	Outer Joint		28	22	57.7	84	61.5	M
	2006.10-2014.10	-	L/R	R	All-wheel Drive Closed Off-Road Vehicle Engine DW12BTED4/224DT	257165	Drive Shaft		28	26	57.7	84	819.5	
	2006.10-2014.10	AT	L	F	All-wheel Drive Closed Off-Road Vehicle Engine DW12BTED4/224DT	251038	Drive Shaft		40	31	57.4	52	538	
	2006.10-2014.10	AT	R	F	All-wheel Drive Closed Off-Road Vehicle Engine DW12BTED4/224DT	251039	Drive Shaft		40	28	57.4	52	1000	
	2006.10-2014.10	MT	L	F	All-wheel Drive Closed Off-Road Vehicle Engine DW12BTED4/224DT	259344	Drive Shaft		40	31	57.4	52	554.5	
	2006.10-2014.10	MT	R	F	All-wheel Drive Closed Off-Road Vehicle Engine DW12BTED4/224DT	259346	Drive Shaft		40	28	57.4	52	1022.5	
3.2 (171 kW)	2006.10-2014.10	AT	-	R	All-wheel Drive Closed Off-Road Vehicle Engine B 6324 S	857132	Outer Joint		28	22	57.7	84	61.5	M
	2006.10-2014.10	AT	-	R	All-wheel Drive Closed Off-Road Vehicle Engine B 6324 S	257165	Drive Shaft		28	26	57.7	84	819.5	
FREELANDER Soft Top (L314)														
1.8 i 16V (88 kW)	1998.02-2006.10	MT	L/R	F/R	All-wheel Drive Open Off-Road Vehicle Engine 18 K4F	851020	Outer Joint	60W	28	32	55.6	85	61	I
	1998.02-2006.10	-	-	F/R	All-wheel Drive Open Off-Road Vehicle Engine 18 K4F	851015	Outer Joint		28	32	55.6	85	61	I
	1998.02-2006.10	-	-	F	All-wheel Drive Open Off-Road Vehicle Engine 18 K4F	251008	Drive Shaft	60W	28	25	57.7	85	613	
	1998.02-2006.10	-	-	F	All-wheel Drive Open Off-Road Vehicle Engine 18 K4F	830009	Outer Joint		28	32	56	83.5	61	I
	1998.02-2006.10	-	-	F	All-wheel Drive Open Off-Road Vehicle Engine 18 K4F	251009	Drive Shaft	60W	28	25	55.6	85	611	
	1998.02-2006.10	-	-	R	All-wheel Drive Open Off-Road Vehicle Engine 18 K4F	251025	Drive Shaft	60W	28	23	55.6	85	808	
	1998.02-2006.10	-	-	R	All-wheel Drive Open Off-Road Vehicle Engine 18 K4F	651012	Inner Joint		23	32	35.7	85.5	124.5	
	1998.02-2006.10	-	-	R	All-wheel Drive Open Off-Road Vehicle Engine 18 K4F	830016	Outer Joint		28	21	57.7	85	61	M
	1998.02-2006.10	-	-	F	All-wheel Drive Open Off-Road Vehicle Engine 18 K4F	230005	Drive Shaft		28	25	56	83.5	610.5	
	1998.02-2006.10	-	-	R	All-wheel Drive Open Off-Road Vehicle Engine 18 K4F	251030	Drive Shaft	60W	28	23	57.7	85	806	
	1998.02-2006.10	-	-	R	All-wheel Drive Open Off-Road Vehicle Engine 18 K4F	818200	Outer Joint	60W	28	21	57.7	85	61	M
	1998.02-2006.10	-	-	R	All-wheel Drive Open Off-Road Vehicle Engine 18 K4F	251037	Drive Shaft		28	23	57.7	85	806	
	1998.02-2006.10	-	-	F	All-wheel Drive Open Off-Road Vehicle Engine 18 K4F	818280	Outer Joint		28	21	57.7	85	61	M
2.0 DI (72 kW)	1998.02-2006.10	-	-	F/R	All-wheel Drive Open Off-Road Vehicle Engine 20 T2N	851015	Outer Joint		28	32	55.6	85	61	I
	1998.02-2006.10	MT	L/R	F/R	All-wheel Drive Open Off-Road Vehicle Engine 20 T2N	851020	Outer Joint	60W	28	32	55.6	85	61	I
	1998.02-2006.10	-	-	F	All-wheel Drive Open Off-Road Vehicle Engine 20 T2N	830009	Outer Joint		28	32	56	83.5	61	I
	1998.02-2006.10	-	-	F	All-wheel Drive Open Off-Road Vehicle Engine 20 T2N	251009	Drive Shaft	60W	28	25	55.6	85	611	
	1998.02-2006.10	-	-	R	All-wheel Drive Open Off-Road Vehicle Engine 20 T2N	251025	Drive Shaft	60W	28	23	55.6	85	808	
	1998.02-2006.10	-	L	F	All-wheel Drive Open Off-Road Vehicle Engine 20 T2N	251024	Drive Shaft	60W	28	25	57.7	85	631	
	1998.02-2006.10	-	R	F	All-wheel Drive Open Off-Road Vehicle Engine 20 T2N	251002	Drive Shaft	60W	28	25	55.6	85	592	
	1998.02-2006.10	-	-	R	All-wheel Drive Open Off-Road Vehicle Engine 20 T2N	651012	Inner Joint		23	32	35.7	85.5	124.5	
	1998.02-2006.10	-	L/R	R	All-wheel Drive Open Off-Road Vehicle Engine 20 T2N	251030	Drive Shaft	60W	28	23	57.7	85	806	

YEAR	TRANSM	L/R	F/R	REMARKS	GSP Ref.	PRODUCT	ABS	Technical Specifications						
								A	B	C	H	L	P	
LAND ROVER														
FREELANDER Soft Top (L314)														
2.0 DI (72 kW)	1998.02-2006.10	-	L/R	R	All-wheel Drive Open Off-Road Vehicle Engine 20 T2N	251037	Drive Shaft		28	23	57.7	85	806	
	1998.02-2006.10	-	-	R	All-wheel Drive Open Off-Road Vehicle Engine 20 T2N	818200	Outer Joint	60W	28	21	57.7	85	61	M
	1998.02-2006.10	-	-	R	All-wheel Drive Open Off-Road Vehicle Engine 20 T2N	818280	Outer Joint		28	21	57.7	85	61	M
FREELANDER V6														
2.0	-	-	-	-	-	651005	Inner Joint		25	26	40	57.5	101.5	
FREELANDER VAN														
1.8 i	1997.12-2000.08	-	-	F	-	651007	Inner Joint		25	25	40	57.5	93	
2.0 TD 8V	1997.12-2000.08	-	-	F	-	651007	Inner Joint		25	25	40	57.5	93	
RANGE ROVER EVOQUE (L538)														
2.0 (177 kW)	2011.06-	-	-	F	All-wheel Drive Closed Off-Road Vehicle Engine 204PT	818250	Outer Joint		31	27	68.3	97	61	I
2.2 D (110 kW)	2011.06-	-	-	F	Closed Off-Road Vehicle Engine 224DT	818250	Outer Joint		31	27	68.3	97	61	I
	2011.06-	-	-	F	All-wheel Drive Closed Off-Road Vehicle Engine 224DT	818250	Outer Joint		31	27	68.3	97	61	I
	2011.06-	MT	L	F	Closed Off-Road Vehicle Engine 224DT	218408	Drive Shaft		31	31	68.3	97	602	
	2011.06-	MT	L	F	All-wheel Drive Closed Off-Road Vehicle Engine 224DT	218408	Drive Shaft		31	31	68.3	97	602	
	2011.06-	MT	R	F	All-wheel Drive Closed Off-Road Vehicle Engine 224DT	218409	Drive Shaft		31	28	68.3	97	1069	
2.2 D (140 kW)	2011.06-	-	-	F	All-wheel Drive Closed Off-Road Vehicle Engine 224DT	818250	Outer Joint		31	27	68.3	97	61	I
	2011.06-	MT	L	F	All-wheel Drive Closed Off-Road Vehicle Engine 224DT	218408	Drive Shaft		31	31	68.3	97	602	
	2011.06-	MT	R	F	All-wheel Drive Closed Off-Road Vehicle Engine 224DT	218409	Drive Shaft		31	28	68.3	97	1069	
RANGE ROVER II (P38A)														
2.5 D (100 kW)	1994.07-2002.03	-	-	F	All-wheel Drive Closed Off-Road Vehicle Engine 25 6T (BMW)	830006	Outer Joint	60T	24	32	61.7	101	60	I
4.0 (136 kW)	1998.06-2002.03	-	-	F	All-wheel Drive Closed Off-Road Vehicle Engine 42 D	830006	Outer Joint	60T	24	32	61.7	101	60	I
4.6 (165 kW)	1994.07-2002.03	-	-	F	All-wheel Drive Closed Off-Road Vehicle Engine 46 D	830006	Outer Joint	60T	24	32	61.7	101	60	I
RANGE ROVER III (L322)														
3.0 D (130 kW)	2002.03-2012.08	-	-	F	All-wheel Drive Closed Off-Road Vehicle Engine 306D1	805004	Outer Joint	48W	30	29	68	84	74	M
	2002.03-2012.08	-	L/R	R	All-wheel Drive Closed Off-Road Vehicle Engine 306D1	251036	Drive Shaft	48W	30		68	84	690	
3.6 D (200 kW)	2006.04-2012.08	-	-	F	All-wheel Drive Closed Off-Road Vehicle Engine 368DT	805004	Outer Joint	48W	30	29	68	84	74	M
	2006.04-2012.08	-	L/R	R	All-wheel Drive Closed Off-Road Vehicle Engine 368DT	251036	Drive Shaft	48W	30		68	84	690	
4.2 (291 kW)	2005.05-2012.08	-	L	R	All-wheel Drive Closed Off-Road Vehicle Engine 428PS	205104	Drive Shaft	48W	30	31	68	84	820	
	2005.05-2012.08	-	R	R	All-wheel Drive Closed Off-Road Vehicle Engine 428PS	205105	Drive Shaft	48W	30	31	68	84	800	
	2005.05-2012.08	-	-	F	All-wheel Drive Closed Off-Road Vehicle Engine 428PS	805004	Outer Joint	48W	30	29	68	84	74	M
4.4 (210 kW)	2002.03-2005.08	-	-	F	All-wheel Drive Closed Off-Road Vehicle Engine M62 B44	805004	Outer Joint	48W	30	29	68	84	74	M
	2002.03-2005.08	-	L/R	R	All-wheel Drive Closed Off-Road Vehicle Engine M62 B44	251036	Drive Shaft	48W	30		68	84	690	
4.4 (220 kW)	2004.08-2012.08	-	-	F	All-wheel Drive Closed Off-Road Vehicle Engine 448PN	805004	Outer Joint	48W	30	29	68	84	74	M
4.4 (225 kW)	2005.05-2012.08	-	L	R	All-wheel Drive Closed Off-Road Vehicle Engine 448PN	205104	Drive Shaft	48W	30	31	68	84	820	
	2005.05-2012.08	-	R	R	All-wheel Drive Closed Off-Road Vehicle Engine 448PN	205105	Drive Shaft	48W	30	31	68	84	800	
	2005.05-2012.08	-	-	F	All-wheel Drive Closed Off-Road Vehicle Engine 448PN	805004	Outer Joint	48W	30	29	68	84	74	M
4.4 D (230 kW)	2010.07-2012.08	-	L	R	All-wheel Drive Closed Off-Road Vehicle Engine 448DT	205104	Drive Shaft	48W	30	31	68	84	820	
	2010.07-2012.08	-	R	R	All-wheel Drive Closed Off-Road Vehicle Engine 448DT	205105	Drive Shaft	48W	30	31	68	84	800	
	2010.07-2012.08	-	-	F	All-wheel Drive Closed Off-Road Vehicle Engine 448DT	805004	Outer Joint	48W	30	29	68	84	74	M
5.0 V8 (276 kW)	2009.09-2012.08	-	L	R	All-wheel Drive Closed Off-Road Vehicle Engine 508PN	205104	Drive Shaft	48W	30	31	68	84	820	
	2009.09-2012.08	-	R	R	All-wheel Drive Closed Off-Road Vehicle Engine 508PN	205105	Drive Shaft	48W	30	31	68	84	800	
	2009.09-2012.08	-	-	F	All-wheel Drive Closed Off-Road Vehicle Engine 508PN	805004	Outer Joint	48W	30	29	68	84	74	M
5.0 V8 (375 kW)	2009.09-2012.08	-	L	R	All-wheel Drive Closed Off-Road Vehicle Engine 508PS	205104	Drive Shaft	48W	30	31	68	84	820	
	2009.09-2012.08	-	R	R	All-wheel Drive Closed Off-Road Vehicle Engine 508PS	205105	Drive Shaft	48W	30	31	68	84	800	
	2009.09-2012.08	-	-	F	All-wheel Drive Closed Off-Road Vehicle Engine 508PS	805004	Outer Joint	48W	30	29	68	84	74	M
RANGE ROVER SPORT (L320)														
2.7 D (140 kW)	2005.02-2013.03	AT	L	F	All-wheel Drive Closed Off-Road Vehicle Engine 276DT	259535	Drive Shaft	48T	29	29	74	96	639	
	2005.02-2013.03	AT	R	F	All-wheel Drive Closed Off-Road Vehicle Engine 276DT	259623	Drive Shaft	48T	29	29	74	96	998	
3.0 D (155 kW)	2010.05-2013.03	-	L	R	All-wheel Drive Closed Off-Road Vehicle Engine 30DDTX	205104	Drive Shaft	48W	30	31	68	84	820	
	2010.05-2013.03	-	R	R	All-wheel Drive Closed Off-Road Vehicle Engine 30DDTX	205105	Drive Shaft	48W	30	31	68	84	800	
3.0 D (180 kW)	2009.09-2013.03	-	L	R	All-wheel Drive Closed Off-Road Vehicle Engine 30DDTX	205104	Drive Shaft	48W	30	31	68	84	820	
	2009.09-2013.03	-	R	R	All-wheel Drive Closed Off-Road Vehicle Engine 30DDTX	205105	Drive Shaft	48W	30	31	68	84	800	
3.0 D (183 kW)	2012.08-2013.03	8AT	L/R	R	All-wheel Drive Closed Off-Road Vehicle Engine 306DT	830014	Outer Joint	48T	31	29	74	96.5	75.5	M
3.0 D (188 kW)	2011.06-2013.03	-	L/R	R	All-wheel Drive Closed Off-Road Vehicle Engine 30DDTX	830014	Outer Joint	48T	31	29	74	96.5	75.5	M
3.6 D (200 kW)	2006.04-2013.03	-	-	F	All-wheel Drive Closed Off-Road Vehicle Engine 368DT	830012	Outer Joint	48T	29	27	74	96	67.5	M
	2006.04-2013.03	AT	L	F	All-wheel Drive Closed Off-Road Vehicle Engine 368DT	230002	Drive Shaft	48T	29	29	74	96	638	
	2006.04-2013.03	AT	R	F	All-wheel Drive Closed Off-Road Vehicle Engine 368DT	259480	Drive Shaft	48T	29	29	74	96	999	
4.2 (287 kW)	2005.02-2013.03	-	-	F	All-wheel Drive Closed Off-Road Vehicle Engine 428PS	830012	Outer Joint	48T	29	27	74	96	67.5	M
	2005.02-2013.03	AT	L	F	All-wheel Drive Closed Off-Road Vehicle Engine 428PS	230002	Drive Shaft	48T	29	29	74	96	638	
	2005.02-2013.03	AT	R	F	All-wheel Drive Closed Off-Road Vehicle Engine 428PS	259480	Drive Shaft	48T	29	29	74	96	999	
4.4 (220 kW)	2005.02-2013.03	-	-	F	All-wheel Drive Closed Off-Road Vehicle Engine 448PN	830012	Outer Joint	48T	29	27	74	96	67.5	M
	2005.02-2013.03	-	-	R	All-wheel Drive Closed Off-Road Vehicle Engine 448PN	818229	Outer Joint	48T	31	27	73	97.5	67.5	M
	2005.02-2013.03	-	L	F	All-wheel Drive Closed Off-Road Vehicle Engine 448PN	659115	Inner Joint		29	27	44	71.5	111.5	
	2005.02-2013.03	-	R	F	All-wheel Drive Closed Off-Road Vehicle Engine 448PN	659194	Inner Joint		29	27	32.1	364	93	
	2005.02-2013.03	AT	L	F	All-wheel Drive Closed Off-Road Vehicle Engine 448PN	230002	Drive Shaft	48T	29	29	74	96	638	
	2005.02-2013.03	AT	R	F	All-wheel Drive Closed Off-Road Vehicle Engine 448PN	259480	Drive Shaft	48T	29	29	74	96	999	

YEAR		TRANSM	L/R	F/R	REMARKS	GSP Ref.	PRODUCT	ABS	Technical Specifications							
									A	B	C	H	L	P		
LAND ROVER																
RANGE ROVER SPORT (L320)																
5.0 (372 kW)	2009.04-	2013.03	-	L/R	R	All-wheel Drive Closed Off-Road Vehicle Engine 508PS	830014	Outer Joint	48T	31	29	74	96.5	75.5	M	
5.0 V8 HN HSE (276 kW)	2009.07-	2013.03	-	L	R	All-wheel Drive Closed Off-Road Vehicle Engine 508PN	205104	Drive Shaft	48W	30	31	68	84	820		
	2009.07-	2013.03	-	R	R	All-wheel Drive Closed Off-Road Vehicle Engine 508PN	205105	Drive Shaft	48W	30	31	68	84	800		
	2009.07-	2013.03	-	L	F	All-wheel Drive Closed Off-Road Vehicle Engine 508PN	659115	Inner Joint		29	27	44	71.5	111.5		
	2009.07-	2013.03	-	R	F	All-wheel Drive Closed Off-Road Vehicle Engine 508PN	659194	Inner Joint		29	27	32.1	364	93		
5.0 V8 SC HSE (375 kW)	2009.09-	2013.03	-	L	R	All-wheel Drive Closed Off-Road Vehicle Engine 508PS	205104	Drive Shaft	48W	30	31	68	84	820		
	2009.09-	2013.03	-	R	R	All-wheel Drive Closed Off-Road Vehicle Engine 508PS	205105	Drive Shaft	48W	30	31	68	84	800		
	2009.09-	2013.03	-	L	F	All-wheel Drive Closed Off-Road Vehicle Engine 508PS	659115	Inner Joint		29	27	44	71.5	111.5		
	2009.09-	2013.03	-	R	F	All-wheel Drive Closed Off-Road Vehicle Engine 508PS	659194	Inner Joint		29	27	32.1	364	93		
RANGE ROVER SPORT (L494)																
3.0 (250 kW)	2013.04-	-	-	-	R	All-wheel Drive Closed Off-Road Vehicle Engine 30HDD	818229	Outer Joint	48T	31	27	73	97.5	67.5	M	
	2013.04-	-	-	-	F	All-wheel Drive Closed Off-Road Vehicle Engine 30HDD	830015	Outer Joint	48T	29	26	74	96	64.5	M	
	2013.04-	-	-	-	R	All-wheel Drive Closed Off-Road Vehicle Engine 30HDD	659195	Inner Joint		29	26	32.1	370	85.5		
3.0 D (215 kW)	2013.04-	-	-	-	F	All-wheel Drive Closed Off-Road Vehicle Engine 306DT	818250	Outer Joint		31	27	68.3	97	61	I	
3.0 D Hybrid (215 kW)	2015.02-	-	-	-	F	All-wheel Drive Closed Off-Road Vehicle Engine 306DT	818250	Outer Joint		31	27	68.3	97	61	I	
LANDWIND (JMC)																
LANDWIND																
2.0 (84 kW)	2005.09-	-	-	MT	L	All-wheel Drive Closed Off-Road Vehicle Engine 4G63S4M	226005	Drive Shaft		17	25	53	144	956.5		
	2005.09-	-	-	MT	R	All-wheel Drive Closed Off-Road Vehicle Engine 4G63S4M	299054	Drive Shaft		17	25	53	144	567		
2.4 (92 kW)	2005.09-	-	-	MT	L	All-wheel Drive Closed Off-Road Vehicle Engine 4G64S4M	226005	Drive Shaft		17	25	53	144	956.5		
	2005.09-	-	-	MT	R	All-wheel Drive Closed Off-Road Vehicle Engine 4G64S4M	299054	Drive Shaft		17	25	53	144	567		
2.8 TD (62 kW)	2007.10-	-	-	MT	L	All-wheel Drive Closed Off-Road Vehicle Engine JX493ZQ4A	226005	Drive Shaft		17	25	53	144	956.5		
	2007.10-	-	-	MT	R	All-wheel Drive Closed Off-Road Vehicle Engine JX493ZQ4A	299054	Drive Shaft		17	25	53	144	567		
	2007.10-	-	-	MT	L	Closed Off-Road Vehicle Engine JX493ZQ4A	226005	Drive Shaft		17	25	53	144	956.5		
	2007.10-	-	-	MT	R	Closed Off-Road Vehicle Engine JX493ZQ4A	299054	Drive Shaft		17	25	53	144	567		
2.8 TD (68 kW)	2005.09-	-	-	MT	L	All-wheel Drive Closed Off-Road Vehicle Engine JX493ZQ	226005	Drive Shaft		17	25	53	144	956.5		
	2005.09-	-	-	MT	R	All-wheel Drive Closed Off-Road Vehicle Engine JX493ZQ	299054	Drive Shaft		17	25	53	144	567		
LDV																
MAXUS																
2.5 D (70 kW)	2005.02-	2008.12	-	L	F	Platform/Chassis Engine VM39C	218231	Drive Shaft	48T	30	30	70	117.5	723		
	2005.02-	2008.12	-	L	F	Bus Engine VM40C/VM39C	835025	Outer Joint		30	36	70	117.5	68.5	I	
	2005.02-	2008.12	-	L	F	Box Engine VM40C/VM39C	835025	Outer Joint		30	36	70	117.5	68.5	I	
	2005.02-	2008.12	-	L	F	Bus Engine VM40C/VM39C	218231	Drive Shaft	48T	30	30	70	117.5	723		
	2005.02-	2008.12	-	L	F	Box Engine VM40C/VM39C	218231	Drive Shaft	48T	30	30	70	117.5	723		
	2005.02-	2008.12	-	R	F	Platform/Chassis Engine VM39C	218232	Drive Shaft	48T	30	30	70	117.5	1095		
	2005.02-	2008.12	-	R	F	Bus Engine VM40C/VM39C	218232	Drive Shaft	48T	30	30	70	117.5	1095		
	2005.02-	2008.12	-	R	F	Box Engine VM40C/VM39C	218232	Drive Shaft	48T	30	30	70	117.5	1095		
	2005.02-	2008.12	-	L	F	Platform/Chassis Engine VM39C	218402	Drive Shaft		30	30	70	117.5	723		
	2005.02-	2008.12	-	L	F	Bus Engine VM40C/VM39C	218402	Drive Shaft		30	30	70	117.5	723		
	2005.02-	2008.12	-	L	F	Box Engine VM40C/VM39C	218402	Drive Shaft		30	30	70	117.5	723		
	2005.02-	2008.12	-	R	F	Platform/Chassis Engine VM39C	275056	Drive Shaft		30	30	70	117.5	1095		
	2005.02-	2008.12	-	R	F	Bus Engine VM40C/VM39C	275056	Drive Shaft		30	30	70	117.5	1095		
	2005.02-	2008.12	-	R	F	Box Engine VM40C/VM39C	275056	Drive Shaft		30	30	70	117.5	1095		
	2005.02-	2008.12	-	L	F	Platform/Chassis Engine VM39C	634112	Inner Joint		30	26	35	86	81		
	2005.02-	2008.12	-	L	F	Bus Engine VM40C/VM39C	634112	Inner Joint		30	26	35	86	81		
	2005.02-	2008.12	-	L	F	Box Engine VM40C/VM39C	634112	Inner Joint		30	26	35	86	81		
	2005.02-	2008.12	-	R	F	Platform/Chassis Engine VM39C	618174	Inner Joint		30	26	35	434	105		
	2005.02-	2008.12	-	-	-	F	Bus Engine VM40C/VM39C	899317	Outer Joint	48T	30	36	70	117.5	68.5	I
	2005.02-	2008.12	-	-	-	F	Box Engine VM40C/VM39C	899317	Outer Joint	48T	30	36	70	117.5	68.5	I
	2005.02-	2008.12	-	R	F	Bus Engine VM40C/VM39C	618174	Inner Joint		30	26	35	434	105		
	2005.02-	2008.12	-	-	-	F	Platform/Chassis Engine VM39C	899317	Outer Joint	48T	30	36	70	117.5	68.5	I
	2005.02-	2008.12	-	R	F	Box Engine VM40C/VM39C	618174	Inner Joint		30	26	35	434	105		
	2005.02-	2008.12	-	L	F	Platform/Chassis Engine VM39C	835025	Outer Joint		30	36	70	117.5	68.5	I	
	2.5 D (88 kW)	2005.02-	2009.12	-	L	F	Bus Engine VM39C	218231	Drive Shaft	48T	30	30	70	117.5	723	
		2005.02-	2009.12	-	R	F	Bus Engine VM39C	218232	Drive Shaft	48T	30	30	70	117.5	1095	
		2005.02-	2009.12	-	L	F	Bus Engine VM39C	218402	Drive Shaft		30	30	70	117.5	723	
		2005.02-	2009.12	-	R	F	Bus Engine VM39C	275056	Drive Shaft		30	30	70	117.5	1095	
		2005.02-	2009.12	-	L	F	Bus Engine VM39C	634112	Inner Joint		30	26	35	86	81	
		2005.02-	2009.12	-	R	F	Bus Engine VM39C	618174	Inner Joint		30	26	35	434	105	
2005.02-		2009.12	-	-	-	F	Bus Engine VM39C	899317	Outer Joint	48T	30	36	70	117.5	68.5	I
2005.02-		2009.12	-	L	F	Bus Engine VM39C	835025	Outer Joint		30	36	70	117.5	68.5	I	
2005.10-		2009.12	-	L	F	Platform/Chassis Engine BS580VM	218231	Drive Shaft	48T	30	30	70	117.5	723		
2005.10-		2009.12	-	L	F	Box Engine BS580VM	835025	Outer Joint		30	36	70	117.5	68.5	I	
2005.10-		2009.12	-	L	F	Box Engine BS580VM	218231	Drive Shaft	48T	30	30	70	117.5	723		
2005.10-		2009.12	-	R	F	Platform/Chassis Engine BS580VM	218232	Drive Shaft	48T	30	30	70	117.5	1095		

	YEAR	TRANSM	L/R	F/R	REMARKS	GSP Ref.	PRODUCT	ABS	Technical Specifications						
									A	B	C	H	L	P	
LDV															
MAXUS															
2.5 D (88 kW)	2005.10-2009.12	-	R	F	Box Engine BS580VM	218232	Drive Shaft	48T	30	30	70	117.5	1095		
	2005.10-2009.12	-	L	F	Platform/Chassis Engine BS580VM	218402	Drive Shaft		30	30	70	117.5	723		
	2005.10-2009.12	-	L	F	Box Engine BS580VM	218402	Drive Shaft		30	30	70	117.5	723		
	2005.10-2009.12	-	R	F	Platform/Chassis Engine BS580VM	275056	Drive Shaft		30	30	70	117.5	1095		
	2005.10-2009.12	-	R	F	Box Engine BS580VM	275056	Drive Shaft		30	30	70	117.5	1095		
	2005.10-2009.12	-	L	F	Platform/Chassis Engine BS580VM	634112	Inner Joint		30	26	35	86	81		
	2005.10-2009.12	-	L	F	Box Engine BS580VM	634112	Inner Joint		30	26	35	86	81		
	2005.10-2009.12	-	R	F	Platform/Chassis Engine BS580VM	618174	Inner Joint		30	26	35	434	105		
	2005.10-2009.12	-	-	F	Box Engine BS580VM	899317	Outer Joint	48T	30	36	70	117.5	68.5	I	
	2005.10-2009.12	-	-	F	Platform/Chassis Engine BS580VM	899317	Outer Joint	48T	30	36	70	117.5	68.5	I	
	2005.10-2009.12	-	R	F	Box Engine BS580VM	618174	Inner Joint		30	26	35	434	105		
	2005.10-2009.12	-	L	F	Platform/Chassis Engine BS580VM	835025	Outer Joint		30	36	70	117.5	68.5	I	
2.5 D (99 kW)	2006.02-2009.12	-	L	F	Bus Engine BS582VM	835025	Outer Joint		30	36	70	117.5	68.5	I	
	2006.02-2009.12	-	L	F	Platform/Chassis Engine BS582VM	835025	Outer Joint		30	36	70	117.5	68.5	I	
	2006.02-2009.12	-	L	F	Box Engine BS582VM	218231	Drive Shaft	48T	30	30	70	117.5	723		
	2006.02-2009.12	-	L	F	Bus Engine BS582VM	218231	Drive Shaft	48T	30	30	70	117.5	723		
	2006.02-2009.12	-	L	F	Platform/Chassis Engine BS582VM	218231	Drive Shaft	48T	30	30	70	117.5	723		
	2006.02-2009.12	-	R	F	Box Engine BS582VM	218232	Drive Shaft	48T	30	30	70	117.5	1095		
	2006.02-2009.12	-	R	F	Bus Engine BS582VM	218232	Drive Shaft	48T	30	30	70	117.5	1095		
	2006.02-2009.12	-	R	F	Platform/Chassis Engine BS582VM	218232	Drive Shaft	48T	30	30	70	117.5	1095		
	2006.02-2009.12	-	L	F	Box Engine BS582VM	218402	Drive Shaft		30	30	70	117.5	723		
	2006.02-2009.12	-	L	F	Bus Engine BS582VM	218402	Drive Shaft		30	30	70	117.5	723		
	2006.02-2009.12	-	L	F	Platform/Chassis Engine BS582VM	218402	Drive Shaft		30	30	70	117.5	723		
	2006.02-2009.12	-	R	F	Box Engine BS582VM	275056	Drive Shaft		30	30	70	117.5	1095		
	2006.02-2009.12	-	R	F	Bus Engine BS582VM	275056	Drive Shaft		30	30	70	117.5	1095		
	2006.02-2009.12	-	R	F	Platform/Chassis Engine BS582VM	275056	Drive Shaft		30	30	70	117.5	1095		
	2006.02-2009.12	-	L	F	Box Engine BS582VM	634112	Inner Joint		30	26	35	86	81		
	2006.02-2009.12	-	L	F	Bus Engine BS582VM	634112	Inner Joint		30	26	35	86	81		
	2006.02-2009.12	-	L	F	Platform/Chassis Engine BS582VM	634112	Inner Joint		30	26	35	86	81		
	2006.02-2009.12	-	R	F	Box Engine BS582VM	618174	Inner Joint		30	26	35	434	105		
	2006.02-2009.12	-	R	F	Bus Engine BS582VM	618174	Inner Joint		30	26	35	434	105		
	2006.02-2009.12	-	-	F	Box Engine BS582VM	899317	Outer Joint	48T	30	36	70	117.5	68.5	I	
	2006.02-2009.12	-	R	F	Platform/Chassis Engine BS582VM	618174	Inner Joint		30	26	35	434	105		
	2006.02-2009.12	-	-	F	Bus Engine BS582VM	899317	Outer Joint	48T	30	36	70	117.5	68.5	I	
	2006.02-2009.12	-	-	F	Platform/Chassis Engine BS582VM	899317	Outer Joint	48T	30	36	70	117.5	68.5	I	
	2006.02-2009.12	-	L	F	Box Engine BS582VM	835025	Outer Joint		30	36	70	117.5	68.5	I	
LEXUS															
CT (ZWA10_)															
2.0 h (73 kW)	2010.12-	-	L/R	F	Hatchback Engine 5ZR-FXE/2ZR-FXE	859244	Outer Joint		26	25	55.6	95.5	57	I	
ES (MCV_ VZV_)															
3.0 (140 kW)	1996.10-2001.07	-	-	F	Saloon Engine 1MZ-FE	859446	Outer Joint	48T	30	27	56	100	66	M	
3.0 (157 kW)	2001.08-2006.10	-	-	F	Saloon Engine 1MZ-FE	859154	Outer Joint	48T	30	27	63.4	100	64.5	M	
	2001.08-2006.10	-	-	-	Saloon Engine 1MZ-FE	231004	Drive Shaft	48T	30	24	61	100	967		
	2001.08-2006.10	-	-	F	Saloon Engine 1MZ-FE	859225	Outer Joint	48T	30	26	61	99	67	M	
	2001.08-2006.10	-	-	-	Saloon Engine 1MZ-FE	631001	Inner Joint		27		33.2				
ES (VCV10_ VZV21_)															
2.5 (118 kW)	1989.12-1991.09	-	-	F	Saloon Engine 2VZ-FE	859011	Outer Joint		26	27	56	100	63	M	
3.0 (138 kW)	1991.09-1997.12	-	-	F	Saloon Engine 3VZ-FE	859009	Outer Joint	48T	30	27	56	100	67.5	I	
	1991.09-1997.12	-	-	F	Saloon Engine 3VZ-FE	859446	Outer Joint	48T	30	27	56	100	66	M	
	1991.09-1997.12	-	-	-	Saloon Engine 3VZ-FE	631001	Inner Joint		27		33.2				
ES (_V6_)															
3.0 h (118 kW)	2012.06-	-	-	-	Saloon Engine 2AR-FXE	231004	Drive Shaft	48T	30	24	61	100	967		
350 (183 kW)	2014.01-	-	AT	L	F	Saloon Engine 2GR-FE	659082	Inner Joint		24	27	50	67	109	
ES2XX/350/300H															
2.5	2015.07-	-	6AT	R	F	ENGINE:2ARFE/ASV60	259654	Drive Shaft	48T	26	24	63.3	100	981	
3.5	2015.07-	-	6AT	L	F	ENGINE: 2GRFE/GSV60	259324	Drive Shaft	48T	30	24	61	100	659	
	2015.07-	-	6AT	R	F	ENGINE:2GRFE/GSV60	259323	Drive Shaft	48T	30	24	61	100	978	
ES300															
-	1992-1996	-	-	-	-	859162	Outer Joint	48T	30	34	56	95.5	70	I	
GS															
3.5	2012.01-2015.09	-	R	F	GEN, LHD, 2GRFSE, ATM, 6FC;RL15LBETQH	631007	Inner Joint		23	30	35	358.5	171		
	2012.01-2015.09	-	R	F	GEN, LHD, 2GRFSE, ATM, 6FC;RL15LBETQH	259686	Drive Shaft		30	23	57	82	995		
	2015.10-	-	R	F	STD, EUR, LHD, 2GRFKS, ATM;GRL16LBETQHW	631007	Inner Joint		23	30	35	358.5	171		
GS (JZS147_)															
300 (156 kW)	1993.01-1997.08	-	AT	L/R	F	Saloon Engine 2JZ-GE	859161	Outer Joint	48T	30	34	56	95.5	70	I

	 YEAR	TRANSM	L/R	F/R	REMARKS	GSP Ref.	 PRODUCT	 ABS	Technical Specifications						
									A	B	C	H	L	P	
LEXUS															
ISI (E1)															
2.0 (114 kW)	1999.04-2005.07	AT	-	R	Saloon Engine 1G-FE	639089	Inner Joint			20		68.6			
	1999.04-2005.07	-	L/R	R	Saloon Engine 1G-FE	859390	Outer Joint	48T	30	27	63	108.5	64	I	
3.0 (157 kW)	2001.09-2005.07	-	L/R	R	Saloon Engine 2JZ-GE	859390	Outer Joint	48T	30	27	63	108.5	64	I	
IS SportCross (E1)															
2.0 (114 kW)	2002.10-2005.10	-	L/R	R	Estate Engine 1G-FE	859390	Outer Joint	48T	30	27	63	108.5	64	I	
3.0 (157 kW)	2001.10-2005.10	-	L/R	R	Estate Engine 2JZ-GE	859390	Outer Joint	48T	30	27	63	108.5	64	I	
LEXUS GS															
3.5	2015.10-	-	-	R	F	STD, EUR, LHD, 2GRFKS, ATM;GRL16LBETQHW	259686	Drive Shaft		30	23	57	82	995	
LEXUS GS2XX/350/450H															
3.5	2015.10-	-	-	R	F	USA, 2GRFKS, ATM, 6FC;GRL16LBETQHA	631007	Inner Joint		23	30	35	358.5	171	
	2015.10-	-	-	R	F	USA, 2GRFKS, ATM, 6FC;GRL16LBETQHA	259686	Drive Shaft		30	23	57	82	995	
LS (F1)															
400 (180 kW)	1989.12-1994.12	AT	L/R	F	Saloon Engine 1UZ-FE	859161	Outer Joint	48T	30	34	56	95.5	70	I	
LS (F2)															
400 (194 kW)	1994.12-1997.08	AT	L/R	F	Saloon Engine 1UZ-FE	859161	Outer Joint	48T	30	34	56	95.5	70	I	
LX (UZJ100)															
4.7 (173 kW)	2001.09-2008.03	-	L/R	F	All-wheel Drive Closed Off-Road Vehicle Engine 2UZ-FE	859085	Outer Joint		30	30	72.58	176	78	I	
	2001.09-2008.03	-	-	-	All-wheel Drive Closed Off-Road Vehicle Engine 2UZ-FE	659107	Inner Joint		30	30	47	77	133.5		
NX (Z1)															
2.0 tAWD (175 kW)	2014.07-	-	AT	-	R	All-wheel Drive Hatchback Engine 8AR-FTS	659213	Inner Joint		20	19	37	60	84	
	2014.07-	-	AT	-	R	All-wheel Drive Hatchback Engine 8AR-FTS	859488	Outer Joint		26	19	51.9	99.5	49	I
NX200T/300H															
2.0	2014.07-	-	6AT	R	R	ENGINE: 8ARFTS/AGZ15	259656	Drive Shaft		26	20	51.9	99.5	811	
NX300H/200T200															
2.0	2014.10-	-	CVT	R	F	ENGINE:3ZRFAE/ZGZ15	259672	Drive Shaft		30	24	61.2	100	967	
	2014.10-	-	CVT	R	R	ENGINE:3ZRFAE/ZGZ15	259656	Drive Shaft		26	20	51.9	99.5	811	
	2014.12-	-	6AT	R	R	ENGINE:8ARFTS/AGZ15	259656	Drive Shaft		26	20	51.9	99.5	811	
RX (L1)															
3.5 AWD (204 kW)	2008.12-2012.02	AT	L	F	All-wheel Drive Closed Off-Road Vehicle Engine 2GR-FXE/2GR-FE	659082	Inner Joint		24	27	50	67	109		
	2008.12-2012.02	-	-	F	All-wheel Drive Closed Off-Road Vehicle Engine 2GR-FXE/2GR-FE	859233	Outer Joint	48T	30	36	63	99	67	I	
	2008.12-2012.02	AT	-	F	All-wheel Drive Closed Off-Road Vehicle Engine 2GR-FXE/2GR-FE	859214	Outer Joint	48T	30	26	61	100	67	I	
RX (L2)															
200t (175 kW)	2015.10-	-	AT	L	F	Closed Off-Road Vehicle Engine 8AR-FTS	659082	Inner Joint		24	27	50	67	109	
	2015.10-	-	AT	-	F	Closed Off-Road Vehicle Engine 8AR-FTS	859431	Outer Joint	48T	30	27	61.2	100	64.5	M
200t AWD (175 kW)	2015.10-	-	AT	L	F	All-wheel Drive Closed Off-Road Vehicle Engine 8AR-FTS	659082	Inner Joint		24	27	50	67	109	
	2015.10-	-	AT	-	F	All-wheel Drive Closed Off-Road Vehicle Engine 8AR-FTS	859431	Outer Joint	48T	30	27	61.2	100	64.5	M
RX (U3)															
3.0 (150 kW)	2003.05-2008.12	-	R	F	All-wheel Drive Closed Off-Road Vehicle Engine 1MZ-FE	859175	Outer Joint	48T	26	27	63.3	100	59	M	
	2003.05-2008.12	AT	L	F	All-wheel Drive Closed Off-Road Vehicle Engine 1MZ-FE	659084	Inner Joint		23	27	50	62	108.5		
	2003.05-2008.12	AT	R	F	All-wheel Drive Closed Off-Road Vehicle Engine 1MZ-FE	659079	Inner Joint		23	27	28	394	123		
3.5 AWD (203 kW)	2006.02-2008.12	AT	R	F	All-wheel Drive Closed Off-Road Vehicle Engine 2GR-FE	659192	Inner Joint		23	26	50	62	108.5		
	2006.02-2008.12	-	-	F	All-wheel Drive Closed Off-Road Vehicle Engine 2GR-FE	859233	Outer Joint	48T	30	36	63	99	67	I	
	2006.02-2008.12	AT	R	F	All-wheel Drive Closed Off-Road Vehicle Engine 2GR-FE	659191	Inner Joint		23	26	34	394	124		
330 AWD (171 kW)	2003.04-2008.12	AT	R	F	All-wheel Drive Closed Off-Road Vehicle Engine 3MZ-FE	659192	Inner Joint		23	26	50	62	108.5		
	2003.04-2008.12	AT	R	F	All-wheel Drive Closed Off-Road Vehicle Engine 3MZ-FE	659191	Inner Joint		23	26	34	394	124		
	2003.04-2008.12	-	-	F	All-wheel Drive Closed Off-Road Vehicle Engine 3MZ-FE	859304	Outer Joint	48T	30	34	61	100	68.5	M	
350(201 kW)	2006.09-2008.12	AT	R	F	All-wheel Drive Closed Off-Road Vehicle Engine 2GR-FE	659192	Inner Joint		23	26	50	62	108.5		
	2006.09-2008.12	AT	R	F	All-wheel Drive Closed Off-Road Vehicle Engine 2GR-FE	659191	Inner Joint		23	26	34	394	124		
4.0 h (155 kW)	2005.09-2008.12	-	-	F	Closed Off-Road Vehicle Engine 3MZ-FE	859233	Outer Joint	48T	30	36	63	99	67	I	
4.0 h AWD (155 kW)	2004.09-2008.12	AT	R	F	All-wheel Drive Closed Off-Road Vehicle Engine 3MZ-FE	659192	Inner Joint		23	26	50	62	108.5		
	2004.09-2008.12	-	-	F	All-wheel Drive Closed Off-Road Vehicle Engine 3MZ-FE	859233	Outer Joint	48T	30	36	63	99	67	I	
	2004.09-2008.12	AT	R	F	All-wheel Drive Closed Off-Road Vehicle Engine 3MZ-FE	659191	Inner Joint		23	26	34	394	124		
	2004.09-2008.12	-	-	F	All-wheel Drive Closed Off-Road Vehicle Engine 3MZ-FE	859304	Outer Joint	48T	30	34	61	100	68.5	M	
LIFAN															
320/SMILY															
1.3 (65 kW)	2006.07-	-	MT	-	-	Hatchback Engine LF479Q3	273001	Drive Shaft	29T	25	25	59	79	542	
620 Saloon SOLANO															
1.5 (93 kW)	2008.11-	-	MT	-	-	Saloon Engine LF479Q2	273002	Drive Shaft	48T	26	25	58	96.5	952	
620/SOLANO															
1.6 (78 kW)	2008.06-	-	MT	-	-	Saloon Engine LF481Q3	273002	Drive Shaft	48T	26	25	58	96.5	952	
1.6 TRITEC (85 kW)	2008.11-2010.12	MT	-	-	-	Saloon Engine T16b3	273002	Drive Shaft	48T	26	25	58	96.5	952	
LINCOLN															
AVIATOR															
-	2003-2005	-	-	F	AWD/PROPELLER SHAFT	661100	Propshaft CV Joint			26		35			

	 YEAR	TRANSM	L/R	F/R	REMARKS	GSP Ref.	 PRODUCT	 ABS	Technical Specifications										
									A	B	C	H	L	P					
LINCOLN																			
CONTINENTAL																			
3.8	1988-1994	AT	-	-	-	818085	Outer Joint	50T	26	32	55.9	105.5	64.5	I					
MARK LT F6																			
-	2004-2014	-	-	-	-	618189	Inner Joint		31	39	46	130	98						
NAVIGATOR																			
-	1998-2000	-	-	-	4WD	818057	Outer Joint		33	28	75.6	113.2	76	I					
-	2008-2014	-	-	-	-	299302	DRIVE SHAFT					38	804						
4X4	1998-2006	AT	L/R	-	-	618040	Inner Joint		28		97.5								
LOTUS																			
ELISE																			
1.8 (88 kW)	1995.08-2000.11	-	-	R	Convertible Engine 18 K4F	899242	Outer Joint	42T	25	22	50	82	56	I					
LSA																			
VAZ-2121																			
-	-	-	-	R	-	628004	Inner Joint		22	22	40	217.8	116						
MAHINDRA																			
PICK PIK UP																			
2.5 16V	2007.01-	-	-	F	RH 4WD	218223	Drive Shaft		31	27	54	163	593						
2.5 D (79 kW)	2010-	-	-	F	-	218224	Drive Shaft		31	30	54	163	508.5						
MARUTI																			
800																			
0.8	-	-	-	L	-	257001	Drive Shaft		23	22	44	89.5	534.5						
-	-	-	-	R	-	257002	Drive Shaft		23	22	44	89.5	689.5						
0.8 (26 kW)	1991.01-2006.12	-	-	-	Saloon Engine F8B	857049	Outer Joint		23	18	44	92	48.5	M					
-	1991.01-2006.12	-	-	-	Saloon Engine F8B	857053	Outer Joint		23	18	44	92	48.5	I					
-	1991.01-2006.12	-	-	-	Saloon Engine F8B	857050	Outer Joint		23	18	44	91.5	45.5	M					
800(T1)																			
-	-	-	-	-	-	857072	Outer Joint		23	18	44	92	48.5	M					
SX4																			
-	-	-	-	L	-	257075	Drive Shaft		28	26	58	85	613						
MASERATI																			
QUATTROPORTE VI																			
3.8 GT S (390 kW)	2013.01-	-	-	F	Saloon Engine M 156 A	824301	Outer Joint	52T	30	35	73	94.5	67	M					
MAZDA																			
121 I (DA)																			
1.1 (42 kW)	1987.10-1990.10	-	-	F	Hatchback Engine B1/B116	834018	Outer Joint		24	21	52	86	50	M					
1.3 (40 kW)	1989.04-1990.10	-	-	-	Hatchback Engine B3	827003	Outer Joint		24	21	52	86	54.5	I					
-	1989.04-1990.10	-	-	-	Hatchback Engine B3	859003	Outer Joint		26	25	56	95.6	61	M					
-	1989.04-1990.10	MT	-	F	Hatchback Engine B3	818030	Outer Joint		24	19	52	86	50.5	M					
-	1989.04-1990.10	-	-	F	Hatchback Engine B3	834018	Outer Joint		24	21	52	86	50	M					
1.3 (44 kW)	1987.10-1990.11	-	-	-	Hatchback Engine B3	827003	Outer Joint		24	21	52	86	54.5	I					
-	1987.10-1990.11	MT	-	F	Hatchback Engine B3	818030	Outer Joint		24	19	52	86	50.5	M					
-	1987.10-1990.11	-	-	F	Hatchback Engine B3	834018	Outer Joint		24	21	52	86	50	M					
1.3 (48 kW)	1987.11-1990.10	-	-	-	Hatchback Engine B3A5	827003	Outer Joint		24	21	52	86	54.5	I					
-	1987.11-1990.10	MT	-	F	Hatchback Engine B3A5	818030	Outer Joint		24	19	52	86	50.5	M					
121 II (DB)																			
1.3 16V (39 kW)	1990.11-1996.03	-	-	-	Saloon Engine B3 (16V)	827003	Outer Joint		24	21	52	86	54.5	I					
-	1990.11-1996.03	AT	L	F	Saloon Engine B3 (16V)	618006	Inner Joint		24	22	35	64	98.5						
-	1990.11-1996.03	-	-	F	Saloon Engine B3 (16V)	834003	Outer Joint		24	21	52	86.5	53	M					
-	1990.11-1996.03	-	-	-	Saloon Engine B3 (16V)	818036	Outer Joint		24	19	52	86	50	M					
-	1990.11-1996.03	MT	L/R	F	Saloon Engine B3 (16V)	834062	Outer Joint	44T	24	19	52	86	54.5	I					
-	1990.11-1996.03	AT	-	F	Saloon Engine B3 (16V)	818030	Outer Joint		24	19	52	86	50.5	M					
-	1990.11-1996.03	-	-	F	Saloon Engine B3 (16V)	834018	Outer Joint		24	21	52	86	50	M					
1.3 i 16V (53 kW)	1990.11-1996.03	-	-	-	Saloon Engine B3 (16V)	827003	Outer Joint		24	21	52	86	54.5	I					
-	1990.11-1996.03	AT	L	F	Saloon Engine B3 (16V)	618006	Inner Joint		24	22	35	64	98.5						
-	1990.11-1996.03	AT	-	F	Saloon Engine B3 (16V)	834003	Outer Joint		24	21	52	86.5	53	M					
-	1990.11-1996.03	-	-	-	Saloon Engine B3 (16V)	818036	Outer Joint		24	19	52	86	50	M					
-	1990.11-1996.03	MT	L/R	F	Saloon Engine B3 (16V)	834062	Outer Joint	44T	24	19	52	86	54.5	I					
-	1990.11-1996.03	AT	-	F	Saloon Engine B3 (16V)	818030	Outer Joint		24	19	52	86	50.5	M					
-	1990.11-1996.03	-	-	F	Saloon Engine B3 (16V)	834018	Outer Joint		24	21	52	86	50	M					
121 III (JASM JBMS)																			
1.25 (55 kW)	1996.03-2003.04	MT	L/R	F	Hatchback Engine DHF/DHG	818004	Outer Joint		25	22	56.5	88.5	53.5	O					
1.3 (37 kW)	1996.03-2003.04	MT	L/R	F	Hatchback Engine JJK/JJM	818012	Outer Joint		25	20	56.5	88.5	49	O					
-	1996.03-2003.04	-	-	F	Hatchback Engine JJK/JJM	834018	Outer Joint		24	21	52	86	50	M					
1.3 (44 kW)	1996.03-2003.04	MT	L/R	F	Hatchback Engine J4R/J4T	818012	Outer Joint		25	20	56.5	88.5	49	O					

YEAR	TRANS	L/R	F/R	REMARKS	GSP Ref.	PRODUCT	ABS	Technical Specifications										
								A	B	C	H	L	P					
MAZDA																		
121 III (JASM JBSM)																		
1.3 (44 kW)	1996.03-	2003.04	-	-	F	Hatchback Engine J4R/J4T	834018	Outer Joint		24	21	52	86	50	M			
1.8 D (44 kW)	1996.03-	2003.04	MT	L/R	F	Hatchback Engine RTK/RTJ	818004	Outer Joint		25	22	56.5	88.5	53.5	O			
2 (DE)/DEMIO																		
1.3 (55 kW)	2007.10-	2015.06	MT	R	F	Hatchback Engine ZJ-VE	218324	Drive Shaft		25	28	53.8	89	576				
	2007.10-	2015.06	-	-	F	Hatchback Engine ZJ-VE	834181	Outer Joint		25	29	53.8	89	51.5	I			
1.3 (63 kW)	2007.10-	2015.06	-	R	F	Hatchback Engine ZJ-VE	218324	Drive Shaft		25	28	53.8	89	576				
	2007.10-	2015.06	-	-	F	Hatchback Engine ZJ-VE	834181	Outer Joint		25	29	53.8	89	51.5	I			
1.3 BiFuel (55 kW)	2011.05-	2014.11	-	-	F	Hatchback Engine ZJ46	834181	Outer Joint		25	29	53.8	89	51.5	I			
1.3 MZR (62 kW)	2010.01-	2015.06	-	R	F	Hatchback Engine ZJ-VE	218324	Drive Shaft		25	28	53.8	89	576				
1.5 (76 kW)	2007.10-	2015.06	MT	R	F	Hatchback Engine ZY-DE/ZY-VE	218324	Drive Shaft		25	28	53.8	89	576				
	2007.10-	2015.06	AT/MT	-	F	Hatchback Engine ZY-DE/ZY-VE	818223	Outer Joint		25	29	53.8	89	51.5	I			
1.5 MZR (75 kW)	2011.06-	2015.06	-	R	F	Hatchback Engine ZY05/ZY66	218324	Drive Shaft		25	28	53.8	89	576				
	2011.06-	2015.06	MT	-	F	Hatchback Engine ZY05/ZY66	818223	Outer Joint		25	29	53.8	89	51.5	I			
2 (DY)/DEMIO																		
1.25 (55 kW)	2003.04-	2007.06	MT	-	F	Hatchback Engine FUJA	818009	Outer Joint		25	22	53.3	90	51	M			
1.4 (59 kW)	2003.04-	2007.06	MT	-	F	Hatchback Engine FXJA	818009	Outer Joint		25	22	53.3	90	51	M			
1.4 CD (50 kW)	2003.04-	2007.06	-	-	F	Hatchback Engine F6JB/F6JA	818001	Outer Joint		25	20	52.9	89	52	M			
1.6 (74 kW)	2003.04-	2007.06	-	-	F	Hatchback Engine FYJA	818009	Outer Joint		25	22	53.3	90	51	M			
2(DE)																		
1.5 L	2007-	-	AT	R	-	-	218424	DRIVE SHAFT		25	28	53.8	89	574				
	2007-	-	AT	L	-	-	218473	DRIVE SHAFT		25	26	53.8	89	621				
3																		
2.0	2004-	2005	AT	R	F	-	234101	Drive Shaft		36	28	55.2	48.5	501				
2.3	2004-	2005	AT	R	F	-	234101	Drive Shaft		36	28	55.2	48.5	501				
3 (BK)																		
1.5	2006.03-	2007.03	-	R	F	-	234101	Drive Shaft		36	28	55.2	48.5	501				
1.6	2006.03-	2007.03	-	R	F	-	234101	Drive Shaft		36	28	55.2	48.5	501				
3 (BK)/AXELA																		
1.4 (62 kW)	2003.10-	2009.06	-	L/R	F	Hatchback Engine ZJ-VE	834015	Outer Joint		36	22	55.2	48.5	55.5	I			
1.6 (77 kW)	2003.10-	2009.06	-	-	-	Hatchback Engine B6ZE	634139	Inner Joint		30	26	50	77.5	107.5				
	2003.10-	2009.06	-	L/R	F	Hatchback Engine B6ZE	834015	Outer Joint		36	22	55.2	48.5	55.5	I			
	2003.10-	2009.06	-	-	-	Hatchback Engine B6ZE	634146	Inner Joint		26	23	35	66.5	109.5				
	2003.10-	2009.06	-	-	F	Hatchback Engine B6ZE	834105	Outer Joint		28	23	56	90	59	I			
	2004.02-	2009.06	-	L/R	F	Saloon Engine Z6	834015	Outer Joint		36	22	55.2	48.5	55.5	I			
	2004.02-	2009.06	-	-	-	Saloon Engine Z6	634139	Inner Joint		30	26	50	77.5	107.5				
	2004.02-	2009.06	-	-	-	Saloon Engine Z6	634146	Inner Joint		26	23	35	66.5	109.5				
	2004.02-	2009.06	-	-	F	Saloon Engine Z6	899272	Outer Joint		28	22	58.6	90	59	I			
	2004.02-	2009.06	-	-	F	Saloon Engine Z6	834105	Outer Joint		28	23	56	90	59	I			
1.6 DI Turbo (80 kW)	2004.06-	2009.06	MT	L	F	Saloon Engine Y601	634049	Inner Joint		28	24	35	67	115				
	2004.06-	2009.06	MT	L	F	Hatchback Engine Y601	634049	Inner Joint		28	24	35	67	115				
	2004.06-	2009.06	-	-	-	Hatchback Engine Y601	834093	Outer Joint		36	24	55.3	48	60	I			
	2004.06-	2009.06	-	-	-	Saloon Engine Y601	834093	Outer Joint		36	24	55.3	48	60	I			
	2004.06-	2009.06	MT	-	F	Hatchback Engine Y601	834091	Outer Joint		28	24	59	90	64	I			
	2004.06-	2009.06	-	-	F	Saloon Engine Y601	834091	Outer Joint		28	24	59	90	64	I			
	2004.06-	2009.06	-	-	-	Hatchback Engine Y601	634139	Inner Joint		30	26	50	77.5	107.5				
	2004.06-	2009.06	-	-	-	Saloon Engine Y601	634139	Inner Joint		30	26	50	77.5	107.5				
1.6 MZ-CD (66 kW)	2006.06-	2009.12	-	-	-	Hatchback Engine Y406	834093	Outer Joint		36	24	55.3	48	60	I			
2.0 (104 kW)	2004.04-	2006.06	-	-	-	Saloon Engine LF17	834174	Outer Joint		28	23	58.6	90	59	M			
	2004.04-	2006.06	-	R	F	Saloon Engine LF17	634124	Inner Joint		28	24	43		128				
2.0 (108 kW)	2003.09-	2006.06	-	-	F	Saloon Engine LF17	834131	Outer Joint		28	22	58.6	90	59	I			
	2003.10-	2006.06	-	-	F	Hatchback Engine LF17	834131	Outer Joint		28	22	58.6	90	59	I			
2.0 (110 kW)	2003.10-	2009.06	-	-	-	Hatchback Engine LF17	634086	Inner Joint		28	24	43	48	76				
	2003.10-	2009.06	AT	L	F	Hatchback Engine LF17	634047	Inner Joint		26	22	35	66.5	109.5				
	2003.10-	2009.06	MT	-	F	Hatchback Engine LF17	834091	Outer Joint		28	24	59	90	64	I			
	2003.10-	2009.06	MT	L/R	F	Hatchback Engine LF17	834048	Outer Joint		36	24	55.3	48.3	55.5	M			
	2003.10-	2009.06	-	R	F	Hatchback Engine LF17	634124	Inner Joint		28	24	43		128				
	2003.10-	2009.06	-	-	-	Hatchback Engine LF17	834015	Outer Joint		36	22	55.2	48.5	55.5	I			
	2003.10-	2009.06	-	-	-	Hatchback Engine LF17	634139	Inner Joint		30	26	50	77.5	107.5				
	2003.10-	2009.06	-	-	F	Hatchback Engine LF17	834131	Outer Joint		28	22	58.6	90	59	I			
	2003.10-	2009.06	-	-	-	Hatchback Engine LF17	634146	Inner Joint		26	23	35	66.5	109.5				
	2004.02-	2009.06	-	-	-	Saloon Engine LF17	634086	Inner Joint		28	24	43	48	76				
	2004.02-	2009.06	AT	L	F	Saloon Engine LF17	634047	Inner Joint		26	22	35	66.5	109.5				
	2004.02-	2009.06	-	-	-	Saloon Engine LF17	834174	Outer Joint		28	23	58.6	90	59	M			
	2004.02-	2009.06	-	-	F	Saloon Engine LF17	834091	Outer Joint		28	24	59	90	64	I			
	2004.02-	2009.06	MT	L/R	F	Saloon Engine LF17	834048	Outer Joint		36	24	55.3	48.3	55.5	M			
	2004.02-	2009.06	-	R	F	Saloon Engine LF17	634124	Inner Joint		28	24	43		128				





YEAR	TRANSM	L/R	F/R	REMARKS	GSP Ref.	PRODUCT	ABS	Technical Specifications					
								A	B	C	H	L	P
MAZDA													
3 (BK)/AXELA													
2.0 (110 kW)	2004.02-2009.06	-	L/R	F	Saloon Engine LF17	834015	Outer Joint	36	22	55.2	48.5	55.5	I
	2004.02-2009.06	-	-	-	Saloon Engine LF17	634139	Inner Joint	30	26	50	77.5	107.5	
	2004.02-2009.06	-	-	F	Saloon Engine LF17	834131	Outer Joint	28	22	58.6	90	59	I
	2004.02-2009.06	-	-	-	Saloon Engine LF17	634146	Inner Joint	26	23	35	66.5	109.5	
2.0 MZR-CD (105 kW)	2006.12-2009.06	-	-	-	Hatchback Engine RF7J	834093	Outer Joint	36	24	55.3	48	60	I
2.3 (118 kW)	2004.03-2009.03	-	-	-	Saloon Engine L3-VE	834174	Outer Joint	28	23	58.6	90	59	M
2.3 DiSi Turbo MPS (184 kW)	2006.06-2009.06	AT	L	F	Hatchback Engine L3YH	634047	Inner Joint	26	22	35	66.5	109.5	
	2006.06-2009.06	MT	L	F	Hatchback Engine L3YH	634091	Inner Joint	24	22	35	64	109.5	
	2006.06-2009.06	-	-	F	Hatchback Engine L3YH	834131	Outer Joint	28	22	58.6	90	59	I
2.3 MPS Turbo (191 kW)	2006.12-2009.06	-	-	-	Hatchback Engine L3N9/L3-VDT	634086	Inner Joint	28	24	43	48	76	
	2006.12-2009.06	AT	L	F	Hatchback Engine L3N9/L3-VDT	634047	Inner Joint	26	22	35	66.5	109.5	
	2006.12-2009.06	MT	L	F	Hatchback Engine L3N9/L3-VDT	634091	Inner Joint	24	22	35	64	109.5	
	2006.12-2009.06	-	-	-	Hatchback Engine L3N9/L3-VDT	634139	Inner Joint	30	26	50	77.5	107.5	
	2006.12-2009.06	-	-	F	Hatchback Engine L3N9/L3-VDT	834131	Outer Joint	28	22	58.6	90	59	I
	2006.12-2009.06	-	-	-	Hatchback Engine L3N9/L3-VDT	634146	Inner Joint	26	23	35	66.5	109.5	
2.3 MZR (115 kW)	2004.03-2009.03	-	-	-	Hatchback Engine L3-VE	834174	Outer Joint	28	23	58.6	90	59	M
3 (BL)/AXELA													
1.6 MZR (77 kW)	2008.12-2014.09	AT	-	F	Hatchback Engine Z6	827082	Outer Joint	28	23	58.6	92	61	I
	2008.12-2014.09	MT	R	F	Hatchback Engine Z6	218421	Drive Shaft	28	28	58.6	92	597	
	2008.12-2014.09	MT	L	F	Hatchback Engine Z6	234254	Drive Shaft	28	24	58.6	92	655	
	2008.12-2014.09	AT	L	F	Hatchback Engine Z6	634047	Inner Joint	26	22	35	66.5	109.5	
	2008.12-2014.09	-	-	-	Hatchback Engine Z6	634146	Inner Joint	26	23	35	66.5	109.5	
	2009.02-2014.09	AT	-	F	Saloon Engine Z6	827082	Outer Joint	28	23	58.6	92	61	I
	2009.02-2014.09	MT	R	F	Saloon Engine Z6	218421	Drive Shaft	28	28	58.6	92	597	
	2009.02-2014.09	MT	L	F	Saloon Engine Z6	234254	Drive Shaft	28	24	58.6	92	655	
	2009.02-2014.09	AT	L	F	Saloon Engine Z6	634047	Inner Joint	26	22	35	66.5	109.5	
1.6 MZR (79 kW)	2010.01-2013.12	AT	-	F	Hatchback Engine Z6	827082	Outer Joint	28	23	58.6	92	61	I
	2010.01-2013.12	AT	L	F	Hatchback Engine Z6	634047	Inner Joint	26	22	35	66.5	109.5	
	2010.01-2013.12	AT	L	F	Hatchback Engine Z6	634125	Inner Joint	28	24	35	66.5	115	
1.6 MZR CD (80 kW)	2008.12-2013.05	-	-	-	Hatchback Engine Y601/Y642	834093	Outer Joint	36	24	55.3	48	60	I
	2008.12-2013.05	MT	R	F	Hatchback Engine Y601/Y642	234195	Drive Shaft	28	28	58.5	92	586	
	2008.12-2013.05	MT	R	F	Saloon Engine Y642	234195	Drive Shaft	28	28	58.5	92	586	
	2008.12-2013.05	-	-	F	Saloon Engine Y642	834200	Outer Joint	28	24	58.5	92	63	I
1.6 MZR CD (85 kW)	2010.09-2013.05	MT	R	F	Saloon Engine Y650/Y655	234195	Drive Shaft	28	28	58.5	92	586	
	2010.09-2013.05	MT	R	F	Hatchback Engine Y655/Y650	234195	Drive Shaft	28	28	58.5	92	586	
	2010.09-2013.05	-	-	F	Saloon Engine Y650/Y655	834200	Outer Joint	28	24	58.5	92	63	I
	2010.09-2013.05	-	-	F	Hatchback Engine Y655/Y650	834200	Outer Joint	28	24	58.5	92	63	I
2.0 (110 kW)	2009.05-2012.02	AT	-	F	Hatchback Engine LF-VDS	827082	Outer Joint	28	23	58.6	92	61	I
	2009.05-2012.02	AT	L	F	Hatchback Engine LF-VDS	634047	Inner Joint	26	22	35	66.5	109.5	
2.0 MZR (108 kW)	2010.06-2014.09	AT	-	F	Hatchback Engine LF5H	827082	Outer Joint	28	23	58.6	92	61	I
	2010.06-2014.09	MT	L	F	Hatchback Engine LF5H	234261	Drive Shaft	28	28	58.5	92	637	
	2010.06-2014.09	AT	L	F	Hatchback Engine LF5H	634047	Inner Joint	26	22	35	66.5	109.5	
2.0 MZR (110 kW)	2009.01-2014.09	MT	L	F	Hatchback Engine LF17/LF-DE	234261	Drive Shaft	28	28	58.5	92	637	
	2009.01-2014.09	-	-	-	Hatchback Engine LF17/LF-DE	634146	Inner Joint	26	23	35	66.5	109.5	
	2009.03-2014.09	MT	L	F	Saloon Engine LF17/LF-DE	234261	Drive Shaft	28	28	58.5	92	637	
	2009.03-2014.09	-	-	-	Saloon Engine LF17/LF-DE	634146	Inner Joint	26	23	35	66.5	109.5	
2.0 MZR DISI (111 kW)	2008.12-2013.05	MT	L	F	Hatchback Engine LF5W/LF5H	234261	Drive Shaft	28	28	58.5	92	637	
	2008.12-2013.05	-	-	-	Hatchback Engine LF5W/LF5H	634146	Inner Joint	26	23	35	66.5	109.5	
	2009.02-2013.05	MT	L	F	Saloon Engine LF5W/LF5W	234261	Drive Shaft	28	28	58.5	92	637	
	2009.02-2013.05	-	-	-	Saloon Engine LF5W/LF5W	634146	Inner Joint	26	23	35	66.5	109.5	
2.2 MZR CD (110 kW)	2009.01-2013.05	-	-	-	Hatchback Engine R2AA	834093	Outer Joint	36	24	55.3	48	60	I
2.2 MZR CD (136 kW)	2009.01-2013.05	-	-	-	Hatchback Engine R2AA	834093	Outer Joint	36	24	55.3	48	60	I
	2009.06-2013.05	-	-	-	Saloon Engine R2AA	834093	Outer Joint	36	24	55.3	48	60	I
323													
-	-	-	-	-	-	899044	Outer Joint	24	30	52	86.5	55	O
	-	-	-	-	-	634001	Inner Joint	24	22	35	64	87	
	1987.01-1989.07	MT/AT	L	F	-	234076	Drive Shaft	24	26	52	86	595	
	1987.01-1989.07	MT/AT	R	F	-	234077	Drive Shaft	24	26	52	86	541	
	1988-1989	-	-	-	-	618004	Inner Joint	24	21	35	64	87	
	1999-	-	-	-	-	818049	Outer Joint	26	28	56	93	61	M
	2002-	-	-	-	-	634027	Inner Joint	24	29	35	64	96	
1.6 SOHC BG	1989.01-1996.05	-	-	-	-	618009	Inner Joint	24	23	35	64	98.5	
	1989.01-1996.05	MT/AT	R	-	-	218057	Drive Shaft	26	24	56	93	905	
323 ASTINA													
1.8	1994-1998	-	-	-	-	834028	Outer Joint	28	30	56	89	59.5	I

YEAR	TRANSM	L/R	F/R	REMARKS	GSP Ref.	PRODUCT	ABS	Technical Specifications						
								A	B	C	H	L	P	
MAZDA														
323 ASTINA														
1.8	1994-1998	MT	L	-	DOHC	227049	Drive Shaft		26	28	56	92	615.5	
	1994-1998	AT	-	-	DOHC	634010	Inner Joint		24	30	35	64	99	
1.8 DOHC	1994-1998	-	-	-	-	608014	Inner Joint		28	30	43	47	72	
	1994-1998	-	R	-	-	259001	Drive Shaft	44T	26	28	56	93	625	
	1994-1998	AT	L	-	-	234011	Drive Shaft		26	24	56	93	627	
	1994-1998	AT	L	F	-	234080	Drive Shaft	44T	26	24	56	93	627	
2.0 V6	1994.01-1998.05	-	L	-	-	234078	Drive Shaft	44T	26	28	56	92	634	
	1994.01-1998.05	-	R	-	-	234079	Drive Shaft	44T	26	28	56	92	565	
323 C IV (BG)/FAMILIA														
1.3 (49 kW)	1989.09-1994.07	MT	R	F	Hatchback Engine B3E	250268	Drive Shaft		23	39	56	84	935	
	1989.09-1994.07	MT	L/R	F	Hatchback Engine B3E	834019	Outer Joint		26	21	56	94	56	I
	1989.09-1994.07	MT	L	F	Hatchback Engine B3E	218056	Drive Shaft		26	24	56	93	625	
	1989.09-1994.07	MT	R	F	Hatchback Engine B3E	234044	Drive Shaft		26	24	56	94	903	
	1989.09-1994.07	-	-	F	Hatchback Engine B3E	834051	Outer Joint		26	21	56	94	56	M
	1989.09-1994.07	MT	R	F	Hatchback Engine B3E	250268	Drive Shaft		23	39	56	84	935	
1.3 16V (54 kW)	1989.09-1994.07	MT	R	F	Hatchback Engine B3 (16V)	250268	Drive Shaft		23	39	56	84	935	
	1989.09-1994.07	AT/MT	L/R	F	Hatchback Engine B3 (16V)	834019	Outer Joint		26	21	56	94	56	I
	1989.09-1994.07	MT	L	F	Hatchback Engine B3 (16V)	218056	Drive Shaft		26	24	56	93	625	
	1989.09-1994.07	MT	R	F	Hatchback Engine B3 (16V)	234044	Drive Shaft		26	24	56	94	903	
	1989.09-1994.07	MT	R	F	Hatchback Engine B3 (16V)	250268	Drive Shaft		23	39	56	84	935	
1.6 (62 kW)	1989.09-1991.06	MT	R	F	Hatchback Engine B6E	250268	Drive Shaft		23	39	56	84	935	
	1989.09-1991.06	MT	L	F	Hatchback Engine B6E	218056	Drive Shaft		26	24	56	93	625	
	1989.09-1991.06	MT	R	F	Hatchback Engine B6E	234044	Drive Shaft		26	24	56	94	903	
	1989.09-1991.06	MT	L/R	F	Hatchback Engine B6E	818034	Outer Joint		26	22	56	94	59	I
	1989.09-1991.06	MT	L/R	F	Hatchback Engine B6E	834007	Outer Joint		26	22	56	93	56.5	I
	1989.09-1991.06	MT	R	F	Hatchback Engine B6E	250268	Drive Shaft		23	39	56	84	935	
1.6 (66 kW)	1993.09-2000.09	AT/MT	L	F	Hatchback Engine B67K	618006	Inner Joint		24	22	35	64	98.5	
1.6 16V (65 kW)	1991.03-1994.10	MT	R	F	Hatchback Engine B6	250268	Drive Shaft		23	39	56	84	935	
	1991.03-1994.10	MT	L	F	Hatchback Engine B6	218056	Drive Shaft		26	24	56	93	625	
	1991.03-1994.10	MT	R	F	Hatchback Engine B6	234044	Drive Shaft		26	24	56	94	903	
	1991.03-1994.10	MT	L/R	F	Hatchback Engine B6	818034	Outer Joint		26	22	56	94	59	I
	1991.03-1994.10	MT	L/R	F	Hatchback Engine B6	834007	Outer Joint		26	22	56	93	56.5	I
	1991.03-1994.10	MT	R	F	Hatchback Engine B6	250268	Drive Shaft		23	39	56	84	935	
1.7 D (41 kW)	1989.08-1994.07	MT	R	F	Hatchback Engine PN54	250268	Drive Shaft		23	39	56	84	935	
	1989.08-1994.07	AT/MT	L/R	F	Hatchback Engine PN54	834019	Outer Joint		26	21	56	94	56	I
	1989.08-1994.07	MT	L	F	Hatchback Engine PN54	218056	Drive Shaft		26	24	56	93	625	
	1989.08-1994.07	MT	R	F	Hatchback Engine PN54	234044	Drive Shaft		26	24	56	94	903	
	1989.08-1994.07	-	-	F	Hatchback Engine PN54	834018	Outer Joint		24	21	52	86	50	M
	1989.08-1994.07	MT	R	F	Hatchback Engine PN54	250268	Drive Shaft		23	39	56	84	935	
1.8 (96 kW)	1989.09-1993.06	-	-	F	Hatchback Engine BP21	834052	Outer Joint		26	30	56	93.5	60	I
1.8 16V (103 kW)	1989.09-1993.03	-	-	F	Hatchback Engine BP31/BP22	834052	Outer Joint		26	30	56	93.5	60	I
	1989.09-1993.03	-	-	-	Hatchback Engine BP31/BP22	827006	Outer Joint		26	22	56	93	55	M
1.8 16V (76 kW)	1991.11-1993.12	MT	L/R	F	All-wheel Drive Hatchback Engine BP	827007	Outer Joint		26	23	56	93	55	M
	1991.11-1993.12	-	-	-	All-wheel Drive Hatchback Engine BP	834052	Outer Joint		26	30	56	93.5	60	I
1.8 16V GT (94 kW)	1989.09-1993.03	MT	L/R	F	Hatchback Engine BP (DOHC)	834081	Outer Joint		26	30	56	93	56.5	M
	1989.09-1993.03	-	-	-	Hatchback Engine BP (DOHC)	834025	Outer Joint		26	30	56	92.5	57.5	I
	1989.09-1993.03	-	-	F	Hatchback Engine BP (DOHC)	834052	Outer Joint		26	30	56	93.5	60	I
	1989.09-1993.03	MT	L/R	F	Hatchback Engine BP (DOHC)	818034	Outer Joint		26	22	56	94	59	I
	1989.09-1993.03	MT	L/R	F	Hatchback Engine BP (DOHC)	834007	Outer Joint		26	22	56	93	56.5	I
1.8 16V Turbo (120 kW)	1990.09-1992.12	-	-	-	All-wheel Drive Hatchback Engine BP Turbo	834052	Outer Joint		26	30	56	93.5	60	I
	1990.09-1992.12	MT	L/R	F	All-wheel Drive Hatchback Engine BP Turbo	834007	Outer Joint		26	22	56	93	56.5	I
1.8 16V Turbo (136 kW)	1993.01-1994.07	-	-	-	All-wheel Drive Hatchback Engine BP Turbo	834052	Outer Joint		26	30	56	93.5	60	I
323 C V (BA)/FAMILIA														
1.3 16V (54 kW)	1994.08-1998.09	-	L	F	Coupe Engine B3 (16V)	618006	Inner Joint		24	22	35	64	98.5	
	1994.08-1998.09	MT	L	F	Coupe Engine B3 (16V)	227047	Drive Shaft		26	24	56	94	636.5	
	1994.08-1998.09	MT	R	F	Coupe Engine B3 (16V)	234005	Drive Shaft		26	28	56	94	576	
	1994.08-1998.09	AT/MT	L/R	F	Coupe Engine B3 (16V)	834005	Outer Joint		26	22	56	94	59	M
	1994.08-1998.09	AT/MT	L/R	F	Coupe Engine B3 (16V)	834006	Outer Joint	44T	26	22	56	94	59	M
	1994.08-1998.09	AT/MT	L	F	Coupe Engine B3 (16V)	227048	Drive Shaft	44T	26	24	56	94	636.5	
	1994.08-1998.09	-	-	-	Coupe Engine B3 (16V)	834055	Outer Joint		26	22	56	94	59	M
1.5 16V (65 kW)	1994.08-1998.09	-	-	F	Coupe Engine Z5-DE	834051	Outer Joint		26	21	56	94	56	M
	1994.08-1998.09	-	L	F	Coupe Engine Z5-DE	227047	Drive Shaft		26	24	56	94	636.5	
	1994.08-1998.09	-	R	F	Coupe Engine Z5-DE	234005	Drive Shaft		26	28	56	94	576	
	1994.08-1998.09	AT/MT	L/R	F	Coupe Engine Z5-DE	834005	Outer Joint		26	22	56	94	59	M
	1994.08-1998.09	AT/MT	L/R	F	Coupe Engine Z5-DE	834006	Outer Joint	44T	26	22	56	94	59	M
	1994.08-1998.09	AT/MT	L	F	Coupe Engine Z5-DE	227048	Drive Shaft	44T	26	24	56	94	636.5	

YEAR	TRANSM	L/R	F/R	REMARKS	GSP Ref.	PRODUCT	ABS	Technical Specifications						
								A	B	C	H	L	P	
MAZDA														
323 C V (BA)/FAMILIA														
1.5 16V (65 kW)	1994.08-1998.09	-	-	-	Coupe Engine Z5-DE	834055	Outer Joint		26	22	56	94	59	M
1.8 16V (84 kW)	1994.08-1998.09	MT	L/R	F	Coupe Engine BP-ZE	834081	Outer Joint		26	30	56	93	56.5	M
	1994.08-1998.09	-	-	F	Coupe Engine BP-ZE	834058	Outer Joint	44T	26	30	56	93	55	I
	1994.08-1998.09	-	-	F	Coupe Engine BP-ZE	834052	Outer Joint		26	30	56	93.5	60	I
323 F IV (BG)/FAMILIA/ASTINA														
1.6 (62 kW)	1989.09-1991.06	MT	R	F	Hatchback Engine B6E	250268	Drive Shaft		23	39	56	84	935	
	1989.09-1991.06	MT	L	F	Hatchback Engine B6E	218056	Drive Shaft		26	24	56	93	625	
	1989.09-1991.06	MT	R	F	Hatchback Engine B6E	234044	Drive Shaft		26	24	56	94	903	
	1989.09-1991.06	MT	L/R	F	Hatchback Engine B6E	818034	Outer Joint		26	22	56	94	59	I
	1989.09-1991.06	MT	L/R	F	Hatchback Engine B6E	834007	Outer Joint		26	22	56	93	56.5	I
	1989.09-1991.06	MT	R	F	Hatchback Engine B6E	250268	Drive Shaft		23	39	56	84	935	
1.6 16V (65 kW)	1991.03-1994.10	MT	R	F	Hatchback Engine B6	250268	Drive Shaft		23	39	56	84	935	
	1991.03-1994.10	MT	L	F	Hatchback Engine B6	218056	Drive Shaft		26	24	56	93	625	
	1991.03-1994.10	MT	R	F	Hatchback Engine B6	234044	Drive Shaft		26	24	56	94	903	
	1991.03-1994.10	MT	L/R	F	Hatchback Engine B6	818034	Outer Joint		26	22	56	94	59	I
	1991.03-1994.10	MT	L/R	F	Hatchback Engine B6	834007	Outer Joint		26	22	56	93	56.5	I
1.8 (76 kW)	1991.03-1994.10	MT	R	F	Hatchback Engine B6	250268	Drive Shaft		23	39	56	84	935	
1.8 16V (103 kW)	1991.01-1994.04	-	-	-	All-wheel Drive Hatchback Engine BPC	834052	Outer Joint		26	30	56	93.5	60	I
1.8 16V (76 kW)	1989.09-1993.03	-	-	F	Hatchback Engine BP31	834052	Outer Joint		26	30	56	93.5	60	I
1.8 16V (84 kW)	1989.08-1994.07	-	-	F	Hatchback Engine BP	834052	Outer Joint		26	30	56	93.5	60	I
1.8 16V GT (94 kW)	1989.08-1994.07	MT	L/R	F	Hatchback Engine BP (DOHC)	834081	Outer Joint		26	30	56	93	56.5	M
	1989.08-1994.07	-	-	-	Hatchback Engine BP (DOHC)	834025	Outer Joint		26	30	56	92.5	57.5	I
	1989.08-1994.07	-	-	F	Hatchback Engine BP (DOHC)	834052	Outer Joint		26	30	56	93.5	60	I
	1989.08-1994.07	MT	L/R	F	Hatchback Engine BP (DOHC)	818034	Outer Joint		26	22	56	94	59	I
	1989.08-1994.07	MT	L/R	F	Hatchback Engine BP (DOHC)	834007	Outer Joint		26	22	56	93	56.5	I
323 F V (BA)/FAMILIA/LANTIS														
1.5 16V (65 kW)	1994.07-1998.09	-	-	F	Hatchback Engine Z5-DE	834051	Outer Joint		26	21	56	94	56	M
	1994.07-1998.09	-	L	F	Hatchback Engine Z5-DE	227047	Drive Shaft		26	24	56	94	636.5	
	1994.07-1998.09	-	R	F	Hatchback Engine Z5-DE	234005	Drive Shaft		26	28	56	94	576	
	1994.07-1998.09	AT/MT	L/R	F	Hatchback Engine Z5-DE	834005	Outer Joint		26	22	56	94	59	M
	1994.07-1998.09	AT/MT	L/R	F	Hatchback Engine Z5-DE	834006	Outer Joint	44T	26	22	56	94	59	M
	1994.07-1998.09	-	-	-	Hatchback Engine Z5-DE	834055	Outer Joint		26	22	56	94	59	M
	1994.07-1998.09	-	-	-	Hatchback Engine Z5-DE	827006	Outer Joint		26	22	56	93	55	M
1.8 16V (84 kW)	1994.08-1998.09	MT	L/R	F	Hatchback Engine BP-ZE	834081	Outer Joint		26	30	56	93	56.5	M
	1994.08-1998.09	-	-	F	Hatchback Engine BP-ZE	834023	Outer Joint		26	30	56	93	55	I
	1994.08-1998.09	-	-	F	Hatchback Engine BP-ZE	834058	Outer Joint	44T	26	30	56	93	55	I
	1994.08-1998.09	-	-	F	Hatchback Engine BP-ZE	834052	Outer Joint		26	30	56	93.5	60	I
	1994.08-1998.09	MT	L/R	F	Hatchback Engine BP-ZE	818034	Outer Joint		26	22	56	94	59	I
2.0 24V (106 kW)	1994.08-1998.09	AT	R	F	Hatchback Engine KF	634014	Inner Joint		28	22	43	47	72	
	1994.08-1998.09	-	-	F	Hatchback Engine KF	827027	Outer Joint	44T	26	23	56	93	55	M
	1994.08-1998.09	-	-	F	Hatchback Engine KF	834075	Outer Joint	44T	26	24	56	92	60	M
323 F VI (BJ)/323 F/P/FAMILIA														
1.4 (53 kW)	2001.01-2004.05	MT	R	F	Hatchback Engine B3 (16V)	634022	Inner Joint		28	29	43	45	70	
	2001.01-2004.05	-	-	F	Hatchback Engine B3 (16V)	834223	Outer Joint		26	28	56	93	53	M
	2001.01-2004.05	MT	-	F	Hatchback Engine B3 (16V)	834124	Outer Joint	44T	26	28	56	93.1	53	M
	2001.01-2004.05	MT	-	F	Hatchback Engine B3 (16V)	834123	Outer Joint	44T	26	29	56	92	56	I
	2001.01-2004.05	MT	-	F	Hatchback Engine B3 (16V)	834026	Outer Joint		26	28	56	93.5	53	I
1.4 16V (54 kW)	1998.09-2001.01	AT/MT	R	F	Hatchback Engine B3 ME	634022	Inner Joint		28	29	43	45	70	
	1998.09-2001.01	-	-	F	Hatchback Engine B3 ME	834059	Outer Joint	44T	26	28	56	93.5	53	I
	1998.09-2001.01	-	-	F	Hatchback Engine B3 ME	834223	Outer Joint		26	28	56	93	53	M
	1998.09-2001.01	MT	-	F	Hatchback Engine B3 ME	834124	Outer Joint	44T	26	28	56	93.1	53	M
	1998.09-2001.01	MT	-	F	Hatchback Engine B3 ME	834123	Outer Joint	44T	26	29	56	92	56	I
	1998.09-2001.01	MT	-	F	Hatchback Engine B3 ME	834026	Outer Joint		26	28	56	93.5	53	I
1.5 16V (65 kW)	1998.09-2001.01	AT/MT	R	F	Hatchback Engine ZL05/ZL06	634022	Inner Joint		28	29	43	45	70	
	1998.09-2001.01	-	-	F	Hatchback Engine ZL05/ZL06	834059	Outer Joint	44T	26	28	56	93.5	53	I
	1998.09-2001.01	MT	-	F	Hatchback Engine ZL05/ZL06	834124	Outer Joint	44T	26	28	56	93.1	53	M
	1998.09-2001.01	MT	-	F	Hatchback Engine ZL05/ZL06	834123	Outer Joint	44T	26	29	56	92	56	I
	1998.09-2001.01	MT	-	F	Hatchback Engine ZL05/ZL06	834026	Outer Joint		26	28	56	93.5	53	I
1.6 (70 kW)	2001.01-2004.05	-	-	F	Hatchback Engine ZM	834059	Outer Joint	44T	26	28	56	93.5	53	I
	2001.01-2004.05	-	-	F	Hatchback Engine ZM	834223	Outer Joint		26	28	56	93	53	M
1.6 (72 kW)	2001.01-2004.05	-	-	F	Hatchback Engine ZM	834059	Outer Joint	44T	26	28	56	93.5	53	I
	2001.01-2004.05	-	-	F	Hatchback Engine ZM	834223	Outer Joint		26	28	56	93	53	M
1.9 16V (84 kW)	1998.09-2001.01	-	-	F	Hatchback Engine FP55/FP	834160	Outer Joint	44T	26	29	56	92	56	I
	1998.09-2001.01	AT/MT	R	F	Hatchback Engine FP55/FP	634022	Inner Joint		28	29	43	45	70	
	1998.09-2001.01	MT	-	F	Hatchback Engine FP55/FP	834124	Outer Joint	44T	26	28	56	93.1	53	M
	1998.09-2001.01	MT	-	F	Hatchback Engine FP55/FP	834123	Outer Joint	44T	26	29	56	92	56	I

YEAR	TRANSM	L/R	F/R	REMARKS	GSP Ref.	PRODUCT	ABS	Technical Specifications									
								A	B	C	H	L	P				
MAZDA																	
323 F VI (BJ)/323 F/P/FAMILIA																	
1.9 16V (84 kW)	1998.09-2001.01	2001.01	MT	-	F	Hatchback Engine FP55/FP	834026	Outer Joint		26	28	56	93.5	53	I		
	1998.09-2001.01	2001.01	AT/MT	L/R	F	Hatchback Engine FP55/FP	834008	Outer Joint		26	29	56	93.5	59	I		
2.0 (96 kW)	2001.01-2004.05	2004.05	-	-	F	Hatchback Engine FS7G/FS7E	834160	Outer Joint	44T	26	29	56	92	56	I		
	2001.01-2004.05	2004.05	AT/MT	R	F	Hatchback Engine FS7G/FS7E	634022	Inner Joint		28	29	43	45	70			
	2001.01-2004.05	2004.05	-	-	F	Hatchback Engine FS7G/FS7E	834060	Outer Joint	44T	26	29	56	93.5	59	I		
	2001.01-2004.05	2004.05	AT/MT	-	F	Hatchback Engine FS7G/FS7E	834020	Outer Joint		26	28	56	93.1	53	M		
	2001.01-2004.05	2004.05	AT/MT	-	F	Hatchback Engine FS7G/FS7E	834124	Outer Joint	44T	26	28	56	93.1	53	M		
	2001.01-2004.05	2004.05	AT/MT	-	F	Hatchback Engine FS7G/FS7E	834123	Outer Joint	44T	26	29	56	92	56	I		
	2001.01-2004.05	2004.05	MT	-	F	Hatchback Engine FS7G/FS7E	834026	Outer Joint		26	28	56	93.5	53	I		
	2001.01-2004.05	2004.05	AT/MT	L/R	F	Hatchback Engine FS7G/FS7E	834008	Outer Joint		26	29	56	93.5	59	I		
2.0 D (52 kW)	1998.09-2004.05	2004.05	-	-	F	Hatchback Engine RF1G	834160	Outer Joint	44T	26	29	56	92	56	I		
	1998.09-2004.05	2004.05	MT	R	F	Hatchback Engine RF1G	634022	Inner Joint		28	29	43	45	70			
	1998.09-2004.05	2004.05	MT	-	F	Hatchback Engine RF1G	834124	Outer Joint	44T	26	28	56	93.1	53	M		
	1998.09-2004.05	2004.05	MT	-	F	Hatchback Engine RF1G	834123	Outer Joint	44T	26	29	56	92	56	I		
	1998.09-2004.05	2004.05	MT	-	F	Hatchback Engine RF1G	834026	Outer Joint		26	28	56	93.5	53	I		
	1998.09-2004.05	2004.05	AT/MT	L/R	F	Hatchback Engine RF1G	834008	Outer Joint		26	29	56	93.5	59	I		
2.0 TD (66 kW)	1998.09-2001.12	2001.12	-	-	F	Hatchback	834160	Outer Joint	44T	26	29	56	92	56	I		
	1998.09-2001.12	2001.12	MT	R	F	Hatchback	634022	Inner Joint		28	29	43	45	70			
	1998.09-2001.12	2001.12	MT	-	F	Hatchback	834124	Outer Joint	44T	26	28	56	93.1	53	M		
	1998.09-2001.12	2001.12	MT	-	F	Hatchback	834123	Outer Joint	44T	26	29	56	92	56	I		
	1998.09-2001.12	2001.12	MT	-	F	Hatchback	834026	Outer Joint		26	28	56	93.5	53	I		
	1998.09-2001.12	2001.12	AT/MT	L/R	F	Hatchback	834008	Outer Joint		26	29	56	93.5	59	I		
2.0 TD (74 kW)	2001.01-2004.05	2004.05	AT/MT	R	F	Hatchback Engine RF4F	634022	Inner Joint		28	29	43	45	70			
	2001.01-2004.05	2004.05	-	-	F	Hatchback Engine RF4F	834160	Outer Joint	44T	26	29	56	92	56	I		
	2001.01-2004.05	2004.05	-	-	F	Hatchback Engine RF4F	834060	Outer Joint	44T	26	29	56	93.5	59	I		
	2001.01-2004.05	2004.05	MT	-	F	Hatchback Engine RF4F	834124	Outer Joint	44T	26	28	56	93.1	53	M		
	2001.01-2004.05	2004.05	MT	-	F	Hatchback Engine RF4F	834123	Outer Joint	44T	26	29	56	92	56	I		
	2001.01-2004.05	2004.05	AT/MT	L/R	F	Hatchback Engine RF4F	834008	Outer Joint		26	29	56	93.5	59	I		
	2001.01-2004.05	2004.05	MT	-	F	Hatchback Engine RF4F	834026	Outer Joint		26	28	56	93.5	53	I		
323 II (BD)/FAMILIA																	
1.3 (50 kW)	1980.11-1989.10	1989.10	-	-	F	Hatchback Engine E3	834003	Outer Joint		24	21	52	86.5	53	M		
	1980.11-1989.10	1989.10	-	-	F	Saloon Engine E3	834003	Outer Joint		24	21	52	86.5	53	M		
323 III (BF)/FAMILIA																	
1.1 (40 kW)	1985.08-1990.04	1990.04	-	-	F	Saloon Engine E1	834003	Outer Joint		24	21	52	86.5	53	M		
	1985.09-1989.10	1989.10	-	-	F	Hatchback Engine E1	834003	Outer Joint		24	21	52	86.5	53	M		
1.3 (44 kW)	1985.08-1989.05	1989.05	-	-	F	Saloon Engine E3	834003	Outer Joint		24	21	52	86.5	53	M		
1.3 i (49 kW)	1985.09-1989.08	1989.08	-	-	F	Hatchback Engine B3E	834003	Outer Joint		24	21	52	86.5	53	M		
1.4 (44 kW)	1987.04-1989.07	1989.07	-	-	F	Saloon Engine B3	834018	Outer Joint		24	21	52	86	50	M		
	1987.09-1989.10	1989.10	-	-	F	Hatchback Engine B3	834018	Outer Joint		24	21	52	86	50	M		
1.5 i Turbo (85 kW)	1985.08-1989.05	1989.05	AT/MT	L/R	F	Hatchback Engine E5E2	818032	Outer Joint		24	23	52	86	57.5	M		
	1985.08-1989.05	1989.05	AT/MT	L/R	F	Saloon Engine E5E2	818032	Outer Joint		24	23	52	86	57.5	M		
1.6 GT Turbo (103 kW)	1985.10-1993.08	1993.08	MT	L/R	F	Hatchback Engine B6T	818032	Outer Joint		24	23	52	86	57.5	M		
	1985.10-1991.11	1991.11	MT	L/R	F	Saloon Engine B6T	818032	Outer Joint		24	23	52	86	57.5	M		
	1987.10-1991.11	1991.11	MT	L/R	F	All-wheel Drive Hatchback Engine B6T	818032	Outer Joint		24	23	52	86	57.5	M		
1.6 GT Turbo (110 kW)	1987.08-1989.10	1989.10	MT	L/R	F	All-wheel Drive Hatchback Engine B6F2	818032	Outer Joint		24	23	52	86	57.5	M		
1.7 D (40 kW)	1986.04-1989.05	1989.05	-	-	F	Hatchback Engine PN27	834018	Outer Joint		24	21	52	86	50	M		
	1986.09-1989.05	1989.05	-	-	F	Saloon Engine PN27	834018	Outer Joint		24	21	52	86	50	M		
1.7 D (42 kW)	1987.01-1989.05	1989.05	-	-	F	Saloon Engine PN46	834018	Outer Joint		24	21	52	86	50	M		
	1987.01-1989.05	1989.05	-	-	F	Hatchback Engine PN46	834018	Outer Joint		24	21	52	86	50	M		
323 III Station Wagon (BW)/FAMILIA																	
1.3 (44 kW)	1986.07-1990.04	1990.04	-	-	F	Estate Engine E3	834003	Outer Joint		24	21	52	86.5	53	M		
1.6 (63 kW)	1986.09-1995.10	1995.10	MT	L	F	Estate Engine B65M/B6E/B6 (SOHC)	218056	Drive Shaft		26	24	56	93	625			
	1986.09-1995.10	1995.10	MT	R	F	Estate Engine B65M/B6E/B6 (SOHC)	234044	Drive Shaft		26	24	56	94	903			
	1986.09-1995.10	1995.10	AT/MT	L/R	F	Estate Engine B65M/B6E/B6 (SOHC)	818034	Outer Joint		26	22	56	94	59	I		
	1986.09-1995.10	1995.10	AT/MT	L/R	F	Estate Engine B65M/B6E/B6 (SOHC)	834007	Outer Joint		26	22	56	93	56.5	I		
	1986.09-1995.10	1995.10	MT	R	F	Estate Engine B65M/B6E/B6 (SOHC)	250268	Drive Shaft		23	39	56	84	935			
	1986.09-1995.10	1995.10	MT	R	F	Estate Engine B65M/B6E/B6 (SOHC)	250268	Drive Shaft		23	39	56	84	935			
	1990.05-1993.03	1993.03	MT	L/R	F	All-wheel Drive Estate Engine B65M/B6E	818032	Outer Joint		24	23	52	86	57.5	M		
	1990.05-1993.03	1993.03	AT/MT	L/R	F	All-wheel Drive Estate Engine B65M/B6E	818034	Outer Joint		26	22	56	94	59	I		
	1990.05-1993.03	1993.03	AT/MT	L/R	F	All-wheel Drive Estate Engine B65M/B6E	834007	Outer Joint		26	22	56	93	56.5	I		
1.7 D (41 kW)	1989.10-1993.03	1993.03	MT	L	F	Estate Engine PN26/PN54	218056	Drive Shaft		26	24	56	93	625			
	1989.10-1993.03	1993.03	MT	R	F	Estate Engine PN26/PN54	234044	Drive Shaft		26	24	56	94	903			
	1989.10-1993.03	1993.03	MT	R	F	Estate Engine PN26/PN54	250268	Drive Shaft		23	39	56	84	935			
	1989.10-1993.03	1993.03	-	-	F	Estate Engine PN26/PN54	834018	Outer Joint		24	21	52	86	50	M		
	1989.10-1993.03	1993.03	MT	R	F	Estate Engine PN26/PN54	250268	Drive Shaft		23	39	56	84	935			
1.7 D (42 kW)	1986.11-1989.10	1989.10	-	-	F	Estate Engine PN26/PN54	834018	Outer Joint		24	21	52	86	50	M		

YEAR	TRANSM	L/R	F/R	REMARKS	GSP Ref.	PRODUCT	ABS	Technical Specifications						
								A	B	C	H	L	P	
MAZDA														
323 IV (BA)														
1.6 TD (60 kW)	1995.02-	1998.09	-	-	-	834097	Outer Joint	44T	26	30	56	93.5	60	I
1.8 16V (84 kW)	1994-	1998	-	-	-	834097	Outer Joint	44T	26	30	56	93.5	60	I
323 P V (BA)/FAMILIA														
1.3 16V (54 kW)	1996.10-	1998.09	MT	L	F	Hatchback Engine B3 (16V)	227047	Drive Shaft		26	24	56	94	636.5
	1996.10-	1998.09	MT	R	F	Hatchback Engine B3 (16V)	234005	Drive Shaft		26	28	56	94	576
	1996.10-	1998.09	AT/MT	L/R	F	Hatchback Engine B3 (16V)	834005	Outer Joint		26	22	56	94	59 M
	1996.10-	1998.09	AT/MT	L/R	F	Hatchback Engine B3 (16V)	834006	Outer Joint	44T	26	22	56	94	59 M
	1996.10-	1998.09	-	-	-	Hatchback Engine B3 (16V)	834055	Outer Joint		26	22	56	94	59 M
1.5 16V (65 kW)	1996.10-	1998.09	-	-	F	Hatchback Engine Z5-DE	834051	Outer Joint		26	21	56	94	56 M
	1996.10-	1998.09	-	L	F	Hatchback Engine Z5-DE	227047	Drive Shaft		26	24	56	94	636.5
	1996.10-	1998.09	-	R	F	Hatchback Engine Z5-DE	234005	Drive Shaft		26	28	56	94	576
	1996.10-	1998.09	AT/MT	L/R	F	Hatchback Engine Z5-DE	834005	Outer Joint		26	22	56	94	59 M
	1996.10-	1998.09	AT/MT	L/R	F	Hatchback Engine Z5-DE	834006	Outer Joint	44T	26	22	56	94	59 M
2.0 D (52 kW)	1996.10-	1998.09	-	-	-	Hatchback Engine RF1G	834055	Outer Joint		26	22	56	94	59 M
323 PROTEGE														
1.8	1994-	1996	MT	L	-	DOHC	227049	Drive Shaft		26	28	56	92	615.5
	1994-	1996	AT	-	-	DOHC	634010	Inner Joint		24	30	35	64	99
1.8 DOHC	1994-	1996	-	-	-	-	608014	Inner Joint		28	30	43	47	72
	1994-	1996	-	R	-	-	259001	Drive Shaft	44T	26	28	56	93	625
	1994-	1996	AT	L	-	-	234011	Drive Shaft		26	24	56	93	627
	1994-	1996	AT	L	F	-	234080	Drive Shaft	44T	26	24	56	93	627
323 S IV (BG)/FAMILIA														
1.3 (49 kW)	1989.09-	1991.06	MT	L/R	F	Saloon Engine B383/B3E	834019	Outer Joint		26	21	56	94	56 I
	1989.09-	1991.06	MT	L	F	Saloon Engine B383/B3E	218056	Drive Shaft		26	24	56	93	625
	1989.09-	1991.06	-	-	F	Saloon Engine B383/B3E	834051	Outer Joint		26	21	56	94	56 M
	1989.09-	1991.06	MT	R	F	Saloon Engine B383/B3E	234044	Drive Shaft		26	24	56	94	903
	1989.09-	1991.06	MT	R	F	Saloon Engine B383/B3E	250268	Drive Shaft		23	39	56	84	935
	1989.09-	1991.06	MT	R	F	Saloon Engine B383/B3E	250268	Drive Shaft		23	39	56	84	935
1.3 16V (54 kW)	1991.04-	1994.07	AT/MT	L/R	F	Saloon Engine B3 (16V)	834019	Outer Joint		26	21	56	94	56 I
	1991.04-	1994.07	MT	L	F	Saloon Engine B3 (16V)	218056	Drive Shaft		26	24	56	93	625
	1991.04-	1994.07	MT	R	F	Saloon Engine B3 (16V)	234044	Drive Shaft		26	24	56	94	903
	1991.04-	1994.07	MT	R	F	Saloon Engine B3 (16V)	250268	Drive Shaft		23	39	56	84	935
	1991.04-	1994.07	MT	R	F	Saloon Engine B3 (16V)	250268	Drive Shaft		23	39	56	84	935
1.6 (62 kW)	1989.09-	1991.06	MT	L	F	Saloon Engine B6E	218056	Drive Shaft		26	24	56	93	625
	1989.09-	1991.06	MT	R	F	Saloon Engine B6E	234044	Drive Shaft		26	24	56	94	903
	1989.09-	1991.06	MT	L/R	F	Saloon Engine B6E	818034	Outer Joint		26	22	56	94	59 I
	1989.09-	1991.06	MT	L/R	F	Saloon Engine B6E	834007	Outer Joint		26	22	56	93	56.5 I
	1989.09-	1991.06	MT	R	F	Saloon Engine B6E	834007	Outer Joint		26	22	56	93	56.5 I
	1989.09-	1991.06	MT	R	F	Saloon Engine B6E	250268	Drive Shaft		23	39	56	84	935
1.6 16V (65 kW)	1989.08-	1994.10	MT	R	F	Saloon Engine B6	250268	Drive Shaft		23	39	56	84	935
	1989.08-	1994.10	MT	L	F	Saloon Engine B6	218056	Drive Shaft		26	24	56	93	625
	1989.08-	1994.10	MT	R	F	Saloon Engine B6	234044	Drive Shaft		26	24	56	94	903
	1989.08-	1994.10	MT	L/R	F	Saloon Engine B6	818034	Outer Joint		26	22	56	94	59 I
	1989.08-	1994.10	MT	L/R	F	Saloon Engine B6	834007	Outer Joint		26	22	56	93	56.5 I
	1989.08-	1994.10	MT	R	F	Saloon Engine B6	250268	Drive Shaft		23	39	56	84	935
1.7 D (41 kW)	1989.08-	1994.07	MT	R	F	Saloon Engine PN46/PN54/PN62	250268	Drive Shaft		23	39	56	84	935
	1989.08-	1994.07	AT/MT	L/R	F	Saloon Engine PN46/PN54/PN62	834019	Outer Joint		26	21	56	94	56 I
	1989.08-	1994.07	MT	L	F	Saloon Engine PN46/PN54/PN62	218056	Drive Shaft		26	24	56	93	625
	1989.08-	1994.07	MT	R	F	Saloon Engine PN46/PN54/PN62	234044	Drive Shaft		26	24	56	94	903
	1989.08-	1994.07	-	-	F	Saloon Engine PN46/PN54/PN62	834018	Outer Joint		24	21	52	86	50 M
	1989.08-	1994.07	MT	R	F	Saloon Engine PN46/PN54/PN62	250268	Drive Shaft		23	39	56	84	935
1.8 16V (76 kW)	1989.08-	1994.07	AT/MT	L/R	F	Saloon Engine BP52	827007	Outer Joint		26	23	56	93	55 M
	1989.08-	1994.07	-	-	F	Saloon Engine BP52	834052	Outer Joint		26	30	56	93.5	60 I
1.8 16V GT (94 kW)	1989.06-	1994.07	MT	L/R	F	Saloon Engine BP (DOHC)	834081	Outer Joint		26	30	56	93	56.5 M
	1989.06-	1994.07	-	-	-	Saloon Engine BP (DOHC)	834025	Outer Joint		26	30	56	92.5	57.5 I
	1989.06-	1994.07	-	-	F	Saloon Engine BP (DOHC)	834052	Outer Joint		26	30	56	93.5	60 I
	1989.06-	1994.07	MT	L/R	F	Saloon Engine BP (DOHC)	818034	Outer Joint		26	22	56	94	59 I
	1989.06-	1994.07	MT	L/R	F	Saloon Engine BP (DOHC)	834007	Outer Joint		26	22	56	93	56.5 I
323 S V (BA)/FAMILIA														
1.3 16V (54 kW)	1994.08-	1998.09	-	L	F	Saloon Engine B3 (16V)	618006	Inner Joint		24	22	35	64	98.5
	1994.08-	1998.09	MT	L	F	Saloon Engine B3 (16V)	227047	Drive Shaft		26	24	56	94	636.5
	1994.08-	1998.09	MT	R	F	Saloon Engine B3 (16V)	234005	Drive Shaft		26	28	56	94	576
	1994.08-	1998.09	AT/MT	L/R	F	Saloon Engine B3 (16V)	834005	Outer Joint		26	22	56	94	59 M
	1994.08-	1998.09	AT/MT	L/R	F	Saloon Engine B3 (16V)	834006	Outer Joint	44T	26	22	56	94	59 M
	1994.08-	1998.09	AT/MT	L	F	Saloon Engine B3 (16V)	227048	Drive Shaft	44T	26	24	56	94	636.5

	 YEAR	TRANSM	L/R	F/R	REMARKS	GSP Ref.	 PRODUCT	 ABS	Technical Specifications					
									A	B	C	H	L	P
MAZDA														
323 S V (BA)/FAMILIA														
1.3 16V (54 kW)	1994.08-1998.09	-	-	-	Saloon Engine B3 (16V)	834055	Outer Joint		26	22	56	94	59	M
1.5 16V (65 kW)	1994.08-1998.09	-	-	F	Saloon Engine Z5-DE	834051	Outer Joint		26	21	56	94	56	M
	1994.08-1998.09	-	L	F	Saloon Engine Z5-DE	227047	Drive Shaft		26	24	56	94	636.5	
	1994.08-1998.09	-	R	F	Saloon Engine Z5-DE	234005	Drive Shaft		26	28	56	94	576	
	1994.08-1998.09	AT/MT	L/R	F	Saloon Engine Z5-DE	834005	Outer Joint		26	22	56	94	59	M
	1994.08-1998.09	AT/MT	L/R	F	Saloon Engine Z5-DE	834006	Outer Joint	44T	26	22	56	94	59	M
	1994.08-1998.09	AT/MT	L	F	Saloon Engine Z5-DE	227048	Drive Shaft	44T	26	24	56	94	636.5	
	1994.08-1998.09	-	-	-	Saloon Engine Z5-DE	834055	Outer Joint		26	22	56	94	59	M
1.6 TD (60 kW)	1994.05-1998.09	MT	L/R	F	Saloon Engine 4EE1-T	834005	Outer Joint		26	22	56	94	59	M
	1994.05-1998.09	-	-	F	Saloon Engine 4EE1-T	834058	Outer Joint	44T	26	30	56	93	55	I
	1994.05-1998.09	MT	L/R	F	Saloon Engine 4EE1-T	834006	Outer Joint	44T	26	22	56	94	59	M
1.8 16V (84 kW)	1994.08-1998.09	MT	L/R	F	Saloon Engine BP-ZE	834081	Outer Joint		26	30	56	93	56.5	M
	1994.08-1998.09	-	L	F	Saloon Engine BP-ZE	618006	Inner Joint		24	22	35	64	98.5	
	1994.08-1998.09	-	-	F	Saloon Engine BP-ZE	834058	Outer Joint	44T	26	30	56	93	55	I
	1994.08-1998.09	-	-	F	Saloon Engine BP-ZE	834052	Outer Joint		26	30	56	93.5	60	I
2.0 D (52 kW)	1996.10-1998.09	-	-	-	Saloon Engine RF1G	834055	Outer Joint		26	22	56	94	59	M
	1996.10-1998.09	-	-	F	Saloon Engine RF1G	834018	Outer Joint		24	21	52	86	50	M
323 S VI (BJ)/PROTEGE/FAMILIA														
1.4 (53 kW)	2001.01-2004.05	MT	R	F	Saloon Engine B3 (16V)	634022	Inner Joint		28	29	43	45	70	
	2001.01-2004.05	-	-	F	Saloon Engine B3 (16V)	834223	Outer Joint		26	28	56	93	53	M
	2001.01-2004.05	MT	-	F	Saloon Engine B3 (16V)	834124	Outer Joint	44T	26	28	56	93.1	53	M
	2001.01-2004.05	MT	-	F	Saloon Engine B3 (16V)	834123	Outer Joint	44T	26	29	56	92	56	I
	2001.01-2004.05	MT	-	F	Saloon Engine B3 (16V)	834026	Outer Joint		26	28	56	93.5	53	I
1.4 16V (54 kW)	1998.09-2001.01	MT	R	F	Saloon Engine B3 ME	634022	Inner Joint		28	29	43	45	70	
	1998.09-2001.01	-	-	F	Saloon Engine B3 ME	834223	Outer Joint		26	28	56	93	53	M
	1998.09-2001.01	MT	-	F	Saloon Engine B3 ME	834124	Outer Joint	44T	26	28	56	93.1	53	M
	1998.09-2001.01	MT	-	F	Saloon Engine B3 ME	834123	Outer Joint	44T	26	29	56	92	56	I
	1998.09-2001.01	MT	-	F	Saloon Engine B3 ME	834026	Outer Joint		26	28	56	93.5	53	I
1.5 16V (65 kW)	1998.09-2001.01	AT/MT	R	F	Saloon Engine ZL06/ZL05	634022	Inner Joint		28	29	43	45	70	
	1998.09-2001.01	-	-	F	Saloon Engine ZL06/ZL05	834223	Outer Joint		26	28	56	93	53	M
	1998.09-2001.01	MT	-	F	Saloon Engine ZL06/ZL05	834124	Outer Joint	44T	26	28	56	93.1	53	M
	1998.09-2001.01	MT	-	F	Saloon Engine ZL06/ZL05	834123	Outer Joint	44T	26	29	56	92	56	I
	1998.09-2001.01	MT	-	F	Saloon Engine ZL06/ZL05	834026	Outer Joint		26	28	56	93.5	53	I
1.6 (70 kW)	2001.01-2004.05	-	-	F	Saloon Engine ZM	834059	Outer Joint	44T	26	28	56	93.5	53	I
	2001.01-2004.05	-	-	F	Saloon Engine ZM	834223	Outer Joint		26	28	56	93	53	M
1.6 (72 kW)	2001.01-2004.05	-	-	F	Saloon Engine ZM	834059	Outer Joint	44T	26	28	56	93.5	53	I
	2001.01-2004.05	-	-	F	Saloon Engine ZM	834223	Outer Joint		26	28	56	93	53	M
1.9 16V (84 kW)	1998.09-2004.05	AT/MT	R	F	Saloon Engine FP55/FP	634022	Inner Joint		28	29	43	45	70	
	1998.09-2004.05	-	-	F	Saloon Engine FP55/FP	834160	Outer Joint	44T	26	29	56	92	56	I
	1998.09-2004.05	MT	-	F	Saloon Engine FP55/FP	834124	Outer Joint	44T	26	28	56	93.1	53	M
	1998.09-2004.05	MT	-	F	Saloon Engine FP55/FP	834123	Outer Joint	44T	26	29	56	92	56	I
	1998.09-2004.05	MT	-	F	Saloon Engine FP55/FP	834026	Outer Joint		26	28	56	93.5	53	I
	1998.09-2004.05	AT/MT	L/R	F	Saloon Engine FP55/FP	834008	Outer Joint		26	29	56	93.5	59	I
2.0 (96 kW)	2001.01-2004.05	AT/MT	R	F	Saloon Engine FS7G/FS7E	634022	Inner Joint		28	29	43	45	70	
	2001.01-2004.05	-	-	F	Saloon Engine FS7G/FS7E	834060	Outer Joint	44T	26	29	56	93.5	59	I
	2001.01-2004.05	AT/MT	-	F	Saloon Engine FS7G/FS7E	834020	Outer Joint		26	28	56	93.1	53	M
	2001.01-2004.05	AT/MT	-	F	Saloon Engine FS7G/FS7E	834124	Outer Joint	44T	26	28	56	93.1	53	M
	2001.01-2004.05	AT/MT	-	F	Saloon Engine FS7G/FS7E	834123	Outer Joint	44T	26	29	56	92	56	I
	2001.01-2004.05	MT	L/R	F	Saloon Engine FS7G/FS7E	834008	Outer Joint		26	29	56	93.5	59	I
2.0 D (52 kW)	2001.01-2004.05	MT	-	F	Saloon Engine FS7G/FS7E	834026	Outer Joint		26	28	56	93.5	53	I
	1998.09-2004.05	-	-	F	Saloon Engine RF1G	834160	Outer Joint	44T	26	29	56	92	56	I
	1998.09-2004.05	MT	R	F	Saloon Engine RF1G	634022	Inner Joint		28	29	43	45	70	
	1998.09-2004.05	MT	-	F	Saloon Engine RF1G	834124	Outer Joint	44T	26	28	56	93.1	53	M
	1998.09-2004.05	MT	-	F	Saloon Engine RF1G	834123	Outer Joint	44T	26	29	56	92	56	I
	1998.09-2004.05	MT	-	F	Saloon Engine RF1G	834026	Outer Joint		26	28	56	93.5	53	I
2.0 DITD (74 kW)	1998.09-2004.05	AT/MT	L/R	F	Saloon Engine RF1G	834008	Outer Joint		26	29	56	93.5	59	I
	2000.10-2002.10	-	L/R	F	Saloon Engine RF4F	834008	Outer Joint		26	29	56	93.5	59	I
	2000.10-2002.10	AT/MT	R	F	Saloon Engine RF4F	634022	Inner Joint		28	29	43	45	70	
	2000.10-2002.10	-	-	F	Saloon Engine RF4F	834060	Outer Joint	44T	26	29	56	93.5	59	I
	2000.10-2002.10	MT	-	F	Saloon Engine RF4F	834124	Outer Joint	44T	26	28	56	93.1	53	M
2.0 TD (66 kW)	2000.10-2002.10	MT	-	F	Saloon Engine RF4F	834123	Outer Joint	44T	26	29	56	92	56	I
	2000.10-2002.10	MT	-	F	Saloon Engine RF4F	834026	Outer Joint		26	28	56	93.5	53	I
	1998.09-2004.05	-	-	F	Saloon Engine RF3F	834160	Outer Joint	44T	26	29	56	92	56	I
	1998.09-2004.05	MT	R	F	Saloon Engine RF3F	634022	Inner Joint		28	29	43	45	70	
1998.09-2004.05	MT	-	F	Saloon Engine RF3F	834124	Outer Joint	44T	26	28	56	93.1	53	M	
	MT	-	F	Saloon Engine RF3F	834123	Outer Joint	44T	26	29	56	92	56	I	





YEAR	TRANSM	L/R	F/R	REMARKS	GSP Ref.	PRODUCT	ABS	Technical Specifications								
								A	B	C	H	L	P			
MAZDA																
323 S VI (BJ)/PROTEGE/FAMILIA																
2.0 TD (66 kW)	1998.09-2004.05	MT	-	F	Saloon Engine RF3F	834026	Outer Joint		26	28	56	93.5	53	I		
	1998.09-2004.05	AT/MT	L/R	F	Saloon Engine RF3F	834008	Outer Joint		26	29	56	93.5	59	I		
323 V (BA)																
1.7 TD (60 kW)	1995.02-1998.09	-	-	-	-	834097	Outer Joint	44T	26	30	56	93.5	60	I		
1.8 16V (103 kW)	1994-1998	-	-	-	-	834097	Outer Joint	44T	26	30	56	93.5	60	I		
5 (CR19)/PREMACY																
1.8 (85 kW)	2005.02-2010.05	-	-	-	MPV Engine L823	634086	Inner Joint		28	24	43	48	76			
	2005.02-2010.05	MT	L	F	MPV Engine L823	234091	Drive Shaft		28	28	59	90	639			
	2005.02-2010.05	-	-	-	MPV Engine L823	234104	Drive Shaft		28	28	59	90	551			
2.0 (107 kW)	2005.02-2010.05	-	-	-	MPV Engine LFF7	634086	Inner Joint		28	24	43	48	76			
	2005.02-2010.05	MT	L	F	MPV Engine LFF7	234091	Drive Shaft		28	28	59	90	639			
	2005.02-2010.05	-	-	-	MPV Engine LFF7	234104	Drive Shaft		28	28	59	90	551			
2.0 CD (105 kW)	2005.02-2010.05	-	-	-	MPV Engine RF7J	634086	Inner Joint		28	24	43	48	76			
	2005.02-2010.05	MT	L	F	MPV Engine RF7J	234226	Drive Shaft		28	30	58.5	88	587			
	2005.02-2010.05	MT	R	F	MPV Engine RF7J	234225	Drive Shaft		28	28	58.5	88	541			
	2005.02-2010.05	-	-	-	MPV Engine RF7J	234104	Drive Shaft		28	28	59	90	551			
2.0 CD (81 kW)	2005.02-2010.05	-	-	-	MPV Engine RF7J	634086	Inner Joint		28	24	43	48	76			
	2005.02-2010.05	MT	L	F	MPV Engine RF7J	234226	Drive Shaft		28	30	58.5	88	587			
	2005.02-2010.05	MT	R	F	MPV Engine RF7J	234225	Drive Shaft		28	28	58.5	88	541			
	2005.02-2010.05	-	-	-	MPV Engine RF7J	234104	Drive Shaft		28	28	59	90	551			
6																
-	2004-2006	-	-	-	CAPACITY	634029	Inner Joint		28	33	35	66.5	114			
1.8/2.0	2002.02-	-	-	-	-	834046	Outer Joint		28	32	56	90	59	I		
2.3	-	-	-	-	-	834065	Outer Joint	44T	28	24	56.6	90	60	M		
6 (GG)																
2.0	2002.06-	MT/AT	-	-	-	834147	Outer Joint	44T	28	33	56.5	90	58.5	M		
6 (GG)/ATENZA																
1.8 (88 kW)	2002.08-2007.08	MT	L/R	F	Hatchback Engine L813	834135	Outer Joint	44T	28	23	56	90	57.5	I		
	2002.08-2007.08	MT	L/R	F	Saloon Engine L813/L823/L828	834135	Outer Joint	44T	28	23	56	90	57.5	I		
	2002.08-2007.08	MT	L	F	Hatchback Engine L813	234137	Drive Shaft	44T	28	28	56.6	90	648			
	2002.08-2007.08	MT	L	F	Saloon Engine L813/L823/L828	234137	Drive Shaft	44T	28	28	56.6	90	648			
	2002.08-2007.08	MT	R	F	Hatchback Engine L813	234088	Drive Shaft	44T	28	28	56.6	90	599			
	2002.08-2007.08	MT	R	F	Saloon Engine L813/L823/L828	234088	Drive Shaft	44T	28	28	56.6	90	599			
	2002.08-2007.08	-	L/R	F	Saloon Engine L813/L823/L828	834110	Outer Joint	44T	28	32	62	90	57.5	I		
	2002.08-2007.08	-	R	F	Hatchback Engine L813	899273	Outer Joint	44T	28	33	56.6	90	59	I		
	2002.08-2007.08	-	R	F	Saloon Engine L813/L823/L828	899273	Outer Joint	44T	28	33	56.6	90	59	I		
	2002.08-2007.08	-	-	F	Hatchback Engine L813	834070	Outer Joint	44T	28	32	56	90	59	I		
	2002.08-2007.08	MT	-	F	Hatchback Engine L813	834021	Outer Joint	44T	28	23	56	90	59	I		
	2002.08-2007.08	-	-	F	Saloon Engine L813/L823/L828	834070	Outer Joint	44T	28	32	56	90	59	I		
	2002.08-2007.08	MT	-	F	Saloon Engine L813/L823/L828	834021	Outer Joint	44T	28	23	56	90	59	I		
2.0 (104 kW)	2002.06-2007.08	MT	L	F	Saloon Engine LF17/LF18	834135	Outer Joint	44T	28	23	56	90	57.5	I		
	2002.06-2007.08	-	R	F	Saloon Engine LF17/LF18	634115	Inner Joint		28	33	43	48	84			
	2002.06-2007.08	MT	-	F	Saloon Engine LF17/LF18	834084	Outer Joint	44T	28	32	62	90	58	I		
	2002.06-2007.08	MT	L	F	Saloon Engine LF17/LF18	234137	Drive Shaft	44T	28	28	56.6	90	648			
	2002.06-2007.08	AT	L	F	Saloon Engine LF17/LF18	218325	Drive Shaft		31	31	65	94	567			
	2002.06-2007.08	MT	R	F	Saloon Engine LF17/LF18	234088	Drive Shaft	44T	28	28	56.6	90	599			
	2002.06-2007.08	-	L/R	F	Saloon Engine LF17/LF18	834110	Outer Joint	44T	28	32	62	90	57.5	I		
	2002.06-2007.08	MT	R	F	Saloon Engine LF17/LF18	899273	Outer Joint	44T	28	33	56.6	90	59	I		
	2002.06-2007.08	-	-	F	Saloon Engine LF17/LF18	834070	Outer Joint	44T	28	32	56	90	59	I		
	2002.06-2007.08	MT	-	F	Saloon Engine LF17/LF18	834021	Outer Joint	44T	28	23	56	90	59	I		
	2002.06-2007.08	-	-	-	Saloon Engine LF17/LF18	634048	Inner Joint		28	33	43	48	84			
	2002.08-2007.08	MT	L	F	Hatchback Engine LF18/LF17	834135	Outer Joint	44T	28	23	56	90	57.5	I		
	2002.08-2007.08	-	R	F	Hatchback Engine LF18/LF17	634115	Inner Joint		28	33	43	48	84			
	2002.08-2007.08	MT	L	F	Hatchback Engine LF18/LF17	234137	Drive Shaft	44T	28	28	56.6	90	648			
	2002.08-2007.08	MT	-	F	Hatchback Engine LF18/LF17	834084	Outer Joint	44T	28	32	62	90	58	I		
	2002.08-2007.08	AT	L	F	Hatchback Engine LF18/LF17	218325	Drive Shaft		31	31	65	94	567			
	2002.08-2007.08	MT	R	F	Hatchback Engine LF18/LF17	234088	Drive Shaft	44T	28	28	56.6	90	599			
	2002.08-2007.08	-	L/R	F	Hatchback Engine LF18/LF17	834110	Outer Joint	44T	28	32	62	90	57.5	I		
	2002.08-2007.08	MT	R	F	Hatchback Engine LF18/LF17	899273	Outer Joint	44T	28	33	56.6	90	59	I		
	2002.08-2007.08	-	-	F	Hatchback Engine LF18/LF17	834070	Outer Joint	44T	28	32	56	90	59	I		
	2002.08-2007.08	MT	-	F	Hatchback Engine LF18/LF17	834021	Outer Joint	44T	28	23	56	90	59	I		
	2002.08-2007.08	-	-	-	Hatchback Engine LF18/LF17	634048	Inner Joint		28	33	43	48	84			
2.0 (108 kW)	2005.03-2007.08	MT	L/R	F	Hatchback Engine LFF7	834135	Outer Joint	44T	28	23	56	90	57.5	I		
	2005.03-2007.08	MT	L/R	F	Saloon Engine LFF7	834135	Outer Joint	44T	28	23	56	90	57.5	I		
	2005.03-2007.08	-	R	F	Hatchback Engine LFF7	634115	Inner Joint		28	33	43	48	84			
	2005.03-2007.08	-	R	F	Saloon Engine LFF7	634115	Inner Joint		28	33	43	48	84			

YEAR	TRANSM	L/R	F/R	REMARKS	GSP Ref.	PRODUCT	ABS	Technical Specifications							
								A	B	C	H	L	P		
MAZDA															
6 (GG)/ATENZA															
2.0 (108 kW)															
2005.03-2007.08	MT	L	F	Hatchback Engine LFF7	234137	Drive Shaft	44T	28	28	56.6	90	648			
2005.03-2007.08	MT	L	F	Saloon Engine LFF7	234137	Drive Shaft	44T	28	28	56.6	90	648			
2005.03-2007.08	MT	R	F	Hatchback Engine LFF7	234088	Drive Shaft	44T	28	28	56.6	90	599			
2005.03-2007.08	MT	R	F	Saloon Engine LFF7	234088	Drive Shaft	44T	28	28	56.6	90	599			
2005.03-2007.08	-	L/R	F	Hatchback Engine LFF7	834110	Outer Joint	44T	28	32	62	90	57.5	I		
2005.03-2007.08	-	L/R	F	Saloon Engine LFF7	834110	Outer Joint	44T	28	32	62	90	57.5	I		
2005.03-2007.08	MT	R	F	Hatchback Engine LFF7	899273	Outer Joint	44T	28	33	56.6	90	59	I		
2005.03-2007.08	MT	R	F	Saloon Engine LFF7	899273	Outer Joint	44T	28	33	56.6	90	59	I		
2005.03-2007.08	-	-	F	Hatchback Engine LFF7	834070	Outer Joint	44T	28	32	56	90	59	I		
2005.03-2007.08	-	-	F	Saloon Engine LFF7	834070	Outer Joint	44T	28	32	56	90	59	I		
2005.03-2007.08	-	-	-	Hatchback Engine LFF7	634048	Inner Joint		28	33	43	48	84			
2005.03-2007.08	-	-	-	Saloon Engine LFF7	634048	Inner Joint		28	33	43	48	84			
2.0 DI (100 kW)															
2002.06-2007.08	-	L/R	F	Saloon Engine RF5C	834161	Outer Joint	44T	31	36	65	94	62.5	I		
2002.06-2007.08	5AT	R	F	Saloon Engine RF5C	234088	Drive Shaft	44T	28	28	56.6	90	599			
2002.06-2007.08	6MT	R	F	Saloon Engine RF5C	234120	Drive Shaft	44T	31	31	65	94	556			
2002.06-2007.08	-	L/R	F	Saloon Engine RF5C	899273	Outer Joint	44T	28	33	56.6	90	59	I		
2002.06-2007.08	-	R	F	Saloon Engine RF5C	634040	Inner Joint		28	33	43	43	82			
2002.06-2007.08	5AT	-	F	Saloon Engine RF5C	834070	Outer Joint	44T	28	32	56	90	59	I		
2002.06-2007.08	MT	-	F	Saloon Engine RF5C	834021	Outer Joint	44T	28	23	56	90	59	I		
2002.06-2007.08	6MT	R	F	Saloon Engine RF5C	634050	Inner Joint		31	36	48	48	78			
2002.06-2007.08	-	R	F	Saloon Engine RF5C	234165	Drive Shaft	44T	31	31	65	94	555			
2002.06-2007.08	-	L	F	Saloon Engine RF5C	234039	Drive Shaft	44T	28	30	56.6	90	643			
2002.06-2007.08	-	R	F	Saloon Engine RF5C	299064	Drive Shaft	44T	28	28	56.6	90	587			
2002.06-2007.08	-	L	F	Saloon Engine RF5C	234153	Drive Shaft	44T	31	30	65	94	611.5			
2002.06-2007.08	6MT	-	F	Saloon Engine RF5C	834114	Outer Joint	44T	31	36	65	94	65	I		
2002.08-2007.08	-	L/R	F	Hatchback Engine RF5C	834161	Outer Joint	44T	31	36	65	94	62.5	I		
2002.08-2007.08	5AT	R	F	Hatchback Engine RF5C	234088	Drive Shaft	44T	28	28	56.6	90	599			
2002.08-2007.08	6MT	R	F	Hatchback Engine RF5C	234120	Drive Shaft	44T	31	31	65	94	556			
2002.08-2007.08	-	R	F	Hatchback Engine RF5C	634040	Inner Joint		28	33	43	43	82			
2002.08-2007.08	-	L/R	F	Hatchback Engine RF5C	899273	Outer Joint	44T	28	33	56.6	90	59	I		
2002.08-2007.08	5AT	-	F	Hatchback Engine RF5C	834070	Outer Joint	44T	28	32	56	90	59	I		
2002.08-2007.08	MT	-	F	Hatchback Engine RF5C	834021	Outer Joint	44T	28	23	56	90	59	I		
2002.08-2007.08	6MT	R	F	Hatchback Engine RF5C	634050	Inner Joint		31	36	48	48	78			
2002.08-2007.08	-	R	F	Hatchback Engine RF5C	234165	Drive Shaft	44T	31	31	65	94	555			
2002.08-2007.08	-	L	F	Hatchback Engine RF5C	234039	Drive Shaft	44T	28	30	56.6	90	643			
2002.08-2007.08	-	R	F	Hatchback Engine RF5C	299064	Drive Shaft	44T	28	28	56.6	90	587			
2002.08-2007.08	-	L	F	Hatchback Engine RF5C	234153	Drive Shaft	44T	31	30	65	94	611.5			
2002.08-2007.08	6MT	-	F	Hatchback Engine RF5C	834114	Outer Joint	44T	31	36	65	94	65	I		
2.0 DI (105 kW)															
2005.06-2007.08	-	L/R	F	Hatchback Engine RF7J	834161	Outer Joint	44T	31	36	65	94	62.5	I		
2005.06-2007.08	-	L/R	F	Saloon Engine RF7J	834161	Outer Joint	44T	31	36	65	94	62.5	I		
2005.06-2007.08	5AT	R	F	Saloon Engine RF7J	234088	Drive Shaft	44T	28	28	56.6	90	599			
2005.06-2007.08	AT	R	F	Hatchback Engine RF7J	234120	Drive Shaft	44T	31	31	65	94	556			
2005.06-2007.08	AT	R	F	Saloon Engine RF7J	234120	Drive Shaft	44T	31	31	65	94	556			
2005.06-2007.08	-	L/R	F	Hatchback Engine RF7J	899273	Outer Joint	44T	28	33	56.6	90	59	I		
2005.06-2007.08	-	L/R	F	Saloon Engine RF7J	899273	Outer Joint	44T	28	33	56.6	90	59	I		
2005.06-2007.08	5AT	-	F	Saloon Engine RF7J	834070	Outer Joint	44T	28	32	56	90	59	I		
2005.06-2007.08	-	R	F	Hatchback Engine RF7J	634040	Inner Joint		28	33	43	43	82			
2005.06-2007.08	AT	R	F	Hatchback Engine RF7J	634050	Inner Joint		31	36	48	48	78			
2005.06-2007.08	6MT	-	F	Hatchback Engine RF7J	834114	Outer Joint	44T	31	36	65	94	65	I		
2005.06-2007.08	AT	R	F	Saloon Engine RF7J	634050	Inner Joint		31	36	48	48	78			
2005.06-2007.08	6MT	-	F	Saloon Engine RF7J	834114	Outer Joint	44T	31	36	65	94	65	I		
2.0 DI (89 kW)															
2002.08-2007.08	-	L/R	F	Hatchback Engine RF5C	834161	Outer Joint	44T	31	36	65	94	62.5	I		
2002.08-2007.08	-	L/R	F	Saloon Engine RF5C	834161	Outer Joint	44T	31	36	65	94	62.5	I		
2002.08-2007.08	5AT	R	F	Hatchback Engine RF5C	234088	Drive Shaft	44T	28	28	56.6	90	599			
2002.08-2007.08	5AT	R	F	Saloon Engine RF5C	234088	Drive Shaft	44T	28	28	56.6	90	599			
2002.08-2007.08	6MT	R	F	Hatchback Engine RF5C	234120	Drive Shaft	44T	31	31	65	94	556			
2002.08-2007.08	6MT	R	F	Saloon Engine RF5C	234120	Drive Shaft	44T	31	31	65	94	556			
2002.08-2007.08	-	R	F	Hatchback Engine RF5C	634040	Inner Joint		28	33	43	43	82			
2002.08-2007.08	-	R	F	Saloon Engine RF5C	634040	Inner Joint		28	33	43	43	82			
2002.08-2007.08	-	L/R	F	Hatchback Engine RF5C	899273	Outer Joint	44T	28	33	56.6	90	59	I		
2002.08-2007.08	-	L/R	F	Saloon Engine RF5C	899273	Outer Joint	44T	28	33	56.6	90	59	I		
2002.08-2007.08	5AT	-	F	Hatchback Engine RF5C	834070	Outer Joint	44T	28	32	56	90	59	I		
2002.08-2007.08	5AT	-	F	Saloon Engine RF5C	834070	Outer Joint	44T	28	32	56	90	59	I		
2002.08-2007.08	MT	-	F	Hatchback Engine RF5C	834021	Outer Joint	44T	28	23	56	90	59	I		
2002.08-2007.08	MT	-	F	Saloon Engine RF5C	834021	Outer Joint	44T	28	23	56	90	59	I		
2002.08-2007.08	6MT	R	F	Hatchback Engine RF5C	634050	Inner Joint		31	36	48	48	78			

YEAR	TRANSM	L/R	F/R	REMARKS	GSP Ref.	PRODUCT	ABS	Technical Specifications							
								A	B	C	H	L	P		
MAZDA															
6 (GG)/ATENZA															
2.0 DI (89 kW)	2002.08-2007.08	6MT	R	F	Saloon Engine RF5C	634050	Inner Joint		31	36	48	48	78		
	2002.08-2007.08	-	R	F	Hatchback Engine RF5C	234165	Drive Shaft	44T	31	31	65	94	555		
	2002.08-2007.08	-	R	F	Saloon Engine RF5C	234165	Drive Shaft	44T	31	31	65	94	555		
	2002.08-2007.08	-	L	F	Hatchback Engine RF5C	234039	Drive Shaft	44T	28	30	56.6	90	643		
	2002.08-2007.08	-	L	F	Saloon Engine RF5C	234039	Drive Shaft	44T	28	30	56.6	90	643		
	2002.08-2007.08	-	R	F	Hatchback Engine RF5C	299064	Drive Shaft	44T	28	28	56.6	90	587		
	2002.08-2007.08	-	R	F	Saloon Engine RF5C	299064	Drive Shaft	44T	28	28	56.6	90	587		
	2002.08-2007.08	-	L	F	Hatchback Engine RF5C	234153	Drive Shaft	44T	31	30	65	94	611.5		
	2002.08-2007.08	-	L	F	Saloon Engine RF5C	234153	Drive Shaft	44T	31	30	65	94	611.5		
	2002.08-2007.08	6MT	-	F	Hatchback Engine RF5C	834114	Outer Joint	44T	31	36	65	94	65	I	
	2002.08-2007.08	6MT	-	F	Saloon Engine RF5C	834114	Outer Joint	44T	31	36	65	94	65	I	
2.3 (120 kW)	2005.03-2007.07	MT	R	F	Saloon Engine L3C1	634026	Inner Joint		28	33	43	48.2	75.8		
	2005.03-2007.07	-	R	F	Saloon Engine L3C1	634115	Inner Joint		28	33	43	48	84		
	2005.03-2007.07	AT	-	F	Saloon Engine L3C1	834070	Outer Joint	44T	28	32	56	90	59	I	
2.3 (122 kW)	2002.06-2007.08	-	R	F	Saloon Engine L3C1	634115	Inner Joint		28	33	43	48	84		
	2002.06-2007.08	MT	R	F	Saloon Engine L3C1	634026	Inner Joint		28	33	43	48.2	75.8		
	2002.06-2007.08	-	L/R	F	Saloon Engine L3C1	834110	Outer Joint	44T	28	32	62	90	57.5	I	
	2002.06-2007.08	-	L/R	F	Saloon Engine L3C1	899273	Outer Joint	44T	28	33	56.6	90	59	I	
	2002.06-2007.08	AT	-	F	Saloon Engine L3C1	834070	Outer Joint	44T	28	32	56	90	59	I	
	2002.06-2007.08	-	-	-	Saloon Engine L3C1	634048	Inner Joint		28	33	43	48	84		
	2002.08-2007.08	-	R	F	Hatchback Engine L3C1	634115	Inner Joint		28	33	43	48	84		
	2002.08-2007.08	MT	R	F	Hatchback Engine L3C1	634026	Inner Joint		28	33	43	48.2	75.8		
	2002.08-2007.08	-	L/R	F	Hatchback Engine L3C1	834110	Outer Joint	44T	28	32	62	90	57.5	I	
	2002.08-2007.08	-	L/R	F	Hatchback Engine L3C1	899273	Outer Joint	44T	28	33	56.6	90	59	I	
	2002.08-2007.08	-	-	-	Hatchback Engine L3C1	634048	Inner Joint		28	33	43	48	84		
2.3 MPS Turbo (191 kW)	2005.12-2007.08	MT	R	F	All-wheel Drive Saloon Engine L3KG	634026	Inner Joint		28	33	43	48.2	75.8		
	2005.12-2007.08	-	R	F	All-wheel Drive Saloon Engine L3KG	634115	Inner Joint		28	33	43	48	84		
	2005.12-2007.08	-	L/R	F	All-wheel Drive Saloon Engine L3KG	834161	Outer Joint	44T	31	36	65	94	62.5	I	
	2005.12-2007.08	-	L/R	F	All-wheel Drive Saloon Engine L3KG	834110	Outer Joint	44T	28	32	62	90	57.5	I	
	2005.12-2007.08	-	L/R	F	All-wheel Drive Saloon Engine L3KG	899273	Outer Joint	44T	28	33	56.6	90	59	I	
	2005.12-2007.08	-	-	-	All-wheel Drive Saloon Engine L3KG	634048	Inner Joint		28	33	43	48	84		
	2005.12-2007.08	-	R	F	All-wheel Drive Saloon Engine L3KG	634050	Inner Joint		31	36	48	48	78		
6 (GH)															
1.8 MZR (88 kW)	2007.08-2013.07	MT	-	F	Saloon Engine L813	834252	Outer Joint		28	32	62	92	57.5	I	
	2007.08-2013.07	MT	R	F	Saloon Engine L813	634050	Inner Joint		31	36	48	48	78		
	2007.08-2013.07	MT	-	F	Saloon Engine L813	834173	Outer Joint		28	33	62	90	58	M	
	2008.02-2013.07	MT	-	F	Estate Engine L813	834252	Outer Joint		28	32	62	92	57.5	I	
	2008.02-2013.07	MT	R	F	Estate Engine L813	634050	Inner Joint		31	36	48	48	78		
2.0 MZR (108 kW)	2007.08-2012.12	MT	R	F	Saloon Engine LF17	634050	Inner Joint		31	36	48	48	78		
	2007.08-2012.12	-	R	F	Saloon Engine LF17	634115	Inner Joint		28	33	43	48	84		
	2007.08-2012.12	-	-	-	Saloon Engine LF17	634048	Inner Joint		28	33	43	48	84		
	2007.12-2013.07	MT	-	F	Estate Engine LF17	834252	Outer Joint		28	32	62	92	57.5	I	
	2007.12-2013.07	MT	R	F	Estate Engine LF17	634050	Inner Joint		31	36	48	48	78		
	2007.12-2013.07	-	R	F	Estate Engine LF17	634115	Inner Joint		28	33	43	48	84		
	2007.12-2013.07	-	-	-	Estate Engine LF17	634048	Inner Joint		28	33	43	48	84		
2.0 MZR (114 kW)	2010.01-2012.12	-	R	F	Saloon Engine LF-DE	634115	Inner Joint		28	33	43	48	84		
	2010.01-2012.12	MT	R	F	Saloon Engine LF-DE	634050	Inner Joint		31	36	48	48	78		
	2010.01-2013.07	-	-	-	Estate Engine LF-DE	634048	Inner Joint		28	33	43	48	84		
	2010.01-2013.07	MT	R	F	Estate Engine LF-DE	634050	Inner Joint		31	36	48	48	78		
	2010.01-2012.12	-	-	-	Saloon Engine LF-DE	634048	Inner Joint		28	33	43	48	84		
	2010.01-2013.07	-	R	F	Estate Engine LF-DE	634115	Inner Joint		28	33	43	48	84		
2.0 MZR-CD (103 kW)	2007.08-2010.10	-	-	F	Saloon Engine RF7J	818245	Outer Joint		31	36	65	94	63	I	
	2007.12-2010.12	-	-	F	Estate Engine RF7J	818245	Outer Joint		31	36	65	94	63	I	
2.2 D (132 kW)	2010.01-2013.07	-	-	F	Saloon Engine R2AA	818245	Outer Joint		31	36	65	94	63	I	
2.2 MZR-CD (120 kW)	2008.08-2013.07	MT	-	F	Estate Engine R2AA	834252	Outer Joint		28	32	62	92	57.5	I	
	2008.08-2013.07	-	-	F	Estate Engine R2AA	818245	Outer Joint		31	36	65	94	63	I	
	2009.01-2012.12	-	-	F	Saloon Engine R2AA	818245	Outer Joint		31	36	65	94	63	I	
2.2 MZR-CD (132 kW)	2010.01-2013.07	-	-	F	Estate Engine R2AA	818245	Outer Joint		31	36	65	94	63	I	
2.2 MZR-CD (136 kW)	2008.08-2011.12	MT	-	F	Estate Engine R2AA	834252	Outer Joint		28	32	62	92	57.5	I	
	2008.08-2011.12	-	-	F	Estate Engine R2AA	818245	Outer Joint		31	36	65	94	63	I	
	2009.01-2012.12	-	-	F	Saloon Engine R2AA	818245	Outer Joint		31	36	65	94	63	I	
2.5 MZR (122 kW)	2008.01-2012.12	-	R	F	All-wheel Drive Saloon	634115	Inner Joint		28	33	43	48	84		
2.5 MZR (125 kW)	2007.08-2013.07	MT	-	F	Saloon Engine L5-VE	834252	Outer Joint		28	32	62	92	57.5	I	
	2007.08-2013.07	-	R	F	Saloon Engine L5-VE	634115	Inner Joint		28	33	43	48	84		
	2007.08-2013.07	-	-	-	Saloon Engine L5-VE	634048	Inner Joint		28	33	43	48	84		
	2008.02-2013.07	MT	-	F	Estate Engine L5-VE	834252	Outer Joint		28	32	62	92	57.5	I	



YEAR	TRANSM	L/R	F/R	REMARKS	GSP Ref.	PRODUCT	ABS	Technical Specifications									
								A	B	C	H	L	P				
MAZDA																	
6 (GH)																	
2.5 MZR (125 kW)	2008.02-	2013.07	-	R	F	Estate Engine L5-VE	634115	Inner Joint		28	33	43	48	84			
	2008.02-	2013.07	-	-	-	Estate Engine L5-VE	634048	Inner Joint		28	33	43	48	84			
6 (GH)/ATENZA																	
1.8 MZR (88 kW)	2007.08-	2013.07	MT	-	F	Hatchback Engine L813	834252	Outer Joint		28	32	62	92	57.5	I		
	2007.08-	2013.07	MT	R	F	Hatchback Engine L813	634050	Inner Joint		31	36	48	48	78			
	2007.08-	2013.07	MT	-	F	Hatchback Engine L813	834173	Outer Joint		28	33	62	90	58	M		
2.0 MZR (108 kW)	2007.08-	2013.07	MT	R	F	Hatchback Engine LF17	634050	Inner Joint		31	36	48	48	78			
	2007.08-	2013.07	-	R	F	Hatchback Engine LF17	634115	Inner Joint		28	33	43	48	84			
	2007.08-	2013.07	-	-	-	Hatchback Engine LF17	634048	Inner Joint		28	33	43	48	84			
2.0 MZR (114 kW)	2010.01-	2012.12	MT	R	F	Hatchback Engine LF-DE	634050	Inner Joint		31	36	48	48	78			
	2010.01-	2012.12	-	-	-	Hatchback Engine LF-DE	634048	Inner Joint		28	33	43	48	84			
	2010.01-	2012.12	-	R	F	Hatchback Engine LF-DE	634115	Inner Joint		28	33	43	48	84			
2.0 MZR-CD (103 kW)	2007.08-	2009.10	-	-	F	Hatchback Engine RF7J	818245	Outer Joint		31	36	65	94	63	I		
2.2 MZR-CD (120 kW)	2009.01-	2012.12	-	-	F	Hatchback Engine R2AA	818245	Outer Joint		31	36	65	94	63	I		
2.2 MZR-CD (132 kW)	2010.01-	2012.12	-	-	F	Hatchback Engine R2AA	818245	Outer Joint		31	36	65	94	63	I		
2.2 MZR-CD (136 kW)	2009.01-	2012.12	-	-	F	Hatchback Engine R2AA	818245	Outer Joint		31	36	65	94	63	I		
2.5 MZR (122 kW)	2008.01-	2012.12	-	R	F	All-wheel Drive Hatchback	634115	Inner Joint		28	33	43	48	84			
2.5 MZR (125 kW)	2007.08-	2013.03	MT	-	F	Hatchback Engine L5-VE	834252	Outer Joint		28	32	62	92	57.5	I		
	2007.08-	2013.03	-	R	F	Hatchback Engine L5-VE	634115	Inner Joint		28	33	43	48	84			
	2007.08-	2013.03	-	-	-	Hatchback Engine L5-VE	634048	Inner Joint		28	33	43	48	84			
6 (GJ GL)/ATENZA																	
2.0 (107 kW)	2013.01-	-	-	R	F	Saloon Engine PEY7	634115	Inner Joint		28	33	43	48	84			
	2013.01-	-	-	R	F	Estate Engine PEY7	634115	Inner Joint		28	33	43	48	84			
	2013.01-	-	-	-	-	Estate Engine PEY7	634048	Inner Joint		28	33	43	48	84			
	2013.01-	-	-	-	-	Saloon Engine PEY7	634048	Inner Joint		28	33	43	48	84			
2.0 (110 kW)	2012.12-	-	-	R	F	Saloon Engine PEY7	634115	Inner Joint		28	33	43	48	84			
2.0 (114 kW)	2012.12-	-	-	R	F	Saloon Engine PEY5	634115	Inner Joint		28	33	43	48	84			
	2012.12-	-	-	R	F	Estate Engine PEY7	634115	Inner Joint		28	33	43	48	84			
	2014.07-	-	-	R	F	Saloon Engine PE-VPR	634115	Inner Joint		28	33	43	48	84			
	2014.07-	-	-	R	F	Estate Engine PE-VPR	634115	Inner Joint		28	33	43	48	84			
2.0 (121 kW)	2013.01-	-	-	R	F	Saloon Engine PEY7	634115	Inner Joint		28	33	43	48	84			
	2013.01-	-	-	R	F	Estate Engine PEY7	634115	Inner Joint		28	33	43	48	84			
	2013.01-	-	-	-	-	Estate Engine PEY7	634048	Inner Joint		28	33	43	48	84			
	2013.01-	-	-	-	-	Saloon Engine PEY7	634048	Inner Joint		28	33	43	48	84			
2.5 (138 kW)	2012.12-	-	-	R	F	Saloon Engine PYY1	634115	Inner Joint		28	33	43	48	84			
	2012.12-	-	-	R	F	Estate Engine PYY1	634115	Inner Joint		28	33	43	48	84			
2.5 (141 kW)	2012.12-	-	-	R	F	Estate Engine PYY1	634115	Inner Joint		28	33	43	48	84			
	2012.12-	-	-	-	-	Estate Engine PYY1	634048	Inner Joint		28	33	43	48	84			
	2013.01-	-	-	R	F	Saloon Engine PYY1	634115	Inner Joint		28	33	43	48	84			
	2013.01-	-	-	-	-	Saloon Engine PYY1	634048	Inner Joint		28	33	43	48	84			
6 (GY)																	
2.0	2002.08-	-	MT/AT	-	-	-	834147	Outer Joint	44T	28	33	56.5	90	58.5	M		
6 Station Wagon (GY)/ATENZA																	
1.8 (88 kW)	2002.08-	2007.08	MT	L/R	F	Estate Engine L813	834135	Outer Joint	44T	28	23	56	90	57.5	I		
	2002.08-	2007.08	MT	-	F	Estate Engine L813	834084	Outer Joint	44T	28	32	62	90	58	I		
	2002.08-	2007.08	MT	L	F	Estate Engine L813	234137	Drive Shaft	44T	28	28	56.6	90	648			
	2002.08-	2007.08	MT	R	F	Estate Engine L813	234088	Drive Shaft	44T	28	28	56.6	90	599			
	2002.08-	2007.08	-	L/R	F	Estate Engine L813	834110	Outer Joint	44T	28	32	62	90	57.5	I		
	2002.08-	2007.08	-	R	F	Estate Engine L813	899273	Outer Joint	44T	28	33	56.6	90	59	I		
	2002.08-	2007.08	-	-	F	Estate Engine L813	834070	Outer Joint	44T	28	32	56	90	59	I		
	2002.08-	2007.08	MT	-	F	Estate Engine L813	834021	Outer Joint	44T	28	23	56	90	59	I		
2.0 (104 kW)	2002.08-	2007.08	MT	L	F	Estate Engine LF17/LF18	834135	Outer Joint	44T	28	23	56	90	57.5	I		
	2002.08-	2007.08	-	-	-	Estate Engine LF17/LF18	634092	Inner Joint		30	33	40	73	114			
	2002.08-	2007.08	-	R	F	Estate Engine LF17/LF18	634115	Inner Joint		28	33	43	48	84			
	2002.08-	2007.08	MT	-	F	Estate Engine LF17/LF18	834084	Outer Joint	44T	28	32	62	90	58	I		
	2002.08-	2007.08	MT	L	F	Estate Engine LF17/LF18	234137	Drive Shaft	44T	28	28	56.6	90	648			
	2002.08-	2007.08	AT	L	F	Estate Engine LF17/LF18	218325	Drive Shaft		31	31	65	94	567			
	2002.08-	2007.08	MT	R	F	Estate Engine LF17/LF18	234088	Drive Shaft	44T	28	28	56.6	90	599			
	2002.08-	2007.08	-	L/R	F	Estate Engine LF17/LF18	834110	Outer Joint	44T	28	32	62	90	57.5	I		
	2002.08-	2007.08	MT	R	F	Estate Engine LF17/LF18	899273	Outer Joint	44T	28	33	56.6	90	59	I		
	2002.08-	2007.08	-	-	F	Estate Engine LF17/LF18	834070	Outer Joint	44T	28	32	56	90	59	I		
	2002.08-	2007.08	MT	-	F	Estate Engine LF17/LF18	834021	Outer Joint	44T	28	23	56	90	59	I		
	2002.08-	2007.08	-	-	-	Estate Engine LF17/LF18	634048	Inner Joint		28	33	43	48	84			
2.0 (108 kW)	2005.03-	2007.08	-	-	-	Estate Engine LFF7	634092	Inner Joint		30	33	40	73	114			
	2005.03-	2007.08	MT	L/R	F	Estate Engine LFF7	834135	Outer Joint	44T	28	23	56	90	57.5	I		
	2005.03-	2007.08	-	R	F	Estate Engine LFF7	634115	Inner Joint		28	33	43	48	84			





YEAR	TRANSM	L/R	F/R	REMARKS	GSP Ref.	PRODUCT	ABS	Technical Specifications									
								A	B	C	H	L	P				
MAZDA																	
6 Station Wagon (GY)/ATENZA																	
2.0 (108 kW)	2005.03-2007.08	MT	L	F	Estate Engine LFF7	234137	Drive Shaft	44T	28	28	56.6	90	648				
	2005.03-2007.08	MT	R	F	Estate Engine LFF7	234088	Drive Shaft	44T	28	28	56.6	90	599				
	2005.03-2007.08	-	L/R	F	Estate Engine LFF7	834110	Outer Joint	44T	28	32	62	90	57.5	I			
	2005.03-2007.08	-	-	F	Estate Engine LFF7	834070	Outer Joint	44T	28	32	56	90	59	I			
	2005.03-2007.08	-	-	-	Estate Engine LFF7	634048	Inner Joint		28	33	43	48	84				
2.0 DI (100 kW)	2002.08-2007.08	-	L/R	F	Estate Engine RF5C	834161	Outer Joint	44T	31	36	65	94	62.5	I			
	2002.08-2007.08	5AT	R	F	Estate Engine RF5C	234088	Drive Shaft	44T	28	28	56.6	90	599				
	2002.08-2007.08	6MT	R	F	Estate Engine RF5C	234120	Drive Shaft	44T	31	31	65	94	556				
	2002.08-2007.08	-	R	F	Estate Engine RF5C	634040	Inner Joint		28	33	43	43	82				
	2002.08-2007.08	-	L/R	F	Estate Engine RF5C	899273	Outer Joint	44T	28	33	56.6	90	59	I			
	2002.08-2007.08	5AT	-	F	Estate Engine RF5C	834070	Outer Joint	44T	28	32	56	90	59	I			
	2002.08-2007.08	MT	-	F	Estate Engine RF5C	834021	Outer Joint	44T	28	23	56	90	59	I			
	2002.08-2007.08	6MT	R	F	Estate Engine RF5C	634050	Inner Joint		31	36	48	48	78				
	2002.08-2007.08	6MT	-	F	Estate Engine RF5C	834114	Outer Joint	44T	31	36	65	94	65	I			
2.0 DI (105 kW)	2005.06-2007.08	-	L/R	F	Estate Engine RF7J	834161	Outer Joint	44T	31	36	65	94	62.5	I			
	2005.06-2007.08	5AT	R	F	Estate Engine RF7J	234088	Drive Shaft	44T	28	28	56.6	90	599				
	2005.06-2007.08	6MT	R	F	Estate Engine RF7J	234120	Drive Shaft	44T	31	31	65	94	556				
	2005.06-2007.08	5AT	-	F	Estate Engine RF7J	834070	Outer Joint	44T	28	32	56	90	59	I			
	2005.06-2007.08	6MT	R	F	Estate Engine RF7J	634050	Inner Joint		31	36	48	48	78				
	2005.06-2007.08	6MT	-	F	Estate Engine RF7J	834114	Outer Joint	44T	31	36	65	94	65	I			
2.0 DI (89 kW)	2002.08-2007.08	-	L/R	F	Estate Engine RF5C	834161	Outer Joint	44T	31	36	65	94	62.5	I			
	2002.08-2007.08	5AT	R	F	Estate Engine RF5C	234088	Drive Shaft	44T	28	28	56.6	90	599				
	2002.08-2007.08	6MT	R	F	Estate Engine RF5C	234120	Drive Shaft	44T	31	31	65	94	556				
	2002.08-2007.08	-	L/R	F	Estate Engine RF5C	899273	Outer Joint	44T	28	33	56.6	90	59	I			
	2002.08-2007.08	-	R	F	Estate Engine RF5C	634040	Inner Joint		28	33	43	43	82				
	2002.08-2007.08	5AT	-	F	Estate Engine RF5C	834070	Outer Joint	44T	28	32	56	90	59	I			
	2002.08-2007.08	MT	-	F	Estate Engine RF5C	834021	Outer Joint	44T	28	23	56	90	59	I			
	2002.08-2007.08	6MT	R	F	Estate Engine RF5C	634050	Inner Joint		31	36	48	48	78				
	2002.08-2007.08	-	R	F	Estate Engine RF5C	234165	Drive Shaft	44T	31	31	65	94	555				
	2002.08-2007.08	-	L	F	Estate Engine RF5C	234039	Drive Shaft	44T	28	30	56.6	90	643				
	2002.08-2007.08	-	R	F	Estate Engine RF5C	299064	Drive Shaft	44T	28	28	56.6	90	587				
	2002.08-2007.08	-	L	F	Estate Engine RF5C	234153	Drive Shaft	44T	31	30	65	94	611.5				
	2002.08-2007.08	6MT	-	F	Estate Engine RF5C	834114	Outer Joint	44T	31	36	65	94	65	I			
2.3 (122 kW)	2002.08-2007.08	-	-	F	Estate Engine L3C1	818218	Outer Joint	44T	31	36	65	94	62.5	I			
	2002.08-2007.08	-	-	-	Estate Engine L3C1	634092	Inner Joint		30	33	40	73	114				
	2002.08-2007.08	-	R	F	Estate Engine L3C1	634115	Inner Joint		28	33	43	48	84				
	2002.08-2007.08	MT	R	F	Estate Engine L3C1	634026	Inner Joint		28	33	43	48.2	75.8				
	2002.08-2007.08	-	L/R	F	Estate Engine L3C1	834110	Outer Joint	44T	28	32	62	90	57.5	I			
	2002.08-2007.08	-	L/R	F	Estate Engine L3C1	899273	Outer Joint	44T	28	33	56.6	90	59	I			
	2002.08-2007.08	AT	-	F	Estate Engine L3C1	834070	Outer Joint	44T	28	32	56	90	59	I			
	2002.08-2007.08	-	-	-	Estate Engine L3C1	634048	Inner Joint		28	33	43	48	84				
2.3 AWD (119 kW)	2002.11-2007.08	-	-	F	All-wheel Drive Estate Engine L3C1	818218	Outer Joint	44T	31	36	65	94	62.5	I			
	2002.11-2007.08	-	-	-	All-wheel Drive Estate Engine L3C1	634092	Inner Joint		30	33	40	73	114				
	2002.11-2007.08	MT	R	F	All-wheel Drive Estate Engine L3C1	634026	Inner Joint		28	33	43	48.2	75.8				
	2002.11-2007.08	-	R	F	All-wheel Drive Estate Engine L3C1	634115	Inner Joint		28	33	43	48	84				
	2002.11-2007.08	-	L/R	F	All-wheel Drive Estate Engine L3C1	834110	Outer Joint	44T	28	32	62	90	57.5	I			
	2002.11-2007.08	-	L/R	F	All-wheel Drive Estate Engine L3C1	899273	Outer Joint	44T	28	33	56.6	90	59	I			
	2002.11-2007.08	AT	-	-	All-wheel Drive Estate Engine L3C1	834070	Outer Joint	44T	28	32	56	90	59	I			
	2002.11-2007.08	-	-	-	All-wheel Drive Estate Engine L3C1	634048	Inner Joint		28	33	43	48	84				
626																	
-	1987-1991	-	-	-	GD6P GD8S	834050	Outer Joint		26	23	56	93.5	56.5	M			
	1991-1997	-	-	-	-	834029	Outer Joint		28	23	56	89	60.5	M			
	1998-2001	-	-	-	-	634013	Inner Joint		28	23	43	42	76.5				
	1998-2001	AT	-	-	-	699113	Inner Joint		26	23	35	67	95				
	1998-2000	AT	-	-	-	234001	Drive Shaft		28		56	90	516.8				
	1998-2000	AT	-	-	-	834038	Outer Joint		28	23	56	90	59	M			
1.8	-	-	-	-	-	634003	Inner Joint		26	23	43	37.8	75.5				
	-	-	-	-	-	834045	Outer Joint		26	25	56	93.5	56.5	O			
	1988-	-	-	-	-	834054	Outer Joint		26	30	56	93	55	M			
1.8 Male	1984-1992	-	-	-	-	634004	Inner Joint		26	23	35	66.7	99.5				
2.0	1984-1992	-	-	-	-	634002	Inner Joint		26	25	42.3	37.8	76.5				
	1984-1992	-	-	-	-	618005	Inner Joint		26	25	35	66.5	103.4				
	1988-1992	-	-	-	-	899052	Outer Joint		26	25	56	93	61	O			
	1993-1996	AT	-	-	-	818045	Outer Joint		28	32	56	91.5	65	I			
	1993-1997	MT	-	-	-	834036	Outer Joint		28	32	56	90	59	I			
2.5	1993-1996	AT	-	-	-	818045	Outer Joint		28	32	56	91.5	65	I			

	 YEAR	TRANSM	L/R	F/R	REMARKS	GSP Ref.	 PRODUCT	 ABS	Technical Specifications						
									A	B	C	H	L	P	
MAZDA															
626															
2.5	1993-	1997	MT	-	-	-	834036	Outer Joint		28	32	56	90	59	I
626 CRONOS															
-	1994-	2001	AT	-	-	6 Cyl (Incl. 4WD Model)	618015	Inner Joint		28	23	43	42	76.5	
-	1994-	2001	MT	-	-	4 Cyl (Incl. 4WD Model)	618015	Inner Joint		28	23	43	42	76.5	
626 III (GD)															
1.6 (60 kW)															
	1987.06-	1992.05	-	-	-	Saloon Engine F6/F659	815002	Outer Joint		26	23	56	93	56.5	M
	1987.06-	1992.05	-	-	-	Coupe	815002	Outer Joint		26	23	56	93	56.5	M
	1987.06-	1992.05	-	-	-	Hatchback Engine F6/F659	815002	Outer Joint		26	23	56	93	56.5	M
	1987.06-	1992.05	AT/MT	L/R	F	Hatchback Engine F6/F659	834074	Outer Joint	90T	26	25	56	93	61	M
	1987.06-	1992.05	AT/MT	L/R	F	Saloon Engine F6/F659	834074	Outer Joint	90T	26	25	56	93	61	M
	1987.06-	1992.05	AT/MT	L/R	F	Coupe	834074	Outer Joint	90T	26	25	56	93	61	M
	1987.06-	1992.05	AT	-	-	Hatchback Engine F6/F659	834004	Outer Joint		26	23	56	93.5	56.5	M
	1987.06-	1992.05	AT	-	-	Saloon Engine F6/F659	834004	Outer Joint		26	23	56	93.5	56.5	M
	1987.06-	1992.05	AT	-	-	Coupe	834004	Outer Joint		26	23	56	93.5	56.5	M
1.8 (65 kW)															
	1987.09-	1991.08	AT/MT	L/R	F	Coupe Engine F8 (12V)	834074	Outer Joint	90T	26	25	56	93	61	M
	1987.09-	1991.08	AT	-	-	Coupe Engine F8 (12V)	834004	Outer Joint		26	23	56	93.5	56.5	M
	1987.11-	1992.05	-	-	-	Saloon Engine F8 (12V)	899251	Outer Joint		26	23	56	92	56	M
	1987.11-	1992.05	-	-	-	Hatchback Engine F8 (12V)	899251	Outer Joint		26	23	56	92	56	M
	1987.11-	1992.05	-	-	-	Saloon Engine F8 (12V)	815002	Outer Joint		26	23	56	93	56.5	M
	1987.11-	1992.05	-	-	-	Hatchback Engine F8 (12V)	815002	Outer Joint		26	23	56	93	56.5	M
	1987.11-	1992.05	AT/MT	L/R	F	Saloon Engine F8 (12V)	834074	Outer Joint	90T	26	25	56	93	61	M
	1987.11-	1992.05	AT/MT	L/R	F	Hatchback Engine F8 (12V)	834074	Outer Joint	90T	26	25	56	93	61	M
	1987.11-	1992.05	AT	-	-	Saloon Engine F8 (12V)	834004	Outer Joint		26	23	56	93.5	56.5	M
	1987.11-	1992.05	AT	-	-	Hatchback Engine F8 (12V)	834004	Outer Joint		26	23	56	93.5	56.5	M
1.8 (69 kW)															
	1987.11-	1992.05	AT/MT	L/R	F	Hatchback Engine F8 (12V)	834074	Outer Joint	90T	26	25	56	93	61	M
	1987.11-	1992.05	AT	-	-	Hatchback Engine F8 (12V)	834004	Outer Joint		26	23	56	93.5	56.5	M
2.0 (66 kW)															
	1987.09-	1990.10	MT	-	-	Hatchback Engine FE (8V)	834082	Outer Joint	44T	28	26	56	94	63	M
	1987.09-	1990.10	MT	-	-	Coupe Engine FE (8V)	834082	Outer Joint	44T	28	26	56	94	63	M
	1987.09-	1990.10	MT	L/R	F	Saloon Engine FE (12V)	818031	Outer Joint		26	25	56	93	61	M
	1987.09-	1990.10	MT	L/R	F	Hatchback Engine FE (8V)	818031	Outer Joint		26	25	56	93	61	M
	1987.09-	1990.10	MT	L/R	F	Coupe Engine FE (8V)	818031	Outer Joint		26	25	56	93	61	M
	1987.09-	1990.10	AT	L/R	F	Saloon Engine FE (12V)	818028	Outer Joint		28	26	56	89	65	I
	1987.09-	1990.10	AT	L/R	F	Hatchback Engine FE (8V)	818028	Outer Joint		28	26	56	89	65	I
	1987.09-	1990.10	AT	L/R	F	Coupe Engine FE (8V)	818028	Outer Joint		28	26	56	89	65	I
	1987.09-	1990.10	-	-	-	Saloon Engine FE (12V)	815002	Outer Joint		26	23	56	93	56.5	M
	1987.09-	1990.10	-	-	-	Coupe Engine FE (8V)	815002	Outer Joint		26	23	56	93	56.5	M
	1987.09-	1990.10	MT	L/R	F	Saloon Engine FE (12V)	834074	Outer Joint	90T	26	25	56	93	61	M
	1987.09-	1990.10	-	-	-	Hatchback Engine FE (8V)	815002	Outer Joint		26	23	56	93	56.5	M
	1987.09-	1990.10	MT	L/R	F	Hatchback Engine FE (8V)	834074	Outer Joint	90T	26	25	56	93	61	M
	1987.09-	1990.10	MT	L/R	F	Coupe Engine FE (8V)	834074	Outer Joint	90T	26	25	56	93	61	M
	1987.09-	1990.10	-	-	F	Saloon Engine FE (12V)	834011	Outer Joint		26	25	56	95	61	M
	1987.09-	1990.10	-	-	F	Coupe Engine FE (8V)	834011	Outer Joint		26	25	56	95	61	M
	1987.09-	1990.10	-	-	F	Hatchback Engine FE (8V)	834011	Outer Joint		26	25	56	95	61	M
2.0 12V (79 kW)															
	1987.09-	1992.05	MT	-	-	Saloon Engine FE (12V)	834082	Outer Joint	44T	28	26	56	94	63	M
	1987.09-	1992.05	AT	L/R	F	Saloon Engine FE (12V)	818031	Outer Joint		26	25	56	93	61	M
	1987.09-	1992.05	MT	L/R	F	Saloon Engine FE (12V)	818028	Outer Joint		28	26	56	89	65	I
	1987.09-	1992.05	-	-	-	Saloon Engine FE (12V)	815002	Outer Joint		26	23	56	93	56.5	M
	1987.09-	1992.05	AT	L/R	F	Saloon Engine FE (12V)	834074	Outer Joint	90T	26	25	56	93	61	M
	1987.09-	1992.05	-	-	F	Saloon Engine FE (12V)	834011	Outer Joint		26	25	56	95	61	M
	1987.11-	1992.05	MT	-	-	Hatchback Engine FE (12V)	834082	Outer Joint	44T	28	26	56	94	63	M
	1987.11-	1992.05	AT	L/R	F	Hatchback Engine FE (12V)	818031	Outer Joint		26	25	56	93	61	M
	1987.11-	1992.05	MT	L/R	F	Hatchback Engine FE (12V)	818028	Outer Joint		28	26	56	89	65	I
	1987.11-	1992.05	-	-	-	Hatchback Engine FE (12V)	815002	Outer Joint		26	23	56	93	56.5	M
	1987.11-	1992.05	AT	L/R	F	Hatchback Engine FE (12V)	834074	Outer Joint	90T	26	25	56	93	61	M
	1987.11-	1992.05	-	-	F	Hatchback Engine FE (12V)	834011	Outer Joint		26	25	56	95	61	M
2.0 16V (103 kW)															
	1987.11-	1990.10	MT	-	-	Hatchback Engine FE (16V)	834082	Outer Joint	44T	28	26	56	94	63	M
	1987.11-	1992.05	MT	-	-	Saloon Engine FE (16V)	834082	Outer Joint	44T	28	26	56	94	63	M
	1987.11-	1990.10	AT	L/R	F	Hatchback Engine FE (16V)	818031	Outer Joint		26	25	56	93	61	M
	1987.11-	1992.05	AT	L/R	F	Saloon Engine FE (16V)	818031	Outer Joint		26	25	56	93	61	M
	1987.11-	1990.10	MT	L/R	F	Hatchback Engine FE (16V)	818028	Outer Joint		28	26	56	89	65	I
	1987.11-	1992.05	MT	L/R	F	Saloon Engine FE (16V)	818028	Outer Joint		28	26	56	89	65	I
	1987.11-	1992.05	-	-	-	Saloon Engine FE (16V)	815002	Outer Joint		26	23	56	93	56.5	M
	1987.11-	1990.10	AT	L/R	F	Hatchback Engine FE (16V)	834074	Outer Joint	90T	26	25	56	93	61	M
	1987.11-	1990.10	-	-	-	Hatchback Engine FE (16V)	815002	Outer Joint		26	23	56	93	56.5	M
	1987.11-	1992.05	AT	L/R	F	Saloon Engine FE (16V)	834074	Outer Joint	90T	26	25	56	93	61	M
	1987.11-	1992.05	-	-	F	Saloon Engine FE (16V)	834011	Outer Joint		26	25	56	95	61	M





	YEAR	TRANSM	L/R	F/R	REMARKS	GSP Ref.	PRODUCT	ABS	Technical Specifications						
									A	B	C	H	L	P	
MAZDA															
626 III (GD)															
2.0 16V (103 kW)	1987.11-1990.10	-	-	F	Hatchback Engine FE (16V)	834011	Outer Joint		26	25	56	95	61	M	
	1987.12-1990.10	MT	-	-	Coupe Engine FE (16V)	834082	Outer Joint	44T	28	26	56	94	63	M	
	1987.12-1990.10	AT	L/R	F	Coupe Engine FE (16V)	818031	Outer Joint		26	25	56	93	61	M	
	1987.12-1990.10	MT	L/R	F	Coupe Engine FE (16V)	818028	Outer Joint		28	26	56	89	65	I	
	1987.12-1990.10	-	-	-	Coupe Engine FE (16V)	815002	Outer Joint		26	23	56	93	56.5	M	
	1987.12-1990.10	AT	L/R	F	Coupe Engine FE (16V)	834074	Outer Joint	90T	26	25	56	93	61	M	
	1987.12-1990.10	-	-	F	Coupe Engine FE (16V)	834011	Outer Joint		26	25	56	95	61	M	
2.0 16V (109 kW)	1987.06-1989.08	AT	L/R	F	Hatchback Engine FE (16V)	818031	Outer Joint		26	25	56	93	61	M	
	1987.06-1989.09	AT	L/R	F	Coupe Engine FE (16V)	818031	Outer Joint		26	25	56	93	61	M	
	1987.06-1989.08	MT	L/R	F	Hatchback Engine FE (16V)	818028	Outer Joint		28	26	56	89	65	I	
	1987.06-1989.09	MT	L/R	F	Coupe Engine FE (16V)	818028	Outer Joint		28	26	56	89	65	I	
	1987.06-1989.08	AT	L/R	F	Hatchback Engine FE (16V)	834074	Outer Joint	90T	26	25	56	93	61	M	
	1987.06-1989.09	AT	L/R	F	Coupe Engine FE (16V)	834074	Outer Joint	90T	26	25	56	93	61	M	
	1987.06-1989.08	MT	-	-	Hatchback Engine FE (16V)	834082	Outer Joint	44T	28	26	56	94	63	M	
	1987.06-1989.09	MT	-	-	Coupe Engine FE (16V)	834082	Outer Joint	44T	28	26	56	94	63	M	
	1987.06-1989.09	-	-	F	Coupe Engine FE (16V)	834011	Outer Joint		26	25	56	95	61	M	
	1987.06-1989.08	-	-	F	Hatchback Engine FE (16V)	834011	Outer Joint		26	25	56	95	61	M	
	1987.07-1989.09	AT	L/R	F	Saloon Engine FE (16V)	818031	Outer Joint		26	25	56	93	61	M	
	1987.07-1989.09	MT	L/R	F	Saloon Engine FE (16V)	818028	Outer Joint		28	26	56	89	65	I	
	1987.07-1989.09	AT	L/R	F	Saloon Engine FE (16V)	834074	Outer Joint	90T	26	25	56	93	61	M	
	1987.07-1989.09	MT	-	-	Saloon Engine FE (16V)	834082	Outer Joint	44T	28	26	56	94	63	M	
	1987.07-1989.09	-	-	F	Saloon Engine FE (16V)	834011	Outer Joint		26	25	56	95	61	M	
2.0 D (44 kW)	1987.07-1991.07	MT	-	-	Saloon Engine RF-N	834082	Outer Joint	44T	28	26	56	94	63	M	
	1987.07-1991.07	MT	-	-	Hatchback Engine RF-N	834082	Outer Joint	44T	28	26	56	94	63	M	
	1987.07-1991.07	AT	L/R	F	Saloon Engine RF-N	818031	Outer Joint		26	25	56	93	61	M	
	1987.07-1991.07	AT	L/R	F	Hatchback Engine RF-N	818031	Outer Joint		26	25	56	93	61	M	
	1987.07-1991.07	MT	L/R	F	Saloon Engine RF-N	818028	Outer Joint		28	26	56	89	65	I	
	1987.07-1991.07	MT	L/R	F	Hatchback Engine RF-N	818028	Outer Joint		28	26	56	89	65	I	
	1987.07-1991.07	-	-	-	Saloon Engine RF-N	899251	Outer Joint		26	23	56	92	56	M	
	1987.07-1991.07	-	-	-	Hatchback Engine RF-N	899251	Outer Joint		26	23	56	92	56	M	
	1987.07-1991.07	-	-	-	Saloon Engine RF-N	815002	Outer Joint		26	23	56	93	56.5	M	
	1987.07-1991.07	AT	L/R	F	Saloon Engine RF-N	834074	Outer Joint	90T	26	25	56	93	61	M	
	1987.07-1991.07	-	-	-	Hatchback Engine RF-N	815002	Outer Joint		26	23	56	93	56.5	M	
	1987.07-1991.07	AT	L/R	F	Hatchback Engine RF-N	834074	Outer Joint	90T	26	25	56	93	61	M	
	1987.07-1991.07	-	-	F	Saloon Engine RF-N	834011	Outer Joint		26	25	56	95	61	M	
	1987.07-1991.07	-	-	F	Hatchback Engine RF-N	834011	Outer Joint		26	25	56	95	61	M	
2.2 12V (85 kW)	1987.11-1990.07	MT	-	-	All-wheel Drive Hatchback Engine F2	834082	Outer Joint	44T	28	26	56	94	63	M	
	1987.11-1991.07	MT	-	-	Saloon Engine F2	834082	Outer Joint	44T	28	26	56	94	63	M	
	1987.11-1991.07	MT	L/R	F	Saloon Engine F2	818028	Outer Joint		28	26	56	89	65	I	
	1987.11-1991.07	AT	L/R	F	Saloon Engine F2	834074	Outer Joint	90T	26	25	56	93	61	M	
	1987.11-1991.07	-	-	F	Saloon Engine F2	834011	Outer Joint		26	25	56	95	61	M	
	1987.11-1990.07	-	-	F	All-wheel Drive Hatchback Engine F2	834011	Outer Joint		26	25	56	95	61	M	
	1988.04-1991.12	MT	-	-	Coupe Engine F2	834082	Outer Joint	44T	28	26	56	94	63	M	
	1988.04-1991.12	MT	L/R	F	Coupe Engine F2	818028	Outer Joint		28	26	56	89	65	I	
	1988.04-1991.12	AT	L/R	F	Coupe Engine F2	834074	Outer Joint	90T	26	25	56	93	61	M	
	1988.04-1991.12	-	-	F	Coupe Engine F2	834011	Outer Joint		26	25	56	95	61	M	
	1988.06-1992.04	MT	-	-	Hatchback Engine F2	834082	Outer Joint	44T	28	26	56	94	63	M	
	1988.06-1992.04	MT	L/R	F	Hatchback Engine F2	818028	Outer Joint		28	26	56	89	65	I	
	1988.06-1992.04	AT	L/R	F	Hatchback Engine F2	834074	Outer Joint	90T	26	25	56	93	61	M	
	1988.06-1992.04	-	-	F	Hatchback Engine F2	834011	Outer Joint		26	25	56	95	61	M	
	1990.01-1992.05	MT	-	-	All-wheel Drive Saloon Engine F2	834082	Outer Joint	44T	28	26	56	94	63	M	
626 III Station Wagon (GV)															
1.8 (65 kW)	1988.01-1992.03	AT	-	-	Estate Engine F8 (12V)	834004	Outer Joint		26	23	56	93.5	56.5	M	
2.0 (66 kW)	1988.10-1997.09	MT	-	-	Estate Engine FE (8V)	834082	Outer Joint	44T	28	26	56	94	63	M	
	1988.10-1997.09	AT	L/R	F	Estate Engine FE (8V)	818031	Outer Joint		26	25	56	93	61	M	
	1988.10-1997.09	MT	L/R	F	Estate Engine FE (8V)	818028	Outer Joint		28	26	56	89	65	I	
	1988.10-1997.09	-	-	-	Estate Engine FE (8V)	815002	Outer Joint		26	23	56	93	56.5	M	
	1988.10-1997.09	AT	L/R	F	Estate Engine FE (8V)	834074	Outer Joint	90T	26	25	56	93	61	M	
	1988.10-1997.09	-	-	F	Estate Engine FE (8V)	834011	Outer Joint		26	25	56	95	61	M	
2.0 12V (81 kW)	1987.09-1990.01	MT	-	-	Estate Engine FE (12V)	834082	Outer Joint	44T	28	26	56	94	63	M	
	1987.09-1990.01	AT	L/R	F	Estate Engine FE (12V)	818031	Outer Joint		26	25	56	93	61	M	
	1987.09-1990.01	MT	L/R	F	Estate Engine FE (12V)	818028	Outer Joint		28	26	56	89	65	I	
	1987.09-1990.01	AT	L/R	F	Estate Engine FE (12V)	834074	Outer Joint	90T	26	25	56	93	61	M	
	1987.09-1990.01	-	-	F	Estate Engine FE (12V)	834011	Outer Joint		26	25	56	95	61	M	
2.0 16V (103 kW)	1988.01-1992.03	MT	-	-	Estate Engine FE (16V)	834082	Outer Joint	44T	28	26	56	94	63	M	
	1988.01-1992.03	AT	L/R	F	Estate Engine FE (16V)	818031	Outer Joint		26	25	56	93	61	M	

YEAR	TRANSM	L/R	F/R	REMARKS	GSP Ref.	PRODUCT	ABS	Technical Specifications										
								A	B	C	H	L	P					
MAZDA																		
626 III Station Wagon (GV)																		
2.0 16V (103 kW)	1988.01-1992.03	MT	L/R	F	Estate Engine FE (16V)	818028	Outer Joint		28	26	56	89	65	I				
	1988.01-1992.03	-	-	-	Estate Engine FE (16V)	815002	Outer Joint		26	23	56	93	56.5	M				
	1988.01-1992.03	AT	L/R	F	Estate Engine FE (16V)	834074	Outer Joint	90T	26	25	56	93	61	M				
	1988.01-1992.03	-	-	F	Estate Engine FE (16V)	834011	Outer Joint		26	25	56	95	61	M				
2.0 D (44 kW)	1988.09-1991.07	MT	-	-	Estate Engine RF-N	834082	Outer Joint	44T	28	26	56	94	63	M				
	1988.09-1991.07	MT	L/R	F	Estate Engine RF-N	818031	Outer Joint		26	25	56	93	61	M				
	1988.09-1991.07	-	-	-	Estate Engine RF-N	899251	Outer Joint		26	23	56	92	56	M				
	1988.09-1991.07	-	-	-	Estate Engine RF-N	815002	Outer Joint		26	23	56	93	56.5	M				
	1988.09-1991.07	MT	L/R	F	Estate Engine RF-N	834074	Outer Joint	90T	26	25	56	93	61	M				
	1988.09-1991.07	-	-	F	Estate Engine RF-N	834011	Outer Joint		26	25	56	95	61	M				
2.0 D (60 kW)	1994.11-1997.09	AT	L/R	F	Estate Engine RFG5	834081	Outer Joint		26	30	56	93	56.5	M				
	1994.11-1997.09	-	-	-	Estate Engine RFG5	899251	Outer Joint		26	23	56	92	56	M				
2.0 D Comprex (55 kW)	1993.05-1996.11	-	-	-	Estate Engine RF-CX	899251	Outer Joint		26	23	56	92	56	M				
2.0 i 16V (110 kW)	1994.11-1997.09	AT	L/R	F	Estate Engine FECM	818031	Outer Joint		26	25	56	93	61	M				
	1994.11-1997.09	MT	L/R	F	Estate Engine FECM	818028	Outer Joint		28	26	56	89	65	I				
	1994.11-1997.09	-	-	-	Estate Engine FECM	815002	Outer Joint		26	23	56	93	56.5	M				
	1994.11-1997.09	AT	L/R	F	Estate Engine FECM	834074	Outer Joint	90T	26	25	56	93	61	M				
	1994.11-1997.09	-	-	F	Estate Engine FECM	834011	Outer Joint		26	25	56	95	61	M				
2.2 12V (85 kW)	1989.03-1996.11	MT	-	-	Estate Engine F2	834082	Outer Joint	44T	28	26	56	94	63	M				
	1989.03-1996.11	AT	L/R	F	Estate Engine F2	818031	Outer Joint		26	25	56	93	61	M				
	1989.03-1996.11	MT	L/R	F	Estate Engine F2	818028	Outer Joint		28	26	56	89	65	I				
	1989.03-1996.11	AT	L/R	F	Estate Engine F2	834074	Outer Joint	90T	26	25	56	93	61	M				
	1989.03-1996.11	-	-	F	Estate Engine F2	834011	Outer Joint		26	25	56	95	61	M				
	1991.05-1992.11	MT	-	-	All-wheel Drive Estate Engine F2/F2L1	834082	Outer Joint	44T	28	26	56	94	63	M				
	1991.05-1992.11	MT	L/R	F	All-wheel Drive Estate Engine F2/F2L1	818028	Outer Joint		28	26	56	89	65	I				
	1991.05-1992.11	AT	L/R	F	All-wheel Drive Estate Engine F2/F2L1	834074	Outer Joint	90T	26	25	56	93	61	M				
	1991.05-1992.11	-	-	F	All-wheel Drive Estate Engine F2/F2L1	834011	Outer Joint		26	25	56	95	61	M				
626 IV (GE)/AUTOZAM CLEF																		
1.8 (66 kW)	1994.08-1997.04	AT/MT	L/R	F	Hatchback Engine FP01LP	818035	Outer Joint		28	23	56	90	59	I				
	1994.08-1997.04	AT/MT	L/R	F	Hatchback Engine FP01LP	834080	Outer Joint	44T	28	23	56	90	59	M				
	1994.08-1997.04	-	-	F	Hatchback Engine FP01LP	834014	Outer Joint		28	23	56	89.1	59.5	M				
1.8 (77 kW)	1991.08-1997.04	MT	L	F	Hatchback Engine FP	250269	Drive Shaft		27	37.1	56.5	91.5	595					
	1991.08-1997.04	AT/MT	L/R	F	Hatchback Engine FP	818035	Outer Joint		28	23	56	90	59	I				
	1991.08-1997.04	MT	L	F	Hatchback Engine FP	250269	Drive Shaft		27	37.1	56.5	91.5	595					
	1991.08-1997.04	AT/MT	L/R	F	Hatchback Engine FP	834080	Outer Joint	44T	28	23	56	90	59	M				
	1991.08-1997.04	-	-	F	Hatchback Engine FP	834014	Outer Joint		28	23	56	89.1	59.5	M				
2.0 D GLX Comprex (55 kW)	1993.01-1997.04	AT/MT	L/R	F	Hatchback Engine RF55	818035	Outer Joint		28	23	56	90	59	I				
	1993.01-1997.04	AT/MT	L/R	F	Hatchback Engine RF55	834080	Outer Joint	44T	28	23	56	90	59	M				
2.0 i (85 kW)	1991.08-1997.04	MT	L	F	Hatchback Engine FS	250269	Drive Shaft		27	37.1	56.5	91.5	595					
	1991.08-1997.04	AT/MT	L/R	F	Hatchback Engine FS	818035	Outer Joint		28	23	56	90	59	I				
	1991.08-1997.04	MT	L	F	Hatchback Engine FS	250269	Drive Shaft		27	37.1	56.5	91.5	595					
	1991.08-1997.04	-	R	F	Hatchback Engine FS	634033	Inner Joint		28	23	43	46	77					
	1991.08-1997.04	AT/MT	L/R	F	Hatchback Engine FS	834080	Outer Joint	44T	28	23	56	90	59	M				
	1991.08-1997.04	-	-	F	Hatchback Engine FS	834014	Outer Joint		28	23	56	89.1	59.5	M				
	1992.04-1997.04	MT	L	F	All-wheel Drive Hatchback Engine FS	250269	Drive Shaft		27	37.1	56.5	91.5	595					
	1992.04-1997.04	-	-	-	All-wheel Drive Hatchback Engine FS	839123	Outer Joint		28	21	56	90	58	I				
	1992.04-1997.04	AT/MT	L/R	F	All-wheel Drive Hatchback Engine FS	818035	Outer Joint		28	23	56	90	59	I				
	1992.04-1997.04	MT	L	F	All-wheel Drive Hatchback Engine FS	250269	Drive Shaft		27	37.1	56.5	91.5	595					
	1992.04-1997.04	-	R	F	All-wheel Drive Hatchback Engine FS	634033	Inner Joint		28	23	43	46	77					
	1992.04-1997.04	AT/MT	L/R	F	All-wheel Drive Hatchback Engine FS	834080	Outer Joint	44T	28	23	56	90	59	M				
	1992.04-1997.04	-	-	F	All-wheel Drive Hatchback Engine FS	834014	Outer Joint		28	23	56	89.1	59.5	M				
2.5 24V (120 kW)	1994.08-1997.04	MT	L	F	Hatchback Engine KL	250269	Drive Shaft		27	37.1	56.5	91.5	595					
	1994.08-1997.04	MT	L	F	Hatchback Engine KL	250269	Drive Shaft		27	37.1	56.5	91.5	595					
	1994.08-1997.04	MT	-	-	Hatchback Engine KL	834082	Outer Joint	44T	28	26	56	94	63	M				
	1994.08-1997.04	MT	L/R	F	Hatchback Engine KL	818028	Outer Joint		28	26	56	89	65	I				
	1994.08-1997.04	AT	L/R	F	Hatchback Engine KL	834117	Outer Joint	44T	28	32	56	89	59	M				
	1994.08-1997.04	-	-	-	Hatchback Engine KL	834087	Outer Joint		26	24	56	93	56.5	M				
	1994.08-1997.04	-	-	F	Hatchback Engine KL	834011	Outer Joint		26	25	56	95	61	M				
2.5 24V (121 kW)	1992.01-1997.04	MT	L	F	Hatchback Engine KL	250269	Drive Shaft		27	37.1	56.5	91.5	595					
	1992.01-1997.04	MT	L	F	Hatchback Engine KL	250269	Drive Shaft		27	37.1	56.5	91.5	595					
	1992.01-1997.04	MT	-	-	Hatchback Engine KL	834082	Outer Joint	44T	28	26	56	94	63	M				
	1992.01-1997.04	MT	L/R	F	Hatchback Engine KL	818028	Outer Joint		28	26	56	89	65	I				
	1992.01-1997.04	AT	L/R	F	Hatchback Engine KL	834117	Outer Joint	44T	28	32	56	89	59	M				
	1992.01-1997.04	-	-	-	Hatchback Engine KL	834087	Outer Joint		26	24	56	93	56.5	M				
	1992.01-1997.04	-	-	F	Hatchback Engine KL	834011	Outer Joint		26	25	56	95	61	M				
	1992.01-1997.04	-	-	-	Hatchback Engine KL	818073	Outer Joint		28	26	56	89	65	M				

 YEAR	TRANSM L/R F/R	REMARKS	GSP Ref.	 PRODUCT	 ABS	Technical Specifications										
						A	B	C	H	L	P					
MAZDA																
626 IV (GE)/AUTOZAM CLEF																
2.5 24V (121 kW)	1992.01-1997.04	- - -	Hatchback Engine KL	834073	Outer Joint	90T	28	26	56	89	65	M				
626 IV (GE)/CRONOS																
1.8 i (66 kW)	1994.08-1997.04	AT/MT L/R F	Saloon	818035	Outer Joint		28	23	56	90	59	I				
	1994.08-1997.04	AT/MT L/R F	Saloon	834080	Outer Joint	44T	28	23	56	90	59	M				
	1994.08-1997.04	- - F	Saloon	834014	Outer Joint		28	23	56	89.1	59.5	M				
1.8 i (77 kW)	1992.01-1997.04	MT L F	Saloon Engine FP	250269	Drive Shaft		27	37.1	56.5	91.5	595					
	1992.01-1997.04	AT/MT L/R F	Saloon Engine FP	818035	Outer Joint		28	23	56	90	59	I				
	1992.01-1997.04	MT L F	Saloon Engine FP	250269	Drive Shaft		27	37.1	56.5	91.5	595					
	1992.01-1997.04	AT/MT L/R F	Saloon Engine FP	834080	Outer Joint	44T	28	23	56	90	59	M				
	1992.01-1997.04	- - F	Saloon Engine FP	834014	Outer Joint		28	23	56	89.1	59.5	M				
2.0 D GLX Complex (55 kW)	1992.10-1997.04	AT/MT L/R F	Saloon Engine RF55	818035	Outer Joint		28	23	56	90	59	I				
	1992.10-1997.04	AT/MT L/R F	Saloon Engine RF55	834080	Outer Joint	44T	28	23	56	90	59	M				
2.0 i (85 kW)	1992.01-1997.04	- - F	Saloon Engine FS	818078	Outer Joint	44T	28	32	56	91.5	65	I				
	1992.01-1997.04	MT L F	Saloon Engine FS	250269	Drive Shaft		27	37.1	56.5	91.5	595					
	1992.01-1997.04	AT/MT L/R F	Saloon Engine FS	818035	Outer Joint		28	23	56	90	59	I				
	1992.01-1997.04	MT L F	Saloon Engine FS	250269	Drive Shaft		27	37.1	56.5	91.5	595					
	1992.01-1997.04	- R F	Saloon Engine FS	634033	Inner Joint		28	23	43	46	77					
	1992.01-1997.04	AT/MT L/R F	Saloon Engine FS	834080	Outer Joint	44T	28	23	56	90	59	M				
	1992.01-1997.04	- - F	Saloon Engine FS	834014	Outer Joint		28	23	56	89.1	59.5	M				
	1992.04-1997.04	- - F	All-wheel Drive Saloon Engine FS	818078	Outer Joint	44T	28	32	56	91.5	65	I				
	1992.04-1997.04	MT L F	All-wheel Drive Saloon Engine FS	250269	Drive Shaft		27	37.1	56.5	91.5	595					
	1992.04-1997.04	- - -	All-wheel Drive Saloon Engine FS	839123	Outer Joint		28	21	56	90	58	I				
	1992.04-1997.04	AT/MT L/R F	All-wheel Drive Saloon Engine FS	818035	Outer Joint		28	23	56	90	59	I				
	1992.04-1997.04	MT L F	All-wheel Drive Saloon Engine FS	250269	Drive Shaft		27	37.1	56.5	91.5	595					
	1992.04-1997.04	- R F	All-wheel Drive Saloon Engine FS	634033	Inner Joint		28	23	43	46	77					
	1992.04-1997.04	AT/MT L/R F	All-wheel Drive Saloon Engine FS	834080	Outer Joint	44T	28	23	56	90	59	M				
	1992.04-1997.04	- - F	All-wheel Drive Saloon Engine FS	834014	Outer Joint		28	23	56	89.1	59.5	M				
2.5 24V (121 kW)	1992.01-1997.04	MT - -	Saloon Engine KL-ZE	834082	Outer Joint	44T	28	26	56	94	63	M				
626 MATSURI																
-	-	- - -	-	634006	Inner Joint		28	23	35	65.5	104					
-	-	- - -	-	634005	Inner Joint		28	23	42.8	42	76.5					
626 V (GF)																
1.8 (66 kW)	1997.05-1999.12	AT/MT L/R F	Saloon Engine FPY3	834010	Outer Joint		28	30	56	89.5	57	I				
	1997.05-1999.12	AT/MT L/R F	Hatchback Engine FPY3	834010	Outer Joint		28	30	56	89.5	57	I				
	1997.05-1999.12	AT/MT L/R F	Saloon Engine FPY3	899042	Outer Joint		28	22	56	89.1	59.5	I				
	1997.05-1999.12	AT/MT L/R F	Hatchback Engine FPY3	899042	Outer Joint		28	22	56	89.1	59.5	I				
	1997.05-1999.12	- - F	Saloon Engine FPY3	899234	Outer Joint	44T	28	30	56	90	54	M				
	1997.05-1999.12	- - F	Hatchback Engine FPY3	899234	Outer Joint	44T	28	30	56	90	54	M				
	1997.05-1999.12	AT L/R F	Saloon Engine FPY3	834013	Outer Joint	44T	28	23	56	90	59	M				
	1997.05-1999.12	AT L/R F	Hatchback Engine FPY3	834013	Outer Joint	44T	28	23	56	90	59	M				
	1997.05-1999.12	- - -	Saloon Engine FPY3	834121	Outer Joint	44T	28	23	56	89.1	59.5	M				
	1997.05-1999.12	- - -	Hatchback Engine FPY3	834121	Outer Joint	44T	28	23	56	89.1	59.5	M				
	1997.05-1999.12	- - F	Saloon Engine FPY3	834072	Outer Joint	44T	28	30	56	89.5	57	I				
	1997.05-1999.12	- - F	Hatchback Engine FPY3	834072	Outer Joint	44T	28	30	56	89.5	57	I				
1.8 (74 kW)	1999.12-2002.10	AT/MT L/R F	Hatchback Engine FP	834010	Outer Joint		28	30	56	89.5	57	I				
	1999.12-2002.10	AT/MT L/R F	Saloon Engine FP9A	834010	Outer Joint		28	30	56	89.5	57	I				
	1999.12-2002.10	- R F	Hatchback Engine FP	634099	Inner Joint		28	23	43	48	71					
	1999.12-2002.10	- R F	Saloon Engine FP9A	634099	Inner Joint		28	23	43	48	71					
	1999.12-2002.10	- - F	Hatchback Engine FP	899234	Outer Joint	44T	28	30	56	90	54	M				
	1999.12-2002.10	- - F	Saloon Engine FP9A	899234	Outer Joint	44T	28	30	56	90	54	M				
	1999.12-2002.10	AT L/R F	Hatchback Engine FP	834013	Outer Joint	44T	28	23	56	90	59	M				
	1999.12-2002.10	AT L/R F	Saloon Engine FP9A	834013	Outer Joint	44T	28	23	56	90	59	M				
	1999.12-2002.10	- - -	Saloon Engine FP9A	834121	Outer Joint	44T	28	23	56	89.1	59.5	M				
	1999.12-2002.10	- - -	Hatchback Engine FP	834121	Outer Joint	44T	28	23	56	89.1	59.5	M				
	1999.12-2002.10	- - F	Hatchback Engine FP	834072	Outer Joint	44T	28	30	56	89.5	57	I				
	1999.12-2002.10	- - F	Saloon Engine FP9A	834072	Outer Joint	44T	28	30	56	89.5	57	I				
2.0 (100 kW)	1998.04-2002.10	AT/MT L/R F	Saloon Engine FS2C	834010	Outer Joint		28	30	56	89.5	57	I				
	1998.04-2002.10	AT - F	Saloon Engine FS2C	834061	Outer Joint	44T	28	23	56	89	60.5	M				
	1998.04-2002.10	- R F	Saloon Engine FS2C	634099	Inner Joint		28	23	43	48	71					
	1998.04-2002.10	MT - F	Saloon Engine FS2C	899234	Outer Joint	44T	28	30	56	90	54	M				
	1998.04-2002.10	- - -	Saloon Engine FS2C	834121	Outer Joint	44T	28	23	56	89.1	59.5	M				
	1998.04-2002.10	MT - F	Saloon Engine FS2C	834072	Outer Joint	44T	28	30	56	89.5	57	I				
2.0 (85 kW)	1997.05-2002.10	AT/MT L/R F	Saloon Engine FS	834010	Outer Joint		28	30	56	89.5	57	I				
	1997.05-2002.10	AT/MT L/R F	Hatchback Engine FS	834010	Outer Joint		28	30	56	89.5	57	I				
	1997.05-2002.10	AT - F	Hatchback Engine FS	834061	Outer Joint	44T	28	23	56	89	60.5	M				
	1997.05-2002.10	- R F	Saloon Engine FS	634099	Inner Joint		28	23	43	48	71					

	 YEAR	TRANSM	L/R	F/R	REMARKS	GSP Ref.	 PRODUCT	 ABS	Technical Specifications					
									A	B	C	H	L	P
MAZDA														
626 V (GF)														
2.0 (85 kW)	1997.05-2002.10	-	R	F	Hatchback Engine FS	634099	Inner Joint		28	23	43	48	71	
	1997.05-2002.10	MT	-	F	Saloon Engine FS	899234	Outer Joint	44T	28	30	56	90	54	M
	1997.05-2002.10	MT	-	F	Hatchback Engine FS	899234	Outer Joint	44T	28	30	56	90	54	M
	1997.05-2002.10	AT	L/R	F	Saloon Engine FS	834013	Outer Joint	44T	28	23	56	90	59	M
	1997.05-2002.10	AT	L/R	F	Hatchback Engine FS	834013	Outer Joint	44T	28	23	56	90	59	M
	1997.05-2002.10	-	-	-	Saloon Engine FS	834121	Outer Joint	44T	28	23	56	89.1	59.5	M
	1997.05-2002.10	-	-	-	Hatchback Engine FS	834121	Outer Joint	44T	28	23	56	89.1	59.5	M
2.0 DI TD (66 kW)	1998.04-2002.10	-	L/R	F	Saloon Engine RF3F	818035	Outer Joint		28	23	56	90	59	I
	1998.04-2002.10	-	-	F	Saloon Engine RF3F	834061	Outer Joint	44T	28	23	56	89	60.5	M
	1998.04-2002.10	-	R	F	Saloon Engine RF3F	634099	Inner Joint		28	23	43	48	71	
	1998.04-2002.10	-	-	-	Saloon Engine RF3F	834121	Outer Joint	44T	28	23	56	89.1	59.5	M
2.0 DITD (66 kW)	1998.04-2002.10	-	L/R	F	Hatchback Engine RF3F	818035	Outer Joint		28	23	56	90	59	I
	1998.04-2002.10	-	R	F	Hatchback Engine RF3F	634099	Inner Joint		28	23	43	48	71	
	1998.04-2002.10	AT/MT	L/R	F	Hatchback Engine RF3F	834013	Outer Joint	44T	28	23	56	90	59	M
	1998.04-2002.10	-	-	-	Hatchback Engine RF3F	834121	Outer Joint	44T	28	23	56	89.1	59.5	M
2.0 H.P. (100 kW)	1998.02-2002.10	AT/MT	L/R	F	Hatchback Engine FS2C	834010	Outer Joint		28	30	56	89.5	57	I
	1998.02-2002.10	AT	-	F	Hatchback Engine FS2C	834061	Outer Joint	44T	28	23	56	89	60.5	M
	1998.02-2002.10	-	R	F	Hatchback Engine FS2C	634099	Inner Joint		28	23	43	48	71	
	1998.02-2002.10	MT	-	F	Hatchback Engine FS2C	899234	Outer Joint	44T	28	30	56	90	54	M
	1998.02-2002.10	AT	L/R	F	Hatchback Engine FS2C	834013	Outer Joint	44T	28	23	56	90	59	M
	1998.02-2002.10	-	-	-	Hatchback Engine FS2C	834121	Outer Joint	44T	28	23	56	89.1	59.5	M
	1998.02-2002.10	MT	-	F	Hatchback Engine FS2C	834072	Outer Joint	44T	28	30	56	89.5	57	I
2.0 TD (81 kW)	2000.10-2002.10	-	L/R	F	Hatchback	818035	Outer Joint		28	23	56	90	59	I
	2000.10-2002.10	-	L/R	F	Saloon Engine RF59	818035	Outer Joint		28	23	56	90	59	I
	2000.10-2002.10	-	-	F	Hatchback	834061	Outer Joint	44T	28	23	56	89	60.5	M
	2000.10-2002.10	AT/MT	L/R	F	Hatchback	834013	Outer Joint	44T	28	23	56	90	59	M
	2000.10-2002.10	AT/MT	L/R	F	Saloon Engine RF59	834013	Outer Joint	44T	28	23	56	90	59	M
	2000.10-2002.10	-	-	-	Saloon Engine RF59	834121	Outer Joint	44T	28	23	56	89.1	59.5	M
	2000.10-2002.10	-	-	-	Hatchback	834121	Outer Joint	44T	28	23	56	89.1	59.5	M
	2000.10-2002.10	-	-	F	Saloon Engine RF59	834072	Outer Joint	44T	28	30	56	89.5	57	I
2.0 Turbo DI (74 kW)	1998.04-2002.10	MT	L/R	F	Hatchback Engine RF4F	818035	Outer Joint		28	23	56	90	59	I
	1998.04-2002.10	MT	L/R	F	Saloon Engine RF4F	818035	Outer Joint		28	23	56	90	59	I
	1998.04-2002.10	-	-	F	Saloon Engine RF4F	834061	Outer Joint	44T	28	23	56	89	60.5	M
	1998.04-2002.10	-	R	F	Hatchback Engine RF4F	634099	Inner Joint		28	23	43	48	71	
	1998.04-2002.10	-	R	F	Saloon Engine RF4F	634099	Inner Joint		28	23	43	48	71	
	1998.04-2002.10	MT	L/R	F	Hatchback Engine RF4F	834080	Outer Joint	44T	28	23	56	90	59	M
	1998.04-2002.10	MT	L/R	F	Saloon Engine RF4F	834080	Outer Joint	44T	28	23	56	90	59	M
	1998.04-2002.10	AT/MT	L/R	F	Hatchback Engine RF4F	834013	Outer Joint	44T	28	23	56	90	59	M
	1998.04-2002.10	AT/MT	L/R	F	Saloon Engine RF4F	834013	Outer Joint	44T	28	23	56	90	59	M
	1998.04-2002.10	-	-	-	Saloon Engine RF4F	834121	Outer Joint	44T	28	23	56	89.1	59.5	M
1998.04-2002.10	-	-	-	Hatchback Engine RF4F	834121	Outer Joint	44T	28	23	56	89.1	59.5	M	
626 V Station Wagon (GW)														
1.8 (66 kW)	1998.02-2000.01	-	L/R	F	Estate Engine FPY3	834010	Outer Joint		28	30	56	89.5	57	I
	1998.02-2000.01	-	L/R	F	Estate Engine FPY3	899042	Outer Joint		28	22	56	89.1	59.5	I
	1998.02-2000.01	-	-	-	Estate Engine FPY3	834121	Outer Joint	44T	28	23	56	89.1	59.5	M
	1998.02-2000.01	-	-	F	Estate Engine FPY3	834072	Outer Joint	44T	28	30	56	89.5	57	I
	1998.02-2000.01	-	-	F	Estate Engine FPY3	899233	Outer Joint	44T	28	22	56	90	59	I
1.8 (74 kW)	2000.01-2002.10	AT/MT	L/R	F	Estate Engine FP9A	834010	Outer Joint		28	30	56	89.5	57	I
	2000.01-2002.10	-	R	F	Estate Engine FP9A	634099	Inner Joint		28	23	43	48	71	
	2000.01-2002.10	-	-	-	Estate Engine FP9A	834121	Outer Joint	44T	28	23	56	89.1	59.5	M
	2000.01-2002.10	-	-	F	Estate Engine FP9A	859055	Outer Joint		26	25	56	96	56	M
	2000.01-2002.10	-	-	F	Estate Engine FP9A	834072	Outer Joint	44T	28	30	56	89.5	57	I
2.0 (85 kW)	1998.02-2002.10	AT/MT	L/R	F	Estate Engine FS	834010	Outer Joint		28	30	56	89.5	57	I
	1998.02-2002.10	-	R	F	Estate Engine FS	634099	Inner Joint		28	23	43	48	71	
	1998.02-2002.10	AT/MT	L/R	F	Estate Engine FS	834013	Outer Joint	44T	28	23	56	90	59	M
	1998.02-2002.10	-	-	-	Estate Engine FS	834121	Outer Joint	44T	28	23	56	89.1	59.5	M
2.0 DITD (66 kW)	1999.09-2002.10	-	L/R	F	Estate Engine RF3F	818035	Outer Joint		28	23	56	90	59	I
	1999.09-2002.10	AT/MT	L/R	F	Estate Engine RF3F	834013	Outer Joint	44T	28	23	56	90	59	M
	1999.09-2002.10	-	-	-	Estate Engine RF3F	834121	Outer Joint	44T	28	23	56	89.1	59.5	M
2.0 H.P. (100 kW)	1998.02-2002.10	AT/MT	L/R	F	Estate Engine FS2C	834010	Outer Joint		28	30	56	89.5	57	I
	1998.02-2002.10	-	R	F	Estate Engine FS2C	634099	Inner Joint		28	23	43	48	71	
	1998.02-2002.10	AT/MT	L/R	F	Estate Engine FS2C	834013	Outer Joint	44T	28	23	56	90	59	M
	1998.02-2002.10	-	-	-	Estate Engine FS2C	834121	Outer Joint	44T	28	23	56	89.1	59.5	M
2.0 TD (81 kW)	2000.10-2002.10	-	L/R	F	Estate	818035	Outer Joint		28	23	56	90	59	I
	2000.10-2002.10	-	-	F	Estate	834061	Outer Joint	44T	28	23	56	89	60.5	M

YEAR	TRANSM	L/R	F/R	REMARKS	GSP Ref.	PRODUCT	ABS	Technical Specifications							
								A	B	C	H	L	P		
MAZDA															
626 V Station Wagon (GW)															
2.0 TD (81 kW)	2000.10-	2002.10	AT/MT	L/R	F	Estate	834013	Outer Joint	44T	28	23	56	90	59	M
	2000.10-	2002.10	-	-	-	Estate	834121	Outer Joint	44T	28	23	56	89.1	59.5	M
2.0 Turbo DI (74 kW)	1998.04-	2002.10	MT	L/R	F	Estate Engine RF4F	818035	Outer Joint		28	23	56	90	59	I
	1998.04-	2002.10	-	-	F	Estate Engine RF4F	834061	Outer Joint	44T	28	23	56	89	60.5	M
	1998.04-	2002.10	AT/MT	L/R	F	Estate Engine RF4F	834013	Outer Joint	44T	28	23	56	90	59	M
	1998.04-	2002.10	MT	L/R	F	Estate Engine RF4F	834080	Outer Joint	44T	28	23	56	90	59	M
	1998.04-	2002.10	-	-	-	Estate Engine RF4F	834121	Outer Joint	44T	28	23	56	89.1	59.5	M
626(GE)															
-	1991.12-	-	MT	L	F	-	634032	Inner Joint		28	23	35	66	105	
1.8	1994.05-	-	MT	L	F	2WD	634032	Inner Joint		28	23	35	66	105	
1.8/2.0	1991.08-	-	MT	L	F	2WD	634032	Inner Joint		28	23	35	66	105	
	1994.06-	-	-	L	-	-	634032	Inner Joint		28	23	35	66	105	
626WAGON(GV)															
-	1992.03	-	AT	R	F	-	834068	Outer Joint	90T	26	25	56	93	61	I
ATENZA MAZDA6 GG3P															
2.3	2005.06-	-	6MT	-	-	Engine L3VDT	834179	Outer Joint	44T	31	36	65	94.5	62	M
2300	2005.06-	-	6MT	-	-	Engine L3VDT	834179	Outer Joint	44T	31	36	65	94.5	62	M
ATENZA SPORT WAGON (GY3W)															
2.3	2002.05-	2007.12	5MT	-	-	Engine L3VE	834180	Outer Joint	44T	28	33	62	90	58	
	2002.05-	2007.12	6MT	-	-	Engine L3VE	834180	Outer Joint	44T	28	33	62	90	58	
ATENZA SPORT WAGON GY3W															
2.3	2002.05-	2007.12	5MT	-	-	Engine L3VE	834180	Outer Joint	44T	28	33	62	90	58	
	2002.05-	2007.12	6MT	-	-	Engine L3VE	834180	Outer Joint	44T	28	33	62	90	58	
2300	2002.05-	2007.12	5MT	-	-	Engine L3VE	834180	Outer Joint	44T	28	33	62	90	58	
	2002.05-	2007.12	6MT	-	-	Engine L3VE	834180	Outer Joint	44T	28	33	62	90	58	
AZ-3 (EC5SA)															
1.5	1991.06-	1998.01	MT/AT	-	-	Engine B5	834191	Outer Joint		26	22	56	92	56	M
AZ-3 (ECPSA)															
1.8	1993.09-	1998.01	4AT	-	-	Engine K8	834009	Outer Joint		26	30	56	93	55	M
	1993.09-	1998.01	5MT	-	-	Engine K8	834009	Outer Joint		26	30	56	93	55	M
AZ-3 EC5SA															
1.5	1991.06-	1998.01	MT/AT	-	-	Engine B5	834191	Outer Joint		26	22	56	92	56	M
1500	1991.06-	1998.01	MT/AT	-	-	Engine B5	834191	Outer Joint		26	22	56	92	56	M
AZ-3 ECPSA															
1.8	1993.09-	1998.01	5MT	-	-	Engine K8	834009	Outer Joint		26	30	56	93	55	M
	1993.09-	1998.01	4AT	-	-	Engine K8	834009	Outer Joint		26	30	56	93	55	M
	1993.09-	1998.01	4AT	-	-	Engine K8	834009	Outer Joint		26	30	56	93	55	M
1800	1993.09-	1998.01	5MT	-	-	Engine K8	834009	Outer Joint		26	30	56	93	55	M
	1993.09-	1998.01	4AT	-	-	Engine K8	834009	Outer Joint		26	30	56	93	55	M
	1993.09-	1998.01	4AT	-	-	Engine K8	834009	Outer Joint		26	30	56	93	55	M
B-SERIE (UF)															
2.5 D (63 kW)	1996.02-	1999.06	MT	L	F	All-wheel Drive Pickup	239001	Drive Shaft		26	26	65	143.5	527	
	1996.02-	1999.06	MT	R	F	All-wheel Drive Pickup	234012	Drive Shaft		26	26	65	143.5	606	
	1996.02-	1999.06	-	L	F	All-wheel Drive Pickup	227063	Drive Shaft	44W	26	26	61	103.5	509	
	1996.02-	1999.06	-	R	F	All-wheel Drive Pickup	227062	Drive Shaft	44W	26	26	61	103.5	579.5	
	1996.02-	1999.06	MT	L	F	All-wheel Drive Pickup	634011	Inner Joint		26	25	40	39	81	
	1996.02-	1999.06	MT	L/R	F	All-wheel Drive Pickup	834056	Outer Joint		26	25	65	143.5	60.5	M
2.5 D 4WD (63 kW)	1996.02-	1999.06	-	L	F	Pickup	634018	Inner Joint		26	25	40	39	68	
B-SERIE (UN)															
2.5 D (57 kW)	1999.06-	2006.11	MT	L	F	Pickup Engine MD25NA	239001	Drive Shaft		26	26	65	143.5	527	
	1999.06-	2006.11	MT	R	F	All-wheel Drive Pickup Engine MD25NA	234012	Drive Shaft		26	26	65	143.5	606	
	1999.06-	2006.11	MT	R	F	Pickup Engine MD25NA	234012	Drive Shaft		26	26	65	143.5	606	
	1999.06-	2006.11	MT	L	F	All-wheel Drive Pickup Engine MD25NA	634011	Inner Joint		26	25	40	39	81	
	1999.06-	2006.11	MT	L	F	Pickup Engine MD25NA	634011	Inner Joint		26	25	40	39	81	
	1999.06-	2006.11	MT	L/R	F	All-wheel Drive Pickup Engine MD25NA	834056	Outer Joint		26	25	65	143.5	60.5	M
	1999.06-	2006.11	MT	L	F	All-wheel Drive Pickup Engine MD25NA	239001	Drive Shaft		26	26	65	143.5	527	
2.5 D (61 kW)	1999.11-	2001.12	MT	L	F	All-wheel Drive Pickup Engine WLE7	239001	Drive Shaft		26	26	65	143.5	527	
	1999.11-	2001.12	MT	R	F	All-wheel Drive Pickup Engine WLE7	234012	Drive Shaft		26	26	65	143.5	606	
	1999.11-	2001.12	-	L	F	All-wheel Drive Pickup Engine WLE7	227063	Drive Shaft	44W	26	26	61	103.5	509	
	1999.11-	2001.12	-	R	F	All-wheel Drive Pickup Engine WLE7	227062	Drive Shaft	44W	26	26	61	103.5	579.5	
	1999.11-	2001.12	MT	L	F	All-wheel Drive Pickup Engine WLE7	634011	Inner Joint		26	25	40	39	81	
2.5 D (62 kW)	2002.12-	2006.11	-	L	F	All-wheel Drive Pickup Engine WLE7	227063	Drive Shaft	44W	26	26	61	103.5	509	
	2002.12-	2006.11	-	R	F	All-wheel Drive Pickup Engine WLE7	227062	Drive Shaft	44W	26	26	61	103.5	579.5	
2.5 D 4WD (61 kW)	1999.11-	2001.12	-	L	F	Pickup Engine WLE7	634018	Inner Joint		26	25	40	39	68	
2.5 D 4WD (62 kW)	2002.12-	-	-	L	F	Pickup Engine WLE7	634018	Inner Joint		26	25	40	39	68	

	 YEAR	TRANSM	L/R	F/R	REMARKS	GSP Ref.	 PRODUCT	 ABS	Technical Specifications						
									A	B	C	H	L	P	
MAZDA															
B-SERIE (UN)															
2.5 TD (80 kW)	1999.06-2006.07	-	L	F	All-wheel Drive Pickup Engine MD25TI	227063	Drive Shaft	44W	26	26	61	103.5	509		
	1999.06-2006.07	-	R	F	All-wheel Drive Pickup Engine MD25TI	227062	Drive Shaft	44W	26	26	61	103.5	579.5		
	1999.06-2006.07	MT	L/R	F	All-wheel Drive Pickup Engine MD25TI	834056	Outer Joint		26	25	65	143.5	60.5	M	
2.5 TD 4WD (80 kW)	1999.06-2006.07	-	L	F	Pickup Engine MD25TI	634018	Inner Joint		26	25	40	39	68		
2.6 12V (90 kW)	1999.06-2006.11	MT	L/R	F	All-wheel Drive Pickup Engine JK26	834056	Outer Joint		26	25	65	143.5	60.5	M	
B2500															
2.5 D 4WD	2002-2006	-	R	F	-	234133	Drive Shaft	44W	26	26	61	103.5	579		
	2002-2006	-	L	F	-	234132	Drive Shaft	44W	26	26	61	103.5	510		
B2500 B2600 B3000 B4000															
-	1998-2000	-	-	-	SUV/Truck/VAN 4WD	818037	Outer Joint		27	34	66.8	115	66	I	
B2600															
-	1988.01-1998.12	-	R	-	-	234019	Drive Shaft		26	26	65	143.5	606		
B2600/BRAVO															
-	-	-	-	-	-	634019	Inner Joint		26	25	35	82.5	95.5		
B4000															
-	1998-2008	-	-	F	4WD/PROPELLER SHAFT	661100	Propshaft CV Joint		26		35				
BRAVO															
-	1988.01-1998.12	-	R	-	-	234019	Drive Shaft		26	26	65	143.5	606		
BT-50 (CD UN)															
2.5 MRZ-CD (105 kW)	2006.12-2015.12	MT	L	F	All-wheel Drive Pickup Engine WLAA	218210	Drive Shaft	44W	28	28	61	104.5	492		
	2006.12-2015.12	MT	R	F	All-wheel Drive Pickup Engine WLAA	218211	Drive Shaft	44W	28	30	61	104.5	577		
	2006.12-2015.12	-	-	F	All-wheel Drive Pickup Engine WLAA	818206	Outer Joint	44W	28	36	61	104.5	78.5	I	
3.0 CDVi (115 kW)	2006.12-2015.12	MT	L	F	Pickup Engine WEAT	218210	Drive Shaft	44W	28	28	61	104.5	492		
	2006.12-2015.12	MT	R	F	Pickup Engine WEAT	218211	Drive Shaft	44W	28	30	61	104.5	577		
	2006.12-2015.12	-	-	F	Pickup Engine WEAT	818206	Outer Joint	44W	28	36	61	104.5	78.5	I	
CAPELLA 626															
2.5	1991-	-	MT	-	Engine GE5P	618012	Inner Joint		28	26	43	44	80		
CAPELLA 626 TELSTER (CG2PP)															
1.8	1994.07-1997.08	4AT	-	-	Engine FP	834145	Outer Joint	44T	28	23	56	89.1	59.5	M	
	1994.07-1997.08	5MT	-	-	Engine FP	834145	Outer Joint	44T	28	23	56	89.1	59.5	M	
	1994.07-1997.08	MT/AT	-	-	Engine FP	834145	Outer Joint	44T	28	23	56	89.1	59.5	M	
CAPELLA 626 TELSTER (CG2SP)															
2.0	1994.07-1997.08	4AT	-	-	Engine FS	834145	Outer Joint	44T	28	23	56	89.1	59.5	M	
	1994.07-1997.08	5MT	-	-	Engine FS	834145	Outer Joint	44T	28	23	56	89.1	59.5	M	
	1994.07-1997.08	MT/AT	-	-	Engine FS	834145	Outer Joint	44T	28	23	56	89.1	59.5	M	
	1994.08-1997.08	5MT	-	-	Engine FSDE	834145	Outer Joint	44T	28	23	56	89.1	59.5	M	
CAPELLA 626 TELSTER (GD8R)															
1.8 4WD	1989.04-1991.10	5MT	-	-	Engine F8	834192	Outer Joint		26	21	56	94	59	M	
	1989.04-1991.10	4AT	-	-	Engine F8	834016	Outer Joint		26	21	56	93.5	55	M	
	1989.04-1991.10	5MT	-	-	Engine F8	834016	Outer Joint		26	21	56	93.5	55	M	
CAPELLA 626 TELSTER (GDEPS)															
2.0	1989.04-1991.10	4AT	-	-	Engine FE	834016	Outer Joint		26	21	56	93.5	55	M	
CAPELLA 626 TELSTER (GDER)															
2.0 4WD	1989.04-1991.10	4AT	-	-	Engine FE	834016	Outer Joint		26	21	56	93.5	55	M	
	1989.04-1991.10	5MT	-	-	Engine FE	834016	Outer Joint		26	21	56	93.5	55	M	
CAPELLA 626 TELSTER (GEFP)															
2.0	1992.04-1994.07	5MT	-	-	Engine RF	834145	Outer Joint	44T	28	23	56	89.1	59.5	M	
	1992.04-1995.10	4AT	-	-	Engine RF	834145	Outer Joint	44T	28	23	56	89.1	59.5	M	
CAPELLA 626 TELSTER (GF)															
1.8	1998.01-	MT/AT	-	-	Engine GE9E	834044	Outer Joint		28	30	56	89.1	59.5	M	
CAPELLA 626 TELSTER (GFEP)															
2.0	1997.08-1999.08	4AT	-	-	Engine FS	834145	Outer Joint	44T	28	23	56	89.1	59.5	M	
	1997.08-1999.09	4AT	-	-	Engine FSZE	834145	Outer Joint	44T	28	23	56	89.1	59.5	M	
CAPELLA 626 TELSTER CG2PP															
1.8	1994.07-1997.08	MT/AT	-	-	Engine FP	834145	Outer Joint	44T	28	23	56	89.1	59.5	M	
	1994.07-1997.08	5MT	-	-	Engine FP	834145	Outer Joint	44T	28	23	56	89.1	59.5	M	
	1994.07-1997.08	4AT	-	-	Engine FP	834145	Outer Joint	44T	28	23	56	89.1	59.5	M	
	1994.08-1997.08	5MT	-	-	Engine FP	834145	Outer Joint	44T	28	23	56	89.1	59.5	M	
	1994.08-1997.08	5MT	-	-	Engine FP	834145	Outer Joint	44T	28	23	56	89.1	59.5	M	
	1994.08-1997.08	4AT	-	-	Engine FP	834145	Outer Joint	44T	28	23	56	89.1	59.5	M	
1800	1994.07-1997.08	MT/AT	-	-	Engine FP	834145	Outer Joint	44T	28	23	56	89.1	59.5	M	
	1994.07-1997.08	5MT	-	-	Engine FP	834145	Outer Joint	44T	28	23	56	89.1	59.5	M	
	1994.07-1997.08	4AT	-	-	Engine FP	834145	Outer Joint	44T	28	23	56	89.1	59.5	M	
	1994.08-1997.08	5MT	-	-	Engine FP	834145	Outer Joint	44T	28	23	56	89.1	59.5	M	
	1994.08-1997.08	5MT	-	-	Engine FP	834145	Outer Joint	44T	28	23	56	89.1	59.5	M	





YEAR	TRANS	L/R	F/R	REMARKS	GSP Ref.	PRODUCT	ABS	Technical Specifications							
								A	B	C	H	L	P		
MAZDA															
CAPELLA 626 TELSTER CG2PP															
1800	1994.08-	1997.08	4AT	-	-	Engine FP	834145	Outer Joint	44T	28	23	56	89.1	59.5	M
CAPELLA 626 TELSTER CG2SP															
2.0	1994.07-	1997.08	MT/AT	-	-	Engine FS	834145	Outer Joint	44T	28	23	56	89.1	59.5	M
	1994.07-	1997.08	5MT	-	-	Engine FS	834145	Outer Joint	44T	28	23	56	89.1	59.5	M
	1994.07-	1997.08	4AT	-	-	Engine FS	834145	Outer Joint	44T	28	23	56	89.1	59.5	M
	1994.08-	1997.08	5MT	-	-	Engine FS	834145	Outer Joint	44T	28	23	56	89.1	59.5	M
	1994.08-	1997.08	5MT	-	-	Engine FSDE	834145	Outer Joint	44T	28	23	56	89.1	59.5	M
	1994.08-	1997.08	5MT	-	-	Engine FSDE	834145	Outer Joint	44T	28	23	56	89.1	59.5	M
2000	1994.07-	1997.08	MT/AT	-	-	Engine FS	834145	Outer Joint	44T	28	23	56	89.1	59.5	M
	1994.07-	1997.08	5MT	-	-	Engine FS	834145	Outer Joint	44T	28	23	56	89.1	59.5	M
	1994.07-	1997.08	4AT	-	-	Engine FS	834145	Outer Joint	44T	28	23	56	89.1	59.5	M
	1994.08-	1997.08	5MT	-	-	Engine FS	834145	Outer Joint	44T	28	23	56	89.1	59.5	M
	1994.08-	1997.08	5MT	-	-	Engine FSDE	834145	Outer Joint	44T	28	23	56	89.1	59.5	M
	1994.08-	1997.08	5MT	-	-	Engine FSDE	834145	Outer Joint	44T	28	23	56	89.1	59.5	M
CAPELLA 626 TELSTER GD8R															
1.8	1989.04-	1991.10	5MT	-	-	Allwheel Drive Engine F8	834192	Outer Joint		26	21	56	94	59	M
	1989.04-	1991.10	5MT	-	-	Allwheel Drive Engine F8	834016	Outer Joint		26	21	56	93.5	55	M
	1989.04-	1991.10	4AT	-	-	Allwheel Drive Engine F8	834016	Outer Joint		26	21	56	93.5	55	M
	1989.04-	1991.10	4AT	-	-	Allwheel Drive Engine F8	834016	Outer Joint		26	21	56	93.5	55	M
1800	1989.04-	1991.10	5MT	-	-	Allwheel Drive Engine F8	834192	Outer Joint		26	21	56	94	59	M
	1989.04-	1991.10	5MT	-	-	Allwheel Drive Engine F8	834016	Outer Joint		26	21	56	93.5	55	M
	1989.04-	1991.10	4AT	-	-	Allwheel Drive Engine F8	834016	Outer Joint		26	21	56	93.5	55	M
	1989.04-	1991.10	4AT	-	-	Allwheel Drive Engine F8	834016	Outer Joint		26	21	56	93.5	55	M
CAPELLA 626 TELSTER GDEPS															
2.0	1989.04-	1991.10	4AT	-	-	Engine FE	834016	Outer Joint		26	21	56	93.5	55	M
2000	1989.04-	1991.10	4AT	-	-	Engine FE	834016	Outer Joint		26	21	56	93.5	55	M
CAPELLA 626 TELSTER GDER															
2.0	1989.04-	1991.10	5MT	-	-	Allwheel Drive Engine FE	834016	Outer Joint		26	21	56	93.5	55	M
	1989.04-	1991.10	4AT	-	-	Allwheel Drive Engine FE	834016	Outer Joint		26	21	56	93.5	55	M
	1989.04-	1991.10	4AT	-	-	Allwheel Drive Engine FE	834016	Outer Joint		26	21	56	93.5	55	M
2000	1989.04-	1991.10	5MT	-	-	Allwheel Drive Engine FE	834016	Outer Joint		26	21	56	93.5	55	M
	1989.04-	1991.10	4AT	-	-	Allwheel Drive Engine FE	834016	Outer Joint		26	21	56	93.5	55	M
	1989.04-	1991.10	4AT	-	-	Allwheel Drive Engine FE	834016	Outer Joint		26	21	56	93.5	55	M
CAPELLA 626 TELSTER GEFP															
2.0	1992.04-	1994.07	5MT	-	-	Engine RF	834145	Outer Joint	44T	28	23	56	89.1	59.5	M
	1992.04-	1995.10	4AT	-	-	Engine RF	834145	Outer Joint	44T	28	23	56	89.1	59.5	M
2000	1992.04-	1994.07	5MT	-	-	Engine RF	834145	Outer Joint	44T	28	23	56	89.1	59.5	M
	1992.04-	1995.10	4AT	-	-	Engine RF	834145	Outer Joint	44T	28	23	56	89.1	59.5	M
CAPELLA 626 TELSTER GFEP															
2.0	1997.08-	1999.08	4AT	-	-	Engine FS	834145	Outer Joint	44T	28	23	56	89.1	59.5	M
	1997.08-	1999.09	4AT	-	-	Engine FSZE	834145	Outer Joint	44T	28	23	56	89.1	59.5	M
2000	1997.08-	1999.09	4AT	-	-	Engine FSZE	834145	Outer Joint	44T	28	23	56	89.1	59.5	M
	1997.08-	1999.08	4AT	-	-	Engine FS	834145	Outer Joint	44T	28	23	56	89.1	59.5	M
CAPELLA TELSTER CARGO/WAGO (GFFP)															
2.0	1998.07-	1999.09	4AT	-	-	Engine RF	834145	Outer Joint	44T	28	23	56	89.1	59.5	M
CAPELLA TELSTER CARGO/WAGO (GV6V)															
1.6	1988.01-	-	5MT	-	-	Engine B6	834176	Outer Joint		26	23	56	107	56	M
	1988.01-	-	4AT	-	-	Engine B6	834176	Outer Joint		26	23	56	107	56	M
CAPELLA TELSTER CARGO/WAGO (GVER)															
2.0 4WD	1990.08-	1994.10	5MT	-	-	Engine FE	834192	Outer Joint		26	21	56	94	59	M
	1990.08-	1994.10	4AT	-	-	Engine FE	834016	Outer Joint		26	21	56	93.5	55	M
CAPELLA TELSTER CARGO/WAGO (GVFR)															
2.0 4WD	1992.08-	1994.10	4AT	-	-	Engine RF DSC	834016	Outer Joint		26	21	56	93.5	55	M
CAPELLA TELSTER CARGO/WAGO (GVFV)															
2.0	1988.01-	-	5MT	-	-	Engine RF	834176	Outer Joint		26	23	56	107	56	M
CAPELLA TELSTER CARGO/WAGO (GWEW)															
2.0	1997.10-	1999.08	4AT	-	-	Engine FSDE	834145	Outer Joint	44T	28	23	56	89.1	59.5	M
CAPELLA TELSTER CARGO/WAGO GFFP															
2.0	1998.07-	1999.09	4AT	-	-	Engine RF	834145	Outer Joint	44T	28	23	56	89.1	59.5	M
CAPELLA TELSTER CARGO/WAGO GV6V															
1.6	1988.01-	-	5MT	-	-	Engine B6	834176	Outer Joint		26	23	56	107	56	M
	1988.01-	-	4AT	-	-	Engine B6	834176	Outer Joint		26	23	56	107	56	M
CAPELLA TELSTER CARGO/WAGO GVER															
2.0	1990.08-	1994.10	5MT	-	-	Allwheel Drive Engine FE	834192	Outer Joint		26	21	56	94	59	M
	1990.08-	1994.10	4AT	-	-	Allwheel Drive Engine FE	834016	Outer Joint		26	21	56	93.5	55	M

YEAR	TRANS	L/R	F/R	REMARKS	GSP Ref.	PRODUCT	ABS	Technical Specifications						
								A	B	C	H	L	P	
MAZDA														
CAPELLA TELSTER CARGO/WAGO GVER														
2.0	1990.08-1994.10	4AT	-	-	Allwheel Drive Engine FE	834016	Outer Joint		26	21	56	93.5	55	M
CAPELLA TELSTER CARGO/WAGO GVFR														
2.0	1992.08-1994.10	4AT	-	-	Allwheel Drive Engine RF DSC	834016	Outer Joint		26	21	56	93.5	55	M
	1992.08-1994.10	4AT	-	-	Allwheel Drive Engine RF DSC	834016	Outer Joint		26	21	56	93.5	55	M
CAPELLA TELSTER CARGO/WAGO GVFP														
2.0	1988.01-	5MT	-	-	Engine RF	834176	Outer Joint		26	23	56	107	56	M
CAPELLA TELSTER CARGO/WAGO GWEW														
2.0	1997.10-1999.08	4AT	-	-	Engine FSDE	834145	Outer Joint	44T	28	23	56	89.1	59.5	M
CAPELLA TELSTER CARGO/WAGON GFFP														
2000	1998.07-1999.09	4AT	-	-	Engine RF	834145	Outer Joint	44T	28	23	56	89.1	59.5	M
CAPELLA TELSTER CARGO/WAGON GV6V														
1600	1988.01-	5MT	-	-	Engine B6	834176	Outer Joint		26	23	56	107	56	M
	1988.01-	4AT	-	-	Engine B6	834176	Outer Joint		26	23	56	107	56	M
CAPELLA TELSTER CARGO/WAGON GVER														
2000	1990.08-1994.10	5MT	-	-	Allwheel Drive Engine FE	834192	Outer Joint		26	21	56	94	59	M
	1990.08-1994.10	4AT	-	-	Allwheel Drive Engine FE	834016	Outer Joint		26	21	56	93.5	55	M
	1990.08-1994.10	4AT	-	-	Allwheel Drive Engine FE	834016	Outer Joint		26	21	56	93.5	55	M
CAPELLA TELSTER CARGO/WAGON GVFR														
2000	1992.08-1994.10	4AT	-	-	Allwheel Drive Engine RF DSC	834016	Outer Joint		26	21	56	93.5	55	M
	1992.08-1994.10	4AT	-	-	Allwheel Drive Engine RF DSC	834016	Outer Joint		26	21	56	93.5	55	M
CAPELLA TELSTER CARGO/WAGON GVFP														
2000	1988.01-	5MT	-	-	Engine RF	834176	Outer Joint		26	23	56	107	56	M
CAPELLA TELSTER CARGO/WAGON GWEW														
2000	1997.10-1999.08	4AT	-	-	Engine FSDE	834145	Outer Joint	44T	28	23	56	89.1	59.5	M
CAPRLLA 626 TELSTER (GE5P)														
2.5	1992.04-1996.01	4AT	-	-	Engine KL	834012	Outer Joint		28	26	56	94	63	M
CAPRLLA 626 TELSTER (GE5PF)														
2.5	1992.04-1996.01	4AT	-	-	Engine KL	834012	Outer Joint		28	26	56	94	63	M
CAPRLLA 626 TELSTER GE5P														
2.5	1992.04-1996.01	4AT	-	-	Engine KL	834012	Outer Joint		28	26	56	94	63	M
	1992.04-1996.01	4AT	-	-	Engine KL	834012	Outer Joint		28	26	56	94	63	M
CAPRLLA 626 TELSTER GE5PF														
2.5	1992.04-1996.01	4AT	-	-	Engine KL	834012	Outer Joint		28	26	56	94	63	M
	1992.04-1996.01	4AT	-	-	Engine KL	834012	Outer Joint		28	26	56	94	63	M
CLEF (GE5PA)														
2.5	1992.04-	4AT	-	-	Engine KL	834012	Outer Joint		28	26	56	94	63	M
CLEF GE5PA														
2.5	1992.04-	4AT	-	-	Engine KL	834012	Outer Joint		28	26	56	94	63	M
	1992.04-	4AT	-	-	Engine KL	834012	Outer Joint		28	26	56	94	63	M
CRONOS (GE5P)														
2.5	1992.04-1996.04	4AT	-	-	Engine KL	834012	Outer Joint		28	26	56	94	63	M
CRONOS (GE8P)														
1.8	1991.09-1994.07	4AT	-	-	Engine K8	834145	Outer Joint	44T	28	23	56	89.1	59.5	M
	1991.09-1994.07	5MT	-	-	Engine K8	834145	Outer Joint	44T	28	23	56	89.1	59.5	M
CRONOS (GEEP)														
2.0	1991.09-1996.04	4AT	-	-	Engine KF	834145	Outer Joint	44T	28	23	56	89.1	59.5	M
	1991.09-1996.04	5MT	-	-	Engine KF	834145	Outer Joint	44T	28	23	56	89.1	59.5	M
CRONOS (GEFP)														
2.0	1992.04-1996.04	4AT	-	-	Engine RF	834145	Outer Joint	44T	28	23	56	89.1	59.5	M
	1992.04-1996.04	5MT	-	-	Engine RF	834145	Outer Joint	44T	28	23	56	89.1	59.5	M
CRONOS (GESR)														
2.0 4WD	1991.11-1996.04	5MT	-	-	Engine FS	834016	Outer Joint		26	21	56	93.5	55	M
CRONOS GE5P														
2.5	1992.04-1996.04	4AT	-	-	Engine KL	834012	Outer Joint		28	26	56	94	63	M
	1992.04-1996.04	4AT	-	-	Engine KL	834012	Outer Joint		28	26	56	94	63	M
	1992.04-1996.04	4AT	-	-	Engine KL	834012	Outer Joint		28	26	56	94	63	M
	1992.04-1996.04	4AT	-	-	Engine KL	834012	Outer Joint		28	26	56	94	63	M
CRONOS GE8P														
1.8	1991.09-1994.07	5MT	-	-	Engine K8	834145	Outer Joint	44T	28	23	56	89.1	59.5	M
	1991.09-1994.07	4AT	-	-	Engine K8	834145	Outer Joint	44T	28	23	56	89.1	59.5	M
1800	1991.09-1994.07	5MT	-	-	Engine K8	834145	Outer Joint	44T	28	23	56	89.1	59.5	M
	1991.09-1994.07	4AT	-	-	Engine K8	834145	Outer Joint	44T	28	23	56	89.1	59.5	M
CRONOS GEEP														
2.0	1991.09-1996.04	5MT	-	-	Engine KF	834145	Outer Joint	44T	28	23	56	89.1	59.5	M
	1991.09-1996.04	4AT	-	-	Engine KF	834145	Outer Joint	44T	28	23	56	89.1	59.5	M

YEAR	TRANSM	L/R	F/R	REMARKS	GSP Ref.	PRODUCT	ABS	Technical Specifications							
								A	B	C	H	L	P		
MAZDA															
CRONOS GEEP															
2000	1991.09-1996.04	5MT	-	-	Engine KF	834145	Outer Joint	44T	28	23	56	89.1	59.5	M	
	1991.09-1996.04	4AT	-	-	Engine KF	834145	Outer Joint	44T	28	23	56	89.1	59.5	M	
CRONOS GEFP															
2.0	1992.04-1996.04	5MT	-	-	Engine RF	834145	Outer Joint	44T	28	23	56	89.1	59.5	M	
	1992.04-1996.04	4AT	-	-	Engine RF	834145	Outer Joint	44T	28	23	56	89.1	59.5	M	
2000	1992.04-1996.04	5MT	-	-	Engine RF	834145	Outer Joint	44T	28	23	56	89.1	59.5	M	
	1992.04-1996.04	4AT	-	-	Engine RF	834145	Outer Joint	44T	28	23	56	89.1	59.5	M	
CRONOS GESR															
2.0	1991.11-1996.04	5MT	-	-	Allwheel Drive Engine FS	834016	Outer Joint		26	21	56	93.5	55	M	
2000	1991.11-1996.04	5MT	-	-	Allwheel Drive Engine FS	834016	Outer Joint		26	21	56	93.5	55	M	
CX-5															
2.0	2011.11-		AT	R	-	4WD	834207	Outer Joint		31	24	59	86.5	69	I
	2011.11-		AT	R	F	-	834207	Outer Joint		31	24	59	86.5	69	I
	2011.11-		AT	L	F	-	834207	Outer Joint		31	24	59	86.5	69	I
	2011.11-		AT	R	-	4WD	634127	Inner Joint		31	24	33.5	416	115	
	2011.11-		AT	R	F	-	634128	Inner Joint		31	24	40	416	115	
	2011.11-		AT	L	F	-	634129	Inner Joint		31	24	40	67	113.5	
	2011.11-		AT	R	-	4WD	234237	Drive Shaft		31	31	59	86.5	1016	
	2011.11-		AT	R	F	-	234235	Drive Shaft		31	31	59	86.5	1016	
	2011.11-		AT	L	F	-	234236	Drive Shaft		31	31	59	86.5	652	
2.5	-	-	-	L	-	4WD	834212	Outer Joint		28	26	51.7	85	56	I
	-	-	-	L	-	4WD	634131	Inner Joint		22	26	30.5	65	98.5	
	-	-	-	L	-	4WD	234240	Drive Shaft	48T	28	22	51.7	85	815	
	2011.11-		AT	L	F	-	834208	Outer Joint		31	26	59	87	69	I
	2011.11-		AT	R	F	-	834208	Outer Joint		31	26	59	87	69	I
	2011.11-		AT	L	F	-	634129	Inner Joint		31	24	40	67	113.5	
	2011.11-		AT	R	F	-	634130	Inner Joint		31	24	33.5	431	115	
	2011.11-		AT	L	F	-	234239	Drive Shaft		31	31	59	87	653	
	2011.11-		AT	R	F	-	234238	Drive Shaft		31	31	59	87	1019	
CX-5 (KE GH)															
2.0 (113 kW)	2015.04-	-	-	R	F	Closed Off-Road Vehicle Engine PEY5/PEY4	634115	Inner Joint		28	33	43	48	84	
2.0 (114 kW)	2012.07-	-	-	R	F	Closed Off-Road Vehicle Engine PEY5/PEY4	634115	Inner Joint		28	33	43	48	84	
2.0 (115 kW)	2012.01-	-	-	R	F	Closed Off-Road Vehicle Engine PE-VPS	634115	Inner Joint		28	33	43	48	84	
2.0 (121 kW)	2011.11-	-	-	-	-	Closed Off-Road Vehicle Engine PEY6/PEY7	834213	Outer Joint	48T	28	26	51.7	85	56	I
	2011.11-	-	-	R	F	Closed Off-Road Vehicle Engine PEY6/PEY7	634115	Inner Joint		28	33	43	48	84	
	2011.11-	-	-	-	-	Closed Off-Road Vehicle Engine PEY6/PEY7	634048	Inner Joint		28	33	43	48	84	
2.0 AWD (113 kW)	2012.07-	-	-	R	F	All-wheel Drive Closed Off-Road Vehicle Engine PEY5/PEY4	634115	Inner Joint		28	33	43	48	84	
2.0 AWD (118 kW)	2011.11-	-	-	-	-	All-wheel Drive Closed Off-Road Vehicle Engine PEY6/PEY7	834213	Outer Joint	48T	28	26	51.7	85	56	I
	2011.11-	-	-	R	F	All-wheel Drive Closed Off-Road Vehicle Engine PEY6/PEY7	634115	Inner Joint		28	33	43	48	84	
	2011.11-	-	-	-	-	All-wheel Drive Closed Off-Road Vehicle Engine PEY6/PEY7	634048	Inner Joint		28	33	43	48	84	
2.5 (135 kW)	2014.07-	-	-	R	F	All-wheel Drive Closed Off-Road Vehicle Engine PY-VPS	634115	Inner Joint		28	33	43	48	84	
2.5 (138 kW)	2013.02-	-	-	R	F	Closed Off-Road Vehicle Engine PY-VPS	634115	Inner Joint		28	33	43	48	84	
2.5 AWD (141 kW)	2015.02-	-	-	-	-	All-wheel Drive Closed Off-Road Vehicle Engine PYY1	634048	Inner Joint		28	33	43	48	84	
	2015.02-	-	-	R	F	All-wheel Drive Closed Off-Road Vehicle Engine PYY1	634115	Inner Joint		28	33	43	48	84	
CX-7 (ER)															
2.3 AWD (182 kW)	2006.06-2012.12	-	-	R	F	All-wheel Drive Closed Off-Road Vehicle Engine L3-VDT	634115	Inner Joint		28	33	43	48	84	
2.3 MZR DISI Turbo (190 kW)	2007.10-2009.08	-	-	-	-	All-wheel Drive Closed Off-Road Vehicle Engine L3-VDT	634048	Inner Joint		28	33	43	48	84	
	2007.10-2009.08	-	-	R	L	All-wheel Drive Closed Off-Road Vehicle Engine L3-VDT	239303	Drive Shaft	44T	28	26	56	92	874	
	2007.10-2009.08	-	-	R	F	All-wheel Drive Closed Off-Road Vehicle Engine L3-VDT	634115	Inner Joint		28	33	43	48	84	
	2007.10-2009.08	-	-	-	-	All-wheel Drive Closed Off-Road Vehicle Engine L3-VDT	634142	Inner Joint		31	36	36.2	65.5	99.5	
	2007.10-2009.08	-	-	-	-	All-wheel Drive Closed Off-Road Vehicle Engine L3-VDT	639114	Inner Joint		26	30	35	78.5	95	
2.3 MZR DISI Turbo (191 kW)	2009.06-2013.03	-	-	-	-	All-wheel Drive Closed Off-Road Vehicle Engine L3-VDT	634142	Inner Joint		31	36	36.2	65.5	99.5	
	2009.06-2013.03	-	-	-	-	All-wheel Drive Closed Off-Road Vehicle Engine L3-VDT	639114	Inner Joint		26	30	35	78.5	95	
2.3 MZR DISI Turbo AWD (175 kW)	2006.06-2014.12	-	-	R	F	All-wheel Drive Closed Off-Road Vehicle Engine L3-VDT	634115	Inner Joint		28	33	43	48	84	
CX-9															
-	2009.07-	-	-	R	R	-	839364	Outer Joint	44T	28	30	56	92	69	I
	2010.08-	-	-	R	R	-	839364	Outer Joint	44T	28	30	56	92	69	I
3.7	2014-	-	-	L	F	V6 GAS DOHC Naturally Aspirated	818316	Outer Joint		31	36	65	94	62.5	I
	2014-	-	-	L	F	V6 GAS DOHC Naturally Aspirated	618257	Inner Joint		31	36	36.2	65	100	
	2014-	-	-	L	F	V6 GAS DOHC Naturally Aspirated	218440	Drive Shaft	44T	31	31	65	94	640	
CX-9 (TB)															
3.7 (204 kW)	2007.01-	-	-	-	-	Closed Off-Road Vehicle Engine CAY5/CAY1/CAY6	634142	Inner Joint		31	36	36.2	65.5	99.5	
	2007.01-	-	-	-	-	Closed Off-Road Vehicle Engine CAY5/CAY1/CAY6	639114	Inner Joint		26	30	35	78.5	95	
3.7 AWD (204 kW)	2007.01-	-	-	-	-	All-wheel Drive Closed Off-Road Vehicle Engine CA/CAY1/CAY5/CAY6	634142	Inner Joint		31	36	36.2	65.5	99.5	
	2007.01-	-	-	-	-	All-wheel Drive Closed Off-Road Vehicle Engine CA/CAY1/CAY5/CAY6	639114	Inner Joint		26	30	35	78.5	95	
CX9 PASSENGER															





MAZDA	YEAR	TRANSM	L/R	F/R	REMARKS	GSP Ref.	PRODUCT	ABS	Technical Specifications											
									A	B	C	H	L	P						
MAZDA																				
CX9 PASSENGER																				
-	-	-	R	F	-	818316	Outer Joint		31	36	65	94	62.5	I						
-	-	-	R	F	-	618255	Inner Joint		31	36	48		137							
-	-	-	R	F	-	218439	Drive Shaft	44T	31	31	65	94	612							
DEMIO (DW)																				
1.3 16V (46 kW)	1998.08-2003.07	-	-	-	Estate Engine B3 ME	818036	Outer Joint		24	19	52	86	50	M						
	1998.08-2003.07	-	L/R	F	Estate Engine B3 ME	834062	Outer Joint	44T	24	19	52	86	54.5	I						
	1998.08-2003.07	-	-	-	Estate Engine B3 ME	834130	Outer Joint	44T	24	19	52	86	50	M						
	1998.08-2003.07	-	-	F	Estate Engine B3 ME	834018	Outer Joint		24	21	52	86	50	M						
1.3 i 16V (53 kW)	1998.08-2000.04	-	-	-	Estate Engine B3 (16V)	818036	Outer Joint		24	19	52	86	50	M						
	1998.08-2000.04	-	L/R	F	Estate Engine B3 (16V)	834062	Outer Joint	44T	24	19	52	86	54.5	I						
	1998.08-2000.04	-	-	-	Estate Engine B3 (16V)	834130	Outer Joint	44T	24	19	52	86	50	M						
	1998.08-2000.04	-	-	F	Estate Engine B3 (16V)	834018	Outer Joint		24	21	52	86	50	M						
1.5 16V (55 kW)	2000.04-2003.07	-	-	-	Estate Engine B5 E	818036	Outer Joint		24	19	52	86	50	M						
	2000.04-2003.07	-	L/R	F	Estate Engine B5 E	834062	Outer Joint	44T	24	19	52	86	54.5	I						
	2000.04-2003.07	-	-	-	Estate Engine B5 E	834130	Outer Joint	44T	24	19	52	86	50	M						
	2000.04-2003.07	-	-	F	Estate Engine B5 E	834018	Outer Joint		24	21	52	86	50	M						
E-SERIE (SD1)																				
E2200 D (47 kW)	1988.11-1997.03	-	-	F	Platform/Chassis Engine R281	834017	Outer Joint		26	23	65	148.5	57	M						
E-SERIE (SG)/BONGO FRIENDEE																				
2.0 i (74 kW)	1995.06-1999.09	-	-	F	MPV Engine FE (8V)	834069	Outer Joint	44T	26	23	56	101	59.5	I						
	1999.08-2001.10	-	-	F	MPV Engine FE (12V)	834069	Outer Joint	44T	26	23	56	101	59.5	I						
2.0 i 12V (74 kW)	1997.11-1999.02	-	-	F	MPV Engine FE (12V)	834069	Outer Joint	44T	26	23	56	101	59.5	I						
	1997.11-1999.02	AT/MT	-	F	MPV Engine FE (12V)	899046	Outer Joint		26	23	56	101	59.5	I						
2.5 i (117 kW)	1995.06-1999.02	-	-	F	MPV Engine J5DE	834069	Outer Joint	44T	26	23	56	101	59.5	I						
	1995.06-1999.02	AT/MT	-	F	MPV Engine J5DE	899046	Outer Joint		26	23	56	101	59.5	I						
2.5 TD (92 kW)	1995.06-1999.09	-	-	F	MPV Engine WL-T (12 V)	834069	Outer Joint	44T	26	23	56	101	59.5	I						
	1995.06-1999.09	-	-	F	All-wheel Drive MPV Engine WL-T (12 V)	834069	Outer Joint	44T	26	23	56	101	59.5	I						
	1995.06-1999.09	AT/MT	-	F	MPV Engine WL-T (12 V)	899046	Outer Joint		26	23	56	101	59.5	I						
	1995.06-1999.09	AT/MT	-	F	All-wheel Drive MPV Engine WL-T (12 V)	899046	Outer Joint		26	23	56	101	59.5	I						
	1999.09-2001.10	-	-	F	MPV Engine WL-T (12 V)	834069	Outer Joint	44T	26	23	56	101	59.5	I						
	1999.09-2001.10	-	-	F	All-wheel Drive MPV Engine WL-T (12 V)	834069	Outer Joint	44T	26	23	56	101	59.5	I						
	1999.09-2001.10	AT/MT	-	F	MPV Engine WL-T (12 V)	899046	Outer Joint		26	23	56	101	59.5	I						
	1999.09-2001.10	AT/MT	-	F	All-wheel Drive MPV Engine WL-T (12 V)	899046	Outer Joint		26	23	56	101	59.5	I						
EUNOS 100 (BG8PE)																				
1.8	1989.10-1994.06	4AT	-	-	Engine BP	834009	Outer Joint		26	30	56	93	55	M						
	1989.10-1994.06	5MT	-	-	Engine BP	834009	Outer Joint		26	30	56	93	55	M						
EUNOS 100 100 BG8PE																				
1.8	1989.10-1994.06	5MT	-	-	Engine BP	834009	Outer Joint		26	30	56	93	55	M						
	1989.10-1994.06	4AT	-	-	Engine BP	834009	Outer Joint		26	30	56	93	55	M						
EUNOS 100 BG8PE																				
1800	1989.10-1994.06	5MT	-	-	Engine BP	834009	Outer Joint		26	30	56	93	55	M						
	1989.10-1994.06	4AT	-	-	Engine BP	834009	Outer Joint		26	30	56	93	55	M						
	1989.10-1994.06	4AT	-	-	Engine BP	834009	Outer Joint		26	30	56	93	55	M						
EUNOS 30X																				
-	1992.10-1996	MT	L	-	-	227049	Drive Shaft		26	28	56	92	615.5							
EUNOS 500 (CA8P)																				
1.8	1991.12-1994.02	5MT	-	-	Engine K8	834145	Outer Joint	44T	28	23	56	89.1	59.5	M						
	1991.12-1994.03	4AT	-	-	Engine K8	834145	Outer Joint	44T	28	23	56	89.1	59.5	M						
EUNOS 500 (CAEP)																				
2.0	1991.12-1994.03	4AT	-	-	Engine KF	834145	Outer Joint	44T	28	23	56	89.1	59.5	M						
	1991.12-1995.12	5MT	-	-	Engine KF	834145	Outer Joint	44T	28	23	56	89.1	59.5	M						
EUNOS 500 (CAPP)																				
1.8	1994.02-1995.12	4AT	-	-	Engine FP	834145	Outer Joint	44T	28	23	56	89.1	59.5	M						
	1994.02-1995.12	5MT	-	-	Engine FP	834145	Outer Joint	44T	28	23	56	89.1	59.5	M						
EUNOS 500 500 CA8P																				
1.8	1991.12-1994.02	5MT	-	-	Engine K8	834145	Outer Joint	44T	28	23	56	89.1	59.5	M						
	1991.12-1994.03	4AT	-	-	Engine K8	834145	Outer Joint	44T	28	23	56	89.1	59.5	M						
EUNOS 500 500 CAEP																				
2.0	1991.12-1995.12	5MT	-	-	Engine KF	834145	Outer Joint	44T	28	23	56	89.1	59.5	M						
	1991.12-1994.03	4AT	-	-	Engine KF	834145	Outer Joint	44T	28	23	56	89.1	59.5	M						
	1994.03-1995.12	5MT	-	-	Engine KF	834145	Outer Joint	44T	28	23	56	89.1	59.5	M						
EUNOS 500 500 CAPP																				
1.8	1994.02-1995.12	5MT	-	-	Engine FP	834145	Outer Joint	44T	28	23	56	89.1	59.5	M						
	1994.02-1995.12	5MT	-	-	Engine FP	834145	Outer Joint	44T	28	23	56	89.1	59.5	M						
	1994.02-1995.12	4AT	-	-	Engine FP	834145	Outer Joint	44T	28	23	56	89.1	59.5	M						

YEAR	TRANS	L/R	F/R	REMARKS	GSP Ref.	PRODUCT	ABS	Technical Specifications						
								A	B	C	H	L	P	
MAZDA														
EUNOS 500 CA8P														
1800	1991.12-1994.02	5MT	-	-	Engine K8	834145	Outer Joint	44T	28	23	56	89.1	59.5	M
	1991.12-1994.03	4AT	-	-	Engine K8	834145	Outer Joint	44T	28	23	56	89.1	59.5	M
EUNOS 500 CAEP														
2000	1991.12-1995.12	5MT	-	-	Engine KF	834145	Outer Joint	44T	28	23	56	89.1	59.5	M
	1991.12-1994.03	4AT	-	-	Engine KF	834145	Outer Joint	44T	28	23	56	89.1	59.5	M
	1994.03-1995.12	5MT	-	-	Engine KF	834145	Outer Joint	44T	28	23	56	89.1	59.5	M
EUNOS 500 CAPP														
1800	1994.02-1995.12	5MT	-	-	Engine FP	834145	Outer Joint	44T	28	23	56	89.1	59.5	M
	1994.02-1995.12	5MT	-	-	Engine FP	834145	Outer Joint	44T	28	23	56	89.1	59.5	M
	1994.02-1995.12	4AT	-	-	Engine FP	834145	Outer Joint	44T	28	23	56	89.1	59.5	M
EUNOS 800 (MILLERCYCLE)														
-	-	-	-	-	-	834057	Outer Joint		31	26	62	95	65	I
EUNOS 800 (TA5)														
2.5	1993.09-2000.07	4AT	-	-	Engine KL	834012	Outer Joint		28	26	56	94	63	M
EUNOS 800 800 TA5														
2.5	1993.09-1996.04	4AT	-	-	Engine KL	834012	Outer Joint		28	26	56	94	63	M
	1993.09-1996.04	4AT	-	-	Engine KL	834012	Outer Joint		28	26	56	94	63	M
	1996.04-2000.07	4AT	-	-	Engine KL	834012	Outer Joint		28	26	56	94	63	M
	1996.04-2000.07	4AT	-	-	Engine KL	834012	Outer Joint		28	26	56	94	63	M
EUNOS 800 TA5														
2.5	1993.09-1996.04	4AT	-	-	Engine KL	834012	Outer Joint		28	26	56	94	63	M
2500 4AT	1993.09-1996.04	-	-	-	Engine KL	834012	Outer Joint		28	26	56	94	63	M
	1996.04-2000.07	-	-	-	Engine KL	834012	Outer Joint		28	26	56	94	63	M
	1996.04-2000.07	-	-	-	Engine KL	834012	Outer Joint		28	26	56	94	63	M
EUNOS PRESSO (EC5S)														
1.5	1993.09-1998.01	MT/AT	-	-	Engine B5	834191	Outer Joint		26	22	56	92	56	M
EUNOS PRESSO (EC8S)														
1.8	1991.04-1998.01	4AT	-	-	Engine K8	834009	Outer Joint		26	30	56	93	55	M
	1991.04-1998.01	5MT	-	-	Engine K8	834009	Outer Joint		26	30	56	93	55	M
EUNOS PRESSO EC5S														
1.5	1993.09-1998.01	MT/AT	-	-	Engine B5	834191	Outer Joint		26	22	56	92	56	M
1500	1993.09-1998.01	MT/AT	-	-	Engine B5	834191	Outer Joint		26	22	56	92	56	M
EUNOS PRESSO EC8S														
1.8	1991.04-1993.10	5MT	-	-	Engine K8	834009	Outer Joint		26	30	56	93	55	M
	1991.04-1993.10	5MT	-	-	Engine K8	834009	Outer Joint		26	30	56	93	55	M
	1991.04-1993.10	4AT	-	-	Engine K8	834009	Outer Joint		26	30	56	93	55	M
	1991.04-1993.10	4AT	-	-	Engine K8	834009	Outer Joint		26	30	56	93	55	M
	1993.10-1998.01	5MT	-	-	Engine K8	834009	Outer Joint		26	30	56	93	55	M
	1993.10-1998.01	5MT	-	-	Engine K8	834009	Outer Joint		26	30	56	93	55	M
	1993.10-1998.01	4AT	-	-	Engine K8	834009	Outer Joint		26	30	56	93	55	M
	1993.10-1998.01	4AT	-	-	Engine K8	834009	Outer Joint		26	30	56	93	55	M
1800	1991.04-1993.10	5MT	-	-	Engine K8	834009	Outer Joint		26	30	56	93	55	M
	1991.04-1993.10	5MT	-	-	Engine K8	834009	Outer Joint		26	30	56	93	55	M
	1991.04-1993.10	4AT	-	-	Engine K8	834009	Outer Joint		26	30	56	93	55	M
	1991.04-1993.10	4AT	-	-	Engine K8	834009	Outer Joint		26	30	56	93	55	M
	1993.10-1998.01	5MT	-	-	Engine K8	834009	Outer Joint		26	30	56	93	55	M
	1993.10-1998.01	5MT	-	-	Engine K8	834009	Outer Joint		26	30	56	93	55	M
	1993.10-1998.01	4AT	-	-	Engine K8	834009	Outer Joint		26	30	56	93	55	M
	1993.10-1998.01	4AT	-	-	Engine K8	834009	Outer Joint		26	30	56	93	55	M
FAMILIA 323														
1.3	1989-1990	AT	-	-	-	634017	Inner Joint		24	21	35	64	97.5	
1.5	1989-1990	AT	-	-	-	634017	Inner Joint		24	21	35	64	97.5	
	1989-1990	MT/AT	-	-	-	634028	Inner Joint		24	22	35	64	94	
1.6	1989-1990	AT	-	-	-	634017	Inner Joint		24	21	35	64	97.5	
	1989-1990	MT/AT	-	-	-	634028	Inner Joint		24	22	35	64	94	
1.7	1989-1990	AT	-	-	-	634017	Inner Joint		24	21	35	64	97.5	
FAMILIA 323 LASER (BG3PS)														
1.3	1989.02-1996.01	MT/AT	-	-	Engine B3	834192	Outer Joint		26	21	56	94	59	M
FAMILIA 323 LASER (BG5SP)														
1.5	1989.02-1994.04	MT/AT	-	-	Engine B5	834192	Outer Joint		26	21	56	94	59	M
FAMILIA 323 LASER (BG7P)														
1.7	1989.01-1994.06	MT/AT	-	-	Engine PN	834192	Outer Joint		26	21	56	94	59	M
FAMILIA 323 LASER (BG8PSP)														
1.8	1990.11-1994.04	4AT	-	-	Engine BP	834009	Outer Joint		26	30	56	93	55	M
FAMILIA 323 LASER (BG8SP)														

		 YEAR	TRANSM	L/R	F/R	REMARKS	GSP Ref.	 PRODUCT	 ABS	Technical Specifications						
										A	B	C	H	L	P	
MAZDA																
FAMILIA 323 LASER (BG8SP)																
1.8	1989.01-	-	MT/AT	-	-	Engine BP	834191	Outer Joint		26	22	56	92	56	M	
	1990.03-	1994.04	5MT	-	-	Engine BP	834009	Outer Joint		26	30	56	93	55	M	
FAMILIA 323 LASER (BHA3PS)																
1.3	1996.10-	1999.05	-	-	-	Engine B3	834191	Outer Joint		26	22	56	92	56	M	
FAMILIA 323 LASER (BHA5PS)																
1.5	1994.05-	-	-	-	-	Engine B5	834191	Outer Joint		26	22	56	92	56	M	
FAMILIA 323 LASER (BHA6R)																
1.6 4WD	1994.09-	1998.06	5MT	-	-	Engine B6	834016	Outer Joint		26	21	56	93.5	55	M	
	1994.10-	-	MT/AT	-	-	Engine B6	834016	Outer Joint		26	21	56	93.5	55	M	
FAMILIA 323 LASER (BHA7P)																
1.7	1994.09-	1998.06	5MT	-	-	Engine 4EE1 TBO	834009	Outer Joint		26	30	56	93	55	M	
	1994.09-	1998.06	-	-	-	Engine 4EE1TBO	834191	Outer Joint		26	22	56	92	56	M	
	1994.10-	-	4AT	-	-	Engine 4EE1 TBO	834009	Outer Joint		26	30	56	93	55	M	
	1994.10-	-	MT/AT	-	-	Engine 4EE1 TBO	834009	Outer Joint		26	30	56	93	55	M	
FAMILIA 323 LASER (BHA7R)																
1.7 4WD	1994.09-	1998.06	5MT	-	-	Engine 4EE1 TBO	834016	Outer Joint		26	21	56	93.5	55	M	
FAMILIA 323 LASER (BHA8PS)																
1.8	1989.01-	-	-	-	-	Engine BP	834191	Outer Joint		26	22	56	92	56	M	
	1994.05-	-	5MT	-	-	Engine BP	834009	Outer Joint		26	30	56	93	55	M	
	1994.06-	1998.06	MT/AT	-	-	Engine BP	834009	Outer Joint		26	30	56	93	55	M	
FAMILIA 323 LASER BG3PS																
1300	1989.02-	1996.01	MT/AT	-	-	Engine B3	834192	Outer Joint		26	21	56	94	59	M	
	1989.02-	1996.01	MT/AT	-	-	Engine B3	834192	Outer Joint		26	21	56	94	59	M	
FAMILIA 323 LASER BG5SP																
1500	1989.02-	1994.04	MT/AT	-	-	Engine B5	834192	Outer Joint		26	21	56	94	59	M	
	1989.02-	1994.04	MT/AT	-	-	Engine B5	834192	Outer Joint		26	21	56	94	59	M	
FAMILIA 323 LASER BG7P																
1700	1989.01-	1994.06	MT/AT	-	-	Engine PN	834192	Outer Joint		26	21	56	94	59	M	
	1989.02-	1994.03	MT/AT	-	-	Engine PN	834192	Outer Joint		26	21	56	94	59	M	
FAMILIA 323 LASER BG8P																
1800	1990.11-	1994.04	MT/AT	-	-	Engine BP	801186	Outer Joint		28	22	56	90	59	M	
FAMILIA 323 LASER BG8PSP																
1800	1990.11-	1994.04	4AT	-	-	Engine BP	834009	Outer Joint		26	30	56	93	55	M	
FAMILIA 323 LASER BG8SP																
1.8	1989.01-	-	MT/AT	-	-	Engine BP	834191	Outer Joint		26	22	56	92	56	M	
	1990.03-	2009.11	5MT	-	-	Engine BP	834009	Outer Joint		26	30	56	93	55	M	
	1990.11-	1994.04	5MT	-	-	Engine BP	834009	Outer Joint		26	30	56	93	55	M	
1800	1989.01-	-	MT/AT	-	-	Engine BP	834191	Outer Joint		26	22	56	92	56	M	
	1990.03-	1990.11	5MT	-	-	Engine BP	834009	Outer Joint		26	30	56	93	55	M	
	1990.11-	1994.04	5MT	-	-	Engine BP	834009	Outer Joint		26	30	56	93	55	M	
FAMILIA 323 LASER BHA3PS																
1.3	1996.10-	1999.05	5MT	-	-	Engine B3	834191	Outer Joint		26	22	56	92	56	M	
	1996.10-	1999.05	MT/AT	-	-	Engine B3	834191	Outer Joint		26	22	56	92	56	M	
	1996.10-	1999.05	3AT	-	-	Engine B3	834191	Outer Joint		26	22	56	92	56	M	
1300	1996.10-	1999.05	5MT	-	-	Engine B3	834191	Outer Joint		26	22	56	92	56	M	
	1996.10-	1999.05	MT/AT	-	-	Engine B3	834191	Outer Joint		26	22	56	92	56	M	
	1996.10-	1999.05	3AT	-	-	Engine B3	834191	Outer Joint		26	22	56	92	56	M	
FAMILIA 323 LASER BHA5PS																
1.5	1994.05-	-	5MT	-	-	Engine B5	834191	Outer Joint		26	22	56	92	56	M	
	1994.05-	-	MT/AT	-	-	Engine B5	834191	Outer Joint		26	22	56	92	56	M	
	1994.05-	1995.07	5MT	-	-	Engine B5	834191	Outer Joint		26	22	56	92	56	M	
	1994.05-	1995.07	4AT	-	-	Engine B5	834191	Outer Joint		26	22	56	92	56	M	
	1994.05-	1995.07	4AT	-	-	Engine B5	834191	Outer Joint		26	22	56	92	56	M	
	1994.06-	1996.10	5MT	-	-	Engine B5	834191	Outer Joint		26	22	56	92	56	M	
	1994.06-	1996.10	5MT	-	-	Engine B5	834191	Outer Joint		26	22	56	92	56	M	
	1994.06-	1996.10	5MT	-	-	Engine B5	834191	Outer Joint		26	22	56	92	56	M	
	1994.06-	1996.10	4AT	-	-	Engine B5	834191	Outer Joint		26	22	56	92	56	M	
	1994.06-	-	4AT	-	-	Engine B5	834191	Outer Joint		26	22	56	92	56	M	
	1994.06-	-	4AT	-	-	Engine B5	834191	Outer Joint		26	22	56	92	56	M	
	1995.07-	1996.10	MT/AT	-	-	Engine B5	834191	Outer Joint		26	22	56	92	56	M	
1500	1994.05-	-	5MT	-	-	Engine B5	834191	Outer Joint		26	22	56	92	56	M	
	1994.05-	-	MT/AT	-	-	Engine B5	834191	Outer Joint		26	22	56	92	56	M	
	1994.05-	1995.07	4AT	-	-	Engine B5	834191	Outer Joint		26	22	56	92	56	M	
	1994.05-	1995.07	5MT	-	-	Engine B5	834191	Outer Joint		26	22	56	92	56	M	
	1994.05-	1995.07	4AT	-	-	Engine B5	834191	Outer Joint		26	22	56	92	56	M	

	YEAR	TRANSM	L/R	F/R	REMARKS	GSP Ref.	PRODUCT	ABS	Technical Specifications												
									A	B	C	H	L	P							
MAZDA																					
FAMILIA 323 LASER BHALPS																					
1500	1994.09-1996.10	5MT	-	-	Engine Z5	834191	Outer Joint		26	22	56	92	56	M							
	1994.09-1996.10	MT/AT	-	-	Engine Z5	834191	Outer Joint		26	22	56	92	56	M							
	1994.09-1996.10	4AT	-	-	Engine Z5	834191	Outer Joint		26	22	56	92	56	M							
	1996.08-1999.05	4AT	-	-	Engine Z5	834191	Outer Joint		26	22	56	92	56	M							
	1996.08-1999.05	5MT	-	-	Engine Z5	834191	Outer Joint		26	22	56	92	56	M							
	1996.08-1999.05	4AT	-	-	Engine Z5	834191	Outer Joint		26	22	56	92	56	M							
FAMILIA 323LASER BG3PS																					
1.3	1989.02-1996.01	MT/AT	-	-	Engine B3	834192	Outer Joint		26	21	56	94	59	M							
	1989.02-1996.01	MT/AT	-	-	Engine B3	834192	Outer Joint		26	21	56	94	59	M							
FAMILIA 323LASER BG5SP																					
1.5	1989.02-1994.04	MT/AT	-	-	Engine B5	834192	Outer Joint		26	21	56	94	59	M							
	1989.02-1994.04	MT/AT	-	-	Engine B5	834192	Outer Joint		26	21	56	94	59	M							
FAMILIA 323LASER BG7P																					
1.7	1989.01-1994.06	MT/AT	-	-	Engine PN	834192	Outer Joint		26	21	56	94	59	M							
	1989.02-1994.03	MT/AT	-	-	Engine PN	834192	Outer Joint		26	21	56	94	59	M							
FAMILIA 323LASER BG8P																					
1.8	1990.11-1994.04	MT/AT	-	-	Engine BP	801186	Outer Joint		28	22	56	90	59	M							
FAMILIA 323LASER BG8PSP																					
1.8	1990.11-1994.04	4AT	-	-	Engine BP	834009	Outer Joint		26	30	56	93	55	M							
FIGHTER																					
-	2007- -	MT	-	-	-	618076	Inner Joint		28	36	42	41.5	70.5								
	2007- -	MT	-	-	-	618077	Inner Joint		30	36	38	94.5	101								
KE2AW																					
2.2	2012.01- -	6AT	R	-	Allwheel Drive Engine SHVPTS	834203	Outer Joint		31	26	59	87	68	M							
KE2FE																					
2.2	2012.01- -	6AT	R	-	Engine SHVPTS	834203	Outer Joint		31	26	59	87	68	M							
KEEAW																					
2.0	2012.01- -	6AT	R	-	Allwheel Drive Engine PEVPS	834249	Outer Joint		31	24	59	87	68	M							
KEEFW																					
2.0	2012.01- -	6AT	R	-	Engine PEVPS	834249	Outer Joint		31	24	59	87	68	M							
LANTIS																					
2.0	1993- -	MT/AT	-	-	KF	827022	Outer Joint		26	24	56	92	60	M							
LANTIS (CBA8P)																					
1.8	1993.08-1997.06	4AT	-	-	Engine BP	834009	Outer Joint		26	30	56	93	55	M							
	1993.08-1997.06	5MT	-	-	Engine BP	834009	Outer Joint		26	30	56	93	55	M							
	1993.08-1997.06	MT/AT	-	-	Engine BP	834009	Outer Joint		26	30	56	93	55	M							
LANTIS CBA8P																					
1.8	1993.08-1997.06	5MT	-	-	Engine BP	834191	Outer Joint		26	22	56	92	56	M							
	1993.08-1997.06	5MT	-	-	Engine BP	834191	Outer Joint		26	22	56	92	56	M							
	1993.08-1997.06	MT/AT	-	-	Engine BP	834191	Outer Joint		26	22	56	92	56	M							
	1993.08-1997.06	4AT	-	-	Engine BP	834191	Outer Joint		26	22	56	92	56	M							
	1993.08-1997.06	MT/AT	-	-	Engine BP	834191	Outer Joint		26	22	56	92	56	M							
	1993.08-1997.06	4AT	-	-	Engine BP	834191	Outer Joint		26	22	56	92	56	M							
	1993.08-1997.06	5MT	-	-	Engine BP	834191	Outer Joint		26	22	56	92	56	M							
1800	1993.08-1997.06	5MT	-	-	Engine BP	834191	Outer Joint		26	22	56	92	56	M							
	1993.08-1997.06	MT/AT	-	-	Engine BP	834191	Outer Joint		26	22	56	92	56	M							
	1993.08-1997.06	4AT	-	-	Engine BP	834191	Outer Joint		26	22	56	92	56	M							
	1993.08-1997.06	5MT	-	-	Engine BP	834191	Outer Joint		26	22	56	92	56	M							
	1993.08-1997.06	5MT	-	-	Engine BP	834191	Outer Joint		26	22	56	92	56	M							
	1993.08-1997.06	4AT	-	-	Engine BP	834191	Outer Joint		26	22	56	92	56	M							
	1993.08-1997.06	MT/AT	-	-	Engine BP	834191	Outer Joint		26	22	56	92	56	M							
LASER (FORD)FIESTA																					
1.8	1990- -	MT	-	-	BG8PE BP	608013	Inner Joint		26	30	43	41	72								
	1990- -	MT	-	-	BG8PE BP	634007	Inner Joint		26	30	35	66.7	99.5								
MAZDA 3																					
2.0 4WD	2006.05-2009.04	4AT	-	-	Engine LFVE	834177	Outer Joint		28	24	58.6	90	60	M							
MAZDA 3 (BK3P)																					
2.3	2006.05- -	6MT	-	-	Engine L3VDT	834178	Outer Joint		28	26	58.6	92	64	M							
MAZDA 3 BK3P																					
2.3	2006.05-2009.04	6MT	-	-	Engine L3VDT	834178	Outer Joint		28	26	58.6	92	64	M							
	2006.05-2009.04	6MT	-	-	Engine L3VDT	834178	Outer Joint		28	26	58.6	92	64	M							
2300	2006.05-2009.04	6MT	-	-	Engine L3VDT	834178	Outer Joint		28	26	58.6	92	64	M							
	2006.05-2009.04	6MT	-	-	Engine L3VDT	834178	Outer Joint		28	26	58.6	92	64	M							
MAZDA 3 BKEP																					
2.0	2006.05-2009.04	4AT	-	-	Allwheel Drive Engine LFVE	834177	Outer Joint		28	24	58.6	90	60	M							

YEAR	TRANS	L/R	F/R	REMARKS	GSP Ref.	PRODUCT	ABS	Technical Specifications								
								A	B	C	H	L	P			
MAZDA																
MAZDA 3 BKEP																
2.0	2006.05-	2009.04	4AT	-	-	Allwheel Drive Engine LFVE	834177	Outer Joint		28	24	58.6	90	60	M	
2000	2006.05-	2009.04	4AT	-	-	Allwheel Drive Engine LFVE	834177	Outer Joint		28	24	58.6	90	60	M	
	2006.05-	2009.04	4AT	-	-	Allwheel Drive Engine LFVE	834177	Outer Joint		28	24	58.6	90	60	M	
	2006.05-	2009.04	4AT	-	-	Allwheel Drive Engine LFVE	834177	Outer Joint		28	24	58.6	90	60	M	
	2006.05-	2009.04	4AT	-	-	Allwheel Drive Engine LFVE	834177	Outer Joint		28	24	58.6	90	60	M	
	2006.05-	2009.04	4AT	-	-	Allwheel Drive Engine LFVE	834177	Outer Joint		28	24	58.6	90	60	M	
MAZDA CX-9 (TB)																
3.7	2009-	2012	-	L	R	-	239302	Drive Shaft	44T	28	26	56	92	818		
	2009-	2012	-	L	R	-	839363	Outer Joint		28	30	56	92	69	I	
MILLENNIA																
2.3	1994-	1997	-	-	-	-	834057	Outer Joint		31	26	62	95	65	I	
	1995-	1999	-	-	-	-	834085	Outer Joint	44T	31	26	62	95	65	I	
MILLENNIA (TA5P)																
2.5	2000.07-	-	4AT	-	-	Engine KLZE	834012	Outer Joint		28	26	56	94	63	M	
MILLENNIA (TAFP)																
2.0	2000.07-	-	4AT	-	-	Engine KFZE	834012	Outer Joint		28	26	56	94	63	M	
MILLENNIA TA5P																
2.5	2000.07-	-	4AT	-	-	Engine KLZE	834012	Outer Joint		28	26	56	94	63	M	
	2000.07-	-	4AT	-	-	Engine KLZE	834012	Outer Joint		28	26	56	94	63	M	
MILLENNIA TAFP																
2.0	2000.07-	-	4AT	-	-	Engine KFZE	834012	Outer Joint		28	26	56	94	63	M	
2000	2000.07-	-	4AT	-	-	Engine KFZE	834012	Outer Joint		28	26	56	94	63	M	
MPV																
-	1989-	1995	-	-	F	Truck	634037	Inner Joint		26	25	35	82.5	100		
	1989-	1998	-	-	-	SUV/Truck/VAN	834037	Outer Joint		26	25	56	102	61	M	
	1989-	1995	-	L	-	Truck 4WD	234069	Drive Shaft		26	26	56	102	481.5		
	1989-	1995	-	R	-	Truck	234068	Drive Shaft		26	26	56	101	547		
	1996-	1998	-	-	-	Truck/VAN 4WD	634012	Inner Joint		26	25	35	82.5	108.5		
	1996-	1998	-	R	-	Truck	234071	Drive Shaft	44T	26	26	56	101	547		
	2000-	2001	-	-	-	Truck/VAN 4WD	618015	Inner Joint		28	23	43	42	76.5		
	2000-	2001	-	R	-	Truck/VAN 4WD	234055	Drive Shaft	44T	28	28	56	89	582		
MPV I (LV)																
3.0 i V6 (109 kW)	1989.11-	1999.09	AT/MT	L/R	F	MPV Engine JE94/JE96	818031	Outer Joint		26	25	56	93	61	M	
3.0 i V6 (113 kW)	1995.03-	1999.09	AT/MT	L/R	F	MPV Engine JE94	818031	Outer Joint		26	25	56	93	61	M	
MPV II (LW)																
2.0 (88 kW)	2000.08-	2002.07	-	-	-	MPV Engine FS	834118	Outer Joint	44T	28	33	56.5	89	59	M	
	2000.08-	2002.07	-	-	F	MPV Engine FS	834063	Outer Joint	44T	28	32	56	90	59	I	
	2000.08-	2002.07	MT	L/R	F	MPV Engine FS	834117	Outer Joint	44T	28	32	56	89	59	M	
2.0 (90 kW)	1999.09-	2000.08	MT	L/R	F	MPV Engine FS-DS	834117	Outer Joint	44T	28	32	56	89	59	M	
2.0 DI (100 kW)	2002.07-	2006.02	-	-	-	MPV Engine RF5C	634048	Inner Joint		28	33	43	48	84		
	2002.07-	2006.02	-	-	-	MPV Engine RF5C	634092	Inner Joint		30	33	40	73	114		
	2002.07-	2006.02	-	R	F	MPV Engine RF5C	634115	Inner Joint		28	33	43	48	84		
	2002.07-	2006.02	-	-	F	MPV Engine RF5C	899285	Outer Joint	44T	28	36	56.6	90	76	I	
	2002.07-	2006.02	MT	L/R	F	MPV Engine RF5C	834117	Outer Joint	44T	28	32	56	89	59	M	
	2002.07-	2006.02	-	-	-	MPV Engine RF5C	834077	Outer Joint	44T	28	35	56	91	65	I	
	2.3 (104 kW)	2002.07-	2006.02	-	-	-	MPV Engine L3	634048	Inner Joint		28	33	43	48	84	
		2002.07-	2006.02	-	-	-	MPV Engine L3	834118	Outer Joint	44T	28	33	56.5	89	59	M
2002.07-		2006.02	-	-	-	MPV Engine L3	634092	Inner Joint		30	33	40	73	114		
2002.07-		2006.02	-	-	F	MPV Engine L3	834063	Outer Joint	44T	28	32	56	90	59	I	
2002.07-		2006.02	-	R	F	MPV Engine L3	634115	Inner Joint		28	33	43	48	84		
2002.07-		2006.02	-	-	F	MPV Engine L3	899285	Outer Joint	44T	28	36	56.6	90	76	I	
2002.07-		2006.02	-	-	-	MPV Engine L3	834077	Outer Joint	44T	28	35	56	91	65	I	
2002.07-		2006.02	MT	L/R	F	MPV Engine L3	834117	Outer Joint	44T	28	32	56	89	59	M	
3.0 i V6 (147 kW)	2002.03-	2006.02	-	R	F	MPV Engine AJ	634115	Inner Joint		28	33	43	48	84		
MS-6 (GE8P)																
1.8	1991.10-	1994.07	4AT	-	-	Engine K8	834145	Outer Joint	44T	28	23	56	89.1	59.5	M	
	1991.10-	1994.07	5MT	-	-	Engine K8	834145	Outer Joint	44T	28	23	56	89.1	59.5	M	
MS-6 (GEEP)																
2.0	1991.10-	1994.07	4AT	-	-	Engine KF	834145	Outer Joint	44T	28	23	56	89.1	59.5	M	
	1991.10-	1994.07	5MT	-	-	Engine KF	834145	Outer Joint	44T	28	23	56	89.1	59.5	M	
MS-6 (GEFP)																
2.0	1993.06-	1994.07	4AT	-	-	Engine RF SPC	834145	Outer Joint	44T	28	23	56	89.1	59.5	M	
MS-6 GE8P																
1.8	1991.10-	1994.07	5MT	-	-	Engine K8	834145	Outer Joint	44T	28	23	56	89.1	59.5	M	
	1991.10-	1994.07	4AT	-	-	Engine K8	834145	Outer Joint	44T	28	23	56	89.1	59.5	M	
1800	1991.10-	1994.07	5MT	-	-	Engine K8	834145	Outer Joint	44T	28	23	56	89.1	59.5	M	

	 YEAR	TRANSM	L/R	F/R	REMARKS	GSP Ref.	 PRODUCT	 ABS	Technical Specifications					
									A	B	C	H	L	P
MAZDA														
MS-6 GE8P														
1800	1991.10-1994.07	4AT	-	-	Engine K8	834145	Outer Joint	44T	28	23	56	89.1	59.5	M
MS-6 GEEP														
2.0	1991.10-1994.07	5MT	-	-	Engine KF	834145	Outer Joint	44T	28	23	56	89.1	59.5	M
	1991.10-1994.07	4AT	-	-	Engine KF	834145	Outer Joint	44T	28	23	56	89.1	59.5	M
2000	1991.10-1994.07	5MT	-	-	Engine KF	834145	Outer Joint	44T	28	23	56	89.1	59.5	M
	1991.10-1994.07	4AT	-	-	Engine KF	834145	Outer Joint	44T	28	23	56	89.1	59.5	M
MS-6 GEFP														
2.0	1993.06-1994.07	4AT	-	-	Engine RF SPC	834145	Outer Joint	44T	28	23	56	89.1	59.5	M
2000	1993.06-1994.07	4AT	-	-	Engine RF SPC	834145	Outer Joint	44T	28	23	56	89.1	59.5	M
MS-8 (MB5A)														
2.5	1992.01-1994.05	4AT	-	-	Engine KL	834012	Outer Joint		28	26	56	94	63	M
MS-8 (MBEP)														
2.0	1992.01-1994.05	4AT	-	-	Engine KF	834145	Outer Joint	44T	28	23	56	89.1	59.5	M
MS-8 MB5A														
2.5	1992.01-1994.05	4AT	-	-	Engine KL	834012	Outer Joint		28	26	56	94	63	M
	1992.01-1994.05	4AT	-	-	Engine KL	834012	Outer Joint		28	26	56	94	63	M
	1992.01-1994.05	4AT	-	-	Engine KL	834012	Outer Joint		28	26	56	94	63	M
	1992.01-1994.05	4AT	-	-	Engine KL	834012	Outer Joint		28	26	56	94	63	M
MS-8 MBEP														
2.0	1992.01-1994.05	4AT	-	-	Engine KF	834145	Outer Joint	44T	28	23	56	89.1	59.5	M
2000	1992.01-1994.05	4AT	-	-	Engine KF	834145	Outer Joint	44T	28	23	56	89.1	59.5	M
MX-3														
1.8	1992-1995	MT	L	F	-	234046	Drive Shaft	44T	26	28	56	93	622.5	
	1992-1995	MT	-	-	-	634009	Inner Joint		28	30	35	66.5	99	
MX-3 (EC)/AZ-3/PRESSO														
1.6 i (65 kW)	1991.07-1997.10	-	L	F	Coupe Engine B69	618006	Inner Joint		24	22	35	64	98.5	
	1991.07-1997.10	AT/MT	L/R	F	Coupe Engine B69	834007	Outer Joint		26	22	56	93	56.5	I
	1991.07-1997.10	MT	L	F	Coupe Engine B69	227048	Drive Shaft	44T	26	24	56	94	636.5	
1.6 i (79 kW)	1994.01-1997.10	MT	L	F	Coupe Engine B6D	227048	Drive Shaft	44T	26	24	56	94	636.5	
	1994.01-1997.10	-	-	-	Coupe Engine B6D	834055	Outer Joint		26	22	56	94	59	M
1.8 i V6 (98 kW)	1992.01-1994.01	AT/MT	L/R	F	Coupe Engine K819	818034	Outer Joint		26	22	56	94	59	I
	1992.01-1994.01	AT/MT	L/R	F	Coupe Engine K819	834007	Outer Joint		26	22	56	93	56.5	I
MX-3/PRECIDIA														
-	1992-1995	MT	L	-	6 Cyl	234013	Drive Shaft		26	28	56	93	622.5	
MX-5 II (NB)/ROADSTER														
1.8 16V (102 kW)	2000.11-2005.10	-	-	F	Convertible Engine BPD	834063	Outer Joint	44T	28	32	56	90	59	I
1.8 16V (103 kW)	1998.05-2005.10	-	-	F	Convertible Engine BP-ZE	834063	Outer Joint	44T	28	32	56	90	59	I
1.8 16V (107 kW)	2000.11-2005.10	-	-	F	Convertible Engine BP-ZE/BPD	834063	Outer Joint	44T	28	32	56	90	59	I
MX-5 III (NC)/ROADSTER														
1.8 (93 kW)	2005.03-2014.12	-	L	R	Convertible Engine L828/L8-DE	234211	Drive Shaft	44T	28	28	56.5	81.5	759	
	2005.03-2014.12	-	R	R	Convertible Engine L828/L8-DE	234212	Drive Shaft	44T	28	28	56.5	81.5	799	
2.0 (118 kW)	2008.09-2014.12	-	L	R	Convertible Engine LF62/LF-DE	234211	Drive Shaft	44T	28	28	56.5	81.5	759	
	2008.09-2014.12	-	R	R	Convertible Engine LF62/LF-DE	234212	Drive Shaft	44T	28	28	56.5	81.5	799	
MX-6														
-	1988-1992	-	-	-	4 Cyl	634002	Inner Joint		26	25	42.3	37.8	76.5	
	1988-1992	-	-	-	4 Cyl	618005	Inner Joint		26	25	35	66.5	103.4	
2.0	1993-1997	MT	-	-	-	834036	Outer Joint		28	32	56	90	59	I
2.5	1993-1997	MT	-	-	-	834036	Outer Joint		28	32	56	90	59	I
MX-6 (GD)														
2.5 (122 kW)	1992.09-1997.01	MT	-	-	Coupe Engine KL	834082	Outer Joint	44T	28	26	56	94	63	M
MX-6 (GE)														
2.0 (85 kW)	1992.02-1997.02	MT	L	F	Coupe Engine FS	250269	Drive Shaft		27	37.1	56.5	91.5	595	
	1992.02-1997.02	AT/MT	L/R	F	Coupe Engine FS	818035	Outer Joint		28	23	56	90	59	I
	1992.02-1997.02	MT	L	F	Coupe Engine FS	250269	Drive Shaft		27	37.1	56.5	91.5	595	
	1992.02-1997.02	-	R	F	Coupe Engine FS	634033	Inner Joint		28	23	43	46	77	
	1992.02-1997.02	AT/MT	L/R	F	Coupe Engine FS	834080	Outer Joint	44T	28	23	56	90	59	M
	1992.02-1997.02	AT	L/R	F	Coupe Engine FS	834117	Outer Joint	44T	28	32	56	89	59	M
	1992.02-1997.02	-	-	F	Coupe Engine FS	834014	Outer Joint		28	23	56	89.1	59.5	M
2.5 24V (121 kW)	1992.02-1997.02	MT	L	F	Coupe Engine KL	250269	Drive Shaft		27	37.1	56.5	91.5	595	
	1992.02-1997.02	MT	L	F	Coupe Engine KL	250269	Drive Shaft		27	37.1	56.5	91.5	595	
	1992.02-1997.02	MT	-	-	Coupe Engine KL	834082	Outer Joint	44T	28	26	56	94	63	M
	1992.02-1997.02	MT	L/R	F	Coupe Engine KL	818028	Outer Joint		28	26	56	89	65	I
	1992.02-1997.02	AT	L/R	F	Coupe Engine KL	834117	Outer Joint	44T	28	32	56	89	59	M
	1992.02-1997.02	-	-	-	Coupe Engine KL	818073	Outer Joint		28	26	56	89	65	M
	1992.02-1997.02	-	-	-	Coupe Engine KL	834073	Outer Joint	90T	28	26	56	89	65	M

YEAR	TRANS	L/R	F/R	REMARKS	GSP Ref.	PRODUCT	ABS	Technical Specifications					
								A	B	C	H	L	P
MAZDA													
MX-6 (GE)													
2.5 24V (123 kW)	1993.02-1995.11	-	-	F Coupe Engine KL	899045	Outer Joint		28	23	56	90	59	M
	1993.02-1995.11	-	-	F Coupe Engine KL	818029	Outer Joint	44T	28	26	56	89	65	I
	1993.02-1995.11	MT	-	- Coupe Engine KL	834082	Outer Joint	44T	28	26	56	94	63	M
2.5 i 24V (120 kW)	1994.08-1997.02	-	-	- Coupe Engine KL	834073	Outer Joint	90T	28	26	56	89	65	M
	1994.08-1997.02	MT	-	- Coupe Engine KL	834082	Outer Joint	44T	28	26	56	94	63	M
	1994.08-1997.02	-	-	F Coupe Engine KL	899045	Outer Joint		28	23	56	90	59	M
	1994.08-1997.02	-	-	F Coupe Engine KL	818029	Outer Joint	44T	28	26	56	89	65	I
	1994.08-1997.02	MT	L/R	F Coupe Engine KL	818028	Outer Joint		28	26	56	89	65	I
	1994.08-1997.02	AT	L/R	F Coupe Engine KL	834117	Outer Joint	44T	28	32	56	89	59	M
	1994.08-1997.02	-	-	- Coupe Engine KL	818073	Outer Joint		28	26	56	89	65	M
MX-6 (GE5SB)													
2.5	1991.11-1996.01	4AT	-	- Engine KL	834012	Outer Joint		28	26	56	94	63	M
MX-6 (GEESB)													
2.0	1991.11-1996.01	4AT	-	- Engine KF	834145	Outer Joint	44T	28	23	56	89.1	59.5	M
	1991.11-1996.01	5MT	-	- Engine KF	834145	Outer Joint	44T	28	23	56	89.1	59.5	M
MX-6 GE5SB													
2.5	1991.11-1996.01	4AT	-	- Engine KL	834012	Outer Joint		28	26	56	94	63	M
	1991.11-1996.01	4AT	-	- Engine KL	834012	Outer Joint		28	26	56	94	63	M
	1991.11-1996.01	4AT	-	- Engine KL	834012	Outer Joint		28	26	56	94	63	M
	1991.11-1996.01	4AT	-	- Engine KL	834012	Outer Joint		28	26	56	94	63	M
MX-6 GEESB													
2.0	1991.11-1996.01	5MT	-	- Engine KF	834145	Outer Joint	44T	28	23	56	89.1	59.5	M
	1991.11-1996.01	4AT	-	- Engine KF	834145	Outer Joint	44T	28	23	56	89.1	59.5	M
2000	1991.11-1996.01	5MT	-	- Engine KF	834145	Outer Joint	44T	28	23	56	89.1	59.5	M
	1991.11-1996.01	4AT	-	- Engine KF	834145	Outer Joint	44T	28	23	56	89.1	59.5	M
MX-6 MYSTERE													
-	1994-1997	AT	-	- 6 Cyl (Incl. 4WD Model)	618015	Inner Joint		28	23	43	42	76.5	
	1994-1997	MT	-	- 4 Cyl (Incl. 4WD Model)	618015	Inner Joint		28	23	43	42	76.5	
MX-6(GE)													
1.8/2.0	1994.06-	MT	L	F -	634032	Inner Joint		28	23	35	66	105	
2.0	1991.07-	MT	L	F -	634032	Inner Joint		28	23	35	66	105	
PICK UP													
-	1987-1994	-	-	- Truck	634018	Inner Joint		26	25	40	39	68	
	1987-1993	-	-	- Truck/VAN 4WD	634012	Inner Joint		26	25	35	82.5	108.5	
	1987-1994	-	L	- Truck	234067	Drive Shaft		26	26	65	143.5	541	
B2500	2000-	-	-	F 4 Cyl	818055	Outer Joint		27	34	59.7	112	80	I
B3000	2000-2002	-	-	F 6 Cyl	818055	Outer Joint		27	34	59.7	112	80	I
B4000	2000-2002	-	-	F 6 Cyl	818055	Outer Joint		27	34	59.7	112	80	I
PRECIDIA													
-	1992-1995	MT	-	- 6 Cyl	634009	Inner Joint		28	30	35	66.5	99	
PREMACY (CP)													
1.9 (74 kW)	1999.07-2005.03	-	-	F MPV Engine FP	834160	Outer Joint	44T	26	29	56	92	56	I
	1999.07-2005.03	AT/MT	L/R	F MPV Engine FP	834008	Outer Joint		26	29	56	93.5	59	I
1.9 (84 kW)	1999.07-2005.03	-	-	F MPV Engine FP	834160	Outer Joint	44T	26	29	56	92	56	I
	1999.07-2005.03	AT/MT	L/R	F MPV Engine FP	834008	Outer Joint		26	29	56	93.5	59	I
2.0 (96 kW)	2001.11-2005.03	-	-	F MPV Engine FS7G/FS7E	834020	Outer Joint		26	28	56	93.1	53	M
	2001.11-2005.03	-	-	F MPV Engine FS7G/FS7E	834124	Outer Joint	44T	26	28	56	93.1	53	M
2.0 TD (66 kW)	1999.10-2000.07	-	-	F MPV Engine RF3F	834160	Outer Joint	44T	26	29	56	92	56	I
	1999.10-2000.07	AT/MT	L/R	F MPV Engine RF3F	834008	Outer Joint		26	29	56	93.5	59	I
2.0 TD (74 kW)	2000.07-2005.03	-	-	F MPV Engine RF4F	834160	Outer Joint	44T	26	29	56	92	56	I
	2000.07-2005.03	AT/MT	L/R	F MPV Engine RF4F	834008	Outer Joint		26	29	56	93.5	59	I
PRIDE													
-	1994.01-1995.12	-	-	-	827023	Outer Joint		24	19	52	86	51	O
PROBE													
-	1988-1992	-	-	- 4 Cyl W/O Turbo	634036	Inner Joint		26	25	43	37.8	75.5	
	1988-	-	-	-	834054	Outer Joint		26	30	56	93	55	M
	1988-1992	-	-	-	634002	Inner Joint		26	25	42.3	37.8	76.5	
	1988-1992	-	-	-	618005	Inner Joint		26	25	35	66.5	103.4	
PROBE (PT22L)													
2.2	1989.11-1992.09	AT	-	- Engine F2	834012	Outer Joint		28	26	56	94	63	M
PROBE PT22L													
2.2	1989.11-1992.09	AT	-	- Engine F2	834012	Outer Joint		28	26	56	94	63	M
	1989.11-1992.09	AT	-	- Engine F2	834012	Outer Joint		28	26	56	94	63	M
PROTEGE													
-	1990-1994	-	-	-	618009	Inner Joint		24	23	35	64	98.5	

YEAR	TRANS	L/R	F/R	REMARKS	GSP Ref.	PRODUCT	ABS	Technical Specifications									
								A	B	C	H	L	P				
MAZDA																	
PROTEGE																	
1.8	1990-1994	-	-	-	-	834050	Outer Joint		26	23	56	93.5	56.5	M			
	1990-1994	-	-	-	-	618039	Inner Joint		24	28	35	64.1	91.5				
	1995-1998	MT	L	F	-	234046	Drive Shaft	44T	26	28	56	93	622.5				
	1995-1998	MT	-	-	-	634009	Inner Joint		28	30	35	66.5	99				
TRIBUTE																	
-	2001-2006	-	-	R	-	635047	Propshaft CV Joint			26		42					
	2001-2004	-	-	-	Truck/VAN	834039	Outer Joint		28	24	56	94	62	M			
TRIBUTE (EP)																	
2.0 (91 kW)	2000.03-2008.05	AT/MT	L/R	F	All-wheel Drive Closed Off-Road Vehicle Engine YF	834090	Outer Joint	44T	28	24	56	89.1	59.5	M			
	2000.03-2008.05	AT/MT	L/R	F	Closed Off-Road Vehicle Engine YF	834090	Outer Joint	44T	28	24	56	89.1	59.5	M			
	2000.03-2008.05	-	-	R	All-wheel Drive Closed Off-Road Vehicle Engine YF	818204	Outer Joint	44T	26	30	56	114	58	I			
	2000.03-2008.05	-	-	R	Closed Off-Road Vehicle Engine YF	818204	Outer Joint	44T	26	30	56	114	58	I			
	2000.03-2008.05	MT	L	F	All-wheel Drive Closed Off-Road Vehicle Engine YF	634071	Inner Joint		28	32	35	66.5	112				
	2000.03-2008.05	MT	L	F	Closed Off-Road Vehicle Engine YF	634071	Inner Joint		28	32	35	66.5	112				
	2000.03-2008.05	MT	L	F	All-wheel Drive Closed Off-Road Vehicle Engine YF	234096	Drive Shaft	44T	28	28	56	94	635				
	2000.03-2008.05	MT	L	F	Closed Off-Road Vehicle Engine YF	234096	Drive Shaft	44T	28	28	56	94	635				
	2000.03-2008.05	MT	R	F	All-wheel Drive Closed Off-Road Vehicle Engine YF	234196	Drive Shaft	44T	28	35	56	94	570				
	2000.03-2008.05	MT	R	F	Closed Off-Road Vehicle Engine YF	234196	Drive Shaft	44T	28	35	56	94	570				
	2000.03-2008.05	-	-	F	All-wheel Drive Closed Off-Road Vehicle Engine YF	834064	Outer Joint	44T	28	24	56	94	62	M			
	2000.03-2008.05	-	-	F	Closed Off-Road Vehicle Engine YF	834064	Outer Joint	44T	28	24	56	94	62	M			
	2.3 AWD (110 kW)	2004.04-2008.05	-	-	-	All-wheel Drive Closed Off-Road Vehicle Engine L3-VE	634048	Inner Joint		28	33	43	48	84			
		2004.04-2008.05	AT/MT	L/R	F	All-wheel Drive Closed Off-Road Vehicle Engine L3-VE	834090	Outer Joint	44T	28	24	56	89.1	59.5	M		
2004.04-2008.05		-	R	F	All-wheel Drive Closed Off-Road Vehicle Engine L3-VE	634115	Inner Joint		28	33	43	48	84				
2.3 GX (110 kW)	2003.12-2004.10	-	-	-	Closed Off-Road Vehicle Engine L3-VE	634048	Inner Joint		28	33	43	48	84				
	2003.12-2004.10	-	R	F	Closed Off-Road Vehicle Engine L3-VE	634115	Inner Joint		28	33	43	48	84				
3.0 V6 24V (145 kW)	2000.03-2008.05	-	-	-	All-wheel Drive Closed Off-Road Vehicle Engine AJ	634048	Inner Joint		28	33	43	48	84				
	2000.03-2008.05	AT/MT	L/R	F	All-wheel Drive Closed Off-Road Vehicle Engine AJ	834090	Outer Joint	44T	28	24	56	89.1	59.5	M			
	2000.03-2008.05	-	-	R	All-wheel Drive Closed Off-Road Vehicle Engine AJ	818204	Outer Joint	44T	26	30	56	114	58	I			
	2000.03-2008.05	-	R	F	All-wheel Drive Closed Off-Road Vehicle Engine AJ	634115	Inner Joint		28	33	43	48	84				
	2000.03-2008.05	AT	L	F	All-wheel Drive Closed Off-Road Vehicle Engine AJ	218083	Drive Shaft	44T	28	35	56	91.5	670				
	2000.03-2008.05	AT	R	F	All-wheel Drive Closed Off-Road Vehicle Engine AJ	234087	Drive Shaft	44T	28	35	56	94	545				
3.0 V6 AWD (149 kW)	2000.03-2008.05	-	-	F	All-wheel Drive Closed Off-Road Vehicle Engine AJ	834064	Outer Joint	44T	28	24	56	94	62	M			
	2004.04-2008.05	-	-	-	All-wheel Drive Closed Off-Road Vehicle Engine AJ	634048	Inner Joint		28	33	43	48	84				
	2004.04-2008.05	AT/MT	L/R	F	All-wheel Drive Closed Off-Road Vehicle Engine AJ	834090	Outer Joint	44T	28	24	56	89.1	59.5	M			
2004.04-2008.05	-	R	F	All-wheel Drive Closed Off-Road Vehicle Engine AJ	634115	Inner Joint		28	33	43	48	84					
XEDOS 6																	
1.6 16V	1993-1997	MT/AT	-	-	-	834033	Outer Joint		28	22	56	90	59	I			
2.0 24V V6	1992-1998	MT/AT	-	-	-	834033	Outer Joint		28	22	56	90	59	I			
XEDOS 6 (CA)/EUNOS 500																	
1.6 16V (79 kW)	1994.06-1999.10	-	-	F	Saloon Engine B6 (DOHC)	899233	Outer Joint	44T	28	22	56	90	59	I			
	1994.06-1999.10	MT	-	F	Saloon Engine B6 (DOHC)	834100	Outer Joint		28	22	56	89.1	59.5	M			
1.6 16V (83 kW)	1992.08-1994.05	-	-	F	Saloon Engine B69	899233	Outer Joint	44T	28	22	56	90	59	I			
	1992.08-1994.05	MT	-	F	Saloon Engine B69	834100	Outer Joint		28	22	56	89.1	59.5	M			
2.0 V6 (103 kW)	1994.06-1999.10	MT	L	F	Saloon Engine KF1	250269	Drive Shaft		27	37.1	56.5	91.5	595				
	1994.06-1999.10	MT	L	F	Saloon Engine KF1	250269	Drive Shaft		27	37.1	56.5	91.5	595				
	1994.06-1999.10	MT	L/R	F	Saloon Engine KF1	818035	Outer Joint		28	23	56	90	59	I			
	1994.06-1999.10	-	R	F	Saloon Engine KF1	634033	Inner Joint		28	23	43	46	77				
	1994.06-1999.10	MT	-	F	Saloon Engine KF1	899045	Outer Joint		28	23	56	90	59	M			
	1994.06-1999.10	MT	L/R	F	Saloon Engine KF1	834080	Outer Joint	44T	28	23	56	90	59	M			
	1994.06-1999.10	-	-	F	Saloon Engine KF1	834014	Outer Joint		28	23	56	89.1	59.5	M			
	1994.06-1999.10	-	-	F	Saloon Engine KF1	899233	Outer Joint	44T	28	22	56	90	59	I			
	1994.06-1999.10	-	-	F	Saloon Engine KF1	899233	Outer Joint	44T	28	22	56	90	59	I			
2.0 V6 (106 kW)	1992.01-1994.05	MT	L	F	Saloon Engine KF1	250269	Drive Shaft		27	37.1	56.5	91.5	595				
	1992.01-1994.05	MT	L/R	F	Saloon Engine KF1	818035	Outer Joint		28	23	56	90	59	I			
	1992.01-1994.05	MT	L	F	Saloon Engine KF1	250269	Drive Shaft		27	37.1	56.5	91.5	595				
	1992.01-1994.05	MT	-	F	Saloon Engine KF1	899045	Outer Joint		28	23	56	90	59	M			
	1992.01-1994.05	MT	L/R	F	Saloon Engine KF1	834080	Outer Joint	44T	28	23	56	90	59	M			
	1992.01-1994.05	-	-	F	Saloon Engine KF1	899233	Outer Joint	44T	28	22	56	90	59	I			
XEDOS 9 (TA)/EUNOS 800																	
2.0 24V (105 kW)	1993.08-2000.01	AT/MT	L/R	F	Saloon Engine KF	818028	Outer Joint		28	26	56	89	65	I			
	1993.08-2000.01	-	-	F	Saloon Engine KF	834014	Outer Joint		28	23	56	89.1	59.5	M			
	1993.08-2000.01	-	-	F	Saloon Engine KF	899233	Outer Joint	44T	28	22	56	90	59	I			
2.3 24V (155 kW)	1995.02-2000.01	AT	L/R	F	Saloon Engine KJ -ZEM	818028	Outer Joint		28	26	56	89	65	I			
2.5 24V (123 kW)	1993.07-2000.07	AT/MT	L/R	F	Saloon Engine KL	818028	Outer Joint		28	26	56	89	65	I			
	1993.07-2000.07	AT	L	F	Saloon Engine KL	218176	Drive Shaft	44T	28	28	56	91.5	629				
	1993.07-2000.07	AT	R	F	Saloon Engine KL	218085	Drive Shaft	44T	28	28	56	89	575.5				
2.5 V6 (120 kW)	2000.07-2002.09	AT/MT	L/R	F	Saloon Engine KL	818028	Outer Joint		28	26	56	89	65	I			

YEAR	TRANSM	L/R	F/R	REMARKS	GSP Ref.	PRODUCT	ABS	Technical Specifications									
								A	B	C	H	L	P				
MAZDA																	
XEDOS-6(CA)																	
2.0	1994.04-	-	MT	L	F	-	634032	Inner Joint		28	23	35	66	105			
MAZDA (CHANGAN)																	
3																	
1.6 (79 kW)	2009.01-	-	AT	-	-	Saloon Engine Z6	234150	Drive Shaft		36	26	55.3	48	922			
	2011.09-	-	AT	-	-	Hatchback Engine Z6	234150	Drive Shaft		36	26	55.3	48	922			
2.0 (110 kW)	2006.02-	2011.12	-	-	-	Saloon Engine LF-DE	234081	Drive Shaft		36	26	55.2	48.5	569			
	2006.02-	2011.12	-	-	-	Saloon Engine LF-DE	234085	Drive Shaft		36	28	55.3	48	588			
	2011.09-	-	-	-	-	Hatchback Engine LF	234085	Drive Shaft		36	28	55.3	48	588			
	2011.09-	-	-	-	-	Hatchback Engine LF	234081	Drive Shaft		36	26	55.2	48.5	569			
	2011.09-	-	-	-	-	Saloon Engine LF	234081	Drive Shaft		36	26	55.2	48.5	569			
	2011.09-	-	-	-	-	Saloon Engine LF	234085	Drive Shaft		36	28	55.3	48	588			
MAZDA (FAW)																	
6																	
2.0 (108 kW)	2003.07-	-	AT	L	-	Saloon Engine LFX	234082	Drive Shaft	44T	28	28	56	90	652			
	2003.07-	-	AT	R	-	Saloon Engine LFX	234083	Drive Shaft	44T	28	28	56	90	596			
2.0 (99 kW)	2003.04-	-	AT	L	-	Saloon Engine LFD	234082	Drive Shaft	44T	28	28	56	90	652			
	2003.04-	-	AT	R	-	Saloon Engine LFD	234083	Drive Shaft	44T	28	28	56	90	596			
2.3 (119 kW)	2003.04-	2005.12	AT	L	-	Saloon Engine L3X	234082	Drive Shaft	44T	28	28	56	90	652			
	2003.04-	2005.12	AT	R	-	Saloon Engine L3X	234083	Drive Shaft	44T	28	28	56	90	596			
2.3 (120 kW)	2003.04-	2009.12	AT	L	-	Estate Engine L3	234082	Drive Shaft	44T	28	28	56	90	652			
	2003.04-	2009.12	AT	R	-	Estate Engine L3	234083	Drive Shaft	44T	28	28	56	90	596			
6 RUI YI																	
2.5 (124 kW)	2009.01-	2014.12	AT	R	F	Saloon Engine L5	234117	Drive Shaft		28	28	62	92	619			
	2009.01-	2014.12	AT	L	F	Saloon Engine L5	299237	Drive Shaft		28	28	62	92	664			
MAZDA CHANGAN																	
3 Saloon																	
1.6 (77 kW)	2006.02-	2014.12	AT	-	-	Saloon Engine B6	234150	Drive Shaft		36	26	55.3	48	922			
MEGA CLUB																	
1.1 i (44 kW)	1992.01-	1999.06	-	-	F	Estate Engine TU1MC	808016	Outer Joint		22	22	52	96.5	53.5	O		
MERCEDES BENZ																	
100 (631)																	
2.5 (55 kW)	1990.12-	1996.02	-	-	F	Box Engine OM 616.963	235014	Drive Shaft		30	30	72	138.5	732.5			
	1990.12-	1996.02	MT	L/R	F	Box Engine OM 616.963	235010	Drive Shaft		30	30	72	142	729			
3.0 (41 kW)	1990.12-	1994.12	-	-	F	BUS Engine OM 616	235014	Drive Shaft		30	30	72	138.5	732.5			
	1990.12-	1994.12	MT	L/R	F	BUS Engine OM 616	235010	Drive Shaft		30	30	72	142	729			
3.0 (53 kW)	1988.02-	1992.05	-	-	F	Box Engine OM 616.963	235014	Drive Shaft		30	30	72	138.5	732.5			
	1988.02-	1992.05	-	-	F	BUS Engine OM 616.963	235014	Drive Shaft		30	30	72	138.5	732.5			
	1988.02-	1992.05	MT	L/R	F	BUS Engine OM 616.963	235010	Drive Shaft		30	30	72	142	729			
	1988.02-	1992.05	MT	L/R	F	Box Engine OM 616.963	235010	Drive Shaft		30	30	72	142	729			
3.0 (55 kW)	1990.12-	1996.02	-	-	F	BUS Engine OM 616/OM 616.963	235014	Drive Shaft		30	30	72	138.5	732.5			
	1990.12-	1996.02	MT	L/R	F	BUS Engine OM 616/OM 616.963	235010	Drive Shaft		30	30	72	142	729			
190 (W201)																	
1.8 (80 kW)	1990.04-	1993.08	AT/MT	L/R	R	Saloon Engine M 102.910	635006	Inner Joint			25		26				
	1990.04-	1993.08	AT/MT	L/R	R	Saloon Engine M 102.910	235006	Drive Shaft		25		62	69	627			
2.0 (53 kW)	1983.08-	1989.08	AT/MT	L/R	R	Saloon Engine OM 601.911	635006	Inner Joint			25		26				
	1983.08-	1989.08	AT/MT	L/R	R	Saloon Engine OM 601.911	235006	Drive Shaft		25		62	69	627			
2.0 (55 kW)	1989.08-	1993.08	AT/MT	L/R	R	Saloon Engine OM 601.911	635006	Inner Joint			25		26				
	1989.08-	1993.08	AT/MT	L/R	R	Saloon Engine OM 601.911	235006	Drive Shaft		25		62	69	627			
2.0 (87 kW)	1985.01-	1993.08	AT/MT	L/R	R	Saloon Engine M 102.962	635006	Inner Joint			25		26				
	1985.01-	1993.08	AT/MT	L/R	R	Saloon Engine M 102.962	235006	Drive Shaft		25		62	69	627			
2.0 (90 kW)	1982.10-	1993.06	AT/MT	L/R	R	Saloon Engine M 102.962/M 102.961	635006	Inner Joint			25		26				
	1982.10-	1993.06	AT/MT	L/R	R	Saloon Engine M 102.962/M 102.961	235006	Drive Shaft		25		62	69	627			
2.3 (100 kW)	1986.10-	1993.08	AT/MT	L/R	R	Saloon Engine M 102.985	635006	Inner Joint			25		26				
	1986.10-	1993.08	AT/MT	L/R	R	Saloon Engine M 102.985	235006	Drive Shaft		25		62	69	627			
2.3 (97 kW)	1986.09-	1991.08	AT/MT	L/R	R	Saloon Engine M 102.985	635006	Inner Joint			25		26				
	1986.09-	1991.08	AT/MT	L/R	R	Saloon Engine M 102.985	235006	Drive Shaft		25		62	69	627			
2.5 (66 kW)	1985.04-	1993.08	AT/MT	L/R	R	Saloon Engine OM 602.911	635006	Inner Joint			25		26				
	1985.04-	1993.08	AT/MT	L/R	R	Saloon Engine OM 602.911	235006	Drive Shaft		25		62	69	627			
2.5 (69 kW)	1989.08-	1993.08	AT/MT	L/R	R	Saloon Engine OM 602.911	635006	Inner Joint			25		26				
	1989.08-	1993.08	AT/MT	L/R	R	Saloon Engine OM 602.911	235006	Drive Shaft		25		62	69	627			
A CLASS																	
1.5TD	2012-	2015	-	L	F	-	235067	Drive Shaft		30	27	65	53	535			
A-CLASS																	

YEAR	TRANSM	L/R	F/R	REMARKS	GSP Ref.	PRODUCT	ABS	Technical Specifications						
								A	B	C	H	L	P	
MERCEDES BENZ														
A-CLASS														
A 150 (70 KW)	2004-	-	-	-	F Hatchback (Petrol)	235074	Drive Shaft		25	22	60	73.5	600	
	2005-	-	-	-	F Hatchback (Petrol)	235074	Drive Shaft		25	22	60	73.5	600	
	2006-	-	-	-	F Hatchback (Petrol)	235074	Drive Shaft		25	22	60	73.5	600	
	2007-	-	-	-	F Hatchback (Petrol)	235074	Drive Shaft		25	22	60	73.5	600	
	2008-	-	-	-	F Hatchback (Petrol)	235074	Drive Shaft		25	22	60	73.5	600	
	2009-	-	-	L	F Hatchback (Petrol)	235074	Drive Shaft		25	22	60	73.5	600	
	2010-	-	-	L	F Hatchback (Petrol)	235074	Drive Shaft		25	22	60	73.5	600	
	2011-	-	-	L	F Hatchback (Petrol)	235074	Drive Shaft		25	22	60	73.5	600	
	2012-	-	-	L	F Hatchback (Petrol)	235074	Drive Shaft		25	22	60	73.5	600	
A 160 (70 KW)	2009-	-	-	L	F Hatchback (Petrol)	235074	Drive Shaft		25	22	60	73.5	600	
	2010-	-	-	L	F Hatchback (Petrol)	235074	Drive Shaft		25	22	60	73.5	600	
	2011-	-	-	L	F Hatchback (Petrol)	235074	Drive Shaft		25	22	60	73.5	600	
	2012-	-	-	L	F Hatchback (Petrol)	235074	Drive Shaft		25	22	60	73.5	600	
A 160 Cdi (60 KW)	2004-	-	-	-	F Hatchback (Diesel)	235074	Drive Shaft		25	22	60	73.5	600	
	2005-	-	-	-	F Hatchback (Diesel)	235074	Drive Shaft		25	22	60	73.5	600	
	2006-	-	-	-	F Hatchback (Diesel)	235074	Drive Shaft		25	22	60	73.5	600	
	2007-	-	-	-	F Hatchback (Diesel)	235074	Drive Shaft		25	22	60	73.5	600	
	2008-	-	-	-	F Hatchback (Diesel)	235074	Drive Shaft		25	22	60	73.5	600	
	2009-	-	-	L	F Hatchback (Diesel)	235074	Drive Shaft		25	22	60	73.5	600	
	2010-	-	-	L	F Hatchback (Diesel)	235074	Drive Shaft		25	22	60	73.5	600	
	2011-	-	-	L	F Hatchback (Diesel)	235074	Drive Shaft		25	22	60	73.5	600	
	2012-	-	-	L	F Hatchback (Diesel)	235074	Drive Shaft		25	22	60	73.5	600	
A 170 (85 KW)	2004-	-	-	-	F Hatchback (Petrol)	235074	Drive Shaft		25	22	60	73.5	600	
	2005-	-	-	-	F Hatchback (Petrol)	235074	Drive Shaft		25	22	60	73.5	600	
	2006-	-	-	-	F Hatchback (Petrol)	235074	Drive Shaft		25	22	60	73.5	600	
	2007-	-	-	-	F Hatchback (Petrol)	235074	Drive Shaft		25	22	60	73.5	600	
	2008-	-	-	-	F Hatchback (Petrol)	235074	Drive Shaft		25	22	60	73.5	600	
	2009-	-	-	L	F Hatchback (Petrol)	235074	Drive Shaft		25	22	60	73.5	600	
	2010-	-	-	L	F Hatchback (Petrol)	235074	Drive Shaft		25	22	60	73.5	600	
	2011-	-	-	L	F Hatchback (Petrol)	235074	Drive Shaft		25	22	60	73.5	600	
	2012-	-	-	L	F Hatchback (Petrol)	235074	Drive Shaft		25	22	60	73.5	600	
A 180 (85 KW)	2009-	-	-	L	F Hatchback (Petrol)	235074	Drive Shaft		25	22	60	73.5	600	
	2010-	-	-	L	F Hatchback (Petrol)	235074	Drive Shaft		25	22	60	73.5	600	
	2011-	-	-	L	F Hatchback (Petrol)	235074	Drive Shaft		25	22	60	73.5	600	
	2012-	-	-	L	F Hatchback (Petrol)	235074	Drive Shaft		25	22	60	73.5	600	
A 200 (100 KW)	2004-	-	-	-	F Hatchback (Petrol)	235074	Drive Shaft		25	22	60	73.5	600	
	2005-	-	-	-	F Hatchback (Petrol)	235074	Drive Shaft		25	22	60	73.5	600	
	2006-	-	-	-	F Hatchback (Petrol)	235074	Drive Shaft		25	22	60	73.5	600	
	2007-	-	-	-	F Hatchback (Petrol)	235074	Drive Shaft		25	22	60	73.5	600	
	2008-	-	-	-	F Hatchback (Petrol)	235074	Drive Shaft		25	22	60	73.5	600	
	2009-	-	-	L	F Hatchback (Petrol)	235074	Drive Shaft		25	22	60	73.5	600	
	2010-	-	-	L	F Hatchback (Petrol)	235074	Drive Shaft		25	22	60	73.5	600	
	2011-	-	-	L	F Hatchback (Petrol)	235074	Drive Shaft		25	22	60	73.5	600	
	2012-	-	-	L	F Hatchback (Petrol)	235074	Drive Shaft		25	22	60	73.5	600	
A-CLASS (W168)														
1.4 (60 kW)	1997.07-2004.08	MT	R	F	Hatchback Engine M 166.940	635010	Inner Joint		22	27	36	459	61	
	1997.07-2004.08	-	-	-	Hatchback Engine M 166.940	835010	Outer Joint		24	27	57	67.5	50	I
	1997.07-2004.08	MT	L/R	F	Hatchback Engine M 166.940	835022	Outer Joint	48W	24	27	57	67.5	56	I
	1997.07-2004.08	AT	L	F	Hatchback Engine M 166.940	235021	Drive Shaft	48W	24	22	57	67.5	561	
	1997.07-2004.08	AT	L/R	F	Hatchback Engine M 166.940	835004	Outer Joint	48W	24	27	57	67.5	56	I
	1997.07-2004.08	5MT	R	F	Hatchback Engine M 166.940	635019	Inner Joint		22	30	36	461	79	
	1997.07-2004.08	MT	R	F	Hatchback Engine M 166.940	235038	Drive Shaft	48W	24	22	57	67.5	954	
	1997.07-2004.08	-	-	-	Hatchback Engine M 166.940	835003	Outer Joint	48W	24	27	57	67.5	50	I
	1997.07-2004.08	MT	L	F	Hatchback Engine M 166.940	235020	Drive Shaft	48W	24	22	57	67.5	568	
	1997.07-2004.08	MT	R	F	Hatchback Engine M 166.940	235047	Drive Shaft		24	22	57	67.5	954	
	1997.07-2004.08	MT	L	F	Hatchback Engine M 166.940	235037	Drive Shaft	48W	24	22	57	67.5	572	
1.6 (60 kW)	2001.01-2004.08	MT	R	F	Hatchback Engine M 166.960	635010	Inner Joint		22	27	36	459	61	
	2001.01-2004.08	MT	L/R	F	Hatchback Engine M 166.960	835022	Outer Joint	48W	24	27	57	67.5	56	I
	2001.01-2004.08	AT	L	F	Hatchback Engine M 166.960	235021	Drive Shaft	48W	24	22	57	67.5	561	
	2001.01-2004.08	AT	L/R	F	Hatchback Engine M 166.960	835004	Outer Joint	48W	24	27	57	67.5	56	I
	2001.01-2004.08	MT	R	F	Hatchback Engine M 166.960	235038	Drive Shaft	48W	24	22	57	67.5	954	
	2001.01-2004.08	-	-	-	Hatchback Engine M 166.960	835003	Outer Joint	48W	24	27	57	67.5	50	I
	2001.01-2004.08	MT	L	F	Hatchback Engine M 166.960	235020	Drive Shaft	48W	24	22	57	67.5	568	
	2001.01-2004.08	MT	R	F	Hatchback Engine M 166.960	235047	Drive Shaft		24	22	57	67.5	954	
	2001.01-2004.08	-	R	-	Hatchback Engine M 166.960	635019	Inner Joint		22	30	36	461	79	
	2001.01-2004.08	MT	L	F	Hatchback Engine M 166.960	235037	Drive Shaft	48W	24	22	57	67.5	572	





	YEAR	TRANSM	L/R	F/R	REMARKS	GSP Ref.	PRODUCT	ABS	Technical Specifications									
									A	B	C	H	L	P				
MERCEDES BENZ																		
A-CLASS (W168)																		
1.6 (75 kW)	1997.07-2004.08	MT	R	F	Hatchback Engine M 166.960	635010	Inner Joint		22	27	36	459	61					
	1997.07-2004.08	-	-	-	Hatchback Engine M 166.960	835010	Outer Joint		24	27	57	67.5	50	I				
	1997.07-2004.08	MT	L/R	F	Hatchback Engine M 166.960	835022	Outer Joint	48W	24	27	57	67.5	56	I				
	1997.07-2004.08	AT	L/R	F	Hatchback Engine M 166.960	835004	Outer Joint	48W	24	27	57	67.5	56	I				
	1997.07-2004.08	AT	L	F	Hatchback Engine M 166.960	235021	Drive Shaft	48W	24	22	57	67.5	561					
	1997.07-2004.08	-	R	F	Hatchback Engine M 166.960	635019	Inner Joint		22	30	36	461	79					
	1997.07-2004.08	MT	R	F	Hatchback Engine M 166.960	235038	Drive Shaft	48W	24	22	57	67.5	954					
	1997.07-2004.08	-	-	F	Hatchback Engine M 166.960	835003	Outer Joint	48W	24	27	57	67.5	50	I				
	1997.07-2004.08	MT	L	F	Hatchback Engine M 166.960	235020	Drive Shaft	48W	24	22	57	67.5	568					
	1997.07-2004.08	MT	R	F	Hatchback Engine M 166.960	235047	Drive Shaft		24	22	57	67.5	954					
1997.07-2004.08	MT	L	F	Hatchback Engine M 166.960	235037	Drive Shaft	48W	24	22	57	67.5	572						
1.7 CDI (44 kW)	1998.07-2001.02	MT	R	F	Hatchback Engine OM 668.941	635010	Inner Joint		22	27	36	459	61					
	1998.07-2001.02	-	-	-	Hatchback Engine OM 668.941	835010	Outer Joint		24	27	57	67.5	50	I				
	1998.07-2001.02	MT	L/R	F	Hatchback Engine OM 668.941	835022	Outer Joint	48W	24	27	57	67.5	56	I				
	1998.07-2001.02	AT	L/R	F	Hatchback Engine OM 668.941	835004	Outer Joint	48W	24	27	57	67.5	56	I				
	1998.07-2001.02	AT	L	F	Hatchback Engine OM 668.941	235021	Drive Shaft	48W	24	22	57	67.5	561					
	1998.07-2001.02	MT	R	F	Hatchback Engine OM 668.941	235038	Drive Shaft	48W	24	22	57	67.5	954					
	1998.07-2001.02	-	-	F	Hatchback Engine OM 668.941	835003	Outer Joint	48W	24	27	57	67.5	50	I				
	1998.07-2001.02	-	R	F	Hatchback Engine OM 668.941	635019	Inner Joint		22	30	36	461	79					
	1998.07-2001.02	MT	L	F	Hatchback Engine OM 668.941	235020	Drive Shaft	48W	24	22	57	67.5	568					
	1998.07-2001.02	MT	R	F	Hatchback Engine OM 668.941	235047	Drive Shaft		24	22	57	67.5	954					
1998.07-2001.02	MT	L	F	Hatchback Engine OM 668.941	235037	Drive Shaft	48W	24	22	57	67.5	572						
1.7 CDI (55 kW)	2001.02-2004.08	MT	R	F	Hatchback Engine OM 668.940	635010	Inner Joint		22	27	36	459	61					
	2001.02-2004.08	-	-	-	Hatchback Engine OM 668.940	835010	Outer Joint		24	27	57	67.5	50	I				
	2001.02-2004.08	MT	L/R	F	Hatchback Engine OM 668.940	835022	Outer Joint	48W	24	27	57	67.5	56	I				
	2001.02-2004.08	AT	L	F	Hatchback Engine OM 668.940	235021	Drive Shaft	48W	24	22	57	67.5	561					
	2001.02-2004.08	AT	L/R	F	Hatchback Engine OM 668.940	835004	Outer Joint	48W	24	27	57	67.5	56	I				
	2001.02-2004.08	MT	R	F	Hatchback Engine OM 668.940	235038	Drive Shaft	48W	24	22	57	67.5	954					
	2001.02-2004.08	-	-	F	Hatchback Engine OM 668.940	835003	Outer Joint	48W	24	27	57	67.5	50	I				
	2001.02-2004.08	MT	R	F	Hatchback Engine OM 668.940	635019	Inner Joint		22	30	36	461	79					
	2001.02-2004.08	MT	L	F	Hatchback Engine OM 668.940	235020	Drive Shaft	48W	24	22	57	67.5	568					
	2001.02-2004.08	MT	R	F	Hatchback Engine OM 668.940	235047	Drive Shaft		24	22	57	67.5	954					
2001.02-2004.08	MT	L	F	Hatchback Engine OM 668.940	235037	Drive Shaft	48W	24	22	57	67.5	572						
1.7 CDI (66 kW)	1998.07-2001.02	MT	R	F	Hatchback Engine OM 668.940	635010	Inner Joint		22	27	36	459	61					
	1998.07-2001.02	-	-	-	Hatchback Engine OM 668.940	835010	Outer Joint		24	27	57	67.5	50	I				
	1998.07-2001.02	MT	L/R	F	Hatchback Engine OM 668.940	835022	Outer Joint	48W	24	27	57	67.5	56	I				
	1998.07-2001.02	AT	L/R	F	Hatchback Engine OM 668.940	835004	Outer Joint	48W	24	27	57	67.5	56	I				
	1998.07-2001.02	AT	L	F	Hatchback Engine OM 668.940	235021	Drive Shaft	48W	24	22	57	67.5	561					
	1998.07-2001.02	MT	R	F	Hatchback Engine OM 668.940	235038	Drive Shaft	48W	24	22	57	67.5	954					
	1998.07-2001.02	-	-	F	Hatchback Engine OM 668.940	835003	Outer Joint	48W	24	27	57	67.5	50	I				
	1998.07-2001.02	MT	R	F	Hatchback Engine OM 668.940	635019	Inner Joint		22	30	36	461	79					
	1998.07-2001.02	MT	L	F	Hatchback Engine OM 668.940	235020	Drive Shaft	48W	24	22	57	67.5	568					
	1998.07-2001.02	MT	R	F	Hatchback Engine OM 668.940	235047	Drive Shaft		24	22	57	67.5	954					
1998.07-2001.02	MT	L	F	Hatchback Engine OM 668.940	235037	Drive Shaft	48W	24	22	57	67.5	572						
1.7 CDI (70 kW)	2001.02-2004.08	MT	R	F	Hatchback Engine OM 668.942	635010	Inner Joint		22	27	36	459	61					
	2001.02-2004.08	-	-	-	Hatchback Engine OM 668.942	835010	Outer Joint		24	27	57	67.5	50	I				
	2001.02-2004.08	MT	L/R	F	Hatchback Engine OM 668.942	835022	Outer Joint	48W	24	27	57	67.5	56	I				
	2001.02-2004.08	AT	L/R	F	Hatchback Engine OM 668.942	835004	Outer Joint	48W	24	27	57	67.5	56	I				
	2001.02-2004.08	AT	L	F	Hatchback Engine OM 668.942	235021	Drive Shaft	48W	24	22	57	67.5	561					
	2001.02-2004.08	MT	R	F	Hatchback Engine OM 668.942	235038	Drive Shaft	48W	24	22	57	67.5	954					
	2001.02-2004.08	-	-	F	Hatchback Engine OM 668.942	835003	Outer Joint	48W	24	27	57	67.5	50	I				
	2001.02-2004.08	MT	R	F	Hatchback Engine OM 668.942	635019	Inner Joint		22	30	36	461	79					
	2001.02-2004.08	MT	L	F	Hatchback Engine OM 668.942	235020	Drive Shaft	48W	24	22	57	67.5	568					
	2001.02-2004.08	MT	R	F	Hatchback Engine OM 668.942	235047	Drive Shaft		24	22	57	67.5	954					
2001.02-2004.08	MT	L	F	Hatchback Engine OM 668.942	235037	Drive Shaft	48W	24	22	57	67.5	572						
1.9 (92 kW)	1999.03-2004.08	MT	R	F	Hatchback Engine M 166.990	635010	Inner Joint		22	27	36	459	61					
	1999.03-2004.08	-	-	-	Hatchback Engine M 166.990	835010	Outer Joint		24	27	57	67.5	50	I				
	1999.03-2004.08	MT	L/R	F	Hatchback Engine M 166.990	835023	Outer Joint	48W	24	27	57	67.5	58	I				
	1999.03-2004.08	AT	L/R	F	Hatchback Engine M 166.990	835005	Outer Joint	48W	24	27	57	67.5	58	I				
	1999.03-2004.08	-	-	F	Hatchback Engine M 166.990	835003	Outer Joint	48W	24	27	57	67.5	50	I				
	1999.03-2004.08	-	R	-	Hatchback Engine M 166.990	635019	Inner Joint		22	30	36	461	79					
	1999.03-2004.08	MT	L	F	Hatchback Engine M 166.990	235020	Drive Shaft	48W	24	22	57	67.5	568					
2.1 (103 kW)	2002.03-2004.08	-	-	F	Hatchback Engine M 166.995	835003	Outer Joint	48W	24	27	57	67.5	50	I				
	2002.03-2004.08	MT	L	F	Hatchback Engine M 166.995	235020	Drive Shaft	48W	24	22	57	67.5	568					
	2002.03-2004.08	-	R	-	Hatchback Engine M 166.995	635019	Inner Joint		22	30	36	461	79					
A-CLASS (W169)																		

YEAR	TRANSM	L/R	F/R	REMARKS	GSP Ref.	PRODUCT	ABS	Technical Specifications							
								A	B	C	H	L	P		
MERCEDES BENZ															
A-CLASS (W169)															
1.5 (70 kW)															
2004.09-2012.06	CVT	L	F	Hatchback Engine M 266.920	235054	Drive Shaft		25	27	60	73.5	608			
2004.09-2012.06	-	-	F	Hatchback Engine M 266.920	835030	Outer Joint		25	25	60.4	74	56	I		
2004.09-2012.06	MT	L	F	Hatchback Engine M 266.920	235032	Drive Shaft		25	22	60.3	43	582			
2004.09-2012.06	MT	R	F	Hatchback Engine M 266.920	235075	Drive Shaft		25	22	60.5	42	944			
2004.09-2012.06	AT	R	F	Hatchback Engine M 266.920	235101	Drive Shaft		25	27	60.5	42	948			
2004.09-2012.06	CVT	L	F	Hatchback Engine M 266.920	235046	Drive Shaft		25	27	60.3	43	583			
2004.09-2012.06	-	L	F	Hatchback Engine M 266.920	635024	Inner Joint		27	25	38	62	120			
2004.09-2012.06	CVT	R	F	Hatchback Engine M 266.920	235080	Drive Shaft		25	27	60.3	43	923			
2004.09-2012.06	AT	L	F	Hatchback Engine M 266.920	235102	Drive Shaft		25	27	60.5	42	608			
2004.09-2012.06	-	-	F	Hatchback Engine M 266.920	835040	Outer Joint		25	27	56	73.5	53.5	I		
2004.09-2012.06	9AT	L	F	Hatchback Engine M 266.920	235066	Drive Shaft		25	27	60	73.5	583			
2004.09-2012.06	MT	R	F	Hatchback Engine M 266.920	235045	Drive Shaft		25	22	56	73.5	985			
2004.09-2012.06	MT	R	F	Hatchback Engine M 266.920	235039	Drive Shaft		25	22	60	73.5	977			
2004.09-2012.06	CVT	L	F	Hatchback Engine M 266.920	235058	Drive Shaft		25	27	60.4	74	613			
2004.09-2012.06	-	-	F	Hatchback Engine M 266.920	835019	Outer Joint		25	25	60.5	42	59	I		
2004.09-2012.06	CVT	R	F	Hatchback Engine M 266.920	235056	Drive Shaft		25	27	56	73.5	955			
2004.09-2012.06	CVT	R	F	Hatchback Engine M 266.920	235055	Drive Shaft		25	27	60	73.5	948			
2004.09-2012.06	MT	L/R	F	Hatchback Engine M 266.920	835026	Outer Joint		25	27	60	73.5	52	I		
2004.09-2012.06	CVT	L	F	Hatchback Engine M 266.920	235025	Drive Shaft		25	27	60	73.5	613			
2004.09-2012.06	MT	R	F	Hatchback Engine M 266.920	635011	Inner Joint		22	27	36	459	81			
2004.09-2012.06	CVT	R	F	Hatchback Engine M 266.920	235049	Drive Shaft		25	27	60	73.5	954			
2004.09-2012.06	AT	R	F	Hatchback Engine M 266.920	635040	Inner Joint		27	25	38	422	100			
2004.09-2012.06	-	-	F	Hatchback Engine M 266.920	835027	Outer Joint		25	27	60.3	43	53	I		
1.6 (70 kW)															
2009.04-2012.06	AT	L	F	Hatchback Engine M 266.920	235054	Drive Shaft		25	27	60	73.5	608			
2009.04-2012.06	-	-	F	Hatchback Engine M 266.920	835030	Outer Joint		25	25	60.4	74	56	I		
2009.04-2012.06	MT	L	F	Hatchback Engine M 266.920	235032	Drive Shaft		25	22	60.3	43	582			
2009.04-2012.06	MT	R	F	Hatchback Engine M 266.920	235075	Drive Shaft		25	22	60.5	42	944			
2009.04-2012.06	AT	R	F	Hatchback Engine M 266.920	235101	Drive Shaft		25	27	60.5	42	948			
2009.04-2012.06	CVT	L	F	Hatchback Engine M 266.920	235046	Drive Shaft		25	27	60.3	43	583			
2009.04-2012.06	CVT	R	F	Hatchback Engine M 266.920	235080	Drive Shaft		25	27	60.3	43	923			
2009.04-2012.06	AT	L	F	Hatchback Engine M 266.920	235102	Drive Shaft		25	27	60.5	42	608			
2009.04-2012.06	-	L	F	Hatchback Engine M 266.920	635024	Inner Joint		27	25	38	62	120			
2009.04-2012.06	-	-	F	Hatchback Engine M 266.920	835040	Outer Joint		25	27	56	73.5	53.5	I		
2009.04-2012.06	9AT	L	F	Hatchback Engine M 266.920	235066	Drive Shaft		25	27	60	73.5	583			
2009.04-2012.06	MT	R	F	Hatchback Engine M 266.920	235045	Drive Shaft		25	22	56	73.5	985			
2009.04-2012.06	MT	R	F	Hatchback Engine M 266.920	235039	Drive Shaft		25	22	60	73.5	977			
2009.04-2012.06	CVT	L	F	Hatchback Engine M 266.920	235058	Drive Shaft		25	27	60.4	74	613			
2009.04-2012.06	-	-	F	Hatchback Engine M 266.920	835019	Outer Joint		25	25	60.5	42	59	I		
2009.04-2012.06	AT	R	F	Hatchback Engine M 266.920	235055	Drive Shaft		25	27	60	73.5	948			
2009.04-2012.06	CVT	R	F	Hatchback Engine M 266.920	235056	Drive Shaft		25	27	56	73.5	955			
2009.04-2012.06	CVT	L	F	Hatchback Engine M 266.920	235025	Drive Shaft		25	27	60	73.5	613			
2009.04-2012.06	CVT	R	F	Hatchback Engine M 266.920	235049	Drive Shaft		25	27	60	73.5	954			
2009.04-2012.06	-	-	F	Hatchback Engine M 266.920	835027	Outer Joint		25	27	60.3	43	53	I		
2009.04-2012.06	AT	R	F	Hatchback Engine M 266.920	635040	Inner Joint		27	25	38	422	100			
1.6 CDI (60 kW)															
2004.09-2012.06	CVT	L	F	Hatchback Engine OM 640.942	235054	Drive Shaft		25	27	60	73.5	608			
2004.09-2012.06	-	-	F	Hatchback Engine OM 640.942	835030	Outer Joint		25	25	60.4	74	56	I		
2004.09-2012.06	MT	L	F	Hatchback Engine OM 640.942	235032	Drive Shaft		25	22	60.3	43	582			
2004.09-2012.06	MT	R	F	Hatchback Engine OM 640.942	235075	Drive Shaft		25	22	60.5	42	944			
2004.09-2012.06	AT	R	F	Hatchback Engine OM 640.942	235101	Drive Shaft		25	27	60.5	42	948			
2004.09-2012.06	CVT	L	F	Hatchback Engine OM 640.942	235046	Drive Shaft		25	27	60.3	43	583			
2004.09-2012.06	-	L	F	Hatchback Engine OM 640.942	635024	Inner Joint		27	25	38	62	120			
2004.09-2012.06	CVT	R	F	Hatchback Engine OM 640.942	235080	Drive Shaft		25	27	60.3	43	923			
2004.09-2012.06	AT	L	F	Hatchback Engine OM 640.942	235102	Drive Shaft		25	27	60.5	42	608			
2004.09-2012.06	-	-	F	Hatchback Engine OM 640.942	835040	Outer Joint		25	27	56	73.5	53.5	I		
2004.09-2012.06	9AT	L	F	Hatchback Engine OM 640.942	235066	Drive Shaft		25	27	60	73.5	583			
2004.09-2012.06	MT	R	F	Hatchback Engine OM 640.942	235045	Drive Shaft		25	22	56	73.5	985			
2004.09-2012.06	MT	R	F	Hatchback Engine OM 640.942	235039	Drive Shaft		25	22	60	73.5	977			
2004.09-2012.06	CVT	L	F	Hatchback Engine OM 640.942	235058	Drive Shaft		25	27	60.4	74	613			
2004.09-2012.06	-	-	F	Hatchback Engine OM 640.942	835019	Outer Joint		25	25	60.5	42	59	I		
2004.09-2012.06	CVT	R	F	Hatchback Engine OM 640.942	235056	Drive Shaft		25	27	56	73.5	955			
2004.09-2012.06	CVT	R	F	Hatchback Engine OM 640.942	235055	Drive Shaft		25	27	60	73.5	948			
2004.09-2012.06	MT	L/R	F	Hatchback Engine OM 640.942	835026	Outer Joint		25	27	60	73.5	52	I		
2004.09-2012.06	CVT	L	F	Hatchback Engine OM 640.942	235025	Drive Shaft		25	27	60	73.5	613			
2004.09-2012.06	MT	R	F	Hatchback Engine OM 640.942	635011	Inner Joint		22	27	36	459	81			
2004.09-2012.06	CVT	R	F	Hatchback Engine OM 640.942	235049	Drive Shaft		25	27	60	73.5	954			
2004.09-2012.06	AT	R	F	Hatchback Engine OM 640.942	635040	Inner Joint		27	25	38	422	100			





YEAR	TRANSM	L/R	F/R	REMARKS	GSP Ref.	PRODUCT	ABS	Technical Specifications							
								A	B	C	H	L	P		
MERCEDES BENZ															
A-CLASS (W169)															
1.6 CDI (60 kW)	2004.09-2012.06	-	-	F	Hatchback Engine OM 640.942	835027	Outer Joint	25	27	60.3	43	53	I		
1.7 (85 kW)	2004.09-2012.06	CVT	L	F	Hatchback Engine M 266.940	235054	Drive Shaft	25	27	60	73.5	608			
	2004.09-2012.06	-	-	F	Hatchback Engine M 266.940	835030	Outer Joint	25	25	60.4	74	56	I		
	2004.09-2012.06	MT	L	F	Hatchback Engine M 266.940	235032	Drive Shaft	25	22	60.3	43	582			
	2004.09-2012.06	MT	R	F	Hatchback Engine M 266.940	235075	Drive Shaft	25	22	60.5	42	944			
	2004.09-2012.06	AT	R	F	Hatchback Engine M 266.940	235101	Drive Shaft	25	27	60.5	42	948			
	2004.09-2012.06	CVT	L	F	Hatchback Engine M 266.940	235046	Drive Shaft	25	27	60.3	43	583			
	2004.09-2012.06	-	L	F	Hatchback Engine M 266.940	635024	Inner Joint	27	25	38	62	120			
	2004.09-2012.06	CVT	R	F	Hatchback Engine M 266.940	235080	Drive Shaft	25	27	60.3	43	923			
	2004.09-2012.06	AT	L	F	Hatchback Engine M 266.940	235102	Drive Shaft	25	27	60.5	42	608			
	2004.09-2012.06	-	-	F	Hatchback Engine M 266.940	835040	Outer Joint	25	27	56	73.5	53.5	I		
	2004.09-2012.06	9AT	L	F	Hatchback Engine M 266.940	235066	Drive Shaft	25	27	60	73.5	583			
	2004.09-2012.06	MT	R	F	Hatchback Engine M 266.940	235045	Drive Shaft	25	22	56	73.5	985			
	2004.09-2012.06	MT	R	F	Hatchback Engine M 266.940	235039	Drive Shaft	25	22	60	73.5	977			
	2004.09-2012.06	CVT	L	F	Hatchback Engine M 266.940	235058	Drive Shaft	25	27	60.4	74	613			
	2004.09-2012.06	-	-	F	Hatchback Engine M 266.940	835019	Outer Joint	25	25	60.5	42	59	I		
	2004.09-2012.06	CVT	R	F	Hatchback Engine M 266.940	235056	Drive Shaft	25	27	56	73.5	955			
	2004.09-2012.06	CVT	R	F	Hatchback Engine M 266.940	235055	Drive Shaft	25	27	60	73.5	948			
	2004.09-2012.06	MT	L/R	F	Hatchback Engine M 266.940	835026	Outer Joint	25	27	60	73.5	52	I		
	2004.09-2012.06	CVT	L	F	Hatchback Engine M 266.940	235025	Drive Shaft	25	27	60	73.5	613			
	2004.09-2012.06	MT	R	F	Hatchback Engine M 266.940	635011	Inner Joint	22	27	36	459	81			
2004.09-2012.06	CVT	R	F	Hatchback Engine M 266.940	235049	Drive Shaft	25	27	60	73.5	954				
2004.09-2012.06	AT	R	F	Hatchback Engine M 266.940	635040	Inner Joint	27	25	38	422	100				
2004.09-2012.06	-	-	F	Hatchback Engine M 266.940	835027	Outer Joint	25	27	60.3	43	53	I			
1.8 (85 kW)	2009.04-2012.06	CVT	L	F	Hatchback Engine M 266.940	235054	Drive Shaft	25	27	60	73.5	608			
	2009.04-2012.06	-	-	F	Hatchback Engine M 266.940	835030	Outer Joint	25	25	60.4	74	56	I		
	2009.04-2012.06	MT	L	F	Hatchback Engine M 266.940	235032	Drive Shaft	25	22	60.3	43	582			
	2009.04-2012.06	MT	R	F	Hatchback Engine M 266.940	235075	Drive Shaft	25	22	60.5	42	944			
	2009.04-2012.06	AT	R	F	Hatchback Engine M 266.940	235101	Drive Shaft	25	27	60.5	42	948			
	2009.04-2012.06	CVT	L	F	Hatchback Engine M 266.940	235046	Drive Shaft	25	27	60.3	43	583			
	2009.04-2012.06	CVT	R	F	Hatchback Engine M 266.940	235080	Drive Shaft	25	27	60.3	43	923			
	2009.04-2012.06	AT	L	F	Hatchback Engine M 266.940	235102	Drive Shaft	25	27	60.5	42	608			
	2009.04-2012.06	-	L	F	Hatchback Engine M 266.940	635024	Inner Joint	27	25	38	62	120			
	2009.04-2012.06	-	-	F	Hatchback Engine M 266.940	835040	Outer Joint	25	27	56	73.5	53.5	I		
	2009.04-2012.06	CVT	L	F	Hatchback Engine M 266.940	235066	Drive Shaft	25	27	60	73.5	583			
	2009.04-2012.06	MT	R	F	Hatchback Engine M 266.940	235045	Drive Shaft	25	22	56	73.5	985			
	2009.04-2012.06	MT	R	F	Hatchback Engine M 266.940	235039	Drive Shaft	25	22	60	73.5	977			
	2009.04-2012.06	CVT	L	F	Hatchback Engine M 266.940	235058	Drive Shaft	25	27	60.4	74	613			
	2009.04-2012.06	-	-	F	Hatchback Engine M 266.940	835019	Outer Joint	25	25	60.5	42	59	I		
	2009.04-2012.06	CVT	R	F	Hatchback Engine M 266.940	235056	Drive Shaft	25	27	56	73.5	955			
	2009.04-2012.06	CVT	R	F	Hatchback Engine M 266.940	235055	Drive Shaft	25	27	60	73.5	948			
	2009.04-2012.06	CVT	L	F	Hatchback Engine M 266.940	235025	Drive Shaft	25	27	60	73.5	613			
	2009.04-2012.06	CVT	R	F	Hatchback Engine M 266.940	235049	Drive Shaft	25	27	60	73.5	954			
	2009.04-2012.06	-	-	F	Hatchback Engine M 266.940	835027	Outer Joint	25	27	60.3	43	53	I		
2009.04-2012.06	AT	R	F	Hatchback Engine M 266.940	635040	Inner Joint	27	25	38	422	100				
1.8 CDI (80 kW)	2004.09-2012.06	CVT	L	F	Hatchback Engine OM 640.940	235054	Drive Shaft	25	27	60	73.5	608			
	2004.09-2012.06	-	-	F	Hatchback Engine OM 640.940	835030	Outer Joint	25	25	60.4	74	56	I		
	2004.09-2012.06	AT	R	F	Hatchback Engine OM 640.940	235101	Drive Shaft	25	27	60.5	42	948			
	2004.09-2012.06	CVT	L	F	Hatchback Engine OM 640.940	235046	Drive Shaft	25	27	60.3	43	583			
	2004.09-2012.06	-	L	F	Hatchback Engine OM 640.940	635024	Inner Joint	27	25	38	62	120			
	2004.09-2012.06	CVT	R	F	Hatchback Engine OM 640.940	235080	Drive Shaft	25	27	60.3	43	923			
	2004.09-2012.06	AT	L	F	Hatchback Engine OM 640.940	235102	Drive Shaft	25	27	60.5	42	608			
	2004.09-2012.06	-	-	F	Hatchback Engine OM 640.940	835040	Outer Joint	25	27	56	73.5	53.5	I		
	2004.09-2012.06	MT	L	F	Hatchback Engine OM 640.940	299296	Drive Shaft	25	27	60	73.5	598			
	2004.09-2012.06	9AT	L	F	Hatchback Engine OM 640.940	235066	Drive Shaft	25	27	60	73.5	583			
	2004.09-2012.06	MT	L	F	Hatchback Engine OM 640.940	235078	Drive Shaft	25	27	60	73.5	583			
	2004.09-2012.06	MT	L	F	Hatchback Engine OM 640.940	235082	Drive Shaft	25	27	60.4	74	583			
	2004.09-2012.06	MT	R	F	Hatchback Engine OM 640.940	235062	Drive Shaft	25	27	60.4	74	989			
	2004.09-2012.06	CVT	L	F	Hatchback Engine OM 640.940	235058	Drive Shaft	25	27	60.4	74	613			
	2004.09-2012.06	-	-	F	Hatchback Engine OM 640.940	835019	Outer Joint	25	25	60.5	42	59	I		
	2004.09-2012.06	MT	L	F	Hatchback Engine OM 640.940	635014	Inner Joint	27	25	38	62	102			
	2004.09-2012.06	MT	L	F	Hatchback Engine OM 640.940	235076	Drive Shaft	25	27	60.5	42	551			
	2004.09-2012.06	CVT	R	F	Hatchback Engine OM 640.940	235056	Drive Shaft	25	27	56	73.5	955			
	2004.09-2012.06	CVT	R	F	Hatchback Engine OM 640.940	235055	Drive Shaft	25	27	60	73.5	948			
	2004.09-2012.06	MT	L/R	F	Hatchback Engine OM 640.940	899037	Outer Joint	25	25	60	73.5	58.5	I		
2004.09-2012.06	MT	R	F	Hatchback Engine OM 640.940	235081	Drive Shaft	25	27	60	73.5	987				





YEAR	TRANSM	L/R	F/R	REMARKS	GSP Ref.	PRODUCT	ABS	Technical Specifications							
								A	B	C	H	L	P		
MERCEDES BENZ															
A-CLASS (W169)															
1.8 CDI (80 kW)															
2004.09-	2012.06	CVT	L	F	Hatchback Engine OM 640.940	235025	Drive Shaft	25	27	60	73.5	613			
2004.09-	2012.06	CVT	R	F	Hatchback Engine OM 640.940	235049	Drive Shaft	25	27	60	73.5	954			
2004.09-	2012.06	AT	R	F	Hatchback Engine OM 640.940	635040	Inner Joint	27	25	38	422	100			
2004.09-	2012.06	-	-	F	Hatchback Engine OM 640.940	835027	Outer Joint	25	27	60.3	43	53	I		
2.0 (100 kW)															
2004.09-	2012.06	CVT	L	F	Hatchback Engine M 266.960	235054	Drive Shaft	25	27	60	73.5	608			
2004.09-	2012.06	-	-	F	Hatchback Engine M 266.960	835030	Outer Joint	25	25	60.4	74	56	I		
2004.09-	2012.06	MT	L	F	Hatchback Engine M 266.960	235032	Drive Shaft	25	22	60.3	43	582			
2004.09-	2012.06	MT	R	F	Hatchback Engine M 266.960	235075	Drive Shaft	25	22	60.5	42	944			
2004.09-	2012.06	CVT	L	F	Hatchback Engine M 266.960	235046	Drive Shaft	25	27	60.3	43	583			
2004.09-	2012.06	AT	R	F	Hatchback Engine M 266.960	235101	Drive Shaft	25	27	60.5	42	948			
2004.09-	2012.06	-	L	F	Hatchback Engine M 266.960	635024	Inner Joint	27	25	38	62	120			
2004.09-	2012.06	CVT	R	F	Hatchback Engine M 266.960	235080	Drive Shaft	25	27	60.3	43	923			
2004.09-	2012.06	AT	L	F	Hatchback Engine M 266.960	235102	Drive Shaft	25	27	60.5	42	608			
2004.09-	2012.06	-	-	F	Hatchback Engine M 266.960	835040	Outer Joint	25	27	56	73.5	53.5	I		
2004.09-	2012.06	AT	L	F	Hatchback Engine M 266.960	235066	Drive Shaft	25	27	60	73.5	583			
2004.09-	2012.06	MT	R	F	Hatchback Engine M 266.960	235045	Drive Shaft	25	22	56	73.5	985			
2004.09-	2012.06	MT	R	F	Hatchback Engine M 266.960	235039	Drive Shaft	25	22	60	73.5	977			
2004.09-	2012.06	CVT	L	F	Hatchback Engine M 266.960	235058	Drive Shaft	25	27	60.4	74	613			
2004.09-	2012.06	-	-	F	Hatchback Engine M 266.960	835019	Outer Joint	25	25	60.5	42	59	I		
2004.09-	2012.06	CVT	R	F	Hatchback Engine M 266.960	235056	Drive Shaft	25	27	56	73.5	955			
2004.09-	2012.06	CVT	R	F	Hatchback Engine M 266.960	235055	Drive Shaft	25	27	60	73.5	948			
2004.09-	2012.06	MT	L/R	F	Hatchback Engine M 266.960	835026	Outer Joint	25	27	60	73.5	52	I		
2004.09-	2012.06	CVT	L	F	Hatchback Engine M 266.960	235025	Drive Shaft	25	27	60	73.5	613			
2004.09-	2012.06	MT	R	F	Hatchback Engine M 266.960	635011	Inner Joint	22	27	36	459	81			
2004.09-	2012.06	CVT	R	F	Hatchback Engine M 266.960	235049	Drive Shaft	25	27	60	73.5	954			
2004.09-	2012.06	AT	R	F	Hatchback Engine M 266.960	635040	Inner Joint	27	25	38	422	100			
2004.09-	2012.06	-	-	F	Hatchback Engine M 266.960	835027	Outer Joint	25	27	60.3	43	53	I		
2.0 CDI (100 kW)															
2004.09-	2012.06	CVT	L	F	Hatchback Engine OM 640.941	235054	Drive Shaft	25	27	60	73.5	608			
2004.09-	2012.06	-	-	F	Hatchback Engine OM 640.941	835030	Outer Joint	25	25	60.4	74	56	I		
2004.09-	2012.06	CVT	L	F	Hatchback Engine OM 640.941	235046	Drive Shaft	25	27	60.3	43	583			
2004.09-	2012.06	AT	R	F	Hatchback Engine OM 640.941	235101	Drive Shaft	25	27	60.5	42	948			
2004.09-	2012.06	-	L	F	Hatchback Engine OM 640.941	635024	Inner Joint	27	25	38	62	120			
2004.09-	2012.06	CVT	R	F	Hatchback Engine OM 640.941	235080	Drive Shaft	25	27	60.3	43	923			
2004.09-	2012.06	AT	L	F	Hatchback Engine OM 640.941	235102	Drive Shaft	25	27	60.5	42	608			
2004.09-	2012.06	-	-	F	Hatchback Engine OM 640.941	835040	Outer Joint	25	27	56	73.5	53.5	I		
2004.09-	2012.06	CVT	L	F	Hatchback Engine OM 640.941	235066	Drive Shaft	25	27	60	73.5	583			
2004.09-	2012.06	MT	L	F	Hatchback Engine OM 640.941	235078	Drive Shaft	25	27	60	73.5	583			
2004.09-	2012.06	MT	L	F	Hatchback Engine OM 640.941	235082	Drive Shaft	25	27	60.4	74	583			
2004.09-	2012.06	CVT	L	F	Hatchback Engine OM 640.941	235058	Drive Shaft	25	27	60.4	74	613			
2004.09-	2012.06	MT	R	F	Hatchback Engine OM 640.941	235062	Drive Shaft	25	27	60.4	74	989			
2004.09-	2012.06	-	-	F	Hatchback Engine OM 640.941	835019	Outer Joint	25	25	60.5	42	59	I		
2004.09-	2012.06	MT	L	F	Hatchback Engine OM 640.941	635014	Inner Joint	27	25	38	62	102			
2004.09-	2012.06	CVT	R	F	Hatchback Engine OM 640.941	235056	Drive Shaft	25	27	56	73.5	955			
2004.09-	2012.06	CVT	R	F	Hatchback Engine OM 640.941	235055	Drive Shaft	25	27	60	73.5	948			
2004.09-	2012.06	MT	L	F	Hatchback Engine OM 640.941	235076	Drive Shaft	25	27	60.5	42	551			
2004.09-	2012.06	MT	R	F	Hatchback Engine OM 640.941	235081	Drive Shaft	25	27	60	73.5	987			
2004.09-	2012.06	CVT	L	F	Hatchback Engine OM 640.941	235025	Drive Shaft	25	27	60	73.5	613			
2004.09-	2012.06	CVT	R	F	Hatchback Engine OM 640.941	235049	Drive Shaft	25	27	60	73.5	954			
2004.09-	2012.06	-	-	F	Hatchback Engine OM 640.941	835027	Outer Joint	25	27	60.3	43	53	I		
2.0 CDI (103 kW)															
2004.09-	2012.06	CVT	L	F	Hatchback Engine OM 640.941	235054	Drive Shaft	25	27	60	73.5	608			
2004.09-	2012.06	-	-	F	Hatchback Engine OM 640.941	835030	Outer Joint	25	25	60.4	74	56	I		
2004.09-	2012.06	AT	R	F	Hatchback Engine OM 640.941	235101	Drive Shaft	25	27	60.5	42	948			
2004.09-	2012.06	CVT	L	F	Hatchback Engine OM 640.941	235046	Drive Shaft	25	27	60.3	43	583			
2004.09-	2012.06	-	L	F	Hatchback Engine OM 640.941	635024	Inner Joint	27	25	38	62	120			
2004.09-	2012.06	CVT	R	F	Hatchback Engine OM 640.941	235080	Drive Shaft	25	27	60.3	43	923			
2004.09-	2012.06	AT	L	F	Hatchback Engine OM 640.941	235102	Drive Shaft	25	27	60.5	42	608			
2004.09-	2012.06	-	-	F	Hatchback Engine OM 640.941	835040	Outer Joint	25	27	56	73.5	53.5	I		
2004.09-	2012.06	MT	L	F	Hatchback Engine OM 640.941	299296	Drive Shaft	25	27	60	73.5	598			
2004.09-	2012.06	CVT	L	F	Hatchback Engine OM 640.941	235066	Drive Shaft	25	27	60	73.5	583			
2004.09-	2012.06	MT	L	F	Hatchback Engine OM 640.941	235078	Drive Shaft	25	27	60	73.5	583			
2004.09-	2012.06	MT	L	F	Hatchback Engine OM 640.941	235082	Drive Shaft	25	27	60.4	74	583			
2004.09-	2012.06	MT	R	F	Hatchback Engine OM 640.941	235062	Drive Shaft	25	27	60.4	74	989			
2004.09-	2012.06	CVT	L	F	Hatchback Engine OM 640.941	235058	Drive Shaft	25	27	60.4	74	613			
2004.09-	2012.06	-	-	F	Hatchback Engine OM 640.941	835019	Outer Joint	25	25	60.5	42	59	I		
2004.09-	2012.06	MT	L	F	Hatchback Engine OM 640.941	635014	Inner Joint	27	25	38	62	102			
2004.09-	2012.06	MT	L	F	Hatchback Engine OM 640.941	235076	Drive Shaft	25	27	60.5	42	551			





YEAR	TRANS	L/R	F/R	REMARKS	GSP Ref.	PRODUCT	ABS	Technical Specifications										
								A	B	C	H	L	P					
MERCEDES BENZ																		
A-CLASS (W169)																		
2.0 CDI (103 kW)	2004.09-2012.06	CVT	R	F	Hatchback Engine OM 640.941	235056	Drive Shaft	25	27	56	73.5	955						
	2004.09-2012.06	CVT	R	F	Hatchback Engine OM 640.941	235055	Drive Shaft	25	27	60	73.5	948						
	2004.09-2012.06	MT	L/R	F	Hatchback Engine OM 640.941	899037	Outer Joint	25	25	60	73.5	58.5	I					
	2004.09-2012.06	MT	R	F	Hatchback Engine OM 640.941	235081	Drive Shaft	25	27	60	73.5	987						
	2004.09-2012.06	CVT	L	F	Hatchback Engine OM 640.941	235025	Drive Shaft	25	27	60	73.5	613						
	2004.09-2012.06	CVT	R	F	Hatchback Engine OM 640.941	235049	Drive Shaft	25	27	60	73.5	954						
	2004.09-2012.06	AT	R	F	Hatchback Engine OM 640.941	635040	Inner Joint	27	25	38	422	100						
	2004.09-2012.06	-	-	F	Hatchback Engine OM 640.941	835027	Outer Joint	25	27	60.3	43	53	I					
2.0 TURBO (142 kW)	2005.09-2012.06	CVT	L	F	Hatchback Engine M 266.980	235054	Drive Shaft	25	27	60	73.5	608						
	2005.09-2012.06	-	-	F	Hatchback Engine M 266.980	835030	Outer Joint	25	25	60.4	74	56	I					
	2005.09-2012.06	AT	R	F	Hatchback Engine M 266.980	235101	Drive Shaft	25	27	60.5	42	948						
	2005.09-2012.06	CVT	L	F	Hatchback Engine M 266.980	235046	Drive Shaft	25	27	60.3	43	583						
	2005.09-2012.06	CVT	R	F	Hatchback Engine M 266.980	235080	Drive Shaft	25	27	60.3	43	923						
	2005.09-2012.06	-	L	F	Hatchback Engine M 266.980	635024	Inner Joint	27	25	38	62	120						
	2005.09-2012.06	AT	L	F	Hatchback Engine M 266.980	235102	Drive Shaft	25	27	60.5	42	608						
	2005.09-2012.06	-	-	F	Hatchback Engine M 266.980	835040	Outer Joint	25	27	56	73.5	53.5	I					
	2005.09-2012.06	MT	L	F	Hatchback Engine M 266.980	299296	Drive Shaft	25	27	60	73.5	598						
	2005.09-2012.06	CVT	L	F	Hatchback Engine M 266.980	235066	Drive Shaft	25	27	60	73.5	583						
	2005.09-2012.06	MT	L	F	Hatchback Engine M 266.980	235078	Drive Shaft	25	27	60	73.5	583						
	2005.09-2012.06	MT	L	F	Hatchback Engine M 266.980	235082	Drive Shaft	25	27	60.4	74	583						
	2005.09-2012.06	MT	R	F	Hatchback Engine M 266.980	235062	Drive Shaft	25	27	60.4	74	989						
	2005.09-2012.06	CVT	L	F	Hatchback Engine M 266.980	235058	Drive Shaft	25	27	60.4	74	613						
	2005.09-2012.06	-	-	F	Hatchback Engine M 266.980	835019	Outer Joint	25	25	60.5	42	59	I					
	2005.09-2012.06	MT	L	F	Hatchback Engine M 266.980	635014	Inner Joint	27	25	38	62	102						
	2005.09-2012.06	MT	L	F	Hatchback Engine M 266.980	235076	Drive Shaft	25	27	60.5	42	551						
	2005.09-2012.06	CVT	R	F	Hatchback Engine M 266.980	235056	Drive Shaft	25	27	56	73.5	955						
	2005.09-2012.06	MT	L/R	F	Hatchback Engine M 266.980	899037	Outer Joint	25	25	60	73.5	58.5	I					
	2005.09-2012.06	CVT	R	F	Hatchback Engine M 266.980	235055	Drive Shaft	25	27	60	73.5	948						
	2005.09-2012.06	MT	R	F	Hatchback Engine M 266.980	235081	Drive Shaft	25	27	60	73.5	987						
	2005.09-2012.06	CVT	L	F	Hatchback Engine M 266.980	235025	Drive Shaft	25	27	60	73.5	613						
	2005.09-2012.06	CVT	R	F	Hatchback Engine M 266.980	235049	Drive Shaft	25	27	60	73.5	954						
	2005.09-2012.06	-	-	F	Hatchback Engine M 266.980	835027	Outer Joint	25	27	60.3	43	53	I					
	2005.09-2012.06	AT	R	F	Hatchback Engine M 266.980	635040	Inner Joint	27	25	38	422	100						
A-CLASS (W176)																		
1.5 CDI/d (66 kW)	2013.06-	MT/AT	R	F	Hatchback Engine OM 607.951	635071	Inner Joint	27	27	42.1	41.5	68						
	2013.06-	MT/AT	L	F	Hatchback Engine OM 607.951	861065	Outer Joint	30	27	65	53	61.5	M					
	2013.06-	MT/AT	L	F	Hatchback Engine OM 607.951	661082	Inner Joint	27	27	38	65	90						
	2013.06-	AT/MT	R	F	Hatchback Engine OM 607.951	235140	Stub Axle	27	27			540						
1.5 CDI/d (80 kW)	2012.06-	MT/AT	L	F	Hatchback Engine OM 607.951	661082	Inner Joint	27	27	38	65	90						
	2012.06-	MT/AT	R	F	Hatchback Engine OM 607.951	635071	Inner Joint	27	27	42.1	41.5	68						
	2012.06-	MT/AT	L	F	Hatchback Engine OM 607.951	861065	Outer Joint	30	27	65	53	61.5	M					
	2012.06-	AT/MT	R	F	Hatchback Engine OM 607.951	235140	Stub Axle	27	27			540						
1.6 (75 kW)	2015.07-	MT/AT	R	F	Hatchback Engine M 270.910	635071	Inner Joint	27	27	42.1	41.5	68						
	2015.07-	MT/AT	R	F	Hatchback Engine M 270.910	235104	Drive Shaft	30	27	65	53	496						
	2015.07-	MT/AT	L	F	Hatchback Engine M 270.910	661082	Inner Joint	27	27	38	65	90						
	2015.07-	AT/MT	R	F	Hatchback Engine M 270.910	235140	Stub Axle	27	27			540						
1.8 (90 kW)	2012.06-	MT/AT	R	F	Hatchback Engine M 270.910	661082	Inner Joint	27	27	38	65	90						
	2012.06-	MT/AT	R	F	Hatchback Engine M 270.910	635071	Inner Joint	27	27	42.1	41.5	68						
	2012.06-	MT/AT	R	F	Hatchback Engine M 270.910	235104	Drive Shaft	30	27	65	53	496						
	2012.06-	AT/MT	R	F	Hatchback Engine M 270.910	235140	Stub Axle	27	27			540						
1.8 CDI (80 kW)	2012.06-	MT/AT	L	F	Hatchback Engine OM 651.901	661082	Inner Joint	27	27	38	65	90						
	2012.06-	MT/AT	R	F	Hatchback Engine OM 651.901	635071	Inner Joint	27	27	42.1	41.5	68						
	2012.06-	MT/AT	L	F	Hatchback Engine OM 651.901	861065	Outer Joint	30	27	65	53	61.5	M					
	2012.06-	AT/MT	R	F	Hatchback Engine OM 651.901	235140	Stub Axle	27	27			540						
2.0 (115 kW)	2012.06-	MT/AT	L	F	Hatchback Engine M 270.910	661082	Inner Joint	27	27	38	65	90						
	2012.06-	MT/AT	R	F	Hatchback Engine M 270.910	635071	Inner Joint	27	27	42.1	41.5	68						
	2012.06-	MT/AT	L	F	Hatchback Engine M 270.910	861065	Outer Joint	30	27	65	53	61.5	M					
	2012.06-	AT/MT	R	F	Hatchback Engine M 270.910	235140	Stub Axle	27	27			540						
2.0 (155 kW)	2012.06-2015.06	MT/AT	L/R	F	Hatchback Engine M 270.920	861065	Outer Joint	30	27	65	53	61.5	M					
2.0 (280 kW)	2015.07-	MT/AT	L/R	F	All-wheel Drive Hatchback Engine M 133.980	861065	Outer Joint	30	27	65	53	61.5	M					
2.0 CDI (100 kW)	2012.06-	MT/AT	L	F	Hatchback Engine OM 651.901	661082	Inner Joint	27	27	38	65	90						
	2012.06-	MT/AT	R	F	Hatchback Engine OM 651.901	635071	Inner Joint	27	27	42.1	41.5	68						
	2012.06-	MT/AT	L	F	Hatchback Engine OM 651.901	861065	Outer Joint	30	27	65	53	61.5	M					
	2012.06-	AT/MT	R	F	Hatchback Engine OM 651.901	235140	Stub Axle	27	27			540						
2.0 CDI d (100 kW)	2014.02-	MT/AT	L	F	Hatchback Engine OM 651.930	661082	Inner Joint	27	27	38	65	90						
	2014.02-	MT/AT	R	F	Hatchback Engine OM 651.930	635071	Inner Joint	27	27	42.1	41.5	68						

	 YEAR	TRANSM	L/R	F/R	REMARKS	GSP Ref.	 PRODUCT	 ABS	Technical Specifications						
									A	B	C	H	L	P	
MERCEDES BENZ															
A-CLASS (W176)															
2.0 CDI d (100 kW)	2014.02-	-	MT/AT	L	F	Hatchback Engine OM 651.930	861065	Outer Joint	30	27	65	53	61.5	M	
	2014.02-	-	AT/MT	R	F	Hatchback Engine OM 651.930	235140	Stub Axle	27	27			540		
2.0 CDI d 4-matic (100 kW)	2014.02-	-	MT/AT	L	F	All-wheel Drive Hatchback Engine OM 651.930	661082	Inner Joint	27	27	38	65	90		
	2014.02-	-	MT/AT	R	F	All-wheel Drive Hatchback Engine OM 651.930	635071	Inner Joint	27	27	42.1	41.5	68		
	2014.02-	-	MT/AT	L	F	All-wheel Drive Hatchback Engine OM 651.930	861065	Outer Joint	30	27	65	53	61.5	M	
	2014.02-	-	AT/MT	R	F	All-wheel Drive Hatchback Engine OM 651.930	235140	Stub Axle	27	27			540		
2.2 CDI (120 kW)	2014.01-	-	MT/AT	L	F	Hatchback Engine OM 651.930	661082	Inner Joint	27	27	38	65	90		
	2014.01-	-	MT/AT	R	F	Hatchback Engine OM 651.930	635071	Inner Joint	27	27	42.1	41.5	68		
	2014.01-	-	MT/AT	L	F	Hatchback Engine OM 651.930	861065	Outer Joint	30	27	65	53	61.5	M	
	2014.01-	-	AT/MT	R	F	Hatchback Engine OM 651.930	235140	Stub Axle	27	27			540		
2.2 CDI (125 kW)	2012.09-	-	MT/AT	L	F	Hatchback Engine OM 651.930	661082	Inner Joint	27	27	38	65	90		
	2012.09-	-	MT/AT	R	F	Hatchback Engine OM 651.930	635071	Inner Joint	27	27	42.1	41.5	68		
	2012.09-	-	MT/AT	L	F	Hatchback Engine OM 651.930	861065	Outer Joint	30	27	65	53	61.5	M	
	2012.09-	-	AT/MT	R	F	Hatchback Engine OM 651.930	235140	Stub Axle	27	27			540		
2.2 CDI 4-matic (125 kW)	2012.09-	-	MT/AT	L	F	All-wheel Drive Hatchback Engine OM 651.930	661082	Inner Joint	27	27	38	65	90		
	2012.09-	-	MT/AT	R	F	All-wheel Drive Hatchback Engine OM 651.930	635071	Inner Joint	27	27	42.1	41.5	68		
	2012.09-	-	MT/AT	L	F	All-wheel Drive Hatchback Engine OM 651.930	861065	Outer Joint	30	27	65	53	61.5	M	
	2012.09-	-	AT/MT	R	F	All-wheel Drive Hatchback Engine OM 651.930	235140	Stub Axle	27	27			540		
2.2 d (130 kW)	2015.07-	-	MT/AT	R	F	Hatchback Engine OM 651.930	635071	Inner Joint	27	27	42.1	41.5	68		
	2015.07-	-	MT/AT	L	F	Hatchback Engine OM 651.930	861065	Outer Joint	30	27	65	53	61.5	M	
	2015.07-	-	MT/AT	L	F	Hatchback Engine OM 651.930	661082	Inner Joint	27	27	38	65	90		
	2015.07-	-	AT/MT	R	F	Hatchback Engine OM 651.930	235140	Stub Axle	27	27			540		
2.2 d 4-matic (130 kW)	2015.07-	-	MT/AT	R	F	All-wheel Drive Hatchback Engine OM 651.930	635071	Inner Joint	27	27	42.1	41.5	68		
	2015.07-	-	MT/AT	L	F	All-wheel Drive Hatchback Engine OM 651.930	861065	Outer Joint	30	27	65	53	61.5	M	
	2015.07-	-	MT/AT	L	F	All-wheel Drive Hatchback Engine OM 651.930	661082	Inner Joint	27	27	38	65	90		
	2015.07-	-	AT/MT	R	F	All-wheel Drive Hatchback Engine OM 651.930	235140	Stub Axle	27	27			540		
B-CLASS															
B 150 (70 KW)	2005-	-	-	L	F	Hatchback (Petrol)	235074	Drive Shaft	25	22	60	73.5	600		
	2006-	-	-	L	F	Hatchback (Petrol)	235074	Drive Shaft	25	22	60	73.5	600		
	2007-	-	-	L	F	Hatchback (Petrol)	235074	Drive Shaft	25	22	60	73.5	600		
	2008-	-	-	L	F	Hatchback (Petrol)	235074	Drive Shaft	25	22	60	73.5	600		
	2009-	-	-	L	F	Hatchback (Petrol)	235074	Drive Shaft	25	22	60	73.5	600		
	2010-	-	-	L	F	Hatchback (Petrol)	235074	Drive Shaft	25	22	60	73.5	600		
B 160 (70 KW)	2009-	-	-	L	F	Hatchback (Petrol)	235074	Drive Shaft	25	22	60	73.5	600		
	2010-	-	-	L	F	Hatchback (Petrol)	235074	Drive Shaft	25	22	60	73.5	600		
B 170 (85 KW)	2005-	-	-	L	F	Hatchback (Petrol)	235074	Drive Shaft	25	22	60	73.5	600		
	2006-	-	-	L	F	Hatchback (Petrol)	235074	Drive Shaft	25	22	60	73.5	600		
	2007-	-	-	L	F	Hatchback (Petrol)	235074	Drive Shaft	25	22	60	73.5	600		
	2008-	-	-	L	F	Hatchback (Petrol)	235074	Drive Shaft	25	22	60	73.5	600		
	2009-	-	-	L	F	Hatchback (Petrol)	235074	Drive Shaft	25	22	60	73.5	600		
	2010-	-	-	L	F	Hatchback (Petrol)	235074	Drive Shaft	25	22	60	73.5	600		
B 180 (85 KW)	2009-	-	-	L	F	Hatchback (Petrol)	235074	Drive Shaft	25	22	60	73.5	600		
2010-	-	-	L	F	Hatchback (Petrol)	235074	Drive Shaft	25	22	60	73.5	600			
B-CLASS (W245)															
1.5 (70 kW)	2005.03-	2011.11	CVT	L	F	Hatchback Engine M 266.920	235054	Drive Shaft	25	27	60	73.5	608		
	2005.03-	2011.11	-	-	F	Hatchback Engine M 266.920	835030	Outer Joint	25	25	60.4	74	56	I	
	2005.03-	2011.11	AT	R	F	Hatchback Engine M 266.920	235101	Drive Shaft	25	27	60.5	42	948		
	2005.03-	2011.11	-	L	F	Hatchback Engine M 266.920	635024	Inner Joint	27	25	38	62	120		
	2005.03-	2011.11	AT	L	F	Hatchback Engine M 266.920	235102	Drive Shaft	25	27	60.5	42	608		
	2005.03-	2011.11	CVT/MT	-	F	Hatchback Engine M 266.920	835040	Outer Joint	25	27	56	73.5	53.5	I	
	2005.03-	2011.11	AT	L	F	Hatchback Engine M 266.920	235066	Drive Shaft	25	27	60	73.5	583		
	2005.03-	2011.11	MT	R	F	Hatchback Engine M 266.920	235045	Drive Shaft	25	22	56	73.5	985		
	2005.03-	2011.11	MT	R	F	Hatchback Engine M 266.920	235039	Drive Shaft	25	22	60	73.5	977		
	2005.03-	2011.11	CVT	L	F	Hatchback Engine M 266.920	235058	Drive Shaft	25	27	60.4	74	613		
	2005.03-	2011.11	MT	L/R	F	Hatchback Engine M 266.920	835026	Outer Joint	25	27	60	73.5	52	I	
	2005.03-	2011.11	CVT	R	F	Hatchback Engine M 266.920	235056	Drive Shaft	25	27	56	73.5	955		
	2005.03-	2011.11	CVT	R	F	Hatchback Engine M 266.920	235055	Drive Shaft	25	27	60	73.5	948		
	2005.03-	2011.11	CVT	L	F	Hatchback Engine M 266.920	235025	Drive Shaft	25	27	60	73.5	613		
	2005.03-	2011.11	MT	R	F	Hatchback Engine M 266.920	635011	Inner Joint	22	27	36	459	81		
	2005.03-	2011.11	AT	R	F	Hatchback Engine M 266.920	635040	Inner Joint	27	25	38	422	100		
	2005.03-	2011.11	CVT	R	F	Hatchback Engine M 266.920	235049	Drive Shaft	25	27	60	73.5	954		
	2009.04-	2011.11	AT	L	F	Hatchback Engine M 266.920	235054	Drive Shaft	25	27	60	73.5	608		
	2009.04-	2011.11	-	-	F	Hatchback Engine M 266.920	835030	Outer Joint	25	25	60.4	74	56	I	
	2009.04-	2011.11	AT	R	F	Hatchback Engine M 266.920	235101	Drive Shaft	25	27	60.5	42	948		
	2009.04-	2011.11	-	L	F	Hatchback Engine M 266.920	635024	Inner Joint	27	25	38	62	120		
	2009.04-	2011.11	AT	L	F	Hatchback Engine M 266.920	235102	Drive Shaft	25	27	60.5	42	608		

	YEAR	TRANSM	L/R	F/R	REMARKS	GSP Ref.	PRODUCT	ABS	Technical Specifications								
									A	B	C	H	L	P			
MERCEDES BENZ																	
B-CLASS (W245)																	
1.5 (70 kW)	2009.04-2011.11	CVT/MT	-	F	Hatchback Engine M 266.920	835040	Outer Joint		25	27	56	73.5	53.5	I			
	2009.04-2011.11	9AT	L	F	Hatchback Engine M 266.920	235066	Drive Shaft		25	27	60	73.5	583				
	2009.04-2011.11	MT	R	F	Hatchback Engine M 266.920	235045	Drive Shaft		25	22	56	73.5	985				
	2009.04-2011.11	MT	R	F	Hatchback Engine M 266.920	235039	Drive Shaft		25	22	60	73.5	977				
	2009.04-2011.11	CVT	L	F	Hatchback Engine M 266.920	235058	Drive Shaft		25	27	60.4	74	613				
	2009.04-2011.11	AT	R	F	Hatchback Engine M 266.920	235055	Drive Shaft		25	27	60	73.5	948				
	2009.04-2011.11	CVT/AT	R	F	Hatchback Engine M 266.920	235056	Drive Shaft		25	27	56	73.5	955				
	2009.04-2011.11	CVT	L	F	Hatchback Engine M 266.920	235025	Drive Shaft		25	27	60	73.5	613				
	2009.04-2011.11	CVT	R	F	Hatchback Engine M 266.920	235049	Drive Shaft		25	27	60	73.5	954				
1.7 (85 kW)	2009.04-2011.11	AT	R	F	Hatchback Engine M 266.920	635040	Inner Joint		27	25	38	422	100				
	2005.03-2011.11	CVT	L	F	Hatchback Engine M 266.940	235054	Drive Shaft		25	27	60	73.5	608				
	2005.03-2011.11	-	-	F	Hatchback Engine M 266.940	835030	Outer Joint		25	25	60.4	74	56	I			
	2005.03-2011.11	AT	R	F	Hatchback Engine M 266.940	235101	Drive Shaft		25	27	60.5	42	948				
	2005.03-2011.11	-	L	F	Hatchback Engine M 266.940	635024	Inner Joint		27	25	38	62	120				
	2005.03-2011.11	AT	L	F	Hatchback Engine M 266.940	235102	Drive Shaft		25	27	60.5	42	608				
	2005.03-2011.11	MT	-	F	Hatchback Engine M 266.940	835040	Outer Joint		25	27	56	73.5	53.5	I			
	2005.03-2011.11	9AT	L	F	Hatchback Engine M 266.940	235066	Drive Shaft		25	27	60	73.5	583				
	2005.03-2011.11	MT	R	F	Hatchback Engine M 266.940	235045	Drive Shaft		25	22	56	73.5	985				
	2005.03-2011.11	MT	R	F	Hatchback Engine M 266.940	235039	Drive Shaft		25	22	60	73.5	977				
	2005.03-2011.11	CVT	L	F	Hatchback Engine M 266.940	235058	Drive Shaft		25	27	60.4	74	613				
	2005.03-2011.11	MT	L/R	F	Hatchback Engine M 266.940	835026	Outer Joint		25	27	60	73.5	52	I			
	2005.03-2011.11	CVT	R	F	Hatchback Engine M 266.940	235056	Drive Shaft		25	27	56	73.5	955				
	2005.03-2011.11	CVT	R	F	Hatchback Engine M 266.940	235055	Drive Shaft		25	27	60	73.5	948				
	2005.03-2011.11	CVT	L	F	Hatchback Engine M 266.940	235025	Drive Shaft		25	27	60	73.5	613				
	2005.03-2011.11	MT	R	F	Hatchback Engine M 266.940	635011	Inner Joint		22	27	36	459	81				
	2005.03-2011.11	AT	R	F	Hatchback Engine M 266.940	635040	Inner Joint		27	25	38	422	100				
	2005.03-2011.11	CVT	R	F	Hatchback Engine M 266.940	235049	Drive Shaft		25	27	60	73.5	954				
	2008.04-2011.11	CVT	L	F	Hatchback Engine M 266.960	235054	Drive Shaft		25	27	60	73.5	608				
	2008.04-2011.11	-	-	F	Hatchback Engine M 266.960	835030	Outer Joint		25	25	60.4	74	56	I			
	2008.04-2011.11	AT	R	F	Hatchback Engine M 266.960	235101	Drive Shaft		25	27	60.5	42	948				
	2008.04-2011.11	-	L	F	Hatchback Engine M 266.960	635024	Inner Joint		27	25	38	62	120				
	2008.04-2011.11	AT	L	F	Hatchback Engine M 266.960	235102	Drive Shaft		25	27	60.5	42	608				
	2008.04-2011.11	9AT	L	F	Hatchback Engine M 266.960	235066	Drive Shaft		25	27	60	73.5	583				
	2008.04-2011.11	CVT	R	F	Hatchback Engine M 266.960	235055	Drive Shaft		25	27	60	73.5	948				
	2008.04-2011.11	AT	R	F	Hatchback Engine M 266.960	635040	Inner Joint		27	25	38	422	100				
	2009.04-2011.11	CVT	L	F	Hatchback Engine M 266.940	235054	Drive Shaft		25	27	60	73.5	608				
	2009.04-2011.11	-	-	F	Hatchback Engine M 266.940	835030	Outer Joint		25	25	60.4	74	56	I			
	2009.04-2011.11	AT	R	F	Hatchback Engine M 266.940	235101	Drive Shaft		25	27	60.5	42	948				
	2009.04-2011.11	-	L	F	Hatchback Engine M 266.940	635024	Inner Joint		27	25	38	62	120				
	2009.04-2011.11	AT	L	F	Hatchback Engine M 266.940	235102	Drive Shaft		25	27	60.5	42	608				
	2009.04-2011.11	-	-	F	Hatchback Engine M 266.940	835040	Outer Joint		25	27	56	73.5	53.5	I			
	2009.04-2011.11	9AT	L	F	Hatchback Engine M 266.940	235066	Drive Shaft		25	27	60	73.5	583				
2009.04-2011.11	MT	R	F	Hatchback Engine M 266.940	235045	Drive Shaft		25	22	56	73.5	985					
2009.04-2011.11	MT	R	F	Hatchback Engine M 266.940	235039	Drive Shaft		25	22	60	73.5	977					
2009.04-2011.11	CVT	L	F	Hatchback Engine M 266.940	235058	Drive Shaft		25	27	60.4	74	613					
2009.04-2011.11	CVT	R	F	Hatchback Engine M 266.940	235056	Drive Shaft		25	27	56	73.5	955					
2009.04-2011.11	CVT	R	F	Hatchback Engine M 266.940	235055	Drive Shaft		25	27	60	73.5	948					
2009.04-2011.11	CVT	L	F	Hatchback Engine M 266.940	235025	Drive Shaft		25	27	60	73.5	613					
2009.04-2011.11	CVT	R	F	Hatchback Engine M 266.940	235049	Drive Shaft		25	27	60	73.5	954					
2009.04-2011.11	AT	R	F	Hatchback Engine M 266.940	635040	Inner Joint		27	25	38	422	100					
2.0 (100 kW)	2005.03-2011.11	CVT	L	F	Hatchback Engine M 266.960	235054	Drive Shaft		25	27	60	73.5	608				
	2005.03-2011.11	-	-	F	Hatchback Engine M 266.960	835030	Outer Joint		25	25	60.4	74	56	I			
	2005.03-2011.11	AT	R	F	Hatchback Engine M 266.960	235101	Drive Shaft		25	27	60.5	42	948				
	2005.03-2011.11	-	L	F	Hatchback Engine M 266.960	635024	Inner Joint		27	25	38	62	120				
	2005.03-2011.11	AT	L	F	Hatchback Engine M 266.960	235102	Drive Shaft		25	27	60.5	42	608				
	2005.03-2011.11	9AT	L	F	Hatchback Engine M 266.960	235066	Drive Shaft		25	27	60	73.5	583				
	2005.03-2011.11	CVT	L	F	Hatchback Engine M 266.960	235058	Drive Shaft		25	27	60.4	74	613				
	2005.03-2011.11	CVT	R	F	Hatchback Engine M 266.960	235056	Drive Shaft		25	27	56	73.5	955				
	2005.03-2011.11	CVT	R	F	Hatchback Engine M 266.960	235055	Drive Shaft		25	27	60	73.5	948				
	2005.03-2011.11	CVT	L	F	Hatchback Engine M 266.960	235025	Drive Shaft		25	27	60	73.5	613				
	2005.03-2011.11	MT	R	F	Hatchback Engine M 266.960	635011	Inner Joint		22	27	36	459	81				
	2005.03-2011.11	AT	R	F	Hatchback Engine M 266.960	635040	Inner Joint		27	25	38	422	100				
	2005.03-2011.11	CVT	R	F	Hatchback Engine M 266.960	235049	Drive Shaft		25	27	60	73.5	954				
2.0 (85 kW)	2008.04-2011.11	CVT	L	F	Hatchback Engine M 266.960	235054	Drive Shaft		25	27	60	73.5	608				
	2008.04-2011.11	-	-	F	Hatchback Engine M 266.960	835030	Outer Joint		25	25	60.4	74	56	I			
	2008.04-2011.11	AT	R	F	Hatchback Engine M 266.960	235101	Drive Shaft		25	27	60.5	42	948				





	 YEAR	TRANSM	L/R	F/R	REMARKS	GSP Ref.	 PRODUCT	 ABS	Technical Specifications					
									A	B	C	H	L	P
MERCEDES BENZ														
B-CLASS (W245)														
2.0 (85 kW)	2008.04-2011.11	-	L	F	Hatchback Engine M 266.960	635024	Inner Joint		27	25	38	62	120	
	2008.04-2011.11	AT	L	F	Hatchback Engine M 266.960	235102	Drive Shaft		25	27	60.5	42	608	
	2008.04-2011.11	9AT	L	F	Hatchback Engine M 266.960	235066	Drive Shaft		25	27	60	73.5	583	
	2008.04-2011.11	CVT	R	F	Hatchback Engine M 266.960	235055	Drive Shaft		25	27	60	73.5	948	
	2008.04-2011.11	AT	R	F	Hatchback Engine M 266.960	635040	Inner Joint		27	25	38	422	100	
2.0 CDI (100 kW)	2005.03-2011.11	AT	R	F	Hatchback Engine OM 640.941	635040	Inner Joint		27	25	38	422	100	
	2005.03-2011.11	CVT	L	F	Hatchback Engine OM 640.941	235054	Drive Shaft		25	27	60	73.5	608	
	2005.03-2011.11	-	-	F	Hatchback Engine OM 640.941	835030	Outer Joint		25	25	60.4	74	56	I
	2005.03-2011.11	-	L	F	Hatchback Engine OM 640.941	635024	Inner Joint		27	25	38	62	120	
	2005.03-2011.11	MT	L	F	Hatchback Engine OM 640.941	299296	Drive Shaft		25	27	60	73.5	598	
	2005.03-2011.11	CVT	-	F	Hatchback Engine OM 640.941	835040	Outer Joint		25	27	56	73.5	53.5	I
	2005.03-2011.11	MT	L	F	Hatchback Engine OM 640.941	235078	Drive Shaft		25	27	60	73.5	583	
	2005.03-2011.11	MT	L	F	Hatchback Engine OM 640.941	235082	Drive Shaft		25	27	60.4	74	583	
	2005.03-2011.11	MT	R	F	Hatchback Engine OM 640.941	235062	Drive Shaft		25	27	60.4	74	989	
	2005.03-2011.11	MT	L	F	Hatchback Engine OM 640.941	635014	Inner Joint		27	25	38	62	102	
	2005.03-2011.11	CVT	L	F	Hatchback Engine OM 640.941	235058	Drive Shaft		25	27	60.4	74	613	
	2005.03-2011.11	CVT	R	F	Hatchback Engine OM 640.941	235056	Drive Shaft		25	27	56	73.5	955	
	2005.03-2011.11	CVT	R	F	Hatchback Engine OM 640.941	235055	Drive Shaft		25	27	60	73.5	948	
	2005.03-2011.11	MT	R	F	Hatchback Engine OM 640.941	235081	Drive Shaft		25	27	60	73.5	987	
2005.03-2011.11	CVT	L	F	Hatchback Engine OM 640.941	235025	Drive Shaft		25	27	60	73.5	613		
2.0 CDI (103 kW)	2005.03-2011.11	CVT	R	F	Hatchback Engine OM 640.941	235025	Drive Shaft		25	27	60	73.5	613	
	2005.03-2011.11	CVT	R	F	Hatchback Engine OM 640.941	235049	Drive Shaft		25	27	60	73.5	954	
	2005.03-2011.11	CVT	L	F	Hatchback Engine OM 640.941	235054	Drive Shaft		25	27	60	73.5	608	
	2005.03-2011.11	-	-	F	Hatchback Engine OM 640.941	835030	Outer Joint		25	25	60.4	74	56	I
	2005.03-2011.11	-	L	F	Hatchback Engine OM 640.941	635024	Inner Joint		27	25	38	62	120	
	2005.03-2011.11	AT	R	F	Hatchback Engine OM 640.941	235101	Drive Shaft		25	27	60.5	42	948	
	2005.03-2011.11	AT	L	F	Hatchback Engine OM 640.941	235102	Drive Shaft		25	27	60.5	42	608	
	2005.03-2011.11	MT	L	F	Hatchback Engine OM 640.941	299296	Drive Shaft		25	27	60	73.5	598	
	2005.03-2011.11	CVT	-	F	Hatchback Engine OM 640.941	835040	Outer Joint		25	27	56	73.5	53.5	I
	2005.03-2011.11	9AT	L	F	Hatchback Engine OM 640.941	235066	Drive Shaft		25	27	60	73.5	583	
	2005.03-2011.11	MT	L	F	Hatchback Engine OM 640.941	235078	Drive Shaft		25	27	60	73.5	583	
	2005.03-2011.11	MT	L	F	Hatchback Engine OM 640.941	235082	Drive Shaft		25	27	60.4	74	583	
	2005.03-2011.11	MT	R	F	Hatchback Engine OM 640.941	235062	Drive Shaft		25	27	60.4	74	989	
	2005.03-2011.11	MT	L	F	Hatchback Engine OM 640.941	635014	Inner Joint		27	25	38	62	102	
	2005.03-2011.11	CVT	R	F	Hatchback Engine OM 640.941	235055	Drive Shaft		25	27	60	73.5	948	
	2005.03-2011.11	MT	L/R	F	Hatchback Engine OM 640.941	899037	Outer Joint		25	25	60	73.5	58.5	I
	2.0 CDI (80 kW)	2005.03-2011.11	CVT	L	F	Hatchback Engine OM 640.940	235054	Drive Shaft		25	27	60	73.5	608
2005.03-2011.11		-	-	F	Hatchback Engine OM 640.940	835030	Outer Joint		25	25	60.4	74	56	I
2005.03-2011.11		AT	R	F	Hatchback Engine OM 640.940	235101	Drive Shaft		25	27	60.5	42	948	
2005.03-2011.11		-	L	F	Hatchback Engine OM 640.940	635024	Inner Joint		27	25	38	62	120	
2005.03-2011.11		AT	L	F	Hatchback Engine OM 640.940	235102	Drive Shaft		25	27	60.5	42	608	
2005.03-2011.11		MT	L	F	Hatchback Engine OM 640.940	299296	Drive Shaft		25	27	60	73.5	598	
2005.03-2011.11		9AT	L	F	Hatchback Engine OM 640.940	235066	Drive Shaft		25	27	60	73.5	583	
2005.03-2011.11		MT	L	F	Hatchback Engine OM 640.940	235078	Drive Shaft		25	27	60	73.5	583	
2005.03-2011.11		MT	L	F	Hatchback Engine OM 640.940	235082	Drive Shaft		25	27	60.4	74	583	
2005.03-2011.11		MT	R	F	Hatchback Engine OM 640.940	235062	Drive Shaft		25	27	60.4	74	989	
2005.03-2011.11		MT	L	F	Hatchback Engine OM 640.940	635014	Inner Joint		27	25	38	62	102	
2005.03-2011.11		CVT	R	F	Hatchback Engine OM 640.940	235055	Drive Shaft		25	27	60	73.5	948	
2005.03-2011.11		MT	L/R	F	Hatchback Engine OM 640.940	899037	Outer Joint		25	25	60	73.5	58.5	I
2005.03-2011.11		MT	R	F	Hatchback Engine OM 640.940	235081	Drive Shaft		25	27	60	73.5	987	
2005.03-2011.11		CVT	L	F	Hatchback Engine OM 640.940	235025	Drive Shaft		25	27	60	73.5	613	
2005.03-2011.11		AT	R	F	Hatchback Engine OM 640.940	635040	Inner Joint		27	25	38	422	100	
2005.03-2011.11		CVT	R	F	Hatchback Engine OM 640.940	235049	Drive Shaft		25	27	60	73.5	954	
2.0 TURBO (142 kW)	2005.03-2011.11	CVT	L	F	Hatchback Engine M 266.980	235054	Drive Shaft		25	27	60	73.5	608	
	2005.03-2011.11	-	-	F	Hatchback Engine M 266.980	835030	Outer Joint		25	25	60.4	74	56	I
	2005.03-2011.11	AT	R	F	Hatchback Engine M 266.980	235101	Drive Shaft		25	27	60.5	42	948	
	2005.03-2011.11	-	L	F	Hatchback Engine M 266.980	635024	Inner Joint		27	25	38	62	120	
	2005.03-2011.11	AT	L	F	Hatchback Engine M 266.980	235102	Drive Shaft		25	27	60.5	42	608	
	2005.03-2011.11	MT	L	F	Hatchback Engine M 266.980	299296	Drive Shaft		25	27	60	73.5	598	
	2005.03-2011.11	CVT	L	F	Hatchback Engine M 266.980	235066	Drive Shaft		25	27	60	73.5	583	
	2005.03-2011.11	CVT	L	F	Hatchback Engine M 266.980	235058	Drive Shaft		25	27	60.4	74	613	
	2005.03-2011.11	CVT	R	F	Hatchback Engine M 266.980	235056	Drive Shaft		25	27	56	73.5	955	
	2005.03-2011.11	CVT	R	F	Hatchback Engine M 266.980	235055	Drive Shaft		25	27	60	73.5	948	





	 YEAR	TRANSM	L/R	F/R	REMARKS	GSP Ref.	 PRODUCT	 ABS	Technical Specifications								
									A	B	C	H	L	P			
MERCEDES BENZ																	
B-CLASS (W245)																	
2.0 TURBO (142 kW)	2005.03-2011.11	MT	L/R	F	Hatchback Engine M 266.980	899037	Outer Joint		25	25	60	73.5	58.5		I		
	2005.03-2011.11	CVT	L	F	Hatchback Engine M 266.980	235025	Drive Shaft		25	27	60	73.5	613				
	2005.03-2011.11	AT	R	F	Hatchback Engine M 266.980	635040	Inner Joint		27	25	38	422	100				
	2005.03-2011.11	CVT	R	F	Hatchback Engine M 266.980	235049	Drive Shaft		25	27	60	73.5	954				
B-CLASS (W246 W242)																	
1.5 CDI/d (66 kW)	2013.05-	MT/AT	R	F	Hatchback Engine OM 607.951	635071	Inner Joint		27	27	42.1	41.5	68				
	2013.05-	MT/AT	L/R	F	Hatchback Engine OM 607.951	861065	Outer Joint		30	27	65	53	61.5		M		
	2013.05-	MT/AT	L	F	Hatchback Engine OM 607.951	661082	Inner Joint		27	27	38	65	90				
	2013.05-	AT/MT	R	F	Hatchback Engine OM 607.951	235140	Stub Axle		27	27			540				
1.5 CDI/d (80 kW)	2013.02-	MT/AT	R	F	Hatchback Engine OM 607.951	635071	Inner Joint		27	27	42.1	41.5	68				
	2013.02-	MT/AT	L/R	F	Hatchback Engine OM 607.951	861065	Outer Joint		30	27	65	53	61.5		M		
	2013.02-	MT/AT	L	F	Hatchback Engine OM 607.951	661082	Inner Joint		27	27	38	65	90				
	2013.02-	AT/MT	R	F	Hatchback Engine OM 607.951	235140	Stub Axle		27	27			540				
1.6 (75 kW)	2015.07-	MT/AT	R	F	Hatchback Engine M 270.910	635071	Inner Joint		27	27	42.1	41.5	68				
	2015.07-	MT/AT	L/R	F	Hatchback Engine M 270.910	861065	Outer Joint		30	27	65	53	61.5		M		
	2015.07-	MT/AT	R	F	Hatchback Engine M 270.910	235104	Drive Shaft		30	27	65	53	496				
	2015.07-	MT/AT	L	F	Hatchback Engine M 270.910	661082	Inner Joint		27	27	38	65	90				
	2015.07-	AT/MT	R	F	Hatchback Engine M 270.910	235140	Stub Axle		27	27			540				
1.6 Turbo (90 kW)	2011.11-	MT/AT	R	F	Hatchback Engine M 270.910	635071	Inner Joint		27	27	42.1	41.5	68				
	2011.11-	MT/AT	L/R	F	Hatchback Engine M 270.910	861065	Outer Joint		30	27	65	53	61.5		M		
	2011.11-	MT/AT	R	F	Hatchback Engine M 270.910	235104	Drive Shaft		30	27	65	53	496				
	2011.11-	AT/MT	R	F	Hatchback Engine M 270.910	235140	Stub Axle		27	27			540				
1.8 CDI (80 kW)	2011.11-	MT/AT	R	F	Hatchback Engine OM 651.901	635071	Inner Joint		27	27	42.1	41.5	68				
	2011.11-	MT/AT	L/R	F	Hatchback Engine OM 651.901	861065	Outer Joint		30	27	65	53	61.5		M		
	2011.11-	MT/AT	L	F	Hatchback Engine OM 651.901	661082	Inner Joint		27	27	38	65	90				
	2011.11-	AT/MT	R	F	Hatchback Engine OM 651.901	235140	Stub Axle		27	27			540				
2.0 4-matic (155 kW)	2014.08-	MT/AT	L/R	F	All-wheel Drive Hatchback Engine M 270.920	861065	Outer Joint		30	27	65	53	61.5		M		
2.0 CDI (100 kW)	2011.11-	MT/AT	R	F	Hatchback Engine OM 651.901	635071	Inner Joint		27	27	42.1	41.5	68				
	2011.11-	MT/AT	L/R	F	Hatchback Engine OM 651.901	861065	Outer Joint		30	27	65	53	61.5		M		
	2011.11-	MT/AT	L	F	Hatchback Engine OM 651.901	661082	Inner Joint		27	27	38	65	90				
	2011.11-	AT/MT	R	F	Hatchback Engine OM 651.901	235140	Stub Axle		27	27			540				
2.0 Turbo (115 kW)	2011.11-	MT/AT	R	F	Hatchback Engine M 270.910	635071	Inner Joint		27	27	42.1	41.5	68				
	2011.11-	MT/AT	L/R	F	Hatchback Engine M 270.910	861065	Outer Joint		30	27	65	53	61.5		M		
	2011.11-	MT/AT	L	F	Hatchback Engine M 270.910	661082	Inner Joint		27	27	38	65	90				
	2011.11-	AT/MT	R	F	Hatchback Engine M 270.910	235140	Stub Axle		27	27			540				
2.0 Turbo (155 kW)	2012.05-	MT/AT	L/R	F	Hatchback Engine M 270.920	861065	Outer Joint		30	27	65	53	61.5		M		
2.1 CDI/d (100 kW)	2014.08-	MT/AT	R	F	Hatchback Engine OM 651.930	635071	Inner Joint		27	27	42.1	41.5	68				
	2014.08-	MT/AT	L	F	Hatchback Engine OM 651.930	661082	Inner Joint		27	27	38	65	90				
	2014.08-	MT/AT	L	F	All-wheel Drive Hatchback Engine OM 651.930	661082	Inner Joint		27	27	38	65	90				
	2014.08-	MT/AT	L	F	Hatchback Engine OM 651.930	861065	Outer Joint		30	27	65	53	61.5		M		
	2014.08-	MT/AT	L	F	All-wheel Drive Hatchback Engine OM 651.930	861065	Outer Joint		30	27	65	53	61.5		M		
	2014.08-	AT/MT	R	F	Hatchback Engine OM 651.930	235140	Stub Axle		27	27			540				
	2014.08-	AT/MT	R	F	All-wheel Drive Hatchback Engine OM 651.930	235140	Stub Axle		27	27			540				
2.1 CDI/d (120 kW)	2013.06-	MT/AT	R	F	Hatchback Engine OM 651.930	635071	Inner Joint		27	27	42.1	41.5	68				
	2013.06-	MT/AT	L	F	Hatchback Engine OM 651.930	861065	Outer Joint		30	27	65	53	61.5		M		
	2013.06-	AT/MT	R	F	Hatchback Engine OM 651.930	235140	Stub Axle		27	27			540				
	2013.06-	MT/AT	L	F	Hatchback Engine OM 651.930	661082	Inner Joint		27	27	38	65	90				
2.1 CDI/d (130 kW)	2014.09-	MT/AT	R	F	Hatchback Engine OM 651.930	635071	Inner Joint		27	27	42.1	41.5	68				
	2014.09-	MT/AT	L	F	Hatchback Engine OM 651.930	661082	Inner Joint		27	27	38	65	90				
	2014.09-	MT/AT	L	F	Hatchback Engine OM 651.930	861065	Outer Joint		30	27	65	53	61.5		M		
	2014.09-	AT/MT	R	F	Hatchback Engine OM 651.930	235140	Stub Axle		27	27			540				
2.1 CDI/d 4-matic (130 kW)	2014.09-	MT/AT	R	F	All-wheel Drive Hatchback Engine OM 651.930	635071	Inner Joint		27	27	42.1	41.5	68				
	2014.09-	MT/AT	L	F	All-wheel Drive Hatchback Engine OM 651.930	661082	Inner Joint		27	27	38	65	90				
	2014.09-	MT/AT	L	F	All-wheel Drive Hatchback Engine OM 651.930	861065	Outer Joint		30	27	65	53	61.5		M		
	2014.09-	AT/MT	R	F	All-wheel Drive Hatchback Engine OM 651.930	235140	Stub Axle		27	27			540				
2.2 CDI (125 kW)	2011.11-	MT/AT	L	F	Hatchback Engine OM 651.930	661082	Inner Joint		27	27	38	65	90				
	2011.11-	MT/AT	R	F	Hatchback Engine OM 651.930	635071	Inner Joint		27	27	42.1	41.5	68				
	2011.11-	MT/AT	L	F	Hatchback Engine OM 651.930	861065	Outer Joint		30	27	65	53	61.5		M		
	2011.11-	AT/MT	R	F	Hatchback Engine OM 651.930	235140	Stub Axle		27	27			540				
C-CLASS (C204)																	
C 63 AMG (336 kW)	2011.06-	AT	L/R	R	Coupe Engine M 156.985	235123	Drive Shaft	48NS	27	30	68	72	774				
C-CLASS (W202)																	
1.8 (90 kW)	1993.03-2000.05	AT/MT	L/R	R	Saloon Engine M 111.920/M 111.921	605007	Inner Joint			24		27					
	1993.03-2000.05	AT/MT	L/R	R	Saloon Engine M 111.920/M 111.921	235007	Drive Shaft		25		62	70.5	630				
2.0 (100 kW)	1994.01-2000.05	AT/MT	L/R	R	Saloon Engine M 111.941/M 111.945	605007	Inner Joint			24		27					

	 YEAR	TRANSM	L/R	F/R	REMARKS	GSP Ref.	 PRODUCT	 ABS	Technical Specifications					
									A	B	C	H	L	P
MERCEDES BENZ														
C-CLASS (W202)														
2.0 (100 kW)	1994.01-2000.05	AT/MT	L/R	R	Saloon Engine M 111.941/M 111.945	235007	Drive Shaft		25		62	70.5	630	
2.0 D (55 kW)	1993.03-2000.05	AT/MT	L/R	R	Saloon Engine OM 601.913	605007	Inner Joint			24		27		
	1993.03-2000.05	AT/MT	L/R	R	Saloon Engine OM 601.913	235007	Drive Shaft		25		62	70.5	630	
2.2 (110 kW)	1993.03-2000.05	AT/MT	L/R	R	Saloon Engine M 111.961	605007	Inner Joint			24		27		
	1993.03-2000.05	AT/MT	L/R	R	Saloon Engine M 111.961	235007	Drive Shaft		25		62	70.5	630	
2.2D (70 kW)	1993.08-2000.05	AT/MT	L/R	R	Saloon Engine OM 604.910	605007	Inner Joint			24		27		
	1993.08-2000.05	AT/MT	L/R	R	Saloon Engine OM 604.910	235007	Drive Shaft		25		62	70.5	630	
2.3 (110 kW)	1996.06-1997.06	AT/MT	L/R	R	Saloon Engine M 111.974	605007	Inner Joint			24		27		
	1996.06-1997.06	AT/MT	L/R	R	Saloon Engine M 111.974	235007	Drive Shaft		25		62	70.5	630	
C-CLASS (W203)														
2.0 CDI (75 kW)	2001.02-2007.02	AT	-	R	Saloon Engine OM 646.962	235133	Drive Shaft	48NS	25	27	64.9	70	731	
2.0 CDI (85 kW)	2000.09-2007.02	AT	-	R	Saloon Engine OM 611.962	235133	Drive Shaft	48NS	25	27	64.9	70	731	
2.0 CDI (90 kW)	2003.04-2007.02	AT	-	R	Saloon Engine OM 646.962	235133	Drive Shaft	48NS	25	27	64.9	70	731	
2.0 CGI Kompressor (125 kW)	2003.07-2007.02	AT	-	R	Saloon Engine M 271.942	235133	Drive Shaft	48NS	25	27	64.9	70	731	
2.0 Kompressor (120 kW)	2000.05-2002.06	AT	-	R	Saloon Engine M 111.955	235133	Drive Shaft	48NS	25	27	64.9	70	731	
	2002.05-2007.02	AT	-	R	Saloon Engine M 271.940	235133	Drive Shaft	48NS	25	27	64.9	70	731	
2.2CDI (110 kW)	2003.02-2007.02	AT	R	R	Saloon Engine OM 646.963	235110	Drive Shaft	48NS	25	27	65	70	720	
2.6 4-matic (125 kW)	2002.07-2007.02	-	-	-	All-wheel Drive Saloon Engine M 112.916	835053	Outer Joint	48NS	35	27	66.6	42	53	I
	2002.07-2007.02	AT	-	R	All-wheel Drive Saloon Engine M 112.916	235133	Drive Shaft	48NS	25	27	64.9	70	731	
	2002.07-2007.02	-	-	-	All-wheel Drive Saloon Engine M 112.916	635061	Inner Joint		24	27	38	55.5	104	
3.0 4-matic (170 kW)	2005.01-2007.02	-	-	-	All-wheel Drive Saloon Engine M 272.941	835053	Outer Joint	48NS	35	27	66.6	42	53	I
	2005.01-2007.02	-	-	-	All-wheel Drive Saloon Engine M 272.941	635061	Inner Joint		24	27	38	55.5	104	
3.2 4-matic (160 kW)	2002.07-2007.02	-	-	-	All-wheel Drive Saloon Engine M 112.953	835053	Outer Joint	48NS	35	27	66.6	42	53	I
	2002.07-2007.02	AT	-	R	All-wheel Drive Saloon Engine M 112.953	235133	Drive Shaft	48NS	25	27	64.9	70	731	
	2002.07-2007.02	-	-	-	All-wheel Drive Saloon Engine M 112.953	635061	Inner Joint		24	27	38	55.5	104	
3.5 4-matic (200 kW)	2005.01-2007.02	-	-	-	All-wheel Drive Saloon Engine M 272.970/M 272.960	835053	Outer Joint	48NS	35	27	66.6	42	53	I
	2005.01-2007.02	-	-	-	All-wheel Drive Saloon Engine M 272.970/M 272.960	635061	Inner Joint		24	27	38	55.5	104	
C 180 (95 kW)	2000.10-2002.05	AT	-	R	Saloon Engine M 111.951	235133	Drive Shaft	48NS	25	27	64.9	70	731	
C 180 Kompressor (105 kW)	2002.05-2007.02	AT	-	R	Saloon Engine M 271.946	235133	Drive Shaft	48NS	25	27	64.9	70	731	
C 230 (150 kW)	2005.01-2007.02	AT	-	R	Saloon Engine M 272.920	235133	Drive Shaft	48NS	25	27	64.9	70	731	
C 230 Kompressor (141 kW)	2004.02-2007.02	AT	-	R	Saloon Engine M 271.948	235133	Drive Shaft	48NS	25	27	64.9	70	731	
C 240 (125 kW)	2000.05-2007.02	AT	-	R	Saloon Engine M 112.912	235133	Drive Shaft	48NS	25	27	64.9	70	731	
C 30 CDI AMG (170 kW)	2003.01-2007.02	AT	L	R	Saloon Engine OM 612.990	235122	Drive Shaft	48NS	25	27	65	70	731	
C 320 (160 kW)	2000.05-2007.02	AT	-	R	Saloon Engine M 112.946	235133	Drive Shaft	48NS	25	27	64.9	70	731	
C 55 AMG (270 kW)	2004.02-2007.02	AT	L/R	R	Saloon Engine M 113.988	235124	Drive Shaft	48NS	25	30	65	70	731	
C-CLASS (W204)														
2.5 4-matic (150 kW)	2007.07-2014.01	-	-	-	All-wheel Drive Saloon Engine M 272.911	835049	Outer Joint		30	25	71	56.5	52	I
2.5 CDI 4-matic (150 kW)	2011.01-2014.01	-	-	-	All-wheel Drive Saloon Engine OM 651.912	835049	Outer Joint		30	25	71	56.5	52	I
3.0 4-matic (170 kW)	2007.07-2014.01	-	-	-	All-wheel Drive Saloon Engine M 272.948	835049	Outer Joint		30	25	71	56.5	52	I
	2007.07-2014.01	-	-	-	All-wheel Drive Saloon Engine M 272.948	835049	Outer Joint		30	25	71	56.5	52	I
3.0 CDI 4-matic (165 kW)	2007.07-2014.01	-	-	-	All-wheel Drive Saloon Engine OM 642.961	835049	Outer Joint		30	25	71	56.5	52	I
	2009.07-2014.01	-	-	-	All-wheel Drive Saloon Engine OM 642.961	835049	Outer Joint		30	25	71	56.5	52	I
3.0 CDI 4-matic (170 kW)	2009.10-2014.01	-	-	-	All-wheel Drive Saloon Engine OM 642.832	835049	Outer Joint		30	25	71	56.5	52	I
	2011.01-2014.01	-	-	-	All-wheel Drive Saloon Engine OM 642.832	835049	Outer Joint		30	25	71	56.5	52	I
3.5 4-matic (200 kW)	2007.07-2014.01	-	-	-	All-wheel Drive Saloon Engine M 272.971	835049	Outer Joint		30	25	71	56.5	52	I
C 200 CDI (100 kW)	2007.01-2010.12	AT	L/R	R	Saloon Engine OM 646.812/OM 646.811	235111	Drive Shaft	48NS	27	27	68	72	771	
	2007.01-2010.12	AT	L/R	R	Saloon Engine OM 646.812/OM 646.811	235134	Drive Shaft	48NS	27	27	68	72	773	
	2007.01-2010.12	7AT	L/R	R	Saloon Engine OM 646.812/OM 646.811	235114	Drive Shaft	48NS	27	27	68	82	773	
C-CLASS T-Model (S202)														
1.8 T (90 kW)	1996.06-2000.09	AT/MT	L/R	R	Estate Engine M 111.920/M 111.921	605007	Inner Joint			24		27		
	1996.06-2000.09	AT/MT	L/R	R	Estate Engine M 111.920/M 111.921	235007	Drive Shaft		25		62	70.5	630	
2.0 T (100 kW)	1996.06-2001.03	AT/MT	L/R	R	Estate Engine M 111.941/M 111.945	605007	Inner Joint			24		27		
	1996.06-2001.03	AT/MT	L/R	R	Estate Engine M 111.941/M 111.945	235007	Drive Shaft		25		62	70.5	630	
2.2T D (55 kW)	1996.06-2001.03	-	L/R	R	Estate Engine OM 604.910	605007	Inner Joint			24		27		
	1996.06-2001.03	-	L/R	R	Estate Engine OM 604.910	235007	Drive Shaft		25		62	70.5	630	
2.2T D (70 kW)	1996.06-1998.09	AT/MT	L/R	R	Estate Engine OM 604.910	605007	Inner Joint			24		27		
	1996.06-1998.09	AT/MT	L/R	R	Estate Engine OM 604.910	235007	Drive Shaft		25		62	70.5	630	
2.3 T (110 kW)	1996.06-1998.06	AT/MT	L/R	R	Estate Engine M 111.974	605007	Inner Joint			24		27		
	1996.06-1998.06	AT/MT	L/R	R	Estate Engine M 111.974	235007	Drive Shaft		25		62	70.5	630	
C-CLASS T-Model (S203)														
2.0 CDI (75 kW)	2001.03-2007.08	AT	-	R	Estate Engine OM 646.962/OM 611.962	235133	Drive Shaft	48NS	25	27	64.9	70	731	
2.0 CDI (85 kW)	2001.03-2007.08	AT	-	R	Estate Engine OM 611.962	235133	Drive Shaft	48NS	25	27	64.9	70	731	
2.0 CDI (90 kW)	2003.04-2007.08	AT	-	R	Estate Engine OM 646.962	235133	Drive Shaft	48NS	25	27	64.9	70	731	
2.0 CGI Kompressor (125 kW)	2003.07-2007.08	AT	-	R	Estate Engine M 271.942	235133	Drive Shaft	48NS	25	27	64.9	70	731	
2.0 Kompressor (120 kW)	2001.03-2002.05	AT	-	R	Estate Engine M 111.955	235133	Drive Shaft	48NS	25	27	64.9	70	731	
	2002.05-2007.08	AT	-	R	Estate Engine M 271.940	235133	Drive Shaft	48NS	25	27	64.9	70	731	

YEAR	TRANSM	L/R	F/R	REMARKS	GSP Ref.	PRODUCT	ABS	Technical Specifications									
								A	B	C	H	L	P				
MERCEDES BENZ																	
C-CLASS T-Model (S203)																	
2.6 4-matic (125 kW)	2002.07-2007.08	-	-	-	All-wheel Drive Estate Engine M 112.916	835053	Outer Joint	48NS	35	27	66.6	42	53	I			
	2002.07-2007.08	AT	-	R	All-wheel Drive Estate Engine M 112.916	235133	Drive Shaft	48NS	25	27	64.9	70	731				
	2002.07-2007.08	-	-	-	All-wheel Drive Estate Engine M 112.916	635061	Inner Joint		24	27	38	55.5	104				
3.0 4-matic (170 kW)	2005.01-2007.08	-	-	-	All-wheel Drive Estate Engine M 272.941	835053	Outer Joint	48NS	35	27	66.6	42	53	I			
	2005.01-2007.08	-	-	-	All-wheel Drive Estate Engine M 272.941	635061	Inner Joint		24	27	38	55.5	104				
3.2 4-matic (160 kW)	2002.07-2007.08	-	-	-	All-wheel Drive Estate Engine M 112.953	835053	Outer Joint	48NS	35	27	66.6	42	53	I			
	2002.07-2007.08	AT	-	R	All-wheel Drive Estate Engine M 112.953	235133	Drive Shaft	48NS	25	27	64.9	70	731				
	2002.07-2007.08	-	-	-	All-wheel Drive Estate Engine M 112.953	635061	Inner Joint		24	27	38	55.5	104				
3.5 4-matic (200 kW)	2005.01-2007.08	-	-	-	All-wheel Drive Estate Engine M 272.970	835053	Outer Joint	48NS	35	27	66.6	42	53	I			
	2005.01-2007.08	-	-	-	All-wheel Drive Estate Engine M 272.970	635061	Inner Joint		24	27	38	55.5	104				
C 180 (95 kW)	2001.03-2002.05	AT	-	R	Estate Engine M 111.951	235133	Drive Shaft	48NS	25	27	64.9	70	731				
C 180 Kompressor (105 kW)	2002.05-2007.08	AT	-	R	Estate Engine M 271.946	235133	Drive Shaft	48NS	25	27	64.9	70	731				
C 230 (150 kW)	2005.01-2007.08	AT	-	R	Estate Engine M 272.920	235133	Drive Shaft	48NS	25	27	64.9	70	731				
C 230 Kompressor (141 kW)	2004.02-2007.08	AT	-	R	Estate Engine M 271.948	235133	Drive Shaft	48NS	25	27	64.9	70	731				
C 240 (125 kW)	2001.03-2007.08	AT	-	R	Estate Engine M 112.912	235133	Drive Shaft	48NS	25	27	64.9	70	731				
C 320 (160 kW)	2001.03-2007.08	AT	-	R	Estate Engine M 112.946	235133	Drive Shaft	48NS	25	27	64.9	70	731				
C-CLASS T-Model (S204)																	
2.5 CDI 4-matic (150 kW)	2010.04-2014.08	-	-	-	All-wheel Drive Estate Engine OM 651.912	835049	Outer Joint		30	25	71	56.5	52	I			
3.0 CDI 4-matic (165 kW)	2007.08-2014.08	-	-	-	All-wheel Drive Estate Engine OM 642.961	835049	Outer Joint		30	25	71	56.5	52	I			
3.0 CDI 4-matic (170 kW)	2009.10-2014.08	-	-	-	All-wheel Drive Estate Engine OM 642.832	835049	Outer Joint		30	25	71	56.5	52	I			
C-CLASS W205																	
-	2015-	-	-	L/R	F	-	235109	Drive Shaft		27	27	68.5	72	785			
C-KLASSE W205																	
2.0 (170 kW)	2014.10-	-	-	R	-	-	235106	Drive Shaft		27	27	68.5	72	785			
CITAN (415)																	
108 CDI (55 kW)	2012.11-	-	MT	L/R	F	Box Engine OM 607.951	850136	Outer Joint		27	22	56.7	91	55	I		
109 CDI (66 kW)	2012.11-	-	MT	L/R	F	Box Engine OM 607.951	850136	Outer Joint		27	22	56.7	91	55	I		
111 CDI (81 kW)	2013.06-	-	MT	L/R	F	Box Engine OM 607.951	850136	Outer Joint		27	22	56.7	91	55	I		
112 (84 kW)	2013.06-	-	MT	L/R	F	Box Engine M 200.711	850136	Outer Joint		27	22	56.7	91	55	I		
CITAN Combi (415)																	
108 CDI (55 kW)	2012.11-	-	MT	L/R	F	Estate Engine OM 607.951	850136	Outer Joint		27	22	56.7	91	55	I		
109 CDI (66 kW)	2012.11-	-	MT	L/R	F	Estate Engine OM 607.951	850136	Outer Joint		27	22	56.7	91	55	I		
111 CDI (81 kW)	2013.06-	-	MT	L/R	F	Estate Engine OM 607.951	850136	Outer Joint		27	22	56.7	91	55	I		
112 (84 kW)	2013.06-	-	MT	L/R	F	Estate Engine M 200.711	850136	Outer Joint		27	22	56.7	91	55	I		
CITAN Mixto (415)																	
109 CDI (66 kW)	2012.11-	-	MT	L/R	F	Box Body/Estate Engine OM 607.951	850136	Outer Joint		27	22	56.7	91	55	I		
111 CDI (81 kW)	2013.06-	-	MT	L/R	F	Box Body/Estate Engine OM 607.951	850136	Outer Joint		27	22	56.7	91	55	I		
CLA (C117)																	
1.5 CDI/d (80 kW)	2013.10-	-	MT/AT	R	F	Coupe Engine OM 607.951	635071	Inner Joint		27	27	42.1	41.5	68			
	2013.10-	-	MT/AT	L/R	F	Coupe Engine OM 607.951	861065	Outer Joint		30	27	65	53	61.5	M		
	2013.10-	-	MT/AT	L	F	Coupe Engine OM 607.951	661082	Inner Joint		27	27	38	65	90			
	2013.10-	-	AT/MT	R	F	Coupe Engine OM 607.951	235140	Stub Axle		27	27			540			
1.6 (90 kW)	2013.01-	-	MT/AT	L	F	Coupe Engine M 270.910	661082	Inner Joint		27	27	38	65	90			
	2013.01-	-	MT/AT	R	F	Coupe Engine M 270.910	635071	Inner Joint		27	27	42.1	41.5	68			
	2013.01-	-	MT/AT	L/R	F	Coupe Engine M 270.910	861065	Outer Joint		30	27	65	53	61.5	M		
	2013.01-	-	MT/AT	R	F	Coupe Engine M 270.910	235104	Drive Shaft		30	27	65	53	496			
	2013.01-	-	AT/MT	R	F	Coupe Engine M 270.910	235140	Stub Axle		27	27			540			
2.0 (115 kW)	2013.01-	-	MT/AT	L	F	Coupe Engine M 270.910	661082	Inner Joint		27	27	38	65	90			
	2013.01-	-	MT/AT	R	F	Coupe Engine M 270.910	635071	Inner Joint		27	27	42.1	41.5	68			
	2013.01-	-	MT/AT	L/R	F	Coupe Engine M 270.910	861065	Outer Joint		30	27	65	53	61.5	M		
	2013.01-	-	AT/MT	R	F	Coupe Engine M 270.910	235140	Stub Axle		27	27			540			
2.0 (155 kW)	2013.07-	-	MT/AT	L/R	F	All-wheel Drive Coupe Engine M 270.920	861065	Outer Joint		30	27	65	53	61.5	M		
2.0 (160 kW)	2015.07-	-	MT/AT	L/R	F	Coupe Engine M 270.920	861065	Outer Joint		30	27	65	53	61.5	M		
2.0 4-matic (160 kW)	2015.07-	-	MT/AT	L/R	F	All-wheel Drive Coupe Engine M 270.920	861065	Outer Joint		30	27	65	53	61.5	M		
2.0 AMG CLA 45 4-matic (280 kW)	2015.07-	-	MT/AT	L/R	F	All-wheel Drive Coupe Engine M 133.980	861065	Outer Joint		30	27	65	53	61.5	M		
2.0 CDI d (100 kW)	2014.07-	-	MT/AT	L	F	Coupe Engine OM 651.930	661082	Inner Joint		27	27	38	65	90			
	2014.07-	-	MT/AT	R	F	Coupe Engine OM 651.930	635071	Inner Joint		27	27	42.1	41.5	68			
	2014.07-	-	MT/AT	L/R	F	Coupe Engine OM 651.930	861065	Outer Joint		30	27	65	53	61.5	M		
	2014.07-	-	AT/MT	R	F	Coupe Engine OM 651.930	235140	Stub Axle		27	27			540			
2.0 CDI d 4-matic (100 kW)	2014.07-	-	MT/AT	L	F	All-wheel Drive Coupe Engine OM 651.930	661082	Inner Joint		27	27	38	65	90			
	2014.07-	-	MT/AT	R	F	All-wheel Drive Coupe Engine OM 651.930	635071	Inner Joint		27	27	42.1	41.5	68			
	2014.07-	-	MT/AT	L	F	All-wheel Drive Coupe Engine OM 651.930	861065	Outer Joint		30	27	65	53	61.5	M		
	2014.07-	-	AT/MT	R	F	All-wheel Drive Coupe Engine OM 651.930	235140	Stub Axle		27	27			540			
2.0 CLA 45 AMG 4-matic (265 kW)	2013.07-	-	MT/AT	L/R	F	All-wheel Drive Coupe Engine M 133.980	861065	Outer Joint		30	27	65	53	61.5	M		
2.2 CDI/d (120 kW)	2013.01-	-	MT/AT	R	F	Coupe Engine OM 651.930	635071	Inner Joint		27	27	42.1	41.5	68			
	2013.01-	-	MT/AT	L	F	Coupe Engine OM 651.930	661082	Inner Joint		27	27	38	65	90			





YEAR	TRANSM	L/R	F/R	REMARKS	GSP Ref.	PRODUCT	ABS	Technical Specifications							
								A	B	C	H	L	P		
MERCEDES BENZ															
CLA (C117)															
2.2 CDI/d (120 kW)	2013.01-	-	MT/AT	L/R	F	Coupe Engine OM 651.930	861065	Outer Joint	30	27	65	53	61.5	M	
	2013.01-	-	AT/MT	R	F	Coupe Engine OM 651.930	235140	Stub Axle	27	27			540		
2.2 CDI/d (130 kW)	2014.09-	-	MT/AT	L	F	Coupe Engine OM 651.930	661082	Inner Joint	27	27	38	65	90		
	2014.09-	-	MT/AT	R	F	Coupe Engine OM 651.930	635071	Inner Joint	27	27	42.1	41.5	68		
	2014.09-	-	MT/AT	L	F	Coupe Engine OM 651.930	861065	Outer Joint	30	27	65	53	61.5	M	
	2014.09-	-	AT/MT	R	F	Coupe Engine OM 651.930	235140	Stub Axle	27	27			540		
2.2 CDI/d 4-matic (120 kW)	2014.08-	-	MT/AT	L	F	All-wheel Drive Coupe Engine OM 651.930	661082	Inner Joint	27	27	38	65	90		
	2014.08-	-	MT/AT	R	F	All-wheel Drive Coupe Engine OM 651.930	635071	Inner Joint	27	27	42.1	41.5	68		
	2014.08-	-	MT/AT	L/R	F	All-wheel Drive Coupe Engine OM 651.930	861065	Outer Joint	30	27	65	53	61.5	M	
	2014.08-	-	AT/MT	R	F	All-wheel Drive Coupe Engine OM 651.930	235140	Stub Axle	27	27			540		
2.2 CDI/d 4-matic (130 kW)	2014.09-	-	MT/AT	L	F	All-wheel Drive Coupe Engine OM 651.930	661082	Inner Joint	27	27	38	65	90		
	2014.09-	-	MT/AT	R	F	All-wheel Drive Coupe Engine OM 651.930	635071	Inner Joint	27	27	42.1	41.5	68		
	2014.09-	-	MT/AT	L	F	All-wheel Drive Coupe Engine OM 651.930	861065	Outer Joint	30	27	65	53	61.5	M	
	2014.09-	-	AT/MT	R	F	All-wheel Drive Coupe Engine OM 651.930	235140	Stub Axle	27	27			540		
2.5 (155 kW)	2013.01-	-	MT/AT	L/R	F	Coupe Engine M 270.920	861065	Outer Joint	30	27	65	53	61.5	M	
CLA Shooting Brake (X117)															
1.5 d (80 kW)	2015.07-	-	MT/AT	R	F	Estate Engine OM 607.951	635071	Inner Joint	27	27	42.1	41.5	68		
	2015.07-	-	MT/AT	L	F	Estate Engine OM 607.951	661082	Inner Joint	27	27	38	65	90		
	2015.07-	-	MT/AT	L	F	Estate Engine OM 607.951	861065	Outer Joint	30	27	65	53	61.5	M	
	2015.07-	-	AT/MT	R	F	Estate Engine OM 607.951	235140	Stub Axle	27	27			540		
1.6 (115 kW)	2015.01-	-	MT/AT	R	F	Estate Engine M 270.910	635071	Inner Joint	27	27	42.1	41.5	68		
	2015.01-	-	MT/AT	L	F	Estate Engine M 270.910	661082	Inner Joint	27	27	38	65	90		
	2015.01-	-	MT/AT	L	F	Estate Engine M 270.910	861065	Outer Joint	30	27	65	53	61.5	M	
	2015.01-	-	AT/MT	R	F	Estate Engine M 270.910	235140	Stub Axle	27	27			540		
1.6 (90 kW)	2015.01-	-	MT/AT	L	F	Estate Engine M 270.910	661082	Inner Joint	27	27	38	65	90		
	2015.01-	-	MT/AT	R	F	Estate Engine M 270.910	235104	Drive Shaft	30	27	65	53	496		
	2015.01-	-	MT/AT	L/R	F	Estate Engine M 270.910	861065	Outer Joint	30	27	65	53	61.5	M	
	2015.01-	-	AT/MT	R	F	Estate Engine M 270.910	235140	Stub Axle	27	27			540		
2.0 (155 kW)	2015.01-	-	MT/AT	L/R	F	Estate Engine M 270.920	861065	Outer Joint	30	27	65	53	61.5	M	
2.0 AMG CLA 45 4-matic (280 kW)	2015.07-	-	MT/AT	L/R	F	All-wheel Drive Estate Engine M 133.980	861065	Outer Joint	30	27	65	53	61.5	M	
2.0 CLA 45 AMG 4-matic (265 kW)	2015.01-	2015.06	MT/AT	L/R	F	All-wheel Drive Estate Engine M 133.980	861065	Outer Joint	30	27	65	53	61.5	M	
2.2 CDI/d (100 kW)	2015.01-	-	MT/AT	R	F	Estate Engine OM 651.930	635071	Inner Joint	27	27	42.1	41.5	68		
	2015.01-	-	MT/AT	L	F	Estate Engine OM 651.930	661082	Inner Joint	27	27	38	65	90		
	2015.01-	-	MT/AT	L	F	Estate Engine OM 651.930	861065	Outer Joint	30	27	65	53	61.5	M	
	2015.01-	-	AT/MT	R	F	Estate Engine OM 651.930	235140	Stub Axle	27	27			540		
2.2 CDI/d (120 kW)	2015.01-	-	MT/AT	R	F	Estate Engine OM 651.930	635071	Inner Joint	27	27	42.1	41.5	68		
	2015.01-	-	MT/AT	L	F	Estate Engine OM 651.930	661082	Inner Joint	27	27	38	65	90		
	2015.01-	-	MT/AT	L	F	Estate Engine OM 651.930	861065	Outer Joint	30	27	65	53	61.5	M	
	2015.01-	-	AT/MT	R	F	Estate Engine OM 651.930	235140	Stub Axle	27	27			540		
2.2 CDI/d (130 kW)	2015.01-	-	MT/AT	L	F	Estate Engine OM 651.930	661082	Inner Joint	27	27	38	65	90		
	2015.01-	-	MT/AT	R	F	Estate Engine OM 651.930	635071	Inner Joint	27	27	42.1	41.5	68		
	2015.01-	-	MT/AT	L/R	F	Estate Engine OM 651.930	861065	Outer Joint	30	27	65	53	61.5	M	
	2015.01-	-	AT/MT	R	F	Estate Engine OM 651.930	235140	Stub Axle	27	27			540		
2.2 CDI/d 4-matic (100 kW)	2015.01-	-	MT/AT	R	F	All-wheel Drive Estate Engine OM 651.930	635071	Inner Joint	27	27	42.1	41.5	68		
	2015.01-	-	MT/AT	L	F	All-wheel Drive Estate Engine OM 651.930	661082	Inner Joint	27	27	38	65	90		
	2015.01-	-	MT/AT	L	F	All-wheel Drive Estate Engine OM 651.930	861065	Outer Joint	30	27	65	53	61.5	M	
	2015.01-	-	AT/MT	R	F	All-wheel Drive Estate Engine OM 651.930	235140	Stub Axle	27	27			540		
2.2 CDI/d 4-matic (120 kW)	2015.09-	-	MT/AT	R	F	All-wheel Drive Estate Engine OM 651.930	635071	Inner Joint	27	27	42.1	41.5	68		
	2015.09-	-	MT/AT	L	F	All-wheel Drive Estate Engine OM 651.930	661082	Inner Joint	27	27	38	65	90		
	2015.09-	-	MT/AT	L	F	All-wheel Drive Estate Engine OM 651.930	861065	Outer Joint	30	27	65	53	61.5	M	
	2015.09-	-	AT/MT	R	F	All-wheel Drive Estate Engine OM 651.930	235140	Stub Axle	27	27			540		
2.2 CDI/d 4-matic (130 kW)	2015.01-	-	MT/AT	L	F	All-wheel Drive Estate Engine OM 651.930	661082	Inner Joint	27	27	38	65	90		
	2015.01-	-	MT/AT	R	F	All-wheel Drive Estate Engine OM 651.930	635071	Inner Joint	27	27	42.1	41.5	68		
	2015.01-	-	MT/AT	L	F	All-wheel Drive Estate Engine OM 651.930	861065	Outer Joint	30	27	65	53	61.5	M	
	2015.01-	-	AT/MT	R	F	All-wheel Drive Estate Engine OM 651.930	235140	Stub Axle	27	27			540		
CLASS AMG															
2.0 (80kW)	2011.11-	-	-	L	F	Hatchback	235067	Drive Shaft	30	27	65	53	535		
CLASSE A															
-	-	-	-	-	-	-	835058	Outer Joint		24	28	57	67	50	I
A 160	1999.01-	2006.12	MT	-	-	-	835021	Outer Joint	48W	24	28	57	67	50	I
	1999.01-	2006.12	MT	-	-	-	635015	Inner Joint		22	28	36	55	79	
A 190	2000.01-	2006.12	MT	-	-	-	835032	Outer Joint	48W	24	28	57	67	54	I
	2000.01-	2006.12	MT	-	-	-	635015	Inner Joint		22	28	36	55	79	
CLASSE A I (W168)															
A 140 (60 kW)	1997.07-	2004.08	-	L	-	Engine M166.940	635013	Inner Joint		22	27	36	55	79	
A 160 (75 kW)	1997.07-	2004.08	-	L	-	Engine M 166.960	635013	Inner Joint		22	27	36	55	79	





	 YEAR	TRANSM	L/R	F/R	REMARKS	GSP Ref.	 PRODUCT	 ABS	Technical Specifications					
									A	B	C	H	L	P
MERCEDES BENZ														
CLASSE A I (W168)														
A 160 CDI (44 kW)	1998.07-2001.02	-	L	-	Engine OM668.941	635013	Inner Joint		22	27	36	55	79	
A 160 CDI (55 kW)	2001.02-2004.08	-	L	-	Engine OM668.940	635013	Inner Joint		22	27	36	55	79	
A 170 CDI (66 kW)	1998.07-2001.02	MT	L	-	Engine OM668.940	635013	Inner Joint		22	27	36	55	79	
A 170 CDI (70 kW)	2001.02-2004.08	-	L	-	Engine OM668.942	635013	Inner Joint		22	27	36	55	79	
A 190 (92 kW)	1999.03-2004.08	-	L	-	Engine OM166.990	635013	Inner Joint		22	27	36	55	79	
CLASSE A II (W169)														
A 150 (70 kW)	2004.09-	-	-	-	-	835020	Outer Joint		25	27	60	73.5	50	I
	2004.09-	-	L	-	Engine 266.920	699136	Inner Joint		22	27	36	55	100	
A 160 (70 kW)	2004-	MT	L	-	Engine 266.920	699136	Inner Joint		22	27	36	55	100	
A 160 CDI (60 kW)	2004-	MT	L	-	Engine 640.920	699136	Inner Joint		22	27	36	55	100	
A 170 (85 kW)	2004-	MT	L	-	Engine 266.940	699136	Inner Joint		22	27	36	55	100	
A 170 NGT (85 kW)	2008-	MT	L	-	Engine 266.940	699136	Inner Joint		22	27	36	55	100	
A 180 (85 kW)	2009-	MT	L	-	Engine 266.940	699136	Inner Joint		22	27	36	55	100	
A 180 CDI (80 kW)	2004-	MT	R	-	Engine 640.940	635012	Inner Joint		27	25	38	476	83	
A 200 (100 kW)	2004-	MT	L	-	Engine 266.920	699136	Inner Joint		22	27	36	55	100	
A 200 CDI (100 kW)	2004-	MT	R	-	Engine 640.941	635012	Inner Joint		27	25	38	476	83	
A 200 CDI (130 kW)	2004-	MT	R	-	Engine 640.941	635012	Inner Joint		27	25	38	476	83	
A 200 T (142 kW)	2005-	MT	R	-	Engine 266.980	635012	Inner Joint		27	25	38	476	83	
CLASSE B I (W245)														
B 150 (70 kW)	2005-	MT	L	-	Engine 266.920	699136	Inner Joint		22	27	36	55	100	
B 160 (70 kW)	2009-	MT	L	-	Engine 266.920	699136	Inner Joint		22	27	36	55	100	
B 170 (85 kW)	2005-	MT	L	-	Engine 266.940	699136	Inner Joint		22	27	36	55	100	
B 180 (85 kW)	2009-	MT	L	-	Engine 266.940	699136	Inner Joint		22	27	36	55	100	
B 180 CDI (80 kW)	2005-	MT	R	-	Engine 640.940	635012	Inner Joint		27	25	38	476	83	
B 180 NGT (85 kW)	2008.11-	MT	L	-	Engine 266.940	699136	Inner Joint		22	27	36	55	100	
B 200 (100 kW)	2005-	MT	L	-	Engine 266.960	699136	Inner Joint		22	27	36	55	100	
B 200 CDI (103 kW)	2005-	MT	R	-	Engine 640.941	635012	Inner Joint		27	25	38	476	83	
B 200 T (142 kW)	2005-	MT	R	-	Engine 266.980	635012	Inner Joint		27	25	38	476	83	
CLASSE B II (W245)														
B 150 (70 kW)	2005.06-2008.04	MT	L	-	Engine 266.920	699136	Inner Joint		22	27	36	55	100	
B 160 (70 kW)	2009.04-2011.11	MT	L	-	Engine 266.920	699136	Inner Joint		22	27	36	55	100	
B 170 (85 kW)	2005.06-2008.04	MT	L	-	Engine 266.920	699136	Inner Joint		22	27	36	55	100	
B 180 (85 kW)	2009.01-2011.11	MT	L	-	Engine 266.940	699136	Inner Joint		22	27	36	55	100	
B 180 NGT (85 kW)	2008.04-2011.11	MT	L	-	Engine 266.960	699136	Inner Joint		22	27	36	55	100	
B 200 (100 kW)	2009.04-2011.11	MT	L	-	Engine 640.941	699136	Inner Joint		22	27	36	55	100	
CLK (A209)														
2.0 CGI (125 kW)	2003.07-2010.03	AT	-	R	Convertible Engine M 271.942	235133	Drive Shaft	48NS	25	27	64.9	70	731	
2.0 Kompressor (120 kW)	2003.02-2010.03	AT	-	R	Convertible Engine M 271.940	235133	Drive Shaft	48NS	25	27	64.9	70	731	
2.0 Kompressor (135 kW)	2006.10-2010.03	AT	-	R	Convertible Engine M 271.955	235133	Drive Shaft	48NS	25	27	64.9	70	731	
CLK 240 (125 kW)	2003.02-2010.03	AT	-	R	Convertible Engine M 112.912	235133	Drive Shaft	48NS	25	27	64.9	70	731	
CLK (C209)														
2.0 CGI (125 kW)	2003.07-2009.05	-	R	F	Coupe Engine M 271.942	210027	Drive Shaft		25	22	56.7	79	868	
	2003.07-2009.05	AT	-	R	Coupe Engine M 271.942	235133	Drive Shaft	48NS	25	27	64.9	70	731	
2.0 Kompressor (120 kW)	2002.09-2009.05	AT	-	R	Coupe Engine M 271.940	235133	Drive Shaft	48NS	25	27	64.9	70	731	
2.0 Kompressor (135 kW)	2006.10-2009.05	AT	-	R	Coupe Engine M 271.955	235133	Drive Shaft	48NS	25	27	64.9	70	731	
240 (125 kW)	2002.06-2009.05	AT	-	R	Coupe Engine M 112.912	235133	Drive Shaft	48NS	25	27	64.9	70	731	
CLS (C218)														
2.5 BlueTEC / d 4-matic (150 kW)	2014.05-	-	-	-	All-wheel Drive Coupe Engine OM 651.924	835049	Outer Joint		30	25	71	56.5	52	I
	2014.05-	-	-	-	All-wheel Drive Coupe Engine OM 651.924	699166	Inner Joint		27	27	38	62	110.5	
3.0 4-matic (185 kW)	2012.11-	-	-	-	All-wheel Drive Coupe Engine OM 642.858	835049	Outer Joint		30	25	71	56.5	52	I
	2012.11-	-	-	-	All-wheel Drive Coupe Engine OM 642.858	699166	Inner Joint		27	27	38	62	110.5	
3.0 4-matic (245 kW)	2014.05-	-	-	-	All-wheel Drive Coupe Engine M 276.820	835049	Outer Joint		30	25	71	56.5	52	I
	2014.05-	-	-	-	All-wheel Drive Coupe Engine M 276.820	699166	Inner Joint		27	27	38	62	110.5	
3.0 CDI 4-matic (195 kW)	2011.09-	-	-	-	All-wheel Drive Coupe Engine OM 642.854	835049	Outer Joint		30	25	71	56.5	52	I
	2011.09-	-	-	-	All-wheel Drive Coupe Engine OM 642.854	699166	Inner Joint		27	27	38	62	110.5	
3.0 d 4-matic (190 kW)	2015.04-	-	-	-	All-wheel Drive Coupe Engine OM 642.854/OM 642.858	835049	Outer Joint		30	25	71	56.5	52	I
	2015.04-	-	-	-	All-wheel Drive Coupe Engine OM 642.854/OM 642.858	699166	Inner Joint		27	27	38	62	110.5	
3.5 4-matic (245 kW)	2014.07-	-	-	-	All-wheel Drive Coupe Engine M 276.850	835049	Outer Joint		30	25	71	56.5	52	I
	2014.07-	-	-	-	All-wheel Drive Coupe Engine M 276.850	699166	Inner Joint		27	27	38	62	110.5	
5.0 4-matic (300 kW)	2011.09-	-	-	-	All-wheel Drive Coupe Engine M 278.922	835049	Outer Joint		30	25	71	56.5	52	I
	2011.09-	-	-	-	All-wheel Drive Coupe Engine M 278.922	699166	Inner Joint		27	27	38	62	110.5	
5.5 CLS 63 AMG 4-matic (410 kW)	2013.05-	-	-	-	All-wheel Drive Coupe Engine M 157.981	235096	Drive Shaft		30	27	71	56.5	529	
	2013.05-	-	-	-	All-wheel Drive Coupe Engine M 157.981	835049	Outer Joint		30	25	71	56.5	52	I
	2013.05-	-	-	-	All-wheel Drive Coupe Engine M 157.981	699166	Inner Joint		27	27	38	62	110.5	
5.5 CLS 63 AMG S (430 kW)	2013.02-	-	-	-	All-wheel Drive Coupe Engine M 157.981	235096	Drive Shaft		30	27	71	56.5	529	
	2013.02-	-	-	-	All-wheel Drive Coupe Engine M 157.981	835049	Outer Joint		30	25	71	56.5	52	I

	 YEAR	TRANSM	L/R	F/R	REMARKS	GSP Ref.	 PRODUCT	 ABS	Technical Specifications					
									A	B	C	H	L	P
MERCEDES BENZ														
CLS (C218)														
5.5 CLS 63 AMG S (430 kW)	2013.02-	-	-	-	All-wheel Drive Coupe Engine M 157.981	699166	Inner Joint		27	27	38	62	110.5	
CLS (C219)														
CLS 350 (200 kW)	2004.10-	2010.12	AT	L/R	R Coupe Engine M 272.964	235125	Drive Shaft	48NS	27	27	68	72	771	
CLS Shooting Brake (X218)														
2.5 BlueTEC / d 4-matic (150 kW)	2014.05-	-	-	-	All-wheel Drive Estate Engine OM 651.924	835049	Outer Joint		30	25	71	56.5	52	I
	2014.05-	-	-	-	All-wheel Drive Estate Engine OM 651.924	699166	Inner Joint		27	27	38	62	110.5	
3.0 4-matic (245 kW)	2014.05-	-	-	-	All-wheel Drive Estate Engine M 276.820	699166	Inner Joint		27	27	38	62	110.5	
	2014.05-	-	-	-	All-wheel Drive Estate Engine M 276.820	835049	Outer Joint		30	25	71	56.5	52	I
3.0 BlueTEC 4-matic (185 kW)	2014.05-	-	AT	R	R All-wheel Drive Estate Engine OM 642.858	235119	Drive Shaft	48NS	27	27	68	82	803	
	2014.05-	-	-	-	All-wheel Drive Estate Engine OM 642.858	835049	Outer Joint		30	25	71	56.5	52	I
	2014.05-	-	-	-	All-wheel Drive Estate Engine OM 642.858	699166	Inner Joint		27	27	38	62	110.5	
3.0 CDI 4-matic (195 kW)	2012.10-	-	-	-	All-wheel Drive Estate Engine OM 642.854	835049	Outer Joint		30	25	71	56.5	52	I
	2012.10-	-	-	-	All-wheel Drive Estate Engine OM 642.854	699166	Inner Joint		27	27	38	62	110.5	
3.0 d 4-matic (190 kW)	2015.04-	-	-	-	All-wheel Drive Estate Engine OM 642.854/OM 642.858	699166	Inner Joint		27	27	38	62	110.5	
	2015.04-	-	-	-	All-wheel Drive Estate Engine OM 642.854/OM 642.858	835049	Outer Joint		30	25	71	56.5	52	I
3.5 4-matic (245 kW)	2014.07-	-	-	-	All-wheel Drive Estate Engine M 276.850	699166	Inner Joint		27	27	38	62	110.5	
	2014.07-	-	-	-	All-wheel Drive Estate Engine M 276.850	835049	Outer Joint		30	25	71	56.5	52	I
5.0 4-matic (300 kW)	2012.10-	-	-	-	All-wheel Drive Estate Engine M 278.922	699166	Inner Joint		27	27	38	62	110.5	
	2012.10-	-	-	-	All-wheel Drive Estate Engine M 278.922	835049	Outer Joint		30	25	71	56.5	52	I
5.5 AMG 4-matic (410 kW)	2013.05-	-	-	-	All-wheel Drive Estate Engine M 157.981	699166	Inner Joint		27	27	38	62	110.5	
	2013.05-	-	-	-	All-wheel Drive Estate Engine M 157.981	235096	Drive Shaft		30	27	71	56.5	529	
	2013.05-	-	-	-	All-wheel Drive Estate Engine M 157.981	835049	Outer Joint		30	25	71	56.5	52	I
5.5 AMG 4-matic (430 kW)	2013.02-	-	-	-	All-wheel Drive Estate Engine M 157.981	699166	Inner Joint		27	27	38	62	110.5	
	2013.02-	-	-	-	All-wheel Drive Estate Engine M 157.981	235096	Drive Shaft		30	27	71	56.5	529	
	2013.02-	-	-	-	All-wheel Drive Estate Engine M 157.981	835049	Outer Joint		30	25	71	56.5	52	I
COUPE (C124)														
2.3 CE (100 kW)	1987.03-	1992.12	AT/MT	L/R	R Coupe Engine M 102.982	635006	Inner Joint			25		26		
	1987.03-	1992.12	AT/MT	L/R	R Coupe Engine M 102.982	235001	Drive Shaft		25		62	69	665	
2.3 CE (97 kW)	1987.03-	1992.12	AT/MT	L/R	R Coupe Engine M 102.982	635006	Inner Joint			25		26		
	1987.03-	1992.12	AT/MT	L/R	R Coupe Engine M 102.982	235001	Drive Shaft		25		62	69	665	
2.3 CE Cat (97 kW)	1989.06-	1992.12	AT/MT	L/R	R Coupe Engine M 102.982	635006	Inner Joint			25		26		
	1989.06-	1992.12	AT/MT	L/R	R Coupe Engine M 102.982	235001	Drive Shaft		25		62	69	665	
3.0 CE (132 kW)	1987.03-	1993.05	AT/MT	L/R	R Coupe Engine M 103.983	699143	Inner Joint			27		28		
	1987.03-	1993.05	AT/MT	L/R	R Coupe Engine M 103.983	235005	Drive Shaft		25		62	69	659	
3.0 CE (138 kW)	1987.03-	1989.12	AT/MT	L/R	R Coupe Engine M 103.983	699143	Inner Joint			27		28		
	1987.03-	1989.12	AT/MT	L/R	R Coupe Engine M 103.983	235005	Drive Shaft		25		62	69	659	
E CLASS (W124)														
2.0	1987-	1992	-	L/R	R -	635003	Inner Joint		25	25	62	69	56	
E-CLASS (W124)														
2.5 D (83 kW)	1993.07-	1995.06	AT	L/R	R Saloon Engine OM 605.911	235008	Drive Shaft	48T	25		62	70.5	674	
	1993.07-	1995.06	AT	L/R	R Saloon Engine OM 605.911	605007	Inner Joint			24		27		
2.5 Turbo-D (93 kW)	1993.06-	1995.06	AT/MT	L/R	R Saloon Engine OM 602.962	699143	Inner Joint			27		28		
	1993.06-	1995.06	AT/MT	L/R	R Saloon Engine OM 602.962	235005	Drive Shaft		25		62	69	659	
3.0 Turbo-D (108 kW)	1993.06-	1995.06	AT/MT	L/R	R Saloon Engine OM 603.960	699143	Inner Joint			27		28		
	1993.06-	1995.06	-	-	R Saloon Engine OM 603.960	235024	Drive Shaft	48W	25		62	69	633	
	1993.06-	1995.06	AT/MT	L/R	R Saloon Engine OM 603.960	235005	Drive Shaft		25		62	69	659	
E 300 4-matic (132 kW)	1993.06-	1995.06	-	-	R All-wheel Drive Saloon Engine M 103.985	235024	Drive Shaft	48W	25		62	69	633	
E 300 D (100 kW)	1993.07-	1995.06	-	-	R Saloon Engine OM 606.910	235024	Drive Shaft	48W	25		62	69	633	
E 300 Turbo-D 4-matic (108 kW)	1993.06-	1995.06	-	-	R All-wheel Drive Saloon Engine OM 603.963	235024	Drive Shaft	48W	25		62	69	633	
E-CLASS (W210)														
2.0 (100 kW)	1995.06-	2000.08	AT	L/R	R Saloon Engine M 111.942	235009	Drive Shaft	48T	25		62	70.5	660	
	1995.06-	2000.08	AT	L/R	R Saloon Engine M 111.942	235008	Drive Shaft	48T	25		62	70.5	674	
	1995.06-	2000.08	AT	L/R	R Saloon Engine M 111.942	605007	Inner Joint			24		27		
2.0 CDI (75 kW)	1998.06-	2002.03	AT	L/R	R Saloon Engine OM 611.961	235009	Drive Shaft	48T	25		62	70.5	660	
	1998.06-	2002.03	AT	L/R	R Saloon Engine OM 611.961	235008	Drive Shaft	48T	25		62	70.5	674	
	1998.06-	2002.03	AT	L/R	R Saloon Engine OM 611.961	605007	Inner Joint			24		27		
2.0 CDI (85 kW)	1999.07-	2002.03	AT	L/R	R Saloon Engine OM 611.961	235009	Drive Shaft	48T	25		62	70.5	660	
	1999.07-	2002.03	AT	L/R	R Saloon Engine OM 611.961	235008	Drive Shaft	48T	25		62	70.5	674	
	1999.07-	2002.03	AT	L/R	R Saloon Engine OM 611.961	605007	Inner Joint			24		27		
2.0 D (65 kW)	1996.01-	2002.03	AT	L/R	R Saloon Engine OM 604.917	235009	Drive Shaft	48T	25		62	70.5	660	
	1996.01-	2002.03	AT	L/R	R Saloon Engine OM 604.917	235008	Drive Shaft	48T	25		62	70.5	674	
	1996.01-	2002.03	AT	L/R	R Saloon Engine OM 604.917	605007	Inner Joint			24		27		
2.0 Kompressor (120 kW)	2000.08-	2002.03	AT	L/R	R Saloon Engine M 111.957	235009	Drive Shaft	48T	25		62	70.5	660	
	2000.08-	2002.03	AT	L/R	R Saloon Engine M 111.957	235008	Drive Shaft	48T	25		62	70.5	674	
	2000.08-	2002.03	AT	L/R	R Saloon Engine M 111.957	605007	Inner Joint			24		27		
2.0 Kompressor (137 kW)	1997.06-	2002.03	AT	L/R	R Saloon Engine M 111.947	235009	Drive Shaft	48T	25		62	70.5	660	





YEAR	TRANSM	L/R	F/R	REMARKS	GSP Ref.	PRODUCT	ABS	Technical Specifications										
								A	B	C	H	L	P					
MERCEDES BENZ																		
E-CLASS (W210)																		
2.0 Kompressor (137 kW)	1997.06-2002.03	AT	L/R	R	Saloon Engine M 111.947	235008	Drive Shaft	48T	25		62	70.5	674					
	1997.06-2002.03	AT	L/R	R	Saloon Engine M 111.947	605007	Inner Joint			24		27						
2.2CDI (100 kW)	1999.07-2002.03	AT	L/R	R	Saloon Engine OM 611.961	235009	Drive Shaft	48T	25		62	70.5	660					
	1999.07-2002.03	AT	L/R	R	Saloon Engine OM 611.961	235008	Drive Shaft	48T	25		62	70.5	674					
	1999.07-2002.03	AT	L/R	R	Saloon Engine OM 611.961	605007	Inner Joint			24		27						
2.2CDI (105 kW)	1999.07-2002.03	AT	L/R	R	Saloon Engine OM 611.961	235009	Drive Shaft	48T	25		62	70.5	660					
	1999.07-2002.03	AT	L/R	R	Saloon Engine OM 611.961	235008	Drive Shaft	48T	25		62	70.5	674					
	1999.07-2002.03	AT	L/R	R	Saloon Engine OM 611.961	605007	Inner Joint			24		27						
2.2CDI (92 kW)	1998.06-1999.07	AT	L/R	R	Saloon Engine OM 611.961	235009	Drive Shaft	48T	25		62	70.5	660					
	1998.06-1999.07	AT	L/R	R	Saloon Engine OM 611.961	235008	Drive Shaft	48T	25		62	70.5	674					
	1998.06-1999.07	AT	L/R	R	Saloon Engine OM 611.961	605007	Inner Joint			24		27						
2.2D (55 kW)	1996.05-2002.03	-	L/R	R	Saloon Engine OM 604.912	235031	Drive Shaft	48W	27		63.5	79.5	687.5					
	1996.05-2002.03	AT	L/R	R	Saloon Engine OM 604.912	235008	Drive Shaft	48T	25		62	70.5	674					
	1996.05-2002.03	AT	L/R	R	Saloon Engine OM 604.912	605007	Inner Joint			24		27						
2.2D (70 kW)	1995.06-1999.07	AT	L/R	R	Saloon Engine OM 604.912	235008	Drive Shaft	48T	25		62	70.5	674					
	1995.06-1999.07	AT	L/R	R	Saloon Engine OM 604.912	605007	Inner Joint			24		27						
2.5 D (83 kW)	1995.06-1999.07	AT	L/R	R	Saloon Engine OM 605.912	235008	Drive Shaft	48T	25		62	70.5	674					
	1995.06-1999.07	AT	L/R	R	Saloon Engine OM 605.912	605007	Inner Joint			24		27						
2.5 Turbo-D (110 kW)	1997.06-1999.07	AT	L/R	R	Saloon Engine OM 605.962	235008	Drive Shaft	48T	25		62	70.5	674					
	1997.06-1999.07	AT	L/R	R	Saloon Engine OM 605.962	605007	Inner Joint			24		27						
2.6 (125 kW)	2000.08-2002.03	-	L/R	R	Saloon Engine M 112.914	235031	Drive Shaft	48W	27		63.5	79.5	687.5					
	2000.08-2002.03	AT	L/R	R	Saloon Engine M 112.914	235008	Drive Shaft	48T	25		62	70.5	674					
	2000.08-2002.03	AT	L/R	R	Saloon Engine M 112.914	605007	Inner Joint			24		27						
E 230 (110 kW)	1995.06-1997.06	-	L/R	R	Saloon Engine M 111.970	235031	Drive Shaft	48W	27		63.5	79.5	687.5					
	1995.06-1997.06	AT	L/R	R	Saloon Engine M 111.970	235008	Drive Shaft	48T	25		62	70.5	674					
	1995.06-1997.06	AT	L/R	R	Saloon Engine M 111.970	605007	Inner Joint			24		27						
E 240 (125 kW)	1997.06-2000.08	-	L/R	R	Saloon Engine M 112.911	235031	Drive Shaft	48W	27		63.5	79.5	687.5					
	1997.06-2000.08	AT	L/R	R	Saloon Engine M 112.911	235008	Drive Shaft	48T	25		62	70.5	674					
	1997.06-2000.08	AT	L/R	R	Saloon Engine M 112.911	605007	Inner Joint			24		27						
E 300 D (100 kW)	1995.06-1997.06	AT	L/R	R	Saloon Engine OM 606.912	235009	Drive Shaft	48T	25		62	70.5	660					
E 300 Turbo-D (130 kW)	1996.12-1999.07	AT	L/R	R	Saloon Engine OM 606.962	235009	Drive Shaft	48T	25		62	70.5	660					
E 320 CDI (145 kW)	1999.07-2002.03	AT	L/R	R	Saloon Engine OM 613.961	235009	Drive Shaft	48T	25		62	70.5	660					
E-CLASS (W211)																		
2.0 CDI (75 kW)	2002.07-2008.12	5AT	R	R	Saloon Engine OM 646.951	235115	Drive Shaft	48NS	27	27	68	82	773					
	2002.07-2008.12	AT	L	R	Saloon Engine OM 646.951	235116	Drive Shaft	48NS	27	27	68	82	773					
2.0 CDI (90 kW)	2002.07-2008.12	5AT	R	R	Saloon Engine OM 646.951	235115	Drive Shaft	48NS	27	27	68	82	773					
	2002.07-2008.12	AT	L	R	Saloon Engine OM 646.951	235116	Drive Shaft	48NS	27	27	68	82	773					
2.6 4-matic (130 kW)	2003.03-2008.12	-	-	-	All-wheel Drive Saloon Engine M 112.917	835053	Outer Joint	48NS	35	27	66.6	42	53	I				
	2003.03-2008.12	-	R	F	All-wheel Drive Saloon Engine M 112.917	635060	Inner Joint			24	27	37.97	55.5	104				
	2003.03-2008.12	-	-	-	All-wheel Drive Saloon Engine M 112.917	635062	Inner Joint			34	27	37.5	140					
2.8 CDI 4-matic (140 kW)	2005.03-2008.12	-	-	-	All-wheel Drive Saloon Engine OM 642.921	835053	Outer Joint	48NS	35	27	66.6	42	53	I				
	2005.03-2008.12	-	R	F	All-wheel Drive Saloon Engine OM 642.921	635060	Inner Joint			24	27	37.97	55.5	104				
	2005.03-2008.12	-	-	-	All-wheel Drive Saloon Engine OM 642.921	635062	Inner Joint			34	27	37.5	140					
3.2 4-matic (165 kW)	2003.03-2008.12	-	-	-	All-wheel Drive Saloon Engine M 112.954	835053	Outer Joint	48NS	35	27	66.6	42	53	I				
	2003.03-2008.12	-	R	F	All-wheel Drive Saloon Engine M 112.954	635060	Inner Joint			24	27	37.97	55.5	104				
	2003.03-2008.12	-	-	-	All-wheel Drive Saloon Engine M 112.954	635062	Inner Joint			34	27	37.5	140					
3.5 4-matic (200 kW)	2005.03-2008.12	-	-	-	All-wheel Drive Saloon Engine M 272.972	835053	Outer Joint	48NS	35	27	66.6	42	53	I				
	2005.03-2008.12	-	R	F	All-wheel Drive Saloon Engine M 272.972	635060	Inner Joint			24	27	37.97	55.5	104				
	2005.03-2008.12	-	-	-	All-wheel Drive Saloon Engine M 272.972	635062	Inner Joint			34	27	37.5	140					
5.0 4-matic (225 kW)	2003.10-2008.12	-	-	-	All-wheel Drive Saloon Engine M 113.969	835053	Outer Joint	48NS	35	27	66.6	42	53	I				
	2003.10-2008.12	-	L	R	All-wheel Drive Saloon Engine M 113.969	235136	Drive Shaft	48NS	27	27	68	82	778					
	2003.10-2008.12	-	R	F	All-wheel Drive Saloon Engine M 113.969	635060	Inner Joint			24	27	37.97	55.5	104				
	2003.10-2008.12	-	-	-	All-wheel Drive Saloon Engine M 113.969	635062	Inner Joint			34	27	37.5	140					
5.1 4-matic (285 kW)	2006.04-2008.12	-	-	-	All-wheel Drive Saloon Engine M 273.962	835053	Outer Joint	48NS	35	27	66.6	42	53	I				
	2006.04-2008.12	-	R	F	All-wheel Drive Saloon Engine M 273.962	635060	Inner Joint			24	27	37.97	55.5	104				
	2006.04-2008.12	-	-	-	All-wheel Drive Saloon Engine M 273.962	635062	Inner Joint			34	27	37.5	140					
E 280 4-matic (170 kW)	2006.01-2008.12	-	R	F	All-wheel Drive Saloon Engine M 272.943	635060	Inner Joint			24	27	37.97	55.5	104				
E 280 CDI (140 kW)	2005.03-2008.12	7AT	L	R	Saloon Engine OM 642.920	235118	Drive Shaft	48NS	27	30	68	82	777					
E 320 CDI 4-matic (165 kW)	2005.03-2008.12	-	-	-	All-wheel Drive Saloon Engine OM 642.910	835053	Outer Joint	48NS	35	27	66.6	42	53	I				
	2005.03-2008.12	-	R	F	All-wheel Drive Saloon Engine OM 642.910	635060	Inner Joint			24	27	37.97	55.5	104				
	2005.03-2008.12	-	-	-	All-wheel Drive Saloon Engine OM 642.910	635062	Inner Joint			34	27	37.5	140					
E 55 AMG Kompressor (350 kW)	2002.10-2008.12	AT	L/R	R	Saloon Engine M 113.990	235126	Drive Shaft	48NS	27	30	68	82	773					
E-CLASS (W212)																		
2.2CDI (120 kW)	2009.01-	-	-	-	Saloon Engine OM 651.924	699166	Inner Joint			27	27	38	62	110.5				
	2009.01-	-	-	-	Saloon Engine OM 651.924	835049	Outer Joint			30	25	71	56.5	52	I			
2.5 CDI / BlueTEC (150 kW)	2009.01-	AT	L/R	R	Saloon Engine OM 651.924	235120	Drive Shaft	48NS	27	30	68	82	800					

YEAR	TRANSM	L/R	F/R	REMARKS	GSP Ref.	PRODUCT	ABS	Technical Specifications							
								A	B	C	H	L	P		
MERCEDES BENZ															
E-CLASS (W212)															
2.5 CDI / BlueTEC 4-matic (150 kW)	2009.01-	-	-	-	All-wheel Drive Saloon Engine OM 651.924	699166	Inner Joint		27	27	38	62	110.5		
	2009.01-	-	AT	L/R	R	All-wheel Drive Saloon Engine OM 651.924	235137	Drive Shaft	48NS	27	27	68	82	807	
	2009.01-	-	-	-	-	All-wheel Drive Saloon Engine OM 651.924	835049	Outer Joint		30	25	71	56.5	52	I
3.5 4-matic (185 kW)	2011.07-	-	-	-	-	All-wheel Drive Saloon Engine M 276.952	699166	Inner Joint		27	27	38	62	110.5	
	2011.07-	-	-	-	-	All-wheel Drive Saloon Engine M 276.952	835049	Outer Joint		30	25	71	56.5	52	I
3.5 4-matic (200 kW)	2009.01-	2011.08	-	-	-	All-wheel Drive Saloon Engine M 272.977	699166	Inner Joint		27	27	38	62	110.5	
	2009.01-	2011.08	-	-	-	All-wheel Drive Saloon Engine M 272.977	835049	Outer Joint		30	25	71	56.5	52	I
3.5 4-matic (225 kW)	2011.09-	-	-	-	-	All-wheel Drive Saloon Engine M 276.952	699166	Inner Joint		27	27	38	62	110.5	
	2011.09-	-	-	-	-	All-wheel Drive Saloon Engine M 276.952	835049	Outer Joint		30	25	71	56.5	52	I
3.5 BlueTEC (185 kW)	2012.11-	-	-	-	-	Saloon Engine OM 642.852	699166	Inner Joint		27	27	38	62	110.5	
	2012.11-	-	-	-	-	Saloon Engine OM 642.852	835049	Outer Joint		30	25	71	56.5	52	I
3.5 BlueTEC 4-matic (185 kW)	2012.11-	-	-	-	-	All-wheel Drive Saloon Engine OM 642.858	699166	Inner Joint		27	27	38	62	110.5	
	2012.11-	-	-	-	-	All-wheel Drive Saloon Engine OM 642.858	835049	Outer Joint		30	25	71	56.5	52	I
3.5 BlueTEC 4-matic (190 kW)	2014.05-	-	-	-	-	All-wheel Drive Saloon Engine OM 642.858	699166	Inner Joint		27	27	38	62	110.5	
	2014.05-	-	-	-	-	All-wheel Drive Saloon Engine OM 642.858	835049	Outer Joint		30	25	71	56.5	52	I
3.5 CDI 4-matic (170 kW)	2009.09-	-	-	-	-	All-wheel Drive Saloon Engine OM 642.856	699166	Inner Joint		27	27	38	62	110.5	
	2009.09-	-	-	-	-	All-wheel Drive Saloon Engine OM 642.856	835049	Outer Joint		30	25	71	56.5	52	I
3.5 CDI 4-matic (195 kW)	2011.03-	-	-	-	-	All-wheel Drive Saloon Engine OM 642.858	699166	Inner Joint		27	27	38	62	110.5	
	2011.03-	-	-	-	-	All-wheel Drive Saloon Engine OM 642.858	835049	Outer Joint		30	25	71	56.5	52	I
4.0 4-matic (245 kW)	2013.01-	-	-	-	-	All-wheel Drive Saloon Engine M 276.820	699166	Inner Joint		27	27	38	62	110.5	
	2013.01-	-	-	-	-	All-wheel Drive Saloon Engine M 276.820	835049	Outer Joint		30	25	71	56.5	52	I
	2014.07-	-	-	-	-	All-wheel Drive Saloon Engine M 276.850	699166	Inner Joint		27	27	38	62	110.5	
	2014.07-	-	-	-	-	All-wheel Drive Saloon Engine M 276.850	835049	Outer Joint		30	25	71	56.5	52	I
5.0 4-matic (285 kW)	2009.01-	-	-	-	-	All-wheel Drive Saloon Engine M 273.970	699166	Inner Joint		27	27	38	62	110.5	
	2009.01-	-	-	-	-	All-wheel Drive Saloon Engine M 273.970	835049	Outer Joint		30	25	71	56.5	52	I
5.0 4-matic (300 kW)	2011.09-	-	-	-	-	All-wheel Drive Saloon Engine M 278.922	699166	Inner Joint		27	27	38	62	110.5	
	2011.09-	-	-	-	-	All-wheel Drive Saloon Engine M 278.922	835049	Outer Joint		30	25	71	56.5	52	I
5.5 AMG 4-matic (410 kW)	2011.02-	-	-	-	-	All-wheel Drive Saloon Engine M 157.981	699166	Inner Joint		27	27	38	62	110.5	
	2011.02-	-	-	-	-	All-wheel Drive Saloon Engine M 157.981	235096	Drive Shaft		30	27	71	56.5	529	
	2011.02-	-	-	-	-	All-wheel Drive Saloon Engine M 157.981	835049	Outer Joint		30	25	71	56.5	52	I
5.5 AMG 4-matic (430 kW)	2013.02-	-	-	-	-	All-wheel Drive Saloon Engine M 157.981	699166	Inner Joint		27	27	38	62	110.5	
	2013.02-	-	-	-	-	All-wheel Drive Saloon Engine M 157.981	235096	Drive Shaft		30	27	71	56.5	529	
	2013.02-	-	-	-	-	All-wheel Drive Saloon Engine M 157.981	835049	Outer Joint		30	25	71	56.5	52	I
E 300 CDI / BlueTEC (170 kW)	2011.03-	-	AT	L/R	R	Saloon Engine OM 642.850/OM 642.852	235127	Drive Shaft	48NS	27	30	68	82	796	
E-CLASS T-Model (S124)															
2.0 T (100 kW)	1993.06-	1996.06	AT/MT	L/R	R	Estate Engine M 111.940	235001	Drive Shaft		25		62	69	665	
3.0 T Turbo-D (108 kW)	1993.06-	1996.06	AT/MT	L/R	R	Estate Engine OM 603.960	699143	Inner Joint			27		28		
	1993.06-	1996.06	-	-	R	Estate Engine OM 603.960	235024	Drive Shaft	48W	25		62	69	633	
	1993.06-	1996.06	AT/MT	L/R	R	Estate Engine OM 603.960	235005	Drive Shaft		25		62	69	659	
E 300 T 4-matic (132 kW)	1993.06-	1996.06	-	-	R	All-wheel Drive Estate Engine M 103.985	235024	Drive Shaft	48W	25		62	69	633	
E 300 T Turbo-D 4-matic (108 kW)	1993.06-	1996.06	-	-	R	All-wheel Drive Estate Engine OM 603.963	235024	Drive Shaft	48W	25		62	69	633	
E-CLASS T-Model (S210)															
2.0 T Kompressor (120 kW)	2000.08-	2003.03	AT	L/R	R	Estate Engine M 111.957	235009	Drive Shaft	48T	25		62	70.5	660	
	2000.08-	2003.03	AT	L/R	R	Estate Engine M 111.957	235008	Drive Shaft	48T	25		62	70.5	674	
	2000.08-	2003.03	AT	L/R	R	Estate Engine M 111.957	605007	Inner Joint			24		27		
2.2T CDI (92 kW)	1998.06-	1999.07	AT	L/R	R	Estate Engine OM 611.961	235008	Drive Shaft	48T	25		62	70.5	674	
	1998.06-	1999.07	AT	L/R	R	Estate Engine OM 611.961	605007	Inner Joint			24		27		
2.4 T (125 kW)	1997.06-	2003.03	-	-	-	Estate Engine M 112.911	635044	Inner Joint							
	1997.06-	2003.03	-	-	R	Estate Engine M 112.911	235031	Drive Shaft	48W	27		63.5	79.5	687.5	
	1997.06-	2003.03	AT	L/R	R	Estate Engine M 112.911	235008	Drive Shaft	48T	25		62	70.5	674	
	1997.06-	2003.03	AT	L/R	R	Estate Engine M 112.911	605007	Inner Joint			24		27		
	2000.08-	2003.03	-	-	-	Estate Engine M 112.914	635044	Inner Joint							
	2000.08-	2003.03	-	-	R	Estate Engine M 112.914	235031	Drive Shaft	48W	27		63.5	79.5	687.5	
2.5 T D (83 kW)	1996.06-	1999.07	-	-	R	Estate Engine OM 605.912	235031	Drive Shaft	48W	27		63.5	79.5	687.5	
	1996.06-	1999.07	AT	L/R	R	Estate Engine OM 605.912	235008	Drive Shaft	48T	25		62	70.5	674	
	1996.06-	1999.07	AT	L/R	R	Estate Engine OM 605.912	605007	Inner Joint			24		27		
2.5 T Turbo-D (110 kW)	1997.06-	1999.07	AT	L/R	R	Estate Engine OM 605.962	235008	Drive Shaft	48T	25		62	70.5	674	
	1997.06-	1999.07	AT	L/R	R	Estate Engine OM 605.962	605007	Inner Joint			24		27		
E 230 T (110 kW)	1996.06-	1997.06	-	L/R	R	Estate Engine M 111.970	235031	Drive Shaft	48W	27		63.5	79.5	687.5	
	1996.06-	1997.06	AT/MT	L/R	R	Estate Engine M 111.970	235008	Drive Shaft	48T	25		62	70.5	674	
	1996.06-	1997.06	AT/MT	L/R	R	Estate Engine M 111.970	605007	Inner Joint			24		27		
E 300 T Turbo-D (130 kW)	1996.12-	1999.07	AT	-	R	Estate Engine OM 606.962	235009	Drive Shaft	48T	25		62	70.5	660	
E-CLASS T-Model (S211)															
2.0 CDI (100 kW)	2006.04-	2009.07	AT	R	R	Estate Engine OM 646.821	235117	Drive Shaft	48NS	27	27	68	82	773	
2.6 T 4-matic (130 kW)	2003.07-	2009.07	-	-	-	All-wheel Drive Estate Engine M 112.917	835053	Outer Joint	48NS	35	27	66.6	42	53	I
	2003.07-	2009.07	-	R	F	All-wheel Drive Estate Engine M 112.917	635060	Inner Joint		24	27	37.97	55.5	104	





	 YEAR	TRANSM	L/R	F/R	REMARKS	GSP Ref.	 PRODUCT	 ABS	Technical Specifications						
									A	B	C	H	L	P	
MERCEDES BENZ															
E-CLASS T-Model (S211)															
2.6 T 4-matic (130 kW)	2003.07-2009.07	-	-	-	All-wheel Drive Estate Engine M 112.917	635062	Inner Joint		34	27	37.5	140			
3.0 T CDI 4-matic (140 kW)	2005.03-2009.07	-	-	-	All-wheel Drive Estate Engine OM 642.921	835053	Outer Joint	48NS	35	27	66.6	42	53	I	
	2005.03-2009.07	-	R	F	All-wheel Drive Estate Engine OM 642.921	635060	Inner Joint		24	27	37.97	55.5	104		
	2005.03-2009.07	-	-	-	All-wheel Drive Estate Engine OM 642.921	635062	Inner Joint		34	27	37.5	140			
3.2 T 4-matic (165 kW)	2003.07-2009.07	-	-	-	All-wheel Drive Estate Engine M 112.954	835053	Outer Joint	48NS	35	27	66.6	42	53	I	
	2003.07-2009.07	-	R	F	All-wheel Drive Estate Engine M 112.954	635060	Inner Joint		24	27	37.97	55.5	104		
	2003.07-2009.07	-	-	-	All-wheel Drive Estate Engine M 112.954	635062	Inner Joint		34	27	37.5	140			
3.5 T 4-matic (200 kW)	2005.03-2009.07	-	-	-	All-wheel Drive Estate Engine M 272.972	835053	Outer Joint	48NS	35	27	66.6	42	53	I	
	2005.03-2009.07	-	R	F	All-wheel Drive Estate Engine M 272.972	635060	Inner Joint		24	27	37.97	55.5	104		
	2005.03-2009.07	-	-	-	All-wheel Drive Estate Engine M 272.972	635062	Inner Joint		34	27	37.5	140			
5.0 T 4-matic (225 kW)	2003.10-2009.07	-	-	-	All-wheel Drive Estate Engine M 113.969	835053	Outer Joint	48NS	35	27	66.6	42	53	I	
	2003.10-2009.07	-	R	F	All-wheel Drive Estate Engine M 113.969	635060	Inner Joint		24	27	37.97	55.5	104		
	2003.10-2009.07	-	-	-	All-wheel Drive Estate Engine M 113.969	635062	Inner Joint		34	27	37.5	140			
5.5 T 4-matic (285 kW)	2006.04-2009.07	-	-	-	All-wheel Drive Estate Engine M 273.962	835053	Outer Joint	48NS	35	27	66.6	42	53	I	
	2006.04-2009.07	-	R	F	All-wheel Drive Estate Engine M 273.962	635060	Inner Joint		24	27	37.97	55.5	104		
	2006.04-2009.07	-	-	-	All-wheel Drive Estate Engine M 273.962	635062	Inner Joint		34	27	37.5	140			
E 280 T 4-matic (170 kW)	2005.03-2009.07	-	R	F	All-wheel Drive Estate Engine M 272.943	635060	Inner Joint		24	27	37.97	55.5	104		
E 320 T CDI 4-matic (165 kW)	2005.03-2009.07	-	R	F	All-wheel Drive Estate Engine OM 642.920	635060	Inner Joint		24	27	37.97	55.5	104		
E-CLASS T-Model (S212)															
2.0 CDI BlueTEC (100 kW)	2009.11-		AT	L	R	Estate Engine OM 651.925	235119	Drive Shaft	48NS	27	27	68	82	803	
2.2BlueTEC (130 kW)	2015.05-		-	-	-	Estate Engine OM 651.924	699166	Inner Joint		27	27	38	62	110.5	
	2015.05-		-	-	-	Estate Engine OM 651.924	835049	Outer Joint		30	25	71	56.5	52	I
2.5 CDI / BlueTEC 4-matic (150 kW)	2010.07-		-	-	-	All-wheel Drive Estate Engine OM 651.924	699166	Inner Joint		27	27	38	62	110.5	
	2010.07-		-	-	-	All-wheel Drive Estate Engine OM 651.924	835049	Outer Joint		30	25	71	56.5	52	I
3.0 (245 kW)	2013.01-		-	-	-	Estate Engine M 276.820	699166	Inner Joint		27	27	38	62	110.5	
	2013.01-		-	-	-	Estate Engine M 276.820	835049	Outer Joint		30	25	71	56.5	52	I
3.0 4-matic (185 kW)	2011.07-		-	-	-	All-wheel Drive Estate Engine M 276.952	699166	Inner Joint		27	27	38	62	110.5	
	2011.07-		-	-	-	All-wheel Drive Estate Engine M 276.952	835049	Outer Joint		30	25	71	56.5	52	I
3.5 4-matic (200 kW)	2009.11-		-	-	-	All-wheel Drive Estate Engine M 272.977	699166	Inner Joint		27	27	38	62	110.5	
	2009.11-		-	-	-	All-wheel Drive Estate Engine M 272.977	835049	Outer Joint		30	25	71	56.5	52	I
3.5 BlueTEC (185 kW)	2012.11-		-	-	-	Estate Engine OM 642.852	699166	Inner Joint		27	27	38	62	110.5	
	2012.11-		-	-	-	Estate Engine OM 642.852	835049	Outer Joint		30	25	71	56.5	52	I
3.5 BlueTEC 4-matic (185 kW)	2012.11-		-	-	-	All-wheel Drive Estate Engine OM 642.858	699166	Inner Joint		27	27	38	62	110.5	
	2012.11-		-	-	-	All-wheel Drive Estate Engine OM 642.858	835049	Outer Joint		30	25	71	56.5	52	I
3.5 BlueTEC 4-matic (190 kW)	2014.07-		-	-	-	All-wheel Drive Estate Engine OM 642.858/OM 642.858	699166	Inner Joint		27	27	38	62	110.5	
	2014.07-		-	-	-	All-wheel Drive Estate Engine OM 642.858/OM 642.858	835049	Outer Joint		30	25	71	56.5	52	I
3.5 CDI 4-matic (170 kW)	2009.11-		-	-	-	All-wheel Drive Estate Engine OM 642.856	699166	Inner Joint		27	27	38	62	110.5	
	2009.11-		AT	R	R	All-wheel Drive Estate Engine OM 642.856	235137	Drive Shaft	48NS	27	27	68	82	807	
	2009.11-		-	-	-	All-wheel Drive Estate Engine OM 642.856	835049	Outer Joint		30	25	71	56.5	52	I
3.5 CDI 4-matic (195 kW)	2011.07-		-	-	-	All-wheel Drive Estate Engine OM 642.858	699166	Inner Joint		27	27	38	62	110.5	
	2011.07-		-	-	-	All-wheel Drive Estate Engine OM 642.858	835049	Outer Joint		30	25	71	56.5	52	I
4.0 4-matic (245 kW)	2013.01-		-	-	-	All-wheel Drive Estate Engine M 276.820	699166	Inner Joint		27	27	38	62	110.5	
	2013.01-		-	-	-	All-wheel Drive Estate Engine M 276.820	835049	Outer Joint		30	25	71	56.5	52	I
	2014.07-		-	-	-	All-wheel Drive Estate Engine M 276.850	699166	Inner Joint		27	27	38	62	110.5	
	2014.07-		-	-	-	All-wheel Drive Estate Engine M 276.850	835049	Outer Joint		30	25	71	56.5	52	I
5.0 4-matic (300 kW)	2011.09-		-	-	-	All-wheel Drive Estate Engine M 278.922	699166	Inner Joint		27	27	38	62	110.5	
	2011.09-		-	-	-	All-wheel Drive Estate Engine M 278.922	835049	Outer Joint		30	25	71	56.5	52	I
5.5 AMG 4-matic (410 kW)	2011.02-		-	-	-	All-wheel Drive Estate Engine M 157.981	699166	Inner Joint		27	27	38	62	110.5	
	2011.02-		-	-	-	All-wheel Drive Estate Engine M 157.981	235096	Drive Shaft		30	27	71	56.5	529	
	2011.02-		-	-	-	All-wheel Drive Estate Engine M 157.981	835049	Outer Joint		30	25	71	56.5	52	I
5.5 AMG 4-matic (430 kW)	2013.02-		-	-	-	All-wheel Drive Estate Engine M 157.981	699166	Inner Joint		27	27	38	62	110.5	
	2013.02-		-	-	-	All-wheel Drive Estate Engine M 157.981	235096	Drive Shaft		30	27	71	56.5	529	
	2013.02-		-	-	-	All-wheel Drive Estate Engine M 157.981	835049	Outer Joint		30	25	71	56.5	52	I
G-CLASS (W460)															
2.3 G (66 kW)	1979.03-1993.07	AT/MT	L/R	F	All-wheel Drive Closed Off-Road Vehicle Engine M 115.973	835018	Outer Joint		27	28	58	110	62	O	
2.3 GE (90 kW)	1987.05-1992.08	AT/MT	L/R	F	All-wheel Drive Closed Off-Road Vehicle Engine M 102.979/M 102.987	835018	Outer Joint		27	28	58	110	62	O	
2.3 GE (92 kW)	1982.04-1992.08	AT/MT	L/R	F	All-wheel Drive Closed Off-Road Vehicle Engine M 102.989/M 102.981/M 102.989	835018	Outer Joint		27	28	58	110	62	O	
2.5 GD (62 kW)	1987.10-1992.12	AT/MT	L/R	F	All-wheel Drive Closed Off-Road Vehicle Engine OM 602.930	835018	Outer Joint		27	28	58	110	62	O	
2.5 GD (68 kW)	1988.12-1992.08	AT/MT	L/R	F	All-wheel Drive Closed Off-Road Vehicle Engine OM 602.930	835018	Outer Joint		27	28	58	110	62	O	
2.8 GE (110 kW)	1984.08-1989.08	AT/MT	L/R	F	All-wheel Drive Closed Off-Road Vehicle Engine M 110.994	835018	Outer Joint		27	28	58	110	62	O	
2.8 GE (115 kW)	1979.11-1989.08	AT/MT	L/R	F	All-wheel Drive Closed Off-Road Vehicle Engine M 110.994	835018	Outer Joint		27	28	58	110	62	O	
3.0 GD (65 kW)	1979.12-1991.12	AT/MT	L/R	F	All-wheel Drive Closed Off-Road Vehicle Engine OM 617.931	835018	Outer Joint		27	28	58	110	62	O	
G-CLASS (W461)															
2.3 GE (90 kW)	1989.09-1996.07	AT/MT	L/R	F	All-wheel Drive Closed Off-Road Vehicle Engine M 102.979	835033	Outer Joint	54T	26	28	62	124	62	O	
2.3 GE (92 kW)	1993.06-2000.07	AT/MT	L/R	F	All-wheel Drive Closed Off-Road Vehicle Engine M 102.996/M 102.997	835033	Outer Joint	54T	26	28	62	124	62	O	
G-CLASS (W463)															

	 YEAR	TRANSM	L/R	F/R	REMARKS	GSP Ref.	 PRODUCT	 ABS	Technical Specifications						
									A	B	C	H	L	P	
MERCEDES BENZ															
G-CLASS (W463)															
2.3 GE (93 kW)	1990.06-1993.06	AT/MT	L/R	F	All-wheel Drive Closed Off-Road Vehicle Engine M 102.989	835033	Outer Joint	54T	26	28	62	124	62	O	
2.5 GD (69 kW)	1990.06-1992.10	AT/MT	L/R	F	All-wheel Drive Closed Off-Road Vehicle Engine OM 602.931	835033	Outer Joint	54T	26	28	62	124	62	O	
3.0 GD (83 kW)	1989.09-1993.06	AT/MT	L/R	F	All-wheel Drive Closed Off-Road Vehicle Engine OM 603.931	835033	Outer Joint	54T	26	28	62	124	62	O	
3.0 GE (125 kW)	1989.09-1993.08	AT/MT	L/R	F	All-wheel Drive Closed Off-Road Vehicle Engine M 103.987	835033	Outer Joint	54T	26	28	62	124	62	O	
3.0 GE (128 kW)	1990.06-1997.08	AT/MT	L/R	F	All-wheel Drive Closed Off-Road Vehicle Engine M 103.987	835033	Outer Joint	54T	26	28	62	124	62	O	
G-CLASS Cabrio (W463)															
3.0 GE (125 kW)	1989.09-1997.09	AT/MT	L/R	F	All-wheel Drive Open Off-Road Vehicle Engine M 103.987	835033	Outer Joint	54T	26	28	62	124	62	O	
GL-CLASS (X164)															
3.0 CDI 4-matic (165 kW)	2006.09-2009.05	-	-	F	All-wheel Drive Closed Off-Road Vehicle Engine OM 642.940	805015	Outer Joint		30	39	70.2	90.5	71	I	
	2009.05-	-	-	F	All-wheel Drive Closed Off-Road Vehicle Engine OM 642.940	805015	Outer Joint		30	39	70.2	90.5	71	I	
3.0 CDI 4-matic (195 kW)	2010.10-	-	-	F	All-wheel Drive Closed Off-Road Vehicle Engine OM 642.822	805015	Outer Joint		30	39	70.2	90.5	71	I	
3.0 CDI/350 BlueTEC 4-matic (155 kW)	2009.12-2012.12	-	-	F	All-wheel Drive Closed Off-Road Vehicle Engine OM 642.820	805015	Outer Joint		30	39	70.2	90.5	71	I	
4.0 CDI 4-matic (225 kW)	2006.09-2009.05	-	-	F	All-wheel Drive Closed Off-Road Vehicle Engine OM 629.912	805015	Outer Joint		30	39	70.2	90.5	71	I	
	2009.05-	-	-	F	All-wheel Drive Closed Off-Road Vehicle Engine OM 629.912	805015	Outer Joint		30	39	70.2	90.5	71	I	
4.5 4-matic (250 kW)	2006.09-	-	-	F	All-wheel Drive Closed Off-Road Vehicle Engine M 273.923	805015	Outer Joint		30	39	70.2	90.5	71	I	
5.5 4-matic (285 kW)	2009.09-2012.12	-	-	F	All-wheel Drive Closed Off-Road Vehicle Engine M 273.963	805015	Outer Joint		30	39	70.2	90.5	71	I	
GL-CLASS (X166)															
5.0 4-matic (320 kW)	2012.07-	-	-	F	All-wheel Drive Closed Off-Road Vehicle Engine M 278.928	805015	Outer Joint		30	39	70.2	90.5	71	I	
	2012.07-	-	-	F	All-wheel Drive Closed Off-Road Vehicle Engine M 278.928	805007	Outer Joint		30	37	70.2	90.5	65.5	I	
	2012.07-	-	-	-	All-wheel Drive Closed Off-Road Vehicle Engine M 278.928	605041	Inner Joint		37	33	45	80	104.5		
5.5 AMG 4-matic (410 kW)	2012.07-	-	-	F	All-wheel Drive Closed Off-Road Vehicle Engine M 157.982	805015	Outer Joint		30	39	70.2	90.5	71	I	
GL 400 4-matic (245 kW)	2013.08-	-	-	F	All-wheel Drive Closed Off-Road Vehicle Engine M 276.821	805015	Outer Joint		30	39	70.2	90.5	71	I	
	2013.08-	-	-	F	All-wheel Drive Closed Off-Road Vehicle Engine M 276.821	805007	Outer Joint		30	37	70.2	90.5	65.5	I	
	2013.08-	-	-	-	All-wheel Drive Closed Off-Road Vehicle Engine M 276.821	605041	Inner Joint		37	33	45	80	104.5		
GL 63 AMG 4-matic (400 kW)	2012.07-	-	-	F	All-wheel Drive Closed Off-Road Vehicle Engine M 157.982	805015	Outer Joint		30	39	70.2	90.5	71	I	
GLE (W166)															
2.2 d (150 kW)	2015.04-	-	-	F	All-wheel Drive Closed Off-Road Vehicle Engine OM 651.960	805015	Outer Joint		30	39	70.2	90.5	71	I	
	2015.04-	-	-	F	All-wheel Drive Closed Off-Road Vehicle Engine OM 651.960	805007	Outer Joint		30	37	70.2	90.5	65.5	I	
	2015.04-	-	-	-	All-wheel Drive Closed Off-Road Vehicle Engine OM 651.960	605041	Inner Joint		37	33	45	80	104.5		
3.0 4-matic (245 kW)	2015.04-	-	-	F	All-wheel Drive Closed Off-Road Vehicle Engine M 276.821	805015	Outer Joint		30	39	70.2	90.5	71	I	
	2015.04-	-	-	F	All-wheel Drive Closed Off-Road Vehicle Engine M 276.821	805007	Outer Joint		30	37	70.2	90.5	65.5	I	
	2015.04-	-	-	-	All-wheel Drive Closed Off-Road Vehicle Engine M 276.821	605041	Inner Joint		37	33	45	80	104.5		
320 4-matic (200 kW)	2015.10-	-	-	F	All-wheel Drive Closed Off-Road Vehicle Engine M 276.821	805015	Outer Joint		30	39	70.2	90.5	71	I	
	2015.10-	-	-	F	All-wheel Drive Closed Off-Road Vehicle Engine M 276.821	805007	Outer Joint		30	37	70.2	90.5	65.5	I	
	2015.10-	-	-	-	All-wheel Drive Closed Off-Road Vehicle Engine M 276.821	605041	Inner Joint		37	33	45	80	104.5		
	2015.10-	-	-	R	All-wheel Drive Closed Off-Road Vehicle Engine M 276.821	235113	Drive Shaft		30	37	73	92	1017		
5.0 4-matic (320 kW)	2015.04-	-	-	F	All-wheel Drive Closed Off-Road Vehicle Engine M 278.928	805015	Outer Joint		30	39	70.2	90.5	71	I	
	2015.04-	-	-	F	All-wheel Drive Closed Off-Road Vehicle Engine M 278.928	805007	Outer Joint		30	37	70.2	90.5	65.5	I	
	2015.04-	-	-	-	All-wheel Drive Closed Off-Road Vehicle Engine M 278.928	605041	Inner Joint		37	33	45	80	104.5		
5.0 4-matic (335 kW)	2015.10-	-	-	F	All-wheel Drive Closed Off-Road Vehicle Engine M 278.928	805015	Outer Joint		30	39	70.2	90.5	71	I	
	2015.10-	-	-	F	All-wheel Drive Closed Off-Road Vehicle Engine M 278.928	805007	Outer Joint		30	37	70.2	90.5	65.5	I	
	2015.10-	-	-	-	All-wheel Drive Closed Off-Road Vehicle Engine M 278.928	605041	Inner Joint		37	33	45	80	104.5		
GLK-CLASS (X204)															
2.2 CDI (120 kW)	2008.12-2015.06	AT	R	R	Closed Off-Road Vehicle Engine OM 651.916	235120	Drive Shaft	48NS	27	30	68	82	800		
2.2 CDI 4-matic (120 kW)	2008.12-2015.06	-	-	-	All-wheel Drive Closed Off-Road Vehicle Engine OM 651.912	835049	Outer Joint		30	25	71	56.5	52	I	
	2008.12-2015.06	-	-	-	All-wheel Drive Closed Off-Road Vehicle Engine OM 651.912	635023	Inner Joint		34	25	37.8	59.5	91		
2.2 CDI 4-matic (125 kW)	2008.12-2015.06	-	-	-	All-wheel Drive Closed Off-Road Vehicle Engine OM 651.912	835049	Outer Joint		30	25	71	56.5	52	I	
	2008.12-2015.06	-	-	-	All-wheel Drive Closed Off-Road Vehicle Engine OM 651.912	635023	Inner Joint		34	25	37.8	59.5	91		
2.5 4-matic (155 kW)	2013.08-2015.06	-	-	-	All-wheel Drive Closed Off-Road Vehicle Engine M 274.920	835049	Outer Joint		30	25	71	56.5	52	I	
	2013.08-2015.06	-	-	-	All-wheel Drive Closed Off-Road Vehicle Engine M 274.920	635023	Inner Joint		34	25	37.8	59.5	91		
2.5 CDI 4-matic (150 kW)	2009.09-2015.06	-	-	-	All-wheel Drive Closed Off-Road Vehicle Engine OM 651.912	835049	Outer Joint		30	25	71	56.5	52	I	
	2009.09-2015.06	-	-	-	All-wheel Drive Closed Off-Road Vehicle Engine OM 651.912	635023	Inner Joint		34	25	37.8	59.5	91		
2.8 4-matic (170 kW)	2008.06-2009.06	-	-	-	All-wheel Drive Closed Off-Road Vehicle Engine M 272.948	835049	Outer Joint		30	25	71	56.5	52	I	
	2008.06-2009.06	-	-	-	All-wheel Drive Closed Off-Road Vehicle Engine M 272.948	635023	Inner Joint		34	25	37.8	59.5	91		
3.0 4-matic (170 kW)	2009.07-2011.04	-	-	-	All-wheel Drive Closed Off-Road Vehicle Engine M 272.948	835049	Outer Joint		30	25	71	56.5	52	I	
	2009.07-2011.04	-	-	-	All-wheel Drive Closed Off-Road Vehicle Engine M 272.948	635023	Inner Joint		34	25	37.8	59.5	91		
3.0 CDI 4-matic (165 kW)	2008.06-2015.06	-	-	-	All-wheel Drive Closed Off-Road Vehicle Engine OM 642.961	835049	Outer Joint		30	25	71	56.5	52	I	
	2008.06-2015.06	-	-	-	All-wheel Drive Closed Off-Road Vehicle Engine OM 642.961	635023	Inner Joint		34	25	37.8	59.5	91		
	2009.07-2010.01	-	-	-	All-wheel Drive Closed Off-Road Vehicle Engine OM 642.832	835049	Outer Joint		30	25	71	56.5	52	I	
	2009.07-2010.01	-	-	-	All-wheel Drive Closed Off-Road Vehicle Engine OM 642.832	635023	Inner Joint		34	25	37.8	59.5	91		
3.0 CDI 4-matic (170 kW)	2010.02-2010.05	-	-	-	All-wheel Drive Closed Off-Road Vehicle Engine OM 642.832	835049	Outer Joint		30	25	71	56.5	52	I	
	2010.02-2010.05	-	-	-	All-wheel Drive Closed Off-Road Vehicle Engine OM 642.832	635023	Inner Joint		34	25	37.8	59.5	91		
3.5 4-matic (185 kW)	2009.09-2015.06	-	-	-	All-wheel Drive Closed Off-Road Vehicle Engine M 276.957	835049	Outer Joint		30	25	71	56.5	52	I	
	2009.09-2015.06	-	-	-	All-wheel Drive Closed Off-Road Vehicle Engine M 276.957	635023	Inner Joint		34	25	37.8	59.5	91		
3.5 4-matic (200 kW)	2008.06-2011.04	-	-	-	All-wheel Drive Closed Off-Road Vehicle Engine M 272.971	835049	Outer Joint		30	25	71	56.5	52	I	
	2008.06-2011.04	-	-	-	All-wheel Drive Closed Off-Road Vehicle Engine M 272.971	635023	Inner Joint		34	25	37.8	59.5	91		

YEAR	TRANSM	L/R	F/R	REMARKS	GSP Ref.	PRODUCT	ABS	Technical Specifications									
								A	B	C	H	L	P				
MERCEDES BENZ																	
GLK-CLASS (X204)																	
3.5 4-matic (225 kW)	2008.06-2015.06	-	-	-	All-wheel Drive Closed Off-Road Vehicle Engine M 276.957	835049	Outer Joint		30	25	71	56.5	52	I			
	2008.06-2015.06	-	-	-	All-wheel Drive Closed Off-Road Vehicle Engine M 276.957	635023	Inner Joint		34	25	37.8	59.5	91				
350 CDI 4-matic (195 kW)	2012.07-2015.06	-	R	F	All-wheel Drive Closed Off-Road Vehicle Engine OM 642.835	835038	Outer Joint		30	25	71	56.5	52	I			
	2012.07-2015.06	AT	L	F	All-wheel Drive Closed Off-Road Vehicle Engine OM 642.835	235094	Drive Shaft		30	34	71	56.5	517				
GLS (X166)																	
3.0 4-matic (245 kW)	2015.11-	-	-	-	F All-wheel Drive Closed Off-Road Vehicle Engine M 276.821	805015	Outer Joint		30	39	70.2	90.5	71	I			
	2015.11-	-	-	-	F All-wheel Drive Closed Off-Road Vehicle Engine M 276.821	805007	Outer Joint		30	37	70.2	90.5	65.5	I			
	2015.11-	-	-	-	All-wheel Drive Closed Off-Road Vehicle Engine M 276.821	605041	Inner Joint		37	33	45	80	104.5				
5.0 (335 kW)	2015.11-	-	-	-	F All-wheel Drive Closed Off-Road Vehicle Engine M 278.928	805015	Outer Joint		30	39	70.2	90.5	71	I			
	2015.11-	-	-	-	F All-wheel Drive Closed Off-Road Vehicle Engine M 278.928	805007	Outer Joint		30	37	70.2	90.5	65.5	I			
AMG 63 4-matic (430 kW)	2015.11-	-	-	-	All-wheel Drive Closed Off-Road Vehicle Engine M 278.928	605041	Inner Joint		37	33	45	80	104.5				
	2015.11-	-	-	-	F All-wheel Drive Closed Off-Road Vehicle Engine M 157.982	805015	Outer Joint		30	39	70.2	90.5	71	I			
KOMBI T-Model (S124)																	
2.0 T (77 kW)	1986.01-1990.05	AT/MT	L/R	R	Estate Engine M 102.922	635006	Inner Joint			25		26					
	1986.01-1990.05	AT/MT	L/R	R	Estate Engine M 102.922	235001	Drive Shaft		25		62	69	665				
2.0 T (80 kW)	1985.09-1989.08	AT/MT	L/R	R	Estate Engine M 102.922	635006	Inner Joint			25		26					
	1985.09-1989.08	AT/MT	L/R	R	Estate Engine M 102.922	235001	Drive Shaft		25		62	69	665				
2.0 T D (53 kW)	1985.09-1991.08	AT/MT	L/R	R	Estate Engine OM 601.912	635006	Inner Joint			25		26					
	1985.09-1991.08	AT/MT	L/R	R	Estate Engine OM 601.912	235001	Drive Shaft		25		62	69	665				
2.0 T D (55 kW)	1988.09-1991.08	AT/MT	L/R	R	Estate Engine OM 601.912	635006	Inner Joint			25		26					
	1988.09-1991.08	AT/MT	L/R	R	Estate Engine OM 601.912	235001	Drive Shaft		25		62	69	665				
2.0 TE (87 kW)	1988.09-1992.08	AT/MT	L/R	R	Estate Engine M 102.963	635006	Inner Joint			25		26					
	1988.09-1992.08	AT/MT	L/R	R	Estate Engine M 102.963	235001	Drive Shaft		25		62	69	665				
2.0 TE (90 kW)	1988.09-1989.12	AT/MT	L/R	R	Estate Engine M 102.962	635006	Inner Joint			25		26					
	1988.09-1989.12	AT/MT	L/R	R	Estate Engine M 102.962	235001	Drive Shaft		25		62	69	665				
2.3 TE (100 kW)	1985.09-1992.08	AT/MT	L/R	R	Estate Engine M 102.982	635006	Inner Joint			25		26					
	1985.09-1992.08	AT/MT	L/R	R	Estate Engine M 102.982	235001	Drive Shaft		25		62	69	665				
2.3 TE (97 kW)	1985.09-1992.08	AT/MT	L/R	R	Estate Engine M 102.982	635006	Inner Joint			25		26					
	1985.09-1992.08	AT/MT	L/R	R	Estate Engine M 102.982	235001	Drive Shaft		25		62	69	665				
2.3 TE Cat (97 kW)	1989.06-1992.08	AT/MT	L/R	R	Estate Engine M 102.982	635006	Inner Joint			25		26					
	1989.06-1992.08	AT/MT	L/R	R	Estate Engine M 102.982	235001	Drive Shaft		25		62	69	665				
2.5 T D (66 kW)	1985.09-1993.06	AT/MT	L/R	R	Estate Engine OM 602.912	635006	Inner Joint			25		26					
	1985.09-1993.06	AT/MT	L/R	R	Estate Engine OM 602.912	235001	Drive Shaft		25		62	69	665				
2.5 T D (69 kW)	1989.01-1993.06	AT/MT	L/R	R	Estate Engine OM 602.912	635006	Inner Joint			25		26					
	1989.01-1993.06	AT/MT	L/R	R	Estate Engine OM 602.912	235001	Drive Shaft		25		62	69	665				
2.6 TE FGST. (118 kW)	1989.09-1992.08	AT/MT	L/R	R	Estate Engine M 103.940	699143	Inner Joint			27		28					
	1989.09-1992.08	AT/MT	L/R	R	Estate Engine M 103.940	235005	Drive Shaft		25		62	69	659				
2.6 TE FGST. (122 kW)	1985.09-1989.12	AT/MT	L/R	R	Estate Engine M 103.940	699143	Inner Joint			27		28					
	1985.09-1989.12	AT/MT	L/R	R	Estate Engine M 103.940	235005	Drive Shaft		25		62	69	659				
3.0 T D (80 kW)	1986.09-1993.06	AT/MT	L/R	R	Estate Engine OM 603.912	699143	Inner Joint			27		28					
	1986.09-1993.06	AT/MT	L/R	R	Estate Engine OM 603.912	235005	Drive Shaft		25		62	69	659				
3.0 T D (81 kW)	1989.01-1993.06	AT/MT	L/R	R	Estate Engine OM 603.912	699143	Inner Joint			27		28					
	1989.01-1993.06	AT/MT	L/R	R	Estate Engine OM 603.912	235005	Drive Shaft		25		62	69	659				
3.0 T D (83 kW)	1989.01-1993.06	AT/MT	L/R	R	Estate Engine OM 603.912	699143	Inner Joint			27		28					
	1989.01-1993.06	AT/MT	L/R	R	Estate Engine OM 603.912	235005	Drive Shaft		25		62	69	659				
3.0 T Turbo-D (105 kW)	1986.09-1989.01	AT/MT	L/R	R	Estate Engine OM 603.963/OM 603.960	699143	Inner Joint			27		28					
	1986.09-1989.01	AT/MT	L/R	R	Estate Engine OM 603.963/OM 603.960	235005	Drive Shaft		25		62	69	659				
3.0 TD (108 kW)	1989.01-1993.06	AT/MT	L/R	R	Estate Engine OM 603.960	699143	Inner Joint			27		28					
	1989.01-1993.06	AT/MT	L/R	R	Estate Engine OM 603.960	235005	Drive Shaft		25		62	69	659				
3.0 TE (132 kW)	1986.01-1992.08	AT/MT	L/R	R	Estate Engine M 103.983	699143	Inner Joint			27		28					
	1986.01-1992.08	AT/MT	L/R	R	Estate Engine M 103.983	235005	Drive Shaft		25		62	69	659				
3.0 TE (138 kW)	1986.01-1989.12	AT/MT	L/R	R	Estate Engine M 103.983	699143	Inner Joint			27		28					
	1986.01-1989.12	AT/MT	L/R	R	Estate Engine M 103.983	235005	Drive Shaft		25		62	69	659				
M-CLASS (W163)																	
-	-	-	-	-	-	699253	Propshaft CV Joint			26		32					
2.3 (110 kW)	1998.02-2005.06	-	R	F	All-wheel Drive Closed Off-Road Vehicle Engine M 111.977	235018	Drive Shaft	48W	30	37	79.1	89	963				
	1998.02-2005.06	-	L	F	All-wheel Drive Closed Off-Road Vehicle Engine M 111.977	635039	Inner Joint		37	26	45	83	117.5				
	1998.02-2005.06	-	-	F	All-wheel Drive Closed Off-Road Vehicle Engine M 111.977	835016	Outer Joint	48W	30	26	79.1	89	60.5	I			
	1998.02-2005.06	-	L	F	All-wheel Drive Closed Off-Road Vehicle Engine M 111.977	235027	Drive Shaft	48W	30	37	79.1	89	630				
	1998.02-2005.06	-	L/R	F	All-wheel Drive Closed Off-Road Vehicle Engine M 111.977	835052	Outer Joint		30	26	79.1	89	60.5	I			
2.7 CDI (120 kW)	1999.12-2005.06	-	L/R	F	All-wheel Drive Closed Off-Road Vehicle Engine OM 612.963	835052	Outer Joint		30	26	79.1	89	60.5	I			
	1999.12-2005.06	-	L	F	All-wheel Drive Closed Off-Road Vehicle Engine OM 612.963	235027	Drive Shaft	48W	30	37	79.1	89	630				
	1999.12-2005.06	-	R	F	All-wheel Drive Closed Off-Road Vehicle Engine OM 612.963	235018	Drive Shaft	48W	30	37	79.1	89	963				
	1999.12-2005.06	-	L	F	All-wheel Drive Closed Off-Road Vehicle Engine OM 612.963	635039	Inner Joint		37	26	45	83	117.5				
	1999.12-2005.06	-	-	F	All-wheel Drive Closed Off-Road Vehicle Engine OM 612.963	835016	Outer Joint	48W	30	26	79.1	89	60.5	I			
3.2 (160 kW)	1998.02-2002.08	-	L/R	F	All-wheel Drive Closed Off-Road Vehicle Engine M 112.942	835052	Outer Joint		30	26	79.1	89	60.5	I			

	 YEAR	TRANSM	L/R	F/R	REMARKS	GSP Ref.	 PRODUCT	 ABS	Technical Specifications									
									A	B	C	H	L	P				
MERCEDES BENZ																		
M-CLASS (W163)																		
3.2 (160 kW)	1998.02-2002.08	-	R	F	All-wheel Drive Closed Off-Road Vehicle Engine M 112.942	235018	Drive Shaft	48W	30	37	79.1	89	963					
	1998.02-2002.08	-	L	F	All-wheel Drive Closed Off-Road Vehicle Engine M 112.942	635039	Inner Joint		37	26	45	83	117.5					
	1998.02-2002.08	-	-	F	All-wheel Drive Closed Off-Road Vehicle Engine M 112.942	835016	Outer Joint	48W	30	26	79.1	89	60.5	I				
	1998.02-2002.08	-	L	F	All-wheel Drive Closed Off-Road Vehicle Engine M 112.942	235027	Drive Shaft	48W	30	37	79.1	89	630					
3.5 (173 kW)	2003.02-2005.06	-	L/R	F	All-wheel Drive Closed Off-Road Vehicle Engine M 112.970	835052	Outer Joint		30	26	79.1	89	60.5	I				
	2003.02-2005.06	-	L	F	All-wheel Drive Closed Off-Road Vehicle Engine M 112.970	235027	Drive Shaft	48W	30	37	79.1	89	630					
	2003.02-2005.06	-	R	F	All-wheel Drive Closed Off-Road Vehicle Engine M 112.970	235018	Drive Shaft	48W	30	37	79.1	89	963					
	2003.02-2005.06	-	L	F	All-wheel Drive Closed Off-Road Vehicle Engine M 112.970	635039	Inner Joint		37	26	45	83	117.5					
3.5 (180 kW)	2002.08-2005.06	-	L/R	F	All-wheel Drive Closed Off-Road Vehicle Engine M 112.970	835052	Outer Joint		30	26	79.1	89	60.5	I				
	2002.08-2005.06	-	L	F	All-wheel Drive Closed Off-Road Vehicle Engine M 112.970	235027	Drive Shaft	48W	30	37	79.1	89	630					
	2002.08-2005.06	-	R	F	All-wheel Drive Closed Off-Road Vehicle Engine M 112.970	235018	Drive Shaft	48W	30	37	79.1	89	963					
	2002.08-2005.06	-	L	F	All-wheel Drive Closed Off-Road Vehicle Engine M 112.970	635039	Inner Joint		37	26	45	83	117.5					
4.0 CDI (184 kW)	2001.09-2005.06	-	L	F	All-wheel Drive Closed Off-Road Vehicle Engine OM 628.963	235027	Drive Shaft	48W	30	37	79.1	89	630					
	2001.09-2005.06	-	L/R	F	All-wheel Drive Closed Off-Road Vehicle Engine OM 628.963	835052	Outer Joint		30	26	79.1	89	60.5	I				
	2001.09-2005.06	-	R	F	All-wheel Drive Closed Off-Road Vehicle Engine OM 628.963	235018	Drive Shaft	48W	30	37	79.1	89	963					
	2001.09-2005.06	-	L	F	All-wheel Drive Closed Off-Road Vehicle Engine OM 628.963	635039	Inner Joint		37	26	45	83	117.5					
4.3 (200 kW)	1998.02-2001.12	-	L/R	F	All-wheel Drive Closed Off-Road Vehicle Engine M 113.942	835052	Outer Joint		30	26	79.1	89	60.5	I				
	1998.02-2001.12	-	R	F	All-wheel Drive Closed Off-Road Vehicle Engine M 113.942	235018	Drive Shaft	48W	30	37	79.1	89	963					
	1998.02-2001.12	-	L	F	All-wheel Drive Closed Off-Road Vehicle Engine M 113.942	635039	Inner Joint		37	26	45	83	117.5					
	1998.02-2001.12	-	-	F	All-wheel Drive Closed Off-Road Vehicle Engine M 113.942	835016	Outer Joint	48W	30	26	79.1	89	60.5	I				
5.0 (215 kW)	2001.09-2005.06	-	L	F	All-wheel Drive Closed Off-Road Vehicle Engine M 113.964/M 113.965	235027	Drive Shaft	48W	30	37	79.1	89	630					
	2001.09-2005.06	-	L/R	F	All-wheel Drive Closed Off-Road Vehicle Engine M 113.964/M 113.965	835052	Outer Joint		30	26	79.1	89	60.5	I				
	2001.09-2005.06	-	R	F	All-wheel Drive Closed Off-Road Vehicle Engine M 113.964/M 113.965	235018	Drive Shaft	48W	30	37	79.1	89	963					
	2001.09-2005.06	-	L	F	All-wheel Drive Closed Off-Road Vehicle Engine M 113.964/M 113.965	635039	Inner Joint		37	26	45	83	117.5					
5.5 AMG (255 kW)	1999.09-2003.12	-	L	F	All-wheel Drive Closed Off-Road Vehicle Engine M 113.981	235027	Drive Shaft	48W	30	37	79.1	89	630					
	1999.09-2003.12	-	L/R	F	All-wheel Drive Closed Off-Road Vehicle Engine M 113.981	835052	Outer Joint		30	26	79.1	89	60.5	I				
	1999.09-2003.12	-	R	F	All-wheel Drive Closed Off-Road Vehicle Engine M 113.981	235018	Drive Shaft	48W	30	37	79.1	89	963					
	1999.09-2003.12	-	L	F	All-wheel Drive Closed Off-Road Vehicle Engine M 113.981	635039	Inner Joint		37	26	45	83	117.5					
	1999.09-2003.12	-	-	F	All-wheel Drive Closed Off-Road Vehicle Engine M 113.981	835016	Outer Joint	48W	30	26	79.1	89	60.5	I				
M-CLASS (W164)																		
2.8 CDI 4-matic (140 kW)	2005.07-2009.07	-	-	F	All-wheel Drive Closed Off-Road Vehicle Engine OM 642.940	805015	Outer Joint		30	39	70.2	90.5	71	I				
	2005.07-2009.07	-	L	F	All-wheel Drive Closed Off-Road Vehicle Engine OM 642.940	205060	Drive Shaft		30	37	70.2	90.5	666					
	2005.07-2009.07	-	R	F	All-wheel Drive Closed Off-Road Vehicle Engine OM 642.940	205061	Drive Shaft		30	37	70.2	90.5	1004					
	2005.07-2009.07	AT	L	R	All-wheel Drive Closed Off-Road Vehicle Engine OM 642.940	605039	Inner Joint		37	33	45	80	101					
	2005.07-2009.07	-	R	F	All-wheel Drive Closed Off-Road Vehicle Engine OM 642.940	605042	Inner Joint		37	33	45	264	111					
3.0 CDI 4-matic (140 kW)	2009.07-2011.12	-	-	F	All-wheel Drive Closed Off-Road Vehicle Engine OM 642.940	805015	Outer Joint		30	39	70.2	90.5	71	I				
	2009.07-2011.12	AT	L	F	All-wheel Drive Closed Off-Road Vehicle Engine OM 642.940	205060	Drive Shaft		30	37	70.2	90.5	666					
	2009.07-2011.12	AT	R	F	All-wheel Drive Closed Off-Road Vehicle Engine OM 642.940	205061	Drive Shaft		30	37	70.2	90.5	1004					
	2009.07-2011.12	AT	R	F	All-wheel Drive Closed Off-Road Vehicle Engine OM 642.940	605042	Inner Joint		37	33	45	264	111					
3.0 CDI 4-matic (150 kW)	2010.02-2011.12	AT	L	F	All-wheel Drive Closed Off-Road Vehicle Engine OM 642.820	205060	Drive Shaft		30	37	70.2	90.5	666					
	2010.02-2011.12	-	-	F	All-wheel Drive Closed Off-Road Vehicle Engine OM 642.820	805015	Outer Joint		30	39	70.2	90.5	71	I				
	2010.02-2011.12	AT	R	F	All-wheel Drive Closed Off-Road Vehicle Engine OM 642.820	205061	Drive Shaft		30	37	70.2	90.5	1004					
	2010.02-2011.12	AT	L	R	All-wheel Drive Closed Off-Road Vehicle Engine OM 642.820	605039	Inner Joint		37	33	45	80	101					
	2010.02-2011.12	AT	R	F	All-wheel Drive Closed Off-Road Vehicle Engine OM 642.820	605042	Inner Joint		37	33	45	264	111					
3.0 CDI 4-matic (155 kW)	2009.09-2011.12	-	-	F	All-wheel Drive Closed Off-Road Vehicle Engine OM 642.820	805015	Outer Joint		30	39	70.2	90.5	71	I				
	2009.09-2011.12	-	L	F	All-wheel Drive Closed Off-Road Vehicle Engine OM 642.820	205060	Drive Shaft		30	37	70.2	90.5	666					
	2009.09-2011.12	-	R	F	All-wheel Drive Closed Off-Road Vehicle Engine OM 642.820	205061	Drive Shaft		30	37	70.2	90.5	1004					
	2009.09-2011.12	-	R	F	All-wheel Drive Closed Off-Road Vehicle Engine OM 642.820	605042	Inner Joint		37	33	45	264	111					
3.0 CDI 4-matic (165 kW)	2005.07-2009.07	-	-	F	All-wheel Drive Closed Off-Road Vehicle Engine OM 642.940	805015	Outer Joint		30	39	70.2	90.5	71	I				
	2005.07-2009.07	-	L	F	All-wheel Drive Closed Off-Road Vehicle Engine OM 642.940	205060	Drive Shaft		30	37	70.2	90.5	666					
	2005.07-2009.07	-	R	F	All-wheel Drive Closed Off-Road Vehicle Engine OM 642.940	205061	Drive Shaft		30	37	70.2	90.5	1004					
	2005.07-2009.07	AT	L	R	All-wheel Drive Closed Off-Road Vehicle Engine OM 642.940	605039	Inner Joint		37	33	45	80	101					
	2005.07-2009.07	-	R	F	All-wheel Drive Closed Off-Road Vehicle Engine OM 642.940	605042	Inner Joint		37	33	45	264	111					
	2009.07-2011.12	-	-	F	All-wheel Drive Closed Off-Road Vehicle Engine OM 642.940	805015	Outer Joint		30	39	70.2	90.5	71	I				
	2009.07-2011.12	-	L	F	All-wheel Drive Closed Off-Road Vehicle Engine OM 642.940	205060	Drive Shaft		30	37	70.2	90.5	666					
	2009.07-2011.12	-	R	F	All-wheel Drive Closed Off-Road Vehicle Engine OM 642.940	205061	Drive Shaft		30	37	70.2	90.5	1004					
	2009.07-2011.12	-	R	F	All-wheel Drive Closed Off-Road Vehicle Engine OM 642.940	605042	Inner Joint		37	33	45	264	111					
	2009.07-2011.12	-	R	F	All-wheel Drive Closed Off-Road Vehicle Engine OM 642.940	605042	Inner Joint		37	33	45	264	111					
3.0 CDI 4-matic (170 kW)	2010.02-2011.12	-	-	F	All-wheel Drive Closed Off-Road Vehicle Engine OM 642.820	805015	Outer Joint		30	39	70.2	90.5	71	I				
	2010.02-2011.12	-	L	F	All-wheel Drive Closed Off-Road Vehicle Engine OM 642.820	205060	Drive Shaft		30	37	70.2	90.5	666					
	2010.02-2011.12	-	R	F	All-wheel Drive Closed Off-Road Vehicle Engine OM 642.820	205061	Drive Shaft		30	37	70.2	90.5	1004					
	2010.02-2011.12	AT	L	R	All-wheel Drive Closed Off-Road Vehicle Engine OM 642.820	605039	Inner Joint		37	33	45	80	101					
	2010.02-2011.12	-	R	F	All-wheel Drive Closed Off-Road Vehicle Engine OM 642.820	605042	Inner Joint		37	33	45	264	111					
3.5 4-matic (200 kW)	2005.07-2011.12	-	-	F	All-wheel Drive Closed Off-Road Vehicle Engine M 272.967	805015	Outer Joint		30	39	70.2	90.5	71	I				
	2005.07-2011.12	-	L	F	All-wheel Drive Closed Off-Road Vehicle Engine M 272.967	205060	Drive Shaft		30	37	70.2	90.5	666					
	2005.07-2011.12	-	R	F	All-wheel Drive Closed Off-Road Vehicle Engine M 272.967	205061	Drive Shaft		30	37	70.2	90.5	1004					

YEAR	TRANSM	L/R	F/R	REMARKS	GSP Ref.	PRODUCT	ABS	Technical Specifications										
								A	B	C	H	L	P					
MERCEDES BENZ																		
M-CLASS (W164)																		
3.5 4-matic (200 kW)	2005.07-2011.12	-	R	F	All-wheel Drive Closed Off-Road Vehicle Engine M 272.967	605042	Inner Joint		37	33	45	264	111					
4.0 CDI 4-matic (225 kW)	2006.02-2009.09	-	-	F	All-wheel Drive Closed Off-Road Vehicle Engine OM 629.912	805015	Outer Joint		30	39	70.2	90.5	71	I				
	2006.02-2009.09	-	L	F	All-wheel Drive Closed Off-Road Vehicle Engine OM 629.912	205060	Drive Shaft		30	37	70.2	90.5	666					
	2006.02-2009.09	-	R	F	All-wheel Drive Closed Off-Road Vehicle Engine OM 629.912	205061	Drive Shaft		30	37	70.2	90.5	1004					
	2006.02-2009.09	AT	L	R	All-wheel Drive Closed Off-Road Vehicle Engine OM 629.912	605039	Inner Joint		37	33	45	80	101					
	2006.02-2009.09	-	R	F	All-wheel Drive Closed Off-Road Vehicle Engine OM 629.912	605042	Inner Joint		37	33	45	264	111					
	2009.09-2011.12	AT	L	F	All-wheel Drive Closed Off-Road Vehicle Engine OM 629.912	205060	Drive Shaft		30	37	70.2	90.5	666					
	2009.09-2011.12	-	-	F	All-wheel Drive Closed Off-Road Vehicle Engine OM 629.912	805015	Outer Joint		30	39	70.2	90.5	71	I				
	2009.09-2011.12	AT	R	F	All-wheel Drive Closed Off-Road Vehicle Engine OM 629.912	205061	Drive Shaft		30	37	70.2	90.5	1004					
	2009.09-2011.12	AT	R	F	All-wheel Drive Closed Off-Road Vehicle Engine OM 629.912	605042	Inner Joint		37	33	45	264	111					
5.0 4-matic (225 kW)	2005.07-2011.12	-	-	F	All-wheel Drive Closed Off-Road Vehicle Engine M 113.964	805015	Outer Joint		30	39	70.2	90.5	71	I				
	2005.07-2011.12	-	L	F	All-wheel Drive Closed Off-Road Vehicle Engine M 113.964	205060	Drive Shaft		30	37	70.2	90.5	666					
	2005.07-2011.12	-	R	F	All-wheel Drive Closed Off-Road Vehicle Engine M 113.964	205061	Drive Shaft		30	37	70.2	90.5	1004					
	2005.07-2011.12	AT	L	R	All-wheel Drive Closed Off-Road Vehicle Engine M 113.964	605039	Inner Joint		37	33	45	80	101					
	2005.07-2011.12	-	R	F	All-wheel Drive Closed Off-Road Vehicle Engine M 113.964	605042	Inner Joint		37	33	45	264	111					
5.0 4-matic (285 kW)	2007.12-2011.12	-	-	F	All-wheel Drive Closed Off-Road Vehicle Engine M 273.963	805015	Outer Joint		30	39	70.2	90.5	71	I				
	2007.12-2011.12	-	L	F	All-wheel Drive Closed Off-Road Vehicle Engine M 273.963	205060	Drive Shaft		30	37	70.2	90.5	666					
	2007.12-2011.12	-	R	F	All-wheel Drive Closed Off-Road Vehicle Engine M 273.963	205061	Drive Shaft		30	37	70.2	90.5	1004					
	2007.12-2011.12	AT	L	R	All-wheel Drive Closed Off-Road Vehicle Engine M 273.963	605039	Inner Joint		37	33	45	80	101					
	2007.12-2011.12	-	R	F	All-wheel Drive Closed Off-Road Vehicle Engine M 273.963	605042	Inner Joint		37	33	45	264	111					
6.3 AMG 4-matic (375 kW)	2006.01-2011.12	-	-	F	All-wheel Drive Closed Off-Road Vehicle Engine M 156.980	805015	Outer Joint		30	39	70.2	90.5	71	I				
	2006.01-2011.12	-	L	F	All-wheel Drive Closed Off-Road Vehicle Engine M 156.980	205060	Drive Shaft		30	37	70.2	90.5	666					
	2006.01-2011.12	-	R	F	All-wheel Drive Closed Off-Road Vehicle Engine M 156.980	205061	Drive Shaft		30	37	70.2	90.5	1004					
	2006.01-2011.12	AT	L	R	All-wheel Drive Closed Off-Road Vehicle Engine M 156.980	605039	Inner Joint		37	33	45	80	101					
	2006.01-2011.12	-	R	F	All-wheel Drive Closed Off-Road Vehicle Engine M 156.980	605042	Inner Joint		37	33	45	264	111					
ML 320 CDI (155 kW)	2005.07-2011.07	-	-	F	All-wheel Drive Closed Off-Road Vehicle Engine OM 642.940	805015	Outer Joint		30	39	70.2	90.5	71	I				
M-CLASS (W166)																		
2.5 CDI / BlueTEC 4-matic (150 kW)	2014.09-	-	-	F	All-wheel Drive Closed Off-Road Vehicle Engine OM 651.960	805007	Outer Joint		30	37	70.2	90.5	65.5	I				
	2014.09-	-	-	-	All-wheel Drive Closed Off-Road Vehicle Engine OM 651.960	605041	Inner Joint		37	33	45	80	104.5					
	2014.09-	AT	R	R	All-wheel Drive Closed Off-Road Vehicle Engine OM 651.960	235121	Drive Shaft		30	30	73	90	846					
	2014.09-	-	-	F	All-wheel Drive Closed Off-Road Vehicle Engine OM 651.960	805015	Outer Joint		30	39	70.2	90.5	71	I				
3.0 4-matic (200 kW)	2013.11-	-	7AT	R	R	All-wheel Drive Closed Off-Road Vehicle Engine M 276.821	235090	Drive Shaft		30	27	73	90.5	841				
	2013.11-	-	7AT	R	R	All-wheel Drive Closed Off-Road Vehicle Engine M 276.821	635063	Inner Joint		30	30	73	90.5	66	I			
	2013.11-	-	7AT	R	R	All-wheel Drive Closed Off-Road Vehicle Engine M 276.821	635068	Inner Joint		27	30	45	79	72.5	I			
3.0 4-matic (245 kW)	2013.08-	-	7AT	R	R	All-wheel Drive Closed Off-Road Vehicle Engine M 276.821	635063	Inner Joint		30	30	73	90.5	66	I			
	2013.08-	-	7AT	R	R	All-wheel Drive Closed Off-Road Vehicle Engine M 276.821	635068	Inner Joint		27	30	45	79	72.5	I			
	2013.08-	-	7AT	L	F	All-wheel Drive Closed Off-Road Vehicle Engine M 276.821	635057	Inner Joint		37	33	45	80	104.5				
	2013.08-	-	-	-	F	All-wheel Drive Closed Off-Road Vehicle Engine M 276.821	805015	Outer Joint		30	39	70.2	90.5	71	I			
	2013.08-	-	-	-	F	All-wheel Drive Closed Off-Road Vehicle Engine M 276.821	805007	Outer Joint		30	37	70.2	90.5	65.5	I			
	2013.08-	-	-	-	-	All-wheel Drive Closed Off-Road Vehicle Engine M 276.821	605041	Inner Joint		37	33	45	80	104.5				
	2013.08-	-	7AT	R	R	All-wheel Drive Closed Off-Road Vehicle Engine M 276.821	235090	Drive Shaft		30	27	73	90.5	841				
	2013.08-	-	7AT	R	F	All-wheel Drive Closed Off-Road Vehicle Engine M 276.821	235088	Drive Shaft		30	37	73	92.5	1015				
	2013.08-	-	7AT	L	F	All-wheel Drive Closed Off-Road Vehicle Engine M 276.821	235089	Drive Shaft		30	37	73	92.5	673				
	2013.08-	-	7AT	L/R	F	All-wheel Drive Closed Off-Road Vehicle Engine M 276.821	835059	Outer Joint		30	37	73	92.5	66	I			
	3.0 BlueTEC 4-matic (190 kW)	2011.06-	-	7AT	R	F	All-wheel Drive Closed Off-Road Vehicle Engine OM 642.826	235088	Drive Shaft		30	37	73	92.5	1015			
2011.06-		-	7AT	L	F	All-wheel Drive Closed Off-Road Vehicle Engine OM 642.826	235089	Drive Shaft		30	37	73	92.5	673				
2011.06-		-	7AT	L	F	All-wheel Drive Closed Off-Road Vehicle Engine OM 642.826	635057	Inner Joint		37	33	45	80	104.5				
2011.06-		-	7AT	L/R	F	All-wheel Drive Closed Off-Road Vehicle Engine OM 642.826	835059	Outer Joint		30	37	73	92.5	66	I			
2011.06-		-	-	-	F	All-wheel Drive Closed Off-Road Vehicle Engine M 276.955	805015	Outer Joint		30	39	70.2	90.5	71	I			
3.5 4-matic (225 kW)	2011.06-	-	-	-	F	All-wheel Drive Closed Off-Road Vehicle Engine M 276.955	805007	Outer Joint		30	37	70.2	90.5	65.5	I			
	2011.06-	-	-	-	-	All-wheel Drive Closed Off-Road Vehicle Engine M 276.955	605041	Inner Joint		37	33	45	80	104.5				
	2011.06-	-	-	-	-	All-wheel Drive Closed Off-Road Vehicle Engine M 276.955	805007	Outer Joint		30	37	70.2	90.5	65.5	I			
5.0 (300 kW)	2012.02-	-	-	-	F	All-wheel Drive Closed Off-Road Vehicle Engine M 278.928	805007	Outer Joint		30	37	70.2	90.5	65.5	I			
	2012.02-	-	-	-	-	All-wheel Drive Closed Off-Road Vehicle Engine M 278.928	605041	Inner Joint		37	33	45	80	104.5				
	2012.02-	-	-	-	F	All-wheel Drive Closed Off-Road Vehicle Engine M 278.928	805015	Outer Joint		30	39	70.2	90.5	71	I			
ML 300 4-matic (185 kW)	2014.04-	-	-	-	F	All-wheel Drive Closed Off-Road Vehicle Engine M 276.955	805015	Outer Joint		30	39	70.2	90.5	71	I			
	2014.04-	-	-	-	F	All-wheel Drive Closed Off-Road Vehicle Engine M 276.955	805007	Outer Joint		30	37	70.2	90.5	65.5	I			
	2014.04-	-	-	-	-	All-wheel Drive Closed Off-Road Vehicle Engine M 276.955	605041	Inner Joint		37	33	45	80	104.5				
M-KLASSE W164																		
-	2013-	-	-	L	F	-	235103	Drive Shaft		30	37	70.2	90	666				
MB																		
-	-	-	-	L/R	-	100120140	635004	Inner Joint		30	30	55	47	73				
-	-	-	-	L/R	-	100120140	835006	Outer Joint		30	27	72	138.5	80	I			
MB 180																		
-	-	-	-	L/R	-	-	210170	Drive Shaft		30	30	72	138.5	725				
R-CLASS (W251 V251)																		
3.0 CDI 4-matic (140 kW)	2006.05-	-	-	L	F	All-wheel Drive MPV Engine OM 642.950	205068	Drive Shaft		30	37	70.2	90.5	682				





	 YEAR	TRANSM	L/R	F/R	REMARKS	GSP Ref.	 PRODUCT	 ABS	Technical Specifications					
									A	B	C	H	L	P
MERCEDES BENZ														
R-CLASS (W251 V251)														
3.0 CDI 4-matic (140 kW)	2006.05-	-	-	L R	All-wheel Drive MPV Engine OM 642.950	235063	Drive Shaft		30	37	70.2	90.5	852	
	2009.07-	-	-	L F	All-wheel Drive MPV Engine OM 642.950	205068	Drive Shaft		30	37	70.2	90.5	682	
	2009.07-	-	-	L R	All-wheel Drive MPV Engine OM 642.950	235063	Drive Shaft		30	37	70.2	90.5	852	
3.0 CDI 4-matic (155 kW)	2006.01-	-	-	L F	All-wheel Drive MPV Engine OM 642.950/OM 642.870	205068	Drive Shaft		30	37	70.2	90.5	682	
	2006.01-	-	-	L R	All-wheel Drive MPV Engine OM 642.950/OM 642.870	235063	Drive Shaft		30	37	70.2	90.5	852	
	2006.01-	-	-	R F	All-wheel Drive MPV Engine OM 642.870/OM 642.950	201561	Drive Shaft		30	37	70.2	90	1018	
3.0 CDI 4-matic (165 kW)	2006.01-	-	-	L F	All-wheel Drive MPV Engine OM 642.950	205068	Drive Shaft		30	37	70.2	90.5	682	
	2006.01-	-	-	L R	All-wheel Drive MPV Engine OM 642.950	235063	Drive Shaft		30	37	70.2	90.5	852	
3.5 (200 kW)	2007.01-	-	AT	L F	MPV Engine M 272.967	205068	Drive Shaft		30	37	70.2	90.5	682	
	2007.01-	-	AT	L R	MPV Engine M 272.967	235063	Drive Shaft		30	37	70.2	90.5	852	
3.5 4-matic (200 kW)	2006.01-	-	AT	L F	All-wheel Drive MPV Engine M 272.967	205068	Drive Shaft		30	37	70.2	90.5	682	
	2006.01-	-	-	L R	All-wheel Drive MPV Engine M 272.967	235063	Drive Shaft		30	37	70.2	90.5	852	
3.5 CGI 4-matic (225 kW)	2011.09-2013.12	-	AT	L F	All-wheel Drive MPV Engine M 276.958	205068	Drive Shaft		30	37	70.2	90.5	682	
	2011.09-2013.12	-	-	L R	All-wheel Drive MPV Engine M 276.958	235063	Drive Shaft		30	37	70.2	90.5	852	
5.0 4-matic (225 kW)	2006.01-2007.12	-	-	L F	All-wheel Drive MPV Engine M 113.960/M 113.971	205068	Drive Shaft		30	37	70.2	90.5	682	
	2006.01-2007.12	-	-	L R	All-wheel Drive MPV Engine M 113.960/M 113.971	235063	Drive Shaft		30	37	70.2	90.5	852	
R 350 CDI 4-matic (165 kW)	2009.07-	-	-	R F	All-wheel Drive MPV Engine OM 642.950	201561	Drive Shaft		30	37	70.2	90	1018	
R 350 CDI 4-matic (195 kW)	2010.08-	-	-	R F	All-wheel Drive MPV Engine OM 642.872	201561	Drive Shaft		30	37	70.2	90	1018	
S-CLASS (C216)														
5.5 4-matic (285 kW)	2008.09-2010.12	-	-	-	All-wheel Drive Coupe Engine M 273.968	699166	Inner Joint		27	27	38	62	110.5	
	2008.09-2010.12	-	-	-	All-wheel Drive Coupe Engine M 273.968	235096	Drive Shaft		30	27	71	56.5	529	
	2008.09-2010.12	-	-	-	All-wheel Drive Coupe Engine M 273.968	835049	Outer Joint		30	25	71	56.5	52	I
5.5 4-matic (320 kW)	2011.02-2013.12	-	-	-	All-wheel Drive Coupe Engine M 278.920	699166	Inner Joint		27	27	38	62	110.5	
	2011.02-2013.12	-	-	-	All-wheel Drive Coupe Engine M 278.920	235096	Drive Shaft		30	27	71	56.5	529	
	2011.02-2013.12	-	-	-	All-wheel Drive Coupe Engine M 278.920	835049	Outer Joint		30	25	71	56.5	52	I
S-CLASS (C217)														
5.5 (335 kW)	2014.04-	-	-	-	All-wheel Drive Coupe Engine M 278.929	835049	Outer Joint		30	25	71	56.5	52	I
5.5 L AMG 4-matic (430 kW)	2014.04-	-	-	-	All-wheel Drive Coupe Engine M 157.985	835049	Outer Joint		30	25	71	56.5	52	I
S-CLASS (W140)														
400 SE, SEL/S420 (210 kW)	1991.02-1998.10	-	AT	-	R Saloon Engine M 119.971	235009	Drive Shaft	48T	25		62	70.5	660	
600 SE, SEL (300 kW)	1991.04-1992.12	-	AT	-	R Saloon Engine M 120.980/M 120.982	235009	Drive Shaft	48T	25		62	70.5	660	
S 420 (205 kW)	1993.01-1998.10	-	AT	-	R Saloon Engine M 119.971	235009	Drive Shaft	48T	25		62	70.5	660	
S 600 (290 kW)	1993.01-1998.10	-	AT	-	R Saloon Engine M 120.980/M 120.982	235009	Drive Shaft	48T	25		62	70.5	660	
S-CLASS (W220)														
3.5 4-matic (180 kW)	2003.06-2005.08	-	-	-	All-wheel Drive Saloon Engine M 112.975	835064	Outer Joint	48W	35	27	66.6	42	53	I
	2003.06-2005.08	-	-	-	All-wheel Drive Saloon Engine M 112.975	635061	Inner Joint		24	27	38	55.5	104	
	2003.06-2005.08	-	-	-	All-wheel Drive Saloon Engine M 112.975	635059	Inner Joint		34	27	37.5	140		
4.3 4-matic (205 kW)	2002.09-2005.08	-	-	-	All-wheel Drive Saloon Engine M 113.948	835064	Outer Joint	48W	35	27	66.6	42	53	I
	2002.09-2005.08	-	-	-	All-wheel Drive Saloon Engine M 113.948	635061	Inner Joint		24	27	38	55.5	104	
	2002.09-2005.08	-	-	-	All-wheel Drive Saloon Engine M 113.948	635059	Inner Joint		34	27	37.5	140		
5.0 4-matic (225 kW)	2002.09-2005.08	-	-	-	All-wheel Drive Saloon Engine M 113.966	835064	Outer Joint	48W	35	27	66.6	42	53	I
	2002.09-2005.08	-	-	-	All-wheel Drive Saloon Engine M 113.966	635061	Inner Joint		24	27	38	55.5	104	
	2002.09-2005.08	-	-	-	All-wheel Drive Saloon Engine M 113.966	635059	Inner Joint		34	27	37.5	140		
S-CLASS (W221)														
3.2 CDI 4-matic (155 kW)	2005.10-2013.12	-	-	-	All-wheel Drive Saloon Engine OM 642.932	699166	Inner Joint		27	27	38	62	110.5	
	2005.10-2013.12	-	-	-	All-wheel Drive Saloon Engine OM 642.932	235096	Drive Shaft		30	27	71	56.5	529	
	2005.10-2013.12	-	-	-	All-wheel Drive Saloon Engine OM 642.932	835049	Outer Joint		30	25	71	56.5	52	I
3.2 CDI 4-matic (173 kW)	2006.10-2013.12	-	-	-	All-wheel Drive Saloon Engine OM 642.932	699166	Inner Joint		27	27	38	62	110.5	
	2006.10-2013.12	-	-	-	All-wheel Drive Saloon Engine OM 642.932	235096	Drive Shaft		30	27	71	56.5	529	
	2006.10-2013.12	-	-	-	All-wheel Drive Saloon Engine OM 642.932	835049	Outer Joint		30	25	71	56.5	52	I
3.5 4-matic (200 kW)	2008.02-2013.12	-	-	-	All-wheel Drive Saloon Engine M 272.975	699166	Inner Joint		27	27	38	62	110.5	
	2008.02-2013.12	-	-	-	All-wheel Drive Saloon Engine M 272.975	235096	Drive Shaft		30	27	71	56.5	529	
	2008.02-2013.12	-	-	-	All-wheel Drive Saloon Engine M 272.975	835049	Outer Joint		30	25	71	56.5	52	I
3.5 BlueTEC 4-matic (190 kW)	2011.04-2013.12	-	-	-	All-wheel Drive Saloon Engine OM 642.868	699166	Inner Joint		27	27	38	62	110.5	
	2011.04-2013.12	-	-	-	All-wheel Drive Saloon Engine OM 642.868	235096	Drive Shaft		30	27	71	56.5	529	
	2011.04-2013.12	-	-	-	All-wheel Drive Saloon Engine OM 642.868	835049	Outer Joint		30	25	71	56.5	52	I
3.5 CDI 4-matic (155 kW)	2009.01-2010.12	-	-	-	All-wheel Drive Saloon Engine OM 642.932	699166	Inner Joint		27	27	38	62	110.5	
	2009.01-2010.12	-	-	-	All-wheel Drive Saloon Engine OM 642.932	235096	Drive Shaft		30	27	71	56.5	529	
	2009.01-2010.12	-	-	-	All-wheel Drive Saloon Engine OM 642.932	835049	Outer Joint		30	25	71	56.5	52	I
3.5 CGI 4-matic (225 kW)	2011.04-2013.12	-	-	-	All-wheel Drive Saloon Engine M 276.950	699166	Inner Joint		27	27	38	62	110.5	
	2011.04-2013.12	-	-	-	All-wheel Drive Saloon Engine M 276.950	235096	Drive Shaft		30	27	71	56.5	529	
	2011.04-2013.12	-	-	-	All-wheel Drive Saloon Engine M 276.950	835049	Outer Joint		30	25	71	56.5	52	I
4.5 4-matic (250 kW)	2005.12-2013.12	-	-	-	All-wheel Drive Saloon Engine M 273.924	699166	Inner Joint		27	27	38	62	110.5	
	2005.12-2013.12	-	-	-	All-wheel Drive Saloon Engine M 273.924	235096	Drive Shaft		30	27	71	56.5	529	
	2005.12-2013.12	-	-	-	All-wheel Drive Saloon Engine M 273.924	835049	Outer Joint		30	25	71	56.5	52	I
5.5 4-matic (285 kW)	2005.10-2013.12	-	-	-	All-wheel Drive Saloon Engine M 273.961/M 273.968	699166	Inner Joint		27	27	38	62	110.5	

YEAR	TRANSM	L/R	F/R	REMARKS	GSP Ref.	PRODUCT	ABS	Technical Specifications						
								A	B	C	H	L	P	
MERCEDES BENZ														
S-CLASS (W221)														
5.5 4-matic (285 kW)	2005.10-2013.12	-	-	-	All-wheel Drive Saloon Engine M 273.961/M 273.968	235096	Drive Shaft		30	27	71	56.5	529	
	2005.10-2013.12	-	-	-	All-wheel Drive Saloon Engine M 273.961/M 273.968	835049	Outer Joint		30	25	71	56.5	52	I
5.5 4-matic (320 kW)	2011.09-2013.12	-	-	-	All-wheel Drive Saloon Engine M 278.932	699166	Inner Joint		27	27	38	62	110.5	
	2011.09-2013.12	-	-	-	All-wheel Drive Saloon Engine M 278.932	235096	Drive Shaft		30	27	71	56.5	529	
	2011.09-2013.12	-	-	-	All-wheel Drive Saloon Engine M 278.932	835049	Outer Joint		30	25	71	56.5	52	I
S-CLASS (W222 V222 X222)														
3.0 4-matic (245 kW)	2014.11-	-	-	-	All-wheel Drive Saloon Engine M 276.824	835049	Outer Joint		30	25	71	56.5	52	I
3.5 BlueTEC 4-matic (185 kW)	2014.02-	-	-	-	All-wheel Drive Saloon Engine OM 642.867	835049	Outer Joint		30	25	71	56.5	52	I
5.5 4-matic (335 kW)	2013.05-	-	-	-	All-wheel Drive Saloon Engine M 278.929	835049	Outer Joint		30	25	71	56.5	52	I
5.5 AMG 4-matic (430 kW)	2013.05-	-	-	-	All-wheel Drive Saloon Engine M 157.985	835049	Outer Joint		30	25	71	56.5	52	I
S 350 BlueTEC / d 4-matic (190 kW)	2014.02-	-	-	-	All-wheel Drive Saloon Engine OM 642.867	835049	Outer Joint		30	25	71	56.5	52	I
S-CLASS W220														
-	2017-	-	-	-	R -	235105	Drive Shaft	48W	27	27	67	78	786	
Saloon (W124)														
2.0 (75 kW)	1986.01-1990.05	AT/MT	L/R	R	Saloon Engine M 102.922	635006	Inner Joint			25		26		
	1986.01-1990.05	AT/MT	L/R	R	Saloon Engine M 102.922	235001	Drive Shaft		25		62	69	665	
2.0 (77 kW)	1986.01-1990.05	AT/MT	L/R	R	Saloon Engine M 102.922	635006	Inner Joint			25		26		
	1986.01-1990.05	AT/MT	L/R	R	Saloon Engine M 102.922	235001	Drive Shaft		25		62	69	665	
2.0 (80 kW)	1985.12-1990.05	AT/MT	L/R	R	Saloon Engine M 102.922	635006	Inner Joint			25		26		
	1985.12-1990.05	AT/MT	L/R	R	Saloon Engine M 102.922	235001	Drive Shaft		25		62	69	665	
2.0 D (53 kW)	1984.12-1989.08	AT/MT	L/R	R	Saloon Engine OM 601.912	635006	Inner Joint			25		26		
	1984.12-1989.08	AT/MT	L/R	R	Saloon Engine OM 601.912	235001	Drive Shaft		25		62	69	665	
2.0 D (55 kW)	1989.08-1993.06	AT/MT	L/R	R	Saloon Engine OM 601.912	635006	Inner Joint			25		26		
	1989.08-1993.06	AT/MT	L/R	R	Saloon Engine OM 601.912	235001	Drive Shaft		25		62	69	665	
2.0 E (87 kW)	1988.09-1992.08	AT/MT	L/R	R	Saloon Engine M 102.963	635006	Inner Joint			25		26		
	1988.09-1992.08	AT/MT	L/R	R	Saloon Engine M 102.963	235001	Drive Shaft		25		62	69	665	
2.3 E (100 kW)	1985.01-1993.06	AT/MT	L/R	R	Saloon Engine M 102.982	635006	Inner Joint			25		26		
	1985.01-1993.06	AT/MT	L/R	R	Saloon Engine M 102.982	235001	Drive Shaft		25		62	69	665	
2.3 E (97 kW)	1984.12-1992.03	AT/MT	L/R	R	Saloon Engine M 102.982	635006	Inner Joint			25		26		
	1984.12-1992.03	AT/MT	L/R	R	Saloon Engine M 102.982	235001	Drive Shaft		25		62	69	665	
2.3 E Cat (97 kW)	1989.06-1993.06	AT/MT	L/R	R	Saloon Engine M 102.982	635006	Inner Joint			25		26		
	1989.06-1993.06	AT/MT	L/R	R	Saloon Engine M 102.982	235001	Drive Shaft		25		62	69	665	
2.5 D (66 kW)	1985.04-1993.06	AT/MT	L/R	R	Saloon Engine OM 602.912	635006	Inner Joint			25		26		
	1985.04-1993.06	AT/MT	L/R	R	Saloon Engine OM 602.912	235001	Drive Shaft		25		62	69	665	
2.5 D (69 kW)	1989.01-1993.06	AT/MT	L/R	R	Saloon Engine OM 602.912	635006	Inner Joint			25		26		
	1989.01-1993.06	AT/MT	L/R	R	Saloon Engine OM 602.912	235001	Drive Shaft		25		62	69	665	
2.5 Turbo-D (93 kW)	1988.09-1993.06	AT/MT	L/R	R	Saloon Engine OM 602.962	699143	Inner Joint			27		28		
	1988.09-1993.06	AT/MT	L/R	R	Saloon Engine OM 602.962	235005	Drive Shaft		25		62	69	659	
2.6 E (118 kW)	1985.09-1992.08	AT/MT	L/R	R	Saloon Engine M 103.940	699143	Inner Joint			27		28		
	1985.09-1992.08	AT/MT	L/R	R	Saloon Engine M 103.940	235005	Drive Shaft		25		62	69	659	
3.0 D (80 kW)	1984.12-1989.08	AT/MT	L/R	R	Saloon Engine OM 603.912	699143	Inner Joint			27		28		
	1984.12-1989.08	AT/MT	L/R	R	Saloon Engine OM 603.912	235005	Drive Shaft		25		62	69	659	
3.0 D (81 kW)	1990.06-1993.06	AT/MT	L/R	R	Saloon Engine OM 603.912	699143	Inner Joint			27		28		
	1990.06-1993.06	AT/MT	L/R	R	Saloon Engine OM 603.912	235005	Drive Shaft		25		62	69	659	
3.0 D (83 kW)	1989.08-1993.06	AT/MT	L/R	R	Saloon Engine OM 603.912	699143	Inner Joint			27		28		
	1989.08-1993.06	AT/MT	L/R	R	Saloon Engine OM 603.912	235005	Drive Shaft		25		62	69	659	
3.0 E (132 kW)	1985.08-1992.08	AT/MT	L/R	R	Saloon Engine M 103.983	699143	Inner Joint			27		28		
	1985.08-1992.08	AT/MT	L/R	R	Saloon Engine M 103.983	235005	Drive Shaft		25		62	69	659	
3.0 Turbo-D (108 kW)	1988.09-1993.06	AT/MT	L/R	R	Saloon Engine OM 603.960	699143	Inner Joint			27		28		
	1988.09-1993.06	AT/MT	L/R	R	Saloon Engine OM 603.960	235005	Drive Shaft		25		62	69	659	
SL (R107)														
420 SL (150 kW)	1986.01-1989.08	-	L/R	R	Convertible Engine M 116.964	235004	Drive Shaft		27	27	60	32.5	627	
420 SL (160 kW)	1986.01-1989.08	-	L/R	R	Convertible Engine M 116.964	235004	Drive Shaft		27	27	60	32.5	627	
SL (R230)														
350 (180 kW)	2003.03-2012.01	-	R	-	Convertible Engine M 112.973	235108	Drive Shaft	48NS	27	27	63	75	767	
	2003.03-2012.01	-	L	-	Convertible Engine M 112.973	235128	Drive Shaft	48NS	27	27	63	75	767	
63 AMG (386 kW)	2008.03-2012.01	AT	L/R	R	Convertible Engine M 156.981	235129	Drive Shaft	48NS	27	30	68	72	763	
SLK (R170)														
2.0 (100 kW)	1996.09-2000.03	-	L/R	R	Convertible Engine M 111.946	605007	Inner Joint			24		27		
	1996.09-2000.03	-	L/R	R	Convertible Engine M 111.946	235007	Drive Shaft		25		62	70.5	630	
SLK (R171)														
2.0 Kompressor (120 kW)	2004.03-2011.02	AT	L/R	R	Convertible Engine M 271.944	235132	Drive Shaft	48NS	25	27	64.9	70	766	
SLK (R172)														
2.5 CDI / d (150 kW)	2012.01-	AT	L	R	Convertible Engine OM 651.980	235107	Drive Shaft	48NS	27	27	68	72	777	
	2012.01-	AT	R	R	Convertible Engine OM 651.980	235112	Drive Shaft	48NS	27	27	68	72	777	
SPRINTER 3-t (903)														





YEAR	TRANSM	L/R	F/R	REMARKS	GSP Ref.	PRODUCT	ABS	Technical Specifications								
								A	B	C	H	L	P			
MERCEDES BENZ																
SPRINTER 3-t (903)																
3.0 (90 kW)	1997.05-2002.08	-	L/R	F	All-wheel Drive BUS Engine OM 602.980	835034	Outer Joint		26	28	62	124	62	O		
	1997.05-2002.08	-	L/R	F	All-wheel Drive BUS Engine OM 602.980	635020	Inner Joint			28		32				
V-CLASS (638/2)																
2.0 (95 kW)	1997.02-2003.07	-	-	F	MPV Engine M 111.948	835007	Outer Joint		27	27	59.8	99	63	I		
	1997.02-2003.07	AT/MT	L/R	F	MPV Engine M 111.948	835001	Outer Joint	48W	27	27	59.8	99	63	I		
	1997.02-2003.07	AT/MT	L/R	F	MPV Engine M 111.948	235002	Drive Shaft	48W	27		59.8	99	531			
	1997.02-2003.07	-	L/R	F	MPV Engine M 111.948	235016	Drive Shaft		27		59.8	99	531			
	1997.02-2003.07	AT/MT	L/R	F	MPV Engine M 111.948	648002	Inner Joint			28		32				
2.0 CDI (75 kW)	1999.03-2003.07	-	L/R	F	MPV Engine OM 611.980	235003	Drive Shaft	48W	27		71.5	99	506			
	1999.03-2003.07	-	-	F	MPV Engine OM 611.980	835008	Outer Joint		27	36	71.5	99	68	I		
	1999.03-2003.07	-	L/R	F	MPV Engine OM 611.980	635001	Inner Joint			30		36.2				
	1999.03-2003.07	-	L/R	F	MPV Engine OM 611.980	835002	Outer Joint	48W	27	36	71.5	99	68	I		
	1999.03-2003.07	-	L/R	F	MPV Engine OM 611.980	235011	Drive Shaft		27		71.5	99	506			
2.2 CDI (90 kW)	1999.03-2003.07	-	L/R	F	MPV Engine OM 611.980	235003	Drive Shaft	48W	27		71.5	99	506			
	1999.03-2003.07	-	-	F	MPV Engine OM 611.980	835008	Outer Joint		27	36	71.5	99	68	I		
	1999.03-2003.07	-	L/R	F	MPV Engine OM 611.980	635001	Inner Joint			30		36.2				
	1999.03-2003.07	-	L/R	F	MPV Engine OM 611.980	835002	Outer Joint	48W	27	36	71.5	99	68	I		
	1999.03-2003.07	-	L/R	F	MPV Engine OM 611.980	235011	Drive Shaft		27		71.5	99	506			
2.3 (105 kW)	1996.10-2003.07	-	-	F	MPV Engine M 111.978	835007	Outer Joint		27	27	59.8	99	63	I		
	1996.10-2003.07	AT/MT	L/R	F	MPV Engine M 111.978	835001	Outer Joint	48W	27	27	59.8	99	63	I		
	1996.10-2003.07	AT/MT	L/R	F	MPV Engine M 111.978	235002	Drive Shaft	48W	27		59.8	99	531			
	1996.10-2003.07	-	L/R	F	MPV Engine M 111.978	235016	Drive Shaft		27		59.8	99	531			
	1996.10-2003.07	AT/MT	L/R	F	MPV Engine M 111.978	648002	Inner Joint			28		32				
2.3 TD (72 kW)	1996.09-2003.07	-	-	F	MPV Engine OM 601.970	835007	Outer Joint		27	27	59.8	99	63	I		
	1996.09-2003.07	AT/MT	L/R	F	MPV Engine OM 601.970	835001	Outer Joint	48W	27	27	59.8	99	63	I		
	1996.09-2003.07	AT/MT	L/R	F	MPV Engine OM 601.970	235002	Drive Shaft	48W	27		59.8	99	531			
	1996.09-2003.07	AT/MT	L/R	F	MPV Engine OM 601.970	648002	Inner Joint			28		32				
	1996.09-2003.07	-	L/R	F	MPV Engine OM 601.970	235016	Drive Shaft		27		59.8	99	531			
2.8 (128 kW)	1997.08-2003.07	-	-	F	MPV Engine M 104.900	835007	Outer Joint		27	27	59.8	99	63	I		
	1997.08-2003.07	-	L/R	F	MPV Engine M 104.900	835002	Outer Joint	48W	27	36	71.5	99	68	I		
VANEO (414)																
1.6 (60 kW)	2002.02-2005.07	MT	R	F	MPV Engine M 166.961	635010	Inner Joint		22	27	36	459	61			
	2002.02-2005.07	-	-	F	MPV Engine M 166.961	835003	Outer Joint	48W	24	27	57	67.5	50	I		
	2002.02-2005.07	MT	L	F	MPV Engine M 166.961	235020	Drive Shaft	48W	24	22	57	67.5	568			
	2002.02-2005.07	-	L	-	-	635013	Inner Joint		22	27	36	55	79			
1.6 (75 kW)	2002.02-2005.07	MT	R	F	MPV Engine M 166.961	635010	Inner Joint		22	27	36	459	61			
	2002.02-2005.07	-	-	F	MPV Engine M 166.961	835003	Outer Joint	48W	24	27	57	67.5	50	I		
	2002.02-2005.07	MT	L	F	MPV Engine M 166.961	235020	Drive Shaft	48W	24	22	57	67.5	568			
	2002.02-2005.07	-	L	-	-	635013	Inner Joint		22	27	36	55	79			
1.7 CDI (55 kW)	2002.02-2005.07	MT	R	F	MPV Engine OM 668.914	635010	Inner Joint		22	27	36	459	61			
	2002.02-2005.07	-	-	F	MPV Engine OM 668.914	835003	Outer Joint	48W	24	27	57	67.5	50	I		
	2002.02-2005.07	MT	L	F	MPV Engine OM 668.914	235020	Drive Shaft	48W	24	22	57	67.5	568			
	2002.02-2005.07	-	L	-	-	635013	Inner Joint		22	27	36	55	79			
1.7 CDI (67 kW)	2002.02-2005.07	MT	R	F	MPV Engine OM 668.914	635010	Inner Joint		22	27	36	459	61			
	2002.02-2005.07	-	-	F	MPV Engine OM 668.914	835003	Outer Joint	48W	24	27	57	67.5	50	I		
	2002.02-2005.07	MT	L	F	MPV Engine OM 668.914	235020	Drive Shaft	48W	24	22	57	67.5	568			
	2002.02-2005.07	-	L	-	-	635013	Inner Joint		22	27	36	55	79			
1.9 (92 kW)	2002.02-2005.07	MT	R	F	MPV Engine M 166.991	635010	Inner Joint		22	27	36	459	61			
	2002.02-2005.07	-	-	F	MPV Engine M 166.991	835003	Outer Joint	48W	24	27	57	67.5	50	I		
	2002.02-2005.07	MT	L	F	MPV Engine M 166.991	235020	Drive Shaft	48W	24	22	57	67.5	568			
	2002.02-2005.07	-	L	-	-	635013	Inner Joint		22	27	36	55	79			
VIANO (W639)/V-CLASS																
2.0 (80 kW)	2003.09-2005.07	AT/MT	L/R	R	MPV Engine OM 646.982	235022	Drive Shaft		30	26	70	94.5	849			
	2003.09-2005.07	AT/MT	L/R	R	MPV Engine OM 646.982	699177	Inner Joint		26	28	45	83.5	78			
	2003.09-2005.07	-	-	R	MPV Engine OM 646.982	835028	Outer Joint		30	36	70	95	68	I		
2.0 4-matic (80 kW)	2005.07-2005.07	-	L/R	R	All-wheel Drive MPV Engine OM 646.982	235022	Drive Shaft		30	26	70	94.5	849			
	2005.07-2005.07	-	L/R	F	All-wheel Drive MPV Engine OM 646.982	235084	Drive Shaft		30		66	96.5	652			
	2005.07-2005.07	-	L/R	R	All-wheel Drive MPV Engine OM 646.982	699177	Inner Joint		26	28	45	83.5	78			
	2005.07-2005.07	-	-	R	All-wheel Drive MPV Engine OM 646.982	835028	Outer Joint		30	36	70	95	68	I		
2.2 (110 kW)	2003.09-2005.07	-	-	R	MPV Engine OM 646.982/OM 646.980	835069	Outer Joint		30	37	70	99.5	62.5	I		
	2003.09-2005.07	-	L	R	MPV Engine OM 646.982/OM 646.980	635069	Inner Joint		26	37	45	83	96			
	2003.09-2005.07	-	L/R	R	MPV Engine OM 646.982/OM 646.980	235093	Drive Shaft		30	26	70	99.5	865			
2.2 4-matic (110 kW)	2005.07-2005.07	-	L/R	F	All-wheel Drive MPV Engine OM 646.982	235084	Drive Shaft		30		66	96.5	652			
	2005.07-2005.07	-	-	R	All-wheel Drive MPV Engine OM 646.982	835069	Outer Joint		30	37	70	99.5	62.5	I		
	2005.07-2005.07	MT	L/R	R	All-wheel Drive MPV Engine OM 646.982	635069	Inner Joint		26	37	45	83	96			
	2005.07-2005.07	-	L/R	R	All-wheel Drive MPV Engine OM 646.982	235093	Drive Shaft		30	26	70	99.5	865			





YEAR	TRANSM	L/R	F/R	REMARKS	GSP Ref.	PRODUCT	ABS	Technical Specifications							
								A	B	C	H	L	P		
MERCEDES BENZ VIANO (W639)/V-CLASS															
3.0 (140 kW)	2003.09-	-	-	R	MPV Engine M 112.951	835069	Outer Joint		30	37	70	99.5	62.5	I	
	2003.09-	-	-	L	R MPV Engine M 112.951	635069	Inner Joint		26	37	45	83	96		
	2003.09-	-	-	L/R	R MPV Engine M 112.951	235093	Drive Shaft		30	26	70	99.5	865		
3.0 (150 kW)	2006.03-	-	-	R	MPV Engine OM 642.990	835069	Outer Joint		30	37	70	99.5	62.5	I	
	2006.03-	-	-	L	R MPV Engine OM 642.990	635069	Inner Joint		26	37	45	83	96		
	2006.03-	-	-	L	R MPV Engine OM 642.990	235059	Drive Shaft		30	26	70	94.5	860		
	2006.03-	-	-	L/R	R MPV Engine OM 642.990	235093	Drive Shaft		30	26	70	99.5	865		
3.2 (160 kW)	2003.09-	-	-	R	MPV Engine M 112.951	835069	Outer Joint		30	37	70	99.5	62.5	I	
	2003.09-	-	-	R	MPV Engine M 112.951	835024	Outer Joint		30	36	70	94.5	68	I	
	2003.09-	-	-	L	R MPV Engine M 112.951	635069	Inner Joint		26	37	45	83	96		
	2003.09-	-	-	R	MPV Engine M 112.951	835036	Outer Joint		30	37	70	94.5	61	I	
	2003.09-	-	-	L/R	R MPV Engine M 112.951	235093	Drive Shaft		30	26	70	99.5	865		
3.7 (170 kW)	2004.06-	-	-	R	MPV Engine M 112.976	835069	Outer Joint		30	37	70	99.5	62.5	I	
	2004.06-	-	-	R	MPV Engine M 112.976	835024	Outer Joint		30	36	70	94.5	68	I	
	2004.06-	-	-	L	R MPV Engine M 112.976	635069	Inner Joint		26	37	45	83	96		
	2004.06-	-	-	R	MPV Engine M 112.976	835036	Outer Joint		30	37	70	94.5	61	I	
	2004.06-	-	-	L/R	R MPV Engine M 112.976	235093	Drive Shaft		30	26	70	99.5	865		
CDI 2.0 (85 kW)	2005.08-	-	-	L/R	R MPV Engine OM 646.982	235093	Drive Shaft		30	26	70	99.5	865		
CDI 3.0 (165 kW)	2010.07-	-	-	R	MPV Engine OM 642.990	835069	Outer Joint		30	37	70	99.5	62.5	I	
	2010.07-	-	-	L/R	R MPV Engine OM 642.990	235093	Drive Shaft		30	26	70	99.5	865		
VITO (638)															
2.0 (95 kW)	1996.02-2003.07	-	-	F	BUS Engine M 111.948/M 111.950	835007	Outer Joint		27	27	59.8	99	63	I	
	1996.02-2003.07	AT/MT	L/R	F	BUS Engine M 111.948/M 111.950	835001	Outer Joint	48W	27	27	59.8	99	63	I	
	1996.02-2003.07	AT/MT	L/R	F	BUS Engine M 111.948/M 111.950	235002	Drive Shaft	48W	27		59.8	99	531		
	1996.02-2003.07	-	-	L/R	F BUS Engine M 111.948/M 111.950	235016	Drive Shaft		27		59.8	99	531		
	1996.02-2003.07	AT/MT	L/R	F	BUS Engine M 111.948/M 111.950	648002	Inner Joint			28		32			
	1997.03-2003.07	-	-	F	Box Engine M 111.948/M 111.950	835007	Outer Joint		27	27	59.8	99	63	I	
	1997.03-2003.07	AT/MT	L/R	F	Box Engine M 111.948/M 111.950	835001	Outer Joint	48W	27	27	59.8	99	63	I	
	1997.03-2003.07	AT/MT	L/R	F	Box Engine M 111.948/M 111.950	235002	Drive Shaft	48W	27		59.8	99	531		
	1997.03-2003.07	-	-	L/R	F Box Engine M 111.948/M 111.950	235016	Drive Shaft		27		59.8	99	531		
	1997.03-2003.07	AT/MT	L/R	F	Box Engine M 111.948/M 111.950	648002	Inner Joint			28		32			
2.2 (60 kW)	1999.03-2003.07	-	-	L/R	F BUS Engine OM 611A (60 KW CDI)	235003	Drive Shaft	48W	27		71.5	99	506		
	1999.03-2003.07	-	-	L/R	F Box Engine OM 611A (60 KW CDI)	235003	Drive Shaft	48W	27		71.5	99	506		
	1999.03-2003.07	-	-	F	BUS Engine OM 611A (60 KW CDI)	835008	Outer Joint		27	36	71.5	99	68	I	
	1999.03-2003.07	-	-	F	Box Engine OM 611A (60 KW CDI)	835008	Outer Joint		27	36	71.5	99	68	I	
	1999.03-2003.07	-	-	L/R	F BUS Engine OM 611A (60 KW CDI)	635001	Inner Joint			30		36.2			
	1999.03-2003.07	-	-	L/R	F Box Engine OM 611A (60 KW CDI)	635001	Inner Joint			30		36.2			
	1999.03-2003.07	-	-	L/R	F BUS Engine OM 611A (60 KW CDI)	835002	Outer Joint	48W	27	36	71.5	99	68	I	
	1999.03-2003.07	-	-	L/R	F Box Engine OM 611A (60 KW CDI)	835002	Outer Joint	48W	27	36	71.5	99	68	I	
	1999.03-2003.07	-	-	L/R	F BUS Engine OM 611A (60 KW CDI)	235011	Drive Shaft		27		71.5	99	506		
	1999.03-2003.07	-	-	L/R	F Box Engine OM 611A (60 KW CDI)	235011	Drive Shaft		27		71.5	99	506		
2.2 (75 kW)	1999.03-2003.07	-	-	L/R	F BUS Engine OM 611LA (75 KW CDI)	235003	Drive Shaft	48W	27		71.5	99	506		
	1999.03-2003.07	-	-	L/R	F Box Engine OM 611LA (75 KW CDI)	235003	Drive Shaft	48W	27		71.5	99	506		
	1999.03-2003.07	-	-	F	BUS Engine OM 611LA (75 KW CDI)	835008	Outer Joint		27	36	71.5	99	68	I	
	1999.03-2003.07	-	-	F	Box Engine OM 611LA (75 KW CDI)	835008	Outer Joint		27	36	71.5	99	68	I	
	1999.03-2003.07	-	-	L/R	F BUS Engine OM 611LA (75 KW CDI)	635001	Inner Joint			30		36.2			
	1999.03-2003.07	-	-	L/R	F Box Engine OM 611LA (75 KW CDI)	635001	Inner Joint			30		36.2			
	1999.03-2003.07	-	-	L/R	F BUS Engine OM 611LA (75 KW CDI)	835002	Outer Joint	48W	27	36	71.5	99	68	I	
	1999.03-2003.07	-	-	L/R	F Box Engine OM 611LA (75 KW CDI)	835002	Outer Joint	48W	27	36	71.5	99	68	I	
	1999.03-2003.07	-	-	L/R	F BUS Engine OM 611LA (75 KW CDI)	235011	Drive Shaft		27		71.5	99	506		
	1999.03-2003.07	-	-	L/R	F Box Engine OM 611LA (75 KW CDI)	235011	Drive Shaft		27		71.5	99	506		
2.2 (90 kW)	1999.03-2003.07	-	-	L/R	F BUS Engine OM 611.980	235003	Drive Shaft	48W	27		71.5	99	506		
	1999.03-2003.07	-	-	L/R	F Box Engine OM 611.980	235003	Drive Shaft	48W	27		71.5	99	506		
	1999.03-2003.07	-	-	F	BUS Engine OM 611.980	835008	Outer Joint		27	36	71.5	99	68	I	
	1999.03-2003.07	-	-	F	Box Engine OM 611.980	835008	Outer Joint		27	36	71.5	99	68	I	
	1999.03-2003.07	-	-	L/R	F BUS Engine OM 611.980	635001	Inner Joint			30		36.2			
	1999.03-2003.07	-	-	L/R	F Box Engine OM 611.980	635001	Inner Joint			30		36.2			
	1999.03-2003.07	-	-	L/R	F BUS Engine OM 611.980	835002	Outer Joint	48W	27	36	71.5	99	68	I	
	1999.03-2003.07	-	-	L/R	F Box Engine OM 611.980	835002	Outer Joint	48W	27	36	71.5	99	68	I	
	1999.03-2003.07	-	-	L/R	F BUS Engine OM 611.980	235011	Drive Shaft		27		71.5	99	506		
	1999.03-2003.07	-	-	L/R	F Box Engine OM 611.980	235011	Drive Shaft		27		71.5	99	506		
2.3 (105 kW)	1996.12-2003.07	-	-	F	BUS Engine M 111.978	835007	Outer Joint		27	27	59.8	99	63	I	
	1996.12-2003.07	AT/MT	L/R	F	BUS Engine M 111.978	835001	Outer Joint	48W	27	27	59.8	99	63	I	
	1996.12-2003.07	AT/MT	L/R	F	BUS Engine M 111.978	235002	Drive Shaft	48W	27		59.8	99	531		
	1996.12-2003.07	-	-	L/R	F BUS Engine M 111.978	235016	Drive Shaft		27		59.8	99	531		
	1996.12-2003.07	AT/MT	L/R	F	BUS Engine M 111.978	648002	Inner Joint			28		32			





	YEAR	TRANSM	L/R	F/R	REMARKS	GSP Ref.	PRODUCT	ABS	Technical Specifications									
									A	B	C	H	L	P				
MERCEDES BENZ																		
VITO (638)																		
2.3 (105 kW)	1997.03-2003.07	-	-	F	Box Engine M 111.978	835007	Outer Joint		27	27	59.8	99	63	I				
	1997.03-2003.07	AT/MT	L/R	F	Box Engine M 111.978	835001	Outer Joint	48W	27	27	59.8	99	63	I				
	1997.03-2003.07	AT/MT	L/R	F	Box Engine M 111.978	235002	Drive Shaft	48W	27		59.8	99	531					
	1997.03-2003.07	-	L/R	F	Box Engine M 111.978	235016	Drive Shaft		27		59.8	99	531					
	1997.03-2003.07	AT/MT	L/R	F	Box Engine M 111.978	648002	Inner Joint			28		32						
2.3 (58 kW)	1996.02-2003.07	-	-	F	BUS Engine OM 601.942	835007	Outer Joint		27	27	59.8	99	63	I				
	1996.02-2003.07	AT/MT	L/R	F	BUS Engine OM 601.942	835001	Outer Joint	48W	27	27	59.8	99	63	I				
	1996.02-2003.07	AT/MT	L/R	F	BUS Engine OM 601.942	235002	Drive Shaft	48W	27		59.8	99	531					
	1996.02-2003.07	AT/MT	L/R	F	BUS Engine OM 601.942	648002	Inner Joint			28		32						
	1996.02-2003.07	-	L/R	F	BUS Engine OM 601.942	235016	Drive Shaft		27		59.8	99	531					
	1997.03-2003.07	-	-	F	Box Engine OM 601.942	835007	Outer Joint		27	27	59.8	99	63	I				
	1997.03-2003.07	AT/MT	L/R	F	Box Engine OM 601.942	835001	Outer Joint	48W	27	27	59.8	99	63	I				
	1997.03-2003.07	AT/MT	L/R	F	Box Engine OM 601.942	235002	Drive Shaft	48W	27		59.8	99	531					
	1997.03-2003.07	AT/MT	L/R	F	Box Engine OM 601.942	648002	Inner Joint			28		32						
2.3 (72 kW)	1997.03-2003.07	-	L/R	F	Box Engine OM 601.942	235016	Drive Shaft		27		59.8	99	531					
	1996.02-2003.07	-	-	F	BUS Engine OM 601.970	835007	Outer Joint		27	27	59.8	99	63	I				
	1996.02-2003.07	AT/MT	L/R	F	BUS Engine OM 601.970	835001	Outer Joint	48W	27	27	59.8	99	63	I				
	1996.02-2003.07	AT/MT	L/R	F	BUS Engine OM 601.970	235002	Drive Shaft	48W	27		59.8	99	531					
	1996.02-2003.07	-	L/R	F	BUS Engine OM 601.970	235016	Drive Shaft		27		59.8	99	531					
	1996.02-2003.07	AT/MT	L/R	F	BUS Engine OM 601.970	648002	Inner Joint			28		32						
	1997.03-2003.07	-	-	F	Box Engine OM 601.970	835007	Outer Joint		27	27	59.8	99	63	I				
	1997.03-2003.07	AT/MT	L/R	F	Box Engine OM 601.970	835001	Outer Joint	48W	27	27	59.8	99	63	I				
	1997.03-2003.07	AT/MT	L/R	F	Box Engine OM 601.970	235002	Drive Shaft	48W	27		59.8	99	531					
	1997.03-2003.07	AT/MT	L/R	F	Box Engine OM 601.970	648002	Inner Joint			28		32						
	1997.03-2003.07	-	L/R	F	Box Engine OM 601.970	235016	Drive Shaft		27		59.8	99	531					
VITO (W639)																		
1.1 CDI (65 kW)	2003.09-	-	MT	L/R	R	BUS Engine OM 646.983	235022	Drive Shaft		30	26	70	94.5	849				
	2003.09-	-	-	-	R	BUS Engine OM 646.983	835024	Outer Joint		30	36	70	94.5	68	I			
	2003.09-	-	MT	L/R	R	BUS Engine OM 646.983	635069	Inner Joint		26	37	45	83	96				
	2003.09-	-	MT	L/R	R	BUS Engine OM 646.983	699177	Inner Joint		26	28	45	83.5	78				
	2003.09-	-	-	-	R	BUS Engine OM 646.983	835036	Outer Joint		30	37	70	94.5	61	I			
	2003.09-	-	-	-	R	BUS Engine OM 646.983	835028	Outer Joint		30	36	70	95	68	I			
1.1 CDI (70 kW)	2006.09-	-	-	L/R	R	BUS Engine OM 646.980	235022	Drive Shaft		30	26	70	94.5	849				
	2006.09-	-	-	-	R	BUS Engine OM 646.980	835024	Outer Joint		30	36	70	94.5	68	I			
	2006.09-	-	MT	L/R	R	BUS Engine OM 646.980	635069	Inner Joint		26	37	45	83	96				
	2006.09-	-	-	-	R	BUS Engine OM 646.980	835036	Outer Joint		30	37	70	94.5	61	I			
	2006.09-	-	-	-	R	BUS Engine OM 646.980	235093	Drive Shaft		30	26	70	99.5	865				
	2006.09-	-	-	L/R	R	BUS Engine OM 646.980	699177	Inner Joint		26	28	45	83.5	78				
	2007.09-	-	-	L/R	R	All-wheel Drive BUS Engine OM 646.981	235022	Drive Shaft		30	26	70	94.5	849				
	2007.09-	-	-	L/R	F	All-wheel Drive BUS Engine OM 646.981	235084	Drive Shaft		30		66	96.5	652				
	2007.09-	-	-	-	R	All-wheel Drive BUS Engine OM 646.981	835024	Outer Joint		30	36	70	94.5	68	I			
	2007.09-	-	MT	L/R	R	All-wheel Drive BUS Engine OM 646.981	635069	Inner Joint		26	37	45	83	96				
	2007.09-	-	-	-	R	All-wheel Drive BUS Engine OM 646.981	835036	Outer Joint		30	37	70	94.5	61	I			
1.9 (140 kW)	2007.09-	-	-	L/R	R	All-wheel Drive BUS Engine OM 646.981	699177	Inner Joint		26	28	45	83.5	78				
	2003.09-	-	-	-	R	BUS Engine M 112.951	835069	Outer Joint		30	37	70	99.5	62.5	I			
	2003.09-	-	MT	L/R	R	BUS Engine M 112.951	635069	Inner Joint		26	37	45	83	96				
2.2 CDI (100 kW)	2003.09-	-	-	L/R	R	BUS Engine M 112.951	235093	Drive Shaft		30	26	70	99.5	865				
	2010.09-	-	-	L/R	R	BUS Engine OM 651.940	235022	Drive Shaft		30	26	70	94.5	849				
	2010.09-	-	-	-	R	BUS Engine OM 651.940	835024	Outer Joint		30	36	70	94.5	68	I			
	2010.09-	-	-	-	R	BUS Engine OM 651.940	835036	Outer Joint		30	37	70	94.5	61	I			
	2010.09-	-	-	L/R	R	BUS Engine OM 651.940	699177	Inner Joint		26	28	45	83.5	78				
2.2 CDI (110 kW)	2010.09-	-	-	L/R	R	BUS Engine OM 651.940	235093	Drive Shaft		30	26	70	99.5	865				
	2003.09-	-	-	-	R	BUS Engine OM 646.980/OM 646.982	835069	Outer Joint		30	37	70	99.5	62.5	I			
	2003.09-	-	-	-	R	BUS Engine OM 646.980/OM 646.982	835024	Outer Joint		30	36	70	94.5	68	I			
	2003.09-	-	MT	L/R	R	BUS Engine OM 646.980/OM 646.982	635069	Inner Joint		26	37	45	83	96				
	2003.09-	-	-	-	R	BUS Engine OM 646.980/OM 646.982	835036	Outer Joint		30	37	70	94.5	61	I			
	2003.09-	-	-	L/R	R	BUS Engine OM 646.980/OM 646.982	235093	Drive Shaft		30	26	70	99.5	865				
	2003.09-	-	-	-	R	BUS Engine OM 646.980/OM 646.982	835028	Outer Joint		30	36	70	95	68	I			
	2007.09-	-	-	L/R	R	All-wheel Drive BUS Engine OM 646.982	235022	Drive Shaft		30	26	70	94.5	849				
	2007.09-	-	-	L/R	F	All-wheel Drive BUS Engine OM 646.982	235084	Drive Shaft		30		66	96.5	652				
	2007.09-	-	MT	L/R	R	All-wheel Drive BUS Engine OM 646.982	635069	Inner Joint		26	37	45	83	96				
2007.09-	-	-	L/R	R	All-wheel Drive BUS Engine OM 646.982	699177	Inner Joint		26	28	45	83.5	78					
2.2 CDI (120 kW)	2007.09-	-	-	-	R	All-wheel Drive BUS Engine OM 646.982	835028	Outer Joint		30	36	70	95	68	I			
	2010.09-	-	-	L/R	R	BUS Engine OM 651.940	235022	Drive Shaft		30	26	70	94.5	849				
	2010.09-	-	-	-	R	BUS Engine OM 651.940	835024	Outer Joint		30	36	70	94.5	68	I			
	2010.09-	-	-	-	R	BUS Engine OM 651.940	835036	Outer Joint		30	37	70	94.5	61	I			





	 YEAR	TRANSM	L/R	F/R	REMARKS	GSP Ref.	 PRODUCT	 ABS	Technical Specifications					
									A	B	C	H	L	P
MERCEDES BENZ														
VITO (W639)														
2.2 CDI (120 kW)	2010.09-	-	-	L/R	R	BUS Engine OM 651.940	699177	Inner Joint	26	28	45	83.5	78	
	2010.09-	-	-	L/R	R	BUS Engine OM 651.940	235093	Drive Shaft	30	26	70	99.5	865	
2.2 CDI (70 kW)	2010.09-	-	-	L/R	R	BUS Engine OM 651.940	235022	Drive Shaft	30	26	70	94.5	849	
	2010.09-	-	-	-	R	BUS Engine OM 651.940	835024	Outer Joint	30	36	70	94.5	68	I
	2010.09-	-	-	-	R	BUS Engine OM 651.940	835036	Outer Joint	30	37	70	94.5	61	I
	2010.09-	-	-	L/R	R	BUS Engine OM 651.940	699177	Inner Joint	26	28	45	83.5	78	
2.2 CDI (80 kW)	2003.09-	-	AT/MT	L/R	R	BUS Engine OM 646.982	235022	Drive Shaft	30	26	70	94.5	849	
	2003.09-	-	-	-	R	BUS Engine OM 646.982	835024	Outer Joint	30	36	70	94.5	68	I
	2003.09-	-	MT	L/R	R	BUS Engine OM 646.982	635069	Inner Joint	26	37	45	83	96	
	2003.09-	-	-	-	R	BUS Engine OM 646.982	835036	Outer Joint	30	37	70	94.5	61	I
	2003.09-	-	AT/MT	L/R	R	BUS Engine OM 646.982	699177	Inner Joint	26	28	45	83.5	78	
	2003.09-	-	-	L/R	R	BUS Engine OM 646.982	235093	Drive Shaft	30	26	70	99.5	865	
	2003.09-	-	-	-	R	BUS Engine OM 646.982	835028	Outer Joint	30	36	70	95	68	I
	2007.09-	-	-	L/R	R	All-wheel Drive BUS Engine OM 646.982	235022	Drive Shaft	30	26	70	94.5	849	
	2007.09-	-	-	L/R	F	All-wheel Drive BUS Engine OM 646.982	235084	Drive Shaft	30		66	96.5	652	
	2007.09-	-	-	-	R	All-wheel Drive BUS Engine OM 646.982	835024	Outer Joint	30	36	70	94.5	68	I
	2007.09-	-	MT	L/R	R	All-wheel Drive BUS Engine OM 646.982	635069	Inner Joint	26	37	45	83	96	
	2007.09-	-	-	L/R	R	All-wheel Drive BUS Engine OM 646.982	699177	Inner Joint	26	28	45	83.5	78	
	2007.09-	-	-	-	R	All-wheel Drive BUS Engine OM 646.982	835036	Outer Joint	30	37	70	94.5	61	I
	2007.09-	-	-	-	R	All-wheel Drive BUS Engine OM 646.982	835028	Outer Joint	30	36	70	95	68	I
2.2 CDI (85 kW)	2007.09-	-	-	L/R	R	BUS Engine OM 646.980	235022	Drive Shaft	30	26	70	94.5	849	
	2007.09-	-	-	-	R	BUS Engine OM 646.980	835024	Outer Joint	30	36	70	94.5	68	I
	2007.09-	-	-	L/R	R	BUS Engine OM 646.980	235093	Drive Shaft	30	26	70	99.5	865	
	2007.09-	-	-	-	R	BUS Engine OM 646.980	835036	Outer Joint	30	37	70	94.5	61	I
	2007.09-	-	-	L/R	R	BUS Engine OM 646.980	699177	Inner Joint	26	28	45	83.5	78	
	2007.09-	-	-	-	R	BUS Engine OM 646.980	835028	Outer Joint	30	36	70	95	68	I
3.2 (160 kW)	2003.09-	-	-	-	R	BUS Engine M 112.951	835069	Outer Joint	30	37	70	99.5	62.5	I
	2003.09-	-	MT	L/R	R	BUS Engine M 112.951	635069	Inner Joint	26	37	45	83	96	
	2003.09-	-	-	L/R	R	BUS Engine M 112.951	235093	Drive Shaft	30	26	70	99.5	865	
3.8 (170 kW)	2004.06-	-	-	-	R	BUS Engine M 112.976	835069	Outer Joint	30	37	70	99.5	62.5	I
	2004.06-	-	MT	L/R	R	BUS Engine M 112.976	635069	Inner Joint	26	37	45	83	96	
	2004.06-	-	-	L/R	R	BUS Engine M 112.976	235093	Drive Shaft	30	26	70	99.5	865	
VITO/MIXTO (W639)														
119 (140 kW)	2003.09-	-	-	-	R	Box Engine M 112.951	835069	Outer Joint	30	37	70	99.5	62.5	I
	2003.09-	-	MT	L/R	R	Box Engine M 112.951	635069	Inner Joint	26	37	45	83	96	
	2003.09-	-	-	L/R	R	Box Engine M 112.951	235093	Drive Shaft	30	26	70	99.5	865	
2.2 (160 kW)	2003.09-	-	-	-	R	Box Engine M 112.951	835069	Outer Joint	30	37	70	99.5	62.5	I
	2003.09-	-	MT	L/R	R	Box Engine M 112.951	635069	Inner Joint	26	37	45	83	96	
	2003.09-	-	-	L/R	R	Box Engine M 112.951	235093	Drive Shaft	30	26	70	99.5	865	
2.2 CDI (100 kW)	2010.09-	-	-	L/R	R	Box Engine OM 651.940	235022	Drive Shaft	30	26	70	94.5	849	
	2010.09-	-	-	-	R	Box Engine OM 651.940	835024	Outer Joint	30	36	70	94.5	68	I
	2010.09-	-	-	-	R	Box Engine OM 651.940	835036	Outer Joint	30	37	70	94.5	61	I
	2010.09-	-	-	L/R	R	Box Engine OM 651.940	699177	Inner Joint	26	28	45	83.5	78	
	2010.09-	-	-	L/R	R	Box Engine OM 651.940	235093	Drive Shaft	30	26	70	99.5	865	
	2010.09-	-	-	-	R	Box Engine OM 651.940	835028	Outer Joint	30	36	70	95	68	I
2.2 CDI (110 kW)	2003.09-	-	-	-	R	Box Engine OM 646.980/OM 646.982	835069	Outer Joint	30	37	70	99.5	62.5	I
	2003.09-	-	-	-	R	Box Engine OM 646.980/OM 646.982	835024	Outer Joint	30	36	70	94.5	68	I
	2003.09-	-	-	-	R	Box Engine OM 646.980/OM 646.982	835036	Outer Joint	30	37	70	94.5	61	I
	2003.09-	-	-	L/R	R	Box Engine OM 646.980/OM 646.982	235093	Drive Shaft	30	26	70	99.5	865	
	2003.09-	-	MT	L/R	R	Box Engine OM 646.980/OM 646.982	635069	Inner Joint	26	37	45	83	96	
	2003.09-	-	-	-	R	Box Engine OM 646.980/OM 646.982	835028	Outer Joint	30	36	70	95	68	I
	2006.07-	-	-	L/R	R	All-wheel Drive Box Engine OM 646.982	235022	Drive Shaft	30	26	70	94.5	849	
	2006.07-	-	-	L/R	F	All-wheel Drive Box Engine OM 646.982	235084	Drive Shaft	30		66	96.5	652	
	2006.07-	-	-	-	R	All-wheel Drive Box Engine OM 646.982	835024	Outer Joint	30	36	70	94.5	68	I
	2006.07-	-	MT	L/R	R	All-wheel Drive Box Engine OM 646.982	635069	Inner Joint	26	37	45	83	96	
	2006.07-	-	-	L/R	R	All-wheel Drive Box Engine OM 646.982	699177	Inner Joint	26	28	45	83.5	78	
	2006.07-	-	-	-	R	All-wheel Drive Box Engine OM 646.982	835036	Outer Joint	30	37	70	94.5	61	I
2006.07-	-	-	-	R	All-wheel Drive Box Engine OM 646.982	835028	Outer Joint	30	36	70	95	68	I	
2.2 CDI (120 kW)	2010.09-	-	-	L/R	R	Box Engine OM 651.940	235022	Drive Shaft	30	26	70	94.5	849	
	2010.09-	-	-	-	R	Box Engine OM 651.940	835024	Outer Joint	30	36	70	94.5	68	I
	2010.09-	-	-	-	R	Box Engine OM 651.940	835036	Outer Joint	30	37	70	94.5	61	I
	2010.09-	-	-	L/R	R	Box Engine OM 651.940	699177	Inner Joint	26	28	45	83.5	78	
	2010.09-	-	-	L/R	R	Box Engine OM 651.940	235093	Drive Shaft	30	26	70	99.5	865	
2.2 CDI (65 kW)	2003.09-	-	MT	L/R	R	Box Engine OM 646.983	235022	Drive Shaft	30	26	70	94.5	849	
	2003.09-	-	-	-	R	Box Engine OM 646.983	835024	Outer Joint	30	36	70	94.5	68	I
	2003.09-	-	MT	L/R	R	Box Engine OM 646.983	699177	Inner Joint	26	28	45	83.5	78	
	2003.09-	-	-	-	R	Box Engine OM 646.983	835036	Outer Joint	30	37	70	94.5	61	I





YEAR	TRANSM	L/R	F/R	REMARKS	GSP Ref.	PRODUCT	ABS	Technical Specifications								
								A	B	C	H	L	P			
MERCEDES BENZ VITO/MIXTO (W639)																
2.2 CDI (65 kW)	2003.09-	-	MT	L/R	R	Box Engine OM 646.983	635069	Inner Joint	26	37	45	83	96			
	2003.09-	-	-	-	R	Box Engine OM 646.983	835028	Outer Joint	30	36	70	95	68	I		
2.2 CDI (70 kW)	2006.08-	-	-	L/R	R	Box Engine OM 646.981/OM 646.980	235022	Drive Shaft	30	26	70	94.5	849			
	2006.08-	-	-	-	R	Box Engine OM 646.981/OM 646.980	835024	Outer Joint	30	36	70	94.5	68	I		
	2006.08-	-	-	-	R	Box Engine OM 646.981/OM 646.980	835036	Outer Joint	30	37	70	94.5	61	I		
	2006.08-	-	-	L/R	R	Box Engine OM 646.981/OM 646.980	699177	Inner Joint	26	28	45	83.5	78			
	2010.09-	-	-	L/R	R	Box Engine OM 651.940	235022	Drive Shaft	30	26	70	94.5	849			
	2010.09-	-	-	-	R	Box Engine OM 651.940	835024	Outer Joint	30	36	70	94.5	68	I		
	2010.09-	-	-	-	R	Box Engine OM 651.940	835036	Outer Joint	30	37	70	94.5	61	I		
	2010.09-	-	-	L/R	R	Box Engine OM 651.940	699177	Inner Joint	26	28	45	83.5	78			
2.2 CDI (80 kW)	2003.09-	-	AT/MT	L/R	R	Box Engine OM 646.982	235022	Drive Shaft	30	26	70	94.5	849			
	2003.09-	-	-	-	R	Box Engine OM 646.982	835024	Outer Joint	30	36	70	94.5	68	I		
	2003.09-	-	-	-	R	Box Engine OM 646.982	835036	Outer Joint	30	37	70	94.5	61	I		
	2003.09-	-	AT/MT	L/R	R	Box Engine OM 646.982	699177	Inner Joint	26	28	45	83.5	78			
	2003.09-	-	-	L/R	R	Box Engine OM 646.982	235093	Drive Shaft	30	26	70	99.5	865			
	2003.09-	-	MT	L/R	R	Box Engine OM 646.982	635069	Inner Joint	26	37	45	83	96			
	2003.09-	-	-	-	R	Box Engine OM 646.982	835028	Outer Joint	30	36	70	95	68	I		
	2007.09-	-	-	L/R	R	All-wheel Drive Box Engine OM 646.982	235022	Drive Shaft	30	26	70	94.5	849			
	2007.09-	-	-	L/R	F	All-wheel Drive Box Engine OM 646.982	235084	Drive Shaft	30		66	96.5	652			
	2007.09-	-	-	-	R	All-wheel Drive Box Engine OM 646.982	835024	Outer Joint	30	36	70	94.5	68	I		
	2007.09-	-	-	L/R	R	All-wheel Drive Box Engine OM 646.982	699177	Inner Joint	26	28	45	83.5	78			
	2007.09-	-	-	-	R	All-wheel Drive Box Engine OM 646.982	835036	Outer Joint	30	37	70	94.5	61	I		
	2007.09-	-	-	MT	L/R	R	All-wheel Drive Box Engine OM 646.982	635069	Inner Joint	26	37	45	83	96		
	2007.09-	-	-	-	R	All-wheel Drive Box Engine OM 646.982	835028	Outer Joint	30	36	70	95	68	I		
	2.2 CDI (85 kW)	2007.09-	-	-	L/R	R	Box Engine OM 646.982/OM 646.980	235022	Drive Shaft	30	26	70	94.5	849		
		2007.09-	-	-	-	R	Box Engine OM 646.982/OM 646.980	835024	Outer Joint	30	36	70	94.5	68	I	
2007.09-		-	-	L/R	R	Box Engine OM 646.982/OM 646.980	699177	Inner Joint	26	28	45	83.5	78			
2007.09-		-	-	-	R	Box Engine OM 646.982/OM 646.980	835036	Outer Joint	30	37	70	94.5	61	I		
2007.09-		-	-	L/R	R	Box Engine OM 646.982/OM 646.980	235093	Drive Shaft	30	26	70	99.5	865			
2007.09-		-	-	-	-	Box Engine OM 646.982/OM 646.980	835028	Outer Joint	30	36	70	95	68	I		
MERCEDES BENZ (BBDC) GLK (X204)																
300 4-matic (180 kW)	2012.04-	-	AT	-	-	All-wheel Drive Closed Off-Road Vehicle Engine M 272.948	235044	Drive Shaft	30	27	71	56.5	551			
MERCURY COUGAR																
-	1989-	1997	-	-	-	-	899146	Outer Joint	28	32	55.9	95.5	64	I		
COUGAR (FWD)																
2.5	1999-	2000	-	-	-	-	818056	Outer Joint	27	32	54.3	91	62	I		
	1999-	2001	-	-	-	-	618067	Inner Joint	35	32	42	50	67.5			
LYNX/LN7																
-	1983.06-	1990	MT	L	-	-	218153	Drive Shaft	26	23	51	88.5	560			
MARINER																
-	2005-	2007	-	-	R	4WD	635047	Propshaft CV Joint			26		42			
	2005-	2007	AT	L	-	-	635034	Inner Joint	30	24	39	73.5	110.5			
2.5L L4	2009-	-	-	-	F	-	218521	Stub Axle	35	35			437			
	2010-	-	-	-	F	-	218521	Stub Axle	35	35			437			
	2011-	-	-	-	F	-	218521	Stub Axle	35	35			437			
3.0L V6	2009-	-	-	-	F	-	218521	Stub Axle	35	35			437			
	2010-	-	-	-	F	-	218521	Stub Axle	35	35			437			
	2011-	-	-	-	F	-	218521	Stub Axle	35	35			437			
MOUNTAINEER																
-	1995-	2001	-	R	-	-	218094	Drive Shaft	27	27	59.7	112	527.4			
	1995-	2001	-	-	F	-	618037	Inner Joint	27	34	35.55	117.3	76			
	1995-	2001	-	R	-	-	618038	Inner Joint	27	34	44	57.8	65.5			
	1995-	2001	-	L	-	Truck 4WD	218093	Drive Shaft	27	27	59.7	112	597.4			
	1997-	2001	-	-	F	-	818055	Outer Joint	27	34	59.7	112	80	I		
	2001-	2005	-	-	F	AWD/PROPELLER SHAFT	661100	Propshaft CV Joint			26		35			
2006-	2008	-	-	-	-	818267	Outer Joint	27	24	66.3	110	58.5	M			
MYSTIQUE																
2.5	1995-	2000	-	-	-	-	818056	Outer Joint	27	32	54.3	91	62	I		
	1995-	2000	-	-	-	-	618067	Inner Joint	35	32	42	50	67.5			
SABLE																
-	1986-	1993	-	-	-	6 Cyl	818041	Outer Joint	26	30	56	106	61	I		
	1994-	1999	-	-	-	-	818041	Outer Joint	26	30	56	106	61	I		





	 YEAR	TRANSM	L/R	F/R	REMARKS	GSP Ref.	 PRODUCT	 ABS	Technical Specifications						
									A	B	C	H	L	P	
MERCURY SABLE															
3.8	1986-1993	-	-	-	6 Cyl	818046	Outer Joint		26	32	55.9	105.5	64.5	I	
	1990-1993	-	-	-	6 Cyl	818085	Outer Joint	50T	26	32	55.9	105.5	64.5	I	
TOPAZ															
-	1984-1991	MT	L	-	-	218153	Drive Shaft		26	23	51	88.5	560		
	1984-1991	AT	L	-	-	218148	Drive Shaft		26	23	51	88.5	562		
	1984-	-	R	-	-	218081	Drive Shaft		26	23	51	88.5	892		
	1992-1994	-	-	-	4 Cyl	618026	Inner Joint		25	28	42	89.5	110		
	1992-1994	-	-	-	-	618027	Inner Joint		25	28	42	66.5	108.8		
2.3	1992-1994	-	-	-	-	818047	Outer Joint		26	28	51	107.5	58	I	
All Models	1984.01-1991.12	AT	-	-	-	818042	Outer Joint		26	23	51	88.5	60	I	
	1985.01-1991.12	MT	-	-	-	818042	Outer Joint		26	23	51	88.5	60	I	
	1986-1991	AT	-	-	-	818059	Outer Joint		26	24	51	88	62	I	
TRACER															
-	1991-1996	-	-	-	-	818048	Outer Joint		26	28	56	93	61	I	
	1991-1996	-	-	-	-	818079	Outer Joint	44T	26	28	56	93	61	I	
	1991-1996	-	-	-	-	618039	Inner Joint		24	28	35	64.1	91.5		
1.8	1991-1996	AT	-	-	-	618068	Inner Joint		24	28	35	63.9	89.5		
1.9	1991-1996	AT	-	-	-	618068	Inner Joint		24	28	35	63.9	89.5		
2.0	1997-1999	AT	-	-	-	618068	Inner Joint		24	28	35	63.9	89.5		
VILLAGER															
-	1993-1999	-	-	-	-	835017	Outer Joint	50T	32	34	62	117.5	71.5	I	
MG MAESTRO															
2.0 EFi (86 kW)	1984.10-1990.09	-	-	F	Hatchback Engine 20HE	851010	Outer Joint		25	22	50	82	56	I	
MG TF															
1.6 (85 kW)	2002.03-2009.12	-	-	-	Convertible Engine 16 K4F	899242	Outer Joint	42T	25	22	50	82	56	I	
	2002.03-2009.12	-	-	-	Convertible Engine 16 K4F	851010	Outer Joint		25	22	50	82	56	I	
	2002.03-2009.12	-	L	R	Convertible Engine 16 K4F	251035	Drive Shaft	42T	25	29	50	82	567.5		
1.8 (100 kW)	2002.03-2009.12	MT	-	R	Convertible Engine 18 K4F	899242	Outer Joint	42T	25	22	50	82	56	I	
	2002.03-2009.12	MT	L	R	Convertible Engine 18 K4F	251035	Drive Shaft	42T	25	29	50	82	567.5		
1.8 (118 kW)	2002.03-2009.12	MT	-	R	Convertible Engine 18 K4K	899242	Outer Joint	42T	25	22	50	82	56	I	
	2002.03-2009.12	MT	L	R	Convertible Engine 18 K4K	251035	Drive Shaft	42T	25	29	50	82	567.5		
1.8 (88 kW)	2002.03-2009.12	-	-	R	Convertible Engine 18 K4F	899242	Outer Joint	42T	25	22	50	82	56	I	
	2002.03-2009.12	-	-	R	Convertible Engine 18 K4F	851010	Outer Joint		25	22	50	82	56	I	
	2002.03-2009.12	-	L	R	Convertible Engine 18 K4F	251035	Drive Shaft	42T	25	29	50	82	567.5		
MG ZR															
1.4 (76 kW)	2001.06-2005.04	MT	-	F	Hatchback Engine 14 K4F	899209	Outer Joint	27T	26	22	49	78.8	55	I	
	2001.06-2005.04	MT	R	F	Hatchback Engine 14 K4F	251010	Drive Shaft		26	22	49	78.8	877		
	2001.06-2005.04	MT	L	F	Hatchback Engine 14 K4F	251021	Drive Shaft	43T	26	23	49	78.8	632		
	2001.06-2005.04	MT	L	F	Hatchback Engine 14 K4F	251001	Drive Shaft		26	22	49	78.8	642		
	2001.06-2005.04	MT	R	F	Hatchback Engine 14 K4F	251020	Drive Shaft	43T	26	23	49	78.8	903		
1.8 (118 kW)	2001.06-2005.04	-	-	F	Hatchback Engine 18 K4K	899209	Outer Joint	27T	26	22	49	78.8	55	I	
	2001.06-2005.04	AT	L	F	Hatchback Engine 18 K4K	251019	Drive Shaft	43T	26	23	49	78.8	630.5		
	2001.06-2005.04	AT	R	F	Hatchback Engine 18 K4K	251018	Drive Shaft	43T	26	23	49	78.8	887		
1.8 (86 kW)	2001.06-2005.04	-	-	F	Hatchback Engine 18 K4F	899209	Outer Joint	27T	26	22	49	78.8	55	I	
	2001.06-2005.04	CVT	L	F	Hatchback Engine 18 K4F	251019	Drive Shaft	43T	26	23	49	78.8	630.5		
	2001.06-2005.04	CVT	R	F	Hatchback Engine 18 K4F	251018	Drive Shaft	43T	26	23	49	78.8	887		
2.0 TD (74 kW)	2001.06-2005.04	-	-	F	Hatchback Engine 20 T2N	851007	Outer Joint	43T	26	32	49	78	68.5	I	
	2001.06-2005.04	-	-	F	Hatchback Engine 20 T2N	851005	Outer Joint		26	32	49	78	68.5	I	
	2001.06-2005.04	MT	L	F	Hatchback Engine 20 T2N	601002	Inner Joint		27	32	40	54	87		
	2001.06-2005.04	MT	L	F	Hatchback Engine 20 T2N	223057	Drive Shaft		26	27	49	79	585.5		
2.0 TD (83 kW)	2002.12-2005.04	-	-	F	Hatchback Engine 20 T2N	851007	Outer Joint	43T	26	32	49	78	68.5	I	
	2002.12-2005.04	-	-	F	Hatchback Engine 20 T2N	851005	Outer Joint		26	32	49	78	68.5	I	
	2002.12-2005.04	MT	L	F	Hatchback Engine 20 T2N	601002	Inner Joint		27	32	40	54	87		
	2002.12-2005.04	MT	L	F	Hatchback Engine 20 T2N	223057	Drive Shaft		26	27	49	79	585.5		
MG ZS															
2.0 TD (74 kW)	2004.01-2005.04	MT	-	F	Saloon Engine 20 T2N	851008	Outer Joint		26	32	55	78	68.5	I	
	2004.01-2005.10	MT	-	F	Hatchback Engine 20 T2N	851008	Outer Joint		26	32	55	78	68.5	I	
2.0 TD (83 kW)	2004.01-2005.04	MT	-	F	Saloon Engine 20 T2N	851008	Outer Joint		26	32	55	78	68.5	I	
	2004.01-2005.10	MT	-	F	Hatchback Engine 20 T2N	851008	Outer Joint		26	32	55	78	68.5	I	
MG ZT															
1.8 16V (88 kW)	2003.01-2005.07	-	-	F	Saloon Engine 18 K4F	851011	Outer Joint		28	23	57.8	83.5	62	M	
1.8 T 16V (118 kW)	2003.01-2005.07	-	-	F	Saloon Engine 18 K4G	899151	Outer Joint		28	24	57.8	83.5	62	M	
160 (118 kW)	2001.06-2005.07	-	-	F	Saloon Engine 25 K4F	899151	Outer Joint		28	24	57.8	83.5	62	M	
180 (130 kW)	2003.01-2005.07	-	-	F	Saloon Engine 25 K4F	899151	Outer Joint		28	24	57.8	83.5	62	M	





	 YEAR	TRANSM	L/R	F/R	REMARKS	GSP Ref.	 PRODUCT	 ABS	Technical Specifications								
									A	B	C	H	L	P			
MG																	
MG ZT																	
190 (140 kW)	2001.06-2005.07	-	-	F	Saloon Engine 25 K4F	899151	Outer Joint		28	24	57.8	83.5	62	M			
2.0 CDTi (85 kW)	2002.06-2003.09	-	-	F	Saloon Engine 204D2	899151	Outer Joint		28	24	57.8	83.5	62	M			
2.0 CDTi (96 kW)	2002.11-2005.07	-	-	F	Saloon Engine 204D2	899151	Outer Joint		28	24	57.8	83.5	62	M			
MG ZT- T																	
1.8 16V (88 kW)	2003.01-2005.07	-	-	F	Estate Engine 18 K4F	851011	Outer Joint		28	23	57.8	83.5	62	M			
1.8 T 16V (118 kW)	2003.01-2005.07	-	-	F	Estate Engine 18 K4G	899151	Outer Joint		28	24	57.8	83.5	62	M			
160 (118 kW)	2001.10-2005.07	-	-	F	Estate Engine 25 K4F	899151	Outer Joint		28	24	57.8	83.5	62	M			
180 (130 kW)	2003.01-2005.07	-	-	F	Estate Engine 25 K4F	899151	Outer Joint		28	24	57.8	83.5	62	M			
190 (140 kW)	2001.10-2005.07	-	-	F	Estate Engine 25 K4F	899151	Outer Joint		28	24	57.8	83.5	62	M			
2.0 CDTi (85 kW)	2002.06-2005.07	-	-	F	Estate Engine 204D2	899151	Outer Joint		28	24	57.8	83.5	62	M			
2.0 CDTi (96 kW)	2002.11-2005.07	-	-	F	Estate Engine 204D2	899151	Outer Joint		28	24	57.8	83.5	62	M			
MGF (RD)																	
1.8 i VVC (118 kW)	2001.10-2002.03	-	-	R	Convertible Engine 18 K4K	899242	Outer Joint	42T	25	22	50	82	56	I			
	2001.10-2002.03	-	-	R	Convertible Engine 18 K4K	851010	Outer Joint		25	22	50	82	56	I			
	2001.10-2002.03	-	L	R	Convertible Engine 18 K4K	251035	Drive Shaft	42T	25	29	50	82	567.5				
1.8 i 16V (88 kW)	1995.03-2002.03	-	-	-	Convertible Engine 18 K4F	899242	Outer Joint	42T	25	22	50	82	56	I			
	1995.03-2002.03	-	-	-	Convertible Engine 18 K4F	851010	Outer Joint		25	22	50	82	56	I			
	1995.03-2002.03	-	L	R	Convertible Engine 18 K4F	251035	Drive Shaft	42T	25	29	50	82	567.5				
1.8 i VVC (107 kW)	1995.03-2002.03	MT	-	R	Convertible Engine 18 K4K	899242	Outer Joint	42T	25	22	50	82	56	I			
	1995.03-2002.03	MT	L	R	Convertible Engine 18 K4K	251035	Drive Shaft	42T	25	29	50	82	567.5				
MONTEGO																	
2.0 EFi (86 kW)	1984.04-1990.09	MT	-	F	Saloon Engine 20HI	851010	Outer Joint		25	22	50	82	56	I			
2.0 Turbo (110 kW)	1984.10-1990.09	MT	-	F	Saloon Engine 20 HT	851010	Outer Joint		25	22	50	82	56	I			
MINI																	
MINI (R50 R53)																	
1.4 (55 kW)	2003.06-2006.09	MT	R	F	Hatchback Engine 1ND	201067	Drive Shaft		26	34	53.5	74	916				
	2003.06-2006.09	-	L	F	Hatchback Engine 1ND	638001	Inner Joint		34	23	40	54	97				
	2003.06-2006.09	MT	L/R	F	Hatchback Engine 1ND	838003	Outer Joint		26	23	53.5	74	63.5	M			
	2003.06-2006.09	-	L	F	Hatchback Engine 1ND	238001	Drive Shaft		26	34	53.5	74	590				
1.4 (65 kW)	2003.06-2006.09	-	L	F	Hatchback Engine 1ND-TV	238001	Drive Shaft		26	34	53.5	74	590				
	2003.06-2006.09	MT	R	F	Hatchback Engine 1ND-TV	201067	Drive Shaft		26	34	53.5	74	916				
	2003.06-2006.09	MT	L	F	Hatchback Engine 1ND-TV	838003	Outer Joint		26	23	53.5	74	63.5	M			
	2003.06-2006.09	-	L	F	Hatchback Engine 1ND-TV	638001	Inner Joint		34	23	40	54	97				
1.6 (120 kW)	2002.03-2006.09	MT	R	F	Hatchback Engine W11 B16 A	238002	Drive Shaft		26	34	53.5	74	917				
	2002.03-2006.09	MT	L	F	Hatchback Engine W11 B16 A	638001	Inner Joint		34	23	40	54	97				
	2002.03-2006.09	MT	L/R	F	Hatchback Engine W11 B16 A	838003	Outer Joint		26	23	53.5	74	63.5	M			
	2002.03-2006.09	MT	R	F	Hatchback Engine W11 B16 A	638002	Inner Joint		34	23	28.5	333	145				
	2002.03-2006.09	AT	L	F	Hatchback Engine W11 B16 A	205024	Drive Shaft		26	26	54	75.5	604				
	2002.03-2006.09	-	-	F	Hatchback Engine W11 B16 A	838001	Outer Joint		26	23	53.5	76	64	M			
	2002.03-2006.09	AT	L	F	Hatchback Engine W11 B16 A	605012	Inner Joint		26	32	40	65	93				
	2002.03-2006.09	MT	L	F	Hatchback Engine W11 B16 A	238001	Drive Shaft		26	34	53.5	74	590				
1.6 (125 kW)	2004.07-2006.09	MT	R	F	Hatchback Engine W11 B16 A	238002	Drive Shaft		26	34	53.5	74	917				
	2004.07-2006.09	MT	L	F	Hatchback Engine W11 B16 A	638001	Inner Joint		34	23	40	54	97				
	2004.07-2006.09	MT	L/R	F	Hatchback Engine W11 B16 A	838003	Outer Joint		26	23	53.5	74	63.5	M			
	2004.07-2006.09	MT	R	F	Hatchback Engine W11 B16 A	638002	Inner Joint		34	23	28.5	333	145				
	2004.07-2006.09	AT	L	F	Hatchback Engine W11 B16 A	205024	Drive Shaft		26	26	54	75.5	604				
	2004.07-2006.09	-	-	F	Hatchback Engine W11 B16 A	838001	Outer Joint		26	23	53.5	76	64	M			
	2004.07-2006.09	AT	L	F	Hatchback Engine W11 B16 A	605012	Inner Joint		26	32	40	65	93				
	2004.07-2006.09	MT	L	F	Hatchback Engine W11 B16 A	238001	Drive Shaft		26	34	53.5	74	590				
1.6 (155 kW)	2003.11-2006.09	-	R	F	Hatchback Engine W11 B16 A	238002	Drive Shaft		26	34	53.5	74	917				
	2003.11-2006.09	-	L	F	Hatchback Engine W11 B16 A	638001	Inner Joint		34	23	40	54	97				
	2003.11-2006.09	-	L/R	F	Hatchback Engine W11 B16 A	838003	Outer Joint		26	23	53.5	74	63.5	M			
	2003.11-2006.09	-	R	F	Hatchback Engine W11 B16 A	638002	Inner Joint		34	23	28.5	333	145				
	2003.11-2006.09	-	L	F	Hatchback Engine W11 B16 A	238001	Drive Shaft		26	34	53.5	74	590				
1.6 (66 kW)	2001.06-2006.09	MT	R	F	Hatchback Engine W10 B16 A	638004	Inner Joint		22	21	28.5	332	96				
	2001.06-2006.09	MT	L	F	Hatchback Engine W10 B16 A	605044	Inner Joint		33	22	34.9	58	106				
	2001.06-2006.09	MT	L/R	F	Hatchback Engine W10 B16 A	838002	Outer Joint		26	21	53.5	76	61	M			
	2001.06-2006.09	MT	R	F	Hatchback Engine W10 B16 A	605043	Inner Joint		33	22	34.8	380	115				
	2001.06-2006.09	MT	L/R	F	Hatchback Engine W10 B16 A	838003	Outer Joint		26	23	53.5	74	63.5	M			
	2001.06-2006.09	CVT	L	F	Hatchback Engine W10 B16 A	299288	Drive Shaft		26	23	53.5	76	617				
	2001.06-2006.09	CVT	R	F	Hatchback Engine W10 B16 A	201066	Drive Shaft		26	23	53.5	76	894				
	2001.06-2006.09	MT	L	F	Hatchback Engine W10 B16 A	805016	Outer Joint		26	22	53.5	76	56.5	M			
	2001.06-2006.09	MT	L	F	Hatchback Engine W10 B16 A	238005	Drive Shaft		26	22	53.5	76	616				
	2001.06-2006.09	MT	L	F	Hatchback Engine W10 B16 A	205026	Drive Shaft		26	33	53.5	76	591				
2001.06-2006.09	MT	R	F	Hatchback Engine W10 B16 A	205025	Drive Shaft		26	33	53.5	76	924					





	 YEAR	TRANSM	L/R	F/R	REMARKS	GSP Ref.	 PRODUCT	 ABS	Technical Specifications					
									A	B	C	H	L	P
MINI														
MINI (R50 R53)														
1.6 (66 kW)	2001.06-2006.09	MT	L	F	Hatchback Engine W10 B16 A	299285	Drive Shaft		26	22	53.5	76	616	
	2001.06-2006.09	MT	R	F	Hatchback Engine W10 B16 A	238003	Drive Shaft		26	22	53.5	76	886	
	2001.06-2006.09	MT	L	F	Hatchback Engine W10 B16 A	205053	Drive Shaft		26	33	53.5	76	588	
	2001.06-2006.09	MT	R	F	Hatchback Engine W10 B16 A	205054	Drive Shaft		26	33	53.5	76	921	
1.6 (85 kW)	2001.06-2006.09	MT	R	F	Hatchback Engine W10 B16 A	638004	Inner Joint		22	21	28.5	332	96	
	2001.06-2006.09	MT	L	F	Hatchback Engine W10 B16 A	605044	Inner Joint		33	22	34.9	58	106	
	2001.06-2006.09	MT	L/R	F	Hatchback Engine W10 B16 A	838002	Outer Joint		26	21	53.5	76	61	M
	2001.06-2006.09	MT	R	F	Hatchback Engine W10 B16 A	605043	Inner Joint		33	22	34.8	380	115	
	2001.06-2006.09	MT	L/R	F	Hatchback Engine W10 B16 A	838003	Outer Joint		26	23	53.5	74	63.5	M
	2001.06-2006.09	CVT	L	F	Hatchback Engine W10 B16 A	299288	Drive Shaft		26	23	53.5	76	617	
	2001.06-2006.09	CVT	R	F	Hatchback Engine W10 B16 A	201066	Drive Shaft		26	23	53.5	76	894	
	2001.06-2006.09	MT	L	F	Hatchback Engine W10 B16 A	805016	Outer Joint		26	22	53.5	76	56.5	M
	2001.06-2006.09	MT	L	F	Hatchback Engine W10 B16 A	238005	Drive Shaft		26	22	53.5	76	616	
	2001.06-2006.09	MT	L	F	Hatchback Engine W10 B16 A	205026	Drive Shaft		26	33	53.5	76	591	
	2001.06-2006.09	MT	R	F	Hatchback Engine W10 B16 A	205025	Drive Shaft		26	33	53.5	76	924	
	2001.06-2006.09	MT	L	F	Hatchback Engine W10 B16 A	299285	Drive Shaft		26	22	53.5	76	616	
	2001.06-2006.09	MT	R	F	Hatchback Engine W10 B16 A	238003	Drive Shaft		26	22	53.5	76	886	
	2001.06-2006.09	MT	L	F	Hatchback Engine W10 B16 A	205053	Drive Shaft		26	33	53.5	76	588	
2001.06-2006.09	MT	R	F	Hatchback Engine W10 B16 A	205054	Drive Shaft		26	33	53.5	76	921		
John Cooper Works (160 kW)	2006.03-2006.09	MT	R	F	Hatchback Engine W11 B16 A	238002	Drive Shaft		26	34	53.5	74	917	
	2006.03-2006.09	MT	L	F	Hatchback Engine W11 B16 A	638001	Inner Joint		34	23	40	54	97	
	2006.03-2006.09	MT	L/R	F	Hatchback Engine W11 B16 A	838003	Outer Joint		26	23	53.5	74	63.5	M
	2006.03-2006.09	MT	R	F	Hatchback Engine W11 B16 A	638002	Inner Joint		34	23	28.5	333	145	
	2006.03-2006.09	MT	L	F	Hatchback Engine W11 B16 A	238001	Drive Shaft		26	34	53.5	74	590	
S Works (149 kW)	2003.11-2005.06	-	L	F	Hatchback Engine W11 B16 A	238001	Drive Shaft		26	34	53.5	74	590	
	2003.11-2005.06	-	R	F	Hatchback Engine W11 B16 A	238002	Drive Shaft		26	34	53.5	74	917	
	2003.11-2005.06	-	L	F	Hatchback Engine W11 B16 A	638001	Inner Joint		34	23	40	54	97	
	2003.11-2005.06	-	L/R	F	Hatchback Engine W11 B16 A	838003	Outer Joint		26	23	53.5	74	63.5	M
	2003.11-2005.06	-	R	F	Hatchback Engine W11 B16 A	638002	Inner Joint		34	23	28.5	333	145	
MINI (R52)														
1.6 (125 kW)	2004.07-2007.11	MT	R	F	Convertible Engine W11 B16 A	238002	Drive Shaft		26	34	53.5	74	917	
	2004.07-2007.11	MT	L	F	Convertible Engine W11 B16 A	638001	Inner Joint		34	23	40	54	97	
	2004.07-2007.11	MT	L/R	F	Convertible Engine W11 B16 A	838003	Outer Joint		26	23	53.5	74	63.5	M
	2004.07-2007.11	MT	R	F	Convertible Engine W11 B16 A	638002	Inner Joint		34	23	28.5	333	145	
	2004.07-2007.11	AT	L	F	Convertible Engine W11 B16 A	205024	Drive Shaft		26	26	54	75.5	604	
	2004.07-2007.11	-	-	F	Convertible Engine W11 B16 A	838001	Outer Joint		26	23	53.5	76	64	M
	2004.07-2007.11	AT	L	F	Convertible Engine W11 B16 A	605012	Inner Joint		26	32	40	65	93	
	2004.07-2007.11	MT	L	F	Convertible Engine W11 B16 A	238001	Drive Shaft		26	34	53.5	74	590	
1.6 (66 kW)	2004.07-2007.11	MT	L	F	Convertible Engine W10 B16 A	605044	Inner Joint		33	22	34.9	58	106	
	2004.07-2007.11	MT	L/R	F	Convertible Engine W10 B16 A	838002	Outer Joint		26	21	53.5	76	61	M
	2004.07-2007.11	MT	R	F	Convertible Engine W10 B16 A	605043	Inner Joint		33	22	34.8	380	115	
	2004.07-2007.11	MT	L	F	Convertible Engine W10 B16 A	805016	Outer Joint		26	22	53.5	76	56.5	M
	2004.07-2007.11	-	L	F	Convertible Engine W10 B16 A	205026	Drive Shaft		26	33	53.5	76	591	
	2004.07-2007.11	-	R	F	Convertible Engine W10 B16 A	205025	Drive Shaft		26	33	53.5	76	924	
	2004.07-2007.11	MT	L	F	Convertible Engine W10 B16 A	205053	Drive Shaft		26	33	53.5	76	588	
	2004.07-2007.11	MT	R	F	Convertible Engine W10 B16 A	205054	Drive Shaft		26	33	53.5	76	921	
1.6 (85 kW)	2004.07-2007.11	MT	L	F	Convertible Engine W10 B16 A	605044	Inner Joint		33	22	34.9	58	106	
	2004.07-2007.11	MT	L/R	F	Convertible Engine W10 B16 A	838002	Outer Joint		26	21	53.5	76	61	M
	2004.07-2007.11	MT	R	F	Convertible Engine W10 B16 A	605043	Inner Joint		33	22	34.8	380	115	
	2004.07-2007.11	CVT	L	F	Convertible Engine W10 B16 A	299288	Drive Shaft		26	23	53.5	76	617	
	2004.07-2007.11	CVT	R	F	Convertible Engine W10 B16 A	201066	Drive Shaft		26	23	53.5	76	894	
	2004.07-2007.11	MT	L	F	Convertible Engine W10 B16 A	805016	Outer Joint		26	22	53.5	76	56.5	M
	2004.07-2007.11	-	L	F	Convertible Engine W10 B16 A	205026	Drive Shaft		26	33	53.5	76	591	
	2004.07-2007.11	-	R	F	Convertible Engine W10 B16 A	205025	Drive Shaft		26	33	53.5	76	924	
	2004.07-2007.11	MT	L	F	Convertible Engine W10 B16 A	205053	Drive Shaft		26	33	53.5	76	588	
	2004.07-2007.11	MT	R	F	Convertible Engine W10 B16 A	205054	Drive Shaft		26	33	53.5	76	921	
Cooper S (120 kW)	2004.07-2007.11	-	L	F	Convertible Engine W11 B16 A	238001	Drive Shaft		26	34	53.5	74	590	
	2004.07-2007.11	-	R	F	Convertible Engine W11 B16 A	238002	Drive Shaft		26	34	53.5	74	917	
	2004.07-2007.11	-	L	F	Convertible Engine W11 B16 A	638001	Inner Joint		34	23	40	54	97	
	2004.07-2007.11	-	L/R	F	Convertible Engine W11 B16 A	838003	Outer Joint		26	23	53.5	74	63.5	M
	2004.07-2007.11	-	R	F	Convertible Engine W11 B16 A	638002	Inner Joint		34	23	28.5	333	145	
John Cooper Works (155 kW)	2004.07-2007.11	-	L	F	Convertible Engine W11 B16 A	238001	Drive Shaft		26	34	53.5	74	590	
	2004.07-2007.11	-	R	F	Convertible Engine W11 B16 A	238002	Drive Shaft		26	34	53.5	74	917	
	2004.07-2007.11	-	L	F	Convertible Engine W11 B16 A	638001	Inner Joint		34	23	40	54	97	
	2004.07-2007.11	-	L/R	F	Convertible Engine W11 B16 A	838003	Outer Joint		26	23	53.5	74	63.5	M
	2004.07-2007.11	-	R	F	Convertible Engine W11 B16 A	638002	Inner Joint		34	23	28.5	333	145	

	 YEAR	TRANSM	L/R	F/R	REMARKS	GSP Ref.	 PRODUCT	 ABS	Technical Specifications					
									A	B	C	H	L	P
MINI														
MINI (R52)														
John Cooper Works (155 kW)	2004.07-2007.11	-	-	F	Convertible Engine W11 B16 A	838001	Outer Joint		26	23	53.5	76	64	M
MINI (R56)														
1.4 (55 kW)	2009.03-2010.03	-	-	F	Hatchback Engine N12 B14 A	805009	Outer Joint		26	24	54	75.5	65.5	M
	2009.03-2010.03	MT	L	F	Hatchback Engine N12 B14 A	205041	Drive Shaft		26	33	54	75.5	619	
	2009.03-2010.03	MT	R	F	Hatchback Engine N12 B14 A	205045	Drive Shaft		26	33	54	75.5	901	
1.4 (70 kW)	2006.11-2010.03	MT	L/R	F	Hatchback Engine N12 B14 A	838002	Outer Joint		26	21	53.5	76	61	M
	2006.11-2010.03	-	-	F	Hatchback Engine N12 B14 A	805009	Outer Joint		26	24	54	75.5	65.5	M
	2006.11-2010.03	MT	L	F	Hatchback Engine N12 B14 A	205041	Drive Shaft		26	33	54	75.5	619	
1.6 (55 kW)	2010.03-2013.11	-	-	F	Hatchback Engine N16 B16 A	805009	Outer Joint		26	24	54	75.5	65.5	M
	2010.03-2013.11	MT	L	F	Hatchback Engine N16 B16 A	205041	Drive Shaft		26	33	54	75.5	619	
	2010.03-2013.11	MT	R	F	Hatchback Engine N16 B16 A	205045	Drive Shaft		26	33	54	75.5	901	
1.6 (72 kW)	2010.03-2013.11	-	-	F	Hatchback Engine N16 B16 A	805009	Outer Joint		26	24	54	75.5	65.5	M
	2010.03-2013.11	MT	L	F	Hatchback Engine N16 B16 A	205041	Drive Shaft		26	33	54	75.5	619	
	2010.03-2013.11	MT	R	F	Hatchback Engine N16 B16 A	205045	Drive Shaft		26	33	54	75.5	901	
Cooper (85 kW)	2010.03-2013.11	MT	L	F	Hatchback Engine N16 B16 A	205041	Drive Shaft		26	33	54	75.5	619	
	2010.03-2013.11	MT	R	F	Hatchback Engine N16 B16 A	205045	Drive Shaft		26	33	54	75.5	901	
Cooper (88 kW)	2006.10-2012.02	AT	R	F	Hatchback Engine N12 B16 A	205086	Drive Shaft		26	26	54	75.5	877	
	2006.10-2012.02	-	L/R	F	Hatchback Engine N12 B16 A	838002	Outer Joint		26	21	53.5	76	61	M
	2006.10-2012.02	-	-	F	Hatchback Engine N12 B16 A	805009	Outer Joint		26	24	54	75.5	65.5	M
	2006.10-2012.02	AT	-	F	Hatchback Engine N12 B16 A	805008	Outer Joint		26	26	54	75.5	70	M
	2006.10-2012.02	AT	L	F	Hatchback Engine N12 B16 A	205024	Drive Shaft		26	26	54	75.5	604	
	2006.10-2012.02	AT	L	F	Hatchback Engine N12 B16 A	605012	Inner Joint		26	32	40	65	93	
	2006.10-2012.02	MT	L	F	Hatchback Engine N12 B16 A	205041	Drive Shaft		26	33	54	75.5	619	
	2006.10-2012.02	MT	R	F	Hatchback Engine N12 B16 A	205045	Drive Shaft		26	33	54	75.5	901	
Cooper (90 kW)	2009.09-2013.11	AT	R	F	Hatchback Engine N16 B16 A	205086	Drive Shaft		26	26	54	75.5	877	
	2009.09-2013.11	-	-	F	Hatchback Engine N16 B16 A	805009	Outer Joint		26	24	54	75.5	65.5	M
	2009.09-2013.11	AT	-	F	Hatchback Engine N16 B16 A	805008	Outer Joint		26	26	54	75.5	70	M
	2009.09-2013.11	AT	L	F	Hatchback Engine N16 B16 A	205024	Drive Shaft		26	26	54	75.5	604	
	2009.09-2013.11	AT	L	F	Hatchback Engine N16 B16 A	605012	Inner Joint		26	32	40	65	93	
	2009.09-2013.11	MT	L	F	Hatchback Engine N16 B16 A	205041	Drive Shaft		26	33	54	75.5	619	
	2009.09-2013.11	MT	R	F	Hatchback Engine N16 B16 A	205045	Drive Shaft		26	33	54	75.5	901	
Cooper D (80 kW)	2006.11-2010.09	MT	R	F	Hatchback Engine W16 D16	205071	Drive Shaft		26	34	54	75.5	918	
	2006.11-2010.09	-	-	F	Hatchback Engine W16 D16	805008	Outer Joint		26	26	54	75.5	70	M
	2006.11-2010.09	AT	L	F	Hatchback Engine W16 D16	205131	Drive Shaft		26	26	54	75.5	589	
	2006.11-2010.09	AT	L	F	Hatchback Engine W16 D16	605012	Inner Joint		26	32	40	65	93	
	2006.11-2010.09	AT	R	F	Hatchback Engine W16 D16	205130	Drive Shaft		26	26	54	75.5	895	
	2006.11-2010.09	MT	L	F	Hatchback Engine W16 D16	205063	Drive Shaft		26	34	54	75.5	590	
Cooper D (82 kW)	2010.06-2013.11	MT	L	F	Hatchback Engine N47 C16 A	205063	Drive Shaft		26	34	54	75.5	590	
	2010.06-2013.11	MT	R	F	Hatchback Engine N47 C16 A	205071	Drive Shaft		26	34	54	75.5	918	
	2010.06-2013.11	-	-	F	Hatchback Engine N47 C16 A	805008	Outer Joint		26	26	54	75.5	70	M
	2010.06-2013.11	AT	L	F	Hatchback Engine N47 C16 A	205131	Drive Shaft		26	26	54	75.5	589	
	2010.06-2013.11	AT	L	F	Hatchback Engine N47 C16 A	605012	Inner Joint		26	32	40	65	93	
	2010.06-2013.11	AT	R	F	Hatchback Engine N47 C16 A	205130	Drive Shaft		26	26	54	75.5	895	
	2011.02-2013.11	MT	R	F	Hatchback Engine N47 C20 A	205071	Drive Shaft		26	34	54	75.5	918	
	2011.02-2013.11	-	-	F	Hatchback Engine N47 C20 A	805008	Outer Joint		26	26	54	75.5	70	M
	2011.02-2013.11	AT	L	F	Hatchback Engine N47 C20 A	205131	Drive Shaft		26	26	54	75.5	589	
	2011.02-2013.11	AT	L	F	Hatchback Engine N47 C20 A	605012	Inner Joint		26	32	40	65	93	
	2011.02-2013.11	AT	R	F	Hatchback Engine N47 C20 A	205130	Drive Shaft		26	26	54	75.5	895	
	2011.02-2013.11	MT	L	F	Hatchback Engine N47 C20 A	205063	Drive Shaft		26	34	54	75.5	590	
Cooper S (120 kW)	2010.03-2013.11	MT	R	F	Hatchback Engine N18 B16 A	205071	Drive Shaft		26	34	54	75.5	918	
	2010.03-2013.11	-	-	F	Hatchback Engine N18 B16 A	805008	Outer Joint		26	26	54	75.5	70	M
	2010.03-2013.11	AT	L	F	Hatchback Engine N18 B16 A	205131	Drive Shaft		26	26	54	75.5	589	
	2010.03-2013.11	AT	L	F	Hatchback Engine N18 B16 A	605012	Inner Joint		26	32	40	65	93	
	2010.03-2013.11	AT	R	F	Hatchback Engine N18 B16 A	205130	Drive Shaft		26	26	54	75.5	895	
	2010.03-2013.11	MT	L	F	Hatchback Engine N18 B16 A	205063	Drive Shaft		26	34	54	75.5	590	
Cooper S (128 kW)	2006.10-2011.01	MT	R	F	Hatchback Engine N14 B16 A	205071	Drive Shaft		26	34	54	75.5	918	
	2006.10-2011.01	MT	L/R	F	Hatchback Engine N14 B16 A	838003	Outer Joint		26	23	53.5	74	63.5	M
	2006.10-2011.01	-	-	F	Hatchback Engine N14 B16 A	805008	Outer Joint		26	26	54	75.5	70	M
	2006.10-2011.01	AT	L	F	Hatchback Engine N14 B16 A	205131	Drive Shaft		26	26	54	75.5	589	
	2006.10-2011.01	AT	L	F	Hatchback Engine N14 B16 A	605012	Inner Joint		26	32	40	65	93	
	2006.10-2011.01	MT	L	F	Hatchback Engine N14 B16 A	205063	Drive Shaft		26	34	54	75.5	590	
Cooper S (135 kW)	2010.03-2013.11	MT	L	F	Hatchback Engine N18 B16 A	205063	Drive Shaft		26	34	54	75.5	590	
	2010.03-2013.11	MT	R	F	Hatchback Engine N18 B16 A	205071	Drive Shaft		26	34	54	75.5	918	
	2010.03-2013.11	-	-	F	Hatchback Engine N18 B16 A	805008	Outer Joint		26	26	54	75.5	70	M
	2010.03-2013.11	AT	L	F	Hatchback Engine N18 B16 A	205131	Drive Shaft		26	26	54	75.5	589	

	 YEAR	TRANSM	L/R	F/R	REMARKS	GSP Ref.	 PRODUCT	 ABS	Technical Specifications					
									A	B	C	H	L	P
MINI														
MINI (R56)														
Cooper S (135 kW)	2010.03-2013.11	AT	L	F	Hatchback Engine N18 B16 A	605012	Inner Joint		26	32	40	65	93	
	2010.03-2013.11	AT	R	F	Hatchback Engine N18 B16 A	205130	Drive Shaft		26	26	54	75.5	895	
Cooper S (147 kW)	2012.01-2013.11	MT	R	F	Hatchback Engine N18 B16 A	205071	Drive Shaft		26	34	54	75.5	918	
	2012.01-2013.11	-	-	F	Hatchback Engine N18 B16 A	805008	Outer Joint		26	26	54	75.5	70	M
	2012.01-2013.11	AT	L	F	Hatchback Engine N18 B16 A	205131	Drive Shaft		26	26	54	75.5	589	
	2012.01-2013.11	AT	L	F	Hatchback Engine N18 B16 A	605012	Inner Joint		26	32	40	65	93	
	2012.01-2013.11	AT	R	F	Hatchback Engine N18 B16 A	205130	Drive Shaft		26	26	54	75.5	895	
	2012.01-2013.11	MT	L	F	Hatchback Engine N18 B16 A	205063	Drive Shaft		26	34	54	75.5	590	
John Cooper Works (155 kW)	2007.11-2013.11	MT	R	F	Hatchback Engine N14 B16 C	205071	Drive Shaft		26	34	54	75.5	918	
	2007.11-2013.11	-	-	F	Hatchback Engine N14 B16 C	805008	Outer Joint		26	26	54	75.5	70	M
	2007.11-2013.11	AT	L	F	Hatchback Engine N14 B16 C	205131	Drive Shaft		26	26	54	75.5	589	
	2007.11-2013.11	AT	L	F	Hatchback Engine N14 B16 C	605012	Inner Joint		26	32	40	65	93	
	2007.11-2013.11	AT	R	F	Hatchback Engine N14 B16 C	205130	Drive Shaft		26	26	54	75.5	895	
John Cooper Works GP (160 kW)	2007.11-2013.11	MT	L	F	Hatchback Engine N14 B16 C	205063	Drive Shaft		26	34	54	75.5	590	
	2012.09-2013.11	MT	L	F	Hatchback Engine N18 B16 C	205063	Drive Shaft		26	34	54	75.5	590	
	2012.09-2013.11	MT	R	F	Hatchback Engine N18 B16 C	205071	Drive Shaft		26	34	54	75.5	918	
	2012.09-2013.11	MT	R	F	Hatchback Engine N18 B16 C	205071	Drive Shaft		26	34	54	75.5	918	
One D (66 kW)	2009.06-2010.07	MT	L	F	Hatchback Engine 9HZ (DV6TED4)	205063	Drive Shaft		26	34	54	75.5	590	
	2009.06-2010.07	MT	R	F	Hatchback Engine 9HZ (DV6TED4)	205071	Drive Shaft		26	34	54	75.5	918	
	2009.06-2010.07	-	-	F	Hatchback Engine 9HZ (DV6TED4)	805008	Outer Joint		26	26	54	75.5	70	M
	2010.07-2013.11	MT	R	F	Hatchback Engine N47 C16 A	205071	Drive Shaft		26	34	54	75.5	918	
	2010.07-2013.11	-	-	F	Hatchback Engine N47 C16 A	805008	Outer Joint		26	26	54	75.5	70	M
2010.07-2013.11	MT	L	F	Hatchback Engine N47 C16 A	205063	Drive Shaft		26	34	54	75.5	590		
MINI (R57)														
Cooper (85 kW)	2007.10-2010.06	AT	R	F	Convertible Engine N16 B16 A	205086	Drive Shaft		26	26	54	75.5	877	
	2007.10-2010.06	-	-	F	Convertible Engine N16 B16 A	805009	Outer Joint		26	24	54	75.5	65.5	M
	2007.10-2010.06	AT	L	F	Convertible Engine N16 B16 A	205024	Drive Shaft		26	26	54	75.5	604	
	2007.10-2010.06	AT	-	F	Convertible Engine N16 B16 A	805008	Outer Joint		26	26	54	75.5	70	M
	2007.10-2010.06	AT	L	F	Convertible Engine N16 B16 A	605012	Inner Joint		26	32	40	65	93	
	2007.10-2010.06	MT	L	F	Convertible Engine N16 B16 A	205041	Drive Shaft		26	33	54	75.5	619	
	2007.10-2010.06	MT	R	F	Convertible Engine N16 B16 A	205045	Drive Shaft		26	33	54	75.5	901	
Cooper (88 kW)	2007.10-2015.06	AT	R	F	Convertible Engine N12 B16 A	205086	Drive Shaft		26	26	54	75.5	877	
	2007.10-2015.06	-	-	F	Convertible Engine N12 B16 A	805009	Outer Joint		26	24	54	75.5	65.5	M
	2007.10-2015.06	AT	-	F	Convertible Engine N12 B16 A	805008	Outer Joint		26	26	54	75.5	70	M
	2007.10-2015.06	AT	L	F	Convertible Engine N12 B16 A	205024	Drive Shaft		26	26	54	75.5	604	
	2007.10-2015.06	AT	L	F	Convertible Engine N12 B16 A	605012	Inner Joint		26	32	40	65	93	
	2007.10-2015.06	MT	L	F	Convertible Engine N12 B16 A	205041	Drive Shaft		26	33	54	75.5	619	
	2007.10-2015.06	MT	R	F	Convertible Engine N12 B16 A	205045	Drive Shaft		26	33	54	75.5	901	
Cooper (90 kW)	2009.09-2015.06	AT	R	F	Convertible Engine N12 B16 A	205086	Drive Shaft		26	26	54	75.5	877	
	2009.09-2015.06	-	-	F	Convertible Engine N12 B16 A	805009	Outer Joint		26	24	54	75.5	65.5	M
	2009.09-2015.06	AT	-	F	Convertible Engine N12 B16 A	805008	Outer Joint		26	26	54	75.5	70	M
	2009.09-2015.06	AT	L	F	Convertible Engine N12 B16 A	205024	Drive Shaft		26	26	54	75.5	604	
	2009.09-2015.06	AT	L	F	Convertible Engine N12 B16 A	605012	Inner Joint		26	32	40	65	93	
	2009.09-2015.06	MT	L	F	Convertible Engine N12 B16 A	205041	Drive Shaft		26	33	54	75.5	619	
	2009.09-2015.06	MT	R	F	Convertible Engine N12 B16 A	205045	Drive Shaft		26	33	54	75.5	901	
Cooper S (128 kW)	2007.11-2010.07	MT	R	F	Convertible Engine N14 B16 A	205071	Drive Shaft		26	34	54	75.5	918	
	2007.11-2010.07	-	-	F	Convertible Engine N14 B16 A	805008	Outer Joint		26	26	54	75.5	70	M
	2007.11-2010.07	AT	L	F	Convertible Engine N14 B16 A	205131	Drive Shaft		26	26	54	75.5	589	
	2007.11-2010.07	AT	L	F	Convertible Engine N14 B16 A	605012	Inner Joint		26	32	40	65	93	
	2007.11-2010.07	MT	L	F	Convertible Engine N14 B16 A	205130	Drive Shaft		26	26	54	75.5	895	
Cooper S (135 kW)	2009.06-2015.06	MT	L	F	Convertible Engine N18 B16 A	205063	Drive Shaft		26	34	54	75.5	590	
	2009.06-2015.06	MT	R	F	Convertible Engine N18 B16 A	205071	Drive Shaft		26	34	54	75.5	918	
	2009.06-2015.06	-	-	F	Convertible Engine N18 B16 A	805008	Outer Joint		26	26	54	75.5	70	M
	2009.06-2015.06	AT	L	F	Convertible Engine N18 B16 A	205131	Drive Shaft		26	26	54	75.5	589	
	2009.06-2015.06	AT	L	F	Convertible Engine N18 B16 A	605012	Inner Joint		26	32	40	65	93	
	2009.06-2015.06	AT	R	F	Convertible Engine N18 B16 A	205130	Drive Shaft		26	26	54	75.5	895	
	2009.06-2015.06	MT	L	F	Convertible Engine N18 B16 A	205063	Drive Shaft		26	34	54	75.5	590	
	2009.06-2015.06	MT	R	F	Convertible Engine N18 B16 A	205071	Drive Shaft		26	34	54	75.5	918	
Cooper S (147 kW)	2009.06-2015.06	MT	R	F	Convertible Engine N18 B16 A	205071	Drive Shaft		26	34	54	75.5	918	
	2009.06-2015.06	-	-	F	Convertible Engine N18 B16 A	805008	Outer Joint		26	26	54	75.5	70	M
	2009.06-2015.06	AT	L	F	Convertible Engine N18 B16 A	205131	Drive Shaft		26	26	54	75.5	589	
	2009.06-2015.06	AT	L	F	Convertible Engine N18 B16 A	605012	Inner Joint		26	32	40	65	93	
	2009.06-2015.06	AT	R	F	Convertible Engine N18 B16 A	205130	Drive Shaft		26	26	54	75.5	895	
John Cooper Works (155 kW)	2009.06-2015.06	MT	L	F	Convertible Engine N18 B16 A	205063	Drive Shaft		26	34	54	75.5	590	
	2008.08-2015.05	MT	R	F	Convertible Engine N14 B16 C	205071	Drive Shaft		26	34	54	75.5	918	
	2008.08-2015.05	-	-	F	Convertible Engine N14 B16 C	805008	Outer Joint		26	26	54	75.5	70	M
	2008.08-2015.05	AT	L	F	Convertible Engine N14 B16 C	205131	Drive Shaft		26	26	54	75.5	589	
2008.08-2015.05	AT	L	F	Convertible Engine N14 B16 C	605012	Inner Joint		26	32	40	65	93		

	 YEAR	TRANSM	L/R	F/R	REMARKS	GSP Ref.	 PRODUCT	 ABS	Technical Specifications					
									A	B	C	H	L	P
MINI														
MINI (R57)														
John Cooper Works (155 kW)	2008.08-2015.05	AT	R	F	Convertible Engine N14 B16 C	205130	Drive Shaft		26	26	54	75.5	895	
	2008.08-2015.05	MT	L	F	Convertible Engine N14 B16 C	205063	Drive Shaft		26	34	54	75.5	590	
One (72 kW)	2009.09-2015.06	MT	L	F	Convertible Engine N16 B16 A	205041	Drive Shaft		26	33	54	75.5	619	
	2009.09-2015.06	MT	R	F	Convertible Engine N16 B16 A	205045	Drive Shaft		26	33	54	75.5	901	
MINI (R58)														
Cooper S (120 kW)	2010.12-2015.04	MT	R	F	Coupe Engine N18 B16 A	205071	Drive Shaft		26	34	54	75.5	918	
	2010.12-2015.04	MT	L	F	Coupe Engine N18 B16 A	205063	Drive Shaft		26	34	54	75.5	590	
Cooper S (135 kW)	2010.12-2015.04	MT	R	F	Coupe Engine N18 B16 A	205071	Drive Shaft		26	34	54	75.5	918	
	2010.12-2015.04	MT	L	F	Coupe Engine N18 B16 A	205063	Drive Shaft		26	34	54	75.5	590	
Cooper S (147 kW)	2010.12-2015.04	MT	R	F	Coupe Engine N18 B16 A	205071	Drive Shaft		26	34	54	75.5	918	
	2010.12-2015.04	MT	L	F	Coupe Engine N18 B16 A	205063	Drive Shaft		26	34	54	75.5	590	
Cooper SD (100 kW)	2010.12-2015.05	MT	R	F	Coupe Engine N47 C20 A	205071	Drive Shaft		26	34	54	75.5	918	
	2010.12-2015.05	MT	L	F	Coupe Engine N47 C20 A	205063	Drive Shaft		26	34	54	75.5	590	
Cooper SD (105 kW)	2010.12-2015.05	MT	R	F	Coupe Engine N47 C20 A	205071	Drive Shaft		26	34	54	75.5	918	
	2010.12-2015.05	MT	L	F	Coupe Engine N47 C20 A	205063	Drive Shaft		26	34	54	75.5	590	
John Cooper Works (155 kW)	2010.12-2015.05	MT	R	F	Coupe Engine N14 B16 C	205071	Drive Shaft		26	34	54	75.5	918	
	2010.12-2015.05	MT	L	F	Coupe Engine N14 B16 C	205063	Drive Shaft		26	34	54	75.5	590	
MINI CLUBMAN (R55)														
Cooper (85 kW)	2010.03-2014.06	-	-	F	Estate Engine N16 B16 A	805008	Outer Joint		26	26	54	75.5	70	M
Cooper (88 kW)	2007.10-2013.12	-	-	F	Estate Engine N16 B16 A	805008	Outer Joint		26	26	54	75.5	70	M
Cooper (90 kW)	2010.03-2014.06	-	-	F	Estate Engine N16 B16 A	805008	Outer Joint		26	26	54	75.5	70	M
Cooper D (80 kW)	2007.10-2010.02	MT	R	F	Estate Engine 9HZ (DV6TED4)	205071	Drive Shaft		26	34	54	75.5	918	
	2007.10-2010.02	-	-	F	Estate Engine 9HZ (DV6TED4)	805008	Outer Joint		26	26	54	75.5	70	M
	2007.10-2010.02	AT	L	F	Estate Engine 9HZ (DV6TED4)	205131	Drive Shaft		26	26	54	75.5	589	
	2007.10-2010.02	AT	L	F	Estate Engine 9HZ (DV6TED4)	605012	Inner Joint		26	32	40	65	93	
	2007.10-2010.02	MT	L	F	Estate Engine 9HZ (DV6TED4)	205063	Drive Shaft		26	34	54	75.5	590	
Cooper D (82 kW)	2010.03-2014.06	MT	L	F	Estate Engine N47 C16 A	205063	Drive Shaft		26	34	54	75.5	590	
	2010.03-2014.06	MT	R	F	Estate Engine N47 C16 A	205071	Drive Shaft		26	34	54	75.5	918	
	2010.03-2014.06	-	-	F	Estate Engine N47 C16 A	805008	Outer Joint		26	26	54	75.5	70	M
	2010.03-2014.06	AT	L	F	Estate Engine N47 C16 A	205131	Drive Shaft		26	26	54	75.5	589	
	2010.03-2014.06	AT	L	F	Estate Engine N47 C16 A	605012	Inner Joint		26	32	40	65	93	
	2011.02-2014.06	MT	R	F	Estate Engine N47 C20 A	205071	Drive Shaft		26	34	54	75.5	918	
	2011.02-2014.06	-	-	F	Estate Engine N47 C20 A	805008	Outer Joint		26	26	54	75.5	70	M
	2011.02-2014.06	AT	L	F	Estate Engine N47 C20 A	205131	Drive Shaft		26	26	54	75.5	589	
	2011.02-2014.06	AT	L	F	Estate Engine N47 C20 A	605012	Inner Joint		26	32	40	65	93	
	2011.02-2014.06	MT	L	F	Estate Engine N47 C20 A	205063	Drive Shaft		26	34	54	75.5	590	
Cooper S (120 kW)	2007.10-2010.02	MT	R	F	Estate Engine N14 B16 A	205071	Drive Shaft		26	34	54	75.5	918	
	2007.10-2010.02	-	-	F	Estate Engine N14 B16 A	805008	Outer Joint		26	26	54	75.5	70	M
	2007.10-2010.02	AT	L	F	Estate Engine N14 B16 A	205131	Drive Shaft		26	26	54	75.5	589	
	2007.10-2010.02	AT	L	F	Estate Engine N14 B16 A	605012	Inner Joint		26	32	40	65	93	
	2007.10-2010.02	AT	R	F	Estate Engine N14 B16 A	205130	Drive Shaft		26	26	54	75.5	895	
	2007.10-2010.02	MT	L	F	Estate Engine N14 B16 A	205063	Drive Shaft		26	34	54	75.5	590	
Cooper S (128 kW)	2007.10-2010.02	MT	R	F	Estate Engine N14 B16 A	205071	Drive Shaft		26	34	54	75.5	918	
	2007.10-2010.02	-	-	F	Estate Engine N14 B16 A	805008	Outer Joint		26	26	54	75.5	70	M
	2007.10-2010.02	AT	L	F	Estate Engine N14 B16 A	205131	Drive Shaft		26	26	54	75.5	589	
	2007.10-2010.02	AT	L	F	Estate Engine N14 B16 A	605012	Inner Joint		26	32	40	65	93	
	2007.10-2010.02	AT	R	F	Estate Engine N14 B16 A	205130	Drive Shaft		26	26	54	75.5	895	
	2007.10-2010.02	MT	L	F	Estate Engine N14 B16 A	205063	Drive Shaft		26	34	54	75.5	590	
Cooper S (135 kW)	2010.03-2014.06	MT	L	F	Estate Engine N18 B16 A	205063	Drive Shaft		26	34	54	75.5	590	
	2010.03-2014.06	MT	R	F	Estate Engine N18 B16 A	205071	Drive Shaft		26	34	54	75.5	918	
	2010.03-2014.06	-	-	F	Estate Engine N18 B16 A	805008	Outer Joint		26	26	54	75.5	70	M
	2010.03-2014.06	AT	L	F	Estate Engine N18 B16 A	205131	Drive Shaft		26	26	54	75.5	589	
	2010.03-2014.06	AT	L	F	Estate Engine N18 B16 A	605012	Inner Joint		26	32	40	65	93	
	2010.03-2014.06	AT	R	F	Estate Engine N18 B16 A	205130	Drive Shaft		26	26	54	75.5	895	
Cooper S (147 kW)	2010.03-2014.06	MT	R	F	Estate Engine N18 B16 A	205071	Drive Shaft		26	34	54	75.5	918	
	2010.03-2014.06	-	-	F	Estate Engine N18 B16 A	805008	Outer Joint		26	26	54	75.5	70	M
	2010.03-2014.06	AT	L	F	Estate Engine N18 B16 A	205131	Drive Shaft		26	26	54	75.5	589	
	2010.03-2014.06	AT	L	F	Estate Engine N18 B16 A	605012	Inner Joint		26	32	40	65	93	
	2010.03-2014.06	AT	R	F	Estate Engine N18 B16 A	205130	Drive Shaft		26	26	54	75.5	895	
	2010.03-2014.06	MT	L	F	Estate Engine N18 B16 A	205063	Drive Shaft		26	34	54	75.5	590	
Cooper SD (100 kW)	2011.02-2014.06	MT	R	F	Estate Engine N47 C20 A	205071	Drive Shaft		26	34	54	75.5	918	
	2011.02-2014.06	-	-	F	Estate Engine N47 C20 A	805008	Outer Joint		26	26	54	75.5	70	M
	2011.02-2014.06	AT	L	F	Estate Engine N47 C20 A	205131	Drive Shaft		26	26	54	75.5	589	
	2011.02-2014.06	AT	L	F	Estate Engine N47 C20 A	605012	Inner Joint		26	32	40	65	93	
	2011.02-2014.06	AT	R	F	Estate Engine N47 C20 A	205130	Drive Shaft		26	26	54	75.5	895	
	2011.02-2014.06	MT	L	F	Estate Engine N47 C20 A	205063	Drive Shaft		26	34	54	75.5	590	





	 YEAR	TRANSM	L/R	F/R	REMARKS	GSP Ref.	 PRODUCT	 ABS	Technical Specifications					
									A	B	C	H	L	P
MINI														
MINI CLUBMAN (R55)														
Cooper SD (105 kW)	2011.02-2014.06	MT	R	F	Estate Engine N47 C20 A	205071	Drive Shaft		26	34	54	75.5	918	
	2011.02-2014.06	-	-	F	Estate Engine N47 C20 A	805008	Outer Joint		26	26	54	75.5	70	M
	2011.02-2014.06	AT	L	F	Estate Engine N47 C20 A	205131	Drive Shaft		26	26	54	75.5	589	
	2011.02-2014.06	AT	L	F	Estate Engine N47 C20 A	605012	Inner Joint		26	32	40	65	93	
	2011.02-2014.06	MT	L	F	Estate Engine N47 C20 A	205063	Drive Shaft		26	34	54	75.5	590	
John Cooper Works (141 kW)	2008.10-2010.02	MT	L	F	Estate Engine N14 B16 A	205063	Drive Shaft		26	34	54	75.5	590	
	2008.10-2010.02	MT	R	F	Estate Engine N14 B16 A	205071	Drive Shaft		26	34	54	75.5	918	
	2008.10-2010.02	-	-	F	Estate Engine N14 B16 A	805008	Outer Joint		26	26	54	75.5	70	M
	2008.10-2010.02	AT	L	F	Estate Engine N14 B16 A	205131	Drive Shaft		26	26	54	75.5	589	
	2008.10-2010.02	AT	L	F	Estate Engine N14 B16 A	605012	Inner Joint		26	32	40	65	93	
John Cooper Works (155 kW)	2007.11-2014.06	MT	R	F	Estate Engine N14 B16 C	205071	Drive Shaft		26	34	54	75.5	918	
	2007.11-2014.06	MT	L	F	Estate Engine N14 B16 C	205063	Drive Shaft		26	34	54	75.5	590	
One (70 kW)	2009.03-2010.02	-	-	F	Estate Engine N12 B14 A	805009	Outer Joint		26	24	54	75.5	65.5	M
	2009.03-2010.02	MT	L	F	Estate Engine N12 B14 A	205041	Drive Shaft		26	33	54	75.5	619	
	2009.03-2010.02	-	R	F	Estate Engine N12 B14 A	205045	Drive Shaft		26	33	54	75.5	901	
One (72 kW)	2010.03-2014.06	-	-	F	Estate Engine N16 B16 A	805009	Outer Joint		26	24	54	75.5	65.5	M
	2010.03-2014.06	MT	L	F	Estate Engine N16 B16 A	205041	Drive Shaft		26	33	54	75.5	619	
	2010.03-2014.06	-	R	F	Estate Engine N16 B16 A	205045	Drive Shaft		26	33	54	75.5	901	
One D (66 kW)	2010.03-2014.06	MT	L	F	Estate Engine N47 C16 A	205063	Drive Shaft		26	34	54	75.5	590	
	2010.03-2014.06	MT	R	F	Estate Engine N47 C16 A	205071	Drive Shaft		26	34	54	75.5	918	
	2010.03-2014.06	-	-	F	Estate Engine N47 C16 A	805008	Outer Joint		26	26	54	75.5	70	M
MINI CLUBVAN (R55)														
Cooper (90 kW)	2012.12-2014.06	-	-	F	Box Body/Estate Engine N16 B16 A	805009	Outer Joint		26	24	54	75.5	65.5	M
	2012.12-2014.06	MT	L	F	Box Body/Estate Engine N16 B16 A	205041	Drive Shaft		26	33	54	75.5	619	
	2012.12-2014.06	-	R	F	Box Body/Estate Engine N16 B16 A	205045	Drive Shaft		26	33	54	75.5	901	
Cooper D (82 kW)	2012.12-2014.06	MT	L	F	Box Body/Estate Engine N47 C16 A	205063	Drive Shaft		26	34	54	75.5	590	
	2012.12-2014.06	MT	L	F	Box Body/Estate Engine N47 C20 A	205063	Drive Shaft		26	34	54	75.5	590	
	2012.12-2014.06	MT	R	F	Box Body/Estate Engine N47 C16 A	205071	Drive Shaft		26	34	54	75.5	918	
	2012.12-2014.06	MT	R	F	Box Body/Estate Engine N47 C20 A	205071	Drive Shaft		26	34	54	75.5	918	
	2012.12-2014.06	-	-	F	Box Body/Estate Engine N47 C16 A	805008	Outer Joint		26	26	54	75.5	70	M
	2012.12-2014.06	-	-	F	Box Body/Estate Engine N47 C20 A	805008	Outer Joint		26	26	54	75.5	70	M
	2012.12-2014.06	AT	L	F	Box Body/Estate Engine N47 C20 A	205131	Drive Shaft		26	26	54	75.5	589	
	2012.12-2014.06	AT	L	F	Box Body/Estate Engine N47 C20 A	605012	Inner Joint		26	32	40	65	93	
	2012.12-2014.06	AT	R	F	Box Body/Estate Engine N47 C20 A	205130	Drive Shaft		26	26	54	75.5	895	
One (72 kW)	2012.12-2014.06	-	-	F	Box Body/Estate Engine N16 B16 A	805009	Outer Joint		26	24	54	75.5	65.5	M
	2012.12-2014.06	MT	L	F	Box Body/Estate Engine N16 B16 A	205041	Drive Shaft		26	33	54	75.5	619	
	2012.12-2014.06	-	R	F	Box Body/Estate Engine N16 B16 A	205045	Drive Shaft		26	33	54	75.5	901	
MINI COUNTRYMAN (R60)/CROSSOVER														
Cooper (85 kW)	2010.01-2016.10	MT	L	F	Estate Engine N16 B16 A	205126	Drive Shaft		26	33	51.9	80	643	
	2010.01-2016.10	MT	R	F	Estate Engine N16 B16 A	205129	Drive Shaft		26	33	51.9	80	923	
Cooper (90 kW)	2010.01-2016.10	MT	L	F	Estate Engine N16 B16 A	205126	Drive Shaft		26	33	51.9	80	643	
	2010.01-2016.10	MT	R	F	Estate Engine N16 B16 A	205129	Drive Shaft		26	33	51.9	80	923	
	2010.01-2016.10	AT	-	F	Estate Engine N16 B16 A	838001	Outer Joint		26	23	53.5	76	64	M
Cooper ALL4 (90 kW)	2012.11-2016.10	-	L	R	All-wheel Drive Estate Engine N18 B16 A	205127	Drive Shaft		26	27	52	80	809	
	2012.11-2016.09	-	L	R	All-wheel Drive Estate Engine N16 B16 A	205127	Drive Shaft		26	27	52	80	809	
	2012.11-2016.10	MT	L	F	All-wheel Drive Estate Engine N18 B16 A	205132	Drive Shaft		26	34	52	80	622	
	2012.11-2016.09	MT	L	F	All-wheel Drive Estate Engine N16 B16 A	205132	Drive Shaft		26	34	52	80	622	
Cooper D (82 kW)	2010.01-2016.10	MT	L	F	Estate Engine N47 C20 A	205132	Drive Shaft		26	34	52	80	622	
	2010.01-2016.10	MT	L	F	Estate Engine N47 C16 A	205132	Drive Shaft		26	34	52	80	622	
	2010.01-2016.10	MT	R	F	Estate Engine N47 C20 A	205128	Drive Shaft		26	34	52	80	949	
	2010.01-2016.10	MT	R	F	Estate Engine N47 C16 A	205128	Drive Shaft		26	34	52	80	949	
Cooper D ALL4 (82 kW)	2010.01-2016.09	MT	L	F	All-wheel Drive Estate Engine N47 C16 A	205132	Drive Shaft		26	34	52	80	622	
	2010.01-2016.09	MT	R	F	All-wheel Drive Estate Engine N47 C16 A	205128	Drive Shaft		26	34	52	80	949	
	2010.07-2016.09	MT	L	R	All-wheel Drive Estate Engine N47 C20 A	205127	Drive Shaft		26	27	52	80	809	
	2010.07-2016.09	MT	L	F	All-wheel Drive Estate Engine N47 C20 A	205132	Drive Shaft		26	34	52	80	622	
	2010.07-2016.09	MT	R	F	All-wheel Drive Estate Engine N47 C20 A	205128	Drive Shaft		26	34	52	80	949	
Cooper S (135 kW)	2010.01-2016.10	MT	L	F	Estate Engine N18 B16 A	205132	Drive Shaft		26	34	52	80	622	
	2010.01-2016.10	MT	R	F	Estate Engine N18 B16 A	205128	Drive Shaft		26	34	52	80	949	
Cooper S (140 kW)	2010.01-2016.10	MT	L	F	Estate Engine N18 B16 A	205132	Drive Shaft		26	34	52	80	622	
	2010.01-2016.10	MT	R	F	Estate Engine N18 B16 A	205128	Drive Shaft		26	34	52	80	949	
Cooper S (147 kW)	2010.01-2016.10	MT	L	F	Estate Engine N18 B16 A	205132	Drive Shaft		26	34	52	80	622	
	2010.01-2016.10	MT	R	F	Estate Engine N18 B16 A	205128	Drive Shaft		26	34	52	80	949	
Cooper S ALL4 (120 kW)	2010.01-2016.10	AT/MT	L	R	All-wheel Drive Estate Engine N18 B16 A	205127	Drive Shaft		26	27	52	80	809	
	2010.01-2016.10	MT	L	F	All-wheel Drive Estate Engine N18 B16 A	205132	Drive Shaft		26	34	52	80	622	
	2010.01-2016.10	MT	R	F	All-wheel Drive Estate Engine N18 B16 A	205128	Drive Shaft		26	34	52	80	949	

	 YEAR	TRANSM	L/R	F/R	REMARKS	GSP Ref.	 PRODUCT	 ABS	Technical Specifications					
									A	B	C	H	L	P
MINI														
MINI COUNTRYMAN (R60)/CROSSOVER														
Cooper S ALL4 (135 kW)	2010.01-2016.10	MT	L	R	All-wheel Drive Estate Engine N14 B16 A	205127	Drive Shaft		26	27	52	80	809	
	2010.01-2016.10	MT	L	F	All-wheel Drive Estate Engine N14 B16 A	205132	Drive Shaft		26	34	52	80	622	
	2010.01-2016.10	MT	R	F	All-wheel Drive Estate Engine N14 B16 A	205128	Drive Shaft		26	34	52	80	949	
Cooper S ALL4 (140 kW)	2010.01-2016.10	MT	L	R	All-wheel Drive Estate Engine N18 B16 A	205127	Drive Shaft		26	27	52	80	809	
	2010.01-2016.10	MT	L	F	All-wheel Drive Estate Engine N18 B16 A	205132	Drive Shaft		26	34	52	80	622	
	2010.01-2016.10	MT	R	F	All-wheel Drive Estate Engine N18 B16 A	205128	Drive Shaft		26	34	52	80	949	
Cooper SD (105 kW)	2010.01-2016.10	MT	L	F	Estate Engine N47 C20 A	205132	Drive Shaft		26	34	52	80	622	
	2010.01-2016.10	MT	R	F	Estate Engine N47 C20 A	205128	Drive Shaft		26	34	52	80	949	
Cooper SD ALL4 (100 kW)	2010.01-2016.09	AT/MT	L	R	All-wheel Drive Estate Engine N47 C20 A	205127	Drive Shaft		26	27	52	80	809	
	2010.01-2016.09	MT	L	F	All-wheel Drive Estate Engine N47 C20 A	205132	Drive Shaft		26	34	52	80	622	
	2010.01-2016.09	MT	R	F	All-wheel Drive Estate Engine N47 C20 A	205128	Drive Shaft		26	34	52	80	949	
Cooper SD ALL4 (105 kW)	2010.01-2016.09	MT	L	F	All-wheel Drive Estate Engine N47 C20 A	205132	Drive Shaft		26	34	52	80	622	
	2010.01-2016.09	MT	R	F	All-wheel Drive Estate Engine N47 C20 A	205128	Drive Shaft		26	34	52	80	949	
John Cooper Works ALL4 (160 kW)	2011.04-2016.10	MT	L	F	All-wheel Drive Estate Engine N18 B16 A	205132	Drive Shaft		26	34	52	80	622	
One (72 kW)	2010.01-2016.09	MT	L	F	Estate Engine N16 B16 A	205126	Drive Shaft		26	33	51.9	80	643	
	2010.01-2016.09	MT	R	F	Estate Engine N16 B16 A	205129	Drive Shaft		26	33	51.9	80	923	
One D (66 kW)	2010.01-2016.10	MT	L	F	Estate Engine N47 C16 A	205132	Drive Shaft		26	34	52	80	622	
	2010.01-2016.10	MT	R	F	Estate Engine N47 C16 A	205128	Drive Shaft		26	34	52	80	949	
MINI PACEMAN (R61)														
Cooper (88 kW)	2012.04-2016.09	MT	L	F	Coupe Engine N16 B16 A	205126	Drive Shaft		26	33	51.9	80	643	
	2012.04-2016.09	MT	R	F	Coupe Engine N16 B16 A	205129	Drive Shaft		26	33	51.9	80	923	
Cooper (90 kW)	2012.04-2016.09	MT	L	F	Coupe Engine N16 B16 A	205126	Drive Shaft		26	33	51.9	80	643	
	2012.04-2016.09	MT	R	F	Coupe Engine N16 B16 A	205129	Drive Shaft		26	33	51.9	80	923	
Cooper ALL4 (90 kW)	2012.11-2016.09	-	L	R	All-wheel Drive Coupe Engine N18 B16 A	205127	Drive Shaft		26	27	52	80	809	
	2012.11-2016.09	MT	L	F	All-wheel Drive Coupe Engine N18 B16 A	205132	Drive Shaft		26	34	52	80	622	
	2013.02-2016.09	-	L	R	All-wheel Drive Coupe Engine N16 B16 A	205127	Drive Shaft		26	27	52	80	809	
	2013.02-2016.09	MT	L	F	All-wheel Drive Coupe Engine N16 B16 A	205132	Drive Shaft		26	34	52	80	622	
Cooper D (82 kW)	2012.04-2016.09	MT	L	F	Coupe Engine N47 C16 A	205132	Drive Shaft		26	34	52	80	622	
	2012.04-2016.09	MT	R	F	Coupe Engine N47 C16 A	205128	Drive Shaft		26	34	52	80	949	
Cooper D ALL4 (82 kW)	2012.04-2016.09	MT	L	F	All-wheel Drive Coupe Engine N47 C16 A	205132	Drive Shaft		26	34	52	80	622	
	2012.04-2016.09	MT	R	F	All-wheel Drive Coupe Engine N47 C16 A	205128	Drive Shaft		26	34	52	80	949	
Cooper S (135 kW)	2012.04-2016.09	MT	L	F	Coupe Engine N18 B16 A	205132	Drive Shaft		26	34	52	80	622	
	2012.04-2016.09	MT	R	F	Coupe Engine N18 B16 A	205128	Drive Shaft		26	34	52	80	949	
Cooper S (140 kW)	2012.04-2016.09	MT	L	F	Coupe Engine N18 B16 A	205132	Drive Shaft		26	34	52	80	622	
	2012.04-2016.09	MT	R	F	Coupe Engine N18 B16 A	205128	Drive Shaft		26	34	52	80	949	
Cooper S ALL4 (135 kW)	2012.03-2016.09	MT	L	R	All-wheel Drive Coupe Engine N18 B16 A	205127	Drive Shaft		26	27	52	80	809	
	2012.03-2016.09	MT	L	F	All-wheel Drive Coupe Engine N18 B16 A	205132	Drive Shaft		26	34	52	80	622	
	2012.03-2016.09	MT	R	F	All-wheel Drive Coupe Engine N18 B16 A	205128	Drive Shaft		26	34	52	80	949	
Cooper S ALL4 (140 kW)	2012.03-2016.09	-	L	R	All-wheel Drive Coupe Engine N18 B16 A	205127	Drive Shaft		26	27	52	80	809	
	2012.03-2016.09	MT	L	F	All-wheel Drive Coupe Engine N18 B16 A	205132	Drive Shaft		26	34	52	80	622	
Cooper SD (105 kW)	2012.03-2016.09	MT	L	F	Coupe Engine N47 C20 A	205132	Drive Shaft		26	34	52	80	622	
	2012.03-2016.09	MT	R	F	Coupe Engine N47 C20 A	205128	Drive Shaft		26	34	52	80	949	
Cooper SD ALL4 (105 kW)	2012.04-2016.09	MT	L	F	All-wheel Drive Coupe Engine N47 C20 A	205132	Drive Shaft		26	34	52	80	622	
	2012.04-2016.09	MT	R	F	All-wheel Drive Coupe Engine N47 C20 A	205128	Drive Shaft		26	34	52	80	949	
John Cooper Works (160 kW)	2012.09-2016.09	MT	L	F	All-wheel Drive Coupe Engine N18 B16 C	205132	Drive Shaft		26	34	52	80	622	
MINI Roadster (R59)														
Cooper (85 kW)	2011.01-2015.04	-	-	F	Convertible Engine N16 B16 A	805008	Outer Joint		26	26	54	75.5	70	M
	2011.01-2015.04	MT	L	F	Convertible Engine N16 B16 A	205041	Drive Shaft		26	33	54	75.5	619	
	2011.01-2015.04	MT	R	F	Convertible Engine N16 B16 A	205045	Drive Shaft		26	33	54	75.5	901	
Cooper (90 kW)	2011.01-2015.04	-	-	F	Convertible Engine N16 B16 A	805008	Outer Joint		26	26	54	75.5	70	M
	2011.01-2015.04	MT	L	F	Convertible Engine N16 B16 A	205041	Drive Shaft		26	33	54	75.5	619	
	2011.01-2015.04	MT	R	F	Convertible Engine N16 B16 A	205045	Drive Shaft		26	33	54	75.5	901	
Cooper S (120 kW)	2011.01-2015.04	MT	R	F	Convertible Engine N18 B16 A	205071	Drive Shaft		26	34	54	75.5	918	
	2011.01-2015.04	MT	L	F	Convertible Engine N18 B16 A	205063	Drive Shaft		26	34	54	75.5	590	
Cooper S (135 kW)	2011.01-2015.04	MT	R	F	Convertible Engine N18 B16 A	205071	Drive Shaft		26	34	54	75.5	918	
	2011.01-2015.04	MT	L	F	Convertible Engine N18 B16 A	205063	Drive Shaft		26	34	54	75.5	590	
Cooper S (147 kW)	2011.01-2015.04	MT	R	F	Convertible Engine N18 B16 A	205071	Drive Shaft		26	34	54	75.5	918	
	2011.01-2015.04	MT	L	F	Convertible Engine N18 B16 A	205063	Drive Shaft		26	34	54	75.5	590	
Cooper SD (100 kW)	2011.01-2015.04	MT	R	F	Convertible Engine N47 C20 A	205071	Drive Shaft		26	34	54	75.5	918	
	2011.01-2015.04	MT	L	F	Convertible Engine N47 C20 A	205063	Drive Shaft		26	34	54	75.5	590	
Cooper SD (105 kW)	2011.01-2015.04	MT	R	F	Convertible Engine N47 C20 A	205071	Drive Shaft		26	34	54	75.5	918	
	2011.01-2015.04	MT	L	F	Convertible Engine N47 C20 A	205063	Drive Shaft		26	34	54	75.5	590	
John Cooper Works (155 kW)	2011.05-2015.04	MT	R	F	Convertible Engine N14 B16 C	205071	Drive Shaft		26	34	54	75.5	918	
	2011.05-2015.04	MT	L	F	Convertible Engine N14 B16 C	205063	Drive Shaft		26	34	54	75.5	590	

YEAR	TRANSM	L/R	F/R	REMARKS	GSP Ref.	PRODUCT	ABS	Technical Specifications								
								A	B	C	H	L	P			
MITSUBISHI																
3.2	2002-2006	MT/AT	R	-	-	839127	Outer Joint	50T	30	36	66	98	67	M		
3000 GT (FWD)																
-	1991-1992	-	-	-	-	615006	Inner Joint		26	26	42	39.5	78.5			
3000 GT (Z1_A)/GTO																
3.0 i 24V (210 kW)	1992.06-1999.08	-	-	-	All-wheel Drive Coupe Engine 6G72 (DOHC 24V)	839037	Outer Joint		27	26	60	97	69	I		
	1992.06-1999.08	-	-	-	All-wheel Drive Coupe Engine 6G72 (DOHC 24V)	839077	Outer Joint	47T	27	26	60	97	69	I		
ALTIMA																
3.5	2013-	AT	L/R	-	-	841331	Outer Joint		32	26	56	102	65	I		
ASX (GA_W_)/RVR																
1.8 DI-D (110 kW)	2010.06-	-	-	F	Closed Off-Road Vehicle Engine 4N13	839137	Outer Joint		28	37	59.5	94.5	71.5	I		
	2010.06-	-	-	F	All-wheel Drive Closed Off-Road Vehicle Engine 4N13	839137	Outer Joint		28	37	59.5	94.5	71.5	I		
	2010.06-	MT	L	F	Closed Off-Road Vehicle Engine 4N13	251047	Drive Shaft		28	24	59.5	94.5	631			
	2010.06-	MT	L	F	All-wheel Drive Closed Off-Road Vehicle Engine 4N13	251047	Drive Shaft		28	24	59.5	94.5	631			
	2010.06-	MT	L	F	Closed Off-Road Vehicle Engine 4N13	659140	Inner Joint		24	36	50	67	116			
	2010.06-	MT	L	F	All-wheel Drive Closed Off-Road Vehicle Engine 4N13	659140	Inner Joint		24	36	50	67	116			
1.8 DI-D (85 kW)	2010.06-	-	-	F	Closed Off-Road Vehicle Engine 4N13	839137	Outer Joint		28	37	59.5	94.5	71.5	I		
	2010.06-	MT	L	F	Closed Off-Road Vehicle Engine 4N13	251047	Drive Shaft		28	24	59.5	94.5	631			
	2010.06-	MT	L	F	Closed Off-Road Vehicle Engine 4N13	659140	Inner Joint		24	36	50	67	116			
CARISMA (DA_)																
1.6 (66 kW)	1995.07-2006.06	MT/AT	L/R	F	Hatchback Engine 4G92 (SOHC 16V)	839098	Outer Joint		25	23	54	95	60	I		
	1995.07-2006.06	AT	L/R	F	Hatchback Engine 4G92 (SOHC 16V)	839024	Outer Joint	43T	25	23	54	95.5	64	M		
	1995.07-2006.06	-	-	F	Hatchback Engine 4G92 (SOHC 16V)	899230	Outer Joint	43T	25	29	54	95	60	O		
	1995.07-2006.06	-	-	F	Hatchback Engine 4G92 (SOHC 16V)	839021	Outer Joint		25	29	54	94.5	64.5	O		
	1995.07-2006.06	AT/MT	L/R	F	Hatchback Engine 4G92 (SOHC 16V)	839022	Outer Joint	43T	25	29	54	94.5	64.5	O		
	1996.09-2006.06	MT/AT	L/R	F	Saloon Engine 4G92 (SOHC 16V)	839098	Outer Joint		25	23	54	95	60	I		
	1996.09-2006.06	AT	L/R	F	Saloon Engine 4G92 (SOHC 16V)	839024	Outer Joint	43T	25	23	54	95.5	64	M		
	1996.09-2006.06	AT/MT	L/R	F	Saloon Engine 4G92 (SOHC 16V)	839022	Outer Joint	43T	25	29	54	94.5	64.5	O		
1.6 (70 kW)	1998.12-2006.06	MT/AT	L/R	F	Hatchback Engine 4G92 (SOHC 16V)	839098	Outer Joint		25	23	54	95	60	I		
	1998.12-2006.06	MT/AT	L/R	F	Saloon Engine 4G92 (SOHC 16V)	839098	Outer Joint		25	23	54	95	60	I		
	1998.12-2006.06	-	-	-	Saloon Engine 4G92 (SOHC 16V)	851014	Outer Joint		25	29	54	95	60	O		
	1998.12-2006.06	-	-	F	Saloon Engine 4G92 (SOHC 16V)	899230	Outer Joint	43T	25	29	54	95	60	O		
	1998.12-2006.06	-	-	F	Saloon Engine 4G92 (SOHC 16V)	839021	Outer Joint		25	29	54	94.5	64.5	O		
	1998.12-2006.06	AT/MT	L/R	F	Hatchback Engine 4G92 (SOHC 16V)	839022	Outer Joint	43T	25	29	54	94.5	64.5	O		
	1998.12-2006.06	AT/MT	L/R	F	Saloon Engine 4G92 (SOHC 16V)	839022	Outer Joint	43T	25	29	54	94.5	64.5	O		
	1998.12-2006.06	-	-	-	Saloon Engine 4G92 (SOHC 16V)	839070	Outer Joint	43T	25	29	54	95	60	O		
1.6 (73 kW)	1997.05-2006.06	MT/AT	L/R	F	Hatchback Engine 4G92 (SOHC 16V)	839098	Outer Joint		25	23	54	95	60	I		
	1997.05-2006.06	MT/AT	L/R	F	Saloon Engine 4G92 (SOHC 16V)	839098	Outer Joint		25	23	54	95	60	I		
	1997.05-2006.06	AT	L/R	F	Saloon Engine 4G92 (SOHC 16V)	839024	Outer Joint	43T	25	23	54	95.5	64	M		
	1997.05-2006.06	-	-	F	Hatchback Engine 4G92 (SOHC 16V)	899230	Outer Joint	43T	25	29	54	95	60	O		
	1997.05-2006.06	-	-	F	Hatchback Engine 4G92 (SOHC 16V)	839021	Outer Joint		25	29	54	94.5	64.5	O		
	1997.05-2006.06	AT/MT	L/R	F	Saloon Engine 4G92 (SOHC 16V)	839022	Outer Joint	43T	25	29	54	94.5	64.5	O		
	1997.05-2006.06	AT/MT	L/R	F	Hatchback Engine 4G92 (SOHC 16V)	839022	Outer Joint	43T	25	29	54	94.5	64.5	O		
1.6 (76 kW)	2000.09-2006.06	AT	L/R	F	Hatchback Engine 4G92 (SOHC 16V)	839024	Outer Joint	43T	25	23	54	95.5	64	M		
	2000.09-2006.06	AT	L/R	F	Saloon Engine 4G92 (SOHC 16V)	839024	Outer Joint	43T	25	23	54	95.5	64	M		
	2000.09-2006.06	-	-	F	Hatchback Engine 4G92 (SOHC 16V)	899230	Outer Joint	43T	25	29	54	95	60	O		
	2000.09-2006.06	-	-	F	Hatchback Engine 4G92 (SOHC 16V)	839021	Outer Joint		25	29	54	94.5	64.5	O		
	2000.09-2006.06	MT	L	F	Saloon Engine 4G92 (SOHC 16V)	239142	Drive Shaft	43T	25	25	54	95.5	618			
1.8 (85 kW)	1995.07-1997.07	-	-	F	Hatchback Engine 4G93 (SOHC 16V)	899230	Outer Joint	43T	25	29	54	95	60	O		
	1995.07-1997.07	AT	L/R	F	Hatchback Engine 4G93 (SOHC 16V)	839024	Outer Joint	43T	25	23	54	95.5	64	M		
	1995.07-1997.07	-	-	F	Hatchback Engine 4G93 (SOHC 16V)	839021	Outer Joint		25	29	54	94.5	64.5	O		
	1995.07-1997.07	AT/MT	L/R	F	Hatchback Engine 4G93 (SOHC 16V)	839022	Outer Joint	43T	25	29	54	94.5	64.5	O		
	1996.09-1997.09	-	-	-	Saloon Engine 4G93 (SOHC 16V)	851014	Outer Joint		25	29	54	95	60	O		
	1996.09-1997.09	AT	L/R	F	Saloon Engine 4G93 (SOHC 16V)	839024	Outer Joint	43T	25	23	54	95.5	64	M		
	1996.09-1997.09	-	-	F	Saloon Engine 4G93 (SOHC 16V)	899230	Outer Joint	43T	25	29	54	95	60	O		
	1996.09-1997.09	-	-	F	Saloon Engine 4G93 (SOHC 16V)	839021	Outer Joint		25	29	54	94.5	64.5	O		
	1996.09-1997.09	AT/MT	L/R	F	Saloon Engine 4G93 (SOHC 16V)	839022	Outer Joint	43T	25	29	54	94.5	64.5	O		
	1996.09-1997.09	-	-	-	Saloon Engine 4G93 (SOHC 16V)	839070	Outer Joint	43T	25	29	54	95	60	O		
1.8 16V GDI (92 kW)	1997.09-2006.06	MT/AT	L/R	F	Hatchback Engine 4G93 (GDI)	839098	Outer Joint		25	23	54	95	60	I		
	1997.09-2006.06	MT/AT	L/R	F	Saloon Engine 4G93 (GDI)	839098	Outer Joint		25	23	54	95	60	I		
	1997.09-2006.06	AT/MT	L/R	F	Hatchback Engine 4G93 (GDI)	839024	Outer Joint	43T	25	23	54	95.5	64	M		
	1997.09-2006.06	AT/MT	L/R	F	Saloon Engine 4G93 (GDI)	839024	Outer Joint	43T	25	23	54	95.5	64	M		
	1997.09-2006.06	-	-	F	Hatchback Engine 4G93 (GDI)	839021	Outer Joint		25	29	54	94.5	64.5	O		
	1997.09-2006.06	MT	L	F	Hatchback Engine 4G93 (GDI)	239142	Drive Shaft	43T	25	25	54	95.5	618			
	1997.09-2006.06	AT/MT	L/R	F	Hatchback Engine 4G93 (GDI)	839022	Outer Joint	43T	25	29	54	94.5	64.5	O		
	1997.09-2006.06	AT/MT	L/R	F	Saloon Engine 4G93 (GDI)	839022	Outer Joint	43T	25	29	54	94.5	64.5	O		
1.8 GDI (90 kW)	2000.10-2006.06	-	L/R	F	Hatchback Engine 4G93 (GDI)	839024	Outer Joint	43T	25	23	54	95.5	64	M		

YEAR	TRANS	L/R	F/R	REMARKS	GSP Ref.	PRODUCT	ABS	Technical Specifications							
								A	B	C	H	L	P		
MITSUBISHI															
CARISMA (DA_)															
1.8 GDI (90 kW)	2000.10-2006.06	-	L/R	F	Saloon Engine 4G93 (GDI)	839024	Outer Joint	43T	25	23	54	95.5	64	M	
	2000.10-2006.06	-	-	F	Hatchback Engine 4G93 (GDI)	839021	Outer Joint		25	29	54	94.5	64.5	O	
	2000.10-2006.06	-	-	F	Saloon Engine 4G93 (GDI)	839021	Outer Joint		25	29	54	94.5	64.5	O	
	2000.10-2006.06	MT	L	F	Hatchback Engine 4G93 (GDI)	239142	Drive Shaft	43T	25	25	54	95.5	618		
	2000.10-2006.06	MT	L	F	Saloon Engine 4G93 (GDI)	239142	Drive Shaft	43T	25	25	54	95.5	618		
1.8 MSX - 16V (103 kW)	1995.07-1997.07	-	R	F	Hatchback Engine 4G93 (DOHC 16V)	839022	Outer Joint	43T	25	29	54	94.5	64.5	O	
1.9 DI-D (75 kW)	2000.09-2006.06	-	L/R	F	Hatchback Engine F9Q1	839084	Outer Joint	43T	26	33	54	95	60	M	
	2000.09-2006.06	-	L/R	F	Saloon Engine F9Q1	839084	Outer Joint	43T	26	33	54	95	60	M	
	2000.09-2006.06	MT	R	F	Hatchback Engine F9Q1	262073	Drive Shaft	43T	26	26	54	95	960		
	2000.09-2006.06	MT	R	F	Saloon Engine F9Q1	262073	Drive Shaft	43T	26	26	54	95	960		
1.9 DI-D (85 kW)	2000.09-2006.06	-	L/R	F	Hatchback Engine F9Q2	839084	Outer Joint	43T	26	33	54	95	60	M	
	2000.09-2006.06	-	L/R	F	Saloon Engine F9Q2	839084	Outer Joint	43T	26	33	54	95	60	M	
	2000.09-2006.06	MT	R	F	Hatchback Engine F9Q2	262073	Drive Shaft	43T	26	26	54	95	960		
	2000.09-2006.06	MT	R	F	Saloon Engine F9Q2	262073	Drive Shaft	43T	26	26	54	95	960		
1.9 TD (66 kW)	1996.10-2000.09	-	-	-	Saloon Engine F8QT	851014	Outer Joint		25	29	54	95	60	O	
	1996.10-2000.09	-	-	F	Hatchback Engine F8QT	899230	Outer Joint	43T	25	29	54	95	60	O	
	1996.10-2000.09	-	-	F	Hatchback Engine F8QT	839021	Outer Joint		25	29	54	94.5	64.5	O	
	1996.10-2000.09	MT	L	F	Hatchback Engine F8QT	239142	Drive Shaft	43T	25	25	54	95.5	618		
	1996.10-2000.09	AT/MT	L/R	F	Hatchback Engine F8QT	839022	Outer Joint	43T	25	29	54	94.5	64.5	O	
	1996.10-2000.09	AT/MT	L/R	F	Saloon Engine F8QT	839022	Outer Joint	43T	25	29	54	94.5	64.5	O	
	1996.10-2000.09	-	-	-	Saloon Engine F8QT	839070	Outer Joint	43T	25	29	54	95	60	O	
2.0 16V GT EVO VI/VII (206 kW)	1999.11-2006.06	-	-	-	All-wheel Drive Saloon Engine 4G63 Turbo	839064	Outer Joint	43T	25	30	54	95	60.5	M	
CHARIOT (D05W)															
1.8	1984.01-1991.03	MT/AT	-	-	Engine G37B	809001	Outer Joint		25	22	50	96	57	M	
CHARIOT (N33W)															
2.0	1991.03-1997.10	MT/AT	-	-	Engine 4G63	839215	Outer Joint		25	30	54	96	59	M	
CHARIOT (N34W)															
2.4	1993.03-1997.10	AT	-	-	Engine 4G64	839215	Outer Joint		25	30	54	96	59	M	
CHARIOT (N43W)															
2.0 4WD	1991.05-1997.10	MT/AT	-	-	Engine 4G63	839215	Outer Joint		25	30	54	96	59	M	
CHARIOT (N44W)															
2.4 4WD	1993.03-1997.10	AT	-	-	Engine 4G64	839215	Outer Joint		25	30	54	96	59	M	
CHARIOT GRANDIS (N96W)															
3.0 4WD	1999.10-	4AT	-	-	Engine 6G72	839228	Outer Joint	43T	27	32	60	97	68.5	I	
CHARIOT N33W															
2.0	1991.03-1996.04	MT/AT	-	-	Engine 4G63	839215	Outer Joint		25	30	54	96	59	M	
	1991.05-1992.05	MT/AT	-	-	Engine 4G63	839215	Outer Joint		25	30	54	96	59	M	
	1992.05-1994.04	MT/AT	-	-	Engine 4G63	839215	Outer Joint		25	30	54	96	59	M	
	1992.06-1997.10	MT/AT	-	-	Engine 4G63	839215	Outer Joint		25	30	54	96	59	M	
	1993.08-1996.04	MT/AT	-	-	Engine 4G63	839215	Outer Joint		25	30	54	96	59	M	
	1994.05-1997.10	MT/AT	-	-	Engine 4G63	839215	Outer Joint		25	30	54	96	59	M	
	1994.09-1996.04	MT/AT	-	-	Engine 4G63	839215	Outer Joint		25	30	54	96	59	M	
2000	1991.03-1996.04	MT/AT	-	-	Engine 4G63	839215	Outer Joint		25	30	54	96	59	M	
	1991.05-1992.05	MT/AT	-	-	Engine 4G63	839215	Outer Joint		25	30	54	96	59	M	
	1992.05-1994.04	MT/AT	-	-	Engine 4G63	839215	Outer Joint		25	30	54	96	59	M	
	1992.06-1997.10	MT/AT	-	-	Engine 4G63	839215	Outer Joint		25	30	54	96	59	M	
	1993.08-1996.04	MT/AT	-	-	Engine 4G63	839215	Outer Joint		25	30	54	96	59	M	
	1994.05-1997.10	MT/AT	-	-	Engine 4G63	839215	Outer Joint		25	30	54	96	59	M	
	1994.09-1996.04	MT/AT	-	-	Engine 4G63	839215	Outer Joint		25	30	54	96	59	M	
CHARIOT N34W															
2.4	1993.03-1997.10	4AT	-	-	Engine 4G64	839215	Outer Joint		25	30	54	96	59	M	
2400	1993.03-1997.10	4AT	-	-	Engine 4G64	839215	Outer Joint		25	30	54	96	59	M	
CHARIOT N43W															
2.0	1991.05-1992.04	MT/AT	-	-	Allwheel Drive Engine 4G63	839215	Outer Joint		25	30	54	96	59	M	
	1991.05-1992.05	MT/AT	-	-	Allwheel Drive Engine 4G63	839215	Outer Joint		25	30	54	96	59	M	
	1992.04-1996.04	MT/AT	-	-	Allwheel Drive Engine 4G63	839215	Outer Joint		25	30	54	96	59	M	
	1992.06-1997.10	MT/AT	-	-	Allwheel Drive Engine 4G63	839215	Outer Joint		25	30	54	96	59	M	
	1992.06-1997.10	MT/AT	-	-	Allwheel Drive Engine 4G63	839215	Outer Joint		25	30	54	96	59	M	
2000	1991.05-1992.04	MT/AT	-	-	Allwheel Drive Engine 4G63	839215	Outer Joint		25	30	54	96	59	M	
	1991.05-1992.05	MT/AT	-	-	Allwheel Drive Engine 4G63	839215	Outer Joint		25	30	54	96	59	M	
	1992.04-1996.04	MT/AT	-	-	Allwheel Drive Engine 4G63	839215	Outer Joint		25	30	54	96	59	M	
	1992.06-1997.10	MT/AT	-	-	Allwheel Drive Engine 4G63	839215	Outer Joint		25	30	54	96	59	M	
	1992.06-1997.10	MT/AT	-	-	Allwheel Drive Engine 4G63	839215	Outer Joint		25	30	54	96	59	M	
CHARIOT N44W															
2.4	1993.03-1997.10	4AT	-	-	Allwheel Drive Engine 4G64	839215	Outer Joint		25	30	54	96	59	M	
	1993.08-1996.04	AT	-	-	Allwheel Drive Engine 4G64	839215	Outer Joint		25	30	54	96	59	M	

	YEAR		TRANSM	L/R	F/R	REMARKS	GSP Ref.	PRODUCT	ABS	Technical Specifications						
	A	B								C	H	L	P			
MITSUBISHI CHARIOT N44W																
2400	1993.03-1997.10	4AT	-	-	Allwheel Drive Engine 4G64	839215	Outer Joint		25	30	54	96	59	M		
	1993.08-1996.04	AT	-	-	Allwheel Drive Engine 4G64	839215	Outer Joint		25	30	54	96	59	M		
CHARIOT(D03W)																
1.8	1983.01-1991.03	AT/MT	L	-	Engine G62B	639002	Inner Joint		25	23	35	62.8	95.5			
	1983.01-1991.03	AT/MT	L	-	Engine G62B	639002	Inner Joint		25	23	35	62.8	95.5			
CHARIOT(D09W)																
1.8	1983.01-1991.03	MT	R	-	Engine DIESEL/(WAGON)	639002	Inner Joint		25	23	35	62.8	95.5			
	1983.01-1991.03	MT	R	-	Engine DIESEL/(WAGON)	639002	Inner Joint		25	23	35	62.8	95.5			
	1983.01-1991.03	MT	R	-	Engine DIESEL/(WAGON)	639002	Inner Joint		25	23	35	62.8	95.5			
COLT (Z23A)																
1.5	2004.09-	MT/CVT	-	-	Engine 4A91	839221	Outer Joint		25	29	55	97	57	I		
	2005.10-2006.10	MT/CVT	-	-	Engine 4A91	839236	Outer Joint		25	30	52.5	96.5	58	M		
COLT (Z24A)																
1.5 4WD	2004.08-	MT/CVT	-	-	Engine 4A91	839236	Outer Joint		25	30	52.5	96.5	58	M		
COLT (Z25A)																
1.3	2002.10-	CVT	-	-	Engine 4G19	839221	Outer Joint		25	29	55	97	57	I		
COLT (Z27A)																
1.5	2002.10-	CVT	-	-	Engine 4G15	839221	Outer Joint		25	29	55	97	57	I		
COLT CZC (RG)																
1.5 (80 kW)	2006.05-2009.07	AT	-	F	Convertible Engine 4A91	839177	Outer Joint		25	21	55	97	57	M		
1.5 Turbo (110 kW)	2006.05-2009.07	AT	-	F	Convertible Engine 4G15T	839177	Outer Joint		25	21	55	97	57	M		
	2006.05-2009.07	-	-	F	Convertible Engine 4G15T	839103	Outer Joint		25	23	54	98	59	M		
COLT III (C5_A)																
1.3 (51 kW)	1988.04-1992.05	AT/MT	L/R	F	Hatchback Engine 4G13 (8V)	809004	Outer Joint		25	22	50	95	58	M		
	1988.04-1992.05	-	-	-	Hatchback Engine 4G13 (8V)	824003	Outer Joint		25	22	50	95	58	I		
1.3 12V (55 kW)	1988.04-1992.05	AT/MT	L/R	F	Hatchback Engine 4G13 (12V)	809004	Outer Joint		25	22	50	95	58	M		
	1988.04-1992.05	-	-	-	Hatchback Engine 4G13 (12V)	824003	Outer Joint		25	22	50	95	58	I		
1.3 GL (44 kW)	1988.04-1990.12	AT/MT	L/R	F	Hatchback Engine 4G13 (8V)	809004	Outer Joint		25	22	50	95	58	M		
	1988.04-1990.12	-	-	-	Hatchback Engine 4G13 (8V)	824003	Outer Joint		25	22	50	95	58	I		
1.3 GL(44kW)	1988.01-1990.01	-	R	F	Hatchback	801443	Outer Joint		25	29	50	96	57	M		
1.3(51kW)	1988.01-1992.01	-	R	F	Hatchback	801443	Outer Joint		25	29	50	96	57	M		
1.5 Cat (66 kW)	1990.07-1992.05	AT/MT	L/R	F	Hatchback Engine 4G15 (12V)	809004	Outer Joint		25	22	50	95	58	M		
	1990.07-1992.05	-	-	-	Hatchback Engine 4G15 (12V)	824003	Outer Joint		25	22	50	95	58	I		
1.5 GLXi (62 kW)	1988.04-1992.05	AT/MT	L/R	F	Hatchback Engine 4G15 (8V)	809004	Outer Joint		25	22	50	95	58	M		
	1988.04-1992.05	-	-	-	Hatchback Engine 4G15 (8V)	824003	Outer Joint		25	22	50	95	58	I		
1.5(66kW)	1990.01-1992.01	-	R	F	Hatchback	801443	Outer Joint		25	29	50	96	57	M		
1.6 GTi 16V (91 kW)	1988.04-1990.05	MT	R	F	Hatchback Engine 4G61	839054	Outer Joint		25	23	50	96	59	M		
	1988.04-1990.05	MT	-	F	Hatchback Engine 4G61	839014	Outer Joint		25	30	50	95	60.5	M		
	1988.04-1990.05	-	L	F	Hatchback Engine 4G61	824009	Outer Joint		25	30	50	95	56.5	M		
	1988.04-1990.05	MT	-	F	Hatchback Engine 4G61	809002	Outer Joint		25	23	50	94.5	63.5	M		
1.8 GTi 16V Cat (100 kW)	1990.06-1992.05	MT	-	F	Hatchback Engine 4G67	809002	Outer Joint		25	23	50	94.5	63.5	M		
	1990.06-1992.05	MT	-	F	Hatchback Engine 4G67	839014	Outer Joint		25	30	50	95	60.5	M		
	1990.06-1992.05	MT	-	-	Hatchback Engine 4G67	639005	Inner Joint		25	30	35	62.8	92.5			
	1990.06-1992.05	-	-	F	Hatchback Engine 4G67	824009	Outer Joint		25	30	50	95	56.5	M		
COLT IV																
1.3	1992.04-1996.03	MT	-	F	-	839085	Outer Joint		25	22	54	96	60	M		
COLT IV (CAA)																
1.6 16V (73 kW)	1992.04-1996.04	MT/AT	-	-	-	839099	Outer Joint		25	30	54	95	60	I		
1.6 16V (84 kW)	1992.04-1996.04	MT/AT	-	-	-	839099	Outer Joint		25	30	54	95	60	I		
1.8 GTi 16V (103 kW)	1992.04-1996.04	MT	-	-	-	839099	Outer Joint		25	30	54	95	60	I		
COLT IV (CA_A)																
1.3 GLi 12V (55 kW)	1992.04-1996.04	MT	-	F	Hatchback Engine 4G13 (12V)	839011	Outer Joint		25	22	54	96	59	M		
	1992.04-1996.04	-	-	F	Hatchback Engine 4G13 (12V)	815003	Outer Joint		25	22	54	95	59.8	I		
	1992.04-1996.04	-	L/R	F	Hatchback Engine 4G13 (12V)	839023	Outer Joint		25	22	54	95	60	I		
1.6 (66 kW)	1994.02-1996.04	-	-	F	Hatchback Engine 4G92 (SOHC 16V)	839007	Outer Joint	43T	25	23	54	95	60	I		
1.6 (84 kW)	1993.08-1995.08	MT	-	F	All-wheel Drive Hatchback Engine 4G92 (SOHC 16V)	839009	Outer Joint		25	30	54	95	60.5	M		
	1993.08-1995.08	MT	-	-	All-wheel Drive Hatchback Engine 4G92 (SOHC 16V)	639005	Inner Joint		25	30	35	62.8	92.5			
	1993.08-1995.08	-	-	-	All-wheel Drive Hatchback Engine 4G92 (SOHC 16V)	839007	Outer Joint	43T	25	23	54	95	60	I		
1.8 GTi 16V (103 kW)	1992.04-1996.04	-	-	F	Hatchback Engine 4G93 (DOHC 16V)	839009	Outer Joint		25	30	54	95	60.5	M		
	1992.04-1996.04	-	-	F	Hatchback Engine 4G93 (DOHC 16V)	839064	Outer Joint	43T	25	30	54	95	60.5	M		
COLT V (CJA)																
1.6 (76 kW)	2000.09-2005.07	-	-	-	-	839099	Outer Joint		25	30	54	95	60	I		
1.6 GLX (66 kW)	1996.05-2000.09	-	-	-	-	839099	Outer Joint		25	30	54	95	60	I		
COLT V (CJ_CP_)																
1.3 (60 kW)	2000.06-2003.09	-	-	F	Hatchback Engine 4G13 (16V)	839008	Outer Joint	43T	25	29	54	95	58	I		

	 YEAR	TRANSM	L/R	F/R	REMARKS	GSP Ref.	 PRODUCT	 ABS	Technical Specifications						
									A	B	C	H	L	P	
MITSUBISHI															
COLT V (CJ_CP_)															
1.3 GL, GLX (55 kW)	1996.05-2000.06	-	-	F	Hatchback Engine 4G13 (12V)	815003	Outer Joint		25	22	54	95	59.8	I	
	1996.05-2000.06	AT/MT	-	F	Hatchback Engine 4G13 (12V)	839008	Outer Joint	43T	25	29	54	95	58	I	
1.5 16V (69 kW)	1999.10-2003.09	-	L/R	F	Hatchback Engine 4G15 (16V)	839023	Outer Joint		25	22	54	95	60	I	
	1999.10-2003.09	-	-	-	Hatchback Engine 4G15 (16V)	839119	Outer Joint	43T	25	21	54	95	51	I	
	1999.10-2003.09	-	-	-	Hatchback Engine 4G15 (16V)	839120	Outer Joint	43T	25	22	54	94	61	I	
	1999.10-2003.09	-	-	-	Hatchback Engine 4G15 (16V)	839121	Outer Joint		25	21	54	95	51	I	
1.6 (76 kW)	2000.09-2003.09	-	-	-	Hatchback Engine 4G92 (SOHC 16V)	639057	Inner Joint		25	30	41	61.5	95		
1.6 GLX (66 kW)	1996.05-2000.09	-	-	F	Hatchback Engine 4G92 (SOHC 16V)	839007	Outer Joint	43T	25	23	54	95	60	I	
COLT VI (Z3_A Z2_A)/MIRAGE															
1.1 (55 kW)	2004.10-2012.06	MT	L	F	Hatchback Engine 3A91	205058	Drive Shaft		25	33	54	98	624		
	2004.10-2012.06	MT	-	F	Hatchback Engine 3A91	817048	Outer Joint		25	21	54	98	59	I	
1.3 (68 kW)	2004.10-2012.06	AT	-	F	Hatchback Engine 4A90	839177	Outer Joint		25	21	55	97	57	M	
	2004.10-2012.06	MT	L	F	Hatchback Engine 4A90	205058	Drive Shaft		25	33	54	98	624		
	2004.10-2012.06	MT	-	F	Hatchback Engine 4A90	817048	Outer Joint		25	21	54	98	59	I	
1.3 (70 kW)	2004.06-2012.06	AT	-	F	Hatchback Engine 4A90	839177	Outer Joint		25	21	55	97	57	M	
	2004.06-2012.06	MT	L	F	Hatchback Engine 4A90	205058	Drive Shaft		25	33	54	98	624		
	2004.06-2012.06	MT	-	F	Hatchback Engine 4A90	817048	Outer Joint		25	21	54	98	59	I	
1.3 LPG (70 kW)	2004.06-2012.06	AT	-	F	Hatchback Engine 4A90	839177	Outer Joint		25	21	55	97	57	M	
	2004.06-2012.06	MT	-	F	Hatchback Engine 4A90	817048	Outer Joint		25	21	54	98	59	I	
1.5 (80 kW)	2004.06-2012.06	AT	-	F	Hatchback Engine 4A91	839177	Outer Joint		25	21	55	97	57	M	
	2004.06-2012.06	-	-	F	Hatchback Engine 4A91	839103	Outer Joint		25	23	54	98	59	M	
	2004.06-2012.06	MT	-	F	Hatchback Engine 4A91	817048	Outer Joint		25	21	54	98	59	I	
1.5 CZT (110 kW)	2005.03-2012.06	AT	-	F	Hatchback Engine 4G15T	839177	Outer Joint		25	21	55	97	57	M	
	2005.03-2012.06	-	-	F	Hatchback Engine 4G15T	839103	Outer Joint		25	23	54	98	59	M	
	2005.03-2012.06	MT	-	F	Hatchback Engine 4G15T	817048	Outer Joint		25	21	54	98	59	I	
1.5 DI-D (50 kW)	2004.08-2012.06	-	-	-	Hatchback Engine OM 639.939	839146	Outer Joint		25	23	53	97	61	M	
	2004.08-2012.06	AT	-	F	Hatchback Engine OM 639.939	839177	Outer Joint		25	21	55	97	57	M	
	2004.08-2012.06	-	-	F	Hatchback Engine OM 639.939	839103	Outer Joint		25	23	54	98	59	M	
	2004.08-2012.06	MT	-	F	Hatchback Engine OM 639.939	817048	Outer Joint		25	21	54	98	59	I	
1.5 DI-D (70 kW)	2004.08-2012.06	-	-	-	Hatchback Engine OM 639.939	839146	Outer Joint		25	23	53	97	61	M	
	2004.08-2012.06	AT	-	F	Hatchback Engine OM 639.939	839177	Outer Joint		25	21	55	97	57	M	
	2004.08-2012.06	-	-	F	Hatchback Engine OM 639.939	839103	Outer Joint		25	23	54	98	59	M	
	2004.08-2012.06	MT	-	F	Hatchback Engine OM 639.939	817048	Outer Joint		25	21	54	98	59	I	
1.5 Ralliart R (132 kW)	2010.02-2012.06	AT	-	F	Hatchback	839177	Outer Joint		25	21	55	97	57	M	
	2010.02-2012.06	MT	-	F	Hatchback	817048	Outer Joint		25	21	54	98	59	I	
COLT Z23A															
1500	2005.10-2006.10	MT/CVT	-	-	Engine 4A91	839236	Outer Joint		25	30	52.5	96.5	58	M	
	2006.10-	5MT	-	-	Engine 4A91	839229	Outer Joint		25	23	52.5	96.5	58	M	
COLT Z24A															
1.5	2004.08-	MT/CVT	-	-	Allwheel Drive Engine 4A91	839236	Outer Joint		25	30	52.5	96.5	58	M	
1500	2004.08-	MT/CVT	-	-	Allwheel Drive Engine 4A91	839236	Outer Joint		25	30	52.5	96.5	58	M	
COLT/LANCER(C54A)															
1.8	1988.04-1995.07	MT	L	F	Engine DIESEL/2WD(2DOOR)	809001	Outer Joint		25	22	50	96	57	M	
COLT/LANCER(C64A)															
1.8	1988.04-1995.07	MT	L	F	Engine DIESEL/2WD(4DOOR)	809001	Outer Joint		25	22	50	96	57	M	
DA1A															
1.6	1995.05-2001.06	MT/AT	R	-	Engine 4G92	839162	Outer Joint	43T	25	29	54	95	65	O	
	1995.05-2001.06	MT/AT	R	-	Engine 4G92	839162	Outer Joint	43T	25	29	54	95	65	O	
DA2A															
1.8	1995.05-1999.02	MT/AT	R	-	Engine 4G93	839162	Outer Joint	43T	25	29	54	95	65	O	
DA4A															
1.9	1995.05-1999.02	MT/AT	R	-	Engine F8QT	839162	Outer Joint	43T	25	29	54	95	65	O	
DEBONAIR (S11A)															
2.0	1986.08-1991.04	AT	-	-	Engine 6G71	839026	Outer Joint		25	26	50	95	64.5	M	
DEBONAIR (S12A)															
3.0	1986.07-1992.07	AT	-	-	Engine 6G72	839026	Outer Joint		25	26	50	95	64.5	M	
DEBONAIR (S22A)															
3.0	1992.08-1995.08	AT	-	-	Engine 6G72	839012	Outer Joint		27	26	60	97	68.5	M	
DEBONAIR (S27A)															
3.5	1992.08-1995.08	AT	-	-	Engine 6G74	839012	Outer Joint		27	26	60	97	68.5	M	
DEBONAIR S11A															
2.0	1986.08-1989.08	AT	-	-	Engine 6G71	839026	Outer Joint		25	26	50	95	64.5	M	
	1989.09-1991.04	AT	-	-	Engine 6G71	839026	Outer Joint		25	26	50	95	64.5	M	
2000	1986.08-1989.08	AT	-	-	Engine 6G71	839026	Outer Joint		25	26	50	95	64.5	M	
	1989.09-1991.04	AT	-	-	Engine 6G71	839026	Outer Joint		25	26	50	95	64.5	M	

YEAR	TRANS	L/R	F/R	REMARKS	GSP Ref.	PRODUCT	ABS	Technical Specifications							
								A	B	C	H	L	P		
MITSUBISHI															
DEBONAIR S12A															
3.0	1986.07-	1992.07	AT	-	-	Engine 6G72	839026	Outer Joint		25	26	50	95	64.5	M
3000	1986.07-	1992.07	AT	-	-	Engine 6G72	839026	Outer Joint		25	26	50	95	64.5	M
DEBONAIR S22A															
3.0	1992.08-	1995.08	AT	-	-	Engine 6G72	839012	Outer Joint		27	26	60	97	68.5	M
3000	1992.08-	1995.08	AT	-	-	Engine 6G72	839012	Outer Joint		27	26	60	97	68.5	M
DEBONAIR S27A															
3.5	1992.08-	1995.08	AT	-	-	Engine 6G74	839012	Outer Joint		27	26	60	97	68.5	M
3500	1992.08-	1995.08	AT	-	-	Engine 6G74	839012	Outer Joint		27	26	60	97	68.5	M
DELICA/SPACE GEAR															
2.0 (83 kW)	1995.09-	2002.10	-	-	F	MPV Engine 4G63 (SOHC 16V)	809002	Outer Joint		25	23	50	94.5	63.5	M
	1995.09-	2002.10	-	-	F	MPV Engine 4G63 (SOHC 16V)	839009	Outer Joint		25	30	54	95	60.5	M
	1995.09-	2002.10	-	-	-	MPV Engine 4G63 (SOHC 16V)	639005	Inner Joint		25	30	35	62.8	92.5	
	1995.09-	2002.10	-	-	F	MPV Engine 4G63 (SOHC 16V)	839245	Outer Joint		25	23	50	96	59	M
2.5(73 kW)	1995.05-	2000.05	MT	L	F	All-wheel Drive MPV Engine 4D56 TD	699083	Inner Joint		28	26	34.7	90.5	90.6	
	1995.05-	2000.05	MT	R	F	All-wheel Drive MPV Engine 4D56 TD	675004	Inner Joint			26		62.5		
	1995.05-	2000.05	-	L	F	All-wheel Drive MPV Engine 4D56 TD	639049	Inner Joint		25	25	32	89	81.5	
	1995.05-	2000.05	-	R	F	All-wheel Drive MPV Engine 4D56 TD	639061	Inner Joint			25		68.6		
2.8 D (103 kW)	1994.01-	2006.12	AT/MT	L	F	All-wheel Drive MPV Engine 4M40-T	699083	Inner Joint		28	26	34.7	90.5	90.6	
	1994.01-	2006.12	AT/MT	R	F	All-wheel Drive MPV Engine 4M40-T	675004	Inner Joint			26		62.5		
	1994.01-	2006.12	AT	L	F	All-wheel Drive MPV Engine 4M40-T	639049	Inner Joint		25	25	32	89	81.5	
	1994.01-	2006.12	AT	R	F	All-wheel Drive MPV Engine 4M40-T	639061	Inner Joint			25		68.6		
DIAMANTE															
-	1992-	-	-	-	-	-	624042	Inner Joint		25	26	35	62.8	100	
DIAMANTE (F13A)															
2.5	1991.10-	1995.01	MT/AT	-	-	Engine 6G73	839012	Outer Joint		27	26	60	97	68.5	M
DIAMANTE (F15A)															
2.5 4WS	1990.05-	1993.11	AT	-	-	Engine 6G73	839012	Outer Joint		27	26	60	97	68.5	M
DIAMANTE F13A															
2.5	1991.10-	1995.01	AT	-	-	Engine 6G73	839012	Outer Joint		27	26	60	97	68.5	M
	1991.10-	1995.01	MT	-	-	Engine 6G73	839012	Outer Joint		27	26	60	97	68.5	M
	1991.10-	1995.01	MT	-	-	Engine 6G73	839012	Outer Joint		27	26	60	97	68.5	M
	1991.10-	1995.01	AT	-	-	Engine 6G73	839012	Outer Joint		27	26	60	97	68.5	M
	1992.09-	1993.09	AT	-	-	Engine 6G73	839012	Outer Joint		27	26	60	97	68.5	M
	1992.09-	1993.09	AT	-	-	Engine 6G73	839012	Outer Joint		27	26	60	97	68.5	M
DIAMANTE F15A 4WS															
2.5	1990.05-	1991.09	AT	-	-	Engine 6G73	839012	Outer Joint		27	26	60	97	68.5	M
	1990.05-	1991.09	AT	-	-	Engine 6G73	839012	Outer Joint		27	26	60	97	68.5	M
	1991.10-	1993.11	AT	-	-	Engine 6G73	839012	Outer Joint		27	26	60	97	68.5	M
	1991.10-	1993.11	AT	-	-	Engine 6G73	839012	Outer Joint		27	26	60	97	68.5	M
DIAMANTE II (F4_A F3_A)															
2.5 (125 kW)	2003.09-	2005.11	-	-	F	Saloon Engine 6A13	839025	Outer Joint		27	25	60	97	68.5	M
2.5 (147 kW)	1999.09-	2004.08	-	-	F	Saloon Engine 6G73	839025	Outer Joint		27	25	60	97	68.5	M
2.5 (151 kW)	2003.09-	2005.11	-	-	F	Saloon Engine 6A13	839025	Outer Joint		27	25	60	97	68.5	M
ECLIPSE															
-	1996-	-	-	-	-	-	839046	Outer Joint		25	25	54	95.5	63.5	I
2.0 (157 kW)	1995.09-	1999.04	AT/MT	-	-	Convertible Engine 4G63 T (DOHC 16V)	639005	Inner Joint		25	30	35	62.8	92.5	
2.4	1996-	1999	-	-	-	-	839041	Outer Joint		25	25	54	95.5	65	M
ECLIPSE (D22A)															
2.0	1989.09-	1995.06	MT/AT	-	-	Engine 4G63	839214	Outer Joint		25	23	54	96	59	M
ECLIPSE (D27A)															
2.0	1989.09-	1995.06	MT	-	-	Engine 4G63	839215	Outer Joint		25	30	54	96	59	M
ECLIPSE D22A															
2.0	1989.09-	1995.06	MT/AT	-	-	Engine 4G63	839214	Outer Joint		25	23	54	96	59	M
2000	1989.09-	1995.06	MT/AT	-	-	Engine 4G63	839214	Outer Joint		25	23	54	96	59	M
ECLIPSE D27A															
2.0	1989.09-	1995.06	MT	-	-	Engine 4G63	839215	Outer Joint		25	30	54	96	59	M
2000	1989.09-	1995.06	MT	-	-	Engine 4G63	839215	Outer Joint		25	30	54	96	59	M
ECLIPSE I (D2_A)															
1.8 (68 kW)	1989.12-	1994.03	MT	-	F	Coupe Engine 4G37	839009	Outer Joint		25	30	54	95	60.5	M
	1989.12-	1994.03	-	L/R	F	Coupe Engine 4G37	839010	Outer Joint		25	30	54	96	60	M
2.0 i 16V (110 kW)	1991.04-	1995.11	-	-	-	Coupe Engine 4G63 (DOHC 16V)	839034	Outer Joint		25	25	50	94.5	65	M
	1991.04-	1995.11	-	-	F	Coupe Engine 4G63 (DOHC 16V)	839036	Outer Joint		25	23	54	96	64.5	M
	1991.04-	1995.11	MT	-	F	All-wheel Drive Coupe Engine 4G63 (DOHC 16V)	839009	Outer Joint		25	30	54	95	60.5	M
	1991.04-	1995.11	AT	-	-	All-wheel Drive Coupe Engine 4G63 (DOHC 16V)	639005	Inner Joint		25	30	35	62.8	92.5	
	1991.04-	1995.11	-	-	-	Coupe Engine 4G63 (DOHC 16V)	639005	Inner Joint		25	30	35	62.8	92.5	

YEAR	TRANSM	L/R	F/R	REMARKS	GSP Ref.	PRODUCT	ABS	Technical Specifications							
								A	B	C	H	L	P		
MITSUBISHI															
ECLIPSE I (D2_A)															
2.0 i 16V (110 kW)	1991.04-1995.11	-	L/R	F	All-wheel Drive Coupe Engine 4G63 (DOHC 16V)	839010	Outer Joint	25	30	54	96	60	M		
	1991.04-1995.11	-	-	-	Coupe Engine 4G63 (DOHC 16V)	839035	Outer Joint	25	23	54	95.5	61	M		
	1991.04-1995.11	-	-	-	All-wheel Drive Coupe Engine 4G63 (DOHC 16V)	839035	Outer Joint	25	23	54	95.5	61	M		
2.0 Turbo (147 kW)	1989.12-1994.03	-	-	-	Coupe Engine 4G63-T (DOHC 16V)	639005	Inner Joint	25	30	35	62.8	92.5			
	1989.12-1994.03	-	-	-	Coupe Engine 4G63-T (DOHC 16V)	839035	Outer Joint	25	23	54	95.5	61	M		
ECLIPSE II (D3_A)															
2.0 GS 16V (107 kW)	1995.12-1999.04	MT	-	-	Coupe Engine 4G63 (DOHC 16V)	639005	Inner Joint	25	30	35	62.8	92.5			
	1995.12-1999.04	-	L/R	F	Coupe Engine 4G63 (DOHC 16V)	839017	Outer Joint	43T	25	23	54	95.5	63.5	I	
	1995.12-1999.04	-	-	-	Coupe Engine 4G63 (DOHC 16V)	839035	Outer Joint	25	23	54	95.5	61	M		
2.0 GT 16V (157 kW)	1995.12-1999.04	MT	-	-	Coupe Engine 4G63 T (DOHC 16V)	639005	Inner Joint	25	30	35	62.8	92.5			
	1995.12-1999.04	-	-	-	Coupe Engine 4G63 T (DOHC 16V)	839097	Outer Joint	25	25	54	96	64.5	I		
	1995.12-1999.04	-	-	-	Coupe Engine 4G63 T (DOHC 16V)	839035	Outer Joint	25	23	54	95.5	61	M		
2.4 GS 16V (105 kW)	1998.09-1999.04	-	-	-	Coupe Engine 4G64 (SOHC 16V)	839035	Outer Joint	25	23	54	95.5	61	M		
EMERAUDE GALANT ETERNA E53A															
1.8	1992.05-1996.10	MT/AT	-	-	Engine 6A11	839214	Outer Joint	25	23	54	96	59	M		
1800	1992.05-1996.10	MT/AT	-	-	Engine 6A11	839214	Outer Joint	25	23	54	96	59	M		
EMERAUDE GALANT ETERNA E54A															
2.0	1992.05-1994.02	MT/AT	-	-	Engine 6A12	839214	Outer Joint	25	23	54	96	59	M		
	1994.03-1996.10	MT/AT	-	-	Engine 6A12	839214	Outer Joint	25	23	54	96	59	M		
2000	1992.05-1994.02	MT/AT	-	-	Engine 6A12	839214	Outer Joint	25	23	54	96	59	M		
	1994.03-1996.10	MT/AT	-	-	Engine 6A12	839214	Outer Joint	25	23	54	96	59	M		
EMERAUDE GALANT ETERNA E57A															
2.0	1992.05-1996.10	MT/AT	-	-	Engine 4D68	839079	Outer Joint	25	24	54	96	59	M		
2000	1992.05-1996.10	MT/AT	-	-	Engine 4D68	839079	Outer Joint	25	24	54	96	59	M		
EMERAUDE GALANT ETERNA E64A 4WS															
2.0	1992.05-1996.10	MT/AT	-	-	Engine 6A12	839214	Outer Joint	25	23	54	96	59	M		
2000	1992.05-1996.10	MT/AT	-	-	Engine 6A12	839214	Outer Joint	25	23	54	96	59	M		
EMERAUDE GALANT ETERNA E72A															
1.8	1992.05-1996.10	MT/AT	-	-	Allwheel Drive Engine 4G93	839215	Outer Joint	25	30	54	96	59	M		
1800	1992.05-1996.10	MT/AT	-	-	Allwheel Drive Engine 4G93	839215	Outer Joint	25	30	54	96	59	M		
EMERAUDE GALANT ETERNA E74A															
2.0	1993.02-1996.10	AT	-	-	Allwheel Drive Engine 6A12	839215	Outer Joint	25	30	54	96	59	M		
	1993.02-1996.10	MT	-	-	Allwheel Drive Engine 6A12	839215	Outer Joint	25	30	54	96	59	M		
2000	1993.02-1996.10	AT	-	-	Allwheel Drive Engine 6A12	839215	Outer Joint	25	30	54	96	59	M		
	1993.02-1996.10	MT	-	-	Allwheel Drive Engine 6A12	839215	Outer Joint	25	30	54	96	59	M		
EMERAUDE GALANT ETERNA E77A															
2.0	1992.05-1996.10	MT/AT	-	-	Allwheel Drive Engine 4D68	839215	Outer Joint	25	30	54	96	59	M		
2000	1992.05-1996.10	MT/AT	-	-	Allwheel Drive Engine 4D68	839215	Outer Joint	25	30	54	96	59	M		
EMERAUDE GALANT ETERNA E84A															
2.0	1992.05-1996.10	AT	-	-	Allwheel Drive Engine 6A12	839215	Outer Joint	25	30	54	96	59	M		
	1992.05-1996.10	MT	-	-	Allwheel Drive Engine 6A12	839215	Outer Joint	25	30	54	96	59	M		
2000	1992.05-1996.10	AT	-	-	Allwheel Drive Engine 6A12	839215	Outer Joint	25	30	54	96	59	M		
	1992.05-1996.10	MT	-	-	Allwheel Drive Engine 6A12	839215	Outer Joint	25	30	54	96	59	M		
EMERAUDE/GALANT/ETERNA (E52A)															
1.8	1992.05-1996.10	MT/AT	-	-	Engine 4G91	839214	Outer Joint	25	23	54	96	59	M		
EMERAUDE/GALANT/ETERNA (E53A)															
1.8	1992.05-1996.10	MT/AT	-	-	Engine 6A11	839214	Outer Joint	25	23	54	96	59	M		
EMERAUDE/GALANT/ETERNA (E54A)															
2.0	1992.05-1996.10	MT/AT	-	-	Engine 6A12	839214	Outer Joint	25	23	54	96	59	M		
EMERAUDE/GALANT/ETERNA (E57A)															
2.0	1992.05-1996.10	MT/AT	-	-	Engine 4D68	839079	Outer Joint	25	24	54	96	59	M		
EMERAUDE/GALANT/ETERNA (E64A)															
2.0	1992.05-1996.10	MT/AT	-	-	Engine 6A12 4WS	839214	Outer Joint	25	23	54	96	59	M		
EMERAUDE/GALANT/ETERNA (E72A)															
1.8 4WD	1992.05-1996.10	MT/AT	-	-	Engine 4G93	839215	Outer Joint	25	30	54	96	59	M		
EMERAUDE/GALANT/ETERNA (E77A)															
2.0 4WD	1992.05-1996.10	MT/AT	-	-	Engine 4G93	839215	Outer Joint	25	30	54	96	59	M		
ETERNA															
2.0	-	-	MT/AT	-	-	639003	Inner Joint	25	23	35	62.8	95.5			
	1992-	-	MT	-	E55A	639010	Inner Joint	25	24	35	62.8	92.5			
	1996-	-	MT	-	-	639028	Inner Joint	25	23	41	62.5	90.5			
ETERNA SIGMA(E12A)															
1.8	1983.08-1990.03	AT/MT	R	-	Engine GASOLINE&LPG	639002	Inner Joint	25	23	35	62.8	95.5			
	1983.08-1990.03	AT/MT	R	-	Engine GASOLINE&LPG	639002	Inner Joint	25	23	35	62.8	95.5			
ETERNA SIGMA(E13A)															

MITSUBISHI	YEAR	TRANSM	L/R	F/R	REMARKS	GSP Ref.	PRODUCT	ABS	Technical Specifications											
									A	B	C	H	L	P						
ETERNA SIGMA(E13A)																				
1.8	1983.08-1990.03	AT/MT	R	-	Engine ECI	639002	Inner Joint		25	23	35	62.8	95.5							
	1983.08-1990.03	AT/MT	R	-	Engine ECI	639002	Inner Joint		25	23	35	62.8	95.5							
	1983.08-1990.03	AT/MT	R	-	Engine (ECI)	639002	Inner Joint		25	23	35	62.8	95.5							
ETERNA SIGMA(E14A)																				
1.8	1983.08-1990.03	AT/MT	R	-	Engine DIESEL	639002	Inner Joint		25	23	35	62.8	95.5							
	1983.08-1990.03	AT/MT	R	-	Engine DIESEL	639002	Inner Joint		25	23	35	62.8	95.5							
ETERNA SIGMA(E15A)																				
2.0	1983.08-1990.03	AT/MT	R	-	Engine STRAIGHT 4 CYLINDER	639002	Inner Joint		25	23	35	62.8	95.5							
	1983.08-1990.03	AT/MT	R	-	Engine STRAIGHT 4 CYLINDER	639002	Inner Joint		25	23	35	62.8	95.5							
EXCEL																				
-	-	-	-	-	-	639001	Inner Joint		25	22	35	55	91							
EXPO																				
2.4	1992-1996	-	-	-	-	839041	Outer Joint		25	25	54	95.5	65	M						
EXPO LRV																				
2.4	1992-1996	-	-	-	-	839041	Outer Joint		25	25	54	95.5	65	M						
GALAN FORTIS (CY4A)																				
2.0	2007.08-	MT/CVT	-	-	Engine 4B11	839178	Outer Joint		28	33	59.6	94.5	61.5	I						
2.0 4WD	2007.08-	CVT	-	-	Engine 4B11	839178	Outer Joint		28	33	59.6	94.5	61.5	I						
GALANT																				
-	2004-	-	L/R	-	-	839058	Outer Joint		25	33	54	95.5	65	I						
	2004-	-	L/R	-	-	839058	Outer Joint		25	33	54	95.5	65	I						
	2004-	-	L/R	-	-	639027	Inner Joint		25	30	41	63	88							
	2004-	-	R	-	-	239118	Drive Shaft 43T		25	25	54	95.5	642							
	2004-	-	L	-	-	239119	Drive Shaft 43T		25	25	54	95.5	946							
2.0	1992-	MT	-	-	E55A	639010	Inner Joint		25	24	35	62.8	92.5							
	1996-	MT	-	-	-	639028	Inner Joint		25	23	41	62.5	90.5							
	1997-	-	-	-	-	639013	Inner Joint		25	23	41	62.5	87.5							
2.4 SOHC	1994-1996	-	-	-	-	839046	Outer Joint		25	25	54	95.5	63.5	I						
2.4/2.5	1994-1998	-	-	-	-	839041	Outer Joint		25	25	54	95.5	65	M						
GALANT ETERNA E17A																				
2.0	1986.10-2009.12	MT/AT	-	-	Engine 6G71	839026	Outer Joint		25	26	50	95	64.5	M						
2000	1986.10-1990.12	MT/AT	-	-	Engine 6G71	839026	Outer Joint		25	26	50	95	64.5	M						
GALANT ETERNA E18A																				
3.0	1989.05-2009.11	AT	-	-	Engine 6G72	839026	Outer Joint		25	26	50	95	64.5	M						
3000	1989.05-1990.11	AT	-	-	Engine 6G72	839026	Outer Joint		25	26	50	95	64.5	M						
GALANT ETERNA E32A																				
1.8	1987.08-1992.09	MT/AT	-	-	Engine 4G37 ECI	839214	Outer Joint		25	23	54	96	59	M						
1800	1987.08-1992.09	MT/AT	-	-	Engine 4G37 ECI	839214	Outer Joint		25	23	54	96	59	M						
GALANT ETERNA E33A																				
2.0	1987.08-1992.09	MT/AT	-	-	Engine 4G63	839214	Outer Joint		25	23	54	96	59	M						
2000	1987.08-1992.09	MT/AT	-	-	Engine 4G63	839214	Outer Joint		25	23	54	96	59	M						
GALANT ETERNA E34A																				
1.8	1988.02-1992.09	MT	-	-	Engine 4D65 TBO	839214	Outer Joint		25	23	54	96	59	M						
1800	1988.02-1992.09	MT	-	-	Engine 4D65TBO	839214	Outer Joint		25	23	54	96	59	M						
GALANT ETERNA E35A																				
1.8	1989.04-1992.09	MT/AT	-	-	Engine 4G67	839214	Outer Joint		25	23	54	96	59	M						
1800	1989.04-1992.09	MT/AT	-	-	Engine 4G67	839214	Outer Joint		25	23	54	96	59	M						
GALANT ETERNA E37A																				
1.8	1988.09-1992.09	MT/AT	-	-	Engine 4G37	839215	Outer Joint		25	30	54	96	59	M						
1800	1988.09-1992.09	MT/AT	-	-	Engine 4G37	839215	Outer Joint		25	30	54	96	59	M						
GALANT ETERNA E38A																				
2.0	1988.02-1992.09	MT	-	-	Engine 4G63 TBO	839215	Outer Joint		25	30	54	96	59	M						
2000	1988.02-1992.09	MT	-	-	Engine 4G63 TBO	839215	Outer Joint		25	30	54	96	59	M						
GALANT ETERNA E39A																				
2.0	1987.01-1992.09	MT	-	-	Allwheel Drive Engine 4G63	839215	Outer Joint		25	30	54	96	59	M						
	1987.09-1992.09	MT	-	-	Engine 4G63	839215	Outer Joint		25	30	54	96	59	M						
2000	1987.01-1992.09	MT	-	-	Allwheel Drive Engine 4G63	839215	Outer Joint		25	30	54	96	59	M						
	1987.09-1992.09	MT	-	-	Engine 4G63	839215	Outer Joint		25	30	54	96	59	M						
GALANT ETERNA EA1A																				
1.8	1996.08-	5MT	-	-	Engine 4G93	839270	Outer Joint		25	23	54	96	59	M						
	1996.08-	5MT	-	-	Engine 4G93	839270	Outer Joint		25	23	54	96	59	M						
1800	1996.08-	5MT	-	-	Engine 4G93	839270	Outer Joint		25	23	54	96	59	M						
	1996.08-	5MT	-	-	Engine 4G93	839270	Outer Joint		25	23	54	96	59	M						
GALANT ETERNA EC5A																				
2.5	1996.08-	MT/AT	-	-	Allwheel Drive Engine 6A13	899228	Outer Joint	43T	25	32	54	96	59	M						

YEAR	TRANSM	L/R	F/R	REMARKS	GSP Ref.	PRODUCT	ABS	Technical Specifications									
								A	B	C	H	L	P				
MITSUBISHI																	
GALANT ETERNA EC5A																	
2.5	1996.08-	-	MT/AT	-	-	Allwheel Drive Engine 6A13	899228	Outer Joint	43T	25	32	54	96	59	M		
	1996.08-	-	MT/AT	-	-	Allwheel Drive Engine 6A13	899228	Outer Joint	43T	25	32	54	96	59	M		
	1996.08-	-	MT/AT	-	-	Allwheel Drive Engine 6A13	899228	Outer Joint	43T	25	32	54	96	59	M		
GALANT FORTIS CY4A																	
2000	2007.08-	-	CVT	-	-	Engine 4B11	839178	Outer Joint		28	33	59.6	94.5	61.5	I		
	2007.08-	-	5MT	-	-	Engine 4B11	839178	Outer Joint		28	33	59.6	94.5	61.5	I		
	2007.08-	-	CVT	-	-	Allwheel Drive Engine 4B11	839178	Outer Joint		28	33	59.6	94.5	61.5	I		
GALANT III (E1_A)																	
1.6 GLX (55 kW)	1984.06-	1990.04	AT/MT	L/R	F	Saloon Engine 4G32	809004	Outer Joint		25	22	50	95	58	M		
1.8 Turbo-D (60 kW)	1984.06-	1990.04	AT/MT	L/R	F	Saloon Engine 4D65 T	839054	Outer Joint		25	23	50	96	59	M		
	1984.06-	1990.04	AT	-	F	Saloon Engine 4D65 T	809002	Outer Joint		25	23	50	94.5	63.5	M		
2.0 GLS (66 kW)	1986.06-	1990.04	-	-	F	Saloon Engine G63B	809002	Outer Joint		25	23	50	94.5	63.5	M		
	1986.06-	1990.04	-	-	F	Saloon Engine G63B	809003	Outer Joint		25	25	50	95	64.5	M		
	1986.06-	1990.04	AT/MT	L/R	F	Saloon Engine G63B	839054	Outer Joint		25	23	50	96	59	M		
	1986.06-	1990.04	-	-	F	Saloon Engine G63B	839245	Outer Joint		25	23	50	96	59	M		
2.0 GLS (75 kW)	1984.06-	1990.04	-	-	F	Saloon Engine 4G63 (SOHC 8V)	809002	Outer Joint		25	23	50	94.5	63.5	M		
	1984.06-	1990.04	-	-	F	Saloon Engine 4G63 (SOHC 8V)	809003	Outer Joint		25	25	50	95	64.5	M		
	1984.06-	1990.04	AT/MT	L/R	F	Saloon Engine 4G63 (SOHC 8V)	839054	Outer Joint		25	23	50	96	59	M		
	1984.06-	1990.04	-	-	F	Saloon Engine 4G63 (SOHC 8V)	839245	Outer Joint		25	23	50	96	59	M		
2.0 Turbo Eci (110 kW)	1984.06-	1990.04	-	-	-	Saloon Engine 4G63 T (SOHC 8V)	839034	Outer Joint		25	25	50	94.5	65	M		
	1984.06-	1990.04	-	-	F	Saloon Engine 4G63 T (SOHC 8V)	809002	Outer Joint		25	23	50	94.5	63.5	M		
	1984.06-	1990.04	-	-	F	Saloon Engine 4G63 T (SOHC 8V)	809003	Outer Joint		25	25	50	95	64.5	M		
	1984.06-	1990.04	MT	R	F	Saloon Engine 4G63 T (SOHC 8V)	839033	Outer Joint		25	25	50	95	65	M		
	1984.06-	1990.04	MT	L	F	Saloon Engine 4G63 T (SOHC 8V)	839032	Outer Joint		25	23	50	95	60.5	M		
	1984.06-	1990.04	-	-	F	Saloon Engine 4G63 T (SOHC 8V)	839245	Outer Joint		25	23	50	96	59	M		
2.4 GLS (82 kW)	1985.07-	1990.04	-	-	-	Saloon Engine G64B	839034	Outer Joint		25	25	50	94.5	65	M		
	1985.07-	1990.04	AT	-	F	Saloon Engine G64B	809003	Outer Joint		25	25	50	95	64.5	M		
	1985.07-	1990.04	-	-	R	F	Saloon Engine G64B	839033	Outer Joint		25	25	50	95	65	M	
	1985.07-	1990.04	-	-	L	F	Saloon Engine G64B	839032	Outer Joint		25	23	50	95	60.5	M	
	1985.07-	1990.04	-	-	F	Saloon Engine G64B	839245	Outer Joint		25	23	50	96	59	M		
GALANT IV																	
1.8	1988.03-	1993.02	MT/AT	-	F	E32A	839085	Outer Joint		25	22	54	96	60	M		
GALANT IV (E3A)																	
2.0 GTi 16V 4WD (106 kW)	1988.11-	1992.10	-	-	F	-	839099	Outer Joint		25	30	54	95	60	I		
2.0 GTi 16V 4WD (107 kW)	1988.11-	1992.10	-	-	F	-	839099	Outer Joint		25	30	54	95	60	I		
GALANT IV (E3_A)																	
1.6 (55 kW)	1988.01-	1992.10	-	-	-	Saloon Engine 4G32	839035	Outer Joint		25	23	54	95.5	61	M		
1.8 (63 kW)	1987.11-	1990.08	-	-	F	Saloon Engine 4G37	839011	Outer Joint		25	22	54	96	59	M		
	1988.11-	1992.10	-	-	-	Hatchback Engine 4G37	839035	Outer Joint		25	23	54	95.5	61	M		
1.8 (66 kW)	1987.11-	1992.10	-	-	F	Saloon Engine 4G37	815003	Outer Joint		25	22	54	95	59.8	I		
	1987.11-	1992.10	-	-	F	Saloon Engine 4G37	839011	Outer Joint		25	22	54	96	59	M		
	1987.11-	1992.10	-	-	-	Saloon Engine 4G37	839035	Outer Joint		25	23	54	95.5	61	M		
	1988.11-	1992.10	-	-	-	Hatchback Engine 4G37	839035	Outer Joint		25	23	54	95.5	61	M		
1.8 Turbo-D (55 kW)	1987.12-	1992.10	MT	-	R	Saloon Engine 4D65 T	839002	Outer Joint		25	23	54	96	60	M		
	1987.12-	1992.10	AT	-	F	Saloon Engine 4D65 T	839245	Outer Joint		25	23	50	96	59	M		
	1987.12-	1992.10	-	-	-	Saloon Engine 4D65 T	839035	Outer Joint		25	23	54	95.5	61	M		
	1988.11-	1992.10	MT	-	R	Hatchback Engine 4D65 T	839002	Outer Joint		25	23	54	96	60	M		
	1988.11-	1992.10	AT	-	F	Hatchback Engine 4D65 T	839245	Outer Joint		25	23	50	96	59	M		
	1988.11-	1992.10	-	-	-	Hatchback Engine 4D65 T	839035	Outer Joint		25	23	54	95.5	61	M		
2.0 (80 kW)	1987.11-	1992.10	AT/MT	-	-	Saloon Engine 4G63 (SOHC 8V)	639005	Inner Joint		25	30	35	62.8	92.5			
	1987.11-	1992.10	-	-	-	Saloon Engine 4G63 (SOHC 8V)	839035	Outer Joint		25	23	54	95.5	61	M		
	1988.12-	1992.10	MT	-	F	All-wheel Drive Saloon Engine 4G63 (SOHC 8V)	839009	Outer Joint		25	30	54	95	60.5	M		
	1988.12-	1992.10	AT	-	-	All-wheel Drive Saloon Engine 4G63 (SOHC 8V)	639005	Inner Joint		25	30	35	62.8	92.5			
	1988.12-	1992.10	-	L/R	F	All-wheel Drive Saloon Engine 4G63 (SOHC 8V)	839010	Outer Joint		25	30	54	96	60	M		
	1988.12-	1992.10	-	-	-	All-wheel Drive Saloon Engine 4G63 (SOHC 8V)	839035	Outer Joint		25	23	54	95.5	61	M		
	1989.04-	1992.10	MT	-	F	All-wheel Drive Hatchback Engine 4G63 (SOHC 8V)	839009	Outer Joint		25	30	54	95	60.5	M		
	1989.04-	1992.10	AT	-	-	All-wheel Drive Hatchback Engine 4G63 (SOHC 8V)	639005	Inner Joint		25	30	35	62.8	92.5			
	1989.04-	1992.10	AT/MT	-	-	Hatchback Engine 4G63 (SOHC 8V)	639005	Inner Joint		25	30	35	62.8	92.5			
	1989.04-	1992.10	-	L/R	F	All-wheel Drive Hatchback Engine 4G63 (SOHC 8V)	839010	Outer Joint		25	30	54	96	60	M		
	1989.04-	1992.10	-	-	-	Hatchback Engine 4G63 (SOHC 8V)	839035	Outer Joint		25	23	54	95.5	61	M		
	1989.04-	1992.10	-	-	-	All-wheel Drive Hatchback Engine 4G63 (SOHC 8V)	839035	Outer Joint		25	23	54	95.5	61	M		
	2.0 GTi 16V (106 kW)	1987.11-	1992.10	-	-	-	Saloon Engine 4G63 (DOHC 16V)	839095	Outer Joint		25	30	54	95	60	M	
1987.11-		1992.10	-	-	F	Saloon Engine 4G63 (DOHC 16V)	839036	Outer Joint		25	23	54	96	64.5	M		
1987.11-		1992.10	AT/MT	-	-	Saloon Engine 4G63 (DOHC 16V)	639005	Inner Joint		25	30	35	62.8	92.5			
1987.11-		1992.10	-	-	-	Saloon Engine 4G63 (DOHC 16V)	839035	Outer Joint		25	23	54	95.5	61	M		
1988.06-		1992.10	MT	-	F	All-wheel Drive Saloon Engine 4G63 (DOHC 16V)	839009	Outer Joint		25	30	54	95	60.5	M		





YEAR	TRANSM	L/R	F/R	REMARKS	GSP Ref.	PRODUCT	ABS	Technical Specifications							
								A	B	C	H	L	P		
MITSUBISHI															
GALANT IV (E3_A)															
2.0 GTi 16V (106 kW)	1988.06-1992.10	AT	-	-	All-wheel Drive Saloon Engine 4G63 (DOHC 16V)	639005	Inner Joint		25	30	35	62.8	92.5		
	1988.06-1992.10	-	L/R	F	All-wheel Drive Saloon Engine 4G63 (DOHC 16V)	839010	Outer Joint		25	30	54	96	60	M	
	1988.06-1992.10	-	-	-	All-wheel Drive Saloon Engine 4G63 (DOHC 16V)	839035	Outer Joint		25	23	54	95.5	61	M	
	1988.11-1992.10	-	-	F	Hatchback Engine 4G63 (DOHC 16V)	839036	Outer Joint		25	23	54	96	64.5	M	
	1988.11-1992.10	AT/MT	-	-	Hatchback Engine 4G63 (DOHC 16V)	639005	Inner Joint		25	30	35	62.8	92.5		
	1988.11-1992.10	-	-	-	Hatchback Engine 4G63 (DOHC 16V)	839035	Outer Joint		25	23	54	95.5	61	M	
	1989.07-1992.12	MT	-	F	All-wheel Drive Hatchback Engine 4G63 (DOHC 16V)	839009	Outer Joint		25	30	54	95	60.5	M	
	1989.07-1992.12	AT	-	-	All-wheel Drive Hatchback Engine 4G63 (DOHC 16V)	639005	Inner Joint		25	30	35	62.8	92.5		
	1989.07-1992.12	-	L/R	F	All-wheel Drive Hatchback Engine 4G63 (DOHC 16V)	839010	Outer Joint		25	30	54	96	60	M	
2.0 GTi 16V (107 kW)	1989.07-1992.12	-	-	-	All-wheel Drive Hatchback Engine 4G63 (DOHC 16V)	839035	Outer Joint		25	23	54	95.5	61	M	
	1988.11-1992.10	-	-	F	Hatchback Engine 4G63 (DOHC 16V)	839036	Outer Joint		25	23	54	96	64.5	M	
	1988.11-1992.10	-	-	F	Saloon Engine 4G63 (DOHC 16V)	839036	Outer Joint		25	23	54	96	64.5	M	
	1988.11-1992.10	AT/MT	-	-	Hatchback Engine 4G63 (DOHC 16V)	639005	Inner Joint		25	30	35	62.8	92.5		
	1988.11-1992.10	AT/MT	-	-	Saloon Engine 4G63 (DOHC 16V)	639005	Inner Joint		25	30	35	62.8	92.5		
2.0 GTi 16V Cat (110 kW)	1988.11-1992.10	-	-	F	Hatchback Engine 4G63 (DOHC 16V)	839064	Outer Joint	43T	25	30	54	95	60.5	M	
	1988.11-1992.10	-	-	-	Hatchback Engine 4G63 (DOHC 16V)	839035	Outer Joint		25	23	54	95.5	61	M	
	1991.09-1992.10	MT	-	F	All-wheel Drive Saloon Engine 4G63 (DOHC 16V)	839009	Outer Joint		25	30	54	95	60.5	M	
	1991.09-1992.10	AT	-	-	All-wheel Drive Saloon Engine 4G63 (DOHC 16V)	639005	Inner Joint		25	30	35	62.8	92.5		
GALANT SIGMA(E11A)	1991.09-1992.10	-	L/R	F	All-wheel Drive Saloon Engine 4G63 (DOHC 16V)	839010	Outer Joint		25	30	54	96	60	M	
	1991.09-1992.10	-	-	-	All-wheel Drive Saloon Engine 4G63 (DOHC 16V)	839035	Outer Joint		25	23	54	95.5	61	M	
	1991.09-1992.10	-	-	-	All-wheel Drive Saloon Engine 4G63 (DOHC 16V)	839035	Outer Joint		25	23	54	95.5	61	M	
1.6	1983.08-1999.08	AT/MT	R	-	-	639002	Inner Joint		25	23	35	62.8	95.5		
GALANT SIGMA(E12A)															
1.8	1983.08-1999.08	AT/MT	R	-	Engine GASOLINE&LPG	639002	Inner Joint		25	23	35	62.8	95.5		
	1983.08-1999.08	AT/MT	R	-	Engine GASOLINE&LPG	639002	Inner Joint		25	23	35	62.8	95.5		
GALANT SIGMA(E12AR)															
1.8	1983.08-1999.08	-	R	-	Engine GAS&LPG(DRIVER'S SCHOOL)	639002	Inner Joint		25	23	35	62.8	95.5		
	1983.08-1999.08	-	R	-	Engine GAS&LPG(DRIVER'S SCHOOL)	639002	Inner Joint		25	23	35	62.8	95.5		
GALANT SIGMA(E13A)															
1.8	1983.08-1999.08	AT/MT	R	-	Engine ECI	639002	Inner Joint		25	23	35	62.8	95.5		
	1983.08-1999.08	AT/MT	R	-	Engine ECI	639002	Inner Joint		25	23	35	62.8	95.5		
GALANT SIGMA(E14A)															
1.8	1983.08-1999.08	AT/MT	R	-	Engine DIESEL	639002	Inner Joint		25	23	35	62.8	95.5		
	1983.08-1999.08	AT/MT	R	-	Engine DIESEL	639002	Inner Joint		25	23	35	62.8	95.5		
GALANT SIGMA(E14AR)															
1.8	1983.08-1999.08	-	R	-	Engine DIESEL(DRIVER'S SCHOOL)	639002	Inner Joint		25	23	35	62.8	95.5		
GALANT SIGMA(E15A)															
2.0	1983.08-1999.08	AT/MT	R	-	Engine STRAIGHT 4 CYLINDER	639002	Inner Joint		25	23	35	62.8	95.5		
	1983.08-1999.08	AT/MT	R	-	Engine STRAIGHT 4 CYLINDER	639002	Inner Joint		25	23	35	62.8	95.5		
GALANT V (E5A, E7A, E8A)															
1.8 (85 kW)	1994.02-1996.08	MT/AT	-	-	-	839099	Outer Joint		25	30	54	95	60	I	
1.8 GDi (93 kW)	1992.11-1996.08	MT/AT	-	-	-	839099	Outer Joint		25	30	54	95	60	I	
GALANT V (E5_A E7_A E8_A)															
1.8 (85 kW)	1994.02-1996.08	-	-	-	Hatchback Engine 4G93 (SOHC 16V)	839095	Outer Joint		25	30	54	95	60	M	
	1994.02-1996.08	AT/MT	L/R	F	Saloon Engine 4G93 (SOHC 16V)	839019	Outer Joint		25	24	54	94.5	62	M	
	1994.02-1996.08	AT/MT	L/R	F	Hatchback Engine 4G93 (SOHC 16V)	839019	Outer Joint		25	24	54	94.5	62	M	
	1994.02-1996.08	-	-	F	Saloon Engine 4G93 (SOHC 16V)	839064	Outer Joint	43T	25	30	54	95	60.5	M	
	1994.02-1996.08	-	-	F	Hatchback Engine 4G93 (SOHC 16V)	839064	Outer Joint	43T	25	30	54	95	60.5	M	
	1994.02-1996.08	-	-	-	Hatchback Engine 4G93 (SOHC 16V)	839035	Outer Joint		25	23	54	95.5	61	M	
	1994.02-1996.08	-	-	-	Saloon Engine 4G93 (SOHC 16V)	839035	Outer Joint		25	23	54	95.5	61	M	
1.8 GLSi (93 kW)	1992.11-1996.08	-	-	F	Saloon Engine 4G93 (SOHC 16V)	839064	Outer Joint	43T	25	30	54	95	60.5	M	
	1992.11-1996.08	-	-	F	Hatchback Engine 4G93 (SOHC 16V)	839064	Outer Joint	43T	25	30	54	95	60.5	M	
	1992.11-1996.08	-	-	F	Saloon Engine 4G93 (SOHC 16V)	839020	Outer Joint	43T	25	24	54	94.5	62	M	
	1992.11-1996.08	-	-	F	Hatchback Engine 4G93 (SOHC 16V)	839020	Outer Joint	43T	25	24	54	94.5	62	M	
	1992.11-1996.08	-	-	-	Hatchback Engine 4G93 (SOHC 16V)	839035	Outer Joint		25	23	54	95.5	61	M	
	1992.11-1996.08	-	-	-	Saloon Engine 4G93 (SOHC 16V)	839035	Outer Joint		25	23	54	95.5	61	M	
2.0 GLSi (101 kW)	1992.11-1996.08	-	-	-	Saloon Engine 4G63 (SOHC 16V)	839089	Outer Joint		25	24	54	95.5	61	M	
	1992.11-1996.08	-	-	-	Hatchback Engine 4G63 (SOHC 16V)	839089	Outer Joint		25	24	54	95.5	61	M	
	1992.11-1996.08	AT/MT	L/R	F	Saloon Engine 4G63 (SOHC 16V)	839019	Outer Joint		25	24	54	94.5	62	M	
	1992.11-1996.08	AT/MT	L/R	F	All-wheel Drive Saloon Engine 4G63 (SOHC 16V)	839019	Outer Joint		25	24	54	94.5	62	M	
	1992.11-1996.08	AT/MT	L/R	F	Hatchback Engine 4G63 (SOHC 16V)	839019	Outer Joint		25	24	54	94.5	62	M	
	1992.11-1996.08	AT/MT	L/R	F	All-wheel Drive Hatchback Engine 4G63 (SOHC 16V)	839019	Outer Joint		25	24	54	94.5	62	M	
	1992.11-1996.08	MT	-	F	All-wheel Drive Saloon Engine 4G63 (SOHC 16V)	839009	Outer Joint		25	30	54	95	60.5	M	
	1992.11-1996.08	MT	-	F	All-wheel Drive Hatchback Engine 4G63 (SOHC 16V)	839009	Outer Joint		25	30	54	95	60.5	M	
	1992.11-1996.08	MT	-	-	All-wheel Drive Saloon Engine 4G63 (SOHC 16V)	639005	Inner Joint		25	30	35	62.8	92.5		
	1992.11-1996.08	MT	-	-	All-wheel Drive Hatchback Engine 4G63 (SOHC 16V)	639005	Inner Joint		25	30	35	62.8	92.5		





YEAR	TRANSM	L/R	F/R	REMARKS	GSP Ref.	PRODUCT	ABS	Technical Specifications									
								A	B	C	H	L	P				
MITSUBISHI																	
GALANT V (E5_A E7_A E8_A)																	
2.0 GLSI (101 kW)	1992.11-1996.08	-	-	F	Saloon Engine 4G63 (SOHC 16V)	839020	Outer Joint	43T	25	24	54	94.5	62	M			
	1992.11-1996.08	-	-	F	All-wheel Drive Saloon Engine 4G63 (SOHC 16V)	839020	Outer Joint	43T	25	24	54	94.5	62	M			
	1992.11-1996.08	-	-	F	Hatchback Engine 4G63 (SOHC 16V)	839020	Outer Joint	43T	25	24	54	94.5	62	M			
	1992.11-1996.08	-	-	F	All-wheel Drive Hatchback Engine 4G63 (SOHC 16V)	839020	Outer Joint	43T	25	24	54	94.5	62	M			
	1992.11-1996.08	-	-	-	All-wheel Drive Hatchback Engine 4G63 (SOHC 16V)	839035	Outer Joint		25	23	54	95.5	61	M			
2.0 GLSTD (66 kW)	1992.11-1996.08	AT/MT	L/R	F	Saloon Engine 4D68 T	839019	Outer Joint		25	24	54	94.5	62	M			
	1992.11-1996.08	AT/MT	L/R	F	Hatchback Engine 4D68 T	839019	Outer Joint		25	24	54	94.5	62	M			
	1992.11-1996.08	-	-	-	Hatchback Engine 4D68 T	839035	Outer Joint		25	23	54	95.5	61	M			
	1992.11-1996.08	-	-	-	Saloon Engine 4D68 T	839035	Outer Joint		25	23	54	95.5	61	M			
2.0 V6-24 (110 kW)	1992.11-1996.08	-	-	F	Saloon Engine 6A12	839064	Outer Joint	43T	25	30	54	95	60.5	M			
	1992.11-1996.08	-	-	F	Hatchback Engine 6A12	839064	Outer Joint	43T	25	30	54	95	60.5	M			
	1992.11-1996.08	-	L/R	F	Saloon Engine 6A12	839017	Outer Joint	43T	25	23	54	95.5	63.5	I			
	1992.11-1996.08	-	L/R	F	Hatchback Engine 6A12	839017	Outer Joint	43T	25	23	54	95.5	63.5	I			
	1992.11-1996.08	-	-	-	Hatchback Engine 6A12	839035	Outer Joint		25	23	54	95.5	61	M			
	1992.11-1996.08	-	-	-	Saloon Engine 6A12	839035	Outer Joint		25	23	54	95.5	61	M			
GALANT VI (EA_)/GALANT/ASPIRE/ASPIRE																	
2.0 (100 kW)	1996.09-2000.09	AT/MT	L	F	Saloon Engine 4G63 (SOHC 16V)	839170	Outer Joint	43T	25	33	54	95	65	I			
	1996.09-2000.09	AT/MT	L/R	F	Saloon Engine 4G63 (SOHC 16V)	839019	Outer Joint		25	24	54	94.5	62	M			
	1996.09-2000.09	-	-	-	Saloon Engine 4G63 (SOHC 16V)	639057	Inner Joint		25	30	41	61.5	95				
2.0 (98 kW)	2000.09-2004.10	AT/MT	L	F	Saloon Engine 4G63 (SOHC 16V)	839170	Outer Joint	43T	25	33	54	95	65	I			
	2000.09-2004.10	MT	L/R	F	Saloon Engine 4G63 (SOHC 16V)	839019	Outer Joint		25	24	54	94.5	62	M			
2.4 GDI (106 kW)	2000.09-2004.10	AT	L/R	F	Saloon Engine 4G64 (GDI)	839005	Outer Joint	43T	25	33	54	95.5	65	I			
	2000.09-2004.10	AT	-	F	Saloon Engine 4G64 (GDI)	839075	Outer Joint	43T	25	32	54	95.5	63.5	I			
2.4 GDI (110 kW)	1999.02-2000.09	AT	L/R	F	Saloon Engine 4G64 (GDI)	839005	Outer Joint	43T	25	33	54	95.5	65	I			
	1999.02-2000.09	AT	-	F	Saloon Engine 4G64 (GDI)	839075	Outer Joint	43T	25	32	54	95.5	63.5	I			
GALANT VI (EA_)/LEGNUM																	
2.0 (100 kW)	1996.09-2000.09	AT/MT	L	F	Estate Engine 4G63 (SOHC 16V)	839170	Outer Joint	43T	25	33	54	95	65	I			
	1996.09-2000.09	AT/MT	L/R	F	Estate Engine 4G63 (SOHC 16V)	839019	Outer Joint		25	24	54	94.5	62	M			
	1996.09-2000.09	AT/MT	-	-	Estate Engine 4G63 (SOHC 16V)	639057	Inner Joint		25	30	41	61.5	95				
2.0 (98 kW)	2000.09-2003.10	AT/MT	L	F	Estate Engine 4G63 (SOHC 16V)	839170	Outer Joint	43T	25	33	54	95	65	I			
	2000.09-2003.10	MT	L/R	F	Estate Engine 4G63 (SOHC 16V)	839019	Outer Joint		25	24	54	94.5	62	M			
	2000.09-2003.10	-	-	-	Estate Engine 4G63 (SOHC 16V)	639057	Inner Joint		25	30	41	61.5	95				
2.4 GDI (106 kW)	2000.09-2003.10	AT	L/R	F	Estate Engine 4G64 (GDI)	839005	Outer Joint	43T	25	33	54	95.5	65	I			
2.4 GDI (110 kW)	1999.02-2003.10	AT	L/R	F	Estate Engine 4G64 (GDI)	839005	Outer Joint	43T	25	33	54	95.5	65	I			
2.5 V6 24V (118 kW)	2000.09-2003.10	MT	L/R	F	Estate Engine 6A13	839005	Outer Joint	43T	25	33	54	95.5	65	I			
2.5 V6 24V (120 kW)	1996.09-2000.09	MT	L/R	F	Estate Engine 6A13	839005	Outer Joint	43T	25	33	54	95.5	65	I			
GALANT/ETERNA (E12A)																	
1.8	1983.08-1989.04	MT/AT	-	-	Engine G37B	809001	Outer Joint		25	22	50	96	57	M			
	1986.01-1989.04	4AT	-	-	Engine G37B	809001	Outer Joint		25	22	50	96	57	M			
GALANT/ETERNA (E17A)																	
2.0	1986.10-1990.12	MT/AT	-	-	Engine 6G71	839026	Outer Joint		25	26	50	95	64.5	M			
GALANT/ETERNA (E18A)																	
3.0	1989.05-1990.11	AT	-	-	Engine 6G72	839026	Outer Joint		25	26	50	95	64.5	M			
GALANT/ETERNA (E31A)																	
1.6	1987.08-1992.09	MT/AT	-	-	Engine 4G32	809001	Outer Joint		25	22	50	96	57	M			
GALANT/ETERNA (E32A)																	
1.8	1987.08-1992.09	MT/AT	-	-	Engine 4G37 ECI	839214	Outer Joint		25	23	54	96	59	M			
GALANT/ETERNA (E33A)																	
2.0	1987.08-1992.09	MT/AT	-	-	Engine 4G63	839214	Outer Joint		25	23	54	96	59	M			
GALANT/ETERNA (E34A)																	
1.8	1988.02-1992.09	MT	-	-	Engine 4D65 TBO	839214	Outer Joint		25	23	54	96	59	M			
GALANT/ETERNA (E35A)																	
1.8	1989.04-1992.09	MT/AT	-	-	Engine 4G67	839214	Outer Joint		25	23	54	96	59	M			
GALANT/ETERNA (E37A)																	
1.8	1988.09-1992.09	MT/AT	-	-	Engine 4G37	839215	Outer Joint		25	30	54	96	59	M			
GALANT/ETERNA (E38A)																	
2.0	1988.02-1992.09	MT	-	-	Engine 4G63 TBO	839215	Outer Joint		25	30	54	96	59	M			
GALANT/ETERNA (E39A)																	
2.0	1987.09-1992.09	MT	-	-	Engine 4G63	839215	Outer Joint		25	30	54	96	59	M			
2.0 4WD	1987.01-1992.09	MT	-	-	Engine 4G63	839215	Outer Joint		25	30	54	96	59	M			
GALANT/ETERNA (EA1A)																	
1.8	1996.08-	5MT	-	-	Engine 4G93	839270	Outer Joint		25	23	54	96	59	M			
GALANT/ETERNA SIGMA HARDTOP(E13A)																	
1.8	1984.09-1990.03	AT/MT	R	-	Engine (ECI)	639002	Inner Joint		25	23	35	62.8	95.5				
GALANT/ETERNA SIGMA HARDTOP(E15A)																	

YEAR	TRANSM	L/R	F/R	REMARKS	GSP Ref.	PRODUCT	ABS	Technical Specifications							
								A	B	C	H	L	P		
MITSUBISHI															
GALANT/ETERNA SIGMA HARDTOP(E15A)															
2.0	1984.09-1990.03	AT/MT	R	-	Engine STRAIGHT 4 CYLINDER	639002	Inner Joint		25	23	35	62.8	95.5		
	1984.09-1990.03	AT/MT	R	-	Engine (STRAIGHT 4 CYLINDER)	639002	Inner Joint		25	23	35	62.8	95.5		
GRANDIS (NA4W)															
2.4	2003-	-	MT/AT	-	Engine 4G69	839161	Outer Joint		28	26	60	89	63	M	
GRANDIS (NA_W)															
2.0 DI-D (100 kW)	2005.09-2010.03	-	-	F	MPV Engine BSY	851028	Outer Joint		28	37	60	89.5	66.5	I	
2.0 DI-D (103 kW)	2007.02-2010.03	-	-	F	MPV Engine BWC	851028	Outer Joint		28	37	60	89.5	66.5	I	
2.4 MIVEC (121 kW)	2004.04-2011.12	-	-	-	MPV Engine 4G69	839135	Outer Joint		28	33	60	89	63	M	
	2004.04-2011.12	-	-	F	MPV Engine 4G69	839134	Outer Joint		28	26	60	89	63	M	
	2004.04-2011.12	AT	-	F	MPV Engine 4G69	639054	Inner Joint		27	24	41	63.5	107		
	2004.04-2011.12	AT	-	F	MPV Engine 4G69	839180	Outer Joint		28	26	60	89	66	I	
KB9T															
3.5	2006.09-2007.12	4AT	R	-	Allwheel Drive	834149	Outer Joint	47T	30	35	69	98.5	66.5	M	
KH8W															
3.2	2008-	-	MT/AT	R	-	Allwheel Drive	834149	Outer Joint	47T	30	35	69	98.5	66.5	M
L 200 (K3_T K2_T K1_T K0_T)															
2.0 (63 kW)	1987.02-1994.05	MT	L	F	All-wheel Drive Pickup Engine 4G63 (SOHC 8V)	639049	Inner Joint		25	25	32	89	81.5		
	1987.02-1994.05	MT	R	F	All-wheel Drive Pickup Engine 4G63 (SOHC 8V)	639061	Inner Joint			25		68.6			
2.5 D (51 kW)	1987.12-1993.05	MT	L	F	All-wheel Drive Pickup Engine 4D56 (8V)	639049	Inner Joint		25	25	32	89	81.5		
	1987.12-1993.05	-	-	F	All-wheel Drive Pickup Engine 4D56 (8V)	839013	Outer Joint		28	25	56	155.5	64	M	
	1987.12-1993.05	MT	R	F	All-wheel Drive Pickup Engine 4D56 (8V)	639061	Inner Joint			25		68.6			
2.5 TD (64 kW)	1992.11-1996.08	MT	L	F	All-wheel Drive Pickup Engine 4D56 T	639049	Inner Joint		25	25	32	89	81.5		
	1992.11-1996.08	-	-	F	All-wheel Drive Pickup Engine 4D56 T	839013	Outer Joint		28	25	56	155.5	64	M	
	1992.11-1996.08	MT	R	F	All-wheel Drive Pickup Engine 4D56 T	639061	Inner Joint			25		68.6			
2.6 (76 kW)	1989.11-1995.05	MT	L	F	All-wheel Drive Pickup Engine G54B	639049	Inner Joint		25	25	32	89	81.5		
	1989.11-1995.05	MT	R	F	All-wheel Drive Pickup Engine G54B	639061	Inner Joint			25		68.6			
L 200 (K7_T K6_T)															
2.4 (97 kW)	1996.06-2007.12	MT	R	F	All-wheel Drive Pickup Engine 4G64 (SOHC 16V)	675004	Inner Joint			26		62.5			
	1996.06-2007.12	-	R	F	All-wheel Drive Pickup Engine 4G64 (SOHC 16V)	239006	Drive Shaft		28		56	154	538		
	1996.06-2007.12	-	L	F	All-wheel Drive Pickup Engine 4G64 (SOHC 16V)	239007	Drive Shaft		28	25	56	154	616		
	1996.06-2007.12	-	R	-	All-wheel Drive Pickup Engine 4G64 (SOHC 16V)	699092	Inner Joint			26		71.5			
	1996.06-2007.12	MT	L	F	All-wheel Drive Pickup Engine 4G64 (SOHC 16V)	639049	Inner Joint		25	25	32	89	81.5		
	1996.06-2007.12	MT	R	F	All-wheel Drive Pickup Engine 4G64 (SOHC 16V)	639061	Inner Joint			25		68.6			
	1996.06-2007.12	-	L	F	All-wheel Drive Pickup Engine 4G64 (SOHC 16V)	299232	Drive Shaft		28	25	56	154	610		
	1996.06-2007.12	-	R	F	All-wheel Drive Pickup Engine 4G64 (SOHC 16V)	239034	Drive Shaft		28		56	155.5	528		
	1996.06-2007.12	-	L/R	F	All-wheel Drive Pickup Engine 4G64 (SOHC 16V)	839018	Outer Joint		28	25	56	154	62	M	
2.5 TD (73 kW)	1996.06-2007.12	-	R	F	All-wheel Drive Pickup Engine 4D56 TD	675004	Inner Joint			26		62.5			
	1996.06-2007.12	-	R	F	All-wheel Drive Pickup Engine 4D56 TD	239006	Drive Shaft		28		56	154	538		
	1996.06-2007.12	-	L	F	All-wheel Drive Pickup Engine 4D56 TD	239007	Drive Shaft		28	25	56	154	616		
	1996.06-2007.12	5MT	R	-	All-wheel Drive Pickup Engine 4D56 TD	699092	Inner Joint			26		71.5			
	1996.06-2007.12	-	-	F	All-wheel Drive Pickup Engine 4D56 TD	839013	Outer Joint		28	25	56	155.5	64	M	
	1996.06-2007.12	-	L	F	All-wheel Drive Pickup Engine 4D56 TD	299232	Drive Shaft		28	25	56	154	610		
	1996.06-2007.12	-	R	F	All-wheel Drive Pickup Engine 4D56 TD	639061	Inner Joint			25		68.6			
	1996.06-2007.12	-	R	F	All-wheel Drive Pickup Engine 4D56 TD	239034	Drive Shaft		28		56	155.5	528		
	1996.06-2007.12	-	L/R	F	All-wheel Drive Pickup Engine 4D56 TD	839018	Outer Joint		28	25	56	154	62	M	
2.5 TD (85 kW)	2001.09-2007.12	MT	L	F	All-wheel Drive Pickup Engine 4D56 T	299232	Drive Shaft		28	25	56	154	610		
	2001.09-2007.12	-	-	F	All-wheel Drive Pickup Engine 4D56 T	839013	Outer Joint		28	25	56	155.5	64	M	
	2001.09-2007.12	MT	R	F	All-wheel Drive Pickup Engine 4D56 T	239034	Drive Shaft		28		56	155.5	528		
	2001.09-2007.12	-	R	F	All-wheel Drive Pickup Engine 4D56 T	639061	Inner Joint			25		68.6			
	2001.09-2007.12	-	L/R	F	All-wheel Drive Pickup Engine 4D56 T	839018	Outer Joint		28	25	56	154	62	M	
2.5 TD (98 kW)	2001.08-2007.12	MT	L	F	All-wheel Drive Pickup Engine 4D56 T	299232	Drive Shaft		28	25	56	154	610		
	2001.08-2007.12	-	-	F	All-wheel Drive Pickup Engine 4D56 T	839013	Outer Joint		28	25	56	155.5	64	M	
	2001.08-2007.12	MT	R	F	All-wheel Drive Pickup Engine 4D56 T	239034	Drive Shaft		28		56	155.5	528		
	2001.08-2007.12	-	R	F	All-wheel Drive Pickup Engine 4D56 T	639061	Inner Joint			25		68.6			
2.8 TD (92 kW)	2003.04-2006.06	MT	R	F	All-wheel Drive Pickup Engine 4M40-T	675004	Inner Joint			26		62.5			
	2003.04-2006.06	MT	L	F	All-wheel Drive Pickup Engine 4M40-T	639049	Inner Joint		25	25	32	89	81.5		
	2003.04-2006.06	MT	R	F	All-wheel Drive Pickup Engine 4M40-T	639061	Inner Joint			25		68.6			
L 200/TRITON (KA_T KB_T)/HUNTER															
2.5 DI-D (100 kW)	2005.11-	-	AT/MT	R	F	All-wheel Drive Pickup Engine 4D56 HP	239164	Drive Shaft	47T	30		69	98	492	
	2005.11-	-	AT/MT	L	F	All-wheel Drive Pickup Engine 4D56 HP	239163	Drive Shaft	47T	30	28	69	98	594	
	2005.11-	-	MT	R	F	All-wheel Drive Pickup Engine 4D56 HP	639036	Inner Joint			33		62.5		
	2005.11-	-	AT/MT	L/R	F	All-wheel Drive Pickup Engine 4D56 HP	839294	Outer Joint		30	33	69	98	66.5	I
	2005.11-	-	-	-	F	All-wheel Drive Pickup Engine 4D56 HP	839166	Outer Joint	47T	30	33	69	98	66.5	I
	2005.11-	-	MT	-	F	All-wheel Drive Pickup Engine 4D56 HP	839159	Outer Joint	47T	30	35	69	98	66.5	I
	2005.11-	-	AT/MT	L	F	All-wheel Drive Pickup Engine 4D56 HP	239147	Drive Shaft	47T	30	28	69	98	594.5	
	2005.11-	-	AT/MT	R	F	All-wheel Drive Pickup Engine 4D56 HP	239148	Drive Shaft	47T	30		69	98	492	





YEAR	TRANSM	L/R	F/R	REMARKS	GSP Ref.	PRODUCT	ABS	Technical Specifications							
								A	B	C	H	L	P		
MITSUBISHI															
L 200/TRITON (KA_T KB_T)/HUNTER															
2.5 DI-D (100 kW)	2005.11-	-	AT/MT	L F	All-wheel Drive Pickup Engine 4D56 HP	639037	Inner Joint		28	33	34.7	90.5	81.5		
2.5 DI-D (123 kW)	2007.08-	-	-	-	F Pickup Engine 4D56 HP	839166	Outer Joint	47T	30	33	69	98	66.5	I	
	2007.08-	-	AT/MT	L F	Pickup Engine 4D56 HP	239147	Drive Shaft	47T	30	28	69	98	594.5		
	2007.08-	-	AT/MT	R F	Pickup Engine 4D56 HP	239148	Drive Shaft	47T	30		69	98	492		
	2007.08-	-	AT/MT	L F	Pickup Engine 4D56 HP	639037	Inner Joint		28	33	34.7	90.5	81.5		
	2007.10-	-	AT/MT	R F	All-wheel Drive Pickup Engine 4D56 HP	239164	Drive Shaft	47T	30		69	98	492		
	2007.10-	-	AT/MT	L F	All-wheel Drive Pickup Engine 4D56 HP	239163	Drive Shaft	47T	30	28	69	98	594		
	2007.10-	-	AT/MT	L/R F	All-wheel Drive Pickup Engine 4D56 HP	839294	Outer Joint		30	33	69	98	66.5	I	
	2007.10-	-	-	-	-	F All-wheel Drive Pickup Engine 4D56 HP	839166	Outer Joint	47T	30	33	69	98	66.5	I
	2007.10-	-	AT/MT	L F	All-wheel Drive Pickup Engine 4D56 HP	239147	Drive Shaft	47T	30	28	69	98	594.5		
	2007.10-	-	AT/MT	R F	All-wheel Drive Pickup Engine 4D56 HP	239148	Drive Shaft	47T	30		69	98	492		
2007.10-	-	AT/MT	L F	All-wheel Drive Pickup Engine 4D56 HP	639037	Inner Joint		28	33	34.7	90.5	81.5			
2.5 DI-D (131 kW)	2010.04-2015.12	-	-	-	F All-wheel Drive Pickup Engine 4D56 HP	839166	Outer Joint	47T	30	33	69	98	66.5	I	
	2010.04-2015.12	AT/MT	L F	All-wheel Drive Pickup Engine 4D56 HP	239147	Drive Shaft	47T	30	28	69	98	594.5			
	2010.04-2015.12	AT/MT	R F	All-wheel Drive Pickup Engine 4D56 HP	239148	Drive Shaft	47T	30		69	98	492			
	2010.04-2015.12	AT/MT	L F	All-wheel Drive Pickup Engine 4D56 HP	639037	Inner Joint		28	33	34.7	90.5	81.5			
2.5 DI-D (94 kW)	2010.04-	-	-	-	F Pickup Engine 4D56 HP	839166	Outer Joint	47T	30	33	69	98	66.5	I	
	2010.04-	-	AT/MT	L F	Pickup Engine 4D56 HP	239147	Drive Shaft	47T	30	28	69	98	594.5		
	2010.04-	-	AT/MT	R F	Pickup Engine 4D56 HP	239148	Drive Shaft	47T	30		69	98	492		
	2010.04-	-	AT/MT	L F	Pickup Engine 4D56 HP	639037	Inner Joint		28	33	34.7	90.5	81.5		
L 200/TRITON (KJ_KK_KL_)/L200															
2.4 DI-D (113 kW)	2015.09-	-	AT/MT	R F	All-wheel Drive Pickup Engine 4N15	239164	Drive Shaft	47T	30		69	98	492		
	2015.09-	-	AT/MT	L/R F	All-wheel Drive Pickup Engine 4N15	839294	Outer Joint		30	33	69	98	66.5	I	
2.4 DI-D (133 kW)	2014.11-	-	AT/MT	R F	All-wheel Drive Pickup Engine 4N15	239164	Drive Shaft	47T	30		69	98	492		
	2014.11-	-	AT/MT	L/R F	All-wheel Drive Pickup Engine 4N15	839294	Outer Joint		30	33	69	98	66.5	I	
L 300 III (P0_V P1_V P_2V)/DELICA															
2.0 (63 kW)	1988.08-1994.05	MT	L F	All-wheel Drive Box Engine 4G63 (SOHC 8V)	639049	Inner Joint		25	25	32	89	81.5			
	1988.08-1994.05	MT	R F	All-wheel Drive Box Engine 4G63 (SOHC 8V)	639061	Inner Joint			25		68.6				
L 300 III (P0_W P1_W P2_W)/DELICA															
2.0 (64 kW)	1986.11-2004.05	-	-	-	F BUS Engine G63B	839013	Outer Joint		28	25	56	155.5	64	M	
2.0 (65 kW)	1986.12-2004.05	MT	L F	All-wheel Drive BUS Engine 4G63 (SOHC 8V)	639049	Inner Joint		25	25	32	89	81.5			
	1986.12-2004.05	MT	R F	All-wheel Drive BUS Engine 4G63 (SOHC 8V)	639061	Inner Joint			25		68.6				
2.0 (66 kW)	1986.11-2004.05	MT	L F	All-wheel Drive BUS Engine 4G63 (SOHC 8V)	639049	Inner Joint		25	25	32	89	81.5			
	1986.11-2004.05	MT	R F	All-wheel Drive BUS Engine 4G63 (SOHC 8V)	639061	Inner Joint			25		68.6				
2.4 (80 kW)	1986.11-1990.12	MT	R F	All-wheel Drive BUS Engine G64B	639061	Inner Joint			25		68.6				
2.4 (82 kW)	1990.11-2004.05	AT	L F	All-wheel Drive BUS Engine 4G64 (8V)	639049	Inner Joint		25	25	32	89	81.5			
	1990.11-2004.05	MT	R F	All-wheel Drive BUS Engine 4G64 (8V)	639061	Inner Joint			25		68.6				
2.5 D (51 kW)	1986.11-2004.05	-	-	-	F BUS Engine 4D56 (8V)	839013	Outer Joint		28	25	56	155.5	64	M	
2.5 TD (64 kW)	1988.11-2004.05	AT	L F	All-wheel Drive BUS Engine 4D56 T	639049	Inner Joint		25	25	32	89	81.5			
	1988.11-2004.05	MT	R F	All-wheel Drive BUS Engine 4D56 T	639061	Inner Joint			25		68.6				
L 400 (PD_W PC_W PA_V PB_V PA_W)															
2.4 (94 kW)	1996.09-2005.06	MT	L F	All-wheel Drive BUS Engine 4G64 (SOHC 16V)	699083	Inner Joint		28	26	34.7	90.5	90.6			
	1996.09-2005.06	MT	R F	All-wheel Drive BUS Engine 4G64 (SOHC 16V)	675004	Inner Joint			26		62.5				
	1996.09-2005.06	AT	L F	All-wheel Drive BUS Engine 4G64 (SOHC 16V)	639049	Inner Joint		25	25	32	89	81.5			
	1996.09-2005.06	MT	R F	All-wheel Drive BUS Engine 4G64 (SOHC 16V)	639061	Inner Joint			25		68.6				
2.4 i (97 kW)	1995.05-2000.05	MT	L F	All-wheel Drive BUS Engine 4G64 (SOHC 16V)	699083	Inner Joint		28	26	34.7	90.5	90.6			
	1995.05-2000.05	MT	R F	All-wheel Drive BUS Engine 4G64 (SOHC 16V)	675004	Inner Joint			26		62.5				
	1995.05-2000.05	AT	L F	All-wheel Drive BUS Engine 4G64 (SOHC 16V)	639049	Inner Joint		25	25	32	89	81.5			
	1995.05-2000.05	MT	R F	All-wheel Drive BUS Engine 4G64 (SOHC 16V)	639061	Inner Joint			25		68.6				
2.5 TD (73 kW)	1995.05-2000.05	MT	L F	All-wheel Drive BUS Engine 4D56 TD	699083	Inner Joint		28	26	34.7	90.5	90.6			
	1995.05-2000.05	MT	R F	All-wheel Drive BUS Engine 4D56 TD	675004	Inner Joint			26		62.5				
	1995.05-2000.05	MT	L F	All-wheel Drive BUS Engine 4D56 TD	639049	Inner Joint		25	25	32	89	81.5			
	1995.05-2000.05	MT	R F	All-wheel Drive BUS Engine 4D56 TD	639061	Inner Joint			25		68.6				
L 400 (PD_W PC_W PB_V PA_W PA_V)															
2.5 TD (64 kW)	1996.09-2005.06	MT	L F	All-wheel Drive Box Engine 4D56 T	699083	Inner Joint		28	26	34.7	90.5	90.6			
	1996.09-2005.06	MT	R F	All-wheel Drive Box Engine 4D56 T	675004	Inner Joint			26		62.5				
	1996.09-2005.06	MT	L F	All-wheel Drive Box Engine 4D56 T	639049	Inner Joint		25	25	32	89	81.5			
	1996.09-2005.06	MT	R F	All-wheel Drive Box Engine 4D56 T	639061	Inner Joint			25		68.6				
L100/MINICAB (U6_T)															
0.7 (35 kW)	1999.03-	-	-	-	-	All-wheel Drive Platform/Chassis Engine 3G83 (SOHC 12V)	839091	Outer Joint		20	19	45.5	104	58	M
L100/MINICAB (U6_V)															
0.7 (35 kW)	1999.03-	-	-	-	-	All-wheel Drive BUS Engine 3G83 (SOHC 12V)	839091	Outer Joint		20	19	45.5	104	58	M
L200/TRITON															
-	2008.06-	-	-	R	-	-	239104	Drive Shaft		30		69	98	492	
-	2008.06-	-	-	L	-	-	239105	Drive Shaft		30	28	69	98	594	
LANCER															





YEAR	TRANSM	L/R	F/R	REMARKS	GSP Ref.	PRODUCT	ABS	Technical Specifications						
								A	B	C	H	L	P	
MITSUBISHI														
LANCER														
-	2001-	-	-	-	-	839048	Outer Joint		25	23	57	94.5	60	I
-	2002- 2003	-	-	-	-	839082	Outer Joint		25	29	57	94.5	60	I
-	2008-	MT/AT	L/R	-	-	851032	Outer Joint		28	33	59.5	95	63.5	I
-	2008-	MT/AT	L	-	-	641056	Inner Joint		27	33	40	62	112	
-	2008-	MT	R	-	-	615014	Inner Joint		28	33	42	40	82	
1.3	1987- 1991	MT/AT	-	-	C61 4G13	639025	Inner Joint		25	22	35	54.7	90.8	
-	1992-	-	-	-	-	639009	Inner Joint		25	22	35	54.7	90.8	
1.5	1987- 1991	MT/AT	-	-	C62 4G15	639025	Inner Joint		25	22	35	54.7	90.8	
1.6	-	MT	-	-	GLXI CB4A	839039	Outer Joint		25	23	54	96	60	I
1.8	1987- 1991	MT/AT	-	-	C64 4G65	639025	Inner Joint		25	22	35	54.7	90.8	
2.0	2004- 2011	MT/AT	-	-	-	639074	Inner Joint		25	30	41	63	97	
LANCER (CK1A, CK2A)														
1.3	1995- 1997	-	-	-	-	639029	Inner Joint		25	22	41	62.5	90.5	
1.5	1995- 1997	-	-	-	-	639029	Inner Joint		25	22	41	62.5	90.5	
LANCER CEDIA (CS1A)														
1.3	2000.03- 2002.12	MT/AT	-	-	Engine 4G13	839059	Outer Joint		25	29	57	95	58	M
LANCER CEDIA (CS5A)														
1.8 4WD	2000.07-	-	CVT	-	Engine 4G93	839142	Outer Joint	43T	25	30	57	95	60.5	M
LANCER CEDIA CS1A														
1.3	2000.03- 2002.12	MT/AT	-	-	Engine 4G13	839059	Outer Joint		25	29	57	95	58	M
-	2000.03- 2002.12	MT/AT	-	-	Engine 4G13	839059	Outer Joint		25	29	57	95	58	M
1300	2000.03- 2002.12	MT/AT	-	-	Engine 4G13	839059	Outer Joint		25	29	57	95	58	M
-	2000.03- 2002.12	MT/AT	-	-	Engine 4G13	839059	Outer Joint		25	29	57	95	58	M
LANCER CEDIA CS5A														
1.8	2000.07-	-	CVT	-	Allwheel Drive Engine 4G93	839142	Outer Joint	43T	25	30	57	95	60.5	M
1800	2000.07-	-	CVT	-	Allwheel Drive Engine 4G93	839142	Outer Joint	43T	25	30	57	95	60.5	M
LANCER CEDIA WAGON (CS5W)														
1.8 4WD	2000.11-	-	CVT	-	Engine 4G93	839142	Outer Joint	43T	25	30	57	95	60.5	M
LANCER CEDIA WAGON CS5W														
1.8	2000.11-	-	CVT	-	Allwheel Drive Engine 4G93	839142	Outer Joint	43T	25	30	57	95	60.5	M
1800	2000.11-	-	CVT	-	Allwheel Drive Engine 4G93	839142	Outer Joint	43T	25	30	57	95	60.5	M
LANCER CY1A														
1.6	2007.03- 2013.02	-	-	-	-	201575	Drive Shaft		28	25	59.5	94.5	946	
LANCER CY2A														
1.5	2007.03- 2013.02	-	-	-	-	201574	Drive Shaft		28	25	59.5	94.5	666	
-	2007.03- 2013.02	-	-	-	-	201575	Drive Shaft		28	25	59.5	94.5	946	
LANCER EVOLUTION (CZ4A)														
2.0	2007.08- 2007.08	5MT	-	-	Engine 4B11TBO	839211	Outer Joint		28	33	60	89	60	I
-	2007.08- 2007.08	6MT	-	-	Engine 4B11TBO	839211	Outer Joint		28	33	60	89	60	I
LANCER EVOLUTION CZ4A														
2000	2007.08-	-	5MT	-	Engine 4B11 TBO	839211	Outer Joint		28	33	60	89	60	I
-	2007.08-	-	6MT	-	Engine 4B11 TBO	839211	Outer Joint		28	33	60	89	60	I
LANCER III Station Wagon (C1_V C3_V)														
1.5 (51 kW)	1985.09- 1989.08	AT/MT	L/R	F	Estate Engine G15B	809004	Outer Joint		25	22	50	95	58	M
-	1985.09- 1989.08	-	-	-	Estate Engine G15B	824003	Outer Joint		25	22	50	95	58	I
1.5 (61 kW)	1988.09- 1990.12	AT/MT	L/R	F	Estate Engine 4G15 (8V)	809004	Outer Joint		25	22	50	95	58	M
1.5 12V (66 kW)	1990.09- 1991.12	AT/MT	L/R	F	Estate Engine 4G15 (12V)	809004	Outer Joint		25	22	50	95	58	M
1.8 (61 kW)	1987.01- 1989.08	MT	L/R	F	All-wheel Drive Estate Engine G37B	839054	Outer Joint		25	23	50	96	59	M
1.8 (69 kW)	1990.08- 1992.06	AT/MT	L/R	F	All-wheel Drive Estate Engine 4G37	809004	Outer Joint		25	22	50	95	58	M
1.8 D (44 kW)	1986.08- 1992.06	MT	-	F	Estate Engine 4D65	809002	Outer Joint		25	23	50	94.5	63.5	M
LANCER IV (C6A, C7A)/MIRAGE														
1.8 GTi 16V (100 kW)	1989.04- 1993.12	-	-	-	-	839099	Outer Joint		25	30	54	95	60	I
1.8 GTi 16V (103 kW)	1989.04- 1993.12	-	-	-	-	839099	Outer Joint		25	30	54	95	60	I
LANCER IV (C6_A C7_A)														
1.3 (44 kW)	1988.04- 1992.05	AT/MT	L/R	F	Saloon Engine 4G13 (8V)	809004	Outer Joint		25	22	50	95	58	M
-	1988.04- 1992.05	-	-	-	Saloon Engine 4G13 (8V)	824003	Outer Joint		25	22	50	95	58	I
1.3 (51 kW)	1988.08- 1992.05	AT/MT	L/R	F	Saloon Engine G13B	809004	Outer Joint		25	22	50	95	58	M
-	1988.08- 1992.05	-	-	-	Saloon Engine G13B	824003	Outer Joint		25	22	50	95	58	I
1.3 12V (55 kW)	1990.07- 1992.06	AT/MT	L/R	F	Saloon Engine 4G13 (12V)	809004	Outer Joint		25	22	50	95	58	M
-	1990.07- 1992.06	-	-	-	Saloon Engine 4G13 (12V)	824003	Outer Joint		25	22	50	95	58	I
-	1992.06- 1994.05	AT/MT	L/R	F	Hatchback Engine 4G13 (12V)	809004	Outer Joint		25	22	50	95	58	M
-	1992.06- 1994.05	-	-	-	Hatchback Engine 4G13 (12V)	824003	Outer Joint		25	22	50	95	58	I
1.5 (62 kW)	1988.04- 1992.05	AT/MT	L/R	F	Saloon Engine 4G15 (12V)	809004	Outer Joint		25	22	50	95	58	M
-	1988.04- 1992.05	-	-	-	Saloon Engine 4G15 (12V)	824003	Outer Joint		25	22	50	95	58	I
-	1988.06- 1992.05	-	-	-	Hatchback Engine 4G15 (8V)	824003	Outer Joint		25	22	50	95	58	I





	 YEAR	TRANSM	L/R	F/R	REMARKS	GSP Ref.	 PRODUCT	 ABS	Technical Specifications					
									A	B	C	H	L	P
MITSUBISHI														
LANCER IV (C6_A C7_A)														
1.5 (65 kW)	1990.09-1992.09	-	-	F	Saloon Engine 4G15 (12V)	839011	Outer Joint		25	22	54	96	59	M
1.5 12V (66 kW)	1989.05-1992.05	AT/MT	L/R	F	Hatchback Engine 4G15 (12V)	809004	Outer Joint		25	22	50	95	58	M
	1989.05-1992.05	-	-	-	Hatchback Engine 4G15 (12V)	824003	Outer Joint		25	22	50	95	58	I
	1990.06-1992.05	AT/MT	L/R	F	Saloon Engine 4G15 (12V)	809004	Outer Joint		25	22	50	95	58	M
	1990.06-1992.05	-	-	-	Saloon Engine 4G15 (12V)	824003	Outer Joint		25	22	50	95	58	I
1.5 GLS (63 kW)	1989.08-1992.08	-	-	F	Saloon Engine 4G15 (12V)	839011	Outer Joint		25	22	54	96	59	M
1.6 16V (83 kW)	1992.06-1994.05	AT/MT	-	F	Hatchback Engine 4G92 (SOHC 16V)	839014	Outer Joint		25	30	50	95	60.5	M
	1992.06-1994.05	-	-	-	Hatchback Engine 4G92 (SOHC 16V)	824003	Outer Joint		25	22	50	95	58	I
1.6 GLX (91 kW)	1989.08-1992.08	MT	-	F	Saloon Engine 4G61	809002	Outer Joint		25	23	50	94.5	63.5	M
	1989.08-1992.08	AT/MT	-	F	Saloon Engine 4G61	839014	Outer Joint		25	30	50	95	60.5	M
	1989.08-1992.08	-	-	F	Saloon Engine 4G61	839009	Outer Joint		25	30	54	95	60.5	M
1.6 GTi (91 kW)	1988.05-1990.05	MT	-	F	Saloon Engine 4G61	809002	Outer Joint		25	23	50	94.5	63.5	M
	1988.05-1990.05	MT	-	F	Saloon Engine 4G61	839014	Outer Joint		25	30	50	95	60.5	M
	1988.05-1990.05	-	L	F	Saloon Engine 4G61	824009	Outer Joint		25	30	50	95	56.5	M
1.8 (71 kW)	1989.09-1992.06	AT/MT	L/R	F	All-wheel Drive Hatchback Engine 4G37	809004	Outer Joint		25	22	50	95	58	M
	1989.09-1992.06	-	-	-	All-wheel Drive Hatchback Engine 4G37	824009	Outer Joint		25	30	50	95	56.5	M
1.8 GTi 16V (100 kW)	1989.11-1992.05	MT	-	-	Hatchback Engine 4G67	639005	Inner Joint		25	30	35	62.8	92.5	
	1989.11-1992.05	-	-	F	Hatchback Engine 4G67	824009	Outer Joint		25	30	50	95	56.5	M
1.8 GTi 16V (103 kW)	1992.06-1993.12	MT	-	-	Hatchback Engine 4G93 (DOHC 16V)	639005	Inner Joint		25	30	35	62.8	92.5	
	1992.06-1993.12	-	-	F	Hatchback Engine 4G93 (DOHC 16V)	839064	Outer Joint	43T	25	30	54	95	60.5	M
2.0 D (50 kW)	1992.06-1993.07	-	-	-	Hatchback Engine 4D68	839096	Outer Joint		25	23	54	95	60	I
LANCER IV (C6_A, C7_A)														
1.5 12V(66kW)	1989.01-1992.01	-	R	F	Liftback	801443	Outer Joint		25	29	50	96	57	M
LANCER SEDAN														
1.6	2003-2007	-	R	F	-	239023	Drive Shaft		25	25	54	95	938.5	
	2003-2007	-	L	F	-	239024	Drive Shaft		25	25	54	95	621	
LANCER V (CB/DA)/MIRAGE														
1.6 16V 4WD (66 kW)	1994.01-	MT/AT	-	-	-	839099	Outer Joint		25	30	54	95	60	I
1.6 16V 4WD (70 kW)	1994.01-	MT/AT	-	-	-	839099	Outer Joint		25	30	54	95	60	I
1.6 16V 4WD (73 kW)	1994.01-	MT/AT	-	-	-	839099	Outer Joint		25	30	54	95	60	I
1.6 16V 4WD (83 kW)	1994.01-	MT/AT	-	-	-	839099	Outer Joint		25	30	54	95	60	I
1.8 16V (103 kW)	1992-	MT	-	-	-	839099	Outer Joint		25	30	54	95	60	I
1.8 16V (85 kW)	1992-	MT	-	-	-	839099	Outer Joint		25	30	54	95	60	I
1.8 16V (90 kW)	1992-	MT	-	-	-	839099	Outer Joint		25	30	54	95	60	I
LANCER V (CB_A CD_A CE_A)/LIBERO														
1.3 (55 kW)	1992.06-1996.12	-	L/R	F	Saloon Engine 4G13 (12V)	839023	Outer Joint		25	22	54	95	60	I
	1992.06-1996.12	-	-	F	Saloon Engine 4G13 (12V)	839011	Outer Joint		25	22	54	96	59	M
1.8 16V (103 kW)	1992.06-1993.12	AT/MT	-	F	Saloon Engine 4G93 (DOHC 16V)	839009	Outer Joint		25	30	54	95	60.5	M
	1992.06-1993.12	-	-	F	Saloon Engine 4G93 (DOHC 16V)	839064	Outer Joint	43T	25	30	54	95	60.5	M
1.8 i Turbo AWD (141 kW)	1992.11-1996.07	-	-	F	All-wheel Drive Saloon Engine 4G93T	839009	Outer Joint		25	30	54	95	60.5	M
	1992.11-1996.07	-	-	-	All-wheel Drive Saloon Engine 4G93T	639005	Inner Joint		25	30	35	62.8	92.5	
	1992.11-1996.07	-	-	-	All-wheel Drive Saloon Engine 4G93T	839064	Outer Joint	43T	25	30	54	95	60.5	M
2.0 Diesel (50 kW)	1992.06-1996.12	MT	-	-	Saloon Engine 4D68	639005	Inner Joint		25	30	35	62.8	92.5	
EVO I (184 kW)	1992.10-1993.12	MT	-	F	All-wheel Drive Saloon Engine 4G63 Turbo	839009	Outer Joint		25	30	54	95	60.5	M
EVO II (192 kW)	1994.01-1995.07	MT	-	F	All-wheel Drive Saloon Engine 4G63 Turbo	839009	Outer Joint		25	30	54	95	60.5	M
	1994.01-1995.07	MT	-	-	All-wheel Drive Saloon Engine 4G63 Turbo	639005	Inner Joint		25	30	35	62.8	92.5	
EVO III (198 kW)	1995.08-1996.07	MT	-	F	All-wheel Drive Saloon Engine 4G63 Turbo	839009	Outer Joint		25	30	54	95	60.5	M
	1995.08-1996.07	MT	-	-	All-wheel Drive Saloon Engine 4G63 Turbo	639005	Inner Joint		25	30	35	62.8	92.5	
LANCER V Station Wagon (CB_W CD_W)/LIBERO														
1.6 16V (83 kW)	1992.12-2003.10	AT	-	F	Estate Engine 4G92 (SOHC 16V)	839009	Outer Joint		25	30	54	95	60.5	M
	1992.12-2003.10	MT	-	F	All-wheel Drive Estate Engine 4G92 (SOHC 16V)	839009	Outer Joint		25	30	54	95	60.5	M
1.8 i (88 kW)	1995.03-2003.10	MT	-	F	Estate Engine 4G93 (SOHC 16V)	839009	Outer Joint		25	30	54	95	60.5	M
2.0 D (50 kW)	1992.12-2003.10	AT/MT	-	-	Estate Engine 4D68	639005	Inner Joint		25	30	35	62.8	92.5	
	1992.12-2003.10	-	-	F	Estate Engine 4D68	839020	Outer Joint	43T	25	24	54	94.5	62	M
2.0 D (65 kW)	1995.03-2003.10	AT/MT	-	-	Estate Engine 4D68 T	639005	Inner Joint		25	30	35	62.8	92.5	
	1995.03-2003.10	-	-	-	Estate Engine 4D68 T	839096	Outer Joint		25	23	54	95	60	I
LANCER VI (CJ-CP_)														
1.3 12V (55 kW)	1995.12-2003.08	-	-	F	Saloon Engine 4G13 (12V)	839008	Outer Joint	43T	25	29	54	95	58	I
1.6 16V (66 kW)	1995.12-2003.08	-	-	F	Saloon Engine 4G92 (SOHC 16V)	839064	Outer Joint	43T	25	30	54	95	60.5	M
	1995.12-2003.08	AT	-	-	Saloon Engine 4G92 (SOHC 16V)	639057	Inner Joint		25	30	41	61.5	95	
1.8 (91 kW)	1995.09-2003.08	-	-	-	Saloon Engine 4G93 (SOHC 16V)	839096	Outer Joint		25	23	54	95	60	I
1.8 16V (151 kW)	1995.09-2003.08	-	-	-	Saloon Engine 4G93T	839096	Outer Joint		25	23	54	95	60	I
1.8 GDI (121 kW)	2000.06-2003.08	-	-	-	All-wheel Drive Saloon Engine 4G93T (GDI)	839096	Outer Joint		25	23	54	95	60	I
1.8 GDI (96 kW)	2000.06-2003.08	-	-	-	Saloon Engine 4G93 (GDI)	839096	Outer Joint		25	23	54	95	60	I
LANCER VI (CK/PA)														
1.6 16V (66 kW)	1995.12-2003.08	-	-	-	-	839099	Outer Joint		25	30	54	95	60	I





	 YEAR	TRANSM	L/R	F/R	REMARKS	GSP Ref.	 PRODUCT	 ABS	Technical Specifications					
									A	B	C	H	L	P
MITSUBISHI														
LANCER VI (CK/PA)														
1.6 16V (70 kW)	1995.12-2003.08	-	-	-	-	839099	Outer Joint		25	30	54	95	60	I
1.6 16V (73 kW)	1995.12-2003.08	-	-	-	-	839099	Outer Joint		25	30	54	95	60	I
1.6 16V (83 kW)	1995.12-2003.08	-	-	-	-	839099	Outer Joint		25	30	54	95	60	I
1.8 16V (151 kW)	1999.01-2003.08	-	-	-	-	839099	Outer Joint		25	30	54	95	60	I
LANCER VII (CS_A CT_A)														
1.3 (60 kW)	2003.09-	-	MT	-	F Saloon Engine 4G13 (16V)	839148	Outer Joint		25	30	57	95	60.5	M
	2003.09-	-	MT	-	F Saloon Engine 4G13 (16V)	839008	Outer Joint	43T	25	29	54	95	58	I
	2003.09-	-	MT	-	F Saloon Engine 4G13 (16V)	639057	Inner Joint		25	30	41	61.5	95	
1.6 (72 kW)	2003.09-	-	-	-	F Saloon Engine 4G18	839200	Outer Joint	43T	25	30	57	94.5	60	I
	2003.09-	-	AT	-	F Saloon Engine 4G18	839114	Outer Joint	43T	25	23	57	95	60.5	M
	2003.09-	-	MT	L	F Saloon Engine 4G18	239228	Drive Shaft	43T	25	25	57	94.5	616	
	2003.09-	-	AT	-	F Saloon Engine 4G18	839141	Outer Joint	43T	25	22	57	95	60.5	M
	2003.09-	-	AT	R	F Saloon Engine 4G18	699089	Inner Joint		25	29	41	62.5	87	
2.0 (99 kW)	2003.12-	-	-	L	F Saloon Engine 4G63 (DOHC 16V)	624102	Inner Joint		27	30	41	62.5	97	
	2003.12-	-	-	-	F Saloon Engine 4G63 (DOHC 16V)	839203	Outer Joint	43T	25	30	54	95	60	I
	2003.12-	-	MT	-	F Saloon Engine 4G63 (DOHC 16V)	839176	Outer Joint	43T	25	29	57	95	58	M
	2003.12-	-	AT	-	F Saloon Engine 4G63 (DOHC 16V)	839148	Outer Joint		25	30	57	95	60.5	M
	2003.12-	-	MT	L	F Saloon Engine 4G63 (DOHC 16V)	239217	Drive Shaft	43T	25	25	54	95	667	
EVO IX (206 kW)	2005.01-2007.09	-	MT	-	F All-wheel Drive Saloon Engine 4G63 Turbo	639115	Inner Joint		27	30	41	62.5	95	
	2005.01-2007.09	-	MT	-	F All-wheel Drive Saloon Engine 4G63 Turbo	839290	Outer Joint		25	30	57	94.5	60	I
	2005.01-2007.09	-	MT	-	F All-wheel Drive Saloon Engine 4G63 Turbo	239282	Drive Shaft	43T	25	27	57	94.5	940	
EVO IX (213 kW)	2005.08-2006.09	-	MT	-	F All-wheel Drive Saloon Engine 4G63 Turbo	839176	Outer Joint	43T	25	29	57	95	58	M
	2005.08-2006.09	-	-	-	F All-wheel Drive Saloon Engine 4G63 Turbo	839148	Outer Joint		25	30	57	95	60.5	M
	2005.08-2006.09	-	-	-	F All-wheel Drive Saloon Engine 4G63 Turbo	639057	Inner Joint		25	30	41	61.5	95	
EVO VII - FQ-300 (228 kW)	2002.06-2002.12	-	AT/MT	-	F All-wheel Drive Saloon Engine 4G63 Turbo	839148	Outer Joint		25	30	57	95	60.5	M
	2002.06-2002.12	-	AT/MT	-	F All-wheel Drive Saloon Engine 4G63 Turbo	639057	Inner Joint		25	30	41	61.5	95	
EVO VIII - 260 (195 kW)	2004.03-2005.07	-	-	-	F All-wheel Drive Saloon Engine 4G63 Turbo	839168	Outer Joint	43T	27	32	60	97	60	I
	2004.03-2005.07	-	MT	L	F All-wheel Drive Saloon Engine 4G63 Turbo	239216	Drive Shaft	43T	27	26	60	97	559	
LANCER VII (CS_W CT_W)														
1.6 (72 kW)	2003.09-2008.10	-	-	-	F Estate Engine 4G18	839200	Outer Joint	43T	25	30	57	94.5	60	I
	2003.09-2008.10	-	MT	L	F Estate Engine 4G18	239228	Drive Shaft	43T	25	25	57	94.5	616	
	2003.09-2008.10	-	-	-	F Estate Engine 4G18	839148	Outer Joint		25	30	57	95	60.5	M
	2003.09-2008.10	-	-	-	F Estate Engine 4G18	639057	Inner Joint		25	30	41	61.5	95	
	2003.09-2008.10	-	AT	R	F Estate Engine 4G18	699089	Inner Joint		25	29	41	62.5	87	
2.0 (99 kW)	2003.09-2007.12	-	-	-	F Estate Engine 4G63 (DOHC 16V)	839203	Outer Joint	43T	25	30	54	95	60	I
	2003.09-2007.12	-	MT	-	F Estate Engine 4G63 (DOHC 16V)	839176	Outer Joint	43T	25	29	57	95	58	M
	2003.09-2007.12	-	MT	L	F Estate Engine 4G63 (DOHC 16V)	239217	Drive Shaft	43T	25	25	54	95	667	
	2003.09-2007.12	-	-	-	F Estate Engine 4G63 (DOHC 16V)	839148	Outer Joint		25	30	57	95	60.5	M
	2003.09-2007.12	-	-	-	F Estate Engine 4G63 (DOHC 16V)	639057	Inner Joint		25	30	41	61.5	95	
LANCER VIII (CY_A CZ_A)/GALANT FORTIS														
1.5 (80 kW)	2008.06-	-	AT/MT	-	F Saloon Engine 4A91	815011	Outer Joint		28	30	59.5	95	57.5	I
1.5 Bifuel (80 kW)	2010.02-	-	AT/MT	-	F Saloon Engine 4A91	815011	Outer Joint		28	30	59.5	95	57.5	I
1.6 MIVEC (86 kW)	2010.05-	-	AT	-	F Saloon Engine 4A92	639057	Inner Joint		25	30	41	61.5	95	
	2010.05-	-	MT	-	F Saloon Engine 4A92	839113	Outer Joint		28	33	59.5	95	61.5	I
1.8 (103 kW)	2010.05-	-	AT/MT	-	F Saloon Engine 4B10	839113	Outer Joint		28	33	59.5	95	61.5	I
	2010.05-	-	AT/MT	-	F Saloon Engine 4B10	639057	Inner Joint		25	30	41	61.5	95	
	2010.05-	-	AT	-	F Saloon Engine 4B10	639040	Inner Joint		27	33	40	62	99	
	2010.05-	-	MT	R	F Saloon Engine 4B10	659205	Inner Joint		24	33	40	95.5	84	
1.8 (105 kW)	2008.02-	-	AT/MT	-	F Saloon Engine 4B10	839113	Outer Joint		28	33	59.5	95	61.5	I
	2008.02-	-	AT/MT	-	F Saloon Engine 4B10	639057	Inner Joint		25	30	41	61.5	95	
	2008.02-	-	AT	-	F Saloon Engine 4B10	639040	Inner Joint		27	33	40	62	99	
	2008.02-	-	MT	R	F Saloon Engine 4B10	659205	Inner Joint		24	33	40	95.5	84	
1.8 Bifuel (105 kW)	2010.01-	-	AT/MT	-	F Saloon Engine 4B10	839113	Outer Joint		28	33	59.5	95	61.5	I
	2010.01-	-	AT/MT	-	F Saloon Engine 4B10	639057	Inner Joint		25	30	41	61.5	95	
	2010.01-	-	AT	-	F Saloon Engine 4B10	639040	Inner Joint		27	33	40	62	99	
	2010.01-	-	MT	R	F Saloon Engine 4B10	659205	Inner Joint		24	33	40	95.5	84	
1.8 DI-D (85 kW)	2010.05-	-	AT/MT	-	F Saloon Engine 4N13	839113	Outer Joint		28	33	59.5	95	61.5	I
	2010.05-	-	AT/MT	-	F Saloon Engine 4N13	639057	Inner Joint		25	30	41	61.5	95	
	2010.05-	-	AT	-	F Saloon Engine 4N13	639040	Inner Joint		27	33	40	62	99	
	2010.05-	-	MT	R	F Saloon Engine 4N13	659205	Inner Joint		24	33	40	95.5	84	
1.8 Flexfuel (103 kW)	2009.03-	-	AT/MT	-	F Saloon Engine 4B10	839113	Outer Joint		28	33	59.5	95	61.5	I
	2009.03-	-	AT/MT	-	F Saloon Engine 4B10	639057	Inner Joint		25	30	41	61.5	95	
	2009.03-	-	AT	-	F Saloon Engine 4B10	639040	Inner Joint		27	33	40	62	99	
	2009.03-	-	MT	R	F Saloon Engine 4B10	659205	Inner Joint		24	33	40	95.5	84	
2.0 DI-D (103 kW)	2008.01-	-	-	-	F Saloon Engine BKD	839117	Outer Joint		28	35	59.5	95	65	I

YEAR	TRANSM	L/R	F/R	REMARKS	GSP Ref.	PRODUCT	ABS	Technical Specifications							
								A	B	C	H	L	P		
MITSUBISHI															
LANCER VIII (CY_A CZ_A)/GALANT FORTIS															
2.0 DI-D (103 kW)	2008.01-	-	-	F	Saloon Engine BKD	839113	Outer Joint	28	33	59.5	95	61.5	I		
	2008.01-	-	-	F	Saloon Engine BKD	851033	Outer Joint	25	26	48	106.5	49	I		
	2008.01-	-	L	F	Saloon Engine BKD	651034	Inner Joint	27	35	40	62	113			
	2008.01-	-	-	R	Saloon Engine BKD	639050	Inner Joint	23	26	35	64	96			
	2008.01-	-	-	-	Saloon Engine BKD	639040	Inner Joint	27	33	40	62	99			
	2008.01-	-	R	F	Saloon Engine BKD	659205	Inner Joint	24	33	40	95.5	84			
2.0 i Ralliart (177 kW)	2008.10-	-	-	F	All-wheel Drive Saloon Engine 4B11 T/C	839117	Outer Joint	28	35	59.5	95	65	I		
	2008.10-	-	-	F	All-wheel Drive Saloon Engine 4B11 T/C	839113	Outer Joint	28	33	59.5	95	61.5	I		
	2008.10-	-	-	F	All-wheel Drive Saloon Engine 4B11 T/C	851033	Outer Joint	25	26	48	106.5	49	I		
	2008.10-	-	L	F	All-wheel Drive Saloon Engine 4B11 T/C	651034	Inner Joint	27	35	40	62	113			
	2008.10-	-	-	R	All-wheel Drive Saloon Engine 4B11 T/C	639050	Inner Joint	23	26	35	64	96			
	2008.10-	-	-	-	All-wheel Drive Saloon Engine 4B11 T/C	639040	Inner Joint	27	33	40	62	99			
	2008.10-	-	R	F	All-wheel Drive Saloon Engine 4B11 T/C	659205	Inner Joint	24	33	40	95.5	84			
EVO X (221 kW)	2008.06-2015.03	-	-	F	All-wheel Drive Saloon Engine 4B11 T/C	839117	Outer Joint	28	35	59.5	95	65	I		
	2008.06-2015.03	-	-	F	All-wheel Drive Saloon Engine 4B11 T/C	839113	Outer Joint	28	33	59.5	95	61.5	I		
	2008.06-2015.03	-	L	F	All-wheel Drive Saloon Engine 4B11 T/C	651034	Inner Joint	27	35	40	62	113			
	2008.06-2015.03	-	-	R	All-wheel Drive Saloon Engine 4B11 T/C	639050	Inner Joint	23	26	35	64	96			
	2008.06-2015.03	-	-	-	All-wheel Drive Saloon Engine 4B11 T/C	639040	Inner Joint	27	33	40	62	99			
	2008.06-2015.03	-	R	F	All-wheel Drive Saloon Engine 4B11 T/C	659205	Inner Joint	24	33	40	95.5	84			
EVO X - FQ330 (242 kW)	2008.03-2015.06	-	-	F	All-wheel Drive Saloon Engine 4B11FQ30	839117	Outer Joint	28	35	59.5	95	65	I		
	2008.03-2015.06	-	-	F	All-wheel Drive Saloon Engine 4B11FQ30	839113	Outer Joint	28	33	59.5	95	61.5	I		
	2008.03-2015.06	-	L	F	All-wheel Drive Saloon Engine 4B11FQ30	651034	Inner Joint	27	35	40	62	113			
	2008.03-2015.06	-	-	R	All-wheel Drive Saloon Engine 4B11FQ30	639050	Inner Joint	23	26	35	64	96			
	2008.03-2015.06	-	-	-	All-wheel Drive Saloon Engine 4B11FQ30	639040	Inner Joint	27	33	40	62	99			
	2008.03-2015.06	-	R	F	All-wheel Drive Saloon Engine 4B11FQ30	659205	Inner Joint	24	33	40	95.5	84			
EVO X - FQ360 (264 kW)	2008.03-2015.06	-	-	F	All-wheel Drive Saloon Engine 4B11FQ60	839117	Outer Joint	28	35	59.5	95	65	I		
	2008.03-2015.06	-	-	F	All-wheel Drive Saloon Engine 4B11FQ60	839113	Outer Joint	28	33	59.5	95	61.5	I		
	2008.03-2015.06	-	L	F	All-wheel Drive Saloon Engine 4B11FQ60	651034	Inner Joint	27	35	40	62	113			
	2008.03-2015.06	-	-	R	All-wheel Drive Saloon Engine 4B11FQ60	639050	Inner Joint	23	26	35	64	96			
	2008.03-2015.06	-	-	-	All-wheel Drive Saloon Engine 4B11FQ60	639040	Inner Joint	27	33	40	62	99			
	2008.03-2015.06	-	R	F	All-wheel Drive Saloon Engine 4B11FQ60	659205	Inner Joint	24	33	40	95.5	84			
LANCER VIII Sportback (CX_A)/GALANT FORTIS															
1.5 (80 kW)	2008.06-	-	AT/MT	-	Hatchback Engine 4A91	815011	Outer Joint	28	30	59.5	95	57.5	I		
1.5 Bifuel (80 kW)	2010.03-	-	MT	-	Hatchback Engine 4A91	815011	Outer Joint	28	30	59.5	95	57.5	I		
1.6 MIVEC (86 kW)	2010.05-	-	AT	-	Hatchback Engine 4A92	639057	Inner Joint	25	30	41	61.5	95			
	2010.05-	-	MT	-	Hatchback Engine 4A92	839113	Outer Joint	28	33	59.5	95	61.5	I		
1.8 (105 kW)	2008.06-	-	AT/MT	-	Hatchback Engine 4B10	839113	Outer Joint	28	33	59.5	95	61.5	I		
	2008.06-	-	AT	-	Hatchback Engine 4B10	639040	Inner Joint	27	33	40	62	99			
	2008.06-	-	MT	R	Hatchback Engine 4B10	659205	Inner Joint	24	33	40	95.5	84			
1.8 Bifuel (105 kW)	2010.02-	-	AT/MT	-	Hatchback Engine 4B10	839113	Outer Joint	28	33	59.5	95	61.5	I		
	2010.02-	-	AT/MT	-	Hatchback Engine 4B10	639057	Inner Joint	25	30	41	61.5	95			
	2010.02-	-	AT	-	Hatchback Engine 4B10	639040	Inner Joint	27	33	40	62	99			
	2010.02-	-	MT	R	Hatchback Engine 4B10	659205	Inner Joint	24	33	40	95.5	84			
1.8 DI-D (85 kW)	2010.05-	-	AT/MT	-	Hatchback Engine 4N13	839113	Outer Joint	28	33	59.5	95	61.5	I		
	2010.05-	-	AT/MT	-	Hatchback Engine 4N13	639057	Inner Joint	25	30	41	61.5	95			
	2010.05-	-	AT	-	Hatchback Engine 4N13	639040	Inner Joint	27	33	40	62	99			
	2010.05-	-	MT	R	Hatchback Engine 4N13	659205	Inner Joint	24	33	40	95.5	84			
1.8 Flex (103 kW)	2009.03-	-	AT/MT	-	Hatchback Engine 4B10	839113	Outer Joint	28	33	59.5	95	61.5	I		
	2009.03-	-	AT/MT	-	Hatchback Engine 4B10	639057	Inner Joint	25	30	41	61.5	95			
	2009.03-	-	AT	-	Hatchback Engine 4B10	639040	Inner Joint	27	33	40	62	99			
	2009.03-	-	MT	R	Hatchback Engine 4B10	659205	Inner Joint	24	33	40	95.5	84			
1.8 MIVEC (103 kW)	2009.03-	-	AT/MT	-	Hatchback Engine 4B10	839113	Outer Joint	28	33	59.5	95	61.5	I		
	2009.03-	-	AT/MT	-	Hatchback Engine 4B10	639057	Inner Joint	25	30	41	61.5	95			
	2009.03-	-	AT	-	Hatchback Engine 4B10	639040	Inner Joint	27	33	40	62	99			
	2009.03-	-	MT	R	Hatchback Engine 4B10	659205	Inner Joint	24	33	40	95.5	84			
2.0 DI-D (103 kW)	2008.06-	-	AT/MT	-	Hatchback Engine BWC	839113	Outer Joint	28	33	59.5	95	61.5	I		
	2008.06-	-	AT	-	Hatchback Engine BWC	639040	Inner Joint	27	33	40	62	99			
	2008.06-	-	MT	R	Hatchback Engine BWC	659205	Inner Joint	24	33	40	95.5	84			
2.0 Ralliart (177 kW)	2008.10-	-	AT	-	All-wheel Drive Hatchback Engine 4B11 T/C	839117	Outer Joint	28	35	59.5	95	65	I		
	2008.10-	-	-	-	All-wheel Drive Hatchback Engine 4B11 T/C	839113	Outer Joint	28	33	59.5	95	61.5	I		
	2008.10-	-	AT	-	All-wheel Drive Hatchback Engine 4B11 T/C	851033	Outer Joint	25	26	48	106.5	49	I		
	2008.10-	-	AT	L	All-wheel Drive Hatchback Engine 4B11 T/C	651034	Inner Joint	27	35	40	62	113			
	2008.10-	-	AT	-	All-wheel Drive Hatchback Engine 4B11 T/C	639050	Inner Joint	23	26	35	64	96			
	2008.10-	-	AT	-	All-wheel Drive Hatchback Engine 4B11 T/C	639040	Inner Joint	27	33	40	62	99			
	2008.10-	-	MT	R	All-wheel Drive Hatchback Engine 4B11 T/C	659205	Inner Joint	24	33	40	95.5	84			
LANCER(C64A)															

	 YEAR	TRANSM	L/R	F/R	REMARKS	GSP Ref.	 PRODUCT	 ABS	Technical Specifications					
									A	B	C	H	L	P
MITSUBISHI														
LANCER(C64A)														
1.8	1988.05-1991.08	AT/MT	L	F	Engine DIESEL/2WD(4DOOR)	809001	Outer Joint		25	22	50	96	57	M
LANCER/COLT														
1.3	1992- -	-	-	-	4G15,CA2A,CA1A	615005	Inner Joint		25	22	35	54.7	90.8	
LEGNUM (EA1W)														
1.8	1996.08- -	5MT	-	-	Engine 4G93	839270	Outer Joint		25	23	54	96	59	M
LEGNUM (EA5W)														
2.5	1996.08- -	MT/AT	-	-	Engine 6A13	839150	Outer Joint	43T	25	24	54	96	59	M
LEGNUM (EC4W)														
2.0 4WD	1996.08- -	MT/AT	-	-	Engine 6A12	839212	Outer Joint	43T	25	29	54	96	59	M
LEGNUM (EC5W)														
2.5 4WD	1996.08- -	MT/AT	-	-	Engine 6A13	839212	Outer Joint	43T	25	29	54	96	59	M
LEGNUM EA1W														
1.8	1996.08- -	5MT	-	-	Engine 4G93	839270	Outer Joint		25	23	54	96	59	M
	1996.08- -	5MT	-	-	Engine 4G93	839270	Outer Joint		25	23	54	96	59	M
1800	1996.08- -	5MT	-	-	Engine 4G93	839270	Outer Joint		25	23	54	96	59	M
	1996.08- -	5MT	-	-	Engine 4G93	839270	Outer Joint		25	23	54	96	59	M
LEGNUM EA5W														
2.5	1996.08- -	MT/AT	-	-	Engine 6A13	839150	Outer Joint	43T	25	24	54	96	59	M
	1996.08- -	MT/AT	-	-	Engine 6A13	839150	Outer Joint	43T	25	24	54	96	59	M
LEGNUM EC5W														
2.5	1996.08- -	5MT	-	-	Allwheel Drive Engine 6A13	899228	Outer Joint	43T	25	32	54	96	59	M
	1996.08- -	5AT	-	-	Allwheel Drive Engine 6A13	899228	Outer Joint	43T	25	32	54	96	59	M
	1996.08- -	5MT	-	-	Allwheel Drive Engine 6A13	899228	Outer Joint	43T	25	32	54	96	59	M
	1996.08- -	5AT	-	-	Allwheel Drive Engine 6A13	899228	Outer Joint	43T	25	32	54	96	59	M
LIBERO LIBERO CARGO CB5W														
1.8	1992.05-1995.08	MT/AT	-	-	Engine 4G93	839215	Outer Joint		25	30	54	96	59	M
1800	1992.05-1995.08	MT/AT	-	-	Engine 4G93	839215	Outer Joint		25	30	54	96	59	M
LIBERO LIBERO CARGO CB8V W														
2.0	1992.06-1995.08	AT	-	-	Engine 4D68	839214	Outer Joint		25	23	54	96	59	M
	1992.06-1995.08	AT	-	-	Engine 4D68 TBO	839214	Outer Joint		25	23	54	96	59	M
	1992.06-1995.08	MT	-	-	Engine 4D68 TBO	839214	Outer Joint		25	23	54	96	59	M
2000	1992.06-1995.08	AT	-	-	Engine 4D68	839214	Outer Joint		25	23	54	96	59	M
	1992.06-1995.08	AT	-	-	Engine 4D68 TBO	839214	Outer Joint		25	23	54	96	59	M
	1992.06-1995.08	MT	-	-	Engine 4D68 TBO	839214	Outer Joint		25	23	54	96	59	M
LIBERO LIBERO CARGO CD5W														
1.8	1992.05-1995.08	MT/AT	-	-	Allwheel Drive Engine 4G93	839215	Outer Joint		25	30	54	96	59	M
1800	1992.05-1995.08	MT/AT	-	-	Allwheel Drive Engine 4G93	839215	Outer Joint		25	30	54	96	59	M
LIBERO LIBERO CARGO CD8V W														
2.0	1992.06-1995.08	MT/AT	-	-	Allwheel Drive Engine 4D68	839215	Outer Joint		25	30	54	96	59	M
2000	1992.06-1995.08	MT/AT	-	-	Allwheel Drive Engine 4D68	839215	Outer Joint		25	30	54	96	59	M
LIBERO/LIBERO CARGO (CB5W)														
1.8	1992.05-1995.08	MT/AT	-	-	Engine 4G93	839215	Outer Joint		25	30	54	96	59	M
LIBERO/LIBERO CARGO (CB8V W)														
2.0	1992.06-1995.08	AT	-	-	Engine 4D68 TBO/4D68	839214	Outer Joint		25	23	54	96	59	M
	1992.06-1995.08	MT	-	-	Engine 4D68 TBO	839214	Outer Joint		25	23	54	96	59	M
LIBERO/LIBERO CARGO (CD5W)														
1.8 4WD	1992.05-1995.08	MT/AT	-	-	Engine 4G93	839215	Outer Joint		25	30	54	96	59	M
LIBERO/LIBERO CARGO (CD8V)														
2.0 4WD	1992.06-1995.08	MT/AT	-	-	Engine 4D68	839215	Outer Joint		25	30	54	96	59	M
MAGNA														
2.6	1991-1992.05	-	L	-	ELITE	239094	Drive Shaft		27	26	60	97	694	
	1991.01-1992.12	AT	-	F	TR ELITE	839110	Outer Joint		27	26	60	97	69	I
MINICA (H2_)														
0.7 (29 kW)	1990.04-1993.07	-	-	-	Hatchback Engine 3G83 (SOHC 6V)	839090	Outer Joint		27	18	43	106	50	I
	1990.04-1993.07	-	-	-	All-wheel Drive Hatchback Engine 3G83 (SOHC 6V)	839090	Outer Joint		27	18	43	106	50	I
0.7 (34 kW)	1990.04-1993.07	-	-	-	Hatchback Engine 3G83 (DOHC 15V)	839090	Outer Joint		27	18	43	106	50	I
0.7 (38 kW)	1990.04-1993.07	-	-	-	Hatchback Engine 3G83 (DOHC 15V)	839090	Outer Joint		27	18	43	106	50	I
MINICA (H3_)														
0.7 (29 kW)	1993.08-1998.03	-	-	-	Hatchback Engine 3G83 (SOHC 6V)	839090	Outer Joint		27	18	43	106	50	I
0.7 (41 kW)	1993.08-1998.03	-	-	-	Hatchback Engine 4A30	839090	Outer Joint		27	18	43	106	50	I
MIRAGE														
-	2014-2017	-	L	F	-	241578	Drive Shaft		24	25	47	90	657	
1.2L L3	2014- -	-	R	F	DE,ES	241579	Drive Shaft		24	25	47	90	857	
	2015- -	-	R	F	DE,ES,RF	241579	Drive Shaft		24	25	47	90	857	
	2017- -	-	R	F	ES,GT,MSE	241579	Drive Shaft		24	25	47	90	857	

	 YEAR	TRANSM	L/R	F/R	REMARKS	GSP Ref.	 PRODUCT	 ABS	Technical Specifications					
									A	B	C	H	L	P
MITSUBISHI														
MIRAGE														
1.2L L3	2017-	-	-	R F	ES,SE	241579	Drive Shaft		24	25	47	90	857	
	2018-	-	-	R F	ES,GT,SE	241579	Drive Shaft		24	25	47	90	857	
	2018-	-	-	R F	ES,SE	241579	Drive Shaft		24	25	47	90	857	
1.3	1987-	1991	MT/AT	- -	C61 4G13	639025	Inner Joint		25	22	35	54.7	90.8	
1.5	1987-	1991	MT/AT	- -	C62 4G15	639025	Inner Joint		25	22	35	54.7	90.8	
1.8	1987-	1991	MT/AT	- -	C64 4G65	639025	Inner Joint		25	22	35	54.7	90.8	
1.8 (108 kW)	1991.12-	1995.08	-	- -	Coupe Engine 6A11	839096	Outer Joint		25	23	54	95	60	I
1.8 Gsi (103 kW)	1991.12-	1995.08	-	- -	Saloon Engine 4G93 (SOHC 16V)	839096	Outer Joint		25	23	54	95	60	I
MIRAGE (CJ_A CL_A)														
1.6 (88 kW)	1991.12-	1995.08	-	- -	Hatchback Engine 4G92 (SOHC 16V)	839096	Outer Joint		25	23	54	95	60	I
MIRAGE (CJ_A)														
1.3 (55 kW)	1995.09-	2003.07	AT/MT	- F	Hatchback Engine 4G13 (12V)	839008	Outer Joint	43T	25	29	54	95	58	I
1.6 (84 kW)	1999.09-	2003.07	-	- -	Hatchback Engine 4G92 (SOHC 16V)	639057	Inner Joint		25	30	41	61.5	95	
MIRAGE (CK_A)														
1.8 (103 kW)	1995.09-	1998.10	-	- -	Saloon Engine 4G93 (SOHC 16V)	839096	Outer Joint		25	23	54	95	60	I
1.8 (152 kW)	1995.09-	1999.08	-	- -	All-wheel Drive Saloon Engine 4G93T	839096	Outer Joint		25	23	54	95	60	I
MIRAGE 4DOOR SEDAN(C64A)														
1.8	1987.12-	1991.08	AT/MT	L F	Engine DIESEL/2WD(4DOOR)	809001	Outer Joint		25	22	50	96	57	M
MIRAGE LANCER														
1.3	1995.10-	2000	MT/AT	- -	Engine 4G13	839233	Outer Joint		25	21	54	96	51.2	M
1.5	1995.10-	2000	MT/AT	- -	Engine 4G15	839233	Outer Joint		25	21	54	96	51.2	M
MIRAGE LANCER CA4A														
1.6	1991.08-	1994.08	MT/AT	- -	Engine 4G92	839215	Outer Joint		25	30	54	96	59	M
	1994.08-	1995.08	MT/AT	- -	Engine 4G92	839215	Outer Joint		25	30	54	96	59	M
1600	1991.08-	1994.08	MT/AT	- -	Engine 4G92	839215	Outer Joint		25	30	54	96	59	M
	1994.08-	1995.08	MT/AT	- -	Engine 4G92	839215	Outer Joint		25	30	54	96	59	M
MIRAGE LANCER CB4A														
1.6	1992.10-	1994.10	MT/AT	- -	Engine 4G92	839215	Outer Joint		25	30	54	96	59	M
	1994.10-	1995.08	MT/AT	- -	Engine 4G92	839215	Outer Joint		25	30	54	96	59	M
1600	1992.10-	1994.10	MT/AT	- -	Engine 4G92	839215	Outer Joint		25	30	54	96	59	M
	1994.10-	1995.08	MT/AT	- -	Engine 4G92	839215	Outer Joint		25	30	54	96	59	M
MIRAGE LANCER CB6A														
1.6	1992.01-	1995.08	MT/AT	- -	Engine 6A10	839215	Outer Joint		25	30	54	96	59	M
1600	1992.01-	1995.08	MT/AT	- -	Engine 6A10	839215	Outer Joint		25	30	54	96	59	M
MIRAGE LANCER CB7A														
1.8	1991.10-	1992.10	AT	- -	Engine 4D65	839214	Outer Joint		25	23	54	96	59	M
	1991.10-	1992.10	MT	- -	Engine 4D65	839214	Outer Joint		25	23	54	96	59	M
1800	1991.10-	1992.10	AT	- -	Engine 4D65	839214	Outer Joint		25	23	54	96	59	M
	1991.10-	1992.10	MT	- -	Engine 4D65	839214	Outer Joint		25	23	54	96	59	M
MIRAGE LANCER CB8A														
2.0	1992.10-	1995.08	AT	- -	Engine 4D68	839214	Outer Joint		25	23	54	96	59	M
2000	1992.10-	1995.08	AT	- -	Engine 4D68	839214	Outer Joint		25	23	54	96	59	M
MIRAGE LANCER CC3A														
1.5	1991.08-	1995.08	MT/AT	- -	Allwheel Drive Engine 4G91	839215	Outer Joint		25	30	54	96	59	M
1500	1991.08-	1995.08	MT/AT	- -	Allwheel Drive Engine 4G91	839215	Outer Joint		25	30	54	96	59	M
MIRAGE LANCER CC4A														
1.6	1991.08-	1995.08	MT/AT	- -	Allwheel Drive Engine 4G92	839215	Outer Joint		25	30	54	96	59	M
1600	1991.08-	1995.08	MT/AT	- -	Allwheel Drive Engine 4G92	839215	Outer Joint		25	30	54	96	59	M
MIRAGE LANCER CD5A														
1.8	1991.10-	1995.08	MT/AT	- -	Allwheel Drive Engine 4G93	839215	Outer Joint		25	30	54	96	59	M
1800	1991.10-	1995.08	MT/AT	- -	Allwheel Drive Engine 4G93	839215	Outer Joint		25	30	54	96	59	M
MIRAGE LANCER CD7A														
1.8	1991.10-	1992.10	MT/AT	- -	Allwheel Drive Engine 4D65	839215	Outer Joint		25	30	54	96	59	M
1800	1991.10-	1992.10	MT/AT	- -	Allwheel Drive Engine 4D65	839215	Outer Joint		25	30	54	96	59	M
MIRAGE LANCER CD8A														
2.0	1992.10-	1995.08	MT/AT	- -	Allwheel Drive Engine 4D68	839215	Outer Joint		25	30	54	96	59	M
2000	1992.10-	1995.08	MT/AT	- -	Allwheel Drive Engine 4D68	839215	Outer Joint		25	30	54	96	59	M
MIRAGE LANCER CD9A														
2.0	1992.10-	1993.12	MT/AT	- -	Allwheel Drive Engine 4G63	839215	Outer Joint		25	30	54	96	59	M
2000	1992.10-	1993.12	MT/AT	- -	Allwheel Drive Engine 4G63	839215	Outer Joint		25	30	54	96	59	M
MIRAGE LANCER CJ1A														
1.3	1995.10-	2000.08	MT/AT	- -	Engine 4G13	839149	Outer Joint		25	22	54	96	59	M
	1995.10-	2000.08	MT/AT	- -	Engine 4G13	839233	Outer Joint		25	21	54	96	51.2	M
1300	1995.10-	2000.08	MT/AT	- -	Engine 4G13	839149	Outer Joint		25	22	54	96	59	M
	1995.10-	2000.08	MT/AT	- -	Engine 4G13	839149	Outer Joint		25	22	54	96	59	M

	 YEAR	TRANSM L/R F/R	REMARKS	GSP Ref.  PRODUCT  ABS	Technical Specifications								
					A	B	C	H	L	P			
mitsubishi													
MIRAGE LANCER CJ1A													
1300	1995.10-2000.08	MT/AT	- -	Engine 4G13	839233	Outer Joint		25	21	54	96	51.2	M
MIRAGE LANCER CJ2A													
1.5	1995.10-2000.08	MT/AT	- -	Engine 4G15	839149	Outer Joint		25	22	54	96	59	M
	1995.10-2000.08	MT/AT	- -	Engine 4G15	839233	Outer Joint		25	21	54	96	51.2	M
1500	1995.10-2000.08	MT/AT	- -	Engine 4G15	839149	Outer Joint		25	22	54	96	59	M
	1995.10-2000.08	MT/AT	- -	Engine 4G15	839149	Outer Joint		25	22	54	96	59	M
	1995.10-2000.08	MT/AT	- -	Engine 4G15	839149	Outer Joint		25	22	54	96	59	M
	1995.10-2000.08	MT/AT	- -	Engine 4G15	839149	Outer Joint		25	22	54	96	59	M
	1995.10-2000.08	MT/AT	- -	Engine 4G15	839233	Outer Joint		25	21	54	96	51.2	M
MIRAGE LANCER CJ4A													
1.6	1995.10-	MT/AT	- -	Engine 4G92	839270	Outer Joint		25	23	54	96	59	M
1600	1995.10-	MT/AT	- -	Engine 4G92	839270	Outer Joint		25	23	54	96	59	M
MIRAGE LANCER CK1													
1.3	1995.10-2000.04	MT/AT	- -	Engine 4G13	839233	Outer Joint		25	21	54	96	51.2	M
	1995.10-2000.04	MT/AT	- -	Engine 4G13	839233	Outer Joint		25	21	54	96	51.2	M
1300	1995.10-2000.04	MT/AT	- -	Engine 4G13	839233	Outer Joint		25	21	54	96	51.2	M
	1995.10-2000.04	MT/AT	- -	Engine 4G13	839233	Outer Joint		25	21	54	96	51.2	M
MIRAGE LANCER CK1A													
1.3	1995.10-2000.07	MT/AT	- -	Engine 4G13	839149	Outer Joint		25	22	54	96	59	M
	1995.10-2000.07	MT/AT	- -	Engine 4G13	839233	Outer Joint		25	21	54	96	51.2	M
1300	1995.10-2000.07	MT/AT	- -	Engine 4G13	839149	Outer Joint		25	22	54	96	59	M
	1995.10-2000.07	MT/AT	- -	Engine 4G13	839149	Outer Joint		25	22	54	96	59	M
	1995.10-2000.07	MT/AT	- -	Engine 4G13	839233	Outer Joint		25	21	54	96	51.2	M
MIRAGE LANCER CK2A													
1.5	1995.10-2000.07	MT/AT	- -	Engine 4G15	839149	Outer Joint		25	22	54	96	59	M
	1995.10-2000.07	MT/AT	- -	Engine 4G15	839233	Outer Joint		25	21	54	96	51.2	M
1500	1995.10-2000.07	MT/AT	- -	Engine 4G15	839149	Outer Joint		25	22	54	96	59	M
	1995.10-2000.07	MT/AT	- -	Engine 4G15	839149	Outer Joint		25	22	54	96	59	M
	1995.10-2000.07	MT/AT	- -	Engine 4G15	839149	Outer Joint		25	22	54	96	59	M
	1995.10-2000.07	MT/AT	- -	Engine 4G15	839149	Outer Joint		25	22	54	96	59	M
	1995.10-2000.07	MT/AT	- -	Engine 4G15	839149	Outer Joint		25	22	54	96	59	M
MIRAGE LANCER CK4A													
1.6	1995.10-	MT/AT	- -	Engine 4G92	839270	Outer Joint		25	23	54	96	59	M
	1995.10-	MT/AT	- -	Engine 4G92	839270	Outer Joint		25	23	54	96	59	M
1600	1995.10-	MT/AT	- -	Engine 4G92	839270	Outer Joint		25	23	54	96	59	M
	1995.10-	MT/AT	- -	Engine 4G92	839270	Outer Joint		25	23	54	96	59	M
MIRAGE LANCER CK6													
1.8	1995.10-	4AT	- -	Engine 6A11	839270	Outer Joint		25	23	54	96	59	M
	1995.10-	4AT	- -	Engine 6A11	839270	Outer Joint		25	23	54	96	59	M
1800	1995.10-	4AT	- -	Engine 6A11	839270	Outer Joint		25	23	54	96	59	M
	1995.10-	4AT	- -	Engine 6A11	839270	Outer Joint		25	23	54	96	59	M
MIRAGE LANCER CK8A													
2000	1995.10-2000.07	MT/AT	- -	Engine 4D68	839214	Outer Joint		25	23	54	96	59	M
MIRAGE/LANCER													
-	1994-	-	- -	-	639023	Inner Joint		25	23	41	62.5	87.5	
1.3	1992.01-	MT/AT	- -	-	809001	Outer Joint		25	22	50	96	57	M
1.5	1988-1991	MT	- -	C63A 4G61	639002	Inner Joint		25	23	35	62.8	95.5	
1.6	1988-1991	MT	- -	C63A 4G61	639002	Inner Joint		25	23	35	62.8	95.5	
MIRAGE/LANCER (4G93)													
1.8 4WD	1991.08-1995.08	MT/AT	- -	Engine 4G93	839215	Outer Joint		25	30	54	96	59	M
MIRAGE/LANCER (C51A)													
1.3	1987.10-1991.08	MT/AT	- -	Engine 4G13	809001	Outer Joint		25	22	50	96	57	M
MIRAGE/LANCER (C52A)													
1.5	1987.10-1991.08	MT/AT	- -	Engine 4G15	809001	Outer Joint		25	22	50	96	57	M
MIRAGE/LANCER (C61A)													
1.3	1988.01-1991.08	MT/AT	- -	Engine 4G13	809001	Outer Joint		25	22	50	96	57	M
MIRAGE/LANCER (C62A)													
1.5	1987.01-1991.08	MT/AT	- -	Engine 4G15	809001	Outer Joint		25	22	50	96	57	M
MIRAGE/LANCER (C64A)													
1.8	1988.05-1991.12	MT/AT	- -	Engine 4D65	809001	Outer Joint		25	22	50	96	57	M
MIRAGE/LANCER (C72A)													
1.5 4WD	1988.01-1991.08	MT/AT	- -	Engine 4G15	809001	Outer Joint		25	22	50	96	57	M
MIRAGE/LANCER (C74A)													
1.8 4WD	1988.05-1991.12	MT	- -	Engine 4D65	809001	Outer Joint		25	22	50	96	57	M
MIRAGE/LANCER (C82A)													

	 YEAR	TRANSM	L/R	F/R	REMARKS	GSP Ref.	 PRODUCT	 ABS	Technical Specifications					
									A	B	C	H	L	P
mitsubishi														
MIRAGE/LANCER (C82A)														
1.5 4WD	1989.09-1991.08	MT/AT	-	-	Engine 4G15	809001	Outer Joint		25	22	50	96	57	M
MIRAGE/LANCER (CA4A)														
1.6	1991.08-1995.08	MT/AT	-	-	Engine 4G92	839215	Outer Joint		25	30	54	96	59	M
MIRAGE/LANCER (CB4A)														
1.6	1992.10-1995.08	MT/AT	-	-	Engine 4G92	839215	Outer Joint		25	30	54	96	59	M
MIRAGE/LANCER (CB6A)														
1.6	1992.10-1995.08	MT/AT	-	-	Engine 6A10	839215	Outer Joint		25	30	54	96	59	M
MIRAGE/LANCER (CB7A)														
1.8	1991.10-1992.10	AT	-	-	Engine 4D65	839214	Outer Joint		25	23	54	96	59	M
	1991.10-1992.10	MT	-	-	Engine 4D65	839215	Outer Joint		25	30	54	96	59	M
MIRAGE/LANCER (CB8A)														
2.0	1992.10-1995.08	AT	-	-	Engine 4D68	839214	Outer Joint		25	23	54	96	59	M
MIRAGE/LANCER (CC3A)														
1.5 4WD	1991.08-1995.08	MT/AT	-	-	Engine 4G91	839215	Outer Joint		25	30	54	96	59	M
MIRAGE/LANCER (CC4A)														
1.6 4WD	1991.08-1995.08	MT/AT	-	-	Engine 4G92	839215	Outer Joint		25	30	54	96	59	M
MIRAGE/LANCER (CD3A)														
1.5 4WD	1991.08-1995.08	MT/AT	-	-	Engine 4G91	839215	Outer Joint		25	30	54	96	59	M
MIRAGE/LANCER (CD7A)														
1.8 4WD	1991.10-1992.10	MT/AT	-	-	Engine 4D65	839215	Outer Joint		25	30	54	96	59	M
MIRAGE/LANCER (CD8A)														
2.0 4WD	1992.10-1995.08	MT/AT	-	-	Engine 4D68	839215	Outer Joint		25	30	54	96	59	M
MIRAGE/LANCER (CD9A)														
2.0 4WD	1992.10-1993.12	MT/AT	-	-	Engine 4G63	839215	Outer Joint		25	30	54	96	59	M
MIRAGE/LANCER (CJ1A)														
1.3	1995.10-2000.08	MT/AT	-	-	Engine 4G13	839149	Outer Joint		25	22	54	96	59	M
MIRAGE/LANCER (CJ2A)														
1.5	1995.10-2000.08	MT/AT	-	-	Engine 4G15	839149	Outer Joint		25	22	54	96	59	M
MIRAGE/LANCER (CJ4A , CK4A)														
1.6	1995.10-	MT/AT	-	-	Engine 4G92	839270	Outer Joint		25	23	54	96	59	M
MIRAGE/LANCER (CK1A)														
1.3	1995.10-2000.07	MT/AT	-	-	Engine 4G13	839149	Outer Joint		25	22	54	96	59	M
MIRAGE/LANCER (CK2A)														
1.5	1995.10-2000.07	MT/AT	-	-	Engine 4G15	839149	Outer Joint		25	22	54	96	59	M
MIRAGE/LANCER (CK6)														
1.8	1995.10-	4AT	-	-	Engine 6A11	839270	Outer Joint		25	23	54	96	59	M
MIRAGE/LANCER VAN/WAGON (C11V)														
1.3	1985.01-1992.03	MT/AT	-	-	Engine G13B	809001	Outer Joint		25	22	50	96	57	M
MIRAGE/LANCER VAN/WAGON (C12V W)														
1.5	1985.01-1992.03	MT/AT	-	-	Engine G15B	809001	Outer Joint		25	22	50	96	57	M
MIRAGE/LANCER/COLT														
1.6	1987-1991	MT/AT	-	-	C53,C63 4G61	839047	Outer Joint		25	30	50	95.5	60.5	M
MONTERO														
-	1983-1991	-	-	-	-	639044	Inner Joint		25		62.5			
MONTERO/OUTLANDER/L200														
-	-	-	-	-	-	699257	Propshaft CV joint		23		52.6			
OUTLANDER I (CU_W)/AIRTREK														
2.0 (100 kW)	2003.05-2006.10	AT/MT	L/R	F	All-wheel Drive Closed Off-Road Vehicle Engine 4G63 (DOHC 16V)	839112	Outer Joint	43T	25	29	57	94.5	57	I
	2003.05-2006.10	AT/MT	L/R	F	Closed Off-Road Vehicle Engine 4G63 (DOHC 16V)	839112	Outer Joint	43T	25	29	57	94.5	57	I
	2003.05-2006.10	AT/MT	-	F	All-wheel Drive Closed Off-Road Vehicle Engine 4G63 (DOHC 16V)	839176	Outer Joint	43T	25	29	57	95	58	M
	2003.05-2006.10	AT/MT	-	F	Closed Off-Road Vehicle Engine 4G63 (DOHC 16V)	839143	Outer Joint	43T	25	33	57	95	60.5	I
	2003.05-2006.10	AT/MT	-	R	All-wheel Drive Closed Off-Road Vehicle Engine 4G63 (DOHC 16V)	839252	Outer Joint	43T	25	29	57	95	71	I
2.0 (93 kW)	2003.05-2006.10	AT/MT	L/R	F	All-wheel Drive Closed Off-Road Vehicle Engine 4G63 (DOHC 16V)	839112	Outer Joint	43T	25	29	57	94.5	57	I
	2003.05-2006.10	AT/MT	-	F	All-wheel Drive Closed Off-Road Vehicle Engine 4G63 (DOHC 16V)	839176	Outer Joint	43T	25	29	57	95	58	M
	2003.05-2006.10	AT/MT	-	R	All-wheel Drive Closed Off-Road Vehicle Engine 4G63 (DOHC 16V)	839252	Outer Joint	43T	25	29	57	95	71	I
	2003.05-2006.10	AT/MT	-	-	All-wheel Drive Closed Off-Road Vehicle Engine 4G63 (DOHC 16V)	699019	Inner Joint		26	29	41	50	90	
2.0 Turbo (148 kW)	2004.04-2006.10	AT/MT	L/R	F	All-wheel Drive Closed Off-Road Vehicle Engine 4G63 T (DOHC 16V)	839112	Outer Joint	43T	25	29	57	94.5	57	I
	2004.04-2006.10	AT/MT	-	F	All-wheel Drive Closed Off-Road Vehicle Engine 4G63 T (DOHC 16V)	839176	Outer Joint	43T	25	29	57	95	58	M
	2004.04-2006.10	MT	-	R	All-wheel Drive Closed Off-Road Vehicle Engine 4G63 T (DOHC 16V)	839252	Outer Joint	43T	25	29	57	95	71	I
	2004.04-2006.10	MT	-	-	All-wheel Drive Closed Off-Road Vehicle Engine 4G63 T (DOHC 16V)	699019	Inner Joint		26	29	41	50	90	
2.0 Turbo-R (177 kW)	2002.01-2006.10	MT	L	F	All-wheel Drive Closed Off-Road Vehicle Engine 4G63 Turbo	203363	Drive Shaft	45W	38		59.5	34.5	611	
	2002.01-2006.10	AT/MT	-	F	All-wheel Drive Closed Off-Road Vehicle Engine 4G63 Turbo	839176	Outer Joint	43T	25	29	57	95	58	M
	2002.01-2006.10	AT/MT	-	R	All-wheel Drive Closed Off-Road Vehicle Engine 4G63 Turbo	839252	Outer Joint	43T	25	29	57	95	71	I
	2002.01-2006.10	AT/MT	-	-	All-wheel Drive Closed Off-Road Vehicle Engine 4G63 Turbo	699019	Inner Joint		26	29	41	50	90	





	YEAR	TRANSM	L/R	F/R	REMARKS	GSP Ref.	PRODUCT	ABS	Technical Specifications					
									A	B	C	H	L	P
MITSUBISHI														
OUTLANDER I (CU_W)/AIRTREK														
2.4 (102 kW)	2003.05-2006.10	AT/MT	L/R	F	All-wheel Drive Closed Off-Road Vehicle Engine 4G64 (SOHC 16V)	839112	Outer Joint	43T	25	29	57	94.5	57	I
	2003.05-2006.10	AT	-	F	All-wheel Drive Closed Off-Road Vehicle Engine 4G64 (SOHC 16V)	839176	Outer Joint	43T	25	29	57	95	58	M
	2003.05-2006.10	AT	-	F	All-wheel Drive Closed Off-Road Vehicle Engine 4G64 (SOHC 16V)	839143	Outer Joint	43T	25	33	57	95	60.5	I
	2003.05-2006.10	AT	-	R	All-wheel Drive Closed Off-Road Vehicle Engine 4G64 (SOHC 16V)	839252	Outer Joint	43T	25	29	57	95	71	I
	2003.05-2006.10	AT	-	-	All-wheel Drive Closed Off-Road Vehicle Engine 4G64 (SOHC 16V)	699019	Inner Joint		26	29	41	50	90	
2.4 (118 kW)	2003.11-2006.10	AT	-	F	All-wheel Drive Closed Off-Road Vehicle Engine 4G69	839143	Outer Joint	43T	25	33	57	95	60.5	I
2.4 (119 kW)	2003.05-2006.10	-	-	F	All-wheel Drive Closed Off-Road Vehicle Engine 4G69	839176	Outer Joint	43T	25	29	57	95	58	M
	2003.05-2006.10	AT	-	F	All-wheel Drive Closed Off-Road Vehicle Engine 4G69	839143	Outer Joint	43T	25	33	57	95	60.5	I
	2003.05-2006.10	-	-	R	All-wheel Drive Closed Off-Road Vehicle Engine 4G69	839252	Outer Joint	43T	25	29	57	95	71	I
	2003.05-2006.10	-	-	-	All-wheel Drive Closed Off-Road Vehicle Engine 4G69	699019	Inner Joint		26	29	41	50	90	
2.4 HDD Mivec (118 kW)	2001.03-2006.12	AT/MT	L/R	F	Closed Off-Road Vehicle Engine 4G69	839112	Outer Joint	43T	25	29	57	94.5	57	I
	2001.03-2006.12	AT	-	F	Closed Off-Road Vehicle Engine 4G69	839143	Outer Joint	43T	25	33	57	95	60.5	I
OUTLANDER II (CW_W)														
2.0 (108 kW)	2006.11-2012.11	AT/MT	-	F	Closed Off-Road Vehicle Engine 4B11	839117	Outer Joint		28	35	59.5	95	65	I
	2006.11-2012.11	AT	L	F	Closed Off-Road Vehicle Engine 4B11	651034	Inner Joint		27	35	40	62	113	
2.0 DI-D (103 kW)	2007.02-2012.11	-	-	-	All-wheel Drive Closed Off-Road Vehicle Engine BSY	839137	Outer Joint		28	37	59.5	94.5	71.5	I
	2007.02-2012.11	MT	L	F	All-wheel Drive Closed Off-Road Vehicle Engine BSY	251047	Drive Shaft		28	24	59.5	94.5	631	
	2007.02-2012.11	AT	-	F	All-wheel Drive Closed Off-Road Vehicle Engine BSY	839117	Outer Joint		28	35	59.5	95	65	I
	2007.02-2012.11	MT	-	R	All-wheel Drive Closed Off-Road Vehicle Engine BSY	839175	Outer Joint		27	26	58	94.5	52.5	I
	2007.02-2012.11	MT	R	F	All-wheel Drive Closed Off-Road Vehicle Engine BSY	251046	Drive Shaft		28	24	59.5	94.5	989	
	2007.02-2012.11	AT/MT	-	F	All-wheel Drive Closed Off-Road Vehicle Engine BSY	851033	Outer Joint		25	26	48	106.5	49	I
	2007.02-2012.11	AT	L	F	All-wheel Drive Closed Off-Road Vehicle Engine BSY	651034	Inner Joint		27	35	40	62	113	
	2007.02-2012.11	AT/MT	-	R	All-wheel Drive Closed Off-Road Vehicle Engine BSY	639050	Inner Joint		23	26	35	64	96	
	2007.02-2012.11	MT	L	F	All-wheel Drive Closed Off-Road Vehicle Engine BSY	659140	Inner Joint		24	36	50	67	116	
2.2 DI-D (115 kW)	2007.08-2012.11	MT	L	F	All-wheel Drive Closed Off-Road Vehicle Engine 4HN	251047	Drive Shaft		28	24	59.5	94.5	631	
	2007.08-2012.11	MT	-	R	All-wheel Drive Closed Off-Road Vehicle Engine 4HN	839175	Outer Joint		27	26	58	94.5	52.5	I
	2007.08-2012.11	MT	-	F	All-wheel Drive Closed Off-Road Vehicle Engine 4HN	851033	Outer Joint		25	26	48	106.5	49	I
	2007.08-2012.11	MT	-	R	All-wheel Drive Closed Off-Road Vehicle Engine 4HN	639050	Inner Joint		23	26	35	64	96	
	2007.08-2012.11	MT	L	F	All-wheel Drive Closed Off-Road Vehicle Engine 4HN	659140	Inner Joint		24	36	50	67	116	
2.2 DI-D (130 kW)	2006.11-2012.11	MT	L	F	Closed Off-Road Vehicle Engine 4N14	251047	Drive Shaft		28	24	59.5	94.5	631	
	2006.11-2012.11	MT	L	F	All-wheel Drive Closed Off-Road Vehicle Engine 4N14	251047	Drive Shaft		28	24	59.5	94.5	631	
	2006.11-2012.11	MT	L	F	Closed Off-Road Vehicle Engine 4N14	659140	Inner Joint		24	36	50	67	116	
	2006.11-2012.11	MT	L	F	All-wheel Drive Closed Off-Road Vehicle Engine 4N14	659140	Inner Joint		24	36	50	67	116	
2.4 (125 kW)	2006.11-2012.11	AT/MT	-	F	Closed Off-Road Vehicle Engine 4B12	839117	Outer Joint		28	35	59.5	95	65	I
	2006.11-2012.11	AT	L	F	Closed Off-Road Vehicle Engine 4B12	651034	Inner Joint		27	35	40	62	113	
2.4 Mivec (125 kW)	2007.09-2012.11	AT/MT	-	F	All-wheel Drive Closed Off-Road Vehicle Engine 4B12	839117	Outer Joint		28	35	59.5	95	65	I
	2007.09-2012.11	-	-	R	All-wheel Drive Closed Off-Road Vehicle Engine 4B12	839175	Outer Joint		27	26	58	94.5	52.5	I
	2007.09-2012.11	AT	-	F	All-wheel Drive Closed Off-Road Vehicle Engine 4B12	851033	Outer Joint		25	26	48	106.5	49	I
	2007.09-2012.11	AT	L	F	All-wheel Drive Closed Off-Road Vehicle Engine 4B12	651034	Inner Joint		27	35	40	62	113	
	2007.09-2012.11	-	-	R	All-wheel Drive Closed Off-Road Vehicle Engine 4B12	639050	Inner Joint		23	26	35	64	96	
PAJERO														
-	1990-1996	-	-	-	-	639045	Inner Joint		28	25	34.7	90.5	81.5	
	2010.09-	-	-	-	-	839201	Outer Joint	50T	30	36	69.2	98.5	67.5	M
3.0 V6	1992-1996	-	-	-	-	899176	Outer Joint		28	27	56	154	62	M
PAJERO (V63W)														
3.0 4WD	2000.08-	AT	-	F	Engine 6G72	839124	Outer Joint	50T	30	33	66	98	67	I
PAJERO (V65W)														
3.5 4WD	1999.06-	AT	-	F	Engine 6G74	839124	Outer Joint	50T	30	33	66	98	67	I
PAJERO (V65W/V75W)														
3.5	1999.09-	4MT/5MT	-	-	Engine 6G74	839124	Outer Joint	50T	30	33	66	98	67	I
PAJERO (V68W)														
3.2 4WD	1999.06-	AT	-	F	Engine 4M41	839124	Outer Joint	50T	30	33	66	98	67	I
PAJERO (V68W/V78W)														
3.2	1999.09-	4MT/5MT	-	-	Engine 4M41	839124	Outer Joint	50T	30	33	66	98	67	I
PAJERO (V73W)														
3.0 4WD	1999.06-	AT	-	F	Engine 6G72	839124	Outer Joint	50T	30	33	66	98	67	I
PAJERO (V75W)														
3.5 4WD	1999.06-	AT	-	F	Engine 6G74	839124	Outer Joint	50T	30	33	66	98	67	I
PAJERO (V78W)														
3.2 4WD	1999.06-	AT	-	F	Engine 4M41	839124	Outer Joint	50T	30	33	66	98	67	I
PAJERO CLASSIC (V2_W)/PAJERO/SHOGUN CLASSIC/MONTERO CLASSIC														
2.5 TD (85 kW)	2002.07-	-	-	L	F	All-wheel Drive Closed Off-Road Vehicle Engine 4D56 T	699083	Inner Joint		28	26	34.7	90.5	90.6
	2002.07-	-	-	R	F	All-wheel Drive Closed Off-Road Vehicle Engine 4D56 T	675004	Inner Joint		26		62.5		
	2002.07-	-	-	L	F	All-wheel Drive Closed Off-Road Vehicle Engine 4D56 T	639049	Inner Joint		25	25	32	89	81.5
	2002.07-	-	-	R	F	All-wheel Drive Closed Off-Road Vehicle Engine 4D56 T	639061	Inner Joint		25		68.6		





YEAR	TRANSM	L/R	F/R	REMARKS	GSP Ref.	PRODUCT	ABS	Technical Specifications					
								A	B	C	H	L	P
MITSUBISHI													
PAJERO I (L04_G L14_G)/MONTERO/PAJERO/SHOGUN													
2.5 TD (64 kW)	1990.01-1991.12	MT	L/R	F	Closed Off-Road Vehicle Engine 4D56 T	839027	Outer Joint	28	25	56	154.1	62	M
	1990.01-1991.12	MT	L	F	Closed Off-Road Vehicle Engine 4D56 T	639049	Inner Joint	25	25	32	89	81.5	
	1990.01-1991.12	-	-	F	Closed Off-Road Vehicle Engine 4D56 T	839013	Outer Joint	28	25	56	155.5	64	M
	1990.01-1991.12	MT	R	F	Closed Off-Road Vehicle Engine 4D56 T	639061	Inner Joint		25		68.6		
2.5 TD (70 kW)	1989.11-1990.11	MT	L/R	F	Closed Off-Road Vehicle Engine 4D56 T	839027	Outer Joint	28	25	56	154.1	62	M
	1989.11-1990.11	MT	L	F	Closed Off-Road Vehicle Engine 4D56 T	639049	Inner Joint	25	25	32	89	81.5	
	1989.11-1990.11	-	-	F	Closed Off-Road Vehicle Engine 4D56 T	839013	Outer Joint	28	25	56	155.5	64	M
	1989.11-1990.11	MT	R	F	Closed Off-Road Vehicle Engine 4D56 T	639061	Inner Joint		25		68.6		
3.0 i (105 kW)	1988.05-1991.05	MT	-	F	All-wheel Drive Closed Off-Road Vehicle Engine 6G72 (SOHC 12V)	839001	Outer Joint	28	27	56	154.5	63	I
	1988.05-1991.05	AT	R	F	All-wheel Drive Closed Off-Road Vehicle Engine 6G72 (SOHC 12V)	639061	Inner Joint		25		68.6		
	1988.05-1991.05	-	-	F	All-wheel Drive Closed Off-Road Vehicle Engine 6G72 (SOHC 12V)	839013	Outer Joint	28	25	56	155.5	64	M
	1988.05-1991.05	AT	R	F	All-wheel Drive Closed Off-Road Vehicle Engine 6G72 (SOHC 12V)	639061	Inner Joint		25		68.6		
3.0 V6 (104 kW)	1988.11-1990.11	MT	-	F	Closed Off-Road Vehicle Engine 6G72 (SOHC 12V)	839001	Outer Joint	28	27	56	154.5	63	I
	1988.11-1990.11	AT	R	F	Closed Off-Road Vehicle Engine 6G72 (SOHC 12V)	639061	Inner Joint		25		68.6		
	1988.11-1990.11	-	-	F	Closed Off-Road Vehicle Engine 6G72 (SOHC 12V)	839013	Outer Joint	28	25	56	155.5	64	M
PAJERO I Canvas Top (L04_G)/MONTERO/PAJERO/SHOGUN													
2.5 TD (62 kW)	1986.05-1989.10	-	-	F	All-wheel Drive Open Off-Road Vehicle Engine 4D56 T	839013	Outer Joint	28	25	56	155.5	64	M
	1986.05-1989.10	MT	L/R	F	All-wheel Drive Open Off-Road Vehicle Engine 4D56 T	839027	Outer Joint	28	25	56	154.1	62	M
2.5 TD (70 kW)	1989.11-1990.11	MT	L/R	F	All-wheel Drive Open Off-Road Vehicle Engine 4D56 T	839027	Outer Joint	28	25	56	154.1	62	M
	1989.11-1990.11	MT	L	F	All-wheel Drive Open Off-Road Vehicle Engine 4D56 T	639049	Inner Joint	25	25	32	89	81.5	
	1989.11-1990.11	-	-	F	All-wheel Drive Open Off-Road Vehicle Engine 4D56 T	839013	Outer Joint	28	25	56	155.5	64	M
	1989.11-1990.11	MT	R	F	All-wheel Drive Open Off-Road Vehicle Engine 4D56 T	639061	Inner Joint		25		68.6		
2.6 (76 kW)	1983.01-1990.11	AT/MT	L	F	All-wheel Drive Open Off-Road Vehicle Engine 4G54	639049	Inner Joint	25	25	32	89	81.5	
	1983.01-1990.11	MT	-	F	All-wheel Drive Open Off-Road Vehicle Engine 4G54	839001	Outer Joint	28	27	56	154.5	63	I
	1983.01-1990.11	AT/MT	R	F	All-wheel Drive Open Off-Road Vehicle Engine 4G54	639061	Inner Joint		25		68.6		
	1983.01-1990.11	-	-	F	All-wheel Drive Open Off-Road Vehicle Engine 4G54	839013	Outer Joint	28	25	56	155.5	64	M
1983.01-1990.11	-	-	F	All-wheel Drive Open Off-Road Vehicle Engine 4G54	839003	Outer Joint	28	27	56	154.1	60	M	
PAJERO II (V3_W V2_W V4_W)/MONTERO/PAJERO/SHOGUN													
2.4 (82 kW)	1991.04-1999.10	MT	L	F	Closed Off-Road Vehicle Engine 4G64 (12V)	699083	Inner Joint	28	26	34.7	90.5	90.6	
	1991.04-1999.10	AT/MT	R	F	Closed Off-Road Vehicle Engine 4G64 (12V)	675004	Inner Joint		26		62.5		
	1991.04-1999.10	MT	L	F	Closed Off-Road Vehicle Engine 4G64 (12V)	639049	Inner Joint	25	25	32	89	81.5	
	1991.04-1999.10	MT	R	F	Closed Off-Road Vehicle Engine 4G64 (12V)	639061	Inner Joint		25		68.6		
	1991.04-1999.10	-	L/R	F	Closed Off-Road Vehicle Engine 4G64 (12V)	839018	Outer Joint	28	25	56	154	62	M
	1991.04-1999.10	-	-	F	Closed Off-Road Vehicle Engine 4G64 (12V)	839003	Outer Joint	28	27	56	154.1	60	M
2.5 TD (73 kW)	1990.12-1999.10	MT	L	F	All-wheel Drive Closed Off-Road Vehicle Engine 4D56 TD	699083	Inner Joint	28	26	34.7	90.5	90.6	
	1990.12-1999.10	MT	R	F	All-wheel Drive Closed Off-Road Vehicle Engine 4D56 TD	675004	Inner Joint		26		62.5		
	1990.12-1999.10	-	R	F	All-wheel Drive Closed Off-Road Vehicle Engine 4D56 TD	239006	Drive Shaft	28		56	154	538	
	1990.12-1999.10	MT	L/R	F	All-wheel Drive Closed Off-Road Vehicle Engine 4D56 TD	839027	Outer Joint	28	25	56	154.1	62	M
	1990.12-1999.10	-	L	F	All-wheel Drive Closed Off-Road Vehicle Engine 4D56 TD	239007	Drive Shaft	28	25	56	154	616	
	1990.12-1999.10	MT	L	F	All-wheel Drive Closed Off-Road Vehicle Engine 4D56 TD	639049	Inner Joint	25	25	32	89	81.5	
	1990.12-1999.10	-	-	F	All-wheel Drive Closed Off-Road Vehicle Engine 4D56 TD	839013	Outer Joint	28	25	56	155.5	64	M
	1990.12-1999.10	MT	L	F	All-wheel Drive Closed Off-Road Vehicle Engine 4D56 TD	299232	Drive Shaft	28	25	56	154	610	
	1990.12-1999.10	MT	R	F	All-wheel Drive Closed Off-Road Vehicle Engine 4D56 TD	639061	Inner Joint		25		68.6		
	1990.12-1999.10	MT	R	F	All-wheel Drive Closed Off-Road Vehicle Engine 4D56 TD	239034	Drive Shaft	28		56	155.5	528	
	1990.12-1999.10	-	L/R	F	All-wheel Drive Closed Off-Road Vehicle Engine 4D56 TD	839018	Outer Joint	28	25	56	154	62	M
1990.12-1999.10	-	R	-	All-wheel Drive Closed Off-Road Vehicle Engine 4D56 TD	699092	Inner Joint		26		71.5			
2.6 (76 kW)	1991.03-1997.10	AT	L	F	All-wheel Drive Closed Off-Road Vehicle Engine 4G54	639049	Inner Joint	25	25	32	89	81.5	
	1991.03-1997.10	MT	L	F	All-wheel Drive Closed Off-Road Vehicle Engine 4G54	299232	Drive Shaft	28	25	56	154	610	
	1991.03-1997.10	-	-	F	All-wheel Drive Closed Off-Road Vehicle Engine 4G54	839013	Outer Joint	28	25	56	155.5	64	M
	1991.03-1997.10	MT	R	F	All-wheel Drive Closed Off-Road Vehicle Engine 4G54	239034	Drive Shaft	28		56	155.5	528	
1991.03-1997.10	-	R	F	All-wheel Drive Closed Off-Road Vehicle Engine 4G54	639061	Inner Joint		25		68.6			
2.8 TD (92 kW)	1994.06-1999.10	AT/MT	R	F	Closed Off-Road Vehicle Engine 4M40-T	675004	Inner Joint		26		62.5		
	1994.06-1999.10	AT/MT	R	F	Closed Off-Road Vehicle Engine 4M40-T	239006	Drive Shaft	28		56	154	538	
	1994.06-1999.10	AT/MT	-	F	Closed Off-Road Vehicle Engine 4M40-T	839001	Outer Joint	28	27	56	154.5	63	I
	1994.06-1999.10	AT	R	F	Closed Off-Road Vehicle Engine 4M40-T	639061	Inner Joint		25		68.6		
	1994.06-1999.10	-	-	F	Closed Off-Road Vehicle Engine 4M40-T	839013	Outer Joint	28	25	56	155.5	64	M
	1994.06-1999.10	AT	L/R	F	Closed Off-Road Vehicle Engine 4M40-T	839018	Outer Joint	28	25	56	154	62	M
	1994.06-1999.10	MT&AT	R	-	Closed Off-Road Vehicle Engine 4M40-T	699092	Inner Joint		26		71.5		
1994.06-1999.10	AT/MT	L	F	Closed Off-Road Vehicle Engine 4M40-T	699083	Inner Joint	28	26	34.7	90.5	90.6		
3.0 V6 (110 kW)	1990.12-1995.12	MT	L	F	All-wheel Drive Closed Off-Road Vehicle Engine 6G72 (SOHC 12V)	699083	Inner Joint	28	26	34.7	90.5	90.6	
	1990.12-1995.12	MT	R	F	All-wheel Drive Closed Off-Road Vehicle Engine 6G72 (SOHC 12V)	675004	Inner Joint		26		62.5		
	1990.12-1995.12	AT	L/R	F	All-wheel Drive Closed Off-Road Vehicle Engine 6G72 (SOHC 12V)	839015	Outer Joint	27	27	60	97	68.5	M
	1990.12-1995.12	AT/MT	R	F	All-wheel Drive Closed Off-Road Vehicle Engine 6G72 (SOHC 12V)	239006	Drive Shaft	28		56	154	538	
	1990.12-1995.12	MT	L/R	F	All-wheel Drive Closed Off-Road Vehicle Engine 6G72 (SOHC 12V)	839027	Outer Joint	28	25	56	154.1	62	M
	1990.12-1995.12	AT	L	F	All-wheel Drive Closed Off-Road Vehicle Engine 6G72 (SOHC 12V)	639049	Inner Joint	25	25	32	89	81.5	
	1990.12-1995.12	AT	L	F	All-wheel Drive Closed Off-Road Vehicle Engine 6G72 (SOHC 12V)	239007	Drive Shaft	28	25	56	154	616	
1990.12-1995.12	AT	R	F	All-wheel Drive Closed Off-Road Vehicle Engine 6G72 (SOHC 12V)	639061	Inner Joint		25		68.6			

	YEAR	TRANSM	L/R	F/R	REMARKS	GSP Ref.	PRODUCT	ABS	Technical Specifications								
									A	B	C	H	L	P			
MITSUBISHI																	
PAJERO II (V3_W V2_W V4_W)/MONTERO/PAJERO/SHOGUN																	
3.0 V6 (110 kW)	1990.12-1995.12	-	-	F	All-wheel Drive Closed Off-Road Vehicle Engine 6G72 (SOHC 12V)	839013	Outer Joint		28	25	56	155.5	64	M			
	1990.12-1995.12	-	L	F	All-wheel Drive Closed Off-Road Vehicle Engine 6G72 (SOHC 12V)	299232	Drive Shaft		28	25	56	154	610				
	1990.12-1995.12	-	R	F	All-wheel Drive Closed Off-Road Vehicle Engine 6G72 (SOHC 12V)	239034	Drive Shaft		28		56	155.5	528				
	1990.12-1995.12	AT/MT	L/R	F	All-wheel Drive Closed Off-Road Vehicle Engine 6G72 (SOHC 12V)	839018	Outer Joint		28	25	56	154	62	M			
	1990.12-1995.12	MT&AT	R	-	All-wheel Drive Closed Off-Road Vehicle Engine 6G72 (SOHC 12V)	699092	Inner Joint			26		71.5					
3.0 V6 24V (130 kW)	1997.06-1999.10	MT	L	F	Closed Off-Road Vehicle Engine 6G72 (SOHC 24V)	699083	Inner Joint		28	26	34.7	90.5	90.6				
	1997.06-1999.10	AT	L/R	F	Closed Off-Road Vehicle Engine 6G72 (SOHC 24V)	839015	Outer Joint		27	27	60	97	68.5	M			
	1997.06-1999.10	AT/MT	R	F	Closed Off-Road Vehicle Engine 6G72 (SOHC 24V)	239006	Drive Shaft		28		56	154	538				
	1997.06-1999.10	AT	L	F	Closed Off-Road Vehicle Engine 6G72 (SOHC 24V)	639049	Inner Joint		25	25	32	89	81.5				
	1997.06-1999.10	AT	L	F	Closed Off-Road Vehicle Engine 6G72 (SOHC 24V)	239007	Drive Shaft		28	25	56	154	616				
	1997.06-1999.10	AT	R	F	Closed Off-Road Vehicle Engine 6G72 (SOHC 24V)	639061	Inner Joint			25		68.6					
	1997.06-1999.10	-	-	F	Closed Off-Road Vehicle Engine 6G72 (SOHC 24V)	839013	Outer Joint		28	25	56	155.5	64	M			
	1997.06-1999.10	-	L	F	Closed Off-Road Vehicle Engine 6G72 (SOHC 24V)	299232	Drive Shaft		28	25	56	154	610				
	1997.06-1999.10	-	R	F	Closed Off-Road Vehicle Engine 6G72 (SOHC 24V)	239034	Drive Shaft		28		56	155.5	528				
	1997.06-1999.10	MT&AT	R	-	Closed Off-Road Vehicle Engine 6G72 (SOHC 24V)	699092	Inner Joint			26		71.5					
	1997.06-1999.10	MT	L/R	F	Closed Off-Road Vehicle Engine 6G72 (SOHC 24V)	839018	Outer Joint		28	25	56	154	62	M			
3.0 V6 24V (133 kW)	1994.06-1997.05	MT	L	F	Closed Off-Road Vehicle Engine 6G72 (SOHC 24V)	699083	Inner Joint		28	26	34.7	90.5	90.6				
	1994.06-1997.05	-	-	-	Closed Off-Road Vehicle Engine 6G72 (SOHC 24V)	839093	Outer Joint		28	26	56	155	64	M			
	1994.06-1997.05	AT/MT	R	F	Closed Off-Road Vehicle Engine 6G72 (SOHC 24V)	675004	Inner Joint			26		62.5					
	1994.06-1997.05	AT/MT	R	F	Closed Off-Road Vehicle Engine 6G72 (SOHC 24V)	239006	Drive Shaft		28		56	154	538				
	1994.06-1997.05	AT	L	F	Closed Off-Road Vehicle Engine 6G72 (SOHC 24V)	639049	Inner Joint		25	25	32	89	81.5				
	1994.06-1997.05	AT	L	F	Closed Off-Road Vehicle Engine 6G72 (SOHC 24V)	239007	Drive Shaft		28	25	56	154	616				
	1994.06-1997.05	AT	R	F	Closed Off-Road Vehicle Engine 6G72 (SOHC 24V)	639061	Inner Joint			25		68.6					
	1994.06-1997.05	-	-	F	Closed Off-Road Vehicle Engine 6G72 (SOHC 24V)	839013	Outer Joint		28	25	56	155.5	64	M			
	1994.06-1997.05	-	L	F	Closed Off-Road Vehicle Engine 6G72 (SOHC 24V)	299232	Drive Shaft		28	25	56	154	610				
	1994.06-1997.05	-	R	F	Closed Off-Road Vehicle Engine 6G72 (SOHC 24V)	239034	Drive Shaft		28		56	155.5	528				
	1994.06-1997.05	AT/MT	L/R	F	Closed Off-Road Vehicle Engine 6G72 (SOHC 24V)	839018	Outer Joint		28	25	56	154	62	M			
	1994.06-1997.05	MT&AT	R	-	Closed Off-Road Vehicle Engine 6G72 (SOHC 24V)	699092	Inner Joint			26		71.5					
3.5 V6 24V (143 kW)	1997.07-1999.10	-	L	F	Closed Off-Road Vehicle Engine 6G74 (DOHC 24V)	699083	Inner Joint		28	26	34.7	90.5	90.6				
	1997.07-1999.10	-	R	F	Closed Off-Road Vehicle Engine 6G74 (DOHC 24V)	675004	Inner Joint			26		62.5					
	1997.07-1999.10	-	-	F	Closed Off-Road Vehicle Engine 6G74 (DOHC 24V)	839001	Outer Joint		28	27	56	154.5	63	I			
	1997.07-1999.10	-	-	F	Closed Off-Road Vehicle Engine 6G74 (DOHC 24V)	839013	Outer Joint		28	25	56	155.5	64	M			
	1997.07-1999.10	-	L	F	Closed Off-Road Vehicle Engine 6G74 (DOHC 24V)	299232	Drive Shaft		28	25	56	154	610				
	1997.07-1999.10	-	R	F	Closed Off-Road Vehicle Engine 6G74 (DOHC 24V)	239034	Drive Shaft		28		56	155.5	528				
	1997.07-1999.10	-	L/R	F	Closed Off-Road Vehicle Engine 6G74 (DOHC 24V)	839018	Outer Joint		28	25	56	154	62	M			
3.5 V6 24V (153 kW)	1994.06-1999.10	-	L	F	Closed Off-Road Vehicle Engine 6G74 (DOHC 24V)	699083	Inner Joint		28	26	34.7	90.5	90.6				
	1994.06-1999.10	-	R	F	Closed Off-Road Vehicle Engine 6G74 (DOHC 24V)	675004	Inner Joint			26		62.5					
	1994.06-1999.10	-	R	F	Closed Off-Road Vehicle Engine 6G74 (DOHC 24V)	239006	Drive Shaft		28		56	154	538				
	1994.06-1999.10	-	-	F	Closed Off-Road Vehicle Engine 6G74 (DOHC 24V)	839001	Outer Joint		28	27	56	154.5	63	I			
	1994.06-1999.10	-	-	F	Closed Off-Road Vehicle Engine 6G74 (DOHC 24V)	839013	Outer Joint		28	25	56	155.5	64	M			
	1994.06-1999.10	-	L	F	Closed Off-Road Vehicle Engine 6G74 (DOHC 24V)	299232	Drive Shaft		28	25	56	154	610				
	1994.06-1999.10	-	R	F	Closed Off-Road Vehicle Engine 6G74 (DOHC 24V)	239034	Drive Shaft		28		56	155.5	528				
	1994.06-1999.10	-	L/R	F	Closed Off-Road Vehicle Engine 6G74 (DOHC 24V)	839018	Outer Joint		28	25	56	154	62	M			
	1994.06-1999.10	-	R	-	Closed Off-Road Vehicle Engine 6G74 (DOHC 24V)	699092	Inner Joint			26		71.5					
PAJERO II Canvas Top (V2_W V4_W)/MONTERO/PAJERO/SHOGUN																	
2.4 (82 kW)	1991.04-2000.04	MT	L	F	Open Off-Road Vehicle Engine 4G64 (12V)	699083	Inner Joint		28	26	34.7	90.5	90.6				
	1991.04-2000.04	AT/MT	R	F	Open Off-Road Vehicle Engine 4G64 (12V)	675004	Inner Joint			26		62.5					
	1991.04-2000.04	MT	L	F	Open Off-Road Vehicle Engine 4G64 (12V)	639049	Inner Joint		25	25	32	89	81.5				
	1991.04-2000.04	-	-	F	Open Off-Road Vehicle Engine 4G64 (12V)	839013	Outer Joint		28	25	56	155.5	64	M			
	1991.04-2000.04	MT	R	F	Open Off-Road Vehicle Engine 4G64 (12V)	639061	Inner Joint			25		68.6					
	1991.04-2000.04	-	L	F	Open Off-Road Vehicle Engine 4G64 (12V)	299232	Drive Shaft		28	25	56	154	610				
	1991.04-2000.04	-	R	F	Open Off-Road Vehicle Engine 4G64 (12V)	239034	Drive Shaft		28		56	155.5	528				
	1991.04-2000.04	-	L/R	F	Open Off-Road Vehicle Engine 4G64 (12V)	839018	Outer Joint		28	25	56	154	62	M			
	1991.04-2000.04	-	-	F	Open Off-Road Vehicle Engine 4G64 (12V)	839003	Outer Joint		28	27	56	154.1	60	M			
2.5 TD (73 kW)	1990.12-2000.04	MT	L	F	All-wheel Drive Open Off-Road Vehicle Engine 4D56 TD	699083	Inner Joint		28	26	34.7	90.5	90.6				
	1990.12-2000.04	MT	R	F	All-wheel Drive Open Off-Road Vehicle Engine 4D56 TD	675004	Inner Joint			26		62.5					
	1990.12-2000.04	AT	L/R	F	All-wheel Drive Open Off-Road Vehicle Engine 4D56 TD	839015	Outer Joint		27	27	60	97	68.5	M			
	1990.12-2000.04	-	R	F	All-wheel Drive Open Off-Road Vehicle Engine 4D56 TD	239006	Drive Shaft		28		56	154	538				
	1990.12-2000.04	MT	L/R	F	All-wheel Drive Open Off-Road Vehicle Engine 4D56 TD	839027	Outer Joint		28	25	56	154.1	62	M			
	1990.12-2000.04	-	L	F	All-wheel Drive Open Off-Road Vehicle Engine 4D56 TD	239007	Drive Shaft		28	25	56	154	616				
	1990.12-2000.04	MT	L	F	All-wheel Drive Open Off-Road Vehicle Engine 4D56 TD	639049	Inner Joint		25	25	32	89	81.5				
	1990.12-2000.04	-	-	F	All-wheel Drive Open Off-Road Vehicle Engine 4D56 TD	839013	Outer Joint		28	25	56	155.5	64	M			
	1990.12-2000.04	MT	R	F	All-wheel Drive Open Off-Road Vehicle Engine 4D56 TD	639061	Inner Joint			25		68.6					
	1990.12-2000.04	-	L	F	All-wheel Drive Open Off-Road Vehicle Engine 4D56 TD	299232	Drive Shaft		28	25	56	154	610				
	1990.12-2000.04	-	R	F	All-wheel Drive Open Off-Road Vehicle Engine 4D56 TD	239034	Drive Shaft		28		56	155.5	528				
	1990.12-2000.04	-	L/R	F	All-wheel Drive Open Off-Road Vehicle Engine 4D56 TD	839018	Outer Joint		28	25	56	154	62	M			





YEAR	TRANSM	L/R	F/R	REMARKS	GSP Ref.	PRODUCT	ABS	Technical Specifications							
								A	B	C	H	L	P		
MITSUBISHI															
PAJERO II Canvas Top (V2_W V4_W)/MONTERO/PAJERO/SHOGUN															
2.5 TD (73 kW)	1990.12-2000.04	5MT	R	-	All-wheel Drive Open Off-Road Vehicle Engine 4D56 TD	699092	Inner Joint			26		71.5			
3.0 V6 (110 kW)	1990.12-1995.12	MT	L	F	Open Off-Road Vehicle Engine 6G72 (SOHC 12V)	699083	Inner Joint		28	26	34.7	90.5	90.6		
	1990.12-1995.12	MT	R	F	Open Off-Road Vehicle Engine 6G72 (SOHC 12V)	675004	Inner Joint			26		62.5			
	1990.12-1995.12	AT/MT	R	F	Open Off-Road Vehicle Engine 6G72 (SOHC 12V)	239006	Drive Shaft		28		56	154	538		
	1990.12-1995.12	MT	L/R	F	Open Off-Road Vehicle Engine 6G72 (SOHC 12V)	839027	Outer Joint		28	25	56	154.1	62	M	
	1990.12-1995.12	AT	L	F	Open Off-Road Vehicle Engine 6G72 (SOHC 12V)	639049	Inner Joint		25	25	32	89	81.5		
	1990.12-1995.12	AT	L	F	Open Off-Road Vehicle Engine 6G72 (SOHC 12V)	239007	Drive Shaft		28	25	56	154	616		
	1990.12-1995.12	AT	R	F	Open Off-Road Vehicle Engine 6G72 (SOHC 12V)	639061	Inner Joint			25		68.6			
	1990.12-1995.12	-	-	F	Open Off-Road Vehicle Engine 6G72 (SOHC 12V)	839013	Outer Joint		28	25	56	155.5	64	M	
	1990.12-1995.12	-	L	F	Open Off-Road Vehicle Engine 6G72 (SOHC 12V)	299232	Drive Shaft		28	25	56	154	610		
	1990.12-1995.12	-	R	F	Open Off-Road Vehicle Engine 6G72 (SOHC 12V)	239034	Drive Shaft		28		56	155.5	528		
3.0 V6 24V (130 kW)	1990.12-1995.12	AT/MT	L/R	F	Open Off-Road Vehicle Engine 6G72 (SOHC 12V)	839018	Outer Joint		28	25	56	154	62	M	
	1990.12-1995.12	MT&AT	R	-	Open Off-Road Vehicle Engine 6G72 (SOHC 12V)	699092	Inner Joint			26		71.5			
	3.0 V6 24V (133 kW)	1994.06-2000.04	MT	L	F	All-wheel Drive Open Off-Road Vehicle Engine 6G72 (DOHC 24V)	699083	Inner Joint		28	26	34.7	90.5	90.6	
		1994.06-2000.04	AT/MT	R	F	All-wheel Drive Open Off-Road Vehicle Engine 6G72 (DOHC 24V)	675004	Inner Joint			26		62.5		
		1994.06-2000.04	AT	L	F	All-wheel Drive Open Off-Road Vehicle Engine 6G72 (DOHC 24V)	639049	Inner Joint		25	25	32	89	81.5	
		1994.06-2000.04	AT	R	F	All-wheel Drive Open Off-Road Vehicle Engine 6G72 (DOHC 24V)	639061	Inner Joint			25		68.6		
	3.0 V6 24V (133 kW)	1994.06-2000.04	MT	L	F	Open Off-Road Vehicle Engine 6G72 (SOHC 24V)	699083	Inner Joint		28	26	34.7	90.5	90.6	
		1994.06-2000.04	AT/MT	R	F	Open Off-Road Vehicle Engine 6G72 (SOHC 24V)	675004	Inner Joint			26		62.5		
		1994.06-2000.04	AT/MT	R	F	Open Off-Road Vehicle Engine 6G72 (SOHC 24V)	239006	Drive Shaft		28		56	154	538	
		1994.06-2000.04	AT	L	F	Open Off-Road Vehicle Engine 6G72 (SOHC 24V)	639049	Inner Joint		25	25	32	89	81.5	
1994.06-2000.04		AT	L	F	Open Off-Road Vehicle Engine 6G72 (SOHC 24V)	239007	Drive Shaft		28	25	56	154	616		
1994.06-2000.04		AT	R	F	Open Off-Road Vehicle Engine 6G72 (SOHC 24V)	639061	Inner Joint			25		68.6			
1994.06-2000.04		-	-	F	Open Off-Road Vehicle Engine 6G72 (SOHC 24V)	839013	Outer Joint		28	25	56	155.5	64	M	
1994.06-2000.04		AT/MT	L/R	F	Open Off-Road Vehicle Engine 6G72 (SOHC 24V)	839018	Outer Joint		28	25	56	154	62	M	
1994.06-2000.04		MT&AT	R	-	Open Off-Road Vehicle Engine 6G72 (SOHC 24V)	699092	Inner Joint			26		71.5			
PAJERO III															
3.5	2000.01-	MT/AT	-	-	Engine	839124	Outer Joint	50T	30	33	66	98	67	I	
PAJERO III (V7_W V6_W)/MONTERO/PAJERO/SHOGUN															
2.5 TDi (73 kW)	2000.04-2006.12	MT	-	F	All-wheel Drive Closed Off-Road Vehicle Engine 4D56 T	839006	Outer Joint	50T	30	33	66	98	67	I	
	2000.04-2006.12	MT	-	R	All-wheel Drive Closed Off-Road Vehicle Engine 4D56 T	821048	Outer Joint	50T	33	43	72	107	92	I	
	2000.04-2006.12	MT	-	R	All-wheel Drive Closed Off-Road Vehicle Engine 4D56 T	641195	Inner Joint			43		84			
2.5 TDi (85 kW)	2001.09-2006.12	-	-	F	All-wheel Drive Closed Off-Road Vehicle Engine 4D56 T	839006	Outer Joint	50T	30	33	66	98	67	I	
	2001.09-2006.12	-	-	R	All-wheel Drive Closed Off-Road Vehicle Engine 4D56 T	821048	Outer Joint	50T	33	43	72	107	92	I	
	2001.09-2006.12	-	-	R	All-wheel Drive Closed Off-Road Vehicle Engine 4D56 T	641195	Inner Joint			43		84			
3.2 Di-D (118 kW)	2000.04-2006.12	-	-	F	All-wheel Drive Closed Off-Road Vehicle Engine 4M41	839028	Outer Joint	50T	30	36	66	98	69	I	
	2000.04-2006.12	AT	-	F	All-wheel Drive Closed Off-Road Vehicle Engine 4M41	839006	Outer Joint	50T	30	33	66	98	67	I	
	2000.04-2006.12	AT/MT	-	R	All-wheel Drive Closed Off-Road Vehicle Engine 4M41	821048	Outer Joint	50T	33	43	72	107	92	I	
	2000.04-2006.12	AT	R	F	All-wheel Drive Closed Off-Road Vehicle Engine 4M41	239202	Drive Shaft	50T	30		66	98	529		
	2000.04-2006.12	AT/MT	-	R	All-wheel Drive Closed Off-Road Vehicle Engine 4M41	641195	Inner Joint			43		84			
	2000.04-2006.12	AT	L	F	All-wheel Drive Closed Off-Road Vehicle Engine 4M41	239064	Drive Shaft	50T	30	28	66	98	600		
3.2 Di-D (121 kW)	2000.04-2001.10	-	-	F	All-wheel Drive Closed Off-Road Vehicle Engine 4M41	839028	Outer Joint	50T	30	36	66	98	69	I	
	2000.04-2001.10	AT	-	F	All-wheel Drive Closed Off-Road Vehicle Engine 4M41	839006	Outer Joint	50T	30	33	66	98	67	I	
	2000.04-2001.10	AT	-	R	All-wheel Drive Closed Off-Road Vehicle Engine 4M41	821048	Outer Joint	50T	33	43	72	107	92	I	
	2000.04-2001.10	AT	R	F	All-wheel Drive Closed Off-Road Vehicle Engine 4M41	239202	Drive Shaft	50T	30		66	98	529		
	2000.04-2001.10	AT	-	R	All-wheel Drive Closed Off-Road Vehicle Engine 4M41	641195	Inner Joint			43		84			
	2000.04-2001.10	AT	L	F	All-wheel Drive Closed Off-Road Vehicle Engine 4M41	239064	Drive Shaft	50T	30	28	66	98	600		
3.5 (149 kW)	2000.04-2007.01	-	-	F	All-wheel Drive Closed Off-Road Vehicle Engine 6G74 (DOHC 24V)	839006	Outer Joint	50T	30	33	66	98	67	I	
	2000.04-2007.01	-	-	R	All-wheel Drive Closed Off-Road Vehicle Engine 6G74 (DOHC 24V)	821048	Outer Joint	50T	33	43	72	107	92	I	
	2000.04-2007.01	-	-	R	All-wheel Drive Closed Off-Road Vehicle Engine 6G74 (DOHC 24V)	641195	Inner Joint			43		84			
3.8 (184 kW)	2003.03-2007.01	AT/MT	-	R	All-wheel Drive Closed Off-Road Vehicle Engine 6G75	641195	Inner Joint			43		84			
PAJERO III (V7_W, V6_W)/MONTERO/PAJERO/SHOGUN															
3.8 (160 kW)	2002.09-2006.12	AT/MT	-	R	All-wheel Drive Closed Off-Road Vehicle Engine 6G75	641195	Inner Joint			43		84			
PAJERO III Canvas Top (V6_W V7_W)/MONTERO/PAJERO/SHOGUN															
2.5 TDi (73 kW)	2000.04-2006.12	MT	-	R	Open Off-Road Vehicle Engine 4D56 T	641195	Inner Joint			43		84			
2.5 TDi (85 kW)	2001.09-2006.12	-	-	F	Open Off-Road Vehicle Engine 4D56 T	839006	Outer Joint	50T	30	33	66	98	67	I	
	2001.09-2006.12	-	-	R	Open Off-Road Vehicle Engine 4D56 T	821048	Outer Joint	50T	33	43	72	107	92	I	
	2001.09-2006.12	-	-	R	Open Off-Road Vehicle Engine 4D56 T	641195	Inner Joint			43		84			
	2001.09-2006.12	-	-	R	Open Off-Road Vehicle Engine 4D56 T	641195	Inner Joint			43		84			
3.2 Di-D (118 kW)	2001.10-2006.12	-	-	F	Open Off-Road Vehicle Engine 4M41	839028	Outer Joint	50T	30	36	66	98	69	I	
	2001.10-2006.12	AT	-	F	Open Off-Road Vehicle Engine 4M41	839006	Outer Joint	50T	30	33	66	98	67	I	
	2001.10-2006.12	AT/MT	-	R	Open Off-Road Vehicle Engine 4M41	821048	Outer Joint	50T	33	43	72	107	92	I	
	2001.10-2006.12	AT	R	F	Open Off-Road Vehicle Engine 4M41	239202	Drive Shaft	50T	30		66	98	529		
	2001.10-2006.12	AT/MT	-	R	Open Off-Road Vehicle Engine 4M41	641195	Inner Joint			43		84			
	2001.10-2006.12	AT	L	F	Open Off-Road Vehicle Engine 4M41	239064	Drive Shaft	50T	30	28	66	98	600		
3.2 Di-D (121 kW)	2000.04-2006.12	-	-	-	Open Off-Road Vehicle Engine 4M41	839157	Outer Joint	50T	30	36	66	98	69	I	
	2000.04-2006.12	-	-	F	Open Off-Road Vehicle Engine 4M41	839028	Outer Joint	50T	30	36	66	98	69	I	

YEAR	TRANSM	L/R	F/R	REMARKS	GSP Ref.	PRODUCT	ABS	Technical Specifications						
								A	B	C	H	L	P	
MITSUBISHI														
PAJERO III Canvas Top (V6_W V7_W)/MONTERO/PAJERO/SHOGUN														
3.2 DI-D (121 kW)	2000.04-2006.12	AT	-	F	Open Off-Road Vehicle Engine 4M41	839006	Outer Joint	50T	30	33	66	98	67	I
	2000.04-2006.12	AT/MT	-	R	Open Off-Road Vehicle Engine 4M41	821048	Outer Joint	50T	33	43	72	107	92	I
	2000.04-2006.12	AT	R	F	Open Off-Road Vehicle Engine 4M41	239202	Drive Shaft	50T	30		66	98	529	
	2000.04-2006.12	AT/MT	-	R	Open Off-Road Vehicle Engine 4M41	641195	Inner Joint				43		84	
	2000.04-2006.12	AT	L	F	Open Off-Road Vehicle Engine 4M41	239064	Drive Shaft	50T	30	28	66	98	600	
3.5 i (160 kW)	2003.09-2006.10	-	-	R	Open Off-Road Vehicle Engine 6G74 (SOHC 24V)	641195	Inner Joint			43		84		
3.5 V6 GDI (149 kW)	2000.04-2006.12	-	-	R	Open Off-Road Vehicle Engine 6G74 (GDI)	641195	Inner Joint			43		84		
PAJERO III Canvas Top (V6_W, V7_W)/MONTERO/PAJERO/SHOGUN														
3.0 (125 kW)	2001.10-2006.12	-	-	R	All-wheel Drive Open Off-Road Vehicle Canvas Top 帆布頂蓋 Engine 6G72 (SOHC 24V)	641195	Inner Joint				43		84	
PAJERO IV (V8_W V9_W)/MONTERO/PAJERO/SHOGUN														
3.2 DI-D (118 kW)	2007.02-	AT/MT	R	F	Closed Off-Road Vehicle Engine 4M41	239261	Drive Shaft	50T	30		69.2	98.5	519	
3.2 DI-D (123 kW)	2007.02-	AT/MT	R	F	All-wheel Drive Closed Off-Road Vehicle Engine 4M41	239261	Drive Shaft	50T	30		69.2	98.5	519	
3.2 DI-D (125 kW)	2007.02-	AT/MT	R	F	Closed Off-Road Vehicle Engine 4M41	239261	Drive Shaft	50T	30		69.2	98.5	519	
3.2 DI-D (147 kW)	2009.01-	AT/MT	R	F	All-wheel Drive Closed Off-Road Vehicle Engine 4M41	239261	Drive Shaft	50T	30		69.2	98.5	519	
3.2 DI-D GLS (124 kW)	2007.02-	AT/MT	R	F	All-wheel Drive Closed Off-Road Vehicle Engine 4M41	239261	Drive Shaft	50T	30		69.2	98.5	519	
3.8 V6 (182 kW)	2010.02-	AT	-	F	All-wheel Drive Closed Off-Road Vehicle Engine 6G75	839207	Outer Joint	50T	30	36	69.2	98.5	67.5	I
	2010.02-	AT	R	F	All-wheel Drive Closed Off-Road Vehicle Engine 6G75	239261	Drive Shaft	50T	30		69.2	98.5	519	
3.8 V6 (184 kW)	2007.02-	AT/MT	-	F	Closed Off-Road Vehicle Engine 6G75	839207	Outer Joint	50T	30	36	69.2	98.5	67.5	I
	2007.02-	AT/MT	R	F	Closed Off-Road Vehicle Engine 6G75	239261	Drive Shaft	50T	30		69.2	98.5	519	
PAJERO IV Van (V90 V80 V8_V)/MONTERO/PAJERO/SHOGUN														
3.2 DI-D (118 kW)	2006.11-	-	-	F	All-wheel Drive Box Engine 4M41	839207	Outer Joint	50T	30	36	69.2	98.5	67.5	I
	2006.11-	AT	R	F	All-wheel Drive Box Engine 4M41	239261	Drive Shaft	50T	30		69.2	98.5	519	
3.2 DI-D (140 kW)	2007.02-	-	-	F	All-wheel Drive Box Body/Estate	839207	Outer Joint	50T	30	36	69.2	98.5	67.5	I
3.2 TD (147 kW)	2010.01-	-	-	F	All-wheel Drive Box Body/Estate Engine 4M41	839207	Outer Joint	50T	30	36	69.2	98.5	67.5	I
PAJERO PININ (H6_W H7_W)/IO/SHOGUN PININ/MONTERO IO														
1.8 (84 kW)	2001.11-2007.06	-	-	-	Closed Off-Road Vehicle Engine 4G93 (SOHC 16V)	839092	Outer Joint		25	29	54	95	60	O
	2001.11-2007.06	-	-	-	Closed Off-Road Vehicle Engine 4G93 (SOHC 16V)	639077	Inner Joint		25	29	35	57.5	90.5	
	2001.11-2007.06	-	-	F	Closed Off-Road Vehicle Engine 4G93 (SOHC 16V)	839186	Outer Joint	43T	25	32	54	94.5	63.5	I
	2001.11-2007.06	-	-	F	Closed Off-Road Vehicle Engine 4G93 (SOHC 16V)	839136	Outer Joint		25	29	54	95	57	I
	2001.11-2007.06	AT/MT	L	F	Closed Off-Road Vehicle Engine 4G93 (SOHC 16V)	239236	Drive Shaft	43T	25	25	54	94.5	551	
1.8 GDI (88 kW)	1999.10-2001.10	-	-	-	Closed Off-Road Vehicle Engine 4G93 (GDI)	839092	Outer Joint		25	29	54	95	60	O
	1999.10-2001.10	-	-	-	Closed Off-Road Vehicle Engine 4G93 (GDI)	639077	Inner Joint		25	29	35	57.5	90.5	
	1999.10-2001.10	-	-	F	Closed Off-Road Vehicle Engine 4G93 (GDI)	839186	Outer Joint	43T	25	32	54	94.5	63.5	I
	1999.10-2001.10	AT/MT	-	F	Closed Off-Road Vehicle Engine 4G93 (GDI)	839136	Outer Joint		25	29	54	95	57	I
	1999.10-2001.10	AT/MT	L	F	Closed Off-Road Vehicle Engine 4G93 (GDI)	239236	Drive Shaft	43T	25	25	54	94.5	551	
2.0 GDI (95 kW)	2000.10-2007.06	-	-	-	Closed Off-Road Vehicle Engine 4G94 (GDI)	839092	Outer Joint		25	29	54	95	60	O
	2000.10-2007.06	-	-	-	Closed Off-Road Vehicle Engine 4G94 (GDI)	639077	Inner Joint		25	29	35	57.5	90.5	
	2000.10-2007.06	-	-	F	Closed Off-Road Vehicle Engine 4G94 (GDI)	839186	Outer Joint	43T	25	32	54	94.5	63.5	I
	2000.10-2007.06	AT	-	F	Closed Off-Road Vehicle Engine 4G94 (GDI)	839136	Outer Joint		25	29	54	95	57	I
	2000.10-2007.06	AT/MT	L	F	Closed Off-Road Vehicle Engine 4G94 (GDI)	239236	Drive Shaft	43T	25	25	54	94.5	551	
PAJERO SPORT I (K7_K9)/CHALLENGER/MONTERO SPORT														
2.5 TD (73 kW)	1998.11-	AT/MT	L	F	All-wheel Drive Closed Off-Road Vehicle Engine 4D56 T	699083	Inner Joint		28	26	34.7	90.5	90.6	
	1998.11-	AT/MT	R	F	All-wheel Drive Closed Off-Road Vehicle Engine 4D56 T	675004	Inner Joint			26		62.5		
	1998.11-	-	R	-	All-wheel Drive Closed Off-Road Vehicle Engine 4D56 T	699092	Inner Joint			26		71.5		
	1998.11-	-	R	F	All-wheel Drive Closed Off-Road Vehicle Engine 4D56 T	239006	Drive Shaft		28		56	154	538	
2.5 TD (83 kW)	1997.11-1998.10	MT	L	F	All-wheel Drive Closed Off-Road Vehicle Engine 4D56 T	699083	Inner Joint		28	26	34.7	90.5	90.6	
	1997.11-1998.10	MT	R	F	All-wheel Drive Closed Off-Road Vehicle Engine 4D56 T	675004	Inner Joint			26		62.5		
2.5 TD (85 kW)	2002.07-	AT/MT	L	F	Closed Off-Road Vehicle Engine 4D56 T	699083	Inner Joint		28	26	34.7	90.5	90.6	
	2002.07-	AT/MT	R	F	Closed Off-Road Vehicle Engine 4D56 T	675004	Inner Joint			26		62.5		
	2002.07-	-	R	F	Closed Off-Road Vehicle Engine 4D56 T	239006	Drive Shaft		28		56	154	538	
	2002.07-	-	L	F	Closed Off-Road Vehicle Engine 4D56 T	639049	Inner Joint		25	25	32	89	81.5	
	2002.07-	-	R	F	Closed Off-Road Vehicle Engine 4D56 T	639061	Inner Joint			25		68.6		
	2002.07-	-	R	-	Closed Off-Road Vehicle Engine 4D56 T	699092	Inner Joint			26		71.5		
2.5 TD (98 kW)	2003.08-	AT/MT	L	F	All-wheel Drive Closed Off-Road Vehicle Engine 4D56 T	699083	Inner Joint		28	26	34.7	90.5	90.6	
	2003.08-	AT/MT	R	F	All-wheel Drive Closed Off-Road Vehicle Engine 4D56 T	675004	Inner Joint			26		62.5		
	2003.08-	-	R	F	All-wheel Drive Closed Off-Road Vehicle Engine 4D56 T	239006	Drive Shaft		28		56	154	538	
	2003.08-	-	R	-	All-wheel Drive Closed Off-Road Vehicle Engine 4D56 T	699092	Inner Joint			26		71.5		
2.8 TDi (92 kW)	1998.11-2003.10	AT	L	F	All-wheel Drive Closed Off-Road Vehicle Engine 4M40-T	699083	Inner Joint		28	26	34.7	90.5	90.6	
	1998.11-2003.10	MT	R	F	All-wheel Drive Closed Off-Road Vehicle Engine 4M40-T	675004	Inner Joint			26		62.5		
	1998.11-2003.10	MT	-	F	All-wheel Drive Closed Off-Road Vehicle Engine 4M40-T	839001	Outer Joint		28	27	56	154.5	63	I
	1998.11-2003.10	MT	L	F	All-wheel Drive Closed Off-Road Vehicle Engine 4M40-T	639049	Inner Joint		25	25	32	89	81.5	
	1998.11-2003.10	MT	R	F	All-wheel Drive Closed Off-Road Vehicle Engine 4M40-T	639061	Inner Joint			25		68.6		
	2008.01-	-	L	F	All-wheel Drive Closed Off-Road Vehicle Engine 4M40-T	699083	Inner Joint		28	26	34.7	90.5	90.6	
	2008.01-	-	R	F	All-wheel Drive Closed Off-Road Vehicle Engine 4M40-T	675004	Inner Joint			26		62.5		
	2008.01-	-	MT	-	F	All-wheel Drive Closed Off-Road Vehicle Engine 4M40-T	839001	Outer Joint		28	27	56	154.5	63
2008.01-	-	MT	L	F	All-wheel Drive Closed Off-Road Vehicle Engine 4M40-T	639049	Inner Joint		25	25	32	89	81.5	

		 YEAR	TRANSM	L/R	F/R	REMARKS	GSP Ref.	 PRODUCT	 ABS	Technical Specifications						
										A	B	C	H	L	P	
MITSUBISHI																
PAJERO SPORT I (K7_ K9_)/CHALLENGER/MONTERO SPORT																
2.8 TDi (92 kW)	2008.01-	-	MT	R	F	All-wheel Drive Closed Off-Road Vehicle Engine 4M40-T	639061	Inner Joint			25		68.6			
3.0 V6 (123 kW)	2003.03-	-	-	R	F	All-wheel Drive Closed Off-Road Vehicle Engine 6G72 (DOHC 24V)	239006	Drive Shaft		28		56	154	538		
3.0 V6 (125 kW)	2000.06-	-	-	R	F	All-wheel Drive Closed Off-Road Vehicle Engine 6G72 (SOHC 24V)	239006	Drive Shaft		28		56	154	538		
3.0 V6 (130 kW)	1998.11-	-	-	R	F	All-wheel Drive Closed Off-Road Vehicle Engine 6G72 (SOHC 24V)	239006	Drive Shaft		28		56	154	538		
PAJERO SPORT II (KH_ KG_)/MONTERO SPORT																
2.5 DI-D (131 kW)	2008.07-	-	5MT	L/R	F	All-wheel Drive Closed Off-Road Vehicle Engine 4D56 HP	839371	Outer Joint	47T	30	35	69	98	66.5	I	
PAJERO SPORT VAN I (K90)/SHOGUN SPORT VAN																
2.5 TD (85 kW)	1999.12-	2008.01	-	-	F	All-wheel Drive Box Engine 4D56 T	839013	Outer Joint		28	25	56	155.5	64	M	
PAJERO V63W																
3.0	2000.08-	2002.07	AT	-	-	Allwheel Drive Engine 6G72	839124	Outer Joint	50T	30	33	66	98	67	I	
	2002.08-	-	AT	-	-	Allwheel Drive Engine 6G72	839124	Outer Joint	50T	30	33	66	98	67	I	
	2002.08-	-	AT	-	-	Allwheel Drive Engine 6G72	839124	Outer Joint	50T	30	33	66	98	67	I	
3000	2000.08-	2002.07	AT	-	-	Allwheel Drive Engine 6G72	839124	Outer Joint	50T	30	33	66	98	67	I	
	2002.08-	-	AT	-	-	Allwheel Drive Engine 6G72	839124	Outer Joint	50T	30	33	66	98	67	I	
	2002.08-	-	AT	-	-	Allwheel Drive Engine 6G72	839124	Outer Joint	50T	30	33	66	98	67	I	
PAJERO V65W																
3.5	1999.06-	2002.07	AT	-	-	Allwheel Drive Engine 6G74	839124	Outer Joint	50T	30	33	66	98	67	I	
	2002.08-	-	AT	-	-	Allwheel Drive Engine 6G74	839124	Outer Joint	50T	30	33	66	98	67	I	
	2002.08-	-	AT	-	-	Allwheel Drive Engine 6G74	839124	Outer Joint	50T	30	33	66	98	67	I	
3500	1999.06-	2002.07	AT	-	-	Allwheel Drive Engine 6G74	839124	Outer Joint	50T	30	33	66	98	67	I	
	2002.08-	-	AT	-	-	Allwheel Drive Engine 6G74	839124	Outer Joint	50T	30	33	66	98	67	I	
	2002.08-	-	AT	-	-	Allwheel Drive Engine 6G74	839124	Outer Joint	50T	30	33	66	98	67	I	
PAJERO V65W /V75W																
3.5	1999.09-	-	4MT/5MT	-	-	Engine 6G74	839124	Outer Joint	50T	30	33	66	98	67	I	
3500	1999.09-	-	4MT/5MT	-	-	Engine 6G74	839124	Outer Joint	50T	30	33	66	98	67	I	
PAJERO V68W																
3.2	1999.06-	2002.07	AT	-	-	Allwheel Drive Engine 4M41	839124	Outer Joint	50T	30	33	66	98	67	I	
	2002.08-	-	AT	-	-	Allwheel Drive Engine 4M41	839124	Outer Joint	50T	30	33	66	98	67	I	
	2002.08-	-	AT	-	-	Allwheel Drive Engine 4M41	839124	Outer Joint	50T	30	33	66	98	67	I	
3200	1999.06-	2002.07	AT	-	-	Allwheel Drive Engine 4M41	839124	Outer Joint	50T	30	33	66	98	67	I	
	2002.08-	-	AT	-	-	Allwheel Drive Engine 4M41	839124	Outer Joint	50T	30	33	66	98	67	I	
	2002.08-	-	AT	-	-	Allwheel Drive Engine 4M41	839124	Outer Joint	50T	30	33	66	98	67	I	
PAJERO V68W /V78W																
3.2	1999.09-	-	4MT/5MT	-	-	Engine 4M41	839124	Outer Joint	50T	30	33	66	98	67	I	
3200	1999.09-	-	4MT/5MT	-	-	Engine 4M41	839124	Outer Joint	50T	30	33	66	98	67	I	
PAJERO V73W																
3.0	1999.06-	2002.07	AT	-	-	Allwheel Drive Engine 6G72	839124	Outer Joint	50T	30	33	66	98	67	I	
	2002.08-	-	AT	-	-	Allwheel Drive Engine 6G72	839124	Outer Joint	50T	30	33	66	98	67	I	
	2002.08-	-	AT	-	-	Allwheel Drive Engine 6G72	839124	Outer Joint	50T	30	33	66	98	67	I	
3000	1999.06-	2002.07	AT	-	-	Allwheel Drive Engine 6G72	839124	Outer Joint	50T	30	33	66	98	67	I	
	2002.08-	-	AT	-	-	Allwheel Drive Engine 6G72	839124	Outer Joint	50T	30	33	66	98	67	I	
	2002.08-	-	AT	-	-	Allwheel Drive Engine 6G72	839124	Outer Joint	50T	30	33	66	98	67	I	
PAJERO V75W																
3.5	1999.06-	2002.07	AT	-	-	Allwheel Drive Engine 6G74	839124	Outer Joint	50T	30	33	66	98	67	I	
	2002.08-	-	AT	-	-	Allwheel Drive Engine 6G74	839124	Outer Joint	50T	30	33	66	98	67	I	
	2002.08-	-	AT	-	-	Allwheel Drive Engine 6G74	839124	Outer Joint	50T	30	33	66	98	67	I	
3500	1999.06-	2002.07	AT	-	-	Allwheel Drive Engine 6G74	839124	Outer Joint	50T	30	33	66	98	67	I	
	2002.08-	-	AT	-	-	Allwheel Drive Engine 6G74	839124	Outer Joint	50T	30	33	66	98	67	I	
	2002.08-	-	AT	-	-	Allwheel Drive Engine 6G74	839124	Outer Joint	50T	30	33	66	98	67	I	
PAJERO V78W																
3.2	1999.06-	2002.07	AT	-	-	Allwheel Drive Engine 4M41	839124	Outer Joint	50T	30	33	66	98	67	I	
	2002.08-	-	AT	-	-	Allwheel Drive Engine 4M41	839124	Outer Joint	50T	30	33	66	98	67	I	
	2002.08-	-	AT	-	-	Allwheel Drive Engine 4M41	839124	Outer Joint	50T	30	33	66	98	67	I	
3200	1999.06-	2002.07	AT	-	-	Allwheel Drive Engine 4M41	839124	Outer Joint	50T	30	33	66	98	67	I	
	2002.08-	-	AT	-	-	Allwheel Drive Engine 4M41	839124	Outer Joint	50T	30	33	66	98	67	I	
	2002.08-	-	AT	-	-	Allwheel Drive Engine 4M41	839124	Outer Joint	50T	30	33	66	98	67	I	
RVR (N13W)																
2.0	1991.01-	1996.04	MT/AT	-	-	Engine 4G63	839215	Outer Joint		25	30	54	96	59	M	
RVR (N23W)																
2.0 4WD	1991.01-	1996.04	MT/AT	-	-	Engine 4G63	839215	Outer Joint		25	30	54	96	59	M	
RVR N13W																
2.0	1991.01-	1992.07	MT/AT	-	-	Engine 4G63	839215	Outer Joint		25	30	54	96	59	M	
	1993.02-	1996.04	MT/AT	-	-	Engine 4G63	839215	Outer Joint		25	30	54	96	59	M	
2000	1991.01-	1992.07	MT/AT	-	-	Engine 4G63	839215	Outer Joint		25	30	54	96	59	M	

	 YEAR	TRANSM	L/R	F/R	REMARKS	GSP Ref.	 PRODUCT	 ABS	Technical Specifications					
									A	B	C	H	L	P
MITSUBISHI														
RVR N13W														
2000	1993.02-1996.04	MT/AT	-	-	Engine 4G63	839215	Outer Joint		25	30	54	96	59	M
RVR N23W														
2.0	1991.01-1992.07	MT/AT	-	-	Allwheel Drive Engine 4G63	839215	Outer Joint		25	30	54	96	59	M
	1992.07-1996.04	MT/AT	-	-	Allwheel Drive Engine 4G63	839215	Outer Joint		25	30	54	96	59	M
2000	1991.01-1992.07	MT/AT	-	-	Allwheel Drive Engine 4G63	839215	Outer Joint		25	30	54	96	59	M
	1992.07-1996.04	MT/AT	-	-	Allwheel Drive Engine 4G63	839215	Outer Joint		25	30	54	96	59	M
SAPPORO III (E16A)														
2.4 (91 kW)	1987.06-1990.08	AT	-	F	Coupe Engine 4G64 (8V)	809003	Outer Joint		25	25	50	95	64.5	M
	1987.06-1990.08	-	-	F	Coupe Engine 4G64 (8V)	839245	Outer Joint		25	23	50	96	59	M
	1987.06-1990.08	-	-	-	Coupe Engine 4G64 (8V)	839035	Outer Joint		25	23	54	95.5	61	M
SIGMA (F13A)														
2.5	1991.10-1993.10	MT/AT	-	-	Engine 6G73	839012	Outer Joint		27	26	60	97	68.5	M
	1993.08-	MT/AT	-	-	Engine 6G73	839012	Outer Joint		27	26	60	97	68.5	M
SIGMA (F15A)														
2.5 4WS	1990.02-1993.09	AT	-	-	Engine 6G73	839012	Outer Joint		27	26	60	97	68.5	M
SIGMA (F2_A F1_A)														
3.0 V6 (130 kW)	1990.12-1996.07	-	-	-	Saloon Engine 6G72 (SOHC 12V)	839042	Outer Joint		27	27	60	97	69	I
	1990.12-1996.07	AT/MT	L/R	F	Saloon Engine 6G72 (SOHC 12V)	839015	Outer Joint		27	27	60	97	68.5	M
3.0 V6 (151 kW)	1990.12-1996.07	-	-	-	Saloon Engine 6G72 (DOHC 24V)	839042	Outer Joint		27	27	60	97	69	I
	1990.12-1996.07	-	-	-	Saloon Engine 6G72 (DOHC 24V)	839045	Outer Joint		25	26	54	95	69	I
	1990.12-1996.07	AT/MT	L/R	F	Saloon Engine 6G72 (DOHC 24V)	839015	Outer Joint		27	27	60	97	68.5	M
SIGMA F13A														
2.5	1991.10-1993.10	MT	-	-	Engine 6G73	839012	Outer Joint		27	26	60	97	68.5	M
	1991.10-1993.10	AT	-	-	Engine 6G73	839012	Outer Joint		27	26	60	97	68.5	M
	1991.10-1993.10	AT	-	-	Engine 6G73	839012	Outer Joint		27	26	60	97	68.5	M
	1991.10-1993.10	MT	-	-	Engine 6G73	839012	Outer Joint		27	26	60	97	68.5	M
	1993.08-	MT/AT	-	-	Engine 6G73	839012	Outer Joint		27	26	60	97	68.5	M
	1993.08-	MT/AT	-	-	Engine 6G73	839012	Outer Joint		27	26	60	97	68.5	M
SIGMA F15A 4WS														
2.5	1990.02-1991.09	AT	-	-	Engine 6G73	839012	Outer Joint		27	26	60	97	68.5	M
	1990.02-1991.09	AT	-	-	Engine 6G73	839012	Outer Joint		27	26	60	97	68.5	M
	1991.10-1993.09	AT	-	-	Engine 6G73	839012	Outer Joint		27	26	60	97	68.5	M
	1991.10-1993.09	AT	-	-	Engine 6G73	839012	Outer Joint		27	26	60	97	68.5	M
SIGMA Station Wagon (F0_W)														
3.0 (125 kW)	1992.06-1996.10	-	-	-	Estate Engine 6G72 (SOHC 12V)	839042	Outer Joint		27	27	60	97	69	I
SPACE RUNNER (N1_W N2_W)/RVR														
1.8 (85 kW)	1996.06-1999.08	-	-	-	MPV Engine 4G93 (SOHC 16V)	839035	Outer Joint		25	23	54	95.5	61	M
	1996.06-1999.08	-	-	-	All-wheel Drive MPV Engine 4G93 (SOHC 16V)	839035	Outer Joint		25	23	54	95.5	61	M
	1996.06-1999.08	-	-	F	All-wheel Drive MPV Engine 4G93 (SOHC 16V)	827008	Outer Joint		27	23	60	95	63.5	M
1.8 (90 kW)	1991.10-1999.08	-	-	-	MPV Engine 4G93 (SOHC 16V)	839035	Outer Joint		25	23	54	95.5	61	M
	1991.10-1999.08	-	-	-	All-wheel Drive MPV Engine 4G93 (SOHC 16V)	839035	Outer Joint		25	23	54	95.5	61	M
	1991.10-1999.08	-	-	F	All-wheel Drive MPV Engine 4G93 (SOHC 16V)	827008	Outer Joint		27	23	60	95	63.5	M
2.0 16V (98 kW)	1997.06-1999.08	MT	-	F	MPV Engine 4G63 (DOHC 16V)	839009	Outer Joint		25	30	54	95	60.5	M
	1997.06-1999.08	AT	-	-	MPV Engine 4G63 (DOHC 16V)	639005	Inner Joint		25	30	35	62.8	92.5	
2.0 TD (60 kW)	1992.10-1999.08	MT	-	-	MPV Engine 4D68 T	639005	Inner Joint		25	30	35	62.8	92.5	
SPACE STAR (DG0)														
1.3 16V (60 kW)	1998.06-	-	-	-	-	839060	Outer Joint		25	22	54	95	54	I
1.3 16V (61 kW)	1998.06-	-	-	-	-	839060	Outer Joint		25	22	54	95	54	I
1.3 16V (63 kW)	1998.06-	-	-	-	-	839060	Outer Joint		25	22	54	95	54	I
1.6 16V (72 kW)	2001.01-	-	-	-	-	839060	Outer Joint		25	22	54	95	54	I
SPACE STAR (DG_A)														
1.3 16V (60 kW)	2000.09-2004.12	-	L/R	F	MPV Engine 4G13 (16V)	839102	Outer Joint	43T	25	22	54	95	54	I
	2000.09-2004.12	MT	L	F	MPV Engine 4G13 (16V)	262056	Drive Shaft	43T	25		54	95	640	
	2000.09-2004.12	MT	R	F	MPV Engine 4G13 (16V)	239139	Drive Shaft		25	23	54	95	816	
1.3 16V (61 kW)	1998.12-2004.12	-	L/R	F	MPV Engine 4G13 (16V)	839102	Outer Joint	43T	25	22	54	95	54	I
	1998.12-2004.12	MT	L	F	MPV Engine 4G13 (16V)	262056	Drive Shaft	43T	25		54	95	640	
	1998.12-2004.12	MT	R	F	MPV Engine 4G13 (16V)	239139	Drive Shaft		25	23	54	95	816	
1.3 16V (63 kW)	1998.06-2004.12	-	L/R	F	MPV Engine 4G13 (16V)	839102	Outer Joint	43T	25	22	54	95	54	I
	1998.06-2004.12	MT	L	F	MPV Engine 4G13 (16V)	262056	Drive Shaft	43T	25		54	95	640	
	1998.06-2004.12	MT	R	F	MPV Engine 4G13 (16V)	239139	Drive Shaft		25	23	54	95	816	
1.6 16V (72 kW)	2001.01-2004.12	AT	L/R	F	MPV Engine 4G18	839024	Outer Joint	43T	25	23	54	95.5	64	M
	2001.01-2004.12	MT	L/R	F	MPV Engine 4G18	839102	Outer Joint	43T	25	22	54	95	54	I
	2001.01-2004.12	MT	L	F	MPV Engine 4G18	262056	Drive Shaft	43T	25		54	95	640	
	2001.01-2004.12	MT	R	F	MPV Engine 4G18	239139	Drive Shaft		25	23	54	95	816	
1.8 GDI (87 kW)	1998.06-2004.12	AT	L/R	F	MPV Engine 4G93 (GDI)	839024	Outer Joint	43T	25	23	54	95.5	64	M

YEAR	TRANSM	L/R	F/R	REMARKS	GSP Ref.	PRODUCT	ABS	Technical Specifications								
								A	B	C	H	L	P			
MITSUBISHI																
SPACE STAR (DG_A)																
1.8 GDI (87 kW)	1998.06-	2004.12	MT	L/R	F	MPV Engine 4G93 (GDI)	839102	Outer Joint	43T	25	22	54	95	54	I	
1.8 GDI (90 kW)	1998.06-	2004.12	AT	L/R	F	MPV Engine 4G93 (GDI)	839024	Outer Joint	43T	25	23	54	95.5	64	M	
	1998.06-	2004.12	MT	L/R	F	MPV Engine 4G93 (GDI)	839102	Outer Joint	43T	25	22	54	95	54	I	
	1998.06-	2004.12	-	R	F	MPV Engine 4G93 (GDI)	239224	Drive Shaft	43T	25	25	54	95.5	937		
1.8 MPI (82 kW)	2002.10-	2004.12	AT	L/R	F	MPV Engine 4G93 (DOHC 16V)	839024	Outer Joint	43T	25	23	54	95.5	64	M	
	2002.10-	2004.12	MT	L/R	F	MPV Engine 4G93 (DOHC 16V)	839102	Outer Joint	43T	25	22	54	95	54	I	
	2002.10-	2004.12	MT	L	F	MPV Engine 4G93 (DOHC 16V)	262056	Drive Shaft	43T	25		54	95	640		
	2002.10-	2004.12	MT	R	F	MPV Engine 4G93 (DOHC 16V)	239139	Drive Shaft		25	23	54	95	816		
1.9 DI-D (75 kW)	2001.02-	2004.12	-	L/R	F	MPV Engine F9Q1	839084	Outer Joint	43T	26	33	54	95	60	M	
	2001.02-	2004.12	MT	R	F	MPV Engine F9Q1	262073	Drive Shaft	43T	26	26	54	95	960		
1.9 DI-D (85 kW)	2002.10-	2004.12	-	L/R	F	MPV Engine F9Q2	839084	Outer Joint	43T	26	33	54	95	60	M	
	2002.10-	2004.12	MT	R	F	MPV Engine F9Q2	262073	Drive Shaft	43T	26	26	54	95	960		
SPACE WAGON (D0_VW)/CHARIOT																
1.8 TD (55 kW)	1986.06-	1991.04	MT	-	F	MPV Engine 4D65 T	809002	Outer Joint		25	23	50	94.5	63.5	M	
	1986.06-	1991.04	-	-	-	MPV Engine 4D65 T	839035	Outer Joint		25	23	54	95.5	61	M	
	1986.06-	1991.04	AT/MT	R	F	MPV Engine 4D65 T	224023	Drive Shaft		25	25	50	95	904		
	1986.06-	1991.04	MT	-	F	MPV Engine 4D65 T	839245	Outer Joint		25	23	50	96	59	M	
	1986.06-	1991.04	AT/MT	L	F	MPV Engine 4D65 T	224022	Drive Shaft		25	25	50	95	610		
2.0 (75 kW)	1985.03-	1991.04	-	-	-	All-wheel Drive MPV Engine 4G63 (SOHC 8V)	839034	Outer Joint		25	25	50	94.5	65	M	
	1985.03-	1991.04	MT	-	F	All-wheel Drive MPV Engine 4G63 (SOHC 8V)	809003	Outer Joint		25	25	50	95	64.5	M	
2.0 GLXi (74 kW)	1988.06-	1991.04	-	-	-	MPV Engine 4G63 (SOHC 8V)	839035	Outer Joint		25	23	54	95.5	61	M	
	1988.06-	1991.04	-	-	F	MPV Engine 4G63 (SOHC 8V)	809002	Outer Joint		25	23	50	94.5	63.5	M	
	1988.06-	1991.04	-	-	F	All-wheel Drive MPV Engine 4G63 (SOHC 8V)	809003	Outer Joint		25	25	50	95	64.5	M	
	1988.06-	1991.04	MT	R	F	All-wheel Drive MPV Engine 4G63 (SOHC 8V)	224023	Drive Shaft		25	25	50	95	904		
	1988.06-	1991.04	AT/MT	R	F	MPV Engine 4G63 (SOHC 8V)	224023	Drive Shaft		25	25	50	95	904		
	1988.06-	1991.04	-	-	F	MPV Engine 4G63 (SOHC 8V)	839245	Outer Joint		25	23	50	96	59	M	
	1988.06-	1991.04	MT	L	F	All-wheel Drive MPV Engine 4G63 (SOHC 8V)	224022	Drive Shaft		25	25	50	95	610		
	1988.06-	1991.04	AT/MT	L	F	MPV Engine 4G63 (SOHC 8V)	224022	Drive Shaft		25	25	50	95	610		
SPACE WAGON (N3_W N4_W)/CHARIOT																
1.8 (90 kW)	1991.10-	1998.10	-	-	-	MPV Engine 4G93 (SOHC 16V)	639005	Inner Joint		25	30	35	62.8	92.5		
	1991.10-	1998.10	-	L/R	F	MPV Engine 4G93 (SOHC 16V)	839017	Outer Joint	43T	25	23	54	95.5	63.5	I	
1.8 TD (55 kW)	1991.10-	1998.10	MT	-	-	MPV Engine 4D65 T	639005	Inner Joint		25	30	35	62.8	92.5		
	1991.10-	1998.10	-	L/R	F	MPV Engine 4D65 T	839017	Outer Joint	43T	25	23	54	95.5	63.5	I	
2.0 (98 kW)	1992.10-	1998.10	-	-	-	MPV Engine 4G63 (SOHC 16V)	839016	Outer Joint		25	23	54	95.5	63.5	I	
	1992.10-	1998.10	-	-	-	All-wheel Drive MPV Engine 4G63 (SOHC 16V)	839016	Outer Joint		25	23	54	95.5	63.5	I	
	1992.10-	1998.10	-	-	F	MPV Engine 4G63 (SOHC 16V)	839009	Outer Joint		25	30	54	95	60.5	M	
	1992.10-	1998.10	-	-	F	All-wheel Drive MPV Engine 4G63 (SOHC 16V)	839009	Outer Joint		25	30	54	95	60.5	M	
	1992.10-	1998.10	-	-	-	All-wheel Drive MPV Engine 4G63 (SOHC 16V)	639005	Inner Joint		25	30	35	62.8	92.5		
	1992.10-	1998.10	-	-	-	MPV Engine 4G63 (SOHC 16V)	839035	Outer Joint		25	23	54	95.5	61	M	
2.0 TD (60 kW)	1992.10-	1998.10	MT	-	-	MPV Engine 4D68 T	639005	Inner Joint		25	30	35	62.8	92.5		
	1992.10-	1998.10	-	-	F	MPV Engine 4D68 T	839064	Outer Joint	43T	25	30	54	95	60.5	M	
	1992.10-	1998.10	-	L/R	F	MPV Engine 4D68 T	839017	Outer Joint	43T	25	23	54	95.5	63.5	I	
SPACE WAGON (N9_W N8_W)/NIM																
2.0 (98 kW)	1998.10-	2004.12	AT/MT	L/R	F	MPV Engine 4G63 (SOHC 16V)	839005	Outer Joint	43T	25	33	54	95.5	65	I	
2.4 GDI (108 kW)	2000.09-	2004.12	-	R	F	MPV Engine 4G64 (GDI)	639032	Inner Joint		28	25	42	40	78		
	2000.09-	2004.12	-	L	F	MPV Engine 4G64 (GDI)	639033	Inner Joint		27	25	41	63	100		
	2000.09-	2004.12	-	-	F	All-wheel Drive MPV Engine 4G64 (GDI)	839004	Outer Joint	43T	25	30	54	95	60	I	
	2000.09-	2004.12	-	-	F	MPV Engine 4G64 (GDI)	839078	Outer Joint	43T	25	25	54	95.5	63.5	I	
	2000.09-	2004.12	-	-	F	All-wheel Drive MPV Engine 4G64 (GDI)	839078	Outer Joint	43T	25	25	54	95.5	63.5	I	
2.4 GDI (110 kW)	1998.10-	2004.12	-	R	F	MPV Engine 4G64 (GDI)	639032	Inner Joint		28	25	42	40	78		
	1998.10-	2004.12	-	L	F	MPV Engine 4G64 (GDI)	639033	Inner Joint		27	25	41	63	100		
	1998.10-	2004.12	MT	L/R	F	All-wheel Drive MPV Engine 4G64 (GDI)	839005	Outer Joint	43T	25	33	54	95.5	65	I	
	1998.10-	2004.12	AT/MT	L/R	F	MPV Engine 4G64 (GDI)	839005	Outer Joint	43T	25	33	54	95.5	65	I	
	1998.10-	2004.12	-	-	F	MPV Engine 4G64 (GDI)	839078	Outer Joint	43T	25	25	54	95.5	63.5	I	
	1998.10-	2004.12	MT	-	F	All-wheel Drive MPV Engine 4G64 (GDI)	839004	Outer Joint	43T	25	30	54	95	60	I	
	1998.10-	2004.12	-	-	F	All-wheel Drive MPV Engine 4G64 (GDI)	839078	Outer Joint	43T	25	25	54	95.5	63.5	I	
SPACE WAGON(D04W)																
2.0	1983.10-	1991.04	AT/MT	R	-	Engine 2WD	639002	Inner Joint		25	23	35	62.8	95.5		
	1983.10-	1991.04	AT/MT	R	-	Engine 2WD	639002	Inner Joint		25	23	35	62.8	95.5		
SPACE WAGON(D09V)																
1.8	1983.10-	1991.04	MT	R	-	Engine DIESEL/(VAN)	639002	Inner Joint		25	23	35	62.8	95.5		
	1983.10-	1991.04	MT	R	-	Engine DIESEL/(VAN)	639002	Inner Joint		25	23	35	62.8	95.5		
SPACE WAGON(D09W)																
1.8	1983.10-	1991.04	MT	R	-	Engine DIESEL/(WAGON)	639002	Inner Joint		25	23	35	62.8	95.5		
	1983.10-	1991.04	MT	R	-	Engine DIESEL/(WAGON)	639002	Inner Joint		25	23	35	62.8	95.5		
V83W																

	 YEAR	TRANSM	L/R	F/R	REMARKS	GSP Ref.	 PRODUCT	 ABS	Technical Specifications						
									A	B	C	H	L	P	
MITSUBISHI															
V83W															
3.0	2010.09-	-	5AT	R	-	Allwheel Drive Engine 6G72	839201	Outer Joint	50T	30	36	69.2	98.5	67.5	M
	2010.09-	-	5MT	R	-	Allwheel Drive Engine 6G72	839201	Outer Joint	50T	30	36	69.2	98.5	67.5	M
V87W															
3.8	2010.09-	2011.09	5AT	R	-	Allwheel Drive Engine 6G75	839201	Outer Joint	50T	30	36	69.2	98.5	67.5	M
V88W															
3.2	2010.09-	-	5AT	R	-	Allwheel Drive Engine 4M41	839201	Outer Joint	50T	30	36	69.2	98.5	67.5	M
V93W															
3.0	2010.09-	-	5AT	R	-	Allwheel Drive Engine 6G72	839201	Outer Joint	50T	30	36	69.2	98.5	67.5	M
	2010.09-	-	5MT	R	-	Allwheel Drive Engine 6G72	839201	Outer Joint	50T	30	36	69.2	98.5	67.5	M
V97W															
3.8	2010.09-	-	5AT	R	-	Allwheel Drive Engine 6G75	839201	Outer Joint	50T	30	36	69.2	98.5	67.5	M
V98W															
3.2	2010.09-	-	5AT	R	-	Allwheel Drive Engine 4M41	839201	Outer Joint	50T	30	36	69.2	98.5	67.5	M
MITSUBISHI (BBDC)															
OUTLANDER (GU_W)															
2.4 (121 kW)	2006.07-	-	-	-	-	Closed Off-Road Vehicle Engine 4 G 69	239169	Drive Shaft		27	23	58	94.5	754.5	
MITSUBISHI (BJC)															
PAJERO SPORT (K9_)															
2.4 (94 kW)	2003.01-	2006.02	AT	L	-	Closed Off-Road Vehicle Engine 4G64S4M	239095	Drive Shaft	50T	30		66	98	527	
3.0 (123 kW)	2003.01-	2006.02	AT	L	-	All-wheel Drive Closed Off-Road Vehicle Engine 6G72	239095	Drive Shaft	50T	30		66	98	527	
MITSUBISHI (SOUEAST)															
LANCER EX															
1.8 (100 kW)	2009.11-	-	MT	-	-	Saloon Engine 4B10	239120	Drive Shaft		28	27	59.5	95	965	
MITSUBISHI BBDC															
OUTLANDER															
2.4 (121 kW)	2006.07-	-	-	-	-	All-wheel Drive Closed Off-Road Vehicle Engine 4 G 69	239169	Drive Shaft		27	23	58	94.5	754.5	
2.4 (99 kW)	2006.07-	-	-	-	-	Closed Off-Road Vehicle Engine 4 G 64	239169	Drive Shaft		27	23	58	94.5	754.5	
MOSKVICH															
2141															
1.5 (51 kW)	1989.05-	2001.12	-	-	-	Hatchback	840001	Outer Joint		25	25	53	88	57.5	O
NISSAN															
100 NX (B13)															
1.6 (66 kW)	1990.03-	1994.10	-	-	F	Coupe Engine GA16DS	841118	Outer Joint		25	23	55	107	61	M
	1990.03-	1994.10	-	-	F	Coupe Engine GA16DS	841033	Outer Joint		25	23	55	107	61	I
	1990.03-	1994.10	AT	-	-	Coupe Engine GA16DS	641089	Inner Joint		25	23	40	63	99	
1.6 SR (75 kW)	1993.09-	1994.10	AT	L	F	Coupe Engine GA16DE	650065	Inner Joint		25	25	40	63	101	
	1993.09-	1994.10	-	-	F	Coupe Engine GA16DE	841118	Outer Joint		25	23	55	107	61	M
2.0 GTI (105 kW)	1991.03-	1994.10	-	-	F	Coupe Engine SR20DE	841087	Outer Joint		25	25	55	106.5	66	I
	1991.03-	1994.10	-	-	-	Coupe Engine SR20DE	841014	Outer Joint	42T	25	25	55	106.5	66	I
AD VAN/WAGON (VB11)															
1.3	1982.10-	1990.09	MT/AT	-	-	Engine E13S	841281	Outer Joint		21	22	48	98.5	56.5	M
AD VAN/WAGON AD/ VB11															
1.3	1982.10-	1990.09	MT/AT	-	-	Engine E13S	841281	Outer Joint		21	22	48	98.5	56.5	M
	1992.10-	1990.09	MT/AT	-	-	Engine E13S	841281	Outer Joint		21	22	48	98.5	56.5	M
AD VAN/WAGON MAX (VHB11)															
1.5	1982.10-	1990.09	MT/AT	-	-	Engine E15S	841041	Outer Joint		24	22	52	105	56	M
AD VAN/WAGON MAX (VSB11)															
1.7	1982.10-	1990.09	MT/AT	-	-	Engine CD17	841041	Outer Joint		24	22	52	105	56	M
	1988.05-	1990.09	AT	-	-	Engine CD17	841041	Outer Joint		24	22	52	105	56	M
AD VAN/WAGON MAX AD VHB11															
1.5	1982.10-	1990.09	MT/AT	-	-	Engine E15S	841041	Outer Joint		24	22	52	105	56	M
	1992.10-	1990.09	MT/AT	-	-	Engine E15S	841041	Outer Joint		24	22	52	105	56	M
AD VAN/WAGON MAX AD VSB11															
1.7	1982.10-	1990.09	MT/AT	-	-	Engine CD17	841041	Outer Joint		24	22	52	105	56	M
	1988.05-	1990.09	AT	-	-	Engine CD17	841041	Outer Joint		24	22	52	105	56	M
AD VAN/WAGON MAX VHB11															
1500	1982.10-	1990.09	MT/AT	-	-	Engine E15S	841041	Outer Joint		24	22	52	105	56	M
	1992.10-	1990.09	MT/AT	-	-	Engine E15S	841041	Outer Joint		24	22	52	105	56	M
AD VAN/WAGON MAX VSB11															
1700	1982.10-	1990.09	MT/AT	-	-	Engine CD17	841041	Outer Joint		24	22	52	105	56	M
	1988.05-	1990.09	AT	-	-	Engine CD17	841041	Outer Joint		24	22	52	105	56	M
AD VAN/WAGON VB11															
1300	1982.10-	1990.09	MT/AT	-	-	Engine E13S	841281	Outer Joint		21	22	48	98.5	56.5	M



YEAR	TRANS	L/R	F/R	REMARKS	GSP Ref.	PRODUCT	ABS	Technical Specifications							
								A	B	C	H	L	P		
NISSAN															
AD VAN/WAGON VB11															
1300	1992.10-	1990.09	MT/AT	-	-	Engine E13S	841281	Outer Joint		21	22	48	98.5	56.5	M
ALMERA															
-	-	-	-	R	-	-	841406	Outer Joint		25	22	55	107.5	57	I
-	-	-	-	L	-	-	841406	Outer Joint		25	22	55	107.5	57	I
-	-	-	-	R	-	-	641198	Inner Joint		24	23	40	51.7	100.4	
-	-	-	-	L	-	-	641198	Inner Joint		24	23	40	51.7	100.4	
-	-	-	-	R	-	-	241525	Drive Shaft	42T	25	24	55	107.5	922	
-	-	-	-	L	-	-	241527	Drive Shaft	42T	25	24	55	107.5	632	
-	-	-	-	R	-	-	841284	Outer Joint	42T	25	22	55	107.5	57	I
-	-	-	-	L	-	-	841284	Outer Joint	42T	25	22	55	107.5	57	I
-	2000.04-	2001.03	AT	R	F	-	241258	Drive Shaft	42T	25	25	55	107	927	
-	2000.04-	2001.03	AT	R	F	-	641141	Inner Joint		25	23	40	63	107	
ALMERA B10RS															
-	2006.01-	2012.11	AT	L	F	ENGINE:QG16 (QG16 TYPE ENGINE)	841407	Outer Joint		25	22	55	100.5	58.5	M
-	2006.01-	2012.11	AT	L	F	ENGINE:QG16 (QG16 TYPE ENGINE)	650050	Inner Joint		25	22	40	63	94	
-	2006.01-	2012.11	AT	L	F	ENGINE:QG16 (QG16 TYPE ENGINE)	241445	Drive Shaft	42T	25	25	55	100.5	621	
-	2006.03-	2013.03	MT	L	-	-	241442	Drive Shaft		25	24	55	100.5	625	
ALMERA Classic (B10)															
1.6 16V (79 kW)	2006.03-	-	-	-	-	F Saloon Engine QG16DE	841327	Outer Joint	42T	25	22	55	100.5	58.5	M
ALMERA CLASSIC B10															
-	2006-	2012	-	-	-	-	241443	Drive Shaft		25	24	55	100.5	914	
-	2006-	2012	-	-	-	-	241443	Drive Shaft		25	24	55	100.5	914	
ALMERA I (N15)															
1.4 (64 kW)	1995.09-	2000.03	MT	-	F	Hatchback Engine GA14DE	841159	Outer Joint	42T	25	22	55	107	57	M
	1995.09-	2000.07	MT	-	F	Saloon Engine GA14DE	841159	Outer Joint	42T	25	22	55	107	57	M
	1995.09-	2000.03	MT	-	-	Hatchback Engine GA14DE	641001	Inner Joint		24	23	40	51.7	100.4	
	1995.09-	2000.07	MT	-	-	Saloon Engine GA14DE	641001	Inner Joint		24	23	40	51.7	100.4	
	1995.09-	2000.03	MT	L	F	Hatchback Engine GA14DE	241035	Drive Shaft		25	24	55	107	622	
	1995.09-	2000.07	MT	L	F	Saloon Engine GA14DE	241035	Drive Shaft		25	24	55	107	622	
	1995.09-	2000.03	MT	R	F	Hatchback Engine GA14DE	241036	Drive Shaft		25	24	55	107	908	
	1995.09-	2000.07	MT	R	F	Saloon Engine GA14DE	241036	Drive Shaft		25	24	55	107	908	
	1995.09-	2000.07	AT/MT	L/R	F	Saloon Engine GA14DE	841001	Outer Joint		25	22	55	107	56	I
	1995.09-	2000.03	AT/MT	L/R	F	Hatchback Engine GA14DE	841001	Outer Joint		25	22	55	107	56	I
	1995.09-	2000.07	-	-	F	Saloon Engine GA14DE	841191	Outer Joint	42T	25	22	55	107	57	M
	1995.09-	2000.03	-	-	F	Hatchback Engine GA14DE	841191	Outer Joint	42T	25	22	55	107	57	M
	1995.09-	2000.03	MT	-	F	Hatchback Engine GA14DE	841124	Outer Joint	42T	25	22	55	107	57	M
	1995.09-	2000.07	MT	-	F	Saloon Engine GA14DE	841124	Outer Joint	42T	25	22	55	107	57	M
	1995.09-	2000.03	MT	-	F	Hatchback Engine GA14DE	834024	Outer Joint		25	22	55	107	57	M
	1995.09-	2000.07	MT	-	F	Saloon Engine GA14DE	834024	Outer Joint		25	22	55	107	57	M
	1995.09-	2000.03	MT	-	F	Hatchback Engine GA14DE	841002	Outer Joint	42T	25	22	55	107	56	I
	1995.09-	2000.07	MT	-	F	Saloon Engine GA14DE	841002	Outer Joint	42T	25	22	55	107	56	I
1.4 GX,LX (55 kW)	1995.09-	2000.07	MT	-	F	Saloon Engine GA14DE	841159	Outer Joint	42T	25	22	55	107	57	M
	1995.09-	2000.07	MT	-	-	Saloon Engine GA14DE	641001	Inner Joint		24	23	40	51.7	100.4	
	1995.09-	2000.07	AT/MT	L/R	F	Saloon Engine GA14DE	841001	Outer Joint		25	22	55	107	56	I
	1995.09-	2000.07	-	-	F	Saloon Engine GA14DE	841191	Outer Joint	42T	25	22	55	107	57	M
	1995.09-	2000.07	MT	-	F	Saloon Engine GA14DE	841002	Outer Joint	42T	25	22	55	107	56	I
1.4 S,GX,LX (55 kW)	1995.09-	2000.03	MT	-	F	Hatchback Engine GA14DE	841159	Outer Joint	42T	25	22	55	107	57	M
	1995.09-	2000.03	MT	-	-	Hatchback Engine GA14DE	641001	Inner Joint		24	23	40	51.7	100.4	
	1995.09-	2000.03	AT/MT	L/R	F	Hatchback Engine GA14DE	841001	Outer Joint		25	22	55	107	56	I
	1995.09-	2000.03	-	-	F	Hatchback Engine GA14DE	841191	Outer Joint	42T	25	22	55	107	57	M
	1995.09-	2000.03	MT	-	F	Hatchback Engine GA14DE	841002	Outer Joint	42T	25	22	55	107	56	I
1.6 (73 kW)	1995.09-	2000.03	AT	-	F	Hatchback Engine GA16DE	841155	Outer Joint	42T	25	23	55	107	61	M
	1995.09-	2000.07	AT	-	F	Saloon Engine GA16DE	841155	Outer Joint	42T	25	23	55	107	61	M
	1995.09-	2000.03	MT	L	F	Hatchback Engine GA16DE	241041	Drive Shaft	42T	25	25	55	107	622	
	1995.09-	2000.07	MT	L	F	Saloon Engine GA16DE	241041	Drive Shaft	42T	25	25	55	107	622	
	1995.09-	2000.03	MT	R	F	Hatchback Engine GA16DE	241039	Drive Shaft	42T	25	25	55	107	913	
	1995.09-	2000.07	MT	R	F	Saloon Engine GA16DE	241039	Drive Shaft	42T	25	25	55	107	913	
	1995.09-	2000.03	AT/MT	L/R	F	Hatchback Engine GA16DE	841078	Outer Joint		25	23	55	107	62	I
	1995.09-	2000.07	AT/MT	L/R	F	Saloon Engine GA16DE	841078	Outer Joint		25	23	55	107	62	I
	1995.09-	2000.07	-	-	F	Saloon Engine GA16DE	841118	Outer Joint		25	23	55	107	61	M
	1995.09-	2000.03	-	-	F	Hatchback Engine GA16DE	841118	Outer Joint		25	23	55	107	61	M
	1995.09-	2000.03	AT/MT	L/R	F	Hatchback Engine GA16DE	841003	Outer Joint	42T	25	23	55	107	62	I
	1995.09-	2000.07	AT/MT	L/R	F	Saloon Engine GA16DE	841003	Outer Joint	42T	25	23	55	107	62	I
1.6 (75 kW)	1995.07-	2000.03	AT	-	F	Hatchback Engine GA16DE	841155	Outer Joint	42T	25	23	55	107	61	M
	1995.07-	2000.03	AT	-	F	Saloon Engine GA16DE	841155	Outer Joint	42T	25	23	55	107	61	M
	1995.07-	2000.03	MT	L	F	Saloon Engine GA16DE	241041	Drive Shaft	42T	25	25	55	107	622	





YEAR	TRANSM	L/R	F/R	REMARKS	GSP Ref.	PRODUCT	ABS	Technical Specifications									
								A	B	C	H	L	P				
NISSAN																	
ALMERA I (N15)																	
1.6 (75 kW)	1995.07-2000.03	MT	R	F	Saloon Engine GA16DE	241039	Drive Shaft	42T	25	25	55	107	913				
	1995.07-2000.03	-	-	F	Saloon Engine GA16DE	841118	Outer Joint		25	23	55	107	61	M			
	1995.07-2000.03	-	-	F	Hatchback Engine GA16DE	841118	Outer Joint		25	23	55	107	61	M			
1.6 SLX (66 kW)	1995.09-2000.07	AT	-	F	Saloon Engine GA16DE	841155	Outer Joint	42T	25	23	55	107	61	M			
	1995.09-2000.07	AT/MT	L/R	F	Saloon Engine GA16DE	841078	Outer Joint		25	23	55	107	62	I			
	1995.09-2000.07	-	-	F	Saloon Engine GA16DE	841118	Outer Joint		25	23	55	107	61	M			
	1995.09-2000.07	AT/MT	L/R	F	Saloon Engine GA16DE	841003	Outer Joint	42T	25	23	55	107	62	I			
1.6 SR,SLX (66 kW)	1995.09-2000.03	AT	-	F	Hatchback Engine GA16DE	841155	Outer Joint	42T	25	23	55	107	61	M			
	1995.09-2000.03	MT	L	F	Hatchback Engine GA16DE	241041	Drive Shaft	42T	25	25	55	107	622				
	1995.09-2000.03	MT	R	F	Hatchback Engine GA16DE	241039	Drive Shaft	42T	25	25	55	107	913				
	1995.09-2000.03	AT/MT	L/R	F	Hatchback Engine GA16DE	841078	Outer Joint		25	23	55	107	62	I			
	1995.09-2000.03	AT/MT	L/R	F	Hatchback Engine GA16DE	841003	Outer Joint	42T	25	23	55	107	62	I			
2.0 D (55 kW)	1995.11-2000.07	MT	L/R	F	Saloon Engine CD20	841078	Outer Joint		25	23	55	107	62	I			
	1995.11-2000.03	MT	L/R	F	Hatchback Engine CD20	841078	Outer Joint		25	23	55	107	62	I			
	1995.11-2000.07	-	-	F	Saloon Engine CD20	841118	Outer Joint		25	23	55	107	61	M			
	1995.11-2000.03	-	-	F	Hatchback Engine CD20	841118	Outer Joint		25	23	55	107	61	M			
	1995.11-2000.03	-	-	F	Hatchback Engine CD20	899252	Outer Joint	44T	25	23	55	100.5	60	M			
	1995.11-2000.07	-	-	F	Saloon Engine CD20	899252	Outer Joint	44T	25	23	55	100.5	60	M			
	1995.11-2000.07	MT	L/R	F	Saloon Engine CD20	841003	Outer Joint	42T	25	23	55	107	62	I			
	1995.11-2000.03	MT	L/R	F	Hatchback Engine CD20	841003	Outer Joint	42T	25	23	55	107	62	I			
2.0 GTi (105 kW)	1996.07-2000.03	MT	L/R	F	Hatchback Engine SR20DE	841078	Outer Joint		25	23	55	107	62	I			
	1996.07-2000.03	MT	L/R	F	Hatchback Engine SR20DE	841003	Outer Joint	42T	25	23	55	107	62	I			
	1996.07-2000.03	-	-	F	Hatchback Engine SR20DE	841210	Outer Joint	42T	25	23	55	106	61.5	I			
ALMERA II (N16)																	
1.5 (66 kW)	2000.03- -	-	-	F	Hatchback Engine QG15DE	841239	Outer Joint		25	22	55	107	57	M			
	2000.03- -	-	-	-	Hatchback Engine QG15DE	641001	Inner Joint		24	23	40	51.7	100.4				
	2000.03- -	-	L/R	F	Hatchback Engine QG15DE	841237	Outer Joint	44T	25	21	55	99	55	M			
	2000.03- -	MT	L	F	Hatchback Engine QG15DE	241270	Drive Shaft	42T	25	24	55	100.5	627				
	2000.03- -	MT	R	F	Hatchback Engine QG15DE	241269	Drive Shaft	42T	25	24	55	100.5	909				
	2000.03- -	-	-	-	Hatchback Engine QG15DE	641090	Inner Joint		24	21	40	51.5	93				
	2000.03- -	-	-	F	Hatchback Engine QG15DE	841109	Outer Joint		25	22	55	100.5	58.5	M			
	2000.03- -	-	-	F	Hatchback Engine QG15DE	841243	Outer Joint	44T	25	21	55	100	54	M			
	2000.03- -	-	L/R	F	Hatchback Engine QG15DE	841048	Outer Joint	42T	25	22	55	100.5	58.5	M			
	2000.03- -	-	-	F	Hatchback Engine QG15DE	841211	Outer Joint	42T	25	22	55	107	57	M			
	2000.03- -	-	-	F	Hatchback Engine QG15DE	841327	Outer Joint	42T	25	22	55	100.5	58.5	M			
	2000.03- -	-	-	F	Hatchback Engine QG15DE	850139	Outer Joint		25	22	55	100.5	58.5	M			
	2000.03- -	-	-	F	Hatchback Engine QG15DE	841206	Outer Joint		25	22	55	107	57	M			
	2000.03- -	-	-	F	Hatchback Engine QG15DE	899252	Outer Joint	44T	25	23	55	100.5	60	M			
	2000.03- -	-	-	F	Hatchback Engine QG15DE	841002	Outer Joint	42T	25	22	55	107	56	I			
	2000.03- -	-	L	F	Hatchback Engine QG15DE	641134	Inner Joint		24	22	40	51.5	97				
	2000.07- -	-	L/R	F	Saloon Engine QG15DE	841237	Outer Joint	44T	25	21	55	99	55	M			
	2000.07- -	MT	L	F	Saloon Engine QG15DE	241270	Drive Shaft	42T	25	24	55	100.5	627				
	2000.07- -	MT	R	F	Saloon Engine QG15DE	241269	Drive Shaft	42T	25	24	55	100.5	909				
	2000.07- -	-	-	-	Saloon Engine QG15DE	641090	Inner Joint		24	21	40	51.5	93				
	2000.07- -	-	-	F	Saloon Engine QG15DE	841109	Outer Joint		25	22	55	100.5	58.5	M			
	2000.07- -	-	-	F	Saloon Engine QG15DE	841243	Outer Joint	44T	25	21	55	100	54	M			
	2000.07- -	-	-	F	Saloon Engine QG15DE	841327	Outer Joint	42T	25	22	55	100.5	58.5	M			
	2000.07- -	-	L/R	F	Saloon Engine QG15DE	841048	Outer Joint	42T	25	22	55	100.5	58.5	M			
	2000.07- -	-	-	F	Saloon Engine QG15DE	841211	Outer Joint	42T	25	22	55	107	57	M			
	2000.07- -	-	-	F	Saloon Engine QG15DE	850139	Outer Joint		25	22	55	100.5	58.5	M			
	2000.07- -	-	-	F	Saloon Engine QG15DE	841206	Outer Joint		25	22	55	107	57	M			
	2000.07- -	-	-	F	Saloon Engine QG15DE	841002	Outer Joint	42T	25	22	55	107	56	I			
	2000.07- -	-	L	F	Saloon Engine QG15DE	641134	Inner Joint		24	22	40	51.5	97				
	1.5 (72 kW)	2002.10- -	AT	-	F	Hatchback Engine QG15DE	841239	Outer Joint		25	22	55	107	57	M		
2002.10- -		AT	-	F	Saloon Engine QG15DE	841239	Outer Joint		25	22	55	107	57	M			
2002.10- -		-	-	F	Hatchback Engine QG15DE	841159	Outer Joint	42T	25	22	55	107	57	M			
2002.10- -		-	-	F	Saloon Engine QG15DE	841159	Outer Joint	42T	25	22	55	107	57	M			
2002.10- -		MT	-	-	Hatchback Engine QG15DE	641001	Inner Joint		24	23	40	51.7	100.4				
2002.10- -		MT	-	-	Saloon Engine QG15DE	641001	Inner Joint		24	23	40	51.7	100.4				
2002.10- -		-	L/R	F	Hatchback Engine QG15DE	841237	Outer Joint	44T	25	21	55	99	55	M			
2002.10- -		-	L/R	F	Hatchback Engine QG15DE	841264	Outer Joint		25	21	55	100	54	M			
2002.10- -		-	L/R	F	Saloon Engine QG15DE	841237	Outer Joint	44T	25	21	55	99	55	M			
2002.10- -		-	L/R	F	Saloon Engine QG15DE	841264	Outer Joint		25	21	55	100	54	M			
2002.10- -		-	-	-	Hatchback Engine QG15DE	641090	Inner Joint		24	21	40	51.5	93				
2002.10- -		-	-	-	Saloon Engine QG15DE	641090	Inner Joint		24	21	40	51.5	93				





YEAR	TRANSM	L/R	F/R	REMARKS	GSP Ref.	PRODUCT	ABS	Technical Specifications							
								A	B	C	H	L	P		
NISSAN															
ALMERA II (N16)															
1.5 (72 kW)	2002.10-	-	-	L F	Saloon Engine QG15DE	241509	Drive Shaft		25	24	55	100	627		
	2002.10-	-	-	L F	Hatchback Engine QG15DE	241509	Drive Shaft		25	24	55	100	627		
	2002.10-	-	-	L F	Hatchback Engine QG15DE	241328	Drive Shaft	44T	25	24	55	100	627		
	2002.10-	-	-	R F	Saloon Engine QG15DE	241510	Drive Shaft		25	24	55	100	910		
	2002.10-	-	-	L F	Saloon Engine QG15DE	241328	Drive Shaft	44T	25	24	55	100	627		
	2002.10-	-	-	R F	Hatchback Engine QG15DE	241510	Drive Shaft		25	24	55	100	910		
	2002.10-	-	-	R F	Hatchback Engine QG15DE	241327	Drive Shaft	44T	25	24	55	100	908		
	2002.10-	-	-	R F	Saloon Engine QG15DE	241327	Drive Shaft	44T	25	24	55	100	908		
	2002.10-	-	-	MT L F	Hatchback Engine QG15DE	241385	Drive Shaft	44T	25	24	55	100.5	627		
	2002.10-	-	-	MT L F	Saloon Engine QG15DE	241385	Drive Shaft	44T	25	24	55	100.5	627		
	2002.10-	-	-	- F	Hatchback Engine QG15DE	841109	Outer Joint		25	22	55	100.5	58.5	M	
	2002.10-	-	-	- F	Saloon Engine QG15DE	841109	Outer Joint		25	22	55	100.5	58.5	M	
	2002.10-	-	-	- F	Saloon Engine QG15DE	841327	Outer Joint	42T	25	22	55	100.5	58.5	M	
	2002.10-	-	-	- F	Hatchback Engine QG15DE	841243	Outer Joint	44T	25	21	55	100	54	M	
	2002.10-	-	-	- F	Saloon Engine QG15DE	841243	Outer Joint	44T	25	21	55	100	54	M	
	2002.10-	-	-	L/R F	Hatchback Engine QG15DE	841048	Outer Joint	42T	25	22	55	100.5	58.5	M	
	2002.10-	-	-	L/R F	Saloon Engine QG15DE	841048	Outer Joint	42T	25	22	55	100.5	58.5	M	
	2002.10-	-	-	- F	Hatchback Engine QG15DE	850139	Outer Joint		25	22	55	100.5	58.5	M	
	2002.10-	-	-	- F	Hatchback Engine QG15DE	841327	Outer Joint	42T	25	22	55	100.5	58.5	M	
	2002.10-	-	-	- F	Saloon Engine QG15DE	850139	Outer Joint		25	22	55	100.5	58.5	M	
	2002.10-	-	-	L F	Hatchback Engine QG15DE	641134	Inner Joint		24	22	40	51.5	97		
	2002.10-	-	-	L F	Saloon Engine QG15DE	641134	Inner Joint		24	22	40	51.5	97		
	2002.10-	-	-	AT/MT L/R F	Saloon Engine QG15DE	841141	Outer Joint	44T	25	22	55	100.5	58.5	M	
	2002.10-	-	-	AT/MT L/R F	Hatchback Engine QG15DE	841141	Outer Joint	44T	25	22	55	100.5	58.5	M	
	2002.10-	-	-	MT R F	Hatchback Engine QG15DE	241386	Drive Shaft	44T	25	24	55	100.5	909		
	2002.10-	-	-	MT R F	Saloon Engine QG15DE	241386	Drive Shaft	44T	25	24	55	100.5	909		
1.5 (77 kW)	2001.03-	-	-	- F	Saloon Engine GA15DE/QA15DE	841327	Outer Joint	42T	25	22	55	100.5	58.5	M	
1.5 dCi (60 kW)	2003.01-	-	-	- -	Saloon Engine K9K 722	841112	Outer Joint		25	23	55	96.5	63.5	M	
	2003.01-	-	-	- -	Hatchback Engine K9K 722	841112	Outer Joint		25	23	55	96.5	63.5	M	
	2003.01-	-	-	L/R F	Hatchback Engine K9K 722	841052	Outer Joint	42T	25	23	55	96.5	63.5	M	
	2003.01-	-	-	L/R F	Saloon Engine K9K 722	841052	Outer Joint	42T	25	23	55	96.5	63.5	M	
	2003.01-	-	-	- F	Hatchback Engine K9K 722	841205	Outer Joint	42T	25	23	55	100.5	60	M	
	2003.01-	-	-	- F	Saloon Engine K9K 722	841205	Outer Joint	42T	25	23	55	100.5	60	M	
	2003.01-	-	-	- F	Hatchback Engine K9K 722	899252	Outer Joint	44T	25	23	55	100.5	60	M	
	2003.01-	-	-	- F	Saloon Engine K9K 722	899252	Outer Joint	44T	25	23	55	100.5	60	M	
1.5 XL (77 kW)	2001.03-	-	-	- F	Hatchback Engine QG15DE	841327	Outer Joint	42T	25	22	55	100.5	58.5	M	
1.8 (84 kW)	2000.01-	-	-	MT L F	Hatchback Engine QG18DE	241040	Drive Shaft		25	25	55	107	622		
	2000.01-	-	-	AT/MT - F	Hatchback Engine QG18DE	899199	Outer Joint		25	23	55	107	62	M	
	2000.01-	-	-	L/R F	Hatchback Engine QG18DE	841052	Outer Joint	42T	25	23	55	96.5	63.5	M	
	2000.01-	-	-	- F	Hatchback Engine QG18DE	841205	Outer Joint	42T	25	23	55	100.5	60	M	
	2000.01-	-	-	- F	Hatchback Engine QG18DE	899252	Outer Joint	44T	25	23	55	100.5	60	M	
	2000.01-	-	-	- F	Hatchback Engine QG18DE	841033	Outer Joint		25	23	55	107	61	I	
	2000.01-	-	-	AT/MT R F	Hatchback Engine QG18DE	241562	Drive Shaft	42T	25	25	55	107	923		
	2000.07-	-	-	MT L F	Saloon Engine QG18DE	241040	Drive Shaft		25	25	55	107	622		
	2000.07-	-	-	AT/MT - F	Saloon Engine QG18DE	899199	Outer Joint		25	23	55	107	62	M	
	2000.07-	-	-	L/R F	Saloon Engine QG18DE	841052	Outer Joint	42T	25	23	55	96.5	63.5	M	
	2000.07-	-	-	- F	Saloon Engine QG18DE	841205	Outer Joint	42T	25	23	55	100.5	60	M	
	2000.07-	-	-	- F	Saloon Engine QG18DE	841033	Outer Joint		25	23	55	107	61	I	
	2000.07-	-	-	AT/MT R F	Saloon Engine QG18DE	241562	Drive Shaft	42T	25	25	55	107	923		
1.8 (85 kW)	2002.10-	-	-	- F	Hatchback Engine QG18DE	841137	Outer Joint	42T	27	35	55	102	69	I	
	2002.10-	-	-	- F	Saloon Engine QG18DE	841137	Outer Joint	42T	27	35	55	102	69	I	
	2002.10-	-	-	L/R F	Hatchback Engine QG18DE	841052	Outer Joint	42T	25	23	55	96.5	63.5	M	
	2002.10-	-	-	L/R F	Saloon Engine QG18DE	841052	Outer Joint	42T	25	23	55	96.5	63.5	M	
	2002.10-	-	-	- F	Hatchback Engine QG18DE	841205	Outer Joint	42T	25	23	55	100.5	60	M	
	2002.10-	-	-	- F	Saloon Engine QG18DE	841205	Outer Joint	42T	25	23	55	100.5	60	M	
2.2 dCi (100 kW)	2003.09-	-	-	- F	Hatchback Engine YD22DDTi	841137	Outer Joint	42T	27	35	55	102	69	I	
	2003.09-	-	-	- -	Saloon Engine YD22DDTi	841236	Outer Joint		27	26	55	102	69	M	
	2003.09-	-	-	- F	Saloon Engine YD22DDTi	841137	Outer Joint	42T	27	35	55	102	69	I	
	2003.09-	-	-	- -	Hatchback Engine YD22DDTi	841236	Outer Joint		27	26	55	102	69	M	
	2003.09-	-	-	L/R F	Hatchback Engine YD22DDTi	841057	Outer Joint	44T	27	26	55	102	69	M	
	2003.09-	-	-	L/R F	Saloon Engine YD22DDTi	841057	Outer Joint	44T	27	26	55	102	69	M	
	2003.09-	-	-	- F	Hatchback Engine YD22DDTi	841099	Outer Joint		27	35	55	102	69	I	
	2003.09-	-	-	- F	Saloon Engine YD22DDTi	841099	Outer Joint		27	35	55	102	69	I	
	2003.09-	-	-	5MT L/R F	Hatchback Engine YD22DDTi	841256	Outer Joint	42T	27	26	55	104	69	M	
	2003.09-	-	-	5MT L/R F	Saloon Engine YD22DDTi	841256	Outer Joint	42T	27	26	55	104	69	M	
2.2 dCi (82 kW)	2003.09-	-	-	- F	Hatchback Engine YD22DDT	841137	Outer Joint	42T	27	35	55	102	69	I	

YEAR	TRANSM	L/R	F/R	REMARKS	GSP Ref.	PRODUCT	ABS	Technical Specifications							
								A	B	C	H	L	P		
NISSAN															
ALMERA II (N16)															
2.2 dCi (82 kW)	2003.09-	-	-	-	Saloon Engine YD22DDT	841236	Outer Joint		27	26	55	102	69	M	
	2003.09-	-	-	F	Saloon Engine YD22DDT	841137	Outer Joint	42T	27	35	55	102	69	I	
	2003.09-	-	-	-	Hatchback Engine YD22DDT	841236	Outer Joint		27	26	55	102	69	M	
	2003.09-	-	-	L/R	F	Hatchback Engine YD22DDT	841057	Outer Joint	44T	27	26	55	102	69	M
	2003.09-	-	-	L/R	F	Saloon Engine YD22DDT	841057	Outer Joint	44T	27	26	55	102	69	M
	2003.09-	-	-	-	F	Hatchback Engine YD22DDT	841099	Outer Joint		27	35	55	102	69	I
	2003.09-	-	-	-	F	Saloon Engine YD22DDT	841099	Outer Joint		27	35	55	102	69	I
	2003.09-	-	5MT	L/R	F	Hatchback Engine YD22DDT	841256	Outer Joint	42T	27	26	55	104	69	M
	2003.09-	-	5MT	L/R	F	Saloon Engine YD22DDT	841256	Outer Joint	42T	27	26	55	104	69	M
2.2 Di (81 kW)	2000.03-	-	-	-	F	Hatchback Engine YD22DDT	841137	Outer Joint	42T	27	35	55	102	69	I
	2000.03-	-	-	L/R	F	Hatchback Engine YD22DDT	841057	Outer Joint	44T	27	26	55	102	69	M
	2000.03-	-	-	-	F	Hatchback Engine YD22DDT	841255	Outer Joint	44T	27	26	55	104	69	M
	2000.03-	-	-	-	F	Hatchback Engine YD22DDT	841099	Outer Joint		27	35	55	102	69	I
	2000.03-	-	5MT	L/R	F	Hatchback Engine YD22DDT	841256	Outer Joint	42T	27	26	55	104	69	M
	2000.07-	-	-	-	F	Saloon Engine YD22DDT	841137	Outer Joint	42T	27	35	55	102	69	I
	2000.07-	-	-	L/R	F	Saloon Engine YD22DDT	841057	Outer Joint	44T	27	26	55	102	69	M
	2000.07-	-	-	-	F	Saloon Engine YD22DDT	841255	Outer Joint	44T	27	26	55	104	69	M
	2000.07-	-	-	-	F	Saloon Engine YD22DDT	841099	Outer Joint		27	35	55	102	69	I
	2000.07-	-	5MT	L/R	F	Saloon Engine YD22DDT	841256	Outer Joint	42T	27	26	55	104	69	M
ALMERA TINO (V10)															
1.8 (84 kW)	2000.08-	-	-	-	F	MPV Engine QG18DE	841054	Outer Joint		27	23	56	103	61.5	M
	2000.08-	-	-	-	-	MPV Engine QG18DE	841055	Outer Joint	44T	27	23	56	102	62	I
	2000.08-	-	MT	R	F	MPV Engine QG18DE	241194	Drive Shaft	44T	27	25	56	103.5	948.5	
	2000.08-	-	AT/MT	L/R	F	MPV Engine QG18DE	841044	Outer Joint	44T	27	23	56	104	60	I
	2000.08-	-	MT	L	F	MPV Engine QG18DE	641110	Inner Joint		25	23	40	63	101	
	2000.08-	-	MT	L	F	MPV Engine QG18DE	241195	Drive Shaft	44T	27	25	56	103.5	661	
1.8 (85 kW)	2002.12-	-	MT	R	F	MPV Engine QG18DE	241194	Drive Shaft	44T	27	25	56	103.5	948.5	
	2002.12-	-	MT	L	F	MPV Engine QG18DE	241195	Drive Shaft	44T	27	25	56	103.5	661	
	2002.12-	-	AT	-	-	MPV Engine QG18DE	641089	Inner Joint		25	23	40	63	99	
	2003.12-	-	MT	L	F	MPV Engine QG18DE	641110	Inner Joint		25	23	40	63	101	
2.0 (100 kW)	2000.08-	-	-	-	F	MPV Engine SR20DE	841054	Outer Joint		27	23	56	103	61.5	M
	2000.08-	-	-	-	F	MPV Engine SR20DE	841282	Outer Joint	44T	27	23	56	103	58.5	I
	2000.08-	-	-	-	F	MPV Engine SR20DE	841015	Outer Joint	44T	27	27	56	103	69	I
	2000.08-	-	-	-	-	MPV Engine SR20DE	641089	Inner Joint		25	23	40	63	99	
2.2 dCi (100 kW)	2003.09-	-	-	-	-	MPV Engine YD22DDTi	841236	Outer Joint		27	26	55	102	69	M
2.2 dCi (82 kW)	2003.09-	-	-	-	-	MPV Engine YD22DDT	841236	Outer Joint		27	26	55	102	69	M
ALTIMA															
-	1993-1999	MT	-	-	-		641036	Inner Joint		27	27	39	63.5	121.5	
	1993-1994	AT	-	-	-		641008	Inner Joint	29/31	27	46	86.8	124		
	1993-1999	-	-	-	-		841088	Outer Joint		27	27	56	103	69	I
	2001.08-	5MT	-	-	ENGINE : QR25DE		241131	Drive Shaft		27	29	56	102	1005	
	2001.08-	5MT	-	-	ENGINE : QR25DE		241131	Drive Shaft		27	29	56	102	1005	
	2004.01-	5MT	-	-	ENGINE : QR25DE		241131	Drive Shaft		27	29	56	102	1005	
	2004.03-2006.05	4AT	-	-	ENGINE : VQ35DE		241253	Drive Shaft	44T	29	29	56	102.5	977	
	2004.03-2006.05	4AT	-	-	ENGINE : VQ35DE		841230	Outer Joint	44T	29	27	56	102.5	71	I
	2006.05-	4AT	-	-	ENGINE : VQ35DE		841230	Outer Joint	44T	29	27	56	102.5	71	I
	2006.05-	4AT	-	-	ENGINE : VQ35DE		241253	Drive Shaft	44T	29	29	56	102.5	977	
	2006.10-2009.09	CVT	-	-	ENGINE : VQ35DE		241564	Drive Shaft		32	29	56	102	996	
	2007.08-2008.07	6MT	-	-	ENGINE : QR25DE		241456	Drive Shaft		29	29	56.1	102	986	
	2007.08-2008.07	6MT	-	-	ENGINE : QR25DE		241456	Drive Shaft		29	29	56.1	102	986	
	2007.08-2008.07	CVT	-	-	ENGINE : VQ35DE		241564	Drive Shaft		32	29	56	102	996	
	2007.08-2008.07	CVT	-	-	ENGINE : VQ35DE		241564	Drive Shaft		32	29	56	102	996	
	2008.07-	6MT	-	-	ENGINE : QR25DE		241456	Drive Shaft		29	29	56.1	102	986	
	2008.07-	6MT	-	-	ENGINE : QR25DE		241456	Drive Shaft		29	29	56.1	102	986	
	2008.07-	CVT	-	-	ENGINE : VQ35DE		241564	Drive Shaft		32	29	56	102	996	
	2008.07-2009.09	CVT	-	-	ENGINE : VQ35DE		241564	Drive Shaft		32	29	56	102	996	
	2008.07-2009.09	CVT	-	-	ENGINE : VQ35DE		241564	Drive Shaft		32	29	56	102	996	
	2009.09-	CVT	-	-	ENGINE : VQ35DE		241564	Drive Shaft		32	29	56	102	996	
	2009.09-	CVT	-	-	ENGINE : VQ35DE		241564	Drive Shaft		32	29	56	102	996	
	2009.09-	CVT	-	-	ENGINE : VQ35DE		241564	Drive Shaft		32	29	56	102	996	
	2012.06-2014.05	CVT	-	-	ENGINE : QR25DE		241559	Drive Shaft		32	27	56	102	989	
	2012.06-2014.05	CVT	-	-	ENGINE : QR25DE		241559	Drive Shaft		32	27	56	102	989	
	2012.06-2014.05	CVT	-	-	ENGINE : QR25DE		241560	Drive Shaft		32	27	56	102	694	
	2012.06-2014.05	CVT	-	-	ENGINE : QR25DE		241560	Drive Shaft		32	27	56	102	694	
	2012.06-2014.05	CVT	-	-	ENGINE : QR25DE		241560	Drive Shaft		32	27	56	102	694	
	2012.06-2014.05	CVT	-	-	ENGINE : QR25DE		241560	Drive Shaft		32	27	56	102	694	

YEAR	TRANS	L/R	F/R	REMARKS	GSP Ref.	PRODUCT	ABS	Technical Specifications							
								A	B	C	H	L	P		
NISSAN															
ALTIMA (L30)															
2.4 (112 kW)	1997.06-	2001.08	-	-	F	Saloon Engine KA24DE	841091	Outer Joint		27	26	56	103	69	I
ALTIMA (L31)															
2.5 (121 kW)	2001.08-	2006.09	-	-	F	Saloon Engine QR25DE	841354	Outer Joint	44T	27	33	56	102	63	I
ALTIMA (L31)															
2.5	2003.04-	-	-	L	-	-	241296	Drive Shaft		27	29	56	102	649	
	2003.04-	-	-	R	-	-	241297	Drive Shaft		27	29	56	102	980	
ALTIMA (L32)															
2.5 (128 kW)	2006.10-	2013.07	AT	-	F	Saloon Engine QR25DE	841214	Outer Joint		29	35	56.1	102	59	I
ALTIMA COUPE															
2.5	2007-	2013	MT	R	F	-	241456	Drive Shaft		29	29	56.1	102	986	
	2007-	2013	MT	R	F	-	641212	Inner Joint		29	33	33	426	109.5	
ALTIMA COUPE CL32															
2.5	2007.04-	2013.06	6MT	R	F	2DOOR COUPE/ENGINE : QR25DE/CA1	241564	Drive Shaft		32	29	56	102	996	
	2007.04-	2013.06	-	R	F	2DOOR COUPE/ENGINE : VQ35DE/GL1	241564	Drive Shaft		32	29	56	102	996	
	2007.04-	2013.06	6MT	R	F	2DOOR COUPE/ENGINE : QR25DE/US1	241564	Drive Shaft		32	29	56	102	996	
	2007.04-	2013.06	6MT	L	F	-	241539	Drive Shaft		29	29	56.1	102	643	
	2007.04-	2013.06	6MT	L	F	-	241539	Drive Shaft		29	29	56.1	102	643	
	2007.04-	2013.06	6MT	R	F	2DOOR COUPE/ENGINE : QR25DE/CA1	641197	Inner Joint		29	29	33	460	98.5	
	2007.04-	2013.06	-	R	F	2DOOR COUPE/ENGINE : VQ35DE/GL1	641197	Inner Joint		29	29	33	460	98.5	
	2007.04-	2013.06	6MT	R	F	2DOOR COUPE/ENGINE : QR25DE/US1	641197	Inner Joint		29	29	33	460	98.5	
	2007.04-	2013.06	6MT	R	F	2DOOR COUPE SEDAN/ENGINE : QR25DE/CA1	241559	Drive Shaft		32	27	56	102	989	
	2007.04-	2013.06	-	R	F	2DOOR COUPE /ENGINE : VQ35DE/GL1/MEXICO	241559	Drive Shaft		32	27	56	102	989	
	2007.04-	2013.06	6MT	R	F	2DOOR COUPE/ENGINE : QR25DE/US1	241559	Drive Shaft		32	27	56	102	989	
	2007.04-	2013.06	6MT	R	F	2DOOR COUP/ENGINE : QR25DE/25S GRADE/CA1	241456	Drive Shaft		29	29	56.1	102	986	
	2007.04-	2013.06	-	R	F	2DOOR COUP/ENGINE : VQ35DE/MEXICO/GL1	241456	Drive Shaft		29	29	56.1	102	986	
	2007.04-	2013.06	6MT	R	F	2DOOR COUP/ENGINE : QR25DE/25S GRADE/FEDERAL/US1	241456	Drive Shaft		29	29	56.1	102	986	
	2007.04-	2013.06	6MT	R	F	2DOOR COUPE SEDAN/ENGINE : QR25DE/CA1	841395	Outer Joint		32	24	56	102	63	M
	2007.04-	2013.06	-	R	F	2DOOR COUPE /ENGINE : VQ35DE/GL1/MEXICO	841395	Outer Joint		32	24	56	102	63	M
	2007.04-	2013.06	6MT	R	F	2DOOR COUPE/ENGINE : QR25DE/US1	841395	Outer Joint		32	24	56	102	63	M
	2007.04-	2013.06	6MT	R	F	2DOOR COUPE SEDAN/ENGINE : QR25DE/CA1	641196	Inner Joint		27	24	33	406	93	
	2007.04-	2013.06	-	R	F	2DOOR COUPE /ENGINE : VQ35DE/GL1/MEXICO	641196	Inner Joint		27	24	33	406	93	
	2007.04-	2013.06	6MT	R	F	2DOOR COUPE/ENGINE : QR25DE/US1	641196	Inner Joint		27	24	33	406	93	
	2007.04-	2013.06	6MT	R	F	2DOOR COUP/ENGINE : QR25DE/25S GRADE/CA1	641212	Inner Joint		29	33	33	426	109.5	
	2007.04-	2013.06	-	R	F	2DOOR COUP/ENGINE : VQ35DE/MEXICO/GL1	641212	Inner Joint		29	33	33	426	109.5	
	2007.04-	2013.06	6MT	R	F	2DOOR COUP/ENGINE : QR25DE/25S GRADE/FEDERAL/US1	641212	Inner Joint		29	33	33	426	109.5	
	2007.04-	2013.06	6MT	L	F	-	641205	Inner Joint		29	33	39	65.5	122	
	2007.04-	2013.06	6MT	L	F	-	641205	Inner Joint		29	33	39	65.5	122	
3.5	2007.04-	2013.06	-	L	F	-	241539	Drive Shaft		29	29	56.1	102	643	
	2007.04-	2013.06	-	L	F	-	641205	Inner Joint		29	33	39	65.5	122	
ALTIMA L31															
2.5	2001.08-	2006.10	4AT	R	F	-	841230	Outer Joint	44T	29	27	56	102.5	71	I
	2001.08-	2006.10	4AT	R	F	-	241253	Drive Shaft	44T	29	29	56	102.5	977	
	2001.08-	2006.10	4AT	R	F	-	241253	Drive Shaft	44T	29	29	56	102.5	977	
	2001.08-	2006.10	4AT	R	F	4DOOR SEDAN/ENGINE : QR25DE/CA1	241131	Drive Shaft		27	29	56	102	1005	
	2001.08-	2006.10	4AT	R	F	4DOOR SEDAN/ENGINE : QR25DE/US1	241131	Drive Shaft		27	29	56	102	1005	
	2001.08-	2006.10	4AT	R	F	4DOOR SEDAN/ENGINE : QR25DE/CA1	841193	Outer Joint		27	33	56	102	63.5	I
	2001.08-	2006.10	4AT	R	F	4DOOR SEDAN/ENGINE : QR25DE/US1	841193	Outer Joint		27	33	56	102	63.5	I
	2001.08-	2006.10	4AT	R	F	4DOOR SEDAN/ENGINE : QR25DE/CA1	641041	Inner Joint		29	33	33	415	96.5	
	2001.08-	2006.10	4AT	R	F	4DOOR SEDAN/ENGINE : QR25DE/US1	641041	Inner Joint		29	33	33	415	96.5	
	2001.08-	2006.10	4AT	R	F	-	641066	Inner Joint		29	27	33	436	97	
	2001.08-	2006.10	4AT	R	F	-	641066	Inner Joint		29	27	33	436	97	
	2004.03-	2007.04	4AT	R	F	-	841230	Outer Joint	44T	29	27	56	102.5	71	I
	2004.03-	2007.04	4AT	R	F	-	241253	Drive Shaft	44T	29	29	56	102.5	977	
	2004.03-	2007.04	4AT	R	F	4DOOR SEDAN/ENGINE : QR25DE/GL1	241131	Drive Shaft		27	29	56	102	1005	
	2004.03-	2007.04	4AT	R	F	4DOOR SEDAN/ENGINE : QR25DE/GL1	841193	Outer Joint		27	33	56	102	63.5	I
	2004.03-	2007.04	4AT	R	F	4DOOR SEDAN/ENGINE : QR25DE/GL1	641041	Inner Joint		29	33	33	415	96.5	
	2004.03-	2007.04	4AT	R	F	4DOOR SEDAN/ENGINE : QR25DE/GL1	641066	Inner Joint		29	27	33	436	97	
2.5 L4 - Gas	-	-	-	L	F	-	641182	Inner Joint		29	33	39	66	112.5	
	-	-	-	L	F	-	241540	Drive Shaft	44T	27	29	56	102	623	
	2003-	-	-	L	F	-	641182	Inner Joint		29	33	39	66	112.5	
	2003-	-	-	L	F	-	241540	Drive Shaft	44T	27	29	56	102	623	
	2004-	-	-	L	F	-	641182	Inner Joint		29	33	39	66	112.5	
	2004-	-	-	L	F	-	241540	Drive Shaft	44T	27	29	56	102	623	
	2005-	-	-	L	F	-	641182	Inner Joint		29	33	39	66	112.5	
	2005-	-	-	L	F	-	241540	Drive Shaft	44T	27	29	56	102	623	
	2006-	-	-	L	F	-	641182	Inner Joint		29	33	39	66	112.5	





				TRANSM		L/R F/R		REMARKS		GSP Ref.				ABS		Technical Specifications					
YEAR																A	B	C	H	L	P
NISSAN																					
ALTIMA L31																					
2.5 L4 - Gas		2006-	-	-	L	F	-			241540	Drive Shaft	44T	27	29	56	102	623				
ALTIMA L32																					
2.5																					
2006.10-	2012.05	6MT	R	F	4DOOR SEDAN/ENGINE : QR25DE/CA1	241564	Drive Shaft		32	29	56	102	996								
2006.10-	2013.07	CVT	R	F	4DOOR SEDAN/ENGINE : QR25DE/GL1/MEXICO	241564	Drive Shaft		32	29	56	102	996								
2006.10-	2012.05	MT	R	F	4DOOR SEDAN/ENGINE : QR25DE/US1	241564	Drive Shaft		32	29	56	102	996								
2006.10-	2012.05	6MT	L	F	-	241539	Drive Shaft		29	29	56.1	102	643								
2006.10-	2013.07	-	L	F	-	241539	Drive Shaft		29	29	56.1	102	643								
2006.10-	2012.05	MT	L	F	-	241539	Drive Shaft		29	29	56.1	102	643								
2006.10-	2012.05	6MT	R	F	4DOOR SEDAN/ENGINE : QR25DE/CA1	641197	Inner Joint		29	29	33	460	98.5								
2006.10-	2013.07	CVT	R	F	4DOOR SEDAN/ENGINE : QR25DE/GL1/MEXICO	641197	Inner Joint		29	29	33	460	98.5								
2006.10-	2012.05	MT	R	F	4DOOR SEDAN/ENGINE : QR25DE/US1	641197	Inner Joint		29	29	33	460	98.5								
2006.10-	2012.05	6MT	R	F	4DOOR SEDAN/ENGINE : QR25DE/CA1	241559	Drive Shaft		32	27	56	102	989								
2006.10-	2013.07	CVT	R	F	4DOOR SEDAN/ENGINE : QR25DE/GL1/MEXICO	241559	Drive Shaft		32	27	56	102	989								
2006.10-	2012.05	MT	R	F	4DOOR SEDAN/ENGINE : QR25DE/US1	241559	Drive Shaft		32	27	56	102	989								
2006.10-	2012.05	6MT	R	F	4DOOR SEDAN/ENGINE : QR25DE/CA1/25S GRADE	241456	Drive Shaft		29	29	56.1	102	986								
2006.10-	2013.07	CVT	R	F	4DOOR SEDAN/ENGINE : QR25DE/MEXICO/GL1	241456	Drive Shaft		29	29	56.1	102	986								
2006.10-	2012.05	MT	R	F	4DOOR SEDAN/ENGINE : QR25DE/25S GRADE/US1	241456	Drive Shaft		29	29	56.1	102	986								
2006.10-	2012.05	6MT	R	F	4DOOR SEDAN/ENGINE : QR25DE/CA1	841395	Outer Joint		32	24	56	102	63	M							
2006.10-	2013.07	CVT	R	F	4DOOR SEDAN/ENGINE : QR25DE/GL1/MEXICO	841395	Outer Joint		32	24	56	102	63	M							
2006.10-	2012.05	MT	R	F	4DOOR SEDAN/ENGINE : QR25DE/US1	841395	Outer Joint		32	24	56	102	63	M							
2006.10-	2012.05	6MT	R	F	4DOOR SEDAN/ENGINE : QR25DE/CA1	641196	Inner Joint		27	24	33	406	93								
2006.10-	2013.07	CVT	R	F	4DOOR SEDAN/ENGINE : QR25DE/GL1/MEXICO	641196	Inner Joint		27	24	33	406	93								
2006.10-	2012.05	MT	R	F	4DOOR SEDAN/ENGINE : QR25DE/US1	641196	Inner Joint		27	24	33	406	93								
2006.10-	2012.05	6MT	R	F	4DOOR SEDAN/ENGINE : QR25DE/CA1/25S GRADE	641212	Inner Joint		29	33	33	426	109.5								
2006.10-	2013.07	CVT	R	F	4DOOR SEDAN/ENGINE : QR25DE/MEXICO/GL1	641212	Inner Joint		29	33	33	426	109.5								
2006.10-	2012.05	MT	R	F	4DOOR SEDAN/ENGINE : QR25DE/25S GRADE/US1	641212	Inner Joint		29	33	33	426	109.5								
2006.10-	2012.05	6MT	L	F	-	641205	Inner Joint		29	33	39	65.5	122								
2006.10-	2013.07	-	L	F	-	641205	Inner Joint		29	33	39	65.5	122								
2006.10-	2012.05	MT	L	F	-	641205	Inner Joint		29	33	39	65.5	122								
ALTIMA L33																					
2.5																					
2012.05-	-	CVT	R	F	4DOOR SEDAN/ENGINE : QR25DE/CA1/BASE GRADE	241559	Drive Shaft		32	27	56	102	989								
2012.05-	-	CVT	R	F	4DOOR SEDAN/ENGINE : QR25DE/US1/BASE GRADE	241559	Drive Shaft		32	27	56	102	989								
2012.05-	-	CVT	L	F	4DOOR SEDAN/ENGINE : QR25DE/CA1	241560	Drive Shaft		32	27	56	102	694								
2012.05-	-	CVT	L	F	4DOOR SEDAN/ENGINE : QR25DE/US1	241560	Drive Shaft		32	27	56	102	694								
2012.05-	-	CVT	R	F	4DOOR SEDAN/ENGINE : QR25DE/CA1/BASE GRADE	841395	Outer Joint		32	24	56	102	63	M							
2012.05-	-	CVT	R	F	4DOOR SEDAN/ENGINE : QR25DE/US1/BASE GRADE	841395	Outer Joint		32	24	56	102	63	M							
2012.05-	-	CVT	R	F	4DOOR SEDAN/ENGINE : QR25DE/CA1/BASE GRADE	641196	Inner Joint		27	24	33	406	93								
2012.05-	-	CVT	R	F	4DOOR SEDAN/ENGINE : QR25DE/US1/BASE GRADE	641196	Inner Joint		27	24	33	406	93								
2012.05-	-	CVT	L	F	4DOOR SEDAN/ENGINE : QR25DE/CA1	841395	Outer Joint		32	24	56	102	63	M							
2012.05-	-	CVT	L	F	4DOOR SEDAN/ENGINE : QR25DE/US1	841395	Outer Joint		32	24	56	102	63	M							
2012.05-	-	CVT	L	F	4DOOR SEDAN/ENGINE : QR25DE/CA1	641073	Inner Joint		27	24	40	62.5	99.5								
2012.05-	-	CVT	L	F	4DOOR SEDAN/ENGINE : QR25DE/US1	641073	Inner Joint		27	24	40	62.5	99.5								
2012.06-	-	CVT	R	F	4DOOR SEDAN/ENGINE : QR25DE/GL1/MEXICO/STANDARD FUEL	241559	Drive Shaft		32	27	56	102	989								
2012.06-	-	CVT	L	F	4DOOR SEDAN/ENGINE : QR25DE/GL1/MEXICO	241560	Drive Shaft		32	27	56	102	694								
2012.06-	-	CVT	R	F	4DOOR SEDAN/ENGINE : QR25DE/GL1/MEXICO/STANDARD FUEL	841395	Outer Joint		32	24	56	102	63	M							
2012.06-	-	CVT	R	F	4DOOR SEDAN/ENGINE : QR25DE/GL1/MEXICO/STANDARD FUEL	641196	Inner Joint		27	24	33	406	93								
2012.06-	-	CVT	L	F	4DOOR SEDAN/ENGINE : QR25DE/GL1/MEXICO	841395	Outer Joint		32	24	56	102	63	M							
2012.06-	-	CVT	L	F	4DOOR SEDAN/ENGINE : QR25DE/GL1/MEXICO	641073	Inner Joint		27	24	40	62.5	99.5								
2015.12-	-	-	R	F	4DOOR SEDAN/ENGINE : QR25DE/EL1/25SV GRADE	241559	Drive Shaft		32	27	56	102	989								
2015.12-	-	CVT	L	F	4DOOR SEDAN/ENGINE : QR25DE/EL1	241560	Drive Shaft		32	27	56	102	694								
2015.12-	-	-	R	F	4DOOR SEDAN/ENGINE : QR25DE/EL1/25SV GRADE	841395	Outer Joint		32	24	56	102	63	M							
2015.12-	-	-	R	F	4DOOR SEDAN/ENGINE : QR25DE/EL1/25SV GRADE	641196	Inner Joint		27	24	33	406	93								
2015.12-	-	CVT	L	F	4DOOR SEDAN/ENGINE : QR25DE/EL1	841395	Outer Joint		32	24	56	102	63	M							
2015.12-	-	CVT	L	F	4DOOR SEDAN/ENGINE : QR25DE/EL1	641073	Inner Joint		27	24	40	62.5	99.5								
ALTIMA(L31)																					
2.5																					
2001.08-	2006.10	4AT	R	F	EGNINE:QR25DE/4DOOR SEDAN/BASE BRADE/CA1	241253	Drive Shaft	44T	29	29	56	102.5	977								
2001.08-	2006.10	4AT	R	F	EGNINE:QR25DE/4DOOR SEDAN/BASE BRADE/US1	241253	Drive Shaft	44T	29	29	56	102.5	977								
2001.08-	2006.10	4AT	R	F	EGNINE:QR25DE/4DOOR SEDAN/BASE BRADE/CA1	841405	Outer Joint		29	27	56	102.5	71	I							
2001.08-	2006.10	4AT	R	F	EGNINE:QR25DE/4DOOR SEDAN/BASE BRADE/US1	841405	Outer Joint		29	27	56	102.5	71	I							
2001.08-	2006.10	4AT	R	F	EGNINE:QR25DE/4DOOR SEDAN/BASE BRADE/CA1	641066	Inner Joint		29	27	33	436	97								
2001.08-	2006.10	4AT	R	F	EGNINE:QR25DE/4DOOR SEDAN/BASE BRADE/US1	641066	Inner Joint		29	27	33	436	97								
2001.08-	2006.10	4AT	R	F	EGNINE:QR25DE/4DOOR SEDAN/BASE BRADE/CA1	841230	Outer Joint	44T	29	27	56	102.5	71	I							
2001.08-	2006.10	4AT	R	F	EGNINE:QR25DE/4DOOR SEDAN/BASE BRADE/US1	841230	Outer Joint	44T	29	27	56	102.5	71	I							
2004.03-	2007.04	4AT	R	F	EGNINE:QR25DE/4DOOR SEDAN/25S GRADE/GL1	241253	Drive Shaft	44T	29	29	56	102.5	977								
2004.03-	2007.04	4AT	R	F	EGNINE:QR25DE/4DOOR SEDAN/25S GRADE/GL1	841405	Outer Joint		29	27	56	102.5	71	I							
2004.03-	2007.04	4AT	R	F	EGNINE:QR25DE/4DOOR SEDAN/25S GRADE/GL1	641066	Inner Joint		29	27	33	436	97								

	 YEAR	TRANSM	L/R	F/R	REMARKS	GSP Ref.	 PRODUCT	 ABS	Technical Specifications						
									A	B	C	H	L	P	
NISSAN															
ALTIMA(L31)															
2.5	2004.03-2007.04	4AT	R	F	EGNINE:QR25DE/4DOOR SEDAN/25S GRADE/GL1	841230	Outer Joint	44T	29	27	56	102.5	71	I	
ARMADA (A60)															
5.6 (227 kW)	2003.08-2006.12	AT	-	F	All-wheel Drive Closed Off-Road Vehicle Engine VK56DE	841403	Outer Joint		29	36	67.3	117	69	I	
	2003.08-2006.12	AT	-	-	All-wheel Drive Closed Off-Road Vehicle Engine VK56DE	641207	Inner Joint			36		79.5			
5.6 (236 kW)	2006.09-2015.12	AT	-	F	All-wheel Drive Closed Off-Road Vehicle Engine VK56DE	841403	Outer Joint		29	36	67.3	117	69	I	
	2006.09-2015.12	AT	-	-	All-wheel Drive Closed Off-Road Vehicle Engine VK56DE	641207	Inner Joint			36		79.5			
AVENIR (W10 PW10)															
2.0 (77 kW)	1989.10-1997.10	-	L	F	Estate Engine CA20E	641004	Inner Joint		25	25	40	63	116.5		
2.0 TD (66 kW)	1992.11-1997.10	AT	L	F	Estate Engine CD20T	650065	Inner Joint		25	25	40	63	101		
AVENIR (W11)															
1.8 (92 kW)	1997.11-2005.12	-	-	-	Estate Engine QG18DE	641089	Inner Joint		25	23	40	63	99		
2.0 (107 kW)	1997.11-2005.12	AT	-	F	All-wheel Drive Estate Engine SR20DE	841184	Outer Joint	44T	27	25	56	103	68	M	
	1997.11-2001.08	AT	-	F	Estate Engine SR20DE	841184	Outer Joint	44T	27	25	56	103	68	M	
	1997.11-2005.12	AT	-	-	All-wheel Drive Estate Engine SR20DE	641014	Inner Joint			27		81.2			
	1997.11-2005.12	AT	-	F	All-wheel Drive Estate Engine SR20DE	841282	Outer Joint	44T	27	23	56	103	58.5	I	
	1997.11-2001.08	AT	-	F	Estate Engine SR20DE	841282	Outer Joint	44T	27	23	56	103	58.5	I	
	1997.11-2005.12	AT	-	F	All-wheel Drive Estate Engine SR20DE	841015	Outer Joint	44T	27	27	56	103	69	I	
BASSARA															
3.0 (162 kW)	1999.11-2003.08	-	R	F	MPV Engine VQ30DE	641019	Inner Joint		29	27	33	437.5	101		
BLUEBIRD															
-	2000.08-2005.12	AT	R	F	-	241258	Drive Shaft	42T	25	25	55	107	927		
	2000.08-2005.12	AT	R	F	-	641141	Inner Joint		25	23	40	63	107		
1.6/1.8	1989-	-	-	-	-	841330	Outer Joint		27	22	56	99	60	I	
BLUEBIRD (EU13)															
1.8	1991.01-1996.01	MT	-	-	Engine SR18DE	841306	Outer Joint		27	25	56	103	61.5	M	
BLUEBIRD (HU13)															
2.0	1991.09-1995.11	AT	-	-	Engine SR20DE	841306	Outer Joint		27	25	56	103	61.5	M	
	1991.09-1995.11	MT	-	-	Engine SR20DE	841306	Outer Joint		27	25	56	103	61.5	M	
BLUEBIRD (HU14)															
2.0	1996.01-	-	MT	-	-	Engine SR20DE	841338	Outer Joint		27	23	56	103	61.5	M
BLUEBIRD (T72 T12 U12)															
1.6 (61 kW)	1986.03-1990.06	-	-	F	Saloon Engine CA16S	841061	Outer Joint		27	23	56	99	60	I	
	1986.03-1990.06	-	-	-	Saloon Engine CA16S	841176	Outer Joint		27	23	56	104	63	I	
	1986.03-1990.06	-	-	-	Saloon Engine CA16S	841045	Outer Joint		27	23	56	103	62	I	
1.8 (61 kW)	1986.05-1990.09	-	-	-	Saloon Engine CA18N	841045	Outer Joint		27	23	56	103	62	I	
	1986.05-1990.09	-	-	F	Saloon Engine CA18N	841023	Outer Joint		27	23	56	103	61.5	M	
	1986.05-1990.09	-	-	-	Saloon Engine CA18N	641089	Inner Joint		25	23	40	63	99		
1.8 i 16V (95 kW)	1989.02-1990.12	-	-	F	Saloon Engine CA18D	841061	Outer Joint		27	23	56	99	60	I	
1.8 Turbo (99 kW)	1985.12-1990.05	-	-	-	Saloon Engine CA18T	841190	Outer Joint		27	25	56	103	66	I	
	1985.12-1990.05	-	-	-	Saloon Engine CA18T	841045	Outer Joint		27	23	56	103	62	I	
2.0 D (49 kW)	1986.03-1990.12	-	-	-	Saloon Engine LD20	841190	Outer Joint		27	25	56	103	66	I	
	1986.03-1990.12	-	-	F	Saloon Engine LD20	841061	Outer Joint		27	23	56	99	60	I	
	1986.03-1990.12	-	-	F	Saloon Engine LD20	841023	Outer Joint		27	23	56	103	61.5	M	
	1986.03-1990.12	-	-	-	Saloon Engine LD20	841045	Outer Joint		27	23	56	103	62	I	
	1986.03-1990.12	-	-	F	Saloon Engine LD20	841017	Outer Joint		27	22	56	103	61.5	M	
2.0 i (77 kW)	1985.12-1990.12	-	-	F	Saloon Engine CA20S/CA20E	841023	Outer Joint		27	23	56	103	61.5	M	
2.0 i (85 kW)	1988.09-1990.09	-	-	F	Saloon Engine CA20E	841061	Outer Joint		27	23	56	99	60	I	
2.0 LX (66 kW)	1985.12-1990.02	-	-	-	Saloon Engine CA20S	841045	Outer Joint		27	23	56	103	62	I	
BLUEBIRD (T72 T12)															
1.6 (61 kW)	1986.03-1990.06	-	-	F	Hatchback Engine CA16S	841061	Outer Joint		27	23	56	99	60	I	
	1986.03-1990.06	-	-	-	Hatchback Engine CA16S	841176	Outer Joint		27	23	56	104	63	I	
1.6 (66 kW)	1986.03-1991.06	-	-	F	Hatchback Engine CA16S	841061	Outer Joint		27	23	56	99	60	I	
	1986.03-1991.06	-	-	-	Hatchback Engine CA16S	841176	Outer Joint		27	23	56	104	63	I	
1.8 (65 kW)	1986.05-1992.11	-	-	F	Hatchback Engine CA18N	841023	Outer Joint		27	23	56	103	61.5	M	
	1987.01-1990.04	-	-	F	Hatchback Engine CA18N	841023	Outer Joint		27	23	56	103	61.5	M	
1.8 i 16V (95 kW)	1989.02-1990.12	-	-	-	Hatchback Engine CA18D	841176	Outer Joint		27	23	56	104	63	I	
1.8 Turbo (99 kW)	1985.12-1992.11	-	-	-	Hatchback Engine CA18T	841190	Outer Joint		27	25	56	103	66	I	
	1985.12-1992.11	-	-	-	Hatchback Engine CA18T	841045	Outer Joint		27	23	56	103	62	I	
2.0 D (49 kW)	1986.03-1990.12	-	-	-	Hatchback Engine LD20	841190	Outer Joint		27	25	56	103	66	I	
	1986.03-1990.12	-	-	F	Hatchback Engine LD20	841061	Outer Joint		27	23	56	99	60	I	
	1986.03-1990.12	MT	-	F	Hatchback Engine LD20	841023	Outer Joint		27	23	56	103	61.5	M	
	1986.03-1990.12	-	-	F	Hatchback Engine LD20	841017	Outer Joint		27	22	56	103	61.5	M	
2.0 i (77 kW)	1985.12-1990.12	-	-	-	Hatchback Engine CA20E	841176	Outer Joint		27	23	56	104	63	I	
	1985.12-1990.12	-	-	F	Hatchback Engine CA20E	841023	Outer Joint		27	23	56	103	61.5	M	
2.0 i (85 kW)	1988.09-1990.09	-	-	-	Hatchback Engine CA20E	841176	Outer Joint		27	23	56	104	63	I	

	 YEAR	TRANSM	L/R	F/R	REMARKS	GSP Ref.	 PRODUCT	 ABS	Technical Specifications					
									A	B	C	H	L	P
NISSAN														
BLUEBIRD (T72, T12)														
1.6 (61 kW)	1989.03-1990.06	MT/AT	-	-	-	841121	Outer Joint		27	23	56	104	63	I
1.6 (66 kW)	1989.03-1990.06	MT/AT	-	-	-	841121	Outer Joint		27	23	56	104	63	I
1.8 i 16V (95 kW)	1989.02-1990.12	MT	-	-	-	841121	Outer Joint		27	23	56	104	63	I
2.0 D (49 kW)	1986.03-1990.12	MT	-	-	-	841121	Outer Joint		27	23	56	104	63	I
2.0 i (85 kW)	1987.12-1990.12	MT	-	-	-	841121	Outer Joint		27	23	56	104	63	I
2.0 i Kat (77 kW)	1987.12-1990.12	MT	-	-	-	841121	Outer Joint		27	23	56	104	63	I
BLUEBIRD (U11)														
1.8 Turbo (99 kW)	1984.04-1990.05	-	-	F	Saloon Engine CA18T	841061	Outer Joint		27	23	56	99	60	I
	1984.04-1990.05	-	-	-	Saloon Engine CA18T	841190	Outer Joint		27	25	56	103	66	I
	1984.04-1990.05	-	-	-	Saloon Engine CA18T	841045	Outer Joint		27	23	56	103	62	I
BLUEBIRD (U11, WU11)														
1.8 Turbo (99 kW)	1985.10-	MT	-	-	-	841121	Outer Joint		27	23	56	104	63	I
BLUEBIRD (U13 U14)														
1.8 (92 kW)	1991.11-1997.03	-	-	-	Saloon Engine SR18DE	841106	Outer Joint		27	23	56	104	60	M
2.0 D (56 kW)	1997.04-2002.05	AT	-	F	Saloon Engine CD20	841189	Outer Joint	44T	27	23	56	103	58.5	M
2.4 i (112 kW)	1992.06-1997.05	-	-	F	Saloon Engine KA24DE	841307	Outer Joint		27	27	56	103	61.5	M
BLUEBIRD EU13														
1.8	1991.01-1996.01	MT/AT	-	-	Engine SR18DE	841306	Outer Joint		27	25	56	103	61.5	M
	1991.01-1996.01	MT	-	-	Engine SR18DE	841306	Outer Joint		27	25	56	103	61.5	M
1800	1991.01-1996.01	MT/AT	-	-	Engine SR18DE	841306	Outer Joint		27	25	56	103	61.5	M
	1991.01-1996.01	MT	-	-	Engine SR18DE	841306	Outer Joint		27	25	56	103	61.5	M
BLUEBIRD HU13														
2.0	1991.09-1995.11	AT	-	-	Engine SR20DE	841306	Outer Joint		27	25	56	103	61.5	M
	1991.09-1995.11	AT	-	-	Engine SR20DE	841306	Outer Joint		27	25	56	103	61.5	M
	1991.09-1995.11	MT	-	-	Engine SR20DE	841306	Outer Joint		27	25	56	103	61.5	M
	1991.09-1995.11	MT	-	-	Engine SR20DE	841306	Outer Joint		27	25	56	103	61.5	M
2000	1991.09-1995.11	AT	-	-	Engine SR20DE	841306	Outer Joint		27	25	56	103	61.5	M
	1991.09-1995.11	MT	-	-	Engine SR20DE	841306	Outer Joint		27	25	56	103	61.5	M
	1991.09-1995.11	AT	-	-	Engine SR20DE	841306	Outer Joint		27	25	56	103	61.5	M
	1991.09-1995.11	MT	-	-	Engine SR20DE	841306	Outer Joint		27	25	56	103	61.5	M
BLUEBIRD Station Wagon (WU11)														
2.0 (75 kW)	1986.04-1990.09	MT	L/R	F	Estate Engine CA20S	841163	Outer Joint		27	25	56	103	66.5	I
	1986.04-1990.09	-	-	-	Estate Engine CA20S	841190	Outer Joint		27	25	56	103	66	I
	1986.04-1990.09	-	-	F	Estate Engine CA20S	841023	Outer Joint		27	23	56	103	61.5	M
2.0 D (49 kW)	1986.03-1990.12	-	-	F	Estate Engine LD20	841035	Outer Joint		27	25	56	101	70	M
	1986.03-1990.12	-	-	-	Estate Engine LD20	841190	Outer Joint		27	25	56	103	66	I
	1986.03-1990.12	-	-	F	Estate Engine LD20	841061	Outer Joint		27	23	56	99	60	I
	1986.03-1990.12	MT	-	-	Estate Engine LD20	841176	Outer Joint		27	23	56	104	63	I
	1986.03-1990.12	-	-	F	Estate Engine LD20	841023	Outer Joint		27	23	56	103	61.5	M
2.0 i (77 kW)	1984.04-1990.12	MT	-	F	Estate Engine CA20E	841061	Outer Joint		27	23	56	99	60	I
	1984.04-1990.12	-	-	-	Estate Engine CA20E	841176	Outer Joint		27	23	56	104	63	I
	1984.04-1990.12	-	-	F	Estate Engine CA20E	841023	Outer Joint		27	23	56	103	61.5	M
2.0 i (85 kW)	1988.09-1990.09	-	-	-	Estate Engine CA20E	841045	Outer Joint		27	23	56	103	62	I
2.0 LX (66 kW)	1985.12-1990.02	-	-	-	Estate Engine CA20S	841045	Outer Joint		27	23	56	103	62	I
BLUEBIRD SYLPHY (G11E)														
1.5	2005.12-2009.05	4AT	-	-	Engine HR15DE	841303	Outer Joint		25	21	49	95	56	M
1.5 4WD	2005.12-2009.05	4AT	-	-	Engine HR15DE	841303	Outer Joint		25	21	49	95	56	M
2.0	2005.12-2007.05	CVT	-	-	-	841308	Outer Joint		25	23	49	95	56.5	M
BLUEBIRD SYLPHY G10														
-	2000.08-2005.12	-	R	F	-	841406	Outer Joint		25	22	55	107.5	57	I
	2000.08-2005.12	-	L	F	-	841406	Outer Joint		25	22	55	107.5	57	I
	2000.08-2005.12	-	R	F	-	641198	Inner Joint		24	23	40	51.7	100.4	
	2000.08-2005.12	-	L	F	-	641198	Inner Joint		24	23	40	51.7	100.4	
	2000.08-2005.12	-	R	F	-	241525	Drive Shaft	42T	25	24	55	107.5	922	
	2000.08-2005.12	-	L	F	-	241527	Drive Shaft	42T	25	24	55	107.5	632	
	2000.08-2005.12	-	R	F	-	841284	Outer Joint	42T	25	22	55	107.5	57	I
	2000.08-2005.12	-	L	F	-	841284	Outer Joint	42T	25	22	55	107.5	57	I
BLUEBIRD SYLPHY G11E														
1500	2005.12-2009.05	4AT	-	-	Engine HR15DE	841303	Outer Joint		25	21	49	95	56	M
	2005.12-2009.05	4AT	-	-	Allwheel Drive Engine HR15DE	841303	Outer Joint		25	21	49	95	56	M
2000	2005.12-2007.05	CVT	-	-	Engine MR20DE	841308	Outer Joint		25	23	49	95	56.5	M
CARAVAN HOMOY (E24)														
2.7 4WD	1987.10-2001.04	MT/AT	-	-	Engine TD27	841085	Outer Joint		26	27	50	148	60	M
	1988.10-1993.05	AT	-	-	Engine TD27T	841085	Outer Joint		26	27	50	148	60	M
	1988.10-1993.05	MT/AT	-	-	Engine TD27T	841085	Outer Joint		26	27	50	148	60	M

YEAR	TRANSM	L/R	F/R	REMARKS	GSP Ref.	PRODUCT	ABS	Technical Specifications						
								A	B	C	H	L	P	
NISSAN														
CARAVAN HOMOY (E24)														
2.7 4WD	1993.05-1995.08	4AT	-	-	Engine TD27TI	841085	Outer Joint		26	27	50	148	60	M
	1995.08-1997.05	4AT	-	-	Engine TD27ETI	841085	Outer Joint		26	27	50	148	60	M
3.2 4WD	1996.09-2001.04	MT/AT	-	-	Engine QD32	841085	Outer Joint		26	27	50	148	60	M
CARAVAN HOMOY E24														
2.7	1987.10-1993.05	MT/AT	-	-	Allwheel Drive Engine TD27	841085	Outer Joint		26	27	50	148	60	M
	1987.10-1993.05	MT/AT	-	-	Allwheel Drive Engine TD27	841085	Outer Joint		26	27	50	148	60	M
	1988.10-1993.05	MT/AT	-	-	Allwheel Drive Engine TD27T	841085	Outer Joint		26	27	50	148	60	M
	1988.10-1993.05	AT	-	-	Allwheel Drive Engine TD27T	841085	Outer Joint		26	27	50	148	60	M
	1993.05-2001.04	MT/AT	-	-	Allwheel Drive Engine TD27	841085	Outer Joint		26	27	50	148	60	M
	1993.05-1995.08	4AT	-	-	Allwheel Drive Engine TD27TI	841085	Outer Joint		26	27	50	148	60	M
	1995.08-1997.05	4AT	-	-	Allwheel Drive Engine TD27ETI	841085	Outer Joint		26	27	50	148	60	M
2700	1987.10-1993.05	MT/AT	-	-	Allwheel Drive Engine TD27	841085	Outer Joint		26	27	50	148	60	M
	1987.10-1993.05	MT/AT	-	-	Allwheel Drive Engine TD27	841085	Outer Joint		26	27	50	148	60	M
	1988.10-1993.05	MT/AT	-	-	Allwheel Drive Engine TD27T	841085	Outer Joint		26	27	50	148	60	M
	1988.10-1993.05	AT	-	-	Allwheel Drive Engine TD27T	841085	Outer Joint		26	27	50	148	60	M
	1988.10-1993.05	MT/AT	-	-	Allwheel Drive Engine TD27T	841085	Outer Joint		26	27	50	148	60	M
	1988.10-1993.05	AT	-	-	Allwheel Drive Engine TD27T	841085	Outer Joint		26	27	50	148	60	M
	1993.05-2001.04	MT/AT	-	-	Allwheel Drive Engine TD27	841085	Outer Joint		26	27	50	148	60	M
	1993.05-1995.08	4AT	-	-	Allwheel Drive Engine TD27TI	841085	Outer Joint		26	27	50	148	60	M
	1995.08-1997.05	4AT	-	-	Allwheel Drive Engine TD27ETI	841085	Outer Joint		26	27	50	148	60	M
3.2	1996.09-2001.04	MT/AT	-	-	Allwheel Drive Engine QD32	841085	Outer Joint		26	27	50	148	60	M
3200	1996.09-2001.04	MT/AT	-	-	Allwheel Drive Engine QD32	841085	Outer Joint		26	27	50	148	60	M
CEDRIC (Y32)														
2.8 TD (69 kW)	1991.06-1995.10	AT	-	-	Saloon Engine RD28	641014	Inner Joint			27		81.2		
CEDRIC X (Y34)														
2.5 (147 kW)	2000.05-2004.08	AT	-	-	Saloon Engine VQ25DD	641014	Inner Joint			27		81.2		
2.5 Turbo (188 kW)	1999.05-2004.08	AT	-	-	All-wheel Drive Saloon Engine RB25DET	641014	Inner Joint			27		81.2		
CEFIRO II (A32)														
2.0 (103 kW)	1994.10-1999.12	-	-	-	Saloon Engine VQ20DE	841131	Outer Joint		29	25	56	103	65.5	I
	1994.10-1999.12	-	R	F	Saloon Engine VQ20DE	641019	Inner Joint		29	27	33	437.5	101	
	1994.10-1999.12	AT	L	F	Saloon Engine VQ20DE	641062	Inner Joint		29	27	39	65.5	114.5	
2.5 (140 kW)	1994.10-1999.12	-	R	F	Saloon Engine VQ25DE	641019	Inner Joint		29	27	33	437.5	101	
3.0 (142 kW)	1994.10-1999.12	-	R	F	Saloon Engine VQ30DE	641019	Inner Joint		29	27	33	437.5	101	
	1994.10-1999.12	AT	L	F	Saloon Engine VQ30DE	641062	Inner Joint		29	27	39	65.5	114.5	
CEFIRO III (A33)														
2.0 (103 kW)	2000.01-2003.09	-	R	F	Saloon Engine VQ20DE	641019	Inner Joint		29	27	33	437.5	101	
3.0 (147 kW)	2000.01-2003.09	-	R	F	Saloon Engine VQ30DE	641019	Inner Joint		29	27	33	437.5	101	
CEFIRO J30														
3.0	1989-1991	-	-	-	Engine VG30E	841075	Outer Joint		27	25	56	103	70.5	I
CEFIRO MAXIMA (A33)														
2.0	1998.12-2002.12	4AT	-	-	Engine VQ20DE	841111	Outer Joint		29	25	56	101	68	M
	1998.12-2002.12	5MT	-	-	Engine VQ20DE	841111	Outer Joint		29	25	56	101	68	M
2.5	1998.12-2002.12	4AT	-	-	Engine VQ25DD	841111	Outer Joint		29	25	56	101	68	M
CEFIRO MAXIMA (PA33)														
2.5	1998.12-2001.01	4AT	-	-	Engine VQ25DD	841111	Outer Joint		29	25	56	101	68	M
CLASSIC(B10)														
1.6 16V	2006-2013	MT	R	F	-	241443	Drive Shaft		25	24	55	100.5	914	
CUBE														
-	2009.02-	CVT	R	F	ENGINE : MR18DE 2WD	241535	Drive Shaft		25	25	49	94.5	920	
	2009.02-	CVT	R	F	ENGINE : MR18DE 2WD	641186	Inner Joint		25	22	33	348	90	
	2009.02-	CVT	-	-	ENGINE : MR18DE 2WD	241535	Drive Shaft		25	25	49	94.5	920	
	2009.02-	CVT	-	-	ENGINE : MR18DE 2WD	241535	Drive Shaft		25	25	49	94.5	920	
	2010.10-	CVT	-	-	ENGINE : MR18DE 2WD	241535	Drive Shaft		25	25	49	94.5	920	
	2010.10-	CVT	-	-	ENGINE : MR18DE 2WD	241535	Drive Shaft		25	25	49	94.5	920	
1.8	2009-2014	AT	L	F	FWD	241514	Drive Shaft		25	25	49	94.5	642	
CUBE (Z10)														
1.3 (55 kW)	1998.03-2000.08	-	-	F	Hatchback Engine CG13DE	841154	Outer Joint	42T	23	19	48	93	53.5	M
1.3 (63 kW)	2000.09-2002.12	-	-	-	Hatchback Engine CGA3DE	841154	Outer Joint	42T	23	19	48	93	53.5	M
	2000.09-2002.12	-	-	-	All-wheel Drive Hatchback Engine CGA3DE	841154	Outer Joint	42T	23	19	48	93	53.5	M
1.3 (74 kW)	2000.09-2002.12	-	-	-	Hatchback Engine CGA3DE	841154	Outer Joint	42T	23	19	48	93	53.5	M
	2000.09-2002.12	-	-	-	All-wheel Drive Hatchback Engine CGA3DE	841154	Outer Joint	42T	23	19	48	93	53.5	M
CUBE (Z11)														
1.4 (72 kW)	2003.01-2005.09	AT	-	F	Hatchback Engine CR14DE	841304	Outer Joint		25	29	49	95	56	I
1.5 (80 kW)	2003.01-2005.09	AT	-	F	Hatchback Engine HR15DE	841304	Outer Joint		25	29	49	95	56	I
CUBE (Z12)														

YEAR	TRANSM	L/R	F/R	REMARKS	GSP Ref.	PRODUCT	ABS	Technical Specifications							
								A	B	C	H	L	P		
NISSAN															
CUBE (Z12)															
1.6 16V (81 kW)	2010.03-	-	MT	L F	Hatchback Engine HR16DE	241366	Drive Shaft		25	26	49.1	95	658		
	2010.03-	-	CVT	- F	Hatchback Engine HR16DE	841289	Outer Joint		25	29	49.1	94.5	53	I	
	2010.03-	-	AT	- F	Hatchback Engine HR16DE	841304	Outer Joint		25	29	49	95	56	I	
CUBE Z11															
-	2002.10-	-	-	-	-	841224	Outer Joint		25	29	49	95	56	I	
CUBE Z12															
-	2009.02-	2014	-	L F	-	641112	Inner Joint		26	23	40	64	104.5		
	2009.02-	2014	-	L F	-	841272	Outer Joint		25	23	49	95	62.5	M	
1.8	2009.02-	2014	-	R F	-	641106	Inner Joint		26	23	33	343	91		
	2009.02-	2014	-	R F	-	841272	Outer Joint		25	23	49	95	62.5	M	
	2009.02-	2014	-	R F	-	241346	Drive Shaft		25	26	49	95	913		
	2009.02-	2014	-	L F	-	241347	Drive Shaft		25	26	49	95	648		
DATSUN (D21)															
2.0 4WD	1985.01-	1989.01	MT/AT	-	Engine Z20	841051	Outer Joint		27	27	50	151	71	M	
	1987.08-	1989.09	MT	-	Engine Z20	841085	Outer Joint		26	27	50	148	60	M	
	1989.09-	1993.10	MT	-	Engine NA20S	841085	Outer Joint		26	27	50	148	60	M	
2.3 4WD	1987.08-	1992.08	MT	-	Engine TD23	841085	Outer Joint		26	27	50	148	60	M	
2.7 4WD	1988.11-	1993.10	MT/AT	-	Engine TD27	841085	Outer Joint		26	27	50	148	60	M	
DATSUN D21															
2.0	1985.01-	1989.01	MT/AT	-	Allwheel Drive Engine Z20	841051	Outer Joint		27	27	50	151	71	M	
	1987.08-	1989.09	MT	-	Allwheel Drive Engine Z20	841085	Outer Joint		26	27	50	148	60	M	
	1989.09-	1993.10	MT	-	Allwheel Drive Engine NA20S	841085	Outer Joint		26	27	50	148	60	M	
2.3	1987.08-	1992.08	MT	-	Allwheel Drive Engine TD23	841085	Outer Joint		26	27	50	148	60	M	
2.7	1988.11-	1993.10	MT/AT	-	Allwheel Drive Engine TD27	841085	Outer Joint		26	27	50	148	60	M	
2000	1985.01-	1989.01	MT/AT	-	Allwheel Drive Engine Z20	841051	Outer Joint		27	27	50	151	71	M	
	1987.08-	1989.09	MT	-	Allwheel Drive Engine Z20	841085	Outer Joint		26	27	50	148	60	M	
	1989.09-	1993.10	MT	-	Allwheel Drive Engine NA20S	841085	Outer Joint		26	27	50	148	60	M	
2300	1987.08-	1992.08	MT	-	Allwheel Drive Engine TD23	841085	Outer Joint		26	27	50	148	60	M	
2700	1988.11-	1993.10	MT/AT	-	Allwheel Drive Engine TD27	841085	Outer Joint		26	27	50	148	60	M	
DNT31															
2.0	2009.11-	2010.07	6MT	R	Allwheel Drive Engine M9R	841312	Outer Joint		29	36	56.3	102.5	69	M	
	2010.07-	-	6AT	R	Allwheel Drive Engine M9R	841312	Outer Joint		29	36	56.3	102.5	69	M	
	2010.07-	-	6MT	R	Allwheel Drive Engine M9R	841312	Outer Joint		29	36	56.3	102.5	69	M	
DUALIS (KJ10)															
2.0	2007-	-	CVT	-	Engine MR20DE	841311	Outer Joint		29	35	56	102.5	59	I	
DUALIS (KNJ10)															
2.0 4WD	2007-	-	CVT	-	Engine MR20DE	841311	Outer Joint		29	35	56	102.5	59	I	
DUALIS(JP) J10															
-	2007.12-	-	-	R F	-	641113	Inner Joint		27	33	33	323	109.5		
	2007.12-	-	-	R F	-	241524	Drive Shaft		29	27	56.1	102	941		
E51															
3.5	2007.10-	2010.08	5AT	R	Engine VQ35DE	841336	Outer Joint		29	25	67	120.5	70.5	M	
ELGRAND (E50)															
3.0 D AWD (113 kW)	1999.08-	2000.08	AT	- F	All-wheel Drive MPV Engine ZD30DDTi	841016	Outer Joint		28	27	50	150	71	I	
	1999.08-	2000.08	AT	- F	All-wheel Drive MPV Engine ZD30DDTi	841100	Outer Joint		28	25	50	150	71	I	
	1999.08-	2000.08	AT	-	All-wheel Drive MPV Engine ZD30DDTi	641014	Inner Joint			27		81.2			
3.0 D AWD (125 kW)	1999.08-	2002.04	AT	- F	All-wheel Drive MPV	841016	Outer Joint		28	27	50	150	71	I	
	1999.08-	2002.04	AT	- F	All-wheel Drive MPV	841100	Outer Joint		28	25	50	150	71	I	
	1999.08-	2002.04	AT	-	All-wheel Drive MPV	641014	Inner Joint			27		81.2			
3.2 D (110 kW)	1995.10-	2001.08	AT	- F	All-wheel Drive MPV Engine QD32ETI	841016	Outer Joint		28	27	50	150	71	I	
	1995.10-	2001.08	AT	-	All-wheel Drive MPV Engine QD32ETI	641014	Inner Joint			27		81.2			
3.3 (125 kW)	1996.04-	2001.08	AT	- F	All-wheel Drive MPV Engine VG33E	841016	Outer Joint		28	27	50	150	71	I	
	1996.04-	2001.08	AT	- F	All-wheel Drive MPV Engine VG33E	841100	Outer Joint		28	25	50	150	71	I	
	1996.04-	2001.08	AT	-	All-wheel Drive MPV Engine VG33E	641014	Inner Joint			27		81.2			
3.5 AWD (177 kW)	2000.08-	2002.04	AT	- F	All-wheel Drive MPV Engine VQ35DE	841016	Outer Joint		28	27	50	150	71	I	
	2000.08-	2002.04	AT	- F	All-wheel Drive MPV Engine VQ35DE	841100	Outer Joint		28	25	50	150	71	I	
	2000.08-	2002.04	AT	-	All-wheel Drive MPV Engine VQ35DE	641014	Inner Joint			27		81.2			
ELGRAND (E51)															
2.5 AWD (137 kW)	2004.12-	2010.12	AT	-	All-wheel Drive MPV Engine VQ25DE	641014	Inner Joint			27		81.2			
3.5 AWD (177 kW)	2002.05-	2010.12	AT	-	All-wheel Drive MPV Engine VQ35DE	641014	Inner Joint			27		81.2			
ELGRAND (E52)															
3.5 (206 kW)	2010.11-	-	AT	R F	MPV Engine VQ35DE	641208	Inner Joint		29	27	33	459	99		
ELGRAND E52															
-	2010.08-	-	-	L F	2WD/ENGINE:VQ35DE	641183	Inner Joint		29	27	39	65.5	115		
	2010.08-	-	-	L F	2WD/ENGINE:VQ35DE	241515	Drive Shaft		32	29	56.3	103	670		

	 YEAR	TRANSM	L/R	F/R	REMARKS	GSP Ref.	 PRODUCT	 ABS	Technical Specifications					
									A	B	C	H	L	P
NISSAN														
EXA (KEN13)														
1.6 4WD	1986.10-1990.07	MT/AT	-	-	Engine CA16DE	899204	Outer Joint		25	25	52.3	106.5	62	M
EXA KEN13														
1.6	1986.10-1990.07	AT	-	-	Allwheel Drive Engine CA16DE	899204	Outer Joint		25	25	52.3	106.5	62	M
	1986.10-1990.07	MT	-	-	Allwheel Drive Engine CA16DE	899204	Outer Joint		25	25	52.3	106.5	62	M
1600	1986.10-1990.07	AT	-	-	Allwheel Drive Engine CA16DE	899204	Outer Joint		25	25	52.3	106.5	62	M
	1986.10-1990.07	MT	-	-	Allwheel Drive Engine CA16DE	899204	Outer Joint		25	25	52.3	106.5	62	M
EXPERT II (W11)														
1.8 (92 kW)	1998.10-2004.04	-	-	-	Estate Engine QG18DE	841106	Outer Joint		27	23	56	104	60	M
FIGARO (FK10)														
1.0 (56 kW)	1991.02-1992.04	AT	-	F	Coupe Engine MA10ET	841090	Outer Joint		23	19	48	93	53.5	M
INTERSTAR														
dCi 120 (84 kW)	2003.08-	MT	R	F	Platform/Chassis Engine G9U 720	650006	Inner Joint		39	27	35	437	98	
	2003.08-	MT	R	F	Platform/Chassis Engine G9U 720	250066	Drive Shaft		28	39	65	96	1142	
INTERSTAR (X70)														
1.9 dCi 80 (60 kW)	2002.07-	MT	R	F	Box Engine F9Q 772	244021	Drive Shaft		28	39	65	96	1126	
	2002.07-	MT	R	F	Bus Engine F9Q 772	244021	Drive Shaft		28	39	65	96	1126	
2.5 dCi 100 (73 kW)	2003.11-	-	R	F	Box Engine G9U 720	250066	Drive Shaft		28	39	65	96	1142	
	2003.11-	-	R	F	Bus Engine G9U 720	250066	Drive Shaft		28	39	65	96	1142	
	2003.11-	MT	R	F	Box Engine G9U 720	650006	Inner Joint		39	27	35	437	98	
2.5 dCi 100 (74 kW)	2006.04-	MT	R	F	Box Engine G9U 720	650006	Inner Joint		39	27	35	437	98	
	2006.04-	-	R	F	Box Engine G9U 720	250066	Drive Shaft		28	39	65	96	1142	
2.5 dCi 120 (84 kW)	2002.07-	-	R	F	Box Engine G9U 720	250066	Drive Shaft		28	39	65	96	1142	
	2002.07-2006.08	MT	R	F	Bus Engine G9U 720	250066	Drive Shaft		28	39	65	96	1142	
	2002.07-2006.08	MT	R	F	Bus Engine G9U 720	650006	Inner Joint		39	27	35	437	98	
2.5 dCi 120 (88 kW)	2006.09-	MT	R	F	Box Engine G9U 650	650006	Inner Joint		39	27	35	437	98	
	2006.09-	-	R	F	Box Engine G9U 650	250066	Drive Shaft		28	39	65	96	1142	
JUKE (F15)														
1.2 DIG-T (85 kW)	2014.05-	MT	L	F	Hatchback Engine HR12DDT	241490	Drive Shaft		29	26	56.2	102.5	695	
	2014.05-	MT	R	F	Hatchback Engine HR12DDT	241487	Drive Shaft		29	26	56.2	102.5	942	
	2014.05-	MT	R	F	Hatchback Engine HR12DDT	641173	Inner Joint		26	24	33	343	99	
	2014.05-	MT	L	F	Hatchback Engine HR12DDT	641174	Inner Joint		26	24	40	64	110	
1.5 dCi (81 kW)	2010.06-	-	-	F	Hatchback Engine K9K 636/K9K 410/K9K 896	859425	Outer Joint		29	26	56	103	69	M
	2010.06-	-	R	F	Hatchback Engine K9K 636/K9K 410/K9K 896	218414	Drive Shaft		29	26	56	103	944	
	2010.06-	-	L	F	Hatchback Engine K9K 636/K9K 410/K9K 896	218361	Drive Shaft		29	26	56	103	693	
1.6	2010.11-	CVT	-	-	Engine MR16DDT	841309	Outer Joint		29	26	56.3	102.5	69	M
1.6 (69 kW)	2013.01-	AT	-	F	Hatchback Engine HR16DE	841343	Outer Joint		29	22	56.2	102	59	M
	2013.01-	MT	R	F	Hatchback Engine HR16DE	241428	Drive Shaft		29	26	56.2	102	938.5	
1.6 (86 kW)	2010.06-	CVT	-	F	Hatchback Engine HR16DE	841279	Outer Joint		29	22	56.2	102	59	M
	2010.06-	AT	-	F	Hatchback Engine HR16DE	841343	Outer Joint		29	22	56.2	102	59	M
	2010.06-	MT	R	F	Hatchback Engine HR16DE	241428	Drive Shaft		29	26	56.2	102	938.5	
	2010.06-	MT	L	F	All-wheel Drive Hatchback Engine MR16DDT	218362	Drive Shaft		29	26	56	103	684	
1.6 DIG-T (140 kW)	2010.06-	MT	L	F	Hatchback Engine MR16DDT	218362	Drive Shaft		29	26	56	103	684	
	2010.06-	MT	R	F	All-wheel Drive Hatchback Engine MR16DDT	218365	Drive Shaft		29	26	56	103	950	
	2010.06-	MT	R	F	Hatchback Engine MR16DDT	218365	Drive Shaft		29	26	56	103	950	
	2010.06-	-	-	F	Hatchback Engine MR16DDT	859425	Outer Joint		29	26	56	103	69	M
	2010.06-	-	-	F	All-wheel Drive Hatchback Engine MR16DDT	841294	Outer Joint		29	24	56.2	102	63	M
	2010.06-	MT	-	F	Hatchback Engine MR16DDT	841214	Outer Joint		29	35	56.1	102	59	I
1.6 DIG-T NISMO (147 kW)	2013.03-2014.07	MT	-	F	Hatchback Engine MR16DDT	841214	Outer Joint		29	35	56.1	102	59	I
1.6 DIG-T NISMO RS (160 kW)	2014.08-	MT	L	F	Hatchback Engine MR16DDT	218362	Drive Shaft		29	26	56	103	684	
	2014.08-	MT	R	F	Hatchback Engine MR16DDT	218365	Drive Shaft		29	26	56	103	950	
	2014.08-	MT	-	F	Hatchback Engine MR16DDT	841214	Outer Joint		29	35	56.1	102	59	I
	2014.08-	AT	R	F	Hatchback Engine MR16DDT	601146	Inner Joint		27	26	33	322	107	
	2014.08-	AT	R	F	Hatchback Engine MR16DDT	201238	Drive Shaft		29	27	56	103	939	
	2014.08-	AT	L	F	Hatchback Engine MR16DDT	241506	Drive Shaft		29	27	56	103	690	
	2014.08-	AT	R	F	Hatchback Engine MR16DDT	201238	Drive Shaft		29	27	56	103	939	
	2014.08-	AT	L	F	Hatchback Engine MR16DDT	241506	Drive Shaft		29	27	56	103	690	
JUKE SL														
1.6 L4-GAS	2012-2016	-	L	-	-	841401	Outer Joint		29	26	56	103	69	I
	2012-2016	-	L	-	-	641199	Inner Joint		27	26	40	62.5	107	
	2012-2016	-	L	-	-	241506	Drive Shaft		29	27	56	103	690	
JUKE YF15														
-	2011.06-	CVT	R	F	-	841399	Outer Joint		29	22	56.2	102	59	M
	2011.06-	-	L	F	-	841399	Outer Joint		29	22	56.2	102	59	M
	2011.06-	CVT	R	F	-	641179	Inner Joint		25	22	40	53	117.5	
	2011.06-	-	L	F	-	641179	Inner Joint		25	22	40	53	117.5	
	2011.06-	CVT	R	F	-	241483	Drive Shaft		29	25	56.2	102	940	

YEAR	TRANSM	L/R	F/R	REMARKS	GSP Ref.	PRODUCT	ABS	Technical Specifications							
								A	B	C	H	L	P		
NISSAN															
JUKE YF15															
-	2011.06-	-	-	L F -		241484	Drive Shaft		29	25	56.2	102	693		
KUBISTAR (X76)															
1.2 (44 kW)	2003.08-	-	MT	R F	Box Engine D7F 764	299072	Drive Shaft	44T	21	23	57	84.5	720		
	2003.08-	-	MT	L/R F	Box Engine D7F 764	850069	Outer Joint	44T	23	30	57.5	86.5	58.5	I	
	2003.08-	-	MT	L F	Box Engine D7F 764	299073	Drive Shaft	44T	21	29.95	57	84.5	628		
1.2 16V (55 kW)	2006.04-	-	MT	R F	Box Engine D4F 712	299072	Drive Shaft	44T	21	23	57	84.5	720		
	2006.04-	-	MT	L/R F	Box Engine D4F 712	850069	Outer Joint	44T	23	30	57.5	86.5	58.5	I	
	2006.04-	-	MT	L F	Box Engine D4F 712	299073	Drive Shaft	44T	21	29.95	57	84.5	628		
1.5 dCi (45 kW)	2005.08-	-	MT	R F	Box Engine K9K 714	250146	Drive Shaft		21	23	57	84.5	732.5		
	2005.08-	-	MT	L/R F	Box Engine K9K 714	850069	Outer Joint	44T	23	30	57.5	86.5	58.5	I	
	2005.08-	-	-	- F	Box Engine K9K 714	850052	Outer Joint	44T	23	30	57.5	86.5	58.5	I	
	2005.08-	-	MT	R F	Box Engine K9K 714	699169	Inner Joint		26	30	33	326	95		
	2005.08-	-	MT	L F	Box Engine K9K 714	250109	Drive Shaft	26T	21	29.95	57	84.5	625.7		
	2005.08-	-	MT	R F	Box Engine K9K 714	250364	Drive Shaft	44T	23	26	57.5	86.5	866		
	2005.08-	-	MT	R F	Box Engine K9K 714	250250	Drive Shaft	26T	21	23	57	84.5	732.5		
	2005.08-	-	MT	L F	Box Engine K9K 714	299073	Drive Shaft	44T	21	29.95	57	84.5	628		
	2005.08-	-	MT	L F	Box Engine K9K 714	250177	Drive Shaft		21	29.95	57	84.5	625.7		
	2005.08-	-	MT	R F	Box Engine K9K 714	299072	Drive Shaft	44T	21	23	57	84.5	720		
1.5 dCi (48 kW)	2003.08-	-	MT	R F	Box Engine K9K 704	299072	Drive Shaft	44T	21	23	57	84.5	720		
	2003.08-	-	MT	L/R F	Box Engine K9K 704	850069	Outer Joint	44T	23	30	57.5	86.5	58.5	I	
	2003.08-	-	MT	L F	Box Engine K9K 704	299073	Drive Shaft	44T	21	29.95	57	84.5	628		
1.5 dCi (60 kW)	2003.08-	-	MT	L/R F	Box Engine K9K 722	850069	Outer Joint	44T	23	30	57.5	86.5	58.5	I	
1.5 dCi 70 (50 kW)	2006.04-	2010.03	MT	L F	Box Engine K9K 716	250177	Drive Shaft		21	29.95	57	84.5	625.7		
	2006.04-	2010.03	MT	R F	Box Engine K9K 716	299072	Drive Shaft	44T	21	23	57	84.5	720		
	2006.04-	2010.03	MT	R F	Box Engine K9K 716	250146	Drive Shaft		21	23	57	84.5	732.5		
	2006.04-	2010.03	-	- F	Box Engine K9K 716	850052	Outer Joint	44T	23	30	57.5	86.5	58.5	I	
	2006.04-	2010.03	MT	R F	Box Engine K9K 716	699169	Inner Joint		26	30	33	326	95		
	2006.04-	2010.03	MT	R F	Box Engine K9K 716	250364	Drive Shaft	44T	23	26	57.5	86.5	866		
	2006.04-	2010.03	MT	L F	Box Engine K9K 716	250109	Drive Shaft	26T	21	29.95	57	84.5	625.7		
	2006.04-	2010.03	MT	R F	Box Engine K9K 716	250250	Drive Shaft	26T	21	23	57	84.5	732.5		
	2006.04-	2010.03	MT	L F	Box Engine K9K 716	299073	Drive Shaft	44T	21	29.95	57	84.5	628		
LANGLEY LIVERTAVILLA (BEN13)															
1.6	1986.10-	1990.07	MT/AT	-	Engine CA16	899204	Outer Joint		25	25	52.3	106.5	62	M	
LANGLEY LIVERTAVILLA BEN13															
1.6	1986.10-	1990.07	AT	-	Engine CA16	899204	Outer Joint		25	25	52.3	106.5	62	M	
	1986.10-	1990.07	MT	-	Engine CA16	899204	Outer Joint		25	25	52.3	106.5	62	M	
1600	1986.10-	1990.07	AT	-	Engine CA16	899204	Outer Joint		25	25	52.3	106.5	62	M	
	1986.10-	1990.07	MT	-	Engine CA16	899204	Outer Joint		25	25	52.3	106.5	62	M	
LARGO (C22)															
2.0 4WD	1986.11-	1993.04	MT/AT	-	Engine CA20/LD20T	841085	Outer Joint		26	27	50	148	60	M	
	1986.11-	1993.04	MT	-	Engine LD20	841085	Outer Joint		26	27	50	148	60	M	
LARGO C22															
1.8	1996.05-	1993.04	MT/AT	-	Allwheel Drive Engine CA18ET	841085	Outer Joint		26	27	50	148	60	M	
1800	1996.05-	1993.04	MT/AT	-	Allwheel Drive Engine CA18ET	841085	Outer Joint		26	27	50	148	60	M	
2.0	1986.11-	1993.04	MT/AT	-	Allwheel Drive Engine CA20	841085	Outer Joint		26	27	50	148	60	M	
	1986.11-	1993.04	MT	-	Allwheel Drive Engine LD20	841085	Outer Joint		26	27	50	148	60	M	
	1986.11-	1993.04	MT/AT	-	Allwheel Drive Engine LD20T	841085	Outer Joint		26	27	50	148	60	M	
2000	1986.11-	1993.04	MT/AT	-	Allwheel Drive Engine CA20	841085	Outer Joint		26	27	50	148	60	M	
	1986.11-	1993.04	MT	-	Allwheel Drive Engine LD20	841085	Outer Joint		26	27	50	148	60	M	
	1986.11-	1993.04	MT/AT	-	Allwheel Drive Engine LD20T	841085	Outer Joint		26	27	50	148	60	M	
LATIO															
-	2008.06-	-	AT	-	ENGINE : MR18DE	241291	Drive Shaft		25	25	49	95	911		
	2008.06-	-	AT	-	ENGINE : MR18DE	241291	Drive Shaft		25	25	49	95	911		
LATIO (JY12)															
1.8	2005.01-	-	MT/AT	-	-	841308	Outer Joint		25	23	49	95	56.5	M	
LATIO (ZE11)															
1.6	2005.01-	-	4AT	-	Engine HR16DE	841302	Outer Joint		25	22	49	95	56	M	
	2005.01-	-	5MT	-	Engine HR16DE	841302	Outer Joint		25	22	49	95	56	M	
LATIO JY12															
1.8	2005.01-	-	MT/AT	-	Engine MR18DE	841308	Outer Joint		25	23	49	95	56.5	M	
1800	2005.01-	-	MT/AT	-	Engine MR18DE	841308	Outer Joint		25	23	49	95	56.5	M	
LATIO ZE11															
1.6	2005.01-	-	4AT	-	Engine HR16DE	841302	Outer Joint		25	22	49	95	56	M	
	2005.01-	-	5MT	-	Engine HR16DE	841302	Outer Joint		25	22	49	95	56	M	
1600	2005.01-	-	4AT	-	Engine HR16DE	841302	Outer Joint		25	22	49	95	56	M	
	2005.01-	-	5MT	-	Engine HR16DE	841302	Outer Joint		25	22	49	95	56	M	





YEAR	TRANS	L/R	F/R	REMARKS	GSP Ref.	PRODUCT	ABS	Technical Specifications							
								A	B	C	H	L	P		
NISSAN LATIO (SC11)															
-	2006.04-	2012.06	AT	R	F	ENGINE : HR16DE/SEDAN/GR1/BP TYPE GRADE	241291	Drive Shaft		25	25	49	95	911	
LAUREL															
1.6	1990-	-	-	-	R	B13 GA13 GA16DE GA16DS	641002	Inner Joint		25	23	40	63	101	
LAUREL SPIRIT (EB12)															
1.6	1986.08-	1990.03	MT/AT	-	-	Engine CA16D	899204	Outer Joint		25	25	52.3	106.5	62	M
LAUREL SPIRIT EB12															
1.6	1986.08-	1990.03	AT	-	-	Engine CA16D	899204	Outer Joint		25	25	52.3	106.5	62	M
	1986.08-	1990.03	MT	-	-	Engine CA16D	899204	Outer Joint		25	25	52.3	106.5	62	M
1600	1986.08-	1990.03	AT	-	-	Engine CA16D	899204	Outer Joint		25	25	52.3	106.5	62	M
	1986.08-	1990.03	MT	-	-	Engine CA16D	899204	Outer Joint		25	25	52.3	106.5	62	M
LEAF (ZE0)															
(80 kW)	2010.11-	-	-	-	L	F	Hatchback Engine EM61	641175	Inner Joint		25	24	40	63	105.5
	2010.11-	-	-	-	R	F	Hatchback Engine EM61	641176	Inner Joint		25	24	33	188	93
	2010.11-	-	-	-	L	F	Hatchback Engine EM61	241493	Drive Shaft		29	25	56.2	102	758
	2010.11-	-	-	-	R	F	Hatchback Engine EM61	241494	Drive Shaft		29	25	56.2	102	871
	2010.11-	-	-	-	L	F	Hatchback Engine EM61	241493	Drive Shaft		29	25	56.2	102	758
	2010.11-	-	-	-	R	F	Hatchback Engine EM61	241494	Drive Shaft		29	25	56.2	102	871
LIVINA															
1.6 (80 kW)	2007.04-	2010.03	AT	L	-	Hatchback Engine HR16DE	241202	Drive Shaft		25	25	49	94	660	
	2007.04-	2010.03	AT	R	-	Hatchback Engine HR16DE	241203	Drive Shaft		25	25	49	94	903	
	2007.04-	2010.03	MT	L	-	Hatchback Engine HR16DE	241427	Drive Shaft		29	26	56.1	102	685	
LIVINA BRA MAKE(L10B)															
1.8	2009.01-	2012.01	4AT	L	F	-	241554	Drive Shaft		25	26	49	94.5	658	
	2009.01-	2012.01	4AT	L	F	-	641202	Inner Joint		26	22	40	64	98	
LIVINA BRA MAKE(L10BB)															
1.8	2012.01-	2014.10	6MT	L	F	-	241554	Drive Shaft		25	26	49	94.5	658	
	2012.01-	2014.10	6MT	L	F	-	641202	Inner Joint		26	22	40	64	98	
MARCH															
-	2012-	2013	MT	L/R	-	-	641130	Inner Joint		26	22	39.97	64	98.5	
MARCH MICRA HK11															
1.3	1992.01-	-	MT/CVT	-	-	Engine CG13DE	841156	Outer Joint	42T	23	22	48	92.5	56.5	M
	1992.01-	1995.12	MT/AT	-	-	Engine CG13DE	841156	Outer Joint	42T	23	22	48	92.5	56.5	M
	1992.01-	1997.05	MT/ATVT	-	-	Engine CG13DE	841156	Outer Joint	42T	23	22	48	92.5	56.5	M
1300	1992.01-	-	MT/CVT	-	-	Engine CG13DE	841156	Outer Joint	42T	23	22	48	92.5	56.5	M
	1992.01-	1995.12	MT/AT	-	-	Engine CG13DE	841156	Outer Joint	42T	23	22	48	92.5	56.5	M
	1992.01-	1997.05	MT/ATV	-	-	Engine CG13DE	841156	Outer Joint	42T	23	22	48	92.5	56.5	M
MARCH MICRA K10															
1.0	1983.10-	1989.01	MT/AT	-	-	Engine MA10S	841291	Outer Joint		21	19	48	97	53.5	M
	1983.10-	1989.01	AT	-	-	Engine MA10S	841291	Outer Joint		21	19	48	97	53.5	M
	1983.10-	1989.01	MT	-	-	Engine MA10S	841291	Outer Joint		21	19	48	97	53.5	M
1000	1983.10-	1989.01	MT/AT	-	-	Engine MA10S	841291	Outer Joint		21	19	48	97	53.5	M
	1983.10-	1989.01	AT	-	-	Engine MA10S	841291	Outer Joint		21	19	48	97	53.5	M
	1983.10-	1989.01	MT	-	-	Engine MA10S	841291	Outer Joint		21	19	48	97	53.5	M
MARCH MICRA K11															
1.0	1992.01-	-	CVT	-	-	Engine CG10DE	841156	Outer Joint	42T	23	22	48	92.5	56.5	M
	1992.01-	1997.05	MT/ATVT	-	-	Engine CG10DE	841156	Outer Joint	42T	23	22	48	92.5	56.5	M
1000	1992.01-	-	CVT	-	-	Engine CG10DE	841156	Outer Joint	42T	23	22	48	92.5	56.5	M
	1992.01-	1997.05	MT/ATV	-	-	Engine CG10DE	841156	Outer Joint	42T	23	22	48	92.5	56.5	M
MARCH/MICRA (HK11)															
1.3	1992.01-	1997.05	MT/ATVT	-	-	Engine CG13DE	841156	Outer Joint	42T	23	22	48	92.5	56.5	M
	1992.01-	1995.12	MT/AT	-	-	Engine CG13DE	841156	Outer Joint	42T	23	22	48	92.5	56.5	M
	1992.01-	-	MT/CVT	-	-	Engine CG13DE	841156	Outer Joint	42T	23	22	48	92.5	56.5	M
MARCH/MICRA (K10)															
1.0	1983.10-	1989.01	MT/AT	-	-	Engine MA10S	841291	Outer Joint		21	19	48	97	53.5	M
	1983.10-	1989.01	AT	-	-	Engine MA10S	841291	Outer Joint		21	19	48	97	53.5	M
	1983.10-	1989.01	MT	-	-	Engine MA10S	841291	Outer Joint		21	19	48	97	53.5	M
MARCH/MICRA (K11)															
1.0	1992.01-	1997.05	MT/ATVT	-	-	Engine CG10DE	841156	Outer Joint	42T	23	22	48	92.5	56.5	M
MAXIMA															
-	1992-	1999	-	-	-	-	641008	Inner Joint		29/31	27	46	86.8	124	
	1992-	1994	-	-	-	-	841089	Outer Joint		29	27	56	103.5	71	I
	1993-	2001	-	-	-	-	841150	Outer Joint	44T	27	26	56	103	69	I
	2008.05-	2011.08	CVT	-	-	ENGINE : VQ35DE	241545	Drive Shaft		32	29	56	102	659	
	2008.05-	2011.08	CVT	-	-	ENGINE : VQ35DE	241545	Drive Shaft		32	29	56	102	659	
MAXIMA (J30)															

YEAR	TRANSM	L/R	F/R	REMARKS	GSP Ref.	PRODUCT	ABS	Technical Specifications						
								A	B	C	H	L	P	
NISSAN														
MAXIMA (J30)														
1.8 T (124 kW)	1988-1994	-	-	-	-	841121	Outer Joint		27	23	56	104	63	I
3.0	1989-1991	-	-	-	Engine VG30E	841075	Outer Joint		27	25	56	103	70.5	I
MAXIMA III (J30)														
3.0 i (125 kW)	1988.10-1994.06	-	-	F	Saloon Engine VG30E	841018	Outer Joint		27	23	56	99	60	I
	1988.10-1994.06	-	-	F	Saloon Engine VG30E	841035	Outer Joint		27	25	56	101	70	M
	1988.10-1994.06	-	-	F	Saloon Engine VG30E	841151	Outer Joint	46T	27	25	56	103	68	I
	1988.10-1994.06	-	-	F	Saloon Engine VG30E	841305	Outer Joint		27	25	56	103	61.5	M
	1988.10-1994.06	-	-	F	Saloon Engine VG30E	841011	Outer Joint		27	25	56	103	66	I
	1988.10-1994.06	-	-	-	Saloon Engine VG30E	841148	Outer Joint	42T	27	25	56	103	66	I
	1988.10-1994.06	AT	L/R	F	Saloon Engine VG30E	899056	Outer Joint	46T	27	25	56	103	70.5	I
	1988.10-1994.06	-	-	F	Saloon Engine VG30E	841149	Outer Joint	46T	29	27	56	103.5	71	I
MAXIMA VII (A35)														
3.5(216 kW)	2008.09-		AT	-	F Saloon Engine VQ35DE	841366	Outer Joint		32	27	56	102	67.5	M
MAXIMA(A35)														
3.5	2008.05	2011.08	CVT	L	F ENGINE : VQ35DE	241545	Drive Shaft		32	29	56	102	659	
	2008.05-	-	CVT	L	F ENGINE : VQ35DE/4DOOR SEDAN/3.5SV GRADE/CA1	241545	Drive Shaft		32	29	56	102	659	
	2008.05-	-	CVT	L	F ENGINE : VQ35DE/4DOOR SEDAN/3.5SV GRADE/GL1/MEXICO	241545	Drive Shaft		32	29	56	102	659	
	2008.05-	-	CVT	L	F ENGINE : VQ35DE/4DOOR SEDAN/3.5SV GRADE/GL1/FEDERAL/US1	241545	Drive Shaft		32	29	56	102	659	
	2008.05-	-	CVT	L	F ENGINE : VQ35DE/4DOOR SEDAN/3.5SV GRADE/CA1	641193	Inner Joint		29	27	39	65.5	115	
	2008.05-	-	CVT	L	F ENGINE : VQ35DE/4DOOR SEDAN/3.5SV GRADE/GL1/MEXICO	641193	Inner Joint		29	27	39	65.5	115	
	2008.05-	-	CVT	L	F ENGINE : VQ35DE/4DOOR SEDAN/3.5SV GRADE/GL1/FEDERAL/US1	641193	Inner Joint		29	27	39	65.5	115	
MAXIMA/MAXIMA QX IV (A32)														
2.0 (103 kW)	1995.02-2000.08	-	R	F	Saloon Engine VQ20DE	641019	Inner Joint		29	27	33	437.5	101	
	1995.02-2000.08	AT	-	F	Saloon Engine VQ20DE	841185	Outer Joint	44T	29	25	56	101	68	M
	1995.02-2000.08	AT	L/R	F	Saloon Engine VQ20DE	841152	Outer Joint	44T	29	27	56	103.5	70.5	I
	1995.02-2000.08	-	-	-	Saloon Engine VQ20DE	841036	Outer Joint		29	27	56	101	68	M
	1995.02-2000.08	-	-	F	Saloon Engine VQ20DE	841157	Outer Joint	46T	29	27	56	103.5	70.5	I
	1995.02-2000.08	-	-	F	Saloon Engine VQ20DE	841022	Outer Joint	46T	29	27	56	103.5	70.5	I
	1995.02-2000.08	AT	L	F	Saloon Engine VQ20DE	641062	Inner Joint		29	27	39	65.5	114.5	
	1995.02-2000.08	AT/MT	L/R	F	Saloon Engine VQ20DE	841021	Outer Joint		29	27	56	103.5	70.5	I
2.5 V6 24V (140 kW)	1995.02-2000.08	-	R	F	Saloon Engine VQ25DE	641019	Inner Joint		29	27	33	437.5	101	
	1995.02-2000.08	-	-	F	Saloon Engine VQ25DE	841157	Outer Joint	46T	29	27	56	103.5	70.5	I
3.0 (142 kW)	1995.01-2000.08	-	R	F	Saloon Engine VQ30DE	641019	Inner Joint		29	27	33	437.5	101	
	1995.01-2000.08	AT	L/R	F	Saloon Engine VQ30DE	841152	Outer Joint	44T	29	27	56	103.5	70.5	I
	1995.01-2000.08	-	-	-	Saloon Engine VQ30DE	841036	Outer Joint		29	27	56	101	68	M
	1995.01-2000.08	-	-	F	Saloon Engine VQ30DE	841157	Outer Joint	46T	29	27	56	103.5	70.5	I
	1995.01-2000.08	-	-	F	Saloon Engine VQ30DE	841022	Outer Joint	46T	29	27	56	103.5	70.5	I
	1995.01-2000.08	AT	L	F	Saloon Engine VQ30DE	641062	Inner Joint		29	27	39	65.5	114.5	
	1995.01-2000.08	AT/MT	L/R	F	Saloon Engine VQ30DE	841021	Outer Joint		29	27	56	103.5	70.5	I
MAXIMA/MAXIMA QX IV Station Wagon (A32)														
2.0 QX (103 kW)	1997.10-2000.12	-	R	F	Estate Engine VQ20DE	641019	Inner Joint		29	27	33	437.5	101	
	1997.10-2000.12	-	-	-	Estate Engine VQ20DE	841036	Outer Joint		29	27	56	101	68	M
	1997.10-2000.12	-	-	F	Estate Engine VQ20DE	841157	Outer Joint	46T	29	27	56	103.5	70.5	I
2.5 V6 24V (140 kW)	1997.10-2000.12	-	R	F	Estate Engine VQ25DE	641019	Inner Joint		29	27	33	437.5	101	
	1997.10-2000.12	-	-	F	Estate Engine VQ25DE	841157	Outer Joint	46T	29	27	56	103.5	70.5	I
3.0 QX (142 kW)	1997.10-2000.12	-	R	F	Estate Engine VQ30DE	641019	Inner Joint		29	27	33	437.5	101	
	1997.10-2000.12	-	-	-	Estate Engine VQ30DE	841036	Outer Joint		29	27	56	101	68	M
	1997.10-2000.12	-	-	F	Estate Engine VQ30DE	841157	Outer Joint	46T	29	27	56	103.5	70.5	I
MAXIMA/MAXIMA QX V (A33)														
2.0 V6 24V (103 kW)	2000.03-2003.11	-	-	-	Saloon Engine VQ20DE	841101	Outer Joint		29	25	56	103.5	70.5	I
	2000.03-2003.11	-	R	F	Saloon Engine VQ20DE	641019	Inner Joint		29	27	33	437.5	101	
	2000.03-2003.11	-	-	F	Saloon Engine VQ20DE	841185	Outer Joint	44T	29	25	56	101	68	M
	2000.03-2003.11	-	-	F	Saloon Engine VQ20DE	841187	Outer Joint	44T	29	23	56	103	62	M
	2000.03-2003.11	MT	L/R	F	Saloon Engine VQ20DE	841152	Outer Joint	44T	29	27	56	103.5	70.5	I
	2000.03-2003.11	-	-	F	Saloon Engine VQ20DE	841157	Outer Joint	46T	29	27	56	103.5	70.5	I
	2000.03-2003.11	AT/MT	L/R	F	Saloon Engine VQ20DE	841037	Outer Joint	44T	29	25	56	103.5	70.5	I
	2000.03-2003.11	AT/MT	L/R	F	Saloon Engine VQ20DE	841021	Outer Joint		29	27	56	103.5	70.5	I
	2000.03-2003.11	-	-	F	Saloon Engine VQ20DE	841149	Outer Joint	46T	29	27	56	103.5	71	I
	2000.03-2003.11	-	-	F	Saloon Engine VQ20DE	841314	Outer Joint	46T	29	27	56	101	68	M
3.0 V6 24V (147 kW)	2000.03-2003.11	-	R	F	Saloon Engine VQ30DE	641019	Inner Joint		29	27	33	437.5	101	
	2000.03-2003.11	-	-	F	Saloon Engine VQ30DE	841185	Outer Joint	44T	29	25	56	101	68	M
	2000.03-2003.11	MT	L/R	F	Saloon Engine VQ30DE	841152	Outer Joint	44T	29	27	56	103.5	70.5	I
	2000.03-2003.11	-	-	F	Saloon Engine VQ30DE	841157	Outer Joint	46T	29	27	56	103.5	70.5	I
	2000.03-2003.11	-	L/R	F	Saloon Engine VQ30DE	841037	Outer Joint	44T	29	25	56	103.5	70.5	I
	2000.03-2003.11	AT	L	F	Saloon Engine VQ30DE	641062	Inner Joint		29	27	39	65.5	114.5	
	2000.03-2003.11	AT/MT	L/R	F	Saloon Engine VQ30DE	841021	Outer Joint		29	27	56	103.5	70.5	I

YEAR	TRANSM	L/R	F/R	REMARKS	GSP Ref.	PRODUCT	ABS	Technical Specifications									
								A	B	C	H	L	P				
NISSAN																	
MAXIMA/MAXIMA QX V (A33)																	
3.0 V6 24V (147 kW)	2000.03-	2003.11	-	-	F	Saloon Engine VQ30DE	841314	Outer Joint	46T	29	27	56	101	68	M		
3.0 V6 24V (157 kW)	1999.12-	2003.11	-	R	F	Saloon Engine VQ30DE	641019	Inner Joint		29	27	33	437.5	101			
ME51																	
2.5	2007.10-	2010.08	5AT	R	-	Engine VQ25DE	841336	Outer Joint		29	25	67	120.5	70.5	M		
MG33S																	
660	2011.12-	2012.05	CVT	R	-	Engine R06A	857188	Outer Joint	43T	23	26	50.3	78.5	56.5	M		
	2012.05-	-	CVT	R	-	Engine R06A	857184	Outer Joint		23	26	47	69	56	M		
	2012.05-	-	CVT	R	-	Engine R06A	857184	Outer Joint		23	26	47	69	56	M		
	2013.07-	-	CVT	R	-	Allwheel Drive Engine R06A	854013	Outer Joint		23	28	47	69	56	M		
	2013.07-	-	CVT	R	-	Allwheel Drive Engine R06A	854013	Outer Joint		23	28	47	69	56	M		
	2013.08-	-	AT	R	-	Allwheel Drive Engine R06A TBO	854013	Outer Joint		23	28	47	69	56	M		
2013.08-	-	CVT	R	-	Allwheel Drive Engine R06A TBO	854013	Outer Joint		23	28	47	69	56	M			
MG33S DOLCE G																	
660	2013.08-	-	CVT	R	-	Engine R06A TBO	857184	Outer Joint		23	26	47	69	56	M		
MG33S DOLCE X																	
660	2013.08-	-	CVT	R	-	Engine R06A	857184	Outer Joint		23	26	47	69	56	M		
	2013.08-	-	CVT	R	-	Engine R06A	857184	Outer Joint		23	26	47	69	56	M		
MICRA C+C III (K12)/MARCH																	
1.4 16V (65 kW)	2005.08-	-	MT	L	F	Convertible Engine CR14DE	241204	Drive Shaft		23	26	49	83.5	655			
	2005.08-	-	AT	-	F	Convertible Engine CR14DE	841188	Outer Joint		25	22	49	95	56	M		
	2005.08-	-	MT	R	F	Convertible Engine CR14DE	241200	Drive Shaft		23	26	49	83.5	892			
	2005.08-	-	AT	-	F	Convertible Engine CR14DE	841271	Outer Joint		25	22	49	94.5	59.5	M		
	2005.08-	-	AT	L	F	Convertible Engine CR14DE	241260	Drive Shaft		23	25	49	83.5	654			
1.6 SR (81 kW)	2005.08-	-	-	-	F	Convertible Engine HR16DE	841119	Outer Joint		23	22	48	92.5	56.5	M		
	2005.08-	-	MT	L	F	Convertible Engine HR16DE	241204	Drive Shaft		23	26	49	83.5	655			
	2005.08-	-	MT	R	F	Convertible Engine HR16DE	241200	Drive Shaft		23	26	49	83.5	892			
	2005.08-	-	-	L	F	Convertible Engine HR16DE	241451	Drive Shaft		23	26	49	83.5	642			
	2005.08-	-	-	R	F	Convertible Engine HR16DE	841340	Outer Joint		23	22	49	83.5	59	M		
	2005.08-	-	AT	L	F	Convertible Engine HR16DE	241260	Drive Shaft		23	25	49	83.5	654			
	2005.08-	-	-	L/R	F	Convertible Engine HR16DE	841047	Outer Joint		23	22	49	83.5	56	M		
	2005.08-	-	-	L	F	Convertible Engine HR16DE	241451	Drive Shaft		23	26	49	83.5	642			
2005.08-	-	-	-	-	Convertible Engine HR16DE	641102	Inner Joint		26	21	40	64.5	95.5				
MICRA I (K10)/MARCH																	
1.0 (37 kW)	1982.12-	1989.12	-	-	F	Hatchback Engine MA10S	841172	Outer Joint		21	19	48	94	53	I		
	1982.12-	1989.12	-	-	F	Hatchback Engine MA10S	841031	Outer Joint		23	19	48	93	53.5	I		
1.0 (40 kW)	1982.12-	1989.05	-	-	F	Hatchback Engine MA10S	841172	Outer Joint		21	19	48	94	53	I		
	1982.12-	1989.05	-	-	F	Hatchback Engine MA10S	841031	Outer Joint		23	19	48	93	53.5	I		
1.2 (40 kW)	1986.07-	1992.07	-	-	F	Hatchback Engine MA12S	841031	Outer Joint		23	19	48	93	53.5	I		
	1986.07-	1992.07	-	-	F	Hatchback Engine MA12S	841172	Outer Joint		21	19	48	94	53	I		
1.2 (44 kW)	1986.07-	1992.07	-	-	F	Hatchback Engine MA12S	841031	Outer Joint		23	19	48	93	53.5	I		
	1986.07-	1992.07	-	-	F	Hatchback Engine MA12S	841172	Outer Joint		21	19	48	94	53	I		
	1986.07-	1992.07	-	-	F	Hatchback Engine MA12S	841090	Outer Joint		23	19	48	93	53.5	M		
	1986.07-	1992.07	AT/MT	L	F	Hatchback Engine MA12S	241066	Drive Shaft		23	24	48	93	596			
1986.07-	1992.07	AT/MT	R	F	Hatchback Engine MA12S	241067	Drive Shaft		23	24	48	93	844				
MICRA II																	
1.0	1993.01-	1998.04	MT	L	F	K11	241154	Drive Shaft	42T	23	21	48	93	607			
MICRA II (K11)/MARCH																	
1.0 (40 kW)	1992.01-	1993.04	MT	-	F	Hatchback Engine MA10S	841090	Outer Joint		23	19	48	93	53.5	M		
	1992.01-	1993.04	CVT/MT	L	F	Hatchback Engine MA10S	241066	Drive Shaft		23	24	48	93	596			
	1992.01-	1993.04	CVT/MT	R	F	Hatchback Engine MA10S	241067	Drive Shaft		23	24	48	93	844			
	1992.01-	1993.04	AT	L	F	Hatchback Engine MA10S	241156	Drive Shaft		23	24	48	93	594.5			
	1992.01-	1993.04	MT	L	F	Hatchback Engine MA10S	241023	Drive Shaft		23	21	48	93	612			
1.0 i 16V (40 kW)	1992.08-	2000.09	-	-	F	Hatchback Engine CG10DE	841114	Outer Joint		23	19	48	93	53.5	M		
	1992.08-	2000.09	-	-	-	Hatchback Engine CG10DE	841154	Outer Joint	42T	23	19	48	93	53.5	M		
	1992.08-	2000.09	AT/MT	R	F	Hatchback Engine CG10DE	241193	Drive Shaft		23	24	48	93	840			
	1992.08-	2000.09	-	L/R	F	Hatchback Engine CG10DE	841020	Outer Joint	42T	23	19	48	93	53.5	M		
	1992.08-	2000.09	MT	-	F	Hatchback Engine CG10DE	841090	Outer Joint		23	19	48	93	53.5	M		
	1992.08-	2000.09	CVT/MT	L	F	Hatchback Engine CG10DE	241066	Drive Shaft		23	24	48	93	596			
	1992.08-	2000.09	CVT/MT	R	F	Hatchback Engine CG10DE	241067	Drive Shaft		23	24	48	93	844			
	1992.08-	2000.09	AT/MT	L	F	Hatchback Engine CG10DE	241156	Drive Shaft		23	24	48	93	594.5			
	1992.08-	2000.09	AT/MT	L/R	F	Hatchback Engine CG10DE	841040	Outer Joint		23	19	48	93	53.5	I		
	1992.08-	2000.09	AT/MT	L/R	F	Hatchback Engine CG10DE	841058	Outer Joint	42T	23	19	48	93	53.5	I		
	1992.08-	2000.09	MT	L	F	Hatchback Engine CG10DE	241023	Drive Shaft		23	21	48	93	612			
	1992.08-	2000.09	MT	R	F	Hatchback Engine CG10DE	241084	Drive Shaft		23	21	48	93	822.5			
	1992.08-	2000.09	MT	L	F	Hatchback Engine CG10DE	241083	Drive Shaft		23	21	48	93	608.5			
1.0 i 16V (44 kW)	2000.09-	2003.02	-	-	F	Hatchback Engine CG10DE	841114	Outer Joint		23	19	48	93	53.5	M		

	YEAR	TRANSM	L/R	F/R	REMARKS	GSP Ref.	PRODUCT	ABS	Technical Specifications								
									A	B	C	H	L	P			
NISSAN																	
MICRA II (K11)/MARCH																	
1.0 i 16V (44 kW)	2000.09-2003.02	-	-	-	Hatchback Engine CG10DE	841154	Outer Joint	42T	23	19	48	93	53.5	M			
	2000.09-2003.02	AT/MT	R	F	Hatchback Engine CG10DE	241193	Drive Shaft		23	24	48	93	840				
	2000.09-2003.02	MT	L/R	F	Hatchback Engine CG10DE	841020	Outer Joint	42T	23	19	48	93	53.5	M			
	2000.09-2003.02	MT	-	F	Hatchback Engine CG10DE	841090	Outer Joint		23	19	48	93	53.5	M			
	2000.09-2003.02	CVT/MT	L	F	Hatchback Engine CG10DE	241066	Drive Shaft		23	24	48	93	596				
	2000.09-2003.02	CVT/MT	R	F	Hatchback Engine CG10DE	241067	Drive Shaft		23	24	48	93	844				
	2000.09-2003.02	AT/MT	L	F	Hatchback Engine CG10DE	241156	Drive Shaft		23	24	48	93	594.5				
	2000.09-2003.02	-	L/R	F	Hatchback Engine CG10DE	841058	Outer Joint	42T	23	19	48	93	53.5	I			
1.3 i 16V (55 kW)	2000.09-2003.02	MT	L	F	Hatchback Engine CG10DE	241023	Drive Shaft		23	21	48	93	612				
	1992.08-2000.09	-	-	F	Hatchback Engine CG13DE	841119	Outer Joint		23	22	48	92.5	56.5	M			
	1992.08-2000.09	AT/MT	R	F	Hatchback Engine CG13DE	241193	Drive Shaft		23	24	48	93	840				
	1992.08-2000.09	-	-	F	Hatchback Engine CG13DE	841013	Outer Joint	42T	23	22	48	93	56.5	I			
	1992.08-2000.09	AT/MT	L	F	Hatchback Engine CG13DE	241156	Drive Shaft		23	24	48	93	594.5				
	1992.08-2000.09	-	L	F	Hatchback Engine CG13DE	641045	Inner Joint		24	22	40	51.5	97				
1.4 i 16V (60 kW)	1992.08-2000.09	AT/MT	L/R	F	Hatchback Engine CG13DE	841012	Outer Joint		23	22	48	93	56.5	I			
	2000.09-2003.02	MT	R	F	Hatchback Engine CGA3DE	241193	Drive Shaft		23	24	48	93	840				
	2000.09-2003.02	-	-	F	Hatchback Engine CGA3DE	841013	Outer Joint	42T	23	22	48	93	56.5	I			
	2000.09-2003.02	MT	L	F	Hatchback Engine CGA3DE	241066	Drive Shaft		23	24	48	93	596				
	2000.09-2003.02	MT	R	F	Hatchback Engine CGA3DE	241067	Drive Shaft		23	24	48	93	844				
2000.09-2003.02	AT/MT	L	F	Hatchback Engine CGA3DE	241156	Drive Shaft		23	24	48	93	594.5					
MICRA III																	
1.0	1998.04-2002.12	MT	L	F	K11	241154	Drive Shaft	42T	23	21	48	93	607				
MICRA III (K12)/MARCH																	
1.0 16V (48 kW)	2003.01-2010.06	-	L	F	Hatchback Engine CG10DE	241204	Drive Shaft		23	26	49	83.5	655				
	2003.01-2010.06	-	R	F	Hatchback Engine CG10DE	241200	Drive Shaft		23	26	49	83.5	892				
	2003.01-2010.06	-	-	F	Hatchback Engine CG10DE	841046	Outer Joint		23	21	49	83.5	56	M			
	2003.01-2010.06	-	-	-	Hatchback Engine CG10DE	641102	Inner Joint		26	21	40	64.5	95.5				
1.2 16V (48 kW)	2003.01-2010.06	MT	L	F	Hatchback Engine CG12DE/CR12DE	241204	Drive Shaft		23	26	49	83.5	655				
	2003.01-2010.06	MT	R	F	Hatchback Engine CG12DE/CR12DE	241200	Drive Shaft		23	26	49	83.5	892				
	2003.01-2010.06	AT	-	F	Hatchback Engine CG12DE/CR12DE	841271	Outer Joint		25	22	49	94.5	59.5	M			
	2003.01-2010.06	AT	L	F	Hatchback Engine CG12DE/CR12DE	241260	Drive Shaft		23	25	49	83.5	654				
1.2 16V (59 kW)	2003.01-2010.06	MT	L	F	Hatchback Engine CR12DE/CG12DE	241204	Drive Shaft		23	26	49	83.5	655				
	2003.01-2010.06	MT	R	F	Hatchback Engine CR12DE/CG12DE	241200	Drive Shaft		23	26	49	83.5	892				
	2003.01-2010.06	AT	-	F	Hatchback Engine CR12DE/CG12DE	841271	Outer Joint		25	22	49	94.5	59.5	M			
	2003.01-2010.06	AT	L	F	Hatchback Engine CR12DE/CG12DE	241260	Drive Shaft		23	25	49	83.5	654				
1.2 LPG (59 kW)	2005.06-2010.06	AT	-	F	Hatchback Engine CR12DE	841271	Outer Joint		25	22	49	94.5	59.5	M			
1.4 16V (65 kW)	2003.01-2010.06	MT	L	F	Hatchback Engine CR14DE	241204	Drive Shaft		23	26	49	83.5	655				
	2003.01-2010.06	AT	-	F	Hatchback Engine CR14DE	841188	Outer Joint		25	22	49	95	56	M			
	2003.01-2010.06	MT	R	F	Hatchback Engine CR14DE	241200	Drive Shaft		23	26	49	83.5	892				
	2003.01-2010.06	AT	-	F	Hatchback Engine CR14DE	841271	Outer Joint		25	22	49	94.5	59.5	M			
	2003.01-2010.06	AT	L	F	Hatchback Engine CR14DE	241260	Drive Shaft		23	25	49	83.5	654				
	2003.01-2010.06	-	-	F	Hatchback Engine CR14DE	841046	Outer Joint		23	21	49	83.5	56	M			
	2003.01-2010.06	-	-	-	Hatchback Engine CR14DE	641102	Inner Joint		26	21	40	64.5	95.5				
	2003.01-2010.06	-	-	F	Hatchback Engine K9K 704	841119	Outer Joint		23	22	48	92.5	56.5	M			
1.5 dCi (48 kW)	2003.01-2010.06	MT	L	F	Hatchback Engine K9K 704	241204	Drive Shaft		23	26	49	83.5	655				
	2003.01-2010.06	MT	R	F	Hatchback Engine K9K 704	241245	Drive Shaft		23	26	49	83.5	893				
	2003.01-2010.06	-	L/R	F	Hatchback Engine K9K 704	841047	Outer Joint		23	22	49	83.5	56	M			
	2003.01-2010.06	-	-	F	Hatchback Engine K9K 708	841119	Outer Joint		23	22	48	92.5	56.5	M			
1.5 dCi (50 kW)	2005.06-2010.06	MT	L	F	Hatchback Engine K9K 708	241204	Drive Shaft		23	26	49	83.5	655				
	2005.06-2010.06	MT	R	F	Hatchback Engine K9K 708	241245	Drive Shaft		23	26	49	83.5	893				
	2005.06-2010.06	-	L/R	F	Hatchback Engine K9K 708	841047	Outer Joint		23	22	49	83.5	56	M			
	2005.06-2010.06	-	-	F	Hatchback Engine K9K 722	241408	Drive Shaft		23	26	49	83.5	897				
	2005.06-2010.06	-	-	F	Hatchback Engine K9K 722	841119	Outer Joint		23	22	48	92.5	56.5	M			
1.5 dCi (60 kW)	2003.09-2010.06	MT	L	F	Hatchback Engine K9K 722	241204	Drive Shaft		23	26	49	83.5	655				
	2003.09-2010.06	MT	R	F	Hatchback Engine K9K 722	241245	Drive Shaft		23	26	49	83.5	893				
	2003.09-2010.06	-	L/R	F	Hatchback Engine K9K 722	841244	Outer Joint		23	23	49	83.5	59	M			
	2003.09-2010.06	-	L/R	F	Hatchback Engine K9K 722	841047	Outer Joint		23	22	49	83.5	56	M			
	2003.09-2010.06	-	L	F	Hatchback Engine K9K 722	241407	Drive Shaft		23	26	49	83.5	646				
	2003.09-2010.06	-	-	F	Hatchback Engine K9K 276	241408	Drive Shaft		23	26	49	83.5	897				
	2003.09-2010.06	-	-	F	Hatchback Engine K9K 276	841119	Outer Joint		23	22	48	92.5	56.5	M			
1.5 dCi (63 kW)	2005.06-2010.06	MT	L	F	Hatchback Engine K9K 276	241204	Drive Shaft		23	26	49	83.5	655				
	2005.06-2010.06	MT	R	F	Hatchback Engine K9K 276	241245	Drive Shaft		23	26	49	83.5	893				
	2005.06-2010.06	-	L/R	F	Hatchback Engine K9K 276	841244	Outer Joint		23	23	49	83.5	59	M			
	2005.06-2010.06	-	L	F	Hatchback Engine K9K 276	241407	Drive Shaft		23	26	49	83.5	646				
	2005.06-2010.06	-	-	F	Hatchback Engine HR16DE	841119	Outer Joint		23	22	48	92.5	56.5	M			
	2005.06-2010.06	MT	L	F	Hatchback Engine HR16DE	241204	Drive Shaft		23	26	49	83.5	655				
1.6 SR (81 kW)	2005.05-2010.06	MT	L	F	Hatchback Engine HR16DE	241204	Drive Shaft		23	26	49	83.5	655				

YEAR	TRANSM	L/R	F/R	REMARKS	GSP Ref.	PRODUCT	ABS	Technical Specifications					
								A	B	C	H	L	P
NISSAN													
MICRA III (K12)/MARCH													
1.6 SR (81 kW)	2005.05-2010.06	MT	R	F	Hatchback Engine HR16DE	241200	Drive Shaft	23	26	49	83.5	892	
	2005.05-2010.06	-	L	F	Hatchback Engine HR16DE	241451	Drive Shaft	23	26	49	83.5	642	
	2005.05-2010.06	-	R	F	Hatchback Engine HR16DE	841340	Outer Joint	23	22	49	83.5	59	M
	2005.05-2010.06	AT	L	F	Hatchback Engine HR16DE	241260	Drive Shaft	23	25	49	83.5	654	
	2005.05-2010.06	-	L/R	F	Hatchback Engine HR16DE	841047	Outer Joint	23	22	49	83.5	56	M
	2005.05-2010.06	-	L	F	Hatchback Engine HR16DE	241451	Drive Shaft	23	26	49	83.5	642	
	2005.05-2010.06	-	-	-	Hatchback Engine HR16DE	641102	Inner Joint	26	21	40	64.5	95.5	
MICRA IV (K13)/MARCH/MARCH/MARCH ACTIVE													
1.2 (56 kW)	2010.05-	-	-	F	Hatchback Engine HR12DE	841304	Outer Joint	25	29	49	95	56	I
	2010.05-	AT/MT	L/R	F	Hatchback Engine HR12DE	818227	Outer Joint	25	20	49	95	55	M
	2010.05-	AT	L	F	Hatchback Engine HR12DE	241488	Drive Shaft	25	25	49	95	702	
	2010.05-	AT	L/R	F	Hatchback Engine HR12DE	618111	Inner Joint	25	20	40	53	110.5	
	2010.05-	AT	R	F	Hatchback Engine HR12DE	241485	Drive Shaft	25	25	49	95	859	
1.2 (58 kW)	2010.05-	-	-	F	Hatchback Engine HR12DE	841304	Outer Joint	25	29	49	95	56	I
	2010.05-	AT/MT	L/R	F	Hatchback Engine HR12DE	818227	Outer Joint	25	20	49	95	55	M
	2010.05-	AT	L	F	Hatchback Engine HR12DE	241488	Drive Shaft	25	25	49	95	702	
	2010.05-	AT	R	F	Hatchback Engine HR12DE	241485	Drive Shaft	25	25	49	95	859	
1.2 (59 kW)	2010.05-	CVT	-	F	Hatchback Engine HR12DE	841289	Outer Joint	25	29	49.1	94.5	53	I
	2010.05-	-	-	F	Hatchback Engine HR12DE	841304	Outer Joint	25	29	49	95	56	I
	2010.05-	CVT	L	F	Hatchback Engine HR12DE	241337	Drive Shaft	25	25	49.1	94.5	699	
	2010.05-	MT	L	F	Hatchback Engine HR12DE	241437	Drive Shaft	25	26	49	95	689	
	2010.05-	4AT	R	F	All-wheel Drive Hatchback Engine HR12DE	641210	Inner Joint	25	20	40	63	99.5	
	2010.05-	AT/MT	L/R	F	Hatchback Engine HR12DE	818227	Outer Joint	25	20	49	95	55	M
	2010.05-	AT	L	F	Hatchback Engine HR12DE	241488	Drive Shaft	25	25	49	95	702	
	2010.05-	AT	R	F	Hatchback Engine HR12DE	241485	Drive Shaft	25	25	49	95	859	
1.2 DIG-S (72 kW)	2011.04-	CVT	-	F	Hatchback Engine HR12DDR	841289	Outer Joint	25	29	49.1	94.5	53	I
	2011.04-	AT	-	F	Hatchback Engine HR12DDR	841297	Outer Joint	25	21	49.1	94	56.5	M
	2011.04-	AT/MT	L/R	F	Hatchback Engine HR12DDR	818227	Outer Joint	25	20	49	95	55	M
MICRA K13													
1.5	2010-2014	MT	L	F	-	241546	Drive Shaft	25	26	49	94.5	632	
	2010-2014	MT	R	F	-	241547	Drive Shaft	25	26	49	94.5	923	
	2010-2014	MT	L	F	-	641206	Inner Joint	26	21	40	64	95.5	
	2010-2014	MT	R	F	-	641206	Inner Joint	26	21	40	64	95.5	
MISTRAL TERRANO H R20													
2700	1994.06-1996.10	AT	-	-	Engine TD27T	841085	Outer Joint	26	27	50	148	60	M
MISTRAL TERRANO II R20													
2.7	1994.06-1996.10	AT	-	-	Engine TD27T	841085	Outer Joint	26	27	50	148	60	M
MISTRAL/TERRANO II (R20)													
2.7	1994.06-1996.10	AT	-	-	Engine TD27T	841085	Outer Joint	26	27	50	148	60	M
MNE51													
2.5	2007.10-2010.08	5AT	R	-	Allwheel Drive Engine VQ25DE	841336	Outer Joint	29	25	67	120.5	70.5	M
MURANO													
3.5	2008.06-2015.04	-	R	F	-	241543	Drive Shaft	32	29	56.3	103	1026	
3.5 V6 - Gas	2011-	-	R	F	-	241543	Drive Shaft	32	29	56.3	103	1026	
	2012-	-	R	F	-	241543	Drive Shaft	32	29	56.3	103	1026	
	2013-	-	R	F	-	241543	Drive Shaft	32	29	56.3	103	1026	
	2014-	-	R	F	-	241543	Drive Shaft	32	29	56.3	103	1026	
MURANO I													
3.5 (170 KW)	2006-	AT	-	-	SUV (Petrol)	241588	Stub Axle	30	29			480	
	2007-	AT	-	-	SUV (Petrol)	241588	Stub Axle	30	29			480	
	2008-	AT	-	-	SUV (Petrol)	241588	Stub Axle	30	29			480	
3.5 (172 KW)	2003-	AT	-	-	SUV (Petrol)	241588	Stub Axle	30	29			480	
	2004-	AT	-	-	SUV (Petrol)	241588	Stub Axle	30	29			480	
	2005-	AT	-	-	SUV (Petrol)	241588	Stub Axle	30	29			480	
	2006-	AT	-	-	SUV (Petrol)	241588	Stub Axle	30	29			480	
	2007-	AT	-	-	SUV (Petrol)	241588	Stub Axle	30	29			480	
	2008-	AT	-	-	SUV (Petrol)	241588	Stub Axle	30	29			480	
MURANO I (Z50)													
3.5 (170 kW)	2006.01-2008.09	AT	-	F	All-wheel Drive Closed Off-Road Vehicle	841245	Outer Joint	29	36	56	102	69.5	I
	2006.01-2008.09	AT	R	F	All-wheel Drive Closed Off-Road Vehicle	641211	Inner Joint	30	36	50		136.5	
	2006.01-2008.09	AT	-	R	All-wheel Drive Closed Off-Road Vehicle	657111	Inner Joint	21	24	38	61	91	
3.5 (172 kW)	2003.08-2008.09	AT	-	F	All-wheel Drive Closed Off-Road Vehicle Engine VQ35DE	841245	Outer Joint	29	36	56	102	69.5	I
	2003.08-2008.09	AT	R	F	All-wheel Drive Closed Off-Road Vehicle Engine VQ35DE	641211	Inner Joint	30	36	50		136.5	
	2003.08-2008.09	-	L/R	F	All-wheel Drive Closed Off-Road Vehicle Engine VQ35DE	841232	Outer Joint	29	36	56	102.5	70	I
	2003.08-2008.09	AT	-	R	All-wheel Drive Closed Off-Road Vehicle Engine VQ35DE	657111	Inner Joint	21	24	38	61	91	
MURANO II (Z51)													

	 YEAR	TRANSM	L/R	F/R	REMARKS	GSP Ref.	 PRODUCT	 ABS	Technical Specifications						
									A	B	C	H	L	P	
NISSAN															
MURANO II (Z51)															
2.5 dCi (140 kW)	2010.01-2014.09	AT	-	R	All-wheel Drive Closed Off-Road Vehicle Engine YD25DDTi	657111	Inner Joint		21	24	38	61	91		
3.5 (188 kW)	2008.10-2014.09	-	L/R	F	All-wheel Drive Closed Off-Road Vehicle Engine VQ35DE	841232	Outer Joint		29	36	56	102.5	70	I	
	2008.10-2014.09	AT	-	F	All-wheel Drive Closed Off-Road Vehicle Engine VQ35DE	841400	Outer Joint		32	27	56.3	103	68	M	
	2008.10-2014.09	AT	-	R	All-wheel Drive Closed Off-Road Vehicle Engine VQ35DE	657111	Inner Joint		21	24	38	61	91		
	2008.10-2014.09	AT	-	F	All-wheel Drive Closed Off-Road Vehicle Engine VQ35DE	641200	Inner Joint		29	27	50		122.5		
	2008.10-2014.09	-	R	-	All-wheel Drive Closed Off-Road Vehicle Engine VQ35DE	841413	Outer Joint		29	24	58	109.5	38.5	I	
	2008.10-2014.09	AT	-	F	All-wheel Drive Closed Off-Road Vehicle Engine VQ35DE	241511	Drive Shaft		32	29	56.3	103	1033		
	2008.10-2014.09	AT	L	F	All-wheel Drive Closed Off-Road Vehicle Engine VQ35DE	641213	Inner Joint		29	27	39	65.5	114.5		
MURANO SL															
3.5 V6-GAS	2003-2008	-	L	-		841365	Outer Joint		29	36	56	102.5	71	I	
	2003-2008	-	L	-		641187	Inner Joint		29	36	39	65.5	124.5		
3.5L V6-GAS	2003-2008	-	L	-		241516	Drive Shaft		29	29	56	102.5	673		
N16															
2.2	2000.03-		MT/AT	R	-		841375	Outer Joint		27	35	55	101	68.5	I
	2000.03-		MT/AT	R	-		841375	Outer Joint		27	35	55	101	68.5	I
	2000.03-		MT/AT	R	-		841375	Outer Joint		27	35	55	101	68.5	I
NAVARA (D21)/DATSUN															
2.5 D (59 kW)	1986.01-2008.03	MT	-	F	All-wheel Drive Pickup Engine TD25	841016	Outer Joint		28	27	50	150	71	I	
	1986.01-2008.03	-	L	F	All-wheel Drive Pickup Engine TD25	241057	Drive Shaft		28		50	150	570.5		
	1986.01-2008.03	MT	-	F	All-wheel Drive Pickup Engine TD25	841086	Outer Joint		27	27	50	150	71	I	
2.7 D (63 kW)	1989.09-1998.08	MT	-	F	All-wheel Drive Pickup Engine TD27	841016	Outer Joint		28	27	50	150	71	I	
	1989.09-1998.08	MT	-	-	All-wheel Drive Pickup Engine TD27	641014	Inner Joint			27		81.2			
	1989.09-1998.08	MT	-	F	All-wheel Drive Pickup Engine TD27	841086	Outer Joint		27	27	50	150	71	I	
2.7 D (73 kW)	1987.09-1996.12	MT	-	F	All-wheel Drive Pickup Engine TD27	841016	Outer Joint		28	27	50	150	71	I	
	1987.09-1996.12	MT	-	-	All-wheel Drive Pickup Engine TD27	641014	Inner Joint			27		81.2			
	1987.09-1996.12	MT	-	F	All-wheel Drive Pickup Engine TD27	841086	Outer Joint		27	27	50	150	71	I	
NAVARA (D22)															
2.5 Di (98 kW)	2002.02-		MT	-	F	Platform/Chassis Engine YD25DDTi	841100	Outer Joint		28	25	50	150	71	I
	2002.02-		MT	-	-	Platform/Chassis Engine YD25DDTi	641014	Inner Joint			27		81.2		
	2002.02-		MT	-	F	All-wheel Drive Platform/Chassis Engine YD25DDTi	841100	Outer Joint		28	25	50	150	71	I
	2002.02-		MT	-	-	All-wheel Drive Platform/Chassis Engine YD25DDTi	641014	Inner Joint			27		81.2		
	2002.02-		-	L	F	All-wheel Drive Platform/Chassis Engine YD25DDTi	241057	Drive Shaft		28		50	150	570.5	
NAVARA (D22_)/FRONTIER/DATSUN															
2.5 D (98 kW)	2001.11-		MT	-	F	All-wheel Drive Pickup Engine YD25DDTi	841100	Outer Joint		28	25	50	150	71	I
	2001.11-		MT	-	-	All-wheel Drive Pickup Engine YD25DDTi	641014	Inner Joint			27		81.2		
	2001.11-		-	L	F	All-wheel Drive Pickup Engine YD25DDTi	241057	Drive Shaft		28		50	150	570.5	
2.5 TDiC (76 kW)	1998.05-2001.10	MT	-	F	All-wheel Drive Pickup Engine TD25TI	841016	Outer Joint		28	27	50	150	71	I	
	1998.05-2001.10	MT	-	F	All-wheel Drive Pickup Engine TD25TI	841100	Outer Joint		28	25	50	150	71	I	
	1998.05-2001.10	MT	-	-	All-wheel Drive Pickup Engine TD25TI	641014	Inner Joint			27		81.2			
	1998.05-2001.10	-	L	F	All-wheel Drive Pickup Engine TD25TI	241057	Drive Shaft		28		50	150	570.5		
NAVARA D22 YD25T															
-	-	-	-	F	-	241393	Drive Shaft		28		50	150	570		
NE51															
3.5	2007.10-2010.08	5AT	R	-	Allwheel Drive Engine VQ35DE	841336	Outer Joint		29	25	67	120.5	70.5	M	
NOTE															
1.2 12V	-	-	-	R	F	-	618110	Inner Joint		26	20	40	64.5	98	
	-	-	-	R	F	-	241495	Drive Shaft		25	26	49	95	870	
NOTE (E11 NE11)															
1.4 (65 kW)	2006.03-2012.06	-	-	F	MPV Engine CR14DE	841119	Outer Joint		23	22	48	92.5	56.5	M	
	2006.03-2012.06	MT	L	F	MPV Engine CR14DE	241204	Drive Shaft		23	26	49	83.5	655		
	2006.03-2012.06	MT	R	F	MPV Engine CR14DE	241463	Drive Shaft		23	26	49	83.5	894		
	2006.03-2012.06	MT	R	F	MPV Engine CR14DE	241200	Drive Shaft		23	26	49	83.5	892		
	2006.03-2012.06	MT	L	F	MPV Engine CR14DE	241451	Drive Shaft		23	26	49	83.5	642		
	2006.03-2012.06	MT	R	F	MPV Engine CR14DE	841340	Outer Joint		23	22	49	83.5	59	M	
	2006.03-2012.06	-	L	F	MPV Engine CR14DE	841047	Outer Joint		23	22	49	83.5	56	M	
	2006.03-2012.06	MT	L	F	MPV Engine CR14DE	241451	Drive Shaft		23	26	49	83.5	642		
	2006.03-2012.06	6MT	R	F	MPV Engine K9K 700	241452	Drive Shaft		23	26	49	83.5	895		
1.5 dCi (50 kW)	2006.03-2012.06	5MT	R	F	MPV Engine K9K 700	241408	Drive Shaft		23	26	49	83.5	897		
	2006.03-2012.06	MT	L	F	MPV Engine K9K 700	241204	Drive Shaft		23	26	49	83.5	655		
	2006.03-2012.06	6MT	L	F	MPV Engine K9K 700	241453	Drive Shaft		23	26	49	83.5	645		
	2006.03-2012.06	6MT	R	F	MPV Engine K9K 700	841341	Outer Joint		23	24	49	83.5	63	M	
	2006.03-2012.06	MT	R	F	MPV Engine K9K 700	241245	Drive Shaft		23	26	49	83.5	893		
	2006.03-2012.06	-	L/R	F	MPV Engine K9K 700	841244	Outer Joint		23	23	49	83.5	59	M	
	2006.03-2012.06	5MT	L	F	MPV Engine K9K 700	241407	Drive Shaft		23	26	49	83.5	646		
	2006.03-2012.06	6MT	R	F	MPV Engine K9K 276	241452	Drive Shaft		23	26	49	83.5	895		
	2006.03-2012.06	5MT	R	F	MPV Engine K9K 276	241408	Drive Shaft		23	26	49	83.5	897		

YEAR	TRANSM	L/R	F/R	REMARKS	GSP Ref.	PRODUCT	ABS	Technical Specifications									
								A	B	C	H	L	P				
NISSAN																	
NOTE (E11 NE11)																	
1.5 dCi (63 kW)	2006.03-2012.06	MT	L	F	MPV Engine K9K 276	241204	Drive Shaft	23	26	49	83.5	655					
	2006.03-2012.06	6MT	L	F	MPV Engine K9K 276	241453	Drive Shaft	23	26	49	83.5	645					
	2006.03-2012.06	6MT	R	F	MPV Engine K9K 276	841341	Outer Joint	23	24	49	83.5	63	M				
	2006.03-2012.06	MT	R	F	MPV Engine K9K 276	241245	Drive Shaft	23	26	49	83.5	893					
	2006.03-2012.06	-	L/R	F	MPV Engine K9K 276	841244	Outer Joint	23	23	49	83.5	59	M				
	2006.03-2012.06	5MT	L	F	MPV Engine K9K 276	241407	Drive Shaft	23	26	49	83.5	646					
1.5 dCi (66 kW)	2010.09-2012.06	-	R	F	MPV Engine K9K 276	241408	Drive Shaft	23	26	49	83.5	897					
	2010.09-2012.06	MT	L	F	MPV Engine K9K 276	241204	Drive Shaft	23	26	49	83.5	655					
	2010.09-2012.06	MT	R	F	MPV Engine K9K 276	241245	Drive Shaft	23	26	49	83.5	893					
	2010.09-2012.06	-	L/R	F	MPV Engine K9K 276	841244	Outer Joint	23	23	49	83.5	59	M				
	2010.09-2012.06	-	L	F	MPV Engine K9K 276	241407	Drive Shaft	23	26	49	83.5	646					
1.5 dCi (76 kW)	2008.07-2012.06	6MT	R	F	MPV Engine K9K 292	241452	Drive Shaft	23	26	49	83.5	895					
	2008.07-2012.06	5MT	R	F	MPV Engine K9K 292	241408	Drive Shaft	23	26	49	83.5	897					
	2008.07-2012.06	MT	L	F	MPV Engine K9K 292	241204	Drive Shaft	23	26	49	83.5	655					
	2008.07-2012.06	6MT	R	F	MPV Engine K9K 292	841341	Outer Joint	23	24	49	83.5	63	M				
	2008.07-2012.06	6MT	L	F	MPV Engine K9K 292	241453	Drive Shaft	23	26	49	83.5	645					
	2008.07-2012.06	MT	R	F	MPV Engine K9K 292	241245	Drive Shaft	23	26	49	83.5	893					
	2008.07-2012.06	-	L/R	F	MPV Engine K9K 292	841244	Outer Joint	23	23	49	83.5	59	M				
	2008.07-2012.06	5MT	L	F	MPV Engine K9K 292	241407	Drive Shaft	23	26	49	83.5	646					
1.6 (81 kW)	2006.03-2012.06	-	-	F	MPV Engine HR16DE	841119	Outer Joint	23	22	48	92.5	56.5	M				
	2006.03-2012.06	MT	L	F	MPV Engine HR16DE	241204	Drive Shaft	23	26	49	83.5	655					
	2006.03-2012.06	MT	R	F	MPV Engine HR16DE	241200	Drive Shaft	23	26	49	83.5	892					
	2006.03-2012.06	MT	L	F	MPV Engine HR16DE	241451	Drive Shaft	23	26	49	83.5	642					
	2006.03-2012.06	MT	R	F	MPV Engine HR16DE	841340	Outer Joint	23	22	49	83.5	59	M				
	2006.03-2012.06	MT	-	F	MPV Engine HR16DE	841271	Outer Joint	25	22	49	94.5	59.5	M				
	2006.03-2012.06	AT	L	F	MPV Engine HR16DE	241260	Drive Shaft	23	25	49	83.5	654					
	2006.03-2012.06	AT	L	F	MPV Engine HR16DE	241409	Drive Shaft	23	25	49	83.5	647					
	2006.03-2012.06	-	L/R	F	MPV Engine HR16DE	841047	Outer Joint	23	22	49	83.5	56	M				
	2006.03-2012.06	MT	L	F	MPV Engine HR16DE	241451	Drive Shaft	23	26	49	83.5	642					
	2006.03-2012.06	AT	R	F	MPV Engine HR16DE	241261	Drive Shaft	23	25	49	83.5	883					
	2006.03-2012.06	-	-	-	MPV Engine HR16DE	641102	Inner Joint	26	21	40	64.5	95.5					
NOTE (E11)																	
1.5 DCi (50 kW)	2006.03-2007.12	6MT	L	F	MPV Engine K9K700	641143	Inner Joint	26	24	40	64	106					
1.5 DCi (63 kW)	2008.05-	6MT	L	F	MPV Engine K9K276	641143	Inner Joint	26	24	40	64	106					
1.5 DCi (76 kW)	2008.07-	6MT	L	F	MPV Engine K9K292	641143	Inner Joint	26	24	40	64	106					
NOTE (E12)																	
1.2 (59 kW)	2013.06-	AT	-	F	MPV Engine HR12DE	841271	Outer Joint	25	22	49	94.5	59.5	M				
	2013.06-	MT	L	F	MPV Engine HR12DE	241437	Drive Shaft	25	26	49	95	689					
	2013.06-	AT/MT	L/R	F	MPV Engine HR12DE	818227	Outer Joint	25	20	49	95	55	M				
1.2 DIG-S (72 kW)	2013.06-	AT/MT	L/R	F	MPV Engine HR12DDR	818227	Outer Joint	25	20	49	95	55	M				
1.5 dCi (66 kW)	2013.06-	-	L	F	MPV Engine K9K 892/K9K 608	241492	Drive Shaft	25	26	49.15	94.5	635					
NP300 (D22)																	
2.5 dCi (98 kW)	2008.04-	MT	-	F	All-wheel Drive Pickup Engine YD25DDTi	841100	Outer Joint	28	25	50	150	71	I				
	2008.04-	MT	-	F	Pickup Engine YD25DDTi	841100	Outer Joint	28	25	50	150	71	I				
	2008.04-	MT	-	-	All-wheel Drive Pickup Engine YD25DDTi	641014	Inner Joint	27			81.2						
	2008.04-	MT	-	-	Pickup Engine YD25DDTi	641014	Inner Joint	27			81.2						
NP300 NAVARA (D40)																	
2.5 dCi (106 kW)	2005.07-	-	-	F	Pickup Engine YD25DDTi	841270	Outer Joint	29	36	67.1	125	60.5	I				
	2005.07-	-	L	F	Pickup Engine YD25DDTi	641100	Inner Joint	27	35	39	63	131.5					
	2005.07-	MT	-	-	Pickup Engine YD25DDTi	841231	Outer Joint	29	36	68	122.5	60	M				
	2008.08-	MT	L/R	F	All-wheel Drive Platform/Chassis Engine YD25DDTi	241262	Drive Shaft	29	27	67	115	634					
	2008.08-	AT	-	F	All-wheel Drive Platform/Chassis Engine YD25DDTi	841257	Outer Joint	29	26	67	115.5	62	M				
	2008.08-	AT	R	F	All-wheel Drive Platform/Chassis Engine YD25DDTi	241394	Drive Shaft	29	27	67	115.5	631					
	2008.08-	AT	L	F	All-wheel Drive Platform/Chassis Engine YD25DDTi	241394	Drive Shaft	29	27	67	115.5	631					
	2008.08-	AT	L/R	F	All-wheel Drive Platform/Chassis Engine YD25DDTi	641075	Inner Joint	27	26	39	61.5	133					
	2008.10-	MT	L/R	F	All-wheel Drive Pickup Engine YD25DDTi	241262	Drive Shaft	29	27	67	115	634					
	2008.10-	AT	L/R	F	All-wheel Drive Pickup Engine YD25DDTi	641075	Inner Joint	27	26	39	61.5	133					
	2008.10-	AT	-	F	All-wheel Drive Pickup Engine YD25DDTi	841257	Outer Joint	29	26	67	115.5	62	M				
	2008.10-	AT	L	F	All-wheel Drive Pickup Engine YD25DDTi	241394	Drive Shaft	29	27	67	115.5	631					
	2008.10-	AT	R	F	All-wheel Drive Pickup Engine YD25DDTi	241394	Drive Shaft	29	27	67	115.5	631					
2.5 dCi (120 kW)	2006.10-	-	-	F	Pickup Engine YD25DDTi	841270	Outer Joint	29	36	67.1	125	60.5	I				
	2006.10-	-	L	F	Pickup Engine YD25DDTi	641100	Inner Joint	27	35	39	63	131.5					
2.5 dCi (126 kW)	2006.10-	MT	L/R	F	All-wheel Drive Pickup Engine YD25DDTi	241262	Drive Shaft	29	27	67	115	634					
	2006.10-	MT	L/R	F	All-wheel Drive Pickup Engine YD25DDTi	841240	Outer Joint	29	27	67	115	63	M				
	2006.10-	-	-	F	All-wheel Drive Pickup Engine YD25DDTi	841270	Outer Joint	29	36	67.1	125	60.5	I				
	2006.10-	AT	-	F	All-wheel Drive Pickup Engine YD25DDTi	841257	Outer Joint	29	26	67	115.5	62	M				

YEAR	TRANSM	L/R	F/R	REMARKS	GSP Ref.	PRODUCT	ABS	Technical Specifications							
								A	B	C	H	L	P		
NISSAN															
NP300 NAVARA (D40)															
2.5 dCi (126 kW)	2006.10-	-	-	L F	All-wheel Drive Pickup Engine YD25DDTi	641100	Inner Joint	27	35	39	63	131.5			
	2006.10-	-	-	-	All-wheel Drive Pickup Engine YD25DDTi	241394	Drive Shaft	29	27	67	115.5	631			
	2006.10-	-	MT	-	All-wheel Drive Pickup Engine YD25DDTi	841231	Outer Joint	29	36	68	122.5	60	M		
	2006.10-	-	AT	L F	All-wheel Drive Pickup Engine YD25DDTi	241394	Drive Shaft	29	27	67	115.5	631			
	2006.10-	-	MT/AT	L/R F	All-wheel Drive Pickup Engine YD25DDTi	641075	Inner Joint	27	26	39	61.5	133			
	2008.08-	-	AT	-	All-wheel Drive Platform/Chassis Engine YD25DDTi	841257	Outer Joint	29	26	67	115.5	62	M		
2.5 dCi (128 kW)	2005.07-	-	MT	L/R F	All-wheel Drive Pickup Engine YD25DDTi	241262	Drive Shaft	29	27	67	115	634			
	2005.07-	-	MT	L/R F	All-wheel Drive Pickup Engine YD25DDTi	841240	Outer Joint	29	27	67	115	63	M		
	2005.07-	-	-	-	All-wheel Drive Pickup Engine YD25DDTi	841270	Outer Joint	29	36	67.1	125	60.5	I		
	2005.07-	-	AT	-	All-wheel Drive Pickup Engine YD25DDTi	841257	Outer Joint	29	26	67	115.5	62	M		
	2005.07-	-	-	L F	All-wheel Drive Pickup Engine YD25DDTi	641100	Inner Joint	27	35	39	63	131.5			
	2005.07-	-	MT	-	All-wheel Drive Pickup Engine YD25DDTi	841231	Outer Joint	29	36	68	122.5	60	M		
	2005.07-	-	-	-	All-wheel Drive Pickup Engine YD25DDTi	241394	Drive Shaft	29	27	67	115.5	631			
	2005.07-	-	AT	L F	All-wheel Drive Pickup Engine YD25DDTi	241394	Drive Shaft	29	27	67	115.5	631			
	2005.07-	-	MT/AT	L/R F	All-wheel Drive Pickup Engine YD25DDTi	641075	Inner Joint	27	26	39	61.5	133			
2.5 dCi (140 kW)	2009.12-	-	MT	L/R F	All-wheel Drive Pickup Engine YD25DDTi	241262	Drive Shaft	29	27	67	115	634			
	2009.12-	-	MT	L/R F	All-wheel Drive Pickup Engine YD25DDTi	841240	Outer Joint	29	27	67	115	63	M		
	2009.12-	-	AT	-	All-wheel Drive Pickup Engine YD25DDTi	841257	Outer Joint	29	26	67	115.5	62	M		
	2009.12-	-	MT/AT	L/R F	All-wheel Drive Pickup Engine YD25DDTi	641075	Inner Joint	27	26	39	61.5	133			
	2009.12-	-	-	-	All-wheel Drive Pickup Engine YD25DDTi	241394	Drive Shaft	29	27	67	115.5	631			
	2009.12-	-	AT	L F	All-wheel Drive Pickup Engine YD25DDTi	241394	Drive Shaft	29	27	67	115.5	631			
	2010.03-	-	-	L/R F	All-wheel Drive Platform/Chassis Engine YD25DDTi	241262	Drive Shaft	29	27	67	115	634			
	2010.03-	-	MT	L/R F	All-wheel Drive Platform/Chassis Engine YD25DDTi	841240	Outer Joint	29	27	67	115	63	M		
	2010.03-	-	AT	-	All-wheel Drive Platform/Chassis Engine YD25DDTi	841257	Outer Joint	29	26	67	115.5	62	M		
	2010.03-	-	-	L/R F	All-wheel Drive Platform/Chassis Engine YD25DDTi	241394	Drive Shaft	29	27	67	115.5	631			
	2010.03-	-	AT	L F	All-wheel Drive Platform/Chassis Engine YD25DDTi	241394	Drive Shaft	29	27	67	115.5	631			
	2010.03-	-	AT	L/R F	All-wheel Drive Platform/Chassis Engine YD25DDTi	641075	Inner Joint	27	26	39	61.5	133			
3.0 dCi (170 kW)	2010.02-	-	AT	L/R F	All-wheel Drive Pickup Engine V9X	241566	Drive Shaft	29	27	67	115.5	635			
	2010.02-	-	AT	-	All-wheel Drive Pickup Engine V9X	841273	Outer Joint	29	36	67	115.5	62	I		
	2010.02-	-	AT	L F	All-wheel Drive Pickup Engine V9X	641100	Inner Joint	27	35	39	63	131.5			
	2010.03-	-	AT	L/R F	All-wheel Drive Platform/Chassis Engine V9X	241566	Drive Shaft	29	27	67	115.5	635			
	2010.03-	-	AT	-	All-wheel Drive Platform/Chassis Engine V9X	841273	Outer Joint	29	36	67	115.5	62	I		
	2010.03-	-	AT	L F	All-wheel Drive Platform/Chassis Engine V9X	641100	Inner Joint	27	35	39	63	131.5			
NV200															
1.5 dci (63 kW)	2010.02-	-	MT	R F	Box Body/Estate Engine K9K 608/K9K 400/K9K 628	241466	Drive Shaft	29	26	56.2	102	914			
1.5 dci (66 kW)	2011.04-	-	MT	R F	Box Body/Estate Engine K9K 892	241466	Drive Shaft	29	26	56.2	102	914			
1.5 Diesel	2013-	-	-	L F	-	641084	Inner Joint	26	23	40	64.5	109.5			
	2013-	-	-	L F	-	241497	Drive Shaft	29	26	56.2	102	666			
NV200/EVALIA															
1.5 dci (63 kW)	2010.07-	-	MT	R F	Bus Engine K9K 608/K9K 400/K9K 628	241466	Drive Shaft	29	26	56.2	102	914			
1.5 dci (66 kW)	2011.04-	-	MT	R F	Bus Engine K9K 892	241466	Drive Shaft	29	26	56.2	102	914			
NV400 (X62 X62B)															
2.3 dCi 100 (74 kW)	2011.11-	2014.06	MT	-	F Bus Engine M9T 670/M9T 672/M9T 676	850132	Outer Joint	31	27	70	100.5	63.5	I		
	2011.11-	2014.05	MT	-	F Box Engine M9T 670/M9T 672/M9T 676	850132	Outer Joint	31	27	70	100.5	63.5	I		
	2011.11-	2014.06	MT	-	F Platform/Chassis Engine M9T 670/M9T 672/M9T 676	850132	Outer Joint	31	27	70	100.5	63.5	I		
	2011.11-	2014.06	-	L F	Bus Engine M9T 670/M9T 672/M9T 676	218247	Drive Shaft	31	39	70	100.5	743			
	2011.11-	2014.05	-	L F	Box Engine M9T 670/M9T 672/M9T 676	218247	Drive Shaft	31	39	70	100.5	743			
	2011.11-	2014.06	-	L F	Platform/Chassis Engine M9T 670/M9T 672/M9T 676	218247	Drive Shaft	31	39	70	100.5	743			
	2011.11-	2014.06	-	R F	Bus Engine M9T 670/M9T 672/M9T 676	218248	Drive Shaft	31	39	70	100.5	1075			
	2011.11-	2014.05	-	R F	Box Engine M9T 670/M9T 672/M9T 676	218248	Drive Shaft	31	39	70	100.5	1075			
	2011.11-	2014.06	-	R F	Platform/Chassis Engine M9T 670/M9T 672/M9T 676	218248	Drive Shaft	31	39	70	100.5	1075			
	2011.11-	2014.06	-	R F	Platform/Chassis Engine M9T 670/M9T 672/M9T 676	218515	Drive Shaft	31	39	70	101	1077			
	2011.11-	2014.06	-	R F	Bus Engine M9T 670/M9T 672/M9T 676	218515	Drive Shaft	31	39	70	101	1077			
	2011.11-	2014.05	-	R F	Box Engine M9T 670/M9T 672/M9T 676	218515	Drive Shaft	31	39	70	101	1077			
2.3 dCi 110 (81 kW)	2014.06-	2016.09	MT	L F	Bus Engine M9T 870	218247	Drive Shaft	31	39	70	100.5	743			
2.3 dCi 125 (92 kW)	2011.11-	2016.09	MT	-	F Bus Engine M9T 670/M9T 672/M9T 676	850132	Outer Joint	31	27	70	100.5	63.5	I		
	2011.11-	2016.09	MT	-	F Box Engine M9T 670/M9T 672/M9T 676	850132	Outer Joint	31	27	70	100.5	63.5	I		
	2011.11-	2016.06	MT	-	F Platform/Chassis Engine M9T 670/M9T 672/M9T 676	850132	Outer Joint	31	27	70	100.5	63.5	I		
	2011.11-	2016.09	-	L F	Bus Engine M9T 670/M9T 672/M9T 676	218247	Drive Shaft	31	39	70	100.5	743			
	2011.11-	2016.09	-	L F	Box Engine M9T 670/M9T 672/M9T 676	218247	Drive Shaft	31	39	70	100.5	743			
	2011.11-	2016.06	-	L F	Platform/Chassis Engine M9T 670/M9T 672/M9T 676	218247	Drive Shaft	31	39	70	100.5	743			
	2011.11-	2016.09	-	R F	Bus Engine M9T 670/M9T 672/M9T 676	218248	Drive Shaft	31	39	70	100.5	1075			
	2011.11-	2016.09	-	R F	Box Engine M9T 670/M9T 672/M9T 676	218248	Drive Shaft	31	39	70	100.5	1075			
	2011.11-	2016.06	-	R F	Platform/Chassis Engine M9T 670/M9T 672/M9T 676	218248	Drive Shaft	31	39	70	100.5	1075			
	2011.11-	2016.09	-	R F	Box Engine M9T 670/M9T 672/M9T 676	218515	Drive Shaft	31	39	70	101	1077			
	2011.11-	2016.06	-	R F	Platform/Chassis Engine M9T 670/M9T 672/M9T 676	218515	Drive Shaft	31	39	70	101	1077			

YEAR	TRANSM	L/R	F/R	REMARKS	GSP Ref.	PRODUCT	ABS	Technical Specifications					
								A	B	C	H	L	P
NISSAN													
NV400 (X62 X62B)													
2.3 dCi 125 (92 kW)	2011.11-2016.09	-	R	F	Bus Engine M9T 670/M9T 672/M9T 676	218515	Drive Shaft	31	39	70	101	1077	
2.3 dCi 125 RWD (92 kW)	2011.11-2016.09	-	L	F	Box Engine M9T 690/M9T 686/M9T 692/M9T 696/M9T 698/M9T 870/M9T 896	218247	Drive Shaft	31	39	70	100.5	743	
	2011.11-2016.06	-	L	F	Platform/Chassis Engine M9T 690/M9T 686/M9T 692/M9T 696/M9T 698/M9T 870/M9T 896	218247	Drive Shaft	31	39	70	100.5	743	
	2011.11-2016.09	-	R	F	Box Engine M9T 690/M9T 686/M9T 692/M9T 696/M9T 698/M9T 870/M9T 896	218248	Drive Shaft	31	39	70	100.5	1075	
	2011.11-2016.06	-	R	F	Platform/Chassis Engine M9T 690/M9T 686/M9T 692/M9T 696/M9T 698/M9T 870/M9T 896	218248	Drive Shaft	31	39	70	100.5	1075	
2.3 dCi 145 (107 kW)	2011.11-2014.02	MT	-	F	Bus Engine M9T 678/M9T 680	850132	Outer Joint	31	27	70	100.5	63.5 I	
	2011.11-2014.02	MT	-	F	Box Engine M9T 678/M9T 680	850132	Outer Joint	31	27	70	100.5	63.5 I	
	2011.11-2016.06	MT	-	F	Platform/Chassis Engine M9T 678/M9T 680	850132	Outer Joint	31	27	70	100.5	63.5 I	
	2011.11-2014.02	-	L	F	Bus Engine M9T 678/M9T 680	218247	Drive Shaft	31	39	70	100.5	743	
	2011.11-2014.02	-	L	F	Box Engine M9T 678/M9T 680	218247	Drive Shaft	31	39	70	100.5	743	
	2011.11-2016.06	-	L	F	Platform/Chassis Engine M9T 678/M9T 680	218247	Drive Shaft	31	39	70	100.5	743	
	2011.11-2014.02	-	R	F	Bus Engine M9T 678/M9T 680	218248	Drive Shaft	31	39	70	100.5	1075	
	2011.11-2014.02	-	R	F	Box Engine M9T 678/M9T 680	218248	Drive Shaft	31	39	70	100.5	1075	
	2011.11-2016.06	-	R	F	Platform/Chassis Engine M9T 678/M9T 680	218248	Drive Shaft	31	39	70	100.5	1075	
	2011.11-2014.02	-	R	F	Bus Engine M9T 678/M9T 680	218515	Drive Shaft	31	39	70	101	1077	
	2011.11-2014.02	-	R	F	Box Engine M9T 678/M9T 680	218515	Drive Shaft	31	39	70	101	1077	
	2.3 dCi 145 RWD (107 kW)	2011.11-2014.02	-	L	F	Box Engine M9T 694/M9T 696/M9T 698	218247	Drive Shaft	31	39	70	100.5	743
2011.11-2016.06		-	L	F	Platform/Chassis Engine M9T 698/M9T 694/M9T 696	218247	Drive Shaft	31	39	70	100.5	743	
2011.11-2014.02		-	R	F	Box Engine M9T 694/M9T 696/M9T 698	218248	Drive Shaft	31	39	70	100.5	1075	
2011.11-2016.06		-	R	F	Platform/Chassis Engine M9T 698/M9T 694/M9T 696	218248	Drive Shaft	31	39	70	100.5	1075	
2.3 dCi 150 (110 kW)	2014.02-2016.09	MT	L	F	Bus Engine M9T 880	218247	Drive Shaft	31	39	70	100.5	743	
NX COUPE													
1.6	1990-	-	-	-	R B13 GA13 GA16DE GA16DS	641002	Inner Joint	25	23	40	63	101	
PATHFINDER													
-	1993-2005	-	L/R	-	-	241178	Drive Shaft	28		50	150	522	
4.0	2004.08-2005.09	5AT	L/R	R	-	241550	Drive Shaft	32		67.3	117.5	661	
	2004.08-2012.09	5AT	L/R	R	-	241550	Drive Shaft	32		67.3	117.5	661	
	2006.01-2012.09	5AT	L/R	R	-	241550	Drive Shaft	32		67.3	117.5	661	
4.0L V6	2009-	-	L/R	F	LE Sport Utility 4Door	841325	Outer Joint	29	36	67.3	115	60.5 M	
	2009-	-	L/R	F	S Sport Utility 4Door	841325	Outer Joint	29	36	67.3	115	60.5 M	
	2009-	-	L/R	F	SE OffRoad Sport Utility 4Door	841325	Outer Joint	29	36	67.3	115	60.5 M	
	2009-	-	L/R	F	SE Sport Utility 4Door	841325	Outer Joint	29	36	67.3	115	60.5 M	
	2010-	-	L/R	F	LE Sport Utility 4Door	841325	Outer Joint	29	36	67.3	115	60.5 M	
	2010-	-	L/R	F	LE Sport Utility 4Door	841325	Outer Joint	29	36	67.3	115	60.5 M	
	2010-	-	L/R	F	S Sport Utility 4Door	841325	Outer Joint	29	36	67.3	115	60.5 M	
	2010-	-	L/R	F	SE Sport Utility 4Door	841325	Outer Joint	29	36	67.3	115	60.5 M	
	2011-	-	L/R	F	LE Sport Utility 4Door	841325	Outer Joint	29	36	67.3	115	60.5 M	
	2011-	-	L/R	F	LE Sport Utility 4Door	841325	Outer Joint	29	36	67.3	115	60.5 M	
	2011-	-	L/R	F	S Sport Utility 4Door	841325	Outer Joint	29	36	67.3	115	60.5 M	
	2011-	-	L/R	F	Silver Edition Sport Utility 4Door	841325	Outer Joint	29	36	67.3	115	60.5 M	
	2011-	-	L/R	F	SV Sport Utility 4Door	841325	Outer Joint	29	36	67.3	115	60.5 M	
	2012-	-	L/R	F	Base Sport Utility 4Door	841325	Outer Joint	29	36	67.3	115	60.5 M	
	2012-	-	L/R	F	LE Sport Utility 4Door	841325	Outer Joint	29	36	67.3	115	60.5 M	
	2012-	-	L/R	F	S Sport Utility 4Door	841325	Outer Joint	29	36	67.3	115	60.5 M	
2012-	-	L/R	F	SV Sport Utility 4Door	841325	Outer Joint	29	36	67.3	115	60.5 M		
PATHFINDER I (WD21)													
2.4 (74 kW)	1986.07-1995.10	MT	-	F	All-wheel Drive Closed Off-Road Vehicle Engine Z24i	841086	Outer Joint	27	27	50	150	71 I	
PATHFINDER II (R50)/TERRANO													
3.0 DDTi (125 kW)	1999.09-2004.12	AT	-	F	All-wheel Drive Closed Off-Road Vehicle Engine ZD30DDTi	841016	Outer Joint	28	27	50	150	71 I	
	1999.09-2004.12	AT	-	F	All-wheel Drive Closed Off-Road Vehicle Engine ZD30DDTi	841100	Outer Joint	28	25	50	150	71 I	
	1999.09-2004.12	AT	-	-	All-wheel Drive Closed Off-Road Vehicle Engine ZD30DDTi	641014	Inner Joint		27		81.2		
3.3 V6 (125 kW)	1997.09-2004.12	-	-	F	All-wheel Drive Closed Off-Road Vehicle Engine VG33E	841100	Outer Joint	28	25	50	150	71 I	
PATHFINDER III (R51)													
2.5 dCi (120 kW)	2005.01-	MT	L/R	F	All-wheel Drive Closed Off-Road Vehicle Engine YD25DDTi	241262	Drive Shaft	29	27	67	115	634	
	2005.01-	MT	L/R	F	All-wheel Drive Closed Off-Road Vehicle Engine YD25DDTi	641075	Inner Joint	27	26	39	61.5	133	
	2005.01-	MT	L/R	F	All-wheel Drive Closed Off-Road Vehicle Engine YD25DDTi	841240	Outer Joint	29	27	67	115	63 M	
2.5 dCi (126 kW)	2006.10-	MT	L/R	F	All-wheel Drive Closed Off-Road Vehicle Engine YD25DDTi	241262	Drive Shaft	29	27	67	115	634	
	2006.10-	MT	L/R	F	All-wheel Drive Closed Off-Road Vehicle Engine YD25DDTi	841240	Outer Joint	29	27	67	115	63 M	
	2006.10-	MT/AT	L/R	F	All-wheel Drive Closed Off-Road Vehicle Engine YD25DDTi	641075	Inner Joint	27	26	39	61.5	133	
	2006.10-	-	-	-	All-wheel Drive Closed Off-Road Vehicle Engine YD25DDTi	241394	Drive Shaft	29	27	67	115.5	631	
	2006.10-	AT	L	F	All-wheel Drive Closed Off-Road Vehicle Engine YD25DDTi	241394	Drive Shaft	29	27	67	115.5	631	
2.5 dCi (128 kW)	2005.03-	MT	L/R	F	All-wheel Drive Closed Off-Road Vehicle Engine YD25DDTi	241262	Drive Shaft	29	27	67	115	634	
	2005.03-	MT	L/R	F	All-wheel Drive Closed Off-Road Vehicle Engine YD25DDTi	841240	Outer Joint	29	27	67	115	63 M	
	2005.03-	MT/AT	L/R	F	All-wheel Drive Closed Off-Road Vehicle Engine YD25DDTi	641075	Inner Joint	27	26	39	61.5	133	
	2005.03-	-	-	-	All-wheel Drive Closed Off-Road Vehicle Engine YD25DDTi	241394	Drive Shaft	29	27	67	115.5	631	





YEAR	TRANSM	L/R	F/R	REMARKS	GSP Ref.	PRODUCT	ABS	Technical Specifications						
								A	B	C	H	L	P	
NISSAN														
PATHFINDER III (R51)														
2.5 dCi (128 kW)	2005.03-	-	AT	L F	All-wheel Drive Closed Off-Road Vehicle Engine YD25DDTi	241394	Drive Shaft		29	27	67	115.5	631	
2.5 dCi (140 kW)	2010.08-	-	MT	L/R F	All-wheel Drive Closed Off-Road Vehicle Engine YD25DDTi	241262	Drive Shaft		29	27	67	115	634	
	2010.08-	-	MT	L/R F	All-wheel Drive Closed Off-Road Vehicle Engine YD25DDTi	841240	Outer Joint		29	27	67	115	63	M
	2010.08-	-	MT/AT	L/R F	All-wheel Drive Closed Off-Road Vehicle Engine YD25DDTi	641075	Inner Joint		27	26	39	61.5	133	
	2010.08-	-	-	-	All-wheel Drive Closed Off-Road Vehicle Engine YD25DDTi	241394	Drive Shaft		29	27	67	115.5	631	
	2010.08-	-	AT	L F	All-wheel Drive Closed Off-Road Vehicle Engine YD25DDTi	241394	Drive Shaft		29	27	67	115.5	631	
3.0 dCi (170 kW)	2010.08-	-	AT	- F	All-wheel Drive Closed Off-Road Vehicle Engine V9X	841273	Outer Joint		29	36	67	115.5	62	I
	2010.08-	-	AT	- R	All-wheel Drive Closed Off-Road Vehicle Engine V9X	841408	Outer Joint		32	29	67	118.5	69	M
	2010.08-	-	AT	L F	All-wheel Drive Closed Off-Road Vehicle Engine V9X	641100	Inner Joint		27	35	39	63	131.5	
4.0 (198 kW)	2005.09-	-	AT	R R	All-wheel Drive Closed Off-Road Vehicle Engine VQ40DE	641209	Inner Joint			37		87.4		
	2005.09-	-	AT	- F	All-wheel Drive Closed Off-Road Vehicle Engine VQ40DE	841273	Outer Joint		29	36	67	115.5	62	I
	2005.09-	-	AT	- F	All-wheel Drive Closed Off-Road Vehicle Engine VQ40DE	841257	Outer Joint		29	26	67	115.5	62	M
	2005.09-	-	AT	- R	All-wheel Drive Closed Off-Road Vehicle Engine VQ40DE	841404	Outer Joint		32	37	67.3	117.5	61.5	I
	2005.09-	-	AT	L F	All-wheel Drive Closed Off-Road Vehicle Engine VQ40DE	641100	Inner Joint		27	35	39	63	131.5	
PATROL														
-	2010.03-	2012.10	7AT	- -	ENGINE : VK56VD AWD	241565	Drive Shaft		34		67.2	123.5	707	
	2012.10-	2013.10	7AT	- -	ENGINE : VK56VD AWD	241565	Drive Shaft		34		67.2	123.5	707	
	2013.10-	2014.11	7AT	- -	ENGINE : VK56VD AWD	241565	Drive Shaft		34		67.2	123.5	707	
	2014.11-	-	7AT	- -	ENGINE : VK56VD AWD	241565	Drive Shaft		34		67.2	123.5	707	
	2010.01-	-	5AT	R F	-	241568	Drive Shaft		32	31	67.2	123.5	709	
5.6	2010.01-	-	5AT	R F	-	841324	Outer Joint		32	43	67.2	123.5	74.5	I
	2010.03-	-	7AT	R F	-	241568	Drive Shaft		32	31	67.2	123.5	709	
	2010.03-	-	7AT	R F	-	841324	Outer Joint		32	43	67.2	123.5	74.5	I
PATROL GR V Wagon (Y61)/SAFARI														
2.8 TD (95 kW)	1997.06-	2000.05	-	R F	All-wheel Drive Closed Off-Road Vehicle Engine RD28Ti	241179	Drive Shaft		31		60	162.5	617	
	1997.06-	2000.05	-	L F	All-wheel Drive Closed Off-Road Vehicle Engine RD28Ti	241221	Drive Shaft		31		60	162.5	1115	
3.0 DTi (116 kW)	2000.05-	-	-	R F	All-wheel Drive Closed Off-Road Vehicle Engine ZD30DDTi	241179	Drive Shaft		31		60	162.5	617	
	2000.05-	-	-	L F	All-wheel Drive Closed Off-Road Vehicle Engine ZD30DDTi	241221	Drive Shaft		31		60	162.5	1115	
3.0 DTi (118 kW)	2000.05-	-	-	R F	All-wheel Drive Closed Off-Road Vehicle Engine ZD30DDTi	241179	Drive Shaft		31		60	162.5	617	
	2000.05-	-	-	L F	All-wheel Drive Closed Off-Road Vehicle Engine ZD30DDTi	241221	Drive Shaft		31		60	162.5	1115	
4.8 (180 kW)	2000.03-	-	-	R F	All-wheel Drive Closed Off-Road Vehicle Engine TB48DE	241179	Drive Shaft		31		60	162.5	617	
	2000.03-	-	-	L F	All-wheel Drive Closed Off-Road Vehicle Engine TB48DE	241221	Drive Shaft		31		60	162.5	1115	
PATROL VI (Y62)														
5.6 (233 kW)	2010.04-	-	-	- R	All-wheel Drive Closed Off-Road Vehicle	641195	Inner Joint			43		84		
	2010.04-	-	AT	- F	All-wheel Drive Closed Off-Road Vehicle	641203	Inner Joint		31	40	43	79.5	134	
5.6 (298 kW)	2010.04-	-	AT	- R	All-wheel Drive Closed Off-Road Vehicle Engine VK56VD	641195	Inner Joint			43		84		
	2010.04-	-	AT	- F	All-wheel Drive Closed Off-Road Vehicle Engine VK56VD	641203	Inner Joint		31	40	43	79.5	134	
5.6 NISMO(315 kW)	2016.1-	-	AT	- R	All-wheel Drive Closed Off-Road Vehicle Engine VK56VD	641195	Inner Joint			43		84		
PATROL Y62														
-	2010.01-	-	7AT	- -	ENGINE : VK56VD; AWD;GL1;4WD	241565	Drive Shaft		34		67.2	123.5	707	
	2010.01-	-	7AT	- -	ENGINE : VK56VD; AWD;GL1;4WD	841393	Outer Joint		34	43	67.2	123.5	74.5	I
	2010.03-	-	7AT	R R	ENGINE : VK56VD; AWD;EL1;4WD;RUSSIA	241565	Drive Shaft		34		67.2	123.5	707	
	2010.03-	-	7AT	R R	ENGINE : VK56VD; AWD;EL1;4WD;RUSSIA	841393	Outer Joint		34	43	67.2	123.5	74.5	I
	2012.11-	-	7AT	R R	ENGINE : VK56VD; GR1;4WD;BASE GRADE;WAGON 3ROW	241565	Drive Shaft		34		67.2	123.5	707	
	2012.11-	-	7AT	R R	ENGINE : VK56VD; GR1;4WD;BASE GRADE;WAGON 3ROW	841393	Outer Joint		34	43	67.2	123.5	74.5	I
PICK UP (D21)/DATSUN														
2.4 (74 kW)	1986.03-	1992.04	-	- -	All-wheel Drive Pickup Engine Z24i	841178	Outer Joint		26	27	50	147.5	64	I
	1986.03-	1992.04	MT	- F	All-wheel Drive Pickup Engine Z24i	841086	Outer Joint		27	27	50	150	71	I
2.4 (76 kW)	1985.09-	1994.05	MT	- F	All-wheel Drive Pickup Engine Z24	841016	Outer Joint		28	27	50	150	71	I
	1985.09-	1994.05	MT	- -	All-wheel Drive Pickup Engine Z24	641014	Inner Joint			27		81.2		
	1985.09-	1994.05	MT	- F	All-wheel Drive Pickup Engine Z24	841086	Outer Joint		27	27	50	150	71	I
2.4 i 12V (93 kW)	1992.04-	1998.02	MT	- F	All-wheel Drive Pickup Engine KA24E	841016	Outer Joint		28	27	50	150	71	I
	1992.04-	1998.02	MT	- -	All-wheel Drive Pickup Engine KA24E	641014	Inner Joint			27		81.2		
	1992.04-	1998.02	MT	- F	All-wheel Drive Pickup Engine KA24E	841086	Outer Joint		27	27	50	150	71	I
2.5 D (55 kW)	1986.03-	1991.08	-	- -	All-wheel Drive Pickup Engine SD25	841178	Outer Joint		26	27	50	147.5	64	I
	1986.03-	1991.08	MT	- F	All-wheel Drive Pickup Engine SD25	841086	Outer Joint		27	27	50	150	71	I
	1987.09-	1998.02	-	L F	Pickup Engine TD25	241057	Drive Shaft		28		50	150	570.5	
	1987.09-	1998.02	-	- -	Pickup Engine TD25	841178	Outer Joint		26	27	50	147.5	64	I
2.5 D (59 kW)	1987.08-	1998.02	MT	- F	All-wheel Drive Pickup Engine TD25	841016	Outer Joint		28	27	50	150	71	I
	1987.08-	1998.02	-	L F	All-wheel Drive Pickup Engine TD25	241057	Drive Shaft		28		50	150	570.5	
	1987.08-	1998.02	-	- -	All-wheel Drive Pickup Engine TD25	841178	Outer Joint		26	27	50	147.5	64	I
	1987.08-	1998.02	MT	- F	All-wheel Drive Pickup Engine TD25	841086	Outer Joint		27	27	50	150	71	I
2.5 D (61 kW)	1992.08-	1998.02	-	L F	Pickup Engine TD25	241057	Drive Shaft		28		50	150	570.5	
	1992.08-	1998.02	-	- -	Pickup Engine TD25	841178	Outer Joint		26	27	50	147.5	64	I
	1996.03-	1998.02	MT	- F	All-wheel Drive Pickup Engine TD25	841016	Outer Joint		28	27	50	150	71	I
	1996.03-	1998.02	-	- -	All-wheel Drive Pickup Engine TD25	841178	Outer Joint		26	27	50	147.5	64	I

YEAR	TRANSM	L/R	F/R	REMARKS	GSP Ref.	PRODUCT	ABS	Technical Specifications									
								A	B	C	H	L	P				
NISSAN																	
PICK UP (D21)/DATSUN																	
2.7 D (73 kW)	1987.08-1998.02	MT	-	F	All-wheel Drive Pickup Engine TD27	841016	Outer Joint		28	27	50	150	71	I			
	1987.08-1998.02	MT	-	-	All-wheel Drive Pickup Engine TD27	641014	Inner Joint			27		81.2					
	1987.08-1998.02	MT	-	F	All-wheel Drive Pickup Engine TD27	841086	Outer Joint		27	27	50	150	71	I			
2.7 TD (73 kW)	1987.09-1996.12	-	-	F	All-wheel Drive Pickup Engine TD27T	841016	Outer Joint		28	27	50	150	71	I			
	1987.09-1996.12	-	-	-	All-wheel Drive Pickup Engine TD27T	641014	Inner Joint			27		81.2					
	1987.09-1996.12	-	-	F	All-wheel Drive Pickup Engine TD27T	841086	Outer Joint		27	27	50	150	71	I			
PICK UP (D22)/DATSUN																	
2.4 i (88 kW)	1998.02-2005.04	MT	-	F	All-wheel Drive Pickup Engine KA24E	841016	Outer Joint		28	27	50	150	71	I			
	1998.02-2005.04	MT	-	F	All-wheel Drive Pickup Engine KA24E	841100	Outer Joint		28	25	50	150	71	I			
	1998.02-2005.04	MT	-	-	All-wheel Drive Pickup Engine KA24E	641014	Inner Joint			27		81.2					
2.5 D (61 kW)	1998.02-2005.04	-	L	F	All-wheel Drive Pickup Engine TD25	241057	Drive Shaft		28		50	150	570.5				
2.5 D (96 kW)	1997.01-2005.04	MT	-	F	All-wheel Drive Pickup	841016	Outer Joint		28	27	50	150	71	I			
	1997.01-2005.04	MT	-	F	All-wheel Drive Pickup	841100	Outer Joint		28	25	50	150	71	I			
	1997.01-2005.04	MT	-	-	All-wheel Drive Pickup	641014	Inner Joint			27		81.2					
	1997.01-2005.04	-	L	F	All-wheel Drive Pickup	241057	Drive Shaft		28		50	150	570.5				
2.5 Di (98 kW)	2002.03-2005.04	MT	-	F	Pickup Engine YD25DDTi	841100	Outer Joint		28	25	50	150	71	I			
	2002.03-2005.04	MT	-	-	Pickup Engine YD25DDTi	641014	Inner Joint			27		81.2					
2.5 TD (76 kW)	1998.05-2005.04	-	-	F	All-wheel Drive Pickup Engine TD25TI	841016	Outer Joint		28	27	50	150	71	I			
	1998.05-2005.04	-	-	F	All-wheel Drive Pickup Engine TD25TI	841100	Outer Joint		28	25	50	150	71	I			
	1998.05-2005.04	-	-	-	All-wheel Drive Pickup Engine TD25TI	641014	Inner Joint			27		81.2					
	1998.05-2005.04	-	L	F	All-wheel Drive Pickup Engine TD25TI	241057	Drive Shaft		28		50	150	570.5				
3.2 D (76 kW)	1998.12-2005.04	-	-	F	All-wheel Drive Pickup Engine QD32	841016	Outer Joint		28	27	50	150	71	I			
PICK-UP (720)																	
-	1987-1998	-	-	-	-	841183	Outer Joint		27	27	50	150	71	I			
PIXO (UA0)																	
1.0 (50 kW)	2009.06-	MT	R	F	Hatchback Engine K10 B	257124	Drive Shaft	43T	23	22	49	81	819.5				
PRAIRIE PRO (M11)																	
2.0 i (68 kW)	1988.10-1992.04	-	-	F	-	841121	Outer Joint		27	23	56	104	63	I			
2.0 i (71 kW)	1988.10-1992.04	-	-	F	-	841121	Outer Joint		27	23	56	104	63	I			
2.0 i (77 kW)	1988.10-1992.04	-	-	F	-	841121	Outer Joint		27	23	56	104	63	I			
2.0 i (85 kW)	1988.10-1992.04	-	-	F	-	841121	Outer Joint		27	23	56	104	63	I			
2.0 i 4WD (68 kW)	1988.10-1992.04	MT	-	F	-	841121	Outer Joint		27	23	56	104	63	I			
2.0 i 4WD (71 kW)	1988.10-1992.04	MT	-	F	-	841121	Outer Joint		27	23	56	104	63	I			
2.0 i 4WD (77 kW)	1988.10-1992.04	MT	-	F	-	841121	Outer Joint		27	23	56	104	63	I			
2.0 i 4WD (85 kW)	1988.10-1992.04	MT	-	F	-	841121	Outer Joint		27	23	56	104	63	I			
2.4 i (98 kW)	1992.04-1994.07	-	-	-	-	841121	Outer Joint		27	23	56	104	63	I			
2.4 i 4WD (98 kW)	1992.04-1994.07	-	-	-	-	841121	Outer Joint		27	23	56	104	63	I			
PRAIRIE PRO (M11)/PRAIRIE/PRAIRIE JOY/AXCESS																	
2.0 (77 kW)	1990.09-1992.03	-	-	-	All-wheel Drive MPV Engine CA20E	841045	Outer Joint		27	23	56	103	62	I			
2.0 i (72 kW)	1988.10-1992.04	-	-	F	MPV Engine CA20E	841035	Outer Joint		27	25	56	101	70	M			
	1988.10-1992.12	-	-	F	All-wheel Drive MPV Engine CA20E	841035	Outer Joint		27	25	56	101	70	M			
	1988.10-1992.04	-	-	F	MPV Engine CA20E	841061	Outer Joint		27	23	56	99	60	I			
	1988.10-1992.12	-	-	F	All-wheel Drive MPV Engine CA20E	841061	Outer Joint		27	23	56	99	60	I			
	1988.10-1992.04	-	-	-	MPV Engine CA20E	841176	Outer Joint		27	23	56	104	63	I			
	1988.10-1992.12	-	-	-	All-wheel Drive MPV Engine CA20E	841176	Outer Joint		27	23	56	104	63	I			
	1988.10-1992.04	-	-	-	MPV Engine CA20E	841045	Outer Joint		27	23	56	103	62	I			
	1988.10-1992.12	-	-	F	All-wheel Drive MPV Engine CA20E	841023	Outer Joint		27	23	56	103	61.5	M			
2.4 i (98 kW)	1992.04-1994.07	-	-	F	MPV Engine KA24E	841305	Outer Joint		27	25	56	103	61.5	M			
	1992.04-1994.07	-	-	F	All-wheel Drive MPV Engine KA24E	841061	Outer Joint		27	23	56	99	60	I			
	1992.04-1994.07	-	-	-	MPV Engine KA24E	841045	Outer Joint		27	23	56	103	62	I			
PRESAGE (U30)																	
3.0 (162 kW)	2001.08-2003.06	-	R	F	MPV Engine VQ30DE	641019	Inner Joint		29	27	33	437.5	101				
PRIMASTAR (X83)																	
1.9 dCi 100 (74 kW)	2001.03-	AT/MT	L/R	F	Bus Engine F9Q 760	818105	Outer Joint		27	26	56.5	93.5	64	M			
	2002.09-	AT/MT	L/R	F	Box Engine F9Q 760	818105	Outer Joint		27	26	56.5	93.5	64	M			
1.9 dCi 80 (60 kW)	2001.03-	AT/MT	L/R	F	Bus Engine F9Q 762	818105	Outer Joint		27	26	56.5	93.5	64	M			
	2002.09-	AT/MT	L/R	F	Box Engine F9Q 762	818105	Outer Joint		27	26	56.5	93.5	64	M			
2.0 (88 kW)	2001.03-	AT/MT	L/R	F	Bus Engine F4R 720/F4R 722	818105	Outer Joint		27	26	56.5	93.5	64	M			
	2003.02-	AT/MT	L/R	F	Box Engine F4R 720	818105	Outer Joint		27	26	56.5	93.5	64	M			
2.5 dCi 140 (99 kW)	2003.07-	AT/MT	L/R	F	Box Engine G9U 730	850041	Outer Joint		27	37	56.5	93	72	I			
	2003.07-	AT/MT	L/R	F	Bus Engine G9U 730	850041	Outer Joint		27	37	56.5	93	72	I			
	2003.07-	-	-	F	Box Engine G9U 730	850080	Outer Joint		27	37	56.5	92	73	I			
	2003.07-	-	-	F	Bus Engine G9U 730	850080	Outer Joint		27	37	56.5	92	73	I			
	2003.07-	-	-	-	Box Engine G9U 730	845015	Outer Joint		21	20	56.4	76	56	O			
	2003.07-	-	-	-	Bus Engine G9U 730	845015	Outer Joint		21	20	56.4	76	56	O			
PRIMER(P10E)																	

YEAR	TRANSM	L/R	F/R	REMARKS	GSP Ref.	PRODUCT	ABS	Technical Specifications							
								A	B	C	H	L	P		
NISSAN PRIMER(P10E)															
1991.01-1993.05	AT	L	F	ENGINE:CD20,BODY:SEDAN/5 DOOR HATCHBACK	841005	Outer Joint		27	32	56	103	61.5	M		
1993.05-1994.09	AT/MT	R	F	ENGINE:SR20DE,TRAIN:2WD,BODY:SEDAN/5 DOOR HATCHBACK	841005	Outer Joint		27	32	56	103	61.5	M		
1994.09-1995.04	AT/MT	R	F	ENGINE:SR20DE,TRAIN:2WD,BODY:SEDAN/5 DOOR HATCHBACK	841005	Outer Joint		27	32	56	103	61.5	M		
1995.04-	-	R	F	ENGINE:SR20DE	841005	Outer Joint		27	32	56	103	61.5	M		
PRIMERA															
-	-	-	-	-	841130	Outer Joint		27	22	56	103	56.5	M		
1990-1996	-	-	-	-	899190	Outer Joint	42T	27	22	56	103.5	61.5	I		
1.6/2.0	1991-1996	-	-	-	841330	Outer Joint		27	22	56	99	60	I		
2.0	1992-1996	-	-	-	641013	Inner Joint		25	25	33	345	102.5			
PRIMERA (P10)															
1.6 (66 kW)	1990.06-1996.01	-	-	F Hatchback Engine GA16DS	841017	Outer Joint		27	22	56	103	61.5	M		
	1990.06-1996.01	-	R	F Saloon Engine GA16DS	241005	Drive Shaft	42T	27	25	56	103.5	922			
	1990.06-1996.01	-	R	F Hatchback Engine GA16DS	241005	Drive Shaft	42T	27	25	56	103.5	922			
	1990.06-1996.01	-	L	F Saloon Engine GA16DS	241001	Drive Shaft	42T	27	25	56	103.5	638			
	1990.06-1996.01	-	L	F Hatchback Engine GA16DS	241001	Drive Shaft	42T	27	25	56	103.5	638			
	1990.06-1996.01	-	-	- Saloon Engine GA16DS	899203	Outer Joint		27	22	56	103.5	61.4	M		
	1990.06-1996.01	-	-	- Hatchback Engine GA16DS	899203	Outer Joint		27	22	56	103.5	61.4	M		
	1990.06-1996.01	MT	L	F Saloon Engine GA16DS	241058	Drive Shaft	42T	27	25	56	103.5	640			
	1990.06-1996.01	MT	L	F Hatchback Engine GA16DS	241058	Drive Shaft	42T	27	25	56	103.5	640			
	1990.06-1996.01	AT/MT	R	F Saloon Engine GA16DS	241004	Drive Shaft		27	25	56	103.5	922			
	1990.06-1996.01	MT	L	F Saloon Engine GA16DS	241094	Drive Shaft		27	25	56	103.5	640			
	1990.06-1996.01	AT/MT	R	F Hatchback Engine GA16DS	241004	Drive Shaft		27	25	56	103.5	922			
	1990.06-1996.01	MT	L	F Hatchback Engine GA16DS	241094	Drive Shaft		27	25	56	103.5	640			
	1990.06-1996.01	-	-	F Saloon Engine GA16DS	841017	Outer Joint		27	22	56	103	61.5	M		
1.6 (71 kW)	1990.06-1993.06	-	-	F Hatchback Engine GA16DS	841017	Outer Joint		27	22	56	103	61.5	M		
	1990.06-1993.06	-	-	F Hatchback Engine GA16DS	841010	Outer Joint	42T	27	22	56	103.5	61.4	I		
	1990.06-1996.01	-	-	- Saloon Engine GA16DS	899203	Outer Joint		27	22	56	103.5	61.4	M		
	1990.06-1993.06	-	-	- Hatchback Engine GA16DS	899203	Outer Joint		27	22	56	103.5	61.4	M		
	1990.06-1996.01	MT	L	F Saloon Engine GA16DS	241058	Drive Shaft	42T	27	25	56	103.5	640			
	1990.06-1996.01	AT/MT	R	F Saloon Engine GA16DS	241004	Drive Shaft		27	25	56	103.5	922			
	1990.06-1993.06	MT	L	F Hatchback Engine GA16DS	241058	Drive Shaft	42T	27	25	56	103.5	640			
	1990.06-1993.06	AT/MT	R	F Hatchback Engine GA16DS	241004	Drive Shaft		27	25	56	103.5	922			
	1990.06-1996.01	MT	L	F Saloon Engine GA16DS	241094	Drive Shaft		27	25	56	103.5	640			
	1990.06-1993.06	MT	L	F Hatchback Engine GA16DS	241094	Drive Shaft		27	25	56	103.5	640			
	1990.06-1996.01	-	-	F Saloon Engine GA16DS	841017	Outer Joint		27	22	56	103	61.5	M		
1.6 (75 kW)	1993.06-1996.01	-	-	F Hatchback Engine GA16DE	841017	Outer Joint		27	22	56	103	61.5	M		
	1993.06-1996.01	-	-	F Saloon Engine GA16DE	841010	Outer Joint	42T	27	22	56	103.5	61.4	I		
	1993.06-1996.01	-	R	F Hatchback Engine GA16DE	241005	Drive Shaft	42T	27	25	56	103.5	922			
	1993.06-1996.01	-	R	F Saloon Engine GA16DE	241005	Drive Shaft	42T	27	25	56	103.5	922			
	1993.06-1996.01	-	L	F Hatchback Engine GA16DE	241001	Drive Shaft	42T	27	25	56	103.5	638			
	1993.06-1996.01	-	L	F Saloon Engine GA16DE	241001	Drive Shaft	42T	27	25	56	103.5	638			
	1993.06-1996.01	-	-	- Hatchback Engine GA16DE	899203	Outer Joint		27	22	56	103.5	61.4	M		
	1993.06-1996.01	-	-	- Saloon Engine GA16DE	899203	Outer Joint		27	22	56	103.5	61.4	M		
	1993.06-1996.01	MT	L	F Saloon Engine GA16DE	241058	Drive Shaft	42T	27	25	56	103.5	640			
	1993.06-1996.01	AT/MT	R	F Hatchback Engine GA16DE	241004	Drive Shaft		27	25	56	103.5	922			
	1993.06-1996.01	AT/MT	R	F Saloon Engine GA16DE	241004	Drive Shaft		27	25	56	103.5	922			
	1993.06-1996.01	MT	L	F Saloon Engine GA16DE	241094	Drive Shaft		27	25	56	103.5	640			
2.0	1990.05-1996.06	MT/AT	L	-	241153	Drive Shaft	42T	27	25	56	103.5	623			
2.0 (110 kW)	1990.06-1996.01	-	R	F Hatchback Engine SR20DE	241024	Drive Shaft	42T	27	25	56	103.5	940			
	1990.06-1996.01	-	L	F Hatchback Engine SR20DE	241280	Drive Shaft	42T	27	25	56	103.5	618			
	1990.06-1996.01	-	-	- Hatchback Engine SR20DE	841163	Outer Joint		27	25	56	103	66.5	I		
	1990.06-1996.01	-	-	- Hatchback Engine SR20DE	841006	Outer Joint		27	32	56	103.5	68.5	I		
	1990.06-1996.01	MT	L	F Hatchback Engine SR20DE	241076	Drive Shaft	42T	27	25	56	103	621.5			
	1990.06-1996.01	MT	R	F Hatchback Engine SR20DE	241017	Drive Shaft	42T	27	25	56	103	935			
2.0 (112 kW)	1990.09-1996.01	MT	L	F Hatchback Engine SR20DE	241076	Drive Shaft	42T	27	25	56	103	621.5			
	1990.09-1996.01	MT	R	F Hatchback Engine SR20DE	241017	Drive Shaft	42T	27	25	56	103	935			
2.0 16V (85 kW)	1990.06-1996.01	-	-	F Saloon Engine SR20DI	841009	Outer Joint		27	22	56	103.5	61.4	I		
	1990.06-1996.01	-	-	F Hatchback Engine SR20DI	841009	Outer Joint		27	22	56	103.5	61.4	I		
	1990.06-1996.01	-	R	F Saloon Engine SR20DI	241024	Drive Shaft	42T	27	25	56	103.5	940			
	1990.06-1996.01	-	R	F Hatchback Engine SR20DI	241024	Drive Shaft	42T	27	25	56	103.5	940			
	1990.06-1996.01	-	L	F Saloon Engine SR20DI	241280	Drive Shaft	42T	27	25	56	103.5	618			
	1990.06-1996.01	-	L	F Hatchback Engine SR20DI	241280	Drive Shaft	42T	27	25	56	103.5	618			
	1990.06-1996.01	-	L	F Saloon Engine SR20DI	650065	Inner Joint		25	25	40	63	101			
	1990.06-1996.01	-	L	F Hatchback Engine SR20DI	650065	Inner Joint		25	25	40	63	101			
	1990.06-1996.01	-	-	- Saloon Engine SR20DI	841163	Outer Joint		27	25	56	103	66.5	I		
	1990.06-1996.01	-	-	- Hatchback Engine SR20DI	841163	Outer Joint		27	25	56	103	66.5	I		

YEAR	TRANSM	L/R	F/R	REMARKS	GSP Ref.	PRODUCT	ABS	Technical Specifications								
								A	B	C	H	L	P			
NISSAN PRIMERA (P10)																
2.0 16V (85 kW)																
1990.06-1996.01	-	-	F	Saloon Engine SR20DI	841062	Outer Joint	44T	27	25	56	103	70.5	I			
1990.06-1996.01	-	-	F	Saloon Engine SR20DI	841006	Outer Joint		27	32	56	103.5	68.5	I			
1990.06-1996.01	-	-	F	Hatchback Engine SR20DI	841006	Outer Joint		27	32	56	103.5	68.5	I			
1990.06-1996.01	-	-	F	Saloon Engine SR20DI	841007	Outer Joint	42T	27	32	56	103.5	68.5	I			
1990.06-1996.01	-	-	F	Hatchback Engine SR20DI	841007	Outer Joint	42T	27	32	56	103.5	68.5	I			
1990.06-1996.01	-	L	F	Saloon Engine SR20DI	641004	Inner Joint		25	25	40	63	116.5				
1990.06-1996.01	-	L	F	Hatchback Engine SR20DI	641004	Inner Joint		25	25	40	63	116.5				
1990.06-1996.01	MT	L	F	Hatchback Engine SR20DI	241076	Drive Shaft	42T	27	25	56	103	621.5				
1990.06-1996.01	-	L	F	Saloon Engine SR20DI	241076	Drive Shaft	42T	27	25	56	103	621.5				
1990.06-1996.01	MT	R	F	Hatchback Engine SR20DI	241017	Drive Shaft	42T	27	25	56	103	935				
1990.06-1996.01	-	R	F	Saloon Engine SR20DI	241017	Drive Shaft	42T	27	25	56	103	935				
1991.04-1996.06	-	-	-	All-wheel Drive Saloon Engine SR20DI	841163	Outer Joint		27	25	56	103	66.5	I			
1991.04-1996.06	-	-	-	All-wheel Drive Hatchback Engine SR20DI	841163	Outer Joint		27	25	56	103	66.5	I			
1991.04-1996.06	-	-	-	All-wheel Drive Saloon Engine SR20DI	841062	Outer Joint	44T	27	25	56	103	70.5	I			
1991.04-1996.06	-	-	-	All-wheel Drive Hatchback Engine SR20DI	841062	Outer Joint	44T	27	25	56	103	70.5	I			
1991.04-1996.06	-	-	F	All-wheel Drive Saloon Engine SR20DI	841007	Outer Joint	42T	27	32	56	103.5	68.5	I			
1991.04-1996.06	-	-	F	All-wheel Drive Hatchback Engine SR20DI	841007	Outer Joint	42T	27	32	56	103.5	68.5	I			
1991.04-1996.06	-	L	F	All-wheel Drive Saloon Engine SR20DI	241076	Drive Shaft	42T	27	25	56	103	621.5				
1991.04-1996.06	-	L	F	All-wheel Drive Hatchback Engine SR20DI	241076	Drive Shaft	42T	27	25	56	103	621.5				
1991.04-1996.06	-	-	F	All-wheel Drive Saloon Engine SR20DI	841023	Outer Joint		27	23	56	103	61.5	M			
1991.04-1996.06	-	R	F	All-wheel Drive Saloon Engine SR20DI	241017	Drive Shaft	42T	27	25	56	103	935				
1991.04-1996.06	-	-	F	All-wheel Drive Hatchback Engine SR20DI	841023	Outer Joint		27	23	56	103	61.5	M			
1991.04-1996.06	-	R	F	All-wheel Drive Hatchback Engine SR20DI	241017	Drive Shaft	42T	27	25	56	103	935				
2.0 D (55 kW)																
1991.01-1996.01	-	-	F	Saloon Engine CD20	841017	Outer Joint		27	22	56	103	61.5	M			
1991.01-1996.01	-	-	F	Hatchback Engine CD20	841017	Outer Joint		27	22	56	103	61.5	M			
1991.01-1996.01	MT	-	F	Saloon Engine CD20	841010	Outer Joint	42T	27	22	56	103.5	61.4	I			
1991.01-1996.01	MT	-	F	Hatchback Engine CD20	841010	Outer Joint	42T	27	22	56	103.5	61.4	I			
1991.01-1996.01	-	-	-	Saloon Engine CD20	841163	Outer Joint		27	25	56	103	66.5	I			
1991.01-1996.01	-	-	-	Hatchback Engine CD20	841163	Outer Joint		27	25	56	103	66.5	I			
1991.01-1996.01	-	-	F	Saloon Engine CD20	841019	Outer Joint	42T	27	23	56	99	60	I			
1991.01-1996.01	-	-	F	Hatchback Engine CD20	841019	Outer Joint	42T	27	23	56	99	60	I			
1991.01-1996.01	AT	-	F	Saloon Engine CD20	841006	Outer Joint		27	32	56	103.5	68.5	I			
1991.01-1996.01	AT	-	F	Hatchback Engine CD20	841006	Outer Joint		27	32	56	103.5	68.5	I			
1991.01-1996.01	AT	-	F	Saloon Engine CD20	841007	Outer Joint	42T	27	32	56	103.5	68.5	I			
1991.01-1996.01	AT	-	F	Hatchback Engine CD20	841007	Outer Joint	42T	27	32	56	103.5	68.5	I			
1991.01-1996.01	-	-	-	Saloon Engine CD20	899203	Outer Joint		27	22	56	103.5	61.4	M			
1991.01-1996.01	-	-	-	Hatchback Engine CD20	899203	Outer Joint		27	22	56	103.5	61.4	M			
1991.01-1996.01	AT	-	F	Saloon Engine CD20	841023	Outer Joint		27	23	56	103	61.5	M			
1991.01-1996.01	AT	-	F	Hatchback Engine CD20	841023	Outer Joint		27	23	56	103	61.5	M			
1991.01-1996.01	AT/MT	R	F	Saloon Engine CD20	241130	Drive Shaft	42T	27	25	56	103.5	962.5				
1991.01-1996.01	AT/MT	R	F	Hatchback Engine CD20	241130	Drive Shaft	42T	27	25	56	103.5	962.5				
2.0 GT (110 kW)																
1990.06-1996.01	-	R	F	Saloon Engine SR20DE	241024	Drive Shaft	42T	27	25	56	103.5	940				
1990.06-1996.01	-	L	F	Saloon Engine SR20DE	241280	Drive Shaft	42T	27	25	56	103.5	618				
1990.06-1996.01	-	-	-	Saloon Engine SR20DE	841163	Outer Joint		27	25	56	103	66.5	I			
1990.06-1996.01	-	-	F	Saloon Engine SR20DE	841305	Outer Joint		27	25	56	103	61.5	M			
1990.06-1996.01	-	-	F	Saloon Engine SR20DE	841006	Outer Joint		27	32	56	103.5	68.5	I			
1990.06-1996.01	-	L	F	Saloon Engine SR20DE	641004	Inner Joint		25	25	40	63	116.5				
1990.06-1996.01	MT	L	F	Saloon Engine SR20DE	241076	Drive Shaft	42T	27	25	56	103	621.5				
1990.06-1996.01	MT	R	F	Saloon Engine SR20DE	241017	Drive Shaft	42T	27	25	56	103	935				
2.0 i (92 kW)																
1995.01-1996.06	-	R	F	Saloon Engine SR20DE	241024	Drive Shaft	42T	27	25	56	103.5	940				
1995.01-1996.06	-	R	F	Hatchback Engine SR20DE	241024	Drive Shaft	42T	27	25	56	103.5	940				
1995.01-1996.06	-	L	F	Saloon Engine SR20DE	241280	Drive Shaft	42T	27	25	56	103.5	618				
1995.01-1996.06	-	L	F	Hatchback Engine SR20DE	241280	Drive Shaft	42T	27	25	56	103.5	618				
1995.01-1996.06	-	-	F	Saloon Engine SR20DE	841305	Outer Joint		27	25	56	103	61.5	M			
1995.01-1996.06	-	-	F	Saloon Engine SR20DE	841062	Outer Joint	44T	27	25	56	103	70.5	I			
1995.01-1996.06	-	-	F	Saloon Engine SR20DE	841006	Outer Joint		27	32	56	103.5	68.5	I			
1995.01-1996.06	-	-	F	Hatchback Engine SR20DE	841006	Outer Joint		27	32	56	103.5	68.5	I			
1995.01-1996.06	-	L	F	Saloon Engine SR20DE	641004	Inner Joint		25	25	40	63	116.5				
1995.01-1996.06	-	L	F	Hatchback Engine SR20DE	641004	Inner Joint		25	25	40	63	116.5				
1995.01-1996.06	MT	L	F	Hatchback Engine SR20DE	241076	Drive Shaft	42T	27	25	56	103	621.5				
1995.01-1996.06	-	L	F	Saloon Engine SR20DE	241076	Drive Shaft	42T	27	25	56	103	621.5				
1995.01-1996.06	MT	R	F	Hatchback Engine SR20DE	241017	Drive Shaft	42T	27	25	56	103	935				
1995.01-1996.06	-	R	F	Saloon Engine SR20DE	241017	Drive Shaft	42T	27	25	56	103	935				
PRIMERA (P11)																
1.6 16V (66 kW)																
1996.09-2001.12	MT	R	F	Saloon Engine GA16DE	241205	Drive Shaft	44T	27	25	56	103.5	923				
1996.09-2002.07	MT	R	F	Hatchback Engine GA16DE	241205	Drive Shaft	44T	27	25	56	103.5	923				

	YEAR	TRANSM	L/R	F/R	REMARKS	GSP Ref.	PRODUCT	ABS	Technical Specifications								
									A	B	C	H	L	P			
NISSAN																	
PRIMERA (P11)																	
1.6 16V (66 kW)	1996.09-2001.12	-	L	F	Saloon Engine GA16DE	241213	Drive Shaft	44T	27	24	56	103.5	639				
	1996.09-2002.07	-	L	F	Hatchback Engine GA16DE	241213	Drive Shaft	44T	27	24	56	103.5	639				
	1996.09-2001.12	-	-	F	Saloon Engine GA16DE	841029	Outer Joint		27	22	56	103.5	61.5	I			
	1996.09-2002.07	-	-	F	Hatchback Engine GA16DE	841029	Outer Joint		27	22	56	103.5	61.5	I			
	1996.09-2001.12	-	-	-	Saloon Engine GA16DE	841186	Outer Joint	44T	27	22	56	103	61.5	M			
	1996.09-2002.07	-	-	-	Hatchback Engine GA16DE	841186	Outer Joint	44T	27	22	56	103	61.5	M			
	1996.09-2001.12	MT	L/R	F	Saloon Engine GA16DE	841030	Outer Joint	44T	27	22	56	103.5	61.5	I			
	1996.09-2002.07	MT	L/R	F	Hatchback Engine GA16DE	841030	Outer Joint	44T	27	22	56	103.5	61.5	I			
	1996.09-2001.12	MT	R	F	Saloon Engine GA16DE	241201	Drive Shaft	44T	27	25	56	103.5	917				
	1996.09-2002.07	MT	R	F	Hatchback Engine GA16DE	241201	Drive Shaft	44T	27	25	56	103.5	917				
	1996.09-2001.12	-	-	F	Saloon Engine GA16DE	841195	Outer Joint	44T	27	22	56	103	57	M			
	1996.09-2002.07	-	-	F	Hatchback Engine GA16DE	841195	Outer Joint	44T	27	22	56	103	57	M			
	1996.09-2001.12	-	L	F	Saloon Engine GA16DE	241003	Drive Shaft	44T	27	25	56	103.5	645				
	1996.09-2002.07	-	L	F	Hatchback Engine GA16DE	241003	Drive Shaft	44T	27	25	56	103.5	645				
	1996.09-2001.12	MT	L	F	Saloon Engine GA16DE	699179	Inner Joint		25	22	40	63	100				
	1996.09-2002.07	MT	L	F	Hatchback Engine GA16DE	699179	Inner Joint		25	22	40	63	100				
1996.09-2001.12	MT	L	F	Saloon Engine GA16DE	241019	Drive Shaft	44T	27	25	56	103.5	643.5					
1996.09-2002.07	MT	L	F	Hatchback Engine GA16DE	241019	Drive Shaft	44T	27	25	56	103.5	643.5					
1.6 16V (73 kW)	1996.09-2000.10	MT	R	F	Saloon Engine GA16DE	241205	Drive Shaft	44T	27	25	56	103.5	923				
	1996.09-2002.07	MT	R	F	Hatchback Engine GA16DE	241205	Drive Shaft	44T	27	25	56	103.5	923				
	1996.09-2000.10	-	L	F	Saloon Engine GA16DE	241213	Drive Shaft	44T	27	24	56	103.5	639				
	1996.09-2002.07	-	L	F	Hatchback Engine GA16DE	241213	Drive Shaft	44T	27	24	56	103.5	639				
	1996.09-2000.10	-	-	F	Saloon Engine GA16DE	841029	Outer Joint		27	22	56	103.5	61.5	I			
	1996.09-2002.07	-	-	F	Hatchback Engine GA16DE	841029	Outer Joint		27	22	56	103.5	61.5	I			
	1996.09-2000.10	-	-	-	Saloon Engine GA16DE	841186	Outer Joint	44T	27	22	56	103	61.5	M			
	1996.09-2002.07	-	-	-	Hatchback Engine GA16DE	841186	Outer Joint	44T	27	22	56	103	61.5	M			
	1996.09-2000.10	MT	L/R	F	Saloon Engine GA16DE	841030	Outer Joint	44T	27	22	56	103.5	61.5	I			
	1996.09-2002.07	MT	L/R	F	Hatchback Engine GA16DE	841030	Outer Joint	44T	27	22	56	103.5	61.5	I			
	1996.09-2000.10	AT/MT	R	F	Saloon Engine GA16DE	241201	Drive Shaft	44T	27	25	56	103.5	917				
	1996.09-2002.07	AT/MT	R	F	Hatchback Engine GA16DE	241201	Drive Shaft	44T	27	25	56	103.5	917				
	1996.09-2000.10	-	-	F	Saloon Engine GA16DE	841195	Outer Joint	44T	27	22	56	103	57	M			
	1996.09-2002.07	-	-	F	Hatchback Engine GA16DE	841195	Outer Joint	44T	27	22	56	103	57	M			
	1996.09-2000.10	-	L	F	Saloon Engine GA16DE	241003	Drive Shaft	44T	27	25	56	103.5	645				
	1996.09-2002.07	-	L	F	Hatchback Engine GA16DE	241003	Drive Shaft	44T	27	25	56	103.5	645				
1996.09-2000.10	MT	L	F	Saloon Engine GA16DE	699179	Inner Joint		25	22	40	63	100					
1996.09-2002.07	MT	L	F	Hatchback Engine GA16DE	699179	Inner Joint		25	22	40	63	100					
1996.09-2000.10	MT	L	F	Saloon Engine GA16DE	241019	Drive Shaft	44T	27	25	56	103.5	643.5					
1996.09-2002.07	MT	L	F	Hatchback Engine GA16DE	241019	Drive Shaft	44T	27	25	56	103.5	643.5					
1.6 16V (78 kW)	1996.06-2001.12	MT	L	F	Saloon Engine QG16DE	699179	Inner Joint		25	22	40	63	100				
	1996.06-2001.12	-	L/R	F	Saloon Engine QG16DE	841142	Outer Joint	44T	27	23	56	103.5	61.5	M			
	1996.06-2001.12	MT	L	F	Saloon Engine QG16DE	241019	Drive Shaft	44T	27	25	56	103.5	643.5				
	1996.06-2001.12	MT	R	F	Saloon Engine QG16DE	241205	Drive Shaft	44T	27	25	56	103.5	923				
	1996.06-2001.12	-	L	F	Saloon Engine QG16DE	241213	Drive Shaft	44T	27	24	56	103.5	639				
	1996.06-2001.12	AT/MT	L/R	F	Saloon Engine QG16DE	841028	Outer Joint	44T	27	32	56	103	68.5	I			
	1996.06-2001.12	AT/MT	R	F	Saloon Engine QG16DE	241201	Drive Shaft	44T	27	25	56	103.5	917				
	1996.06-2001.12	-	-	F	Saloon Engine QG16DE	841195	Outer Joint	44T	27	22	56	103	57	M			
	2000.09-2002.07	-	L/R	F	Hatchback Engine QG16DE	841142	Outer Joint	44T	27	23	56	103.5	61.5	M			
	2000.09-2002.07	MT	L	F	Hatchback Engine QG16DE	699179	Inner Joint		25	22	40	63	100				
	2000.09-2002.07	MT	L	F	Hatchback Engine QG16DE	241019	Drive Shaft	44T	27	25	56	103.5	643.5				
	2000.09-2002.07	MT	R	F	Hatchback Engine QG16DE	241205	Drive Shaft	44T	27	25	56	103.5	923				
	2000.09-2002.07	-	L	F	Hatchback Engine QG16DE	241213	Drive Shaft	44T	27	24	56	103.5	639				
	2000.09-2002.07	AT/MT	L/R	F	Hatchback Engine QG16DE	841028	Outer Joint	44T	27	32	56	103	68.5	I			
	2000.09-2002.07	-	-	F	Hatchback Engine QG16DE	841029	Outer Joint		27	22	56	103.5	61.5	I			
	2000.09-2002.07	AT/MT	R	F	Hatchback Engine QG16DE	241201	Drive Shaft	44T	27	25	56	103.5	917				
2000.09-2002.07	-	-	F	Hatchback Engine QG16DE	841195	Outer Joint	44T	27	22	56	103	57	M				
1.8	1999.06-2001.12	MT/AT	-	-	Engine QG18DE	841300	Outer Joint	44T	27	32	56	103	68	I			
	1999.06-2001.12	MT/AT	-	-	Engine QG18DE	841300	Outer Joint	44T	27	32	56	103	68	I			
1.8 16V (84 kW)	1999.08-2001.12	-	L/R	F	Saloon Engine QG18DE	841142	Outer Joint	44T	27	23	56	103.5	61.5	M			
	1999.08-2001.12	MT	L	F	Saloon Engine QG18DE	241019	Drive Shaft	44T	27	25	56	103.5	643.5				
	1999.08-2002.07	MT	L	F	Hatchback Engine QG18DE	241019	Drive Shaft	44T	27	25	56	103.5	643.5				
	1999.08-2002.07	-	L/R	F	Hatchback Engine QG18DE	841142	Outer Joint	44T	27	23	56	103.5	61.5	M			
	1999.08-2001.12	MT	R	F	Saloon Engine QG18DE	241205	Drive Shaft	44T	27	25	56	103.5	923				
	1999.08-2002.07	MT	R	F	Hatchback Engine QG18DE	241205	Drive Shaft	44T	27	25	56	103.5	923				
	1999.08-2001.12	AT/MT	L/R	F	Saloon Engine QG18DE	841028	Outer Joint	44T	27	32	56	103	68.5	I			
	1999.08-2002.07	AT/MT	L/R	F	Hatchback Engine QG18DE	841028	Outer Joint	44T	27	32	56	103	68.5	I			
1999.08-2001.12	AT/MT	R	F	Saloon Engine QG18DE	241201	Drive Shaft	44T	27	25	56	103.5	917					

	 YEAR	TRANSM	L/R	F/R	REMARKS	GSP Ref.	 PRODUCT	 ABS	Technical Specifications						
									A	B	C	H	L	P	
NISSAN PRIMERA (P11)															
1.8 16V (84 kW)	1999.08-2002.07	AT/MT	R	F	Hatchback Engine QG18DE	241201	Drive Shaft	44T	27	25	56	103.5	917		
	1999.08-2001.12	MT	L	F	Saloon Engine QG18DE	699179	Inner Joint		25	22	40	63	100		
	1999.08-2002.07	MT	L	F	Hatchback Engine QG18DE	699179	Inner Joint		25	22	40	63	100		
2.0	-	-	-	R	Engine CD20T/SR20DE	841096	Outer Joint		27	32	56	103	68.5	I	
2.0 (140 kW)	1996.06-1999.05	-	-	-	Saloon Engine SR20VE	841106	Outer Joint		27	23	56	104	60	M	
2.0 16V (103 kW)	1999.08-2001.12	-	-	-	Saloon Engine SR20DE	841043	Outer Joint	44T	27	23	56	104	60	M	
	1999.08-2002.07	-	-	-	Hatchback Engine SR20DE	841043	Outer Joint	44T	27	23	56	104	60	M	
	1999.08-2001.12	-	-	F	Saloon Engine SR20DE	841054	Outer Joint		27	23	56	103	61.5	M	
	1999.08-2002.07	MT	-	F	Hatchback Engine SR20DE	841139	Outer Joint	44T	27	32	56	102	69	M	
	1999.08-2001.12	MT	-	F	Saloon Engine SR20DE	841139	Outer Joint	44T	27	32	56	102	69	M	
	1999.08-2001.12	-	-	-	Saloon Engine SR20DE	841176	Outer Joint		27	23	56	104	63	I	
	1999.08-2002.07	AT/MT	L	F	Hatchback Engine SR20DE	241025	Drive Shaft	44T	27	25	56	103	619		
	1999.08-2001.12	AT/MT	L	F	Saloon Engine SR20DE	241025	Drive Shaft	44T	27	25	56	103	619		
	1999.08-2002.07	AT/MT	R	F	Hatchback Engine SR20DE	241002	Drive Shaft	44T	27	25	56	103	938		
	1999.08-2001.12	AT/MT	R	F	Saloon Engine SR20DE	241002	Drive Shaft	44T	27	25	56	103	938		
	1999.08-2002.07	-	L	F	Hatchback Engine SR20DE	241020	Drive Shaft	44T	27	25	56	103	621		
	1999.08-2001.12	-	L	F	Saloon Engine SR20DE	241020	Drive Shaft	44T	27	25	56	103	621		
	1999.08-2002.07	-	R	F	Hatchback Engine SR20DE	241021	Drive Shaft	44T	27	25	56	103	940		
	1999.08-2001.12	-	R	F	Saloon Engine SR20DE	241021	Drive Shaft	44T	27	25	56	103	940		
2.0 16V (110 kW)	1996.09-2001.12	-	-	-	Saloon Engine SR20DE	841043	Outer Joint	44T	27	23	56	104	60	M	
	1996.09-2002.07	-	-	-	Hatchback Engine SR20DE	841043	Outer Joint	44T	27	23	56	104	60	M	
	1996.09-2001.12	-	-	F	Saloon Engine SR20DE	841054	Outer Joint		27	23	56	103	61.5	M	
	1996.09-2002.07	-	-	F	Hatchback Engine SR20DE	841054	Outer Joint		27	23	56	103	61.5	M	
	1996.09-2001.12	MT	-	F	Saloon Engine SR20DE	841139	Outer Joint	44T	27	32	56	102	69	M	
	1996.09-2002.07	MT	-	F	Hatchback Engine SR20DE	841139	Outer Joint	44T	27	32	56	102	69	M	
	1996.09-2001.12	AT/MT	L	F	Saloon Engine SR20DE	241025	Drive Shaft	44T	27	25	56	103	619		
	1996.09-2002.07	AT/MT	L	F	Hatchback Engine SR20DE	241025	Drive Shaft	44T	27	25	56	103	619		
	1996.09-2001.12	-	-	-	Saloon Engine SR20DE	841106	Outer Joint		27	23	56	104	60	M	
	1996.09-2002.07	-	-	-	Hatchback Engine SR20DE	841106	Outer Joint		27	23	56	104	60	M	
	1996.09-2001.12	AT/MT	R	F	Saloon Engine SR20DE	241002	Drive Shaft	44T	27	25	56	103	938		
	1996.09-2002.07	AT/MT	R	F	Hatchback Engine SR20DE	241002	Drive Shaft	44T	27	25	56	103	938		
	1996.09-2001.12	-	-	F	Saloon Engine SR20DE	841024	Outer Joint	42T	27	23	56	103	61.5	M	
	1996.09-2001.12	-	-	-	Saloon Engine SR20DE	641089	Inner Joint		25	23	40	63	99		
	1996.09-2001.12	-	L	F	Saloon Engine SR20DE	241020	Drive Shaft	44T	27	25	56	103	621		
	1996.09-2002.07	-	-	F	Hatchback Engine SR20DE	841024	Outer Joint	42T	27	23	56	103	61.5	M	
	1996.09-2002.07	-	-	-	Hatchback Engine SR20DE	641089	Inner Joint		25	23	40	63	99		
	1996.09-2002.07	-	L	F	Hatchback Engine SR20DE	241020	Drive Shaft	44T	27	25	56	103	621		
	1996.09-2002.07	-	L	F	Hatchback Engine SR20DE	241020	Drive Shaft	44T	27	25	56	103	621		
	1996.09-2001.12	-	R	F	Saloon Engine SR20DE	241021	Drive Shaft	44T	27	25	56	103	940		
	1996.09-2002.07	-	R	F	Hatchback Engine SR20DE	241021	Drive Shaft	44T	27	25	56	103	940		
2.0 16V (85 kW)	1996.09-2001.12	-	-	-	Saloon Engine SR20De	841043	Outer Joint	44T	27	23	56	104	60	M	
	1996.09-2002.07	-	-	-	Hatchback Engine SR20De	841043	Outer Joint	44T	27	23	56	104	60	M	
	1996.09-2001.12	-	-	F	Saloon Engine SR20De	841054	Outer Joint		27	23	56	103	61.5	M	
	1996.09-2002.07	-	-	F	Hatchback Engine SR20De	841054	Outer Joint		27	23	56	103	61.5	M	
	1996.09-2001.12	AT/MT	L/R	F	Saloon Engine SR20De	841028	Outer Joint	44T	27	32	56	103	68.5	I	
	1996.09-2002.07	AT/MT	L/R	F	Hatchback Engine SR20De	841028	Outer Joint	44T	27	32	56	103	68.5	I	
	1996.09-2001.12	MT	-	F	Saloon Engine SR20De	899200	Outer Joint		27	32	56	103.5	68.5	M	
	1996.09-2002.07	MT	-	F	Hatchback Engine SR20De	899200	Outer Joint		27	32	56	103.5	68.5	M	
	1996.09-2001.12	MT	-	F	Saloon Engine SR20De	841139	Outer Joint	44T	27	32	56	102	69	M	
	1996.09-2002.07	MT	-	F	Hatchback Engine SR20De	841139	Outer Joint	44T	27	32	56	102	69	M	
	1996.09-2001.12	AT/MT	L	F	Saloon Engine SR20De	241025	Drive Shaft	44T	27	25	56	103	619		
	1996.09-2002.07	AT/MT	L	F	Hatchback Engine SR20De	241025	Drive Shaft	44T	27	25	56	103	619		
	1996.09-2001.12	AT/MT	R	F	Saloon Engine SR20De	241002	Drive Shaft	44T	27	25	56	103	938		
	1996.09-2001.12	-	-	-	Saloon Engine SR20De	841106	Outer Joint		27	23	56	104	60	M	
	1996.09-2002.07	-	-	-	Hatchback Engine SR20De	841106	Outer Joint		27	23	56	104	60	M	
	1996.09-2002.07	AT/MT	R	F	Hatchback Engine SR20De	241022	Drive Shaft	44T	27	25	56	103	938		
	1996.09-2001.12	-	-	F	Saloon Engine SR20De	841024	Outer Joint	42T	27	23	56	103	61.5	M	
	1996.09-2001.12	-	-	-	Saloon Engine SR20De	641089	Inner Joint		25	23	40	63	99		
	1996.09-2001.12	-	L	F	Saloon Engine SR20De	241020	Drive Shaft	44T	27	25	56	103	621		
	1996.09-2002.07	-	-	F	Hatchback Engine SR20De	841024	Outer Joint	42T	27	23	56	103	61.5	M	
	1996.09-2002.07	-	-	-	Hatchback Engine SR20De	641089	Inner Joint		25	23	40	63	99		
	1996.09-2002.07	-	L	F	Hatchback Engine SR20De	241020	Drive Shaft	44T	27	25	56	103	621		
	1996.09-2001.12	-	R	F	Saloon Engine SR20De	241021	Drive Shaft	44T	27	25	56	103	940		
	1996.09-2002.07	-	R	F	Hatchback Engine SR20De	241021	Drive Shaft	44T	27	25	56	103	940		
2.0 16V (96 kW)	1996.09-2001.12	-	-	-	Saloon Engine SR20DE	841043	Outer Joint	44T	27	23	56	104	60	M	
	1996.09-2002.07	-	-	-	Hatchback Engine SR20DE	841043	Outer Joint	44T	27	23	56	104	60	M	
	1996.09-2001.12	-	-	F	Saloon Engine SR20DE	841054	Outer Joint		27	23	56	103	61.5	M	

	YEAR	TRANSM	L/R	F/R	REMARKS	GSP Ref.	PRODUCT	ABS	Technical Specifications									
									A	B	C	H	L	P				
NISSAN																		
PRIMERA (P11)																		
2.0 16V (96 kW)	1996.09-2002.07	-	-	F	Hatchback Engine SR20DE	841054	Outer Joint		27	23	56	103	61.5	M				
	1996.09-2001.12	AT/MT	L/R	F	Saloon Engine SR20DE	841028	Outer Joint	44T	27	32	56	103	68.5	I				
	1996.09-2002.07	AT/MT	L/R	F	Hatchback Engine SR20DE	841028	Outer Joint	44T	27	32	56	103	68.5	I				
	1996.09-2001.12	MT	-	F	Saloon Engine SR20DE	841139	Outer Joint	44T	27	32	56	102	69	M				
	1996.09-2002.07	MT	-	F	Hatchback Engine SR20DE	841139	Outer Joint	44T	27	32	56	102	69	M				
	1996.09-2001.12	AT/MT	L	F	Saloon Engine SR20DE	241025	Drive Shaft	44T	27	25	56	103	619					
	1996.09-2002.07	AT/MT	L	F	Hatchback Engine SR20DE	241025	Drive Shaft	44T	27	25	56	103	619					
	1996.09-2001.12	AT/MT	R	F	Saloon Engine SR20DE	241002	Drive Shaft	44T	27	25	56	103	938					
	1996.09-2002.07	AT/MT	R	F	Hatchback Engine SR20DE	241002	Drive Shaft	44T	27	25	56	103	938					
	1996.09-2001.12	-	-	-	Saloon Engine SR20DE	841106	Outer Joint		27	23	56	104	60	M				
	1996.09-2002.07	-	-	-	Hatchback Engine SR20DE	841106	Outer Joint		27	23	56	104	60	M				
	1996.09-2001.12	-	-	F	Saloon Engine SR20DE	841024	Outer Joint	42T	27	23	56	103	61.5	M				
	1996.09-2001.12	-	-	-	Saloon Engine SR20DE	641089	Inner Joint		25	23	40	63	99					
	1996.09-2001.12	-	L	F	Saloon Engine SR20DE	241020	Drive Shaft	44T	27	25	56	103	621					
	1996.09-2002.07	-	-	F	Hatchback Engine SR20DE	841024	Outer Joint	42T	27	23	56	103	61.5	M				
	1996.09-2002.07	-	-	-	Hatchback Engine SR20DE	641089	Inner Joint		25	23	40	63	99					
	1996.09-2002.07	-	L	F	Hatchback Engine SR20DE	241020	Drive Shaft	44T	27	25	56	103	621					
	1996.09-2001.12	-	R	F	Saloon Engine SR20DE	241021	Drive Shaft	44T	27	25	56	103	940					
	1996.09-2002.07	-	R	F	Hatchback Engine SR20DE	241021	Drive Shaft	44T	27	25	56	103	940					
2.0 16V LPG(96 kW)	1996.09-2002.07	MT	-	F	Hatchback	841139	Outer Joint	44T	27	32	56	102	69	M				
2.0 TD (66 kW)	1996.09-2001.12	MT	R	F	Saloon Engine CD20T	241206	Drive Shaft	44T	27	25	56	103	954					
	1996.09-2002.07	MT	R	F	Hatchback Engine CD20T	241206	Drive Shaft	44T	27	25	56	103	954					
	1996.09-2001.12	MT	R	F	Saloon Engine CD20T	241082	Drive Shaft	44T	27	25	56	103	960					
	1996.09-2002.07	MT	R	F	Hatchback Engine CD20T	241082	Drive Shaft	44T	27	25	56	103	960					
	1996.09-2001.12	AT/MT	L/R	F	Saloon Engine CD20T	841028	Outer Joint	44T	27	32	56	103	68.5	I				
	1996.09-2002.07	AT/MT	L/R	F	Hatchback Engine CD20T	841028	Outer Joint	44T	27	32	56	103	68.5	I				
	1996.09-2001.12	-	-	F	Saloon Engine CD20T	899200	Outer Joint		27	32	56	103.5	68.5	M				
	1996.09-2002.07	-	-	F	Hatchback Engine CD20T	899200	Outer Joint		27	32	56	103.5	68.5	M				
	1996.09-2001.12	-	-	F	Saloon Engine CD20T	841139	Outer Joint	44T	27	32	56	102	69	M				
	1996.09-2002.07	-	-	F	Hatchback Engine CD20T	841139	Outer Joint	44T	27	32	56	102	69	M				
	1996.09-2001.12	-	L	F	Saloon Engine CD20T	241081	Drive Shaft	44T	27	25	56	103	608					
	1996.09-2002.07	-	L	F	Hatchback Engine CD20T	241081	Drive Shaft	44T	27	25	56	103	608					
PRIMERA (P12)																		
1.6 (80 kW)	2002.01-2002.07	-	-	L/R	F	Saloon Engine QG16DE	841142	Outer Joint	44T	27	23	56	103.5	61.5	M			
	2002.07-2002.07	-	-	L/R	F	Hatchback Engine QG16DE	841142	Outer Joint	44T	27	23	56	103.5	61.5	M			
1.8 (85 kW)	2002.03-2002.03	-	AT/MT	L	F	Saloon Engine QG18DE	699179	Inner Joint		25	22	40	63	100				
	2002.03-2002.03	-	-	L/R	F	Saloon Engine QG18DE	841142	Outer Joint	44T	27	23	56	103.5	61.5	M			
	2002.03-2002.03	-	AT/MT	R	F	Saloon Engine QG18DE	241392	Drive Shaft	44T	27	25	56	103.5	961				
	2002.03-2002.03	-	AT	-	F	Saloon Engine QG18DE	841282	Outer Joint	44T	27	23	56	103	58.5	I			
	2002.03-2002.03	-	AT	-	-	Saloon Engine QG18DE	641089	Inner Joint		25	23	40	63	99				
	2002.07-2002.07	-	-	L	F	Hatchback Engine QG18DE	699179	Inner Joint		25	22	40	63	100				
	2002.07-2002.07	-	-	L/R	F	Hatchback Engine QG18DE	841142	Outer Joint	44T	27	23	56	103.5	61.5	M			
	2002.07-2002.07	-	-	R	F	Hatchback Engine QG18DE	241392	Drive Shaft	44T	27	25	56	103.5	961				
	2002.07-2002.07	-	AT	-	F	Hatchback Engine QG18DE	841282	Outer Joint	44T	27	23	56	103	58.5	I			
	2002.07-2002.07	-	AT	-	-	Hatchback Engine QG18DE	641089	Inner Joint		25	23	40	63	99				
1.9 dCi (85 kW)	2002.08-2002.08	-	-	-	F	Hatchback Engine F9Q	841050	Outer Joint	44T	27	35	56	103	69	I			
	2002.08-2002.08	-	-	-	F	Saloon Engine F9Q	841050	Outer Joint	44T	27	35	56	103	69	I			
1.9 dCi (88 kW)	2003.04-2003.04	-	-	-	F	Saloon Engine F9Q	841050	Outer Joint	44T	27	35	56	103	69	I			
	2003.04-2003.04	-	-	-	F	Hatchback Engine F9Q	841050	Outer Joint	44T	27	35	56	103	69	I			
2.0 (103 kW)	2002.03-2002.03	-	CVT	L	F	Saloon Engine QR20DE	699179	Inner Joint		25	22	40	63	100				
	2002.03-2002.03	-	CVT	L	F	Saloon Engine QR20DE	241019	Drive Shaft	44T	27	25	56	103.5	643.5				
	2002.03-2002.03	-	AT	L	F	Saloon Engine QR20DE	641067	Inner Joint		25	24	40	63	105.5				
	2002.03-2002.03	-	AT	-	F	Saloon Engine QR20DE	841184	Outer Joint	44T	27	25	56	103	68	M			
	2002.03-2002.03	-	MT	-	F	Saloon Engine QR20DE	841038	Outer Joint	44T	27	26	56	103	69	M			
	2002.03-2002.03	-	AT	-	F	Saloon Engine QR20DE	841282	Outer Joint	44T	27	23	56	103	58.5	I			
	2002.03-2002.03	-	-	-	F	Saloon Engine QR20DE	899236	Outer Joint	44T	27	26	56	103	69	M			
	2002.03-2002.03	-	-	-	-	Saloon Engine QR20DE	841339	Outer Joint	44T	27	24	56	103	61.5	M			
	2002.03-2002.03	-	CVT/MT	-	F	Saloon Engine QR20DE	841049	Outer Joint	44T	27	24	56	103	63	M			
	2002.03-2002.03	-	MT	R	F	Saloon Engine QR20DE	641217	Inner joint		29	24	33	374.5	88.5				
	2002.03-2002.03	-	MT	R	F	Saloon Engine QR20DE	241576	Drive Shaft	44T	27	29	56	103	988				
	2002.07-2002.07	-	CVT	L	F	Hatchback Engine QR20DE	699179	Inner Joint		25	22	40	63	100				
	2002.07-2002.07	-	CVT	L	F	Hatchback Engine QR20DE	241019	Drive Shaft	44T	27	25	56	103.5	643.5				
	2002.07-2002.07	-	AT	L	F	Hatchback Engine QR20DE	641067	Inner Joint		25	24	40	63	105.5				
	2002.07-2002.07	-	AT	-	F	Hatchback Engine QR20DE	841184	Outer Joint	44T	27	25	56	103	68	M			
	2002.07-2002.07	-	MT	-	F	Hatchback Engine QR20DE	841038	Outer Joint	44T	27	26	56	103	69	M			
	2002.07-2002.07	-	AT	-	F	Hatchback Engine QR20DE	841282	Outer Joint	44T	27	23	56	103	58.5	I			





YEAR	TRANSM	L/R	F/R	REMARKS	GSP Ref.	PRODUCT	ABS	Technical Specifications							
								A	B	C	H	L	P		
NISSAN PRIMERA (P12)															
2.0 (103 kW)	2002.07-	-	-	F	Hatchback Engine QR20DE	899236	Outer Joint	44T	27	26	56	103	69	M	
	2002.07-	-	-	-	Hatchback Engine QR20DE	841339	Outer Joint	44T	27	24	56	103	61.5	M	
	2002.07-	-	CVT/MT	-	F	Hatchback Engine QR20DE	841049	Outer Joint	44T	27	24	56	103	63	M
	2002.07-	-	MT	R	F	Hatchback Engine QR20DE	641217	Inner joint		29	24	33	374.5	88.5	
	2002.07-	-	MT	R	F	Hatchback Engine QR20DE	241576	Drive Shaft	44T	27	29	56	103	988	
2.2 dCi (102 kW)	2003.04-	-	MT	L	F	Saloon Engine YD22DDT	641144	Inner Joint		29	34	39	65.5	114.5	
	2003.04-	-	MT	L	F	Hatchback Engine YD22DDT	641144	Inner Joint		29	34	39	65.5	114.5	
	2003.04-	-	MT	L	F	Hatchback Engine YD22DDT	841335	Outer Joint		27	26	56	103	69	M
	2003.04-	-	MT	L	F	Saloon Engine YD22DDT	641132	Inner Joint		39	34	39	70	114.5	
	2003.04-	-	MT	L	F	Hatchback Engine YD22DDT	641132	Inner Joint		39	34	39	70	114.5	
	2003.04-	-	-	-	F	Saloon Engine YD22DDT	841038	Outer Joint	44T	27	26	56	103	69	M
	2003.04-	-	-	-	F	Hatchback Engine YD22DDT	841038	Outer Joint	44T	27	26	56	103	69	M
	2003.04-	-	MT	L	F	Saloon Engine YD22DDT	241214	Drive Shaft	44T	27	29	56	103	613	
	2003.04-	-	MT	L	F	Hatchback Engine YD22DDT	241214	Drive Shaft	44T	27	29	56	103	613	
	2003.04-	-	MT	L	F	Saloon Engine YD22DDT	241244	Drive Shaft	44T	27	39	56	103	619	
	2003.04-	-	MT	L	F	Hatchback Engine YD22DDT	241244	Drive Shaft	44T	27	39	56	103	619	
	2003.04-	-	MT	R	F	Saloon Engine YD22DDT	241271	Drive Shaft	44T	27	39	56	103	984.5	
	2003.04-	-	MT	R	F	Hatchback Engine YD22DDT	241271	Drive Shaft	44T	27	39	56	103	984.5	
	2003.04-	-	-	-	F	Saloon Engine YD22DDT	899236	Outer Joint	44T	27	26	56	103	69	M
	2003.04-	-	-	-	F	Hatchback Engine YD22DDT	899236	Outer Joint	44T	27	26	56	103	69	M
	2003.04-	-	MT	R	F	Saloon Engine YD22DDT	241215	Drive Shaft	44T	27	29	56	103	988	
	2003.04-	-	MT	R	F	Hatchback Engine YD22DDT	241215	Drive Shaft	44T	27	29	56	103	988	
2.2 Di (93 kW)	2002.03-	-	MT	L	F	Saloon Engine YD22DDT	641144	Inner Joint		29	34	39	65.5	114.5	
	2002.03-	-	-	-	F	Saloon Engine YD22DDT	841038	Outer Joint	44T	27	26	56	103	69	M
	2002.03-	-	MT	L	F	Saloon Engine YD22DDT	241214	Drive Shaft	44T	27	29	56	103	613	
	2002.03-	-	-	-	F	Saloon Engine YD22DDT	899236	Outer Joint	44T	27	26	56	103	69	M
	2002.03-	-	MT	R	F	Saloon Engine YD22DDT	241215	Drive Shaft	44T	27	29	56	103	988	
	2002.07-	-	MT	L	F	Hatchback Engine YD22DDT	641144	Inner Joint		29	34	39	65.5	114.5	
	2002.07-	-	-	-	F	Hatchback Engine YD22DDT	841038	Outer Joint	44T	27	26	56	103	69	M
	2002.07-	-	MT	L	F	Hatchback Engine YD22DDT	241214	Drive Shaft	44T	27	29	56	103	613	
	2002.07-	-	-	-	F	Hatchback Engine YD22DDT	899236	Outer Joint	44T	27	26	56	103	69	M
	2002.07-	-	MT	R	F	Hatchback Engine YD22DDT	241215	Drive Shaft	44T	27	29	56	103	988	
PRIMERA (WP12)															
1.6 Visia (80 kW)	2002.01-	-	-	L/R	F	Estate Engine QG16DE	841142	Outer Joint	44T	27	23	56	103.5	61.5	M
1.8 (85 kW)	2002.03-	-	-	L	F	Estate Engine QG18DE	699179	Inner Joint		25	22	40	63	100	
	2002.03-	-	-	L/R	F	Estate Engine QG18DE	841142	Outer Joint	44T	27	23	56	103.5	61.5	M
	2002.03-	-	-	R	F	Estate Engine QG18DE	241392	Drive Shaft	44T	27	25	56	103.5	961	
	2002.03-	-	AT	-	F	Estate Engine QG18DE	841282	Outer Joint	44T	27	23	56	103	58.5	I
	2002.03-	-	AT	-	-	Estate Engine QG18DE	641089	Inner Joint		25	23	40	63	99	
2.0 (103 kW)	2002.03-	-	CVT	L	F	Estate Engine QR20DE	699179	Inner Joint		25	22	40	63	100	
	2002.03-	-	CVT	L	F	Estate Engine QR20DE	241019	Drive Shaft	44T	27	25	56	103.5	643.5	
	2002.03-	-	AT	L	F	Estate Engine QR20DE	641067	Inner Joint		25	24	40	63	105.5	
	2002.03-	-	AT	-	F	Estate Engine QR20DE	841184	Outer Joint	44T	27	25	56	103	68	M
	2002.03-	-	5MT	-	F	Estate Engine QR20DE	841038	Outer Joint	44T	27	26	56	103	69	M
	2002.03-	-	AT	-	F	Estate Engine QR20DE	841282	Outer Joint	44T	27	23	56	103	58.5	I
	2002.03-	-	-	-	F	Estate Engine QR20DE	899236	Outer Joint	44T	27	26	56	103	69	M
	2002.03-	-	-	-	F	Estate Engine QR20DE	841339	Outer Joint	44T	27	24	56	103	61.5	M
	2002.03-	-	CVT/MT	-	F	Estate Engine QR20DE	841049	Outer Joint	44T	27	24	56	103	63	M
	2002.03-	-	MT	R	F	Estate Engine QR20DE	641217	Inner joint		29	24	33	374.5	88.5	
	2002.03-	-	MT	R	F	Estate Engine QR20DE	241576	Drive Shaft	44T	27	29	56	103	988	
2.2 dCi (102 kW)	2003.04-	-	MT	L	F	Estate Engine YD22DDT	641144	Inner Joint		29	34	39	65.5	114.5	
	2003.04-	-	MT	L	F	Estate Engine YD22DDT	641132	Inner Joint		39	34	39	70	114.5	
	2003.04-	-	MT	L	F	Estate Engine YD22DDT	241214	Drive Shaft	44T	27	29	56	103	613	
	2003.04-	-	MT	L	F	Estate Engine YD22DDT	241244	Drive Shaft	44T	27	39	56	103	619	
	2003.04-	-	MT	R	F	Estate Engine YD22DDT	241271	Drive Shaft	44T	27	39	56	103	984.5	
	2003.04-	-	-	-	F	Estate Engine YD22DDT	899236	Outer Joint	44T	27	26	56	103	69	M
	2003.04-	-	MT	R	F	Estate Engine YD22DDT	241215	Drive Shaft	44T	27	29	56	103	988	
2.2 Di (93 kW)	2002.03-	-	MT	L	F	Estate Engine YD22DDT	641144	Inner Joint		29	34	39	65.5	114.5	
	2002.03-	-	MT	L	F	Estate Engine YD22DDT	241214	Drive Shaft	44T	27	29	56	103	613	
	2002.03-	-	MT	R	F	Estate Engine YD22DDT	241215	Drive Shaft	44T	27	29	56	103	988	
PRIMERA CAMINO (HP11)															
2.0	1995.09-	1997.09	MT	-	-	Engine SR20DE	841338	Outer Joint		27	23	56	103	61.5	M
PRIMERA CAMINO P10															
2.0	1991.01-	1993.12	4AT	-	-	Engine SR20DI	899235	Outer Joint	42T	27	22	56	103.5	61.4	M
	1991.01-	1993.12	4AT	-	-	Engine SR20DE	899235	Outer Joint	42T	27	22	56	103.5	61.4	M
2000	1991.01-	1993.12	4AT	-	-	Engine SR20DI	899235	Outer Joint	42T	27	22	56	103.5	61.4	M

YEAR	TRANS	L/R	F/R	REMARKS	GSP Ref.	PRODUCT	ABS	Technical Specifications						
								A	B	C	H	L	P	
NISSAN														
PRIMERA CAMINO P10														
2000	1991.01-1993.12	4AT	-	-	Engine SR20DE	899235	Outer Joint	42T	27	22	56	103.5	61.4	M
PRIMERA CAMINO P11														
1.8	1999.06-	MT/AT	-	-	Engine QG18DE	841300	Outer Joint	44T	27	32	56	103	68	I
1800	1999.06-	MT/AT	-	-	Engine QG18DE	841300	Outer Joint	44T	27	32	56	103	68	I
PRIMERA II/III														
1.6	1996.06-2002.02	MT	-	-	Estate W11	841140	Outer Joint	44T	27	23	56	103	62	I
PRIMERA II/III (P11)														
2.0	1996.06-2002.02	MT/AT	R	-	Hatchback, Saloon	841096	Outer Joint		27	32	56	103	68.5	I
PRIMERA Traveller (W10)														
1.6 i (66 kW)	1990.07-1998.03	-	-	F	Estate Engine GA16DS	841018	Outer Joint		27	23	56	99	60	I
	1990.07-1998.03	AT	L	F	Estate Engine GA16DS	650065	Inner Joint		25	25	40	63	101	
	1990.07-1998.03	-	-	F	Estate Engine GA16DS	841042	Outer Joint	44T	27	23	56	103.5	61.4	I
	1990.07-1998.03	-	-	F	Estate Engine GA16DS	841019	Outer Joint	42T	27	23	56	99	60	I
	1990.07-1998.03	-	-	-	Estate Engine GA16DS	841176	Outer Joint		27	23	56	104	63	I
	1990.07-1998.03	-	-	F	Estate Engine GA16DS	841024	Outer Joint	42T	27	23	56	103	61.5	M
1.6 i (75 kW)	1990.07-1998.03	AT/MT	R	F	Estate Engine GA16DS	241004	Drive Shaft		27	25	56	103.5	922	
	1991.02-1998.03	-	-	F	Estate Engine GA16DE	841018	Outer Joint		27	23	56	99	60	I
	1991.02-1998.03	-	R	F	Estate Engine GA16DE	241005	Drive Shaft	42T	27	25	56	103.5	922	
	1991.02-1998.03	-	L	F	Estate Engine GA16DE	241001	Drive Shaft	42T	27	25	56	103.5	638	
	1991.02-1998.03	-	-	F	Estate Engine GA16DE	841042	Outer Joint	44T	27	23	56	103.5	61.4	I
	1991.02-1998.03	-	-	F	Estate Engine GA16DE	841019	Outer Joint	42T	27	23	56	99	60	I
	1991.02-1998.03	-	-	-	Estate Engine GA16DE	841176	Outer Joint		27	23	56	104	63	I
	1991.02-1998.03	MT	-	F	Estate Engine GA16DE	841023	Outer Joint		27	23	56	103	61.5	M
2.0 D (55 kW)	1991.02-1998.03	MT	-	F	Estate Engine GA16DE	841024	Outer Joint	42T	27	23	56	103	61.5	M
	1991.02-1998.03	MT	-	-	Estate Engine GA16DE	641089	Inner Joint		25	23	40	63	99	
	1990.07-1995.12	-	-	F	Estate Engine CD20	841017	Outer Joint		27	22	56	103	61.5	M
	1990.07-1995.12	-	-	F	Estate Engine CD20	841019	Outer Joint	42T	27	23	56	99	60	I
2.0 i (85 kW)	1990.07-1995.12	-	-	F	Estate Engine CD20	841024	Outer Joint	42T	27	23	56	103	61.5	M
	1990.07-1998.03	-	-	F	Estate Engine SR20DI	841305	Outer Joint		27	25	56	103	61.5	M
	1990.07-1998.03	-	-	F	Estate Engine SR20DI	841062	Outer Joint	44T	27	25	56	103	70.5	I
	1990.07-1998.03	-	-	-	Estate Engine SR20DI	841148	Outer Joint	42T	27	25	56	103	66	I
	1990.07-1998.03	-	L	F	Estate Engine SR20DI	241076	Drive Shaft	42T	27	25	56	103	621.5	
1990.07-1998.03	-	R	F	Estate Engine SR20DI	241017	Drive Shaft	42T	27	25	56	103	935		
PRIMERA Traveller (WP11)														
1.6 16V (66 kW)	1998.04-2001.12	MT	L	F	Estate Engine GA16DE	241019	Drive Shaft	44T	27	25	56	103.5	643.5	
	1998.04-2001.12	MT	R	F	Estate Engine GA16DE	241205	Drive Shaft	44T	27	25	56	103.5	923	
	1998.04-2001.12	-	L	F	Estate Engine GA16DE	241213	Drive Shaft	44T	27	24	56	103.5	639	
	1998.04-2001.12	-	-	F	Estate Engine GA16DE	841029	Outer Joint		27	22	56	103.5	61.5	I
	1998.04-2001.12	-	-	-	Estate Engine GA16DE	841186	Outer Joint	44T	27	22	56	103	61.5	M
	1998.04-2001.12	MT	L/R	F	Estate Engine GA16DE	841030	Outer Joint	44T	27	22	56	103.5	61.5	I
	1998.04-2001.12	-	-	F	Estate Engine GA16DE	841195	Outer Joint	44T	27	22	56	103	57	M
	1998.04-2001.12	-	L	F	Estate Engine GA16DE	241003	Drive Shaft	44T	27	25	56	103.5	645	
1.6 16V (73 kW)	1998.04-2001.12	MT	L	F	Estate Engine GA16DE	699179	Inner Joint		25	22	40	63	100	
	1998.04-2001.12	MT	L	F	Estate Engine GA16DE	241019	Drive Shaft	44T	27	25	56	103.5	643.5	
	1998.04-2001.12	MT	R	F	Estate Engine GA16DE	241205	Drive Shaft	44T	27	25	56	103.5	923	
	1998.04-2001.12	-	L	F	Estate Engine GA16DE	241213	Drive Shaft	44T	27	24	56	103.5	639	
	1998.04-2001.12	-	-	F	Estate Engine GA16DE	841029	Outer Joint		27	22	56	103.5	61.5	I
	1998.04-2001.12	-	-	-	Estate Engine GA16DE	841186	Outer Joint	44T	27	22	56	103	61.5	M
	1998.04-2001.12	MT	L/R	F	Estate Engine GA16DE	841030	Outer Joint	44T	27	22	56	103.5	61.5	I
	1998.04-2001.12	MT	R	F	Estate Engine GA16DE	241201	Drive Shaft	44T	27	25	56	103.5	917	
	1998.04-2001.12	-	-	F	Estate Engine GA16DE	841195	Outer Joint	44T	27	22	56	103	57	M
	1998.04-2001.12	-	L	F	Estate Engine GA16DE	241003	Drive Shaft	44T	27	25	56	103.5	645	
1.6 16V (81 kW)	1998.04-2001.12	MT	L	F	Estate Engine GA16DE	699179	Inner Joint		25	22	40	63	100	
	1998.04-2002.01	-	-	-	Estate Engine GA16DE	841186	Outer Joint	44T	27	22	56	103	61.5	M
1.8 16V (84 kW)	1999.08-2001.12	MT	L	F	Estate Engine QG18DE	699179	Inner Joint		25	22	40	63	100	
	1999.08-2001.12	-	L/R	F	Estate Engine QG18DE	841142	Outer Joint	44T	27	23	56	103.5	61.5	M
	1999.08-2001.12	MT	L	F	Estate Engine QG18DE	241019	Drive Shaft	44T	27	25	56	103.5	643.5	
	1999.08-2001.12	MT	R	F	Estate Engine QG18DE	241205	Drive Shaft	44T	27	25	56	103.5	923	
	1999.08-2001.12	AT/MT	L/R	F	Estate Engine QG18DE	841028	Outer Joint	44T	27	32	56	103	68.5	I
	1999.08-2001.12	-	-	F	Estate Engine QG18DE	841139	Outer Joint	44T	27	32	56	102	69	M
1.8 16V LPG(84 kW)	1999.08-2001.12	MT	R	F	Estate Engine QG18DE	241201	Drive Shaft	44T	27	25	56	103.5	917	
	1999.08-2001.12	-	-	F	Estate/Break/Traveller	841139	Outer Joint	44T	27	32	56	102	69	M
2.0 16V (103 kW)	1999.08-2001.12	-	-	-	Estate Engine SR20DE	841043	Outer Joint	44T	27	23	56	104	60	M
	1999.08-2001.12	-	-	F	Estate Engine SR20DE	841054	Outer Joint		27	23	56	103	61.5	M
	1999.08-2001.12	MT	-	F	Estate Engine SR20DE	841139	Outer Joint	44T	27	32	56	102	69	M
	1999.08-2001.12	AT/MT	L	F	Estate Engine SR20DE	241025	Drive Shaft	44T	27	25	56	103	619	

YEAR	TRANSM	L/R	F/R	REMARKS	GSP Ref.	PRODUCT	ABS	Technical Specifications						
								A	B	C	H	L	P	
NISSAN														
PRIMERA Traveller (WP11)														
2.0 16V (103 kW)	1999.08-2001.12	-	-	-	Estate Engine SR20DE	841106	Outer Joint		27	23	56	104	60	M
	1999.08-2001.12	AT/MT	R	F	Estate Engine SR20DE	241002	Drive Shaft	44T	27	25	56	103	938	
	1999.08-2001.12	-	L	F	Estate Engine SR20DE	241020	Drive Shaft	44T	27	25	56	103	621	
	1999.08-2001.12	-	R	F	Estate Engine SR20DE	241021	Drive Shaft	44T	27	25	56	103	940	
2.0 16V (140 kW)	1996.06-1999.05	-	-	-	Estate Engine SR20VE	841106	Outer Joint		27	23	56	104	60	M
2.0 16V (85 kW)	1996.06-2001.12	-	-	-	Estate Engine SR20De	841043	Outer Joint	44T	27	23	56	104	60	M
	1996.06-2001.12	-	-	F	Estate Engine SR20De	841054	Outer Joint		27	23	56	103	61.5	M
	1996.06-2001.12	AT/MT	L/R	F	Estate Engine SR20De	841028	Outer Joint	44T	27	32	56	103	68.5	I
	1996.06-2001.12	MT	-	F	Estate Engine SR20De	841139	Outer Joint	44T	27	32	56	102	69	M
	1996.06-2001.12	-	-	-	Estate Engine SR20De	841106	Outer Joint		27	23	56	104	60	M
	1996.06-2001.12	-	-	F	Estate Engine SR20De	841024	Outer Joint	42T	27	23	56	103	61.5	M
	1996.06-2001.12	-	-	-	Estate Engine SR20De	641089	Inner Joint		25	23	40	63	99	
	1996.06-2001.12	-	L	F	Estate Engine SR20De	241020	Drive Shaft	44T	27	25	56	103	621	
	1996.06-2001.12	-	R	F	Estate Engine SR20De	241021	Drive Shaft	44T	27	25	56	103	940	
2.0 16V (96 kW)	1998.04-2001.12	-	-	F	Estate Engine SR20DE	841054	Outer Joint		27	23	56	103	61.5	M
	1998.04-2001.12	AT/MT	L	F	Estate Engine SR20DE	241025	Drive Shaft	44T	27	25	56	103	619	
	1998.04-2001.12	AT/MT	R	F	Estate Engine SR20DE	241002	Drive Shaft	44T	27	25	56	103	938	
	1998.04-2001.12	-	-	-	Estate Engine SR20DE	841106	Outer Joint		27	23	56	104	60	M
	1998.04-2001.12	-	L	F	Estate Engine SR20DE	241020	Drive Shaft	44T	27	25	56	103	621	
	1998.04-2001.12	-	R	F	Estate Engine SR20DE	241021	Drive Shaft	44T	27	25	56	103	940	
2.0 TD (66 kW)	1998.04-2001.12	MT	R	F	Estate Engine CD20T	241206	Drive Shaft	44T	27	25	56	103	954	
	1998.04-2001.12	MT	R	F	Estate Engine CD20T	241082	Drive Shaft	44T	27	25	56	103	960	
	1998.04-2001.12	AT/MT	L/R	F	Estate Engine CD20T	841028	Outer Joint	44T	27	32	56	103	68.5	I
	1998.04-2001.12	-	L	F	Estate Engine CD20T	241081	Drive Shaft	44T	27	25	56	103	608	
PRIMERA UK (FHP10)														
2.0	1990.01-	-	MT	-	Engine SR20DE	841005	Outer Joint		27	32	56	103	61.5	M
PRIMERA UK (P10)														
2.0	1990.01-	-	AT	-	Engine CD20	841005	Outer Joint		27	32	56	103	61.5	M
PRIMERA UK P10														
2000	1991.01-1993.12	4AT	-	-	Engine CD20	899235	Outer Joint	42T	27	22	56	103.5	61.4	M
PRIMERA UK UK P10														
2.0	1991.01-1993.12	4AT	-	-	Engine CD20	899235	Outer Joint	42T	27	22	56	103.5	61.4	M
PRIMERA WAGON (WHP11)														
2.0	1997.09-2001.01	CVT	-	-	Engine SR20DE	841306	Outer Joint		27	25	56	103	61.5	M
PRIMERA WAGON CAMINO WAGON (WHP11)														
2.0	1996.11-	4AT	-	-	Engine SR20DE	841338	Outer Joint		27	23	56	103	61.5	M
PRIMERA WAGON CAMINO WAGON (WP11)														
1.8	1997.09-2001.01	5MT	-	-	Engine SR18DE	841338	Outer Joint		27	23	56	103	61.5	M
PRIMERA WAGON CAMINO WAGON WHP11														
2.0	1997.09-2001.01	CVT	-	-	Engine SR20DE	841306	Outer Joint		27	25	56	103	61.5	M
2000	1997.09-2001.01	CVT	-	-	Engine SR20DE	841306	Outer Joint		27	25	56	103	61.5	M
PRIMERA WAGON CAMINO WAGON WP11														
1.8	1997.09-2001.01	MT/AT	-	-	Engine SR18DE	841338	Outer Joint		27	23	56	103	61.5	M
	1997.09-2001.01	5MT	-	-	Engine SR18DE	841338	Outer Joint		27	23	56	103	61.5	M
1800	1997.09-2001.01	5MT	-	-	Engine SR18DE	841338	Outer Joint		27	23	56	103	61.5	M
PRIMERA(P10E)														
-	1991.01-1993.05	AT	L	F	Engine CD20,BODY:5 DOOR HATCHBACK,TRAIN:2WD	841005	Outer Joint		27	32	56	103	61.5	M
	1991.01-1993.05	AT	L	F	Engine CD20,BODY:SEDAN,TRAIN:2WD	841005	Outer Joint		27	32	56	103	61.5	M
	1993.04-	AT/MT	R	F	Engine SR20DE,BODY:5 DOOR HATCHBACK,TRAIN:2WD	841005	Outer Joint		27	32	56	103	61.5	M
	1993.04-	AT/MT	R	F	Engine SR20DE,BODY:SEDAN,TRAIN:2WD	841005	Outer Joint		27	32	56	103	61.5	M
PULSAR														
-	-	-	-	-	-	241444	Drive Shaft	42T	25	25	55	100.5	919	
	-	-	-	-	-	241444	Drive Shaft	42T	25	25	55	100.5	919	
	-	-	-	-	-	617041	Inner Joint		25	22	40	63	99.5	
	-	-	-	-	-	617041	Inner Joint		25	22	40	63	99.5	
	1999.11-2009.07	AT	-	-	ENGINE : QG13DE	241530	Drive Shaft		25	25	55	107.5	926	
	1999.11-2009.07	AT	-	-	ENGINE : QG13DE	241531	Drive Shaft		25	25	55	107.5	630	
	2003.03-2009.07	AT	-	-	ENGINE : QG13DE	241530	Drive Shaft		25	25	55	107.5	926	
	2003.03-2009.07	AT	-	-	ENGINE : QG13DE	241531	Drive Shaft		25	25	55	107.5	630	
	2009.07-	AT	-	-	ENGINE : QG13DE	241530	Drive Shaft		25	25	55	107.5	926	
	2009.07-	AT	-	-	ENGINE : QG13DE	241531	Drive Shaft		25	25	55	107.5	630	
1.3	1999.11-2011.12	AT	L	F	N16/ENGINE : QG13DE/GR1	241531	Drive Shaft		25	25	55	107.5	630	
	1999.11-2011.12	AT	R	F	N16/ENGINE : QG13DE/GR1	241530	Drive Shaft		25	25	55	107.5	926	
	1999.11-2011.12	AT	L/R	F	N16/ENGINE : QG13DE/GR1	841355	Outer Joint		25	22	55	107.5	57	I
	1999.11-2011.12	AT	R	F	N16/ENGINE : QG13DE/GR1	641185	Inner Joint		25	23	40	63	104	

YEAR	TRANSM	L/R	F/R	REMARKS	GSP Ref.	PRODUCT	ABS	Technical Specifications						
								A	B	C	H	L	P	
NISSAN PULSAR														
1.6	1990-	-	-	R	B13 GA13 GA16DE GA16DS	641002	Inner Joint		25	23	40	63	101	
1.8	1999.12-	2011.12	AT	L	F N16/ENGINE : QG18DE/GL1	241531	Drive Shaft		25	25	55	107.5	630	
	1999.12-	2011.12	AT	R	F N16/ENGINE : QG18DE/GL1	241530	Drive Shaft		25	25	55	107.5	926	
	1999.12-	2011.12	AT	L/R	F N16/ENGINE : QG18DE/GL1	841355	Outer Joint		25	22	55	107.5	57	I
	1999.12-	2011.12	AT	R	F N16/ENGINE : QG18DE/GL1	641185	Inner Joint		25	23	40	63	104	
PULSAR -15														
1.5 DCI	-	-	-	R	F -	841348	Outer Joint		29	25	56.2	102.5	65	M
	-	-	-	R	F -	241486	Drive Shaft		29	26	56.2	102.5	943	
	-	-	-	R	F -	641142	Inner Joint		26	24	33	327	93	
PULSAR LUCINO ALMERA EN13														
1.6	1986.05-	1990.07	AT	-	- Engine CA16D	899204	Outer Joint		25	25	52.3	106.5	62	M
	1986.05-	1990.07	MT	-	- Engine CA16D	899204	Outer Joint		25	25	52.3	106.5	62	M
1600	1986.05-	1990.07	AT	-	- Engine CA16D	899204	Outer Joint		25	25	52.3	106.5	62	M
	1986.05-	1990.07	MT	-	- Engine CA16D	899204	Outer Joint		25	25	52.3	106.5	62	M
PULSAR/LUCINO/ALMERA (EN13)														
1.6	1986.05-	1990.07	MT/AT	-	- Engine CA16D	899204	Outer Joint		25	25	52.3	106.5	62	M
QASHQAI II (J11 J11_)														
1.6 dCi ALL MODE-i (96 kW)	2013.11-	-	-	R	All-wheel Drive Closed Off-Road Vehicle Engine R9M	841285	Outer Joint	48T	25	24	56	110.5	38.5	I
	2013.11-	-	-	R	All-wheel Drive Closed Off-Road Vehicle Engine R9M	657111	Inner Joint		21	24	38	61	91	
QASHQAI/QASHQAI +2 I (J10 JJ10)/DUALIS														
1.5 dCi (76 kW)	2008.07-	2013.12	6MT	L	F Closed Off-Road Vehicle Engine K9K 282/K9K 292	241329	Drive Shaft		29	26	56.1	102	692	
	2008.07-	2013.12	6MT	L	F Closed Off-Road Vehicle Engine K9K 282/K9K 292	641091	Inner Joint		26	35	40	64	125	
	2008.07-	2013.12	MT	R	F Closed Off-Road Vehicle Engine K9K 282/K9K 292	241330	Drive Shaft		29	26	56.1	102	941	
	2008.07-	2013.12	-	L	F Closed Off-Road Vehicle Engine K9K 282/K9K 292	641103	Inner Joint		26	30	40	64	113	
	2008.07-	2013.12	MT	R	F Closed Off-Road Vehicle Engine K9K 282/K9K 292	641092	Inner Joint		26	35	33	326.5	111.5	
1.5 dCi (78 kW)	2007.02-	2013.12	6MT	L	F Closed Off-Road Vehicle Engine K9K 282/K9K 292	241329	Drive Shaft		29	26	56.1	102	692	
	2007.02-	2013.12	6MT	L	F Closed Off-Road Vehicle Engine K9K 282/K9K 292	641091	Inner Joint		26	35	40	64	125	
	2007.02-	2013.12	MT	R	F Closed Off-Road Vehicle Engine K9K 282/K9K 292	241330	Drive Shaft		29	26	56.1	102	941	
	2007.02-	2013.12	-	L	F Closed Off-Road Vehicle Engine K9K 282/K9K 292	641103	Inner Joint		26	30	40	64	113	
	2007.02-	2013.12	MT	R	F Closed Off-Road Vehicle Engine K9K 282/K9K 292	641092	Inner Joint		26	35	33	326.5	111.5	
1.5 dCi (81 kW)	2010.01-	2013.12	6MT	L	F Closed Off-Road Vehicle Engine K9K 430	241329	Drive Shaft		29	26	56.1	102	692	
	2010.01-	2013.12	6MT	L	F Closed Off-Road Vehicle Engine K9K 430	641091	Inner Joint		26	35	40	64	125	
	2010.01-	2013.12	MT	R	F Closed Off-Road Vehicle Engine K9K 430	241330	Drive Shaft		29	26	56.1	102	941	
	2010.01-	2013.12	-	L	F Closed Off-Road Vehicle Engine K9K 430	641103	Inner Joint		26	30	40	64	113	
	2010.01-	2013.12	MT	R	F Closed Off-Road Vehicle Engine K9K 430	641092	Inner Joint		26	35	33	326.5	111.5	
1.6 (84 kW)	2007.02-	2013.12	6MT	L	F Closed Off-Road Vehicle Engine HR16DE	241329	Drive Shaft		29	26	56.1	102	692	
	2007.02-	2013.12	6MT	L	F Closed Off-Road Vehicle Engine HR16DE	641091	Inner Joint		26	35	40	64	125	
	2007.02-	2013.12	5AT	L	F Closed Off-Road Vehicle Engine HR16DE	241300	Drive Shaft		29	26	56	102	691	
	2007.02-	2013.12	CVT/5MT	-	F Closed Off-Road Vehicle Engine HR16DE	841286	Outer Joint		29	33	56	102	57.5	I
	2007.02-	2013.12	5MT	R	F Closed Off-Road Vehicle Engine HR16DE	241301	Drive Shaft		29	26	56	102	940	
	2007.02-	2013.12	MT	R	F Closed Off-Road Vehicle Engine HR16DE	641157	Inner Joint		26	30	33	321.5	104.5	
1.6 (86 kW)	2010.11-	2013.12	5AT	L	F Closed Off-Road Vehicle Engine HR16DE	241300	Drive Shaft		29	26	56	102	691	
	2010.11-	2013.12	CVT/5MT	-	F Closed Off-Road Vehicle Engine HR16DE	841286	Outer Joint		29	33	56	102	57.5	I
	2010.11-	2013.12	5MT	R	F Closed Off-Road Vehicle Engine HR16DE	241301	Drive Shaft		29	26	56	102	940	
	2010.11-	2013.12	MT	R	F Closed Off-Road Vehicle Engine HR16DE	641157	Inner Joint		26	30	33	321.5	104.5	
1.6 dCi (96 kW)	2011.10-	2013.12	-	R	F All-wheel Drive Closed Off-Road Vehicle Engine R9M	641131	Inner Joint		29	29	33	482	100	
	2011.10-	2013.12	AT/MT	L	F Closed Off-Road Vehicle Engine R9M	641076	Inner Joint		29	29	39	65.5	116	
	2011.10-	2013.12	AT/MT	L	F Closed Off-Road Vehicle Engine R9M	241286	Drive Shaft		29	29	56	102	649	
	2011.10-	2013.12	AT/MT	R	F Closed Off-Road Vehicle Engine R9M	241299	Drive Shaft		29	29	56	102	979	
	2011.10-	2013.12	6MT	L	F All-wheel Drive Closed Off-Road Vehicle Engine R9M	241454	Drive Shaft		29	29	56	103.5	619	
	2011.10-	2013.12	-	R	F All-wheel Drive Closed Off-Road Vehicle Engine R9M	241441	Drive Shaft		29	29	56	102	1009	
	2011.10-	2013.12	-	L	F Closed Off-Road Vehicle Engine R9M	241577	Drive Shaft		29	29	56	102	650	
	2011.10-	2013.12	-	L	F Closed Off-Road Vehicle Engine R9M	641108	Inner Joint		27	33	40	107	114	
2.0 (102 kW)	2007.02-	2013.12	AT	L	F All-wheel Drive Closed Off-Road Vehicle Engine MR20DE	641108	Inner Joint		27	33	40	107	114	
	2007.02-	2013.12	AT	R	F All-wheel Drive Closed Off-Road Vehicle Engine MR20DE	641170	Inner Joint		27	33	33	367	109.5	
	2007.02-	2013.12	AT	R	F Closed Off-Road Vehicle Engine MR20DE	641167	Inner Joint		27	33	33	322	109.5	
	2007.02-	2013.12	AT	L	F Closed Off-Road Vehicle Engine MR20DE	641168	Inner Joint		27	33	40	62.5	118	
	2007.02-	2013.12	AT	L	F All-wheel Drive Closed Off-Road Vehicle Engine MR20DE	641108	Inner Joint		27	33	40	107	114	
2.0 (104 kW)	2007.02-	2013.12	AT	R	F All-wheel Drive Closed Off-Road Vehicle Engine MR20DE	641170	Inner Joint		27	33	33	367	109.5	
	2007.02-	2013.12	AT	R	F Closed Off-Road Vehicle Engine MR20DE	641167	Inner Joint		27	33	33	322	109.5	
	2007.02-	2013.12	AT	L	F Closed Off-Road Vehicle Engine MR20DE	641168	Inner Joint		27	33	40	62.5	118	
	2007.02-	2013.12	AT	L	F All-wheel Drive Closed Off-Road Vehicle Engine MR20DE	641108	Inner Joint		27	33	40	107	114	
	2007.02-	2013.12	AT	L	F Closed Off-Road Vehicle Engine MR20DE	641167	Inner Joint		27	33	33	322	109.5	
2.0 dCi (110 kW)	2007.02-	2013.12	MT	R	F All-wheel Drive Closed Off-Road Vehicle Engine M9R/M1D	641131	Inner Joint		29	29	33	482	100	
	2007.02-	2013.12	AT/MT	L	F Closed Off-Road Vehicle Engine M9R/M1D	641076	Inner Joint		29	29	39	65.5	116	
	2007.02-	2013.12	AT/MT	L	F Closed Off-Road Vehicle Engine M9R/M1D	241286	Drive Shaft		29	29	56	102	649	
	2007.02-	2013.12	AT/MT	R	F Closed Off-Road Vehicle Engine M9R/M1D	241299	Drive Shaft		29	29	56	102	979	
	2007.02-	2013.12	6AT	R	F All-wheel Drive Closed Off-Road Vehicle Engine M9R/M1D	241475	Drive Shaft		29	30	56	102	971	
	2007.02-	2013.12	6MT	L	F All-wheel Drive Closed Off-Road Vehicle Engine M9R/M1D	241454	Drive Shaft		29	29	56	103.5	619	

YEAR	TRANSM	L/R	F/R	REMARKS	GSP Ref.	PRODUCT	ABS	Technical Specifications							
								A	B	C	H	L	P		
NISSAN															
QASHQAI/QASHQAI +2 I (J10 JJ10)/DUALIS															
2.0 dCi (110 kW)	2007.02-2013.12	2013.12	MT	R	F	All-wheel Drive Closed Off-Road Vehicle Engine M9R/M1D	241441	Drive Shaft		29	29	56	102	1009	
	2007.02-2013.12		-	L	F	Closed Off-Road Vehicle Engine M9R/M1D	241577	Drive Shaft		29	29	56	102	650	
QUEST															
-	1993-	1999	-	-	-		835017	Outer Joint	50T	32	34	62	117.5	71.5	I
QUEST (RE52)															
3.5 V6 (194 kW)	2012.02-		AT	R	F	MPV Engine VQ35DE	641208	Inner Joint		29	27	33	459	99	
QUEST (V40)															
3.0 (113 kW)	1992.05-	1998.09	-	-	-	MPV Engine VG30E	818075	Outer Joint		32	34	62	117.5	71.5	I
QUEST (V42)															
3.5 (176 kW)	2003.05-		AT	L	F	MPV Engine VQ35DE	699109	Inner Joint		26	26	31	50	105	
	2003.05-		AT	-	F	MPV Engine VQ35DE	841352	Outer Joint		29	36	56	102	73	I
QX80 Z62															
-	2014.11-		7AT	R	R	ENGINE : VK56VD; GR2;4WD;PREMIUM GRADE;WAGON 3ROW	241565	Drive Shaft		34		67.2	123.5	707	
	2014.11-		7AT	R	R	ENGINE : VK56VD; GR2;4WD;PREMIUM GRADE;WAGON 3ROW;7 PASSENGER	241565	Drive Shaft		34		67.2	123.5	707	
	2014.11-		7AT	R	R	ENGINE : VK56VD; GR2;4WD;PREMIUM GRADE;WAGON 3ROW	841393	Outer Joint		34	43	67.2	123.5	74.5	I
	2014.11-		7AT	R	R	ENGINE : VK56VD; GR2;4WD;PREMIUM GRADE;WAGON 3ROW;7 PASSENGER	841393	Outer Joint		34	43	67.2	123.5	74.5	I
ROGUE															
4 Cyl 2.5	2008-	2015	-	R	F	ENGINE:QR25DE	641079	Inner Joint		27	33	33	416.5	107.5	
4 Cyl 2.5L	2008-	2015	-	R	F	ENGINE:QR25DE	241399	Drive Shaft		29	27	56.1	102	968	
ROSINS															
-	-	-	-	-	R	-	201159	Stub Axle							
S-CARGO (G20)															
1.5	1989.01-	1990.11	AT	-	-	Engine E15S	841041	Outer Joint		24	22	52	105	56	M
S-CARGO G20															
15001 AT	-	1990.11	-	-	-	Engine E15S	841041	Outer Joint		24	22	52	105	56	M
S-CARGO S- G20															
1.5	1989.01-	2009.11	AT	-	-	Engine E15S	841041	Outer Joint		24	22	52	105	56	M
SENTRA															
-	1992.01-	1995.12	MT/AT	-	-	-	841084	Outer Joint		25	24	55	105	62	I
	2001-	2002	MT	-	-	-	641028	Inner Joint		25	32	40	63	108	
	2001-	2002	MT/AT	-	-	-	641028	Inner Joint		25	32	40	63	108	
	2001-	2002	AT	-	-	-	641037	Inner Joint		25	32	40	63	107	
	2007-	2012	-	-	-	-	841117	Outer Joint		29	24	56.2	102	63	M
1.6	1987-	1990	-	-	-	SOHC	641003	Inner Joint		24	23	40	51.5	107.5	
1.8 LTS	2013-	2015	ATVT	-	-	-	841332	Outer Joint		29	23	56.2	102	63	M
1.8, 1.8S, CA, GXE, XE	2000-	2006	-	R	F	-	241258	Drive Shaft	42T	25	25	55	107	927	
	2000-	2006	-	R	F	-	641141	Inner Joint		25	23	40	63	107	
2.5 Lts	2002-	2005	AT	-	-	-	841411	Outer Joint	42T	27	25	56	103	66	M
SENTRA HF/LUCINO HF															
-	1996-	2000	AT	-	-	-	641028	Inner Joint		25	32	40	63	108	
	1996-	2000	MT/AT	-	-	-	841135	Outer Joint	42T	25	32	55	105	62	I
SENTRA HS															
-	2001-	2002	MT/AT	-	-	-	841135	Outer Joint	42T	25	32	55	105	62	I
	2013-		AT	L/R	-	-	841332	Outer Joint		29	23	56.2	102	63	M
	2013-		MT	R	-	-	641106	Inner Joint		26	23	33	343	91	
	2013-		MT	L	-	-	641112	Inner Joint		26	23	40	64	104.5	
	2013-		AT	L/R	-	-	641129	Inner Joint		25	23	40	53	112	
2.0	2007-	2012	MT	L	-	-	641126	Inner Joint		26	24	40	64	104.5	
	2007-	2012	MT	R	-	-	641127	Inner Joint		26	24	33	343	91	
	2007-	2012	AT	L	-	-	641073	Inner Joint		27	24	40	62.5	99.5	
	2007-	2012	AT	R	-	-	641101	Inner Joint		27	24	33	321	92	
SENTRA V (B15)															
2.0 (107 kW)	2000.01-	2006.12	-	-	-	Saloon Engine SR20DE	841092	Outer Joint		25	32	55	105	62	I
SERENA (C23)/LARGO/VANETTE SERENA															
1.6 (71 kW)	1993.02-	2001.09	MT	-	-	MPV Engine GA16DE	641014	Inner Joint			27		81.2		
	1993.02-	2001.09	-	-	-	MPV Engine GA16DE	841176	Outer Joint		27	23	56	104	63	I
2.0 (93 kW)	1992.11-	2001.09	-	-	-	MPV Engine SR20DE	841176	Outer Joint		27	23	56	104	63	I
2.0 D (49 kW)	1992.11-	2001.09	MT	-	-	MPV Engine LD20	641014	Inner Joint			27		81.2		
	1992.11-	2001.09	-	-	-	MPV Engine LD20	841176	Outer Joint		27	23	56	104	63	I
2.3 D (55 kW)	1995.01-	2001.09	MT	-	-	MPV Engine LD23	641014	Inner Joint			27		81.2		
	1995.01-	2001.09	AT/MT	L/R	F	MPV Engine LD23	841107	Outer Joint		27	23	56	104	60	I
SERENA (C23M)															
1.6 16V (71 kW)	1993.02-		-	-	-	-	841121	Outer Joint		27	23	56	104	63	I
SERENA (C24)															
2.0 SGX (107 kW)	2000.09-	2005.09	AT	-	F	All-wheel Drive MPV Engine SR20DE	841184	Outer Joint	44T	27	25	56	103	68	M

	 YEAR	TRANSM	L/R	F/R	REMARKS	GSP Ref.	 PRODUCT	 ABS	Technical Specifications					
									A	B	C	H	L	P
NISSAN														
SERENA (C24)														
2.0 SGX (107 kW)	2000.09-2005.09	AT	-	F	MPV Engine SR20DE	841184	Outer Joint	44T	27	25	56	103	68	M
	2000.09-2005.09	-	-	F	MPV Engine SR20DE	839248	Outer Joint	44T	27	35	56	103	68	I
	2000.09-2005.09	AT	-	-	All-wheel Drive MPV Engine SR20DE	641014	Inner Joint			27		81.2		
	2000.09-2005.09	AT	-	F	All-wheel Drive MPV Engine SR20DE	841282	Outer Joint	44T	27	23	56	103	58.5	I
	2000.09-2005.09	AT	-	F	MPV Engine SR20DE	841282	Outer Joint	44T	27	23	56	103	58.5	I
2.5 DCi SGX (110 kW)	1999.06-2005.09	AT	-	F	MPV Engine YD25DDTi	841184	Outer Joint	44T	27	25	56	103	68	M
	1999.06-2005.09	AT	-	F	All-wheel Drive MPV Engine YD25DDTi	841184	Outer Joint	44T	27	25	56	103	68	M
	1999.06-2005.09	AT	-	F	MPV Engine YD25DDTi	841282	Outer Joint	44T	27	23	56	103	58.5	I
	1999.06-2005.09	AT	-	F	All-wheel Drive MPV Engine YD25DDTi	841282	Outer Joint	44T	27	23	56	103	58.5	I
	1999.06-2005.09	AT	-	-	All-wheel Drive MPV Engine YD25DDTi	641014	Inner Joint			27		81.2		
	1999.06-2005.09	AT	-	F	MPV Engine YD25DDTi	841015	Outer Joint	44T	27	27	56	103	69	I
	1999.06-2005.09	AT	-	F	All-wheel Drive MPV Engine YD25DDTi	841015	Outer Joint	44T	27	27	56	103	69	I
	1999.06-2005.09	AT	L	F	MPV Engine YD25DDTi	641062	Inner Joint		29	27	39	65.5	114.5	
	1999.06-2005.09	AT	L	F	All-wheel Drive MPV Engine YD25DDTi	641062	Inner Joint		29	27	39	65.5	114.5	
SERENA (C25)														
2.0	2007.12-2010.11	CVT	-	-	Engine MR20DE	841334	Outer Joint		29	24	56	102.5	59	M
SERENA (C26)														
2.0	2010.11-	CVT	-	-	Engine MR20DD	841334	Outer Joint		29	24	56	102.5	59	M
SERENA (CC25)														
2.0	2007.12-2010.11	CVT	-	-	Engine MR20DE	841334	Outer Joint		29	24	56	102.5	59	M
SERENA (CNC25)														
2.0 4WD	2007.12-2010.11	CVT	-	-	Engine MR20DE	841334	Outer Joint		29	24	56	102.5	59	M
SERENA (NC25)														
2.0 4WD	2007.12-2010.11	CVT	-	-	Engine MR20DE	841334	Outer Joint		29	24	56	102.5	59	M
SERENA (NC26)														
2.0 4WD	2010.11-	CVT	-	-	Engine MR20DD	841334	Outer Joint		29	24	56	102.5	59	M
SERENA (PC26)														
2.0	2010.11-	CVT	-	-	Engine MR20DD	841334	Outer Joint		29	24	56	102.5	59	M
SERENA (PNC26)														
2.0 4WD	2010.11-	CVT	-	-	Engine MR20DD	841334	Outer Joint		29	24	56	102.5	59	M
SERENA C24														
2000	1999.06-	CVT	-	-	Engine SR20DE	841360	Outer Joint	44T	27	27	56	103	68	M
	1999.06-2000.07	CVT/C	-	-	Engine SR20DE	841360	Outer Joint	44T	27	27	56	103	68	M
	1999.06-2000.07	CVT/C	-	-	Engine SR20DE	841360	Outer Joint	44T	27	27	56	103	68	M
	1999.06-2000.07	CVT/C	-	-	Engine SR20DE	841360	Outer Joint	44T	27	27	56	103	68	M
SKYLINE (R32)														
2.0 (114 kW)	1989.03-1993.06	-	-	-	Coupe Engine RB20DE	641014	Inner Joint			27		81.2		
2.0 Turbo (158 kW)	1989.03-1993.06	-	-	-	All-wheel Drive Coupe Engine RB20DET	641014	Inner Joint			27		81.2		
	1989.03-1993.06	-	-	-	All-wheel Drive Saloon Engine RB20DET	641014	Inner Joint			27		81.2		
2.6 Twin Turbo (206 kW)	1989.04-1993.06	MT	-	-	All-wheel Drive Coupe Engine RB26DETT	641014	Inner Joint			27		81.2		
SKYLINE (R33)														
2.0 (96 kW)	1993.07-1998.05	-	-	-	Coupe Engine RB20E	641014	Inner Joint			27		81.2		
2.5 (140 kW)	1993.07-1998.05	-	-	-	Coupe Engine RB25DE	641014	Inner Joint			27		81.2		
	1993.07-1998.05	-	-	-	All-wheel Drive Coupe Engine RB25DE	641014	Inner Joint			27		81.2		
2.6 Twin Turbo (206 kW)	1994.07-1999.09	MT	-	-	All-wheel Drive Coupe Engine RB26DETT	641014	Inner Joint			27		81.2		
SKYLINE (R34)														
2.6 Turbo (244 kW)	1999.01-2008.02	MT	-	-	All-wheel Drive Coupe Engine RB26DETT	641014	Inner Joint			27		81.2		
SKYLINE (V35)														
2.5 (158 kW)	2006.01-2007.08	AT	-	-	Coupe Engine VQ25DD	641014	Inner Joint			27		81.2		
SPIRIT														
1.6	1990-	-	-	R	B13 GA13 GA16DE GA16DS	641002	Inner Joint		25	23	40	63	101	
STAGEA (M35)														
2.5 AWD (138 kW)	2001.10-2006.12	AT	-	-	All-wheel Drive Estate	641014	Inner Joint			27		81.2		
STAGEA (WC34)														
2.0 (96 kW)	1996.09-2001.10	AT	-	-	Estate Engine RB20E	641014	Inner Joint			27		81.2		
SUNNY														
1.3	1993-	-	-	-	BM10 PM10	899187	Outer Joint		24	23	52	104.5	60	I
1.6	1990-	-	-	R	B13 GA13 GA16DE GA16DS	641002	Inner Joint		25	23	40	63	101	
SUNNY B15														
-	1998.10-2004.10	MT	R	F	2WD.QG15DE.MT +QG13DE.MT	841406	Outer Joint		25	22	55	107.5	57	I
	1998.10-2004.10	MT	L	F	2WD.QG15DE.MT +QG13DE.MT	841406	Outer Joint		25	22	55	107.5	57	I
	1998.10-2004.10	MT	R	F	2WD.QG15DE.MT +QG13DE.MT	641198	Inner Joint		24	23	40	51.7	100.4	
	1998.10-2004.10	MT	L	F	2WD.QG15DE.MT +QG13DE.MT	641198	Inner Joint		24	23	40	51.7	100.4	
	1998.10-2004.10	MT	R	F	2WD.QG15DE.MT +QG13DE.MT	241525	Drive Shaft	42T	25	24	55	107.5	922	
	1998.10-2004.10	MT	L	F	2WD.QG15DE.MT +QG13DE.MT	241527	Drive Shaft	42T	25	24	55	107.5	632	

YEAR	TRANSM	L/R	F/R	REMARKS	GSP Ref.	PRODUCT	ABS	Technical Specifications									
								A	B	C	H	L	P				
NISSAN																	
SUNNY B15																	
-	1998.10-2004.10	MT	R	F	2WD.QG15DE.MT +QG13DE.MT	841284	Outer Joint	42T	25	22	55	107.5	57	I			
-	1998.10-2004.10	MT	L	F	2WD.QG15DE.MT +QG13DE.MT	841284	Outer Joint	42T	25	22	55	107.5	57	I			
SUNNY I Traveller (B11)																	
1.3 (44 kW)	1982.08-1990.08	-	-	-	Estate Engine E13	641001	Inner Joint		24	23	40	51.7	100.4				
	1982.08-1990.08	-	-	F	Estate Engine E13	841069	Outer Joint		25	22	52.2	107	55.5	M			
SUNNY II (B12)																	
1.6 GTI 16V (81 kW)	1987.05-1989.05	MT	-	F	Coupe Engine CA16D	822003	Outer Joint		25	25	52.2	107	66	M			
	1987.05-1989.05	AT/MT	L/R	F	Coupe Engine CA16D	841168	Outer Joint		25	25	52.2	107	66	I			
	1987.05-1989.05	-	-	-	Coupe Engine CA16D	841068	Outer Joint		25	23	52.2	107	62.5	I			
1.6 i (54 kW)	1986.06-1989.05	-	-	F	Coupe Engine E16i	841077	Outer Joint		25	23	52.3	107	62	I			
	1986.06-1989.05	-	-	F	Coupe Engine E16i	841069	Outer Joint		25	22	52.2	107	55.5	M			
	1986.06-1989.05	AT	-	-	Coupe Engine E16i	841105	Outer Joint		25	22	52.2	107	55.5	I			
	1986.06-1989.05	AT/MT	L/R	F	Coupe Engine E16i	841008	Outer Joint		25	23	52.2	102	62	I			
	1986.06-1989.05	-	-	F	Coupe Engine E16i	841039	Outer Joint		25	22	52.3	107.4	55.7	M			
	1986.06-1989.05	-	-	-	Coupe Engine E16i	641001	Inner Joint		24	23	40	51.7	100.4				
1.6 i 12V (66 kW)	1988.10-1991.06	-	-	F	Coupe Engine GA16i	841039	Outer Joint		25	22	52.3	107.4	55.7	M			
	1988.10-1991.06	-	-	F	Coupe Engine GA16i	841069	Outer Joint		25	22	52.2	107	55.5	M			
	1988.10-1991.06	AT	-	-	Coupe Engine GA16i	841105	Outer Joint		25	22	52.2	107	55.5	I			
	1988.10-1991.06	AT/MT	L/R	F	Coupe Engine GA16i	841073	Outer Joint		25	22	52.2	103	56	I			
1.6 SGX (70 kW)	1988.10-1990.09	MT	-	F	Coupe Engine GA16S	841077	Outer Joint		25	23	52.3	107	62	I			
	1988.10-1990.09	AT	-	F	Coupe Engine GA16S	841069	Outer Joint		25	22	52.2	107	55.5	M			
1.8 GTI 16V (92 kW)	1989.01-1991.06	-	-	F	Coupe Engine CA18D	822003	Outer Joint		25	25	52.2	107	66	M			
SUNNY II (N13)																	
1.0 (37 kW)	1986.07-1990.09	-	-	F	Hatchback Engine E10S	841069	Outer Joint		25	22	52.2	107	55.5	M			
1.3 (44 kW)	1986.07-1991.10	-	-	F	Saloon Engine E13S	841039	Outer Joint		25	22	52.3	107.4	55.7	M			
	1986.07-1991.10	-	-	-	Saloon Engine E13S	841180	Outer Joint		25	22	52.2	108.5	59	I			
	1986.07-1991.10	AT/MT	L/R	F	Saloon Engine E13S	841073	Outer Joint		25	22	52.2	103	56	I			
1.4 LX (55 kW)	1988.10-1991.08	-	-	F	Saloon Engine GA14S	841039	Outer Joint		25	22	52.3	107.4	55.7	M			
	1988.10-1991.08	MT	L/R	F	Saloon Engine GA14S	841073	Outer Joint		25	22	52.2	103	56	I			
	1989.01-1991.08	-	-	F	Hatchback Engine GA14S	841039	Outer Joint		25	22	52.3	107.4	55.7	M			
	1989.01-1991.08	-	-	F	Hatchback Engine GA14S	841069	Outer Joint		25	22	52.2	107	55.5	M			
	1989.01-1991.08	MT	L/R	F	Hatchback Engine GA14S	841073	Outer Joint		25	22	52.2	103	56	I			
1.6 GTI 16V (81 kW)	1987.06-1989.05	MT	-	F	Hatchback Engine CA16D	822003	Outer Joint		25	25	52.2	107	66	M			
	1987.06-1989.05	-	-	-	Hatchback Engine CA16D	841180	Outer Joint		25	22	52.2	108.5	59	I			
1.6 i (54 kW)	1986.06-1990.10	-	-	F	Saloon Engine E16i	841039	Outer Joint		25	22	52.3	107.4	55.7	M			
	1986.06-1990.10	-	-	F	Hatchback Engine E16i	841039	Outer Joint		25	22	52.3	107.4	55.7	M			
	1986.06-1990.10	MT	-	F	Saloon Engine E16i	841077	Outer Joint		25	23	52.3	107	62	I			
	1986.06-1990.10	MT	-	F	Hatchback Engine E16i	841077	Outer Joint		25	23	52.3	107	62	I			
	1986.06-1990.10	AT	-	F	Saloon Engine E16i	841069	Outer Joint		25	22	52.2	107	55.5	M			
	1986.06-1990.10	AT	-	F	Hatchback Engine E16i	841069	Outer Joint		25	22	52.2	107	55.5	M			
	1986.06-1990.10	AT	-	-	Saloon Engine E16i	841105	Outer Joint		25	22	52.2	107	55.5	I			
	1986.06-1990.10	AT	-	-	All-wheel Drive Saloon Engine E16i	841105	Outer Joint		25	22	52.2	107	55.5	I			
	1986.06-1990.10	AT	-	-	Hatchback Engine E16i	841105	Outer Joint		25	22	52.2	107	55.5	I			
	1986.06-1990.10	AT/MT	L/R	F	Saloon Engine E16i	841008	Outer Joint		25	23	52.2	102	62	I			
	1986.06-1990.10	-	-	F	All-wheel Drive Saloon Engine E16i	841023	Outer Joint		27	23	56	103	61.5	M			
	1986.06-1990.10	AT/MT	L/R	F	Hatchback Engine E16i	841008	Outer Joint		25	23	52.2	102	62	I			
1.6 i 12V (66 kW)	1986.06-1990.10	AT	-	-	Hatchback Engine GA16i	641001	Inner Joint		24	23	40	51.7	100.4				
	1986.06-1990.10	-	-	F	Hatchback Engine GA16i	841039	Outer Joint		25	22	52.3	107.4	55.7	M			
	1986.06-1990.10	MT	-	F	Hatchback Engine GA16i	841077	Outer Joint		25	23	52.3	107	62	I			
	1986.06-1990.10	AT	-	F	Hatchback Engine GA16i	841069	Outer Joint		25	22	52.2	107	55.5	M			
	1986.06-1990.10	AT	-	-	Hatchback Engine GA16i	841105	Outer Joint		25	22	52.2	107	55.5	I			
	1986.06-1990.10	AT/MT	L/R	F	Hatchback Engine GA16i	841008	Outer Joint		25	23	52.2	102	62	I			
	1988.10-1991.06	-	-	F	Saloon Engine GA16S/GA16i	841039	Outer Joint		25	22	52.3	107.4	55.7	M			
	1988.10-1991.06	MT	-	F	Saloon Engine GA16S/GA16i	841077	Outer Joint		25	23	52.3	107	62	I			
	1988.10-1991.06	AT	-	F	Saloon Engine GA16S/GA16i	841069	Outer Joint		25	22	52.2	107	55.5	M			
	1988.10-1991.06	AT	-	-	Saloon Engine GA16S/GA16i	841105	Outer Joint		25	22	52.2	107	55.5	I			
	1988.10-1991.06	AT/MT	L/R	F	Saloon Engine GA16S/GA16i	841073	Outer Joint		25	22	52.2	103	56	I			
1.7 D (40 kW)	1986.06-1991.01	-	-	F	Hatchback Engine CD17	841039	Outer Joint		25	22	52.3	107.4	55.7	M			
	1986.06-1989.05	-	-	F	Saloon Engine CD17	841069	Outer Joint		25	22	52.2	107	55.5	M			
	1986.06-1989.05	AT/MT	L/R	F	Saloon Engine CD17	841073	Outer Joint		25	22	52.2	103	56	I			
	1986.06-1991.01	-	-	F	Hatchback Engine CD17	841069	Outer Joint		25	22	52.2	107	55.5	M			
	1986.06-1989.05	-	-	-	Saloon Engine CD17	841180	Outer Joint		25	22	52.2	108.5	59	I			
	1986.06-1991.01	-	-	-	Hatchback Engine CD17	841180	Outer Joint		25	22	52.2	108.5	59	I			
	1986.06-1991.01	AT/MT	L/R	F	Hatchback Engine CD17	841073	Outer Joint		25	22	52.2	103	56	I			
	1986.06-1989.05	-	-	F	Saloon Engine CD17	841039	Outer Joint		25	22	52.3	107.4	55.7	M			
1.8 GTI 16V (92 kW)	1989.01-1991.06	-	-	F	Hatchback Engine CA18D	822003	Outer Joint		25	25	52.2	107	66	M			





YEAR	TRANSM	L/R	F/R	REMARKS	GSP Ref.	PRODUCT	ABS	Technical Specifications							
								A	B	C	H	L	P		
NISSAN															
SUNNY II Traveller (B12)															
1.6 i (54 kW)	1986.06-1989.05	AT	-	-	All-wheel Drive Estate Engine E16i	841105	Outer Joint		25	22	52.2	107	55.5	I	
	1986.06-1989.05	MT	-	F	All-wheel Drive Estate Engine E16i	841023	Outer Joint		27	23	56	103	61.5	M	
	1986.08-1989.05	MT	-	F	Estate Engine E16i	841077	Outer Joint		25	23	52.3	107	62	I	
	1986.08-1989.05	AT	-	F	Estate Engine E16i	841069	Outer Joint		25	22	52.2	107	55.5	M	
	1986.08-1989.05	AT	-	-	Estate Engine E16i	841105	Outer Joint		25	22	52.2	107	55.5	I	
	1986.08-1989.05	AT/MT	L/R	F	Estate Engine E16i	841008	Outer Joint		25	23	52.2	102	62	I	
	1986.08-1989.05	-	-	F	Estate Engine E16i	841039	Outer Joint		25	22	52.3	107.4	55.7	M	
1.6 i 12V (66 kW)	1988.10-1991.06	-	-	F	Estate Engine GA16i	841039	Outer Joint		25	22	52.3	107.4	55.7	M	
	1988.10-1991.06	-	-	F	All-wheel Drive Estate Engine GA16i	841039	Outer Joint		25	22	52.3	107.4	55.7	M	
	1988.10-1991.06	MT	-	F	Estate Engine GA16i	841077	Outer Joint		25	23	52.3	107	62	I	
	1988.10-1991.06	AT	-	F	Estate Engine GA16i	841069	Outer Joint		25	22	52.2	107	55.5	M	
	1988.10-1991.06	AT	-	-	Estate Engine GA16i	841105	Outer Joint		25	22	52.2	107	55.5	I	
	1988.10-1991.06	AT	-	-	All-wheel Drive Estate Engine GA16i	841105	Outer Joint		25	22	52.2	107	55.5	I	
	1988.10-1991.06	AT/MT	L/R	F	Estate Engine GA16i	841073	Outer Joint		25	22	52.2	103	56	I	
1.7 D (40 kW)	1986.01-1991.06	-	-	F	Estate Engine CD17	841039	Outer Joint		25	22	52.3	107.4	55.7	M	
	1986.01-1991.06	-	-	-	Estate Engine CD17	841180	Outer Joint		25	22	52.2	108.5	59	I	
	1986.01-1991.06	AT/MT	L/R	F	Estate Engine CD17	841073	Outer Joint		25	22	52.2	103	56	I	
SUNNY III (N14)															
1.4 (60 kW)	1990.10-1995.06	MT	-	-	Hatchback Engine GA14DS	641001	Inner Joint		24	23	40	51.7	100.4		
	1990.10-1995.06	-	-	F	Hatchback Engine GA14DS	841191	Outer Joint	42T	25	22	55	107	57	M	
	1990.10-1995.06	MT	-	F	Hatchback Engine GA14DS	841002	Outer Joint	42T	25	22	55	107	56	I	
	1990.10-1995.06	MT	-	F	Hatchback Engine GA14DS	841033	Outer Joint		25	23	55	107	61	I	
	1990.10-1995.06	MT	-	-	Hatchback Engine GA14DS	641089	Inner Joint		25	23	40	63	99		
1.4 i (55 kW)	1990.10-1995.05	MT	-	-	Hatchback Engine GA14DE/GA14DS	641001	Inner Joint		24	23	40	51.7	100.4		
	1990.10-1995.05	AT/MT	L/R	F	Hatchback Engine GA14DE/GA14DS	841001	Outer Joint		25	22	55	107	56	I	
	1990.10-1995.05	AT	-	F	Hatchback Engine GA14DE/GA14DS	899199	Outer Joint		25	23	55	107	62	M	
	1990.10-1995.05	-	-	F	Hatchback Engine GA14DE/GA14DS	841191	Outer Joint	42T	25	22	55	107	57	M	
	1990.10-1995.05	-	-	F	Hatchback Engine GA14DE/GA14DS	834024	Outer Joint		25	22	55	107	57	M	
	1990.10-1995.05	MT	-	F	Hatchback Engine GA14DE/GA14DS	841002	Outer Joint	42T	25	22	55	107	56	I	
	1990.10-1995.05	-	-	-	Hatchback Engine GA14DE/GA14DS	841076	Outer Joint		25	30	55	107	56	I	
1.4 i 16V (64 kW)	1990.10-1995.05	MT	-	-	Hatchback Engine GA14DE	641001	Inner Joint		24	23	40	51.7	100.4		
	1990.10-1995.05	AT/MT	L/R	F	Hatchback Engine GA14DE	841001	Outer Joint		25	22	55	107	56	I	
	1990.10-1995.05	-	-	F	Hatchback Engine GA14DE	841191	Outer Joint	42T	25	22	55	107	57	M	
	1990.10-1995.05	-	-	F	Hatchback Engine GA14DE	834024	Outer Joint		25	22	55	107	57	M	
	1990.10-1995.05	MT	-	F	Hatchback Engine GA14DE	841002	Outer Joint	42T	25	22	55	107	56	I	
	1990.10-1995.05	AT	-	F	Hatchback Engine GA14DE	841033	Outer Joint		25	23	55	107	61	I	
1.6 i (66 kW)	1990.10-1995.05	AT	L	F	Hatchback Engine GA16DE/GA16DS/GA16DEL	650065	Inner Joint		25	25	40	63	101		
	1992.10-1995.05	AT	L	F	Hatchback Engine GA16DE	650065	Inner Joint		25	25	40	63	101		
1.6 i 16V (75 kW)	1992.10-1995.05	AT/MT	L/R	F	Hatchback Engine GA16DE	841078	Outer Joint		25	23	55	107	62	I	
	1992.10-1995.05	AT/MT	L/R	F	Hatchback Engine GA16DE	841003	Outer Joint	42T	25	23	55	107	62	I	
	1992.10-1995.05	AT/MT	L/R	F	Hatchback Engine GA16DE	841001	Outer Joint		25	22	55	107	56	I	
2.0 D (55 kW)	1990.10-1995.05	AT/MT	L/R	F	Hatchback Engine CD20	841001	Outer Joint		25	22	55	107	56	I	
	1990.10-1995.05	-	-	F	Hatchback Engine CD20	841191	Outer Joint	42T	25	22	55	107	57	M	
	1990.10-1995.05	MT	-	F	Hatchback Engine CD20	841002	Outer Joint	42T	25	22	55	107	56	I	
	1990.10-1995.05	MT	-	F	Hatchback Engine CD20	841033	Outer Joint		25	23	55	107	61	I	
	1990.10-1995.05	MT	-	-	Hatchback Engine CD20	641089	Inner Joint		25	23	40	63	99		
2.0 GTI 16V (105 kW)	1990.10-1995.05	-	-	-	Hatchback Engine SR20DE	841014	Outer Joint	42T	25	25	55	106.5	66	I	
2.0 GTI-R (162 kW)	1990.10-1995.05	AT/MT	L/R	F	All-wheel Drive Hatchback Engine SR20DET	841078	Outer Joint		25	23	55	107	62	I	
	1990.10-1995.05	AT/MT	L/R	F	All-wheel Drive Hatchback Engine SR20DET	841003	Outer Joint	42T	25	23	55	107	62	I	
	1990.10-1995.05	MT	-	F	All-wheel Drive Hatchback Engine SR20DET	841033	Outer Joint		25	23	55	107	61	I	
SUNNY III (N14)/PULSAR															
1.4 (60 kW)	1990.10-1995.06	MT	-	-	Saloon Engine GA14DS	641001	Inner Joint		24	23	40	51.7	100.4		
	1990.10-1995.06	AT	-	F	Saloon Engine GA14DS	899199	Outer Joint		25	23	55	107	62	M	
	1990.10-1995.06	-	-	F	Saloon Engine GA14DS	841191	Outer Joint	42T	25	22	55	107	57	M	
	1990.10-1995.06	-	-	F	Saloon Engine GA14DS	834024	Outer Joint		25	22	55	107	57	M	
	1990.10-1995.06	MT	-	F	Saloon Engine GA14DS	841002	Outer Joint	42T	25	22	55	107	56	I	
	1990.10-1995.06	MT	-	F	Saloon Engine GA14DS	841033	Outer Joint		25	23	55	107	61	I	
	1990.10-1995.06	MT	-	-	Saloon Engine GA14DS	641089	Inner Joint		25	23	40	63	99		
1.4 i (55 kW)	1990.10-1995.05	MT	-	-	Saloon Engine GA14DE/GA14DS	641001	Inner Joint		24	23	40	51.7	100.4		
	1990.10-1995.05	AT/MT	L/R	F	Saloon Engine GA14DE/GA14DS	841001	Outer Joint		25	22	55	107	56	I	
	1990.10-1995.05	AT	-	F	Saloon Engine GA14DE/GA14DS	899199	Outer Joint		25	23	55	107	62	M	
	1990.10-1995.05	-	-	F	Saloon Engine GA14DE/GA14DS	841191	Outer Joint	42T	25	22	55	107	57	M	
	1990.10-1995.05	MT	-	F	Saloon Engine GA14DE/GA14DS	841002	Outer Joint	42T	25	22	55	107	56	I	
	1990.10-1995.05	-	-	-	Saloon Engine GA14DE/GA14DS	841076	Outer Joint		25	30	55	107	56	I	
1.4 i 16V (64 kW)	1990.10-1995.06	MT	-	-	Saloon Engine GA14DE	641001	Inner Joint		24	23	40	51.7	100.4		

YEAR	TRANSM	L/R	F/R	REMARKS	GSP Ref.	PRODUCT	ABS	Technical Specifications						
								A	B	C	H	L	P	
NISSAN														
SUNNY III (N14)/PULSAR														
1.4 i 16V (64 kW)	1990.10-1995.06	AT/MT	L/R	F	Saloon Engine GA14DE	841001	Outer Joint		25	22	55	107	56	I
	1990.10-1995.06	AT	-	F	Saloon Engine GA14DE	899199	Outer Joint		25	23	55	107	62	M
	1990.10-1995.06	-	-	F	Saloon Engine GA14DE	841191	Outer Joint	42T	25	22	55	107	57	M
	1990.10-1995.06	-	-	F	Saloon Engine GA14DE	834024	Outer Joint		25	22	55	107	57	M
	1990.10-1995.06	MT	-	F	Saloon Engine GA14DE	841002	Outer Joint	42T	25	22	55	107	56	I
	1990.10-1995.06	AT	-	F	Saloon Engine GA14DE	841033	Outer Joint		25	23	55	107	61	I
	1990.10-1995.06	AT	-	-	Saloon Engine GA14DE	641089	Inner Joint		25	23	40	63	99	
1.6 (70 kW)	1992.09-1996.12	AT	L	F	Saloon Engine GA16DE	650065	Inner Joint		25	25	40	63	101	
1.6 i (66 kW)	1990.10-1995.05	AT	L	F	Saloon Engine GA16DE/GA16DS/GA16DEL	650065	Inner Joint		25	25	40	63	101	
1.6 i 16V (66 kW)	1990.10-1995.05	MT	-	F	All-wheel Drive Saloon Engine GA16DS	841002	Outer Joint	42T	25	22	55	107	56	I
	1990.10-1995.05	MT	-	F	All-wheel Drive Saloon Engine GA16DS	841033	Outer Joint		25	23	55	107	61	I
1.6 i 16V (75 kW)	1992.10-1995.05	AT	L	F	Saloon Engine GA16DE	650065	Inner Joint		25	25	40	63	101	
	1992.10-1995.05	AT/MT	L/R	F	Saloon Engine GA16DE	841078	Outer Joint		25	23	55	107	62	I
	1992.10-1995.05	AT/MT	L/R	F	Saloon Engine GA16DE	841003	Outer Joint	42T	25	23	55	107	62	I
2.0 D (55 kW)	1990.10-1995.05	AT/MT	L/R	F	Saloon Engine CD20	841001	Outer Joint		25	22	55	107	56	I
	1990.10-1995.05	-	-	F	Saloon Engine CD20	841191	Outer Joint	42T	25	22	55	107	57	M
	1990.10-1995.05	MT	-	F	Saloon Engine CD20	841002	Outer Joint	42T	25	22	55	107	56	I
	1990.10-1995.05	MT	-	F	Saloon Engine CD20	841033	Outer Joint		25	23	55	107	61	I
	1990.10-1995.05	MT	-	-	Saloon Engine CD20	641089	Inner Joint		25	23	40	63	99	
SUNNY III (Y10)														
1.6 i 16V (66 kW)	1992.10-2000.03	-	-	F	Box Engine GA16DE	899199	Outer Joint		25	23	55	107	62	M
	1992.10-2000.03	MT	-	F	Box Engine GA16DE	841033	Outer Joint		25	23	55	107	61	I
	1992.10-2000.03	MT	-	-	Box Engine GA16DE	641089	Inner Joint		25	23	40	63	99	
1.7 D (40 kW)	1990.11-2000.03	MT	-	-	Box Engine CD17	641001	Inner Joint		24	23	40	51.7	100.4	
	1990.11-2000.03	AT	L	F	Box Engine CD17	650065	Inner Joint		25	25	40	63	101	
	1990.11-2000.03	MT	L/R	F	Box Engine CD17	841001	Outer Joint		25	22	55	107	56	I
	1990.11-2000.03	-	-	F	Box Engine CD17	841191	Outer Joint	42T	25	22	55	107	57	M
	1990.11-2000.03	-	-	F	Box Engine CD17	834024	Outer Joint		25	22	55	107	57	M
	1990.11-2000.03	MT	-	F	Box Engine CD17	841033	Outer Joint		25	23	55	107	61	I
SUNNY III Liftback (N14)														
1.4 i (55 kW)	1990.10-1995.05	MT	-	-	Hatchback Engine GA14DS/GA14DE	641001	Inner Joint		24	23	40	51.7	100.4	
	1990.10-1995.05	AT/MT	L/R	F	Hatchback Engine GA14DS/GA14DE	841001	Outer Joint		25	22	55	107	56	I
	1990.10-1995.05	AT	-	F	Hatchback Engine GA14DS/GA14DE	899199	Outer Joint		25	23	55	107	62	M
	1990.10-1995.05	-	-	F	Hatchback Engine GA14DS/GA14DE	841191	Outer Joint	42T	25	22	55	107	57	M
	1990.10-1995.05	-	-	F	Hatchback Engine GA14DS/GA14DE	834024	Outer Joint		25	22	55	107	57	M
	1990.10-1995.05	MT	-	F	Hatchback Engine GA14DS/GA14DE	841002	Outer Joint	42T	25	22	55	107	56	I
	1990.10-1995.05	-	-	-	Hatchback Engine GA14DS/GA14DE	841076	Outer Joint		25	30	55	107	56	I
1.4 i 16V (64 kW)	1990.10-1995.06	MT	-	-	Hatchback Engine GA14DE	641001	Inner Joint		24	23	40	51.7	100.4	
	1990.10-1995.06	AT/MT	L/R	F	Hatchback Engine GA14DE	841001	Outer Joint		25	22	55	107	56	I
	1990.10-1995.06	AT	-	F	Hatchback Engine GA14DE	899199	Outer Joint		25	23	55	107	62	M
	1990.10-1995.06	-	-	F	Hatchback Engine GA14DE	841191	Outer Joint	42T	25	22	55	107	57	M
	1990.10-1995.06	-	-	F	Hatchback Engine GA14DE	834024	Outer Joint		25	22	55	107	57	M
	1990.10-1995.06	MT	-	F	Hatchback Engine GA14DE	841002	Outer Joint	42T	25	22	55	107	56	I
	1990.10-1995.06	AT	-	F	Hatchback Engine GA14DE	841033	Outer Joint		25	23	55	107	61	I
	1990.10-1995.06	AT	-	-	Hatchback Engine GA14DE	641089	Inner Joint		25	23	40	63	99	
	1990.10-1995.06	AT	L	F	Hatchback Engine GA16DE/GA16DS/GA16DEL	650065	Inner Joint		25	25	40	63	101	
	1990.10-1995.05	AT/MT	L/R	F	Hatchback Engine CD20	841001	Outer Joint		25	22	55	107	56	I
2.0 D (55 kW)	1990.10-1995.05	-	-	F	Hatchback Engine CD20	841191	Outer Joint	42T	25	22	55	107	57	M
	1990.10-1995.05	MT	-	F	Hatchback Engine CD20	841002	Outer Joint	42T	25	22	55	107	56	I
	1990.10-1995.05	MT	-	F	Hatchback Engine CD20	841033	Outer Joint		25	23	55	107	61	I
	1990.10-1995.05	MT	-	-	Hatchback Engine CD20	641089	Inner Joint		25	23	40	63	99	
	1990.10-1995.05	-	-	-	Hatchback Engine SR20DE	841014	Outer Joint	42T	25	25	55	106.5	66	I
SUNNY III Traveller (Y10)														
1.6 (75 kW)	1995.07-2000.03	MT	-	F	Estate Engine GA16DE	841033	Outer Joint		25	23	55	107	61	I
	1995.07-2000.03	MT	-	-	Estate Engine GA16DE	641089	Inner Joint		25	23	40	63	99	
1.6 i (66 kW)	1991.06-2000.03	-	-	-	Estate Engine GA16DE/GA16DS	841068	Outer Joint		25	23	52.2	107	62.5	I
1.6 i 16V (75 kW)	1992.10-2000.03	AT/MT	L/R	F	All-wheel Drive Estate Engine GA16DE	841078	Outer Joint		25	23	55	107	62	I
	1992.10-2000.03	AT/MT	L/R	F	All-wheel Drive Estate Engine GA16DE	841003	Outer Joint	42T	25	23	55	107	62	I
	1992.10-2000.03	MT	-	F	All-wheel Drive Estate Engine GA16DE	841033	Outer Joint		25	23	55	107	61	I
	1992.10-2000.03	MT	-	-	All-wheel Drive Estate Engine GA16DE	641089	Inner Joint		25	23	40	63	99	
	1992.10-2000.03	AT	L	F	Estate Engine CD20	650065	Inner Joint		25	25	40	63	101	
2.0 D (55 kW)	1991.06-2000.03	AT/MT	L/R	F	Estate Engine CD20	841001	Outer Joint		25	22	55	107	56	I
	1991.06-2000.03	-	-	F	Estate Engine CD20	841191	Outer Joint	42T	25	22	55	107	57	M
	1991.06-2000.03	-	-	F	Estate Engine CD20	841002	Outer Joint	42T	25	22	55	107	56	I
	1991.06-2000.03	-	-	F	Estate Engine CD20	841033	Outer Joint		25	23	55	107	61	I
	1991.06-2000.03	AT	-	F	Estate Engine CD20	841033	Outer Joint		25	23	55	107	61	I
SUNNY IV (N16)														





YEAR	TRANSM	L/R	F/R	REMARKS	GSP Ref.	PRODUCT	ABS	Technical Specifications							
								A	B	C	H	L	P		
NISSAN															
SUNNY IV (N16)															
1.5 (77 kW)	1997.09-2000.03	-	-	F	All-wheel Drive Saloon Engine QG15DE	841034	Outer Joint	42T	25	23	55	107	61	I	
SUNNY SENTRA B12															
1.5	1985.09-1997.09	AT	-	-	Engine E15T	899204	Outer Joint		25	25	52.3	106.5	62	M	
SUNNY SENTRA EB12															
1.6	1986.01-1990.01	MT/AT	-	-	Engine CA16D	899204	Outer Joint		25	25	52.3	106.5	62	M	
	1986.08-1990.01	AT	-	-	Engine CA16D	899204	Outer Joint		25	25	52.3	106.5	62	M	
SUNNY/SENTRA (B12)															
1.5	1985.09-1997.09	AT	-	-	Engine E15T	899204	Outer Joint		25	25	52.3	106.5	62	M	
SUNNY/SENTRA (EB12)															
1.6	1986.01-1990.01	MT/AT	-	-	Engine CA16D	899204	Outer Joint		25	25	52.3	106.5	62	M	
	1986.08-1990.01	AT	-	-	Engine CA16D	899204	Outer Joint		25	25	52.3	106.5	62	M	
SUNNYSENTRA B12															
1500	1985.09-1997.09	AT	-	-	Engine E15T	899204	Outer Joint		25	25	52.3	106.5	62	M	
SUNNYSENTRA EB12															
1600	1986.01-1990.01	MT/AT	-	-	Engine CA16D	899204	Outer Joint		25	25	52.3	106.5	62	M	
	1986.08-1990.01	AT	-	-	Engine CA16D	899204	Outer Joint		25	25	52.3	106.5	62	M	
TEANA (J32)															
2.5 4WD	2008.06-	CVT	-	-	QR25DE	841252	Outer Joint		29	26	56	101	68	M	
3.5	2008.06-	CVT	-	-	Engine VQ35DE	841222	Outer Joint		32	27	56	102.5	67.5	M	
TEANA I (J31)															
2.3 (127 kW)	2003.10-2008.06	AT	-	F	Saloon Engine VQ23DE	841251	Outer Joint		29	24	56	103	62	M	
	2003.10-2008.06	-	R	F	Saloon Engine VQ23DE	641019	Inner Joint		29	27	33	437.5	101		
	2003.10-2008.06	AT	L	F	Saloon Engine VQ23DE	641062	Inner Joint		29	27	39	65.5	114.5		
	2003.10-2008.06	AT	R	F	Saloon Engine VQ23DE	641104	Inner Joint		29	27	33	436	99		
3.5 (170 kW)	2003.10-2008.06	-	-	-	Saloon Engine VQ35DE	841250	Outer Joint		29	25	56	101	68	M	
TEANA II (J32)															
2.5 (134 kW)	2008.07-2013.09	-	-	-	Saloon Engine VQ25DE	841250	Outer Joint		29	25	56	101	68	M	
3.5 (183 kW)	2008.07-2013.09	-	-	-	Saloon Engine VQ35DE	841250	Outer Joint		29	25	56	101	68	M	
	2008.07-2013.09	AT	R	F	Saloon Engine VQ35DE	641208	Inner Joint		29	27	33	459	99		
3.5 (185 kW)	2009.01-2011.03	AT	R	F	Saloon Engine VQ35DE	641208	Inner Joint		29	27	33	459	99		
TEANA J32															
-	2008.02-2013.12	-	L	F	Engine VQ35DE	641183	Inner Joint		29	27	39	65.5	115		
	2008.02-2013.12	-	L	F	Engine VQ35DE	241533	Drive Shaft		32	29	56.3	103	637		
2.5	2008.06-	CVT	-	-	Allwheel Drive Engine QR25DE	841376	Outer Joint		29	26	56	101	68.3	M	
	2008.06-	CVT	-	-	Allwheel Drive Engine QR25DE	841376	Outer Joint		29	26	56	101	68.3	M	
	2008.06-2013.12	CVT	L	F	2wd/ENGINE:VQ25DE	641073	Inner Joint		27	24	40	62.5	99.5		
	2008.06-2013.12	CVT	L	F	2wd/ENGINE:VQ25DE	241377	Drive Shaft		29	27	56.2	102	646		
2.5i. V6 VQ25DE	-	CVT	R	-	2wd	641054	Inner Joint		27	24	33	435	94		
	-	CVT	R	-	2wd	241378	Drive Shaft		29	27	56.2	102	992		
3.5	2008.06-	CVT	-	-	Engine VQ35DE	841222	Outer Joint		32	27	56	102.5	67.5	M	
3500	2008.06-	CVT	-	-	Engine VQ35DE	841222	Outer Joint		32	27	56	102.5	67.5	M	
TERRANO I (WD21)/PATHFINDER															
2.4 i (76 kW)	1987.10-1993.02	AT/MT	L/R	F	All-wheel Drive Closed Off-Road Vehicle Engine Z24i	241055	Drive Shaft		27		50	150	520		
	1987.10-1993.02	MT	-	F	All-wheel Drive Closed Off-Road Vehicle Engine Z24i	841086	Outer Joint		27	27	50	150	71	I	
2.7 TD (73 kW)	1989.02-1996.02	-	-	F	All-wheel Drive Closed Off-Road Vehicle Engine TD27T	841016	Outer Joint		28	27	50	150	71	I	
	1989.02-1996.02	-	-	-	All-wheel Drive Closed Off-Road Vehicle Engine TD27T	641014	Inner Joint			27		81.2			
	1989.02-1996.02	AT/MT	L/R	F	All-wheel Drive Closed Off-Road Vehicle Engine TD27T	241055	Drive Shaft		27		50	150	520		
	1989.02-1996.02	-	-	-	All-wheel Drive Closed Off-Road Vehicle Engine TD27T	841178	Outer Joint		26	27	50	147.5	64	I	
3.0 i (109 kW)	1989.02-1996.02	-	-	F	All-wheel Drive Closed Off-Road Vehicle Engine TD27T	841086	Outer Joint		27	27	50	150	71	I	
	1990.01-1995.12	AT/MT	L/R	F	All-wheel Drive Closed Off-Road Vehicle Engine VG30E	241055	Drive Shaft		27		50	150	520		
	1990.01-1995.12	MT	-	F	All-wheel Drive Closed Off-Road Vehicle Engine VG30E	841086	Outer Joint		27	27	50	150	71	I	
TERRANO II (R20)/MISTRAL															
2.4 (85 kW)	1996.05-2002.01	MT	L/R	F	All-wheel Drive Closed Off-Road Vehicle Engine KA24E	841025	Outer Joint		27	32	50	150	68.5	I	
	1996.05-2002.01	MT	L/R	F	All-wheel Drive Closed Off-Road Vehicle Engine KA24E	241464	Drive Shaft		27		50	150	521		
	1996.05-2002.01	AT/MT	L/R	F	All-wheel Drive Closed Off-Road Vehicle Engine KA24E	241055	Drive Shaft		27		50	150	520		
2.4 (87 kW)	1996.05-2007.09	MT	L/R	F	All-wheel Drive Closed Off-Road Vehicle Engine KA24E	241464	Drive Shaft		27		50	150	521		
	1996.05-2007.09	MT	L/R	F	All-wheel Drive Closed Off-Road Vehicle Engine KA24E	841025	Outer Joint		27	32	50	150	68.5	I	
	1996.05-2007.09	AT/MT	L/R	F	All-wheel Drive Closed Off-Road Vehicle Engine KA24E	241055	Drive Shaft		27		50	150	520		
2.4 i 12V (91 kW)	1993.02-1997.12	MT	L/R	F	All-wheel Drive Closed Off-Road Vehicle Engine KA24E	841025	Outer Joint		27	32	50	150	68.5	I	
	1993.02-1997.12	MT	L/R	F	All-wheel Drive Closed Off-Road Vehicle Engine KA24E	241464	Drive Shaft		27		50	150	521		
	1993.02-1997.12	AT/MT	L/R	F	All-wheel Drive Closed Off-Road Vehicle Engine KA24E	241055	Drive Shaft		27		50	150	520		
2.7 TD (74 kW)	1993.02-2002.01	AT	-	-	All-wheel Drive Closed Off-Road Vehicle Engine TD27T	641014	Inner Joint			27		81.2			
	1993.02-2002.01	MT	L/R	F	All-wheel Drive Closed Off-Road Vehicle Engine TD27T	241464	Drive Shaft		27		50	150	521		
	1993.02-2002.01	AT/MT	L/R	F	All-wheel Drive Closed Off-Road Vehicle Engine TD27T	241055	Drive Shaft		27		50	150	520		
	1993.02-2002.01	AT	-	F	All-wheel Drive Closed Off-Road Vehicle Engine TD27T	841086	Outer Joint		27	27	50	150	71	I	
2.7 TDi (92 kW)	1996.05-2007.09	MT	L/R	F	All-wheel Drive Closed Off-Road Vehicle Engine TD27T	241464	Drive Shaft		27		50	150	521		

YEAR	TRANSM	L/R	F/R	REMARKS	GSP Ref.	PRODUCT	ABS	Technical Specifications									
								A	B	C	H	L	P				
NISSAN																	
TERRANO II (R20)/MISTRAL																	
2.7 TDi (92 kW)	1996.05-2007.09	MT	L/R	F	All-wheel Drive Closed Off-Road Vehicle Engine TD27Ti	841025	Outer Joint	27	32	50	150	68.5	I				
	1996.05-2007.09	AT	-	-	All-wheel Drive Closed Off-Road Vehicle Engine TD27Ti	641014	Inner Joint		27		81.2						
	1996.05-2007.09	AT/MT	L/R	F	All-wheel Drive Closed Off-Road Vehicle Engine TD27Ti	241055	Drive Shaft	27		50	150	520					
	1996.05-2007.09	AT	-	F	All-wheel Drive Closed Off-Road Vehicle Engine TD27Ti	841086	Outer Joint	27	27	50	150	71	I				
3.0 Di (113 kW)	2002.05-2007.09	MT	L/R	F	All-wheel Drive Closed Off-Road Vehicle Engine ZD30	841025	Outer Joint	27	32	50	150	68.5	I				
	2002.05-2007.09	-	L/R	F	All-wheel Drive Closed Off-Road Vehicle Engine ZD30	241464	Drive Shaft	27		50	150	521					
	2002.05-2007.09	AT/MT	L/R	F	All-wheel Drive Closed Off-Road Vehicle Engine ZD30	241055	Drive Shaft	27		50	150	520					
3.0 DiTD (125 kW)	1997.10-2004.12	AT/MT	L/R	F	All-wheel Drive Closed Off-Road Vehicle Engine ZD30DDTi	241055	Drive Shaft	27		50	150	520					
3.3 (125 kW)	1992.10-2004.12	AT/MT	L/R	F	Closed Off-Road Vehicle Engine VG33E	241055	Drive Shaft	27		50	150	520					
TERRANO II Van (R20)																	
2.7 TDi (92 kW)	1998.06-2007.09	AT/MT	L/R	F	All-wheel Drive Box Engine TD27Ti	241055	Drive Shaft	27		50	150	520					
3.0 Di (113 kW)	2003.04-2007.09	-	L/R	F	All-wheel Drive Box Engine ZD30/ZD30Ti	241464	Drive Shaft	27		50	150	521					
	2003.04-2007.09	-	L/R	F	All-wheel Drive Box Engine ZD30/ZD30Ti	841025	Outer Joint	27	32	50	150	68.5	I				
	2003.04-2007.09	AT/MT	L/R	F	All-wheel Drive Box Engine ZD30/ZD30Ti	241055	Drive Shaft	27		50	150	520					
TERRANO PATHFINDER BYD21																	
2.7	1986.08-1989.10	MT/AT	-	-	Allwheel Drive Engine TD27T	841051	Outer Joint	27	27	50	151	71	M				
2700	1986.08-1989.10	MT/AT	-	-	Allwheel Drive Engine TD27T	841051	Outer Joint	27	27	50	151	71	M				
TERRANO PATHFINDER D21																	
2.7	1986.01-1989.01	MT/AT	-	-	Allwheel Drive Engine TG27E	841051	Outer Joint	27	27	50	151	71	M				
	1989.10-	MT/AT	-	-	Allwheel Drive Engine TD27T	841085	Outer Joint	26	27	50	148	60	M				
2700	1986.01-1989.01	MT/AT	-	-	Allwheel Drive Engine TG27E	841051	Outer Joint	27	27	50	151	71	M				
	1989.10-	MT/AT	-	-	Allwheel Drive Engine TD27T	841085	Outer Joint	26	27	50	148	60	M				
3.0	1987.10-1989.10	MT/AT	-	-	Allwheel Drive Engine VG30E	841051	Outer Joint	27	27	50	151	71	M				
3000	1987.10-1989.10	MT/AT	-	-	Allwheel Drive Engine VG30E	841051	Outer Joint	27	27	50	151	71	M				
TERRANO/PATHFINDER (BYD21)																	
2.7 4WD	1986.08-1989.10	MT/AT	-	-	Engine TD27T	841051	Outer Joint	27	27	50	151	71	M				
TERRANO/PATHFINDER (D21)																	
2.7 4WD	1986.01-1989.01	MT/AT	-	-	Engine TG27E	841051	Outer Joint	27	27	50	151	71	M				
	1989.10-	MT/AT	-	-	Engine TD27T	841085	Outer Joint	26	27	50	148	60	M				
3.0 4WD	1987.10-1989.10	MT/AT	-	-	Engine VG30E	841051	Outer Joint	27	27	50	151	71	M				
TIIDA																	
-	2007-	MT	R	-	-	641106	Inner Joint	26	23	33	343	91					
	2007-	MT	L	-	-	641112	Inner Joint	26	23	40	64	104.5					
	2007-	AT	L	-	-	641125	Inner Joint	25	23	40	63	98.5					
1.6	-	-	-	-	-	841229	Outer Joint	25	32	49.1	95	61	I				
1.8 LTS	2007-2013	MT	L/R	-	-	841272	Outer Joint	25	23	49	95	62.5	M				
	2007-2013	MT	L/R	-	-	841272	Outer Joint	25	23	49	95	62.5	M				
TIIDA (C11)																	
1.5	2004.09-	CVT	-	-	Engine HR15DE	841302	Outer Joint	25	22	49	95	56	M				
	2006-	4AT	-	-	Engine HR15DE	841303	Outer Joint	25	21	49	95	56	M				
1.5 4WD	2004.09-2010.08	4AT	-	-	Engine HR15DE	841302	Outer Joint	25	22	49	95	56	M				
1.8	2005.01-	CVT	-	-	Engine MR18DE	841302	Outer Joint	25	22	49	95	56	M				
	2008.01-2010.08	6MT	-	-	-	841308	Outer Joint	25	23	49	95	56.5	M				
TIIDA (C11)/LATIO																	
1.5 (80 kW)	2004.05-2012.08	-	-	-	Hatchback Engine HR15DE	841167	Outer Joint	25	22	49	94	56	M				
1.5 dCi (78 kW)	2007.09-2011.12	-	-	-	Hatchback Engine K9K 278	841233	Outer Joint	25	24	49.1	95	61	M				
	2007.09-2011.12	MT	-	-	Hatchback Engine K9K 278	641117	Inner Joint	25	22	40	63	98.5					
1.6 (81 kW)	2007.09-2011.12	-	-	-	Hatchback Engine HR16DE	841167	Outer Joint	25	22	49	94	56	M				
	2007.09-2011.12	AT	-	F	Hatchback Engine HR16DE	841304	Outer Joint	25	29	49	95	56	I				
	2007.09-2011.12	-	-	F	Hatchback Engine HR16DE	841217	Outer Joint	25	23	49.15	94.5	63	M				
	2007.09-2011.12	AT	-	-	Hatchback Engine HR16DE	641117	Inner Joint	25	22	40	63	98.5					
	2007.09-2011.12	MT	-	-	Hatchback Engine HR16DE	659036	Inner Joint	26	22	40	64.5	98					
1.8 (81 kW)	2004.05-2007.02	AT	R	F	Hatchback Engine HR18DE	641133	Inner Joint	25	23	33	335	101					
	2004.05-2007.02	AT	R	F	All-wheel Drive Hatchback Engine HR18DE	641133	Inner Joint	25	23	33	335	101					
1.8 (93 kW)	2007.09-2011.12	-	-	-	Hatchback Engine MR18DE	841167	Outer Joint	25	22	49	94	56	M				
	2007.09-2011.12	-	-	-	Hatchback Engine MR18DE	841234	Outer Joint	25	23	49.1	92	57	M				
	2007.09-2011.12	-	-	F	Hatchback Engine MR18DE	841271	Outer Joint	25	22	49	94.5	59.5	M				
TIIDA (SC11)/TIIDA LATIO																	
1.5 dCi (76 kW)	2007.01-2012.12	MT	-	-	Saloon Engine K9K 772	641117	Inner Joint	25	22	40	63	98.5					
1.5 dCi (78 kW)	2007.09-2012.12	-	-	-	Saloon Engine K9K	841233	Outer Joint	25	24	49.1	95	61	M				
	2007.09-2012.12	MT	-	-	Saloon Engine K9K	641117	Inner Joint	25	22	40	63	98.5					
1.6 (81 kW)	2007.09-2012.12	-	-	-	Saloon Engine HR16DE	841167	Outer Joint	25	22	49	94	56	M				
	2007.09-2012.12	AT	-	F	Saloon Engine HR16DE	841304	Outer Joint	25	29	49	95	56	I				
	2007.09-2012.12	-	-	F	Saloon Engine HR16DE	841217	Outer Joint	25	23	49.15	94.5	63	M				
	2007.09-2012.12	AT	-	-	Saloon Engine HR16DE	641117	Inner Joint	25	22	40	63	98.5					
	2007.09-2012.12	MT	-	-	Saloon Engine HR16DE	659036	Inner Joint	26	22	40	64.5	98					

	YEAR	TRANSM	L/R	F/R	REMARKS	GSP Ref.	PRODUCT	ABS	Technical Specifications												
									A	B	C	H	L	P							
NISSAN																					
TIIDA (SC11)/TIIDA LATIO																					
1.8 (93 kW)	2007.09-	2012.12	-	-	-	Saloon Engine MR18DE	841234	Outer Joint		25	23	49.1	92	57	M						
	2007.09-	2012.12	-	-	F	Saloon Engine MR18DE	841271	Outer Joint		25	22	49	94.5	59.5	M						
TIIDA C11																					
1.6	2005-	2010	-	R	F	-	241537	Drive Shaft		25	26	49	94.5	903							
1500	2004.09-	-	4AT	-	-	Engine HR15DE	841303	Outer Joint		25	21	49	95	56	M						
	2004.09-	-	CVT	-	-	Engine HR15DE	841302	Outer Joint		25	22	49	95	56	M						
	2004.09-	-	4AT	-	-	Allwheel Drive Engine HR15DE	841302	Outer Joint		25	22	49	95	56	M						
	2004.09-	-	4AT	-	-	Allwheel Drive Engine HR15DE	841302	Outer Joint		25	22	49	95	56	M						
	2006.01-	-	4AT	-	-	Engine HR15DE	841303	Outer Joint		25	21	49	95	56	M						
	2006.01-	-	4AT	-	-	Engine HR15DE	841303	Outer Joint		25	21	49	95	56	M						
	2006.12-	2010.08	4AT	-	-	Allwheel Drive Engine HR15DE	841302	Outer Joint		25	22	49	95	56	M						
1800	2005.01-	-	CVT	-	-	Engine MR18DE	841302	Outer Joint		25	22	49	95	56	M						
	2008.01-	2010.08	6MT	-	-	Engine MR18DE	841308	Outer Joint		25	23	49	95	56.5	M						
TIIDA JPN MAKE(C11)																					
-	2005.08-	2012.06	AT	R	F	ENGINE : HR16DE/HATCH BACK/GL1/BP TYPE/2WD	241291	Drive Shaft		25	25	49	95	911							
TIIDA LATIO																					
-	2005.12-	2008.06	AT	-	-	ENGINE : MR18DE 2WD	241536	Drive Shaft		25	25	49.15	94.5	647							
	2005.12-	2008.06	AT	-	-	ENGINE : MR18DE 2WD	241536	Drive Shaft		25	25	49.15	94.5	647							
	2008.06-	2010.08	AT	-	-	ENGINE : MR18DE	241536	Drive Shaft		25	25	49.15	94.5	647							
	2008.06-	-	AT	-	-	ENGINE : MR18DE	241536	Drive Shaft		25	25	49.15	94.5	647							
TIIDA LATIO (C11)																					
1.5 4WD	2006.12-	2010.08	4AT	-	-	Engine HR15DE	841302	Outer Joint		25	22	49	95	56	M						
1.8	2008.01-	2010.08	6MT	-	-	-	841308	Outer Joint		25	23	49	95	56.5	M						
TIIDA LATIO C11																					
1500	2006.12-	2010.08	4AT	-	-	Allwheel Drive Engine HR15DE	841302	Outer Joint		25	22	49	95	56	M						
1800	2008.01-	2010.08	6MT	-	-	Engine MR18DE	841308	Outer Joint		25	23	49	95	56.5	M						
TIIDA MEX MAKE(C11X)																					
1.8	2006.06-	2013.04	AT	L	F	-	241553	Drive Shaft		25	25	49	94.5	657							
	2006.06-	2013.04	AT	L	F	-	241554	Drive Shaft		25	26	49	94.5	658							
	2006.06-	2013.04	AT	L	F	-	641201	Inner Joint		25	22	40	62.5	98.5							
	2006.06-	2013.04	AT	L	F	-	641202	Inner Joint		26	22	40	64	98							
TIIDA MOT																					
1.8 DOHC 16V	2006-	2013	MT	L	-	-	641158	Inner Joint		26	23	40	64.5	99							
TIIDA SEDAN(SC11X)																					
-	2007.01-	-	AT	R	F	ENGINE : MR18DE/SEDAN/BASE GRADE/GL1	241291	Drive Shaft		25	25	49	95	911							
1.8	2007.01-	-	AT	L	F	-	241553	Drive Shaft		25	25	49	94.5	657							
	2007.01-	-	AT	L	F	-	241554	Drive Shaft		25	26	49	94.5	658							
	2007.01-	-	AT	L	F	-	641201	Inner Joint		25	22	40	62.5	98.5							
	2007.01-	-	AT	L	F	-	641202	Inner Joint		26	22	40	64	98							
	2007.02-	-	MT	L	F	-	241553	Drive Shaft		25	25	49	94.5	657							
	2007.02-	-	MT	L	F	-	241553	Drive Shaft		25	25	49	94.5	657							
	2007.02-	-	MT	L	F	-	241554	Drive Shaft		25	26	49	94.5	658							
	2007.02-	-	MT	L	F	-	241554	Drive Shaft		25	26	49	94.5	658							
	2007.02-	-	MT	L	F	-	641201	Inner Joint		25	22	40	62.5	98.5							
	2007.02-	-	MT	L	F	-	641201	Inner Joint		25	22	40	62.5	98.5							
	2007.02-	-	MT	L	F	-	641202	Inner Joint		26	22	40	64	98							
	2007.02-	-	MT	L	F	-	641202	Inner Joint		26	22	40	64	98							
TIIDA(C11X)																					
1.8	2007.03-	-	MT	L	F	-	241553	Drive Shaft		25	25	49	94.5	657							
	2007.03-	-	MT	L	F	-	241553	Drive Shaft		25	25	49	94.5	657							
	2007.03-	-	MT	L	F	-	241554	Drive Shaft		25	26	49	94.5	658							
	2007.03-	-	MT	L	F	-	641201	Inner Joint		25	22	40	62.5	98.5							
	2007.03-	-	MT	L	F	-	641201	Inner Joint		25	22	40	62.5	98.5							
	2007.03-	-	MT	L	F	-	641202	Inner Joint		26	22	40	64	98							
TIIDAL ATIO																					
-	2005.12	2008.06	AT	L	F	ENGINE : MR18DE 2WD	241536	Drive Shaft		25	25	49.15	94.5	647							
	2005.12	2008.06	AT	L	F	ENGINE : MR18DE 2WD	641125	Inner Joint		25	23	40	63	98.5							
TITAN																					
5.6 (227 kW)	2003.10-	-	AT	-	F	All-wheel Drive Pickup Engine VK56DE	841403	Outer Joint		29	36	67.3	117	69	I						
	2003.10-	-	AT	-	-	All-wheel Drive Pickup Engine VK56DE	641207	Inner Joint			36		79.5								
5.6 Flex-Fuel (227 kW)	2003.10-	2006.12	AT	-	F	All-wheel Drive Pickup Engine VK56DE	841403	Outer Joint		29	36	67.3	117	69	I						
	2003.10-	2006.12	AT	-	-	All-wheel Drive Pickup Engine VK56DE	641207	Inner Joint			36		79.5								
TSUBAME																					
-	1993-	1997	MT/AT	L/R	-	-	841094	Outer Joint		25	24	55	107	62	I						
	1993-	1997	MT	-	-	-	641015	Inner Joint		25	24	40	63	108.5							

	 YEAR	TRANSM	L/R	F/R	REMARKS	GSP Ref.	 PRODUCT	 ABS	Technical Specifications					
									A	B	C	H	L	P
NISSAN														
TSUBAME														
-	1993.01-1995.12	MT/AT	-	-	-	841084	Outer Joint		25	24	55	105	62	I
-	1993.01-1995.12	AT	-	-	-	841113	Outer Joint		25	24	55	96	62	I
-	1993.01-1995.12	MT	-	-	-	841113	Outer Joint		25	24	55	96	62	I
TSURU														
-	1988-1992	MT/AT	-	-	-	641016	Inner Joint		24	24	40	51.5	102.5	
-	1992-2000	MT	-	-	-	641015	Inner Joint		25	24	40	63	108.5	
TSURU GS														
-	1992.01-1995.12	AT	-	-	-	841113	Outer Joint		25	24	55	96	62	I
-	1992.01-1995.12	MT	-	-	-	841113	Outer Joint		25	24	55	96	62	I
TSURU III														
-	2005-2007	-	-	-	-	641038	Inner Joint		25	23	40	63	105.5	
1.6	1992-1999	MT/AT	L/R	-	-	841094	Outer Joint		25	24	55	107	62	I
TSURU III GS														
-	1992.01-1995.12	MT/AT	-	-	-	841084	Outer Joint		25	24	55	105	62	I
TSURU/TSUBAME														
-	2001-2002	MT	-	-	-	641032	Inner Joint		25	32	40	63	108	
-	2001-2002	AT	-	-	-	641028	Inner Joint		25	32	40	63	108	
1.6 16V	1992-2000	MT	-	-	-	641034	Inner Joint		25	24	40	63	108	
URVAN (E24)/CARAVAN														
2.0 (64 kW)	1987.05-1997.05	MT	L	F	Box Engine Z20	203371	Drive Shaft		42		76.5	34	465	
-	1987.05-1997.05	MT	R	F	Box Engine Z20	203371	Drive Shaft		42		76.5	34	465	
VANETTE (C22)/VANETTE/LARGO VAN														
2.0 (66 kW)	1987.07-1994.08	-	-	-	Bus Engine Z20S	841045	Outer Joint		27	23	56	103	62	I
2.0 D (47 kW)	1986.10-1995.12	-	-	-	Bus Engine LD20	841045	Outer Joint		27	23	56	103	62	I
VANETTE CARGO (HC 23)														
1.6 i (71 kW)	1994.09-2001.05	-	-	-	Box Engine GA16DE	641014	Inner Joint			27		81.2		
1.6 i (72 kW)	1996.01-2001.05	-	-	-	Bus Engine GA16DE	641014	Inner Joint			27		81.2		
-	1996.01-2001.05	-	-	-	Bus Engine GA16DE	841045	Outer Joint		27	23	56	103	62	I
2.3 D (55 kW)	1994.09-2002.05	-	-	-	Box Engine LD23	641014	Inner Joint			27		81.2		
-	1994.09-2001.05	-	-	-	Bus Engine LD23	641014	Inner Joint			27		81.2		
VERSA														
-	2012-2014	MT	L/R	-	-	641130	Inner Joint		26	22	39.97	64	98.5	
VERSA NOTE														
1.6	2014-2016	-	R	F	-	241512	Drive Shaft		25	26	49	94.5	923	
-	2014-2016	MT	L	F	-	241513	Drive Shaft		25	26	49	94.5	634	
VERSA SEDAN(SC11X)														
1.8	2006.12-2011.06	AT	L	F	-	241554	Drive Shaft		25	26	49	94.5	658	
-	2006.12-2011.06	AT	L	F	-	241554	Drive Shaft		25	26	49	94.5	658	
-	2006.12-2011.06	AT	L	F	-	641202	Inner Joint		26	22	40	64	98	
-	2006.12-2011.06	AT	L	F	-	641202	Inner Joint		26	22	40	64	98	
VERSA SEDAN (SC11X)														
1.8	2006.12-2011.06	MT	L	F	-	241553	Drive Shaft		25	25	49	94.5	657	
-	2006.12-2011.06	AT	L	F	-	241553	Drive Shaft		25	25	49	94.5	657	
-	2006.12-2011.06	MT	L	F	-	641201	Inner Joint		25	22	40	62.5	98.5	
-	2006.12-2011.06	AT	L	F	-	641201	Inner Joint		25	22	40	62.5	98.5	
VQ40														
-	2006-	AT	-	-	-	841325	Outer Joint		29	36	67.3	115	60.5	M
WINGROAD														
-	-	-	R	F	2WD/ENGINE:QG15	841406	Outer Joint		25	22	55	107.5	57	I
-	-	-	R	F	2WD/ENGINE:QG15	241532	Drive Shaft	42T	25	25	55	107.5	926	
-	-	-	R	F	2WD/ENGINE:QG15	641185	Inner Joint		25	23	40	63	104	
-	-	-	R	F	2WD/ENGINE:QG15	841284	Outer Joint	42T	25	22	55	107.5	57	I
X-TRAIL														
-	2001.01-2002.05	AT	L	-	4WD	241198	Drive Shaft	46T	29	29	56	103.5	650	
-	2001.01-2002.05	AT	R	-	4WD	241197	Drive Shaft	46T	29		56	103.5	552	
-	2001.01-2002.05	MT	L	-	4WD	241199	Drive Shaft	46T	29	29	56	103.5	620	
2.5	2002-2007	AT	-	-	-	641122	Inner Joint		29	26	33	390	96.5	
-	2002-2007	AT	-	-	-	641124	Inner Joint		29	26	39	65	114	
X-TRAIL (NT30)														
2.0 4WD	2000.10-	4AT	-	-	Engine QR20DE/QR20VET/SR20VET	841111	Outer Joint		29	25	56	101	68	M
-	2000.10-	5MT	-	-	Engine QR20DE	841111	Outer Joint		29	25	56	101	68	M
-	2000.10-	MT/AT	-	-	Engine QR20DE	841111	Outer Joint		29	25	56	101	68	M
X-TRAIL (NT31)														
2.0 4WD	2009-	-	-	-	Engine MR20DE	841311	Outer Joint		29	35	56	102.5	59	I
X-TRAIL (T30)														

YEAR	TRANSM	L/R	F/R	REMARKS	GSP Ref.	PRODUCT	ABS	Technical Specifications						
								A	B	C	H	L	P	
NISSAN														
X-TRAIL (T30)														
2.0 (103 kW)	2001.07-2013.01	MT	-	-	Closed Off-Road Vehicle Engine QR20DE	241474	Drive Shaft	44T	29		56	103.5	547	
	2001.07-2013.01	MT	-	-	All-wheel Drive Closed Off-Road Vehicle Engine QR20DE	241474	Drive Shaft	44T	29		56	103.5	547	
	2001.07-2013.01	MT	L	F	All-wheel Drive Closed Off-Road Vehicle Engine QR20DE	241127	Drive Shaft	44T	29	29	56	103.5	619	
	2001.07-2013.01	MT	L	F	Closed Off-Road Vehicle Engine QR20DE	241127	Drive Shaft	44T	29	29	56	103.5	619	
	2001.07-2013.01	-	L/R	F	Closed Off-Road Vehicle Engine QR20DE	841037	Outer Joint	44T	29	25	56	103.5	70.5	I
	2001.07-2013.01	-	L/R	F	All-wheel Drive Closed Off-Road Vehicle Engine QR20DE	841037	Outer Joint	44T	29	25	56	103.5	70.5	I
	2001.07-2013.01	MT	L	F	All-wheel Drive Closed Off-Road Vehicle Engine QR20DE	641007	Inner Joint		29	27	39	65.5	120.7	
	2001.07-2013.01	MT	R	F	Closed Off-Road Vehicle Engine QR20DE	241523	Drive Shaft	44T	29	29	56	103.5	617	
	2001.07-2013.01	MT	R	F	All-wheel Drive Closed Off-Road Vehicle Engine QR20DE	241523	Drive Shaft	44T	29	29	56	103.5	617	
	2001.07-2013.01	MT	L	F	Closed Off-Road Vehicle Engine QR20DE	641007	Inner Joint		29	27	39	65.5	120.7	
2.0 (110 kW)	2001.09-2013.01	AT/MT	R	F	All-wheel Drive Closed Off-Road Vehicle Engine QR20DE	241474	Drive Shaft	44T	29		56	103.5	547	
2.0 (206 kW)	2001.06-2013.01	AT	R	F	All-wheel Drive Closed Off-Road Vehicle Engine SR20VET	641068	Inner Joint				26		81	
	2001.06-2013.01	AT	-	F	All-wheel Drive Closed Off-Road Vehicle Engine SR20VET	841185	Outer Joint	44T	29	25	56	101	68	M
	2001.06-2013.01	AT	-	R	All-wheel Drive Closed Off-Road Vehicle Engine SR20VET	657111	Inner Joint		21	24	38	61	91	
2.2 dCi (100 kW)	2003.12-2013.01	MT	-	-	All-wheel Drive Closed Off-Road Vehicle Engine YD22DDTi	241474	Drive Shaft	44T	29		56	103.5	547	
	2003.12-2013.01	MT	-	-	Closed Off-Road Vehicle Engine YD22DDTi	241474	Drive Shaft	44T	29		56	103.5	547	
	2003.12-2013.01	MT	R	F	Closed Off-Road Vehicle Engine YD22DDTi	641068	Inner Joint				26		81	
	2003.12-2013.01	MT	R	F	All-wheel Drive Closed Off-Road Vehicle Engine YD22DDTi	641068	Inner Joint				26		81	
	2003.12-2013.01	MT	-	F	Closed Off-Road Vehicle Engine YD22DDTi	841185	Outer Joint	44T	29	25	56	101	68	M
	2003.12-2013.01	MT	-	F	All-wheel Drive Closed Off-Road Vehicle Engine YD22DDTi	841185	Outer Joint	44T	29	25	56	101	68	M
	2003.12-2013.01	MT	L	F	All-wheel Drive Closed Off-Road Vehicle Engine YD22DDTi	241127	Drive Shaft	44T	29	29	56	103.5	619	
	2003.12-2013.01	MT	L	F	Closed Off-Road Vehicle Engine YD22DDTi	241127	Drive Shaft	44T	29	29	56	103.5	619	
	2003.12-2013.01	MT	-	R	All-wheel Drive Closed Off-Road Vehicle Engine YD22DDTi	657111	Inner Joint		21	24	38	61	91	
	2003.12-2013.01	-	L/R	F	Closed Off-Road Vehicle Engine YD22DDTi	841037	Outer Joint	44T	29	25	56	103.5	70.5	I
	2003.12-2013.01	-	L/R	F	All-wheel Drive Closed Off-Road Vehicle Engine YD22DDTi	841037	Outer Joint	44T	29	25	56	103.5	70.5	I
	2003.12-2013.01	MT	L	F	All-wheel Drive Closed Off-Road Vehicle Engine YD22DDTi	641007	Inner Joint		29	27	39	65.5	120.7	
	2003.12-2013.01	MT	R	F	All-wheel Drive Closed Off-Road Vehicle Engine YD22DDTi	241523	Drive Shaft	44T	29	29	56	103.5	617	
	2003.12-2013.01	MT	R	F	Closed Off-Road Vehicle Engine YD22DDTi	241523	Drive Shaft	44T	29	29	56	103.5	617	
	2003.12-2013.01	MT	L	F	Closed Off-Road Vehicle Engine YD22DDTi	641007	Inner Joint		29	27	39	65.5	120.7	
2.2 DCi FWD (84 kW)	2001.06-2003.09	MT	R	F	Closed Off-Road Vehicle Engine YD22DDTi	241474	Drive Shaft	44T	29		56	103.5	547	
	2001.06-2003.09	MT	L	F	Closed Off-Road Vehicle Engine YD22DDTi	241523	Drive Shaft	44T	29	29	56	103.5	617	
2.2 Di (84 kW)	2001.07-2005.10	MT	-	-	All-wheel Drive Closed Off-Road Vehicle Engine YD22ETi	241474	Drive Shaft	44T	29		56	103.5	547	
	2001.07-2005.10	MT	R	F	All-wheel Drive Closed Off-Road Vehicle Engine YD22ETi	641068	Inner Joint				26		81	
	2001.07-2005.10	MT	-	F	All-wheel Drive Closed Off-Road Vehicle Engine YD22ETi	841185	Outer Joint	44T	29	25	56	101	68	M
	2001.07-2005.10	MT	L	F	All-wheel Drive Closed Off-Road Vehicle Engine YD22ETi	241127	Drive Shaft	44T	29	29	56	103.5	619	
	2001.07-2005.10	MT	-	R	All-wheel Drive Closed Off-Road Vehicle Engine YD22ETi	657111	Inner Joint		21	24	38	61	91	
	2001.07-2005.10	-	L/R	F	All-wheel Drive Closed Off-Road Vehicle Engine YD22ETi	841037	Outer Joint	44T	29	25	56	103.5	70.5	I
	2001.07-2005.10	MT	L	F	All-wheel Drive Closed Off-Road Vehicle Engine YD22ETi	641007	Inner Joint		29	27	39	65.5	120.7	
	2001.07-2005.10	MT	R	F	All-wheel Drive Closed Off-Road Vehicle Engine YD22ETi	241523	Drive Shaft	44T	29	29	56	103.5	617	
2.5 (121 kW)	2002.09-2013.01	MT	-	-	All-wheel Drive Closed Off-Road Vehicle Engine QR25DE	241474	Drive Shaft	44T	29		56	103.5	547	
	2002.09-2013.01	AT	R	F	All-wheel Drive Closed Off-Road Vehicle Engine QR25DE	641068	Inner Joint				26		81	
	2002.09-2013.01	MT	L	F	All-wheel Drive Closed Off-Road Vehicle Engine QR25DE	241127	Drive Shaft	44T	29	29	56	103.5	619	
	2002.09-2013.01	-	L/R	F	All-wheel Drive Closed Off-Road Vehicle Engine QR25DE	841037	Outer Joint	44T	29	25	56	103.5	70.5	I
	2002.09-2013.01	MT	L	F	All-wheel Drive Closed Off-Road Vehicle Engine QR25DE	641007	Inner Joint		29	27	39	65.5	120.7	
	2002.09-2013.01	AT	R	F	All-wheel Drive Closed Off-Road Vehicle Engine QR25DE	241523	Drive Shaft	44T	29	29	56	103.5	617	
X-TRAIL (T31)														
2.0	2009-	-	CVT	-	Engine MR20DE	841311	Outer Joint		29	35	56	102.5	59	I
2.0 (101 kW)	2007.06-2013.11	AT	L	F	All-wheel Drive Closed Off-Road Vehicle Engine MR20DE	641108	Inner Joint		27	33	40	107	114	
	2007.06-2013.11	AT	R	F	All-wheel Drive Closed Off-Road Vehicle Engine MR20DE	641170	Inner Joint		27	33	33	367	109.5	
	2007.06-2013.11	AT	R	F	All-wheel Drive Closed Off-Road Vehicle Engine MR20DE	641167	Inner Joint		27	33	33	322	109.5	
2.0 (103 kW)	2008.06-2013.11	AT	L	F	All-wheel Drive Closed Off-Road Vehicle Engine MR20DE	641108	Inner Joint		27	33	40	107	114	
	2008.06-2013.11	AT	R	F	All-wheel Drive Closed Off-Road Vehicle Engine MR20DE	641170	Inner Joint		27	33	33	367	109.5	
	2008.06-2013.11	AT	R	F	All-wheel Drive Closed Off-Road Vehicle Engine MR20DE	641167	Inner Joint		27	33	33	322	109.5	
2.0 (104 kW)	2007.06-2013.11	AT	L	F	All-wheel Drive Closed Off-Road Vehicle Engine MR20DE	641108	Inner Joint		27	33	40	107	114	
	2007.06-2013.11	AT	R	F	All-wheel Drive Closed Off-Road Vehicle Engine MR20DE	641170	Inner Joint		27	33	33	367	109.5	
	2007.06-2013.11	AT	R	F	All-wheel Drive Closed Off-Road Vehicle Engine MR20DE	641167	Inner Joint		27	33	33	322	109.5	
2.0 dCi (110 kW)	2007.06-2013.11	MT	L	F	All-wheel Drive Closed Off-Road Vehicle Engine M9R	641076	Inner Joint		29	29	39	65.5	116	
	2007.06-2013.11	MT	R	F	All-wheel Drive Closed Off-Road Vehicle Engine M9R	241482	Drive Shaft		29	29	56	102	1009	
	2007.06-2013.11	AT	L	F	All-wheel Drive Closed Off-Road Vehicle Engine M9R	241521	Drive Shaft		29	27	56.1	102	667	
	2007.06-2013.11	MT	L	F	All-wheel Drive Closed Off-Road Vehicle Engine M9R	241481	Drive Shaft		29	29	56	102	615	
2.0 dCi (127 kW)	2007.06-2013.11	MT	L	F	All-wheel Drive Closed Off-Road Vehicle Engine M9R 760	641076	Inner Joint		29	29	39	65.5	116	
	2007.06-2013.11	MT	R	F	All-wheel Drive Closed Off-Road Vehicle Engine M9R 760	241482	Drive Shaft		29	29	56	102	1009	
	2007.06-2013.11	MT	L	F	All-wheel Drive Closed Off-Road Vehicle Engine M9R 760	241481	Drive Shaft		29	29	56	102	615	
	2007.06-2013.11	AT	L	F	All-wheel Drive Closed Off-Road Vehicle Engine M9R 760	241521	Drive Shaft		29	27	56.1	102	667	
2.0 dCi FWD (110 kW)	2007.06-2013.11	MT	L	F	Closed Off-Road Vehicle Engine M9R	641076	Inner Joint		29	29	39	65.5	116	
	2007.06-2013.11	MT	L	F	Closed Off-Road Vehicle Engine M9R	241481	Drive Shaft		29	29	56	102	615	





	 YEAR	TRANSM	L/R	F/R	REMARKS	GSP Ref.	 PRODUCT	 ABS	Technical Specifications						
									A	B	C	H	L	P	
NISSAN															
X-TRAIL (T31)															
2.0 dCi FWD (110 kW)	2007.06-	2013.11	MT	R	F	Closed Off-Road Vehicle Engine M9R	241482	Drive Shaft		29	29	56	102	1009	
2.0 FWD (103 kW)	2008.06-	2013.11	AT	R	F	Closed Off-Road Vehicle Engine MR20DE	641167	Inner Joint		27	33	33	322	109.5	
2.0 FWD (104 kW)	2007.03-	2013.11	AT	R	F	Closed Off-Road Vehicle Engine MR20DE	641167	Inner Joint		27	33	33	322	109.5	
2.5 (124 kW)	2007.06-	2013.11	AT	L	F	All-wheel Drive Closed Off-Road Vehicle Engine QR25DE	641108	Inner Joint		27	33	40	107	114	
X-TRAIL (T32_)															
1.6 dCi ALL MODE-i (96 kW)	2013.12-	-	MT	-	R	All-wheel Drive Closed Off-Road Vehicle Engine R9M	841285	Outer Joint	48T	25	24	56	110.5	38.5	I
	2013.12-	-	MT	-	R	All-wheel Drive Closed Off-Road Vehicle Engine R9M	657111	Inner Joint		21	24	38	61	91	
X-TRAIL (TNT31)															
2.5	2009-	-	CVT	-	-	Engine QR25DE	841311	Outer Joint		29	35	56	102.5	59	I
X-TRAIL INNMAKE															
-	2008.12-	2011.08	-	-	-	ENGINE : MR20DE	241400	Drive Shaft		29	27	56.1	102	689	
	2011.08-	-	-	-	-	ENGINE : MR20DE	241400	Drive Shaft		29	27	56.1	102	689	
X-TRAIL INNMAKE(T31N)															
2.5	2008.06-	2014.09	MCVT	L	F	ENGINE : QR25DE;WAGON;BASE GRADE;GR1	241400	Drive Shaft		29	27	56.1	102	689	
	2008.06-	2014.09	MCVT	L	F	ENGINE : QR25DE;WAGON;BASE GRADE;GR1	641056	Inner Joint		27	33	40	62	112	
X-TRAIL T30															
-	2001.06-	2013.01	MT/AT	L	F	4WD	899193	Outer Joint		29	25	56	103.5	70.5	I
	2001.06-	2013.01	MT/AT	L	F	4WD	675036	Inner Joint		29	26	39	65.5	114	
	2001.06-	2013.01	MT/AT	L	F	4WD	241522	Drive Shaft	44T	29	29	56	103.5	645	
2.5	2001.09-	2006.06	AT	R	F	-	841138	Outer Joint	44T	29	25	56	103.5	70.5	I
	2001.09-	2006.06	AT	R	F	-	241570	Drive Shaft	44T	29	29	56	103.5	964	
	2001.09-	2006.06	AT	R	F	-	641122	Inner Joint		29	26	33	390	96.5	
X-TRAIL(T31)															
2.0	2007-	2014	CVT	L	F	-	241542	Drive Shaft		29	27	56.1	102	690	
	2007-	2014	CVT	L	F	-	641181	Inner Joint		27	33	40	107	118	
XTERRA															
4.0L V6	2005-	-	-	L/R	F	OffRoad Sport Utility 4Door	841325	Outer Joint		29	36	67.3	115	60.5	M
	2005-	-	-	L/R	F	S Sport Utility 4Door	841325	Outer Joint		29	36	67.3	115	60.5	M
	2005-	-	-	L/R	F	SE Sport Utility 4Door	841325	Outer Joint		29	36	67.3	115	60.5	M
	2006-	-	-	L/R	F	OffRoad Sport Utility 4Door	841325	Outer Joint		29	36	67.3	115	60.5	M
	2006-	-	-	L/R	F	S Sport Utility 4Door	841325	Outer Joint		29	36	67.3	115	60.5	M
	2006-	-	-	L/R	F	SE Sport Utility 4Door	841325	Outer Joint		29	36	67.3	115	60.5	M
	2006-	-	-	L/R	F	X Sport Utility 4Door	841325	Outer Joint		29	36	67.3	115	60.5	M
	2007-	-	-	L/R	F	X Sport Utility 4Door	841325	Outer Joint		29	36	67.3	115	60.5	M
	2007-	-	-	L/R	F	OffRoad Sport Utility 4Door	841325	Outer Joint		29	36	67.3	115	60.5	M
	2007-	-	-	L/R	F	S Sport Utility 4Door	841325	Outer Joint		29	36	67.3	115	60.5	M
	2007-	-	-	L/R	F	SE Sport Utility 4Door	841325	Outer Joint		29	36	67.3	115	60.5	M
	2008-	-	-	L/R	F	OffRoad Sport Utility 4Door	841325	Outer Joint		29	36	67.3	115	60.5	M
	2008-	-	-	L/R	F	S Sport Utility 4Door	841325	Outer Joint		29	36	67.3	115	60.5	M
	2008-	-	-	L/R	F	SE Sport Utility 4Door	841325	Outer Joint		29	36	67.3	115	60.5	M
	2008-	-	-	L/R	F	X Sport Utility 4Door	841325	Outer Joint		29	36	67.3	115	60.5	M
	2009-	-	-	L/R	F	OffRoad Sport Utility 4Door	841325	Outer Joint		29	36	67.3	115	60.5	M
	2009-	-	-	L/R	F	S Sport Utility 4Door	841325	Outer Joint		29	36	67.3	115	60.5	M
	2009-	-	-	L/R	F	SE Sport Utility 4Door	841325	Outer Joint		29	36	67.3	115	60.5	M
	2009-	-	-	L/R	F	X Sport Utility 4Door	841325	Outer Joint		29	36	67.3	115	60.5	M
	2010-	-	-	L/R	F	OffRoad Sport Utility 4Door	841325	Outer Joint		29	36	67.3	115	60.5	M
	2010-	-	-	L/R	F	S Sport Utility 4Door	841325	Outer Joint		29	36	67.3	115	60.5	M
	2010-	-	-	L/R	F	SE Sport Utility 4Door	841325	Outer Joint		29	36	67.3	115	60.5	M
	2010-	-	-	L/R	F	X Sport Utility 4Door	841325	Outer Joint		29	36	67.3	115	60.5	M
	2011-	-	-	L/R	F	PRO4X Sport Utility 4Door	841325	Outer Joint		29	36	67.3	115	60.5	M
	2011-	-	-	L/R	F	S Sport Utility 4Door	841325	Outer Joint		29	36	67.3	115	60.5	M
	2011-	-	-	L/R	F	SV Sport Utility 4Door	841325	Outer Joint		29	36	67.3	115	60.5	M
	2011-	-	-	L/R	F	X Sport Utility 4Door	841325	Outer Joint		29	36	67.3	115	60.5	M
	2012-	-	-	L/R	F	PRO4X Sport Utility 4Door	841325	Outer Joint		29	36	67.3	115	60.5	M
	2012-	-	-	L/R	F	S Sport Utility 4Door	841325	Outer Joint		29	36	67.3	115	60.5	M
	2012-	-	-	L/R	F	SV Sport Utility 4Door	841325	Outer Joint		29	36	67.3	115	60.5	M
	2012-	-	-	L/R	F	X Sport Utility 4Door	841325	Outer Joint		29	36	67.3	115	60.5	M
	2013-	-	-	L/R	F	PRO4X Sport Utility 4Door	841325	Outer Joint		29	36	67.3	115	60.5	M
	2013-	-	-	L/R	F	S Sport Utility 4Door	841325	Outer Joint		29	36	67.3	115	60.5	M
	2013-	-	-	L/R	F	X Sport Utility 4Door	841325	Outer Joint		29	36	67.3	115	60.5	M
	2014-	-	-	L/R	F	PRO4X Sport Utility 4Door	841325	Outer Joint		29	36	67.3	115	60.5	M
	2014-	-	-	L/R	F	S Sport Utility 4Door	841325	Outer Joint		29	36	67.3	115	60.5	M
	2014-	-	-	L/R	F	X Sport Utility 4Door	841325	Outer Joint		29	36	67.3	115	60.5	M
	2015-	-	-	L/R	F	PRO4X Sport Utility 4Door	841325	Outer Joint		29	36	67.3	115	60.5	M
	2015-	-	-	L/R	F	S Sport Utility 4Door	841325	Outer Joint		29	36	67.3	115	60.5	M
	2015-	-	-	L/R	F	X Sport Utility 4Door	841325	Outer Joint		29	36	67.3	115	60.5	M





YEAR	TRANSM	L/R	F/R	REMARKS	GSP Ref.	PRODUCT	ABS	Technical Specifications							
								A	B	C	H	L	P		
NISSAN (DONGFENG)															
BLUEBIRD (G10)															
2.0 (107 kW)	2000.04-2006.12	MT	R	-	Saloon Engine SR20DE	241207	Drive Shaft	44T	27	27	56	102	946		
	2000.04-2006.12	MT	L	-	Saloon Engine SR20DE	241208	Drive Shaft	44T	27	27	56	102	619		
BLUEBIRD SYLPHY/SYLPHY CLASSIC (G11)															
1.6 (80 kW)	2007.01-2009.04	-	-	-	Saloon Engine HR16DE	241228	Drive Shaft	44T	27	25	56	103	932		
	2007.01-2009.04	-	-	-	Saloon Engine HR16DE	241229	Drive Shaft	44T	27	25	56	103	623.5		
	2007.01-2009.04	-	-	-	Saloon Engine HR16DE	241427	Drive Shaft		29	26	56.1	102	685		
1.6 (86 kW)	2009.04-2012.12	AT	R	-	Saloon Engine HR16DE	241228	Drive Shaft	44T	27	25	56	103	932		
	2009.04-2012.12	AT	L	-	Saloon Engine HR16DE	241229	Drive Shaft	44T	27	25	56	103	623.5		
2.0 (100 kW)	2006.08-2009.04	AT	L	-	Saloon Engine MR20DE	210223	Drive Shaft		25	27	49.15	94.5	654		
	2006.08-2009.04	AT	R	-	Saloon Engine MR20DE	241228	Drive Shaft	44T	27	25	56	103	932		
	2006.08-2009.04	AT	L	-	Saloon Engine MR20DE	241229	Drive Shaft	44T	27	25	56	103	623.5		
2.0 (105 kW)	2009.04-2012.12	AT	L	-	Saloon Engine MR20DE	210223	Drive Shaft		25	27	49.15	94.5	654		
	2009.04-2012.12	AT	R	-	Saloon Engine MR20DE	241228	Drive Shaft	44T	27	25	56	103	932		
	2009.04-2012.12	AT	L	-	Saloon Engine MR20DE	241229	Drive Shaft	44T	27	25	56	103	623.5		
QASHQAI (J10)															
1.6 (81 kW)	2008.11-2010.12	AT	R	F	Closed Off-Road Vehicle Engine HR16DE	241325	Drive Shaft		29	25	56	102	941		
	2008.11-2010.12	AT	L	F	Closed Off-Road Vehicle Engine HR16DE	241326	Drive Shaft		29	25	56	102	694		
1.6 (89 kW)	2011.01-	AT	R	-	Closed Off-Road Vehicle Engine HR16DE	241325	Drive Shaft		29	25	56	102	941		
	2011.01-	AT	L	-	Closed Off-Road Vehicle Engine HR16DE	241326	Drive Shaft		29	25	56	102	694		
	2011.01-	MT	L	-	Closed Off-Road Vehicle Engine HR16DE	241247	Drive Shaft		25	26	49.1	95	658		
2.0 (102 kW)	2008.03-2010.12	MT	L	-	All-wheel Drive Closed Off-Road Vehicle Engine MR20DE	241417	Drive Shaft		29	29	56	103	633		
	2008.03-2010.12	MT	L	-	All-wheel Drive Closed Off-Road Vehicle Engine MR20DE	241418	Drive Shaft		29	26	56.1	102	949		
	2008.03-2010.12	AT	R	-	All-wheel Drive Closed Off-Road Vehicle Engine MR20DE	241419	Drive Shaft		29	27	56	102	943		
	2008.03-2010.12	MT	L	-	Closed Off-Road Vehicle Engine MR20DE	241417	Drive Shaft		29	29	56	103	633		
	2008.03-2010.12	MT	R	-	Closed Off-Road Vehicle Engine MR20DE	241418	Drive Shaft		29	26	56.1	102	949		
	2008.03-2010.12	AT	R	-	Closed Off-Road Vehicle Engine MR20DE	241419	Drive Shaft		29	27	56	102	943		
2.0 (106 kW)	2011.01-	MT	L	-	Closed Off-Road Vehicle Engine MR20DE	241417	Drive Shaft		29	29	56	103	633		
	2011.01-	MT	R	-	Closed Off-Road Vehicle Engine MR20DE	241418	Drive Shaft		29	26	56.1	102	949		
	2011.01-	AT	R	-	Closed Off-Road Vehicle Engine MR20DE	241419	Drive Shaft		29	27	56	102	943		
SUNNY (N16)															
2.0 (107 kW)	2003.06-2007.12	-	-	-	Saloon Engine SR20DE	241254	Drive Shaft	42T	25	25	55	106	632.5		
	2003.06-2007.12	-	-	-	Saloon Engine SR20DE	241255	Drive Shaft	42T	25	25	55	106	933.5		
TEANA (J31)															
2.3 (127 kW)	2006.04-2008.06	AT	R	-	Saloon Engine VQ 23 DE	241210	Drive Shaft		29	29	56.2	102	976		
	2006.04-2008.06	AT	L	-	Saloon Engine VQ 23 DE	241211	Drive Shaft		29	29	56.2	102	646		
	2006.04-2008.06	-	R	F	Saloon Engine VQ 23 DE	641019	Inner Joint		29	27	33	437.5	101		
3.5 (180 kW)	2006.04-2008.06	-	-	-	Saloon Engine VQ35DE	241431	Drive Shaft		29	27	56	102	692		
TEANA (J32Z)															
3.5 (185 kW)	2008.06-2010.11	-	-	-	Saloon Engine VQ35DE	241265	Drive Shaft		29	29	56	103.5	971		
	2010.11-	-	-	-	Saloon Engine VQ35DE	241265	Drive Shaft		29	29	56	103.5	971		
TIIDA (C12)															
1.6 (93 kW)	2011.05-	MT	L	-	Hatchback Engine HR16DE	241247	Drive Shaft		25	26	49.1	95	658		
	2011.05-	AT	R	-	Hatchback Engine HR16DE	241203	Drive Shaft		25	25	49	94	903		
1.6 GTS (140 kW)	2011.06-	-	R	-	Hatchback Engine MR16	241247	Drive Shaft		25	26	49.1	95	658		
	2011.06-	-	L	-	Hatchback Engine MR16	241203	Drive Shaft		25	25	49	94	903		
TIIDA QIDA (C11)															
1.6 (80 kW)	2005.07-	MT	L	-	Hatchback Engine HR16DE	241427	Drive Shaft		29	26	56.1	102	685		
	2005.07-	AT	L	-	Hatchback Engine HR16DE	241202	Drive Shaft		25	25	49	94	660		
	2005.07-	AT	R	-	Hatchback Engine HR16DE	241203	Drive Shaft		25	25	49	94	903		
TIIDA YIDA (C11)															
1.6 (80 kW)	2005.04-	MT	L	-	Saloon Engine HR16DE	241247	Drive Shaft		25	26	49.1	95	658		
	2005.04-	AT	R	-	Saloon Engine HR16DE	241203	Drive Shaft		25	25	49	94	903		
	2005.04-	AT	L	-	Saloon Engine HR16DE	241202	Drive Shaft		25	25	49	94	660		
OLDSMOBILE															
BRAVADA															
-	1991-1997	-	-	-	-	699117	Propshaft CV Joint			22		88.5			
	1991-1997	-	-	-	-	699117	Inner Joint			22		88.5			
	1997-2004	-	-	-	SUV/Truck/VAN 4WD	808011	Outer Joint		27	34	55.8	127.5	64	O	
	1997-2004	-	-	-	-	608008	Inner Joint		26	34	40	92	98		
	1997-2001	-	-	-	4WD	608009	Inner Joint		26	34	40	55	85		
CUTLASS SUPREME															
-	1988-1997	-	-	-	Excl. A/T, 3 Speed.	806011	Outer Joint	47T	33	32	73	88	55	O	
	1988-1997	-	-	-	Excl. A/T, 3 Speed.	806002	Outer Joint		33	32	73	88	55	O	
	1992-1994	AT	-	-	3 Speed	808024	Outer Joint		33	29	73	88	54.5	O	
2.8 V6 (97 kW)	1988.09-1997.12	-	-	-	Coupe Engine LB6	821007	Outer Joint		27	32	61.5	120	63	I	





YEAR	TRANSM	L/R	F/R	REMARKS	GSP Ref.	PRODUCT	ABS	Technical Specifications								
								A	B	C	H	L	P			
OLDSMOBILE																
OLDSMOBILE BRAVADA																
-	1991-1997	-	-	-	699117	Propshaft CV Joint		22		88.5						
-	1991-1997	-	-	-	699117	Inner Joint		22		88.5						
OPEL																
ADAM																
-	2013-	-	-	F	Engine A14XEL,A14XER	644020	Inner Joint	22	27	35	57.5	92				
-	2013-	-	-	F	Engine A14XEL,A14XER	644020	Inner Joint	22	27	35	57.5	92				
ADAM (M13)																
1.2 (51 kW)	2012.10-	-	MT	L	F	Hatchback Engine A 12 XEL/B 12 XEL	644013	Inner Joint	22	21	35	57.5	93			
	2012.10-	-	-	L	F	Hatchback Engine A 12 XEL/B 12 XEL	817089	Outer Joint	22	20	51	79.5	51	M		
	2012.10-	-	MT	L	F	Hatchback Engine A 12 XEL/B 12 XEL	260023	Drive Shaft	22	22	51.2	79.5	615			
1.4 (64 kW)	2012.10-	-	MT	L	F	Hatchback Engine A 14 XEL/B 14 XEL	644013	Inner Joint	22	21	35	57.5	93			
	2012.10-	-	-	R	F	Hatchback Engine A 14 XEL/B 14 XEL	244078	Drive Shaft	22	22	51	79.5	918			
	2012.10-	-	-	R	F	Hatchback Engine A 14 XEL/B 14 XEL	817089	Outer Joint	22	20	51	79.5	51	M		
	2012.10-	-	-	L	F	Hatchback Engine A 14 XEL/B 14 XEL	244079	Drive Shaft	22	22	51	79.5	615			
	2012.10-	-	-	L/R	F	Hatchback Engine A 14 XEL/B 14 XEL	817052	Outer Joint	22	21	51.2	79.5	54	M		
	2012.10-	-	MT	L	F	Hatchback Engine A 14 XEL/B 14 XEL	260023	Drive Shaft	22	22	51.2	79.5	615			
1.4 (74 kW)	2012.10-	-	MT	L	F	Hatchback Engine A 14 XEL/B 14 XEL	644013	Inner Joint	22	21	35	57.5	93			
	2012.10-	-	-	R	F	Hatchback Engine A 14 XEL/B 14 XEL	244078	Drive Shaft	22	22	51	79.5	918			
	2012.10-	-	-	R	F	Hatchback Engine A 14 XEL/B 14 XEL	817089	Outer Joint	22	20	51	79.5	51	M		
	2012.10-	-	-	L	F	Hatchback Engine A 14 XEL/B 14 XEL	244079	Drive Shaft	22	22	51	79.5	615			
	2012.10-	-	MT	L/R	F	Hatchback Engine A 14 XEL/B 14 XEL	817052	Outer Joint	22	21	51.2	79.5	54	M		
	2012.10-	-	MT	L	F	Hatchback Engine A 14 XEL/B 14 XEL	260023	Drive Shaft	22	22	51.2	79.5	615			
1.4 LPG (64 kW)	2013.07-	-	-	R	F	Hatchback Engine A 14 XEL/B 14 XEL	244078	Drive Shaft	22	22	51	79.5	918			
	2013.07-	-	-	R	F	Hatchback Engine A 14 XEL/B 14 XEL	817089	Outer Joint	22	20	51	79.5	51	M		
	2013.07-	-	-	L	F	Hatchback Engine A 14 XEL/B 14 XEL	244079	Drive Shaft	22	22	51	79.5	615			
	2013.07-	-	-	L/R	F	Hatchback Engine A 14 XEL/B 14 XEL	817052	Outer Joint	22	21	51.2	79.5	54	M		
	2013.07-	-	MT	L	F	Hatchback Engine A 14 XEL/B 14 XEL	260023	Drive Shaft	22	22	51.2	79.5	615			
	2013.07-	-	MT	L	F	Hatchback Engine A 14 XEL/B 14 XEL	644013	Inner Joint	22	21	35	57.5	93			
1.4 S (110 kW)	2014.11-	-	MT	L	F	Hatchback Engine B 14 NEH	217070	Drive Shaft	25	25	51	84.5	576			
AGILA (A) (H00)																
1.0 (44 kW)	2003.08-	2007.12	-	L/R	F	Hatchback Engine Z 10 XEP	844001	Outer Joint	43T	23	20	49	78	61	M	
	2003.08-	2007.12	MT	L	F	Hatchback Engine Z 10 XEP	257087	Drive Shaft	43T	23	22	49	78	638		
	2003.08-	2007.12	MT	R	F	Hatchback Engine Z 10 XEP	244043	Drive Shaft	43T	23	22	49	78	853		
1.0 12V (43 kW)	2000.09-	2007.12	-	L/R	F	Hatchback Engine Z 10 XE	844001	Outer Joint	43T	23	20	49	78	61	M	
	2000.09-	2007.12	MT	L	F	Hatchback Engine Z 10 XE	257087	Drive Shaft	43T	23	22	49	78	638		
	2000.09-	2007.12	MT	R	F	Hatchback Engine Z 10 XE	244043	Drive Shaft	43T	23	22	49	78	853		
1.2 16V (55 kW)	2000.09-	2007.12	-	L/R	F	Hatchback Engine Z 12 XE	844001	Outer Joint	43T	23	20	49	78	61	M	
1.2 16V Twinport (59 kW)	2004.07-	2007.12	-	L/R	F	Hatchback Engine Z 12 XEP	844001	Outer Joint	43T	23	20	49	78	61	M	
1.3 CDTI (51 kW)	2003.08-	2007.12	AT/MT	L/R	F	Hatchback Engine Z 13 DT	844080	Outer Joint	43T	25	21	49	76	66.5	M	
AGILA (B) (H08)																
1.0 (48 kW)	2008.04-	-	MT	L	F	Hatchback Engine K10B	257296	Drive Shaft		25	22	49	81.5	641		
	2008.04-	-	MT	L	F	Hatchback Engine K10B	657156	Inner Joint		22	19	40	57	97.5		
	2008.04-	-	MT	L/R	F	Hatchback Engine K10B	844085	Outer Joint		25	20	49	81.5	61	M	
	2008.04-	-	MT	L	F	Hatchback Engine K10B	257175	Drive Shaft		25	22	49	82	635		
	2008.04-	-	MT	L	F	Hatchback Engine K10B	257222	Drive Shaft		25	22	49	81.5	641		
	2008.04-	-	MT	R	F	Hatchback Engine K10B	257221	Drive Shaft		25	22	49	81.5	882		
1.0 (50 kW)	2011.07-	-	MT	L	F	Hatchback Engine K10B	657156	Inner Joint		22	19	40	57	97.5		
	2011.07-	-	MT	L	F	Hatchback Engine K10B	257175	Drive Shaft		25	22	49	82	635		
1.0 LPG (48 kW)	2010.01-	-	MT	L	F	Hatchback Engine K10B	257296	Drive Shaft		25	22	49	81.5	641		
	2010.01-	-	MT	L	F	Hatchback Engine K10B	657156	Inner Joint		22	19	40	57	97.5		
	2010.01-	-	-	L/R	F	Hatchback Engine K10B	844085	Outer Joint		25	20	49	81.5	61	M	
	2010.01-	-	MT	L	F	Hatchback Engine K10B	257175	Drive Shaft		25	22	49	82	635		
	2010.01-	-	-	L	F	Hatchback Engine K10B	257222	Drive Shaft		25	22	49	81.5	641		
	2010.01-	-	-	R	F	Hatchback Engine K10B	257221	Drive Shaft		25	22	49	81.5	882		
1.2 (63 kW)	2008.04-	-	MT	L	F	Hatchback Engine K12B	257296	Drive Shaft		25	22	49	81.5	641		
	2008.04-	-	MT	L	F	Hatchback Engine K12B	657156	Inner Joint		22	19	40	57	97.5		
	2008.04-	-	MT	L/R	F	Hatchback Engine K12B	844085	Outer Joint		25	20	49	81.5	61	M	
	2008.04-	-	MT	L	F	Hatchback Engine K12B	257175	Drive Shaft		25	22	49	82	635		
	2008.04-	-	MT	L	F	Hatchback Engine K12B	257222	Drive Shaft		25	22	49	81.5	641		
	2008.04-	-	MT	R	F	Hatchback Engine K12B	257221	Drive Shaft		25	22	49	81.5	882		
1.2 (69 kW)	2010.11-	-	MT	L	F	Hatchback Engine K12B	657156	Inner Joint		22	19	40	57	97.5		
	2010.11-	-	AT	-	-	Hatchback Engine K12B	857103	Outer Joint		25	28	49	82	61	I	
	2010.11-	-	MT	L	F	Hatchback Engine K12B	257175	Drive Shaft		25	22	49	82	635		
1.2 LPG (63 kW)	2008.04-	-	MT	L	F	Hatchback Engine K12B	257296	Drive Shaft		25	22	49	81.5	641		
	2008.04-	-	MT	L	F	Hatchback Engine K12B	657156	Inner Joint		22	19	40	57	97.5		





YEAR	TRANSM	L/R	F/R	REMARKS	GSP Ref.	PRODUCT	ABS	Technical Specifications							
								A	B	C	H	L	P		
OPEL															
AGILA (B) (H08)															
1.2 LPG (63 kW)	2008.04-	-	MT	L/R	F	Hatchback Engine K12B	844085	Outer Joint	25	20	49	81.5	61	M	
	2008.04-	-	MT	L	F	Hatchback Engine K12B	257175	Drive Shaft	25	22	49	82	635		
	2008.04-	-	MT	L	F	Hatchback Engine K12B	257222	Drive Shaft	25	22	49	81.5	641		
	2008.04-	-	MT	R	F	Hatchback Engine K12B	257221	Drive Shaft	25	22	49	81.5	882		
1.3 CDTI (55 kW)	2008.04-	-	-	-	F	Hatchback Engine D13A/Z 13 DT3	857100	Outer Joint	25	21	49	82.5	64	M	
	2008.04-	-	MT	L	F	Hatchback Engine D13A/Z 13 DT3	257210	Drive Shaft	25	26	49	81.5	630		
	2008.04-	-	MT	L	F	Hatchback Engine D13A/Z 13 DT3	257223	Drive Shaft	25	26	49	81.5	629		
	2008.04-	-	MT	R	F	Hatchback Engine D13A/Z 13 DT3	257197	Drive Shaft	25	22	49	81.5	614		
ANTARA															
-	2006-	-	-	-	-	-	821047	Outer Joint	30	22		105.5	53.5	O	
ANTARA (L07)															
2.0 CDTI (110 kW)	2006.05-	-	-	-	-	All-wheel Drive Closed Off-Road Vehicle Engine Z 20 DMH/Z 20 S	822009	Outer Joint	30	34	54	105.5	64.5	O	
	2006.05-	-	-	-	-	All-wheel Drive Closed Off-Road Vehicle Engine Z 20 DMH/Z 20 S	612009	Inner Joint	34	22	35	80.5	58		
	2006.05-	-	-	-	F	Closed Off-Road Vehicle Engine Z 20 S/Z 20 DMH	822009	Outer Joint	30	34	54	105.5	64.5	O	
	2006.05-	-	MT	R	F	All-wheel Drive Closed Off-Road Vehicle Engine Z 20 DMH/Z 20 S	608035	Inner Joint	27	34	43.3	51	77		
	2006.05-	-	MT	R	F	Closed Off-Road Vehicle Engine Z 20 S/Z 20 DMH	608035	Inner Joint	27	34	43.3	51	77		
2.0 CDTI (93 kW)	2007.03-	-	-	-	-	All-wheel Drive Closed Off-Road Vehicle Engine Z 20 S	822009	Outer Joint	30	34	54	105.5	64.5	O	
	2007.03-	-	-	-	-	All-wheel Drive Closed Off-Road Vehicle Engine Z 20 S	612009	Inner Joint	34	22	35	80.5	58		
	2007.03-	-	MT	R	F	All-wheel Drive Closed Off-Road Vehicle Engine Z 20 S	608035	Inner Joint	27	34	43.3	51	77		
	2008.09-	-	-	-	F	Closed Off-Road Vehicle Engine Z 20 DM	822009	Outer Joint	30	34	54	105.5	64.5	O	
	2008.09-	-	MT	R	F	Closed Off-Road Vehicle Engine Z 20 DM	608035	Inner Joint	27	34	43.3	51	77		
2.2 CDTI (120 kW)	2010.12-	-	-	-	F	Closed Off-Road Vehicle Engine A 22 DM	822009	Outer Joint	30	34	54	105.5	64.5	O	
	2010.12-	-	-	-	-	All-wheel Drive Closed Off-Road Vehicle Engine A 22 DM	612009	Inner Joint	34	22	35	80.5	58		
	2010.12-	-	MT	R	F	Closed Off-Road Vehicle Engine A 22 DM	608035	Inner Joint	27	34	43.3	51	77		
2.2 CDTI (135 kW)	2010.12-	-	-	-	-	All-wheel Drive Closed Off-Road Vehicle Engine A 22 DMH	612009	Inner Joint	34	22	35	80.5	58		
2.4 (103 kW)	2007.01-	-	-	-	-	All-wheel Drive Closed Off-Road Vehicle Engine Z 24 XE	822009	Outer Joint	30	34	54	105.5	64.5	O	
	2007.01-	-	-	-	-	All-wheel Drive Closed Off-Road Vehicle Engine Z 24 XE	612009	Inner Joint	34	22	35	80.5	58		
	2007.01-	-	MT	R	F	All-wheel Drive Closed Off-Road Vehicle Engine Z 24 XE	608035	Inner Joint	27	34	43.3	51	77		
	2008.09-	-	-	-	F	Closed Off-Road Vehicle Engine Z 24 XE	822009	Outer Joint	30	34	54	105.5	64.5	O	
	2008.09-	-	MT	R	F	Closed Off-Road Vehicle Engine Z 24 XE	608035	Inner Joint	27	34	43.3	51	77		
2.4 (104 kW)	2006.05-	-	-	-	-	All-wheel Drive Closed Off-Road Vehicle Engine Z 24 XED	822009	Outer Joint	30	34	54	105.5	64.5	O	
	2006.05-	-	-	-	-	All-wheel Drive Closed Off-Road Vehicle Engine Z 24 XED	612009	Inner Joint	34	22	35	80.5	58		
	2006.05-	-	MT	R	F	All-wheel Drive Closed Off-Road Vehicle Engine Z 24 XED	608035	Inner Joint	27	34	43.3	51	77		
2.4 (123 kW)	2010.12-	-	-	-	F	Closed Off-Road Vehicle Engine A 24 XE	822009	Outer Joint	30	34	54	105.5	64.5	O	
	2010.12-	-	-	-	-	All-wheel Drive Closed Off-Road Vehicle Engine A 24 XE	612009	Inner Joint	34	22	35	80.5	58		
	2010.12-	-	MT	R	F	Closed Off-Road Vehicle Engine A 24 XE	608035	Inner Joint	27	34	43.3	51	77		
2.4 LPG (103 kW)	2008.10-	-	-	-	F	Closed Off-Road Vehicle Engine Z 24 XE	822009	Outer Joint	30	34	54	105.5	64.5	O	
	2008.10-	-	-	-	-	All-wheel Drive Closed Off-Road Vehicle Engine Z 24 XE	822009	Outer Joint	30	34	54	105.5	64.5	O	
	2008.10-	-	-	-	-	All-wheel Drive Closed Off-Road Vehicle Engine Z 24 XE	612009	Inner Joint	34	22	35	80.5	58		
	2008.10-	-	MT	R	F	Closed Off-Road Vehicle Engine Z 24 XE	608035	Inner Joint	27	34	43.3	51	77		
	2008.10-	-	MT	R	F	All-wheel Drive Closed Off-Road Vehicle Engine Z 24 XE	608035	Inner Joint	27	34	43.3	51	77		
3.0 (190 kW)	2010.11-	-	-	-	-	All-wheel Drive Closed Off-Road Vehicle Engine A 30 XH	822009	Outer Joint	30	34	54	105.5	64.5	O	
	2010.11-	-	-	-	-	All-wheel Drive Closed Off-Road Vehicle Engine A 30 XH	612009	Inner Joint	34	22	35	80.5	58		
3.2 V6 (167 kW)	2007.03-	-	-	-	-	All-wheel Drive Closed Off-Road Vehicle Engine Z 32 SEE/10 HM	822009	Outer Joint	30	34	54	105.5	64.5	O	
	2007.03-	-	-	-	-	All-wheel Drive Closed Off-Road Vehicle Engine Z 32 SEE/10 HM	612009	Inner Joint	34	22	35	80.5	58		
ARENA (A97)															
1.9 D (44 kW)	1997.01-	2001.12	MT	L/R	F	Box Engine 19 DJ/19 DL	244006	Drive Shaft	25	27	56.3	110.5	713.5		
	1997.01-	2001.12	MT	L/R	F	Bus Engine 19 DJ/19 DL	244006	Drive Shaft	25	27	56.3	110.5	713.5		
2.5 D (55 kW)	1997.01-	2001.12	MT	L/R	F	Box Engine 25 DM/25 DG	244006	Drive Shaft	25	27	56.3	110.5	713.5		
	1997.01-	2001.12	MT	L/R	F	Bus Engine 25 DG/25 DM	244006	Drive Shaft	25	27	56.3	110.5	713.5		
ARENA (TB TF)															
1.9 D (44 kW)	1998.03-	2001.08	MT	L/R	F	Box Engine F8Q 606/F8Q 600	244006	Drive Shaft	25	27	56.3	110.5	713.5		
2.5 D (55 kW)	1998.03-	2001.08	MT	L/R	F	Box Engine S8U 780/S8U 782/S8U 758	244006	Drive Shaft	25	27	56.3	110.5	713.5		
ARENA Combi (A97)															
1.9 D (44 kW)	1998.03-	2001.08	MT	L/R	F	Bus Engine F8Q 600/F8Q 606	244006	Drive Shaft	25	27	56.3	110.5	713.5		
2.5 D (55 kW)	1998.03-	2001.08	MT	L/R	F	Bus Engine S8U 780/S8U 782/S8U 758	244006	Drive Shaft	25	27	56.3	110.5	713.5		
ASCONA															
-	1981-	-	-	-	-	DIESEL	844047	Outer Joint	33	29	52	109	61	O	
ASTRA F															
1.8	1991-	1998	-	L	F	-	244047	Drive Shaft	33	34	52	108	592		
2.0	1991-	1998	-	L	F	-	244047	Drive Shaft	33	34	52	108	592		
ASTRA F (56, 57), SW															
1.4 (53 kW)	1999.09-	-	-	-	-	-	844060	Outer Joint	29T	22	22	52	98	51	O
1.4 (55 kW)	1999.09-	-	-	-	-	-	844060	Outer Joint	29T	22	22	52	98	51	O
1.4 i 16V Cabrio (66 kW)	1996.02-	1998.09	-	-	-	-	844060	Outer Joint	29T	22	22	52	98	51	O
1.4 Si (60 kW)	1992.03-	1998.09	-	-	-	-	844060	Outer Joint	29T	22	22	52	98	51	O

YEAR	TRANS	L/R	F/R	REMARKS	GSP Ref.	PRODUCT	ABS	Technical Specifications									
								A	B	C	H	L	P				
OPEL																	
ASTRA F (56, 57), SW																	
1.6 i (55 kW)	1992.03-	1998.09	-	-	-	-	844060	Outer Joint	29T	22	22	52	98	51	O		
1.6 i 16V (74 kW)	1994.08-	1998.09	-	-	-	ChP2732834	844060	Outer Joint	29T	22	22	52	98	51	O		
1.6 Si (74 kW)	1992.05-	1994.12	-	-	-	-	844060	Outer Joint	29T	22	22	52	98	51	O		
1.7 D (44 kW)	1992.03-	1992.09	MT	-	-	-	844060	Outer Joint	29T	22	22	52	98	51	O		
ASTRA F (T92)																	
1.4 (60 kW)	1992.09-	1998.09	MT	L/R	F	Saloon Engine 14 SE	844007	Outer Joint	29T	22	22	52	94.5	50	O		
	1992.09-	1998.01	MT	L/R	F	Estate Engine 14 SE	844007	Outer Joint	29T	22	22	52	94.5	50	O		
	1992.09-	1998.01	MT	L/R	F	Hatchback Engine 14 SE	644004	Inner Joint		22	22	34.95	57.5	72.5			
	1992.09-	1998.09	MT	L/R	F	Saloon Engine 14 SE	644004	Inner Joint		22	22	34.95	57.5	72.5			
	1992.09-	1998.01	MT	L/R	F	Estate Engine 14 SE	644004	Inner Joint		22	22	34.95	57.5	72.5			
	1992.09-	1998.01	-	-	F	Hatchback Engine 14 SE	844023	Outer Joint		22	22	52	95	50	O		
	1992.09-	1998.01	MT	L/R	F	Hatchback Engine 14 SE	844051	Outer Joint	29T	22	22	52	95	50.5	O		
	1992.09-	1998.09	-	-	F	Saloon Engine 14 SE	844023	Outer Joint		22	22	52	95	50	O		
	1992.09-	1998.09	MT	L/R	F	Saloon Engine 14 SE	844051	Outer Joint	29T	22	22	52	95	50.5	O		
	1992.09-	1998.01	-	-	F	Estate Engine 14 SE	844023	Outer Joint		22	22	52	95	50	O		
	1992.09-	1998.01	MT	L/R	F	Estate Engine 14 SE	844051	Outer Joint	29T	22	22	52	95	50.5	O		
	1992.09-	1998.01	MT	L	F	Hatchback Engine 14 SE	244002	Drive Shaft	29T	22	22	52	95	585			
	1992.09-	1998.09	MT	L	F	Saloon Engine 14 SE	244002	Drive Shaft	29T	22	22	52	95	585			
	1992.09-	1998.01	MT	L	F	Estate Engine 14 SE	244002	Drive Shaft	29T	22	22	52	95	585			
	1992.09-	1998.01	MT	R	F	Hatchback Engine 14 SE	260002	Drive Shaft	29T	22	22	52	95	926			
	1992.09-	1998.09	MT	R	F	Saloon Engine 14 SE	260002	Drive Shaft	29T	22	22	52	95	926			
	1992.09-	1998.01	MT	R	F	Estate Engine 14 SE	260002	Drive Shaft	29T	22	22	52	95	926			
	1992.09-	1998.01	MT	L/R	F	Hatchback Engine 14 SE	844007	Outer Joint	29T	22	22	52	94.5	50	O		
1.4 i (44 kW)	1991.09-	1998.09	MT	L/R	F	Saloon Engine C 14 NZ/X 14 NZ	844051	Outer Joint	29T	22	22	52	95	50.5	O		
	1991.09-	1998.01	MT	L/R	F	Estate Engine C 14 NZ	844051	Outer Joint	29T	22	22	52	95	50.5	O		
	1991.09-	1998.09	MT	L	F	Saloon Engine C 14 NZ/X 14 NZ	244002	Drive Shaft	29T	22	22	52	95	585			
	1991.09-	1998.01	MT	L	F	Estate Engine C 14 NZ	244002	Drive Shaft	29T	22	22	52	95	585			
	1991.09-	1998.09	MT	L/R	F	Saloon Engine C 14 NZ/X 14 NZ	644004	Inner Joint		22	22	34.95	57.5	72.5			
	1991.09-	1998.01	MT	L/R	F	Estate Engine C 14 NZ	644004	Inner Joint		22	22	34.95	57.5	72.5			
	1991.09-	1998.09	-	-	F	Saloon Engine C 14 NZ/X 14 NZ	844023	Outer Joint		22	22	52	95	50	O		
	1991.09-	1998.01	-	-	F	Estate Engine C 14 NZ	844023	Outer Joint		22	22	52	95	50	O		
	1991.09-	1998.09	MT	R	F	Saloon Engine C 14 NZ/X 14 NZ	260002	Drive Shaft	29T	22	22	52	95	926			
	1991.09-	1998.09	MT	L/R	F	Saloon Engine C 14 NZ/X 14 NZ	844007	Outer Joint	29T	22	22	52	94.5	50	O		
	1991.09-	1998.01	MT	R	F	Estate Engine C 14 NZ	260002	Drive Shaft	29T	22	22	52	95	926			
	1991.09-	1998.01	MT	L/R	F	Estate Engine C 14 NZ	844007	Outer Joint	29T	22	22	52	94.5	50	O		
	1992.03-	1998.01	MT	L/R	F	Hatchback Engine C 14 NZ	844051	Outer Joint	29T	22	22	52	95	50.5	O		
	1992.03-	1998.01	MT	L	F	Hatchback Engine C 14 NZ	244002	Drive Shaft	29T	22	22	52	95	585			
	1992.03-	1998.01	-	-	-	Hatchback Engine C 14 NZ	844063	Outer Joint		22	30	52	94.5	55	I		
	1992.03-	1998.01	MT	L/R	F	Hatchback Engine C 14 NZ	644004	Inner Joint		22	22	34.95	57.5	72.5			
	1992.03-	1998.01	-	-	F	Hatchback Engine C 14 NZ	844023	Outer Joint		22	22	52	95	50	O		
	1992.03-	1998.01	MT	R	F	Hatchback Engine C 14 NZ	260002	Drive Shaft	29T	22	22	52	95	926			
	1992.03-	1998.01	MT	L/R	F	Hatchback Engine C 14 NZ	844007	Outer Joint	29T	22	22	52	94.5	50	O		
1.4 i 16V (66 kW)	1996.01-	1998.01	AT/MT	R	F	Hatchback Engine X 14 XE	650097	Inner Joint		39	35	30	409	90			
	1996.01-	2001.03	AT/MT	R	F	Convertible Engine X 14 XE	650097	Inner Joint		39	35	30	409	90			
	1996.01-	2001.03	AT/MT	L/R	F	Convertible Engine X 14 XE	844007	Outer Joint	29T	22	22	52	94.5	50	O		
	1996.01-	1998.01	AT/MT	L/R	F	Hatchback Engine X 14 XE	844007	Outer Joint	29T	22	22	52	94.5	50	O		
	1996.01-	1998.01	AT/MT	R	F	Hatchback Engine X 14 XE	250209	Drive Shaft		27	39	56.5	92	1014			
	1996.01-	2001.03	AT/MT	R	F	Convertible Engine X 14 XE	250209	Drive Shaft		27	39	56.5	92	1014			
	1996.01-	1998.01	AT/MT	R	F	Hatchback Engine X 14 XE	250209	Drive Shaft		27	39	56.5	92	1014			
	1996.01-	2001.03	AT/MT	R	F	Convertible Engine X 14 XE	250209	Drive Shaft		27	39	56.5	92	1014			
	1996.01-	1998.01	AT/MT	R	F	Hatchback Engine X 14 XE	250209	Drive Shaft		27	39	56.5	92	1014			
	1996.01-	2001.03	AT/MT	R	F	Convertible Engine X 14 XE	250209	Drive Shaft		27	39	56.5	92	1014			
	1996.01-	2001.03	AT/MT	R	F	Convertible Engine X 14 XE	260019	Drive Shaft		22	22	52	95	926			
	1996.01-	1998.01	AT/MT	R	F	Hatchback Engine X 14 XE	260019	Drive Shaft		22	22	52	95	926			
	1996.01-	1998.01	-	-	F	Hatchback Engine X 14 XE	844023	Outer Joint		22	22	52	95	50	O		
	1996.02-	1998.09	AT/MT	R	F	Saloon Engine X 14 XE	650097	Inner Joint		39	35	30	409	90			
	1996.02-	1998.01	AT/MT	R	F	Estate Engine X 14 XE	650097	Inner Joint		39	35	30	409	90			
	1996.02-	1998.09	AT/MT	L/R	F	Saloon Engine X 14 XE	844007	Outer Joint	29T	22	22	52	94.5	50	O		
	1996.02-	1998.01	AT/MT	L/R	F	Estate Engine X 14 XE	844007	Outer Joint	29T	22	22	52	94.5	50	O		
	1996.02-	1998.09	AT/MT	R	F	Saloon Engine X 14 XE	250209	Drive Shaft		27	39	56.5	92	1014			
	1996.02-	1998.01	AT/MT	R	F	Estate Engine X 14 XE	250209	Drive Shaft		27	39	56.5	92	1014			
	1996.02-	1998.09	AT/MT	R	F	Saloon Engine X 14 XE	250209	Drive Shaft		27	39	56.5	92	1014			
	1996.02-	1998.01	AT/MT	R	F	Estate Engine X 14 XE	250209	Drive Shaft		27	39	56.5	92	1014			
	1996.02-	1998.09	AT/MT	R	F	Saloon Engine X 14 XE	250209	Drive Shaft		27	39	56.5	92	1014			
	1996.02-	1998.01	AT/MT	R	F	Estate Engine X 14 XE	250209	Drive Shaft		27	39	56.5	92	1014			
	1996.02-	1998.09	AT/MT	R	F	Saloon Engine X 14 XE	250209	Drive Shaft		27	39	56.5	92	1014			
	1996.02-	1998.01	AT/MT	R	F	Estate Engine X 14 XE	250209	Drive Shaft		27	39	56.5	92	1014			
	1996.02-	1998.09	AT/MT	R	F	Saloon Engine X 14 XE	260019	Drive Shaft		22	22	52	95	926			





	 YEAR	TRANSM	L/R	F/R	REMARKS	GSP Ref.	 PRODUCT	 ABS	Technical Specifications					
									A	B	C	H	L	P
OPEL														
ASTRA F (T92)														
1.4 i 16V (66 kW)	1996.02-1998.01	AT/MT	R	F	Estate Engine X 14 XE	260019	Drive Shaft		22	22	52	95	926	
	1996.02-1998.09	-	-	F	Saloon Engine X 14 XE	844023	Outer Joint		22	22	52	95	50	O
	1996.02-1998.01	-	-	F	Estate Engine X 14 XE	844023	Outer Joint		22	22	52	95	50	O
1.4 Si (60 kW)	1992.03-1998.09	MT	L/R	F	Saloon Engine C 14 SE	844051	Outer Joint	29T	22	22	52	95	50.5	O
	1992.03-1998.01	MT	L/R	F	Hatchback Engine C 14 SE	844051	Outer Joint	29T	22	22	52	95	50.5	O
	1992.03-1998.01	MT	L/R	F	Estate Engine C 14 SE	844051	Outer Joint	29T	22	22	52	95	50.5	O
	1992.03-1998.09	MT	L	F	Saloon Engine C 14 SE	244002	Drive Shaft	29T	22	22	52	95	585	
	1992.03-1998.01	MT	L	F	Hatchback Engine C 14 SE	244002	Drive Shaft	29T	22	22	52	95	585	
	1992.03-1998.01	MT	L	F	Estate Engine C 14 SE	244002	Drive Shaft	29T	22	22	52	95	585	
	1992.03-1998.09	AT/MT	R	F	Saloon Engine C 14 SE	250209	Drive Shaft		27	39	56.5	92	1014	
	1992.03-1998.01	AT/MT	R	F	Hatchback Engine C 14 SE	250209	Drive Shaft		27	39	56.5	92	1014	
	1992.03-1998.01	AT/MT	R	F	Estate Engine C 14 SE	250209	Drive Shaft		27	39	56.5	92	1014	
	1992.03-1998.09	AT/MT	R	F	Saloon Engine C 14 SE	250209	Drive Shaft		27	39	56.5	92	1014	
	1992.03-1998.01	AT/MT	R	F	Hatchback Engine C 14 SE	250209	Drive Shaft		27	39	56.5	92	1014	
	1992.03-1998.01	AT/MT	R	F	Estate Engine C 14 SE	250209	Drive Shaft		27	39	56.5	92	1014	
	1992.03-1998.09	AT/MT	R	F	Saloon Engine C 14 SE	250209	Drive Shaft		27	39	56.5	92	1014	
	1992.03-1998.01	AT/MT	R	F	Hatchback Engine C 14 SE	250209	Drive Shaft		27	39	56.5	92	1014	
	1992.03-1998.01	AT/MT	R	F	Estate Engine C 14 SE	250209	Drive Shaft		27	39	56.5	92	1014	
	1992.03-1998.09	AT/MT	R	F	Saloon Engine C 14 SE	250209	Drive Shaft		27	39	56.5	92	1014	
	1992.03-1998.01	AT/MT	R	F	Hatchback Engine C 14 SE	250209	Drive Shaft		27	39	56.5	92	1014	
	1992.03-1998.01	AT/MT	R	F	Estate Engine C 14 SE	250209	Drive Shaft		27	39	56.5	92	1014	
	1992.03-1998.09	AT/MT	R	F	Saloon Engine C 14 SE	250209	Drive Shaft		27	39	56.5	92	1014	
	1992.03-1998.01	AT/MT	R	F	Hatchback Engine C 14 SE	250209	Drive Shaft		27	39	56.5	92	1014	
	1992.03-1998.01	AT/MT	R	F	Estate Engine C 14 SE	250209	Drive Shaft		27	39	56.5	92	1014	
	1992.03-1998.09	AT/MT	R	F	Saloon Engine C 14 SE	250209	Drive Shaft		27	39	56.5	92	1014	
	1992.03-1998.01	AT/MT	R	F	Hatchback Engine C 14 SE	250209	Drive Shaft		27	39	56.5	92	1014	
	1992.03-1998.01	AT/MT	R	F	Estate Engine C 14 SE	250209	Drive Shaft		27	39	56.5	92	1014	
	1992.03-1998.09	MT	L/R	F	Saloon Engine C 14 SE	644004	Inner Joint		22	22	34.95	57.5	72.5	
	1992.03-1998.01	MT	L/R	F	Hatchback Engine C 14 SE	644004	Inner Joint		22	22	34.95	57.5	72.5	
	1992.03-1998.01	MT	L/R	F	Estate Engine C 14 SE	644004	Inner Joint		22	22	34.95	57.5	72.5	
	1992.03-1998.09	-	-	F	Saloon Engine C 14 SE	844023	Outer Joint		22	22	52	95	50	O
	1992.03-1998.01	-	-	F	Hatchback Engine C 14 SE	844023	Outer Joint		22	22	52	95	50	O
	1992.03-1998.01	-	-	F	Estate Engine C 14 SE	844023	Outer Joint		22	22	52	95	50	O
	1992.03-1998.09	MT	R	F	Saloon Engine C 14 SE	260002	Drive Shaft	29T	22	22	52	95	926	
	1992.03-1998.01	MT	R	F	Hatchback Engine C 14 SE	260002	Drive Shaft	29T	22	22	52	95	926	
	1992.03-1998.09	MT	L/R	F	Saloon Engine C 14 SE	844007	Outer Joint	29T	22	22	52	94.5	50	O
	1992.03-1998.01	MT	L/R	F	Hatchback Engine C 14 SE	844007	Outer Joint	29T	22	22	52	94.5	50	O
	1992.03-1998.01	MT	R	F	Estate Engine C 14 SE	260002	Drive Shaft	29T	22	22	52	95	926	
	1992.03-1998.01	MT	L/R	F	Estate Engine C 14 SE	844007	Outer Joint	29T	22	22	52	94.5	50	O
1992.03-1998.09	AT/MT	R	F	Saloon Engine C 14 SE	650097	Inner Joint		39	35	30	409	90		
1992.03-1998.01	AT/MT	R	F	Hatchback Engine C 14 SE	650097	Inner Joint		39	35	30	409	90		
1992.03-1998.01	AT/MT	R	F	Estate Engine C 14 SE	650097	Inner Joint		39	35	30	409	90		
1993.05-2001.03	MT	L/R	F	Convertible Engine C 14 SE	844051	Outer Joint	29T	22	22	52	95	50.5	O	
1993.05-2001.03	MT	L	F	Convertible Engine C 14 SE	244002	Drive Shaft	29T	22	22	52	95	585		
1993.05-2001.03	AT/MT	R	F	Convertible Engine C 14 SE	250209	Drive Shaft		27	39	56.5	92	1014		
1993.05-2001.03	AT/MT	R	F	Convertible Engine C 14 SE	250209	Drive Shaft		27	39	56.5	92	1014		
1993.05-2001.03	AT/MT	R	F	Convertible Engine C 14 SE	250209	Drive Shaft		27	39	56.5	92	1014		
1993.05-2001.03	AT/MT	R	F	Convertible Engine C 14 SE	260019	Drive Shaft		22	22	52	95	926		
1993.05-2001.03	MT	L/R	F	Convertible Engine C 14 SE	644004	Inner Joint		22	22	34.95	57.5	72.5		
1993.05-2001.03	MT	R	F	Convertible Engine C 14 SE	260002	Drive Shaft	29T	22	22	52	95	926		
1993.05-2001.03	MT	L/R	F	Convertible Engine C 14 SE	844007	Outer Joint	29T	22	22	52	94.5	50	O	
1993.05-2001.03	AT/MT	R	F	Convertible Engine C 14 SE	650097	Inner Joint		39	35	30	409	90		
1993.05-2001.03	AT/MT	R	F	Convertible Engine C 14 SE	650097	Inner Joint		39	35	30	409	90		
1995.09-1998.01	MT	L/R	F	Hatchback Engine 16 NZR/16 LZ2	644004	Inner Joint		22	22	34.95	57.5	72.5		
1995.09-1998.09	AT/MT	L/R	F	Saloon Engine 16 NZR/16 LZ2	844007	Outer Joint	29T	22	22	52	94.5	50	O	
1995.09-1998.09	MT	L/R	F	Saloon Engine 16 NZR/16 LZ2	644004	Inner Joint		22	22	34.95	57.5	72.5		
1995.09-1998.01	MT	L/R	F	Estate Engine 16 NZR/16 LZ2	644004	Inner Joint		22	22	34.95	57.5	72.5		
1995.09-1998.09	-	-	F	Saloon Engine 16 NZR/16 LZ2	844023	Outer Joint		22	22	52	95	50	O	
1995.09-1998.01	AT/MT	L/R	F	Hatchback Engine 16 NZR/16 LZ2	844051	Outer Joint	29T	22	22	52	95	50.5	O	
1995.09-1998.01	-	-	F	Estate Engine 16 NZR/16 LZ2	844023	Outer Joint		22	22	52	95	50	O	
1995.09-1998.09	AT/MT	L/R	F	Saloon Engine 16 NZR/16 LZ2	844051	Outer Joint	29T	22	22	52	95	50.5	O	
1995.09-1998.01	AT/MT	L/R	F	Estate Engine 16 NZR/16 LZ2	844051	Outer Joint	29T	22	22	52	95	50.5	O	
1995.09-1998.01	MT	L	F	Hatchback Engine 16 NZR/16 LZ2	244002	Drive Shaft	29T	22	22	52	95	585		
1995.09-1998.09	MT	L	F	Saloon Engine 16 NZR/16 LZ2	244002	Drive Shaft	29T	22	22	52	95	585		
1995.09-1998.01	MT	L	F	Estate Engine 16 NZR/16 LZ2	244002	Drive Shaft	29T	22	22	52	95	585		
1995.09-1998.09	-	-	-	Saloon Engine 16 NZR/16 LZ2	844068	Outer Joint	29T	22	30	52	94.5	55	I	
1995.09-1998.01	-	-	-	Estate Engine 16 NZR/16 LZ2	844068	Outer Joint	29T	22	30	52	94.5	55	I	
1995.09-1998.01	-	-	-	Hatchback Engine 16 NZR/16 LZ2	844068	Outer Joint	29T	22	30	52	94.5	55	I	
1995.09-1998.01	AT/MT	L/R	F	Hatchback Engine 16 NZR/16 LZ2	844007	Outer Joint	29T	22	22	52	94.5	50	O	
1995.09-1998.01	AT/MT	L/R	F	Estate Engine 16 NZR/16 LZ2	844007	Outer Joint	29T	22	22	52	94.5	50	O	
1995.09-1998.01	MT	R	F	Hatchback Engine 16 NZR/16 LZ2	260002	Drive Shaft	29T	22	22	52	95	926		
1995.09-1998.09	MT	R	F	Saloon Engine 16 NZR/16 LZ2	260002	Drive Shaft	29T	22	22	52	95	926		
1995.09-1998.01	MT	R	F	Estate Engine 16 NZR/16 LZ2	260002	Drive Shaft	29T	22	22	52	95	926		





	 YEAR	TRANSM	L/R	F/R	REMARKS	GSP Ref.	 PRODUCT	 ABS	Technical Specifications					
									A	B	C	H	L	P
OPEL														
ASTRA F (T92)														
1.6 i (52 kW)	1993.03-1996.08	MT	L/R	F	Convertible Engine X 16 SZ	644004	Inner Joint		22	22	34.95	57.5	72.5	
	1993.03-1996.08	-	-	F	Convertible Engine X 16 SZ	844023	Outer Joint		22	22	52	95	50	O
	1993.03-1996.08	-	-	-	Convertible Engine X 16 SZ	844068	Outer Joint	29T	22	30	52	94.5	55	I
	1993.03-1996.08	AT/MT	L/R	F	Convertible Engine X 16 SZ	844007	Outer Joint	29T	22	22	52	94.5	50	O
	1993.05-1996.07	AT/MT	L/R	F	Saloon Engine X 16 SZ	844007	Outer Joint	29T	22	22	52	94.5	50	O
	1993.05-1996.07	AT/MT	L/R	F	Hatchback Engine X 16 SZ	844007	Outer Joint	29T	22	22	52	94.5	50	O
	1993.05-1996.07	AT/MT	L/R	F	Estate Engine X 16 SZ	844007	Outer Joint	29T	22	22	52	94.5	50	O
	1993.05-1996.07	MT	L/R	F	Saloon Engine X 16 SZ	644004	Inner Joint		22	22	34.95	57.5	72.5	
	1993.05-1996.07	MT	L/R	F	Hatchback Engine X 16 SZ	644004	Inner Joint		22	22	34.95	57.5	72.5	
	1993.05-1996.07	-	-	-	Saloon Engine X 16 SZ	844068	Outer Joint	29T	22	30	52	94.5	55	I
	1993.05-1996.07	MT	L/R	F	Estate Engine X 16 SZ	644004	Inner Joint		22	22	34.95	57.5	72.5	
	1993.05-1996.07	-	-	F	Saloon Engine X 16 SZ	844023	Outer Joint		22	22	52	95	50	O
	1993.05-1996.07	-	-	F	Hatchback Engine X 16 SZ	844023	Outer Joint		22	22	52	95	50	O
	1993.05-1996.07	-	-	-	Estate Engine X 16 SZ	844068	Outer Joint	29T	22	30	52	94.5	55	I
1993.05-1996.07	-	-	-	Hatchback Engine X 16 SZ	844068	Outer Joint	29T	22	30	52	94.5	55	I	
1993.05-1996.07	-	-	F	Estate Engine X 16 SZ	844023	Outer Joint		22	22	52	95	50	O	
1.6 i (55 kW)	1991.09-1998.01	AT/MT	L/R	F	Hatchback Engine C 16 NZ/X 16 SZR	844051	Outer Joint	29T	22	22	52	95	50.5	O
	1991.09-1998.01	AT/MT	L/R	F	Estate Engine X 16 SZR/X 16 NZ	844051	Outer Joint	29T	22	22	52	95	50.5	O
	1991.09-1998.01	MT	L	F	Hatchback Engine C 16 NZ/X 16 SZR	244002	Drive Shaft	29T	22	22	52	95	585	
	1991.09-1998.01	MT	L	F	Estate Engine X 16 SZR/X 16 NZ	244002	Drive Shaft	29T	22	22	52	95	585	
	1991.09-1998.01	MT	R	F	Hatchback Engine C 16 NZ/X 16 SZR	250209	Drive Shaft		27	39	56.5	92	1014	
	1991.09-1998.01	MT	R	F	Hatchback Engine C 16 NZ/X 16 SZR	250209	Drive Shaft		27	39	56.5	92	1014	
	1991.09-1998.01	MT	R	F	Hatchback Engine C 16 NZ/X 16 SZR	260019	Drive Shaft		22	22	52	95	926	
	1991.09-1998.01	MT	L/R	F	Hatchback Engine C 16 NZ/X 16 SZR	644004	Inner Joint		22	22	34.95	57.5	72.5	
	1991.09-1998.01	MT	L/R	F	Estate Engine X 16 SZR/X 16 NZ	644004	Inner Joint		22	22	34.95	57.5	72.5	
	1991.09-1998.01	-	-	F	Hatchback Engine C 16 NZ/X 16 SZR	844023	Outer Joint		22	22	52	95	50	O
	1991.09-1998.01	-	-	-	Estate Engine X 16 SZR/X 16 NZ	844068	Outer Joint	29T	22	30	52	94.5	55	I
	1991.09-1998.01	-	-	-	Hatchback Engine C 16 NZ/X 16 SZR	844068	Outer Joint	29T	22	30	52	94.5	55	I
	1991.09-1998.01	-	-	F	Estate Engine X 16 SZR/X 16 NZ	844023	Outer Joint		22	22	52	95	50	O
	1991.09-1998.01	AT/MT	L/R	F	Hatchback Engine C 16 NZ/X 16 SZR	844007	Outer Joint	29T	22	22	52	94.5	50	O
	1991.09-1998.01	AT/MT	L/R	F	Estate Engine X 16 SZR/X 16 NZ	844007	Outer Joint	29T	22	22	52	94.5	50	O
	1991.09-1998.01	MT	R	F	Hatchback Engine C 16 NZ/X 16 SZR	260002	Drive Shaft	29T	22	22	52	95	926	
	1991.09-1998.01	MT	R	F	Estate Engine X 16 SZR/X 16 NZ	260002	Drive Shaft	29T	22	22	52	95	926	
	1991.09-1998.01	MT	R	F	Hatchback Engine C 16 NZ/X 16 SZR	650097	Inner Joint		39	35	30	409	90	
	1992.03-1998.09	AT/MT	L/R	F	Saloon Engine C 16 NZ/X 16 SZR	844007	Outer Joint	29T	22	22	52	94.5	50	O
	1992.03-1998.09	AT/MT	L/R	F	Saloon Engine C 16 NZ/X 16 SZR	844051	Outer Joint	29T	22	22	52	95	50.5	O
	1992.03-1998.09	MT	L	F	Saloon Engine C 16 NZ/X 16 SZR	244002	Drive Shaft	29T	22	22	52	95	585	
	1992.03-1998.09	MT	R	F	Saloon Engine C 16 NZ/X 16 SZR	250209	Drive Shaft		27	39	56.5	92	1014	
	1992.03-1998.09	MT	R	F	Saloon Engine C 16 NZ/X 16 SZR	250209	Drive Shaft		27	39	56.5	92	1014	
	1992.03-1998.09	MT	R	F	Saloon Engine C 16 NZ/X 16 SZR	260019	Drive Shaft		22	22	52	95	926	
	1992.03-1998.09	MT	L/R	F	Saloon Engine C 16 NZ/X 16 SZR	644004	Inner Joint		22	22	34.95	57.5	72.5	
	1992.03-1998.09	-	-	-	Saloon Engine C 16 NZ/X 16 SZR	844068	Outer Joint	29T	22	30	52	94.5	55	I
	1992.03-1998.09	-	-	F	Saloon Engine C 16 NZ/X 16 SZR	844023	Outer Joint		22	22	52	95	50	O
	1992.03-1998.09	MT	R	F	Saloon Engine C 16 NZ/X 16 SZR	260002	Drive Shaft	29T	22	22	52	95	926	
1992.03-1998.09	MT	R	F	Saloon Engine C 16 NZ/X 16 SZR	650097	Inner Joint		39	35	30	409	90		
1992.03-1998.09	MT	R	F	Saloon Engine C 16 NZ/X 16 SZR	650097	Inner Joint		39	35	30	409	90		
1996.01-2001.03	AT/MT	L/R	F	Convertible Engine X 16 SZR	844007	Outer Joint	29T	22	22	52	94.5	50	O	
1996.01-2001.03	-	-	-	Convertible Engine X 16 SZR	844068	Outer Joint	29T	22	30	52	94.5	55	I	
1.6 i 16V (74 kW)	1994.08-1998.01	-	-	F	Estate Engine X 16 XEL	844023	Outer Joint		22	22	52	95	50	O
	1994.08-1998.09	MT	R	F	Saloon Engine X 16 XEL	260002	Drive Shaft	29T	22	22	52	95	926	
	1994.08-1998.01	MT	R	F	Hatchback Engine X 16 XEL	260002	Drive Shaft	29T	22	22	52	95	926	
	1994.08-1998.01	MT	R	F	Estate Engine X 16 XEL	260002	Drive Shaft	29T	22	22	52	95	926	
	1994.08-1998.09	AT/MT	R	F	Saloon Engine X 16 XEL	650097	Inner Joint		39	35	30	409	90	
	1994.08-1998.01	AT/MT	R	F	Hatchback Engine X 16 XEL	650097	Inner Joint		39	35	30	409	90	
	1994.08-1998.01	AT/MT	R	F	Estate Engine X 16 XEL	650097	Inner Joint		39	35	30	409	90	
	1994.08-1998.09	AT/MT	L/R	F	Saloon Engine X 16 XEL	844007	Outer Joint	29T	22	22	52	94.5	50	O
	1994.08-1998.01	AT/MT	L/R	F	Hatchback Engine X 16 XEL	844007	Outer Joint	29T	22	22	52	94.5	50	O
	1994.08-1998.01	AT/MT	L/R	F	Estate Engine X 16 XEL	844007	Outer Joint	29T	22	22	52	94.5	50	O
	1994.08-1998.09	MT	L	F	Saloon Engine X 16 XEL	244002	Drive Shaft	29T	22	22	52	95	585	
	1994.08-1998.01	MT	L	F	Hatchback Engine X 16 XEL	244002	Drive Shaft	29T	22	22	52	95	585	
	1994.08-1998.01	MT	L	F	Estate Engine X 16 XEL	244002	Drive Shaft	29T	22	22	52	95	585	
	1994.08-1998.09	AT/MT	R	F	Saloon Engine X 16 XEL	250209	Drive Shaft		27	39	56.5	92	1014	
	1994.08-1998.01	AT/MT	R	F	Hatchback Engine X 16 XEL	250209	Drive Shaft		27	39	56.5	92	1014	
	1994.08-1998.01	AT/MT	R	F	Estate Engine X 16 XEL	250209	Drive Shaft		27	39	56.5	92	1014	
	1994.08-1998.09	AT/MT	R	F	Saloon Engine X 16 XEL	250209	Drive Shaft		27	39	56.5	92	1014	
	1994.08-1998.01	AT/MT	R	F	Hatchback Engine X 16 XEL	250209	Drive Shaft		27	39	56.5	92	1014	
	1994.08-1998.01	AT/MT	R	F	Estate Engine X 16 XEL	250209	Drive Shaft		27	39	56.5	92	1014	

	 YEAR	TRANSM	L/R	F/R	REMARKS	GSP Ref.	 PRODUCT	 ABS	Technical Specifications					
									A	B	C	H	L	P
OPEL														
ASTRA F (T92)														
1.6 i 16V (74 kW)	1994.08-1998.09	AT/MT	R	F	Saloon Engine X 16 XEL	250209	Drive Shaft		27	39	56.5	92	1014	
	1994.08-1998.01	AT/MT	R	F	Hatchback Engine X 16 XEL	250209	Drive Shaft		27	39	56.5	92	1014	
	1994.08-1998.01	AT/MT	R	F	Estate Engine X 16 XEL	250209	Drive Shaft		27	39	56.5	92	1014	
	1994.08-1998.09	AT/MT	R	F	Saloon Engine X 16 XEL	260019	Drive Shaft		22	22	52	95	926	
	1994.08-1998.01	AT/MT	R	F	Estate Engine X 16 XEL	260019	Drive Shaft		22	22	52	95	926	
	1994.08-1998.01	AT/MT	R	F	Hatchback Engine X 16 XEL	260019	Drive Shaft		22	22	52	95	926	
	1994.08-1998.09	-	-	-	Saloon Engine X 16 XEL	844068	Outer Joint	29T	22	30	52	94.5	55	I
	1994.08-1998.01	-	-	-	Estate Engine X 16 XEL	844068	Outer Joint	29T	22	30	52	94.5	55	I
	1994.08-1998.01	-	-	-	Hatchback Engine X 16 XEL	844068	Outer Joint	29T	22	30	52	94.5	55	I
	1994.08-1998.09	MT	L/R	F	Saloon Engine X 16 XEL	644004	Inner Joint		22	22	34.95	57.5	72.5	
	1994.08-1998.01	MT	L/R	F	Hatchback Engine X 16 XEL	644004	Inner Joint		22	22	34.95	57.5	72.5	
	1994.08-1998.01	MT	L/R	F	Estate Engine X 16 XEL	644004	Inner Joint		22	22	34.95	57.5	72.5	
	1994.08-1998.09	-	-	-	Saloon Engine X 16 XEL	844023	Outer Joint		22	22	52	95	50	O
	1994.08-1998.01	-	-	-	Hatchback Engine X 16 XEL	844023	Outer Joint		22	22	52	95	50	O
1.6 Si (74 kW)	1992.03-1994.12	MT	L/R	F	Hatchback Engine C 16 SE	844051	Outer Joint	29T	22	22	52	95	50.5	O
	1992.03-1994.12	MT	L/R	F	Estate Engine C 16 SE	844051	Outer Joint	29T	22	22	52	95	50.5	O
	1992.03-1994.12	MT	L	F	Hatchback Engine C 16 SE	244002	Drive Shaft	29T	22	22	52	95	585	
	1992.03-1994.12	MT	L	F	Estate Engine C 16 SE	244002	Drive Shaft	29T	22	22	52	95	585	
	1992.03-1994.12	MT	L/R	F	Hatchback Engine C 16 SE	644004	Inner Joint		22	22	34.95	57.5	72.5	
	1992.03-1994.12	MT	L/R	F	Estate Engine C 16 SE	644004	Inner Joint		22	22	34.95	57.5	72.5	
	1992.03-1994.12	-	-	-	Hatchback Engine C 16 SE	844023	Outer Joint		22	22	52	95	50	O
	1992.03-1994.12	-	-	-	Estate Engine C 16 SE	844068	Outer Joint	29T	22	30	52	94.5	55	I
	1992.03-1994.12	-	-	-	Hatchback Engine C 16 SE	844068	Outer Joint	29T	22	30	52	94.5	55	I
	1992.03-1994.12	-	-	-	Estate Engine C 16 SE	844023	Outer Joint		22	22	52	95	50	O
	1992.03-1994.12	MT	R	F	Hatchback Engine C 16 SE	260002	Drive Shaft	29T	22	22	52	95	926	
	1992.03-1994.12	MT	L/R	F	Hatchback Engine C 16 SE	844007	Outer Joint	29T	22	22	52	94.5	50	O
	1992.03-1994.12	MT	R	F	Estate Engine C 16 SE	260002	Drive Shaft	29T	22	22	52	95	926	
	1992.03-1994.12	MT	L/R	F	Estate Engine C 16 SE	844007	Outer Joint	29T	22	22	52	94.5	50	O
	1992.05-1994.12	MT	L	F	Saloon Engine C 16 SE	244002	Drive Shaft	29T	22	22	52	95	585	
	1992.05-1994.12	MT	L/R	F	Saloon Engine C 16 SE	644004	Inner Joint		22	22	34.95	57.5	72.5	
	1992.05-1994.12	-	-	-	Saloon Engine C 16 SE	844068	Outer Joint	29T	22	30	52	94.5	55	I
	1992.05-1994.12	-	-	-	Saloon Engine C 16 SE	844023	Outer Joint		22	22	52	95	50	O
	1992.05-1994.12	MT	R	F	Saloon Engine C 16 SE	260002	Drive Shaft	29T	22	22	52	95	926	
	1992.05-1994.12	MT	L/R	F	Saloon Engine C 16 SE	844007	Outer Joint	29T	22	22	52	94.5	50	O
1992.05-1994.12	MT	L/R	F	Saloon Engine C 16 SE	844051	Outer Joint	29T	22	22	52	95	50.5	O	
1.7 D (42 kW)	1991.12-1992.09	MT	L/R	F	Hatchback Engine 17 D	644004	Inner Joint		22	22	34.95	57.5	72.5	
	1991.12-1992.09	-	-	-	Hatchback Engine 17 D	844023	Outer Joint		22	22	52	95	50	O
	1991.12-1992.09	MT	L/R	F	Estate Engine 17 D	644004	Inner Joint		22	22	34.95	57.5	72.5	
	1991.12-1992.09	AT/MT	L/R	F	Hatchback Engine 17 D	844056	Outer Joint	29T	33	25	52	109	61	O
	1991.12-1992.09	AT/MT	L/R	F	Estate Engine 17 D	844056	Outer Joint	29T	33	25	52	109	61	O
	1991.12-1992.09	-	-	-	Estate Engine 17 D	844023	Outer Joint		22	22	52	95	50	O
	1992.03-1992.09	MT	L/R	F	Saloon Engine 17 D	644004	Inner Joint		22	22	34.95	57.5	72.5	
	1992.03-1992.09	-	-	-	Saloon Engine 17 D	844023	Outer Joint		22	22	52	95	50	O
	1992.03-1992.09	AT/MT	L/R	F	Saloon Engine 17 D	844056	Outer Joint	29T	33	25	52	109	61	O
	1992.03-1992.09	AT/MT	L/R	F	Saloon Engine 17 D	844056	Outer Joint	29T	33	25	52	109	61	O
1.7 D (44 kW)	1992.07-1998.01	AT/MT	L/R	F	Estate Engine 17 DR	844056	Outer Joint	29T	33	25	52	109	61	O
	1992.07-1998.01	MT	L/R	F	Estate Engine 17 DR	644004	Inner Joint		22	22	34.95	57.5	72.5	
	1992.07-1998.09	AT/MT	L/R	F	Saloon Engine 17 DR	844056	Outer Joint	29T	33	25	52	109	61	O
	1992.07-1998.09	MT	L/R	F	Saloon Engine 17 DR	644004	Inner Joint		22	22	34.95	57.5	72.5	
	1992.07-1998.01	AT/MT	L/R	F	Hatchback Engine 17 DR	844056	Outer Joint	29T	33	25	52	109	61	O
	1992.07-1998.01	MT	L/R	F	Hatchback Engine 17 DR	644004	Inner Joint		22	22	34.95	57.5	72.5	
	1992.07-1998.01	-	-	-	Hatchback Engine 17 DR	844023	Outer Joint		22	22	52	95	50	O
	1992.07-1998.09	-	-	-	Saloon Engine 17 DR	844023	Outer Joint		22	22	52	95	50	O
	1992.07-1998.01	-	-	-	Estate Engine 17 DR	844023	Outer Joint		22	22	52	95	50	O
	1992.07-1998.01	AT/MT	L/R	F	Hatchback Engine 17 DR	844007	Outer Joint	29T	22	22	52	94.5	50	O
1992.07-1998.09	AT/MT	L/R	F	Saloon Engine 17 DR	844007	Outer Joint	29T	22	22	52	94.5	50	O	
1.7 TD (50 kW)	1994.11-1998.01	AT/MT	L/R	F	Hatchback Engine X 17 DTL	621011	Inner Joint		34	25	35	78	64	
	1994.11-1998.01	AT/MT	L/R	F	Estate Engine X 17 DTL	621011	Inner Joint		34	25	35	78	64	
	1994.11-1998.01	-	-	-	Hatchback Engine X 17 DTL	808003	Outer Joint		33	25	52	109	61	O
	1994.11-1998.09	AT/MT	L/R	F	Saloon Engine X 17 DTL	621011	Inner Joint		34	25	35	78	64	
	1994.11-1998.01	-	-	-	Estate Engine X 17 DTL	808003	Outer Joint		33	25	52	109	61	O
	1994.11-1998.09	-	-	-	Saloon Engine X 17 DTL	808003	Outer Joint		33	25	52	109	61	O
	1994.11-1998.09	AT/MT	L/R	F	Saloon Engine X 17 DTL	844056	Outer Joint	29T	33	25	52	109	61	O
	1994.11-1998.01	AT/MT	L/R	F	Hatchback Engine X 17 DTL	844056	Outer Joint	29T	33	25	52	109	61	O
1.7 TDS (60 kW)	1991.12-1998.01	AT/MT	L/R	F	Hatchback Engine X 17 DT (TC4EE1)/17 DT (TC4EE1)	644002	Inner Joint		34	25	35	56.2	85.6	
	1991.12-1998.01	MT	L/R	F	Estate Engine 17 DT (TC4EE1)	644002	Inner Joint		34	25	35	56.2	85.6	





		 YEAR	TRANSM	L/R	F/R	REMARKS	GSP Ref.	 PRODUCT	 ABS	Technical Specifications						
										A	B	C	H	L	P	
OPEL																
ASTRA F (T92)																
1.7 TDS (60 kW)		1991.12-1998.01	MT	L	F	Hatchback Engine X 17 DT (TC4EE1)/17 DT (TC4EE1)	244011	Drive Shaft	29T	33	34	52	109	594.5		
		1991.12-1998.01	AT/MT	L/R	F	Hatchback Engine X 17 DT (TC4EE1)/17 DT (TC4EE1)	621011	Inner Joint		34	25	35	78	64		
		1991.12-1998.01	-	-	F	Hatchback Engine X 17 DT (TC4EE1)/17 DT (TC4EE1)	808003	Outer Joint		33	25	52	109	61	O	
		1991.12-1998.01	MT	L	F	Estate Engine 17 DT (TC4EE1)	244011	Drive Shaft	29T	33	34	52	109	594.5		
		1991.12-1998.01	AT/MT	L/R	F	Estate Engine 17 DT (TC4EE1)	621011	Inner Joint		34	25	35	78	64		
		1991.12-1998.01	-	-	F	Estate Engine 17 DT (TC4EE1)	808003	Outer Joint		33	25	52	109	61	O	
		1991.12-1998.01	MT	R	F	Hatchback Engine X 17 DT (TC4EE1)/17 DT (TC4EE1)	244059	Drive Shaft	29T	33	34	52	109	938		
		1991.12-1998.01	MT	R	F	Estate Engine 17 DT (TC4EE1)	244059	Drive Shaft	29T	33	34	52	109	938		
		1991.12-1998.01	AT/MT	L/R	F	Hatchback Engine X 17 DT (TC4EE1)/17 DT (TC4EE1)	844056	Outer Joint	29T	33	25	52	109	61	O	
		1991.12-1998.01	AT/MT	L/R	F	Estate Engine 17 DT (TC4EE1)	844056	Outer Joint	29T	33	25	52	109	61	O	
		1992.03-1998.09	MT	L/R	F	Saloon Engine 17 DT (TC4EE1)/X 17 DT (TC4EE1)	621011	Inner Joint		34	25	35	78	64		
		1992.03-1998.09	MT	L	F	Saloon Engine 17 DT (TC4EE1)/X 17 DT (TC4EE1)	244011	Drive Shaft	29T	33	34	52	109	594.5		
		1992.03-1998.09	-	-	F	Saloon Engine 17 DT (TC4EE1)/X 17 DT (TC4EE1)	808003	Outer Joint		33	25	52	109	61	O	
		1992.03-1998.09	AT/MT	L/R	F	Saloon Engine 17 DT (TC4EE1)/X 17 DT (TC4EE1)	844056	Outer Joint	29T	33	25	52	109	61	O	
		1992.03-1998.09	MT	R	F	Saloon Engine 17 DT (TC4EE1)/X 17 DT (TC4EE1)	244059	Drive Shaft	29T	33	34	52	109	938		
		1992.03-1998.09	MT	L/R	F	Saloon Engine 17 DT (TC4EE1)/X 17 DT (TC4EE1)	644002	Inner Joint		34	25	35	56.2	85.6		
1.8 i (66 kW)		1991.09-1998.01	MT	L	F	Hatchback Engine C 18 NZ	244011	Drive Shaft	29T	33	34	52	109	594.5		
		1991.09-1998.01	MT	L	F	Estate Engine C 18 NZ	244011	Drive Shaft	29T	33	34	52	109	594.5		
		1991.09-1998.01	AT/MT	L/R	F	Hatchback Engine C 18 NZ	621011	Inner Joint		34	25	35	78	64		
		1991.09-1998.01	-	-	F	Hatchback Engine C 18 NZ	808003	Outer Joint		33	25	52	109	61	O	
		1991.09-1998.01	AT/MT	L/R	F	Estate Engine C 18 NZ	621011	Inner Joint		34	25	35	78	64		
		1991.09-1998.01	-	-	F	Estate Engine C 18 NZ	808003	Outer Joint		33	25	52	109	61	O	
		1991.09-1998.01	AT/MT	L/R	F	Hatchback Engine C 18 NZ	844056	Outer Joint	29T	33	25	52	109	61	O	
		1991.09-1998.01	AT/MT	L/R	F	Estate Engine C 18 NZ	844056	Outer Joint	29T	33	25	52	109	61	O	
		1991.09-1998.01	MT	R	F	Hatchback Engine C 18 NZ	244059	Drive Shaft	29T	33	34	52	109	938		
		1991.09-1998.01	MT	R	F	Estate Engine C 18 NZ	244059	Drive Shaft	29T	33	34	52	109	938		
		1991.09-1998.01	MT	L/R	F	Hatchback Engine C 18 NZ	644002	Inner Joint		34	25	35	56.2	85.6		
		1991.09-1998.01	MT	L/R	F	Estate Engine C 18 NZ	644002	Inner Joint		34	25	35	56.2	85.6		
		1992.03-1998.09	MT	L	F	Saloon Engine C 18 NZ	244011	Drive Shaft	29T	33	34	52	109	594.5		
		1992.03-1998.09	AT/MT	L/R	F	Saloon Engine C 18 NZ	621011	Inner Joint		34	25	35	78	64		
		1992.03-1998.09	-	-	F	Saloon Engine C 18 NZ	808003	Outer Joint		33	25	52	109	61	O	
		1992.03-1998.09	AT/MT	L/R	F	Saloon Engine C 18 NZ	844056	Outer Joint	29T	33	25	52	109	61	O	
		1992.03-1998.09	MT	R	F	Saloon Engine C 18 NZ	244059	Drive Shaft	29T	33	34	52	109	938		
		1992.03-1998.09	MT	L/R	F	Saloon Engine C 18 NZ	644002	Inner Joint		34	25	35	56.2	85.6		
1.8 i 16V (82 kW)		1995.09-1996.09	-	-	F	Saloon Engine 18 SE	808003	Outer Joint		33	25	52	109	61	O	
1.8 i 16V (85 kW)		1994.07-1998.01	MT	L/R	F	Estate Engine C 18 XEL/C 18 XE	644002	Inner Joint		34	25	35	56.2	85.6		
		1994.07-1998.01	AT/MT	L/R	F	Estate Engine C 18 XEL/C 18 XE	621011	Inner Joint		34	25	35	78	64		
		1994.07-1998.01	-	-	F	Estate Engine C 18 XEL/C 18 XE	808003	Outer Joint		33	25	52	109	61	O	
		1994.09-1998.01	MT	L/R	F	Hatchback Engine C 18 XEL/C 18 XE	644002	Inner Joint		34	25	35	56.2	85.6		
		1994.09-1998.01	AT/MT	L/R	F	Hatchback Engine C 18 XEL/C 18 XE	621011	Inner Joint		34	25	35	78	64		
		1994.09-1998.01	-	-	F	Hatchback Engine C 18 XEL/C 18 XE	808003	Outer Joint		33	25	52	109	61	O	
		1994.11-1998.09	MT	L/R	F	Saloon Engine X 18 XE/C 18 XEL	644002	Inner Joint		34	25	35	56.2	85.6		
		1994.11-2001.03	MT	L/R	F	Convertible Engine C 18 XEL/C 18 XE	644002	Inner Joint		34	25	35	56.2	85.6		
		1994.11-1998.09	AT/MT	L/R	F	Saloon Engine X 18 XE/C 18 XEL	621011	Inner Joint		34	25	35	78	64		
		1994.11-1998.09	-	-	F	Saloon Engine X 18 XE/C 18 XEL	808003	Outer Joint		33	25	52	109	61	O	
		1995.09-1997.08	MT	L/R	F	Saloon Engine C 18 SEL	644002	Inner Joint		34	25	35	56.2	85.6		
		1995.09-1997.08	-	-	F	Saloon Engine C 18 SEL	808003	Outer Joint		33	25	52	109	61	O	
1.8 i 16V (92 kW)		1993.06-1994.10	AT/MT	L/R	F	Saloon Engine C 18 XE	621011	Inner Joint		34	25	35	78	64		
		1993.06-1994.10	MT	L/R	F	Saloon Engine C 18 XE	644002	Inner Joint		34	25	35	56.2	85.6		
		1993.06-1994.10	-	-	F	Saloon Engine C 18 XE	808003	Outer Joint		33	25	52	109	61	O	
		1993.06-1998.01	MT	L/R	F	Estate Engine C 18 XE	644002	Inner Joint		34	25	35	56.2	85.6		
		1993.06-1994.08	MT	L/R	F	Hatchback Engine C 18 XE	644002	Inner Joint		34	25	35	56.2	85.6		
		1993.06-1998.01	AT/MT	L/R	F	Estate Engine C 18 XE	621011	Inner Joint		34	25	35	78	64		
		1993.06-1998.01	-	-	F	Estate Engine C 18 XE	808003	Outer Joint		33	25	52	109	61	O	
		1993.06-1994.08	AT/MT	L/R	F	Hatchback Engine C 18 XE	621011	Inner Joint		34	25	35	78	64		
		1993.06-1994.08	-	-	F	Hatchback Engine C 18 XE	808003	Outer Joint		33	25	52	109	61	O	
2.0 GSI 16V (110 kW)		1991.09-1998.01	MT	L/R	F	Hatchback Engine C 20 XE	644002	Inner Joint		34	25	35	56.2	85.6		
		1991.09-1998.01	MT	L	F	Hatchback Engine C 20 XE	244011	Drive Shaft	29T	33	34	52	109	594.5		
		1991.09-1998.01	AT/MT	L	F	Hatchback Engine C 20 XE	621011	Inner Joint		34	25	35	78	64		
		1991.09-1998.01	-	-	F	Hatchback Engine C 20 XE	808003	Outer Joint		33	25	52	109	61	O	
		1991.09-1998.01	MT	R	F	Hatchback Engine C 20 XE	244059	Drive Shaft	29T	33	34	52	109	938		
		1991.09-1998.01	MT	L/R	F	Hatchback Engine C 20 XE	844056	Outer Joint	29T	33	25	52	109	61	O	
2.0 i (85 kW)		1991.09-1998.01	MT	L/R	F	Hatchback Engine C 20 NE	644002	Inner Joint		34	25	35	56.2	85.6		
		1991.09-1994.07	MT	L/R	F	Estate Engine C 20 NE	644002	Inner Joint		34	25	35	56.2	85.6		
		1991.09-1998.01	MT	L	F	Hatchback Engine C 20 NE	244011	Drive Shaft	29T	33	34	52	109	594.5		
		1991.09-1994.07	MT	L	F	Estate Engine C 20 NE	244011	Drive Shaft	29T	33	34	52	109	594.5		





YEAR	TRANSM	L/R	F/R	REMARKS	GSP Ref.	PRODUCT	ABS	Technical Specifications										
								A	B	C	H	L	P					
OPEL																		
ASTRA F (T92)																		
2.0 i (85 kW)																		
1991.09-1998.01	AT/MT	L/R	F	Hatchback Engine C 20 NE	621011	Inner Joint		34	25	35	78	64						
1991.09-1998.01	-	-	F	Hatchback Engine C 20 NE	808003	Outer Joint		33	25	52	109	61	O					
1991.09-1994.07	AT/MT	L/R	F	Estate Engine C 20 NE	621011	Inner Joint		34	25	35	78	64						
1991.09-1994.07	-	-	F	Estate Engine C 20 NE	808003	Outer Joint		33	25	52	109	61	O					
1991.09-1998.01	MT	R	F	Hatchback Engine C 20 NE	244059	Drive Shaft	29T	33	34	52	109	938						
1991.09-1994.07	MT	R	F	Estate Engine C 20 NE	244059	Drive Shaft	29T	33	34	52	109	938						
1991.09-1998.01	AT/MT	L/R	F	Hatchback Engine C 20 NE	844056	Outer Joint	29T	33	25	52	109	61	O					
1991.09-1994.07	AT/MT	L/R	F	Estate Engine C 20 NE	844056	Outer Joint	29T	33	25	52	109	61	O					
1992.03-1998.09	MT	L	F	Saloon Engine C 20 NE	244011	Drive Shaft	29T	33	34	52	109	594.5						
1992.03-1998.09	AT/MT	L/R	F	Saloon Engine C 20 NE	621011	Inner Joint		34	25	35	78	64						
1992.03-1998.09	-	-	F	Saloon Engine C 20 NE	808003	Outer Joint		33	25	52	109	61	O					
1992.03-1998.09	AT/MT	L/R	F	Saloon Engine C 20 NE	844056	Outer Joint	29T	33	25	52	109	61	O					
1992.03-1998.09	MT	R	F	Saloon Engine C 20 NE	244059	Drive Shaft	29T	33	34	52	109	938						
1992.03-1998.09	MT	L/R	F	Saloon Engine C 20 NE	644002	Inner Joint		34	25	35	56.2	85.6						
1993.03-1994.10	MT	L/R	F	Convertible Engine C 20 NE	644002	Inner Joint		34	25	35	56.2	85.6						
1993.03-1994.10	MT	L	F	Convertible Engine C 20 NE	244011	Drive Shaft	29T	33	34	52	109	594.5						
1993.03-1994.10	AT/MT	L/R	F	Convertible Engine C 20 NE	621011	Inner Joint		34	25	35	78	64						
1993.03-1994.10	-	-	F	Convertible Engine C 20 NE	808003	Outer Joint		33	25	52	109	61	O					
1993.03-1994.10	MT	R	F	Convertible Engine C 20 NE	244059	Drive Shaft	29T	33	34	52	109	938						
1993.03-1994.10	AT/MT	L/R	F	Convertible Engine C 20 NE	844056	Outer Joint	29T	33	25	52	109	61	O					
2.0 i 16V (100 kW)																		
1995.02-1998.01	AT/MT	L	F	Estate Engine X 20 XEV	621011	Inner Joint		34	25	35	78	64						
1995.02-1998.01	AT/MT	L/R	F	Estate Engine X 20 XEV	844056	Outer Joint	29T	33	25	52	109	61	O					
1995.02-1998.09	AT/MT	L/R	F	Saloon Engine X 20 XEV	844056	Outer Joint	29T	33	25	52	109	61	O					
1995.02-1998.09	AT/MT	L	F	Saloon Engine X 20 XEV	621011	Inner Joint		34	25	35	78	64						
1995.02-1998.09	-	-	F	Saloon Engine X 20 XEV	808003	Outer Joint		33	25	52	109	61	O					
1995.02-1998.01	AT/MT	L	F	Hatchback Engine X 20 XEV	621011	Inner Joint		34	25	35	78	64						
1995.02-1998.01	-	-	F	Estate Engine X 20 XEV	808003	Outer Joint		33	25	52	109	61	O					
1995.02-1998.01	-	-	F	Hatchback Engine X 20 XEV	808003	Outer Joint		33	25	52	109	61	O					
1995.02-1998.01	AT/MT	L/R	F	Hatchback Engine X 20 XEV	844056	Outer Joint	29T	33	25	52	109	61	O					
2.0 i 16V (110 kW)																		
1993.03-1998.01	MT	L/R	F	Estate Engine C 20 XE	644002	Inner Joint		34	25	35	56.2	85.6						
1993.03-1998.01	MT	L	F	Estate Engine C 20 XE	244011	Drive Shaft	29T	33	34	52	109	594.5						
1993.03-1998.01	AT/MT	L	F	Estate Engine C 20 XE	621011	Inner Joint		34	25	35	78	64						
1993.03-1998.01	-	-	F	Estate Engine C 20 XE	808003	Outer Joint		33	25	52	109	61	O					
1993.03-1998.01	MT	R	F	Estate Engine C 20 XE	244059	Drive Shaft	29T	33	34	52	109	938						
1993.03-1998.01	MT	L/R	F	Estate Engine C 20 XE	844056	Outer Joint	29T	33	25	52	109	61	O					
ASTRA F CLASSIC (T92)																		
1.4 i (44 kW)																		
1998.01-2005.01	-	-	F	Estate Engine X 14 NZ	844083	Outer Joint	29T	22	29	52.1	97.5	62.5	O					
1998.01-2002.08	-	-	F	Hatchback Engine X 14 NZ	844083	Outer Joint	29T	22	29	52.1	97.5	62.5	O					
1998.01-2002.08	-	-	F	Saloon Engine X 14 NZ	844083	Outer Joint	29T	22	29	52.1	97.5	62.5	O					
1.6 i (55 kW)																		
1998.01-2005.01	-	-	-	Estate Engine X 16 SZR	844068	Outer Joint	29T	22	30	52	94.5	55	I					
1998.01-2002.08	-	-	-	Hatchback Engine X 16 SZR	844068	Outer Joint	29T	22	30	52	94.5	55	I					
1998.01-2005.01	-	-	F	Estate Engine X 16 SZR	844083	Outer Joint	29T	22	29	52.1	97.5	62.5	O					
1998.01-2002.08	-	-	F	Hatchback Engine X 16 SZR	844083	Outer Joint	29T	22	29	52.1	97.5	62.5	O					
1998.01-2002.08	-	-	F	Saloon Engine X 16 SZR	844083	Outer Joint	29T	22	29	52.1	97.5	62.5	O					
1.6 i 16V (74 kW)																		
1998.01-2002.08	AT/MT	L/R	F	Saloon Engine X 16 XEL	644004	Inner Joint		22	22	34.95	57.5	72.5						
1998.01-2002.08	MT	L/R	F	Saloon Engine X 16 XEL	844007	Outer Joint	29T	22	22	52	94.5	50	O					
1998.01-2005.01	-	-	-	Estate Engine X 16 XEL	844068	Outer Joint	29T	22	30	52	94.5	55	I					
1998.01-2005.01	-	-	F	Estate Engine X 16 XEL	844083	Outer Joint	29T	22	29	52.1	97.5	62.5	O					
1998.01-2002.08	-	-	F	Hatchback Engine X 16 XEL	844083	Outer Joint	29T	22	29	52.1	97.5	62.5	O					
1998.01-2002.08	-	-	F	Saloon Engine X 16 XEL	844083	Outer Joint	29T	22	29	52.1	97.5	62.5	O					
ASTRA F CLASSIC, SW																		
1.4 i (44 kW)																		
1998-2004	-	-	-	ChP2732834	844060	Outer Joint	29T	22	22	52	98	51	O					
1.4 i (46 kW)																		
1998-2004	-	-	-	ChP2732834	844060	Outer Joint	29T	22	22	52	98	51	O					
1.7 TD (50 kW)																		
1998-2000	-	-	-	ChP8202126	844060	Outer Joint	29T	22	22	52	98	51	O					
2.0 i (100 kW)																		
1998-2000	-	-	-	ChP8202126	844060	Outer Joint	29T	22	22	52	98	51	O					
ASTRA F Van (T92)																		
1.4 i (44 kW)																		
1991.10-1999.01	-	-	F	Box Engine C 14 NZ	844023	Outer Joint		22	22	52	95	50	O					
1991.10-1999.01	MT	L	F	Box Engine C 14 NZ	244002	Drive Shaft	29T	22	22	52	95	585						
1991.10-1999.01	MT	L/R	F	Box Engine C 14 NZ	644004	Inner Joint		22	22	34.95	57.5	72.5						
1991.10-1999.01	MT	R	F	Box Engine C 14 NZ	260002	Drive Shaft	29T	22	22	52	95	926						
1991.10-1999.01	MT	L/R	F	Box Engine C 14 NZ	844007	Outer Joint	29T	22	22	52	94.5	50	O					
1991.10-1999.01	MT	L/R	F	Box Engine C 14 NZ	844051	Outer Joint	29T	22	22	52	95	50.5	O					
1.6 i (52 kW)																		
1993.02-1996.07	MT	L/R	F	Box Engine X 16 SZ	644004	Inner Joint		22	22	34.95	57.5	72.5						
1993.02-1996.07	-	-	F	Box Engine X 16 SZ	844023	Outer Joint		22	22	52	95	50	O					
1993.02-1996.07	AT/MT	L/R	F	Box Engine X 16 SZ	844007	Outer Joint	29T	22	22	52	94.5	50	O					
1.6 i (55 kW)																		
1991.10-1993.04	MT	L/R	F	Box Engine C 16 NZ	644004	Inner Joint		22	22	34.95	57.5	72.5						





	 YEAR	TRANSM	L/R	F/R	REMARKS	GSP Ref.	 PRODUCT	 ABS	Technical Specifications					
									A	B	C	H	L	P
OPEL														
ASTRA F Van (T92)														
1.6 i (55 kW)	1991.10-1993.04	MT	R	F	Box Engine C 16 NZ	650097	Inner Joint		39	35	30	409	90	
	1991.10-1993.04	-	-	F	Box Engine C 16 NZ	844023	Outer Joint		22	22	52	95	50	O
	1991.10-1993.04	MT	L/R	F	Box Engine C 16 NZ	844051	Outer Joint	29T	22	22	52	95	50.5	O
	1991.10-1993.04	MT	L	F	Box Engine C 16 NZ	244002	Drive Shaft	29T	22	22	52	95	585	
	1991.10-1993.04	MT	R	F	Box Engine C 16 NZ	250209	Drive Shaft		27	39	56.5	92	1014	
	1991.10-1993.04	MT	R	F	Box Engine C 16 NZ	250209	Drive Shaft		27	39	56.5	92	1014	
	1991.10-1993.04	MT	R	F	Box Engine C 16 NZ	260019	Drive Shaft		22	22	52	95	926	
1.6 i 16V (74 kW)	1991.10-1993.04	MT	R	F	Box Engine C 16 NZ	260002	Drive Shaft	29T	22	22	52	95	926	
	1994.08-1998.03	AT/MT	R	F	Box Engine X 16 XEL	650097	Inner Joint		39	35	30	409	90	
	1994.08-1998.03	-	-	F	Box Engine X 16 XEL	844023	Outer Joint		22	22	52	95	50	O
	1994.08-1998.03	AT/MT	R	F	Box Engine X 16 XEL	250209	Drive Shaft		27	39	56.5	92	1014	
	1994.08-1998.03	AT/MT	R	F	Box Engine X 16 XEL	250209	Drive Shaft		27	39	56.5	92	1014	
	1994.08-1998.03	AT/MT	R	F	Box Engine X 16 XEL	260019	Drive Shaft		22	22	52	95	926	
	1994.08-1998.03	MT	-	-	Box Engine X 16 XEL	844068	Outer Joint	29T	22	30	52	94.5	55	I
1.7 D (42 kW)	1991.12-1992.09	MT	L/R	F	Box Engine 17 D	644004	Inner Joint		22	22	34.95	57.5	72.5	
	1991.12-1992.09	-	-	F	Box Engine 17 D	844023	Outer Joint		22	22	52	95	50	O
	1991.12-1992.09	AT/MT	L/R	F	Box Engine 17 D	844056	Outer Joint	29T	33	25	52	109	61	O
1.7 D (44 kW)	1992.07-1999.01	MT	L/R	F	Box Engine 17 DR	644004	Inner Joint		22	22	34.95	57.5	72.5	
	1992.07-1999.01	-	-	F	Box Engine 17 DR	844023	Outer Joint		22	22	52	95	50	O
	1992.07-1999.01	AT/MT	L/R	F	Box Engine 17 DR	844056	Outer Joint	29T	33	25	52	109	61	O
	1992.07-1999.01	AT/MT	L/R	F	Box Engine 17 DR	844007	Outer Joint	29T	22	22	52	94.5	50	O
1.7 TD (50 kW)	1994.08-1999.01	AT/MT	L/R	F	Box Engine X 17 DTL	844056	Outer Joint	29T	33	25	52	109	61	O
	1994.08-1999.01	AT/MT	L/R	F	Box Engine X 17 DTL	621011	Inner Joint		34	25	35	78	64	
	1994.08-1999.01	-	-	F	Box Engine X 17 DTL	808003	Outer Joint		33	25	52	109	61	O
1.7 TD (60 kW)	1995.03-1998.02	-	L	F	Box Engine X 17 DT (TC4EE1)	244014	Drive Shaft	43T	33	34	52	103.5	587	
	1995.03-1998.02	-	R	F	Box Engine X 17 DT (TC4EE1)	244048	Drive Shaft		33	34	52	109	938	
	1995.03-1998.02	-	-	F	Box Engine X 17 DT (TC4EE1)	808003	Outer Joint		33	25	52	109	61	O
ASTRA G														
2.2 DTi (86 kW)	2002.09-2005.01	-	-	-	-	699188	Inner Joint		27	35	35	101	88.5	
2.2 DTi (92 kW)	2002.09-2005.01	-	-	-	-	699188	Inner Joint		27	35	35	101	88.5	
ASTRA G (F70)														
1.6 (55 kW)	1999.01-2000.09	-	L/R	F	Box Engine X 16 SZR	644004	Inner Joint		22	22	34.95	57.5	72.5	
	1999.01-2000.09	MT	L	F	Box Engine X 16 SZR	260013	Drive Shaft		33	22	52	103	595	
	1999.01-2000.09	MT	R	F	Box Engine X 16 SZR	244033	Drive Shaft		33	22	52	103	950.5	
	1999.01-2000.09	MT	L	F	Box Engine X 16 SZR	621014	Inner Joint		22	22	35	57.5	75	
	1999.01-2000.09	AT/MT	L/R	F	Box Engine X 16 SZR	844030	Outer Joint		33	22	52	103	50.5	O
1.6 (62 kW)	2000.09-2005.04	MT	L	F	Box Engine Z 16 SE	260013	Drive Shaft		33	22	52	103	595	
	2000.09-2005.04	-	-	F	Box Engine Z 16 SE	844010	Outer Joint	29T	33	22	52	103	50.5	O
	2000.09-2005.04	MT	R	F	Box Engine Z 16 SE	244033	Drive Shaft		33	22	52	103	950.5	
	2000.09-2005.04	-	L/R	F	Box Engine Z 16 SE	644004	Inner Joint		22	22	34.95	57.5	72.5	
	2000.09-2005.04	MT	L	F	Box Engine Z 16 SE	621014	Inner Joint		22	22	35	57.5	75	
	2000.09-2005.04	AT/MT	L/R	F	Box Engine Z 16 SE	844030	Outer Joint		33	22	52	103	50.5	O
1.7 DTi 16V (55 kW)	2000.02-2005.04	-	R	F	Box Engine Y 17 DT	260035	Drive Shaft		33	22	52	109	961	
	2000.02-2005.04	-	R	F	Box Engine Y 17 DT	699026	Inner Joint		22	25	35	57	82.5	
1.7 TD (50 kW)	1999.01-2005.04	MT	L	F	Box Engine X 17 DTL	260013	Drive Shaft		33	22	52	103	595	
	1999.01-2005.04	MT	R	F	Box Engine X 17 DTL	244033	Drive Shaft		33	22	52	103	950.5	
	1999.01-2005.04	-	L/R	F	Box Engine X 17 DTL	644004	Inner Joint		22	22	34.95	57.5	72.5	
	1999.01-2005.04	MT	L	F	Box Engine X 17 DTL	621014	Inner Joint		22	22	35	57.5	75	
	1999.01-2005.04	AT/MT	L/R	F	Box Engine X 17 DTL	844030	Outer Joint		33	22	52	103	50.5	O
2.0 DI (60 kW)	1999.01-2005.04	-	L	F	Box Engine X 20 DTL	244044	Drive Shaft		33	34	52	103.5	595	
	1999.01-2005.04	MT	L/R	F	Box Engine X 20 DTL	621011	Inner Joint		34	25	35	78	64	
	1999.01-2005.04	-	L/R	F	Box Engine X 20 DTL	644002	Inner Joint		34	25	35	56.2	85.6	
	1999.01-2005.04	-	L/R	F	Box Engine X 20 DTL	844006	Outer Joint	29T	33	25	52	103.5	61	O
	1999.01-2005.04	-	-	F	Box Engine X 20 DTL	844049	Outer Joint		33	25	52	109	61	O
ASTRA G (T98)														
1.2 16V (48 kW)	1998.02-2000.09	-	-	F	Hatchback Engine X 12 XE	844012	Outer Joint		33	28	52	104	54.5	O
	1998.02-2000.09	-	-	F	Estate Engine X 12 XE	844012	Outer Joint		33	28	52	104	54.5	O
	1998.09-2000.09	-	-	F	Saloon Engine X 12 XE	844012	Outer Joint		33	28	52	104	54.5	O
1.2 16V (55 kW)	2000.09-2005.01	-	-	F	Hatchback Engine Z 12 XE	844012	Outer Joint		33	28	52	104	54.5	O
	2000.09-2005.01	-	-	F	Saloon Engine Z 12 XE	844012	Outer Joint		33	28	52	104	54.5	O
	2000.09-2004.07	-	-	F	Estate Engine Z 12 XE	844012	Outer Joint		33	28	52	104	54.5	O
1.4 (66 kW)	2004.10-2009.12	-	L/R	F	Estate Engine Z 14 XEP	644004	Inner Joint		22	22	34.95	57.5	72.5	
	2004.10-2009.12	-	L	F	Estate Engine Z 14 XEP	260013	Drive Shaft		33	22	52	103	595	
	2004.10-2009.12	-	R	F	Estate Engine Z 14 XEP	244033	Drive Shaft		33	22	52	103	950.5	
	2004.10-2009.12	-	L	F	Estate Engine Z 14 XEP	621014	Inner Joint		22	22	35	57.5	75	





	 YEAR	TRANSM	L/R	F/R	REMARKS	GSP Ref.	 PRODUCT	 ABS	Technical Specifications					
									A	B	C	H	L	P
OPEL														
ASTRA G (T98)														
1.4 (66 kW)	2007.09-2009.12	-	L/R	F	Hatchback Engine Z 14 XEP	644004	Inner Joint		22	22	34.95	57.5	72.5	
	2007.09-2009.12	5MT	L/R	F	Saloon Engine Z 14 XEP	644004	Inner Joint		22	22	34.95	57.5	72.5	
	2007.09-2009.12	-	L	F	Hatchback Engine Z 14 XEP	260013	Drive Shaft		33	22	52	103	595	
	2007.09-2009.12	5MT	L	F	Saloon Engine Z 14 XEP	260013	Drive Shaft		33	22	52	103	595	
	2007.09-2009.12	-	R	F	Hatchback Engine Z 14 XEP	244033	Drive Shaft		33	22	52	103	950.5	
	2007.09-2009.12	5MT	R	F	Saloon Engine Z 14 XEP	244033	Drive Shaft		33	22	52	103	950.5	
	2007.09-2009.12	-	L	F	Hatchback Engine Z 14 XEP	621014	Inner Joint		22	22	35	57.5	75	
1.4 16V (66 kW)	2007.09-2009.12	5MT	L	F	Saloon Engine Z 14 XEP	621014	Inner Joint		22	22	35	57.5	75	
	1998.02-2005.01	-	L/R	F	Hatchback Engine Z 14 XE/X 14 XE	644004	Inner Joint		22	22	34.95	57.5	72.5	
	1998.02-2005.01	MT	L	F	Hatchback Engine Z 14 XE/X 14 XE	260013	Drive Shaft		33	22	52	103	595	
	1998.02-2005.01	MT	R	F	Hatchback Engine Z 14 XE/X 14 XE	244033	Drive Shaft		33	22	52	103	950.5	
	1998.02-2005.01	MT	L	F	Hatchback Engine Z 14 XE/X 14 XE	621014	Inner Joint		22	22	35	57.5	75	
	1998.02-2005.01	AT/MT	L/R	F	Hatchback Engine Z 14 XE/X 14 XE	844030	Outer Joint		33	22	52	103	50.5	O
	1998.06-2004.07	-	L/R	F	Estate Engine X 14 XE/Z 14 XE	644004	Inner Joint		22	22	34.95	57.5	72.5	
	1998.06-2004.07	MT	L	F	Estate Engine X 14 XE/Z 14 XE	260013	Drive Shaft		33	22	52	103	595	
	1998.06-2004.07	MT	R	F	Estate Engine X 14 XE/Z 14 XE	244033	Drive Shaft		33	22	52	103	950.5	
	1998.06-2004.07	MT	L	F	Estate Engine X 14 XE/Z 14 XE	621014	Inner Joint		22	22	35	57.5	75	
	1998.06-2004.07	AT/MT	L/R	F	Estate Engine X 14 XE/Z 14 XE	844030	Outer Joint		33	22	52	103	50.5	O
	1998.09-2005.01	-	L/R	F	Saloon Engine X 14 XE/Z 14 XE	644004	Inner Joint		22	22	34.95	57.5	72.5	
	1998.09-2005.01	MT	L	F	Saloon Engine X 14 XE/Z 14 XE	260013	Drive Shaft		33	22	52	103	595	
	1998.09-2005.01	MT	R	F	Saloon Engine X 14 XE/Z 14 XE	244033	Drive Shaft		33	22	52	103	950.5	
1998.09-2005.01	MT	L	F	Saloon Engine X 14 XE/Z 14 XE	621014	Inner Joint		22	22	35	57.5	75		
1998.09-2005.01	AT/MT	L/R	F	Saloon Engine X 14 XE/Z 14 XE	844030	Outer Joint		33	22	52	103	50.5	O	
1.6 (55 kW)	1998.02-2000.09	-	L/R	F	Hatchback Engine X 16 SZR	644004	Inner Joint		22	22	34.95	57.5	72.5	
	1998.02-2000.09	-	L/R	F	Estate Engine X 16 SZR	644004	Inner Joint		22	22	34.95	57.5	72.5	
	1998.02-2000.09	MT	L	F	Hatchback Engine X 16 SZR	260013	Drive Shaft		33	22	52	103	595	
	1998.02-2000.09	MT	L	F	Estate Engine X 16 SZR	260013	Drive Shaft		33	22	52	103	595	
	1998.02-2000.09	MT	R	F	Hatchback Engine X 16 SZR	244033	Drive Shaft		33	22	52	103	950.5	
	1998.02-2000.09	MT	R	F	Estate Engine X 16 SZR	244033	Drive Shaft		33	22	52	103	950.5	
	1998.02-2000.09	MT	L	F	Hatchback Engine X 16 SZR	621014	Inner Joint		22	22	35	57.5	75	
	1998.02-2000.09	MT	L	F	Estate Engine X 16 SZR	621014	Inner Joint		22	22	35	57.5	75	
	1998.02-2000.09	AT/MT	L/R	F	Hatchback Engine X 16 SZR	844030	Outer Joint		33	22	52	103	50.5	O
	1998.02-2000.09	AT/MT	L/R	F	Estate Engine X 16 SZR	844030	Outer Joint		33	22	52	103	50.5	O
	1998.09-2000.09	-	L/R	F	Saloon Engine X 16 SZR	644004	Inner Joint		22	22	34.95	57.5	72.5	
	1998.09-2000.09	MT	L	F	Saloon Engine X 16 SZR	260013	Drive Shaft		33	22	52	103	595	
	1998.09-2000.09	MT	R	F	Saloon Engine X 16 SZR	244033	Drive Shaft		33	22	52	103	950.5	
	1998.09-2000.09	MT	L	F	Saloon Engine X 16 SZR	621014	Inner Joint		22	22	35	57.5	75	
	1998.09-2000.09	AT/MT	L/R	F	Saloon Engine X 16 SZR	844030	Outer Joint		33	22	52	103	50.5	O
	1.6 (62 kW)	2000.09-2005.01	-	L/R	F	Hatchback Engine Z 16 SE	644004	Inner Joint		22	22	34.95	57.5	72.5
2000.09-2005.01		-	L/R	F	Saloon Engine Z 16 SE	644004	Inner Joint		22	22	34.95	57.5	72.5	
2000.09-2004.07		-	L/R	F	Estate Engine Z 16 SE	644004	Inner Joint		22	22	34.95	57.5	72.5	
2000.09-2005.01		MT	L	F	Hatchback Engine Z 16 SE	260013	Drive Shaft		33	22	52	103	595	
2000.09-2005.01		MT	L	F	Saloon Engine Z 16 SE	260013	Drive Shaft		33	22	52	103	595	
2000.09-2004.07		MT	L	F	Estate Engine Z 16 SE	260013	Drive Shaft		33	22	52	103	595	
2000.09-2005.01		-	-	F	Hatchback Engine Z 16 SE	844010	Outer Joint	29T	33	22	52	103	50.5	O
2000.09-2005.01		-	-	F	Saloon Engine Z 16 SE	844010	Outer Joint	29T	33	22	52	103	50.5	O
2000.09-2004.07		-	-	F	Estate Engine Z 16 SE	844010	Outer Joint	29T	33	22	52	103	50.5	O
2000.09-2005.01		MT	R	F	Hatchback Engine Z 16 SE	244033	Drive Shaft		33	22	52	103	950.5	
2000.09-2005.01		MT	R	F	Saloon Engine Z 16 SE	244033	Drive Shaft		33	22	52	103	950.5	
2000.09-2004.07		MT	R	F	Estate Engine Z 16 SE	244033	Drive Shaft		33	22	52	103	950.5	
2000.09-2005.01		MT	L	F	Hatchback Engine Z 16 SE	621014	Inner Joint		22	22	35	57.5	75	
2000.09-2005.01		MT	L	F	Saloon Engine Z 16 SE	621014	Inner Joint		22	22	35	57.5	75	
2000.09-2004.07		MT	L	F	Estate Engine Z 16 SE	621014	Inner Joint		22	22	35	57.5	75	
2000.09-2005.01		AT/MT	L/R	F	Hatchback Engine Z 16 SE	844030	Outer Joint		33	22	52	103	50.5	O
2000.09-2005.01		AT/MT	L/R	F	Saloon Engine Z 16 SE	844030	Outer Joint		33	22	52	103	50.5	O
2000.09-2004.07		AT/MT	L/R	F	Estate Engine Z 16 SE	844030	Outer Joint		33	22	52	103	50.5	O
1.6 (76 kW)		2002.12-2009.07	MT	L	F	Estate Engine Z 16 XEP	260013	Drive Shaft		33	22	52	103	595
	2002.12-2009.12	MT	L	F	Saloon Engine Z 16 XEP	260013	Drive Shaft		33	22	52	103	595	
	2002.12-2009.12	MT	L	F	Hatchback Engine Z 16 XEP	260013	Drive Shaft		33	22	52	103	595	
	2002.12-2009.12	-	-	F	Hatchback Engine Z 16 XEP	844010	Outer Joint	29T	33	22	52	103	50.5	O
	2002.12-2009.12	-	-	F	Saloon Engine Z 16 XEP	844010	Outer Joint	29T	33	22	52	103	50.5	O
	2002.12-2009.07	-	-	F	Estate Engine Z 16 XEP	844010	Outer Joint	29T	33	22	52	103	50.5	O
	2002.12-2009.07	MT	R	F	Estate Engine Z 16 XEP	244033	Drive Shaft		33	22	52	103	950.5	
	2002.12-2009.12	MT	R	F	Saloon Engine Z 16 XEP	244033	Drive Shaft		33	22	52	103	950.5	
	2002.12-2009.12	MT	R	F	Hatchback Engine Z 16 XEP	244033	Drive Shaft		33	22	52	103	950.5	
	2002.12-2009.07	-	L/R	F	Estate Engine Z 16 XEP	644004	Inner Joint		22	22	34.95	57.5	72.5	

YEAR	TRANSM	L/R	F/R	REMARKS	GSP Ref.	PRODUCT	ABS	Technical Specifications										
								A	B	C	H	L	P					
OPEL																		
ASTRA G (T98)																		
1.6 (76 kW)	2002.12-2009.12	-	L/R	F	Saloon Engine Z 16 XEP	644004	Inner Joint		22	22	34.95	57.5	72.5					
	2002.12-2009.12	-	L/R	F	Hatchback Engine Z 16 XEP	644004	Inner Joint		22	22	34.95	57.5	72.5					
	2002.12-2009.07	MT	L	F	Estate Engine Z 16 XEP	621014	Inner Joint		22	22	35	57.5	75					
	2002.12-2009.12	MT	L	F	Saloon Engine Z 16 XEP	621014	Inner Joint		22	22	35	57.5	75					
	2002.12-2009.12	MT	L	F	Hatchback Engine Z 16 XEP	621014	Inner Joint		22	22	35	57.5	75					
	2002.12-2009.07	AT/MT	L/R	F	Estate Engine Z 16 XEP	844030	Outer Joint		33	22	52	103	50.5	O				
	2002.12-2009.12	AT/MT	L/R	F	Saloon Engine Z 16 XEP	844030	Outer Joint		33	22	52	103	50.5	O				
	2002.12-2009.12	AT/MT	L/R	F	Hatchback Engine Z 16 XEP	844030	Outer Joint		33	22	52	103	50.5	O				
	2003.01-2005.10	MT	L	F	Convertible Engine Z 16 XEP	260013	Drive Shaft		33	22	52	103	595					
	2003.01-2005.10	MT	R	F	Convertible Engine Z 16 XEP	244033	Drive Shaft		33	22	52	103	950.5					
	2003.01-2005.10	-	-	F	Convertible Engine Z 16 XEP	844010	Outer Joint	29T	33	22	52	103	50.5	O				
	2003.01-2005.10	-	L/R	F	Convertible Engine Z 16 XEP	644004	Inner Joint		22	22	34.95	57.5	72.5					
	2003.01-2005.10	MT	L	F	Convertible Engine Z 16 XEP	621014	Inner Joint		22	22	35	57.5	75					
	2003.01-2005.10	AT/MT	L/R	F	Convertible Engine Z 16 XEP	844030	Outer Joint		33	22	52	103	50.5	O				
1.6 16V (74 kW)	1998.02-2005.01	-	L/R	F	Hatchback Engine Z 16 XE/X 16 XEL/C 16 SEL	644004	Inner Joint		22	22	34.95	57.5	72.5					
	1998.02-2004.07	-	L/R	F	Estate Engine Z 16 XE/X 16 XEL	644004	Inner Joint		22	22	34.95	57.5	72.5					
	1998.02-2005.01	MT	L	F	Hatchback Engine Z 16 XE/X 16 XEL/C 16 SEL	260013	Drive Shaft		33	22	52	103	595					
	1998.02-2004.07	MT	L	F	Estate Engine Z 16 XE/X 16 XEL	260013	Drive Shaft		33	22	52	103	595					
	1998.02-2005.01	MT	R	F	Hatchback Engine Z 16 XE/X 16 XEL/C 16 SEL	244033	Drive Shaft		33	22	52	103	950.5					
	1998.02-2004.07	MT	R	F	Estate Engine Z 16 XE/X 16 XEL	244033	Drive Shaft		33	22	52	103	950.5					
	1998.02-2005.01	MT	L	F	Hatchback Engine Z 16 XE/X 16 XEL/C 16 SEL	621014	Inner Joint		22	22	35	57.5	75					
	1998.02-2005.01	AT	-	F	Hatchback Engine Z 16 XE/X 16 XEL/C 16 SEL	844049	Outer Joint		33	25	52	109	61	O				
	1998.02-2004.07	AT	-	F	Estate Engine Z 16 XE/X 16 XEL	844049	Outer Joint		33	25	52	109	61	O				
	1998.02-2004.07	MT	L	F	Estate Engine Z 16 XE/X 16 XEL	621014	Inner Joint		22	22	35	57.5	75					
	1998.02-2005.01	AT/MT	L/R	F	Hatchback Engine Z 16 XE/X 16 XEL/C 16 SEL	844030	Outer Joint		33	22	52	103	50.5	O				
	1998.02-2004.07	AT/MT	L/R	F	Estate Engine Z 16 XE/X 16 XEL	844030	Outer Joint		33	22	52	103	50.5	O				
	1998.09-2005.01	-	L/R	F	Saloon Engine Z 16 XE/X 16 XEL	644004	Inner Joint		22	22	34.95	57.5	72.5					
	1998.09-2005.01	MT	L	F	Saloon Engine Z 16 XE/X 16 XEL	260013	Drive Shaft		33	22	52	103	595					
	1998.09-2005.01	MT	R	F	Saloon Engine Z 16 XE/X 16 XEL	244033	Drive Shaft		33	22	52	103	950.5					
	1998.09-2005.01	MT	L	F	Saloon Engine Z 16 XE/X 16 XEL	621014	Inner Joint		22	22	35	57.5	75					
	1998.09-2005.01	AT/MT	L/R	F	Saloon Engine Z 16 XE/X 16 XEL	844030	Outer Joint		33	22	52	103	50.5	O				
	2000.03-2005.05	-	-	F	Coupe Engine Z 16 XE	844010	Outer Joint	29T	33	22	52	103	50.5	O				
	2000.03-2005.05	-	L	F	Coupe Engine Z 16 XE	260013	Drive Shaft		33	22	52	103	595					
	2000.03-2005.05	-	R	F	Coupe Engine Z 16 XE	244033	Drive Shaft		33	22	52	103	950.5					
	2000.03-2005.05	-	L	F	Coupe Engine Z 16 XE	621014	Inner Joint		22	22	35	57.5	75					
	2001.03-2005.10	MT	L	F	Convertible Engine Z 16 XE	260013	Drive Shaft		33	22	52	103	595					
	2001.03-2005.10	-	-	F	Convertible Engine Z 16 XE	844010	Outer Joint	29T	33	22	52	103	50.5	O				
	2001.03-2005.10	MT	R	F	Convertible Engine Z 16 XE	244033	Drive Shaft		33	22	52	103	950.5					
	2001.03-2005.10	-	L/R	F	Convertible Engine Z 16 XE	644004	Inner Joint		22	22	34.95	57.5	72.5					
	2001.03-2005.10	MT	L	F	Convertible Engine Z 16 XE	621014	Inner Joint		22	22	35	57.5	75					
	2001.03-2005.10	AT/MT	L/R	F	Convertible Engine Z 16 XE	844030	Outer Joint		33	22	52	103	50.5	O				
1.6 16V (76 kW)	2000.03-2005.05	MT	L	F	Coupe Engine Z 16 XEP	260013	Drive Shaft		33	22	52	103	595					
	2000.03-2005.05	MT	R	F	Coupe Engine Z 16 XEP	244033	Drive Shaft		33	22	52	103	950.5					
	2000.03-2005.05	-	L/R	F	Coupe Engine Z 16 XEP	644004	Inner Joint		22	22	34.95	57.5	72.5					
	2000.03-2005.05	MT	L	F	Coupe Engine Z 16 XEP	621014	Inner Joint		22	22	35	57.5	75					
	2000.03-2005.05	AT/MT	L/R	F	Coupe Engine Z 16 XEP	844030	Outer Joint		33	22	52	103	50.5	O				
1.6 CNG (71 kW)	2003.03-2004.07	MT	R	F	Estate Engine Z 16 YNG	699026	Inner Joint		22	25	35	57	82.5					
	2003.03-2004.07	-	L/R	F	Estate Engine Z 16 YNG	644004	Inner Joint		22	22	34.95	57.5	72.5					
	2003.03-2004.07	-	L	F	Estate Engine Z 16 YNG	260013	Drive Shaft		33	22	52	103	595					
	2003.03-2004.07	-	R	F	Estate Engine Z 16 YNG	244033	Drive Shaft		33	22	52	103	950.5					
	2003.03-2004.07	MT	R	F	Estate Engine Z 16 YNG	260035	Drive Shaft		33	22	52	109	961					
	2003.03-2004.07	-	L	F	Estate Engine Z 16 YNG	621014	Inner Joint		22	22	35	57.5	75					
1.6 LPG (74 kW)	2002.06-2005.01	-	L/R	F	Saloon Engine Z 16 XE	644004	Inner Joint		22	22	34.95	57.5	72.5					
	2002.06-2005.01	-	L/R	F	Hatchback Engine Z 16 XE	644004	Inner Joint		22	22	34.95	57.5	72.5					
	2002.06-2005.01	AT/MT	L	F	Saloon Engine Z 16 XE	260013	Drive Shaft		33	22	52	103	595					
	2002.06-2005.01	AT/MT	L	F	Hatchback Engine Z 16 XE	260013	Drive Shaft		33	22	52	103	595					
	2002.06-2005.01	-	-	F	Saloon Engine Z 16 XE	844010	Outer Joint	29T	33	22	52	103	50.5	O				
	2002.06-2005.01	-	-	F	Hatchback Engine Z 16 XE	844010	Outer Joint	29T	33	22	52	103	50.5	O				
	2002.06-2005.01	AT/MT	R	F	Saloon Engine Z 16 XE	244033	Drive Shaft		33	22	52	103	950.5					
	2002.06-2005.01	AT/MT	R	F	Hatchback Engine Z 16 XE	244033	Drive Shaft		33	22	52	103	950.5					
	2002.06-2005.01	AT/MT	L	F	Saloon Engine Z 16 XE	621014	Inner Joint		22	22	35	57.5	75					
	2002.06-2005.01	AT/MT	L	F	Hatchback Engine Z 16 XE	621014	Inner Joint		22	22	35	57.5	75					
1.7 CDTI (59 kW)	2003.04-2009.07	MT	R	F	Estate Engine Z 17 DTL	699026	Inner Joint		22	25	35	57	82.5					
	2003.04-2009.12	MT	R	F	Hatchback Engine Z 17 DTL	699026	Inner Joint		22	25	35	57	82.5					
	2003.04-2009.12	MT	R	F	Saloon Engine Z 17 DTL	699026	Inner Joint		22	25	35	57	82.5					
	2003.04-2009.12	-	-	F	Hatchback Engine Z 17 DTL	844049	Outer Joint		33	25	52	109	61	O				

	 YEAR	TRANSM	L/R	F/R	REMARKS	GSP Ref.	 PRODUCT	 ABS	Technical Specifications					
									A	B	C	H	L	P
OPEL														
ASTRA G (T98)														
1.7 CDTI (59 kW)	2003.04-2009.12	-	-	F	Saloon Engine Z 17 DTL	844049	Outer Joint		33	25	52	109	61	O
	2003.04-2009.07	-	-	F	Estate Engine Z 17 DTL	844049	Outer Joint		33	25	52	109	61	O
	2003.04-2009.07	-	L/R	F	Estate Engine Z 17 DTL	644004	Inner Joint		22	22	34.95	57.5	72.5	
	2003.04-2009.12	-	L/R	F	Hatchback Engine Z 17 DTL	644004	Inner Joint		22	22	34.95	57.5	72.5	
	2003.04-2009.12	-	L/R	F	Saloon Engine Z 17 DTL	644004	Inner Joint		22	22	34.95	57.5	72.5	
	2003.04-2009.07	MT	R	F	Estate Engine Z 17 DTL	260035	Drive Shaft		33	22	52	109	961	
	2003.04-2009.12	MT	R	F	Hatchback Engine Z 17 DTL	260035	Drive Shaft		33	22	52	109	961	
1.7 DTI 16V (55 kW)	2000.02-2005.01	MT	R	F	Hatchback Engine Y 17 DT	699026	Inner Joint		22	25	35	57	82.5	
	2000.02-2004.07	MT	R	F	Estate Engine Y 17 DT	699026	Inner Joint		22	25	35	57	82.5	
	2000.02-2005.01	MT	R	F	Saloon Engine Y 17 DT	260035	Drive Shaft		33	22	52	109	961	
	2000.02-2004.07	-	-	F	Estate Engine Y 17 DT	844049	Outer Joint		33	25	52	109	61	O
	2000.02-2005.01	MT	R	F	Hatchback Engine Y 17 DT	260035	Drive Shaft		33	22	52	109	961	
	2000.02-2004.07	MT	R	F	Estate Engine Y 17 DT	260035	Drive Shaft		33	22	52	109	961	
	2000.02-2005.01	-	-	F	Hatchback Engine Y 17 DT	844049	Outer Joint		33	25	52	109	61	O
1.7 TD (50 kW)	2000.02-2005.01	-	-	F	Saloon Engine Y 17 DT	844049	Outer Joint		33	25	52	109	61	O
	2000.02-2005.01	MT	R	F	Saloon Engine Y 17 DT	699026	Inner Joint		22	25	35	57	82.5	
	1998.02-2000.08	-	L/R	F	Hatchback Engine X 17 DTL	644004	Inner Joint		22	22	34.95	57.5	72.5	
	1998.02-2000.08	-	L/R	F	Estate Engine X 17 DTL	644004	Inner Joint		22	22	34.95	57.5	72.5	
	1998.02-2000.08	MT	L	F	Hatchback Engine X 17 DTL	260013	Drive Shaft		33	22	52	103	595	
	1998.02-2000.08	MT	L	F	Estate Engine X 17 DTL	260013	Drive Shaft		33	22	52	103	595	
	1998.02-2000.08	MT	R	F	Hatchback Engine X 17 DTL	244033	Drive Shaft		33	22	52	103	950.5	
1.8 16V (85 kW)	1998.02-2000.08	MT	R	F	Estate Engine X 17 DTL	244033	Drive Shaft		33	22	52	103	950.5	
	1998.02-2000.08	MT	L	F	Hatchback Engine X 17 DTL	621014	Inner Joint		22	22	35	57.5	75	
	1998.02-2000.08	MT	L	F	Estate Engine X 17 DTL	621014	Inner Joint		22	22	35	57.5	75	
	1998.02-2000.08	AT/MT	L/R	F	Hatchback Engine X 17 DTL	844030	Outer Joint		33	22	52	103	50.5	O
	1998.02-2000.08	AT/MT	L/R	F	Estate Engine X 17 DTL	844030	Outer Joint		33	22	52	103	50.5	O
	1998.09-2000.08	-	L/R	F	Saloon Engine X 17 DTL	644004	Inner Joint		22	22	34.95	57.5	72.5	
	1998.09-2000.08	MT	L	F	Saloon Engine X 17 DTL	260013	Drive Shaft		33	22	52	103	595	
	1998.09-2000.08	MT	R	F	Saloon Engine X 17 DTL	244033	Drive Shaft		33	22	52	103	950.5	
	1998.09-2000.08	MT	L	F	Saloon Engine X 17 DTL	621014	Inner Joint		22	22	35	57.5	75	
	1998.09-2000.08	AT/MT	L/R	F	Saloon Engine X 17 DTL	844030	Outer Joint		33	22	52	103	50.5	O
	1998.02-2000.09	MT	R	F	Hatchback Engine X 18 XE1	699026	Inner Joint		22	25	35	57	82.5	
	1998.02-2000.09	MT	R	F	Estate Engine X 18 XE1	699026	Inner Joint		22	25	35	57	82.5	
	1.8 16V (92 kW)	1998.02-2000.09	AT/MT	L/R	F	Hatchback Engine X 18 XE1	844006	Outer Joint	29T	33	25	52	103.5	61
1998.02-2000.09		AT/MT	L/R	F	Estate Engine X 18 XE1	844006	Outer Joint	29T	33	25	52	103.5	61	O
1998.02-2000.09		MT	R	F	Hatchback Engine X 18 XE1	260035	Drive Shaft		33	22	52	109	961	
1998.02-2000.09		-	-	F	Hatchback Engine X 18 XE1	844049	Outer Joint		33	25	52	109	61	O
1998.02-2000.09		MT	R	F	Estate Engine X 18 XE1	260035	Drive Shaft		33	22	52	109	961	
1998.02-2000.09		-	-	F	Estate Engine X 18 XE1	844049	Outer Joint		33	25	52	109	61	O
1998.09-2000.09		MT	R	F	Saloon Engine X 18 XE1	699026	Inner Joint		22	25	35	57	82.5	
1998.09-2000.09		AT/MT	L/R	F	Saloon Engine X 18 XE1	844006	Outer Joint	29T	33	25	52	103.5	61	O
1998.09-2000.09		MT	R	F	Saloon Engine X 18 XE1	260035	Drive Shaft		33	22	52	109	961	
1998.09-2000.09		-	-	F	Saloon Engine X 18 XE1	844049	Outer Joint		33	25	52	109	61	O
2000.03-2000.10		MT	R	F	Coupe Engine X 18 XE1	699026	Inner Joint		22	25	35	57	82.5	
2000.03-2000.10		AT/MT	L/R	F	Coupe Engine X 18 XE1	844006	Outer Joint	29T	33	25	52	103.5	61	O
2000.03-2000.10		MT	R	F	Coupe Engine X 18 XE1	260035	Drive Shaft		33	22	52	109	961	
2000.03-2000.10	-	-	F	Coupe Engine X 18 XE1	844049	Outer Joint		33	25	52	109	61	O	
2.0 16V (100 kW)	2000.06-2005.01	MT	R	F	Saloon Engine Z 18 XE	699026	Inner Joint		22	25	35	57	82.5	
	2000.06-2005.01	MT	R	F	Saloon Engine Z 18 XE	260035	Drive Shaft		33	22	52	109	961	
	2000.06-2005.01	-	-	F	Saloon Engine Z 18 XE	844049	Outer Joint		33	25	52	109	61	O
	2000.09-2005.05	MT	R	F	Coupe Engine Z 18 XE	699026	Inner Joint		22	25	35	57	82.5	
	2000.09-2005.01	MT	R	F	Hatchback Engine Z 18 XE	699026	Inner Joint		22	25	35	57	82.5	
	2000.09-2004.07	MT	R	F	Estate Engine Z 18 XE	699026	Inner Joint		22	25	35	57	82.5	
	2000.09-2005.05	MT	R	F	Coupe Engine Z 18 XE	260035	Drive Shaft		33	22	52	109	961	
	2000.09-2005.01	MT	R	F	Hatchback Engine Z 18 XE	260035	Drive Shaft		33	22	52	109	961	
	2000.09-2004.07	MT	R	F	Estate Engine Z 18 XE	260035	Drive Shaft		33	22	52	109	961	
	2000.09-2005.05	-	-	F	Coupe Engine Z 18 XE	844049	Outer Joint		33	25	52	109	61	O
	2000.09-2005.01	-	-	F	Hatchback Engine Z 18 XE	844049	Outer Joint		33	25	52	109	61	O
	2000.09-2004.07	-	-	F	Estate Engine Z 18 XE	844049	Outer Joint		33	25	52	109	61	O
	2001.03-2005.10	MT	R	F	Convertible Engine Z 18 XE	699026	Inner Joint		22	25	35	57	82.5	
2001.03-2005.10	MT	R	F	Convertible Engine Z 18 XE	260035	Drive Shaft		33	22	52	109	961		
2001.03-2005.10	-	-	F	Convertible Engine Z 18 XE	844049	Outer Joint		33	25	52	109	61	O	
2.0 16V (100 kW)	1998.02-2005.01	MT	L/R	F	Hatchback Engine X 20 XEV/C 20 SEL	621011	Inner Joint		34	25	35	78	64	
	1998.02-2004.07	MT	L/R	F	Estate Engine X 20 XEV	621011	Inner Joint		34	25	35	78	64	
	1998.02-2005.01	AT/MT	L/R	F	Hatchback Engine X 20 XEV/C 20 SEL	844006	Outer Joint	29T	33	25	52	103.5	61	O





	 YEAR	TRANSM	L/R	F/R	REMARKS	GSP Ref.	 PRODUCT	 ABS	Technical Specifications					
									A	B	C	H	L	P
OPEL														
ASTRA G (T98)														
2.0 16V (100 kW)	1998.02-2004.07	-	L/R	F	Estate Engine X 20 XEV	644002	Inner Joint		34	25	35	56.2	85.6	
	1998.02-2004.07	AT/MT	L/R	F	Estate Engine X 20 XEV	844006	Outer Joint	29T	33	25	52	103.5	61	O
	1998.02-2005.01	-	L/R	F	Hatchback Engine X 20 XEV/C 20 SEL	644002	Inner Joint		34	25	35	56.2	85.6	
	1998.02-2005.01	-	-	F	Hatchback Engine X 20 XEV/C 20 SEL	844049	Outer Joint		33	25	52	109	61	O
	1998.02-2004.07	-	-	F	Estate Engine X 20 XEV	844049	Outer Joint		33	25	52	109	61	O
	1998.02-2005.01	-	L	F	Hatchback Engine X 20 XEV/C 20 SEL	244044	Drive Shaft		33	34	52	103.5	595	
	1998.02-2004.07	-	L	F	Estate Engine X 20 XEV	244044	Drive Shaft		33	34	52	103.5	595	
	1998.09-2005.01	MT	L/R	F	Saloon Engine X 20 XEV	621011	Inner Joint		34	25	35	78	64	
	1998.09-2005.01	-	L/R	F	Saloon Engine X 20 XEV	644002	Inner Joint		34	25	35	56.2	85.6	
	1998.09-2005.01	AT/MT	L/R	F	Saloon Engine X 20 XEV	844006	Outer Joint	29T	33	25	52	103.5	61	O
	1998.09-2005.01	-	-	F	Saloon Engine X 20 XEV	844049	Outer Joint		33	25	52	109	61	O
1998.09-2005.01	-	L	F	Saloon Engine X 20 XEV	244044	Drive Shaft		33	34	52	103.5	595		
2.0 16V OPC (118 kW)	1999.11-2002.09	AT/MT	L/R	F	Hatchback Engine X 20 XER	844006	Outer Joint	29T	33	25	52	103.5	61	O
	1999.11-2002.09	-	L/R	F	Hatchback Engine X 20 XER	644002	Inner Joint		34	25	35	56.2	85.6	
	1999.11-2002.09	-	-	F	Hatchback Engine X 20 XER	844049	Outer Joint		33	25	52	109	61	O
	1999.11-2002.09	-	L	F	Hatchback Engine X 20 XER	244044	Drive Shaft		33	34	52	103.5	595	
2.0 16V Turbo (140 kW)	2000.09-2001.08	MT	-	F	Coupe Engine Z 20 LET	899061	Outer Joint		33	35	55	104	67.5	I
	2000.09-2001.08	MT	L	F	Coupe Engine Z 20 LET	644018	Inner Joint		34	35	35	56	119.5	
	2000.09-2001.08	MT	L	F	Coupe Engine Z 20 LET	244025	Drive Shaft		33	34	55	104	593	
	2000.09-2001.08	MT	R	F	Coupe Engine Z 20 LET	244082	Drive Shaft		33	34	55	104	663	
2.0 16V Turbo (141 kW)	2001.08-2005.05	MT	R	F	Coupe Engine Z 20 LET	244082	Drive Shaft		33	34	55	104	663	
	2001.08-2005.05	MT	-	F	Coupe Engine Z 20 LET	899061	Outer Joint		33	35	55	104	67.5	I
	2001.08-2005.05	MT	L	F	Coupe Engine Z 20 LET	644018	Inner Joint		34	35	35	56	119.5	
	2001.08-2005.05	MT	L	F	Coupe Engine Z 20 LET	244025	Drive Shaft		33	34	55	104	593	
2.0 16V Turbo (147 kW)	2002.11-2005.05	MT	R	F	Coupe Engine Z 20 LET	244082	Drive Shaft		33	34	55	104	663	
	2002.11-2005.10	MT	R	F	Convertible Engine Z 20 LET	244082	Drive Shaft		33	34	55	104	663	
	2002.11-2005.05	MT	-	F	Coupe Engine Z 20 LET	899061	Outer Joint		33	35	55	104	67.5	I
	2002.11-2005.10	-	-	F	Convertible Engine Z 20 LET	899061	Outer Joint		33	35	55	104	67.5	I
	2002.11-2005.05	MT	L	F	Coupe Engine Z 20 LET	644018	Inner Joint		34	35	35	56	119.5	
	2002.11-2005.10	MT	L	F	Convertible Engine Z 20 LET	644018	Inner Joint		34	35	35	56	119.5	
	2002.11-2005.05	MT	L	F	Coupe Engine Z 20 LET	244025	Drive Shaft		33	34	55	104	593	
	2002.11-2005.10	MT	L	F	Convertible Engine Z 20 LET	244025	Drive Shaft		33	34	55	104	593	
2.0 DI (60 kW)	1998.02-2005.01	MT	L/R	F	Hatchback Engine Y 20 DTL/X 20 DTL	621011	Inner Joint		34	25	35	78	64	
	1998.02-2004.07	MT	L/R	F	Estate Engine Y 20 DTL/X 20 DTL	621011	Inner Joint		34	25	35	78	64	
	1998.02-2005.01	-	L/R	F	Hatchback Engine Y 20 DTL/X 20 DTL	644002	Inner Joint		34	25	35	56.2	85.6	
	1998.02-2004.07	-	L/R	F	Estate Engine Y 20 DTL/X 20 DTL	644002	Inner Joint		34	25	35	56.2	85.6	
	1998.02-2005.01	AT/MT	L/R	F	Hatchback Engine Y 20 DTL/X 20 DTL	844006	Outer Joint	29T	33	25	52	103.5	61	O
	1998.02-2004.07	AT/MT	L/R	F	Estate Engine Y 20 DTL/X 20 DTL	844006	Outer Joint	29T	33	25	52	103.5	61	O
	1998.02-2005.01	-	-	F	Hatchback Engine Y 20 DTL/X 20 DTL	844049	Outer Joint		33	25	52	109	61	O
	1998.02-2004.07	-	-	F	Estate Engine Y 20 DTL/X 20 DTL	844049	Outer Joint		33	25	52	109	61	O
	1998.02-2005.01	-	L	F	Hatchback Engine Y 20 DTL/X 20 DTL	244044	Drive Shaft		33	34	52	103.5	595	
	1998.02-2004.07	-	L	F	Estate Engine Y 20 DTL/X 20 DTL	244044	Drive Shaft		33	34	52	103.5	595	
	1998.09-2005.01	MT	L/R	F	Saloon Engine Y 20 DTL/X 20 DTL	621011	Inner Joint		34	25	35	78	64	
	1998.09-2005.01	-	L/R	F	Saloon Engine Y 20 DTL/X 20 DTL	644002	Inner Joint		34	25	35	56.2	85.6	
	1998.09-2005.01	AT/MT	L/R	F	Saloon Engine Y 20 DTL/X 20 DTL	844006	Outer Joint	29T	33	25	52	103.5	61	O
	1998.09-2005.01	-	-	F	Saloon Engine Y 20 DTL/X 20 DTL	844049	Outer Joint		33	25	52	109	61	O
	1998.09-2005.01	-	L	F	Saloon Engine Y 20 DTL/X 20 DTL	244044	Drive Shaft		33	34	52	103.5	595	
2.0 DTI 16V (74 kW)	1999.08-2005.01	MT	L/R	F	Hatchback Engine X 20 DTH/Y 20 DTH	621011	Inner Joint		34	25	35	78	64	
	1999.08-2005.01	MT	L/R	F	Saloon Engine X 20 DTH/Y 20 DTH	621011	Inner Joint		34	25	35	78	64	
	1999.08-2004.07	MT	L/R	F	Estate Engine X 20 DTH/Y 20 DTH	621011	Inner Joint		34	25	35	78	64	
	1999.08-2004.07	-	L/R	F	Estate Engine X 20 DTH/Y 20 DTH	644002	Inner Joint		34	25	35	56.2	85.6	
	1999.08-2005.01	AT/MT	-	F	Saloon Engine X 20 DTH/Y 20 DTH	844049	Outer Joint		33	25	52	109	61	O
	1999.08-2005.01	AT/MT	-	F	Hatchback Engine X 20 DTH/Y 20 DTH	844049	Outer Joint		33	25	52	109	61	O
	1999.08-2004.07	AT/MT	-	F	Estate Engine X 20 DTH/Y 20 DTH	844049	Outer Joint		33	25	52	109	61	O
	1999.08-2005.01	-	L/R	F	Hatchback Engine X 20 DTH/Y 20 DTH	644002	Inner Joint		34	25	35	56.2	85.6	
	1999.08-2005.01	-	L/R	F	Saloon Engine X 20 DTH/Y 20 DTH	644002	Inner Joint		34	25	35	56.2	85.6	
	1999.08-2005.01	-	L	F	Hatchback Engine X 20 DTH/Y 20 DTH	244044	Drive Shaft		33	34	52	103.5	595	
	1999.08-2005.01	-	L	F	Saloon Engine X 20 DTH/Y 20 DTH	244044	Drive Shaft		33	34	52	103.5	595	
	1999.08-2004.07	-	L	F	Estate Engine X 20 DTH/Y 20 DTH	244044	Drive Shaft		33	34	52	103.5	595	
	2.0 OPC (141 kW)	2002.03-2005.10	MT	-	F	Convertible Engine Z 20 LET	899061	Outer Joint		33	35	55	104	67.5
2002.03-2005.10		MT	L	F	Convertible Engine Z 20 LET	644018	Inner Joint		34	35	35	56	119.5	
2002.03-2005.10		MT	L	F	Convertible Engine Z 20 LET	244025	Drive Shaft		33	34	55	104	593	
2002.03-2005.10		MT	R	F	Convertible Engine Z 20 LET	244082	Drive Shaft		33	34	55	104	663	
2002.09-2005.01		MT	R	F	Hatchback Engine Z 20 LET	244082	Drive Shaft		33	34	55	104	663	
2002.09-2004.07		MT	-	F	Estate Engine Z 20 LET	899061	Outer Joint		33	35	55	104	67.5	I
2002.09-2005.01		MT	-	F	Hatchback Engine Z 20 LET	899061	Outer Joint		33	35	55	104	67.5	I





	 YEAR	TRANSM	L/R	F/R	REMARKS	GSP Ref.	 PRODUCT	 ABS	Technical Specifications					
									A	B	C	H	L	P
OPEL														
ASTRA G (T98)														
2.0 OPC (141 kW)	2002.09-2004.07	MT	L	F	Estate Engine Z 20 LET	644018	Inner Joint		34	35	35	56	119.5	
	2002.09-2005.01	MT	L	F	Hatchback Engine Z 20 LET	644018	Inner Joint		34	35	35	56	119.5	
	2002.09-2004.07	MT	L	F	Estate Engine Z 20 LET	244025	Drive Shaft		33	34	55	104	593	
	2002.09-2005.01	MT	L	F	Hatchback Engine Z 20 LET	244025	Drive Shaft		33	34	55	104	593	
	2002.09-2004.07	MT	R	F	Estate Engine Z 20 LET	244082	Drive Shaft		33	34	55	104	663	
2.0 OPC (147 kW)	2002.11-2005.01	MT	R	F	Hatchback Engine Z 20 LET	244082	Drive Shaft		33	34	55	104	663	
	2002.11-2004.07	MT	R	F	Estate Engine Z 20 LET	244082	Drive Shaft		33	34	55	104	663	
	2002.11-2005.01	MT	-	F	Hatchback Engine Z 20 LET	899061	Outer Joint		33	35	55	104	67.5	I
	2002.11-2004.07	MT	-	F	Estate Engine Z 20 LET	899061	Outer Joint		33	35	55	104	67.5	I
	2002.11-2005.01	MT	L	F	Hatchback Engine Z 20 LET	644018	Inner Joint		34	35	35	56	119.5	
	2002.11-2004.07	MT	L	F	Hatchback Engine Z 20 LET	244025	Drive Shaft		33	34	55	104	593	
	2002.11-2004.07	MT	L	F	Estate Engine Z 20 LET	244025	Drive Shaft		33	34	55	104	593	
2.2 16V (108 kW)	2000.06-2005.01	MT	L/R	F	Hatchback Engine Z 22 SE	621011	Inner Joint		34	25	35	78	64	
	2000.06-2005.01	-	L/R	F	Hatchback Engine Z 22 SE	644002	Inner Joint		34	25	35	56.2	85.6	
	2000.06-2005.01	-	L	F	Hatchback Engine Z 22 SE	244044	Drive Shaft		33	34	52	103.5	595	
	2000.06-2005.01	-	-	F	Hatchback Engine Z 22 SE	844049	Outer Joint		33	25	52	109	61	O
	2000.09-2005.05	-	L	F	Coupe Engine Z 22 SE	244044	Drive Shaft		33	34	52	103.5	595	
	2000.09-2005.05	MT	L/R	F	Coupe Engine Z 22 SE	621011	Inner Joint		34	25	35	78	64	
	2000.09-2005.05	-	L/R	F	Coupe Engine Z 22 SE	644002	Inner Joint		34	25	35	56.2	85.6	
	2000.09-2005.05	-	-	F	Coupe Engine Z 22 SE	844049	Outer Joint		33	25	52	109	61	O
	2001.03-2005.10	-	L	F	Convertible Engine Z 22 SE	244044	Drive Shaft		33	34	52	103.5	595	
	2001.03-2005.01	-	L	F	Saloon Engine Z 22 SE	244044	Drive Shaft		33	34	52	103.5	595	
	2001.03-2004.07	-	L	F	Estate Engine Z 22 SE	244044	Drive Shaft		33	34	52	103.5	595	
	2001.03-2005.10	MT	L/R	F	Convertible Engine Z 22 SE	621011	Inner Joint		34	25	35	78	64	
	2001.03-2005.01	MT	L/R	F	Saloon Engine Z 22 SE	621011	Inner Joint		34	25	35	78	64	
	2001.03-2004.07	MT	L/R	F	Estate Engine Z 22 SE	621011	Inner Joint		34	25	35	78	64	
	2001.03-2005.10	-	L/R	F	Convertible Engine Z 22 SE	644002	Inner Joint		34	25	35	56.2	85.6	
	2001.03-2005.01	-	L/R	F	Saloon Engine Z 22 SE	644002	Inner Joint		34	25	35	56.2	85.6	
	2001.03-2004.07	-	L/R	F	Estate Engine Z 22 SE	644002	Inner Joint		34	25	35	56.2	85.6	
	2001.03-2005.10	-	-	F	Convertible Engine Z 22 SE	844049	Outer Joint		33	25	52	109	61	O
	2001.03-2005.01	-	-	F	Saloon Engine Z 22 SE	844049	Outer Joint		33	25	52	109	61	O
	2001.03-2004.07	-	-	F	Estate Engine Z 22 SE	844049	Outer Joint		33	25	52	109	61	O
2.2 DTI (92 kW)	2002.09-2005.10	-	-	F	Convertible Engine Y 22 DTR	844049	Outer Joint		33	25	52	109	61	O
	2002.09-2005.01	-	-	F	Saloon Engine Y 22 DTR	844049	Outer Joint		33	25	52	109	61	O
	2002.09-2005.10	AT/MT	L	F	Convertible Engine Y 22 DTR	244058	Drive Shaft	29T	33	27	55	104	586	
	2002.09-2005.05	AT/MT	L	F	Coupe Engine Y 22 DTR	244058	Drive Shaft	29T	33	27	55	104	586	
	2002.09-2005.01	AT/MT	L	F	Hatchback Engine Y 22 DTR	244058	Drive Shaft	29T	33	27	55	104	586	
	2002.09-2005.01	AT/MT	L	F	Saloon Engine Y 22 DTR	244058	Drive Shaft	29T	33	27	55	104	586	
2002.09-2004.07	AT/MT	L	F	Estate Engine Y 22 DTR	244058	Drive Shaft	29T	33	27	55	104	586		
ASTRA G, SW														
-	1998-	-	-	-	ChYG039154/1G043744	844060	Outer Joint	29T	22	22	52	98	51	O
ASTRA G, SW														
-	1998-	-	-	-	Excl.Italy Classic Ch.No YG039154/ 1G043744	844033	Outer Joint		22	22	52	98	51	O
Classic	1998-	-	-	-	Ch.No YG039154 / 1G043744	844060	Outer Joint	29T	22	22	52	98	51	O
ASTRA H														
1.3 CDTi	-	-	-	-	-	644008	Inner Joint		25	25	35	77.5	64	
	2004-	-	-	L	F	-	644008	Inner Joint		25	25	35	77.5	64
1.3(66kW)	2004-	2014	-	R	F	Box	644011	Inner Joint		34	25	37.5	46	55
	2004-	2014	-	R	F	Estate	644011	Inner Joint		34	25	37.5	46	55
	2004-	2014	-	R	F	Hatchback	644011	Inner Joint		34	25	37.5	46	55
	2004-	2014	-	R	F	Box	644011	Inner Joint		34	25	37.5	46	55
	2004-	2014	-	R	F	Estate	644011	Inner Joint		34	25	37.5	46	55
	2004-	2014	-	R	F	Hatchback	644011	Inner Joint		34	25	37.5	46	55
	2004-	2014	-	R	F	Box	644011	Inner Joint		34	25	37.5	46	55
	2004-	2014	-	R	F	Estate	644011	Inner Joint		34	25	37.5	46	55
	2004-	2014	-	R	F	Hatchback	644011	Inner Joint		34	25	37.5	46	55
	2004-	2014	-	R	F	Box	644011	Inner Joint		34	25	37.5	46	55
	2004-	2014	-	R	F	Estate	644011	Inner Joint		34	25	37.5	46	55
	2004-	2014	-	R	F	Hatchback	644011	Inner Joint		34	25	37.5	46	55
	2004-	2014	-	R	F	Box	644011	Inner Joint		34	25	37.5	46	55
	2004-	2014	-	R	F	Estate	644011	Inner Joint		34	25	37.5	46	55
	2004-	2014	-	R	F	Hatchback	644011	Inner Joint		34	25	37.5	46	55
2007-	2014	-	R	F	Saloon	644011	Inner Joint		34	25	37.5	46	55	





	 YEAR	TRANSM	L/R	F/R	REMARKS	GSP Ref.	 PRODUCT	 ABS	Technical Specifications									
									A	B	C	H	L	P				
OPEL																		
ASTRA H																		
1.3(66kW)	2007-2014	-	R	F	Saloon	644011	Inner Joint		34	25	37.5	46	55					
	2007-2014	-	R	F	Hatchback	644011	Inner Joint		34	25	37.5	46	55					
	2007-2014	-	R	F	Saloon	644011	Inner Joint		34	25	37.5	46	55					
	2007-2014	-	R	F	Saloon	644011	Inner Joint		34	25	37.5	46	55					
1.6	2004-	-	L	F	-	644008	Inner Joint		25	25	35	77.5	64					
ASTRA H (A04)																		
1.2 (59 kW)	2005.08-2010.10	-	L	F	Hatchback Engine Z 12 XEP	244028	Drive Shaft		33	22	53	95	590					
	2005.08-2010.10	-	L	F	Hatchback Engine Z 12 XEP	621014	Inner Joint		22	22	35	57.5	75					
	2005.08-2010.10	-	R	F	Hatchback Engine Z 12 XEP	244030	Drive Shaft		33	22	53	95	952					
	2005.08-2010.10	-	L/R	F	Hatchback Engine Z 12 XEP	844003	Outer Joint		33	22	53	95	54.5	M				
1.3 CDTI (66 kW)	2005.08-2010.10	-	R	F	Hatchback Engine Z 13 DTH	244051	Drive Shaft		33	34	53	93.5	570					
	2005.08-2010.10	-	R	F	Estate Engine Z 13 DTH	244051	Drive Shaft		33	34	53	93.5	570					
	2005.08-2010.10	-	L	F	Hatchback Engine Z 13 DTH	244052	Drive Shaft		33	25	53	93.5	573					
	2005.08-2010.10	-	L	F	Estate Engine Z 13 DTH	244052	Drive Shaft		33	25	53	93.5	573					
	2005.08-2010.10	-	L	F	Hatchback Engine Z 13 DTH	260020	Drive Shaft		33	25	52.5	94	561					
	2005.08-2010.10	-	L	F	Estate Engine Z 13 DTH	260020	Drive Shaft		33	25	52.5	94	561					
	2005.08-2010.10	-	L/R	F	Hatchback Engine Z 13 DTH	844028	Outer Joint		33	24	53	93.5	63.5	M				
	2005.08-2010.10	-	L/R	F	Estate Engine Z 13 DTH	844028	Outer Joint		33	24	53	93.5	63.5	M				
	2005.08-2010.10	-	L	F	Hatchback Engine Z 13 DTH	621018	Inner Joint		25	34	35	58	116					
	2005.08-2010.10	-	L	F	Estate Engine Z 13 DTH	621018	Inner Joint		25	34	35	58	116					
1.4 (55 kW)	2004.04-2004.10	-	L	F	Hatchback Engine Z 14 XEL	244028	Drive Shaft		33	22	53	95	590					
	2004.04-2004.10	-	L	F	Hatchback Engine Z 14 XEL	621014	Inner Joint		22	22	35	57.5	75					
	2004.04-2004.10	-	R	F	Hatchback Engine Z 14 XEL	244030	Drive Shaft		33	22	53	95	952					
	2004.04-2004.10	-	L/R	F	Hatchback Engine Z 14 XEL	844003	Outer Joint		33	22	53	95	54.5	M				
	2004.08-2010.10	-	L	F	Estate Engine Z 14 XEL	244028	Drive Shaft		33	22	53	95	590					
	2004.08-2010.10	-	L	F	Estate Engine Z 14 XEL	621014	Inner Joint		22	22	35	57.5	75					
	2004.08-2010.10	-	R	F	Estate Engine Z 14 XEL	244030	Drive Shaft		33	22	53	95	952					
	2004.08-2010.10	-	L/R	F	Estate Engine Z 14 XEL	844003	Outer Joint		33	22	53	95	54.5	M				
1.4 (66 kW)	2004.03-2010.10	MT	L	F	Hatchback Engine Z 14 XEP	244028	Drive Shaft		33	22	53	95	590					
	2004.03-2010.10	MT	L	F	Hatchback Engine Z 14 XEP	621014	Inner Joint		22	22	35	57.5	75					
	2004.03-2010.10	MT	L/R	F	Hatchback Engine Z 14 XEP	844003	Outer Joint		33	22	53	95	54.5	M				
	2004.03-2010.10	MT	R	F	Hatchback Engine Z 14 XEP	244030	Drive Shaft		33	22	53	95	952					
	2004.08-2010.10	-	L	F	Estate Engine Z 14 XEP	244028	Drive Shaft		33	22	53	95	590					
	2004.08-2010.10	-	L	F	Estate Engine Z 14 XEP	621014	Inner Joint		22	22	35	57.5	75					
	2004.08-2010.10	MT	L/R	F	Estate Engine Z 14 XEP	844003	Outer Joint		33	22	53	95	54.5	M				
	2004.08-2010.10	-	R	F	Estate Engine Z 14 XEP	244030	Drive Shaft		33	22	53	95	952					
1.4 LPG (66 kW)	2009.08-2010.10	-	L	F	Hatchback Engine Z 14 XEP	244028	Drive Shaft		33	22	53	95	590					
	2009.08-2010.10	-	L	F	Hatchback Engine Z 14 XEP	621014	Inner Joint		22	22	35	57.5	75					
	2009.08-2010.10	-	L	F	Estate Engine Z 14 XEP	244028	Drive Shaft		33	22	53	95	590					
	2009.08-2010.10	-	L	F	Estate Engine Z 14 XEP	621014	Inner Joint		22	22	35	57.5	75					
	2009.08-2010.10	-	R	F	Estate Engine Z 14 XEP	244030	Drive Shaft		33	22	53	95	952					
	2009.08-2010.10	-	R	F	Hatchback Engine Z 14 XEP	244030	Drive Shaft		33	22	53	95	952					
	2009.08-2010.10	-	L/R	F	Hatchback Engine Z 14 XEP	844003	Outer Joint		33	22	53	95	54.5	M				
	2009.08-2010.10	-	L/R	F	Estate Engine Z 14 XEP	844003	Outer Joint		33	22	53	95	54.5	M				
1.6 (77 kW)	2004.03-2010.10	MT	L	F	Hatchback Engine Z 16 XE1/Z 16 XEP	244028	Drive Shaft		33	22	53	95	590					
	2004.03-2010.10	MT	L	F	Hatchback Engine Z 16 XE1/Z 16 XEP	621014	Inner Joint		22	22	35	57.5	75					
	2004.03-2010.10	MT	L/R	F	Hatchback Engine Z 16 XE1/Z 16 XEP	844003	Outer Joint		33	22	53	95	54.5	M				
	2004.03-2010.10	MT	R	F	Hatchback Engine Z 16 XE1/Z 16 XEP	244030	Drive Shaft		33	22	53	95	952					
	2004.08-2010.10	MT	L	F	Estate Engine Z 16 XE1/Z 16 XEP	244028	Drive Shaft		33	22	53	95	590					
	2004.08-2010.10	MT	L	F	Estate Engine Z 16 XE1/Z 16 XEP	621014	Inner Joint		22	22	35	57.5	75					
	2004.08-2010.10	MT	L/R	F	Estate Engine Z 16 XE1/Z 16 XEP	844003	Outer Joint		33	22	53	95	54.5	M				
	2004.08-2010.10	MT	R	F	Estate Engine Z 16 XE1/Z 16 XEP	244030	Drive Shaft		33	22	53	95	952					
1.6 (85 kW)	2006.12-2014.05	-	L	F	Hatchback Engine Z 16 XER/A 16 XER	244028	Drive Shaft		33	22	53	95	590					
	2006.12-2014.05	-	L	F	Estate Engine Z 16 XER/A 16 XER	244028	Drive Shaft		33	22	53	95	590					
	2006.12-2014.05	-	L	F	Hatchback Engine Z 16 XER/A 16 XER	621014	Inner Joint		22	22	35	57.5	75					
	2006.12-2014.05	-	L	F	Estate Engine Z 16 XER/A 16 XER	621014	Inner Joint		22	22	35	57.5	75					
	2006.12-2014.05	-	L/R	F	Hatchback Engine Z 16 XER/A 16 XER	844003	Outer Joint		33	22	53	95	54.5	M				
	2006.12-2014.05	-	L/R	F	Estate Engine Z 16 XER/A 16 XER	844003	Outer Joint		33	22	53	95	54.5	M				
	2006.12-2014.05	-	R	F	Hatchback Engine Z 16 XER/A 16 XER	244030	Drive Shaft		33	22	53	95	952					
	2006.12-2014.05	-	R	F	Estate Engine Z 16 XER/A 16 XER	244030	Drive Shaft		33	22	53	95	952					
1.6 LPG (85 kW)	2009.08-2010.10	-	L	F	Estate Engine Z 16 XER	244028	Drive Shaft		33	22	53	95	590					
	2009.08-2010.10	-	L	F	Estate Engine Z 16 XER	621014	Inner Joint		22	22	35	57.5	75					
	2009.08-2010.10	-	L/R	F	Estate Engine Z 16 XER	844003	Outer Joint		33	22	53	95	54.5	M				
	2009.08-2010.10	-	R	F	Estate Engine Z 16 XER	244030	Drive Shaft		33	22	53	95	952					
1.6 Turbo (132 kW)	2007.02-2010.10	-	L/R	F	Hatchback Engine Z 16 LET	844028	Outer Joint		33	24	53	93.5	63.5	M				
	2007.02-2010.10	-	L/R	F	Estate Engine Z 16 LET	844028	Outer Joint		33	24	53	93.5	63.5	M				





	YEAR	TRANSM	L/R	F/R	REMARKS	GSP Ref.	PRODUCT	ABS	Technical Specifications								
									A	B	C	H	L	P			
OPEL																	
ASTRA H (A04)																	
1.7 CDTI (59 kW)	2004.03-2010.10	MT	L	F	Hatchback Engine Z 17 DTL	699026	Inner Joint		22	25	35	57	82.5				
	2004.03-2010.10	-	R	F	Hatchback Engine Z 17 DTL	644005	Inner Joint		34	25	35	54	47				
	2004.03-2010.10	MT	L	F	Hatchback Engine Z 17 DTL	221063	Drive Shaft		33	22	53	93.5	586				
	2004.03-2010.10	MT	R	F	Hatchback Engine Z 17 DTL	221055	Drive Shaft		33	22	53	93.5	950				
	2004.03-2010.10	MT	L/R	F	Hatchback Engine Z 17 DTL	844028	Outer Joint		33	24	53	93.5	63.5	M			
	2004.08-2010.10	MT	L	F	Estate Engine Z 17 DTL	699026	Inner Joint		22	25	35	57	82.5				
	2004.08-2010.10	-	R	F	Estate Engine Z 17 DTL	644005	Inner Joint		34	25	35	54	47				
	2004.08-2010.10	MT	L	F	Estate Engine Z 17 DTL	221063	Drive Shaft		33	22	53	93.5	586				
	2004.08-2010.10	MT	L/R	F	Estate Engine Z 17 DTL	844028	Outer Joint		33	24	53	93.5	63.5	M			
1.7 CDTI (74 kW)	2004.03-2010.10	5MT	L	F	Hatchback Engine Z 17 DTH	244029	Drive Shaft		33	34	53	93.5	594				
	2004.03-2010.10	5MT	R	F	Hatchback Engine Z 17 DTH	244031	Drive Shaft		33	34	53	93.5	559				
	2004.03-2010.10	6MT	L	F	Hatchback Engine Z 17 DTH	244052	Drive Shaft		33	25	53	93.5	573				
	2004.03-2010.10	5AT	R	F	Hatchback Engine Z 17 DTH	644005	Inner Joint		34	25	35	54	47				
	2004.03-2010.10	5AT	L	F	Hatchback Engine Z 17 DTH	244024	Drive Shaft		33	34	53	93.5	589				
	2004.03-2010.10	MT	L/R	F	Hatchback Engine Z 17 DTH	844028	Outer Joint		33	24	53	93.5	63.5	M			
	2004.03-2010.10	5MT	L	F	Hatchback Engine Z 17 DTH	644002	Inner Joint		34	25	35	56.2	85.6				
	2004.08-2010.10	5MT	L	F	Estate Engine Z 17 DTH	244029	Drive Shaft		33	34	53	93.5	594				
	2004.08-2010.10	5MT	R	F	Estate Engine Z 17 DTH	244031	Drive Shaft		33	34	53	93.5	559				
	2004.08-2010.10	6MT	L	F	Estate Engine Z 17 DTH	244052	Drive Shaft		33	25	53	93.5	573				
	2004.08-2010.10	MT/5MT	L	F	Estate Engine Z 17 DTH	621011	Inner Joint		34	25	35	78	64				
	2004.08-2010.10	5AT	R	F	Estate Engine Z 17 DTH	644005	Inner Joint		34	25	35	54	47				
	2004.08-2010.10	5AT	L	F	Estate Engine Z 17 DTH	244024	Drive Shaft		33	34	53	93.5	589				
	2004.08-2010.10	MT	L/R	F	Estate Engine Z 17 DTH	844028	Outer Joint		33	24	53	93.5	63.5	M			
	2004.08-2010.10	5MT	L	F	Estate Engine Z 17 DTH	644002	Inner Joint		34	25	35	56.2	85.6				
	1.7 CDTI (81 kW)	2007.02-2014.05	-	R	F	Hatchback Engine A 17 DTJ/Z 17 DTJ	644016	Inner Joint		34	28	37.5	46	54			
2007.02-2014.05		-	R	F	Estate Engine Z 17 DTJ/A 17 DTJ	644016	Inner Joint		34	28	37.5	46	54				
2007.02-2014.05		-	R	F	Hatchback Engine A 17 DTJ/Z 17 DTJ	244099	Drive Shaft		33	34	52.5	94	563				
2007.02-2014.05		-	R	F	Estate Engine Z 17 DTJ/A 17 DTJ	244099	Drive Shaft		33	34	52.5	94	563				
2007.02-2014.05		-	L	F	Hatchback Engine A 17 DTJ/Z 17 DTJ	699186	Inner Joint		25	28	35	57.5	81.5				
2007.02-2014.05		-	L	F	Estate Engine Z 17 DTJ/A 17 DTJ	699186	Inner Joint		25	28	35	57.5	81.5				
2007.02-2014.05		5AT	R	F	Hatchback Engine A 17 DTJ/Z 17 DTJ	644005	Inner Joint		34	25	35	54	47				
2007.02-2014.05		5AT	R	F	Estate Engine Z 17 DTJ/A 17 DTJ	644005	Inner Joint		34	25	35	54	47				
2007.02-2014.05		-	L	F	Hatchback Engine A 17 DTJ/Z 17 DTJ	221051	Drive Shaft		33	25	52.5	94	579				
2007.02-2014.05		-	L	F	Estate Engine Z 17 DTJ/A 17 DTJ	221051	Drive Shaft		33	25	52.5	94	579				
2007.02-2014.05		-	L/R	F	Hatchback Engine A 17 DTJ/Z 17 DTJ	844027	Outer Joint		33	26	52.5	94	65.5	M			
2007.02-2014.05		-	L/R	F	Estate Engine Z 17 DTJ/A 17 DTJ	844027	Outer Joint		33	26	52.5	94	65.5	M			
1.7 CDTI (92 kW)		2007.02-2014.05	-	R	F	Hatchback Engine Z 17 DTR/A 17 DTR	644016	Inner Joint		34	28	37.5	46	54			
	2007.02-2014.05	-	R	F	Estate Engine A 17 DTR/Z 17 DTR	644016	Inner Joint		34	28	37.5	46	54				
	2007.02-2014.05	-	R	F	Hatchback Engine Z 17 DTR/A 17 DTR	244099	Drive Shaft		33	34	52.5	94	563				
	2007.02-2014.05	-	R	F	Estate Engine A 17 DTR/Z 17 DTR	244099	Drive Shaft		33	34	52.5	94	563				
	2007.02-2014.05	-	L	F	Hatchback Engine Z 17 DTR/A 17 DTR	699186	Inner Joint		25	28	35	57.5	81.5				
	2007.02-2014.05	-	L	F	Estate Engine A 17 DTR/Z 17 DTR	699186	Inner Joint		25	28	35	57.5	81.5				
	2007.02-2014.05	-	R	F	Hatchback Engine Z 17 DTR/A 17 DTR	644005	Inner Joint		34	25	35	54	47				
	2007.02-2014.05	-	R	F	Estate Engine A 17 DTR/Z 17 DTR	644005	Inner Joint		34	25	35	54	47				
	2007.02-2014.05	-	L	F	Hatchback Engine Z 17 DTR/A 17 DTR	221051	Drive Shaft		33	25	52.5	94	579				
	2007.02-2014.05	-	L	F	Estate Engine A 17 DTR/Z 17 DTR	221051	Drive Shaft		33	25	52.5	94	579				
	2007.02-2014.05	-	-	F	Hatchback Engine Z 17 DTR/A 17 DTR	899024	Outer Joint		33	26	52.5	94	65.5	M			
	2007.02-2014.05	-	-	F	Estate Engine A 17 DTR/Z 17 DTR	899024	Outer Joint		33	26	52.5	94	65.5	M			
	2007.02-2014.05	-	L/R	F	Hatchback Engine Z 17 DTR/A 17 DTR	844027	Outer Joint		33	26	52.5	94	65.5	M			
	2007.02-2014.05	-	L/R	F	Estate Engine A 17 DTR/Z 17 DTR	844027	Outer Joint		33	26	52.5	94	65.5	M			
1.8 (103 kW)	2005.08-2010.10	MT	L	F	Estate Engine Z 18 XER/A 18 XER	699026	Inner Joint		22	25	35	57	82.5				
	2005.08-2010.10	MT	L	F	Estate Engine Z 18 XER/A 18 XER	221063	Drive Shaft		33	22	53	93.5	586				
	2005.08-2010.10	AT/MT	R	F	Estate Engine Z 18 XER/A 18 XER	221055	Drive Shaft		33	22	53	93.5	950				
	2005.08-2010.10	AT	L	F	Estate Engine Z 18 XER/A 18 XER	244097	Drive Shaft		33	22	53	93.5	588				
	2005.08-2010.10	-	L/R	F	Estate Engine Z 18 XER/A 18 XER	844028	Outer Joint		33	24	53	93.5	63.5	M			
	2005.08-2010.10	AT	R	F	Estate Engine Z 18 XER/A 18 XER	244098	Drive Shaft		33	22	53	93.5	950				
	2006.01-2010.10	MT	L	F	Hatchback Engine Z 18 XER/A 18 XER	699026	Inner Joint		22	25	35	57	82.5				
	2006.01-2010.10	MT	L	F	Hatchback Engine Z 18 XER/A 18 XER	221063	Drive Shaft		33	22	53	93.5	586				
	2006.01-2010.10	AT/MT	R	F	Hatchback Engine Z 18 XER/A 18 XER	221055	Drive Shaft		33	22	53	93.5	950				
	2006.01-2010.10	AT	L	F	Hatchback Engine Z 18 XER/A 18 XER	244097	Drive Shaft		33	22	53	93.5	588				
	2006.01-2010.10	-	L/R	F	Hatchback Engine Z 18 XER/A 18 XER	844028	Outer Joint		33	24	53	93.5	63.5	M			
1.8 (92 kW)	2004.03-2010.10	MT	L	F	Hatchback Engine Z 18 XE	699026	Inner Joint		22	25	35	57	82.5				
	2004.03-2010.10	MT	L	F	Hatchback Engine Z 18 XE	221063	Drive Shaft		33	22	53	93.5	586				
	2004.03-2010.10	AT/MT	L/R	F	Hatchback Engine Z 18 XE	844028	Outer Joint		33	24	53	93.5	63.5	M			





YEAR	TRANSM	L/R	F/R	REMARKS	GSP Ref.	PRODUCT	ABS	Technical Specifications									
								A	B	C	H	L	P				
OPEL																	
ASTRA H (A04)																	
1.8 (92 kW)	2004.03-2010.10	AT/MT	R	F	Hatchback Engine Z 18 XE	221055	Drive Shaft	33	22	53	93.5	950					
	2004.03-2010.10	AT	L	F	Hatchback Engine Z 18 XE	244097	Drive Shaft	33	22	53	93.5	588					
	2004.03-2010.10	AT	R	F	Hatchback Engine Z 18 XE	244098	Drive Shaft	33	22	53	93.5	950					
	2004.08-2010.10	MT	L	F	Estate Engine Z 18 XE	699026	Inner Joint	22	25	35	57	82.5					
	2004.08-2010.10	MT	L	F	Estate Engine Z 18 XE	221063	Drive Shaft	33	22	53	93.5	586					
	2004.08-2010.10	AT/MT	L/R	F	Estate Engine Z 18 XE	844028	Outer Joint	33	24	53	93.5	63.5	M				
	2004.08-2010.10	AT/MT	R	F	Estate Engine Z 18 XE	221055	Drive Shaft	33	22	53	93.5	950					
	2004.08-2010.10	AT	L	F	Estate Engine Z 18 XE	244097	Drive Shaft	33	22	53	93.5	588					
	2004.08-2010.10	AT	R	F	Estate Engine Z 18 XE	244098	Drive Shaft	33	22	53	93.5	950					
1.9 CDTI (110 kW)	2004.09-2010.10	MT	L/R	F	Hatchback Engine Z 19 DTH	817051	Outer Joint	30	26	53.8	94.5	65.5	M				
	2004.09-2010.10	MT	L/R	F	Estate Engine Z 19 DTH	817051	Outer Joint	30	26	53.8	94.5	65.5	M				
	2004.09-2010.10	-	L	F	Hatchback Engine Z 19 DTH	221035	Drive Shaft	30	25	53.8	94.5	581					
	2004.09-2010.10	-	L	F	Estate Engine Z 19 DTH	221035	Drive Shaft	30	25	53.8	94.5	581					
	2004.09-2010.10	-	L	F	Hatchback Engine Z 19 DTH	699186	Inner Joint	25	28	35	57.5	81.5					
	2004.09-2010.10	-	L	F	Hatchback Engine Z 19 DTH	621018	Inner Joint	25	34	35	58	116					
	2004.09-2010.10	-	L	F	Estate Engine Z 19 DTH	699186	Inner Joint	25	28	35	57.5	81.5					
	2004.09-2010.10	-	L	F	Estate Engine Z 19 DTH	621018	Inner Joint	25	34	35	58	116					
	2004.09-2010.10	-	L	F	Hatchback Engine Z 19 DTH	221071	Drive Shaft	30	25	53.8	94.5	576					
	2004.09-2010.10	-	-	F	Hatchback Engine Z 19 DTH	899023	Outer Joint	30	26	53.8	94.5	65.5	M				
	2004.09-2010.10	-	-	F	Estate Engine Z 19 DTH	899023	Outer Joint	30	26	53.8	94.5	65.5	M				
	2004.09-2010.10	-	L	F	Estate Engine Z 19 DTH	221071	Drive Shaft	30	25	53.8	94.5	576					
	2004.09-2010.10	-	R	F	Hatchback Engine Z 19 DTH	221062	Drive Shaft	30	34	53.8	94.5	595					
	2004.09-2010.10	-	R	F	Hatchback Engine Z 19 DTH	260016	Drive Shaft	30	34	52.5	105	588					
	2004.09-2010.10	-	R	F	Estate Engine Z 19 DTH	221062	Drive Shaft	30	34	53.8	94.5	595					
	2004.09-2010.10	-	R	F	Estate Engine Z 19 DTH	260016	Drive Shaft	30	34	52.5	105	588					
1.9 CDTI (74 kW)	2005.09-2010.10	-	R	F	Hatchback Engine Z 19 DTL	221056	Drive Shaft	33	34	52.5	94	595					
	2005.09-2010.10	-	R	F	Estate Engine Z 19 DTL	221056	Drive Shaft	33	34	52.5	94	595					
	2005.09-2010.10	-	L	F	Estate Engine Z 19 DTL	221073	Drive Shaft	33	25	52.5	94	578					
	2005.09-2010.10	-	L	F	Estate Engine Z 19 DTL	621018	Inner Joint	25	34	35	58	116					
	2005.09-2010.10	-	L	F	Hatchback Engine Z 19 DTL	221073	Drive Shaft	33	25	52.5	94	578					
	2005.09-2010.10	-	L	F	Hatchback Engine Z 19 DTL	621018	Inner Joint	25	34	35	58	116					
	2005.09-2010.10	-	L	F	Estate Engine Z 19 DTL	699186	Inner Joint	25	28	35	57.5	81.5					
	2005.09-2010.10	-	L	F	Hatchback Engine Z 19 DTL	699186	Inner Joint	25	28	35	57.5	81.5					
	2005.09-2010.10	AT	L	F	Hatchback Engine Z 19 DTL	221111	Drive Shaft	33	27	52.5	94	562					
	2005.09-2010.10	AT	L	F	Estate Engine Z 19 DTL	221111	Drive Shaft	33	27	52.5	94	562					
	2005.09-2010.10	-	-	F	Hatchback Engine Z 19 DTL	899024	Outer Joint	33	26	52.5	94	65.5	M				
	2005.09-2010.10	-	-	F	Estate Engine Z 19 DTL	899024	Outer Joint	33	26	52.5	94	65.5	M				
	2005.09-2010.10	AT	R	F	Hatchback Engine Z 19 DTL	221110	Drive Shaft	33	27	52.5	94	576					
	2005.09-2010.10	AT	R	F	Estate Engine Z 19 DTL	221110	Drive Shaft	33	27	52.5	94	576					
	2005.09-2010.10	-	L/R	F	Hatchback Engine Z 19 DTL	844027	Outer Joint	33	26	52.5	94	65.5	M				
	2005.09-2010.10	-	L/R	F	Estate Engine Z 19 DTL	844027	Outer Joint	33	26	52.5	94	65.5	M				
1.9 CDTI (88 kW)	2004.06-2010.10	-	R	F	Hatchback Engine Z 19 DT	221056	Drive Shaft	33	34	52.5	94	595					
	2004.06-2010.10	-	L	F	Hatchback Engine Z 19 DT	221073	Drive Shaft	33	25	52.5	94	578					
	2004.06-2010.10	-	L	F	Hatchback Engine Z 19 DT	621018	Inner Joint	25	34	35	58	116					
	2004.06-2010.10	-	L	F	Hatchback Engine Z 19 DT	699186	Inner Joint	25	28	35	57.5	81.5					
	2004.06-2010.10	AT	L	F	Hatchback Engine Z 19 DT	221111	Drive Shaft	33	27	52.5	94	562					
	2004.06-2010.10	-	-	F	Hatchback Engine Z 19 DT	899024	Outer Joint	33	26	52.5	94	65.5	M				
	2004.06-2010.10	AT	R	F	Hatchback Engine Z 19 DT	221110	Drive Shaft	33	27	52.5	94	576					
	2004.06-2010.10	-	L/R	F	Hatchback Engine Z 19 DT	844027	Outer Joint	33	26	52.5	94	65.5	M				
	2005.09-2010.10	-	R	F	Estate Engine Z 19 DT	221056	Drive Shaft	33	34	52.5	94	595					
	2005.09-2010.10	-	L	F	Estate Engine Z 19 DT	221073	Drive Shaft	33	25	52.5	94	578					
	2005.09-2010.10	-	L	F	Estate Engine Z 19 DT	621018	Inner Joint	25	34	35	58	116					
	2005.09-2010.10	-	L	F	Estate Engine Z 19 DT	699186	Inner Joint	25	28	35	57.5	81.5					
	2005.09-2010.10	AT	L	F	Estate Engine Z 19 DT	221111	Drive Shaft	33	27	52.5	94	562					
	2005.09-2010.10	-	-	F	Estate Engine Z 19 DT	899024	Outer Joint	33	26	52.5	94	65.5	M				
	2005.09-2010.10	AT	R	F	Estate Engine Z 19 DT	221110	Drive Shaft	33	27	52.5	94	576					
	2005.09-2010.10	-	L/R	F	Estate Engine Z 19 DT	844027	Outer Joint	33	26	52.5	94	65.5	M				
1.9 CDTI 16V (88 kW)	2004.04-2010.10	-	R	F	Hatchback Engine Z 19 DTJ	221056	Drive Shaft	33	34	52.5	94	595					
	2004.04-2010.10	-	L	F	Hatchback Engine Z 19 DTJ	221073	Drive Shaft	33	25	52.5	94	578					
	2004.04-2010.10	-	L	F	Hatchback Engine Z 19 DTJ	621018	Inner Joint	25	34	35	58	116					
	2004.04-2010.10	-	L	F	Hatchback Engine Z 19 DTJ	699186	Inner Joint	25	28	35	57.5	81.5					
	2004.04-2010.10	-	-	F	Hatchback Engine Z 19 DTJ	899024	Outer Joint	33	26	52.5	94	65.5	M				
	2004.04-2010.10	AT	L	F	Hatchback Engine Z 19 DTJ	221111	Drive Shaft	33	27	52.5	94	562					
	2004.04-2010.10	AT	R	F	Hatchback Engine Z 19 DTJ	221110	Drive Shaft	33	27	52.5	94	576					
	2004.04-2010.10	MT	L/R	F	Hatchback Engine Z 19 DTJ	844027	Outer Joint	33	26	52.5	94	65.5	M				
	2004.04-2010.10	MT	L/R	F	Hatchback Engine Z 19 DTJ	817051	Outer Joint	30	26	53.8	94.5	65.5	M				





	 YEAR	TRANSM	L/R	F/R	REMARKS	GSP Ref.	 PRODUCT	 ABS	Technical Specifications					
									A	B	C	H	L	P
OPEL														
ASTRA H (A04)														
1.9 CDTI 16V (88 kW)	2004.08-2010.10	-	R	F	Estate Engine Z 19 DTJ	221056	Drive Shaft		33	34	52.5	94	595	
	2004.08-2010.10	-	L	F	Estate Engine Z 19 DTJ	221073	Drive Shaft		33	25	52.5	94	578	
	2004.08-2010.10	-	L	F	Estate Engine Z 19 DTJ	621018	Inner Joint		25	34	35	58	116	
	2004.08-2010.10	-	L	F	Estate Engine Z 19 DTJ	699186	Inner Joint		25	28	35	57.5	81.5	
	2004.08-2010.10	-	-	F	Estate Engine Z 19 DTJ	899024	Outer Joint		33	26	52.5	94	65.5	M
	2004.08-2010.10	AT	L	F	Estate Engine Z 19 DTJ	221111	Drive Shaft		33	27	52.5	94	562	
	2004.08-2010.10	AT	R	F	Estate Engine Z 19 DTJ	221110	Drive Shaft		33	27	52.5	94	576	
	2004.08-2010.10	MT	L/R	F	Estate Engine Z 19 DTJ	844027	Outer Joint		33	26	52.5	94	65.5	M
2.0 Turbo (125 kW)	2004.03-2010.10	-	-	F	Hatchback Engine Z 20 LEL	899024	Outer Joint		33	26	52.5	94	65.5	M
	2004.03-2010.10	-	L/R	F	Hatchback Engine Z 20 LEL	844027	Outer Joint		33	26	52.5	94	65.5	M
	2004.03-2010.10	-	R	F	Hatchback Engine Z 20 LEL	221056	Drive Shaft		33	34	52.5	94	595	
	2004.08-2010.10	-	-	F	Estate Engine Z 20 LEL	899024	Outer Joint		33	26	52.5	94	65.5	M
	2004.08-2010.10	-	L/R	F	Estate Engine Z 20 LEL	844027	Outer Joint		33	26	52.5	94	65.5	M
	2004.08-2010.10	-	R	F	Estate Engine Z 20 LEL	221056	Drive Shaft		33	34	52.5	94	595	
2.0 Turbo (147 kW)	2004.09-2010.10	-	R	F	Hatchback Engine Z 20 LER	221056	Drive Shaft		33	34	52.5	94	595	
	2004.09-2010.10	-	R	F	Estate Engine Z 20 LER	221056	Drive Shaft		33	34	52.5	94	595	
	2004.09-2010.10	-	-	F	Hatchback Engine Z 20 LER	899024	Outer Joint		33	26	52.5	94	65.5	M
	2004.09-2010.10	-	-	F	Estate Engine Z 20 LER	899024	Outer Joint		33	26	52.5	94	65.5	M
	2004.09-2010.10	-	L/R	F	Hatchback Engine Z 20 LER	844027	Outer Joint		33	26	52.5	94	65.5	M
	2004.09-2010.10	-	L/R	F	Estate Engine Z 20 LER	844027	Outer Joint		33	26	52.5	94	65.5	M
2.0 Turbo (177 kW)	2005.03-2010.10	-	L/R	F	Hatchback Engine Z 20 LEH	817051	Outer Joint		30	26	53.8	94.5	65.5	M
	2005.03-2010.10	-	R	F	Hatchback Engine Z 20 LEH	221062	Drive Shaft		30	34	53.8	94.5	595	
	2005.03-2010.10	-	-	F	Hatchback Engine Z 20 LEH	899023	Outer Joint		30	26	53.8	94.5	65.5	M
	2005.03-2010.10	-	R	F	Hatchback Engine Z 20 LEH	260016	Drive Shaft		30	34	52.5	105	588	
ASTRA H (A04)/ASTRA A+														
1.3 CDTI (66 kW)	2007.02-2010.10	-	R	F	Saloon Engine Z 13 DTH	244051	Drive Shaft		33	34	53	93.5	570	
	2007.02-2010.10	-	L	F	Saloon Engine Z 13 DTH	244052	Drive Shaft		33	25	53	93.5	573	
	2007.02-2010.10	-	L/R	F	Saloon Engine Z 13 DTH	844028	Outer Joint		33	24	53	93.5	63.5	M
1.6 (85 kW)	2007.02-2014.05	-	L	F	Saloon Engine Z 16 XER	244028	Drive Shaft		33	22	53	95	590	
	2007.02-2014.05	-	L	F	Saloon Engine Z 16 XER	621014	Inner Joint		22	22	35	57.5	75	
	2007.02-2014.05	-	L/R	F	Saloon Engine Z 16 XER	844003	Outer Joint		33	22	53	95	54.5	M
	2007.02-2014.05	-	R	F	Saloon Engine Z 16 XER	244030	Drive Shaft		33	22	53	95	952	
1.7 CDTI (74 kW)	2007.02-2010.10	5MT	L	F	Saloon Engine Z 17 DTH	244029	Drive Shaft		33	34	53	93.5	594	
	2007.02-2010.10	-	R	F	Saloon Engine Z 17 DTH	244031	Drive Shaft		33	34	53	93.5	559	
	2007.02-2010.10	6MT	L	F	Saloon Engine Z 17 DTH	244052	Drive Shaft		33	25	53	93.5	573	
	2007.02-2010.10	MT/5MT	L	F	Saloon Engine Z 17 DTH	621011	Inner Joint		34	25	35	78	64	
	2007.02-2010.10	-	L/R	F	Saloon Engine Z 17 DTH	844028	Outer Joint		33	24	53	93.5	63.5	M
	2007.02-2010.10	5MT	L	F	Saloon Engine Z 17 DTH	644002	Inner Joint		34	25	35	56.2	85.6	
1.7 CDTI (81 kW)	2007.02-2014.05	-	R	F	Saloon Engine Z 17 DTJ	644016	Inner Joint		34	28	37.5	46	54	
	2007.02-2014.05	-	R	F	Saloon Engine Z 17 DTJ	244099	Drive Shaft		33	34	52.5	94	563	
	2007.02-2014.05	-	L	F	Saloon Engine Z 17 DTJ	699186	Inner Joint		25	28	35	57.5	81.5	
	2007.02-2014.05	5AT	R	F	Saloon Engine Z 17 DTJ	644005	Inner Joint		34	25	35	54	47	
	2007.02-2014.05	5AT	L	F	Saloon Engine Z 17 DTJ	244024	Drive Shaft		33	34	53	93.5	589	
	2007.02-2014.05	-	L	F	Saloon Engine Z 17 DTJ	221051	Drive Shaft		33	25	52.5	94	579	
	2007.02-2014.05	-	L/R	F	Saloon Engine Z 17 DTJ	844027	Outer Joint		33	26	52.5	94	65.5	M
	2007.02-2010.10	MT	L	F	Saloon Engine A 18 XER/Z 18 XER	699026	Inner Joint		22	25	35	57	82.5	
1.8 (103 kW)	2007.02-2010.10	MT	L	F	Saloon Engine A 18 XER/Z 18 XER	221063	Drive Shaft		33	22	53	93.5	586	
	2007.02-2010.10	-	L/R	F	Saloon Engine A 18 XER/Z 18 XER	844028	Outer Joint		33	24	53	93.5	63.5	M
	2007.02-2010.10	AT	L	F	Saloon Engine A 18 XER/Z 18 XER	244097	Drive Shaft		33	22	53	93.5	588	
	2007.02-2010.10	AT	R	F	Saloon Engine A 18 XER/Z 18 XER	244098	Drive Shaft		33	22	53	93.5	950	
	ASTRA H (L70)													
1.3 CDTI (66 kW)	2005.08-2010.10	-	R	F	Box Engine Z 13 DTH	244051	Drive Shaft		33	34	53	93.5	570	
	2005.08-2010.10	-	L	F	Box Engine Z 13 DTH	244052	Drive Shaft		33	25	53	93.5	573	
	2005.08-2010.10	-	L	F	Box Engine Z 13 DTH	260020	Drive Shaft		33	25	52.5	94	561	
	2005.08-2010.10	-	L/R	F	Box Engine Z 13 DTH	844028	Outer Joint		33	24	53	93.5	63.5	M
	2005.08-2010.10	-	L	F	Box Engine Z 13 DTH	621018	Inner Joint		25	34	35	58	116	
1.6 (76 kW)	2004.02-2004.11	-	L	F	Box Engine Z 16 XEP	244028	Drive Shaft		33	22	53	95	590	
	2004.02-2004.11	-	L	F	Box Engine Z 16 XEP	621014	Inner Joint		22	22	35	57.5	75	
	2004.02-2004.11	-	R	F	Box Engine Z 16 XEP	244030	Drive Shaft		33	22	53	95	952	
	2004.02-2004.11	-	L/R	F	Box Engine Z 16 XEP	844003	Outer Joint		33	22	53	95	54.5	M
1.7 CDTI (74 kW)	2004.03-2010.10	5MT	L	F	Box Engine Z 17 DTH	244029	Drive Shaft		33	34	53	93.5	594	
	2004.03-2010.10	-	R	F	Box Engine Z 17 DTH	244031	Drive Shaft		33	34	53	93.5	559	
	2004.03-2010.10	6MT	L	F	Box Engine Z 17 DTH	244052	Drive Shaft		33	25	53	93.5	573	
	2004.03-2010.10	5AT	R	F	Box Engine Z 17 DTH	644005	Inner Joint		34	25	35	54	47	
	2004.03-2010.10	5AT	L	F	Box Engine Z 17 DTH	244024	Drive Shaft		33	34	53	93.5	589	
	2004.03-2010.10	-	L/R	F	Box Engine Z 17 DTH	844028	Outer Joint		33	24	53	93.5	63.5	M





	 YEAR	TRANSM	L/R	F/R	REMARKS	GSP Ref.	 PRODUCT	 ABS	Technical Specifications					
									A	B	C	H	L	P
OPEL														
ASTRA H (L70)														
1.7 CDTI (74 kW)	2004.03-2010.10	5MT	L	F	Box Engine Z 17 DTH	644002	Inner Joint		34	25	35	56.2	85.6	
1.7 CDTI (81 kW)	2007.02-2010.10	-	R	F	Box Engine Z 17 DTJ	644016	Inner Joint		34	28	37.5	46	54	
	2007.02-2010.10	-	R	F	Box Engine Z 17 DTJ	244099	Drive Shaft		33	34	52.5	94	563	
	2007.02-2010.10	-	L	F	Box Engine Z 17 DTJ	699186	Inner Joint		25	28	35	57.5	81.5	
	2007.02-2010.10	5AT	R	F	Box Engine Z 17 DTJ	644005	Inner Joint		34	25	35	54	47	
	2007.02-2010.10	-	L	F	Box Engine Z 17 DTJ	221051	Drive Shaft		33	25	52.5	94	579	
	2007.02-2010.10	-	L/R	F	Box Engine Z 17 DTJ	844027	Outer Joint		33	26	52.5	94	65.5	M
1.7 CDTI (92 kW)	2007.02-2010.10	-	R	F	Box Engine Z 17 DTR	644016	Inner Joint		34	28	37.5	46	54	
	2007.02-2010.10	-	R	F	Box Engine Z 17 DTR	244099	Drive Shaft		33	34	52.5	94	563	
	2007.02-2010.10	-	L	F	Box Engine Z 17 DTR	699186	Inner Joint		25	28	35	57.5	81.5	
	2007.02-2010.10	-	R	F	Box Engine Z 17 DTR	644005	Inner Joint		34	25	35	54	47	
	2007.02-2010.10	-	-	F	Box Engine Z 17 DTR	899024	Outer Joint		33	26	52.5	94	65.5	M
	2007.02-2010.10	-	L	F	Box Engine Z 17 DTR	221051	Drive Shaft		33	25	52.5	94	579	
	2007.02-2010.10	-	L/R	F	Box Engine Z 17 DTR	844027	Outer Joint		33	26	52.5	94	65.5	M
1.9 CDTI (110 kW)	2004.09-2010.10	-	L	F	Box Engine Z 19 DTH	221035	Drive Shaft		30	25	53.8	94.5	581	
	2004.09-2010.10	-	-	F	Box Engine Z 19 DTH	899023	Outer Joint		30	26	53.8	94.5	65.5	M
	2004.09-2010.10	-	L/R	F	Box Engine Z 19 DTH	817051	Outer Joint		30	26	53.8	94.5	65.5	M
	2004.09-2010.10	-	L	F	Box Engine Z 19 DTH	699186	Inner Joint		25	28	35	57.5	81.5	
	2004.09-2010.10	-	L	F	Box Engine Z 19 DTH	621018	Inner Joint		25	34	35	58	116	
	2004.09-2010.10	-	L	F	Box Engine Z 19 DTH	221071	Drive Shaft		30	25	53.8	94.5	576	
	2004.09-2010.10	-	R	F	Box Engine Z 19 DTH	221062	Drive Shaft		30	34	53.8	94.5	595	
	2004.09-2010.10	-	R	F	Box Engine Z 19 DTH	260016	Drive Shaft		30	34	52.5	105	588	
1.9 CDTI (88 kW)	2005.09-2010.10	MT	R	F	Box Engine Z 19 DT	221056	Drive Shaft		33	34	52.5	94	595	
	2005.09-2010.10	MT	L	F	Box Engine Z 19 DT	221073	Drive Shaft		33	25	52.5	94	578	
	2005.09-2010.10	MT	L	F	Box Engine Z 19 DT	621018	Inner Joint		25	34	35	58	116	
	2005.09-2010.10	MT	L	F	Box Engine Z 19 DT	699186	Inner Joint		25	28	35	57.5	81.5	
	2005.09-2010.10	-	-	F	Box Engine Z 19 DT	899024	Outer Joint		33	26	52.5	94	65.5	M
	2005.09-2010.10	AT	L	F	Box Engine Z 19 DT	221111	Drive Shaft		33	27	52.5	94	562	
	2005.09-2010.10	AT	R	F	Box Engine Z 19 DT	221110	Drive Shaft		33	27	52.5	94	576	
	2005.09-2010.10	-	L/R	F	Box Engine Z 19 DT	844027	Outer Joint		33	26	52.5	94	65.5	M
1.9 CDTI 16V (88 kW)	2004.08-2010.10	-	R	F	Box Engine Z 19 DTJ	221056	Drive Shaft		33	34	52.5	94	595	
	2004.08-2010.10	-	L	F	Box Engine Z 19 DTJ	221073	Drive Shaft		33	25	52.5	94	578	
	2004.08-2010.10	-	L	F	Box Engine Z 19 DTJ	621018	Inner Joint		25	34	35	58	116	
	2004.08-2010.10	-	L	F	Box Engine Z 19 DTJ	699186	Inner Joint		25	28	35	57.5	81.5	
	2004.08-2010.10	-	-	F	Box Engine Z 19 DTJ	899024	Outer Joint		33	26	52.5	94	65.5	M
	2004.08-2010.10	AT	L	F	Box Engine Z 19 DTJ	221111	Drive Shaft		33	27	52.5	94	562	
	2004.08-2010.10	AT	R	F	Box Engine Z 19 DTJ	221110	Drive Shaft		33	27	52.5	94	576	
	2004.08-2010.10	-	L/R	F	Box Engine Z 19 DTJ	844027	Outer Joint		33	26	52.5	94	65.5	M
ASTRA H GTC (A04)														
1.2 (59 kW)	2005.08-2010.10	-	L	F	Hatchback Engine Z 12 XEP	244028	Drive Shaft		33	22	53	95	590	
	2005.08-2010.10	-	L	F	Hatchback Engine Z 12 XEP	621014	Inner Joint		22	22	35	57.5	75	
	2005.08-2010.10	-	R	F	Hatchback Engine Z 12 XEP	244030	Drive Shaft		33	22	53	95	952	
	2005.08-2010.10	-	L/R	F	Hatchback Engine Z 12 XEP	844003	Outer Joint		33	22	53	95	54.5	M
1.3 CDTI (66 kW)	2005.04-2010.10	-	R	F	Hatchback Engine Z 13 DTH	244051	Drive Shaft		33	34	53	93.5	570	
	2005.04-2010.10	-	L	F	Hatchback Engine Z 13 DTH	244052	Drive Shaft		33	25	53	93.5	573	
	2005.04-2010.10	-	L	F	Hatchback Engine Z 13 DTH	260020	Drive Shaft		33	25	52.5	94	561	
	2005.04-2010.10	-	L/R	F	Hatchback Engine Z 13 DTH	844028	Outer Joint		33	24	53	93.5	63.5	M
	2005.04-2010.10	-	L	F	Hatchback Engine Z 13 DTH	621018	Inner Joint		25	34	35	58	116	
1.4 (55 kW)	2005.03-2010.10	MT	L	F	Hatchback Engine Z 14 XEL	244028	Drive Shaft		33	22	53	95	590	
	2005.03-2010.10	MT	L	F	Hatchback Engine Z 14 XEL	621014	Inner Joint		22	22	35	57.5	75	
	2005.03-2010.10	MT	L/R	F	Hatchback Engine Z 14 XEL	844003	Outer Joint		33	22	53	95	54.5	M
	2005.03-2010.10	MT	R	F	Hatchback Engine Z 14 XEL	244030	Drive Shaft		33	22	53	95	952	
1.4 (66 kW)	2005.03-2010.10	MT	L	F	Hatchback Engine Z 14 XEP	244028	Drive Shaft		33	22	53	95	590	
	2005.03-2010.10	MT	L	F	Hatchback Engine Z 14 XEP	621014	Inner Joint		22	22	35	57.5	75	
	2005.03-2010.10	MT	L/R	F	Hatchback Engine Z 14 XEP	844003	Outer Joint		33	22	53	95	54.5	M
	2005.03-2010.10	MT	R	F	Hatchback Engine Z 14 XEP	244030	Drive Shaft		33	22	53	95	952	
1.6 (77 kW)	2005.03-2010.10	MT	L	F	Hatchback Engine Z 16 XEP/Z 16 XE1	244028	Drive Shaft		33	22	53	95	590	
	2005.03-2010.10	MT	L	F	Hatchback Engine Z 16 XEP/Z 16 XE1	621014	Inner Joint		22	22	35	57.5	75	
	2005.03-2010.10	MT	L/R	F	Hatchback Engine Z 16 XEP/Z 16 XE1	844003	Outer Joint		33	22	53	95	54.5	M
	2005.03-2010.10	MT	R	F	Hatchback Engine Z 16 XEP/Z 16 XE1	244030	Drive Shaft		33	22	53	95	952	
1.6 (85 kW)	2006.12-2010.10	-	L	F	Hatchback Engine Z 16 XER	244028	Drive Shaft		33	22	53	95	590	
	2006.12-2010.10	-	L	F	Hatchback Engine Z 16 XER	621014	Inner Joint		22	22	35	57.5	75	
	2006.12-2010.10	-	R	F	Hatchback Engine Z 16 XER	244030	Drive Shaft		33	22	53	95	952	
	2006.12-2010.10	-	L/R	F	Hatchback Engine Z 16 XER	844003	Outer Joint		33	22	53	95	54.5	M
1.6 Turbo (132 kW)	2007.02-2010.10	-	L/R	F	Hatchback Engine Z 16 LET	844028	Outer Joint		33	24	53	93.5	63.5	M
1.7 CDTI (59 kW)	2005.03-2010.10	-	L	F	Hatchback Engine Z 17 DTL	699026	Inner Joint		22	25	35	57	82.5	

	 YEAR	TRANSM	L/R	F/R	REMARKS	GSP Ref.	 PRODUCT	 ABS	Technical Specifications						
									A	B	C	H	L	P	
OPEL															
ASTRA H GTC (A04)															
1.7 CDTI (59 kW)	2005.03-2010.10	-	R	F	Hatchback Engine Z 17 DTL	644005	Inner Joint		34	25	35	54	47		
	2005.03-2010.10	-	L	F	Hatchback Engine Z 17 DTL	221063	Drive Shaft		33	22	53	93.5	586		
	2005.03-2010.10	-	L/R	F	Hatchback Engine Z 17 DTL	844028	Outer Joint		33	24	53	93.5	63.5	M	
	2005.03-2010.10	MT	R	F	Hatchback Engine Z 17 DTL	221055	Drive Shaft		33	22	53	93.5	950		
1.7 CDTI (74 kW)	2005.03-2010.10	5MT	L	F	Hatchback Engine Z 17 DTH	244029	Drive Shaft		33	34	53	93.5	594		
	2005.03-2010.10	5MT	R	F	Hatchback Engine Z 17 DTH	244031	Drive Shaft		33	34	53	93.5	559		
	2005.03-2010.10	6MT	L	F	Hatchback Engine Z 17 DTH	244052	Drive Shaft		33	25	53	93.5	573		
	2005.03-2010.10	MT/5MT	L	F	Hatchback Engine Z 17 DTH	621011	Inner Joint		34	25	35	78	64		
	2005.03-2010.10	5AT	R	F	Hatchback Engine Z 17 DTH	644005	Inner Joint		34	25	35	54	47		
	2005.03-2010.10	5AT	L	F	Hatchback Engine Z 17 DTH	244024	Drive Shaft		33	34	53	93.5	589		
	2005.03-2010.10	MT	L/R	F	Hatchback Engine Z 17 DTH	844028	Outer Joint		33	24	53	93.5	63.5	M	
	2005.03-2010.10	5MT	L	F	Hatchback Engine Z 17 DTH	644002	Inner Joint		34	25	35	56.2	85.6		
1.7 CDTI (81 kW)	2007.02-2010.10	-	L/R	F	Hatchback Engine A 17 DTJ	844027	Outer Joint		33	26	52.5	94	65.5	M	
	2007.02-2010.10	-	R	F	Hatchback Engine A 17 DTJ	644016	Inner Joint		34	28	37.5	46	54		
	2007.02-2010.10	-	R	F	Hatchback Engine A 17 DTJ	244099	Drive Shaft		33	34	52.5	94	563		
	2007.02-2010.10	-	L	F	Hatchback Engine A 17 DTJ	699186	Inner Joint		25	28	35	57.5	81.5		
	2007.02-2010.10	5AT	R	F	Hatchback Engine A 17 DTJ	644005	Inner Joint		34	25	35	54	47		
	2007.02-2010.10	-	L	F	Hatchback Engine A 17 DTJ	221051	Drive Shaft		33	25	52.5	94	579		
1.7 CDTI (92 kW)	2007.02-2010.10	-	L/R	F	Hatchback Engine A 17 DTR	844027	Outer Joint		33	26	52.5	94	65.5	M	
	2007.02-2010.10	-	R	F	Hatchback Engine A 17 DTR	644016	Inner Joint		34	28	37.5	46	54		
	2007.02-2010.10	-	R	F	Hatchback Engine A 17 DTR	244099	Drive Shaft		33	34	52.5	94	563		
	2007.02-2010.10	-	L	F	Hatchback Engine A 17 DTR	699186	Inner Joint		25	28	35	57.5	81.5		
	2007.02-2010.10	-	R	F	Hatchback Engine A 17 DTR	644005	Inner Joint		34	25	35	54	47		
	2007.02-2010.10	-	-	F	Hatchback Engine A 17 DTR	899024	Outer Joint		33	26	52.5	94	65.5	M	
	2007.02-2010.10	-	L	F	Hatchback Engine A 17 DTR	221051	Drive Shaft		33	25	52.5	94	579		
	1.8 (103 kW)	2006.01-2010.10	MT	L	F	Hatchback Engine Z 18 XER	699026	Inner Joint		22	25	35	57	82.5	
2006.01-2010.10		MT	L	F	Hatchback Engine Z 18 XER	221063	Drive Shaft		33	22	53	93.5	586		
2006.01-2010.10		AT/MT	R	F	Hatchback Engine Z 18 XER	221055	Drive Shaft		33	22	53	93.5	950		
2006.01-2010.10		AT	L	F	Hatchback Engine Z 18 XER	244097	Drive Shaft		33	22	53	93.5	588		
2006.01-2010.10		-	L/R	F	Hatchback Engine Z 18 XER	844028	Outer Joint		33	24	53	93.5	63.5	M	
2006.01-2010.10		AT	R	F	Hatchback Engine Z 18 XER	244098	Drive Shaft		33	22	53	93.5	950		
1.8 (92 kW)	2005.03-2010.10	MT	L	F	Hatchback Engine Z 18 XE	699026	Inner Joint		22	25	35	57	82.5		
	2005.03-2010.10	MT	L	F	Hatchback Engine Z 18 XE	221063	Drive Shaft		33	22	53	93.5	586		
	2005.03-2010.10	AT/MT	L/R	F	Hatchback Engine Z 18 XE	844028	Outer Joint		33	24	53	93.5	63.5	M	
	2005.03-2010.10	AT/MT	R	F	Hatchback Engine Z 18 XE	221055	Drive Shaft		33	22	53	93.5	950		
	2005.03-2010.10	AT	L	F	Hatchback Engine Z 18 XE	244097	Drive Shaft		33	22	53	93.5	588		
	2005.03-2010.10	AT	R	F	Hatchback Engine Z 18 XE	244098	Drive Shaft		33	22	53	93.5	950		
1.9 CDTI (110 kW)	2005.03-2010.10	MT	L/R	F	Hatchback Engine Z 19 DTH	817051	Outer Joint		30	26	53.8	94.5	65.5	M	
	2005.03-2010.10	-	L	F	Hatchback Engine Z 19 DTH	221035	Drive Shaft		30	25	53.8	94.5	581		
	2005.03-2010.10	-	L	F	Hatchback Engine Z 19 DTH	699186	Inner Joint		25	28	35	57.5	81.5		
	2005.03-2010.10	-	L	F	Hatchback Engine Z 19 DTH	621018	Inner Joint		25	34	35	58	116		
	2005.03-2010.10	-	L	F	Hatchback Engine Z 19 DTH	221071	Drive Shaft		30	25	53.8	94.5	576		
	2005.03-2010.10	-	-	F	Hatchback Engine Z 19 DTH	899023	Outer Joint		30	26	53.8	94.5	65.5	M	
	2005.03-2010.10	-	R	F	Hatchback Engine Z 19 DTH	221062	Drive Shaft		30	34	53.8	94.5	595		
	2005.03-2010.10	-	R	F	Hatchback Engine Z 19 DTH	260016	Drive Shaft		30	34	52.5	105	588		
	2005.03-2010.10	-	L/R	F	Hatchback Engine Z 19 DTH	844027	Outer Joint		33	26	52.5	94	65.5	M	
1.9 CDTI (74 kW)	2006.01-2010.10	-	R	F	Hatchback Engine Z 19 DTL	221056	Drive Shaft		33	34	52.5	94	595		
	2006.01-2010.10	-	L	F	Hatchback Engine Z 19 DTL	221073	Drive Shaft		33	25	52.5	94	578		
	2006.01-2010.10	-	L	F	Hatchback Engine Z 19 DTL	621018	Inner Joint		25	34	35	58	116		
	2006.01-2010.10	-	L	F	Hatchback Engine Z 19 DTL	699186	Inner Joint		25	28	35	57.5	81.5		
	2006.01-2010.10	AT	L	F	Hatchback Engine Z 19 DTL	221111	Drive Shaft		33	27	52.5	94	562		
	2006.01-2010.10	-	-	F	Hatchback Engine Z 19 DTL	899024	Outer Joint		33	26	52.5	94	65.5	M	
	2006.01-2010.10	AT	R	F	Hatchback Engine Z 19 DTL	221110	Drive Shaft		33	27	52.5	94	576		
	1.9 CDTI (88 kW)	2005.09-2010.10	-	L/R	F	Hatchback Engine Z 19 DT	844027	Outer Joint		33	26	52.5	94	65.5	M
		2005.09-2010.10	-	R	F	Hatchback Engine Z 19 DT	221056	Drive Shaft		33	34	52.5	94	595	
2005.09-2010.10		-	L	F	Hatchback Engine Z 19 DT	221073	Drive Shaft		33	25	52.5	94	578		
2005.09-2010.10		-	L	F	Hatchback Engine Z 19 DT	621018	Inner Joint		25	34	35	58	116		
2005.09-2010.10		-	L	F	Hatchback Engine Z 19 DT	699186	Inner Joint		25	28	35	57.5	81.5		
2005.09-2010.10		AT	L	F	Hatchback Engine Z 19 DT	221111	Drive Shaft		33	27	52.5	94	562		
2005.09-2010.10		-	-	F	Hatchback Engine Z 19 DT	899024	Outer Joint		33	26	52.5	94	65.5	M	
2005.09-2010.10		AT	R	F	Hatchback Engine Z 19 DT	221110	Drive Shaft		33	27	52.5	94	576		
1.9 CDTI 16V (88 kW)		2005.03-2010.10	-	R	F	Hatchback Engine Z 19 DTJ	221056	Drive Shaft		33	34	52.5	94	595	
	2005.03-2010.10	-	L	F	Hatchback Engine Z 19 DTJ	221073	Drive Shaft		33	25	52.5	94	578		
	2005.03-2010.10	-	L	F	Hatchback Engine Z 19 DTJ	621018	Inner Joint		25	34	35	58	116		
	2005.03-2010.10	-	L	F	Hatchback Engine Z 19 DTJ	699186	Inner Joint		25	28	35	57.5	81.5		
	2005.03-2010.10	AT	L	F	Hatchback Engine Z 19 DTJ	221111	Drive Shaft		33	27	52.5	94	562		





	 YEAR	TRANSM	L/R	F/R	REMARKS	GSP Ref.	 PRODUCT	 ABS	Technical Specifications								
									A	B	C	H	L	P			
OPEL																	
ASTRA H GTC (A04)																	
1.9 CDTI 16V (88 kW)	2005.03-2010.10	-	-	F	Hatchback Engine Z 19 DTJ	899024	Outer Joint		33	26	52.5	94	65.5	M			
	2005.03-2010.10	AT	R	F	Hatchback Engine Z 19 DTJ	221110	Drive Shaft		33	27	52.5	94	576				
	2005.03-2010.10	-	L/R	F	Hatchback Engine Z 19 DTJ	844027	Outer Joint		33	26	52.5	94	65.5	M			
2.0 Turbo (125 kW)	2005.03-2010.10	-	R	F	Hatchback Engine Z 20 LEL	221056	Drive Shaft		33	34	52.5	94	595				
	2005.03-2010.10	-	-	F	Hatchback Engine Z 20 LEL	899024	Outer Joint		33	26	52.5	94	65.5	M			
	2005.03-2010.10	-	L/R	F	Hatchback Engine Z 20 LEL	844027	Outer Joint		33	26	52.5	94	65.5	M			
2.0 Turbo (147 kW)	2005.03-2010.10	-	R	F	Hatchback Engine Z 20 LER	221056	Drive Shaft		33	34	52.5	94	595				
	2005.03-2010.10	-	-	F	Hatchback Engine Z 20 LER	899024	Outer Joint		33	26	52.5	94	65.5	M			
	2005.03-2010.10	-	L/R	F	Hatchback Engine Z 20 LER	844027	Outer Joint		33	26	52.5	94	65.5	M			
2.0 Turbo (177 kW)	2005.08-2010.10	-	L/R	F	Hatchback Engine Z 20 LEH	817051	Outer Joint		30	26	53.8	94.5	65.5	M			
	2005.08-2010.10	-	R	F	Hatchback Engine Z 20 LEH	221062	Drive Shaft		30	34	53.8	94.5	595				
	2005.08-2010.10	-	R	F	Hatchback Engine Z 20 LEH	260016	Drive Shaft		30	34	52.5	105	588				
2005.08-2010.10	-	-	F	Hatchback Engine Z 20 LEH	899023	Outer Joint		30	26	53.8	94.5	65.5	M				
ASTRA H SPORT HATCH																	
1.3(66kW)	2005-2010	-	R	F	Hatchback	644011	Inner Joint		34	25	37.5	46	55				
	2005-2010	-	R	F	Hatchback	644011	Inner Joint		34	25	37.5	46	55				
	2005-2010	-	R	F	Hatchback	644011	Inner Joint		34	25	37.5	46	55				
	2005-2010	-	R	F	Hatchback	644011	Inner Joint		34	25	37.5	46	55				
	2005-2010	-	R	F	Hatchback	644011	Inner Joint		34	25	37.5	46	55				
	2005-2010	-	R	F	Hatchback	644011	Inner Joint		34	25	37.5	46	55				
ASTRA H TwinTop (A04)																	
1.6 (77 kW)	2005.09-2010.10	MT	L	F	Convertible Engine Z 16 XEP/Z 16 XE1	244028	Drive Shaft		33	22	53	95	590				
	2005.09-2010.10	MT	L	F	Convertible Engine Z 16 XEP/Z 16 XE1	621014	Inner Joint		22	22	35	57.5	75				
	2005.09-2010.10	MT	L/R	F	Convertible Engine Z 16 XEP/Z 16 XE1	844003	Outer Joint		33	22	53	95	54.5	M			
	2005.09-2010.10	MT	R	F	Convertible Engine Z 16 XEP/Z 16 XE1	244030	Drive Shaft		33	22	53	95	952				
1.6 (85 kW)	2006.12-2010.10	-	L	F	Convertible Engine Z 16 XER	244028	Drive Shaft		33	22	53	95	590				
	2006.12-2010.10	-	L	F	Convertible Engine Z 16 XER	621014	Inner Joint		22	22	35	57.5	75				
	2006.12-2010.10	-	R	F	Convertible Engine Z 16 XER	244030	Drive Shaft		33	22	53	95	952				
	2006.12-2010.10	-	L/R	F	Convertible Engine Z 16 XER	844003	Outer Joint		33	22	53	95	54.5	M			
1.6 Turbo (132 kW)	2007.02-2010.10	-	L/R	F	Convertible Engine Z 16 LET	844028	Outer Joint		33	24	53	93.5	63.5	M			
1.8 (103 kW)	2005.09-2010.10	MT	L	F	Convertible Engine Z 18 XER/A 18 XER	699026	Inner Joint		22	25	35	57	82.5				
	2005.09-2010.10	MT	L	F	Convertible Engine Z 18 XER/A 18 XER	221063	Drive Shaft		33	22	53	93.5	586				
	2005.09-2010.10	-	L/R	F	Convertible Engine Z 18 XER/A 18 XER	844028	Outer Joint		33	24	53	93.5	63.5	M			
	2005.09-2010.10	AT	L	F	Convertible Engine Z 18 XER/A 18 XER	244097	Drive Shaft		33	22	53	93.5	588				
	2005.09-2010.10	AT/MT	R	F	Convertible Engine Z 18 XER/A 18 XER	221055	Drive Shaft		33	22	53	93.5	950				
	2005.09-2010.10	AT	R	F	Convertible Engine Z 18 XER/A 18 XER	244098	Drive Shaft		33	22	53	93.5	950				
1.8 (92 kW)	2005.09-2010.10	MT	L	F	Convertible Engine Z 18 XE	699026	Inner Joint		22	25	35	57	82.5				
	2005.09-2010.10	MT	L	F	Convertible Engine Z 18 XE	221063	Drive Shaft		33	22	53	93.5	586				
	2005.09-2010.10	AT/MT	L/R	F	Convertible Engine Z 18 XE	844028	Outer Joint		33	24	53	93.5	63.5	M			
	2005.09-2010.10	AT/MT	R	F	Convertible Engine Z 18 XE	221055	Drive Shaft		33	22	53	93.5	950				
	2005.09-2010.10	AT	L	F	Convertible Engine Z 18 XE	244097	Drive Shaft		33	22	53	93.5	588				
	2005.09-2010.10	AT	R	F	Convertible Engine Z 18 XE	244098	Drive Shaft		33	22	53	93.5	950				
1.9 CDTI (110 kW)	2005.09-2010.10	-	L	F	Convertible Engine Z 19 DTH	221035	Drive Shaft		30	25	53.8	94.5	581				
	2005.09-2010.10	MT	L/R	F	Convertible Engine Z 19 DTH	817051	Outer Joint		30	26	53.8	94.5	65.5	M			
	2005.09-2010.10	-	L	F	Convertible Engine Z 19 DTH	699186	Inner Joint		25	28	35	57.5	81.5				
	2005.09-2010.10	-	L	F	Convertible Engine Z 19 DTH	621018	Inner Joint		25	34	35	58	116				
	2005.09-2010.10	-	L	F	Convertible Engine Z 19 DTH	221071	Drive Shaft		30	25	53.8	94.5	576				
	2005.09-2010.10	-	R	F	Convertible Engine Z 19 DTH	221062	Drive Shaft		30	34	53.8	94.5	595				
	2005.09-2010.10	-	R	F	Convertible Engine Z 19 DTH	260016	Drive Shaft		30	34	52.5	105	588				
	2005.09-2010.10	-	-	F	Convertible Engine Z 19 DTH	899023	Outer Joint		30	26	53.8	94.5	65.5	M			
2.0 Turbo (125 kW)	2005.09-2010.10	-	R	F	Convertible Engine Z 20 LEL	221056	Drive Shaft		33	34	52.5	94	595				
	2005.09-2010.10	-	-	F	Convertible Engine Z 20 LEL	899024	Outer Joint		33	26	52.5	94	65.5	M			
	2005.09-2010.10	-	L/R	F	Convertible Engine Z 20 LEL	844027	Outer Joint		33	26	52.5	94	65.5	M			
2.0 Turbo (147 kW)	2005.09-2010.10	-	R	F	Convertible Engine Z 20 LER	221056	Drive Shaft		33	34	52.5	94	595				
	2005.09-2010.10	-	-	F	Convertible Engine Z 20 LER	899024	Outer Joint		33	26	52.5	94	65.5	M			
	2005.09-2010.10	-	L/R	F	Convertible Engine Z 20 LER	844027	Outer Joint		33	26	52.5	94	65.5	M			
ASTRA J																	
-	2010-	-	-	-	-	608054	Inner Joint		34	23	37.5		121.5				
1.3 CDTI (70 kW)	2012.06-	-	-	F	Saloon Engine A 13 DTE	808047	Outer Joint		33	23	52.5	94	59.5	M			
1.4 (74 kW)	2012.06-	MT	L	F	Saloon Engine A 14 XER	244064	Drive Shaft		33	22	53	95	618				
	2012.06-	MT	R	F	Saloon Engine A 14 XER	244065	Drive Shaft		33	22	53	95	983				
	2012.06-	MT	L	F	Saloon Engine A 14 XER	621014	Inner Joint		22	22	35	57.5	75				
1.4 LPG (103 kW)	2014.07-	MT	R	F	Saloon Engine A 14 NET	644005	Inner Joint		34	25	35	54	47				
	2014.07-	AT	-	F	Saloon Engine A 14 NET	808047	Outer Joint		33	23	52.5	94	59.5	M			
	2014.07-	MT	R	F	Saloon Engine A 14 NET	221109	Drive Shaft		33	34	53	93.5	588				
1.4 Turbo (103 kW)	2012.06-	MT	R	F	Saloon Engine A 14 NET/B 14 NET	644005	Inner Joint		34	25	35	54	47				

	 YEAR	TRANSM	L/R	F/R	REMARKS	GSP Ref.	 PRODUCT	 ABS	Technical Specifications						
									A	B	C	H	L	P	
OPEL															
ASTRA J															
1.4 Turbo (103 kW)	2012.06-	-	AT	-	F Saloon Engine A 14 NET/B 14 NET	808047	Outer Joint		33	23	52.5	94	59.5	M	
	2012.06-	-	MT	R	F Saloon Engine A 14 NET/B 14 NET	221109	Drive Shaft		33	34	53	93.5	588		
1.4 Turbo (88 kW)	2012.06-	-	MT	R	F Saloon Engine A 14 NEL/B 14 NEL	644005	Inner Joint		34	25	35	54	47		
	2012.06-	-	AT	-	F Saloon Engine A 14 NEL/B 14 NEL	808047	Outer Joint		33	23	52.5	94	59.5	M	
	2012.06-	-	MT	L	F Saloon Engine A 14 NEL/B 14 NEL	244064	Drive Shaft		33	22	53	95	618		
	2012.06-	-	MT	R	F Saloon Engine A 14 NEL/B 14 NEL	221109	Drive Shaft		33	34	53	93.5	588		
	2012.06-	-	MT	R	F Saloon Engine A 14 NEL/B 14 NEL	244065	Drive Shaft		33	22	53	95	983		
	2012.06-	-	MT	L	F Saloon Engine A 14 NEL/B 14 NEL	621014	Inner Joint		22	22	35	57.5	75		
1.6 (85 kW)	2012.06-	-	AT	R	F Saloon Engine A 16 XER/B 16 XER	208077	Drive Shaft		33	34	52.5	94	951		
	2012.06-	-	AT	R	F Saloon Engine A 16 XER/B 16 XER	621029	Inner Joint		22	23	35	57.5	103		
	2012.06-	-	AT	R	F Saloon Engine A 16 XER/B 16 XER	844088	Outer Joint		33	23	52.3	94	59.5	M	
	2012.06-	-	AT	-	F Saloon Engine A 16 XER/B 16 XER	808047	Outer Joint		33	23	52.5	94	59.5	M	
	2012.06-	-	MT	L	F Saloon Engine A 16 XER/B 16 XER	244064	Drive Shaft		33	22	53	95	618		
	2012.06-	-	AT	R	F Saloon Engine A 16 XER/B 16 XER	221072	Drive Shaft		33	22	52.3	94	957		
1.6 CDTI (100 kW)	2012.06-	-	MT	R	F Saloon Engine A 16 XER/B 16 XER	244065	Drive Shaft		33	22	53	95	983		
	2012.06-	-	MT	L	F Saloon Engine A 16 XER/B 16 XER	621014	Inner Joint		22	22	35	57.5	75		
	2014.01-	-	-	-	F Saloon Engine B 16 DTH	899023	Outer Joint		30	26	53.8	94.5	65.5	M	
	2014.01-	-	MT	L/R	F Saloon Engine B 16 DTH	817051	Outer Joint		30	26	53.8	94.5	65.5	M	
	2014.04-	-	MT	L/R	F Saloon Engine B 16 DTL	817051	Outer Joint		30	26	53.8	94.5	65.5	M	
	2014.04-	-	-	-	F Saloon Engine B 16 DTL	899023	Outer Joint		30	26	53.8	94.5	65.5	M	
1.6 SIDI (125 kW)	2012.12-	-	-	-	F Saloon Engine A 16 XHT	899023	Outer Joint		30	26	53.8	94.5	65.5	M	
	2012.12-	-	MT	L	F Saloon Engine A 16 XHT	821049	Outer Joint		30	26	52.5	94	65.5	M	
	2012.12-	-	AT/MT	L/R	F Saloon Engine A 16 XHT	817051	Outer Joint		30	26	53.8	94.5	65.5	M	
1.6 Turbo (132 kW)	2012.06-	-	MT	R	F Saloon Engine A 16 LET	821049	Outer Joint		30	26	52.5	94	65.5	M	
	2012.06-	-	-	-	F Saloon Engine A 16 LET	899023	Outer Joint		30	26	53.8	94.5	65.5	M	
	2012.06-	-	-	L/R	F Saloon Engine A 16 LET	817051	Outer Joint		30	26	53.8	94.5	65.5	M	
	2012.06-	-	MT	R	F Saloon Engine A 16 LET	221074	Drive Shaft		30	34	52.5	94	589		
1.7 CDTI (81 kW)	2012.06-	-	-	-	F Saloon Engine A 17 DTC/A 17 DTJ/A 17 DTE	899023	Outer Joint		30	26	53.8	94.5	65.5	M	
	2012.06-	-	MT	L	F Saloon Engine A 17 DTC/A 17 DTJ/A 17 DTE	821049	Outer Joint		30	26	52.5	94	65.5	M	
	2012.06-	-	MT	L	F Saloon Engine A 17 DTC/A 17 DTJ/A 17 DTE	221076	Drive Shaft		30	25	52.5	94	601		
	2012.06-	-	MT	L/R	F Saloon Engine A 17 DTC/A 17 DTJ/A 17 DTE	817051	Outer Joint		30	26	53.8	94.5	65.5	M	
1.7 CDTI (96 kW)	2012.06-	-	-	-	F Saloon Engine A 17 DTS/A 17 DTF	899023	Outer Joint		30	26	53.8	94.5	65.5	M	
	2012.06-	-	MT	L	F Saloon Engine A 17 DTS/A 17 DTF	821049	Outer Joint		30	26	52.5	94	65.5	M	
	2012.06-	-	MT	L	F Saloon Engine A 17 DTS/A 17 DTF	221076	Drive Shaft		30	25	52.5	94	601		
	2012.06-	-	MT	L/R	F Saloon Engine A 17 DTS/A 17 DTF	817051	Outer Joint		30	26	53.8	94.5	65.5	M	
ASTRA J (P10)															
1.3 CDTI (70 kW)	2009.12-	-	-	-	F Hatchback Engine A 13 DTE	808047	Outer Joint		33	23	52.5	94	59.5	M	
1.4 (64 kW)	2009.12-	-	-	L	F Hatchback Engine A 14 XEL	244064	Drive Shaft		33	22	53	95	618		
	2009.12-	-	-	R	F Hatchback Engine A 14 XEL	244065	Drive Shaft		33	22	53	95	983		
	2009.12-	-	-	L	F Hatchback Engine A 14 XEL	621014	Inner Joint		22	22	35	57.5	75		
1.4 (74 kW)	2009.12-	-	-	L	F Hatchback Engine A 14 XER	244064	Drive Shaft		33	22	53	95	618		
	2009.12-	-	-	R	F Hatchback Engine A 14 XER	244065	Drive Shaft		33	22	53	95	983		
	2009.12-	-	-	L	F Hatchback Engine A 14 XER	621014	Inner Joint		22	22	35	57.5	75		
1.4 LPG (103 kW)	2012.01-	-	MT	R	F Hatchback Engine A 14 NET	644005	Inner Joint		34	25	35	54	47		
	2012.01-	-	AT	-	F Hatchback Engine A 14 NET	808047	Outer Joint		33	23	52.5	94	59.5	M	
	2012.01-	-	MT	R	F Hatchback Engine A 14 NET	221109	Drive Shaft		33	34	53	93.5	588		
1.4 Turbo (103 kW)	2009.12-	-	MT	R	F Hatchback Engine A 14 NET	644005	Inner Joint		34	25	35	54	47		
	2009.12-	-	AT	-	F Hatchback Engine A 14 NET	808047	Outer Joint		33	23	52.5	94	59.5	M	
	2009.12-	-	MT	R	F Hatchback Engine A 14 NET	221109	Drive Shaft		33	34	53	93.5	588		
1.4 Turbo (88 kW)	2010.10-	-	MT	R	F Hatchback Engine A 14 NEL/B 14 NEL	644005	Inner Joint		34	25	35	54	47		
	2010.10-	-	AT	-	F Hatchback Engine A 14 NEL/B 14 NEL	808047	Outer Joint		33	23	52.5	94	59.5	M	
	2010.10-	-	MT	R	F Hatchback Engine A 14 NEL/B 14 NEL	221109	Drive Shaft		33	34	53	93.5	588		
1.6 (85 kW)	2009.12-	-	-	R	F Hatchback Engine A 16 XER/B 16 XER	208077	Drive Shaft		33	34	52.5	94	951		
	2009.12-	-	AT	R	F Hatchback Engine A 16 XER/B 16 XER	621029	Inner Joint		22	23	35	57.5	103		
	2009.12-	-	AT	R	F Hatchback Engine A 16 XER/B 16 XER	844088	Outer Joint		33	23	52.3	94	59.5	M	
	2009.12-	-	AT	-	F Hatchback Engine A 16 XER/B 16 XER	808047	Outer Joint		33	23	52.5	94	59.5	M	
	2009.12-	-	MT	L	F Hatchback Engine A 16 XER/B 16 XER	244064	Drive Shaft		33	22	53	95	618		
	2009.12-	-	MT	R	F Hatchback Engine A 16 XER/B 16 XER	244065	Drive Shaft		33	22	53	95	983		
	2009.12-	-	AT	R	F Hatchback Engine A 16 XER/B 16 XER	221072	Drive Shaft		33	22	52.3	94	957		
	2009.12-	-	MT	L	F Hatchback Engine A 16 XER/B 16 XER	621014	Inner Joint		22	22	35	57.5	75		
1.6 CDTI (100 kW)	2014.01-	-	-	-	F Hatchback Engine B 16 DTH	899023	Outer Joint		30	26	53.8	94.5	65.5	M	
	2014.01-	-	MT	L/R	F Hatchback Engine B 16 DTH	817051	Outer Joint		30	26	53.8	94.5	65.5	M	
1.6 CDTI (81 kW)	2014.02-	-	-	-	F Hatchback Engine B 16 DTL	899023	Outer Joint		30	26	53.8	94.5	65.5	M	
	2014.02-	-	MT	L/R	F Hatchback Engine B 16 DTL	817051	Outer Joint		30	26	53.8	94.5	65.5	M	
1.6 SIDI (125 kW)	2012.12-	-	-	-	F Hatchback Engine A 16 XHT/B 16 SHL	899023	Outer Joint		30	26	53.8	94.5	65.5	M	
	2012.12-	-	MT	L	F Hatchback Engine A 16 XHT/B 16 SHL	821049	Outer Joint		30	26	52.5	94	65.5	M	





	 YEAR	TRANSM	L/R	F/R	REMARKS	GSP Ref.	 PRODUCT	 ABS	Technical Specifications					
									A	B	C	H	L	P
OPEL														
ASTRA J (P10)														
1.6 SIDI (125 kW)	2012.12-	-	AT/MT	L/R	F	Hatchback Engine A 16 XHT/B 16 SHL	817051	Outer Joint	30	26	53.8	94.5	65.5	M
1.6 Turbo (132 kW)	2009.12-	-	-	-	F	Hatchback Engine A 16 LET	899023	Outer Joint	30	26	53.8	94.5	65.5	M
	2009.12-	-	MT	R	F	Hatchback Engine A 16 LET	821049	Outer Joint	30	26	52.5	94	65.5	M
	2009.12-	-	-	L/R	F	Hatchback Engine A 16 LET	817051	Outer Joint	30	26	53.8	94.5	65.5	M
	2009.12-	-	MT	R	F	Hatchback Engine A 16 LET	221074	Drive Shaft	30	34	52.5	94	589	
1.7 CDTI (74 kW)	2010.10-	-	MT	L	F	Hatchback Engine A 17 DTL	821049	Outer Joint	30	26	52.5	94	65.5	M
	2010.10-	-	MT	L	F	Hatchback Engine A 17 DTL	221076	Drive Shaft	30	25	52.5	94	601	
	2010.10-	-	-	-	F	Hatchback Engine A 17 DTL	899023	Outer Joint	30	26	53.8	94.5	65.5	M
1.7 CDTI (81 kW)	2009.12-	-	-	-	F	Hatchback Engine A 17 DTJ/A 17 DTC/A 17 DTE	899023	Outer Joint	30	26	53.8	94.5	65.5	M
	2009.12-	-	-	R	F	Hatchback Engine A 17 DTJ/A 17 DTC/A 17 DTE	821049	Outer Joint	30	26	52.5	94	65.5	M
	2009.12-	-	MT	L	F	Hatchback Engine A 17 DTJ/A 17 DTC/A 17 DTE	221076	Drive Shaft	30	25	52.5	94	601	
	2009.12-	-	-	L/R	F	Hatchback Engine A 17 DTJ/A 17 DTC/A 17 DTE	817051	Outer Joint	30	26	53.8	94.5	65.5	M
	2009.12-	-	-	R	F	Hatchback Engine A 17 DTJ/A 17 DTC/A 17 DTE	221074	Drive Shaft	30	34	52.5	94	589	
1.7 CDTI (92 kW)	2009.12-	-	-	-	F	Hatchback Engine A 17 DTR	899023	Outer Joint	30	26	53.8	94.5	65.5	M
	2009.12-	-	-	R	F	Hatchback Engine A 17 DTR	821049	Outer Joint	30	26	52.5	94	65.5	M
	2009.12-	-	MT	L	F	Hatchback Engine A 17 DTR	221076	Drive Shaft	30	25	52.5	94	601	
	2009.12-	-	-	L/R	F	Hatchback Engine A 17 DTR	817051	Outer Joint	30	26	53.8	94.5	65.5	M
	2009.12-	-	-	R	F	Hatchback Engine A 17 DTR	221074	Drive Shaft	30	34	52.5	94	589	
1.7 CDTI (96 kW)	2009.12-	-	-	R	F	Hatchback Engine A 17 DTS/A 17 DTF	821049	Outer Joint	30	26	52.5	94	65.5	M
	2009.12-	-	-	L/R	F	Hatchback Engine A 17 DTS/A 17 DTF	817051	Outer Joint	30	26	53.8	94.5	65.5	M
	2009.12-	-	MT	L	F	Hatchback Engine A 17 DTS/A 17 DTF	221076	Drive Shaft	30	25	52.5	94	601	
	2009.12-	-	-	-	F	Hatchback Engine A 17 DTS/A 17 DTF	899023	Outer Joint	30	26	53.8	94.5	65.5	M
	2009.12-	-	-	R	F	Hatchback Engine A 17 DTS/A 17 DTF	221074	Drive Shaft	30	34	52.5	94	589	
2.0 BiTurbo CDTI (143 kW)	2012.12-	-	MT	L	F	Hatchback Engine A 20 DTR	221075	Drive Shaft	30	27	52.5	94	599	
	2012.12-	-	MT	L	F	Hatchback Engine A 20 DTR	821049	Outer Joint	30	26	52.5	94	65.5	M
2.0 CDTI (118 kW)	2009.12-	-	-	-	F	Hatchback Engine A 20 DTH	899023	Outer Joint	30	26	53.8	94.5	65.5	M
	2009.12-	-	MT	L	F	Hatchback Engine A 20 DTH	221075	Drive Shaft	30	27	52.5	94	599	
	2009.12-	-	MT	L	F	Hatchback Engine A 20 DTH	821049	Outer Joint	30	26	52.5	94	65.5	M
	2009.12-	-	-	L/R	F	Hatchback Engine A 20 DTH	817051	Outer Joint	30	26	53.8	94.5	65.5	M
2.0 CDTI (121 kW)	2011.06-	-	-	-	F	Hatchback Engine A 20 DTH	899023	Outer Joint	30	26	53.8	94.5	65.5	M
	2011.06-	-	-	L/R	F	Hatchback Engine A 20 DTH	817051	Outer Joint	30	26	53.8	94.5	65.5	M
ASTRA J GTC														
1.4 (103 kW)	2011.10-	-	MT	R	F	Hatchback Engine A 14 NET/B 14 NET	644005	Inner Joint	34	25	35	54	47	
	2011.10-	-	AT	-	F	Hatchback Engine A 14 NET/B 14 NET	808047	Outer Joint	33	23	52.5	94	59.5	M
	2011.10-	-	MT	R	F	Hatchback Engine A 14 NET/B 14 NET	221109	Drive Shaft	33	34	53	93.5	588	
	2011.10-	-	MT	L/R	F	Hatchback Engine A 14 NET/B 14 NET	817051	Outer Joint	30	26	53.8	94.5	65.5	M
1.4 (88 kW)	2011.10-	-	MT	R	F	Hatchback Engine A 14 NEL/B 14 NEL	644005	Inner Joint	34	25	35	54	47	
	2011.10-	-	AT	-	F	Hatchback Engine A 14 NEL/B 14 NEL	808047	Outer Joint	33	23	52.5	94	59.5	M
	2011.10-	-	MT	R	F	Hatchback Engine A 14 NEL/B 14 NEL	221109	Drive Shaft	33	34	53	93.5	588	
	2011.10-	-	MT	L/R	F	Hatchback Engine A 14 NEL/B 14 NEL	817051	Outer Joint	30	26	53.8	94.5	65.5	M
1.6 (132 kW)	2011.10-	-	MT	L	F	Hatchback Engine A 16 LET	821049	Outer Joint	30	26	52.5	94	65.5	M
	2011.10-	-	-	-	F	Hatchback Engine A 16 LET	899023	Outer Joint	30	26	53.8	94.5	65.5	M
	2011.10-	-	MT	L/R	F	Hatchback Engine A 16 LET	817051	Outer Joint	30	26	53.8	94.5	65.5	M
1.6 CDTI (100 kW)	2014.07-	-	-	-	F	Hatchback Engine B 16 DTH	899023	Outer Joint	30	26	53.8	94.5	65.5	M
	2014.07-	-	MT	L	F	Hatchback Engine B 16 DTH	817051	Outer Joint	30	26	53.8	94.5	65.5	M
1.6 CDTI (81 kW)	2014.07-	-	-	-	F	Hatchback Engine B 16 DTL	899023	Outer Joint	30	26	53.8	94.5	65.5	M
	2014.07-	-	MT	L	F	Hatchback Engine B 16 DTL	817051	Outer Joint	30	26	53.8	94.5	65.5	M
1.6 SIDI (125 kW)	2012.12-	-	-	-	F	Hatchback Engine A 16 XHT/B 16 SHL	899023	Outer Joint	30	26	53.8	94.5	65.5	M
	2012.12-	-	MT	L	F	Hatchback Engine A 16 XHT/B 16 SHL	821049	Outer Joint	30	26	52.5	94	65.5	M
	2012.12-	-	-	L	F	Hatchback Engine A 16 XHT/B 16 SHL	817051	Outer Joint	30	26	53.8	94.5	65.5	M
1.6 SIDI (147 kW)	2013.07-	-	-	-	F	Hatchback Engine A 16 SHT/B 16 SHT	899023	Outer Joint	30	26	53.8	94.5	65.5	M
	2013.07-	-	MT	L	F	Hatchback Engine A 16 SHT/B 16 SHT	821049	Outer Joint	30	26	52.5	94	65.5	M
	2013.07-	-	-	L/R	F	Hatchback Engine A 16 SHT/B 16 SHT	817051	Outer Joint	30	26	53.8	94.5	65.5	M
1.7 CDTI (81 kW)	2011.10-	-	MT	L	F	Hatchback Engine A 17 DTJ/A 17 DTC/A 17 DTE	821049	Outer Joint	30	26	52.5	94	65.5	M
	2011.10-	-	MT	L	F	Hatchback Engine A 17 DTJ/A 17 DTC/A 17 DTE	221076	Drive Shaft	30	25	52.5	94	601	
	2011.10-	-	-	-	F	Hatchback Engine A 17 DTJ/A 17 DTC/A 17 DTE	899023	Outer Joint	30	26	53.8	94.5	65.5	M
	2011.10-	-	MT	L/R	F	Hatchback Engine A 17 DTJ/A 17 DTC/A 17 DTE	817051	Outer Joint	30	26	53.8	94.5	65.5	M
1.7 CDTI (96 kW)	2011.10-	-	MT	L	F	Hatchback Engine A 17 DTS/A 17 DTF	821049	Outer Joint	30	26	52.5	94	65.5	M
	2011.10-	-	MT	L	F	Hatchback Engine A 17 DTS/A 17 DTF	221076	Drive Shaft	30	25	52.5	94	601	
	2011.10-	-	-	-	F	Hatchback Engine A 17 DTS/A 17 DTF	899023	Outer Joint	30	26	53.8	94.5	65.5	M
	2011.10-	-	MT	L/R	F	Hatchback Engine A 17 DTS/A 17 DTF	817051	Outer Joint	30	26	53.8	94.5	65.5	M
2.0 (206 kW)	2012.04-	-	-	-	F	Hatchback Engine A 20 NFT/B 20 NFT	899367	Outer Joint	30	27	58.9	94	64.5	M
	2012.04-	-	MT	-	F	Hatchback Engine A 20 NFT/B 20 NFT	821057	Outer Joint	30	27	59.1	94	65	M
2.0 CDTI (121 kW)	2011.10-	-	-	-	F	Hatchback Engine A 20 DTH	899023	Outer Joint	30	26	53.8	94.5	65.5	M
	2011.10-	-	AT	L	F	Hatchback Engine A 20 DTH	817051	Outer Joint	30	26	53.8	94.5	65.5	M
	2011.10-	-	MT	L	F	Hatchback Engine A 20 DTH	221075	Drive Shaft	30	27	52.5	94	599	





	 YEAR	TRANSM	L/R	F/R	REMARKS	GSP Ref.	 PRODUCT	 ABS	Technical Specifications						
									A	B	C	H	L	P	
OPEL															
ASTRA J GTC															
2.0 CDTI (121 kW)	2011.10-	-	MT	L	F	Hatchback Engine A 20 DTH	821049	Outer Joint		30	26	52.5	94	65.5	M
ASTRA J Sports Tourer (P10)															
1.3 CDTI (70 kW)	2010.10-	-	-	-	F	Estate Engine A 13 DTE	808047	Outer Joint		33	23	52.5	94	59.5	M
1.4 (64 kW)	2010.10-	2015.10	-	L	F	Estate Engine A 14 XEL	244064	Drive Shaft		33	22	53	95	618	
	2010.10-	2015.10	-	R	F	Estate Engine A 14 XEL	244065	Drive Shaft		33	22	53	95	983	
	2010.10-	2015.10	-	L	F	Estate Engine A 14 XEL	621014	Inner Joint		22	22	35	57.5	75	
1.4 (74 kW)	2010.10-	-	-	L	F	Estate Engine A 14 XER	244064	Drive Shaft		33	22	53	95	618	
	2010.10-	-	-	R	F	Estate Engine A 14 XER	244065	Drive Shaft		33	22	53	95	983	
	2010.10-	-	-	L	F	Estate Engine A 14 XER	621014	Inner Joint		22	22	35	57.5	75	
1.4 LPG (103 kW)	2012.01-	-	MT	R	F	Estate Engine A 14 NET	644005	Inner Joint		34	25	35	54	47	
	2012.01-	-	AT	-	F	Estate Engine A 14 NET	808047	Outer Joint		33	23	52.5	94	59.5	M
	2012.01-	-	MT	R	F	Estate Engine A 14 NET	221109	Drive Shaft		33	34	53	93.5	588	
1.4 Turbo (103 kW)	2010.10-	-	MT	R	F	Estate Engine A 14 NET/B 14 NET	644005	Inner Joint		34	25	35	54	47	
	2010.10-	-	AT	-	F	Estate Engine A 14 NET/B 14 NET	808047	Outer Joint		33	23	52.5	94	59.5	M
	2010.10-	-	MT	R	F	Estate Engine A 14 NET/B 14 NET	221109	Drive Shaft		33	34	53	93.5	588	
1.4 Turbo (88 kW)	2010.10-	-	MT	R	F	Estate Engine A 14 NEL/B 14 NEL	644005	Inner Joint		34	25	35	54	47	
	2010.10-	-	AT	-	F	Estate Engine A 14 NEL/B 14 NEL	808047	Outer Joint		33	23	52.5	94	59.5	M
	2010.10-	-	MT	R	F	Estate Engine A 14 NEL/B 14 NEL	221109	Drive Shaft		33	34	53	93.5	588	
1.6 (85 kW)	2010.10-	-	AT	R	F	Estate Engine A 16 XER/B 16 XER	208077	Drive Shaft		33	34	52.5	94	951	
	2010.10-	-	AT	R	F	Estate Engine A 16 XER/B 16 XER	621029	Inner Joint		22	23	35	57.5	103	
	2010.10-	-	AT	R	F	Estate Engine A 16 XER/B 16 XER	844088	Outer Joint		33	23	52.3	94	59.5	M
	2010.10-	-	AT	-	F	Estate Engine A 16 XER/B 16 XER	808047	Outer Joint		33	23	52.5	94	59.5	M
	2010.10-	-	MT	L	F	Estate Engine A 16 XER/B 16 XER	244064	Drive Shaft		33	22	53	95	618	
	2010.10-	-	MT	R	F	Estate Engine A 16 XER/B 16 XER	244065	Drive Shaft		33	22	53	95	983	
	2010.10-	-	AT	R	F	Estate Engine A 16 XER/B 16 XER	221072	Drive Shaft		33	22	52.3	94	957	
	2010.10-	-	MT	L	F	Estate Engine A 16 XER/B 16 XER	621014	Inner Joint		22	22	35	57.5	75	
1.6 CDTI (100 kW)	2014.01-	-	-	-	F	Estate Engine B 16 DTH	899023	Outer Joint		30	26	53.8	94.5	65.5	M
1.6 CDTI (81 kW)	2014.01-	-	MT	L/R	F	Estate Engine B 16 DTH	817051	Outer Joint		30	26	53.8	94.5	65.5	M
	2014.02-	-	-	-	F	Estate Engine B 16 DTL	899023	Outer Joint		30	26	53.8	94.5	65.5	M
1.6 LPG (84 kW)	2014.02-	-	MT	L/R	F	Estate Engine B 16 DTL	817051	Outer Joint		30	26	53.8	94.5	65.5	M
	2012.10-	-	AT	R	F	Estate Engine A 16 XER	621029	Inner Joint		22	23	35	57.5	103	
1.6 SIDI (125 kW)	2012.10-	-	AT	R	F	Estate Engine A 16 XER	844088	Outer Joint		33	23	52.3	94	59.5	M
	2012.10-	-	AT	-	F	Estate Engine A 16 XER	808047	Outer Joint		33	23	52.5	94	59.5	M
	2012.10-	-	AT	R	F	Estate Engine A 16 XER	221072	Drive Shaft		33	22	52.3	94	957	
	2012.12-	-	-	-	F	Estate Engine A 16 XHT/B 16 SHL	899023	Outer Joint		30	26	53.8	94.5	65.5	M
1.6 Turbo (132 kW)	2012.12-	-	MT	L	F	Estate Engine A 16 XHT/B 16 SHL	821049	Outer Joint		30	26	52.5	94	65.5	M
	2012.12-	-	AT/MT	L/R	F	Estate Engine A 16 XHT/B 16 SHL	817051	Outer Joint		30	26	53.8	94.5	65.5	M
	2010.10-	-	MT	R	F	Estate Engine A 16 LET	821049	Outer Joint		30	26	52.5	94	65.5	M
	2010.10-	-	-	-	F	Estate Engine A 16 LET	899023	Outer Joint		30	26	53.8	94.5	65.5	M
	2010.10-	-	MT	L/R	F	Estate Engine A 16 LET	817051	Outer Joint		30	26	53.8	94.5	65.5	M
1.7 CDTI (74 kW)	2010.10-	-	MT	R	F	Estate Engine A 16 LET	221074	Drive Shaft		30	34	52.5	94	589	
	2010.10-	-	-	-	F	Estate Engine A 17 DTL/A 17 DTN	821049	Outer Joint		30	26	52.5	94	65.5	M
	2010.10-	-	-	-	F	Estate Engine A 17 DTL/A 17 DTN	899023	Outer Joint		30	26	53.8	94.5	65.5	M
	2010.10-	-	MT	L	F	Estate Engine A 17 DTL/A 17 DTN	221076	Drive Shaft		30	25	52.5	94	601	
	2010.10-	-	-	L/R	F	Estate Engine A 17 DTL/A 17 DTN	817051	Outer Joint		30	26	53.8	94.5	65.5	M
1.7 CDTI (81 kW)	2010.10-	-	-	R	F	Estate Engine A 17 DTL/A 17 DTN	221074	Drive Shaft		30	34	52.5	94	589	
	2010.10-	-	-	R	F	Estate Engine A 17 DTJ/A 17 DTC/A 17 DTE	821049	Outer Joint		30	26	52.5	94	65.5	M
	2010.10-	-	-	-	F	Estate Engine A 17 DTJ/A 17 DTC/A 17 DTE	899023	Outer Joint		30	26	53.8	94.5	65.5	M
	2010.10-	-	MT	L	F	Estate Engine A 17 DTJ/A 17 DTC/A 17 DTE	221076	Drive Shaft		30	25	52.5	94	601	
	2010.10-	-	-	L/R	F	Estate Engine A 17 DTJ/A 17 DTC/A 17 DTE	817051	Outer Joint		30	26	53.8	94.5	65.5	M
1.7 CDTI (92 kW)	2010.10-	-	-	R	F	Estate Engine A 17 DTJ/A 17 DTC/A 17 DTE	221074	Drive Shaft		30	34	52.5	94	589	
	2010.10-	-	-	-	F	Estate Engine A 17 DTR	821049	Outer Joint		30	26	52.5	94	65.5	M
	2010.10-	-	-	-	F	Estate Engine A 17 DTR	899023	Outer Joint		30	26	53.8	94.5	65.5	M
	2010.10-	-	MT	L	F	Estate Engine A 17 DTR	221076	Drive Shaft		30	25	52.5	94	601	
	2010.10-	-	-	L/R	F	Estate Engine A 17 DTR	817051	Outer Joint		30	26	53.8	94.5	65.5	M
1.7 CDTI (96 kW)	2010.10-	-	-	R	F	Estate Engine A 17 DTR	221074	Drive Shaft		30	34	52.5	94	589	
	2010.10-	-	-	-	F	Estate Engine A 17 DTS/A 17 DTF	821049	Outer Joint		30	26	52.5	94	65.5	M
	2010.10-	-	MT	L	F	Estate Engine A 17 DTS/A 17 DTF	221076	Drive Shaft		30	25	52.5	94	601	
	2010.10-	-	-	-	F	Estate Engine A 17 DTS/A 17 DTF	899023	Outer Joint		30	26	53.8	94.5	65.5	M
	2010.10-	-	-	L/R	F	Estate Engine A 17 DTS/A 17 DTF	817051	Outer Joint		30	26	53.8	94.5	65.5	M
2.0 CDTI (118 kW)	2010.10-	-	-	R	F	Estate Engine A 17 DTS/A 17 DTF	221074	Drive Shaft		30	34	52.5	94	589	
	2010.10-	-	-	-	F	Estate Engine A 20 DTH	899023	Outer Joint		30	26	53.8	94.5	65.5	M
	2010.10-	-	-	L/R	F	Estate Engine A 20 DTH	817051	Outer Joint		30	26	53.8	94.5	65.5	M
2.0 CDTI (121 kW)	2011.08-	-	-	-	F	Estate Engine A 20 DTH	899023	Outer Joint		30	26	53.8	94.5	65.5	M
	2011.08-	-	-	L/R	F	Estate Engine A 20 DTH	817051	Outer Joint		30	26	53.8	94.5	65.5	M
ASTRA-J															





YEAR	TRANSM	L/R	F/R	REMARKS	GSP Ref.	PRODUCT	ABS	Technical Specifications						
								A	B	C	H	L	P	
OPEL														
ASTRA-J														
1.6L	2010-2017	6AT	L	-	Engine A16XER	201619	Drive Shaft		33	22	52.3	94	633	
	2010-2017	6AT	L	-	Engine A16XER	201619	Drive Shaft		33	22	52.3	94	633	
	2010-2017	6AT	R	-	Engine A16XER	201620	Drive Shaft		33	22	52.3	94	958	
	2010-2017	6AT	R	-	Engine A16XER	201620	Drive Shaft		33	22	52.3	94	958	
ASTRA/VECTRA														
-	-	-	-	-	-	899237	Outer Joint	29T	33	25	52	103.5	61	I
-	-	-	-	-	-	899066	Outer Joint		33	25	52	103.5	61	O
-	-	-	-	-	-	899238	Outer Joint	29T	33	25	52	103.5	61	O
CALIBRA A (C89)														
2.0 i (85 kW)	1990.06-1997.07	MT	L/R	F	Coupe Engine C 20 NE	644002	Inner Joint		34	25	35	56.2	85.6	
	1990.06-1997.07	-	R	F	Coupe Engine C 20 NE	644005	Inner Joint		34	25	35	54	47	
	1990.06-1997.07	-	R	F	All-wheel Drive Coupe Engine C 20 NE	644005	Inner Joint		34	25	35	54	47	
	1990.06-1997.07	AT/MT	L/R	F	Coupe Engine C 20 NE	621011	Inner Joint		34	25	35	78	64	
	1990.06-1997.07	MT	L	F	Coupe Engine C 20 NE	244011	Drive Shaft	29T	33	34	52	109	594.5	
	1990.06-1997.07	AT/MT	L/R	F	All-wheel Drive Coupe Engine C 20 NE	621011	Inner Joint		34	25	35	78	64	
	1990.06-1997.07	MT	L	F	All-wheel Drive Coupe Engine C 20 NE	244011	Drive Shaft	29T	33	34	52	109	594.5	
	1990.06-1997.07	MT	R	F	Coupe Engine C 20 NE	244059	Drive Shaft	29T	33	34	52	109	938	
	1990.06-1997.07	AT/MT	L/R	F	Coupe Engine C 20 NE	844056	Outer Joint	29T	33	25	52	109	61	O
	1990.06-1997.07	AT/MT	L/R	F	Coupe Engine C 20 NE	844057	Outer Joint	43T	33	25	52	109	61	O
	1990.06-1997.07	MT	L/R	F	All-wheel Drive Coupe Engine C 20 NE	844056	Outer Joint	29T	33	25	52	109	61	O
	1990.06-1997.07	MT	L/R	F	All-wheel Drive Coupe Engine C 20 NE	844057	Outer Joint	43T	33	25	52	109	61	O
	1990.06-1997.07	MT	L	F	All-wheel Drive Coupe Engine C 20 NE	644002	Inner Joint		34	25	35	56.2	85.6	
2.0 i 16V (100 kW)	1994.02-1997.07	-	L/R	F	Coupe Engine X 20 XEV	844006	Outer Joint	29T	33	25	52	103.5	61	O
	1994.02-1997.07	-	R	F	All-wheel Drive Coupe Engine X 20 XEV	644005	Inner Joint		34	25	35	54	47	
	1994.02-1997.07	-	R	F	Coupe Engine X 20 XEV	644005	Inner Joint		34	25	35	54	47	
	1994.02-1997.07	MT	L/R	F	All-wheel Drive Coupe Engine X 20 XEV	844056	Outer Joint	29T	33	25	52	109	61	O
	1994.02-1997.07	MT	L/R	F	Coupe Engine X 20 XEV	844056	Outer Joint	29T	33	25	52	109	61	O
	1994.02-1997.07	AT/MT	L	F	Coupe Engine X 20 XEV	621011	Inner Joint		34	25	35	78	64	
	1994.02-1997.07	MT	L/R	F	All-wheel Drive Coupe Engine X 20 XEV	844057	Outer Joint	43T	33	25	52	109	61	O
	1994.02-1997.07	MT	L/R	F	Coupe Engine X 20 XEV	844057	Outer Joint	43T	33	25	52	109	61	O
	1994.02-1997.07	AT/MT	L	F	All-wheel Drive Coupe Engine X 20 XEV	621011	Inner Joint		34	25	35	78	64	
2.0 i 16V (110 kW)	1990.06-1994.02	-	R	F	Coupe Engine C 20 XE	644005	Inner Joint		34	25	35	54	47	
	1990.06-1994.02	-	R	F	All-wheel Drive Coupe Engine C 20 XE	644005	Inner Joint		34	25	35	54	47	
	1990.06-1994.02	MT	L	F	All-wheel Drive Coupe Engine C 20 XE	244011	Drive Shaft	29T	33	34	52	109	594.5	
	1990.06-1994.02	AT/MT	L/R	F	Coupe Engine C 20 XE	621011	Inner Joint		34	25	35	78	64	
	1990.06-1994.02	MT	L	F	Coupe Engine C 20 XE	244011	Drive Shaft	29T	33	34	52	109	594.5	
	1990.06-1994.02	AT/MT	L/R	F	All-wheel Drive Coupe Engine C 20 XE	621011	Inner Joint		34	25	35	78	64	
	1990.06-1994.02	MT	L/R	F	All-wheel Drive Coupe Engine C 20 XE	844056	Outer Joint	29T	33	25	52	109	61	O
	1990.06-1994.02	MT	L	F	All-wheel Drive Coupe Engine C 20 XE	644002	Inner Joint		34	25	35	56.2	85.6	
	1990.06-1994.02	MT	L/R	F	All-wheel Drive Coupe Engine C 20 XE	844057	Outer Joint	43T	33	25	52	109	61	O
	1990.06-1994.02	MT	L/R	F	Coupe Engine C 20 XE	844056	Outer Joint	29T	33	25	52	109	61	O
	1990.06-1994.02	MT	L/R	F	Coupe Engine C 20 XE	844057	Outer Joint	43T	33	25	52	109	61	O
	1990.06-1994.02	MT	L	F	Coupe Engine C 20 XE	644002	Inner Joint		34	25	35	56.2	85.6	
2.0 i Turbo (150 kW)	1992.03-1997.07	-	R	F	All-wheel Drive Coupe Engine C 20 LET	644005	Inner Joint		34	25	35	54	47	
	1992.03-1997.07	MT	L	F	All-wheel Drive Coupe Engine C 20 LET	244011	Drive Shaft	29T	33	34	52	109	594.5	
	1992.03-1997.07	AT/MT	L/R	F	All-wheel Drive Coupe Engine C 20 LET	621011	Inner Joint		34	25	35	78	64	
	1992.03-1997.07	MT	L/R	F	All-wheel Drive Coupe Engine C 20 LET	844056	Outer Joint	29T	33	25	52	109	61	O
	1992.03-1997.07	MT	L	F	All-wheel Drive Coupe Engine C 20 LET	644002	Inner Joint		34	25	35	56.2	85.6	
2.5 i V6 (125 kW)	1993.04-1997.07	-	R	F	Coupe Engine X 25 XE/C 25 XE	644005	Inner Joint		34	25	35	54	47	
	1993.04-1997.07	AT/MT	L	F	Coupe Engine X 25 XE/C 25 XE	621011	Inner Joint		34	25	35	78	64	
	1993.04-1997.07	MT	L	F	Coupe Engine X 25 XE/C 25 XE	644002	Inner Joint		34	25	35	56.2	85.6	
CAMPO (TF0 TF1)														
2.3 (72 kW)	1994.08-1996.09	MT	L/R	F	All-wheel Drive Pickup Engine 4 ZD1	826002	Outer Joint		17	23	53	144	62.5	M
CASCADA (W13)														
1.4 (88 kW)	2013.03-	AT	-	F	Convertible Engine A 14 NEL	899023	Outer Joint		30	26	53.8	94.5	65.5	M
1.4 Turbo (103 kW)	2013.03-	AT	-	F	Convertible Engine A 14 NET	899023	Outer Joint		30	26	53.8	94.5	65.5	M
1.6 (147 kW)	2013.11-	AT	-	F	Convertible Engine A 16 SHT/B 16 SHT	899023	Outer Joint		30	26	53.8	94.5	65.5	M
1.6 SIDI (125 kW)	2013.03-	AT	-	F	Convertible Engine A 16 XHT	899023	Outer Joint		30	26	53.8	94.5	65.5	M
2.0 CDTI (121 kW)	2013.03-	AT	-	F	Convertible Engine A 20 DTH	899023	Outer Joint		30	26	53.8	94.5	65.5	M
	2013.03-	-	L/R	F	Convertible Engine A 20 DTH	817051	Outer Joint		30	26	53.8	94.5	65.5	M
2.0 CDTI (125 kW)	2015.07-	-	L	F	Convertible Engine B 20 DTH	899023	Outer Joint		30	26	53.8	94.5	65.5	M
	2015.07-	-	R	F	Convertible Engine B 20 DTH	899367	Outer Joint		30	27	58.9	94	64.5	M
2.0 CDTI (143 kW)	2013.03-	AT	-	F	Convertible Engine A 20 DTR	899023	Outer Joint		30	26	53.8	94.5	65.5	M
	2013.03-	-	L/R	F	Convertible Engine A 20 DTR	817051	Outer Joint		30	26	53.8	94.5	65.5	M
CHEVY														
-	-	-	-	-	-	644007	Inner Joint		22	28	34.95	57	96.5	





	 YEAR	TRANSM	L/R	F/R	REMARKS	GSP Ref.	 PRODUCT	 ABS	Technical Specifications						
									A	B	C	H	L	P	
OPEL															
COMBO															
1.3 CDTI 16V (51 kW)	2005.08.-	-	AT/MT	L	F	Box Body/Estate Engine Z 13 DT	299069	Drive Shaft	29T	22	22	52	97.5	584	
	2005.08.-	-	-	L	F	Box Body/Estate Engine Z 13 DT	244027	Drive Shaft	29T	22	22	52	98	580	
	2005.08.-	-	-	-	-	Box Body/Estate Engine Z 13 DT	644009	Inner Joint		22	23	35	57.5	96	
	2005.08.-	-	-	R	F	Box Body/Estate Engine Z 13 DT	244026	Drive Shaft	29T	22	22	52	98	930	
	2005.08.-	-	-	L	F	Box Body/Estate Engine Z 13 DT	244045	Drive Shaft	29T	22	22	52	97	579	
	2005.08.-	-	MT	L	F	Box Body/Estate Engine Z 13 DT	250174	Drive Shaft		23	37.1	56.2	83.5	597.5	
	2005.08.-	-	-	L/R	F	Box Body/Estate Engine Z 13 DT	844002	Outer Joint	29T	22	23	52	97.5	61	M
	2005.08.-	-	MT	L	F	Box Body/Estate Engine Z 13 DT	250174	Drive Shaft		23	37.1	56.2	83.5	597.5	
	2005.08.-	-	MT	L	F	Box Body/Estate Engine Z 13 DT	244061	Drive Shaft		22	22	52	98	580	
1.3 CDTI 16V (55 kW)	2005.10.-	-	-	R	F	Box Body/Estate Engine Z 13 DTJ	244075	Drive Shaft	29T	22	22	52	97.5	926	
	2005.10.-	-	AT/MT	L	F	Box Body/Estate Engine Z 13 DTJ	299069	Drive Shaft	29T	22	22	52	97.5	584	
	2005.10.-	-	-	L	F	Box Body/Estate Engine Z 13 DTJ	244027	Drive Shaft	29T	22	22	52	98	580	
	2005.10.-	-	-	-	-	Box Body/Estate Engine Z 13 DTJ	644009	Inner Joint		22	23	35	57.5	96	
	2005.10.-	-	-	R	F	Box Body/Estate Engine Z 13 DTJ	244026	Drive Shaft	29T	22	22	52	98	930	
	2005.10.-	-	MT	L	F	Box Body/Estate Engine Z 13 DTJ	250174	Drive Shaft		23	37.1	56.2	83.5	597.5	
	2005.10.-	-	-	L	F	Box Body/Estate Engine Z 13 DTJ	244045	Drive Shaft	29T	22	22	52	97	579	
	2005.10.-	-	-	L/R	F	Box Body/Estate Engine Z 13 DTJ	844002	Outer Joint	29T	22	23	52	97.5	61	M
	2005.10.-	-	MT	L	F	Box Body/Estate Engine Z 13 DTJ	244061	Drive Shaft		22	22	52	98	580	
1.4 16V (66 kW)	2005.08.-	-	-	R	F	Box Body/Estate Engine Z 14 XEP	299205	Drive Shaft		22	22	52	97.5	930	
	2005.08.-	-	-	R	F	Box Body/Estate Engine Z 14 XEP	844043	Outer Joint		22	28	52	97.5	57.5	O
	2005.08.-	-	MT	L	F	Box Body/Estate Engine Z 14 XEP	299069	Drive Shaft	29T	22	22	52	97.5	584	
	2005.08.-	-	AT/MT	L	F	Box Body/Estate Engine Z 14 XEP	244027	Drive Shaft	29T	22	22	52	98	580	
	2005.08.-	-	-	-	-	Box Body/Estate Engine Z 14 XEP	644009	Inner Joint		22	23	35	57.5	96	
	2005.08.-	-	-	L/R	F	Box Body/Estate Engine Z 14 XEP	844020	Outer Joint	29T	22	28	52	97.5	57.5	O
	2005.08.-	-	AT/MT	R	F	Box Body/Estate Engine Z 14 XEP	244026	Drive Shaft	29T	22	22	52	98	930	
	2005.08.-	-	MT	L	F	Box Body/Estate Engine Z 14 XEP	250174	Drive Shaft		23	37.1	56.2	83.5	597.5	
	2005.08.-	-	-	L	F	Box Body/Estate Engine Z 14 XEP	244045	Drive Shaft	29T	22	22	52	97	579	
1.6 (64 kW)	2005.08.-	-	MT	L	F	Box Body/Estate Engine Z 14 XEP	250174	Drive Shaft		23	37.1	56.2	83.5	597.5	
	2005.08.-	-	MT	L	F	Box Body/Estate Engine Z 14 XEP	244061	Drive Shaft		22	22	52	98	580	
	2005.08.-	-	-	R	F	Box Body/Estate Engine Z 14 XEP	244075	Drive Shaft	29T	22	22	52	97.5	926	
	2001.10.-	-	AT/MT	L	F	Box Body/Estate Engine Z 16 SE	299069	Drive Shaft	29T	22	22	52	97.5	584	
	2001.10.-	-	-	R	F	Box Body/Estate Engine Z 16 SE	844043	Outer Joint		22	28	52	97.5	57.5	O
	2001.10.-	-	AT/MT	L	F	Box Body/Estate Engine Z 16 SE	244027	Drive Shaft	29T	22	22	52	98	580	
	2001.10.-	-	AT/MT	R	F	Box Body/Estate Engine Z 16 SE	244026	Drive Shaft	29T	22	22	52	98	930	
	2001.10.-	-	-	L/R	F	Box Body/Estate Engine Z 16 SE	844020	Outer Joint	29T	22	28	52	97.5	57.5	O
	2001.10.-	-	-	-	-	Box Body/Estate Engine Z 16 SE	644009	Inner Joint		22	23	35	57.5	96	
1.6 CNG 16V (69 kW)	2001.10.-	-	-	L	F	Box Body/Estate Engine Z 16 SE	244045	Drive Shaft	29T	22	22	52	97	579	
	2001.10.-	-	MT	L	F	Box Body/Estate Engine Z 16 SE	250174	Drive Shaft		23	37.1	56.2	83.5	597.5	
	2001.10.-	-	MT	L	F	Box Body/Estate Engine Z 16 SE	250174	Drive Shaft		23	37.1	56.2	83.5	597.5	
	2001.10.-	-	MT	L	F	Box Body/Estate Engine Z 16 SE	244061	Drive Shaft		22	22	52	98	580	
	2001.10.-	-	-	R	F	Box Body/Estate Engine Z 16 SE	244075	Drive Shaft	29T	22	22	52	97.5	926	
	2001.10.-	-	-	R	F	Box Body/Estate Engine Z 16 SE	299205	Drive Shaft		22	22	52	97.5	930	
	2006.06.-	-	-	R	F	Box Body/Estate Engine Z 16 YNG	244075	Drive Shaft	29T	22	22	52	97.5	926	
	2006.06.-	-	-	R	F	Box Body/Estate Engine Z 16 YNG	299205	Drive Shaft		22	22	52	97.5	930	
	2006.06.-	-	-	R	F	Box Body/Estate Engine Z 16 YNG	844043	Outer Joint		22	28	52	97.5	57.5	O
1.6 CNG 16V (71 kW)	2006.06.-	-	-	L	F	Box Body/Estate Engine Z 16 YNG	244027	Drive Shaft	29T	22	22	52	98	580	
	2006.06.-	-	-	-	-	Box Body/Estate Engine Z 16 YNG	644009	Inner Joint		22	23	35	57.5	96	
	2006.06.-	-	-	L/R	F	Box Body/Estate Engine Z 16 YNG	844020	Outer Joint	29T	22	28	52	97.5	57.5	O
	2006.06.-	-	-	R	F	Box Body/Estate Engine Z 16 YNG	244026	Drive Shaft	29T	22	22	52	98	930	
	2006.06.-	-	-	L	F	Box Body/Estate Engine Z 16 YNG	244045	Drive Shaft	29T	22	22	52	97	579	
	2005.04.-	-	-	L	F	Box Body/Estate Engine Z 16 YNG	244027	Drive Shaft	29T	22	22	52	98	580	
	2005.04.-	-	-	-	-	Box Body/Estate Engine Z 16 YNG	644009	Inner Joint		22	23	35	57.5	96	
	2005.04.-	-	-	L/R	F	Box Body/Estate Engine Z 16 YNG	844020	Outer Joint	29T	22	28	52	97.5	57.5	O
	2005.04.-	-	-	R	F	Box Body/Estate Engine Z 16 YNG	244026	Drive Shaft	29T	22	22	52	98	930	
1.7 CDTI 16V (74 kW)	2005.04.-	-	-	L	F	Box Body/Estate Engine Z 16 YNG	244045	Drive Shaft	29T	22	22	52	97	579	
	2005.04.-	-	-	R	F	Box Body/Estate Engine Z 16 YNG	244075	Drive Shaft	29T	22	22	52	97.5	926	
	2004.12.-	-	-	R	F	Box Body/Estate Engine Z 17 DTH	244092	Drive Shaft	29T	33	34	52	104	609	
	2004.12.-	-	-	L	F	Box Body/Estate Engine Z 17 DTH	244032	Drive Shaft	29T	33	34	52	104	587.5	
	2004.12.-	-	-	R	F	Box Body/Estate Engine Z 17 DTH	660003	Inner Joint		34	24	35.5	47	70.5	
	2004.12.-	-	-	L	F	Box Body/Estate Engine Z 17 DTH	621034	Inner Joint		34	24	35	56.5	102	
1.7 DI 16V (48 kW)	2004.12.-	-	-	L/R	F	Box Body/Estate Engine Z 17 DTH	844004	Outer Joint	29T	33	24	52	104	64	M
	2004.12.-	-	MT	R	F	Box Body/Estate Engine Z 17 DTH	260021	Drive Shaft	29T	33	34	52	104	612	
	2001.10.-	-	MT	L	F	Box Body/Estate Engine Y 17 DTL	299069	Drive Shaft	29T	22	22	52	97.5	584	
2001.10.-	-	-	R	F	Box Body/Estate Engine Y 17 DTL	844043	Outer Joint		22	28	52	97.5	57.5	O	

YEAR	TRANS	L/R	F/R	REMARKS	GSP Ref.	PRODUCT	ABS	Technical Specifications							
								A	B	C	H	L	P		
OPEL COMBO															
1.7 DI 16V (48 kW)	2001.10-	-	AT/MT	L F	Box Body/Estate Engine Y 17 DTL	244027	Drive Shaft	29T	22	22	52	98	580		
	2001.10-	-	AT/MT	R F	Box Body/Estate Engine Y 17 DTL	244026	Drive Shaft	29T	22	22	52	98	930		
	2001.10-	-	-	L/R F	Box Body/Estate Engine Y 17 DTL	844020	Outer Joint	29T	22	28	52	97.5	57.5	O	
	2001.10-	-	-	-	Box Body/Estate Engine Y 17 DTL	644009	Inner Joint		22	23	35	57.5	96		
	2001.10-	-	-	L F	Box Body/Estate Engine Y 17 DTL	244045	Drive Shaft	29T	22	22	52	97	579		
	2001.10-	-	MT	L F	Box Body/Estate Engine Y 17 DTL	250174	Drive Shaft		23	37.1	56.2	83.5	597.5		
	2001.10-	-	MT	L F	Box Body/Estate Engine Y 17 DTL	250174	Drive Shaft		23	37.1	56.2	83.5	597.5		
	2001.10-	-	MT	L F	Box Body/Estate Engine Y 17 DTL	244061	Drive Shaft		22	22	52	98	580		
	2001.10-	-	-	R F	Box Body/Estate Engine Y 17 DTL	244075	Drive Shaft	29T	22	22	52	97.5	926		
	2001.10-	-	-	R F	Box Body/Estate Engine Y 17 DTL	299205	Drive Shaft		22	22	52	97.5	930		
1.7 DTI 16V (55 kW)	2001.10-	-	MT	L F	Box Body/Estate Engine Y 17 DT	299069	Drive Shaft	29T	22	22	52	97.5	584		
	2001.10-	-	-	L F	Box Body/Estate Engine Y 17 DT	244027	Drive Shaft	29T	22	22	52	98	580		
	2001.10-	-	-	R F	Box Body/Estate Engine Y 17 DT	244026	Drive Shaft	29T	22	22	52	98	930		
	2001.10-	-	-	-	Box Body/Estate Engine Y 17 DT	644009	Inner Joint		22	23	35	57.5	96		
	2001.10-	-	-	L F	Box Body/Estate Engine Y 17 DT	244045	Drive Shaft	29T	22	22	52	97	579		
	2001.10-	-	-	L/R F	Box Body/Estate Engine Y 17 DT	844002	Outer Joint	29T	22	23	52	97.5	61	M	
	2001.10-	-	-	R F	Box Body/Estate Engine Y 17 DT	244075	Drive Shaft	29T	22	22	52	97.5	926		
COMBO (71_)															
1.2 (33 kW)	1994.07-	2001.10	MT	L/R F	Box Engine C 12 NZ/X 12 NZ	844020	Outer Joint	29T	22	28	52	97.5	57.5	O	
	1994.07-	2001.10	MT	L F	Box Engine C 12 NZ/X 12 NZ	244001	Drive Shaft	29T	22	22	52	95	573		
	1994.07-	2001.10	-	R F	Box Engine C 12 NZ/X 12 NZ	208005	Drive Shaft	29T	22	22	52	98	916.5		
1.4 (44 kW)	1994.07-	2001.10	MT	L/R F	Box Engine C 14 NZ/X 14 SZ	844020	Outer Joint	29T	22	28	52	97.5	57.5	O	
	1994.07-	2001.10	MT	L F	Box Engine C 14 NZ/X 14 SZ	244001	Drive Shaft	29T	22	22	52	95	573		
	1994.07-	2001.10	-	R F	Box Engine C 14 NZ/X 14 SZ	208005	Drive Shaft	29T	22	22	52	98	916.5		
1.4 (60 kW)	1994.07-	2001.10	MT	L/R F	Box Engine C 14 SE	844020	Outer Joint	29T	22	28	52	97.5	57.5	O	
	1994.07-	2001.10	MT	L F	Box Engine C 14 SE	244001	Drive Shaft	29T	22	22	52	95	573		
	1994.07-	2001.10	-	R F	Box Engine C 14 SE	208005	Drive Shaft	29T	22	22	52	98	916.5		
1.7 D (44 kW)	1994.07-	2001.10	MT	L/R F	Box Engine X 17 D (4EE1)/17 D (4EE1)	844020	Outer Joint	29T	22	28	52	97.5	57.5	O	
	1994.07-	2001.10	MT	L F	Box Engine X 17 D (4EE1)/17 D (4EE1)	244001	Drive Shaft	29T	22	22	52	95	573		
	1994.07-	2001.10	-	R F	Box Engine X 17 D (4EE1)/17 D (4EE1)	208005	Drive Shaft	29T	22	22	52	98	916.5		
COMBO (X12)															
1.4 (88 kW)	2012.02-	-	-	-	F	Box Body/Estate Engine A 14 FC	899298	Outer Joint		27	26	59	84.5	63	M
1.4 CNG (88 kW)	2012.02-	-	-	-	F	Box Body/Estate Engine A 14 FC	899298	Outer Joint		27	26	59	84.5	63	M
1.6 CDTI (66 kW)	2012.02-	-	-	-	F	Box Body/Estate Engine A 16 FDL	899298	Outer Joint		27	26	59	84.5	63	M
1.6 CDTI (74 kW)	2012.02-	-	-	-	F	Box Body/Estate Engine A 16 FDH	899298	Outer Joint		27	26	59	84.5	63	M
COMBO Combi/Tour (X12)															
1.4 (88 kW)	2012.02-	-	-	-	F	MPV Engine A 14 FC	899298	Outer Joint		27	26	59	84.5	63	M
1.4 CNG (88 kW)	2012.02-	-	-	-	F	MPV Engine A 14 FC	899298	Outer Joint		27	26	59	84.5	63	M
1.6 CDTI (66 kW)	2012.02-	-	-	-	F	MPV Engine A 16 FDL	899298	Outer Joint		27	26	59	84.5	63	M
COMBO Tour															
1.3 CDTI 16V (51 kW)	2004.10-	-	AT/MT	L F	MPV Engine Z 13 DT/Y 13 DT	299069	Drive Shaft	29T	22	22	52	97.5	584		
	2004.10-	-	-	L F	MPV Engine Z 13 DT/Y 13 DT	244027	Drive Shaft	29T	22	22	52	98	580		
	2004.10-	-	-	-	MPV Engine Z 13 DT/Y 13 DT	644009	Inner Joint		22	23	35	57.5	96		
	2004.10-	-	-	R F	MPV Engine Z 13 DT/Y 13 DT	244026	Drive Shaft	29T	22	22	52	98	930		
	2004.10-	-	-	L F	MPV Engine Z 13 DT/Y 13 DT	244045	Drive Shaft	29T	22	22	52	97	579		
	2004.10-	-	MT	L F	MPV Engine Z 13 DT/Y 13 DT	250174	Drive Shaft		23	37.1	56.2	83.5	597.5		
	2004.10-	-	-	L/R F	MPV Engine Z 13 DT/Y 13 DT	844002	Outer Joint	29T	22	23	52	97.5	61	M	
	2004.10-	-	MT	L F	MPV Engine Z 13 DT/Y 13 DT	250174	Drive Shaft		23	37.1	56.2	83.5	597.5		
	2004.10-	-	MT	L F	MPV Engine Z 13 DT/Y 13 DT	244061	Drive Shaft		22	22	52	98	580		
	2004.10-	-	-	R F	MPV Engine Z 13 DT/Y 13 DT	244075	Drive Shaft	29T	22	22	52	97.5	926		
1.3 CDTI 16V (55 kW)	2005.10-	-	AT/MT	L F	MPV Engine Z 13 DTJ	299069	Drive Shaft	29T	22	22	52	97.5	584		
	2005.10-	-	-	L F	MPV Engine Z 13 DTJ	244027	Drive Shaft	29T	22	22	52	98	580		
	2005.10-	-	-	-	MPV Engine Z 13 DTJ	644009	Inner Joint		22	23	35	57.5	96		
	2005.10-	-	-	R F	MPV Engine Z 13 DTJ	244026	Drive Shaft	29T	22	22	52	98	930		
	2005.10-	-	-	L F	MPV Engine Z 13 DTJ	244045	Drive Shaft	29T	22	22	52	97	579		
	2005.10-	-	MT	L F	MPV Engine Z 13 DTJ	250174	Drive Shaft		23	37.1	56.2	83.5	597.5		
	2005.10-	-	-	L/R F	MPV Engine Z 13 DTJ	844002	Outer Joint	29T	22	23	52	97.5	61	M	
	2005.10-	-	MT	L F	MPV Engine Z 13 DTJ	250174	Drive Shaft		23	37.1	56.2	83.5	597.5		
	2005.10-	-	MT	L F	MPV Engine Z 13 DTJ	244061	Drive Shaft		22	22	52	98	580		
	2005.10-	-	-	R F	MPV Engine Z 13 DTJ	244075	Drive Shaft	29T	22	22	52	97.5	926		
1.4 (66 kW)	2004.10-	-	-	R F	MPV Engine Z 14 XEP	299205	Drive Shaft		22	22	52	97.5	930		
	2004.10-	-	-	R F	MPV Engine Z 14 XEP	844043	Outer Joint		22	28	52	97.5	57.5	O	
	2004.10-	-	AT/MT	L F	MPV Engine Z 14 XEP	299069	Drive Shaft	29T	22	22	52	97.5	584		
	2004.10-	-	AT/MT	L F	MPV Engine Z 14 XEP	244027	Drive Shaft	29T	22	22	52	98	580		
	2004.10-	-	-	-	MPV Engine Z 14 XEP	644009	Inner Joint		22	23	35	57.5	96		
	2004.10-	-	-	L/R F	MPV Engine Z 14 XEP	844020	Outer Joint	29T	22	28	52	97.5	57.5	O	

	 YEAR	TRANSM	L/R	F/R	REMARKS	GSP Ref.	 PRODUCT	 ABS	Technical Specifications						
									A	B	C	H	L	P	
OPEL															
COMBO Tour															
1.4 (66 kW)	2004.10-	-	AT/MT	R	F	MPV Engine Z 14 XEP	244026	Drive Shaft	29T	22	22	52	98	930	
	2004.10-	-	-	L	F	MPV Engine Z 14 XEP	244045	Drive Shaft	29T	22	22	52	97	579	
	2004.10-	-	MT	L	F	MPV Engine Z 14 XEP	250174	Drive Shaft		23	37.1	56.2	83.5	597.5	
	2004.10-	-	MT	L	F	MPV Engine Z 14 XEP	250174	Drive Shaft		23	37.1	56.2	83.5	597.5	
	2004.10-	-	MT	L	F	MPV Engine Z 14 XEP	244061	Drive Shaft		22	22	52	98	580	
	2004.10-	-	-	R	F	MPV Engine Z 14 XEP	244075	Drive Shaft	29T	22	22	52	97.5	926	
1.6 (64 kW)	2001.10-	-	-	R	F	MPV Engine Z 16 SE	844043	Outer Joint		22	28	52	97.5	57.5	O
	2001.10-	-	AT/MT	L	F	MPV Engine Z 16 SE	299069	Drive Shaft	29T	22	22	52	97.5	584	
	2001.10-	-	-	L	F	MPV Engine Z 16 SE	244027	Drive Shaft	29T	22	22	52	98	580	
	2001.10-	-	-	L/R	F	MPV Engine Z 16 SE	844020	Outer Joint	29T	22	28	52	97.5	57.5	O
	2001.10-	-	-	-	-	MPV Engine Z 16 SE	644009	Inner Joint		22	23	35	57.5	96	
	2001.10-	-	-	R	F	MPV Engine Z 16 SE	244026	Drive Shaft	29T	22	22	52	98	930	
	2001.10-	-	-	L	F	MPV Engine Z 16 SE	244045	Drive Shaft	29T	22	22	52	97	579	
	2001.10-	-	MT	L	F	MPV Engine Z 16 SE	250174	Drive Shaft		23	37.1	56.2	83.5	597.5	
	2001.10-	-	MT	L	F	MPV Engine Z 16 SE	250174	Drive Shaft		23	37.1	56.2	83.5	597.5	
	2001.10-	-	MT	L	F	MPV Engine Z 16 SE	244061	Drive Shaft		22	22	52	98	580	
	2001.10-	-	-	R	F	MPV Engine Z 16 SE	244075	Drive Shaft	29T	22	22	52	97.5	926	
	2001.10-	-	-	R	F	MPV Engine Z 16 SE	299205	Drive Shaft		22	22	52	97.5	930	
1.6 CNG (69 kW)	2006.06-	-	-	R	F	MPV Engine Z 16 YNG	299205	Drive Shaft		22	22	52	97.5	930	
	2006.06-	-	-	R	F	MPV Engine Z 16 YNG	844043	Outer Joint		22	28	52	97.5	57.5	O
	2006.06-	-	-	L	F	MPV Engine Z 16 YNG	244027	Drive Shaft	29T	22	22	52	98	580	
	2006.06-	-	-	-	-	MPV Engine Z 16 YNG	644009	Inner Joint		22	23	35	57.5	96	
	2006.06-	-	-	L/R	F	MPV Engine Z 16 YNG	844020	Outer Joint	29T	22	28	52	97.5	57.5	O
	2006.06-	-	-	R	F	MPV Engine Z 16 YNG	244026	Drive Shaft	29T	22	22	52	98	930	
	2006.06-	-	-	L	F	MPV Engine Z 16 YNG	244045	Drive Shaft	29T	22	22	52	97	579	
	2006.06-	-	-	R	F	MPV Engine Z 16 YNG	244075	Drive Shaft	29T	22	22	52	97.5	926	
1.6 CNG (71 kW)	2005.04-	-	-	L	F	MPV Engine Z 16 YNG	244027	Drive Shaft	29T	22	22	52	98	580	
	2005.04-	-	-	-	-	MPV Engine Z 16 YNG	644009	Inner Joint		22	23	35	57.5	96	
	2005.04-	-	-	L/R	F	MPV Engine Z 16 YNG	844020	Outer Joint	29T	22	28	52	97.5	57.5	O
	2005.04-	-	-	R	F	MPV Engine Z 16 YNG	244026	Drive Shaft	29T	22	22	52	98	930	
	2005.04-	-	-	L	F	MPV Engine Z 16 YNG	244045	Drive Shaft	29T	22	22	52	97	579	
	2005.04-	-	-	R	F	MPV Engine Z 16 YNG	244075	Drive Shaft	29T	22	22	52	97.5	926	
1.7 CDTI 16V (74 kW)	2004.12-	-	-	R	F	MPV Engine Z 17 DTH	244092	Drive Shaft	29T	33	34	52	104	609	
	2004.12-	-	-	L	F	MPV Engine Z 17 DTH	244032	Drive Shaft	29T	33	34	52	104	587.5	
	2004.12-	-	-	R	F	MPV Engine Z 17 DTH	660003	Inner Joint		34	24	35.5	47	70.5	
	2004.12-	-	-	L	F	MPV Engine Z 17 DTH	621034	Inner Joint		34	24	35	56.5	102	
	2004.12-	-	-	L/R	F	MPV Engine Z 17 DTH	844004	Outer Joint	29T	33	24	52	104	64	M
	2004.12-	-	MT	R	F	MPV Engine Z 17 DTH	260021	Drive Shaft	29T	33	34	52	104	612	
1.7 DI 16V (48 kW)	2001.10-	-	-	R	F	MPV Engine Y 17 DTL	844043	Outer Joint		22	28	52	97.5	57.5	O
	2001.10-	-	MT	L	F	MPV Engine Y 17 DTL	299069	Drive Shaft	29T	22	22	52	97.5	584	
	2001.10-	-	-	L	F	MPV Engine Y 17 DTL	244027	Drive Shaft	29T	22	22	52	98	580	
	2001.10-	-	-	L/R	F	MPV Engine Y 17 DTL	844020	Outer Joint	29T	22	28	52	97.5	57.5	O
	2001.10-	-	-	R	F	MPV Engine Y 17 DTL	244026	Drive Shaft	29T	22	22	52	98	930	
	2001.10-	-	-	-	-	MPV Engine Y 17 DTL	644009	Inner Joint		22	23	35	57.5	96	
	2001.10-	-	-	L	F	MPV Engine Y 17 DTL	244045	Drive Shaft	29T	22	22	52	97	579	
	2001.10-	-	MT	L	F	MPV Engine Y 17 DTL	250174	Drive Shaft		23	37.1	56.2	83.5	597.5	
	2001.10-	-	MT	L	F	MPV Engine Y 17 DTL	250174	Drive Shaft		23	37.1	56.2	83.5	597.5	
	2001.10-	-	MT	L	F	MPV Engine Y 17 DTL	244061	Drive Shaft		22	22	52	98	580	
	2001.10-	-	-	R	F	MPV Engine Y 17 DTL	244075	Drive Shaft	29T	22	22	52	97.5	926	
	2001.10-	-	-	R	F	MPV Engine Y 17 DTL	299205	Drive Shaft		22	22	52	97.5	930	
1.7 DTI 16V (55 kW)	2001.10-	-	MT	L	F	MPV Engine Y 17 DT	299069	Drive Shaft	29T	22	22	52	97.5	584	
	2001.10-	-	-	L	F	MPV Engine Y 17 DT	244027	Drive Shaft	29T	22	22	52	98	580	
	2001.10-	-	-	R	F	MPV Engine Y 17 DT	244026	Drive Shaft	29T	22	22	52	98	930	
	2001.10-	-	-	-	-	MPV Engine Y 17 DT	644009	Inner Joint		22	23	35	57.5	96	
	2001.10-	-	-	L	F	MPV Engine Y 17 DT	244045	Drive Shaft	29T	22	22	52	97	579	
	2001.10-	-	-	L/R	F	MPV Engine Y 17 DT	844002	Outer Joint	29T	22	23	52	97.5	61	M
	2001.10-	-	-	R	F	MPV Engine Y 17 DT	244075	Drive Shaft	29T	22	22	52	97.5	926	
CORSA															
1.5 TD (49 kW)	1987.09-	1993.03	MT	-	-	-	844062	Outer Joint		22	22	52	94.5	50	O
1.6 GSi (72-74 kW)	1987.09-	1993.03	-	-	-	-	844062	Outer Joint		22	22	52	94.5	50	O
CORSA A (S83)															
1.0 (33 kW)	1982.09-	1993.03	MT	L/R	F	Hatchback Engine 10 S	844046	Outer Joint		22	28	52.2	97.5	55	O
	1986.02-	1989.04	MT	L/R	F	Box Engine 10 S	844046	Outer Joint		22	28	52.2	97.5	55	O
1.2 (33 kW)	1982.09-	1990.08	MT	L/R	F	Hatchback Engine 12 NC/E 12 GV	844046	Outer Joint		22	28	52.2	97.5	55	O
	1986.02-	1989.04	MT	L/R	F	Box Engine 12 NC/E 12 GV	844046	Outer Joint		22	28	52.2	97.5	55	O
1.2 (40 kW)	1986.02-	1989.04	MT	L/R	F	Box Engine 12 ST	844046	Outer Joint		22	28	52.2	97.5	55	O





	 YEAR	TRANSM	L/R	F/R	REMARKS	GSP Ref.	 PRODUCT	 ABS	Technical Specifications					
									A	B	C	H	L	P
OPEL														
CORSA A (S83)														
1.2 i (33 kW)	1989.09-1993.03	MT	L/R	F	Hatchback Engine C 12 NZ	844046	Outer Joint		22	28	52.2	97.5	55	O
1.2 N (38 kW)	1990.01-1993.03	MT	L/R	F	Hatchback Engine 12 NV	844046	Outer Joint		22	28	52.2	97.5	55	O
1.2 S (40 kW)	1982.09-1990.02	MT	L/R	F	Hatchback Engine 12 ST	844046	Outer Joint		22	28	52.2	97.5	55	O
1.3 (44 kW)	1985.09-1989.10	MT	L/R	F	Hatchback Engine 13 NB	844046	Outer Joint		22	28	52.2	97.5	55	O
	1986.02-1989.04	MT	L/R	F	Box Engine 13 NB	844046	Outer Joint		22	28	52.2	97.5	55	O
1.3 (51 kW)	1986.02-1989.04	MT	L/R	F	Box Engine 13 SB	844046	Outer Joint		22	28	52.2	97.5	55	O
1.3 i (44 kW)	1986.09-1990.09	MT	L/R	F	Hatchback Engine C 13 N	844046	Outer Joint		22	28	52.2	97.5	55	O
1.3 S (51 kW)	1982.09-1989.10	MT	L/R	F	Hatchback Engine 13 SB	844046	Outer Joint		22	28	52.2	97.5	55	O
1.4 i (44 kW)	1990.01-1993.03	MT	L/R	F	Hatchback Engine C 14 NZ	844046	Outer Joint		22	28	52.2	97.5	55	O
1.4 S (53 kW)	1990.01-1993.03	MT	L/R	F	Hatchback Engine 14 NV	844046	Outer Joint		22	28	52.2	97.5	55	O
1.4 Si (60 kW)	1991.09-1993.03	MT	L/R	F	Hatchback Engine C 14 SE	844046	Outer Joint		22	28	52.2	97.5	55	O
1.5 D (37 kW)	1987.06-1989.04	MT	L/R	F	Box Engine 15 D (4EC1)	844046	Outer Joint		22	28	52.2	97.5	55	O
	1987.09-1993.03	MT	L/R	F	Hatchback Engine 15 D (4EC1)	844046	Outer Joint		22	28	52.2	97.5	55	O
1.5 TD (49 kW)	1988.03-1993.03	MT	L/R	F	Hatchback Engine 15 DT (T4EC1)	844041	Outer Joint		22	22	52	95	50	O
	1988.03-1993.03	MT	L/R	F	Hatchback Engine 15 DT (T4EC1)	644004	Inner Joint		22	22	34.95	57.5	72.5	
	1988.03-1993.03	MT	-	F	Hatchback Engine 15 DT (T4EC1)	844024	Outer Joint		22	22	52.2	97	50	O
1.6 GSI (72 kW)	1989.09-1993.03	MT	L/R	F	Hatchback Engine C 16 SEI	844041	Outer Joint		22	22	52	95	50	O
	1989.09-1993.03	MT	L/R	F	Hatchback Engine C 16 SEI	644004	Inner Joint		22	22	34.95	57.5	72.5	
	1989.09-1993.03	MT	-	F	Hatchback Engine C 16 SEI	844024	Outer Joint		22	22	52.2	97	50	O
1.6 GSI (74 kW)	1988.05-1992.03	MT	L/R	F	Hatchback Engine E 16 SE	844041	Outer Joint		22	22	52	95	50	O
	1988.05-1992.03	MT	L/R	F	Hatchback Engine E 16 SE	644004	Inner Joint		22	22	34.95	57.5	72.5	
	1988.05-1992.03	MT	-	F	Hatchback Engine E 16 SE	844024	Outer Joint		22	22	52.2	97	50	O
1.6 GSI Cat (74 kW)	1992.02-1993.03	MT	L/R	F	Hatchback Engine C 16 SE	844041	Outer Joint		22	22	52	95	50	O
	1992.02-1993.03	MT	L	F	Hatchback Engine C 16 SE	844024	Outer Joint		22	22	52.2	97	50	O
	1992.02-1993.03	MT	L/R	F	Hatchback Engine C 16 SE	644004	Inner Joint		22	22	34.95	57.5	72.5	
CORSA A TR (S83)														
1.0 (33 kW)	1982.09-1992.09	MT	L/R	F	Saloon Engine 10 S	844046	Outer Joint		22	28	52.2	97.5	55	O
1.2 i (33 kW)	1989.09-1993.03	MT	L/R	F	Saloon Engine C 12 NZ	844046	Outer Joint		22	28	52.2	97.5	55	O
1.2 S (40 kW)	1982.09-1993.03	MT	L/R	F	Saloon Engine 12 ST	844046	Outer Joint		22	28	52.2	97.5	55	O
1.4 i (44 kW)	1989.10-1993.03	MT	L/R	F	Saloon Engine C 14 NZ	844046	Outer Joint		22	28	52.2	97.5	55	O
1.4 S (53 kW)	1989.09-1993.03	MT	L/R	F	Saloon Engine 14 NV	844046	Outer Joint		22	28	52.2	97.5	55	O
1.5 D (37 kW)	1987.10-1992.11	MT	L/R	F	Saloon Engine 15 D (4EC1)	844046	Outer Joint		22	28	52.2	97.5	55	O
1.5 TD (49 kW)	1987.10-1993.03	AT/MT	-	-	Saloon Engine 15 DT (T4EC1)	844024	Outer Joint		22	22	52.2	97	50	O
CORSA B														
1.6	1993-2000	-	L	F	-	244049	Drive Shaft	29T	22	22	52	98	564	
	1993-2000	-	R	F	-	244050	Drive Shaft	29T	22	22	52	95	911	
CORSA B (73, 78, 79, F35)														
1.5 D (37 kW)	1993.03-2000.09	MT	-	-	-	844060	Outer Joint	29T	22	22	52	98	51	O
1.6 GSi 16V (80 kW)	1993.03-2000.09	-	-	-	-	844060	Outer Joint	29T	22	22	52	98	51	O
1.6 i 16V (78 kW)	1994.09-2000.09	-	-	-	-	844060	Outer Joint	29T	22	22	52	98	51	O
CORSA B (S93)														
1.0 i 12V (40 kW)	1996.11-2000.09	-	L/R	F	Hatchback Engine X 10 XE	844014	Outer Joint	29T	22	28	52	98	60	I
	1996.11-2000.09	-	-	F	Hatchback Engine X 10 XE	844031	Outer Joint		22	28	52	95.5	57.5	I
	1996.11-2000.09	-	L	F	Hatchback Engine X 10 XE	244001	Drive Shaft	29T	22	22	52	95	573	
	1996.11-2000.09	-	L	F	Hatchback Engine X 10 XE	244036	Drive Shaft	29T	22	22	52	95	565	
	1996.11-2000.09	AT/MT	L	F	Hatchback Engine X 10 XE	299139	Drive Shaft		22	22	52	98	570.5	
	1996.11-2000.09	-	R	F	Hatchback Engine X 10 XE	244037	Drive Shaft	29T	22	22	52	97	921	
	1996.11-2000.09	AT/MT	R	F	Hatchback Engine X 10 XE	299138	Drive Shaft		22	22	52	98	916.5	
	1996.11-2000.09	-	R	F	Hatchback Engine X 10 XE	208005	Drive Shaft	29T	22	22	52	98	916.5	
1.2 i (33 kW)	1993.03-2000.09	-	L	F	Hatchback Engine 12 NZ	244046	Drive Shaft		22	22	52	95	573	
	1993.03-2000.09	-	L	F	Hatchback Engine C 12 NZ/X 12 NZ	244046	Drive Shaft		22	22	52	95	573	
	1993.03-2000.09	MT	L/R	F	Hatchback Engine C 12 NZ/X 12 NZ	844020	Outer Joint	29T	22	28	52	97.5	57.5	O
	1993.03-2000.09	-	R	F	Hatchback Engine C 12 NZ/X 12 NZ	208005	Drive Shaft	29T	22	22	52	98	916.5	
	1993.03-2000.09	-	L	F	Hatchback Engine C 12 NZ/X 12 NZ	244001	Drive Shaft	29T	22	22	52	95	573	
	1993.03-2000.09	-	R	F	Hatchback Engine 12 NZ	208005	Drive Shaft	29T	22	22	52	98	916.5	
1.2 i 16V (48 kW)	1998.03-2000.09	MT	L/R	F	Hatchback Engine X 12 XE	844020	Outer Joint	29T	22	28	52	97.5	57.5	O
	1998.03-2000.09	-	L	F	Hatchback Engine X 12 XE	244046	Drive Shaft		22	22	52	95	573	
	1998.03-2000.09	MT	L	F	Hatchback Engine X 12 XE	244001	Drive Shaft	29T	22	22	52	95	573	
	1998.03-2000.09	-	R	F	Hatchback Engine X 12 XE	208005	Drive Shaft	29T	22	22	52	98	916.5	
1.4 (54 kW)	1993.04-1994.08	-	L	F	Hatchback Engine C 14 SE	244046	Drive Shaft		22	22	52	95	573	
1.4 i (44 kW)	1993.03-2000.09	-	L	F	Hatchback Engine C 14 NZ/X 14 SZ	244046	Drive Shaft		22	22	52	95	573	
	1993.03-2000.09	MT	L/R	F	Hatchback Engine C 14 NZ/X 14 SZ	844020	Outer Joint	29T	22	28	52	97.5	57.5	O
	1993.03-2000.09	MT	L	F	Hatchback Engine C 14 NZ/X 14 SZ	244001	Drive Shaft	29T	22	22	52	95	573	
	1993.03-2000.09	-	R	F	Hatchback Engine C 14 NZ/X 14 SZ	208005	Drive Shaft	29T	22	22	52	98	916.5	
	1999.08-2000.09	-	L	F	Box Engine X 14 SZ	244046	Drive Shaft		22	22	52	95	573	





	 YEAR	TRANSM	L/R	F/R	REMARKS	GSP Ref.	 PRODUCT	 ABS	Technical Specifications									
									A	B	C	H	L	P				
OPEL																		
CORSA B (S93)																		
1.4 i (44 kW)	1999.08-2000.09	-	L	F	Box Engine X 14 SZ	244001	Drive Shaft	29T	22	22	52	95	573					
	1999.08-2000.09	-	R	F	Box Engine X 14 SZ	208005	Drive Shaft	29T	22	22	52	98	916.5					
1.4 i 16V (63 kW)	1997.08-2000.09	-	L	F	Hatchback Engine C 14 SEL	244046	Drive Shaft		22	22	52	95	573					
1.4 i 16V (66 kW)	1994.09-2000.09	-	L	F	Hatchback Engine X 14 XE	244046	Drive Shaft		22	22	52	95	573					
	1994.09-2000.09	MT	L/R	F	Hatchback Engine X 14 XE	844020	Outer Joint	29T	22	28	52	97.5	57.5	O				
	1994.09-2000.09	-	L	F	Hatchback Engine X 14 XE	244001	Drive Shaft	29T	22	22	52	95	573					
	1994.09-2000.09	-	R	F	Hatchback Engine X 14 XE	208005	Drive Shaft	29T	22	22	52	98	916.5					
	1999.01-2002.12	-	L	F	Estate Engine X 14 XE	244001	Drive Shaft	29T	22	22	52	95	573					
1.4 Si (60 kW)	1993.03-2000.09	-	L	F	Hatchback Engine C 14 SE	244046	Drive Shaft		22	22	52	95	573					
	1993.03-2000.09	MT	L/R	F	Hatchback Engine C 14 SE	844020	Outer Joint	29T	22	28	52	97.5	57.5	O				
	1993.03-2000.09	MT	L	F	Hatchback Engine C 14 SE	244001	Drive Shaft	29T	22	22	52	95	573					
	1993.03-2000.09	-	R	F	Hatchback Engine C 14 SE	208005	Drive Shaft	29T	22	22	52	98	916.5					
1.5 D (37 kW)	1993.03-2000.09	-	L	F	Hatchback Engine 15 D (4EC1)	244046	Drive Shaft		22	22	52	95	573					
	1993.03-2000.09	MT	L/R	F	Hatchback Engine 15 D (4EC1)	844020	Outer Joint	29T	22	28	52	97.5	57.5	O				
	1993.03-2000.09	MT	L	F	Hatchback Engine 15 D (4EC1)	244001	Drive Shaft	29T	22	22	52	95	573					
	1993.03-2000.09	-	R	F	Hatchback Engine 15 D (4EC1)	208005	Drive Shaft	29T	22	22	52	98	916.5					
1.5 TD (49 kW)	1993.03-2000.09	-	L	F	Hatchback Engine X 15 DT (T4EC1)/15 DT (T4EC1)	244046	Drive Shaft		22	22	52	95	573					
	1993.03-2000.09	MT	L/R	F	Hatchback Engine X 15 DT (T4EC1)/15 DT (T4EC1)	844020	Outer Joint	29T	22	28	52	97.5	57.5	O				
	1993.03-2000.09	MT	L	F	Hatchback Engine X 15 DT (T4EC1)/15 DT (T4EC1)	244001	Drive Shaft	29T	22	22	52	95	573					
	1993.03-2000.09	-	R	F	Hatchback Engine X 15 DT (T4EC1)/15 DT (T4EC1)	208005	Drive Shaft	29T	22	22	52	98	916.5					
1.6 GSI 16V (80 kW)	1993.03-2000.09	MT	L/R	F	Hatchback Engine C 16 XE	644004	Inner Joint		22	22	34.95	57.5	72.5					
1.6 i 16V (74 kW)	1997.08-2000.09	-	L	F	Hatchback Engine C 16 SEL	244046	Drive Shaft		22	22	52	95	573					
1.6 i 16V (78 kW)	1994.09-2000.09	MT	L/R	F	Hatchback Engine X 16 XE	644004	Inner Joint		22	22	34.95	57.5	72.5					
1.7 D (44 kW)	1996.02-2000.09	-	L	F	Hatchback Engine 17 D (4EE1)/X 17 D (4EE1)	244046	Drive Shaft		22	22	52	95	573					
	1996.02-2000.09	MT	L/R	F	Hatchback Engine 17 D (4EE1)/X 17 D (4EE1)	844020	Outer Joint	29T	22	28	52	97.5	57.5	O				
	1996.02-2000.09	MT	L	F	Hatchback Engine 17 D (4EE1)/X 17 D (4EE1)	244001	Drive Shaft	29T	22	22	52	95	573					
	1996.02-2000.09	-	R	F	Hatchback Engine 17 D (4EE1)/X 17 D (4EE1)	208005	Drive Shaft	29T	22	22	52	98	916.5					
	1999.08-2000.09	-	L	F	Box Engine 17 D (4EE1)	244046	Drive Shaft		22	22	52	95	573					
	1999.08-2000.09	-	L	F	Box Engine 17 D (4EE1)	244001	Drive Shaft	29T	22	22	52	95	573					
	1999.08-2000.09	-	R	F	Box Engine 17 D (4EE1)	208005	Drive Shaft	29T	22	22	52	98	916.5					
CORSA C																		
-	-	-	-	-	-	644010	Inner Joint		22	27	34.9	57.5	96.5					
	-	-	R	-	-	244007	Drive Shaft	29T	22	22	52	97.5	912					
	-	-	L	-	-	244008	Drive Shaft	29T	22	22	52	97.5	562					
CORSA C (F08, F68)																		
1.0 12V (43 kW)	2000.09-	-	-	-	-	860001	Outer Joint		22	28	52	97.5	54.5	O				
1.0 12V (44 kW)	2000.09-	-	-	-	-	860001	Outer Joint		22	28	52	97.5	54.5	O				
1.2 16V (55 kW)	2000.09-	-	-	-	-	860001	Outer Joint		22	28	52	97.5	54.5	O				
1.2 Twinport (59 kW)	2004.07-	-	-	-	-	860001	Outer Joint		22	28	52	97.5	54.5	O				
1.4 16V (66 kW)	2000.09-	-	-	-	-	860001	Outer Joint		22	28	52	97.5	54.5	O				
1.4 Twinport (66 kW)	2003.06-	-	-	-	-	860001	Outer Joint		22	28	52	97.5	54.5	O				
CORSA C (X01)																		
1.0 (43 kW)	2000.09-2003.06	AT/MT	R	F	Hatchback Engine Z 10 XE	244075	Drive Shaft	29T	22	22	52	97.5	926					
	2000.09-2003.06	MT	L	F	Hatchback Engine Z 10 XE	299069	Drive Shaft	29T	22	22	52	97.5	584					
	2000.09-2003.06	-	L	F	Hatchback Engine Z 10 XE	244027	Drive Shaft	29T	22	22	52	98	580					
	2000.09-2003.06	-	-	-	Hatchback Engine Z 10 XE	644009	Inner Joint		22	23	35	57.5	96					
	2000.09-2003.06	-	R	F	Hatchback Engine Z 10 XE	244026	Drive Shaft	29T	22	22	52	98	930					
	2000.09-2003.06	AT/MT	L	F	Hatchback Engine Z 10 XE	244045	Drive Shaft	29T	22	22	52	97	579					
	2000.09-2003.06	-	L/R	F	Hatchback Engine Z 10 XE	844013	Outer Joint	29T	22	28	52	98	52	O				
1.0 (44 kW)	2003.06-2009.12	AT/MT	R	F	Hatchback Engine Z 10 XEP	244075	Drive Shaft	29T	22	22	52	97.5	926					
	2003.06-2009.12	MT	L	F	Hatchback Engine Z 10 XEP	299069	Drive Shaft	29T	22	22	52	97.5	584					
	2003.06-2009.12	-	L	F	Hatchback Engine Z 10 XEP	244027	Drive Shaft	29T	22	22	52	98	580					
	2003.06-2009.12	-	-	-	Hatchback Engine Z 10 XEP	644009	Inner Joint		22	23	35	57.5	96					
	2003.06-2009.12	-	R	F	Hatchback Engine Z 10 XEP	244026	Drive Shaft	29T	22	22	52	98	930					
	2003.06-2009.12	AT/MT	L	F	Hatchback Engine Z 10 XEP	244045	Drive Shaft	29T	22	22	52	97	579					
	2003.06-2009.12	-	L/R	F	Hatchback Engine Z 10 XEP	844013	Outer Joint	29T	22	28	52	98	52	O				
1.2 (55 kW)	2000.09-2009.12	AT/MT	L	F	Hatchback Engine Z 12 XE	299069	Drive Shaft	29T	22	22	52	97.5	584					
	2000.09-2009.12	-	L	F	Hatchback Engine Z 12 XE	244027	Drive Shaft	29T	22	22	52	98	580					
	2000.09-2009.12	-	R	F	Hatchback Engine Z 12 XE	244026	Drive Shaft	29T	22	22	52	98	930					
	2000.09-2009.12	AT/MT	L	F	Hatchback Engine Z 12 XE	244095	Drive Shaft	29T	22	22	52	97	566					
	2000.09-2009.12	AT/MT	R	F	Hatchback Engine Z 12 XE	244096	Drive Shaft	29T	22	22	52	97	917					
	2000.09-2009.12	-	-	-	Hatchback Engine Z 12 XE	644009	Inner Joint		22	23	35	57.5	96					
	2000.09-2009.12	AT/MT	L	F	Hatchback Engine Z 12 XE	244045	Drive Shaft	29T	22	22	52	97	579					
	2000.09-2009.12	AT/MT	R	F	Hatchback Engine Z 12 XE	244075	Drive Shaft	29T	22	22	52	97.5	926					
	2000.09-2009.12	-	L/R	F	Hatchback Engine Z 12 XE	844013	Outer Joint	29T	22	28	52	98	52	O				
1.2 (59 kW)	2005.07-	-	L	F	Box Engine Z 12 XEP	244027	Drive Shaft	29T	22	22	52	98	580					

	 YEAR	TRANSM	L/R	F/R	REMARKS	GSP Ref.	 PRODUCT	 ABS	Technical Specifications						
									A	B	C	H	L	P	
OPEL															
CORSA C (X01)															
1.2 (59 kW)	2005.07-	-	AT/MT	L	F	Box Engine Z 12 XEP	299069	Drive Shaft	29T	22	22	52	97.5	584	
	2005.07-	-	-	R	F	Box Engine Z 12 XEP	244026	Drive Shaft	29T	22	22	52	98	930	
	2005.07-	-	-	-	-	Box Engine Z 12 XEP	644009	Inner Joint		22	23	35	57.5	96	
	2005.07-	-	-	L	F	Box Engine Z 12 XEP	244045	Drive Shaft	29T	22	22	52	97	579	
	2005.07-	-	-	R	F	Box Engine Z 12 XEP	244075	Drive Shaft	29T	22	22	52	97.5	926	
	2005.07-	-	-	L/R	F	Box Engine Z 12 XEP	844013	Outer Joint	29T	22	28	52	98	52	O
1.2 16V (55 kW)	2000.09-	-	AT/MT	L	F	Box Engine Z 12 XE	299069	Drive Shaft	29T	22	22	52	97.5	584	
	2000.09-	-	-	L	F	Box Engine Z 12 XE	244027	Drive Shaft	29T	22	22	52	98	580	
	2000.09-	-	-	R	F	Box Engine Z 12 XE	244026	Drive Shaft	29T	22	22	52	98	930	
	2000.09-	-	AT/MT	L	F	Box Engine Z 12 XE	244095	Drive Shaft	29T	22	22	52	97	566	
	2000.09-	-	AT/MT	R	F	Box Engine Z 12 XE	244096	Drive Shaft	29T	22	22	52	97	917	
	2000.09-	-	-	-	-	Box Engine Z 12 XE	644009	Inner Joint		22	23	35	57.5	96	
	2000.09-	-	AT/MT	L	F	Box Engine Z 12 XE	244045	Drive Shaft	29T	22	22	52	97	579	
	2000.09-	-	AT/MT	R	F	Box Engine Z 12 XE	244075	Drive Shaft	29T	22	22	52	97.5	926	
2000.09-	-	-	L/R	F	Box Engine Z 12 XE	844013	Outer Joint	29T	22	28	52	98	52	O	
1.2 Twinport (59 kW)	2004.07-2009.12		AT/MT	L	F	Hatchback Engine Z 12 XEP	299069	Drive Shaft	29T	22	22	52	97.5	584	
	2004.07-2009.12		-	L	F	Hatchback Engine Z 12 XEP	244027	Drive Shaft	29T	22	22	52	98	580	
	2004.07-2009.12		-	-	-	Hatchback Engine Z 12 XEP	817034	Outer Joint		22	21	51	79.5	54	M
	2004.07-2009.12		-	R	F	Hatchback Engine Z 12 XEP	244026	Drive Shaft	29T	22	22	52	98	930	
	2004.07-2009.12		-	-	-	Hatchback Engine Z 12 XEP	644009	Inner Joint		22	23	35	57.5	96	
	2004.07-2009.12		-	L	F	Hatchback Engine Z 12 XEP	244045	Drive Shaft	29T	22	22	52	97	579	
	2004.07-2009.12		-	R	F	Hatchback Engine Z 12 XEP	244075	Drive Shaft	29T	22	22	52	97.5	926	
2004.07-2009.12		MT	L/R	F	Hatchback Engine Z 12 XEP	844013	Outer Joint	29T	22	28	52	98	52	O	
1.3 CDTI (51 kW)	2003.06-2009.12		-	R	F	Hatchback Engine Z 13 DT	299205	Drive Shaft		22	22	52	97.5	930	
	2003.06-2009.12		-	R	F	Hatchback Engine Z 13 DT	844043	Outer Joint		22	28	52	97.5	57.5	O
	2003.06-2009.12		AT/MT	L	F	Hatchback Engine Z 13 DT	299069	Drive Shaft	29T	22	22	52	97.5	584	
	2003.06-2009.12		AT/MT	L	F	Hatchback Engine Z 13 DT	244027	Drive Shaft	29T	22	22	52	98	580	
	2003.06-2009.12		-	L/R	F	Hatchback Engine Z 13 DT	844020	Outer Joint	29T	22	28	52	97.5	57.5	O
	2003.06-2009.12		AT/MT	R	F	Hatchback Engine Z 13 DT	244026	Drive Shaft	29T	22	22	52	98	930	
	2003.06-2009.12		-	-	-	Hatchback Engine Z 13 DT	644009	Inner Joint		22	23	35	57.5	96	
	2003.06-2009.12		-	L	F	Hatchback Engine Z 13 DT	244045	Drive Shaft	29T	22	22	52	97	579	
	2003.06-2009.12		MT	L	F	Hatchback Engine Z 13 DT	250174	Drive Shaft		23	37.1	56.2	83.5	597.5	
	2003.06-2009.12		MT	L	F	Hatchback Engine Z 13 DT	250174	Drive Shaft		23	37.1	56.2	83.5	597.5	
2003.06-2009.12		MT	L	F	Hatchback Engine Z 13 DT	244061	Drive Shaft		22	22	52	98	580		
2003.06-2009.12		-	R	F	Hatchback Engine Z 13 DT	244075	Drive Shaft	29T	22	22	52	97.5	926		
1.3 CDTI 16V (51 kW)	2005.08-	-	-	R	F	Box Engine Z 13 DT	299205	Drive Shaft		22	22	52	97.5	930	
	2005.08-	-	-	R	F	Box Engine Z 13 DT	844043	Outer Joint		22	28	52	97.5	57.5	O
	2005.08-	-	AT/MT	L	F	Box Engine Z 13 DT	244027	Drive Shaft	29T	22	22	52	98	580	
	2005.08-	-	AT/MT	L	F	Box Engine Z 13 DT	299069	Drive Shaft	29T	22	22	52	97.5	584	
	2005.08-	-	-	L/R	F	Box Engine Z 13 DT	844020	Outer Joint	29T	22	28	52	97.5	57.5	O
	2005.08-	-	AT/MT	R	F	Box Engine Z 13 DT	244026	Drive Shaft	29T	22	22	52	98	930	
	2005.08-	-	-	-	-	Box Engine Z 13 DT	644009	Inner Joint		22	23	35	57.5	96	
	2005.08-	-	-	L	F	Box Engine Z 13 DT	244045	Drive Shaft	29T	22	22	52	97	579	
	2005.08-	-	MT	L	F	Box Engine Z 13 DT	250174	Drive Shaft		23	37.1	56.2	83.5	597.5	
	2005.08-	-	MT	L	F	Box Engine Z 13 DT	250174	Drive Shaft		23	37.1	56.2	83.5	597.5	
2005.08-	-	MT	L	F	Box Engine Z 13 DT	244061	Drive Shaft		22	22	52	98	580		
2005.08-	-	-	R	F	Box Engine Z 13 DT	244075	Drive Shaft	29T	22	22	52	97.5	926		
1.4 (66 kW)	2000.09-2009.12		AT/MT	L	F	Hatchback Engine Z 14 XE	299069	Drive Shaft	29T	22	22	52	97.5	584	
	2000.09-2009.12		-	R	F	Hatchback Engine Z 14 XE	844043	Outer Joint		22	28	52	97.5	57.5	O
	2000.09-2009.12		AT/MT	L	F	Hatchback Engine Z 14 XE	244027	Drive Shaft	29T	22	22	52	98	580	
	2000.09-2009.12		-	R	F	Hatchback Engine Z 14 XE	244060	Drive Shaft		22	22	52	98	930	
	2000.09-2009.12		-	L	F	Hatchback Engine Z 14 XE	299204	Drive Shaft		22	22	52	97.5	584	
	2000.09-2009.12		AT/MT	R	F	Hatchback Engine Z 14 XE	244026	Drive Shaft	29T	22	22	52	98	930	
	2000.09-2009.12		-	L/R	F	Hatchback Engine Z 14 XE	844020	Outer Joint	29T	22	28	52	97.5	57.5	O
	2000.09-2009.12		-	-	-	Hatchback Engine Z 14 XE	644009	Inner Joint		22	23	35	57.5	96	
	2000.09-2009.12		-	L	F	Hatchback Engine Z 14 XE	244045	Drive Shaft	29T	22	22	52	97	579	
	2000.09-2009.12		AT/MT	L	F	Hatchback Engine Z 14 XE	250174	Drive Shaft		23	37.1	56.2	83.5	597.5	
	2000.09-2009.12		AT/MT	L	F	Hatchback Engine Z 14 XE	250174	Drive Shaft		23	37.1	56.2	83.5	597.5	
	2000.09-2009.12		AT/MT	L	F	Hatchback Engine Z 14 XE	250174	Drive Shaft		23	37.1	56.2	83.5	597.5	
	2000.09-2009.12		-	R	F	Hatchback Engine Z 14 XE	244075	Drive Shaft	29T	22	22	52	97.5	926	
	2000.09-2009.12		AT/MT	L	F	Hatchback Engine Z 14 XE	244061	Drive Shaft		22	22	52	98	580	
	2000.09-2009.12		-	R	F	Hatchback Engine Z 14 XE	299205	Drive Shaft		22	22	52	97.5	930	
	2003.08-	-	-	R	F	Box Engine Z 14 XEP	299205	Drive Shaft		22	22	52	97.5	930	
	2003.08-	-	-	R	F	Box Engine Z 14 XEP	844043	Outer Joint		22	28	52	97.5	57.5	O
	2003.08-	-	-	L	F	Box Engine Z 14 XEP	244027	Drive Shaft	29T	22	22	52	98	580	
	2003.08-	-	-	L/R	F	Box Engine Z 14 XEP	844020	Outer Joint	29T	22	28	52	97.5	57.5	O





YEAR	TRANSM	L/R	F/R	REMARKS	GSP Ref.	PRODUCT	ABS	Technical Specifications										
								A	B	C	H	L	P					
OPEL																		
CORSA C (X01)																		
1.4 (66 kW)																		
2003.08-	-	-	R	F	Box Engine Z 14 XEP	244026	Drive Shaft	29T	22	22	52	98	930					
2003.08-	-	-	L	F	Box Engine Z 14 XEP	244045	Drive Shaft	29T	22	22	52	97	579					
2003.08-	-	MT	L	F	Box Engine Z 14 XEP	250174	Drive Shaft		23	37.1	56.2	83.5	597.5					
2003.08-	-	MT	L	F	Box Engine Z 14 XEP	250174	Drive Shaft		23	37.1	56.2	83.5	597.5					
2003.08-	-	MT	L	F	Box Engine Z 14 XEP	244061	Drive Shaft		22	22	52	98	580					
2003.08-	-	-	R	F	Box Engine Z 14 XEP	244075	Drive Shaft	29T	22	22	52	97.5	926					
1.4 Twinport (66 kW)																		
2003.06-	2009.12	-	R	F	Hatchback Engine Z 14 XEP	299205	Drive Shaft		22	22	52	97.5	930					
2003.06-	2009.12	-	R	F	Hatchback Engine Z 14 XEP	844043	Outer Joint		22	28	52	97.5	57.5			O		
2003.06-	2009.12	AT/MT	L	F	Hatchback Engine Z 14 XEP	299069	Drive Shaft	29T	22	22	52	97.5	584					
2003.06-	2009.12	AT/MT	L	F	Hatchback Engine Z 14 XEP	244027	Drive Shaft	29T	22	22	52	98	580					
2003.06-	2009.12	-	L/R	F	Hatchback Engine Z 14 XEP	844020	Outer Joint	29T	22	28	52	97.5	57.5			O		
2003.06-	2009.12	AT/MT	R	F	Hatchback Engine Z 14 XEP	244026	Drive Shaft	29T	22	22	52	98	930					
2003.06-	2009.12	-	-	-	Hatchback Engine Z 14 XEP	644009	Inner Joint		22	23	35	57.5	96					
2003.06-	2009.12	-	L	F	Hatchback Engine Z 14 XEP	244045	Drive Shaft	29T	22	22	52	97	579					
2003.06-	2009.12	MT	L	F	Hatchback Engine Z 14 XEP	250174	Drive Shaft		23	37.1	56.2	83.5	597.5					
2003.06-	2009.12	MT	L	F	Hatchback Engine Z 14 XEP	250174	Drive Shaft		23	37.1	56.2	83.5	597.5					
2003.06-	2009.12	MT	L	F	Hatchback Engine Z 14 XEP	244061	Drive Shaft		22	22	52	98	580					
2003.06-	2009.12	-	R	F	Hatchback Engine Z 14 XEP	244075	Drive Shaft	29T	22	22	52	97.5	926					
1.7 CDTI (74 kW)																		
2003.06-	2009.12	-	R	F	Hatchback Engine Z 17 DTH	244092	Drive Shaft	29T	33	34	52	104	609					
2003.06-	2009.12	-	L	F	Hatchback Engine Z 17 DTH	244032	Drive Shaft	29T	33	34	52	104	587.5					
2003.06-	2009.12	-	R	F	Hatchback Engine Z 17 DTH	660003	Inner Joint		34	24	35.5	47	70.5					
2003.06-	2009.12	-	L	F	Hatchback Engine Z 17 DTH	621034	Inner Joint		34	24	35	56.5	102					
2003.06-	2009.12	-	L/R	F	Hatchback Engine Z 17 DTH	844004	Outer Joint	29T	33	24	52	104	64			M		
2003.06-	2009.12	MT	L	F	Hatchback Engine Z 17 DTH	250174	Drive Shaft		23	37.1	56.2	83.5	597.5					
2003.06-	2009.12	MT	L	F	Hatchback Engine Z 17 DTH	250174	Drive Shaft		23	37.1	56.2	83.5	597.5					
2003.06-	2009.12	MT	R	F	Hatchback Engine Z 17 DTH	260021	Drive Shaft	29T	33	34	52	104	612					
2003.06-	2009.12	MT	L	F	Hatchback Engine Z 17 DTH	244061	Drive Shaft		22	22	52	98	580					
2003.08-	-	-	R	F	Box Engine Z 17 DTH	244092	Drive Shaft	29T	33	34	52	104	609					
2003.08-	-	-	L	F	Box Engine Z 17 DTH	244032	Drive Shaft	29T	33	34	52	104	587.5					
2003.08-	-	-	R	F	Box Engine Z 17 DTH	660003	Inner Joint		34	24	35.5	47	70.5					
2003.08-	-	-	L	F	Box Engine Z 17 DTH	621034	Inner Joint		34	24	35	56.5	102					
2003.08-	-	-	L/R	F	Box Engine Z 17 DTH	844004	Outer Joint	29T	33	24	52	104	64			M		
2003.08-	-	MT	L	F	Box Engine Z 17 DTH	250174	Drive Shaft		23	37.1	56.2	83.5	597.5					
2003.08-	-	MT	L	F	Box Engine Z 17 DTH	250174	Drive Shaft		23	37.1	56.2	83.5	597.5					
2003.08-	-	MT	L	F	Box Engine Z 17 DTH	244061	Drive Shaft		22	22	52	98	580					
1.7 DI (48 kW)																		
2000.09-	2009.12	MT	L	F	Hatchback Engine Y 17 DTL	299069	Drive Shaft	29T	22	22	52	97.5	584					
2000.09-	2009.12	-	R	F	Hatchback Engine Y 17 DTL	844043	Outer Joint		22	28	52	97.5	57.5			O		
2000.09-	2009.12	AT/MT	L	F	Hatchback Engine Y 17 DTL	244027	Drive Shaft	29T	22	22	52	98	580					
2000.09-	2009.12	-	R	F	Hatchback Engine Y 17 DTL	244060	Drive Shaft		22	22	52	98	930					
2000.09-	2009.12	-	L	F	Hatchback Engine Y 17 DTL	299204	Drive Shaft		22	22	52	97.5	584					
2000.09-	2009.12	AT/MT	R	F	Hatchback Engine Y 17 DTL	244026	Drive Shaft	29T	22	22	52	98	930					
2000.09-	2009.12	-	L/R	F	Hatchback Engine Y 17 DTL	844020	Outer Joint	29T	22	28	52	97.5	57.5			O		
2000.09-	2009.12	-	-	-	Hatchback Engine Y 17 DTL	644009	Inner Joint		22	23	35	57.5	96					
2000.09-	2009.12	-	L	F	Hatchback Engine Y 17 DTL	244045	Drive Shaft	29T	22	22	52	97	579					
2000.09-	2009.12	MT	L	F	Hatchback Engine Y 17 DTL	250174	Drive Shaft		23	37.1	56.2	83.5	597.5					
2000.09-	2009.12	MT	L	F	Hatchback Engine Y 17 DTL	250174	Drive Shaft		23	37.1	56.2	83.5	597.5					
2000.09-	2009.12	-	R	F	Hatchback Engine Y 17 DTL	244075	Drive Shaft	29T	22	22	52	97.5	926					
2000.09-	2009.12	MT	L	F	Hatchback Engine Y 17 DTL	244061	Drive Shaft		22	22	52	98	580					
2000.09-	2009.12	-	R	F	Hatchback Engine Y 17 DTL	299205	Drive Shaft		22	22	52	97.5	930					
1.7 DI 16V (48 kW)																		
2000.09-	-	MT	L	F	Box Engine Y 17 DTL	299069	Drive Shaft	29T	22	22	52	97.5	584					
2000.09-	-	-	R	F	Box Engine Y 17 DTL	844043	Outer Joint		22	28	52	97.5	57.5			O		
2000.09-	-	-	L	F	Box Engine Y 17 DTL	244027	Drive Shaft	29T	22	22	52	98	580					
2000.09-	-	-	R	F	Box Engine Y 17 DTL	244060	Drive Shaft		22	22	52	98	930					
2000.09-	-	-	L	F	Box Engine Y 17 DTL	299204	Drive Shaft		22	22	52	97.5	584					
2000.09-	-	-	R	F	Box Engine Y 17 DTL	244026	Drive Shaft	29T	22	22	52	98	930					
2000.09-	-	-	L/R	F	Box Engine Y 17 DTL	844020	Outer Joint	29T	22	28	52	97.5	57.5			O		
2000.09-	-	-	-	-	Box Engine Y 17 DTL	644009	Inner Joint		22	23	35	57.5	96					
2000.09-	-	-	L	F	Box Engine Y 17 DTL	244045	Drive Shaft	29T	22	22	52	97	579					
2000.09-	-	MT	L	F	Box Engine Y 17 DTL	250174	Drive Shaft		23	37.1	56.2	83.5	597.5					
2000.09-	-	MT	L	F	Box Engine Y 17 DTL	250174	Drive Shaft		23	37.1	56.2	83.5	597.5					
2000.09-	-	-	R	F	Box Engine Y 17 DTL	244075	Drive Shaft	29T	22	22	52	97.5	926					
2000.09-	-	MT	L	F	Box Engine Y 17 DTL	244061	Drive Shaft		22	22	52	98	580					
2000.09-	-	-	R	F	Box Engine Y 17 DTL	299205	Drive Shaft		22	22	52	97.5	930					
1.7 DTI (55 kW)																		
2000.09-	2009.12	MT	L	F	Hatchback Engine Y 17 DT	299069	Drive Shaft	29T	22	22	52	97.5	584					
2000.09-	2009.12	-	R	F	Hatchback Engine Y 17 DT	844043	Outer Joint		22	28	52	97.5	57.5			O		
2000.09-	2009.12	AT/MT	L	F	Hatchback Engine Y 17 DT	244027	Drive Shaft	29T	22	22	52	98	580					





	YEAR		TRANSM	L/R	F/R	REMARKS	GSP Ref.	PRODUCT	ABS	Technical Specifications												
										A	B	C	H	L	P							
OPEL																						
CORSA C (X01)																						
1.7 DTI (55 kW)	2000.09-	2009.12	-	R	F	Hatchback Engine Y 17 DT	244060	Drive Shaft		22	22	52	98	930								
	2000.09-	2009.12	-	L	F	Hatchback Engine Y 17 DT	299204	Drive Shaft		22	22	52	97.5	584								
	2000.09-	2009.12	AT/MT	R	F	Hatchback Engine Y 17 DT	244026	Drive Shaft	29T	22	22	52	98	930								
	2000.09-	2009.12	-	L/R	F	Hatchback Engine Y 17 DT	844020	Outer Joint	29T	22	28	52	97.5	57.5	O							
	2000.09-	2009.12	-	-	-	Hatchback Engine Y 17 DT	644009	Inner Joint		22	23	35	57.5	96								
	2000.09-	2009.12	-	L	F	Hatchback Engine Y 17 DT	244045	Drive Shaft	29T	22	22	52	97	579								
	2000.09-	2009.12	MT	L	F	Hatchback Engine Y 17 DT	250174	Drive Shaft		23	37.1	56.2	83.5	597.5								
	2000.09-	2009.12	MT	L	F	Hatchback Engine Y 17 DT	250174	Drive Shaft		23	37.1	56.2	83.5	597.5								
	2000.09-	2009.12	-	R	F	Hatchback Engine Y 17 DT	244075	Drive Shaft	29T	22	22	52	97.5	926								
	2000.09-	2009.12	MT	L	F	Hatchback Engine Y 17 DT	244061	Drive Shaft		22	22	52	98	580								
	2000.09-	2009.12	-	R	F	Hatchback Engine Y 17 DT	299205	Drive Shaft		22	22	52	97.5	930								
1.7 DTI 16V (55 kW)	2000.09-	-	MT	L	F	Box Engine Y 17 DT	299069	Drive Shaft	29T	22	22	52	97.5	584								
	2000.09-	-	-	R	F	Box Engine Y 17 DT	844043	Outer Joint		22	28	52	97.5	57.5	O							
	2000.09-	-	-	L	F	Box Engine Y 17 DT	244027	Drive Shaft	29T	22	22	52	98	580								
	2000.09-	-	-	R	F	Box Engine Y 17 DT	244060	Drive Shaft		22	22	52	98	930								
	2000.09-	-	-	L	F	Box Engine Y 17 DT	299204	Drive Shaft		22	22	52	97.5	584								
	2000.09-	-	-	R	F	Box Engine Y 17 DT	244026	Drive Shaft	29T	22	22	52	98	930								
	2000.09-	-	-	L/R	F	Box Engine Y 17 DT	844020	Outer Joint	29T	22	28	52	97.5	57.5	O							
	2000.09-	-	-	-	-	Box Engine Y 17 DT	644009	Inner Joint		22	23	35	57.5	96								
	2000.09-	-	-	L	F	Box Engine Y 17 DT	244045	Drive Shaft	29T	22	22	52	97	579								
	2000.09-	-	MT	L	F	Box Engine Y 17 DT	250174	Drive Shaft		23	37.1	56.2	83.5	597.5								
	2000.09-	-	MT	L	F	Box Engine Y 17 DT	250174	Drive Shaft		23	37.1	56.2	83.5	597.5								
	2000.09-	-	-	R	F	Box Engine Y 17 DT	244075	Drive Shaft	29T	22	22	52	97.5	926								
	2000.09-	-	MT	L	F	Box Engine Y 17 DT	244061	Drive Shaft		22	22	52	98	580								
	2000.09-	-	-	R	F	Box Engine Y 17 DT	299205	Drive Shaft		22	22	52	97.5	930								
1.8 (92 kW)	2000.09-	2009.12	MT	L	F	Hatchback Engine Z 18 XE	299069	Drive Shaft	29T	22	22	52	97.5	584								
	2000.09-	2009.12	-	L	F	Hatchback Engine Z 18 XE	244027	Drive Shaft	29T	22	22	52	98	580								
	2000.09-	2009.12	-	R	F	Hatchback Engine Z 18 XE	244026	Drive Shaft	29T	22	22	52	98	930								
	2000.09-	2009.12	-	L	F	Hatchback Engine Z 18 XE	244045	Drive Shaft	29T	22	22	52	97	579								
	2000.09-	2009.12	-	-	-	Hatchback Engine Z 18 XE	644009	Inner Joint		22	23	35	57.5	96								
	2000.09-	2009.12	-	L/R	F	Hatchback Engine Z 18 XE	844002	Outer Joint	29T	22	23	52	97.5	61	M							
	2000.09-	2009.12	-	R	F	Hatchback Engine Z 18 XE	244075	Drive Shaft	29T	22	22	52	97.5	926								
CORSA C VAN (F08, W5L)																						
1.2 (59 kW)	2005.07-	-	-	-	-	LCV	860001	Outer Joint		22	28	52	97.5	54.5	O							
1.2 16V (55 kW)	2000.09-	-	-	-	-	LCV	860001	Outer Joint		22	28	52	97.5	54.5	O							
1.4 (66 kW)	2003.08-	-	-	-	-	LCV	860001	Outer Joint		22	28	52	97.5	54.5	O							
CORSA C VAN(FO8,W5L)																						
1.2 16V(55KW)	2000.09-	-	-	-	-	LCV	844053	Outer Joint	29T	22	28	52	97.5	54.5	O							
1.2(59KW)	2005.07-	-	-	-	-	LCV	844053	Outer Joint	29T	22	28	52	97.5	54.5	O							
1.4(66KW)	2003.08-	-	-	-	-	LCV	844053	Outer Joint	29T	22	28	52	97.5	54.5	O							
CORSA C(FO8,F68)																						
1.0 12V(43-44)KW	2000.09-	-	-	-	-	-	844053	Outer Joint	29T	22	28	52	97.5	54.5	O							
1.2 16V(55KW)	2000.09-	-	-	-	-	-	844053	Outer Joint	29T	22	28	52	97.5	54.5	O							
1.2 TWINPORT(59KW)	2004.07-	-	-	-	-	-	844053	Outer Joint	29T	22	28	52	97.5	54.5	O							
1.4 16V(66KW)	2000.09-	-	-	-	-	-	844053	Outer Joint	29T	22	28	52	97.5	54.5	O							
1.4 TWINPORT(66KW)	2003.06-	-	-	-	-	-	844053	Outer Joint	29T	22	28	52	97.5	54.5	O							
CORSA D																						
1.3 CDTi	2006-	-	-	R	F	Engine Z13DTJ	644017	Inner Joint		22	23	35	57.5	116								
	2006-	-	-	-	F	Engine Z13DTH	644012	Inner Joint		25	23	34.9	56.5	118								
	2006-	-	-	-	F	Engine Z13DTH	644014	Inner Joint		25	23	34.9	57.5	102								
CORSA D (S07)																						
1.0 (44 kW)	2006.07-	-	-	-	F	Hatchback Engine Z 10 XEP	899018	Outer Joint		22	27	51	79.5	54	O							
	2006.07-	-	MT	R	F	Hatchback Engine Z 10 XEP	644013	Inner Joint		22	21	35	57.5	93								
	2006.07-	-	MT	L	F	Hatchback Engine Z 10 XEP	244079	Drive Shaft		22	22	51	79.5	615								
	2006.07-	-	MT	L	F	Hatchback Engine Z 10 XEP	817089	Outer Joint		22	20	51	79.5	51	M							
	2006.07-	-	-	L/R	F	Hatchback Engine Z 10 XEP	817052	Outer Joint		22	21	51.2	79.5	54	M							
	2006.07-	-	MT	L	F	Hatchback Engine Z 10 XEP	260023	Drive Shaft		22	22	51.2	79.5	615								
	2006.07-	-	MT	R	F	Hatchback Engine Z 10 XEP	217044	Drive Shaft		22	22	51.2	79.5	919								
1.0 (48 kW)	2010.01-	-	-	L	F	Hatchback Engine A 10 XEP	817089	Outer Joint		22	20	51	79.5	51	M							
	2010.01-	-	MT	L	F	Hatchback Engine A 10 XEP	260023	Drive Shaft		22	22	51.2	79.5	615								
	2010.01-	-	MT	L	F	Hatchback Engine A 10 XEP	644013	Inner Joint		22	21	35	57.5	93								
1.2 (51 kW)	2010.06-	-	AT/MT	L	F	Hatchback Engine A 12 XEL	644013	Inner Joint		22	21	35	57.5	93								
	2010.06-	-	MT	L	F	Hatchback Engine A 12 XEL	817089	Outer Joint		22	20	51	79.5	51	M							
	2010.06-	-	-	L/R	F	Hatchback Engine A 12 XEL	817052	Outer Joint		22	21	51.2	79.5	54	M							
	2010.06-	-	AT/MT	L	F	Hatchback Engine A 12 XEL	260023	Drive Shaft		22	22	51.2	79.5	615								
1.2 (59 kW)	2006.07-	-	-	-	F	Hatchback Engine Z 12 XEP	899018	Outer Joint		22	27	51	79.5	54	O							

	 YEAR	TRANSM	L/R	F/R	REMARKS	GSP Ref.	 PRODUCT	 ABS	Technical Specifications					
									A	B	C	H	L	P
OPEL														
CORSA D (S07)														
1.2 (59 kW)	2006.07-	-	MT	R	F	Hatchback Engine Z 12 XEP	644013	Inner Joint	22	21	35	57.5	93	
	2006.07-	-	MT	R	F	Hatchback Engine Z 12 XEP	244078	Drive Shaft	22	22	51	79.5	918	
	2006.07-	-	MT	R	F	Hatchback Engine Z 12 XEP	817089	Outer Joint	22	20	51	79.5	51	M
	2006.07-	-	MT	L	F	Hatchback Engine Z 12 XEP	244079	Drive Shaft	22	22	51	79.5	615	
	2006.07-	-	-	L/R	F	Hatchback Engine Z 12 XEP	817052	Outer Joint	22	21	51.2	79.5	54	M
	2006.07-	-	AT/MT	L	F	Hatchback Engine Z 12 XEP	260023	Drive Shaft	22	22	51.2	79.5	615	
	2006.07-	-	MT	R	F	Hatchback Engine Z 12 XEP	217044	Drive Shaft	22	22	51.2	79.5	919	
1.2 (63 kW)	2010.06-	-	MT	L	F	Hatchback Engine A 12 XER	817089	Outer Joint	22	20	51	79.5	51	M
	2010.06-	-	MT	L	F	Hatchback Engine A 12 XER	260023	Drive Shaft	22	22	51.2	79.5	615	
	2010.06-	-	MT	L	F	Hatchback Engine A 12 XER	644013	Inner Joint	22	21	35	57.5	93	
1.2 LPG (59 kW)	2009.09-	-	-	-	F	Hatchback Engine Z 12 XEP	899018	Outer Joint	22	27	51	79.5	54	O
	2009.09-	-	MT	R	F	Hatchback Engine Z 12 XEP	644013	Inner Joint	22	21	35	57.5	93	
	2009.09-	-	MT	R	F	Hatchback Engine Z 12 XEP	244078	Drive Shaft	22	22	51	79.5	918	
	2009.09-	-	MT	R	F	Hatchback Engine Z 12 XEP	817089	Outer Joint	22	20	51	79.5	51	M
	2009.09-	-	MT	L	F	Hatchback Engine Z 12 XEP	244079	Drive Shaft	22	22	51	79.5	615	
	2009.09-	-	-	L/R	F	Hatchback Engine Z 12 XEP	817052	Outer Joint	22	21	51.2	79.5	54	M
	2009.09-	-	AT/MT	L	F	Hatchback Engine Z 12 XEP	260023	Drive Shaft	22	22	51.2	79.5	615	
1.2 LPG (61 kW)	2011.06-	-	MT	L	F	Hatchback Engine A 12 XER	817089	Outer Joint	22	20	51	79.5	51	M
	2011.06-	-	MT	L	F	Hatchback Engine A 12 XER	260023	Drive Shaft	22	22	51.2	79.5	615	
	2011.06-	-	MT	L	F	Hatchback Engine A 12 XER	644013	Inner Joint	22	21	35	57.5	93	
1.2 LPG (63 kW)	2011.08-	-	-	L	F	Hatchback Engine A 12 XER	817089	Outer Joint	22	20	51	79.5	51	M
	2011.08-	-	MT	L	F	Hatchback Engine A 12 XER	260023	Drive Shaft	22	22	51.2	79.5	615	
	2011.08-	-	MT	L	F	Hatchback Engine A 12 XER	644013	Inner Joint	22	21	35	57.5	93	
1.3 CDTI (55 kW)	2006.07-	-	-	L/R	F	Hatchback Engine Z 13 DT/J/A 13 DTC	817053	Outer Joint	25	23	51	84.5	60	M
	2006.07-	-	MT	L	F	Hatchback Engine Z 13 DT/J/A 13 DTC	244040	Drive Shaft	25	22	51	84.5	616	
	2006.07-	-	MT	R	F	Hatchback Engine Z 13 DT/J/A 13 DTC	244042	Drive Shaft	25	22	51	84.5	920	
	2006.07-	-	-	-	F	Hatchback Engine Z 13 DT/J/A 13 DTC	817027	Outer Joint	25	23	51	84.5	60	M
1.3 CDTI (66 kW)	2006.07-	-	-	L/R	F	Hatchback Engine Z 13 DTH	817053	Outer Joint	25	23	51	84.5	60	M
	2006.07-	-	MT	R	F	Hatchback Engine Z 13 DTH	217071	Drive Shaft	25	25	51	84.5	952	
	2006.07-	-	MT	L	F	Hatchback Engine Z 13 DTH	217070	Drive Shaft	25	25	51	84.5	576	
	2006.07-	-	-	-	F	Hatchback Engine Z 13 DTH	817027	Outer Joint	25	23	51	84.5	60	M
1.3 CDTI (70 kW)	2010.06-	-	-	L/R	F	Hatchback Engine A 13 DTE/Z 13 DTE/A 13 DTR	817053	Outer Joint	25	23	51	84.5	60	M
	2010.06-	-	-	-	F	Hatchback Engine A 13 DTE/Z 13 DTE/A 13 DTR	817027	Outer Joint	25	23	51	84.5	60	M
1.4 (64 kW)	2009.09-	-	AT/MT	L	F	Hatchback Engine A 14 XEL	644013	Inner Joint	22	21	35	57.5	93	
	2009.09-	-	-	R	F	Hatchback Engine A 14 XEL	244078	Drive Shaft	22	22	51	79.5	918	
	2009.09-	-	-	R	F	Hatchback Engine A 14 XEL	817089	Outer Joint	22	20	51	79.5	51	M
	2009.09-	-	-	L	F	Hatchback Engine A 14 XEL	244079	Drive Shaft	22	22	51	79.5	615	
	2009.09-	-	-	L/R	F	Hatchback Engine A 14 XEL	817052	Outer Joint	22	21	51.2	79.5	54	M
	2009.09-	-	AT/MT	L	F	Hatchback Engine A 14 XEL	260023	Drive Shaft	22	22	51.2	79.5	615	
1.4 (66 kW)	2006.07-	-	MT	L	F	Hatchback Engine Z 14 XEP	644013	Inner Joint	22	21	35	57.5	93	
	2006.07-	-	MT	R	F	Hatchback Engine Z 14 XEP	244078	Drive Shaft	22	22	51	79.5	918	
	2006.07-	-	MT	R	F	Hatchback Engine Z 14 XEP	817089	Outer Joint	22	20	51	79.5	51	M
	2006.07-	-	MT	L	F	Hatchback Engine Z 14 XEP	244079	Drive Shaft	22	22	51	79.5	615	
	2006.07-	-	MT	L/R	F	Hatchback Engine Z 14 XEP	817052	Outer Joint	22	21	51.2	79.5	54	M
	2006.07-	-	AT/MT	L	F	Hatchback Engine Z 14 XEP	260023	Drive Shaft	22	22	51.2	79.5	615	
1.4 (74 kW)	2010.06-	-	MT	R	F	Hatchback Engine A 14 XER	244078	Drive Shaft	22	22	51	79.5	918	
	2010.06-	-	MT	R	F	Hatchback Engine A 14 XER	817089	Outer Joint	22	20	51	79.5	51	M
	2010.06-	-	MT	L	F	Hatchback Engine A 14 XER	244079	Drive Shaft	22	22	51	79.5	615	
	2010.06-	-	-	L/R	F	Hatchback Engine A 14 XER	817052	Outer Joint	22	21	51.2	79.5	54	M
	2010.06-	-	MT	L	F	Hatchback Engine A 14 XER	260023	Drive Shaft	22	22	51.2	79.5	615	
	2010.06-	-	MT	L	F	Hatchback Engine A 14 XER	644013	Inner Joint	22	21	35	57.5	93	
	2012.07-	-	MT	L/R	F	Hatchback Engine A 14 NEL	817053	Outer Joint	25	23	51	84.5	60	M
1.4 LPG (64 kW)	2009.09-	-	AT/MT	L	F	Hatchback Engine A 14 XEL	644013	Inner Joint	22	21	35	57.5	93	
	2009.09-	-	5MT	R	F	Hatchback Engine A 14 XEL	244078	Drive Shaft	22	22	51	79.5	918	
	2009.09-	-	5MT	R	F	Hatchback Engine A 14 XEL	817089	Outer Joint	22	20	51	79.5	51	M
	2009.09-	-	5MT	L	F	Hatchback Engine A 14 XEL	244079	Drive Shaft	22	22	51	79.5	615	
1.4 LPG (66 kW)	2009.09-	-	5MT	L/R	F	Hatchback Engine A 14 XEL	817052	Outer Joint	22	21	51.2	79.5	54	M
	2009.09-	-	AT/MT	L	F	Hatchback Engine A 14 XEL	260023	Drive Shaft	22	22	51.2	79.5	615	
	2006.07-	-	AT/MT	L	F	Hatchback Engine Z 14 XEP	644013	Inner Joint	22	21	35	57.5	93	
	2006.07-	-	MT	R	F	Hatchback Engine Z 14 XEP	244078	Drive Shaft	22	22	51	79.5	918	
	2006.07-	-	MT	R	F	Hatchback Engine Z 14 XEP	817089	Outer Joint	22	20	51	79.5	51	M
2006.07-	-	MT	L	F	Hatchback Engine Z 14 XEP	244079	Drive Shaft	22	22	51	79.5	615		
2006.07-	-	-	L/R	F	Hatchback Engine Z 14 XEP	817052	Outer Joint	22	21	51.2	79.5	54	M	

	 YEAR	TRANSM	L/R	F/R	REMARKS	GSP Ref.	 PRODUCT	 ABS	Technical Specifications									
									A	B	C	H	L	P				
OPEL																		
CORSA D (S07)																		
1.4 LPG (66 kW)	2006.07-	-	AT/MT	L	F	Hatchback Engine Z 14 XEP	260023	Drive Shaft		22	22	51.2	79.5	615				
1.6 Turbo (110 kW)	2007.02-	-	-	-	F	Hatchback Engine Z 16 LEL/A 16 LEL	860006	Outer Joint		25	35	51	84.5	63	I			
	2007.02-	-	MT	L	F	Hatchback Engine Z 16 LEL/A 16 LEL	260025	Drive Shaft		25	25	51	84.5	579.5				
	2007.02-	-	MT	R	F	Hatchback Engine Z 16 LEL/A 16 LEL	260024	Drive Shaft		25	34	51	84.5	608				
1.6 Turbo (141 kW)	2007.02-	-	-	-	F	Hatchback Engine Z 16 LER/A 16 LER/B 16 LER	860006	Outer Joint		25	35	51	84.5	63	I			
	2007.02-	-	MT	L	F	Hatchback Engine Z 16 LER/A 16 LER/B 16 LER	260025	Drive Shaft		25	25	51	84.5	579.5				
	2007.02-	-	MT	R	F	Hatchback Engine Z 16 LER/A 16 LER/B 16 LER	260024	Drive Shaft		25	34	51	84.5	608				
1.6 Turbo (155 kW)	2011.06-	-	-	-	F	Hatchback Engine A 16 LES	860006	Outer Joint		25	35	51	84.5	63	I			
	2011.06-	-	MT	L	F	Hatchback Engine A 16 LES	260025	Drive Shaft		25	25	51	84.5	579.5				
	2011.06-	-	MT	R	F	Hatchback Engine A 16 LES	260024	Drive Shaft		25	34	51	84.5	608				
1.7 CDTI (96 kW)	2010.06-	-	-	-	F	Hatchback Engine A 17 DTS	860006	Outer Joint		25	35	51	84.5	63	I			
CORSA D Van (S07)																		
1.0 (44 kW)	2006.07-	-	-	R	F	Box Engine A 10 XEP	644013	Inner Joint		22	21	35	57.5	93				
	2006.07-	-	-	L	F	Box Engine A 10 XEP	244079	Drive Shaft		22	22	51	79.5	615				
	2006.07-	-	-	L	F	Box Engine A 10 XEP	817089	Outer Joint		22	20	51	79.5	51	M			
	2006.07-	-	-	L/R	F	Box Engine A 10 XEP	817052	Outer Joint		22	21	51.2	79.5	54	M			
	2006.07-	-	MT	L	F	Box Engine A 10 XEP	260023	Drive Shaft		22	22	51.2	79.5	615				
	2006.07-	-	-	R	F	Box Engine A 10 XEP	217044	Drive Shaft		22	22	51.2	79.5	919				
1.0 (48 kW)	2010.01-	-	-	L	F	Box Engine A 10 XEP	817089	Outer Joint		22	20	51	79.5	51	M			
	2010.01-	-	MT	L	F	Box Engine A 10 XEP	260023	Drive Shaft		22	22	51.2	79.5	615				
	2010.01-	-	MT	L	F	Box Engine A 10 XEP	644013	Inner Joint		22	21	35	57.5	93				
1.2 (51 kW)	2010.06-	-	AT/MT	L	F	Box Engine A 12 XEL	644013	Inner Joint		22	21	35	57.5	93				
	2010.06-	-	-	L	F	Box Engine A 12 XEL	817089	Outer Joint		22	20	51	79.5	51	M			
	2010.06-	-	AT/MT	L	F	Box Engine A 12 XEL	260023	Drive Shaft		22	22	51.2	79.5	615				
1.2 (59 kW)	2009.07-	-	-	-	F	Box Engine Z 12 XEP	899018	Outer Joint		22	27	51	79.5	54	O			
	2009.07-	-	-	R	F	Box Engine Z 12 XEP	644013	Inner Joint		22	21	35	57.5	93				
	2009.07-	-	-	R	F	Box Engine Z 12 XEP	244078	Drive Shaft		22	22	51	79.5	918				
	2009.07-	-	-	R	F	Box Engine Z 12 XEP	817089	Outer Joint		22	20	51	79.5	51	M			
	2009.07-	-	-	L	F	Box Engine Z 12 XEP	244079	Drive Shaft		22	22	51	79.5	615				
	2009.07-	-	-	L/R	F	Box Engine Z 12 XEP	817052	Outer Joint		22	21	51.2	79.5	54	M			
	2009.07-	-	AT/MT	L	F	Box Engine Z 12 XEP	260023	Drive Shaft		22	22	51.2	79.5	615				
	2009.07-	-	-	R	F	Box Engine Z 12 XEP	217044	Drive Shaft		22	22	51.2	79.5	919				
1.2 (63 kW)	2010.06-	-	-	L	F	Box Engine A 12 XER	817089	Outer Joint		22	20	51	79.5	51	M			
	2010.06-	-	MT	L	F	Box Engine A 12 XER	260023	Drive Shaft		22	22	51.2	79.5	615				
	2010.06-	-	MT	L	F	Box Engine A 12 XER	644013	Inner Joint		22	21	35	57.5	93				
1.3 CDTI (55 kW)	2006.07-	-	-	L/R	F	Box Engine Z 13 DTJ/A 13 DTC	817053	Outer Joint		25	23	51	84.5	60	M			
	2006.07-	-	-	L	F	Box Engine Z 13 DTJ/A 13 DTC	244040	Drive Shaft		25	22	51	84.5	616				
	2006.07-	-	-	R	F	Box Engine Z 13 DTJ/A 13 DTC	244042	Drive Shaft		25	22	51	84.5	920				
	2006.07-	-	-	-	F	Box Engine Z 13 DTJ/A 13 DTC	817027	Outer Joint		25	23	51	84.5	60	M			
1.3 CDTI (66 kW)	2006.07-	-	-	L/R	F	Box Engine Z 13 DTH	817053	Outer Joint		25	23	51	84.5	60	M			
	2006.07-	-	-	R	F	Box Engine Z 13 DTH	217071	Drive Shaft		25	25	51	84.5	952				
	2006.07-	-	-	L	F	Box Engine Z 13 DTH	217070	Drive Shaft		25	25	51	84.5	576				
	2006.07-	-	-	-	F	Box Engine Z 13 DTH	817027	Outer Joint		25	23	51	84.5	60	M			
1.3 CDTI (70 kW)	2010.06-	-	-	L/R	F	Box Engine A 13 DTE/Z 13 DTE/A 13 DTR	817053	Outer Joint		25	23	51	84.5	60	M			
	2010.06-	-	-	-	F	Box Engine A 13 DTE/Z 13 DTE/A 13 DTR	817027	Outer Joint		25	23	51	84.5	60	M			
CORSA E (X15)																		
1.2 (51 kW)	2014.09-	-	MT	L	F	Hatchback Engine B 12 XER/B 12 XEL	817089	Outer Joint		22	20	51	79.5	51	M			
1.4 (55 kW)	2014.09-	-	MT	R	F	Hatchback Engine B 14 XEJ	244078	Drive Shaft		22	22	51	79.5	918				
	2014.09-	-	MT	R	F	Hatchback Engine B 14 XEJ	817089	Outer Joint		22	20	51	79.5	51	M			
	2014.09-	-	MT	L	F	Hatchback Engine B 14 XEJ	244079	Drive Shaft		22	22	51	79.5	615				
1.4 (66 kW)	2014.09-	-	AT	R	F	Hatchback Engine B 14 XEL	244078	Drive Shaft		22	22	51	79.5	918				
	2014.09-	-	AT	R	F	Hatchback Engine B 14 XEL	817089	Outer Joint		22	20	51	79.5	51	M			
	2014.09-	-	AT	L	F	Hatchback Engine B 14 XEL	244079	Drive Shaft		22	22	51	79.5	615				
1.4 LPG (66 kW)	2015.03-	-	MT	R	F	Hatchback Engine B 14 XEL	244078	Drive Shaft		22	22	51	79.5	918				
	2015.03-	-	MT	R	F	Hatchback Engine B 14 XEL	817089	Outer Joint		22	20	51	79.5	51	M			
	2015.03-	-	MT	L	F	Hatchback Engine B 14 XEL	244079	Drive Shaft		22	22	51	79.5	615				
1.4 Turbo (110 kW)	2015.03-	-	MT	L	F	Hatchback Engine B 14 NEH	217070	Drive Shaft		25	25	51	84.5	576				
1.4 Turbo (74 kW)	2014.09-	-	MT	L	F	Hatchback Engine B 14 NEJ	217070	Drive Shaft		25	25	51	84.5	576				
CORSA E Van (X15)																		
1.2 (51 kW)	2015.01-	-	MT	L	F	Box Engine B 12 XEL	817089	Outer Joint		22	20	51	79.5	51	M			
1.4 (55 kW)	2014.09-	-	MT	R	F	Box Engine B 14 XEJ	244078	Drive Shaft		22	22	51	79.5	918				
	2014.09-	-	MT	R	F	Box Engine B 14 XEJ	817089	Outer Joint		22	20	51	79.5	51	M			
	2014.09-	-	MT	L	F	Box Engine B 14 XEJ	244079	Drive Shaft		22	22	51	79.5	615				
1.4 (66 kW)	2014.09-	-	-	R	F	Box Engine B 14 XEL	244078	Drive Shaft		22	22	51	79.5	918				
	2014.09-	-	-	R	F	Box Engine B 14 XEL	817089	Outer Joint		22	20	51	79.5	51	M			
	2014.09-	-	-	L	F	Box Engine B 14 XEL	244079	Drive Shaft		22	22	51	79.5	615				

YEAR	TRANSM	L/R	F/R	REMARKS	GSP Ref.	PRODUCT	ABS	Technical Specifications										
								A	B	C	H	L	P					
OPEL																		
CORSA-D																		
-	2007-	-	-	-	F	Engine A14XEL,A14XER,Z10XEP,Z12XEP,Z14XEP	644020	Inner Joint		22	27	35	57.5	92				
-	2007-	-	-	-	F	Engine A14XEL,A14XER,Z10XEP,Z12XEP,Z14XEP	644020	Inner Joint		22	27	35	57.5	92				
CORSAD																		
1.4	-	-	-	-	-	Engine Z10XEP,Z12XEP	644020	Inner Joint		22	27	35	57.5	92				
-	-	-	-	-	-	Engine Z10XEP,Z12XEP	644020	Inner Joint		22	27	35	57.5	92				
FRONTERA A (U92)																		
2.2 i (100 kW)	1995.03-	1998.10	-	-	-	All-wheel Drive Closed Off-Road Vehicle Engine X 22 XE	826004	Outer Joint		17	33	53	144	69.5	I			
2.3 TD (74 kW)	1992.03-	1998.10	-	-	-	All-wheel Drive Closed Off-Road Vehicle Engine 23 DTR	826004	Outer Joint		17	33	53	144	69.5	I			
2.5 TDS (85 kW)	1996.09-	1998.10	-	-	-	All-wheel Drive Closed Off-Road Vehicle Engine 25TDS (VM41B)	826004	Outer Joint		17	33	53	144	69.5	I			
2.8 TD (83 kW)	1995.03-	1998.10	-	-	-	All-wheel Drive Closed Off-Road Vehicle Engine 28 TDI (4JB1T)	826004	Outer Joint		17	33	53	144	69.5	I			
FRONTERA A Sport (U92)																		
2.5 TDS (85 kW)	1996.09-	1998.10	-	-	-	All-wheel Drive Open Off-Road Vehicle Engine 2.5 TDS	826004	Outer Joint		17	33	53	144	69.5	I			
2.8 TD (83 kW)	1995.03-	1996.08	-	-	-	All-wheel Drive Open Off-Road Vehicle Engine 2.8 TD	826004	Outer Joint		17	33	53	144	69.5	I			
FRONTERA B (U99)																		
2.2 i (100 kW)	1998.10-	-	-	-	-	All-wheel Drive Closed Off-Road Vehicle Engine X 22 SE/Y 22 SE	826004	Outer Joint		17	33	53	144	69.5	I			
3.2 i (151 kW)	1998.10-	-	-	-	-	All-wheel Drive Closed Off-Road Vehicle Engine 6 VD1/Y 32 NE	826004	Outer Joint		17	33	53	144	69.5	I			
INSIGNIA A (G09)																		
1.4 (103 kW)	2011.04-	-	-	-	F	Hatchback Engine A 14 NET/B 14 NET	899023	Outer Joint		30	26	53.8	94.5	65.5	M			
-	2011.04-	-	-	-	F	Saloon Engine A 14 NET/B 14 NET	899023	Outer Joint		30	26	53.8	94.5	65.5	M			
-	2011.04-	-	6MT	L/R	F	Hatchback Engine A 14 NET/B 14 NET	817051	Outer Joint		30	26	53.8	94.5	65.5	M			
-	2011.04-	-	6MT	L/R	F	Saloon Engine A 14 NET/B 14 NET	817051	Outer Joint		30	26	53.8	94.5	65.5	M			
1.4 LPG (103 kW)	2012.07-	-	-	-	F	Hatchback Engine A 14 NET	899023	Outer Joint		30	26	53.8	94.5	65.5	M			
-	2012.07-	-	-	-	F	Saloon Engine A 14 NET	899023	Outer Joint		30	26	53.8	94.5	65.5	M			
-	2012.07-	-	MT	L/R	F	Hatchback Engine A 14 NET	817051	Outer Joint		30	26	53.8	94.5	65.5	M			
-	2012.07-	-	MT	L/R	F	Saloon Engine A 14 NET	817051	Outer Joint		30	26	53.8	94.5	65.5	M			
1.6 (85 kW)	2008.07-	-	-	-	F	Hatchback Engine A 16 XER	821038	Outer Joint		30	24	52	94	64	M			
-	2008.07-	-	-	-	F	Saloon Engine A 16 XER	821038	Outer Joint		30	24	52	94	64	M			
-	2008.07-	-	MT	L/R	F	Hatchback Engine A 16 XER	621011	Inner Joint		34	25	35	78	64				
-	2008.07-	-	MT	L/R	F	Saloon Engine A 16 XER	621011	Inner Joint		34	25	35	78	64				
1.6 CDTI (100 kW)	2015.07-	2017.03	-	R	F	Estate/Country Tourer Engine B 16 DTH	260027	Drive Shaft		30	27	52.5	94.5	619				
-	2015.07-	-	-	-	F	Hatchback Engine B 16 DTH	899023	Outer Joint		30	26	53.8	94.5	65.5	M			
-	2015.07-	-	-	-	F	Saloon Engine B 16 DTH	899023	Outer Joint		30	26	53.8	94.5	65.5	M			
-	2015.07-	2017.03	-	L/R	F	Estate/Country Tourer Engine B 16 DTH	817051	Outer Joint		30	26	53.8	94.5	65.5	M			
-	2015.07-	-	-	L/R	F	Hatchback Engine B 16 DTH	817051	Outer Joint		30	26	53.8	94.5	65.5	M			
-	2015.07-	-	-	L/R	F	Saloon Engine B 16 DTH	817051	Outer Joint		30	26	53.8	94.5	65.5	M			
-	2015.07-	-	6MT	R	F	Hatchback Engine B 16 DTH	260027	Drive Shaft		30	27	52.5	94.5	619				
-	2015.07-	-	6MT	R	F	Saloon Engine B 16 DTH	260027	Drive Shaft		30	27	52.5	94.5	619				
1.6 CDTI (88 kW)	2015.07-	2017.03	6MT	R	F	Estate/Country Tourer Engine B 16 DTJ	260027	Drive Shaft		30	27	52.5	94.5	619				
-	2015.07-	2017.03	6MT	L/R	F	Estate/Country Tourer Engine B 16 DTJ	817051	Outer Joint		30	26	53.8	94.5	65.5	M			
-	2015.07-	-	-	-	F	Hatchback Engine B 16 DTJ/B 16 DTH	899023	Outer Joint		30	26	53.8	94.5	65.5	M			
-	2015.07-	-	-	-	F	Saloon Engine B 16 DTJ/B 16 DTH	899023	Outer Joint		30	26	53.8	94.5	65.5	M			
-	2015.07-	-	6MT	L/R	F	Hatchback Engine B 16 DTJ/B 16 DTH	817051	Outer Joint		30	26	53.8	94.5	65.5	M			
-	2015.07-	-	6MT	L/R	F	Saloon Engine B 16 DTJ/B 16 DTH	817051	Outer Joint		30	26	53.8	94.5	65.5	M			
-	2015.07-	-	6MT	R	F	Hatchback Engine B 16 DTJ/B 16 DTH	260027	Drive Shaft		30	27	52.5	94.5	619				
-	2015.07-	-	6MT	R	F	Saloon Engine B 16 DTJ/B 16 DTH	260027	Drive Shaft		30	27	52.5	94.5	619				
1.6 SIDI (125 kW)	2013.03-	-	-	-	F	Hatchback Engine A 16 XHT	899023	Outer Joint		30	26	53.8	94.5	65.5	M			
-	2013.03-	-	-	-	F	Saloon Engine A 16 XHT	899023	Outer Joint		30	26	53.8	94.5	65.5	M			
-	2013.03-	-	AT/MT	L/R	F	Hatchback Engine A 16 XHT	817051	Outer Joint		30	26	53.8	94.5	65.5	M			
-	2013.03-	-	AT/MT	L/R	F	Saloon Engine A 16 XHT	817051	Outer Joint		30	26	53.8	94.5	65.5	M			
-	2013.03-	-	6AT	R	F	Hatchback Engine A 16 XHT	221045	Drive Shaft		30	27	52.5	94.5	615				
-	2013.03-	-	6AT	R	F	Saloon Engine A 16 XHT	221045	Drive Shaft		30	27	52.5	94.5	615				
-	2013.03-	-	MT	R	F	Hatchback Engine A 16 XHT	260027	Drive Shaft		30	27	52.5	94.5	619				
-	2013.03-	-	MT	R	F	Saloon Engine A 16 XHT	260027	Drive Shaft		30	27	52.5	94.5	619				
-	2014.07-	2017.03	6MT	R	F	Estate/Country Tourer Engine A 16 XHT, B 16 SHL	260027	Drive Shaft		30	27	52.5	94.5	619				
-	2014.07-	2017.03	-	L/R	F	Estate/Country Tourer Engine A 16 XHT, B 16 SHL	817051	Outer Joint		30	26	53.8	94.5	65.5	M			
-	2014.07-	2017.03	6AT	R	F	Estate/Country Tourer Engine A 16 XHT, B 16 SHL	221045	Drive Shaft		30	27	52.5	94.5	615				
1.6 Turbo (132 kW)	2008.07-	-	MT	L/R	F	Hatchback Engine A 16 LET	817051	Outer Joint		30	26	53.8	94.5	65.5	M			
-	2008.07-	-	-	-	F	Hatchback Engine A 16 LET	899023	Outer Joint		30	26	53.8	94.5	65.5	M			
-	2009.01-	-	MT	L/R	F	Saloon Engine A 16 LET	817051	Outer Joint		30	26	53.8	94.5	65.5	M			
-	2009.01-	-	-	-	F	Saloon Engine A 16 LET	899023	Outer Joint		30	26	53.8	94.5	65.5	M			
1.8 (103 kW)	2008.07-	-	-	-	F	Hatchback Engine A 18 XER	821038	Outer Joint		30	24	52	94	64	M			
-	2008.07-	-	-	-	F	Saloon Engine A 18 XER	821038	Outer Joint		30	24	52	94	64	M			
-	2008.07-	-	MT	L/R	F	Hatchback Engine A 18 XER	621011	Inner Joint		34	25	35	78	64				
-	2008.07-	-	MT	L/R	F	Saloon Engine A 18 XER	621011	Inner Joint		34	25	35	78	64				
-	2008.07-	-	MT	L	F	Hatchback Engine A 18 XER	221050	Drive Shaft		30	25	52	94	622				
-	2008.07-	-	MT	R	F	Hatchback Engine A 18 XER	221054	Drive Shaft		30	25	52	94	1008				





	 YEAR	TRANSM	L/R	F/R	REMARKS	GSP Ref.	 PRODUCT	 ABS	Technical Specifications						
									A	B	C	H	L	P	
OPEL															
INSIGNIA A (G09)															
2.0 Biturbo CDTI (140 kW)	2008.07-	-	-	F	All-wheel Drive Saloon Engine A 20 DTR	899023	Outer Joint		30	26	53.8	94.5	65.5	M	
	2008.07-	AT	L/R	F	Hatchback Engine A 20 DTR	221045	Drive Shaft		30	27	52.5	94.5	615		
	2008.07-	AT	L/R	F	Saloon Engine A 20 DTR	221045	Drive Shaft		30	27	52.5	94.5	615		
	2008.07-	AT	L/R	F	All-wheel Drive Saloon Engine A 20 DTR	221045	Drive Shaft		30	27	52.5	94.5	615		
	2008.07-	-	-	F	Hatchback Engine A 20 DTR	899367	Outer Joint		30	27	58.9	94	64.5	M	
	2008.07-	-	-	F	Saloon Engine A 20 DTR	899367	Outer Joint		30	27	58.9	94	64.5	M	
	2008.07-	AT	L/R	F	Hatchback Engine A 20 DTR	817051	Outer Joint		30	26	53.8	94.5	65.5	M	
	2008.07-	AT	L/R	F	Saloon Engine A 20 DTR	817051	Outer Joint		30	26	53.8	94.5	65.5	M	
	2008.07-	AT/MT	L/R	F	All-wheel Drive Saloon Engine A 20 DTR	817051	Outer Joint		30	26	53.8	94.5	65.5	M	
	2008.07-	MT	-	F	Hatchback Engine A 20 DTR	821057	Outer Joint		30	27	59.1	94	65	M	
	2008.07-	MT	-	F	Saloon Engine A 20 DTR	821057	Outer Joint		30	27	59.1	94	65	M	
	2008.07-	MT	L/R	F	All-wheel Drive Saloon Engine A 20 DTR	260027	Drive Shaft		30	27	52.5	94.5	619		
	2009.05-	AT	L/R	F	All-wheel Drive Hatchback Engine A 20 DTR	221045	Drive Shaft		30	27	52.5	94.5	615		
	2009.05-	AT/MT	L/R	F	All-wheel Drive Hatchback Engine A 20 DTR	817051	Outer Joint		30	26	53.8	94.5	65.5	M	
	2009.05-	MT	L/R	F	All-wheel Drive Hatchback Engine A 20 DTR	260027	Drive Shaft		30	27	52.5	94.5	619		
	2009.05-	-	-	F	All-wheel Drive Hatchback Engine A 20 DTR	899023	Outer Joint		30	26	53.8	94.5	65.5	M	
2.0 Biturbo CDTI (143 kW)	2012.01-	-	-	F	Hatchback Engine A 20 DTR	899367	Outer Joint		30	27	58.9	94	64.5	M	
	2012.01-	-	-	F	Saloon Engine A 20 DTR	899367	Outer Joint		30	27	58.9	94	64.5	M	
	2012.01-	AT	R	F	Hatchback Engine A 20 DTR	221045	Drive Shaft		30	27	52.5	94.5	615		
	2012.01-	6AT	R	F	All-wheel Drive Hatchback Engine A 20 DTR	221045	Drive Shaft		30	27	52.5	94.5	615		
	2012.01-	AT	R	F	Saloon Engine A 20 DTR	221045	Drive Shaft		30	27	52.5	94.5	615		
	2012.01-	6AT	R	F	All-wheel Drive Saloon Engine A 20 DTR	221045	Drive Shaft		30	27	52.5	94.5	615		
	2012.01-	-	-	F	All-wheel Drive Hatchback Engine A 20 DTR	899023	Outer Joint		30	26	53.8	94.5	65.5	M	
	2012.01-	-	-	F	All-wheel Drive Saloon Engine A 20 DTR	899023	Outer Joint		30	26	53.8	94.5	65.5	M	
	2012.01-	MT	-	F	Hatchback Engine A 20 DTR	821057	Outer Joint		30	27	59.1	94	65	M	
	2012.01-	-	-	F	Saloon Engine A 20 DTR	821057	Outer Joint		30	27	59.1	94	65	M	
	2012.01-	AT	L/R	F	Hatchback Engine A 20 DTR	817051	Outer Joint		30	26	53.8	94.5	65.5	M	
	2012.01-	MT	L/R	F	All-wheel Drive Hatchback Engine A 20 DTR	817051	Outer Joint		30	26	53.8	94.5	65.5	M	
	2012.01-	AT	L/R	F	Saloon Engine A 20 DTR	817051	Outer Joint		30	26	53.8	94.5	65.5	M	
	2012.01-	MT	L/R	F	All-wheel Drive Saloon Engine A 20 DTR	817051	Outer Joint		30	26	53.8	94.5	65.5	M	
	2012.01-	MT	L/R	F	All-wheel Drive Hatchback Engine A 20 DTR	260027	Drive Shaft		30	27	52.5	94.5	619		
	2012.01-	MT	L/R	F	All-wheel Drive Saloon Engine A 20 DTR	260027	Drive Shaft		30	27	52.5	94.5	619		
2.0 CDTI (103 kW)	2013.07-	MT	L/R	F	Saloon Engine A 20 DTE	817051	Outer Joint		30	26	53.8	94.5	65.5	M	
	2013.07-	-	-	F	Saloon Engine A 20 DTE	899023	Outer Joint		30	26	53.8	94.5	65.5	M	
	2013.07-	MT	L/R	F	Hatchback Engine A 20 DTE	817051	Outer Joint		30	26	53.8	94.5	65.5	M	
	2013.07-	-	-	F	Hatchback Engine A 20 DTE	899023	Outer Joint		30	26	53.8	94.5	65.5	M	
	2013.07-	MT	L/R	F	Saloon Engine A 20 DTE	260027	Drive Shaft		30	27	52.5	94.5	619		
	2013.07-	MT	L/R	F	Hatchback Engine A 20 DTE	260027	Drive Shaft		30	27	52.5	94.5	619		
2.0 CDTI (118 kW)	2008.07-	AT	L/R	F	Hatchback Engine A 20 DTH	221045	Drive Shaft		30	27	52.5	94.5	615		
	2008.07-	AT	L/R	F	Saloon Engine A 20 DTH	221045	Drive Shaft		30	27	52.5	94.5	615		
	2008.07-	AT/MT	L/R	F	Hatchback Engine A 20 DTH	817051	Outer Joint		30	26	53.8	94.5	65.5	M	
	2008.07-	AT/MT	L/R	F	Saloon Engine A 20 DTH	817051	Outer Joint		30	26	53.8	94.5	65.5	M	
	2008.07-	-	-	F	Hatchback Engine A 20 DTH	899023	Outer Joint		30	26	53.8	94.5	65.5	M	
	2008.07-	-	-	F	Saloon Engine A 20 DTH	899023	Outer Joint		30	26	53.8	94.5	65.5	M	
	2008.07-	MT	L/R	F	Hatchback Engine A 20 DTH	260027	Drive Shaft		30	27	52.5	94.5	619		
	2008.07-	MT	L/R	F	Saloon Engine A 20 DTH	260027	Drive Shaft		30	27	52.5	94.5	619		
	2010.06-	-	-	-	All-wheel Drive Hatchback Engine A 20 DTH	899023	Outer Joint		30	26	53.8	94.5	65.5	M	
	2010.06-	-	-	F	All-wheel Drive Saloon Engine A 20 DTH	899023	Outer Joint		30	26	53.8	94.5	65.5	M	
	2010.06-	AT	L/R	F	All-wheel Drive Hatchback Engine A 20 DTH	221045	Drive Shaft		30	27	52.5	94.5	615		
	2010.06-	AT	L/R	F	All-wheel Drive Saloon Engine A 20 DTH	221045	Drive Shaft		30	27	52.5	94.5	615		
	2010.06-	-	L	F	All-wheel Drive Hatchback Engine A 20 DTH	817051	Outer Joint		30	26	53.8	94.5	65.5	M	
	2010.06-	-	L	F	All-wheel Drive Saloon Engine A 20 DTH	817051	Outer Joint		30	26	53.8	94.5	65.5	M	
	2010.06-	MT	L/R	F	All-wheel Drive Hatchback Engine A 20 DTH	260027	Drive Shaft		30	27	52.5	94.5	619		
	2010.06-	MT	L/R	F	All-wheel Drive Saloon Engine A 20 DTH	260027	Drive Shaft		30	27	52.5	94.5	619		
2.0 CDTI (120 kW)	2013.07-	-	-	F	All-wheel Drive Saloon Engine A 20 DTH	899023	Outer Joint		30	26	53.8	94.5	65.5	M	
	2013.07-	6AT	R	F	Hatchback Engine A 20 DTH	221045	Drive Shaft		30	27	52.5	94.5	615		
	2013.07-	6AT	R	F	Saloon Engine A 20 DTH	221045	Drive Shaft		30	27	52.5	94.5	615		
	2013.07-	6AT	R	F	All-wheel Drive Hatchback Engine A 20 DTH	221045	Drive Shaft		30	27	52.5	94.5	615		
	2013.07-	6AT	R	F	All-wheel Drive Saloon Engine A 20 DTH	221045	Drive Shaft		30	27	52.5	94.5	615		
	2013.07-	AT/MT	L/R	F	Hatchback Engine A 20 DTH	817051	Outer Joint		30	26	53.8	94.5	65.5	M	
	2013.07-	AT/MT	L/R	F	Saloon Engine A 20 DTH	817051	Outer Joint		30	26	53.8	94.5	65.5	M	
	2013.07-	-	-	F	Hatchback Engine A 20 DTH	899023	Outer Joint		30	26	53.8	94.5	65.5	M	
	2013.07-	-	-	F	Saloon Engine A 20 DTH	899023	Outer Joint		30	26	53.8	94.5	65.5	M	
	2013.07-	AT/MT	L/R	F	All-wheel Drive Hatchback Engine A 20 DTH	817051	Outer Joint		30	26	53.8	94.5	65.5	M	
	2013.07-	AT/MT	L/R	F	All-wheel Drive Saloon Engine A 20 DTH	817051	Outer Joint		30	26	53.8	94.5	65.5	M	
	2013.07-	MT	L/R	F	Hatchback Engine A 20 DTH	260027	Drive Shaft		30	27	52.5	94.5	619		





	 YEAR	TRANSM	L/R	F/R	REMARKS	GSP Ref.	 PRODUCT	 ABS	Technical Specifications					
									A	B	C	H	L	P
OPEL														
INSIGNIA A (G09)														
2.0 CDTI (120 kW)	2013.07-	-	MT	L/R	F	Saloon Engine A 20 DTH	260027	Drive Shaft	30	27	52.5	94.5	619	
	2013.07-	-	-	-	F	All-wheel Drive Hatchback Engine A 20 DTH	899023	Outer Joint	30	26	53.8	94.5	65.5	M
	2013.07-	-	MT	L/R	F	All-wheel Drive Hatchback Engine A 20 DTH	260027	Drive Shaft	30	27	52.5	94.5	619	
	2013.07-	-	MT	L/R	F	All-wheel Drive Saloon Engine A 20 DTH	260027	Drive Shaft	30	27	52.5	94.5	619	
2.0 CDTI (125 kW)	2014.11-	-	-	-	F	Hatchback Engine B 20 DTH	899023	Outer Joint	30	26	53.8	94.5	65.5	M
	2014.11-	-	-	-	F	All-wheel Drive Hatchback Engine B 20 DTH	899023	Outer Joint	30	26	53.8	94.5	65.5	M
	2014.11-	-	-	-	F	All-wheel Drive Saloon Engine B 20 DTH	899023	Outer Joint	30	26	53.8	94.5	65.5	M
	2014.11-	-	-	-	F	Saloon Engine B 20 DTH	899023	Outer Joint	30	26	53.8	94.5	65.5	M
	2014.11-	-	6AT	R	F	Hatchback Engine B 20 DTH	221045	Drive Shaft	30	27	52.5	94.5	615	
	2014.11-	-	6AT	R	F	Saloon Engine B 20 DTH	221045	Drive Shaft	30	27	52.5	94.5	615	
	2014.11-	-	6AT	L/R	F	Hatchback Engine B 20 DTH	817051	Outer Joint	30	26	53.8	94.5	65.5	M
	2014.11-	-	6AT	L/R	F	Saloon Engine B 20 DTH	817051	Outer Joint	30	26	53.8	94.5	65.5	M
2.0 CDTi (143 kW)	2013.09-	2017.03	-	L	F	All-wheel Drive Estate/Country Tourer Engine A 20 DTR	817051	Outer Joint	30	26	53.8	94.5	65.5	M
	2013.09-	2017.03	-	R	F	All-wheel Drive Estate/Country Tourer Engine A 20 DTR	221045	Drive Shaft	30	27	52.5	94.5	615	
2.0 CDTI (81 kW)	2008.07-	-	-	L	F	Hatchback Engine A 20 DTC/A 20 DTL	260026	Drive Shaft	30	25	52.5	94.5	631	
	2008.07-	-	-	L	F	Saloon Engine A 20 DTC/A 20 DTL	260026	Drive Shaft	30	25	52.5	94.5	631	
	2008.07-	-	-	R	F	Hatchback Engine A 20 DTC/A 20 DTL	260027	Drive Shaft	30	27	52.5	94.5	619	
	2008.07-	-	-	R	F	Saloon Engine A 20 DTC/A 20 DTL	260027	Drive Shaft	30	27	52.5	94.5	619	
	2008.07-	-	MT	L/R	F	Hatchback Engine A 20 DTC/A 20 DTL	817051	Outer Joint	30	26	53.8	94.5	65.5	M
	2008.07-	-	MT	L/R	F	Saloon Engine A 20 DTC/A 20 DTL	817051	Outer Joint	30	26	53.8	94.5	65.5	M
	2008.07-	-	-	-	F	Hatchback Engine A 20 DTC/A 20 DTL	899023	Outer Joint	30	26	53.8	94.5	65.5	M
	2008.07-	-	-	-	F	Saloon Engine A 20 DTC/A 20 DTL	899023	Outer Joint	30	26	53.8	94.5	65.5	M
2.0 CDTI (88 kW)	2012.03-	2017.03	6MT	L/R	F	Estate/Country Tourer Engine A 20 DTE	260027	Drive Shaft	30	27	52.5	94.5	619	
	2012.03-	-	-	-	F	Saloon Engine A 20 DTE	899023	Outer Joint	30	26	53.8	94.5	65.5	M
	2012.03-	-	-	-	F	Hatchback Engine A 20 DTE	899023	Outer Joint	30	26	53.8	94.5	65.5	M
	2012.03-	2017.03	6MT	L/R	F	Estate/Country Tourer Engine A 20 DTE	817051	Outer Joint	30	26	53.8	94.5	65.5	M
	2012.03-	-	MT	L/R	F	Saloon Engine A 20 DTE	817051	Outer Joint	30	26	53.8	94.5	65.5	M
	2012.03-	-	MT	L/R	F	Hatchback Engine A 20 DTE	817051	Outer Joint	30	26	53.8	94.5	65.5	M
	2012.03-	-	MT	L/R	F	Saloon Engine A 20 DTE	260027	Drive Shaft	30	27	52.5	94.5	619	
	2012.03-	-	MT	L/R	F	Hatchback Engine A 20 DTE	260027	Drive Shaft	30	27	52.5	94.5	619	
2.0 CDTI (96 kW)	2008.07-	-	MT	L	F	Hatchback Engine A 20 DT/J/A 20 DT	260026	Drive Shaft	30	25	52.5	94.5	631	
	2008.07-	-	MT	L	F	Saloon Engine A 20 DT/J/A 20 DT	260026	Drive Shaft	30	25	52.5	94.5	631	
	2008.07-	-	AT	L/R	F	Hatchback Engine A 20 DT/J/A 20 DT	221045	Drive Shaft	30	27	52.5	94.5	615	
	2008.07-	-	AT	L/R	F	Saloon Engine A 20 DT/J/A 20 DT	221045	Drive Shaft	30	27	52.5	94.5	615	
	2008.07-	-	MT	R	F	Hatchback Engine A 20 DT/J/A 20 DT	260027	Drive Shaft	30	27	52.5	94.5	619	
	2008.07-	-	MT	R	F	Saloon Engine A 20 DT/J/A 20 DT	260027	Drive Shaft	30	27	52.5	94.5	619	
	2008.07-	-	AT/MT	L/R	F	Hatchback Engine A 20 DT/J/A 20 DT	817051	Outer Joint	30	26	53.8	94.5	65.5	M
	2008.07-	-	AT/MT	L/R	F	Saloon Engine A 20 DT/J/A 20 DT	817051	Outer Joint	30	26	53.8	94.5	65.5	M
	2008.07-	-	-	-	F	Hatchback Engine A 20 DT/J/A 20 DT	899023	Outer Joint	30	26	53.8	94.5	65.5	M
	2008.07-	-	-	-	F	Saloon Engine A 20 DT/J/A 20 DT	899023	Outer Joint	30	26	53.8	94.5	65.5	M
2.0 E85 Turbo (162 kW)	2010.09-	-	-	-	F	Hatchback Engine A 20 NHT	899023	Outer Joint	30	26	53.8	94.5	65.5	M
	2010.09-	-	AT	R	F	Hatchback Engine A 20 NHT	221045	Drive Shaft	30	27	52.5	94.5	615	
	2010.09-	-	-	L/R	F	Hatchback Engine A 20 NHT	817051	Outer Joint	30	26	53.8	94.5	65.5	M
	2010.09-	-	MT	L/R	F	Hatchback Engine A 20 NHT	260027	Drive Shaft	30	27	52.5	94.5	619	
2.0 Turbo (162 kW)	2008.07-	-	AT	L/R	F	Hatchback Engine A 20 NHT	221045	Drive Shaft	30	27	52.5	94.5	615	
	2008.07-	-	AT	L/R	F	Saloon Engine A 20 NHT	221045	Drive Shaft	30	27	52.5	94.5	615	
	2008.07-	-	AT	L/R	F	All-wheel Drive Saloon Engine A 20 NHT	221045	Drive Shaft	30	27	52.5	94.5	615	
	2008.07-	-	AT	L/R	F	All-wheel Drive Hatchback Engine A 20 NHT	221045	Drive Shaft	30	27	52.5	94.5	615	
	2008.07-	-	MT	L/R	F	Hatchback Engine A 20 NHT	260027	Drive Shaft	30	27	52.5	94.5	619	
	2008.07-	-	MT	L/R	F	Saloon Engine A 20 NHT	260027	Drive Shaft	30	27	52.5	94.5	619	
	2008.07-	-	AT/MT	L/R	F	Hatchback Engine A 20 NHT	817051	Outer Joint	30	26	53.8	94.5	65.5	M
	2008.07-	-	AT/MT	L/R	F	Saloon Engine A 20 NHT	817051	Outer Joint	30	26	53.8	94.5	65.5	M
	2008.07-	-	AT/MT	L/R	F	All-wheel Drive Saloon Engine A 20 NHT	817051	Outer Joint	30	26	53.8	94.5	65.5	M
	2008.07-	-	-	-	F	Hatchback Engine A 20 NHT	899023	Outer Joint	30	26	53.8	94.5	65.5	M
	2008.07-	-	AT/MT	L/R	F	All-wheel Drive Hatchback Engine A 20 NHT	817051	Outer Joint	30	26	53.8	94.5	65.5	M
	2008.07-	-	-	-	F	Saloon Engine A 20 NHT	899023	Outer Joint	30	26	53.8	94.5	65.5	M
	2008.07-	-	MT	L/R	F	All-wheel Drive Saloon Engine A 20 NHT	260027	Drive Shaft	30	27	52.5	94.5	619	
	2008.07-	-	MT	L/R	F	All-wheel Drive Hatchback Engine A 20 NHT	260027	Drive Shaft	30	27	52.5	94.5	619	
	2008.07-	-	-	-	F	All-wheel Drive Saloon Engine A 20 NHT	899023	Outer Joint	30	26	53.8	94.5	65.5	M
	2008.07-	-	-	-	F	All-wheel Drive Hatchback Engine A 20 NHT	899023	Outer Joint	30	26	53.8	94.5	65.5	M
2.0 Turbo (184 kW)	2011.09-	-	AT	L/R	F	All-wheel Drive Hatchback Engine A 20 NFT	221045	Drive Shaft	30	27	52.5	94.5	615	
	2011.09-	-	AT	L/R	F	All-wheel Drive Saloon Engine A 20 NFT	221045	Drive Shaft	30	27	52.5	94.5	615	
	2011.09-	-	-	-	F	All-wheel Drive Hatchback Engine A 20 NFT	899023	Outer Joint	30	26	53.8	94.5	65.5	M
	2011.09-	-	-	-	F	All-wheel Drive Saloon Engine A 20 NFT	899023	Outer Joint	30	26	53.8	94.5	65.5	M
	2011.09-	-	-	L/R	F	All-wheel Drive Hatchback Engine A 20 NFT	817051	Outer Joint	30	26	53.8	94.5	65.5	M
	2011.09-	-	-	L/R	F	All-wheel Drive Saloon Engine A 20 NFT	817051	Outer Joint	30	26	53.8	94.5	65.5	M





YEAR	TRANSM	L/R	F/R	REMARKS	GSP Ref.	PRODUCT	ABS	Technical Specifications						
								A	B	C	H	L	P	
OPEL														
INSIGNIA A (G09)														
2.0 Turbo (184 kW)	2011.09-	-	MT	L/R	F	All-wheel Drive Hatchback Engine A 20 NFT	260027	Drive Shaft	30	27	52.5	94.5	619	
	2011.09-	-	MT	L/R	F	All-wheel Drive Saloon Engine A 20 NFT	260027	Drive Shaft	30	27	52.5	94.5	619	
	2013.09-	2017.03	-	L/R	F	All-wheel Drive Estate/Country Tourer Engine A 20 NHT, B 20 NHT	817051	Outer Joint	30	26	53.8	94.5	65.5	M
	2013.09-	2017.03	6MT	L/R	F	All-wheel Drive Estate/Country Tourer Engine A 20 NHT, B 20 NHT	260027	Drive Shaft	30	27	52.5	94.5	619	
	2014.04-	-	-	-	F	Hatchback Engine A 20 NHT	899023	Outer Joint	30	26	53.8	94.5	65.5	M
	2014.04-	-	-	-	F	Saloon Engine A 20 NHT	899023	Outer Joint	30	26	53.8	94.5	65.5	M
	2014.04-	-	AT	L/R	F	Hatchback Engine A 20 NHT	221045	Drive Shaft	30	27	52.5	94.5	615	
	2014.04-	-	AT	L/R	F	Saloon Engine A 20 NHT	221045	Drive Shaft	30	27	52.5	94.5	615	
	2014.04-	-	AT/MT	L/R	F	Hatchback Engine A 20 NHT	817051	Outer Joint	30	26	53.8	94.5	65.5	M
	2014.04-	-	AT/MT	L/R	F	Saloon Engine A 20 NHT	817051	Outer Joint	30	26	53.8	94.5	65.5	M
	2014.04-	-	MT	L/R	F	Hatchback Engine A 20 NHT	260027	Drive Shaft	30	27	52.5	94.5	619	
2.0 Turbo E85 (162 kW)	2008.07-	-	-	-	F	Saloon Engine A 20 NFT	899023	Outer Joint	30	26	53.8	94.5	65.5	M
	2008.07-	-	-	L/R	F	Saloon Engine A 20 NFT	817051	Outer Joint	30	26	53.8	94.5	65.5	M
	2008.07-	-	AT	R	F	Saloon Engine A 20 NFT	221045	Drive Shaft	30	27	52.5	94.5	615	
	2008.07-	-	MT	L/R	F	Saloon Engine A 20 NFT	260027	Drive Shaft	30	27	52.5	94.5	619	
2.8 V6 Turbo (191 kW)	2008.07-	-	-	-	F	All-wheel Drive Hatchback Engine A 28 NET	899023	Outer Joint	30	26	53.8	94.5	65.5	M
	2008.07-	-	-	-	F	All-wheel Drive Saloon Engine A 28 NET	899023	Outer Joint	30	26	53.8	94.5	65.5	M
	2008.07-	-	-	-	F	All-wheel Drive Hatchback Engine A 28 NET	899367	Outer Joint	30	27	58.9	94	64.5	M
	2008.07-	-	-	-	F	All-wheel Drive Saloon Engine A 28 NET	899367	Outer Joint	30	27	58.9	94	64.5	M
	2008.07-	-	AT	L/R	F	All-wheel Drive Hatchback Engine A 28 NET	221045	Drive Shaft	30	27	52.5	94.5	615	
	2008.07-	-	AT	L/R	F	All-wheel Drive Saloon Engine A 28 NET	221045	Drive Shaft	30	27	52.5	94.5	615	
	2008.07-	-	AT/MT	-	F	All-wheel Drive Hatchback Engine A 28 NET	821057	Outer Joint	30	27	59.1	94	65	M
	2008.07-	-	AT/MT	-	F	All-wheel Drive Saloon Engine A 28 NET	821057	Outer Joint	30	27	59.1	94	65	M
	2008.07-	-	AT	L/R	F	All-wheel Drive Hatchback Engine A 28 NET	817051	Outer Joint	30	26	53.8	94.5	65.5	M
	2008.07-	-	AT	L/R	F	All-wheel Drive Saloon Engine A 28 NET	817051	Outer Joint	30	26	53.8	94.5	65.5	M
2.8 V6 Turbo OPC (239 kW)	2009.07-	-	-	-	F	All-wheel Drive Hatchback Engine A 28 NER	899367	Outer Joint	30	27	58.9	94	64.5	M
	2009.07-	-	-	-	F	All-wheel Drive Saloon Engine A 28 NER	899367	Outer Joint	30	27	58.9	94	64.5	M
	2009.07-	-	MT	-	F	All-wheel Drive Hatchback Engine A 28 NER	821057	Outer Joint	30	27	59.1	94	65	M
	2009.07-	-	MT	-	F	All-wheel Drive Saloon Engine A 28 NER	821057	Outer Joint	30	27	59.1	94	65	M
INSIGNIA A Country Tourer (G09)														
2.0 CDTi (47) (120 kW)	2013.09-	2017.03	6MT	L/R	F	All-wheel Drive Estate Engine A 20 DTH	260027	Drive Shaft	30	27	52.5	94.5	619	
	2013.09-	2017.03	-	L	F	All-wheel Drive Estate Engine A 20 DTH	817051	Outer Joint	30	26	53.8	94.5	65.5	M
	2013.09-	2017.03	6AT	R	F	All-wheel Drive Estate Engine A 20 DTH	221045	Drive Shaft	30	27	52.5	94.5	615	
	2014.07-	2017.03	6MT	L/R	F	Estate Engine A 20 DTH	260027	Drive Shaft	30	27	52.5	94.5	619	
	2014.07-	2017.03	-	L	F	Estate Engine A 20 DTH	817051	Outer Joint	30	26	53.8	94.5	65.5	M
	2014.07-	2017.03	6AT	R	F	Estate Engine A 20 DTH	221045	Drive Shaft	30	27	52.5	94.5	615	
2.0 CDTi (47) (96 kW)	2008.07-	2017.03	-	L	F	Estate Engine A 20 DT	260026	Drive Shaft	30	25	52.5	94.5	631	
	2008.07-	2017.03	-	L/R	F	Estate Engine A 20 DT	817051	Outer Joint	30	26	53.8	94.5	65.5	M
	2008.07-	2017.03	-	L/R	F	Estate Engine A 20 DT	260027	Drive Shaft	30	27	52.5	94.5	619	
INSIGNIA A Sports Tourer (G09)														
1.4 (103 kW)	2011.09-	-	6MT	L/R	F	Estate Engine A 14 NET	817051	Outer Joint	30	26	53.8	94.5	65.5	M
	2011.09-	-	-	-	F	Estate Engine A 14 NET	899023	Outer Joint	30	26	53.8	94.5	65.5	M
1.4 LPG (103 kW)	2012.07-	-	-	-	F	Estate Engine A 14 NET	899023	Outer Joint	30	26	53.8	94.5	65.5	M
	2012.07-	-	MT	L/R	F	Estate Engine A 14 NET	817051	Outer Joint	30	26	53.8	94.5	65.5	M
1.6 (85 kW)	2008.07-	-	-	-	F	Estate Engine A 16 XER	821038	Outer Joint	30	24	52	94	64	M
	2008.07-	-	MT	L/R	F	Estate Engine A 16 XER	621011	Inner Joint	34	25	35	78	64	
1.6 CDTi (100 kW)	2015.07-	-	6MT	R	F	Estate Engine B 16 DTH	260027	Drive Shaft	30	27	52.5	94.5	619	
	2015.07-	-	-	-	F	Estate Engine B 16 DTH	899023	Outer Joint	30	26	53.8	94.5	65.5	M
	2015.07-	-	-	L/R	F	Estate Engine B 16 DTH	817051	Outer Joint	30	26	53.8	94.5	65.5	M
1.6 CDTi (88 kW)	2015.07-	-	6MT	R	F	Estate Engine B 16 DTJ/B 16 DTH	260027	Drive Shaft	30	27	52.5	94.5	619	
	2015.07-	-	6MT	L/R	F	Estate Engine B 16 DTJ/B 16 DTH	817051	Outer Joint	30	26	53.8	94.5	65.5	M
	2015.07-	-	-	-	F	Estate Engine B 16 DTJ/B 16 DTH	899023	Outer Joint	30	26	53.8	94.5	65.5	M
1.6 SIDI (125 kW)	2013.03-	-	-	-	F	Estate Engine A 16 XHT	899023	Outer Joint	30	26	53.8	94.5	65.5	M
	2013.03-	-	-	L/R	F	Estate Engine A 16 XHT	817051	Outer Joint	30	26	53.8	94.5	65.5	M
	2013.03-	-	6AT	R	F	Estate Engine A 16 XHT	221045	Drive Shaft	30	27	52.5	94.5	615	
	2013.03-	-	6MT	L/R	F	Estate Engine A 16 XHT	260027	Drive Shaft	30	27	52.5	94.5	619	
1.6 Turbo (132 kW)	2009.01-	-	MT	L/R	F	Estate Engine A 16 LET	817051	Outer Joint	30	26	53.8	94.5	65.5	M
	2009.01-	-	-	-	F	Estate Engine A 16 LET	899023	Outer Joint	30	26	53.8	94.5	65.5	M
1.8 (103 kW)	2008.07-	-	-	-	F	Estate Engine A 18 XER	821038	Outer Joint	30	24	52	94	64	M
	2008.07-	-	MT	L/R	F	Estate Engine A 18 XER	621011	Inner Joint	34	25	35	78	64	
2.0 Biturbo CDTi (140 kW)	2008.07-	-	-	-	F	All-wheel Drive Estate Engine A 20 DTR	899023	Outer Joint	30	26	53.8	94.5	65.5	M
	2008.07-	-	AT	L/R	F	Estate Engine A 20 DTR	221045	Drive Shaft	30	27	52.5	94.5	615	
	2008.07-	-	AT	L/R	F	All-wheel Drive Estate Engine A 20 DTR	221045	Drive Shaft	30	27	52.5	94.5	615	
	2008.07-	-	-	-	F	Estate Engine A 20 DTR	899367	Outer Joint	30	27	58.9	94	64.5	M
	2008.07-	-	AT	L/R	F	Estate Engine A 20 DTR	817051	Outer Joint	30	26	53.8	94.5	65.5	M

YEAR	TRANSM	L/R	F/R	REMARKS	GSP Ref.	PRODUCT	ABS	Technical Specifications									
								A	B	C	H	L	P				
OPEL																	
INSIGNIA A Sports Tourer (G09)																	
2.0 Biturbo CDTI (140 kW)	2008.07-	-	AT/MT	L/R	F	All-wheel Drive Estate Engine A 20 DTR	817051	Outer Joint		30	26	53.8	94.5	65.5	M		
	2008.07-	-	MT	-	F	Estate Engine A 20 DTR	821057	Outer Joint		30	27	59.1	94	65	M		
	2008.07-	-	MT	L/R	F	All-wheel Drive Estate Engine A 20 DTR	260027	Drive Shaft		30	27	52.5	94.5	619			
2.0 Biturbo CDTI (143 kW)	2012.01-	-	AT	L/R	F	Estate Engine A 20 DTR	817051	Outer Joint		30	26	53.8	94.5	65.5	M		
	2012.01-	-	-	L	F	All-wheel Drive Estate Engine A 20 DTR	817051	Outer Joint		30	26	53.8	94.5	65.5	M		
	2012.01-	-	-	-	F	Estate Engine A 20 DTR	899367	Outer Joint		30	27	58.9	94	64.5	M		
	2012.01-	-	-	-	F	All-wheel Drive Estate Engine A 20 DTR	899023	Outer Joint		30	26	53.8	94.5	65.5	M		
	2012.01-	-	AT	R	F	Estate Engine A 20 DTR	221045	Drive Shaft		30	27	52.5	94.5	615			
	2012.01-	-	MT	-	F	All-wheel Drive Estate Engine A 20 DTR	821057	Outer Joint		30	27	59.1	94	65	M		
	2012.01-	-	MT	-	F	Estate Engine A 20 DTR	821057	Outer Joint		30	27	59.1	94	65	M		
2.0 CDTI (103 kW)	2013.07-	-	6AT	R	F	All-wheel Drive Estate Engine A 20 DTR	221045	Drive Shaft		30	27	52.5	94.5	615			
	2013.07-	-	MT	L/R	F	Estate Engine A 20 DTE	260027	Drive Shaft		30	27	52.5	94.5	619			
	2013.07-	-	MT	L/R	F	Estate Engine A 20 DTE	817051	Outer Joint		30	26	53.8	94.5	65.5	M		
2.0 CDTI (118 kW)	2013.07-	-	-	-	F	Estate Engine A 20 DTE	899023	Outer Joint		30	26	53.8	94.5	65.5	M		
	2008.07-	-	MT	L/R	F	Estate Engine A 20 DTH	260027	Drive Shaft		30	27	52.5	94.5	619			
	2008.07-	-	AT/MT	L/R	F	Estate Engine A 20 DTH	817051	Outer Joint		30	26	53.8	94.5	65.5	M		
	2008.07-	-	AT	L/R	F	Estate Engine A 20 DTH	221045	Drive Shaft		30	27	52.5	94.5	615			
	2008.07-	-	-	-	F	Estate Engine A 20 DTH	899023	Outer Joint		30	26	53.8	94.5	65.5	M		
	2010.06-	-	-	-	F	All-wheel Drive Estate Engine A 20 DTH	899023	Outer Joint		30	26	53.8	94.5	65.5	M		
	2010.06-	-	MT	L/R	F	All-wheel Drive Estate Engine A 20 DTH	260027	Drive Shaft		30	27	52.5	94.5	619			
2.0 CDTI (120 kW)	2010.06-	-	-	L	F	All-wheel Drive Estate Engine A 20 DTH	817051	Outer Joint		30	26	53.8	94.5	65.5	M		
	2010.06-	-	AT	L/R	F	All-wheel Drive Estate Engine A 20 DTH	221045	Drive Shaft		30	27	52.5	94.5	615			
	2013.07-	-	6MT	L/R	F	All-wheel Drive Estate Engine A 20 DTH	260027	Drive Shaft		30	27	52.5	94.5	619			
	2013.07-	-	6MT	L/R	F	Estate Engine A 20 DTH	260027	Drive Shaft		30	27	52.5	94.5	619			
	2013.07-	-	-	L	F	All-wheel Drive Estate Engine A 20 DTH	817051	Outer Joint		30	26	53.8	94.5	65.5	M		
	2013.07-	-	-	L	F	Estate Engine A 20 DTH	817051	Outer Joint		30	26	53.8	94.5	65.5	M		
	2013.07-	-	6AT	R	F	All-wheel Drive Estate Engine A 20 DTH	221045	Drive Shaft		30	27	52.5	94.5	615			
2.0 CDTI (125 kW)	2013.07-	-	6AT	R	F	Estate Engine A 20 DTH	221045	Drive Shaft		30	27	52.5	94.5	615			
	2013.07-	-	-	-	F	All-wheel Drive Estate Engine A 20 DTH	899023	Outer Joint		30	26	53.8	94.5	65.5	M		
	2013.07-	-	-	-	F	Estate Engine A 20 DTH	899023	Outer Joint		30	26	53.8	94.5	65.5	M		
	2014.11-	-	-	-	F	Estate Engine B 20 DTH	899023	Outer Joint		30	26	53.8	94.5	65.5	M		
	2014.11-	-	-	-	F	All-wheel Drive Estate Engine B 20 DTH	899023	Outer Joint		30	26	53.8	94.5	65.5	M		
	2008.07-	-	MT	L/R	F	Estate Engine A 20 DTC/A 20 DTL	817051	Outer Joint		30	26	53.8	94.5	65.5	M		
	2008.07-	-	-	L	F	Estate Engine A 20 DTC/A 20 DTL	260026	Drive Shaft		30	25	52.5	94.5	631			
2.0 CDTI (88 kW)	2008.07-	-	-	R	F	Estate Engine A 20 DTC/A 20 DTL	260027	Drive Shaft		30	27	52.5	94.5	619			
	2008.07-	-	-	-	F	Estate Engine A 20 DTC/A 20 DTL	899023	Outer Joint		30	26	53.8	94.5	65.5	M		
	2012.03-	-	6MT	L/R	F	Estate Engine A 20 DTE	260027	Drive Shaft		30	27	52.5	94.5	619			
2.0 CDTI (96 kW)	2012.03-	-	-	-	F	Estate Engine A 20 DTE	899023	Outer Joint		30	26	53.8	94.5	65.5	M		
	2012.03-	-	6MT	L/R	F	Estate Engine A 20 DTE	817051	Outer Joint		30	26	53.8	94.5	65.5	M		
	2008.07-	-	6MT	L	F	Estate Engine A 20 DTJ/A 20 DT	260026	Drive Shaft		30	25	52.5	94.5	631			
2.0 E85 Turbo (162 kW)	2008.07-	-	-	L/R	F	Estate Engine A 20 DTJ/A 20 DT	817051	Outer Joint		30	26	53.8	94.5	65.5	M		
	2008.07-	-	6AT	L/R	F	Estate Engine A 20 DTJ/A 20 DT	221045	Drive Shaft		30	27	52.5	94.5	615			
	2008.07-	-	6MT	L/R	F	Estate Engine A 20 DTJ/A 20 DT	260027	Drive Shaft		30	27	52.5	94.5	619			
	2008.07-	-	-	-	F	Estate Engine A 20 DTJ/A 20 DT	899023	Outer Joint		30	26	53.8	94.5	65.5	M		
	2010.09-	-	MT	L/R	F	Estate Engine A 20 NFT	260027	Drive Shaft		30	27	52.5	94.5	615			
2.0 Turbo (162 kW)	2010.09-	-	-	-	F	Estate Engine A 20 NFT	899023	Outer Joint		30	26	53.8	94.5	65.5	M		
	2010.09-	-	-	L/R	F	Estate Engine A 20 NFT	817051	Outer Joint		30	26	53.8	94.5	65.5	M		
	2010.09-	-	AT	R	F	Estate Engine A 20 NFT	221045	Drive Shaft		30	27	52.5	94.5	615			
	2008.07-	-	MT	L/R	F	All-wheel Drive Estate Engine A 20 NHT	260027	Drive Shaft		30	27	52.5	94.5	619			
	2008.07-	-	AT/MT	L/R	F	Estate Engine A 20 NHT	817051	Outer Joint		30	26	53.8	94.5	65.5	M		
	2008.07-	-	AT/MT	L/R	F	All-wheel Drive Estate Engine A 20 NHT	817051	Outer Joint		30	26	53.8	94.5	65.5	M		
	2008.07-	-	AT	L/R	F	Estate Engine A 20 NHT	221045	Drive Shaft		30	27	52.5	94.5	615			
2.0 Turbo (184 kW)	2008.07-	-	AT	L/R	F	All-wheel Drive Estate Engine A 20 NHT	221045	Drive Shaft		30	27	52.5	94.5	615			
	2008.07-	-	MT	L/R	F	Estate Engine A 20 NHT	260027	Drive Shaft		30	27	52.5	94.5	619			
	2008.07-	-	-	-	F	Estate Engine A 20 NHT	899023	Outer Joint		30	26	53.8	94.5	65.5	M		
	2008.07-	-	-	-	F	All-wheel Drive Estate Engine A 20 NHT	899023	Outer Joint		30	26	53.8	94.5	65.5	M		
	2011.09-	-	-	L/R	F	All-wheel Drive Estate Engine A 20 NHT	817051	Outer Joint		30	26	53.8	94.5	65.5	M		
	2011.09-	-	-	-	F	All-wheel Drive Estate Engine A 20 NHT	899023	Outer Joint		30	26	53.8	94.5	65.5	M		
	2011.09-	-	6MT	L/R	F	All-wheel Drive Estate Engine A 20 NHT	260027	Drive Shaft		30	27	52.5	94.5	619			
2.8 V6 Turbo (191 kW)	2014.04-	-	MT	L/R	F	Estate Engine A 20 NHT	260027	Drive Shaft		30	27	52.5	94.5	619			
	2014.04-	-	AT/MT	L/R	F	Estate Engine A 20 NHT	817051	Outer Joint		30	26	53.8	94.5	65.5	M		
	2014.04-	-	-	-	F	Estate Engine A 20 NHT	899023	Outer Joint		30	26	53.8	94.5	65.5	M		
	2014.04-	-	AT	L/R	F	Estate Engine A 20 NHT	221045	Drive Shaft		30	27	52.5	94.5	615			
	2008.10-	-	-	-	F	All-wheel Drive Estate Engine A 28 NET	899023	Outer Joint		30	26	53.8	94.5	65.5	M		
2008.10-	-	AT	L/R	F	All-wheel Drive Estate Engine A 28 NET	221045	Drive Shaft		30	27	52.5	94.5	615				
2008.10-	-	-	-	F	All-wheel Drive Estate Engine A 28 NET	899367	Outer Joint		30	27	58.9	94	64.5	M			





YEAR	TRANSM	L/R	F/R	REMARKS	GSP Ref.	PRODUCT	ABS	Technical Specifications									
								A	B	C	H	L	P				
OPEL																	
INSIGNIA A Sports Tourer (G09)																	
2.8 V6 Turbo (191 kW)	2008.10-	-	AT/MT	-	F	All-wheel Drive Estate Engine A 28 NET	821057	Outer Joint		30	27	59.1	94	65	M		
	2008.10-	-	AT	L/R	F	All-wheel Drive Estate Engine A 28 NET	817051	Outer Joint		30	26	53.8	94.5	65.5	M		
2.8 V6 Turbo OPC (239 kW)	2009.07-	-	-	-	F	All-wheel Drive Estate Engine A 28 NER	899367	Outer Joint		30	27	58.9	94	64.5	M		
	2009.07-	-	MT	-	F	All-wheel Drive Estate Engine A 28 NER	821057	Outer Joint		30	27	59.1	94	65	M		
KADETT																	
-	1981-	-	-	-	-	DIESEL	844047	Outer Joint		33	29	52	109	61	O		
1.0 (29-37-40-45 kW)	1981.07-	1994	-	-	-	-	844062	Outer Joint		22	22	52	94.5	50	O		
1.2 (29-37-40-45 kW)	1981.07-	1994	-	-	-	-	844062	Outer Joint		22	22	52	94.5	50	O		
1.2 (40-45-54-56 kW)	1984.09-	1991	-	-	F	-	844062	Outer Joint		22	22	52	94.5	50	O		
1.3 (40-45-54-56 kW)	1984.09-	1991	-	-	F	-	844062	Outer Joint		22	22	52	94.5	50	O		
1.3 (55 kW)	1981-	-	-	-	F	-	844062	Outer Joint		22	22	52	94.5	50	O		
1.4 (40-45-54-56 kW)	1984.09-	1991	-	-	F	-	844062	Outer Joint		22	22	52	94.5	50	O		
1.6 (55 kW)	1984.09-	1991	-	-	F	-	844062	Outer Joint		22	22	52	94.5	50	O		
KADETT E (T85)																	
1.3 i Cat (44 kW)	1985.09-	1991.08	MT	L/R	F	Hatchback Engine C 13 N	844051	Outer Joint	29T	22	22	52	95	50.5	O		
	1985.09-	1991.08	MT	L/R	F	Saloon Engine C 13 N	844051	Outer Joint	29T	22	22	52	95	50.5	O		
	1985.09-	1991.08	MT	L/R	F	Estate Engine C 13 N	844051	Outer Joint	29T	22	22	52	95	50.5	O		
	1985.09-	1991.08	AT/MT	L/R	F	Hatchback Engine C 13 N	844041	Outer Joint		22	22	52	95	50	O		
	1985.09-	1991.08	AT/MT	L/R	F	Saloon Engine C 13 N	844041	Outer Joint		22	22	52	95	50	O		
	1985.09-	1991.08	AT/MT	L/R	F	Estate Engine C 13 N	844041	Outer Joint		22	22	52	95	50	O		
	1985.09-	1991.08	MT	L	F	Saloon Engine C 13 N	844024	Outer Joint		22	22	52.2	97	50	O		
	1985.09-	1991.08	AT/MT	L	F	Estate Engine C 13 N	844024	Outer Joint		22	22	52.2	97	50	O		
	1985.09-	1991.08	AT/MT	L	F	Hatchback Engine C 13 N	844024	Outer Joint		22	22	52.2	97	50	O		
	1985.09-	1991.08	MT	L/R	F	Hatchback Engine C 13 N	644004	Inner Joint		22	22	34.95	57.5	72.5			
	1985.09-	1991.08	MT	L/R	F	Saloon Engine C 13 N	644004	Inner Joint		22	22	34.95	57.5	72.5			
	1985.09-	1991.08	MT	L/R	F	Estate Engine C 13 N	644004	Inner Joint		22	22	34.95	57.5	72.5			
1.3 N (44 kW)	1984.09-	1991.08	MT	L/R	F	Hatchback Engine 13 N/13 NB	844051	Outer Joint	29T	22	22	52	95	50.5	O		
	1984.09-	1991.08	MT	L/R	F	Estate Engine 13 N	844051	Outer Joint	29T	22	22	52	95	50.5	O		
	1984.09-	1989.08	MT	L/R	F	Saloon Engine 13 NB	844051	Outer Joint	29T	22	22	52	95	50.5	O		
	1984.09-	1989.07	MT	L/R	F	Box Engine 13 NB	844051	Outer Joint	29T	22	22	52	95	50.5	O		
	1984.09-	1989.08	MT	L/R	F	Saloon Engine 13 NB	644004	Inner Joint		22	22	34.95	57.5	72.5			
	1984.09-	1989.07	MT	L/R	F	Box Engine 13 NB	644004	Inner Joint		22	22	34.95	57.5	72.5			
	1984.09-	1989.08	AT/MT	L/R	F	Saloon Engine 13 NB	844041	Outer Joint		22	22	52	95	50	O		
	1984.09-	1989.07	AT/MT	L/R	F	Box Engine 13 NB	844041	Outer Joint		22	22	52	95	50	O		
	1984.09-	1991.08	AT/MT	L/R	F	Hatchback Engine 13 N/13 NB	844041	Outer Joint		22	22	52	95	50	O		
	1984.09-	1991.08	AT/MT	L/R	F	Estate Engine 13 N	844041	Outer Joint		22	22	52	95	50	O		
	1984.09-	1991.08	MT	L/R	F	Hatchback Engine 13 N/13 NB	644004	Inner Joint		22	22	34.95	57.5	72.5			
	1984.09-	1991.08	MT	L/R	F	Estate Engine 13 N	644004	Inner Joint		22	22	34.95	57.5	72.5			
	1984.09-	1991.08	AT/MT	-	F	Estate Engine 13 N	844024	Outer Joint		22	22	52.2	97	50	O		
	1984.09-	1989.08	AT/MT	-	-	Saloon Engine 13 NB	844024	Outer Joint		22	22	52.2	97	50	O		
	1984.09-	1989.07	AT/MT	-	-	Box Engine 13 NB	844024	Outer Joint		22	22	52.2	97	50	O		
	1984.09-	1991.08	MT	-	F	Hatchback Engine 13 N/13 NB	844024	Outer Joint		22	22	52.2	97	50	O		
1.3 S (55 kW)	1987.03-	1993.02	MT	L/R	F	Convertible Engine 13 S	844051	Outer Joint	29T	22	22	52	95	50.5	O		
	1987.03-	1993.02	AT/MT	L/R	F	Convertible Engine 13 S	844041	Outer Joint		22	22	52	95	50	O		
	1987.03-	1993.02	AT/MT	L	F	Convertible Engine 13 S	844024	Outer Joint		22	22	52.2	97	50	O		
	1987.03-	1993.02	MT	L/R	F	Convertible Engine 13 S	644004	Inner Joint		22	22	34.95	57.5	72.5			
1.4 i (44 kW)	1990.01-	1991.08	MT	L/R	F	Box Engine C 14 NZ	844051	Outer Joint	29T	22	22	52	95	50.5	O		
	1990.01-	1991.08	MT	L/R	F	Box Engine C 14 NZ	644004	Inner Joint		22	22	34.95	57.5	72.5			
	1990.01-	1991.08	MT	L/R	F	Convertible Engine C 14 NZ	644004	Inner Joint		22	22	34.95	57.5	72.5			
	1990.01-	1991.08	MT	L/R	F	Hatchback Engine C 14 NZ	844051	Outer Joint	29T	22	22	52	95	50.5	O		
	1990.01-	1991.08	MT	L/R	F	Saloon Engine C 14 NZ	844051	Outer Joint	29T	22	22	52	95	50.5	O		
	1990.01-	1991.08	MT	L/R	F	Estate Engine C 14 NZ	844051	Outer Joint	29T	22	22	52	95	50.5	O		
	1990.01-	1991.08	MT	L/R	F	Convertible Engine C 14 NZ	844051	Outer Joint	29T	22	22	52	95	50.5	O		
	1990.01-	1991.08	MT	L/R	F	Hatchback Engine C 14 NZ	844041	Outer Joint		22	22	52	95	50	O		
	1990.01-	1991.08	MT	L/R	F	Saloon Engine C 14 NZ	844041	Outer Joint		22	22	52	95	50	O		
	1990.01-	1991.08	MT	L/R	F	Estate Engine C 14 NZ	844041	Outer Joint		22	22	52	95	50	O		
	1990.01-	1991.08	MT	L/R	F	Box Engine C 14 NZ	844041	Outer Joint		22	22	52	95	50	O		
	1990.01-	1991.08	MT	L/R	F	Convertible Engine C 14 NZ	844041	Outer Joint		22	22	52	95	50	O		
	1990.01-	1991.08	MT	L/R	F	Hatchback Engine C 14 NZ	644004	Inner Joint		22	22	34.95	57.5	72.5			
	1990.01-	1991.08	MT	L/R	F	Saloon Engine C 14 NZ	644004	Inner Joint		22	22	34.95	57.5	72.5			
	1990.01-	1991.08	MT	L/R	F	Estate Engine C 14 NZ	644004	Inner Joint		22	22	34.95	57.5	72.5			
	1990.01-	1991.08	MT	-	F	Saloon Engine C 14 NZ	844024	Outer Joint		22	22	52.2	97	50	O		
	1990.01-	1991.08	MT	-	-	Box Engine C 14 NZ	844024	Outer Joint		22	22	52.2	97	50	O		
	1990.01-	1991.08	MT	-	-	Convertible Engine C 14 NZ	844024	Outer Joint		22	22	52.2	97	50	O		
	1990.01-	1991.08	MT	-	F	Estate Engine C 14 NZ	844024	Outer Joint		22	22	52.2	97	50	O		
	1990.01-	1991.08	MT	-	F	Hatchback Engine C 14 NZ	844024	Outer Joint		22	22	52.2	97	50	O		

	 YEAR	TRANSM	L/R	F/R	REMARKS	GSP Ref.	 PRODUCT	 ABS	Technical Specifications						
									A	B	C	H	L	P	
OPEL															
KADETT E (T85)															
1.4 S (55 kW)	1990.01-1991.08	MT	L/R	F	Hatchback Engine 14 NV	844051	Outer Joint	29T	22	22	52	95	50.5	O	
	1990.01-1991.08	MT	L/R	F	Saloon Engine 14 NV	844051	Outer Joint	29T	22	22	52	95	50.5	O	
	1990.01-1991.08	MT	L/R	F	Estate Engine 14 NV	844051	Outer Joint	29T	22	22	52	95	50.5	O	
	1990.01-1991.08	MT	L/R	F	Hatchback Engine 14 NV	844041	Outer Joint		22	22	52	95	50	O	
	1990.01-1991.08	MT	L/R	F	Saloon Engine 14 NV	844041	Outer Joint		22	22	52	95	50	O	
	1990.01-1991.08	MT	L/R	F	Estate Engine 14 NV	844041	Outer Joint		22	22	52	95	50	O	
	1990.01-1991.08	MT	L/R	F	Hatchback Engine 14 NV	644004	Inner Joint		22	22	34.95	57.5	72.5		
	1990.01-1991.08	MT	L/R	F	Saloon Engine 14 NV	644004	Inner Joint		22	22	34.95	57.5	72.5		
	1990.01-1991.08	MT	L/R	F	Estate Engine 14 NV	644004	Inner Joint		22	22	34.95	57.5	72.5		
	1990.01-1991.08	MT	-	F	Saloon Engine 14 NV	844024	Outer Joint		22	22	52.2	97	50	O	
	1990.01-1991.08	MT	-	F	Estate Engine 14 NV	844024	Outer Joint		22	22	52.2	97	50	O	
1990.01-1991.08	MT	-	F	Hatchback Engine 14 NV	844024	Outer Joint		22	22	52.2	97	50	O		
1.5 TD (53 kW)	1988.07-1991.08	MT	L/R	F	Estate Engine 15 DT (T4EC1)	899205	Outer Joint		33	25	52	109	61	O	
1.6 (60 kW)	1986.09-1991.08	-	-	F	Estate Engine 16 SV	699025	Inner Joint		34	22	35	80	58		
	1986.09-1991.08	MT	L/R	F	Estate Engine 16 SV	899205	Outer Joint		33	25	52	109	61	O	
1.6 D (40 kW)	1984.09-1989.01	-	-	F	Estate Engine 16 DA/16 D	699025	Inner Joint		34	22	35	80	58		
	1984.09-1989.01	-	-	F	Hatchback Engine 16 D/16 DA	699025	Inner Joint		34	22	35	80	58		
	1984.09-1989.01	-	-	F	Saloon Engine 16 D/16 DA	699025	Inner Joint		34	22	35	80	58		
	1984.09-1989.01	MT	L/R	F	Hatchback Engine 16 D/16 DA	899205	Outer Joint		33	25	52	109	61	O	
	1984.09-1989.01	MT	L/R	F	Saloon Engine 16 D/16 DA	899205	Outer Joint		33	25	52	109	61	O	
	1984.09-1989.01	MT	L/R	F	Estate Engine 16 DA/16 D	899205	Outer Joint		33	25	52	109	61	O	
	1984.09-1989.01	MT	L/R	F	Hatchback Engine 16 D/16 DA	844056	Outer Joint	29T	33	25	52	109	61	O	
	1984.09-1989.01	MT	L/R	F	Saloon Engine 16 D/16 DA	844056	Outer Joint	29T	33	25	52	109	61	O	
	1984.09-1989.01	MT	L/R	F	Estate Engine 16 DA/16 D	844056	Outer Joint	29T	33	25	52	109	61	O	
	1984.09-1989.01	MT	L/R	F	Hatchback Engine 16 D/16 DA	644004	Inner Joint		22	22	34.95	57.5	72.5		
	1984.09-1989.01	MT	L/R	F	Saloon Engine 16 D/16 DA	644004	Inner Joint		22	22	34.95	57.5	72.5		
	1984.09-1989.01	MT	L/R	F	Estate Engine 16 DA/16 D	644004	Inner Joint		22	22	34.95	57.5	72.5		
	1984.09-1989.01	MT	L/R	F	Hatchback Engine 16 D/16 DA	844057	Outer Joint	43T	33	25	52	109	61	O	
	1984.09-1989.01	MT	L/R	F	Saloon Engine 16 D/16 DA	844057	Outer Joint	43T	33	25	52	109	61	O	
	1984.09-1989.01	MT	L/R	F	Estate Engine 16 DA/16 D	844057	Outer Joint	43T	33	25	52	109	61	O	
	1.6 i (55 kW)	1986.09-1991.08	MT	L/R	F	Hatchback Engine E 16 NZ	844051	Outer Joint	29T	22	22	52	95	50.5	O
		1986.09-1991.08	MT	L/R	F	Saloon Engine E 16 NZ	844051	Outer Joint	29T	22	22	52	95	50.5	O
1986.09-1991.08		MT	L/R	F	Estate Engine E 16 NZ	844051	Outer Joint	29T	22	22	52	95	50.5	O	
1986.09-1991.08		AT/MT	L/R	F	Hatchback Engine E 16 NZ	844041	Outer Joint		22	22	52	95	50	O	
1986.09-1991.08		AT/MT	L/R	F	Saloon Engine E 16 NZ	844041	Outer Joint		22	22	52	95	50	O	
1986.09-1991.08		AT/MT	L/R	F	Estate Engine E 16 NZ	844041	Outer Joint		22	22	52	95	50	O	
1986.09-1991.08		MT	L/R	F	Hatchback Engine E 16 NZ	644004	Inner Joint		22	22	34.95	57.5	72.5		
1986.09-1991.08		MT	L/R	F	Saloon Engine E 16 NZ	644004	Inner Joint		22	22	34.95	57.5	72.5		
1986.09-1991.08		MT	-	-	Saloon Engine E 16 NZ	844024	Outer Joint		22	22	52.2	97	50	O	
1986.09-1991.08		AT/MT	-	F	Estate Engine E 16 NZ	844024	Outer Joint		22	22	52.2	97	50	O	
1986.09-1991.08		AT/MT	-	F	Hatchback Engine E 16 NZ	844024	Outer Joint		22	22	52.2	97	50	O	
1986.09-1991.08		AT	L/R	F	Hatchback Engine E 16 NZ	844057	Outer Joint	43T	33	25	52	109	61	O	
1986.09-1991.08		AT	L/R	F	Saloon Engine E 16 NZ	844057	Outer Joint	43T	33	25	52	109	61	O	
1986.09-1991.08		AT	L/R	F	Estate Engine E 16 NZ	844057	Outer Joint	43T	33	25	52	109	61	O	
1986.10-1993.02		MT	L/R	F	Convertible Engine E 16 NZ	844051	Outer Joint	29T	22	22	52	95	50.5	O	
1986.10-1993.02		AT/MT	L/R	F	Convertible Engine E 16 NZ	844041	Outer Joint		22	22	52	95	50	O	
1986.10-1993.02		MT	L/R	F	Convertible Engine E 16 NZ	644004	Inner Joint		22	22	34.95	57.5	72.5		
1986.10-1993.02		MT	-	F	Convertible Engine E 16 NZ	844024	Outer Joint		22	22	52.2	97	50	O	
1986.10-1993.02		AT	L/R	F	Convertible Engine E 16 NZ	844057	Outer Joint	43T	33	25	52	109	61	O	
1989.08-1993.09		MT	L/R	F	Box Engine C 16 NZ	844051	Outer Joint	29T	22	22	52	95	50.5	O	
1989.08-1993.09		MT	L/R	F	Box Engine C 16 NZ	644004	Inner Joint		22	22	34.95	57.5	72.5		
1989.08-1993.09	AT/MT	L/R	F	Box Engine C 16 NZ	844041	Outer Joint		22	22	52	95	50	O		
1989.08-1993.09	MT	-	-	Box Engine C 16 NZ	844024	Outer Joint		22	22	52.2	97	50	O		
1989.08-1993.09	AT	L/R	F	Box Engine C 16 NZ	844057	Outer Joint	43T	33	25	52	109	61	O		
1.6 i (60 kW)	1989.07-1993.02	MT	L/R	F	Convertible Engine 16 SV	899205	Outer Joint		33	25	52	109	61	O	
1.6 i Cat (55 kW)	1986.09-1991.08	MT	L/R	F	Hatchback Engine C 16 LZ/C 16 NZ	844051	Outer Joint	29T	22	22	52	95	50.5	O	
	1986.09-1991.08	MT	L/R	F	Saloon Engine C 16 LZ/C 16 NZ	844051	Outer Joint	29T	22	22	52	95	50.5	O	
	1986.09-1991.08	MT	L/R	F	Estate Engine C 16 LZ/C 16 NZ	844051	Outer Joint	29T	22	22	52	95	50.5	O	
	1986.09-1991.08	AT/MT	L/R	F	Hatchback Engine C 16 LZ/C 16 NZ	844041	Outer Joint		22	22	52	95	50	O	
	1986.09-1991.08	AT/MT	L/R	F	Saloon Engine C 16 LZ/C 16 NZ	844041	Outer Joint		22	22	52	95	50	O	
	1986.09-1991.08	AT/MT	L/R	F	Estate Engine C 16 LZ/C 16 NZ	844041	Outer Joint		22	22	52	95	50	O	
	1986.09-1991.08	MT	L	F	Saloon Engine C 16 LZ/C 16 NZ	844024	Outer Joint		22	22	52.2	97	50	O	
	1986.09-1991.08	AT/MT	L	F	Estate Engine C 16 LZ/C 16 NZ	844024	Outer Joint		22	22	52.2	97	50	O	
	1986.09-1991.08	AT/MT	L	F	Hatchback Engine C 16 LZ/C 16 NZ	844024	Outer Joint		22	22	52.2	97	50	O	
1986.09-1991.08	AT	L/R	F	Hatchback Engine C 16 LZ/C 16 NZ	844057	Outer Joint	43T	33	25	52	109	61	O		

	 YEAR	TRANSM	L/R	F/R	REMARKS	GSP Ref.	 PRODUCT	 ABS	Technical Specifications						
									A	B	C	H	L	P	
OPEL															
KADETT E (T85)															
1.6 i Cat (55 kW)	1986.09-1991.08	AT	L/R	F	Saloon Engine C 16 LZ/C 16 NZ	844057	Outer Joint	43T	33	25	52	109	61	O	
	1986.09-1991.08	AT	L/R	F	Estate Engine C 16 LZ/C 16 NZ	844057	Outer Joint	43T	33	25	52	109	61	O	
	1986.09-1991.08	MT	L/R	F	Hatchback Engine C 16 LZ/C 16 NZ	644004	Inner Joint		22	22	34.95	57.5	72.5		
	1986.09-1991.08	MT	L/R	F	Saloon Engine C 16 LZ/C 16 NZ	644004	Inner Joint		22	22	34.95	57.5	72.5		
	1986.09-1991.08	MT	L/R	F	Estate Engine C 16 LZ/C 16 NZ	644004	Inner Joint		22	22	34.95	57.5	72.5		
	1987.10-1993.02	MT	L/R	F	Convertible Engine C 16 LZ/C 16 NZ	844051	Outer Joint	29T	22	22	52	95	50.5	O	
	1987.10-1993.02	AT/MT	L/R	F	Convertible Engine C 16 LZ/C 16 NZ	844041	Outer Joint		22	22	52	95	50	O	
	1987.10-1993.02	AT/MT	L	F	Convertible Engine C 16 LZ/C 16 NZ	844024	Outer Joint		22	22	52.2	97	50	O	
	1987.10-1993.02	AT	L/R	F	Convertible Engine C 16 LZ/C 16 NZ	844057	Outer Joint	43T	33	25	52	109	61	O	
1.6 S (60 kW)	1987.10-1993.02	MT	L/R	F	Convertible Engine C 16 LZ/C 16 NZ	644004	Inner Joint		22	22	34.95	57.5	72.5		
	1986.09-1991.08	-	-	F	Hatchback Engine 16 SV	699025	Inner Joint		34	22	35	80	58		
	1986.09-1991.08	-	-	F	Saloon Engine 16 SV	699025	Inner Joint		34	22	35	80	58		
	1986.09-1991.08	MT	L/R	F	Hatchback Engine 16 SV	899205	Outer Joint		33	25	52	109	61	O	
1.7 D (42 kW)	1986.09-1991.08	MT	L/R	F	Saloon Engine 16 SV	899205	Outer Joint		33	25	52	109	61	O	
	1988.08-1992.09	MT	L/R	F	Box Engine 17 D	644002	Inner Joint		34	25	35	56.2	85.6		
	1988.08-1992.09	MT	L/R	F	Box Engine 17 D	899205	Outer Joint		33	25	52	109	61	O	
	1988.08-1992.09	MT	L/R	F	Box Engine 17 D	844057	Outer Joint	43T	33	25	52	109	61	O	
	1988.08-1992.09	MT	L/R	F	Box Engine 17 D	844056	Outer Joint	29T	33	25	52	109	61	O	
	1989.02-1991.08	MT	L/R	F	Hatchback Engine 17 D	844056	Outer Joint	29T	33	25	52	109	61	O	
	1989.02-1991.08	MT	L/R	F	Saloon Engine 17 D	844056	Outer Joint	29T	33	25	52	109	61	O	
	1989.02-1991.08	MT	L/R	F	Estate Engine 17 D	844056	Outer Joint	29T	33	25	52	109	61	O	
	1989.02-1991.08	MT	L/R	F	Hatchback Engine 17 D	644002	Inner Joint		34	25	35	56.2	85.6		
	1989.02-1991.08	MT	L/R	F	Saloon Engine 17 D	644002	Inner Joint		34	25	35	56.2	85.6		
	1989.02-1991.08	MT	L/R	F	Estate Engine 17 D	644002	Inner Joint		34	25	35	56.2	85.6		
	1989.02-1991.08	MT	L/R	F	Hatchback Engine 17 D	844057	Outer Joint	43T	33	25	52	109	61	O	
	1989.02-1991.08	MT	L/R	F	Saloon Engine 17 D	844057	Outer Joint	43T	33	25	52	109	61	O	
	1989.02-1991.08	MT	L/R	F	Estate Engine 17 D	844057	Outer Joint	43T	33	25	52	109	61	O	
	1989.02-1991.08	MT	L/R	F	Hatchback Engine 17 D	899205	Outer Joint		33	25	52	109	61	O	
	1989.02-1991.08	MT	L/R	F	Saloon Engine 17 D	899205	Outer Joint		33	25	52	109	61	O	
	1989.02-1991.08	MT	L/R	F	Estate Engine 17 D	899205	Outer Joint		33	25	52	109	61	O	
	1.8 (84 kW)	1987.09-1990.08	MT	L/R	F	Saloon Engine 18 E	644002	Inner Joint		34	25	35	56.2	85.6	
		1987.09-1990.08	MT	L/R	F	Saloon Engine 18 E	899205	Outer Joint		33	25	52	109	61	O
		1987.09-1990.08	MT	L/R	F	Saloon Engine 18 E	844057	Outer Joint	43T	33	25	52	109	61	O
1987.09-1990.08		MT	L/R	F	Saloon Engine 18 E	844056	Outer Joint	29T	33	25	52	109	61	O	
1.8 i (66 kW)	1984.08-1992.09	MT	L/R	F	Box Engine C 18 NT	644002	Inner Joint		34	25	35	56.2	85.6		
	1984.08-1992.09	MT	L/R	F	Box Engine C 18 NT	899205	Outer Joint		33	25	52	109	61	O	
	1984.08-1992.09	MT	L/R	F	Box Engine C 18 NT	844057	Outer Joint	43T	33	25	52	109	61	O	
	1984.08-1992.09	MT	L/R	F	Box Engine C 18 NT	844056	Outer Joint	29T	33	25	52	109	61	O	
	1985.06-1991.08	MT	L/R	F	Hatchback Engine C 18 NZ/C 18 NT/S 18 NV	899205	Outer Joint		33	25	52	109	61	O	
	1985.06-1991.08	MT	L/R	F	Estate Engine C 18 NT/C 18 NZ	899205	Outer Joint		33	25	52	109	61	O	
	1985.06-1991.08	MT	L/R	F	Hatchback Engine C 18 NZ/C 18 NT/S 18 NV	844056	Outer Joint	29T	33	25	52	109	61	O	
	1985.06-1991.08	MT	L/R	F	Hatchback Engine C 18 NZ/C 18 NT/S 18 NV	844057	Outer Joint	43T	33	25	52	109	61	O	
	1985.06-1991.08	MT	L/R	F	Estate Engine C 18 NT/C 18 NZ	844056	Outer Joint	29T	33	25	52	109	61	O	
	1985.06-1991.08	MT	L/R	F	Estate Engine C 18 NT/C 18 NZ	844057	Outer Joint	43T	33	25	52	109	61	O	
	1985.06-1991.08	MT	L/R	F	Hatchback Engine C 18 NZ/C 18 NT/S 18 NV	644002	Inner Joint		34	25	35	56.2	85.6		
	1985.06-1991.08	MT	L/R	F	Estate Engine C 18 NT/C 18 NZ	644002	Inner Joint		34	25	35	56.2	85.6		
	1990.09-1991.08	MT	L/R	F	Saloon Engine C 18 NZ/C 18 NT/18 SV	899205	Outer Joint		33	25	52	109	61	O	
	1990.09-1991.08	MT	L/R	F	Saloon Engine C 18 NZ/C 18 NT/18 SV	844056	Outer Joint	29T	33	25	52	109	61	O	
	1990.09-1991.08	MT	L/R	F	Saloon Engine C 18 NZ/C 18 NT/18 SV	844057	Outer Joint	43T	33	25	52	109	61	O	
	1990.09-1991.08	MT	L/R	F	Saloon Engine C 18 NZ/C 18 NT/18 SV	644002	Inner Joint		34	25	35	56.2	85.6		
1.8 S (62 kW)	1987.09-1991.08	MT	L/R	F	Hatchback Engine S 18 NV/E 18 NV	899205	Outer Joint		33	25	52	109	61	O	
	1987.09-1991.08	MT	L/R	F	Saloon Engine E 18 NV	899205	Outer Joint		33	25	52	109	61	O	
	1987.09-1991.08	MT	L/R	F	Estate Engine E 18 NV	899205	Outer Joint		33	25	52	109	61	O	
	1987.09-1991.08	MT	L/R	F	Hatchback Engine S 18 NV/E 18 NV	844056	Outer Joint	29T	33	25	52	109	61	O	
	1987.09-1991.08	MT	L/R	F	Hatchback Engine S 18 NV/E 18 NV	844057	Outer Joint	43T	33	25	52	109	61	O	
	1987.09-1991.08	MT	L/R	F	Saloon Engine E 18 NV	844056	Outer Joint	29T	33	25	52	109	61	O	
	1987.09-1991.08	MT	L/R	F	Saloon Engine E 18 NV	844057	Outer Joint	43T	33	25	52	109	61	O	
	1987.09-1991.08	MT	L/R	F	Estate Engine E 18 NV	844056	Outer Joint	29T	33	25	52	109	61	O	
	1987.09-1991.08	MT	L/R	F	Estate Engine E 18 NV	844057	Outer Joint	43T	33	25	52	109	61	O	
	1987.09-1991.08	MT	L/R	F	Hatchback Engine S 18 NV/E 18 NV	644002	Inner Joint		34	25	35	56.2	85.6		
	1987.09-1991.08	MT	L/R	F	Saloon Engine E 18 NV	644002	Inner Joint		34	25	35	56.2	85.6		
	1987.09-1991.08	MT	L/R	F	Estate Engine E 18 NV	644002	Inner Joint		34	25	35	56.2	85.6		
	2.0 GSI (85 kW)	1986.09-1991.08	MT	L/R	F	Hatchback Engine 20 NE	899205	Outer Joint		33	25	52	109	61	O
1986.09-1991.08		MT	L/R	F	Hatchback Engine 20 NE	844056	Outer Joint	29T	33	25	52	109	61	O	
1986.09-1991.08		MT	L/R	F	Hatchback Engine 20 NE	844057	Outer Joint	43T	33	25	52	109	61	O	
1986.09-1991.08		MT	L/R	F	Hatchback Engine 20 NE	644002	Inner Joint		34	25	35	56.2	85.6		

	 YEAR	TRANSM	L/R	F/R	REMARKS	GSP Ref.	 PRODUCT	 ABS	Technical Specifications						
									A	B	C	H	L	P	
OPEL															
KADETT E (T85)															
2.0 GSI (95 kW)	1986.09-1991.08	MT	L/R	F	Hatchback Engine 20 SEH	899205	Outer Joint		33	25	52	109	61	O	
	1986.09-1991.08	MT	L/R	F	Hatchback Engine 20 SEH	844056	Outer Joint	29T	33	25	52	109	61	O	
	1986.09-1991.08	MT	L/R	F	Hatchback Engine 20 SEH	844057	Outer Joint	43T	33	25	52	109	61	O	
	1986.09-1991.08	MT	L/R	F	Hatchback Engine 20 SEH	644002	Inner Joint		34	25	35	56.2	85.6		
2.0 GSI 16V (110 kW)	1988.03-1991.08	MT	L/R	F	Hatchback Engine 20 XEJ	844056	Outer Joint	29T	33	25	52	109	61	O	
	1988.03-1991.08	MT	L/R	F	Hatchback Engine 20 XEJ	644002	Inner Joint		34	25	35	56.2	85.6		
	1988.03-1991.08	MT	L/R	F	Hatchback Engine 20 XEJ	844057	Outer Joint	43T	33	25	52	109	61	O	
	1988.03-1991.08	MT	L/R	F	Hatchback Engine 20 XEJ	899205	Outer Joint		33	25	52	109	61	O	
2.0 GSI 16V Cat (110 kW)	1988.03-1991.08	MT	L/R	F	Hatchback Engine C 20 XE	844056	Outer Joint	29T	33	25	52	109	61	O	
	1988.03-1991.08	MT	L/R	F	Hatchback Engine C 20 XE	644002	Inner Joint		34	25	35	56.2	85.6		
	1988.03-1991.08	MT	L/R	F	Hatchback Engine C 20 XE	844057	Outer Joint	43T	33	25	52	109	61	O	
	1988.03-1991.08	MT	L/R	F	Hatchback Engine C 20 XE	899205	Outer Joint		33	25	52	109	61	O	
2.0 GSI Cat (85 kW)	1986.09-1991.08	MT	L/R	F	Hatchback Engine C 20 NE	644002	Inner Joint		34	25	35	56.2	85.6		
	1986.09-1991.08	MT	L/R	F	Hatchback Engine C 20 NE	899205	Outer Joint		33	25	52	109	61	O	
	1986.09-1991.08	MT	L/R	F	Hatchback Engine C 20 NE	844057	Outer Joint	43T	33	25	52	109	61	O	
	1986.09-1991.08	MT	L/R	F	Hatchback Engine C 20 NE	844056	Outer Joint	29T	33	25	52	109	61	O	
2.0 i (85 kW)	1986.10-1993.02	MT	L/R	F	Convertible Engine 20 NE	899205	Outer Joint		33	25	52	109	61	O	
	1986.10-1993.02	MT	L/R	F	Convertible Engine 20 NE	844056	Outer Joint	29T	33	25	52	109	61	O	
	1986.10-1993.02	MT	L/R	F	Convertible Engine 20 NE	844057	Outer Joint	43T	33	25	52	109	61	O	
	1986.10-1993.02	MT	L/R	F	Convertible Engine 20 NE	644002	Inner Joint		34	25	35	56.2	85.6		
	1987.03-1991.08	MT	L/R	F	Saloon Engine 20 SE/20 NE	899205	Outer Joint		33	25	52	109	61	O	
	1987.03-1991.08	MT	L/R	F	Saloon Engine 20 SE/20 NE	844056	Outer Joint	29T	33	25	52	109	61	O	
	1987.03-1991.08	MT	L/R	F	Saloon Engine 20 SE/20 NE	844057	Outer Joint	43T	33	25	52	109	61	O	
	1987.03-1991.08	MT	L/R	F	Saloon Engine 20 SE/20 NE	644002	Inner Joint		34	25	35	56.2	85.6		
	1987.09-1991.08	MT	L/R	F	Estate Engine 20 NE	899205	Outer Joint		33	25	52	109	61	O	
	1987.09-1991.08	MT	L/R	F	Estate Engine 20 NE	844056	Outer Joint	29T	33	25	52	109	61	O	
	1987.09-1991.08	MT	L/R	F	Estate Engine 20 NE	844057	Outer Joint	43T	33	25	52	109	61	O	
	1987.09-1991.08	MT	L/R	F	Estate Engine 20 NE	644002	Inner Joint		34	25	35	56.2	85.6		
2.0 i Cat (85 kW)	1986.10-1993.02	MT	L/R	F	Convertible Engine C 20 NE	644002	Inner Joint		34	25	35	56.2	85.6		
	1986.10-1993.02	MT	L/R	F	Convertible Engine C 20 NE	899205	Outer Joint		33	25	52	109	61	O	
	1986.10-1993.02	MT	L/R	F	Convertible Engine C 20 NE	844057	Outer Joint	43T	33	25	52	109	61	O	
	1986.10-1993.02	MT	L/R	F	Convertible Engine C 20 NE	844056	Outer Joint	29T	33	25	52	109	61	O	
	1987.03-1991.08	MT	L/R	F	Saloon Engine C 20 NE	844056	Outer Joint	29T	33	25	52	109	61	O	
	1987.03-1991.08	MT	L/R	F	Saloon Engine C 20 NE	644002	Inner Joint		34	25	35	56.2	85.6		
	1987.03-1991.08	MT	L/R	F	Saloon Engine C 20 NE	844057	Outer Joint	43T	33	25	52	109	61	O	
	1987.03-1991.08	MT	L/R	F	Saloon Engine C 20 NE	899205	Outer Joint		33	25	52	109	61	O	
	1987.03-1991.08	MT	L/R	F	Saloon Engine C 20 NE	644002	Inner Joint		34	25	35	56.2	85.6		
	1987.09-1991.08	MT	L/R	F	Estate Engine C 20 NE	899205	Outer Joint		33	25	52	109	61	O	
	1987.09-1991.08	MT	L/R	F	Estate Engine C 20 NE	844057	Outer Joint	43T	33	25	52	109	61	O	
	1987.09-1991.08	MT	L/R	F	Estate Engine C 20 NE	844056	Outer Joint	29T	33	25	52	109	61	O	
KADETT E Combo (T85)															
1.3 N (44 kW)	1986.01-1989.12	MT	L/R	F	Box Engine 13 N	844051	Outer Joint	29T	22	22	52	95	50.5	O	
	1986.01-1989.12	MT	L/R	F	Box Engine 13 N	644004	Inner Joint		22	22	34.95	57.5	72.5		
	1986.01-1989.12	AT/MT	L/R	F	Box Engine 13 N	844041	Outer Joint		22	22	52	95	50	O	
	1986.01-1989.12	AT/MT	L	F	Box Engine 13 N	844024	Outer Joint		22	22	52.2	97	50	O	
1.3 S (55 kW)	1986.01-1989.12	MT	L/R	F	Box Engine 13 S	844051	Outer Joint	29T	22	22	52	95	50.5	O	
	1986.01-1989.12	MT	L/R	F	Box Engine 13 S	644004	Inner Joint		22	22	34.95	57.5	72.5		
	1986.01-1989.12	AT/MT	L/R	F	Box Engine 13 S	844041	Outer Joint		22	22	52	95	50	O	
	1986.01-1989.12	AT/MT	L	F	Box Engine 13 S	844024	Outer Joint		22	22	52.2	97	50	O	
1.4 i (44 kW)	1991.08-1994.07	MT	L/R	F	Box Engine C 14 NZ	844051	Outer Joint	29T	22	22	52	95	50.5	O	
	1991.08-1994.07	MT	L/R	F	Box Engine C 14 NZ	644004	Inner Joint		22	22	34.95	57.5	72.5		
	1991.08-1994.07	MT	L/R	F	Box Engine C 14 NZ	844041	Outer Joint		22	22	52	95	50	O	
	1991.08-1994.07	MT	-	-	Box Engine C 14 NZ	844024	Outer Joint		22	22	52.2	97	50	O	
1.4 S (55 kW)	1989.07-1991.08	MT	L/R	F	Box Engine 14 NV	844041	Outer Joint		22	22	52	95	50	O	
	1989.07-1991.08	MT	-	-	Box Engine 14 NV	844024	Outer Joint		22	22	52.2	97	50	O	
	1989.07-1991.08	MT	L/R	F	Box Engine 14 NV	844051	Outer Joint	29T	22	22	52	95	50.5	O	
1.6 (60 kW)	1986.09-1991.12	-	-	F	Box Engine 16 SV	699025	Inner Joint		34	22	35	80	58		
	1986.09-1991.12	MT	L/R	F	Box Engine 16 SV	899205	Outer Joint		33	25	52	109	61	O	
1.6 D (40 kW)	1986.01-1989.12	-	-	F	Box Engine 16 DA	699025	Inner Joint		34	22	35	80	58		
	1986.01-1989.12	MT	L/R	F	Box Engine 16 DA	899205	Outer Joint		33	25	52	109	61	O	
	1986.01-1989.12	MT	L/R	F	Box Engine 16 DA	844056	Outer Joint	29T	33	25	52	109	61	O	
	1986.01-1989.12	MT	L/R	F	Box Engine 16 DA	644004	Inner Joint		22	22	34.95	57.5	72.5		
	1986.01-1989.12	MT	L/R	F	Box Engine 16 DA	844057	Outer Joint	43T	33	25	52	109	61	O	
1.6 i (55 kW)	1991.08-1994.07	AT/MT	L/R	F	Box Engine C 16 NZ	844041	Outer Joint		22	22	52	95	50	O	
	1991.08-1994.07	AT/MT	-	-	Box Engine C 16 NZ	844024	Outer Joint		22	22	52.2	97	50	O	
	1991.08-1994.07	AT	L/R	F	Box Engine C 16 NZ	844057	Outer Joint	43T	33	25	52	109	61	O	





YEAR	TRANSM	L/R	F/R	REMARKS	GSP Ref.	PRODUCT	ABS	Technical Specifications									
								A	B	C	H	L	P				
OPEL																	
KADETT E Combo (T85)																	
1.6 i (55 kW)	1991.08-1994.07	MT	L/R	F	Box Engine C 16 NZ	844051	Outer Joint	29T	22	22	52	95	50.5	O			
	1991.08-1994.07	MT	L/R	F	Box Engine C 16 NZ	644004	Inner Joint		22	22	34.95	57.5	72.5				
1.7 D (42 kW)	1989.01-1994.07	MT	L/R	F	Box Engine 17 D	644002	Inner Joint		34	25	35	56.2	85.6				
	1989.01-1994.07	MT	L/R	F	Box Engine 17 D	899205	Outer Joint		33	25	52	109	61	O			
	1989.01-1994.07	MT	L/R	F	Box Engine 17 D	844057	Outer Joint	43T	33	25	52	109	61	O			
	1989.01-1994.07	MT	L/R	F	Box Engine 17 D	844056	Outer Joint	29T	33	25	52	109	61	O			
1.7 D (44 kW)	1992.07-1994.07	MT	L/R	F	Box Engine 17 DR	844056	Outer Joint	29T	33	25	52	109	61	O			
	1992.07-1994.07	MT	L/R	F	Box Engine 17 DR	899205	Outer Joint		33	25	52	109	61	O			
MERIVA A (X03)																	
1.3 CDTI (51 kW)	2005.04-2010.05	MT	L	F	MPV Engine Z 13 DT/Y 13 DT	299069	Drive Shaft	29T	22	22	52	97.5	584				
	2005.04-2010.05	-	-	-	MPV Engine Z 13 DT/Y 13 DT	644009	Inner Joint		22	23	35	57.5	96				
	2005.04-2010.05	-	L/R	F	MPV Engine Z 13 DT/Y 13 DT	844002	Outer Joint	29T	22	23	52	97.5	61	M			
1.3 CDTI (55 kW)	2003.09-2010.05	MT	L	F	MPV Engine Z 13 DTJ	299069	Drive Shaft	29T	22	22	52	97.5	584				
	2003.09-2010.05	-	L/R	F	MPV Engine Z 13 DTJ	844002	Outer Joint	29T	22	23	52	97.5	61	M			
1.4 16V Twinport (66 kW)	2004.07-2010.05	MT	L	F	MPV Engine Z 14 XEP	299069	Drive Shaft	29T	22	22	52	97.5	584				
	2004.07-2010.05	-	L/R	F	MPV Engine Z 14 XEP	844020	Outer Joint	29T	22	28	52	97.5	57.5	O			
1.4 16V Twinport LPG (66 kW)	2004.07-2010.05	MT	L	F	MPV Engine Z 14 XEP	299069	Drive Shaft	29T	22	22	52	97.5	584				
	2004.07-2010.05	-	L/R	F	MPV Engine Z 14 XEP	844020	Outer Joint	29T	22	28	52	97.5	57.5	O			
1.6 (64 kW)	2003.05-2010.05	MT	L	F	MPV Engine Z 16 SE	299069	Drive Shaft	29T	22	22	52	97.5	584				
	2003.05-2010.05	-	L	F	MPV Engine Z 16 SE	244100	Drive Shaft	29T	22	22	52	97.5	590				
	2003.05-2010.05	-	R	F	MPV Engine Z 16 SE	299157	Drive Shaft	29T	22	22	52	97.5	930				
	2003.05-2010.05	-	L/R	F	MPV Engine Z 16 SE	844020	Outer Joint	29T	22	28	52	97.5	57.5	O			
	2003.05-2010.05	-	L/R	F	MPV Engine Z 16 SE	844005	Outer Joint	29T	22	22	52	97.5	58.5	M			
	2003.05-2010.05	-	-	F	MPV Engine Z 16 SE	822007	Outer Joint	29T	22	22	52	98	51	M			
	2003.05-2010.05	-	-	F	MPV Engine Z 16 SE	822007	Outer Joint	29T	22	22	52	98	51	M			
1.6 (77 kW)	2006.01-2010.05	AT/MT	L	F	MPV Engine Z 16 XEP	299069	Drive Shaft	29T	22	22	52	97.5	584				
	2006.01-2010.05	-	L/R	F	MPV Engine Z 16 XEP	844020	Outer Joint	29T	22	28	52	97.5	57.5	O			
	2006.01-2010.05	-	-	F	MPV Engine Z 16 XEP	822007	Outer Joint	29T	22	22	52	98	51	M			
1.6 16V (74 kW)	2003.05-2006.01	AT/MT	L	F	MPV Engine Z 16 XE	299069	Drive Shaft	29T	22	22	52	97.5	584				
	2003.05-2006.01	-	L	F	MPV Engine Z 16 XE	244100	Drive Shaft	29T	22	22	52	97.5	590				
	2003.05-2006.01	-	R	F	MPV Engine Z 16 XE	299157	Drive Shaft	29T	22	22	52	97.5	930				
	2003.05-2006.01	-	L/R	F	MPV Engine Z 16 XE	844020	Outer Joint	29T	22	28	52	97.5	57.5	O			
	2003.05-2006.01	-	L/R	F	MPV Engine Z 16 XE	844005	Outer Joint	29T	22	22	52	97.5	58.5	M			
	2003.05-2006.01	-	-	F	MPV Engine Z 16 XE	822007	Outer Joint	29T	22	22	52	98	51	M			
	2003.05-2006.01	-	-	F	MPV Engine Z 16 XE	822007	Outer Joint	29T	22	22	52	98	51	M			
1.6 Turbo (132 kW)	2005.09-2010.05	-	R	F	MPV Engine Z 16 LET	244093	Drive Shaft	29T	33	34	52	104	619				
	2005.09-2010.05	-	R	F	MPV Engine Z 16 LET	660003	Inner Joint		34	24	35.5	47	70.5				
	2005.09-2010.05	-	L/R	F	MPV Engine Z 16 LET	844004	Outer Joint	29T	33	24	52	104	64	M			
	2005.09-2010.05	MT	R	F	MPV Engine Z 16 LET	260021	Drive Shaft	29T	33	34	52	104	612				
	2005.09-2010.05	-	R	F	MPV Engine Z 16 LET	244093	Drive Shaft	29T	33	34	52	104	619				
1.7 CDTI (74 kW)	2003.09-2010.05	-	R	F	MPV Engine Z 17 DT/Z 17 DTH	244093	Drive Shaft	29T	33	34	52	104	619				
	2003.09-2010.05	-	L	F	MPV Engine Z 17 DT/Z 17 DTH	244094	Drive Shaft	29T	33	34	52	104	599				
	2003.09-2010.05	-	R	F	MPV Engine Z 17 DT/Z 17 DTH	660003	Inner Joint		34	24	35.5	47	70.5				
	2003.09-2010.05	-	L	F	MPV Engine Z 17 DT/Z 17 DTH	621034	Inner Joint		34	24	35	56.5	102				
	2003.09-2010.05	-	L/R	F	MPV Engine Z 17 DT/Z 17 DTH	844004	Outer Joint	29T	33	24	52	104	64	M			
	2003.09-2010.05	MT	R	F	MPV Engine Z 17 DT/Z 17 DTH	260021	Drive Shaft	29T	33	34	52	104	612				
	2003.09-2010.05	MT	R	F	MPV Engine Z 17 DT/Z 17 DTH	250175	Drive Shaft		23	37.1	56.2	83.5	540				
	2003.09-2010.05	MT	R	F	MPV Engine Z 17 DT/Z 17 DTH	250175	Drive Shaft		23	37.1	56.2	83.5	540				
1.7 CDTI (92 kW)	2006.09-2010.05	-	R	F	MPV Engine A 17 DTR/Z 17 DTR	244093	Drive Shaft	29T	33	34	52	104	619				
	2006.09-2010.05	-	R	F	MPV Engine A 17 DTR/Z 17 DTR	660003	Inner Joint		34	24	35.5	47	70.5				
	2006.09-2010.05	-	L/R	F	MPV Engine A 17 DTR/Z 17 DTR	844004	Outer Joint	29T	33	24	52	104	64	M			
1.7 DTI (55 kW)	2003.09-2010.05	MT	L	F	MPV Engine Y 17 DT	299069	Drive Shaft	29T	22	22	52	97.5	584				
	2003.09-2010.05	-	-	-	MPV Engine Y 17 DT	644009	Inner Joint		22	23	35	57.5	96				
	2003.09-2010.05	-	L/R	F	MPV Engine Y 17 DT	844002	Outer Joint	29T	22	23	52	97.5	61	M			
1.8 (92 kW)	2003.05-2010.05	AT/MT	L	F	MPV Engine Z 18 XE	299069	Drive Shaft	29T	22	22	52	97.5	584				
	2003.05-2010.05	-	-	-	MPV Engine Z 18 XE	644009	Inner Joint		22	23	35	57.5	96				
	2003.05-2010.05	-	L/R	F	MPV Engine Z 18 XE	844002	Outer Joint	29T	22	23	52	97.5	61	M			
MERIVA B (S10)																	
1.3 CDTI (55 kW)	2010.06-	MT	R	F	MPV Engine A 13 DTC	844093	Outer Joint		33	23	52	103.5	60	M			
	2010.06-	-	-	F	MPV Engine A 13 DTC	808047	Outer Joint		33	23	52.5	94	59.5	M			
	2010.06-	MT	R	F	MPV Engine A 13 DTC	244088	Drive Shaft		33	22	52	103.5	953				
1.3 CDTI (70 kW)	2010.06-	-	R	F	MPV Engine A 13 DTE	844093	Outer Joint		33	23	52	103.5	60	M			
	2010.06-	-	-	F	MPV Engine A 13 DTE	808047	Outer Joint		33	23	52.5	94	59.5	M			
	2010.06-	-	R	F	MPV Engine A 13 DTE	244088	Drive Shaft		33	22	52	103.5	953				
1.4 LPG (88 kW)	2011.06-	-	-	F	MPV Engine A 14 NEL/B 14 NEL	808047	Outer Joint		33	23	52.5	94	59.5	M			
1.4 T (88 kW)	2010.06-	-	-	F	MPV Engine A 14 NEL/B 14 NEL	808047	Outer Joint		33	23	52.5	94	59.5	M			
1.6 CDTI (100 kW)	2013.08-	-	-	F	MPV Engine B 16 DTH	899024	Outer Joint		33	26	52.5	94	65.5	M			
1.6 CDTI (70 kW)	2014.01-	-	-	F	MPV Engine B 16 DTC	899024	Outer Joint		33	26	52.5	94	65.5	M			
1.6 CDTI (81 kW)	2014.03-	-	-	F	MPV Engine B 16 DTL/B 16 DTE/B 16 DTN	899024	Outer Joint		33	26	52.5	94	65.5	M			

	 YEAR	TRANSM	L/R	F/R	REMARKS	GSP Ref.	 PRODUCT	 ABS	Technical Specifications							
									A	B	C	H	L	P		
OPEL																
MERIVA B (S10)																
1.7 CDTI (74 kW)	2010.06-	-	-	-	F	MPV Engine A 17 DT	808047	Outer Joint		33	23	52.5	94	59.5	M	
1.7 CDTI (81 kW)	2010.06-	-	-	-	F	MPV Engine A 17 DTC/A 17 DTI	899024	Outer Joint		33	26	52.5	94	65.5	M	
1.7 CDTI (96 kW)	2010.06-	-	-	-	F	MPV Engine A 17 DTS	899024	Outer Joint		33	26	52.5	94	65.5	M	
MONTEREY A (M92)																
3.1 TD (84 kW)	1991.09-	1998.07	AT/MT	L/R	F	All-wheel Drive Closed Off-Road Vehicle Engine 4 JG2TC	826003	Outer Joint		17	26	53	144	70.5	M	
3.2 (130 kW)	1992.06-	1998.07	AT/MT	L/R	F	All-wheel Drive Closed Off-Road Vehicle Engine 6 VD1	826003	Outer Joint		17	26	53	144	70.5	M	
MOVANO (X70)																
1.9 DTI (59 kW)	2000.09-	2001.10	MT	R	F	Box Engine F9Q 770	250060	Drive Shaft	51T	28	39	65	96	1126		
	2000.09-	2001.10	MT	L	F	Box Engine F9Q 770	250246	Drive Shaft		28	37.1	65	96	644		
	2000.09-	2001.10	MT	R	F	Box Engine F9Q 770	244022	Drive Shaft		28	39	67.1	93.5	1147		
	2000.09-	2001.10	MT	L	F	Box Engine F9Q 770	244005	Drive Shaft	51T	28	37.1	65	96	670		
	2000.09-	2001.10	MT	R	F	Box Engine F9Q 770	244022	Drive Shaft		28	39	67.1	93.5	1147		
	2000.09-	2001.10	MT	L	F	Box Engine F9Q 770	250010	Drive Shaft		28	37.1	67.1	93.5	669		
1.9 DTI (60 kW)	2001.10-	-	MT	R	F	Box Engine F9Q 774/F9Q 772	250060	Drive Shaft	51T	28	39	65	96	1126		
	2001.10-	-	MT	L	F	Box Engine F9Q 774/F9Q 772	250246	Drive Shaft		28	37.1	65	96	644		
	2001.10-	-	MT	L	F	Box Engine F9Q 774/F9Q 772	250058	Drive Shaft	51T	28	37.1	65	96	644		
	2001.10-	-	MT	R	F	Box Engine F9Q 774/F9Q 772	244022	Drive Shaft		28	39	67.1	93.5	1147		
	2001.10-	-	MT	L	F	Box Engine F9Q 774/F9Q 772	244005	Drive Shaft	51T	28	37.1	65	96	670		
	2001.10-	-	MT	L	F	Box Engine F9Q 774/F9Q 772	250010	Drive Shaft		28	37.1	67.1	93.5	669		
	2001.10-	-	MT	R	F	Box Engine F9Q 774/F9Q 772	244022	Drive Shaft		28	39	67.1	93.5	1147		
2.2 DTI (66 kW)	2000.09-	-	MT	R	F	Box Engine G9T 750/G9T 720/G9T 722	250214	Drive Shaft		28	39	65	96	1132		
	2000.09-	-	MT	R	F	Platform/Chassis Engine G9T 720/G9T 722/G9T 750	250214	Drive Shaft		28	39	65	96	1132		
	2000.09-	-	MT	R	F	Box Engine G9T 750/G9T 720/G9T 722	244016	Drive Shaft	51T	28	39	65	96	1132		
	2000.09-	-	MT	R	F	Platform/Chassis Engine G9T 720/G9T 722/G9T 750	244016	Drive Shaft	51T	28	39	65	96	1132		
	2000.09-	-	MT	R	F	Dumptruck Engine G9T 750/G9T 720/G9T 722	650006	Inner Joint		39	27	35	437	98		
	2000.09-	-	MT	L	F	Box Engine G9T 750/G9T 720/G9T 722	244005	Drive Shaft	51T	28	37.1	65	96	670		
	2000.09-	-	MT	L	F	Platform/Chassis Engine G9T 720/G9T 722/G9T 750	244005	Drive Shaft	51T	28	37.1	65	96	670		
	2000.09-	-	MT	L	F	Dumptruck Engine G9T 750/G9T 720/G9T 722	244005	Drive Shaft	51T	28	37.1	65	96	670		
	2000.09-	-	MT	R	F	Platform/Chassis Engine G9T 720/G9T 722/G9T 750	244004	Drive Shaft	51T	28	39	67.1	93.5	1118		
	2000.09-	-	MT	R	F	Dumptruck Engine G9T 750/G9T 720/G9T 722	244004	Drive Shaft	51T	28	39	67.1	93.5	1118		
	2000.09-	-	MT	L	F	Box Engine G9T 750/G9T 720/G9T 722	250010	Drive Shaft		28	37.1	67.1	93.5	669		
	2000.09-	-	MT	L	F	Platform/Chassis Engine G9T 720/G9T 722/G9T 750	250010	Drive Shaft		28	37.1	67.1	93.5	669		
	2000.09-	-	MT	L	F	Dumptruck Engine G9T 750/G9T 720/G9T 722	250010	Drive Shaft		28	37.1	67.1	93.5	669		
	2000.09-	-	MT	R	F	Platform/Chassis Engine G9T 720/G9T 722/G9T 750	250011	Drive Shaft		28	39	67.1	93.5	1118		
	2000.09-	-	MT	R	F	Dumptruck Engine G9T 750/G9T 720/G9T 722	250011	Drive Shaft		28	39	67.1	93.5	1118		
	2.5 CDTI (107 kW)	2003.10-	-	MT	R	F	Box Engine G9U 650/G9U 632	650006	Inner Joint		39	27	35	437	98	
2003.10-		-	-	R	F	Box Engine G9U 650/G9U 632	250066	Drive Shaft		28	39	65	96	1142		
2003.10-		-	-	L	F	Box Engine G9U 650/G9U 632	299286	Drive Shaft	51T	28	39	65	96	700		
2006.08-		-	-	R	F	Platform/Chassis Engine G9U 632/G9U 650	250066	Drive Shaft		28	39	65	96	1142		
2006.08-		-	MT	R	F	Dumptruck Engine G9U 650/G9U 632	650006	Inner Joint		39	27	35	437	98		
2006.08-		-	-	R	F	Dumptruck Engine G9U 650/G9U 632	250066	Drive Shaft		28	39	65	96	1142		
2006.08-		-	-	L	F	Platform/Chassis Engine G9U 632/G9U 650	299286	Drive Shaft	51T	28	39	65	96	700		
2006.08-		-	-	L	F	Dumptruck Engine G9U 650/G9U 632	299286	Drive Shaft	51T	28	39	65	96	700		
2.5 CDTI (74 kW)		2003.10-	-	MT	R	F	Box Engine G9U 650	650006	Inner Joint		39	27	35	437	98	
		2003.10-	-	-	R	F	Box Engine G9U 650	250066	Drive Shaft		28	39	65	96	1142	
	2003.10-	-	-	L	F	Box Engine G9U 650	299286	Drive Shaft	51T	28	39	65	96	700		
	2006.08-	-	MT	R	F	Dumptruck Engine G9U 650	650006	Inner Joint		39	27	35	437	98		
	2006.08-	-	-	R	F	Platform/Chassis Engine G9U 650	250066	Drive Shaft		28	39	65	96	1142		
	2006.08-	-	-	R	F	Dumptruck Engine G9U 650	250066	Drive Shaft		28	39	65	96	1142		
	2006.08-	-	-	L	F	Platform/Chassis Engine G9U 650	299286	Drive Shaft	51T	28	39	65	96	700		
	2006.08-	-	-	L	F	Dumptruck Engine G9U 650	299286	Drive Shaft	51T	28	39	65	96	700		
	2.5 CDTI (88 kW)	2003.10-	-	MT	R	F	Box Engine G9U 650/G9U 632	650006	Inner Joint		39	27	35	437	98	
		2003.10-	-	-	R	F	Box Engine G9U 650/G9U 632	250066	Drive Shaft		28	39	65	96	1142	
2003.10-		-	-	L	F	Box Engine G9U 650/G9U 632	299286	Drive Shaft	51T	28	39	65	96	700		
2006.08-		-	MT	R	F	Dumptruck Engine G9U 650/G9U 632	650006	Inner Joint		39	27	35	437	98		
2006.08-		-	-	R	F	Platform/Chassis Engine G9U 632/G9U 650	250066	Drive Shaft		28	39	65	96	1142		
2006.08-		-	-	R	F	Dumptruck Engine G9U 650/G9U 632	250066	Drive Shaft		28	39	65	96	1142		
2006.08-		-	-	L	F	Platform/Chassis Engine G9U 632/G9U 650	299286	Drive Shaft	51T	28	39	65	96	700		
2006.08-		-	-	L	F	Dumptruck Engine G9U 650/G9U 632	299286	Drive Shaft	51T	28	39	65	96	700		
2.5 D (59 kW)		1998.07-	2000.09	MT	R	F	Platform/Chassis Engine S8U 770/S8U 772	650006	Inner Joint		39	27	35	437	98	
		1998.07-	2000.09	MT	L	F	Platform/Chassis Engine S8U 770/S8U 772	244005	Drive Shaft	51T	28	37.1	65	96	670	
	1998.07-	2000.09	MT	R	F	Platform/Chassis Engine S8U 770/S8U 772	244004	Drive Shaft	51T	28	39	67.1	93.5	1118		
	1998.07-	2000.09	MT	L	F	Platform/Chassis Engine S8U 770/S8U 772	250010	Drive Shaft		28	37.1	67.1	93.5	669		
	1998.07-	2000.09	MT	R	F	Platform/Chassis Engine S8U 770/S8U 772	250011	Drive Shaft		28	39	67.1	93.5	1118		
	1999.01-	2000.09	MT	R	F	Dumptruck Engine S8U 770/S8U 772	250011	Drive Shaft		28	39	67.1	93.5	1118		





YEAR	TRANSM	L/R	F/R	REMARKS	GSP Ref.	PRODUCT	ABS	Technical Specifications								
								A	B	C	H	L	P			
OPEL																
MOVANO (X70)																
2.5 D (59 kW)	1999.01-2000.09	MT	R	F	Box Engine S8U 770/S8U 772	650006	Inner Joint		39	27	35	437	98			
	1999.01-2000.09	MT	R	F	Dumptruck Engine S8U 770/S8U 772	650006	Inner Joint		39	27	35	437	98			
	1999.01-2000.09	MT	L	F	Box Engine S8U 770/S8U 772	244005	Drive Shaft	51T	28	37.1	65	96	670			
	1999.01-2000.09	MT	L	F	Dumptruck Engine S8U 770/S8U 772	244005	Drive Shaft	51T	28	37.1	65	96	670			
	1999.01-2000.09	MT	R	F	Box Engine S8U 770/S8U 772	244004	Drive Shaft	51T	28	39	67.1	93.5	1118			
	1999.01-2000.09	MT	R	F	Dumptruck Engine S8U 770/S8U 772	244004	Drive Shaft	51T	28	39	67.1	93.5	1118			
	1999.01-2000.09	MT	L	F	Box Engine S8U 770/S8U 772	250010	Drive Shaft		28	37.1	67.1	93.5	669			
	1999.01-2000.09	MT	L	F	Dumptruck Engine S8U 770/S8U 772	250010	Drive Shaft		28	37.1	67.1	93.5	669			
	1999.01-2000.09	MT	R	F	Box Engine S8U 770/S8U 772	250011	Drive Shaft		28	39	67.1	93.5	1118			
2.5 DTI (84 kW)	2001.10-	MT	R	F	Dumptruck Engine G9U 720/G9U 724/G9U 754/G9U 750	650006	Inner Joint		39	27	35	437	98			
	2001.10-	MT	L	F	Box Engine G9U 720/G9U 724/G9U 754	244012	Drive Shaft		28	37.1	65	96	663			
	2001.10-	MT	L	F	Platform/Chassis Engine G9U 720/G9U 724/G9U 754/G9U 750	244012	Drive Shaft		28	37.1	65	96	663			
	2001.10-	MT	R	F	Box Engine G9U 720/G9U 724/G9U 754	250249	Drive Shaft		28	39	65	96	1144			
	2001.10-	MT	R	F	Platform/Chassis Engine G9U 720/G9U 724/G9U 754/G9U 750	250249	Drive Shaft		28	39	65	96	1144			
	2001.10-	MT	L	F	Box Engine G9U 720/G9U 724/G9U 754	250166	Drive Shaft	51T	28	37.1	65	96	663			
	2001.10-	MT	L	F	Platform/Chassis Engine G9U 720/G9U 724/G9U 754/G9U 750	250166	Drive Shaft	51T	28	37.1	65	96	663			
	2001.10-	MT	R	F	Box Engine G9U 720/G9U 724/G9U 754	299151	Drive Shaft	51T	28	39	65	96	1144			
	2001.10-	MT	R	F	Platform/Chassis Engine G9U 720/G9U 724/G9U 754/G9U 750	299151	Drive Shaft	51T	28	39	65	96	1144			
	2001.10-	MT	R	F	Dumptruck Engine G9U 720/G9U 724/G9U 754/G9U 750	250066	Drive Shaft		28	39	65	96	1142			
	2001.10-	MT	R	F	Box Engine G9U 720/G9U 724/G9U 754	250066	Drive Shaft		28	39	65	96	1142			
	2001.10-	MT	R	F	Platform/Chassis Engine G9U 720/G9U 724/G9U 754/G9U 750	250066	Drive Shaft		28	39	65	96	1142			
	2001.10-	MT	R	F	Box Engine G9U 720/G9U 724/G9U 754	650006	Inner Joint		39	27	35	437	98			
	2001.10-	MT	R	F	Platform/Chassis Engine G9U 720/G9U 724/G9U 754/G9U 750	650006	Inner Joint		39	27	35	437	98			
2.8 DTI (84 kW)	1998.07-2001.10	MT	R	F	Platform/Chassis Engine S9W 702/S9W 700	250011	Drive Shaft		28	39	67.1	93.5	1118			
	1998.07-2001.10	MT	R	F	Platform/Chassis Engine S9W 702/S9W 700	650006	Inner Joint		39	27	35	437	98			
	1998.07-2001.10	MT	L	F	Platform/Chassis Engine S9W 702/S9W 700	244005	Drive Shaft	51T	28	37.1	65	96	670			
	1998.07-2001.10	MT	R	F	Platform/Chassis Engine S9W 702/S9W 700	244004	Drive Shaft	51T	28	39	67.1	93.5	1118			
	1998.07-2001.10	MT	L	F	Platform/Chassis Engine S9W 702/S9W 700	250010	Drive Shaft		28	37.1	67.1	93.5	669			
	1999.01-2001.10	MT	R	F	Dumptruck Engine S9W 700/S9W 702	250011	Drive Shaft		28	39	67.1	93.5	1118			
	1999.01-2001.10	MT	R	F	Box Engine S9W 702/S9W 700	250011	Drive Shaft		28	39	67.1	93.5	1118			
	1999.01-2001.10	MT	R	F	Box Engine S9W 702/S9W 700	650006	Inner Joint		39	27	35	437	98			
	1999.01-2001.10	MT	R	F	Dumptruck Engine S9W 700/S9W 702	650006	Inner Joint		39	27	35	437	98			
	1999.01-2001.10	MT	L	F	Dumptruck Engine S9W 700/S9W 702	244005	Drive Shaft	51T	28	37.1	65	96	670			
	1999.01-2001.10	MT	L	F	Box Engine S9W 702/S9W 700	244005	Drive Shaft	51T	28	37.1	65	96	670			
	1999.01-2001.10	MT	R	F	Dumptruck Engine S9W 700/S9W 702	244004	Drive Shaft	51T	28	39	67.1	93.5	1118			
	1999.01-2001.10	MT	R	F	Box Engine S9W 702/S9W 700	244004	Drive Shaft	51T	28	39	67.1	93.5	1118			
	1999.01-2001.10	MT	L	F	Dumptruck Engine S9W 700/S9W 702	250010	Drive Shaft		28	37.1	67.1	93.5	669			
	1999.01-2001.10	MT	L	F	Box Engine S9W 702/S9W 700	250010	Drive Shaft		28	37.1	67.1	93.5	669			
	MOVANO B (X62)															
	2.3 CDTI (100 kW)	2014.05-	MT	L	F	BUS Engine M9T 702	218247	Drive Shaft		31	39	70	100.5	743		
2014.05-		MT	R	F	BUS Engine M9T 702	218248	Drive Shaft		31	39	70	100.5	1075			
2.3 CDTI (107 kW)	2010.12-	MT	-	F	BUS Engine M9T 680/M9T 678	850132	Outer Joint		31	27	70	100.5	63.5	I		
	2010.12-	MT	L	F	BUS Engine M9T 680/M9T 678	218247	Drive Shaft		31	39	70	100.5	743			
	2010.12-	MT	R	F	BUS Engine M9T 680/M9T 678	218248	Drive Shaft		31	39	70	100.5	1075			
	2010.12-	-	R	F	BUS Engine M9T 680/M9T 678	218515	Drive Shaft		31	39	70	101	1077			
	2010.12-	-	R	F	BUS Engine M9T 680/M9T 678	218515	Drive Shaft		31	39	70	101	1077			
2.3 CDTI (110 kW)	2013.01-	AT/MT	L	F	BUS Engine M9T 880	218247	Drive Shaft		31	39	70	100.5	743			
	2013.01-	AT/MT	R	F	BUS Engine M9T 880	218248	Drive Shaft		31	39	70	100.5	1075			
	2013.01-	-	R	F	BUS Engine M9T 880	218515	Drive Shaft		31	39	70	101	1077			
2.3 CDTI (120 kW)	2014.05-	MT	L	F	BUS Engine M9T 702	218247	Drive Shaft		31	39	70	100.5	743			
	2014.05-	MT	R	F	BUS Engine M9T 702	218248	Drive Shaft		31	39	70	100.5	1075			
2.3 CDTI (125 kW)	2015.07-	-	L	F	BUS	218247	Drive Shaft		31	39	70	100.5	743			
2.3 CDTI (74 kW)	2010.12-	MT	-	F	BUS Engine M9T 676/M9T 670/M9T 672	850132	Outer Joint		31	27	70	100.5	63.5	I		
	2010.12-	MT	L	F	BUS Engine M9T 676/M9T 670/M9T 672	218247	Drive Shaft		31	39	70	100.5	743			
	2010.12-	MT	R	F	BUS Engine M9T 676/M9T 670/M9T 672	218248	Drive Shaft		31	39	70	100.5	1075			
	2010.12-	-	R	F	BUS Engine M9T 676/M9T 670/M9T 672	218515	Drive Shaft		31	39	70	101	1077			
	2010.12-	-	R	F	BUS Engine M9T 676/M9T 670/M9T 672	218515	Drive Shaft		31	39	70	101	1077			
2.3 CDTI (81 kW)	2014.05-	MT	L	F	BUS Engine M9T 870	218247	Drive Shaft		31	39	70	100.5	743			
	2014.05-	MT	R	F	BUS Engine M9T 870	218248	Drive Shaft		31	39	70	100.5	1075			
2.3 CDTI (92 kW)	2010.12-	MT	-	F	BUS Engine M9T 680/M9T 670/M9T 676/M9T 672/M9T 876	850132	Outer Joint		31	27	70	100.5	63.5	I		
	2010.12-	-	L	F	BUS Engine M9T 680/M9T 670/M9T 676/M9T 672/M9T 876	218247	Drive Shaft		31	39	70	100.5	743			
	2010.12-	-	R	F	BUS Engine M9T 680/M9T 670/M9T 676/M9T 672/M9T 876	218248	Drive Shaft		31	39	70	100.5	1075			
	2010.12-	-	R	F	BUS Engine M9T 680/M9T 670/M9T 676/M9T 672/M9T 876	218515	Drive Shaft		31	39	70	101	1077			
	2010.12-	-	R	F	BUS Engine M9T 680/M9T 670/M9T 676/M9T 672/M9T 876	218515	Drive Shaft		31	39	70	101	1077			
2.3 CDTI FWD (100 kW)	2014.05-	MT	L	F	Box Engine M9T 702	218247	Drive Shaft		31	39	70	100.5	743			
	2014.05-	MT	L	F	Platform/Chassis Engine M9T 702	218247	Drive Shaft		31	39	70	100.5	743			
	2014.05-	MT	R	F	Box Engine M9T 702	218248	Drive Shaft		31	39	70	100.5	1075			
	2014.05-	MT	R	F	Platform/Chassis Engine M9T 702	218248	Drive Shaft		31	39	70	100.5	1075			
2.3 CDTI FWD (107 kW)	2010.05-	MT	L	F	Platform/Chassis Engine M9T 678/M9T 680	218247	Drive Shaft		31	39	70	100.5	743			





YEAR	TRANSM	L/R	F/R	REMARKS	GSP Ref.	PRODUCT	ABS	Technical Specifications										
								A	B	C	H	L	P					
OPEL																		
MOVANO B (X62)																		
2.3 CDTI FWD (107 kW)	2010.05-	-	-	L	F	Box Engine M9T 680/M9T 678	218247	Drive Shaft		31	39	70	100.5	743				
	2010.05-	-	MT	R	F	Platform/Chassis Engine M9T 678/M9T 680	218248	Drive Shaft		31	39	70	100.5	1075				
	2010.05-	-	MT	R	F	Dumptruck Engine M9T 678, M9T 680	218248	Drive Shaft		31	39	70	100.5	1075				
	2010.05-	-	-	R	F	Box Engine M9T 680/M9T 678	218248	Drive Shaft		31	39	70	100.5	1075				
2.3 CDTI FWD (110 kW)	2013.01-	-	AT/MT	L	F	Platform/Chassis Engine M9T 880	218247	Drive Shaft		31	39	70	100.5	743				
	2013.01-	-	AT/MT	L	F	Box Engine M9T 880	218247	Drive Shaft		31	39	70	100.5	743				
	2013.01-	-	AT/MT	R	F	Platform/Chassis Engine M9T 880	218248	Drive Shaft		31	39	70	100.5	1075				
	2013.01-	-	AT/MT	R	F	Box Engine M9T 880	218248	Drive Shaft		31	39	70	100.5	1075				
	2013.01-	-	-	R	F	Platform/Chassis Engine M9T 880	218515	Drive Shaft		31	39	70	101	1077				
2013.01-	-	-	R	F	Box Engine M9T 880	218515	Drive Shaft		31	39	70	101	1077					
2.3 CDTI FWD (120 kW)	2014.05-	-	MT	L	F	Box Engine M9T 702	218247	Drive Shaft		31	39	70	100.5	743				
	2014.05-	-	MT	L	F	Platform/Chassis Engine M9T 702	218247	Drive Shaft		31	39	70	100.5	743				
	2014.05-	-	MT	R	F	Box Engine M9T 702	218248	Drive Shaft		31	39	70	100.5	1075				
	2014.05-	-	MT	R	F	Platform/Chassis Engine M9T 702	218248	Drive Shaft		31	39	70	100.5	1075				
	2014.05-	-	MT	R	F	Dumptruck Engine M9T 702	218248	Drive Shaft		31	39	70	100.5	1075				
2.3 CDTI FWD (125 kW)	2016.11-	-	MT	L	F	Dumptruck Engine M9T 706	218247	Drive Shaft		31	39	70	100.5	743				
	2016.11-	-	6MT	L	F	Platform/Chassis Engine M9T 706	218247	Drive Shaft		31	39	70	100.5	743				
2.3 CDTI FWD (74 kW)	2010.05-	-	AT/MT	L	F	Platform/Chassis Engine M9T 670/M9T 676/M9T 672	218247	Drive Shaft		31	39	70	100.5	743				
	2010.05-	-	MT	L	F	Box Engine M9T 670/M9T 676/M9T 672	218247	Drive Shaft		31	39	70	100.5	743				
	2010.05-	-	MT	-	F	Box Engine M9T 670/M9T 676/M9T 672	850132	Outer Joint		31	27	70	100.5	63.5	I			
	2010.05-	-	AT/MT	R	F	Platform/Chassis Engine M9T 670/M9T 676/M9T 672	218248	Drive Shaft		31	39	70	100.5	1075				
	2010.05-	-	MT	R	F	Box Engine M9T 670/M9T 676/M9T 672	218248	Drive Shaft		31	39	70	100.5	1075				
	2010.05-	-	-	R	F	Box Engine M9T 670/M9T 676/M9T 672	218515	Drive Shaft		31	39	70	101	1077				
2.3 CDTI FWD (81 kW)	2012.02-	-	MT	L	F	Box Engine M9T 870	218247	Drive Shaft		31	39	70	100.5	743				
	2012.02-	-	MT	R	F	Box Engine M9T 870	218248	Drive Shaft		31	39	70	100.5	1075				
	2014.05-	-	MT	L	F	Platform/Chassis Engine M9T 870	218247	Drive Shaft		31	39	70	100.5	743				
	2014.05-	-	MT	R	F	Platform/Chassis Engine M9T 870	218248	Drive Shaft		31	39	70	100.5	1075				
2.3 CDTI FWD (92 kW)	2010.05-	-	MT	L	F	Platform/Chassis Engine M9T 670/M9T 676/M9T 672/M9T 680/M9T 876	218247	Drive Shaft		31	39	70	100.5	743				
	2010.05-	-	MT	-	F	Box Engine M9T 676/M9T 670/M9T 672/M9T 876	850132	Outer Joint		31	27	70	100.5	63.5	I			
	2010.05-	-	-	L	F	Box Engine M9T 676/M9T 670/M9T 672/M9T 876	218247	Drive Shaft		31	39	70	100.5	743				
	2010.05-	-	MT	R	F	Platform/Chassis Engine M9T 670/M9T 676/M9T 672/M9T 680/M9T 876	218248	Drive Shaft		31	39	70	100.5	1075				
	2010.05-	-	-	R	F	Box Engine M9T 676/M9T 670/M9T 672/M9T 876	218248	Drive Shaft		31	39	70	100.5	1075				
2010.05-	-	-	R	F	Box Engine M9T 676/M9T 670/M9T 672/M9T 876	218515	Drive Shaft		31	39	70	101	1077					
2.3 CDTI FWD (96 kW)	2016.11-	-	MT	L	F	Dumptruck Engine M9T 704	218247	Drive Shaft		31	39	70	100.5	743				
MOVANO Combi (X70)																		
1.9 DTI (59 kW)	2000.09-2001.10		MT	R	F	Bus Engine F9Q 770	250060	Drive Shaft	51T	28	39	65	96	1126				
	2000.09-2001.10		MT	L	F	Bus Engine F9Q 770	250246	Drive Shaft		28	37.1	65	96	644				
	2000.09-2001.10		MT	L	F	Bus Engine F9Q 770	250058	Drive Shaft	51T	28	37.1	65	96	644				
	2000.09-2001.10		MT	R	F	Bus Engine F9Q 770	244022	Drive Shaft		28	39	67.1	93.5	1147				
	2000.09-2001.10		MT	L	F	Bus Engine F9Q 770	244005	Drive Shaft	51T	28	37.1	65	96	670				
	2000.09-2001.10		MT	L	F	Bus Engine F9Q 770	250010	Drive Shaft		28	37.1	67.1	93.5	669				
1.9 DTI (60 kW)	2001.10-	-	MT	R	F	Bus Engine F9Q 772/F9Q 774	250060	Drive Shaft	51T	28	39	65	96	1126				
	2001.10-	-	MT	L	F	Bus Engine F9Q 772/F9Q 774	250246	Drive Shaft		28	37.1	65	96	644				
	2001.10-	-	MT	R	F	Bus Engine F9Q 772/F9Q 774	244022	Drive Shaft		28	39	67.1	93.5	1147				
	2001.10-	-	MT	L	F	Bus Engine F9Q 772/F9Q 774	244005	Drive Shaft	51T	28	37.1	65	96	670				
	2001.10-	-	MT	L	F	Bus Engine F9Q 772/F9Q 774	250010	Drive Shaft		28	37.1	67.1	93.5	669				
	2001.10-	-	MT	R	F	Bus Engine F9Q 772/F9Q 774	244022	Drive Shaft		28	39	67.1	93.5	1147				
	2001.10-	-	MT	R	F	Bus Engine F9Q 772/F9Q 774	244021	Drive Shaft		28	39	65	96	1126				
2.2 DTI (66 kW)	2000.09-	-	MT	R	F	Bus Engine G9T 720	250214	Drive Shaft		28	39	65	96	1132				
	2000.09-	-	MT	R	F	Bus Engine G9T 720	244016	Drive Shaft	51T	28	39	65	96	1132				
	2000.09-	-	MT	L	F	Bus Engine G9T 720	244005	Drive Shaft	51T	28	37.1	65	96	670				
	2000.09-	-	MT	L	F	Bus Engine G9T 720	250010	Drive Shaft		28	37.1	67.1	93.5	669				
2.5 CDTI (107 kW)	2006.08-	-	MT	R	F	Bus Engine G9U 650/G9U 632	650006	Inner Joint		39	27	35	437	98				
	2006.08-	-	-	R	F	Bus Engine G9U 650/G9U 632	250066	Drive Shaft		28	39	65	96	1142				
	2006.08-	-	-	L	F	Bus Engine G9U 650/G9U 632	299286	Drive Shaft	51T	28	39	65	96	700				
2.5 CDTI (73 kW)	2003.10-2006.12		MT	R	F	Bus Engine G9U 754	650006	Inner Joint		39	27	35	437	98				
	2003.10-2006.12		MT	R	F	Bus Engine G9U 754	250066	Drive Shaft		28	39	65	96	1142				
2.5 CDTI (74 kW)	2007.09-	-	MT	R	F	Bus Engine G9U 650	650006	Inner Joint		39	27	35	437	98				
	2007.09-	-	-	L	F	Bus Engine G9U 650	299286	Drive Shaft	51T	28	39	65	96	700				
2.5 CDTI (88 kW)	2006.08-	-	MT	R	F	Bus Engine G9U 650/G9U 632	650006	Inner Joint		39	27	35	437	98				
	2006.08-	-	-	R	F	Bus Engine G9U 650/G9U 632	250066	Drive Shaft		28	39	65	96	1142				
	2006.08-	-	-	L	F	Bus Engine G9U 650/G9U 632	299286	Drive Shaft	51T	28	39	65	96	700				
2.5 D (59 kW)	1998.07-2000.09		MT	R	F	Bus Engine S8U 770/S8U 772	650006	Inner Joint		39	27	35	437	98				
	1998.07-2000.09		MT	L	F	Bus Engine S8U 770/S8U 772	244005	Drive Shaft	51T	28	37.1	65	96	670				
	1998.07-2000.09		MT	R	F	Bus Engine S8U 770/S8U 772	244004	Drive Shaft	51T	28	39	67.1	93.5	1118				
	1998.07-2000.09		MT	L	F	Bus Engine S8U 770/S8U 772	250010	Drive Shaft		28	37.1	67.1	93.5	669				





YEAR	TRANSM	L/R	F/R	REMARKS	GSP Ref.	PRODUCT	ABS	Technical Specifications									
								A	B	C	H	L	P				
OPEL																	
MOVANO Combi (X70)																	
2.5 D (59 kW)	1998.07-2000.09	MT	R	F	Bus Engine S8U 770/S8U 772	250011	Drive Shaft		28	39	67.1	93.5	1118				
2.5 DTI (84 kW)	2001.10-	MT	L	F	Bus Engine G9U 720/G9U 724/G9U 754/G9U 750	244012	Drive Shaft		28	37.1	65	96	663				
	2001.10-	MT	R	F	Bus Engine G9U 720/G9U 724/G9U 754/G9U 750	250249	Drive Shaft		28	39	65	96	1144				
	2001.10-	MT	L	F	Bus Engine G9U 720/G9U 724/G9U 754/G9U 750	250166	Drive Shaft	51T	28	37.1	65	96	663				
	2001.10-	MT	R	F	Bus Engine G9U 720/G9U 724/G9U 754/G9U 750	299151	Drive Shaft	51T	28	39	65	96	1144				
	2001.10-	MT	R	F	Bus Engine G9U 720/G9U 724/G9U 754/G9U 750	250066	Drive Shaft		28	39	65	96	1142				
	2001.10-	MT	R	F	Bus Engine G9U 720/G9U 724/G9U 754/G9U 750	650006	Inner Joint		39	27	35	437	98				
2.8 DTI (84 kW)	1998.07-2001.10	MT	R	F	Bus Engine S9W 702/S9W 700	250011	Drive Shaft		28	39	67.1	93.5	1118				
	1998.07-2001.10	MT	R	F	Bus Engine S9W 702/S9W 700	650006	Inner Joint		39	27	35	437	98				
	1998.07-2001.10	MT	L	F	Bus Engine S9W 702/S9W 700	244005	Drive Shaft	51T	28	37.1	65	96	670				
	1998.07-2001.10	MT	R	F	Bus Engine S9W 702/S9W 700	244004	Drive Shaft	51T	28	39	67.1	93.5	1118				
	1998.07-2001.10	MT	L	F	Bus Engine S9W 702/S9W 700	250010	Drive Shaft		28	37.1	67.1	93.5	669				
OMEGA A (V87)																	
2.0 (74 kW)	1990.09-1994.03	AT/MT	L/R	R	Estate Engine C 20 NEF	648002	Inner Joint		28		32						
2.0 (90 kW)	1986.09-1994.03	AT/MT	L/R	R	Estate Engine 20 SE	648002	Inner Joint		28		32						
2.0 i (73 kW)	1990.09-1994.03	AT/MT	L/R	R	Estate Engine C 20 NEJ	648002	Inner Joint		28		32						
2.0 i (85 kW)	1986.09-1994.03	AT/MT	L/R	R	Estate Engine C 20 NE	648002	Inner Joint		28		32						
2.3 TD Interc. (74 kW)	1988.08-1994.03	AT/MT	L/R	R	Saloon Engine 23 DTR	648002	Inner Joint		28		32						
	1988.09-1994.03	AT/MT	L/R	R	Estate Engine 23 DTR	648002	Inner Joint		28		32						
2.4 i (92 kW)	1988.09-1994.03	AT/MT	L/R	R	Saloon Engine C 24 NE	648002	Inner Joint		28		32						
	1988.09-1994.03	AT/MT	L/R	R	Estate Engine C 24 NE	648002	Inner Joint		28		32						
2.6 i (110 kW)	1990.09-1994.03	AT/MT	L/R	R	Saloon Engine C 26 NE	648002	Inner Joint		28		32						
	1990.09-1994.03	AT/MT	L/R	R	Estate Engine C 26 NE	648002	Inner Joint		28		32						
3.0 (115 kW)	1987.03-1994.03	AT/MT	L/R	R	Estate Engine C 30 LE	648002	Inner Joint		28		32						
3.0 (130 kW)	1987.03-1990.09	AT/MT	L/R	R	Estate Engine 30 NE	648002	Inner Joint		28		32						
	1987.03-1990.09	AT/MT	L/R	R	Saloon Engine 30 NE	648002	Inner Joint		28		32						
3.0 24V (147 kW)	1989.09-1994.03	AT/MT	L/R	R	Saloon Engine C 30 SEJ	648002	Inner Joint		28		32						
	1989.09-1994.03	AT/MT	L/R	R	Estate Engine C 30 SEJ	648002	Inner Joint		28		32						
3.0 24V (150 kW)	1989.09-1994.03	AT/MT	L/R	R	Saloon Engine C 30 SE	648002	Inner Joint		28		32						
3.0 Cat (130 kW)	1987.03-1994.03	AT/MT	L/R	R	Estate Engine C 30 NE	648002	Inner Joint		28		32						
	1988.03-1994.03	AT/MT	L/R	R	Saloon Engine C 30 NE	648002	Inner Joint		28		32						
OMEGA B (V94)																	
3.0 V6 (155 kW)	1994.04-2001.02	-	R	F	Estate Engine X 30 XE	250117	Drive Shaft		21	23	49.8	83.5	698.5				
SENATOR B (V88)																	
2.5 i (103 kW)	1990.09-1993.09	AT/MT	L/R	R	Saloon Engine 25 NE	648002	Inner Joint		28		32						
2.6 i (110 kW)	1990.09-1993.09	AT/MT	L/R	R	Saloon Engine C 26 NE	648002	Inner Joint		28		32						
3.0 (115 kW)	1987.09-1993.09	AT/MT	L/R	R	Saloon Engine C 30 LE	648002	Inner Joint		28		32						
3.0 (130 kW)	1988.01-1990.09	AT/MT	L/R	R	Saloon Engine 30 NE	648002	Inner Joint		28		32						
3.0 24V (150 kW)	1989.09-1993.09	AT/MT	L/R	R	Saloon Engine C 30 SE	648002	Inner Joint		28		32						
3.0 i Cat (130 kW)	1988.01-1993.09	AT/MT	L/R	R	Saloon Engine C 30 NE	648002	Inner Joint		28		32						
SIGNUM																	
1.9 CDTi (110 kW)	2004.04-	-	-	-	-	699138	Inner Joint		27	28	35	78	83				
1.9 CDTi (74 kW)	2004.04-	-	-	-	-	699138	Inner Joint		27	28	35	78	83				
1.9 CDTi (88 kW)	2004.04-	-	-	-	-	699138	Inner Joint		27	28	35	78	83				
2.0 Turbo 16V (129 kW)	2003.05-	-	-	-	-	699138	Inner Joint		27	28	35	78	83				
2.2 DTi 16V (92 kW)	2003.05-	-	-	-	-	699138	Inner Joint		27	28	35	78	83				
2.8 V6 Turbo (169 kW)	2005.09-	MT	-	-	-	852014	Outer Joint		30	28	55.4	100	64.5	M			
	2005.09-	MT	-	-	-	699138	Inner Joint		27	28	35	78	83				
2.8 V6 Turbo (184 kW)	2005.09-	MT	-	-	-	852014	Outer Joint		30	28	55.4	100	64.5	M			
	2005.09-	MT	-	-	-	699138	Inner Joint		27	28	35	78	83				
3.0 V6 CDTi (130 kW)	2003.05-	-	-	-	-	699138	Inner Joint		27	28	35	78	83				
3.0 V6 CDTi (135 kW)	2005-	MT	-	-	-	852014	Outer Joint		30	28	55.4	100	64.5	M			
	2005.09-	MT	-	-	-	699138	Inner Joint		27	28	35	78	83				
3.2 V6 (155 kW)	2003.05-	-	-	-	-	699138	Inner Joint		27	28	35	78	83				
SIGNUM (Z03)																	
1.8 (103 kW)	2005.09-	MT	L	F	Hatchback Engine Z 18 XER	699026	Inner Joint		22	25	35	57	82.5				
	2005.09-	MT	L	F	Hatchback Engine Z 18 XER	244020	Drive Shaft		30	22	52.5	105	617.5				
	2005.09-	MT	R	F	Hatchback Engine Z 18 XER	217040	Drive Shaft		30	22	52.5	105	987				
	2005.09-	-	L/R	F	Hatchback Engine Z 18 XER	817007	Outer Joint		30	25	52.5	105	62	O			
	2005.09-	-	L	F	Hatchback Engine Z 18 XER	217223	Drive Shaft		30	22	52	94	609				
1.8 (90 kW)	2003.05-	MT	L	F	Hatchback Engine Z 18 XE	699026	Inner Joint		22	25	35	57	82.5				
	2003.05-	MT	L	F	Hatchback Engine Z 18 XE	244020	Drive Shaft		30	22	52.5	105	617.5				
	2003.05-	MT	R	F	Hatchback Engine Z 18 XE	217040	Drive Shaft		30	22	52.5	105	987				
	2003.05-	MT	L/R	F	Hatchback Engine Z 18 XE	817007	Outer Joint		30	25	52.5	105	62	O			
	2003.05-	-	L	F	Hatchback Engine Z 18 XE	217223	Drive Shaft		30	22	52	94	609				
1.9 CDTi (110 kW)	2004.04-	AT/MT	L/R	F	Hatchback Engine Z 19 DTH	817051	Outer Joint		30	26	53.8	94.5	65.5	M			





	 YEAR	TRANSM	L/R	F/R	REMARKS	GSP Ref.	 PRODUCT	 ABS	Technical Specifications						
									A	B	C	H	L	P	
OPEL															
SIGNUM (Z03)															
1.9 CDTI (110 kW)	2004.04-	-	MT	L/R	F	Hatchback Engine Z 19 DTH	221036	Drive Shaft	30	27	55.4	100	602		
	2004.04-	-	MT	R	F	Hatchback Engine Z 19 DTH	221053	Drive Shaft	30	34	53.8	94.5	617		
	2004.04-	-	MT	L	F	Hatchback Engine Z 19 DTH	221092	Drive Shaft	30	25	53.8	94.5	604		
	2004.04-	-	MT	R	F	Hatchback Engine Z 19 DTH	644016	Inner Joint	34	28	37.5	46	54		
	2004.04-	-	AT	L/R	F	Hatchback Engine Z 19 DTH	621024	Inner Joint	27	34	35	101	88		
	2004.04-	-	MT	L	F	Hatchback Engine Z 19 DTH	699186	Inner Joint	25	28	35	57.5	81.5		
	2004.04-	-	MT	R	F	Hatchback Engine Z 19 DTH	221032	Drive Shaft	30	27	53.8	94.5	605		
	2004.04-	-	AT	L/R	F	Hatchback Engine Z 19 DTH	244080	Drive Shaft	30	27	53.8	94.5	591		
1.9 CDTI (74 kW)	2005.08-	-	MT	L/R	F	Hatchback Engine Z 19 DTL	817051	Outer Joint	30	26	53.8	94.5	65.5	M	
	2005.08-	-	MT	R	F	Hatchback Engine Z 19 DTL	221036	Drive Shaft	30	27	55.4	100	602		
	2005.08-	-	-	R	F	Hatchback Engine Z 19 DTL	221053	Drive Shaft	30	34	53.8	94.5	617		
	2005.08-	-	-	L	F	Hatchback Engine Z 19 DTL	221092	Drive Shaft	30	25	53.8	94.5	604		
	2005.08-	-	-	R	F	Hatchback Engine Z 19 DTL	644016	Inner Joint	34	28	37.5	46	54		
	2005.08-	-	-	L	F	Hatchback Engine Z 19 DTL	699186	Inner Joint	25	28	35	57.5	81.5		
	2005.08-	-	MT	R	F	Hatchback Engine Z 19 DTL	221032	Drive Shaft	30	27	53.8	94.5	605		
1.9 CDTI (88 kW)	2004.04-	-	MT	L/R	F	Hatchback Engine Z 19 DT	817051	Outer Joint	30	26	53.8	94.5	65.5	M	
	2004.04-	-	MT	L/R	F	Hatchback Engine Z 19 DT	221036	Drive Shaft	30	27	55.4	100	602		
	2004.04-	-	-	R	F	Hatchback Engine Z 19 DT	221053	Drive Shaft	30	34	53.8	94.5	617		
	2004.04-	-	-	L	F	Hatchback Engine Z 19 DT	221092	Drive Shaft	30	25	53.8	94.5	604		
	2004.04-	-	-	R	F	Hatchback Engine Z 19 DT	644016	Inner Joint	34	28	37.5	46	54		
	2004.04-	-	-	L	F	Hatchback Engine Z 19 DT	699186	Inner Joint	25	28	35	57.5	81.5		
	2004.04-	-	MT	R	F	Hatchback Engine Z 19 DT	221032	Drive Shaft	30	27	53.8	94.5	605		
2.0 DTI (74 kW)	2003.05-	-	MT	L/R	F	Hatchback Engine Y 20 DTH	817007	Outer Joint	30	25	52.5	105	62	O	
	2003.05-	-	-	L	F	Hatchback Engine Y 20 DTH	644002	Inner Joint	34	25	35	56.2	85.6		
	2003.05-	-	MT	R	F	Hatchback Engine Y 20 DTH	221061	Drive Shaft	30	34	52.5	105	968		
2.0 Turbo (129 kW)	2003.05-	-	MT	L/R	F	Hatchback Engine Z 20 NET	817051	Outer Joint	30	26	53.8	94.5	65.5	M	
	2003.05-	-	-	-	F	Hatchback Engine Z 20 NET	899023	Outer Joint	30	26	53.8	94.5	65.5	M	
	2003.05-	-	MT	L/R	F	Hatchback Engine Z 20 NET	221036	Drive Shaft	30	27	55.4	100	602		
	2003.05-	-	MT	L/R	F	Hatchback Engine Z 20 NET	221032	Drive Shaft	30	27	53.8	94.5	605		
2.2 direct (114 kW)	2003.05-	-	MT	L/R	F	Hatchback Engine Z 22 YH	817007	Outer Joint	30	25	52.5	105	62	O	
	2003.05-	-	-	L	F	Hatchback Engine Z 22 YH	644002	Inner Joint	34	25	35	56.2	85.6		
2.2 DTI (92 kW)	2003.05-	-	MT	L/R	F	Hatchback Engine Y 22 DTR	221032	Drive Shaft	30	27	53.8	94.5	605		
	2003.05-	-	MT	L/R	F	Hatchback Engine Y 22 DTR	817051	Outer Joint	30	26	53.8	94.5	65.5	M	
	2003.05-	-	-	-	F	Hatchback Engine Y 22 DTR	899023	Outer Joint	30	26	53.8	94.5	65.5	M	
	2003.05-	-	AT/MT	L/R	F	Hatchback Engine Y 22 DTR	221036	Drive Shaft	30	27	55.4	100	602		
2.8 V6 Turbo (169 kW)	2005.09-	-	AT/MT	L/R	F	Hatchback Engine Z 28 NEL	221036	Drive Shaft	30	27	55.4	100	602		
	2005.09-	-	MT	-	F	Hatchback Engine Z 28 NEL	899023	Outer Joint	30	26	53.8	94.5	65.5	M	
2.8 V6 Turbo (184 kW)	2006.01-	-	MT	-	F	Hatchback Engine Z 28 NET	899023	Outer Joint	30	26	53.8	94.5	65.5	M	
	2006.01-	-	-	L/R	F	Hatchback Engine Z 28 NET	221036	Drive Shaft	30	27	55.4	100	602		
3.0 V6 CDTI (130 kW)	2003.05-	-	MT	L/R	F	Hatchback Engine Y 30 DT	817051	Outer Joint	30	26	53.8	94.5	65.5	M	
	2003.05-	-	-	L/R	F	Hatchback Engine Y 30 DT	221032	Drive Shaft	30	27	53.8	94.5	605		
	2003.05-	-	-	-	F	Hatchback Engine Y 30 DT	899023	Outer Joint	30	26	53.8	94.5	65.5	M	
	2003.05-	-	AT/MT	L/R	F	Hatchback Engine Y 30 DT	221036	Drive Shaft	30	27	55.4	100	602		
3.0 V6 CDTI (135 kW)	2005.09-	-	AT/MT	L/R	F	Hatchback Engine Z 30 DT	221036	Drive Shaft	30	27	55.4	100	602		
	2005.09-	-	-	-	F	Hatchback Engine Z 30 DT	899023	Outer Joint	30	26	53.8	94.5	65.5	M	
3.2 V6 (155 kW)	2003.05-	-	MT	L/R	F	Hatchback Engine Z 32 SE	221032	Drive Shaft	30	27	53.8	94.5	605		
	2003.05-	-	MT	L/R	F	Hatchback Engine Z 32 SE	817051	Outer Joint	30	26	53.8	94.5	65.5	M	
	2003.05-	-	-	-	F	Hatchback Engine Z 32 SE	899023	Outer Joint	30	26	53.8	94.5	65.5	M	
	2003.05-	-	AT/MT	L/R	F	Hatchback Engine Z 32 SE	221036	Drive Shaft	30	27	55.4	100	602		
SINTRA (APV)															
2.2 DTI (85 kW)	1997.07-	1999.04	-	-	F	MPV Engine X 22 DTH	806005	Outer Joint	33	34	50	105	62.5	O	
2.2 i 16V (104 kW)	1996.11-	1999.04	-	-	F	MPV Engine X 22 XE	899020	Outer Joint	33	25	50	105	61	O	
	1996.11-	1999.04	-	L/R	F	MPV Engine X 22 XE	644002	Inner Joint	34	25	35	56.2	85.6		
	1996.11-	1999.04	AT/MT	L/R	F	MPV Engine X 22 XE	621011	Inner Joint	34	25	35	78	64		
3.0 i 24V (148 kW)	1996.11-	1999.04	-	-	F	MPV Engine X 30 XE	806005	Outer Joint	33	34	50	105	62.5	O	
TIGRA (S93)															
1.4 16V (66 kW)	1994.07-	2000.12	-	L/R	F	Coupe Engine X 14 XE	844020	Outer Joint	29T	22	28	52	97.5	57.5	O
	1994.07-	2000.12	MT	L	F	Coupe Engine X 14 XE	244001	Drive Shaft	29T	22	22	52	95	573	
	1994.07-	2000.12	-	R	F	Coupe Engine X 14 XE	208005	Drive Shaft	29T	22	22	52	98	916.5	
1.6 16V (78 kW)	1994.07-	1998.08	-	L/R	F	Coupe Engine X 16 XE	844007	Outer Joint	29T	22	22	52	94.5	50	O
	1994.07-	1998.08	MT	L/R	F	Coupe Engine X 16 XE	644004	Inner Joint	22	22	34.95	57.5	72.5		
TIGRA A															
1.6 i 16V (78 kW)	1994.07-	1998.08	MT	-	-	-	844060	Outer Joint	29T	22	22	52	98	51	O
TIGRA TwinTop (X04)															
1.3 CDTI (51 kW)	2004.06-	-	-	R	F	Convertible Engine Z 13 DT	299205	Drive Shaft	22	22	52	97.5	930		
	2004.06-	-	-	R	F	Convertible Engine Z 13 DT	844043	Outer Joint	22	28	52	97.5	57.5	O	





YEAR	TRANSM	L/R	F/R	REMARKS	GSP Ref.	PRODUCT	ABS	Technical Specifications									
								A	B	C	H	L	P				
OPEL																	
TIGRA TwinTop (X04)																	
1.3 CDTI (51 kW)	2004.06-	-	MT	L	F	Convertible Engine Z 13 DT	299069	Drive Shaft	29T	22	22	52	97.5	584			
	2004.06-	-	AT/MT	L	F	Convertible Engine Z 13 DT	244027	Drive Shaft	29T	22	22	52	98	580			
	2004.06-	-	-	L/R	F	Convertible Engine Z 13 DT	844020	Outer Joint	29T	22	28	52	97.5	57.5	O		
	2004.06-	-	AT/MT	R	F	Convertible Engine Z 13 DT	244026	Drive Shaft	29T	22	22	52	98	930			
	2004.06-	-	-	-	-	Convertible Engine Z 13 DT	644009	Inner Joint		22	23	35	57.5	96			
	2004.06-	-	-	L	F	Convertible Engine Z 13 DT	244045	Drive Shaft	29T	22	22	52	97	579			
	2004.06-	-	MT	L	F	Convertible Engine Z 13 DT	250174	Drive Shaft		23	37.1	56.2	83.5	597.5			
	2004.06-	-	MT	L	F	Convertible Engine Z 13 DT	250174	Drive Shaft		23	37.1	56.2	83.5	597.5			
	2004.06-	-	MT	L	F	Convertible Engine Z 13 DT	244061	Drive Shaft		22	22	52	98	580			
	2004.06-	-	-	R	F	Convertible Engine Z 13 DT	244075	Drive Shaft	29T	22	22	52	97.5	926			
1.4 (66 kW)	2004.06-	-	-	R	F	Convertible Engine Z 14 XEP	299205	Drive Shaft		22	22	52	97.5	930			
	2004.06-	-	-	R	F	Convertible Engine Z 14 XEP	844043	Outer Joint		22	28	52	97.5	57.5	O		
	2004.06-	-	AT/MT	L	F	Convertible Engine Z 14 XEP	299069	Drive Shaft	29T	22	22	52	97.5	584			
	2004.06-	-	-	L	F	Convertible Engine Z 14 XEP	244027	Drive Shaft	29T	22	22	52	98	580			
	2004.06-	-	-	L/R	F	Convertible Engine Z 14 XEP	844020	Outer Joint	29T	22	28	52	97.5	57.5	O		
	2004.06-	-	-	R	F	Convertible Engine Z 14 XEP	244026	Drive Shaft	29T	22	22	52	98	930			
	2004.06-	-	-	-	-	Convertible Engine Z 14 XEP	644009	Inner Joint		22	23	35	57.5	96			
	2004.06-	-	-	L	F	Convertible Engine Z 14 XEP	244045	Drive Shaft	29T	22	22	52	97	579			
	2004.06-	-	MT	L	F	Convertible Engine Z 14 XEP	250174	Drive Shaft		23	37.1	56.2	83.5	597.5			
	2004.06-	-	MT	L	F	Convertible Engine Z 14 XEP	250174	Drive Shaft		23	37.1	56.2	83.5	597.5			
	2004.06-	-	MT	L	F	Convertible Engine Z 14 XEP	244061	Drive Shaft		22	22	52	98	580			
	2004.06-	-	-	R	F	Convertible Engine Z 14 XEP	244075	Drive Shaft	29T	22	22	52	97.5	926			
1.8 (92 kW)	2004.06-	-	MT	L	F	Convertible Engine Z 18 XE	299069	Drive Shaft	29T	22	22	52	97.5	584			
	2004.06-	-	-	L	F	Convertible Engine Z 18 XE	244027	Drive Shaft	29T	22	22	52	98	580			
	2004.06-	-	-	R	F	Convertible Engine Z 18 XE	244026	Drive Shaft	29T	22	22	52	98	930			
	2004.06-	-	-	-	-	Convertible Engine Z 18 XE	644009	Inner Joint		22	23	35	57.5	96			
	2004.06-	-	-	L	F	Convertible Engine Z 18 XE	244045	Drive Shaft	29T	22	22	52	97	579			
	2004.06-	-	-	L/R	F	Convertible Engine Z 18 XE	844002	Outer Joint	29T	22	23	52	97.5	61	M		
	2004.06-	-	-	R	F	Convertible Engine Z 18 XE	244075	Drive Shaft	29T	22	22	52	97.5	926			
VECTRA A																	
1.8	1988-	1995	-	L	F	-	244047	Drive Shaft		33	34	52	108	592			
2.0	1988-	1995	-	L	F	-	244047	Drive Shaft		33	34	52	108	592			
VECTRA A (86, 87)																	
1.4 S (55 kW)	1988.09-	1992.06	-	-	-	ChP1175250	844060	Outer Joint	29T	22	22	52	98	51	O		
1.6 (60 kW)	1988.09-	1993.05	-	-	-	-	844060	Outer Joint	29T	22	22	52	98	51	O		
1.6 i (52 kW)	1993.09-	1995.11	-	-	-	-	844060	Outer Joint	29T	22	22	52	98	51	O		
1.6 i (55 kW)	1993.09-	1995.11	-	-	-	-	844060	Outer Joint	29T	22	22	52	98	51	O		
VECTRA A (J89)																	
1.4 S (55 kW)	1988.04-	1992.06	MT	L	F	Hatchback Engine 14 NV	244002	Drive Shaft	29T	22	22	52	95	585			
	1988.04-	1992.06	MT	L/R	F	Hatchback Engine 14 NV	644004	Inner Joint		22	22	34.95	57.5	72.5			
	1988.04-	1992.06	MT	R	F	Hatchback Engine 14 NV	260002	Drive Shaft	29T	22	22	52	95	926			
	1988.04-	1992.06	AT/MT	L/R	F	Hatchback Engine 14 NV	844051	Outer Joint	29T	22	22	52	95	50.5	O		
	1988.09-	1992.06	AT/MT	L/R	F	Saloon Engine 14 NV	844051	Outer Joint	29T	22	22	52	95	50.5	O		
	1988.09-	1992.06	MT	L/R	F	Saloon Engine 14 NV	644004	Inner Joint		22	22	34.95	57.5	72.5			
	1988.09-	1992.06	MT	L	F	Saloon Engine 14 NV	244002	Drive Shaft	29T	22	22	52	95	585			
	1988.09-	1992.06	MT	R	F	Saloon Engine 14 NV	260002	Drive Shaft	29T	22	22	52	95	926			
1.6 (60 kW)	1988.09-	1993.05	MT	L/R	F	Saloon Engine 16 SV	844051	Outer Joint	29T	22	22	52	95	50.5	O		
	1988.09-	1993.05	MT	L	F	Saloon Engine 16 SV	244002	Drive Shaft	29T	22	22	52	95	585			
	1988.09-	1993.05	MT	R	F	Saloon Engine 16 SV	250209	Drive Shaft		27	39	56.5	92	1014			
	1988.09-	1993.05	MT	R	F	Saloon Engine 16 SV	250209	Drive Shaft		27	39	56.5	92	1014			
	1988.09-	1993.05	MT	L/R	F	Saloon Engine 16 SV	644004	Inner Joint		22	22	34.95	57.5	72.5			
	1988.09-	1993.05	MT	R	F	Saloon Engine 16 SV	260019	Drive Shaft		22	22	52	95	926			
	1988.09-	1993.05	AT/MT	L/R	F	Saloon Engine 16 SV	844055	Outer Joint	43T	22	22	52	95	50.5	O		
	1988.09-	1993.05	MT	R	F	Saloon Engine 16 SV	260002	Drive Shaft	29T	22	22	52	95	926			
	1988.09-	1993.05	MT	R	F	Saloon Engine 16 SV	650097	Inner Joint		39	35	30	409	90			
1.6 i (52 kW)	1993.09-	1995.11	MT	L/R	F	Hatchback Engine X 16 SZ	644004	Inner Joint		22	22	34.95	57.5	72.5			
	1993.09-	1995.11	MT	L/R	F	Saloon Engine X 16 SZ	644004	Inner Joint		22	22	34.95	57.5	72.5			
	1993.09-	1995.11	MT	L/R	F	Saloon Engine X 16 SZ	844051	Outer Joint	29T	22	22	52	95	50.5	O		
1.6 i (55 kW)	1988.09-	1995.11	AT/MT	L/R	F	Saloon Engine C 16 NZ/E 16 NZ/C 16 NZ2	844051	Outer Joint	29T	22	22	52	95	50.5	O		
	1988.09-	1995.11	MT	L	F	Saloon Engine C 16 NZ/E 16 NZ/C 16 NZ2	244002	Drive Shaft	29T	22	22	52	95	585			
	1988.09-	1995.11	MT	R	F	Saloon Engine C 16 NZ/E 16 NZ/C 16 NZ2	250209	Drive Shaft		27	39	56.5	92	1014			
	1988.09-	1995.11	MT	R	F	Saloon Engine C 16 NZ/E 16 NZ/C 16 NZ2	250209	Drive Shaft		27	39	56.5	92	1014			
	1988.09-	1995.11	MT	L/R	F	Saloon Engine C 16 NZ/E 16 NZ/C 16 NZ2	644004	Inner Joint		22	22	34.95	57.5	72.5			
	1988.09-	1995.11	MT	R	F	Saloon Engine C 16 NZ/E 16 NZ/C 16 NZ2	260019	Drive Shaft		22	22	52	95	926			
	1988.09-	1995.11	MT	R	F	Saloon Engine C 16 NZ/E 16 NZ/C 16 NZ2	260002	Drive Shaft	29T	22	22	52	95	926			
	1988.09-	1995.11	MT	R	F	Saloon Engine C 16 NZ/E 16 NZ/C 16 NZ2	650097	Inner Joint		39	35	30	409	90			





	 YEAR	TRANSM	L/R	F/R	REMARKS	GSP Ref.	 PRODUCT	 ABS	Technical Specifications						
									A	B	C	H	L	P	
OPEL															
VECTRA A (J89)															
1.6 i (55 kW)	1993.09-1995.11	AT/MT	L/R	F	Saloon Engine 16 LZ2/C 16 LZ2	844051	Outer Joint	29T	22	22	52	95	50.5	O	
	1993.09-1995.11	AT/MT	L/R	F	Hatchback Engine 16 LZ2	844051	Outer Joint	29T	22	22	52	95	50.5	O	
	1993.09-1995.11	MT	L/R	F	Hatchback Engine 16 LZ2	644004	Inner Joint		22	22	34.95	57.5	72.5		
	1993.09-1995.11	MT	L	F	Saloon Engine 16 LZ2/C 16 LZ2	244002	Drive Shaft	29T	22	22	52	95	585		
	1993.09-1995.11	MT	L	F	Hatchback Engine 16 LZ2	244002	Drive Shaft	29T	22	22	52	95	585		
	1993.09-1995.11	MT	R	F	Saloon Engine 16 LZ2/C 16 LZ2	260002	Drive Shaft	29T	22	22	52	95	926		
	1993.09-1995.11	MT	R	F	Hatchback Engine 16 LZ2	260002	Drive Shaft	29T	22	22	52	95	926		
	1993.09-1995.11	MT	L/R	F	Saloon Engine 16 LZ2/C 16 LZ2	644004	Inner Joint		22	22	34.95	57.5	72.5		
1.6 i Cat (55 kW)	1988.09-1995.11	AT/MT	L/R	F	Hatchback Engine C 16 NZ2/C 16 NZ	844051	Outer Joint	29T	22	22	52	95	50.5	O	
	1988.09-1995.11	MT	L	F	Hatchback Engine C 16 NZ2/C 16 NZ	244002	Drive Shaft	29T	22	22	52	95	585		
	1988.09-1995.11	MT	R	F	Hatchback Engine C 16 NZ2/C 16 NZ	250209	Drive Shaft		27	39	56.5	92	1014		
	1988.09-1995.11	MT	R	F	Hatchback Engine C 16 NZ2/C 16 NZ	250209	Drive Shaft		27	39	56.5	92	1014		
	1988.09-1995.11	MT	L/R	F	Hatchback Engine C 16 NZ2/C 16 NZ	644004	Inner Joint		22	22	34.95	57.5	72.5		
	1988.09-1995.11	MT	R	F	Hatchback Engine C 16 NZ2/C 16 NZ	260019	Drive Shaft		22	22	52	95	926		
	1988.09-1995.11	AT/MT	L/R	F	Hatchback Engine C 16 NZ2/C 16 NZ	844055	Outer Joint	43T	22	22	52	95	50.5	O	
	1988.09-1995.11	MT	R	F	Hatchback Engine C 16 NZ2/C 16 NZ	260002	Drive Shaft	29T	22	22	52	95	926		
1.6 S (60 kW)	1988.09-1993.05	AT/MT	L/R	F	Hatchback Engine 16 SV	844051	Outer Joint	29T	22	22	52	95	50.5	O	
	1988.09-1993.05	MT	L	F	Hatchback Engine 16 SV	244002	Drive Shaft	29T	22	22	52	95	585		
	1988.09-1993.05	-	-	F	Hatchback Engine 16 SV	844010	Outer Joint	29T	33	22	52	103	50.5	O	
	1988.09-1993.05	MT	R	F	Hatchback Engine 16 SV	250209	Drive Shaft		27	39	56.5	92	1014		
	1988.09-1993.05	MT	R	F	Hatchback Engine 16 SV	250209	Drive Shaft		27	39	56.5	92	1014		
	1988.09-1993.05	MT	L/R	F	Hatchback Engine 16 SV	644004	Inner Joint		22	22	34.95	57.5	72.5		
	1988.09-1993.05	MT	R	F	Hatchback Engine 16 SV	260019	Drive Shaft		22	22	52	95	926		
	1988.09-1993.05	AT/MT	L/R	F	Hatchback Engine 16 SV	844055	Outer Joint	43T	22	22	52	95	50.5	O	
1.7 D (42 kW)	1988.09-1993.05	MT	R	F	Hatchback Engine 16 SV	260002	Drive Shaft	29T	22	22	52	95	926		
	1988.09-1993.05	MT	R	F	Hatchback Engine 16 SV	650097	Inner Joint		39	35	30	409	90		
	1988.09-1992.09	AT/MT	L/R	F	Hatchback Engine 17 D	621011	Inner Joint		34	25	35	78	64		
	1988.09-1992.09	MT	L	F	Hatchback Engine 17 D	244011	Drive Shaft	29T	33	34	52	109	594.5		
	1988.09-1992.09	MT	R	F	Hatchback Engine 17 D	244059	Drive Shaft	29T	33	34	52	109	938		
	1988.09-1992.09	AT/MT	L/R	F	Hatchback Engine 17 D	844056	Outer Joint	29T	33	25	52	109	61	O	
	1988.09-1992.09	AT/MT	L/R	F	Hatchback Engine 17 D	844057	Outer Joint	43T	33	25	52	109	61	O	
	1988.09-1992.09	MT	L/R	F	Hatchback Engine 17 D	644004	Inner Joint		22	22	34.95	57.5	72.5		
	1988.09-1992.09	MT	L/R	F	Hatchback Engine 17 D	644002	Inner Joint		34	25	35	56.2	85.6		
	1988.10-1992.09	AT/MT	L/R	F	Saloon Engine 17 D	621011	Inner Joint		34	25	35	78	64		
	1988.10-1992.09	MT	L	F	Saloon Engine 17 D	244011	Drive Shaft	29T	33	34	52	109	594.5		
	1988.10-1992.09	MT	R	F	Saloon Engine 17 D	244059	Drive Shaft	29T	33	34	52	109	938		
	1988.10-1992.09	AT/MT	L/R	F	Saloon Engine 17 D	844056	Outer Joint	29T	33	25	52	109	61	O	
	1988.10-1992.09	AT/MT	L/R	F	Saloon Engine 17 D	844057	Outer Joint	43T	33	25	52	109	61	O	
	1988.10-1992.09	MT	L/R	F	Saloon Engine 17 D	644004	Inner Joint		22	22	34.95	57.5	72.5		
	1988.10-1992.09	MT	L/R	F	Saloon Engine 17 D	644002	Inner Joint		34	25	35	56.2	85.6		
1.7 D (44 kW)	1992.07-1995.11	AT/MT	L/R	F	Saloon Engine 17 DR	621011	Inner Joint		34	25	35	78	64		
	1992.07-1995.11	AT/MT	L/R	F	Hatchback Engine 17 DR	621011	Inner Joint		34	25	35	78	64		
	1992.07-1995.11	MT	L	F	Hatchback Engine 17 DR	244011	Drive Shaft	29T	33	34	52	109	594.5		
	1992.07-1995.11	AT/MT	L/R	F	Saloon Engine 17 DR	844056	Outer Joint	29T	33	25	52	109	61	O	
	1992.07-1995.11	AT/MT	L/R	F	Hatchback Engine 17 DR	844056	Outer Joint	29T	33	25	52	109	61	O	
	1992.07-1995.11	MT	L	F	Saloon Engine 17 DR	244011	Drive Shaft	29T	33	34	52	109	594.5		
	1992.07-1995.11	MT	L/R	F	Hatchback Engine 17 DR	644004	Inner Joint		22	22	34.95	57.5	72.5		
	1992.07-1995.11	MT	R	F	Hatchback Engine 17 DR	244059	Drive Shaft	29T	33	34	52	109	938		
	1992.07-1995.11	MT	L/R	F	Hatchback Engine 17 DR	644002	Inner Joint		34	25	35	56.2	85.6		
	1992.07-1995.11	MT	R	F	Saloon Engine 17 DR	244059	Drive Shaft	29T	33	34	52	109	938		
	1992.07-1995.11	MT	L/R	F	Saloon Engine 17 DR	644004	Inner Joint		22	22	34.95	57.5	72.5		
	1992.07-1995.11	MT	L/R	F	Saloon Engine 17 DR	644002	Inner Joint		34	25	35	56.2	85.6		
1.7 TD (60 kW)	1990.03-1995.11	AT/MT	L/R	F	Saloon Engine 17 DT (TC4EE1)X 17 DT (TC4EE1)	621011	Inner Joint		34	25	35	78	64		
	1990.03-1995.11	AT/MT	L/R	F	Hatchback Engine 17 DT (TC4EE1)X 17 DT (TC4EE1)	621011	Inner Joint		34	25	35	78	64		
	1990.03-1995.11	MT	L	F	Saloon Engine 17 DT (TC4EE1)X 17 DT (TC4EE1)	244011	Drive Shaft	29T	33	34	52	109	594.5		
	1990.03-1995.11	MT	L	F	Hatchback Engine 17 DT (TC4EE1)X 17 DT (TC4EE1)	244011	Drive Shaft	29T	33	34	52	109	594.5		
	1990.03-1995.11	MT	R	F	Saloon Engine 17 DT (TC4EE1)X 17 DT (TC4EE1)	244059	Drive Shaft	29T	33	34	52	109	938		
	1990.03-1995.11	AT/MT	L/R	F	Saloon Engine 17 DT (TC4EE1)X 17 DT (TC4EE1)	844056	Outer Joint	29T	33	25	52	109	61	O	
	1990.03-1995.11	MT	R	F	Hatchback Engine 17 DT (TC4EE1)X 17 DT (TC4EE1)	244059	Drive Shaft	29T	33	34	52	109	938		
	1990.03-1995.11	AT/MT	L/R	F	Hatchback Engine 17 DT (TC4EE1)X 17 DT (TC4EE1)	844056	Outer Joint	29T	33	25	52	109	61	O	
	1990.03-1995.11	MT	L/R	F	Saloon Engine 17 DT (TC4EE1)X 17 DT (TC4EE1)	844057	Outer Joint	43T	33	25	52	109	61	O	
	1990.03-1995.11	MT	L/R	F	Hatchback Engine 17 DT (TC4EE1)X 17 DT (TC4EE1)	844057	Outer Joint	43T	33	25	52	109	61	O	
	1990.03-1995.11	MT	L/R	F	Saloon Engine 17 DT (TC4EE1)X 17 DT (TC4EE1)	644002	Inner Joint		34	25	35	56.2	85.6		
	1990.03-1995.11	MT	L/R	F	Hatchback Engine 17 DT (TC4EE1)X 17 DT (TC4EE1)	644002	Inner Joint		34	25	35	56.2	85.6		
1.8 i (66 kW)	1988.09-1990.10	MT	L/R	F	Hatchback Engine 18 SV	644002	Inner Joint		34	25	35	56.2	85.6		





	 YEAR	TRANSM	L/R	F/R	REMARKS	GSP Ref.	 PRODUCT	 ABS	Technical Specifications					
									A	B	C	H	L	P
OPEL														
VECTRA A (J89)														
1.8 i (66 kW)	1988.09-1990.10	MT	L	F	Hatchback Engine 18 SV	244011	Drive Shaft	29T	33	34	52	109	594.5	
	1988.09-1990.10	MT	R	F	Hatchback Engine 18 SV	244059	Drive Shaft	29T	33	34	52	109	938	
	1988.09-1990.10	AT/MT	L/R	F	Hatchback Engine 18 SV	844056	Outer Joint	29T	33	25	52	109	61	O
	1988.09-1990.10	AT/MT	L/R	F	Hatchback Engine 18 SV	844057	Outer Joint	43T	33	25	52	109	61	O
1.8 i Cat (66 kW)	1990.03-1995.11	MT	L/R	F	Saloon Engine C 18 NZ	644002	Inner Joint		34	25	35	56.2	85.6	
	1990.03-1995.11	MT	L/R	F	Hatchback Engine C 18 NZ	644002	Inner Joint		34	25	35	56.2	85.6	
	1990.03-1995.11	AT/MT	L/R	F	Saloon Engine C 18 NZ	621011	Inner Joint		34	25	35	78	64	
	1990.03-1995.11	AT/MT	L/R	F	Hatchback Engine C 18 NZ	621011	Inner Joint		34	25	35	78	64	
	1990.03-1995.11	MT	L	F	Saloon Engine C 18 NZ	244011	Drive Shaft	29T	33	34	52	109	594.5	
	1990.03-1995.11	MT	L	F	Hatchback Engine C 18 NZ	244011	Drive Shaft	29T	33	34	52	109	594.5	
	1990.03-1995.11	MT	R	F	Saloon Engine C 18 NZ	244059	Drive Shaft	29T	33	34	52	109	938	
	1990.03-1995.11	AT/MT	L/R	F	Saloon Engine C 18 NZ	844056	Outer Joint	29T	33	25	52	109	61	O
	1990.03-1995.11	MT	R	F	Hatchback Engine C 18 NZ	244059	Drive Shaft	29T	33	34	52	109	938	
	1990.03-1995.11	AT/MT	L/R	F	Hatchback Engine C 18 NZ	844056	Outer Joint	29T	33	25	52	109	61	O
	1990.03-1995.11	AT/MT	L/R	F	Saloon Engine C 18 NZ	844057	Outer Joint	43T	33	25	52	109	61	O
1.8 S (65 kW)	1988.09-1989.07	MT	L/R	F	Saloon Engine E 18 NVR	644002	Inner Joint		34	25	35	56.2	85.6	
	1988.09-1989.07	MT	L/R	F	Hatchback Engine E 18 NVR	644002	Inner Joint		34	25	35	56.2	85.6	
	1988.09-1989.07	AT/MT	L/R	F	Saloon Engine E 18 NVR	844057	Outer Joint	43T	33	25	52	109	61	O
	1988.09-1989.07	AT/MT	L/R	F	Hatchback Engine E 18 NVR	844057	Outer Joint	43T	33	25	52	109	61	O
	1989.01-1989.07	MT	L/R	F	All-wheel Drive Saloon Engine E 18 NVR	644002	Inner Joint		34	25	35	56.2	85.6	
	1989.01-1989.07	AT/MT	L/R	F	All-wheel Drive Saloon Engine E 18 NVR	844057	Outer Joint	43T	33	25	52	109	61	O
1.8 S (66 kW)	1989.09-1990.10	MT	L/R	F	Saloon Engine 18 SV	644002	Inner Joint		34	25	35	56.2	85.6	
	1989.09-1990.10	MT	L	F	Saloon Engine 18 SV	244011	Drive Shaft	29T	33	34	52	109	594.5	
	1989.09-1990.10	MT	R	F	Saloon Engine 18 SV	244059	Drive Shaft	29T	33	34	52	109	938	
	1989.09-1990.10	AT/MT	L/R	F	Saloon Engine 18 SV	844056	Outer Joint	29T	33	25	52	109	61	O
	1989.09-1990.10	AT/MT	L/R	F	Saloon Engine 18 SV	844057	Outer Joint	43T	33	25	52	109	61	O
2.0 (74 kW)	1988.04-1989.09	MT	L/R	F	Hatchback Engine C 20 NEF	644002	Inner Joint		34	25	35	56.2	85.6	
	1988.04-1989.09	MT	L/R	F	Hatchback Engine C 20 NEF	844057	Outer Joint	43T	33	25	52	109	61	O
	1988.09-1989.09	MT	L/R	F	Saloon Engine C 20 NEF	644002	Inner Joint		34	25	35	56.2	85.6	
	1988.09-1989.09	MT	L/R	F	Saloon Engine C 20 NEF	844057	Outer Joint	43T	33	25	52	109	61	O
2.0 16V (110 kW)	1989.01-1990.10	-	R	F	All-wheel Drive Saloon Engine 20 XEJ	244048	Drive Shaft		33	34	52	109	938	
	1989.01-1990.10	MT	L/R	F	All-wheel Drive Saloon Engine 20 XEJ	844056	Outer Joint	29T	33	25	52	109	61	O
	1989.01-1990.10	MT	L/R	F	All-wheel Drive Saloon Engine 20 XEJ	844057	Outer Joint	43T	33	25	52	109	61	O
	1989.01-1990.10	MT	L	F	All-wheel Drive Saloon Engine 20 XEJ	644002	Inner Joint		34	25	35	56.2	85.6	
2.0 i (85 kW)	1988.09-1990.10	MT	L	F	Saloon Engine 20 NE	244011	Drive Shaft	29T	33	34	52	109	594.5	
	1988.09-1990.10	MT	L	F	Hatchback Engine 20 NE	244011	Drive Shaft	29T	33	34	52	109	594.5	
	1988.09-1990.10	AT/MT	L/R	F	Saloon Engine 20 NE	844057	Outer Joint	43T	33	25	52	109	61	O
	1988.09-1990.10	AT/MT	L/R	F	Saloon Engine 20 NE	844056	Outer Joint	29T	33	25	52	109	61	O
	1988.09-1990.10	AT/MT	L/R	F	Hatchback Engine 20 NE	844056	Outer Joint	29T	33	25	52	109	61	O
	1988.09-1990.10	MT	R	F	Saloon Engine 20 NE	244059	Drive Shaft	29T	33	34	52	109	938	
	1988.09-1990.10	MT	R	F	Hatchback Engine 20 NE	244059	Drive Shaft	29T	33	34	52	109	938	
	1988.09-1990.10	AT/MT	L/R	F	Hatchback Engine 20 NE	844057	Outer Joint	43T	33	25	52	109	61	O
	1988.09-1990.10	MT	L/R	F	Saloon Engine 20 NE	644002	Inner Joint		34	25	35	56.2	85.6	
	1988.09-1990.10	MT	L/R	F	Hatchback Engine 20 NE	644002	Inner Joint		34	25	35	56.2	85.6	
	1989.01-1990.10	MT	L/R	F	All-wheel Drive Saloon Engine 20 NE	844056	Outer Joint	29T	33	25	52	109	61	O
	1989.01-1990.10	MT	L/R	F	All-wheel Drive Saloon Engine 20 NE	844057	Outer Joint	43T	33	25	52	109	61	O
	1989.01-1990.10	MT	L	F	All-wheel Drive Saloon Engine 20 NE	644002	Inner Joint		34	25	35	56.2	85.6	
2.0 i (95 kW)	1988.09-1992.09	AT/MT	L/R	F	Saloon Engine 20 SEH	621011	Inner Joint		34	25	35	78	64	
	1988.09-1992.09	MT	L	F	Saloon Engine 20 SEH	244011	Drive Shaft	29T	33	34	52	109	594.5	
	1988.09-1992.09	MT	L/R	F	Saloon Engine 20 SEH	844056	Outer Joint	29T	33	25	52	109	61	O
	1988.09-1992.09	MT	R	F	Saloon Engine 20 SEH	244059	Drive Shaft	29T	33	34	52	109	938	
	1988.09-1992.09	MT	L/R	F	Saloon Engine 20 SEH	844057	Outer Joint	43T	33	25	52	109	61	O
	1988.09-1992.09	MT	L/R	F	Saloon Engine 20 SEH	644002	Inner Joint		34	25	35	56.2	85.6	
	1989.01-1992.09	MT	L/R	F	All-wheel Drive Saloon Engine 20 SEH	844056	Outer Joint	29T	33	25	52	109	61	O
	1989.01-1992.09	MT	L/R	F	All-wheel Drive Saloon Engine 20 SEH	844057	Outer Joint	43T	33	25	52	109	61	O
	1989.01-1992.09	MT	L	F	All-wheel Drive Saloon Engine 20 SEH	644002	Inner Joint		34	25	35	56.2	85.6	
2.0 i 16V (100 kW)	1994.06-1995.11	MT	L	F	All-wheel Drive Saloon Engine X 20 XEV	644002	Inner Joint		34	25	35	56.2	85.6	
	1994.06-1995.11	MT	L	F	Saloon Engine X 20 XEV	644002	Inner Joint		34	25	35	56.2	85.6	
	1994.06-1995.11	MT	L	F	Hatchback Engine X 20 XEV	644002	Inner Joint		34	25	35	56.2	85.6	
2.0 i 16V (110 kW)	1989.02-1990.10	-	L	F	Hatchback Engine 20 XEJ	244014	Drive Shaft	43T	33	34	52	103.5	587	
	1989.02-1990.10	-	R	F	Hatchback Engine 20 XEJ	244048	Drive Shaft		33	34	52	109	938	
	1989.02-1990.10	MT	L	F	Hatchback Engine 20 XEJ	244011	Drive Shaft	29T	33	34	52	109	594.5	
	1989.02-1990.10	MT	L/R	F	Hatchback Engine 20 XEJ	844056	Outer Joint	29T	33	25	52	109	61	O
	1989.02-1990.10	MT	L/R	F	Hatchback Engine 20 XEJ	844057	Outer Joint	43T	33	25	52	109	61	O
	1989.02-1990.10	MT	L	F	Hatchback Engine 20 XEJ	644002	Inner Joint		34	25	35	56.2	85.6	





	 YEAR	TRANSM	L/R	F/R	REMARKS	GSP Ref.	 PRODUCT	 ABS	Technical Specifications					
									A	B	C	H	L	P
OPEL														
VECTRA A (J89)														
2.0 i 16V Cat (110 kW)	1990.02-1995.11	-	R	F	Hatchback Engine C 20 XE	244048	Drive Shaft		33	34	52	109	938	
	1990.02-1995.11	AT/MT	L/R	F	Hatchback Engine C 20 XE	621011	Inner Joint		34	25	35	78	64	
	1990.02-1995.11	MT	L	F	Hatchback Engine C 20 XE	244011	Drive Shaft	29T	33	34	52	109	594.5	
	1990.02-1995.11	MT	L/R	F	Hatchback Engine C 20 XE	844056	Outer Joint	29T	33	25	52	109	61	O
	1990.02-1995.11	MT	L/R	F	Hatchback Engine C 20 XE	844057	Outer Joint	43T	33	25	52	109	61	O
	1990.02-1995.11	MT	L	F	Hatchback Engine C 20 XE	644002	Inner Joint		34	25	35	56.2	85.6	
2.0 i Cat (85 kW)	1988.09-1995.11	AT/MT	L/R	F	Saloon Engine C 20 NE	621011	Inner Joint		34	25	35	78	64	
	1988.09-1995.11	AT/MT	L/R	F	Hatchback Engine C 20 NE	621011	Inner Joint		34	25	35	78	64	
	1988.09-1995.11	MT	L/R	F	Saloon Engine C 20 NE	644002	Inner Joint		34	25	35	56.2	85.6	
	1988.09-1995.11	MT	L/R	F	Hatchback Engine C 20 NE	644002	Inner Joint		34	25	35	56.2	85.6	
	1988.09-1995.11	MT	L	F	Saloon Engine C 20 NE	244011	Drive Shaft	29T	33	34	52	109	594.5	
	1988.09-1995.11	MT	L	F	Hatchback Engine C 20 NE	244011	Drive Shaft	29T	33	34	52	109	594.5	
	1988.09-1995.11	AT/MT	L/R	F	Saloon Engine C 20 NE	844057	Outer Joint	43T	33	25	52	109	61	O
	1988.09-1995.11	MT	R	F	Saloon Engine C 20 NE	244059	Drive Shaft	29T	33	34	52	109	938	
	1988.09-1995.11	MT	R	F	Hatchback Engine C 20 NE	244059	Drive Shaft	29T	33	34	52	109	938	
	1988.09-1995.11	AT/MT	L/R	F	Saloon Engine C 20 NE	844056	Outer Joint	29T	33	25	52	109	61	O
	1988.09-1995.11	AT/MT	L/R	F	Hatchback Engine C 20 NE	844056	Outer Joint	29T	33	25	52	109	61	O
	1988.09-1995.11	AT/MT	L/R	F	Hatchback Engine C 20 NE	844057	Outer Joint	43T	33	25	52	109	61	O
	1989.01-1995.11	MT	L/R	F	All-wheel Drive Saloon Engine C 20 NE	844056	Outer Joint	29T	33	25	52	109	61	O
	1989.01-1995.11	MT	L/R	F	All-wheel Drive Saloon Engine C 20 NE	844057	Outer Joint	43T	33	25	52	109	61	O
	1989.01-1995.11	MT	L	F	All-wheel Drive Saloon Engine C 20 NE	644002	Inner Joint		34	25	35	56.2	85.6	
2.0 i GT (95 kW)	1988.09-1995.11	AT/MT	L/R	F	Hatchback Engine 20 SEH	621011	Inner Joint		34	25	35	78	64	
	1988.09-1995.11	MT	L	F	Hatchback Engine 20 SEH	244011	Drive Shaft	29T	33	34	52	109	594.5	
	1988.09-1995.11	AT/MT	L/R	F	Hatchback Engine 20 SEH	844056	Outer Joint	29T	33	25	52	109	61	O
	1988.09-1995.11	MT	R	F	Hatchback Engine 20 SEH	244059	Drive Shaft	29T	33	34	52	109	938	
	1988.09-1995.11	AT/MT	L/R	F	Hatchback Engine 20 SEH	844057	Outer Joint	43T	33	25	52	109	61	O
	1988.09-1995.11	MT	L/R	F	Hatchback Engine 20 SEH	644002	Inner Joint		34	25	35	56.2	85.6	
2.0/GT 16V (110 kW)	1989.01-1994.06	-	L	F	Saloon Engine 20 XEJ	244014	Drive Shaft	43T	33	34	52	103.5	587	
	1989.01-1994.06	-	R	F	Saloon Engine 20 XEJ	244048	Drive Shaft		33	34	52	109	938	
	1989.01-1994.06	MT	L	F	Saloon Engine 20 XEJ	244011	Drive Shaft	29T	33	34	52	109	594.5	
	1989.01-1994.06	MT	L/R	F	Saloon Engine 20 XEJ	844056	Outer Joint	29T	33	25	52	109	61	O
	1989.01-1994.06	MT	L/R	F	Saloon Engine 20 XEJ	844057	Outer Joint	43T	33	25	52	109	61	O
	1989.01-1994.06	MT	L	F	Saloon Engine 20 XEJ	644002	Inner Joint		34	25	35	56.2	85.6	
2.0/GT 16V Cat (110 kW)	1990.02-1995.11	-	R	F	Saloon Engine C 20 XE	244048	Drive Shaft		33	34	52	109	938	
	1990.02-1995.11	-	R	F	All-wheel Drive Saloon Engine C 20 XE	244048	Drive Shaft		33	34	52	109	938	
	1990.02-1995.11	AT/MT	L/R	F	Saloon Engine C 20 XE	621011	Inner Joint		34	25	35	78	64	
	1990.02-1995.11	MT	L	F	Saloon Engine C 20 XE	244011	Drive Shaft	29T	33	34	52	109	594.5	
	1990.02-1995.11	MT	L/R	F	Saloon Engine C 20 XE	844056	Outer Joint	29T	33	25	52	109	61	O
	1990.02-1995.11	MT	L/R	F	All-wheel Drive Saloon Engine C 20 XE	844056	Outer Joint	29T	33	25	52	109	61	O
	1990.02-1995.11	MT	L/R	F	Saloon Engine C 20 XE	844057	Outer Joint	43T	33	25	52	109	61	O
	1990.02-1995.11	MT	L/R	F	All-wheel Drive Saloon Engine C 20 XE	844057	Outer Joint	43T	33	25	52	109	61	O
	1990.02-1995.11	MT	L	F	Saloon Engine C 20 XE	644002	Inner Joint		34	25	35	56.2	85.6	
	1990.02-1995.11	MT	L	F	All-wheel Drive Saloon Engine C 20 XE	644002	Inner Joint		34	25	35	56.2	85.6	
2.5 V6 (125 kW)	1993.02-1995.11	MT	L	F	Hatchback Engine C 25 XE	644002	Inner Joint		34	25	35	56.2	85.6	
	1993.02-1995.11	MT	L	F	Saloon Engine C 25 XE	644002	Inner Joint		34	25	35	56.2	85.6	
VECTRA B (36), SW														
1.6 i (55 kW)	1995.10-2002.04	-	-	-	ChW1285446	844060	Outer Joint	29T	22	22	52	98	51	O
1.6 i 16V (74 kW)	1995.10-2002.04	-	-	-	ChW1285446	844060	Outer Joint	29T	22	22	52	98	51	O
VECTRA B (J96)														
1.6 i (55 kW)	1995.10-2003.07	-	L/R	F	Hatchback Engine X 16 SZR	844007	Outer Joint	29T	22	22	52	94.5	50	O
	1995.10-2002.04	-	L/R	F	Saloon Engine X 16 SZR	844007	Outer Joint	29T	22	22	52	94.5	50	O
	1995.10-2003.07	5MT	R	F	Hatchback Engine 16 LZ2	244039	Drive Shaft	29T	33	34	52	103.5	959	
	1995.10-2002.04	5MT	R	F	Saloon Engine 16 LZ2	244039	Drive Shaft	29T	33	34	52	103.5	959	
	1995.10-2003.07	-	L/R	F	Hatchback Engine 16 LZ2	844007	Outer Joint	29T	22	22	52	94.5	50	O
	1995.10-2002.04	-	L/R	F	Saloon Engine 16 LZ2	844007	Outer Joint	29T	22	22	52	94.5	50	O
	1995.10-2003.07	-	L	F	Hatchback Engine X 16 SZR	244076	Drive Shaft	29T	22	22	52	95	592	
	1995.10-2002.04	-	L	F	Saloon Engine X 16 SZR	244076	Drive Shaft	29T	22	22	52	95	592	
	1995.10-2003.07	-	L	F	Hatchback Engine 16 LZ2	244076	Drive Shaft	29T	22	22	52	95	592	
	1995.10-2002.04	-	L	F	Saloon Engine 16 LZ2	244076	Drive Shaft	29T	22	22	52	95	592	
	1995.10-2003.07	-	R	F	Hatchback Engine X 16 SZR	244077	Drive Shaft	29T	22	22	52	95	955	
	1995.10-2002.04	-	R	F	Saloon Engine X 16 SZR	244077	Drive Shaft	29T	22	22	52	95	955	
	1995.10-2003.07	-	L/R	F	Hatchback Engine X 16 SZR	844011	Outer Joint	29T	33	22	52	103	50.5	O
	1995.10-2003.07	-	R	F	Hatchback Engine 16 LZ2	244077	Drive Shaft	29T	22	22	52	95	955	
	1995.10-2002.04	-	R	F	Saloon Engine 16 LZ2	244077	Drive Shaft	29T	22	22	52	95	955	
	1995.10-2002.04	-	L/R	F	Saloon Engine X 16 SZR	844011	Outer Joint	29T	33	22	52	103	50.5	O
	1995.10-2003.07	-	L/R	F	Hatchback Engine 16 LZ2	844011	Outer Joint	29T	33	22	52	103	50.5	O





	 YEAR	TRANSM	L/R	F/R	REMARKS	GSP Ref.	 PRODUCT	 ABS	Technical Specifications						
									A	B	C	H	L	P	
OPEL															
VECTRA B (J96)															
1.6 i (55 kW)															
1995.10-2002.04	-	L/R	F	Saloon Engine 16 LZ2	844011	Outer Joint	29T	33	22	52	103	50.5	O		
1995.10-2003.07	-	-	F	Hatchback Engine X 16 SZR	844010	Outer Joint	29T	33	22	52	103	50.5	O		
1995.10-2002.04	-	-	F	Saloon Engine X 16 SZR	844010	Outer Joint	29T	33	22	52	103	50.5	O		
1995.10-2003.07	-	-	F	Hatchback Engine 16 LZ2	844010	Outer Joint	29T	33	22	52	103	50.5	O		
1995.10-2002.04	-	-	F	Saloon Engine 16 LZ2	844010	Outer Joint	29T	33	22	52	103	50.5	O		
1995.10-2003.07	-	L	F	Hatchback Engine X 16 SZR	621014	Inner Joint		22	22	35	57.5	75			
1995.10-2002.04	-	L	F	Saloon Engine X 16 SZR	621014	Inner Joint		22	22	35	57.5	75			
1995.10-2003.07	-	L	F	Hatchback Engine 16 LZ2	621014	Inner Joint		22	22	35	57.5	75			
1995.10-2002.04	-	L	F	Saloon Engine 16 LZ2	621014	Inner Joint		22	22	35	57.5	75			
1995.10-2003.07	-	L/R	F	Hatchback Engine X 16 SZR	644004	Inner Joint		22	22	34.95	57.5	72.5			
1995.10-2002.04	-	L/R	F	Saloon Engine X 16 SZR	644004	Inner Joint		22	22	34.95	57.5	72.5			
1995.10-2003.07	-	L/R	F	Hatchback Engine 16 LZ2	644004	Inner Joint		22	22	34.95	57.5	72.5			
1995.10-2002.04	-	L/R	F	Saloon Engine 16 LZ2	644004	Inner Joint		22	22	34.95	57.5	72.5			
1995.10-2003.07	5MT	L	F	Hatchback Engine X 16 SZR	244038	Drive Shaft	29T	33	34	52	103.5	595			
1995.10-2002.04	5MT	L	F	Saloon Engine X 16 SZR	244038	Drive Shaft	29T	33	34	52	103.5	595			
1995.10-2003.07	-	L/R	F	Hatchback Engine X 16 SZR	644002	Inner Joint		34	25	35	56.2	85.6			
1995.10-2002.04	-	L/R	F	Saloon Engine X 16 SZR	644002	Inner Joint		34	25	35	56.2	85.6			
1995.10-2003.07	-	L/R	F	Hatchback Engine 16 LZ2	644002	Inner Joint		34	25	35	56.2	85.6			
1995.10-2002.04	-	L/R	F	Saloon Engine 16 LZ2	644002	Inner Joint		34	25	35	56.2	85.6			
1995.10-2003.07	5MT	L	F	Hatchback Engine 16 LZ2	244038	Drive Shaft	29T	33	34	52	103.5	595			
1995.10-2002.04	5MT	L	F	Saloon Engine 16 LZ2	244038	Drive Shaft	29T	33	34	52	103.5	595			
1995.10-2003.07	5MT	R	F	Hatchback Engine X 16 SZR	244039	Drive Shaft	29T	33	34	52	103.5	959			
1995.10-2002.04	5MT	R	F	Saloon Engine X 16 SZR	244039	Drive Shaft	29T	33	34	52	103.5	959			
1996.11-2000.06	5MT	R	F	Estate Engine X 16 SZR	244039	Drive Shaft	29T	33	34	52	103.5	959			
1996.11-2000.06	AT/MT	L/R	F	Estate Engine X 16 SZR	844007	Outer Joint	29T	22	22	52	94.5	50	O		
1996.11-2000.06	-	L	F	Estate Engine X 16 SZR	244076	Drive Shaft	29T	22	22	52	95	592			
1996.11-2000.06	-	R	F	Estate Engine X 16 SZR	244077	Drive Shaft	29T	22	22	52	95	955			
1996.11-2000.06	AT/MT	L/R	F	Estate Engine X 16 SZR	844011	Outer Joint	29T	33	22	52	103	50.5	O		
1996.11-2000.06	-	-	F	Estate Engine X 16 SZR	844010	Outer Joint	29T	33	22	52	103	50.5	O		
1996.11-2000.06	-	L	F	Estate Engine X 16 SZR	621014	Inner Joint		22	22	35	57.5	75			
1996.11-2000.06	-	L/R	F	Estate Engine X 16 SZR	644004	Inner Joint		22	22	34.95	57.5	72.5			
1996.11-2000.06	5MT	L	F	Estate Engine X 16 SZR	244038	Drive Shaft	29T	33	34	52	103.5	595			
1996.11-2000.06	-	L/R	F	Estate Engine X 16 SZR	644002	Inner Joint		34	25	35	56.2	85.6			
1.6 i 16V (74 kW)															
1995.10-2002.07	AT/MT	L/R	F	Hatchback Engine Y 16 XE/Z 16 XE/X 16 XEL	844007	Outer Joint	29T	22	22	52	94.5	50	O		
1995.10-2002.04	AT/MT	L/R	F	Saloon Engine X 16 XEL/Y 16 XE/Z 16 XE	844007	Outer Joint	29T	22	22	52	94.5	50	O		
1995.10-2002.07	-	L/R	F	Hatchback Engine Y 16 XE/Z 16 XE/X 16 XEL	644004	Inner Joint		22	22	34.95	57.5	72.5			
1995.10-2002.04	-	L/R	F	Saloon Engine X 16 XEL/Y 16 XE/Z 16 XE	644004	Inner Joint		22	22	34.95	57.5	72.5			
1995.10-2002.07	-	L	F	Hatchback Engine Y 16 XE/Z 16 XE/X 16 XEL	244076	Drive Shaft	29T	22	22	52	95	592			
1995.10-2002.04	-	L	F	Saloon Engine X 16 XEL/Y 16 XE/Z 16 XE	244076	Drive Shaft	29T	22	22	52	95	592			
1995.10-2002.07	-	R	F	Hatchback Engine Y 16 XE/Z 16 XE/X 16 XEL	244077	Drive Shaft	29T	22	22	52	95	955			
1995.10-2002.04	-	R	F	Saloon Engine X 16 XEL/Y 16 XE/Z 16 XE	244077	Drive Shaft	29T	22	22	52	95	955			
1995.10-2002.07	AT/MT	L/R	F	Hatchback Engine Y 16 XE/Z 16 XE/X 16 XEL	844011	Outer Joint	29T	33	22	52	103	50.5	O		
1995.10-2002.04	AT/MT	L/R	F	Saloon Engine X 16 XEL/Y 16 XE/Z 16 XE	844011	Outer Joint	29T	33	22	52	103	50.5	O		
1995.10-2002.07	-	-	F	Hatchback Engine Y 16 XE/Z 16 XE/X 16 XEL	844010	Outer Joint	29T	33	22	52	103	50.5	O		
1995.10-2002.04	-	-	F	Saloon Engine X 16 XEL/Y 16 XE/Z 16 XE	844010	Outer Joint	29T	33	22	52	103	50.5	O		
1995.10-2002.07	AT/MT	R	F	Hatchback Engine Y 16 XE/Z 16 XE/X 16 XEL	250209	Drive Shaft		27	39	56.5	92	1014			
1995.10-2002.04	AT/MT	R	F	Saloon Engine X 16 XEL/Y 16 XE/Z 16 XE	250209	Drive Shaft		27	39	56.5	92	1014			
1995.10-2002.07	-	L	F	Hatchback Engine Y 16 XE/Z 16 XE/X 16 XEL	621014	Inner Joint		22	22	35	57.5	75			
1995.10-2002.07	AT/MT	R	F	Hatchback Engine Y 16 XE/Z 16 XE/X 16 XEL	250209	Drive Shaft		27	39	56.5	92	1014			
1995.10-2002.04	AT/MT	R	F	Saloon Engine X 16 XEL/Y 16 XE/Z 16 XE	250209	Drive Shaft		27	39	56.5	92	1014			
1995.10-2002.04	-	L	F	Saloon Engine X 16 XEL/Y 16 XE/Z 16 XE	621014	Inner Joint		22	22	35	57.5	75			
1995.10-2002.07	AT/MT	R	F	Hatchback Engine Y 16 XE/Z 16 XE/X 16 XEL	250209	Drive Shaft		27	39	56.5	92	1014			
1995.10-2002.04	AT/MT	R	F	Saloon Engine X 16 XEL/Y 16 XE/Z 16 XE	250209	Drive Shaft		27	39	56.5	92	1014			
1995.10-2002.04	AT/MT	R	F	Saloon Engine X 16 XEL/Y 16 XE/Z 16 XE	260019	Drive Shaft		22	22	52	95	926			
1995.10-2002.07	AT/MT	R	F	Hatchback Engine Y 16 XE/Z 16 XE/X 16 XEL	260019	Drive Shaft		22	22	52	95	926			
1995.10-2002.07	AT/MT	R	F	Hatchback Engine Y 16 XE/Z 16 XE/X 16 XEL	650097	Inner Joint		39	35	30	409	90			
1995.10-2002.04	AT/MT	R	F	Saloon Engine X 16 XEL/Y 16 XE/Z 16 XE	650097	Inner Joint		39	35	30	409	90			
1996.11-2002.07	AT/MT	R	F	Estate Engine Z 16 XE/Y 16 XE/X 16 XEL	650097	Inner Joint		39	35	30	409	90			
1996.11-2002.07	-	L/R	F	Estate Engine Z 16 XE/Y 16 XE/X 16 XEL	844007	Outer Joint	29T	22	22	52	94.5	50	O		
1996.11-2002.07	-	L/R	F	Estate Engine Z 16 XE/Y 16 XE/X 16 XEL	644004	Inner Joint		22	22	34.95	57.5	72.5			
1996.11-2002.07	-	L	F	Estate Engine Z 16 XE/Y 16 XE/X 16 XEL	244076	Drive Shaft	29T	22	22	52	95	592			
1996.11-2002.07	-	R	F	Estate Engine Z 16 XE/Y 16 XE/X 16 XEL	244077	Drive Shaft	29T	22	22	52	95	955			
1996.11-2002.07	-	L/R	F	Estate Engine Z 16 XE/Y 16 XE/X 16 XEL	844011	Outer Joint	29T	33	22	52	103	50.5	O		
1996.11-2002.07	-	-	F	Estate Engine Z 16 XE/Y 16 XE/X 16 XEL	844010	Outer Joint	29T	33	22	52	103	50.5	O		
1996.11-2002.07	AT/MT	R	F	Estate Engine Z 16 XE/Y 16 XE/X 16 XEL	250209	Drive Shaft		27	39	56.5	92	1014			
1996.11-2002.07	-	L	F	Estate Engine Z 16 XE/Y 16 XE/X 16 XEL	621014	Inner Joint		22	22	35	57.5	75			

	 YEAR	TRANSM	L/R	F/R	REMARKS	GSP Ref.	 PRODUCT	 ABS	Technical Specifications						
									A	B	C	H	L	P	
OPEL															
VECTRA B (J96)															
1.6 i 16V (74 kW)	1996.11-2002.07	AT/MT	R	F	Estate Engine Z 16 XE/Y 16 XE/X 16 XEL	250209	Drive Shaft		27	39	56.5	92	1014		
	1996.11-2002.07	AT/MT	R	F	Estate Engine Z 16 XE/Y 16 XE/X 16 XEL	250209	Drive Shaft		27	39	56.5	92	1014		
	1996.11-2002.07	AT/MT	R	F	Estate Engine Z 16 XE/Y 16 XE/X 16 XEL	260019	Drive Shaft		22	22	52	95	926		
1.7 TD (60 kW)	1995.10-1998.12	MT	L/R	F	Hatchback Engine X 17 DT (TC4EE1)	621011	Inner Joint		34	25	35	78	64		
	1995.10-1998.12	MT	L/R	F	Saloon Engine X 17 DT (TC4EE1)	621011	Inner Joint		34	25	35	78	64		
	1995.10-1998.12	-	L/R	F	Hatchback Engine X 17 DT (TC4EE1)	644002	Inner Joint		34	25	35	56.2	85.6		
	1995.10-1998.12	-	L/R	F	Saloon Engine X 17 DT (TC4EE1)	644002	Inner Joint		34	25	35	56.2	85.6		
	1995.10-1998.12	AT/MT	L/R	F	Hatchback Engine X 17 DT (TC4EE1)	844006	Outer Joint	29T	33	25	52	103.5	61	O	
	1995.10-1998.12	AT/MT	L/R	F	Saloon Engine X 17 DT (TC4EE1)	844006	Outer Joint	29T	33	25	52	103.5	61	O	
	1995.10-1998.12	5MT	L	F	Hatchback Engine X 17 DT (TC4EE1)	244038	Drive Shaft	29T	33	34	52	103.5	595		
	1995.10-1998.12	5MT	L	F	Saloon Engine X 17 DT (TC4EE1)	244038	Drive Shaft	29T	33	34	52	103.5	595		
	1995.10-1998.12	5MT	R	F	Hatchback Engine X 17 DT (TC4EE1)	244039	Drive Shaft	29T	33	34	52	103.5	959		
	1995.10-1998.12	5MT	R	F	Saloon Engine X 17 DT (TC4EE1)	244039	Drive Shaft	29T	33	34	52	103.5	959		
	1996.11-1997.12	-	R	F	Estate Engine X 17 DT (TC4EE1)	244039	Drive Shaft	29T	33	34	52	103.5	959		
	1996.11-1997.12	MT	L/R	F	Estate Engine X 17 DT (TC4EE1)	621011	Inner Joint		34	25	35	78	64		
	1996.11-1997.12	-	L/R	F	Estate Engine X 17 DT (TC4EE1)	644002	Inner Joint		34	25	35	56.2	85.6		
	1996.11-1997.12	-	L/R	F	Estate Engine X 17 DT (TC4EE1)	844006	Outer Joint	29T	33	25	52	103.5	61	O	
1.8 i 16V (85 kW)	1995.10-2000.09	-	R	F	Hatchback Engine X 18 XE	244039	Drive Shaft	29T	33	34	52	103.5	959		
	1995.10-2000.09	-	R	F	Saloon Engine X 18 XE	244039	Drive Shaft	29T	33	34	52	103.5	959		
	1995.10-2000.09	MT	L/R	F	Hatchback Engine X 18 XE1/Z 18 XE1	621011	Inner Joint		34	25	35	78	64		
	1995.10-2000.09	-	L/R	F	Hatchback Engine X 18 XE1/Z 18 XE1	644002	Inner Joint		34	25	35	56.2	85.6		
	1995.10-2000.09	MT	L/R	F	Saloon Engine Z 18 XEL/X 18 XE1	621011	Inner Joint		34	25	35	78	64		
	1995.10-2000.09	-	L/R	F	Saloon Engine Z 18 XEL/X 18 XE1	644002	Inner Joint		34	25	35	56.2	85.6		
	1995.10-2000.09	AT/MT	L/R	F	Hatchback Engine X 18 XE1/Z 18 XE1	844006	Outer Joint	29T	33	25	52	103.5	61	O	
	1995.10-2000.09	AT/MT	L/R	F	Saloon Engine Z 18 XEL/X 18 XE1	844006	Outer Joint	29T	33	25	52	103.5	61	O	
	1995.10-2000.09	-	L/R	F	Hatchback Engine X 18 XE	644002	Inner Joint		34	25	35	56.2	85.6		
	1995.10-2000.09	-	L/R	F	Saloon Engine X 18 XE	644002	Inner Joint		34	25	35	56.2	85.6		
	1995.10-2000.09	-	L/R	F	Hatchback Engine X 18 XE	844006	Outer Joint	29T	33	25	52	103.5	61	O	
	1995.10-2000.09	-	L/R	F	Saloon Engine X 18 XE	844006	Outer Joint	29T	33	25	52	103.5	61	O	
	1995.10-2000.09	4AT/5MT	L	F	Saloon Engine Z 18 XEL/X 18 XE1	244038	Drive Shaft	29T	33	34	52	103.5	595		
	1995.10-2000.09	-	L	F	Hatchback Engine X 18 XE	244038	Drive Shaft	29T	33	34	52	103.5	595		
	1995.10-2000.09	-	L	F	Saloon Engine X 18 XE	244038	Drive Shaft	29T	33	34	52	103.5	595		
	1995.10-2000.09	4AT/5MT	R	F	Saloon Engine Z 18 XEL/X 18 XE1	244039	Drive Shaft	29T	33	34	52	103.5	959		
	1996.11-2000.09	-	R	F	Estate Engine X 18 XE	244039	Drive Shaft	29T	33	34	52	103.5	959		
	1996.11-2000.09	MT	L/R	F	Estate Engine X 18 XE1/Z 18 XEL	621011	Inner Joint		34	25	35	78	64		
	1996.11-2000.09	-	L/R	F	Estate Engine X 18 XE1/Z 18 XEL	644002	Inner Joint		34	25	35	56.2	85.6		
	1996.11-2000.09	-	L/R	F	Estate Engine X 18 XE	644002	Inner Joint		34	25	35	56.2	85.6		
	1996.11-2000.09	AT/MT	L/R	F	Estate Engine X 18 XE1/Z 18 XEL	844006	Outer Joint	29T	33	25	52	103.5	61	O	
	1996.11-2000.09	-	L/R	F	Estate Engine X 18 XE	844006	Outer Joint	29T	33	25	52	103.5	61	O	
	1996.11-2000.09	4AT/5MT	L	F	Estate Engine X 18 XE1/Z 18 XEL	244038	Drive Shaft	29T	33	34	52	103.5	595		
	1996.11-2000.09	-	L	F	Estate Engine X 18 XE	244038	Drive Shaft	29T	33	34	52	103.5	595		
	1996.11-2000.09	4AT/5MT	R	F	Estate Engine X 18 XE1/Z 18 XEL	244039	Drive Shaft	29T	33	34	52	103.5	959		
	1.8 i 16V (92 kW)	2000.09-2003.07	MT	L/R	F	Hatchback Engine Z 18 XE	621011	Inner Joint		34	25	35	78	64	
		2000.09-2002.04	MT	L/R	F	Saloon Engine Z 18 XE	621011	Inner Joint		34	25	35	78	64	
		2000.09-2003.07	MT	L/R	F	Estate Engine Z 18 XE	621011	Inner Joint		34	25	35	78	64	
2000.09-2003.07		-	L/R	F	Hatchback Engine Z 18 XE	644002	Inner Joint		34	25	35	56.2	85.6		
2000.09-2002.04		-	L/R	F	Saloon Engine Z 18 XE	644002	Inner Joint		34	25	35	56.2	85.6		
2000.09-2003.07		-	L/R	F	Estate Engine Z 18 XE	644002	Inner Joint		34	25	35	56.2	85.6		
2000.09-2003.07		AT/MT	L/R	F	Hatchback Engine Z 18 XE	844006	Outer Joint	29T	33	25	52	103.5	61	O	
2000.09-2002.04		AT/MT	L/R	F	Saloon Engine Z 18 XE	844006	Outer Joint	29T	33	25	52	103.5	61	O	
2000.09-2003.07		AT/MT	L/R	F	Estate Engine Z 18 XE	844006	Outer Joint	29T	33	25	52	103.5	61	O	
2.0 DI 16V (60 kW)		1996.11-2002.04	5MT	R	F	Saloon Engine X 20 DTL	244039	Drive Shaft	29T	33	34	52	103.5	959	
	1996.11-2000.06	5MT	R	F	Hatchback Engine X 20 DTL	244039	Drive Shaft	29T	33	34	52	103.5	959		
	1996.11-2000.06	5MT	R	F	Estate Engine X 20 DTL/Y 20 DTL	244039	Drive Shaft	29T	33	34	52	103.5	959		
	1996.11-2002.04	MT	L/R	F	Saloon Engine X 20 DTL	621011	Inner Joint		34	25	35	78	64		
	1996.11-2000.06	MT	L/R	F	Hatchback Engine X 20 DTL	621011	Inner Joint		34	25	35	78	64		
	1996.11-2002.04	-	L/R	F	Saloon Engine X 20 DTL	644002	Inner Joint		34	25	35	56.2	85.6		
	1996.11-2000.06	-	L/R	F	Hatchback Engine X 20 DTL	644002	Inner Joint		34	25	35	56.2	85.6		
	1996.11-2000.06	MT	L/R	F	Estate Engine X 20 DTL/Y 20 DTL	621011	Inner Joint		34	25	35	78	64		
	1996.11-2000.06	-	L/R	F	Estate Engine X 20 DTL/Y 20 DTL	644002	Inner Joint		34	25	35	56.2	85.6		
	1996.11-2002.04	AT/MT	L/R	F	Saloon Engine X 20 DTL	844006	Outer Joint	29T	33	25	52	103.5	61	O	
	1996.11-2000.06	AT/MT	L/R	F	Hatchback Engine X 20 DTL	844006	Outer Joint	29T	33	25	52	103.5	61	O	
	1996.11-2000.06	AT/MT	L/R	F	Estate Engine X 20 DTL/Y 20 DTL	844006	Outer Joint	29T	33	25	52	103.5	61	O	
	1996.11-2002.04	5MT	L	F	Saloon Engine X 20 DTL	244038	Drive Shaft	29T	33	34	52	103.5	595		
	1996.11-2000.06	5MT	L	F	Hatchback Engine X 20 DTL	244038	Drive Shaft	29T	33	34	52	103.5	595		





	 YEAR	TRANSM	L/R	F/R	REMARKS	GSP Ref.	 PRODUCT	 ABS	Technical Specifications						
									A	B	C	H	L	P	
OPEL															
VECTRA B (J96)															
2.0 DI 16V (60 kW)	1996.11-2000.06	5MT	L	F	Estate Engine X 20 DTL/Y 20 DTL	244038	Drive Shaft	29T	33	34	52	103.5	595		
2.0 DTI 16V (74 kW)	1997.06-2002.04	5MT	R	F	Saloon Engine X 20 DTH/Y 20 DTH	244039	Drive Shaft	29T	33	34	52	103.5	959		
	1997.06-2003.07	5MT	R	F	Hatchback Engine X 20 DTH/V 20 DTH	244039	Drive Shaft	29T	33	34	52	103.5	959		
	1997.06-2003.07	5MT	R	F	Estate Engine X 20 DTH/Y 20 DTH	244039	Drive Shaft	29T	33	34	52	103.5	959		
	1997.06-2002.04	MT	L/R	F	Saloon Engine X 20 DTH/Y 20 DTH	621011	Inner Joint		34	25	35	78	64		
	1997.06-2003.07	MT	L/R	F	Hatchback Engine X 20 DTH/V 20 DTH	621011	Inner Joint		34	25	35	78	64		
	1997.06-2003.07	MT	L/R	F	Estate Engine X 20 DTH/Y 20 DTH	621011	Inner Joint		34	25	35	78	64		
	1997.06-2002.04	-	L/R	F	Saloon Engine X 20 DTH/Y 20 DTH	644002	Inner Joint		34	25	35	56.2	85.6		
	1997.06-2003.07	-	L/R	F	Hatchback Engine X 20 DTH/V 20 DTH	644002	Inner Joint		34	25	35	56.2	85.6		
	1997.06-2003.07	-	L/R	F	Estate Engine X 20 DTH/Y 20 DTH	644002	Inner Joint		34	25	35	56.2	85.6		
	1997.06-2002.04	AT/MT	L/R	F	Saloon Engine X 20 DTH/Y 20 DTH	844006	Outer Joint	29T	33	25	52	103.5	61	O	
	1997.06-2003.07	AT/MT	L/R	F	Hatchback Engine X 20 DTH/V 20 DTH	844006	Outer Joint	29T	33	25	52	103.5	61	O	
	1997.06-2003.07	AT/MT	L/R	F	Estate Engine X 20 DTH/Y 20 DTH	844006	Outer Joint	29T	33	25	52	103.5	61	O	
	1997.06-2002.04	5MT	L	F	Saloon Engine X 20 DTH/Y 20 DTH	244038	Drive Shaft	29T	33	34	52	103.5	595		
1997.06-2003.07	5MT	L	F	Hatchback Engine X 20 DTH/V 20 DTH	244038	Drive Shaft	29T	33	34	52	103.5	595			
1997.06-2003.07	5MT	L	F	Estate Engine X 20 DTH/Y 20 DTH	244038	Drive Shaft	29T	33	34	52	103.5	595			
2.0 i 16V (100 kW)	1995.10-2000.09	MT	L/R	F	Hatchback Engine X 20 XEV/C 20 SEL	621011	Inner Joint		34	25	35	78	64		
	1995.10-2000.09	-	L/R	F	Hatchback Engine X 20 XEV/C 20 SEL	644002	Inner Joint		34	25	35	56.2	85.6		
	1995.10-2000.09	MT	L/R	F	Saloon Engine X 20 XEV/C 20 SEL	621011	Inner Joint		34	25	35	78	64		
	1995.10-2000.09	-	L/R	F	Saloon Engine X 20 XEV/C 20 SEL	644002	Inner Joint		34	25	35	56.2	85.6		
	1995.10-2000.09	AT/MT	L/R	F	Hatchback Engine X 20 XEV/C 20 SEL	844006	Outer Joint	29T	33	25	52	103.5	61	O	
	1995.10-2000.09	AT/MT	L/R	F	Saloon Engine X 20 XEV/C 20 SEL	844006	Outer Joint	29T	33	25	52	103.5	61	O	
	1995.10-2000.09	4AT/5MT	L	F	Hatchback Engine X 20 XEV/C 20 SEL	244038	Drive Shaft	29T	33	34	52	103.5	595		
	1995.10-2000.09	4AT/5MT	L	F	Saloon Engine X 20 XEV/C 20 SEL	244038	Drive Shaft	29T	33	34	52	103.5	595		
	1995.10-2000.09	4AT/5MT	R	F	Hatchback Engine X 20 XEV/C 20 SEL	244039	Drive Shaft	29T	33	34	52	103.5	959		
	1995.10-2000.09	4AT/5MT	R	F	Saloon Engine X 20 XEV/C 20 SEL	244039	Drive Shaft	29T	33	34	52	103.5	959		
	1996.11-2000.09	AT/MT	L/R	F	Estate Engine X 20 XEV/C 20 SEL	844006	Outer Joint	29T	33	25	52	103.5	61	O	
	1996.11-2000.09	MT	L/R	F	Estate Engine X 20 XEV/C 20 SEL	621011	Inner Joint		34	25	35	78	64		
	1996.11-2000.09	-	L/R	F	Estate Engine X 20 XEV/C 20 SEL	644002	Inner Joint		34	25	35	56.2	85.6		
1996.11-2000.09	4AT/5MT	L	F	Estate Engine X 20 XEV/C 20 SEL	244038	Drive Shaft	29T	33	34	52	103.5	595			
1996.11-2000.09	4AT/5MT	R	F	Estate Engine X 20 XEV/C 20 SEL	244039	Drive Shaft	29T	33	34	52	103.5	959			
2.2 DTI 16V (88 kW)	2000.09-2002.04	-	-	F	Saloon Engine Y 22 DTR	844065	Outer Joint	29T	33	35	55	104	67.5	I	
	2000.09-2002.04	-	-	F	Estate Engine Y 22 DTR	844065	Outer Joint	29T	33	35	55	104	67.5	I	
	2000.09-2002.04	-	-	F	Hatchback Engine Y 22 DTR	844065	Outer Joint	29T	33	35	55	104	67.5	I	
2.2 DTI 16V (92 kW)	2000.09-2003.07	MT	L	F	Hatchback Engine Y 22 DTR	244058	Drive Shaft	29T	33	27	55	104	586		
	2000.09-2002.04	MT	L	F	Saloon Engine Y 22 DTR	244058	Drive Shaft	29T	33	27	55	104	586		
	2000.09-2003.07	-	-	F	Hatchback Engine Y 22 DTR	844065	Outer Joint	29T	33	35	55	104	67.5	I	
	2000.09-2003.07	MT	L	F	Estate Engine Y 22 DTR	244058	Drive Shaft	29T	33	27	55	104	586		
	2000.09-2002.04	-	-	F	Saloon Engine Y 22 DTR	844065	Outer Joint	29T	33	35	55	104	67.5	I	
	2000.09-2003.07	-	-	F	Estate Engine Y 22 DTR	844065	Outer Joint	29T	33	35	55	104	67.5	I	
2.2 i 16V (108 kW)	2000.09-2003.07	4AT/5MT	R	F	Hatchback Engine Z 22 SE	244039	Drive Shaft	29T	33	34	52	103.5	959		
	2000.09-2002.04	4AT/5MT	R	F	Saloon Engine Z 22 SE	244039	Drive Shaft	29T	33	34	52	103.5	959		
	2000.09-2003.07	4AT/5MT	R	F	Estate Engine Z 22 SE	244039	Drive Shaft	29T	33	34	52	103.5	959		
	2000.09-2003.07	-	L/R	F	Hatchback Engine Z 22 SE	644002	Inner Joint		34	25	35	56.2	85.6		
	2000.09-2002.04	-	L/R	F	Saloon Engine Z 22 SE	644002	Inner Joint		34	25	35	56.2	85.6		
	2000.09-2003.07	-	L/R	F	Estate Engine Z 22 SE	644002	Inner Joint		34	25	35	56.2	85.6		
	2000.09-2003.07	-	L/R	F	Hatchback Engine Z 22 SE	844006	Outer Joint	29T	33	25	52	103.5	61	O	
	2000.09-2002.04	-	L/R	F	Saloon Engine Z 22 SE	844006	Outer Joint	29T	33	25	52	103.5	61	O	
	2000.09-2003.07	-	L/R	F	Estate Engine Z 22 SE	844006	Outer Joint	29T	33	25	52	103.5	61	O	
	2000.09-2003.07	4AT/5MT	L	F	Hatchback Engine Z 22 SE	244038	Drive Shaft	29T	33	34	52	103.5	595		
	2000.09-2002.04	4AT/5MT	L	F	Saloon Engine Z 22 SE	244038	Drive Shaft	29T	33	34	52	103.5	595		
2000.09-2003.07	4AT/5MT	L	F	Estate Engine Z 22 SE	244038	Drive Shaft	29T	33	34	52	103.5	595			
2.5 (144 kW)	1999.10-2000.06	-	R	F	Hatchback Engine X 25 XE	644005	Inner Joint		34	25	35	54	47		
	1999.10-2000.06	-	L/R	F	Hatchback Engine X 25 XE	644002	Inner Joint		34	25	35	56.2	85.6		
	1999.10-2000.06	-	L/R	F	Hatchback Engine X 25 XE	844006	Outer Joint	29T	33	25	52	103.5	61	O	
	1999.10-2000.06	-	L	F	Hatchback Engine X 25 XE	244038	Drive Shaft	29T	33	34	52	103.5	595		
2.5 i V6 (125 kW)	1995.10-2000.09	-	L	F	Hatchback Engine X 25 XE	644002	Inner Joint		34	25	35	56.2	85.6		
	1995.10-2000.09	AT/MT	L/R	F	Saloon Engine X 25 XE	844006	Outer Joint	29T	33	25	52	103.5	61	O	
	1995.10-2000.09	-	R	F	Hatchback Engine X 25 XE	644005	Inner Joint		34	25	35	54	47		
	1995.10-2000.09	-	R	F	Saloon Engine X 25 XE	644005	Inner Joint		34	25	35	54	47		
	1995.10-2000.09	AT/MT	L/R	F	Hatchback Engine X 25 XE	844006	Outer Joint	29T	33	25	52	103.5	61	O	
	1995.10-2000.09	-	L	F	Saloon Engine X 25 XE	644002	Inner Joint		34	25	35	56.2	85.6		
	1995.10-2000.09	4AT/5MT	L	F	Saloon Engine X 25 XE	244038	Drive Shaft	29T	33	34	52	103.5	595		
	1995.10-2000.09	4AT/5MT	L	F	Hatchback Engine X 25 XE	244038	Drive Shaft	29T	33	34	52	103.5	595		
	1995.10-2000.09	4AT/5MT	R	F	Saloon Engine X 25 XE	244039	Drive Shaft	29T	33	34	52	103.5	959		
	1996.11-2000.09	4AT/5MT	R	F	Estate Engine X 25 XE	244039	Drive Shaft	29T	33	34	52	103.5	959		

	 YEAR	TRANSM	L/R	F/R	REMARKS	GSP Ref.	 PRODUCT	 ABS	Technical Specifications						
									A	B	C	H	L	P	
OPEL															
VECTRA B (J96)															
2.5 i V6 (125 kW)	1996.11-2000.09	-	L	F	Estate Engine X 25 XE	644002	Inner Joint		34	25	35	56.2	85.6		
	1996.11-2000.09	-	R	F	Estate Engine X 25 XE	644005	Inner Joint		34	25	35	54	47		
	1996.11-2000.09	AT/MT	L/R	F	Estate Engine X 25 XE	844006	Outer Joint	29T	33	25	52	103.5	61	O	
	1996.11-2000.09	4AT/5MT	L	F	Estate Engine X 25 XE	244038	Drive Shaft	29T	33	34	52	103.5	595		
2.6 i V6 (125 kW)	2000.09-2003.07	-	-	F	Hatchback Engine Y 26 SE	844065	Outer Joint	29T	33	35	55	104	67.5	I	
	2000.09-2002.04	-	-	F	Saloon Engine Y 26 SE	844065	Outer Joint	29T	33	35	55	104	67.5	I	
	2000.09-2003.07	-	-	F	Estate Engine Y 26 SE	844065	Outer Joint	29T	33	35	55	104	67.5	I	
	2000.09-2003.07	-	R	F	Hatchback Engine Y 26 SE	644005	Inner Joint		34	25	35	54	47		
	2000.09-2002.04	-	R	F	Saloon Engine Y 26 SE	644005	Inner Joint		34	25	35	54	47		
	2000.09-2003.07	-	R	F	Estate Engine Y 26 SE	644005	Inner Joint		34	25	35	54	47		
i 500 2.5 (143 kW)	1998.05-2000.09	-	L	F	Saloon Engine X 25 XE	644002	Inner Joint		34	25	35	56.2	85.6		
	1998.05-2000.09	-	L	F	Estate Engine X 25 XE	644002	Inner Joint		34	25	35	56.2	85.6		
	1998.05-2000.09	-	L/R	F	Saloon Engine X 25 XE	844006	Outer Joint	29T	33	25	52	103.5	61	O	
	1998.05-2000.09	-	L/R	F	Estate Engine X 25 XE	844006	Outer Joint	29T	33	25	52	103.5	61	O	
	1998.05-2000.09	-	L	F	Saloon Engine X 25 XE	244038	Drive Shaft	29T	33	34	52	103.5	595		
	1998.05-2000.09	-	L	F	Estate Engine X 25 XE	244038	Drive Shaft	29T	33	34	52	103.5	595		
VECTRA C															
1.9 CDTi	2002-	-	-	-	-	644007	Inner Joint		22	28	34.95	57	96.5		
2.2 CDTi	2002-	-	-	-	-	644007	Inner Joint		22	28	34.95	57	96.5		
VECTRA C (Z02)															
1.6 (77 kW)	2006.01-	-	MT	L	F	Estate Engine Z 16 XEP	699026	Inner Joint		22	25	35	57	82.5	
	2006.01-	-	MT	L	F	Estate Engine Z 16 XEP	244020	Drive Shaft		30	22	52.5	105	617.5	
	2006.01-	-	MT	L	F	Saloon Engine Z 16 XEP	699026	Inner Joint		22	25	35	57	82.5	
	2006.01-	-	MT	L	F	Saloon Engine Z 16 XEP	244020	Drive Shaft		30	22	52.5	105	617.5	
	2006.01-	-	MT	R	F	Estate Engine Z 16 XEP	217040	Drive Shaft		30	22	52.5	105	987	
	2006.01-	-	-	L/R	F	Estate Engine Z 16 XEP	817007	Outer Joint		30	25	52.5	105	62	O
	2006.01-	-	MT	R	F	Saloon Engine Z 16 XEP	217040	Drive Shaft		30	22	52.5	105	987	
	2006.01-	-	-	L/R	F	Saloon Engine Z 16 XEP	817007	Outer Joint		30	25	52.5	105	62	O
	2006.01-	-	-	L	F	Saloon Engine Z 16 XEP	217223	Drive Shaft		30	22	52	94	609	
	2006.01-	-	-	L	F	Estate Engine Z 16 XEP	217223	Drive Shaft		30	22	52	94	609	
1.6 16V (74 kW)	2004.06-	-	MT	L	F	Saloon Engine Z 16 XE	699026	Inner Joint		22	25	35	57	82.5	
	2004.06-	-	MT	L	F	Estate Engine Z 16 XE	699026	Inner Joint		22	25	35	57	82.5	
	2004.06-	-	MT	L	F	Saloon Engine Z 16 XE	244020	Drive Shaft		30	22	52.5	105	617.5	
	2004.06-	-	MT	L	F	Estate Engine Z 16 XE	244020	Drive Shaft		30	22	52.5	105	617.5	
	2004.06-	-	MT	R	F	Saloon Engine Z 16 XE	217040	Drive Shaft		30	22	52.5	105	987	
	2004.06-	-	MT	R	F	Estate Engine Z 16 XE	217040	Drive Shaft		30	22	52.5	105	987	
	2004.06-	-	MT	L/R	F	Saloon Engine Z 16 XE	817007	Outer Joint		30	25	52.5	105	62	O
	2004.06-	-	MT	L/R	F	Estate Engine Z 16 XE	817007	Outer Joint		30	25	52.5	105	62	O
	2004.06-	-	-	L	F	Saloon Engine Z 16 XE	217223	Drive Shaft		30	22	52	94	609	
	2004.06-	-	-	L	F	Estate Engine Z 16 XE	217223	Drive Shaft		30	22	52	94	609	
1.8 (103 kW)	2006.01-	-	MT	L	F	Saloon Engine Z 18 XER	699026	Inner Joint		22	25	35	57	82.5	
	2006.01-	-	MT	L	F	Estate Engine Z 18 XER	699026	Inner Joint		22	25	35	57	82.5	
	2006.01-	-	MT	L	F	Saloon Engine Z 18 XER	244020	Drive Shaft		30	22	52.5	105	617.5	
	2006.01-	-	MT	L	F	Estate Engine Z 18 XER	244020	Drive Shaft		30	22	52.5	105	617.5	
	2006.01-	-	MT	R	F	Saloon Engine Z 18 XER	217040	Drive Shaft		30	22	52.5	105	987	
	2006.01-	-	MT	R	F	Estate Engine Z 18 XER	217040	Drive Shaft		30	22	52.5	105	987	
	2006.01-	-	-	L/R	F	Saloon Engine Z 18 XER	817007	Outer Joint		30	25	52.5	105	62	O
	2006.01-	-	-	L/R	F	Estate Engine Z 18 XER	817007	Outer Joint		30	25	52.5	105	62	O
	2006.01-	-	-	-	F	Saloon Engine Z 18 XER	821038	Outer Joint		30	24	52	94	64	M
	2006.01-	-	-	-	F	Estate Engine Z 18 XER	821038	Outer Joint		30	24	52	94	64	M
	2006.01-	-	-	L	F	Saloon Engine Z 18 XER	217223	Drive Shaft		30	22	52	94	609	
	2006.01-	-	-	L	F	Estate Engine Z 18 XER	217223	Drive Shaft		30	22	52	94	609	
1.8 (81 kW)	2002.04-	-	MT	L	F	Saloon Engine Z 18 XEL	699026	Inner Joint		22	25	35	57	82.5	
	2002.04-	-	MT	L	F	Saloon Engine Z 18 XEL	244020	Drive Shaft		30	22	52.5	105	617.5	
	2002.04-	-	MT	R	F	Saloon Engine Z 18 XEL	217040	Drive Shaft		30	22	52.5	105	987	
	2002.04-	-	MT	L/R	F	Saloon Engine Z 18 XEL	817007	Outer Joint		30	25	52.5	105	62	O
	2002.04-	-	-	-	F	Saloon Engine Z 18 XEL	821038	Outer Joint		30	24	52	94	64	M
	2002.04-	-	-	L	F	Saloon Engine Z 18 XEL	217223	Drive Shaft		30	22	52	94	609	
1.8 (90 kW)	2003.10-	-	MT	L	F	Estate Engine Z 18 XE	699026	Inner Joint		22	25	35	57	82.5	
	2003.10-	-	MT	L	F	Estate Engine Z 18 XE	244020	Drive Shaft		30	22	52.5	105	617.5	
	2003.10-	-	MT	R	F	Estate Engine Z 18 XE	217040	Drive Shaft		30	22	52.5	105	987	
	2003.10-	-	MT	L/R	F	Estate Engine Z 18 XE	817007	Outer Joint		30	25	52.5	105	62	O
	2003.10-	-	-	-	F	Estate Engine Z 18 XE	821038	Outer Joint		30	24	52	94	64	M
	2003.10-	-	-	L	F	Estate Engine Z 18 XE	217223	Drive Shaft		30	22	52	94	609	
1.8 16V (90 kW)	2002.04-	-	MT	L	F	Saloon Engine Z 18 XE	699026	Inner Joint		22	25	35	57	82.5	
	2002.04-	-	MT	L	F	Saloon Engine Z 18 XE	244020	Drive Shaft		30	22	52.5	105	617.5	

	 YEAR	TRANSM	L/R	F/R	REMARKS	GSP Ref.	 PRODUCT	 ABS	Technical Specifications						
									A	B	C	H	L	P	
OPEL															
VECTRA C (Z02)															
1.8 16V (90 kW)	2002.04-	-	MT	R	F	Saloon Engine Z 18 XE	217040	Drive Shaft	30	22	52.5	105	987		
	2002.04-	-	MT	L/R	F	Saloon Engine Z 18 XE	817007	Outer Joint	30	25	52.5	105	62	O	
	2002.04-	-	-	-	F	Saloon Engine Z 18 XE	821038	Outer Joint	30	24	52	94	64	M	
	2002.04-	-	-	L	F	Saloon Engine Z 18 XE	217223	Drive Shaft	30	22	52	94	609		
1.9 CDTI (110 kW)	2004.04-	-	AT/MT	L/R	F	Saloon Engine Z 19 DTH	221036	Drive Shaft	30	27	55.4	100	602		
	2004.04-	-	AT/MT	L/R	F	Estate Engine Z 19 DTH	221036	Drive Shaft	30	27	55.4	100	602		
	2004.04-	-	MT	R	F	Saloon Engine Z 19 DTH	221053	Drive Shaft	30	34	53.8	94.5	617		
	2004.04-	-	MT	R	F	Estate Engine Z 19 DTH	221053	Drive Shaft	30	34	53.8	94.5	617		
	2004.04-	-	AT/MT	L/R	F	Saloon Engine Z 19 DTH	817051	Outer Joint	30	26	53.8	94.5	65.5	M	
	2004.04-	-	AT/MT	L/R	F	Estate Engine Z 19 DTH	817051	Outer Joint	30	26	53.8	94.5	65.5	M	
	2004.04-	-	MT	L	F	Saloon Engine Z 19 DTH	221092	Drive Shaft	30	25	53.8	94.5	604		
	2004.04-	-	MT	L	F	Estate Engine Z 19 DTH	221092	Drive Shaft	30	25	53.8	94.5	604		
	2004.04-	-	MT	R	F	Saloon Engine Z 19 DTH	644016	Inner Joint	34	28	37.5	46	54		
	2004.04-	-	MT	R	F	Estate Engine Z 19 DTH	644016	Inner Joint	34	28	37.5	46	54		
	2004.04-	-	MT	L	F	Saloon Engine Z 19 DTH	699186	Inner Joint	25	28	35	57.5	81.5		
	2004.04-	-	AMT	L/R	F	Saloon Engine Z 19 DTH	621024	Inner Joint	27	34	35	101	88		
	2004.04-	-	MT	L	F	Estate Engine Z 19 DTH	699186	Inner Joint	25	28	35	57.5	81.5		
	2004.04-	-	AMT	L/R	F	Estate Engine Z 19 DTH	621024	Inner Joint	27	34	35	101	88		
	2004.04-	-	-	-	F	Saloon Engine Z 19 DTH	899023	Outer Joint	30	26	53.8	94.5	65.5	M	
	2004.04-	-	-	-	F	Estate Engine Z 19 DTH	899023	Outer Joint	30	26	53.8	94.5	65.5	M	
	2004.04-	-	MT	R	F	Saloon Engine Z 19 DTH	221032	Drive Shaft	30	27	53.8	94.5	605		
	2004.04-	-	MT	R	F	Estate Engine Z 19 DTH	221032	Drive Shaft	30	27	53.8	94.5	605		
	2004.04-	-	Semi-AT	L/R	F	Saloon Engine Z 19 DTH	244080	Drive Shaft	30	27	53.8	94.5	591		
	2004.04-	-	Semi-AT	L/R	F	Estate Engine Z 19 DTH	244080	Drive Shaft	30	27	53.8	94.5	591		
1.9 CDTI (74 kW)	2005.10-	-	-	R	F	Estate Engine Z 19 DTL	221053	Drive Shaft	30	34	53.8	94.5	617		
	2005.10-	-	-	R	F	Saloon Engine Z 19 DTL	221053	Drive Shaft	30	34	53.8	94.5	617		
	2005.10-	-	MT	L/R	F	Estate Engine Z 19 DTL	817051	Outer Joint	30	26	53.8	94.5	65.5	M	
	2005.10-	-	MT	L/R	F	Saloon Engine Z 19 DTL	817051	Outer Joint	30	26	53.8	94.5	65.5	M	
	2005.10-	-	-	L	F	Estate Engine Z 19 DTL	221092	Drive Shaft	30	25	53.8	94.5	604		
	2005.10-	-	-	L	F	Saloon Engine Z 19 DTL	221092	Drive Shaft	30	25	53.8	94.5	604		
	2005.10-	-	-	R	F	Estate Engine Z 19 DTL	644016	Inner Joint	34	28	37.5	46	54		
	2005.10-	-	-	R	F	Saloon Engine Z 19 DTL	644016	Inner Joint	34	28	37.5	46	54		
	2005.10-	-	-	L	F	Estate Engine Z 19 DTL	699186	Inner Joint	25	28	35	57.5	81.5		
	2005.10-	-	-	L	F	Saloon Engine Z 19 DTL	699186	Inner Joint	25	28	35	57.5	81.5		
	2005.10-	-	MT	R	F	Estate Engine Z 19 DTL	221032	Drive Shaft	30	27	53.8	94.5	605		
	2005.10-	-	MT	R	F	Saloon Engine Z 19 DTL	221032	Drive Shaft	30	27	53.8	94.5	605		
	1.9 CDTI (88 kW)	2004.04-	-	MT	L/R	F	Estate Engine Z 19 DT	817051	Outer Joint	30	26	53.8	94.5	65.5	M
		2004.04-	-	MT	L/R	F	Saloon Engine Z 19 DT	817051	Outer Joint	30	26	53.8	94.5	65.5	M
2004.04-		-	-	R	F	Estate Engine Z 19 DT	221053	Drive Shaft	30	34	53.8	94.5	617		
2004.04-		-	-	R	F	Saloon Engine Z 19 DT	221053	Drive Shaft	30	34	53.8	94.5	617		
2004.04-		-	-	L	F	Estate Engine Z 19 DT	221092	Drive Shaft	30	25	53.8	94.5	604		
2004.04-		-	-	L	F	Saloon Engine Z 19 DT	221092	Drive Shaft	30	25	53.8	94.5	604		
2004.04-		-	-	R	F	Estate Engine Z 19 DT	644016	Inner Joint	34	28	37.5	46	54		
2004.04-		-	-	R	F	Saloon Engine Z 19 DT	644016	Inner Joint	34	28	37.5	46	54		
2004.04-		-	-	L	F	Estate Engine Z 19 DT	699186	Inner Joint	25	28	35	57.5	81.5		
2004.04-		-	-	L	F	Saloon Engine Z 19 DT	699186	Inner Joint	25	28	35	57.5	81.5		
2004.04-		-	MT	R	F	Estate Engine Z 19 DT	221032	Drive Shaft	30	27	53.8	94.5	605		
2004.04-	-	MT	R	F	Saloon Engine Z 19 DT	221032	Drive Shaft	30	27	53.8	94.5	605			
2.0 16V Turbo (129 kW)	2003.03-	-	-	L/R	F	Saloon Engine Z 20 NET	221036	Drive Shaft	30	27	55.4	100	602		
	2003.03-	-	MT	L/R	F	Saloon Engine Z 20 NET	817051	Outer Joint	30	26	53.8	94.5	65.5	M	
	2003.03-	-	-	-	F	Saloon Engine Z 20 NET	899023	Outer Joint	30	26	53.8	94.5	65.5	M	
	2003.03-	-	MT	L/R	F	Saloon Engine Z 20 NET	221032	Drive Shaft	30	27	53.8	94.5	605		
2.0 DTI (74 kW)	2003.10-	-	MT	L/R	F	Estate Engine Y 20 DTH	817007	Outer Joint	30	25	52.5	105	62	O	
	2003.10-	-	MT	L	F	Estate Engine Y 20 DTH	260015	Drive Shaft	30	34	52.5	105	628		
	2003.10-	-	-	L	F	Estate Engine Y 20 DTH	644002	Inner Joint	34	25	35	56.2	85.6		
	2003.10-	-	AT/MT	L	F	Estate Engine Y 20 DTH	621011	Inner Joint	34	25	35	78	64		
	2003.10-	-	MT	R	F	Estate Engine Y 20 DTH	221061	Drive Shaft	30	34	52.5	105	968		
2.0 DTI 16V (74 kW)	2002.04-	-	MT	L/R	F	Saloon Engine Y 20 DTH	817007	Outer Joint	30	25	52.5	105	62	O	
	2002.04-	-	MT	L	F	Saloon Engine Y 20 DTH	260015	Drive Shaft	30	34	52.5	105	628		
	2002.04-	-	-	L	F	Saloon Engine Y 20 DTH	644002	Inner Joint	34	25	35	56.2	85.6		
	2002.04-	-	AT/MT	L	F	Saloon Engine Y 20 DTH	621011	Inner Joint	34	25	35	78	64		
	2002.04-	-	MT	R	F	Saloon Engine Y 20 DTH	221061	Drive Shaft	30	34	52.5	105	968		
2.0 Turbo (129 kW)	2003.10-	-	-	L/R	F	Estate Engine Z 20 NET	221036	Drive Shaft	30	27	55.4	100	602		
	2003.10-	-	MT	L/R	F	Estate Engine Z 20 NET	817051	Outer Joint	30	26	53.8	94.5	65.5	M	
	2003.10-	-	-	-	F	Estate Engine Z 20 NET	899023	Outer Joint	30	26	53.8	94.5	65.5	M	
	2003.10-	-	MT	L/R	F	Estate Engine Z 20 NET	221032	Drive Shaft	30	27	53.8	94.5	605		





	 YEAR	TRANSM	L/R	F/R	REMARKS	GSP Ref.	 PRODUCT	 ABS	Technical Specifications					
									A	B	C	H	L	P
OPEL														
VECTRA C (Z02)														
2.2 16V (108 kW)	2002.04-	-	MT	L/R	F	Saloon Engine Z 22 SE	817007	Outer Joint	30	25	52.5	105	62	O
	2002.04-	-	-	-	F	Saloon Engine Z 22 SE	821038	Outer Joint	30	24	52	94	64	M
	2002.04-	-	MT	L	F	Saloon Engine Z 22 SE	644002	Inner Joint	34	25	35	56.2	85.6	
	2002.04-	-	AT/MT	L	F	Saloon Engine Z 22 SE	621011	Inner Joint	34	25	35	78	64	
2.2 direct (114 kW)	2003.10-	-	MT	L/R	F	Saloon Engine Z 22 YH	817007	Outer Joint	30	25	52.5	105	62	O
	2003.10-	-	-	L/R	F	Estate Engine Z 22 YH	817007	Outer Joint	30	25	52.5	105	62	O
	2003.10-	-	-	-	F	Estate Engine Z 22 YH	821038	Outer Joint	30	24	52	94	64	M
	2003.10-	-	-	-	F	Saloon Engine Z 22 YH	821038	Outer Joint	30	24	52	94	64	M
	2003.10-	-	MT	L	F	Saloon Engine Z 22 YH	644002	Inner Joint	34	25	35	56.2	85.6	
	2003.10-	-	MT	L	F	Estate Engine Z 22 YH	644002	Inner Joint	34	25	35	56.2	85.6	
	2003.10-	-	AT/MT	L	F	Estate Engine Z 22 YH	621011	Inner Joint	34	25	35	78	64	
	2003.10-	-	AT/MT	L	F	Saloon Engine Z 22 YH	621011	Inner Joint	34	25	35	78	64	
2.2 DTI (92 kW)	2003.10-	-	-	L/R	F	Estate Engine Y 22 DTR	221036	Drive Shaft	30	27	55.4	100	602	
	2003.10-	-	MT	L/R	F	Estate Engine Y 22 DTR	817051	Outer Joint	30	26	53.8	94.5	65.5	M
	2003.10-	-	-	-	F	Estate Engine Y 22 DTR	899023	Outer Joint	30	26	53.8	94.5	65.5	M
	2003.10-	-	MT	L/R	F	Estate Engine Y 22 DTR	221032	Drive Shaft	30	27	53.8	94.5	605	
2.2 DTI 16V (86 kW)	2002.04-2004.12		MT	L/R	F	Saloon Engine Y 22 DTR	221032	Drive Shaft	30	27	53.8	94.5	605	
	2002.04-2004.12		-	-	F	Saloon Engine Y 22 DTR	899023	Outer Joint	30	26	53.8	94.5	65.5	M
	2002.04-2004.12		MT	L/R	F	Saloon Engine Y 22 DTR	817051	Outer Joint	30	26	53.8	94.5	65.5	M
	2002.04-2004.12		-	L/R	F	Saloon Engine Y 22 DTR	221036	Drive Shaft	30	27	55.4	100	602	
2.2 DTI 16V (92 kW)	2002.04-	-	-	L/R	F	Saloon Engine Y 22 DTR	221036	Drive Shaft	30	27	55.4	100	602	
	2002.04-	-	MT	L/R	F	Saloon Engine Y 22 DTR	817051	Outer Joint	30	26	53.8	94.5	65.5	M
	2002.04-	-	-	-	F	Saloon Engine Y 22 DTR	899023	Outer Joint	30	26	53.8	94.5	65.5	M
	2002.04-	-	MT	L/R	F	Saloon Engine Y 22 DTR	221032	Drive Shaft	30	27	53.8	94.5	605	
2.8 V6 Turbo (169 kW)	2005.08-	-	MT	L/R	F	Saloon Engine Z 28 NEL	221036	Drive Shaft	30	27	55.4	100	602	
	2005.08-	-	MT	L/R	F	Estate Engine Z 28 NEL	221036	Drive Shaft	30	27	55.4	100	602	
2.8 V6 Turbo (184 kW)	2006.08-	-	MT	L/R	F	Saloon Engine Z 28 NET	221036	Drive Shaft	30	27	55.4	100	602	
	2007.01-	-	MT	L/R	F	Estate Engine Z 28 NET	221036	Drive Shaft	30	27	55.4	100	602	
2.8 V6 Turbo (188 kW)	2005.08-	-	MT	L/R	F	Saloon Engine Z 28 NET	221036	Drive Shaft	30	27	55.4	100	602	
	2005.08-	-	MT	L/R	F	Estate Engine Z 28 NET	221036	Drive Shaft	30	27	55.4	100	602	
2.8 V6 Turbo (206 kW)	2007.01-	-	MT	L/R	F	Estate Engine Z 28 NET	221036	Drive Shaft	30	27	55.4	100	602	
2.8 V6 Turbo OPC (206 kW)	2006.09-2008.09		MT	L/R	F	Saloon Engine Z 28 NET	221036	Drive Shaft	30	27	55.4	100	602	
3.0 CDTI (130 kW)	2003.06-	-	AT/MT	L/R	F	Saloon Engine Y 30 DT	221036	Drive Shaft	30	27	55.4	100	602	
	2003.06-	-	MT	L/R	F	Saloon Engine Y 30 DT	817051	Outer Joint	30	26	53.8	94.5	65.5	M
	2003.06-	-	-	-	F	Saloon Engine Y 30 DT	899023	Outer Joint	30	26	53.8	94.5	65.5	M
	2003.06-	-	-	L/R	F	Saloon Engine Y 30 DT	221032	Drive Shaft	30	27	53.8	94.5	605	
3.0 CDTI (135 kW)	2005.08-	-	AT/MT	L/R	F	Saloon Engine Z 30 DT	221036	Drive Shaft	30	27	55.4	100	602	
	2005.08-	-	-	-	F	Saloon Engine Z 30 DT	899023	Outer Joint	30	26	53.8	94.5	65.5	M
3.0 V6 CDTI (130 kW)	2003.10-	-	AT/MT	L/R	F	Estate Engine Y 30 DT	221036	Drive Shaft	30	27	55.4	100	602	
	2003.10-	-	MT	L/R	F	Estate Engine Y 30 DT	817051	Outer Joint	30	26	53.8	94.5	65.5	M
	2003.10-	-	-	-	F	Estate Engine Y 30 DT	899023	Outer Joint	30	26	53.8	94.5	65.5	M
	2003.10-	-	-	L/R	F	Estate Engine Y 30 DT	221032	Drive Shaft	30	27	53.8	94.5	605	
3.0 V6 CDTI (135 kW)	2005.08-	-	AT/MT	L/R	F	Estate Engine Z 30 DT	221036	Drive Shaft	30	27	55.4	100	602	
	2005.08-	-	-	-	F	Estate Engine Z 30 DT	899023	Outer Joint	30	26	53.8	94.5	65.5	M
3.2 V6 (155 kW)	2002.08-	-	AT/MT	L/R	F	Saloon Engine Z 32 SE	221036	Drive Shaft	30	27	55.4	100	602	
	2002.08-	-	MT	L/R	F	Saloon Engine Z 32 SE	817051	Outer Joint	30	26	53.8	94.5	65.5	M
	2002.08-	-	-	-	F	Saloon Engine Z 32 SE	899023	Outer Joint	30	26	53.8	94.5	65.5	M
	2002.08-	-	MT	L/R	F	Saloon Engine Z 32 SE	221032	Drive Shaft	30	27	53.8	94.5	605	
	2003.10-	-	AT/MT	L/R	F	Estate Engine Z 32 SE	221036	Drive Shaft	30	27	55.4	100	602	
	2003.10-	-	MT	L/R	F	Estate Engine Z 32 SE	817051	Outer Joint	30	26	53.8	94.5	65.5	M
	2003.10-	-	-	-	F	Estate Engine Z 32 SE	899023	Outer Joint	30	26	53.8	94.5	65.5	M
	2003.10-	-	MT	L/R	F	Estate Engine Z 32 SE	221032	Drive Shaft	30	27	53.8	94.5	605	
VECTRA C GTS (Z02)														
1.6 (74 kW)	2005.08-	-	MT	L	F	Hatchback Engine Z 16 XE	699026	Inner Joint	22	25	35	57	82.5	
	2005.08-	-	MT	L	F	Hatchback Engine Z 16 XE	244020	Drive Shaft	30	22	52.5	105	617.5	
	2005.08-	-	MT	R	F	Hatchback Engine Z 16 XE	217040	Drive Shaft	30	22	52.5	105	987	
	2005.08-	-	MT	L/R	F	Hatchback Engine Z 16 XE	817007	Outer Joint	30	25	52.5	105	62	O
	2005.08-	-	-	L	F	Hatchback Engine Z 16 XE	217223	Drive Shaft	30	22	52	94	609	
1.6 (77 kW)	2006.01-	-	MT	L	F	Hatchback Engine Z 16 XEP	699026	Inner Joint	22	25	35	57	82.5	
	2006.01-	-	MT	L	F	Hatchback Engine Z 16 XEP	244020	Drive Shaft	30	22	52.5	105	617.5	
	2006.01-	-	MT	R	F	Hatchback Engine Z 16 XEP	217040	Drive Shaft	30	22	52.5	105	987	
	2006.01-	-	-	L/R	F	Hatchback Engine Z 16 XEP	817007	Outer Joint	30	25	52.5	105	62	O
	2006.01-	-	-	L	F	Hatchback Engine Z 16 XEP	217223	Drive Shaft	30	22	52	94	609	
1.8 (103 kW)	2006.01-	-	MT	L	F	Hatchback Engine Z 18 XER	699026	Inner Joint	22	25	35	57	82.5	
	2006.01-	-	MT	L	F	Hatchback Engine Z 18 XER	244020	Drive Shaft	30	22	52.5	105	617.5	
	2006.01-	-	MT	R	F	Hatchback Engine Z 18 XER	217040	Drive Shaft	30	22	52.5	105	987	





YEAR	TRANSM	L/R	F/R	REMARKS	GSP Ref.	PRODUCT	ABS	Technical Specifications							
								A	B	C	H	L	P		
OPEL															
VECTRA C GTS (Z02)															
1.8 (103 kW)	2006.01-	-	L/R	F	Hatchback Engine Z 18 XER	817007	Outer Joint	30	25	52.5	105	62	O		
	2006.01-	-	-	F	Hatchback Engine Z 18 XER	821038	Outer Joint	30	24	52	94	64	M		
	2006.01-	-	L	F	Hatchback Engine Z 18 XER	217223	Drive Shaft	30	22	52	94	609			
1.8 16V (81 kW)	2002.08-2006.12	-	L	F	Hatchback Engine Z 18 XEL	699026	Inner Joint	22	25	35	57	82.5			
	2002.08-2006.12	-	L	F	Hatchback Engine Z 18 XEL	244020	Drive Shaft	30	22	52.5	105	617.5			
	2002.08-2006.12	-	R	F	Hatchback Engine Z 18 XEL	217040	Drive Shaft	30	22	52.5	105	987			
	2002.08-2006.12	-	L/R	F	Hatchback Engine Z 18 XEL	817007	Outer Joint	30	25	52.5	105	62	O		
	2002.08-2006.12	-	-	F	Hatchback Engine Z 18 XEL	821038	Outer Joint	30	24	52	94	64	M		
	2002.08-2006.12	-	L	F	Hatchback Engine Z 18 XEL	217223	Drive Shaft	30	22	52	94	609			
1.8 16V (90 kW)	2002.08-	-	MT	L	F	Hatchback Engine Z 18 XE	699026	Inner Joint	22	25	35	57	82.5		
	2002.08-	-	MT	L	F	Hatchback Engine Z 18 XE	244020	Drive Shaft	30	22	52.5	105	617.5		
	2002.08-	-	MT	R	F	Hatchback Engine Z 18 XE	217040	Drive Shaft	30	22	52.5	105	987		
	2002.08-	-	MT	L/R	F	Hatchback Engine Z 18 XE	817007	Outer Joint	30	25	52.5	105	62	O	
	2002.08-	-	-	F	Hatchback Engine Z 18 XE	821038	Outer Joint	30	24	52	94	64	M		
	2002.08-	-	-	L	F	Hatchback Engine Z 18 XE	217223	Drive Shaft	30	22	52	94	609		
1.9 CDTI (110 kW)	2004.04-	-	AT/MT	L/R	F	Hatchback Engine Z 19 DTH	221036	Drive Shaft	30	27	55.4	100	602		
	2004.04-	-	MT	R	F	Hatchback Engine Z 19 DTH	221053	Drive Shaft	30	34	53.8	94.5	617		
	2004.04-	-	AT/MT	L/R	F	Hatchback Engine Z 19 DTH	817051	Outer Joint	30	26	53.8	94.5	65.5	M	
	2004.04-	-	MT	R	F	Hatchback Engine Z 19 DTH	221092	Drive Shaft	30	25	53.8	94.5	604		
	2004.04-	-	MT	R	F	Hatchback Engine Z 19 DTH	644016	Inner Joint	34	28	37.5	46	54		
	2004.04-	-	MT	L	F	Hatchback Engine Z 19 DTH	699186	Inner Joint	25	28	35	57.5	81.5		
	2004.04-	-	AMT	L/R	F	Hatchback Engine Z 19 DTH	621024	Inner Joint	27	34	35	101	88		
	2004.04-	-	-	F	Hatchback Engine Z 19 DTH	899023	Outer Joint	30	26	53.8	94.5	65.5	M		
	2004.04-	-	MT	R	F	Hatchback Engine Z 19 DTH	221032	Drive Shaft	30	27	53.8	94.5	605		
	2004.04-	-	Semi-AT	L/R	F	Hatchback Engine Z 19 DTH	244080	Drive Shaft	30	27	53.8	94.5	591		
1.9 CDTI (74 kW)	2005.10-	-	-	R	F	Hatchback Engine Z 19 DTL	221053	Drive Shaft	30	34	53.8	94.5	617		
	2005.10-	-	MT	L/R	F	Hatchback Engine Z 19 DTL	817051	Outer Joint	30	26	53.8	94.5	65.5	M	
	2005.10-	-	-	L	F	Hatchback Engine Z 19 DTL	221092	Drive Shaft	30	25	53.8	94.5	604		
	2005.10-	-	-	R	F	Hatchback Engine Z 19 DTL	644016	Inner Joint	34	28	37.5	46	54		
	2005.10-	-	-	L	F	Hatchback Engine Z 19 DTL	699186	Inner Joint	25	28	35	57.5	81.5		
	2005.10-	-	MT	R	F	Hatchback Engine Z 19 DTL	221032	Drive Shaft	30	27	53.8	94.5	605		
1.9 CDTI (88 kW)	2004.04-	-	MT	L/R	F	Hatchback Engine Z 19 DT	817051	Outer Joint	30	26	53.8	94.5	65.5	M	
	2004.04-	-	-	R	F	Hatchback Engine Z 19 DT	221053	Drive Shaft	30	34	53.8	94.5	617		
	2004.04-	-	-	L	F	Hatchback Engine Z 19 DT	221092	Drive Shaft	30	25	53.8	94.5	604		
	2004.04-	-	-	R	F	Hatchback Engine Z 19 DT	644016	Inner Joint	34	28	37.5	46	54		
	2004.04-	-	-	L	F	Hatchback Engine Z 19 DT	699186	Inner Joint	25	28	35	57.5	81.5		
	2004.04-	-	MT	R	F	Hatchback Engine Z 19 DT	221032	Drive Shaft	30	27	53.8	94.5	605		
2.0 16V Turbo (129 kW)	2003.03-	-	-	L/R	F	Hatchback Engine Z 20 NET	221036	Drive Shaft	30	27	55.4	100	602		
	2003.03-	-	MT	L/R	F	Hatchback Engine Z 20 NET	817051	Outer Joint	30	26	53.8	94.5	65.5	M	
	2003.03-	-	-	F	Hatchback Engine Z 20 NET	899023	Outer Joint	30	26	53.8	94.5	65.5	M		
	2003.03-	-	MT	L/R	F	Hatchback Engine Z 20 NET	221032	Drive Shaft	30	27	53.8	94.5	605		
2.0 DTI 16V (74 kW)	2002.08-	-	MT	L/R	F	Hatchback Engine Y 20 DTH	817007	Outer Joint	30	25	52.5	105	62	O	
	2002.08-	-	MT	L	F	Hatchback Engine Y 20 DTH	260015	Drive Shaft	30	34	52.5	105	628		
	2002.08-	-	-	L	F	Hatchback Engine Y 20 DTH	644002	Inner Joint	34	25	35	56.2	85.6		
	2002.08-	-	AT/MT	L	F	Hatchback Engine Y 20 DTH	621011	Inner Joint	34	25	35	78	64		
	2002.08-	-	MT	R	F	Hatchback Engine Y 20 DTH	221061	Drive Shaft	30	34	52.5	105	968		
2.2 16V (108 kW)	2002.08-	-	MT	L/R	F	Hatchback Engine Z 22 SE	817007	Outer Joint	30	25	52.5	105	62	O	
	2002.08-	-	-	F	Hatchback Engine Z 22 SE	821038	Outer Joint	30	24	52	94	64	M		
	2002.08-	-	MT	L	F	Hatchback Engine Z 22 SE	644002	Inner Joint	34	25	35	56.2	85.6		
	2002.08-	-	AT/MT	L	F	Hatchback Engine Z 22 SE	621011	Inner Joint	34	25	35	78	64		
2.2 direct (114 kW)	2003.10-	-	MT	L/R	F	Hatchback Engine Z 22 YH	817007	Outer Joint	30	25	52.5	105	62	O	
	2003.10-	-	-	F	Hatchback Engine Z 22 YH	821038	Outer Joint	30	24	52	94	64	M		
	2003.10-	-	MT	L	F	Hatchback Engine Z 22 YH	644002	Inner Joint	34	25	35	56.2	85.6		
	2003.10-	-	AT/MT	L	F	Hatchback Engine Z 22 YH	621011	Inner Joint	34	25	35	78	64		
2.2 DTI 16V (86 kW)	2002.08-2008.06	-	MT	L/R	F	Hatchback Engine Y 22 DTR	221032	Drive Shaft	30	27	53.8	94.5	605		
	2002.08-2008.06	-	-	F	Hatchback Engine Y 22 DTR	899023	Outer Joint	30	26	53.8	94.5	65.5	M		
	2002.08-2008.06	-	MT	L/R	F	Hatchback Engine Y 22 DTR	817051	Outer Joint	30	26	53.8	94.5	65.5	M	
	2002.08-2008.06	-	L/R	F	Hatchback Engine Y 22 DTR	221036	Drive Shaft	30	27	55.4	100	602			
2.2 DTI 16V (92 kW)	2002.08-	-	-	L/R	F	Hatchback Engine Y 22 DTR	221036	Drive Shaft	30	27	55.4	100	602		
	2002.08-	-	MT	L/R	F	Hatchback Engine Y 22 DTR	817051	Outer Joint	30	26	53.8	94.5	65.5	M	
	2002.08-	-	-	F	Hatchback Engine Y 22 DTR	899023	Outer Joint	30	26	53.8	94.5	65.5	M		
	2002.08-	-	MT	L/R	F	Hatchback Engine Y 22 DTR	221032	Drive Shaft	30	27	53.8	94.5	605		
2.8 V6 Turbo (169 kW)	2005.08-	-	MT	L/R	F	Hatchback Engine Z 28 NEL	221036	Drive Shaft	30	27	55.4	100	602		
2.8 V6 Turbo (184 kW)	2006.08-	-	MT	L/R	F	Hatchback Engine Z 28 NET	221036	Drive Shaft	30	27	55.4	100	602		
2.8 V6 Turbo (188 kW)	2005.08-	-	MT	L/R	F	Hatchback Engine Z 28 NET	221036	Drive Shaft	30	27	55.4	100	602		
2.8 V6 Turbo (206 kW)	2006.08-	-	MT	L/R	F	Hatchback Engine Z 28 NET	221036	Drive Shaft	30	27	55.4	100	602		





	 YEAR	TRANSM	L/R	F/R	REMARKS	GSP Ref.	 PRODUCT	 ABS	Technical Specifications								
									A	B	C	H	L	P			
OPEL																	
VECTRA C GTS (Z02)																	
3.0 CDTi (130 kW)	2003.06-	-	MT	L/R	F	Hatchback Engine Y 30 DT	817051	Outer Joint		30	26	53.8	94.5	65.5	M		
	2003.06-	-	-	-	F	Hatchback Engine Y 30 DT	899023	Outer Joint		30	26	53.8	94.5	65.5	M		
	2003.06-	-	-	L/R	F	Hatchback Engine Y 30 DT	221032	Drive Shaft		30	27	53.8	94.5	605			
	2003.06-	-	AT/MT	L/R	F	Hatchback Engine Y 30 DT	221036	Drive Shaft		30	27	55.4	100	602			
3.0 CDTi (135 kW)	2005.08-	-	AT/MT	L/R	F	Hatchback Engine Z 30 DT	221036	Drive Shaft		30	27	55.4	100	602			
	2005.08-	-	-	-	F	Hatchback Engine Z 30 DT	899023	Outer Joint		30	26	53.8	94.5	65.5	M		
3.2 V6 (155 kW)	2002.08-	-	MT	L/R	F	Hatchback Engine Z 32 SE	817051	Outer Joint		30	26	53.8	94.5	65.5	M		
	2002.08-	-	-	-	F	Hatchback Engine Z 32 SE	899023	Outer Joint		30	26	53.8	94.5	65.5	M		
	2002.08-	-	MT	L/R	F	Hatchback Engine Z 32 SE	221032	Drive Shaft		30	27	53.8	94.5	605			
	2002.08-	-	AT/MT	L/R	F	Hatchback Engine Z 32 SE	221036	Drive Shaft		30	27	55.4	100	602			
VECTRA C, SW																	
1.9 CDTi (110 kW)	2004.04-	-	MT	-	-	-	699138	Inner Joint		27	28	35	78	83			
1.9 CDTi (74 kW)	2004.04-	-	MT	-	-	-	699138	Inner Joint		27	28	35	78	83			
1.9 CDTi (88 kW)	2004.04-	-	MT	-	-	-	699138	Inner Joint		27	28	35	78	83			
2.0 T 16V (129 kW)	2003.03-	-	-	-	-	-	699138	Inner Joint		27	28	35	78	83			
2.2 DTi 16V (92 kW)	2002.04-	-	-	-	-	-	699138	Inner Joint		27	28	35	78	83			
2.8 T V6 (163 kW)	2005.08-	-	MT	-	-	-	852014	Outer Joint		30	28	55.4	100	64.5	M		
2.8 T V6 (188 kW)	2005.08-	-	MT	-	-	-	852014	Outer Joint		30	28	55.4	100	64.5	M		
3.0 CDTi (130 kW)	2005.08-	-	-	-	-	-	699138	Inner Joint		27	28	35	78	83			
3.0 CDTi (135 kW)	2005-	-	MT	-	-	-	852014	Outer Joint		30	28	55.4	100	64.5	M		
3.2 V6 (155 kW)	2002.08-	-	MT	-	-	-	699138	Inner Joint		27	28	35	78	83			
VIVARO A (X83)																	
1.9 DI (60 kW)	2001.08-	-	-	L	F	Box Engine F9Q 762	244003	Drive Shaft		27	37.1	56.5	93.5	676			
	2001.08-	-	-	L	F	Platform/Chassis Engine F9Q 762	244003	Drive Shaft		27	37.1	56.5	93.5	676			
	2001.08-	-	-	R	F	Box Engine F9Q 762	244013	Drive Shaft		27	39	56.5	93.5	1020			
	2001.08-	-	-	R	F	Platform/Chassis Engine F9Q 762	244013	Drive Shaft		27	39	56.5	93.5	1020			
	2001.08-	-	MT	L/R	F	Platform/Chassis Engine F9Q 762	818105	Outer Joint		27	26	56.5	93.5	64	M		
	2001.08-	-	AT/MT	L/R	F	Box Engine F9Q 762	818105	Outer Joint		27	26	56.5	93.5	64	M		
1.9 DTi (74 kW)	2001.08-	-	-	L	F	Box Engine F9Q 760	244003	Drive Shaft		27	37.1	56.5	93.5	676			
	2001.08-	-	-	R	F	Box Engine F9Q 760	244013	Drive Shaft		27	39	56.5	93.5	1020			
	2001.08-	-	AT/MT	L/R	F	Box Engine F9Q 760	818105	Outer Joint		27	26	56.5	93.5	64	M		
	2006.08-	-	-	L	F	Platform/Chassis Engine F9Q 760	244003	Drive Shaft		27	37.1	56.5	93.5	676			
	2006.08-	-	-	R	F	Platform/Chassis Engine F9Q 760	244013	Drive Shaft		27	39	56.5	93.5	1020			
	2006.08-	-	-	L	F	Platform/Chassis Engine F9Q 760	244038	Drive Shaft	29T	33	34	52	103.5	595			
2.0 16V (88 kW)	2001.08-	-	-	L	F	Box Engine F4R 720	244003	Drive Shaft		27	37.1	56.5	93.5	676			
	2001.08-	-	-	R	F	Box Engine F4R 720	244013	Drive Shaft		27	39	56.5	93.5	1020			
	2001.08-	-	AT/MT	L/R	F	Box Engine F4R 720	818105	Outer Joint		27	26	56.5	93.5	64	M		
	2003.08-	-	-	L	F	Platform/Chassis Engine F4R 720	244003	Drive Shaft		27	37.1	56.5	93.5	676			
	2003.08-	-	-	R	F	Platform/Chassis Engine F4R 720	244013	Drive Shaft		27	39	56.5	93.5	1020			
	2003.08-	-	AT/MT	L/R	F	Platform/Chassis Engine F4R 720	818105	Outer Joint		27	26	56.5	93.5	64	M		
2.0 CDTi (66 kW)	2006.01-	-	-	L	F	Platform/Chassis Engine M9R 780/M9R 782/M9R 786/M9R 630	260022	Drive Shaft		27	39	56.6	94	694			
	2006.01-	-	-	R	F	Platform/Chassis Engine M9R 780/M9R 782/M9R 786/M9R 630	218271	Drive Shaft		27	39	56.6	94	1013			
	2006.08-	-	-	L	F	Box Engine M9R 782/M9R 780/M9R 786/M9R 630	260022	Drive Shaft		27	39	56.6	94	694			
	2006.08-	-	-	R	F	Box Engine M9R 782/M9R 780/M9R 786/M9R 630	218271	Drive Shaft		27	39	56.6	94	1013			
2.0 CDTi (84 kW)	2006.08-	-	-	L	F	Box Engine M9R 784/M9R 788/M9R 780/M9R 786/M9R 630/M9R 692	260022	Drive Shaft		27	39	56.6	94	694			
	2006.08-	-	-	L	F	Platform/Chassis Engine M9R 780/M9R 630	260022	Drive Shaft		27	39	56.6	94	694			
	2006.08-	-	-	R	F	Box Engine M9R 784/M9R 788/M9R 780/M9R 786/M9R 630/M9R 692	218271	Drive Shaft		27	39	56.6	94	1013			
	2006.08-	-	-	R	F	Platform/Chassis Engine M9R 780/M9R 630	218271	Drive Shaft		27	39	56.6	94	1013			
2.0 ECOTEC (86 kW)	2006.08-	-	-	L	F	Box Engine F4R 820	244003	Drive Shaft		27	37.1	56.5	93.5	676			
	2006.08-	-	-	L	F	Platform/Chassis Engine F4R 820	244003	Drive Shaft		27	37.1	56.5	93.5	676			
	2006.08-	-	-	R	F	Box Engine F4R 820	244013	Drive Shaft		27	39	56.5	93.5	1020			
	2006.08-	-	-	R	F	Platform/Chassis Engine F4R 820	244013	Drive Shaft		27	39	56.5	93.5	1020			
	2006.08-	-	AT/MT	L/R	F	Box Engine F4R 820	818105	Outer Joint		27	26	56.5	93.5	64	M		
	2006.08-	-	AT/MT	L/R	F	Platform/Chassis Engine F4R 820	818105	Outer Joint		27	26	56.5	93.5	64	M		
	2006.08-	-	-	L	F	Box Engine F4R 820	244038	Drive Shaft	29T	33	34	52	103.5	595			
	2006.08-	-	-	L	F	Platform/Chassis Engine F4R 820	244038	Drive Shaft	29T	33	34	52	103.5	595			
	2006.08-	-	-	R	F	Box Engine F4R 820	244039	Drive Shaft	29T	33	34	52	103.5	959			
	2006.08-	-	-	R	F	Platform/Chassis Engine F4R 820	244039	Drive Shaft	29T	33	34	52	103.5	959			
2.5 CDTi (107 kW)	2006.08-	-	-	R	F	Box Engine G9MB6/G9U 630	218301	Drive Shaft		27	39	56.6	94	1045			
	2006.08-	-	-	R	F	Platform/Chassis Engine G9U 630	218301	Drive Shaft		27	39	56.6	94	1045			
	2006.08-	-	-	R	F	Box Engine G9MB6/G9U 630	650097	Inner Joint		39	35	30	409	90			
	2006.08-	-	-	R	F	Platform/Chassis Engine G9U 630	650097	Inner Joint		39	35	30	409	90			
	2006.08-	-	-	L	F	Box Engine G9MB6/G9U 630	250557	Drive Shaft		27	37.1	56.5	92	634			
	2006.08-	-	-	L	F	Platform/Chassis Engine G9U 630	250557	Drive Shaft		27	37.1	56.5	92	634			
	2006.08-	-	-	R	F	Box Engine G9MB6/G9U 630	250562	Drive Shaft		27	39	56.5	92	1056			





YEAR	TRANSM	L/R	F/R	REMARKS	GSP Ref.	PRODUCT	ABS	Technical Specifications									
								A	B	C	H	L	P				
OPEL																	
VIVARO A (X83)																	
2.5 CDTi (107 kW)	2006.08-	-	-	R	F	Platform/Chassis Engine G9U 630	250562	Drive Shaft		27	39	56.5	92	1056			
	2006.08-	-	-	L	F	Box Engine G9MB6/G9U 630	250497	Drive Shaft		27	39	56.6	94	667			
	2006.08-	-	-	L	F	Platform/Chassis Engine G9U 630	250497	Drive Shaft		27	39	56.6	94	667			
2.5 CDTi (84 kW)	2006.08-	-	-	R	F	Box Engine G9U 630	218301	Drive Shaft		27	39	56.6	94	1045			
	2006.08-	-	-	R	F	Platform/Chassis Engine G9U 630	218301	Drive Shaft		27	39	56.6	94	1045			
	2006.08-	-	-	R	F	Box Engine G9U 630	650097	Inner Joint		39	35	30	409	90			
	2006.08-	-	-	R	F	Platform/Chassis Engine G9U 630	650097	Inner Joint		39	35	30	409	90			
	2006.08-	-	-	L	F	Box Engine G9U 630	250557	Drive Shaft		27	37.1	56.5	92	634			
	2006.08-	-	-	L	F	Platform/Chassis Engine G9U 630	250557	Drive Shaft		27	37.1	56.5	92	634			
	2006.08-	-	-	R	F	Box Engine G9U 630	250562	Drive Shaft		27	39	56.5	92	1056			
	2006.08-	-	-	R	F	Platform/Chassis Engine G9U 630	250562	Drive Shaft		27	39	56.5	92	1056			
	2006.08-	-	-	L	F	Box Engine G9U 630	250497	Drive Shaft		27	39	56.6	94	667			
	2006.08-	-	-	L	F	Platform/Chassis Engine G9U 630	250497	Drive Shaft		27	39	56.6	94	667			
2.5 DTi (99 kW)	2003.05-	-	-	R	F	Box Engine G9U 730	218301	Drive Shaft		27	39	56.6	94	1045			
	2003.05-	-	AT/MT	L/R	F	Box Engine G9U 730	850041	Outer Joint		27	37	56.5	93	72	I		
	2003.05-	-	-	R	F	Box Engine G9U 730	650097	Inner Joint		39	35	30	409	90			
	2003.05-	-	-	-	F	Box Engine G9U 730	850080	Outer Joint		27	37	56.5	92	73	I		
	2003.05-	-	-	L	F	Box Engine G9U 730	250557	Drive Shaft		27	37.1	56.5	92	634			
	2003.05-	-	-	R	F	Box Engine G9U 730	250562	Drive Shaft		27	39	56.5	92	1056			
	2003.05-	-	-	L	F	Box Engine G9U 730	250497	Drive Shaft		27	39	56.6	94	667			
	2003.08-	-	-	R	F	Platform/Chassis Engine G9U 730	218301	Drive Shaft		27	39	56.6	94	1045			
	2003.08-	-	-	R	F	Platform/Chassis Engine G9U 730	650097	Inner Joint		39	35	30	409	90			
	2003.08-	-	-	L	F	Platform/Chassis Engine G9U 730	250557	Drive Shaft		27	37.1	56.5	92	634			
	2003.08-	-	-	R	F	Platform/Chassis Engine G9U 730	250562	Drive Shaft		27	39	56.5	92	1056			
	2003.08-	-	-	L	F	Platform/Chassis Engine G9U 730	250497	Drive Shaft		27	39	56.6	94	667			
VIVARO A Combi (X83)																	
1.9 DI (60 kW)	2001.08-	-	-	L	F	Bus Engine F9Q 762	244003	Drive Shaft		27	37.1	56.5	93.5	676			
	2001.08-	-	-	R	F	Bus Engine F9Q 762	244013	Drive Shaft		27	39	56.5	93.5	1020			
	2001.08-	-	AT/MT	L/R	F	Bus Engine F9Q 762	818105	Outer Joint		27	26	56.5	93.5	64	M		
1.9 DTi (74 kW)	2001.08-	-	-	L	F	Bus Engine F9Q 760	244003	Drive Shaft		27	37.1	56.5	93.5	676			
	2001.08-	-	-	R	F	Bus Engine F9Q 760	244013	Drive Shaft		27	39	56.5	93.5	1020			
	2001.08-	-	AT/MT	L/R	F	Bus Engine F9Q 760	818105	Outer Joint		27	26	56.5	93.5	64	M		
2.0 16V (88 kW)	2001.08-	-	-	L	F	Bus Engine F4R 720	244003	Drive Shaft		27	37.1	56.5	93.5	676			
	2001.08-	-	-	R	F	Bus Engine F4R 720	244013	Drive Shaft		27	39	56.5	93.5	1020			
	2001.08-	-	AT/MT	L/R	F	Bus Engine F4R 720	818105	Outer Joint		27	26	56.5	93.5	64	M		
2.0 CDTi (66 kW)	2006.08-	-	-	L	F	Bus Engine M9R 780/M9R 782/M9R 786	260022	Drive Shaft		27	39	56.6	94	694			
	2006.08-	-	-	R	F	Bus Engine M9R 780/M9R 782/M9R 786	218271	Drive Shaft		27	39	56.6	94	1013			
2.0 CDTi (84 kW)	2006.08-	-	-	L	F	Bus Engine M9R 692/M9R 780/M9R 784/M9R 786/M9R 788/M9R 630	260022	Drive Shaft		27	39	56.6	94	694			
	2006.08-	-	-	R	F	Bus Engine M9R 692/M9R 780/M9R 784/M9R 786/M9R 788/M9R 630	218271	Drive Shaft		27	39	56.6	94	1013			
2.0 ECOTEC (86 kW)	2006.08-	-	-	L	F	Bus Engine F4R 820	244003	Drive Shaft		27	37.1	56.5	93.5	676			
	2006.08-	-	-	R	F	Bus Engine F4R 820	244013	Drive Shaft		27	39	56.5	93.5	1020			
	2006.08-	-	AT/MT	L/R	F	Bus Engine F4R 820	818105	Outer Joint		27	26	56.5	93.5	64	M		
	2006.08-	-	-	L	F	Bus Engine F4R 820	244038	Drive Shaft	29T	33	34	52	103.5	595			
	2006.08-	-	-	R	F	Bus Engine F4R 820	244039	Drive Shaft	29T	33	34	52	103.5	959			
2.5 CDTi (107 kW)	2006.08-	-	-	R	F	Bus Engine G9U 630	218301	Drive Shaft		27	39	56.6	94	1045			
	2006.08-	-	-	R	F	Bus Engine G9U 630	650097	Inner Joint		39	35	30	409	90			
	2006.08-	-	-	L	F	Bus Engine G9U 630	250557	Drive Shaft		27	37.1	56.5	92	634			
	2006.08-	-	-	R	F	Bus Engine G9U 630	250562	Drive Shaft		27	39	56.5	92	1056			
	2006.08-	-	-	L	F	Bus Engine G9U 630	250497	Drive Shaft		27	39	56.6	94	667			
2.5 CDTi (84 kW)	2006.08-	-	-	R	F	Bus Engine G9U 630	218301	Drive Shaft		27	39	56.6	94	1045			
	2006.08-	-	-	R	F	Bus Engine G9U 630	650097	Inner Joint		39	35	30	409	90			
	2006.08-	-	-	L	F	Bus Engine G9U 630	250557	Drive Shaft		27	37.1	56.5	92	634			
	2006.08-	-	-	R	F	Bus Engine G9U 630	250562	Drive Shaft		27	39	56.5	92	1056			
	2006.08-	-	-	L	F	Bus Engine G9U 630	250497	Drive Shaft		27	39	56.6	94	667			
2.5 DTi (99 kW)	2003.05-	-	-	R	F	Bus Engine G9U 730	218301	Drive Shaft		27	39	56.6	94	1045			
	2003.05-	-	AT/MT	L/R	F	Bus Engine G9U 730	850041	Outer Joint		27	37	56.5	93	72	I		
	2003.05-	-	-	R	F	Bus Engine G9U 730	650097	Inner Joint		39	35	30	409	90			
	2003.05-	-	-	-	F	Bus Engine G9U 730	850080	Outer Joint		27	37	56.5	92	73	I		
	2003.05-	-	-	L	F	Bus Engine G9U 730	250557	Drive Shaft		27	37.1	56.5	92	634			
	2003.05-	-	-	R	F	Bus Engine G9U 730	250562	Drive Shaft		27	39	56.5	92	1056			
	2003.05-	-	-	L	F	Bus Engine G9U 730	250497	Drive Shaft		27	39	56.6	94	667			
ZAFIRA																	
-	-	-	-	-	-	-	899064	Outer Joint		33	24	52	104	64	M		
-	-	-	-	R	-	-	208011	Drive Shaft		33	34	52	104	959			
ZAFIRA A																	
2.2 DTi 16v (86 kW)	2002.01-	2005.06	-	-	-	-	699188	Inner Joint		27	35	35	101	88.5			





YEAR	TRANSM	L/R	F/R	REMARKS	GSP Ref.	PRODUCT	ABS	Technical Specifications										
								A	B	C	H	L	P					
OPEL																		
ZAFIRA A																		
2.2 DTI 16v (92 kW)	2002.01-	2005.06	-	-	-			699188	Inner Joint		27	35	35	101	88.5			
ZAFIRA A (T98)																		
1.6 16V (74 kW)	1999.04-	2005.06	-	R	F	MPV Engine Z 16 XE/X 16 XEL		699026	Inner Joint		22	25	35	57	82.5			
	1999.04-	2005.06	-	L	F	MPV Engine Z 16 XE/X 16 XEL		260013	Drive Shaft		33	22	52	103	595			
	1999.04-	2005.06	-	L/R	F	MPV Engine Z 16 XE/X 16 XEL		644004	Inner Joint		22	22	34.95	57.5	72.5			
	1999.04-	2005.06	AT/MT	L/R	F	MPV Engine Z 16 XE/X 16 XEL		844006	Outer Joint	29T	33	25	52	103.5	61	O		
	1999.04-	2005.06	-	-	F	MPV Engine Z 16 XE/X 16 XEL		844010	Outer Joint	29T	33	22	52	103	50.5	O		
	1999.04-	2005.06	-	R	F	MPV Engine Z 16 XE/X 16 XEL		244033	Drive Shaft		33	22	52	103	950.5			
	1999.04-	2005.06	-	L	F	MPV Engine Z 16 XE/X 16 XEL		621014	Inner Joint		22	22	35	57.5	75			
	1999.04-	2005.06	-	-	F	MPV Engine Z 16 XE/X 16 XEL		844049	Outer Joint		33	25	52	109	61	O		
	1999.04-	2005.06	-	R	F	MPV Engine Z 16 XE/X 16 XEL		260035	Drive Shaft		33	22	52	109	961			
1.6 CNG (71 kW)	2001.09-	2005.06	MT	R	F	MPV Engine Z 16 YNG		699026	Inner Joint		22	25	35	57	82.5			
	2001.09-	2005.06	-	L	F	MPV Engine Z 16 YNG		260013	Drive Shaft		33	22	52	103	595			
	2001.09-	2005.06	-	-	F	MPV Engine Z 16 YNG		844010	Outer Joint	29T	33	22	52	103	50.5	O		
	2001.09-	2005.06	-	R	F	MPV Engine Z 16 YNG		244033	Drive Shaft		33	22	52	103	950.5			
	2001.09-	2005.06	-	L/R	F	MPV Engine Z 16 YNG		644004	Inner Joint		22	22	34.95	57.5	72.5			
	2001.09-	2005.06	-	L	F	MPV Engine Z 16 YNG		621014	Inner Joint		22	22	35	57.5	75			
	2001.09-	2005.06	-	-	F	MPV Engine Z 16 YNG		844049	Outer Joint		33	25	52	109	61	O		
	2001.09-	2005.06	MT	R	F	MPV Engine Z 16 YNG		260035	Drive Shaft		33	22	52	109	961			
1.8 16V (85 kW)	1999.04-	2000.09	MT	R	F	MPV Engine X 18 XE1		699026	Inner Joint		22	25	35	57	82.5			
	1999.04-	2000.09	AT/MT	L/R	F	MPV Engine X 18 XE1		844006	Outer Joint	29T	33	25	52	103.5	61	O		
	1999.04-	2000.09	MT	R	F	MPV Engine X 18 XE1		260035	Drive Shaft		33	22	52	109	961			
	1999.04-	2000.09	-	-	F	MPV Engine X 18 XE1		844049	Outer Joint		33	25	52	109	61	O		
1.8 16V (92 kW)	2000.09-	2005.06	MT	R	F	MPV Engine Z 18 XE		699026	Inner Joint		22	25	35	57	82.5			
	2000.09-	2005.06	AT/MT	L/R	F	MPV Engine Z 18 XE		844006	Outer Joint	29T	33	25	52	103.5	61	O		
	2000.09-	2005.06	MT	R	F	MPV Engine Z 18 XE		260035	Drive Shaft		33	22	52	109	961			
	2000.09-	2005.06	-	-	F	MPV Engine Z 18 XE		844049	Outer Joint		33	25	52	109	61	O		
2.0 DI (63 kW)	1999.07-	2000.06	-	L	F	MPV Engine X 20 DTL		244044	Drive Shaft		33	34	52	103.5	595			
	1999.07-	2000.06	-	L/R	F	MPV Engine X 20 DTL		644002	Inner Joint		34	25	35	56.2	85.6			
	1999.07-	2000.06	AT/MT	L/R	F	MPV Engine X 20 DTL		844006	Outer Joint	29T	33	25	52	103.5	61	O		
	1999.07-	2000.06	AT/MT	L	F	MPV Engine X 20 DTL		208010	Drive Shaft		33	34	52	104	593			
2.0 DI 16V (60 kW)	1999.07-	2005.06	-	L	F	MPV Engine X 20 DTL		244044	Drive Shaft		33	34	52	103.5	595			
	1999.07-	2005.06	MT	L/R	F	MPV Engine X 20 DTL		621011	Inner Joint		34	25	35	78	64			
	1999.07-	2005.06	-	L/R	F	MPV Engine X 20 DTL		644002	Inner Joint		34	25	35	56.2	85.6			
	1999.07-	2005.06	AT/MT	L/R	F	MPV Engine X 20 DTL		844006	Outer Joint	29T	33	25	52	103.5	61	O		
	1999.07-	2005.06	AT/MT	L	F	MPV Engine X 20 DTL		208010	Drive Shaft		33	34	52	104	593			
	1999.07-	2005.06	-	-	F	MPV Engine X 20 DTL		844049	Outer Joint		33	25	52	109	61	O		
2.0 DTI 16V (74 kW)	2000.09-	2005.06	-	L	F	MPV Engine Y 20 DTH		244044	Drive Shaft		33	34	52	103.5	595			
	2000.09-	2005.06	MT	L/R	F	MPV Engine Y 20 DTH		621011	Inner Joint		34	25	35	78	64			
	2000.09-	2005.06	-	L/R	F	MPV Engine Y 20 DTH		644002	Inner Joint		34	25	35	56.2	85.6			
	2000.09-	2005.06	AT/MT	L/R	F	MPV Engine Y 20 DTH		844006	Outer Joint	29T	33	25	52	103.5	61	O		
	2000.09-	2005.06	AT/MT	L	F	MPV Engine Y 20 DTH		208010	Drive Shaft		33	34	52	104	593			
	2000.09-	2005.06	-	-	F	MPV Engine Y 20 DTH		844049	Outer Joint		33	25	52	109	61	O		
2.0 OPC (141 kW)	2001.09-	2005.06	MT	-	F	MPV Engine Z 20 LET		899061	Outer Joint		33	35	55	104	67.5	I		
	2001.09-	2005.06	MT	L	F	MPV Engine Z 20 LET		644018	Inner Joint		34	35	35	56	119.5			
	2001.09-	2005.06	MT	L	F	MPV Engine Z 20 LET		244025	Drive Shaft		33	34	55	104	593			
	2001.09-	2005.06	MT	R	F	MPV Engine Z 20 LET		244082	Drive Shaft		33	34	55	104	663			
2.0 OPC (147 kW)	2002.11-	2005.06	MT	R	F	MPV Engine Z 20 LER/Z 20 LET		244082	Drive Shaft		33	34	55	104	663			
	2002.11-	2005.06	MT	-	F	MPV Engine Z 20 LER/Z 20 LET		899061	Outer Joint		33	35	55	104	67.5	I		
	2002.11-	2005.06	MT	L	F	MPV Engine Z 20 LER/Z 20 LET		644018	Inner Joint		34	35	35	56	119.5			
	2002.11-	2005.06	MT	L	F	MPV Engine Z 20 LER/Z 20 LET		244025	Drive Shaft		33	34	55	104	593			
2.2 16V (108 kW)	2000.09-	2005.06	-	L	F	MPV Engine Z 22 SE		244044	Drive Shaft		33	34	52	103.5	595			
	2000.09-	2005.06	MT	L/R	F	MPV Engine Z 22 SE		621011	Inner Joint		34	25	35	78	64			
	2000.09-	2005.06	-	L/R	F	MPV Engine Z 22 SE		644002	Inner Joint		34	25	35	56.2	85.6			
	2000.09-	2005.06	AT/MT	L	F	MPV Engine Z 22 SE		208010	Drive Shaft		33	34	52	104	593			
	2000.09-	2005.06	-	-	F	MPV Engine Z 22 SE		844049	Outer Joint		33	25	52	109	61	O		
2.2 DTI 16V (92 kW)	2002.01-	2005.06	AT/MT	L	F	MPV Engine Y 22 DTR		244058	Drive Shaft	29T	33	27	55	104	586			
ZAFIRA B (A05)																		
1.6 (77 kW)	2005.07-	-	MT	L	F	MPV Engine Z 16 XEP/Z 16 XE1		244028	Drive Shaft		33	22	53	95	590			
	2005.07-	-	MT	L	F	MPV Engine Z 16 XEP/Z 16 XE1		621014	Inner Joint		22	22	35	57.5	75			
	2005.07-	-	MT	L/R	F	MPV Engine Z 16 XEP/Z 16 XE1		844003	Outer Joint		33	22	53	95	54.5	M		
	2005.07-	-	MT	R	F	MPV Engine Z 16 XEP/Z 16 XE1		244030	Drive Shaft		33	22	53	95	952			
1.6 (85 kW)	2008.01-	-	MT	L	F	MPV Engine Z 16 XER/A 16 XER		244028	Drive Shaft		33	22	53	95	590			
	2008.01-	-	MT	L	F	MPV Engine Z 16 XER/A 16 XER		621014	Inner Joint		22	22	35	57.5	75			
	2008.01-	-	MT	L/R	F	MPV Engine Z 16 XER/A 16 XER		844003	Outer Joint		33	22	53	95	54.5	M		
	2008.01-	-	MT	R	F	MPV Engine Z 16 XER/A 16 XER		244030	Drive Shaft		33	22	53	95	952			

	 YEAR	TRANSM	L/R	F/R	REMARKS	GSP Ref.	 PRODUCT	 ABS	Technical Specifications					
									A	B	C	H	L	P
OPEL														
ZAFIRA B (A05)														
1.6 CNG (69 kW)	2006.01-	-	MT	L	F	MPV Engine Z 16 YNG	244028	Drive Shaft	33	22	53	95	590	
	2006.01-	-	MT	L	F	MPV Engine Z 16 YNG	621014	Inner Joint	22	22	35	57.5	75	
	2006.01-	-	-	L/R	F	MPV Engine Z 16 YNG	844003	Outer Joint	33	22	53	95	54.5	M
	2006.01-	-	MT	R	F	MPV Engine Z 16 YNG	244030	Drive Shaft	33	22	53	95	952	
1.6 CNG Turbo (110 kW)	2009.02-	-	-	-	-	MPV Engine Z 16 XNT/A 16 XNT	644005	Inner Joint	34	25	35	54	47	
	2009.02-	-	-	L/R	F	MPV Engine Z 16 XNT/A 16 XNT	844028	Outer Joint	33	24	53	93.5	63.5	M
1.7 CDTI (81 kW)	2008.01-	-	-	L/R	F	MPV Engine A 17 DTJ/Z A 17 DTJ	844027	Outer Joint	33	26	52.5	94	65.5	M
	2008.01-	-	-	R	F	MPV Engine A 17 DTJ/Z A 17 DTJ	644016	Inner Joint	34	28	37.5	46	54	
	2008.01-	-	-	R	F	MPV Engine A 17 DTJ/Z A 17 DTJ	244099	Drive Shaft	33	34	52.5	94	563	
	2008.01-	-	-	L	F	MPV Engine A 17 DTJ/Z A 17 DTJ	699186	Inner Joint	25	28	35	57.5	81.5	
	2008.01-	-	MT	-	F	MPV Engine A 17 DTJ/Z A 17 DTJ	899024	Outer Joint	33	26	52.5	94	65.5	M
	2008.01-	-	-	L	F	MPV Engine A 17 DTJ/Z A 17 DTJ	221051	Drive Shaft	33	25	52.5	94	579	
1.7 CDTI (92 kW)	2008.01-	-	MT	R	F	MPV Engine A 17 DTR	644016	Inner Joint	34	28	37.5	46	54	
	2008.01-	-	MT	R	F	MPV Engine A 17 DTR	244099	Drive Shaft	33	34	52.5	94	563	
	2008.01-	-	MT	L	F	MPV Engine A 17 DTR	699186	Inner Joint	25	28	35	57.5	81.5	
	2008.01-	-	MT	-	F	MPV Engine A 17 DTR	899024	Outer Joint	33	26	52.5	94	65.5	M
	2008.01-	-	MT	L	F	MPV Engine A 17 DTR	221051	Drive Shaft	33	25	52.5	94	579	
	2008.01-	-	MT	L/R	F	MPV Engine A 17 DTR	844027	Outer Joint	33	26	52.5	94	65.5	M
1.8 (103 kW)	2005.07-	-	MT	L	F	MPV Engine Z 18 XER/A 18 XER	699026	Inner Joint	22	25	35	57	82.5	
	2005.07-	-	MT	L	F	MPV Engine Z 18 XER/A 18 XER	221063	Drive Shaft	33	22	53	93.5	586	
	2005.07-	-	MT	L/R	F	MPV Engine Z 18 XER/A 18 XER	844028	Outer Joint	33	24	53	93.5	63.5	M
	2005.07-	-	AT/MT	R	F	MPV Engine Z 18 XER/A 18 XER	221055	Drive Shaft	33	22	53	93.5	950	
1.8 (88 kW)	2013.06-	-	MT	L	F	MPV Engine A 18 XEL	699026	Inner Joint	22	25	35	57	82.5	
	2013.06-	-	MT	L	F	MPV Engine A 18 XEL	221063	Drive Shaft	33	22	53	93.5	586	
	2013.06-	-	MT	L/R	F	MPV Engine A 18 XEL	844028	Outer Joint	33	24	53	93.5	63.5	M
1.8 LPG (103 kW)	2009.07-2015.04	-	-	L	F	MPV Engine Z 18 XER	699026	Inner Joint	22	25	35	57	82.5	
	2009.07-2015.04	-	-	L	F	MPV Engine Z 18 XER	221063	Drive Shaft	33	22	53	93.5	586	
	2009.07-2015.04	-	-	L/R	F	MPV Engine Z 18 XER	844028	Outer Joint	33	24	53	93.5	63.5	M
1.9 CDTI (110 kW)	2005.07-	-	MT	L	F	MPV Engine Z 19 DTH	221035	Drive Shaft	30	25	53.8	94.5	581	
	2005.07-	-	MT	L/R	F	MPV Engine Z 19 DTH	817051	Outer Joint	30	26	53.8	94.5	65.5	M
	2005.07-	-	MT	L	F	MPV Engine Z 19 DTH	699186	Inner Joint	25	28	35	57.5	81.5	
	2005.07-	-	MT	L	F	MPV Engine Z 19 DTH	621018	Inner Joint	25	34	35	58	116	
	2005.07-	-	MT	L	F	MPV Engine Z 19 DTH	221071	Drive Shaft	30	25	53.8	94.5	576	
	2005.07-	-	MT	R	F	MPV Engine Z 19 DTH	221062	Drive Shaft	30	34	53.8	94.5	595	
	2005.07-	-	MT	R	F	MPV Engine Z 19 DTH	260016	Drive Shaft	30	34	52.5	105	588	
	2005.07-	-	-	-	F	MPV Engine Z 19 DTH	899023	Outer Joint	30	26	53.8	94.5	65.5	M
	2005.07-	-	-	-	F	MPV Engine Z 19 DTH	221056	Drive Shaft	33	34	52.5	94	595	
1.9 CDTI (74 kW)	2005.07-	-	MT	L	F	MPV Engine Z 19 DTL	221073	Drive Shaft	33	25	52.5	94	578	
	2005.07-	-	MT	L	F	MPV Engine Z 19 DTL	221073	Drive Shaft	33	25	52.5	94	578	
	2005.07-	-	MT	L	F	MPV Engine Z 19 DTL	621018	Inner Joint	25	34	35	58	116	
	2005.07-	-	MT	L	F	MPV Engine Z 19 DTL	699186	Inner Joint	25	28	35	57.5	81.5	
	2005.07-	-	AT	L	F	MPV Engine Z 19 DTL	221111	Drive Shaft	33	27	52.5	94	562	
	2005.07-	-	-	-	F	MPV Engine Z 19 DTL	899024	Outer Joint	33	26	52.5	94	65.5	M
	2005.07-	-	AT	R	F	MPV Engine Z 19 DTL	221110	Drive Shaft	33	27	52.5	94	576	
	2005.07-	-	-	L/R	F	MPV Engine Z 19 DTL	844027	Outer Joint	33	26	52.5	94	65.5	M
	2005.07-	-	MT	L	F	MPV Engine Z 19 DT	221073	Drive Shaft	33	25	52.5	94	578	
1.9 CDTI (88 kW)	2005.07-	-	MT	L	F	MPV Engine Z 19 DT	621018	Inner Joint	25	34	35	58	116	
	2005.07-	-	MT	L	F	MPV Engine Z 19 DT	699186	Inner Joint	25	28	35	57.5	81.5	
	2005.07-	-	AT	L	F	MPV Engine Z 19 DT	221111	Drive Shaft	33	27	52.5	94	562	
	2005.07-	-	-	-	F	MPV Engine Z 19 DT	899024	Outer Joint	33	26	52.5	94	65.5	M
	2005.07-	-	-	L/R	F	MPV Engine Z 19 DT	844027	Outer Joint	33	26	52.5	94	65.5	M
	2005.07-	-	AT	R	F	MPV Engine Z 19 DT	221110	Drive Shaft	33	27	52.5	94	576	
	2005.07-	-	MT	R	F	MPV Engine Z 19 DT	221056	Drive Shaft	33	34	52.5	94	595	
	2005.07-	-	-	-	F	MPV Engine Z 20 LER	899024	Outer Joint	33	26	52.5	94	65.5	M
	2005.07-	-	-	L/R	F	MPV Engine Z 20 LER	844027	Outer Joint	33	26	52.5	94	65.5	M
2.0 (147 kW)	2005.07-	-	-	R	F	MPV Engine Z 20 LER	221056	Drive Shaft	33	34	52.5	94	595	
	2006.01-	-	-	L/R	F	MPV Engine Z 20 LEH	817051	Outer Joint	30	26	53.8	94.5	65.5	M
	2006.01-	-	-	R	F	MPV Engine Z 20 LEH	221062	Drive Shaft	30	34	53.8	94.5	595	
	2006.01-	-	-	R	F	MPV Engine Z 20 LEH	260016	Drive Shaft	30	34	52.5	105	588	
	2006.01-	-	-	-	F	MPV Engine Z 20 LEH	899023	Outer Joint	30	26	53.8	94.5	65.5	M
2.2 (110 kW)	2005.07-	-	MT	R	F	MPV Engine Z 22 YH	244051	Drive Shaft	33	34	53	93.5	570	
	2005.07-	-	-	L/R	F	MPV Engine Z 22 YH	844028	Outer Joint	33	24	53	93.5	63.5	M
ZAFIRA B Van (A05)														
1.6 CNG Turbo (110 kW)	2009.02-	-	-	-	-	Box Engine Z 16 XNT/A 16 XNT	644005	Inner Joint	34	25	35	54	47	
	2009.02-	-	-	L/R	F	Box Engine Z 16 XNT/A 16 XNT	844028	Outer Joint	33	24	53	93.5	63.5	M
1.7 CDTI (81 kW)	2008.01-	-	-	R	F	Box Engine Z 17 DTJ/A 17 DTJ	644016	Inner Joint	34	28	37.5	46	54	
	2008.01-	-	-	R	F	Box Engine Z 17 DTJ/A 17 DTJ	244099	Drive Shaft	33	34	52.5	94	563	

	 YEAR	TRANSM	L/R	F/R	REMARKS	GSP Ref.	 PRODUCT	 ABS	Technical Specifications					
									A	B	C	H	L	P
OPEL														
ZAFIRA B Van (A05)														
1.7 CDTI (81 kW)	2008.01-	-	L	F	Box Engine Z 17 DTJ/A 17 DTJ	699186	Inner Joint		25	28	35	57.5	81.5	
	2008.01-	MT	-	F	Box Engine Z 17 DTJ/A 17 DTJ	899024	Outer Joint		33	26	52.5	94	65.5	M
	2008.01-	-	L	F	Box Engine Z 17 DTJ/A 17 DTJ	221051	Drive Shaft		33	25	52.5	94	57.9	
	2008.01-	-	L/R	F	Box Engine Z 17 DTJ/A 17 DTJ	844027	Outer Joint		33	26	52.5	94	65.5	M
1.7 CDTI (92 kW)	2008.01-	-	R	F	Box Engine A 17 DTR	644016	Inner Joint		34	28	37.5	46	54	
	2008.01-	-	R	F	Box Engine A 17 DTR	244099	Drive Shaft		33	34	52.5	94	56.3	
	2008.01-	-	L	F	Box Engine A 17 DTR	699186	Inner Joint		25	28	35	57.5	81.5	
	2008.01-	MT	-	F	Box Engine A 17 DTR	899024	Outer Joint		33	26	52.5	94	65.5	M
	2008.01-	-	L	F	Box Engine A 17 DTR	221051	Drive Shaft		33	25	52.5	94	57.9	
	2008.01-	-	L/R	F	Box Engine A 17 DTR	844027	Outer Joint		33	26	52.5	94	65.5	M
1.8 (103 kW)	2005.07-	-	L	F	Box Engine Z 18 XER/A 18 XER	699026	Inner Joint		22	25	35	57	82.5	
	2005.07-	AT/MT	R	F	Box Engine Z 18 XER/A 18 XER	221055	Drive Shaft		33	22	53	93.5	95.0	
	2005.07-	-	L	F	Box Engine Z 18 XER/A 18 XER	221063	Drive Shaft		33	22	53	93.5	58.6	
	2005.07-	-	L/R	F	Box Engine Z 18 XER/A 18 XER	844028	Outer Joint		33	24	53	93.5	63.5	M
ZAFIRA TOURER C (P12)														
1.6 CDTI (100 kW)	2013.02-	MT	R	F	MPV Engine B 16 DTH	260027	Drive Shaft		30	27	52.5	94.5	61.9	
	2013.02-	-	-	F	MPV Engine B 16 DTH	899023	Outer Joint		30	26	53.8	94.5	65.5	M
1.6 CDTI (88 kW)	2014.07-	MT	L	F	MPV Engine B 16 DTJ	260027	Drive Shaft		30	27	52.5	94.5	61.9	
	2014.07-	-	-	F	MPV Engine B 16 DTJ	899023	Outer Joint		30	26	53.8	94.5	65.5	M
1.6 CDTI (99 kW)	2016.11-	-	L	F	MPV Engine B 16 DTH	260027	Drive Shaft		30	27	52.5	94.5	61.9	
1.6 CNG (110 kW)	2011.10-	-	-	F	MPV Engine A 16 XNT/B 16 XNT	899023	Outer Joint		30	26	53.8	94.5	65.5	M
	2011.10-	MT	L/R	F	MPV Engine A 16 XNT/B 16 XNT	817051	Outer Joint		30	26	53.8	94.5	65.5	M
1.6 SIDI (125 kW)	2012.12-	-	-	F	MPV Engine A 16 XHT	899023	Outer Joint		30	26	53.8	94.5	65.5	M
	2012.12-	AT	R	F	MPV Engine A 16 XHT	817051	Outer Joint		30	26	53.8	94.5	65.5	M
1.6 SIDI (147 kW)	2013.07-	-	-	F	MPV Engine A 16 SHT	899023	Outer Joint		30	26	53.8	94.5	65.5	M
2.0 BiTurbo CDTI (143 kW)	2013.01-	MT	R	F	MPV Engine A 20 DTR	260027	Drive Shaft		30	27	52.5	94.5	61.9	
2.0 CDTI (121 kW)	2011.10-	6AT	L/R	F	MPV Engine A 20 DTH	817051	Outer Joint		30	26	53.8	94.5	65.5	M
	2011.10-	MT	L	F	MPV Engine A 20 DTH	260027	Drive Shaft		30	27	52.5	94.5	61.9	
2.0 CDTI (125 kW)	2015.01-	MT	L	F	MPV Engine B 20 DTH	260027	Drive Shaft		30	27	52.5	94.5	61.9	
	2015.01-	6AT	L	F	MPV Engine B 20 DTH	817051	Outer Joint		30	26	53.8	94.5	65.5	M
	2015.01-	-	-	F	MPV Engine B 20 DTH	899023	Outer Joint		30	26	53.8	94.5	65.5	M
2.0 CDTI (81 kW)	2011.10-	-	L	F	MPV Engine A 20 DTL	260027	Drive Shaft		30	27	52.5	94.5	61.9	
2.0 CDTI (96 kW)	2011.10-	-	L	F	MPV Engine Y 20 DTJ/Z 20 DTJ/A 20 DT	260027	Drive Shaft		30	27	52.5	94.5	61.9	
	2011.10-	6AT	L/R	F	MPV Engine Y 20 DTJ/Z 20 DTJ/A 20 DT	817051	Outer Joint		30	26	53.8	94.5	65.5	M
PERODUA														
ALZA														
-	-	-	R	-	-	249013	Drive Shaft		26	23	55.5	96	89.3	
	-	-	L	-	-	249014	Drive Shaft		26	23	55.5	96	67.1	
KELISA (L7_)														
1.0 DVVT (43 kW)	2002.02-	-	-	F	Hatchback Engine EJ-VE	814028	Outer Joint		24	19	47	84.5	47.5	I
	2002.02-	-	L	F	Hatchback Engine EJ-VE	214035	Drive Shaft		24	23	47	84.5	58.1	
	2002.02-	-	R	F	Hatchback Engine EJ-VE	214036	Drive Shaft		24	23	47	84.5	79.4	
PEUGEOT														
1007 (KM_)														
1.4 (54 kW)	2005.04-	MT	L/R	F	Hatchback Engine KFV (TU3JP)/KFV (TU3A)	845056	Outer Joint		21	27	49	86	53	O
	2005.04-	-	L	F	Hatchback Engine KFV (TU3JP)/KFV (TU3A)	210125	Drive Shaft		21	22	48	86.5	64.9	
	2005.04-	-	R	F	Hatchback Engine KFV (TU3JP)/KFV (TU3A)	210124	Drive Shaft		21	22	48	86.5	84.0	
1.4 16V (65 kW)	2005.10-	-	R	F	Hatchback Engine KFV (ET3J4)	210242	Drive Shaft		21	22	48	86.5	84.4	
	2005.10-	-	L	F	Hatchback Engine KFV (ET3J4)	210241	Drive Shaft		21	22	48	86.5	64.2	
	2005.10-	-	L	F	Hatchback Engine KFV (ET3J4)	210146	Drive Shaft		21	22	48	86.5	64.2	
	2005.10-	-	R	F	Hatchback Engine KFV (ET3J4)	210144	Drive Shaft		21	22	48	86.5	84.3	
1.4 HDi (50 kW)	2005.04-	-	R	F	Hatchback Engine 8HZ (DV4TD)/8HX (DV4TD)	210259	Drive Shaft		21	22	48.5	86	84.9	
	2005.04-	-	-	F	Hatchback Engine 8HZ (DV4TD)/8HX (DV4TD)	810077	Outer Joint		21	28	49	86	56.5	O
	2005.04-	-	L	F	Hatchback Engine 8HZ (DV4TD)/8HX (DV4TD)	210419	Drive Shaft		21	22	48.5	86	64.3	
	2005.04-	-	L	F	Hatchback Engine 8HZ (DV4TD)/8HX (DV4TD)	210420	Drive Shaft		21	22	48	86.5	63.7	
1.6 16V (80 kW)	2005.04-	-	R	F	Hatchback Engine NFU (TU5JP4)	210242	Drive Shaft		21	22	48	86.5	84.4	
	2005.04-	-	L	F	Hatchback Engine NFU (TU5JP4)	210241	Drive Shaft		21	22	48	86.5	64.2	
	2005.04-	-	L	F	Hatchback Engine NFU (TU5JP4)	210146	Drive Shaft		21	22	48	86.5	64.2	
	2005.04-	-	R	F	Hatchback Engine NFU (TU5JP4)	210144	Drive Shaft		21	22	48	86.5	84.3	
1.6 HDi (80 kW)	2007.06-	MT	R	F	Hatchback Engine 9HZ (DV6TED4)	610082	Inner Joint		24	34	29.8	291	88	
	2007.06-	MT	L	F	Hatchback Engine 9HZ (DV6TED4)	610080	Inner Joint		24	34	40	69	89.5	
	2007.06-	MT	L	F	Hatchback Engine 9HZ (DV6TED4)	610092	Inner Joint		24	22	40	69	86	
	2007.06-	MT	L	F	Hatchback Engine 9HZ (DV6TED4)	210364	Drive Shaft		21	24	50	85	63.1	
	2007.06-	MT	R	F	Hatchback Engine 9HZ (DV6TED4)	245226	Drive Shaft		21	24	48.3	86.5	85.6	
	2007.06-	MT	L	F	Hatchback Engine 9HZ (DV6TED4)	899301	Outer Joint		21	22	50	85	53	I

	 YEAR	TRANSM	L/R	F/R	REMARKS	GSP Ref.	 PRODUCT	 ABS	Technical Specifications					
									A	B	C	H	L	P
PEUGEOT														
106														
-	1999.10-	-	-	L	-	210045	Drive Shaft	48T	21	22	50	86.5	625	
-	1999.10-	-	-	-	-	610006	Inner Joint		22	22	40	58.5	87	
106 I														
1.3	1994.01-1996.06	MT	R	F	-	245046	Drive Shaft	48T	21	22	58.5	76	800	
1.4	1993.07-1996.06	MT	R	F	-	245046	Drive Shaft	48T	21	22	58.5	76	800	
1.6	1994.08-1996.06	MT	R	F	-	245046	Drive Shaft	48T	21	22	58.5	76	800	
106 I (1A 1C)														
1.0 (33 kW)	1991.09-1996.04	-	-	-	Hatchback Engine CDY (TU9M)/TU9	210089	Drive Shaft		21	22	56.4	76	790	
	1991.09-1996.04	MT	R	F	Hatchback Engine CDY (TU9M)/TU9	210062	Drive Shaft		21	22	49.9	81	798	
	1991.09-1996.04	MT	L	F	Hatchback Engine CDY (TU9M)/TU9	810034	Outer Joint		21	20	50	81.5	54	O
	1991.09-1996.04	-	-	F	Hatchback Engine CDY (TU9M)/TU9	808016	Outer Joint		22	22	52	96.5	53.5	O
	1991.09-1996.04	MT	L	F	Hatchback Engine CDY (TU9M)/TU9	210164	Drive Shaft		21	22	58.5	76	614	
	1991.09-1996.04	MT	L	F	Hatchback Engine CDY (TU9M)/TU9	210009	Drive Shaft		21	22	50	81.5	618	
	1991.09-1996.04	MT	R	F	Hatchback Engine CDY (TU9M)/TU9	210085	Drive Shaft		21	22	56.4	76	798	
	1991.09-1996.04	MT	R	F	Hatchback Engine CDY (TU9M)/TU9	210186	Drive Shaft	48T	21	22	54	75.5	799	
1.0 (37 kW)	1991.09-1996.04	MT	R	F	Hatchback Engine CDZ (TU9M)	210062	Drive Shaft		21	22	49.9	81	798	
	1991.09-1996.04	MT	L	F	Hatchback Engine CDZ (TU9M)	810034	Outer Joint		21	20	50	81.5	54	O
	1991.09-1996.04	-	-	F	Hatchback Engine CDZ (TU9M)	808016	Outer Joint		22	22	52	96.5	53.5	O
	1991.09-1996.04	MT	L	F	Hatchback Engine CDZ (TU9M)	210009	Drive Shaft		21	22	50	81.5	618	
1.1 (44 kW)	1991.09-1996.04	-	-	-	Hatchback Engine HDZ (TU1M)	210089	Drive Shaft		21	22	56.4	76	790	
	1991.09-1996.04	MT	R	F	Hatchback Engine HDZ (TU1M)	210062	Drive Shaft		21	22	49.9	81	798	
	1991.09-1996.04	MT	L	F	Hatchback Engine HDZ (TU1M)	810034	Outer Joint		21	20	50	81.5	54	O
	1991.09-1996.04	MT	L	F	Hatchback Engine HDZ (TU1M)	210094	Drive Shaft		21	22	56.4	76	615	
	1991.09-1996.04	-	-	F	Hatchback Engine HDZ (TU1M)	808016	Outer Joint		22	22	52	96.5	53.5	O
	1991.09-1996.04	MT	L	F	Hatchback Engine HDZ (TU1M)	210164	Drive Shaft		21	22	58.5	76	614	
	1991.09-1996.04	MT	R	F	Hatchback Engine HDZ (TU1M)	210093	Drive Shaft		21	22	56.4	76	796	
	1991.09-1996.04	MT	L	F	Hatchback Engine HDZ (TU1M)	210009	Drive Shaft		21	22	50	81.5	618	
	1991.09-1996.04	MT	R	F	Hatchback Engine HDZ (TU1M)	210085	Drive Shaft		21	22	56.4	76	798	
	1991.09-1996.04	MT	L	F	Hatchback Engine HDZ (TU1M)	210061	Drive Shaft		21	22	49.9	81	620	
1.3 (72 kW)	1993.10-1996.04	MT	R	F	Hatchback Engine TU2J2	299158	Drive Shaft	48T	21	22	54	75.5	801	
	1993.10-1996.04	MT	L	F	Hatchback Engine TU2J2	210054	Drive Shaft		21	22	56.4	76	610	
	1993.10-1996.04	MT	R	F	Hatchback Engine TU2J2	299203	Drive Shaft		21	22	54	75.5	801	
	1993.10-1996.04	MT	L	F	Hatchback Engine TU2J2	210159	Drive Shaft		21	22	58.5	76	615	
	1993.10-1996.04	MT	R	F	Hatchback Engine TU2J2	210118	Drive Shaft		21	22	56.4	76	800	
	1993.10-1996.04	MT	L	F	Hatchback Engine TU2J2	210020	Drive Shaft	48T	21	22	58.5	76	615	
	1993.10-1996.04	MT	R	F	Hatchback Engine TU2J2	210174	Drive Shaft	48T	21	22	58.5	76	800	
	1993.10-1996.04	MT	L	F	Hatchback Engine TU2J2	299160	Drive Shaft	48T	21	22	54	75.5	608	
1.4 (51 kW)	1991.08-1996.03	MT	R	F	Hatchback Engine K5A (TU3)	210062	Drive Shaft		21	22	49.9	81	798	
	1991.08-1996.03	MT	L	F	Hatchback Engine K5A (TU3)	210094	Drive Shaft		21	22	56.4	76	615	
	1991.08-1996.03	MT	R	F	Hatchback Engine K5A (TU3)	210093	Drive Shaft		21	22	56.4	76	796	
	1991.08-1996.03	MT	L	F	Hatchback Engine K5A (TU3)	210061	Drive Shaft		21	22	49.9	81	620	
1.4 (55 kW)	1991.09-1996.04	-	-	-	Hatchback Engine KDX (TU3MC)/KDY (TU3M)	210089	Drive Shaft		21	22	56.4	76	790	
	1991.09-1996.04	MT	R	F	Hatchback Engine KDX (TU3MC)/KDY (TU3M)	210062	Drive Shaft		21	22	49.9	81	798	
	1991.09-1996.04	MT	L	F	Hatchback Engine KDX (TU3MC)/KDY (TU3M)	210094	Drive Shaft		21	22	56.4	76	615	
	1991.09-1996.04	MT	L	F	Hatchback Engine KDX (TU3MC)/KDY (TU3M)	210164	Drive Shaft		21	22	58.5	76	614	
	1991.09-1996.04	MT	R	F	Hatchback Engine KDX (TU3MC)/KDY (TU3M)	210093	Drive Shaft		21	22	56.4	76	796	
	1991.09-1996.04	MT	R	F	Hatchback Engine KDX (TU3MC)/KDY (TU3M)	210085	Drive Shaft		21	22	56.4	76	798	
	1991.09-1996.04	MT	R	F	Hatchback Engine KDX (TU3MC)/KDY (TU3M)	210186	Drive Shaft	48T	21	22	54	75.5	799	
	1991.09-1996.04	MT	L	F	Hatchback Engine KDX (TU3MC)/KDY (TU3M)	210038	Drive Shaft	48T	21	22	58.5	76	614	
	1991.09-1996.04	MT	L	F	Hatchback Engine KDX (TU3MC)/KDY (TU3M)	210061	Drive Shaft		21	22	49.9	81	620	
	1991.09-1996.04	MT	R	F	Hatchback Engine KDX (TU3MC)/KDY (TU3M)	210042	Drive Shaft	48T	21	22	56.4	76	798	
1.4 (69 kW)	1991.09-1996.04	MT	L	F	Hatchback Engine KFZ (TU3J2/Z)	299160	Drive Shaft	48T	21	22	54	75.5	608	
	1991.09-1996.04	MT	R	F	Hatchback Engine KFZ (TU3J2/Z)	299158	Drive Shaft	48T	21	22	54	75.5	801	
	1991.09-1996.04	MT	L	F	Hatchback Engine KFZ (TU3J2/Z)	210054	Drive Shaft		21	22	56.4	76	610	
	1991.09-1996.04	MT	R	F	Hatchback Engine KFZ (TU3J2/Z)	299203	Drive Shaft		21	22	54	75.5	801	
	1991.09-1996.04	MT	L	F	Hatchback Engine KFZ (TU3J2/Z)	210159	Drive Shaft		21	22	58.5	76	615	
	1991.09-1996.04	MT	R	F	Hatchback Engine KFZ (TU3J2/Z)	210118	Drive Shaft		21	22	56.4	76	800	
	1991.09-1996.04	MT	L	F	Hatchback Engine KFZ (TU3J2/Z)	210020	Drive Shaft	48T	21	22	58.5	76	615	
	1991.09-1996.04	MT	R	F	Hatchback Engine KFZ (TU3J2/Z)	210174	Drive Shaft	48T	21	22	58.5	76	800	
1.4 (72 kW)	1991.08-1996.03	MT	L	F	Hatchback	299160	Drive Shaft	48T	21	22	54	75.5	608	
	1991.08-1996.03	MT	R	F	Hatchback	299158	Drive Shaft	48T	21	22	54	75.5	801	
	1991.08-1996.03	MT	L	F	Hatchback	210054	Drive Shaft		21	22	56.4	76	610	
	1991.08-1996.03	MT	R	F	Hatchback	299203	Drive Shaft		21	22	54	75.5	801	
1.4 D (37 kW)	1992.09-1996.04	-	-	-	Hatchback Engine K9Y (TUD3Y)	210089	Drive Shaft		21	22	56.4	76	790	

	 YEAR	TRANSM	L/R	F/R	REMARKS	GSP Ref.	 PRODUCT	 ABS	Technical Specifications						
									A	B	C	H	L	P	
PEUGEOT															
106 I (1A 1C)															
1.4 D (37 kW)	1992.09-1996.04	MT	L	F	Hatchback Engine K9Y (TUD3Y)	210094	Drive Shaft		21	22	56.4	76	615		
	1992.09-1996.04	MT	L	F	Hatchback Engine K9Y (TUD3Y)	210164	Drive Shaft		21	22	58.5	76	614		
	1992.09-1996.04	MT	R	F	Hatchback Engine K9Y (TUD3Y)	210093	Drive Shaft		21	22	56.4	76	796		
	1992.09-1996.04	MT	R	F	Hatchback Engine K9Y (TUD3Y)	210085	Drive Shaft		21	22	56.4	76	798		
	1992.09-1996.04	MT	R	F	Hatchback Engine K9Y (TUD3Y)	210186	Drive Shaft	48T	21	22	54	75.5	799		
	1992.09-1996.04	MT	L	F	Hatchback Engine K9Y (TUD3Y)	210038	Drive Shaft	48T	21	22	58.5	76	614		
	1992.09-1996.04	MT	R	F	Hatchback Engine K9Y (TUD3Y)	210042	Drive Shaft	48T	21	22	56.4	76	798		
1.5 D (40 kW)	1994.06-1996.04	MT	L	F	Hatchback Engine VJY (TUD5)	210094	Drive Shaft		21	22	56.4	76	615		
	1994.06-1996.04	MT	R	F	Hatchback Engine VJY (TUD5)	210093	Drive Shaft		21	22	56.4	76	796		
	1994.06-1996.04	MT	L	F	Hatchback Engine VJY (TUD5)	299007	Drive Shaft	48T	21	22	58.5	76	608		
	1994.06-1996.04	MT	R	F	Hatchback Engine VJY (TUD5)	299009	Drive Shaft	48T	21	22	58.5	76	797		
	1994.06-1996.04	MT	R	F	Hatchback Engine VJY (TUD5)	210186	Drive Shaft	48T	21	22	54	75.5	799		
1.5 D (43 kW)	1994.06-1996.04	MT	L	F	Hatchback Engine VJY (TUD5)/VJZ (TUD5)	210094	Drive Shaft		21	22	56.4	76	615		
	1994.06-1996.04	MT	R	F	Hatchback Engine VJY (TUD5)/VJZ (TUD5)	210093	Drive Shaft		21	22	56.4	76	796		
	1994.06-1996.04	MT	L	F	Hatchback Engine VJY (TUD5)/VJZ (TUD5)	299007	Drive Shaft	48T	21	22	58.5	76	608		
	1994.06-1996.04	MT	R	F	Hatchback Engine VJY (TUD5)/VJZ (TUD5)	299009	Drive Shaft	48T	21	22	58.5	76	797		
	1994.06-1996.04	MT	R	F	Hatchback Engine VJY (TUD5)/VJZ (TUD5)	210186	Drive Shaft	48T	21	22	54	75.5	799		
1.6 (65 kW)	1993.06-1996.04	MT	L	F	Hatchback Engine NFZ (TU5JP)	299160	Drive Shaft	48T	21	22	54	75.5	608		
	1993.06-1996.04	MT	R	F	Hatchback Engine NFZ (TU5JP)	299158	Drive Shaft	48T	21	22	54	75.5	801		
	1993.06-1996.04	MT	L	F	Hatchback Engine NFZ (TU5JP)	210054	Drive Shaft		21	22	56.4	76	610		
	1993.06-1996.04	MT	R	F	Hatchback Engine NFZ (TU5JP)	299203	Drive Shaft		21	22	54	75.5	801		
	1993.06-1996.04	MT	L	F	Hatchback Engine NFZ (TU5JP)	299007	Drive Shaft	48T	21	22	58.5	76	608		
	1993.06-1996.04	MT	R	F	Hatchback Engine NFZ (TU5JP)	210186	Drive Shaft	48T	21	22	54	75.5	799		
	1993.06-1996.04	MT	R	F	Hatchback Engine NFZ (TU5JP)	299009	Drive Shaft	48T	21	22	58.5	76	797		
1.6 (76 kW)	1994.01-1996.04	MT	L	F	Hatchback Engine NFY (TU5J2)	299160	Drive Shaft	48T	21	22	54	75.5	608		
	1994.01-1996.04	MT	R	F	Hatchback Engine NFY (TU5J2)	299158	Drive Shaft	48T	21	22	54	75.5	801		
	1994.01-1996.04	MT	L	F	Hatchback Engine NFY (TU5J2)	210054	Drive Shaft		21	22	56.4	76	610		
	1994.01-1996.04	MT	R	F	Hatchback Engine NFY (TU5J2)	299203	Drive Shaft		21	22	54	75.5	801		
	1994.01-1996.04	MT	L	F	Hatchback Engine NFY (TU5J2)	210159	Drive Shaft		21	22	58.5	76	615		
	1994.01-1996.04	MT	R	F	Hatchback Engine NFY (TU5J2)	210118	Drive Shaft		21	22	56.4	76	800		
	1994.01-1996.04	MT	L	F	Hatchback Engine NFY (TU5J2)	210020	Drive Shaft	48T	21	22	58.5	76	615		
	1994.01-1996.04	MT	R	F	Hatchback Engine NFY (TU5J2)	210174	Drive Shaft	48T	21	22	58.5	76	800		
106 II															
1.6	1997.01-1998.04	MT	R	F	-	245046	Drive Shaft	48T	21	22	58.5	76	800		
106 II (1)															
1.0 i (33 kW)	1996.05-1999.10	MT	R	F	Hatchback Engine CDY (TU9M)	210062	Drive Shaft		21	22	49.9	81	798		
	1996.05-1999.10	MT	R	F	Hatchback Engine CDY (TU9M)	210089	Drive Shaft		21	22	56.4	76	790		
	1996.05-1999.10	-	L	F	Hatchback Engine CDY (TU9M)	210161	Drive Shaft		21	22	58.5	86	624		
	1996.05-1999.10	-	R	F	Hatchback Engine CDY (TU9M)	210156	Drive Shaft		21	22	58.5	86	807		
	1996.05-1999.10	MT	L	F	Hatchback Engine CDY (TU9M)	210094	Drive Shaft		21	22	56.4	76	615		
	1996.05-1999.10	MT	L	F	Hatchback Engine CDY (TU9M)	245071	Drive Shaft		21	22	48	86.5	622		
	1996.05-1999.10	-	-	F	Hatchback Engine CDY (TU9M)	808016	Outer Joint		22	22	52	96.5	53.5	O	
	1996.05-1999.10	MT	R	F	Hatchback Engine CDY (TU9M)	245072	Drive Shaft		21	22	48	86.5	798.5		
	1996.05-1999.10	MT	R	F	Hatchback Engine CDY (TU9M)	210093	Drive Shaft		21	22	56.4	76	796		
	1996.05-1999.10	-	R	F	Hatchback Engine CDY (TU9M)	210085	Drive Shaft		21	22	56.4	76	798		
	1996.05-1999.10	MT	L	F	Hatchback Engine CDY (TU9M)	210061	Drive Shaft		21	22	49.9	81	620		
	1.0 i (37 kW)	1997.01--	MT	R	F	Hatchback Engine CDZ (TU9M)	210089	Drive Shaft		21	22	56.4	76	790	
		1997.01--	MT	R	F	Hatchback Engine CDZ (TU9M)	210062	Drive Shaft		21	22	49.9	81	798	
1997.01--		-	L	F	Hatchback Engine CDZ (TU9M)	210161	Drive Shaft		21	22	58.5	86	624		
1997.01--		-	R	F	Hatchback Engine CDZ (TU9M)	210156	Drive Shaft		21	22	58.5	86	807		
1997.01--		MT	L	F	Hatchback Engine CDZ (TU9M)	210094	Drive Shaft		21	22	56.4	76	615		
1997.01--		MT	L	F	Hatchback Engine CDZ (TU9M)	245071	Drive Shaft		21	22	48	86.5	622		
1997.01--		-	-	F	Hatchback Engine CDZ (TU9M)	808016	Outer Joint		22	22	52	96.5	53.5	O	
1997.01--		MT	R	F	Hatchback Engine CDZ (TU9M)	245072	Drive Shaft		21	22	48	86.5	798.5		
1997.01--		MT	R	F	Hatchback Engine CDZ (TU9M)	210093	Drive Shaft		21	22	56.4	76	796		
1997.01--		-	R	F	Hatchback Engine CDZ (TU9M)	210085	Drive Shaft		21	22	56.4	76	798		
1997.01--		MT	R	F	Hatchback Engine CDZ (TU9M)	210186	Drive Shaft	48T	21	22	54	75.5	799		
1997.01--		MT	L	F	Hatchback Engine CDZ (TU9M)	210061	Drive Shaft		21	22	49.9	81	620		
1.1 i (40 kW)		1997.01--	MT	R	F	Hatchback Engine HDY (TU1M)	210089	Drive Shaft		21	22	56.4	76	790	
	1997.01--	MT	R	F	Hatchback Engine HDY (TU1M)	210062	Drive Shaft		21	22	49.9	81	798		
	1997.01--	-	L	F	Hatchback Engine HDY (TU1M)	210161	Drive Shaft		21	22	58.5	86	624		
	1997.01--	-	R	F	Hatchback Engine HDY (TU1M)	210156	Drive Shaft		21	22	58.5	86	807		
	1997.01--	MT	L	F	Hatchback Engine HDY (TU1M)	210094	Drive Shaft		21	22	56.4	76	615		
	1997.01--	MT	L	F	Hatchback Engine HDY (TU1M)	245071	Drive Shaft		21	22	48	86.5	622		
	1997.01--	-	-	F	Hatchback Engine HDY (TU1M)	808016	Outer Joint		22	22	52	96.5	53.5	O	
	1997.01--	MT	R	F	Hatchback Engine HDY (TU1M)	245072	Drive Shaft		21	22	48	86.5	798.5		

	 YEAR	TRANSM	L/R	F/R	REMARKS	GSP Ref.	 PRODUCT	 ABS	Technical Specifications						
									A	B	C	H	L	P	
PEUGEOT															
106 II (1)															
1.1 i (40 kW)	1997.01- -	MT	R	F	Hatchback Engine HDY (TU1M)	210093	Drive Shaft		21	22	56.4	76	796		
	1997.01- -	-	R	F	Hatchback Engine HDY (TU1M)	210085	Drive Shaft		21	22	56.4	76	798		
	1997.01- -	MT	L	F	Hatchback Engine HDY (TU1M)	210061	Drive Shaft		21	22	49.9	81	620		
1.1 i (44 kW)	1996.05-2004.07	MT	R	F	Hatchback Engine HDZ (TU1M)/HFX (TU1JP)	210062	Drive Shaft		21	22	49.9	81	798		
	1996.05-2004.07	MT	R	F	Hatchback Engine HDZ (TU1M)/HFX (TU1JP)	210089	Drive Shaft		21	22	56.4	76	790		
	1996.05-2004.07	-	L	F	Hatchback Engine HDZ (TU1M)/HFX (TU1JP)	210161	Drive Shaft		21	22	58.5	86	624		
	1996.05-2004.07	-	R	F	Hatchback Engine HDZ (TU1M)/HFX (TU1JP)	210156	Drive Shaft		21	22	58.5	86	807		
	1996.05-2004.07	MT	L	F	Hatchback Engine HDZ (TU1M)/HFX (TU1JP)	210094	Drive Shaft		21	22	56.4	76	615		
	1996.05-2004.07	MT	L	F	Hatchback Engine HDZ (TU1M)/HFX (TU1JP)	245071	Drive Shaft		21	22	48	86.5	622		
	1996.05-2004.07	-	F	F	Hatchback Engine HDZ (TU1M)/HFX (TU1JP)	808016	Outer Joint		22	22	52	96.5	53.5	O	
	1996.05-2004.07	MT	R	F	Hatchback Engine HDZ (TU1M)/HFX (TU1JP)	245072	Drive Shaft		21	22	48	86.5	798.5		
	1996.05-2004.07	MT	R	F	Hatchback Engine HDZ (TU1M)/HFX (TU1JP)	210093	Drive Shaft		21	22	56.4	76	796		
1.4 i (55 kW)	1996.05-2004.07	MT	R	F	Hatchback Engine KFW (TU3JP)/KFX (TU3JP)	210062	Drive Shaft		21	22	49.9	81	798		
	1996.05-2004.07	-	-	-	Hatchback Engine KFW (TU3JP)/KFX (TU3JP)	210089	Drive Shaft		21	22	56.4	76	790		
	1996.05-2004.07	MT	L	F	Hatchback Engine KFW (TU3JP)/KFX (TU3JP)	210161	Drive Shaft		21	22	58.5	86	624		
	1996.05-2004.07	MT	R	F	Hatchback Engine KFW (TU3JP)/KFX (TU3JP)	210156	Drive Shaft		21	22	58.5	86	807		
	1996.05-2004.07	MT	L	F	Hatchback Engine KFW (TU3JP)/KFX (TU3JP)	299006	Drive Shaft	48T	21	22	58.5	86	624		
	1996.05-2004.07	MT	L	F	Hatchback Engine KFW (TU3JP)/KFX (TU3JP)	210094	Drive Shaft		21	22	56.4	76	615		
	1996.05-2004.07	MT	R	F	Hatchback Engine KFW (TU3JP)/KFX (TU3JP)	299010	Drive Shaft	48T	21	22	58.5	86	807		
	1996.05-2004.07	MT	L	F	Hatchback Engine KFW (TU3JP)/KFX (TU3JP)	245071	Drive Shaft		21	22	48	86.5	622		
	1996.05-2004.07	-	F	F	Hatchback Engine KFW (TU3JP)/KFX (TU3JP)	808016	Outer Joint		22	22	52	96.5	53.5	O	
	1996.05-2004.07	MT	R	F	Hatchback Engine KFW (TU3JP)/KFX (TU3JP)	245072	Drive Shaft		21	22	48	86.5	798.5		
	1996.05-2004.07	MT	R	F	Hatchback Engine KFW (TU3JP)/KFX (TU3JP)	210093	Drive Shaft		21	22	56.4	76	796		
	1996.05-2004.07	MT	L	F	Hatchback Engine KFW (TU3JP)/KFX (TU3JP)	210164	Drive Shaft		21	22	58.5	76	614		
	1996.05-2004.07	MT	R	F	Hatchback Engine KFW (TU3JP)/KFX (TU3JP)	210085	Drive Shaft		21	22	56.4	76	798		
	1996.05-2004.07	AT	L	F	Hatchback Engine KFW (TU3JP)/KFX (TU3JP)	210138	Drive Shaft	48T	21	29.95	50	86	603.5		
	1996.05-2004.07	MT	R	F	Hatchback Engine KFW (TU3JP)/KFX (TU3JP)	210186	Drive Shaft	48T	21	22	54	75.5	799		
	1996.05-2004.07	MT	L	F	Hatchback Engine KFW (TU3JP)/KFX (TU3JP)	210061	Drive Shaft		21	22	49.9	81	620		
	1996.05-2004.07	MT	L	F	Hatchback Engine KFW (TU3JP)/KFX (TU3JP)	210038	Drive Shaft	48T	21	22	58.5	76	614		
	1996.05-2004.07	MT	R	F	Hatchback Engine KFW (TU3JP)/KFX (TU3JP)	210042	Drive Shaft	48T	21	22	56.4	76	798		
	1.5 D (40 kW)	1996.05-2001.03	MT	R	F	Hatchback Engine VJY (TUD5)	210062	Drive Shaft		21	22	49.9	81	798	
1996.05-2001.03		MT	R	F	Hatchback Engine VJY (TUD5)	210089	Drive Shaft		21	22	56.4	76	790		
1996.05-2001.03		-	L	F	Hatchback Engine VJY (TUD5)	210161	Drive Shaft		21	22	58.5	86	624		
1996.05-2001.03		-	R	F	Hatchback Engine VJY (TUD5)	210156	Drive Shaft		21	22	58.5	86	807		
1996.05-2001.03		-	L	F	Hatchback Engine VJY (TUD5)	299006	Drive Shaft	48T	21	22	58.5	86	624		
1996.05-2001.03		MT	L	F	Hatchback Engine VJY (TUD5)	210094	Drive Shaft		21	22	56.4	76	615		
1996.05-2001.03		-	R	F	Hatchback Engine VJY (TUD5)	299010	Drive Shaft	48T	21	22	58.5	86	807		
1996.05-2001.03		MT	L	F	Hatchback Engine VJY (TUD5)	245071	Drive Shaft		21	22	48	86.5	622		
1996.05-2001.03		-	F	F	Hatchback Engine VJY (TUD5)	808016	Outer Joint		22	22	52	96.5	53.5	O	
1996.05-2001.03		MT	R	F	Hatchback Engine VJY (TUD5)	245072	Drive Shaft		21	22	48	86.5	798.5		
1996.05-2001.03		MT	R	F	Hatchback Engine VJY (TUD5)	210093	Drive Shaft		21	22	56.4	76	796		
1996.05-2001.03		-	L	F	Hatchback Engine VJY (TUD5)	210164	Drive Shaft		21	22	58.5	76	614		
1996.05-2001.03		MT	L	F	Hatchback Engine VJY (TUD5)	299007	Drive Shaft	48T	21	22	58.5	76	608		
1996.05-2001.03		-	R	F	Hatchback Engine VJY (TUD5)	210085	Drive Shaft		21	22	56.4	76	798		
1996.05-2001.03		MT	L	F	Hatchback Engine VJY (TUD5)	210061	Drive Shaft		21	22	49.9	81	620		
1996.05-2001.03		MT	L	F	Hatchback Engine VJY (TUD5)	210038	Drive Shaft	48T	21	22	58.5	76	614		
1996.05-2001.03		MT	R	F	Hatchback Engine VJY (TUD5)	299009	Drive Shaft	48T	21	22	58.5	76	797		
1996.05-2001.03		-	R	F	Hatchback Engine VJY (TUD5)	210042	Drive Shaft	48T	21	22	56.4	76	798		
1.5 D (42 kW)		1998.04- -	MT	R	F	Hatchback Engine VJZ (TUD5)/VJY (TUD5)/VJX (TUD5)	210062	Drive Shaft		21	22	49.9	81	798	
		1998.04- -	-	L	F	Hatchback Engine VJZ (TUD5)/VJY (TUD5)/VJX (TUD5)	210161	Drive Shaft		21	22	58.5	86	624	
	1998.04- -	-	R	F	Hatchback Engine VJZ (TUD5)/VJY (TUD5)/VJX (TUD5)	210156	Drive Shaft		21	22	58.5	86	807		
	1998.04- -	-	L	F	Hatchback Engine VJZ (TUD5)/VJY (TUD5)/VJX (TUD5)	299006	Drive Shaft	48T	21	22	58.5	86	624		
	1998.04- -	-	R	F	Hatchback Engine VJZ (TUD5)/VJY (TUD5)/VJX (TUD5)	299010	Drive Shaft	48T	21	22	58.5	86	807		
	1998.04- -	MT	L	F	Hatchback Engine VJZ (TUD5)/VJY (TUD5)/VJX (TUD5)	210094	Drive Shaft		21	22	56.4	76	615		
	1998.04- -	MT	L	F	Hatchback Engine VJZ (TUD5)/VJY (TUD5)/VJX (TUD5)	245071	Drive Shaft		21	22	48	86.5	622		
	1998.04- -	-	F	F	Hatchback Engine VJZ (TUD5)/VJY (TUD5)/VJX (TUD5)	808016	Outer Joint		22	22	52	96.5	53.5	O	
	1998.04- -	MT	R	F	Hatchback Engine VJZ (TUD5)/VJY (TUD5)/VJX (TUD5)	245072	Drive Shaft		21	22	48	86.5	798.5		
	1998.04- -	-	L	F	Hatchback Engine VJZ (TUD5)/VJY (TUD5)/VJX (TUD5)	210164	Drive Shaft		21	22	58.5	76	614		
	1998.04- -	MT	R	F	Hatchback Engine VJZ (TUD5)/VJY (TUD5)/VJX (TUD5)	210093	Drive Shaft		21	22	56.4	76	796		
	1998.04- -	-	R	F	Hatchback Engine VJZ (TUD5)/VJY (TUD5)/VJX (TUD5)	210085	Drive Shaft		21	22	56.4	76	798		
	1998.04- -	MT	L	F	Hatchback Engine VJZ (TUD5)/VJY (TUD5)/VJX (TUD5)	210038	Drive Shaft	48T	21	22	58.5	76	614		
	1998.04- -	MT	L	F	Hatchback Engine VJZ (TUD5)/VJY (TUD5)/VJX (TUD5)	210061	Drive Shaft		21	22	49.9	81	620		
	1998.04- -	-	R	F	Hatchback Engine VJZ (TUD5)/VJY (TUD5)/VJX (TUD5)	210042	Drive Shaft	48T	21	22	56.4	76	798		
1.6 i (65 kW)	1996.05-1999.10	MT	L	F	Hatchback Engine NFZ (TU5JP)	299160	Drive Shaft	48T	21	22	54	75.5	608		





	YEAR	TRANSM	L/R	F/R	REMARKS	GSP Ref.	PRODUCT	ABS	Technical Specifications									
									A	B	C	H	L	P				
PEUGEOT																		
106 II (1)																		
1.6 i (65 kW)	1996.05-1999.10	MT	R	F	Hatchback Engine NFZ (TU5JP)	645003	Inner Joint		22	22	29.8	253.5	92					
	1996.05-1999.10	MT	L	F	Hatchback Engine NFZ (TU5JP)	210054	Drive Shaft		21	22	56.4	76	610					
	1996.05-1999.10	MT	L	F	Hatchback Engine NFZ (TU5JP)	210157	Drive Shaft		21	22	58.5	86	616					
	1996.05-1999.10	MT	R	F	Hatchback Engine NFZ (TU5JP)	210152	Drive Shaft		21	22	50	85	812					
	1996.05-1999.10	MT	L	F	Hatchback Engine NFZ (TU5JP)	210048	Drive Shaft	48T	21	22	58.5	86	616					
	1996.05-1999.10	-	-	F	Hatchback Engine NFZ (TU5JP)	808016	Outer Joint		22	22	52	96.5	53.5	O				
	1996.05-1999.10	MT	R	F	Hatchback Engine NFZ (TU5JP)	210049	Drive Shaft	48T	21	22	58.5	86	811.5					
	1996.05-1999.10	MT	L	F	Hatchback Engine NFZ (TU5JP)	210159	Drive Shaft		21	22	58.5	76	615					
	1996.05-1999.10	MT	R	F	Hatchback Engine NFZ (TU5JP)	210118	Drive Shaft		21	22	56.4	76	800					
	1996.05-1999.10	MT	R	F	Hatchback Engine NFZ (TU5JP)	210093	Drive Shaft		21	22	56.4	76	796					
	1996.05-1999.10	AT	L	F	Hatchback Engine NFZ (TU5JP)	845030	Outer Joint		21	22	56	76	58	I				
	1996.05-1999.10	AT	R	F	Hatchback Engine NFZ (TU5JP)	210028	Drive Shaft	48T	21	23	50.5	76.5	693.5					
	1996.05-1999.10	AT	L	F	Hatchback Engine NFZ (TU5JP)	299079	Drive Shaft		21	29.95	56	76	603					
	1996.05-1999.10	AT	L	F	Hatchback Engine NFZ (TU5JP)	210138	Drive Shaft	48T	21	29.95	50	86	603.5					
	1996.05-1999.10	MT	L	F	Hatchback Engine NFZ (TU5JP)	210020	Drive Shaft	48T	21	22	58.5	76	615					
	1996.05-1999.10	AT	R	F	Hatchback Engine NFZ (TU5JP)	299014	Drive Shaft		21	23	56	76	704.5					
	1996.05-1999.10	MT	R	F	Hatchback Engine NFZ (TU5JP)	210174	Drive Shaft	48T	21	22	58.5	76	800					
1.6 i (74 kW)	1996.05-2001.01	MT	L	F	Hatchback Engine NFY (TU5J2)/NFW (TU5J2)	299160	Drive Shaft	48T	21	22	54	75.5	608					
	1996.05-2001.01	MT	R	F	Hatchback Engine NFY (TU5J2)/NFW (TU5J2)	299158	Drive Shaft	48T	21	22	54	75.5	801					
	1996.05-2001.01	MT	R	F	Hatchback Engine NFY (TU5J2)/NFW (TU5J2)	645003	Inner Joint		22	22	29.8	253.5	92					
	1996.05-2001.01	MT	L	F	Hatchback Engine NFY (TU5J2)/NFW (TU5J2)	210054	Drive Shaft		21	22	56.4	76	610					
	1996.05-2001.01	MT	R	F	Hatchback Engine NFY (TU5J2)/NFW (TU5J2)	299203	Drive Shaft		21	22	54	75.5	801					
	1996.05-2001.01	-	-	F	Hatchback Engine NFY (TU5J2)/NFW (TU5J2)	808016	Outer Joint		22	22	52	96.5	53.5	O				
1.6 S16 (87 kW)	1996.05-2004.07	MT	R	F	Hatchback Engine NFX (TU5J4)	299158	Drive Shaft	48T	21	22	54	75.5	801					
	1996.05-2004.07	MT	L	F	Hatchback Engine NFX (TU5J4)	210054	Drive Shaft		21	22	56.4	76	610					
	1996.05-2004.07	MT	R	F	Hatchback Engine NFX (TU5J4)	645003	Inner Joint		22	22	29.8	253.5	92					
	1996.05-2004.07	MT	R	F	Hatchback Engine NFX (TU5J4)	299203	Drive Shaft		21	22	54	75.5	801					
	1996.05-2004.07	-	-	F	Hatchback Engine NFX (TU5J4)	808016	Outer Joint		22	22	52	96.5	53.5	O				
	1996.05-2004.07	MT	L	F	Hatchback Engine NFX (TU5J4)	299027	Drive Shaft		21	22	50	86	620					
	1996.05-2004.07	MT	R	F	Hatchback Engine NFX (TU5J4)	299026	Drive Shaft		21	22	50	86	815					
	1996.05-2004.07	AT	L	F	Hatchback Engine NFX (TU5J4)	845030	Outer Joint		21	22	56	76	58	I				
	1996.05-2004.07	AT	R	F	Hatchback Engine NFX (TU5J4)	210028	Drive Shaft	48T	21	23	50.5	76.5	693.5					
	1996.05-2004.07	AT	L	F	Hatchback Engine NFX (TU5J4)	299079	Drive Shaft		21	29.95	56	76	603					
	1996.05-2004.07	-	R	F	Hatchback Engine NFX (TU5J4)	210119	Drive Shaft	48T	21	22	50	85	812					
	1996.05-2004.07	AT	R	F	Hatchback Engine NFX (TU5J4)	299014	Drive Shaft		21	23	56	76	704.5					
	1996.05-2004.07	MT	L	F	Hatchback Engine NFX (TU5J4)	299160	Drive Shaft	48T	21	22	54	75.5	608					
Electric (20 kW)	1996.04-2004.07	-	-	F	Hatchback Engine SA13	808016	Outer Joint		22	22	52	96.5	53.5	O				
106 Van (1_)																		
1.0 (33 kW)	1991.09-2001.03	-	-	F	Box Engine TU9/CDY (TU9M)	808016	Outer Joint		22	22	52	96.5	53.5	O				
1.5 D (40 kW)	1996.05-2001.03	-	L	F	Box Engine VJY (TUD5)	210161	Drive Shaft		21	22	58.5	86	624					
	1996.05-2001.03	-	R	F	Box Engine VJY (TUD5)	210156	Drive Shaft		21	22	58.5	86	807					
	1996.05-2001.03	-	-	F	Box Engine VJY (TUD5)	808016	Outer Joint		22	22	52	96.5	53.5	O				
1.5 D (42 kW)	2000.10-2001.03	MT	L	F	Box Engine VJX (TUD5)	210161	Drive Shaft		21	22	58.5	86	624					
	2000.10-2001.03	MT	R	F	Box Engine VJX (TUD5)	210156	Drive Shaft		21	22	58.5	86	807					
	2000.10-2001.03	MT	L	F	Box Engine VJX (TUD5)	299006	Drive Shaft	48T	21	22	58.5	86	624					
	2000.10-2001.03	MT	R	F	Box Engine VJX (TUD5)	299010	Drive Shaft	48T	21	22	58.5	86	807					
	2000.10-2001.03	MT	L	F	Box Engine VJX (TUD5)	245071	Drive Shaft		21	22	48	86.5	622					
	2000.10-2001.03	MT	R	F	Box Engine VJX (TUD5)	245072	Drive Shaft		21	22	48	86.5	798.5					
	2000.10-2001.03	-	-	F	Box Engine VJX (TUD5)	808016	Outer Joint		22	22	52	96.5	53.5	O				
Electric (20 kW)	1996.04-2001.03	-	-	F	Box	808016	Outer Joint		22	22	52	96.5	53.5	O				
107																		
1.0 (50 kW)	2005.06-	-	L	F	Hatchback Engine CFA (384F)/CFB (1KR)	210232	Drive Shaft		24	23	49.5	91	650					
	2005.06-	-	R	F	Hatchback Engine CFA (384F)/CFB (1KR)	210231	Drive Shaft		24	23	49.5	91	841					
	2005.06-	-	-	-	-	659069	Inner Joint		23	19	34	60	101					
	2005.06-	-	L/R	F	Hatchback Engine CFA (384F)/CFB (1KR)	899128	Outer Joint		24	19	49.5	91	46	M				
	2005.06-	-	-	F	Hatchback Engine CFA (384F)/CFB (1KR)	859268	Outer Joint		24	26	47	85.5	47.5	I				
1.4 HDi (40 kW)	2005.06-	-	L	F	Hatchback Engine 8HT (DV4TD)	259495	Drive Shaft		24	23	49.5	91	593					
	2005.06-	-	-	-	-	659069	Inner Joint		23	19	34	60	101					
	2005.06-	-	L/R	F	Hatchback Engine 8HT (DV4TD)	845058	Outer Joint		24	20	49.5	91	46	M				
2008																		
1.4 HDi (50 kW)	2013.06-	-	-	F	Estate Engine 8HR (DV4C)	845012	Outer Joint		21	34	48.5	86	55.5	I				
1.6 BlueHDi 120 (88 kW)	2014.07-	-	MT	L	Estate Engine BHZ (DV6FC)	810148	Outer Joint		25	34	58.5	79	55.5	I				
	2014.07-	-	MT	R	Estate Engine BHZ (DV6FC)	210325	Drive Shaft		25	24	58.5	79	940					
	2014.07-	-	MT	L	Estate Engine BHZ (DV6FC)	610057	Inner Joint		24	34	40	52.5	90					
	2014.07-	-	MT	R	Estate Engine BHZ (DV6FC)	610058	Inner Joint		24	34	29.8	365	88					
	2014.07-	-	MT	L	Estate Engine BHZ (DV6FC)	210253	Drive Shaft		25	24	58.5	79	626					





YEAR	TRANSM	L/R	F/R	REMARKS	GSP Ref.	PRODUCT	ABS	Technical Specifications						
								A	B	C	H	L	P	
PEUGEOT														
2008														
1.6 HDi (68 kW)	2013.03-	-	6MT	L F	Estate Engine 9HP (DV6DTEd)	810148	Outer Joint		25	34	58.5	79	55.5	I
	2013.03-	-	AT	L F	Estate Engine 9HP (DV6DTEd)	245202	Drive Shaft		25	26	58.5	78.5	620	
	2013.03-	-	AT	R F	Estate Engine 9HP (DV6DTEd)	210267	Drive Shaft		25	26	58.5	79.5	766	
	2013.03-	-	-	-	Estate Engine 9HP (DV6DTEd)	899366	Outer Joint		25	34	58.5	79	55	I
	2013.03-	-	6MT	L F	Estate Engine 9HP (DV6DTEd)	610057	Inner Joint		24	34	40	52.5	90	
	2013.03-	-	AT	L F	Estate Engine 9HP (DV6DTEd)	245194	Drive Shaft		25	26	58.5	79	621	
	2013.03-	-	6MT	L F	Estate Engine 9HP (DV6DTEd)	210253	Drive Shaft		25	24	58.5	79	626	
1.6 HDi (84 kW)	2013.03-	-	MT	L F	Estate Engine 9HD (DV6CTED)	810148	Outer Joint		25	34	58.5	79	55.5	I
	2013.03-	-	MT	L F	Estate Engine 9HD (DV6CTED)	610057	Inner Joint		24	34	40	52.5	90	
	2013.03-	-	AT	L F	Estate Engine 9HD (DV6CTED)	245194	Drive Shaft		25	26	58.5	79	621	
	2013.03-	-	MT	L F	Estate Engine 9HD (DV6CTED)	210253	Drive Shaft		25	24	58.5	79	626	
1.6 HDi (85 kW)	2014.07-	-	MT	L F	Estate Engine BHX (DV6FC)	210253	Drive Shaft		25	24	58.5	79	626	
	2014.07-	-	MT	L F	Estate Engine BHX (DV6FC)	810148	Outer Joint		25	34	58.5	79	55.5	I
	2014.07-	-	MT	R F	Estate Engine BHX (DV6FC)	210325	Drive Shaft		25	24	58.5	79	940	
	2014.07-	-	MT	L F	Estate Engine BHX (DV6FC)	610057	Inner Joint		24	34	40	52.5	90	
	2014.07-	-	MT	R F	Estate Engine BHX (DV6FC)	610058	Inner Joint		24	34	29.8	365	88	
205														
-	-	-	MT/AT	L -	-	299013	Drive Shaft		21	24	56	76	564	
	-	-	MT/AT	R -	-	299012	Drive Shaft		21	24	56	76	838	
	-	-	MT/AT	- -	-	645015	Inner Joint		24	29	29.8	348	99.5	
	-	-	MT/AT	- -	-	610005	Inner Joint		24	29	40	69	99	
1.0/1.1	1987.08-	-	-	L -	-	645010	Inner Joint		22	22	40	65.8	87	
	1987.08-	-	-	L -	-	845016	Outer Joint		21	22	56.4	76	61	O
1.1 (40 kW)	1987.08- 1990.07	-	-	L F	Box Engine H1B (TU1)	245015	Drive Shaft		21	22	56.4	76	576	
	1987.08- 1990.07	-	-	R F	Box Engine H1B (TU1)	210096	Drive Shaft		21	22	56.4	76	834	
1.7 Diesel (44 kW)	1994.03- 1997.05	-	MT	L F	Box Engine 161A (XUD7)	210039	Drive Shaft		21	24	56.4	76	567	
	1994.03- 1997.05	-	MT	R F	Box Engine 161A (XUD7)	210007	Drive Shaft		21	24	48	75.5	845	
1.8 D (44 kW)	1983.02- 1990.07	-	-	L F	Box Engine A9A (XUD7)	245068	Drive Shaft		21	24	56.4	76	563	
1.9 CTI/GTI	1987.01- 1994.01	-	MT/AT	- F	-	810065	Outer Joint	48T	25	34	58.5	80	55	I
205 I (741B 20D)														
1.1 CJ (44 kW)	1989.10- 1994.12	-	MT	R F	Convertible Engine HDZ (TU1M)	245001	Drive Shaft		21	22	56.4	76	830.5	
	1989.10- 1994.12	-	MT	L F	Convertible Engine HDZ (TU1M)	210010	Drive Shaft		21	22	54	76	572	
	1989.10- 1994.12	-	-	R F	Convertible Engine HDZ (TU1M)	245066	Drive Shaft		21	24	56.4	76	825.5	
1.4 CJ (44 kW)	1988.03- 1989.05	-	MT	R F	Convertible Engine 150D (XY7)/150G (XY7)	245001	Drive Shaft		21	22	56.4	76	830.5	
	1988.03- 1989.05	-	MT	L F	Convertible Engine 150D (XY7)/150G (XY7)	210010	Drive Shaft		21	22	54	76	572	
1.4 CJ (49 kW)	1989.03- 1994.12	-	MT	R F	Convertible Engine K1D (TU3A)	245001	Drive Shaft		21	22	56.4	76	830.5	
	1989.03- 1994.12	-	MT	L F	Convertible Engine K1D (TU3A)	210010	Drive Shaft		21	22	54	76	572	
1.4 CJ (55 kW)	1991.05- 1994.12	-	MT	R F	Convertible Engine KDZ (TU3M)/KDY (TU3M)	245001	Drive Shaft		21	22	56.4	76	830.5	
	1991.05- 1994.12	-	MT	L F	Convertible Engine KDZ (TU3M)/KDY (TU3M)	210010	Drive Shaft		21	22	54	76	572	
1.4 CJ Cat (44 kW)	1989.01- 1993.09	-	MT	R F	Convertible Engine KAY (TU3CP)	245001	Drive Shaft		21	22	56.4	76	830.5	
	1989.01- 1993.09	-	MT	L F	Convertible Engine KAY (TU3CP)	210010	Drive Shaft		21	22	54	76	572	
1.6 (85 kW)	1987.08- 1992.07	-	-	L F	Convertible Engine B6D (XU5JA)	245068	Drive Shaft		21	24	56.4	76	563	
1.6 CJ (65 kW)	1992.08- 1994.12	-	-	L F	Convertible Engine BDY (XU5M3Z)	245068	Drive Shaft		21	24	56.4	76	563	
	1992.08- 1994.12	-	MT	L F	Convertible Engine BDY (XU5M3Z)	210039	Drive Shaft		21	24	56.4	76	567	
	1992.08- 1994.12	-	MT	R F	Convertible Engine BDY (XU5M3Z)	210007	Drive Shaft		21	24	48	75.5	845	
1.6 CTi (76 kW)	1986.04- 1990.10	-	-	L F	Convertible Engine 180Z (XU5J)/180A (XU5J)	245068	Drive Shaft		21	24	56.4	76	563	
1.9 CTi (74 kW)	1987.08- 1990.07	-	-	L F	Convertible Engine DFZ (XU9J1)	299161	Drive Shaft		25	24	54.8	78.5	577.5	
1.9 CTi (75 kW)	1987.10- 1994.12	-	-	R F	Convertible Engine DFZ (XU9J1)	210177	Drive Shaft		25	24	54.8	78.5	845	
	1987.10- 1994.12	-	-	L F	Convertible Engine DFZ (XU9J1)	299161	Drive Shaft		25	24	54.8	78.5	577.5	
	1987.10- 1994.12	-	-	L F	Convertible Engine DFZ (XU9J1)	245134	Drive Shaft		25	24	54.8	78.5	573	
1.9 CTi (92 kW)	1990.08- 1992.07	-	-	L F	Convertible Engine DKZ (XU9JAZ)	299161	Drive Shaft		25	24	54.8	78.5	577.5	
205 II (20A/C)														
1.0 (33 kW)	1987.10- 1998.09	-	MT	R F	Hatchback Engine TU9	245001	Drive Shaft		21	22	56.4	76	830.5	
	1987.10- 1998.09	-	MT	L F	Hatchback Engine TU9	245015	Drive Shaft		21	22	56.4	76	576	
	1987.10- 1998.09	-	MT	L F	Hatchback Engine TU9	210010	Drive Shaft		21	22	54	76	572	
	1987.10- 1998.09	-	-	R F	Hatchback Engine TU9	210096	Drive Shaft		21	22	56.4	76	834	
1.1 (36 kW)	1987.10- 1990.10	-	MT	R F	Hatchback Engine 109N (XW7)	245001	Drive Shaft		21	22	56.4	76	830.5	
	1987.10- 1990.10	-	MT	L F	Hatchback Engine 109N (XW7)	210010	Drive Shaft		21	22	54	76	572	
	1987.10- 1990.10	-	-	R F	Hatchback Engine 109N (XW7)	245066	Drive Shaft		21	24	56.4	76	825.5	
1.1 (40 kW)	1987.10- 1990.10	-	MT	L F	Hatchback Engine H1B (TU1)	245015	Drive Shaft		21	22	56.4	76	576	
	1987.10- 1990.10	-	MT	R F	Hatchback Engine H1B (TU1)	245001	Drive Shaft		21	22	56.4	76	830.5	
	1987.10- 1990.10	-	MT	L F	Hatchback Engine H1B (TU1)	210010	Drive Shaft		21	22	54	76	572	
	1987.10- 1990.10	-	-	R F	Hatchback Engine H1B (TU1)	245066	Drive Shaft		21	24	56.4	76	825.5	
	1987.10- 1990.10	-	-	R F	Hatchback Engine H1B (TU1)	210096	Drive Shaft		21	22	56.4	76	834	
1.1 (44 kW)	1989.07- 1998.09	-	MT	L F	Hatchback Engine HDZ (TU1M)	245015	Drive Shaft		21	22	56.4	76	576	
	1989.07- 1998.09	-	MT	R F	Hatchback Engine HDZ (TU1M)	245001	Drive Shaft		21	22	56.4	76	830.5	

YEAR	TRANSM	L/R	F/R	REMARKS	GSP Ref.	PRODUCT	ABS	Technical Specifications										
								A	B	C	H	L	P					
PEUGEOT																		
205 II (20A/C)																		
1.1 (44 kW)	1989.07-1988.09	MT	L	F	Hatchback Engine HDZ (TU1M)	210010	Drive Shaft		21	22	54	76	572					
	1989.07-1988.09	-	R	F	Hatchback Engine HDZ (TU1M)	245066	Drive Shaft		21	24	56.4	76	825.5					
	1989.07-1988.09	-	R	F	Hatchback Engine HDZ (TU1M)	210096	Drive Shaft		21	22	56.4	76	834					
1.4 (44 kW)	1987.10-1989.05	MT	L	F	Hatchback Engine 150D (XY7)/150G (XY7)	245015	Drive Shaft		21	22	56.4	76	576					
	1987.10-1989.05	-	R	F	Hatchback Engine 150D (XY7)/150G (XY7)	210096	Drive Shaft		21	22	56.4	76	834					
	1987.10-1989.05	MT	L/R	F	Hatchback Engine 150D (XY7)/150G (XY7)	245111	Drive Shaft		21	22	56.4	76	714					
	1987.10-1989.05	MT	R	F	Hatchback Engine 150D (XY7)/150G (XY7)	245001	Drive Shaft		21	22	56.4	76	830.5					
	1987.10-1989.05	MT	L	F	Hatchback Engine 150D (XY7)/150G (XY7)	210010	Drive Shaft		21	22	54	76	572					
1.4 (49 kW)	1987.10-1990.10	MT	L	F	Hatchback Engine K1D (TU3A)	245015	Drive Shaft		21	22	56.4	76	576					
	1987.10-1990.10	MT	R	F	Hatchback Engine K1D (TU3A)	245001	Drive Shaft		21	22	56.4	76	830.5					
	1987.10-1990.10	MT	L	F	Hatchback Engine K1D (TU3A)	210010	Drive Shaft		21	22	54	76	572					
	1987.10-1990.10	-	R	F	Hatchback Engine K1D (TU3A)	210096	Drive Shaft		21	22	56.4	76	834					
	1987.10-1990.10	-	R	F	Hatchback Engine K1D (TU3A)	210044	Drive Shaft		21	22	56.4	76	832.5					
1.4 (55 kW)	1988.07-1988.09	MT	L	F	Hatchback Engine KDZ (TU3M)/KDY (TU3M)/KFX (TU3JP)	245015	Drive Shaft		21	22	56.4	76	576					
	1988.07-1988.09	MT	R	F	Hatchback Engine KDZ (TU3M)/KDY (TU3M)/KFX (TU3JP)	245001	Drive Shaft		21	22	56.4	76	830.5					
	1988.07-1988.09	MT	L	F	Hatchback Engine KDZ (TU3M)/KDY (TU3M)/KFX (TU3JP)	210010	Drive Shaft		21	22	54	76	572					
	1988.07-1988.09	-	R	F	Hatchback Engine KDZ (TU3M)/KDY (TU3M)/KFX (TU3JP)	210096	Drive Shaft		21	22	56.4	76	834					
	1988.07-1988.09	-	R	F	Hatchback Engine KDZ (TU3M)/KDY (TU3M)/KFX (TU3JP)	210044	Drive Shaft		21	22	56.4	76	832.5					
	1990.08-1988.07	-	L	F	Hatchback Engine KDY (TU3M)/KDX (TU3MC)/KDZ (TU3M)/TU32	210022	Drive Shaft	48T	25	24	54.8	78.5	573					
	1990.08-1988.07	MT	R	F	Hatchback Engine KDY (TU3M)/KDX (TU3MC)/KDZ (TU3M)/TU32	245001	Drive Shaft		21	22	56.4	76	830.5					
	1990.08-1988.07	MT	L	F	Hatchback Engine KDY (TU3M)/KDX (TU3MC)/KDZ (TU3M)/TU32	210010	Drive Shaft		21	22	54	76	572					
1.4 (58 kW)	1988.07-1989.05	MT	L	F	Hatchback Engine 150B (XY8)/150H (XY8)	245015	Drive Shaft		21	22	56.4	76	576					
	1988.07-1989.05	-	R	F	Hatchback Engine 150B (XY8)/150H (XY8)	210096	Drive Shaft		21	22	56.4	76	834					
	1988.07-1989.05	MT	L/R	F	Hatchback Engine 150B (XY8)/150H (XY8)	245111	Drive Shaft		21	22	56.4	76	714					
1.4 (62 kW)	1987.06-1989.12	MT	L	F	Hatchback Engine K2B (TU3S)	245015	Drive Shaft		21	22	56.4	76	576					
	1987.06-1989.12	-	R	F	Hatchback Engine K2B (TU3S)	210044	Drive Shaft		21	22	56.4	76	832.5					
	1987.06-1989.12	-	R	F	Hatchback Engine K2B (TU3S)	210096	Drive Shaft		21	22	56.4	76	834					
	1987.06-1989.12	MT	R	F	Hatchback Engine K2B (TU3S)	245001	Drive Shaft		21	22	56.4	76	830.5					
	1987.06-1989.12	MT	L	F	Hatchback Engine K2B (TU3S)	210010	Drive Shaft		21	22	54	76	572					
1.4 Cat (44 kW)	1987.08-1993.09	MT	R	F	Hatchback Engine KAY (TU3CP)	245001	Drive Shaft		21	22	56.4	76	830.5					
	1987.08-1993.09	MT	L	F	Hatchback Engine KAY (TU3CP)	210010	Drive Shaft		21	22	54	76	572					
	1987.08-1993.09	MT	L/R	F	Hatchback Engine KAY (TU3CP)	245111	Drive Shaft		21	22	56.4	76	714					
	1987.08-1993.09	-	R	F	Hatchback Engine KAY (TU3CP)	210044	Drive Shaft		21	22	56.4	76	832.5					
1.6 (53 kW)	1987.10-1988.09	-	L	F	Hatchback Engine B1E (XU51C)	210022	Drive Shaft	48T	25	24	54.8	78.5	573					
	1987.10-1988.09	AT	L	F	Hatchback Engine B1E (XU51C)	210039	Drive Shaft		21	24	56.4	76	567					
	1987.10-1988.09	AT	R	F	Hatchback Engine B1E (XU51C)	210007	Drive Shaft		21	24	48	75.5	845					
1.6 (55 kW)	1987.10-1988.09	-	L	F	Hatchback Engine BAZ (XU5CP)/B1A (XU51C)	210022	Drive Shaft	48T	25	24	54.8	78.5	573					
	1987.10-1988.09	-	L	F	Hatchback Engine BAZ (XU5CP)/B1A (XU51C)	245068	Drive Shaft		21	24	56.4	76	563					
	1987.10-1988.09	MT	L	F	Hatchback Engine BAZ (XU5CP)/B1A (XU51C)	210039	Drive Shaft		21	24	56.4	76	567					
	1987.10-1988.09	MT	R	F	Hatchback Engine BAZ (XU5CP)/B1A (XU51C)	210007	Drive Shaft		21	24	48	75.5	845					
1.6 (66 kW)	1990.08-1992.07	-	L	F	Hatchback Engine 171 (XU5S)	245068	Drive Shaft		21	24	56.4	76	563					
1.6 Aut. (58 kW)	1987.10-1988.09	AT	R	F	Hatchback	210007	Drive Shaft		21	24	48	75.5	845					
	1987.10-1988.09	-	L	F	Hatchback	210022	Drive Shaft	48T	25	24	54.8	78.5	573					
	1987.10-1988.09	-	L	F	Hatchback	245068	Drive Shaft		21	24	56.4	76	563					
	1987.10-1988.09	AT	L	F	Hatchback	210039	Drive Shaft		21	24	56.4	76	567					
1.6 Aut. (65 kW)	1990.05-1988.09	-	L	F	Hatchback Engine BDY (XU5M2Z)/BDY (XU5M3Z)	210022	Drive Shaft	48T	25	24	54.8	78.5	573					
	1990.05-1988.09	AT	L	F	Hatchback Engine BDY (XU5M2Z)/BDY (XU5M3Z)	210039	Drive Shaft		21	24	56.4	76	567					
	1990.05-1988.09	AT	R	F	Hatchback Engine BDY (XU5M2Z)/BDY (XU5M3Z)	210007	Drive Shaft		21	24	48	75.5	845					
1.6 GTI (76 kW)	1987.10-1989.12	-	L	F	Hatchback Engine 180Z (XU5J)/180A (XU5J)	210022	Drive Shaft	48T	25	24	54.8	78.5	573					
	1987.10-1989.12	-	L	F	Hatchback Engine 180Z (XU5J)/180A (XU5J)	245068	Drive Shaft		21	24	56.4	76	563					
1.6 GTX (69 kW)	1987.01-1991.10	-	L	F	Hatchback	210022	Drive Shaft	48T	25	24	54.8	78.5	573					
	1987.01-1991.10	MT	L	F	Hatchback	210039	Drive Shaft		21	24	56.4	76	567					
	1987.01-1991.10	MT	R	F	Hatchback	210007	Drive Shaft		21	24	48	75.5	845					
1.7 Diesel (44 kW)	1987.07-1988.09	MT	L	F	Hatchback Engine 161A (XUD7)	210039	Drive Shaft		21	24	56.4	76	567					
	1987.07-1988.09	MT	R	F	Hatchback Engine 161A (XUD7)	210007	Drive Shaft		21	24	48	75.5	845					
1.8 TD (57 kW)	1990.01-1988.09	-	L	F	Hatchback Engine A8B (XUD7TE)	210022	Drive Shaft	48T	25	24	54.8	78.5	573					
	1990.01-1988.09	MT	L	F	Hatchback Engine A8B (XUD7TE)	210039	Drive Shaft		21	24	56.4	76	567					
	1990.01-1988.09	MT	R	F	Hatchback Engine A8B (XUD7TE)	210007	Drive Shaft		21	24	48	75.5	845					
1.8 XDT (58 kW)	1990.08-1997.05	-	L	F	Hatchback Engine XUD7T	245068	Drive Shaft		21	24	56.4	76	563					
1.9 Diesel (47 kW)	1987.10-1988.09	-	L	F	Hatchback Engine DJZ (XUD9Y)	210022	Drive Shaft	48T	25	24	54.8	78.5	573					
	1987.10-1988.09	AT/MT	L	F	Hatchback Engine DJZ (XUD9Y)	210039	Drive Shaft		21	24	56.4	76	567					
	1987.10-1988.09	AT/MT	R	F	Hatchback Engine DJZ (XUD9Y)	210007	Drive Shaft		21	24	48	75.5	845					
1.9 GTI (75 kW)	1987.10-1989.05	MT	L/R	F	Hatchback Engine D2A (XU92C)	810002	Outer Joint		25	23	54.8	78.5	56	I				
	1987.10-1989.05	MT	L/R	F	Hatchback Engine D2A (XU92C)	810024	Outer Joint	48T	25	34	55.7	79	55	I				
	1987.10-1989.05	-	L	F	Hatchback Engine D2A (XU92C)	245134	Drive Shaft		25	24	54.8	78.5	573					
	1987.10-1989.05	-	L	F	Hatchback Engine D2A (XU92C)	210022	Drive Shaft	48T	25	24	54.8	78.5	573					





YEAR	TRANSM	L/R	F/R	REMARKS	GSP Ref.	PRODUCT	ABS	Technical Specifications										
								A	B	C	H	L	P					
PEUGEOT																		
205 II (20A/C)																		
1.9 GTI (75 kW)	1987.10-1989.05	-	R	F	Hatchback Engine D2A (XU92C)	210177	Drive Shaft		25	24	54.8	78.5	845					
	1987.10-1989.05	-	L	F	Hatchback Engine D2A (XU92C)	299161	Drive Shaft		25	24	54.8	78.5	577.5					
1.9 GTI (88 kW)	1987.10-1994.10	-	L	F	Hatchback Engine DKZ (XU9JAZ)	210022	Drive Shaft	48T	25	24	54.8	78.5	573					
	1987.10-1994.10	AT/MT	L/R	F	Hatchback Engine DKZ (XU9JAZ)	810005	Outer Joint	90T	25	23	54.8	78.5	56	I				
	1987.10-1994.10	MT	L/R	F	Hatchback Engine DKZ (XU9JAZ)	810002	Outer Joint		25	23	54.8	78.5	56	I				
	1987.10-1994.10	-	R	F	Hatchback Engine DKZ (XU9JAZ)	210177	Drive Shaft		25	24	54.8	78.5	845					
	1987.10-1994.10	-	L	F	Hatchback Engine DKZ (XU9JAZ)	299161	Drive Shaft		25	24	54.8	78.5	577.5					
	1987.10-1994.10	MT	L/R	F	Hatchback Engine DKZ (XU9JAZ)	810024	Outer Joint	48T	25	34	55.7	79	55	I				
	1987.10-1994.10	-	L	F	Hatchback Engine DKZ (XU9JAZ)	245134	Drive Shaft		25	24	54.8	78.5	573					
1.9 GTI (94 kW)	1987.10-1998.09	-	L	F	Hatchback Engine D6B (XU9JA)	210022	Drive Shaft	48T	25	24	54.8	78.5	573					
	1987.10-1998.09	AT/MT	L/R	F	Hatchback Engine D6B (XU9JA)	810005	Outer Joint	90T	25	23	54.8	78.5	56	I				
	1987.10-1998.09	MT	L/R	F	Hatchback Engine D6B (XU9JA)	810002	Outer Joint		25	23	54.8	78.5	56	I				
	1987.10-1998.09	-	R	F	Hatchback Engine D6B (XU9JA)	210177	Drive Shaft		25	24	54.8	78.5	845					
	1987.10-1998.09	-	L	F	Hatchback Engine D6B (XU9JA)	299161	Drive Shaft		25	24	54.8	78.5	577.5					
	1987.10-1998.09	MT	L/R	F	Hatchback Engine D6B (XU9JA)	810024	Outer Joint	48T	25	34	55.7	79	55	I				
	1987.10-1998.09	-	L	F	Hatchback Engine D6B (XU9JA)	245134	Drive Shaft		25	24	54.8	78.5	573					
1.9 GTI Cat (75 kW)	1987.10-1994.07	-	L	F	Hatchback Engine DFZ (XU9J1)	210022	Drive Shaft	48T	25	24	54.8	78.5	573					
	1987.10-1994.07	AT/MT	L/R	F	Hatchback Engine DFZ (XU9J1)	810005	Outer Joint	90T	25	23	54.8	78.5	56	I				
	1987.10-1994.07	MT	L/R	F	Hatchback Engine DFZ (XU9J1)	810002	Outer Joint		25	23	54.8	78.5	56	I				
	1987.10-1994.07	-	R	F	Hatchback Engine DFZ (XU9J1)	210177	Drive Shaft		25	24	54.8	78.5	845					
	1987.10-1994.07	-	L	F	Hatchback Engine DFZ (XU9J1)	299161	Drive Shaft		25	24	54.8	78.5	577.5					
	1987.10-1994.07	MT	L/R	F	Hatchback Engine DFZ (XU9J1)	810024	Outer Joint	48T	25	34	55.7	79	55	I				
	1987.10-1994.07	-	L	F	Hatchback Engine DFZ (XU9J1)	245134	Drive Shaft		25	24	54.8	78.5	573					
206																		
-	-	-	-	-	-	845010	Outer Joint		21	22	50.5	86.5	56	I				
-	-	-	-	-	LADO DIREITO	645019	Inner Joint		22	22	29.85	329.5	87.5					
-	-	-	L	-	-	245089	Drive Shaft	48T	25	22	60	78.7	597					
-	-	-	R	-	-	245090	Drive Shaft	48T	25	22	60	78.7	579					
1998-2009	MT	L/R	-	-	-	845061	Outer Joint		21	22	50	85	53	M				
1998-2009	MT	L/R	-	-	-	845061	Outer Joint		21	22	50	85	53	M				
1999-2004	MT	-	-	-	-	810100	Outer Joint		21	21	48.5	86	54	I				
1.0 16V	2002-	-	-	-	-	899009	Outer Joint		21	22	50	87	51	I				
1.1	1998-	MT	-	-	-	845048	Outer Joint	48T	21	22	48	86.5	54	I				
1.1/1.4	1998.10-	MT	-	F	-	845046	Outer Joint		21	22	50	86.5	54	I				
1.4	1998-	MT	-	-	-	845048	Outer Joint	48T	21	22	48	86.5	54	I				
	1998.09-	-	L	-	-	645011	Inner Joint		22	22	40	65.2	87.8					
	1998.09-	-	-	-	-	645011	Inner Joint		22	22	40	65.2	87.8					
	1998.09-	-	-	-	-	645012	Inner Joint		22	22	29.85	329.5	87.5					
	1998.09-	-	L	-	-	210063	Drive Shaft		21	22	48	86.5	619.5					
1.4 (55 kW)	2007.03-	AT	L	F	Saloon Engine KFW (TU3JP)/KfV (TU3A)	245146	Drive Shaft		21	26	48.5	86	588					
	2007.03-	AT	R	F	Saloon Engine KFW (TU3JP)/KfV (TU3A)	245147	Drive Shaft		21	23	48.5	86	807					
	2007.03-	-	L	F	Saloon Engine KFW (TU3JP)/KfV (TU3A)	210043	Drive Shaft		21	22	48	86.5	610					
	2007.03-	AT	L	F	Saloon Engine KFW (TU3JP)/KfV (TU3A)	699001	Inner Joint		26	34	42.5	46.5	103.5					
	2007.03-	-	R	F	Saloon Engine KFW (TU3JP)/KfV (TU3A)	245094	Drive Shaft		21	22	48	86.5	886					
	2007.03-	AT	R	F	Saloon Engine KFW (TU3JP)/KfV (TU3A)	650098	Inner Joint		23	34	30	209	88					
	2007.03-	-	L	F	Saloon Engine KFW (TU3JP)/KfV (TU3A)	245027	Drive Shaft	48T	21	22	48	86.5	610					
	2007.03-	MT	R	F	Saloon Engine KFW (TU3JP)/KfV (TU3A)	245098	Drive Shaft	48T	21	22	48	86.5	884					
	2007.03-	MT	L/R	F	Saloon Engine KFW (TU3JP)/KfV (TU3A)	845033	Outer Joint	48T	21	22	48	86.5	54	I				
	2007.03-	MT	R	F	Saloon Engine KFW (TU3JP)/KfV (TU3A)	245035	Drive Shaft	48T	21	22	48	86.5	886					
	2007.03-	MT	L	F	Saloon Engine KFW (TU3JP)/KfV (TU3A)	245191	Drive Shaft	48T	21	22	48	86.5	610					
	2007.03-	MT	L/R	F	Saloon Engine KFW (TU3JP)/KfV (TU3A)	845067	Outer Joint	48T	21	21	48.5	86	54	I				
	2007.03-	AT	-	F	Saloon Engine KFW (TU3JP)/KfV (TU3A)	810056	Outer Joint	48T	21	34	48.5	86	55.5	I				
	2007.03-	MT	R	F	Saloon Engine KFW (TU3JP)/KfV (TU3A)	245192	Drive Shaft	48T	21	22	48	86.5	884					
	2007.03-	AT	-	F	Saloon Engine KFW (TU3JP)/KfV (TU3A)	845012	Outer Joint		21	34	48.5	86	55.5	I				
	2007.03-	-	L	F	Saloon Engine KFW (TU3JP)/KfV (TU3A)	210281	Drive Shaft	48T	21	26	48.5	86	588					
	2007.03-	-	R	F	Saloon Engine KFW (TU3JP)/KfV (TU3A)	210326	Drive Shaft	48T	21	23	48.5	86	807					
	2007.03-	-	R	F	Saloon Engine KFW (TU3JP)/KfV (TU3A)	210433	Drive Shaft		21	26	48.5	86	809					
	2007.03-	-	R	F	Saloon Engine KFW (TU3JP)/KfV (TU3A)	210287	Drive Shaft	48T	21	26	48.5	86	809					
	2007.03-	MT	L/R	F	Saloon Engine KFW (TU3JP)/KfV (TU3A)	845011	Outer Joint		21	22	48	86.5	54	I				
2007.03-	MT	L/R	F	Saloon Engine KFW (TU3JP)/KfV (TU3A)	845065	Outer Joint		21	21	48.5	86	54	I					
1.4 HDi eco 70 (50 kW)	2008.09-	-	R	F	Saloon Engine 8HZ (DV4TD)	245094	Drive Shaft		21	22	48	86.5	886					
	2008.09-	-	L	F	Saloon Engine 8HZ (DV4TD)	245027	Drive Shaft	48T	21	22	48	86.5	610					
	2008.09-	MT	R	F	Saloon Engine 8HZ (DV4TD)	245035	Drive Shaft	48T	21	22	48	86.5	886					
	2008.09-	-	L	F	Saloon Engine 8HZ (DV4TD)	245031	Drive Shaft		21	22	48	86.5	604.5					
	2008.09-	MT	L/R	F	Saloon Engine 8HZ (DV4TD)	845057	Outer Joint		21	22	48	86.5	54	I				
1.6 16V	1998-2010	-	L/R	F	Engine TU5J4	845037	Outer Joint	48T	25	22	60	78.7	54	M				





YEAR	TRANSM	L/R	F/R	REMARKS	GSP Ref.	PRODUCT	ABS	Technical Specifications							
								A	B	C	H	L	P		
PEUGEOT															
206															
1.6 16V (80 kW)	2007.03-	-	MT	-	F	Saloon Engine NFU (TU5JP4)	899267	Outer Joint	48T	25	22	60	78.5	54	I
	2007.03-	-	MT	-	F	Saloon Engine NFU (TU5JP4)	899309	Outer Joint		25	22	60	78.5	54	I
	2007.03-	-	AT	L	F	Saloon Engine NFU (TU5JP4)	699001	Inner Joint		26	34	42.5	46.5	103.5	
	2007.03-	-	MT	L	F	Saloon Engine NFU (TU5JP4)	245049	Drive Shaft	48T	25	22	60	78.7	607.5	
	2007.03-	-	MT	R	F	Saloon Engine NFU (TU5JP4)	299017	Drive Shaft	48T	25	22	60	78.7	884.5	
	2007.03-	-	AT	L	F	Saloon Engine NFU (TU5JP4)	210345	Drive Shaft	48T	25	26	58.5	78.5	580	
	2007.03-	-	-	L	F	Saloon Engine NFU (TU5JP4)	245012	Drive Shaft	48T	25	22	60	78.5	601	
	2007.03-	-	-	R	F	Saloon Engine NFU (TU5JP4)	245011	Drive Shaft	48T	25	22	60	78.5	880	
	2007.03-	-	-	L	F	Saloon Engine NFU (TU5JP4)	245138	Drive Shaft		25	22	60	78.5	601	
	2007.03-	-	-	R	F	Saloon Engine NFU (TU5JP4)	245137	Drive Shaft		25	22	60	78.5	880	
	2007.03-	-	AT	-	F	Saloon Engine NFU (TU5JP4)	845035	Outer Joint	48T	25	34	58	79	55.5	I
2.0 16V	1999.06-	-	MT	-	F	-	845047	Outer Joint	48T	25	34	59	78.5	54	I
2.0 16V/2.0 Hdi	1999.06-	-	MT	L	F	-	645020	Inner Joint		24	34	40	69	89	
	1999.06-	-	MT	L	F	-	245115	Drive Shaft	48T	25	24	58	78.5	599	
2.0 Hdi	1999.06-	-	MT	-	F	-	845047	Outer Joint	48T	25	34	59	78.5	54	I
206 (2A/C)															
1.1 (40 kW)	1998.08-2000.07	-	L	F	F	Hatchback Engine HFY (TU1JP)	210043	Drive Shaft		21	22	48	86.5	610	
	1998.08-2000.07	-	R	F	F	Hatchback Engine HFY (TU1JP)	245094	Drive Shaft		21	22	48	86.5	886	
	1998.08-2000.07	-	L	F	F	Hatchback Engine HFY (TU1JP)	245027	Drive Shaft	48T	21	22	48	86.5	610	
	1998.08-2000.07	-	MT	R	F	Hatchback Engine HFY (TU1JP)	245098	Drive Shaft	48T	21	22	48	86.5	884	
	1998.08-2000.07	-	R	F	F	Hatchback Engine HFY (TU1JP)	245035	Drive Shaft	48T	21	22	48	86.5	886	
	1998.08-2000.07	-	MT	L	F	Hatchback Engine HFY (TU1JP)	245191	Drive Shaft	48T	21	22	48	86.5	610	
	1998.08-2000.07	-	MT	R	F	Hatchback Engine HFY (TU1JP)	245192	Drive Shaft	48T	21	22	48	86.5	884	
	1998.09-	-	MT	-	-	-	810081	Outer Joint	48T	21	22	48	86.5	54	I
1.1 (44 kW)	1998.09-	-	MT	-	-	-	810081	Outer Joint	48T	21	22	48	86.5	54	I
1.1 i (44 kW)	1998.09-	-	MT	L	F	Hatchback Engine HFX (TU1JP)/HFZ (TU1JP)	210043	Drive Shaft		21	22	48	86.5	610	
	1998.09-	-	MT	R	F	Hatchback Engine HFX (TU1JP)/HFZ (TU1JP)	245094	Drive Shaft		21	22	48	86.5	886	
	1998.09-	-	MT	L	F	Hatchback Engine HFX (TU1JP)/HFZ (TU1JP)	245027	Drive Shaft	48T	21	22	48	86.5	610	
	1998.09-	-	MT	R	F	Hatchback Engine HFX (TU1JP)/HFZ (TU1JP)	245098	Drive Shaft	48T	21	22	48	86.5	884	
	1998.09-	-	MT	R	F	Hatchback Engine HFX (TU1JP)/HFZ (TU1JP)	245035	Drive Shaft	48T	21	22	48	86.5	886	
	1998.09-	-	MT	L/R	F	Hatchback Engine HFX (TU1JP)/HFZ (TU1JP)	845033	Outer Joint	48T	21	22	48	86.5	54	I
	1998.09-	-	MT	L	F	Hatchback Engine HFX (TU1JP)/HFZ (TU1JP)	245191	Drive Shaft	48T	21	22	48	86.5	610	
	1998.09-	-	MT	L/R	F	Hatchback Engine HFX (TU1JP)/HFZ (TU1JP)	845067	Outer Joint	48T	21	21	48.5	86	54	I
	1998.09-	-	MT	R	F	Hatchback Engine HFX (TU1JP)/HFZ (TU1JP)	245192	Drive Shaft	48T	21	22	48	86.5	884	
	1998.09-	-	MT	L/R	F	Hatchback Engine HFX (TU1JP)/HFZ (TU1JP)	845011	Outer Joint		21	22	48	86.5	54	I
	1998.09-	-	MT	L/R	F	Hatchback Engine HFX (TU1JP)/HFZ (TU1JP)	845065	Outer Joint		21	21	48.5	86	54	I
	1998.09-	-	MT	L/R	F	Hatchback Engine HFX (TU1JP)/HFZ (TU1JP)	845057	Outer Joint		21	22	48	86.5	54	I
1.4 16V (65 kW)	2003.10-	-	AT	L	F	Hatchback Engine KFU (ET3J4)	245146	Drive Shaft		21	26	48.5	86	588	
	2003.10-	-	-	L	F	Hatchback Engine KFU (ET3J4)	210043	Drive Shaft		21	22	48	86.5	610	
	2003.10-	-	AT	R	F	Hatchback Engine KFU (ET3J4)	245147	Drive Shaft		21	23	48.5	86	807	
	2003.10-	-	AT	L	F	Hatchback Engine KFU (ET3J4)	699001	Inner Joint		26	34	42.5	46.5	103.5	
	2003.10-	-	-	R	F	Hatchback Engine KFU (ET3J4)	245094	Drive Shaft		21	22	48	86.5	886	
	2003.10-	-	AT	R	F	Hatchback Engine KFU (ET3J4)	650098	Inner Joint		23	34	30	209	88	
	2003.10-	-	-	L	F	Hatchback Engine KFU (ET3J4)	245027	Drive Shaft	48T	21	22	48	86.5	610	
	2003.10-	-	-	R	F	Hatchback Engine KFU (ET3J4)	245035	Drive Shaft	48T	21	22	48	86.5	886	
	2003.10-	-	MT	L/R	F	Hatchback Engine KFU (ET3J4)	845033	Outer Joint	48T	21	22	48	86.5	54	I
	2003.10-	-	MT	R	F	Hatchback Engine KFU (ET3J4)	245098	Drive Shaft	48T	21	22	48	86.5	884	
	2003.10-	-	MT	L	F	Hatchback Engine KFU (ET3J4)	245191	Drive Shaft	48T	21	22	48	86.5	610	
	2003.10-	-	MT	L/R	F	Hatchback Engine KFU (ET3J4)	845067	Outer Joint	48T	21	21	48.5	86	54	I
	2003.10-	-	AT	-	F	Hatchback Engine KFU (ET3J4)	810056	Outer Joint	48T	21	34	48.5	86	55.5	I
	2003.10-	-	MT	R	F	Hatchback Engine KFU (ET3J4)	245192	Drive Shaft	48T	21	22	48	86.5	884	
	2003.10-	-	AT	-	F	Hatchback Engine KFU (ET3J4)	845012	Outer Joint		21	34	48.5	86	55.5	I
	2003.10-	-	MT	L/R	F	Hatchback Engine KFU (ET3J4)	845011	Outer Joint		21	22	48	86.5	54	I
	2003.10-	-	MT	L/R	F	Hatchback Engine KFU (ET3J4)	845065	Outer Joint		21	21	48.5	86	54	I
1.4 HDi (50 kW)	2001.09-	-	-	-	-	-	810081	Outer Joint	48T	21	22	48	86.5	54	I
1.4 HDi (51 kW)	2001.09-	-	-	-	-	-	810081	Outer Joint	48T	21	22	48	86.5	54	I
	2002.09-2007.02	-	MT	R	F	Hatchback Engine 8HX (DV4TD)	245094	Drive Shaft		21	22	48	86.5	886	
	2002.09-2007.02	-	MT	L	F	Hatchback Engine 8HX (DV4TD)	245027	Drive Shaft	48T	21	22	48	86.5	610	
	2002.09-2007.02	-	MT	R	F	Hatchback Engine 8HX (DV4TD)	245098	Drive Shaft	48T	21	22	48	86.5	884	
	2002.09-2007.02	-	MT	R	F	Hatchback Engine 8HX (DV4TD)	245035	Drive Shaft	48T	21	22	48	86.5	886	
	2002.09-2007.02	-	MT	L	F	Hatchback Engine 8HX (DV4TD)	245031	Drive Shaft		21	22	48	86.5	604.5	
	2002.09-2007.02	-	MT	L	F	Hatchback Engine 8HX (DV4TD)	245032	Drive Shaft	48T	21	22	48	86.5	604.5	
	2002.09-2007.02	-	MT	L	F	Hatchback Engine 8HX (DV4TD)	245191	Drive Shaft	48T	21	22	48	86.5	610	
	2002.09-2007.02	-	MT	R	F	Hatchback Engine 8HX (DV4TD)	245192	Drive Shaft	48T	21	22	48	86.5	884	
1.4 HDi eco 70 (50 kW)	2001.09-	-	-	R	F	Hatchback Engine 8HX (DV4TD)/8HZ (DV4TD)	245094	Drive Shaft		21	22	48	86.5	886	
	2001.09-	-	-	L	F	Hatchback Engine 8HX (DV4TD)/8HZ (DV4TD)	245027	Drive Shaft	48T	21	22	48	86.5	610	

	 YEAR	TRANSM	L/R	F/R	REMARKS	GSP Ref.	 PRODUCT	 ABS	Technical Specifications						
									A	B	C	H	L	P	
PEUGEOT															
206 (2A/C)															
1.4 HDi eco 70 (50 kW)	2001.09.-	-	MT	R	F	Hatchback Engine 8HX (DV4TD)/8HZ (DV4TD)	245098	Drive Shaft	48T	21	22	48	86.5	884	
	2001.09.-	-	MT	R	F	Hatchback Engine 8HX (DV4TD)/8HZ (DV4TD)	245035	Drive Shaft	48T	21	22	48	86.5	886	
	2001.09.-	-	MT	L/R	F	Hatchback Engine 8HX (DV4TD)/8HZ (DV4TD)	845033	Outer Joint	48T	21	22	48	86.5	54	I
	2001.09.-	-	-	L	F	Hatchback Engine 8HX (DV4TD)/8HZ (DV4TD)	245031	Drive Shaft		21	22	48	86.5	604.5	
	2001.09.-	-	MT	L	F	Hatchback Engine 8HX (DV4TD)/8HZ (DV4TD)	245191	Drive Shaft	48T	21	22	48	86.5	610	
	2001.09.-	-	MT	L/R	F	Hatchback Engine 8HX (DV4TD)/8HZ (DV4TD)	845067	Outer Joint	48T	21	21	48.5	86	54	I
	2001.09.-	-	MT	L	F	Hatchback Engine 8HX (DV4TD)/8HZ (DV4TD)	245032	Drive Shaft	48T	21	22	48	86.5	604.5	
	2001.09.-	-	MT	R	F	Hatchback Engine 8HX (DV4TD)/8HZ (DV4TD)	245192	Drive Shaft	48T	21	22	48	86.5	884	
	2001.09.-	-	MT	L/R	F	Hatchback Engine 8HX (DV4TD)/8HZ (DV4TD)	845011	Outer Joint		21	22	48	86.5	54	I
	2001.09.-	-	MT	L/R	F	Hatchback Engine 8HX (DV4TD)/8HZ (DV4TD)	845065	Outer Joint		21	21	48.5	86	54	I
	2001.09.-	-	MT	L/R	F	Hatchback Engine 8HX (DV4TD)/8HZ (DV4TD)	845057	Outer Joint		21	22	48	86.5	54	I
1.4 i (55 kW)	1998.09.-	-	AT	L	F	Hatchback Engine KFX (TU3JP)/KFW (TU3JP)	245146	Drive Shaft		21	26	48.5	86	588	
	1998.09.-	-	AT	R	F	Hatchback Engine KFX (TU3JP)/KFW (TU3JP)	245147	Drive Shaft		21	23	48.5	86	807	
	1998.09.-	-	MT	L	F	Hatchback Engine KFX (TU3JP)/KFW (TU3JP)	210043	Drive Shaft		21	22	48	86.5	610	
	1998.09.-	-	AT	L	F	Hatchback Engine KFX (TU3JP)/KFW (TU3JP)	699001	Inner Joint		26	34	42.5	46.5	103.5	
	1998.09.-	-	AT	R	F	Hatchback Engine KFX (TU3JP)/KFW (TU3JP)	650098	Inner Joint		23	34	30	209	88	
	1998.09.-	-	MT	R	F	Hatchback Engine KFX (TU3JP)/KFW (TU3JP)	245094	Drive Shaft		21	22	48	86.5	886	
	1998.09.-	-	MT	L	F	Hatchback Engine KFX (TU3JP)/KFW (TU3JP)	245027	Drive Shaft	48T	21	22	48	86.5	610	
	1998.09.-	-	MT	R	F	Hatchback Engine KFX (TU3JP)/KFW (TU3JP)	245098	Drive Shaft	48T	21	22	48	86.5	884	
	1998.09.-	-	MT	L/R	F	Hatchback Engine KFX (TU3JP)/KFW (TU3JP)	845033	Outer Joint	48T	21	22	48	86.5	54	I
	1998.09.-	-	MT	R	F	Hatchback Engine KFX (TU3JP)/KFW (TU3JP)	245035	Drive Shaft	48T	21	22	48	86.5	886	
	1998.09.-	-	MT	L	F	Hatchback Engine KFX (TU3JP)/KFW (TU3JP)	245191	Drive Shaft	48T	21	22	48	86.5	610	
	1998.09.-	-	MT	L/R	F	Hatchback Engine KFX (TU3JP)/KFW (TU3JP)	845067	Outer Joint	48T	21	21	48.5	86	54	I
	1998.09.-	-	AT	-	F	Hatchback Engine KFX (TU3JP)/KFW (TU3JP)	810056	Outer Joint	48T	21	34	48.5	86	55.5	I
	1998.09.-	-	MT	R	F	Hatchback Engine KFX (TU3JP)/KFW (TU3JP)	245192	Drive Shaft	48T	21	22	48	86.5	884	
	1998.09.-	-	AT	-	F	Hatchback Engine KFX (TU3JP)/KFW (TU3JP)	845012	Outer Joint		21	34	48.5	86	55.5	I
	1998.09.-	-	-	L	F	Hatchback Engine KFX (TU3JP)/KFW (TU3JP)	210281	Drive Shaft	48T	21	26	48.5	86	588	
	1998.09.-	-	-	R	F	Hatchback Engine KFX (TU3JP)/KFW (TU3JP)	210326	Drive Shaft	48T	21	23	48.5	86	807	
	1998.09.-	-	-	R	F	Hatchback Engine KFX (TU3JP)/KFW (TU3JP)	210433	Drive Shaft		21	26	48.5	86	809	
	1998.09.-	-	-	R	F	Hatchback Engine KFX (TU3JP)/KFW (TU3JP)	210287	Drive Shaft	48T	21	26	48.5	86	809	
	1998.09.-	-	MT	-	-		810081	Outer Joint	48T	21	22	48	86.5	54	I
	1998.09.-	-	MT	L/R	F	Hatchback Engine KFX (TU3JP)/KFW (TU3JP)	845011	Outer Joint		21	22	48	86.5	54	I
	1998.09.-	-	MT	L/R	F	Hatchback Engine KFX (TU3JP)/KFW (TU3JP)	845065	Outer Joint		21	21	48.5	86	54	I
1.6 16V (80 kW)	2000.12.-	-	MT	-	F	Hatchback Engine NFU (TU5JP4)	899267	Outer Joint	48T	25	22	60	78.5	54	I
	2000.12.-	-	MT	-	F	Hatchback Engine NFU (TU5JP4)	899309	Outer Joint		25	22	60	78.5	54	I
	2000.12.-	-	AT	L	F	Hatchback Engine NFU (TU5JP4)	699001	Inner Joint		26	34	42.5	46.5	103.5	
	2000.12.-	-	MT	L	F	Hatchback Engine NFU (TU5JP4)	245049	Drive Shaft	48T	25	22	60	78.7	607.5	
	2000.12.-	-	MT	L/R	F	Hatchback Engine NFU (TU5JP4)	845045	Outer Joint		25	22	60	78.5	54	I
	2000.12.-	-	MT	L/R	F	Hatchback Engine NFU (TU5JP4)	899008	Outer Joint	48T	25	22	60	78.5	54	I
	2000.12.-	-	MT	R	F	Hatchback Engine NFU (TU5JP4)	299017	Drive Shaft	48T	25	22	60	78.7	884.5	
	2000.12.-	-	AT	L	F	Hatchback Engine NFU (TU5JP4)	210345	Drive Shaft	48T	25	26	58.5	78.5	580	
	2000.12.-	-	MT	L	F	Hatchback Engine NFU (TU5JP4)	245012	Drive Shaft	48T	25	22	60	78.5	601	
	2000.12.-	-	MT	R	F	Hatchback Engine NFU (TU5JP4)	245011	Drive Shaft	48T	25	22	60	78.5	880	
	2000.12.-	-	MT	L	F	Hatchback Engine NFU (TU5JP4)	245138	Drive Shaft		25	22	60	78.5	601	
	2000.12.-	-	MT	R	F	Hatchback Engine NFU (TU5JP4)	245137	Drive Shaft		25	22	60	78.5	880	
	2000.12.-	-	AT	-	F	Hatchback Engine NFU (TU5JP4)	845035	Outer Joint	48T	25	34	58	79	55.5	I
1.6 8V (66 kW)	1999.05.-	2003.10	-	L	F	Hatchback Engine NFZ (TU5JP)	210281	Drive Shaft	48T	21	26	48.5	86	588	
	1999.05.-	2003.10	-	R	F	Hatchback Engine NFZ (TU5JP)	210326	Drive Shaft	48T	21	23	48.5	86	807	
	1999.05.-	2003.10	-	R	F	Hatchback Engine NFZ (TU5JP)	210433	Drive Shaft		21	26	48.5	86	809	
	1999.05.-	2003.10	-	L	F	Hatchback Engine NFZ (TU5JP)	699001	Inner Joint		26	34	42.5	46.5	103.5	
	1999.05.-	2003.10	-	R	F	Hatchback Engine NFZ (TU5JP)	650098	Inner Joint		23	34	30	209	88	
1.6 HDi 110 (80 kW)	2004.05.-	-	MT	R	F	Hatchback Engine 9HY (DV6TED4)/9HZ (DV6TED4)	299162	Drive Shaft	48T	25	24	58	79	888	
	2004.05.-	-	-	L	F	Hatchback Engine 9HY (DV6TED4)/9HZ (DV6TED4)	245101	Drive Shaft	48T	25	24	58	79	592	
	2004.05.-	-	-	R	F	Hatchback Engine 9HY (DV6TED4)/9HZ (DV6TED4)	245016	Drive Shaft	48T	25	24	60	78.7	888	
	2004.05.-	-	MT	L	F	Hatchback Engine 9HY (DV6TED4)/9HZ (DV6TED4)	299163	Drive Shaft	48T	25	24	58	79	600	
	2004.05.-	-	-	-	F	Hatchback Engine 9HY (DV6TED4)/9HZ (DV6TED4)	845035	Outer Joint	48T	25	34	58	79	55.5	I
1.6 i (65 kW)	1998.09.-	2000.12	AT	L	F	Hatchback Engine NFZ (TU5JP)	245146	Drive Shaft		21	26	48.5	86	588	
	1998.09.-	2000.12	AT	R	F	Hatchback Engine NFZ (TU5JP)	245147	Drive Shaft		21	23	48.5	86	807	
	1998.09.-	2000.12	AT	L	F	Hatchback Engine NFZ (TU5JP)	699001	Inner Joint		26	34	42.5	46.5	103.5	
	1998.09.-	2000.12	MT	R	F	Hatchback Engine NFZ (TU5JP)	245094	Drive Shaft		21	22	48	86.5	886	
	1998.09.-	2000.12	AT	R	F	Hatchback Engine NFZ (TU5JP)	650098	Inner Joint		23	34	30	209	88	
	1998.09.-	2000.12	MT	R	F	Hatchback Engine NFZ (TU5JP)	245098	Drive Shaft	48T	21	22	48	86.5	884	
	1998.09.-	2000.12	MT	L/R	F	Hatchback Engine NFZ (TU5JP)	845033	Outer Joint	48T	21	22	48	86.5	54	I
	1998.09.-	2000.12	MT	R	F	Hatchback Engine NFZ (TU5JP)	245035	Drive Shaft	48T	21	22	48	86.5	886	
	1998.09.-	2000.12	MT	L	F	Hatchback Engine NFZ (TU5JP)	245191	Drive Shaft	48T	21	22	48	86.5	610	
	1998.09.-	2000.12	MT	L	F	Hatchback Engine NFZ (TU5JP)	245031	Drive Shaft		21	22	48	86.5	604.5	

	 YEAR	TRANSM	L/R	F/R	REMARKS	GSP Ref.	 PRODUCT	 ABS	Technical Specifications					
									A	B	C	H	L	P
PEUGEOT														
206 (2A/C)														
1.6 i (65 kW)	1998.09-2000.12	MT	L	F	Hatchback Engine NFZ (TU5JP)	245032	Drive Shaft	48T	21	22	48	86.5	604.5	
	1998.09-2000.12	AT	-	F	Hatchback Engine NFZ (TU5JP)	810056	Outer Joint	48T	21	34	48.5	86	55.5	I
	1998.09-2000.12	MT	R	F	Hatchback Engine NFZ (TU5JP)	245192	Drive Shaft	48T	21	22	48	86.5	884	
	1998.09-2000.12	AT	-	F	Hatchback Engine NFZ (TU5JP)	845012	Outer Joint		21	34	48.5	86	55.5	I
	1998.09-2000.12	-	L	F	Hatchback Engine NFZ (TU5JP)	210281	Drive Shaft	48T	21	26	48.5	86	588	
	1998.09-2000.12	-	R	F	Hatchback Engine NFZ (TU5JP)	210326	Drive Shaft	48T	21	23	48.5	86	807	
	1998.09-2000.12	-	R	F	Hatchback Engine NFZ (TU5JP)	210433	Drive Shaft		21	26	48.5	86	809	
	1998.09-2000.12	-	R	F	Hatchback Engine NFZ (TU5JP)	210287	Drive Shaft	48T	21	26	48.5	86	809	
	1998.09-2000.12	MT	-	-	-	810081	Outer Joint	48T	21	22	48	86.5	54	I
1998.09-2000.12	MT	L/R	F	Hatchback Engine NFZ (TU5JP)	845011	Outer Joint		21	22	48	86.5	54	I	
1998.09-2000.12	MT	L/R	F	Hatchback Engine NFZ (TU5JP)	845057	Outer Joint		21	22	48	86.5	54	I	
1.9 D (51 kW)	1998.09-2001.11	-	-	F	Hatchback Engine WJZ (DW8)/WJY (DW8B)	810056	Outer Joint	48T	21	34	48.5	86	55.5	I
	1998.09-2001.11	MT	L	F	Hatchback Engine WJZ (DW8)/WJY (DW8B)	245009	Drive Shaft	48T	21	24	48	86.5	602	
	1998.09-2001.11	MT	R	F	Hatchback Engine WJZ (DW8)/WJY (DW8B)	245010	Drive Shaft	48T	21	24	48	86.5	896	
	1998.09-2001.11	-	-	F	Hatchback Engine WJZ (DW8)/WJY (DW8B)	845012	Outer Joint		21	34	48.5	86	55.5	I
	1998.09-2001.11	MT	L	F	Hatchback Engine WJZ (DW8)/WJY (DW8B)	245064	Drive Shaft	48T	21	24	48.5	86	611.5	
	1998.09-2001.11	MT	R	F	Hatchback Engine WJZ (DW8)/WJY (DW8B)	245065	Drive Shaft	48T	21	24	48.5	86	900	
	1998.09-2001.11	MT	L	F	Hatchback Engine WJZ (DW8)/WJY (DW8B)	210136	Drive Shaft		21	24	48.5	86	611.5	
	1998.09-2001.11	MT	R	F	Hatchback Engine WJZ (DW8)/WJY (DW8B)	210137	Drive Shaft		21	24	48.5	86	900	
2.0 HDI 90 (66 kW)	1999.12-2000.12	MT	L	F	Hatchback Engine RHY (DW10TD)	610093	Inner Joint		24	22	40	62	90	
	1999.12-2000.12	MT	R	F	Hatchback Engine RHY (DW10TD)	299162	Drive Shaft	48T	25	24	58	79	888	
	1999.12-2000.12	MT	L	F	Hatchback Engine RHY (DW10TD)	245101	Drive Shaft	48T	25	24	58	79	592	
	1999.12-2000.12	MT	R	F	Hatchback Engine RHY (DW10TD)	245016	Drive Shaft	48T	25	24	60	78.7	888	
	1999.12-2000.12	-	-	F	Hatchback Engine RHY (DW10TD)	845035	Outer Joint	48T	25	34	58	79	55.5	I
	1999.12-2000.12	MT	L	F	Hatchback Engine RHY (DW10TD)	299163	Drive Shaft	48T	25	24	58	79	600	
	1999.12-2000.12	MT	L	F	Hatchback Engine RHY (DW10TD)	299028	Drive Shaft		25	24	54.8	78.5	598.5	
2.0 RC (130 kW)	1999.12-2000.12	MT	R	F	Hatchback Engine RFK (EW10J4S)	299162	Drive Shaft	48T	25	24	58	79	888	
	2003.07-2004.07	-	L	F	Hatchback Engine RFK (EW10J4S)	245101	Drive Shaft	48T	25	24	58	79	592	
	2003.07-2004.07	-	R	F	Hatchback Engine RFK (EW10J4S)	245016	Drive Shaft	48T	25	24	60	78.7	888	
	2003.07-2004.07	MT	L	F	Hatchback Engine RFK (EW10J4S)	299163	Drive Shaft	48T	25	24	58	79	600	
	2003.07-2004.07	-	-	F	Hatchback Engine RFK (EW10J4S)	845035	Outer Joint	48T	25	34	58	79	55.5	I
2.0 S16 (100 kW)	1999.06-2000.12	MT	R	F	Hatchback Engine RFN (EW10J4)/RFR (DEW10J4)	299162	Drive Shaft	48T	25	24	58	79	888	
	1999.06-2000.12	MT	L	F	Hatchback Engine RFN (EW10J4)/RFR (DEW10J4)	245101	Drive Shaft	48T	25	24	58	79	592	
	1999.06-2000.12	MT	R	F	Hatchback Engine RFN (EW10J4)/RFR (DEW10J4)	245016	Drive Shaft	48T	25	24	60	78.7	888	
	1999.06-2000.12	-	-	F	Hatchback Engine RFN (EW10J4)/RFR (DEW10J4)	845035	Outer Joint	48T	25	34	58	79	55.5	I
	1999.06-2000.12	MT	L	F	Hatchback Engine RFN (EW10J4)/RFR (DEW10J4)	299163	Drive Shaft	48T	25	24	58	79	600	
2.0 S16 (99 kW)	1999.04-2000.10	MT	R	F	Hatchback Engine RFR (DEW10J4)	299162	Drive Shaft	48T	25	24	58	79	888	
	1999.04-2000.10	MT	L	F	Hatchback Engine RFR (DEW10J4)	245101	Drive Shaft	48T	25	24	58	79	592	
	1999.04-2000.10	MT	R	F	Hatchback Engine RFR (DEW10J4)	245016	Drive Shaft	48T	25	24	60	78.7	888	
	1999.04-2000.10	-	-	F	Hatchback Engine RFR (DEW10J4)	845035	Outer Joint	48T	25	34	58	79	55.5	I
	1999.04-2000.10	MT	L	F	Hatchback Engine RFR (DEW10J4)	299163	Drive Shaft	48T	25	24	58	79	600	
206 CC (2D)														
1.6 16V (80 kW)	2000.09-2001.09	MT	-	F	Convertible Engine NFU (TU5JP4)	899267	Outer Joint	48T	25	22	60	78.5	54	I
	2000.09-2001.09	MT	-	F	Convertible Engine NFU (TU5JP4)	899309	Outer Joint		25	22	60	78.5	54	I
	2000.09-2001.09	AT	L	F	Convertible Engine NFU (TU5JP4)	699001	Inner Joint		26	34	42.5	46.5	103.5	
	2000.09-2001.09	MT	L/R	F	Convertible Engine NFU (TU5JP4)	845045	Outer Joint		25	22	60	78.5	54	I
	2000.09-2001.09	MT	L	F	Convertible Engine NFU (TU5JP4)	245049	Drive Shaft	48T	25	22	60	78.7	607.5	
	2000.09-2001.09	MT	L/R	F	Convertible Engine NFU (TU5JP4)	899008	Outer Joint	48T	25	22	60	78.5	54	I
	2000.09-2001.09	MT	R	F	Convertible Engine NFU (TU5JP4)	299017	Drive Shaft	48T	25	22	60	78.7	884.5	
	2000.09-2001.09	AT	L	F	Convertible Engine NFU (TU5JP4)	210345	Drive Shaft	48T	25	26	58.5	78.5	580	
	2000.09-2001.09	MT	L	F	Convertible Engine NFU (TU5JP4)	245012	Drive Shaft	48T	25	22	60	78.5	601	
	2000.09-2001.09	MT	R	F	Convertible Engine NFU (TU5JP4)	245011	Drive Shaft	48T	25	22	60	78.5	880	
	2000.09-2001.09	MT	L	F	Convertible Engine NFU (TU5JP4)	245138	Drive Shaft		25	22	60	78.5	601	
	2000.09-2001.09	MT	R	F	Convertible Engine NFU (TU5JP4)	245137	Drive Shaft		25	22	60	78.5	880	
	2000.09-2001.09	AT	-	F	Convertible Engine NFU (TU5JP4)	845035	Outer Joint	48T	25	34	58	79	55.5	I
1.6 HDi 110 (80 kW)	2005.04-2006.04	-	-	F	Convertible Engine 9HZ (DV6TED4)	845035	Outer Joint	48T	25	34	58	79	55.5	I
	2005.04-2006.04	MT	R	F	Convertible Engine 9HZ (DV6TED4)	299162	Drive Shaft	48T	25	24	58	79	888	
	2005.04-2006.04	-	L	F	Convertible Engine 9HZ (DV6TED4)	245101	Drive Shaft	48T	25	24	58	79	592	
	2005.04-2006.04	-	R	F	Convertible Engine 9HZ (DV6TED4)	245016	Drive Shaft	48T	25	24	60	78.7	888	
	2005.04-2006.04	-	-	F	Convertible Engine 9HZ (DV6TED4)	845049	Outer Joint	48T	25	34	58	79	55.5	I
2005.04-2006.04	MT	L	F	Convertible Engine 9HZ (DV6TED4)	299163	Drive Shaft	48T	25	24	58	79	600		
2.0 S16 (100 kW)	2000.09-2001.09	MT	R	F	Convertible Engine RFN (EW10J4)	299162	Drive Shaft	48T	25	24	58	79	888	
	2000.09-2001.09	MT	L	F	Convertible Engine RFN (EW10J4)	245101	Drive Shaft	48T	25	24	58	79	592	
	2000.09-2001.09	MT	R	F	Convertible Engine RFN (EW10J4)	245016	Drive Shaft	48T	25	24	60	78.7	888	
	2000.09-2001.09	-	-	F	Convertible Engine RFN (EW10J4)	845049	Outer Joint	48T	25	34	58	79	55.5	I





YEAR	TRANSM	L/R	F/R	REMARKS	GSP Ref.	PRODUCT	ABS	Technical Specifications								
								A	B	C	H	L	P			
PEUGEOT																
206 CC (2D)																
2.0 S16 (100 kW)	2000.09-	-	-	F	Convertible Engine RFN (EW10J4)	845035	Outer Joint	48T	25	34	58	79	55.5	I		
	2000.09-	-	MT	L	Convertible Engine RFN (EW10J4)	299163	Drive Shaft	48T	25	24	58	79	600			
206 SW (2E/K)																
1.1 (44 kW)	2002.07-	-	-	L	F	Estate Engine HFX (TU1JP)	210043	Drive Shaft		21	22	48	86.5	610		
	2002.07-	-	-	R	F	Estate Engine HFX (TU1JP)	245094	Drive Shaft		21	22	48	86.5	886		
	2002.07-	-	-	L	F	Estate Engine HFX (TU1JP)	245027	Drive Shaft	48T	21	22	48	86.5	610		
	2002.07-	-	-	R	F	Estate Engine HFX (TU1JP)	245035	Drive Shaft	48T	21	22	48	86.5	886		
	2002.07-	-	MT	L/R	F	Estate Engine HFX (TU1JP)	845033	Outer Joint	48T	21	22	48	86.5	54	I	
	2002.07-	-	MT	R	F	Estate Engine HFX (TU1JP)	245098	Drive Shaft	48T	21	22	48	86.5	884		
	2002.07-	-	MT	L	F	Estate Engine HFX (TU1JP)	245191	Drive Shaft	48T	21	22	48	86.5	610		
	2002.07-	-	MT	L/R	F	Estate Engine HFX (TU1JP)	845067	Outer Joint	48T	21	21	48.5	86	54	I	
	2002.07-	-	MT	R	F	Estate Engine HFX (TU1JP)	245192	Drive Shaft	48T	21	22	48	86.5	884		
	2002.07-	-	MT	L/R	F	Estate Engine HFX (TU1JP)	845011	Outer Joint		21	22	48	86.5	54	I	
	2002.07-	-	MT	L/R	F	Estate Engine HFX (TU1JP)	845065	Outer Joint		21	21	48.5	86	54	I	
	2002.07-	-	MT	L/R	F	Estate Engine HFX (TU1JP)	845057	Outer Joint		21	22	48	86.5	54	I	
1.4 (55 kW)	2002.07-	-	AT	L	F	Estate Engine KFW (TU3JP)/KFV (TU3A)	245146	Drive Shaft		21	26	48.5	86	588		
	2002.07-	-	-	L	F	Estate Engine KFW (TU3JP)/KFV (TU3A)	210043	Drive Shaft		21	22	48	86.5	610		
	2002.07-	-	AT	R	F	Estate Engine KFW (TU3JP)/KFV (TU3A)	245147	Drive Shaft		21	23	48.5	86	807		
	2002.07-	-	-	R	F	Estate Engine KFW (TU3JP)/KFV (TU3A)	245094	Drive Shaft		21	22	48	86.5	886		
	2002.07-	-	AT	L	F	Estate Engine KFW (TU3JP)/KFV (TU3A)	699001	Inner Joint		26	34	42.5	46.5	103.5		
	2002.07-	-	AT	R	F	Estate Engine KFW (TU3JP)/KFV (TU3A)	650098	Inner Joint		23	34	30	209	88		
	2002.07-	-	-	L	F	Estate Engine KFW (TU3JP)/KFV (TU3A)	245027	Drive Shaft	48T	21	22	48	86.5	610		
	2002.07-	-	-	R	F	Estate Engine KFW (TU3JP)/KFV (TU3A)	245035	Drive Shaft	48T	21	22	48	86.5	886		
	2002.07-	-	MT	L/R	F	Estate Engine KFW (TU3JP)/KFV (TU3A)	845033	Outer Joint	48T	21	22	48	86.5	54	I	
	2002.07-	-	MT	R	F	Estate Engine KFW (TU3JP)/KFV (TU3A)	245098	Drive Shaft	48T	21	22	48	86.5	884		
	2002.07-	-	MT	L	F	Estate Engine KFW (TU3JP)/KFV (TU3A)	245191	Drive Shaft	48T	21	22	48	86.5	610		
	2002.07-	-	MT	L/R	F	Estate Engine KFW (TU3JP)/KFV (TU3A)	845067	Outer Joint	48T	21	21	48.5	86	54	I	
	2002.07-	-	AT	-	F	Estate Engine KFW (TU3JP)/KFV (TU3A)	810056	Outer Joint	48T	21	34	48.5	86	55.5	I	
	2002.07-	-	MT	R	F	Estate Engine KFW (TU3JP)/KFV (TU3A)	245192	Drive Shaft	48T	21	22	48	86.5	884		
	2002.07-	-	AT	-	F	Estate Engine KFW (TU3JP)/KFV (TU3A)	845012	Outer Joint		21	34	48.5	86	55.5	I	
	2002.07-	-	-	L	F	Estate Engine KFW (TU3JP)/KFV (TU3A)	210281	Drive Shaft	48T	21	26	48.5	86	588		
	2002.07-	-	-	R	F	Estate Engine KFW (TU3JP)/KFV (TU3A)	210326	Drive Shaft	48T	21	23	48.5	86	807		
	2002.07-	-	-	R	F	Estate Engine KFW (TU3JP)/KFV (TU3A)	210433	Drive Shaft		21	26	48.5	86	809		
	2002.07-	-	-	R	F	Estate Engine KFW (TU3JP)/KFV (TU3A)	210287	Drive Shaft	48T	21	26	48.5	86	809		
	2002.07-	-	MT	L/R	F	Estate Engine KFW (TU3JP)/KFV (TU3A)	845011	Outer Joint		21	22	48	86.5	54	I	
	2002.07-	-	MT	L/R	F	Estate Engine KFW (TU3JP)/KFV (TU3A)	845065	Outer Joint		21	21	48.5	86	54	I	
	2002.07-	-	MT	L/R	F	Estate Engine KFW (TU3JP)/KFV (TU3A)	845057	Outer Joint		21	22	48	86.5	54	I	
1.4 16V (65 kW)	2003.10-	-	AT	L	F	Estate Engine KFV (ET3J4)	245146	Drive Shaft		21	26	48.5	86	588		
	2003.10-	-	-	L	F	Estate Engine KFV (ET3J4)	210043	Drive Shaft		21	22	48	86.5	610		
	2003.10-	-	AT	R	F	Estate Engine KFV (ET3J4)	245147	Drive Shaft		21	23	48.5	86	807		
	2003.10-	-	AT	L	F	Estate Engine KFV (ET3J4)	699001	Inner Joint		26	34	42.5	46.5	103.5		
	2003.10-	-	-	R	F	Estate Engine KFV (ET3J4)	245094	Drive Shaft		21	22	48	86.5	886		
	2003.10-	-	AT	R	F	Estate Engine KFV (ET3J4)	650098	Inner Joint		23	34	30	209	88		
	2003.10-	-	-	L	F	Estate Engine KFV (ET3J4)	245027	Drive Shaft	48T	21	22	48	86.5	610		
	2003.10-	-	-	R	F	Estate Engine KFV (ET3J4)	245035	Drive Shaft	48T	21	22	48	86.5	886		
	2003.10-	-	MT	L/R	F	Estate Engine KFV (ET3J4)	845033	Outer Joint	48T	21	22	48	86.5	54	I	
	2003.10-	-	MT	R	F	Estate Engine KFV (ET3J4)	245098	Drive Shaft	48T	21	22	48	86.5	884		
	2003.10-	-	MT	L	F	Estate Engine KFV (ET3J4)	245191	Drive Shaft	48T	21	22	48	86.5	610		
	2003.10-	-	MT	L/R	F	Estate Engine KFV (ET3J4)	845067	Outer Joint	48T	21	21	48.5	86	54	I	
	2003.10-	-	AT	-	F	Estate Engine KFV (ET3J4)	810056	Outer Joint	48T	21	34	48.5	86	55.5	I	
	2003.10-	-	MT	R	F	Estate Engine KFV (ET3J4)	245192	Drive Shaft	48T	21	22	48	86.5	884		
	2003.10-	-	AT	-	F	Estate Engine KFV (ET3J4)	845012	Outer Joint		21	34	48.5	86	55.5	I	
	2003.10-	-	MT	L/R	F	Estate Engine KFV (ET3J4)	845011	Outer Joint		21	22	48	86.5	54	I	
	2003.10-	-	MT	L/R	F	Estate Engine KFV (ET3J4)	845065	Outer Joint		21	21	48.5	86	54	I	
1.4 HDi (50 kW)	2002.07-	-	-	R	F	Estate Engine 8HX (DV4TD)	245094	Drive Shaft		21	22	48	86.5	886		
	2002.07-	-	-	L	F	Estate Engine 8HX (DV4TD)	245027	Drive Shaft	48T	21	22	48	86.5	610		
	2002.07-	-	-	R	F	Estate Engine 8HX (DV4TD)	245035	Drive Shaft	48T	21	22	48	86.5	886		
	2002.07-	-	MT	L/R	F	Estate Engine 8HX (DV4TD)	845033	Outer Joint	48T	21	22	48	86.5	54	I	
	2002.07-	-	MT	R	F	Estate Engine 8HX (DV4TD)	245098	Drive Shaft	48T	21	22	48	86.5	884		
	2002.07-	-	-	L	F	Estate Engine 8HX (DV4TD)	245031	Drive Shaft		21	22	48	86.5	604.5		
	2002.07-	-	MT	L	F	Estate Engine 8HX (DV4TD)	245191	Drive Shaft	48T	21	22	48	86.5	610		
	2002.07-	-	MT	L/R	F	Estate Engine 8HX (DV4TD)	845067	Outer Joint	48T	21	21	48.5	86	54	I	
	2002.07-	-	-	L	F	Estate Engine 8HX (DV4TD)	245032	Drive Shaft	48T	21	22	48	86.5	604.5		
	2002.07-	-	MT	R	F	Estate Engine 8HX (DV4TD)	245192	Drive Shaft	48T	21	22	48	86.5	884		
	2002.07-	-	MT	L/R	F	Estate Engine 8HX (DV4TD)	845011	Outer Joint		21	22	48	86.5	54	I	
	2002.07-	-	MT	L/R	F	Estate Engine 8HX (DV4TD)	845065	Outer Joint		21	21	48.5	86	54	I	





	 YEAR	TRANSM	L/R	F/R	REMARKS	GSP Ref.	 PRODUCT	 ABS	Technical Specifications						
									A	B	C	H	L	P	
PEUGEOT															
206 SW (2E/K)															
1.4 HDi (50 kW)	2002.07-	-	MT	L/R	F	Estate Engine 8HX (DV4TD)	845057	Outer Joint		21	22	48	86.5	54	I
1.6 16V (80 kW)	2002.07-	-	MT	-	F	Estate Engine NFU (TU5JP4)	899267	Outer Joint	48T	25	22	60	78.5	54	I
	2002.07-	-	MT	-	F	Estate Engine NFU (TU5JP4)	899309	Outer Joint		25	22	60	78.5	54	I
	2002.07-	-	AT	L	F	Estate Engine NFU (TU5JP4)	699001	Inner Joint		26	34	42.5	46.5	103.5	
	2002.07-	-	MT	L/R	F	Estate Engine NFU (TU5JP4)	845045	Outer Joint		25	22	60	78.5	54	I
	2002.07-	-	MT	L	F	Estate Engine NFU (TU5JP4)	245049	Drive Shaft	48T	25	22	60	78.7	607.5	
	2002.07-	-	MT	L/R	F	Estate Engine NFU (TU5JP4)	899008	Outer Joint	48T	25	22	60	78.5	54	I
	2002.07-	-	MT	R	F	Estate Engine NFU (TU5JP4)	299017	Drive Shaft	48T	25	22	60	78.7	884.5	
	2002.07-	-	AT	L	F	Estate Engine NFU (TU5JP4)	210345	Drive Shaft	48T	25	26	58.5	78.5	580	
	2002.07-	-	MT	L	F	Estate Engine NFU (TU5JP4)	245012	Drive Shaft	48T	25	22	60	78.5	601	
	2002.07-	-	MT	R	F	Estate Engine NFU (TU5JP4)	245011	Drive Shaft	48T	25	22	60	78.5	880	
	2002.07-	-	MT	L	F	Estate Engine NFU (TU5JP4)	245138	Drive Shaft		25	22	60	78.5	601	
	2002.07-	-	MT	R	F	Estate Engine NFU (TU5JP4)	245137	Drive Shaft		25	22	60	78.5	880	
	2002.07-	-	AT	-	F	Estate Engine NFU (TU5JP4)	845035	Outer Joint	48T	25	34	58	79	55.5	I
1.6 HDi 110 (80 kW)	2004.05-	-	MT	R	F	Estate Engine 9HZ (DV6TED4)	299162	Drive Shaft	48T	25	24	58	79	888	
	2004.05-	-	-	L	F	Estate Engine 9HZ (DV6TED4)	245101	Drive Shaft	48T	25	24	58	79	592	
	2004.05-	-	-	R	F	Estate Engine 9HZ (DV6TED4)	245016	Drive Shaft	48T	25	24	60	78.7	888	
	2004.05-	-	-	-	F	Estate Engine 9HZ (DV6TED4)	845049	Outer Joint	48T	25	34	58	79	55.5	I
	2004.05-	-	MT	L	F	Estate Engine 9HZ (DV6TED4)	299163	Drive Shaft	48T	25	24	58	79	600	
	2004.05-	-	-	-	F	Estate Engine 9HZ (DV6TED4)	845035	Outer Joint	48T	25	34	58	79	55.5	I
2.0 16V (100 kW)	2002.07-	-	MT	R	F	Estate Engine RFN (EW10J4)	299162	Drive Shaft	48T	25	24	58	79	888	
	2002.07-	-	MT	L	F	Estate Engine RFN (EW10J4)	245101	Drive Shaft	48T	25	24	58	79	592	
	2002.07-	-	MT	R	F	Estate Engine RFN (EW10J4)	245016	Drive Shaft	48T	25	24	60	78.7	888	
	2002.07-	-	MT	L	F	Estate Engine RFN (EW10J4)	299163	Drive Shaft	48T	25	24	58	79	600	
	2002.07-	-	-	-	F	Estate Engine RFN (EW10J4)	845035	Outer Joint	48T	25	34	58	79	55.5	I
2.0 HDi (66 kW)	2002.07-	-	MT	L	F	Estate Engine RHY (DW10TD)	610093	Inner Joint		24	22	40	62	90	
	2002.07-	-	MT	R	F	Estate Engine RHY (DW10TD)	299162	Drive Shaft	48T	25	24	58	79	888	
	2002.07-	-	MT	L	F	Estate Engine RHY (DW10TD)	245101	Drive Shaft	48T	25	24	58	79	592	
	2002.07-	-	MT	R	F	Estate Engine RHY (DW10TD)	245016	Drive Shaft	48T	25	24	60	78.7	888	
	2002.07-	-	MT	L	F	Estate Engine RHY (DW10TD)	299163	Drive Shaft	48T	25	24	58	79	600	
	2002.07-	-	MT	L	F	Estate Engine RHY (DW10TD)	299028	Drive Shaft		25	24	54.8	78.5	598.5	
	2002.07-	-	-	-	F	Estate Engine RHY (DW10TD)	845035	Outer Joint	48T	25	34	58	79	55.5	I
	2002.07-	-	MT	R	F	Estate Engine RHY (DW10TD)	245038	Drive Shaft		25	24	58	79	888	
206 Van															
1.4 HDi (50 kW)	2001.09-	2009.03	-	R	F	Box Engine 8HZ (DV4TD)/8HX (DV4TD)	245094	Drive Shaft		21	22	48	86.5	886	
	2001.09-	2009.03	-	L	F	Box Engine 8HZ (DV4TD)/8HX (DV4TD)	245027	Drive Shaft	48T	21	22	48	86.5	610	
	2001.09-	2009.03	MT	R	F	Box Engine 8HZ (DV4TD)/8HX (DV4TD)	245098	Drive Shaft	48T	21	22	48	86.5	884	
	2001.09-	2009.03	-	R	F	Box Engine 8HZ (DV4TD)/8HX (DV4TD)	245035	Drive Shaft	48T	21	22	48	86.5	886	
	2001.09-	2009.03	MT	L	F	Box Engine 8HZ (DV4TD)/8HX (DV4TD)	245191	Drive Shaft	48T	21	22	48	86.5	610	
	2001.09-	2009.03	-	L	F	Box Engine 8HZ (DV4TD)/8HX (DV4TD)	245031	Drive Shaft		21	22	48	86.5	604.5	
	2001.09-	2009.03	-	L	F	Box Engine 8HZ (DV4TD)/8HX (DV4TD)	245032	Drive Shaft	48T	21	22	48	86.5	604.5	
	2001.09-	2009.03	MT	R	F	Box Engine 8HZ (DV4TD)/8HX (DV4TD)	245192	Drive Shaft	48T	21	22	48	86.5	884	
	2001.09-	2009.03	MT	L/R	F	Box Engine 8HZ (DV4TD)/8HX (DV4TD)	845057	Outer Joint		21	22	48	86.5	54	I
1.9 D (51 kW)	1999.04-	2007.05	-	-	F	Box Engine WJZ (DW8)/WJY (DW8B)	810056	Outer Joint	48T	21	34	48.5	86	55.5	I
	1999.04-	2007.05	-	L	F	Box Engine WJZ (DW8)/WJY (DW8B)	245009	Drive Shaft	48T	21	24	48	86.5	602	
	1999.04-	2007.05	-	R	F	Box Engine WJZ (DW8)/WJY (DW8B)	245010	Drive Shaft	48T	21	24	48	86.5	896	
	1999.04-	2007.05	-	-	F	Box Engine WJZ (DW8)/WJY (DW8B)	845012	Outer Joint		21	34	48.5	86	55.5	I
	1999.04-	2007.05	MT	R	F	Box Engine WJZ (DW8)/WJY (DW8B)	245065	Drive Shaft	48T	21	24	48.5	86	900	
	1999.04-	2007.05	MT	L	F	Box Engine WJZ (DW8)/WJY (DW8B)	210136	Drive Shaft		21	24	48.5	86	611.5	
1999.04-	2007.05	MT	R	F	Box Engine WJZ (DW8)/WJY (DW8B)	210137	Drive Shaft		21	24	48.5	86	900		
206+ (T3E)															
1.1 (44 kW)	2009.01-	-	-	R	F	Hatchback Engine TU1AE5/HFX(TU1JP)/HFX(TU1A)	610067	Inner Joint		22	21	29.85	329.5	87.5	
	2009.01-	-	-	L	F	Hatchback Engine TU1AE5/HFX(TU1JP)/HFX(TU1A)	610068	Inner Joint		22	21	40	65	87.5	
	2009.01-	-	MT	-	F	Hatchback Engine TU1AE5/HFX(TU1JP)/HFX(TU1A)	845093	Outer Joint	48T	21	21	48.5	86	54	I
	2009.01-	-	-	L	F	Hatchback Engine TU1AE5/HFX(TU1JP)/HFX(TU1A)	245220	Drive Shaft	48T	21	22	48.5	86	610	
	2009.01-	-	-	R	F	Hatchback Engine TU1AE5/HFX(TU1JP)/HFX(TU1A)	245223	Drive Shaft	48T	21	22	48.5	86	886	
	2009.01-	-	-	-	F	Hatchback Engine TU1AE5/HFX(TU1JP)/HFX(TU1A)	610067	Inner Joint		22	21	29.85	329.5	87.5	
1.4 HDi eco 70 (50 kW)	2009.01-	-	-	R	F	Hatchback Engine 8HX (DV4TD)/8HZ (DV4TD)/8HR (DV4C)	610067	Inner Joint		22	21	29.85	329.5	87.5	
	2009.01-	-	-	L	F	Hatchback Engine 8HX (DV4TD)/8HZ (DV4TD)/8HR (DV4C)	610068	Inner Joint		22	21	40	65	87.5	
	2009.01-	-	MT	-	F	Hatchback Engine 8HX (DV4TD)/8HZ (DV4TD)/8HR (DV4C)	845093	Outer Joint	48T	21	21	48.5	86	54	I
	2009.01-	-	-	L	F	Hatchback Engine 8HX (DV4TD)/8HZ (DV4TD)/8HR (DV4C)	245220	Drive Shaft	48T	21	22	48.5	86	610	
	2009.01-	-	-	R	F	Hatchback Engine 8HX (DV4TD)/8HZ (DV4TD)/8HR (DV4C)	245223	Drive Shaft	48T	21	22	48.5	86	886	
	2009.01-	-	MT	L/R	F	Hatchback Engine 8HX (DV4TD)/8HZ (DV4TD)/8HR (DV4C)	845057	Outer Joint		21	22	48	86.5	54	I
1.4 i (54 kW)	2010.09-	-	-	R	F	Hatchback Engine KFT (TU3A)	610067	Inner Joint		22	21	29.85	329.5	87.5	
	2010.09-	-	-	L	F	Hatchback Engine KFT (TU3A)	610068	Inner Joint		22	21	40	65	87.5	
	2010.09-	-	MT	-	F	Hatchback Engine KFT (TU3A)	845093	Outer Joint	48T	21	21	48.5	86	54	I
	2010.09-	-	-	L	F	Hatchback Engine KFT (TU3A)	245220	Drive Shaft	48T	21	22	48.5	86	610	





	 YEAR	TRANSM	L/R	F/R	REMARKS	GSP Ref.	 PRODUCT	 ABS	Technical Specifications						
									A	B	C	H	L	P	
PEUGEOT															
206+ (T3E)															
1.4 i (54 kW)	2010.09.	-	-	R	F	Hatchback Engine KFT (TU3A)	245223	Drive Shaft	48T	21	22	48.5	86	886	
1.4 i (55 kW)	2009.01.	-	-	R	F	Hatchback Engine KFV (TU3A)/KFW (TU3A)	610067	Inner Joint		22	21	29.85	329.5	87.5	
	2009.01.	-	-	L	F	Hatchback Engine KFV (TU3A)/KFW (TU3A)	610068	Inner Joint		22	21	40	65	87.5	
	2009.01.	-	MT	-	F	Hatchback Engine KFV (TU3A)/KFW (TU3A)	845093	Outer Joint	48T	21	21	48.5	86	54	I
	2009.01.	-	-	L	F	Hatchback Engine KFV (TU3A)/KFW (TU3A)	245220	Drive Shaft	48T	21	22	48.5	86	610	
	2009.01.	-	-	R	F	Hatchback Engine KFV (TU3A)/KFW (TU3A)	245223	Drive Shaft	48T	21	22	48.5	86	886	
206-TRE VOLUMI															
1.4 (50 kW)	2007.03.	2008	MT	-	-	-	810081	Outer Joint	48T	21	22	48	86.5	54	I
1.4 (55 kW)	2007.03.	2008	MT	-	-	-	810081	Outer Joint	48T	21	22	48	86.5	54	I
207															
-	-	-	-	-	-	-	210319	Drive Shaft		25	24	55.7	79	636	
1.4 (54 kW)	2007.12.	-	-	L	F	Saloon Engine KFT (TU3A)/KFV (TU3A)	299272	Drive Shaft		21	22	48	86.5	655	
	2007.12.	-	-	R	F	Saloon Engine KFT (TU3A)/KFV (TU3A)	299271	Drive Shaft		21	22	48	86.5	858	
1.6 HDi	2006.05.	-	MT	-	F	-	845047	Outer Joint	48T	25	34	59	78.5	54	I
1.6 T	2006.05.	-	MT	-	F	-	845047	Outer Joint	48T	25	34	59	78.5	54	I
207 (WA_ WC_)															
1.4 (53 kW)	2006.02.	-	-	L	F	Hatchback Engine KFV (TU3A)	299272	Drive Shaft		21	22	48	86.5	655	
	2006.02.	-	-	-	F	Hatchback Engine KFV (TU3A)	845068	Outer Joint		21	22	48	86.5	54	M
	2006.02.	-	-	R	F	Hatchback Engine KFV (TU3A)	299271	Drive Shaft		21	22	48	86.5	858	
	2006.02.	-	MT	L/R	F	Hatchback Engine KFV (TU3A)	845057	Outer Joint		21	22	48	86.5	54	I
1.4 (54 kW)	2007.12.	-	-	L	F	Hatchback Engine KFT (TU3A)/KFV (TU3A)	299272	Drive Shaft		21	22	48	86.5	655	
	2007.12.	-	MT	-	F	Hatchback Engine KFT (TU3A)/KFV (TU3A)	845068	Outer Joint		21	22	48	86.5	54	M
	2007.12.	-	-	R	F	Hatchback Engine KFT (TU3A)/KFV (TU3A)	299271	Drive Shaft		21	22	48	86.5	858	
	2007.12.	-	MT	L/R	F	Hatchback Engine KFT (TU3A)/KFV (TU3A)	845057	Outer Joint		21	22	48	86.5	54	I
1.4 (55 kW)	2008.08.	-	MT	L	F	Hatchback Engine KFV (TU3A)/KFW (TU3A)	299272	Drive Shaft		21	22	48	86.5	655	
	2008.08.	-	-	-	F	Hatchback Engine KFV (TU3A)/KFW (TU3A)	845068	Outer Joint		21	22	48	86.5	54	M
	2008.08.	-	MT	R	F	Hatchback Engine KFV (TU3A)/KFW (TU3A)	299271	Drive Shaft		21	22	48	86.5	858	
	2008.08.	-	MT	L/R	F	Hatchback Engine KFV (TU3A)/KFW (TU3A)	845057	Outer Joint		21	22	48	86.5	54	I
1.4 16V (65 kW)	2006.02.	-	-	L	F	Hatchback Engine KFV (TU3A)	299272	Drive Shaft		21	22	48	86.5	655	
	2006.02.	-	-	-	F	Hatchback Engine KFV (TU3A)	845068	Outer Joint		21	22	48	86.5	54	M
	2006.02.	-	-	R	F	Hatchback Engine KFV (TU3A)	299271	Drive Shaft		21	22	48	86.5	858	
	2006.02.	-	MT	L/R	F	Hatchback Engine KFV (TU3A)	845057	Outer Joint		21	22	48	86.5	54	I
1.4 16V (70 kW)	2007.06.	-	-	L	F	Hatchback Engine 8FS (EP3)/EP3/EP3C	210311	Drive Shaft		21	22	48	86.5	647	
	2007.06.	-	-	L	F	Hatchback Engine 8FS (EP3)/EP3/EP3C	245200	Drive Shaft		25	22	58.5	78.5	640	
	2007.06.	-	-	R	F	Hatchback Engine 8FS (EP3)/EP3/EP3C	245201	Drive Shaft		25	22	58.5	79	854	
	2007.06.	-	MT	-	F	Hatchback Engine 8FS (EP3)/EP3/EP3C	845068	Outer Joint		21	22	48	86.5	54	M
	2007.06.	-	MT	L/R	F	Hatchback Engine 8FS (EP3)/EP3/EP3C	845057	Outer Joint		21	22	48	86.5	54	I
1.4 16V (72 kW)	2009.10.	-	-	L	F	Hatchback Engine 8FR (EP3)	210311	Drive Shaft		21	22	48	86.5	647	
	2009.10.	-	-	L	F	Hatchback Engine 8FR (EP3)	245200	Drive Shaft		25	22	58.5	78.5	640	
	2009.10.	-	-	R	F	Hatchback Engine 8FR (EP3)	245201	Drive Shaft		25	22	58.5	79	854	
	2009.10.	-	MT	-	F	Hatchback Engine 8FR (EP3)	845068	Outer Joint		21	22	48	86.5	54	M
1.4 HDi (50 kW)	2006.02.	-	MT	R	F	Hatchback Engine 8HZ (DV4TD)/8HR (DV4C)	845021	Outer Joint		25	22	60	78.7	54	M
	2006.02.	-	MT	L	F	Hatchback Engine 8HZ (DV4TD)/8HR (DV4C)	210311	Drive Shaft		21	22	48	86.5	647	
	2006.02.	-	MT	L	F	Hatchback Engine 8HZ (DV4TD)/8HR (DV4C)	245200	Drive Shaft		25	22	58.5	78.5	640	
	2006.02.	-	-	R	F	Hatchback Engine 8HZ (DV4TD)/8HR (DV4C)	245201	Drive Shaft		25	22	58.5	79	854	
	2006.02.	-	MT	-	F	Hatchback Engine 8HZ (DV4TD)/8HR (DV4C)	845068	Outer Joint		21	22	48	86.5	54	M
	2006.02.	-	MT	L	F	Hatchback Engine 8HZ (DV4TD)/8HR (DV4C)	210292	Drive Shaft		25	22	58.5	79	645	
	2006.02.	-	MT	R	F	Hatchback Engine 8HZ (DV4TD)/8HR (DV4C)	210294	Drive Shaft		25	22	60	78.7	855	
	2006.02.	-	MT	L/R	F	Hatchback Engine 8HZ (DV4TD)/8HR (DV4C)	845057	Outer Joint		21	22	48	86.5	54	I
1.6 (81 kW)	2008.08.	-	MT	L	F	Hatchback Engine N6A (TU5JP4)	210292	Drive Shaft		25	22	58.5	79	645	
	2008.08.	-	MT	R	F	Hatchback Engine N6A (TU5JP4)	210294	Drive Shaft		25	22	60	78.7	855	
	2008.08.	-	MT	R	F	Hatchback Engine N6A (TU5JP4)	845021	Outer Joint		25	22	60	78.7	54	M
1.6 16V (80 kW)	2006.02.	-	MT	R	F	Hatchback Engine NFU (TU5JP4)	845021	Outer Joint		25	22	60	78.7	54	M
	2006.02.	-	-	L	F	Hatchback Engine NFU (TU5JP4)	245203	Drive Shaft		25	22	58.5	79	645	
	2006.02.	-	-	R	F	Hatchback Engine NFU (TU5JP4)	245204	Drive Shaft		25	22	58.5	79	846	
	2006.02.	-	MT	L/R	F	Hatchback Engine NFU (TU5JP4)	810025	Outer Joint		25	22	60	80	54	I
	2006.02.	-	MT	L	F	Hatchback Engine NFU (TU5JP4)	210292	Drive Shaft		25	22	58.5	79	645	
	2006.02.	-	MT	R	F	Hatchback Engine NFU (TU5JP4)	210294	Drive Shaft		25	22	60	78.7	855	
	2006.02.	-	-	R	F	Hatchback Engine NFU (TU5JP4)	245193	Drive Shaft		25	26	58.5	79	759	
1.6 16V RC (128 kW)	2007.02.	-	-	-	F	Hatchback Engine 5FY (EP6DTS)	810067	Outer Joint	48W	25	34	58.5	79	55	I
	2007.02.	-	-	L	F	Hatchback Engine 5FY (EP6DTS)	210250	Drive Shaft		25	24	58.5	79	634	
	2007.02.	-	-	R	F	Hatchback Engine 5FY (EP6DTS)	210249	Drive Shaft		25	24	58.5	79	864	
1.6 16V Turbo (110 kW)	2006.02.	-	-	-	F	Hatchback Engine 5FX (EP6DT)	810067	Outer Joint	48W	25	34	58.5	79	55	I
	2006.02.	-	MT	L	F	Hatchback Engine 5FX (EP6DT)	210250	Drive Shaft		25	24	58.5	79	634	
	2006.02.	-	-	R	F	Hatchback Engine 5FX (EP6DT)	210249	Drive Shaft		25	24	58.5	79	864	
1.6 16V Turbo (115 kW)	2009.10.	-	6MT	-	F	Hatchback Engine 5FR (EP6DT)	810028	Outer Joint		25	34	58	89	56	I





YEAR	TRANSM	L/R	F/R	REMARKS	GSP Ref.	PRODUCT	ABS	Technical Specifications								
								A	B	C	H	L	P			
PEUGEOT																
207 (WA_ WC_)																
1.6 16V Turbo (115 kW)	2009.10-	-	-	-	Hatchback Engine 5FR (EP6DT)	899366	Outer Joint		25	34	58.5	79	55	I		
	2009.10-	-	-	L	F	Hatchback Engine 5FR (EP6DT)	210250	Drive Shaft		25	24	58.5	79	634		
	2009.10-	-	-	R	F	Hatchback Engine 5FR (EP6DT)	210249	Drive Shaft		25	24	58.5	79	864		
1.6 16V VTi (88 kW)	2007.02-	-	-	R	F	Hatchback Engine 5FW (EP6)/5FS (EP6C)/EP6	845021	Outer Joint		25	22	60	78.7	54	M	
	2007.02-	-	-	L	F	Hatchback Engine 5FW (EP6)/5FS (EP6C)/EP6	245200	Drive Shaft		25	22	58.5	78.5	640		
	2007.02-	-	-	R	F	Hatchback Engine 5FW (EP6)/5FS (EP6C)/EP6	245201	Drive Shaft		25	22	58.5	79	854		
	2007.02-	-	-	L	F	Hatchback Engine 5FW (EP6)/5FS (EP6C)/EP6	245202	Drive Shaft		25	26	58.5	78.5	620		
	2007.02-	-	-	R	F	Hatchback Engine 5FW (EP6)/5FS (EP6C)/EP6	210267	Drive Shaft		25	26	58.5	79.5	766		
	2007.02-	-	-	MT	L/R	F	Hatchback Engine 5FW (EP6)/5FS (EP6C)/EP6	810025	Outer Joint		25	22	60	80	54	I
	2007.02-	-	-	AT	L	F	Hatchback Engine 5FW (EP6)/5FS (EP6C)/EP6	245194	Drive Shaft		25	26	58.5	79	621	
	2007.02-	-	-	MT	L	F	Hatchback Engine 5FW (EP6)/5FS (EP6C)/EP6	210292	Drive Shaft		25	22	58.5	79	645	
	2007.02-	-	-	MT	R	F	Hatchback Engine 5FW (EP6)/5FS (EP6C)/EP6	210294	Drive Shaft		25	22	60	78.7	855	
1.6 HDi (66 kW)	2006.02-	-	-	-	F	Hatchback Engine 9HX (DV6ATED4)/9HV (DV6TED4)	810067	Outer Joint	48W	25	34	58.5	79	55	I	
	2006.02-	-	-	L	F	Hatchback Engine 9HX (DV6ATED4)/9HV (DV6TED4)	210248	Drive Shaft		25	24	58.5	79	642		
	2006.02-	-	-	R	F	Hatchback Engine 9HX (DV6ATED4)/9HV (DV6TED4)	210249	Drive Shaft		25	24	58.5	79	864		
1.6 HDi (68 kW)	2009.11-	-	-	R	F	Hatchback Engine 9HP (DV6DTE)	210249	Drive Shaft		25	24	58.5	79	864		
1.6 HDi (80 kW)	2006.02-	-	-	R	F	Hatchback Engine 9HY (DV6TED4)/9HZ (DV6TED4)	810158	Outer Joint		25	26	58.5	89	61.5	M	
	2006.02-	-	-	-	F	Hatchback Engine 9HY (DV6TED4)/9HZ (DV6TED4)	810067	Outer Joint	48W	25	34	58.5	79	55	I	
	2006.02-	-	-	R	F	Hatchback Engine 9HY (DV6TED4)/9HZ (DV6TED4)	210143	Drive Shaft		25	24	58.5	89	936		
	2006.02-	-	-	L	F	Hatchback Engine 9HY (DV6TED4)/9HZ (DV6TED4)	210142	Drive Shaft		25	24	58.5	89	648		
	2006.02-	-	-	L	F	Hatchback Engine 9HY (DV6TED4)/9HZ (DV6TED4)	210250	Drive Shaft		25	24	58.5	79	634		
	2006.02-	-	-	R	F	Hatchback Engine 9HY (DV6TED4)/9HZ (DV6TED4)	210249	Drive Shaft		25	24	58.5	79	864		
1.6 HDi 110 (82 kW)	2009.08-	-	-	-	F	Hatchback Engine 9HR (DV6C)	899366	Outer Joint		25	34	58.5	79	55	I	
	2009.08-	-	-	L	F	Hatchback Engine 9HR (DV6C)	610057	Inner Joint		24	34	40	52.5	90		
	2009.08-	-	-	L	F	Hatchback Engine 9HR (DV6C)	210253	Drive Shaft		25	24	58.5	79	626		
	2009.08-	-	-	L	F	Hatchback Engine 9HR (DV6C)	810148	Outer Joint		25	34	58.5	79	55.5	I	
207 CC (WD_)																
1.6 (90 kW)	2010.09-	2011.12	-	-	-	Convertible	245194	Drive Shaft		25	26	58.5	79	621		
	2010.09-	2011.12	-	-	L	F	Convertible	210292	Drive Shaft		25	22	58.5	79	645	
	2010.09-	2011.12	-	-	R	F	Convertible	210294	Drive Shaft		25	22	60	78.7	855	
1.6 16V (88 kW)	2007.02-	-	-	-	F	Convertible Engine 5FW (EP6)/5FS (EP6C)/EP6	845021	Outer Joint		25	22	60	78.7	54	M	
	2007.02-	-	-	L	F	Convertible Engine 5FW (EP6)/5FS (EP6C)/EP6	245200	Drive Shaft		25	22	58.5	78.5	640		
	2007.02-	-	-	R	F	Convertible Engine 5FW (EP6)/5FS (EP6C)/EP6	245201	Drive Shaft		25	22	58.5	79	854		
	2007.02-	-	-	L	F	Convertible Engine 5FW (EP6)/5FS (EP6C)/EP6	245202	Drive Shaft		25	26	58.5	78.5	620		
	2007.02-	-	-	L	F	Convertible Engine 5FW (EP6)/5FS (EP6C)/EP6	610057	Inner Joint		24	34	40	52.5	90		
	2007.02-	-	-	R	F	Convertible Engine 5FW (EP6)/5FS (EP6C)/EP6	210267	Drive Shaft		25	26	58.5	79.5	766		
	2007.02-	-	-	MT	L/R	F	Convertible Engine 5FW (EP6)/5FS (EP6C)/EP6	810025	Outer Joint		25	22	60	80	54	I
	2007.02-	-	-	AT	L	F	Convertible Engine 5FW (EP6)/5FS (EP6C)/EP6	245194	Drive Shaft		25	26	58.5	79	621	
	2007.02-	-	-	MT	L	F	Convertible Engine 5FW (EP6)/5FS (EP6C)/EP6	210292	Drive Shaft		25	22	58.5	79	645	
	2007.02-	-	-	MT	R	F	Convertible Engine 5FW (EP6)/5FS (EP6C)/EP6	210294	Drive Shaft		25	22	60	78.7	855	
	2007.02-	-	-	L	F	Convertible Engine 5FW (EP6)/5FS (EP6C)/EP6	210253	Drive Shaft		25	24	58.5	79	626		
	2007.02-	-	-	L	F	Convertible Engine 5FW (EP6)/5FS (EP6C)/EP6	810148	Outer Joint		25	34	58.5	79	55.5	I	
1.6 16V Turbo (110 kW)	2007.02-	-	-	-	F	Convertible Engine 5FX (EP6DT)	810067	Outer Joint	48W	25	34	58.5	79	55	I	
	2007.02-	-	-	L	F	Convertible Engine 5FX (EP6DT)	210250	Drive Shaft		25	24	58.5	79	634		
	2007.02-	-	-	R	F	Convertible Engine 5FX (EP6DT)	210249	Drive Shaft		25	24	58.5	79	864		
1.6 16V Turbo (115 kW)	2009.10-	-	-	-	F	Convertible Engine 5FR (EP6DT)/EP6C	810028	Outer Joint		25	34	58	89	56	I	
	2009.10-	-	-	-	F	Convertible Engine 5FR (EP6DT)/EP6C	899366	Outer Joint		25	34	58.5	79	55	I	
	2009.10-	-	-	-	F	Convertible Engine 5FR (EP6DT)/EP6C	810067	Outer Joint	48W	25	34	58.5	79	55	I	
	2009.10-	-	-	L	F	Convertible Engine 5FR (EP6DT)/EP6C	210250	Drive Shaft		25	24	58.5	79	634		
	2009.10-	-	-	R	F	Convertible Engine 5FR (EP6DT)/EP6C	210249	Drive Shaft		25	24	58.5	79	864		
1.6 HDi (80 kW)	2007.02-	-	-	R	F	Convertible Engine 9HZ (DV6TED4)	210249	Drive Shaft		25	24	58.5	79	864		
1.6 HDi (82 kW)	2009.08-	-	-	-	F	Convertible Engine 9HR (DV6C)	899366	Outer Joint		25	34	58.5	79	55	I	
	2009.08-	-	-	L	F	Convertible Engine 9HR (DV6C)	610057	Inner Joint		24	34	40	52.5	90		
	2009.08-	-	-	L	F	Convertible Engine 9HR (DV6C)	210253	Drive Shaft		25	24	58.5	79	626		
	2009.08-	-	-	L	F	Convertible Engine 9HR (DV6C)	810148	Outer Joint		25	34	58.5	79	55.5	I	
207 SW (WK_)																
1.4 (54 kW)	2007.06-	-	-	-	F	Estate Engine KFT (TU3A)/KFV (TU3A)	299272	Drive Shaft		21	22	48	86.5	655		
	2007.06-	-	-	-	F	Estate Engine KFT (TU3A)/KFV (TU3A)	845068	Outer Joint		21	22	48	86.5	54	M	
	2007.06-	-	-	R	F	Estate Engine KFT (TU3A)/KFV (TU3A)	299271	Drive Shaft		21	22	48	86.5	858		
	2007.06-	-	-	MT	L/R	F	Estate Engine KFT (TU3A)/KFV (TU3A)	845057	Outer Joint		21	22	48	86.5	54	I
1.4 16V (70 kW)	2007.06-	-	-	L	F	Estate Engine 8FS (EP3)/EP3/EP3C	210311	Drive Shaft		21	22	48	86.5	647		
	2007.06-	-	-	L	F	Estate Engine 8FS (EP3)/EP3/EP3C	245200	Drive Shaft		25	22	58.5	78.5	640		
	2007.06-	-	-	R	F	Estate Engine 8FS (EP3)/EP3/EP3C	245201	Drive Shaft		25	22	58.5	79	854		
	2007.06-	-	-	MT	-	F	Estate Engine 8FS (EP3)/EP3/EP3C	845068	Outer Joint		21	22	48	86.5	54	M
	2007.06-	-	-	MT	L/R	F	Estate Engine 8FS (EP3)/EP3/EP3C	845057	Outer Joint		21	22	48	86.5	54	I
1.4 16V (72 kW)	2009.11-	-	-	L	F	Estate Engine 8FR (EP3)	210311	Drive Shaft		21	22	48	86.5	647		

YEAR	TRANSM	L/R	F/R	REMARKS	GSP Ref.	PRODUCT	ABS	Technical Specifications									
								A	B	C	H	L	P				
PEUGEOT																	
207 SW (WK_)																	
1.4 16V (72 kW)	2009.11-	-	MT	L F	Estate Engine 8FR (EP3)	245200	Drive Shaft		25	22	58.5	78.5	640				
	2009.11-	-	MT	R F	Estate Engine 8FR (EP3)	245201	Drive Shaft		25	22	58.5	79	854				
	2009.11-	-	MT	- F	Estate Engine 8FR (EP3)	845068	Outer Joint		21	22	48	86.5	54	M			
1.6 16V (88 kW)	2007.06-	-	MT	L F	Estate Engine 5FW (EP6)/5FS (EP6C)/EP6	245200	Drive Shaft		25	22	58.5	78.5	640				
	2007.06-	-	MT	R F	Estate Engine 5FW (EP6)/5FS (EP6C)/EP6	845021	Outer Joint		25	22	60	78.7	54	M			
	2007.06-	-	MT	R F	Estate Engine 5FW (EP6)/5FS (EP6C)/EP6	245201	Drive Shaft		25	22	58.5	79	854				
	2007.06-	-	AT	L F	Estate Engine 5FW (EP6)/5FS (EP6C)/EP6	245202	Drive Shaft		25	26	58.5	78.5	620				
	2007.06-	-	AT	R F	Estate Engine 5FW (EP6)/5FS (EP6C)/EP6	210267	Drive Shaft		25	26	58.5	79.5	766				
	2007.06-	-	MT	L/R F	Estate Engine 5FW (EP6)/5FS (EP6C)/EP6	810025	Outer Joint		25	22	60	80	54	I			
	2007.06-	-	AT	L F	Estate Engine 5FW (EP6)/5FS (EP6C)/EP6	245194	Drive Shaft		25	26	58.5	79	621				
	2007.06-	-	MT	L F	Estate Engine 5FW (EP6)/5FS (EP6C)/EP6	210292	Drive Shaft		25	22	58.5	79	645				
	2007.06-	-	MT	R F	Estate Engine 5FW (EP6)/5FS (EP6C)/EP6	210294	Drive Shaft		25	22	60	78.7	855				
1.6 16V RC (128 kW)	2007.02-	-	-	- F	Estate Engine 5FY (EP6DTS)	810067	Outer Joint	48W	25	34	58.5	79	55	I			
	2007.02-	-	-	L F	Estate Engine 5FY (EP6DTS)	210250	Drive Shaft		25	24	58.5	79	634				
	2007.02-	-	-	R F	Estate Engine 5FY (EP6DTS)	210249	Drive Shaft		25	24	58.5	79	864				
1.6 16V Turbo (110 kW)	2007.02-	-	MT	R F	Estate Engine 5FX (EP6DT)	210249	Drive Shaft		25	24	58.5	79	864				
1.6 HDi (66 kW)	2007.06-	-	-	- F	Estate Engine 9HX (DV6ATED4)/9HV (DV6TED4)	810067	Outer Joint	48W	25	34	58.5	79	55	I			
	2007.06-	-	-	L F	Estate Engine 9HX (DV6ATED4)/9HV (DV6TED4)	210248	Drive Shaft		25	24	58.5	79	642				
	2007.06-	-	-	R F	Estate Engine 9HX (DV6ATED4)/9HV (DV6TED4)	210249	Drive Shaft		25	24	58.5	79	864				
1.6 HDi (68 kW)	2009.11-	-	-	R F	Estate Engine 9HP (DV6DTEd)	210249	Drive Shaft		25	24	58.5	79	864				
1.6 HDi (80 kW)	2007.06-	-	-	- F	Estate Engine 9HZ (DV6TED4)	810067	Outer Joint	48W	25	34	58.5	79	55	I			
	2007.06-	-	-	R F	Estate Engine 9HZ (DV6TED4)	210249	Drive Shaft		25	24	58.5	79	864				
1.6 HDi (82 kW)	2009.08-	-	6MT	- -	Estate Engine 9HR (DV6C)	899366	Outer Joint		25	34	58.5	79	55	I			
	2009.08-	-	-	L F	Estate Engine 9HR (DV6C)	610057	Inner Joint		24	34	40	52.5	90				
	2009.08-	-	-	L F	Estate Engine 9HR (DV6C)	210253	Drive Shaft		25	24	58.5	79	626				
	2009.08-	-	-	L F	Estate Engine 9HR (DV6C)	810148	Outer Joint		25	34	58.5	79	55.5	I			
207 Van																	
1.4 (54 kW)	2007.06-	2008.10	MT	L F	Box Engine KFV (TU3A)	299272	Drive Shaft		21	22	48	86.5	655				
	2007.06-	2008.10	MT	R F	Box Engine KFV (TU3A)	299271	Drive Shaft		21	22	48	86.5	858				
1.4 HDi (50 kW)	2007.04-	-	-	L F	Box Engine 8HZ (DV4TD)	210311	Drive Shaft		21	22	48	86.5	647				
	2007.04-	-	-	L F	Box Engine 8HZ (DV4TD)	245200	Drive Shaft		25	22	58.5	78.5	640				
	2007.04-	-	-	R F	Box Engine 8HZ (DV4TD)	245201	Drive Shaft		25	22	58.5	79	854				
	2007.04-	-	MT	- F	Box Engine 8HZ (DV4TD)	845068	Outer Joint		21	22	48	86.5	54	M			
	2007.04-	-	MT	L F	Box Engine 8HZ (DV4TD)	210292	Drive Shaft		25	22	58.5	79	645				
	2007.04-	-	MT	R F	Box Engine 8HZ (DV4TD)	210294	Drive Shaft		25	22	60	78.7	855				
	2007.04-	-	MT	R F	Box Engine 8HZ (DV4TD)	845021	Outer Joint		25	22	60	78.7	54	M			
	2007.04-	-	MT	L/R F	Box Engine 8HZ (DV4TD)	845057	Outer Joint		21	22	48	86.5	54	I			
1.6 HDi (66 kW)	2007.04-	-	-	- F	Box Engine 9HX (DV6ATED4)/9HV (DV6TED4)	810067	Outer Joint	48W	25	34	58.5	79	55	I			
	2007.04-	-	-	L F	Box Engine 9HX (DV6ATED4)/9HV (DV6TED4)	210248	Drive Shaft		25	24	58.5	79	642				
	2007.04-	-	-	R F	Box Engine 9HX (DV6ATED4)/9HV (DV6TED4)	210249	Drive Shaft		25	24	58.5	79	864				
1.6 HDi (68 kW)	2009.11-	-	5MT	R F	Box Engine 9HP (DV6DTEd)	210249	Drive Shaft		25	24	58.5	79	864				
208																	
1.0 (50 kW)	2012.03-	-	MT	R F	Hatchback Engine ZMZ (EB0)	810212	Outer Joint		21	22	48	86.5	54	I			
	2012.03-	-	MT	L F	Hatchback Engine ZMZ (EB0)	210306	Drive Shaft		21	22	49	86	652				
	2012.03-	-	MT	R F	Hatchback Engine ZMZ (EB0)	245222	Drive Shaft		21	22	48	86.5	862				
1.2 (60 kW)	2012.03-	-	MT	R F	Hatchback Engine HMZ (EB2F)	810212	Outer Joint		21	22	48	86.5	54	I			
	2012.03-	-	MT	L F	Hatchback Engine HMZ (EB2F)	210306	Drive Shaft		21	22	49	86	652				
	2012.03-	-	MT	R F	Hatchback Engine HMZ (EB2F)	245222	Drive Shaft		21	22	48	86.5	862				
	2013-	-	-	R F	-	617030	Inner Joint		22	22	43.1	96.5	99				
1.2 GPL (60 kW)	2015.06-	-	MT	L F	Hatchback Engine HMZ (EB2F)	210306	Drive Shaft		21	22	49	86	652				
1.4 HDi (50 kW)	2012.03-	-	MT	R F	Hatchback Engine 8HP (DV4C)/8HR (DV4C)	810212	Outer Joint		21	22	48	86.5	54	I			
	2012.03-	-	MT	L F	Hatchback Engine 8HP (DV4C)/8HR (DV4C)	210306	Drive Shaft		21	22	49	86	652				
	2012.03-	-	MT	R F	Hatchback Engine 8HP (DV4C)/8HR (DV4C)	245222	Drive Shaft		21	22	48	86.5	862				
1.4 VTi (70 kW)	2012.03-	-	MT	R F	Hatchback Engine 8FS (EP3)/EP3C	245222	Drive Shaft		21	22	48	86.5	862				
	2012.03-	-	MT	R F	Hatchback Engine 8FS (EP3)/EP3C	810212	Outer Joint		21	22	48	86.5	54	I			
1.6 (115 kW)	2012.03-	-	MT	R F	Hatchback Engine 5FV (EP6CDT)	610165	Inner Joint		24	34	29.8	305.5	87.5				
	2012.03-	-	-	L F	Hatchback Engine 5FV (EP6CDT)	210253	Drive Shaft		25	24	58.5	79	626				
	2012.03-	-	-	- F	Hatchback Engine 5FV (EP6CDT)	810028	Outer Joint		25	34	58	89	56	I			
	2012.03-	-	-	L F	Hatchback Engine 5FV (EP6CDT)	810148	Outer Joint		25	34	58.5	79	55.5	I			
	2012.03-	-	MT	R F	Hatchback Engine 5FV (EP6CDT)	810212	Outer Joint		21	22	48	86.5	54	I			
	2012.03-	-	-	R F	Hatchback Engine 5FV (EP6CDT)	245221	Drive Shaft		25	24	58.5	79	881				
	2012.03-	-	-	L F	Hatchback Engine 5FV (EP6CDT)	610057	Inner Joint		24	34	40	52.5	90				
	2012.03-	-	MT	R F	Hatchback Engine 5FV (EP6CDT)	245222	Drive Shaft		21	22	48	86.5	862				
1.6 (88 kW)	2012.03-	-	MT	R F	Hatchback Engine 5FS (EP6C)	245222	Drive Shaft		21	22	48	86.5	862				
	2012.03-	-	MT	R F	Hatchback Engine 5FS (EP6C)	810212	Outer Joint		21	22	48	86.5	54	I			
	2012.03-	-	MT	L F	Hatchback Engine 5FS (EP6C)	210306	Drive Shaft		21	22	49	86	652				



	 YEAR	TRANSM	L/R	F/R	REMARKS	GSP Ref.	 PRODUCT	 ABS	Technical Specifications					
									A	B	C	H	L	P
PEUGEOT														
208														
1.6 BlueHDi 100 (73 kW)	2015.01-	-	MT	R	F	Hatchback Engine BHY (DV6FD)	210249	Drive Shaft	25	24	58.5	79	864	
1.6 BlueHDi 120 (88 kW)	2013.11-	-	MT	L	F	Hatchback Engine BHZ (DV6FC)	610057	Inner Joint	24	34	40	52.5	90	
	2013.11-	-	MT	L	F	Hatchback Engine BHZ (DV6FC)	210253	Drive Shaft	25	24	58.5	79	626	
	2013.11-	-	MT	L	F	Hatchback Engine BHZ (DV6FC)	810148	Outer Joint	25	34	58.5	79	55.5	I
1.6 GTi (147 kW)	2012.08-	-	MT	R	F	Hatchback Engine 5FU (EP6CDTX)	245222	Drive Shaft	21	22	48	86.5	862	
	2012.08-	-	-	L	F	Hatchback Engine 5FU (EP6CDTX)	210253	Drive Shaft	25	24	58.5	79	626	
	2012.08-	-	MT	R	F	Hatchback Engine 5FU (EP6CDTX)	810212	Outer Joint	21	22	48	86.5	54	I
	2012.08-	-	-	L	F	Hatchback Engine 5FU (EP6CDTX)	810148	Outer Joint	25	34	58.5	79	55.5	I
	2012.08-	-	-	L	F	Hatchback Engine 5FU (EP6CDTX)	610057	Inner Joint	24	34	40	52.5	90	
1.6 GTi (153 kW)	2014.10-	-	MT	L	F	Hatchback	810148	Outer Joint	25	34	58.5	79	55.5	I
	2014.10-	-	MT	L	F	Hatchback	610057	Inner Joint	24	34	40	52.5	90	
	2014.10-	-	MT	L	F	Hatchback	210253	Drive Shaft	25	24	58.5	79	626	
1.6 HDi (68 kW)	2012.03-	-	6MT	-	F	Hatchback Engine 9HP (DV6DTEd)	810028	Outer Joint	25	34	58	89	56	I
	2012.03-	-	MT	R	F	Hatchback Engine 9HP (DV6DTEd)	610165	Inner Joint	24	34	29.8	305.5	87.5	
	2012.03-	-	6MT	-	-	Hatchback Engine 9HP (DV6DTEd)	899366	Outer Joint	25	34	58.5	79	55	I
	2012.03-	-	-	-	F	Hatchback Engine 9HP (DV6DTEd)	845012	Outer Joint	21	34	48.5	86	55.5	I
	2012.03-	-	-	R	F	Hatchback Engine 9HP (DV6DTEd)	245221	Drive Shaft	25	24	58.5	79	881	
	2012.03-	-	MT	R	F	Hatchback Engine 9HP (DV6DTEd)	810212	Outer Joint	21	22	48	86.5	54	I
	2012.03-	-	5MT	-	-	Hatchback Engine 9HP (DV6DTEd)	810130	Outer Joint	21	34	48.3	86.5	55.5	I
	2012.03-	-	-	R	F	Hatchback Engine 9HP (DV6DTEd)	810148	Outer Joint	25	34	58.5	79	55.5	I
	2012.03-	-	MT	L	F	Hatchback Engine 9HP (DV6DTEd)	210309	Drive Shaft	21	24	48.3	86.5	641	
	2012.03-	-	MT	R	F	Hatchback Engine 9HP (DV6DTEd)	245222	Drive Shaft	21	22	48	86.5	862	
1.6 HDi (84 kW)	2012.03-	-	MT	R	F	Hatchback Engine 9HD (DV6CTED)	610165	Inner Joint	24	34	29.8	305.5	87.5	
	2012.03-	-	-	-	F	Hatchback Engine 9HD (DV6CTED)	810028	Outer Joint	25	34	58	89	56	I
	2012.03-	-	-	R	F	Hatchback Engine 9HD (DV6CTED)	245221	Drive Shaft	25	24	58.5	79	881	
	2012.03-	-	MT	R	F	Hatchback Engine 9HD (DV6CTED)	810212	Outer Joint	21	22	48	86.5	54	I
	2012.03-	-	-	L	F	Hatchback Engine 9HD (DV6CTED)	810148	Outer Joint	25	34	58.5	79	55.5	I
	2012.03-	-	MT	R	F	Hatchback Engine 9HD (DV6CTED)	245222	Drive Shaft	21	22	48	86.5	862	
1.6 HDi (85 kW)	2014.04-	-	MT	R	F	Hatchback Engine BHX (DV6FC)	210325	Drive Shaft	25	24	58.5	79	940	
	2014.04-	-	MT	L	F	Hatchback Engine BHX (DV6FC)	610057	Inner Joint	24	34	40	52.5	90	
	2014.04-	-	MT	R	F	Hatchback Engine BHX (DV6FC)	610058	Inner Joint	24	34	29.8	365	88	
	2014.04-	-	MT	L	F	Hatchback Engine BHX (DV6FC)	210253	Drive Shaft	25	24	58.5	79	626	
	2014.04-	-	MT	L	F	Hatchback Engine BHX (DV6FC)	810148	Outer Joint	25	34	58.5	79	55.5	I
1.6 HDi / BlueHDi 75 (55 kW)	2013.01-	-	-	R	F	Hatchback Engine 9HK (DV6ETEDM)/BHW(DV6FE)	245222	Drive Shaft	21	22	48	86.5	862	
	2013.01-	-	MT	R	F	Hatchback Engine 9HK (DV6ETEDM)/BHW(DV6FE)	610165	Inner Joint	24	34	29.8	305.5	87.5	
	2013.01-	-	-	R	F	Hatchback Engine 9HK (DV6ETEDM)/BHW(DV6FE)	245221	Drive Shaft	25	24	58.5	79	881	
	2013.01-	-	-	R	F	Hatchback Engine 9HK (DV6ETEDM)/BHW(DV6FE)	810148	Outer Joint	25	34	58.5	79	55.5	I
	2013.01-	-	-	R	F	Hatchback Engine 9HK (DV6ETEDM)/BHW(DV6FE)	210249	Drive Shaft	25	24	58.5	79	864	
1.6 THP 165 (121 kW)	2015.03-	-	MT	L	F	Hatchback	810148	Outer Joint	25	34	58.5	79	55.5	I
	2015.03-	-	MT	R	F	Hatchback	210325	Drive Shaft	25	24	58.5	79	940	
	2015.03-	-	MT	L	F	Hatchback	610057	Inner Joint	24	34	40	52.5	90	
	2015.03-	-	MT	R	F	Hatchback	610058	Inner Joint	24	34	29.8	365	88	
	2015.03-	-	MT	L	F	Hatchback	210253	Drive Shaft	25	24	58.5	79	626	
3008 (0U_)														
1.2 (96 kW)	2015.01-	-	MT	L	F	MPV Engine HNY (EB2DTS)	810148	Outer Joint	25	34	58.5	79	55.5	I
	2015.01-	-	MT	R	F	MPV Engine HNY (EB2DTS)	210325	Drive Shaft	25	24	58.5	79	940	
	2015.01-	-	MT	L	F	MPV Engine HNY (EB2DTS)	610057	Inner Joint	24	34	40	52.5	90	
	2015.01-	-	MT	R	F	MPV Engine HNY (EB2DTS)	610058	Inner Joint	24	34	29.8	365	88	
	2015.01-	-	MT	L	F	MPV Engine HNY (EB2DTS)	210253	Drive Shaft	25	24	58.5	79	626	
1.6 BlueHDi 120 (88 kW)	2014.05-	-	MT	L	F	MPV Engine BHZ (DV6FC)	810148	Outer Joint	25	34	58.5	79	55.5	I
	2014.05-	-	MT	R	F	MPV Engine BHZ (DV6FC)	210325	Drive Shaft	25	24	58.5	79	940	
	2014.05-	-	AT/MT	-	-	MPV Engine BHZ (DV6FC)	899366	Outer Joint	25	34	58.5	79	55	I
	2014.05-	-	MT	L	F	MPV Engine BHZ (DV6FC)	610057	Inner Joint	24	34	40	52.5	90	
	2014.05-	-	-	L	F	MPV Engine BHZ (DV6FC)	210312	Drive Shaft	25	37	58.5	89	625	
	2014.05-	-	MT	R	F	MPV Engine BHZ (DV6FC)	610058	Inner Joint	24	34	29.8	365	88	
	2014.05-	-	MT	L	F	MPV Engine BHZ (DV6FC)	210253	Drive Shaft	25	24	58.5	79	626	
1.6 HDi (80 kW)	2009.06-	-	6MT	R	F	MPV Engine 9HZ (DV6TED4)	210325	Drive Shaft	25	24	58.5	79	940	
	2009.06-	-	-	-	F	MPV Engine 9HZ (DV6TED4)	810028	Outer Joint	25	34	58	89	56	I
	2009.06-	-	Semi-AT/MT	R	F	MPV Engine 9HZ (DV6TED4)	610041	Inner Joint	37	39	32	399	95.5	
	2009.06-	-	6MT	L	F	MPV Engine 9HZ (DV6TED4)	810158	Outer Joint	25	26	58.5	89	61.5	M
	2009.06-	-	6MT	L	F	MPV Engine 9HZ (DV6TED4)	210427	Drive Shaft	25	37	58.5	89	638	
	2009.06-	-	6MT	L	F	MPV Engine 9HZ (DV6TED4)	610057	Inner Joint	24	34	40	52.5	90	
	2009.06-	-	AT	L	F	MPV Engine 9HZ (DV6TED4)	210375	Drive Shaft	25	37	58.4	89	619	
	2009.06-	-	6MT	R	F	MPV Engine 9HZ (DV6TED4)	210421	Drive Shaft	25	37	58.5	89	972	
	2009.06-	-	MT	L	F	MPV Engine 9HZ (DV6TED4)	210312	Drive Shaft	25	37	58.5	89	625	
	2009.06-	-	6AT	L	F	MPV Engine 9HZ (DV6TED4)	210380	Drive Shaft	25	37	58.5	89	635	

	 YEAR	TRANSM	L/R	F/R	REMARKS	GSP Ref.	 PRODUCT	 ABS	Technical Specifications						
									A	B	C	H	L	P	
PEUGEOT															
3008 (0U_)															
1.6 HDi (80 kW)	2009.06-	-	6AT	R	F	MPV Engine 9HZ (DV6TED4)	210363	Drive Shaft	25	37	58.5	89	935		
	2009.06-	-	6MT	R	F	MPV Engine 9HZ (DV6TED4)	610058	Inner Joint	24	34	29.8	365	88		
	2009.06-	-	Semi-AT/MT	L	F	MPV Engine 9HZ (DV6TED4)	210210	Drive Shaft	25	37	58.5	89	638		
	2009.06-	-	Semi-AT/MT	R	F	MPV Engine 9HZ (DV6TED4)	210361	Drive Shaft	25	37	58.5	89	959		
	2009.06-	-	6AT	R	F	MPV Engine 9HZ (DV6TED4)	610091	Inner Joint	37	26	31.5	366	100		
	2009.06-	-	6MT	L	F	MPV Engine 9HZ (DV6TED4)	210253	Drive Shaft	25	24	58.5	79	626		
	2009.06-	-	6MT	L	F	MPV Engine 9HZ (DV6TED4)	810148	Outer Joint	25	34	58.5	79	55.5	I	
1.6 HDi (82 kW)	2010.08-	-	6MT	L	F	MPV Engine 9HR (DV6C)	810148	Outer Joint	25	34	58.5	79	55.5	I	
	2010.08-	-	6MT	R	F	MPV Engine 9HR (DV6C)	210325	Drive Shaft	25	24	58.5	79	940		
	2010.08-	-	Semi-AT	R	F	MPV Engine 9HR (DV6C)	610041	Inner Joint	37	39	32	399	95.5		
	2010.08-	-	-	-	F	MPV Engine 9HR (DV6C)	810028	Outer Joint	25	34	58	89	56	I	
	2010.08-	-	6MT	L	F	MPV Engine 9HR (DV6C)	810158	Outer Joint	25	26	58.5	89	61.5	M	
	2010.08-	-	6MT	L	F	MPV Engine 9HR (DV6C)	210427	Drive Shaft	25	37	58.5	89	638		
	2010.08-	-	AT	L	F	MPV Engine 9HR (DV6C)	210375	Drive Shaft	25	37	58.4	89	619		
	2010.08-	-	6MT	L	F	MPV Engine 9HR (DV6C)	610057	Inner Joint	24	34	40	52.5	90		
	2010.08-	-	MT	L	F	MPV Engine 9HR (DV6C)	210312	Drive Shaft	25	37	58.5	89	625		
	2010.08-	-	6MT	R	F	MPV Engine 9HR (DV6C)	210421	Drive Shaft	25	37	58.5	89	972		
	2010.08-	-	6AT	L	F	MPV Engine 9HR (DV6C)	210380	Drive Shaft	25	37	58.5	89	635		
	2010.08-	-	6AT	R	F	MPV Engine 9HR (DV6C)	210363	Drive Shaft	25	37	58.5	89	935		
	2010.08-	-	Semi-AT	L	F	MPV Engine 9HR (DV6C)	210210	Drive Shaft	25	37	58.5	89	638		
	2010.08-	-	6MT	R	F	MPV Engine 9HR (DV6C)	610058	Inner Joint	24	34	29.8	365	88		
	2010.08-	-	Semi-AT	R	F	MPV Engine 9HR (DV6C)	210361	Drive Shaft	25	37	58.5	89	959		
	2010.08-	-	6AT	R	F	MPV Engine 9HR (DV6C)	610091	Inner Joint	37	26	31.5	366	100		
	2010.08-	-	6MT	L	F	MPV Engine 9HR (DV6C)	210253	Drive Shaft	25	24	58.5	79	626		
1.6 HDi (84 kW)	2013.03-	-	MT	L	F	MPV Engine 9HD (DV6CTED)	810148	Outer Joint	25	34	58.5	79	55.5	I	
	2013.03-	-	MT	R	F	MPV Engine 9HD (DV6CTED)	210325	Drive Shaft	25	24	58.5	79	940		
	2013.03-	-	Semi-AT	R	F	MPV Engine 9HD (DV6CTED)	610041	Inner Joint	37	39	32	399	95.5		
	2013.03-	-	MT	L	F	MPV Engine 9HD (DV6CTED)	610057	Inner Joint	24	34	40	52.5	90		
	2013.03-	-	AT	L	F	MPV Engine 9HD (DV6CTED)	210375	Drive Shaft	25	37	58.4	89	619		
	2013.03-	-	MT	L	F	MPV Engine 9HD (DV6CTED)	210312	Drive Shaft	25	37	58.5	89	625		
	2013.03-	-	MT	R	F	MPV Engine 9HD (DV6CTED)	610058	Inner Joint	24	34	29.8	365	88		
	2013.03-	-	Semi-AT	L	F	MPV Engine 9HD (DV6CTED)	210210	Drive Shaft	25	37	58.5	89	638		
	2013.03-	-	Semi-AT	R	F	MPV Engine 9HD (DV6CTED)	210361	Drive Shaft	25	37	58.5	89	959		
	2013.03-	-	MT	L	F	MPV Engine 9HD (DV6CTED)	210253	Drive Shaft	25	24	58.5	79	626		
	1.6 THP (110 kW)	2009.06-	-	6MT	-	F	MPV Engine 5FX (EP6DT)	810028	Outer Joint	25	34	58	89	56	I
2009.06-		-	6MT	-	-	MPV Engine 5FX (EP6DT)	899366	Outer Joint	25	34	58.5	79	55	I	
2009.06-		-	MT	R	F	MPV Engine 5FX (EP6DT)	610041	Inner Joint	37	39	32	399	95.5		
2009.06-		-	MT	R	F	MPV Engine 5FX (EP6DT)	210325	Drive Shaft	25	24	58.5	79	940		
2009.06-		-	6MT	L	F	MPV Engine 5FX (EP6DT)	810158	Outer Joint	25	26	58.5	89	61.5	M	
2009.06-		-	6MT	L	F	MPV Engine 5FX (EP6DT)	210427	Drive Shaft	25	37	58.5	89	638		
2009.06-		-	-	L	F	MPV Engine 5FX (EP6DT)	610057	Inner Joint	24	34	40	52.5	90		
2009.06-		-	6MT	R	F	MPV Engine 5FX (EP6DT)	210421	Drive Shaft	25	37	58.5	89	972		
2009.06-		-	MT	L	F	MPV Engine 5FX (EP6DT)	210312	Drive Shaft	25	37	58.5	89	625		
2009.06-		-	MT	L	F	MPV Engine 5FX (EP6DT)	210210	Drive Shaft	25	37	58.5	89	638		
2009.06-		-	6MT	-	-	MPV Engine 5FX (EP6DT)	810155	Outer Joint	25	39	58.5	89	63.5	I	
2009.06-		-	MT	R	F	MPV Engine 5FX (EP6DT)	610058	Inner Joint	24	34	29.8	365	88		
2009.06-		-	MT	R	F	MPV Engine 5FX (EP6DT)	210361	Drive Shaft	25	37	58.5	89	959		
2009.06-		-	-	L	F	MPV Engine 5FX (EP6DT)	210253	Drive Shaft	25	24	58.5	79	626		
2009.06-		-	-	L	F	MPV Engine 5FX (EP6DT)	810148	Outer Joint	25	34	58.5	79	55.5	I	
1.6 THP (115 kW)		2009.06-	-	6MT	-	F	MPV Engine 5FV (EP6CDT)	810028	Outer Joint	25	34	58	89	56	I
		2009.06-	-	6MT	-	-	MPV Engine 5FV (EP6CDT)	899366	Outer Joint	25	34	58.5	79	55	I
	2009.06-	-	MT	R	F	MPV Engine 5FV (EP6CDT)	610041	Inner Joint	37	39	32	399	95.5		
	2009.06-	-	MT	R	F	MPV Engine 5FV (EP6CDT)	210325	Drive Shaft	25	24	58.5	79	940		
	2009.06-	-	6MT	L	F	MPV Engine 5FV (EP6CDT)	810158	Outer Joint	25	26	58.5	89	61.5	M	
	2009.06-	-	6MT	L	F	MPV Engine 5FV (EP6CDT)	210427	Drive Shaft	25	37	58.5	89	638		
	2009.06-	-	-	L	F	MPV Engine 5FV (EP6CDT)	610057	Inner Joint	24	34	40	52.5	90		
	2009.06-	-	6MT	R	F	MPV Engine 5FV (EP6CDT)	210421	Drive Shaft	25	37	58.5	89	972		
	2009.06-	-	MT	L	F	MPV Engine 5FV (EP6CDT)	210312	Drive Shaft	25	37	58.5	89	625		
	2009.06-	-	MT	L	F	MPV Engine 5FV (EP6CDT)	210210	Drive Shaft	25	37	58.5	89	638		
	2009.06-	-	6MT	-	-	MPV Engine 5FV (EP6CDT)	810155	Outer Joint	25	39	58.5	89	63.5	I	
	2009.06-	-	MT	R	F	MPV Engine 5FV (EP6CDT)	610058	Inner Joint	24	34	29.8	365	88		
	2009.06-	-	MT	R	F	MPV Engine 5FV (EP6CDT)	210361	Drive Shaft	25	37	58.5	89	959		
	2009.06-	-	-	L	F	MPV Engine 5FV (EP6CDT)	210253	Drive Shaft	25	24	58.5	79	626		
	2009.06-	-	-	L	F	MPV Engine 5FV (EP6CDT)	810148	Outer Joint	25	34	58.5	79	55.5	I	
1.6 VTi (88 kW)	2009.06-	-	6MT	-	F	MPV Engine EP6/5FS (EP6C)/5FW (EP6)	810028	Outer Joint	25	34	58	89	56	I	
	2009.06-	-	MT	R	F	MPV Engine EP6/5FS (EP6C)/5FW (EP6)	210251	Drive Shaft	25	24	58.5	79	935		

	 YEAR	TRANSM	L/R	F/R	REMARKS	GSP Ref.	 PRODUCT	 ABS	Technical Specifications							
									A	B	C	H	L	P		
PEUGEOT																
3008 (0U_)																
1.6 VTi (88 kW)	2009.06-	-	6MT	-	-	MPV Engine EP6/5FS (EP6C)/5FW (EP6)	899366	Outer Joint		25	34	58.5	79	55	I	
	2009.06-	-	MT	L	F	MPV Engine EP6/5FS (EP6C)/5FW (EP6)	210312	Drive Shaft		25	37	58.5	89	625		
	2009.06-	-	6MT	-	-	MPV Engine EP6/5FS (EP6C)/5FW (EP6)	810155	Outer Joint		25	39	58.5	89	63.5	I	
2.0 HDi (100 kW)	2011.09-	-	MT	R	F	MPV	610041	Inner Joint		37	39	32	399	95.5		
	2011.09-	-	MT	L	F	MPV	810158	Outer Joint		25	26	58.5	89	61.5	M	
	2011.09-	-	MT	L	F	MPV	210427	Drive Shaft		25	37	58.5	89	638		
	2011.09-	-	MT	R	F	MPV	210421	Drive Shaft		25	37	58.5	89	972		
	2011.09-	-	MT	L	F	MPV	210312	Drive Shaft		25	37	58.5	89	625		
	2011.09-	-	MT	L	F	MPV	210210	Drive Shaft		25	37	58.5	89	638		
2.0 HDi (120 kW)	2009.06-	-	6MT	L	F	MPV Engine RHH (DW10CTED4)	810148	Outer Joint		25	34	58.5	79	55.5	I	
	2009.06-	-	MT	R	F	MPV Engine RHH (DW10CTED4)	610041	Inner Joint		37	39	32	399	95.5		
	2009.06-	-	6MT	R	F	MPV Engine RHH (DW10CTED4)	210325	Drive Shaft		25	24	58.5	79	940		
	2009.06-	-	6MT	L	F	MPV Engine RHH (DW10CTED4)	810158	Outer Joint		25	26	58.5	89	61.5	M	
	2009.06-	-	6MT	L	F	MPV Engine RHH (DW10CTED4)	210427	Drive Shaft		25	37	58.5	89	638		
	2009.06-	-	6MT	L	F	MPV Engine RHH (DW10CTED4)	610057	Inner Joint		24	34	40	52.5	90		
	2009.06-	-	6MT	R	F	MPV Engine RHH (DW10CTED4)	210421	Drive Shaft		25	37	58.5	89	972		
	2009.06-	-	6MT	L	F	MPV Engine RHH (DW10CTED4)	210312	Drive Shaft		25	37	58.5	89	625		
	2009.06-	-	6AT	L	F	MPV Engine RHH (DW10CTED4)	210380	Drive Shaft		25	37	58.5	89	635		
	2009.06-	-	6AT	R	F	MPV Engine RHH (DW10CTED4)	210363	Drive Shaft		25	37	58.5	89	935		
	2009.06-	-	MT	L	F	MPV Engine RHH (DW10CTED4)	210210	Drive Shaft		25	37	58.5	89	638		
	2009.06-	-	6MT	R	F	MPV Engine RHH (DW10CTED4)	610058	Inner Joint		24	34	29.8	365	88		
	2009.06-	-	MT	R	F	MPV Engine RHH (DW10CTED4)	210361	Drive Shaft		25	37	58.5	89	959		
	2009.06-	-	6AT	R	F	MPV Engine RHH (DW10CTED4)	610091	Inner Joint		37	26	31.5	366	100		
2009.06-	-	6MT	L	F	MPV Engine RHH (DW10CTED4)	210253	Drive Shaft		25	24	58.5	79	626			
2.0 HDi 150 / BlueHDi 150 (110 kW)	2009.06-	-	-	-	-	MPV Engine RHE (DW10CTED4)/AHX (DW10FD)	899366	Outer Joint		25	34	58.5	79	55	I	
	2009.06-	-	MT	R	F	MPV Engine RHE (DW10CTED4)/AHX (DW10FD)	610041	Inner Joint		37	39	32	399	95.5		
	2009.06-	-	6MT	R	F	MPV Engine RHE (DW10CTED4)/AHX (DW10FD)	210325	Drive Shaft		25	24	58.5	79	940		
	2009.06-	-	6MT	L	F	MPV Engine RHE (DW10CTED4)/AHX (DW10FD)	810158	Outer Joint		25	26	58.5	89	61.5	M	
	2009.06-	-	6MT	L	F	MPV Engine RHE (DW10CTED4)/AHX (DW10FD)	210427	Drive Shaft		25	37	58.5	89	638		
	2009.06-	-	6MT	L	F	MPV Engine RHE (DW10CTED4)/AHX (DW10FD)	610057	Inner Joint		24	34	40	52.5	90		
	2009.06-	-	6MT	R	F	MPV Engine RHE (DW10CTED4)/AHX (DW10FD)	210421	Drive Shaft		25	37	58.5	89	972		
	2009.06-	-	6MT	L	F	MPV Engine RHE (DW10CTED4)/AHX (DW10FD)	210312	Drive Shaft		25	37	58.5	89	625		
	2009.06-	-	6AT	L	F	MPV Engine RHE (DW10CTED4)/AHX (DW10FD)	210380	Drive Shaft		25	37	58.5	89	635		
	2009.06-	-	6AT	R	F	MPV Engine RHE (DW10CTED4)/AHX (DW10FD)	210363	Drive Shaft		25	37	58.5	89	935		
	2009.06-	-	MT	L	F	MPV Engine RHE (DW10CTED4)/AHX (DW10FD)	210210	Drive Shaft		25	37	58.5	89	638		
	2009.06-	-	6MT	R	F	MPV Engine RHE (DW10CTED4)/AHX (DW10FD)	610058	Inner Joint		24	34	29.8	365	88		
	2009.06-	-	MT	R	F	MPV Engine RHE (DW10CTED4)/AHX (DW10FD)	210361	Drive Shaft		25	37	58.5	89	959		
	2009.06-	-	6AT	R	F	MPV Engine RHE (DW10CTED4)/AHX (DW10FD)	610091	Inner Joint		37	26	31.5	366	100		
	2009.06-	-	6MT	L	F	MPV Engine RHE (DW10CTED4)/AHX (DW10FD)	210253	Drive Shaft		25	24	58.5	79	626		
	2009.06-	-	6MT	L	F	MPV Engine RHE (DW10CTED4)/AHX (DW10FD)	810148	Outer Joint		25	34	58.5	79	55.5	I	
	2.0 HDi Hybrid4 (120 kW)	2011.02-	-	MT	R	F	All-wheel Drive MPV Engine RHC (DW10CTED4)/RHH (DW10CTED4)	610041	Inner Joint		37	39	32	399	95.5	
		2011.02-	-	-	L	F	All-wheel Drive MPV Engine RHC (DW10CTED4)/RHH (DW10CTED4)	210312	Drive Shaft		25	37	58.5	89	625	
2011.02-		-	MT	L	F	All-wheel Drive MPV Engine RHC (DW10CTED4)/RHH (DW10CTED4)	210210	Drive Shaft		25	37	58.5	89	638		
2011.02-		-	MT	R	F	All-wheel Drive MPV Engine RHC (DW10CTED4)/RHH (DW10CTED4)	210361	Drive Shaft		25	37	58.5	89	959		
2011.02-		-	MT	R	F	All-wheel Drive MPV Engine RHC (DW10CTED4)/RHH (DW10CTED4)	610091	Inner Joint		37	26	31.5	366	100		
3008 SUV (M_)																
2.0 BlueHDi 150 (110 kW)	2016.05-	-	6MT	L	F	Closed Off-Road Vehicle Engine AHX (DW10FD)	210312	Drive Shaft		25	37	58.5	89	625		
301																
1.2 VTi 72 (53 kW)	2012.11-	-	MT	R	F	Saloon Engine HMY (EB2M)	210347	Drive Shaft		21	22	49	86	884		
306																
-	-	-	-	-	-	LADO ESQUERDO	645021	Inner Joint		22	27	40	65	87.5		
	-	-	-	-	-	-	845008	Outer Joint		25	23	56.7	79	58.5	M	
	-	-	-	-	-	LADO ESQUERDO	645020	Inner Joint		24	34	40	69	89		
	1994-	1997	-	L	-	-	299001	Drive Shaft		25		56.7	79	514.5		
	1994-	1997	-	-	-	-	610003	Inner Joint		24	34	40	69	99		
1994-	1997	-	-	-	-	610004	Inner Joint		24	34	29.8	348	99.5			
2.0	1980.01-	1990.12	MT	-	-	-	810038	Outer Joint		25	25	60	79	61.5	O	
306 (7A 7C N3 N5)																
1.1 (44 kW)	1993.05-	2001.05	MT	L	F	Hatchback Engine HDZ (TU1M)	245004	Drive Shaft		21	22	56.4	76	614		
	1993.05-	2001.05	MT	L	F	Hatchback Engine HDZ (TU1M)	245157	Drive Shaft	29T	25	22	54.5	79.5	605		
	1993.05-	2001.05	MT	R	F	Hatchback Engine HDZ (TU1M)	245025	Drive Shaft		21	22	56.4	76	877.5		
	1993.05-	2001.05	MT	R	F	Hatchback Engine HDZ (TU1M)	245158	Drive Shaft	29T	25	22	54.5	79.5	875		
	1993.05-	2001.05	-	R	F	Hatchback Engine HDZ (TU1M)	245156	Drive Shaft	48T	25	22	54.5	79.5	869.5		
1.4 (55 kW)	1993.05-	2001.05	-	R	F	Hatchback Engine KFW (TU3JP)/KFX (TU3JP)/KDX (TU3MC)	299038	Drive Shaft	29T	25	22	60	80	879		
	1993.05-	2001.05	MT	L	F	Hatchback Engine KFW (TU3JP)/KFX (TU3JP)/KDX (TU3MC)	245004	Drive Shaft		21	22	56.4	76	614		
	1993.05-	2001.05	MT	L	F	Hatchback Engine KFW (TU3JP)/KFX (TU3JP)/KDX (TU3MC)	245157	Drive Shaft	29T	25	22	54.5	79.5	605		





		 YEAR	TRANSM	L/R	F/R	REMARKS	GSP Ref.	 PRODUCT	 ABS	Technical Specifications					
										A	B	C	H	L	P
PEUGEOT															
306 (7A 7C N3 N5)															
1.4 (55 kW)		1993.05-2001.05	MT	R	F	Hatchback Engine KFW (TU3JP)/KFX (TU3JP)/KDX (TU3MC)	245025	Drive Shaft		21	22	56.4	76	877.5	
		1993.05-2001.05	-	L	F	Hatchback Engine KFW (TU3JP)/KFX (TU3JP)/KDX (TU3MC)	299135	Drive Shaft		25	22	60	80	608	
		1993.05-2001.05	MT	R	F	Hatchback Engine KFW (TU3JP)/KFX (TU3JP)/KDX (TU3MC)	245158	Drive Shaft	29T	25	22	54.5	79.5	875	
		1993.05-2001.05	-	R	F	Hatchback Engine KFW (TU3JP)/KFX (TU3JP)/KDX (TU3MC)	299136	Drive Shaft		25	22	60	80	879	
		1993.05-2001.05	MT	L	F	Hatchback Engine KFW (TU3JP)/KFX (TU3JP)/KDX (TU3MC)	245138	Drive Shaft		25	22	60	78.5	601	
		1993.05-2001.05	MT	R	F	Hatchback Engine KFW (TU3JP)/KFX (TU3JP)/KDX (TU3MC)	245137	Drive Shaft		25	22	60	78.5	880	
		1993.05-2001.05	-	L	F	Hatchback Engine KFW (TU3JP)/KFX (TU3JP)/KDX (TU3MC)	245155	Drive Shaft	48T	25	22	54.5	79.5	609	
		1993.05-2001.05	-	-	F	Hatchback Engine KFW (TU3JP)/KFX (TU3JP)/KDX (TU3MC)	845036	Outer Joint	29T	25	22	60	80	54	I
		1993.05-2001.05	-	R	F	Hatchback Engine KFW (TU3JP)/KFX (TU3JP)/KDX (TU3MC)	245156	Drive Shaft	48T	25	22	54.5	79.5	869.5	
1.6 (65 kW)		1993.05-2000.10	-	R	F	Hatchback Engine NFZ (TU5JP)	299038	Drive Shaft	29T	25	22	60	80	879	
		1993.05-2000.10	MT	L	F	Hatchback Engine NFZ (TU5JP)	245021	Drive Shaft		25	22	54.8	79	607	
		1993.05-2000.10	MT	R	F	Hatchback Engine NFZ (TU5JP)	245014	Drive Shaft		25	22	54.8	79	879.5	
		1993.05-2000.10	MT	R	F	Hatchback Engine NFZ (TU5JP)	245158	Drive Shaft	29T	25	22	54.5	79.5	875	
		1993.05-2000.10	-	L	F	Hatchback Engine NFZ (TU5JP)	299135	Drive Shaft		25	22	60	80	608	
		1993.05-2000.10	-	R	F	Hatchback Engine NFZ (TU5JP)	299136	Drive Shaft		25	22	60	80	879	
		1993.05-2000.10	MT	L	F	Hatchback Engine NFZ (TU5JP)	245138	Drive Shaft		25	22	60	78.5	601	
		1993.05-2000.10	MT	R	F	Hatchback Engine NFZ (TU5JP)	245137	Drive Shaft		25	22	60	78.5	880	
		1993.05-2000.10	MT	L/R	F	Hatchback Engine NFZ (TU5JP)	810004	Outer Joint	48T	25	23	54.8	78.5	56	I
		1993.05-2000.10	MT	-	F	Hatchback Engine NFZ (TU5JP)	845036	Outer Joint	29T	25	22	60	80	54	I
		1993.05-2000.10	-	R	F	Hatchback Engine NFZ (TU5JP)	245156	Drive Shaft	48T	25	22	54.5	79.5	869.5	
		1993.05-2000.10	AT	-	F	Hatchback Engine NFZ (TU5JP)	810022	Outer Joint	29W	25	34	55.7	79	55	I
1.6 (66 kW)		2000.07-2001.05	MT	R	F	Hatchback Engine NFZ (TU5JP)	299038	Drive Shaft	29T	25	22	60	80	879	
		2000.07-2001.05	MT	L	F	Hatchback Engine NFZ (TU5JP)	299135	Drive Shaft		25	22	60	80	608	
		2000.07-2001.05	MT	R	F	Hatchback Engine NFZ (TU5JP)	299136	Drive Shaft		25	22	60	80	879	
		2000.07-2001.05	MT	-	F	Hatchback Engine NFZ (TU5JP)	845036	Outer Joint	29T	25	22	60	80	54	I
		2000.07-2001.05	AT	-	F	Hatchback Engine NFZ (TU5JP)	810022	Outer Joint	29W	25	34	55.7	79	55	I
1.6 (72 kW)		2000.10-2001.05	MT	R	F	Hatchback Engine NFT (TU5JP)	299038	Drive Shaft	29T	25	22	60	80	879	
		2000.10-2001.05	MT	L	F	Hatchback Engine NFT (TU5JP)	299135	Drive Shaft		25	22	60	80	608	
		2000.10-2001.05	MT	R	F	Hatchback Engine NFT (TU5JP)	299136	Drive Shaft		25	22	60	80	879	
		2000.10-2001.05	MT	-	F	Hatchback Engine NFT (TU5JP)	845036	Outer Joint	29T	25	22	60	80	54	I
		2000.10-2001.05	AT	-	F	Hatchback Engine NFT (TU5JP)	810022	Outer Joint	29W	25	34	55.7	79	55	I
1.8 (74 kW)		1993.05-2001.05	-	R	F	Hatchback Engine LFZ (XU7JP)	245075	Drive Shaft	48T	25	24	55.7	79	884	
		1993.05-2001.05	AT/MT	L	F	Hatchback Engine LFZ (XU7JP)	245167	Drive Shaft		25	24	56.7	79	608	
		1993.05-2001.05	AT/MT	R	F	Hatchback Engine LFZ (XU7JP)	845014	Outer Joint		25	22	56.7	80	59	O
		1993.05-2001.05	AT/MT	R	F	Hatchback Engine LFZ (XU7JP)	245198	Drive Shaft		25	24	56.7	80	891	
		1993.05-2001.05	AT/MT	L/R	F	Hatchback Engine LFZ (XU7JP)	810003	Outer Joint	29T	25	23	54.8	78.5	56	I
		1993.05-2001.05	-	-	F	Hatchback Engine LFZ (XU7JP)	845001	Outer Joint	29T	25	34	54.8	78.5	56	I
		1993.05-2001.05	AT/MT	L	F	Hatchback Engine LFZ (XU7JP)	245024	Drive Shaft	29T	25	24	55.7	79	603.5	
		1993.05-2001.05	AT/MT	L/R	F	Hatchback Engine LFZ (XU7JP)	810002	Outer Joint		25	23	54.8	78.5	56	I
		1993.05-2001.05	-	-	F	Hatchback Engine LFZ (XU7JP)	810027	Outer Joint	48T	25	34	55.7	79	55	I
		1993.05-2001.05	-	R	F	Hatchback Engine LFZ (XU7JP)	245074	Drive Shaft		25	24	55.7	79	884	
		1993.05-2001.05	AT/MT	R	F	Hatchback Engine LFZ (XU7JP)	245017	Drive Shaft	29T	25	24	55.7	79	881	
		1993.05-2001.05	MT	R	F	Hatchback Engine LFZ (XU7JP)	210126	Drive Shaft	29W	25	24	55.7	79	886	
		1993.05-2001.05	-	L	F	Hatchback Engine LFZ (XU7JP)	245073	Drive Shaft		25	24	54.8	78.5	601	
		1993.05-2001.05	AT/MT	L/R	F	Hatchback Engine LFZ (XU7JP)	810024	Outer Joint	48T	25	34	55.7	79	55	I
		1993.05-2001.05	-	-	F	Hatchback Engine LFZ (XU7JP)	810022	Outer Joint	29W	25	34	55.7	79	55	I
1.8 16V (81 kW)		1997.03-2001.05	AT/MT	L	F	Hatchback Engine LFY (XU7JP4)	245167	Drive Shaft		25	24	56.7	79	608	
		1997.03-2001.05	AT/MT	R	F	Hatchback Engine LFY (XU7JP4)	845014	Outer Joint		25	22	56.7	80	59	O
		1997.03-2001.05	AT/MT	R	F	Hatchback Engine LFY (XU7JP4)	245198	Drive Shaft		25	24	56.7	80	891	
		1997.03-2001.05	AT/MT	L/R	F	Hatchback Engine LFY (XU7JP4)	810003	Outer Joint	29T	25	23	54.8	78.5	56	I
		1997.03-2001.05	AT/MT	L	F	Hatchback Engine LFY (XU7JP4)	245024	Drive Shaft	29T	25	24	55.7	79	603.5	
		1997.03-2001.05	-	R	F	Hatchback Engine LFY (XU7JP4)	245074	Drive Shaft		25	24	55.7	79	884	
		1997.03-2001.05	AT/MT	R	F	Hatchback Engine LFY (XU7JP4)	245017	Drive Shaft	29T	25	24	55.7	79	881	
		1997.03-2001.05	-	-	F	Hatchback Engine LFY (XU7JP4)	810022	Outer Joint	29W	25	34	55.7	79	55	I
1.8 D (43 kW)		1993.05-2001.05	AT/MT	L/R	F	Hatchback Engine A9A (XUD7)	810003	Outer Joint	29T	25	23	54.8	78.5	56	I
1.9 D (47 kW)		1993.05-2001.05	-	R	F	Hatchback Engine DJZ (XUD9Y)	245075	Drive Shaft	48T	25	24	55.7	79	884	
		1993.05-2001.05	AT/MT	L	F	Hatchback Engine DJZ (XUD9Y)	245167	Drive Shaft		25	24	56.7	79	608	
		1993.05-2001.05	AT/MT	R	F	Hatchback Engine DJZ (XUD9Y)	845014	Outer Joint		25	22	56.7	80	59	O
		1993.05-2001.05	AT/MT	R	F	Hatchback Engine DJZ (XUD9Y)	245198	Drive Shaft		25	24	56.7	80	891	
		1993.05-2001.05	-	-	F	Hatchback Engine DJZ (XUD9Y)	845001	Outer Joint	29T	25	34	54.8	78.5	56	I
		1993.05-2001.05	AT/MT	L	F	Hatchback Engine DJZ (XUD9Y)	245024	Drive Shaft	29T	25	24	55.7	79	603.5	
		1993.05-2001.05	AT/MT	L/R	F	Hatchback Engine DJZ (XUD9Y)	810002	Outer Joint		25	23	54.8	78.5	56	I
		1993.05-2001.05	-	-	F	Hatchback Engine DJZ (XUD9Y)	810027	Outer Joint	48T	25	34	55.7	79	55	I
		1993.05-2001.05	AT/MT	R	F	Hatchback Engine DJZ (XUD9Y)	245017	Drive Shaft	29T	25	24	55.7	79	881	
		1993.05-2001.05	MT	R	F	Hatchback Engine DJZ (XUD9Y)	210126	Drive Shaft	29W	25	24	55.7	79	886	
		1993.05-2001.05	-	L	F	Hatchback Engine DJZ (XUD9Y)	245073	Drive Shaft		25	24	54.8	78.5	601	

YEAR	TRANSM	L/R	F/R	REMARKS	GSP Ref.	PRODUCT	ABS	Technical Specifications										
								A	B	C	H	L	P					
PEUGEOT																		
306 (7A 7C N3 N5)																		
1.9 D (47 kW)	1993.05-2001.05	AT/MT	L/R	F	Hatchback Engine DJZ (XUD9Y)	810024	Outer Joint	48T	25	34	55.7	79	55	I				
	1993.05-2001.05	-	-	F	Hatchback Engine DJZ (XUD9Y)	810022	Outer Joint	29W	25	34	55.7	79	55	I				
	1993.05-2001.05	AT/MT	L/R	F	Hatchback Engine DJZ (XUD9Y)	810003	Outer Joint	29T	25	23	54.8	78.5	56	I				
1.9 D (50 kW)	1994.06-2001.05	-	R	F	Hatchback Engine DJY (XUD9A)	245075	Drive Shaft	48T	25	24	55.7	79	884					
	1994.06-2001.05	AT/MT	L	F	Hatchback Engine DJY (XUD9A)	245167	Drive Shaft		25	24	56.7	79	608					
	1994.06-2001.05	AT/MT	R	F	Hatchback Engine DJY (XUD9A)	845014	Outer Joint		25	22	56.7	80	59	O				
	1994.06-2001.05	AT/MT	R	F	Hatchback Engine DJY (XUD9A)	245198	Drive Shaft		25	24	56.7	80	891					
	1994.06-2001.05	AT/MT	L	F	Hatchback Engine DJY (XUD9A)	245024	Drive Shaft	29T	25	24	55.7	79	603.5					
	1994.06-2001.05	-	-	F	Hatchback Engine DJY (XUD9A)	845001	Outer Joint	29T	25	34	54.8	78.5	56	I				
	1994.06-2001.05	AT/MT	L/R	F	Hatchback Engine DJY (XUD9A)	810002	Outer Joint		25	23	54.8	78.5	56	I				
	1994.06-2001.05	-	-	F	Hatchback Engine DJY (XUD9A)	810027	Outer Joint	48T	25	34	55.7	79	55	I				
	1994.06-2001.05	AT/MT	R	F	Hatchback Engine DJY (XUD9A)	245017	Drive Shaft	29T	25	24	55.7	79	881					
	1994.06-2001.05	MT	R	F	Hatchback Engine DJY (XUD9A)	210126	Drive Shaft	29W	25	24	55.7	79	886					
	1994.06-2001.05	-	L	F	Hatchback Engine DJY (XUD9A)	245073	Drive Shaft		25	24	54.8	78.5	601					
	1994.06-2001.05	AT/MT	L/R	F	Hatchback Engine DJY (XUD9A)	810024	Outer Joint	48T	25	34	55.7	79	55	I				
	1994.06-2001.05	-	-	F	Hatchback Engine DJY (XUD9A)	810022	Outer Joint	29W	25	34	55.7	79	55	I				
	1994.06-2001.05	AT/MT	L/R	F	Hatchback Engine DJY (XUD9A)	810003	Outer Joint	29T	25	23	54.8	78.5	56	I				
1.9 D (51 kW)	1993.04-1999.05	-	R	F	Hatchback Engine XUD9/D9B (XUD9A)/DJY (XUD9A)	245075	Drive Shaft	48T	25	24	55.7	79	884					
	1993.04-1999.05	-	-	F	Hatchback Engine XUD9/D9B (XUD9A)/DJY (XUD9A)	810022	Outer Joint	29W	25	34	55.7	79	55	I				
	1993.04-1999.05	-	-	F	Hatchback Engine XUD9/D9B (XUD9A)/DJY (XUD9A)	810027	Outer Joint	48T	25	34	55.7	79	55	I				
	1993.04-1999.05	-	L	F	Hatchback Engine XUD9/D9B (XUD9A)/DJY (XUD9A)	245073	Drive Shaft		25	24	54.8	78.5	601					
	1993.04-1999.05	MT	R	F	Hatchback Engine XUD9/D9B (XUD9A)/DJY (XUD9A)	210126	Drive Shaft	29W	25	24	55.7	79	886					
	1998.09-2001.05	-	-	F	Hatchback Engine WJZ (DW8)/WJY (DW8B)	810022	Outer Joint	29W	25	34	55.7	79	55	I				
	1998.09-2001.05	AT/MT	L	F	Hatchback Engine WJZ (DW8)/WJY (DW8B)	245167	Drive Shaft		25	24	56.7	79	608					
	1998.09-2001.05	AT/MT	R	F	Hatchback Engine WJZ (DW8)/WJY (DW8B)	845014	Outer Joint		25	22	56.7	80	59	O				
	1998.09-2001.05	AT/MT	R	F	Hatchback Engine WJZ (DW8)/WJY (DW8B)	245198	Drive Shaft		25	24	56.7	80	891					
	1998.09-2001.05	AT/MT	L/R	F	Hatchback Engine WJZ (DW8)/WJY (DW8B)	810002	Outer Joint		25	23	54.8	78.5	56	I				
	1998.09-2001.05	AT/MT	L	F	Hatchback Engine WJZ (DW8)/WJY (DW8B)	245024	Drive Shaft	29T	25	24	55.7	79	603.5					
	1998.09-2001.05	-	-	F	Hatchback Engine WJZ (DW8)/WJY (DW8B)	845001	Outer Joint	29T	25	34	54.8	78.5	56	I				
	1998.09-2001.05	AT/MT	R	F	Hatchback Engine WJZ (DW8)/WJY (DW8B)	245017	Drive Shaft	29T	25	24	55.7	79	881					
1.9 D (55 kW)	1998.03-2001.05	-	-	F	Hatchback Engine DHV (XUD9BSD)	810022	Outer Joint	29W	25	34	55.7	79	55	I				
	1998.03-2001.05	AT/MT	L/R	F	Hatchback Engine DHV (XUD9BSD)	810002	Outer Joint		25	23	54.8	78.5	56	I				
	1998.03-2001.05	-	-	F	Hatchback Engine DHV (XUD9BSD)	845001	Outer Joint	29T	25	34	54.8	78.5	56	I				
	1998.03-2001.05	AT/MT	L/R	F	Hatchback Engine DHV (XUD9BSD)	810024	Outer Joint	48T	25	34	55.7	79	55	I				
1.9 D (69 kW)	1993.04-1997.04	-	R	F	Hatchback Engine XUD9TE/DHY(XUD9TE)	245075	Drive Shaft	48T	25	24	55.7	79	884					
	1993.04-1997.04	-	-	F	Hatchback Engine XUD9TE/DHY(XUD9TE)	810022	Outer Joint	29W	25	34	55.7	79	55	I				
	1993.04-1997.04	-	-	F	Hatchback Engine XUD9TE/DHY(XUD9TE)	810027	Outer Joint	48T	25	34	55.7	79	55	I				
	1993.04-1997.04	MT	R	F	Hatchback Engine XUD9TE/DHY(XUD9TE)	210126	Drive Shaft	29W	25	24	55.7	79	886					
	1993.04-1997.04	-	L	F	Hatchback Engine XUD9TE/DHY(XUD9TE)	245073	Drive Shaft		25	24	54.8	78.5	601					
1.9 DT (66 kW)	1993.05-2001.05	-	L	F	Hatchback Engine DHY (XUD9TE)/D8A (XUD9TE)	245008	Drive Shaft		25	24	54.8	78.5	601.5					
	1993.05-2001.05	-	L	F	Hatchback Engine DHY (XUD9TE)/D8A (XUD9TE)	610018	Inner Joint		24	29	40	62.5	99					
	1993.05-2001.05	-	R	F	Hatchback Engine DHY (XUD9TE)/D8A (XUD9TE)	245070	Drive Shaft		25	24	54.8	78.5	880					
	1993.05-2001.05	MT	L/R	F	Hatchback Engine DHY (XUD9TE)/D8A (XUD9TE)	810002	Outer Joint		25	23	54.8	78.5	56	I				
	1993.05-2001.05	-	L	F	Hatchback Engine DHY (XUD9TE)/D8A (XUD9TE)	245024	Drive Shaft	29T	25	24	55.7	79	603.5					
	1993.05-2001.05	-	-	F	Hatchback Engine DHY (XUD9TE)/D8A (XUD9TE)	845001	Outer Joint	29T	25	34	54.8	78.5	56	I				
	1993.05-2001.05	-	R	F	Hatchback Engine DHY (XUD9TE)/D8A (XUD9TE)	245017	Drive Shaft	29T	25	24	55.7	79	881					
	1993.05-2001.05	MT	L/R	F	Hatchback Engine DHY (XUD9TE)/D8A (XUD9TE)	810024	Outer Joint	48T	25	34	55.7	79	55	I				
	1993.05-2001.05	-	-	F	Hatchback Engine DHY (XUD9TE)/D8A (XUD9TE)	810022	Outer Joint	29W	25	34	55.7	79	55	I				
2.0 16V (97 kW)	1997.03-2001.05	-	-	F	Hatchback Engine RFV (XU10J4R)	845001	Outer Joint	29T	25	34	54.8	78.5	56	I				
	1997.03-2001.05	-	-	F	Hatchback Engine RFV (XU10J4R)	810022	Outer Joint	29W	25	34	55.7	79	55	I				
2.0 16V (99 kW)	1997.03-2000.06	-	-	F	Hatchback Engine RFV (XU10J4R)	810022	Outer Joint	29W	25	34	55.7	79	55	I				
2.0 HDI 90 (66 kW)	1999.06-2001.05	MT	L	F	Hatchback Engine RHY (DW10TD)	245008	Drive Shaft		25	24	54.8	78.5	601.5					
	1999.06-2001.05	MT	R	F	Hatchback Engine RHY (DW10TD)	245070	Drive Shaft		25	24	54.8	78.5	880					
	1999.06-2001.05	MT	L	F	Hatchback Engine RHY (DW10TD)	610018	Inner Joint		24	29	40	62.5	99					
	1999.06-2001.05	MT	L	F	Hatchback Engine RHY (DW10TD)	245024	Drive Shaft	29T	25	24	55.7	79	603.5					
	1999.06-2001.05	MT	R	F	Hatchback Engine RHY (DW10TD)	210126	Drive Shaft	29W	25	24	55.7	79	886					
	1999.06-2001.05	MT	R	F	Hatchback Engine RHY (DW10TD)	245017	Drive Shaft	29T	25	24	55.7	79	881					
2.0 S16 (110 kW)	1994.06-2001.05	-	L	F	Hatchback Engine RFY (XU10J4Z)/RFT (XU10J4)	245008	Drive Shaft		25	24	54.8	78.5	601.5					
	1994.06-2001.05	-	R	F	Hatchback Engine RFY (XU10J4Z)/RFT (XU10J4)	245070	Drive Shaft		25	24	54.8	78.5	880					
	1994.06-2001.05	AT/MT	L/R	F	Hatchback Engine RFY (XU10J4Z)/RFT (XU10J4)	810002	Outer Joint		25	23	54.8	78.5	56	I				
	1994.06-2001.05	AT/MT	L	F	Hatchback Engine RFY (XU10J4Z)/RFT (XU10J4)	245024	Drive Shaft	29T	25	24	55.7	79	603.5					
	1994.06-2001.05	-	-	F	Hatchback Engine RFY (XU10J4Z)/RFT (XU10J4)	845001	Outer Joint	29T	25	34	54.8	78.5	56	I				
	1994.06-2001.05	MT	R	F	Hatchback Engine RFY (XU10J4Z)/RFT (XU10J4)	210126	Drive Shaft	29W	25	24	55.7	79	886					
	1994.06-2001.05	AT/MT	L/R	F	Hatchback Engine RFY (XU10J4Z)/RFT (XU10J4)	810024	Outer Joint	48T	25	34	55.7	79	55	I				
	1994.06-2001.05	AT/MT	R	F	Hatchback Engine RFY (XU10J4Z)/RFT (XU10J4)	245017	Drive Shaft	29T	25	24	55.7	79	881					
2.0 S16 (112 kW)	1993.05-2001.05	-	L	F	Hatchback Engine RFY (XU10J4Z)	245008	Drive Shaft		25	24	54.8	78.5	601.5					





			TRANSM	L/R	F/R	REMARKS	GSP Ref.		ABS	Technical Specifications					
YEAR										A	B	C	H	L	P
PEUGEOT															
306 (7A 7C N3 N5)															
2.0 S16 (112 kW)		1993.05-2001.05	-	R	F	Hatchback Engine RFY (XU10J4Z)	245070	Drive Shaft		25	24	54.8	78.5	880	
		1993.05-2001.05	AT/MT	L/R	F	Hatchback Engine RFY (XU10J4Z)	810002	Outer Joint		25	23	54.8	78.5	56	I
		1993.05-2001.05	AT/MT	L	F	Hatchback Engine RFY (XU10J4Z)	245024	Drive Shaft	29T	25	24	55.7	79	603.5	
		1993.05-2001.05	-	-	F	Hatchback Engine RFY (XU10J4Z)	845001	Outer Joint	29T	25	34	54.8	78.5	56	I
		1993.05-2001.05	MT	R	F	Hatchback Engine RFY (XU10J4Z)	210126	Drive Shaft	29W	25	24	55.7	79	886	
		1993.05-2001.05	AT/MT	L/R	F	Hatchback Engine RFY (XU10J4Z)	810024	Outer Joint	48T	25	34	55.7	79	55	I
		1993.05-2001.05	AT/MT	R	F	Hatchback Engine RFY (XU10J4Z)	245017	Drive Shaft	29T	25	24	55.7	79	881	
2.0 S16 (120 kW)		1996.03-2001.05	-	R	F	Hatchback Engine RFS (XU10J4RS)	245075	Drive Shaft	48T	25	24	55.7	79	884	
		1996.03-2001.05	-	-	F	Hatchback Engine RFS (XU10J4RS)	810027	Outer Joint	48T	25	34	55.7	79	55	I
		1996.03-2001.05	-	-	F	Hatchback Engine RFS (XU10J4RS)	845001	Outer Joint	29T	25	34	54.8	78.5	56	I
		1996.03-2001.05	-	L	F	Hatchback Engine RFS (XU10J4RS)	245073	Drive Shaft		25	24	54.8	78.5	601	
		1996.03-2001.05	MT	R	F	Hatchback Engine RFS (XU10J4RS)	210126	Drive Shaft	29W	25	24	55.7	79	886	
		1996.03-2001.05	-	-	F	Hatchback Engine RFS (XU10J4RS)	810022	Outer Joint	29W	25	34	55.7	79	55	I
2.0 XSi (89 kW)		1993.05-2001.05	-	L	F	Hatchback Engine RFX (XU10J2)	245160	Drive Shaft		25	24	54.8	78.5	609	
		1993.05-2001.05	AT/MT	L	F	Hatchback Engine RFX (XU10J2)	245008	Drive Shaft		25	24	54.8	78.5	601.5	
		1993.05-2001.05	MT/AT	L	F	Hatchback Engine RFX (XU10J2)	610018	Inner Joint		24	29	40	62.5	99	
		1993.05-2001.05	AT/MT	R	F	Hatchback Engine RFX (XU10J2)	245070	Drive Shaft		25	24	54.8	78.5	880	
		1993.05-2001.05	-	-	F	Hatchback Engine RFX (XU10J2)	845001	Outer Joint	29T	25	34	54.8	78.5	56	I
		1993.05-2001.05	AT/MT	L/R	F	Hatchback Engine RFX (XU10J2)	810002	Outer Joint		25	23	54.8	78.5	56	I
		1993.05-2001.05	AT/MT	L	F	Hatchback Engine RFX (XU10J2)	245024	Drive Shaft	29T	25	24	55.7	79	603.5	
		1993.05-2001.05	MT	R	F	Hatchback Engine RFX (XU10J2)	210126	Drive Shaft	29W	25	24	55.7	79	886	
		1993.05-2001.05	AT/MT	L/R	F	Hatchback Engine RFX (XU10J2)	810024	Outer Joint	48T	25	34	55.7	79	55	I
		1993.05-2001.05	AT/MT	R	F	Hatchback Engine RFX (XU10J2)	245017	Drive Shaft	29T	25	24	55.7	79	881	
306 (7B N3 N5)															
1.1 (44 kW)		1994.06-2001.05	MT	L	F	Saloon Engine HDZ (TU1M)	245004	Drive Shaft		21	22	56.4	76	614	
		1994.06-2001.05	MT	L	F	Saloon Engine HDZ (TU1M)	245157	Drive Shaft	29T	25	22	54.5	79.5	605	
		1994.06-2001.05	MT	R	F	Saloon Engine HDZ (TU1M)	245025	Drive Shaft		21	22	56.4	76	877.5	
		1994.06-2001.05	MT	R	F	Saloon Engine HDZ (TU1M)	245158	Drive Shaft	29T	25	22	54.5	79.5	875	
		1994.06-2001.05	-	R	F	Saloon Engine HDZ (TU1M)	245156	Drive Shaft	48T	25	22	54.5	79.5	869.5	
1.4 SL (55 kW)		1994.06-2001.05	-	R	F	Saloon Engine KDX (TU3MC)/KFW (TU3JP)/KFX (TU3JP)	299038	Drive Shaft	29T	25	22	60	80	879	
		1994.06-2001.05	MT	L	F	Saloon Engine KDX (TU3MC)/KFW (TU3JP)/KFX (TU3JP)	245004	Drive Shaft		21	22	56.4	76	614	
		1994.06-2001.05	MT	L	F	Saloon Engine KDX (TU3MC)/KFW (TU3JP)/KFX (TU3JP)	245157	Drive Shaft	29T	25	22	54.5	79.5	605	
		1994.06-2001.05	MT	R	F	Saloon Engine KDX (TU3MC)/KFW (TU3JP)/KFX (TU3JP)	245025	Drive Shaft		21	22	56.4	76	877.5	
		1994.06-2001.05	-	L	F	Saloon Engine KDX (TU3MC)/KFW (TU3JP)/KFX (TU3JP)	299135	Drive Shaft		25	22	60	80	608	
		1994.06-2001.05	MT	R	F	Saloon Engine KDX (TU3MC)/KFW (TU3JP)/KFX (TU3JP)	245158	Drive Shaft	29T	25	22	54.5	79.5	875	
		1994.06-2001.05	MT	L	F	Saloon Engine KDX (TU3MC)/KFW (TU3JP)/KFX (TU3JP)	299037	Drive Shaft	29T	25	22	60	80	608	
		1994.06-2001.05	-	R	F	Saloon Engine KDX (TU3MC)/KFW (TU3JP)/KFX (TU3JP)	299136	Drive Shaft		25	22	60	80	879	
		1994.06-2001.05	MT	L	F	Saloon Engine KDX (TU3MC)/KFW (TU3JP)/KFX (TU3JP)	245138	Drive Shaft		25	22	60	80	601	
		1994.06-2001.05	MT	R	F	Saloon Engine KDX (TU3MC)/KFW (TU3JP)/KFX (TU3JP)	245137	Drive Shaft		25	22	60	78.5	880	
		1994.06-2001.05	-	L	F	Saloon Engine KDX (TU3MC)/KFW (TU3JP)/KFX (TU3JP)	245155	Drive Shaft	48T	25	22	54.5	79.5	609	
		1994.06-2001.05	-	-	F	Saloon Engine KDX (TU3MC)/KFW (TU3JP)/KFX (TU3JP)	845036	Outer Joint	29T	25	22	60	80	54	I
		1994.06-2001.05	-	R	F	Saloon Engine KDX (TU3MC)/KFW (TU3JP)/KFX (TU3JP)	245156	Drive Shaft	48T	25	22	54.5	79.5	869.5	
1.6 (66 kW)		2000.07-2001.05	MT	R	F	Saloon	299038	Drive Shaft	29T	25	22	60	80	879	
		2000.07-2001.05	MT	L	F	Saloon	299135	Drive Shaft		25	22	60	80	608	
		2000.07-2001.05	MT	R	F	Saloon	299136	Drive Shaft		25	22	60	80	879	
		2000.07-2001.05	MT	-	F	Saloon	845036	Outer Joint	29T	25	22	60	80	54	I
		2000.07-2001.05	AT	-	F	Saloon	810022	Outer Joint	29W	25	34	55.7	79	55	I
1.6 (72 kW)		2000.10-2001.05	MT	R	F	Saloon Engine NFT (TU5JP)	299038	Drive Shaft	29T	25	22	60	80	879	
		2000.10-2001.05	MT	L	F	Saloon Engine NFT (TU5JP)	299135	Drive Shaft		25	22	60	80	608	
		2000.10-2001.05	MT	L	F	Saloon Engine NFT (TU5JP)	299037	Drive Shaft	29T	25	22	60	80	608	
		2000.10-2001.05	MT	R	F	Saloon Engine NFT (TU5JP)	299136	Drive Shaft		25	22	60	80	879	
		2000.10-2001.05	MT	-	F	Saloon Engine NFT (TU5JP)	845036	Outer Joint	29T	25	22	60	80	54	I
		2000.10-2001.05	AT	-	F	Saloon Engine NFT (TU5JP)	810022	Outer Joint	29W	25	34	55.7	79	55	I
1.6 SR (65 kW)		1994.06-2000.10	MT	R	F	Saloon Engine NFZ (TU5JP)	299038	Drive Shaft	29T	25	22	60	80	879	
		1994.06-2000.10	MT	L	F	Saloon Engine NFZ (TU5JP)	245021	Drive Shaft		25	22	54.8	79	607	
		1994.06-2000.10	MT	L	F	Saloon Engine NFZ (TU5JP)	299135	Drive Shaft		25	22	60	80	608	
		1994.06-2000.10	MT	R	F	Saloon Engine NFZ (TU5JP)	245014	Drive Shaft		25	22	54.8	79	879.5	
		1994.06-2000.10	MT	R	F	Saloon Engine NFZ (TU5JP)	245158	Drive Shaft	29T	25	22	54.5	79.5	875	
		1994.06-2000.10	MT	L	F	Saloon Engine NFZ (TU5JP)	299037	Drive Shaft	29T	25	22	60	80	608	
		1994.06-2000.10	MT	R	F	Saloon Engine NFZ (TU5JP)	299136	Drive Shaft		25	22	60	80	879	
		1994.06-2000.10	MT	L	F	Saloon Engine NFZ (TU5JP)	245138	Drive Shaft		25	22	60	78.5	601	
		1994.06-2000.10	MT	R	F	Saloon Engine NFZ (TU5JP)	245137	Drive Shaft		25	22	60	78.5	880	
		1994.06-2000.10	MT	L/R	F	Saloon Engine NFZ (TU5JP)	810004	Outer Joint	48T	25	23	54.8	78.5	56	I
		1994.06-2000.10	MT	-	F	Saloon Engine NFZ (TU5JP)	845036	Outer Joint	29T	25	22	60	80	54	I
		1994.06-2000.10	-	R	F	Saloon Engine NFZ (TU5JP)	245156	Drive Shaft	48T	25	22	54.5	79.5	869.5	
		1994.06-2000.10	AT	-	F	Saloon Engine NFZ (TU5JP)	810022	Outer Joint	29W	25	34	55.7	79	55	I





YEAR	TRANSM	L/R	F/R	REMARKS	GSP Ref.	PRODUCT	ABS	Technical Specifications										
								A	B	C	H	L	P					
PEUGEOT																		
306 (7B N3 N5)																		
1.8 (74 kW)																		
1995.10-	1997.04	-	R	F	Saloon Engine LFZ (XU7JP)	245075	Drive Shaft	48T	25	24	55.7	79	884					
1995.10-	1997.04	AT/MT	L	F	Saloon Engine LFZ (XU7JP)	245167	Drive Shaft		25	24	56.7	79	608					
1995.10-	1997.04	AT/MT	R	F	Saloon Engine LFZ (XU7JP)	845014	Outer Joint		25	22	56.7	80	59	O				
1995.10-	1997.04	-	-	F	Saloon Engine LFZ (XU7JP)	810022	Outer Joint	29W	25	34	55.7	79	55	I				
1995.10-	1997.04	AT/MT	R	F	Saloon Engine LFZ (XU7JP)	245198	Drive Shaft		25	24	56.7	80	891					
1995.10-	1997.04	AT/MT	L	F	Saloon Engine LFZ (XU7JP)	245024	Drive Shaft	29T	25	24	55.7	79	603.5					
1995.10-	1997.04	AT/MT	L/R	F	Saloon Engine LFZ (XU7JP)	810002	Outer Joint		25	23	54.8	78.5	56	I				
1995.10-	1997.04	AT/MT	R	F	Saloon Engine LFZ (XU7JP)	245017	Drive Shaft	29T	25	24	55.7	79	881					
1995.10-	1997.04	-	-	F	Saloon Engine LFZ (XU7JP)	810027	Outer Joint	48T	25	34	55.7	79	55	I				
1995.10-	1997.04	MT	R	F	Saloon Engine LFZ (XU7JP)	210126	Drive Shaft	29W	25	24	55.7	79	886					
1995.10-	1997.04	AT/MT	L/R	F	Saloon Engine LFZ (XU7JP)	810024	Outer Joint	48T	25	34	55.7	79	55	I				
1995.10-	1997.04	-	L	F	Saloon Engine LFZ (XU7JP)	245073	Drive Shaft		25	24	54.8	78.5	601					
1.8 16V (81 kW)																		
1997.03-	2001.05	AT/MT	L	F	Saloon Engine LFY (XU7JP4)	245167	Drive Shaft		25	24	56.7	79	608					
1997.03-	2001.05	AT/MT	R	F	Saloon Engine LFY (XU7JP4)	845014	Outer Joint		25	22	56.7	80	59	O				
1997.03-	2001.05	AT/MT	R	F	Saloon Engine LFY (XU7JP4)	245198	Drive Shaft		25	24	56.7	80	891					
1997.03-	2001.05	AT/MT	L/R	F	Saloon Engine LFY (XU7JP4)	810003	Outer Joint	29T	25	23	54.8	78.5	56	I				
1997.03-	2001.05	AT/MT	L	F	Saloon Engine LFY (XU7JP4)	245024	Drive Shaft	29T	25	24	55.7	79	603.5					
1997.03-	2001.05	AT/MT	R	F	Saloon Engine LFY (XU7JP4)	245017	Drive Shaft	29T	25	24	55.7	79	881					
1997.03-	2001.05	-	-	F	Saloon Engine LFY (XU7JP4)	810022	Outer Joint	29W	25	34	55.7	79	55	I				
1.8 ST (74 kW)																		
1994.06-	2001.05	-	R	F	Saloon Engine LFZ (XU7JP)	245075	Drive Shaft	48T	25	24	55.7	79	884					
1994.06-	2001.05	AT/MT	L	F	Saloon Engine LFZ (XU7JP)	245167	Drive Shaft		25	24	56.7	79	608					
1994.06-	2001.05	AT/MT	R	F	Saloon Engine LFZ (XU7JP)	845014	Outer Joint		25	22	56.7	80	59	O				
1994.06-	2001.05	AT/MT	R	F	Saloon Engine LFZ (XU7JP)	245198	Drive Shaft		25	24	56.7	80	891					
1994.06-	2001.05	AT/MT	L	F	Saloon Engine LFZ (XU7JP)	245024	Drive Shaft	29T	25	24	55.7	79	603.5					
1994.06-	2001.05	-	-	F	Saloon Engine LFZ (XU7JP)	845001	Outer Joint	29T	25	34	54.8	78.5	56	I				
1994.06-	2001.05	AT/MT	L/R	F	Saloon Engine LFZ (XU7JP)	810002	Outer Joint		25	23	54.8	78.5	56	I				
1994.06-	2001.05	-	-	F	Saloon Engine LFZ (XU7JP)	810027	Outer Joint	48T	25	34	55.7	79	55	I				
1994.06-	2001.05	AT/MT	R	F	Saloon Engine LFZ (XU7JP)	245017	Drive Shaft	29T	25	24	55.7	79	881					
1994.06-	2001.05	MT	R	F	Saloon Engine LFZ (XU7JP)	210126	Drive Shaft	29W	25	24	55.7	79	886					
1994.06-	2001.05	-	L	F	Saloon Engine LFZ (XU7JP)	245073	Drive Shaft		25	24	54.8	78.5	601					
1994.06-	2001.05	AT/MT	L/R	F	Saloon Engine LFZ (XU7JP)	810024	Outer Joint	48T	25	34	55.7	79	55	I				
1994.06-	2001.05	-	-	F	Saloon Engine LFZ (XU7JP)	810022	Outer Joint	29W	25	34	55.7	79	55	I				
1.9 D (51 kW)																		
1998.09-	2001.05	-	-	F	Saloon Engine WJZ (DW8)/WJY (DW8B)	810022	Outer Joint	29W	25	34	55.7	79	55	I				
1998.09-	2001.05	AT/MT	L	F	Saloon Engine WJZ (DW8)/WJY (DW8B)	245167	Drive Shaft		25	24	56.7	79	608					
1998.09-	2001.05	AT/MT	R	F	Saloon Engine WJZ (DW8)/WJY (DW8B)	845014	Outer Joint		25	22	56.7	80	59	O				
1998.09-	2001.05	AT/MT	R	F	Saloon Engine WJZ (DW8)/WJY (DW8B)	245198	Drive Shaft		25	24	56.7	80	891					
1998.09-	2001.05	AT/MT	L/R	F	Saloon Engine WJZ (DW8)/WJY (DW8B)	810002	Outer Joint		25	23	54.8	78.5	56	I				
1998.09-	2001.05	AT/MT	L	F	Saloon Engine WJZ (DW8)/WJY (DW8B)	245024	Drive Shaft	29T	25	24	55.7	79	603.5					
1998.09-	2001.05	-	-	F	Saloon Engine WJZ (DW8)/WJY (DW8B)	845001	Outer Joint	29T	25	34	54.8	78.5	56	I				
1998.09-	2001.05	AT/MT	R	F	Saloon Engine WJZ (DW8)/WJY (DW8B)	245017	Drive Shaft	29T	25	24	55.7	79	881					
1.9 D (55 kW)																		
1998.03-	2001.05	-	-	F	Saloon Engine DHV (XUD9BSD)	810022	Outer Joint	29W	25	34	55.7	79	55	I				
1998.03-	2001.05	AT/MT	L/R	F	Saloon Engine DHV (XUD9BSD)	810002	Outer Joint		25	23	54.8	78.5	56	I				
1998.03-	2001.05	-	-	F	Saloon Engine DHV (XUD9BSD)	845001	Outer Joint	29T	25	34	54.8	78.5	56	I				
1998.03-	2001.05	AT/MT	L/R	F	Saloon Engine DHV (XUD9BSD)	810024	Outer Joint	48T	25	34	55.7	79	55	I				
1.9 D (69 kW)																		
1994.02-	1997.04	-	R	F	Saloon Engine XUD9TE/DHY (XUD9TE)	245075	Drive Shaft	48T	25	24	55.7	79	884					
1994.02-	1997.04	-	-	F	Saloon Engine XUD9TE/DHY (XUD9TE)	810022	Outer Joint	29W	25	34	55.7	79	55	I				
1994.02-	1997.04	-	-	F	Saloon Engine XUD9TE/DHY (XUD9TE)	810027	Outer Joint	48T	25	34	55.7	79	55	I				
1994.02-	1997.04	MT	R	F	Saloon Engine XUD9TE/DHY (XUD9TE)	210126	Drive Shaft	29W	25	24	55.7	79	886					
1994.02-	1997.04	-	L	F	Saloon Engine XUD9TE/DHY (XUD9TE)	245073	Drive Shaft		25	24	54.8	78.5	601					
1.9 SLD (47 kW)																		
1994.06-	2001.05	-	R	F	Saloon Engine DJZ (XUD9Y)	245075	Drive Shaft	48T	25	24	55.7	79	884					
1994.06-	2001.05	AT/MT	L	F	Saloon Engine DJZ (XUD9Y)	245167	Drive Shaft		25	24	56.7	79	608					
1994.06-	2001.05	AT/MT	R	F	Saloon Engine DJZ (XUD9Y)	845014	Outer Joint		25	22	56.7	80	59	O				
1994.06-	2001.05	AT/MT	R	F	Saloon Engine DJZ (XUD9Y)	245198	Drive Shaft		25	24	56.7	80	891					
1994.06-	2001.05	AT/MT	L	F	Saloon Engine DJZ (XUD9Y)	245024	Drive Shaft	29T	25	24	55.7	79	603.5					
1994.06-	2001.05	-	-	F	Saloon Engine DJZ (XUD9Y)	845001	Outer Joint	29T	25	34	54.8	78.5	56	I				
1994.06-	2001.05	AT/MT	L/R	F	Saloon Engine DJZ (XUD9Y)	810002	Outer Joint		25	23	54.8	78.5	56	I				
1994.06-	2001.05	-	-	F	Saloon Engine DJZ (XUD9Y)	810027	Outer Joint	48T	25	34	55.7	79	55	I				
1994.06-	2001.05	AT/MT	R	F	Saloon Engine DJZ (XUD9Y)	245017	Drive Shaft	29T	25	24	55.7	79	881					
1994.06-	2001.05	MT	R	F	Saloon Engine DJZ (XUD9Y)	210126	Drive Shaft	29W	25	24	55.7	79	886					
1994.06-	2001.05	-	L	F	Saloon Engine DJZ (XUD9Y)	245073	Drive Shaft		25	24	54.8	78.5	601					
1994.06-	2001.05	AT/MT	L/R	F	Saloon Engine DJZ (XUD9Y)	810024	Outer Joint	48T	25	34	55.7	79	55	I				
1994.06-	2001.05	-	-	F	Saloon Engine DJZ (XUD9Y)	810022	Outer Joint	29W	25	34	55.7	79	55	I				
1994.06-	2001.05	AT/MT	L/R	F	Saloon Engine DJZ (XUD9Y)	810003	Outer Joint	29T	25	23	54.8	78.5	56	I				
1.9 SLD (50 kW)																		
1994.06-	2001.05	-	R	F	Saloon Engine DJY (XUD9A)	245075	Drive Shaft	48T	25	24	55.7	79	884					
1994.06-	2001.05	AT/MT	L	F	Saloon Engine DJY (XUD9A)	245167	Drive Shaft		25	24	56.7	79	608					
1994.06-	2001.05	AT/MT	R	F	Saloon Engine DJY (XUD9A)	845014	Outer Joint		25	22	56.7	80	59	O				





YEAR	TRANSM	L/R	F/R	REMARKS	GSP Ref.	PRODUCT	ABS	Technical Specifications									
								A	B	C	H	L	P				
PEUGEOT																	
306 (7B N3 N5)																	
1.9 SLD (50 kW)	1994.06-2001.05	AT/MT	R	F	Saloon Engine DJY (XUD9A)	245198	Drive Shaft		25	24	56.7	80	891				
	1994.06-2001.05	AT/MT	L	F	Saloon Engine DJY (XUD9A)	245024	Drive Shaft	29T	25	24	55.7	79	603.5				
	1994.06-2001.05	AT/MT	L/R	F	Saloon Engine DJY (XUD9A)	810002	Outer Joint		25	23	54.8	78.5	56	I			
	1994.06-2001.05	-	-	F	Saloon Engine DJY (XUD9A)	810027	Outer Joint	48T	25	34	55.7	79	55	I			
	1994.06-2001.05	-	-	F	Saloon Engine DJY (XUD9A)	845001	Outer Joint	29T	25	34	54.8	78.5	56	I			
	1994.06-2001.05	AT/MT	R	F	Saloon Engine DJY (XUD9A)	245017	Drive Shaft	29T	25	24	55.7	79	881				
	1994.06-2001.05	-	L	F	Saloon Engine DJY (XUD9A)	245073	Drive Shaft		25	24	54.8	78.5	601				
	1994.06-2001.05	MT	R	F	Saloon Engine DJY (XUD9A)	210126	Drive Shaft	29W	25	24	55.7	79	886				
	1994.06-2001.05	AT/MT	L/R	F	Saloon Engine DJY (XUD9A)	810024	Outer Joint	48T	25	34	55.7	79	55	I			
	1994.06-2001.05	-	-	F	Saloon Engine DJY (XUD9A)	810022	Outer Joint	29W	25	34	55.7	79	55	I			
	1994.06-2001.05	AT/MT	L/R	F	Saloon Engine DJY (XUD9A)	810003	Outer Joint	29T	25	23	54.8	78.5	56	I			
1.9 SRDT (66 kW)	1994.06-2001.05	-	R	F	Saloon Engine D8A (XUD9TE)/DHY (XUD9TE)	245075	Drive Shaft	48T	25	24	55.7	79	884				
	1994.06-2001.05	MT	L	F	Saloon Engine D8A (XUD9TE)/DHY (XUD9TE)	245008	Drive Shaft		25	24	54.8	78.5	601.5				
	1994.06-2001.05	MT	R	F	Saloon Engine D8A (XUD9TE)/DHY (XUD9TE)	245070	Drive Shaft		25	24	54.8	78.5	880				
	1994.06-2001.05	MT	L/R	F	Saloon Engine D8A (XUD9TE)/DHY (XUD9TE)	810002	Outer Joint		25	23	54.8	78.5	56	I			
	1994.06-2001.05	MT	L	F	Saloon Engine D8A (XUD9TE)/DHY (XUD9TE)	245024	Drive Shaft	29T	25	24	55.7	79	603.5				
	1994.06-2001.05	-	-	F	Saloon Engine D8A (XUD9TE)/DHY (XUD9TE)	810027	Outer Joint	48T	25	34	55.7	79	55	I			
	1994.06-2001.05	-	-	F	Saloon Engine D8A (XUD9TE)/DHY (XUD9TE)	845001	Outer Joint	29T	25	34	54.8	78.5	56	I			
	1994.06-2001.05	MT	R	F	Saloon Engine D8A (XUD9TE)/DHY (XUD9TE)	210126	Drive Shaft	29W	25	24	55.7	79	886				
	1994.06-2001.05	-	L	F	Saloon Engine D8A (XUD9TE)/DHY (XUD9TE)	245073	Drive Shaft		25	24	54.8	78.5	601				
	1994.06-2001.05	MT	R	F	Saloon Engine D8A (XUD9TE)/DHY (XUD9TE)	245017	Drive Shaft	29T	25	24	55.7	79	881				
	1994.06-2001.05	MT	L/R	F	Saloon Engine D8A (XUD9TE)/DHY (XUD9TE)	810024	Outer Joint	48T	25	34	55.7	79	55	I			
	1994.06-2001.05	MT	L	F	Saloon Engine D8A (XUD9TE)/DHY (XUD9TE)	610018	Inner Joint		24	29	40	62.5	99				
	1994.06-2001.05	-	-	F	Saloon Engine D8A (XUD9TE)/DHY (XUD9TE)	810022	Outer Joint	29W	25	34	55.7	79	55	I			
1.9 STD (51 kW)	1994.02-1995.10	-	R	F	Saloon Engine XUD9/D9B (XUD9A)	245075	Drive Shaft	48T	25	24	55.7	79	884				
	1994.02-1995.10	-	-	F	Saloon Engine XUD9/D9B (XUD9A)	810027	Outer Joint	48T	25	34	55.7	79	55	I			
	1994.02-1995.10	MT	R	F	Saloon Engine XUD9/D9B (XUD9A)	210126	Drive Shaft	29W	25	24	55.7	79	886				
	1994.02-1995.10	-	L	F	Saloon Engine XUD9/D9B (XUD9A)	245073	Drive Shaft		25	24	54.8	78.5	601				
2.0 (97 kW)	1997.03-2001.05	-	-	F	Saloon Engine RFV (XU10J4R)	845001	Outer Joint	29T	25	34	54.8	78.5	56	I			
	1997.03-2001.05	-	-	F	Saloon Engine RFV (XU10J4R)	810022	Outer Joint	29W	25	34	55.7	79	55	I			
2.0 HDI 90 (66 kW)	1999.06-2001.05	MT	L	F	Saloon Engine RHY (DW10TD)	245008	Drive Shaft		25	24	54.8	78.5	601.5				
	1999.06-2001.05	MT	R	F	Saloon Engine RHY (DW10TD)	245070	Drive Shaft		25	24	54.8	78.5	880				
	1999.06-2001.05	MT	L	F	Saloon Engine RHY (DW10TD)	610018	Inner Joint		24	29	40	62.5	99				
	1999.06-2001.05	MT	L	F	Saloon Engine RHY (DW10TD)	245024	Drive Shaft	29T	25	24	55.7	79	603.5				
	1999.06-2001.05	MT	R	F	Saloon Engine RHY (DW10TD)	210126	Drive Shaft	29W	25	24	55.7	79	886				
	1999.06-2001.05	MT	R	F	Saloon Engine RHY (DW10TD)	245017	Drive Shaft	29T	25	24	55.7	79	881				
2.0 S16 (110 kW)	1994.06-2001.05	-	L	F	Saloon Engine RFT (XU10J4)	245008	Drive Shaft		25	24	54.8	78.5	601.5				
	1994.06-2001.05	-	R	F	Saloon Engine RFT (XU10J4)	245070	Drive Shaft		25	24	54.8	78.5	880				
	1994.06-2001.05	AT/MT	L/R	F	Saloon Engine RFT (XU10J4)	810002	Outer Joint		25	23	54.8	78.5	56	I			
	1994.06-2001.05	AT/MT	L	F	Saloon Engine RFT (XU10J4)	245024	Drive Shaft	29T	25	24	55.7	79	603.5				
	1994.06-2001.05	-	-	F	Saloon Engine RFT (XU10J4)	845001	Outer Joint	29T	25	34	54.8	78.5	56	I			
	1994.06-2001.05	MT	R	F	Saloon Engine RFT (XU10J4)	210126	Drive Shaft	29W	25	24	55.7	79	886				
	1994.06-2001.05	AT/MT	R	F	Saloon Engine RFT (XU10J4)	245017	Drive Shaft	29T	25	24	55.7	79	881				
	1994.06-2001.05	AT/MT	L/R	F	Saloon Engine RFT (XU10J4)	810024	Outer Joint	48T	25	34	55.7	79	55	I			
2.0 S16 (112 kW)	1994.06-2001.05	-	L	F	Saloon Engine RFY (XU10J4Z)	245008	Drive Shaft		25	24	54.8	78.5	601.5				
	1994.06-2001.05	-	R	F	Saloon Engine RFY (XU10J4Z)	245070	Drive Shaft		25	24	54.8	78.5	880				
	1994.06-2001.05	AT/MT	L/R	F	Saloon Engine RFY (XU10J4Z)	810002	Outer Joint		25	23	54.8	78.5	56	I			
	1994.06-2001.05	AT/MT	L	F	Saloon Engine RFY (XU10J4Z)	245024	Drive Shaft	29T	25	24	55.7	79	603.5				
	1994.06-2001.05	-	-	F	Saloon Engine RFY (XU10J4Z)	845001	Outer Joint	29T	25	34	54.8	78.5	56	I			
	1994.06-2001.05	MT	R	F	Saloon Engine RFY (XU10J4Z)	210126	Drive Shaft	29W	25	24	55.7	79	886				
	1994.06-2001.05	AT/MT	R	F	Saloon Engine RFY (XU10J4Z)	245017	Drive Shaft	29T	25	24	55.7	79	881				
	1994.06-2001.05	AT/MT	L/R	F	Saloon Engine RFY (XU10J4Z)	810024	Outer Joint	48T	25	34	55.7	79	55	I			
2.0 ST (89 kW)	1994.07-2001.05	-	L	F	Saloon Engine RFX (XU10J2)	245160	Drive Shaft		25	24	54.8	78.5	609				
	1994.07-2001.05	-	R	F	Saloon Engine RFX (XU10J2)	245075	Drive Shaft	48T	25	24	55.7	79	884				
	1994.07-2001.05	AT/MT	L	F	Saloon Engine RFX (XU10J2)	245008	Drive Shaft		25	24	54.8	78.5	601.5				
	1994.07-2001.05	AT/MT	R	F	Saloon Engine RFX (XU10J2)	245070	Drive Shaft		25	24	54.8	78.5	880				
	1994.07-2001.05	-	-	F	Saloon Engine RFX (XU10J2)	845001	Outer Joint	29T	25	34	54.8	78.5	56	I			
	1994.07-2001.05	AT/MT	L/R	F	Saloon Engine RFX (XU10J2)	810002	Outer Joint		25	23	54.8	78.5	56	I			
	1994.07-2001.05	AT/MT	L	F	Saloon Engine RFX (XU10J2)	245024	Drive Shaft	29T	25	24	55.7	79	603.5				
	1994.07-2001.05	-	-	F	Saloon Engine RFX (XU10J2)	810027	Outer Joint	48T	25	34	55.7	79	55	I			
	1994.07-2001.05	MT	R	F	Saloon Engine RFX (XU10J2)	210126	Drive Shaft	29W	25	24	55.7	79	886				
	1994.07-2001.05	-	L	F	Saloon Engine RFX (XU10J2)	245073	Drive Shaft		25	24	54.8	78.5	601				
	1994.07-2001.05	AT/MT	R	F	Saloon Engine RFX (XU10J2)	245017	Drive Shaft	29T	25	24	55.7	79	881				
	1994.07-2001.05	AT/MT	L/R	F	Saloon Engine RFX (XU10J2)	810024	Outer Joint	48T	25	34	55.7	79	55	I			
	1994.07-2001.05	MT/AT	L	F	Saloon Engine RFX (XU10J2)	610018	Inner Joint		24	29	40	62.5	99				
	1994.07-2001.05	-	-	F	Saloon Engine RFX (XU10J2)	810022	Outer Joint	29W	25	34	55.7	79	55	I			





	 YEAR	TRANSM	L/R	F/R	REMARKS	GSP Ref.	 PRODUCT	 ABS	Technical Specifications								
									A	B	C	H	L	P			
PEUGEOT																	
306 (7B N3 N5)																	
2.0 ST (89 kW)	1994.07-	2001.05	AT/MT	L/R	F	Saloon Engine RFX (XU10J2)	810003	Outer Joint	29T	25	23	54.8	78.5	56	I		
306 (7D N3 N5)																	
1.6 (65 kW)	1996.04-	2000.10	MT	R	F	Convertible Engine NFZ (TU5JP)	299038	Drive Shaft	29T	25	22	60	80	879			
	1996.04-	2000.10	MT	R	F	Convertible Engine NFZ (TU5JP)	245158	Drive Shaft	29T	25	22	54.5	79.5	875			
	1996.04-	2000.10	MT	L	F	Convertible Engine NFZ (TU5JP)	245021	Drive Shaft		25	22	54.8	79	607			
	1996.04-	2000.10	MT	L	F	Convertible Engine NFZ (TU5JP)	299135	Drive Shaft		25	22	60	80	608			
	1996.04-	2000.10	MT	R	F	Convertible Engine NFZ (TU5JP)	245014	Drive Shaft		25	22	54.8	79	879.5			
	1996.04-	2000.10	MT	L	F	Convertible Engine NFZ (TU5JP)	299037	Drive Shaft	29T	25	22	60	80	608			
	1996.04-	2000.10	MT	R	F	Convertible Engine NFZ (TU5JP)	299136	Drive Shaft		25	22	60	80	879			
	1996.04-	2000.10	MT	L	F	Convertible Engine NFZ (TU5JP)	245138	Drive Shaft		25	22	60	78.5	601			
	1996.04-	2000.10	MT	R	F	Convertible Engine NFZ (TU5JP)	245137	Drive Shaft		25	22	60	78.5	880			
	1996.04-	2000.10	MT	L/R	F	Convertible Engine NFZ (TU5JP)	810004	Outer Joint	48T	25	23	54.8	78.5	56	I		
	1996.04-	2000.10	MT	-	F	Convertible Engine NFZ (TU5JP)	845036	Outer Joint	29T	25	22	60	80	54	I		
	1996.04-	2000.10	-	R	F	Convertible Engine NFZ (TU5JP)	245156	Drive Shaft	48T	25	22	54.5	79.5	869.5			
	1996.04-	2000.10	AT	-	F	Convertible Engine NFZ (TU5JP)	810022	Outer Joint	29W	25	34	55.7	79	55	I		
1.6 (72 kW)	2000.10-	2002.04	MT	R	F	Convertible Engine NFT (TU5JP)	299038	Drive Shaft	29T	25	22	60	80	879			
	2000.10-	2002.04	MT	L	F	Convertible Engine NFT (TU5JP)	299135	Drive Shaft		25	22	60	80	608			
	2000.10-	2002.04	MT	L	F	Convertible Engine NFT (TU5JP)	299037	Drive Shaft	29T	25	22	60	80	608			
	2000.10-	2002.04	MT	R	F	Convertible Engine NFT (TU5JP)	299136	Drive Shaft		25	22	60	80	879			
	2000.10-	2002.04	MT	-	F	Convertible Engine NFT (TU5JP)	845036	Outer Joint	29T	25	22	60	80	54	I		
	2000.10-	2002.04	AT	-	F	Convertible Engine NFT (TU5JP)	810022	Outer Joint	29W	25	34	55.7	79	55	I		
1.8 (74 kW)	1994.03-	2002.04	-	R	F	Convertible Engine LFZ (XU7JP)	245075	Drive Shaft	48T	25	24	55.7	79	884			
	1994.03-	2002.04	AT/MT	L	F	Convertible Engine LFZ (XU7JP)	245167	Drive Shaft		25	24	56.7	79	608			
	1994.03-	2002.04	AT/MT	R	F	Convertible Engine LFZ (XU7JP)	845014	Outer Joint		25	22	56.7	80	59	O		
	1994.03-	2002.04	AT/MT	R	F	Convertible Engine LFZ (XU7JP)	245198	Drive Shaft		25	24	56.7	80	891			
	1994.03-	2002.04	AT/MT	L	F	Convertible Engine LFZ (XU7JP)	245024	Drive Shaft	29T	25	24	55.7	79	603.5			
	1994.03-	2002.04	-	-	F	Convertible Engine LFZ (XU7JP)	845001	Outer Joint	29T	25	34	54.8	78.5	56	I		
	1994.03-	2002.04	AT/MT	L/R	F	Convertible Engine LFZ (XU7JP)	810002	Outer Joint		25	23	54.8	78.5	56	I		
	1994.03-	2002.04	-	-	F	Convertible Engine LFZ (XU7JP)	810027	Outer Joint	48T	25	34	55.7	79	55	I		
	1994.03-	2002.04	AT/MT	R	F	Convertible Engine LFZ (XU7JP)	245017	Drive Shaft	29T	25	24	55.7	79	881			
	1994.03-	2002.04	MT	R	F	Convertible Engine LFZ (XU7JP)	210126	Drive Shaft	29W	25	24	55.7	79	886			
	1994.03-	2002.04	-	L	F	Convertible Engine LFZ (XU7JP)	245073	Drive Shaft		25	24	54.8	78.5	601			
	1994.03-	2002.04	AT/MT	L/R	F	Convertible Engine LFZ (XU7JP)	810024	Outer Joint	48T	25	34	55.7	79	55	I		
	1994.03-	2002.04	-	-	F	Convertible Engine LFZ (XU7JP)	810022	Outer Joint	29W	25	34	55.7	79	55	I		
	1994.03-	2002.04	AT/MT	L/R	F	Convertible Engine LFZ (XU7JP)	810003	Outer Joint	29T	25	23	54.8	78.5	56	I		
1.8 16V (81 kW)	2000.07-	2002.04	AT/MT	L	F	Convertible Engine LFY (XU7JP4)	245167	Drive Shaft		25	24	56.7	79	608			
	2000.07-	2002.04	AT/MT	R	F	Convertible Engine LFY (XU7JP4)	845014	Outer Joint		25	22	56.7	80	59	O		
	2000.07-	2002.04	AT/MT	R	F	Convertible Engine LFY (XU7JP4)	245198	Drive Shaft		25	24	56.7	80	891			
	2000.07-	2002.04	AT/MT	L/R	F	Convertible Engine LFY (XU7JP4)	810003	Outer Joint	29T	25	23	54.8	78.5	56	I		
	2000.07-	2002.04	AT/MT	L	F	Convertible Engine LFY (XU7JP4)	245024	Drive Shaft	29T	25	24	55.7	79	603.5			
	2000.07-	2002.04	AT/MT	R	F	Convertible Engine LFY (XU7JP4)	245017	Drive Shaft	29T	25	24	55.7	79	881			
	2000.07-	2002.04	-	-	F	Convertible Engine LFY (XU7JP4)	810022	Outer Joint	29W	25	34	55.7	79	55	I		
2.0 (89 kW)	1994.03-	2002.04	-	L	F	Convertible Engine RFX (XU10J2)	245160	Drive Shaft		25	24	54.8	78.5	609			
	1994.03-	2002.04	-	R	F	Convertible Engine RFX (XU10J2)	245075	Drive Shaft	48T	25	24	55.7	79	884			
	1994.03-	2002.04	AT/MT	L	F	Convertible Engine RFX (XU10J2)	245008	Drive Shaft		25	24	54.8	78.5	601.5			
	1994.03-	2002.04	AT/MT	R	F	Convertible Engine RFX (XU10J2)	245070	Drive Shaft		25	24	54.8	78.5	880			
	1994.03-	2002.04	AT/MT	L/R	F	Convertible Engine RFX (XU10J2)	810002	Outer Joint		25	23	54.8	78.5	56	I		
	1994.03-	2002.04	AT/MT	L	F	Convertible Engine RFX (XU10J2)	245024	Drive Shaft	29T	25	24	55.7	79	603.5			
	1994.03-	2002.04	-	-	F	Convertible Engine RFX (XU10J2)	845001	Outer Joint	29T	25	34	54.8	78.5	56	I		
	1994.03-	2002.04	-	-	F	Convertible Engine RFX (XU10J2)	810027	Outer Joint	48T	25	34	55.7	79	55	I		
	1994.03-	2002.04	AT/MT	R	F	Convertible Engine RFX (XU10J2)	245017	Drive Shaft	29T	25	24	55.7	79	881			
	1994.03-	2002.04	AT/MT	L/R	F	Convertible Engine RFX (XU10J2)	810024	Outer Joint	48T	25	34	55.7	79	55	I		
	1994.03-	2002.04	MT	R	F	Convertible Engine RFX (XU10J2)	210126	Drive Shaft	29W	25	24	55.7	79	886			
	1994.03-	2002.04	-	L	F	Convertible Engine RFX (XU10J2)	245073	Drive Shaft		25	24	54.8	78.5	601			
	1994.03-	2002.04	MT/AT	L	F	Convertible Engine RFX (XU10J2)	610018	Inner Joint		24	29	40	62.5	99			
	1994.03-	2002.04	-	-	F	Convertible Engine RFX (XU10J2)	810022	Outer Joint	29W	25	34	55.7	79	55	I		
	1994.03-	2002.04	AT/MT	L/R	F	Convertible Engine RFX (XU10J2)	810003	Outer Joint	29T	25	23	54.8	78.5	56	I		
2.0 16V (97 kW)	1997.03-	2002.04	-	-	F	Convertible Engine RFV (XU10J4R)	845001	Outer Joint	29T	25	34	54.8	78.5	56	I		
	1997.03-	2002.04	-	-	F	Convertible Engine RFV (XU10J4R)	810022	Outer Joint	29W	25	34	55.7	79	55	I		
2.0 16V (99 kW)	1997.03-	2002.04	-	-	F	Convertible Engine RFV (XU10J4R)	810022	Outer Joint	29W	25	34	55.7	79	55	I		
306 (N_7_)																	
1.9 D (69 kW)	1994.02-	1999.04	-	-	F	Box Body/Estate Engine XUD9TE	810022	Outer Joint	29W	25	34	55.7	79	55	I		
	1994.02-	1999.04	-	R	F	Box Body/Estate Engine XUD9TE	245075	Drive Shaft	48T	25	24	55.7	79	884			
	1994.02-	1999.04	-	-	F	Box Body/Estate Engine XUD9TE	810027	Outer Joint	48T	25	34	55.7	79	55	I		
	1994.02-	1999.04	-	L	F	Box Body/Estate Engine XUD9TE	245073	Drive Shaft		25	24	54.8	78.5	601			
	1994.02-	1999.04	MT	R	F	Box Body/Estate Engine XUD9TE	210126	Drive Shaft	29W	25	24	55.7	79	886			





YEAR	TRANSM	L/R	F/R	REMARKS	GSP Ref.	PRODUCT	ABS	Technical Specifications										
								A	B	C	H	L	P					
PEUGEOT																		
306 (N_7_)																		
1.9 STD (51 kW)																		
1994.02-1999.05	-	R	F	Box Body/Estate Engine XUD9	245075	Drive Shaft	48T	25	24	55.7	79	884						
1994.02-1999.05	-	-	F	Box Body/Estate Engine XUD9	810027	Outer Joint	48T	25	34	55.7	79	55	I					
1994.02-1999.05	MT	R	F	Box Body/Estate Engine XUD9	210126	Drive Shaft	29W	25	24	55.7	79	886						
1994.02-1999.05	-	L	F	Box Body/Estate Engine XUD9	245073	Drive Shaft		25	24	54.8	78.5	601						
306 Break (7E N3 N5)																		
1.4 (55 kW)																		
1997.03-2002.04	MT	L	F	Estate Engine KFX (TU3JP)/KFW (TU3JP)	245157	Drive Shaft	29T	25	22	54.5	79.5	605						
1997.03-2002.04	MT	L	F	Estate Engine KFX (TU3JP)/KFW (TU3JP)	245004	Drive Shaft		21	22	56.4	76	614						
1997.03-2002.04	MT	R	F	Estate Engine KFX (TU3JP)/KFW (TU3JP)	245025	Drive Shaft		21	22	56.4	76	877.5						
1997.03-2002.04	MT	R	F	Estate Engine KFX (TU3JP)/KFW (TU3JP)	245158	Drive Shaft	29T	25	22	54.5	79.5	875						
1997.03-2002.04	-	R	F	Estate Engine KFX (TU3JP)/KFW (TU3JP)	299038	Drive Shaft	29T	25	22	60	80	879						
1997.03-2002.04	MT	L	F	Estate Engine KFX (TU3JP)/KFW (TU3JP)	299037	Drive Shaft	29T	25	22	60	80	608						
1997.03-2002.04	-	L	F	Estate Engine KFX (TU3JP)/KFW (TU3JP)	299135	Drive Shaft		25	22	60	80	608						
1997.03-2002.04	-	R	F	Estate Engine KFX (TU3JP)/KFW (TU3JP)	299136	Drive Shaft		25	22	60	80	879						
1997.03-2002.04	MT	L	F	Estate Engine KFX (TU3JP)/KFW (TU3JP)	245138	Drive Shaft		25	22	60	78.5	601						
1997.03-2002.04	MT	R	F	Estate Engine KFX (TU3JP)/KFW (TU3JP)	245137	Drive Shaft		25	22	60	78.5	880						
1997.03-2002.04	-	-	F	Estate Engine KFX (TU3JP)/KFW (TU3JP)	845036	Outer Joint	29T	25	22	60	80	54	I					
1997.03-2002.04	-	R	F	Estate Engine KFX (TU3JP)/KFW (TU3JP)	245156	Drive Shaft	48T	25	22	54.5	79.5	869.5						
1.6 (65 kW)																		
1997.03-2000.10	MT	R	F	Estate Engine NFZ (TU5JP)	299038	Drive Shaft	29T	25	22	60	80	879						
1997.03-2000.10	MT	L	F	Estate Engine NFZ (TU5JP)	245021	Drive Shaft		25	22	54.8	79	607						
1997.03-2000.10	MT	L	F	Estate Engine NFZ (TU5JP)	299135	Drive Shaft		25	22	60	80	608						
1997.03-2000.10	MT	R	F	Estate Engine NFZ (TU5JP)	245014	Drive Shaft		25	22	54.8	79	879.5						
1997.03-2000.10	MT	R	F	Estate Engine NFZ (TU5JP)	245158	Drive Shaft	29T	25	22	54.5	79.5	875						
1997.03-2000.10	MT	L	F	Estate Engine NFZ (TU5JP)	299037	Drive Shaft	29T	25	22	60	80	608						
1997.03-2000.10	MT	R	F	Estate Engine NFZ (TU5JP)	299136	Drive Shaft		25	22	60	80	879						
1997.03-2000.10	MT	L	F	Estate Engine NFZ (TU5JP)	245138	Drive Shaft		25	22	60	78.5	601						
1997.03-2000.10	MT	R	F	Estate Engine NFZ (TU5JP)	245137	Drive Shaft		25	22	60	78.5	880						
1997.03-2000.10	MT	-	F	Estate Engine NFZ (TU5JP)	845036	Outer Joint	29T	25	22	60	80	54	I					
1997.03-2000.10	-	R	F	Estate Engine NFZ (TU5JP)	245156	Drive Shaft	48T	25	22	54.5	79.5	869.5						
1997.03-2000.10	AT	-	F	Estate Engine NFZ (TU5JP)	810022	Outer Joint	29W	25	34	55.7	79	55	I					
1.6 (72 kW)																		
2000.10-2002.04	MT	R	F	Estate Engine NFT (TU5JP)	299038	Drive Shaft	29T	25	22	60	80	879						
2000.10-2002.04	MT	L	F	Estate Engine NFT (TU5JP)	299135	Drive Shaft		25	22	60	80	608						
2000.10-2002.04	MT	L	F	Estate Engine NFT (TU5JP)	299037	Drive Shaft	29T	25	22	60	80	608						
2000.10-2002.04	MT	R	F	Estate Engine NFT (TU5JP)	299136	Drive Shaft		25	22	60	80	879						
2000.10-2002.04	MT	-	F	Estate Engine NFT (TU5JP)	845036	Outer Joint	29T	25	22	60	80	54	I					
2000.10-2002.04	AT	-	F	Estate Engine NFT (TU5JP)	810022	Outer Joint	29W	25	34	55.7	79	55	I					
1.8 (74 kW)																		
1997.03-2002.04	AT/MT	L	F	Estate Engine LFZ (XU7JP)	245167	Drive Shaft		25	24	56.7	79	608						
1997.03-2002.04	AT/MT	R	F	Estate Engine LFZ (XU7JP)	845014	Outer Joint		25	22	56.7	80	59	O					
1997.03-2002.04	AT/MT	R	F	Estate Engine LFZ (XU7JP)	245198	Drive Shaft		25	24	56.7	80	891						
1997.03-2002.04	AT/MT	L/R	F	Estate Engine LFZ (XU7JP)	810002	Outer Joint		25	23	54.8	78.5	56	I					
1997.03-2002.04	AT/MT	L	F	Estate Engine LFZ (XU7JP)	245024	Drive Shaft	29T	25	24	55.7	79	603.5						
1997.03-2002.04	-	-	F	Estate Engine LFZ (XU7JP)	845001	Outer Joint	29T	25	34	54.8	78.5	56	I					
1997.03-2002.04	AT/MT	R	F	Estate Engine LFZ (XU7JP)	245017	Drive Shaft	29T	25	24	55.7	79	881						
1997.03-2002.04	AT/MT	L/R	F	Estate Engine LFZ (XU7JP)	810024	Outer Joint	48T	25	34	55.7	79	55	I					
1997.03-2002.04	-	-	F	Estate Engine LFZ (XU7JP)	810022	Outer Joint	29W	25	34	55.7	79	55	I					
1.8 16V (81 kW)																		
1997.03-2002.04	AT/MT	L	F	Estate Engine LFY (XU7JP4)	245167	Drive Shaft		25	24	56.7	79	608						
1997.03-2002.04	AT/MT	R	F	Estate Engine LFY (XU7JP4)	845014	Outer Joint		25	22	56.7	80	59	O					
1997.03-2002.04	AT/MT	R	F	Estate Engine LFY (XU7JP4)	245198	Drive Shaft		25	24	56.7	80	891						
1997.03-2002.04	AT/MT	L/R	F	Estate Engine LFY (XU7JP4)	810003	Outer Joint	29T	25	23	54.8	78.5	56	I					
1997.03-2002.04	AT/MT	L	F	Estate Engine LFY (XU7JP4)	245024	Drive Shaft	29T	25	24	55.7	79	603.5						
1997.03-2002.04	AT/MT	R	F	Estate Engine LFY (XU7JP4)	245017	Drive Shaft	29T	25	24	55.7	79	881						
1997.03-2002.04	-	-	F	Estate Engine LFY (XU7JP4)	810022	Outer Joint	29W	25	34	55.7	79	55	I					
1.9 D (50 kW)																		
1997.03-2002.04	AT/MT	L	F	Estate Engine DJY (XUD9A)	245167	Drive Shaft		25	24	56.7	79	608						
1997.03-2002.04	AT/MT	R	F	Estate Engine DJY (XUD9A)	845014	Outer Joint		25	22	56.7	80	59	O					
1997.03-2002.04	AT/MT	R	F	Estate Engine DJY (XUD9A)	245198	Drive Shaft		25	24	56.7	80	891						
1997.03-2002.04	AT/MT	L/R	F	Estate Engine DJY (XUD9A)	810002	Outer Joint		25	23	54.8	78.5	56	I					
1997.03-2002.04	AT/MT	L	F	Estate Engine DJY (XUD9A)	245024	Drive Shaft	29T	25	24	55.7	79	603.5						
1997.03-2002.04	-	-	F	Estate Engine DJY (XUD9A)	845001	Outer Joint	29T	25	34	54.8	78.5	56	I					
1997.03-2002.04	AT/MT	R	F	Estate Engine DJY (XUD9A)	245017	Drive Shaft	29T	25	24	55.7	79	881						
1997.03-2002.04	AT/MT	L/R	F	Estate Engine DJY (XUD9A)	810024	Outer Joint	48T	25	34	55.7	79	55	I					
1997.03-2002.04	-	-	F	Estate Engine DJY (XUD9A)	810022	Outer Joint	29W	25	34	55.7	79	55	I					
1.9 D (51 kW)																		
1997.05-1999.05	-	-	F	Estate Engine DJY (XUD9A)	810022	Outer Joint	29W	25	34	55.7	79	55	I					
1998.09-2002.04	-	-	F	Estate Engine WJZ (DW8)/WJY (DW8B)	810022	Outer Joint	29W	25	34	55.7	79	55	I					
1998.09-2002.04	AT/MT	L	F	Estate Engine WJZ (DW8)/WJY (DW8B)	245167	Drive Shaft		25	24	56.7	79	608						
1998.09-2002.04	AT/MT	R	F	Estate Engine WJZ (DW8)/WJY (DW8B)	845014	Outer Joint		25	22	56.7	80	59	O					
1998.09-2002.04	AT/MT	R	F	Estate Engine WJZ (DW8)/WJY (DW8B)	245198	Drive Shaft		25	24	56.7	80	891						
1998.09-2002.04	AT/MT	L/R	F	Estate Engine WJZ (DW8)/WJY (DW8B)	810002	Outer Joint		25	23	54.8	78.5	56	I					





		 YEAR	TRANSM	L/R	F/R	REMARKS	GSP Ref.	 PRODUCT	 ABS	Technical Specifications						
										A	B	C	H	L	P	
PEUGEOT																
306 Break (7E N3 N5)																
1.9 D (51 kW)	1998.09-2002.04	AT/MT	L	F	Estate Engine WJZ (DW8)/WJY (DW8B)	245024	Drive Shaft	29T	25	24	55.7	79	603.5			
	1998.09-2002.04	-	-	F	Estate Engine WJZ (DW8)/WJY (DW8B)	845001	Outer Joint	29T	25	34	54.8	78.5	56	I		
	1998.09-2002.04	AT/MT	R	F	Estate Engine WJZ (DW8)/WJY (DW8B)	245017	Drive Shaft	29T	25	24	55.7	79	881			
	1998.09-2002.04	AT/MT	L/R	F	Estate Engine WJZ (DW8)/WJY (DW8B)	810024	Outer Joint	48T	25	34	55.7	79	55	I		
1.9 D (55 kW)	1998.03-2002.04	-	-	F	Estate Engine DHV (XUD9BSD)	810022	Outer Joint	29W	25	34	55.7	79	55	I		
	1998.03-2002.04	AT/MT	L/R	F	Estate Engine DHV (XUD9BSD)	810002	Outer Joint		25	23	54.8	78.5	56	I		
	1998.03-2002.04	-	-	F	Estate Engine DHV (XUD9BSD)	845001	Outer Joint	29T	25	34	54.8	78.5	56	I		
	1998.03-2002.04	AT/MT	L/R	F	Estate Engine DHV (XUD9BSD)	810024	Outer Joint	48T	25	34	55.7	79	55	I		
1.9 TD (66 kW)	1997.02-2002.04	MT	L	F	Estate Engine DHY (XUD9TE)/D8A (XUD9TE)	245008	Drive Shaft		25	24	54.8	78.5	601.5			
	1997.02-2002.04	MT	L	F	Estate Engine DHY (XUD9TE)/D8A (XUD9TE)	610018	Inner Joint		24	29	40	62.5	99			
	1997.02-2002.04	MT	R	F	Estate Engine DHY (XUD9TE)/D8A (XUD9TE)	245070	Drive Shaft		25	24	54.8	78.5	880			
	1997.02-2002.04	MT	L	F	Estate Engine DHY (XUD9TE)/D8A (XUD9TE)	245024	Drive Shaft	29T	25	24	55.7	79	603.5			
	1997.02-2002.04	-	-	F	Estate Engine DHY (XUD9TE)/D8A (XUD9TE)	845001	Outer Joint	29T	25	34	54.8	78.5	56	I		
	1997.02-2002.04	MT	L/R	F	Estate Engine DHY (XUD9TE)/D8A (XUD9TE)	810002	Outer Joint		25	23	54.8	78.5	56	I		
	1997.02-2002.04	MT	R	F	Estate Engine DHY (XUD9TE)/D8A (XUD9TE)	245017	Drive Shaft	29T	25	24	55.7	79	881			
	1997.02-2002.04	MT	L/R	F	Estate Engine DHY (XUD9TE)/D8A (XUD9TE)	810024	Outer Joint	48T	25	34	55.7	79	55	I		
	1997.02-2002.04	-	-	F	Estate Engine DHY (XUD9TE)/D8A (XUD9TE)	810022	Outer Joint	29W	25	34	55.7	79	55	I		
2.0 (97 kW)	1997.03-2002.04	-	-	F	Estate Engine RFV (XU10J4R)	845001	Outer Joint	29T	25	34	54.8	78.5	56	I		
	1997.03-2002.04	-	-	F	Estate Engine RFV (XU10J4R)	810022	Outer Joint	29W	25	34	55.7	79	55	I		
2.0 HDI 90 (66 kW)	1999.06-2002.04	MT	L	F	Estate Engine RHY (DW10TD)	245008	Drive Shaft		25	24	54.8	78.5	601.5			
	1999.06-2002.04	MT	R	F	Estate Engine RHY (DW10TD)	245070	Drive Shaft		25	24	54.8	78.5	880			
	1999.06-2002.04	MT	L	F	Estate Engine RHY (DW10TD)	610018	Inner Joint		24	29	40	62.5	99			
	1999.06-2002.04	MT	L	F	Estate Engine RHY (DW10TD)	245024	Drive Shaft	29T	25	24	55.7	79	603.5			
	1999.06-2002.04	MT	R	F	Estate Engine RHY (DW10TD)	210126	Drive Shaft	29W	25	24	55.7	79	886			
	1999.06-2002.04	MT	R	F	Estate Engine RHY (DW10TD)	245017	Drive Shaft	29T	25	24	55.7	79	881			
306 I																
1.4	1993.04-1997.04	MT	R	F	-	245118	Drive Shaft	48T	21	22	56.5	76	869			
1.9 TD	1993.07-1997.04	MT	R	F	-	245048	Drive Shaft	29T	25	24	55.7	79	881.5			
2.0 16V	1994.01-1997.04	MT	R	F	-	245048	Drive Shaft	29T	25	24	55.7	79	881.5			
306 II																
1.4	1997.04-2002.05	MT	L	F	-	245117	Drive Shaft	29T	25	22	55	79.5	615			
	1997.04-2002.05	MT	R	-	-	245018	Drive Shaft	29T	25	22	60	80	878.5			
1.6	1997.04-2002.09	MT	L	F	-	610023	Inner Joint		22	22	40	58.5	86			
1.8	1997.04-2002.09	MT/AT	R	-	-	245048	Drive Shaft	29T	25	24	55.7	79	881.5			
1.9 D	1997.04-2002.05	MT	R	-	-	245048	Drive Shaft	29T	25	24	55.7	79	881.5			
1.9 TD	1997.04-1999.05	MT	L	F	-	245041	Drive Shaft	29T	25	24	58	78.5	600			
	1997.04-1999.05	MT	R	F	-	245040	Drive Shaft	29T	25	24	58	78.5	880			
2.0 16V	1997.04-2000.12	-	-	-	-	610001	Inner Joint		24	34	29.8	350	89.5			
	1997.04-2000.12	-	-	-	-	610020	Inner Joint		24	34	40	62.5	99			
	1997.04-2000.12	-	L	F	-	245041	Drive Shaft	29T	25	24	58	78.5	600			
	1997.04-2000.12	-	R	F	-	245040	Drive Shaft	29T	25	24	58	78.5	880			
2.0 HDi	1999.05-2002.05	MT	L	F	-	245041	Drive Shaft	29T	25	24	58	78.5	600			
	1999.05-2002.05	MT	R	F	-	245040	Drive Shaft	29T	25	24	58	78.5	880			
307 (3A/C)																
1.4 (55 kW)	2000.08-2000.08	MT	L/R	F	Hatchback Engine KFW (TU3JP)	810025	Outer Joint		25	22	60	80	54	I		
	2000.08-2000.08	MT	R	F	Hatchback Engine KFW (TU3JP)	299170	Drive Shaft		25	22	60	80	910			
	2000.08-2000.08	MT	L	F	Hatchback Engine KFW (TU3JP)	245119	Drive Shaft		25	22	58.5	79.5	633			
	2000.08-2000.08	MT	R	F	Hatchback Engine KFW (TU3JP)	245113	Drive Shaft		25	22	58.5	79.5	915			
1.4 16V (65 kW)	2003.11-2003.11	MT	L/R	F	Hatchback Engine KFU (ET3J4)	810025	Outer Joint		25	22	60	80	54	I		
	2003.11-2003.11	MT	R	F	Hatchback Engine KFU (ET3J4)	299170	Drive Shaft		25	22	60	80	910			
	2003.11-2003.11	MT	L	F	Hatchback Engine KFU (ET3J4)	245119	Drive Shaft		25	22	58.5	79.5	633			
	2003.11-2003.11	MT	R	F	Hatchback Engine KFU (ET3J4)	245113	Drive Shaft		25	22	58.5	79.5	915			
1.4 HDi (50 kW)	2001.10-2001.10	-	L	F	Hatchback Engine 8HZ (DV4TD)/8HX (DV4TD)	245105	Drive Shaft		25	24	58	79	625			
	2001.10-2001.10	MT	L	F	Hatchback Engine 8HZ (DV4TD)/8HX (DV4TD)	245126	Drive Shaft		25	24	58.5	89	630			
	2001.10-2001.10	MT	L	F	Hatchback Engine 8HZ (DV4TD)/8HX (DV4TD)	299019	Drive Shaft	29T	25	24	55.7	79	620			
	2001.10-2001.10	MT	R	F	Hatchback Engine 8HZ (DV4TD)/8HX (DV4TD)	245104	Drive Shaft		25	24	58	79	925			
	2001.10-2001.10	-	-	F	Hatchback Engine 8HZ (DV4TD)/8HX (DV4TD)	810028	Outer Joint		25	34	58	89	56	I		
	2001.10-2001.10	MT	R	F	Hatchback Engine 8HZ (DV4TD)/8HX (DV4TD)	210229	Drive Shaft		25	24	58.5	79	935			
1.6 (81 kW)	2006.07-2006.07	AT/MT	L	F	Hatchback Engine NFU (TU5JP4)	245105	Drive Shaft		25	24	58	79	625			
	2006.07-2006.07	AT/MT	L	F	Hatchback Engine NFU (TU5JP4)	245126	Drive Shaft		25	24	58.5	89	630			
	2006.07-2006.07	-	-	F	Hatchback Engine NFU (TU5JP4)	810097	Outer Joint		25	30	58.5	79.5	55	I		
	2006.07-2006.07	MT	R	F	Hatchback Engine NFU (TU5JP4)	299170	Drive Shaft		25	22	60	80	910			
	2006.07-2006.07	AT/Semi-AT	R	F	Hatchback Engine NFU (TU5JP4)	210291	Drive Shaft		25	26	58.5	79	833			
	2006.07-2006.07	MT	L	F	Hatchback Engine NFU (TU5JP4)	299019	Drive Shaft	29T	25	24	55.7	79	620			
	2006.07-2006.07	MT	L	F	Hatchback Engine NFU (TU5JP4)	245119	Drive Shaft		25	22	58.5	79.5	633			
	2006.07-2006.07	MT	R	F	Hatchback Engine NFU (TU5JP4)	245113	Drive Shaft		25	22	58.5	79.5	915			





	 YEAR	TRANSM	L/R	F/R	REMARKS	GSP Ref.	 PRODUCT	 ABS	Technical Specifications						
									A	B	C	H	L	P	
PEUGEOT															
307 (3A/C)															
1.6 (81 kW)	2006.07.-	-	MT	R	F	Hatchback Engine NFU (TU5JP4)	245104	Drive Shaft		25	24	58	79	925	
	2006.07.-	-	MT	R	F	Hatchback Engine NFU (TU5JP4)	210229	Drive Shaft		25	24	58.5	79	935	
1.6 (85 kW)	2005.08.-2009.12	-	-	-	F	Hatchback Engine NFP (EC5)	810097	Outer Joint		25	30	58.5	79.5	55	I
	2005.08.-2009.12	MT	R	F	Hatchback Engine NFP (EC5)	299170	Drive Shaft		25	22	60	80	910		
	2005.08.-2009.12	MT	R	F	Hatchback Engine NFP (EC5)	210229	Drive Shaft		25	24	58.5	79	935		
	2005.08.-2009.12	AT/Semi-AT	R	F	Hatchback Engine NFP (EC5)	210291	Drive Shaft		25	26	58.5	79	833		
	2005.08.-2009.12	MT	L	F	Hatchback Engine NFP (EC5)	299019	Drive Shaft	29T	25	24	55.7	79	620		
1.6 16V (80 kW)	2000.08.-	-	MT	L	F	Hatchback Engine NFU (TU5JP4)	245105	Drive Shaft		25	24	58	79	625	
	2000.08.-	-	MT	L	F	Hatchback Engine NFU (TU5JP4)	245126	Drive Shaft		25	24	58.5	89	630	
	2000.08.-	-	-	-	F	Hatchback Engine NFU (TU5JP4)	810097	Outer Joint		25	30	58.5	79.5	55	I
	2000.08.-	-	MT	L/R	F	Hatchback Engine NFU (TU5JP4)	810025	Outer Joint		25	22	60	80	54	I
	2000.08.-	-	MT	R	F	Hatchback Engine NFU (TU5JP4)	299170	Drive Shaft		25	22	60	80	910	
	2000.08.-	-	AT	-	-	Hatchback Engine NFU (TU5JP4)	899366	Outer Joint		25	34	58.5	79	55	I
	2000.08.-	-	-	L	F	Hatchback Engine NFU (TU5JP4)	699001	Inner Joint		26	34	42.5	46.5	103.5	
	2000.08.-	-	AT/Semi-AT	R	F	Hatchback Engine NFU (TU5JP4)	210291	Drive Shaft		25	26	58.5	79	833	
	2000.08.-	-	MT	L	F	Hatchback Engine NFU (TU5JP4)	299019	Drive Shaft	29T	25	24	55.7	79	620	
	2000.08.-	-	MT	L	F	Hatchback Engine NFU (TU5JP4)	245119	Drive Shaft		25	22	58.5	79.5	633	
	2000.08.-	-	MT	R	F	Hatchback Engine NFU (TU5JP4)	245113	Drive Shaft		25	22	58.5	79.5	915	
	2000.08.-	-	-	-	F	Hatchback Engine NFU (TU5JP4)	810028	Outer Joint		25	34	58	89	56	I
	2000.08.-	-	MT	R	F	Hatchback Engine NFU (TU5JP4)	245104	Drive Shaft		25	24	58	79	925	
	2000.08.-	-	-	L	F	Hatchback Engine NFU (TU5JP4)	210286	Drive Shaft		25	26	58.5	79	613	
	2000.08.-	-	MT	R	F	Hatchback Engine NFU (TU5JP4)	210229	Drive Shaft		25	24	58.5	79	935	
1.6 HDi (66 kW)	2005.04.-	-	-	L	F	Hatchback Engine 9HV (DV6ATED4)9HX (DV6ATED4)9HV (DV6TED4)	245105	Drive Shaft		25	24	58	79	625	
	2005.04.-	-	MT	R	F	Hatchback Engine 9HV (DV6ATED4)9HX (DV6ATED4)9HV (DV6TED4)	210229	Drive Shaft		25	24	58.5	79	935	
	2005.04.-	-	-	L	F	Hatchback Engine 9HV (DV6ATED4)9HX (DV6ATED4)9HV (DV6TED4)	245126	Drive Shaft		25	24	58.5	89	630	
	2005.04.-	-	-	R	F	Hatchback Engine 9HV (DV6ATED4)9HX (DV6ATED4)9HV (DV6TED4)	245104	Drive Shaft		25	24	58	79	925	
	2005.04.-	-	MT	L	F	Hatchback Engine 9HV (DV6ATED4)9HX (DV6ATED4)9HV (DV6TED4)	299019	Drive Shaft	29T	25	24	55.7	79	620	
2005.04.-	-	-	-	F	Hatchback Engine 9HV (DV6ATED4)9HX (DV6ATED4)9HV (DV6TED4)	810028	Outer Joint		25	34	58	89	56	I	
1.6 HDi 110 (80 kW)	2004.02.-	-	MT	R	F	Hatchback Engine 9HZ (DV6TED4)9HY (DV6TED4)	210229	Drive Shaft		25	24	58.5	79	935	
	2004.02.-	-	-	R	F	Hatchback Engine 9HZ (DV6TED4)9HY (DV6TED4)	210173	Drive Shaft	29W	25	24	58.5	79	921	
	2004.02.-	-	MT	L	F	Hatchback Engine 9HZ (DV6TED4)9HY (DV6TED4)	245105	Drive Shaft		25	24	58	79	625	
	2004.02.-	-	-	L	F	Hatchback Engine 9HZ (DV6TED4)9HY (DV6TED4)	245126	Drive Shaft		25	24	58.5	89	630	
	2004.02.-	-	MT	L	F	Hatchback Engine 9HZ (DV6TED4)9HY (DV6TED4)	299019	Drive Shaft	29T	25	24	55.7	79	620	
	2004.02.-	-	MT	R	F	Hatchback Engine 9HZ (DV6TED4)9HY (DV6TED4)	245104	Drive Shaft		25	24	58	79	925	
	2004.02.-	-	-	-	F	Hatchback Engine 9HZ (DV6TED4)9HY (DV6TED4)	810028	Outer Joint		25	34	58	89	56	I
2.0 16V (100 kW)	2000.08.-	-	MT	L	F	Hatchback Engine RFN (EW10J4)	245105	Drive Shaft		25	24	58	79	625	
	2000.08.-	-	MT	L	F	Hatchback Engine RFN (EW10J4)	245126	Drive Shaft		25	24	58.5	89	630	
	2000.08.-	-	AT	R	F	Hatchback Engine RFN (EW10J4)	210291	Drive Shaft		25	26	58.5	79	833	
	2000.08.-	-	-	L	F	Hatchback Engine RFN (EW10J4)	699001	Inner Joint		26	34	42.5	46.5	103.5	
	2000.08.-	-	MT	L	F	Hatchback Engine RFN (EW10J4)	299019	Drive Shaft	29T	25	24	55.7	79	620	
	2000.08.-	-	MT	R	F	Hatchback Engine RFN (EW10J4)	245104	Drive Shaft		25	24	58	79	925	
	2000.08.-	-	-	-	F	Hatchback Engine RFN (EW10J4)	810028	Outer Joint		25	34	58	89	56	I
	2000.08.-	-	-	L	F	Hatchback Engine RFN (EW10J4)	210286	Drive Shaft		25	26	58.5	79	613	
	2000.08.-	-	MT	R	F	Hatchback Engine RFN (EW10J4)	210229	Drive Shaft		25	24	58.5	79	935	
2.0 16V (103 kW)	2005.03.-	-	MT	R	F	Hatchback Engine RFJ (EW10A)/RFN (EW10J4)	210229	Drive Shaft		25	24	58.5	79	935	
	2005.03.-	-	-	L	F	Hatchback Engine RFJ (EW10A)/RFN (EW10J4)	245105	Drive Shaft		25	24	58	79	625	
	2005.03.-	-	MT	L	F	Hatchback Engine RFJ (EW10A)/RFN (EW10J4)	245126	Drive Shaft		25	24	58.5	89	630	
	2005.03.-	-	AT	R	F	Hatchback Engine RFJ (EW10A)/RFN (EW10J4)	210291	Drive Shaft		25	26	58.5	79	833	
	2005.03.-	-	-	L	F	Hatchback Engine RFJ (EW10A)/RFN (EW10J4)	699001	Inner Joint		26	34	42.5	46.5	103.5	
	2005.03.-	-	MT	L	F	Hatchback Engine RFJ (EW10A)/RFN (EW10J4)	299019	Drive Shaft	29T	25	24	55.7	79	620	
	2005.03.-	-	-	R	F	Hatchback Engine RFJ (EW10A)/RFN (EW10J4)	245104	Drive Shaft		25	24	58	79	925	
	2005.03.-	-	-	-	F	Hatchback Engine RFJ (EW10A)/RFN (EW10J4)	810028	Outer Joint		25	34	58	89	56	I
2005.03.-	-	-	L	F	Hatchback Engine RFJ (EW10A)/RFN (EW10J4)	210286	Drive Shaft		25	26	58.5	79	613		
2.0 16V (130 kW)	2005.06.-	-	MT	R	F	Hatchback Engine RFK (EW10J4S)	210229	Drive Shaft		25	24	58.5	79	935	
	2005.06.-	-	-	L	F	Hatchback Engine RFK (EW10J4S)	245105	Drive Shaft		25	24	58	79	625	
	2005.06.-	-	MT	L	F	Hatchback Engine RFK (EW10J4S)	245126	Drive Shaft		25	24	58.5	89	630	
	2005.06.-	-	-	L	F	Hatchback Engine RFK (EW10J4S)	699001	Inner Joint		26	34	42.5	46.5	103.5	
	2005.06.-	-	MT	L	F	Hatchback Engine RFK (EW10J4S)	299019	Drive Shaft	29T	25	24	55.7	79	620	
	2005.06.-	-	-	R	F	Hatchback Engine RFK (EW10J4S)	245104	Drive Shaft		25	24	58	79	925	
	2005.06.-	-	-	-	F	Hatchback Engine RFK (EW10J4S)	810028	Outer Joint		25	34	58	89	56	I
	2005.06.-	-	-	L	F	Hatchback Engine RFK (EW10J4S)	210286	Drive Shaft		25	26	58.5	79	613	
2.0 HDi 110 (79 kW)	2000.08.-	-	MT	L	F	Hatchback Engine RHS (DW10ATED)	245105	Drive Shaft		25	24	58	79	625	
	2000.08.-	-	-	R	F	Hatchback Engine RHS (DW10ATED)	210173	Drive Shaft	29W	25	24	58.5	79	921	
	2000.08.-	-	MT	L	F	Hatchback Engine RHS (DW10ATED)	245126	Drive Shaft		25	24	58.5	89	630	
	2000.08.-	-	MT	L	F	Hatchback Engine RHS (DW10ATED)	299019	Drive Shaft	29T	25	24	55.7	79	620	
	2000.08.-	-	MT	R	F	Hatchback Engine RHS (DW10ATED)	245104	Drive Shaft		25	24	58	79	925	





	 YEAR	TRANSM	L/R	F/R	REMARKS	GSP Ref.	 PRODUCT	 ABS	Technical Specifications						
									A	B	C	H	L	P	
PEUGEOT															
307 (3A/C)															
2.0 HDi 110 (79 kW)	2000.08-	-	-	F	Hatchback Engine RHS (DW10ATED)	810028	Outer Joint		25	34	58	89	56	I	
	2000.08-		MT	R	F	Hatchback Engine RHS (DW10ATED)	210229	Drive Shaft		25	24	58.5	79	935	
2.0 HDi 135 (100 kW)	2003.10-	-	-	R	F	Hatchback Engine RHR (DW10BTED4)	210173	Drive Shaft	29W	25	24	58.5	79	921	
	2003.10-	-	MT	L	F	Hatchback Engine RHR (DW10BTED4)	245105	Drive Shaft		25	24	58	79	625	
	2003.10-	-	6MT	L	F	Hatchback Engine RHR (DW10BTED4)	210268	Drive Shaft		25	37	58.5	89	621	
	2003.10-	-	6MT	R	F	Hatchback Engine RHR (DW10BTED4)	208082	Drive Shaft		25	37	58.5	89	949	
	2003.10-	-	-	-	F	Hatchback Engine RHR (DW10BTED4)	810085	Outer Joint		25	39	59	89	63.5	I
	2003.10-	-	MT	R	F	Hatchback Engine RHR (DW10BTED4)	245104	Drive Shaft		25	24	58	79	925	
	2003.10-	-	6MT	R	F	Hatchback Engine RHR (DW10BTED4)	610041	Inner Joint		37	39	32	399	95.5	
2.0 HDi 90 (66 kW)	2000.08-	-	MT	L	F	Hatchback Engine RHY (DW10TD)	245105	Drive Shaft		25	24	58	79	625	
	2000.08-	-	-	R	F	Hatchback Engine RHY (DW10TD)	210173	Drive Shaft	29W	25	24	58.5	79	921	
	2000.08-	-	-	L	F	Hatchback Engine RHY (DW10TD)	245126	Drive Shaft		25	24	58.5	89	630	
	2000.08-	-	MT	L	F	Hatchback Engine RHY (DW10TD)	299019	Drive Shaft	29T	25	24	55.7	79	620	
	2000.08-	-	MT	R	F	Hatchback Engine RHY (DW10TD)	245104	Drive Shaft		25	24	58	79	925	
	2000.08-	-	-	-	F	Hatchback Engine RHY (DW10TD)	810028	Outer Joint		25	34	58	89	56	I
	2000.08-	-	MT	R	F	Hatchback Engine RHY (DW10TD)	210229	Drive Shaft		25	24	58.5	79	935	
307 Break (3E)															
1.4 (55 kW)	2002.04-	2003.09	-	R	F	Estate Engine KFW (TU3JP)	299170	Drive Shaft		25	22	60	80	910	
	2002.04-	2003.09	-	L	F	Estate Engine KFW (TU3JP)	245119	Drive Shaft		25	22	58.5	79.5	633	
	2002.04-	2003.09	-	R	F	Estate Engine KFW (TU3JP)	245113	Drive Shaft		25	22	58.5	79.5	915	
1.4 16V (65 kW)	2003.11-	-	MT	R	F	Estate Engine KFU (ET3J4)	299170	Drive Shaft		25	22	60	80	910	
	2003.11-	-	MT	L/R	F	Estate Engine KFU (ET3J4)	810025	Outer Joint		25	22	60	80	54	I
	2003.11-	-	MT	L	F	Estate Engine KFU (ET3J4)	245119	Drive Shaft		25	22	58.5	79.5	633	
	2003.11-	-	MT	R	F	Estate Engine KFU (ET3J4)	245113	Drive Shaft		25	22	58.5	79.5	915	
1.4 HDi (50 kW)	2002.03-	-	MT	R	F	Estate Engine 8HZ (DV4TD)	210229	Drive Shaft		25	24	58.5	79	935	
	2002.03-	-	MT	L	F	Estate Engine 8HZ (DV4TD)	245126	Drive Shaft		25	24	58.5	89	630	
	2002.03-	-	-	L	F	Estate Engine 8HZ (DV4TD)	245105	Drive Shaft		25	24	58	79	625	
	2002.03-	-	MT	L	F	Estate Engine 8HZ (DV4TD)	299019	Drive Shaft	29T	25	24	55.7	79	620	
	2002.03-	-	MT	R	F	Estate Engine 8HZ (DV4TD)	245104	Drive Shaft		25	24	58	79	925	
	2002.03-	-	-	-	F	Estate Engine 8HZ (DV4TD)	810028	Outer Joint		25	34	58	89	56	I
	2002.03-	-	MT	R	F	Estate Engine NFU (TU5JP4)	210229	Drive Shaft		25	24	58.5	79	935	
1.6 16V (80 kW)	2002.03-	-	MT	L	F	Estate Engine NFU (TU5JP4)	245105	Drive Shaft		25	24	58	79	625	
	2002.03-	-	MT	L	F	Estate Engine NFU (TU5JP4)	245126	Drive Shaft		25	24	58.5	89	630	
	2002.03-	-	-	-	F	Estate Engine NFU (TU5JP4)	810097	Outer Joint		25	30	58.5	79.5	55	I
	2002.03-	-	MT	L/R	F	Estate Engine NFU (TU5JP4)	810025	Outer Joint		25	22	60	80	54	I
	2002.03-	-	MT	R	F	Estate Engine NFU (TU5JP4)	299170	Drive Shaft		25	22	60	80	910	
	2002.03-	-	AT	-	-	Estate Engine NFU (TU5JP4)	899366	Outer Joint		25	34	58.5	79	55	I
	2002.03-	-	-	L	F	Estate Engine NFU (TU5JP4)	699001	Inner Joint		26	34	42.5	46.5	103.5	
	2002.03-	-	AT/Semi-AT	R	F	Estate Engine NFU (TU5JP4)	210291	Drive Shaft		25	26	58.5	79	833	
	2002.03-	-	MT	L	F	Estate Engine NFU (TU5JP4)	299019	Drive Shaft	29T	25	24	55.7	79	620	
	2002.03-	-	MT	L	F	Estate Engine NFU (TU5JP4)	245119	Drive Shaft		25	22	58.5	79.5	633	
	2002.03-	-	MT	R	F	Estate Engine NFU (TU5JP4)	245113	Drive Shaft		25	22	58.5	79.5	915	
	2002.03-	-	MT	R	F	Estate Engine NFU (TU5JP4)	245104	Drive Shaft		25	24	58	79	925	
	2002.03-	-	-	-	F	Estate Engine NFU (TU5JP4)	810028	Outer Joint		25	34	58	89	56	I
	2002.03-	-	-	L	F	Estate Engine NFU (TU5JP4)	210286	Drive Shaft		25	26	58.5	79	613	
	1.6 HDi (66 kW)	2005.04-	-	MT	R	F	Estate Engine 9HV (DV6ATED4)	210229	Drive Shaft		25	24	58.5	79	935
2005.04-		-	-	L	F	Estate Engine 9HV (DV6ATED4)	245105	Drive Shaft		25	24	58	79	625	
2005.04-		-	-	L	F	Estate Engine 9HV (DV6ATED4)	245126	Drive Shaft		25	24	58.5	89	630	
2005.04-		-	MT	L	F	Estate Engine 9HV (DV6ATED4)	299019	Drive Shaft	29T	25	24	55.7	79	620	
2005.04-		-	-	-	F	Estate Engine 9HV (DV6ATED4)	810028	Outer Joint		25	34	58	89	56	I
2005.04-	-	-	R	F	Estate Engine 9HV (DV6ATED4)	245104	Drive Shaft		25	24	58	79	925		
1.6 HDi 110 (80 kW)	2004.02-	-	MT	R	F	Estate Engine 9HZ (DV6TED4)/9HY (DV6TED4)	210229	Drive Shaft		25	24	58.5	79	935	
	2004.02-	-	-	R	F	Estate Engine 9HZ (DV6TED4)/9HY (DV6TED4)	210173	Drive Shaft	29W	25	24	58.5	79	921	
	2004.02-	-	MT	L	F	Estate Engine 9HZ (DV6TED4)/9HY (DV6TED4)	245105	Drive Shaft		25	24	58	79	625	
	2004.02-	-	MT	L	F	Estate Engine 9HZ (DV6TED4)/9HY (DV6TED4)	245126	Drive Shaft		25	24	58.5	89	630	
	2004.02-	-	MT	L	F	Estate Engine 9HZ (DV6TED4)/9HY (DV6TED4)	299019	Drive Shaft	29T	25	24	55.7	79	620	
	2004.02-	-	MT	R	F	Estate Engine 9HZ (DV6TED4)/9HY (DV6TED4)	245104	Drive Shaft		25	24	58	79	925	
2.0 (100 kW)	2002.03-	-	MT	R	F	Estate Engine RFN (EW10J4)	210229	Drive Shaft		25	24	58.5	79	935	
	2002.03-	-	MT	L	F	Estate Engine RFN (EW10J4)	245126	Drive Shaft		25	24	58.5	89	630	
	2002.03-	-	MT	L	F	Estate Engine RFN (EW10J4)	245105	Drive Shaft		25	24	58	79	625	
	2002.03-	-	AT	R	F	Estate Engine RFN (EW10J4)	210291	Drive Shaft		25	26	58.5	79	833	
	2002.03-	-	-	L	F	Estate Engine RFN (EW10J4)	699001	Inner Joint		26	34	42.5	46.5	103.5	
	2002.03-	-	MT	L	F	Estate Engine RFN (EW10J4)	299019	Drive Shaft	29T	25	24	55.7	79	620	
	2002.03-	-	-	-	F	Estate Engine RFN (EW10J4)	810028	Outer Joint		25	34	58	89	56	I
	2002.03-	-	MT	R	F	Estate Engine RFN (EW10J4)	245104	Drive Shaft		25	24	58	79	925	





	 YEAR	TRANSM	L/R	F/R	REMARKS	GSP Ref.	 PRODUCT	 ABS	Technical Specifications						
									A	B	C	H	L	P	
PEUGEOT															
307 Break (3E)															
2.0 (100 kW)	2002.03-	-	L	F	Estate Engine RFN (EW10J4)	210286	Drive Shaft		25	26	58.5	79	613		
2.0 16V (103 kW)	2005.03-	MT	R	F	Estate Engine RFJ (EW10A)	210229	Drive Shaft		25	24	58.5	79	935		
	2005.03-	-	L	F	Estate Engine RFJ (EW10A)	245105	Drive Shaft		25	24	58	79	625		
	2005.03-	MT	L	F	Estate Engine RFJ (EW10A)	245126	Drive Shaft		25	24	58.5	89	630		
	2005.03-	AT	R	F	Estate Engine RFJ (EW10A)	210291	Drive Shaft		25	26	58.5	79	833		
	2005.03-	-	L	F	Estate Engine RFJ (EW10A)	699001	Inner Joint		26	34	42.5	46.5	103.5		
	2005.03-	MT	L	F	Estate Engine RFJ (EW10A)	299019	Drive Shaft	29T	25	24	55.7	79	620		
	2005.03-	-	-	F	Estate Engine RFJ (EW10A)	810028	Outer Joint		25	34	58	89	56	I	
	2005.03-	-	R	F	Estate Engine RFJ (EW10A)	245104	Drive Shaft		25	24	58	79	925		
2.0 16V (130 kW)	2005.03-	-	L	F	Estate Engine RFJ (EW10A)	210286	Drive Shaft		25	26	58.5	79	613		
	2005.06-	MT	R	F	Estate Engine RFK (EW10J4S)	210229	Drive Shaft		25	24	58.5	79	935		
	2005.06-	MT	L	F	Estate Engine RFK (EW10J4S)	245105	Drive Shaft		25	24	58	79	625		
	2005.06-	MT	L	F	Estate Engine RFK (EW10J4S)	245126	Drive Shaft		25	24	58.5	89	630		
	2005.06-	-	L	F	Estate Engine RFK (EW10J4S)	699001	Inner Joint		26	34	42.5	46.5	103.5		
	2005.06-	MT	L	F	Estate Engine RFK (EW10J4S)	299019	Drive Shaft	29T	25	24	55.7	79	620		
	2005.06-	-	-	F	Estate Engine RFK (EW10J4S)	810028	Outer Joint		25	34	58	89	56	I	
	2005.06-	MT	R	F	Estate Engine RFK (EW10J4S)	245104	Drive Shaft		25	24	58	79	925		
2.0 HDI 110 (79 kW)	2005.06-	-	L	F	Estate Engine RFK (EW10J4S)	210286	Drive Shaft		25	26	58.5	79	613		
	2002.03-	MT	R	F	Estate Engine RHS (DW10ATED)	210229	Drive Shaft		25	24	58.5	79	935		
	2002.03-	MT	L	F	Estate Engine RHS (DW10ATED)	245105	Drive Shaft		25	24	58	79	625		
	2002.03-	-	L	F	Estate Engine RHS (DW10ATED)	245126	Drive Shaft		25	24	58.5	89	630		
	2002.03-	MT	L	F	Estate Engine RHS (DW10ATED)	299019	Drive Shaft	29T	25	24	55.7	79	620		
	2002.03-	MT	R	F	Estate Engine RHS (DW10ATED)	245104	Drive Shaft		25	24	58	79	925		
	2002.03-	-	-	F	Estate Engine RHS (DW10ATED)	810028	Outer Joint		25	34	58	89	56	I	
	2002.03-	-	R	F	Estate Engine RHS (DW10ATED)	210173	Drive Shaft	29W	25	24	58.5	79	921		
2.0 HDi 135 (100 kW)	2004.02-	-	R	F	Estate Engine RHR (DW10BTED4)	210173	Drive Shaft	29W	25	24	58.5	79	921		
	2004.02-	MT	L	F	Estate Engine RHR (DW10BTED4)	245105	Drive Shaft		25	24	58	79	625		
	2004.02-	6MT	L	F	Estate Engine RHR (DW10BTED4)	210268	Drive Shaft		25	37	58.5	89	621		
	2004.02-	6MT	R	F	Estate Engine RHR (DW10BTED4)	208082	Drive Shaft		25	37	58.5	89	949		
	2004.02-	-	-	F	Estate Engine RHR (DW10BTED4)	810085	Outer Joint		25	39	59	89	63.5	I	
	2004.02-	MT	R	F	Estate Engine RHR (DW10BTED4)	245104	Drive Shaft		25	24	58	79	925		
	2004.02-	6MT	R	F	Estate Engine RHR (DW10BTED4)	610041	Inner Joint		37	39	32	399	95.5		
	2004.02-	-	L	F	Estate Engine RHR (DW10BTED4)	210286	Drive Shaft		25	26	58.5	79	613		
2.0 HDI 90 (66 kW)	2002.03-	MT	R	F	Estate Engine RHY (DW10TD)	210229	Drive Shaft		25	24	58.5	79	935		
	2002.03-	-	R	F	Estate Engine RHY (DW10TD)	210173	Drive Shaft	29W	25	24	58.5	79	921		
	2002.03-	MT	L	F	Estate Engine RHY (DW10TD)	245105	Drive Shaft		25	24	58	79	625		
	2002.03-	-	L	F	Estate Engine RHY (DW10TD)	245126	Drive Shaft		25	24	58.5	89	630		
	2002.03-	MT	L	F	Estate Engine RHY (DW10TD)	299019	Drive Shaft	29T	25	24	55.7	79	620		
	2002.03-	MT	R	F	Estate Engine RHY (DW10TD)	245104	Drive Shaft		25	24	58	79	925		
	2002.03-	-	-	F	Estate Engine RHY (DW10TD)	810028	Outer Joint		25	34	58	89	56	I	
	2002.03-	-	R	F	Estate Engine RHY (DW10TD)	210173	Drive Shaft	29W	25	24	58.5	79	921		
307 CC (3B)															
1.6 16V (80 kW)	2005.02-	MT	R	F	Convertible Engine NFU (TU5JP4)	210229	Drive Shaft		25	24	58.5	79	935		
	2005.02-	-	L	F	Convertible Engine NFU (TU5JP4)	245105	Drive Shaft		25	24	58	79	625		
	2005.02-	-	L	F	Convertible Engine NFU (TU5JP4)	245126	Drive Shaft		25	24	58.5	89	630		
	2005.02-	-	-	F	Convertible Engine NFU (TU5JP4)	810097	Outer Joint		25	30	58.5	79.5	55	I	
	2005.02-	MT	L/R	F	Convertible Engine NFU (TU5JP4)	810025	Outer Joint		25	22	60	80	54	I	
	2005.02-	MT	R	F	Convertible Engine NFU (TU5JP4)	299170	Drive Shaft		25	22	60	80	910		
	2005.02-	AT	-	-	Convertible Engine NFU (TU5JP4)	899366	Outer Joint		25	34	58.5	79	55	I	
	2005.02-	-	L	F	Convertible Engine NFU (TU5JP4)	699001	Inner Joint		26	34	42.5	46.5	103.5		
	2005.02-	AT/Semi-AT	R	F	Convertible Engine NFU (TU5JP4)	210291	Drive Shaft		25	26	58.5	79	833		
	2005.02-	-	L	F	Convertible Engine NFU (TU5JP4)	245119	Drive Shaft		25	22	58.5	79.5	633		
	2005.02-	MT	L	F	Convertible Engine NFU (TU5JP4)	299019	Drive Shaft	29T	25	24	55.7	79	620		
	2005.02-	-	R	F	Convertible Engine NFU (TU5JP4)	245113	Drive Shaft		25	22	58.5	79.5	915		
	2005.02-	-	R	F	Convertible Engine NFU (TU5JP4)	245104	Drive Shaft		25	24	58	79	925		
	2005.02-	-	-	F	Convertible Engine NFU (TU5JP4)	810028	Outer Joint		25	34	58	89	56	I	
	2005.02-	-	L	F	Convertible Engine NFU (TU5JP4)	210286	Drive Shaft		25	26	58.5	79	613		
	2.0 16V (100 kW)	2003.10-	MT	R	F	Convertible Engine RFN (EW10J4)	210229	Drive Shaft		25	24	58.5	79	935	
		2003.10-	MT	L	F	Convertible Engine RFN (EW10J4)	245105	Drive Shaft		25	24	58	79	625	
		2003.10-	MT	L	F	Convertible Engine RFN (EW10J4)	245126	Drive Shaft		25	24	58.5	89	630	
2003.10-		AT	R	F	Convertible Engine RFN (EW10J4)	210291	Drive Shaft		25	26	58.5	79	833		
2003.10-		-	L	F	Convertible Engine RFN (EW10J4)	699001	Inner Joint		26	34	42.5	46.5	103.5		
2003.10-		MT	L	F	Convertible Engine RFN (EW10J4)	299019	Drive Shaft	29T	25	24	55.7	79	620		
2003.10-		MT	R	F	Convertible Engine RFN (EW10J4)	245104	Drive Shaft		25	24	58	79	925		
2003.10-		-	-	F	Convertible Engine RFN (EW10J4)	810028	Outer Joint		25	34	58	89	56	I	
2003.10-		-	L	F	Convertible Engine RFN (EW10J4)	210286	Drive Shaft		25	26	58.5	79	613		
2.0 16V (103 kW)	2005.03-	MT	R	F	Convertible Engine RFJ (EW10A)	210229	Drive Shaft		25	24	58.5	79	935		
	2005.03-	-	L	F	Convertible Engine RFJ (EW10A)	245105	Drive Shaft		25	24	58	79	625		
	2005.03-	MT	L	F	Convertible Engine RFJ (EW10A)	245126	Drive Shaft		25	24	58.5	89	630		





	 YEAR	TRANSM	L/R	F/R	REMARKS	GSP Ref.	 PRODUCT	 ABS	Technical Specifications						
									A	B	C	H	L	P	
PEUGEOT															
307 CC (3B)															
2.0 16V (103 kW)	2005.03.-	-	AT	R	F	Convertible Engine RFJ (EW10A)	210291	Drive Shaft		25	26	58.5	79	833	
	2005.03.-	-	-	L	F	Convertible Engine RFJ (EW10A)	699001	Inner Joint		26	34	42.5	46.5	103.5	
	2005.03.-	-	MT	L	F	Convertible Engine RFJ (EW10A)	299019	Drive Shaft	29T	25	24	55.7	79	620	
	2005.03.-	-	-	R	F	Convertible Engine RFJ (EW10A)	245104	Drive Shaft		25	24	58	79	925	
	2005.03.-	-	-	-	F	Convertible Engine RFJ (EW10A)	810028	Outer Joint		25	34	58	89	56	I
	2005.03.-	-	-	L	F	Convertible Engine RFJ (EW10A)	210286	Drive Shaft		25	26	58.5	79	613	
2.0 16V (130 kW)	2003.10.-	-	MT	R	F	Convertible Engine RFK (EW10J4S)	210229	Drive Shaft		25	24	58.5	79	935	
	2003.10.-	-	MT	L	F	Convertible Engine RFK (EW10J4S)	245105	Drive Shaft		25	24	58	79	625	
	2003.10.-	-	MT	L	F	Convertible Engine RFK (EW10J4S)	245126	Drive Shaft		25	24	58.5	89	630	
	2003.10.-	-	-	L	F	Convertible Engine RFK (EW10J4S)	699001	Inner Joint		26	34	42.5	46.5	103.5	
	2003.10.-	-	MT	L	F	Convertible Engine RFK (EW10J4S)	299019	Drive Shaft	29T	25	24	55.7	79	620	
	2003.10.-	-	MT	R	F	Convertible Engine RFK (EW10J4S)	245104	Drive Shaft		25	24	58	79	925	
	2003.10.-	-	-	-	F	Convertible Engine RFK (EW10J4S)	810028	Outer Joint		25	34	58	89	56	I
	2003.10.-	-	-	L	F	Convertible Engine RFK (EW10J4S)	210286	Drive Shaft		25	26	58.5	79	613	
2.0 HDi 135 (100 kW)	2005.06.-	-	MT	L	F	Convertible Engine RHR (DW10BTED4)	210268	Drive Shaft		25	37	58.5	89	621	
	2005.06.-	-	MT	R	F	Convertible Engine RHR (DW10BTED4)	208082	Drive Shaft		25	37	58.5	89	949	
	2005.06.-	-	-	-	F	Convertible Engine RHR (DW10BTED4)	810085	Outer Joint		25	39	59	89	63.5	I
	2005.06.-	-	MT	R	F	Convertible Engine RHR (DW10BTED4)	610041	Inner Joint		37	39	32	399	95.5	
307 SW (3H)															
1.4 (55 kW)	2002.04.-	2003.09	-	L	F	Estate Engine KFW (TU3JP)	245119	Drive Shaft		25	22	58.5	79.5	633	
	2002.04.-	2003.09	-	R	F	Estate Engine KFW (TU3JP)	245113	Drive Shaft		25	22	58.5	79.5	915	
1.4 16V (65 kW)	2003.11.-	-	MT	R	F	Estate Engine KFJ (ET3J4)	299170	Drive Shaft		25	22	60	80	910	
	2003.11.-	-	MT	L/R	F	Estate Engine KFJ (ET3J4)	810025	Outer Joint		25	22	60	80	54	I
	2003.11.-	-	MT	L	F	Estate Engine KFJ (ET3J4)	245119	Drive Shaft		25	22	58.5	79.5	633	
	2003.11.-	-	MT	R	F	Estate Engine KFJ (ET3J4)	245113	Drive Shaft		25	22	58.5	79.5	915	
1.4 HDi 70 (50 kW)	2002.03.-	2005.01	MT	R	F	Estate Engine 8HZ (DV4TD)	210229	Drive Shaft		25	24	58.5	79	935	
	2002.03.-	2005.01	MT	L	F	Estate Engine 8HZ (DV4TD)	299019	Drive Shaft	29T	25	24	55.7	79	620	
1.6 16V (80 kW)	2002.03.-	-	MT	L	F	Estate Engine NFU (TU5JP4)	245105	Drive Shaft		25	24	58	79	625	
	2002.03.-	-	MT	L	F	Estate Engine NFU (TU5JP4)	245126	Drive Shaft		25	24	58.5	89	630	
	2002.03.-	-	-	-	F	Estate Engine NFU (TU5JP4)	810097	Outer Joint		25	30	58.5	79.5	55	I
	2002.03.-	-	MT	L/R	F	Estate Engine NFU (TU5JP4)	810025	Outer Joint		25	22	60	80	54	I
	2002.03.-	-	MT	R	F	Estate Engine NFU (TU5JP4)	299170	Drive Shaft		25	22	60	80	910	
	2002.03.-	-	AT	-	-	Estate Engine NFU (TU5JP4)	899366	Outer Joint		25	34	58.5	79	55	I
	2002.03.-	-	-	L	F	Estate Engine NFU (TU5JP4)	699001	Inner Joint		26	34	42.5	46.5	103.5	
	2002.03.-	-	AT/Semi-AT	R	F	Estate Engine NFU (TU5JP4)	210291	Drive Shaft		25	26	58.5	79	833	
	2002.03.-	-	MT	L	F	Estate Engine NFU (TU5JP4)	299019	Drive Shaft	29T	25	24	55.7	79	620	
	2002.03.-	-	MT	L	F	Estate Engine NFU (TU5JP4)	245119	Drive Shaft		25	22	58.5	79.5	633	
	2002.03.-	-	MT	R	F	Estate Engine NFU (TU5JP4)	245113	Drive Shaft		25	22	58.5	79.5	915	
	2002.03.-	-	MT	R	F	Estate Engine NFU (TU5JP4)	245104	Drive Shaft		25	24	58	79	925	
	2002.03.-	-	-	-	F	Estate Engine NFU (TU5JP4)	810028	Outer Joint		25	34	58	89	56	I
	2002.03.-	-	-	L	F	Estate Engine NFU (TU5JP4)	210286	Drive Shaft		25	26	58.5	79	613	
2002.03.-	-	MT	R	F	Estate Engine NFU (TU5JP4)	210229	Drive Shaft		25	24	58.5	79	935		
1.6 HDi 110 (80 kW)	2004.02.-	-	MT	R	F	Estate Engine 9HY (DV6TED4)/9HZ (DV6TED4)	210229	Drive Shaft		25	24	58.5	79	935	
	2004.02.-	-	-	R	F	Estate Engine 9HY (DV6TED4)/9HZ (DV6TED4)	210173	Drive Shaft	29W	25	24	58.5	79	921	
	2004.02.-	-	MT	L	F	Estate Engine 9HY (DV6TED4)/9HZ (DV6TED4)	245105	Drive Shaft		25	24	58	79	625	
	2004.02.-	-	MT	L	F	Estate Engine 9HY (DV6TED4)/9HZ (DV6TED4)	245126	Drive Shaft		25	24	58.5	89	630	
	2004.02.-	-	MT	L	F	Estate Engine 9HY (DV6TED4)/9HZ (DV6TED4)	299019	Drive Shaft	29T	25	24	55.7	79	620	
	2004.02.-	-	MT	R	F	Estate Engine 9HY (DV6TED4)/9HZ (DV6TED4)	245104	Drive Shaft		25	24	58	79	925	
1.6 HDi 90 (66 kW)	2006.12.-	-	-	L	F	Estate Engine 9HV (DV6ATED4)/9HX (DV6ATED4)	245105	Drive Shaft		25	24	58	79	625	
	2006.12.-	-	-	L	F	Estate Engine 9HV (DV6ATED4)/9HX (DV6ATED4)	245126	Drive Shaft		25	24	58.5	89	630	
	2006.12.-	-	-	R	F	Estate Engine 9HV (DV6ATED4)/9HX (DV6ATED4)	245104	Drive Shaft		25	24	58	79	925	
2.0 16V (100 kW)	2002.03.-	-	MT	L	F	Estate Engine RFN (EW10J4)	245105	Drive Shaft		25	24	58	79	625	
	2002.03.-	-	MT	L	F	Estate Engine RFN (EW10J4)	245126	Drive Shaft		25	24	58.5	89	630	
	2002.03.-	-	AT	R	F	Estate Engine RFN (EW10J4)	210291	Drive Shaft		25	26	58.5	79	833	
	2002.03.-	-	-	L	F	Estate Engine RFN (EW10J4)	699001	Inner Joint		26	34	42.5	46.5	103.5	
	2002.03.-	-	MT	L	F	Estate Engine RFN (EW10J4)	299019	Drive Shaft	29T	25	24	55.7	79	620	
	2002.03.-	-	MT	R	F	Estate Engine RFN (EW10J4)	245104	Drive Shaft		25	24	58	79	925	
	2002.03.-	-	-	-	F	Estate Engine RFN (EW10J4)	810028	Outer Joint		25	34	58	89	56	I
	2002.03.-	-	-	L	F	Estate Engine RFN (EW10J4)	210286	Drive Shaft		25	26	58.5	79	613	
	2002.03.-	-	MT	R	F	Estate Engine RFN (EW10J4)	210229	Drive Shaft		25	24	58.5	79	935	
2.0 16V (103 kW)	2005.03.-	-	MT	R	F	Estate Engine RFN (EW10J4)/RFJ (EW10A)	210229	Drive Shaft		25	24	58.5	79	935	
	2005.03.-	-	-	L	F	Estate Engine RFN (EW10J4)/RFJ (EW10A)	245105	Drive Shaft		25	24	58	79	625	
	2005.03.-	-	MT	L	F	Estate Engine RFN (EW10J4)/RFJ (EW10A)	245126	Drive Shaft		25	24	58.5	89	630	
	2005.03.-	-	AT	R	F	Estate Engine RFN (EW10J4)/RFJ (EW10A)	210291	Drive Shaft		25	26	58.5	79	833	
	2005.03.-	-	-	L	F	Estate Engine RFN (EW10J4)/RFJ (EW10A)	699001	Inner Joint		26	34	42.5	46.5	103.5	





	 YEAR	TRANSM	L/R	F/R	REMARKS	GSP Ref.	 PRODUCT	 ABS	Technical Specifications						
									A	B	C	H	L	P	
PEUGEOT															
307 SW (3H)															
2.0 16V (103 kW)	2005.03-	-	MT	L	F	Estate Engine RFN (EW10J4)/RFJ (EW10A)	299019	Drive Shaft	29T	25	24	55.7	79	620	
	2005.03-	-	-	R	F	Estate Engine RFN (EW10J4)/RFJ (EW10A)	245104	Drive Shaft		25	24	58	79	925	
	2005.03-	-	-	-	F	Estate Engine RFN (EW10J4)/RFJ (EW10A)	810028	Outer Joint		25	34	58	89	56	I
	2005.03-	-	-	L	F	Estate Engine RFN (EW10J4)/RFJ (EW10A)	210286	Drive Shaft		25	26	58.5	79	613	
2.0 HDI 110 (79 kW)	2002.03-	-	MT	R	F	Estate Engine RHS (DW10ATED)	210229	Drive Shaft		25	24	58.5	79	935	
	2002.03-	-	MT	L	F	Estate Engine RHS (DW10ATED)	245105	Drive Shaft		25	24	58	79	625	
	2002.03-	-	-	R	F	Estate Engine RHS (DW10ATED)	210173	Drive Shaft	29W	25	24	58.5	79	921	
	2002.03-	-	-	L	F	Estate Engine RHS (DW10ATED)	245126	Drive Shaft		25	24	58.5	89	630	
	2002.03-	-	MT	L	F	Estate Engine RHS (DW10ATED)	299019	Drive Shaft	29T	25	24	55.7	79	620	
	2002.03-	-	MT	R	F	Estate Engine RHS (DW10ATED)	245104	Drive Shaft		25	24	58	79	925	
	2002.03-	-	-	-	F	Estate Engine RHS (DW10ATED)	810028	Outer Joint		25	34	58	89	56	I
2.0 HDi 135 (100 kW)	2004.02-	-	-	R	F	Estate Engine RHR (DW10BTED4)	210173	Drive Shaft	29W	25	24	58.5	79	921	
	2004.02-	-	MT	L	F	Estate Engine RHR (DW10BTED4)	245105	Drive Shaft		25	24	58	79	625	
	2004.02-	-	6MT	L	F	Estate Engine RHR (DW10BTED4)	210268	Drive Shaft		25	37	58.5	89	621	
	2004.02-	-	6MT	R	F	Estate Engine RHR (DW10BTED4)	208082	Drive Shaft		25	37	58.5	89	949	
	2004.02-	-	-	-	F	Estate Engine RHR (DW10BTED4)	810085	Outer Joint		25	39	59	89	63.5	I
	2004.02-	-	MT	R	F	Estate Engine RHR (DW10BTED4)	245104	Drive Shaft		25	24	58	79	925	
	2004.02-	-	6MT	R	F	Estate Engine RHR (DW10BTED4)	610041	Inner Joint		37	39	32	399	95.5	
2.0 HDI 90 (66 kW)	2002.03-	-	MT	R	F	Estate Engine RHY (DW10TD)	210229	Drive Shaft		25	24	58.5	79	935	
	2002.03-	-	-	R	F	Estate Engine RHY (DW10TD)	210173	Drive Shaft	29W	25	24	58.5	79	921	
	2002.03-	-	MT	L	F	Estate Engine RHY (DW10TD)	245105	Drive Shaft		25	24	58	79	625	
	2002.03-	-	-	L	F	Estate Engine RHY (DW10TD)	245126	Drive Shaft		25	24	58.5	89	630	
	2002.03-	-	MT	L	F	Estate Engine RHY (DW10TD)	299019	Drive Shaft	29T	25	24	55.7	79	620	
	2002.03-	-	MT	R	F	Estate Engine RHY (DW10TD)	245104	Drive Shaft		25	24	58	79	925	
	2002.03-	-	-	-	F	Estate Engine RHY (DW10TD)	810028	Outer Joint		25	34	58	89	56	I
308 (4A_4C_)															
1.4 16V (70 kW)	2007.09-	-	MT	R	F	Hatchback Engine EP3/8FS (EP3)	210251	Drive Shaft		25	24	58.5	79	935	
	2007.09-	-	-	-	F	Hatchback Engine EP3/8FS (EP3)	810067	Outer Joint	48W	25	34	58.5	79	55	I
	2007.09-	-	-	L	F	Hatchback Engine EP3/8FS (EP3)	210250	Drive Shaft		25	24	58.5	79	634	
	2007.09-	-	6MT	-	-	Hatchback Engine EP3/8FS (EP3)	810155	Outer Joint		25	39	58.5	89	63.5	I
1.4 16V (72 kW)	2009.12-	-	MT	R	F	Hatchback Engine 8FR (EP3)	210251	Drive Shaft		25	24	58.5	79	935	
	2009.12-	-	-	-	F	Hatchback Engine 8FR (EP3)	810028	Outer Joint		25	34	58	89	56	I
	2009.12-	-	6MT	-	-	Hatchback Engine 8FR (EP3)	810155	Outer Joint		25	39	58.5	89	63.5	I
	2009.12-	-	AT	-	-	Hatchback Engine 8FR (EP3)	899366	Outer Joint		25	34	58.5	79	55	I
1.6 16V (103 kW)	2007.09-	-	MT	R	F	Hatchback Engine 5FT (EP6DT)	210251	Drive Shaft		25	24	58.5	79	935	
	2007.09-	-	AT	L	F	Hatchback Engine 5FT (EP6DT)	699001	Inner Joint		26	34	42.5	46.5	103.5	
	2007.09-	-	AT	L	F	Hatchback Engine 5FT (EP6DT)	210362	Drive Shaft		25	26	58.5	79	624	
	2007.09-	-	AT	R	F	Hatchback Engine 5FT (EP6DT)	210383	Drive Shaft		25	26	58	79	842	
	2007.09-	-	AT	R	F	Hatchback Engine 5FT (EP6DT)	810035	Outer Joint		25	34	58	79	55.5	I
	2007.09-	-	AT	L	F	Hatchback Engine 5FT (EP6DT)	810028	Outer Joint		25	34	58	89	56	I
1.6 16V (110 kW)	2007.09-	-	MT	R	F	Hatchback Engine 5FX (EP6DT)	210325	Drive Shaft		25	24	58.5	79	940	
	2007.09-	-	AT	R	F	Hatchback Engine 5FX (EP6DT)	810035	Outer Joint		25	34	58	79	55.5	I
	2007.09-	-	AT	L	F	Hatchback Engine 5FX (EP6DT)	699001	Inner Joint		26	34	42.5	46.5	103.5	
	2007.09-	-	MT	L	F	Hatchback Engine 5FX (EP6DT)	610057	Inner Joint		24	34	40	52.5	90	
	2007.09-	-	-	-	F	Hatchback Engine 5FX (EP6DT)	810067	Outer Joint	48W	25	34	58.5	79	55	I
	2007.09-	-	AT	L	F	Hatchback Engine 5FX (EP6DT)	210362	Drive Shaft		25	26	58.5	79	624	
	2007.09-	-	AT	R	F	Hatchback Engine 5FX (EP6DT)	210383	Drive Shaft		25	26	58	79	842	
	2007.09-	-	MT	R	F	Hatchback Engine 5FX (EP6DT)	610058	Inner Joint		24	34	29.8	365	88	
	2007.09-	-	MT	L	F	Hatchback Engine 5FX (EP6DT)	210253	Drive Shaft		25	24	58.5	79	626	
	2007.09-	-	AT	L	F	Hatchback Engine 5FX (EP6DT)	810028	Outer Joint		25	34	58	89	56	I
	2007.09-	-	MT	L	F	Hatchback Engine 5FX (EP6DT)	810148	Outer Joint		25	34	58.5	79	55.5	I
1.6 16V (115 kW)	2009.10-	-	MT	R	F	Hatchback Engine EP6CDT	210325	Drive Shaft		25	24	58.5	79	940	
	2009.10-	-	MT	L	F	Hatchback Engine EP6CDT	610057	Inner Joint		24	34	40	52.5	90	
	2009.10-	-	MT	R	F	Hatchback Engine EP6CDT	610058	Inner Joint		24	34	29.8	365	88	
	2009.10-	-	6MT	-	-	Hatchback Engine EP6CDT	810155	Outer Joint		25	39	58.5	89	63.5	I
	2009.10-	-	MT	L	F	Hatchback Engine EP6CDT	210253	Drive Shaft		25	24	58.5	79	626	
	2009.10-	-	MT	L	F	Hatchback Engine EP6CDT	810148	Outer Joint		25	34	58.5	79	55.5	I
	2009.10-	-	AT	-	-	Hatchback Engine EP6CDT	899366	Outer Joint		25	34	58.5	79	55	I
	2009.10-	-	AT	-	F	Hatchback Engine EP6CDT	810028	Outer Joint		25	34	58	89	56	I
1.6 16V (128 kW)	2008.03-	-	MT	R	F	Hatchback Engine 5FY (EP6DTS)	210325	Drive Shaft		25	24	58.5	79	940	
	2008.03-	-	AT	L	F	Hatchback Engine 5FY (EP6DTS)	699001	Inner Joint		26	34	42.5	46.5	103.5	
	2008.03-	-	-	L	F	Hatchback Engine 5FY (EP6DTS)	610057	Inner Joint		24	34	40	52.5	90	
	2008.03-	-	AT	R	F	Hatchback Engine 5FY (EP6DTS)	810035	Outer Joint		25	34	58	79	55.5	I
	2008.03-	-	AT	L	F	Hatchback Engine 5FY (EP6DTS)	210362	Drive Shaft		25	26	58.5	79	624	
	2008.03-	-	AT	R	F	Hatchback Engine 5FY (EP6DTS)	210383	Drive Shaft		25	26	58	79	842	
	2008.03-	-	MT	R	F	Hatchback Engine 5FY (EP6DTS)	610058	Inner Joint		24	34	29.8	365	88	

	 YEAR	TRANSM	L/R	F/R	REMARKS	GSP Ref.	 PRODUCT	 ABS	Technical Specifications					
									A	B	C	H	L	P
PEUGEOT														
308 (4A_4C_)														
1.6 16V (128 kW)	2008.03-	-	-	L F	Hatchback Engine 5FY (EP6DTS)	210253	Drive Shaft		25	24	58.5	79	626	
	2008.03-	-	-	L F	Hatchback Engine 5FY (EP6DTS)	810148	Outer Joint		25	34	58.5	79	55.5	I
1.6 16V (88 kW)	2007.09-	-	MT	R F	Hatchback Engine 5FW (EP6)/EP6	210251	Drive Shaft		25	24	58.5	79	935	
	2007.09-	-	AT	R F	Hatchback Engine 5FW (EP6)/EP6	810035	Outer Joint		25	34	58	79	55.5	I
	2007.09-	-	AT	L F	Hatchback Engine 5FW (EP6)/EP6	699001	Inner Joint		26	34	42.5	46.5	103.5	
	2007.09-	-	-	-	F Hatchback Engine 5FW (EP6)/EP6	810067	Outer Joint	48W	25	34	58.5	79	55	I
	2007.09-	-	-	L F	Hatchback Engine 5FW (EP6)/EP6	210250	Drive Shaft		25	24	58.5	79	634	
	2007.09-	-	AT	L F	Hatchback Engine 5FW (EP6)/EP6	210362	Drive Shaft		25	26	58.5	79	624	
	2007.09-	-	AT	R F	Hatchback Engine 5FW (EP6)/EP6	210383	Drive Shaft		25	26	58	79	842	
	2007.09-	-	6MT	-	Hatchback Engine 5FW (EP6)/EP6	810155	Outer Joint		25	39	58.5	89	63.5	I
	2007.09-	-	AT	L F	Hatchback Engine 5FW (EP6)/EP6	810028	Outer Joint		25	34	58	89	56	I
1.6 BioFlex (80 kW)	2008.04-	-	-	R F	Hatchback Engine NFU (TU5JP4)	210251	Drive Shaft		25	24	58.5	79	935	
1.6 GTi (147 kW)	2010.07-	-	AT	-	F Hatchback Engine EP6CDTX	810028	Outer Joint		25	34	58	89	56	I
	2010.07-	-	6MT	-	Hatchback Engine EP6CDTX	810155	Outer Joint		25	39	58.5	89	63.5	I
	2010.07-	-	AT	-	Hatchback Engine EP6CDTX	899366	Outer Joint		25	34	58.5	79	55	I
1.6 HDi (66 kW)	2007.09-	-	MT	R F	Hatchback Engine 9HX (DV6ATED4)/9HV (DV6TED4)	210251	Drive Shaft		25	24	58.5	79	935	
	2007.09-	-	-	-	F Hatchback Engine 9HX (DV6ATED4)/9HV (DV6TED4)	810067	Outer Joint	48W	25	34	58.5	79	55	I
	2007.09-	-	-	L F	Hatchback Engine 9HX (DV6ATED4)/9HV (DV6TED4)	210250	Drive Shaft		25	24	58.5	79	634	
	2007.09-	-	6MT	-	Hatchback Engine 9HX (DV6ATED4)/9HV (DV6TED4)	810155	Outer Joint		25	39	58.5	89	63.5	I
1.6 HDi (68 kW)	2009.11-	-	-	R F	Hatchback Engine 9HP (DV6DTE4)	210251	Drive Shaft		25	24	58.5	79	935	
	2009.11-	-	6MT	-	Hatchback Engine 9HP (DV6DTE4)	810155	Outer Joint		25	39	58.5	89	63.5	I
	2009.11-	-	AT	-	Hatchback Engine 9HP (DV6DTE4)	899366	Outer Joint		25	34	58.5	79	55	I
	2009.11-	-	AT	-	F Hatchback Engine 9HP (DV6DTE4)	810028	Outer Joint		25	34	58	89	56	I
1.6 HDi (80 kW)	2007.09-	-	MT	R F	Hatchback Engine 9HZ (DV6TED4)	210325	Drive Shaft		25	24	58.5	79	940	
	2007.09-	-	-	L F	Hatchback Engine 9HZ (DV6TED4)	610057	Inner Joint		24	34	40	52.5	90	
	2007.09-	-	-	-	F Hatchback Engine 9HZ (DV6TED4)	810067	Outer Joint	48W	25	34	58.5	79	55	I
	2007.09-	-	MT	R F	Hatchback Engine 9HZ (DV6TED4)	610058	Inner Joint		24	34	29.8	365	88	
	2007.09-	-	-	L F	Hatchback Engine 9HZ (DV6TED4)	210253	Drive Shaft		25	24	58.5	79	626	
	2007.09-	-	-	L F	Hatchback Engine 9HZ (DV6TED4)	810148	Outer Joint		25	34	58.5	79	55.5	I
1.6 HDi (82 kW)	2009.12-	-	MT	R F	Hatchback Engine 9HR (DV6C)	210325	Drive Shaft		25	24	58.5	79	940	
	2009.12-	-	-	L F	Hatchback Engine 9HR (DV6C)	610057	Inner Joint		24	34	40	52.5	90	
	2009.12-	-	MT	R F	Hatchback Engine 9HR (DV6C)	610058	Inner Joint		24	34	29.8	365	88	
	2009.12-	-	6MT	-	Hatchback Engine 9HR (DV6C)	810155	Outer Joint		25	39	58.5	89	63.5	I
	2009.12-	-	-	L F	Hatchback Engine 9HR (DV6C)	210253	Drive Shaft		25	24	58.5	79	626	
	2009.12-	-	-	L F	Hatchback Engine 9HR (DV6C)	810148	Outer Joint		25	34	58.5	79	55.5	I
	2009.12-	-	AT	-	Hatchback Engine 9HR (DV6C)	899366	Outer Joint		25	34	58.5	79	55	I
	2009.12-	-	AT	-	F Hatchback Engine 9HR (DV6C)	810028	Outer Joint		25	34	58	89	56	I
1.6 HDi (84 kW)	2013.03-	-	-	R F	Hatchback	210325	Drive Shaft		25	24	58.5	79	940	
	2013.03-	-	-	L F	Hatchback	610057	Inner Joint		24	34	40	52.5	90	
	2013.03-	-	-	R F	Hatchback	610058	Inner Joint		24	34	29.8	365	88	
	2013.03-	-	-	L F	Hatchback	210253	Drive Shaft		25	24	58.5	79	626	
	2013.03-	-	-	L F	Hatchback	810148	Outer Joint		25	34	58.5	79	55.5	I
2.0 Bioflex (103 kW)	2008.01-	2012.01	-	R F	Hatchback Engine RFJ (EW10A)	210251	Drive Shaft		25	24	58.5	79	935	
2.0 HDi (100 kW)	2007.09-	-	MT	R F	Hatchback Engine RHR (DW10BTED4)	610041	Inner Joint		37	39	32	399	95.5	
	2007.09-	-	6MT	L F	Hatchback Engine RHR (DW10BTED4)	810158	Outer Joint		25	26	58.5	89	61.5	M
	2007.09-	-	6MT	L F	Hatchback Engine RHR (DW10BTED4)	210427	Drive Shaft		25	37	58.5	89	638	
	2007.09-	-	6MT	L F	Hatchback Engine RHR (DW10BTED4)	210312	Drive Shaft		25	37	58.5	89	625	
	2007.09-	-	MT	R F	Hatchback Engine RHR (DW10BTED4)	210421	Drive Shaft		25	37	58.5	89	972	
	2007.09-	-	AT	L F	Hatchback Engine RHR (DW10BTED4)	210375	Drive Shaft		25	37	58.4	89	619	
	2007.09-	-	AT	L F	Hatchback Engine RHR (DW10BTED4)	210380	Drive Shaft		25	37	58.5	89	635	
	2007.09-	-	AT	R F	Hatchback Engine RHR (DW10BTED4)	210363	Drive Shaft		25	37	58.5	89	935	
	2007.09-	-	MT	L F	Hatchback Engine RHR (DW10BTED4)	210210	Drive Shaft		25	37	58.5	89	638	
	2007.09-	-	MT	R F	Hatchback Engine RHR (DW10BTED4)	210361	Drive Shaft		25	37	58.5	89	959	
	2007.09-	-	AT	R F	Hatchback Engine RHR (DW10BTED4)	610091	Inner Joint		37	26	31.5	366	100	
2.0 HDi (103 kW)	2010.07-	-	MT	R F	Hatchback Engine RHR (DW10BTED4)	610041	Inner Joint		37	39	32	399	95.5	
	2010.07-	-	6MT	L F	Hatchback Engine RHR (DW10BTED4)	810158	Outer Joint		25	26	58.5	89	61.5	M
	2010.07-	-	6MT	L F	Hatchback Engine RHR (DW10BTED4)	210427	Drive Shaft		25	37	58.5	89	638	
	2010.07-	-	6MT	L F	Hatchback Engine RHR (DW10BTED4)	210312	Drive Shaft		25	37	58.5	89	625	
	2010.07-	-	MT	R F	Hatchback Engine RHR (DW10BTED4)	210421	Drive Shaft		25	37	58.5	89	972	
	2010.07-	-	AT	L F	Hatchback Engine RHR (DW10BTED4)	210375	Drive Shaft		25	37	58.4	89	619	
	2010.07-	-	AT	L F	Hatchback Engine RHR (DW10BTED4)	210380	Drive Shaft		25	37	58.5	89	635	
	2010.07-	-	AT	R F	Hatchback Engine RHR (DW10BTED4)	210363	Drive Shaft		25	37	58.5	89	935	
	2010.07-	-	MT	L F	Hatchback Engine RHR (DW10BTED4)	210210	Drive Shaft		25	37	58.5	89	638	
	2010.07-	-	6MT	-	Hatchback Engine RHR (DW10BTED4)	810155	Outer Joint		25	39	58.5	89	63.5	I
	2010.07-	-	MT	R F	Hatchback Engine RHR (DW10BTED4)	210361	Drive Shaft		25	37	58.5	89	959	
	2010.07-	-	AT	R F	Hatchback Engine RHR (DW10BTED4)	610091	Inner Joint		37	26	31.5	366	100	

	 YEAR	TRANSM	L/R	F/R	REMARKS	GSP Ref.	 PRODUCT	 ABS	Technical Specifications						
									A	B	C	H	L	P	
PEUGEOT															
308 (4A_4C_)															
2.0 HDi (110 kW)	2011.10.-	-	AT	-	F	Hatchback Engine RHE (DW10CTED4)	810028	Outer Joint	25	34	58	89	56	I	
	2011.10.-	-	MT	R	F	Hatchback Engine RHE (DW10CTED4)	610041	Inner Joint	37	39	32	399	95.5		
	2011.10.-	-	MT	L	F	Hatchback Engine RHE (DW10CTED4)	810158	Outer Joint	25	26	58.5	89	61.5	M	
	2011.10.-	-	MT	L	F	Hatchback Engine RHE (DW10CTED4)	210427	Drive Shaft	25	37	58.5	89	638		
	2011.10.-	-	MT	R	F	Hatchback Engine RHE (DW10CTED4)	210421	Drive Shaft	25	37	58.5	89	972		
	2011.10.-	-	AT	L	F	Hatchback Engine RHE (DW10CTED4)	210380	Drive Shaft	25	37	58.5	89	635		
	2011.10.-	-	AT	R	F	Hatchback Engine RHE (DW10CTED4)	210363	Drive Shaft	25	37	58.5	89	935		
	2011.10.-	-	-	-	-	Hatchback Engine RHE (DW10CTED4)	810155	Outer Joint	25	39	58.5	89	63.5	I	
	2011.10.-	-	MT	L	F	Hatchback Engine RHE (DW10CTED4)	210210	Drive Shaft	25	37	58.5	89	638		
	2011.10.-	-	MT	R	F	Hatchback Engine RHE (DW10CTED4)	210361	Drive Shaft	25	37	58.5	89	959		
	2011.10.-	-	AT	R	F	Hatchback Engine RHE (DW10CTED4)	610091	Inner Joint	37	26	31.5	366	100		
2.0 HDi (120 kW)	2012.04.-	-	AT	-	-	Hatchback Engine RHH (DW10CTED4)	899366	Outer Joint	25	34	58.5	79	55	I	
	2012.04.-	-	MT	R	F	Hatchback Engine RHH (DW10CTED4)	610041	Inner Joint	37	39	32	399	95.5		
	2012.04.-	-	-	-	F	Hatchback Engine RHH (DW10CTED4)	810028	Outer Joint	25	34	58	89	56	I	
	2012.04.-	-	-	R	F	Hatchback Engine RHH (DW10CTED4)	810158	Outer Joint	25	26	58.5	89	61.5	M	
	2012.04.-	-	AT	L	F	Hatchback Engine RHH (DW10CTED4)	210375	Drive Shaft	25	37	58.4	89	619		
	2012.04.-	-	-	L	F	Hatchback Engine RHH (DW10CTED4)	210380	Drive Shaft	25	37	58.5	89	635		
	2012.04.-	-	-	R	F	Hatchback Engine RHH (DW10CTED4)	210363	Drive Shaft	25	37	58.5	89	935		
	2012.04.-	-	5MT	-	-	Hatchback Engine RHH (DW10CTED4)	810155	Outer Joint	25	39	58.5	89	63.5	I	
	2012.04.-	-	MT	L	F	Hatchback Engine RHH (DW10CTED4)	210210	Drive Shaft	25	37	58.5	89	638		
	2012.04.-	-	MT	R	F	Hatchback Engine RHH (DW10CTED4)	210361	Drive Shaft	25	37	58.5	89	959		
	2012.04.-	-	-	R	F	Hatchback Engine RHH (DW10CTED4)	610091	Inner Joint	37	26	31.5	366	100		
308 CC (4B_)															
1.6 16V (103 kW)	2009.06.-	-	MT	R	F	Convertible Engine 5FT (EP6DT)	210325	Drive Shaft	25	24	58.5	79	940		
	2009.06.-	-	MT/6MT	-	-	Convertible Engine 5FT (EP6DT)	899366	Outer Joint	25	34	58.5	79	55	I	
	2009.06.-	-	AT	L	F	Convertible Engine 5FT (EP6DT)	699001	Inner Joint	26	34	42.5	46.5	103.5		
	2009.06.-	-	MT	L	F	Convertible Engine 5FT (EP6DT)	610057	Inner Joint	24	34	40	52.5	90		
	2009.06.-	-	AT	L	F	Convertible Engine 5FT (EP6DT)	210362	Drive Shaft	25	26	58.5	79	624		
	2009.06.-	-	AT	R	F	Convertible Engine 5FT (EP6DT)	210383	Drive Shaft	25	26	58	79	842		
	2009.06.-	-	MT	R	F	Convertible Engine 5FT (EP6DT)	610058	Inner Joint	24	34	29.8	365	88		
	2009.06.-	-	MT/6MT	-	-	Convertible Engine 5FT (EP6DT)	810155	Outer Joint	25	39	58.5	89	63.5	I	
	2009.06.-	-	AT	R	F	Convertible Engine 5FT (EP6DT)	810035	Outer Joint	25	34	58	79	55.5	I	
	2009.06.-	-	MT	L	F	Convertible Engine 5FT (EP6DT)	210253	Drive Shaft	25	24	58.5	79	626		
	2009.06.-	-	AT/6MT	L	F	Convertible Engine 5FT (EP6DT)	810028	Outer Joint	25	34	58	89	56	I	
	2009.06.-	-	MT	L	F	Convertible Engine 5FT (EP6DT)	810148	Outer Joint	25	34	58.5	79	55.5	I	
	1.6 16V (110 kW)	2009.06.-	-	MT	R	F	Convertible Engine 5FX (EP6DT)	210325	Drive Shaft	25	24	58.5	79	940	
		2009.06.-	-	MT/6MT	-	-	Convertible Engine 5FX (EP6DT)	899366	Outer Joint	25	34	58.5	79	55	I
2009.06.-		-	AT	L	F	Convertible Engine 5FX (EP6DT)	699001	Inner Joint	26	34	42.5	46.5	103.5		
2009.06.-		-	MT	L	F	Convertible Engine 5FX (EP6DT)	610057	Inner Joint	24	34	40	52.5	90		
2009.06.-		-	AT	R	F	Convertible Engine 5FX (EP6DT)	810035	Outer Joint	25	34	58	79	55.5	I	
2009.06.-		-	AT	L	F	Convertible Engine 5FX (EP6DT)	210362	Drive Shaft	25	26	58.5	79	624		
2009.06.-		-	AT	R	F	Convertible Engine 5FX (EP6DT)	210383	Drive Shaft	25	26	58	79	842		
2009.06.-		-	MT	R	F	Convertible Engine 5FX (EP6DT)	610058	Inner Joint	24	34	29.8	365	88		
2009.06.-		-	MT/6MT	-	-	Convertible Engine 5FX (EP6DT)	810155	Outer Joint	25	39	58.5	89	63.5	I	
2009.06.-		-	MT	L	F	Convertible Engine 5FX (EP6DT)	210253	Drive Shaft	25	24	58.5	79	626		
2009.06.-		-	MT	L	F	Convertible Engine 5FX (EP6DT)	810148	Outer Joint	25	34	58.5	79	55.5	I	
1.6 16V (115 kW)		2009.06.-	-	MT	R	F	Convertible Engine EP6CDT	210325	Drive Shaft	25	24	58.5	79	940	
		2009.06.-	-	MT/6MT	-	-	Convertible Engine EP6CDT	899366	Outer Joint	25	34	58.5	79	55	I
		2009.06.-	-	MT	L	F	Convertible Engine EP6CDT	610057	Inner Joint	24	34	40	52.5	90	
	2009.06.-	-	MT	R	F	Convertible Engine EP6CDT	610058	Inner Joint	24	34	29.8	365	88		
	2009.06.-	-	MT/6MT	-	-	Convertible Engine EP6CDT	810155	Outer Joint	25	39	58.5	89	63.5	I	
	2009.06.-	-	MT	L	F	Convertible Engine EP6CDT	210253	Drive Shaft	25	24	58.5	79	626		
	2009.06.-	-	MT	-	F	Convertible Engine EP6CDT	810028	Outer Joint	25	34	58	89	56	I	
	2009.06.-	-	MT	L	F	Convertible Engine EP6CDT	810148	Outer Joint	25	34	58.5	79	55.5	I	
1.6 16V (88 kW)	2009.06.-	-	MT	R	F	Convertible Engine EP6	210251	Drive Shaft	25	24	58.5	79	935		
	2009.06.-	-	AT	L	F	Convertible Engine EP6	699001	Inner Joint	26	34	42.5	46.5	103.5		
	2009.06.-	-	-	L	F	Convertible Engine EP6	210250	Drive Shaft	25	24	58.5	79	634		
	2009.06.-	-	AT	L	F	Convertible Engine EP6	210362	Drive Shaft	25	26	58.5	79	624		
	2009.06.-	-	AT	R	F	Convertible Engine EP6	210383	Drive Shaft	25	26	58	79	842		
	2009.06.-	-	AT	R	F	Convertible Engine EP6	810035	Outer Joint	25	34	58	79	55.5	I	
	2009.06.-	-	AT	L	F	Convertible Engine EP6	810028	Outer Joint	25	34	58	89	56	I	
1.6 HDi (82 kW)	2009.06.-	-	MT	R	F	Convertible Engine 9HR (DV6C)	210325	Drive Shaft	25	24	58.5	79	940		
	2009.06.-	-	-	L	F	Convertible Engine 9HR (DV6C)	610057	Inner Joint	24	34	40	52.5	90		
	2009.06.-	-	-	-	F	Convertible Engine 9HR (DV6C)	810067	Outer Joint	48W	25	34	58.5	79	55	I
	2009.06.-	-	MT	R	F	Convertible Engine 9HR (DV6C)	610058	Inner Joint	24	34	29.8	365	88		

	 YEAR	TRANSM	L/R	F/R	REMARKS	GSP Ref.	 PRODUCT	 ABS	Technical Specifications						
									A	B	C	H	L	P	
PEUGEOT															
308 CC (4B_)															
1.6 HDi (82 kW)	2009.06-	-	-	L	F	Convertible Engine 9HR (DV6C)	210253	Drive Shaft		25	24	58.5	79	626	
	2009.06-	-	-	L	F	Convertible Engine 9HR (DV6C)	810148	Outer Joint		25	34	58.5	79	55.5	I
1.6 HDi (84 kW)	2013.03-	-	-	R	F	Convertible Engine 9HD (DV6C)	210325	Drive Shaft		25	24	58.5	79	940	
	2013.03-	-	AT/MT/6MT	-	-	Convertible Engine 9HD (DV6C)	899366	Outer Joint		25	34	58.5	79	55	I
	2013.03-	-	-	L	F	Convertible Engine 9HD (DV6C)	610057	Inner Joint		24	34	40	52.5	90	
	2013.03-	-	-	R	F	Convertible Engine 9HD (DV6C)	610058	Inner Joint		24	34	29.8	365	88	
	2013.03-	-	MT/6MT	-	-	Convertible Engine 9HD (DV6C)	810155	Outer Joint		25	39	58.5	89	63.5	I
	2013.03-	-	-	L	F	Convertible Engine 9HD (DV6C)	210253	Drive Shaft		25	24	58.5	79	626	
	2013.03-	-	-	L	F	Convertible Engine 9HD (DV6C)	810148	Outer Joint		25	34	58.5	79	55.5	I
1.6 HDi(82 kW)	2009.02-2012.05	MT	L	F	Convertible Engine 9HZ (DV6TED4)	210253	Drive Shaft		25	24	58.5	79	626		
	2009.02-2012.05	MT	L	F	Convertible Engine 9HZ (DV6TED4)	810148	Outer Joint		25	34	58.5	79	55.5	I	
	2009.02-2012.05	MT	R	F	Convertible Engine 9HZ (DV6TED4)	210325	Drive Shaft		25	24	58.5	79	940		
	2009.02-2012.05	MT	L	F	Convertible Engine 9HZ (DV6TED4)	610057	Inner Joint		24	34	40	52.5	90		
	2009.02-2012.05	MT	R	F	Convertible Engine 9HZ (DV6TED4)	610058	Inner Joint		24	34	29.8	365	88		
1.6 THP (147 kW)	2010.10-	-	MT/6MT	-	-	Convertible Engine EP6CDTX	899366	Outer Joint		25	34	58.5	79	55	I
	2010.10-	-	MT/6MT	-	-	Convertible Engine EP6CDTX	810155	Outer Joint		25	39	58.5	89	63.5	I
	2010.10-	-	MT	-	F	Convertible Engine EP6CDTX	810028	Outer Joint		25	34	58	89	56	I
2.0 CVVT (103 kW)	2009.07-2014.11	MT	R	F	Convertible Engine RFJ (EW10A)	210251	Drive Shaft		25	24	58.5	79	935		
	2009.07-2014.11	AT	L	F	Convertible Engine RFJ (EW10A)	699001	Inner Joint		26	34	42.5	46.5	103.5		
	2009.07-2014.11	AT	L	F	Convertible Engine RFJ (EW10A)	210362	Drive Shaft		25	26	58.5	79	624		
	2009.07-2014.11	AT	R	F	Convertible Engine RFJ (EW10A)	210383	Drive Shaft		25	26	58	79	842		
2.0 HDi (100 kW)	2009.04-	-	MT/6MT	-	-	Convertible Engine RHR (DW10BTED4)	899366	Outer Joint		25	34	58.5	79	55	I
	2009.04-	-	MT	R	F	Convertible Engine RHR (DW10BTED4)	610041	Inner Joint		37	39	32	399	95.5	
	2009.04-	-	6MT	L	F	Convertible Engine RHR (DW10BTED4)	810158	Outer Joint		25	26	58.5	89	61.5	M
	2009.04-	-	6MT	L	F	Convertible Engine RHR (DW10BTED4)	210427	Drive Shaft		25	37	58.5	89	638	
	2009.04-	-	6MT	L	F	Convertible Engine RHR (DW10BTED4)	210312	Drive Shaft		25	37	58.5	89	625	
	2009.04-	-	MT	R	F	Convertible Engine RHR (DW10BTED4)	210421	Drive Shaft		25	37	58.5	89	972	
	2009.04-	-	AT	L	F	Convertible Engine RHR (DW10BTED4)	210375	Drive Shaft		25	37	58.4	89	619	
	2009.04-	-	AT	L	F	Convertible Engine RHR (DW10BTED4)	210380	Drive Shaft		25	37	58.5	89	635	
	2009.04-	-	AT	R	F	Convertible Engine RHR (DW10BTED4)	210363	Drive Shaft		25	37	58.5	89	935	
	2009.04-	-	MT	L	F	Convertible Engine RHR (DW10BTED4)	210210	Drive Shaft		25	37	58.5	89	638	
	2009.04-	-	MT/6MT	-	-	Convertible Engine RHR (DW10BTED4)	810155	Outer Joint		25	39	58.5	89	63.5	I
	2009.04-	-	MT	R	F	Convertible Engine RHR (DW10BTED4)	210361	Drive Shaft		25	37	58.5	89	959	
	2009.04-	-	AT	R	F	Convertible Engine RHR (DW10BTED4)	610091	Inner Joint		37	26	31.5	366	100	
	2009.04-	-	MT	-	F	Convertible Engine RHR (DW10BTED4)	810028	Outer Joint		25	34	58	89	56	I
2.0 HDi (103 kW)	2009.04-	-	MT	R	F	Convertible Engine RHF (DW10BTED4)	610041	Inner Joint		37	39	32	399	95.5	
	2009.04-	-	6MT	L	F	Convertible Engine RHF (DW10BTED4)	810158	Outer Joint		25	26	58.5	89	61.5	M
	2009.04-	-	6MT	L	F	Convertible Engine RHF (DW10BTED4)	210427	Drive Shaft		25	37	58.5	89	638	
	2009.04-	-	6MT	L	F	Convertible Engine RHF (DW10BTED4)	210312	Drive Shaft		25	37	58.5	89	625	
	2009.04-	-	MT	R	F	Convertible Engine RHF (DW10BTED4)	210421	Drive Shaft		25	37	58.5	89	972	
	2009.04-	-	AT	L	F	Convertible Engine RHF (DW10BTED4)	210375	Drive Shaft		25	37	58.4	89	619	
	2009.04-	-	AT	L	F	Convertible Engine RHF (DW10BTED4)	210380	Drive Shaft		25	37	58.5	89	635	
	2009.04-	-	AT	R	F	Convertible Engine RHF (DW10BTED4)	210363	Drive Shaft		25	37	58.5	89	935	
	2009.04-	-	MT	L	F	Convertible Engine RHF (DW10BTED4)	210210	Drive Shaft		25	37	58.5	89	638	
	2009.04-	-	MT	R	F	Convertible Engine RHF (DW10BTED4)	210361	Drive Shaft		25	37	58.5	89	959	
	2009.04-	-	AT	R	F	Convertible Engine RHF (DW10BTED4)	610091	Inner Joint		37	26	31.5	366	100	
2.0 HDi (120 kW)	2009.06-	-	MT/6MT	-	-	Convertible Engine RHH (DW10CTED4)	899366	Outer Joint		25	34	58.5	79	55	I
	2009.06-	-	MT	R	F	Convertible Engine RHH (DW10CTED4)	610041	Inner Joint		37	39	32	399	95.5	
	2009.06-	-	AT	R	F	Convertible Engine RHH (DW10CTED4)	810158	Outer Joint		25	26	58.5	89	61.5	M
	2009.06-	-	AT	L	F	Convertible Engine RHH (DW10CTED4)	210375	Drive Shaft		25	37	58.4	89	619	
	2009.06-	-	AT	L	F	Convertible Engine RHH (DW10CTED4)	210380	Drive Shaft		25	37	58.5	89	635	
	2009.06-	-	AT	R	F	Convertible Engine RHH (DW10CTED4)	210363	Drive Shaft		25	37	58.5	89	935	
	2009.06-	-	MT	L	F	Convertible Engine RHH (DW10CTED4)	210210	Drive Shaft		25	37	58.5	89	638	
	2009.06-	-	MT/6MT	-	-	Convertible Engine RHH (DW10CTED4)	810155	Outer Joint		25	39	58.5	89	63.5	I
	2009.06-	-	MT	R	F	Convertible Engine RHH (DW10CTED4)	210361	Drive Shaft		25	37	58.5	89	959	
	2009.06-	-	AT	R	F	Convertible Engine RHH (DW10CTED4)	610091	Inner Joint		37	26	31.5	366	100	
	2009.06-	-	MT	-	F	Convertible Engine RHH (DW10CTED4)	810028	Outer Joint		25	34	58	89	56	I
308 II															
1.2 THP 130 (96 kW)	2013.11-	-	-	-	F	Hatchback Engine HNY (EB2DTS)	810052	Outer Joint		28	34	58.5	92	55	I
1.6 (115 kW)	2013.09-	-	-	-	F	Hatchback Engine 5FV (EP6CDT)	810052	Outer Joint		28	34	58.5	92	55	I
1.6 THP 125 (92 kW)	2013.09-	-	-	-	F	Hatchback Engine 5FA (EP6CDT)	810052	Outer Joint		28	34	58.5	92	55	I
1.6 THP 150 (110 kW)	2014.03-	-	-	-	F	Hatchback	810052	Outer Joint		28	34	58.5	92	55	I
308 SW (4E_ 4H_)															
1.4 16V (70 kW)	2007.09-	-	MT	R	F	Estate Engine 8FS (EP3)	210251	Drive Shaft		25	24	58.5	79	935	
	2007.09-	-	-	-	F	Estate Engine 8FS (EP3)	810067	Outer Joint	48W	25	34	58.5	79	55	I
	2007.09-	-	-	L	F	Estate Engine 8FS (EP3)	210250	Drive Shaft		25	24	58.5	79	634	





	 YEAR	TRANSM	L/R	F/R	REMARKS	GSP Ref.	 PRODUCT	 ABS	Technical Specifications						
									A	B	C	H	L	P	
PEUGEOT															
308 SW (4E_ 4H_)															
1.4 16V (70 kW)	2007.09-	-	-	-	Estate Engine 8FS (EP3)	810155	Outer Joint		25	39	58.5	89	63.5	I	
1.4 16V (72 kW)	2009.12-	-	R	F	Estate Engine 8FR (EP3)	210251	Drive Shaft		25	24	58.5	79	935		
	2009.12-	-	-	-	Estate Engine 8FR (EP3)	810155	Outer Joint		25	39	58.5	89	63.5	I	
1.6 16V (103 kW)	2007.09-	-	MT/6MT	-	Estate Engine 5FT (EP6DT)	899366	Outer Joint		25	34	58.5	79	55	I	
	2007.09-	-	AT	L	F	Estate Engine 5FT (EP6DT)	699001	Inner Joint		26	34	42.5	46.5	103.5	
	2007.09-	-	AT	L	F	Estate Engine 5FT (EP6DT)	210362	Drive Shaft		25	26	58.5	79	624	
	2007.09-	-	AT	R	F	Estate Engine 5FT (EP6DT)	210383	Drive Shaft		25	26	58	79	842	
	2007.09-	-	AT	R	F	Estate Engine 5FT (EP6DT)	810035	Outer Joint		25	34	58	79	55.5	I
	2007.09-	-	MT/6MT	-	-	Estate Engine 5FT (EP6DT)	810155	Outer Joint		25	39	58.5	89	63.5	I
1.6 16V (110 kW)	2007.09-	-	AT/MT	L	F	Estate Engine 5FT (EP6DT)	810028	Outer Joint		25	34	58	89	56	I
	2007.09-	-	MT	R	F	Estate Engine 5FX (EP6DT)	210325	Drive Shaft		25	24	58.5	79	940	
	2007.09-	-	AT	L	F	Estate Engine 5FX (EP6DT)	699001	Inner Joint		26	34	42.5	46.5	103.5	
	2007.09-	-	-	L	F	Estate Engine 5FX (EP6DT)	610057	Inner Joint		24	34	40	52.5	90	
	2007.09-	-	-	-	F	Estate Engine 5FX (EP6DT)	810067	Outer Joint	48W	25	34	58.5	79	55	I
	2007.09-	-	AT	R	F	Estate Engine 5FX (EP6DT)	810035	Outer Joint		25	34	58	79	55.5	I
	2007.09-	-	AT	L	F	Estate Engine 5FX (EP6DT)	210362	Drive Shaft		25	26	58.5	79	624	
	2007.09-	-	AT	R	F	Estate Engine 5FX (EP6DT)	210383	Drive Shaft		25	26	58	79	842	
	2007.09-	-	MT	R	F	Estate Engine 5FX (EP6DT)	610058	Inner Joint		24	34	29.8	365	88	
	2007.09-	-	-	L	F	Estate Engine 5FX (EP6DT)	210253	Drive Shaft		25	24	58.5	79	626	
1.6 16V (115 kW)	2009.10-	-	AT	-	F	Estate Engine EP6CDT	810028	Outer Joint		25	34	58	89	56	I
	2009.10-	-	MT	R	F	Estate Engine EP6CDT	210325	Drive Shaft		25	24	58.5	79	940	
	2009.10-	-	MT	L	F	Estate Engine EP6CDT	610057	Inner Joint		24	34	40	52.5	90	
	2009.10-	-	MT	R	F	Estate Engine EP6CDT	610058	Inner Joint		24	34	29.8	365	88	
	2009.10-	-	6MT	-	-	Estate Engine EP6CDT	810155	Outer Joint		25	39	58.5	89	63.5	I
	2009.10-	-	MT	L	F	Estate Engine EP6CDT	210253	Drive Shaft		25	24	58.5	79	626	
	2009.10-	-	MT	L	F	Estate Engine EP6CDT	810148	Outer Joint		25	34	58.5	79	55.5	I
	2009.10-	-	AT	-	-	Estate Engine EP6CDT	899366	Outer Joint		25	34	58.5	79	55	I
1.6 16V (128 kW)	2008.03-	-	MT	R	F	Estate Engine 5FY (EP6DTS)	210325	Drive Shaft		25	24	58.5	79	940	
	2008.03-	-	AT	L	F	Estate Engine 5FY (EP6DTS)	699001	Inner Joint		26	34	42.5	46.5	103.5	
	2008.03-	-	-	L	F	Estate Engine 5FY (EP6DTS)	610057	Inner Joint		24	34	40	52.5	90	
	2008.03-	-	AT	R	F	Estate Engine 5FY (EP6DTS)	810035	Outer Joint		25	34	58	79	55.5	I
	2008.03-	-	AT	L	F	Estate Engine 5FY (EP6DTS)	210362	Drive Shaft		25	26	58.5	79	624	
	2008.03-	-	AT	R	F	Estate Engine 5FY (EP6DTS)	210383	Drive Shaft		25	26	58	79	842	
	2008.03-	-	MT	R	F	Estate Engine 5FY (EP6DTS)	610058	Inner Joint		24	34	29.8	365	88	
	2008.03-	-	-	L	F	Estate Engine 5FY (EP6DTS)	210253	Drive Shaft		25	24	58.5	79	626	
	2008.03-	-	AT	L	F	Estate Engine 5FY (EP6DTS)	810028	Outer Joint		25	34	58	89	56	I
1.6 16V (88 kW)	2008.03-	-	-	L	F	Estate Engine 5FY (EP6DTS)	810148	Outer Joint		25	34	58.5	79	55.5	I
	2007.09-	-	MT	R	F	Estate Engine 5FW (EP6)/EP6	210251	Drive Shaft		25	24	58.5	79	935	
	2007.09-	-	AT	L	F	Estate Engine 5FW (EP6)/EP6	699001	Inner Joint		26	34	42.5	46.5	103.5	
	2007.09-	-	-	-	F	Estate Engine 5FW (EP6)/EP6	810067	Outer Joint	48W	25	34	58.5	79	55	I
	2007.09-	-	AT	R	F	Estate Engine 5FW (EP6)/EP6	810035	Outer Joint		25	34	58	79	55.5	I
	2007.09-	-	-	L	F	Estate Engine 5FW (EP6)/EP6	210250	Drive Shaft		25	24	58.5	79	634	
	2007.09-	-	AT	L	F	Estate Engine 5FW (EP6)/EP6	210362	Drive Shaft		25	26	58.5	79	624	
	2007.09-	-	AT	R	F	Estate Engine 5FW (EP6)/EP6	210383	Drive Shaft		25	26	58	79	842	
	2007.09-	-	6MT	-	-	Estate Engine 5FW (EP6)/EP6	810155	Outer Joint		25	39	58.5	89	63.5	I
1.6 Bioflex (82 kW)	2007.09-	-	AT	-	F	Estate Engine 5FW (EP6)/EP6	810028	Outer Joint		25	34	58	89	56	I
	2009.03-	-	-	R	F	Estate Engine NFU (TU5JP4)	210325	Drive Shaft		25	24	58.5	79	940	
	2009.03-	-	-	L	F	Estate Engine NFU (TU5JP4)	610057	Inner Joint		24	34	40	52.5	90	
	2009.03-	-	-	R	F	Estate Engine NFU (TU5JP4)	610058	Inner Joint		24	34	29.8	365	88	
	2009.03-	-	-	L	F	Estate Engine NFU (TU5JP4)	210253	Drive Shaft		25	24	58.5	79	626	
1.6 HDi (66 kW)	2009.03-	-	-	L	F	Estate Engine NFU (TU5JP4)	810148	Outer Joint		25	34	58.5	79	55.5	I
	2007.09-	-	MT	R	F	Estate Engine 9HX (DV6ATED4)/9HV (DV6ATED4)	210251	Drive Shaft		25	24	58.5	79	935	
	2007.09-	-	-	-	F	Estate Engine 9HX (DV6ATED4)/9HV (DV6ATED4)	810067	Outer Joint	48W	25	34	58.5	79	55	I
	2007.09-	-	-	L	F	Estate Engine 9HX (DV6ATED4)/9HV (DV6ATED4)	210250	Drive Shaft		25	24	58.5	79	634	
1.6 HDi (68 kW)	2007.09-	-	6MT	-	-	Estate Engine 9HX (DV6ATED4)/9HV (DV6ATED4)	810155	Outer Joint		25	39	58.5	89	63.5	I
	2009.11-	-	-	R	F	Estate Engine 9HP (DV6DTED)	210251	Drive Shaft		25	24	58.5	79	935	
	2009.11-	-	6MT	-	-	Estate Engine 9HP (DV6DTED)	810155	Outer Joint		25	39	58.5	89	63.5	I
	2009.11-	-	AT	-	F	Estate Engine 9HP (DV6DTED)	810028	Outer Joint		25	34	58	89	56	I
1.6 HDi (80 kW)	2009.11-	-	AT	-	-	Estate Engine 9HP (DV6DTED)	899366	Outer Joint		25	34	58.5	79	55	I
	2007.09-	-	MT	R	F	Estate Engine 9HZ (DV6TED4)	210251	Drive Shaft		25	24	58.5	79	935	
	2007.09-	-	-	-	F	Estate Engine 9HZ (DV6TED4)	810067	Outer Joint	48W	25	34	58.5	79	55	I
1.6 HDi (82 kW)	2007.09-	-	-	L	F	Estate Engine 9HZ (DV6TED4)	210250	Drive Shaft		25	24	58.5	79	634	
	2009.12-	-	AT	-	F	Estate Engine 9HR (DV6C)	810028	Outer Joint		25	34	58	89	56	I
	2009.12-	-	MT	R	F	Estate Engine 9HR (DV6C)	210251	Drive Shaft		25	24	58.5	79	935	

	 YEAR	TRANSM	L/R	F/R	REMARKS	GSP Ref.	 PRODUCT	 ABS	Technical Specifications					
									A	B	C	H	L	P
PEUGEOT														
308 SW (4E_4H_)														
1.6 HDi (82 kW)	2009.12-	-	6MT	-	-	Estate Engine 9HR (DV6C)	810155	Outer Joint	25	39	58.5	89	63.5	I
	2009.12-	-	AT	-	-	Estate Engine 9HR (DV6C)	899366	Outer Joint	25	34	58.5	79	55	I
1.6 HDi (84 kW)	2013.03-	-	-	R	F	Estate	210251	Drive Shaft	25	24	58.5	79	935	
2.0 Bioflex (103 kW)	2008.01-	-	MT	R	F	Estate Engine RFJ (EW10A)	210251	Drive Shaft	25	24	58.5	79	935	
	2008.01-	-	AT	L	F	Estate Engine RFJ (EW10A)	699001	Inner Joint	26	34	42.5	46.5	103.5	
	2008.01-	-	AT	L	F	Estate Engine RFJ (EW10A)	210362	Drive Shaft	25	26	58.5	79	624	
	2008.01-	-	AT	R	F	Estate Engine RFJ (EW10A)	210383	Drive Shaft	25	26	58	79	842	
2.0 HDi (100 kW)	2007.09-	-	MT	R	F	Estate Engine RHR (DW10BTED4)	610041	Inner Joint	37	39	32	399	95.5	
	2007.09-	-	6MT	L	F	Estate Engine RHR (DW10BTED4)	810158	Outer Joint	25	26	58.5	89	61.5	M
	2007.09-	-	6MT	L	F	Estate Engine RHR (DW10BTED4)	210427	Drive Shaft	25	37	58.5	89	638	
	2007.09-	-	6MT	L	F	Estate Engine RHR (DW10BTED4)	210312	Drive Shaft	25	37	58.5	89	625	
	2007.09-	-	MT	R	F	Estate Engine RHR (DW10BTED4)	210421	Drive Shaft	25	37	58.5	89	972	
	2007.09-	-	AT	L	F	Estate Engine RHR (DW10BTED4)	210375	Drive Shaft	25	37	58.4	89	619	
	2007.09-	-	AT	L	F	Estate Engine RHR (DW10BTED4)	210380	Drive Shaft	25	37	58.5	89	635	
	2007.09-	-	AT	R	F	Estate Engine RHR (DW10BTED4)	210363	Drive Shaft	25	37	58.5	89	935	
	2007.09-	-	MT	L	F	Estate Engine RHR (DW10BTED4)	210210	Drive Shaft	25	37	58.5	89	638	
	2007.09-	-	MT	R	F	Estate Engine RHR (DW10BTED4)	210361	Drive Shaft	25	37	58.5	89	959	
	2007.09-	-	AT	R	F	Estate Engine RHR (DW10BTED4)	610091	Inner Joint	37	26	31.5	366	100	
2.0 HDi (103 kW)	2007.09-	-	MT	R	F	Estate Engine RHR (DW10BTED4)	610041	Inner Joint	37	39	32	399	95.5	
	2007.09-	-	6MT	L	F	Estate Engine RHR (DW10BTED4)	810158	Outer Joint	25	26	58.5	89	61.5	M
	2007.09-	-	6MT	L	F	Estate Engine RHR (DW10BTED4)	210427	Drive Shaft	25	37	58.5	89	638	
	2007.09-	-	6MT	L	F	Estate Engine RHR (DW10BTED4)	210312	Drive Shaft	25	37	58.5	89	625	
	2007.09-	-	MT	R	F	Estate Engine RHR (DW10BTED4)	210421	Drive Shaft	25	37	58.5	89	972	
	2007.09-	-	AT	L	F	Estate Engine RHR (DW10BTED4)	210375	Drive Shaft	25	37	58.4	89	619	
	2007.09-	-	AT	L	F	Estate Engine RHR (DW10BTED4)	210380	Drive Shaft	25	37	58.5	89	635	
	2007.09-	-	AT	R	F	Estate Engine RHR (DW10BTED4)	210363	Drive Shaft	25	37	58.5	89	935	
	2007.09-	-	MT	L	F	Estate Engine RHR (DW10BTED4)	210210	Drive Shaft	25	37	58.5	89	638	
	2007.09-	-	MT	R	F	Estate Engine RHR (DW10BTED4)	210361	Drive Shaft	25	37	58.5	89	959	
	2007.09-	-	AT	R	F	Estate Engine RHR (DW10BTED4)	610091	Inner Joint	37	26	31.5	366	100	
2.0 HDi (110 kW)	2011.04-	-	AT	-	-	Estate Engine RHE (DW10CTED4)	899366	Outer Joint	25	34	58.5	79	55	I
	2011.04-	-	AT	-	F	Estate Engine RHE (DW10CTED4)	810028	Outer Joint	25	34	58	89	56	I
	2011.04-	-	MT	R	F	Estate Engine RHE (DW10CTED4)	610041	Inner Joint	37	39	32	399	95.5	
	2011.04-	-	-	R	F	Estate Engine RHE (DW10CTED4)	810158	Outer Joint	25	26	58.5	89	61.5	M
	2011.04-	-	-	L	F	Estate Engine RHE (DW10CTED4)	210380	Drive Shaft	25	37	58.5	89	635	
	2011.04-	-	-	R	F	Estate Engine RHE (DW10CTED4)	210363	Drive Shaft	25	37	58.5	89	935	
	2011.04-	-	6MT	-	-	Estate Engine RHE (DW10CTED4)	810155	Outer Joint	25	39	58.5	89	63.5	I
	2011.04-	-	MT	L	F	Estate Engine RHE (DW10CTED4)	210210	Drive Shaft	25	37	58.5	89	638	
	2011.04-	-	MT	R	F	Estate Engine RHE (DW10CTED4)	210361	Drive Shaft	25	37	58.5	89	959	
	2011.04-	-	-	R	F	Estate Engine RHE (DW10CTED4)	610091	Inner Joint	37	26	31.5	366	100	
2.0 HDi (120 kW)	2009.06-	-	MT	R	F	Estate Engine RHH (DW10CTED4)	610041	Inner Joint	37	39	32	399	95.5	
	2009.06-	-	AT	R	F	Estate Engine RHH (DW10CTED4)	810158	Outer Joint	25	26	58.5	89	61.5	M
	2009.06-	-	AT	L	F	Estate Engine RHH (DW10CTED4)	210375	Drive Shaft	25	37	58.4	89	619	
	2009.06-	-	AT	L	F	Estate Engine RHH (DW10CTED4)	210380	Drive Shaft	25	37	58.5	89	635	
	2009.06-	-	AT	R	F	Estate Engine RHH (DW10CTED4)	210363	Drive Shaft	25	37	58.5	89	935	
	2009.06-	-	6MT	-	-	Estate Engine RHH (DW10CTED4)	810155	Outer Joint	25	39	58.5	89	63.5	I
	2009.06-	-	MT	L	F	Estate Engine RHH (DW10CTED4)	210210	Drive Shaft	25	37	58.5	89	638	
	2009.06-	-	MT	R	F	Estate Engine RHH (DW10CTED4)	210361	Drive Shaft	25	37	58.5	89	959	
	2009.06-	-	AT	R	F	Estate Engine RHH (DW10CTED4)	610091	Inner Joint	37	26	31.5	366	100	
	2009.06-	-	AT	-	-	Estate Engine RHH (DW10CTED4)	899366	Outer Joint	25	34	58.5	79	55	I
2009.06-	-	AT	-	F	Estate Engine RHH (DW10CTED4)	810028	Outer Joint	25	34	58	89	56	I	
308 SW II														
1.2 THP 130 (96 kW)	2014.03-	-	-	-	F	Estate Engine HNY (EB2DTS)	810052	Outer Joint	28	34	58.5	92	55	I
1.6 THP 125 (92 kW)	2014.03-	-	-	-	F	Estate	810052	Outer Joint	28	34	58.5	92	55	I
1.6 THP 150 (110 kW)	2014.03-	-	-	-	F	Estate	810052	Outer Joint	28	34	58.5	92	55	I
1.6 THP 155 (115 kW)	2014.03-	-	-	-	F	Estate Engine 5FV (EP6CDT)	810052	Outer Joint	28	34	58.5	92	55	I
309 I (10C 10A)														
1.1 (40 kW)	1985.10-	1989.07	-	L	F	Hatchback Engine E1	245013	Drive Shaft	21	24	56.4	76	582	
	1985.10-	1989.07	-	R	F	Hatchback Engine E1	245036	Drive Shaft	21	24	56.4	76	840	
1.3 (47 kW)	1985.10-	1989.07	-	L	F	Hatchback Engine G1A	245013	Drive Shaft	21	24	56.4	76	582	
	1985.10-	1989.07	-	R	F	Hatchback Engine G1A	245036	Drive Shaft	21	24	56.4	76	840	
1.4 (49 kW)	1989.03-	1989.07	MT	R	F	Hatchback Engine K1D (TU3A)	245034	Drive Shaft	21	22	56.4	76	847.5	
	1989.03-	1989.07	MT	L	F	Hatchback Engine K1D (TU3A)	245033	Drive Shaft	21	22	56.4	76	588	
1.4 (55 kW)	1989.03-	1989.07	-	R	F	Hatchback Engine KDY (TU3M)/KDZ (TU3M)	845014	Outer Joint	25	22	56.7	80	59	O
	1989.03-	1989.07	-	R	F	Hatchback Engine KDY (TU3M)/KDZ (TU3M)	245110	Drive Shaft	25	22	56.7	80	844.5	
	1989.03-	1989.07	MT	R	F	Hatchback Engine KDY (TU3M)/KDZ (TU3M)	245034	Drive Shaft	21	22	56.4	76	847.5	
	1989.03-	1989.07	MT	L	F	Hatchback Engine KDY (TU3M)/KDZ (TU3M)	245033	Drive Shaft	21	22	56.4	76	588	

YEAR	TRANSM	L/R	F/R	REMARKS	GSP Ref.	PRODUCT	ABS	Technical Specifications						
								A	B	C	H	L	P	
PEUGEOT														
309 I (10C 10A)														
1.9 (72 kW)	1986.03-1989.07	MT	L	F	Hatchback Engine DFZ (XU9J1)	845014	Outer Joint		25	22	56.7	80	59	O
	1986.03-1989.07	MT	L	F	Hatchback Engine DFZ (XU9J1)	245003	Drive Shaft		25	24	56.7	80	581	
1.9 (75 kW)	1985.10-1989.07	MT	L	F	Hatchback Engine D2B (XU9S)	845014	Outer Joint		25	22	56.7	80	59	O
	1985.10-1989.07	MT	L	F	Hatchback Engine D2B (XU9S)	245003	Drive Shaft		25	24	56.7	80	581	
1.9 D (47 kW)	1986.06-1989.07	MT	R	F	Hatchback Engine 162 (XUD9)/D9A (XUD9)	845014	Outer Joint		25	22	56.7	80	59	O
	1986.06-1989.07	MT	R	F	Hatchback Engine 162 (XUD9)/D9A (XUD9)	245029	Drive Shaft		25	24	56.7	80	845	
	1986.06-1989.07	MT	L	F	Hatchback Engine 162 (XUD9)/D9A (XUD9)	245030	Drive Shaft		25	24	56.7	80	579	
1.9 GTI (88 kW)	1988.07-1989.07	MT	L/R	F	Hatchback Engine DKZ (XU9JAZ)	810002	Outer Joint		25	23	54.8	78.5	56	I
	1988.07-1989.07	AT/MT	L/R	F	Hatchback Engine DKZ (XU9JAZ)	810005	Outer Joint	90T	25	23	54.8	78.5	56	I
1.9 GTI (94 kW)	1986.10-1989.07	MT	L/R	F	Hatchback Engine D6B (XU9JA)	810002	Outer Joint		25	23	54.8	78.5	56	I
	1986.10-1989.07	MT	L/R	F	Hatchback Engine D6B (XU9JA)	810024	Outer Joint	48T	25	34	55.7	79	55	I
	1986.10-1989.07	AT/MT	L/R	F	Hatchback Engine D6B (XU9JA)	810005	Outer Joint	90T	25	23	54.8	78.5	56	I
309 II (3C 3A)														
1.1 (44 kW)	1990.08-1993.12	MT	R	F	Hatchback Engine HDZ (TU1M)	245034	Drive Shaft		21	22	56.4	76	847.5	
	1990.08-1993.12	MT	L	F	Hatchback Engine HDZ (TU1M)	245033	Drive Shaft		21	22	56.4	76	588	
1.4 (49 kW)	1990.07-1993.12	MT	R	F	Hatchback Engine K1D (TU3A)	245034	Drive Shaft		21	22	56.4	76	847.5	
	1990.07-1993.12	MT	L	F	Hatchback Engine K1D (TU3A)	245033	Drive Shaft		21	22	56.4	76	588	
1.4 (55 kW)	1989.07-1993.12	MT	R	F	Hatchback Engine KDY (TU3M)/KDZ (TU3M)	245034	Drive Shaft		21	22	56.4	76	847.5	
	1989.07-1993.12	MT	L	F	Hatchback Engine KDY (TU3M)/KDZ (TU3M)	245033	Drive Shaft		21	22	56.4	76	588	
	1989.07-1993.12	-	R	F	Hatchback Engine KDY (TU3M)/KDZ (TU3M)	845014	Outer Joint		25	22	56.7	80	59	O
	1989.07-1993.12	-	R	F	Hatchback Engine KDY (TU3M)/KDZ (TU3M)	245110	Drive Shaft		25	22	56.7	80	844.5	
1.6 (65 kW)	1989.07-1993.12	MT	R	F	Hatchback Engine BDY (XU5M3Z)/BDZ (XU5M)/BDY (XU5M2Z)	245029	Drive Shaft		25	24	56.7	80	845	
	1989.07-1993.12	MT	L	F	Hatchback Engine BDY (XU5M3Z)/BDZ (XU5M)/BDY (XU5M2Z)	245030	Drive Shaft		25	24	56.7	80	579	
	1989.07-1993.12	MT	R	F	Hatchback Engine BDY (XU5M3Z)/BDZ (XU5M)/BDY (XU5M2Z)	845014	Outer Joint		25	22	56.7	80	59	O
1.6 (68 kW)	1989.07-1993.12	MT	R	F	Hatchback Engine B2A (XU52C/K)	245029	Drive Shaft		25	24	56.7	80	845	
	1989.07-1993.12	MT	L	F	Hatchback Engine B2A (XU52C/K)	245030	Drive Shaft		25	24	56.7	80	579	
	1989.07-1993.12	MT	R	F	Hatchback Engine B2A (XU52C/K)	845014	Outer Joint		25	22	56.7	80	59	O
1.6 (69 kW)	1989.07-1993.12	MT	R	F	Hatchback Engine B2A (XU52C/K)	245029	Drive Shaft		25	24	56.7	80	845	
	1989.07-1993.12	MT	L	F	Hatchback Engine B2A (XU52C/K)	245030	Drive Shaft		25	24	56.7	80	579	
	1989.07-1993.12	MT	R	F	Hatchback Engine B2A (XU52C/K)	845014	Outer Joint		25	22	56.7	80	59	O
1.8 Diesel (44 kW)	1989.07-1993.12	AT/MT	R	F	Hatchback Engine 161A (XUD7)	245029	Drive Shaft		25	24	56.7	80	845	
	1989.07-1993.12	AT/MT	L	F	Hatchback Engine 161A (XUD7)	245030	Drive Shaft		25	24	56.7	80	579	
	1989.07-1993.12	AT/MT	R	F	Hatchback Engine 161A (XUD7)	845014	Outer Joint		25	22	56.7	80	59	O
	1989.07-1993.12	AT/MT	L/R	F	Hatchback Engine 161A (XUD7)	810005	Outer Joint	90T	25	23	54.8	78.5	56	I
1.8 TD (57 kW)	1989.08-1993.12	AT/MT	R	F	Hatchback Engine A8B (XUD7TE)	245029	Drive Shaft		25	24	56.7	80	845	
	1989.08-1993.12	AT/MT	L	F	Hatchback Engine A8B (XUD7TE)	245030	Drive Shaft		25	24	56.7	80	579	
	1989.08-1993.12	AT/MT	R	F	Hatchback Engine A8B (XUD7TE)	845014	Outer Joint		25	22	56.7	80	59	O
	1989.08-1993.12	AT/MT	L/R	F	Hatchback Engine A8B (XUD7TE)	810005	Outer Joint	90T	25	23	54.8	78.5	56	I
1.9 (72 kW)	1989.08-1993.12	MT	L	F	Hatchback Engine DFZ (XU9J1)	245003	Drive Shaft		25	24	56.7	80	581	
	1989.08-1993.12	MT	L	F	Hatchback Engine DFZ (XU9J1)	845014	Outer Joint		25	22	56.7	80	59	O
1.9 (80 kW)	1990.10-1993.12	MT	L	F	Hatchback Engine DDZ (XU9M)	245003	Drive Shaft		25	24	56.7	80	581	
	1990.10-1993.12	MT	L	F	Hatchback Engine DDZ (XU9M)	845014	Outer Joint		25	22	56.7	80	59	O
1.9 Diesel (47 kW)	1989.07-1993.12	MT	R	F	Hatchback Engine D9A (XUD9)/DJZ (XUD9Y)/162 (XUD9)	245029	Drive Shaft		25	24	56.7	80	845	
	1989.07-1993.12	MT	L	F	Hatchback Engine D9A (XUD9)/DJZ (XUD9Y)/162 (XUD9)	245030	Drive Shaft		25	24	56.7	80	579	
	1989.07-1993.12	MT	R	F	Hatchback Engine D9A (XUD9)/DJZ (XUD9Y)/162 (XUD9)	845014	Outer Joint		25	22	56.7	80	59	O
	1989.07-1993.12	AT/MT	L/R	F	Hatchback Engine D9A (XUD9)/DJZ (XUD9Y)/162 (XUD9)	810005	Outer Joint	90T	25	23	54.8	78.5	56	I
1.9 GTI (88 kW)	1989.07-1993.12	MT	L/R	F	Hatchback Engine DKZ (XU9JAZ)	810002	Outer Joint		25	23	54.8	78.5	56	I
	1989.07-1993.12	MT	L/R	F	Hatchback Engine DKZ (XU9JAZ)	810024	Outer Joint	48T	25	34	55.7	79	55	I
1.9 GTI 16V (108 kW)	1990.10-1993.12	MT	L/R	F	Hatchback Engine DFW (XU9J4Z)	810024	Outer Joint	48T	25	34	55.7	79	55	I
4007 (GP_)														
2.2 HDi (115 kW)	2007.02-	MT	L	F	All-wheel Drive Closed Off-Road Vehicle Engine 4HN (DW 12MTED4)4HK (DW 12MTED4)	659140	Inner Joint		24	36	50	67	116	
	2007.02-	MT	R	F	All-wheel Drive Closed Off-Road Vehicle Engine 4HN (DW 12MTED4)4HK (DW 12MTED4)	651021	Inner Joint		24	36	32	280.5	129	
	2007.02-	MT	R	F	All-wheel Drive Closed Off-Road Vehicle Engine 4HN (DW 12MTED4)4HK (DW 12MTED4)	251050	Drive Shaft		28	24	59.5	94.5	993	
405														
-	-	-	L/R	-	-	845020	Outer Joint		25	24	58.5	79	60	M
-	-	-	L	-	-	645017	Inner Joint		24	34	40	69	99	
-	-	-	-	-	-	845028	Outer Joint		25	20	55.5	78.5	50	O
-	-	-	-	-	-	845009	Outer Joint		25	30	55.5	78.5	50	I
-	-	-	L	-	-	645016	Inner Joint		24	24	40	69	107.5	
-	-	-	-	-	LADO ESQUERDO	645021	Inner Joint		22	27	40	65	87.5	
-	-	-	-	-	LADO ESQUERDO	645017	Inner Joint		24	34	40	69	99	
-	-	-	-	-	-	845019	Outer Joint		25	22	57.7	79	50	I
-	-	-	-	-	-	845020	Outer Joint		25	24	58.5	79	60	M
-	-	-	R	-	-	245063	Drive Shaft		25	24	54.8	78.5	887	
-	-	-	L	-	-	245039	Drive Shaft		25	24	58	79	606	

YEAR	TRANSM	L/R	F/R	REMARKS	GSP Ref.	PRODUCT	ABS	Technical Specifications									
								A	B	C	H	L	P				
PEUGEOT																	
405																	
-	-	-	L	-	-	210065	Drive Shaft		25	24	54.8	78.5	605				
-	-	-	-	-	-	645016	Inner Joint		24	24	40	69	107.5				
-	-	-	L	-	-	245080	Drive Shaft		25	24	58.5	79	604				
-	-	-	R	-	-	245079	Drive Shaft		25	24	57.7	79	879				
1.6	1992.07-1995.09	MT/AT	-	F	-	810066	Outer Joint		25	31	55	78	46	I			
1.6/1.8/1.8D/1.9/1.9D	1987.05-	-	-	-	Gear BE 1/3	645014	Inner Joint		24	30	40	69	89.5				
	1987.05-	-	-	-	Gear BE 1/3	645007	Inner Joint		24	29	29.8	348	99.5				
1.9 D	1992.07-1997.02	MT	-	F	-	810066	Outer Joint		25	31	55	78	46	I			
2.0	1992.01-1998.12	MT	-	-	-	810038	Outer Joint		25	25	60	79	61.5	O			
405 I (15B)																	
1.4 (47 kW)	1987.01-1992.07	MT	L/R	F	Saloon Engine K5A (TU3)	810001	Outer Joint		25	22	54.8	79	48	I			
1.6 (53 kW)	1987.07-1992.12	MT	R	F	Saloon Engine B1E (XU51C)	245022	Drive Shaft		25	24	54.8	79	880				
	1987.07-1992.12	AT/MT	L/R	F	Saloon Engine B1E (XU51C)	810003	Outer Joint	29T	25	23	54.8	78.5	56	I			
	1987.07-1992.12	MT	L	F	Saloon Engine B1E (XU51C)	245023	Drive Shaft		25	24	60	80	608				
	1987.07-1992.12	MT	L/R	F	Saloon Engine B1E (XU51C)	810001	Outer Joint		25	22	54.8	79	48	I			
	1987.07-1992.12	AT/MT	L/R	F	Saloon Engine B1E (XU51C)	810005	Outer Joint	90T	25	23	54.8	78.5	56	I			
	1987.07-1992.12	-	-	F	Saloon Engine B1E (XU51C)	845031	Outer Joint		25	31	55.5	78.5	50	I			
	1987.07-1992.12	-	R	F	Saloon Engine B1E (XU51C)	245074	Drive Shaft		25	24	55.7	79	884				
	1987.07-1992.12	-	L	F	Saloon Engine B1E (XU51C)	245073	Drive Shaft		25	24	54.8	78.5	601				
	1987.07-1992.12	-	R	F	Saloon Engine B1E (XU51C)	210126	Drive Shaft	29W	25	24	55.7	79	886				
	1987.07-1992.12	-	L	F	Saloon Engine B1E (XU51C)	245069	Drive Shaft		25	24	54.8	78.5	606				
1.6 (65 kW)	1987.07-1992.12	MT	R	F	Saloon Engine BDY (XU5M2Z)/BDZ (XU5M)	245022	Drive Shaft		25	24	54.8	79	880				
	1987.07-1992.12	AT/MT	L/R	F	Saloon Engine BDY (XU5M2Z)/BDZ (XU5M)	810003	Outer Joint	29T	25	23	54.8	78.5	56	I			
	1987.07-1992.12	MT	L	F	Saloon Engine BDY (XU5M2Z)/BDZ (XU5M)	245023	Drive Shaft		25	24	60	80	608				
	1987.07-1992.12	MT	L/R	F	Saloon Engine BDY (XU5M2Z)/BDZ (XU5M)	810001	Outer Joint		25	22	54.8	79	48	I			
	1987.07-1992.12	AT/MT	L/R	F	Saloon Engine BDY (XU5M2Z)/BDZ (XU5M)	810005	Outer Joint	90T	25	23	54.8	78.5	56	I			
	1987.07-1992.12	-	-	F	Saloon Engine BDY (XU5M2Z)/BDZ (XU5M)	845031	Outer Joint		25	31	55.5	78.5	50	I			
	1987.07-1992.12	-	R	F	Saloon Engine BDY (XU5M2Z)/BDZ (XU5M)	245074	Drive Shaft		25	24	55.7	79	884				
	1987.07-1992.12	-	L	F	Saloon Engine BDY (XU5M2Z)/BDZ (XU5M)	245073	Drive Shaft		25	24	54.8	78.5	601				
	1987.07-1992.12	-	R	F	Saloon Engine BDY (XU5M2Z)/BDZ (XU5M)	210126	Drive Shaft	29W	25	24	55.7	79	886				
	1987.07-1992.12	-	L	F	Saloon Engine BDY (XU5M2Z)/BDZ (XU5M)	245069	Drive Shaft		25	24	54.8	78.5	606				
1.6 (66 kW)	1989.10-1992.12	MT	R	F	Saloon Engine BDZ (XU5M)	245022	Drive Shaft		25	24	54.8	79	880				
	1989.10-1992.12	MT	L	F	Saloon Engine BDZ (XU5M)	245023	Drive Shaft		25	24	60	80	608				
	1989.10-1992.12	MT	L/R	F	Saloon Engine BDZ (XU5M)	810001	Outer Joint		25	22	54.8	79	48	I			
	1989.10-1992.12	AT/MT	L/R	F	Saloon Engine BDZ (XU5M)	810005	Outer Joint	90T	25	23	54.8	78.5	56	I			
	1989.10-1992.12	-	-	F	Saloon Engine BDZ (XU5M)	845031	Outer Joint		25	31	55.5	78.5	50	I			
	1989.10-1992.12	-	R	F	Saloon Engine BDZ (XU5M)	245074	Drive Shaft		25	24	55.7	79	884				
	1989.10-1992.12	-	L	F	Saloon Engine BDZ (XU5M)	245073	Drive Shaft		25	24	54.8	78.5	601				
	1989.10-1992.12	-	R	F	Saloon Engine BDZ (XU5M)	210126	Drive Shaft	29W	25	24	55.7	79	886				
	1989.10-1992.12	-	L	F	Saloon Engine BDZ (XU5M)	245069	Drive Shaft		25	24	54.8	78.5	606				
1.6 (69 kW)	1987.01-1992.12	MT	R	F	Saloon Engine B2A (XU52C/K)	245022	Drive Shaft		25	24	54.8	79	880				
	1987.01-1992.12	MT	L/R	F	Saloon Engine B2A (XU52C/K)	810001	Outer Joint		25	22	54.8	79	48	I			
	1987.01-1992.12	MT	L	F	Saloon Engine B2A (XU52C/K)	245023	Drive Shaft		25	24	60	80	608				
	1987.01-1992.12	AT/MT	L/R	F	Saloon Engine B2A (XU52C/K)	810003	Outer Joint	29T	25	23	54.8	78.5	56	I			
	1987.01-1992.12	-	-	F	Saloon Engine B2A (XU52C/K)	845031	Outer Joint		25	31	55.5	78.5	50	I			
	1987.01-1992.12	AT/MT	L/R	F	Saloon Engine B2A (XU52C/K)	810005	Outer Joint	90T	25	23	54.8	78.5	56	I			
	1987.01-1992.12	-	R	F	Saloon Engine B2A (XU52C/K)	245074	Drive Shaft		25	24	55.7	79	884				
	1987.01-1992.12	-	L	F	Saloon Engine B2A (XU52C/K)	245073	Drive Shaft		25	24	54.8	78.5	601				
	1987.01-1992.12	-	R	F	Saloon Engine B2A (XU52C/K)	210126	Drive Shaft	29W	25	24	55.7	79	886				
	1987.01-1992.12	-	L	F	Saloon Engine B2A (XU52C/K)	245069	Drive Shaft		25	24	54.8	78.5	606				
1.8 Turbo Diesel (66 kW)	1988.03-1992.12	-	L	F	Saloon Engine A8A (XUD7TE)/AJZ (XUD7TEY)	245160	Drive Shaft		25	24	54.8	78.5	609				
	1988.03-1992.12	AT/MT	L/R	F	Saloon Engine A8A (XUD7TE)/AJZ (XUD7TEY)	810003	Outer Joint	29T	25	23	54.8	78.5	56	I			
	1988.03-1992.12	MT	L/R	F	Saloon Engine A8A (XUD7TE)/AJZ (XUD7TEY)	810002	Outer Joint		25	23	54.8	78.5	56	I			
	1988.03-1992.12	AT/MT	L/R	F	Saloon Engine A8A (XUD7TE)/AJZ (XUD7TEY)	810005	Outer Joint	90T	25	23	54.8	78.5	56	I			
	1988.03-1992.12	MT	L	F	Saloon Engine A8A (XUD7TE)/AJZ (XUD7TEY)	245024	Drive Shaft	29T	25	24	55.7	79	603.5				
	1988.03-1992.12	MT	R	F	Saloon Engine A8A (XUD7TE)/AJZ (XUD7TEY)	245017	Drive Shaft	29T	25	24	55.7	79	881				
	1988.03-1992.12	-	L	F	Saloon Engine A8A (XUD7TE)/AJZ (XUD7TEY)	245073	Drive Shaft		25	24	54.8	78.5	601				
	1988.03-1992.12	-	R	F	Saloon Engine A8A (XUD7TE)/AJZ (XUD7TEY)	210126	Drive Shaft	29W	25	24	55.7	79	886				
1.9 (70 kW)	1987.07-1992.12	AT/MT	R	F	Saloon Engine D2C (XU92C)	245022	Drive Shaft		25	24	54.8	79	880				
	1987.07-1992.12	AT/MT	L/R	F	Saloon Engine D2C (XU92C)	810003	Outer Joint	29T	25	23	54.8	78.5	56	I			
	1987.07-1992.12	AT/MT	L	F	Saloon Engine D2C (XU92C)	245023	Drive Shaft		25	24	60	80	608				
	1987.07-1992.12	AT/MT	L/R	F	Saloon Engine D2C (XU92C)	810001	Outer Joint		25	22	54.8	79	48	I			
	1987.07-1992.12	AT/MT	L/R	F	Saloon Engine D2C (XU92C)	810005	Outer Joint	90T	25	23	54.8	78.5	56	I			
	1987.07-1992.12	-	R	F	Saloon Engine D2C (XU92C)	245074	Drive Shaft		25	24	55.7	79	884				
	1987.07-1992.12	-	L	F	Saloon Engine D2C (XU92C)	245073	Drive Shaft		25	24	54.8	78.5	601				
	1987.07-1992.12	-	R	F	Saloon Engine D2C (XU92C)	210126	Drive Shaft	29W	25	24	55.7	79	886				





YEAR	TRANSM	L/R	F/R	REMARKS	GSP Ref.	PRODUCT	ABS	Technical Specifications									
								A	B	C	H	L	P				
PEUGEOT																	
405 I (15B)																	
1.9 (70 kW)	1987.07-1992.12	-	L	F	Saloon Engine D2C (XU92C)	245069	Drive Shaft		25	24	54.8	78.5	606				
1.9 (80 kW)	1988.07-1992.12	MT	L/R	F	All-wheel Drive Saloon Engine DDZ (XU9M)	810003	Outer Joint	29T	25	23	54.8	78.5	56	I			
	1988.07-1992.12	AT/MT	R	F	Saloon Engine DDZ (XU9M)	245022	Drive Shaft		25	24	54.8	79	880				
	1988.07-1992.12	AT/MT	L/R	F	Saloon Engine DDZ (XU9M)	810003	Outer Joint	29T	25	23	54.8	78.5	56	I			
	1988.07-1992.12	AT/MT	L	F	Saloon Engine DDZ (XU9M)	245023	Drive Shaft		25	24	60	80	608				
	1988.07-1992.12	AT/MT	L/R	F	Saloon Engine DDZ (XU9M)	810001	Outer Joint		25	22	54.8	79	48	I			
	1988.07-1992.12	MT	L/R	F	All-wheel Drive Saloon Engine DDZ (XU9M)	810005	Outer Joint	90T	25	23	54.8	78.5	56	I			
	1988.07-1992.12	AT/MT	L/R	F	Saloon Engine DDZ (XU9M)	810005	Outer Joint	90T	25	23	54.8	78.5	56	I			
	1988.07-1992.12	-	R	F	Saloon Engine DDZ (XU9M)	245074	Drive Shaft		25	24	55.7	79	884				
	1988.07-1992.12	-	L	F	Saloon Engine DDZ (XU9M)	245073	Drive Shaft		25	24	54.8	78.5	601				
	1988.07-1992.12	-	R	F	Saloon Engine DDZ (XU9M)	210126	Drive Shaft	29W	25	24	55.7	79	886				
1988.07-1992.12	-	L	F	Saloon Engine DDZ (XU9M)	245069	Drive Shaft		25	24	54.8	78.5	606					
1.9 (88 kW)	1988.07-1992.12	-	L	F	Saloon Engine DKZ (XU9JAZ)	245160	Drive Shaft		25	24	54.8	78.5	609				
	1988.07-1992.12	AT/MT	L/R	F	Saloon Engine DKZ (XU9JAZ)	810003	Outer Joint	29T	25	23	54.8	78.5	56	I			
	1988.07-1992.12	AT	R	F	Saloon Engine DKZ (XU9JAZ)	245022	Drive Shaft		25	24	54.8	79	880				
	1988.07-1992.12	AT	L	F	Saloon Engine DKZ (XU9JAZ)	245023	Drive Shaft		25	24	60	80	608				
	1988.07-1992.12	AT	L/R	F	Saloon Engine DKZ (XU9JAZ)	810001	Outer Joint		25	22	54.8	79	48	I			
	1988.07-1992.12	AT/MT	L/R	F	Saloon Engine DKZ (XU9JAZ)	810005	Outer Joint	90T	25	23	54.8	78.5	56	I			
	1988.07-1992.12	MT	L	F	Saloon Engine DKZ (XU9JAZ)	245024	Drive Shaft	29T	25	24	55.7	79	603.5				
	1988.07-1992.12	-	R	F	Saloon Engine DKZ (XU9JAZ)	245074	Drive Shaft		25	24	55.7	79	884				
	1988.07-1992.12	MT	R	F	Saloon Engine DKZ (XU9JAZ)	245017	Drive Shaft	29T	25	24	55.7	79	881				
	1988.07-1992.12	-	L	F	Saloon Engine DKZ (XU9JAZ)	245073	Drive Shaft		25	24	54.8	78.5	601				
1.9 (90 kW)	1988.07-1992.12	-	R	F	Saloon Engine DKZ (XU9JAZ)	210126	Drive Shaft	29W	25	24	55.7	79	886				
	1988.07-1992.12	-	L	F	Saloon Engine DKZ (XU9JAZ)	245069	Drive Shaft		25	24	54.8	78.5	606				
1.9 (93 kW)	1989.01-1992.12	-	L	F	Saloon Engine D6A (XU9J2)	245073	Drive Shaft		25	24	54.8	78.5	601				
	1989.01-1992.12	-	R	F	Saloon Engine D6A (XU9J2)	210126	Drive Shaft	29W	25	24	55.7	79	886				
1.9 Diesel (47 kW)	1987.07-1993.12	-	L	F	Saloon Engine D6A (XU9J2)	245160	Drive Shaft		25	24	54.8	78.5	609				
	1987.07-1993.12	-	L	F	Saloon Engine D6A (XU9J2)	245073	Drive Shaft		25	24	54.8	78.5	601				
	1987.07-1993.12	-	R	F	Saloon Engine D6A (XU9J2)	210126	Drive Shaft	29W	25	24	55.7	79	886				
1.9 Diesel (51 kW)	1988.07-1992.09	MT	R	F	Saloon Engine DJZ (XUD9Y)	245022	Drive Shaft		25	24	54.8	79	880				
	1988.07-1992.09	AT/MT	L/R	F	Saloon Engine DJZ (XUD9Y)	810003	Outer Joint	29T	25	23	54.8	78.5	56	I			
	1988.07-1992.09	MT	L	F	Saloon Engine DJZ (XUD9Y)	245023	Drive Shaft		25	24	60	80	608				
	1988.07-1992.09	MT	L/R	F	Saloon Engine DJZ (XUD9Y)	810001	Outer Joint		25	22	54.8	79	48	I			
	1988.07-1992.09	AT/MT	L/R	F	Saloon Engine DJZ (XUD9Y)	810005	Outer Joint	90T	25	23	54.8	78.5	56	I			
	1988.07-1992.09	-	-	F	Saloon Engine DJZ (XUD9Y)	845031	Outer Joint		25	31	55.5	78.5	50	I			
	1988.07-1992.09	-	R	F	Saloon Engine DJZ (XUD9Y)	245074	Drive Shaft		25	24	55.7	79	884				
	1988.07-1992.09	-	-	F	Saloon Engine DJZ (XUD9Y)	810042	Outer Joint		25	34	54.8	78.5	56	I			
	1988.07-1992.09	-	L	F	Saloon Engine DJZ (XUD9Y)	245073	Drive Shaft		25	24	54.8	78.5	601				
	1988.07-1992.09	-	R	F	Saloon Engine DJZ (XUD9Y)	210126	Drive Shaft	29W	25	24	55.7	79	886				
1.9 Diesel (51 kW)	1988.07-1992.09	-	L	F	Saloon Engine DJZ (XUD9Y)	245069	Drive Shaft		25	24	54.8	78.5	606				
	1988.03-1992.12	MT	R	F	Saloon Engine D9B (XUD9A)	245022	Drive Shaft		25	24	54.8	79	880				
	1988.03-1992.12	AT/MT	L/R	F	Saloon Engine D9B (XUD9A)	810003	Outer Joint	29T	25	23	54.8	78.5	56	I			
	1988.03-1992.12	MT	L/R	F	Saloon Engine D9B (XUD9A)	810001	Outer Joint		25	22	54.8	79	48	I			
	1988.03-1992.12	MT	L	F	Saloon Engine D9B (XUD9A)	245023	Drive Shaft		25	24	60	80	608				
	1988.03-1992.12	AT/MT	L/R	F	Saloon Engine D9B (XUD9A)	810005	Outer Joint	90T	25	23	54.8	78.5	56	I			
	1988.03-1992.12	-	-	F	Saloon Engine D9B (XUD9A)	845031	Outer Joint		25	31	55.5	78.5	50	I			
	1988.03-1992.12	-	R	F	Saloon Engine D9B (XUD9A)	245074	Drive Shaft		25	24	55.7	79	884				
	1988.03-1992.12	-	-	F	Saloon Engine D9B (XUD9A)	810042	Outer Joint		25	34	54.8	78.5	56	I			
	1988.03-1992.12	-	L	F	Saloon Engine D9B (XUD9A)	245073	Drive Shaft		25	24	54.8	78.5	601				
1988.03-1992.12	-	R	F	Saloon Engine D9B (XUD9A)	210126	Drive Shaft	29W	25	24	55.7	79	886					
1.9 Injection (77 kW)	1988.03-1992.12	-	L	F	Saloon Engine D9B (XUD9A)	245069	Drive Shaft		25	24	54.8	78.5	606				
	1987.07-1992.12	-	L	F	Saloon Engine DFZ (XU9J1)	245160	Drive Shaft		25	24	54.8	78.5	609				
	1987.07-1992.12	AT/MT	L/R	F	Saloon Engine DFZ (XU9J1)	810003	Outer Joint	29T	25	23	54.8	78.5	56	I			
	1987.07-1992.12	AT	R	F	Saloon Engine DFZ (XU9J1)	245022	Drive Shaft		25	24	54.8	79	880				
	1987.07-1992.12	AT	L	F	Saloon Engine DFZ (XU9J1)	245023	Drive Shaft		25	24	60	80	608				
	1987.07-1992.12	AT	L/R	F	Saloon Engine DFZ (XU9J1)	810001	Outer Joint		25	22	54.8	79	48	I			
	1987.07-1992.12	AT/MT	L/R	F	Saloon Engine DFZ (XU9J1)	810005	Outer Joint	90T	25	23	54.8	78.5	56	I			
	1987.07-1992.12	MT	L	F	Saloon Engine DFZ (XU9J1)	245024	Drive Shaft	29T	25	24	55.7	79	603.5				
	1987.07-1992.12	-	R	F	Saloon Engine DFZ (XU9J1)	245074	Drive Shaft		25	24	55.7	79	884				
	1987.07-1992.12	MT	R	F	Saloon Engine DFZ (XU9J1)	245017	Drive Shaft	29T	25	24	55.7	79	881				
1.9 Sport MI-16 (108 kW)	1987.07-1992.12	-	L	F	Saloon Engine DFZ (XU9J1)	245073	Drive Shaft		25	24	54.8	78.5	601				
	1987.07-1992.12	-	R	F	Saloon Engine DFZ (XU9J1)	210126	Drive Shaft	29W	25	24	55.7	79	886				
	1987.07-1992.12	-	L	F	Saloon Engine DFZ (XU9J1)	245069	Drive Shaft		25	24	54.8	78.5	606				
	1987.07-1992.12	-	L	F	Saloon Engine DFW (XU9J4Z)	245160	Drive Shaft		25	24	54.8	78.5	609				
1988.04-1992.12	-	L	F	All-wheel Drive Saloon Engine DFW (XU9J4Z)	245160	Drive Shaft		25	24	54.8	78.5	609					
1988.04-1992.12	MT	L/R	F	All-wheel Drive Saloon Engine DFW (XU9J4Z)	810003	Outer Joint	29T	25	23	54.8	78.5	56	I				

		 YEAR	TRANSM	L/R	F/R	REMARKS	GSP Ref.	 PRODUCT	 ABS	Technical Specifications						
										A	B	C	H	L	P	
PEUGEOT																
405 I (15B)																
1.9 Sport MI-16 (108 kW)		1988.04-1992.12	AT/MT	L/R	F	Saloon Engine DFW (XU9J4Z)	810003	Outer Joint	29T	25	23	54.8	78.5	56	I	
		1988.04-1992.12	MT	L/R	F	All-wheel Drive Saloon Engine DFW (XU9J4Z)	810005	Outer Joint	90T	25	23	54.8	78.5	56	I	
		1988.04-1992.12	AT/MT	L/R	F	Saloon Engine DFW (XU9J4Z)	810005	Outer Joint	90T	25	23	54.8	78.5	56	I	
		1988.04-1992.12	MT	L/R	F	Saloon Engine DFW (XU9J4Z)	810002	Outer Joint		25	23	54.8	78.5	56	I	
		1988.04-1992.12	MT	L	F	Saloon Engine DFW (XU9J4Z)	245024	Drive Shaft	29T	25	24	55.7	79	603.5		
		1988.04-1992.12	MT	R	F	Saloon Engine DFW (XU9J4Z)	245017	Drive Shaft	29T	25	24	55.7	79	881		
		1988.04-1992.12	-	L	F	Saloon Engine DFW (XU9J4Z)	245073	Drive Shaft		25	24	54.8	78.5	601		
		1988.04-1992.12	-	R	F	Saloon Engine DFW (XU9J4Z)	210126	Drive Shaft	29W	25	24	55.7	79	886		
1.9 Sport MI-16 (116 kW)		1987.07-1991.11	-	L	F	Saloon Engine D6C (XU9J4)	245160	Drive Shaft		25	24	54.8	78.5	609		
		1987.07-1991.11	-	-	-	Saloon Engine D6C (XU9J4)	810036	Outer Joint		25	34	55.7	79	55	I	
		1987.07-1991.11	-	L	F	Saloon Engine D6C (XU9J4)	245073	Drive Shaft		25	24	54.8	78.5	601		
		1987.07-1991.11	-	R	F	Saloon Engine D6C (XU9J4)	210126	Drive Shaft	29W	25	24	55.7	79	886		
405 I Break (15E)																
1.6 (53 kW)		1988.10-1992.08	MT	R	F	Estate Engine B1E (XU51C)	245022	Drive Shaft		25	24	54.8	79	880		
		1988.10-1992.08	AT/MT	L/R	F	Estate Engine B1E (XU51C)	810003	Outer Joint	29T	25	23	54.8	78.5	56	I	
		1988.10-1992.08	MT	L	F	Estate Engine B1E (XU51C)	245023	Drive Shaft		25	24	60	80	608		
		1988.10-1992.08	MT	L/R	F	Estate Engine B1E (XU51C)	810001	Outer Joint		25	22	54.8	79	48	I	
		1988.10-1992.08	-	-	F	Estate Engine B1E (XU51C)	845031	Outer Joint		25	31	55.5	78.5	50	I	
		1988.10-1992.08	AT/MT	L/R	F	Estate Engine B1E (XU51C)	810005	Outer Joint	90T	25	23	54.8	78.5	56	I	
		1988.10-1992.08	-	R	F	Estate Engine B1E (XU51C)	245074	Drive Shaft		25	24	55.7	79	884		
		1988.10-1992.08	-	L	F	Estate Engine B1E (XU51C)	245073	Drive Shaft		25	24	54.8	78.5	601		
		1988.10-1992.08	-	R	F	Estate Engine B1E (XU51C)	210126	Drive Shaft	29W	25	24	55.7	79	886		
		1988.10-1992.08	-	L	F	Estate Engine B1E (XU51C)	245069	Drive Shaft		25	24	54.8	78.5	606		
1.6 (55 kW)		1988.10-1992.08	MT	R	F	Estate Engine BAZ (XU5CP)	245022	Drive Shaft		25	24	54.8	79	880		
		1988.10-1992.08	AT/MT	L/R	F	Estate Engine BAZ (XU5CP)	810003	Outer Joint	29T	25	23	54.8	78.5	56	I	
		1988.10-1992.08	MT	L	F	Estate Engine BAZ (XU5CP)	245023	Drive Shaft		25	24	60	80	608		
		1988.10-1992.08	MT	L/R	F	Estate Engine BAZ (XU5CP)	810001	Outer Joint		25	22	54.8	79	48	I	
		1988.10-1992.08	-	-	F	Estate Engine BAZ (XU5CP)	845031	Outer Joint		25	31	55.5	78.5	50	I	
		1988.10-1992.08	AT/MT	L/R	F	Estate Engine BAZ (XU5CP)	810005	Outer Joint	90T	25	23	54.8	78.5	56	I	
		1988.10-1992.08	-	R	F	Estate Engine BAZ (XU5CP)	245074	Drive Shaft		25	24	55.7	79	884		
		1988.10-1992.08	-	L	F	Estate Engine BAZ (XU5CP)	245073	Drive Shaft		25	24	54.8	78.5	601		
		1988.10-1992.08	-	R	F	Estate Engine BAZ (XU5CP)	210126	Drive Shaft	29W	25	24	55.7	79	886		
		1988.10-1992.08	-	L	F	Estate Engine BAZ (XU5CP)	245069	Drive Shaft		25	24	54.8	78.5	606		
1.6 (65 kW)		1988.10-1992.08	MT	R	F	Estate Engine BDZ (XU5M)/BDY (XU5M3Z)/BDY (XU5M2Z)	245022	Drive Shaft		25	24	54.8	79	880		
		1988.10-1992.08	AT/MT	L/R	F	Estate Engine BDZ (XU5M)/BDY (XU5M3Z)/BDY (XU5M2Z)	810003	Outer Joint	29T	25	23	54.8	78.5	56	I	
		1988.10-1992.08	MT	L	F	Estate Engine BDZ (XU5M)/BDY (XU5M3Z)/BDY (XU5M2Z)	245023	Drive Shaft		25	24	60	80	608		
		1988.10-1992.08	MT	L/R	F	Estate Engine BDZ (XU5M)/BDY (XU5M3Z)/BDY (XU5M2Z)	810001	Outer Joint		25	22	54.8	79	48	I	
		1988.10-1992.08	-	-	F	Estate Engine BDZ (XU5M)/BDY (XU5M3Z)/BDY (XU5M2Z)	845031	Outer Joint		25	31	55.5	78.5	50	I	
		1988.10-1992.08	AT/MT	L/R	F	Estate Engine BDZ (XU5M)/BDY (XU5M3Z)/BDY (XU5M2Z)	810005	Outer Joint	90T	25	23	54.8	78.5	56	I	
		1988.10-1992.08	-	R	F	Estate Engine BDZ (XU5M)/BDY (XU5M3Z)/BDY (XU5M2Z)	245074	Drive Shaft		25	24	55.7	79	884		
		1988.10-1992.08	-	L	F	Estate Engine BDZ (XU5M)/BDY (XU5M3Z)/BDY (XU5M2Z)	245073	Drive Shaft		25	24	54.8	78.5	601		
		1988.10-1992.08	-	R	F	Estate Engine BDZ (XU5M)/BDY (XU5M3Z)/BDY (XU5M2Z)	210126	Drive Shaft	29W	25	24	55.7	79	886		
		1988.10-1992.08	-	L	F	Estate Engine BDZ (XU5M)/BDY (XU5M3Z)/BDY (XU5M2Z)	245069	Drive Shaft		25	24	54.8	78.5	606		
1.6 (66 kW)		1988.10-1992.08	MT	R	F	Estate Engine BDZ (XU5M)	245022	Drive Shaft		25	24	54.8	79	880		
		1988.10-1992.08	AT/MT	L/R	F	Estate Engine BDZ (XU5M)	810003	Outer Joint	29T	25	23	54.8	78.5	56	I	
		1988.10-1992.08	MT	L	F	Estate Engine BDZ (XU5M)	245023	Drive Shaft		25	24	60	80	608		
		1988.10-1992.08	MT	L/R	F	Estate Engine BDZ (XU5M)	810001	Outer Joint		25	22	54.8	79	48	I	
		1988.10-1992.08	-	-	F	Estate Engine BDZ (XU5M)	845031	Outer Joint		25	31	55.5	78.5	50	I	
		1988.10-1992.08	AT/MT	L/R	F	Estate Engine BDZ (XU5M)	810005	Outer Joint	90T	25	23	54.8	78.5	56	I	
		1988.10-1992.08	-	R	F	Estate Engine BDZ (XU5M)	245074	Drive Shaft		25	24	55.7	79	884		
		1988.10-1992.08	-	L	F	Estate Engine BDZ (XU5M)	245073	Drive Shaft		25	24	54.8	78.5	601		
		1988.10-1992.08	-	R	F	Estate Engine BDZ (XU5M)	210126	Drive Shaft	29W	25	24	55.7	79	886		
		1988.10-1992.08	-	L	F	Estate Engine BDZ (XU5M)	245069	Drive Shaft		25	24	54.8	78.5	606		
1.6 (68 kW)		1988.05-1992.07	-	-	F	Estate Engine B2A (XU52C/K)	845031	Outer Joint		25	31	55.5	78.5	50	I	
		1988.05-1992.07	-	L	F	Estate Engine B2A (XU52C/K)	245073	Drive Shaft		25	24	54.8	78.5	601		
		1988.05-1992.07	-	R	F	Estate Engine B2A (XU52C/K)	210126	Drive Shaft	29W	25	24	55.7	79	886		
1.6 (69 kW)		1988.10-1992.08	MT	R	F	Estate Engine BDZ (XU5M)	245022	Drive Shaft		25	24	54.8	79	880		
		1988.10-1992.08	MT	L	F	Estate Engine BDZ (XU5M)	245023	Drive Shaft		25	24	60	80	608		
		1988.10-1992.08	MT	L/R	F	Estate Engine BDZ (XU5M)	810001	Outer Joint		25	22	54.8	79	48	I	
		1988.10-1992.08	-	-	F	Estate Engine BDZ (XU5M)	845031	Outer Joint		25	31	55.5	78.5	50	I	
		1988.10-1992.08	-	R	F	Estate Engine BDZ (XU5M)	245074	Drive Shaft		25	24	55.7	79	884		
		1988.10-1992.08	-	L	F	Estate Engine BDZ (XU5M)	245073	Drive Shaft		25	24	54.8	78.5	601		
		1988.10-1992.08	-	R	F	Estate Engine BDZ (XU5M)	210126	Drive Shaft	29W	25	24	55.7	79	886		
		1988.10-1992.08	-	L	F	Estate Engine BDZ (XU5M)	245069	Drive Shaft		25	24	54.8	78.5	606		
1.8 TD (66 kW)		1988.10-1992.08	-	L	F	Estate Engine A8A (XUD7TE)/AJZ (XUD7TEY)	245160	Drive Shaft		25	24	54.8	78.5	609		
		1988.10-1992.08	AT/MT	L/R	F	Estate Engine A8A (XUD7TE)/AJZ (XUD7TEY)	810003	Outer Joint	29T	25	23	54.8	78.5	56	I	

YEAR	TRANSM	L/R	F/R	REMARKS	GSP Ref.	PRODUCT	ABS	Technical Specifications								
								A	B	C	H	L	P			
PEUGEOT																
405 I Break (15E)																
1.8 TD (66 kW)	1988.10-1992.08	AT/MT	L/R	F	Estate Engine A8A (XUD7TE)/AJZ (XUD7TEY)	810005	Outer Joint	90T	25	23	54.8	78.5	56	I		
	1988.10-1992.08	MT	L/R	F	Estate Engine A8A (XUD7TE)/AJZ (XUD7TEY)	810002	Outer Joint		25	23	54.8	78.5	56	I		
	1988.10-1992.08	MT	L	F	Estate Engine A8A (XUD7TE)/AJZ (XUD7TEY)	245024	Drive Shaft	29T	25	24	55.7	79	603.5			
	1988.10-1992.08	MT	R	F	Estate Engine A8A (XUD7TE)/AJZ (XUD7TEY)	245017	Drive Shaft	29T	25	24	55.7	79	881			
1.9 (70 kW)	1988.10-1992.08	AT/MT	R	F	Estate Engine D2C (XU92C)	245022	Drive Shaft		25	24	54.8	79	880			
	1988.10-1992.08	AT/MT	L/R	F	Estate Engine D2C (XU92C)	810003	Outer Joint	29T	25	23	54.8	78.5	56	I		
	1988.10-1992.08	AT/MT	L	F	Estate Engine D2C (XU92C)	245023	Drive Shaft		25	24	60	80	608			
	1988.10-1992.08	AT/MT	L/R	F	Estate Engine D2C (XU92C)	810001	Outer Joint		25	22	54.8	79	48	I		
	1988.10-1992.08	AT/MT	L/R	F	Estate Engine D2C (XU92C)	810005	Outer Joint	90T	25	23	54.8	78.5	56	I		
	1988.10-1992.08	-	R	F	Estate Engine D2C (XU92C)	245074	Drive Shaft		25	24	55.7	79	884			
	1988.10-1992.08	-	L	F	Estate Engine D2C (XU92C)	245073	Drive Shaft		25	24	54.8	78.5	601			
	1988.10-1992.08	-	R	F	Estate Engine D2C (XU92C)	210126	Drive Shaft	29W	25	24	55.7	79	886			
	1988.10-1992.08	-	L	F	Estate Engine D2C (XU92C)	245069	Drive Shaft		25	24	54.8	78.5	606			
1.9 (72 kW)	1988.05-1992.07	-	L	F	Estate Engine DFZ (XU9J1)	245073	Drive Shaft		25	24	54.8	78.5	601			
	1988.05-1992.07	-	R	F	Estate Engine DFZ (XU9J1)	210126	Drive Shaft	29W	25	24	55.7	79	886			
1.9 (77 kW)	1988.10-1992.08	-	L	F	Estate Engine DFZ (XU9J1)	245160	Drive Shaft		25	24	54.8	78.5	609			
	1988.10-1992.08	AT/MT	L/R	F	Estate Engine DFZ (XU9J1)	810003	Outer Joint	29T	25	23	54.8	78.5	56	I		
	1988.10-1992.08	AT/MT	R	F	Estate Engine DFZ (XU9J1)	245022	Drive Shaft		25	24	54.8	79	880			
	1988.10-1992.08	AT/MT	L	F	Estate Engine DFZ (XU9J1)	245023	Drive Shaft		25	24	60	80	608			
	1988.10-1992.08	AT/MT	L/R	F	Estate Engine DFZ (XU9J1)	810001	Outer Joint		25	22	54.8	79	48	I		
	1988.10-1992.08	AT/MT	L/R	F	Estate Engine DFZ (XU9J1)	810005	Outer Joint	90T	25	23	54.8	78.5	56	I		
	1988.10-1992.08	-	R	F	Estate Engine DFZ (XU9J1)	245074	Drive Shaft		25	24	55.7	79	884			
	1988.10-1992.08	-	L	F	Estate Engine DFZ (XU9J1)	245069	Drive Shaft		25	24	54.8	78.5	606			
1.9 (80 kW)	1988.10-1992.08	-	L	F	Estate Engine DDZ (XU9M)	245069	Drive Shaft		25	24	54.8	78.5	606			
	1988.10-1992.08	MT	L/R	F	All-wheel Drive Estate Engine DDZ (XU9M)	810003	Outer Joint	29T	25	23	54.8	78.5	56	I		
	1988.10-1992.08	AT/MT	R	F	Estate Engine DDZ (XU9M)	245022	Drive Shaft		25	24	54.8	79	880			
	1988.10-1992.08	AT/MT	L/R	F	Estate Engine DDZ (XU9M)	810003	Outer Joint	29T	25	23	54.8	78.5	56	I		
	1988.10-1992.08	AT/MT	L	F	Estate Engine DDZ (XU9M)	245023	Drive Shaft		25	24	60	80	608			
	1988.10-1992.08	AT/MT	L/R	F	Estate Engine DDZ (XU9M)	810001	Outer Joint		25	22	54.8	79	48	I		
	1988.10-1992.08	MT	L/R	F	All-wheel Drive Estate Engine DDZ (XU9M)	810005	Outer Joint	90T	25	23	54.8	78.5	56	I		
	1988.10-1992.08	AT/MT	L/R	F	Estate Engine DDZ (XU9M)	810005	Outer Joint	90T	25	23	54.8	78.5	56	I		
	1988.10-1992.08	-	R	F	Estate Engine DDZ (XU9M)	245074	Drive Shaft		25	24	55.7	79	884			
	1988.10-1992.08	-	L	F	Estate Engine DDZ (XU9M)	245073	Drive Shaft		25	24	54.8	78.5	601			
	1988.10-1992.08	-	R	F	Estate Engine DDZ (XU9M)	210126	Drive Shaft	29W	25	24	55.7	79	886			
1.9 (88 kW)	1988.10-1992.08	-	L	F	Estate Engine DKZ (XU9JAZ)	245069	Drive Shaft		25	24	54.8	78.5	606			
	1988.10-1992.08	-	L	F	Estate Engine DKZ (XU9JAZ)	245160	Drive Shaft		25	24	54.8	78.5	609			
	1988.10-1992.08	AT	R	F	Estate Engine DKZ (XU9JAZ)	245022	Drive Shaft		25	24	54.8	79	880			
	1988.10-1992.08	AT/MT	L/R	F	Estate Engine DKZ (XU9JAZ)	810003	Outer Joint	29T	25	23	54.8	78.5	56	I		
	1988.10-1992.08	AT	L	F	Estate Engine DKZ (XU9JAZ)	245023	Drive Shaft		25	24	60	80	608			
	1988.10-1992.08	AT	L/R	F	Estate Engine DKZ (XU9JAZ)	810001	Outer Joint		25	22	54.8	79	48	I		
	1988.10-1992.08	AT/MT	L/R	F	Estate Engine DKZ (XU9JAZ)	810005	Outer Joint	90T	25	23	54.8	78.5	56	I		
	1988.10-1992.08	MT	L	F	Estate Engine DKZ (XU9JAZ)	245024	Drive Shaft	29T	25	24	55.7	79	603.5			
	1988.10-1992.08	-	R	F	Estate Engine DKZ (XU9JAZ)	245074	Drive Shaft		25	24	55.7	79	884			
	1988.10-1992.08	MT	R	F	Estate Engine DKZ (XU9JAZ)	245017	Drive Shaft	29T	25	24	55.7	79	881			
	1988.10-1992.08	-	L	F	Estate Engine DKZ (XU9JAZ)	245073	Drive Shaft		25	24	54.8	78.5	601			
	1988.10-1992.08	-	R	F	Estate Engine DKZ (XU9JAZ)	210126	Drive Shaft	29W	25	24	55.7	79	886			
1.9 D (47 kW)	1988.10-1992.08	-	L	F	Estate Engine DJZ (XUD9Y)	245069	Drive Shaft		25	24	54.8	78.5	606			
	1988.10-1992.08	MT	R	F	Estate Engine DJZ (XUD9Y)	245022	Drive Shaft		25	24	54.8	79	880			
	1988.10-1992.08	AT/MT	L/R	F	Estate Engine DJZ (XUD9Y)	810003	Outer Joint	29T	25	23	54.8	78.5	56	I		
	1988.10-1992.08	MT	L	F	Estate Engine DJZ (XUD9Y)	245023	Drive Shaft		25	24	60	80	608			
	1988.10-1992.08	MT	L/R	F	Estate Engine DJZ (XUD9Y)	810001	Outer Joint		25	22	54.8	79	48	I		
	1988.10-1992.08	AT/MT	L/R	F	Estate Engine DJZ (XUD9Y)	810005	Outer Joint	90T	25	23	54.8	78.5	56	I		
	1988.10-1992.08	-	R	F	Estate Engine DJZ (XUD9Y)	245074	Drive Shaft		25	24	55.7	79	884			
1.9 D (51 kW)	1988.10-1992.08	-	L	F	Estate Engine D9B (XUD9A)/DJY (XUD9A)	245069	Drive Shaft		25	24	54.8	78.5	606			
	1988.10-1992.08	MT	R	F	Estate Engine D9B (XUD9A)/DJY (XUD9A)	245022	Drive Shaft		25	24	54.8	79	880			
	1988.10-1992.08	AT/MT	L/R	F	Estate Engine D9B (XUD9A)/DJY (XUD9A)	810003	Outer Joint	29T	25	23	54.8	78.5	56	I		
	1988.10-1992.08	MT	L	F	Estate Engine D9B (XUD9A)/DJY (XUD9A)	245023	Drive Shaft		25	24	60	80	608			
	1988.10-1992.08	MT	L/R	F	Estate Engine D9B (XUD9A)/DJY (XUD9A)	810001	Outer Joint		25	22	54.8	79	48	I		
	1988.10-1992.08	-	-	F	Estate Engine D9B (XUD9A)/DJY (XUD9A)	845031	Outer Joint		25	31	55.5	78.5	50	I		
	1988.10-1992.08	AT/MT	L/R	F	Estate Engine D9B (XUD9A)/DJY (XUD9A)	810005	Outer Joint	90T	25	23	54.8	78.5	56	I		
	1988.10-1992.08	-	R	F	Estate Engine D9B (XUD9A)/DJY (XUD9A)	245074	Drive Shaft		25	24	55.7	79	884			
	1988.10-1992.08	-	-	F	Estate Engine D9B (XUD9A)/DJY (XUD9A)	810042	Outer Joint		25	34	54.8	78.5	56	I		
	1988.10-1992.08	-	L	F	Estate Engine D9B (XUD9A)/DJY (XUD9A)	245073	Drive Shaft		25	24	54.8	78.5	601			
	1988.10-1992.08	-	R	F	Estate Engine D9B (XUD9A)/DJY (XUD9A)	210126	Drive Shaft	29W	25	24	55.7	79	886			
405 II (4B)																
1.4 (55 kW)	1992.08-1995.10	MT	L	F	Saloon Engine KDX (TU3MC)	245157	Drive Shaft	29T	25	22	54.5	79.5	605			





YEAR	TRANSM	L/R	F/R	REMARKS	GSP Ref.	PRODUCT	ABS	Technical Specifications										
								A	B	C	H	L	P					
PEUGEOT																		
405 II (4B)																		
1.4 (55 kW)	1992.08-1995.10	MT	R	F	Saloon Engine KDX (TU3MC)	245158	Drive Shaft	29T	25	22	54.5	79.5	875					
	1992.08-1995.10	MT	L/R	F	Saloon Engine KDX (TU3MC)	845006	Outer Joint		25	31	55	79.5	47.5	I				
1.6 (65 kW)	1992.08-1995.10	-	L	F	Saloon Engine BFZ (XU5JP)/BDZ (XU5M)/BDY (XU5M3Z)/BDY (XU5M2Z)	245069	Drive Shaft		25	24	54.8	78.5	606					
	1992.08-1995.10	MT	R	F	Saloon Engine BFZ (XU5JP)/BDZ (XU5M)/BDY (XU5M3Z)/BDY (XU5M2Z)	245022	Drive Shaft		25	24	54.8	79	880					
	1992.08-1995.10	AT/MT	L/R	F	Saloon Engine BFZ (XU5JP)/BDZ (XU5M)/BDY (XU5M3Z)/BDY (XU5M2Z)	810003	Outer Joint	29T	25	23	54.8	78.5	56	I				
	1992.08-1995.10	MT	L	F	Saloon Engine BFZ (XU5JP)/BDZ (XU5M)/BDY (XU5M3Z)/BDY (XU5M2Z)	245023	Drive Shaft		25	24	60	80	608					
	1992.08-1995.10	-	-	F	Saloon Engine BFZ (XU5JP)/BDZ (XU5M)/BDY (XU5M3Z)/BDY (XU5M2Z)	845004	Outer Joint	90T	25	34	55.7	79	55	I				
	1992.08-1995.10	AT/MT	L/R	F	Saloon Engine BFZ (XU5JP)/BDZ (XU5M)/BDY (XU5M3Z)/BDY (XU5M2Z)	810005	Outer Joint	90T	25	23	54.8	78.5	56	I				
	1992.08-1995.10	-	-	F	Saloon Engine BFZ (XU5JP)/BDZ (XU5M)/BDY (XU5M3Z)/BDY (XU5M2Z)	845031	Outer Joint		25	31	55.5	78.5	50	I				
	1992.08-1995.10	AT/MT	L/R	F	Saloon Engine BFZ (XU5JP)/BDZ (XU5M)/BDY (XU5M3Z)/BDY (XU5M2Z)	845006	Outer Joint		25	31	55	79.5	47.5	I				
	1992.08-1995.10	-	R	F	Saloon Engine BFZ (XU5JP)/BDZ (XU5M)/BDY (XU5M3Z)/BDY (XU5M2Z)	245153	Drive Shaft	90T	25	24	55.7	79	880					
	1992.08-1995.10	-	R	F	Saloon Engine BFZ (XU5JP)/BDZ (XU5M)/BDY (XU5M3Z)/BDY (XU5M2Z)	245074	Drive Shaft		25	24	55.7	79	884					
	1992.08-1995.10	-	L	F	Saloon Engine BFZ (XU5JP)/BDZ (XU5M)/BDY (XU5M3Z)/BDY (XU5M2Z)	245073	Drive Shaft		25	24	54.8	78.5	601					
	1992.08-1995.10	-	R	F	Saloon Engine BFZ (XU5JP)/BDZ (XU5M)/BDY (XU5M3Z)/BDY (XU5M2Z)	210126	Drive Shaft	29W	25	24	55.7	79	886					
1.6 (66 kW)	1992.08-1997.05	-	-	F	Saloon Engine BFZ (XU5JP)/B2A (XU52C/K)	845031	Outer Joint		25	31	55.5	78.5	50	I				
	1992.08-1997.05	-	L	F	Saloon Engine BFZ (XU5JP)/B2A (XU52C/K)	245073	Drive Shaft		25	24	54.8	78.5	601					
	1992.08-1997.05	-	R	F	Saloon Engine BFZ (XU5JP)/B2A (XU52C/K)	210126	Drive Shaft	29W	25	24	55.7	79	886					
1.6 (68 kW)	1992.08-1994.08	-	-	F	Saloon Engine BFZ (XU5JP)/B2A (XU52C/K)	845031	Outer Joint		25	31	55.5	78.5	50	I				
	1992.08-1994.08	-	L	F	Saloon Engine BFZ (XU5JP)/B2A (XU52C/K)	245073	Drive Shaft		25	24	54.8	78.5	601					
	1992.08-1994.08	-	R	F	Saloon Engine BFZ (XU5JP)/B2A (XU52C/K)	210126	Drive Shaft	29W	25	24	55.7	79	886					
1.8 (74 kW)	1992.08-1995.10	AT/MT	L/R	F	Saloon Engine LFZ (XU7JP)	810003	Outer Joint	29T	25	23	54.8	78.5	56	I				
	1992.08-1995.10	AT/MT	L/R	F	Saloon Engine LFZ (XU7JP)	810005	Outer Joint	90T	25	23	54.8	78.5	56	I				
	1992.08-1995.10	AT/MT	L/R	F	Saloon Engine LFZ (XU7JP)	845006	Outer Joint		25	31	55	79.5	47.5	I				
	1992.08-1995.10	-	L	F	Saloon Engine LFZ (XU7JP)	245073	Drive Shaft		25	24	54.8	78.5	601					
	1992.08-1995.10	-	R	F	Saloon Engine LFZ (XU7JP)	210126	Drive Shaft	29W	25	24	55.7	79	886					
1.8 (76 kW)	1996.08-1999.11	-	L	F	Saloon Engine LFZ (XU7JP)	245073	Drive Shaft		25	24	54.8	78.5	601					
	1996.08-1999.11	-	R	F	Saloon Engine LFZ (XU7JP)	210126	Drive Shaft	29W	25	24	55.7	79	886					
1.9 D (47 kW)	1992.08-1995.10	-	L	F	Saloon Engine DJZ (XUD9Y)	245069	Drive Shaft		25	24	54.8	78.5	606					
	1992.08-1995.10	MT	R	F	Saloon Engine DJZ (XUD9Y)	245022	Drive Shaft		25	24	54.8	79	880					
	1992.08-1995.10	AT/MT	L/R	F	Saloon Engine DJZ (XUD9Y)	810003	Outer Joint	29T	25	23	54.8	78.5	56	I				
	1992.08-1995.10	MT	L	F	Saloon Engine DJZ (XUD9Y)	245023	Drive Shaft		25	24	60	80	608					
	1992.08-1995.10	-	-	F	Saloon Engine DJZ (XUD9Y)	845004	Outer Joint	90T	25	34	55.7	79	55	I				
	1992.08-1995.10	AT/MT	L/R	F	Saloon Engine DJZ (XUD9Y)	810005	Outer Joint	90T	25	23	54.8	78.5	56	I				
	1992.08-1995.10	-	-	F	Saloon Engine DJZ (XUD9Y)	845031	Outer Joint		25	31	55.5	78.5	50	I				
	1992.08-1995.10	AT/MT	L/R	F	Saloon Engine DJZ (XUD9Y)	845006	Outer Joint		25	31	55	79.5	47.5	I				
	1992.08-1995.10	-	-	F	Saloon Engine DJZ (XUD9Y)	845001	Outer Joint	29T	25	34	54.8	78.5	56	I				
	1992.08-1995.10	-	R	F	Saloon Engine DJZ (XUD9Y)	245153	Drive Shaft	90T	25	24	55.7	79	880					
	1992.08-1995.10	-	R	F	Saloon Engine DJZ (XUD9Y)	245074	Drive Shaft		25	24	55.7	79	884					
	1992.08-1995.10	-	-	F	Saloon Engine DJZ (XUD9Y)	810042	Outer Joint		25	34	54.8	78.5	56	I				
	1992.08-1995.10	-	L	F	Saloon Engine DJZ (XUD9Y)	245073	Drive Shaft		25	24	54.8	78.5	601					
	1992.08-1995.10	-	R	F	Saloon Engine DJZ (XUD9Y)	210126	Drive Shaft	29W	25	24	55.7	79	886					
1.9 D (50 kW)	1994.06-1995.10	-	-	F	Saloon Engine DJY (XUD9A)	845004	Outer Joint	90T	25	34	55.7	79	55	I				
	1994.06-1995.10	-	-	F	Saloon Engine DJY (XUD9A)	845031	Outer Joint		25	31	55.5	78.5	50	I				
	1994.06-1995.10	-	-	F	Saloon Engine DJY (XUD9A)	845001	Outer Joint	29T	25	34	54.8	78.5	56	I				
	1994.06-1995.10	-	R	F	Saloon Engine DJY (XUD9A)	245153	Drive Shaft	90T	25	24	55.7	79	880					
	1994.06-1995.10	-	-	-	Saloon Engine DJY (XUD9A)	810036	Outer Joint		25	34	55.7	79	55	I				
	1994.06-1995.10	-	-	F	Saloon Engine DJY (XUD9A)	810042	Outer Joint		25	34	54.8	78.5	56	I				
	1994.06-1995.10	-	L	F	Saloon Engine DJY (XUD9A)	245073	Drive Shaft		25	24	54.8	78.5	601					
	1994.06-1995.10	-	R	F	Saloon Engine DJY (XUD9A)	210126	Drive Shaft	29W	25	24	55.7	79	886					
1.9 D (51 kW)	1992.08-1994.08	-	-	F	Saloon Engine DJY (XUD9A)	845031	Outer Joint		25	31	55.5	78.5	50	I				
	1992.08-1994.08	-	L	F	Saloon Engine DJY (XUD9A)	245073	Drive Shaft		25	24	54.8	78.5	601					
	1992.08-1994.08	-	-	F	Saloon Engine DJY (XUD9A)	810042	Outer Joint		25	34	54.8	78.5	56	I				
	1992.08-1994.08	-	R	F	Saloon Engine DJY (XUD9A)	210126	Drive Shaft	29W	25	24	55.7	79	886					
1.9 D (52 kW)	1997.08-1999.11	-	-	F	Saloon Engine D9B (XUD9A)	845031	Outer Joint		25	31	55.5	78.5	50	I				
	1997.08-1999.11	-	L	F	Saloon Engine D9B (XUD9A)	245073	Drive Shaft		25	24	54.8	78.5	601					
	1997.08-1999.11	-	-	F	Saloon Engine D9B (XUD9A)	810042	Outer Joint		25	34	54.8	78.5	56	I				
	1997.08-1999.11	-	R	F	Saloon Engine D9B (XUD9A)	210126	Drive Shaft	29W	25	24	55.7	79	886					
1.9 TD (66 kW)	1992.08-1995.10	MT	L	F	Saloon Engine DHY (XUD9TE)	610018	Inner Joint		24	29	40	62.5	99					
	1992.08-1995.10	MT	L	F	Saloon Engine DHY (XUD9TE)	245008	Drive Shaft		25	24	54.8	78.5	601.5					
	1992.08-1995.10	MT	R	F	Saloon Engine DHY (XUD9TE)	245070	Drive Shaft		25	24	54.8	78.5	880					
	1992.08-1995.10	-	-	F	Saloon Engine DHY (XUD9TE)	845004	Outer Joint	90T	25	34	55.7	79	55	I				
	1992.08-1995.10	-	-	F	Saloon Engine DHY (XUD9TE)	845031	Outer Joint		25	31	55.5	78.5	50	I				
	1992.08-1995.10	MT	L	F	Saloon Engine DHY (XUD9TE)	245024	Drive Shaft	29T	25	24	55.7	79	603.5					
	1992.08-1995.10	-	-	F	Saloon Engine DHY (XUD9TE)	845001	Outer Joint	29T	25	34	54.8	78.5	56	I				
	1992.08-1995.10	-	R	F	Saloon Engine DHY (XUD9TE)	245153	Drive Shaft	90T	25	24	55.7	79	880					
	1992.08-1995.10	MT	R	F	Saloon Engine DHY (XUD9TE)	245017	Drive Shaft	29T	25	24	55.7	79	881					

YEAR	TRANSM	L/R	F/R	REMARKS	GSP Ref.	PRODUCT	ABS	Technical Specifications									
								A	B	C	H	L	P				
PEUGEOT																	
405 II (4B)																	
1.9 TD (66 kW)	1992.08-1995.10	-	-	-	Saloon Engine DHY (XUD9TE)	810036	Outer Joint		25	34	55.7	79	55				
	1992.08-1995.10	MT	R	F	Saloon Engine DHY (XUD9TE)	210126	Drive Shaft	29W	25	24	55.7	79	886				
	1992.08-1995.10	-	L	F	Saloon Engine DHY (XUD9TE)	245073	Drive Shaft		25	24	54.8	78.5	601				
	1992.08-1995.10	MT	L/R	F	Saloon Engine DHY (XUD9TE)	810043	Outer Joint		25	34	54.8	78.5	56				
1.9 TD (69 kW)	1992.08-1997.05	-	-	F	Saloon Engine XUD9TE	845031	Outer Joint		25	31	55.5	78.5	50				
	1992.08-1997.05	-	L	F	Saloon Engine XUD9TE	245073	Drive Shaft		25	24	54.8	78.5	601				
	1992.08-1997.05	-	-	F	Saloon Engine XUD9TE	810042	Outer Joint		25	34	54.8	78.5	56				
	1992.08-1997.05	-	R	F	Saloon Engine XUD9TE	210126	Drive Shaft	29W	25	24	55.7	79	886				
2.0 (89 kW)	1992.08-1995.10	MT	L	F	Saloon Engine RFX (XU10J2)	610018	Inner Joint		24	29	40	62.5	99				
	1992.08-1995.10	MT	L	F	Saloon Engine RFX (XU10J2)	245008	Drive Shaft		25	24	54.8	78.5	601.5				
	1992.08-1995.10	MT	R	F	Saloon Engine RFX (XU10J2)	245070	Drive Shaft		25	24	54.8	78.5	880				
	1992.08-1995.10	-	-	F	Saloon Engine RFX (XU10J2)	845004	Outer Joint	90T	25	34	55.7	79	55				
	1992.08-1995.10	MT	L	F	Saloon Engine RFX (XU10J2)	245024	Drive Shaft	29T	25	24	55.7	79	603.5				
	1992.08-1995.10	-	-	F	Saloon Engine RFX (XU10J2)	845001	Outer Joint	29T	25	34	54.8	78.5	56				
	1992.08-1995.10	-	R	F	Saloon Engine RFX (XU10J2)	245153	Drive Shaft	90T	25	24	55.7	79	880				
	1992.08-1995.10	MT	R	F	Saloon Engine RFX (XU10J2)	245017	Drive Shaft	29T	25	24	55.7	79	881				
	1992.08-1995.10	-	-	F	Saloon Engine RFX (XU10J2)	810042	Outer Joint		25	34	54.8	78.5	56				
	1992.08-1995.10	-	-	-	Saloon Engine RFX (XU10J2)	810036	Outer Joint		25	34	55.7	79	55				
	1992.08-1995.10	MT	R	F	Saloon Engine RFX (XU10J2)	210126	Drive Shaft	29W	25	24	55.7	79	886				
	1992.08-1995.10	MT	L/R	F	Saloon Engine RFX (XU10J2)	810043	Outer Joint		25	34	54.8	78.5	56				
2.0 16V (110 kW)	1994.06-1995.10	-	-	F	Saloon Engine RFT (XU10J4)	845004	Outer Joint	90T	25	34	55.7	79	55				
	1994.06-1995.10	MT	L	F	Saloon Engine RFT (XU10J4)	245024	Drive Shaft	29T	25	24	55.7	79	603.5				
	1994.06-1995.10	-	-	F	Saloon Engine RFT (XU10J4)	845001	Outer Joint	29T	25	34	54.8	78.5	56				
	1994.06-1995.10	-	-	F/R	Saloon Engine RFT (XU10J4)	810042	Outer Joint		25	34	54.8	78.5	56				
	1994.06-1995.10	-	R	F	Saloon Engine RFT (XU10J4)	245153	Drive Shaft	90T	25	24	55.7	79	880				
	1994.06-1995.10	MT	R	F	Saloon Engine RFT (XU10J4)	245017	Drive Shaft	29T	25	24	55.7	79	881				
2.0 MI-16 (112 kW)	1992.08-1995.10	MT	L	F	Saloon Engine RFY (XU10J4Z)	610018	Inner Joint		24	29	40	62.5	99				
	1992.08-1995.10	MT	L	F	Saloon Engine RFY (XU10J4Z)	245008	Drive Shaft		25	24	54.8	78.5	601.5				
	1992.08-1995.10	MT	R	F	Saloon Engine RFY (XU10J4Z)	245070	Drive Shaft		25	24	54.8	78.5	880				
	1992.08-1995.10	-	-	F	Saloon Engine RFY (XU10J4Z)	845004	Outer Joint	90T	25	34	55.7	79	55				
	1992.08-1995.10	MT	L	F	Saloon Engine RFY (XU10J4Z)	245024	Drive Shaft	29T	25	24	55.7	79	603.5				
	1992.08-1995.10	-	-	F	Saloon Engine RFY (XU10J4Z)	845001	Outer Joint	29T	25	34	54.8	78.5	56				
	1992.08-1995.10	-	R	F	Saloon Engine RFY (XU10J4Z)	245153	Drive Shaft	90T	25	24	55.7	79	880				
	1992.08-1995.10	MT	R	F	Saloon Engine RFY (XU10J4Z)	245017	Drive Shaft	29T	25	24	55.7	79	881				
	1992.08-1995.10	-	-	F	Saloon Engine RFY (XU10J4Z)	810042	Outer Joint		25	34	54.8	78.5	56				
	1992.08-1995.10	MT	R	F	Saloon Engine RFY (XU10J4Z)	210126	Drive Shaft	29W	25	24	55.7	79	886				
	1992.08-1995.10	MT	L/R	F	Saloon Engine RFY (XU10J4Z)	810043	Outer Joint		25	34	54.8	78.5	56				
	2.0 T 16 X4 (144 kW)	1992.08-1995.10	-	-	-	All-wheel Drive Saloon Engine RGZ (XU10J4TE/Z)	810042	Outer Joint		25	34	54.8	78.5	56			
1992.08-1995.10		-	R	F	All-wheel Drive Saloon Engine RGZ (XU10J4TE/Z)	210126	Drive Shaft	29W	25	24	55.7	79	886				
2.0 X4 (89 kW)	1992.08-1995.10	-	-	F	All-wheel Drive Saloon Engine RFX (XU10J2)	845004	Outer Joint	90T	25	34	55.7	79	55				
	1992.08-1995.10	-	-	F	All-wheel Drive Saloon Engine RFX (XU10J2)	845001	Outer Joint	29T	25	34	54.8	78.5	56				
	1992.08-1995.10	-	-	R	All-wheel Drive Saloon Engine RFX (XU10J2)	810042	Outer Joint		25	34	54.8	78.5	56				
	1992.08-1995.10	-	R	F	All-wheel Drive Saloon Engine RFX (XU10J2)	245153	Drive Shaft	90T	25	24	55.7	79	880				
	1992.08-1995.10	-	-	-	All-wheel Drive Saloon Engine RFX (XU10J2)	810036	Outer Joint		25	34	55.7	79	55				
	1992.08-1995.10	-	R	F	All-wheel Drive Saloon Engine RFX (XU10J2)	210126	Drive Shaft	29W	25	24	55.7	79	886				
405 II Break (4E)																	
1.4 (55 kW)	1992.08-1996.10	MT	L	F	Estate Engine KDX (TU3MC)	245157	Drive Shaft	29T	25	22	54.5	79.5	605				
	1992.08-1996.10	MT	R	F	Estate Engine KDX (TU3MC)	245158	Drive Shaft	29T	25	22	54.5	79.5	875				
	1992.08-1996.10	MT	L/R	F	Estate Engine KDX (TU3MC)	845006	Outer Joint		25	31	55	79.5	47.5				
1.6 (65 kW)	1992.08-1996.10	-	L	F	Estate Engine BFZ (XU5JP)/BDZ (XU5M)/BDY (XU5M3Z)/BDY (XU5M2Z)	245069	Drive Shaft		25	24	54.8	78.5	606				
	1992.08-1996.10	MT	R	F	Estate Engine BFZ (XU5JP)/BDZ (XU5M)/BDY (XU5M3Z)/BDY (XU5M2Z)	245022	Drive Shaft		25	24	54.8	79	880				
	1992.08-1996.10	AT/MT	L/R	F	Estate Engine BFZ (XU5JP)/BDZ (XU5M)/BDY (XU5M3Z)/BDY (XU5M2Z)	810003	Outer Joint	29T	25	23	54.8	78.5	56				
	1992.08-1996.10	MT	L	F	Estate Engine BFZ (XU5JP)/BDZ (XU5M)/BDY (XU5M3Z)/BDY (XU5M2Z)	245023	Drive Shaft		25	24	60	80	608				
	1992.08-1996.10	-	-	F	Estate Engine BFZ (XU5JP)/BDZ (XU5M)/BDY (XU5M3Z)/BDY (XU5M2Z)	845004	Outer Joint	90T	25	34	55.7	79	55				
	1992.08-1996.10	-	-	F	Estate Engine BFZ (XU5JP)/BDZ (XU5M)/BDY (XU5M3Z)/BDY (XU5M2Z)	845031	Outer Joint		25	31	55.5	78.5	50				
	1992.08-1996.10	AT/MT	L/R	F	Estate Engine BFZ (XU5JP)/BDZ (XU5M)/BDY (XU5M3Z)/BDY (XU5M2Z)	810005	Outer Joint	90T	25	23	54.8	78.5	56				
	1992.08-1996.10	AT/MT	L/R	F	Estate Engine BFZ (XU5JP)/BDZ (XU5M)/BDY (XU5M3Z)/BDY (XU5M2Z)	845006	Outer Joint		25	31	55	79.5	47.5				
	1992.08-1996.10	-	R	F	Estate Engine BFZ (XU5JP)/BDZ (XU5M)/BDY (XU5M3Z)/BDY (XU5M2Z)	245074	Drive Shaft		25	24	55.7	79	884				
	1992.08-1996.10	-	R	F	Estate Engine BFZ (XU5JP)/BDZ (XU5M)/BDY (XU5M3Z)/BDY (XU5M2Z)	245153	Drive Shaft	90T	25	24	55.7	79	880				
	1992.08-1996.10	-	L	F	Estate Engine BFZ (XU5JP)/BDZ (XU5M)/BDY (XU5M3Z)/BDY (XU5M2Z)	245073	Drive Shaft		25	24	54.8	78.5	601				
	1992.08-1996.10	-	R	F	Estate Engine BFZ (XU5JP)/BDZ (XU5M)/BDY (XU5M3Z)/BDY (XU5M2Z)	210126	Drive Shaft	29W	25	24	55.7	79	886				
1.8 (74 kW)	1992.08-1996.10	AT/MT	L/R	F	Estate Engine LFZ (XU7JP)	810003	Outer Joint	29T	25	23	54.8	78.5	56				
	1992.08-1996.10	AT/MT	L/R	F	Estate Engine LFZ (XU7JP)	810005	Outer Joint	90T	25	23	54.8	78.5	56				
	1992.08-1996.10	AT/MT	L/R	F	Estate Engine LFZ (XU7JP)	845006	Outer Joint		25	31	55	79.5	47.5				
	1992.08-1996.10	-	L	F	Estate Engine LFZ (XU7JP)	245073	Drive Shaft		25	24	54.8	78.5	601				





	 YEAR	TRANSM	L/R	F/R	REMARKS	GSP Ref.	 PRODUCT	 ABS	Technical Specifications					
									A	B	C	H	L	P
PEUGEOT														
405 II Break (4E)														
1.8 (74 kW)	1992.08-1996.10	-	R	F	Estate Engine LFZ (XU7JP)	210126	Drive Shaft	29W	25	24	55.7	79	886	
1.9 D (47 kW)	1992.08-1996.10	-	L	F	Estate Engine DJZ (XUD9Y)	245069	Drive Shaft		25	24	54.8	78.5	606	
	1992.08-1996.10	MT	R	F	Estate Engine DJZ (XUD9Y)	245022	Drive Shaft		25	24	54.8	79	880	
	1992.08-1996.10	AT/MT	L/R	F	Estate Engine DJZ (XUD9Y)	810003	Outer Joint	29T	25	23	54.8	78.5	56	I
	1992.08-1996.10	MT	L	F	Estate Engine DJZ (XUD9Y)	245023	Drive Shaft		25	24	60	80	608	
	1992.08-1996.10	-	-	F	Estate Engine DJZ (XUD9Y)	845004	Outer Joint	90T	25	34	55.7	79	55	I
	1992.08-1996.10	-	-	F	Estate Engine DJZ (XUD9Y)	845031	Outer Joint		25	31	55.5	78.5	50	I
	1992.08-1996.10	AT/MT	L/R	F	Estate Engine DJZ (XUD9Y)	810005	Outer Joint	90T	25	23	54.8	78.5	56	I
	1992.08-1996.10	AT/MT	L/R	F	Estate Engine DJZ (XUD9Y)	845006	Outer Joint		25	31	55	79.5	47.5	I
	1992.08-1996.10	-	-	F	Estate Engine DJZ (XUD9Y)	845001	Outer Joint	29T	25	34	54.8	78.5	56	I
	1992.08-1996.10	-	R	F	Estate Engine DJZ (XUD9Y)	245153	Drive Shaft	90T	25	24	55.7	79	880	
	1992.08-1996.10	-	R	F	Estate Engine DJZ (XUD9Y)	245074	Drive Shaft		25	24	55.7	79	884	
	1992.08-1996.10	-	-	F	Estate Engine DJZ (XUD9Y)	810042	Outer Joint		25	34	54.8	78.5	56	I
	1992.08-1996.10	-	L	F	Estate Engine DJZ (XUD9Y)	245073	Drive Shaft		25	24	54.8	78.5	601	
1992.08-1996.10	-	R	F	Estate Engine DJZ (XUD9Y)	210126	Drive Shaft	29W	25	24	55.7	79	886		
1.9 D (50 kW)	1994.06-1996.10	-	L	F	Estate Engine DJY (XUD9A)	245069	Drive Shaft		25	24	54.8	78.5	606	
	1994.06-1996.10	MT	R	F	Estate Engine DJY (XUD9A)	245022	Drive Shaft		25	24	54.8	79	880	
	1994.06-1996.10	AT/MT	L/R	F	Estate Engine DJY (XUD9A)	810003	Outer Joint	29T	25	23	54.8	78.5	56	I
	1994.06-1996.10	MT	L	F	Estate Engine DJY (XUD9A)	245023	Drive Shaft		25	24	60	80	608	
	1994.06-1996.10	-	-	F	Estate Engine DJY (XUD9A)	845004	Outer Joint	90T	25	34	55.7	79	55	I
	1994.06-1996.10	-	-	F	Estate Engine DJY (XUD9A)	845031	Outer Joint		25	31	55.5	78.5	50	I
	1994.06-1996.10	AT/MT	L/R	F	Estate Engine DJY (XUD9A)	810005	Outer Joint	90T	25	23	54.8	78.5	56	I
	1994.06-1996.10	AT/MT	L/R	F	Estate Engine DJY (XUD9A)	845006	Outer Joint		25	31	55	79.5	47.5	I
	1994.06-1996.10	-	-	F	Estate Engine DJY (XUD9A)	845001	Outer Joint	29T	25	34	54.8	78.5	56	I
	1994.06-1996.10	-	R	F	Estate Engine DJY (XUD9A)	245074	Drive Shaft		25	24	55.7	79	884	
	1994.06-1996.10	-	R	F	Estate Engine DJY (XUD9A)	245153	Drive Shaft	90T	25	24	55.7	79	880	
	1994.06-1996.10	-	-	-	Estate Engine DJY (XUD9A)	810036	Outer Joint		25	34	55.7	79	55	I
	1994.06-1996.10	-	-	F	Estate Engine DJY (XUD9A)	810042	Outer Joint		25	34	54.8	78.5	56	I
1994.06-1996.10	-	L	F	Estate Engine DJY (XUD9A)	245073	Drive Shaft		25	24	54.8	78.5	601		
1994.06-1996.10	-	R	F	Estate Engine DJY (XUD9A)	210126	Drive Shaft	29W	25	24	55.7	79	886		
1.9 D (51 kW)	1993.09-1995.12	-	-	F	Estate Engine XUD9	845031	Outer Joint		25	31	55.5	78.5	50	I
	1993.09-1995.12	-	-	-	Estate Engine XUD9	810036	Outer Joint		25	34	55.7	79	55	I
	1993.09-1995.12	-	L	F	Estate Engine XUD9	245073	Drive Shaft		25	24	54.8	78.5	601	
	1993.09-1995.12	-	-	F	Estate Engine XUD9	810042	Outer Joint		25	34	54.8	78.5	56	I
	1993.09-1995.12	-	R	F	Estate Engine XUD9	210126	Drive Shaft	29W	25	24	55.7	79	886	
1.9 TD (66 kW)	1992.08-1996.10	MT	L	F	Estate Engine DHY (XUD9TE)	610018	Inner Joint		24	29	40	62.5	99	
	1992.08-1996.10	MT	L	F	Estate Engine DHY (XUD9TE)	245008	Drive Shaft		25	24	54.8	78.5	601.5	
	1992.08-1996.10	MT	R	F	Estate Engine DHY (XUD9TE)	245070	Drive Shaft		25	24	54.8	78.5	880	
	1992.08-1996.10	-	-	F	Estate Engine DHY (XUD9TE)	845004	Outer Joint	90T	25	34	55.7	79	55	I
	1992.08-1996.10	-	-	F	Estate Engine DHY (XUD9TE)	845031	Outer Joint		25	31	55.5	78.5	50	I
	1992.08-1996.10	MT	L	F	Estate Engine DHY (XUD9TE)	245024	Drive Shaft	29T	25	24	55.7	79	603.5	
	1992.08-1996.10	-	-	F	Estate Engine DHY (XUD9TE)	845001	Outer Joint	29T	25	34	54.8	78.5	56	I
	1992.08-1996.10	-	R	F	Estate Engine DHY (XUD9TE)	245153	Drive Shaft	90T	25	24	55.7	79	880	
	1992.08-1996.10	MT	R	F	Estate Engine DHY (XUD9TE)	245017	Drive Shaft	29T	25	24	55.7	79	881	
	1992.08-1996.10	-	-	F	Estate Engine DHY (XUD9TE)	810042	Outer Joint		25	34	54.8	78.5	56	I
	1992.08-1996.10	-	-	-	Estate Engine DHY (XUD9TE)	810036	Outer Joint		25	34	55.7	79	55	I
	1992.08-1996.10	-	L	F	Estate Engine DHY (XUD9TE)	245073	Drive Shaft		25	24	54.8	78.5	601	
	1992.08-1996.10	MT	L/R	F	Estate Engine DHY (XUD9TE)	810043	Outer Joint		25	34	54.8	78.5	56	I
1992.08-1996.10	-	R	F	Estate Engine DHY (XUD9TE)	210126	Drive Shaft	29W	25	24	55.7	79	886		
2.0 (144 kW)	1992.08-1995.12	-	-	R	All-wheel Drive Estate Engine RGZ (XU10J4TE/Z)	810042	Outer Joint		25	34	54.8	78.5	56	I
	1992.08-1995.12	-	R	F	All-wheel Drive Estate Engine RGZ (XU10J4TE/Z)	210126	Drive Shaft	29W	25	24	55.7	79	886	
2.0 (89 kW)	1992.08-1996.10	MT	L	F	Estate Engine RFX (XU10J2)	610018	Inner Joint		24	29	40	62.5	99	
	1992.08-1996.10	MT	L	F	Estate Engine RFX (XU10J2)	245008	Drive Shaft		25	24	54.8	78.5	601.5	
	1992.08-1996.10	MT	R	F	Estate Engine RFX (XU10J2)	245070	Drive Shaft		25	24	54.8	78.5	880	
	1992.08-1996.10	-	-	F	Estate Engine RFX (XU10J2)	845004	Outer Joint	90T	25	34	55.7	79	55	I
	1992.08-1996.10	-	-	F	All-wheel Drive Estate Engine RFX (XU10J2)	845004	Outer Joint	90T	25	34	55.7	79	55	I
	1992.08-1996.10	MT	L	F	Estate Engine RFX (XU10J2)	245024	Drive Shaft	29T	25	24	55.7	79	603.5	
	1992.08-1996.10	-	-	F	Estate Engine RFX (XU10J2)	845001	Outer Joint	29T	25	34	54.8	78.5	56	I
	1992.08-1996.10	-	-	F	All-wheel Drive Estate Engine RFX (XU10J2)	845001	Outer Joint	29T	25	34	54.8	78.5	56	I
	1992.08-1996.10	-	-	F/R	Estate Engine RFX (XU10J2)	810042	Outer Joint		25	34	54.8	78.5	56	I
	1992.08-1996.10	-	-	R	All-wheel Drive Estate Engine RFX (XU10J2)	810042	Outer Joint		25	34	54.8	78.5	56	I
	1992.08-1996.10	-	R	F	Estate Engine RFX (XU10J2)	245153	Drive Shaft	90T	25	24	55.7	79	880	
	1992.08-1996.10	-	R	F	All-wheel Drive Estate Engine RFX (XU10J2)	245153	Drive Shaft	90T	25	24	55.7	79	880	
	1992.08-1996.10	MT	R	F	Estate Engine RFX (XU10J2)	245017	Drive Shaft	29T	25	24	55.7	79	881	
1992.08-1996.10	-	-	-	Estate Engine RFX (XU10J2)	810036	Outer Joint		25	34	55.7	79	55	I	
1992.08-1996.10	MT	L/R	F	Estate Engine RFX (XU10J2)	810043	Outer Joint		25	34	54.8	78.5	56	I	





YEAR	TRANSM	L/R	F/R	REMARKS	GSP Ref.	PRODUCT	ABS	Technical Specifications										
								A	B	C	H	L	P					
PEUGEOT																		
405 II Break (4E)																		
2.0 (89 kW)	1992.08-1996.10	-	R	F	Estate Engine RFX (XU10J2)	210126	Drive Shaft	29W	25	24	55.7	79	886					
	1992.08-1996.10	-	R	F	All-wheel Drive Estate Engine RFX (XU10J2)	210126	Drive Shaft	29W	25	24	55.7	79	886					
406																		
1.6/1.8/1.9TD	-	-	-	-	-	610003	Inner Joint		24	34	40	69	99					
	-	-	-	R	-	610004	Inner Joint		24	34	29.8	348	99.5					
2.0	1992.01-1998.12	MT	-	-	-	810038	Outer Joint		25	25	60	79	61.5	O				
406 (8B)																		
1.6 (65 kW)	1995.11-2004.05	-	L	F	Saloon Engine BFZ (XU5JP)	245182	Drive Shaft		25	24	55.7	79	630					
	1995.11-2004.05	-	R	F	Saloon Engine BFZ (XU5JP)	245136	Drive Shaft		25	24	55.7	79	904.5					
	1995.11-2004.05	-	R	F	Saloon Engine BFZ (XU5JP)	245150	Drive Shaft		25	24	55.7	79	900					
	1995.11-2004.05	MT	L	F	Saloon Engine BFZ (XU5JP)	245151	Drive Shaft	29T	25	24	55.7	79	630					
	1995.11-2004.05	-	L	F	Saloon Engine BFZ (XU5JP)	245159	Drive Shaft	29T	25	24	58.5	78.5	629					
	1995.11-2004.05	MT	L	F	Saloon Engine BFZ (XU5JP)	245152	Drive Shaft	48T	25	24	55.7	79	630					
	1995.11-2004.05	MT	R	F	Saloon Engine BFZ (XU5JP)	245020	Drive Shaft	48T	25	24	58	79	905.5					
	1995.11-2004.05	MT	L	F	Saloon Engine BFZ (XU5JP)	299159	Drive Shaft	48T	25	24	58	79	619					
	1995.11-2004.05	MT	R	F	Saloon Engine BFZ (XU5JP)	245002	Drive Shaft	29T	25	24	55.7	79	904.5					
	1995.11-2004.05	MT	L/R	F	Saloon Engine BFZ (XU5JP)	810086	Outer Joint	48T	25	34	55.7	79	55	I				
	1995.11-2004.05	-	-	-	Saloon Engine BFZ (XU5JP)	845027	Outer Joint		25	34	58	79	55.5	I				
	1995.11-2004.05	-	-	-	Saloon Engine BFZ (XU5JP)	845005	Outer Joint	29T	25	34	55.7	79	55	I				
1.8 (66 kW)	1997.05-2004.05	MT	R	F	Saloon Engine LFX (XU7JB)	245042	Drive Shaft	48T	25	24	55.7	79	909					
	1997.05-2004.05	-	L	F	Saloon Engine LFX (XU7JB)	245182	Drive Shaft		25	24	55.7	79	630					
	1997.05-2004.05	-	R	F	Saloon Engine LFX (XU7JB)	299018	Drive Shaft	29T	25	24	58.5	78.5	904					
	1997.05-2004.05	-	R	F	Saloon Engine LFX (XU7JB)	245136	Drive Shaft		25	24	55.7	79	904.5					
	1997.05-2004.05	-	-	F	Saloon Engine LFX (XU7JB)	845003	Outer Joint	29T	25	34	58	79	55.5	I				
	1997.05-2004.05	-	R	F	Saloon Engine LFX (XU7JB)	245150	Drive Shaft		25	24	55.7	79	900					
	1997.05-2004.05	MT	L	F	Saloon Engine LFX (XU7JB)	245151	Drive Shaft	29T	25	24	55.7	79	630					
	1997.05-2004.05	-	L	F	Saloon Engine LFX (XU7JB)	245159	Drive Shaft	29T	25	24	58.5	78.5	629					
	1997.05-2004.05	MT	L	F	Saloon Engine LFX (XU7JB)	245152	Drive Shaft	48T	25	24	55.7	79	630					
	1997.05-2004.05	MT	R	F	Saloon Engine LFX (XU7JB)	245020	Drive Shaft	48T	25	24	58	79	905.5					
	1997.05-2004.05	MT	L	F	Saloon Engine LFX (XU7JB)	299159	Drive Shaft	48T	25	24	58	79	619					
	1997.05-2004.05	MT	R	F	Saloon Engine LFX (XU7JB)	245002	Drive Shaft	29T	25	24	55.7	79	904.5					
	1997.05-2004.05	MT	L/R	F	Saloon Engine LFX (XU7JB)	810086	Outer Joint	48T	25	34	55.7	79	55	I				
	1997.05-2004.05	-	-	F	Saloon Engine LFX (XU7JB)	845035	Outer Joint	48T	25	34	58	79	55.5	I				
	1997.05-2004.05	-	-	-	Saloon Engine LFX (XU7JB)	845027	Outer Joint		25	34	58	79	55.5	I				
	1997.05-2004.05	-	-	-	Saloon Engine LFX (XU7JB)	845005	Outer Joint	29T	25	34	55.7	79	55	I				
1.8 16V (81 kW)	1995.11-2000.10	MT	R	F	Saloon Engine LFY (XU7JP4)	245042	Drive Shaft	48T	25	24	55.7	79	909					
	1995.11-2000.10	-	L	F	Saloon Engine LFY (XU7JP4)	245182	Drive Shaft		25	24	55.7	79	630					
	1995.11-2000.10	-	R	F	Saloon Engine LFY (XU7JP4)	245136	Drive Shaft		25	24	55.7	79	904.5					
	1995.11-2000.10	-	R	F	Saloon Engine LFY (XU7JP4)	245150	Drive Shaft		25	24	55.7	79	900					
	1995.11-2000.10	MT	L	F	Saloon Engine LFY (XU7JP4)	245151	Drive Shaft	29T	25	24	55.7	79	630					
	1995.11-2000.10	-	L	F	Saloon Engine LFY (XU7JP4)	245159	Drive Shaft	29T	25	24	58.5	78.5	629					
	1995.11-2000.10	MT	L	F	Saloon Engine LFY (XU7JP4)	245152	Drive Shaft	48T	25	24	55.7	79	630					
	1995.11-2000.10	MT	R	F	Saloon Engine LFY (XU7JP4)	245020	Drive Shaft	48T	25	24	58	79	905.5					
	1995.11-2000.10	MT	L	F	Saloon Engine LFY (XU7JP4)	299159	Drive Shaft	48T	25	24	58	79	619					
	1995.11-2000.10	MT	R	F	Saloon Engine LFY (XU7JP4)	245002	Drive Shaft	29T	25	24	55.7	79	904.5					
	1995.11-2000.10	MT	L/R	F	Saloon Engine LFY (XU7JP4)	810086	Outer Joint	48T	25	34	55.7	79	55	I				
	1995.11-2000.10	-	-	-	Saloon Engine LFY (XU7JP4)	845027	Outer Joint		25	34	58	79	55.5	I				
	1995.11-2000.10	-	-	F	Saloon Engine LFY (XU7JP4)	845035	Outer Joint	48T	25	34	58	79	55.5	I				
	1995.11-2000.10	-	-	-	Saloon Engine LFY (XU7JP4)	845005	Outer Joint	29T	25	34	55.7	79	55	I				
1.8 16V (85 kW)	2000.10-2004.05	MT	R	F	Saloon Engine 6FZ (EW7J4)	245042	Drive Shaft	48T	25	24	55.7	79	909					
	2000.10-2004.05	MT	L	F	Saloon Engine 6FZ (EW7J4)	245152	Drive Shaft	48T	25	24	55.7	79	630					
	2000.10-2004.05	MT	R	F	Saloon Engine 6FZ (EW7J4)	245020	Drive Shaft	48T	25	24	58	79	905.5					
	2000.10-2004.05	MT	L	F	Saloon Engine 6FZ (EW7J4)	299159	Drive Shaft	48T	25	24	58	79	619					
	2000.10-2004.05	-	-	F	Saloon Engine 6FZ (EW7J4)	845035	Outer Joint	48T	25	34	58	79	55.5	I				
1.9 D (55 kW)	1996.10-2004.05	-	-	-	Saloon Engine DHW (XUD9SD)	845005	Outer Joint	29T	25	34	55.7	79	55	I				
	1996.10-2004.05	-	L	F	Saloon Engine DHW (XUD9SD)	245182	Drive Shaft		25	24	55.7	79	630					
	1996.10-2004.05	MT	R	F	Saloon Engine DHW (XUD9SD)	299018	Drive Shaft	29T	25	24	58.5	78.5	904					
	1996.10-2004.05	-	R	F	Saloon Engine DHW (XUD9SD)	245136	Drive Shaft		25	24	55.7	79	904.5					
	1996.10-2004.05	-	R	F	Saloon Engine DHW (XUD9SD)	245150	Drive Shaft		25	24	55.7	79	900					
	1996.10-2004.05	MT	L	F	Saloon Engine DHW (XUD9SD)	245151	Drive Shaft	29T	25	24	55.7	79	630					
	1996.10-2004.05	-	L	F	Saloon Engine DHW (XUD9SD)	245159	Drive Shaft	29T	25	24	58.5	78.5	629					
	1996.10-2004.05	MT	L	F	Saloon Engine DHW (XUD9SD)	245152	Drive Shaft	48T	25	24	55.7	79	630					
	1996.10-2004.05	MT	R	F	Saloon Engine DHW (XUD9SD)	245020	Drive Shaft	48T	25	24	58	79	905.5					
	1996.10-2004.05	MT	R	F	Saloon Engine DHW (XUD9SD)	245002	Drive Shaft	29T	25	24	55.7	79	904.5					
	1996.10-2004.05	MT	L/R	F	Saloon Engine DHW (XUD9SD)	810086	Outer Joint	48T	25	34	55.7	79	55	I				
	1996.10-2004.05	-	-	-	Saloon Engine DHW (XUD9SD)	845027	Outer Joint		25	34	58	79	55.5	I				





YEAR	TRANSM	L/R	F/R	REMARKS	GSP Ref.	PRODUCT	ABS	Technical Specifications										
								A	B	C	H	L	P					
PEUGEOT																		
406 (8B)																		
1.9 TD (66 kW)																		
1996.01-2004.05	-	L	F	Saloon Engine DHX (XUD9TE)	245182	Drive Shaft		25	24	55.7	79	630						
1996.01-2004.05	MT	L/R	F	Saloon Engine DHX (XUD9TE)	845002	Outer Joint	29T	25	34	58.5	78.5	55	I					
1996.01-2004.05	-	R	F	Saloon Engine DHX (XUD9TE)	245136	Drive Shaft		25	24	55.7	79	904.5						
1996.01-2004.05	-	L	F	Saloon Engine DHX (XUD9TE)	245086	Drive Shaft	29T	25	24	55.7	79	620						
1996.01-2004.05	-	R	F	Saloon Engine DHX (XUD9TE)	245150	Drive Shaft		25	24	55.7	79	900						
1996.01-2004.05	MT	L	F	Saloon Engine DHX (XUD9TE)	245135	Drive Shaft		25	24	55.7	79	621						
1996.01-2004.05	-	L	F	Saloon Engine DHX (XUD9TE)	245159	Drive Shaft	29T	25	24	58.5	78.5	629						
1996.01-2004.05	MT	L	F	Saloon Engine DHX (XUD9TE)	610093	Inner Joint		24	22	40	62	90						
1996.01-2004.05	MT	R	F	Saloon Engine DHX (XUD9TE)	245020	Drive Shaft	48T	25	24	58	79	905.5						
1996.01-2004.05	MT	L	F	Saloon Engine DHX (XUD9TE)	245026	Drive Shaft	48T	25	24	55.7	79	620						
1996.01-2004.05	MT	R	F	Saloon Engine DHX (XUD9TE)	245002	Drive Shaft	29T	25	24	55.7	79	904.5						
1996.01-2004.05	MT	L/R	F	Saloon Engine DHX (XUD9TE)	810086	Outer Joint	48T	25	34	55.7	79	55	I					
1996.01-2004.05	MT	L	F	Saloon Engine DHX (XUD9TE)	245007	Drive Shaft	29T	25	24	55.7	79	621						
1996.01-2004.05	-	-	-	Saloon Engine DHX (XUD9TE)	845027	Outer Joint		25	34	58	79	55.5	I					
1996.01-2004.05	-	-	-	Saloon Engine DHX (XUD9TE)	845005	Outer Joint	29T	25	34	55.7	79	55	I					
1.9 TD (68 kW)																		
1996.01-2004.05	MT	L/R	F	Saloon Engine DHY (XUD9TE)	845002	Outer Joint	29T	25	34	58.5	78.5	55	I					
1996.01-2004.05	MT	R	F	Saloon Engine DHY (XUD9TE)	299018	Drive Shaft	29T	25	24	58.5	78.5	904						
1996.01-2004.05	-	R	F	Saloon Engine DHY (XUD9TE)	245136	Drive Shaft		25	24	55.7	79	904.5						
1996.01-2004.05	-	-	F	Saloon Engine DHY (XUD9TE)	845003	Outer Joint	29T	25	34	58	79	55.5	I					
1996.01-2004.05	-	L	F	Saloon Engine DHY (XUD9TE)	245086	Drive Shaft	29T	25	24	55.7	79	620						
1996.01-2004.05	-	R	F	Saloon Engine DHY (XUD9TE)	245150	Drive Shaft		25	24	55.7	79	900						
1996.01-2004.05	MT	L	F	Saloon Engine DHY (XUD9TE)	245135	Drive Shaft		25	24	55.7	79	621						
1996.01-2004.05	-	L	F	Saloon Engine DHY (XUD9TE)	245159	Drive Shaft	29T	25	24	58.5	78.5	629						
1996.01-2004.05	MT	L	F	Saloon Engine DHY (XUD9TE)	610093	Inner Joint		24	22	40	62	90						
1996.01-2004.05	MT	R	F	Saloon Engine DHY (XUD9TE)	245002	Drive Shaft	29T	25	24	55.7	79	904.5						
1996.01-2004.05	MT	L/R	F	Saloon Engine DHY (XUD9TE)	810086	Outer Joint	48T	25	34	55.7	79	55	I					
1996.01-2004.05	MT	L	F	Saloon Engine DHY (XUD9TE)	245007	Drive Shaft	29T	25	24	55.7	79	621						
1996.01-2004.05	-	-	-	Saloon Engine DHY (XUD9TE)	845027	Outer Joint		25	34	58	79	55.5	I					
1996.01-2004.05	-	-	-	Saloon Engine DHY (XUD9TE)	845005	Outer Joint	29T	25	34	55.7	79	55	I					
2.0 (104 kW)																		
1996.11-1999.03	MT	R	F	Saloon Engine RGY (XU10J2TE)	299018	Drive Shaft	29T	25	24	58.5	78.5	904						
1996.11-1999.03	-	-	F	Saloon Engine RGY (XU10J2TE)	845003	Outer Joint	29T	25	34	58	79	55.5	I					
2.0 16V (100 kW)																		
2000.08-2004.06	MT	R	F	Saloon Engine RFN (EW10J4)	245042	Drive Shaft	48T	25	24	55.7	79	909						
2000.08-2004.06	MT	R	F	Saloon Engine RFN (EW10J4)	245020	Drive Shaft	48T	25	24	58	79	905.5						
2000.08-2004.06	MT	L	F	Saloon Engine RFN (EW10J4)	245026	Drive Shaft	48T	25	24	55.7	79	620						
2000.08-2004.06	-	-	F	Saloon Engine RFN (EW10J4)	845035	Outer Joint	48T	25	34	58	79	55.5	I					
2.0 16V (97 kW)																		
1995.11-2004.05	MT	R	F	Saloon Engine RFV (XU10J4R)	299018	Drive Shaft	29T	25	24	58.5	78.5	904						
1995.11-2004.05	AT/MT	L/R	F	Saloon Engine RFV (XU10J4R)	845002	Outer Joint	29T	25	34	58.5	78.5	55	I					
1995.11-2004.05	-	R	F	Saloon Engine RFV (XU10J4R)	245136	Drive Shaft		25	24	55.7	79	904.5						
1995.11-2004.05	-	-	F	Saloon Engine RFV (XU10J4R)	845003	Outer Joint	29T	25	34	58	79	55.5	I					
1995.11-2004.05	-	L	F	Saloon Engine RFV (XU10J4R)	245086	Drive Shaft	29T	25	24	55.7	79	620						
1995.11-2004.05	AT	-	F	Saloon Engine RFV (XU10J4R)	899003	Outer Joint	29T	25	39	59	89	63.5	I					
1995.11-2004.05	-	R	F	Saloon Engine RFV (XU10J4R)	245150	Drive Shaft		25	24	55.7	79	900						
1995.11-2004.05	MT	L	F	Saloon Engine RFV (XU10J4R)	245135	Drive Shaft		25	24	55.7	79	621						
1995.11-2004.05	MT	L	F	Saloon Engine RFV (XU10J4R)	610093	Inner Joint		24	22	40	62	90						
1995.11-2004.05	AT	R	F	Saloon Engine RFV (XU10J4R)	210153	Drive Shaft	29T	25	37	59	89	902						
1995.11-2004.05	MT	R	F	Saloon Engine RFV (XU10J4R)	245020	Drive Shaft	48T	25	24	58	79	905.5						
1995.11-2004.05	MT	L	F	Saloon Engine RFV (XU10J4R)	245026	Drive Shaft	48T	25	24	55.7	79	620						
1995.11-2004.05	MT	R	F	Saloon Engine RFV (XU10J4R)	245002	Drive Shaft	29T	25	24	55.7	79	904.5						
1995.11-2004.05	-	-	F	Saloon Engine RFV (XU10J4R)	845035	Outer Joint	48T	25	34	58	79	55.5	I					
1995.11-2004.05	MT	L/R	F	Saloon Engine RFV (XU10J4R)	810086	Outer Joint	48T	25	34	55.7	79	55	I					
1995.11-2004.05	MT	L	F	Saloon Engine RFV (XU10J4R)	245007	Drive Shaft	29T	25	24	55.7	79	621						
1995.11-2004.05	-	-	-	Saloon Engine RFV (XU10J4R)	845027	Outer Joint		25	34	58	79	55.5	I					
1995.11-2004.05	-	-	-	Saloon Engine RFV (XU10J4R)	845005	Outer Joint	29T	25	34	55.7	79	55	I					
1995.11-2004.05	AT	L	F	Saloon Engine RFV (XU10J4R)	245044	Drive Shaft	29T	25	37	59	89	592						
1995.11-2004.05	MT	R	F	Saloon Engine RFV (XU10J4R)	245042	Drive Shaft	48T	25	24	55.7	79	909						
2.0 16V (99 kW)																		
1999.01-2000.08	MT	R	F	Saloon Engine RFR (DEW10J4)	245042	Drive Shaft	48T	25	24	55.7	79	909						
1999.01-2000.08	MT	R	F	Saloon Engine RFR (DEW10J4)	299018	Drive Shaft	29T	25	24	58.5	78.5	904						
1999.01-2000.08	-	-	F	Saloon Engine RFR (DEW10J4)	845003	Outer Joint	29T	25	34	58	79	55.5	I					
1999.01-2000.08	-	R	F	Saloon Engine RFR (DEW10J4)	245136	Drive Shaft		25	24	55.7	79	904.5						
1999.01-2000.08	-	L	F	Saloon Engine RFR (DEW10J4)	245086	Drive Shaft	29T	25	24	55.7	79	620						
1999.01-2000.08	-	R	F	Saloon Engine RFR (DEW10J4)	245150	Drive Shaft		25	24	55.7	79	900						
1999.01-2000.08	MT	L	F	Saloon Engine RFR (DEW10J4)	610093	Inner Joint		24	22	40	62	90						
1999.01-2000.08	MT	R	F	Saloon Engine RFR (DEW10J4)	245020	Drive Shaft	48T	25	24	58	79	905.5						
1999.01-2000.08	-	-	F	Saloon Engine RFR (DEW10J4)	845035	Outer Joint	48T	25	34	58	79	55.5	I					
1999.01-2000.08	MT	L	F	Saloon Engine RFR (DEW10J4)	245026	Drive Shaft	48T	25	24	55.7	79	620						
1999.01-2000.08	MT	R	F	Saloon Engine RFR (DEW10J4)	245002	Drive Shaft	29T	25	24	55.7	79	904.5						

	 YEAR	TRANSM	L/R	F/R	REMARKS	GSP Ref.	 PRODUCT	 ABS	Technical Specifications					
									A	B	C	H	L	P
PEUGEOT														
406 (8B)														
2.0 16V (99 kW)	1999.01-2000.08	MT	L	F	Saloon Engine RFR (DEW10J4)	245007	Drive Shaft	29T	25	24	55.7	79	621	
	1999.01-2000.08	-	-	-	Saloon Engine RFR (DEW10J4)	845027	Outer Joint		25	34	58	79	55.5	I
	1999.01-2000.08	-	-	-	Saloon Engine RFR (DEW10J4)	845005	Outer Joint	29T	25	34	55.7	79	55	I
2.0 16V HPi (103 kW)	2001.05-2004.05	MT	R	F	Saloon Engine RLZ (EW10D)	245042	Drive Shaft	48T	25	24	55.7	79	909	
	2001.05-2004.05	-	R	F	Saloon Engine RLZ (EW10D)	245020	Drive Shaft	48T	25	24	58	79	905.5	
	2001.05-2004.05	-	L	F	Saloon Engine RLZ (EW10D)	245026	Drive Shaft	48T	25	24	55.7	79	620	
	2001.05-2004.05	-	-	F	Saloon Engine RLZ (EW10D)	845035	Outer Joint	48T	25	34	58	79	55.5	I
2.0 HDi 110 (79 kW)	2001.08-2004.05	MT	R	F	Saloon Engine RHZ (DW10ATED)/RHS (DW10ATED)	245108	Drive Shaft	48T	25	37	59	89	928	
	2001.08-2004.05	MT	-	F	Saloon Engine RHZ (DW10ATED)/RHS (DW10ATED)	810019	Outer Joint	48T	25	39	59	89	63.5	I
	2001.08-2004.05	MT	-	F	Saloon Engine RHZ (DW10ATED)/RHS (DW10ATED)	845052	Outer Joint	48T	25	39	59	89	63.5	I
	2001.08-2004.05	MT	L	F	Saloon Engine RHZ (DW10ATED)/RHS (DW10ATED)	299165	Drive Shaft	48T	25	37	59	89	620.5	
	2001.08-2004.05	MT	L	F	Saloon Engine RHZ (DW10ATED)/RHS (DW10ATED)	645032	Inner Joint		37	39	40	68.5	100	
	2001.08-2004.05	AT	-	F	Saloon Engine RHZ (DW10ATED)/RHS (DW10ATED)	845035	Outer Joint	48T	25	34	58	79	55.5	I
	2001.08-2004.05	MT	L	F	Saloon Engine RHZ (DW10ATED)/RHS (DW10ATED)	210162	Drive Shaft	48T	25	37	59	89	625	
2.0 HDi 110 (80 kW)	1998.06-2001.08	-	-	-	Saloon Engine RHZ (DW10ATED)	810127	Outer Joint	29T	25	39	59	89	63.5	I
	1998.06-2001.08	-	L	F	Saloon Engine RHZ (DW10ATED)	245086	Drive Shaft	29T	25	24	55.7	79	620	
	1998.06-2001.08	MT	-	F	Saloon Engine RHZ (DW10ATED)	845052	Outer Joint	48T	25	39	59	89	63.5	I
	1998.06-2001.08	MT	L	F	Saloon Engine RHZ (DW10ATED)	245106	Drive Shaft	29T	25	37	59	89	628	
	1998.06-2001.08	MT	L	F	Saloon Engine RHZ (DW10ATED)	610093	Inner Joint		24	22	40	62	90	
	1998.06-2001.08	MT	R	F	Saloon Engine RHZ (DW10ATED)	245020	Drive Shaft	48T	25	24	58	79	905.5	
	1998.06-2001.08	MT	L	F	Saloon Engine RHZ (DW10ATED)	245026	Drive Shaft	48T	25	24	55.7	79	620	
	1998.06-2001.08	MT	R	F	Saloon Engine RHZ (DW10ATED)	245002	Drive Shaft	29T	25	24	55.7	79	904.5	
	1998.06-2001.08	MT	R	F	Saloon Engine RHZ (DW10ATED)	299003	Drive Shaft	29T	25	37	59	89	928	
	1998.06-2001.08	MT	L/R	F	Saloon Engine RHZ (DW10ATED)	810086	Outer Joint	48T	25	34	55.7	79	55	I
	1998.06-2001.08	MT	L	F	Saloon Engine RHZ (DW10ATED)	245007	Drive Shaft	29T	25	24	55.7	79	621	
	1998.06-2001.08	MT	L	F	Saloon Engine RHZ (DW10ATED)	210162	Drive Shaft	48T	25	37	59	89	625	
	1998.06-2001.08	MT	R	F	Saloon Engine RHZ (DW10ATED)	245108	Drive Shaft	48T	25	37	59	89	928	
2.0 HDi 90 (66 kW)	1999.02-2004.05	MT	R	F	Saloon Engine RHY (DW10TD)	245042	Drive Shaft	48T	25	24	55.7	79	909	
	1999.02-2004.05	-	-	-	Saloon Engine RHY (DW10TD)	810127	Outer Joint	29T	25	39	59	89	63.5	I
	1999.02-2004.05	-	L	F	Saloon Engine RHY (DW10TD)	245086	Drive Shaft	29T	25	24	55.7	79	620	
	1999.02-2004.05	MT	R	F	Saloon Engine RHY (DW10TD)	245020	Drive Shaft	48T	25	24	58	79	905.5	
	1999.02-2004.05	MT	L	F	Saloon Engine RHY (DW10TD)	245026	Drive Shaft	48T	25	24	55.7	79	620	
	1999.02-2004.05	MT	L/R	F	Saloon Engine RHY (DW10TD)	810086	Outer Joint	48T	25	34	55.7	79	55	I
	1999.02-2004.05	-	-	F	Saloon Engine RHY (DW10TD)	845035	Outer Joint	48T	25	34	58	79	55.5	I
2.0 Turbo (108 kW)	1996.04-2004.05	-	-	-	Saloon Engine RGX (XU10J2TE)	810127	Outer Joint	29T	25	39	59	89	63.5	I
	1996.04-2004.05	MT	L	F	Saloon Engine RGX (XU10J2TE)	645032	Inner Joint		37	39	40	68.5	100	
	1996.04-2004.05	-	-	F	Saloon Engine RGX (XU10J2TE)	810019	Outer Joint	48T	25	39	59	89	63.5	I
	1996.04-2004.05	-	L	F	Saloon Engine RGX (XU10J2TE)	245086	Drive Shaft	29T	25	24	55.7	79	620	
	1996.04-2004.05	-	-	F	Saloon Engine RGX (XU10J2TE)	899003	Outer Joint	29T	25	39	59	89	63.5	I
	1996.04-2004.05	MT	L	F	Saloon Engine RGX (XU10J2TE)	245106	Drive Shaft	29T	25	37	59	89	628	
	1996.04-2004.05	MT	L	F	Saloon Engine RGX (XU10J2TE)	299165	Drive Shaft	48T	25	37	59	89	620.5	
	1996.04-2004.05	MT	L	F	Saloon Engine RGX (XU10J2TE)	610093	Inner Joint		24	22	40	62	90	
	1996.04-2004.05	MT	R	F	Saloon Engine RGX (XU10J2TE)	245002	Drive Shaft	29T	25	24	55.7	79	904.5	
	1996.04-2004.05	-	R	F	Saloon Engine RGX (XU10J2TE)	299003	Drive Shaft	29T	25	37	59	89	928	
	1996.04-2004.05	MT	L/R	F	Saloon Engine RGX (XU10J2TE)	810086	Outer Joint	48T	25	34	55.7	79	55	I
2.1 TD 12V (80 kW)	1996.01-2004.05	-	-	-	Saloon Engine P8C (XUD11BTE)	810127	Outer Joint	29T	25	39	59	89	63.5	I
	1996.01-2004.05	MT	-	F	Saloon Engine P8C (XUD11BTE)	899003	Outer Joint	29T	25	39	59	89	63.5	I
	1996.01-2004.05	MT	L	F	Saloon Engine P8C (XUD11BTE)	245106	Drive Shaft	29T	25	37	59	89	628	
	1996.01-2004.05	MT	R	F	Saloon Engine P8C (XUD11BTE)	299003	Drive Shaft	29T	25	37	59	89	928	
2.2 (116 kW)	2000.07-2004.05	-	-	F	Saloon Engine 3FZ (EW12J4)	810019	Outer Joint	48T	25	39	59	89	63.5	I
	2000.07-2004.05	MT	-	F	Saloon Engine 3FZ (EW12J4)	845052	Outer Joint	48T	25	39	59	89	63.5	I
	2000.07-2004.05	MT	L	F	Saloon Engine 3FZ (EW12J4)	299165	Drive Shaft	48T	25	37	59	89	620.5	
	2000.07-2004.05	MT	L	F	Saloon Engine 3FZ (EW12J4)	645032	Inner Joint		37	39	40	68.5	100	
	2000.07-2004.05	MT	L	F	Saloon Engine 3FZ (EW12J4)	210162	Drive Shaft	48T	25	37	59	89	625	
	2000.07-2004.05	MT	R	F	Saloon Engine 3FZ (EW12J4)	245108	Drive Shaft	48T	25	37	59	89	928	
2.2 HDi (98 kW)	2000.03-2004.05	-	-	F	Saloon Engine 4HX (DW12TED4/FAP)	810019	Outer Joint	48T	25	39	59	89	63.5	I
	2000.03-2004.05	MT	-	F	Saloon Engine 4HX (DW12TED4/FAP)	845052	Outer Joint	48T	25	39	59	89	63.5	I
	2000.03-2004.05	MT	L	F	Saloon Engine 4HX (DW12TED4/FAP)	299165	Drive Shaft	48T	25	37	59	89	620.5	
	2000.03-2004.05	MT	L	F	Saloon Engine 4HX (DW12TED4/FAP)	645032	Inner Joint		37	39	40	68.5	100	
	2000.03-2004.05	MT	L	F	Saloon Engine 4HX (DW12TED4/FAP)	210162	Drive Shaft	48T	25	37	59	89	625	
	2000.03-2004.05	MT	R	F	Saloon Engine 4HX (DW12TED4/FAP)	245108	Drive Shaft	48T	25	37	59	89	928	
3.0 24V (140 kW)	1996.10-2004.05	-	-	-	Saloon Engine XFZ (ES9J4)	810127	Outer Joint	29T	25	39	59	89	63.5	I
	1996.10-2004.05	-	-	F	Saloon Engine XFZ (ES9J4)	810019	Outer Joint	48T	25	39	59	89	63.5	I
	1996.10-2004.05	MT	-	F	Saloon Engine XFZ (ES9J4)	845052	Outer Joint	48T	25	39	59	89	63.5	I
	1996.10-2004.05	-	-	F	Saloon Engine XFZ (ES9J4)	899003	Outer Joint	29T	25	39	59	89	63.5	I

	YEAR	TRANSM	L/R	F/R	REMARKS	GSP Ref.	PRODUCT	ABS	Technical Specifications								
									A	B	C	H	L	P			
PEUGEOT																	
406 (8B)																	
3.0 24V (140 kW)	1996.10-2004.05	MT	L	F	Saloon Engine Xfz (ES9J4)	645032	Inner Joint		37	39	40	68.5	100				
	1996.10-2004.05	MT	L	F	Saloon Engine Xfz (ES9J4)	245106	Drive Shaft	29T	25	37	59	89	628				
	1996.10-2004.05	MT	L	F	Saloon Engine Xfz (ES9J4)	299165	Drive Shaft	48T	25	37	59	89	620.5				
	1996.10-2004.05	AT	R	F	Saloon Engine Xfz (ES9J4)	210153	Drive Shaft	29T	25	37	59	89	902				
	1996.10-2004.05	MT	R	F	Saloon Engine Xfz (ES9J4)	299003	Drive Shaft	29T	25	37	59	89	928				
	1996.10-2004.05	MT	L	F	Saloon Engine Xfz (ES9J4)	210162	Drive Shaft	48T	25	37	59	89	625				
	1996.10-2004.05	MT	R	F	Saloon Engine Xfz (ES9J4)	245108	Drive Shaft	48T	25	37	59	89	928				
	1996.10-2004.05	-	L	F	Saloon Engine Xfz (ES9J4)	245044	Drive Shaft	29T	25	37	59	89	592				
3.0 24V (143 kW)	1998.01-1999.06	AT	R	F	Saloon Engine Xfz (ES9J4)	210153	Drive Shaft	29T	25	37	59	89	902				
3.0 V6 (152 kW)	2000.03-2004.05	-	-	F	Saloon Engine Xfz (ES9J4S)	810019	Outer Joint	48T	25	39	59	89	63.5	I			
	2000.03-2004.05	MT	L	F	Saloon Engine Xfz (ES9J4S)	845052	Outer Joint	48T	25	39	59	89	63.5	I			
	2000.03-2004.05	MT	L	F	Saloon Engine Xfz (ES9J4S)	299165	Drive Shaft	48T	25	37	59	89	620.5				
	2000.03-2004.05	AT	R	F	Saloon Engine Xfz (ES9J4S)	210153	Drive Shaft	29T	25	37	59	89	902				
	2000.03-2004.05	MT	L	F	Saloon Engine Xfz (ES9J4S)	645032	Inner Joint		37	39	40	68.5	100				
	2000.03-2004.05	MT	L	F	Saloon Engine Xfz (ES9J4S)	210162	Drive Shaft	48T	25	37	59	89	625				
3.0 V6 (154 kW)	2000.03-2004.05	MT	R	F	Saloon Engine Xfz (ES9J4S)	245108	Drive Shaft	48T	25	37	59	89	928				
3.0 V6 (154 kW)	1999.03-2001.12	AT	R	F	Saloon	210153	Drive Shaft	29T	25	37	59	89	902				
406 (8C)																	
2.0 16V (100 kW)	2000.10-2004.12	MT	R	F	Coupe Engine RFV (XU10J4R)/RFN (EW10J4)	245042	Drive Shaft	48T	25	24	55.7	79	909				
	2000.10-2004.12	MT	R	F	Coupe Engine RFV (XU10J4R)/RFN (EW10J4)	245020	Drive Shaft	48T	25	24	58	79	905.5				
	2000.10-2004.12	MT	L	F	Coupe Engine RFV (XU10J4R)/RFN (EW10J4)	245026	Drive Shaft	48T	25	24	55.7	79	620				
	2000.10-2004.12	-	-	F	Coupe Engine RFV (XU10J4R)/RFN (EW10J4)	845035	Outer Joint	48T	25	34	58	79	55.5	I			
2.0 16V (97 kW)	1997.03-2004.12	MT	R	F	Coupe Engine RFV (XU10J4R)	245042	Drive Shaft	48T	25	24	55.7	79	909				
	1997.03-2004.12	MT	R	F	Coupe Engine RFV (XU10J4R)	299018	Drive Shaft	29T	25	24	58.5	78.5	904				
	1997.03-2004.12	AT/MT	L/R	F	Coupe Engine RFV (XU10J4R)	845002	Outer Joint	29T	25	34	58.5	78.5	55	I			
	1997.03-2004.12	-	-	F	Coupe Engine RFV (XU10J4R)	845003	Outer Joint	29T	25	34	58	79	55.5	I			
	1997.03-2004.12	-	R	F	Coupe Engine RFV (XU10J4R)	245136	Drive Shaft		25	24	55.7	79	904.5				
	1997.03-2004.12	-	L	F	Coupe Engine RFV (XU10J4R)	245086	Drive Shaft	29T	25	24	55.7	79	620				
	1997.03-2004.12	-	R	F	Coupe Engine RFV (XU10J4R)	245150	Drive Shaft		25	24	55.7	79	900				
	1997.03-2004.12	MT	L	F	Coupe Engine RFV (XU10J4R)	610093	Inner Joint		24	22	40	62	90				
	1997.03-2004.12	AT	R	F	Coupe Engine RFV (XU10J4R)	210153	Drive Shaft	29T	25	37	59	89	902				
	1997.03-2004.12	MT	R	F	Coupe Engine RFV (XU10J4R)	245020	Drive Shaft	48T	25	24	58	79	905.5				
	1997.03-2004.12	MT	L	F	Coupe Engine RFV (XU10J4R)	245026	Drive Shaft	48T	25	24	55.7	79	620				
	1997.03-2004.12	-	-	F	Coupe Engine RFV (XU10J4R)	845035	Outer Joint	48T	25	34	58	79	55.5	I			
	1997.03-2004.12	MT	R	F	Coupe Engine RFV (XU10J4R)	245002	Drive Shaft	29T	25	24	55.7	79	904.5				
	1997.03-2004.12	MT	L/R	F	Coupe Engine RFV (XU10J4R)	810086	Outer Joint	48T	25	34	55.7	79	55	I			
	1997.03-2004.12	MT	L	F	Coupe Engine RFV (XU10J4R)	245007	Drive Shaft	29T	25	24	55.7	79	621				
	1997.03-2004.12	-	-	-	Coupe Engine RFV (XU10J4R)	845027	Outer Joint		25	34	58	79	55.5	I			
1997.03-2004.12	-	-	-	Coupe Engine RFV (XU10J4R)	845005	Outer Joint	29T	25	34	55.7	79	55	I				
2.0 16V (99 kW)	1999.01-2000.10	MT	R	F	Coupe Engine RFR (DEW10J4)	245042	Drive Shaft	48T	25	24	55.7	79	909				
	1999.01-2000.10	MT	R	F	Coupe Engine RFR (DEW10J4)	299018	Drive Shaft	29T	25	24	58.5	78.5	904				
	1999.01-2000.10	-	-	F	Coupe Engine RFR (DEW10J4)	845003	Outer Joint	29T	25	34	58	79	55.5	I			
	1999.01-2000.10	-	R	F	Coupe Engine RFR (DEW10J4)	245136	Drive Shaft		25	24	55.7	79	904.5				
	1999.01-2000.10	-	L	F	Coupe Engine RFR (DEW10J4)	245086	Drive Shaft	29T	25	24	55.7	79	620				
	1999.01-2000.10	-	R	F	Coupe Engine RFR (DEW10J4)	245150	Drive Shaft		25	24	55.7	79	900				
	1999.01-2000.10	MT	L	F	Coupe Engine RFR (DEW10J4)	610093	Inner Joint		24	22	40	62	90				
	1999.01-2000.10	MT	R	F	Coupe Engine RFR (DEW10J4)	245020	Drive Shaft	48T	25	24	58	79	905.5				
	1999.01-2000.10	-	-	F	Coupe Engine RFR (DEW10J4)	845035	Outer Joint	48T	25	34	58	79	55.5	I			
	1999.01-2000.10	MT	L	F	Coupe Engine RFR (DEW10J4)	245026	Drive Shaft	48T	25	24	55.7	79	620				
	1999.01-2000.10	MT	R	F	Coupe Engine RFR (DEW10J4)	245002	Drive Shaft	29T	25	24	55.7	79	904.5				
	1999.01-2000.10	MT	L	F	Coupe Engine RFR (DEW10J4)	245007	Drive Shaft	29T	25	24	55.7	79	621				
	1999.01-2000.10	-	-	-	Coupe Engine RFR (DEW10J4)	845027	Outer Joint		25	34	58	79	55.5	I			
	1999.01-2000.10	-	-	-	Coupe Engine RFR (DEW10J4)	845005	Outer Joint	29T	25	34	55.7	79	55	I			
	1999.04-2004.09	-	-	F	Coupe Engine RFV (XU10J4R)	845035	Outer Joint	48T	25	34	58	79	55.5	I			
	1999.04-2004.09	MT	R	F	Coupe Engine RFV (XU10J4R)	245042	Drive Shaft	48T	25	24	55.7	79	909				
	1999.04-2004.09	AT	R	F	Coupe Engine RFV (XU10J4R)	210153	Drive Shaft	29T	25	37	59	89	902				
	2.2 (116 kW)	2002.03-2004.12	MT	-	F	Coupe Engine 3fz (EW12J4)	810019	Outer Joint	48T	25	39	59	89	63.5	I		
2002.03-2004.12		MT	-	F	Coupe Engine 3fz (EW12J4)	845052	Outer Joint	48T	25	39	59	89	63.5	I			
2002.03-2004.12		MT	L	F	Coupe Engine 3fz (EW12J4)	299165	Drive Shaft	48T	25	37	59	89	620.5				
2002.03-2004.12		MT	L	F	Coupe Engine 3fz (EW12J4)	645032	Inner Joint		37	39	40	68.5	100				
2002.03-2004.12		MT	L	F	Coupe Engine 3fz (EW12J4)	210162	Drive Shaft	48T	25	37	59	89	625				
2002.03-2004.12		MT	R	F	Coupe Engine 3fz (EW12J4)	245108	Drive Shaft	48T	25	37	59	89	928				
2.2 HDI (98 kW)	2000.03-2004.12	MT	-	F	Coupe Engine 4HX (DW12TED4/FAP)	810019	Outer Joint	48T	25	39	59	89	63.5	I			
	2000.03-2004.12	MT	-	F	Coupe Engine 4HX (DW12TED4/FAP)	845052	Outer Joint	48T	25	39	59	89	63.5	I			
	2000.03-2004.12	MT	L	F	Coupe Engine 4HX (DW12TED4/FAP)	245106	Drive Shaft	29T	25	37	59	89	628				
	2000.03-2004.12	MT	L	F	Coupe Engine 4HX (DW12TED4/FAP)	299165	Drive Shaft	48T	25	37	59	89	620.5				





	 YEAR	TRANSM	L/R	F/R	REMARKS	GSP Ref.	 PRODUCT	 ABS	Technical Specifications					
									A	B	C	H	L	P
PEUGEOT														
406 (8C)														
2.2 HDI (98 kW)	2000.03-2004.12	MT	L	F	Coupe Engine 4HX (DW12TED4/FAP)	645032	Inner Joint		37	39	40	68.5	100	
	2000.03-2004.12	MT	L	F	Coupe Engine 4HX (DW12TED4/FAP)	210162	Drive Shaft	48T	25	37	59	89	625	
	2000.03-2004.12	MT	R	F	Coupe Engine 4HX (DW12TED4/FAP)	245108	Drive Shaft	48T	25	37	59	89	928	
3.0 24V (143 kW)	1997.05-1999.06	AT	R	F	Coupe Engine XFZ (ES9J4)	210153	Drive Shaft	29T	25	37	59	89	902	
3.0 V6 (152 kW)	2000.03-2004.12	-	-	F	Coupe Engine XFX (ES9J4S)	810019	Outer Joint	48T	25	39	59	89	63.5	I
	2000.03-2004.12	MT	-	F	Coupe Engine XFX (ES9J4S)	845052	Outer Joint	48T	25	39	59	89	63.5	I
	2000.03-2004.12	MT	L	F	Coupe Engine XFX (ES9J4S)	299165	Drive Shaft	48T	25	37	59	89	620.5	
	2000.03-2004.12	AT	R	F	Coupe Engine XFX (ES9J4S)	210153	Drive Shaft	29T	25	37	59	89	902	
	2000.03-2004.12	MT	L	F	Coupe Engine XFX (ES9J4S)	645032	Inner Joint		37	39	40	68.5	100	
	2000.03-2004.12	MT	L	F	Coupe Engine XFX (ES9J4S)	210162	Drive Shaft	48T	25	37	59	89	625	
	2000.03-2004.12	MT	R	F	Coupe Engine XFX (ES9J4S)	245108	Drive Shaft	48T	25	37	59	89	928	
3.0 V6 (154 kW)	1999.03-2001.06	AT	R	F	Coupe	210153	Drive Shaft	29T	25	37	59	89	902	
3.0 V6 24V (140 kW)	1997.03-2004.12	-	-	-	Coupe Engine XFZ (ES9J4)	810127	Outer Joint	29T	25	39	59	89	63.5	I
	1997.03-2004.12	-	-	F	Coupe Engine XFZ (ES9J4)	810019	Outer Joint	48T	25	39	59	89	63.5	I
	1997.03-2004.12	MT	-	F	Coupe Engine XFZ (ES9J4)	845052	Outer Joint	48T	25	39	59	89	63.5	I
	1997.03-2004.12	-	-	F	Coupe Engine XFZ (ES9J4)	899003	Outer Joint	29T	25	39	59	89	63.5	I
	1997.03-2004.12	MT	L	F	Coupe Engine XFZ (ES9J4)	645032	Inner Joint		37	39	40	68.5	100	
	1997.03-2004.12	MT	L	F	Coupe Engine XFZ (ES9J4)	245106	Drive Shaft	29T	25	37	59	89	628	
	1997.03-2004.12	MT	L	F	Coupe Engine XFZ (ES9J4)	299165	Drive Shaft	48T	25	37	59	89	620.5	
	1997.03-2004.12	AT	R	F	Coupe Engine XFZ (ES9J4)	210153	Drive Shaft	29T	25	37	59	89	902	
	1997.03-2004.12	MT	R	F	Coupe Engine XFZ (ES9J4)	299003	Drive Shaft	29T	25	37	59	89	928	
	1997.03-2004.12	-	L	F	Coupe Engine XFZ (ES9J4)	245044	Drive Shaft	29T	25	37	59	89	592	
406 Break (8E/F)														
1.8 (66 kW)	1997.05-2004.10	-	L	F	Estate Engine LFX (XU7JB)	245182	Drive Shaft		25	24	55.7	79	630	
	1997.05-2004.10	-	R	F	Estate Engine LFX (XU7JB)	245136	Drive Shaft		25	24	55.7	79	904.5	
	1997.05-2004.10	-	R	F	Estate Engine LFX (XU7JB)	245150	Drive Shaft		25	24	55.7	79	900	
	1997.05-2004.10	MT	L	F	Estate Engine LFX (XU7JB)	245151	Drive Shaft	29T	25	24	55.7	79	630	
	1997.05-2004.10	-	L	F	Estate Engine LFX (XU7JB)	245159	Drive Shaft	29T	25	24	58.5	78.5	629	
	1997.05-2004.10	MT	L	F	Estate Engine LFX (XU7JB)	245152	Drive Shaft	48T	25	24	55.7	79	630	
	1997.05-2004.10	MT	R	F	Estate Engine LFX (XU7JB)	245020	Drive Shaft	48T	25	24	58	79	905.5	
	1997.05-2004.10	MT	L	F	Estate Engine LFX (XU7JB)	299159	Drive Shaft	48T	25	24	58	79	619	
	1997.05-2004.10	MT	R	F	Estate Engine LFX (XU7JB)	245002	Drive Shaft	29T	25	24	55.7	79	904.5	
	1997.05-2004.10	MT	L/R	F	Estate Engine LFX (XU7JB)	810086	Outer Joint	48T	25	34	55.7	79	55	I
	1997.05-2004.10	-	-	-	Estate Engine LFX (XU7JB)	845027	Outer Joint		25	34	58	79	55.5	I
	1997.05-2004.10	-	-	-	Estate Engine LFX (XU7JB)	845005	Outer Joint	29T	25	34	55.7	79	55	I
1.8 16V (81 kW)	1996.10-2000.10	-	L	F	Estate Engine LFY (XU7JP4)	245182	Drive Shaft		25	24	55.7	79	630	
	1996.10-2000.10	-	R	F	Estate Engine LFY (XU7JP4)	245136	Drive Shaft		25	24	55.7	79	904.5	
	1996.10-2000.10	-	R	F	Estate Engine LFY (XU7JP4)	245150	Drive Shaft		25	24	55.7	79	900	
	1996.10-2000.10	MT	L	F	Estate Engine LFY (XU7JP4)	245151	Drive Shaft	29T	25	24	55.7	79	630	
	1996.10-2000.10	-	L	F	Estate Engine LFY (XU7JP4)	245159	Drive Shaft	29T	25	24	58.5	78.5	629	
	1996.10-2000.10	MT	L	F	Estate Engine LFY (XU7JP4)	245152	Drive Shaft	48T	25	24	55.7	79	630	
	1996.10-2000.10	MT	R	F	Estate Engine LFY (XU7JP4)	245020	Drive Shaft	48T	25	24	58	79	905.5	
	1996.10-2000.10	MT	L	F	Estate Engine LFY (XU7JP4)	299159	Drive Shaft	48T	25	24	58	79	619	
	1996.10-2000.10	MT	R	F	Estate Engine LFY (XU7JP4)	245002	Drive Shaft	29T	25	24	55.7	79	904.5	
	1996.10-2000.10	MT	L/R	F	Estate Engine LFY (XU7JP4)	810086	Outer Joint	48T	25	34	55.7	79	55	I
	1996.10-2000.10	-	-	-	Estate Engine LFY (XU7JP4)	845027	Outer Joint		25	34	58	79	55.5	I
	1996.10-2000.10	-	-	-	Estate Engine LFY (XU7JP4)	845005	Outer Joint	29T	25	34	55.7	79	55	I
1.8 16V (85 kW)	2000.10-2004.10	MT	R	F	Estate Engine 6FZ (EW7J4)	245042	Drive Shaft	48T	25	24	55.7	79	909	
	2000.10-2004.10	MT	L	F	Estate Engine 6FZ (EW7J4)	245152	Drive Shaft	48T	25	24	55.7	79	630	
	2000.10-2004.10	MT	R	F	Estate Engine 6FZ (EW7J4)	245020	Drive Shaft	48T	25	24	58	79	905.5	
	2000.10-2004.10	MT	L	F	Estate Engine 6FZ (EW7J4)	299159	Drive Shaft	48T	25	24	58	79	619	
	2000.10-2004.10	-	-	F	Estate Engine 6FZ (EW7J4)	845035	Outer Joint	48T	25	34	58	79	55.5	I
	2000.10-2004.10	-	-	-	Estate Engine 6FZ (EW7J4)	845005	Outer Joint	29T	25	34	55.7	79	55	I
1.9 D (55 kW)	1996.10-2004.10	-	L	F	Estate Engine DHW (XUD9SD)	245182	Drive Shaft		25	24	55.7	79	630	
	1996.10-2004.10	MT	R	F	Estate Engine DHW (XUD9SD)	299018	Drive Shaft	29T	25	24	58.5	78.5	904	
	1996.10-2004.10	-	R	F	Estate Engine DHW (XUD9SD)	245136	Drive Shaft		25	24	55.7	79	904.5	
	1996.10-2004.10	-	R	F	Estate Engine DHW (XUD9SD)	245150	Drive Shaft		25	24	55.7	79	900	
	1996.10-2004.10	MT	L	F	Estate Engine DHW (XUD9SD)	245151	Drive Shaft	29T	25	24	55.7	79	630	
	1996.10-2004.10	-	L	F	Estate Engine DHW (XUD9SD)	245159	Drive Shaft	29T	25	24	58.5	78.5	629	
	1996.10-2004.10	MT	L	F	Estate Engine DHW (XUD9SD)	245152	Drive Shaft	48T	25	24	55.7	79	630	
	1996.10-2004.10	MT	R	F	Estate Engine DHW (XUD9SD)	245020	Drive Shaft	48T	25	24	58	79	905.5	
	1996.10-2004.10	MT	R	F	Estate Engine DHW (XUD9SD)	245002	Drive Shaft	29T	25	24	55.7	79	904.5	
	1996.10-2004.10	MT	L/R	F	Estate Engine DHW (XUD9SD)	810086	Outer Joint	48T	25	34	55.7	79	55	I
	1996.10-2004.10	-	-	-	Estate Engine DHW (XUD9SD)	845027	Outer Joint		25	34	58	79	55.5	I
	1996.10-2004.10	-	-	-	Estate Engine DHW (XUD9SD)	845005	Outer Joint	29T	25	34	55.7	79	55	I
	1996.10-2004.10	-	L	F	Estate Engine DHX (XUD9TE)	245182	Drive Shaft		25	24	55.7	79	630	
1996.10-2004.10	MT	L/R	F	Estate Engine DHX (XUD9TE)	845002	Outer Joint	29T	25	34	58.5	78.5	55	I	

	 YEAR	TRANSM	L/R	F/R	REMARKS	GSP Ref.	 PRODUCT	 ABS	Technical Specifications					
									A	B	C	H	L	P
PEUGEOT														
406 Break (8E/F)														
1.9 TD (66 kW)	1996.10-2004.10	MT	R	F	Estate Engine DHX (XUD9TE)	299018	Drive Shaft	29T	25	24	58.5	78.5	904	
	1996.10-2004.10	-	R	F	Estate Engine DHX (XUD9TE)	245136	Drive Shaft		25	24	55.7	79	904.5	
	1996.10-2004.10	-	-	F	Estate Engine DHX (XUD9TE)	845003	Outer Joint	29T	25	34	58	79	55.5	I
	1996.10-2004.10	-	L	F	Estate Engine DHX (XUD9TE)	245086	Drive Shaft	29T	25	24	55.7	79	620	
	1996.10-2004.10	-	R	F	Estate Engine DHX (XUD9TE)	245150	Drive Shaft		25	24	55.7	79	900	
	1996.10-2004.10	MT	L	F	Estate Engine DHX (XUD9TE)	245135	Drive Shaft		25	24	55.7	79	621	
	1996.10-2004.10	-	L	F	Estate Engine DHX (XUD9TE)	245159	Drive Shaft	29T	25	24	58.5	78.5	629	
	1996.10-2004.10	MT	L	F	Estate Engine DHX (XUD9TE)	610093	Inner Joint		24	22	40	62	90	
	1996.10-2004.10	MT	R	F	Estate Engine DHX (XUD9TE)	245020	Drive Shaft	48T	25	24	58	79	905.5	
	1996.10-2004.10	MT	L	F	Estate Engine DHX (XUD9TE)	245026	Drive Shaft	48T	25	24	55.7	79	620	
	1996.10-2004.10	MT	R	F	Estate Engine DHX (XUD9TE)	245002	Drive Shaft	29T	25	24	55.7	79	904.5	
	1996.10-2004.10	MT	L/R	F	Estate Engine DHX (XUD9TE)	810086	Outer Joint	48T	25	34	55.7	79	55	I
	1996.10-2004.10	MT	L	F	Estate Engine DHX (XUD9TE)	245007	Drive Shaft	29T	25	24	55.7	79	621	
	1996.10-2004.10	-	-	-	Estate Engine DHX (XUD9TE)	845027	Outer Joint		25	34	58	79	55.5	I
1996.10-2004.10	-	-	-	Estate Engine DHX (XUD9TE)	845005	Outer Joint	29T	25	34	55.7	79	55	I	
2.0 (104 kW)	1996.11-1999.03	-	R	F	Estate Engine RGY (XU10J2TE)	299018	Drive Shaft	29T	25	24	58.5	78.5	904	
	1996.11-1999.03	-	-	F	Estate Engine RGY (XU10J2TE)	845003	Outer Joint	29T	25	34	58	79	55.5	I
2.0 16V (100 kW)	2000.10-2004.10	MT	R	F	Estate Engine RFN (EW10J4)	245042	Drive Shaft	48T	25	24	55.7	79	909	
	2000.10-2004.10	MT	R	F	Estate Engine RFN (EW10J4)	245020	Drive Shaft	48T	25	24	58	79	905.5	
	2000.10-2004.10	MT	L	F	Estate Engine RFN (EW10J4)	245026	Drive Shaft	48T	25	24	55.7	79	620	
	2000.10-2004.10	-	-	F	Estate Engine RFN (EW10J4)	845035	Outer Joint	48T	25	34	58	79	55.5	I
2.0 16V (97 kW)	1996.10-2004.10	MT	R	F	Estate Engine RFV (XU10J4R)	299018	Drive Shaft	29T	25	24	58.5	78.5	904	
	1996.10-2004.10	AT/MT	L/R	F	Estate Engine RFV (XU10J4R)	845002	Outer Joint	29T	25	34	58.5	78.5	55	I
	1996.10-2004.10	-	-	F	Estate Engine RFV (XU10J4R)	845003	Outer Joint	29T	25	34	58	79	55.5	I
	1996.10-2004.10	-	R	F	Estate Engine RFV (XU10J4R)	245136	Drive Shaft		25	24	55.7	79	904.5	
	1996.10-2004.10	-	L	F	Estate Engine RFV (XU10J4R)	245086	Drive Shaft	29T	25	24	55.7	79	620	
	1996.10-2004.10	-	R	F	Estate Engine RFV (XU10J4R)	245150	Drive Shaft		25	24	55.7	79	900	
	1996.10-2004.10	MT	L	F	Estate Engine RFV (XU10J4R)	245135	Drive Shaft		25	24	55.7	79	621	
	1996.10-2004.10	MT	L	F	Estate Engine RFV (XU10J4R)	610093	Inner Joint		24	22	40	62	90	
	1996.10-2004.10	AT	R	F	Estate Engine RFV (XU10J4R)	210153	Drive Shaft	29T	25	37	59	89	902	
	1996.10-2004.10	MT	R	F	Estate Engine RFV (XU10J4R)	245020	Drive Shaft	48T	25	24	58	79	905.5	
	1996.10-2004.10	MT	L	F	Estate Engine RFV (XU10J4R)	245026	Drive Shaft	48T	25	24	55.7	79	620	
	1996.10-2004.10	-	-	F	Estate Engine RFV (XU10J4R)	845035	Outer Joint	48T	25	34	58	79	55.5	I
	1996.10-2004.10	MT	R	F	Estate Engine RFV (XU10J4R)	245002	Drive Shaft	29T	25	24	55.7	79	904.5	
	1996.10-2004.10	MT	L/R	F	Estate Engine RFV (XU10J4R)	810086	Outer Joint	48T	25	34	55.7	79	55	I
	1996.10-2004.10	MT	L	F	Estate Engine RFV (XU10J4R)	245007	Drive Shaft	29T	25	24	55.7	79	621	
	1996.10-2004.10	-	-	-	Estate Engine RFV (XU10J4R)	845027	Outer Joint		25	34	58	79	55.5	I
1996.10-2004.10	-	-	-	Estate Engine RFV (XU10J4R)	845005	Outer Joint	29T	25	34	55.7	79	55	I	
1996.10-2004.10	MT	R	F	Estate Engine RFV (XU10J4R)	245042	Drive Shaft	48T	25	24	55.7	79	909		
2.0 16V (99 kW)	1999.01-2000.10	MT	R	F	Estate Engine RFR (DEW10J4)	245042	Drive Shaft	48T	25	24	55.7	79	909	
	1999.01-2000.10	MT	R	F	Estate Engine RFR (DEW10J4)	299018	Drive Shaft	29T	25	24	58.5	78.5	904	
	1999.01-2000.10	-	-	F	Estate Engine RFR (DEW10J4)	845003	Outer Joint	29T	25	34	58	79	55.5	I
	1999.01-2000.10	-	R	F	Estate Engine RFR (DEW10J4)	245136	Drive Shaft		25	24	55.7	79	904.5	
	1999.01-2000.10	-	L	F	Estate Engine RFR (DEW10J4)	245086	Drive Shaft	29T	25	24	55.7	79	620	
	1999.01-2000.10	-	R	F	Estate Engine RFR (DEW10J4)	245150	Drive Shaft		25	24	55.7	79	900	
	1999.01-2000.10	MT	L	F	Estate Engine RFR (DEW10J4)	610093	Inner Joint		24	22	40	62	90	
	1999.01-2000.10	MT	R	F	Estate Engine RFR (DEW10J4)	245020	Drive Shaft	48T	25	24	58	79	905.5	
	1999.01-2000.10	-	-	F	Estate Engine RFR (DEW10J4)	845035	Outer Joint	48T	25	34	58	79	55.5	I
	1999.01-2000.10	MT	L	F	Estate Engine RFR (DEW10J4)	245026	Drive Shaft	48T	25	24	55.7	79	620	
	1999.01-2000.10	MT	R	F	Estate Engine RFR (DEW10J4)	245002	Drive Shaft	29T	25	24	55.7	79	904.5	
	1999.01-2000.10	MT	L	F	Estate Engine RFR (DEW10J4)	245007	Drive Shaft	29T	25	24	55.7	79	621	
	1999.01-2000.10	-	-	-	Estate Engine RFR (DEW10J4)	845027	Outer Joint		25	34	58	79	55.5	I
	1999.01-2000.10	-	-	-	Estate Engine RFR (DEW10J4)	845005	Outer Joint	29T	25	34	55.7	79	55	I
2.0 16V HPi (103 kW)	2001.05-2004.10	MT	R	F	Estate Engine RLZ (EW10D)	245042	Drive Shaft	48T	25	24	55.7	79	909	
	2001.05-2004.10	-	R	F	Estate Engine RLZ (EW10D)	245020	Drive Shaft	48T	25	24	58	79	905.5	
	2001.05-2004.10	-	L	F	Estate Engine RLZ (EW10D)	245026	Drive Shaft	48T	25	24	55.7	79	620	
	2001.05-2004.10	-	-	F	Estate Engine RLZ (EW10D)	845035	Outer Joint	48T	25	34	58	79	55.5	I
2.0 HDi 110 (79 kW)	2001.08-2004.10	MT	-	F	Estate Engine RHS (DW10ATED)/RHZ (DW10ATED)	810019	Outer Joint	48T	25	39	59	89	63.5	I
	2001.08-2004.10	MT	-	F	Estate Engine RHS (DW10ATED)/RHZ (DW10ATED)	845052	Outer Joint	48T	25	39	59	89	63.5	I
	2001.08-2004.10	MT	L	F	Estate Engine RHS (DW10ATED)/RHZ (DW10ATED)	299165	Drive Shaft	48T	25	37	59	89	620.5	
	2001.08-2004.10	MT	L	F	Estate Engine RHS (DW10ATED)/RHZ (DW10ATED)	645032	Inner Joint		37	39	40	68.5	100	
	2001.08-2004.10	AT	-	F	Estate Engine RHS (DW10ATED)/RHZ (DW10ATED)	845035	Outer Joint	48T	25	34	58	79	55.5	I
	2001.08-2004.10	MT	L	F	Estate Engine RHS (DW10ATED)/RHZ (DW10ATED)	210162	Drive Shaft	48T	25	37	59	89	625	
2001.08-2004.10	MT	R	F	Estate Engine RHS (DW10ATED)/RHZ (DW10ATED)	245108	Drive Shaft	48T	25	37	59	89	928		
2.0 HDi 110 (80 kW)	1999.02-2004.04	MT	R	F	Estate Engine RHZ (DW10ATED)	245108	Drive Shaft	48T	25	37	59	89	928	
	1999.02-2004.04	MT	-	F	Estate Engine RHZ (DW10ATED)	810019	Outer Joint	48T	25	39	59	89	63.5	I





	 YEAR	TRANSM	L/R	F/R	REMARKS	GSP Ref.	 PRODUCT	 ABS	Technical Specifications					
									A	B	C	H	L	P
PEUGEOT														
406 Break (8E/F)														
2.0 HDI 110 (80 kW)	1999.02-2004.04	-	L	F	Estate Engine RHZ (DW10ATED)	245086	Drive Shaft	29T	25	24	55.7	79	620	
	1999.02-2004.04	MT	-	F	Estate Engine RHZ (DW10ATED)	845052	Outer Joint	48T	25	39	59	89	63.5	I
	1999.02-2004.04	MT	L	F	Estate Engine RHZ (DW10ATED)	245106	Drive Shaft	29T	25	37	59	89	628	
	1999.02-2004.04	MT	L	F	Estate Engine RHZ (DW10ATED)	299165	Drive Shaft	48T	25	37	59	89	620.5	
	1999.02-2004.04	MT	L	F	Estate Engine RHZ (DW10ATED)	645032	Inner Joint		37	39	40	68.5	100	
	1999.02-2004.04	MT	L	F	Estate Engine RHZ (DW10ATED)	610093	Inner Joint		24	22	40	62	90	
	1999.02-2004.04	MT	R	F	Estate Engine RHZ (DW10ATED)	245020	Drive Shaft	48T	25	24	58	79	905.5	
	1999.02-2004.04	MT	L	F	Estate Engine RHZ (DW10ATED)	245026	Drive Shaft	48T	25	24	55.7	79	620	
	1999.02-2004.04	AT	-	F	Estate Engine RHZ (DW10ATED)	845035	Outer Joint	48T	25	34	58	79	55.5	I
	1999.02-2004.04	MT	R	F	Estate Engine RHZ (DW10ATED)	245002	Drive Shaft	29T	25	24	55.7	79	904.5	
	1999.02-2004.04	MT	R	F	Estate Engine RHZ (DW10ATED)	299003	Drive Shaft	29T	25	37	59	89	928	
	1999.02-2004.04	MT	L/R	F	Estate Engine RHZ (DW10ATED)	810086	Outer Joint	48T	25	34	55.7	79	55	I
1999.02-2004.04	MT	L	F	Estate Engine RHZ (DW10ATED)	245007	Drive Shaft	29T	25	24	55.7	79	621		
1999.02-2004.04	MT	L	F	Estate Engine RHZ (DW10ATED)	210162	Drive Shaft	48T	25	37	59	89	625		
2.0 HDI 90 (66 kW)	1999.02-2004.10	MT	R	F	Estate Engine RHZ (DW10ATED)	245042	Drive Shaft	48T	25	24	55.7	79	909	
	1999.02-2004.10	-	-	-	Estate Engine RHZ (DW10ATED)	810127	Outer Joint	29T	25	39	59	89	63.5	I
	1999.02-2004.10	-	L	F	Estate Engine RHZ (DW10ATED)	245086	Drive Shaft	29T	25	24	55.7	79	620	
	1999.02-2004.10	MT	R	F	Estate Engine RHZ (DW10ATED)	245020	Drive Shaft	48T	25	24	58	79	905.5	
	1999.02-2004.10	MT	L	F	Estate Engine RHZ (DW10ATED)	245026	Drive Shaft	48T	25	24	55.7	79	620	
	1999.02-2004.10	MT	L/R	F	Estate Engine RHZ (DW10ATED)	810086	Outer Joint	48T	25	34	55.7	79	55	I
2.0 Turbo (108 kW)	1996.10-2004.10	-	-	-	Estate Engine RGX (XU10J2TE)	810127	Outer Joint	29T	25	39	59	89	63.5	I
	1996.10-2004.10	-	-	F	Estate Engine RGX (XU10J2TE)	810019	Outer Joint	48T	25	39	59	89	63.5	I
	1996.10-2004.10	-	L	F	Estate Engine RGX (XU10J2TE)	245086	Drive Shaft	29T	25	24	55.7	79	620	
	1996.10-2004.10	-	-	F	Estate Engine RGX (XU10J2TE)	899003	Outer Joint	29T	25	39	59	89	63.5	I
	1996.10-2004.10	MT	L	F	Estate Engine RGX (XU10J2TE)	645032	Inner Joint		37	39	40	68.5	100	
	1996.10-2004.10	MT	L	F	Estate Engine RGX (XU10J2TE)	245106	Drive Shaft	29T	25	37	59	89	628	
	1996.10-2004.10	MT	L	F	Estate Engine RGX (XU10J2TE)	299165	Drive Shaft	48T	25	37	59	89	620.5	
	1996.10-2004.10	MT	L	F	Estate Engine RGX (XU10J2TE)	610093	Inner Joint		24	22	40	62	90	
	1996.10-2004.10	MT	R	F	Estate Engine RGX (XU10J2TE)	245002	Drive Shaft	29T	25	24	55.7	79	904.5	
	1996.10-2004.10	-	R	F	Estate Engine RGX (XU10J2TE)	299003	Drive Shaft	29T	25	37	59	89	928	
1996.10-2004.10	MT	L/R	F	Estate Engine RGX (XU10J2TE)	810086	Outer Joint	48T	25	34	55.7	79	55	I	
2.1 TD 12V (80 kW)	1996.10-2004.10	-	-	-	Estate Engine P8C (XUD11BTE)	810127	Outer Joint	29T	25	39	59	89	63.5	I
	1996.10-2004.10	MT	-	F	Estate Engine P8C (XUD11BTE)	899003	Outer Joint	29T	25	39	59	89	63.5	I
	1996.10-2004.10	MT	L	F	Estate Engine P8C (XUD11BTE)	245106	Drive Shaft	29T	25	37	59	89	628	
	1996.10-2004.10	MT	R	F	Estate Engine P8C (XUD11BTE)	299003	Drive Shaft	29T	25	37	59	89	928	
2.2 (116 kW)	2000.07-2004.10	MT	-	F	Estate Engine 3FZ (EW12J4)	810019	Outer Joint	48T	25	39	59	89	63.5	I
	2000.07-2004.10	MT	-	F	Estate Engine 3FZ (EW12J4)	845052	Outer Joint	48T	25	39	59	89	63.5	I
	2000.07-2004.10	MT	L	F	Estate Engine 3FZ (EW12J4)	299165	Drive Shaft	48T	25	37	59	89	620.5	
	2000.07-2004.10	MT	L	F	Estate Engine 3FZ (EW12J4)	645032	Inner Joint		37	39	40	68.5	100	
	2000.07-2004.10	MT	L	F	Estate Engine 3FZ (EW12J4)	210162	Drive Shaft	48T	25	37	59	89	625	
2.2 HDI (98 kW)	2000.07-2004.10	MT	R	F	Estate Engine 3FZ (EW12J4)	245108	Drive Shaft	48T	25	37	59	89	928	
	2000.03-2004.10	MT	-	F	Estate Engine 4HX (DW12TED4/FAP)	810019	Outer Joint	48T	25	39	59	89	63.5	I
	2000.03-2004.10	MT	-	F	Estate Engine 4HX (DW12TED4/FAP)	845052	Outer Joint	48T	25	39	59	89	63.5	I
	2000.03-2004.10	MT	L	F	Estate Engine 4HX (DW12TED4/FAP)	245106	Drive Shaft	29T	25	37	59	89	628	
	2000.03-2004.10	MT	L	F	Estate Engine 4HX (DW12TED4/FAP)	299165	Drive Shaft	48T	25	37	59	89	620.5	
	2000.03-2004.10	MT	L	F	Estate Engine 4HX (DW12TED4/FAP)	645032	Inner Joint		37	39	40	68.5	100	
3.0 24V (140 kW)	2000.03-2004.10	MT	L	F	Estate Engine 4HX (DW12TED4/FAP)	210162	Drive Shaft	48T	25	37	59	89	625	
	2000.03-2004.10	MT	R	F	Estate Engine 4HX (DW12TED4/FAP)	245108	Drive Shaft	48T	25	37	59	89	928	
	1996.10-2004.10	-	-	-	Estate Engine XFZ (ES9J4)	810127	Outer Joint	29T	25	39	59	89	63.5	I
	1996.10-2004.10	-	-	F	Estate Engine XFZ (ES9J4)	810019	Outer Joint	48T	25	39	59	89	63.5	I
	1996.10-2004.10	MT	-	F	Estate Engine XFZ (ES9J4)	845052	Outer Joint	48T	25	39	59	89	63.5	I
	1996.10-2004.10	-	-	F	Estate Engine XFZ (ES9J4)	899003	Outer Joint	29T	25	39	59	89	63.5	I
	1996.10-2004.10	MT	L	F	Estate Engine XFZ (ES9J4)	645032	Inner Joint		37	39	40	68.5	100	
	1996.10-2004.10	MT	L	F	Estate Engine XFZ (ES9J4)	245106	Drive Shaft	29T	25	37	59	89	628	
	1996.10-2004.10	MT	L	F	Estate Engine XFZ (ES9J4)	299165	Drive Shaft	48T	25	37	59	89	620.5	
	1996.10-2004.10	AT	R	F	Estate Engine XFZ (ES9J4)	210153	Drive Shaft	29T	25	37	59	89	902	
3.0 V6 (152 kW)	1996.10-2004.10	MT	R	F	Estate Engine XFZ (ES9J4)	299003	Drive Shaft	29T	25	37	59	89	928	
	1996.10-2004.10	MT	L	F	Estate Engine XFZ (ES9J4)	210162	Drive Shaft	48T	25	37	59	89	625	
	1996.10-2004.10	MT	R	F	Estate Engine XFZ (ES9J4)	245108	Drive Shaft	48T	25	37	59	89	928	
	1996.10-2004.10	-	L	F	Estate Engine XFZ (ES9J4)	245044	Drive Shaft	29T	25	37	59	89	592	
	2000.03-2004.10	-	-	F	Estate Engine XFX (ES9J4S)	810019	Outer Joint	48T	25	39	59	89	63.5	I
2000.03-2004.10	MT	-	F	Estate Engine XFX (ES9J4S)	845052	Outer Joint	48T	25	39	59	89	63.5	I	
2000.03-2004.10	MT	L	F	Estate Engine XFX (ES9J4S)	299165	Drive Shaft	48T	25	37	59	89	620.5		
2000.03-2004.10	AT	R	F	Estate Engine XFX (ES9J4S)	210153	Drive Shaft	29T	25	37	59	89	902		

YEAR	TRANSM	L/R	F/R	REMARKS	GSP Ref.	PRODUCT	ABS	Technical Specifications									
								A	B	C	H	L	P				
PEUGEOT																	
406 Break (8E/F)																	
3.0 V6 (152 kW)	2000.03-2004.10	MT	L	F	Estate Engine XFX (ES9J4S)	645032	Inner Joint		37	39	40	68.5	100				
	2000.03-2004.10	MT	L	F	Estate Engine XFX (ES9J4S)	210162	Drive Shaft	48T	25	37	59	89	625				
	2000.03-2004.10	MT	R	F	Estate Engine XFX (ES9J4S)	245108	Drive Shaft	48T	25	37	59	89	928				
406 II																	
1.8	1999.03-	MT	-	F	-	845047	Outer Joint	48T	25	34	59	78.5	54	I			
2.0	1999.03-	MT	-	F	-	845047	Outer Joint	48T	25	34	59	78.5	54	I			
2.0 HDi	1999.03-	MT	-	F	-	845047	Outer Joint	48T	25	34	59	78.5	54	I			
	1999.03-	MT	R	F	-	245116	Drive Shaft	48T	25	37	59	89	935				
2.2	2000.07-	MT	R	F	-	245116	Drive Shaft	48T	25	37	59	89	935				
2.2 HDi	2000.10-	MT	R	F	-	245116	Drive Shaft	48T	25	37	59	89	935				
3.0 V6	1999.03-	MT	R	F	-	245116	Drive Shaft	48T	25	37	59	89	935				
407 (6C_)																	
2.0 HDi (100 kW)	2005.10-	MT	R	F	Coupe Engine RHR (DW10BTED4)	610041	Inner Joint		37	39	32	399	95.5				
	2005.10-	-	L	F	Coupe Engine RHR (DW10BTED4)	645032	Inner Joint		37	39	40	68.5	100				
	2005.10-	6AT	R	F	Coupe Engine RHR (DW10BTED4)	210435	Drive Shaft		28	37	58.6	94	952				
	2005.10-	MT	R	F	Coupe Engine RHR (DW10BTED4)	210302	Drive Shaft		28	37	58.6	94	969				
	2005.10-	AT	L	F	Coupe Engine RHR (DW10BTED4)	210385	Drive Shaft		28	37	58.6	93	615				
	2005.10-	-	-	F	Coupe Engine RHR (DW10BTED4)	810051	Outer Joint		28	39	58.6	94	63	I			
2.0 HDi (103 kW)	2008.09-2009.12	AT	L	F	Coupe Engine RHR (DW10BTED4)	210385	Drive Shaft		28	37	58.6	93	615				
	2008.09-2009.12	-	-	F	Coupe Engine RHR (DW10BTED4)	810051	Outer Joint		28	39	58.6	94	63	I			
2.0 HDi (110 kW)	2010.02-	-	-	F	Coupe Engine RHE (DW10CTED4)	810051	Outer Joint		28	39	58.6	94	63	I			
2.0 HDi (120 kW)	2009.06-	-	R	F	Coupe Engine RHH (DW10CTED4)	610041	Inner Joint		37	39	32	399	95.5				
	2009.06-	-	R	F	Coupe Engine RHH (DW10CTED4)	210302	Drive Shaft		28	37	58.6	94	969				
	2009.06-	-	-	F	Coupe Engine RHH (DW10CTED4)	810051	Outer Joint		28	39	58.6	94	63	I			
2.2 16V (120 kW)	2005.10-	-	-	F	Coupe Engine 3FY (EW12J4)	810051	Outer Joint		28	39	58.6	94	63	I			
2.7 HDi (150 kW)	2005.10-	-	-	F	Coupe Engine UHZ (DT17)	810051	Outer Joint		28	39	58.6	94	63	I			
3.0 V6 (155 kW)	2005.10-	-	-	F	Coupe Engine Xfv (ES9A)	810051	Outer Joint		28	39	58.6	94	63	I			
407 (6D_)																	
1.6 HDi 110 (80 kW)	2004.05-	MT	-	F	Saloon Engine 9HZ (DV6TED4)	810052	Outer Joint		28	34	58.5	92	55	I			
	2004.05-	-	R	F	Saloon Engine 9HZ (DV6TED4)	210265	Drive Shaft		28	24	59	91	951				
	2004.05-	-	L	F	Saloon Engine 9HZ (DV6TED4)	210310	Drive Shaft		28	24	59	91	670				
1.8 (85 kW)	2004.05-	-	-	F	Saloon Engine 6FZ (EW7J4)	810052	Outer Joint		28	34	58.5	92	55	I			
	2004.05-	-	L	F	Saloon Engine 6FZ (EW7J4)	210266	Drive Shaft		28	24	59	91	678				
	2004.05-	-	R	F	Saloon Engine 6FZ (EW7J4)	210265	Drive Shaft		28	24	59	91	951				
1.8 16V (92 kW)	2005.09-	MT	-	F	Saloon Engine 6FY (EW7A)	810052	Outer Joint		28	34	58.5	92	55	I			
	2005.09-	-	L	F	Saloon Engine 6FY (EW7A)	210266	Drive Shaft		28	24	59	91	678				
	2005.09-	-	R	F	Saloon Engine 6FY (EW7A)	210265	Drive Shaft		28	24	59	91	951				
	2005.09-	-	L	F	Saloon Engine 6FY (EW7A)	210310	Drive Shaft		28	24	59	91	670				
2.0 (100 kW)	2004.05-	AT	L	F	Saloon Engine RFN (EW10J4)	699001	Inner Joint		26	34	42.5	46.5	103.5				
	2004.05-	-	-	F	Saloon Engine RFN (EW10J4)	810052	Outer Joint		28	34	58.5	92	55	I			
	2004.05-	MT	L	F	Saloon Engine RFN (EW10J4)	210266	Drive Shaft		28	24	59	91	678				
	2004.05-	-	R	F	Saloon Engine RFN (EW10J4)	210265	Drive Shaft		28	24	59	91	951				
	2004.05-	AT	L	F	Saloon Engine RFN (EW10J4)	210285	Drive Shaft		28	26	58.5	92	661				
	2004.05-	-	L	F	Saloon Engine RFN (EW10J4)	210310	Drive Shaft		28	24	59	91	670				
	2004.05-	AT	R	F	Saloon Engine RFN (EW10J4)	210283	Drive Shaft		28	26	58.5	92	866				
2.0 16V (103 kW)	2005.09-	AT	L	F	Saloon Engine RFJ (EW10A)	699001	Inner Joint		26	34	42.5	46.5	103.5				
	2005.09-	-	-	F	Saloon Engine RFJ (EW10A)	810052	Outer Joint		28	34	58.5	92	55	I			
	2005.09-	MT	L	F	Saloon Engine RFJ (EW10A)	210266	Drive Shaft		28	24	59	91	678				
	2005.09-	-	R	F	Saloon Engine RFJ (EW10A)	210265	Drive Shaft		28	24	59	91	951				
	2005.09-	AT	L	F	Saloon Engine RFJ (EW10A)	210285	Drive Shaft		28	26	58.5	92	661				
	2005.09-	-	L	F	Saloon Engine RFJ (EW10A)	210310	Drive Shaft		28	24	59	91	670				
	2005.09-	AT	R	F	Saloon Engine RFJ (EW10A)	210283	Drive Shaft		28	26	58.5	92	866				
2.0 Bioflex (103 kW)	2007.09-	AT	L	F	Saloon Engine RFJ (EW10A)	699001	Inner Joint		26	34	42.5	46.5	103.5				
	2007.09-	-	-	F	Saloon Engine RFJ (EW10A)	810052	Outer Joint		28	34	58.5	92	55	I			
	2007.09-	MT	L	F	Saloon Engine RFJ (EW10A)	210266	Drive Shaft		28	24	59	91	678				
	2007.09-	MT	R	F	Saloon Engine RFJ (EW10A)	210265	Drive Shaft		28	24	59	91	951				
	2007.09-	AT	L	F	Saloon Engine RFJ (EW10A)	210285	Drive Shaft		28	26	58.5	92	661				
	2007.09-	AT	R	F	Saloon Engine RFJ (EW10A)	210283	Drive Shaft		28	26	58.5	92	866				
2.0 HDi (103 kW)	2008.08-	MT	R	F	Saloon Engine RHF (DW10BTED4)	610041	Inner Joint		37	39	32	399	95.5				
	2008.08-	MT	L	F	Saloon Engine RHF (DW10BTED4)	645032	Inner Joint		37	39	40	68.5	100				
	2008.08-	MT	R	F	Saloon Engine RHF (DW10BTED4)	210302	Drive Shaft		28	37	58.6	94	969				
	2008.08-	AT	L	F	Saloon Engine RHF (DW10BTED4)	210385	Drive Shaft		28	37	58.6	93	615				
	2008.08-	-	-	F	Saloon Engine RHF (DW10BTED4)	810051	Outer Joint		28	39	58.6	94	63	I			
2.0 HDi (110 kW)	2010.02-	-	-	F	Saloon Engine RHE (DW10CTED4)	810051	Outer Joint		28	39	58.6	94	63	I			
2.0 HDi (120 kW)	2009.07-	MT	R	F	Saloon Engine RHH (DW10CTED4)	610041	Inner Joint		37	39	32	399	95.5				
	2009.07-	MT	R	F	Saloon Engine RHH (DW10CTED4)	210302	Drive Shaft		28	37	58.6	94	969				

YEAR	TRANSM	L/R	F/R	REMARKS	GSP Ref.	PRODUCT	ABS	Technical Specifications									
								A	B	C	H	L	P				
PEUGEOT																	
407 (6D_)																	
2.0 HDi (120 kW)	2009.07-	-	AT	L	F	Saloon Engine RHH (DW10CTED4)	210385	Drive Shaft		28	37	58.6	93	615			
	2009.07-	-	-	-	F	Saloon Engine RHH (DW10CTED4)	810051	Outer Joint		28	39	58.6	94	63	I		
2.0 HDi 135 (100 kW)	2004.05-	-	MT	R	F	Saloon Engine RHR (DW10BTED4)	610041	Inner Joint		37	39	32	399	95.5			
	2004.05-	-	6AT	R	F	Saloon Engine RHR (DW10BTED4)	210435	Drive Shaft		28	37	58.6	94	952			
	2004.05-	-	MT	R	F	Saloon Engine RHR (DW10BTED4)	210302	Drive Shaft		28	37	58.6	94	969			
	2004.05-	-	-	-	F	Saloon Engine RHR (DW10BTED4)	810051	Outer Joint		28	39	58.6	94	63	I		
	2004.05-	-	AT	L	F	Saloon Engine RHR (DW10BTED4)	210385	Drive Shaft		28	37	58.6	93	615			
	2004.05-	-	MT	L	F	Saloon Engine RHR (DW10BTED4)	645032	Inner Joint		37	39	40	68.5	100			
2.2 (116 kW)	2004.05-	-	MT	-	F	Saloon Engine 3FZ (EW12J4)	810051	Outer Joint		28	39	58.6	94	63	I		
2.2 16V (120 kW)	2005.09-	-	-	-	F	Saloon Engine 3FY (EW12J4)	810051	Outer Joint		28	39	58.6	94	63	I		
2.2 HDi (120 kW)	2008.06-	-	-	R	F	Saloon Engine 4HP (DW12BTED4)	201105	Drive Shaft		28	37	58.6	93	978			
	2008.06-	-	-	-	F	Saloon Engine 4HP (DW12BTED4)	810051	Outer Joint		28	39	58.6	94	63	I		
2.2 HDi 170 (125 kW)	2006.05-	-	-	R	F	Saloon Engine 4HT (DW12BTED4)	201105	Drive Shaft		28	37	58.6	93	978			
	2006.05-	-	-	-	F	Saloon Engine 4HT (DW12BTED4)	810051	Outer Joint		28	39	58.6	94	63	I		
2.7 HDi (150 kW)	2005.10-	-	-	-	F	Saloon Engine UHZ (DT17)	810051	Outer Joint		28	39	58.6	94	63	I		
3.0 (155 kW)	2004.05-	-	-	-	F	Saloon Engine XFV (ES9A)	810051	Outer Joint		28	39	58.6	94	63	I		
407 SW (6E_)																	
1.6 HDi 110 (80 kW)	2004.05-	-	MT	-	F	Estate Engine 9HZ (DV6TED4)	810052	Outer Joint		28	34	58.5	92	55	I		
	2004.05-	-	-	R	F	Estate Engine 9HZ (DV6TED4)	210265	Drive Shaft		28	24	59	91	951			
	2004.05-	-	-	L	F	Estate Engine 9HZ (DV6TED4)	210310	Drive Shaft		28	24	59	91	670			
1.8 (85 kW)	2004.05-	-	MT	-	F	Estate Engine 6FZ (EW7J4)	810052	Outer Joint		28	34	58.5	92	55	I		
	2004.05-	-	-	L	F	Estate Engine 6FZ (EW7J4)	210266	Drive Shaft		28	24	59	91	678			
	2004.05-	-	-	R	F	Estate Engine 6FZ (EW7J4)	210265	Drive Shaft		28	24	59	91	951			
1.8 16V (92 kW)	2005.09-	-	MT	-	F	Estate Engine 6FY (EW7A)	810052	Outer Joint		28	34	58.5	92	55	I		
	2005.09-	-	-	L	F	Estate Engine 6FY (EW7A)	210266	Drive Shaft		28	24	59	91	678			
	2005.09-	-	-	R	F	Estate Engine 6FY (EW7A)	210265	Drive Shaft		28	24	59	91	951			
	2005.09-	-	-	L	F	Estate Engine 6FY (EW7A)	210310	Drive Shaft		28	24	59	91	670			
2.0 (100 kW)	2004.05-	-	AT	L	F	Estate Engine RFN (EW10J4)	699001	Inner Joint		26	34	42.5	46.5	103.5			
	2004.05-	-	-	-	F	Estate Engine RFN (EW10J4)	810052	Outer Joint		28	34	58.5	92	55	I		
	2004.05-	-	MT	L	F	Estate Engine RFN (EW10J4)	210266	Drive Shaft		28	24	59	91	678			
	2004.05-	-	-	R	F	Estate Engine RFN (EW10J4)	210265	Drive Shaft		28	24	59	91	951			
	2004.05-	-	-	L	F	Estate Engine RFN (EW10J4)	210310	Drive Shaft		28	24	59	91	670			
	2004.05-	-	AT	L	F	Estate Engine RFN (EW10J4)	210285	Drive Shaft		28	26	58.5	92	661			
	2004.05-	-	AT	R	F	Estate Engine RFN (EW10J4)	210283	Drive Shaft		28	26	58.5	92	866			
2.0 16V (103 kW)	2005.09-	-	AT	L	F	Estate Engine RFJ (EW10A)	699001	Inner Joint		26	34	42.5	46.5	103.5			
	2005.09-	-	-	-	F	Estate Engine RFJ (EW10A)	810052	Outer Joint		28	34	58.5	92	55	I		
	2005.09-	-	MT	L	F	Estate Engine RFJ (EW10A)	210266	Drive Shaft		28	24	59	91	678			
	2005.09-	-	-	R	F	Estate Engine RFJ (EW10A)	210265	Drive Shaft		28	24	59	91	951			
	2005.09-	-	AT	L	F	Estate Engine RFJ (EW10A)	210285	Drive Shaft		28	26	58.5	92	661			
	2005.09-	-	-	L	F	Estate Engine RFJ (EW10A)	210310	Drive Shaft		28	24	59	91	670			
	2005.09-	-	AT	R	F	Estate Engine RFJ (EW10A)	210283	Drive Shaft		28	26	58.5	92	866			
2.0 HDi (103 kW)	2008.08-	-	MT	R	F	Estate Engine RHR (DW10BTED4)	610041	Inner Joint		37	39	32	399	95.5			
	2008.08-	-	-	L	F	Estate Engine RHR (DW10BTED4)	645032	Inner Joint		37	39	40	68.5	100			
	2008.08-	-	MT	R	F	Estate Engine RHR (DW10BTED4)	210302	Drive Shaft		28	37	58.6	94	969			
	2008.08-	-	6AT/AT	L	F	Estate Engine RHR (DW10BTED4)	210385	Drive Shaft		28	37	58.6	93	615			
	2008.08-	-	-	-	F	Estate Engine RHR (DW10BTED4)	810051	Outer Joint		28	39	58.6	94	63	I		
2.0 HDi (110 kW)	2010.02-	-	-	-	F	Estate Engine RHE (DW10CTED4)	810051	Outer Joint		28	39	58.6	94	63	I		
2.0 HDi (120 kW)	2009.07-	-	MT	R	F	Estate Engine RHH (DW10CTED4)	610041	Inner Joint		37	39	32	399	95.5			
	2009.07-	-	MT	R	F	Estate Engine RHH (DW10CTED4)	210302	Drive Shaft		28	37	58.6	94	969			
	2009.07-	-	-	-	F	Estate Engine RHH (DW10CTED4)	810051	Outer Joint		28	39	58.6	94	63	I		
2.0 HDi 135 (100 kW)	2004.05-	-	MT	R	F	Estate Engine RHR (DW10BTED4)	610041	Inner Joint		37	39	32	399	95.5			
	2004.05-	-	6AT	R	F	Estate Engine RHR (DW10BTED4)	210435	Drive Shaft		28	37	58.6	94	952			
	2004.05-	-	MT	R	F	Estate Engine RHR (DW10BTED4)	210302	Drive Shaft		28	37	58.6	94	969			
	2004.05-	-	MT	-	F	Estate Engine RHR (DW10BTED4)	810051	Outer Joint		28	39	58.6	94	63	I		
	2004.05-	-	6AT/AT	L	F	Estate Engine RHR (DW10BTED4)	210385	Drive Shaft		28	37	58.6	93	615			
	2004.05-	-	-	L	F	Estate Engine RHR (DW10BTED4)	645032	Inner Joint		37	39	40	68.5	100			
2.2 (116 kW)	2004.05-	-	MT	-	F	Estate Engine 3FZ (EW12J4)	810051	Outer Joint		28	39	58.6	94	63	I		
2.2 16V (120 kW)	2005.09-	-	-	-	F	Estate Engine 3FY (EW12J4)	810051	Outer Joint		28	39	58.6	94	63	I		
2.2 HDi (120 kW)	2008.06-	-	-	R	F	Estate Engine 4HP (DW12BTED4)	201105	Drive Shaft		28	37	58.6	93	978			
	2008.06-	-	-	-	F	Estate Engine 4HP (DW12BTED4)	810051	Outer Joint		28	39	58.6	94	63	I		
2.2 HDi 170 (125 kW)	2006.05-	-	-	R	F	Estate Engine 4HT (DW12BTED4)	201105	Drive Shaft		28	37	58.6	93	978			
	2006.05-	-	-	-	F	Estate Engine 4HT (DW12BTED4)	810051	Outer Joint		28	39	58.6	94	63	I		
2.7 HDi (150 kW)	2005.10-	-	-	-	F	Estate Engine UHZ (DT17)	810051	Outer Joint		28	39	58.6	94	63	I		
3.0 (155 kW)	2004.05-	-	-	-	F	Estate Engine XFV (ES9A)	810051	Outer Joint		28	39	58.6	94	63	I		
5008																	
1.2 (96 kW)	2015.01-	-	MT	L	F	MPV Engine HNY (EB2DTS)	810148	Outer Joint		25	34	58.5	79	55.5	I		





	 YEAR	TRANSM	L/R	F/R	REMARKS	GSP Ref.	 PRODUCT	 ABS	Technical Specifications					
									A	B	C	H	L	P
PEUGEOT														
5008														
1.2 (96 kW)	2015.01-	-	MT	R	F	MPV Engine HNY (EB2DTS)	210325	Drive Shaft	25	24	58.5	79	940	
	2015.01-	-	MT	L	F	MPV Engine HNY (EB2DTS)	610057	Inner Joint	24	34	40	52.5	90	
	2015.01-	-	MT	R	F	MPV Engine HNY (EB2DTS)	610058	Inner Joint	24	34	29.8	365	88	
	2015.01-	-	MT	L	F	MPV Engine HNY (EB2DTS)	210253	Drive Shaft	25	24	58.5	79	626	
1.6 16V (115 kW)	2009.09-	-	MT	L	F	MPV Engine 5FV (EP6CDT)	810148	Outer Joint	25	34	58.5	79	55.5	I
	2009.09-	-	6MT	-	F	MPV Engine 5FV (EP6CDT)	810028	Outer Joint	25	34	58	89	56	I
	2009.09-	-	6MT	-	-	MPV Engine 5FV (EP6CDT)	899366	Outer Joint	25	34	58.5	79	55	I
	2009.09-	-	MT	R	F	MPV Engine 5FV (EP6CDT)	210325	Drive Shaft	25	24	58.5	79	940	
	2009.09-	-	MT	L	F	MPV Engine 5FV (EP6CDT)	610057	Inner Joint	24	34	40	52.5	90	
	2009.09-	-	6MT	-	-	MPV Engine 5FV (EP6CDT)	810155	Outer Joint	25	39	58.5	89	63.5	I
	2009.09-	-	MT	R	F	MPV Engine 5FV (EP6CDT)	610058	Inner Joint	24	34	29.8	365	88	
	2009.09-	-	MT	L	F	MPV Engine 5FV (EP6CDT)	210253	Drive Shaft	25	24	58.5	79	626	
1.6 16V (88 kW)	2009.09-	-	6MT	-	F	MPV Engine EP6/5FS (EP6C)/5FW (EP6)	810028	Outer Joint	25	34	58	89	56	I
	2009.09-	-	MT	R	F	MPV Engine EP6/5FS (EP6C)/5FW (EP6)	210251	Drive Shaft	25	24	58.5	79	935	
	2009.09-	-	6MT	-	-	MPV Engine EP6/5FS (EP6C)/5FW (EP6)	899366	Outer Joint	25	34	58.5	79	55	I
	2009.09-	-	6MT	-	-	MPV Engine EP6/5FS (EP6C)/5FW (EP6)	810155	Outer Joint	25	39	58.5	89	63.5	I
1.6 BlueHDi 120 (88 kW)	2014.05-	-	MT	L	F	MPV Engine BHZ (DV6FC)	810148	Outer Joint	25	34	58.5	79	55.5	I
	2014.05-	-	MT	R	F	MPV Engine BHZ (DV6FC)	210325	Drive Shaft	25	24	58.5	79	940	
	2014.05-	-	MT	L	F	MPV Engine BHZ (DV6FC)	610057	Inner Joint	24	34	40	52.5	90	
	2014.05-	-	MT	R	F	MPV Engine BHZ (DV6FC)	610058	Inner Joint	24	34	29.8	365	88	
	2014.05-	-	MT	L	F	MPV Engine BHZ (DV6FC)	210253	Drive Shaft	25	24	58.5	79	626	
1.6 HDi (80 kW)	2009.09-	-	MT	L	F	MPV Engine 9HZ (DV6TED4)	810148	Outer Joint	25	34	58.5	79	55.5	I
	2009.09-	-	6MT	-	-	MPV Engine 9HZ (DV6TED4)	899366	Outer Joint	25	34	58.5	79	55	I
	2009.09-	-	MT	R	F	MPV Engine 9HZ (DV6TED4)	210325	Drive Shaft	25	24	58.5	79	940	
	2009.09-	-	MT	L	F	MPV Engine 9HZ (DV6TED4)	610057	Inner Joint	24	34	40	52.5	90	
	2009.09-	-	-	L	F	MPV Engine 9HZ (DV6TED4)	210312	Drive Shaft	25	37	58.5	89	625	
	2009.09-	-	6MT	-	-	MPV Engine 9HZ (DV6TED4)	810155	Outer Joint	25	39	58.5	89	63.5	I
	2009.09-	-	MT	R	F	MPV Engine 9HZ (DV6TED4)	610058	Inner Joint	24	34	29.8	365	88	
	2009.09-	-	MT	-	F	MPV Engine 9HZ (DV6TED4)	810028	Outer Joint	25	34	58	89	56	I
	2009.09-	-	MT	L	F	MPV Engine 9HZ (DV6TED4)	210253	Drive Shaft	25	24	58.5	79	626	
	2009.09-	-	MT	L	F	MPV Engine 9HR (DV6C)	810148	Outer Joint	25	34	58.5	79	55.5	I
1.6 HDi (82 kW)	2010.08-	-	MT	R	F	MPV Engine 9HR (DV6C)	210325	Drive Shaft	25	24	58.5	79	940	
	2010.08-	-	MT/6MT	-	-	MPV Engine 9HR (DV6C)	899366	Outer Joint	25	34	58.5	79	55	I
	2010.08-	-	MT	L	F	MPV Engine 9HR (DV6C)	610057	Inner Joint	24	34	40	52.5	90	
	2010.08-	-	6MT	-	-	MPV Engine 9HR (DV6C)	810155	Outer Joint	25	39	58.5	89	63.5	I
	2010.08-	-	MT	R	F	MPV Engine 9HR (DV6C)	610058	Inner Joint	24	34	29.8	365	88	
	2010.08-	-	MT	-	F	MPV Engine 9HR (DV6C)	810028	Outer Joint	25	34	58	89	56	I
	2010.08-	-	MT	L	F	MPV Engine 9HR (DV6C)	210253	Drive Shaft	25	24	58.5	79	626	
	2010.08-	-	MT	L	F	MPV Engine 9HR (DV6C)	810148	Outer Joint	25	34	58.5	79	55.5	I
1.6 HDi (84 kW)	2013.03-	-	-	-	F	MPV Engine 9HD (DV6CTED)	810028	Outer Joint	25	34	58	89	56	I
	2013.03-	-	-	L	F	MPV Engine 9HD (DV6CTED)	210312	Drive Shaft	25	37	58.5	89	625	
1.6 THP 150 (110 kW)	2012.02-	-	6AT	R	F	MPV Engine 5FX (EP6DT)	241299	Drive Shaft	29	29	56	102	979	
1.6 THP 163 (120 kW)	2012.02-	-	6AT	R	F	MPV Engine 5GZ (EP6FDT)	241299	Drive Shaft	29	29	56	102	979	
1.6 THP 165 (121 kW)	2012.02-	-	6AT	R	F	MPV Engine 5GZ (EP6FDT)	241299	Drive Shaft	29	29	56	102	979	
2.0 HDi (120 kW)	2009.09-	-	MT	R	F	MPV Engine RHH (DW10CTED4)	610041	Inner Joint	37	39	32	399	95.5	
	2009.09-	-	6MT	L	F	MPV Engine RHH (DW10CTED4)	810158	Outer Joint	25	26	58.5	89	61.5	M
	2009.09-	-	6MT	L	F	MPV Engine RHH (DW10CTED4)	210427	Drive Shaft	25	37	58.5	89	638	
	2009.09-	-	MT	R	F	MPV Engine RHH (DW10CTED4)	210421	Drive Shaft	25	37	58.5	89	972	
	2009.09-	-	6MT	L	F	MPV Engine RHH (DW10CTED4)	210312	Drive Shaft	25	37	58.5	89	625	
	2009.09-	-	AT	L	F	MPV Engine RHH (DW10CTED4)	210380	Drive Shaft	25	37	58.5	89	635	
	2009.09-	-	AT	R	F	MPV Engine RHH (DW10CTED4)	210363	Drive Shaft	25	37	58.5	89	935	
	2009.09-	-	MT	L	F	MPV Engine RHH (DW10CTED4)	210210	Drive Shaft	25	37	58.5	89	638	
	2009.09-	-	MT	-	-	MPV Engine RHH (DW10CTED4)	810155	Outer Joint	25	39	58.5	89	63.5	I
	2009.09-	-	MT	R	F	MPV Engine RHH (DW10CTED4)	210361	Drive Shaft	25	37	58.5	89	959	
2.0 HDi 136 / BlueHDi 136 (100 kW)	2012.02-	-	MT	R	F	MPV Engine RHD (DW10CTED4)/AHV (DW10FD)	610041	Inner Joint	37	39	32	399	95.5	
	2012.02-	-	6MT	L	F	MPV Engine RHD (DW10CTED4)/AHV (DW10FD)	810158	Outer Joint	25	26	58.5	89	61.5	M
	2012.02-	-	6MT	L	F	MPV Engine RHD (DW10CTED4)/AHV (DW10FD)	210427	Drive Shaft	25	37	58.5	89	638	
	2012.02-	-	6MT	R	F	MPV Engine RHD (DW10CTED4)/AHV (DW10FD)	210421	Drive Shaft	25	37	58.5	89	972	
	2012.02-	-	6MT	L	F	MPV Engine RHD (DW10CTED4)/AHV (DW10FD)	210312	Drive Shaft	25	37	58.5	89	625	
	2012.02-	-	-	-	-	MPV Engine RHD (DW10CTED4)/AHV (DW10FD)	810155	Outer Joint	25	39	58.5	89	63.5	I
	2012.02-	-	MT	L	F	MPV Engine RHD (DW10CTED4)/AHV (DW10FD)	210210	Drive Shaft	25	37	58.5	89	638	
	2012.02-	-	MT	R	F	MPV Engine RHD (DW10CTED4)/AHV (DW10FD)	210361	Drive Shaft	25	37	58.5	89	959	
2.0 HDi 150 / BlueHDi 150 (110 kW)	2009.06-	-	6MT	-	-	MPV Engine AHX (DW10FD)/AHR (DW10FD)/RHE (DW10CTED4)	899366	Outer Joint	25	34	58.5	79	55	I
	2009.06-	-	MT	R	F	MPV Engine AHX (DW10FD)/AHR (DW10FD)/RHE (DW10CTED4)	610041	Inner Joint	37	39	32	399	95.5	
	2009.06-	-	6MT	L	F	MPV Engine AHX (DW10FD)/AHR (DW10FD)/RHE (DW10CTED4)	810158	Outer Joint	25	26	58.5	89	61.5	M
	2009.06-	-	6MT	L	F	MPV Engine AHX (DW10FD)/AHR (DW10FD)/RHE (DW10CTED4)	210427	Drive Shaft	25	37	58.5	89	638	

YEAR	TRANSM	L/R	F/R	REMARKS	GSP Ref.	PRODUCT	ABS	Technical Specifications									
								A	B	C	H	L	P				
PEUGEOT																	
5008																	
2.0 HDi 150 / BlueHDi 150 (110 kW)	2009.06-	-	MT	R	F	MPV Engine AHX (DW10FD)/AHR (DW10FD)/RHE (DW10CTED4)	210421	Drive Shaft		25	37	58.5	89	972			
	2009.06-	-	6MT	L	F	MPV Engine AHX (DW10FD)/AHR (DW10FD)/RHE (DW10CTED4)	210312	Drive Shaft		25	37	58.5	89	625			
	2009.06-	-	AT	L	F	MPV Engine AHX (DW10FD)/AHR (DW10FD)/RHE (DW10CTED4)	210380	Drive Shaft		25	37	58.5	89	635			
	2009.06-	-	AT	R	F	MPV Engine AHX (DW10FD)/AHR (DW10FD)/RHE (DW10CTED4)	210363	Drive Shaft		25	37	58.5	89	935			
	2009.06-	-	6MT	-	-	MPV Engine AHX (DW10FD)/AHR (DW10FD)/RHE (DW10CTED4)	810155	Outer Joint		25	39	58.5	89	63.5	I		
	2009.06-	-	MT	L	F	MPV Engine AHX (DW10FD)/AHR (DW10FD)/RHE (DW10CTED4)	210210	Drive Shaft		25	37	58.5	89	638			
	2009.06-	-	MT	R	F	MPV Engine AHX (DW10FD)/AHR (DW10FD)/RHE (DW10CTED4)	210361	Drive Shaft		25	37	58.5	89	959			
	2009.06-	-	AT	R	F	MPV Engine AHX (DW10FD)/AHR (DW10FD)/RHE (DW10CTED4)	610091	Inner Joint		37	26	31.5	366	100			
	2009.06-	-	MT	-	F	MPV Engine AHX (DW10FD)/AHR (DW10FD)/RHE (DW10CTED4)	810028	Outer Joint		25	34	58	89	56	I		
504																	
-	-	-	-	-	-	-	245093	Drive Shaft		27	27	54	90.5	700			
508																	
1.6 BlueHDi 120 (88 kW)	2014.03-	-	5AT/6AT	-	F	Saloon Engine BHZ (DV6FC)	810052	Outer Joint		28	34	58.5	92	55	I		
	2014.03-	-	6MT	-	F	Saloon Engine BHZ (DV6FC)	810051	Outer Joint		28	39	58.6	94	63	I		
	2014.03-	-	MT	L	F	Saloon Engine BHZ (DV6FC)	210343	Drive Shaft		28	37	58.6	93	672			
1.6 HDi (82 kW)	2010.11-	-	5AT/6AT	-	F	Saloon Engine 9HR (DV6C)/9HL (DV6C)	810052	Outer Joint		28	34	58.5	92	55	I		
	2010.11-	-	-	R	F	Saloon Engine 9HR (DV6C)/9HL (DV6C)	299214	Drive Shaft		28	37	58.6	94	978			
	2010.11-	-	6MT	-	F	Saloon Engine 9HR (DV6C)/9HL (DV6C)	810051	Outer Joint		28	39	58.6	94	63	I		
	2010.11-	-	-	R	F	Saloon Engine 9HR (DV6C)/9HL (DV6C)	810159	Outer Joint		28	39	58.6	94	63	I		
	2010.11-	-	MT	L	F	Saloon Engine 9HR (DV6C)/9HL (DV6C)	210343	Drive Shaft		28	37	58.6	93	672			
	2010.11-	-	MT	R	F	Saloon Engine 9HR (DV6C)/9HL (DV6C)	210244	Drive Shaft		28	37	58.6	93	979			
	2010.11-	-	-	R	F	Saloon Engine 9HR (DV6C)/9HL (DV6C)	610041	Inner Joint		37	39	32	399	95.5			
1.6 HDi (84 kW)	2012.02-	-	MT	R	F	Saloon Engine 9HD (DV6CTED)	210244	Drive Shaft		28	37	58.6	93	979			
	2012.02-	-	5AT/6AT	-	F	Saloon Engine 9HD (DV6CTED)	810052	Outer Joint		28	34	58.5	92	55	I		
	2012.02-	-	6MT	-	F	Saloon Engine 9HD (DV6CTED)	810051	Outer Joint		28	39	58.6	94	63	I		
	2012.02-	-	MT	R	F	Saloon Engine 9HD (DV6CTED)	610041	Inner Joint		37	39	32	399	95.5			
	2012.02-	-	MT	L	F	Saloon Engine 9HD (DV6CTED)	210343	Drive Shaft		28	37	58.6	93	672			
1.6 THP (110 kW)	2010.11-	-	-	R	F	Saloon Engine 5FN (EP6CDT)	299214	Drive Shaft		28	37	58.6	94	978			
	2010.11-	-	AT/5AT	-	F	Saloon Engine 5FN (EP6CDT)	810052	Outer Joint		28	34	58.5	92	55	I		
	2010.11-	-	6MT	-	F	Saloon Engine 5FN (EP6CDT)	810051	Outer Joint		28	39	58.6	94	63	I		
	2010.11-	-	-	R	F	Saloon Engine 5FN (EP6CDT)	810159	Outer Joint		28	39	58.6	94	63	I		
	2010.11-	-	-	R	F	Saloon Engine 5FN (EP6CDT)	610041	Inner Joint		37	39	32	399	95.5			
1.6 THP (115 kW)	2010.11-	-	-	R	F	Saloon Engine EP6CDT	299214	Drive Shaft		28	37	58.6	94	978			
	2010.11-	-	AT/5AT	-	F	Saloon Engine EP6CDT	810052	Outer Joint		28	34	58.5	92	55	I		
	2010.11-	-	6MT	-	F	Saloon Engine EP6CDT	810051	Outer Joint		28	39	58.6	94	63	I		
	2010.11-	-	-	R	F	Saloon Engine EP6CDT	810159	Outer Joint		28	39	58.6	94	63	I		
	2010.11-	-	MT	R	F	Saloon Engine EP6CDT	210244	Drive Shaft		28	37	58.6	93	979			
	2010.11-	-	-	R	F	Saloon Engine EP6CDT	610041	Inner Joint		37	39	32	399	95.5			
1.6 VTi (85 kW)	2010.11-	-	AT/5AT	-	F	Saloon Engine 5FH (EP6C)	810052	Outer Joint		28	34	58.5	92	55	I		
	2010.11-	-	6MT	-	F	Saloon Engine 5FH (EP6C)	810051	Outer Joint		28	39	58.6	94	63	I		
1.6 VTi (88 kW)	2010.11-	-	-	R	F	Saloon Engine 5FS (EP6C)	299214	Drive Shaft		28	37	58.6	94	978			
	2010.11-	-	AT/5AT	-	F	Saloon Engine 5FS (EP6C)	810052	Outer Joint		28	34	58.5	92	55	I		
	2010.11-	-	6MT	-	F	Saloon Engine 5FS (EP6C)	810051	Outer Joint		28	39	58.6	94	63	I		
	2010.11-	-	-	R	F	Saloon Engine 5FS (EP6C)	810159	Outer Joint		28	39	58.6	94	63	I		
	2010.11-	-	MT	R	F	Saloon Engine 5FS (EP6C)	210244	Drive Shaft		28	37	58.6	93	979			
	2010.11-	-	-	R	F	Saloon Engine 5FS (EP6C)	610041	Inner Joint		37	39	32	399	95.5			
2.0 HDi (100 kW)	2010.11-	-	MT	R	F	Saloon Engine RHR (DW10BTED4)	210244	Drive Shaft		28	37	58.6	93	979			
	2010.11-	-	-	R	F	Saloon Engine RHR (DW10BTED4)	299214	Drive Shaft		28	37	58.6	94	978			
	2010.11-	-	-	R	F	Saloon Engine RHR (DW10BTED4)	810159	Outer Joint		28	39	58.6	94	63	I		
	2010.11-	-	-	R	F	Saloon Engine RHR (DW10BTED4)	610041	Inner Joint		37	39	32	399	95.5			
2.0 HDi (103 kW)	2010.11-	-	-	R	F	Saloon Engine RHF (DW10BTED4)	299214	Drive Shaft		28	37	58.6	94	978			
	2010.11-	-	-	R	F	Saloon Engine RHF (DW10BTED4)	810159	Outer Joint		28	39	58.6	94	63	I		
	2010.11-	-	6MT	L	F	Saloon Engine RHF (DW10BTED4)	210343	Drive Shaft		28	37	58.6	93	672			
	2010.11-	-	MT	R	F	Saloon Engine RHF (DW10BTED4)	210244	Drive Shaft		28	37	58.6	93	979			
	2010.11-	-	-	R	F	Saloon Engine RHF (DW10BTED4)	610041	Inner Joint		37	39	32	399	95.5			
2.0 HDi (120 kW)	2010.11-	-	-	R	F	Saloon Engine RHH (DW10CTED4)	299214	Drive Shaft		28	37	58.6	94	978			
	2010.11-	-	-	R	F	Saloon Engine RHH (DW10CTED4)	810159	Outer Joint		28	39	58.6	94	63	I		
	2010.11-	-	6MT	L	F	Saloon Engine RHH (DW10CTED4)	210343	Drive Shaft		28	37	58.6	93	672			
	2010.11-	-	MT	R	F	Saloon Engine RHH (DW10CTED4)	210244	Drive Shaft		28	37	58.6	93	979			
	2010.11-	-	-	R	F	Saloon Engine RHH (DW10CTED4)	610041	Inner Joint		37	39	32	399	95.5			
2.0 HDi Hybrid4 AWC (120 kW)	2010.11-	-	6MT	L	F	All-wheel Drive Saloon Engine RHC (DW10CTED4)	210343	Drive Shaft		28	37	58.6	93	672			
2.0 HDi Hybrid4 AWC (147 kW)	2010.11-	-	6MT	L	F	All-wheel Drive Saloon Engine RHC (DW10CTED4)/RHH (DW10CTED4)	210343	Drive Shaft		28	37	58.6	93	672			
2.2 HDi (150 kW)	2010.11-	-	-	R	F	Saloon Engine 4HL (DW12C)	299214	Drive Shaft		28	37	58.6	94	978			
	2010.11-	-	-	-	F	Saloon Engine 4HL (DW12C)	810051	Outer Joint		28	39	58.6	94	63	I		
	2010.11-	-	-	R	F	Saloon Engine 4HL (DW12C)	810159	Outer Joint		28	39	58.6	94	63	I		
	2010.11-	-	MT	R	F	Saloon Engine 4HL (DW12C)	210244	Drive Shaft		28	37	58.6	93	979			





	 YEAR	TRANSM	L/R	F/R	REMARKS	GSP Ref.	 PRODUCT	 ABS	Technical Specifications						
									A	B	C	H	L	P	
PEUGEOT															
508															
2.2 HDi (150 kW)	2010.11-	-	-	R	F	Saloon Engine 4HL (DW12C)	610041	Inner Joint		37	39	32	399	95.5	
508 SW															
1.6 BlueHDi 120 (88 kW)	2014.03-	5AT/6AT	-	F	F	Estate Engine BHZ (DV6FC)	810052	Outer Joint		28	34	58.5	92	55	I
	2014.03-	6MT	-	F	F	Estate Engine BHZ (DV6FC)	810051	Outer Joint		28	39	58.6	94	63	I
	2014.03-	MT	L	F	F	Estate Engine BHZ (DV6FC)	210343	Drive Shaft		28	37	58.6	93	672	
1.6 HDi (82 kW)	2010.11-	5AT/6AT	-	F	F	Estate Engine 9HR (DV6C)/9HL (DV6C)	810052	Outer Joint		28	34	58.5	92	55	I
	2010.11-	-	R	F	F	Estate Engine 9HR (DV6C)/9HL (DV6C)	299214	Drive Shaft		28	37	58.6	94	978	
	2010.11-	6MT	-	F	F	Estate Engine 9HR (DV6C)/9HL (DV6C)	810051	Outer Joint		28	39	58.6	94	63	I
	2010.11-	-	R	F	F	Estate Engine 9HR (DV6C)/9HL (DV6C)	810159	Outer Joint		28	39	58.6	94	63	I
	2010.11-	MT	L	F	F	Estate Engine 9HR (DV6C)/9HL (DV6C)	210343	Drive Shaft		28	37	58.6	93	672	
	2010.11-	MT	R	F	F	Estate Engine 9HR (DV6C)/9HL (DV6C)	210244	Drive Shaft		28	37	58.6	93	979	
	2010.11-	-	R	F	F	Estate Engine 9HR (DV6C)/9HL (DV6C)	610041	Inner Joint		37	39	32	399	95.5	
1.6 HDi (84 kW)	2012.02-	-	R	F	F	Estate Engine 9HD (DV6CTED)	610041	Inner Joint		37	39	32	399	95.5	
	2012.02-	MT	R	F	F	Estate Engine 9HD (DV6CTED)	210244	Drive Shaft		28	37	58.6	93	979	
	2012.02-	5AT/6AT	-	F	F	Estate Engine 9HD (DV6CTED)	810052	Outer Joint		28	34	58.5	92	55	I
	2012.02-	-	R	F	F	Estate Engine 9HD (DV6CTED)	299214	Drive Shaft		28	37	58.6	94	978	
	2012.02-	6MT	-	F	F	Estate Engine 9HD (DV6CTED)	810051	Outer Joint		28	39	58.6	94	63	I
	2012.02-	-	R	F	F	Estate Engine 9HD (DV6CTED)	810159	Outer Joint		28	39	58.6	94	63	I
	2012.02-	MT	L	F	F	Estate Engine 9HD (DV6CTED)	210343	Drive Shaft		28	37	58.6	93	672	
1.6 THP (110 kW)	2010.11-	-	R	F	F	Estate Engine 5FX (EP6DT)	610041	Inner Joint		37	39	32	399	95.5	
	2010.11-	-	R	F	F	Estate Engine 5FX (EP6DT)	299214	Drive Shaft		28	37	58.6	94	978	
	2010.11-	AT/5AT	-	F	F	Estate Engine 5FX (EP6DT)	810052	Outer Joint		28	34	58.5	92	55	I
	2010.11-	6MT	-	F	F	Estate Engine 5FX (EP6DT)	810051	Outer Joint		28	39	58.6	94	63	I
	2010.11-	-	R	F	F	Estate Engine 5FX (EP6DT)	810159	Outer Joint		28	39	58.6	94	63	I
1.6 THP (115 kW)	2010.11-	-	R	F	F	Estate Engine EP6CDT	299214	Drive Shaft		28	37	58.6	94	978	
	2010.11-	AT/5AT	-	F	F	Estate Engine EP6CDT	810052	Outer Joint		28	34	58.5	92	55	I
	2010.11-	6MT	-	F	F	Estate Engine EP6CDT	810051	Outer Joint		28	39	58.6	94	63	I
	2010.11-	-	R	F	F	Estate Engine EP6CDT	810159	Outer Joint		28	39	58.6	94	63	I
	2010.11-	MT	R	F	F	Estate Engine EP6CDT	210244	Drive Shaft		28	37	58.6	93	979	
	2010.11-	-	R	F	F	Estate Engine EP6CDT	610041	Inner Joint		37	39	32	399	95.5	
1.6 VTi (85 kW)	2010.11-	-	R	F	F	Estate Engine 5FH (EP6C)	610041	Inner Joint		37	39	32	399	95.5	
	2010.11-	MT	R	F	F	Estate Engine 5FH (EP6C)	210244	Drive Shaft		28	37	58.6	93	979	
	2010.11-	-	R	F	F	Estate Engine 5FH (EP6C)	299214	Drive Shaft		28	37	58.6	94	978	
	2010.11-	AT/5AT	-	F	F	Estate Engine 5FH (EP6C)	810052	Outer Joint		28	34	58.5	92	55	I
	2010.11-	6MT	-	F	F	Estate Engine 5FH (EP6C)	810051	Outer Joint		28	39	58.6	94	63	I
	2010.11-	-	R	F	F	Estate Engine 5FH (EP6C)	810159	Outer Joint		28	39	58.6	94	63	I
1.6 VTi (88 kW)	2010.11-	-	R	F	F	Estate Engine 5FS (EP6C)	299214	Drive Shaft		28	37	58.6	94	978	
	2010.11-	AT/5AT	-	F	F	Estate Engine 5FS (EP6C)	810052	Outer Joint		28	34	58.5	92	55	I
	2010.11-	6MT	-	F	F	Estate Engine 5FS (EP6C)	810051	Outer Joint		28	39	58.6	94	63	I
	2010.11-	-	R	F	F	Estate Engine 5FS (EP6C)	810159	Outer Joint		28	39	58.6	94	63	I
	2010.11-	MT	R	F	F	Estate Engine 5FS (EP6C)	210244	Drive Shaft		28	37	58.6	93	979	
	2010.11-	-	R	F	F	Estate Engine 5FS (EP6C)	610041	Inner Joint		37	39	32	399	95.5	
2.0 HDi (100 kW)	2010.11-	MT	R	F	F	Estate Engine RHR (DW10BTED4)	210244	Drive Shaft		28	37	58.6	93	979	
	2010.11-	MT	R	F	F	Estate Engine RHR (DW10BTED4)	299214	Drive Shaft		28	37	58.6	94	978	
	2010.11-	MT	R	F	F	Estate Engine RHR (DW10BTED4)	810159	Outer Joint		28	39	58.6	94	63	I
	2010.11-	MT	R	F	F	Estate Engine RHR (DW10BTED4)	610041	Inner Joint		37	39	32	399	95.5	
2.0 HDi (103 kW)	2010.11-	-	R	F	F	Estate Engine RHF (DW10BTED4)	299214	Drive Shaft		28	37	58.6	94	978	
	2010.11-	-	R	F	F	Estate Engine RHF (DW10BTED4)	810159	Outer Joint		28	39	58.6	94	63	I
	2010.11-	6MT	L	F	F	Estate Engine RHF (DW10BTED4)	210343	Drive Shaft		28	37	58.6	93	672	
	2010.11-	MT	R	F	F	Estate Engine RHF (DW10BTED4)	210244	Drive Shaft		28	37	58.6	93	979	
	2010.11-	-	R	F	F	Estate Engine RHF (DW10BTED4)	610041	Inner Joint		37	39	32	399	95.5	
2.0 HDi (120 kW)	2010.11-	-	L	F	F	Estate Engine RHH (DW10CTED4)	210022	Drive Shaft	48T	25	24	54.8	78.5	573	
	2010.11-	-	R	F	F	Estate Engine RHH (DW10CTED4)	299214	Drive Shaft		28	37	58.6	94	978	
	2010.11-	-	R	F	F	Estate Engine RHH (DW10CTED4)	810159	Outer Joint		28	39	58.6	94	63	I
	2010.11-	6MT	L	F	F	Estate Engine RHH (DW10CTED4)	210343	Drive Shaft		28	37	58.6	93	672	
	2010.11-	MT	R	F	F	Estate Engine RHH (DW10CTED4)	210244	Drive Shaft		28	37	58.6	93	979	
	2010.11-	-	R	F	F	Estate Engine RHH (DW10CTED4)	610041	Inner Joint		37	39	32	399	95.5	
2.2 HDi (150 kW)	2010.11-	-	R	F	F	Estate Engine 4HL (DW12C)	299214	Drive Shaft		28	37	58.6	94	978	
	2010.11-	-	-	F	F	Estate Engine 4HL (DW12C)	810051	Outer Joint		28	39	58.6	94	63	I
	2010.11-	-	R	F	F	Estate Engine 4HL (DW12C)	810159	Outer Joint		28	39	58.6	94	63	I
	2010.11-	MT	R	F	F	Estate Engine 4HL (DW12C)	210244	Drive Shaft		28	37	58.6	93	979	
	2010.11-	-	R	F	F	Estate Engine 4HL (DW12C)	610041	Inner Joint		37	39	32	399	95.5	
605															
2.0	1990-	MT/AT	-	-	-		810072	Outer Joint		28	23	58	88.5	55	I
2.1	1990-	MT/AT	-	-	-		810072	Outer Joint		28	23	58	88.5	55	I
605 (6B)															





YEAR	TRANSM	L/R	F/R	REMARKS	GSP Ref.	PRODUCT	ABS	Technical Specifications										
								A	B	C	H	L	P					
PEUGEOT																		
605 (6B)																		
2.0 (79 kW)	1990.02-1999.09	-	-	F Saloon	810083	Outer Joint	48T	28	39	58	89	63	I					
	1990.02-1999.09	-	-	F Saloon	810008	Outer Joint	48T	28	27	58	89	63	I					
	1990.02-1999.09	MT	R	F Saloon	210084	Drive Shaft	48T	28	24	58	88.5	942.5						
	1990.02-1999.09	MT	L	F Saloon	210083	Drive Shaft	48T	28	24	58	88.5	651						
	1990.02-1999.09	-	R	F Saloon	210114	Drive Shaft		28	24	58	88.5	942.5						
	1990.02-1999.09	-	-	- Saloon	810006	Outer Joint		28	23	59	88.5	55	I					
	1990.02-1999.09	MT/AT	L	F Saloon	610018	Inner Joint		24	29	40	62.5	99						
	1990.02-1999.09	-	-	F Saloon	810021	Outer Joint	29T	28	23	58	88.5	55	I					
	1990.02-1999.09	-	-	L F Saloon	210113	Drive Shaft		28	24	58	88.5	651						
2.0 (84 kW)	1989.06-1999.09	-	-	- Saloon Engine R5A (XU102C)	810006	Outer Joint		28	23	59	88.5	55	I					
2.0 (89 kW)	1989.06-1999.09	-	L	F Saloon Engine RFZ (XU10J2Z)	210107	Drive Shaft		28	37	58	89	641.5						
	1989.06-1999.09	-	R	F Saloon Engine RFZ (XU10J2Z)	210106	Drive Shaft		28	37	58	89	939						
	1989.06-1999.09	-	L	F Saloon Engine RFZ (XU10J2Z)	210191	Drive Shaft	29T	28	37	58	88	642						
	1989.06-1999.09	-	R	F Saloon Engine RFZ (XU10J2Z)	210190	Drive Shaft	29T	28	37	58	88	935						
	1989.06-1999.09	AT	L	F Saloon Engine RFZ (XU10J2Z)	210071	Drive Shaft	48T	28	37	58	89	641.5						
	1989.06-1999.09	MT/AT	L	F Saloon Engine RFZ (XU10J2Z)	610018	Inner Joint		24	29	40	62.5	99						
	1989.06-1999.09	MT	R	F Saloon Engine RFZ (XU10J2Z)	210084	Drive Shaft	48T	28	24	58	88.5	942.5						
	1989.06-1999.09	MT	L	F Saloon Engine RFZ (XU10J2Z)	210083	Drive Shaft	48T	28	24	58	88.5	651						
	1989.06-1999.09	-	R	F Saloon Engine RFZ (XU10J2Z)	210114	Drive Shaft		28	24	58	88.5	942.5						
	1989.06-1999.09	AT	R	F Saloon Engine RFZ (XU10J2Z)	210070	Drive Shaft	48T	28	37	58	89	939						
	1989.06-1999.09	-	-	- Saloon Engine RFZ (XU10J2Z)	810047	Outer Joint		28	27	58	89	63	I					
	1989.06-1999.09	-	-	- Saloon Engine RFZ (XU10J2Z)	810029	Outer Joint	29T	28	27	58	89	63	I					
	1989.06-1999.09	-	L	F Saloon Engine RFZ (XU10J2Z)	210113	Drive Shaft		28	24	58	88.5	651						
	1989.06-1999.09	AT/MT	L/R	F Saloon Engine RFZ (XU10J2Z)	810007	Outer Joint	48T	28	23	58	88.5	55	I					
2.0 16V (97 kW)	1994.07-1999.09	-	-	F Saloon Engine RFV (XU10J4R)	810083	Outer Joint	48T	28	39	58	89	63	I					
	1994.07-1999.09	-	-	F Saloon Engine RFV (XU10J4R)	810008	Outer Joint	48T	28	27	58	89	63	I					
	1994.07-1999.09	MT	R	F Saloon Engine RFV (XU10J4R)	210084	Drive Shaft	48T	28	24	58	88.5	942.5						
	1994.07-1999.09	MT	L	F Saloon Engine RFV (XU10J4R)	210083	Drive Shaft	48T	28	24	58	88.5	651						
	1994.07-1999.09	-	R	F Saloon Engine RFV (XU10J4R)	210114	Drive Shaft		28	24	58	88.5	942.5						
	1994.07-1999.09	-	-	F Saloon Engine RFV (XU10J4R)	810021	Outer Joint	29T	28	23	58	88.5	55	I					
	1994.07-1999.09	-	L	F Saloon Engine RFV (XU10J4R)	210113	Drive Shaft		28	24	58	88.5	651						
	1994.07-1999.09	MT/AT	L	F Saloon Engine RFV (XU10J4R)	610018	Inner Joint		24	29	40	62.5	99						
	1994.07-1999.09	AT/MT	L/R	F Saloon Engine RFV (XU10J4R)	810007	Outer Joint	48T	28	23	58	88.5	55	I					
2.0 Turbo (104 kW)	1992.07-1999.09	-	-	F Saloon Engine RGY (XU10J2TE)	810083	Outer Joint	48T	28	39	58	89	63	I					
	1992.07-1999.09	-	L	F Saloon Engine RGY (XU10J2TE)	210107	Drive Shaft		28	37	58	89	641.5						
	1992.07-1999.09	-	R	F Saloon Engine RGY (XU10J2TE)	210106	Drive Shaft		28	37	58	89	939						
	1992.07-1999.09	-	L	F Saloon Engine RGY (XU10J2TE)	210191	Drive Shaft	29T	28	37	58	88	642						
	1992.07-1999.09	-	R	F Saloon Engine RGY (XU10J2TE)	210190	Drive Shaft	29T	28	37	58	88	935						
	1992.07-1999.09	-	-	F Saloon Engine RGY (XU10J2TE)	810008	Outer Joint	48T	28	27	58	89	63	I					
	1992.07-1999.09	MT/AT	L	F Saloon Engine RGY (XU10J2TE)	610018	Inner Joint		24	29	40	62.5	99						
	1992.07-1999.09	MT	L	F Saloon Engine RGY (XU10J2TE)	210441	Drive Shaft	48T	28	37	58.5	88	623						
	1992.07-1999.09	MT	R	F Saloon Engine RGY (XU10J2TE)	210442	Drive Shaft	48T	28	37	58	89	920						
	1992.07-1999.09	-	-	- Saloon Engine RGY (XU10J2TE)	810047	Outer Joint		28	27	58	89	63	I					
	1992.07-1999.09	-	-	F Saloon Engine RGY (XU10J2TE)	810021	Outer Joint	29T	28	23	58	88.5	55	I					
	1992.07-1999.09	-	-	- Saloon Engine RGY (XU10J2TE)	810029	Outer Joint	29T	28	27	58	89	63	I					
2.0 Turbo (108 kW)	1991.07-1999.09	-	-	F Saloon Engine RGX (XU10J2TE)	810083	Outer Joint	48T	28	39	58	89	63	I					
	1991.07-1999.09	-	L	F Saloon Engine RGX (XU10J2TE)	210107	Drive Shaft		28	37	58	89	641.5						
	1991.07-1999.09	-	R	F Saloon Engine RGX (XU10J2TE)	210106	Drive Shaft		28	37	58	89	939						
	1991.07-1999.09	-	L	F Saloon Engine RGX (XU10J2TE)	210191	Drive Shaft	29T	28	37	58	88	642						
	1991.07-1999.09	-	R	F Saloon Engine RGX (XU10J2TE)	210190	Drive Shaft	29T	28	37	58	88	935						
	1991.07-1999.09	-	-	F Saloon Engine RGX (XU10J2TE)	810008	Outer Joint	48T	28	27	58	89	63	I					
	1991.07-1999.09	MT	L	F Saloon Engine RGX (XU10J2TE)	210441	Drive Shaft	48T	28	37	58.5	88	623						
	1991.07-1999.09	MT	R	F Saloon Engine RGX (XU10J2TE)	210442	Drive Shaft	48T	28	37	58	89	920						
	1991.07-1999.09	-	-	- Saloon Engine RGX (XU10J2TE)	810047	Outer Joint		28	27	58	89	63	I					
	1991.07-1999.09	-	-	F Saloon Engine RGX (XU10J2TE)	810021	Outer Joint	29T	28	23	58	88.5	55	I					
	1991.07-1999.09	-	-	- Saloon Engine RGX (XU10J2TE)	810029	Outer Joint	29T	28	27	58	89	63	I					
2.1 D (60 kW)	1989.06-1995.07	-	-	F Saloon Engine P9A (XUD11A)	810054	Outer Joint	48T	28	23	59	88.5	55	I					
	1989.06-1995.07	-	-	F Saloon Engine P9A (XUD11A)	810083	Outer Joint	48T	28	39	58	89	63	I					
	1989.06-1995.07	MT/AT	L	F Saloon Engine P9A (XUD11A)	610018	Inner Joint		24	29	40	62.5	99						
	1989.06-1995.07	-	-	F Saloon Engine P9A (XUD11A)	810008	Outer Joint	48T	28	27	58	89	63	I					
	1989.06-1995.07	MT	R	F Saloon Engine P9A (XUD11A)	210084	Drive Shaft	48T	28	24	58	88.5	942.5						
	1989.06-1995.07	MT	L	F Saloon Engine P9A (XUD11A)	210083	Drive Shaft	48T	28	24	58	88.5	651						
	1989.06-1995.07	-	R	F Saloon Engine P9A (XUD11A)	210114	Drive Shaft		28	24	58	88.5	942.5						
	1989.06-1995.07	-	-	- Saloon Engine P9A (XUD11A)	810006	Outer Joint		28	23	59	88.5	55	I					
	1989.06-1995.07	-	L	F Saloon Engine P9A (XUD11A)	210113	Drive Shaft		28	24	58	88.5	651						
	1989.06-1995.07	AT/MT	L/R	F Saloon Engine P9A (XUD11A)	810007	Outer Joint	48T	28	23	58	88.5	55	I					

	YEAR	TRANSM	L/R	F/R	REMARKS	GSP Ref.	PRODUCT	ABS	Technical Specifications										
									A	B	C	H	L	P					
PEUGEOT																			
605 (6B)																			
2.1 TD 12V (80 kW)	1994.08-1999.09	-	-	F	Saloon Engine P8C (XUD11BTE)/PHZ (XUD11ATE)	810083	Outer Joint	48T	28	39	58	89	63	I					
	1994.08-1999.09	-	-	F	Saloon Engine P8C (XUD11BTE)/PHZ (XUD11ATE)	810008	Outer Joint	48T	28	27	58	89	63	I					
2.1 Turbo Diesel (80 kW)	1989.06-1999.09	-	-	F	Saloon Engine PHZ (XUD11ATE)	810083	Outer Joint	48T	28	39	58	89	63	I					
	1989.06-1999.09	-	L	F	Saloon Engine PHZ (XUD11ATE)	210107	Drive Shaft		28	37	58	89	641.5						
	1989.06-1999.09	-	R	F	Saloon Engine PHZ (XUD11ATE)	210106	Drive Shaft		28	37	58	89	939						
	1989.06-1999.09	-	L	F	Saloon Engine PHZ (XUD11ATE)	210191	Drive Shaft	29T	28	37	58	88	642						
	1989.06-1999.09	-	R	F	Saloon Engine PHZ (XUD11ATE)	210190	Drive Shaft	29T	28	37	58	88	935						
	1989.06-1999.09	-	-	F	Saloon Engine PHZ (XUD11ATE)	810008	Outer Joint	48T	28	27	58	89	63	I					
	1989.06-1999.09	-	L	F	Saloon Engine PHZ (XUD11ATE)	210071	Drive Shaft	48T	28	37	58	89	641.5						
	1989.06-1999.09	MT	L	F	Saloon Engine PHZ (XUD11ATE)	210441	Drive Shaft	48T	28	37	58.5	88	623						
	1989.06-1999.09	MT	R	F	Saloon Engine PHZ (XUD11ATE)	210442	Drive Shaft	48T	28	37	58	89	920						
	1989.06-1999.09	-	R	F	Saloon Engine PHZ (XUD11ATE)	210070	Drive Shaft	48T	28	37	58	89	939						
	1989.06-1999.09	-	-	-	Saloon Engine PHZ (XUD11ATE)	810047	Outer Joint		28	27	58	89	63	I					
	1989.06-1999.09	-	-	-	Saloon Engine PHZ (XUD11ATE)	810029	Outer Joint	29T	28	27	58	89	63	I					
3.0 (123 kW)	1989.08-1994.06	-	-	F	Saloon Engine SFZ (ZPJZ)/UFZ (ZPJ)	810083	Outer Joint	48T	28	39	58	89	63	I					
	1989.08-1994.06	-	-	F	Saloon Engine SFZ (ZPJZ)/UFZ (ZPJ)	810008	Outer Joint	48T	28	27	58	89	63	I					
	1989.10-1999.09	-	-	F	Saloon Engine UFZ (ZPJ)	810083	Outer Joint	48T	28	39	58	89	63	I					
	1989.10-1999.09	-	L	F	Saloon Engine UFZ (ZPJ)	210107	Drive Shaft		28	37	58	89	641.5						
	1989.10-1999.09	-	R	F	Saloon Engine UFZ (ZPJ)	210106	Drive Shaft		28	37	58	89	939						
	1989.10-1999.09	-	L	F	Saloon Engine UFZ (ZPJ)	210191	Drive Shaft	29T	28	37	58	88	642						
	1989.10-1999.09	-	R	F	Saloon Engine UFZ (ZPJ)	210190	Drive Shaft	29T	28	37	58	88	935						
	1989.10-1999.09	-	-	F	Saloon Engine UFZ (ZPJ)	810008	Outer Joint	48T	28	27	58	89	63	I					
	1989.10-1999.09	-	L	F	Saloon Engine UFZ (ZPJ)	210071	Drive Shaft	48T	28	37	58	89	641.5						
	1989.10-1999.09	MT	L	F	Saloon Engine UFZ (ZPJ)	210441	Drive Shaft	48T	28	37	58.5	88	623						
	1989.10-1999.09	MT	R	F	Saloon Engine UFZ (ZPJ)	210442	Drive Shaft	48T	28	37	58	89	920						
	1989.10-1999.09	-	R	F	Saloon Engine UFZ (ZPJ)	210070	Drive Shaft	48T	28	37	58	89	939						
	1989.10-1999.09	-	-	-	Saloon Engine UFZ (ZPJ)	810047	Outer Joint		28	27	58	89	63	I					
	1989.10-1999.09	-	-	-	Saloon Engine UFZ (ZPJ)	810029	Outer Joint	29T	28	27	58	89	63	I					
3.0 (147 kW)	1989.08-1994.06	-	-	F	Saloon Engine UKZ (ZPJ4/Z)/SKZ (ZPJ4/Z)	810083	Outer Joint	48T	28	39	58	89	63	I					
	1989.08-1994.06	-	-	F	Saloon Engine UKZ (ZPJ4/Z)/SKZ (ZPJ4/Z)	810008	Outer Joint	48T	28	27	58	89	63	I					
3.0 SV 24 (147 kW)	1989.08-1999.09	-	-	F	Saloon Engine UKZ (ZPJ4/Z)	810083	Outer Joint	48T	28	39	58	89	63	I					
	1989.08-1999.09	-	L	F	Saloon Engine UKZ (ZPJ4/Z)	210107	Drive Shaft		28	37	58	89	641.5						
	1989.08-1999.09	-	R	F	Saloon Engine UKZ (ZPJ4/Z)	210106	Drive Shaft		28	37	58	89	939						
	1989.08-1999.09	-	L	F	Saloon Engine UKZ (ZPJ4/Z)	210191	Drive Shaft	29T	28	37	58	88	642						
	1989.08-1999.09	-	R	F	Saloon Engine UKZ (ZPJ4/Z)	210190	Drive Shaft	29T	28	37	58	88	935						
	1989.08-1999.09	-	-	F	Saloon Engine UKZ (ZPJ4/Z)	810008	Outer Joint	48T	28	27	58	89	63	I					
	1989.08-1999.09	-	L	F	Saloon Engine UKZ (ZPJ4/Z)	210071	Drive Shaft	48T	28	37	58	89	641.5						
	1989.08-1999.09	MT	L	F	Saloon Engine UKZ (ZPJ4/Z)	210441	Drive Shaft	48T	28	37	58.5	88	623						
	1989.08-1999.09	MT	R	F	Saloon Engine UKZ (ZPJ4/Z)	210442	Drive Shaft	48T	28	37	58	89	920						
	1989.08-1999.09	-	R	F	Saloon Engine UKZ (ZPJ4/Z)	210070	Drive Shaft	48T	28	37	58	89	939						
	1989.08-1999.09	-	-	-	Saloon Engine UKZ (ZPJ4/Z)	810047	Outer Joint		28	27	58	89	63	I					
	1989.08-1999.09	-	-	-	Saloon Engine UKZ (ZPJ4/Z)	810029	Outer Joint	29T	28	27	58	89	63	I					
3.0 V6 (140 kW)	1997.04-1999.09	-	-	F	Saloon Engine XFZ (ES9J4)	810083	Outer Joint	48T	28	39	58	89	63	I					
	1997.04-1999.09	-	-	F	Saloon Engine XFZ (ES9J4)	810008	Outer Joint	48T	28	27	58	89	63	I					
607 (9D 9U)																			
2.0 (100 kW)	2000.02-		MT	R	F	Saloon Engine RFN (EW10J4)	210221	Drive Shaft	48T	28	37	58	89	948					
2.0 HDI (100 kW)	2005.09-		MT	-	F	Saloon Engine RHR (DW10BTEd4)	810051	Outer Joint		28	39	58.6	94	63	I				
2.0 HDi (79 kW)	2001.03-2004.07	MT	R	F	Saloon Engine RHS (DW10ATED)	210221	Drive Shaft	48T	28	37	58	89	948						
	2001.03-2004.07	-	L	F	Saloon Engine RHS (DW10ATED)	210218	Drive Shaft	48T	28	37	58	89	638						
	2001.03-2004.07	MT	L	F	Saloon Engine RHS (DW10ATED)	245166	Drive Shaft	48T	28	37	58	88	648						
	2001.03-2004.07	MT	R	F	Saloon Engine RHS (DW10ATED)	245165	Drive Shaft	48T	28	37	58	89	960						
2.0 HDi (80 kW)	2000.05-		MT	R	F	Saloon Engine RHZ (DW10ATED)	210221	Drive Shaft	48T	28	37	58	89	948					
	2000.05-		-	L	F	Saloon Engine RHZ (DW10ATED)	210218	Drive Shaft	48T	28	37	58	89	638					
	2000.05-		MT	L	F	Saloon Engine RHZ (DW10ATED)	245166	Drive Shaft	48T	28	37	58	88	648					
	2000.05-		MT	R	F	Saloon Engine RHZ (DW10ATED)	245165	Drive Shaft	48T	28	37	58	89	960					
2.2 16V (116 kW)	2000.02-		MT	R	F	Saloon Engine 3FZ (EW12J4)	210221	Drive Shaft	48T	28	37	58	89	948					
2.2 16V (120 kW)	2005.09-		MT	R	F	Saloon Engine 3FY (EW12J4)	210221	Drive Shaft	48T	28	37	58	89	948					
2.2 HDi (125 kW)	2006.05-		MT	-	F	Saloon Engine 4HT (DW12BTEd4)	810051	Outer Joint		28	39	58.6	94	63	I				
2.2 HDi (98 kW)	2000.02-		MT	R	F	Saloon Engine 4HX (DW12TED4/FAP)	210221	Drive Shaft	48T	28	37	58	89	948					
	2000.02-		MT	L	F	Saloon Engine 4HX (DW12TED4/FAP)	210218	Drive Shaft	48T	28	37	58	89	638					
	2000.02-		MT	L	F	Saloon Engine 4HX (DW12TED4/FAP)	245166	Drive Shaft	48T	28	37	58	88	648					
	2000.02-		MT	R	F	Saloon Engine 4HX (DW12TED4/FAP)	245165	Drive Shaft	48T	28	37	58	89	960					
2.7 HDi 24V (150 kW)	2004.12-		AT	R	F	Saloon Engine DT17TED4	210396	Drive Shaft		28	37	58.6	94	925					
	2004.12-		AT	R	F	Saloon Engine DT17TED4	810159	Outer Joint		28	39	58.6	94	63	I				
3.0 V6 24V (152 kW)	2000.02-		AT	R	F	Saloon Engine XFX (ES9J4S)	210396	Drive Shaft		28	37	58.6	94	925					
	2000.02-		AT	R	F	Saloon Engine XFX (ES9J4S)	810159	Outer Joint		28	39	58.6	94	63	I				





	 YEAR	TRANSM	L/R	F/R	REMARKS	GSP Ref.	 PRODUCT	 ABS	Technical Specifications						
									A	B	C	H	L	P	
PEUGEOT															
607 (9D 9U)															
3.0 V6 24V (155 kW)	2004.03-	-	AT	R	F	Saloon Engine XFX (ES9J4S)/XFV (ES9A)	210396	Drive Shaft		28	37	58.6	94	925	
	2004.03-	-	AT	R	F	Saloon Engine XFX (ES9J4S)/XFV (ES9A)	810159	Outer Joint		28	39	58.6	94	63	I
806 (221)															
1.8 (73 kW)	1995.07-	2002.08	MT	L	F	MPV Engine LFW (XU7JP)	210082	Drive Shaft	48T	27	24	59	82	648	
	1995.07-	2002.08	MT	R	F	MPV Engine LFW (XU7JP)	210012	Drive Shaft	48T	27	24	64	80.5	928	
	1995.07-	2002.08	MT	L/R	F	MPV Engine LFW (XU7JP)	810018	Outer Joint	48T	27	34	61	82	55	I
	1995.07-	2002.08	MT	L	F	MPV Engine LFW (XU7JP)	210052	Drive Shaft		27	24	61	82	648	
	1995.07-	2002.08	MT	R	F	MPV Engine LFW (XU7JP)	210120	Drive Shaft		27	24	59	82	928	
1.9 TD (66 kW)	1995.07-	2002.08	MT	L	F	MPV Engine DHX (XUD9TE)	610015	Inner Joint		37	39	40	68.5	104	
	1995.07-	2002.08	MT	R	F	MPV Engine DHX (XUD9TE)	610034	Inner Joint		37	39	31.9	369.5	99	
	1995.07-	2002.08	MT	L	F	MPV Engine DHX (XUD9TE)	210072	Drive Shaft		27	37	59	82	641	
	1995.07-	2002.08	MT	R	F	MPV Engine DHX (XUD9TE)	210155	Drive Shaft		27	37	59	82	947	
	1995.07-	2002.08	-	L/R	F	MPV Engine DHX (XUD9TE)	810015	Outer Joint	48T	27	39	59	82	63	I
	1995.07-	2002.08	MT	L	F	MPV Engine DHX (XUD9TE)	210016	Drive Shaft	48T	27	37	59	82	641	
	1995.07-	2002.08	MT	R	F	MPV Engine DHX (XUD9TE)	210014	Drive Shaft	48T	27	37	59	82	947	
1.9 TD (68 kW)	1997.05-	2002.08	AT/MT	L	F	MPV Engine DHY (XUD9TE)	610015	Inner Joint		37	39	40	68.5	104	
	1997.05-	2002.08	AT/MT	R	F	MPV Engine DHY (XUD9TE)	610034	Inner Joint		37	39	31.9	369.5	99	
	1997.05-	2002.08	-	L	F	MPV Engine DHY (XUD9TE)	210073	Drive Shaft	48T	27	37	59	82	641	
	1997.05-	2002.08	AT/MT	L	F	MPV Engine DHY (XUD9TE)	210072	Drive Shaft		27	37	59	82	641	
	1997.05-	2002.08	-	-	F	MPV Engine DHY (XUD9TE)	810014	Outer Joint		27	39	59	82	63	I
	1997.05-	2002.08	-	R	F	MPV Engine DHY (XUD9TE)	210108	Drive Shaft	48T	27	37	59	82	939	
	1997.05-	2002.08	-	R	F	MPV Engine DHY (XUD9TE)	210074	Drive Shaft		27	37	59	82	939	
	1997.05-	2002.08	AT/MT	R	F	MPV Engine DHY (XUD9TE)	210155	Drive Shaft		27	37	59	82	947	
	1997.05-	2002.08	-	L/R	F	MPV Engine DHY (XUD9TE)	810015	Outer Joint	48T	27	39	59	82	63	I
	1997.05-	2002.08	AT/MT	L	F	MPV Engine DHY (XUD9TE)	210016	Drive Shaft	48T	27	37	59	82	641	
	1997.05-	2002.08	AT/MT	R	F	MPV Engine DHY (XUD9TE)	210014	Drive Shaft	48T	27	37	59	82	947	
2.0 (89 kW)	1994.06-	2002.08	-	-	F	MPV Engine RFU (XU10J2)	810016	Outer Joint		27	34	59	82	55	I
	1994.06-	2002.08	MT	L	F	MPV Engine RFU (XU10J2)	210082	Drive Shaft	48T	27	24	59	82	648	
	1994.06-	2002.08	-	R	F	MPV Engine RFU (XU10J2)	210081	Drive Shaft	48T	27	24	59	82	935	
	1994.06-	2002.08	-	L	F	MPV Engine RFU (XU10J2)	210112	Drive Shaft		27	24	59	82	648	
	1994.06-	2002.08	MT	R	F	MPV Engine RFU (XU10J2)	210012	Drive Shaft	48T	27	24	64	80.5	928	
	1994.06-	2002.08	-	R	F	MPV Engine RFU (XU10J2)	210111	Drive Shaft		27	24	59	82	935	
	1994.06-	2002.08	MT	L/R	F	MPV Engine RFU (XU10J2)	810018	Outer Joint	48T	27	34	61	82	55	I
	1994.06-	2002.08	MT	L	F	MPV Engine RFU (XU10J2)	210052	Drive Shaft		27	24	61	82	648	
	1994.06-	2002.08	MT	R	F	MPV Engine RFU (XU10J2)	210120	Drive Shaft		27	24	59	82	928	
	1994.06-	2002.08	-	-	F	MPV Engine RFU (XU10J2)	810059	Outer Joint	48T	27	34	59	82	55	I
2.0 16V (100 kW)	2000.09-	2002.08	MT	R	F	MPV Engine RFN (EW10J4)	210120	Drive Shaft		27	24	59	82	928	
	2000.09-	2002.08	-	-	F	MPV Engine RFN (EW10J4)	810016	Outer Joint		27	34	59	82	55	I
	2000.09-	2002.08	MT	R	F	MPV Engine RFN (EW10J4)	210081	Drive Shaft	48T	27	24	59	82	935	
	2000.09-	2002.08	MT	L	F	MPV Engine RFN (EW10J4)	210082	Drive Shaft	48T	27	24	59	82	648	
	2000.09-	2002.08	-	L	F	MPV Engine RFN (EW10J4)	210112	Drive Shaft		27	24	59	82	648	
	2000.09-	2002.08	-	R	F	MPV Engine RFN (EW10J4)	210111	Drive Shaft		27	24	59	82	935	
	2000.09-	2002.08	MT	R	F	MPV Engine RFN (EW10J4)	210012	Drive Shaft	48T	27	24	64	80.5	928	
	2000.09-	2002.08	MT	L/R	F	MPV Engine RFN (EW10J4)	810018	Outer Joint	48T	27	34	61	82	55	I
	2000.09-	2002.08	MT	L	F	MPV Engine RFN (EW10J4)	210052	Drive Shaft		27	24	61	82	648	
	2000.09-	2002.08	-	-	F	MPV Engine RFN (EW10J4)	810059	Outer Joint	48T	27	34	59	82	55	I
2.0 16V (97 kW)	1998.05-	2000.09	-	-	F	MPV Engine RFV (XU10J4R)	810016	Outer Joint		27	34	59	82	55	I
	1998.05-	2000.09	MT	R	F	MPV Engine RFV (XU10J4R)	210081	Drive Shaft	48T	27	24	59	82	935	
	1998.05-	2000.09	-	L	F	MPV Engine RFV (XU10J4R)	610015	Inner Joint		37	39	40	68.5	104	
	1998.05-	2000.09	-	L	F	MPV Engine RFV (XU10J4R)	210112	Drive Shaft		27	24	59	82	648	
	1998.05-	2000.09	-	R	F	MPV Engine RFV (XU10J4R)	210111	Drive Shaft		27	24	59	82	935	
	1998.05-	2000.09	-	R	F	MPV Engine RFV (XU10J4R)	610034	Inner Joint		37	39	31.9	369.5	99	
	1998.05-	2000.09	MT	L/R	F	MPV Engine RFV (XU10J4R)	810018	Outer Joint	48T	27	34	61	82	55	I
	1998.05-	2000.09	-	L	F	MPV Engine RFV (XU10J4R)	210072	Drive Shaft		27	37	59	82	641	
	1998.05-	2000.09	-	R	F	MPV Engine RFV (XU10J4R)	210155	Drive Shaft		27	37	59	82	947	
	1998.05-	2000.09	-	L	F	MPV Engine RFV (XU10J4R)	210016	Drive Shaft	48T	27	37	59	82	641	
	1998.05-	2000.09	-	-	F	MPV Engine RFV (XU10J4R)	810059	Outer Joint	48T	27	34	59	82	55	I
	1998.05-	2000.09	-	R	F	MPV Engine RFV (XU10J4R)	210014	Drive Shaft	48T	27	37	59	82	947	
2.0 HDI (80 kW)	1999.08-	2002.08	-	L	F	MPV Engine RHZ (DW10ATED)	210430	Drive Shaft		27	37	59	82	630	
	1999.08-	2002.08	-	R	F	MPV Engine RHZ (DW10ATED)	210237	Drive Shaft	48T	27	37	59	82	953	
	1999.08-	2002.08	-	R	F	MPV Engine RHZ (DW10ATED)	210057	Drive Shaft		27	37	59	82	960	
	1999.08-	2002.08	-	L	F	MPV Engine RHZ (DW10ATED)	210264	Drive Shaft	48T	27	37	59	82	630	
	1999.08-	2002.08	-	R	F	MPV Engine RHZ (DW10ATED)	245120	Drive Shaft	48T	27	37	59	82	960	
	1999.08-	2002.08	-	L	F	MPV Engine RHZ (DW10ATED)	610015	Inner Joint		37	39	40	68.5	104	
	1999.08-	2002.08	-	R	F	MPV Engine RHZ (DW10ATED)	610034	Inner Joint		37	39	31.9	369.5	99	
2.0 HDI 16V (80 kW)	1999.08-	2002.08	-	L	F	MPV Engine RHW (DW10ATED4)	210430	Drive Shaft		27	37	59	82	630	





YEAR	TRANSM	L/R	F/R	REMARKS	GSP Ref.	PRODUCT	ABS	Technical Specifications									
								A	B	C	H	L	P				
PEUGEOT																	
806 (221)																	
2.0 HDI 16V (80 kW)	1999.08-2002.08	-	R	F	MPV Engine RHW (DW10ATED4)	210057	Drive Shaft		27	37	59	82	960				
	1999.08-2002.08	-	L	F	MPV Engine RHW (DW10ATED4)	210264	Drive Shaft	48T	27	37	59	82	630				
	1999.08-2002.08	-	R	F	MPV Engine RHW (DW10ATED4)	245120	Drive Shaft	48T	27	37	59	82	960				
	1999.08-2002.08	-	L	F	MPV Engine RHW (DW10ATED4)	610015	Inner Joint		37	39	40	68.5	104				
	1999.08-2002.08	-	R	F	MPV Engine RHW (DW10ATED4)	610034	Inner Joint		37	39	31.9	369.5	99				
2.0 Turbo (108 kW)	1994.06-2002.08	MT	L	F	MPV Engine RGX (XU10J2TE)	610015	Inner Joint		37	39	40	68.5	104				
	1994.06-2002.08	MT	R	F	MPV Engine RGX (XU10J2TE)	610034	Inner Joint		37	39	31.9	369.5	99				
	1994.06-2002.08	-	-	F	MPV Engine RGX (XU10J2TE)	810014	Outer Joint		27	39	59	82	63	I			
	1994.06-2002.08	MT	L	F	MPV Engine RGX (XU10J2TE)	210072	Drive Shaft		27	37	59	82	641				
	1994.06-2002.08	MT	R	F	MPV Engine RGX (XU10J2TE)	210155	Drive Shaft		27	37	59	82	947				
	1994.06-2002.08	-	L/R	F	MPV Engine RGX (XU10J2TE)	810015	Outer Joint	48T	27	39	59	82	63	I			
	1994.06-2002.08	MT	L	F	MPV Engine RGX (XU10J2TE)	210016	Drive Shaft	48T	27	37	59	82	641				
	1994.06-2002.08	MT	R	F	MPV Engine RGX (XU10J2TE)	210014	Drive Shaft	48T	27	37	59	82	947				
2.1 td 12V (80 kW)	1996.06-1999.08	-	L	F	MPV Engine P8C (XUD11BTE)	610015	Inner Joint		37	39	40	68.5	104				
	1996.06-1999.08	-	R	F	MPV Engine P8C (XUD11BTE)	610034	Inner Joint		37	39	31.9	369.5	99				
	1996.06-1999.08	-	-	F	MPV Engine P8C (XUD11BTE)	810014	Outer Joint		27	39	59	82	63	I			
	1996.06-1999.08	-	L	F	MPV Engine P8C (XUD11BTE)	210072	Drive Shaft		27	37	59	82	641				
	1996.06-1999.08	-	R	F	MPV Engine P8C (XUD11BTE)	210155	Drive Shaft		27	37	59	82	947				
	1996.06-1999.08	-	L/R	F	MPV Engine P8C (XUD11BTE)	810015	Outer Joint	48T	27	39	59	82	63	I			
	1996.06-1999.08	-	L	F	MPV Engine P8C (XUD11BTE)	210016	Drive Shaft	48T	27	37	59	82	641				
	1996.06-1999.08	-	R	F	MPV Engine P8C (XUD11BTE)	210014	Drive Shaft	48T	27	37	59	82	947				
807 (E)																	
2.0 (100 kW)	2002.06-	-	-	F	MPV Engine RFN (EW10J4)	810016	Outer Joint		27	34	59	82	55	I			
	2002.06-	-	-	F	MPV Engine RFN (EW10J4)	845059	Outer Joint		27	34	58	81.5	55	I			
	2002.06-	MT	L	F	MPV Engine RFN (EW10J4)	210422	Drive Shaft		27	24	58	81.5	659				
	2002.06-	MT	R	F	MPV Engine RFN (EW10J4)	210431	Drive Shaft		27	24	59	82	944				
	2002.06-	AT	R	F	MPV Engine RFN (EW10J4)	210425	Drive Shaft		27	26	59	82	855				
	2002.06-	-	L	F	MPV Engine RFN (EW10J4)	217220	Drive Shaft		27	26	58	81.5	648				
	2002.06-	-	R	F	MPV Engine RFN (EW10J4)	217218	Drive Shaft		27	26	58	81.5	855				
2.0 16V (103 kW)	2005.09-	-	-	F	MPV Engine RFJ (EW10A)	810016	Outer Joint		27	34	59	82	55	I			
	2005.09-	-	-	F	MPV Engine RFJ (EW10A)	845059	Outer Joint		27	34	58	81.5	55	I			
	2005.09-	MT	L	F	MPV Engine RFJ (EW10A)	210422	Drive Shaft		27	24	58	81.5	659				
	2005.09-	MT	R	F	MPV Engine RFJ (EW10A)	210431	Drive Shaft		27	24	59	82	944				
	2005.09-	AT	R	F	MPV Engine RFJ (EW10A)	210425	Drive Shaft		27	26	59	82	855				
	2005.09-	-	L	F	MPV Engine RFJ (EW10A)	217220	Drive Shaft		27	26	58	81.5	648				
	2005.09-	-	R	F	MPV Engine RFJ (EW10A)	217218	Drive Shaft		27	26	58	81.5	855				
2.0 HDI (100 kW)	2006.06-	MT	R	F	MPV Engine RHR (DW10BTED4)	610160	Inner joint		37	28	32	399	95.5				
	2006.06-	MT	R	F	MPV Engine RHR (DW10BTED4)	210440	Drive Shaft		27	37	58	81	973				
2.0 HDi (120 kW)	2009.06-	MT	L	F	MPV Engine RHH (DW10CTED4)	210424	Drive Shaft		27	37	61.3	84	637				
	2009.06-	MT	L	F	MPV Engine RHH (DW10CTED4)	610015	Inner Joint		37	39	40	68.5	104				
2.0 HDi (79 kW)	2002.06-	AT	-	F	MPV Engine RHW (DW10ATED4)/RHT (DW10ATED4)/RHM (DW10ATED4)	810016	Outer Joint		27	34	59	82	55	I			
	2002.06-	-	L	F	MPV Engine RHW (DW10ATED4)/RHT (DW10ATED4)/RHM (DW10ATED4)	210423	Drive Shaft		27	26	58	81.5	635				
	2002.06-	-	R	F	MPV Engine RHW (DW10ATED4)/RHT (DW10ATED4)/RHM (DW10ATED4)	210425	Drive Shaft		27	26	59	82	855				
2.0 HDi (80 kW)	2004.04-2006.05	AT	-	F	MPV Engine RHW (DW10ATED4)	810016	Outer Joint		27	34	59	82	55	I			
2.0 HDi (88 kW)	2006.02-	-	R	F	MPV Engine RHK (DW10UTED4)	610160	Inner joint		37	28	32	399	95.5				
	2006.02-	-	R	F	MPV Engine RHK (DW10UTED4)	210440	Drive Shaft		27	37	58	81	973				
2.2 HDi (100 kW)	2004.04-	-	R	F	MPV Engine 4HZ (DW12TED4)	218291	Drive Shaft		27	37	58	81	977				
2.2 HDi (120 kW)	2006.06-	MT	L	F	MPV Engine 4HT (DW12BTED4)	210424	Drive Shaft		27	37	61.3	84	637				
	2006.06-	MT	L	F	MPV Engine 4HT (DW12BTED4)	610015	Inner Joint		37	39	40	68.5	104				
2.2 HDi (125 kW)	2006.06-	MT	L	F	MPV Engine 4HT (DW12BTED4)	210424	Drive Shaft		27	37	61.3	84	637				
	2006.06-	MT	L	F	MPV Engine 4HT (DW12BTED4)	610015	Inner Joint		37	39	40	68.5	104				
2.2 HDi (94 kW)	2002.06-	-	R	F	MPV Engine 4HX (DW12TED4/FAP)	218291	Drive Shaft		27	37	58	81	977				
3.0 V6 (150 kW)	2002.06-	AT	R	F	MPV Engine XFX (ES9J4S)	217217	Drive Shaft		27	37	58	81.5	924				
	2002.06-	AT	L	F	MPV Engine XFX (ES9J4S)	217221	Drive Shaft		27	37	58	81.5	624				
	2002.06-	AT	R	F	MPV Engine XFX (ES9J4S)	250218	Drive Shaft		23	39	56.2	83.5	1001				
	2002.06-	AT	R	F	MPV Engine XFX (ES9J4S)	250218	Drive Shaft		23	39	56.2	83.5	1001				
BIPPER																	
1.4 HDI	2007-	-	-	L	F	-	617029	Inner Joint		22	22	40	58.5	101			
BIPPER (AA_)																	
1.3 HDi 75 (55 kW)	2010.10-	MT	L	F	Box Engine FHZ (F13DTE5)/199 A9.000	217166	Drive Shaft		25	24	51	84.5	605				
	2010.10-	MT	R	F	Box Engine FHZ (F13DTE5)/199 A9.000	217167	Drive Shaft		25	24	51	84.5	919				
1.4 (54 kW)	2008.02-	-	L/R	F	Box Engine KFV (TU3A)	817070	Outer Joint		22	22	51	79	57.5	M			
1.4 HDi (50 kW)	2008.02-	MT	L	F	Box Engine 8HS (DV4TED)	217151	Drive Shaft		25	22	51	84	656				
	2008.02-	MT	L	F	Box Engine 8HS (DV4TED)	217051	Drive Shaft		25	22	51	84	648				
	2008.02-	MT	R	F	Box Engine 8HS (DV4TED)	217052	Drive Shaft		25	22	51	84	879				
	2008.02-	-	-	F	Box Engine 8HS (DV4TED)	817067	Outer Joint		25	22	51	84	57.5	M			

	 YEAR	TRANSM	L/R	F/R	REMARKS	GSP Ref.	 PRODUCT	 ABS	Technical Specifications						
									A	B	C	H	L	P	
PEUGEOT															
BIPPER (AA_)															
1.4 HDi (50 kW)	2008.02-	-	-	-	Box Engine 8HS (DV4TED)	817068	Outer Joint		25	22	51	84	57.5	M	
BIPPER Tepee															
1.4 (54 kW)	2008.04-	-	-	L/R	F	Estate Engine KFV (TU3A)	817070	Outer Joint		22	22	51	79	57.5	M
1.4 HDi (50 kW)	2008.04-	-	MT	L	F	Estate Engine 8HS (DV4TED)	217151	Drive Shaft	25	22	51	84	656		
	2008.04-	-	MT	L	F	Estate Engine 8HS (DV4TED)	217051	Drive Shaft	25	22	51	84	648		
	2008.04-	-	MT	R	F	Estate Engine 8HS (DV4TED)	217052	Drive Shaft	25	22	51	84	879		
	2008.04-	-	-	-	F	Estate Engine 8HS (DV4TED)	817067	Outer Joint	25	22	51	84	57.5	M	
	2008.04-	-	-	-	-	Estate Engine 8HS (DV4TED)	817068	Outer Joint	25	22	51	84	57.5	M	
BOXER															
2.2 HDi (88 kW)	2006.04-	-	-	-	LCV	817054	Outer Joint		35	29	71.5	127	71	M	
2.2 HDi (96 kW)	2006.04-	-	-	-	LCV	817054	Outer Joint		35	29	71.5	127	71	M	
2.2 HDi 100 (74 kW)	2006.04-	-	5MT	L/R	F	Box Engine 4HV (P22DTE)	817055	Outer Joint	35	27	71.5	127	66.5	I	
	2006.04-	-	5MT	L/R	F	Bus Engine 4HV (P22DTE)	817055	Outer Joint	35	27	71.5	127	66.5	I	
	2006.04-	-	5MT	L/R	F	Platform/Chassis Engine 4HV (P22DTE)	817055	Outer Joint	35	27	71.5	127	66.5	I	
	2006.04-	-	5MT	L	F	Box Engine 4HV (P22DTE)	617028	Inner Joint	41	29	43	69.5	109.5		
	2006.04-	-	5MT	L	F	Bus Engine 4HV (P22DTE)	617028	Inner Joint	41	29	43	69.5	109.5		
	2006.04-	-	5MT	L	F	Platform/Chassis Engine 4HV (P22DTE)	617028	Inner Joint	41	29	43	69.5	109.5		
	2006.04-	-	5MT	R	F	Box Engine 4HV (P22DTE)	617020	Inner Joint	41	29	34.85	403	109		
	2006.04-	-	5MT	R	F	Bus Engine 4HV (P22DTE)	617020	Inner Joint	41	29	34.85	403	109		
	2006.04-	-	5MT	R	F	Platform/Chassis Engine 4HV (P22DTE)	617020	Inner Joint	41	29	34.85	403	109		
	2006.04-	-	5MT	L	F	Box Engine 4HV (P22DTE)	617042	Inner Joint	41	27	43	70	102		
	2006.04-	-	5MT	L	F	Bus Engine 4HV (P22DTE)	617042	Inner Joint	41	27	43	70	102		
	2006.04-	-	5MT	L	F	Platform/Chassis Engine 4HV (P22DTE)	617042	Inner Joint	41	27	43	70	102		
	2006.04-	-	5MT	R	F	Box Engine 4HV (P22DTE)	610038	Inner Joint	41	27	34.85	403	102		
	2006.04-	-	5MT	R	F	Bus Engine 4HV (P22DTE)	610038	Inner Joint	41	27	34.85	403	102		
	2006.04-	-	5MT	R	F	Platform/Chassis Engine 4HV (P22DTE)	610038	Inner Joint	41	27	34.85	403	102		
	2006.04-	-	5MT	L	F	Bus Engine 4HV (P22DTE)	245176	Drive Shaft	35	41	71.5	127	808		
	2006.04-	-	5MT	L	F	Box Engine 4HV (P22DTE)	245176	Drive Shaft	35	41	71.5	127	808		
	2006.04-	-	5MT	L	F	Platform/Chassis Engine 4HV (P22DTE)	245176	Drive Shaft	35	41	71.5	127	808		
	2.2 HDi 110 (81 kW)	2006.04-	-	5MT	L/R	F	Box Engine 4HV (P22DTE)	817045	Outer Joint	35	29	71.5	127	71	M
		2006.04-	-	5MT	L/R	F	Bus Engine 4HV (P22DTE)	817045	Outer Joint	35	29	71.5	127	71	M
2006.04-		-	5MT	L/R	F	Platform/Chassis Engine 4HV (P22DTE)	817045	Outer Joint	35	29	71.5	127	71	M	
2011.03-		-	-	L	F	Platform/Chassis Engine 4HG (P22DTE)	217053	Drive Shaft	35	41	71.5	127	806		
2011.03-		-	-	R	F	Bus Engine 4HG (P22DTE)	217050	Drive Shaft	35	41	71.5	127	1140		
2011.03-		-	-	R	F	Box Engine 4HG (P22DTE)	217050	Drive Shaft	35	41	71.5	127	1140		
2011.03-		-	-	R	F	Platform/Chassis Engine 4HG (P22DTE)	217050	Drive Shaft	35	41	71.5	127	1140		
2011.03-		-	-	L	F	Bus Engine 4HG (P22DTE)	217053	Drive Shaft	35	41	71.5	127	806		
2.2 HDi 120 (88 kW)	2011.03-	-	-	L	F	Box Engine 4HG (P22DTE)	217053	Drive Shaft	35	41	71.5	127	806		
	2006.04-	-	-	L	F	Box Engine 4HU (P22DTE)	217053	Drive Shaft	35	41	71.5	127	806		
	2006.04-	-	5MT	L/R	F	Bus Engine 4HU (P22DTE)	817055	Outer Joint	35	27	71.5	127	66.5	I	
	2006.04-	-	5MT	L/R	F	Platform/Chassis Engine 4HU (P22DTE)	817055	Outer Joint	35	27	71.5	127	66.5	I	
	2006.04-	-	5MT	L/R	F	Box Engine 4HU (P22DTE)	817055	Outer Joint	35	27	71.5	127	66.5	I	
	2006.04-	-	-	R	F	Bus Engine 4HU (P22DTE)	217050	Drive Shaft	35	41	71.5	127	1140		
	2006.04-	-	-	R	F	Platform/Chassis Engine 4HU (P22DTE)	217050	Drive Shaft	35	41	71.5	127	1140		
	2006.04-	-	5MT	L	F	Bus Engine 4HU (P22DTE)	617028	Inner Joint	41	29	43	69.5	109.5		
	2006.04-	-	5MT	L	F	Platform/Chassis Engine 4HU (P22DTE)	617028	Inner Joint	41	29	43	69.5	109.5		
	2006.04-	-	5MT	L	F	Box Engine 4HU (P22DTE)	617028	Inner Joint	41	29	43	69.5	109.5		
	2006.04-	-	-	R	F	Box Engine 4HU (P22DTE)	217050	Drive Shaft	35	41	71.5	127	1140		
	2006.04-	-	5MT	R	F	Bus Engine 4HU (P22DTE)	617020	Inner Joint	41	29	34.85	403	109		
	2006.04-	-	5MT	R	F	Platform/Chassis Engine 4HU (P22DTE)	617020	Inner Joint	41	29	34.85	403	109		
	2006.04-	-	5MT	R	F	Box Engine 4HU (P22DTE)	617020	Inner Joint	41	29	34.85	403	109		
	2006.04-	-	5MT	L	F	Bus Engine 4HU (P22DTE)	617042	Inner Joint	41	27	43	70	102		
	2006.04-	-	5MT	L	F	Platform/Chassis Engine 4HU (P22DTE)	617042	Inner Joint	41	27	43	70	102		
	2006.04-	-	5MT	L	F	Box Engine 4HU (P22DTE)	617042	Inner Joint	41	27	43	70	102		
	2006.04-	-	5MT	R	F	Bus Engine 4HU (P22DTE)	610038	Inner Joint	41	27	34.85	403	102		
	2006.04-	-	5MT	R	F	Platform/Chassis Engine 4HU (P22DTE)	610038	Inner Joint	41	27	34.85	403	102		
	2006.04-	-	5MT	R	F	Box Engine 4HU (P22DTE)	610038	Inner Joint	41	27	34.85	403	102		
2006.04-	-	5MT	L/R	F	Bus Engine 4HU (P22DTE)	817045	Outer Joint	35	29	71.5	127	71	M		
2006.04-	-	5MT	L/R	F	Platform/Chassis Engine 4HU (P22DTE)	817045	Outer Joint	35	29	71.5	127	71	M		
2006.04-	-	5MT	L/R	F	Box Engine 4HU (P22DTE)	817045	Outer Joint	35	29	71.5	127	71	M		
2006.04-	-	-	L	F	Bus Engine 4HU (P22DTE)	217053	Drive Shaft	35	41	71.5	127	806			
2006.04-	-	-	L	F	Platform/Chassis Engine 4HU (P22DTE)	217053	Drive Shaft	35	41	71.5	127	806			
2.2 HDi 130 (96 kW)	2011.03-	-	-	L	F	Box Engine 4HH (P22DTE)	217053	Drive Shaft	35	41	71.5	127	806		
	2011.03-	-	-	L	F	Platform/Chassis Engine 4HH (P22DTE)	217053	Drive Shaft	35	41	71.5	127	806		
	2011.03-	-	-	R	F	Bus Engine 4HH (P22DTE)	217050	Drive Shaft	35	41	71.5	127	1140		
	2011.03-	-	-	R	F	Box Engine 4HH (P22DTE)	217050	Drive Shaft	35	41	71.5	127	1140		
	2011.03-	-	-	R	F	Platform/Chassis Engine 4HH (P22DTE)	217050	Drive Shaft	35	41	71.5	127	1140		



	 YEAR	TRANSM	L/R	F/R	REMARKS	GSP Ref.	 PRODUCT	 ABS	Technical Specifications						
									A	B	C	H	L	P	
PEUGEOT BOXER															
2.2 HDi 130 (96 kW)	2011.03-	-	-	R	F	Platform/Chassis Engine 4HH (P22DTE)	217050	Drive Shaft		35	41	71.5	127	1140	
	2011.03-	-	-	L	F	Bus Engine 4HH (P22DTE)	217053	Drive Shaft		35	41	71.5	127	806	
2.2 HDi 150 (110 kW)	2011.03-	-	MT	L	F	Bus Engine 4HJ (P22DTE)	245176	Drive Shaft		35	41	71.5	127	808	
	2011.03-	-	MT	L	F	Box Engine 4HJ (P22DTE)	245176	Drive Shaft		35	41	71.5	127	808	
	2011.03-	-	MT	L	F	Platform/Chassis Engine 4HJ (P22DTE)	245176	Drive Shaft		35	41	71.5	127	808	
3.0 D (116 kW)	2008.09-2009.12		6MT	L/R	F	Box	817060	Outer Joint		35	29	71.5	127	71	I
	2008.09-2009.12		6MT	L	F	Box	617022	Inner Joint		31	29	44.95	77	109.5	
	2008.09-2009.12		6MT	R	F	Box	617021	Inner Joint		31	29	34.85	530	109	
3.0 HDi (115 kW)	2006.07-	-	-	L	F	Box Engine F1CE0481D (F30DT)	245175	Drive Shaft		35	31	71.5	127	749.5	
	2006.07-	-	-	R	F	Box Engine F1CE0481D (F30DT)	245174	Drive Shaft		35	31	71.5	127	1199	
	2007.02-	-	6MT	L/R	F	Platform/Chassis Engine F1CE0481D (F30DT)	817060	Outer Joint		35	29	71.5	127	71	I
	2007.02-	-	6MT	L	F	Platform/Chassis Engine F1CE0481D (F30DT)	617022	Inner Joint		31	29	44.95	77	109.5	
	2007.02-	-	6MT	R	F	Platform/Chassis Engine F1CE0481D (F30DT)	617021	Inner Joint		31	29	34.85	530	109	
	2007.02-	-	-	L	F	Platform/Chassis Engine F1CE0481D (F30DT)	245175	Drive Shaft		35	31	71.5	127	749.5	
	2007.02-	-	-	R	F	Platform/Chassis Engine F1CE0481D (F30DT)	245174	Drive Shaft		35	31	71.5	127	1199	
3.0 HDi 145 (107 kW)	2010.04-	-	MT	L	F	Bus Engine F1CE3481N (F30DTE)	245175	Drive Shaft		35	31	71.5	127	749.5	
	2010.04-	-	MT	L	F	Box Engine F1CE3481N (F30DTE)	245175	Drive Shaft		35	31	71.5	127	749.5	
	2010.04-	-	MT	L	F	Platform/Chassis Engine F1CE3481N (F30DTE)	245175	Drive Shaft		35	31	71.5	127	749.5	
	2010.04-	-	MT	R	F	Bus Engine F1CE3481N (F30DTE)	245174	Drive Shaft		35	31	71.5	127	1199	
	2010.04-	-	MT	R	F	Box Engine F1CE3481N (F30DTE)	245174	Drive Shaft		35	31	71.5	127	1199	
	2010.04-	-	MT	R	F	Platform/Chassis Engine F1CE3481N (F30DTE)	245174	Drive Shaft		35	31	71.5	127	1199	
3.0 HDi 160 (116 kW)	2006.04-	-	6MT	L/R	F	Bus Engine F1CE0481D (F30DT)	817060	Outer Joint		35	29	71.5	127	71	I
	2006.04-	-	6MT	L/R	F	Box Engine F1CE0481D (F30DT)	817060	Outer Joint		35	29	71.5	127	71	I
	2006.04-	-	6MT	L	F	Bus Engine F1CE0481D (F30DT)	617022	Inner Joint		31	29	44.95	77	109.5	
	2006.04-	-	6MT	L	F	Box Engine F1CE0481D (F30DT)	617022	Inner Joint		31	29	44.95	77	109.5	
	2006.04-	-	6MT	R	F	Bus Engine F1CE0481D (F30DT)	617021	Inner Joint		31	29	34.85	530	109	
	2006.04-	-	6MT	R	F	Box Engine F1CE0481D (F30DT)	617021	Inner Joint		31	29	34.85	530	109	
	2006.04-	-	-	L	F	Bus Engine F1CE0481D (F30DT)	245175	Drive Shaft		35	31	71.5	127	749.5	
	2006.04-	-	-	L	F	Box Engine F1CE0481D (F30DT)	245175	Drive Shaft		35	31	71.5	127	749.5	
	2006.04-	-	-	L	F	Platform/Chassis Engine F1CE0481D (F30DT)	245175	Drive Shaft		35	31	71.5	127	749.5	
	2006.04-	-	-	R	F	Bus Engine F1CE0481D (F30DT)	245174	Drive Shaft		35	31	71.5	127	1199	
	2006.04-	-	-	R	F	Box Engine F1CE0481D (F30DT)	245174	Drive Shaft		35	31	71.5	127	1199	
	2006.04-	-	-	R	F	Platform/Chassis Engine F1CE0481D (F30DT)	245174	Drive Shaft		35	31	71.5	127	1199	
3.0 HDi 175 (130 kW)	2011.03-	-	-	L	F	Bus Engine F1CE3481E (F30DTE)	245175	Drive Shaft		35	31	71.5	127	749.5	
	2011.03-	-	-	L	F	Box Engine F1CE3481E (F30DTE)	245175	Drive Shaft		35	31	71.5	127	749.5	
	2011.03-	-	-	L	F	Platform/Chassis Engine F1CE3481E (F30DTE)	245175	Drive Shaft		35	31	71.5	127	749.5	
	2011.03-	-	-	R	F	Bus Engine F1CE3481E (F30DTE)	245174	Drive Shaft		35	31	71.5	127	1199	
	2011.03-	-	-	R	F	Box Engine F1CE3481E (F30DTE)	245174	Drive Shaft		35	31	71.5	127	1199	
	2011.03-	-	-	R	F	Platform/Chassis Engine F1CE3481E (F30DTE)	245174	Drive Shaft		35	31	71.5	127	1199	
BOXER (230L)															
1.9 D (50 kW)	1999.07-2002.04		MT	L	F	Box Engine DJY (XUD9A)	210067	Drive Shaft		35	41	70	117	762	
	1999.07-2002.04		MT	L	F	Box Engine DJY (XUD9A)	210033	Drive Shaft	54T	35	41	70	117	762	
	1999.07-2002.04		MT	R	F	Box Engine DJY (XUD9A)	210069	Drive Shaft		28	37	63	112.5	1072	
	1999.07-2002.04		MT	L/R	F	Box Engine DJY (XUD9A)	810050	Outer Joint		35	45	70	117	73	I
	1999.07-2002.04		MT	L	F	Box Engine DJY (XUD9A)	210035	Drive Shaft	54T	28	41	63	112.5	757.5	
	1999.07-2002.04		MT	R	F	Box Engine DJY (XUD9A)	610009	Inner Joint		41	45	34.9	367.5	115.6	
	1999.07-2002.04		MT	L	F	Box Engine DJY (XUD9A)	610015	Inner Joint		37	39	40	68.5	104	
	1999.07-2002.04		MT	L/R	F	Box Engine DJY (XUD9A)	810012	Outer Joint		28	39	63	112.5	63	I
	1999.07-2002.04		MT	L	F	Box Engine DJY (XUD9A)	210102	Drive Shaft		28	41	63	112.5	757.5	
	1999.07-2002.04		MT	L	F	Box Engine DJY (XUD9A)	210037	Drive Shaft	54T	28	37	63	112.5	771	
	1999.07-2002.04		MT	R	F	Box Engine DJY (XUD9A)	210036	Drive Shaft	54T	28	41	63	112.5	1079	
	1999.07-2002.04		MT	R	F	Box Engine DJY (XUD9A)	210066	Drive Shaft		35	41	70	117	1085	
	1999.07-2002.04		-	-	-	Box Engine DJY (XUD9A)	645013	Inner Joint		37	39	40	68.5	100	
	1999.07-2002.04		MT	R	F	Box Engine DJY (XUD9A)	610034	Inner Joint		37	39	31.9	369.5	99	
	1999.07-2002.04		MT	L/R	F	Box Engine DJY (XUD9A)	810011	Outer Joint	54T	35	45	70	117	73	I
	1999.07-2002.04		MT	R	F	Box Engine DJY (XUD9A)	210032	Drive Shaft	54T	35	41	70	117	1085	
	1999.07-2002.04		MT	L	F	Box Engine DJY (XUD9A)	210105	Drive Shaft		28	37	63	112.5	771	
	1999.07-2002.04		MT	R	F	Box Engine DJY (XUD9A)	210103	Drive Shaft		28	41	63	112.5	1079	
	1999.07-2002.04		MT	L/R	F	Box Engine DJY (XUD9A)	810013	Outer Joint	54T	28	39	63	112.5	63	I
	1999.07-2002.04		MT	R	F	Box Engine DJY (XUD9A)	210104	Drive Shaft	54T	28	37	63	112.5	1072	
1.9 D (51 kW)	1994.03-2002.04		MT	L	F	Box Engine D9B (XUD9AU)	210067	Drive Shaft		35	41	70	117	762	
	1994.03-2002.04		MT	L	F	Box Engine D9B (XUD9AU)	210033	Drive Shaft	54T	35	41	70	117	762	
	1994.03-2002.04		MT	R	F	Box Engine D9B (XUD9AU)	210069	Drive Shaft		28	37	63	112.5	1072	
	1994.03-2002.04		MT	L/R	F	Box Engine D9B (XUD9AU)	810050	Outer Joint		35	45	70	117	73	I
	1994.03-2002.04		MT	L	F	Box Engine D9B (XUD9AU)	210035	Drive Shaft	54T	28	41	63	112.5	757.5	
	1994.03-2002.04		MT	R	F	Box Engine D9B (XUD9AU)	610009	Inner Joint		41	45	34.9	367.5	115.6	

	YEAR	TRANSM	L/R	F/R	REMARKS	GSP Ref.	PRODUCT	ABS	Technical Specifications								
									A	B	C	H	L	P			
PEUGEOT BOXER (230L)																	
1.9 D (51 kW)	1994.03-2002.04	MT	L	F	Box Engine D9B (XUD9AU)	610015	Inner Joint		37	39	40	68.5	104				
	1994.03-2002.04	MT	L/R	F	Box Engine D9B (XUD9AU)	810012	Outer Joint		28	39	63	112.5	63	I			
	1994.03-2002.04	MT	L	F	Box Engine D9B (XUD9AU)	210102	Drive Shaft		28	41	63	112.5	757.5				
	1994.03-2002.04	MT	L	F	Box Engine D9B (XUD9AU)	210037	Drive Shaft	54T	28	37	63	112.5	771				
	1994.03-2002.04	MT	R	F	Box Engine D9B (XUD9AU)	210036	Drive Shaft	54T	28	41	63	112.5	1079				
	1994.03-2002.04	MT	R	F	Box Engine D9B (XUD9AU)	210066	Drive Shaft		35	41	70	117	1085				
	1994.03-2002.04	-	-	-	Box Engine D9B (XUD9AU)	645013	Inner Joint		37	39	40	68.5	100				
	1994.03-2002.04	MT	R	F	Box Engine D9B (XUD9AU)	610034	Inner Joint		37	39	31.9	369.5	99				
	1994.03-2002.04	MT	L/R	F	Box Engine D9B (XUD9AU)	810011	Outer Joint	54T	35	45	70	117	73	I			
	1994.03-2002.04	MT	R	F	Box Engine D9B (XUD9AU)	210032	Drive Shaft	54T	35	41	70	117	1085				
	1994.03-2002.04	MT	L	F	Box Engine D9B (XUD9AU)	210105	Drive Shaft		28	37	63	112.5	771				
	1994.03-2002.04	MT	R	F	Box Engine D9B (XUD9AU)	210103	Drive Shaft		28	41	63	112.5	1079				
	1994.03-2002.04	MT	L/R	F	Box Engine D9B (XUD9AU)	810013	Outer Joint	54T	28	39	63	112.5	63	I			
	1994.03-2002.04	MT	R	F	Box Engine D9B (XUD9AU)	210104	Drive Shaft	54T	28	37	63	112.5	1072				
1.9 TD (68 kW)	1994.03-2002.04	MT	L	F	Box Engine D8C (XUD9UTF)	210067	Drive Shaft		35	41	70	117	762				
	1994.03-2002.04	MT	L	F	Box Engine D8C (XUD9UTF)	210033	Drive Shaft	54T	35	41	70	117	762				
	1994.03-2002.04	MT	R	F	Box Engine D8C (XUD9UTF)	210069	Drive Shaft		28	37	63	112.5	1072				
	1994.03-2002.04	MT	L/R	F	Box Engine D8C (XUD9UTF)	810050	Outer Joint		35	45	70	117	73	I			
	1994.03-2002.04	MT	L	F	Box Engine D8C (XUD9UTF)	210035	Drive Shaft	54T	28	41	63	112.5	757.5				
	1994.03-2002.04	MT	R	F	Box Engine D8C (XUD9UTF)	610009	Inner Joint		41	45	34.9	367.5	115.6				
	1994.03-2002.04	MT	L	F	Box Engine D8C (XUD9UTF)	610015	Inner Joint		37	39	40	68.5	104				
	1994.03-2002.04	MT	L/R	F	Box Engine D8C (XUD9UTF)	810012	Outer Joint		28	39	63	112.5	63	I			
	1994.03-2002.04	MT	L	F	Box Engine D8C (XUD9UTF)	210102	Drive Shaft		28	41	63	112.5	757.5				
	1994.03-2002.04	MT	L	F	Box Engine D8C (XUD9UTF)	210037	Drive Shaft	54T	28	37	63	112.5	771				
	1994.03-2002.04	MT	R	F	Box Engine D8C (XUD9UTF)	210036	Drive Shaft	54T	28	41	63	112.5	1079				
	1994.03-2002.04	MT	R	F	Box Engine D8C (XUD9UTF)	210066	Drive Shaft		35	41	70	117	1085				
	1994.03-2002.04	-	-	-	Box Engine D8C (XUD9UTF)	645013	Inner Joint		37	39	40	68.5	100				
	1994.03-2002.04	MT	R	F	Box Engine D8C (XUD9UTF)	610034	Inner Joint		37	39	31.9	369.5	99				
	1994.03-2002.04	MT	L/R	F	Box Engine D8C (XUD9UTF)	810011	Outer Joint	54T	35	45	70	117	73	I			
	1994.03-2002.04	MT	R	F	Box Engine D8C (XUD9UTF)	210032	Drive Shaft	54T	35	41	70	117	1085				
	1994.03-2002.04	MT	L	F	Box Engine D8C (XUD9UTF)	210105	Drive Shaft		28	37	63	112.5	771				
	1994.03-2002.04	MT	R	F	Box Engine D8C (XUD9UTF)	210103	Drive Shaft		28	41	63	112.5	1079				
	1994.03-2002.04	MT	L/R	F	Box Engine D8C (XUD9UTF)	810013	Outer Joint	54T	28	39	63	112.5	63	I			
	1994.03-2002.04	MT	R	F	Box Engine D8C (XUD9UTF)	210104	Drive Shaft	54T	28	37	63	112.5	1072				
2.0 i (80 kW)	1994.06-2002.04	MT	R	F	Box Engine RFW (XU10J2)	610009	Inner Joint		41	45	34.9	367.5	115.6				
	1994.06-2002.04	MT	L	F	Box Engine RFW (XU10J2)	210035	Drive Shaft	54T	28	41	63	112.5	757.5				
	1994.06-2002.04	MT	L	F	Box Engine RFW (XU10J2)	610015	Inner Joint		37	39	40	68.5	104				
	1994.06-2002.04	MT	L/R	F	Box Engine RFW (XU10J2)	810012	Outer Joint		28	39	63	112.5	63	I			
	1994.06-2002.04	MT	L	F	Box Engine RFW (XU10J2)	210102	Drive Shaft		28	41	63	112.5	757.5				
	1994.06-2002.04	MT	L	F	Box Engine RFW (XU10J2)	210037	Drive Shaft	54T	28	37	63	112.5	771				
	1994.06-2002.04	MT	R	F	Box Engine RFW (XU10J2)	210066	Drive Shaft		35	41	70	117	1085				
	1994.06-2002.04	MT	R	F	Box Engine RFW (XU10J2)	210036	Drive Shaft	54T	28	41	63	112.5	1079				
	1994.06-2002.04	MT	R	F	Box Engine RFW (XU10J2)	210032	Drive Shaft	54T	35	41	70	117	1085				
	1994.06-2002.04	MT	L/R	F	Box Engine RFW (XU10J2)	810011	Outer Joint	54T	35	45	70	117	73	I			
	1994.06-2002.04	MT	R	F	Box Engine RFW (XU10J2)	610034	Inner Joint		37	39	31.9	369.5	99				
	1994.06-2002.04	MT	L	F	Box Engine RFW (XU10J2)	210105	Drive Shaft		28	37	63	112.5	771				
	1994.06-2002.04	-	-	-	Box Engine RFW (XU10J2)	645013	Inner Joint		37	39	40	68.5	100				
	1994.06-2002.04	MT	R	F	Box Engine RFW (XU10J2)	210103	Drive Shaft		28	41	63	112.5	1079				
	1994.06-2002.04	MT	L/R	F	Box Engine RFW (XU10J2)	810013	Outer Joint	54T	28	39	63	112.5	63	I			
	1994.06-2002.04	MT	R	F	Box Engine RFW (XU10J2)	210104	Drive Shaft	54T	28	37	63	112.5	1072				
	1994.06-2002.04	MT	L	F	Box Engine RFW (XU10J2)	210067	Drive Shaft		35	41	70	117	762				
	1994.06-2002.04	MT	L	F	Box Engine RFW (XU10J2)	210033	Drive Shaft	54T	35	41	70	117	762				
	1994.06-2002.04	MT	L/R	F	Box Engine RFW (XU10J2)	810050	Outer Joint		35	45	70	117	73	I			
	1994.06-2002.04	MT	R	F	Box Engine RFW (XU10J2)	210069	Drive Shaft		28	37	63	112.5	1072				
2.5 D (63 kW)	1994.03-2002.04	MT	L	F	Box Engine T9A (DJ5)	210035	Drive Shaft	54T	28	41	63	112.5	757.5				
	1994.03-2002.04	MT	L	F	Box Engine T9A (DJ5)	610015	Inner Joint		37	39	40	68.5	104				
	1994.03-2002.04	MT	L/R	F	Box Engine T9A (DJ5)	810012	Outer Joint		28	39	63	112.5	63	I			
	1994.03-2002.04	MT	L	F	Box Engine T9A (DJ5)	210102	Drive Shaft		28	41	63	112.5	757.5				
	1994.03-2002.04	MT	L	F	Box Engine T9A (DJ5)	210037	Drive Shaft	54T	28	37	63	112.5	771				
	1994.03-2002.04	MT	R	F	Box Engine T9A (DJ5)	210066	Drive Shaft		35	41	70	117	1085				
	1994.03-2002.04	MT	R	F	Box Engine T9A (DJ5)	210036	Drive Shaft	54T	28	41	63	112.5	1079				
	1994.03-2002.04	MT	R	F	Box Engine T9A (DJ5)	210032	Drive Shaft	54T	35	41	70	117	1085				
	1994.03-2002.04	MT	L/R	F	Box Engine T9A (DJ5)	810011	Outer Joint	54T	35	45	70	117	73	I			
	1994.03-2002.04	MT	R	F	Box Engine T9A (DJ5)	610034	Inner Joint		37	39	31.9	369.5	99				
	1994.03-2002.04	MT	L	F	Box Engine T9A (DJ5)	210105	Drive Shaft		28	37	63	112.5	771				
1994.03-2002.04	-	-	-	Box Engine T9A (DJ5)	645013	Inner Joint		37	39	40	68.5	100					





	 YEAR	TRANSM	L/R	F/R	REMARKS	GSP Ref.	 PRODUCT	 ABS	Technical Specifications							
									A	B	C	H	L	P		
PEUGEOT																
BOXER (230L)																
2.5 D (63 kW)																
1994.03-2002.04	2002.04	MT	R	F	Box Engine T9A (DJ5)	210103	Drive Shaft		28	41	63	112.5	1079			
1994.03-2002.04	2002.04	MT	L/R	F	Box Engine T9A (DJ5)	810013	Outer Joint	54T	28	39	63	112.5	63	I		
1994.03-2002.04	2002.04	MT	R	F	Box Engine T9A (DJ5)	210104	Drive Shaft	54T	28	37	63	112.5	1072			
1994.03-2002.04	2002.04	MT	L	F	Box Engine T9A (DJ5)	210067	Drive Shaft		35	41	70	117	762			
1994.03-2002.04	2002.04	MT	L	F	Box Engine T9A (DJ5)	210033	Drive Shaft	54T	35	41	70	117	762			
1994.03-2002.04	2002.04	MT	L/R	F	Box Engine T9A (DJ5)	810050	Outer Joint		35	45	70	117	73	I		
1994.03-2002.04	2002.04	MT	R	F	Box Engine T9A (DJ5)	210069	Drive Shaft		28	37	63	112.5	1072			
1994.03-2002.04	2002.04	MT	R	F	Box Engine T9A (DJ5)	610009	Inner Joint		41	45	34.9	367.5	115.6			
1999.07-2002.04	2002.04	MT	L	F	All-wheel Drive Box Engine T9A (DJ5)	610015	Inner Joint		37	39	40	68.5	104			
1999.07-2002.04	2002.04	MT	L/R	F	All-wheel Drive Box Engine T9A (DJ5)	810012	Outer Joint		28	39	63	112.5	63	I		
1999.07-2002.04	2002.04	MT	L	F	All-wheel Drive Box Engine T9A (DJ5)	210102	Drive Shaft		28	41	63	112.5	757.5			
1999.07-2002.04	2002.04	MT	L	F	All-wheel Drive Box Engine T9A (DJ5)	210037	Drive Shaft	54T	28	37	63	112.5	771			
1999.07-2002.04	2002.04	MT	R	F	All-wheel Drive Box Engine T9A (DJ5)	210066	Drive Shaft		35	41	70	117	1085			
1999.07-2002.04	2002.04	MT	R	F	All-wheel Drive Box Engine T9A (DJ5)	210036	Drive Shaft	54T	28	41	63	112.5	1079			
1999.07-2002.04	2002.04	MT	R	F	All-wheel Drive Box Engine T9A (DJ5)	210032	Drive Shaft	54T	35	41	70	117	1085			
1999.07-2002.04	2002.04	MT	L/R	F	All-wheel Drive Box Engine T9A (DJ5)	810011	Outer Joint	54T	35	45	70	117	73	I		
1999.07-2002.04	2002.04	MT	R	F	All-wheel Drive Box Engine T9A (DJ5)	610034	Inner Joint		37	39	31.9	369.5	99			
1999.07-2002.04	2002.04	MT	L	F	All-wheel Drive Box Engine T9A (DJ5)	210105	Drive Shaft		28	37	63	112.5	771			
1999.07-2002.04	2002.04	MT	R	F	All-wheel Drive Box Engine T9A (DJ5)	210103	Drive Shaft		28	41	63	112.5	1079			
1999.07-2002.04	2002.04	-	-	-	All-wheel Drive Box Engine T9A (DJ5)	645013	Inner Joint		37	39	40	68.5	100			
1999.07-2002.04	2002.04	MT	L/R	F	All-wheel Drive Box Engine T9A (DJ5)	810013	Outer Joint	54T	28	39	63	112.5	63	I		
1999.07-2002.04	2002.04	MT	R	F	All-wheel Drive Box Engine T9A (DJ5)	210104	Drive Shaft	54T	28	37	63	112.5	1072			
1999.07-2002.04	2002.04	MT	L	F	All-wheel Drive Box Engine T9A (DJ5)	210067	Drive Shaft		35	41	70	117	762			
1999.07-2002.04	2002.04	MT	L	F	All-wheel Drive Box Engine T9A (DJ5)	210033	Drive Shaft	54T	35	41	70	117	762			
1999.07-2002.04	2002.04	MT	L/R	F	All-wheel Drive Box Engine T9A (DJ5)	810050	Outer Joint		35	45	70	117	73	I		
1999.07-2002.04	2002.04	MT	R	F	All-wheel Drive Box Engine T9A (DJ5)	210069	Drive Shaft		28	37	63	112.5	1072			
1999.07-2002.04	2002.04	MT	R	F	All-wheel Drive Box Engine T9A (DJ5)	610009	Inner Joint		41	45	34.9	367.5	115.6			
1999.07-2002.04	2002.04	MT	L	F	All-wheel Drive Box Engine T9A (DJ5)	210035	Drive Shaft	54T	28	41	63	112.5	757.5			
2.5 TD (76 kW)																
1994.03-2002.04	2002.04	MT	L	F	Box Engine T8A (DJ5T)	610015	Inner Joint		28	39	40	68.5	104			
1994.03-2002.04	2002.04	MT	L/R	F	Box Engine T8A (DJ5T)	810012	Outer Joint		28	39	63	112.5	63	I		
1994.03-2002.04	2002.04	MT	L	F	Box Engine T8A (DJ5T)	210102	Drive Shaft		28	41	63	112.5	757.5			
1994.03-2002.04	2002.04	MT	L	F	Box Engine T8A (DJ5T)	210037	Drive Shaft	54T	28	37	63	112.5	771			
1994.03-2002.04	2002.04	MT	R	F	Box Engine T8A (DJ5T)	210066	Drive Shaft		35	41	70	117	1085			
1994.03-2002.04	2002.04	MT	R	F	Box Engine T8A (DJ5T)	210036	Drive Shaft	54T	28	41	63	112.5	1079			
1994.03-2002.04	2002.04	MT	R	F	Box Engine T8A (DJ5T)	210032	Drive Shaft	54T	35	41	70	117	1085			
1994.03-2002.04	2002.04	MT	L/R	F	Box Engine T8A (DJ5T)	810011	Outer Joint	54T	35	45	70	117	73	I		
1994.03-2002.04	2002.04	MT	R	F	Box Engine T8A (DJ5T)	610034	Inner Joint		37	39	31.9	369.5	99			
1994.03-2002.04	2002.04	MT	L	F	Box Engine T8A (DJ5T)	210105	Drive Shaft		28	37	63	112.5	771			
1994.03-2002.04	2002.04	MT	R	F	Box Engine T8A (DJ5T)	210103	Drive Shaft		28	41	63	112.5	1079			
1994.03-2002.04	2002.04	MT	L/R	F	Box Engine T8A (DJ5T)	810013	Outer Joint	54T	28	39	63	112.5	63	I		
1994.03-2002.04	2002.04	-	-	-	Box Engine T8A (DJ5T)	645013	Inner Joint		37	39	40	68.5	100			
1994.03-2002.04	2002.04	MT	R	F	Box Engine T8A (DJ5T)	210104	Drive Shaft	54T	28	37	63	112.5	1072			
1994.03-2002.04	2002.04	MT	L	F	Box Engine T8A (DJ5T)	210067	Drive Shaft		35	41	70	117	762			
1994.03-2002.04	2002.04	MT	L	F	Box Engine T8A (DJ5T)	210033	Drive Shaft	54T	35	41	70	117	762			
1994.03-2002.04	2002.04	MT	L/R	F	Box Engine T8A (DJ5T)	810050	Outer Joint		35	45	70	117	73	I		
1994.03-2002.04	2002.04	MT	R	F	Box Engine T8A (DJ5T)	210069	Drive Shaft		28	37	63	112.5	1072			
1994.03-2002.04	2002.04	MT	R	F	Box Engine T8A (DJ5T)	610009	Inner Joint		41	45	34.9	367.5	115.6			
1994.03-2002.04	2002.04	MT	L	F	Box Engine T8A (DJ5T)	210035	Drive Shaft	54T	28	41	63	112.5	757.5			
2.5 TDI (79 kW)																
1997.01-2002.04	2002.04	MT	L/R	F	Box Engine THX (DJ5TED)	810012	Outer Joint		28	39	63	112.5	63	I		
1997.01-2002.04	2002.04	MT	L	F	Box Engine THX (DJ5TED)	210102	Drive Shaft		28	41	63	112.5	757.5			
1997.01-2002.04	2002.04	MT	L	F	Box Engine THX (DJ5TED)	210037	Drive Shaft	54T	28	37	63	112.5	771			
1997.01-2002.04	2002.04	MT	R	F	Box Engine THX (DJ5TED)	210066	Drive Shaft		35	41	70	117	1085			
1997.01-2002.04	2002.04	MT	R	F	Box Engine THX (DJ5TED)	210036	Drive Shaft	54T	28	41	63	112.5	1079			
1997.01-2002.04	2002.04	MT	R	F	Box Engine THX (DJ5TED)	210032	Drive Shaft	54T	35	41	70	117	1085			
1997.01-2002.04	2002.04	MT	L/R	F	Box Engine THX (DJ5TED)	810011	Outer Joint	54T	35	45	70	117	73	I		
1997.01-2002.04	2002.04	MT	R	F	Box Engine THX (DJ5TED)	610034	Inner Joint		37	39	31.9	369.5	99			
1997.01-2002.04	2002.04	MT	L	F	Box Engine THX (DJ5TED)	210105	Drive Shaft		28	37	63	112.5	771			
1997.01-2002.04	2002.04	MT	R	F	Box Engine THX (DJ5TED)	210103	Drive Shaft		28	41	63	112.5	1079			
1997.01-2002.04	2002.04	MT	L/R	F	Box Engine THX (DJ5TED)	810013	Outer Joint	54T	28	39	63	112.5	63	I		
1997.01-2002.04	2002.04	-	-	-	Box Engine THX (DJ5TED)	645013	Inner Joint		37	39	40	68.5	100			
1997.01-2002.04	2002.04	MT	R	F	Box Engine THX (DJ5TED)	210104	Drive Shaft	54T	28	37	63	112.5	1072			
1997.01-2002.04	2002.04	MT	L	F	Box Engine THX (DJ5TED)	210067	Drive Shaft		35	41	70	117	762			
1997.01-2002.04	2002.04	MT	L	F	Box Engine THX (DJ5TED)	210033	Drive Shaft	54T	35	41	70	117	762			
1997.01-2002.04	2002.04	MT	L/R	F	Box Engine THX (DJ5TED)	810050	Outer Joint		35	45	70	117	73	I		
1997.01-2002.04	2002.04	MT	R	F	Box Engine THX (DJ5TED)	210069	Drive Shaft		28	37	63	112.5	1072			
1997.01-2002.04	2002.04	MT	R	F	Box Engine THX (DJ5TED)	610009	Inner Joint		41	45	34.9	367.5	115.6			





	 YEAR	TRANSM	L/R	F/R	REMARKS	GSP Ref.	 PRODUCT	 ABS	Technical Specifications					
									A	B	C	H	L	P
PEUGEOT														
BOXER (230L)														
2.5 TDI (79 kW)														
1997.01-2002.04	2002.04	MT	L	F	Box Engine THX (DJ5TED)	210035	Drive Shaft	54T	28	41	63	112.5	757.5	
1997.01-2002.04	2002.04	MT	L	F	Box Engine THX (DJ5TED)	610015	Inner Joint		37	39	40	68.5	104	
1999.07-2002.04	2002.04	MT	L	F	All-wheel Drive Box Engine THX (DJ5TED)	610015	Inner Joint		37	39	40	68.5	104	
1999.07-2002.04	2002.04	MT	L/R	F	All-wheel Drive Box Engine THX (DJ5TED)	810012	Outer Joint		28	39	63	112.5	63	I
1999.07-2002.04	2002.04	MT	L	F	All-wheel Drive Box Engine THX (DJ5TED)	210102	Drive Shaft		28	41	63	112.5	757.5	
1999.07-2002.04	2002.04	MT	L	F	All-wheel Drive Box Engine THX (DJ5TED)	210037	Drive Shaft	54T	28	37	63	112.5	771	
1999.07-2002.04	2002.04	MT	R	F	All-wheel Drive Box Engine THX (DJ5TED)	210066	Drive Shaft		35	41	70	117	1085	
1999.07-2002.04	2002.04	MT	R	F	All-wheel Drive Box Engine THX (DJ5TED)	210036	Drive Shaft	54T	28	41	63	112.5	1079	
1999.07-2002.04	2002.04	MT	R	F	All-wheel Drive Box Engine THX (DJ5TED)	210032	Drive Shaft	54T	35	41	70	117	1085	
1999.07-2002.04	2002.04	MT	L/R	F	All-wheel Drive Box Engine THX (DJ5TED)	810011	Outer Joint	54T	35	45	70	117	73	I
1999.07-2002.04	2002.04	MT	R	F	All-wheel Drive Box Engine THX (DJ5TED)	610034	Inner Joint		37	39	31.9	369.5	99	
1999.07-2002.04	2002.04	MT	L	F	All-wheel Drive Box Engine THX (DJ5TED)	210105	Drive Shaft		28	37	63	112.5	771	
1999.07-2002.04	2002.04	MT	R	F	All-wheel Drive Box Engine THX (DJ5TED)	210103	Drive Shaft		28	41	63	112.5	1079	
1999.07-2002.04	2002.04	-	-	-	All-wheel Drive Box Engine THX (DJ5TED)	645013	Inner Joint		37	39	40	68.5	100	
1999.07-2002.04	2002.04	MT	L/R	F	All-wheel Drive Box Engine THX (DJ5TED)	810013	Outer Joint	54T	28	39	63	112.5	63	I
1999.07-2002.04	2002.04	MT	R	F	All-wheel Drive Box Engine THX (DJ5TED)	210104	Drive Shaft	54T	28	37	63	112.5	1072	
1999.07-2002.04	2002.04	MT	L	F	All-wheel Drive Box Engine THX (DJ5TED)	210067	Drive Shaft		35	41	70	117	762	
1999.07-2002.04	2002.04	MT	L	F	All-wheel Drive Box Engine THX (DJ5TED)	210033	Drive Shaft	54T	35	41	70	117	762	
1999.07-2002.04	2002.04	MT	L/R	F	All-wheel Drive Box Engine THX (DJ5TED)	810050	Outer Joint		35	45	70	117	73	I
1999.07-2002.04	2002.04	MT	R	F	All-wheel Drive Box Engine THX (DJ5TED)	210069	Drive Shaft		28	37	63	112.5	1072	
1999.07-2002.04	2002.04	MT	R	F	All-wheel Drive Box Engine THX (DJ5TED)	610009	Inner Joint		41	45	34.9	367.5	115.6	
1999.07-2002.04	2002.04	MT	L	F	All-wheel Drive Box Engine THX (DJ5TED)	210035	Drive Shaft	54T	28	41	63	112.5	757.5	
2.8 HDI (94 kW)														
2000.11-2002.04	2002.04	MT	L	F	Box Engine 8140.43S (F28DTCR)	210067	Drive Shaft		35	41	70	117	762	
2000.11-2002.04	2002.04	MT	L/R	F	Box Engine 8140.43S (F28DTCR)	810050	Outer Joint		35	45	70	117	73	I
2000.11-2002.04	2002.04	MT	L	F	Box Engine 8140.43S (F28DTCR)	210033	Drive Shaft	54T	35	41	70	117	762	
2000.11-2002.04	2002.04	MT	R	F	Box Engine 8140.43S (F28DTCR)	610009	Inner Joint		41	45	34.9	367.5	115.6	
2000.11-2002.04	2002.04	MT	R	F	Box Engine 8140.43S (F28DTCR)	210066	Drive Shaft		35	41	70	117	1085	
2000.11-2002.04	2002.04	MT	L/R	F	Box Engine 8140.43S (F28DTCR)	810011	Outer Joint	54T	35	45	70	117	73	I
2000.11-2002.04	2002.04	MT	R	F	Box Engine 8140.43S (F28DTCR)	210032	Drive Shaft	54T	35	41	70	117	1085	
BOXER (230P)														
1.9 D (51 kW)														
1994.03-2002.04	2002.04	MT	L	F	Bus Engine D9B (XUD9AU)	210035	Drive Shaft	54T	28	41	63	112.5	757.5	
1994.03-2002.04	2002.04	MT	L	F	Bus Engine D9B (XUD9AU)	610015	Inner Joint		37	39	40	68.5	104	
1994.03-2002.04	2002.04	MT	L/R	F	Bus Engine D9B (XUD9AU)	810012	Outer Joint		28	39	63	112.5	63	I
1994.03-2002.04	2002.04	MT	L	F	Bus Engine D9B (XUD9AU)	210102	Drive Shaft		28	41	63	112.5	757.5	
1994.03-2002.04	2002.04	MT	L	F	Bus Engine D9B (XUD9AU)	210037	Drive Shaft	54T	28	37	63	112.5	771	
1994.03-2002.04	2002.04	MT	R	F	Bus Engine D9B (XUD9AU)	210066	Drive Shaft		35	41	70	117	1085	
1994.03-2002.04	2002.04	MT	R	F	Bus Engine D9B (XUD9AU)	210036	Drive Shaft	54T	28	41	63	112.5	1079	
1994.03-2002.04	2002.04	MT	R	F	Bus Engine D9B (XUD9AU)	210032	Drive Shaft	54T	35	41	70	117	1085	
1994.03-2002.04	2002.04	MT	L/R	F	Bus Engine D9B (XUD9AU)	810011	Outer Joint	54T	35	45	70	117	73	I
1994.03-2002.04	2002.04	MT	R	F	Bus Engine D9B (XUD9AU)	610034	Inner Joint		37	39	31.9	369.5	99	
1994.03-2002.04	2002.04	MT	L	F	Bus Engine D9B (XUD9AU)	210105	Drive Shaft		28	37	63	112.5	771	
1994.03-2002.04	2002.04	-	-	-	Bus Engine D9B (XUD9AU)	645013	Inner Joint		37	39	40	68.5	100	
1994.03-2002.04	2002.04	MT	R	F	Bus Engine D9B (XUD9AU)	210103	Drive Shaft		28	41	63	112.5	1079	
1994.03-2002.04	2002.04	MT	L/R	F	Bus Engine D9B (XUD9AU)	810013	Outer Joint	54T	28	39	63	112.5	63	I
1994.03-2002.04	2002.04	MT	R	F	Bus Engine D9B (XUD9AU)	210104	Drive Shaft	54T	28	37	63	112.5	1072	
1994.03-2002.04	2002.04	MT	L	F	Bus Engine D9B (XUD9AU)	210067	Drive Shaft		35	41	70	117	762	
1994.03-2002.04	2002.04	MT	L	F	Bus Engine D9B (XUD9AU)	210033	Drive Shaft	54T	35	41	70	117	762	
1994.03-2002.04	2002.04	MT	L/R	F	Bus Engine D9B (XUD9AU)	810050	Outer Joint		35	45	70	117	73	I
1994.03-2002.04	2002.04	MT	R	F	Bus Engine D9B (XUD9AU)	210069	Drive Shaft		28	37	63	112.5	1072	
1994.03-2002.04	2002.04	MT	R	F	Bus Engine D9B (XUD9AU)	610009	Inner Joint		41	45	34.9	367.5	115.6	
1.9 TD (66 kW)														
1994.08-2002.04	2002.04	MT	L	F	Bus Engine DHY (XUD9TE)	210033	Drive Shaft	54T	35	41	70	117	762	
1994.08-2002.04	2002.04	MT	R	F	Bus Engine DHY (XUD9TE)	210069	Drive Shaft		28	37	63	112.5	1072	
1994.08-2002.04	2002.04	MT	L/R	F	Bus Engine DHY (XUD9TE)	810050	Outer Joint		35	45	70	117	73	I
1994.08-2002.04	2002.04	MT	L	F	Bus Engine DHY (XUD9TE)	210035	Drive Shaft	54T	28	41	63	112.5	757.5	
1994.08-2002.04	2002.04	MT	R	F	Bus Engine DHY (XUD9TE)	610009	Inner Joint		41	45	34.9	367.5	115.6	
1994.08-2002.04	2002.04	MT	L	F	Bus Engine DHY (XUD9TE)	610015	Inner Joint		37	39	40	68.5	104	
1994.08-2002.04	2002.04	MT	L/R	F	Bus Engine DHY (XUD9TE)	810012	Outer Joint		28	39	63	112.5	63	I
1994.08-2002.04	2002.04	MT	L	F	Bus Engine DHY (XUD9TE)	210102	Drive Shaft		28	41	63	112.5	757.5	
1994.08-2002.04	2002.04	MT	L	F	Bus Engine DHY (XUD9TE)	210037	Drive Shaft	54T	28	37	63	112.5	771	
1994.08-2002.04	2002.04	MT	R	F	Bus Engine DHY (XUD9TE)	210036	Drive Shaft	54T	28	41	63	112.5	1079	
1994.08-2002.04	2002.04	MT	R	F	Bus Engine DHY (XUD9TE)	210066	Drive Shaft		35	41	70	117	1085	
1994.08-2002.04	2002.04	MT	R	F	Bus Engine DHY (XUD9TE)	610034	Inner Joint		37	39	31.9	369.5	99	
1994.08-2002.04	2002.04	MT	L/R	F	Bus Engine DHY (XUD9TE)	810011	Outer Joint	54T	35	45	70	117	73	I
1994.08-2002.04	2002.04	MT	R	F	Bus Engine DHY (XUD9TE)	210032	Drive Shaft	54T	35	41	70	117	1085	
1994.08-2002.04	2002.04	MT	L	F	Bus Engine DHY (XUD9TE)	210105	Drive Shaft		28	37	63	112.5	771	
1994.08-2002.04	2002.04	-	-	-	Bus Engine DHY (XUD9TE)	645013	Inner Joint		37	39	40	68.5	100	





YEAR	TRANSM	L/R	F/R	REMARKS	GSP Ref.	PRODUCT	ABS	Technical Specifications							
								A	B	C	H	L	P		
PEUGEOT															
BOXER (230P)															
1.9 TD (66 kW)	1994.08-2002.04	MT	R	F	Bus Engine DHY (XUD9TE)	210103	Drive Shaft		28	41	63	112.5	1079		
	1994.08-2002.04	MT	L/R	F	Bus Engine DHY (XUD9TE)	810013	Outer Joint	54T	28	39	63	112.5	63	I	
	1994.08-2002.04	MT	R	F	Bus Engine DHY (XUD9TE)	210104	Drive Shaft	54T	28	37	63	112.5	1072		
	1994.08-2002.04	MT	L	F	Bus Engine DHY (XUD9TE)	210067	Drive Shaft		35	41	70	117	762		
1.9 TD (68 kW)	1994.03-2002.04	MT	L	F	Bus Engine D8C (XUD9UTF)	210067	Drive Shaft		35	41	70	117	762		
	1994.03-2002.04	MT	L	F	Bus Engine D8C (XUD9UTF)	210033	Drive Shaft	54T	35	41	70	117	762		
	1994.03-2002.04	MT	R	F	Bus Engine D8C (XUD9UTF)	210069	Drive Shaft		28	37	63	112.5	1072		
	1994.03-2002.04	MT	L/R	F	Bus Engine D8C (XUD9UTF)	810050	Outer Joint		35	45	70	117	73	I	
	1994.03-2002.04	MT	L	F	Bus Engine D8C (XUD9UTF)	210035	Drive Shaft	54T	28	41	63	112.5	757.5		
	1994.03-2002.04	MT	R	F	Bus Engine D8C (XUD9UTF)	610009	Inner Joint		41	45	34.9	367.5	115.6		
	1994.03-2002.04	MT	L	F	Bus Engine D8C (XUD9UTF)	610015	Inner Joint		37	39	40	68.5	104		
	1994.03-2002.04	MT	L/R	F	Bus Engine D8C (XUD9UTF)	810012	Outer Joint		28	39	63	112.5	63	I	
	1994.03-2002.04	MT	L	F	Bus Engine D8C (XUD9UTF)	210102	Drive Shaft		28	41	63	112.5	757.5		
	1994.03-2002.04	MT	L	F	Bus Engine D8C (XUD9UTF)	210037	Drive Shaft	54T	28	37	63	112.5	771		
	1994.03-2002.04	MT	R	F	Bus Engine D8C (XUD9UTF)	210036	Drive Shaft	54T	28	41	63	112.5	1079		
	1994.03-2002.04	MT	R	F	Bus Engine D8C (XUD9UTF)	210066	Drive Shaft		35	41	70	117	1085		
	1994.03-2002.04	MT	R	F	Bus Engine D8C (XUD9UTF)	610034	Inner Joint		37	39	31.9	369.5	99		
	1994.03-2002.04	MT	L/R	F	Bus Engine D8C (XUD9UTF)	810011	Outer Joint	54T	35	45	70	117	73	I	
	1994.03-2002.04	MT	R	F	Bus Engine D8C (XUD9UTF)	210032	Drive Shaft	54T	35	41	70	117	1085		
	1994.03-2002.04	MT	L	F	Bus Engine D8C (XUD9UTF)	210105	Drive Shaft		28	37	63	112.5	771		
	1994.03-2002.04	-	-	-	Bus Engine D8C (XUD9UTF)	645013	Inner Joint		37	39	40	68.5	100		
	1994.03-2002.04	MT	R	F	Bus Engine D8C (XUD9UTF)	210103	Drive Shaft		28	41	63	112.5	1079		
	1994.03-2002.04	MT	L/R	F	Bus Engine D8C (XUD9UTF)	810013	Outer Joint	54T	28	39	63	112.5	63	I	
	1994.03-2002.04	MT	R	F	Bus Engine D8C (XUD9UTF)	210104	Drive Shaft	54T	28	37	63	112.5	1072		
	1996.07-2002.04	MT	L	F	All-wheel Drive Bus Engine D8C (XUD9UTF)	610015	Inner Joint		37	39	40	68.5	104		
	1996.07-2002.04	MT	L/R	F	All-wheel Drive Bus Engine D8C (XUD9UTF)	810012	Outer Joint		28	39	63	112.5	63	I	
	1996.07-2002.04	MT	L	F	All-wheel Drive Bus Engine D8C (XUD9UTF)	210102	Drive Shaft		28	41	63	112.5	757.5		
	1996.07-2002.04	MT	L	F	All-wheel Drive Bus Engine D8C (XUD9UTF)	210037	Drive Shaft	54T	28	37	63	112.5	771		
	1996.07-2002.04	MT	R	F	All-wheel Drive Bus Engine D8C (XUD9UTF)	210066	Drive Shaft		35	41	70	117	1085		
	1996.07-2002.04	MT	R	F	All-wheel Drive Bus Engine D8C (XUD9UTF)	210036	Drive Shaft	54T	28	41	63	112.5	1079		
	1996.07-2002.04	MT	R	F	All-wheel Drive Bus Engine D8C (XUD9UTF)	210032	Drive Shaft	54T	35	41	70	117	1085		
	1996.07-2002.04	MT	L/R	F	All-wheel Drive Bus Engine D8C (XUD9UTF)	810011	Outer Joint	54T	35	45	70	117	73	I	
	1996.07-2002.04	MT	R	F	All-wheel Drive Bus Engine D8C (XUD9UTF)	610034	Inner Joint		37	39	31.9	369.5	99		
	1996.07-2002.04	MT	L	F	All-wheel Drive Bus Engine D8C (XUD9UTF)	210105	Drive Shaft		28	37	63	112.5	771		
	1996.07-2002.04	MT	R	F	All-wheel Drive Bus Engine D8C (XUD9UTF)	210103	Drive Shaft		28	41	63	112.5	1079		
	1996.07-2002.04	MT	L/R	F	All-wheel Drive Bus Engine D8C (XUD9UTF)	810013	Outer Joint	54T	28	39	63	112.5	63	I	
	1996.07-2002.04	-	-	-	All-wheel Drive Bus Engine D8C (XUD9UTF)	645013	Inner Joint		37	39	40	68.5	100		
	1996.07-2002.04	MT	R	F	All-wheel Drive Bus Engine D8C (XUD9UTF)	210104	Drive Shaft	54T	28	37	63	112.5	1072		
	1996.07-2002.04	MT	L	F	All-wheel Drive Bus Engine D8C (XUD9UTF)	210067	Drive Shaft		35	41	70	117	762		
	1996.07-2002.04	MT	L	F	All-wheel Drive Bus Engine D8C (XUD9UTF)	210033	Drive Shaft	54T	35	41	70	117	762		
	1996.07-2002.04	MT	L/R	F	All-wheel Drive Bus Engine D8C (XUD9UTF)	810050	Outer Joint		35	45	70	117	73	I	
	1996.07-2002.04	MT	R	F	All-wheel Drive Bus Engine D8C (XUD9UTF)	210069	Drive Shaft		28	37	63	112.5	1072		
	1996.07-2002.04	MT	R	F	All-wheel Drive Bus Engine D8C (XUD9UTF)	610009	Inner Joint		41	45	34.9	367.5	115.6		
	1996.07-2002.04	MT	L	F	All-wheel Drive Bus Engine D8C (XUD9UTF)	210035	Drive Shaft	54T	28	41	63	112.5	757.5		
2.0 i (80 kW)	1994.03-2002.04	MT	L	F	Bus Engine RFW (XU10J2)	210035	Drive Shaft	54T	28	41	63	112.5	757.5		
	1994.03-2002.04	MT	L	F	Bus Engine RFW (XU10J2)	610015	Inner Joint		37	39	40	68.5	104		
	1994.03-2002.04	MT	L/R	F	Bus Engine RFW (XU10J2)	810012	Outer Joint		28	39	63	112.5	63	I	
	1994.03-2002.04	MT	L	F	Bus Engine RFW (XU10J2)	210102	Drive Shaft		28	41	63	112.5	757.5		
	1994.03-2002.04	MT	L	F	Bus Engine RFW (XU10J2)	210037	Drive Shaft	54T	28	37	63	112.5	771		
	1994.03-2002.04	MT	R	F	Bus Engine RFW (XU10J2)	210066	Drive Shaft		35	41	70	117	1085		
	1994.03-2002.04	MT	R	F	Bus Engine RFW (XU10J2)	210036	Drive Shaft	54T	28	41	63	112.5	1079		
	1994.03-2002.04	MT	R	F	Bus Engine RFW (XU10J2)	210032	Drive Shaft	54T	35	41	70	117	1085		
	1994.03-2002.04	MT	L/R	F	Bus Engine RFW (XU10J2)	810011	Outer Joint	54T	35	45	70	117	73	I	
	1994.03-2002.04	MT	R	F	Bus Engine RFW (XU10J2)	610034	Inner Joint		37	39	31.9	369.5	99		
	1994.03-2002.04	MT	L	F	Bus Engine RFW (XU10J2)	210105	Drive Shaft		28	37	63	112.5	771		
	1994.03-2002.04	-	-	-	Bus Engine RFW (XU10J2)	645013	Inner Joint		37	39	40	68.5	100		
	1994.03-2002.04	MT	R	F	Bus Engine RFW (XU10J2)	210103	Drive Shaft		28	41	63	112.5	1079		
	1994.03-2002.04	MT	L/R	F	Bus Engine RFW (XU10J2)	810013	Outer Joint	54T	28	39	63	112.5	63	I	
	1994.03-2002.04	MT	R	F	Bus Engine RFW (XU10J2)	210104	Drive Shaft	54T	28	37	63	112.5	1072		
	1994.03-2002.04	MT	L	F	Bus Engine RFW (XU10J2)	210067	Drive Shaft		35	41	70	117	762		
	1994.03-2002.04	MT	L	F	Bus Engine RFW (XU10J2)	210033	Drive Shaft	54T	35	41	70	117	762		
	1994.03-2002.04	MT	L/R	F	Bus Engine RFW (XU10J2)	810050	Outer Joint		35	45	70	117	73	I	
	1994.03-2002.04	MT	R	F	Bus Engine RFW (XU10J2)	210069	Drive Shaft		28	37	63	112.5	1072		
	1994.03-2002.04	MT	R	F	Bus Engine RFW (XU10J2)	610009	Inner Joint		41	45	34.9	367.5	115.6		
	1996.08-2002.04	MT	L	F	All-wheel Drive Bus Engine RFW (XU10J2)	610015	Inner Joint		37	39	40	68.5	104		
	1996.08-2002.04	MT	L/R	F	All-wheel Drive Bus Engine RFW (XU10J2)	810012	Outer Joint		28	39	63	112.5	63	I	

		YEAR	TRANSM	L/R	F/R	REMARKS	GSP Ref.		ABS	Technical Specifications					
										A	B	C	H	L	P
PEUGEOT															
BOXER (230P)															
2.0 i (80 kW)															
1996.08-	2002.04	MT	L	F	All-wheel Drive Bus Engine RFW (XU10J2)	210102	Drive Shaft			28	41	63	112.5	757.5	
1996.08-	2002.04	MT	L	F	All-wheel Drive Bus Engine RFW (XU10J2)	210037	Drive Shaft	54T		28	37	63	112.5	771	
1996.08-	2002.04	MT	R	F	All-wheel Drive Bus Engine RFW (XU10J2)	210066	Drive Shaft			35	41	70	117	1085	
1996.08-	2002.04	MT	R	F	All-wheel Drive Bus Engine RFW (XU10J2)	210036	Drive Shaft	54T		28	41	63	112.5	1079	
1996.08-	2002.04	MT	R	F	All-wheel Drive Bus Engine RFW (XU10J2)	210032	Drive Shaft	54T		35	41	70	117	1085	
1996.08-	2002.04	MT	L/R	F	All-wheel Drive Bus Engine RFW (XU10J2)	810011	Outer Joint	54T		35	45	70	117	73	I
1996.08-	2002.04	MT	R	F	All-wheel Drive Bus Engine RFW (XU10J2)	610034	Inner Joint			37	39	31.9	369.5	99	
1996.08-	2002.04	MT	L	F	All-wheel Drive Bus Engine RFW (XU10J2)	210105	Drive Shaft			28	37	63	112.5	771	
1996.08-	2002.04	MT	R	F	All-wheel Drive Bus Engine RFW (XU10J2)	210103	Drive Shaft			28	41	63	112.5	1079	
1996.08-	2002.04	MT	L/R	F	All-wheel Drive Bus Engine RFW (XU10J2)	810013	Outer Joint	54T		28	39	63	112.5	63	I
1996.08-	2002.04	-	-	-	All-wheel Drive Bus Engine RFW (XU10J2)	645013	Inner Joint			37	39	40	68.5	100	
1996.08-	2002.04	MT	R	F	All-wheel Drive Bus Engine RFW (XU10J2)	210104	Drive Shaft	54T		28	37	63	112.5	1072	
1996.08-	2002.04	MT	L	F	All-wheel Drive Bus Engine RFW (XU10J2)	210067	Drive Shaft			35	41	70	117	762	
1996.08-	2002.04	MT	L	F	All-wheel Drive Bus Engine RFW (XU10J2)	210033	Drive Shaft	54T		35	41	70	117	762	
1996.08-	2002.04	MT	L/R	F	All-wheel Drive Bus Engine RFW (XU10J2)	810050	Outer Joint			35	45	70	117	73	I
1996.08-	2002.04	MT	R	F	All-wheel Drive Bus Engine RFW (XU10J2)	210069	Drive Shaft			28	37	63	112.5	1072	
1996.08-	2002.04	MT	R	F	All-wheel Drive Bus Engine RFW (XU10J2)	610009	Inner Joint			41	45	34.9	367.5	115.6	
1996.08-	2002.04	MT	L	F	All-wheel Drive Bus Engine RFW (XU10J2)	210035	Drive Shaft	54T		28	41	63	112.5	757.5	
2.5 D (63 kW)															
1994.08-	2002.04	MT	L	F	Bus Engine T9A (DJ5)	210035	Drive Shaft	54T		28	41	63	112.5	757.5	
1994.08-	2002.04	MT	L	F	Bus Engine T9A (DJ5)	610015	Inner Joint			37	39	40	68.5	104	
1994.08-	2002.04	MT	L/R	F	Bus Engine T9A (DJ5)	810012	Outer Joint			28	39	63	112.5	63	I
1994.08-	2002.04	MT	L	F	Bus Engine T9A (DJ5)	210102	Drive Shaft			28	41	63	112.5	757.5	
1994.08-	2002.04	MT	L	F	Bus Engine T9A (DJ5)	210037	Drive Shaft	54T		28	37	63	112.5	771	
1994.08-	2002.04	MT	R	F	Bus Engine T9A (DJ5)	210066	Drive Shaft			35	41	70	117	1085	
1994.08-	2002.04	MT	R	F	Bus Engine T9A (DJ5)	210036	Drive Shaft	54T		28	41	63	112.5	1079	
1994.08-	2002.04	MT	R	F	Bus Engine T9A (DJ5)	210032	Drive Shaft	54T		35	41	70	117	1085	
1994.08-	2002.04	MT	L/R	F	Bus Engine T9A (DJ5)	810011	Outer Joint	54T		35	45	70	117	73	I
1994.08-	2002.04	MT	R	F	Bus Engine T9A (DJ5)	610034	Inner Joint			37	39	31.9	369.5	99	
1994.08-	2002.04	MT	L	F	Bus Engine T9A (DJ5)	210105	Drive Shaft			28	37	63	112.5	771	
1994.08-	2002.04	MT	R	F	Bus Engine T9A (DJ5)	210103	Drive Shaft			28	41	63	112.5	1079	
1994.08-	2002.04	-	-	-	Bus Engine T9A (DJ5)	645013	Inner Joint			37	39	40	68.5	100	
1994.08-	2002.04	MT	L/R	F	Bus Engine T9A (DJ5)	810013	Outer Joint	54T		28	39	63	112.5	63	I
1994.08-	2002.04	MT	R	F	Bus Engine T9A (DJ5)	210104	Drive Shaft	54T		28	37	63	112.5	1072	
1994.08-	2002.04	MT	L	F	Bus Engine T9A (DJ5)	210067	Drive Shaft			35	41	70	117	762	
1994.08-	2002.04	MT	L	F	Bus Engine T9A (DJ5)	210033	Drive Shaft	54T		35	41	70	117	762	
1994.08-	2002.04	MT	L/R	F	Bus Engine T9A (DJ5)	810050	Outer Joint			35	45	70	117	73	I
1994.08-	2002.04	MT	R	F	Bus Engine T9A (DJ5)	210069	Drive Shaft			28	37	63	112.5	1072	
1994.08-	2002.04	MT	R	F	Bus Engine T9A (DJ5)	610009	Inner Joint			41	45	34.9	367.5	115.6	
1996.07-	2002.04	MT	L	F	All-wheel Drive Bus Engine T9A (DJ5)	610015	Inner Joint			37	39	40	68.5	104	
1996.07-	2002.04	MT	L/R	F	All-wheel Drive Bus Engine T9A (DJ5)	810012	Outer Joint			28	39	63	112.5	63	I
1996.07-	2002.04	MT	L	F	All-wheel Drive Bus Engine T9A (DJ5)	210102	Drive Shaft			28	41	63	112.5	757.5	
1996.07-	2002.04	MT	L	F	All-wheel Drive Bus Engine T9A (DJ5)	210037	Drive Shaft	54T		28	37	63	112.5	771	
1996.07-	2002.04	MT	R	F	All-wheel Drive Bus Engine T9A (DJ5)	210066	Drive Shaft			35	41	70	117	1085	
1996.07-	2002.04	MT	R	F	All-wheel Drive Bus Engine T9A (DJ5)	210036	Drive Shaft	54T		28	41	63	112.5	1079	
1996.07-	2002.04	MT	R	F	All-wheel Drive Bus Engine T9A (DJ5)	210032	Drive Shaft	54T		35	41	70	117	1085	
1996.07-	2002.04	MT	L/R	F	All-wheel Drive Bus Engine T9A (DJ5)	810011	Outer Joint	54T		35	45	70	117	73	I
1996.07-	2002.04	MT	R	F	All-wheel Drive Bus Engine T9A (DJ5)	610034	Inner Joint			37	39	31.9	369.5	99	
1996.07-	2002.04	MT	L	F	All-wheel Drive Bus Engine T9A (DJ5)	210105	Drive Shaft			28	37	63	112.5	771	
1996.07-	2002.04	MT	R	F	All-wheel Drive Bus Engine T9A (DJ5)	210103	Drive Shaft			28	41	63	112.5	1079	
1996.07-	2002.04	MT	L/R	F	All-wheel Drive Bus Engine T9A (DJ5)	810013	Outer Joint	54T		28	39	63	112.5	63	I
1996.07-	2002.04	-	-	-	All-wheel Drive Bus Engine T9A (DJ5)	645013	Inner Joint			37	39	40	68.5	100	
1996.07-	2002.04	MT	R	F	All-wheel Drive Bus Engine T9A (DJ5)	210104	Drive Shaft	54T		28	37	63	112.5	1072	
1996.07-	2002.04	MT	L	F	All-wheel Drive Bus Engine T9A (DJ5)	210067	Drive Shaft			35	41	70	117	762	
1996.07-	2002.04	MT	L	F	All-wheel Drive Bus Engine T9A (DJ5)	210033	Drive Shaft	54T		35	41	70	117	762	
1996.07-	2002.04	MT	L/R	F	All-wheel Drive Bus Engine T9A (DJ5)	810050	Outer Joint			35	45	70	117	73	I
1996.07-	2002.04	MT	R	F	All-wheel Drive Bus Engine T9A (DJ5)	210069	Drive Shaft			28	37	63	112.5	1072	
1996.07-	2002.04	MT	R	F	All-wheel Drive Bus Engine T9A (DJ5)	610009	Inner Joint			41	45	34.9	367.5	115.6	
1996.07-	2002.04	MT	L	F	All-wheel Drive Bus Engine T9A (DJ5)	210035	Drive Shaft	54T		28	41	63	112.5	757.5	
2.5 TD (76 kW)															
1994.07-	2002.04	MT	L	F	Bus Engine T8A (DJ5T)	610015	Inner Joint			37	39	40	68.5	104	
1994.07-	2002.04	MT	L/R	F	Bus Engine T8A (DJ5T)	810012	Outer Joint			28	39	63	112.5	63	I
1994.07-	2002.04	MT	L	F	Bus Engine T8A (DJ5T)	210102	Drive Shaft			28	41	63	112.5	757.5	
1994.07-	2002.04	MT	L	F	Bus Engine T8A (DJ5T)	210037	Drive Shaft	54T		28	37	63	112.5	771	
1994.07-	2002.04	MT	R	F	Bus Engine T8A (DJ5T)	210066	Drive Shaft			35	41	70	117	1085	
1994.07-	2002.04	MT	R	F	Bus Engine T8A (DJ5T)	210036	Drive Shaft	54T		28	41	63	112.5	1079	
1994.07-	2002.04	MT	R	F	Bus Engine T8A (DJ5T)	210032	Drive Shaft	54T		35	41	70	117	1085	
1994.07-	2002.04	MT	L/R	F	Bus Engine T8A (DJ5T)	810011	Outer Joint	54T		35	45	70	117	73	I





YEAR	TRANSM	L/R	F/R	REMARKS	GSP Ref.	PRODUCT	ABS	Technical Specifications							
								A	B	C	H	L	P		
PEUGEOT															
BOXER (230P)															
2.5 TD (76 kW)															
1994.07-	2002.04	MT	R	F	Bus Engine T8A (DJ5T)	610034	Inner Joint		37	39	31.9	369.5	99		
1994.07-	2002.04	MT	L	F	Bus Engine T8A (DJ5T)	210105	Drive Shaft		28	37	63	112.5	771		
1994.07-	2002.04	MT	R	F	Bus Engine T8A (DJ5T)	210103	Drive Shaft		28	41	63	112.5	1079		
1994.07-	2002.04	MT	L/R	F	Bus Engine T8A (DJ5T)	810013	Outer Joint	54T	28	39	63	112.5	63	I	
1994.07-	2002.04	-	-	-	Bus Engine T8A (DJ5T)	645013	Inner Joint		37	39	40	68.5	100		
1994.07-	2002.04	MT	R	F	Bus Engine T8A (DJ5T)	210104	Drive Shaft	54T	28	37	63	112.5	1072		
1994.07-	2002.04	MT	L	F	Bus Engine T8A (DJ5T)	210067	Drive Shaft		35	41	70	117	762		
1994.07-	2002.04	MT	L	F	Bus Engine T8A (DJ5T)	210033	Drive Shaft	54T	35	41	70	117	762		
1994.07-	2002.04	MT	L/R	F	Bus Engine T8A (DJ5T)	810050	Outer Joint		35	45	70	117	73	I	
1994.07-	2002.04	MT	R	F	Bus Engine T8A (DJ5T)	210069	Drive Shaft		28	37	63	112.5	1072		
1994.07-	2002.04	MT	R	F	Bus Engine T8A (DJ5T)	610009	Inner Joint		41	45	34.9	367.5	115.6		
1994.07-	2002.04	MT	L	F	Bus Engine T8A (DJ5T)	210035	Drive Shaft	54T	28	41	63	112.5	757.5		
1996.07-	2002.04	MT	L	F	All-wheel Drive Bus Engine T8A (DJ5T)	210067	Drive Shaft		35	41	70	117	762		
1996.07-	2002.04	MT	L	F	All-wheel Drive Bus Engine T8A (DJ5T)	210033	Drive Shaft	54T	35	41	70	117	762		
1996.07-	2002.04	MT	R	F	All-wheel Drive Bus Engine T8A (DJ5T)	210069	Drive Shaft		28	37	63	112.5	1072		
1996.07-	2002.04	MT	L/R	F	All-wheel Drive Bus Engine T8A (DJ5T)	810050	Outer Joint		35	45	70	117	73	I	
1996.07-	2002.04	MT	L	F	All-wheel Drive Bus Engine T8A (DJ5T)	210035	Drive Shaft	54T	28	41	63	112.5	757.5		
1996.07-	2002.04	MT	R	F	All-wheel Drive Bus Engine T8A (DJ5T)	610009	Inner Joint		41	45	34.9	367.5	115.6		
1996.07-	2002.04	MT	L	F	All-wheel Drive Bus Engine T8A (DJ5T)	610015	Inner Joint		37	39	40	68.5	104		
1996.07-	2002.04	MT	L/R	F	All-wheel Drive Bus Engine T8A (DJ5T)	810012	Outer Joint		28	39	63	112.5	63	I	
1996.07-	2002.04	MT	L	F	All-wheel Drive Bus Engine T8A (DJ5T)	210102	Drive Shaft		28	41	63	112.5	757.5		
1996.07-	2002.04	MT	L	F	All-wheel Drive Bus Engine T8A (DJ5T)	210037	Drive Shaft	54T	28	37	63	112.5	771		
1996.07-	2002.04	MT	R	F	All-wheel Drive Bus Engine T8A (DJ5T)	210036	Drive Shaft	54T	28	41	63	112.5	1079		
1996.07-	2002.04	MT	R	F	All-wheel Drive Bus Engine T8A (DJ5T)	210066	Drive Shaft		35	41	70	117	1085		
1996.07-	2002.04	MT	R	F	All-wheel Drive Bus Engine T8A (DJ5T)	610034	Inner Joint		37	39	31.9	369.5	99		
1996.07-	2002.04	MT	L/R	F	All-wheel Drive Bus Engine T8A (DJ5T)	810011	Outer Joint	54T	35	45	70	117	73	I	
1996.07-	2002.04	MT	R	F	All-wheel Drive Bus Engine T8A (DJ5T)	210032	Drive Shaft	54T	35	41	70	117	1085		
1996.07-	2002.04	MT	L	F	All-wheel Drive Bus Engine T8A (DJ5T)	210105	Drive Shaft		28	37	63	112.5	771		
1996.07-	2002.04	-	-	-	All-wheel Drive Bus Engine T8A (DJ5T)	645013	Inner Joint		37	39	40	68.5	100		
1996.07-	2002.04	MT	R	F	All-wheel Drive Bus Engine T8A (DJ5T)	210103	Drive Shaft		28	41	63	112.5	1079		
1996.07-	2002.04	MT	L/R	F	All-wheel Drive Bus Engine T8A (DJ5T)	810013	Outer Joint	54T	28	39	63	112.5	63	I	
1996.07-	2002.04	MT	R	F	All-wheel Drive Bus Engine T8A (DJ5T)	210104	Drive Shaft	54T	28	37	63	112.5	1072		
2.5 TDI (79 kW)															
1997.01-	2002.04	MT	L	F	All-wheel Drive Bus Engine THX (DJ5TED)	610015	Inner Joint		37	39	40	68.5	104		
1997.01-	2002.04	MT	L/R	F	Bus Engine THX (DJ5TED)	810012	Outer Joint		28	39	63	112.5	63	I	
1997.01-	2002.04	MT	L/R	F	All-wheel Drive Bus Engine THX (DJ5TED)	810012	Outer Joint		28	39	63	112.5	63	I	
1997.01-	2002.04	MT	L	F	Bus Engine THX (DJ5TED)	210102	Drive Shaft		28	41	63	112.5	757.5		
1997.01-	2002.04	MT	L	F	All-wheel Drive Bus Engine THX (DJ5TED)	210102	Drive Shaft		28	41	63	112.5	757.5		
1997.01-	2002.04	MT	L	F	Bus Engine THX (DJ5TED)	210037	Drive Shaft	54T	28	37	63	112.5	771		
1997.01-	2002.04	MT	R	F	Bus Engine THX (DJ5TED)	210066	Drive Shaft		35	41	70	117	1085		
1997.01-	2002.04	MT	L	F	All-wheel Drive Bus Engine THX (DJ5TED)	210037	Drive Shaft	54T	28	37	63	112.5	771		
1997.01-	2002.04	MT	R	F	Bus Engine THX (DJ5TED)	210036	Drive Shaft	54T	28	41	63	112.5	1079		
1997.01-	2002.04	MT	R	F	All-wheel Drive Bus Engine THX (DJ5TED)	210066	Drive Shaft		35	41	70	117	1085		
1997.01-	2002.04	MT	R	F	All-wheel Drive Bus Engine THX (DJ5TED)	210036	Drive Shaft	54T	28	41	63	112.5	1079		
1997.01-	2002.04	MT	R	F	Bus Engine THX (DJ5TED)	210032	Drive Shaft	54T	35	41	70	117	1085		
1997.01-	2002.04	MT	R	F	All-wheel Drive Bus Engine THX (DJ5TED)	210032	Drive Shaft	54T	35	41	70	117	1085		
1997.01-	2002.04	MT	L/R	F	Bus Engine THX (DJ5TED)	810011	Outer Joint	54T	35	45	70	117	73	I	
1997.01-	2002.04	MT	L/R	F	All-wheel Drive Bus Engine THX (DJ5TED)	810011	Outer Joint	54T	35	45	70	117	73	I	
1997.01-	2002.04	MT	R	F	Bus Engine THX (DJ5TED)	610034	Inner Joint		37	39	31.9	369.5	99		
1997.01-	2002.04	MT	R	F	All-wheel Drive Bus Engine THX (DJ5TED)	610034	Inner Joint		37	39	31.9	369.5	99		
1997.01-	2002.04	MT	L	F	Bus Engine THX (DJ5TED)	210105	Drive Shaft		28	37	63	112.5	771		
1997.01-	2002.04	MT	L	F	All-wheel Drive Bus Engine THX (DJ5TED)	210105	Drive Shaft		28	37	63	112.5	771		
1997.01-	2002.04	MT	R	F	Bus Engine THX (DJ5TED)	210103	Drive Shaft		28	41	63	112.5	1079		
1997.01-	2002.04	MT	R	F	All-wheel Drive Bus Engine THX (DJ5TED)	210103	Drive Shaft		28	41	63	112.5	1079		
1997.01-	2002.04	MT	L/R	F	Bus Engine THX (DJ5TED)	810013	Outer Joint	54T	28	39	63	112.5	63	I	
1997.01-	2002.04	MT	L/R	F	All-wheel Drive Bus Engine THX (DJ5TED)	810013	Outer Joint	54T	28	39	63	112.5	63	I	
1997.01-	2002.04	-	-	-	Bus Engine THX (DJ5TED)	645013	Inner Joint		37	39	40	68.5	100		
1997.01-	2002.04	-	-	-	All-wheel Drive Bus Engine THX (DJ5TED)	645013	Inner Joint		37	39	40	68.5	100		
1997.01-	2002.04	MT	R	F	Bus Engine THX (DJ5TED)	210104	Drive Shaft	54T	28	37	63	112.5	1072		
1997.01-	2002.04	MT	R	F	All-wheel Drive Bus Engine THX (DJ5TED)	210104	Drive Shaft	54T	28	37	63	112.5	1072		
1997.01-	2002.04	MT	L	F	Bus Engine THX (DJ5TED)	210067	Drive Shaft		35	41	70	117	762		
1997.01-	2002.04	MT	L	F	All-wheel Drive Bus Engine THX (DJ5TED)	210067	Drive Shaft		35	41	70	117	762		
1997.01-	2002.04	MT	L	F	Bus Engine THX (DJ5TED)	210033	Drive Shaft	54T	35	41	70	117	762		
1997.01-	2002.04	MT	L/R	F	Bus Engine THX (DJ5TED)	810050	Outer Joint		35	45	70	117	73	I	
1997.01-	2002.04	MT	L	F	All-wheel Drive Bus Engine THX (DJ5TED)	210033	Drive Shaft	54T	35	41	70	117	762		
1997.01-	2002.04	MT	L/R	F	All-wheel Drive Bus Engine THX (DJ5TED)	810050	Outer Joint		35	45	70	117	73	I	
1997.01-	2002.04	MT	R	F	Bus Engine THX (DJ5TED)	210069	Drive Shaft		28	37	63	112.5	1072		





	 YEAR	TRANSM	L/R	F/R	REMARKS	GSP Ref.	 PRODUCT	 ABS	Technical Specifications						
									A	B	C	H	L	P	
PEUGEOT BOXER (230P)															
2.5 TDI (79 kW)	1997.01-2002.04	MT	R	F	Bus Engine THX (DJ5TED)	610009	Inner Joint		41	45	34.9	367.5	115.6		
	1997.01-2002.04	MT	R	F	All-wheel Drive Bus Engine THX (DJ5TED)	210069	Drive Shaft	54T	28	37	63	112.5	1072		
	1997.01-2002.04	MT	R	F	All-wheel Drive Bus Engine THX (DJ5TED)	610009	Inner Joint		41	45	34.9	367.5	115.6		
	1997.01-2002.04	MT	L	F	Bus Engine THX (DJ5TED)	210035	Drive Shaft	54T	28	41	63	112.5	757.5		
	1997.01-2002.04	MT	L	F	All-wheel Drive Bus Engine THX (DJ5TED)	210035	Drive Shaft	54T	28	41	63	112.5	757.5		
	1997.01-2002.04	MT	L	F	Bus Engine THX (DJ5TED)	610015	Inner Joint		37	39	40	68.5	104		
2.8 HDi (94 kW)	2000.11-2002.04	MT	L	F	Bus Engine 8140.43S (F28DTCR)	210067	Drive Shaft		35	41	70	117	762		
	2000.11-2002.04	MT	L/R	F	Bus Engine 8140.43S (F28DTCR)	810050	Outer Joint		35	45	70	117	73	I	
	2000.11-2002.04	MT	L	F	Bus Engine 8140.43S (F28DTCR)	210033	Drive Shaft	54T	35	41	70	117	762		
	2000.11-2002.04	MT	R	F	Bus Engine 8140.43S (F28DTCR)	610009	Inner Joint		41	45	34.9	367.5	115.6		
	2000.11-2002.04	MT	R	F	Bus Engine 8140.43S (F28DTCR)	210066	Drive Shaft		35	41	70	117	1085		
	2000.11-2002.04	MT	L/R	F	Bus Engine 8140.43S (F28DTCR)	810011	Outer Joint	54T	35	45	70	117	73	I	
2000.11-2002.04	MT	R	F	Bus Engine 8140.43S (F28DTCR)	210032	Drive Shaft	54T	35	41	70	117	1085			
BOXER (244 Z_)															
2.0 (81 kW)	2002.04-	MT	R	F	Bus Engine RFL (XU10J2U)	610009	Inner Joint		41	45	34.9	367.5	115.6		
	2002.04-	MT	R	F	Bus Engine RFL (XU10J2U)	210036	Drive Shaft	54T	28	41	63	112.5	1079		
	2002.04-	MT	R	F	Bus Engine RFL (XU10J2U)	210066	Drive Shaft		35	41	70	117	1085		
	2002.04-	MT	R	F	Bus Engine RFL (XU10J2U)	210032	Drive Shaft	54T	35	41	70	117	1085		
	2002.04-	MT	L/R	F	Bus Engine RFL (XU10J2U)	810011	Outer Joint	54T	35	45	70	117	73	I	
	2002.04-	MT	L/R	F	Bus Engine RFL (XU10J2U)	810013	Outer Joint	54T	28	39	63	112.5	63	I	
2.0 HDi (62 kW)	2002.04-	-	R	F	Bus Engine RHV (DW10UTD)	210069	Drive Shaft		28	37	63	112.5	1072		
	2002.04-	-	L	F	Bus Engine RHV (DW10UTD)	610015	Inner Joint		37	39	40	68.5	104		
	2002.04-	-	L	F	Bus Engine RHV (DW10UTD)	210037	Drive Shaft	54T	28	37	63	112.5	771		
	2002.04-	-	R	F	Bus Engine RHV (DW10UTD)	610034	Inner Joint		37	39	31.9	369.5	99		
	2002.04-	-	L	F	Bus Engine RHV (DW10UTD)	210105	Drive Shaft		28	37	63	112.5	771		
	2002.04-	MT	L/R	F	Bus Engine RHV (DW10UTD)	810013	Outer Joint	54T	28	39	63	112.5	63	I	
2.2 HDi (74 kW)	2002.04-	-	R	F	Bus Engine RHV (DW10UTD)	210104	Drive Shaft	54T	28	37	63	112.5	1072		
	2002.04-	MT	R	F	Bus Engine 4HY (DW12UTD)	610009	Inner Joint		41	45	34.9	367.5	115.6		
	2002.04-	MT	R	F	Bus Engine 4HY (DW12UTD)	210036	Drive Shaft	54T	28	41	63	112.5	1079		
	2002.04-	MT	R	F	Bus Engine 4HY (DW12UTD)	210066	Drive Shaft		35	41	70	117	1085		
	2002.04-	MT	R	F	Bus Engine 4HY (DW12UTD)	210032	Drive Shaft	54T	35	41	70	117	1085		
	2002.04-	-	R	F	Bus Engine RHV (DW10UTD)	610009	Inner Joint		41	45	34.9	367.5	115.6		
2.8 HDi (107 kW)	2004.04-	MT	R	F	Bus Engine 8140.43N	210036	Drive Shaft	54T	28	41	63	112.5	1079		
	2004.04-	MT	R	F	Bus Engine 8140.43N	210066	Drive Shaft		35	41	70	117	1085		
	2004.04-	MT	R	F	Bus Engine 8140.43N	210032	Drive Shaft	54T	35	41	70	117	1085		
	2004.04-	MT	R	F	Bus Engine 8140.43N	610009	Inner Joint		41	45	34.9	367.5	115.6		
2.8 HDi (94 kW)	2002.04-	MT	R	F	Bus Engine 8140.43S (F28DTCR)	610009	Inner Joint		41	45	34.9	367.5	115.6		
	2002.04-	-	R	F	All-wheel Drive Bus Engine 8140.43S (F28DTCR)	610009	Inner Joint		41	45	34.9	367.5	115.6		
	2002.04-	MT	R	F	Bus Engine 8140.43S (F28DTCR)	210036	Drive Shaft	54T	28	41	63	112.5	1079		
	2002.04-	MT	R	F	Bus Engine 8140.43S (F28DTCR)	210066	Drive Shaft		35	41	70	117	1085		
	2002.04-	-	R	F	All-wheel Drive Bus Engine 8140.43S (F28DTCR)	210036	Drive Shaft	54T	28	41	63	112.5	1079		
	2002.04-	-	R	F	All-wheel Drive Bus Engine 8140.43S (F28DTCR)	210066	Drive Shaft		35	41	70	117	1085		
	2002.04-	MT	R	F	Bus Engine 8140.43S (F28DTCR)	210032	Drive Shaft	54T	35	41	70	117	1085		
	2002.04-	-	R	F	All-wheel Drive Bus Engine 8140.43S (F28DTCR)	210032	Drive Shaft	54T	35	41	70	117	1085		
	2002.04-	MT	L/R	F	Bus Engine 8140.43S (F28DTCR)	810011	Outer Joint	54T	35	45	70	117	73	I	
	2002.04-	MT	L/R	F	Bus Engine 8140.43S (F28DTCR)	810013	Outer Joint	54T	28	39	63	112.5	63	I	
2002.04-	MT	L/R	F	All-wheel Drive Bus Engine 8140.43S (F28DTCR)	810013	Outer Joint	54T	28	39	63	112.5	63	I		
BOXER (244)															
2.0 (81 kW)	2002.04-	MT	R	F	Box Engine RFL (XU10J2U)	610009	Inner Joint		41	45	34.9	367.5	115.6		
	2002.04-	MT	R	F	Box Engine RFL (XU10J2U)	210036	Drive Shaft	54T	28	41	63	112.5	1079		
	2002.04-	MT	R	F	Box Engine RFL (XU10J2U)	210066	Drive Shaft		35	41	70	117	1085		
	2002.04-	MT	R	F	Box Engine RFL (XU10J2U)	210032	Drive Shaft	54T	35	41	70	117	1085		
	2002.04-	MT	L/R	F	Box Engine RFL (XU10J2U)	810011	Outer Joint	54T	35	45	70	117	73	I	
	2002.04-	MT	L/R	F	Box Engine RFL (XU10J2U)	810013	Outer Joint	54T	28	39	63	112.5	63	I	
2.0 HDi (62 kW)	2002.04-	-	R	F	Platform/Chassis Engine RHV (DW10TD)/RHV (DW10UTD)	210069	Drive Shaft		28	37	63	112.5	1072		
	2002.04-	-	R	F	Box Engine RHV (DW10TD)/RHV (DW10UTD)	210069	Drive Shaft		28	37	63	112.5	1072		
	2002.04-	-	L	F	Platform/Chassis Engine RHV (DW10TD)/RHV (DW10UTD)	610015	Inner Joint		37	39	40	68.5	104		
	2002.04-	-	L	F	Box Engine RHV (DW10TD)/RHV (DW10UTD)	610015	Inner Joint		37	39	40	68.5	104		
	2002.04-	-	L	F	Platform/Chassis Engine RHV (DW10TD)/RHV (DW10UTD)	210037	Drive Shaft	54T	28	37	63	112.5	771		
	2002.04-	-	L	F	Box Engine RHV (DW10TD)/RHV (DW10UTD)	210037	Drive Shaft	54T	28	37	63	112.5	771		
	2002.04-	-	R	F	Platform/Chassis Engine RHV (DW10TD)/RHV (DW10UTD)	610034	Inner Joint		37	39	31.9	369.5	99		
	2002.04-	-	R	F	Box Engine RHV (DW10TD)/RHV (DW10UTD)	610034	Inner Joint		37	39	31.9	369.5	99		
	2002.04-	-	L	F	Platform/Chassis Engine RHV (DW10TD)/RHV (DW10UTD)	210105	Drive Shaft		28	37	63	112.5	771		
	2002.04-	-	L	F	Box Engine RHV (DW10TD)/RHV (DW10UTD)	210105	Drive Shaft		28	37	63	112.5	771		
	2002.04-	MT	L/R	F	Platform/Chassis Engine RHV (DW10TD)/RHV (DW10UTD)	810013	Outer Joint	54T	28	39	63	112.5	63	I	
	2002.04-	MT	L/R	F	Box Engine RHV (DW10TD)/RHV (DW10UTD)	810013	Outer Joint	54T	28	39	63	112.5	63	I	
	2002.04-	-	R	F	Platform/Chassis Engine RHV (DW10TD)/RHV (DW10UTD)	210104	Drive Shaft	54T	28	37	63	112.5	1072		

	 YEAR	TRANSM	L/R	F/R	REMARKS	GSP Ref.	 PRODUCT	 ABS	Technical Specifications							
									A	B	C	H	L	P		
PEUGEOT BOXER (244)																
2.0 HDi (62 kW)	2002.04-	-		R	F	Box Engine RHV (DW10TD)/RHV (DW10UTD)	210104	Drive Shaft	54T	28	37	63	112.5	1072		
2.2 HDi (74 kW)	2002.04-		MT		R	F	Platform/Chassis Engine 4HY (DW12UTED)	610009	Inner Joint		41	45	34.9	367.5	115.6	
	2002.04-		MT		R	F	Box Engine 4HY (DW12UTED)	610009	Inner Joint		41	45	34.9	367.5	115.6	
	2002.04-		MT		R	F	Platform/Chassis Engine 4HY (DW12UTED)	210036	Drive Shaft	54T	28	41	63	112.5	1079	
	2002.04-		MT		R	F	Box Engine 4HY (DW12UTED)	210036	Drive Shaft	54T	28	41	63	112.5	1079	
	2002.04-		MT		R	F	Platform/Chassis Engine 4HY (DW12UTED)	210066	Drive Shaft		35	41	70	117	1085	
	2002.04-		MT		R	F	Box Engine 4HY (DW12UTED)	210066	Drive Shaft		35	41	70	117	1085	
	2002.04-		MT		R	F	Platform/Chassis Engine 4HY (DW12UTED)	210032	Drive Shaft	54T	35	41	70	117	1085	
	2002.04-		MT		R	F	Box Engine 4HY (DW12UTED)	210032	Drive Shaft	54T	35	41	70	117	1085	
2.8 HDi (107 kW)	2004.04-		MT		R	F	Box Engine 8140.43N	610009	Inner Joint		41	45	34.9	367.5	115.6	
	2004.04-		-		R	F	Platform/Chassis Engine 8140.43N	610009	Inner Joint		41	45	34.9	367.5	115.6	
	2004.04-		MT		R	F	Box Engine 8140.43N	210066	Drive Shaft		35	41	70	117	1085	
	2004.04-		-		R	F	Platform/Chassis Engine 8140.43N	210066	Drive Shaft		35	41	70	117	1085	
	2004.04-		MT		R	F	Box Engine 8140.43N	210032	Drive Shaft	54T	35	41	70	117	1085	
2.8 HDi (94 kW)	2004.04-		-		R	F	Platform/Chassis Engine 8140.43N	210032	Drive Shaft	54T	35	41	70	117	1085	
	2002.04-		MT		R	F	Box Engine 8140.43S (F28DTCR)	610009	Inner Joint		41	45	34.9	367.5	115.6	
	2002.04-		-		R	F	All-wheel Drive Box Engine 8140.43S (F28DTCR)	610009	Inner Joint		41	45	34.9	367.5	115.6	
	2002.04-		-		R	F	All-wheel Drive Platform/Chassis Engine 8140.43S (F28DTCR)	610009	Inner Joint		41	45	34.9	367.5	115.6	
	2002.04-		MT		R	F	Platform/Chassis Engine 8140.43S (F28DTCR)	210066	Drive Shaft		35	41	70	117	1085	
	2002.04-		MT		R	F	Platform/Chassis Engine 8140.43S (F28DTCR)	210032	Drive Shaft	54T	35	41	70	117	1085	
	2002.04-		MT		R	F	Platform/Chassis Engine 8140.43S (F28DTCR)	210036	Drive Shaft	54T	28	41	63	112.5	1079	
	2002.04-		MT		R	F	Box Engine 8140.43S (F28DTCR)	210036	Drive Shaft	54T	28	41	63	112.5	1079	
	2002.04-		MT		R	F	Box Engine 8140.43S (F28DTCR)	210066	Drive Shaft		35	41	70	117	1085	
	2002.04-		-		R	F	All-wheel Drive Box Engine 8140.43S (F28DTCR)	210036	Drive Shaft	54T	28	41	63	112.5	1079	
	2002.04-		-		R	F	All-wheel Drive Platform/Chassis Engine 8140.43S (F28DTCR)	210036	Drive Shaft	54T	28	41	63	112.5	1079	
	2002.04-		-		R	F	All-wheel Drive Box Engine 8140.43S (F28DTCR)	210066	Drive Shaft		35	41	70	117	1085	
	2002.04-		-		R	F	All-wheel Drive Platform/Chassis Engine 8140.43S (F28DTCR)	210066	Drive Shaft		35	41	70	117	1085	
	2002.04-		MT		R	F	Box Engine 8140.43S (F28DTCR)	210032	Drive Shaft	54T	35	41	70	117	1085	
	2002.04-		-		R	F	All-wheel Drive Box Engine 8140.43S (F28DTCR)	210032	Drive Shaft	54T	35	41	70	117	1085	
	2002.04-		-		R	F	All-wheel Drive Platform/Chassis Engine 8140.43S (F28DTCR)	210032	Drive Shaft	54T	35	41	70	117	1085	
	2002.04-		MT	L/R	F	F	Platform/Chassis Engine 8140.43S (F28DTCR)	810011	Outer Joint	54T	35	45	70	117	73	I
	2002.04-		MT	L/R	F	F	Box Engine 8140.43S (F28DTCR)	810011	Outer Joint	54T	35	45	70	117	73	I
	2002.04-		MT	R	F	F	Platform/Chassis Engine 8140.43S (F28DTCR)	610009	Inner Joint		41	45	34.9	367.5	115.6	
	2002.04-		MT	L/R	F	F	Platform/Chassis Engine 8140.43S (F28DTCR)	810013	Outer Joint	54T	28	39	63	112.5	63	I
	2002.04-		MT	L/R	F	F	Box Engine 8140.43S (F28DTCR)	810013	Outer Joint	54T	28	39	63	112.5	63	I
	2002.04-		MT	L/R	F	F	All-wheel Drive Box Engine 8140.43S (F28DTCR)	810013	Outer Joint	54T	28	39	63	112.5	63	I
	2002.04-		MT	L/R	F	F	All-wheel Drive Platform/Chassis Engine 8140.43S (F28DTCR)	810013	Outer Joint	54T	28	39	63	112.5	63	I
BOXER (ZCT_)																
1.9 TD (66 kW)	1994.06-	2002.04	MT	L	F	Platform/Chassis Engine XUD9TE/DHY (XUD9TE)	610015	Inner Joint		37	39	40	68.5	104		
	1994.06-	2002.04	MT	L/R	F	Platform/Chassis Engine XUD9TE/DHY (XUD9TE)	810012	Outer Joint		28	39	63	112.5	63	I	
	1994.06-	2002.04	MT	L	F	Platform/Chassis Engine XUD9TE/DHY (XUD9TE)	210102	Drive Shaft		28	41	63	112.5	757.5		
	1994.06-	2002.04	MT	L	F	Platform/Chassis Engine XUD9TE/DHY (XUD9TE)	210037	Drive Shaft	54T	28	37	63	112.5	771		
	1994.06-	2002.04	MT	R	F	Platform/Chassis Engine XUD9TE/DHY (XUD9TE)	210066	Drive Shaft		35	41	70	117	1085		
	1994.06-	2002.04	MT	R	F	Platform/Chassis Engine XUD9TE/DHY (XUD9TE)	210036	Drive Shaft	54T	28	41	63	112.5	1079		
	1994.06-	2002.04	MT	R	F	Platform/Chassis Engine XUD9TE/DHY (XUD9TE)	210032	Drive Shaft	54T	35	41	70	117	1085		
	1994.06-	2002.04	MT	L/R	F	Platform/Chassis Engine XUD9TE/DHY (XUD9TE)	810011	Outer Joint	54T	35	45	70	117	73	I	
	1994.06-	2002.04	MT	R	F	Platform/Chassis Engine XUD9TE/DHY (XUD9TE)	610034	Inner Joint		37	39	31.9	369.5	99		
	1994.06-	2002.04	MT	L	F	Platform/Chassis Engine XUD9TE/DHY (XUD9TE)	210105	Drive Shaft		28	37	63	112.5	771		
	1994.06-	2002.04	MT	R	F	Platform/Chassis Engine XUD9TE/DHY (XUD9TE)	210103	Drive Shaft		28	41	63	112.5	1079		
	1994.06-	2002.04	MT	L/R	F	Platform/Chassis Engine XUD9TE/DHY (XUD9TE)	810013	Outer Joint	54T	28	39	63	112.5	63	I	
	1994.06-	2002.04	-	-	-	-	Platform/Chassis Engine XUD9TE/DHY (XUD9TE)	645013	Inner Joint		37	39	40	68.5	100	
	1994.06-	2002.04	MT	R	F	Platform/Chassis Engine XUD9TE/DHY (XUD9TE)	210104	Drive Shaft	54T	28	37	63	112.5	1072		
	1994.06-	2002.04	MT	L	F	Platform/Chassis Engine XUD9TE/DHY (XUD9TE)	210067	Drive Shaft		35	41	70	117	762		
	1994.06-	2002.04	MT	L	F	Platform/Chassis Engine XUD9TE/DHY (XUD9TE)	210033	Drive Shaft	54T	35	41	70	117	762		
	1994.06-	2002.04	MT	L/R	F	Platform/Chassis Engine XUD9TE/DHY (XUD9TE)	810050	Outer Joint		35	45	70	117	73	I	
	1994.06-	2002.04	MT	R	F	Platform/Chassis Engine XUD9TE/DHY (XUD9TE)	210069	Drive Shaft		28	37	63	112.5	1072		
	1994.06-	2002.04	MT	R	F	Platform/Chassis Engine XUD9TE/DHY (XUD9TE)	610009	Inner Joint		41	45	34.9	367.5	115.6		
	1994.06-	2002.04	MT	L	F	Platform/Chassis Engine XUD9TE/DHY (XUD9TE)	210035	Drive Shaft	54T	28	41	63	112.5	757.5		
	1.9 TD (68 kW)	1994.07-	2002.04	MT	L/R	F	Platform/Chassis Engine D8C (XUD9UTF)	810012	Outer Joint		28	39	63	112.5	63	I
		1994.07-	2002.04	MT	L	F	Platform/Chassis Engine D8C (XUD9UTF)	210102	Drive Shaft		28	41	63	112.5	757.5	
		1994.07-	2002.04	MT	L	F	Platform/Chassis Engine D8C (XUD9UTF)	210037	Drive Shaft	54T	28	37	63	112.5	771	
1994.07-		2002.04	MT	R	F	Platform/Chassis Engine D8C (XUD9UTF)	210066	Drive Shaft		35	41	70	117	1085		
1994.07-		2002.04	MT	R	F	Platform/Chassis Engine D8C (XUD9UTF)	210036	Drive Shaft	54T	28	41	63	112.5	1079		
1994.07-		2002.04	MT	R	F	Platform/Chassis Engine D8C (XUD9UTF)	210032	Drive Shaft	54T	35	41	70	117	1085		
1994.07-		2002.04	MT	L/R	F	Platform/Chassis Engine D8C (XUD9UTF)	810011	Outer Joint	54T	35	45	70	117	73	I	
1994.07-	2002.04	MT	R	F	Platform/Chassis Engine D8C (XUD9UTF)	610034	Inner Joint		37	39	31.9	369.5	99			

		 YEAR	TRANSM	L/R	F/R	REMARKS	GSP Ref.	 PRODUCT	 ABS	Technical Specifications					
										A	B	C	H	L	P
PEUGEOT															
BOXER (ZCT_)															
1.9 TD (68 kW)															
1994.07-	2002.04	MT	L	F	Platform/Chassis Engine D8C (XUD9UTF)	210105	Drive Shaft			28	37	63	112.5	771	
1994.07-	2002.04	MT	R	F	Platform/Chassis Engine D8C (XUD9UTF)	210103	Drive Shaft			28	41	63	112.5	1079	
1994.07-	2002.04	MT	L/R	F	Platform/Chassis Engine D8C (XUD9UTF)	810013	Outer Joint	54T		28	39	63	112.5	63	I
1994.07-	2002.04	-	-	-	Platform/Chassis Engine D8C (XUD9UTF)	645013	Inner Joint			37	39	40	68.5	100	
1994.07-	2002.04	MT	R	F	Platform/Chassis Engine D8C (XUD9UTF)	210104	Drive Shaft	54T		28	37	63	112.5	1072	
1994.07-	2002.04	MT	L	F	Platform/Chassis Engine D8C (XUD9UTF)	210067	Drive Shaft			35	41	70	117	762	
1994.07-	2002.04	MT	L	F	Platform/Chassis Engine D8C (XUD9UTF)	210033	Drive Shaft	54T		35	41	70	117	762	
1994.07-	2002.04	MT	L/R	F	Platform/Chassis Engine D8C (XUD9UTF)	810050	Outer Joint			35	45	70	117	73	I
1994.07-	2002.04	MT	R	F	Platform/Chassis Engine D8C (XUD9UTF)	210069	Drive Shaft			28	37	63	112.5	1072	
1994.07-	2002.04	MT	R	F	Platform/Chassis Engine D8C (XUD9UTF)	610009	Inner Joint			41	45	34.9	367.5	115.6	
1994.07-	2002.04	MT	L	F	Platform/Chassis Engine D8C (XUD9UTF)	210035	Drive Shaft	54T		28	41	63	112.5	757.5	
1994.07-	2002.04	MT	L	F	Platform/Chassis Engine D8C (XUD9UTF)	610015	Inner Joint			37	39	40	68.5	104	
2.0 (81 kW)															
2001.12-	2002.04	MT	R	F	Platform/Chassis Engine RFL (XU10J2U)	610009	Inner Joint			41	45	34.9	367.5	115.6	
2001.12-	2002.04	MT	R	F	Platform/Chassis Engine RFL (XU10J2U)	210036	Drive Shaft	54T		28	41	63	112.5	1079	
2001.12-	2002.04	MT	R	F	Platform/Chassis Engine RFL (XU10J2U)	210066	Drive Shaft			35	41	70	117	1085	
2001.12-	2002.04	MT	R	F	Platform/Chassis Engine RFL (XU10J2U)	210032	Drive Shaft	54T		35	41	70	117	1085	
2.0 i (80 kW)															
1994.06-	2002.04	MT	R	F	Platform/Chassis Engine RFW (XU10J2)	210069	Drive Shaft			28	37	63	112.5	1072	
1994.06-	2002.04	MT	R	F	Platform/Chassis Engine RFW (XU10J2)	610009	Inner Joint			41	45	34.9	367.5	115.6	
1994.06-	2002.04	MT	L	F	Platform/Chassis Engine RFW (XU10J2)	210035	Drive Shaft	54T		28	41	63	112.5	757.5	
1994.06-	2002.04	MT	L	F	Platform/Chassis Engine RFW (XU10J2)	610015	Inner Joint			37	39	40	68.5	104	
1994.06-	2002.04	MT	L/R	F	Platform/Chassis Engine RFW (XU10J2)	810012	Outer Joint			28	39	63	112.5	63	I
1994.06-	2002.04	MT	L	F	Platform/Chassis Engine RFW (XU10J2)	210102	Drive Shaft			28	41	63	112.5	757.5	
1994.06-	2002.04	MT	L	F	Platform/Chassis Engine RFW (XU10J2)	210037	Drive Shaft	54T		28	37	63	112.5	771	
1994.06-	2002.04	MT	R	F	Platform/Chassis Engine RFW (XU10J2)	210066	Drive Shaft			35	41	70	117	1085	
1994.06-	2002.04	MT	R	F	Platform/Chassis Engine RFW (XU10J2)	210036	Drive Shaft	54T		28	41	63	112.5	1079	
1994.06-	2002.04	MT	R	F	Platform/Chassis Engine RFW (XU10J2)	210032	Drive Shaft	54T		35	41	70	117	1085	
1994.06-	2002.04	MT	L/R	F	Platform/Chassis Engine RFW (XU10J2)	810011	Outer Joint	54T		35	45	70	117	73	I
1994.06-	2002.04	MT	R	F	Platform/Chassis Engine RFW (XU10J2)	610034	Inner Joint			37	39	31.9	369.5	99	
1994.06-	2002.04	MT	L	F	Platform/Chassis Engine RFW (XU10J2)	210105	Drive Shaft			28	37	63	112.5	771	
1994.06-	2002.04	MT	R	F	Platform/Chassis Engine RFW (XU10J2)	210103	Drive Shaft			28	41	63	112.5	1079	
1994.06-	2002.04	-	-	-	Platform/Chassis Engine RFW (XU10J2)	645013	Inner Joint			37	39	40	68.5	100	
1994.06-	2002.04	MT	L/R	F	Platform/Chassis Engine RFW (XU10J2)	810013	Outer Joint	54T		28	39	63	112.5	63	I
1994.06-	2002.04	MT	R	F	Platform/Chassis Engine RFW (XU10J2)	210104	Drive Shaft	54T		28	37	63	112.5	1072	
1994.06-	2002.04	MT	L	F	Platform/Chassis Engine RFW (XU10J2)	210067	Drive Shaft			35	41	70	117	762	
1994.06-	2002.04	MT	L	F	Platform/Chassis Engine RFW (XU10J2)	210033	Drive Shaft	54T		35	41	70	117	762	
1994.06-	2002.04	MT	L/R	F	Platform/Chassis Engine RFW (XU10J2)	810050	Outer Joint			35	45	70	117	73	I
2.5 D (63 kW)															
1994.03-	2002.04	MT	L	F	Platform/Chassis Engine T9A (DJ5)	210067	Drive Shaft			35	41	70	117	762	
1994.03-	2002.04	MT	L	F	Platform/Chassis Engine T9A (DJ5)	210033	Drive Shaft	54T		35	41	70	117	762	
1994.03-	2002.04	MT	R	F	Platform/Chassis Engine T9A (DJ5)	210069	Drive Shaft			28	37	63	112.5	1072	
1994.03-	2002.04	MT	L/R	F	Platform/Chassis Engine T9A (DJ5)	810050	Outer Joint			35	45	70	117	73	I
1994.03-	2002.04	MT	L	F	Platform/Chassis Engine T9A (DJ5)	210035	Drive Shaft	54T		28	41	63	112.5	757.5	
1994.03-	2002.04	MT	R	F	Platform/Chassis Engine T9A (DJ5)	610009	Inner Joint			41	45	34.9	367.5	115.6	
1994.03-	2002.04	MT	L	F	Platform/Chassis Engine T9A (DJ5)	610015	Inner Joint			37	39	40	68.5	104	
1994.03-	2002.04	MT	L/R	F	Platform/Chassis Engine T9A (DJ5)	810012	Outer Joint			28	39	63	112.5	63	I
1994.03-	2002.04	MT	L	F	Platform/Chassis Engine T9A (DJ5)	210102	Drive Shaft			28	41	63	112.5	757.5	
1994.03-	2002.04	MT	L	F	Platform/Chassis Engine T9A (DJ5)	210037	Drive Shaft	54T		28	37	63	112.5	771	
1994.03-	2002.04	MT	R	F	Platform/Chassis Engine T9A (DJ5)	210036	Drive Shaft	54T		28	41	63	112.5	1079	
1994.03-	2002.04	MT	R	F	Platform/Chassis Engine T9A (DJ5)	210066	Drive Shaft			35	41	70	117	1085	
1994.03-	2002.04	MT	R	F	Platform/Chassis Engine T9A (DJ5)	610034	Inner Joint			37	39	31.9	369.5	99	
1994.03-	2002.04	MT	L/R	F	Platform/Chassis Engine T9A (DJ5)	810011	Outer Joint	54T		35	45	70	117	73	I
1994.03-	2002.04	MT	R	F	Platform/Chassis Engine T9A (DJ5)	210032	Drive Shaft	54T		35	41	70	117	1085	
1994.03-	2002.04	MT	L	F	Platform/Chassis Engine T9A (DJ5)	210105	Drive Shaft			28	37	63	112.5	771	
1994.03-	2002.04	-	-	-	Platform/Chassis Engine T9A (DJ5)	645013	Inner Joint			37	39	40	68.5	100	
1994.03-	2002.04	MT	R	F	Platform/Chassis Engine T9A (DJ5)	210103	Drive Shaft			28	41	63	112.5	1079	
1994.03-	2002.04	MT	L/R	F	Platform/Chassis Engine T9A (DJ5)	810013	Outer Joint	54T		28	39	63	112.5	63	I
1994.03-	2002.04	MT	R	F	Platform/Chassis Engine T9A (DJ5)	210104	Drive Shaft	54T		28	37	63	112.5	1072	
1999.07-	2002.04	MT	L	F	All-wheel Drive Platform/Chassis Engine T9A (DJ5)	210067	Drive Shaft			35	41	70	117	762	
1999.07-	2002.04	MT	L	F	All-wheel Drive Platform/Chassis Engine T9A (DJ5)	210033	Drive Shaft	54T		35	41	70	117	762	
1999.07-	2002.04	MT	R	F	All-wheel Drive Platform/Chassis Engine T9A (DJ5)	210069	Drive Shaft			28	37	63	112.5	1072	
1999.07-	2002.04	MT	L/R	F	All-wheel Drive Platform/Chassis Engine T9A (DJ5)	810050	Outer Joint			35	45	70	117	73	I
1999.07-	2002.04	MT	L	F	All-wheel Drive Platform/Chassis Engine T9A (DJ5)	210035	Drive Shaft	54T		28	41	63	112.5	757.5	
1999.07-	2002.04	MT	R	F	All-wheel Drive Platform/Chassis Engine T9A (DJ5)	610009	Inner Joint			41	45	34.9	367.5	115.6	
1999.07-	2002.04	MT	L	F	All-wheel Drive Platform/Chassis Engine T9A (DJ5)	610015	Inner Joint			37	39	40	68.5	104	
1999.07-	2002.04	MT	L/R	F	All-wheel Drive Platform/Chassis Engine T9A (DJ5)	810012	Outer Joint			28	39	63	112.5	63	I
1999.07-	2002.04	MT	L	F	All-wheel Drive Platform/Chassis Engine T9A (DJ5)	210102	Drive Shaft			28	41	63	112.5	757.5	
1999.07-	2002.04	MT	L	F	All-wheel Drive Platform/Chassis Engine T9A (DJ5)	210037	Drive Shaft	54T		28	37	63	112.5	771	

YEAR		TRANSM	L/R	F/R	REMARKS	GSP Ref.	PRODUCT	ABS	Technical Specifications								
									A	B	C	H	L	P			
PEUGEOT																	
BOXER (ZCT_)																	
2.5 D (63 kW)																	
1999.07-	2002.04	MT	R	F	All-wheel Drive Platform/Chassis Engine T9A (DJ5)	210036	Drive Shaft	54T	28	41	63	112.5	1079				
1999.07-	2002.04	MT	R	F	All-wheel Drive Platform/Chassis Engine T9A (DJ5)	210066	Drive Shaft		35	41	70	117	1085				
1999.07-	2002.04	MT	R	F	All-wheel Drive Platform/Chassis Engine T9A (DJ5)	610034	Inner Joint		37	39	31.9	369.5	99				
1999.07-	2002.04	MT	L/R	F	All-wheel Drive Platform/Chassis Engine T9A (DJ5)	810011	Outer Joint	54T	35	45	70	117	73	I			
1999.07-	2002.04	MT	R	F	All-wheel Drive Platform/Chassis Engine T9A (DJ5)	210032	Drive Shaft	54T	35	41	70	117	1085				
1999.07-	2002.04	MT	L	F	All-wheel Drive Platform/Chassis Engine T9A (DJ5)	210105	Drive Shaft		28	37	63	112.5	771				
1999.07-	2002.04	-	-	-	All-wheel Drive Platform/Chassis Engine T9A (DJ5)	645013	Inner Joint		37	39	40	68.5	100				
1999.07-	2002.04	MT	R	F	All-wheel Drive Platform/Chassis Engine T9A (DJ5)	210103	Drive Shaft		28	41	63	112.5	1079				
1999.07-	2002.04	MT	L/R	F	All-wheel Drive Platform/Chassis Engine T9A (DJ5)	810013	Outer Joint	54T	28	39	63	112.5	63	I			
1999.07-	2002.04	MT	R	F	All-wheel Drive Platform/Chassis Engine T9A (DJ5)	210104	Drive Shaft	54T	28	37	63	112.5	1072				
2.5 TD (76 kW)																	
1994.03-	2002.04	MT	L	F	Platform/Chassis Engine T8A (DJ5T)	610015	Inner Joint		37	39	40	68.5	104				
1994.03-	2002.04	MT	L/R	F	Platform/Chassis Engine T8A (DJ5T)	810012	Outer Joint		28	39	63	112.5	63	I			
1994.03-	2002.04	MT	L	F	Platform/Chassis Engine T8A (DJ5T)	210102	Drive Shaft		28	41	63	112.5	757.5				
1994.03-	2002.04	MT	L	F	Platform/Chassis Engine T8A (DJ5T)	210037	Drive Shaft	54T	28	37	63	112.5	771				
1994.03-	2002.04	MT	R	F	Platform/Chassis Engine T8A (DJ5T)	210066	Drive Shaft		35	41	70	117	1085				
1994.03-	2002.04	MT	R	F	Platform/Chassis Engine T8A (DJ5T)	210036	Drive Shaft	54T	28	41	63	112.5	1079				
1994.03-	2002.04	MT	R	F	Platform/Chassis Engine T8A (DJ5T)	210032	Drive Shaft	54T	35	41	70	117	1085				
1994.03-	2002.04	MT	L/R	F	Platform/Chassis Engine T8A (DJ5T)	810011	Outer Joint	54T	35	45	70	117	73	I			
1994.03-	2002.04	MT	R	F	Platform/Chassis Engine T8A (DJ5T)	610034	Inner Joint		37	39	31.9	369.5	99				
1994.03-	2002.04	MT	L	F	Platform/Chassis Engine T8A (DJ5T)	210105	Drive Shaft		28	37	63	112.5	771				
1994.03-	2002.04	MT	R	F	Platform/Chassis Engine T8A (DJ5T)	210103	Drive Shaft		28	41	63	112.5	1079				
1994.03-	2002.04	MT	L/R	F	Platform/Chassis Engine T8A (DJ5T)	810013	Outer Joint	54T	28	39	63	112.5	63	I			
1994.03-	2002.04	-	-	-	Platform/Chassis Engine T8A (DJ5T)	645013	Inner Joint		37	39	40	68.5	100				
1994.03-	2002.04	MT	R	F	Platform/Chassis Engine T8A (DJ5T)	210104	Drive Shaft	54T	28	37	63	112.5	1072				
1994.03-	2002.04	MT	L	F	Platform/Chassis Engine T8A (DJ5T)	210067	Drive Shaft		35	41	70	117	762				
1994.03-	2002.04	MT	L	F	Platform/Chassis Engine T8A (DJ5T)	210033	Drive Shaft	54T	35	41	70	117	762				
1994.03-	2002.04	MT	L/R	F	Platform/Chassis Engine T8A (DJ5T)	810050	Outer Joint		35	45	70	117	73	I			
1994.03-	2002.04	MT	R	F	Platform/Chassis Engine T8A (DJ5T)	210069	Drive Shaft		28	37	63	112.5	1072				
1994.03-	2002.04	MT	R	F	Platform/Chassis Engine T8A (DJ5T)	610009	Inner Joint		41	45	34.9	367.5	115.6				
1994.03-	2002.04	MT	L	F	Platform/Chassis Engine T8A (DJ5T)	210035	Drive Shaft	54T	28	41	63	112.5	757.5				
2.5 TDI (79 kW)																	
1997.01-	2002.04	MT	L/R	F	Platform/Chassis Engine THX (DJ5TED)	810012	Outer Joint		28	39	63	112.5	63	I			
1997.01-	2002.04	MT	L	F	Platform/Chassis Engine THX (DJ5TED)	210102	Drive Shaft		28	41	63	112.5	757.5				
1997.01-	2002.04	MT	L	F	Platform/Chassis Engine THX (DJ5TED)	210037	Drive Shaft	54T	28	37	63	112.5	771				
1997.01-	2002.04	MT	R	F	Platform/Chassis Engine THX (DJ5TED)	210066	Drive Shaft		35	41	70	117	1085				
1997.01-	2002.04	MT	R	F	Platform/Chassis Engine THX (DJ5TED)	210036	Drive Shaft	54T	28	41	63	112.5	1079				
1997.01-	2002.04	MT	R	F	Platform/Chassis Engine THX (DJ5TED)	210032	Drive Shaft	54T	35	41	70	117	1085				
1997.01-	2002.04	MT	L/R	F	Platform/Chassis Engine THX (DJ5TED)	810011	Outer Joint	54T	35	45	70	117	73	I			
1997.01-	2002.04	MT	R	F	Platform/Chassis Engine THX (DJ5TED)	610034	Inner Joint		37	39	31.9	369.5	99				
1997.01-	2002.04	MT	L	F	Platform/Chassis Engine THX (DJ5TED)	210105	Drive Shaft		28	37	63	112.5	771				
1997.01-	2002.04	MT	R	F	Platform/Chassis Engine THX (DJ5TED)	210103	Drive Shaft		28	41	63	112.5	1079				
1997.01-	2002.04	MT	L/R	F	Platform/Chassis Engine THX (DJ5TED)	810013	Outer Joint	54T	28	39	63	112.5	63	I			
1997.01-	2002.04	-	-	-	Platform/Chassis Engine THX (DJ5TED)	645013	Inner Joint		37	39	40	68.5	100				
1997.01-	2002.04	MT	R	F	Platform/Chassis Engine THX (DJ5TED)	210104	Drive Shaft	54T	28	37	63	112.5	1072				
1997.01-	2002.04	MT	L	F	Platform/Chassis Engine THX (DJ5TED)	210067	Drive Shaft		35	41	70	117	762				
1997.01-	2002.04	MT	L	F	Platform/Chassis Engine THX (DJ5TED)	210033	Drive Shaft	54T	35	41	70	117	762				
1997.01-	2002.04	MT	L/R	F	Platform/Chassis Engine THX (DJ5TED)	810050	Outer Joint		35	45	70	117	73	I			
1997.01-	2002.04	MT	R	F	Platform/Chassis Engine THX (DJ5TED)	210069	Drive Shaft		28	37	63	112.5	1072				
1997.01-	2002.04	MT	R	F	Platform/Chassis Engine THX (DJ5TED)	610009	Inner Joint		41	45	34.9	367.5	115.6				
1997.01-	2002.04	MT	L	F	Platform/Chassis Engine THX (DJ5TED)	210035	Drive Shaft	54T	28	41	63	112.5	757.5				
1997.01-	2002.04	MT	L	F	Platform/Chassis Engine THX (DJ5TED)	610015	Inner Joint		37	39	40	68.5	104				
1999.07-	2002.04	MT	L	F	All-wheel Drive Platform/Chassis Engine THX (DJ5TED)	610015	Inner Joint		37	39	40	68.5	104				
1999.07-	2002.04	MT	L/R	F	All-wheel Drive Platform/Chassis Engine THX (DJ5TED)	810012	Outer Joint		28	39	63	112.5	63	I			
1999.07-	2002.04	MT	L	F	All-wheel Drive Platform/Chassis Engine THX (DJ5TED)	210102	Drive Shaft		28	41	63	112.5	757.5				
1999.07-	2002.04	MT	L	F	All-wheel Drive Platform/Chassis Engine THX (DJ5TED)	210037	Drive Shaft	54T	28	37	63	112.5	771				
1999.07-	2002.04	MT	R	F	All-wheel Drive Platform/Chassis Engine THX (DJ5TED)	210066	Drive Shaft		35	41	70	117	1085				
1999.07-	2002.04	MT	R	F	All-wheel Drive Platform/Chassis Engine THX (DJ5TED)	210036	Drive Shaft	54T	28	41	63	112.5	1079				
1999.07-	2002.04	MT	R	F	All-wheel Drive Platform/Chassis Engine THX (DJ5TED)	210032	Drive Shaft	54T	35	41	70	117	1085				
1999.07-	2002.04	MT	L/R	F	All-wheel Drive Platform/Chassis Engine THX (DJ5TED)	810011	Outer Joint	54T	35	45	70	117	73	I			
1999.07-	2002.04	MT	R	F	All-wheel Drive Platform/Chassis Engine THX (DJ5TED)	610034	Inner Joint		37	39	31.9	369.5	99				
1999.07-	2002.04	MT	L	F	All-wheel Drive Platform/Chassis Engine THX (DJ5TED)	210105	Drive Shaft		28	37	63	112.5	771				
1999.07-	2002.04	MT	R	F	All-wheel Drive Platform/Chassis Engine THX (DJ5TED)	210103	Drive Shaft		28	41	63	112.5	1079				
1999.07-	2002.04	MT	L/R	F	All-wheel Drive Platform/Chassis Engine THX (DJ5TED)	810013	Outer Joint	54T	28	39	63	112.5	63	I			
1999.07-	2002.04	-	-	-	All-wheel Drive Platform/Chassis Engine THX (DJ5TED)	645013	Inner Joint		37	39	40	68.5	100				
1999.07-	2002.04	MT	R	F	All-wheel Drive Platform/Chassis Engine THX (DJ5TED)	210104	Drive Shaft	54T	28	37	63	112.5	1072				
1999.07-	2002.04	MT	L	F	All-wheel Drive Platform/Chassis Engine THX (DJ5TED)	210067	Drive Shaft		35	41	70	117	762				
1999.07-	2002.04	MT	L	F	All-wheel Drive Platform/Chassis Engine THX (DJ5TED)	210033	Drive Shaft	54T	35	41	70	117	762				

		 YEAR	TRANSM	L/R	F/R	REMARKS	GSP Ref.	 PRODUCT	 ABS	Technical Specifications						
										A	B	C	H	L	P	
PEUGEOT																
BOXER (ZCT_)																
2.5 TDI (79 kW)	1999.07-2002.04	MT	L/R	F	All-wheel Drive Platform/Chassis Engine THX (DJ5TED)	810050	Outer Joint			35	45	70	117	73	I	
	1999.07-2002.04	MT	R	F	All-wheel Drive Platform/Chassis Engine THX (DJ5TED)	210069	Drive Shaft			28	37	63	112.5	1072		
	1999.07-2002.04	MT	R	F	All-wheel Drive Platform/Chassis Engine THX (DJ5TED)	610009	Inner Joint			41	45	34.9	367.5	115.6		
	1999.07-2002.04	MT	L	F	All-wheel Drive Platform/Chassis Engine THX (DJ5TED)	210035	Drive Shaft	54T		28	41	63	112.5	757.5		
2.8 HDI (94 kW)	2000.11-2002.04	MT	L	F	Platform/Chassis Engine 8140.43S (F28DTCR)	210067	Drive Shaft			35	41	70	117	762		
	2000.11-2002.04	MT	L/R	F	Platform/Chassis Engine 8140.43S (F28DTCR)	810050	Outer Joint			35	45	70	117	73	I	
	2000.11-2002.04	MT	L	F	Platform/Chassis Engine 8140.43S (F28DTCR)	210033	Drive Shaft	54T		35	41	70	117	762		
	2000.11-2002.04	MT	R	F	Platform/Chassis Engine 8140.43S (F28DTCR)	610009	Inner Joint			41	45	34.9	367.5	115.6		
	2000.11-2002.04	MT	R	F	Platform/Chassis Engine 8140.43S (F28DTCR)	210066	Drive Shaft			35	41	70	117	1085		
	2000.11-2002.04	MT	L/R	F	Platform/Chassis Engine 8140.43S (F28DTCR)	810011	Outer Joint	54T		35	45	70	117	73	I	
	2000.11-2002.04	MT	R	F	Platform/Chassis Engine 8140.43S (F28DTCR)	210032	Drive Shaft	54T		35	41	70	117	1085		
BOXER I-II																
2.5 D	1994-2006	-	L	F	-	610010	Inner Joint			41	45	43	70	115.5		
2.8 HDI	1994-2006	-	L	F	-	610010	Inner Joint			41	45	43	70	115.5		
EXPERT																
1.6 HdI 90 16V (66 kW)	2007.01--	-	R	F	Platform/Chassis Engine 9HU (DV6UTED4)	210239	Drive Shaft			28	24	58.5	92	958		
	2007.01--	-	L	F	Platform/Chassis Engine 9HU (DV6UTED4)	645032	Inner Joint			37	39	40	68.5	100		
	2007.01--	MT	-	F	Platform/Chassis Engine 9HU (DV6UTED4)	810052	Outer Joint			28	34	58.5	92	55	I	
	2007.01--	-	-	F	Platform/Chassis Engine 9HU (DV6UTED4)	810051	Outer Joint			28	39	58.6	94	63	I	
1.6 HdI 90 8V (66 kW)	2007.01--	MT	R	F	Platform/Chassis	210239	Drive Shaft			28	24	58.5	92	958		
	2007.01--	MT	-	F	Platform/Chassis	810052	Outer Joint			28	34	58.5	92	55	I	
	2007.01--	-	-	F	Platform/Chassis	810051	Outer Joint			28	39	58.6	94	63	I	
1.9 TD	1995-2006	-	R	F	-	210296	Drive Shaft	48T		27	37	59	82	947		
2.0 BlueHdI 120 (90 kW)	2016.04--	-	-	F	Box	810051	Outer Joint			28	39	58.6	94	63	I	
	2016.09--	-	-	F	Platform/Chassis	810051	Outer Joint			28	39	58.6	94	63	I	
2.0 BlueHdI 150 (110 kW)	2016.04--	-	-	F	Box Engine AHX (DW10FD)	810051	Outer Joint			28	39	58.6	94	63	I	
	2016.09--	-	-	F	Platform/Chassis Engine AHX (DW10FD)	810051	Outer Joint			28	39	58.6	94	63	I	
2.0 HdI	1995-2006	-	R	F	-	210296	Drive Shaft	48T		27	37	59	82	947		
2.0 HdI 120 (88 kW)	2007.01--	MT	R	F	Platform/Chassis Engine RHK (DW10UTED4)	210244	Drive Shaft			28	37	58.6	93	979		
	2007.01--	MT	L	F	Platform/Chassis Engine RHK (DW10UTED4)	645032	Inner Joint			37	39	40	68.5	100		
	2007.01--	MT	L	F	Platform/Chassis Engine RHK (DW10UTED4)	245133	Drive Shaft			28	37	58.6	94	653		
	2007.01--	MT	R	F	Platform/Chassis Engine RHK (DW10UTED4)	299214	Drive Shaft			28	37	58.6	94	978		
	2007.01--	-	-	F	Platform/Chassis Engine RHK (DW10UTED4)	810098	Outer Joint			28	39	58.6	93	63	I	
	2007.01--	MT	L	F	Platform/Chassis Engine RHK (DW10UTED4)	210234	Drive Shaft			28	37	58.6	93	648		
	2007.01--	MT	R	F	Platform/Chassis Engine RHK (DW10UTED4)	810159	Outer Joint			28	39	58.6	94	63	I	
	2007.01--	-	-	F	Platform/Chassis Engine RHK (DW10UTED4)	810051	Outer Joint			28	39	58.6	94	63	I	
	2007.01--	MT	R	F	Platform/Chassis Engine RHK (DW10UTED4)	610041	Inner Joint			37	39	32	399	95.5		
	2007.01--	MT	R	F	Platform/Chassis Engine RHK (DW10UTED4)	210244	Drive Shaft			28	37	58.6	93	979		
2.0 HdI 130 (94 kW)	2011.03--	MT	R	F	Platform/Chassis Engine AHZ (DW10CD)	210244	Drive Shaft			28	37	58.6	94	653		
	2011.03--	MT	L	F	Platform/Chassis Engine AHZ (DW10CD)	245133	Drive Shaft			28	37	58.6	94	653		
	2011.03--	MT	R	F	Platform/Chassis Engine AHZ (DW10CD)	299214	Drive Shaft			28	37	58.6	94	978		
	2011.03--	MT	R	F	Platform/Chassis Engine AHZ (DW10CD)	810159	Outer Joint			28	39	58.6	94	63	I	
2.0 HdI 140 (100 kW)	2011.03--	MT	R	F	Platform/Chassis Engine AHZ (DW10CD)	610041	Inner Joint			37	39	32	399	95.5		
	2007.01--	MT	R	F	Platform/Chassis Engine RHR (DW10BTED4)	210244	Drive Shaft			28	37	58.6	93	979		
	2007.01--	MT	L	F	Platform/Chassis Engine RHR (DW10BTED4)	645032	Inner Joint			37	39	40	68.5	100		
	2007.01--	MT	L	F	Platform/Chassis Engine RHR (DW10BTED4)	245133	Drive Shaft			28	37	58.6	94	653		
	2007.01--	MT	R	F	Platform/Chassis Engine RHR (DW10BTED4)	299214	Drive Shaft			28	37	58.6	94	978		
	2007.01--	-	-	F	Platform/Chassis Engine RHR (DW10BTED4)	810098	Outer Joint			28	39	58.6	93	63	I	
	2007.01--	MT	L	F	Platform/Chassis Engine RHR (DW10BTED4)	210234	Drive Shaft			28	37	58.6	93	648		
	2007.01--	MT	R	F	Platform/Chassis Engine RHR (DW10BTED4)	810159	Outer Joint			28	39	58.6	94	63	I	
	2007.01--	-	-	F	Platform/Chassis Engine RHR (DW10BTED4)	810051	Outer Joint			28	39	58.6	94	63	I	
	2007.01--	MT	R	F	Platform/Chassis Engine RHR (DW10BTED4)	610041	Inner Joint			37	39	32	399	95.5		
2.0 HdI 165 (120 kW)	2009.09--	MT	R	F	Platform/Chassis Engine RHH (DW10CTED4)	210244	Drive Shaft			28	37	58.6	93	979		
	2009.09--	-	L	F	Platform/Chassis Engine RHH (DW10CTED4)	245133	Drive Shaft			28	37	58.6	94	653		
	2009.09--	-	R	F	Platform/Chassis Engine RHH (DW10CTED4)	299214	Drive Shaft			28	37	58.6	94	978		
	2009.09--	-	R	F	Platform/Chassis Engine RHH (DW10CTED4)	810159	Outer Joint			28	39	58.6	94	63	I	
	2009.09--	MT	-	F	Platform/Chassis Engine RHH (DW10CTED4)	810051	Outer Joint			28	39	58.6	94	63	I	
	2009.09--	-	R	F	Platform/Chassis Engine RHH (DW10CTED4)	610041	Inner Joint			37	39	32	399	95.5		
EXPERT (222)																
1.6 (58 kW)	1996.02-2000.09	MT	L	F	Box Engine 222A2 (1580 SPI)	210082	Drive Shaft	48T		27	24	59	82	648		
	1996.02-2000.09	MT	R	F	Box Engine 222A2 (1580 SPI)	210012	Drive Shaft	48T		27	24	64	80.5	928		
	1996.02-2000.09	MT	L/R	F	Box Engine 222A2 (1580 SPI)	810018	Outer Joint	48T		27	34	61	82	55	I	
	1996.02-2000.09	MT	L	F	Box Engine 222A2 (1580 SPI)	210052	Drive Shaft			27	24	61	82	648		
	1996.02-2000.09	MT	R	F	Box Engine 222A2 (1580 SPI)	210120	Drive Shaft			27	24	59	82	928		
1.8 (74 kW)	1996.10-2000.09	-	R	F	Box Engine LFZ (XU7JP)	210120	Drive Shaft			27	24	59	82	928		
	1996.10-2000.09	-	L	F	Box Engine LFZ (XU7JP)	210082	Drive Shaft	48T		27	24	59	82	648		
	1996.10-2000.09	-	R	F	Box Engine LFZ (XU7JP)	210012	Drive Shaft	48T		27	24	64	80.5	928		

	 YEAR	TRANSM	L/R	F/R	REMARKS	GSP Ref.	 PRODUCT	 ABS	Technical Specifications					
									A	B	C	H	L	P
PEUGEOT EXPERT (222)														
1.8 (74 kW)	1996.10-2000.09	-	L	F	Box Engine LFZ (XU7JP)	210052	Drive Shaft		27	24	61	82	648	
1.9 D (51 kW)	1996.02-1998.12	-	-	F	Box Engine D9B (XUD9AU)	810016	Outer Joint		27	34	59	82	55	I
	1996.02-1998.12	MT	L	F	Box Engine D9B (XUD9AU)	210082	Drive Shaft	48T	27	24	59	82	648	
	1996.02-1998.12	-	R	F	Box Engine D9B (XUD9AU)	210081	Drive Shaft	48T	27	24	59	82	935	
	1996.02-1998.12	-	L	F	Box Engine D9B (XUD9AU)	210112	Drive Shaft		27	24	59	82	648	
	1996.02-1998.12	MT	R	F	Box Engine D9B (XUD9AU)	210012	Drive Shaft	48T	27	24	64	80.5	928	
	1996.02-1998.12	-	R	F	Box Engine D9B (XUD9AU)	210111	Drive Shaft		27	24	59	82	935	
	1996.02-1998.12	MT	L/R	F	Box Engine D9B (XUD9AU)	810018	Outer Joint	48T	27	34	61	82	55	I
	1996.02-1998.12	MT	L	F	Box Engine D9B (XUD9AU)	210052	Drive Shaft		27	24	61	82	648	
	1996.02-1998.12	-	-	F	Box Engine D9B (XUD9AU)	810059	Outer Joint	48T	27	34	59	82	55	I
1.9 D 70 (51 kW)	1998.12-2006.12	-	-	F	Box Engine WJZ (DW8)/WJY (DW8B)	810016	Outer Joint		27	34	59	82	55	I
	1998.12-2006.12	MT	L	F	Box Engine WJZ (DW8)/WJY (DW8B)	210082	Drive Shaft	48T	27	24	59	82	648	
	1998.12-2006.12	-	R	F	Box Engine WJZ (DW8)/WJY (DW8B)	210081	Drive Shaft	48T	27	24	59	82	935	
	1998.12-2006.12	-	L	F	Box Engine WJZ (DW8)/WJY (DW8B)	210112	Drive Shaft		27	24	59	82	648	
	1998.12-2006.12	MT	R	F	Box Engine WJZ (DW8)/WJY (DW8B)	210012	Drive Shaft	48T	27	24	64	80.5	928	
	1998.12-2006.12	-	R	F	Box Engine WJZ (DW8)/WJY (DW8B)	210111	Drive Shaft		27	24	59	82	935	
	1998.12-2006.12	MT	L/R	F	Box Engine WJZ (DW8)/WJY (DW8B)	810018	Outer Joint	48T	27	34	61	82	55	I
	1998.12-2006.12	MT	L	F	Box Engine WJZ (DW8)/WJY (DW8B)	210052	Drive Shaft		27	24	61	82	648	
	1998.12-2006.12	MT	R	F	Box Engine WJZ (DW8)/WJY (DW8B)	210120	Drive Shaft		27	24	59	82	928	
1.9 TD (66 kW)	1996.02-2000.09	-	L	F	Box Engine DHX (XUD9TE)	210082	Drive Shaft	48T	27	24	59	82	648	
	1996.02-2000.09	-	L	F	Box Engine DHX (XUD9TE)	610015	Inner Joint		37	39	40	68.5	104	
	1996.02-2000.09	-	R	F	Box Engine DHX (XUD9TE)	210012	Drive Shaft	48T	27	24	64	80.5	928	
	1996.02-2000.09	-	R	F	Box Engine DHX (XUD9TE)	610034	Inner Joint		37	39	31.9	369.5	99	
	1996.02-2000.09	MT	L	F	Box Engine DHX (XUD9TE)	210073	Drive Shaft	48T	27	37	59	82	641	
	1996.02-2000.09	MT	R	F	Box Engine DHX (XUD9TE)	210108	Drive Shaft	48T	27	37	59	82	939	
	1996.02-2000.09	-	L	F	Box Engine DHX (XUD9TE)	210072	Drive Shaft		27	37	59	82	641	
	1996.02-2000.09	-	R	F	Box Engine DHX (XUD9TE)	210074	Drive Shaft		27	37	59	82	939	
	1996.02-2000.09	-	R	F	Box Engine DHX (XUD9TE)	210155	Drive Shaft		27	37	59	82	947	
	1996.02-2000.09	-	L/R	F	Box Engine DHX (XUD9TE)	810015	Outer Joint	48T	27	39	59	82	63	I
	1996.02-2000.09	-	L	F	Box Engine DHX (XUD9TE)	210052	Drive Shaft		27	24	61	82	648	
	1996.02-2000.09	-	L	F	Box Engine DHX (XUD9TE)	210016	Drive Shaft	48T	27	37	59	82	641	
	1996.02-2000.09	-	R	F	Box Engine DHX (XUD9TE)	210014	Drive Shaft	48T	27	37	59	82	947	
	1996.02-2000.09	-	R	F	Box Engine DHX (XUD9TE)	210120	Drive Shaft		27	24	59	82	928	
1.9 TD (68 kW)	1996.02-1998.05	-	R	F	Box Engine D8B (XUD9TE)	210120	Drive Shaft		27	24	59	82	928	
	1996.02-1998.05	-	L	F	Box Engine D8B (XUD9TE)	210082	Drive Shaft	48T	27	24	59	82	648	
	1996.02-1998.05	-	L	F	Box Engine D8B (XUD9TE)	610015	Inner Joint		37	39	40	68.5	104	
	1996.02-1998.05	-	R	F	Box Engine D8B (XUD9TE)	210012	Drive Shaft	48T	27	24	64	80.5	928	
	1996.02-1998.05	-	R	F	Box Engine D8B (XUD9TE)	610034	Inner Joint		37	39	31.9	369.5	99	
	1996.02-1998.05	-	L	F	Box Engine D8B (XUD9TE)	210073	Drive Shaft	48T	27	37	59	82	641	
	1996.02-1998.05	-	R	F	Box Engine D8B (XUD9TE)	210108	Drive Shaft	48T	27	37	59	82	939	
	1996.02-1998.05	-	L	F	Box Engine D8B (XUD9TE)	210072	Drive Shaft		27	37	59	82	641	
	1996.02-1998.05	-	R	F	Box Engine D8B (XUD9TE)	210074	Drive Shaft		27	37	59	82	939	
	1996.02-1998.05	-	R	F	Box Engine D8B (XUD9TE)	210155	Drive Shaft		27	37	59	82	947	
	1996.02-1998.05	-	L/R	F	Box Engine D8B (XUD9TE)	810015	Outer Joint	48T	27	39	59	82	63	I
	1996.02-1998.05	-	L	F	Box Engine D8B (XUD9TE)	210052	Drive Shaft		27	24	61	82	648	
	1996.02-1998.05	-	L	F	Box Engine D8B (XUD9TE)	210016	Drive Shaft	48T	27	37	59	82	641	
	1996.02-1998.05	-	R	F	Box Engine D8B (XUD9TE)	210014	Drive Shaft	48T	27	37	59	82	947	
2.0 (100 kW)	2002.09-2006.12	MT	R	F	Box Engine RFN (EW10J4)	210120	Drive Shaft		27	24	59	82	928	
	2002.09-2006.12	MT	L	F	Box Engine RFN (EW10J4)	210430	Drive Shaft		27	37	59	82	630	
	2002.09-2006.12	MT	R	F	Box Engine RFN (EW10J4)	210057	Drive Shaft		27	37	59	82	960	
	2002.09-2006.12	MT	L	F	Box Engine RFN (EW10J4)	210082	Drive Shaft	48T	27	24	59	82	648	
	2002.09-2006.12	MT	L	F	Box Engine RFN (EW10J4)	210264	Drive Shaft	48T	27	37	59	82	630	
	2002.09-2006.12	MT	R	F	Box Engine RFN (EW10J4)	245120	Drive Shaft	48T	27	37	59	82	960	
	2002.09-2006.12	MT	R	F	Box Engine RFN (EW10J4)	210012	Drive Shaft	48T	27	24	64	80.5	928	
	2002.09-2006.12	MT	L/R	F	Box Engine RFN (EW10J4)	810018	Outer Joint	48T	27	34	61	82	55	I
	2002.09-2006.12	MT	L	F	Box Engine RFN (EW10J4)	610015	Inner Joint		37	39	40	68.5	104	
	2002.09-2006.12	MT	L	F	Box Engine RFN (EW10J4)	210052	Drive Shaft		27	24	61	82	648	
	2002.09-2006.12	MT	R	F	Box Engine RFN (EW10J4)	610034	Inner Joint		37	39	31.9	369.5	99	
2.0 HDI (69 kW)	2000.07-2006.12	-	L	F	Box Engine RHX (DW10BTED)	210430	Drive Shaft		27	37	59	82	630	
	2000.07-2006.12	-	L	F	Box Engine RHX (DW10BTED)	210082	Drive Shaft	48T	27	24	59	82	648	
	2000.07-2006.12	-	R	F	Box Engine RHX (DW10BTED)	210057	Drive Shaft		27	37	59	82	960	
	2000.07-2006.12	-	L	F	Box Engine RHX (DW10BTED)	210264	Drive Shaft	48T	27	37	59	82	630	
	2000.07-2006.12	-	R	F	Box Engine RHX (DW10BTED)	210012	Drive Shaft	48T	27	24	64	80.5	928	
	2000.07-2006.12	-	R	F	Box Engine RHX (DW10BTED)	245120	Drive Shaft	48T	27	37	59	82	960	

YEAR	TRANSM	L/R	F/R	REMARKS	GSP Ref.	PRODUCT	ABS	Technical Specifications										
								A	B	C	H	L	P					
PEUGEOT																		
EXPERT (222)																		
2.0 HDI (69 kW)	2000.07-2006.12	-	L	F	Box Engine RHX (DW10BTED)	210052	Drive Shaft		27	24	61	82	648					
	2000.07-2006.12	-	L	F	Box Engine RHX (DW10BTED)	610015	Inner Joint		37	39	40	68.5	104					
	2000.07-2006.12	-	R	F	Box Engine RHX (DW10BTED)	610034	Inner Joint		37	39	31.9	369.5	99					
	2000.07-2006.12	-	R	F	Box Engine RHX (DW10BTED)	210120	Drive Shaft		27	24	59	82	928					
2.0 HDI (80 kW)	2000.07-2006.12	-	R	F	Box Engine RHZ (DW10BTED+YRHZ (DW10ATED)RHZ (DW10BTED)RHZ (DW10CTED))	210120	Drive Shaft		27	24	59	82	928					
	2000.07-2006.12	-	R	F	Box Engine RHW (DW10ATED4)	210120	Drive Shaft		27	24	59	82	928					
	2000.07-2006.12	-	L	F	Box Engine RHZ (DW10BTED+YRHZ (DW10ATED)RHZ (DW10BTED)RHZ (DW10CTED))	210430	Drive Shaft		27	37	59	82	630					
	2000.07-2006.12	-	L	F	Box Engine RHW (DW10ATED4)	210430	Drive Shaft		27	37	59	82	630					
	2000.07-2006.12	-	R	F	Box Engine RHZ (DW10BTED+YRHZ (DW10ATED)RHZ (DW10BTED)RHZ (DW10CTED))	210057	Drive Shaft		27	37	59	82	960					
	2000.07-2006.12	-	R	F	Box Engine RHW (DW10ATED4)	210057	Drive Shaft		27	37	59	82	960					
	2000.07-2006.12	-	L	F	Box Engine RHZ (DW10BTED+YRHZ (DW10ATED)RHZ (DW10BTED)RHZ (DW10CTED))	210082	Drive Shaft	48T	27	24	59	82	648					
	2000.07-2006.12	-	L	F	Box Engine RHW (DW10ATED4)	210082	Drive Shaft	48T	27	24	59	82	648					
	2000.07-2006.12	-	L	F	Box Engine RHZ (DW10BTED+YRHZ (DW10ATED)RHZ (DW10BTED)RHZ (DW10CTED))	210264	Drive Shaft	48T	27	37	59	82	630					
	2000.07-2006.12	-	L	F	Box Engine RHW (DW10ATED4)	210264	Drive Shaft	48T	27	37	59	82	630					
	2000.07-2006.12	-	R	F	Box Engine RHZ (DW10BTED+YRHZ (DW10ATED)RHZ (DW10BTED)RHZ (DW10CTED))	245120	Drive Shaft	48T	27	37	59	82	960					
	2000.07-2006.12	-	R	F	Box Engine RHZ (DW10BTED+YRHZ (DW10ATED)RHZ (DW10BTED)RHZ (DW10CTED))	210012	Drive Shaft	48T	27	24	64	80.5	928					
	2000.07-2006.12	-	R	F	Box Engine RHW (DW10ATED4)	245120	Drive Shaft	48T	27	37	59	82	960					
	2000.07-2006.12	-	R	F	Box Engine RHW (DW10ATED4)	210012	Drive Shaft	48T	27	24	64	80.5	928					
	2000.07-2006.12	-	L	F	Box Engine RHZ (DW10BTED+YRHZ (DW10ATED)RHZ (DW10BTED)RHZ (DW10CTED))	610015	Inner Joint		37	39	40	68.5	104					
	2000.07-2006.12	-	L	F	Box Engine RHW (DW10ATED4)	610015	Inner Joint		37	39	40	68.5	104					
	2000.07-2006.12	-	L	F	Box Engine RHZ (DW10BTED+YRHZ (DW10ATED)RHZ (DW10BTED)RHZ (DW10CTED))	210052	Drive Shaft		27	24	61	82	648					
	2000.07-2006.12	-	L	F	Box Engine RHW (DW10ATED4)	210052	Drive Shaft		27	24	61	82	648					
	2000.07-2006.12	-	R	F	Box Engine RHZ (DW10BTED+YRHZ (DW10ATED)RHZ (DW10BTED)RHZ (DW10CTED))	610034	Inner Joint		37	39	31.9	369.5	99					
	2000.07-2006.12	-	R	F	Box Engine RHW (DW10ATED4)	610034	Inner Joint		37	39	31.9	369.5	99					
EXPERT (223)																		
1.6 (58 kW)	1996.02-2000.09	MT	L	F	Platform/Chassis Engine 222A2 (1580 SPI)	210082	Drive Shaft	48T	27	24	59	82	648					
	1996.02-2000.09	MT	R	F	Platform/Chassis Engine 222A2 (1580 SPI)	210012	Drive Shaft	48T	27	24	64	80.5	928					
	1996.02-2000.09	MT	L/R	F	Platform/Chassis Engine 222A2 (1580 SPI)	810018	Outer Joint	48T	27	34	61	82	55	I				
	1996.02-2000.09	MT	L	F	Platform/Chassis Engine 222A2 (1580 SPI)	210052	Drive Shaft		27	24	61	82	648					
	1996.02-2000.09	MT	R	F	Platform/Chassis Engine 222A2 (1580 SPI)	210120	Drive Shaft		27	24	59	82	928					
1.9 D (51 kW)	1996.02-1998.12	-	-	F	Platform/Chassis Engine D9B (XUD9AU)	810016	Outer Joint		27	34	59	82	55	I				
	1996.02-1998.12	MT	L	F	Platform/Chassis Engine D9B (XUD9AU)	210082	Drive Shaft	48T	27	24	59	82	648					
	1996.02-1998.12	-	R	F	Platform/Chassis Engine D9B (XUD9AU)	210081	Drive Shaft	48T	27	24	59	82	935					
	1996.02-1998.12	-	L	F	Platform/Chassis Engine D9B (XUD9AU)	210112	Drive Shaft		27	24	59	82	648					
	1996.02-1998.12	MT	R	F	Platform/Chassis Engine D9B (XUD9AU)	210012	Drive Shaft	48T	27	24	64	80.5	928					
	1996.02-1998.12	-	R	F	Platform/Chassis Engine D9B (XUD9AU)	210111	Drive Shaft		27	24	59	82	935					
	1996.02-1998.12	MT	L/R	F	Platform/Chassis Engine D9B (XUD9AU)	810018	Outer Joint	48T	27	34	61	82	55	I				
	1996.02-1998.12	MT	L	F	Platform/Chassis Engine D9B (XUD9AU)	210052	Drive Shaft		27	24	61	82	648					
	1996.02-1998.12	-	-	F	Platform/Chassis Engine D9B (XUD9AU)	810059	Outer Joint	48T	27	34	59	82	55	I				
	1996.02-1998.12	MT	R	F	Platform/Chassis Engine D9B (XUD9AU)	210120	Drive Shaft		27	24	59	82	928					
	1998.06-2001.09	-	R	F	Platform/Chassis Engine WJZ (DW8)/WJY (DW8B)	210120	Drive Shaft		27	24	59	82	928					
	1998.06-2001.09	-	L	F	Platform/Chassis Engine WJZ (DW8)/WJY (DW8B)	210082	Drive Shaft	48T	27	24	59	82	648					
	1998.06-2001.09	-	R	F	Platform/Chassis Engine WJZ (DW8)/WJY (DW8B)	210012	Drive Shaft	48T	27	24	64	80.5	928					
	1998.06-2001.09	-	L	F	Platform/Chassis Engine WJZ (DW8)/WJY (DW8B)	210052	Drive Shaft		27	24	61	82	648					
1.9 TD (66 kW)	1996.02-2000.09	-	L	F	Platform/Chassis Engine DHX (XUD9TE)	210082	Drive Shaft	48T	27	24	59	82	648					
	1996.02-2000.09	-	L	F	Platform/Chassis Engine DHX (XUD9TE)	610015	Inner Joint		37	39	40	68.5	104					
	1996.02-2000.09	-	R	F	Platform/Chassis Engine DHX (XUD9TE)	210012	Drive Shaft	48T	27	24	64	80.5	928					
	1996.02-2000.09	-	R	F	Platform/Chassis Engine DHX (XUD9TE)	610034	Inner Joint		37	39	31.9	369.5	99					
	1996.02-2000.09	-	L	F	Platform/Chassis Engine DHX (XUD9TE)	210073	Drive Shaft	48T	27	37	59	82	641					
	1996.02-2000.09	-	R	F	Platform/Chassis Engine DHX (XUD9TE)	210108	Drive Shaft	48T	27	37	59	82	939					
	1996.02-2000.09	-	L	F	Platform/Chassis Engine DHX (XUD9TE)	210072	Drive Shaft		27	37	59	82	641					
	1996.02-2000.09	-	R	F	Platform/Chassis Engine DHX (XUD9TE)	210074	Drive Shaft		27	37	59	82	939					
	1996.02-2000.09	-	R	F	Platform/Chassis Engine DHX (XUD9TE)	210155	Drive Shaft		27	37	59	82	947					
	1996.02-2000.09	-	L/R	F	Platform/Chassis Engine DHX (XUD9TE)	810015	Outer Joint	48T	27	39	59	82	63	I				
	1996.02-2000.09	-	L	F	Platform/Chassis Engine DHX (XUD9TE)	210052	Drive Shaft		27	24	61	82	648					
	1996.02-2000.09	-	L	F	Platform/Chassis Engine DHX (XUD9TE)	210016	Drive Shaft	48T	27	37	59	82	641					
	1996.02-2000.09	-	R	F	Platform/Chassis Engine DHX (XUD9TE)	210014	Drive Shaft	48T	27	37	59	82	947					
	1996.02-2000.09	-	R	F	Platform/Chassis Engine DHX (XUD9TE)	210120	Drive Shaft		27	24	59	82	928					
1.9 TD (68 kW)	1996.02-1998.05	-	R	F	Platform/Chassis Engine D8B (XUD9TE)	210120	Drive Shaft		27	24	59	82	928					
	1996.02-1998.05	-	L	F	Platform/Chassis Engine D8B (XUD9TE)	210082	Drive Shaft	48T	27	24	59	82	648					
	1996.02-1998.05	-	L	F	Platform/Chassis Engine D8B (XUD9TE)	610015	Inner Joint		37	39	40	68.5	104					
	1996.02-1998.05	-	R	F	Platform/Chassis Engine D8B (XUD9TE)	210012	Drive Shaft	48T	27	24	64	80.5	928					
	1996.02-1998.05	-	R	F	Platform/Chassis Engine D8B (XUD9TE)	610034	Inner Joint		37	39	31.9	369.5	99					
	1996.02-1998.05	-	L	F	Platform/Chassis Engine D8B (XUD9TE)	210073	Drive Shaft	48T	27	37	59	82	641					
	1996.02-1998.05	-	R	F	Platform/Chassis Engine D8B (XUD9TE)	210108	Drive Shaft	48T	27	37	59	82	939					
	1996.02-1998.05	-	L	F	Platform/Chassis Engine D8B (XUD9TE)	210072	Drive Shaft		27	37	59	82	641					





YEAR	TRANSM	L/R	F/R	REMARKS	GSP Ref.	PRODUCT	ABS	Technical Specifications										
								A	B	C	H	L	P					
PEUGEOT																		
EXPERT (223)																		
1.9 TD (68 kW)	1996.02-1998.05	-	R	F	Platform/Chassis Engine D8B (XUD9TE)	210074	Drive Shaft		27	37	59	82	939					
	1996.02-1998.05	-	R	F	Platform/Chassis Engine D8B (XUD9TE)	210155	Drive Shaft		27	37	59	82	947					
	1996.02-1998.05	-	L/R	F	Platform/Chassis Engine D8B (XUD9TE)	810015	Outer Joint	48T	27	39	59	82	63	I				
	1996.02-1998.05	-	L	F	Platform/Chassis Engine D8B (XUD9TE)	210052	Drive Shaft		27	24	61	82	648					
	1996.02-1998.05	-	L	F	Platform/Chassis Engine D8B (XUD9TE)	210016	Drive Shaft	48T	27	37	59	82	641					
	1996.02-1998.05	-	R	F	Platform/Chassis Engine D8B (XUD9TE)	210014	Drive Shaft	48T	27	37	59	82	947					
2.0 HDi (80 kW)	2000.10-2006.10	-	R	F	Platform/Chassis Engine RHW (DW10ATED4)	210120	Drive Shaft		27	24	59	82	928					
	2000.10-2006.10	-	L	F	Platform/Chassis Engine RHW (DW10ATED4)	210430	Drive Shaft		27	37	59	82	630					
	2000.10-2006.10	-	R	F	Platform/Chassis Engine RHW (DW10ATED4)	210057	Drive Shaft		27	37	59	82	960					
	2000.10-2006.10	-	L	F	Platform/Chassis Engine RHW (DW10ATED4)	210082	Drive Shaft	48T	27	24	59	82	648					
	2000.10-2006.10	-	L	F	Platform/Chassis Engine RHW (DW10ATED4)	210264	Drive Shaft	48T	27	37	59	82	630					
	2000.10-2006.10	-	R	F	Platform/Chassis Engine RHW (DW10ATED4)	245120	Drive Shaft	48T	27	37	59	82	960					
	2000.10-2006.10	-	R	F	Platform/Chassis Engine RHW (DW10ATED4)	210012	Drive Shaft	48T	27	24	64	80.5	928					
	2000.10-2006.10	-	L	F	Platform/Chassis Engine RHW (DW10ATED4)	610015	Inner Joint		37	39	40	68.5	104					
	2000.10-2006.10	-	L	F	Platform/Chassis Engine RHW (DW10ATED4)	210052	Drive Shaft		27	24	61	82	648					
	2000.10-2006.10	-	R	F	Platform/Chassis Engine RHW (DW10ATED4)	610034	Inner Joint		37	39	31.9	369.5	99					
EXPERT (224)																		
1.6 (58 kW)	1996.02-2000.09	MT	L	F	MPV Engine 222A2 (1580 SPI)	210082	Drive Shaft	48T	27	24	59	82	648					
	1996.02-2000.09	MT	R	F	MPV Engine 222A2 (1580 SPI)	210012	Drive Shaft	48T	27	24	64	80.5	928					
	1996.02-2000.09	MT	L/R	F	MPV Engine 222A2 (1580 SPI)	810018	Outer Joint	48T	27	34	61	82	55	I				
	1996.02-2000.09	MT	L	F	MPV Engine 222A2 (1580 SPI)	210052	Drive Shaft		27	24	61	82	648					
	1996.02-2000.09	MT	R	F	MPV Engine 222A2 (1580 SPI)	210120	Drive Shaft		27	24	59	82	928					
1.8 (74 kW)	1996.10-2000.09	-	R	F	MPV Engine LFZ (XU7JP)	210120	Drive Shaft		27	24	59	82	928					
	1996.10-2000.09	-	L	F	MPV Engine LFZ (XU7JP)	210082	Drive Shaft	48T	27	24	59	82	648					
	1996.10-2000.09	-	R	F	MPV Engine LFZ (XU7JP)	210012	Drive Shaft	48T	27	24	64	80.5	928					
	1996.10-2000.09	-	L	F	MPV Engine LFZ (XU7JP)	210052	Drive Shaft		27	24	61	82	648					
1.9 D (51 kW)	1996.02-1998.12	-	-	F	MPV Engine D9B (XUD9AU)	810016	Outer Joint		27	34	59	82	55	I				
	1996.02-1998.12	MT	L	F	MPV Engine D9B (XUD9AU)	210082	Drive Shaft	48T	27	24	59	82	648					
	1996.02-1998.12	-	R	F	MPV Engine D9B (XUD9AU)	210081	Drive Shaft	48T	27	24	59	82	935					
	1996.02-1998.12	-	L	F	MPV Engine D9B (XUD9AU)	210112	Drive Shaft		27	24	59	82	648					
	1996.02-1998.12	MT	R	F	MPV Engine D9B (XUD9AU)	210012	Drive Shaft	48T	27	24	64	80.5	928					
	1996.02-1998.12	-	R	F	MPV Engine D9B (XUD9AU)	210111	Drive Shaft		27	24	59	82	935					
	1996.02-1998.12	MT	L/R	F	MPV Engine D9B (XUD9AU)	810018	Outer Joint	48T	27	34	61	82	55	I				
	1996.02-1998.12	MT	L	F	MPV Engine D9B (XUD9AU)	210052	Drive Shaft		27	24	61	82	648					
	1996.02-1998.12	MT	R	F	MPV Engine D9B (XUD9AU)	210120	Drive Shaft		27	24	59	82	928					
	1996.02-1998.12	-	-	F	MPV Engine D9B (XUD9AU)	810059	Outer Joint	48T	27	34	59	82	55	I				
	2003.12-2006.12	-	R	F	MPV Engine WJZ (DW8)/WJY (DW8B)	210120	Drive Shaft		27	24	59	82	928					
	2003.12-2006.12	-	L	F	MPV Engine WJZ (DW8)/WJY (DW8B)	210082	Drive Shaft	48T	27	24	59	82	648					
	2003.12-2006.12	-	R	F	MPV Engine WJZ (DW8)/WJY (DW8B)	210012	Drive Shaft	48T	27	24	64	80.5	928					
2003.12-2006.12	-	L	F	MPV Engine WJZ (DW8)/WJY (DW8B)	210052	Drive Shaft		27	24	61	82	648						
1.9 TD (66 kW)	1996.02-2000.09	-	L	F	MPV Engine DHX (XUD9TE)	210082	Drive Shaft	48T	27	24	59	82	648					
	1996.02-2000.09	-	L	F	MPV Engine DHX (XUD9TE)	610015	Inner Joint		37	39	40	68.5	104					
	1996.02-2000.09	-	R	F	MPV Engine DHX (XUD9TE)	210012	Drive Shaft	48T	27	24	64	80.5	928					
	1996.02-2000.09	-	R	F	MPV Engine DHX (XUD9TE)	610034	Inner Joint		37	39	31.9	369.5	99					
	1996.02-2000.09	-	L	F	MPV Engine DHX (XUD9TE)	210073	Drive Shaft	48T	27	37	59	82	641					
	1996.02-2000.09	-	R	F	MPV Engine DHX (XUD9TE)	210108	Drive Shaft	48T	27	37	59	82	939					
	1996.02-2000.09	-	L	F	MPV Engine DHX (XUD9TE)	210072	Drive Shaft		27	37	59	82	641					
	1996.02-2000.09	-	R	F	MPV Engine DHX (XUD9TE)	210074	Drive Shaft		27	37	59	82	939					
	1996.02-2000.09	-	R	F	MPV Engine DHX (XUD9TE)	210155	Drive Shaft		27	37	59	82	947					
	1996.02-2000.09	-	L/R	F	MPV Engine DHX (XUD9TE)	810015	Outer Joint	48T	27	39	59	82	63	I				
	1996.02-2000.09	-	L	F	MPV Engine DHX (XUD9TE)	210052	Drive Shaft		27	24	61	82	648					
	1996.02-2000.09	-	L	F	MPV Engine DHX (XUD9TE)	210016	Drive Shaft	48T	27	37	59	82	641					
	1996.02-2000.09	-	R	F	MPV Engine DHX (XUD9TE)	210014	Drive Shaft	48T	27	37	59	82	947					
	1996.02-2000.09	-	R	F	MPV Engine DHX (XUD9TE)	210120	Drive Shaft		27	24	59	82	928					
	1.9 TD (68 kW)	1996.02-1998.05	-	L	F	MPV Engine D8B (XUD9TE)	210082	Drive Shaft	48T	27	24	59	82	648				
1996.02-1998.05		-	L	F	MPV Engine D8B (XUD9TE)	610015	Inner Joint		37	39	40	68.5	104					
1996.02-1998.05		-	R	F	MPV Engine D8B (XUD9TE)	210012	Drive Shaft	48T	27	24	64	80.5	928					
1996.02-1998.05		-	R	F	MPV Engine D8B (XUD9TE)	610034	Inner Joint		37	39	31.9	369.5	99					
1996.02-1998.05		-	L	F	MPV Engine D8B (XUD9TE)	210073	Drive Shaft	48T	27	37	59	82	641					
1996.02-1998.05		-	-	F	MPV Engine D8B (XUD9TE)	810014	Outer Joint		27	39	59	82	63	I				
1996.02-1998.05		-	R	F	MPV Engine D8B (XUD9TE)	210108	Drive Shaft	48T	27	37	59	82	939					
1996.02-1998.05		-	L	F	MPV Engine D8B (XUD9TE)	210072	Drive Shaft		27	37	59	82	641					
1996.02-1998.05		-	R	F	MPV Engine D8B (XUD9TE)	210074	Drive Shaft		27	37	59	82	939					
1996.02-1998.05		-	R	F	MPV Engine D8B (XUD9TE)	210155	Drive Shaft		27	37	59	82	947					
1996.02-1998.05		-	L/R	F	MPV Engine D8B (XUD9TE)	810015	Outer Joint	48T	27	39	59	82	63	I				
1996.02-1998.05		-	L	F	MPV Engine D8B (XUD9TE)	210052	Drive Shaft		27	24	61	82	648					

YEAR	TRANSM	L/R	F/R	REMARKS	GSP Ref.	PRODUCT	ABS	Technical Specifications							
								A	B	C	H	L	P		
PEUGEOT EXPERT (224)															
1.9 TD (68 kW)	1996.02-1998.05	-	L	F	MPV Engine D8B (XUD9TE)	210016	Drive Shaft	48T	27	37	59	82	641		
	1996.02-1998.05	-	R	F	MPV Engine D8B (XUD9TE)	210014	Drive Shaft	48T	27	37	59	82	947		
	1996.02-1998.05	-	R	F	MPV Engine D8B (XUD9TE)	210120	Drive Shaft		27	24	59	82	928		
2.0 (100 kW)	2000.07-2006.12	MT	L	F	MPV Engine RFN (EW10J4)	210430	Drive Shaft		27	37	59	82	630		
	2000.07-2006.12	MT	L	F	MPV Engine RFN (EW10J4)	210082	Drive Shaft	48T	27	24	59	82	648		
	2000.07-2006.12	MT	R	F	MPV Engine RFN (EW10J4)	210057	Drive Shaft		27	37	59	82	960		
	2000.07-2006.12	MT	L	F	MPV Engine RFN (EW10J4)	210264	Drive Shaft	48T	27	37	59	82	630		
	2000.07-2006.12	MT	R	F	MPV Engine RFN (EW10J4)	210012	Drive Shaft	48T	27	24	64	80.5	928		
	2000.07-2006.12	MT	L/R	F	MPV Engine RFN (EW10J4)	810018	Outer Joint	48T	27	34	61	82	55	I	
	2000.07-2006.12	MT	R	F	MPV Engine RFN (EW10J4)	245120	Drive Shaft	48T	27	37	59	82	960		
	2000.07-2006.12	MT	L	F	MPV Engine RFN (EW10J4)	210052	Drive Shaft		27	24	61	82	648		
	2000.07-2006.12	MT	L	F	MPV Engine RFN (EW10J4)	610015	Inner Joint		37	39	40	68.5	104		
	2000.07-2006.12	MT	R	F	MPV Engine RFN (EW10J4)	610034	Inner Joint		37	39	31.9	369.5	99		
2.0 HDi (69 kW)	2000.10-2006.10	-	R	F	MPV Engine RHX (DW10BTED)	210120	Drive Shaft		27	24	59	82	928		
	2000.10-2006.10	-	L	F	MPV Engine RHX (DW10BTED)	210430	Drive Shaft		27	37	59	82	630		
	2000.10-2006.10	-	R	F	MPV Engine RHX (DW10BTED)	210057	Drive Shaft		27	37	59	82	960		
	2000.10-2006.10	-	L	F	MPV Engine RHX (DW10BTED)	210082	Drive Shaft	48T	27	24	59	82	648		
	2000.10-2006.10	-	L	F	MPV Engine RHX (DW10BTED)	210264	Drive Shaft	48T	27	37	59	82	630		
	2000.10-2006.10	-	R	F	MPV Engine RHX (DW10BTED)	210012	Drive Shaft	48T	27	24	64	80.5	928		
	2000.10-2006.10	-	R	F	MPV Engine RHX (DW10BTED)	245120	Drive Shaft	48T	27	37	59	82	960		
	2000.10-2006.10	-	L	F	MPV Engine RHX (DW10BTED)	610015	Inner Joint		37	39	40	68.5	104		
	2000.10-2006.10	-	L	F	MPV Engine RHX (DW10BTED)	210052	Drive Shaft		27	24	61	82	648		
	2000.10-2006.10	-	R	F	MPV Engine RHX (DW10BTED)	610034	Inner Joint		37	39	31.9	369.5	99		
2.0 HDi (80 kW)	2000.07-2006.12	-	R	F	MPV Engine RHZ (DW10BTED)+RHZ (DW10ATED)+RHZ (DW10BTED)+RHZ (DW10CTED)	210120	Drive Shaft		27	24	59	82	928		
	2000.07-2006.12	-	L	F	MPV Engine RHZ (DW10BTED)+RHZ (DW10ATED)+RHZ (DW10BTED)+RHZ (DW10CTED)	210430	Drive Shaft		27	37	59	82	630		
	2000.07-2006.12	-	R	F	MPV Engine RHZ (DW10BTED)+RHZ (DW10ATED)+RHZ (DW10BTED)+RHZ (DW10CTED)	210057	Drive Shaft		27	37	59	82	960		
	2000.07-2006.12	-	L	F	MPV Engine RHZ (DW10BTED)+RHZ (DW10ATED)+RHZ (DW10BTED)+RHZ (DW10CTED)	210082	Drive Shaft	48T	27	24	59	82	648		
	2000.07-2006.12	-	R	F	MPV Engine RHZ (DW10BTED)+RHZ (DW10ATED)+RHZ (DW10BTED)+RHZ (DW10CTED)	210237	Drive Shaft	48T	27	37	59	82	953		
	2000.07-2006.12	-	L	F	MPV Engine RHZ (DW10BTED)+RHZ (DW10ATED)+RHZ (DW10BTED)+RHZ (DW10CTED)	210264	Drive Shaft	48T	27	37	59	82	630		
	2000.07-2006.12	-	R	F	MPV Engine RHZ (DW10BTED)+RHZ (DW10ATED)+RHZ (DW10BTED)+RHZ (DW10CTED)	245120	Drive Shaft	48T	27	37	59	82	960		
	2000.07-2006.12	-	R	F	MPV Engine RHZ (DW10BTED)+RHZ (DW10ATED)+RHZ (DW10BTED)+RHZ (DW10CTED)	210012	Drive Shaft	48T	27	24	64	80.5	928		
	2000.07-2006.12	-	L	F	MPV Engine RHZ (DW10BTED)+RHZ (DW10ATED)+RHZ (DW10BTED)+RHZ (DW10CTED)	610015	Inner Joint		37	39	40	68.5	104		
	2000.07-2006.12	-	L	F	MPV Engine RHZ (DW10BTED)+RHZ (DW10ATED)+RHZ (DW10BTED)+RHZ (DW10CTED)	210052	Drive Shaft		27	24	61	82	648		
2.0 HDi 16V (80 kW)	2000.07-2006.12	-	R	F	MPV Engine RHZ (DW10BTED)+RHZ (DW10ATED)+RHZ (DW10BTED)+RHZ (DW10CTED)	610034	Inner Joint		37	39	31.9	369.5	99		
	2000.07-2006.12	-	L	F	MPV Engine RHW (DW10ATED4)	210430	Drive Shaft		27	37	59	82	630		
	2000.07-2006.12	-	L	F	MPV Engine RHW (DW10ATED4)	210082	Drive Shaft	48T	27	24	59	82	648		
	2000.07-2006.12	-	R	F	MPV Engine RHW (DW10ATED4)	210057	Drive Shaft		27	37	59	82	960		
	2000.07-2006.12	-	L	F	MPV Engine RHW (DW10ATED4)	210264	Drive Shaft	48T	27	37	59	82	630		
	2000.07-2006.12	-	R	F	MPV Engine RHW (DW10ATED4)	210012	Drive Shaft	48T	27	24	64	80.5	928		
	2000.07-2006.12	-	R	F	MPV Engine RHW (DW10ATED4)	245120	Drive Shaft	48T	27	37	59	82	960		
	2000.07-2006.12	-	L	F	MPV Engine RHW (DW10ATED4)	210052	Drive Shaft		27	24	61	82	648		
	2000.07-2006.12	-	L	F	MPV Engine RHW (DW10ATED4)	610015	Inner Joint		37	39	40	68.5	104		
	2000.07-2006.12	-	R	F	MPV Engine RHW (DW10ATED4)	610034	Inner Joint		37	39	31.9	369.5	99		
2000.07-2006.12	-	R	F	MPV Engine RHW (DW10ATED4)	210120	Drive Shaft		27	24	59	82	928			
EXPERT (VF3A_ VF3U_ VF3X_)															
1.6 HDi 90 16V (66 kW)	2007.01-	-	R	F	Box Engine 9HU (DV6UTED4)	210239	Drive Shaft		28	24	58.5	92	958		
	2007.01-	-	L	F	Box Engine 9HU (DV6UTED4)	645032	Inner Joint		37	39	40	68.5	100		
	2007.01-	MT	-	F	Box Engine 9HU (DV6UTED4)	810052	Outer Joint		28	34	58.5	92	55	I	
	2007.01-	-	-	F	Box Engine 9HU (DV6UTED4)	810051	Outer Joint		28	39	58.6	94	63	I	
1.6 HDi 90 8V (66 kW)	2007.01-	MT	R	F	Box Engine 9HM (DV6UC)/9HH (DV6DUM)	210239	Drive Shaft		28	24	58.5	92	958		
	2007.01-	MT	-	F	Box Engine 9HM (DV6UC)/9HH (DV6DUM)	810052	Outer Joint		28	34	58.5	92	55	I	
	2007.01-	-	-	F	Box Engine 9HM (DV6UC)/9HH (DV6DUM)	810051	Outer Joint		28	39	58.6	94	63	I	
2.0 16V (103 kW)	2007.01-	-	R	F	Box Engine RFJ (EW10A)/RFH (EW10A)	210239	Drive Shaft		28	24	58.5	92	958		
2.0 HDi 100 (72 kW)	2011.03-	MT	L	F	Box	645032	Inner Joint		37	39	40	68.5	100		
	2011.03-	-	-	F	Box	810051	Outer Joint		28	39	58.6	94	63	I	
2.0 HDi 120 (88 kW)	2007.01-	MT	R	F	Box Engine RHK (DW10UTED4)	210244	Drive Shaft		28	37	58.6	93	979		
	2007.01-	MT	L	F	Box Engine RHK (DW10UTED4)	645032	Inner Joint		37	39	40	68.5	100		
	2007.01-	MT	L	F	Box Engine RHK (DW10UTED4)	245133	Drive Shaft		28	37	58.6	94	653		
	2007.01-	MT	R	F	Box Engine RHK (DW10UTED4)	299214	Drive Shaft		28	37	58.6	94	978		
	2007.01-	-	-	F	Box Engine RHK (DW10UTED4)	810098	Outer Joint		28	39	58.6	93	63	I	
	2007.01-	MT	L	F	Box Engine RHK (DW10UTED4)	210234	Drive Shaft		28	37	58.6	93	648		
	2007.01-	MT	R	F	Box Engine RHK (DW10UTED4)	810159	Outer Joint		28	39	58.6	94	63	I	
	2007.01-	-	-	F	Box Engine RHK (DW10UTED4)	810051	Outer Joint		28	39	58.6	94	63	I	
	2007.01-	MT	R	F	Box Engine RHK (DW10UTED4)	610041	Inner Joint		37	39	32	399	95.5		
2.0 HDi 130 (94 kW)	2011.03-	-	L	F	Box Engine AHZ (DW10CD)	245133	Drive Shaft		28	37	58.6	94	653		

YEAR	TRANSM	L/R	F/R	REMARKS	GSP Ref.	PRODUCT	ABS	Technical Specifications										
								A	B	C	H	L	P					
PEUGEOT																		
EXPERT (VF3A_VF3U_VF3X_)																		
2.0 HDi 130 (94 kW)	2011.03-	-	MT	L F	Box Engine AHZ (DW10CD)	645032	Inner Joint	37	39	40	68.5	100						
	2011.03-	-	MT	R F	Box Engine AHZ (DW10CD)	610041	Inner Joint	37	39	32	399	95.5						
	2011.03-	-	-	-	Box Engine AHZ (DW10CD)	810051	Outer Joint	28	39	58.6	94	63	I					
	2011.03-	-	MT	R F	Box Engine AHZ (DW10CD)	210244	Drive Shaft	28	37	58.6	93	979						
2.0 HDi 140 (100 kW)	2007.01-	-	MT	R F	Box Engine RHR (DW10BTED4)	210244	Drive Shaft	28	37	58.6	93	979						
	2007.01-	-	MT	L F	Box Engine RHR (DW10BTED4)	645032	Inner Joint	37	39	40	68.5	100						
	2007.01-	-	MT	L F	Box Engine RHR (DW10BTED4)	245133	Drive Shaft	28	37	58.6	94	653						
	2007.01-	-	MT	R F	Box Engine RHR (DW10BTED4)	299214	Drive Shaft	28	37	58.6	94	978						
	2007.01-	-	-	-	Box Engine RHR (DW10BTED4)	810098	Outer Joint	28	39	58.6	93	63	I					
	2007.01-	-	MT	L F	Box Engine RHR (DW10BTED4)	210234	Drive Shaft	28	37	58.6	93	648						
	2007.01-	-	MT	R F	Box Engine RHR (DW10BTED4)	810159	Outer Joint	28	39	58.6	94	63	I					
	2007.01-	-	-	-	Box Engine RHR (DW10BTED4)	810051	Outer Joint	28	39	58.6	94	63	I					
	2007.01-	-	MT	R F	Box Engine RHR (DW10BTED4)	610041	Inner Joint	37	39	32	399	95.5						
2.0 HDi 165 (120 kW)	2009.09-	-	MT	R F	Box Engine RHH (DW10CTED4)	210244	Drive Shaft	28	37	58.6	93	979						
	2009.09-	-	MT	L F	Box Engine RHH (DW10CTED4)	245133	Drive Shaft	28	37	58.6	94	653						
	2009.09-	-	MT	R F	Box Engine RHH (DW10CTED4)	299214	Drive Shaft	28	37	58.6	94	978						
	2009.09-	-	MT	R F	Box Engine RHH (DW10CTED4)	810159	Outer Joint	28	39	58.6	94	63	I					
	2009.09-	-	MT	L F	Box Engine RHH (DW10CTED4)	645032	Inner Joint	37	39	40	68.5	100						
	2009.09-	-	MT	R F	Box Engine RHH (DW10CTED4)	610041	Inner Joint	37	39	32	399	95.5						
	2009.09-	-	-	-	Box Engine RHH (DW10CTED4)	810051	Outer Joint	28	39	58.6	94	63	I					
EXPERT TEPEE																		
1.6 HDi	2006-	-	-	L F	-	699158	Inner Joint	24	34	40	62	89						
	2006-	-	-	L F	-	810095	Outer Joint	28	34	58.5	92	55	I					
EXPERT Tepee (VF3V_)																		
1.6 HDi 90 16V (66 kW)	2007.01-	-	-	R F	MPV Engine 9HU (DV6UTED4)	210239	Drive Shaft	28	24	58.5	92	958						
	2007.01-	-	-	L F	MPV Engine 9HU (DV6UTED4)	645032	Inner Joint	37	39	40	68.5	100						
	2007.01-	-	MT	-	MPV Engine 9HU (DV6UTED4)	810052	Outer Joint	28	34	58.5	92	55	I					
	2007.01-	-	-	-	MPV Engine 9HU (DV6UTED4)	810051	Outer Joint	28	39	58.6	94	63	I					
1.6 HDi 90 8V (66 kW)	2007.01-	-	MT	R F	MPV Engine 9HH (DV6DUM)9HM (DV6UC)	210239	Drive Shaft	28	24	58.5	92	958						
	2007.01-	-	MT	-	MPV Engine 9HH (DV6DUM)9HM (DV6UC)	810052	Outer Joint	28	34	58.5	92	55	I					
	2007.01-	-	-	-	MPV Engine 9HH (DV6DUM)9HM (DV6UC)	810051	Outer Joint	28	39	58.6	94	63	I					
2.0 16V (103 kW)	2007.01-	-	-	R F	MPV Engine RFJ (EW10A)/RFH (EW10A)	210239	Drive Shaft	28	24	58.5	92	958						
2.0 HDi 100 (72 kW)	2011.03-	-	-	L F	MPV Engine AHY (DW10CE)	245133	Drive Shaft	28	37	58.6	94	653						
	2011.03-	-	MT	L F	MPV Engine AHY (DW10CE)	645032	Inner Joint	37	39	40	68.5	100						
	2011.03-	-	-	R F	MPV Engine AHY (DW10CE)	299214	Drive Shaft	28	37	58.6	94	978						
	2011.03-	-	MT	L F	MPV Engine AHY (DW10CE)	210234	Drive Shaft	28	37	58.6	93	648						
	2011.03-	-	-	R F	MPV Engine AHY (DW10CE)	810159	Outer Joint	28	39	58.6	94	63	I					
	2011.03-	-	-	-	MPV Engine AHY (DW10CE)	810051	Outer Joint	28	39	58.6	94	63	I					
	2011.03-	-	-	R F	MPV Engine AHY (DW10CE)	610041	Inner Joint	37	39	32	399	95.5						
2.0 HDi 120 (88 kW)	2007.01-	-	-	-	All-wheel Drive MPV Engine RHK (DW10UTED4)	810051	Outer Joint	28	39	58.6	94	63	I					
	2007.01-	-	MT	R F	MPV Engine RHK (DW10UTED4)	210244	Drive Shaft	28	37	58.6	93	979						
	2007.01-	-	MT	L F	MPV Engine RHK (DW10UTED4)	645032	Inner Joint	37	39	40	68.5	100						
	2007.01-	-	MT	L F	MPV Engine RHK (DW10UTED4)	245133	Drive Shaft	28	37	58.6	94	653						
	2007.01-	-	-	L F	All-wheel Drive MPV Engine RHK (DW10UTED4)	245133	Drive Shaft	28	37	58.6	94	653						
	2007.01-	-	MT	R F	MPV Engine RHK (DW10UTED4)	299214	Drive Shaft	28	37	58.6	94	978						
	2007.01-	-	-	R F	All-wheel Drive MPV Engine RHK (DW10UTED4)	299214	Drive Shaft	28	37	58.6	94	978						
	2007.01-	-	MT	L F	All-wheel Drive MPV Engine RHK (DW10UTED4)	645032	Inner Joint	37	39	40	68.5	100						
	2007.01-	-	-	-	MPV Engine RHK (DW10UTED4)	810098	Outer Joint	28	39	58.6	93	63	I					
	2007.01-	-	MT	L F	MPV Engine RHK (DW10UTED4)	210234	Drive Shaft	28	37	58.6	93	648						
	2007.01-	-	MT	R F	MPV Engine RHK (DW10UTED4)	810159	Outer Joint	28	39	58.6	94	63	I					
	2007.01-	-	-	R F	All-wheel Drive MPV Engine RHK (DW10UTED4)	810159	Outer Joint	28	39	58.6	94	63	I					
	2007.01-	-	-	-	MPV Engine RHK (DW10UTED4)	810051	Outer Joint	28	39	58.6	94	63	I					
	2007.01-	-	MT	R F	MPV Engine RHK (DW10UTED4)	610041	Inner Joint	37	39	32	399	95.5						
	2007.01-	-	-	R F	All-wheel Drive MPV Engine RHK (DW10UTED4)	610041	Inner Joint	37	39	32	399	95.5						
2.0 HDi 130 (94 kW)	2011.03-	-	MT	L F	MPV Engine AHZ (DW10CD)	245133	Drive Shaft	28	37	58.6	94	653						
	2011.03-	-	MT	R F	MPV Engine AHZ (DW10CD)	299214	Drive Shaft	28	37	58.6	94	978						
	2011.03-	-	MT	L F	MPV Engine AHZ (DW10CD)	645032	Inner Joint	37	39	40	68.5	100						
	2011.03-	-	MT	L F	MPV Engine AHZ (DW10CD)	210234	Drive Shaft	28	37	58.6	93	648						
	2011.03-	-	MT	R F	MPV Engine AHZ (DW10CD)	810159	Outer Joint	28	39	58.6	94	63	I					
	2011.03-	-	-	-	MPV Engine AHZ (DW10CD)	810051	Outer Joint	28	39	58.6	94	63	I					
	2011.03-	-	MT	R F	MPV Engine AHZ (DW10CD)	610041	Inner Joint	37	39	32	399	95.5						
	2011.03-	-	MT	R F	MPV Engine AHZ (DW10CD)	210244	Drive Shaft	28	37	58.6	93	979						
2.0 HDi 140 (100 kW)	2007.01-	-	MT	R F	MPV Engine RHR (DW10BTED4)	210244	Drive Shaft	28	37	58.6	93	979						
	2007.01-	-	MT	L F	MPV Engine RHR (DW10BTED4)	645032	Inner Joint	37	39	40	68.5	100						
	2007.01-	-	MT	L F	MPV Engine RHR (DW10BTED4)	245133	Drive Shaft	28	37	58.6	94	653						
	2007.01-	-	MT	R F	MPV Engine RHR (DW10BTED4)	299214	Drive Shaft	28	37	58.6	94	978						

YEAR	TRANSM	L/R	F/R	REMARKS	GSP Ref.	PRODUCT	ABS	Technical Specifications						
								A	B	C	H	L	P	
PEUGEOT														
EXPERT Tepee (VF3V_)														
2.0 HDi 140 (100 kW)	2007.01-	-	-	F	MPV Engine RHR (DW10BTED4)	810098	Outer Joint	28	39	58.6	93	63	I	
	2007.01-	MT	L	F	MPV Engine RHR (DW10BTED4)	210234	Drive Shaft	28	37	58.6	93	648		
	2007.01-	MT	R	F	MPV Engine RHR (DW10BTED4)	810159	Outer Joint	28	39	58.6	94	63	I	
	2007.01-	-	-	F	MPV Engine RHR (DW10BTED4)	810051	Outer Joint	28	39	58.6	94	63	I	
	2007.01-	MT	R	F	MPV Engine RHR (DW10BTED4)	610041	Inner Joint	37	39	32	399	95.5		
2.0 HDi 165 (120 kW)	2009.09-	MT	R	F	MPV Engine RHH (DW10CTED4)	210244	Drive Shaft	28	37	58.6	93	979		
	2009.09-	MT	L	F	MPV Engine RHH (DW10CTED4)	245133	Drive Shaft	28	37	58.6	94	653		
	2009.09-	MT	R	F	MPV Engine RHH (DW10CTED4)	299214	Drive Shaft	28	37	58.6	94	978		
	2009.09-	MT	L	F	MPV Engine RHH (DW10CTED4)	210234	Drive Shaft	28	37	58.6	93	648		
	2009.09-	MT	-	F	MPV Engine RHH (DW10CTED4)	810051	Outer Joint	28	39	58.6	94	63	I	
	2009.09-	MT	L	F	MPV Engine RHH (DW10CTED4)	645032	Inner Joint	37	39	40	68.5	100		
	2009.09-	MT	R	F	MPV Engine RHH (DW10CTED4)	810159	Outer Joint	28	39	58.6	94	63	I	
	2009.09-	MT	R	F	MPV Engine RHH (DW10CTED4)	610041	Inner Joint	37	39	32	399	95.5		
GRAND RAID														
1.8L	2004-	2009	MT	-	-	810171	Outer Joint	29W	25	34	55.7	79	55	I
J10 PREMIER														
2.3 D	2010-	-	-	L/R	F	810109	Outer Joint	72T	30	30	74.45	120.3	63	M
	2010-	-	-	L/R	F	645031	Inner Joint		34	30	61.3	47.5	75	
	2010-	-	-	R	F	210270	Drive Shaft	72T	30	34	74.45	120.3	771.5	
	2010-	-	-	L	F	210269	Drive Shaft	72T	30	34	74.45	120.3	721.5	
J5														
-	-	-	-	-	-	810104	Outer Joint	54T	28	27	63	112.5	63	I
J5 (280L)														
1.9 D (51 kW)	1987.09-	1990.08	AT/MT	L	F	Box Engine D9B (XUD9A)/XUD9	210034	Drive Shaft	28	25	63	112.5	701	
	1987.09-	1990.08	AT/MT	R	F	Box Engine D9B (XUD9A)/XUD9	210013	Drive Shaft	28	25	63	112.5	1072	
	1987.09-	1990.08	AT/MT	R	F	Box Engine D9B (XUD9A)/XUD9	210068	Drive Shaft	28	25	63	112.5	1068	
	1987.09-	1990.08	AT/MT	L/R	F	Box Engine D9B (XUD9A)/XUD9	810010	Outer Joint	28	27	63	112.5	63	I
2.5 D (54 kW)	1981.09-	1990.09	AT/MT	L/R	F	Platform/Chassis Engine CRD93 (U25/661)	810010	Outer Joint	28	27	63	112.5	63	I
	1981.09-	1990.09	AT/MT	R	F	Platform/Chassis Engine CRD93 (U25/661)	210068	Drive Shaft	28	25	63	112.5	1068	
	1981.09-	1990.09	AT/MT	L	F	Platform/Chassis Engine CRD93 (U25/661)	210034	Drive Shaft	28	25	63	112.5	701	
2.5 DT (70 kW)	1981.09-	1990.08	AT/MT	L	F	All-wheel Drive Box Engine CRD93L	210034	Drive Shaft	28	25	63	112.5	701	
	1981.09-	1990.08	AT/MT	L/R	F	All-wheel Drive Box Engine CRD93L	810010	Outer Joint	28	27	63	112.5	63	I
	1981.09-	1990.08	AT/MT	R	F	All-wheel Drive Box Engine CRD93L	210068	Drive Shaft	28	25	63	112.5	1068	
J5 (280P)														
2.0 (55 kW)	1981.09-	1990.09	AT/MT	L/R	F	BUS Engine 170B (XN1T)	810010	Outer Joint	28	27	63	112.5	63	I
	1981.09-	1990.09	AT/MT	R	F	BUS Engine 170B (XN1T)	210068	Drive Shaft	28	25	63	112.5	1068	
	1981.09-	1990.09	AT/MT	L	F	BUS Engine 170B (XN1T)	210034	Drive Shaft	28	25	63	112.5	701	
2.0 (58 kW)	1983.01-	1990.09	AT/MT	L/R	F	BUS Engine 170 (XN1T)	810010	Outer Joint	28	27	63	112.5	63	I
	1983.01-	1990.09	AT/MT	R	F	BUS Engine 170 (XN1T)	210068	Drive Shaft	28	25	63	112.5	1068	
	1983.01-	1990.09	AT/MT	L	F	BUS Engine 170 (XN1T)	210034	Drive Shaft	28	25	63	112.5	701	
2.5 D (54 kW)	1981.09-	1990.09	AT/MT	L/R	F	BUS Engine CRD93 (U25/661)	810010	Outer Joint	28	27	63	112.5	63	I
	1981.09-	1990.09	AT/MT	R	F	BUS Engine CRD93 (U25/661)	210068	Drive Shaft	28	25	63	112.5	1068	
	1981.09-	1990.09	AT/MT	L	F	BUS Engine CRD93 (U25/661)	210034	Drive Shaft	28	25	63	112.5	701	
J5 (290L)														
1.9 D (51 kW)	1990.10-	1994.03	AT/MT	L	F	Box Engine D9B (XUD9A)	210034	Drive Shaft	28	25	63	112.5	701	
	1990.10-	1994.02	AT/MT	L	F	Platform/Chassis Engine D9B (XUD9A)	210034	Drive Shaft	28	25	63	112.5	701	
	1990.10-	1994.03	AT/MT	R	F	Box Engine D9B (XUD9A)	210013	Drive Shaft	28	25	63	112.5	1072	
	1990.10-	1994.02	AT/MT	R	F	Platform/Chassis Engine D9B (XUD9A)	210013	Drive Shaft	28	25	63	112.5	1072	
	1990.10-	1994.03	AT/MT	R	F	Box Engine D9B (XUD9A)	210068	Drive Shaft	28	25	63	112.5	1068	
	1990.10-	1994.02	AT/MT	R	F	Platform/Chassis Engine D9B (XUD9A)	210068	Drive Shaft	28	25	63	112.5	1068	
	1990.10-	1994.03	AT/MT	L/R	F	Box Engine D9B (XUD9A)	810010	Outer Joint	28	27	63	112.5	63	I
	1990.10-	1994.02	AT/MT	L/R	F	Platform/Chassis Engine D9B (XUD9A)	810010	Outer Joint	28	27	63	112.5	63	I
2.0 (62 kW)	1990.10-	1994.02	AT/MT	L	F	Platform/Chassis Engine 170D (XN1TACP)	210034	Drive Shaft	28	25	63	112.5	701	
	1990.10-	1994.02	AT/MT	L/R	F	Platform/Chassis Engine 170D (XN1TACP)	810010	Outer Joint	28	27	63	112.5	63	I
	1990.10-	1994.02	AT/MT	R	F	Platform/Chassis Engine 170D (XN1TACP)	210068	Drive Shaft	28	25	63	112.5	1068	
2.5 D (54 kW)	1990.10-	1994.02	AT/MT	L	F	Platform/Chassis Engine CRD93 (U25/661)	210034	Drive Shaft	28	25	63	112.5	701	
	1990.10-	1994.02	AT/MT	L	F	All-wheel Drive Platform/Chassis Engine CRD93 (U25/661)	210034	Drive Shaft	28	25	63	112.5	701	
	1990.10-	1994.03	AT/MT	L/R	F	All-wheel Drive Box Engine CRD93 (U25/661)	810010	Outer Joint	28	27	63	112.5	63	I
	1990.10-	1994.02	AT/MT	L/R	F	Platform/Chassis Engine CRD93 (U25/661)	810010	Outer Joint	28	27	63	112.5	63	I
	1990.10-	1994.02	AT/MT	L/R	F	All-wheel Drive Platform/Chassis Engine CRD93 (U25/661)	810010	Outer Joint	28	27	63	112.5	63	I
	1990.10-	1994.03	AT/MT	R	F	All-wheel Drive Box Engine CRD93 (U25/661)	210068	Drive Shaft	28	25	63	112.5	1068	
	1990.10-	1994.02	AT/MT	R	F	Platform/Chassis Engine CRD93 (U25/661)	210068	Drive Shaft	28	25	63	112.5	1068	
	1990.10-	1994.02	AT/MT	R	F	All-wheel Drive Platform/Chassis Engine CRD93 (U25/661)	210068	Drive Shaft	28	25	63	112.5	1068	
	1990.10-	1994.03	AT/MT	L	F	All-wheel Drive Box Engine CRD93 (U25/661)	210034	Drive Shaft	28	25	63	112.5	701	





YEAR	TRANSM	L/R	F/R	REMARKS	GSP Ref.	PRODUCT	ABS	Technical Specifications					
								A	B	C	H	L	P
PEUGEOT													
J5 (290L)													
2.5 TD (70 kW)													
1990.10-1994.02	AT/MT	L	F	All-wheel Drive Platform/Chassis Engine CRD93LS (U25/673)	210034	Drive Shaft		28	25	63	112.5	701	
1990.10-1994.02	AT/MT	L/R	F	Platform/Chassis Engine CRD93LS (U25/673)	810010	Outer Joint		28	27	63	112.5	63 I	
1990.10-1994.03	AT/MT	L/R	F	All-wheel Drive Box Engine CRD93LS (U25/673)	810010	Outer Joint		28	27	63	112.5	63 I	
1990.10-1994.02	AT/MT	L/R	F	All-wheel Drive Platform/Chassis Engine CRD93LS (U25/673)	810010	Outer Joint		28	27	63	112.5	63 I	
1990.10-1994.02	AT/MT	R	F	Platform/Chassis Engine CRD93LS (U25/673)	210068	Drive Shaft		28	25	63	112.5	1068	
1990.10-1994.03	AT/MT	R	F	All-wheel Drive Box Engine CRD93LS (U25/673)	210068	Drive Shaft		28	25	63	112.5	1068	
1990.10-1994.02	AT/MT	R	F	All-wheel Drive Platform/Chassis Engine CRD93LS (U25/673)	210068	Drive Shaft		28	25	63	112.5	1068	
1990.10-1994.02	AT/MT	L	F	Platform/Chassis Engine CRD93LS (U25/673)	210034	Drive Shaft		28	25	63	112.5	701	
1990.10-1994.03	AT/MT	L	F	All-wheel Drive Box Engine CRD93LS (U25/673)	210034	Drive Shaft		28	25	63	112.5	701	
J5 (290P)													
1.9 D (51 kW)													
1990.10-1994.02	AT/MT	R	F	BUS Engine D9B (XUD9A)	210013	Drive Shaft		28	25	63	112.5	1072	
1990.10-1994.02	AT/MT	L/R	F	BUS Engine D9B (XUD9A)	810010	Outer Joint		28	27	63	112.5	63 I	
1990.10-1994.02	AT/MT	R	F	BUS Engine D9B (XUD9A)	210068	Drive Shaft		28	25	63	112.5	1068	
1990.10-1994.02	AT/MT	L	F	BUS Engine D9B (XUD9A)	210034	Drive Shaft		28	25	63	112.5	701	
2.0 (62 kW)													
1990.10-1994.02	AT/MT	L/R	F	BUS Engine 170D (XN1TACP)	810010	Outer Joint		28	27	63	112.5	63 I	
1990.10-1994.02	AT/MT	R	F	BUS Engine 170D (XN1TACP)	210068	Drive Shaft		28	25	63	112.5	1068	
1990.10-1994.02	AT/MT	L	F	BUS Engine 170D (XN1TACP)	210034	Drive Shaft		28	25	63	112.5	701	
2.5 D (54 kW)													
1990.10-1994.02	AT/MT	L	F	BUS Engine CRD93 (U25/661)	210034	Drive Shaft		28	25	63	112.5	701	
1990.10-1994.02	AT/MT	R	F	BUS Engine CRD93 (U25/661)	210029	Drive Shaft		28	25	63	112.5	1073	
1990.10-1994.02	AT/MT	L/R	F	All-wheel Drive BUS Engine CRD93 (U25/661)	810010	Outer Joint		28	27	63	112.5	63 I	
1990.10-1994.02	AT/MT	L/R	F	BUS Engine CRD93 (U25/661)	810010	Outer Joint		28	27	63	112.5	63 I	
1990.10-1994.02	AT/MT	R	F	All-wheel Drive BUS Engine CRD93 (U25/661)	210068	Drive Shaft		28	25	63	112.5	1068	
1990.10-1994.02	AT/MT	R	F	BUS Engine CRD93 (U25/661)	210068	Drive Shaft		28	25	63	112.5	1068	
1990.10-1994.02	AT/MT	L	F	All-wheel Drive BUS Engine CRD93 (U25/661)	210034	Drive Shaft		28	25	63	112.5	701	
2.5 TD (70 kW)													
1990.10-1994.02	AT/MT	L/R	F	BUS Engine CRD93LS (U25/673)	810010	Outer Joint		28	27	63	112.5	63 I	
1990.10-1994.02	AT/MT	L/R	F	All-wheel Drive BUS Engine CRD93LS (U25/673)	810010	Outer Joint		28	27	63	112.5	63 I	
1990.10-1994.02	AT/MT	R	F	BUS Engine CRD93LS (U25/673)	210068	Drive Shaft		28	25	63	112.5	1068	
1990.10-1994.02	AT/MT	R	F	All-wheel Drive BUS Engine CRD93LS (U25/673)	210068	Drive Shaft		28	25	63	112.5	1068	
1990.10-1994.02	AT/MT	L	F	BUS Engine CRD93LS (U25/673)	210034	Drive Shaft		28	25	63	112.5	701	
1990.10-1994.02	AT/MT	L	F	All-wheel Drive BUS Engine CRD93LS (U25/673)	210034	Drive Shaft		28	25	63	112.5	701	
J9													
-	1994-	-	-	-	899002	Outer Joint		30	27	74.45	120.3	63 I	
J9 PREMIER													
2.8 D													
2007-2010	-	R	F	-	245189	Drive Shaft	72T	30	30	74.45	120.3	718	
2007-2010	-	R	F	-	610037	Inner Joint		30	30	54.5	47.5	78.5	
2007-2010	-	L/R	F	-	810061	Outer Joint	72T	30	27	74.45	120.3	63 I	
2007-2010	-	L/R	F	-	610027	Inner Joint		30	30	54.5	47.5	78.5	
2007-2010	-	R	F	-	810149	Outer Joint		30	27	74.45	120.3	63 I	
2007-2010	-	R	F	-	610037	Inner Joint		30	30	54.5	47.5	78.5	
2007-2010	-	L	F	-	244023	Drive Shaft	72T	30	30	74.45	120.3	668	
PARTNER													
1.6 (66 kW)													
2008.04-	-	-	F	Box Engine NFR (TU5JP4B)	810028	Outer Joint		25	34	58	89	56 I	
2008.04-	-	MT	R	Box Engine NFR (TU5JP4B)	210229	Drive Shaft		25	24	58.5	79	935	
2008.04-	-	MT	L	Box Engine NFR (TU5JP4B)	245105	Drive Shaft		25	24	58	79	625	
2008.04-	-	-	L	Box Engine NFR (TU5JP4B)	245126	Drive Shaft		25	24	58.5	89	630	
2008.04-	-	MT	L	Box Engine NFR (TU5JP4B)	299019	Drive Shaft	29T	25	24	55.7	79	620	
2008.04-	-	MT	R	Box Engine NFR (TU5JP4B)	245104	Drive Shaft		25	24	58	79	925	
1.6 (72 kW)													
2010.11-	-	-	F	Box Engine 5FK (EP6CB)	810028	Outer Joint		25	34	58	89	56 I	
2010.11-	-	-	R	Box Engine 5FK (EP6CB)	610058	Inner Joint		24	34	29.8	365	88	
2010.11-	-	-	L	Box Engine 5FK (EP6CB)	210255	Drive Shaft		25	24	58.5	79	616	
2010.11-	-	-	L	Box Engine 5FK (EP6CB)	245105	Drive Shaft		25	24	58	79	625	
2010.11-	-	-	R	Box Engine 5FK (EP6CB)	210254	Drive Shaft		25	24	58.5	79	939	
2010.11-	-	-	L	Box Engine 5FK (EP6CB)	245126	Drive Shaft		25	24	58.5	89	630	
2010.11-	-	MT	L	Box Engine 5FK (EP6CB)	299019	Drive Shaft	29T	25	24	55.7	79	620	
2010.11-	-	-	R	Box Engine 5FK (EP6CB)	245104	Drive Shaft		25	24	58	79	925	
2010.11-	-	MT	R	Box Engine 5FK (EP6CB)	210229	Drive Shaft		25	24	58.5	79	935	
2010.11-	-	-	L	Box Engine 5FK (EP6CB)	610057	Inner Joint		24	34	40	52.5	90	
1.6 (80 kW)													
2008.04-	-	-	F	Box Engine NFU (TU5JP4)	810028	Outer Joint		25	34	58	89	56 I	
2008.04-	-	MT	R	Box Engine NFU (TU5JP4)	210229	Drive Shaft		25	24	58.5	79	935	
2008.04-	-	MT	L	Box Engine NFU (TU5JP4)	245105	Drive Shaft		25	24	58	79	625	
2008.04-	-	-	L	Box Engine NFU (TU5JP4)	245126	Drive Shaft		25	24	58.5	89	630	
2008.04-	-	MT	L	Box Engine NFU (TU5JP4)	299019	Drive Shaft	29T	25	24	55.7	79	620	
2008.04-	-	MT	R	Box Engine NFU (TU5JP4)	245104	Drive Shaft		25	24	58	79	925	
1.6 (88 kW)													
2010.04-	-	-	F	Box Engine 5FS (EP6C)	810028	Outer Joint		25	34	58	89	56 I	
2010.04-	-	-	L	Box Engine 5FS (EP6C)	245105	Drive Shaft		25	24	58	79	625	
2010.04-	-	-	L	Box Engine 5FS (EP6C)	245126	Drive Shaft		25	24	58.5	89	630	





	 YEAR	TRANSM	L/R	F/R	REMARKS	GSP Ref.	 PRODUCT	 ABS	Technical Specifications									
									A	B	C	H	L	P				
PEUGEOT PARTNER																		
1.6 (88 kW)	2010.04-	-	MT	L	F	Box Engine 5FS (EP6C)	299019	Drive Shaft	29T	25	24	55.7	79	620				
	2010.04-	-	-	R	F	Box Engine 5FS (EP6C)	245104	Drive Shaft		25	24	58	79	925				
	2010.04-	-	MT	R	F	Box Engine 5FS (EP6C)	210229	Drive Shaft		25	24	58.5	79	935				
1.6 BlueHDi 100 (73 kW)	2015.04-	-	MT	L	F	Box Engine BHY (DV6FD)	610057	Inner Joint		24	34	40	52.5	90				
	2015.04-	-	MT	R	F	Box Engine BHY (DV6FD)	610058	Inner Joint		24	34	29.8	365	88				
	2015.04-	-	MT	-	-	Box Engine BHY (DV6FD)	899366	Outer Joint		25	34	58.5	79	55	I			
	2015.04-	-	MT	L	F	Box Engine BHY (DV6FD)	210255	Drive Shaft		25	24	58.5	79	616				
	2015.04-	-	MT	R	F	Box Engine BHY (DV6FD)	210229	Drive Shaft		25	24	58.5	79	935				
	2015.04-	-	5MT	L	F	Box Engine BHY (DV6FD)	245105	Drive Shaft		25	24	58	79	625				
	2015.04-	-	5MT	L	F	Box Engine BHY (DV6FD)	245126	Drive Shaft		25	24	58.5	89	630				
	2015.04-	-	MT	R	F	Box Engine BHY (DV6FD)	210254	Drive Shaft		25	24	58.5	79	939				
	2015.04-	-	MT	L	F	Box Engine BHY (DV6FD)	299019	Drive Shaft	29T	25	24	55.7	79	620				
1.6 BlueHDi 120 (88 kW)	2015.04-	-	MT	L	F	Box Engine BHZ (DV6FC)	610057	Inner Joint		24	34	40	52.5	90				
	2015.04-	-	MT	R	F	Box Engine BHZ (DV6FC)	610058	Inner Joint		24	34	29.8	365	88				
	2015.04-	-	MT	L	F	Box Engine BHZ (DV6FC)	210255	Drive Shaft		25	24	58.5	79	616				
	2015.04-	-	MT	R	F	Box Engine BHZ (DV6FC)	210229	Drive Shaft		25	24	58.5	79	935				
	2015.04-	-	MT	R	F	Box Engine BHZ (DV6FC)	210254	Drive Shaft		25	24	58.5	79	939				
1.6 HDi (55 kW)	2015.04-	-	MT	L	F	Box Engine BHZ (DV6FC)	299019	Drive Shaft	29T	25	24	55.7	79	620				
	2015.04-	-	5MT	R	F	Box Engine BHZ (DV6FC)	245104	Drive Shaft		25	24	58	79	925				
	2008.04-	-	-	-	F	Box Engine 9HT (DV6BTED4)/9HW (DV6BTED4)	810028	Outer Joint		25	34	58	89	56	I			
	2008.04-	-	MT	R	F	Box Engine 9HT (DV6BTED4)/9HW (DV6BTED4)	210229	Drive Shaft		25	24	58.5	79	935				
	2008.04-	-	MT	L	F	Box Engine 9HT (DV6BTED4)/9HW (DV6BTED4)	245126	Drive Shaft		25	24	58.5	89	630				
	2008.04-	-	-	L	F	Box Engine 9HT (DV6BTED4)/9HW (DV6BTED4)	245105	Drive Shaft		25	24	58	79	625				
1.6 HDi (66 kW)	2008.04-	-	MT	L	F	Box Engine 9HT (DV6BTED4)/9HW (DV6BTED4)	299019	Drive Shaft	29T	25	24	55.7	79	620				
	2008.04-	-	-	R	F	Box Engine 9HT (DV6BTED4)/9HW (DV6BTED4)	245104	Drive Shaft		25	24	58	79	925				
	2013.03-	-	MT	R	F	Box Engine 9HF (DV6DTE4)	210229	Drive Shaft		25	24	58.5	79	935				
	2013.03-	-	MT	L	F	Box Engine 9HF (DV6DTE4)	245105	Drive Shaft		25	24	58	79	625				
	2013.03-	-	MT	L	F	Box Engine 9HF (DV6DTE4)	245126	Drive Shaft		25	24	58.5	89	630				
1.6 HDi (67 kW)	2013.03-	-	MT	R	F	Box Engine 9HF (DV6DTE4)	299019	Drive Shaft	29T	25	24	55.7	79	620				
	2013.03-	-	MT	R	F	Box Engine 9HF (DV6DTE4)	245104	Drive Shaft		25	24	58	79	925				
	2009.09-	-	MT	-	-	Box Engine 9HX (DV6ATED4)	899366	Outer Joint		25	34	58.5	79	55	I			
	2009.09-	-	MT	R	F	Box Engine 9HX (DV6ATED4)	210229	Drive Shaft		25	24	58.5	79	935				
1.6 HDi (80 kW)	2009.09-	-	MT	L	F	Box Engine 9HX (DV6ATED4)	299019	Drive Shaft	29T	25	24	55.7	79	620				
	2008.04-	-	-	-	F	Box Engine 9HZ (DV6TED4)	810028	Outer Joint		25	34	58	89	56	I			
	2008.04-	-	MT	R	F	Box Engine 9HZ (DV6TED4)	210229	Drive Shaft		25	24	58.5	79	935				
	2008.04-	-	MT	L	F	Box Engine 9HZ (DV6TED4)	245105	Drive Shaft		25	24	58	79	625				
	2008.04-	-	-	L	F	Box Engine 9HZ (DV6TED4)	245126	Drive Shaft		25	24	58.5	89	630				
	2008.04-	-	MT	L	F	Box Engine 9HZ (DV6TED4)	299019	Drive Shaft	29T	25	24	55.7	79	620				
1.6 HDi (84 kW)	2008.04-	-	MT	R	F	Box Engine 9HZ (DV6TED4)	245104	Drive Shaft		25	24	58	79	925				
	2013.03-	-	-	L	F	Box Engine 9HL (DV6C)	610057	Inner Joint		24	34	40	52.5	90				
	2013.03-	-	-	R	F	Box Engine 9HL (DV6C)	610058	Inner Joint		24	34	29.8	365	88				
	2013.03-	-	MT	R	F	Box Engine 9HL (DV6C)	210229	Drive Shaft		25	24	58.5	79	935				
	2013.03-	-	-	L	F	Box Engine 9HL (DV6C)	210255	Drive Shaft		25	24	58.5	79	616				
	2013.03-	-	MT	L	F	Box Engine 9HL (DV6C)	245126	Drive Shaft		25	24	58.5	89	630				
	2013.03-	-	-	L	F	Box Engine 9HL (DV6C)	245105	Drive Shaft		25	24	58	79	625				
	2013.03-	-	-	R	F	Box Engine 9HL (DV6C)	210254	Drive Shaft		25	24	58.5	79	939				
	2013.03-	-	MT	L	F	Box Engine 9HL (DV6C)	299019	Drive Shaft	29T	25	24	55.7	79	620				
2013.03-	-	-	R	F	Box Engine 9HL (DV6C)	245104	Drive Shaft		25	24	58	79	925					
1.6 HDi / BlueHDi 75 (55 kW)	2014.01-	-	MT	L	F	Box Engine 9HN (DV6ETED4)/BHW (DV6FE)	245105	Drive Shaft		25	24	58	79	625				
	2014.01-	-	MT	R	F	Box Engine 9HN (DV6ETED4)/BHW (DV6FE)	210229	Drive Shaft		25	24	58.5	79	935				
	2014.01-	-	MT	L	F	Box Engine 9HN (DV6ETED4)/BHW (DV6FE)	245126	Drive Shaft		25	24	58.5	89	630				
	2014.01-	-	MT	L	F	Box Engine 9HN (DV6ETED4)/BHW (DV6FE)	299019	Drive Shaft	29T	25	24	55.7	79	620				
	2014.01-	-	MT	R	F	Box Engine 9HN (DV6ETED4)/BHW (DV6FE)	245104	Drive Shaft		25	24	58	79	925				
1.6 HDi 16V (66 kW)	2008.04-	-	-	R	F	Box Engine 9HX (DV6AUTED4)/9HS (DV6TED4BU)/9HX (DV6ATED4)	245104	Drive Shaft		25	24	58	79	925				
	2008.04-	-	AT	L	F	Box Engine 9HX (DV6AUTED4)/9HS (DV6TED4BU)/9HX (DV6ATED4)	610057	Inner Joint		24	34	40	52.5	90				
	2008.04-	-	AT	R	F	Box Engine 9HX (DV6AUTED4)/9HS (DV6TED4BU)/9HX (DV6ATED4)	610058	Inner Joint		24	34	29.8	365	88				
	2008.04-	-	-	-	F	Box Engine 9HX (DV6AUTED4)/9HS (DV6TED4BU)/9HX (DV6ATED4)	810028	Outer Joint		25	34	58	89	56	I			
	2008.04-	-	MT	R	F	Box Engine 9HX (DV6AUTED4)/9HS (DV6TED4BU)/9HX (DV6ATED4)	210229	Drive Shaft		25	24	58.5	79	935				
	2008.04-	-	AT	L	F	Box Engine 9HX (DV6AUTED4)/9HS (DV6TED4BU)/9HX (DV6ATED4)	210255	Drive Shaft		25	24	58.5	79	616				
	2008.04-	-	AT	R	F	Box Engine 9HX (DV6AUTED4)/9HS (DV6TED4BU)/9HX (DV6ATED4)	210254	Drive Shaft		25	24	58.5	79	939				
	2008.04-	-	-	L	F	Box Engine 9HX (DV6AUTED4)/9HS (DV6TED4BU)/9HX (DV6ATED4)	245126	Drive Shaft		25	24	58.5	89	630				
	2008.04-	-	-	L	F	Box Engine 9HX (DV6AUTED4)/9HS (DV6TED4BU)/9HX (DV6ATED4)	245105	Drive Shaft		25	24	58	79	625				
	2008.04-	-	MT	L	F	Box Engine 9HX (DV6AUTED4)/9HS (DV6TED4BU)/9HX (DV6ATED4)	299019	Drive Shaft	29T	25	24	55.7	79	620				
1.6 HDi 16V(68 kW)	2010.04-	-	-	L	F	Box Engine 9HJ (DV6DTE4), 9HX (DV6ATED4)	610057	Inner Joint		24	34	40	52.5	90				
	2010.04-	-	-	R	F	Box Engine 9HJ (DV6DTE4), 9HX (DV6ATED4)	610058	Inner Joint		24	34	29.8	365	88				
	2010.04-	-	-	L	F	Box Engine 9HJ (DV6DTE4), 9HX (DV6ATED4)	210255	Drive Shaft		25	24	58.5	79	616				

YEAR	TRANSM	L/R	F/R	REMARKS	GSP Ref.	PRODUCT	ABS	Technical Specifications								
								A	B	C	H	L	P			
PEUGEOT PARTNER																
1.6 HDi 16V(68 kW)	2010.04-	-	-	L F	Box Engine 9HJ (DV6DTEDM), 9HX (DV6ATED4)	245105	Drive Shaft		25	24	58	79	625			
	2010.04-	-	-	R F	Box Engine 9HJ (DV6DTEDM), 9HX (DV6ATED4)	210254	Drive Shaft		25	24	58.5	79	939			
	2010.04-	-	-	L F	Box Engine 9HJ (DV6DTEDM), 9HX (DV6ATED4)	245126	Drive Shaft		25	24	58.5	89	630			
	2010.04-	-	-	R F	Box Engine 9HJ (DV6DTEDM), 9HX (DV6ATED4)	245104	Drive Shaft		25	24	58	79	925			
1.6 HDi 90 (68 kW)	2010.04-	-	MT	L F	Box Engine 9HP (DV6DTEDM)	245105	Drive Shaft		25	24	58	79	625			
	2010.04-	-	MT	L F	Box Engine 9HP (DV6DTEDM)	245126	Drive Shaft		25	24	58.5	89	630			
	2010.04-	-	MT	- -	Box Engine 9HP (DV6DTEDM)	899366	Outer Joint		25	34	58.5	79	55	I		
	2010.04-	-	MT	L F	Box Engine 9HP (DV6DTEDM)	299019	Drive Shaft	29T	25	24	55.7	79	620			
	2010.04-	-	MT	R F	Box Engine 9HP (DV6DTEDM)	245104	Drive Shaft		25	24	58	79	925			
	2010.04-	-	MT	R F	Box Engine 9HP (DV6DTEDM)	210229	Drive Shaft		25	24	58.5	79	935			
1.8	1980.01-	1990.12	MT	- -	-	810038	Outer Joint		25	25	60	79	61.5	O		
1.8/1.9 Diesel	-	-	-	L -	-	210079	Drive Shaft		25	24	55.7	79	597			
1.8/1.9 Diesel BE3	-	-	-	- -	-	810049	Outer Joint		25	34	55.7	79	55	I		
	-	-	-	R -	-	210077	Drive Shaft		25	24	55.7	79	872			
1.8L	2004-	2009	MT	- -	-	810171	Outer Joint	29W	25	34	55.7	79	55	I		
1.9 D (51 kW)	1999.01-	2008.07	-	L F	Platform/Chassis Engine WJZ (DW8)/WJY (DW8B)	299195	Drive Shaft	48W	25	24	58.5	79	585			
	1999.01-	2008.07	-	L F	Platform/Chassis Engine WJZ (DW8)/WJY (DW8B)	210128	Drive Shaft	29T	25	24	55.7	79	594			
	1999.01-	2008.07	-	R F	Platform/Chassis Engine WJZ (DW8)/WJY (DW8B)	299196	Drive Shaft	48W	25	24	58.5	79	869			
	1999.01-	2008.07	-	- -	Platform/Chassis Engine WJZ (DW8)/WJY (DW8B)	810076	Outer Joint	29W	25	34	58.5	79	55	I		
	1999.01-	2008.07	-	L F	Platform/Chassis Engine WJZ (DW8)/WJY (DW8B)	210165	Drive Shaft		25	24	55.7	79	594			
2.0 HDI	1999.01-	-	-	R -	-	210077	Drive Shaft		25	24	55.7	79	872			
PARTNER (5)/PARTNER ORIGIN/RANCH																
1.1 (44 kW)	1996.06-	2005.09	MT	R F	Box Engine HDZ (TU1M)	210188	Drive Shaft	29T	25	22	54.5	79.5	860			
	1996.06-	2005.09	-	L F	Box Engine HDZ (TU1M)	210075	Drive Shaft	29T	25	22	54.5	79.5	587			
	1996.06-	2005.09	-	R F	Box Engine HDZ (TU1M)	210205	Drive Shaft		25	22	58.5	79	866			
	1996.06-	2005.09	-	L F	Box Engine HDZ (TU1M)	210026	Drive Shaft		25	22	56.7	79	594			
	1996.06-	2005.09	-	R F	Box Engine HDZ (TU1M)	210015	Drive Shaft		25	22	56.7	79	868			
	1996.06-	2005.09	-	R F	Box Engine HDZ (TU1M)	210019	Drive Shaft	29T	25	22	60	80	867			
	1996.06-	2005.09	-	L F	Box Engine HDZ (TU1M)	210021	Drive Shaft	29T	25	22	60	80	593			
	1996.06-	2005.09	-	L F	Box Engine HDZ (TU1M)	210187	Drive Shaft	29T	25	22	54.5	79.5	590.5			
1.4 (54 kW)	2002.11-	2006.10	MT	R F	Box Engine KFV (TU3A)	210110	Drive Shaft		25	22	54.5	79.5	862			
1.4 (55 kW)	1996.06-	2015.12	MT	R F	Box Engine KFX (TU3JP)/TU32	210188	Drive Shaft	29T	25	22	54.5	79.5	860			
	1996.06-	2015.12	-	L F	Box Engine KFX (TU3JP)/TU32	210075	Drive Shaft	29T	25	22	54.5	79.5	587			
	1996.06-	2015.12	-	R F	Box Engine KFX (TU3JP)/TU32	210205	Drive Shaft		25	22	58.5	79	866			
	1996.06-	2015.12	-	L F	Box Engine KFX (TU3JP)/TU32	210026	Drive Shaft		25	22	56.7	79	594			
	1996.06-	2015.12	MT	R F	Box Engine KFX (TU3JP)/TU32	210110	Drive Shaft		25	22	54.5	79.5	862			
	1996.06-	2015.12	-	R F	Box Engine KFX (TU3JP)/TU32	210015	Drive Shaft		25	22	56.7	79	868			
	1996.06-	2015.12	-	R F	Box Engine KFX (TU3JP)/TU32	210019	Drive Shaft	29T	25	22	60	80	867			
	1996.06-	2015.12	-	L F	Box Engine KFX (TU3JP)/TU32	210021	Drive Shaft	29T	25	22	60	80	593			
1.4 BiFuel (55 kW)	2003.04-	2006.10	MT	R F	Box Engine KFW (TU3JP)	210188	Drive Shaft	29T	25	22	54.5	79.5	860			
	2003.04-	2006.10	-	R F	Box Engine KFW (TU3JP)	210205	Drive Shaft		25	22	58.5	79	866			
	2003.04-	2006.10	MT	R F	Box Engine KFW (TU3JP)	210110	Drive Shaft		25	22	54.5	79.5	862			
	2003.04-	2006.10	-	R F	Box Engine KFW (TU3JP)	210015	Drive Shaft		25	22	56.7	79	868			
	2003.04-	2006.10	-	L F	Box Engine KFW (TU3JP)	210204	Drive Shaft		25	22	58.5	79	594			
1.6 HDi 75 (55 kW)	2006.02-	2008.07	-	R F	Box Engine 9HW (DV6BTED4)	299196	Drive Shaft	48W	25	24	58.5	79	869			
	2006.02-	2008.07	-	L F	Box Engine 9HW (DV6BTED4)	210080	Drive Shaft	29W	25	24	55.7	79	597			
	2006.02-	2008.07	-	- F	Box Engine 9HW (DV6BTED4)	899293	Outer Joint	48W	25	34	58.5	79	55	I		
	2006.02-	2008.07	-	- F	Box Engine 9HW (DV6BTED4)	810022	Outer Joint	29W	25	34	55.7	79	55	I		
	2006.02-	2008.07	-	- F	Box Engine 9HW (DV6BTED4)	810042	Outer Joint		25	34	54.8	78.5	56	I		
	2006.02-	2008.07	-	L F	Box Engine 9HW (DV6BTED4)	299195	Drive Shaft	48W	25	24	58.5	79	585			
1.6 HDi 75(55 kW)	2005.08-	2008.07	MT	L F	Box/Van Engine 9HK (DV6ETEDM)	299195	Drive Shaft	48W	25	24	58.5	79	585			
	2005.08-	2008.07	MT	R F	Box/Van Engine 9HK (DV6ETEDM)	299196	Drive Shaft	48W	25	24	58.5	79	869			
1.6 HDi 90 (66 kW)	2006.02-	2015.12	MT	- F	Box Engine 9HX (DV6ATED4)	899293	Outer Joint	48W	25	34	58.5	79	55	I		
	2006.02-	2015.12	-	R F	Box Engine 9HX (DV6ATED4)	299196	Drive Shaft	48W	25	24	58.5	79	869			
	2006.02-	2015.12	-	L F	Box Engine 9HX (DV6ATED4)	210080	Drive Shaft	29W	25	24	55.7	79	597			
	2006.02-	2015.12	-	- F	Box Engine 9HX (DV6ATED4)	810022	Outer Joint	29W	25	34	55.7	79	55	I		
	2006.02-	2015.12	-	- F	Box Engine 9HX (DV6ATED4)	810042	Outer Joint		25	34	54.8	78.5	56	I		
	2006.02-	2015.12	-	L F	Box Engine 9HX (DV6ATED4)	299195	Drive Shaft	48W	25	24	58.5	79	585			
1.8 D (43 kW)	1996.06-	2002.12	MT	L F	Box Engine A9A (XUD7)	210025	Drive Shaft	29T	25	24	54.8	78.5	593			
	1996.06-	2002.12	-	- F	Box Engine A9A (XUD7)	899293	Outer Joint	48W	25	34	58.5	79	55	I		
	1996.06-	2002.12	MT	R F	Box Engine A9A (XUD7)	210167	Drive Shaft		25	24	55.7	79	868			
	1996.06-	2002.12	MT	L F	Box Engine A9A (XUD7)	299025	Drive Shaft	29W	25	24	55.7	79	597			
	1996.06-	2002.12	MT	R F	Box Engine A9A (XUD7)	210023	Drive Shaft	29T	25	24	55.7	79	868			
	1996.06-	2002.12	MT	R F	Box Engine A9A (XUD7)	210078	Drive Shaft	29W	25	24	55.7	79	872			
	1996.06-	2002.12	-	L F	Box Engine A9A (XUD7)	210165	Drive Shaft		25	24	55.7	79	594			
	1996.06-	2002.12	MT	R F	Box Engine A9A (XUD7)	210091	Drive Shaft		25	24	54.8	78.5	869.5			

YEAR	TRANSM	L/R	F/R	REMARKS	GSP Ref.	PRODUCT	ABS	Technical Specifications										
								A	B	C	H	L	P					
PEUGEOT																		
PARTNER (5)/PARTNER ORIGIN/RANCH																		
1.8 D (43 kW)	1996.06-2002.12	MT	L	F	Box Engine A9A (XUD7)	210090	Drive Shaft		25	24	54.8	78.5	593					
	1996.06-2002.12	-	L	F	Box Engine A9A (XUD7)	210128	Drive Shaft	29T	25	24	55.7	79	594					
	1996.06-2002.12	-	-	F	Box Engine A9A (XUD7)	810022	Outer Joint	29W	25	34	55.7	79	55	I				
1.8 D (44 kW)	1996.11-1998.02	-	-	F	Box Engine A9A (XUD7)	899293	Outer Joint	48W	25	34	58.5	79	55	I				
	1996.11-1998.02	-	L	F	Box Engine A9A (XUD7)	299025	Drive Shaft	29W	25	24	55.7	79	597					
	1996.11-1998.02	-	R	F	Box Engine A9A (XUD7)	210078	Drive Shaft	29W	25	24	55.7	79	872					
	1996.11-1998.02	-	L	F	Box Engine A9A (XUD7)	210165	Drive Shaft		25	24	55.7	79	594					
	1996.11-1998.02	-	-	-	Box Engine A9A (XUD7)	810076	Outer Joint	29W	25	34	58.5	79	55	I				
	1996.11-1998.02	-	R	F	Box Engine A9A (XUD7)	210091	Drive Shaft		25	24	54.8	78.5	869.5					
1.9 D (51 kW)	1996.11-1998.02	-	L	F	Box Engine A9A (XUD7)	210128	Drive Shaft	29T	25	24	55.7	79	594					
	1996.06-2015.12	MT	L	F	Box Engine WJZ (DW8)/WJY (DW8B)	210090	Drive Shaft		25	24	54.8	78.5	593					
	1996.06-2002.12	MT	L	F	Box Engine DJY (XUD9A)	210025	Drive Shaft	29T	25	24	54.8	78.5	593					
	1996.06-2015.12	-	L	F	Box Engine WJZ (DW8)/WJY (DW8B)	210025	Drive Shaft	29T	25	24	54.8	78.5	593					
	1996.06-2002.12	-	-	F	Box Engine DJY (XUD9A)	899293	Outer Joint	48W	25	34	58.5	79	55	I				
	1996.06-2015.12	-	R	F	Box Engine WJZ (DW8)/WJY (DW8B)	299196	Drive Shaft	48W	25	24	58.5	79	869					
	1996.06-2015.12	-	-	F	Box Engine WJZ (DW8)/WJY (DW8B)	899293	Outer Joint	48W	25	34	58.5	79	55	I				
	1996.06-2002.12	MT	R	F	Box Engine DJY (XUD9A)	210167	Drive Shaft		25	24	55.7	79	868					
	1996.06-2002.12	MT	R	F	Box Engine DJY (XUD9A)	210023	Drive Shaft	29T	25	24	55.7	79	868					
	1996.06-2002.12	-	L	F	Box Engine DJY (XUD9A)	299025	Drive Shaft	29W	25	24	55.7	79	597					
	1996.06-2015.12	-	L	F	Box Engine WJZ (DW8)/WJY (DW8B)	299025	Drive Shaft	29W	25	24	55.7	79	597					
	1996.06-2002.12	-	-	-	Box Engine DJY (XUD9A)	810020	Outer Joint	29T	25	34	58	78.5	55	I				
	1996.06-2002.12	-	R	F	Box Engine DJY (XUD9A)	210078	Drive Shaft	29W	25	24	55.7	79	872					
	1996.06-2015.12	-	R	F	Box Engine WJZ (DW8)/WJY (DW8B)	210078	Drive Shaft	29W	25	24	55.7	79	872					
	1996.06-2002.12	-	L	F	Box Engine DJY (XUD9A)	210165	Drive Shaft		25	24	55.7	79	594					
	1996.06-2015.12	-	L	F	Box Engine WJZ (DW8)/WJY (DW8B)	210165	Drive Shaft		25	24	55.7	79	594					
	1996.06-2015.12	-	-	-	Box Engine WJZ (DW8)/WJY (DW8B)	810076	Outer Joint	29W	25	34	58.5	79	55	I				
	1996.06-2002.12	-	R	F	Box Engine DJY (XUD9A)	210091	Drive Shaft		25	24	54.8	78.5	869.5					
	1996.06-2015.12	-	R	F	Box Engine WJZ (DW8)/WJY (DW8B)	210091	Drive Shaft		25	24	54.8	78.5	869.5					
	1996.06-2002.12	MT	L	F	Box Engine DJY (XUD9A)	210090	Drive Shaft		25	24	54.8	78.5	593					
	1996.06-2002.12	-	L	F	Box Engine DJY (XUD9A)	210128	Drive Shaft	29T	25	24	55.7	79	594					
	1996.06-2015.12	-	L	F	Box Engine WJZ (DW8)/WJY (DW8B)	299195	Drive Shaft	48W	25	24	58.5	79	585					
	1996.06-2015.12	-	L	F	Box Engine WJZ (DW8)/WJY (DW8B)	210128	Drive Shaft	29T	25	24	55.7	79	594					
	2004.04-2007.11	-	L	F	All-wheel Drive Box Engine WJY (DW8B)	299195	Drive Shaft	48W	25	24	58.5	79	585					
	2004.04-2007.11	-	-	-	All-wheel Drive Box Engine WJY (DW8B)	899293	Outer Joint	48W	25	34	58.5	79	55	I				
	2004.04-2007.11	-	L	F	All-wheel Drive Box Engine WJY (DW8B)	210128	Drive Shaft	29T	25	24	55.7	79	594					
2004.04-2007.11	-	R	F	All-wheel Drive Box Engine WJY (DW8B)	299196	Drive Shaft	48W	25	24	58.5	79	869						
2004.04-2007.11	-	L	F	All-wheel Drive Box Engine WJY (DW8B)	299025	Drive Shaft	29W	25	24	55.7	79	597						
2004.04-2007.11	-	R	F	All-wheel Drive Box Engine WJY (DW8B)	210078	Drive Shaft	29W	25	24	55.7	79	872						
2004.04-2007.11	-	L	F	All-wheel Drive Box Engine WJY (DW8B)	210165	Drive Shaft		25	24	55.7	79	594						
2004.04-2007.11	-	R	F	All-wheel Drive Box Engine WJY (DW8B)	210091	Drive Shaft		25	24	54.8	78.5	869.5						
2004.04-2007.11	MT	L	F	All-wheel Drive Box Engine WJY (DW8B)	210090	Drive Shaft		25	24	54.8	78.5	593						
2.0 HDi (66 kW)	2000.04-2008.07	-	L	F	Box Engine RHY (DW10TD)	210128	Drive Shaft	29T	25	24	55.7	79	594					
	2000.04-2008.07	-	R	F	Box Engine RHY (DW10TD)	210090	Drive Shaft		25	24	54.8	78.5	593					
	2000.04-2008.07	MT	-	F	Box Engine RHY (DW10TD)	899293	Outer Joint	48W	25	34	58.5	79	55	I				
	2000.04-2008.07	-	L	F	Box Engine RHY (DW10TD)	210080	Drive Shaft	29W	25	24	55.7	79	597					
	2000.04-2008.07	-	R	F	Box Engine RHY (DW10TD)	299196	Drive Shaft	48W	25	24	58.5	79	869					
	2000.04-2008.07	-	-	F	Box Engine RHY (DW10TD)	810022	Outer Joint	29W	25	34	55.7	79	55	I				
	2000.04-2008.07	MT	L	F	Box Engine RHY (DW10TD)	210163	Drive Shaft		25	24	54.8	78.5	583					
	2000.04-2008.07	MT	L	F	Box Engine RHY (DW10TD)	210131	Drive Shaft	29T	25	24	54.8	78.5	583					
	2000.04-2008.07	MT	L	F	Box Engine RHY (DW10TD)	610018	Inner Joint		24	29	40	62.5	99					
	2000.04-2008.07	-	L	F	Box Engine RHY (DW10TD)	210165	Drive Shaft		25	24	55.7	79	594					
2000.04-2008.07	-	L	F	Box Engine RHY (DW10TD)	299195	Drive Shaft	48W	25	24	58.5	79	585						
PARTNER (5F)/PARTNER ORIGIN/RANCH																		
1.6 16V(81 kW)																		
PARTNER Combispac (5F)/PARTNER ORIGIN/RANCH																		
1.1 (44 kW)	2000.09-2015.12	-	-	-	MPV/Combispac Engine NFU (TU5JP4)	810076	Outer Joint	29W	25	34	58.5	79	55	I				
	1996.06-2002.10	MT	R	F	MPV Engine HFX (TU1JP)/HDZ (TU1M)	210188	Drive Shaft	29T	25	22	54.5	79.5	860					
	1996.06-2002.10	-	L	F	MPV Engine HFX (TU1JP)/HDZ (TU1M)	210075	Drive Shaft	29T	25	22	54.5	79.5	587					
	1996.06-2002.10	-	R	F	MPV Engine HFX (TU1JP)/HDZ (TU1M)	210205	Drive Shaft		25	22	58.5	79	866					
	1996.06-2002.10	-	L	F	MPV Engine HFX (TU1JP)/HDZ (TU1M)	210026	Drive Shaft		25	22	56.7	79	594					
	1996.06-2002.10	-	R	F	MPV Engine HFX (TU1JP)/HDZ (TU1M)	210015	Drive Shaft		25	22	56.7	79	868					
	1996.06-2002.10	-	R	F	MPV Engine HFX (TU1JP)/HDZ (TU1M)	210019	Drive Shaft	29T	25	22	60	80	867					
	1996.06-2002.10	-	L	F	MPV Engine HFX (TU1JP)/HDZ (TU1M)	210021	Drive Shaft	29T	25	22	60	80	593					
1.4 (54 kW)	1996.06-2002.10	-	L	F	MPV Engine HFX (TU1JP)/HDZ (TU1M)	210187	Drive Shaft	29T	25	22	54.5	79.5	590.5					
	2002.11-2006.10	-	R	F	MPV Engine KFW (TU3JP)	210205	Drive Shaft		25	22	58.5	79	866					
	2002.11-2006.10	-	L	F	MPV Engine KFW (TU3JP)	210026	Drive Shaft		25	22	56.7	79	594					
2002.11-2006.10	-	R	F	MPV Engine KFW (TU3JP)	210015	Drive Shaft		25	22	56.7	79	868						



YEAR	TRANSM	L/R	F/R	REMARKS	GSP Ref.	PRODUCT	ABS	Technical Specifications						
								A	B	C	H	L	P	
PEUGEOT														
PARTNER Combispace (5F)/PARTNER ORIGIN/RANCH														
1.4 (54 kW)	2002.11-2006.10	MT	R	F	MPV Engine KFW (TU3JP)	210110	Drive Shaft		25	22	54.5	79.5	862	
	2002.11-2006.10	-	R	F	MPV Engine KFW (TU3JP)	210019	Drive Shaft	29T	25	22	60	80	867	
	2002.11-2006.10	-	L	F	MPV Engine KFW (TU3JP)	210021	Drive Shaft	29T	25	22	60	80	593	
1.4 (55 kW)	1996.06-2015.12	MT	R	F	MPV Engine TU32/KFW (TU3JP)/KFX (TU3JP)	210188	Drive Shaft	29T	25	22	54.5	79.5	860	
	1996.06-2015.12	-	L	F	MPV Engine TU32/KFW (TU3JP)/KFX (TU3JP)	210075	Drive Shaft	29T	25	22	54.5	79.5	587	
	1996.06-2015.12	-	R	F	MPV Engine TU32/KFW (TU3JP)/KFX (TU3JP)	210205	Drive Shaft		25	22	58.5	79	866	
	1996.06-2015.12	-	L	F	MPV Engine TU32/KFW (TU3JP)/KFX (TU3JP)	210026	Drive Shaft		25	22	56.7	79	594	
	1996.06-2015.12	MT	R	F	MPV Engine TU32/KFW (TU3JP)/KFX (TU3JP)	210110	Drive Shaft		25	22	54.5	79.5	862	
	1996.06-2015.12	-	R	F	MPV Engine TU32/KFW (TU3JP)/KFX (TU3JP)	210015	Drive Shaft		25	22	56.7	79	868	
	1996.06-2015.12	-	R	F	MPV Engine TU32/KFW (TU3JP)/KFX (TU3JP)	210019	Drive Shaft	29T	25	22	60	80	867	
	1996.06-2015.12	-	L	F	MPV Engine TU32/KFW (TU3JP)/KFX (TU3JP)	210204	Drive Shaft		25	22	58.5	79	594	
1.6 16V (80 kW)	2001.07-2008.03	MT	L	F	MPV Engine NFU (TU5JP4)	210025	Drive Shaft	29T	25	24	54.8	78.5	593	
	2001.07-2008.03	-	R	F	MPV Engine NFU (TU5JP4)	299196	Drive Shaft	48W	25	24	58.5	79	869	
	2001.07-2008.03	-	L	F	MPV Engine NFU (TU5JP4)	210163	Drive Shaft		25	24	54.8	78.5	583	
	2001.07-2008.03	-	L	F	MPV Engine NFU (TU5JP4)	210131	Drive Shaft	29T	25	24	54.8	78.5	583	
	2001.07-2008.03	MT	R	F	MPV Engine NFU (TU5JP4)	210167	Drive Shaft		25	24	55.7	79	868	
	2001.07-2008.03	MT	R	F	MPV Engine NFU (TU5JP4)	210023	Drive Shaft	29T	25	24	55.7	79	868	
	2001.07-2008.03	-	L	F	MPV Engine NFU (TU5JP4)	210165	Drive Shaft		25	24	55.7	79	594	
	2001.07-2008.03	-	L	F	MPV Engine NFU (TU5JP4)	299195	Drive Shaft	48W	25	24	58.5	79	585	
1.6 Flexfuel (80 kW)	2000.09-2002.10	-	L	F	MPV Engine NFU (TU5JP4)	210128	Drive Shaft	29T	25	24	55.7	79	594	
	2000.09-2002.10	-	L	F	MPV Engine NFU (TU5JP4)	210165	Drive Shaft		25	24	55.7	79	594	
1.6 HDi 75 (55 kW)	2006.02-2013.12	-	L	F	MPV Engine 9HW (DV6BTEd4)	210128	Drive Shaft	29T	25	24	55.7	79	594	
	2006.02-2013.12	MT	-	F	MPV Engine 9HW (DV6BTEd4)	899293	Outer Joint	48W	25	34	58.5	79	55	I
	2006.02-2013.12	-	R	F	MPV Engine 9HW (DV6BTEd4)	299196	Drive Shaft	48W	25	24	58.5	79	869	
	2006.02-2013.12	-	L	F	MPV Engine 9HW (DV6BTEd4)	210131	Drive Shaft	29T	25	24	54.8	78.5	583	
1.6 HDi 90 (66 kW)	2006.02-2013.12	-	L	F	MPV Engine 9HW (DV6BTEd4)	299195	Drive Shaft	48W	25	24	58.5	79	585	
	2005.10-2015.12	MT	-	F	MPV Engine 9HX (DV6ATED4)	899293	Outer Joint	48W	25	34	58.5	79	55	I
	2005.10-2015.12	-	R	F	MPV Engine 9HX (DV6ATED4)	299196	Drive Shaft	48W	25	24	58.5	79	869	
	2005.10-2015.12	-	L	F	MPV Engine 9HX (DV6ATED4)	299195	Drive Shaft	48W	25	24	58.5	79	585	
1.8 (66 kW)	1997.05-2003.12	MT	L	F	MPV Engine LFX (XU7JB)	210025	Drive Shaft	29T	25	24	54.8	78.5	593	
	1997.05-2003.12	MT	R	F	MPV Engine LFX (XU7JB)	210167	Drive Shaft		25	24	55.7	79	868	
	1997.05-2003.12	MT	L	F	MPV Engine LFX (XU7JB)	299025	Drive Shaft	29W	25	24	55.7	79	597	
	1997.05-2003.12	MT	R	F	MPV Engine LFX (XU7JB)	210023	Drive Shaft	29T	25	24	55.7	79	868	
	1997.05-2003.12	MT	R	F	MPV Engine LFX (XU7JB)	210078	Drive Shaft	29W	25	24	55.7	79	872	
	1997.05-2003.12	-	-	-	MPV Engine LFX (XU7JB)	810020	Outer Joint	29T	25	34	58	78.5	55	I
	1997.05-2003.12	MT	R	F	MPV Engine LFX (XU7JB)	210091	Drive Shaft		25	24	54.8	78.5	869.5	
	1997.05-2003.12	-	L	F	MPV Engine LFX (XU7JB)	210165	Drive Shaft		25	24	55.7	79	594	
	1997.05-2003.12	MT	-	F	MPV Engine LFX (XU7JB)	810022	Outer Joint	29W	25	34	55.7	79	55	I
	1997.05-2003.12	MT	L	F	MPV Engine LFX (XU7JB)	210090	Drive Shaft		25	24	54.8	78.5	593	
	1997.05-2003.12	-	L	F	MPV Engine LFX (XU7JB)	210128	Drive Shaft	29T	25	24	55.7	79	594	
1.9 D (50 kW)	1996.06-2002.12	MT	L	F	MPV Engine DJY (XUD9A)	210025	Drive Shaft	29T	25	24	54.8	78.5	593	
	1996.06-2002.12	-	-	F	MPV Engine DJY (XUD9A)	899293	Outer Joint	48W	25	34	58.5	79	55	I
	1996.06-2002.12	-	L	F	MPV Engine DJY (XUD9A)	210128	Drive Shaft	29T	25	24	55.7	79	594	
	1996.06-2002.12	MT	L	F	MPV Engine DJY (XUD9A)	299025	Drive Shaft	29W	25	24	55.7	79	597	
	1996.06-2002.12	MT	R	F	MPV Engine DJY (XUD9A)	210167	Drive Shaft		25	24	55.7	79	868	
	1996.06-2002.12	MT	R	F	MPV Engine DJY (XUD9A)	210023	Drive Shaft	29T	25	24	55.7	79	868	
	1996.06-2002.12	MT	R	F	MPV Engine DJY (XUD9A)	210078	Drive Shaft	29W	25	24	55.7	79	872	
	1996.06-2002.12	-	-	-	MPV Engine DJY (XUD9A)	810020	Outer Joint	29T	25	34	58	78.5	55	I
	1996.06-2002.12	MT	R	F	MPV Engine DJY (XUD9A)	210091	Drive Shaft		25	24	54.8	78.5	869.5	
	1996.06-2002.12	-	L	F	MPV Engine DJY (XUD9A)	210165	Drive Shaft		25	24	55.7	79	594	
	1996.06-2002.12	MT	L	F	MPV Engine DJY (XUD9A)	210090	Drive Shaft		25	24	54.8	78.5	593	
1.9 D (51 kW)	1996.05-1998.12	-	L	F	MPV Engine XUD9	299025	Drive Shaft	29W	25	24	55.7	79	597	
	1996.05-1998.12	-	R	F	MPV Engine XUD9	210078	Drive Shaft	29W	25	24	55.7	79	872	
	1996.05-1998.12	-	L	F	MPV Engine XUD9	210165	Drive Shaft		25	24	55.7	79	594	
	1996.05-1998.12	-	R	F	MPV Engine XUD9	210091	Drive Shaft		25	24	54.8	78.5	869.5	
	1996.05-1998.12	-	L	F	MPV Engine XUD9	210128	Drive Shaft	29T	25	24	55.7	79	594	
	1998.12-2008.07	-	L	F	MPV Engine WJZ (DW8)/WJY (DW8B)	299195	Drive Shaft	48W	25	24	58.5	79	585	
	1998.12-2008.07	MT	L	F	MPV Engine WJZ (DW8)/WJY (DW8B)	210025	Drive Shaft	29T	25	24	54.8	78.5	593	
	1998.12-2008.07	-	R	F	MPV Engine WJZ (DW8)/WJY (DW8B)	299196	Drive Shaft	48W	25	24	58.5	79	869	
	1998.12-2008.07	-	L	F	MPV Engine WJZ (DW8)/WJY (DW8B)	210128	Drive Shaft	29T	25	24	55.7	79	594	
	1998.12-2008.07	-	-	-	MPV Engine WJZ (DW8)/WJY (DW8B)	899293	Outer Joint	48W	25	34	58.5	79	55	I
	1998.12-2008.07	MT	L	F	MPV Engine WJZ (DW8)/WJY (DW8B)	299025	Drive Shaft	29W	25	24	55.7	79	597	
	1998.12-2008.07	MT	R	F	MPV Engine WJZ (DW8)/WJY (DW8B)	210167	Drive Shaft		25	24	55.7	79	868	
	1998.12-2008.07	MT	R	F	MPV Engine WJZ (DW8)/WJY (DW8B)	210023	Drive Shaft	29T	25	24	55.7	79	868	





		 YEAR	TRANSM	L/R	F/R	REMARKS	GSP Ref.	 PRODUCT	 ABS	Technical Specifications						
										A	B	C	H	L	P	
PEUGEOT																
PARTNER Combispace (5F)/PARTNER ORIGIN/RANCH																
1.9 D (51 kW)																
1998.12-	2008.07	MT	R	F	MPV Engine WJZ (DW8)/WJY (DW8B)	210078	Drive Shaft	29W		25	24	55.7	79	872		
1998.12-	2008.07	MT	R	F	MPV Engine WJZ (DW8)/WJY (DW8B)	210091	Drive Shaft			25	24	54.8	78.5	869.5		
1998.12-	2008.07	-	L	F	MPV Engine WJZ (DW8)/WJY (DW8B)	210165	Drive Shaft			25	24	55.7	79	594		
1998.12-	2008.07	MT	L	F	MPV Engine WJZ (DW8)/WJY (DW8B)	210090	Drive Shaft			25	24	54.8	78.5	593		
2004.04-	2005.08	MT	-	-	All-wheel Drive MPV Engine WJY (DW8B)	899293	Outer Joint	48W		25	34	58.5	79	55	I	
2004.04-	2005.08	-	L	F	All-wheel Drive MPV Engine WJY (DW8B)	299195	Drive Shaft	48W		25	24	58.5	79	585		
2004.04-	2005.08	-	L	F	All-wheel Drive MPV Engine WJY (DW8B)	210128	Drive Shaft	29T		25	24	55.7	79	594		
2004.04-	2005.08	-	R	F	All-wheel Drive MPV Engine WJY (DW8B)	299196	Drive Shaft	48W		25	24	58.5	79	869		
2004.04-	2005.08	-	L	F	All-wheel Drive MPV Engine WJY (DW8B)	299025	Drive Shaft	29W		25	24	55.7	79	597		
2004.04-	2005.08	-	R	F	All-wheel Drive MPV Engine WJY (DW8B)	210078	Drive Shaft	29W		25	24	55.7	79	872		
2004.04-	2005.08	-	-	-	All-wheel Drive MPV Engine WJY (DW8B)	810076	Outer Joint	29W		25	34	58.5	79	55	I	
2004.04-	2005.08	-	L	F	All-wheel Drive MPV Engine WJY (DW8B)	210165	Drive Shaft			25	24	55.7	79	594		
2.0 HDI (66 kW)																
2000.02-	2008.07	MT	-	F	MPV Engine RHY (DW10TD)	899293	Outer Joint	48W		25	34	58.5	79	55	I	
2000.02-	2008.07	-	L	F	MPV Engine RHY (DW10TD)	210080	Drive Shaft	29W		25	24	55.7	79	597		
2000.02-	2008.07	-	-	F	MPV Engine RHY (DW10TD)	810022	Outer Joint	29W		25	34	55.7	79	55	I	
2000.02-	2008.07	-	R	F	MPV Engine RHY (DW10TD)	299196	Drive Shaft	48W		25	24	58.5	79	869		
2000.02-	2008.07	MT	L	F	MPV Engine RHY (DW10TD)	210163	Drive Shaft			25	24	54.8	78.5	583		
2000.02-	2008.07	MT	L	F	MPV Engine RHY (DW10TD)	210131	Drive Shaft	29T		25	24	54.8	78.5	583		
2000.02-	2008.07	MT	L	F	MPV Engine RHY (DW10TD)	610018	Inner Joint			24	29	40	62.5	99		
2000.02-	2008.07	-	L	F	MPV Engine RHY (DW10TD)	210165	Drive Shaft			25	24	55.7	79	594		
2000.02-	2008.07	-	L	F	MPV Engine RHY (DW10TD)	210128	Drive Shaft	29T		25	24	55.7	79	594		
2000.02-	2008.07	-	L	F	MPV Engine RHY (DW10TD)	299195	Drive Shaft	48W		25	24	58.5	79	585		
2004.04-	2005.08	-	L	F	All-wheel Drive MPV Engine RHY (DW10TD)	299195	Drive Shaft	48W		25	24	58.5	79	585		
2004.04-	2005.08	-	L	F	All-wheel Drive MPV Engine RHY (DW10TD)	210128	Drive Shaft	29T		25	24	55.7	79	594		
2004.04-	2005.08	-	-	-	All-wheel Drive MPV Engine RHY (DW10TD)	899293	Outer Joint	48W		25	34	58.5	79	55	I	
2004.04-	2005.08	-	R	F	All-wheel Drive MPV Engine RHY (DW10TD)	299196	Drive Shaft	48W		25	24	58.5	79	869		
2004.04-	2005.08	-	-	F	All-wheel Drive MPV Engine RHY (DW10TD)	810022	Outer Joint	29W		25	34	55.7	79	55	I	
2004.04-	2005.08	-	L	F	All-wheel Drive MPV Engine RHY (DW10TD)	210131	Drive Shaft	29T		25	24	54.8	78.5	583		
2004.04-	2005.08	-	L	F	All-wheel Drive MPV Engine RHY (DW10TD)	299025	Drive Shaft	29W		25	24	55.7	79	597		
2004.04-	2005.08	-	R	F	All-wheel Drive MPV Engine RHY (DW10TD)	210078	Drive Shaft	29W		25	24	55.7	79	872		
2004.04-	2005.08	-	R	F	All-wheel Drive MPV Engine RHY (DW10TD)	210091	Drive Shaft			25	24	54.8	78.5	869.5		
PARTNER MPV																
1.6 16V																
2002.10-	-	MT	L	-	-	210050	Drive Shaft			25	24	55.7	79	583		
1.9 D																
2001.06-	-	MT	L	-	-	210050	Drive Shaft			25	24	55.7	79	583		
PARTNER Tepee																
1.2 THP (81 kW)																
2016.02-	-	-	-	-	MPV Engine HNV (EB2DTM)/HNZ (EB2DT)	899366	Outer Joint			25	34	58.5	79	55	I	
2016.02-	-	5MT	L	F	MPV Engine HNV (EB2DTM)/HNZ (EB2DT)	245105	Drive Shaft			25	24	58	79	625		
2016.02-	-	MT	R	F	MPV Engine HNV (EB2DTM)/HNZ (EB2DT)	210229	Drive Shaft			25	24	58.5	79	935		
2016.02-	-	5MT	L	F	MPV Engine HNV (EB2DTM)/HNZ (EB2DT)	245126	Drive Shaft			25	24	58.5	89	630		
2016.02-	-	MT	L	F	MPV Engine HNV (EB2DTM)/HNZ (EB2DT)	299019	Drive Shaft	29T		25	24	55.7	79	620		
2016.02-	-	5MT	R	F	MPV Engine HNV (EB2DTM)/HNZ (EB2DT)	245104	Drive Shaft			25	24	58	79	925		
1.6 (66 kW)																
2008.04-	-	MT	R	F	MPV Engine NFR (TU5JP4B)	610058	Inner Joint			24	34	29.8	365	88		
2008.04-	-	-	-	F	MPV Engine NFR (TU5JP4B)	810028	Outer Joint			25	34	58	89	56	I	
2008.04-	-	MT	R	F	MPV Engine NFR (TU5JP4B)	210229	Drive Shaft			25	24	58.5	79	935		
2008.04-	-	MT	L	F	MPV Engine NFR (TU5JP4B)	210255	Drive Shaft			25	24	58.5	79	616		
2008.04-	-	MT	R	F	MPV Engine NFR (TU5JP4B)	210254	Drive Shaft			25	24	58.5	79	939		
2008.04-	-	-	L	F	MPV Engine NFR (TU5JP4B)	245105	Drive Shaft			25	24	58	79	625		
2008.04-	-	-	L	F	MPV Engine NFR (TU5JP4B)	245126	Drive Shaft			25	24	58.5	89	630		
2008.04-	-	MT	L	F	MPV Engine NFR (TU5JP4B)	299019	Drive Shaft	29T		25	24	55.7	79	620		
2008.04-	-	-	R	F	MPV Engine NFR (TU5JP4B)	245104	Drive Shaft			25	24	58	79	925		
2008.04-	-	MT	L	F	MPV Engine NFR (TU5JP4B)	610057	Inner Joint			24	34	40	52.5	90		
1.6 (72 kW)																
2010.08-	-	-	R	F	MPV Engine 5FK (EP6CB)	245104	Drive Shaft			25	24	58	79	925		
2010.08-	-	MT	R	F	MPV Engine 5FK (EP6CB)	210229	Drive Shaft			25	24	58.5	79	935		
2010.08-	-	-	-	F	MPV Engine 5FK (EP6CB)	810028	Outer Joint			25	34	58	89	56	I	
2010.08-	-	-	L	F	MPV Engine 5FK (EP6CB)	245105	Drive Shaft			25	24	58	79	625		
2010.08-	-	-	L	F	MPV Engine 5FK (EP6CB)	245126	Drive Shaft			25	24	58.5	89	630		
2010.08-	-	MT	L	F	MPV Engine 5FK (EP6CB)	299019	Drive Shaft	29T		25	24	55.7	79	620		
1.6 (80 kW)																
2008.04-	-	MT	R	F	MPV Engine NFU (TU5JP4)	610058	Inner Joint			24	34	29.8	365	88		
2008.04-	-	-	-	F	MPV Engine NFU (TU5JP4)	810028	Outer Joint			25	34	58	89	56	I	
2008.04-	-	MT	R	F	MPV Engine NFU (TU5JP4)	210229	Drive Shaft			25	24	58.5	79	935		
2008.04-	-	MT	L	F	MPV Engine NFU (TU5JP4)	210255	Drive Shaft			25	24	58.5	79	616		
2008.04-	-	MT	R	F	MPV Engine NFU (TU5JP4)	210254	Drive Shaft			25	24	58.5	79	939		
2008.04-	-	-	L	F	MPV Engine NFU (TU5JP4)	245105	Drive Shaft			25	24	58	79	625		
2008.04-	-	-	L	F	MPV Engine NFU (TU5JP4)	245126	Drive Shaft			25	24	58.5	89	630		
2008.04-	-	MT	L	F	MPV Engine NFU (TU5JP4)	299019	Drive Shaft	29T		25	24	55.7	79	620		
2008.04-	-	-	R	F	MPV Engine NFU (TU5JP4)	245104	Drive Shaft			25	24	58	79	925		





	 YEAR	TRANSM	L/R	F/R	REMARKS	GSP Ref.	 PRODUCT	 ABS	Technical Specifications						
									A	B	C	H	L	P	
PEUGEOT															
PARTNER Tepee															
1.6 (80 kW)	2008.04-	-	MT	L	F	MPV Engine NFU (TU5JP4)	610057	Inner Joint		24	34	40	52.5	90	
1.6 (81 kW)	2008.09-	-	-	-	-	MPV Engine NFU (TU5JP4)	899366	Outer Joint		25	34	58.5	79	55	I
	2008.09-	-	MT	R	F	MPV Engine NFU (TU5JP4)	210229	Drive Shaft		25	24	58.5	79	935	
	2008.09-	-	MT	L	F	MPV Engine NFU (TU5JP4)	299019	Drive Shaft	29T	25	24	55.7	79	620	
1.6 (88 kW)	2010.04-	-	-	R	F	MPV Engine 5FS (EP6C)	245104	Drive Shaft		25	24	58	79	925	
	2010.04-	-	-	-	F	MPV Engine 5FS (EP6C)	810028	Outer Joint		25	34	58	89	56	I
	2010.04-	-	MT	R	F	MPV Engine 5FS (EP6C)	210229	Drive Shaft		25	24	58.5	79	935	
	2010.04-	-	-	L	F	MPV Engine 5FS (EP6C)	245105	Drive Shaft		25	24	58	79	625	
	2010.04-	-	-	L	F	MPV Engine 5FS (EP6C)	245126	Drive Shaft		25	24	58.5	89	630	
	2010.04-	-	MT	L	F	MPV Engine 5FS (EP6C)	299019	Drive Shaft	29T	25	24	55.7	79	620	
1.6 BlueHDi 100 (73 kW)	2014.12-	-	6MT	L	F	MPV Engine BHY (DV6FD)	610057	Inner Joint		24	34	40	52.5	90	
	2014.12-	-	6MT/Semi-AT	R	F	MPV Engine BHY (DV6FD)	610058	Inner Joint		24	34	29.8	365	88	
	2014.12-	-	MT	-	-	MPV Engine BHY (DV6FD)	899366	Outer Joint		25	34	58.5	79	55	I
	2014.12-	-	MT	R	F	MPV Engine BHY (DV6FD)	210229	Drive Shaft		25	24	58.5	79	935	
	2014.12-	-	6MT	L	F	MPV Engine BHY (DV6FD)	210255	Drive Shaft		25	24	58.5	79	616	
	2014.12-	-	5MT	L	F	MPV Engine BHY (DV6FD)	245105	Drive Shaft		25	24	58	79	625	
	2014.12-	-	5MT	L	F	MPV Engine BHY (DV6FD)	245126	Drive Shaft		25	24	58.5	89	630	
	2014.12-	-	6MT/Semi-AT	R	F	MPV Engine BHY (DV6FD)	210254	Drive Shaft		25	24	58.5	79	939	
	2014.12-	-	MT	L	F	MPV Engine BHY (DV6FD)	299019	Drive Shaft	29T	25	24	55.7	79	620	
	2014.12-	-	5MT	R	F	MPV Engine BHY (DV6FD)	245104	Drive Shaft		25	24	58	79	925	
1.6 BlueHDi 120 (88 kW)	2014.12-	-	MT	L	F	MPV Engine BHZ (DV6FC)	610057	Inner Joint		24	34	40	52.5	90	
	2014.12-	-	MT	R	F	MPV Engine BHZ (DV6FC)	610058	Inner Joint		24	34	29.8	365	88	
	2014.12-	-	MT	L	F	MPV Engine BHZ (DV6FC)	210255	Drive Shaft		25	24	58.5	79	616	
	2014.12-	-	MT	R	F	MPV Engine BHZ (DV6FC)	210229	Drive Shaft		25	24	58.5	79	935	
	2014.12-	-	MT	R	F	MPV Engine BHZ (DV6FC)	210254	Drive Shaft		25	24	58.5	79	939	
	2014.12-	-	MT	L	F	MPV Engine BHZ (DV6FC)	299019	Drive Shaft	29T	25	24	55.7	79	620	
1.6 BlueHDi 75 (55 kW)	2015.01-	-	MT	L	F	MPV Engine BHW (DV6FE)	245105	Drive Shaft		25	24	58	79	625	
	2015.01-	-	MT	R	F	MPV Engine BHW (DV6FE)	210229	Drive Shaft		25	24	58.5	79	935	
	2015.01-	-	MT	L	F	MPV Engine BHW (DV6FE)	245126	Drive Shaft		25	24	58.5	89	630	
	2015.01-	-	MT	L	F	MPV Engine BHW (DV6FE)	299019	Drive Shaft	29T	25	24	55.7	79	620	
	2015.01-	-	MT	R	F	MPV Engine BHW (DV6FE)	245104	Drive Shaft		25	24	58	79	925	
1.6 HDi (55 kW)	2008.04-	-	MT	L	F	MPV Engine 9HT (DV6BTEd4)9HW (DV6BTEd4)9HN (DV6ETED4)	610057	Inner Joint		24	34	40	52.5	90	
	2008.04-	-	MT	R	F	MPV Engine 9HT (DV6BTEd4)9HW (DV6BTEd4)9HN (DV6ETED4)	610058	Inner Joint		24	34	29.8	365	88	
	2008.04-	-	-	-	F	MPV Engine 9HT (DV6BTEd4)9HW (DV6BTEd4)9HN (DV6ETED4)	810028	Outer Joint		25	34	58	89	56	I
	2008.04-	-	MT	R	F	MPV Engine 9HT (DV6BTEd4)9HW (DV6BTEd4)9HN (DV6ETED4)	210229	Drive Shaft		25	24	58.5	79	935	
	2008.04-	-	MT	L	F	MPV Engine 9HT (DV6BTEd4)9HW (DV6BTEd4)9HN (DV6ETED4)	210255	Drive Shaft		25	24	58.5	79	616	
	2008.04-	-	MT	R	F	MPV Engine 9HT (DV6BTEd4)9HW (DV6BTEd4)9HN (DV6ETED4)	210254	Drive Shaft		25	24	58.5	79	939	
	2008.04-	-	-	L	F	MPV Engine 9HT (DV6BTEd4)9HW (DV6BTEd4)9HN (DV6ETED4)	245105	Drive Shaft		25	24	58	79	625	
	2008.04-	-	-	L	F	MPV Engine 9HT (DV6BTEd4)9HW (DV6BTEd4)9HN (DV6ETED4)	245126	Drive Shaft		25	24	58.5	89	630	
	2008.04-	-	MT	R	F	MPV Engine 9HT (DV6BTEd4)9HW (DV6BTEd4)9HN (DV6ETED4)	210299	Drive Shaft		21	22	49	86	863	
	2008.04-	-	MT	L	F	MPV Engine 9HT (DV6BTEd4)9HW (DV6BTEd4)9HN (DV6ETED4)	299019	Drive Shaft	29T	25	24	55.7	79	620	
2008.04-	-	-	R	F	MPV Engine 9HT (DV6BTEd4)9HW (DV6BTEd4)9HN (DV6ETED4)	245104	Drive Shaft		25	24	58	79	925		
1.6 HDi (66 kW)	2013.03-	-	-	R	F	MPV Engine 9HF (DV6DTEd)	245104	Drive Shaft		25	24	58	79	925	
	2013.03-	-	-	-	-	MPV Engine 9HF (DV6DTEd)	899366	Outer Joint		25	34	58.5	79	55	I
	2013.03-	-	MT	R	F	MPV Engine 9HF (DV6DTEd)	210229	Drive Shaft		25	24	58.5	79	935	
	2013.03-	-	-	L	F	MPV Engine 9HF (DV6DTEd)	245105	Drive Shaft		25	24	58	79	625	
	2013.03-	-	-	L	F	MPV Engine 9HF (DV6DTEd)	245126	Drive Shaft		25	24	58.5	89	630	
	2013.03-	-	MT	L	F	MPV Engine 9HF (DV6DTEd)	299019	Drive Shaft	29T	25	24	55.7	79	620	
1.6 HDi (80 kW)	2008.04-	-	MT	L	F	MPV Engine 9HZ (DV6TEd4)	610057	Inner Joint		24	34	40	52.5	90	
	2008.04-	-	MT	R	F	MPV Engine 9HZ (DV6TEd4)	610058	Inner Joint		24	34	29.8	365	88	
	2008.04-	-	-	-	F	MPV Engine 9HZ (DV6TEd4)	810028	Outer Joint		25	34	58	89	56	I
	2008.04-	-	MT	R	F	MPV Engine 9HZ (DV6TEd4)	210229	Drive Shaft		25	24	58.5	79	935	
	2008.04-	-	MT	L	F	MPV Engine 9HZ (DV6TEd4)	210255	Drive Shaft		25	24	58.5	79	616	
	2008.04-	-	MT	R	F	MPV Engine 9HZ (DV6TEd4)	210254	Drive Shaft		25	24	58.5	79	939	
	2008.04-	-	-	L	F	MPV Engine 9HZ (DV6TEd4)	245105	Drive Shaft		25	24	58	79	625	
	2008.04-	-	-	L	F	MPV Engine 9HZ (DV6TEd4)	245126	Drive Shaft		25	24	58.5	89	630	
	2008.04-	-	MT	R	F	MPV Engine 9HZ (DV6TEd4)	210299	Drive Shaft		21	22	49	86	863	
	2008.04-	-	MT	L	F	MPV Engine 9HZ (DV6TEd4)	299019	Drive Shaft	29T	25	24	55.7	79	620	
2008.04-	-	-	R	F	MPV Engine 9HZ (DV6TEd4)	245104	Drive Shaft		25	24	58	79	925		
1.6 HDi (82 kW)	2010.08-	-	MT	R	F	MPV Engine 9HL (DV6C)	210229	Drive Shaft		25	24	58.5	79	935	
	2010.08-	-	-	-	F	MPV Engine 9HL (DV6C)	810028	Outer Joint		25	34	58	89	56	I
	2010.08-	-	MT	L	F	MPV Engine 9HL (DV6C)	245105	Drive Shaft		25	24	58	79	625	
	2010.08-	-	MT	L	F	MPV Engine 9HL (DV6C)	245126	Drive Shaft		25	24	58.5	89	630	
	2010.08-	-	MT	L	F	MPV Engine 9HL (DV6C)	299019	Drive Shaft	29T	25	24	55.7	79	620	
	2010.08-	-	MT	R	F	MPV Engine 9HL (DV6C)	245104	Drive Shaft		25	24	58	79	925	
1.6 HDi (84 kW)	2013.03-	-	MT	R	F	MPV Engine 9HL (DV6C)	210229	Drive Shaft		25	24	58.5	79	935	

YEAR	TRANSM	L/R	F/R	REMARKS	GSP Ref.	PRODUCT	ABS	Technical Specifications						
								A	B	C	H	L	P	
PEUGEOT														
PARTNER Tepee														
1.6 HdI (84 kW)	2013.03-	-	MT	L F	MPV Engine 9HL (DV6C)	245105	Drive Shaft		25	24	58	79	625	
	2013.03-	-	MT	L F	MPV Engine 9HL (DV6C)	245126	Drive Shaft		25	24	58.5	89	630	
	2013.03-	-	MT	L F	MPV Engine 9HL (DV6C)	299019	Drive Shaft	29T	25	24	55.7	79	620	
	2013.03-	-	MT	R F	MPV Engine 9HL (DV6C)	245104	Drive Shaft		25	24	58	79	925	
1.6 HdI 16V (66 kW)	2008.04-	-	MT	L F	MPV Engine 9HV (DV6TED4)/9HX (DV6ATED4)	610057	Inner Joint		24	34	40	52.5	90	
	2008.04-	-	MT	R F	MPV Engine 9HV (DV6TED4)/9HX (DV6ATED4)	610058	Inner Joint		24	34	29.8	365	88	
	2008.04-	-	-	-	MPV Engine 9HV (DV6TED4)/9HX (DV6ATED4)	810028	Outer Joint		25	34	58	89	56	I
	2008.04-	-	MT	R F	MPV Engine 9HV (DV6TED4)/9HX (DV6ATED4)	210229	Drive Shaft		25	24	58.5	79	935	
	2008.04-	-	MT	L F	MPV Engine 9HV (DV6TED4)/9HX (DV6ATED4)	210255	Drive Shaft		25	24	58.5	79	616	
	2008.04-	-	MT	R F	MPV Engine 9HV (DV6TED4)/9HX (DV6ATED4)	210254	Drive Shaft		25	24	58.5	79	939	
	2008.04-	-	-	-	MPV Engine 9HV (DV6TED4)/9HX (DV6ATED4)	245105	Drive Shaft		25	24	58	79	625	
	2008.04-	-	-	-	MPV Engine 9HV (DV6TED4)/9HX (DV6ATED4)	245126	Drive Shaft		25	24	58.5	89	630	
	2008.04-	-	MT	R F	MPV Engine 9HV (DV6TED4)/9HX (DV6ATED4)	210299	Drive Shaft		21	22	49	86	863	
	2008.04-	-	MT	L F	MPV Engine 9HV (DV6TED4)/9HX (DV6ATED4)	299019	Drive Shaft	29T	25	24	55.7	79	620	
	2008.04-	-	-	-	MPV Engine 9HV (DV6TED4)/9HX (DV6ATED4)	245104	Drive Shaft		25	24	58	79	925	
1.6 HdI 90 (68 kW)	2010.04-	-	-	-	MPV Engine 9HP (DV6DTED)	810028	Outer Joint		25	34	58	89	56	I
	2010.04-	-	MT	-	MPV Engine 9HP (DV6DTED)	899366	Outer Joint		25	34	58.5	79	55	I
	2010.04-	-	MT	L F	MPV Engine 9HP (DV6DTED)	245105	Drive Shaft		25	24	58	79	625	
	2010.04-	-	MT	L F	MPV Engine 9HP (DV6DTED)	245126	Drive Shaft		25	24	58.5	89	630	
	2010.04-	-	MT	L F	MPV Engine 9HP (DV6DTED)	299019	Drive Shaft	29T	25	24	55.7	79	620	
	2010.04-	-	MT	R F	MPV Engine 9HP (DV6DTED)	245104	Drive Shaft		25	24	58	79	925	
	2010.04-	-	MT	R F	MPV Engine 9HP (DV6DTED)	210229	Drive Shaft		25	24	58.5	79	935	
PARTNER VAN														
1.8 D/1.9 D	1996.10-	-	MT/AT	L -	LCV	210050	Drive Shaft		25	24	55.7	79	583	
RCZ														
1.6 16V (115 kW)	2010.03-	-	6MT	-	F Coupe Engine EP6CDT	810028	Outer Joint		25	34	58	89	56	I
	2010.03-	-	6MT	-	Coupe Engine EP6CDT	899366	Outer Joint		25	34	58.5	79	55	I
1.6 16V (147 kW)	2010.06-	-	6MT	-	F Coupe Engine EP6CDTX	810028	Outer Joint		25	34	58	89	56	I
	2010.06-	-	6MT	-	Coupe Engine EP6CDTX	899366	Outer Joint		25	34	58.5	79	55	I
2.0 HdI (120 kW)	2010.03-	-	6MT	-	F Coupe Engine RHH (DW10CTED4)	810155	Outer Joint		25	39	58.5	89	63.5	I
	2010.03-	-	-	-	Coupe Engine RHH (DW10CTED4)	810051	Outer Joint		28	39	58.6	94	63	I
PEUGEOT (DF-PSA)														
307														
1.6 (78 kW)	2004.08-	2014.12	AT	L -	Saloon Engine TU5JP4	245127	Drive Shaft	29T	25	26	55.7	79	580	
	2004.08-	2014.12	AT	R -	Saloon Engine TU5JP4	245128	Drive Shaft	29T	25	26	55.7	79	736	
	2004.08-	2014.12	MT	L -	Saloon Engine TU5JP4	245129	Drive Shaft		25	22	59	80	639	
	2004.08-	2014.12	MT	R -	Saloon Engine TU5JP4	245130	Drive Shaft		25	22	59	80	914	
	2008.02-	2014.12	AT	L -	Hatchback Engine TU5JP4	245127	Drive Shaft	29T	25	26	55.7	79	580	
	2008.02-	2014.12	AT	R -	Hatchback Engine TU5JP4	245128	Drive Shaft	29T	25	26	55.7	79	736	
	2008.02-	2014.12	MT	L -	Hatchback Engine TU5JP4	245129	Drive Shaft		25	22	59	80	639	
	2008.02-	2014.12	MT	R -	Hatchback Engine TU5JP4	245130	Drive Shaft		25	22	59	80	914	
2.0 (108 kW)	2006.05-	2010.12	AT	L -	Saloon Engine EW10A	245127	Drive Shaft	29T	25	26	55.7	79	580	
	2006.05-	2010.12	AT	R -	Saloon Engine EW10A	245128	Drive Shaft	29T	25	26	55.7	79	736	
	2006.05-	2010.12	MT	L -	Saloon Engine EW10A	245131	Drive Shaft		25	24	59	80	623	
	2006.05-	2010.12	MT	R -	Saloon Engine EW10A	245132	Drive Shaft		25	24	59	80	920	
	2008.02-	2012.12	AT	L -	Hatchback Engine EW10A	245127	Drive Shaft	29T	25	26	55.7	79	580	
	2008.02-	2012.12	AT	R -	Hatchback Engine EW10A	245128	Drive Shaft	29T	25	26	55.7	79	736	
	2008.02-	2012.12	MT/AT	L -	Hatchback Engine EW10A	245131	Drive Shaft		25	24	59	80	623	
	2008.02-	2012.12	MT/AT	R -	Hatchback Engine EW10A	245132	Drive Shaft		25	24	59	80	920	
PIAGGIO														
PORTER														
1.3 i 16V (48 kW)	1998.05-	-	-	L/R	F All-wheel Drive Box	875007	Outer Joint		24	20	44	125.5	53	O
PLYMOUTH														
ACCLAIM														
-	1989-	1990	-	-	Saginaw	809010	Outer Joint		26	29	54	99.5	62.5	O
	1989-	1995	-	-	-	809008	Outer Joint		26	28	54	98	58	I
	1991-	-	-	-	-	609026	Inner Joint		25	32	40	71	124	
	1991-	1993	-	-	GKN PASSENGER	609027	Inner Joint		25	32	28	172	137	
BREEZE														
-	1996-	1999	-	-	-	609010	Inner Joint		25	32	40	74	113	
COLT VISTA														
2.4	1992-	1994	AT	-	-	839041	Outer Joint		25	25	54	95.5	65	M
NEON														
-	1995-	1999	AT	R	-	215009	Drive Shaft		23	25	57.7	91.8	942	

YEAR	TRANS	L/R	F/R	REMARKS	GSP Ref.	PRODUCT	ABS	Technical Specifications						
								A	B	C	H	L	P	
PLYMOUTH NEON														
-	1995-1996	MT/AT	L	-	-	215006	Drive Shaft		23	25	57.7	91.8	582	
-	1995-1996	MT/AT	-	-	-	609020	Inner Joint		25	28	40	71.5	109.5	
-	1995-1999	AT	-	-	-	615003	Inner Joint		25	28	28	172.5	103	
RELIANT														
-	1986-1989	-	-	-	SAGINAW	809010	Outer Joint		26	29	54	99.5	62.5	O
SUNDANCE														
-	1987-1992	-	-	-	Saginaw	809010	Outer Joint		26	29	54	99.5	62.5	O
VOYAGER														
-	1991-1995	-	-	-	-	609026	Inner Joint		25	32	40	71	124	
-	1991-1995	-	-	-	SUV/Truck/VAN GKN PASSENGER	609027	Inner Joint		25	32	28	172	137	
-	1996-2000	-	-	-	SUV/Truck/VAN	609021	Inner Joint		25	32	28	173	107	
-	1996-2000	-	-	-	SUV/Truck/VAN	699059	Inner Joint		25	32	40	71.5	107	
VOYAGER VAN														
-	1996-1997	-	-	-	TRUCK	609011	Inner Joint		25	32	40	71.5	107	
VOYAGER/GRAND VOYAGER														
2.0 i (98 kW)	1995.01-2001.03	4AT/5MT	-	F	MPV	809029	Outer Joint	47T	26	32	54	98.5	61.5	I
2.4 i (111 kW)	1995.01-2001.03	4AT/5MT	-	F	MPV Engine EDZ	809029	Outer Joint	47T	26	32	54	98.5	61.5	I
2.5 TD (85 kW)	1995.01-2001.03	4AT/5MT	-	F	MPV Engine ENC	809029	Outer Joint	47T	26	32	54	98.5	61.5	I
3.0 (112 kW)	1995.01-2001.03	4AT/5MT	-	F	MPV Engine EFA	809029	Outer Joint	47T	26	32	54	98.5	61.5	I
3.3 i (116 kW)	1995.01-2001.03	4AT/5MT	-	F	MPV Engine EGM	809029	Outer Joint	47T	26	32	54	98.5	61.5	I
3.8 i (122 kW)	1995.01-2001.03	4AT/5MT	-	F	MPV Engine EGH	809029	Outer Joint	47T	26	32	54	98.5	61.5	I
3.8 i (131 kW)	1995.01-2001.03	4AT/5MT	-	F	MPV Engine EGH	809029	Outer Joint	47T	26	32	54	98.5	61.5	I
3.8 i AWD (122 kW)	1995.01-2001.03	4AT/5MT	-	F	All-wheel Drive MPV Engine EGH	809029	Outer Joint	47T	26	32	54	98.5	61.5	I
3.8 i AWD (131 kW)	1995.01-2001.03	4AT/5MT	-	F	All-wheel Drive MPV Engine EGH	809029	Outer Joint	47T	26	32	54	98.5	61.5	I
PONTIAC 6000														
AWD	1989-1990	-	-	-	-	699117	Propshaft CV Joint			22		88.5		
	1989-1990	-	-	-	-	699117	Inner Joint			22		88.5		
6000 (AWD)														
-	1989-1990	-	-	-	-	699117	Propshaft CV Joint			22		88.5		
G3														
-	2007-2009	MT	L/R	-	-	621021	Inner Joint		34	22	35	56.5	106	
-	2007-2009	AT	L/R	-	-	608043	Inner Joint		22	22	38	59.5	101.5	
-	2007-2009	MT/AT	L/R	-	-	844096	Outer Joint		22	22	52	95	56.5	M
GRAND AM														
-	1999-2004	AT	L/R	-	-	608007	Inner Joint		34	32	36.7	39	90	
GRAND PRIX														
-	1988-1993	AT	-	-	3 Speed	808024	Outer Joint		33	29	73	88	54.5	O
-	1988-1996	-	-	-	Excl. A/T, 3 Speed.	806011	Outer Joint	47T	33	32	73	88	55	O
-	1988-1996	-	-	-	Excl. A/T, 3 Speed.	806002	Outer Joint		33	32	73	88	55	O
LEMANS														
-	1988-	-	-	-	1st Design	844062	Outer Joint		22	22	52	94.5	50	O
MATIZ														
1.0	2004-2012	MT	L/R	-	-	812045	Outer Joint		23	19	46	91.5	56.5	O
MONTANA														
3.4 AWD (138 kW)	1998.04-2005.08	-	-	-	All-wheel Drive MPV Engine LA1	606026	Propshaft CV Joint			25		40		
PONTIAC 6000 (AWD)														
-	1989-1990	-	-	-	-	699117	Inner Joint			22		88.5		
SOLSTICE														
-	2007-2009	-	-	R	-	635045	Propshaft CV Joint			24		32		
SUNBIRD (J-BODY)														
-	1992-1995	-	-	-	LD Driveline&Brakes	821018	Outer Joint	48T	33	29	47.6	108	63	O
SUNFIRE														
-	1997-2005	MT/AT	L/R	-	-	608007	Inner Joint		34	32	36.7	39	90	
-	1997-1999	MT/AT	L/R	-	-	808023	Outer Joint	48T	33	29	47.6	108	63	M
-	1997-1999	MT/AT	L/R	-	-	808010	Outer Joint		33	29	47.6	108	63	M
-	1997-1999	MT/AT	L/R	-	-	808023	Outer Joint	48T	33	29	47.6	108	63	M
TORRENT														
-	2006-	-	-	-	AWD	635046	Propshaft CV Joint			25		26		
PORSCHE 911														
3.2 (160 kW)	1986.08-1989.08	-	-	R	Coupe Engine 930.25	661015	Inner Joint			28		32		
	1986.08-1989.08	MT	L/R	R	Coupe Engine 930.25	248001	Drive Shaft		28		53	98	601	
3.2 Carrera Speedster (160 kW)	1986.08-1989.08	MT	L/R	R	Convertible Engine 930.25	248001	Drive Shaft		28		53	98	601	





	 YEAR	TRANSM	L/R	F/R	REMARKS	GSP Ref.	 PRODUCT	 ABS	Technical Specifications					
									A	B	C	H	L	P
PORSCHE														
911														
3.2 Carrera Speedster (170 kW)	1986.08-1989.08	-	L/R	R	Convertible Engine 930.20	248003	Drive Shaft				32.2	494		
	1986.08-1989.08	-	L/R	R	Convertible Engine 930.20	248001	Drive Shaft	28		53	98	601		
3.2 SC Carrera (152 kW)	1984.10-1989.08	MT	L/R	R	Convertible Engine 930.21	248001	Drive Shaft	28		53	98	601		
3.2 SC Carrera (170 kW)	1983.08-1989.08	MT	L/R	R	Coupe Engine 930.26/930.20	248001	Drive Shaft	28		53	98	601		
3.3 Turbo (221 kW)	1986.06-1989.08	-	-	-	Coupe Engine 930.66	661015	Inner Joint		28		32			
3.3 Turbo (243 kW)	1986.09-1990.11	MT	-	-	Coupe Engine 930.60	661015	Inner Joint		28		32			
911 (991)														
3.8 Turbo (383 kW)	2013.09-	-	L	-	All-wheel Drive Coupe Engine MA1.71	248004	Drive Shaft	48W	28		60.3	100	512	
	2013.09-	-	R	-	All-wheel Drive Coupe Engine MA1.71	248005	Drive Shaft	48T	28		56.5	94	683	
3.8 Turbo S (412 kW)	2013.09-	-	L	-	All-wheel Drive Coupe Engine MA1.71	248004	Drive Shaft	48W	28		60.3	100	512	
	2013.09-	-	R	-	All-wheel Drive Coupe Engine MA1.71	248005	Drive Shaft	48T	28		56.5	94	683	
911 (996)														
3.4 Carrera (221 kW)	1997.09-2001.09	-	L	-	Coupe Engine M 96.01/M 96.04	248004	Drive Shaft	48W	28		60.3	100	512	
	1997.09-2001.09	-	R	-	Coupe Engine M 96.01/M 96.04	248005	Drive Shaft	48T	28		56.5	94	683	
3.4 Carrera 4 (221 kW)	1997.09-2001.09	-	L	F	All-wheel Drive Coupe Engine M 96.01/M 96.04	248004	Drive Shaft	48W	28		60.3	100	512	
	1997.09-2001.09	-	R	R	All-wheel Drive Coupe Engine M 96.01/M 96.04	248005	Drive Shaft	48T	28		56.5	94	683	
3.6 (235 kW)	2001.12-2005.08	-	L	-	Targa Engine M 96.03	248004	Drive Shaft	48W	28		60.3	100	512	
	2001.12-2005.08	-	R	-	Targa Engine M 96.03	248005	Drive Shaft	48T	28		56.5	94	683	
3.6 Carrera (235 kW)	2001.10-2005.08	-	L	-	Convertible Engine M 96.03	248004	Drive Shaft	48W	28		60.3	100	512	
	2001.10-2005.08	-	R	-	Convertible Engine M 96.03	248005	Drive Shaft	48T	28		56.5	94	683	
	2001.10-2005.08	-	L	-	Coupe Engine M 96.03	248004	Drive Shaft	48W	28		60.3	100	512	
	2001.10-2005.08	-	R	-	Coupe Engine M 96.03	248005	Drive Shaft	48T	28		56.5	94	683	
3.6 Carrera 4 (235 kW)	2001.10-2005.08	-	L	-	All-wheel Drive Convertible Engine M 96.03	248004	Drive Shaft	48W	28		60.3	100	512	
	2001.10-2005.08	-	R	-	All-wheel Drive Convertible Engine M 96.03	248005	Drive Shaft	48T	28		56.5	94	683	
	2001.10-2005.08	-	L	-	All-wheel Drive Coupe Engine M 96.03	248004	Drive Shaft	48W	28		60.3	100	512	
	2001.10-2005.08	-	R	-	All-wheel Drive Coupe Engine M 96.03	248005	Drive Shaft	48T	28		56.5	94	683	
3.6 Carrera 4S (254 kW)	2002.06-2005.08	-	L	-	All-wheel Drive Convertible Engine M 96.03	248004	Drive Shaft	48W	28		60.3	100	512	
	2002.06-2005.08	-	R	-	All-wheel Drive Convertible Engine M 96.03	248005	Drive Shaft	48T	28		56.5	94	683	
	2003.02-2005.08	-	L	-	All-wheel Drive Coupe Engine M 96.03	248004	Drive Shaft	48W	28		60.3	100	512	
	2003.02-2005.08	-	R	-	All-wheel Drive Coupe Engine M 96.03	248005	Drive Shaft	48T	28		56.5	94	683	
3.6 Carrera S (254 kW)	2002.06-2005.08	-	L	-	Convertible Engine M 96.03	248004	Drive Shaft	48W	28		60.3	100	512	
	2002.06-2005.08	-	R	-	Convertible Engine M 96.03	248005	Drive Shaft	48T	28		56.5	94	683	
	2003.02-2005.08	-	L	-	Coupe Engine M 96.03	248004	Drive Shaft	48W	28		60.3	100	512	
	2003.02-2005.08	-	R	-	Coupe Engine M 96.03	248005	Drive Shaft	48T	28		56.5	94	683	
3.6 GT2 (340 kW)	2001.04-2005.08	-	L	-	Coupe Engine M 96.70	248004	Drive Shaft	48W	28		60.3	100	512	
	2001.04-2005.08	-	R	-	Coupe Engine M 96.70	248005	Drive Shaft	48T	28		56.5	94	683	
3.6 GT2 (355 kW)	2003.10-2005.08	-	L	-	Coupe Engine M 96.70	248004	Drive Shaft	48W	28		60.3	100	512	
	2003.10-2005.08	-	R	-	Coupe Engine M 96.70	248005	Drive Shaft	48T	28		56.5	94	683	
3.6 GT3 (265 kW)	1999.03-2005.08	-	L	-	Coupe Engine M 96.76	248004	Drive Shaft	48W	28		60.3	100	512	
	1999.03-2005.08	-	R	-	Coupe Engine M 96.76	248005	Drive Shaft	48T	28		56.5	94	683	
3.6 GT3 (280 kW)	2003.03-2005.08	-	L	-	Coupe Engine M 96.79	248004	Drive Shaft	48W	28		60.3	100	512	
	2003.03-2005.08	-	R	-	Coupe Engine M 96.79	248005	Drive Shaft	48T	28		56.5	94	683	
3.6 S (331 kW)	2004.08-2005.08	-	L	F	Convertible Engine M 96.70	248004	Drive Shaft	48W	28		60.3	100	512	
	2004.08-2005.08	-	R	F	Convertible Engine M 96.70	248005	Drive Shaft	48T	28		56.5	94	683	
	2004.08-2005.08	-	L	F	Coupe Engine M 96.70	248004	Drive Shaft	48W	28		60.3	100	512	
	2004.08-2005.08	-	R	F	Coupe Engine M 96.70	248005	Drive Shaft	48T	28		56.5	94	683	
3.6 Turbo 4 (309 kW)	2000.06-2005.08	-	L	-	All-wheel Drive Coupe Engine M 96.70	248004	Drive Shaft	48W	28		60.3	100	512	
	2000.06-2005.08	-	R	-	All-wheel Drive Coupe Engine M 96.70	248005	Drive Shaft	48T	28		56.5	94	683	
3.6 Turbo 4S (331 kW)	2003.02-2005.08	-	L	-	All-wheel Drive Coupe Engine M 96.70	248004	Drive Shaft	48W	28		60.3	100	512	
	2003.02-2005.08	-	R	-	All-wheel Drive Coupe Engine M 96.70	248005	Drive Shaft	48T	28		56.5	94	683	
911 (997)														
3.6 Carrera (239 kW)	2004.07-2008.12	-	L	F	Coupe Engine M 96.05	248004	Drive Shaft	48W	28		60.3	100	512	
	2004.07-2008.12	-	R	F	Coupe Engine M 96.05	248005	Drive Shaft	48T	28		56.5	94	683	
	2005.04-2008.12	-	L	-	Convertible Engine M 96.05	248004	Drive Shaft	48W	28		60.3	100	512	
	2005.04-2008.12	-	R	-	Convertible Engine M 96.05	248005	Drive Shaft	48T	28		56.5	94	683	
3.6 Carrera (254 kW)	2008.06-2011.12	-	L/R	R	Coupe Engine MA1.02	248004	Drive Shaft	48W	28		60.3	100	512	
	2008.06-2011.12	-	L/R	F	Coupe Engine MA1.02	248005	Drive Shaft	48T	28		56.5	94	683	
	2008.06-2011.12	-	L/R	R	Convertible Engine MA1.02	248004	Drive Shaft	48W	28		60.3	100	512	
	2008.06-2011.12	-	L/R	F	Convertible Engine MA1.02	248005	Drive Shaft	48T	28		56.5	94	683	
3.6 Carrera 4 (239 kW)	2004.07-2008.12	-	L	-	All-wheel Drive Coupe Engine M 96.05	248004	Drive Shaft	48W	28		60.3	100	512	
	2004.07-2008.12	-	R	-	All-wheel Drive Coupe Engine M 96.05	248005	Drive Shaft	48T	28		56.5	94	683	
	2005.04-2008.12	-	L	-	All-wheel Drive Convertible Engine M 96.05	248004	Drive Shaft	48W	28		60.3	100	512	
	2005.04-2008.12	-	R	-	All-wheel Drive Convertible Engine M 96.05	248005	Drive Shaft	48T	28		56.5	94	683	
	2006.07-2008.12	-	L/R	R	All-wheel Drive Targa Engine M 96.05	248004	Drive Shaft	48W	28		60.3	100	512	
	2006.07-2008.12	-	L/R	F	All-wheel Drive Targa Engine M 96.05	248005	Drive Shaft	48T	28		56.5	94	683	
3.6 Carrera 4 (254 kW)	2008.06-2012.12	-	L/R	R	All-wheel Drive Coupe Engine MA1.02	248004	Drive Shaft	48W	28		60.3	100	512	



	 YEAR	TRANSM	L/R	F/R	REMARKS	GSP Ref.	 PRODUCT	 ABS	Technical Specifications					
									A	B	C	H	L	P
PORSCHE														
911 (997)														
3.6 Carrera 4 (254 kW)	2008.06-2012.12	-	L/R	F	All-wheel Drive Coupe Engine MA1.02	248005	Drive Shaft	48T	28	56.5	94	683		
	2008.06-2012.12	-	L/R	R	All-wheel Drive Convertible Engine MA1.02	248004	Drive Shaft	48W	28	60.3	100	512		
	2008.06-2012.12	-	L/R	F	All-wheel Drive Convertible Engine MA1.02	248005	Drive Shaft	48T	28	56.5	94	683		
	2008.10-2012.12	-	L/R	R	All-wheel Drive Targa Engine MA1.02	248004	Drive Shaft	48W	28	60.3	100	512		
	2008.10-2012.12	-	L/R	F	All-wheel Drive Targa Engine MA1.02	248005	Drive Shaft	48T	28	56.5	94	683		
3.6 GT 2 (390 kW)	2007.09-2012.12	-	L	-	Coupe Engine M 97.70S	248004	Drive Shaft	48W	28	60.3	100	512		
	2007.09-2012.12	-	R	-	Coupe Engine M 97.70S	248005	Drive Shaft	48T	28	56.5	94	683		
3.6 GT3 (305 kW)	2006.03-2009.12	-	L/R	-	Coupe Engine M 97.76	248004	Drive Shaft	48W	28	60.3	100	512		
	2006.03-2009.12	-	L/R	-	Coupe Engine M 97.76	248005	Drive Shaft	48T	28	56.5	94	683		
3.6 Turbo (353 kW)	2006.03-2009.12	-	L/R	-	All-wheel Drive Coupe Engine M 97.70	248004	Drive Shaft	48W	28	60.3	100	512		
	2006.03-2009.12	-	L/R	-	All-wheel Drive Coupe Engine M 97.70	248005	Drive Shaft	48T	28	56.5	94	683		
	2007.09-2009.12	-	L	-	All-wheel Drive Convertible Engine M 97.70	248004	Drive Shaft	48W	28	60.3	100	512		
	2007.09-2009.12	-	R	-	All-wheel Drive Convertible Engine M 97.70	248005	Drive Shaft	48T	28	56.5	94	683		
3.8 Carrera 4S (261 kW)	2004.07-2008.12	-	L	-	All-wheel Drive Coupe Engine M 97.01	248004	Drive Shaft	48W	28	60.3	100	512		
	2004.07-2008.12	-	R	-	All-wheel Drive Coupe Engine M 97.01	248005	Drive Shaft	48T	28	56.5	94	683		
	2005.04-2008.12	-	L	-	All-wheel Drive Convertible Engine M 97.01	248004	Drive Shaft	48W	28	60.3	100	512		
	2005.04-2008.12	-	R	-	All-wheel Drive Convertible Engine M 97.01	248005	Drive Shaft	48T	28	56.5	94	683		
	2006.07-2008.12	-	L/R	R	All-wheel Drive Targa Engine M 97.01	248004	Drive Shaft	48W	28	60.3	100	512		
	2006.07-2008.12	-	L/R	F	All-wheel Drive Targa Engine M 97.01	248005	Drive Shaft	48T	28	56.5	94	683		
3.8 Carrera 4S (280 kW)	2005.08-2008.12	-	L	F	All-wheel Drive Convertible Engine M 97.01S	248004	Drive Shaft	48W	28	60.3	100	512		
	2005.08-2008.12	-	R	F	All-wheel Drive Convertible Engine M 97.01S	248005	Drive Shaft	48T	28	56.5	94	683		
	2005.08-2008.12	-	L	-	All-wheel Drive Coupe Engine M 97.01S	248004	Drive Shaft	48W	28	60.3	100	512		
	2005.08-2008.12	-	R	-	All-wheel Drive Coupe Engine M 97.01S	248005	Drive Shaft	48T	28	56.5	94	683		
3.8 Carrera 4S (283 kW)	2008.06-2012.12	-	L/R	R	All-wheel Drive Coupe Engine MA1.01	248004	Drive Shaft	48W	28	60.3	100	512		
	2008.06-2012.12	-	L/R	F	All-wheel Drive Coupe Engine MA1.01	248005	Drive Shaft	48T	28	56.5	94	683		
	2008.06-2012.12	-	L/R	R	All-wheel Drive Convertible Engine MA1.01	248004	Drive Shaft	48W	28	60.3	100	512		
	2008.06-2012.12	-	L/R	F	All-wheel Drive Convertible Engine MA1.01	248005	Drive Shaft	48T	28	56.5	94	683		
3.8 Carrera S (261 kW)	2004.07-2008.12	-	L	F	Coupe Engine M 97.01	248004	Drive Shaft	48W	28	60.3	100	512		
	2004.07-2008.12	-	R	F	Coupe Engine M 97.01	248005	Drive Shaft	48T	28	56.5	94	683		
	2005.04-2008.12	-	L	-	Convertible Engine M 97.01	248004	Drive Shaft	48W	28	60.3	100	512		
	2005.04-2008.12	-	R	-	Convertible Engine M 97.01	248005	Drive Shaft	48T	28	56.5	94	683		
3.8 Carrera S (280 kW)	2005.08-2008.12	-	L	-	Convertible Engine M 97.01S	248004	Drive Shaft	48W	28	60.3	100	512		
	2005.08-2008.12	-	R	-	Convertible Engine M 97.01S	248005	Drive Shaft	48T	28	56.5	94	683		
	2005.08-2008.12	-	L	-	Coupe Engine M 97.01S	248004	Drive Shaft	48W	28	60.3	100	512		
	2005.08-2008.12	-	R	-	Coupe Engine M 97.01S	248005	Drive Shaft	48T	28	56.5	94	683		
3.8 Carrera S (283 kW)	2008.06-2011.12	-	L/R	R	Coupe Engine MA1.01	248004	Drive Shaft	48W	28	60.3	100	512		
	2008.06-2011.12	-	L/R	F	Coupe Engine MA1.01	248005	Drive Shaft	48T	28	56.5	94	683		
	2008.06-2011.12	-	L/R	R	Convertible Engine MA1.01	248004	Drive Shaft	48W	28	60.3	100	512		
	2008.06-2011.12	-	L/R	F	Convertible Engine MA1.01	248005	Drive Shaft	48T	28	56.5	94	683		
3.8 GT3 (320 kW)	2009.05-2011.12	-	L/R	R	Coupe Engine M 97.77	248004	Drive Shaft	48W	28	60.3	100	512		
	2009.05-2011.12	-	L/R	F	Coupe Engine M 97.77	248005	Drive Shaft	48T	28	56.5	94	683		
3.8 GT3 RS (331 kW)	2009.08-2011.12	-	L	-	Coupe Engine M 97.77R	248004	Drive Shaft	48W	28	60.3	100	512		
	2009.08-2011.12	-	R	-	Coupe Engine M 97.77R	248005	Drive Shaft	48T	28	56.5	94	683		
944														
2.5 (118 kW)	1987.08-1990.12	AT/MT	L/R	R	Coupe Engine M 44.10/M 44.09/M 44.05	648003	Inner Joint			33		34		
3.0 S2 (155 kW)	1988.12-1991.07	MT	L/R	R	Coupe Engine M 44.41	648003	Inner Joint			33		34		
BOXSTER (981)														
2.7 (195 kW)	2012.04-	AT	L/R	R	Convertible Engine MA1.22	605013	Inner Joint			28		26		
	2012.04-	AT	L/R	R	Convertible Engine MA1.22	648010	Inner Joint		28	28	56	92	55.5	
BOXSTER (986)														
2.5 (150 kW)	1996.09-1999.08	-	-	R	Convertible Engine M 96.20	602006	Inner Joint			25		32		
S 3.2 (191 kW)	2002.07-2004.12	-	-	R	Convertible Engine M 96.24	248002	Drive Shaft	48W	28	61	94	680		
S 3.2 (196 kW)	2004.01-2004.12	-	-	R	Convertible Engine M 96.24	248002	Drive Shaft	48W	28	61	94	680		
CAYENNE (92A)														
3.0 Diesel (155 kW)	2010.06-	AT/MT	L/R	R	All-wheel Drive Closed Off-Road Vehicle Engine MCV.VC/MCR.CB	261298	Drive Shaft		30	37	64	103.5	863	
3.0 Diesel (176 kW)	2010.06-	-	R	F	All-wheel Drive Closed Off-Road Vehicle Engine M 05.9E/MCN.RB	235085	Drive Shaft		30		64.4	103.5	525	
3.0 Diesel (184 kW)	2014.08-	AT	L/R	F	All-wheel Drive Closed Off-Road Vehicle Engine MCV.VB	235085	Drive Shaft		30		64.4	103.5	525	
	2014.08-	AT	L/R	F	All-wheel Drive Closed Off-Road Vehicle Engine MCV.VB	699148	Inner Joint			28		34		
	2014.08-	AT	L/R	R	All-wheel Drive Closed Off-Road Vehicle Engine MCV.VB	261298	Drive Shaft		30	37	64	103.5	863	
3.0 Diesel (193 kW)	2014.10-	AT	L/R	F	All-wheel Drive Closed Off-Road Vehicle Engine MCV.VA	235085	Drive Shaft		30		64.4	103.5	525	
	2014.10-	AT	L/R	F	All-wheel Drive Closed Off-Road Vehicle Engine MCV.VA	699148	Inner Joint			28		34		
	2014.10-	AT	L/R	R	All-wheel Drive Closed Off-Road Vehicle Engine MCV.VA	261298	Drive Shaft		30	37	64	103.5	863	
3.0 S E-Hybrid (245 kW)	2010.06-	-	R	F	All-wheel Drive Closed Off-Road Vehicle Engine MCG.FA/MCG.EA/MCG.E/M 06.EC	235085	Drive Shaft		30		64.4	103.5	525	
3.0 S E-Hybrid (306 kW)	2014.10-	-	L/R	F	All-wheel Drive Closed Off-Road Vehicle Engine MCG.FA/MCG.EA/MCG.E/M 07.EC	235085	Drive Shaft		30		64.4	103.5	525	
	2014.10-	-	L/R	F	All-wheel Drive Closed Off-Road Vehicle Engine MCG.FA/MCG.EA/MCG.E/M 07.EC	699148	Inner Joint			28		34		
	2014.10-	-	L/R	R	All-wheel Drive Closed Off-Road Vehicle Engine MCG.FA/MCG.EA/MCG.E/M 07.EC	261298	Drive Shaft		30	37	64	103.5	863	





	 YEAR	TRANSM	L/R	F/R	REMARKS	GSP Ref.	 PRODUCT	 ABS	Technical Specifications						
									A	B	C	H	L	P	
PORSCHE															
CAYENNE (92A)															
3.6 (220 kW)	2010.06-	-	AT/MT	L/R	R	All-wheel Drive Closed Off-Road Vehicle Engine M 55.02/MCE.YA	261298	Drive Shaft		30	37	64	103.5	863	
4.2 S Diesel (281 kW)	2012.10-	-	-	R	-	All-wheel Drive Closed Off-Road Vehicle Engine MCU.DB	201106	Drive Shaft		30	32	64	103.5	865	
	2012.10-	-	-	R	-	All-wheel Drive Closed Off-Road Vehicle Engine MCU.DB	601044	Inner Joint		30	30	64	103.5	58	I
	2012.10-	-	-	R	-	All-wheel Drive Closed Off-Road Vehicle Engine MCU.DB	601053	Inner Joint		32	30	50	94	80	I
	2012.10-	-	AT	L/R	F	All-wheel Drive Closed Off-Road Vehicle Engine MCU.DB	699148	Inner Joint			28		34		
4.2 S Diesel (283 kW)	2014.10-	-	AT	L/R	F	All-wheel Drive Closed Off-Road Vehicle Engine MCU.DC	699148	Inner Joint			28		34		
4.8 GTS (309 kW)	2012.06-	-	AT	L/R	F	All-wheel Drive Closed Off-Road Vehicle Engine M 48.02	235085	Drive Shaft		30		64.4	103.5	525	
	2012.06-	-	AT	L/R	F	All-wheel Drive Closed Off-Road Vehicle Engine M 48.02	699148	Inner Joint			28		34		
4.8 S (294 kW)	2010.06-	-	-	R	F	All-wheel Drive Closed Off-Road Vehicle Engine M 48.02	235085	Drive Shaft		30		64.4	103.5	525	
4.8 Turbo (368 kW)	2010.06-	-	-	R	-	All-wheel Drive Closed Off-Road Vehicle Engine M 48.52	201106	Drive Shaft		30	32	64	103.5	865	
	2010.06-	-	-	R	-	All-wheel Drive Closed Off-Road Vehicle Engine M 48.52	601044	Inner Joint		30	30	64	103.5	58	I
	2010.06-	-	-	R	-	All-wheel Drive Closed Off-Road Vehicle Engine M 48.52	601053	Inner Joint		32	30	50	94	80	I
	2010.06-	-	-	R	F	All-wheel Drive Closed Off-Road Vehicle Engine M 48.52	235085	Drive Shaft		30		64.4	103.5	525	
4.8 Turbo (397 kW)	2010.06-	-	-	R	-	All-wheel Drive Closed Off-Road Vehicle Engine M 48.52	201106	Drive Shaft		30	32	64	103.5	865	
	2010.06-	-	-	R	-	All-wheel Drive Closed Off-Road Vehicle Engine M 48.52	601044	Inner Joint		30	30	64	103.5	58	I
	2010.06-	-	-	R	-	All-wheel Drive Closed Off-Road Vehicle Engine M 48.52	601053	Inner Joint		32	30	50	94	80	I
4.8 Turbo S (419 kW)	2015.01-	-	-	R	F	All-wheel Drive Closed Off-Road Vehicle Engine MCY.XA	235085	Drive Shaft		30		64.4	103.5	525	
CAYENNE (9PA)															
3.0 TDI (176 kW)	2009.02-	2010.09	-	-	-	All-wheel Drive Closed Off-Road Vehicle Engine M 05.9D	661064	Inner Joint		30	28	64	103.5	64	
	2009.02-	2010.09	AT	L/R	F	All-wheel Drive Closed Off-Road Vehicle Engine M 05.9D	699148	Inner Joint			28		34		
	2009.02-	2010.09	AT	L/R	F	All-wheel Drive Closed Off-Road Vehicle Engine M 05.9D	299213	Drive Shaft		30		64	103.5	523	
	2009.02-	2010.09	AT	L/R	F	All-wheel Drive Closed Off-Road Vehicle Engine M 05.9D	861050	Outer Joint		30	27	64	103.5	63.5	M
	2009.02-	2010.09	AT	L/R	R	All-wheel Drive Closed Off-Road Vehicle Engine M 05.9D	603027	Inner Joint			28		28		
	2009.02-	2010.09	AT/MT	L/R	R	All-wheel Drive Closed Off-Road Vehicle Engine M 05.9D	261236	Drive Shaft		30		64	103.5	734	
	2009.02-	2010.09	AT/MT	L/R	R	All-wheel Drive Closed Off-Road Vehicle Engine M 05.9D	661066	Inner Joint			28		28		
3.2 (184 kW)	2003.10-	2007.09	-	L/R	F	All-wheel Drive Closed Off-Road Vehicle Engine M02.2Y	699148	Inner Joint			28		34		
	2003.10-	2007.09	-	L/R	F	All-wheel Drive Closed Off-Road Vehicle Engine M02.2Y	299213	Drive Shaft		30		64	103.5	523	
	2003.10-	2007.09	-	L/R	F	All-wheel Drive Closed Off-Road Vehicle Engine M02.2Y	861050	Outer Joint		30	27	64	103.5	63.5	M
	2003.10-	2007.09	-	L/R	R	All-wheel Drive Closed Off-Road Vehicle Engine M02.2Y	603027	Inner Joint			28		28		
	2003.10-	2007.09	-	L/R	R	All-wheel Drive Closed Off-Road Vehicle Engine M02.2Y	261236	Drive Shaft		30		64	103.5	734	
	2003.10-	2007.09	-	L/R	R	All-wheel Drive Closed Off-Road Vehicle Engine M02.2Y	661066	Inner Joint			28		28		
3.6 (213 kW)	2007.02-	2010.09	-	L/R	F	All-wheel Drive Closed Off-Road Vehicle Engine M 55.01	699148	Inner Joint			28		34		
	2007.02-	2010.09	-	-	F	All-wheel Drive Closed Off-Road Vehicle Engine M 55.01	235043	Drive Shaft		30		64	103.5	535	
	2007.02-	2010.09	-	L/R	F	All-wheel Drive Closed Off-Road Vehicle Engine M 55.01	299213	Drive Shaft		30		64	103.5	523	
	2007.02-	2010.09	-	L/R	F	All-wheel Drive Closed Off-Road Vehicle Engine M 55.01	861050	Outer Joint		30	27	64	103.5	63.5	M
	2007.02-	2010.09	-	L/R	R	All-wheel Drive Closed Off-Road Vehicle Engine M 55.01	603027	Inner Joint			28		28		
	2007.02-	2010.09	-	L/R	R	All-wheel Drive Closed Off-Road Vehicle Engine M 55.01	261236	Drive Shaft		30		64	103.5	734	
	2007.02-	2010.09	-	L/R	R	All-wheel Drive Closed Off-Road Vehicle Engine M 55.01	661066	Inner Joint			28		28		
GTS 4.8 (298 kW)	2007.10-	2010.09	-	L/R	R	All-wheel Drive Closed Off-Road Vehicle Engine M 48.01	661066	Inner Joint			28		28		
	2007.10-	2010.09	-	-	F	All-wheel Drive Closed Off-Road Vehicle Engine M 48.01	235043	Drive Shaft		30		64	103.5	535	
	2007.10-	2010.09	AT/MT	L/R	F	All-wheel Drive Closed Off-Road Vehicle Engine M 48.01	699148	Inner Joint			28		34		
	2007.10-	2010.09	-	L/R	F	All-wheel Drive Closed Off-Road Vehicle Engine M 48.01	299213	Drive Shaft		30		64	103.5	523	
	2007.10-	2010.09	AT/MT	L/R	F	All-wheel Drive Closed Off-Road Vehicle Engine M 48.01	861050	Outer Joint		30	27	64	103.5	63.5	M
	2007.10-	2010.09	AT	L/R	R	All-wheel Drive Closed Off-Road Vehicle Engine M 48.01	603027	Inner Joint			28		28		
	2007.10-	2010.09	-	L/R	R	All-wheel Drive Closed Off-Road Vehicle Engine M 48.01	261236	Drive Shaft		30		64	103.5	734	
S 4.5 (250 kW)	2002.09-	2007.09	-	-	-	All-wheel Drive Closed Off-Road Vehicle Engine M 48.00	661064	Inner Joint		30	28	64	103.5	64	
	2002.09-	2007.09	AT/MT	L/R	F	All-wheel Drive Closed Off-Road Vehicle Engine M 48.00	699148	Inner Joint			28		34		
	2002.09-	2007.09	AT/MT	L/R	F	All-wheel Drive Closed Off-Road Vehicle Engine M 48.00	299213	Drive Shaft		30		64	103.5	523	
	2002.09-	2007.09	AT/MT	L/R	F	All-wheel Drive Closed Off-Road Vehicle Engine M 48.00	861050	Outer Joint		30	27	64	103.5	63.5	M
	2002.09-	2007.09	AT	L/R	R	All-wheel Drive Closed Off-Road Vehicle Engine M 48.00	603027	Inner Joint			28		28		
	2002.09-	2007.09	AT	L/R	R	All-wheel Drive Closed Off-Road Vehicle Engine M 48.00	261236	Drive Shaft		30		64	103.5	734	
	2002.09-	2007.09	AT	L/R	R	All-wheel Drive Closed Off-Road Vehicle Engine M 48.00	661066	Inner Joint			28		28		
S 4.8 (283 kW)	2007.02-	2010.09	-	L/R	R	All-wheel Drive Closed Off-Road Vehicle Engine M 48.01	661066	Inner Joint			28		28		
	2007.02-	2010.09	-	-	F	All-wheel Drive Closed Off-Road Vehicle Engine M 48.01	235043	Drive Shaft		30		64	103.5	535	
	2007.02-	2010.09	AT/MT	L/R	F	All-wheel Drive Closed Off-Road Vehicle Engine M 48.01	699148	Inner Joint			28		34		
	2007.02-	2010.09	-	L/R	F	All-wheel Drive Closed Off-Road Vehicle Engine M 48.01	299213	Drive Shaft		30		64	103.5	523	
	2007.02-	2010.09	AT/MT	L/R	F	All-wheel Drive Closed Off-Road Vehicle Engine M 48.01	861050	Outer Joint		30	27	64	103.5	63.5	M
	2007.02-	2010.09	AT	L/R	R	All-wheel Drive Closed Off-Road Vehicle Engine M 48.01	603027	Inner Joint			28		28		
	2007.02-	2010.09	-	L/R	R	All-wheel Drive Closed Off-Road Vehicle Engine M 48.01	261236	Drive Shaft		30		64	103.5	734	
Turbo 4.5 (331 kW)	2002.09-	2007.09	-	L/R	F	All-wheel Drive Closed Off-Road Vehicle Engine M 48.50	699148	Inner Joint			28		34		
	2002.09-	2007.09	-	L/R	F	All-wheel Drive Closed Off-Road Vehicle Engine M 48.50	299213	Drive Shaft		30		64	103.5	523	
	2002.09-	2007.09	-	L/R	F	All-wheel Drive Closed Off-Road Vehicle Engine M 48.50	861050	Outer Joint		30	27	64	103.5	63.5	M
	2002.09-	2007.09	-	L/R	R	All-wheel Drive Closed Off-Road Vehicle Engine M 48.50	603027	Inner Joint			28		28		
	2002.09-	2007.09	-	L/R	R	All-wheel Drive Closed Off-Road Vehicle Engine M 48.50	261236	Drive Shaft		30		64	103.5	734	
	2002.09-	2007.09	-	L/R	R	All-wheel Drive Closed Off-Road Vehicle Engine M 48.50	661066	Inner Joint			28		28		
Turbo S 4.5 (368 kW)	2004.01-	2007.09	AT	L/R	F	All-wheel Drive Closed Off-Road Vehicle Engine M 48.50S	699148	Inner Joint			28		34		

YEAR	TRANSM	L/R	F/R	REMARKS	GSP Ref.	PRODUCT	ABS	Technical Specifications										
								A	B	C	H	L	P					
PORSCHE																		
CAYENNE (9PA)																		
Turbo S 4.5 (368 kW)	2004.01-2007.09	AT	L/R	F	All-wheel Drive Closed Off-Road Vehicle Engine M 48.50S	299213	Drive Shaft		30		64	103.5	523					
	2004.01-2007.09	AT	L/R	F	All-wheel Drive Closed Off-Road Vehicle Engine M 48.50S	861050	Outer Joint		30	27	64	103.5	63.5	M				
	2004.01-2007.09	-	L/R	R	All-wheel Drive Closed Off-Road Vehicle Engine M 48.50S	261236	Drive Shaft		30		64	103.5	734					
	2004.01-2007.09	-	L/R	R	All-wheel Drive Closed Off-Road Vehicle Engine M 48.50S	661066	Inner Joint			28		28						
Turbo S 4.5 (383 kW)	2006.03-2007.09	-	L/R	R	All-wheel Drive Closed Off-Road Vehicle Engine M 48.50T	661066	Inner Joint			28		28						
	2006.03-2007.09	AT	L/R	F	All-wheel Drive Closed Off-Road Vehicle Engine M 48.50T	699148	Inner Joint			28		34						
	2006.03-2007.09	AT	L/R	F	All-wheel Drive Closed Off-Road Vehicle Engine M 48.50T	299213	Drive Shaft		30		64	103.5	523					
	2006.03-2007.09	AT	L/R	F	All-wheel Drive Closed Off-Road Vehicle Engine M 48.50T	861050	Outer Joint		30	27	64	103.5	63.5	M				
	2006.03-2007.09	-	L/R	R	All-wheel Drive Closed Off-Road Vehicle Engine M 48.50T	261236	Drive Shaft		30		64	103.5	734					
Turbo S 4.8 (368 kW)	2007.02-2010.09	-	L/R	R	All-wheel Drive Closed Off-Road Vehicle Engine M 48.51	699148	Inner Joint			28		34						
	2007.02-2010.09	-	-	F	All-wheel Drive Closed Off-Road Vehicle Engine M 48.51	235043	Drive Shaft		30		64	103.5	535					
	2007.02-2010.09	-	L/R	F	All-wheel Drive Closed Off-Road Vehicle Engine M 48.51	299213	Drive Shaft		30		64	103.5	523					
	2007.02-2010.09	-	L/R	F	All-wheel Drive Closed Off-Road Vehicle Engine M 48.51	861050	Outer Joint		30	27	64	103.5	63.5	M				
	2007.02-2010.09	-	L/R	R	All-wheel Drive Closed Off-Road Vehicle Engine M 48.51	261236	Drive Shaft		30		64	103.5	734					
	2007.02-2010.09	-	L/R	R	All-wheel Drive Closed Off-Road Vehicle Engine M 48.51	661066	Inner Joint			28		28						
Turbo S 4.8 (397 kW)	2007.02-2010.09	-	L/R	F	All-wheel Drive Closed Off-Road Vehicle Engine M 48.51	699148	Inner Joint			28		34						
	2007.02-2010.09	-	L/R	F	All-wheel Drive Closed Off-Road Vehicle Engine M 48.51	299213	Drive Shaft		30		64	103.5	523					
	2007.02-2010.09	-	L/R	F	All-wheel Drive Closed Off-Road Vehicle Engine M 48.51	861050	Outer Joint		30	27	64	103.5	63.5	M				
Turbo S 4.8 (404 kW)	2008.08-2010.09	AT/MT	L/R	R	All-wheel Drive Closed Off-Road Vehicle Engine M 48.51	661066	Inner Joint			28		28						
	2008.08-2010.09	-	-	-	All-wheel Drive Closed Off-Road Vehicle Engine M 48.51	661064	Inner Joint		30	28	64	103.5	64					
	2008.08-2010.09	AT	L/R	F	All-wheel Drive Closed Off-Road Vehicle Engine M 48.51	699148	Inner Joint			28		34						
	2008.08-2010.09	AT	L/R	F	All-wheel Drive Closed Off-Road Vehicle Engine M 48.51	299213	Drive Shaft		30		64	103.5	523					
	2008.08-2010.09	AT	L/R	F	All-wheel Drive Closed Off-Road Vehicle Engine M 48.51	861050	Outer Joint		30	27	64	103.5	63.5	M				
	2008.08-2010.09	AT	L/R	R	All-wheel Drive Closed Off-Road Vehicle Engine M 48.51	603027	Inner Joint			28		28						
	2008.08-2010.09	AT/MT	L/R	R	All-wheel Drive Closed Off-Road Vehicle Engine M 48.51	261236	Drive Shaft		30		64	103.5	734					
CAYMAN (981)																		
2.7 (202 kW)	2013.03-	-	AT	L/R	R	Coupe Engine MA1.22	605013	Inner Joint			28		26					
	2013.03-	-	AT	L/R	R	Coupe Engine MA1.22	648010	Inner Joint		28	28	56	92	55.5				
MACAN (95B)																		
3.0 S Diesel (190 kW)	2014.02-	-	-	L/R	-	All-wheel Drive Closed Off-Road Vehicle Engine MCT.BA	661106	Inner joint		32	28	50	83	80				
	2014.02-	-	-	L/R	-	All-wheel Drive Closed Off-Road Vehicle Engine MCT.BA	661107	Inner Joint		42	28	76.5	34	53				
3.6 Turbo (294 kW)	2014.02-	-	-	-	F	All-wheel Drive Closed Off-Road Vehicle Engine MCT.LA	201107	Drive Shaft		42		76.5	34	494				
PROTON																		
EXORA																		
-	-	-	-	L	-	-	249011	Drive Shaft	46T	25	27	54	95.5	649				
	-	-	-	L	-	-	249011	Drive Shaft	46T	25	27	54	95.5	649				
	-	-	-	R	-	-	249012	Drive Shaft	46T	25	27	54	95.5	980				
	-	-	-	R	-	-	249012	Drive Shaft	46T	25	27	54	95.5	980				
JUMBUCK																		
1.5 (64 kW)	2002.05-	-	-	-	F	Pickup Engine 4 G 15	824009	Outer Joint		25	30	50	95	56.5	M			
PERSONA (CM3)																		
1.3	2007.01-	-	MT/AT	-	-	-	839234	Outer Joint		25	22	54	96	51.2	M			
PERSONA (CM6)																		
1.6	2007.01-	-	MT/AT	-	-	-	839234	Outer Joint		25	22	54	96	51.2	M			
PERSONA 300 (C9_M)/SATRIA																		
313i (55 kW)	1996.03-2000.01	-	L/R	F	Hatchback Engine G 13 B	839023	Outer Joint		25	22	54	95	60	I				
	1996.03-2000.01	-	-	F	Hatchback Engine G 13 B	824009	Outer Joint		25	30	50	95	56.5	M				
315 GLi/GLSi (66 kW)	1996.03-2000.07	-	L/R	F	Hatchback Engine 4 G 15 M	839023	Outer Joint		25	22	54	95	60	I				
	1996.03-2000.07	AT	-	F	Hatchback Engine 4 G 15 M	824009	Outer Joint		25	30	50	95	56.5	M				
315 GLSi (64 kW)	1996.09-2000.07	-	L/R	F	Hatchback Engine G 15 B	839023	Outer Joint		25	22	54	95	60	I				
	1996.09-2000.07	AT	-	F	Hatchback Engine G 15 B	824009	Outer Joint		25	30	50	95	56.5	M				
316 (70 kW)	1996.03-2004.07	-	L/R	F	Hatchback Engine 4 G 92	839023	Outer Joint		25	22	54	95	60	I				
	1996.03-2004.07	-	-	F	Hatchback Engine 4 G 92	839064	Outer Joint	43T	25	30	54	95	60.5	M				
316 GLXi (83 kW)	1996.03-2000.07	-	L/R	F	Hatchback Engine 4 G 92	839023	Outer Joint		25	22	54	95	60	I				
	1996.03-2000.07	-	-	F	Hatchback Engine 4 G 92	839064	Outer Joint	43T	25	30	54	95	60.5	M				
318 16V GTi (99 kW)	1996.03-2000.07	-	-	F	Hatchback Engine 4 G 93 (DOHC)	839064	Outer Joint	43T	25	30	54	95	60.5	M				
PERSONA 400 (C9_C C9_S)/WIRA																		
413 GLSi (55 kW)	1994.01-2000.01	-	L/R	F	Hatchback Engine 4 G 13	839023	Outer Joint		25	22	54	95	60	I				
	1994.01-2000.01	-	-	F	Hatchback Engine 4 G 13	824009	Outer Joint		25	30	50	95	56.5	M				
415 GLi/GLSi (66 kW)	1994.01-2000.07	-	-	-	Hatchback Engine 4 G 15	839040	Outer Joint		25	30	54	95	61	M				
	1994.01-2000.07	-	L/R	F	Hatchback Engine 4 G 15	839023	Outer Joint		25	22	54	95	60	I				
	1994.01-2000.07	-	-	F	Hatchback Engine 4 G 15	824009	Outer Joint		25	30	50	95	56.5	M				
416 GLXi (83 kW)	1994.01-2000.07	-	-	-	Hatchback Engine 4 G 92	839040	Outer Joint		25	30	54	95	61	M				
	1994.01-2000.07	-	-	F	Hatchback Engine 4 G 92	839064	Outer Joint	43T	25	30	54	95	60.5	M				
416 i (70 kW)	1995.12-2000.07	-	-	F	Hatchback Engine 4 G 92	839064	Outer Joint	43T	25	30	54	95	60.5	M				

YEAR	TRANSM	L/R	F/R	REMARKS	GSP Ref.	PRODUCT	ABS	Technical Specifications						
								A	B	C	H	L	P	
PROTON														
PERSONA 400 (C9_C C9_S)/WIRA														
418 GLXi (85 kW)	1996.05-2000.07	-	-	F	Hatchback Engine 4 G 93 (DOHC)	839064	Outer Joint	43T	25	30	54	95	60.5	M
420 D (60 kW)	1996.09-2000.07	-	-	F	Hatchback Engine 4 D 68 T	824009	Outer Joint		25	30	50	95	56.5	M
420 GLS D (48 kW)	1996.05-1999.04	-	-	F	Hatchback Engine 4 D 68	824009	Outer Joint		25	30	50	95	56.5	M
PERSONA 400 (C9_S)/WIRA														
413 (55 kW)	1994.01-2003.06	-	L/R	F	Saloon Engine 4 G 13 P	839023	Outer Joint		25	22	54	95	60	I
	1994.01-2003.06	-	-	F	Saloon Engine 4 G 13 P	824009	Outer Joint		25	30	50	95	56.5	M
415 GLi/GLSi (66 kW)	1994.01-2000.07	-	-	-	Saloon Engine 4 G 15	839040	Outer Joint		25	30	54	95	61	M
	1994.01-2000.07	-	L/R	F	Saloon Engine 4 G 15	839023	Outer Joint		25	22	54	95	60	I
	1994.01-2000.07	-	-	F	Saloon Engine 4 G 15	824009	Outer Joint		25	30	50	95	56.5	M
416 (70 kW)	2000.08-2002.02	-	-	F	Saloon Engine 4 G 92	839064	Outer Joint	43T	25	30	54	95	60.5	M
416 GLXi (83 kW)	1994.01-2000.07	-	-	-	Saloon Engine 4 G 92	839040	Outer Joint		25	30	54	95	61	M
	1994.01-2000.07	-	-	F	Saloon Engine 4 G 92	839064	Outer Joint	43T	25	30	54	95	60.5	M
418 (85 kW)	1996.05-2000.07	-	-	F	Saloon Engine 4 G 93 (DOHC)	839064	Outer Joint	43T	25	30	54	95	60.5	M
420 GLS D (48 kW)	1996.05-1999.04	-	-	F	Saloon Engine 4 D 68	824009	Outer Joint		25	30	50	95	56.5	M
420 TD (60 kW)	1996.09-2000.07	-	-	F	Saloon Engine 4 D 68 T	824009	Outer Joint		25	30	50	95	56.5	M
PERSONA CM3														
1.3	2007.01-	-	MT/AT	-	Engine	839234	Outer Joint		25	22	54	96	51.2	M
1300	2007.01-	-	MT/AT	-	Engine	839234	Outer Joint		25	22	54	96	51.2	M
PERSONA CM6														
1.6	2007.01-	-	MT/AT	-	Engine	839234	Outer Joint		25	22	54	96	51.2	M
	2007.01-	-	MT/AT	-	Engine	839234	Outer Joint		25	22	54	96	51.2	M
	2007.01-	-	MT/AT	-	Engine	839234	Outer Joint		25	22	54	96	51.2	M
1600	2007.01-	-	MT/AT	-	Engine	839234	Outer Joint		25	22	54	96	51.2	M
	2007.01-	-	MT/AT	-	Engine	839234	Outer Joint		25	22	54	96	51.2	M
	2007.01-	-	MT/AT	-	Engine	839234	Outer Joint		25	22	54	96	51.2	M
PROTON														
1.3 12V MPI	1991.01-1996.08	-	-	F	-	839085	Outer Joint		25	22	54	96	60	M
1.5 12V MPI	1991.01-1996.08	-	-	F	-	839085	Outer Joint		25	22	54	96	60	M
SAGA														
-	-	-	-	L/R	-	224001	Drive Shaft		25	25	50	95	581.2	
	-	-	-	L/R	-	639001	Inner Joint		25	22	35	55	91	
1.3	-	-	-	R	-	249005	Drive Shaft		25	24	54	94.5	927	
	-	-	-	L	-	249006	Drive Shaft		25	24	54	94.5	605	
SAGA (BT3)														
1.3	2008.08-	-	5MT	-	Engine S4P13	839234	Outer Joint		25	22	54	96	51.2	M
	2008.08-	-	4AT	-	Engine S4P13	839234	Outer Joint		25	22	54	96	51.2	M
SAGA BT3														
1.3	2008.08-	-	5MT	-	Engine S4P13	839234	Outer Joint		25	22	54	96	51.2	M
	2008.08-	-	4AT	-	Engine S4P13	839234	Outer Joint		25	22	54	96	51.2	M
1300	2008.08-	-	5MT	-	Engine S4P13	839234	Outer Joint		25	22	54	96	51.2	M
	2008.08-	-	4AT	-	Engine S4P13	839234	Outer Joint		25	22	54	96	51.2	M
SATRIA (C9_M)/COMPACT														
1.8 GTi (103 kW)	2000.08-2006.05	MT	-	F	Hatchback Engine 4 G 93 (DOHC)	839064	Outer Joint	43T	25	30	54	95	60.5	M
SATRIA NEO														
-	-	-	-	L	-	249009	Drive Shaft	29T	25	25	54	94.5	628	
	-	-	-	R	-	249010	Drive Shaft	29T	25	25	54	94.5	932	
1.3 (70 kW)	2007.02-2008.09	-	-	F	Hatchback Engine S4PE	824009	Outer Joint		25	30	50	95	56.5	M
WIRA														
1.3 (55 kW)	2000.08-	-	-	-	Saloon Engine 4 G 13	839040	Outer Joint		25	30	54	95	61	M
	2000.08-	-	-	-	Hatchback Engine 4 G 13	839040	Outer Joint		25	30	54	95	61	M
	2000.08-	-	-	F	Saloon Engine 4 G 13	824009	Outer Joint		25	30	50	95	56.5	M
	2000.08-	-	-	F	Hatchback Engine 4 G 13	824009	Outer Joint		25	30	50	95	56.5	M
1.5 (64 kW)	2000.08-	-	-	-	Saloon Engine 4 G 15	839040	Outer Joint		25	30	54	95	61	M
	2000.08-	-	-	-	Hatchback Engine 4 G 15 M	839040	Outer Joint		25	30	54	95	61	M
	2000.08-	-	-	F	Saloon Engine 4 G 15	824009	Outer Joint		25	30	50	95	56.5	M
	2000.08-	-	-	F	Hatchback Engine 4 G 15 M	824009	Outer Joint		25	30	50	95	56.5	M
1.6 (70 kW)	2000.08-2002.02	-	-	F	Saloon Engine 4 G 92	839064	Outer Joint	43T	25	30	54	95	60.5	M
2.0 D (48 kW)	2000.01-	-	-	-	Saloon Engine 4 D 68	824009	Outer Joint		25	30	50	95	56.5	M
	2000.01-	-	-	F	Hatchback Engine 4 D 68	824009	Outer Joint		25	30	50	95	56.5	M
RENAULT														
-	-	-	-	-	-	250179	Drive Shaft		21	29.95	57	84.5	630.7	
	-	-	-	-	-	250179	Drive Shaft		21	29.95	57	84.5	630.7	
12														
-	1988.01-1998.12	MT	-	-	-	850110	Outer Joint		20	30	48	107	57.5	I

	 YEAR	TRANSM	L/R	F/R	REMARKS	GSP Ref.	 PRODUCT	 ABS	Technical Specifications					
									A	B	C	H	L	P
RENAULT														
18														
1.4/1.6	-	-	-	-	Motor	850016	Outer Joint		23	30	56.3	80.5	58	O
18 GTL														
-	-	-	-	-	-	650059	Inner Joint		23	22	36.3	41	64.5	
-	-	-	-	-	-	299132	Drive Shaft		20	23	48	107	666.5	
18 GTX														
-	-	-	-	-	-	250165	Drive Shaft		23	23	56.3	80.5	687	
19														
1.6	-	-	-	-	-	899070	Outer Joint		21	25	46.3	79	58	O
19 I (B/C53_)														
1.4 (43 kW)	1989.01-1989.12	MT	R	F	Hatchback Engine C2J 772	250037	Drive Shaft		21	23	46.2	82	718	
	1989.01-1989.12	3AT/MT	R	F	Hatchback Engine C2J 772	250002	Drive Shaft		21	23	49.8	83.5	734	
	1989.01-1989.12	MT	L	F	Hatchback Engine C2J 772	250001	Drive Shaft		21	29.95	49.8	83.5	639.5	
	1989.01-1989.12	MT	L	F	Hatchback Engine C2J 772	250036	Drive Shaft		21	29.95	46.4	81.5	652	
1.4 (59 kW)	1988.01-1992.12	3AT/MT	R	F	Hatchback Engine E6J 700/ E6J 701	250002	Drive Shaft		21	23	49.8	83.5	734	
	1988.01-1992.12	MT	L	F	Hatchback Engine E6J 700/ E6J 701	250001	Drive Shaft		21	29.95	49.8	83.5	639.5	
	1988.01-1992.12	MT	L	F	Hatchback Engine E6J 700/ E6J 701	250036	Drive Shaft		21	29.95	46.4	81.5	652	
1.7 (54 kW)	1988.09-1992.04	3AT/MT	R	F	Hatchback Engine F3N 740/F3N 741	250002	Drive Shaft		21	23	49.8	83.5	734	
	1988.09-1992.04	MT	L	F	Hatchback Engine F3N 740/F3N 741	250001	Drive Shaft		21	29.95	49.8	83.5	639.5	
	1988.09-1992.04	MT	L	F	Hatchback Engine F3N 740/F3N 741	250036	Drive Shaft		21	29.95	46.4	81.5	652	
1.7 (66 kW)	1988.09-1992.04	3AT/MT	R	F	Hatchback Engine F3N 742/F3N 743	250002	Drive Shaft		21	23	49.8	83.5	734	
	1988.09-1992.04	MT	L	F	Hatchback Engine F3N 742/F3N 743	250001	Drive Shaft		21	29.95	49.8	83.5	639.5	
	1988.09-1992.04	MT	L	F	Hatchback Engine F3N 742/F3N 743	250036	Drive Shaft		21	29.95	46.4	81.5	652	
1.8 16V (99 kW)	1989.06-1992.04	AT/MT	L/R	F	Hatchback Engine F7P 704	850008	Outer Joint		21	25	56.2	83.5	58	O
	1989.06-1992.04	-	L	F	Hatchback Engine F7P 704	250157	Drive Shaft	48T	21	29.95	56.2	83.5	639	
	1989.06-1992.04	-	R	F	Hatchback Engine F7P 704	250158	Drive Shaft	48T	21	23	56.2	83.5	743	
1.9 D (47 kW)	1988.09-1992.04	MT	R	F	Hatchback Engine F8Q 706/F8Q 742	250002	Drive Shaft		21	23	49.8	83.5	734	
	1988.09-1992.04	MT	L	F	Hatchback Engine F8Q 706/F8Q 742	250001	Drive Shaft		21	29.95	49.8	83.5	639.5	
	1988.09-1992.04	-	L	F	Hatchback Engine F8Q 706/F8Q 742	250157	Drive Shaft	48T	21	29.95	56.2	83.5	639	
	1988.09-1992.04	-	R	F	Hatchback Engine F8Q 706/F8Q 742	250158	Drive Shaft	48T	21	23	56.2	83.5	743	
1.9 DT (68 kW)	1990.09-1992.04	-	L	F	Hatchback Engine F8Q 610	250157	Drive Shaft	48T	21	29.95	56.2	83.5	639	
	1990.09-1992.04	-	R	F	Hatchback Engine F8Q 610	250158	Drive Shaft	48T	21	23	56.2	83.5	743	
19 I Cabriolet (D53_)														
1.7 (55 kW)	1991.07-1992.04	3AT/MT	R	F	Convertible Engine F2N 724	250002	Drive Shaft		21	23	49.8	83.5	734	
	1991.07-1992.04	MT	L	F	Convertible Engine F2N 724	250001	Drive Shaft		21	29.95	49.8	83.5	639.5	
	1991.07-1992.04	MT	L	F	Convertible Engine F2N 724	250036	Drive Shaft		21	29.95	46.4	81.5	652	
1.7 (70 kW)	1991.07-1992.04	3AT/MT	R	F	Convertible Engine F3N 742/F3N 743	250002	Drive Shaft		21	23	49.8	83.5	734	
	1991.07-1992.04	MT	L	F	Convertible Engine F3N 742/F3N 743	250001	Drive Shaft		21	29.95	49.8	83.5	639.5	
	1991.07-1992.04	MT	L	F	Convertible Engine F3N 742/F3N 743	250036	Drive Shaft		21	29.95	46.4	81.5	652	
1.8 16V (101 kW)	1991.07-1992.04	AT/MT	L/R	F	Convertible Engine F7P 700/F7P 704	850008	Outer Joint		21	25	56.2	83.5	58	O
	1991.07-1992.04	-	L	F	Convertible Engine F7P 700/F7P 704	250157	Drive Shaft	48T	21	29.95	56.2	83.5	639	
	1991.07-1992.04	-	R	F	Convertible Engine F7P 700/F7P 704	250158	Drive Shaft	48T	21	23	56.2	83.5	743	
19 I Chamade (L53_)														
1.4 (43 kW)	1988.07-1992.04	3AT/MT	R	F	Saloon Engine C2J 772/C3J 710	250002	Drive Shaft		21	23	49.8	83.5	734	
	1988.07-1992.04	-	R	F	Saloon Engine C2J 772/C3J 710	250037	Drive Shaft		21	23	46.2	82	718	
	1988.07-1992.04	MT	L	F	Saloon Engine C2J 772/C3J 710	250001	Drive Shaft		21	29.95	49.8	83.5	639.5	
	1988.07-1992.04	MT	L	F	Saloon Engine C2J 772/C3J 710	250036	Drive Shaft		21	29.95	46.4	81.5	652	
1.7 (54 kW)	1989.10-1992.04	3AT/MT	R	F	Saloon Engine F3N 740/F3N 741	250002	Drive Shaft		21	23	49.8	83.5	734	
	1989.10-1992.04	MT	L	F	Saloon Engine F3N 740/F3N 741	250001	Drive Shaft		21	29.95	49.8	83.5	639.5	
	1989.10-1992.04	MT	L	F	Saloon Engine F3N 740/F3N 741	250036	Drive Shaft		21	29.95	46.4	81.5	652	
1.7 (66 kW)	1988.07-1992.04	3AT/MT	R	F	Saloon Engine F3N 742/F3N 743	250002	Drive Shaft		21	23	49.8	83.5	734	
	1988.07-1992.04	MT	L	F	Saloon Engine F3N 742/F3N 743	250001	Drive Shaft		21	29.95	49.8	83.5	639.5	
	1988.07-1992.04	MT	L	F	Saloon Engine F3N 742/F3N 743	250036	Drive Shaft		21	29.95	46.4	81.5	652	
1.8 16V (99 kW)	1989.10-1992.04	AT/MT	L/R	F	Saloon Engine F7P 704	850008	Outer Joint		21	25	56.2	83.5	58	O
	1989.10-1992.04	-	L	F	Saloon Engine F7P 704	250157	Drive Shaft	48T	21	29.95	56.2	83.5	639	
	1989.10-1992.04	-	R	F	Saloon Engine F7P 704	250158	Drive Shaft	48T	21	23	56.2	83.5	743	
1.9 D (47 kW)	1989.10-1992.04	MT	R	F	Saloon Engine F8Q 706/F8Q 742	250002	Drive Shaft		21	23	49.8	83.5	734	
	1989.10-1992.04	MT	L	F	Saloon Engine F8Q 706/F8Q 742	250001	Drive Shaft		21	29.95	49.8	83.5	639.5	
	1989.10-1992.04	-	L	F	Saloon Engine F8Q 706/F8Q 742	250157	Drive Shaft	48T	21	29.95	56.2	83.5	639	
	1989.10-1992.04	-	R	F	Saloon Engine F8Q 706/F8Q 742	250158	Drive Shaft	48T	21	23	56.2	83.5	743	
1.9 TD (68 kW)	1990.09-1992.04	-	L	F	Saloon Engine F8Q 740	250157	Drive Shaft	48T	21	29.95	56.2	83.5	639	
	1990.09-1992.04	-	R	F	Saloon Engine F8Q 740	250158	Drive Shaft	48T	21	23	56.2	83.5	743	
19 II (B/C53_)														
1.4 (59 kW)	1992.01-1995.12	3AT/MT	R	F	Hatchback Engine E6J 700/E7J 706	250002	Drive Shaft		21	23	49.8	83.5	734	
	1992.01-1995.12	MT	L	F	Hatchback Engine E6J 700/E7J 706	250001	Drive Shaft		21	29.95	49.8	83.5	639.5	
	1992.01-1995.12	MT	L	F	Hatchback Engine E6J 700/E7J 706	250036	Drive Shaft		21	29.95	46.4	81.5	652	
1.8 (65 kW)	1992.04-1995.12	3AT/MT	L/R	F	Hatchback Engine F3P 706/F3P 707/F3P 708/F3P 760	850008	Outer Joint		21	25	56.2	83.5	58	O

REMARKS	GSP Ref.	PRODUCT	ABS	Technical Specifications									
				A	B	C	H	L	P				
		TRANSM	L/R	F/R	YEAR								
RENAULT													
19 II (B/C53_)													
1.8 (65 kW)	1992.04-1995.12	3AT/MT	R	F	Hatchback Engine F3P 706/F3P 707/F3P 708/F3P 760	250002	Drive Shaft	21	23	49.8	83.5	734	
	1992.04-1995.12	MT	L	F	Hatchback Engine F3P 706/F3P 707/F3P 708/F3P 760	250001	Drive Shaft	21	29.95	49.8	83.5	639.5	
	1992.04-1995.12	MT	L	F	Hatchback Engine F3P 706/F3P 707/F3P 708/F3P 760	250036	Drive Shaft	21	29.95	46.4	81.5	652	
1.8 (66 kW)	1992.04-1995.12	3AT/MT	R	F	Hatchback Engine F3P 706/F3P 760	250002	Drive Shaft	21	23	49.8	83.5	734	
	1992.04-1995.12	MT	L	F	Hatchback Engine F3P 706/F3P 760	250001	Drive Shaft	21	29.95	49.8	83.5	639.5	
	1992.04-1995.12	MT	L	F	Hatchback Engine F3P 706/F3P 760	250036	Drive Shaft	21	29.95	46.4	81.5	652	
1.8 (79 kW)	1994.05-1995.12	3AT/MT	L/R	F	Hatchback Engine F3P 682/F3P 765	850008	Outer Joint	21	25	56.2	83.5	58	O
	1994.05-1995.12	3AT/MT	R	F	Hatchback Engine F3P 682/F3P 765	250002	Drive Shaft	21	23	49.8	83.5	734	
	1994.05-1995.12	MT	L	F	Hatchback Engine F3P 682/F3P 765	250001	Drive Shaft	21	29.95	49.8	83.5	639.5	
	1994.05-1995.12	MT	L	F	Hatchback Engine F3P 682/F3P 765	250036	Drive Shaft	21	29.95	46.4	81.5	652	
1.8 (81 kW)	1992.04-1994.05	3AT/MT	L/R	F	Hatchback Engine F3P 700	850008	Outer Joint	21	25	56.2	83.5	58	O
	1992.04-1994.05	3AT/MT	R	F	Hatchback Engine F3P 700	250002	Drive Shaft	21	23	49.8	83.5	734	
	1992.04-1994.05	MT	L	F	Hatchback Engine F3P 700	250001	Drive Shaft	21	29.95	49.8	83.5	639.5	
	1992.04-1994.05	MT	L	F	Hatchback Engine F3P 700	250036	Drive Shaft	21	29.95	46.4	81.5	652	
19 II (S53_)													
1.9 dT (68 kW)	1992.03-1995.12	MT	L/R	F	Box Engine F8Q 740	850008	Outer Joint	21	25	56.2	83.5	58	O
	1992.03-1995.12	MT	R	F	Box Engine F8Q 740	250002	Drive Shaft	21	23	49.8	83.5	734	
	1992.03-1995.12	MT	L	F	Box Engine F8Q 740	250001	Drive Shaft	21	29.95	49.8	83.5	639.5	
19 II Cabriolet (D53_ 853_)													
1.8 (65 kW)	1992.04-1996.06	3AT/MT	R	F	Convertible Engine F3P 704/F3P 705/F3P 706/F3P 707/F3P 708/F3P 760	250002	Drive Shaft	21	23	49.8	83.5	734	
	1992.04-1996.06	MT	L	F	Convertible Engine F3P 704/F3P 705/F3P 706/F3P 707/F3P 708/F3P 760	250001	Drive Shaft	21	29.95	49.8	83.5	639.5	
	1992.04-1996.06	MT	L	F	Convertible Engine F3P 704/F3P 705/F3P 706/F3P 707/F3P 708/F3P 760	250036	Drive Shaft	21	29.95	46.4	81.5	652	
1.8 (66 kW)	1993.09-1996.06	3AT/MT	L/R	F	Convertible Engine F3P 706/F3P 760	850008	Outer Joint	21	25	56.2	83.5	58	O
	1993.09-1996.06	3AT/MT	R	F	Convertible Engine F3P 706/F3P 760	250002	Drive Shaft	21	23	49.8	83.5	734	
	1993.09-1996.06	MT	L	F	Convertible Engine F3P 706/F3P 760	250001	Drive Shaft	21	29.95	49.8	83.5	639.5	
	1993.09-1996.06	MT	L	F	Convertible Engine F3P 706/F3P 760	250036	Drive Shaft	21	29.95	46.4	81.5	652	
1.8 (79 kW)	1994.07-1996.06	3AT/MT	L/R	F	Convertible Engine F3P 682/F3P 764/F3P 765	850008	Outer Joint	21	25	56.2	83.5	58	O
	1994.07-1996.06	3AT/MT	R	F	Convertible Engine F3P 682/F3P 764/F3P 765	250002	Drive Shaft	21	23	49.8	83.5	734	
	1994.07-1996.06	MT	L	F	Convertible Engine F3P 682/F3P 764/F3P 765	250001	Drive Shaft	21	29.95	49.8	83.5	639.5	
	1994.07-1996.06	MT	L	F	Convertible Engine F3P 682/F3P 764/F3P 765	250036	Drive Shaft	21	29.95	46.4	81.5	652	
1.8 16V (99 kW)	1992.04-1996.06	AT/MT	L/R	F	Convertible Engine F7P 704	850008	Outer Joint	21	25	56.2	83.5	58	O
19 II Chamade (L53_)													
1.4 (44 kW)	1992.05-1994.09	3AT/MT	R	F	Saloon Engine C1J 742/C2J 772/C3J 710	250002	Drive Shaft	21	23	49.8	83.5	734	
	1992.05-1994.09	MT	L	F	Saloon Engine C1J 742/C2J 772/C3J 710	250001	Drive Shaft	21	29.95	49.8	83.5	639.5	
	1992.05-1994.09	MT	L	F	Saloon Engine C1J 742/C2J 772/C3J 710	250036	Drive Shaft	21	29.95	46.4	81.5	652	
1.8 (65 kW)	1992.04-1995.12	3AT/MT	L/R	F	Saloon Engine F3P 704/F3P 705/F3P 706/F3P 707/F3P 708/F3P 760	850008	Outer Joint	21	25	56.2	83.5	58	O
	1992.04-1995.12	3AT/MT	R	F	Saloon Engine F3P 704/F3P 705/F3P 706/F3P 707/F3P 708/F3P 760	250002	Drive Shaft	21	23	49.8	83.5	734	
	1992.04-1995.12	MT	L	F	Saloon Engine F3P 704/F3P 705/F3P 706/F3P 707/F3P 708/F3P 760	250001	Drive Shaft	21	29.95	49.8	83.5	639.5	
	1992.04-1995.12	MT	L	F	Saloon Engine F3P 704/F3P 705/F3P 706/F3P 707/F3P 708/F3P 760	250036	Drive Shaft	21	29.95	46.4	81.5	652	
1.8 (66 kW)	1992.04-1995.12	3AT/MT	L/R	F	Saloon Engine F3P 706/F3P 760	850008	Outer Joint	21	25	56.2	83.5	58	O
	1992.04-1995.12	3AT/MT	R	F	Saloon Engine F3P 706/F3P 760	250002	Drive Shaft	21	23	49.8	83.5	734	
	1992.04-1995.12	MT	L	F	Saloon Engine F3P 706/F3P 760	250001	Drive Shaft	21	29.95	49.8	83.5	639.5	
	1992.04-1995.12	MT	L	F	Saloon Engine F3P 706/F3P 760	250036	Drive Shaft	21	29.95	46.4	81.5	652	
1.8 (79 kW)	1992.05-1995.11	3AT/MT	L/R	F	Saloon Engine F3P 700/F3P 706	850008	Outer Joint	21	25	56.2	83.5	58	O
	1992.05-1995.11	3AT/MT	R	F	Saloon Engine F3P 700/F3P 706	250002	Drive Shaft	21	23	49.8	83.5	734	
	1992.05-1995.11	MT	L	F	Saloon Engine F3P 700/F3P 706	250001	Drive Shaft	21	29.95	49.8	83.5	639.5	
	1992.05-1995.11	MT	L	F	Saloon Engine F3P 700/F3P 706	250036	Drive Shaft	21	29.95	46.4	81.5	652	
	1994.05-1995.12	3AT/MT	L/R	F	Saloon Engine F3P 682	850008	Outer Joint	21	25	56.2	83.5	58	O
	1994.05-1995.12	3AT/MT	R	F	Saloon Engine F3P 682	250002	Drive Shaft	21	23	49.8	83.5	734	
	1994.05-1995.12	MT	L	F	Saloon Engine F3P 682	250001	Drive Shaft	21	29.95	49.8	83.5	639.5	
	1994.05-1995.12	MT	L	F	Saloon Engine F3P 682	250036	Drive Shaft	21	29.95	46.4	81.5	652	
1.8 (81 kW)	1992.04-1994.05	3AT/MT	L/R	F	Saloon Engine F3P 700	850008	Outer Joint	21	25	56.2	83.5	58	O
	1992.04-1994.05	3AT/MT	R	F	Saloon Engine F3P 700	250002	Drive Shaft	21	23	49.8	83.5	734	
	1992.04-1994.05	MT	L	F	Saloon Engine F3P 700	250001	Drive Shaft	21	29.95	49.8	83.5	639.5	
	1992.04-1994.05	MT	L	F	Saloon Engine F3P 700	250036	Drive Shaft	21	29.95	46.4	81.5	652	
21													
-	-	-	-	-	-	650059	Inner Joint	23	22	36.3	41	64.5	
21 (B48_)													
1.7 (54 kW)	1989.09-1992.10	-	-	-	Hatchback Engine F3N 726	850001	Outer Joint	23	24	56.3	80	58	I
	1989.09-1992.10	MT	R	F	Hatchback Engine F3N 726	250138	Drive Shaft	21	23	46.2	82	741	
	1989.09-1992.10	MT	L	F	Hatchback Engine F3N 726	250033	Drive Shaft	21	29.95	46.3	84	648	
1.7 (55 kW)	1989.07-1993.05	-	-	-	Hatchback Engine F2N 712/F3N 726	850001	Outer Joint	23	24	56.3	80	58	I
1.7 (65 kW)	1989.07-1993.05	-	-	-	Hatchback Engine F2N 711/F2N 754	850001	Outer Joint	23	24	56.3	80	58	I
1.7 (66 kW)	1989.09-1994.06	-	-	-	Hatchback Engine F3N 722/F3N 723	850001	Outer Joint	23	24	56.3	80	58	I
	1989.09-1994.06	MT	R	F	Hatchback Engine F3N 722/F3N 723	250138	Drive Shaft	21	23	46.2	82	741	
	1989.09-1994.06	MT	L	F	Hatchback Engine F3N 722/F3N 723	250033	Drive Shaft	21	29.95	46.3	84	648	

	 YEAR	TRANSM	L/R	F/R	REMARKS	GSP Ref.	 PRODUCT	 ABS	Technical Specifications								
									A	B	C	H	L	P			
RENAULT																	
21 (B48_)																	
1.9 D (47 kW)	1989.09-1994.01	-	-	-	Hatchback Engine F8Q 710	850001	Outer Joint		23	24	56.3	80	58	I			
	1989.09-1994.01	MT	R	F	Hatchback Engine F8Q 710	250138	Drive Shaft		21	23	46.2	82	741				
	1989.09-1994.01	MT	L	F	Hatchback Engine F8Q 710	250033	Drive Shaft		21	29.95	46.3	84	648				
2.0 (88 kW)	1989.09-1993.12	-	-	F	Hatchback Engine J7R 746/J7R 747	250121	Drive Shaft		23	23	56.3	80.5	701				
	1989.09-1993.12	MT	L	F	Hatchback Engine J7R 746/J7R 747	250033	Drive Shaft		21	29.95	46.3	84	648				
	1989.09-1993.12	AT/MT	L/R	F	Hatchback Engine J7R 746/J7R 747	850026	Outer Joint		23	25	56.2	83.5	58	O			
	1989.09-1993.12	AT/MT	L/R	F	Hatchback Engine J7R 746/J7R 747	250007	Drive Shaft		23	23	57.5	83.5	698.5				
	1989.09-1993.12	-	-	-	Hatchback Engine J7R 746/J7R 747	850051	Outer Joint	48T	23	25	56.3	80	58	O			
2.0 (99 kW)	1990.02-1992.10	-	-	-	Hatchback Engine J7R 740	850001	Outer Joint		23	24	56.3	80	58	I			
	1990.02-1992.10	-	-	F	Hatchback Engine J7R 740	250121	Drive Shaft		23	23	56.3	80.5	701				
	1990.02-1992.10	AT/MT	L/R	F	Hatchback Engine J7R 740	850026	Outer Joint		23	25	56.2	83.5	58	O			
	1990.02-1992.10	AT/MT	L/R	F	Hatchback Engine J7R 740	250007	Drive Shaft		23	23	57.5	83.5	698.5				
	1990.02-1992.10	-	-	-	Hatchback Engine J7R 740	850051	Outer Joint	48T	23	25	56.3	80	58	O			
	1990.09-1992.10	-	-	-	All-wheel Drive Hatchback Engine J7R 740	850001	Outer Joint		23	24	56.3	80	58	I			
	1990.09-1992.10	-	-	F	All-wheel Drive Hatchback Engine J7R 740	250121	Drive Shaft		23	23	56.3	80.5	701				
	1990.09-1992.10	AT/MT	L/R	F	All-wheel Drive Hatchback Engine J7R 740	850026	Outer Joint		23	25	56.2	83.5	58	O			
	1990.09-1992.10	AT/MT	L/R	F	All-wheel Drive Hatchback Engine J7R 740	250007	Drive Shaft		23	23	57.5	83.5	698.5				
	1990.09-1992.10	-	-	-	All-wheel Drive Hatchback Engine J7R 740	850051	Outer Joint	48T	23	25	56.3	80	58	O			
2.1 D (51 kW)	1992.04-1994.06	-	-	-	Hatchback Engine J8S 784	850001	Outer Joint		23	24	56.3	80	58	I			
2.1 D (53 kW)	1989.09-1992.12	-	-	-	Hatchback Engine J8S 600/J8S 740	850001	Outer Joint		23	24	56.3	80	58	I			
2.1 Turbo-D (65 kW)	1989.09-1994.06	-	-	F	Hatchback Engine J8S 714/J8S 786/J8S 788	250121	Drive Shaft		23	23	56.3	80.5	701				
	1989.09-1994.06	MT	L/R	F	Hatchback Engine J8S 714/J8S 786/J8S 788	850026	Outer Joint		23	25	56.2	83.5	58	O			
	1989.09-1994.06	MT	L/R	F	Hatchback Engine J8S 714/J8S 786/J8S 788	250007	Drive Shaft		23	23	57.5	83.5	698.5				
	1989.09-1994.06	-	-	-	Hatchback Engine J8S 714/J8S 786/J8S 788	850051	Outer Joint	48T	23	25	56.3	80	58	O			
2.2 (79 kW)	1989.09-1994.06	-	-	-	Hatchback Engine J7T 754/J7T 755	850001	Outer Joint		23	24	56.3	80	58	I			
	1989.09-1994.06	-	-	F	Hatchback Engine J7T 754/J7T 755	250121	Drive Shaft		23	23	56.3	80.5	701				
	1989.09-1994.06	AT/MT	L/R	F	Hatchback Engine J7T 754/J7T 755	850026	Outer Joint		23	25	56.2	83.5	58	O			
	1989.09-1994.06	AT/MT	L/R	F	Hatchback Engine J7T 754/J7T 755	250007	Drive Shaft		23	23	57.5	83.5	698.5				
	1989.09-1994.06	-	-	-	Hatchback Engine J7T 754/J7T 755	850051	Outer Joint	48T	23	25	56.3	80	58	O			
	1990.07-1994.06	-	-	-	All-wheel Drive Hatchback Engine J7T 754/J7T 755	850001	Outer Joint		23	24	56.3	80	58	I			
	1990.07-1994.06	-	-	F	All-wheel Drive Hatchback Engine J7T 754/J7T 755	250121	Drive Shaft		23	23	56.3	80.5	701				
	1990.07-1994.06	AT/MT	L/R	F	All-wheel Drive Hatchback Engine J7T 754/J7T 755	850026	Outer Joint		23	25	56.2	83.5	58	O			
	1990.07-1994.06	AT/MT	L/R	F	All-wheel Drive Hatchback Engine J7T 754/J7T 755	250007	Drive Shaft		23	23	57.5	83.5	698.5				
	1990.07-1994.06	-	-	-	All-wheel Drive Hatchback Engine J7T 754/J7T 755	850051	Outer Joint	48T	23	25	56.3	80	58	O			
21 (K48_)																	
1.7 (54 kW)	1986.06-1989.12	MT	L	F	Estate Engine F2N 750	250033	Drive Shaft		21	29.95	46.3	84	648				
	1986.06-1989.12	-	-	-	Estate Engine F2N 750	850001	Outer Joint		23	24	56.3	80	58	I			
	1986.06-1989.12	MT	R	F	Estate Engine F2N 750	250138	Drive Shaft		21	23	46.2	82	741				
1.7 (55 kW)	1986.06-1993.03	-	-	-	Estate Engine F2N 712	850001	Outer Joint		23	24	56.3	80	58	I			
	1986.06-1993.03	MT	R	F	Estate Engine F2N 712	250138	Drive Shaft		21	23	46.2	82	741				
1.7 (64 kW)	1987.06-1989.04	MT	L	F	Estate Engine F2N 752	250033	Drive Shaft		21	29.95	46.3	84	648				
	1987.06-1989.04	-	-	-	Estate Engine F2N 752	850001	Outer Joint		23	24	56.3	80	58	I			
	1987.06-1989.04	MT	R	F	Estate Engine F2N 752	250138	Drive Shaft		21	23	46.2	82	741				
1.7 (66 kW)	1989.10-1993.12	-	-	-	Estate Engine F3N 722/F3N 723	850001	Outer Joint		23	24	56.3	80	58	I			
	1989.10-1993.12	MT	R	F	Estate Engine F3N 722/F3N 723	250138	Drive Shaft		21	23	46.2	82	741				
	1989.10-1993.12	MT	L	F	Estate Engine F3N 722/F3N 723	250033	Drive Shaft		21	29.95	46.3	84	648				
1.7 (69 kW)	1986.06-1989.12	MT	L	F	Estate Engine F3N 722/F3N 723	250033	Drive Shaft		21	29.95	46.3	84	648				
	1986.06-1989.12	-	-	-	Estate Engine F3N 722/F3N 723	850001	Outer Joint		23	24	56.3	80	58	I			
	1986.06-1989.12	MT	R	F	Estate Engine F3N 722/F3N 723	250138	Drive Shaft		21	23	46.2	82	741				
1.7 Cat (54 kW)	1988.05-1993.06	-	-	-	Estate Engine F3N 726	850001	Outer Joint		23	24	56.3	80	58	I			
	1988.05-1993.06	MT	R	F	Estate Engine F3N 726	250138	Drive Shaft		21	23	46.2	82	741				
	1988.05-1993.06	MT	L	F	Estate Engine F3N 726	250033	Drive Shaft		21	29.95	46.3	84	648				
1.9 D (47 kW)	1986.03-1994.08	-	-	-	Estate Engine F8Q 710	850001	Outer Joint		23	24	56.3	80	58	I			
	1986.03-1994.08	MT	R	F	Estate Engine F8Q 710	250138	Drive Shaft		21	23	46.2	82	741				
	1986.03-1994.08	MT	L	F	Estate Engine F8Q 710	250033	Drive Shaft		21	29.95	46.3	84	648				
2.0 (75 kW)	1991.06-1993.05	-	-	-	Estate Engine J6R 758/J6R 759/J6R 792	850001	Outer Joint		23	24	56.3	80	58	I			
2.0 (88 kW)	1986.03-1993.12	-	-	F	Estate Engine J7R 746/J7R 747	250121	Drive Shaft		23	23	56.3	80.5	701				
	1986.03-1993.12	AT/MT	L/R	F	Estate Engine J7R 746/J7R 747	850026	Outer Joint		23	25	56.2	83.5	58	O			
	1986.03-1993.12	AT/MT	L/R	F	Estate Engine J7R 746/J7R 747	250007	Drive Shaft		23	23	57.5	83.5	698.5				
	1986.03-1993.12	-	-	-	Estate Engine J7R 746/J7R 747	850051	Outer Joint	48T	23	25	56.3	80	58	O			
	1989.03-1993.12	-	-	F	All-wheel Drive Estate Engine J7R 746/J7R 747	250121	Drive Shaft		23	23	56.3	80.5	701				
	1989.03-1993.12	AT/MT	L/R	F	All-wheel Drive Estate Engine J7R 746/J7R 747	850026	Outer Joint		23	25	56.2	83.5	58	O			
	1989.03-1993.12	AT/MT	L/R	F	All-wheel Drive Estate Engine J7R 746/J7R 747	250007	Drive Shaft		23	23	57.5	83.5	698.5				
	1989.03-1993.12	-	-	-	All-wheel Drive Estate Engine J7R 746/J7R 747	850051	Outer Joint	48T	23	25	56.3	80	58	O			
	1989.03-1993.12	-	-	-	All-wheel Drive Estate Engine J7R 746/J7R 747	850051	Outer Joint	48T	23	25	56.3	80	58	O			
2.0 (99 kW)	1990.06-1994.02	-	-	-	Estate Engine J7R 740	850001	Outer Joint		23	24	56.3	80	58	I			

REMARKS	YEAR	TRANSM	L/R	F/R	GSP Ref.	PRODUCT	ABS	Technical Specifications						
								A	B	C	H	L	P	
RENAULT														
21 (K48_)														
2.0 (99 kW)	1990.06-1994.02	-	-	F	Estate Engine J7R 740	250121	Drive Shaft		23	23	56.3	80.5	701	
	1990.06-1994.02	AT/MT	L/R	F	Estate Engine J7R 740	850026	Outer Joint		23	25	56.2	83.5	58	O
	1990.06-1994.02	AT/MT	L/R	F	Estate Engine J7R 740	250007	Drive Shaft		23	23	57.5	83.5	698.5	
	1990.06-1994.02	-	-	-	Estate Engine J7R 740	850051	Outer Joint	48T	23	25	56.3	80	58	O
2.1 D (48 kW)	1986.10-1990.09	-	-	F	Estate Engine J8S 704	250121	Drive Shaft		23	23	56.3	80.5	701	
	1986.10-1990.09	AT/MT	L/R	F	Estate Engine J8S 704	850026	Outer Joint		23	25	56.2	83.5	58	O
	1986.10-1990.09	AT/MT	L/R	F	Estate Engine J8S 704	250007	Drive Shaft		23	23	57.5	83.5	698.5	
	1986.10-1990.09	-	-	-	Estate Engine J8S 704	850051	Outer Joint	48T	23	25	56.3	80	58	O
	1988.10-1992.05	-	-	-	All-wheel Drive Estate Engine J8S 704	850051	Outer Joint	48T	23	25	56.3	80	58	O
	1988.10-1992.05	-	-	F	All-wheel Drive Estate Engine J8S 704	250121	Drive Shaft		23	23	56.3	80.5	701	
	1988.10-1992.05	AT/MT	L/R	F	All-wheel Drive Estate Engine J8S 704	850026	Outer Joint		23	25	56.2	83.5	58	O
	1988.10-1992.05	AT/MT	L/R	F	All-wheel Drive Estate Engine J8S 704	250007	Drive Shaft		23	23	57.5	83.5	698.5	
2.1 D (51 kW)	1992.02-1995.09	-	-	-	Estate Engine J8S 784	850051	Outer Joint	48T	23	25	56.3	80	58	O
	1992.02-1995.09	-	-	-	Estate Engine J8S 784	850001	Outer Joint		23	24	56.3	80	58	I
	1992.02-1995.09	-	-	F	Estate Engine J8S 784	250121	Drive Shaft		23	23	56.3	80.5	701	
	1992.02-1995.09	AT/MT	L/R	F	Estate Engine J8S 784	850026	Outer Joint		23	25	56.2	83.5	58	O
	1992.02-1995.09	AT/MT	L/R	F	Estate Engine J8S 784	250007	Drive Shaft		23	23	57.5	83.5	698.5	
2.1 D (53 kW)	1989.08-1992.12	-	-	-	Estate Engine J8S 600/J8S 740	850051	Outer Joint	48T	23	25	56.3	80	58	O
	1989.08-1992.12	-	-	-	Estate Engine J8S 600/J8S 740	850001	Outer Joint		23	24	56.3	80	58	I
	1989.08-1992.12	-	-	F	Estate Engine J8S 600/J8S 740	250121	Drive Shaft		23	23	56.3	80.5	701	
	1989.08-1992.12	AT/MT	L/R	F	Estate Engine J8S 600/J8S 740	850026	Outer Joint		23	25	56.2	83.5	58	O
	1989.08-1992.12	AT/MT	L/R	F	Estate Engine J8S 600/J8S 740	250007	Drive Shaft		23	23	57.5	83.5	698.5	
2.1 Turbo-D (65 kW)	1986.10-1993.11	-	-	-	Estate Engine J8S 714/J8S 786/J8S 788	850051	Outer Joint	48T	23	25	56.3	80	58	O
	1986.10-1993.11	-	-	-	Estate Engine J8S 714/J8S 786/J8S 788	850001	Outer Joint		23	24	56.3	80	58	I
	1986.10-1993.11	MT	L/R	F	Estate Engine J8S 714/J8S 786/J8S 788	850026	Outer Joint		23	25	56.2	83.5	58	O
	1986.10-1993.11	-	-	F	Estate Engine J8S 714/J8S 786/J8S 788	250121	Drive Shaft		23	23	56.3	80.5	701	
	1986.10-1993.11	MT	L/R	F	Estate Engine J8S 714/J8S 786/J8S 788	250007	Drive Shaft		23	23	57.5	83.5	698.5	
2.2 (79 kW)	1986.06-1993.11	-	-	-	Estate Engine J7T 754/J7T 755	850051	Outer Joint	48T	23	25	56.3	80	58	O
	1986.06-1993.12	-	-	-	All-wheel Drive Estate Engine J7T 754/J7T 755	850051	Outer Joint	48T	23	25	56.3	80	58	O
	1986.06-1993.11	-	-	-	Estate Engine J7T 754/J7T 755	850001	Outer Joint		23	24	56.3	80	58	I
	1986.06-1993.12	-	-	-	All-wheel Drive Estate Engine J7T 754/J7T 755	850001	Outer Joint		23	24	56.3	80	58	I
	1986.06-1993.11	-	-	F	Estate Engine J7T 754/J7T 755	250121	Drive Shaft		23	23	56.3	80.5	701	
	1986.06-1993.12	-	-	F	All-wheel Drive Estate Engine J7T 754/J7T 755	250121	Drive Shaft		23	23	56.3	80.5	701	
	1986.06-1993.11	AT/MT	L/R	F	Estate Engine J7T 754/J7T 755	850026	Outer Joint		23	25	56.2	83.5	58	O
	1986.06-1993.12	AT/MT	L/R	F	All-wheel Drive Estate Engine J7T 754/J7T 755	850026	Outer Joint		23	25	56.2	83.5	58	O
	1986.06-1993.11	AT/MT	L/R	F	Estate Engine J7T 754/J7T 755	250007	Drive Shaft		23	23	57.5	83.5	698.5	
	1986.06-1993.12	AT/MT	L/R	F	All-wheel Drive Estate Engine J7T 754/J7T 755	250007	Drive Shaft		23	23	57.5	83.5	698.5	
21 (L48_)														
1.7 (54 kW)	1986.07-1994.02	-	-	-	Saloon Engine F2N 750/F3N 726	850001	Outer Joint		23	24	56.3	80	58	I
	1986.07-1994.02	MT	R	F	Saloon Engine F2N 750/F3N 726	250138	Drive Shaft		21	23	46.2	82	741	
	1986.07-1994.02	MT	L	F	Saloon Engine F2N 750/F3N 726	250033	Drive Shaft		21	29.95	46.3	84	648	
1.7 (64 kW)	1987.06-1989.04	MT	L	F	Saloon Engine F2N 752	250033	Drive Shaft		21	29.95	46.3	84	648	
	1987.06-1989.04	-	-	-	Saloon Engine F2N 752	850001	Outer Joint		23	24	56.3	80	58	I
	1987.06-1989.04	MT	R	F	Saloon Engine F2N 752	250138	Drive Shaft		21	23	46.2	82	741	
1.7 (65 kW)	1986.03-1993.03	MT	R	F	Saloon Engine F2N 710	250138	Drive Shaft		21	23	46.2	82	741	
	1986.03-1993.03	MT	L	F	Saloon Engine F2N 710	250033	Drive Shaft		21	29.95	46.3	84	648	
	1986.03-1993.03	-	-	-	Saloon Engine F2N 710	850001	Outer Joint		23	24	56.3	80	58	I
1.7 (66 kW)	1989.09-1994.02	-	-	-	Saloon Engine F3N 722/F3N 723	850001	Outer Joint		23	24	56.3	80	58	I
	1989.09-1994.02	MT	R	F	Saloon Engine F3N 722/F3N 723	250138	Drive Shaft		21	23	46.2	82	741	
	1989.09-1994.02	MT	L	F	Saloon Engine F3N 722/F3N 723	250033	Drive Shaft		21	29.95	46.3	84	648	
1.7 (69 kW)	1986.03-1994.02	MT	R	F	Saloon Engine F3N 722/F3N 723	250138	Drive Shaft		21	23	46.2	82	741	
	1986.03-1994.02	MT	L	F	Saloon Engine F3N 722/F3N 723	250033	Drive Shaft		21	29.95	46.3	84	648	
	1986.03-1994.02	-	-	-	Saloon Engine F3N 722/F3N 723	850001	Outer Joint		23	24	56.3	80	58	I
1.9 D (47 kW)	1989.08-1993.10	-	-	-	Saloon Engine F8Q 710	850001	Outer Joint		23	24	56.3	80	58	I
	1989.08-1993.10	MT	R	F	Saloon Engine F8Q 710	250138	Drive Shaft		21	23	46.2	82	741	
	1989.08-1993.10	MT	L	F	Saloon Engine F8Q 710	250033	Drive Shaft		21	29.95	46.3	84	648	
2.0 (75 kW)	1986.03-1993.10	-	-	-	Saloon Engine J6R 758/J6R 759/J6R 792/J6R 793	850051	Outer Joint	48T	23	25	56.3	80	58	O
	1986.03-1993.10	-	-	-	Saloon Engine J6R 758/J6R 759/J6R 792/J6R 793	850001	Outer Joint		23	24	56.3	80	58	I
	1986.03-1993.10	-	-	F	Saloon Engine J6R 758/J6R 759/J6R 792/J6R 793	250121	Drive Shaft		23	23	56.3	80.5	701	
	1986.03-1993.10	AT/MT	L/R	F	Saloon Engine J6R 758/J6R 759/J6R 792/J6R 793	850026	Outer Joint		23	25	56.2	83.5	58	O
	1986.03-1993.10	AT/MT	L/R	F	Saloon Engine J6R 758/J6R 759/J6R 792/J6R 793	250007	Drive Shaft		23	23	57.5	83.5	698.5	
2.0 (78 kW)	1991.05-1993.10	-	-	-	Saloon Engine J6R 758	850051	Outer Joint	48T	23	25	56.3	80	58	O
	1991.05-1993.10	-	-	-	Saloon Engine J6R 758	850001	Outer Joint		23	24	56.3	80	58	I
	1991.05-1993.10	-	-	F	Saloon Engine J6R 758	250121	Drive Shaft		23	23	56.3	80.5	701	
	1991.05-1993.10	AT/MT	L/R	F	Saloon Engine J6R 758	850026	Outer Joint		23	25	56.2	83.5	58	O
	1991.05-1993.10	AT/MT	L/R	F	Saloon Engine J6R 758	250007	Drive Shaft		23	23	57.5	83.5	698.5	

REMARKS	YEAR	TRANSM	L/R	F/R	GSP Ref.	PRODUCT	ABS	Technical Specifications										
								A	B	C	H	L	P					
RENAULT																		
21 (L48_)																		
2.0 (88 kW)	1986.03-1993.12	-	-	-	Saloon Engine J7R 746/J7R 747	850051	Outer Joint	48T	23	25	56.3	80	58	O				
	1986.03-1993.12	-	-	F	Saloon Engine J7R 746/J7R 747	250121	Drive Shaft		23	23	56.3	80.5	701					
	1986.03-1993.12	AT/MT	L/R	F	Saloon Engine J7R 746/J7R 747	850026	Outer Joint		23	25	56.2	83.5	58	O				
	1986.03-1993.12	AT/MT	L/R	F	Saloon Engine J7R 746/J7R 747	250007	Drive Shaft		23	23	57.5	83.5	698.5					
2.0 (99 kW)	1989.12-1994.02	-	-	-	All-wheel Drive Saloon Engine J7R 740	850051	Outer Joint	48T	23	25	56.3	80	58	O				
	1989.12-1994.02	-	-	F	All-wheel Drive Saloon Engine J7R 740	250121	Drive Shaft		23	23	56.3	80.5	701					
	1989.12-1994.02	AT/MT	L/R	F	All-wheel Drive Saloon Engine J7R 740	850026	Outer Joint		23	25	56.2	83.5	58	O				
	1989.12-1994.02	AT/MT	L/R	F	All-wheel Drive Saloon Engine J7R 740	250007	Drive Shaft		23	23	57.5	83.5	698.5					
	1990.02-1994.06	-	-	-	Saloon Engine J7R 740	850051	Outer Joint	48T	23	25	56.3	80	58	O				
	1990.02-1994.06	-	-	F	Saloon Engine J7R 740	250121	Drive Shaft		23	23	56.3	80.5	701					
	1990.02-1994.06	AT/MT	L/R	F	Saloon Engine J7R 740	850026	Outer Joint		23	25	56.2	83.5	58	O				
	1990.02-1994.06	AT/MT	L/R	F	Saloon Engine J7R 740	250007	Drive Shaft		23	23	57.5	83.5	698.5					
2.1 D (48 kW)	1986.03-1989.12	AT/MT	L/R	F	Saloon Engine J8S 704	850026	Outer Joint		23	25	56.2	83.5	58	O				
	1986.03-1989.12	-	-	F	Saloon Engine J8S 704	250121	Drive Shaft		23	23	56.3	80.5	701					
	1986.03-1989.12	-	-	-	Saloon Engine J8S 704	850051	Outer Joint	48T	23	25	56.3	80	58	O				
	1986.03-1989.12	AT/MT	L/R	F	Saloon Engine J8S 704	250007	Drive Shaft		23	23	57.5	83.5	698.5					
2.1 D (51 kW)	1992.10-1994.06	-	-	-	Saloon Engine J8S 784	850001	Outer Joint		23	24	56.3	80	58	I				
2.1 D (53 kW)	1989.05-1994.06	-	-	-	Saloon Engine J8S 600/J8S 740	850001	Outer Joint		23	24	56.3	80	58	I				
2.1 TD (50 kW)	1986.04-1989.06	-	-	-	Saloon Engine J8S 704	850001	Outer Joint		23	24	56.3	80	58	I				
2.1 Turbo-D (65 kW)	1986.03-1994.06	-	-	-	Saloon Engine J8S 714/J8S 786/J8S 788	850051	Outer Joint	48T	23	25	56.3	80	58	O				
	1986.03-1994.06	-	-	F	Saloon Engine J8S 714/J8S 786/J8S 788	250121	Drive Shaft		23	23	56.3	80.5	701					
	1986.03-1994.06	MT	L/R	F	Saloon Engine J8S 714/J8S 786/J8S 788	850026	Outer Joint		23	25	56.2	83.5	58	O				
	1986.03-1994.06	MT	L/R	F	Saloon Engine J8S 714/J8S 786/J8S 788	250007	Drive Shaft		23	23	57.5	83.5	698.5					
	1986.03-1994.06	-	-	-	Saloon Engine J8S 714/J8S 786/J8S 788	850001	Outer Joint		23	24	56.3	80	58	I				
2.2 (79 kW)	1986.07-1994.02	-	-	-	Saloon Engine J7T 754/J7T 755	850001	Outer Joint		23	24	56.3	80	58	I				
	1986.07-1994.02	-	-	-	Saloon Engine J7T 754/J7T 755	850051	Outer Joint	48T	23	25	56.3	80	58	O				
	1986.07-1994.02	-	-	F	Saloon Engine J7T 754/J7T 755	250121	Drive Shaft		23	23	56.3	80.5	701					
	1986.07-1994.02	AT/MT	L/R	F	Saloon Engine J7T 754/J7T 755	850026	Outer Joint		23	25	56.2	83.5	58	O				
	1986.07-1994.02	AT/MT	L/R	F	Saloon Engine J7T 754/J7T 755	250007	Drive Shaft		23	23	57.5	83.5	698.5					
	1990.07-1994.02	-	-	-	All-wheel Drive Saloon Engine J7T 754/J7T 755	850051	Outer Joint	48T	23	25	56.3	80	58	O				
	1990.07-1994.02	-	-	-	All-wheel Drive Saloon Engine J7T 754/J7T 755	850001	Outer Joint		23	24	56.3	80	58	I				
	1990.07-1994.02	-	-	F	All-wheel Drive Saloon Engine J7T 754/J7T 755	250121	Drive Shaft		23	23	56.3	80.5	701					
	1990.07-1994.02	AT/MT	L/R	F	All-wheel Drive Saloon Engine J7T 754/J7T 755	850026	Outer Joint		23	25	56.2	83.5	58	O				
	1990.07-1994.02	AT/MT	L/R	F	All-wheel Drive Saloon Engine J7T 754/J7T 755	250007	Drive Shaft		23	23	57.5	83.5	698.5					
21 (S48_)																		
2.1 D (49 kW)	1986.06-1994.08	-	-	F	Box Engine J8S 704	250121	Drive Shaft		23	23	56.3	80.5	701					
	1986.06-1994.08	-	-	-	Box Engine J8S 704	850051	Outer Joint	48T	23	25	56.3	80	58	O				
25 (B29_)																		
2.0 (74 kW)	1984.04-1992.12	MT	L/R	F	Hatchback Engine J6R 706/J6R 707/J6R 760/J6R 762/J6R 763	250031	Drive Shaft	48T	23	23	56	85	720					
	1984.04-1992.12	AT/MT	L/R	F	Hatchback Engine J6R 706/J6R 707/J6R 760/J6R 762/J6R 763	250052	Drive Shaft		23	23	56.3	80.5	713					
2.1 Diesel (46 kW)	1984.04-1989.05	MT	L/R	F	Hatchback Engine J8S 706	250052	Drive Shaft		23	23	56.3	80.5	713					
	1984.04-1989.05	MT	L/R	F	Hatchback Engine J8S 706	250031	Drive Shaft	48T	23	23	56	85	720					
2.1 Turbo-D FWD (63 kW)	1984.04-1992.12	MT	L/R	F	Hatchback Engine J8S 708/J8S 738	250031	Drive Shaft	48T	23	23	56	85	720					
	1984.04-1992.12	MT	L/R	F	Hatchback Engine J8S 708/J8S 738	250052	Drive Shaft		23	23	56.3	80.5	713					
2.2 (79 kW)	1986.09-1992.12	MT	L/R	F	Hatchback Engine J7T 708/J7T 732/J7T 733	250031	Drive Shaft	48T	23	23	56	85	720					
	1986.09-1992.12	MT	L/R	F	Hatchback Engine J7T 708/J7T 732/J7T 733	250052	Drive Shaft		23	23	56.3	80.5	713					
2.2 (89 kW)	1984.04-1989.12	MT	L/R	F	Hatchback Engine J7T 706/J7T 707/J7T 714/J7T 715	250052	Drive Shaft		23	23	56.3	80.5	713					
	1984.04-1989.12	MT	L/R	F	Hatchback Engine J7T 706/J7T 707/J7T 714/J7T 715	250031	Drive Shaft	48T	23	23	56	85	720					
2.2 (91 kW)	1984.04-1989.12	MT	L/R	F	Hatchback Engine J7T 730/J7T 731	250052	Drive Shaft		23	23	56.3	80.5	713					
	1984.04-1989.12	MT	L/R	F	Hatchback Engine J7T 730/J7T 731	250031	Drive Shaft	48T	23	23	56	85	720					
4																		
-	-	-	-	-	-	650013	Inner Joint		22	21	36	49	94					
4 (112)																		
1.1 (1128) (25 kW)	1978-1990	-	-	-	-	850018	Outer Joint		23	30	36.3	90.5	58	O				
4 (112_)																		
1.1 (25 kW)	1978.06-1990.06	MT	L/R	F	Estate Engine 688 712/C1E 714/C1E 719	250005	Drive Shaft		23	22	36.3	90.5	661.5					
4 (R21_ R23_)																		
0.8 (21 kW)	1983.04-1989.07	MT	L/R	F	Box Engine 800 705/B1B 707	250005	Drive Shaft		23	22	36.3	90.5	661.5					
1.1 (25 kW)	1976.10-1989.07	MT	L/R	F	Box Engine 688 711/688 712/C1E 714/C1E 718/C1E 719	250005	Drive Shaft		23	22	36.3	90.5	661.5					
1.1 (26 kW)	1982.07-1989.05	MT	L/R	F	Box Engine C1E 718/C1E 719	250005	Drive Shaft		23	22	36.3	90.5	661.5					
6																		
1.1 (1181) (33 kW)	1970-	-	-	-	-	850018	Outer Joint		23	30	36.3	90.5	58	O				
9																		
-	-	-	-	-	-	650059	Inner Joint		23	22	36.3	41	64.5					
9 (L42_)																		
1.7 (59 kW)	1984.09-1989.12	-	R	F	Saloon Engine F2N 700/F2N 704	250142	Drive Shaft		21	23	49.8	83.5	723					



REMARKS	YEAR	TRANSM	L/R	F/R	GSP Ref.	PRODUCT	ABS	Technical Specifications						
								A	B	C	H	L	P	
RENAULT														
9 (L42_)														
1.7 (59 kW)	1984.09-1989.12	-	L	F	Saloon Engine F2N 700/F2N 704	250143	Drive Shaft	21	29.95	49.8	83.5	629.5		
	1984.09-1989.12	MT	L	F	Saloon Engine F2N 700/F2N 704	250013	Drive Shaft	21	29.95	46.4	81.5	633.5		
	1984.09-1989.12	MT	R	F	Saloon Engine F2N 700/F2N 704	250012	Drive Shaft	21	23	46.4	81.5	726		
AVANTIME (DE0_)														
2.0 16V Turbo (120 kW)	2001.11-2003.05	-	-	F	MPV Engine F4R 760	850057	Outer Joint	44T	27	27	64	90	68	I
2.2 dCi (110 kW)	2002.05-2003.05	MT	L	F	MPV Engine G9T 712	250225	Drive Shaft	44T	27	37.1	64	90	594	
	2002.05-2003.05	MT	R	F	MPV Engine G9T 712	250272	Drive Shaft	44T	27	39	64	90	1010	
3.0 V6 (152 kW)	2001.09-2003.05	-	-	F	MPV Engine L7X 721	850057	Outer Joint	44T	27	27	64	90	68	I
CAPTUR (J5_H5_)														
0.9 TCe 90 (66 kW)	2013.06-	MT	R	F	Hatchback Engine H4B 400	650139	Inner joint		26	21	33	347.5	92.5	
	2013.06-	MT	L/R	F	Hatchback Engine H4B 400	850213	Outer Joint		23	21	48.7	86	54	M
	2013.06-	MT	L	F	Hatchback Engine H4B 400	250620	Drive Shaft		23	26	48.7	86	678	
	2013.06-	MT	R	F	Hatchback Engine H4B 400	250618	Drive Shaft		23	26	48.7	86	918	
1.2 TCe 120 (87 kW)	2016.01-	-	-	F	Hatchback Engine H5F 408/H5F 412	899213	Outer Joint		25	33	53	88	61.5	I
1.2 TCe 120 (88 kW)	2013.06-	-	-	F	Hatchback Engine H5F 403	899213	Outer Joint		25	33	53	88	61.5	I
	2013.06-	-	L	F	Hatchback Engine H5F 403	650140	Inner joint		34	33	40	54	106	
	2013.06-	-	R	F	Hatchback Engine H5F 403	650136	Inner joint		34	33	32.5	396.5	89.5	
	2013.06-	-	R	F	Hatchback Engine H5F 403	250615	Drive Shaft		25	34	52.7	88.5	976	
	2013.06-	-	L	F	Hatchback Engine H5F 403	250617	Drive Shaft		25	34	52.7	88.5	625	
1.5 dCi 110 (81 kW)	2015.01-	AT	L	F	Hatchback Engine K9K 646	250564	Drive Shaft		25	26	52.4	88.5	678	
1.5 dCi 90 (66 kW)	2013.06-	-	L	F	Hatchback Engine K9K 608/K9K 609	650140	Inner joint		34	33	40	54	106	
	2013.06-	-	L	F	Hatchback Engine K9K 608/K9K 609	250617	Drive Shaft		25	34	52.7	88.5	625	
	2013.06-	AT	L	F	Hatchback Engine K9K 608/K9K 609	250564	Drive Shaft		25	26	52.4	88.5	678	
CLIO														
-	-	-	-	-	-	899070	Outer Joint		21	25	46.3	79	58	O
	-	-	-	-	-	850017	Outer Joint		21	22	51.5	83	56.5	I
	2002-	AT	-	-	-	650015	Inner Joint		23	21	36.25	50.5	68	
	2002-	MT	-	-	-	650015	Inner Joint		23	21	36.25	50.5	68	
	2004-2006	MT	-	-	-	850090	Outer Joint	44T	21	21	55	83.5	57.5	M
1.0	-	-	R	-	-	250293	Drive Shaft		21	23	46.3	80.5	709.5	
	2000-	-	-	-	-	899207	Outer Joint		21	22	46.4	86	58	I
1.1	1990-	-	R	-	-	650059	Inner Joint		23	22	36.3	41	64.5	
1.2	1990-	-	R	-	-	650059	Inner Joint		23	22	36.3	41	64.5	
1.4	1990-	-	R	-	-	650059	Inner Joint		23	22	36.3	41	64.5	
1.6	-	-	R	-	-	250293	Drive Shaft		21	23	46.3	80.5	709.5	
	2000.01-2006.12	MT	-	-	-	850048	Outer Joint	26T	21	21	55	83.5	57.5	M
	2002-	-	-	-	-	899207	Outer Joint		21	22	46.4	86	58	I
	2002.02-2006.12	MT	-	-	-	841081	Outer Joint		21	21	55	83.5	57.5	M
1.6 16V	2000.01-2006.12	MT	-	-	-	850048	Outer Joint	26T	21	21	55	83.5	57.5	M
	2002.02-2006.12	MT	-	-	-	841081	Outer Joint		21	21	55	83.5	57.5	M
1.6 8V	1994-1999	-	R	-	-	250291	Drive Shaft		21	23	46.3	80.5	701.5	
	2000.01-2006.12	MT	-	-	-	850048	Outer Joint	26T	21	21	55	83.5	57.5	M
	2002.02-2006.12	MT	-	-	-	841081	Outer Joint		21	21	55	83.5	57.5	M
1.7	1990-	-	R	-	-	650059	Inner Joint		23	22	36.3	41	64.5	
1.9	1990-	-	R	-	-	650059	Inner Joint		23	22	36.3	41	64.5	
1.9 D	-	-	-	-	-	850034	Outer Joint		21	22	51.5	83	56.5	O
	-	-	-	-	-	850062	Outer Joint	26T	21	22	51.5	83	56.5	O
	-	-	-	-	-	850063	Outer Joint	44T	21	22	51.5	83	56.5	O
CLIO Grandtour (KR0/1_)														
1.2 16V (55 kW)	2008.02-	-	-	F	Estate Engine D4F 740	850112	Outer Joint		23	28	49	83.5	54.5	I
	2008.02-	MT	R	F	Estate Engine D4F 740	250372	Drive Shaft		23	26	49	83.5	890	
	2008.02-	MT	L	F	Estate Engine D4F 740	250369	Drive Shaft		23	26	49	83.5	651	
1.2 16V (58 kW)	2008.02-	-	-	F	Estate Engine D4F 764	850112	Outer Joint		23	28	49	83.5	54.5	I
	2008.02-	-	R	F	Estate Engine D4F 764	250372	Drive Shaft		23	26	49	83.5	890	
	2008.02-	-	L	F	Estate Engine D4F 764	250369	Drive Shaft		23	26	49	83.5	651	
1.2 16V (74 kW)	2008.02-	-	-	F	Estate Engine D4F 784	850112	Outer Joint		23	28	49	83.5	54.5	I
	2008.02-	-	L	F	Estate Engine D4F 784	250605	Drive Shaft		27	26	56.7	88.5	686	
	2008.02-	MT	L	F	Estate Engine D4F 784	250568	Drive Shaft		23	26	49	86	648	
	2008.02-	-	-	F	Estate Engine D4F 784	850092	Outer Joint		23	29	49	86	57	I
	2008.02-	-	R	F	Estate Engine D4F 784	250573	Drive Shaft		23	26	49	86	891	
1.2 16V (76 kW)	2010.09-	-	-	F	Estate Engine D4F 786	850112	Outer Joint		23	28	49	83.5	54.5	I
	2010.09-	MT	L	F	Estate Engine D4F 786	250568	Drive Shaft		23	26	49	86	648	
	2010.09-	-	R	F	Estate Engine D4F 786	250573	Drive Shaft		23	26	49	86	891	
1.2 16V Hi-Flex (55 kW)	2008.07-	-	-	F	Estate Engine D4F 740	850112	Outer Joint		23	28	49	83.5	54.5	I
	2008.07-	-	R	F	Estate Engine D4F 740	250372	Drive Shaft		23	26	49	83.5	890	
	2008.07-	-	L	F	Estate Engine D4F 740	250369	Drive Shaft		23	26	49	83.5	651	

REMARKS	YEAR	TRANSM	L/R	F/R	GSP Ref.	PRODUCT	ABS	Technical Specifications							
								A	B	C	H	L	P		
RENAULT															
CLIO Grandtour (KR0/1_)															
1.4 16V (72 kW)	2010.02-	-	-	R	F	Estate Engine K4J 780	699169	Inner Joint		26	30	33	326	95	
	2010.02-	-	-	R	F	Estate Engine K4J 780	650148	Inner Joint		26	30	33	326	90	
	2010.02-	-	-	R	F	Estate Engine K4J 780	250625	Drive Shaft		23	26	49	83.5	893	
	2010.02-	-	-	L	F	Estate Engine K4J 780	250630	Drive Shaft		23	26	49	83	653	
	2010.02-	-	-	R	F	Estate Engine K4J 780	250354	Drive Shaft		23	26	49	86	897	
	2010.02-	-	-	L	F	Estate Engine K4J 780	250353	Drive Shaft		23	26	49	86	649	
	2010.02-	-	-	L	F	Estate Engine K4J 780	250278	Drive Shaft		23	26	49	86	653.5	
	2010.02-	-	-	R	F	Estate Engine K4J 780	250277	Drive Shaft		23	26	49	86	898	
1.5 dCi (48 kW)	2010.02-	-	MT	L	F	Estate Engine K9K 752	250177	Drive Shaft		21	29.95	57	84.5	625.7	
	2010.02-	-	MT	R	F	Estate Engine K9K 752	299072	Drive Shaft	44T	21	23	57	84.5	720	
	2010.02-	-	-	R	F	Estate Engine K9K 752	699169	Inner Joint		26	30	33	326	95	
	2010.02-	-	-	R	F	Estate Engine K9K 752	650148	Inner Joint		26	30	33	326	90	
	2010.02-	-	MT	R	F	Estate Engine K9K 752	250146	Drive Shaft		21	23	57	84.5	732.5	
	2010.02-	-	-	R	F	Estate Engine K9K 752	250625	Drive Shaft		23	26	49	83.5	893	
	2010.02-	-	-	L	F	Estate Engine K9K 752	250630	Drive Shaft		23	26	49	83	653	
	2010.02-	-	MT	L	F	Estate Engine K9K 752	250109	Drive Shaft	26T	21	29.95	57	84.5	625.7	
	2010.02-	-	-	R	F	Estate Engine K9K 752	250354	Drive Shaft		23	26	49	86	897	
	2010.02-	-	-	L	F	Estate Engine K9K 752	250353	Drive Shaft		23	26	49	86	649	
	2010.02-	-	MT	R	F	Estate Engine K9K 752	250250	Drive Shaft	26T	21	23	57	84.5	732.5	
	2010.02-	-	MT	L	F	Estate Engine K9K 752	299073	Drive Shaft	44T	21	29.95	57	84.5	628	
1.5 dCi (50 kW)	2008.02-	-	-	R	F	Estate Engine K9K 768/K9K 714	699169	Inner Joint		26	30	33	326	95	
	2008.02-	-	-	R	F	Estate Engine K9K 768/K9K 714	650148	Inner Joint		26	30	33	326	90	
	2008.02-	-	-	R	F	Estate Engine K9K 768/K9K 714	250625	Drive Shaft		23	26	49	83.5	893	
	2008.02-	-	-	L	F	Estate Engine K9K 768/K9K 714	250630	Drive Shaft		23	26	49	83	653	
	2008.02-	-	MT	-	F	Estate Engine K9K 768/K9K 714	899085	Outer Joint		23	30	49	86	59	I
	2008.02-	-	-	R	F	Estate Engine K9K 768/K9K 714	250354	Drive Shaft		23	26	49	86	897	
	2008.02-	-	-	L	F	Estate Engine K9K 768/K9K 714	250353	Drive Shaft		23	26	49	86	649	
	2008.02-	-	-	L	F	Estate Engine K9K 768/K9K 714	250278	Drive Shaft		23	26	49	86	653.5	
	2008.02-	-	-	R	F	Estate Engine K9K 768/K9K 714	250277	Drive Shaft		23	26	49	86	898	
1.5 dCi (55 kW)	2010.08-	-	-	R	F	Estate Engine K9K 770	650148	Inner Joint		26	30	33	326	90	
	2010.08-	-	-	R	F	Estate Engine K9K 770	850168	Outer Joint		23	30	49	83.5	54.5	I
	2010.08-	-	-	R	F	Estate Engine K9K 770	250625	Drive Shaft		23	26	49	83.5	893	
	2010.08-	-	-	L	F	Estate Engine K9K 770	250630	Drive Shaft		23	26	49	83	653	
	2010.08-	-	-	L	F	Estate Engine K9K 770	250353	Drive Shaft		23	26	49	86	649	
	2010.08-	-	-	-	F	Estate Engine K9K 770	850143	Outer Joint		25	32	52.8	85.5	62.5	I
1.5 dCi (63 kW)	2008.02-	-	-	R	F	Estate Engine K9K 766	699169	Inner Joint		26	30	33	326	95	
	2008.02-	-	-	R	F	Estate Engine K9K 766	650148	Inner Joint		26	30	33	326	90	
	2008.02-	-	-	R	F	Estate Engine K9K 766	250625	Drive Shaft		23	26	49	83.5	893	
	2008.02-	-	-	L	F	Estate Engine K9K 766	250630	Drive Shaft		23	26	49	83	653	
	2008.02-	-	MT	-	F	Estate Engine K9K 766	899085	Outer Joint		23	30	49	86	59	I
	2008.02-	-	-	R	F	Estate Engine K9K 766	250354	Drive Shaft		23	26	49	86	897	
	2008.02-	-	-	L	F	Estate Engine K9K 766	250353	Drive Shaft		23	26	49	86	649	
	2008.02-	-	-	L	F	Estate Engine K9K 766	250278	Drive Shaft		23	26	49	86	653.5	
	2008.02-	-	-	R	F	Estate Engine K9K 766	250277	Drive Shaft		23	26	49	86	898	
1.5 dCi (65 kW)	2010.08-	-	-	R	F	Estate Engine K9K 772/K9K 770	650148	Inner Joint		26	30	33	326	90	
	2010.08-	-	-	L	F	Estate Engine K9K 772/K9K 770	250379	Drive Shaft		25	26	52.8	85.5	650	
	2010.08-	-	-	R	F	Estate Engine K9K 772/K9K 770	850168	Outer Joint		23	30	49	83.5	54.5	I
	2010.08-	-	-	R	F	Estate Engine K9K 772/K9K 770	250625	Drive Shaft		23	26	49	83.5	893	
	2010.08-	-	-	L	F	Estate Engine K9K 772/K9K 770	250630	Drive Shaft		23	26	49	83	653	
	2010.08-	-	-	L	F	Estate Engine K9K 772/K9K 770	250353	Drive Shaft		23	26	49	86	649	
	2010.08-	-	-	-	F	Estate Engine K9K 772/K9K 770	850143	Outer Joint		25	32	52.8	85.5	62.5	I
	2010.08-	-	-	R	F	Estate Engine K9K 772/K9K 770	250483	Drive Shaft		25	26	52.8	85.5	891	
1.5 dCi (76 kW)	2008.02-	-	-	L	F	Estate Engine K9K 772	250379	Drive Shaft		25	26	52.8	85.5	650	
	2008.02-	-	MT	-	F	Estate Engine K9K 772	899085	Outer Joint		23	30	49	86	59	I
	2008.02-	-	-	-	F	Estate Engine K9K 772	850143	Outer Joint		25	32	52.8	85.5	62.5	I
	2008.02-	-	-	R	F	Estate Engine K9K 772	250483	Drive Shaft		25	26	52.8	85.5	891	
1.5 dCi (78 kW)	2008.02-	-	-	R	F	Estate Engine K9K 774/K9K 764	250483	Drive Shaft		25	26	52.8	85.5	891	
	2008.02-	-	MT	R	F	Estate Engine K9K 774/K9K 764	699169	Inner Joint		26	30	33	326	95	
	2008.02-	-	-	L	F	Estate Engine K9K 774/K9K 764	250379	Drive Shaft		25	26	52.8	85.5	650	
	2008.02-	-	MT	-	F	Estate Engine K9K 774/K9K 764	899085	Outer Joint		23	30	49	86	59	I
	2008.02-	-	MT	R	F	Estate Engine K9K 774/K9K 764	250354	Drive Shaft		23	26	49	86	897	
	2008.02-	-	MT	L	F	Estate Engine K9K 774/K9K 764	250353	Drive Shaft		23	26	49	86	649	
	2008.02-	-	-	-	F	Estate Engine K9K 774/K9K 764	850143	Outer Joint		25	32	52.8	85.5	62.5	I
1.6 16V (82 kW)	2008.02-	-	-	R	F	Estate Engine K4M 801/K4M 800	699169	Inner Joint		26	30	33	326	95	
	2008.02-	-	-	L	F	Estate Engine K4M 801/K4M 800	250630	Drive Shaft		23	26	49	83	653	
	2008.02-	-	MT	L	F	Estate Engine K4M 801/K4M 800	250278	Drive Shaft		23	26	49	86	653.5	



RENAULT	YEAR	TRANSM	L/R	F/R	REMARKS	GSP Ref.	PRODUCT	ABS	Technical Specifications							
									A	B	C	H	L	P		
RENAULT																
CLIO Grandtour (KR0/1_)																
1.6 16V (82 kW)	2008.02-	-	-	R	F	Estate Engine K4M 801/K4M 800	250354	Drive Shaft		23	26	49	86	897		
	2008.02-	-	-	-	F	Estate Engine K4M 801/K4M 800	899085	Outer Joint		23	30	49	86	59	I	
	2008.02-	-	-	L	F	Estate Engine K4M 801/K4M 800	250353	Drive Shaft		23	26	49	86	649		
	2008.02-	-	MT	R	F	Estate Engine K4M 801/K4M 800	250277	Drive Shaft		23	26	49	86	898		
	2008.02-	-	-	L	F	Estate Engine K4M 801/K4M 800	250574	Drive Shaft		23	26	49	86	652		
	2008.02-	-	-	R	F	Estate Engine K4M 801/K4M 800	250443	Drive Shaft		23	23	49	86	789		
1.6 16V (94 kW)	2008.11-	-	MT	R	F	Estate Engine K4M 862	699169	Inner Joint		26	30	33	326	95		
	2008.11-	-	-	L	F	Estate Engine K4M 862	250630	Drive Shaft		23	26	49	83	653		
	2008.11-	-	MT	L	F	Estate Engine K4M 862	250278	Drive Shaft		23	26	49	86	653.5		
	2008.11-	-	-	L	F	Estate Engine K4M 862	250353	Drive Shaft		23	26	49	86	649		
	2008.11-	-	MT	R	F	Estate Engine K4M 862	250277	Drive Shaft		23	26	49	86	898		
	2008.11-	-	-	R	F	Estate Engine K4M 862	250483	Drive Shaft		25	26	52.8	85.5	891		
CLIO I																
1.1	1991.03-	1998.04	MT	L	F	-	250097	Drive Shaft		21	29.95	46.2	82	621		
1.2	1991.03-	1998.04	MT	L	F	-	250097	Drive Shaft		21	29.95	46.2	82	621		
1.5	-	-	-	-	-	-	850101	Outer Joint	44T	21	30	52.2	85.5	59	I	
CLIO I (B/C57_5/357_)/LUTECIA																
1.1 (34 kW)	1991.01-	1998.09	MT	L	F	Hatchback Engine C1E 700	250116	Drive Shaft		21	29.95	49.8	83.5	610		
	1991.01-	1998.09	MT	L/R	F	Hatchback Engine C1E 700	850008	Outer Joint		21	25	56.2	83.5	58	O	
	1991.01-	1998.09	-	R	F	Hatchback Engine C1E 700	250117	Drive Shaft		21	23	49.8	83.5	698.5		
	1991.01-	1998.09	MT	R	F	Hatchback Engine C1E 700	250014	Drive Shaft		21	23	46.4	81.5	707		
	1991.01-	1998.09	MT	L	F	Hatchback Engine C1E 700	250015	Drive Shaft		21	29.95	46.4	81.5	612.5		
1.1 (36 kW)	1992.04-	1992.08	MT	L	F	Hatchback Engine C1E 700	250116	Drive Shaft		21	29.95	49.8	83.5	610		
1.2 (40 kW)	1991.01-	1996.06	MT	L/R	F	Hatchback Engine E7F 706	850008	Outer Joint		21	25	56.2	83.5	58	O	
	1991.01-	1996.06	MT	L	F	Hatchback Engine E7F 706	250116	Drive Shaft		21	29.95	49.8	83.5	610		
	1991.01-	1996.06	-	R	F	Hatchback Engine E7F 706	250117	Drive Shaft		21	23	49.8	83.5	698.5		
	1991.01-	1996.06	MT	R	F	Hatchback Engine E7F 706	250014	Drive Shaft		21	23	46.4	81.5	707		
	1991.01-	1996.06	MT	L	F	Hatchback Engine E7F 706	250015	Drive Shaft		21	29.95	56.5	83	618		
	1991.01-	1996.06	MT	L	F	Hatchback Engine E7F 706	250015	Drive Shaft		21	29.95	46.4	81.5	612.5		
	1996.01-	1998.09	MT	L/R	F	Hatchback Engine D7F 730	850008	Outer Joint		21	25	56.2	83.5	58	O	
	1996.01-	1996.12	MT	L/R	F	Hatchback Engine C3G 720	850008	Outer Joint		21	25	56.2	83.5	58	O	
	1996.01-	1998.09	MT	L	F	Hatchback Engine D7F 730	250116	Drive Shaft		21	29.95	49.8	83.5	610		
	1996.01-	1996.12	MT	L	F	Hatchback Engine C3G 720	250116	Drive Shaft		21	29.95	49.8	83.5	610		
	1996.01-	1998.09	-	R	F	Hatchback Engine D7F 730	250117	Drive Shaft		21	23	49.8	83.5	698.5		
	1996.01-	1996.12	-	R	F	Hatchback Engine C3G 720	250117	Drive Shaft		21	23	49.8	83.5	698.5		
	1996.01-	1998.09	MT	R	F	Hatchback Engine D7F 730	250014	Drive Shaft		21	23	46.4	81.5	707		
	1996.01-	1996.12	MT	R	F	Hatchback Engine C3G 720	250014	Drive Shaft		21	23	46.4	81.5	707		
	1996.01-	1998.09	MT	L	F	Hatchback Engine D7F 730	250015	Drive Shaft		21	29.95	46.4	81.5	612.5		
	1996.01-	1998.09	MT	L	F	Hatchback Engine D7F 730	250050	Drive Shaft		21	29.95	56.5	83	618		
	1996.01-	1996.12	MT	L	F	Hatchback Engine C3G 720	250050	Drive Shaft		21	29.95	56.5	83	618		
	1996.01-	1996.12	MT	L	F	Hatchback Engine C3G 720	250015	Drive Shaft		21	29.95	46.4	81.5	612.5		
1.2 (43 kW)	1990.05-	1998.09	MT	L/R	F	Hatchback Engine E7F 750/E7F 700/E7F 708	850008	Outer Joint		21	25	56.2	83.5	58	O	
	1990.05-	1998.09	MT	L	F	Hatchback Engine E7F 750/E7F 700/E7F 708	250116	Drive Shaft		21	29.95	49.8	83.5	610		
	1990.05-	1998.09	-	R	F	Hatchback Engine E7F 750/E7F 700/E7F 708	250117	Drive Shaft		21	23	49.8	83.5	698.5		
	1990.05-	1998.09	MT	R	F	Hatchback Engine E7F 750/E7F 700/E7F 708	250014	Drive Shaft		21	23	46.4	81.5	707		
	1990.05-	1998.09	MT	L	F	Hatchback Engine E7F 750/E7F 700/E7F 708	250015	Drive Shaft		21	29.95	56.5	83	618		
	1990.05-	1998.09	MT	L	F	Hatchback Engine E7F 750/E7F 700/E7F 708	250015	Drive Shaft		21	29.95	46.4	81.5	612.5		
	1996.01-	1998.09	MT	L/R	F	Hatchback Engine D7F 730	850008	Outer Joint		21	25	56.2	83.5	58	O	
	1996.01-	1998.09	MT	L	F	Hatchback Engine D7F 730	250116	Drive Shaft		21	29.95	49.8	83.5	610		
	1996.01-	1998.09	-	R	F	Hatchback Engine D7F 730	250117	Drive Shaft		21	23	49.8	83.5	698.5		
	1996.01-	1998.09	MT	R	F	Hatchback Engine D7F 730	250014	Drive Shaft		21	23	46.4	81.5	707		
	1996.01-	1998.09	MT	L	F	Hatchback Engine D7F 730	250015	Drive Shaft		21	29.95	46.4	81.5	612.5		
	1996.01-	1998.09	MT	L	F	Hatchback Engine D7F 730	250050	Drive Shaft		21	29.95	56.5	83	618		
1.2 (44 kW)	1990.05-	1996.03	MT	L	F	Hatchback Engine E5F 710	250116	Drive Shaft		21	29.95	49.8	83.5	610		
	1990.05-	1996.03	-	R	F	Hatchback Engine E5F 710	250014	Drive Shaft		21	23	46.4	81.5	707		
	1990.05-	1996.03	-	L	F	Hatchback Engine E5F 710	250015	Drive Shaft		21	29.95	46.4	81.5	612.5		
	1990.05-	1996.03	MT	L	F	Hatchback Engine E5F 710	250050	Drive Shaft		21	29.95	56.5	83	618		
1.4 (55 kW)	1991.01-	1998.09	MT	L	F	Hatchback Engine E7J 757/E7J 756	250116	Drive Shaft		21	29.95	49.8	83.5	610		
	1991.01-	1998.09	-	R	F	Hatchback Engine E7J 757/E7J 756	250205	Drive Shaft		21	23	57	85	703		
1.4 (57 kW)	1990.05-	1998.02	MT	L/R	F	Hatchback Engine E6J 760/E6J 712/E6J 713	850008	Outer Joint		21	25	56.2	83.5	58	O	
	1990.05-	1998.02	MT	L	F	Hatchback Engine E6J 760/E6J 712/E6J 713	250116	Drive Shaft		21	29.95	49.8	83.5	610		
	1990.05-	1998.02	3AT	R	F	Hatchback Engine E6J 760/E6J 712/E6J 713	250022	Drive Shaft		21	23	46.3	84	706		
	1990.05-	1998.02	MT	R	F	Hatchback Engine E6J 760/E6J 712/E6J 713	250014	Drive Shaft		21	23	46.4	81.5	707		
	1990.05-	1998.02	MT	L	F	Hatchback Engine E6J 760/E6J 712/E6J 713	250015	Drive Shaft		21	29.95	46.4	81.5	612.5		
1.4 (58 kW)	1991.01-	1998.09	MT	L/R	F	Hatchback Engine E7J 601/E7J 718/E7J 719/E7J 754	850008	Outer Joint		21	25	56.2	83.5	58	O	
	1991.01-	1998.09	-	R	F	Hatchback Engine E7J 601/E7J 718/E7J 719/E7J 754	250205	Drive Shaft		21	23	57	85	703		

	YEAR	TRANSM	L/R	F/R	REMARKS	GSP Ref.	PRODUCT	ABS	Technical Specifications									
									A	B	C	H	L	P				
RENAULT																		
CLIO I (B/C57_ 5/357_)/LUTECIA																		
1.4 (58 kW)	1991.01-1998.09	-	R	F	Hatchback Engine E7J 601/E7J 718/E7J 719/E7J 754	250117	Drive Shaft		21	23	49.8	83.5	698.5					
	1991.01-1998.09	3AT	R	F	Hatchback Engine E7J 601/E7J 718/E7J 719/E7J 754	250022	Drive Shaft		21	23	46.3	84	706					
	1991.01-1998.09	MT	R	F	Hatchback Engine E7J 601/E7J 718/E7J 719/E7J 754	250014	Drive Shaft		21	23	46.4	81.5	707					
	1991.01-1998.09	MT	L	F	Hatchback Engine E7J 601/E7J 718/E7J 719/E7J 754	250015	Drive Shaft		21	29.95	46.4	81.5	612.5					
1.4 (59 kW)	1991.01-1998.09	MT	L/R	F	Hatchback Engine E7J 711/E7J 710	850008	Outer Joint		21	25	56.2	83.5	58	O				
	1991.01-1998.09	MT	L	F	Hatchback Engine E7J 711/E7J 710	250116	Drive Shaft		21	29.95	49.8	83.5	610					
	1991.01-1998.09	-	R	F	Hatchback Engine E7J 711/E7J 710	250205	Drive Shaft		21	23	57	85	703					
	1991.01-1998.09	3AT	R	F	Hatchback Engine E7J 711/E7J 710	250022	Drive Shaft		21	23	46.3	84	706					
	1991.01-1998.09	-	R	F	Hatchback Engine E7J 711/E7J 710	250117	Drive Shaft		21	23	49.8	83.5	698.5					
	1991.01-1998.09	MT	R	F	Hatchback Engine E7J 711/E7J 710	250014	Drive Shaft		21	23	46.4	81.5	707					
	1991.01-1998.09	MT	L	F	Hatchback Engine E7J 711/E7J 710	250015	Drive Shaft		21	29.95	46.4	81.5	612.5					
1.7 (68 kW)	1991.01-1993.12	-	R	F	Hatchback Engine F2N 770	250117	Drive Shaft		21	23	49.8	83.5	698.5					
1.8 (65 kW)	1991.01-1998.09	MT	L/R	F	Hatchback Engine F3P 710/F3P 714	850008	Outer Joint		21	25	56.2	83.5	58	O				
	1991.01-1998.09	MT	L/R	F	Hatchback Engine F3P 710/F3P 714	850011	Outer Joint	26T	21	25	56.2	83.5	58	O				
	1991.01-1998.09	MT	R	F	Hatchback Engine F3P 710/F3P 714	250022	Drive Shaft		21	23	46.3	84	706					
	1991.01-1998.09	-	R	F	Hatchback Engine F3P 710/F3P 714	250117	Drive Shaft		21	23	49.8	83.5	698.5					
	1991.01-1998.09	MT	L	F	Hatchback Engine F3P 710/F3P 714	250020	Drive Shaft		21	29.95	50	84	610.5					
1.8 (66 kW)	1994.08-1998.09	MT	L/R	F	Hatchback Engine F3P 755/F3P 754	850011	Outer Joint	26T	21	25	56.2	83.5	58	O				
1.8 (70 kW)	1991.01-1998.09	MT	L/R	F	Hatchback Engine F3P 710	850008	Outer Joint		21	25	56.2	83.5	58	O				
	1991.01-1998.09	AT/MT	L/R	F	Hatchback Engine F3P 710	850011	Outer Joint	26T	21	25	56.2	83.5	58	O				
	1991.01-1998.09	-	R	F	Hatchback Engine F3P 710	250117	Drive Shaft		21	23	49.8	83.5	698.5					
	1991.01-1998.09	MT	R	F	Hatchback Engine F3P 710	250022	Drive Shaft		21	23	46.3	84	706					
	1991.01-1998.09	MT	L	F	Hatchback Engine F3P 710	250020	Drive Shaft		21	29.95	50	84	610.5					
1.8 16V (99 kW)	1991.01-1996.03	MT	L/R	F	Hatchback Engine F7P 722	850008	Outer Joint		21	25	56.2	83.5	58	O				
	1991.01-1996.03	AT/MT	L/R	F	Hatchback Engine F7P 722	850011	Outer Joint	26T	21	25	56.2	83.5	58	O				
1.8 Rsi (79 kW)	1995.08-1998.09	MT	L/R	F	Hatchback Engine F3P 758	850008	Outer Joint		21	25	56.2	83.5	58	O				
	1995.08-1998.09	AT/MT	L/R	F	Hatchback Engine F3P 758	850011	Outer Joint	26T	21	25	56.2	83.5	58	O				
	1995.08-1998.09	MT	R	F	Hatchback Engine F3P 758	250022	Drive Shaft		21	23	46.3	84	706					
	1995.08-1998.09	-	R	F	Hatchback Engine F3P 758	250117	Drive Shaft		21	23	49.8	83.5	698.5					
	1995.08-1998.09	MT	L	F	Hatchback Engine F3P 758	250020	Drive Shaft		21	29.95	50	84	610.5					
1.8 Rsi (80 kW)	1993.01-1995.08	MT	L/R	F	Hatchback Engine F3P 712	850008	Outer Joint		21	25	56.2	83.5	58	O				
	1993.01-1995.08	AT/MT	L/R	F	Hatchback Engine F3P 712	850011	Outer Joint	26T	21	25	56.2	83.5	58	O				
	1993.01-1995.08	MT	R	F	Hatchback Engine F3P 712	250022	Drive Shaft		21	23	46.3	84	706					
	1993.01-1995.08	-	R	F	Hatchback Engine F3P 712	250117	Drive Shaft		21	23	49.8	83.5	698.5					
	1993.01-1995.08	MT	L	F	Hatchback Engine F3P 712	250020	Drive Shaft		21	29.95	50	84	610.5					
1.9 D (40 kW)	1997.01-1998.09	MT	L	F	Hatchback Engine F8Q 678	250116	Drive Shaft		21	29.95	49.8	83.5	610					
	1997.01-1998.09	-	-	F	Hatchback Engine F8Q 678	250303	Drive Shaft		21	29.95	57	84	634					
	1997.01-1998.09	-	-	R	Hatchback Engine F8Q 678	250051	Drive Shaft		21	23	46	83.5	718					
	1997.01-1998.09	-	-	F	Hatchback Engine F8Q 678	250045	Drive Shaft	26T	21	29.95	51.5	83	634					
	1997.01-1998.09	-	-	R	Hatchback Engine F8Q 678	250082	Drive Shaft	26T	21	23	51.5	83	717					
	1997.01-1998.09	-	R	F	Hatchback Engine F8Q 678	250205	Drive Shaft		21	23	57	85	703					
	1997.01-1998.09	-	R	F	Hatchback Engine F8Q 678	250117	Drive Shaft		21	23	49.8	83.5	698.5					
1.9 D (47 kW)	1991.01-1998.09	MT	L/R	F	Hatchback Engine F8Q 730/F8Q 732	850008	Outer Joint		21	25	56.2	83.5	58	O				
	1991.01-1998.09	MT	L	F	Hatchback Engine F8Q 730/F8Q 732	250116	Drive Shaft		21	29.95	49.8	83.5	610					
	1991.01-1998.09	AT/MT	L/R	F	Hatchback Engine F8Q 730/F8Q 732	850011	Outer Joint	26T	21	25	56.2	83.5	58	O				
	1991.01-1998.09	-	R	F	Hatchback Engine F8Q 730/F8Q 732	250205	Drive Shaft		21	23	57	85	703					
	1991.01-1998.09	MT	R	F	Hatchback Engine F8Q 730/F8Q 732	250022	Drive Shaft		21	23	46.3	84	706					
	1991.01-1998.09	MT	L	F	Hatchback Engine F8Q 730/F8Q 732	250020	Drive Shaft		21	29.95	50	84	610.5					
1.9 D (48 kW)	1996.05-1998.02	MT	L	F	Hatchback Engine F8Q 676/F8Q 696/F8Q 632/F8Q 714	250116	Drive Shaft		21	29.95	49.8	83.5	610					
Williams (108 kW)	1994.01-1998.09	MT	L/R	F	Hatchback Engine F7R 700	850008	Outer Joint		21	25	56.2	83.5	58	O				
	1994.01-1998.09	AT/MT	L/R	F	Hatchback Engine F7R 700	850011	Outer Joint	26T	21	25	56.2	83.5	58	O				
CLIO I (S57_)																		
1.1 (34 kW)	1991.01-1998.09	-	R	F	Box Engine C1E 700	250117	Drive Shaft		21	23	49.8	83.5	698.5					
1.2 (40 kW)	1991.01-1998.09	-	R	F	Box Engine E7F 706	250117	Drive Shaft		21	23	49.8	83.5	698.5					
1.2 (44 kW)	1991.01-1998.09	MT	L/R	F	Box Engine E7F 750	850008	Outer Joint		21	25	56.2	83.5	58	O				
	1991.01-1998.09	MT	L	F	Box Engine E7F 750	250116	Drive Shaft		21	29.95	49.8	83.5	610					
	1991.01-1998.09	-	R	F	Box Engine E7F 750	250117	Drive Shaft		21	23	49.8	83.5	698.5					
	1991.01-1998.09	MT	R	F	Box Engine E7F 750	250014	Drive Shaft		21	23	46.4	81.5	707					
	1991.01-1998.09	MT	L	F	Box Engine E7F 750	250015	Drive Shaft		21	29.95	46.4	81.5	612.5					
1.9 D (48 kW)	1991.01-1998.09	MT	L/R	F	Box Engine F8Q 730/F8Q 732	850008	Outer Joint		21	25	56.2	83.5	58	O				
	1991.01-1998.09	-	R	F	Box Engine F8Q 730/F8Q 732	250205	Drive Shaft		21	23	57	85	703					
	1991.01-1998.09	MT	R	F	Box Engine F8Q 730/F8Q 732	250022	Drive Shaft		21	23	46.3	84	706					
	1991.01-1998.09	-	R	F	Box Engine F8Q 730/F8Q 732	250117	Drive Shaft		21	23	49.8	83.5	698.5					
	1991.01-1998.09	MT	L	F	Box Engine F8Q 730/F8Q 732	250020	Drive Shaft		21	29.95	50	84	610.5					
CLIO II																		
1.2	1998.05-	MT	R	-	-	250092	Drive Shaft		21	23	57	84.5	719					

	YEAR	TRANSM	L/R	F/R	REMARKS	GSP Ref.	PRODUCT	ABS	Technical Specifications						
									A	B	C	H	L	P	
RENAULT															
CLIO II															
1.2	2001.04-	-	MT	L	F	-	250103	Drive Shaft	44T	21	29.95	57	84.5	625.7	
	2001.04-	-	MT	R	F	-	250241	Drive Shaft	44T	21	23	57	84.5	718.5	
1.4	1998- 2005	-	-	L	F	-	250363	Drive Shaft	26T	21	29.95	52.2	85.5	630	
	1998.05-	-	MT	R	-	-	250092	Drive Shaft		21	23	57	84.5	719	
	2000.04-	-	AT	L	F	-	250216	Drive Shaft	26T	21	26	57	84.5	617	
	2000.04-	-	AT	R	F	-	250233	Drive Shaft	26T	21	23	57	84.5	737	
	2001.04-	-	MT	L	F	-	250103	Drive Shaft	44T	21	29.95	57	84.5	625.7	
	2001.04-	-	MT	R	F	-	250241	Drive Shaft	44T	21	23	57	84.5	718.5	
1.5 DCi	1998- 2005	-	-	L	F	-	250363	Drive Shaft	26T	21	29.95	52.2	85.5	630	
	2001.04-	-	MT	L	F	-	250103	Drive Shaft	44T	21	29.95	57	84.5	625.7	
	2001.04-	-	MT	R	F	-	250241	Drive Shaft	44T	21	23	57	84.5	718.5	
1.9 D	1998.05-	-	MT	R	-	-	250092	Drive Shaft		21	23	57	84.5	719	
1.9 DTi	2001-	-	MT	R	-	-	250092	Drive Shaft		21	23	57	84.5	719	
CLIO II (B/C/ B0/1)															
1.5 DCi (48 kW)	2001.06-	-	-	-	-	-	850066	Outer Joint	44T	21	28	52.5	85	51	I
1.5 DCi (60 kW)	2001.06-	-	-	-	-	-	850066	Outer Joint	44T	21	28	52.5	85	51	I
CLIO II (B/C/B0/1)															
1.2 (43 kW)	1998.09-	2005.05	-	-	-	-	899070	Outer Joint		21	25	46.3	79	58	O
CLIO II (BB_ CB_)/LUTECIA															
1.2 (43 kW)	1998.09-	-	MT	R	F	Hatchback Engine D7F 766/D7F 720/D7F 728/D7F 746/D7F 764/D7F 710/D7F 722	250146	Drive Shaft		21	23	57	84.5	732.5	
	1998.09-	-	-	L	F	Hatchback Engine D7F 766/D7F 720/D7F 728/D7F 746/D7F 764/D7F 710/D7F 722	250004	Drive Shaft	26T	21	29.95	57	84.5	625.7	
	1998.09-	-	-	R	F	Hatchback Engine D7F 766/D7F 720/D7F 728/D7F 746/D7F 764/D7F 710/D7F 722	250263	Drive Shaft	44T	21	23	52.2	85.5	723.5	
	1998.09-	-	-	R	F	Hatchback Engine D7F 766/D7F 720/D7F 728/D7F 746/D7F 764/D7F 710/D7F 722	250017	Drive Shaft	26T	21	23	51.5	83	715	
	1998.09-	-	-	L	F	Hatchback Engine D7F 766/D7F 720/D7F 728/D7F 746/D7F 764/D7F 710/D7F 722	250261	Drive Shaft	44T	23	29.95	57.5	86.5	630	
	1998.09-	-	AT	L/R	F	Hatchback Engine D7F 766/D7F 720/D7F 728/D7F 746/D7F 764/D7F 710/D7F 722	850004	Outer Joint	26T	21	30	52.2	85.5	59	I
	1998.09-	-	-	L	F	Hatchback Engine D7F 766/D7F 720/D7F 728/D7F 746/D7F 764/D7F 710/D7F 722	250401	Drive Shaft	44T	21	29.95	57	84	629	
	1998.09-	-	MT	L	F	Hatchback Engine D7F 766/D7F 720/D7F 728/D7F 746/D7F 764/D7F 710/D7F 722	250109	Drive Shaft	26T	21	29.95	57	84.5	625.7	
	1998.09-	-	-	L	F	Hatchback Engine D7F 766/D7F 720/D7F 728/D7F 746/D7F 764/D7F 710/D7F 722	250150	Drive Shaft		21	29.95	49.8	83.5	623	
	1998.09-	-	MT	R	F	Hatchback Engine D7F 766/D7F 720/D7F 728/D7F 746/D7F 764/D7F 710/D7F 722	250250	Drive Shaft	26T	21	23	57	84.5	732.5	
	1998.09-	-	MT	L	F	Hatchback Engine D7F 766/D7F 720/D7F 728/D7F 746/D7F 764/D7F 710/D7F 722	299073	Drive Shaft	44T	21	29.95	57	84.5	628	
	1998.09-	-	-	R	F	Hatchback Engine D7F 766/D7F 720/D7F 728/D7F 746/D7F 764/D7F 710/D7F 722	650008	Inner Joint		23	30	36.3	52.2	68.5	
	1998.09-	-	MT	R	F	Hatchback Engine D7F 766/D7F 720/D7F 728/D7F 746/D7F 764/D7F 710/D7F 722	250125	Drive Shaft		21	23	57	84.5	713.5	
	1998.09-	-	MT	L	F	Hatchback Engine D7F 766/D7F 720/D7F 728/D7F 746/D7F 764/D7F 710/D7F 722	250177	Drive Shaft		21	29.95	57	84.5	625.7	
	1998.09-	-	MT	R	F	Hatchback Engine D7F 766/D7F 720/D7F 728/D7F 746/D7F 764/D7F 710/D7F 722	299072	Drive Shaft	44T	21	23	57	84.5	720	
1.2 (44 kW)	1999.03-	2001.05	MT	L	F	Hatchback Engine D7F 722	250177	Drive Shaft		21	29.95	57	84.5	625.7	
	1999.03-	2001.05	MT	R	F	Hatchback Engine D7F 722	299072	Drive Shaft	44T	21	23	57	84.5	720	
	1999.03-	2001.05	MT	R	F	Hatchback Engine D7F 722	250146	Drive Shaft		21	23	57	84.5	732.5	
	1999.03-	2001.05	-	L	F	Hatchback Engine D7F 722	250004	Drive Shaft	26T	21	29.95	57	84.5	625.7	
	1999.03-	2001.05	-	R	F	Hatchback Engine D7F 722	250017	Drive Shaft	26T	21	23	51.5	83	715	
	1999.03-	2001.05	MT	L	F	Hatchback Engine D7F 722	250109	Drive Shaft	26T	21	29.95	57	84.5	625.7	
	1999.03-	2001.05	-	L	F	Hatchback Engine D7F 722	250150	Drive Shaft		21	29.95	49.8	83.5	623	
	1999.03-	2001.05	MT	R	F	Hatchback Engine D7F 722	250125	Drive Shaft		21	23	57	84.5	713.5	
	1999.03-	2001.05	MT	R	F	Hatchback Engine D7F 722	250250	Drive Shaft	26T	21	23	57	84.5	732.5	
	1999.03-	2001.05	MT	L	F	Hatchback Engine D7F 722	299073	Drive Shaft	44T	21	29.95	57	84.5	628	
	1999.03-	2001.05	MT	R	F	Hatchback Engine D7F 722	650008	Inner Joint		23	30	36.3	52.2	68.5	
1.2 16V (55 kW)	2001.06-	-	MT	L	F	Hatchback Engine D4F 722/D4F 712/D4F 714/D4F 706/D4F 728	250177	Drive Shaft		21	29.95	57	84.5	625.7	
	2001.06-	-	Semi-AT/MT	R	F	Hatchback Engine D4F 722/D4F 712/D4F 714/D4F 706/D4F 728	299072	Drive Shaft	44T	21	23	57	84.5	720	
	2001.06-	-	-	R	F	Hatchback Engine D4F 722/D4F 712/D4F 714/D4F 706/D4F 728	250162	Drive Shaft	26T	21	23	52.2	85.5	723.5	
	2001.06-	-	AT	R	F	Hatchback Engine D4F 722/D4F 712/D4F 714/D4F 706/D4F 728	299242	Drive Shaft	44T	21	26	52.2	85.5	621	
	2001.06-	-	-	R	F	Hatchback Engine D4F 722/D4F 712/D4F 714/D4F 706/D4F 728	250263	Drive Shaft	44T	21	23	52.2	85.5	723.5	
	2001.06-	-	MT	R	F	Hatchback Engine D4F 722/D4F 712/D4F 714/D4F 706/D4F 728	250146	Drive Shaft		21	23	57	84.5	732.5	
	2001.06-	-	AT	R	F	Hatchback Engine D4F 722/D4F 712/D4F 714/D4F 706/D4F 728	250485	Drive Shaft	44T	21	23	52.2	85.5	733	
	2001.06-	-	-	L	F	Hatchback Engine D4F 722/D4F 712/D4F 714/D4F 706/D4F 728	250004	Drive Shaft	26T	21	29.95	57	84.5	625.7	
	2001.06-	-	-	L	F	Hatchback Engine D4F 722/D4F 712/D4F 714/D4F 706/D4F 728	250261	Drive Shaft	44T	23	29.95	57.5	86.5	630	
	2001.06-	-	AT	L/R	F	Hatchback Engine D4F 722/D4F 712/D4F 714/D4F 706/D4F 728	850004	Outer Joint	26T	21	30	52.2	85.5	59	I
	2001.06-	-	MT	L	F	Hatchback Engine D4F 722/D4F 712/D4F 714/D4F 706/D4F 728	250401	Drive Shaft	44T	21	29.95	57	84	629	
	2001.06-	-	Semi-AT	L	F	Hatchback Engine D4F 722/D4F 712/D4F 714/D4F 706/D4F 728	250502	Drive Shaft	44T	21		57	84.5	628	
	2001.06-	-	MT	L	F	Hatchback Engine D4F 722/D4F 712/D4F 714/D4F 706/D4F 728	250109	Drive Shaft	26T	21	29.95	57	84.5	625.7	
	2001.06-	-	-	L	F	Hatchback Engine D4F 722/D4F 712/D4F 714/D4F 706/D4F 728	250150	Drive Shaft		21	29.95	49.8	83.5	623	
	2001.06-	-	AT	L	F	Hatchback Engine D4F 722/D4F 712/D4F 714/D4F 706/D4F 728	299169	Drive Shaft	26T	21	26	52.2	85.5	621	
	2001.06-	-	AT	R	F	Hatchback Engine D4F 722/D4F 712/D4F 714/D4F 706/D4F 728	250486	Drive Shaft	26T	21	23	52.2	85.5	733	
	2001.06-	-	Semi-AT/MT	R	F	Hatchback Engine D4F 722/D4F 712/D4F 714/D4F 706/D4F 728	250250	Drive Shaft	26T	21	23	57	84.5	732.5	
	2001.06-	-	-	R	F	Hatchback Engine D4F 722/D4F 712/D4F 714/D4F 706/D4F 728	650008	Inner Joint		23	30	36.3	52.2	68.5	
	2001.06-	-	MT	L	F	Hatchback Engine D4F 722/D4F 712/D4F 714/D4F 706/D4F 728	299073	Drive Shaft	44T	21	29.95	57	84.5	628	
1.2 LPG (43 kW)	1998.09-	2009.06	-	R	F	Hatchback Engine D7F 764/D7F 766	250151	Drive Shaft		21	23	49.8	83.5	712	
	1998.09-	2009.06	-	R	F	Hatchback Engine D7F 764/D7F 766	250017	Drive Shaft	26T	21	23	51.5	83	715	

			TRANSM	L/R	F/R	REMARKS	GSP Ref.		ABS	Technical Specifications					
YEAR										A	B	C	H	L	P
RENAULT															
CLIO II (BB_ CB_)/LUTECIA															
1.2 LPG (43 kW)		1998.09-2009.06	MT	R	F	Hatchback Engine D7F 764/D7F 766	650008	Inner Joint		23	30	36.3	52.2	68.5	
		1998.09-2009.06	MT	R	F	Hatchback Engine D7F 764/D7F 766	250125	Drive Shaft		21	23	57	84.5	713.5	
1.4 (55 kW)		1998.09-2005.05	-	R	F	Hatchback Engine E7J 634/E7J 780/E7J 700	250162	Drive Shaft	26T	21	23	52.2	85.5	723.5	
		1998.09-2005.05	-	R	F	Hatchback Engine E7J 634/E7J 780/E7J 700	299150	Drive Shaft	26T	21	23	52.2	85.5	747	
		1998.09-2005.05	MT	R	F	Hatchback Engine E7J 634/E7J 780/E7J 700	250146	Drive Shaft		21	23	57	84.5	732.5	
		1998.09-2005.05	MT	R	F	Hatchback Engine E7J 634/E7J 780/E7J 700	250151	Drive Shaft		21	23	49.8	83.5	712	
		1998.09-2005.05	-	L	F	Hatchback Engine E7J 634/E7J 780/E7J 700	250004	Drive Shaft	26T	21	29.95	57	84.5	625.7	
		1998.09-2005.05	-	R	F	Hatchback Engine E7J 634/E7J 780/E7J 700	250017	Drive Shaft	26T	21	23	51.5	83	715	
		1998.09-2005.05	AT/MT	L/R	F	Hatchback Engine E7J 634/E7J 780/E7J 700	850004	Outer Joint	26T	21	30	52.2	85.5	59	I
		1998.09-2005.05	-	R	F	Hatchback Engine E7J 634/E7J 780/E7J 700	250588	Drive Shaft	26T	21	23	57	84	739	
		1998.09-2005.05	-	R	F	Hatchback Engine E7J 634/E7J 780/E7J 700	650008	Inner Joint		23	30	36.3	52.2	68.5	
		1998.09-2005.05	MT	R	F	Hatchback Engine E7J 634/E7J 780/E7J 700	250395	Drive Shaft	26T	21	23	51.5	83	728	
		1998.09-2005.05	MT	L	F	Hatchback Engine E7J 634/E7J 780/E7J 700	250109	Drive Shaft	26T	21	29.95	57	84.5	625.7	
		1998.09-2005.05	-	L	F	Hatchback Engine E7J 634/E7J 780/E7J 700	250150	Drive Shaft		21	29.95	49.8	83.5	623	
		1998.09-2005.05	MT	R	F	Hatchback Engine E7J 634/E7J 780/E7J 700	250250	Drive Shaft	26T	21	23	57	84.5	732.5	
		1998.09-2005.05	MT	R	F	Hatchback Engine E7J 634/E7J 780/E7J 700	250125	Drive Shaft		21	23	57	84.5	713.5	
		1998.09-2005.05	MT	L	F	Hatchback Engine E7J 634/E7J 780/E7J 700	250177	Drive Shaft		21	29.95	57	84.5	625.7	
1.4 16V (70 kW)		1999.10-2004.09	MT	R	F	Hatchback Engine K4J 712/K4J 713	299072	Drive Shaft	44T	21	23	57	84.5	720	
		1999.10-2004.09	MT	R	F	Hatchback Engine K4J 712/K4J 713	250162	Drive Shaft	26T	21	23	52.2	85.5	723.5	
		1999.10-2004.09	-	R	F	Hatchback Engine K4J 712/K4J 713	299150	Drive Shaft	26T	21	23	52.2	85.5	747	
		1999.10-2004.09	MT	R	F	Hatchback Engine K4J 712/K4J 713	250151	Drive Shaft		21	23	49.8	83.5	712	
		1999.10-2004.09	AT	L	F	Hatchback Engine K4J 712/K4J 713	299242	Drive Shaft	44T	21	26	52.2	85.5	621	
		1999.10-2004.09	MT	R	F	Hatchback Engine K4J 712/K4J 713	250146	Drive Shaft		21	23	57	84.5	732.5	
		1999.10-2004.09	MT	R	F	Hatchback Engine K4J 712/K4J 713	250263	Drive Shaft	44T	21	23	52.2	85.5	723.5	
		1999.10-2004.09	AT	R	F	Hatchback Engine K4J 712/K4J 713	250485	Drive Shaft	44T	21	23	52.2	85.5	733	
		1999.10-2004.09	MT	L	F	Hatchback Engine K4J 712/K4J 713	250004	Drive Shaft	26T	21	29.95	57	84.5	625.7	
		1999.10-2004.09	MT	L	F	Hatchback Engine K4J 712/K4J 713	250261	Drive Shaft	44T	23	29.95	57.5	86.5	630	
		1999.10-2004.09	MT	R	F	Hatchback Engine K4J 712/K4J 713	250017	Drive Shaft	26T	21	23	51.5	83	715	
		1999.10-2004.09	AT	L	F	Hatchback Engine K4J 712/K4J 713	250579	Drive Shaft	26T	21	26	52.2	85.5	613	
		1999.10-2004.09	AT	L/R	F	Hatchback Engine K4J 712/K4J 713	850004	Outer Joint	26T	21	30	52.2	85.5	59	I
		1999.10-2004.09	AT	R	F	Hatchback Engine K4J 712/K4J 713	250588	Drive Shaft	26T	21	23	57	84	739	
		1999.10-2004.09	MT	R	F	Hatchback Engine K4J 712/K4J 713	250395	Drive Shaft	26T	21	23	51.5	83	728	
		1999.10-2004.09	MT	L	F	Hatchback Engine K4J 712/K4J 713	250401	Drive Shaft	44T	21	29.95	57	84	629	
		1999.10-2004.09	MT	L	F	Hatchback Engine K4J 712/K4J 713	250109	Drive Shaft	26T	21	29.95	57	84.5	625.7	
		1999.10-2004.09	MT	L	F	Hatchback Engine K4J 712/K4J 713	250150	Drive Shaft		21	29.95	49.8	83.5	623	
		1999.10-2004.09	AT	L	F	Hatchback Engine K4J 712/K4J 713	299169	Drive Shaft	26T	21	26	52.2	85.5	621	
		1999.10-2004.09	AT	R	F	Hatchback Engine K4J 712/K4J 713	250486	Drive Shaft	26T	21	23	52.2	85.5	733	
		1999.10-2004.09	MT	R	F	Hatchback Engine K4J 712/K4J 713	250250	Drive Shaft	26T	21	23	57	84.5	732.5	
		1999.10-2004.09	MT	L	F	Hatchback Engine K4J 712/K4J 713	299073	Drive Shaft	44T	21	29.95	57	84.5	628	
		1999.10-2004.09	MT	R	F	Hatchback Engine K4J 712/K4J 713	650008	Inner Joint		23	30	36.3	52.2	68.5	
		1999.10-2004.09	MT	R	F	Hatchback Engine K4J 712/K4J 713	250125	Drive Shaft		21	23	57	84.5	713.5	
		1999.10-2004.09	MT	L	F	Hatchback Engine K4J 712/K4J 713	250177	Drive Shaft		21	29.95	57	84.5	625.7	
1.4 16V (72 kW)		2000.08-2006.12	MT	L	F	Hatchback Engine K4J 711/K4J 712/K4J 713/K4J 710	250177	Drive Shaft		21	29.95	57	84.5	625.7	
		2000.08-2006.12	MT	R	F	Hatchback Engine K4J 711/K4J 712/K4J 713/K4J 710	299072	Drive Shaft	44T	21	23	57	84.5	720	
		2000.08-2006.12	-	R	F	Hatchback Engine K4J 711/K4J 712/K4J 713/K4J 710	250162	Drive Shaft	26T	21	23	52.2	85.5	723.5	
		2000.08-2006.12	-	R	F	Hatchback Engine K4J 711/K4J 712/K4J 713/K4J 710	299150	Drive Shaft	26T	21	23	52.2	85.5	747	
		2000.08-2006.12	AT	L	F	Hatchback Engine K4J 711/K4J 712/K4J 713/K4J 710	299242	Drive Shaft	44T	21	26	52.2	85.5	621	
		2000.08-2006.12	MT	R	F	Hatchback Engine K4J 711/K4J 712/K4J 713/K4J 710	250146	Drive Shaft		21	23	57	84.5	732.5	
		2000.08-2006.12	AT	R	F	Hatchback Engine K4J 711/K4J 712/K4J 713/K4J 710	250485	Drive Shaft	44T	21	23	52.2	85.5	733	
		2000.08-2006.12	-	L	F	Hatchback Engine K4J 711/K4J 712/K4J 713/K4J 710	250004	Drive Shaft	26T	21	29.95	57	84.5	625.7	
		2000.08-2006.12	-	L	F	Hatchback Engine K4J 711/K4J 712/K4J 713/K4J 710	250261	Drive Shaft	44T	23	29.95	57.5	86.5	630	
		2000.08-2006.12	-	L	F	Hatchback Engine K4J 711/K4J 712/K4J 713/K4J 710	250579	Drive Shaft	26T	21	26	52.2	85.5	613	
		2000.08-2006.12	-	R	F	Hatchback Engine K4J 711/K4J 712/K4J 713/K4J 710	250588	Drive Shaft	26T	21	23	57	84	739	
		2000.08-2006.12	-	R	F	Hatchback Engine K4J 711/K4J 712/K4J 713/K4J 710	650008	Inner Joint		23	30	36.3	52.2	68.5	
		2000.08-2006.12	AT	L/R	F	Hatchback Engine K4J 711/K4J 712/K4J 713/K4J 710	850004	Outer Joint	26T	21	30	52.2	85.5	59	I
		2000.08-2006.12	-	L	F	Hatchback Engine K4J 711/K4J 712/K4J 713/K4J 710	250401	Drive Shaft	44T	21	29.95	57	84	629	
		2000.08-2006.12	MT	L	F	Hatchback Engine K4J 711/K4J 712/K4J 713/K4J 710	250109	Drive Shaft	26T	21	29.95	57	84.5	625.7	
		2000.08-2006.12	-	L	F	Hatchback Engine K4J 711/K4J 712/K4J 713/K4J 710	250150	Drive Shaft		21	29.95	49.8	83.5	623	
		2000.08-2006.12	AT	L	F	Hatchback Engine K4J 711/K4J 712/K4J 713/K4J 710	299169	Drive Shaft	26T	21	26	52.2	85.5	621	
		2000.08-2006.12	AT	R	F	Hatchback Engine K4J 711/K4J 712/K4J 713/K4J 710	250486	Drive Shaft	26T	21	23	52.2	85.5	733	
		2000.08-2006.12	MT	R	F	Hatchback Engine K4J 711/K4J 712/K4J 713/K4J 710	250250	Drive Shaft	26T	21	23	57	84.5	732.5	
		2000.08-2006.12	MT	L	F	Hatchback Engine K4J 711/K4J 712/K4J 713/K4J 710	299073	Drive Shaft	44T	21	29.95	57	84.5	628	
1.5 dCi (42 kW)		2001.06-2006.12	MT	R	F	Hatchback Engine K9K 704	250162	Drive Shaft	26T	21	23	52.2	85.5	723.5	
		2001.06-2006.12	MT	L	F	Hatchback Engine K9K 704	250177	Drive Shaft		21	29.95	57	84.5	625.7	
		2001.06-2006.12	MT	R	F	Hatchback Engine K9K 704	299072	Drive Shaft	44T	21	23	57	84.5	720	
		2001.06-2006.12	MT	L	F	Hatchback Engine K9K 704	250004	Drive Shaft	26T	21	29.95	57	84.5	625.7	

REMARKS	YEAR	TRANSM	L/R	F/R	GSP Ref.	PRODUCT	ABS	Technical Specifications								
								A	B	C	H	L	P			
RENAULT CLIO II (BB_ CB_)/LUTECIA																
1.5 dCi (42 kW)	2001.06-2006.12	MT	R	F	Hatchback Engine K9K 704	250146	Drive Shaft		21	23	57	84.5	732.5			
	2001.06-2006.12	MT	L	F	Hatchback Engine K9K 704	250261	Drive Shaft	44T	23	29.95	57.5	86.5	630			
	2001.06-2006.12	MT	R	F	Hatchback Engine K9K 704	650008	Inner Joint		23	30	36.3	52.2	68.5			
	2001.06-2006.12	MT	L	F	Hatchback Engine K9K 704	250401	Drive Shaft	44T	21	29.95	57	84	629			
	2001.06-2006.12	MT	L	F	Hatchback Engine K9K 704	250150	Drive Shaft		21	29.95	49.8	83.5	623			
	2001.06-2006.12	MT	L	F	Hatchback Engine K9K 704	250109	Drive Shaft	26T	21	29.95	57	84.5	625.7			
	2001.06-2006.12	MT	R	F	Hatchback Engine K9K 704	250250	Drive Shaft	26T	21	23	57	84.5	732.5			
	2001.06-2006.12	MT	L	F	Hatchback Engine K9K 704	299073	Drive Shaft	44T	21	29.95	57	84.5	628			
1.5 dCi (47 kW)	2005.06-	MT	L	F	Hatchback Engine K9K 740	250177	Drive Shaft		21	29.95	57	84.5	625.7			
	2005.06-	MT	R	F	Hatchback Engine K9K 740	299072	Drive Shaft	44T	21	23	57	84.5	720			
	2005.06-	MT	R	F	Hatchback Engine K9K 740	250146	Drive Shaft		21	23	57	84.5	732.5			
	2005.06-	MT	L	F	Hatchback Engine K9K 740	250109	Drive Shaft	26T	21	29.95	57	84.5	625.7			
	2005.06-	-	L	F	Hatchback Engine K9K 740	250280	Drive Shaft	44T	23	26	57.5	86.5	602			
	2005.06-	MT	R	F	Hatchback Engine K9K 740	250250	Drive Shaft	26T	21	23	57	84.5	732.5			
	2005.06-	-	R	F	Hatchback Engine K9K 740	250373	Drive Shaft	44T	23	26	57.5	86.5	864			
	2005.06-	MT	L	F	Hatchback Engine K9K 740	299073	Drive Shaft	44T	21	29.95	57	84.5	628			
	2005.06-	-	R	F	Hatchback Engine K9K 740	699169	Inner Joint		26	30	33	326	95			
1.5 dCi (48 kW)	2001.06-	MT	L	F	Hatchback Engine K9K 700/K9K 704	250177	Drive Shaft		21	29.95	57	84.5	625.7			
	2001.06-	MT	R	F	Hatchback Engine K9K 700/K9K 704	299072	Drive Shaft	44T	21	23	57	84.5	720			
	2001.06-	-	R	F	Hatchback Engine K9K 700/K9K 704	250162	Drive Shaft	26T	21	23	52.2	85.5	723.5			
	2001.06-	MT	R	F	Hatchback Engine K9K 700/K9K 704	250146	Drive Shaft		21	23	57	84.5	732.5			
	2001.06-	-	L	F	Hatchback Engine K9K 700/K9K 704	250004	Drive Shaft	26T	21	29.95	57	84.5	625.7			
	2001.06-	MT	L	F	Hatchback Engine K9K 700/K9K 704	850106	Outer Joint	26T	23	30	57.5	86.5	58.5	I		
	2001.06-	-	L	F	Hatchback Engine K9K 700/K9K 704	250261	Drive Shaft	44T	23	29.95	57.5	86.5	630			
	2001.06-	-	R	F	Hatchback Engine K9K 700/K9K 704	650008	Inner Joint		23	30	36.3	52.2	68.5			
	2001.06-	MT	R	F	Hatchback Engine K9K 700/K9K 704	250395	Drive Shaft	26T	21	23	51.5	83	728			
	2001.06-	MT	L	F	Hatchback Engine K9K 700/K9K 704	250397	Drive Shaft		21	29.95	50	84	632			
	2001.06-	MT	R	F	Hatchback Engine K9K 700/K9K 704	250437	Drive Shaft		21	23	51.5	83	729			
	2001.06-	-	L	F	Hatchback Engine K9K 700/K9K 704	250401	Drive Shaft	44T	21	29.95	57	84	629			
	2001.06-	MT	L	F	Hatchback Engine K9K 700/K9K 704	250109	Drive Shaft	26T	21	29.95	57	84.5	625.7			
	2001.06-	-	L	F	Hatchback Engine K9K 700/K9K 704	250150	Drive Shaft		21	29.95	49.8	83.5	623			
	2001.06-	MT	L	F	Hatchback Engine K9K 700/K9K 704	250194	Drive Shaft	26T	23	29.95	57.5	86.5	631			
	2001.06-	MT	R	F	Hatchback Engine K9K 700/K9K 704	250250	Drive Shaft	26T	21	23	57	84.5	732.5			
	2001.06-	MT	L	F	Hatchback Engine K9K 700/K9K 704	299073	Drive Shaft	44T	21	29.95	57	84.5	628			
1.5 dCi (50 kW)	2004.08-	MT	L	F	Hatchback Engine K9K 700/K9K 714	250177	Drive Shaft		21	29.95	57	84.5	625.7			
	2004.08-	MT	R	F	Hatchback Engine K9K 700/K9K 714	299072	Drive Shaft	44T	21	23	57	84.5	720			
	2004.08-	MT	L	F	Hatchback Engine K9K 700/K9K 714	650085	Inner Joint		26	33	40	64	123			
	2004.08-	MT	R	F	Hatchback Engine K9K 700/K9K 714	850069	Outer Joint	44T	23	30	57.5	86.5	58.5	I		
	2004.08-	MT	R	F	Hatchback Engine K9K 700/K9K 714	250146	Drive Shaft		21	23	57	84.5	732.5			
	2004.08-	MT	L	F	Hatchback Engine K9K 700/K9K 714	250376	Drive Shaft		23	26	57.5	86.5	606			
	2004.08-	MT	-	F	Hatchback Engine K9K 700/K9K 714	850052	Outer Joint	44T	23	30	57.5	86.5	58.5	I		
	2004.08-	MT	L	F	Hatchback Engine K9K 700/K9K 714	899087	Outer Joint		23	30	57.5	86.5	58.5	I		
	2004.08-	MT	R	F	Hatchback Engine K9K 700/K9K 714	250364	Drive Shaft	44T	23	26	57.5	86.5	866			
	2004.08-	MT	L	F	Hatchback Engine K9K 700/K9K 714	250109	Drive Shaft	26T	21	29.95	57	84.5	625.7			
	2004.08-	-	-	F	Hatchback Engine K9K 700/K9K 714	899085	Outer Joint		23	30	49	86	59	I		
	2004.08-	-	L	F	Hatchback Engine K9K 700/K9K 714	250280	Drive Shaft	44T	23	26	57.5	86.5	602			
	2004.08-	MT	R	F	Hatchback Engine K9K 700/K9K 714	250250	Drive Shaft	26T	21	23	57	84.5	732.5			
	2004.08-	MT	L	F	Hatchback Engine K9K 700/K9K 714	299073	Drive Shaft	44T	21	29.95	57	84.5	628			
	2004.08-	-	R	F	Hatchback Engine K9K 700/K9K 714	250373	Drive Shaft	44T	23	26	57.5	86.5	864			
	2004.08-	-	R	F	Hatchback Engine K9K 700/K9K 714	699169	Inner Joint		26	30	33	326	95			
1.5 dCi (59 kW)	2001.06-2003.10	MT	L/R	F	Hatchback Engine K9K 702	850069	Outer Joint	44T	23	30	57.5	86.5	58.5	I		
	2001.06-2003.10	MT	R	F	Hatchback Engine K9K 702	650008	Inner Joint		23	30	36.3	52.2	68.5			
	2001.06-2003.10	MT	R	F	Hatchback Engine K9K 702	850106	Outer Joint	26T	23	30	57.5	86.5	58.5	I		
	2001.06-2003.10	MT	L	F	Hatchback Engine K9K 702	250394	Drive Shaft		23	29.95	57.5	86.5	631			
	2001.06-2003.10	MT	R	F	Hatchback Engine K9K 702	250193	Drive Shaft	26T	23	23	57.5	86.5	724			
	2001.06-2003.10	MT	L	F	Hatchback Engine K9K 702	250194	Drive Shaft	26T	23	29.95	57.5	86.5	631			
1.5 dCi (60 kW)	2001.06-	MT	L/R	F	Hatchback Engine K9K 702	850069	Outer Joint	44T	23	30	57.5	86.5	58.5	I		
	2001.06-	-	R	F	Hatchback Engine K9K 702	650008	Inner Joint		23	30	36.3	52.2	68.5			
	2001.06-	-	L	F	Hatchback Engine K9K 702	250261	Drive Shaft	44T	23	29.95	57.5	86.5	630			
	2001.06-	-	R	F	Hatchback Engine K9K 702	850106	Outer Joint	26T	23	30	57.5	86.5	58.5	I		
	2001.06-	-	L	F	Hatchback Engine K9K 702	250394	Drive Shaft		23	29.95	57.5	86.5	631			
	2001.06-	-	R	F	Hatchback Engine K9K 702	250193	Drive Shaft	26T	23	23	57.5	86.5	724			
	2001.06-	-	L	F	Hatchback Engine K9K 702	250401	Drive Shaft	44T	21	29.95	57	84	629			
	2001.06-	-	R	F	Hatchback Engine K9K 702	250260	Drive Shaft	44T	23	23	57.5	86.5	724			
	2001.06-	MT	L	F	Hatchback Engine K9K 702	250194	Drive Shaft	26T	23	29.95	57.5	86.5	631			
1.5 dCi (62 kW)	2007.02-	-	-	L	F	Hatchback Engine K9K 718	650085	Inner Joint		26	33	40	64	123		

REMARKS	GSP Ref.	PRODUCT	ABS	Technical Specifications											
				A	B	C	H	L	P						
		YEAR	TRANSM	L/R	F/R										
RENAULT CLIO II (BB_CB)/LUTECIA															
1.5 dCi (62 kW)	2007.02-	-	-	R	F	Hatchback Engine K9K 718	650086	Inner Joint		26	33	33	326	94	
	2007.02-	-	MT	L/R	F	Hatchback Engine K9K 718	850069	Outer Joint	44T	23	30	57.5	86.5	58.5	I
	2007.02-	-	MT	L	F	Hatchback Engine K9K 718	250278	Drive Shaft		23	26	49	86	653.5	
	2007.02-	-	MT	R	F	Hatchback Engine K9K 718	250277	Drive Shaft		23	26	49	86	898	
	2007.02-	-	-	L	F	Hatchback Engine K9K 718	250514	Drive Shaft	44T	23	26	57.5	86.5	606	
	2007.02-	-	-	R	F	Hatchback Engine K9K 718	250515	Drive Shaft	44T	23	26	57.5	86.5	866	
	2007.02-	-	-	L	F	Hatchback Engine K9K 718	250280	Drive Shaft	44T	23	26	57.5	86.5	602	
	2007.02-	-	-	R	F	Hatchback Engine K9K 718	250373	Drive Shaft	44T	23	26	57.5	86.5	864	
	2007.02-	-	-	R	F	Hatchback Engine K9K 718	699169	Inner Joint		26	30	33	326	95	
1.5 dCi (74 kW)	2004.01-	-	MT	L	F	Hatchback Engine K9K 712	650085	Inner Joint		26	33	40	64	123	
	2004.01-	-	MT	L	F	Hatchback Engine K9K 712	250376	Drive Shaft		23	26	57.5	86.5	606	
	2004.01-	-	-	-	F	Hatchback Engine K9K 712	850052	Outer Joint	44T	23	30	57.5	86.5	58.5	I
	2004.01-	-	MT	R	F	Hatchback Engine K9K 712	699169	Inner Joint		26	30	33	326	95	
	2004.01-	-	MT	L	F	Hatchback Engine K9K 712	899087	Outer Joint		23	30	57.5	86.5	58.5	I
	2004.01-	-	MT	R	F	Hatchback Engine K9K 712	250364	Drive Shaft	44T	23	26	57.5	86.5	866	
	2004.01-	-	-	L	F	Hatchback Engine K9K 712	250279	Drive Shaft	44T	23	26	58.8	85	596	
	2004.01-	-	-	-	F	Hatchback Engine K9K 712	850082	Outer Joint	44T	23	23	58.8	85	61	M
1.6 (66 kW)	1998.09-	2005.05	-	R	F	Hatchback Engine K7M 744/K7M 745/K7M 746	250162	Drive Shaft	26T	21	23	52.2	85.5	723.5	
	1998.09-	2005.05	AT	L	F	Hatchback Engine K7M 744/K7M 745/K7M 746	299242	Drive Shaft	44T	21	26	52.2	85.5	621	
	1998.09-	2005.05	MT	R	F	Hatchback Engine K7M 744/K7M 745/K7M 746	250151	Drive Shaft		21	23	49.8	83.5	712	
	1998.09-	2005.05	AT	R	F	Hatchback Engine K7M 744/K7M 745/K7M 746	250485	Drive Shaft	44T	21	23	52.2	85.5	733	
	1998.09-	2005.05	MT	L	F	Hatchback Engine K7M 744/K7M 745/K7M 746	250004	Drive Shaft	26T	21	29.95	57	84.5	625.7	
	1998.09-	2005.05	MT	R	F	Hatchback Engine K7M 744/K7M 745/K7M 746	250017	Drive Shaft	26T	21	23	51.5	83	715	
	1998.09-	2005.05	-	L	F	Hatchback Engine K7M 744/K7M 745/K7M 746	250579	Drive Shaft	26T	21	26	52.2	85.5	613	
	1998.09-	2005.05	-	R	F	Hatchback Engine K7M 744/K7M 745/K7M 746	250588	Drive Shaft	26T	21	23	57	84	739	
	1998.09-	2005.05	-	R	F	Hatchback Engine K7M 744/K7M 745/K7M 746	650008	Inner Joint		23	30	36.3	52.2	68.5	
	1998.09-	2005.05	MT	R	F	Hatchback Engine K7M 744/K7M 745/K7M 746	250395	Drive Shaft	26T	21	23	51.5	83	728	
	1998.09-	2005.05	MT	L	F	Hatchback Engine K7M 744/K7M 745/K7M 746	250109	Drive Shaft	26T	21	29.95	57	84.5	625.7	
	1998.09-	2005.05	AT	L	F	Hatchback Engine K7M 744/K7M 745/K7M 746	299169	Drive Shaft	26T	21	26	52.2	85.5	621	
	1998.09-	2005.05	AT	R	F	Hatchback Engine K7M 744/K7M 745/K7M 746	250486	Drive Shaft	26T	21	23	52.2	85.5	733	
	1998.09-	2005.05	MT	L	F	Hatchback Engine K7M 744/K7M 745/K7M 746	250150	Drive Shaft		21	29.95	49.8	83.5	623	
	1998.09-	2005.05	MT	R	F	Hatchback Engine K7M 744/K7M 745/K7M 746	250250	Drive Shaft	26T	21	23	57	84.5	732.5	
	1998.09-	2005.05	MT	L	F	Hatchback Engine K7M 744/K7M 745/K7M 746	299073	Drive Shaft	44T	21	29.95	57	84.5	628	
	1998.09-	2005.05	MT	R	F	Hatchback Engine K7M 744/K7M 745/K7M 746	250125	Drive Shaft		21	23	57	84.5	713.5	
	1998.09-	2005.05	MT	R	F	Hatchback Engine K7M 744/K7M 745/K7M 746	299072	Drive Shaft	44T	21	23	57	84.5	720	
1.6 (81 kW)	2004.11-	2009.02	MT	R	F	Hatchback Engine K4M 740/K4M 748	299072	Drive Shaft	44T	21	23	57	84.5	720	
	2004.11-	2009.02	AT	L	F	Hatchback Engine K4M 740/K4M 748	299242	Drive Shaft	44T	21	26	52.2	85.5	621	
	2004.11-	2009.02	AT	R	F	Hatchback Engine K4M 740/K4M 748	250485	Drive Shaft	44T	21	23	52.2	85.5	733	
	2004.11-	2009.02	MT	L	F	Hatchback Engine K4M 740/K4M 748	250109	Drive Shaft	26T	21	29.95	57	84.5	625.7	
	2004.11-	2009.02	AT	L	F	Hatchback Engine K4M 740/K4M 748	299169	Drive Shaft	26T	21	26	52.2	85.5	621	
	2004.11-	2009.02	AT	R	F	Hatchback Engine K4M 740/K4M 748	250486	Drive Shaft	26T	21	23	52.2	85.5	733	
	2004.11-	2009.02	MT	R	F	Hatchback Engine K4M 740/K4M 748	250250	Drive Shaft	26T	21	23	57	84.5	732.5	
	2004.11-	2009.02	MT	L	F	Hatchback Engine K4M 740/K4M 748	299073	Drive Shaft	44T	21	29.95	57	84.5	628	
1.6 16V (79 kW)	1998.09-	-	MT	R	F	Hatchback Engine K4M 742/K4M 743/K4M 745/K4M 744/K4M 740/K4M 748/K4M 708	250151	Drive Shaft		21	23	49.8	83.5	712	
	1998.09-	-	AT	L	F	Hatchback Engine K4M 742/K4M 743/K4M 745/K4M 744/K4M 740/K4M 748/K4M 708	299242	Drive Shaft	44T	21	26	52.2	85.5	621	
	1998.09-	-	AT	R	F	Hatchback Engine K4M 742/K4M 743/K4M 745/K4M 744/K4M 740/K4M 748/K4M 708	250485	Drive Shaft	44T	21	23	52.2	85.5	733	
	1998.09-	-	-	L	F	Hatchback Engine K4M 742/K4M 743/K4M 745/K4M 744/K4M 740/K4M 748/K4M 708	250004	Drive Shaft	26T	21	29.95	57	84.5	625.7	
	1998.09-	-	-	R	F	Hatchback Engine K4M 742/K4M 743/K4M 745/K4M 744/K4M 740/K4M 748/K4M 708	250017	Drive Shaft	26T	21	23	51.5	83	715	
	1998.09-	-	-	L	F	Hatchback Engine K4M 742/K4M 743/K4M 745/K4M 744/K4M 740/K4M 748/K4M 708	250261	Drive Shaft	44T	23	29.95	57.5	86.5	630	
	1998.09-	-	AT/MT	L/R	F	Hatchback Engine K4M 742/K4M 743/K4M 745/K4M 744/K4M 740/K4M 748/K4M 708	850004	Outer Joint	26T	21	30	52.2	85.5	59	I
	1998.09-	-	MT	R	F	Hatchback Engine K4M 742/K4M 743/K4M 745/K4M 744/K4M 740/K4M 748/K4M 708	250395	Drive Shaft	26T	21	23	51.5	83	728	
	1998.09-	-	-	L	F	Hatchback Engine K4M 742/K4M 743/K4M 745/K4M 744/K4M 740/K4M 748/K4M 708	250401	Drive Shaft	44T	21	29.95	57	84	629	
	1998.09-	-	MT	R	F	Hatchback Engine K4M 742/K4M 743/K4M 745/K4M 744/K4M 740/K4M 748/K4M 708	250437	Drive Shaft		21	23	51.5	83	729	
	1998.09-	-	-	R	F	Hatchback Engine K4M 742/K4M 743/K4M 745/K4M 744/K4M 740/K4M 748/K4M 708	250410	Drive Shaft	26T	21	23	52.2	85.5	723	
	1998.09-	-	MT	L	F	Hatchback Engine K4M 742/K4M 743/K4M 745/K4M 744/K4M 740/K4M 748/K4M 708	250109	Drive Shaft	26T	21	29.95	57	84.5	625.7	
	1998.09-	-	-	L	F	Hatchback Engine K4M 742/K4M 743/K4M 745/K4M 744/K4M 740/K4M 748/K4M 708	250150	Drive Shaft		21	29.95	49.8	83.5	623	
	1998.09-	-	AT	L	F	Hatchback Engine K4M 742/K4M 743/K4M 745/K4M 744/K4M 740/K4M 748/K4M 708	299169	Drive Shaft	26T	21	26	52.2	85.5	621	
	1998.09-	-	AT	R	F	Hatchback Engine K4M 742/K4M 743/K4M 745/K4M 744/K4M 740/K4M 748/K4M 708	250486	Drive Shaft	26T	21	23	52.2	85.5	733	
	1998.09-	-	MT	R	F	Hatchback Engine K4M 742/K4M 743/K4M 745/K4M 744/K4M 740/K4M 748/K4M 708	250365	Drive Shaft	44T	21	23	52.2	85.5	723	
	1998.09-	-	MT	R	F	Hatchback Engine K4M 742/K4M 743/K4M 745/K4M 744/K4M 740/K4M 748/K4M 708	250250	Drive Shaft	26T	21	23	57	84.5	732.5	
	1998.09-	-	MT	L	F	Hatchback Engine K4M 742/K4M 743/K4M 745/K4M 744/K4M 740/K4M 748/K4M 708	299073	Drive Shaft	44T	21	29.95	57	84.5	628	
	1998.09-	-	MT	R	F	Hatchback Engine K4M 742/K4M 743/K4M 745/K4M 744/K4M 740/K4M 748/K4M 708	299072	Drive Shaft	44T	21	23	57	84.5	720	
1.6 Flex (81 kW)	2000.05-	2006.12	MT	R	F	Hatchback Engine K4M 740/K4M 748	299072	Drive Shaft	44T	21	23	57	84.5	720	
	2000.05-	2006.12	AT	L	F	Hatchback Engine K4M 740/K4M 748	299242	Drive Shaft	44T	21	26	52.2	85.5	621	
	2000.05-	2006.12	AT	R	F	Hatchback Engine K4M 740/K4M 748	250485	Drive Shaft	44T	21	23	52.2	85.5	733	
	2000.05-	2006.12	MT	L	F	Hatchback Engine K4M 740/K4M 748	250109	Drive Shaft	26T	21	29.95	57	84.5	625.7	

REMARKS	GSP Ref.	PRODUCT	ABS	Technical Specifications															
				A	B	C	H	L	P										
RENAULT CLIO II (BB_CB_)/LUTECIA																			
1.6 Flex (81 kW)	2000.05-2006.12	AT	L	F	Hatchback Engine K4M 740/K4M 748	299169	Drive Shaft	26T	21	26	52.2	85.5	621						
	2000.05-2006.12	AT	R	F	Hatchback Engine K4M 740/K4M 748	250486	Drive Shaft	26T	21	23	52.2	85.5	733						
	2000.05-2006.12	MT	R	F	Hatchback Engine K4M 740/K4M 748	250250	Drive Shaft	26T	21	23	57	84.5	732.5						
	2000.05-2006.12	MT	L	F	Hatchback Engine K4M 740/K4M 748	299073	Drive Shaft	44T	21	29.95	57	84.5	628						
1.9 D (47 kW)	1998.09-2005.05	MT	R	F	Hatchback Engine F8Q 630	250151	Drive Shaft		21	23	49.8	83.5	712						
	1998.09-2005.05	MT	R	F	Hatchback Engine F8Q 630	250146	Drive Shaft		21	23	57	84.5	732.5						
	1998.09-2005.05	-	L	F	Hatchback Engine F8Q 630	250004	Drive Shaft	26T	21	29.95	57	84.5	625.7						
	1998.09-2005.05	MT	R	F	Hatchback Engine F8Q 630	250017	Drive Shaft	26T	21	23	51.5	83	715						
	1998.09-2005.05	AT	L/R	F	Hatchback Engine F8Q 630	850004	Outer Joint	26T	21	30	52.2	85.5	59	I					
	1998.09-2005.05	MT	R	F	Hatchback Engine F8Q 630	250395	Drive Shaft	26T	21	23	51.5	83	728						
	1998.09-2005.05	MT	L	F	Hatchback Engine F8Q 630	250397	Drive Shaft		21	29.95	50	84	632						
	1998.09-2005.05	MT	R	F	Hatchback Engine F8Q 630	250437	Drive Shaft		21	23	51.5	83	729						
	1998.09-2005.05	MT	L	F	Hatchback Engine F8Q 630	250109	Drive Shaft	26T	21	29.95	57	84.5	625.7						
	1998.09-2005.05	-	L	F	Hatchback Engine F8Q 630	250150	Drive Shaft		21	29.95	49.8	83.5	623						
	1998.09-2005.05	MT	R	F	Hatchback Engine F8Q 630	250250	Drive Shaft	26T	21	23	57	84.5	732.5						
	1998.09-2005.05	MT	R	F	Hatchback Engine F8Q 630	250180	Drive Shaft		21	23	57	84.5	724.5						
	1998.09-2005.05	MT	L	F	Hatchback Engine F8Q 630	250177	Drive Shaft		21	29.95	57	84.5	625.7						
1.9 D (48 kW)	2000.02-2001.05	MT	L	F	Hatchback Engine F8Q 630/F8Q 632	250177	Drive Shaft		21	29.95	57	84.5	625.7						
	2000.02-2001.05	-	R	F	Hatchback Engine F8Q 630/F8Q 632	250151	Drive Shaft		21	23	49.8	83.5	712						
	2000.02-2001.05	MT	R	F	Hatchback Engine F8Q 630/F8Q 632	250146	Drive Shaft		21	23	57	84.5	732.5						
	2000.02-2001.05	-	L	F	Hatchback Engine F8Q 630/F8Q 632	250004	Drive Shaft	26T	21	29.95	57	84.5	625.7						
	2000.02-2001.05	-	R	F	Hatchback Engine F8Q 630/F8Q 632	250017	Drive Shaft	26T	21	23	51.5	83	715						
	2000.02-2001.05	-	L	F	Hatchback Engine F8Q 630/F8Q 632	250397	Drive Shaft		21	29.95	50	84	632						
	2000.02-2001.05	-	R	F	Hatchback Engine F8Q 630/F8Q 632	250395	Drive Shaft	26T	21	23	51.5	83	728						
	2000.02-2001.05	-	R	F	Hatchback Engine F8Q 630/F8Q 632	250437	Drive Shaft		21	23	51.5	83	729						
	2000.02-2001.05	MT	L	F	Hatchback Engine F8Q 630/F8Q 632	250109	Drive Shaft	26T	21	29.95	57	84.5	625.7						
	2000.02-2001.05	-	L	F	Hatchback Engine F8Q 630/F8Q 632	250150	Drive Shaft		21	29.95	49.8	83.5	623						
	2000.02-2001.05	MT	R	F	Hatchback Engine F8Q 630/F8Q 632	250250	Drive Shaft	26T	21	23	57	84.5	732.5						
	2000.02-2001.05	MT	R	F	Hatchback Engine F8Q 630/F8Q 632	250180	Drive Shaft		21	23	57	84.5	724.5						
1.9 dTi (59 kW)	1999.12-2005.05	MT	L	F	Hatchback Engine F9Q 780	250177	Drive Shaft		21	29.95	57	84.5	625.7						
	1999.12-2005.05	MT	R	F	Hatchback Engine F9Q 780	250146	Drive Shaft		21	23	57	84.5	732.5						
	1999.12-2005.05	-	L	F	Hatchback Engine F9Q 780	250004	Drive Shaft	26T	21	29.95	57	84.5	625.7						
	1999.12-2005.05	-	L	F	Hatchback Engine F9Q 780	250261	Drive Shaft	44T	23	29.95	57.5	86.5	630						
	1999.12-2005.05	-	R	F	Hatchback Engine F9Q 780	250017	Drive Shaft	26T	21	23	51.5	83	715						
	1999.12-2005.05	AT	L/R	F	Hatchback Engine F9Q 780	850004	Outer Joint	26T	21	30	52.2	85.5	59	I					
	1999.12-2005.05	MT	L	F	Hatchback Engine F9Q 780	250397	Drive Shaft		21	29.95	50	84	632						
	1999.12-2005.05	-	L	F	Hatchback Engine F9Q 780	250401	Drive Shaft	44T	21	29.95	57	84	629						
	1999.12-2005.05	MT	R	F	Hatchback Engine F9Q 780	250437	Drive Shaft		21	23	51.5	83	729						
	1999.12-2005.05	MT	L	F	Hatchback Engine F9Q 780	250109	Drive Shaft	26T	21	29.95	57	84.5	625.7						
	1999.12-2005.05	-	L	F	Hatchback Engine F9Q 780	250150	Drive Shaft		21	29.95	49.8	83.5	623						
	1999.12-2005.05	MT	R	F	Hatchback Engine F9Q 780	250250	Drive Shaft	26T	21	23	57	84.5	732.5						
2.0 16V Sport (124 kW)	2000.02-2001.05	MT	R	F	Hatchback Engine F4R 730/F4R 736	650008	Inner Joint		23	30	36.3	52.2	68.5						
	2000.02-2001.05	MT	R	F	Hatchback Engine F4R 730/F4R 736	250159	Drive Shaft	44T	23	23	57	87	748						
	2000.02-2001.05	MT	L	F	Hatchback Engine F4R 730/F4R 736	250521	Drive Shaft	44T	23		57.5	87	640						
	2000.02-2001.05	MT	R	F	Hatchback Engine F4R 730/F4R 736	250522	Drive Shaft	44T	23	23	57.5	87	732						
	2000.02-2001.05	MT	L/R	F	Hatchback Engine F4R 730/F4R 736	850114	Outer Joint	44T	23	35	57.5	87	71	I					
	2000.02-2001.05	MT	L	F	Hatchback Engine F4R 730/F4R 736	250504	Drive Shaft	44T	23		57.5	86	648						
	2000.02-2001.05	MT	R	F	Hatchback Engine F4R 730/F4R 736	250505	Drive Shaft	44T	23	23	57.5	86	733						
2.0 16V Sport (132 kW)	2004.01-2005.05	-	R	F	Hatchback Engine F4R 738	299217	Drive Shaft	44T	23	23	57.5	86	733						
	2004.01-2005.05	MT	R	F	Hatchback Engine F4R 738	650008	Inner Joint		23	30	36.3	52.2	68.5						
	2004.01-2005.05	MT	R	F	Hatchback Engine F4R 738	250159	Drive Shaft	44T	23	23	57	87	748						
	2004.01-2005.05	MT	L	F	Hatchback Engine F4R 738	250504	Drive Shaft	44T	23		57.5	86	648						
	2004.01-2005.05	MT	R	F	Hatchback Engine F4R 738	250505	Drive Shaft	44T	23	23	57.5	86	733						
CLIO II (SB0/1/2_)																			
1.1 (43 kW)	1998.09-2005.05	MT	L	F	Box Engine D7F 720/D7F 726/D7F 746	250177	Drive Shaft		21	29.95	57	84.5	625.7						
	1998.09-2005.05	MT	R	F	Box Engine D7F 720/D7F 726/D7F 746	299072	Drive Shaft	44T	21	23	57	84.5	720						
	1998.09-2005.05	MT	R	F	Box Engine D7F 720/D7F 726/D7F 746	250146	Drive Shaft		21	23	57	84.5	732.5						
	1998.09-2005.05	-	R	F	Box Engine D7F 720/D7F 726/D7F 746	250263	Drive Shaft	44T	21	23	52.2	85.5	723.5						
	1998.09-2005.05	-	L	F	Box Engine D7F 720/D7F 726/D7F 746	250004	Drive Shaft	26T	21	29.95	57	84.5	625.7						
	1998.09-2005.05	-	R	F	Box Engine D7F 720/D7F 726/D7F 746	250017	Drive Shaft	26T	21	23	51.5	83	715						
	1998.09-2005.05	-	L	F	Box Engine D7F 720/D7F 726/D7F 746	250261	Drive Shaft	44T	23	29.95	57.5	86.5	630						
	1998.09-2005.05	-	L	F	Box Engine D7F 720/D7F 726/D7F 746	250401	Drive Shaft	44T	21	29.95	57	84	629						
	1998.09-2005.05	MT	L	F	Box Engine D7F 720/D7F 726/D7F 746	250109	Drive Shaft	26T	21	29.95	57	84.5	625.7						
	1998.09-2005.05	-	L	F	Box Engine D7F 720/D7F 726/D7F 746	250150	Drive Shaft		21	29.95	49.8	83.5	623						
	1998.09-2005.05	MT	R	F	Box Engine D7F 720/D7F 726/D7F 746	250250	Drive Shaft	26T	21	23	57	84.5	732.5						
	1998.09-2005.05	MT	L	F	Box Engine D7F 720/D7F 726/D7F 746	299073	Drive Shaft	44T	21	29.95	57	84.5	628						

REMARKS	YEAR	TRANSM	L/R	F/R	GSP Ref.	PRODUCT	ABS	Technical Specifications							
								A	B	C	H	L	P		
RENAULT															
CLIO II (SB0/1/2_)															
1.1 (43 kW)	1998.09-	-	-	R	F	Box Engine D7F 720/D7F 726/D7F 746	650008	Inner Joint		23	30	36.3	52.2	68.5	
1.5 dCi (48 kW)	2001.06-	-	MT	L	F	Box Engine K9K 700/K9K 704	250177	Drive Shaft		21	29.95	57	84.5	625.7	
	2001.06-	-	-	R	F	Box Engine K9K 700/K9K 704	250162	Drive Shaft	26T	21	23	52.2	85.5	723.5	
	2001.06-	-	MT	R	F	Box Engine K9K 700/K9K 704	299072	Drive Shaft	44T	21	23	57	84.5	720	
	2001.06-	-	MT	R	F	Box Engine K9K 700/K9K 704	250146	Drive Shaft		21	23	57	84.5	732.5	
	2001.06-	-	-	L	F	Box Engine K9K 700/K9K 704	250004	Drive Shaft	26T	21	29.95	57	84.5	625.7	
	2001.06-	-	-	L	F	Box Engine K9K 700/K9K 704	850106	Outer Joint	26T	23	30	57.5	86.5	58.5	I
	2001.06-	-	-	L	F	Box Engine K9K 700/K9K 704	250261	Drive Shaft	44T	23	29.95	57.5	86.5	630	
	2001.06-	-	-	R	F	Box Engine K9K 700/K9K 704	650008	Inner Joint		23	30	36.3	52.2	68.5	
	2001.06-	-	MT	R	F	Box Engine K9K 700/K9K 704	699169	Inner Joint		26	30	33	326	95	
	2001.06-	-	-	R	F	Box Engine K9K 700/K9K 704	250395	Drive Shaft	26T	21	23	51.5	83	728	
	2001.06-	-	MT	L	F	Box Engine K9K 700/K9K 704	250397	Drive Shaft		21	29.95	50	84	632	
	2001.06-	-	MT	R	F	Box Engine K9K 700/K9K 704	250437	Drive Shaft		21	23	51.5	83	729	
	2001.06-	-	-	L	F	Box Engine K9K 700/K9K 704	250401	Drive Shaft	44T	21	29.95	57	84	629	
	2001.06-	-	MT	R	F	Box Engine K9K 700/K9K 704	250364	Drive Shaft	44T	23	26	57.5	86.5	866	
	2001.06-	-	MT	L	F	Box Engine K9K 700/K9K 704	250109	Drive Shaft	26T	21	29.95	57	84.5	625.7	
	2001.06-	-	-	L	F	Box Engine K9K 700/K9K 704	250150	Drive Shaft		21	29.95	49.8	83.5	623	
	2001.06-	-	-	L	F	Box Engine K9K 700/K9K 704	250194	Drive Shaft	26T	23	29.95	57.5	86.5	631	
	2001.06-	-	MT	R	F	Box Engine K9K 700/K9K 704	250250	Drive Shaft	26T	21	23	57	84.5	732.5	
	2001.06-	-	MT	L	F	Box Engine K9K 700/K9K 704	299073	Drive Shaft	44T	21	29.95	57	84.5	628	
1.5 dCi (50 kW)	2004.04-	-	MT	L	F	Box Engine K9K 714	250177	Drive Shaft		21	29.95	57	84.5	625.7	
	2004.04-	-	MT	R	F	Box Engine K9K 714	299072	Drive Shaft	44T	21	23	57	84.5	720	
	2004.04-	-	MT	R	F	Box Engine K9K 714	250146	Drive Shaft		21	23	57	84.5	732.5	
	2004.04-	-	MT	-	F	Box Engine K9K 714	850052	Outer Joint	44T	23	30	57.5	86.5	58.5	I
	2004.04-	-	MT	R	F	Box Engine K9K 714	250364	Drive Shaft	44T	23	26	57.5	86.5	866	
	2004.04-	-	MT	L	F	Box Engine K9K 714	250109	Drive Shaft	26T	21	29.95	57	84.5	625.7	
	2004.04-	-	-	L	F	Box Engine K9K 714	250280	Drive Shaft	44T	23	26	57.5	86.5	602	
	2004.04-	-	MT	R	F	Box Engine K9K 714	250250	Drive Shaft	26T	21	23	57	84.5	732.5	
	2004.04-	-	MT	L	F	Box Engine K9K 714	299073	Drive Shaft	44T	21	29.95	57	84.5	628	
	2004.04-	-	-	R	F	Box Engine K9K 714	250373	Drive Shaft	44T	23	26	57.5	86.5	864	
2004.04-	-	-	R	F	Box Engine K9K 714	699169	Inner Joint		26	30	33	326	95		
1.9 D (47 kW)	1998.09-	-	MT	R	F	Box Engine F8Q 630	250151	Drive Shaft		21	23	49.8	83.5	712	
	1998.09-	-	-	L	F	Box Engine F8Q 630	250004	Drive Shaft	26T	21	29.95	57	84.5	625.7	
	1998.09-	-	MT	R	F	Box Engine F8Q 630	250017	Drive Shaft	26T	21	23	51.5	83	715	
	1998.09-	-	MT	R	F	Box Engine F8Q 630	250395	Drive Shaft	26T	21	23	51.5	83	728	
	1998.09-	-	MT	L	F	Box Engine F8Q 630	250397	Drive Shaft		21	29.95	50	84	632	
	1998.09-	-	MT	R	F	Box Engine F8Q 630	250437	Drive Shaft		21	23	51.5	83	729	
	1998.09-	-	-	L	F	Box Engine F8Q 630	250150	Drive Shaft		21	29.95	49.8	83.5	623	
	1998.09-	-	MT	R	F	Box Engine F8Q 630	250180	Drive Shaft		21	23	57	84.5	724.5	
1.9 D (48 kW)	2000.02-2001.05	MT	L	F	Box Engine F8Q 632	250177	Drive Shaft		21	29.95	57	84.5	625.7		
	2000.02-2001.05	MT	R	F	Box Engine F8Q 632	250146	Drive Shaft		21	23	57	84.5	732.5		
	2000.02-2001.05	-	L	F	Box Engine F8Q 632	250004	Drive Shaft	26T	21	29.95	57	84.5	625.7		
	2000.02-2001.05	-	R	F	Box Engine F8Q 632	250017	Drive Shaft	26T	21	23	51.5	83	715		
	2000.02-2001.05	-	R	F	Box Engine F8Q 632	250357	Drive Shaft	26T	21	23	57	84	718		
	2000.02-2001.05	MT	L	F	Box Engine F8Q 632	250109	Drive Shaft	26T	21	29.95	57	84.5	625.7		
	2000.02-2001.05	-	L	F	Box Engine F8Q 632	250150	Drive Shaft		21	29.95	49.8	83.5	623		
	2000.02-2001.05	MT	R	F	Box Engine F8Q 632	250250	Drive Shaft	26T	21	23	57	84.5	732.5		
	2000.02-2001.05	MT	R	F	Box Engine F8Q 632	250180	Drive Shaft		21	23	57	84.5	724.5		
1.9 DTi (59 kW)	2000.02-2001.05	-	R	F	Box Engine F9Q 780	250357	Drive Shaft	26T	21	23	57	84	718		
CLIO III															
1.5	-	-	-	-	-	-	850101	Outer Joint	44T	21	30	52.2	85.5	59	I
CLIO III (BR0/1 CR0/1)/LUTECIA															
1.2 (57 kW)	2005.10-	-	-	-	F	Hatchback Engine D4F 764	850112	Outer Joint		23	28	49	83.5	54.5	I
1.2 16V (48 kW)	2005.06-	-	-	-	F	Hatchback Engine D4F 740	850112	Outer Joint		23	28	49	83.5	54.5	I
	2005.06-	-	-	R	F	Hatchback Engine D4F 740	250372	Drive Shaft		23	26	49	83.5	890	
	2005.06-	-	-	L	F	Hatchback Engine D4F 740	250369	Drive Shaft		23	26	49	83.5	651	
1.2 16V (55 kW)	2005.06-	-	-	-	F	Hatchback Engine D4F 740/D4F 706/D4F 764	850112	Outer Joint		23	28	49	83.5	54.5	I
	2005.06-	-	-	R	F	Hatchback Engine D4F 740/D4F 706/D4F 764	250372	Drive Shaft		23	26	49	83.5	890	
	2005.06-	-	-	L	F	Hatchback Engine D4F 740/D4F 706/D4F 764	250369	Drive Shaft		23	26	49	83.5	651	
1.2 16V (58 kW)	2005.06-	-	-	-	F	Hatchback Engine D4F 764	850112	Outer Joint		23	28	49	83.5	54.5	I
	2005.06-	-	-	R	F	Hatchback Engine D4F 764	250372	Drive Shaft		23	26	49	83.5	890	
	2005.06-	-	-	L	F	Hatchback Engine D4F 764	250369	Drive Shaft		23	26	49	83.5	651	
1.2 16V (74 kW)	2007.05-	-	-	R	F	Hatchback Engine D4F 784	250573	Drive Shaft		23	26	49	86	891	
	2007.05-	-	-	-	F	Hatchback Engine D4F 784	850112	Outer Joint		23	28	49	83.5	54.5	I
	2007.05-	-	MT	L	F	Hatchback Engine D4F 784	250568	Drive Shaft		23	26	49	86	648	
	2007.05-	-	-	-	F	Hatchback Engine D4F 784	850092	Outer Joint		23	29	49	86	57	I

	YEAR	TRANSM	L/R	F/R	REMARKS	GSP Ref.	PRODUCT	ABS	Technical Specifications								
									A	B	C	H	L	P			
RENAULT																	
CLIO III (BR0/1 CR0/1)/LUTECIA																	
1.2 16V (76 kW)	2010.09-	-	-	-	F Hatchback Engine D4F 786	850112	Outer Joint		23	28	49	83.5	54.5	I			
	2010.09-	-	MT	L	F Hatchback Engine D4F 786	250568	Drive Shaft		23	26	49	86	648				
	2010.09-	-	-	-	F Hatchback Engine D4F 786	850092	Outer Joint		23	29	49	86	57	I			
	2010.09-	-	-	R	F Hatchback Engine D4F 786	250573	Drive Shaft		23	26	49	86	891				
1.2 16V Hi-Flex (55 kW)	2008.07-	-	-	-	F Hatchback Engine D4F 740/D4F 742	850112	Outer Joint		23	28	49	83.5	54.5	I			
	2008.07-	-	-	R	F Hatchback Engine D4F 740/D4F 742	250372	Drive Shaft		23	26	49	83.5	890				
	2008.07-	-	-	L	F Hatchback Engine D4F 740/D4F 742	250369	Drive Shaft		23	26	49	83.5	651				
1.2 Ethanol (55 kW)	2008.07-	-	-	-	F Hatchback Engine D4F 712	850112	Outer Joint		23	28	49	83.5	54.5	I			
	2008.07-	-	-	R	F Hatchback Engine D4F 712	250372	Drive Shaft		23	26	49	83.5	890				
	2008.07-	-	-	L	F Hatchback Engine D4F 712	250369	Drive Shaft		23	26	49	83.5	651				
1.4 16V (72 kW)	2005.06-	-	-	R	F Hatchback Engine K4J 780	699169	Inner Joint		26	30	33	326	95				
	2005.06-	-	-	R	F Hatchback Engine K4J 780	650148	Inner Joint		26	30	33	326	90				
	2005.06-	-	-	R	F Hatchback Engine K4J 780	250625	Drive Shaft		23	26	49	83.5	893				
	2005.06-	-	-	L	F Hatchback Engine K4J 780	250630	Drive Shaft		23	26	49	83	653				
	2005.06-	-	MT	-	F Hatchback Engine K4J 780	899085	Outer Joint		23	30	49	86	59	I			
	2005.06-	-	-	R	F Hatchback Engine K4J 780	250354	Drive Shaft		23	26	49	86	897				
	2005.06-	-	-	L	F Hatchback Engine K4J 780	250278	Drive Shaft		23	26	49	86	653.5				
	2005.06-	-	-	L	F Hatchback Engine K4J 780	250353	Drive Shaft		23	26	49	86	649				
	2005.06-	-	-	R	F Hatchback Engine K4J 780	250277	Drive Shaft		23	26	49	86	898				
1.5 dCi (47 kW)	2005.06-	-	-	R	F Hatchback Engine K9K 752	699169	Inner Joint		26	30	33	326	95				
	2005.06-	-	-	R	F Hatchback Engine K9K 752	650148	Inner Joint		26	30	33	326	90				
	2005.06-	-	-	R	F Hatchback Engine K9K 752	250625	Drive Shaft		23	26	49	83.5	893				
	2005.06-	-	-	L	F Hatchback Engine K9K 752	250630	Drive Shaft		23	26	49	83	653				
	2005.06-	-	-	R	F Hatchback Engine K9K 752	250354	Drive Shaft		23	26	49	86	897				
	2005.06-	-	-	L	F Hatchback Engine K9K 752	250353	Drive Shaft		23	26	49	86	649				
	2005.06-	-	-	L	F Hatchback Engine K9K 752	250278	Drive Shaft		23	26	49	86	653.5				
	2005.06-	-	-	R	F Hatchback Engine K9K 752	250277	Drive Shaft		23	26	49	86	898				
1.5 dCi (48 kW)	2005.05-	-	-	R	F Hatchback Engine K9K 752	699169	Inner Joint		26	30	33	326	95				
	2005.05-	-	-	R	F Hatchback Engine K9K 752	250354	Drive Shaft		23	26	49	86	897				
	2005.05-	-	-	L	F Hatchback Engine K9K 752	250353	Drive Shaft		23	26	49	86	649				
	2005.05-	-	-	L	F Hatchback Engine K9K 752	250278	Drive Shaft		23	26	49	86	653.5				
	2005.05-	-	-	R	F Hatchback Engine K9K 752	250277	Drive Shaft		23	26	49	86	898				
1.5 dCi (50 kW)	2005.06-	-	-	R	F Hatchback Engine K9K 768/K9K 714	699169	Inner Joint		26	30	33	326	95				
	2005.06-	-	-	L	F Hatchback Engine K9K 768/K9K 714	250630	Drive Shaft		23	26	49	83	653				
	2005.06-	-	-	-	F Hatchback Engine K9K 768/K9K 714	899085	Outer Joint		23	30	49	86	59	I			
	2005.06-	-	-	L	F Hatchback Engine K9K 768/K9K 714	250278	Drive Shaft		23	26	49	86	653.5				
	2005.06-	-	-	R	F Hatchback Engine K9K 768/K9K 714	250354	Drive Shaft		23	26	49	86	897				
	2005.06-	-	-	L	F Hatchback Engine K9K 768/K9K 714	250353	Drive Shaft		23	26	49	86	649				
	2005.06-	-	-	R	F Hatchback Engine K9K 768/K9K 714	250277	Drive Shaft		23	26	49	86	898				
1.5 dCi (55 kW)	2010.08-	-	-	R	F Hatchback Engine K9K 770	650148	Inner Joint		26	30	33	326	90				
	2010.08-	-	-	R	F Hatchback Engine K9K 770	850168	Outer Joint		23	30	49	83.5	54.5	I			
	2010.08-	-	-	R	F Hatchback Engine K9K 770	250625	Drive Shaft		23	26	49	83.5	893				
	2010.08-	-	-	L	F Hatchback Engine K9K 770	250630	Drive Shaft		23	26	49	83	653				
	2010.08-	-	-	L	F Hatchback Engine K9K 770	250353	Drive Shaft		23	26	49	86	649				
1.5 dCi (60 kW)	2007.11-	-	-	R	F Hatchback Engine K9K 750	650148	Inner Joint		26	30	33	326	90				
1.5 dCi (63 kW)	2005.06-	-	-	R	F Hatchback Engine K9K 766	699169	Inner Joint		26	30	33	326	95				
	2005.06-	-	-	R	F Hatchback Engine K9K 766	650148	Inner Joint		26	30	33	326	90				
	2005.06-	-	-	R	F Hatchback Engine K9K 766	250625	Drive Shaft		23	26	49	83.5	893				
	2005.06-	-	-	L	F Hatchback Engine K9K 766	250630	Drive Shaft		23	26	49	83	653				
	2005.06-	-	MT	-	F Hatchback Engine K9K 766	899085	Outer Joint		23	30	49	86	59	I			
	2005.06-	-	MT	L	F Hatchback Engine K9K 766	250278	Drive Shaft		23	26	49	86	653.5				
	2005.06-	-	-	R	F Hatchback Engine K9K 766	250354	Drive Shaft		23	26	49	86	897				
	2005.06-	-	-	L	F Hatchback Engine K9K 766	250353	Drive Shaft		23	26	49	86	649				
	2005.06-	-	MT	R	F Hatchback Engine K9K 766	250277	Drive Shaft		23	26	49	86	898				
1.5 dCi (65 kW)	2010.08-	-	-	R	F Hatchback Engine K9K 770	650148	Inner Joint		26	30	33	326	90				
	2010.08-	-	-	R	F Hatchback Engine K9K 770	850168	Outer Joint		23	30	49	83.5	54.5	I			
	2010.08-	-	-	R	F Hatchback Engine K9K 770	250625	Drive Shaft		23	26	49	83.5	893				
	2010.08-	-	-	L	F Hatchback Engine K9K 770	250630	Drive Shaft		23	26	49	83	653				
	2010.08-	-	-	L	F Hatchback Engine K9K 770	250353	Drive Shaft		23	26	49	86	649				
	2010.08-	-	-	-	F Hatchback Engine K9K 770	850143	Outer Joint		25	32	52.8	85.5	62.5	I			
1.5 dCi (76 kW)	2005.06-	-	-	R	F Hatchback Engine K9K 772	699169	Inner Joint		26	30	33	326	95				
	2005.06-	-	-	L	F Hatchback Engine K9K 772	250379	Drive Shaft		25	26	52.8	85.5	650				
	2005.06-	-	-	R	F Hatchback Engine K9K 772	250354	Drive Shaft		23	26	49	86	897				
	2005.06-	-	-	L	F Hatchback Engine K9K 772	250353	Drive Shaft		23	26	49	86	649				
	2005.06-	-	-	-	F Hatchback Engine K9K 772	899085	Outer Joint		23	30	49	86	59	I			
	2005.06-	-	-	-	F Hatchback Engine K9K 772	850143	Outer Joint		25	32	52.8	85.5	62.5	I			

REMARKS	YEAR	TRANSM	L/R	F/R	GSP Ref.	PRODUCT	ABS	Technical Specifications							
								A	B	C	H	L	P		
RENAULT															
CLIO III (BR0/1 CR0/1)/LUTECIA															
1.5 dCi (76 kW)	2005.06-	-	-	R	F	Hatchback Engine K9K 772	250483	Drive Shaft	25	26	52.8	85.5	891		
1.5 dCi (78 kW)	2005.06-	-	-	L	F	Hatchback Engine K9K 764/K9K 774	250379	Drive Shaft	25	26	52.8	85.5	650		
	2005.06-	-	-	-	F	Hatchback Engine K9K 764/K9K 774	850143	Outer Joint	25	32	52.8	85.5	62.5	I	
	2005.06-	-	-	R	F	Hatchback Engine K9K 764/K9K 774	250483	Drive Shaft	25	26	52.8	85.5	891		
1.6 16V (65 kW)	2005.06-	-	-	R	F	Hatchback Engine K4M 804	699169	Inner Joint	26	30	33	326	95		
	2005.06-	-	-	R	F	Hatchback Engine K4M 804	250354	Drive Shaft	23	26	49	86	897		
	2005.06-	-	-	L	F	Hatchback Engine K4M 804	250353	Drive Shaft	23	26	49	86	649		
	2005.06-	-	-	-	F	Hatchback Engine K4M 804	899085	Outer Joint	23	30	49	86	59	I	
	2005.06-	-	-	L	F	Hatchback Engine K4M 804	250278	Drive Shaft	23	26	49	86	653.5		
	2005.06-	-	-	R	F	Hatchback Engine K4M 804	250277	Drive Shaft	23	26	49	86	898		
1.6 16V (82 kW)	2005.06-	-	-	R	F	Hatchback Engine K4M 800/K4M 801	699169	Inner Joint	26	30	33	326	95		
	2005.06-	-	-	L	F	Hatchback Engine K4M 800/K4M 801	250630	Drive Shaft	23	26	49	83	653		
	2005.06-	-	MT	L	F	Hatchback Engine K4M 800/K4M 801	250278	Drive Shaft	23	26	49	86	653.5		
	2005.06-	-	-	-	F	Hatchback Engine K4M 800/K4M 801	899085	Outer Joint	23	30	49	86	59	I	
	2005.06-	-	-	L	F	Hatchback Engine K4M 800/K4M 801	250353	Drive Shaft	23	26	49	86	649		
	2005.06-	-	-	R	F	Hatchback Engine K4M 800/K4M 801	250354	Drive Shaft	23	26	49	86	897		
	2005.06-	-	MT	R	F	Hatchback Engine K4M 800/K4M 801	250277	Drive Shaft	23	26	49	86	898		
	2005.06-	-	-	L	F	Hatchback Engine K4M 800/K4M 801	250574	Drive Shaft	23	26	49	86	652		
1.6 16V GT (94 kW)	2005.06-	-	-	R	F	Hatchback Engine K4M 800/K4M 801	250443	Drive Shaft	23	23	49	86	789		
	2009.06-	-	-	R	F	Hatchback Engine K4M 862	250483	Drive Shaft	25	26	52.8	85.5	891		
	2009.06-	-	-	L	F	Hatchback Engine K4M 862	250630	Drive Shaft	23	26	49	83	653		
	2009.06-	-	-	L	F	Hatchback Engine K4M 862	250353	Drive Shaft	23	26	49	86	649		
	2009.06-	-	-	-	F	Hatchback Engine K4M 862	850143	Outer Joint	25	32	52.8	85.5	62.5	I	
2.0 16V (102 kW)	2006.09-	-	-	-	F	Hatchback Engine M4R 700/M4R 701	850149	Outer Joint	27	33	56.7	88.5	59.5	I	
	2006.09-	-	MT	L	F	Hatchback Engine M4R 700/M4R 701	250468	Drive Shaft	27	26	56.7	88.5	689		
	2006.09-	-	MT	R	F	Hatchback Engine M4R 700/M4R 701	250467	Drive Shaft	27	26	56.7	88.5	940		
2.0 16V Sport (145 kW)	2006.02-	-	-	L	F	Hatchback Engine F4R 830	250605	Drive Shaft	27	26	56.7	88.5	686		
	2006.02-	-	-	-	F	Hatchback Engine F4R 830	850152	Outer Joint	27	33	56.7	87	62	I	
2.0 16V Sport (148 kW)	2008.09-	-	-	L	F	Hatchback Engine F4R 830	250605	Drive Shaft	27	26	56.7	88.5	686		
	2008.09-	-	-	-	F	Hatchback Engine F4R 830	850152	Outer Joint	27	33	56.7	87	62	I	
CLIO III (BR0/1, CR0/1)															
2.0 16V (102 kW)	2006.09-	-	-	-	-	-	850124	Outer Joint	25	22	52.6	88	55	I	
CLIO III (SB_ SR_)															
1.5 dCi (50 kW)	2005.10-	2010.07	-	R	F	Box Engine K9K 768	699169	Inner Joint	26	30	33	326	95		
	2005.10-	2010.07	-	R	F	Box Engine K9K 768	250354	Drive Shaft	23	26	49	86	897		
	2005.10-	2010.07	-	L	F	Box Engine K9K 768	250353	Drive Shaft	23	26	49	86	649		
1.5 dCi (55 kW)	2010.08-	2014.12	-	L	F	Box	250379	Drive Shaft	25	26	52.8	85.5	650		
	2010.08-	2014.12	-	R	F	Box	250625	Drive Shaft	23	26	49	83.5	893		
CLIO IV (BH_)/LUTECIA															
0.9 TCe 90 (66 kW)	2012.11-	-	-	L	F	Hatchback Engine H4B 400	650134	Inner joint	26	30	40	64	96		
	2012.11-	-	-	L/R	F	Hatchback Engine H4B 400	850167	Outer Joint	23	30	49	86	53.5	O	
	2012.11-	-	MT	R	F	Hatchback Engine H4B 400	250563	Drive Shaft	23	26	49	86	909		
1.2 16V (54 kW)	2012.11-	-	-	-	F	Hatchback Engine D4F 728/D4F 740	850112	Outer Joint	23	28	49	83.5	54.5	I	
	2012.11-	-	-	L/R	F	Hatchback Engine D4F 728/D4F 740	850219	Outer Joint	23	28	49	86	52	I	
	2012.11-	-	MT	L	F	Hatchback Engine D4F 728/D4F 740	250490	Drive Shaft	23	26	49	86	666		
	2012.11-	-	MT	R	F	Hatchback Engine D4F 728/D4F 740	250488	Drive Shaft	23	26	49	86	908		
1.2 16V (55 kW)	2015.06-	-	-	L/R	F	Hatchback Engine D4F 740	850219	Outer Joint	23	28	49	86	52	I	
1.5 dCi 75 (55 kW)	2012.11-	-	MT	L	F	Hatchback Engine K9K 612	250619	Drive Shaft	23	26	49	86	663		
	2012.11-	-	-	L	F	Hatchback Engine K9K 612	650134	Inner joint	26	30	40	64	96		
	2012.11-	-	-	L/R	F	Hatchback Engine K9K 612	850167	Outer Joint	23	30	49	86	53.5	O	
	2012.11-	-	MT	L	F	Hatchback Engine K9K 612	650096	Inner Joint	26	30	40	64	96		
	2012.11-	-	MT	L	F	Hatchback Engine K9K 612	250487	Drive Shaft	23	26	49	86	662		
	2012.11-	-	MT	R	F	Hatchback Engine K9K 612	250489	Drive Shaft	23	26	49	86	910		
1.5 dCi 90 (66 kW)	2012.11-	-	MT	L	F	Hatchback Engine K9K 628/K9K 608	250619	Drive Shaft	23	26	49	86	663		
	2012.11-	-	-	L	F	Hatchback Engine K9K 628/K9K 608	650134	Inner joint	26	30	40	64	96		
	2012.11-	-	-	L/R	F	Hatchback Engine K9K 628/K9K 608	850167	Outer Joint	23	30	49	86	53.5	O	
	2012.11-	-	MT	L	F	Hatchback Engine K9K 628/K9K 608	650096	Inner Joint	26	30	40	64	96		
	2012.11-	-	MT	L	F	Hatchback Engine K9K 628/K9K 608	250487	Drive Shaft	23	26	49	86	662		
	2012.11-	-	MT	R	F	Hatchback Engine K9K 628/K9K 608	250489	Drive Shaft	23	26	49	86	910		
1.6 RS (147 kW)	2013.03-	-	-	L/R	F	Hatchback Engine M5M 450/M5M 400	850160	Outer Joint	27	35	56.5	91.5	61	I	
CLIO IV Grandtour (KH_)															
0.9 TCe 90 (66 kW)	2013.01-	-	-	L	F	Estate Engine H4B 400	650134	Inner joint	26	30	40	64	96		
	2013.01-	-	-	L/R	F	Estate Engine H4B 400	850167	Outer Joint	23	30	49	86	53.5	O	
	2013.01-	-	MT	R	F	Estate Engine H4B 400	250563	Drive Shaft	23	26	49	86	909		
1.2 16V (54 kW)	2013.01-	-	-	-	F	Estate Engine D4F 740	850112	Outer Joint	23	28	49	83.5	54.5	I	
	2013.01-	-	-	L/R	F	Estate Engine D4F 740	850219	Outer Joint	23	28	49	86	52	I	

RENAULT	YEAR	TRANSM	L/R	F/R	REMARKS	GSP Ref.	PRODUCT	ABS	Technical Specifications						
									A	B	C	H	L	P	
RENAULT															
CLIO IV Grandtour (KH_)															
1.2 16V (54 kW)	2013.01-	-	MT	L	F	Estate Engine D4F 740	250490	Drive Shaft		23	26	49	86	666	
	2013.01-	-	MT	R	F	Estate Engine D4F 740	250488	Drive Shaft		23	26	49	86	908	
1.5 dCi 75 (55 kW)	2013.01-	-	-	L	F	Estate Engine K9K 612	650134	Inner joint		26	30	40	64	96	
	2013.01-	-	-	L/R	F	Estate Engine K9K 612	850167	Outer Joint		23	30	49	86	53.5	O
	2013.01-	-	MT	L	F	Estate Engine K9K 612	650096	Inner Joint		26	30	40	64	96	
	2013.01-	-	MT	L	F	Estate Engine K9K 612	250487	Drive Shaft		23	26	49	86	662	
	2013.01-	-	MT	R	F	Estate Engine K9K 612	250489	Drive Shaft		23	26	49	86	910	
1.5 dCi 90 (66 kW)	2013.01-	-	-	L	F	Estate Engine K9K 608	650134	Inner joint		26	30	40	64	96	
	2013.01-	-	-	L/R	F	Estate Engine K9K 608	850167	Outer Joint		23	30	49	86	53.5	O
	2013.01-	-	MT	L	F	Estate Engine K9K 608	650096	Inner Joint		26	30	40	64	96	
	2013.01-	-	MT	L	F	Estate Engine K9K 608	250487	Drive Shaft		23	26	49	86	662	
	2013.01-	-	MT	R	F	Estate Engine K9K 608	250489	Drive Shaft		23	26	49	86	910	
CLIO VAN I															
1.2	1994.01-	1995.04	MT	L	F	LCV	250097	Drive Shaft		21	29.95	46.2	82	621	
CLIO/THALIA															
-	-	-	-	-	-	-	650058	Inner Joint		23	22	36.3	40	64.5	
DOKKER															
1.5 dCi (66 kW)	2013.12-	-	-	-	R	Box Engine K9K 612	812034	Outer Joint		24	20	44	113.5	48.5	I
DUSTER															
2.0 16V	2012-	-	AT	L	F	4*4	250584	Drive Shaft		25	26	52.7	88.5	709	
	2012-	-	AT	R	F	4*4	250585	Drive Shaft		25	26	52.7	88.5	837	
	2012-	-	AT	R	F	4*4	641189	Inner Joint		26	33	42.5	176.5	103.5	
2.0 Lts	2011-	2013	MT	-	-	-	650073	Inner Joint		26	33	40	64	118	
DUSTER (HS_)															
1.6 16V (75 kW)	2012.02-	-	-	R	F	Closed Off-Road Vehicle Engine K4M 616	641190	Inner Joint		26	33	33	329	101	
2.0 (98 kW)	2012.02-	-	-	L/R	F	Closed Off-Road Vehicle Engine F4R 405/F4R 403	850148	Outer Joint		25	35	52.6	89	60	I
	2012.02-	-	-	R	F	Closed Off-Road Vehicle Engine F4R 405/F4R 403	250463	Drive Shaft		25	31	52.6	89	611	
	2012.02-	-	-	L	F	Closed Off-Road Vehicle Engine F4R 405/F4R 403	250464	Drive Shaft		25	27	52.6	89	652	
	2012.02-	-	-	R	F	Closed Off-Road Vehicle Engine F4R 405/F4R 403	812034	Outer Joint		24	20	44	113.5	48.5	I
2.0 (99 kW)	2012.02-	-	-	R	R	All-wheel Drive Closed Off-Road Vehicle Engine F4R	857203	Outer Joint	48T	25	28	52.2	88.5	60	I
	2012.02-	-	-	L	R	All-wheel Drive Closed Off-Road Vehicle Engine F4R	657129	Inner Joint		21	28	38	55	96	
	2012.02-	-	-	L/R	F	All-wheel Drive Closed Off-Road Vehicle Engine F4R	850148	Outer Joint		25	35	52.6	89	60	I
	2012.02-	-	-	R	F	All-wheel Drive Closed Off-Road Vehicle Engine F4R	250463	Drive Shaft		25	31	52.6	89	611	
	2012.02-	-	-	L	F	All-wheel Drive Closed Off-Road Vehicle Engine F4R	250464	Drive Shaft		25	27	52.6	89	652	
ESPACE I (J11_)															
2.0 (74 kW)	1988.01-	1990.12	-	L/R	F	MPV Engine J6R 734	250030	Drive Shaft		23	23	56.3	80.5	697	
	1988.01-	1990.12	-	-	F	MPV Engine J6R 734	850007	Outer Joint		23	25	56.3	80.5	56	O
2.0 (80 kW)	1984.07-	1990.12	-	L/R	F	MPV Engine J6R 234/J6R 236	250030	Drive Shaft		23	23	56.3	80.5	697	
	1984.07-	1990.12	-	-	F	MPV Engine J6R 234/J6R 236	850007	Outer Joint		23	25	56.3	80.5	56	O
	1984.07-	1990.12	-	L/R	F	MPV Engine J6R 234/J6R 236	250300	Drive Shaft		23	23	56.3	80	679	
2.0 i (87 kW)	1989.01-	1990.12	-	-	F	MPV Engine J7R 760	850007	Outer Joint		23	25	56.3	80.5	56	O
	1989.01-	1990.12	-	L/R	F	MPV Engine J7R 760	250300	Drive Shaft		23	23	56.3	80	679	
2.0 i Quadra (87 kW)	1988.03-	1992.12	-	L/R	F	All-wheel Drive MPV Engine J7R 760	250030	Drive Shaft		23	23	56.3	80.5	697	
	1988.03-	1992.12	-	-	F	All-wheel Drive MPV Engine J7R 760	850007	Outer Joint		23	25	56.3	80.5	56	O
2.1 TD (65 kW)	1984.10-	1990.12	-	L/R	F	MPV Engine J8S 776/J8S 774/J8S 240	250030	Drive Shaft		23	23	56.3	80.5	697	
	1984.10-	1990.12	-	-	F	MPV Engine J8S 776/J8S 774/J8S 240	850007	Outer Joint		23	25	56.3	80.5	56	O
	1984.10-	1990.12	-	L/R	F	MPV Engine J8S 776/J8S 774/J8S 240	250300	Drive Shaft		23	23	56.3	80	679	
2.2 (79 kW)	1986.07-	1990.12	-	L/R	F	MPV Engine J7T 770	250030	Drive Shaft		23	23	56.3	80.5	697	
	1986.07-	1990.12	-	-	F	MPV Engine J7T 770	850007	Outer Joint		23	25	56.3	80.5	56	O
	1986.07-	1990.12	-	L/R	F	MPV Engine J7T 770	250300	Drive Shaft		23	23	56.3	80	679	
2.2 Quadra (79 kW)	1988.01-	1990.12	-	L/R	F	All-wheel Drive MPV Engine J7T 770	250030	Drive Shaft		23	23	56.3	80.5	697	
	1988.01-	1990.12	-	-	F	All-wheel Drive MPV Engine J7T 770	850007	Outer Joint		23	25	56.3	80.5	56	O
ESPACE II (J/S63_)															
2.0 (76 kW)	1991.01-	1996.10	AT/MT	L/R	F	MPV Engine J7R 768	250031	Drive Shaft	48T	23	23	56	85	720	
	1991.01-	1996.10	AT/MT	L/R	F	MPV Engine J7R 768	250052	Drive Shaft		23	23	56.3	80.5	713	
	1991.01-	1996.10	MT	-	F	MPV Engine J7R 768	850007	Outer Joint		23	25	56.3	80.5	56	O
2.1 TD (65 kW)	1991.01-	1996.10	AT/MT	L/R	F	MPV Engine J8S 778/J8S 772/J8S 776/J8S 610	250031	Drive Shaft	48T	23	23	56	85	720	
	1991.01-	1996.10	AT/MT	L/R	F	MPV Engine J8S 778/J8S 772/J8S 776/J8S 610	250052	Drive Shaft		23	23	56.3	80.5	713	
	1991.01-	1996.10	MT	-	F	MPV Engine J8S 778/J8S 772/J8S 776/J8S 610	850007	Outer Joint		23	25	56.3	80.5	56	O
2.1 TD (66 kW)	1994.11-	1996.10	MT	-	F	MPV Engine J8S 612	850007	Outer Joint		23	25	56.3	80.5	56	O
2.2 (79 kW)	1991.01-	1996.10	AT/MT	L/R	F	MPV Engine J7T 773/J7T 772/J7T 776	250031	Drive Shaft	48T	23	23	56	85	720	
	1991.01-	1996.10	AT/MT	L/R	F	MPV Engine J7T 773/J7T 772/J7T 776	250052	Drive Shaft		23	23	56.3	80.5	713	
	1991.01-	1996.10	MT	-	F	MPV Engine J7T 773/J7T 772/J7T 776	850007	Outer Joint		23	25	56.3	80.5	56	O
	1991.03-	1996.12	AT/MT	L/R	F	All-wheel Drive MPV Engine J7T 772/J7T 773	250031	Drive Shaft	48T	23	23	56	85	720	
	1991.03-	1996.12	AT/MT	L/R	F	All-wheel Drive MPV Engine J7T 772/J7T 773	250052	Drive Shaft		23	23	56.3	80.5	713	
	1991.03-	1996.12	MT	-	F	All-wheel Drive MPV Engine J7T 772/J7T 773	850007	Outer Joint		23	25	56.3	80.5	56	O



REMARKS	YEAR	TRANSM	L/R	F/R	GSP Ref.	PRODUCT	ABS	Technical Specifications						
								A	B	C	H	L	P	
RENAULT														
ESPACE III (JE0_)														
1.9 dTi (72 kW)	1999.02-2002.10	-	-	-	MPV Engine F9Q 722	850035	Outer Joint		27	25	64	89	60	O
	1999.02-2002.10	MT	L	F	MPV Engine F9Q 722	250221	Drive Shaft	44T	27	29.95	64	89	729	
	1999.02-2002.10	MT	R	F	MPV Engine F9Q 722	250223	Drive Shaft	44T	27	23	64	89	773	
	1999.02-2002.10	-	-	F	MPV Engine F9Q 722	850089	Outer Joint	44T	27	32	65	88.5	62.5	I
	1999.02-2002.10	MT	R	F	MPV Engine F9Q 722	650008	Inner Joint		23	30	36.3	52.2	68.5	
2.0 (102 kW)	2001.09-2002.10	-	-	F	MPV Engine F4R 700/F4R 701	850065	Outer Joint	44T	27	25	64	89	60	O
	2001.09-2002.10	-	-	-	MPV Engine F4R 700/F4R 701	850035	Outer Joint		27	25	64	89	60	O
	2001.09-2002.10	-	-	F	MPV Engine F4R 700/F4R 701	850091	Outer Joint	44T	27	35	65	89	71	I
	2001.09-2002.10	MT	L	F	MPV Engine F4R 700/F4R 701	250229	Drive Shaft	44T	27	29.95	64	89	730	
	2001.09-2002.10	MT	R	F	MPV Engine F4R 700/F4R 701	650008	Inner Joint		23	30	36.3	52.2	68.5	
	2001.09-2002.10	MT	R	F	MPV Engine F4R 700/F4R 701	250211	Drive Shaft	44T	27	23	65	88.5	772	
	2001.09-2002.10	MT	L	F	MPV Engine F4R 700/F4R 701	250221	Drive Shaft	44T	27	29.95	64	89	729	
2.0 (84 kW)	1996.11-2000.10	-	-	F	MPV Engine F3R 768/F3R 769/F3R 728/F3R 729/F3R 742	850065	Outer Joint	44T	27	25	64	89	60	O
	1996.11-2000.10	-	-	-	MPV Engine F3R 768/F3R 769/F3R 728/F3R 729/F3R 742	850035	Outer Joint		27	25	64	89	60	O
	1996.11-2000.10	-	-	F	MPV Engine F3R 768/F3R 769/F3R 728/F3R 729/F3R 742	850091	Outer Joint	44T	27	35	65	89	71	I
	1996.11-2000.10	MT	L	F	MPV Engine F3R 768/F3R 769/F3R 728/F3R 729/F3R 742	250229	Drive Shaft	44T	27	29.95	64	89	730	
	1996.11-2000.10	MT	R	F	MPV Engine F3R 768/F3R 769/F3R 728/F3R 729/F3R 742	650008	Inner Joint		23	30	36.3	52.2	68.5	
	1996.11-2000.10	MT	R	F	MPV Engine F3R 768/F3R 769/F3R 728/F3R 729/F3R 742	250211	Drive Shaft	44T	27	23	65	88.5	772	
	1996.11-2000.10	MT	L	F	MPV Engine F3R 768/F3R 769/F3R 728/F3R 729/F3R 742	250221	Drive Shaft	44T	27	29.95	64	89	729	
	1996.11-2000.10	MT	-	F	MPV Engine F3R 768/F3R 769/F3R 728/F3R 729/F3R 742	850089	Outer Joint	44T	27	32	65	88.5	62.5	I
2.0 16V (103 kW)	1998.10-2002.10	-	-	F	MPV Engine F4R 700/F4R 701	850065	Outer Joint	44T	27	25	64	89	60	O
	1998.10-2002.10	-	-	-	MPV Engine F4R 700/F4R 701	850035	Outer Joint		27	25	64	89	60	O
	1998.10-2002.10	-	-	F	MPV Engine F4R 700/F4R 701	850091	Outer Joint	44T	27	35	65	89	71	I
	1998.10-2002.10	MT	L	F	MPV Engine F4R 700/F4R 701	250229	Drive Shaft	44T	27	29.95	64	89	730	
	1998.10-2002.10	MT	R	F	MPV Engine F4R 700/F4R 701	650008	Inner Joint		23	30	36.3	52.2	68.5	
	1998.10-2002.10	MT	R	F	MPV Engine F4R 700/F4R 701	250211	Drive Shaft	44T	27	23	65	88.5	772	
	1998.10-2002.10	MT	L	F	MPV Engine F4R 700/F4R 701	250221	Drive Shaft	44T	27	29.95	64	89	729	
	1998.10-2002.10	MT	-	F	MPV Engine F4R 700/F4R 701	850089	Outer Joint	44T	27	32	65	88.5	62.5	I
2.2 12V TD (83 kW)	1996.11-2000.10	-	-	F	MPV Engine G8T 760/G8T 714/G8T 716	850065	Outer Joint	44T	27	25	64	89	60	O
	1996.11-2000.10	-	-	-	MPV Engine G8T 760/G8T 714/G8T 716	850035	Outer Joint		27	25	64	89	60	O
	1996.11-2000.10	-	-	F	MPV Engine G8T 760/G8T 714/G8T 716	850091	Outer Joint	44T	27	35	65	89	71	I
	1996.11-2000.10	MT	L	F	MPV Engine G8T 760/G8T 714/G8T 716	250065	Drive Shaft	44T	27	37.1	64	89	619.5	
	1996.11-2000.10	MT	R	F	MPV Engine G8T 760/G8T 714/G8T 716	250019	Drive Shaft	44T	27	39	64	89	978	
	1996.11-2000.10	MT	L	F	MPV Engine G8T 760/G8T 714/G8T 716	250200	Drive Shaft	44T	27	37.1	64	89	619	
2.2 D (84 kW)	1997.11-2000.01	-	-	F	MPV Engine G8T 716	850065	Outer Joint	44T	27	25	64	89	60	O
	1997.11-2000.01	-	-	F	MPV Engine G8T 716	850091	Outer Joint	44T	27	35	65	89	71	I
	1997.11-2000.01	MT	L	F	MPV Engine G8T 716	250065	Drive Shaft	44T	27	37.1	64	89	619.5	
	1997.11-2000.01	-	R	F	MPV Engine G8T 716	250019	Drive Shaft	44T	27	39	64	89	978	
	1997.11-2000.01	-	L	F	MPV Engine G8T 716	250200	Drive Shaft	44T	27	37.1	64	89	619	
2.2 dCi (85 kW)	2000.07-2002.10	MT	L	F	MPV Engine G9T 710	250367	Drive Shaft	44T	27	37.1	64	89	599	
	2000.07-2002.10	MT	R	F	MPV Engine G9T 710	250368	Drive Shaft	44T	27	39	64	89	1008	
	2000.07-2002.10	-	-	F	MPV Engine G9T 710	850080	Outer Joint		27	37	56.5	92	73	I
	2000.07-2002.10	MT	L	F	MPV Engine G9T 710	250225	Drive Shaft	44T	27	37.1	64	90	594	
	2000.07-2002.10	MT	R	F	MPV Engine G9T 710	250272	Drive Shaft	44T	27	39	64	90	1010	
2.2 dCi (95 kW)	2000.10-2002.10	MT	L	F	MPV Engine G9T 710/G9T 642	250367	Drive Shaft	44T	27	37.1	64	89	599	
	2000.10-2002.10	MT	R	F	MPV Engine G9T 710/G9T 642	250368	Drive Shaft	44T	27	39	64	89	1008	
	2000.10-2002.10	-	-	-	MPV Engine G9T 710/G9T 642	850035	Outer Joint		27	25	64	89	60	O
	2000.10-2002.10	-	-	F	MPV Engine G9T 710/G9T 642	850057	Outer Joint	44T	27	27	64	90	68	I
	2000.10-2002.10	MT	L	F	MPV Engine G9T 710/G9T 642	250225	Drive Shaft	44T	27	37.1	64	90	594	
	2000.10-2002.10	MT	R	F	MPV Engine G9T 710/G9T 642	250272	Drive Shaft	44T	27	39	64	90	1010	
3.0 (123 kW)	1996.11-1998.10	-	-	-	MPV Engine Z7X 775	850035	Outer Joint		27	25	64	89	60	O
	1996.11-1998.10	-	-	F	MPV Engine Z7X 775	850057	Outer Joint	44T	27	27	64	90	68	I
3.0 V6 24V (140 kW)	1998.10-2002.10	-	-	-	MPV Engine L7X 727	850035	Outer Joint		27	25	64	89	60	O
	1998.10-2002.10	-	-	F	MPV Engine L7X 727	850057	Outer Joint	44T	27	27	64	90	68	I
ESPACE IV (JK0/1)														
2.0 (125 kW)	2006.01-	-	-	-	-	850108	Outer Joint		27	35	56.5	90.5	71	I
2.0 (98 kW)	2006.01-	-	-	-	-	850108	Outer Joint		27	35	56.5	90.5	71	I
ESPACE IV (JK0/1_)														
1.9 dCi (85 kW)	2003.04-2005.02	MT	L/R	F	MPV Engine F9Q 820/F9Q 680/F9Q 826	850041	Outer Joint		27	37	56.5	93	72	I
	2003.04-2005.02	-	R	F	MPV Engine F9Q 820/F9Q 680/F9Q 826	250391	Drive Shaft		27	39	56.5	92	995	
	2003.04-2005.02	-	L	F	MPV Engine F9Q 820/F9Q 680/F9Q 826	250390	Drive Shaft		27	37.1	56.5	92	659	
1.9 dCi (88 kW)	2002.11-	MT	L/R	F	MPV Engine F9Q 820/F9Q 680/F9Q 826	850041	Outer Joint		27	37	56.5	93	72	I
	2002.11-	-	-	F	MPV Engine F9Q 820/F9Q 680/F9Q 826	850080	Outer Joint		27	37	56.5	92	73	I
	2002.11-	-	R	F	MPV Engine F9Q 820/F9Q 680/F9Q 826	250391	Drive Shaft		27	39	56.5	92	995	
	2002.11-	-	L	F	MPV Engine F9Q 820/F9Q 680/F9Q 826	250390	Drive Shaft		27	37.1	56.5	92	659	
2.0 (100 kW)	2002.11-	AT/MT	L/R	F	MPV Engine F4R 792	850041	Outer Joint		27	37	56.5	93	72	I

REMARKS	YEAR	TRANSM	L/R	F/R	GSP Ref.	PRODUCT	ABS	Technical Specifications						
								A	B	C	H	L	P	
RENAULT														
ESPACE IV (JK0/1_)														
2.0 (100 kW)	2002.11-	-	-	F	MPV Engine F4R 792	850080	Outer Joint	27	37	56.5	92	73	I	
	2002.11-	AT	R	F	MPV Engine F4R 792	250454	Drive Shaft	27	26	56.5	92	963		
	2002.11-	-	R	F	MPV Engine F4R 792	250391	Drive Shaft	27	39	56.5	92	995		
	2002.11-	-	L	F	MPV Engine F4R 792	250390	Drive Shaft	27	37.1	56.5	92	659		
2.0 (125 kW)	2005.04-	AT/MT	L/R	F	MPV Engine F4R 897/F4R 896/F4R 797/F4R 796	850041	Outer Joint	27	37	56.5	93	72	I	
	2005.04-	-	-	F	MPV Engine F4R 897/F4R 896/F4R 797/F4R 796	850080	Outer Joint	27	37	56.5	92	73	I	
	2005.04-	-	R	F	MPV Engine F4R 897/F4R 896/F4R 797/F4R 796	250391	Drive Shaft	27	39	56.5	92	995		
	2005.04-	MT	L	F	MPV Engine F4R 897/F4R 896/F4R 797/F4R 796	250390	Drive Shaft	27	37.1	56.5	92	659		
2.0 (98 kW)	2002.11-	2005.02	-	L	MPV Engine F4R 790	250390	Drive Shaft	27	37.1	56.5	92	659		
2.0 dCi (110 kW)	2006.01-	-	MT	L	MPV Engine M9R 740/M9R 750/M9R 815	650071	Inner Joint	39	35	39	74	102.5		
	2006.01-	AT/MT	L/R	F	MPV Engine M9R 740/M9R 750/M9R 815	850041	Outer Joint	27	37	56.5	93	72	I	
	2006.01-	-	L	F	MPV Engine M9R 740/M9R 750/M9R 815	250493	Drive Shaft	27	39	56.8	90	663		
	2006.01-	-	R	F	MPV Engine M9R 740/M9R 750/M9R 815	250592	Drive Shaft	27	39	56.8	90	1006		
	2006.01-	AT	L	F	MPV Engine M9R 740/M9R 750/M9R 815	250572	Drive Shaft	27	30	56.5	91	666		
	2006.01-	AT	R	F	MPV Engine M9R 740/M9R 750/M9R 815	250540	Drive Shaft	27	30	56.5	91	979		
	2006.01-	-	-	F	MPV Engine M9R 740/M9R 750/M9R 815	899291	Outer Joint	27	37	56.8	90	73	I	
	2006.01-	MT	R	F	MPV Engine M9R 740/M9R 750/M9R 815	250631	Drive Shaft	27	39	56.8	90	1013		
2.0 dCi (127 kW)	2006.01-	-	MT	L	MPV Engine M9R 763/M9R 762/M9R 760/M9R 761/M9R 815	650071	Inner Joint	39	35	39	74	102.5		
	2006.01-	AT/MT	L/R	F	MPV Engine M9R 763/M9R 762/M9R 760/M9R 761/M9R 815	850041	Outer Joint	27	37	56.5	93	72	I	
	2006.01-	MT	L	F	MPV Engine M9R 763/M9R 762/M9R 760/M9R 761/M9R 815	250493	Drive Shaft	27	39	56.8	90	663		
	2006.01-	MT	R	F	MPV Engine M9R 763/M9R 762/M9R 760/M9R 761/M9R 815	250592	Drive Shaft	27	39	56.8	90	1006		
	2006.01-	AT	L	F	MPV Engine M9R 763/M9R 762/M9R 760/M9R 761/M9R 815	250572	Drive Shaft	27	30	56.5	91	666		
	2006.01-	AT	R	F	MPV Engine M9R 763/M9R 762/M9R 760/M9R 761/M9R 815	250540	Drive Shaft	27	30	56.5	91	979		
	2006.01-	-	-	F	MPV Engine M9R 763/M9R 762/M9R 760/M9R 761/M9R 815	899291	Outer Joint	27	37	56.8	90	73	I	
	2006.01-	MT	R	F	MPV Engine M9R 763/M9R 762/M9R 760/M9R 761/M9R 815	250631	Drive Shaft	27	39	56.8	90	1013		
2.0 dCi (96 kW)	2006.01-	AT/MT	L/R	F	MPV Engine M9R 762/M9R 740/M9R 750/M9R 760/M9R 761/M9R 763	850041	Outer Joint	27	37	56.5	93	72	I	
	2006.01-	MT	L	F	MPV Engine M9R 762/M9R 740/M9R 750/M9R 760/M9R 761/M9R 763	250493	Drive Shaft	27	39	56.8	90	663		
	2006.01-	MT	L	F	MPV Engine M9R 762/M9R 740/M9R 750/M9R 760/M9R 761/M9R 763	650071	Inner Joint	39	35	39	74	102.5		
	2006.01-	MT	R	F	MPV Engine M9R 762/M9R 740/M9R 750/M9R 760/M9R 761/M9R 763	250592	Drive Shaft	27	39	56.8	90	1006		
	2006.01-	AT	L	F	MPV Engine M9R 762/M9R 740/M9R 750/M9R 760/M9R 761/M9R 763	250572	Drive Shaft	27	30	56.5	91	666		
	2006.01-	AT	R	F	MPV Engine M9R 762/M9R 740/M9R 750/M9R 760/M9R 761/M9R 763	250540	Drive Shaft	27	30	56.5	91	979		
	2006.01-	-	-	F	MPV Engine M9R 762/M9R 740/M9R 750/M9R 760/M9R 761/M9R 763	899291	Outer Joint	27	37	56.8	90	73	I	
	2006.01-	MT	R	F	MPV Engine M9R 762/M9R 740/M9R 750/M9R 760/M9R 761/M9R 763	250631	Drive Shaft	27	39	56.8	90	1013		
2.0 Turbo (120 kW)	2002.11-	AT/MT	L/R	F	MPV Engine F4R 794/F4R 795/F4R 796/F4R 797	850041	Outer Joint	27	37	56.5	93	72	I	
	2002.11-	-	-	F	MPV Engine F4R 794/F4R 795/F4R 796/F4R 797	850080	Outer Joint	27	37	56.5	92	73	I	
	2002.11-	MT	L	F	MPV Engine F4R 794/F4R 795/F4R 796/F4R 797	250390	Drive Shaft	27	37.1	56.5	92	659		
2.2 dCi (102 kW)	2006.02-	AT/MT	L/R	F	MPV Engine G9T 645	850041	Outer Joint	27	37	56.5	93	72	I	
	2006.02-	-	R	F	MPV Engine G9T 645	650097	Inner Joint	39	35	30	409	90		
	2006.02-	-	L	F	MPV Engine G9T 645	250392	Drive Shaft	27	37.1	56.8	90	619		
	2006.02-	-	R	F	MPV Engine G9T 645	250393	Drive Shaft	27	39	56.5	92	1035		
	2006.02-	-	L/R	F	MPV Engine G9T 645	250637	Drive Shaft	27	26	56.5	92	640		
	2006.02-	-	-	F	MPV Engine G9T 645	850080	Outer Joint	27	37	56.5	92	73	I	
2.2 dCi (110 kW)	2002.11-	AT/MT	L/R	F	MPV Engine G9T 742/G9T 743	850041	Outer Joint	27	37	56.5	93	72	I	
	2002.11-	-	-	F	MPV Engine G9T 742/G9T 743	850080	Outer Joint	27	37	56.5	92	73	I	
	2002.11-	MT	R	F	MPV Engine G9T 742/G9T 743	650097	Inner Joint	39	35	30	409	90		
	2002.11-	MT	L	F	MPV Engine G9T 742/G9T 743	250392	Drive Shaft	27	37.1	56.8	90	619		
	2002.11-	MT	R	F	MPV Engine G9T 742/G9T 743	250393	Drive Shaft	27	39	56.5	92	1035		
	2002.11-	-	L	F	MPV Engine G9T 742/G9T 743	250637	Drive Shaft	27	26	56.5	92	640		
3.0 dCi (120 kW)	2005.09-	-	-	F	MPV Engine P9X 701/P9X 715	850080	Outer Joint	27	37	56.5	92	73	I	
3.0 dCi (130 kW)	2002.11-	AT	L/R	F	MPV Engine P9X 701	850041	Outer Joint	27	37	56.5	93	72	I	
	2002.11-	-	-	F	MPV Engine P9X 701	850080	Outer Joint	27	37	56.5	92	73	I	
3.0 dCi (133 kW)	2006.01-	-	-	F	MPV Engine P9X 715	850080	Outer Joint	27	37	56.5	92	73	I	
3.5 V6 (177 kW)	2002.11-	AT	L/R	F	MPV Engine V4Y 715/V4Y 711	850041	Outer Joint	27	37	56.5	93	72	I	
	2002.11-	-	-	F	MPV Engine V4Y 715/V4Y 711	850080	Outer Joint	27	37	56.5	92	73	I	
EXPRESS														
-	-	-	-	-	-	899070	Outer Joint	21	25	46.3	79	58	O	
1.9	1990.02-	1998.02	-	-	(B/CB0F/A,B/CB10/K,B/CB2D/H)	899070	Outer Joint	21	25	46.3	79	58	O	
FLUENCE														
1.5 DCi 16V	2009-	-	-	R	F	-	250384	Drive Shaft	25	26	52.7	88.5	931	
1.6 16V	2009-	-	-	R	F	-	250384	Drive Shaft	25	26	52.7	88.5	931	
FLUENCE (L3_)														
1.5 dCi (63 kW)	2010.02-	-	6MT	L	F	Saloon Engine K9K 830	250426	Drive Shaft	25	26	52.7	88.5	680	
	2010.02-	-	5MT	L	F	Saloon Engine K9K 830	250383	Drive Shaft	25	26	52.7	88.5	688	
	2010.02-	-	5MT	L	F	Saloon Engine K9K 830	650096	Inner Joint	26	30	40	64	96	
	2010.02-	-	5MT/6MT	-	F	Saloon Engine K9K 830	899213	Outer Joint	25	33	53	88	61.5	I
1.5 dCi (66 kW)	2010.02-	-	-	L	F	Saloon Engine K9K 834	250426	Drive Shaft	25	26	52.7	88.5	680	

REMARKS	YEAR	TRANSM	L/R	F/R	GSP Ref.	PRODUCT	ABS	Technical Specifications					
								A	B	C	H	L	P
RENAULT FLUENCE (L3_)													
1.5 dCi (66 kW)	2010.02-	5MT/6MT	-	F	Saloon Engine K9K 834	899213	Outer Joint	25	33	53	88	61.5	I
1.5 dCi (70 kW)	2014.07-	6MT	R	F	Saloon Engine K9K 826	250510	Drive Shaft	25	26	52.4	88.5	929	
	2014.07-	MT	L	F	Saloon Engine K9K 826	250426	Drive Shaft	25	26	52.7	88.5	680	
	2014.07-	6MT	-	F	Saloon Engine K9K 826	850163	Outer Joint	25	23	52.4	88.5	61	M
1.5 dCi (78 kW)	2010.02-	6MT	R	F	Saloon Engine K9K 832	250510	Drive Shaft	25	26	52.4	88.5	929	
	2010.02-	-	L	F	Saloon Engine K9K 832	250426	Drive Shaft	25	26	52.7	88.5	680	
	2010.02-	6MT	-	F	Saloon Engine K9K 832	850163	Outer Joint	25	23	52.4	88.5	61	M
	2010.02-	5MT/6MT	-	F	Saloon Engine K9K 832	899213	Outer Joint	25	33	53	88	61.5	I
1.5 dCi (81 kW)	2010.02-	6MT	R	F	Saloon Engine K9K 836/K9K 837	250510	Drive Shaft	25	26	52.4	88.5	929	
	2010.02-	-	L	F	Saloon Engine K9K 836/K9K 837	250426	Drive Shaft	25	26	52.7	88.5	680	
	2010.02-	6MT	-	F	Saloon Engine K9K 836/K9K 837	850157	Outer Joint	25	33	52.6	89	60	I
	2010.02-	-	R	F	Saloon Engine K9K 836/K9K 837	250536	Drive Shaft	25	34	52.6	89	984	
	2010.02-	6MT	-	F	Saloon Engine K9K 836/K9K 837	850163	Outer Joint	25	23	52.4	88.5	61	M
	2010.02-	-	L	F	Saloon Engine K9K 836/K9K 837	250535	Drive Shaft	25	34	52.7	88.5	632	
	2010.02-	5MT/6MT	-	F	Saloon Engine K9K 836/K9K 837	899213	Outer Joint	25	33	53	88	61.5	I
	2010.02-	MT	L	F	Saloon Engine K4M 838	250383	Drive Shaft	25	26	52.7	88.5	688	
1.6 16V (78 kW)	2010.02-	MT	L/R	F	Saloon Engine K4M 838	850162	Outer Joint	25	23	52.5	88.5	60.5	M
	2010.02-	MT	L	F	Saloon Engine K4M 838	650096	Inner Joint	26	30	40	64	96	
	2010.02-	AT	R	F	Saloon Engine K4M 839/K4M 838	650084	Inner Joint	23	30	26.5	173	86	
1.6 16V (81 kW)	2010.02-	AT	R	F	Saloon Engine K4M 839/K4M 838	234222	Drive Shaft	25	23	52.7	88.5	822	
	2010.02-	AT	L	F	Saloon Engine K4M 839/K4M 838	234223	Drive Shaft	25	26	52.7	88.5	685	
	2010.02-	MT	L	F	Saloon Engine K4M 839/K4M 838	250383	Drive Shaft	25	26	52.7	88.5	688	
	2010.02-	MT	L/R	F	Saloon Engine K4M 839/K4M 838	850162	Outer Joint	25	23	52.5	88.5	60.5	M
	2010.02-	MT	L	F	Saloon Engine K4M 839/K4M 838	650096	Inner Joint	26	30	40	64	96	
	2010.02-	5MT/6MT	-	F	Saloon Engine K4M 839/K4M 838	899213	Outer Joint	25	33	53	88	61.5	I
	2010.02-	AT	R	F	Saloon Engine K4M 838	650084	Inner Joint	23	30	26.5	173	86	
	2010.02-	AT	R	F	Saloon Engine K4M 838	234222	Drive Shaft	25	23	52.7	88.5	822	
1.6 16V (82 kW)	2010.02-	AT	L	F	Saloon Engine K4M 838	234223	Drive Shaft	25	26	52.7	88.5	685	
	2010.02-	MT	L	F	Saloon Engine K4M 838	250383	Drive Shaft	25	26	52.7	88.5	688	
	2010.02-	MT	L/R	F	Saloon Engine K4M 838	850162	Outer Joint	25	23	52.5	88.5	60.5	M
	2010.02-	MT	L	F	Saloon Engine K4M 838	650096	Inner Joint	26	30	40	64	96	
	2010.02-	5MT/6MT	-	F	Saloon Engine K4M 838	899213	Outer Joint	25	33	53	88	61.5	I
	2010.02-	AT	R	F	Saloon Engine K4M 838	650084	Inner Joint	23	30	26.5	173	86	
	2010.02-	AT	R	F	Saloon Engine K4M 838	234222	Drive Shaft	25	23	52.7	88.5	822	
	2010.02-	AT	L	F	Saloon Engine K4M 838	234223	Drive Shaft	25	26	52.7	88.5	685	
1.6 dCi (96 kW)	2014.07-	MT	L	F	Saloon Engine R9M 402	250428	Drive Shaft	25	39	52.6	89	656	
2.0 16V (103 kW)	2010.02-	6MT	-	-	Saloon Engine M4R 714/M4R 751	850157	Outer Joint	25	33	52.6	89	60	I
	2010.02-	5MT/6MT	-	F	Saloon Engine M4R 714/M4R 751	899213	Outer Joint	25	33	53	88	61.5	I
GRAND SCENIC I (JM0/1)													
1.5 DCi (78 kW)	2007-	2008	-	-	-	850124	Outer Joint	25	22	52.6	88	55	I
1.6 16V (83 kW)	2004.04-	-	-	-	-	850124	Outer Joint	25	22	52.6	88	55	I
GRAND SCENIC II (JM0/1_)													
1.5 dCi (74 kW)	2004.04-	-	L	F	MPV Engine K9K 728	250402	Drive Shaft	25	26	53	88	660	
	2004.04-	-	L	F	MPV Engine K9K 728	250403	Drive Shaft	25	26	52.6	88	674	
	2004.04-	-	R	F	MPV Engine K9K 728	250348	Drive Shaft	25	26	53	88	905	
	2004.04-	-	R	F	MPV Engine K9K 728	250442	Drive Shaft	25	26	52.6	88	911	
	2004.04-	-	R	F	MPV Engine K9K 728	250495	Drive Shaft	25	26	52.6	88	914	
	2004.04-	MT	-	F	MPV Engine K9K 728	899213	Outer Joint	25	33	53	88	61.5	I
	2004.04-	-	R	F	MPV Engine K9K 728	699169	Inner Joint	26	30	33	326	95	
	2004.04-	MT	L	F	MPV Engine K9K 728	250350	Drive Shaft	25	26	52.6	88	668.5	
1.5 dCi (76 kW)	2006.06-	2008.11	-	L	MPV Engine K9K 734	250403	Drive Shaft	25	26	52.6	88	674	
	2006.06-	2008.11	-	R	MPV Engine K9K 734	250495	Drive Shaft	25	26	52.6	88	914	
	2006.06-	2008.11	-	R	MPV Engine K9K 734	699169	Inner Joint	26	30	33	326	95	
	2006.06-	2008.11	MT	L	MPV Engine K9K 734	250350	Drive Shaft	25	26	52.6	88	668.5	
1.5 dCi (78 kW)	2005.05-	-	MT	L	MPV Engine K9K 732	250402	Drive Shaft	25	26	53	88	660	
	2005.05-	-	L	F	MPV Engine K9K 732	250403	Drive Shaft	25	26	52.6	88	674	
	2005.05-	-	MT	R	MPV Engine K9K 732	250348	Drive Shaft	25	26	53	88	905	
	2005.05-	-	MT	R	MPV Engine K9K 732	250495	Drive Shaft	25	26	52.6	88	914	
	2005.05-	-	MT	R	MPV Engine K9K 732	699169	Inner Joint	26	30	33	326	95	
	2005.05-	-	MT	L	MPV Engine K9K 732	250350	Drive Shaft	25	26	52.6	88	668.5	
1.6 (82 kW)	2006.06-	2008.11	AT/MT	L	MPV Engine K4M 812	250494	Drive Shaft	25	26	52.6	88	664	
	2006.06-	2008.11	AT/MT	R	MPV Engine K4M 812	699169	Inner Joint	26	30	33	326	95	
	2006.06-	2008.11	-	R	MPV Engine K4M 812	250386	Drive Shaft	25	23	52.6	88	806	
	2006.06-	2008.11	MT	L	MPV Engine K4M 812	250350	Drive Shaft	25	26	52.6	88	668.5	
1.6 (83 kW)	2004.04-	-	AT/MT	L	MPV Engine K4M 761/K4M 782	250494	Drive Shaft	25	26	52.6	88	664	
	2004.04-	-	MT	-	MPV Engine K4M 761/K4M 782	850116	Outer Joint	25	22	52.6	88	55	I
	2004.04-	-	AT/MT	R	MPV Engine K4M 761/K4M 782	699169	Inner Joint	26	30	33	326	95	
	2004.04-	-	AT	R	MPV Engine K4M 761/K4M 782	250386	Drive Shaft	25	23	52.6	88	806	
	2004.04-	-	MT	L	MPV Engine K4M 761/K4M 782	250350	Drive Shaft	25	26	52.6	88	668.5	

REMARKS	YEAR	TRANSM	L/R	F/R	GSP Ref.	PRODUCT	ABS	Technical Specifications							
								A	B	C	H	L	P		
RENAULT GRAND SCENIC II (JM0/1_)															
1.6 Flex (82 kW)	2006.06-2008.11	AT/MT	L	F	MPV Engine K4M 766	250494	Drive Shaft	25	26	52.6	88	664			
	2006.06-2008.11	AT/MT	R	F	MPV Engine K4M 766	699169	Inner Joint	26	30	33	326	95			
1.9 dCi (81 kW)	2005.05-	AT/MT	R	F	MPV Engine F9Q E 804	250400	Drive Shaft	25	39	53	88	932			
	2005.05-	AT/MT	L	F	MPV Engine F9Q E 804	699150	Inner Joint	39	32	39	66	104.5			
	2005.05-	AT/MT	L	F	MPV Engine F9Q E 804	299201	Drive Shaft	25	39	53	88	638			
	2005.05-	MT	-	F	MPV Engine F9Q E 804	899213	Outer Joint	25	33	53	88	61.5	I		
	2005.05-	AT/MT	R	F	MPV Engine F9Q E 804	699160	Inner Joint	39	32	33	352	90			
1.9 dCi (85 kW)	2005.05-2009.01	AT/MT	R	F	MPV Engine F9Q 803/F9Q 804/F9Q 812	250400	Drive Shaft	25	39	53	88	932			
	2005.05-2009.01	AT/MT	L	F	MPV Engine F9Q 803/F9Q 804/F9Q 812	699150	Inner Joint	39	32	39	66	104.5			
	2005.05-2009.01	AT/MT	L	F	MPV Engine F9Q 803/F9Q 804/F9Q 812	299201	Drive Shaft	25	39	53	88	638			
	2005.05-2009.01	AT/MT	R	F	MPV Engine F9Q 803/F9Q 804/F9Q 812	699160	Inner Joint	39	32	33	352	90			
1.9 dCi (88 kW)	2004.04-	AT/MT	R	F	MPV Engine F9Q 812	250400	Drive Shaft	25	39	53	88	932			
	2004.04-	AT/MT	L	F	MPV Engine F9Q 812	699150	Inner Joint	39	32	39	66	104.5			
	2004.04-	AT/MT	L	F	MPV Engine F9Q 812	299201	Drive Shaft	25	39	53	88	638			
	2004.04-	MT	-	F	MPV Engine F9Q 812	899213	Outer Joint	25	33	53	88	61.5	I		
	2004.04-	AT/MT	R	F	MPV Engine F9Q 812	699160	Inner Joint	39	32	33	352	90			
1.9 dCi (96 kW)	2005.05-	AT/MT	R	F	MPV Engine F9Q 816/F9Q818/F9Q EE 804/F9Q J 803	250400	Drive Shaft	25	39	53	88	932			
	2005.05-	AT/MT	L	F	MPV Engine F9Q 816/F9Q818/F9Q EE 804/F9Q J 803	699150	Inner Joint	39	32	39	66	104.5			
	2005.05-	-	L	F	MPV Engine F9Q 816/F9Q818/F9Q EE 804/F9Q J 803	299186	Drive Shaft	25	26	52.6	88	669			
	2005.05-	AT/MT	L	F	MPV Engine F9Q 816/F9Q818/F9Q EE 804/F9Q J 803	299201	Drive Shaft	25	39	53	88	638			
	2005.05-	MT	-	F	MPV Engine F9Q 816/F9Q818/F9Q EE 804/F9Q J 803	899213	Outer Joint	25	33	53	88	61.5	I		
	2005.05-	AT/MT	R	F	MPV Engine F9Q 816/F9Q818/F9Q EE 804/F9Q J 803	699160	Inner Joint	39	32	33	352	90			
2.0 (120 kW)	2004.04-	AT/MT	R	F	MPV Engine F4R 776	250400	Drive Shaft	25	39	53	88	932			
	2004.04-	AT/MT	L	F	MPV Engine F4R 776	699150	Inner Joint	39	32	39	66	104.5			
	2004.04-	AT/MT	L	F	MPV Engine F4R 776	299201	Drive Shaft	25	39	53	88	638			
	2004.04-	MT	-	F	MPV Engine F4R 776	899213	Outer Joint	25	33	53	88	61.5	I		
	2004.04-	AT/MT	R	F	MPV Engine F4R 776	699160	Inner Joint	39	32	33	352	90			
2.0 (99 kW)	2004.04-	AT/MT	R	F	MPV Engine F4R 770/F4R 771	250400	Drive Shaft	25	39	53	88	932			
	2004.04-	AT	-	F	MPV Engine F4R 770/F4R 771	850137	Outer Joint	25	32	52.6	88	58	I		
	2004.04-	AT/MT	L	F	MPV Engine F4R 770/F4R 771	699150	Inner Joint	39	32	39	66	104.5			
	2004.04-	AT	L	F	MPV Engine F4R 770/F4R 771	299186	Drive Shaft	25	26	52.6	88	669			
	2004.04-	AT	R	F	MPV Engine F4R 770/F4R 771	250399	Drive Shaft	25	23	52.6	88	803			
	2004.04-	AT/MT	L	F	MPV Engine F4R 770/F4R 771	299201	Drive Shaft	25	39	53	88	638			
	2004.04-	MT	-	F	MPV Engine F4R 770/F4R 771	899213	Outer Joint	25	33	53	88	61.5	I		
	2004.04-	AT/MT	R	F	MPV Engine F4R 770/F4R 771	699160	Inner Joint	39	32	33	352	90			
2.0 dCi (110 kW)	2005.09-	AT/MT	R	F	MPV Engine M9R 700, M9R 721, M9R 722	650087	Inner Joint	39	35	30	367	89.5			
	2005.09-	AT/MT	R	F	MPV Engine M9R 700, M9R 721, M9R 722	250453	Drive Shaft	27	39	56.5	90.5	973.5			
	2005.09-	AT/MT	L	F	MPV Engine M9R 700, M9R 721, M9R 722	250444	Drive Shaft	27	39	56.5	90.5	626			
GRAND SCENIC III (JZ0/1_)															
1.2 TCe (85 kW)	2012.04-	-	-	F	MPV Engine H5F 400	850163	Outer Joint	25	23	52.4	88.5	61	M		
1.2 TCe (97 kW)	2013.01-	-	-	F	MPV Engine H5F 404	850163	Outer Joint	25	23	52.4	88.5	61	M		
1.4 16V (96 kW)	2009.02-	-	R	F	MPV Engine H4J 700	250604	Drive Shaft	25	26	52.6	89	942			
1.5 dCi (63 kW)	2009.04-	-	-	F	MPV Engine K9K 830	899213	Outer Joint	25	33	53	88	61.5	I		
	2009.04-	-	R	F	MPV Engine K9K 830	250425	Drive Shaft	25	26	52.7	88.5	931			
	2009.04-	-	L	F	MPV Engine K9K 830	250426	Drive Shaft	25	26	52.7	88.5	680			
1.5 dCi (70 kW)	2010.11-	-	R	F	MPV Engine K9K 846	250604	Drive Shaft	25	26	52.6	89	942			
	2010.11-	MT	R	F	MPV Engine K9K 846	250425	Drive Shaft	25	26	52.7	88.5	931			
	2010.11-	-	L	F	MPV Engine K9K 846	250426	Drive Shaft	25	26	52.7	88.5	680			
1.5 dCi (78 kW)	2009.02-	-	-	F	MPV Engine K9K 832	899213	Outer Joint	25	33	53	88	61.5	I		
	2009.02-	-	R	F	MPV Engine K9K 832	250604	Drive Shaft	25	26	52.6	89	942			
	2009.02-	-	R	F	MPV Engine K9K 832	250425	Drive Shaft	25	26	52.7	88.5	931			
	2009.02-	-	L	F	MPV Engine K9K 832	250426	Drive Shaft	25	26	52.7	88.5	680			
	2009.02-	-	-	F	MPV Engine K9K 832	850145	Outer Joint	25	33	52.7	88.5	59.5	I		
1.5 dCi (81 kW)	2009.04-	MT	R	F	MPV Engine K9K 636/K9K 836/K9K 837	250604	Drive Shaft	25	26	52.6	89	942			
	2009.04-	-	R	F	MPV Engine K9K 636/K9K 836/K9K 837	250425	Drive Shaft	25	26	52.7	88.5	931			
	2009.04-	-	R	F	MPV Engine K9K 636/K9K 836/K9K 837	850148	Outer Joint	25	35	52.6	89	60	I		
	2009.04-	MT	L	F	MPV Engine K9K 636/K9K 836/K9K 837	250426	Drive Shaft	25	26	52.7	88.5	680			
	2009.04-	-	-	F	MPV Engine K9K 636/K9K 836/K9K 837	850145	Outer Joint	25	33	52.7	88.5	59.5	I		
	2009.04-	-	R	F	MPV Engine K9K 636/K9K 836/K9K 837	250536	Drive Shaft	25	34	52.6	89	984			
	2009.04-	-	L	F	MPV Engine K9K 636/K9K 836/K9K 837	250535	Drive Shaft	25	34	52.7	88.5	632			
	2009.04-	-	-	-	MPV Engine K9K 636/K9K 836/K9K 837	250610	Drive Shaft	25	34	52.7	88.5	1000			
	2009.04-	-	-	F	MPV Engine K9K 636/K9K 836/K9K 837	899213	Outer Joint	25	33	53	88	61.5	I		
1.6 16V (81 kW)	2009.02-	MT	R	F	MPV Engine K4M 858	250510	Drive Shaft	25	26	52.4	88.5	929			
	2009.02-	-	-	F	MPV Engine K4M 858	850163	Outer Joint	25	23	52.4	88.5	61	M		
1.6 16V Bifuel (79 kW)	2012.04-	MT	R	F	MPV Engine K4M 866	250510	Drive Shaft	25	26	52.4	88.5	929			
	2012.04-	-	-	F	MPV Engine K4M 866	850163	Outer Joint	25	23	52.4	88.5	61	M		

REMARKS	YEAR	TRANSM	L/R	F/R	GSP Ref.	PRODUCT	ABS	Technical Specifications							
								A	B	C	H	L	P		
RENAULT															
GRAND SCENIC III (JZ0/1_)															
1.6 16V Bifuel (81 kW)	2009.02-	-	MT	R	F	MPV Engine K4M 866	250510	Drive Shaft		25	26	52.4	88.5	929	
	2009.02-	-	-	-	F	MPV Engine K4M 866	850163	Outer Joint		25	23	52.4	88.5	61	M
1.6 dCi (96 kW)	2011.04-	-	-	R	F	MPV Engine R9M 402/R9M 404	250429	Drive Shaft		27	39	56.5	91.5	956	
	2011.04-	-	-	L/R	F	MPV Engine R9M 402/R9M 404	850160	Outer Joint		27	35	56.5	91.5	61	I
1.6 E85 (81 kW)	2009.02-	-	MT	R	F	MPV Engine K4M 866	250510	Drive Shaft		25	26	52.4	88.5	929	
	2009.02-	-	-	-	F	MPV Engine K4M 866	850163	Outer Joint		25	23	52.4	88.5	61	M
1.9 dCi (96 kW)	2009.02-	-	-	R	F	MPV Engine F9Q 870/F9Q 872	250429	Drive Shaft		27	39	56.5	91.5	956	
	2009.02-	-	-	L/R	F	MPV Engine F9Q 870/F9Q 872	850160	Outer Joint		27	35	56.5	91.5	61	I
2.0 16V (103 kW)	2009.02-	-	-	-	F	MPV Engine M4R 711	899213	Outer Joint		25	33	53	88	61.5	I
2.0 dCi (110 kW)	2009.02-	-	AT	L	F	MPV Engine M9R 615	218274	Drive Shaft		27	30	56.5	90	624	
GRAND SCENIC IV (R9_)															
1.5 dCi 110 (81 kW)	2016.09-	-	5MT/6MT	-	F	MPV Engine K9K 646/K9K 647	899213	Outer Joint		25	33	53	88	61.5	I
KANGOO															
-	-	-	-	-	-	-	850017	Outer Joint		21	22	51.5	83	56.5	I
	1997-	1999	-	R	-	-	250178	Drive Shaft		21	23	57	84.5	742.9	
1.0	-	-	-	R	-	-	250293	Drive Shaft		21	23	46.3	80.5	709.5	
1.2	1997-	-	-	R	-	-	250114	Drive Shaft	26T	21	23	57	84.5	724.5	
1.4	1997-	-	-	R	-	-	250114	Drive Shaft	26T	21	23	57	84.5	724.5	
1.5	-	-	-	-	-	-	850101	Outer Joint	44T	21	30	52.2	85.5	59	I
1.5 DCi	1998-	2005	-	L	F	-	250363	Drive Shaft	26T	21	29.95	52.2	85.5	630	
1.6	-	-	-	-	-	-	850034	Outer Joint		21	22	51.5	83	56.5	O
	-	-	-	-	-	-	850062	Outer Joint	26T	21	22	51.5	83	56.5	O
	-	-	-	-	-	-	850063	Outer Joint	44T	21	22	51.5	83	56.5	O
	2000.01-	-	-	R	-	-	250293	Drive Shaft		21	23	46.3	80.5	709.5	
1.6 16V	2002-	-	-	-	-	-	899207	Outer Joint		21	22	46.4	86	58	I
1.9 D	1997-	-	-	R	-	-	250114	Drive Shaft	26T	21	23	57	84.5	724.5	
KANGOO (KC0/1)															
1.5 DCi (KC07) (48 kW)	2001.12-	-	-	-	-	-	850066	Outer Joint	44T	21	28	52.5	85	51	I
1.6 16V (70 kW)	2001.06-	-	-	-	-	-	850066	Outer Joint	44T	21	28	52.5	85	51	I
KANGOO (KC0/1_)															
1.2 (43 kW)	1997.08-	-	-	R	F	MPV Engine D7F 710/D7F 720/D7F 726/D7F 722/D7F 744/D7F 746	250526	Drive Shaft	26T	21	23	52.3	84.5	724	
	1997.08-	-	MT	R	F	MPV Engine D7F 710/D7F 720/D7F 726/D7F 722/D7F 744/D7F 746	250146	Drive Shaft		21	23	57	84.5	732.5	
	1997.08-	-	-	L	F	MPV Engine D7F 710/D7F 720/D7F 726/D7F 722/D7F 744/D7F 746	250004	Drive Shaft	26T	21	29.95	57	84.5	625.7	
	1997.08-	-	-	L	F	MPV Engine D7F 710/D7F 720/D7F 726/D7F 722/D7F 744/D7F 746	250261	Drive Shaft	44T	23	29.95	57.5	86.5	630	
	1997.08-	-	AT/MT	L/R	F	MPV Engine D7F 710/D7F 720/D7F 726/D7F 722/D7F 744/D7F 746	850004	Outer Joint	26T	21	30	52.2	85.5	59	I
	1997.08-	-	-	R	F	MPV Engine D7F 710/D7F 720/D7F 726/D7F 722/D7F 744/D7F 746	250395	Drive Shaft	26T	21	23	51.5	83	728	
	1997.08-	-	-	R	F	MPV Engine D7F 710/D7F 720/D7F 726/D7F 722/D7F 744/D7F 746	250094	Drive Shaft		21	23	57	84.5	726	
	1997.08-	-	-	L	F	MPV Engine D7F 710/D7F 720/D7F 726/D7F 722/D7F 744/D7F 746	250401	Drive Shaft	44T	21	29.95	57	84	629	
	1997.08-	-	MT	L	F	MPV Engine D7F 710/D7F 720/D7F 726/D7F 722/D7F 744/D7F 746	250109	Drive Shaft	26T	21	29.95	57	84.5	625.7	
	1997.08-	-	MT	R	F	MPV Engine D7F 710/D7F 720/D7F 726/D7F 722/D7F 744/D7F 746	250357	Drive Shaft	26T	21	23	57	84	718	
	1997.08-	-	-	L	F	MPV Engine D7F 710/D7F 720/D7F 726/D7F 722/D7F 744/D7F 746	250150	Drive Shaft		21	29.95	49.8	83.5	623	
	1997.08-	-	-	L	F	MPV Engine D7F 710/D7F 720/D7F 726/D7F 722/D7F 744/D7F 746	250356	Drive Shaft	26T	21	29.95	51.5	83	634	
	1997.08-	-	MT	R	F	MPV Engine D7F 710/D7F 720/D7F 726/D7F 722/D7F 744/D7F 746	250250	Drive Shaft	26T	21	23	57	84.5	732.5	
	1997.08-	-	MT	L	F	MPV Engine D7F 710/D7F 720/D7F 726/D7F 722/D7F 744/D7F 746	299073	Drive Shaft	44T	21	29.95	57	84.5	628	
	1997.08-	-	MT	R	F	MPV Engine D7F 710/D7F 720/D7F 726/D7F 722/D7F 744/D7F 746	250125	Drive Shaft		21	23	57	84.5	713.5	
	1997.08-	-	-	L	F	MPV Engine D7F 710/D7F 720/D7F 726/D7F 722/D7F 744/D7F 746	250112	Drive Shaft	26T	21	29.95	57	84.5	630.7	
	1997.08-	-	MT	R	F	MPV Engine D7F 710/D7F 720/D7F 726/D7F 722/D7F 744/D7F 746	650008	Inner Joint		23	30	36.3	52.2	68.5	
	1997.08-	-	MT	L	F	MPV Engine D7F 710/D7F 720/D7F 726/D7F 722/D7F 744/D7F 746	250177	Drive Shaft		21	29.95	57	84.5	625.7	
	1997.08-	-	MT	R	F	MPV Engine D7F 710/D7F 720/D7F 726/D7F 722/D7F 744/D7F 746	299072	Drive Shaft	44T	21	23	57	84.5	720	
1.2 16V (55 kW)	2001.06-	-	-	L	F	MPV Engine D4F 716/D4F 712/D4F 714/D4F 730	250411	Drive Shaft	44T	23	29.95	57.5	86.5	631	
	2001.06-	-	MT	L	F	MPV Engine D4F 716/D4F 712/D4F 714/D4F 730	250177	Drive Shaft		21	29.95	57	84.5	625.7	
	2001.06-	-	-	R	F	MPV Engine D4F 716/D4F 712/D4F 714/D4F 730	299072	Drive Shaft	44T	21	23	57	84.5	720	
	2001.06-	-	MT	R	F	MPV Engine D4F 716/D4F 712/D4F 714/D4F 730	250146	Drive Shaft		21	23	57	84.5	732.5	
	2001.06-	-	MT	R	F	MPV Engine D4F 716/D4F 712/D4F 714/D4F 730	850106	Outer Joint	26T	23	30	57.5	86.5	58.5	I
	2001.06-	-	-	L	F	MPV Engine D4F 716/D4F 712/D4F 714/D4F 730	250261	Drive Shaft	44T	23	29.95	57.5	86.5	630	
	2001.06-	-	MT	L/R	F	MPV Engine D4F 716/D4F 712/D4F 714/D4F 730	850004	Outer Joint	26T	21	30	52.2	85.5	59	I
	2001.06-	-	MT	R	F	MPV Engine D4F 716/D4F 712/D4F 714/D4F 730	250395	Drive Shaft	26T	21	23	51.5	83	728	
	2001.06-	-	MT	R	F	MPV Engine D4F 716/D4F 712/D4F 714/D4F 730	650008	Inner Joint		23	30	36.3	52.2	68.5	
	2001.06-	-	MT	R	F	MPV Engine D4F 716/D4F 712/D4F 714/D4F 730	250357	Drive Shaft	26T	21	23	57	84	718	
	2001.06-	-	MT	R	F	MPV Engine D4F 716/D4F 712/D4F 714/D4F 730	250339	Drive Shaft		21	23	57	84.5	718.5	
	2001.06-	-	MT	L	F	MPV Engine D4F 716/D4F 712/D4F 714/D4F 730	250401	Drive Shaft	44T	21	29.95	57	84	629	
	2001.06-	-	MT	L	F	MPV Engine D4F 716/D4F 712/D4F 714/D4F 730	250109	Drive Shaft	26T	21	29.95	57	84.5	625.7	
	2001.06-	-	MT	L	F	MPV Engine D4F 716/D4F 712/D4F 714/D4F 730	250523	Drive Shaft	26T	23		58.8	85	641	
	2001.06-	-	MT	R	F	MPV Engine D4F 716/D4F 712/D4F 714/D4F 730	250524	Drive Shaft	26T	23	23	57.5	86.5	729	
	2001.06-	-	MT	L	F	MPV Engine D4F 716/D4F 712/D4F 714/D4F 730	250150	Drive Shaft		21	29.95	49.8	83.5	623	
	2001.06-	-	MT	R	F	MPV Engine D4F 716/D4F 712/D4F 714/D4F 730	250250	Drive Shaft	26T	21	23	57	84.5	732.5	

REMARKS	GSP Ref.	PRODUCT	ABS	Technical Specifications											
				A	B	C	H	L	P						
		TRANSM	L/R	F/R	YEAR										
RENAULT KANGOO (KC0/1_)															
1.2 16V (55 kW)	2001.06-	-	MT	L	F	MPV Engine D4F 716/D4F 712/D4F 714/D4F 730	299073	Drive Shaft	44T	21	29.95	57	84.5	628	
	2001.06-	-	MT	R	F	MPV Engine D4F 716/D4F 712/D4F 714/D4F 730	250125	Drive Shaft		21	23	57	84.5	713.5	
1.4 (55 kW)	1997.08-	-	-	R	F	MPV Engine E7J 780/E7J 634/E7J 635/K7J 700/K7J 701	250525	Drive Shaft	44T	21	23	52.2	85.5	741	
	1997.08-	-	-	R	F	MPV Engine E7J 780/E7J 634/E7J 635/K7J 700/K7J 701	250526	Drive Shaft	26T	21	23	52.3	84.5	724	
	1997.08-	-	MT	R	F	MPV Engine E7J 780/E7J 634/E7J 635/K7J 700/K7J 701	250146	Drive Shaft		21	23	57	84.5	732.5	
	1997.08-	-	AT	R	F	MPV Engine E7J 780/E7J 634/E7J 635/K7J 700/K7J 701	299150	Drive Shaft	26T	21	23	52.2	85.5	747	
	1997.08-	-	AT	L	F	MPV Engine E7J 780/E7J 634/E7J 635/K7J 700/K7J 701	299242	Drive Shaft	44T	21	26	52.2	85.5	621	
	1997.08-	-	-	L	F	MPV Engine E7J 780/E7J 634/E7J 635/K7J 700/K7J 701	250519	Drive Shaft	44T	21	26	52.2	85.5	609	
	1997.08-	-	AT	R	F	MPV Engine E7J 780/E7J 634/E7J 635/K7J 700/K7J 701	250485	Drive Shaft	44T	21	23	52.2	85.5	733	
	1997.08-	-	-	L	F	MPV Engine E7J 780/E7J 634/E7J 635/K7J 700/K7J 701	250004	Drive Shaft	26T	21	29.95	57	84.5	625.7	
	1997.08-	-	-	L	F	MPV Engine E7J 780/E7J 634/E7J 635/K7J 700/K7J 701	250261	Drive Shaft	44T	23	29.95	57.5	86.5	630	
	1997.08-	-	AT	L	F	MPV Engine E7J 780/E7J 634/E7J 635/K7J 700/K7J 701	250579	Drive Shaft	26T	21	26	52.2	85.5	613	
	1997.08-	-	AT	R	F	MPV Engine E7J 780/E7J 634/E7J 635/K7J 700/K7J 701	250588	Drive Shaft	26T	21	23	57	84	739	
	1997.08-	-	MT	R	F	MPV Engine E7J 780/E7J 634/E7J 635/K7J 700/K7J 701	250395	Drive Shaft	26T	21	23	51.5	83	728	
	1997.08-	-	AT/MT	L/R	F	MPV Engine E7J 780/E7J 634/E7J 635/K7J 700/K7J 701	850004	Outer Joint	26T	21	30	52.2	85.5	59	I
	1997.08-	-	-	R	F	MPV Engine E7J 780/E7J 634/E7J 635/K7J 700/K7J 701	250094	Drive Shaft		21	23	57	84.5	726	
	1997.08-	-	MT	R	F	MPV Engine E7J 780/E7J 634/E7J 635/K7J 700/K7J 701	650008	Inner Joint		23	30	36.3	52.2	68.5	
	1997.08-	-	-	L	F	MPV Engine E7J 780/E7J 634/E7J 635/K7J 700/K7J 701	250401	Drive Shaft	44T	21	29.95	57	84	629	
	1997.08-	-	MT	L	F	MPV Engine E7J 780/E7J 634/E7J 635/K7J 700/K7J 701	250109	Drive Shaft	26T	21	29.95	57	84.5	625.7	
	1997.08-	-	MT	R	F	MPV Engine E7J 780/E7J 634/E7J 635/K7J 700/K7J 701	250339	Drive Shaft		21	23	57	84.5	718.5	
	1997.08-	-	MT	R	F	MPV Engine E7J 780/E7J 634/E7J 635/K7J 700/K7J 701	250357	Drive Shaft	26T	21	23	57	84	718	
	1997.08-	-	-	L	F	MPV Engine E7J 780/E7J 634/E7J 635/K7J 700/K7J 701	250356	Drive Shaft	26T	21	29.95	51.5	83	634	
	1997.08-	-	AT	L	F	MPV Engine E7J 780/E7J 634/E7J 635/K7J 700/K7J 701	299169	Drive Shaft	26T	21	26	52.2	85.5	621	
	1997.08-	-	AT	R	F	MPV Engine E7J 780/E7J 634/E7J 635/K7J 700/K7J 701	250486	Drive Shaft	26T	21	23	52.2	85.5	733	
	1997.08-	-	MT	L	F	MPV Engine E7J 780/E7J 634/E7J 635/K7J 700/K7J 701	250150	Drive Shaft		21	29.95	49.8	83.5	623	
	1997.08-	-	MT	R	F	MPV Engine E7J 780/E7J 634/E7J 635/K7J 700/K7J 701	250250	Drive Shaft	26T	21	23	57	84.5	732.5	
	1997.08-	-	MT	R	F	MPV Engine E7J 780/E7J 634/E7J 635/K7J 700/K7J 701	250125	Drive Shaft		21	23	57	84.5	713.5	
	1997.08-	-	-	L	F	MPV Engine E7J 780/E7J 634/E7J 635/K7J 700/K7J 701	250112	Drive Shaft	26T	21	29.95	57	84.5	630.7	
	1997.08-	-	MT	L	F	MPV Engine E7J 780/E7J 634/E7J 635/K7J 700/K7J 701	250177	Drive Shaft		21	29.95	57	84.5	625.7	
1.5 dCi (42 kW)	2003.07-	-	MT	L	F	MPV Engine K9K 704	250177	Drive Shaft		21	29.95	57	84.5	625.7	
	2003.07-	-	MT	R	F	MPV Engine K9K 704	299072	Drive Shaft	44T	21	23	57	84.5	720	
	2003.07-	-	MT	R	F	MPV Engine K9K 704	250146	Drive Shaft		21	23	57	84.5	732.5	
	2003.07-	-	-	R	F	MPV Engine K9K 704	250245	Drive Shaft	44T	21	23	52.5	85	726	
	2003.07-	-	-	L	F	MPV Engine K9K 704	250261	Drive Shaft	44T	23	29.95	57.5	86.5	630	
	2003.07-	-	-	R	F	MPV Engine K9K 704	250017	Drive Shaft	26T	21	23	51.5	83	715	
	2003.07-	-	-	R	F	MPV Engine K9K 704	250395	Drive Shaft	26T	21	23	51.5	83	728	
	2003.07-	-	-	L	F	MPV Engine K9K 704	250401	Drive Shaft	44T	21	29.95	57	84	629	
	2003.07-	-	MT	L	F	MPV Engine K9K 704	250109	Drive Shaft	26T	21	29.95	57	84.5	625.7	
	2003.07-	-	-	R	F	MPV Engine K9K 704	650008	Inner Joint		23	30	36.3	52.2	68.5	
	2003.07-	-	MT	R	F	MPV Engine K9K 704	250250	Drive Shaft	26T	21	23	57	84.5	732.5	
	2003.07-	-	MT	L	F	MPV Engine K9K 704	299073	Drive Shaft	44T	21	29.95	57	84.5	628	
1.5 dCi (45 kW)	2005.04-	2010.06	-	R	F	MPV Engine K9K 700/K9K 702	250245	Drive Shaft	44T	21	23	52.5	85	726	
	2005.04-	2010.06	-	L	F	MPV Engine K9K 700/K9K 702	250261	Drive Shaft	44T	23	29.95	57.5	86.5	630	
	2005.04-	2010.06	-	L	F	MPV Engine K9K 700/K9K 702	250401	Drive Shaft	44T	21	29.95	57	84	629	
	2005.04-	2010.06	-	R	F	MPV Engine K9K 700/K9K 702	650008	Inner Joint		23	30	36.3	52.2	68.5	
1.5 dCi (48 kW)	2001.12-	-	-	L	F	MPV Engine K9K 700/K9K 704	250411	Drive Shaft	44T	23	29.95	57.5	86.5	631	
	2001.12-	-	MT	L	F	MPV Engine K9K 700/K9K 704	250177	Drive Shaft		21	29.95	57	84.5	625.7	
	2001.12-	-	MT	R	F	MPV Engine K9K 700/K9K 704	299072	Drive Shaft	44T	21	23	57	84.5	720	
	2001.12-	-	MT	R	F	MPV Engine K9K 700/K9K 704	250146	Drive Shaft		21	23	57	84.5	732.5	
	2001.12-	-	-	L	F	MPV Engine K9K 700/K9K 704	250004	Drive Shaft	26T	21	29.95	57	84.5	625.7	
	2001.12-	-	-	R	F	MPV Engine K9K 700/K9K 704	250245	Drive Shaft	44T	21	23	52.5	85	726	
	2001.12-	-	-	R	F	MPV Engine K9K 700/K9K 704	250017	Drive Shaft	26T	21	23	51.5	83	715	
	2001.12-	-	-	L	F	MPV Engine K9K 700/K9K 704	250261	Drive Shaft	44T	23	29.95	57.5	86.5	630	
	2001.12-	-	MT	L/R	F	MPV Engine K9K 700/K9K 704	850004	Outer Joint	26T	21	30	52.2	85.5	59	I
	2001.12-	-	MT	R	F	MPV Engine K9K 700/K9K 704	250395	Drive Shaft	26T	21	23	51.5	83	728	
	2001.12-	-	MT	R	F	MPV Engine K9K 700/K9K 704	650008	Inner Joint		23	30	36.3	52.2	68.5	
	2001.12-	-	-	L	F	MPV Engine K9K 700/K9K 704	250401	Drive Shaft	44T	21	29.95	57	84	629	
	2001.12-	-	MT	R	F	MPV Engine K9K 700/K9K 704	250339	Drive Shaft		21	23	57	84.5	718.5	
	2001.12-	-	MT	L	F	MPV Engine K9K 700/K9K 704	250398	Drive Shaft		21	29.95	50	84	632	
	2001.12-	-	MT	L	F	MPV Engine K9K 700/K9K 704	250109	Drive Shaft	26T	21	29.95	57	84.5	625.7	
	2001.12-	-	-	L	F	MPV Engine K9K 700/K9K 704	250150	Drive Shaft		21	29.95	49.8	83.5	623	
	2001.12-	-	MT	L	F	MPV Engine K9K 700/K9K 704	250356	Drive Shaft	26T	21	29.95	51.5	83	634	
	2001.12-	-	MT	R	F	MPV Engine K9K 700/K9K 704	250250	Drive Shaft	26T	21	23	57	84.5	732.5	
	2001.12-	-	MT	L	F	MPV Engine K9K 700/K9K 704	299073	Drive Shaft	44T	21	29.95	57	84.5	628	
	2001.12-	-	-	L	F	MPV Engine K9K 700/K9K 704	250112	Drive Shaft	26T	21	29.95	57	84.5	630.7	
1.5 dCi (50 kW)	2005.06-	-	-	L	F	MPV Engine K9K 714	650085	Inner Joint		26	33	40	64	123	

REMARKS	YEAR	TRANSM	L/R	F/R	GSP Ref.	PRODUCT	ABS	Technical Specifications							
								A	B	C	H	L	P		
RENAULT KANGOO (KC0/1_)															
1.5 dCi (50 kW)	2005.06-	-	-	R	F	MPV Engine K9K 714	250571	Drive Shaft	44T	23	26	57.3	84.5	868	
	2005.06-	-	-	R	F	MPV Engine K9K 714	650086	Inner Joint		26	33	33	326	94	
	2005.06-	-	MT	L/R	F	MPV Engine K9K 714	850069	Outer Joint	44T	23	30	57.5	86.5	58.5	I
	2005.06-	-	MT	-	F	MPV Engine K9K 714	850052	Outer Joint	44T	23	30	57.5	86.5	58.5	I
	2005.06-	-	MT	L	F	MPV Engine K9K 714	250376	Drive Shaft		23	26	57.5	86.5	606	
	2005.06-	-	MT	R	F	MPV Engine K9K 714	699169	Inner Joint		26	30	33	326	95	
	2005.06-	-	MT	R	F	MPV Engine K9K 714	899087	Outer Joint		23	30	57.5	86.5	58.5	I
	2005.06-	-	MT	R	F	MPV Engine K9K 714	250364	Drive Shaft	44T	23	26	57.5	86.5	866	
	2005.06-	-	-	L	F	MPV Engine K9K 714	250514	Drive Shaft	44T	23	26	57.5	86.5	606	
	2005.06-	-	-	R	F	MPV Engine K9K 714	250515	Drive Shaft	44T	23	26	57.5	86.5	866	
	2005.06-	-	MT	R	F	MPV Engine K9K 714	250375	Drive Shaft		23	26	57.5	86.5	866	
1.5 dCi (60 kW)	2002.07-	-	-	L	F	MPV Engine K9K 702/K9K 710	250411	Drive Shaft	44T	23	29.95	57.5	86.5	631	
	2002.07-	-	-	R	F	MPV Engine K9K 702/K9K 710	250151	Drive Shaft		21	23	49.8	83.5	712	
	2002.07-	-	MT	L/R	F	MPV Engine K9K 702/K9K 710	850069	Outer Joint	44T	23	30	57.5	86.5	58.5	I
	2002.07-	-	MT	R	F	MPV Engine K9K 702/K9K 710	650008	Inner Joint		23	30	36.3	52.2	68.5	
	2002.07-	-	-	L	F	MPV Engine K9K 702/K9K 710	250261	Drive Shaft	44T	23	29.95	57.5	86.5	630	
	2002.07-	-	MT	R	F	MPV Engine K9K 702/K9K 710	850106	Outer Joint	26T	23	30	57.5	86.5	58.5	I
	2002.07-	-	MT	R	F	MPV Engine K9K 702/K9K 710	899087	Outer Joint		23	30	57.5	86.5	58.5	I
	2002.07-	-	MT	L	F	MPV Engine K9K 702/K9K 710	250394	Drive Shaft		23	29.95	57.5	86.5	631	
	2002.07-	-	-	L	F	MPV Engine K9K 702/K9K 710	250401	Drive Shaft	44T	21	29.95	57	84	629	
	2002.07-	-	MT	R	F	MPV Engine K9K 702/K9K 710	250193	Drive Shaft	26T	23	23	57.5	86.5	724	
	2002.07-	-	MT	R	F	MPV Engine K9K 702/K9K 710	250462	Drive Shaft		23	23	57.5	86.5	724	
	2002.07-	-	MT	L	F	MPV Engine K9K 702/K9K 710	250194	Drive Shaft	26T	23	29.95	57.5	86.5	631	
1.5 dCi (62 kW)	2005.06-	-	-	L	F	MPV Engine K9K 718	650085	Inner Joint		26	33	40	64	123	
	2005.06-	-	-	R	F	MPV Engine K9K 718	250571	Drive Shaft	44T	23	26	57.3	84.5	868	
	2005.06-	-	-	R	F	MPV Engine K9K 718	650086	Inner Joint		26	33	33	326	94	
	2005.06-	-	MT	L	F	MPV Engine K9K 718	250376	Drive Shaft		23	26	57.5	86.5	606	
	2005.06-	-	-	-	F	MPV Engine K9K 718	850052	Outer Joint	44T	23	30	57.5	86.5	58.5	I
	2005.06-	-	MT	R	F	MPV Engine K9K 718	699169	Inner Joint		26	30	33	326	95	
	2005.06-	-	MT	R	F	MPV Engine K9K 718	899087	Outer Joint		23	30	57.5	86.5	58.5	I
	2005.06-	-	MT	R	F	MPV Engine K9K 718	250364	Drive Shaft	44T	23	26	57.5	86.5	866	
	2005.06-	-	-	L	F	MPV Engine K9K 718	250514	Drive Shaft	44T	23	26	57.5	86.5	606	
	2005.06-	-	-	R	F	MPV Engine K9K 718	250515	Drive Shaft	44T	23	26	57.5	86.5	866	
	2005.06-	-	MT	R	F	MPV Engine K9K 718	250375	Drive Shaft		23	26	57.5	86.5	866	
1.6 (66 kW)	1999.09-	2001.06	-	R	F	MPV Engine K7M 746	250395	Drive Shaft	26T	21	23	51.5	83	728	
	1999.09-	2001.06	-	L	F	MPV Engine K7M 746	250356	Drive Shaft	26T	21	29.95	51.5	83	634	
1.6 16V (70 kW)	2001.06-	-	-	L	F	MPV Engine K4M 706/K4M 752/K4M 753/K4M 750	250411	Drive Shaft	44T	23	29.95	57.5	86.5	631	
	2001.06-	-	MT	R	F	MPV Engine K4M 706/K4M 752/K4M 753/K4M 750	250146	Drive Shaft		21	23	57	84.5	732.5	
	2001.06-	-	AT	L	F	MPV Engine K4M 706/K4M 752/K4M 753/K4M 750	299242	Drive Shaft	44T	21	26	52.2	85.5	621	
	2001.06-	-	AT	R	F	MPV Engine K4M 706/K4M 752/K4M 753/K4M 750	250485	Drive Shaft	44T	21	23	52.2	85.5	733	
	2001.06-	-	-	L	F	MPV Engine K4M 706/K4M 752/K4M 753/K4M 750	250519	Drive Shaft	44T	21	26	52.2	85.5	609	
	2001.06-	-	MT	R	F	MPV Engine K4M 706/K4M 752/K4M 753/K4M 750	250263	Drive Shaft	44T	21	23	52.2	85.5	723.5	
	2001.06-	-	-	L	F	MPV Engine K4M 706/K4M 752/K4M 753/K4M 750	250004	Drive Shaft	26T	21	29.95	57	84.5	625.7	
	2001.06-	-	-	L	F	MPV Engine K4M 706/K4M 752/K4M 753/K4M 750	250261	Drive Shaft	44T	23	29.95	57.5	86.5	630	
	2001.06-	-	MT	L/R	F	MPV Engine K4M 706/K4M 752/K4M 753/K4M 750	850004	Outer Joint	26T	21	30	52.2	85.5	59	I
	2001.06-	-	-	R	F	MPV Engine K4M 706/K4M 752/K4M 753/K4M 750	250094	Drive Shaft		21	23	57	84.5	726	
	2001.06-	-	MT	R	F	MPV Engine K4M 706/K4M 752/K4M 753/K4M 750	250395	Drive Shaft	26T	21	23	51.5	83	728	
	2001.06-	-	MT	R	F	MPV Engine K4M 706/K4M 752/K4M 753/K4M 750	650008	Inner Joint		23	30	36.3	52.2	68.5	
	2001.06-	-	MT	L	F	MPV Engine K4M 706/K4M 752/K4M 753/K4M 750	250109	Drive Shaft	26T	21	29.95	57	84.5	625.7	
	2001.06-	-	-	L	F	MPV Engine K4M 706/K4M 752/K4M 753/K4M 750	250401	Drive Shaft	44T	21	29.95	57	84	629	
	2001.06-	-	MT	R	F	MPV Engine K4M 706/K4M 752/K4M 753/K4M 750	250357	Drive Shaft	26T	21	23	57	84	718	
	2001.06-	-	MT	R	F	MPV Engine K4M 706/K4M 752/K4M 753/K4M 750	250339	Drive Shaft		21	23	57	84.5	718.5	
	2001.06-	-	AT	L	F	MPV Engine K4M 706/K4M 752/K4M 753/K4M 750	299169	Drive Shaft	26T	21	26	52.2	85.5	621	
	2001.06-	-	MT	R	F	MPV Engine K4M 706/K4M 752/K4M 753/K4M 750	250250	Drive Shaft	26T	21	23	57	84.5	732.5	
	2001.06-	-	MT	L	F	MPV Engine K4M 706/K4M 752/K4M 753/K4M 750	250150	Drive Shaft		21	29.95	49.8	83.5	623	
	2001.06-	-	AT	R	F	MPV Engine K4M 706/K4M 752/K4M 753/K4M 750	250486	Drive Shaft	26T	21	23	52.2	85.5	733	
	2001.06-	-	-	L	F	MPV Engine K4M 706/K4M 752/K4M 753/K4M 750	250112	Drive Shaft	26T	21	29.95	57	84.5	630.7	
	2001.06-	-	MT	L	F	MPV Engine K4M 706/K4M 752/K4M 753/K4M 750	250177	Drive Shaft		21	29.95	57	84.5	625.7	
	2001.10-	-	AT	R	F	All-wheel Drive MPV Engine K4M 752/K4M 750/K4M 753	250525	Drive Shaft	44T	21	23	52.2	85.5	741	
	2001.10-	-	-	L	F	All-wheel Drive MPV Engine K4M 752/K4M 750/K4M 753	250519	Drive Shaft	44T	21	26	52.2	85.5	609	
	2001.10-	-	AT	L	F	All-wheel Drive MPV Engine K4M 752/K4M 750/K4M 753	250579	Drive Shaft	26T	21	26	52.2	85.5	613	
	2001.10-	-	MT	-	R	All-wheel Drive MPV Engine K4M 752/K4M 750/K4M 753	850222	Outer Joint	44T	23	21	59	83.5	53	I
	2001.10-	-	AT	R	F	All-wheel Drive MPV Engine K4M 752/K4M 750/K4M 753	250588	Drive Shaft	26T	21	23	57	84	739	
	2001.10-	-	MT	R	F	All-wheel Drive MPV Engine K4M 752/K4M 750/K4M 753	650008	Inner Joint		23	30	36.3	52.2	68.5	
	2001.10-	-	-	R	F	All-wheel Drive MPV Engine K4M 752/K4M 750/K4M 753	250094	Drive Shaft		21	23	57	84.5	726	
	2001.10-	-	-	R	F	All-wheel Drive MPV Engine K4M 752/K4M 750/K4M 753	650079	Inner Joint		23	22	36.3	50	55.5	

REMARKS	YEAR	TRANSM	L/R	F/R	GSP Ref.	PRODUCT	ABS	Technical Specifications							
								A	B	C	H	L	P		
RENAULT KANGOO (KC0/1_)															
1.6 16V (70 kW)	2001.10-	-	-	L	F	All-wheel Drive MPV Engine K4M 752/K4M 750/K4M 753	250506	Drive Shaft	44T	23	29.95	58.8	85	645	
	2001.10-	-	-	L/R	R	All-wheel Drive MPV Engine K4M 752/K4M 750/K4M 753	250627	Drive Shaft	44T	23	21	59	83.5	755	
	2001.10-	-	-	L	F	All-wheel Drive MPV Engine K4M 752/K4M 750/K4M 753	250112	Drive Shaft	26T	21	29.95	57	84.5	630.7	
1.9 dCi (59 kW)	2001.10-	-	-	R	F	All-wheel Drive MPV Engine F9Q 782/F9Q 790	250527	Drive Shaft	44T	23	23	58.8	85	739	
	2001.10-	-	MT	-	R	All-wheel Drive MPV Engine F9Q 782/F9Q 790	850222	Outer Joint	44T	23	21	59	83.5	53	I
	2001.10-	-	MT	R	F	All-wheel Drive MPV Engine F9Q 782/F9Q 790	650008	Inner Joint		23	30	36.3	52.2	68.5	
	2001.10-	-	-	R	F	All-wheel Drive MPV Engine F9Q 782/F9Q 790	650079	Inner Joint		23	22	36.3	50	55.5	
	2001.10-	-	-	L	F	All-wheel Drive MPV Engine F9Q 782/F9Q 790	250506	Drive Shaft	44T	23	29.95	58.8	85	645	
	2001.10-	-	-	L/R	R	All-wheel Drive MPV Engine F9Q 782/F9Q 790	250627	Drive Shaft	44T	23	21	59	83.5	755	
	2001.10-	-	-	L	F	All-wheel Drive MPV Engine F9Q 782/F9Q 790	250112	Drive Shaft	26T	21	29.95	57	84.5	630.7	
1.9 dCi (62 kW)	2003.10-	-	MT	-	R	All-wheel Drive MPV Engine F9Q 790	850222	Outer Joint	44T	23	21	59	83.5	53	I
	2003.10-	-	MT	R	F	All-wheel Drive MPV Engine F9Q 790	650008	Inner Joint		23	30	36.3	52.2	68.5	
	2003.10-	-	-	R	F	All-wheel Drive MPV Engine F9Q 790	650079	Inner Joint		23	22	36.3	50	55.5	
	2003.10-	-	-	L	F	All-wheel Drive MPV Engine F9Q 790	250506	Drive Shaft	44T	23	29.95	58.8	85	645	
	2003.10-	-	-	L/R	R	All-wheel Drive MPV Engine F9Q 790	250627	Drive Shaft	44T	23	21	59	83.5	755	
1.9 dTi (59 kW)	2000.02-	-	MT	R	F	MPV Engine F9Q 780	299072	Drive Shaft	44T	21	23	57	84.5	720	
	2000.02-	-	MT	R	F	MPV Engine F9Q 780	250146	Drive Shaft		21	23	57	84.5	732.5	
	2000.02-	-	-	L	F	MPV Engine F9Q 780	250004	Drive Shaft	26T	21	29.95	57	84.5	625.7	
	2000.02-	-	-	R	F	MPV Engine F9Q 780	250017	Drive Shaft	26T	21	23	51.5	83	715	
	2000.02-	-	-	L	F	MPV Engine F9Q 780	250261	Drive Shaft	44T	23	29.95	57.5	86.5	630	
	2000.02-	-	MT	L/R	F	MPV Engine F9Q 780	850004	Outer Joint	26T	21	30	52.2	85.5	59	I
	2000.02-	-	MT	R	F	MPV Engine F9Q 780	250395	Drive Shaft	26T	21	23	51.5	83	728	
	2000.02-	-	MT	R	F	MPV Engine F9Q 780	650008	Inner Joint		23	30	36.3	52.2	68.5	
	2000.02-	-	-	L	F	MPV Engine F9Q 780	250401	Drive Shaft	44T	21	29.95	57	84	629	
	2000.02-	-	MT	R	F	MPV Engine F9Q 780	250339	Drive Shaft		21	23	57	84.5	718.5	
	2000.02-	-	MT	L	F	MPV Engine F9Q 780	250109	Drive Shaft	26T	21	29.95	57	84.5	625.7	
	2000.02-	-	-	L	F	MPV Engine F9Q 780	250150	Drive Shaft		21	29.95	49.8	83.5	623	
	2000.02-	-	MT	L	F	MPV Engine F9Q 780	250398	Drive Shaft		21	29.95	50	84	632	
	2000.02-	-	MT	L	F	MPV Engine F9Q 780	250356	Drive Shaft	26T	21	29.95	51.5	83	634	
	2000.02-	-	MT	R	F	MPV Engine F9Q 780	250250	Drive Shaft	26T	21	23	57	84.5	732.5	
	2000.02-	-	MT	L	F	MPV Engine F9Q 780	299073	Drive Shaft	44T	21	29.95	57	84.5	628	
	2000.02-	-	MT	L	F	MPV Engine F9Q 780	250177	Drive Shaft		21	29.95	57	84.5	625.7	
1.9 RXED (48 kW)	1999.09-2001.06	-	-	R	F	MPV Engine F8Q 630/F8Q 632	250395	Drive Shaft	26T	21	23	51.5	83	728	
	1999.09-2001.06	-	-	L	F	MPV Engine F8Q 630/F8Q 632	250356	Drive Shaft	26T	21	29.95	51.5	83	634	
	1999.09-2001.06	-	-	L	F	MPV Engine F8Q 630/F8Q 632	250150	Drive Shaft		21	29.95	49.8	83.5	623	
	1999.09-2001.06	-	-	R	F	MPV Engine F8Q 630/F8Q 632	250063	Drive Shaft		21	23	51.5	83	720	
	1999.09-2001.06	MT	R	F	MPV Engine F8Q 630/F8Q 632	250180	Drive Shaft		21	23	57	84.5	724.5		
D 55 1.9 (40 kW)	1997.08-	-	MT	R	F	MPV Engine F8Q 662	250146	Drive Shaft		21	23	57	84.5	732.5	
	1997.08-	-	-	L	F	MPV Engine F8Q 662	250004	Drive Shaft	26T	21	29.95	57	84.5	625.7	
	1997.08-	-	-	R	F	MPV Engine F8Q 662	250017	Drive Shaft	26T	21	23	51.5	83	715	
	1997.08-	-	MT	R	F	MPV Engine F8Q 662	250395	Drive Shaft	26T	21	23	51.5	83	728	
	1997.08-	-	AT/MT	L/R	F	MPV Engine F8Q 662	850004	Outer Joint	26T	21	30	52.2	85.5	59	I
	1997.08-	-	MT	R	F	MPV Engine F8Q 662	650008	Inner Joint		23	30	36.3	52.2	68.5	
	1997.08-	-	MT	L	F	MPV Engine F8Q 662	250109	Drive Shaft	26T	21	29.95	57	84.5	625.7	
	1997.08-	-	MT	R	F	MPV Engine F8Q 662	250339	Drive Shaft		21	23	57	84.5	718.5	
	1997.08-	-	MT	R	F	MPV Engine F8Q 662	250357	Drive Shaft	26T	21	23	57	84	718	
	1997.08-	-	MT	L	F	MPV Engine F8Q 662	250398	Drive Shaft		21	29.95	50	84	632	
	1997.08-	-	-	L	F	MPV Engine F8Q 662	250150	Drive Shaft		21	29.95	49.8	83.5	623	
	1997.08-	-	MT	L	F	MPV Engine F8Q 662	250356	Drive Shaft	26T	21	29.95	51.5	83	634	
	1997.08-	-	MT	R	F	MPV Engine F8Q 662	250250	Drive Shaft	26T	21	23	57	84.5	732.5	
	1997.08-	-	MT	L	F	MPV Engine F8Q 662	299073	Drive Shaft	44T	21	29.95	57	84.5	628	
	1997.08-	-	MT	R	F	MPV Engine F8Q 662	250125	Drive Shaft		21	23	57	84.5	713.5	
	1997.08-	-	MT	R	F	MPV Engine F8Q 662	250180	Drive Shaft		21	23	57	84.5	724.5	
	1997.08-	-	-	L	F	MPV Engine F8Q 662	250112	Drive Shaft	26T	21	29.95	57	84.5	630.7	
	1997.08-	-	MT	L	F	MPV Engine F8Q 662	250177	Drive Shaft		21	29.95	57	84.5	625.7	
	1997.08-	-	MT	R	F	MPV Engine F8Q 662	299072	Drive Shaft	44T	21	23	57	84.5	720	
D 65 1.9 (47 kW)	1997.08-	-	MT	R	F	MPV Engine F8Q 630/F8Q 632	250526	Drive Shaft	26T	21	23	52.3	84.5	724	
	1997.08-	-	MT	R	F	MPV Engine F8Q 630/F8Q 632	250146	Drive Shaft		21	23	57	84.5	732.5	
	1997.08-	-	MT	R	F	MPV Engine F8Q 630/F8Q 632	250017	Drive Shaft	26T	21	23	51.5	83	715	
	1997.08-	-	MT	R	F	MPV Engine F8Q 630/F8Q 632	250395	Drive Shaft	26T	21	23	51.5	83	728	
	1997.08-	-	AT/MT	L/R	F	MPV Engine F8Q 630/F8Q 632	850004	Outer Joint	26T	21	30	52.2	85.5	59	I
	1997.08-	-	-	R	F	MPV Engine F8Q 630/F8Q 632	250094	Drive Shaft		21	23	57	84.5	726	
	1997.08-	-	MT	R	F	MPV Engine F8Q 630/F8Q 632	650008	Inner Joint		23	30	36.3	52.2	68.5	
	1997.08-	-	MT	L	F	MPV Engine F8Q 630/F8Q 632	250109	Drive Shaft	26T	21	29.95	57	84.5	625.7	
	1997.08-	-	MT	R	F	MPV Engine F8Q 630/F8Q 632	250339	Drive Shaft		21	23	57	84.5	718.5	
	1997.08-	-	MT	R	F	MPV Engine F8Q 630/F8Q 632	250357	Drive Shaft	26T	21	23	57	84	718	

YEAR	TRANSM	L/R	F/R	REMARKS	GSP Ref.	PRODUCT	ABS	Technical Specifications								
								A	B	C	H	L	P			
RENAULT KANGOO (KC0/1_)																
D 65 1.9 (47 kW)	1997.08-	-	MT	L	F	MPV Engine F8Q 630/F8Q 632	250398	Drive Shaft		21	29.95	50	84	632		
	1997.08-	-	MT	L	F	MPV Engine F8Q 630/F8Q 632	250356	Drive Shaft	26T	21	29.95	51.5	83	634		
	1997.08-	-	MT	L	F	MPV Engine F8Q 630/F8Q 632	250150	Drive Shaft		21	29.95	49.8	83.5	623		
	1997.08-	-	MT	R	F	MPV Engine F8Q 630/F8Q 632	250250	Drive Shaft	26T	21	23	57	84.5	732.5		
	1997.08-	-	MT	L	F	MPV Engine F8Q 630/F8Q 632	299073	Drive Shaft	44T	21	29.95	57	84.5	628		
	1997.08-	-	MT	R	F	MPV Engine F8Q 630/F8Q 632	250125	Drive Shaft		21	23	57	84.5	713.5		
	1997.08-	-	MT	R	F	MPV Engine F8Q 630/F8Q 632	250180	Drive Shaft		21	23	57	84.5	724.5		
	1997.08-	-	-	L	F	MPV Engine F8Q 630/F8Q 632	250112	Drive Shaft	26T	21	29.95	57	84.5	630.7		
	1997.08-	-	MT	L	F	MPV Engine F8Q 630/F8Q 632	250177	Drive Shaft		21	29.95	57	84.5	625.7		
	1997.08-	-	MT	R	F	MPV Engine F8Q 630/F8Q 632	299072	Drive Shaft	44T	21	23	57	84.5	720		
KANGOO BE BOP																
1.6(78kW)	2009-	2018	-	-	F	MPV	650040	Inner Joint		26	30	43	42.5	83		
	2009-	2018	-	-	F	MPV	650040	Inner Joint		26	30	43	42.5	83		
	2009-	2018	-	-	F	MPV	650040	Inner Joint		26	30	43	42.5	83		
	2009-	2018	-	-	F	MPV	650040	Inner Joint		26	30	43	42.5	83		
	2009-	2018	-	-	F	MPV	650040	Inner Joint		26	30	43	42.5	83		
	2009-	2018	-	-	F	MPV	650040	Inner Joint		26	30	43	42.5	83		
	2009-	2018	-	-	F	MPV	650040	Inner Joint		26	30	43	42.5	83		
	2009-	2018	-	-	F	MPV	650040	Inner Joint		26	30	43	42.5	83		
	2009-	2018	-	-	F	MPV	650040	Inner Joint		26	30	43	42.5	83		
	2009-	2018	-	-	F	MPV	650040	Inner Joint		26	30	43	42.5	83		
	2009-	2018	-	L	F	MPV	650040	Inner Joint		26	30	43	42.5	83		
KANGOO BE BOP (KW0/1_)																
1.5 dCi (66 kW)	2009.06-	-	-	R	F	MPV Engine K9K 808	650137	Inner joint		26	22	33	330	96.5		
	2009.06-	-	MT	L/R	F	MPV Engine K9K 808	850136	Outer Joint		27	22	56.7	91	55	I	
	2009.06-	-	MT	R	F	MPV Engine K9K 808	699169	Inner Joint		26	30	33	326	95		
	2009.06-	-	-	-	-	MPV Engine K9K 808	250612	Drive Shaft		27	26	56.7	91	918		
	2009.06-	-	MT	L	F	MPV Engine K9K 808	299228	Drive Shaft		27	26	56.7	91	675		
	2009.06-	-	MT	L	F	MPV Engine K9K 808	299070	Drive Shaft		23	26	49	86	675		
	2009.06-	-	MT	R	F	MPV Engine K9K 808	299229	Drive Shaft		27	26	56.7	91	920		
1.5 dCi (76 kW)	2009.02-	-	-	L	F	MPV Engine K9K 806	250423	Drive Shaft		27	26	56.7	91	680		
1.5 dCi (80 kW)	2009.06-	-	MT	L	F	MPV Engine K9K 804	250423	Drive Shaft		27	26	56.7	91	680		
1.5 dCi 75 (55 kW)	2010.09-	-	MT	R	F	MPV Engine K9K 802	699169	Inner Joint		26	30	33	326	95		
	2010.09-	-	MT	L	F	MPV Engine K9K 802	299228	Drive Shaft		27	26	56.7	91	675		
	2010.09-	-	MT	L	F	MPV Engine K9K 802	299070	Drive Shaft		23	26	49	86	675		
	2010.09-	-	MT	R	F	MPV Engine K9K 802	299229	Drive Shaft		27	26	56.7	91	920		
1.6 (78 kW)	2009.02-	-	-	R	F	MPV Engine K4M 830	650137	Inner joint		26	22	33	330	96.5		
	2009.02-	-	MT	L/R	F	MPV Engine K4M 830	850136	Outer Joint		27	22	56.7	91	55	I	
	2009.02-	-	MT	R	F	MPV Engine K4M 830	699169	Inner Joint		26	30	33	326	95		
	2009.02-	-	-	R	F	MPV Engine K4M 830	250616	Drive Shaft		27	23	56.7	91	816		
	2009.02-	-	-	-	-	MPV Engine K4M 830	250612	Drive Shaft		27	26	56.7	91	918		
	2009.02-	-	MT	L	F	MPV Engine K4M 830	299228	Drive Shaft		27	26	56.7	91	675		
	2009.02-	-	MT	L	F	MPV Engine K4M 830	299070	Drive Shaft		23	26	49	86	675		
	2009.02-	-	AT	R	F	MPV Engine K4M 830	299229	Drive Shaft		27	26	56.7	91	920		
KANGOO EXPRESS																
1.6 16V(78kW)	2008-	2018	-	L	F	Box	650040	Inner Joint		26	30	43	42.5	83		
	2008-	2018	-	L	F	Box	650040	Inner Joint		26	30	43	42.5	83		
	2008-	2018	-	L	F	Box	650040	Inner Joint		26	30	43	42.5	83		
	2008-	2018	-	L	F	Box	650040	Inner Joint		26	30	43	42.5	83		
	2008-	2018	-	L	F	Box	650040	Inner Joint		26	30	43	42.5	83		
	2008-	2018	-	L	F	Box	650040	Inner Joint		26	30	43	42.5	83		
	2008-	2018	-	L	F	Box	650040	Inner Joint		26	30	43	42.5	83		
	2008-	2018	-	L	F	Box	650040	Inner Joint		26	30	43	42.5	83		
	2008-	2018	-	L	F	Box	650040	Inner Joint		26	30	43	42.5	83		
	2008-	2018	-	L	F	Box	650040	Inner Joint		26	30	43	42.5	83		
	2008-	2018	-	L	F	Box	650040	Inner Joint		26	30	43	42.5	83		
KANGOO Express (FC0/1_)																
1.2 (43 kW)	1997.08-	-	-	R	F	Box Engine D7F 710/D7F 720/D7F 722/D7F 726/D7F 744/D7F 746	250526	Drive Shaft	26T	21	23	52.3	84.5	724		
	1997.08-	-	MT	R	F	Box Engine D7F 710/D7F 720/D7F 722/D7F 726/D7F 744/D7F 746	250146	Drive Shaft		21	23	57	84.5	732.5		
	1997.08-	-	AT	L/R	F	Box Engine D7F 710/D7F 720/D7F 722/D7F 726/D7F 744/D7F 746	850004	Outer Joint	26T	21	30	52.2	85.5	59	I	
	1997.08-	-	MT	R	F	Box Engine D7F 710/D7F 720/D7F 722/D7F 726/D7F 744/D7F 746	250395	Drive Shaft	26T	21	23	51.5	83	728		
	1997.08-	-	MT	R	F	Box Engine D7F 710/D7F 720/D7F 722/D7F 726/D7F 744/D7F 746	650008	Inner Joint		23	30	36.3	52.2	68.5		
	1997.08-	-	-	R	F	Box Engine D7F 710/D7F 720/D7F 722/D7F 726/D7F 744/D7F 746	250094	Drive Shaft		21	23	57	84.5	726		
	1997.08-	-	MT	L	F	Box Engine D7F 710/D7F 720/D7F 722/D7F 726/D7F 744/D7F 746	250401	Drive Shaft	44T	21	29.95	57	84	629		
	1997.08-	-	MT	R	F	Box Engine D7F 710/D7F 720/D7F 722/D7F 726/D7F 744/D7F 746	250339	Drive Shaft		21	23	57	84.5	718.5		
	1997.08-	-	MT	L	F	Box Engine D7F 710/D7F 720/D7F 722/D7F 726/D7F 744/D7F 746	250109	Drive Shaft	26T	21	29.95	57	84.5	625.7		
	1997.08-	-	MT	R	F	Box Engine D7F 710/D7F 720/D7F 722/D7F 726/D7F 744/D7F 746	250357	Drive Shaft	26T	21	23	57	84	718		





REMARKS	GSP Ref.	PRODUCT	ABS	Technical Specifications															
				A	B	C	H	L	P										
RENAULT KANGOO Express (FC0/1_)																			
1.2 (43 kW)																			
1997.08- -	250150	Drive Shaft		21	29.95	49.8	83.5	623											
1997.08- -	250356	Drive Shaft	26T	21	29.95	51.5	83	634											
1997.08- -	250250	Drive Shaft	26T	21	23	57	84.5	732.5											
1997.08- -	299073	Drive Shaft	44T	21	29.95	57	84.5	628											
1997.08- -	250125	Drive Shaft		21	23	57	84.5	713.5											
1997.08- -	250112	Drive Shaft	26T	21	29.95	57	84.5	630.7											
1997.08- -	250177	Drive Shaft		21	29.95	57	84.5	625.7											
1997.08- -	299072	Drive Shaft	44T	21	23	57	84.5	720											
1.2 (44 kW)																			
1998.07- 2001.07	250526	Drive Shaft	26T	21	23	52.3	84.5	724											
1998.07- 2001.07	250395	Drive Shaft	26T	21	23	51.5	83	728											
1998.07- 2001.07	250356	Drive Shaft	26T	21	29.95	51.5	83	634											
1998.07- 2001.07	250150	Drive Shaft		21	29.95	49.8	83.5	623											
1998.07- 2001.07	650008	Inner Joint		23	30	36.3	52.2	68.5											
1998.07- 2001.07	250125	Drive Shaft		21	23	57	84.5	713.5											
1.2 16V (55 kW)																			
2001.10- -	250177	Drive Shaft		21	29.95	57	84.5	625.7											
2001.10- -	299072	Drive Shaft	44T	21	23	57	84.5	720											
2001.10- -	250526	Drive Shaft	26T	21	23	52.3	84.5	724											
2001.10- -	250146	Drive Shaft		21	23	57	84.5	732.5											
2001.10- -	250261	Drive Shaft	44T	23	29.95	57.5	86.5	630											
2001.10- -	850004	Outer Joint	26T	21	30	52.2	85.5	59	I										
2001.10- -	250395	Drive Shaft	26T	21	23	51.5	83	728											
2001.10- -	650008	Inner Joint		23	30	36.3	52.2	68.5											
2001.10- -	250094	Drive Shaft		21	23	57	84.5	726											
2001.10- -	250401	Drive Shaft	44T	21	29.95	57	84	629											
2001.10- -	250339	Drive Shaft		21	23	57	84.5	718.5											
2001.10- -	250357	Drive Shaft	26T	21	23	57	84	718											
2001.10- -	250150	Drive Shaft		21	29.95	49.8	83.5	623											
2001.10- -	250109	Drive Shaft	26T	21	29.95	57	84.5	625.7											
2001.10- -	250356	Drive Shaft	26T	21	29.95	51.5	83	634											
2001.10- -	250250	Drive Shaft	26T	21	23	57	84.5	732.5											
2001.10- -	299073	Drive Shaft	44T	21	29.95	57	84.5	628											
2001.10- -	250112	Drive Shaft	26T	21	29.95	57	84.5	630.7											
1.2 BiFuel (43 kW)																			
1998.07- 2001.07	250526	Drive Shaft	26T	21	23	52.3	84.5	724											
1998.07- 2001.07	250395	Drive Shaft	26T	21	23	51.5	83	728											
1998.07- 2001.07	250356	Drive Shaft	26T	21	29.95	51.5	83	634											
1998.07- 2001.07	250150	Drive Shaft		21	29.95	49.8	83.5	623											
1.4 (55 kW)																			
1997.08- -	250525	Drive Shaft	44T	21	23	52.2	85.5	741											
1997.08- -	250526	Drive Shaft	26T	21	23	52.3	84.5	724											
1997.08- -	299150	Drive Shaft	26T	21	23	52.2	85.5	747											
1997.08- -	299242	Drive Shaft	44T	21	26	52.2	85.5	621											
1997.08- -	250146	Drive Shaft		21	23	57	84.5	732.5											
1997.08- -	250004	Drive Shaft	26T	21	29.95	57	84.5	625.7											
1997.08- -	250519	Drive Shaft	44T	21	26	52.2	85.5	609											
1997.08- -	250485	Drive Shaft	44T	21	23	52.2	85.5	733											
1997.08- -	250261	Drive Shaft	44T	23	29.95	57.5	86.5	630											
1997.08- -	250579	Drive Shaft	26T	21	26	52.2	85.5	613											
1997.08- -	250588	Drive Shaft	26T	21	23	57	84	739											
1997.08- -	250395	Drive Shaft	26T	21	23	51.5	83	728											
1997.08- -	850004	Outer Joint	26T	21	30	52.2	85.5	59	I										
1997.08- -	650008	Inner Joint		23	30	36.3	52.2	68.5											
1997.08- -	250401	Drive Shaft	44T	21	29.95	57	84	629											
1997.08- -	250339	Drive Shaft		21	23	57	84.5	718.5											
1997.08- -	250109	Drive Shaft	26T	21	29.95	57	84.5	625.7											
1997.08- -	250357	Drive Shaft	26T	21	23	57	84	718											
1997.08- -	250150	Drive Shaft		21	29.95	49.8	83.5	623											
1997.08- -	250356	Drive Shaft	26T	21	29.95	51.5	83	634											
1997.08- -	299169	Drive Shaft	26T	21	26	52.2	85.5	621											
1997.08- -	250486	Drive Shaft	26T	21	23	52.2	85.5	733											
1997.08- -	250250	Drive Shaft	26T	21	23	57	84.5	732.5											
1997.08- -	250063	Drive Shaft		21	23	51.5	83	720											
1997.08- -	250125	Drive Shaft		21	23	57	84.5	713.5											
1997.08- -	250112	Drive Shaft	26T	21	29.95	57	84.5	630.7											
1997.08- -	250177	Drive Shaft		21	29.95	57	84.5	625.7											
1.5 dCi (42 kW)																			
2002.12- -	250177	Drive Shaft		21	29.95	57	84.5	625.7											
2002.12- -	299072	Drive Shaft	44T	21	23	57	84.5	720											
2002.12- -	250146	Drive Shaft		21	23	57	84.5	732.5											

YEAR	TRANSM	L/R	F/R	REMARKS	GSP Ref.	PRODUCT	ABS	Technical Specifications									
								A	B	C	H	L	P				
RENAULT																	
KANGOO Express (FC0/1_)																	
1.5 dCi (42 kW)																	
2002.12-	-	-	R	F	Box Engine K9K 704	250245	Drive Shaft	44T	21	23	52.5	85	726				
2002.12-	-	-	L	F	Box Engine K9K 704	850106	Outer Joint	26T	23	30	57.5	86.5	58.5	I			
2002.12-	-	-	L	F	Box Engine K9K 704	250261	Drive Shaft	44T	23	29.95	57.5	86.5	630				
2002.12-	-	-	L	F	Box Engine K9K 704	250394	Drive Shaft		23	29.95	57.5	86.5	631				
2002.12-	-	MT	R	F	Box Engine K9K 704	250395	Drive Shaft	26T	21	23	51.5	83	728				
2002.12-	-	MT	R	F	Box Engine K9K 704	650008	Inner Joint		23	30	36.3	52.2	68.5				
2002.12-	-	MT	L	F	Box Engine K9K 704	250401	Drive Shaft	44T	21	29.95	57	84	629				
2002.12-	-	MT	R	F	Box Engine K9K 704	250339	Drive Shaft		21	23	57	84.5	718.5				
2002.12-	-	MT	L	F	Box Engine K9K 704	250398	Drive Shaft		21	29.95	50	84	632				
2002.12-	-	MT	L	F	Box Engine K9K 704	250109	Drive Shaft	26T	21	29.95	57	84.5	625.7				
2002.12-	-	MT	L	F	Box Engine K9K 704	250356	Drive Shaft	26T	21	29.95	51.5	83	634				
2002.12-	-	MT	R	F	Box Engine K9K 704	250260	Drive Shaft	44T	23	23	57.5	86.5	724				
2002.12-	-	-	L	F	Box Engine K9K 704	250194	Drive Shaft	26T	23	29.95	57.5	86.5	631				
2002.12-	-	MT	R	F	Box Engine K9K 704	250250	Drive Shaft	26T	21	23	57	84.5	732.5				
2002.12-	-	MT	L	F	Box Engine K9K 704	299073	Drive Shaft	44T	21	29.95	57	84.5	628				
1.5 dCi (45 kW)																	
2005.10-	-	-	R	F	Box Engine K9K 716	650086	Inner Joint		26	33	33	326	94				
2005.10-	-	MT	R	F	Box Engine K9K 716	250146	Drive Shaft		21	23	57	84.5	732.5				
2005.10-	-	MT	R	F	Box Engine K9K 716	250245	Drive Shaft	44T	21	23	52.5	85	726				
2005.10-	-	MT	L	F	Box Engine K9K 716	250261	Drive Shaft	44T	23	29.95	57.5	86.5	630				
2005.10-	-	MT	L	F	Box Engine K9K 716	250109	Drive Shaft	26T	21	29.95	57	84.5	625.7				
2005.10-	-	MT	L	F	Box Engine K9K 716	250401	Drive Shaft	44T	21	29.95	57	84	629				
2005.10-	-	MT	R	F	Box Engine K9K 716	250250	Drive Shaft	26T	21	23	57	84.5	732.5				
2005.10-	-	MT	L	F	Box Engine K9K 716	299073	Drive Shaft	44T	21	29.95	57	84.5	628				
2005.10-	-	-	R	F	Box Engine K9K 716	250515	Drive Shaft	44T	23	26	57.5	86.5	866				
2005.10-	-	MT	R	F	Box Engine K9K 716	650008	Inner Joint		23	30	36.3	52.2	68.5				
2005.10-	-	MT	L	F	Box Engine K9K 716	250177	Drive Shaft		21	29.95	57	84.5	625.7				
2005.10-	-	MT	R	F	Box Engine K9K 716	299072	Drive Shaft	44T	21	23	57	84.5	720				
1.5 dCi (48 kW)																	
2001.12-	-	-	L	F	Box Engine K9K 700/K9K 702/K9K 704	250411	Drive Shaft	44T	23	29.95	57.5	86.5	631				
2001.12-	-	MT	L	F	Box Engine K9K 700/K9K 702/K9K 704	250177	Drive Shaft		21	29.95	57.5	84.5	625.7				
2001.12-	-	MT	R	F	Box Engine K9K 700/K9K 702/K9K 704	299072	Drive Shaft	44T	21	23	57	84.5	720				
2001.12-	-	MT	R	F	Box Engine K9K 700/K9K 702/K9K 704	250146	Drive Shaft		21	23	57	84.5	732.5				
2001.12-	-	-	L	F	Box Engine K9K 700/K9K 702/K9K 704	250004	Drive Shaft	26T	21	29.95	57	84.5	625.7				
2001.12-	-	-	R	F	Box Engine K9K 700/K9K 702/K9K 704	250245	Drive Shaft	44T	21	23	52.5	85	726				
2001.12-	-	-	L	F	Box Engine K9K 700/K9K 702/K9K 704	850106	Outer Joint	26T	23	30	57.5	86.5	58.5	I			
2001.12-	-	-	R	F	Box Engine K9K 700/K9K 702/K9K 704	250017	Drive Shaft	26T	21	23	51.5	83	715				
2001.12-	-	-	L	F	Box Engine K9K 700/K9K 702/K9K 704	250261	Drive Shaft	44T	23	29.95	57.5	86.5	630				
2001.12-	-	-	L	F	Box Engine K9K 700/K9K 702/K9K 704	250394	Drive Shaft		23	29.95	57.5	86.5	631				
2001.12-	-	MT	L/R	F	Box Engine K9K 700/K9K 702/K9K 704	850004	Outer Joint	26T	21	30	52.2	85.5	59	I			
2001.12-	-	MT	R	F	Box Engine K9K 700/K9K 702/K9K 704	250395	Drive Shaft	26T	21	23	51.5	83	728				
2001.12-	-	MT	R	F	Box Engine K9K 700/K9K 702/K9K 704	650008	Inner Joint		23	30	36.3	52.2	68.5				
2001.12-	-	-	L	F	Box Engine K9K 700/K9K 702/K9K 704	250401	Drive Shaft	44T	21	29.95	57	84	629				
2001.12-	-	MT	R	F	Box Engine K9K 700/K9K 702/K9K 704	250339	Drive Shaft		21	23	57	84.5	718.5				
2001.12-	-	MT	L	F	Box Engine K9K 700/K9K 702/K9K 704	250398	Drive Shaft		21	29.95	50	84	632				
2001.12-	-	MT	L	F	Box Engine K9K 700/K9K 702/K9K 704	250109	Drive Shaft	26T	21	29.95	57	84.5	625.7				
2001.12-	-	-	L	F	Box Engine K9K 700/K9K 702/K9K 704	250150	Drive Shaft		21	29.95	49.8	83.5	623				
2001.12-	-	MT	L	F	Box Engine K9K 700/K9K 702/K9K 704	250356	Drive Shaft	26T	21	29.95	51.5	83	634				
2001.12-	-	-	L	F	Box Engine K9K 700/K9K 702/K9K 704	250194	Drive Shaft	26T	23	29.95	57.5	86.5	631				
2001.12-	-	MT	R	F	Box Engine K9K 700/K9K 702/K9K 704	250250	Drive Shaft	26T	21	23	57	84.5	732.5				
2001.12-	-	MT	L	F	Box Engine K9K 700/K9K 702/K9K 704	299073	Drive Shaft	44T	21	29.95	57	84.5	628				
2001.12-	-	-	L	F	Box Engine K9K 700/K9K 702/K9K 704	250112	Drive Shaft	26T	21	29.95	57	84.5	630.7				
1.5 dCi (50 kW)																	
2005.06-	-	-	L	F	Box Engine K9K 714	650085	Inner Joint		26	33	40	64	123				
2005.06-	-	MT	L	F	Box Engine K9K 714	250177	Drive Shaft		21	29.95	57	84.5	625.7				
2005.06-	-	MT	R	F	Box Engine K9K 714	299072	Drive Shaft	44T	21	23	57	84.5	720				
2005.06-	-	-	R	F	Box Engine K9K 714	650086	Inner Joint		26	33	33	326	94				
2005.06-	-	-	R	F	Box Engine K9K 714	250571	Drive Shaft	44T	23	26	57.3	84.5	868				
2005.06-	-	MT	L/R	F	Box Engine K9K 714	850069	Outer Joint	44T	23	30	57.5	86.5	58.5	I			
2005.06-	-	MT	R	F	Box Engine K9K 714	250146	Drive Shaft		21	23	57	84.5	732.5				
2005.06-	-	MT	L	F	Box Engine K9K 714	250376	Drive Shaft		23	26	57.5	86.5	606				
2005.06-	-	-	-	F	Box Engine K9K 714	850052	Outer Joint	44T	23	30	57.5	86.5	58.5	I			
2005.06-	-	MT	R	F	Box Engine K9K 714	699169	Inner Joint		26	30	33	326	95				
2005.06-	-	MT	R	F	Box Engine K9K 714	899087	Outer Joint		23	30	57.5	86.5	58.5	I			
2005.06-	-	MT	R	F	Box Engine K9K 714	250364	Drive Shaft	44T	23	26	57.5	86.5	866				
2005.06-	-	MT	L	F	Box Engine K9K 714	250109	Drive Shaft	26T	21	29.95	57	84.5	625.7				
2005.06-	-	-	L	F	Box Engine K9K 714	250514	Drive Shaft	44T	23	26	57.5	86.5	606				
2005.06-	-	-	R	F	Box Engine K9K 714	250515	Drive Shaft	44T	23	26	57.5	86.5	866				
2005.06-	-	MT	R	F	Box Engine K9K 714	250250	Drive Shaft	26T	21	23	57	84.5	732.5				

REMARKS	YEAR	TRANSM	L/R	F/R	GSP Ref.	PRODUCT	ABS	Technical Specifications							
								A	B	C	H	L	P		
RENAULT															
KANGOO Express (FC0/1_)															
1.5 dCi (50 kW)	2005.06-	-	MT	R	F	Box Engine K9K 714	250375	Drive Shaft		23	26	57.5	86.5	866	
	2005.06-	-	MT	L	F	Box Engine K9K 714	299073	Drive Shaft	44T	21	29.95	57	84.5	628	
1.5 dCi (60 kW)	2003.04-	-	-	L	F	Box Engine K9K 702/K9K 710	250411	Drive Shaft	44T	23	29.95	57.5	86.5	631	
	2003.04-	-	MT	L/R	F	Box Engine K9K 702/K9K 710	850069	Outer Joint	44T	23	30	57.5	86.5	58.5	I
	2003.04-	-	MT	R	F	Box Engine K9K 702/K9K 710	650008	Inner Joint		23	30	36.3	52.2	68.5	
	2003.04-	-	-	L	F	Box Engine K9K 702/K9K 710	250261	Drive Shaft	44T	23	29.95	57.5	86.5	630	
	2003.04-	-	MT	R	F	Box Engine K9K 702/K9K 710	850106	Outer Joint	26T	23	30	57.5	86.5	58.5	I
	2003.04-	-	MT	R	F	Box Engine K9K 702/K9K 710	899087	Outer Joint		23	30	57.5	86.5	58.5	I
	2003.04-	-	MT	L	F	Box Engine K9K 702/K9K 710	250394	Drive Shaft		23	29.95	57.5	86.5	631	
	2003.04-	-	MT	L	F	Box Engine K9K 702/K9K 710	250401	Drive Shaft	44T	21	29.95	57	84	629	
	2003.04-	-	MT	R	F	Box Engine K9K 702/K9K 710	250193	Drive Shaft	26T	23	23	57.5	86.5	724	
	2003.04-	-	MT	R	F	Box Engine K9K 702/K9K 710	250462	Drive Shaft		23	23	57.5	86.5	724	
	2003.04-	-	MT	R	F	Box Engine K9K 702/K9K 710	250260	Drive Shaft	44T	23	23	57.5	86.5	724	
	2003.04-	-	MT	L	F	Box Engine K9K 702/K9K 710	250194	Drive Shaft	26T	23	29.95	57.5	86.5	631	
1.5 dCi (62 kW)	2005.06-	-	-	L	F	Box Engine K9K 718	650085	Inner Joint		26	33	40	64	123	
	2005.06-	-	-	R	F	Box Engine K9K 718	650086	Inner Joint		26	33	33	326	94	
	2005.06-	-	MT	L	F	Box Engine K9K 718	250376	Drive Shaft		23	26	57.5	86.5	606	
	2005.06-	-	-	-	F	Box Engine K9K 718	850052	Outer Joint	44T	23	30	57.5	86.5	58.5	I
	2005.06-	-	MT	R	F	Box Engine K9K 718	699169	Inner Joint		26	30	33	326	95	
	2005.06-	-	MT	R	F	Box Engine K9K 718	899087	Outer Joint		23	30	57.5	86.5	58.5	I
	2005.06-	-	MT	R	F	Box Engine K9K 718	250364	Drive Shaft	44T	23	26	57.5	86.5	866	
	2005.06-	-	-	L	F	Box Engine K9K 718	250514	Drive Shaft	44T	23	26	57.5	86.5	606	
	2005.06-	-	-	R	F	Box Engine K9K 718	250515	Drive Shaft	44T	23	26	57.5	86.5	866	
	2005.06-	-	MT	R	F	Box Engine K9K 718	250375	Drive Shaft		23	26	57.5	86.5	866	
1.6 16V (70 kW)	2001.10-	-	-	L	F	Box Engine K4M 706/K4M 752	250411	Drive Shaft	44T	23	29.95	57.5	86.5	631	
	2001.10-	-	MT	R	F	Box Engine K4M 706/K4M 752	250146	Drive Shaft		21	23	57	84.5	732.5	
	2001.10-	-	-	R	F	Box Engine K4M 706/K4M 752	250151	Drive Shaft		21	23	49.8	83.5	712	
	2001.10-	-	AT	L	F	Box Engine K4M 706/K4M 752	299242	Drive Shaft	44T	21	26	52.2	85.5	621	
	2001.10-	-	-	L	F	Box Engine K4M 706/K4M 752	250004	Drive Shaft	26T	21	29.95	57	84.5	625.7	
	2001.10-	-	-	L	F	All-wheel Drive Box Engine K4M 750/K4M 752/K4M 753	250519	Drive Shaft	44T	21	26	52.2	85.5	609	
	2001.10-	-	-	L	F	Box Engine K4M 706/K4M 752	250519	Drive Shaft	44T	21	26	52.2	85.5	609	
	2001.10-	-	AT	R	F	Box Engine K4M 706/K4M 752	250485	Drive Shaft	44T	21	23	52.2	85.5	733	
	2001.10-	-	-	L	F	Box Engine K4M 706/K4M 752	250261	Drive Shaft	44T	23	29.95	57.5	86.5	630	
	2001.10-	-	MT	-	R	All-wheel Drive Box Engine K4M 750/K4M 752/K4M 753	850222	Outer Joint	44T	23	21	59	83.5	53	I
	2001.10-	-	MT	R	F	Box Engine K4M 706/K4M 752	250395	Drive Shaft	26T	21	23	51.5	83	728	
	2001.10-	-	MT	L/R	F	Box Engine K4M 706/K4M 752	850004	Outer Joint	26T	21	30	52.2	85.5	59	I
	2001.10-	-	MT	R	F	All-wheel Drive Box Engine K4M 750/K4M 752/K4M 753	650008	Inner Joint		23	30	36.3	52.2	68.5	
	2001.10-	-	MT	R	F	Box Engine K4M 706/K4M 752	650008	Inner Joint		23	30	36.3	52.2	68.5	
	2001.10-	-	-	L	F	Box Engine K4M 706/K4M 752	250401	Drive Shaft	44T	21	29.95	57	84	629	
	2001.10-	-	MT	L	F	Box Engine K4M 706/K4M 752	250109	Drive Shaft	26T	21	29.95	57	84.5	625.7	
	2001.10-	-	MT	R	F	Box Engine K4M 706/K4M 752	250339	Drive Shaft		21	23	57	84.5	718.5	
	2001.10-	-	MT	R	F	Box Engine K4M 706/K4M 752	250357	Drive Shaft	26T	21	23	57	84	718	
	2001.10-	-	MT	L	F	Box Engine K4M 706/K4M 752	250150	Drive Shaft		21	29.95	49.8	83.5	623	
	2001.10-	-	AT	L	F	Box Engine K4M 706/K4M 752	299169	Drive Shaft	26T	21	26	52.2	85.5	621	
	2001.10-	-	MT	R	F	Box Engine K4M 706/K4M 752	250250	Drive Shaft	26T	21	23	57	84.5	732.5	
	2001.10-	-	AT	R	F	Box Engine K4M 706/K4M 752	250486	Drive Shaft	26T	21	23	52.2	85.5	733	
	2001.10-	-	-	L	F	All-wheel Drive Box Engine K4M 750/K4M 752/K4M 753	250506	Drive Shaft	44T	23	29.95	58.8	85	645	
	2001.10-	-	-	L/R	R	All-wheel Drive Box Engine K4M 750/K4M 752/K4M 753	250627	Drive Shaft	44T	23	21	59	83.5	755	
	2001.10-	-	MT	L	F	Box Engine K4M 706/K4M 752	250177	Drive Shaft		21	29.95	57	84.5	625.7	
	2001.10-	-	-	L	F	Box Engine K4M 706/K4M 752	250112	Drive Shaft	26T	21	29.95	57	84.5	630.7	
	2001.10-	-	-	L	F	All-wheel Drive Box Engine K4M 750/K4M 752/K4M 753	250112	Drive Shaft	26T	21	29.95	57	84.5	630.7	
1.9 D (48 kW)	1999.09-	2003.06	MT	L	F	Box Engine F8Q 632	250177	Drive Shaft		21	29.95	57	84.5	625.7	
	1999.09-	2003.06	MT	R	F	Box Engine F8Q 632	299072	Drive Shaft	44T	21	23	57	84.5	720	
	1999.09-	2003.06	MT	R	F	Box Engine F8Q 632	250146	Drive Shaft		21	23	57	84.5	732.5	
	1999.09-	2003.06	-	L	F	Box Engine F8Q 632	250261	Drive Shaft	44T	23	29.95	57.5	86.5	630	
	1999.09-	2003.06	-	R	F	Box Engine F8Q 632	250094	Drive Shaft		21	23	57	84.5	726	
	1999.09-	2003.06	-	R	F	Box Engine F8Q 632	250395	Drive Shaft	26T	21	23	51.5	83	728	
	1999.09-	2003.06	-	L	F	Box Engine F8Q 632	250401	Drive Shaft	44T	21	29.95	57	84	629	
	1999.09-	2003.06	-	L	F	Box Engine F8Q 632	250356	Drive Shaft	26T	21	29.95	51.5	83	634	
	1999.09-	2003.06	MT	L	F	Box Engine F8Q 632	250109	Drive Shaft	26T	21	29.95	57	84.5	625.7	
	1999.09-	2003.06	-	L	F	Box Engine F8Q 632	250150	Drive Shaft		21	29.95	49.8	83.5	623	
	1999.09-	2003.06	-	R	F	Box Engine F8Q 632	250063	Drive Shaft		21	23	51.5	83	720	
	1999.09-	2003.06	MT	R	F	Box Engine F8Q 632	250250	Drive Shaft	26T	21	23	57	84.5	732.5	
	1999.09-	2003.06	MT	R	F	Box Engine F8Q 632	250180	Drive Shaft		21	23	57	84.5	724.5	
	1999.09-	2003.06	MT	L	F	Box Engine F8Q 632	299073	Drive Shaft	44T	21	29.95	57	84.5	628	
	1999.09-	2003.06	MT	R	F	Box Engine F8Q 632	650008	Inner Joint		23	30	36.3	52.2	68.5	





REMARKS	YEAR	TRANSM	L/R	F/R	GSP Ref.	PRODUCT	ABS	Technical Specifications							
								A	B	C	H	L	P		
RENAULT															
KANGOO Express (FC0/1_)															
1.9 D (48 kW)	1999.09-	2003.06	MT	R	F	Box Engine F8Q 632	250125	Drive Shaft		21	23	57	84.5	713.5	
1.9 dCi (59 kW)	2001.10-	-	-	R	F	All-wheel Drive Box Engine F9Q 782/F9Q 790	250527	Drive Shaft	44T	23	23	58.8	85	739	
	2001.10-	-	MT	-	R	All-wheel Drive Box Engine F9Q 782/F9Q 790	850222	Outer Joint	44T	23	21	59	83.5	53	I
	2001.10-	-	MT	R	F	All-wheel Drive Box Engine F9Q 782/F9Q 790	650008	Inner Joint		23	30	36.3	52.2	68.5	
	2001.10-	-	-	R	F	All-wheel Drive Box Engine F9Q 782/F9Q 790	650079	Inner Joint		23	22	36.3	50	55.5	
	2001.10-	-	-	L	F	All-wheel Drive Box Engine F9Q 782/F9Q 790	250506	Drive Shaft	44T	23	29.95	58.8	85	645	
	2001.10-	-	-	L/R	R	All-wheel Drive Box Engine F9Q 782/F9Q 790	250627	Drive Shaft	44T	23	21	59	83.5	755	
1.9 dCi (62 kW)	2001.10-	-	-	L	F	All-wheel Drive Box Engine F9Q 782/F9Q 790	250112	Drive Shaft	26T	21	29.95	57	84.5	630.7	
	2003.07-	-	-	L	F	Box Engine F9Q 782/F9Q 790	250411	Drive Shaft	44T	23	29.95	57.5	86.5	631	
	2003.07-	-	-	L	F	Box Engine F9Q 782/F9Q 790	250261	Drive Shaft	44T	23	29.95	57.5	86.5	630	
	2003.07-	-	MT	-	R	All-wheel Drive Box Engine F9Q 790	850222	Outer Joint	44T	23	21	59	83.5	53	I
	2003.07-	-	MT	R	F	All-wheel Drive Box Engine F9Q 790	650008	Inner Joint		23	30	36.3	52.2	68.5	
	2003.07-	-	-	L	F	Box Engine F9Q 782/F9Q 790	250401	Drive Shaft	44T	21	29.95	57	84	629	
1.9 dTi (59 kW)	2003.07-	-	-	L	F	All-wheel Drive Box Engine F9Q 790	250506	Drive Shaft	44T	23	29.95	58.8	85	645	
	2003.07-	-	-	L/R	R	All-wheel Drive Box Engine F9Q 790	250627	Drive Shaft	44T	23	21	59	83.5	755	
	2000.02-	-	MT	L	F	Box Engine F9Q 780	250177	Drive Shaft		21	29.95	57	84.5	625.7	
	2000.02-	-	MT	R	F	Box Engine F9Q 780	299072	Drive Shaft	44T	21	23	57	84.5	720	
	2000.02-	-	MT	R	F	Box Engine F9Q 780	250146	Drive Shaft		21	23	57	84.5	732.5	
	2000.02-	-	-	L	F	Box Engine F9Q 780	250004	Drive Shaft	26T	21	29.95	57	84.5	625.7	
	2000.02-	-	-	L	F	Box Engine F9Q 780	250261	Drive Shaft	44T	23	29.95	57.5	86.5	630	
	2000.02-	-	-	R	F	Box Engine F9Q 780	250017	Drive Shaft	26T	21	23	51.5	83	715	
	2000.02-	-	MT	L/R	F	Box Engine F9Q 780	850004	Outer Joint	26T	21	30	52.2	85.5	59	I
	2000.02-	-	MT	R	F	Box Engine F9Q 780	250395	Drive Shaft	26T	21	23	51.5	83	728	
	2000.02-	-	MT	R	F	Box Engine F9Q 780	650008	Inner Joint		23	30	36.3	52.2	68.5	
	2000.02-	-	-	L	F	Box Engine F9Q 780	250401	Drive Shaft	44T	21	29.95	57	84	629	
	2000.02-	-	MT	R	F	Box Engine F9Q 780	250339	Drive Shaft		21	23	57	84.5	718.5	
	2000.02-	-	MT	L	F	Box Engine F9Q 780	250398	Drive Shaft		21	29.95	50	84	632	
	2000.02-	-	MT	L	F	Box Engine F9Q 780	250109	Drive Shaft	26T	21	29.95	57	84.5	625.7	
	2000.02-	-	-	L	F	Box Engine F9Q 780	250150	Drive Shaft		21	29.95	49.8	83.5	623	
2000.02-	-	MT	L	F	Box Engine F9Q 780	250356	Drive Shaft	26T	21	29.95	51.5	83	634		
2000.02-	-	MT	R	F	Box Engine F9Q 780	250250	Drive Shaft	26T	21	23	57	84.5	732.5		
2000.02-	-	MT	L	F	Box Engine F9Q 780	299073	Drive Shaft	44T	21	29.95	57	84.5	628		
D 55 1.9 (40 kW)	1997.08-	-	MT	R	F	Box Engine F8Q 662	250146	Drive Shaft		21	23	57	84.5	732.5	
	1997.08-	-	-	L	F	Box Engine F8Q 662	250004	Drive Shaft	26T	21	29.95	57	84.5	625.7	
	1997.08-	-	-	R	F	Box Engine F8Q 662	250017	Drive Shaft	26T	21	23	51.5	83	715	
	1997.08-	-	MT	R	F	Box Engine F8Q 662	250395	Drive Shaft	26T	21	23	51.5	83	728	
	1997.08-	-	AT/MT	L/R	F	Box Engine F8Q 662	850004	Outer Joint	26T	21	30	52.2	85.5	59	I
	1997.08-	-	MT	R	F	Box Engine F8Q 662	650008	Inner Joint		23	30	36.3	52.2	68.5	
	1997.08-	-	MT	R	F	Box Engine F8Q 662	250339	Drive Shaft		21	23	57	84.5	718.5	
	1997.08-	-	MT	L	F	Box Engine F8Q 662	250109	Drive Shaft	26T	21	29.95	57	84.5	625.7	
	1997.08-	-	MT	L	F	Box Engine F8Q 662	250398	Drive Shaft		21	29.95	50	84	632	
	1997.08-	-	MT	R	F	Box Engine F8Q 662	250357	Drive Shaft	26T	21	23	57	84	718	
	1997.08-	-	MT	L	F	Box Engine F8Q 662	250356	Drive Shaft	26T	21	29.95	51.5	83	634	
	1997.08-	-	-	L	F	Box Engine F8Q 662	250150	Drive Shaft		21	29.95	49.8	83.5	623	
	1997.08-	-	MT	R	F	Box Engine F8Q 662	250250	Drive Shaft	26T	21	23	57	84.5	732.5	
	1997.08-	-	MT	L	F	Box Engine F8Q 662	299073	Drive Shaft	44T	21	29.95	57	84.5	628	
	1997.08-	-	-	R	F	Box Engine F8Q 662	250063	Drive Shaft		21	23	51.5	83	720	
	1997.08-	-	MT	R	F	Box Engine F8Q 662	250180	Drive Shaft		21	23	57	84.5	724.5	
	1997.08-	-	MT	R	F	Box Engine F8Q 662	250125	Drive Shaft		21	23	57	84.5	713.5	
	1997.08-	-	-	L	F	Box Engine F8Q 662	250112	Drive Shaft	26T	21	29.95	57	84.5	630.7	
	1997.08-	-	MT	L	F	Box Engine F8Q 662	250177	Drive Shaft		21	29.95	57	84.5	625.7	
	1997.08-	-	MT	R	F	Box Engine F8Q 662	299072	Drive Shaft	44T	21	23	57	84.5	720	
D 65 1.9 (47 kW)	1997.08-	-	5MT	L	F	Box Engine F8Q 630/F8Q 632	250411	Drive Shaft	44T	23	29.95	57.5	86.5	631	
	1997.08-	-	MT	R	F	Box Engine F8Q 630/F8Q 632	250146	Drive Shaft		21	23	57	84.5	732.5	
	1997.08-	-	5MT	L	F	Box Engine F8Q 630/F8Q 632	250004	Drive Shaft	26T	21	29.95	57	84.5	625.7	
	1997.08-	-	5MT	R	F	Box Engine F8Q 630/F8Q 632	250017	Drive Shaft	26T	21	23	51.5	83	715	
	1997.08-	-	5MT	L	F	Box Engine F8Q 630/F8Q 632	250261	Drive Shaft	44T	23	29.95	57.5	86.5	630	
	1997.08-	-	MT	R	F	Box Engine F8Q 630/F8Q 632	250395	Drive Shaft	26T	21	23	51.5	83	728	
	1997.08-	-	AT/MT	L/R	F	Box Engine F8Q 630/F8Q 632	850004	Outer Joint	26T	21	30	52.2	85.5	59	I
	1997.08-	-	MT	R	F	Box Engine F8Q 630/F8Q 632	650008	Inner Joint		23	30	36.3	52.2	68.5	
	1997.08-	-	-	R	F	Box Engine F8Q 630/F8Q 632	250094	Drive Shaft		21	23	57	84.5	726	
	1997.08-	-	5MT	L	F	Box Engine F8Q 630/F8Q 632	250401	Drive Shaft	44T	21	29.95	57	84	629	
	1997.08-	-	MT	R	F	Box Engine F8Q 630/F8Q 632	250339	Drive Shaft		21	23	57	84.5	718.5	
	1997.08-	-	MT	L	F	Box Engine F8Q 630/F8Q 632	250109	Drive Shaft	26T	21	29.95	57	84.5	625.7	
	1997.08-	-	MT	L	F	Box Engine F8Q 630/F8Q 632	250398	Drive Shaft		21	29.95	50	84	632	
	1997.08-	-	MT	R	F	Box Engine F8Q 630/F8Q 632	250357	Drive Shaft	26T	21	23	57	84	718	





REMARKS	YEAR	TRANSM	L/R	F/R	GSP Ref.	PRODUCT	ABS	Technical Specifications						
								A	B	C	H	L	P	
RENAULT														
KANGOO Express (FC0/1_)														
D 65 1.9 (47 kW)	1997.08-	5MT	L	F	Box Engine F8Q 630/F8Q 632	250150	Drive Shaft		21	29.95	49.8	83.5	623	
	1997.08-	5MT	L	F	Box Engine F8Q 630/F8Q 632	250523	Drive Shaft	26T	23		58.8	85	641	
	1997.08-	MT	L	F	Box Engine F8Q 630/F8Q 632	250356	Drive Shaft	26T	21	29.95	51.5	83	634	
	1997.08-	MT	R	F	Box Engine F8Q 630/F8Q 632	250250	Drive Shaft	26T	21	23	57	84.5	732.5	
	1997.08-	MT	L	F	Box Engine F8Q 630/F8Q 632	299073	Drive Shaft	44T	21	29.95	57	84.5	628	
	1997.08-	-	R	F	Box Engine F8Q 630/F8Q 632	250063	Drive Shaft		21	23	51.5	83	720	
	1997.08-	MT	R	F	Box Engine F8Q 630/F8Q 632	250180	Drive Shaft		21	23	57	84.5	724.5	
	1997.08-	MT	R	F	Box Engine F8Q 630/F8Q 632	250125	Drive Shaft		21	23	57	84.5	713.5	
	1997.08-	-	L	F	Box Engine F8Q 630/F8Q 632	250112	Drive Shaft	26T	21	29.95	57	84.5	630.7	
	1997.08-	MT	L	F	Box Engine F8Q 630/F8Q 632	250177	Drive Shaft		21	29.95	57	84.5	625.7	
	1997.08-	MT	R	F	Box Engine F8Q 630/F8Q 632	299072	Drive Shaft	44T	21	23	57	84.5	720	
KANGOO Express (FW0/1_)														
1.5 dCi (50 kW)	2008.02-	5MT	L	F	Box Engine K9K 800	250541	Drive Shaft		23	26	49	83.5	913	
	2008.02-	-	R	F	Box Engine K9K 800	650137	Inner joint		26	22	33	330	96.5	
	2008.02-	MT	L/R	F	Box Engine K9K 800	850136	Outer Joint		27	22	56.7	91	55	I
	2008.02-	-	R	F	Box Engine K9K 800	699169	Inner Joint		26	30	33	326	95	
	2008.02-	-	-	-	Box Engine K9K 800	250612	Drive Shaft		27	26	56.7	91	918	
	2008.02-	MT	L	F	Box Engine K9K 800	299228	Drive Shaft		27	26	56.7	91	675	
	2008.02-	-	L	F	Box Engine K9K 800	299070	Drive Shaft		23	26	49	86	675	
	2008.02-	MT	R	F	Box Engine K9K 800	299229	Drive Shaft		27	26	56.7	91	920	
1.5 dCi (76 kW)	2008.02-	-	L	F	Box Engine K9K 806	250423	Drive Shaft		27	26	56.7	91	680	
1.5 dCi 110 (80 kW)	2010.09-	-	L	F	Box Engine K9K 804	250423	Drive Shaft		27	26	56.7	91	680	
1.5 dCi 110 (81 kW)	2013.09-	MT	L	F	Box Engine K9K 636	250423	Drive Shaft		27	26	56.7	91	680	
1.5 dCi 75 (55 kW)	2010.09-	MT	L/R	F	Box Engine K9K 608/K9K 808	850136	Outer Joint		27	22	56.7	91	55	I
	2010.09-	-	R	F	Box Engine K9K 608/K9K 808	699169	Inner Joint		26	30	33	326	95	
	2010.09-	-	L	F	Box Engine K9K 608/K9K 808	299228	Drive Shaft		27	26	56.7	91	675	
	2010.09-	-	L	F	Box Engine K9K 608/K9K 808	299070	Drive Shaft		23	26	49	86	675	
	2010.09-	-	R	F	Box Engine K9K 608/K9K 808	299229	Drive Shaft		27	26	56.7	91	920	
1.5 dCi 85 (63 kW)	2008.02-	-	R	F	Box Engine K9K 800/K9K 802	650137	Inner joint		26	22	33	330	96.5	
	2008.02-	-	R	F	Box Engine K9K 800/K9K 802	699169	Inner Joint		26	30	33	326	95	
	2008.02-	MT	L/R	F	Box Engine K9K 800/K9K 802	850136	Outer Joint		27	22	56.7	91	55	I
	2008.02-	-	-	-	Box Engine K9K 800/K9K 802	250612	Drive Shaft		27	26	56.7	91	918	
	2008.02-	-	L	F	Box Engine K9K 800/K9K 802	299228	Drive Shaft		27	26	56.7	91	675	
	2008.02-	-	L	F	Box Engine K9K 800/K9K 802	299070	Drive Shaft		23	26	49	86	675	
	2008.02-	-	R	F	Box Engine K9K 800/K9K 802	299229	Drive Shaft		27	26	56.7	91	920	
1.5 dCi 90 (66 kW)	2009.06-	-	R	F	Box Engine K9K 608/K9K 808	650137	Inner joint		26	22	33	330	96.5	
	2009.06-	MT	L/R	F	Box Engine K9K 608/K9K 808	850136	Outer Joint		27	22	56.7	91	55	I
	2009.06-	MT	R	F	Box Engine K9K 608/K9K 808	699169	Inner Joint		26	30	33	326	95	
	2009.06-	-	-	-	Box Engine K9K 608/K9K 808	250612	Drive Shaft		27	26	56.7	91	918	
	2009.06-	MT	L	F	Box Engine K9K 608/K9K 808	299228	Drive Shaft		27	26	56.7	91	675	
	2009.06-	MT	L	F	Box Engine K9K 608/K9K 808	299070	Drive Shaft		23	26	49	86	675	
	2009.06-	MT	R	F	Box Engine K9K 608/K9K 808	299229	Drive Shaft		27	26	56.7	91	920	
1.6 (64 kW)	2008.02-	-	R	F	Box Engine K7M 750	250541	Drive Shaft		23	26	49	83.5	913	
	2008.02-	-	R	F	Box Engine K7M 750	650137	Inner joint		26	22	33	330	96.5	
	2008.02-	-	R	F	Box Engine K7M 750	850168	Outer Joint		23	30	49	83.5	54.5	I
	2008.02-	-	R	F	Box Engine K7M 750	699169	Inner Joint		26	30	33	326	95	
	2008.02-	MT	L/R	F	Box Engine K7M 750	850136	Outer Joint		27	22	56.7	91	55	I
	2008.02-	-	-	-	Box Engine K7M 750	250612	Drive Shaft		27	26	56.7	91	918	
	2008.02-	MT	L	F	Box Engine K7M 750	299228	Drive Shaft		27	26	56.7	91	675	
	2008.02-	-	L	F	Box Engine K7M 750	299070	Drive Shaft		23	26	49	86	675	
	2008.02-	MT	R	F	Box Engine K7M 750	299229	Drive Shaft		27	26	56.7	91	920	
1.6 16V (78 kW)	2008.02-	-	R	F	Box Engine K4M 830	650137	Inner joint		26	22	33	330	96.5	
	2008.02-	MT	R	F	Box Engine K4M 830	699169	Inner Joint		26	30	33	326	95	
	2008.02-	MT	L/R	F	Box Engine K4M 830	850136	Outer Joint		27	22	56.7	91	55	I
	2008.02-	-	R	F	Box Engine K4M 830	250612	Drive Shaft		27	23	56.7	91	816	
	2008.02-	-	-	-	Box Engine K4M 830	250612	Drive Shaft		27	26	56.7	91	918	
	2008.02-	MT	L	F	Box Engine K4M 830	299228	Drive Shaft		27	26	56.7	91	675	
	2008.02-	MT	L	F	Box Engine K4M 830	299070	Drive Shaft		23	26	49	86	675	
	2008.02-	MT	R	F	Box Engine K4M 830	299229	Drive Shaft		27	26	56.7	91	920	
1.6 16V LPG (72 kW)	2008.02-	-	R	F	Box Engine K4M 834	650137	Inner joint		26	22	33	330	96.5	
	2008.02-	MT	R	F	Box Engine K4M 834	699169	Inner Joint		26	30	33	326	95	
	2008.02-	MT	L/R	F	Box Engine K4M 834	850136	Outer Joint		27	22	56.7	91	55	I
	2008.02-	-	-	-	Box Engine K4M 834	250612	Drive Shaft		27	26	56.7	91	918	
	2008.02-	MT	L	F	Box Engine K4M 834	299228	Drive Shaft		27	26	56.7	91	675	
	2008.02-	MT	L	F	Box Engine K4M 834	299070	Drive Shaft		23	26	49	86	675	
	2008.02-	MT	R	F	Box Engine K4M 834	299229	Drive Shaft		27	26	56.7	91	920	

	 YEAR	TRANSM	L/R	F/R	REMARKS	GSP Ref.	 PRODUCT	 ABS	Technical Specifications						
									A	B	C	H	L	P	
RENAULT KANGOO MPV															
1.2 16V	2002.01-	-	MT	R	-	-	250092	Drive Shaft		21	23	57	84.5	719	
1.4 8V	1999.10-	2003.04	AT	L	F	-	250216	Drive Shaft	26T	21	26	57	84.5	617	
	1999.10-	2003.04	AT	R	F	-	250233	Drive Shaft	26T	21	23	57	84.5	737	
	1999.10-	-	MT	R	-	-	250092	Drive Shaft		21	23	57	84.5	719	
1.9 D	1999.10-	-	MT	R	-	-	250092	Drive Shaft		21	23	57	84.5	719	
1.9 DTi	2001.03-	-	MT	R	-	-	250092	Drive Shaft		21	23	57	84.5	719	
KANGOO VAN															
1.2	1998.05-	1999.09	MT	L	-	-	250018	Drive Shaft		21	29.95	57	85	622.5	
	1998.05-	1999.09	MT	R	F	-	250164	Drive Shaft		21	23	57	84.5	714.5	
1.9 D	1998.05-	1999.09	MT	L	-	-	250018	Drive Shaft		21	29.95	57	85	622.5	
	1998.05-	1999.09	MT	R	F	-	250164	Drive Shaft		21	23	57	84.5	714.5	
KANGOO/GRAND KANGOO															
1.6 16V(78kW)	2008-	2018	-	L	F	MPV	650040	Inner Joint		26	30	43	42.5	83	
	2008-	2018	-	L	F	MPV	650040	Inner Joint		26	30	43	42.5	83	
	2008-	2018	-	L	F	MPV	650040	Inner Joint		26	30	43	42.5	83	
	2008-	2018	-	L	F	MPV	650040	Inner Joint		26	30	43	42.5	83	
	2008-	2018	-	L	F	MPV	650040	Inner Joint		26	30	43	42.5	83	
	2008-	2018	-	L	F	MPV	650040	Inner Joint		26	30	43	42.5	83	
	2008-	2018	-	L	F	MPV	650040	Inner Joint		26	30	43	42.5	83	
	2008-	2018	-	L	F	MPV	650040	Inner Joint		26	30	43	42.5	83	
	2008-	2018	-	L	F	MPV	650040	Inner Joint		26	30	43	42.5	83	
	2008-	2018	-	L	F	MPV	650040	Inner Joint		26	30	43	42.5	83	
	2008-	2018	-	L	F	MPV	650040	Inner Joint		26	30	43	42.5	83	
	2008-	2018	-	L	F	MPV	650040	Inner Joint		26	30	43	42.5	83	
	2008-	2018	-	L	F	MPV	650040	Inner Joint		26	30	43	42.5	83	
	2008-	2018	-	L	F	MPV	650040	Inner Joint		26	30	43	42.5	83	
	2008-	2018	-	L	F	MPV	650040	Inner Joint		26	30	43	42.5	83	
	2008-	2018	-	L	F	MPV	650040	Inner Joint		26	30	43	42.5	83	
	2008-	2018	-	L	F	MPV	650040	Inner Joint		26	30	43	42.5	83	
	2008-	2018	-	L	F	MPV	650040	Inner Joint		26	30	43	42.5	83	
	KANGOO/GRAND KANGOO (KW01_)														
	1.5 dCi (50 kW)	2008.02-	-	-	R	F	MPV Engine K9K 714/K9K 800/K9K 840	650137	Inner joint		26	22	33	330	96.5
2008.02-		-	MT/6MT	L/R	F	MPV Engine K9K 714/K9K 800/K9K 840	850136	Outer Joint		27	22	56.7	91	55	I
2008.02-		-	-	R	F	MPV Engine K9K 714/K9K 800/K9K 840	699169	Inner Joint		26	30	33	326	95	
2008.02-		-	-	-	-	MPV Engine K9K 714/K9K 800/K9K 840	250612	Drive Shaft		27	26	56.7	91	918	
2008.02-		-	MT	L	F	MPV Engine K9K 714/K9K 800/K9K 840	299228	Drive Shaft		27	26	56.7	91	675	
2008.02-		-	-	L	F	MPV Engine K9K 714/K9K 800/K9K 840	299070	Drive Shaft		23	26	49	86	675	
2008.02-		-	MT	R	F	MPV Engine K9K 714/K9K 800/K9K 840	299229	Drive Shaft		27	26	56.7	91	920	
2008.02-		-	-	-	-	-	299229	Drive Shaft		27	26	56.7	91	920	
1.5 dCi (55 kW)	2012.11-	-	-	R	F	MPV Engine K9K 608/K9K 802	699169	Inner Joint		26	30	33	326	95	
	2012.11-	-	-	R	F	MPV Engine K9K 608/K9K 802	299229	Drive Shaft		27	26	56.7	91	920	
1.5 dCi (63 kW)	2008.02-	-	-	R	F	MPV Engine K9K 802	650137	Inner joint		26	22	33	330	96.5	
	2008.02-	-	MT	L/R	F	MPV Engine K9K 802	850136	Outer Joint		27	22	56.7	91	55	I
	2008.02-	-	-	R	F	MPV Engine K9K 802	699169	Inner Joint		26	30	33	326	95	
	2008.02-	-	-	-	-	MPV Engine K9K 802	250612	Drive Shaft		27	26	56.7	91	918	
	2008.02-	-	-	L	F	MPV Engine K9K 802	299228	Drive Shaft		27	26	56.7	91	675	
	2008.02-	-	-	L	F	MPV Engine K9K 802	299070	Drive Shaft		23	26	49	86	675	
	2008.02-	-	-	R	F	MPV Engine K9K 802	299229	Drive Shaft		27	26	56.7	91	920	
1.5 dCi (66 kW)	2012.11-	-	-	R	F	MPV Engine K9K 808	699169	Inner Joint		26	30	33	326	95	
	2012.11-	-	-	R	F	MPV Engine K9K 808	299229	Drive Shaft		27	26	56.7	91	920	
1.5 dCi (76 kW)	2008.02-	-	-	L	F	MPV Engine K9K 804/K9K 806	250423	Drive Shaft		27	26	56.7	91	680	
	2008.02-	-	-	R	F	MPV Engine K9K 804/K9K 806	250422	Drive Shaft		27	26	56.7	91	922	
	2008.02-	-	MT	L/R	F	MPV Engine K9K 804/K9K 806	850136	Outer Joint		27	22	56.7	91	55	I
1.5 dCi (78 kW)	2008.02-	-	MT	L	F	MPV Engine K9K 804	250423	Drive Shaft		27	26	56.7	91	680	
1.5 dCi 110 (80 kW)	2010.09-	-	-	L	F	MPV Engine K9K 804	250423	Drive Shaft		27	26	56.7	91	680	
1.6 (64 kW)	2008.02-	-	-	R	F	MPV Engine K7M 750	250541	Drive Shaft		23	26	49	83.5	913	
	2008.02-	-	-	R	F	MPV Engine K7M 750	650137	Inner joint		26	22	33	330	96.5	
	2008.02-	-	-	R	F	MPV Engine K7M 750	850168	Outer Joint		23	30	49	83.5	54.5	I
	2008.02-	-	MT	L/R	F	MPV Engine K7M 750	850136	Outer Joint		27	22	56.7	91	55	I
	2008.02-	-	-	R	F	MPV Engine K7M 750	699169	Inner Joint		26	30	33	326	95	
	2008.02-	-	-	-	-	MPV Engine K7M 750	250612	Drive Shaft		27	26	56.7	91	918	
	2008.02-	-	MT	L	F	MPV Engine K7M 750	299228	Drive Shaft		27	26	56.7	91	675	
2008.02-	-	MT	R	F	MPV Engine K7M 750	299229	Drive Shaft		27	26	56.7	91	920		

REMARKS	YEAR	TRANSM	L/R	F/R	GSP Ref.	PRODUCT	ABS	Technical Specifications							
								A	B	C	H	L	P		
RENAULT															
KANGOO/GRAND KANGOO (KW0/1_)															
1.6 (64 kW)	2008.02-	-	-	L	F	MPV Engine K7M 750	299070	Drive Shaft		23	26	49	86	675	
1.6 16V (78 kW)	2008.02-	-	-	R	F	MPV Engine K4M 830/K4M 831	650137	Inner joint		26	22	33	330	96.5	
	2008.02-	-	MT	L/R	F	MPV Engine K4M 830/K4M 831	850136	Outer Joint		27	22	56.7	91	55	I
	2008.02-	-	MT	R	F	MPV Engine K4M 830/K4M 831	699169	Inner Joint		26	30	33	326	95	
	2008.02-	-	-	-	-	MPV Engine K4M 830/K4M 831	250612	Drive Shaft		27	26	56.7	91	918	
	2008.02-	-	-	R	F	MPV Engine K4M 830/K4M 831	250616	Drive Shaft		27	23	56.7	91	816	
	2008.02-	-	MT	L	F	MPV Engine K4M 830/K4M 831	299228	Drive Shaft		27	26	56.7	91	675	
	2008.02-	-	MT	L	F	MPV Engine K4M 830/K4M 831	299070	Drive Shaft		23	26	49	86	675	
	2008.02-	-	MT	R	F	MPV Engine K4M 830/K4M 831	299229	Drive Shaft		27	26	56.7	91	920	
1.6 16V Hi-Flex (78 kW)	2008.02-	-	-	R	F	MPV Engine K4M 834/K4M 850	650137	Inner joint		26	22	33	330	96.5	
	2008.02-	-	MT	L/R	F	MPV Engine K4M 834/K4M 850	850136	Outer Joint		27	22	56.7	91	55	I
	2008.02-	-	MT	R	F	MPV Engine K4M 834/K4M 850	699169	Inner Joint		26	30	33	326	95	
	2008.02-	-	-	-	-	MPV Engine K4M 834/K4M 850	250612	Drive Shaft		27	26	56.7	91	918	
	2008.02-	-	MT	L	F	MPV Engine K4M 834/K4M 850	299228	Drive Shaft		27	26	56.7	91	675	
	2008.02-	-	MT	L	F	MPV Engine K4M 834/K4M 850	299070	Drive Shaft		23	26	49	86	675	
	2008.02-	-	MT	R	F	MPV Engine K4M 834/K4M 850	299229	Drive Shaft		27	26	56.7	91	920	
	2008.02-	-	MT	R	F	MPV Engine K4M 834	299229	Drive Shaft		27	26	56.7	91	920	
1.6 16V LPG (78 kW)	2008.12-	-	MT	R	F	MPV Engine K4M 834	699169	Inner Joint		26	30	33	326	95	
	2008.12-	-	MT	L	F	MPV Engine K4M 834	299228	Drive Shaft		27	26	56.7	91	675	
	2008.12-	-	MT	L	F	MPV Engine K4M 834	299070	Drive Shaft		23	26	49	86	675	
	2008.12-	-	MT	R	F	MPV Engine K4M 834	299229	Drive Shaft		27	26	56.7	91	920	
KOLEOS I (HY_)															
2.0 dCi (110 kW)	2008.09-	-	6MT	R	F	Renault Drive Closed Off-Road Vehicle Engine M9R 830, M9R 830, M9R 830, M9R 830, M9R 830, M9R 830, M9R 830, M9R 830	641131	Inner Joint		29	29	33	482	100	
	2008.09-	-	-	-	-	Renault Drive Closed Off-Road Vehicle Engine M9R 830, M9R 830, M9R 830, M9R 830, M9R 830, M9R 830, M9R 830, M9R 830	241538	Drive Shaft	48T	25	21	56	110.5	801	
	2008.09-	-	AT	R	F	Renault Drive Closed Off-Road Vehicle Engine M9R 830, M9R 830, M9R 830, M9R 830, M9R 830, M9R 830, M9R 830, M9R 830	241475	Drive Shaft		29	30	56	102	971	
	2008.09-	-	6MT	L	F	Renault Drive Closed Off-Road Vehicle Engine M9R 830, M9R 830, M9R 830, M9R 830, M9R 830, M9R 830, M9R 830, M9R 830	241454	Drive Shaft		29	29	56	103.5	619	
	2008.09-	-	-	-	F	Renault Drive Closed Off-Road Vehicle Engine M9R 830, M9R 830, M9R 830, M9R 830, M9R 830, M9R 830, M9R 830, M9R 830	841249	Outer Joint		29	36	56	102	72	I
	2008.09-	-	AT	L	F	Closed Off-Road Vehicle Engine M9R 855, M9R 856, M9R 862, M9R 865, M9R 866	241365	Drive Shaft		29	30	56	102	650	
	2008.09-	-	AT	L	F	Renault Drive Closed Off-Road Vehicle Engine M9R 830, M9R 830, M9R 830, M9R 830, M9R 830, M9R 830, M9R 830, M9R 830	241365	Drive Shaft		29	30	56	102	650	
	2008.09-	-	6MT	R	F	Renault Drive Closed Off-Road Vehicle Engine M9R 830, M9R 830, M9R 830, M9R 830, M9R 830, M9R 830, M9R 830, M9R 830	241441	Drive Shaft		29	29	56	102	1009	
2.0 dCi (127 kW)	2008.09-	-	MT	R	F	All-wheel Drive Closed Off-Road Vehicle Engine M9R 830	641131	Inner Joint		29	29	33	482	100	
	2008.09-	-	-	-	-	All-wheel Drive Closed Off-Road Vehicle Engine M9R 830	241538	Drive Shaft	48T	25	21	56	110.5	801	
	2008.09-	-	6MT	L	F	All-wheel Drive Closed Off-Road Vehicle Engine M9R 830	241454	Drive Shaft		29	29	56	103.5	619	
	2008.09-	-	AT	L	F	All-wheel Drive Closed Off-Road Vehicle Engine M9R 830	241365	Drive Shaft		29	30	56	102	650	
	2008.09-	-	MT	R	F	All-wheel Drive Closed Off-Road Vehicle Engine M9R 830	241441	Drive Shaft		29	29	56	102	1009	
	2008.09-	-	AT/MT	-	R	All-wheel Drive Closed Off-Road Vehicle Engine 2TR 700/2TR 702/2TR 703	241538	Drive Shaft	48T	25	21	56	110.5	801	
KWID															
-	-	-	-	-	-	-	201721	Drive Shaft		23	27	46.2	77.5	811	
1.0	2018-	-	-	-	-	-	201722	Drive Shaft		23	27	46.2	77.5	621	
LAGUNA															
1.8/2.0	1993-	2001	-	-	-	-	850135	Outer Joint		23	25	56.3	84	61.5	O
2.2 D	1994-	-	-	-	-	-	850046	Outer Joint	44T	23	29	57.5	83.5	62	O
3.0 V6	1994-	-	-	-	-	-	850046	Outer Joint	44T	23	29	57.5	83.5	62	O
LAGUNA (DT0/1)															
1.5 dCi (81 kW)	2012.03-	-	-	-	F	Coupe Engine K9K 846	850130	Outer Joint		27	33	56.7	91	61	I
	2012.03-	-	MT	L	F	Coupe Engine K9K 846	250378	Drive Shaft		27	26	56.7	91	687	
	2012.03-	-	6MT	R	F	Coupe Engine K9K 846	250377	Drive Shaft		27	26	56.7	91	940	
2.0 16V Turbo (125 kW)	2008.09-	-	AT	-	-	Coupe Engine F4R 811/F4Rt 811	250413	Drive Shaft		27	26	56.5	92	824	
	2008.09-	-	-	L	F	Coupe Engine F4R 811/F4Rt 811	250626	Drive Shaft		27	30	56.7	86.5	642	
2.0 dCi (110 kW)	2008.09-	-	AT	-	F	Coupe Engine M9R 802/M9R 805/M9R 814	850131	Outer Joint		27	36	56.7	86.5	66	I
	2008.09-	-	MT	R	F	Coupe Engine M9R 802/M9R 805/M9R 814	250380	Drive Shaft		27	39	56.7	86.5	985	
	2008.09-	-	MT	L	F	Coupe Engine M9R 802/M9R 805/M9R 814	250496	Drive Shaft		27	39	56.5	90.5	640	
	2008.09-	-	-	L/R	F	Coupe Engine M9R 802/M9R 805/M9R 814	850161	Outer Joint		27	36	56.7	87	62	I
	2008.09-	-	-	L	F	Coupe Engine M9R 802/M9R 805/M9R 814	250626	Drive Shaft		27	30	56.7	86.5	642	
	2008.09-	-	AT	R	F	Coupe Engine M9R 802/M9R 805/M9R 814	250596	Drive Shaft		27	30	56.7	86.5	959	
2.0 dCi (127 kW)	2008.09-	-	-	-	F	Coupe Engine M9R 800/M9R 809/M9R 815	850131	Outer Joint		27	36	56.7	86.5	66	I
	2008.09-	-	-	R	F	Coupe Engine M9R 800/M9R 809/M9R 815	250380	Drive Shaft		27	39	56.7	86.5	985	
	2008.09-	-	-	L	F	Coupe Engine M9R 800/M9R 809/M9R 815	250496	Drive Shaft		27	39	56.5	90.5	640	
	2008.09-	-	-	L/R	F	Coupe Engine M9R 800/M9R 809/M9R 815	850161	Outer Joint		27	36	56.7	87	62	I
	2008.09-	-	-	L	F	Coupe Engine M9R 800/M9R 809/M9R 815	250626	Drive Shaft		27	30	56.7	86.5	642	
	2008.09-	-	-	R	F	Coupe Engine M9R 800/M9R 809/M9R 815	250596	Drive Shaft		27	30	56.7	86.5	959	
2.0 dCi GT (131 kW)	2008.09-	-	-	-	F	Coupe Engine M9R 816/M9R 820	850131	Outer Joint		27	36	56.7	86.5	66	I
	2008.09-	-	-	-	F	Coupe Engine M9R 816/M9R 820	850080	Outer Joint		27	37	56.5	92	73	I
	2008.09-	-	-	L	F	Coupe Engine M9R 816/M9R 820	250496	Drive Shaft		27	39	56.5	90.5	640	
	2008.09-	-	MT	L	F	Coupe Engine M9R 816/M9R 820	650071	Inner Joint		39	35	39	74	102.5	
	2008.09-	-	-	L/R	F	Coupe Engine M9R 816/M9R 820	850161	Outer Joint		27	36	56.7	87	62	I





REMARKS	YEAR	TRANSM	L/R	F/R	GSP Ref.	PRODUCT	ABS	Technical Specifications								
								A	B	C	H	L	P			
RENAULT LAGUNA (DT0/1)																
2.0 GT (150 kW)	2008.09-	-	-	-	F	Coupe Engine F4R 800	850131	Outer Joint		27	36	56.7	86.5	66	I	
LAGUNA I (B56_ 556_)																
1.6 16V (79 kW)	1997.11-2001.03	-	-	F	Hatchback Engine K4M 720/K4M 724	899084	Outer Joint		23	29	56	80	63	O		
	1997.11-2001.03	-	L	F	Hatchback Engine K4M 720/K4M 724	250197	Drive Shaft		23	29.95	56.3	85	706			
	1997.11-2001.03	MT	L	F	Hatchback Engine K4M 720/K4M 724	250096	Drive Shaft		23	29.95	56	84	700			
	1997.11-2001.03	MT	R	F	Hatchback Engine K4M 720/K4M 724	250189	Drive Shaft		23	23	57.5	86.5	742			
	1997.11-2001.03	-	-	F	Hatchback Engine K4M 720/K4M 724	899086	Outer Joint		23	32	56.3	85	62.5	I		
	1997.11-2001.03	-	-	F	Hatchback Engine K4M 720/K4M 724	850025	Outer Joint		23	25	56	84	61	O		
	1997.11-2001.03	-	R	F	Hatchback Engine K4M 720/K4M 724	650008	Inner Joint		23	30	36.3	52.2	68.5			
1.8 (66 kW)	1993.11-2001.03	MT	R	F	Hatchback Engine F3P 720/F3P 724	250046	Drive Shaft		23	23	56.2	83.5	748			
	1993.11-2001.03	-	-	-	Hatchback Engine F3P 720/F3P 724	850051	Outer Joint	48T	23	25	56.3	80	58	O		
	1993.11-2001.03	MT	L	F	Hatchback Engine F3P 720/F3P 724	250093	Drive Shaft		23	29.95	56.3	80	700			
	1993.11-2001.03	MT	L/R	F	Hatchback Engine F3P 720/F3P 724	850008	Outer Joint		21	25	56.2	83.5	58	O		
	1993.11-2001.03	MT	R	F	Hatchback Engine F3P 720/F3P 724	250134	Drive Shaft	44T	23	23	56.2	83.5	748			
	1993.11-2001.03	-	L	F	Hatchback Engine F3P 720/F3P 724	250075	Drive Shaft	44T	21	29.95	56.2	83.5	703			
	1993.11-2001.03	MT	L/R	F	Hatchback Engine F3P 720/F3P 724	850026	Outer Joint		23	25	56.2	83.5	58	O		
	1993.11-2001.03	-	R	F	Hatchback Engine F3P 720/F3P 724	250053	Drive Shaft		21	23	56.2	83.5	751			
	1993.11-2001.03	MT	R	F	Hatchback Engine F3P 720/F3P 724	250035	Drive Shaft		21	23	50	85	751			
	1993.11-2001.03	MT	L	F	Hatchback Engine F3P 720/F3P 724	250034	Drive Shaft		21	29.95	56.2	83.5	699			
	1993.11-2001.03	-	L	F	Hatchback Engine F3P 720/F3P 724	250309	Drive Shaft		21	29.95	56.2	83.5	702			
	1993.11-2001.03	-	R	F	Hatchback Engine F3P 720/F3P 724	250310	Drive Shaft		21	23	56.2	83.5	747			
	1993.11-2001.03	MT	L	F	Hatchback Engine F3P 720/F3P 724	250026	Drive Shaft	44T	23	29.95	57.5	83.5	702			
	1993.11-2001.03	-	-	F	Hatchback Engine F3P 720/F3P 724	850005	Outer Joint	44T	23	25	56.3	84	61.5	O		
	1995.08-2001.03	-	-	-	Hatchback Engine F3P 670/F3P 678	850051	Outer Joint	48T	23	25	56.3	80	58	O		
	1995.08-2001.03	-	L	F	Hatchback Engine F3P 670/F3P 678	250075	Drive Shaft	44T	21	29.95	56.2	83.5	703			
	1995.08-2001.03	-	R	F	Hatchback Engine F3P 670/F3P 678	250053	Drive Shaft		21	23	56.2	83.5	751			
	1995.08-2001.03	MT	R	F	Hatchback Engine F3P 670/F3P 678	250035	Drive Shaft		21	23	50	85	751			
	1995.08-2001.03	MT	L	F	Hatchback Engine F3P 670/F3P 678	250034	Drive Shaft		21	29.95	56.2	83.5	699			
	1995.08-2001.03	-	L	F	Hatchback Engine F3P 670/F3P 678	250309	Drive Shaft		21	29.95	56.2	83.5	702			
	1995.08-2001.03	-	R	F	Hatchback Engine F3P 670/F3P 678	250310	Drive Shaft		21	23	56.2	83.5	747			
	1995.08-2001.03	MT	L	F	Hatchback Engine F3P 670/F3P 678	250026	Drive Shaft	44T	23	29.95	57.5	83.5	702			
1.8 (69 kW)	1995.08-2001.03	MT	R	F	Hatchback Engine F3P 720/F3P 724	250046	Drive Shaft		23	23	56.2	83.5	748			
	1995.08-2001.03	-	-	-	Hatchback Engine F3P 720/F3P 724	850051	Outer Joint	48T	23	25	56.3	80	58	O		
	1995.08-2001.03	MT	L	F	Hatchback Engine F3P 720/F3P 724	250093	Drive Shaft		23	29.95	56.3	80	700			
	1995.08-2001.03	MT	L/R	F	Hatchback Engine F3P 720/F3P 724	850008	Outer Joint		21	25	56.2	83.5	58	O		
	1995.08-2001.03	MT	R	F	Hatchback Engine F3P 720/F3P 724	250134	Drive Shaft	44T	23	23	56.2	83.5	748			
	1995.08-2001.03	-	L	F	Hatchback Engine F3P 720/F3P 724	250075	Drive Shaft	44T	21	29.95	56.2	83.5	703			
	1995.08-2001.03	MT	L/R	F	Hatchback Engine F3P 720/F3P 724	850026	Outer Joint		23	25	56.2	83.5	58	O		
	1995.08-2001.03	-	R	F	Hatchback Engine F3P 720/F3P 724	250035	Drive Shaft		21	23	50	85	751			
	1995.08-2001.03	-	R	F	Hatchback Engine F3P 720/F3P 724	250053	Drive Shaft		21	23	56.2	83.5	751			
	1995.08-2001.03	-	L	F	Hatchback Engine F3P 720/F3P 724	250309	Drive Shaft		21	29.95	56.2	83.5	702			
	1995.08-2001.03	-	R	F	Hatchback Engine F3P 720/F3P 724	250310	Drive Shaft		21	23	56.2	83.5	747			
1.8 (70 kW)	1995.06-1998.06	-	-	F	Hatchback Engine F3P 678	899088	Outer Joint		21	29	57.4	82	63	O		
	1995.06-1998.06	-	-	F	Hatchback Engine F3P 676	899088	Outer Joint		21	29	57.4	82	63	O		
	1995.06-1998.06	-	L	F	Hatchback Engine F3P 676	250075	Drive Shaft	44T	21	29.95	56.2	83.5	703			
	1995.06-1998.06	-	-	F	Hatchback Engine F3P 678	850068	Outer Joint	44T	23	25	56.2	83.5	58	O		
	1995.06-1998.06	-	-	F	Hatchback Engine F3P 676	850068	Outer Joint	44T	23	25	56.2	83.5	58	O		
	1995.06-1998.06	-	-	F	Hatchback Engine F3P 678	850015	Outer Joint		23	29	56.3	80	63	O		
	1995.06-1998.06	-	-	F	Hatchback Engine F3P 676	850015	Outer Joint		23	29	56.3	80	63	O		
1.8 16V (88 kW)	1998.04-2001.03	-	-	F	Hatchback Engine F4P 760/F4P 770	899084	Outer Joint		23	29	56	80	63	O		
	1998.04-2001.03	-	L	F	Hatchback Engine F4P 760/F4P 770	250197	Drive Shaft		23	29.95	56.3	85	706			
	1998.04-2001.03	MT	L	F	Hatchback Engine F4P 760/F4P 770	250096	Drive Shaft		23	29.95	56	84	700			
	1998.04-2001.03	MT	R	F	Hatchback Engine F4P 760/F4P 770	250189	Drive Shaft		23	23	57.5	86.5	742			
	1998.04-2001.03	-	-	F	Hatchback Engine F4P 760/F4P 770	899086	Outer Joint		23	32	56.3	85	62.5	I		
	1998.04-2001.03	-	-	F	Hatchback Engine F4P 760/F4P 770	850025	Outer Joint		23	25	56	84	61	O		
	1998.04-2001.03	-	R	F	Hatchback Engine F4P 760/F4P 770	650008	Inner Joint		23	30	36.3	52.2	68.5			
1.9 dCi (79 kW)	1999.09-2001.03	-	-	F	Hatchback Engine F9Q 718	850025	Outer Joint		23	25	56	84	61	O		
1.9 dTi (72 kW)	1997.10-2001.03	-	-	F	Hatchback Engine F9Q 710/F9Q 716/F9Q 717	899084	Outer Joint		23	29	56	80	63	O		
	1997.10-2001.03	MT	L	F	Hatchback Engine F9Q 710/F9Q 716/F9Q 717	250197	Drive Shaft		23	29.95	56.3	85	706			
	1997.10-2001.03	MT	L	F	Hatchback Engine F9Q 710/F9Q 716/F9Q 717	250096	Drive Shaft		23	29.95	56	84	700			
	1997.10-2001.03	MT	R	F	Hatchback Engine F9Q 710/F9Q 716/F9Q 717	250189	Drive Shaft		23	23	57.5	86.5	742			
	1997.10-2001.03	MT	R	F	Hatchback Engine F9Q 710/F9Q 716/F9Q 717	250043	Drive Shaft		23	23	56	84	747			
	1997.10-2001.03	-	-	F	Hatchback Engine F9Q 710/F9Q 716/F9Q 717	899086	Outer Joint		23	32	56.3	85	62.5	I		
	1997.10-2001.03	-	-	F	Hatchback Engine F9Q 710/F9Q 716/F9Q 717	850025	Outer Joint		23	25	56	84	61	O		
	1997.10-2001.03	MT	R	F	Hatchback Engine F9Q 710/F9Q 716/F9Q 717	650008	Inner Joint		23	30	36.3	52.2	68.5			
2.0 (102 kW)	1999.09-2001.02	AT	-	-	Hatchback Engine F4R 780	250413	Drive Shaft		27	26	56.5	92	824			

		 YEAR	TRANSM	L/R	F/R	REMARKS	GSP Ref.	 PRODUCT	 ABS	Technical Specifications					
										A	B	C	H	L	P
RENAULT															
LAGUNA I (B56_ 556_)															
2.0 (103 kW)		1995.06-2001.02	AT	R	-	Hatchback Engine N7Q 700/N7Q 704	250413	Drive Shaft		27	26	56.5	92	824	
		1995.06-2001.02	MT	R	F	Hatchback Engine N7Q 700/N7Q 704	250132	Drive Shaft		23	23	57.5	83.5	801	
		1995.06-2001.02	MT	L	F	Hatchback Engine N7Q 700/N7Q 704	250130	Drive Shaft		23	29.95	56.2	83.5	658.5	
2.0 (80 kW)		1999.03-2001.03	-	L	F	Hatchback Engine F3R 611	250075	Drive Shaft	44T	21	29.95	56.2	83.5	703	
		1999.03-2001.03	-	R	F	Hatchback Engine F3R 611	250035	Drive Shaft		21	23	50	85	751	
		1999.03-2001.03	-	R	F	Hatchback Engine F3R 611	250053	Drive Shaft		21	23	56.2	83.5	751	
		1999.03-2001.03	-	L	F	Hatchback Engine F3R 611	250309	Drive Shaft		21	29.95	56.2	83.5	702	
		1999.03-2001.03	-	R	F	Hatchback Engine F3R 611	250310	Drive Shaft		21	23	56.2	83.5	747	
		1999.03-2001.03	AT	R	-	Hatchback Engine F3R 611	250413	Drive Shaft		27	26	56.5	92	824	
2.0 (83 kW)		1993.11-2001.03	-	-	F	Hatchback Engine F3R 722/F3R 723	899088	Outer Joint		21	29	57.4	82	63	O
		1993.11-2001.03	MT	R	F	Hatchback Engine F3R 722/F3R 723	250046	Drive Shaft		23	23	56.2	83.5	748	
		1993.11-2001.03	-	-	F	Hatchback Engine F3R 722/F3R 723	899084	Outer Joint		23	29	56	80	63	O
		1993.11-2001.03	-	-	-	Hatchback Engine F3R 722/F3R 723	850051	Outer Joint	48T	23	25	56.3	80	58	O
		1993.11-2001.03	MT	L	F	Hatchback Engine F3R 722/F3R 723	250093	Drive Shaft		23	29.95	56.3	80	700	
		1993.11-2001.03	MT	L/R	F	Hatchback Engine F3R 722/F3R 723	850008	Outer Joint		21	25	56.2	83.5	58	O
		1993.11-2001.03	MT	R	F	Hatchback Engine F3R 722/F3R 723	250134	Drive Shaft	44T	23	23	56.2	83.5	748	
		1993.11-2001.03	-	L	F	Hatchback Engine F3R 722/F3R 723	250075	Drive Shaft	44T	21	29.95	56.2	83.5	703	
		1993.11-2001.03	MT	L	F	Hatchback Engine F3R 722/F3R 723	250096	Drive Shaft		23	29.95	56	84	700	
		1993.11-2001.03	-	R	F	Hatchback Engine F3R 722/F3R 723	250189	Drive Shaft		23	23	57.5	86.5	742	
		1993.11-2001.03	-	R	F	Hatchback Engine F3R 722/F3R 723	650008	Inner Joint		23	30	36.3	52.2	68.5	
		1993.11-2001.03	MT	L/R	F	Hatchback Engine F3R 722/F3R 723	850026	Outer Joint		23	25	56.2	83.5	58	O
		1993.11-2001.03	-	R	F	Hatchback Engine F3R 722/F3R 723	250053	Drive Shaft		21	23	56.2	83.5	751	
		1993.11-2001.03	MT	R	F	Hatchback Engine F3R 722/F3R 723	250035	Drive Shaft		21	23	50	85	751	
		1993.11-2001.03	MT	L	F	Hatchback Engine F3R 722/F3R 723	250034	Drive Shaft		21	29.95	56.2	83.5	699	
		1993.11-2001.03	-	L	F	Hatchback Engine F3R 722/F3R 723	250309	Drive Shaft		21	29.95	56.2	83.5	702	
		1993.11-2001.03	-	R	F	Hatchback Engine F3R 722/F3R 723	250310	Drive Shaft		21	23	56.2	83.5	747	
		1993.11-2001.03	MT	L	F	Hatchback Engine F3R 722/F3R 723	250026	Drive Shaft	44T	23	29.95	57.5	83.5	702	
		1993.11-2001.03	-	-	F	Hatchback Engine F3R 722/F3R 723	850025	Outer Joint		23	25	56	84	61	O
		1993.11-2001.03	-	-	F	Hatchback Engine F3R 722/F3R 723	850068	Outer Joint	44T	23	25	56.2	83.5	58	O
		1993.11-2001.03	AT	R	F	Hatchback Engine F3R 722/F3R 723	250413	Drive Shaft		27	26	56.5	92	824	
		1993.11-2001.03	-	-	F	Hatchback Engine F3R 722/F3R 723	850015	Outer Joint		23	29	56.3	80	63	O
2.0 (84 kW)		1995.06-2001.02	-	-	F	Hatchback Engine F3R 722/F3R 768	899088	Outer Joint		21	29	57.4	82	63	O
		1995.06-2001.02	-	-	F	Hatchback Engine F3R 722/F3R 768	899084	Outer Joint		23	29	56	80	63	O
		1995.06-2001.02	-	L	F	Hatchback Engine F3R 722/F3R 768	250075	Drive Shaft	44T	21	29.95	56.2	83.5	703	
		1995.06-2001.02	MT	L	F	Hatchback Engine F3R 722/F3R 768	250096	Drive Shaft		23	29.95	56	84	700	
		1995.06-2001.02	-	R	F	Hatchback Engine F3R 722/F3R 768	250189	Drive Shaft		23	23	57.5	86.5	742	
		1995.06-2001.02	-	R	F	Hatchback Engine F3R 722/F3R 768	650008	Inner Joint		23	30	36.3	52.2	68.5	
		1995.06-2001.02	-	-	F	Hatchback Engine F3R 722/F3R 768	850025	Outer Joint		23	25	56	84	61	O
		1995.06-2001.02	-	-	F	Hatchback Engine F3R 722/F3R 768	850068	Outer Joint	44T	23	25	56.2	83.5	58	O
		1995.06-2001.02	-	-	F	Hatchback Engine F3R 722/F3R 768	850015	Outer Joint		23	29	56.3	80	63	O
2.0 16V (102 kW)		1995.06-2001.03	-	-	F	Hatchback Engine N7Q 700/N7Q 704	899088	Outer Joint		21	29	57.4	82	63	O
		1995.06-2001.03	-	-	F	Hatchback Engine N7Q 700/N7Q 704	899084	Outer Joint		23	29	56	80	63	O
		1995.06-2001.03	MT	L	F	Hatchback Engine N7Q 700/N7Q 704	250096	Drive Shaft		23	29.95	56	84	700	
		1995.06-2001.03	-	R	F	Hatchback Engine N7Q 700/N7Q 704	250189	Drive Shaft		23	23	57.5	86.5	742	
		1995.06-2001.03	-	R	F	Hatchback Engine N7Q 700/N7Q 704	650008	Inner Joint		23	30	36.3	52.2	68.5	
		1995.06-2001.03	-	-	F	Hatchback Engine N7Q 700/N7Q 704	850025	Outer Joint		23	25	56	84	61	O
		1995.06-2001.03	MT	L	F	Hatchback Engine N7Q 700/N7Q 704	850008	Outer Joint	44T	23	25	56.2	83.5	58	O
		1995.06-2001.03	-	-	F	Hatchback Engine N7Q 700/N7Q 704	850015	Outer Joint		23	29	56.3	80	63	O
		1995.06-2001.03	MT	R	F	Hatchback Engine N7Q 700/N7Q 704	250132	Drive Shaft		23	23	57.5	83.5	801	
		1995.06-2001.03	MT	L	F	Hatchback Engine N7Q 700/N7Q 704	250130	Drive Shaft		23	29.95	56.2	83.5	658.5	
2.0 16V (103 kW)		1999.09-2001.03	-	L	F	Hatchback Engine F4R 780	250197	Drive Shaft		23	29.95	56.3	85	706	
		1999.09-2001.03	-	R	F	Hatchback Engine F4R 780	650008	Inner Joint		23	30	36.3	52.2	68.5	
2.2 D (61 kW)		1993.11-2001.03	-	-	F	Hatchback Engine G8T 706/G8T 752/G8T 790/G8T 794	899088	Outer Joint		21	29	57.4	82	63	O
		1993.11-2001.03	-	-	-	Hatchback Engine G8T 706/G8T 752/G8T 790/G8T 794	850051	Outer Joint	48T	23	25	56.3	80	58	O
		1993.11-2001.03	-	-	F	Hatchback Engine G8T 706/G8T 752/G8T 790/G8T 794	899084	Outer Joint		23	29	56	80	63	O
		1993.11-2001.03	MT	R	F	Hatchback Engine G8T 706/G8T 752/G8T 790/G8T 794	250133	Drive Shaft	44T	23	23	57.5	83.5	801	
		1993.11-2001.03	-	R	F	Hatchback Engine G8T 706/G8T 752/G8T 790/G8T 794	250047	Drive Shaft		23	23	55.5	82.5	795	
		1993.11-2001.03	MT	L	F	Hatchback Engine G8T 706/G8T 752/G8T 790/G8T 794	250096	Drive Shaft		23	29.95	56	84	700	
		1993.11-2001.03	MT	R	F	Hatchback Engine G8T 706/G8T 752/G8T 790/G8T 794	250189	Drive Shaft		23	23	57.5	86.5	742	
		1993.11-2001.03	MT	R	F	Hatchback Engine G8T 706/G8T 752/G8T 790/G8T 794	650008	Inner Joint		23	30	36.3	52.2	68.5	
		1993.11-2001.03	-	R	F	Hatchback Engine G8T 706/G8T 752/G8T 790/G8T 794	250047	Drive Shaft		23	23	55.5	82.5	795	
		1993.11-2001.03	MT	L	F	Hatchback Engine G8T 706/G8T 752/G8T 790/G8T 794	250301	Drive Shaft		23	29.95	56.3	85	662	
		1993.11-2001.03	-	-	F	Hatchback Engine G8T 706/G8T 752/G8T 790/G8T 794	850003	Outer Joint		23	29	57.5	83.5	62	O
		1993.11-2001.03	MT	L/R	F	Hatchback Engine G8T 706/G8T 752/G8T 790/G8T 794	850026	Outer Joint		23	25	56.2	83.5	58	O
		1993.11-2001.03	MT	R	F	Hatchback Engine G8T 706/G8T 752/G8T 790/G8T 794	250215	Drive Shaft	44T	23	23	56.2	83.5	802	

		 YEAR	TRANSM	L/R	F/R	REMARKS	GSP Ref.	 PRODUCT	 ABS	Technical Specifications					
										A	B	C	H	L	P
RENAULT															
LAGUNA I Grandtour (K56_)															
2.0 (83 kW)		1995.09-2001.03	MT	L	F	Estate Engine F3R 722/F3R 723	250096	Drive Shaft		23	29.95	56	84	700	
		1995.09-2001.03	-	R	F	Estate Engine F3R 722/F3R 723	250189	Drive Shaft		23	23	57.5	86.5	742	
		1995.09-2001.03	-	R	F	Estate Engine F3R 722/F3R 723	650008	Inner Joint		23	30	36.3	52.2	68.5	
		1995.09-2001.03	MT	L/R	F	Estate Engine F3R 722/F3R 723	850026	Outer Joint		23	25	56.2	83.5	58	O
		1995.09-2001.03	-	R	F	Estate Engine F3R 722/F3R 723	250035	Drive Shaft		21	23	50	85	751	
		1995.09-2001.03	-	R	F	Estate Engine F3R 722/F3R 723	250053	Drive Shaft		21	23	56.2	83.5	751	
		1995.09-2001.03	-	L	F	Estate Engine F3R 722/F3R 723	250309	Drive Shaft		21	29.95	56.2	83.5	702	
		1995.09-2001.03	-	R	F	Estate Engine F3R 722/F3R 723	250310	Drive Shaft		21	23	56.2	83.5	747	
		1995.09-2001.03	-	-	F	Estate Engine F3R 722/F3R 723	850025	Outer Joint		23	25	56	84	61	O
		1995.09-2001.03	MT	L	F	Estate Engine F3R 722/F3R 723	250026	Drive Shaft	44T	23	29.95	57.5	83.5	702	
		1995.09-2001.03	-	-	F	Estate Engine F3R 722/F3R 723	850068	Outer Joint	44T	23	25	56.2	83.5	58	O
		1995.09-2001.03	-	-	F	Estate Engine F3R 722/F3R 723	850015	Outer Joint		23	29	56.3	80	63	O
2.0 (84 kW)		1998.10-2001.01	-	-	F	Estate Engine F3R 728/F3R 768	899084	Outer Joint		23	29	56	80	63	O
		1998.10-2001.01	MT	L	F	Estate Engine F3R 728/F3R 768	250096	Drive Shaft		23	29.95	56	84	700	
		1998.10-2001.01	MT	R	F	Estate Engine F3R 728/F3R 768	250189	Drive Shaft		23	23	57.5	86.5	742	
		1998.10-2001.01	MT	R	F	Estate Engine F3R 728/F3R 768	650008	Inner Joint		23	30	36.3	52.2	68.5	
		1998.10-2001.01	-	-	F	Estate Engine F3R 728/F3R 768	899086	Outer Joint		23	32	56.3	85	62.5	I
		1998.10-2001.01	-	-	F	Estate Engine F3R 728/F3R 768	850025	Outer Joint		23	25	56	84	61	O
2.0 16V (102 kW)		1995.09-2001.03	-	-	F	Estate Engine N7Q 700/N7Q 704	899088	Outer Joint		21	29	57.4	82	63	O
		1995.09-2001.03	-	-	F	Estate Engine N7Q 700/N7Q 704	899084	Outer Joint		23	29	56	80	63	O
		1995.09-2001.03	MT	L	F	Estate Engine N7Q 700/N7Q 704	250096	Drive Shaft		23	29.95	56	84	700	
		1995.09-2001.03	-	R	F	Estate Engine N7Q 700/N7Q 704	250189	Drive Shaft		23	23	57.5	86.5	742	
		1995.09-2001.03	-	R	F	Estate Engine N7Q 700/N7Q 704	650008	Inner Joint		23	30	36.3	52.2	68.5	
		1995.09-2001.03	-	-	F	Estate Engine N7Q 700/N7Q 704	850025	Outer Joint		23	25	56	84	61	O
		1995.09-2001.03	MT	-	F	Estate Engine N7Q 700/N7Q 704	850005	Outer Joint	44T	23	25	56.3	84	61.5	O
		1995.09-2001.03	-	-	F	Estate Engine N7Q 700/N7Q 704	850068	Outer Joint	44T	23	25	56.2	83.5	58	O
		1995.09-2001.03	-	-	F	Estate Engine N7Q 700/N7Q 704	850015	Outer Joint		23	29	56.3	80	63	O
		1995.09-2001.03	MT	R	F	Estate Engine N7Q 700/N7Q 704	250132	Drive Shaft		23	23	57.5	83.5	801	
		1995.09-2001.03	MT	L	F	Estate Engine N7Q 700/N7Q 704	250130	Drive Shaft		23	29.95	56.2	83.5	658.5	
2.0 16V (103 kW)		1999.09-2001.03	-	-	F	Estate Engine F4R 780	899084	Outer Joint		23	29	56	80	63	O
		1999.09-2001.03	MT	L	F	Estate Engine F4R 780	250096	Drive Shaft		23	29.95	56	84	700	
		1999.09-2001.03	MT	R	F	Estate Engine F4R 780	250189	Drive Shaft		23	23	57.5	86.5	742	
		1999.09-2001.03	MT	R	F	Estate Engine F4R 780	650008	Inner Joint		23	30	36.3	52.2	68.5	
		1999.09-2001.03	-	-	F	Estate Engine F4R 780	899086	Outer Joint		23	32	56.3	85	62.5	I
		1999.09-2001.03	-	-	F	Estate Engine F4R 780	850025	Outer Joint		23	25	56	84	61	O
2.2 D (61 kW)		1995.09-2001.03	-	-	F	Estate Engine G8T 706/G8T 752/G8T 790/G8T 794	899088	Outer Joint		21	29	57.4	82	63	O
		1995.09-2001.03	-	-	F	Estate Engine G8T 706/G8T 752/G8T 790/G8T 794	850051	Outer Joint	48T	23	25	56.3	80	58	O
		1995.09-2001.03	-	-	F	Estate Engine G8T 706/G8T 752/G8T 790/G8T 794	899084	Outer Joint		23	29	56	80	63	O
		1995.09-2001.03	MT	R	F	Estate Engine G8T 706/G8T 752/G8T 790/G8T 794	250133	Drive Shaft	44T	23	23	57.5	83.5	801	
		1995.09-2001.03	-	R	F	Estate Engine G8T 706/G8T 752/G8T 790/G8T 794	250047	Drive Shaft		23	23	55.5	82.5	795	
		1995.09-2001.03	MT	L	F	Estate Engine G8T 706/G8T 752/G8T 790/G8T 794	250096	Drive Shaft		23	29.95	56	84	700	
		1995.09-2001.03	MT	R	F	Estate Engine G8T 706/G8T 752/G8T 790/G8T 794	250189	Drive Shaft		23	23	57.5	86.5	742	
		1995.09-2001.03	MT	R	F	Estate Engine G8T 706/G8T 752/G8T 790/G8T 794	650008	Inner Joint		23	30	36.3	52.2	68.5	
		1995.09-2001.03	MT	L/R	F	Estate Engine G8T 706/G8T 752/G8T 790/G8T 794	850026	Outer Joint		23	25	56.2	83.5	58	O
		1995.09-2001.03	-	R	F	Estate Engine G8T 706/G8T 752/G8T 790/G8T 794	250047	Drive Shaft		23	23	55.5	82.5	795	
		1995.09-2001.03	MT	L	F	Estate Engine G8T 706/G8T 752/G8T 790/G8T 794	250301	Drive Shaft		23	29.95	56.3	85	662	
		1995.09-2001.03	-	-	F	Estate Engine G8T 706/G8T 752/G8T 790/G8T 794	850003	Outer Joint		23	29	57.5	83.5	62	O
		1995.09-2001.03	MT	R	F	Estate Engine G8T 706/G8T 752/G8T 790/G8T 794	250215	Drive Shaft	44T	23	23	56.2	83.5	802	
		1995.09-2001.03	MT	L	F	Estate Engine G8T 706/G8T 752/G8T 790/G8T 794	250131	Drive Shaft	44T	23	29.95	56.2	83.5	658.5	
		1995.09-2001.03	MT	-	F	Estate Engine G8T 706/G8T 752/G8T 790/G8T 794	850025	Outer Joint		23	25	56	84	61	O
		1995.09-2001.03	MT	-	F	Estate Engine G8T 706/G8T 752/G8T 790/G8T 794	850005	Outer Joint	44T	23	25	56.3	84	61.5	O
		1995.09-2001.03	MT	L	F	Estate Engine G8T 706/G8T 752/G8T 790/G8T 794	250461	Drive Shaft	44T	23	29.95	56.3	84	658	
		1995.09-2001.03	MT	-	F	Estate Engine G8T 706/G8T 752/G8T 790/G8T 794	850015	Outer Joint		23	29	56.3	80	63	O
		1995.09-2001.03	MT	R	F	Estate Engine G8T 706/G8T 752/G8T 790/G8T 794	250132	Drive Shaft		23	23	57.5	83.5	801	
		1995.09-2001.03	MT	L	F	Estate Engine G8T 706/G8T 752/G8T 790/G8T 794	250130	Drive Shaft		23	29.95	56.2	83.5	658.5	
2.2 dT (83 kW)		1996.03-2001.03	-	R	F	Estate Engine G8T 760	250319	Drive Shaft		23	39	56.3	85	958	
		1996.03-2001.03	-	R	F	Estate Engine G8T 760	250319	Drive Shaft		23	39	56.3	85	958	
3.0 (123 kW)		1996.02-2001.03	-	R	F	Estate Engine Z7X 765	250319	Drive Shaft		23	39	56.3	85	958	
		1996.02-2001.03	-	R	F	Estate Engine Z7X 765	250319	Drive Shaft		23	39	56.3	85	958	
3.0 24V (140 kW)		1997.03-2001.03	-	-	F	Estate Engine L7X 700/L7X 701	899084	Outer Joint		23	29	56	80	63	O
		1997.03-2001.03	-	R	F	Estate Engine L7X 700/L7X 701	250319	Drive Shaft		23	39	56.3	85	958	
		1997.03-2001.03	-	R	F	Estate Engine L7X 700/L7X 701	250319	Drive Shaft		23	39	56.3	85	958	
		1997.03-2001.03	-	-	F	Estate Engine L7X 700/L7X 701	850025	Outer Joint		23	25	56	84	61	O
		1997.03-2001.03	MT	R	F	Estate Engine L7X 700/L7X 701	850105	Outer Joint		23	27	56.3	85	68	I
		1997.03-2001.03	MT	R	F	Estate Engine L7X 700/L7X 701	250331	Drive Shaft		23	39	56.3	85	955	
		1997.03-2001.03	-	-	F	Estate Engine L7X 700/L7X 701	850068	Outer Joint	44T	23	25	56.2	83.5	58	O

REMARKS	YEAR	TRANSM	L/R	F/R	GSP Ref.	PRODUCT	ABS	Technical Specifications								
								A	B	C	H	L	P			
RENAULT																
LAGUNA II																
2.0 16V	-	-	-	L	-	650048	Inner Joint		26	30	40	64	121			
LAGUNA II (B74, K74), SW																
1.8 16V (85 kW)	2001.03	-	-	-	-	850133	Outer Joint		27	32	56.5	92	62.5	I		
1.8 16V (88 kW)	2001.03	-	-	-	-	850133	Outer Joint		27	32	56.5	92	62.5	I		
1.8 16V (89 kW)	2001.03	-	-	-	-	850133	Outer Joint		27	32	56.5	92	62.5	I		
1.9 DCi (74 kW)	2001.06	-	-	-	-	850133	Outer Joint		27	32	56.5	92	62.5	I		
1.9 DCi (77 kW)	2001.06	-	-	-	-	850133	Outer Joint		27	32	56.5	92	62.5	I		
1.9 DCi (96 kW)	2001.06	-	-	-	-	850133	Outer Joint		27	32	56.5	92	62.5	I		
2.0 16V (103 kW)	2002.08	2007	-	-	-	850133	Outer Joint		27	32	56.5	92	62.5	I		
2.0 16V (99 kW)	2002.08	2007	-	-	-	850133	Outer Joint		27	32	56.5	92	62.5	I		
LAGUNA II (BG01_)																
1.6 16V (79 kW)	2001.03	-	5MT	L	F	Hatchback Engine K4M 710/K4M 714	250446	Drive Shaft	27	29.95	56.5	91.5	719			
	2001.03	-	AT	L	F	Hatchback Engine K4M 710/K4M 714	250328	Drive Shaft	27	26	56.5	91.5	697			
	2001.03	-	AT	R	F	Hatchback Engine K4M 710/K4M 714	250329	Drive Shaft	27	23	56.5	91.5	824			
	2001.03	-	-	-	F	Hatchback Engine K4M 710/K4M 714	850083	Outer Joint	27	30	56.5	91.5	59	I		
1.6 16V (82 kW)	2005.02	-	AT	R	F	Hatchback Engine K4M 716	250509	Drive Shaft	27	26	56.7	91	822			
	2005.02	-	-	-	F	Hatchback Engine K4M 716	850083	Outer Joint	27	30	56.5	91.5	59	I		
1.8 16V (85 kW)	2001.03	-	AT	L	F	Hatchback Engine F4P 770/F4P 771/F4P 773/F4P 774/F4P 775	250590	Drive Shaft	27	26	56.5	92	697			
	2001.03	-	AT	L	F	Hatchback Engine F4P 770/F4P 771/F4P 773/F4P 774/F4P 775	250281	Drive Shaft	27	26	56.5	92	700			
	2001.03	-	AT	R	F	Hatchback Engine F4P 770/F4P 771/F4P 773/F4P 774/F4P 775	250509	Drive Shaft	27	26	56.7	91	822			
	2001.03	-	MT	R	F	Hatchback Engine F4P 770/F4P 771/F4P 773/F4P 774/F4P 775	250226	Drive Shaft	27	23	56.5	92	802			
	2001.03	-	AT	R	F	Hatchback Engine F4P 770/F4P 771/F4P 773/F4P 774/F4P 775	250219	Drive Shaft	27	23	56.5	91.5	793.5			
	2001.03	-	AT	L	F	Hatchback Engine F4P 770/F4P 771/F4P 773/F4P 774/F4P 775	250632	Drive Shaft	27	26	56.7	91	689			
	2001.03	-	MT	L	F	Hatchback Engine F4P 770/F4P 771/F4P 773/F4P 774/F4P 775	250446	Drive Shaft	27	29.95	56.5	91.5	719			
	2001.03	-	MT	-	F	Hatchback Engine F4P 770/F4P 771/F4P 773/F4P 774/F4P 775	850079	Outer Joint	27	32	56.5	92	62.5	I		
	2001.03	-	AT/MT	-	F	Hatchback Engine F4P 770/F4P 771/F4P 773/F4P 774/F4P 775	850083	Outer Joint	27	30	56.5	91.5	59	I		
1.8 16V (86 kW)	2001.03	-	AT	R	F	Hatchback Engine F4P 770/F4P 774	250509	Drive Shaft	27	26	56.7	91	822			
	2001.03	-	MT	R	F	Hatchback Engine F4P 770/F4P 774	250226	Drive Shaft	27	23	56.5	92	802			
	2001.03	-	MT	L	F	Hatchback Engine F4P 770/F4P 774	250446	Drive Shaft	27	29.95	56.5	91.5	719			
	2001.03	-	AT/MT	-	F	Hatchback Engine F4P 770/F4P 774	850083	Outer Joint	27	30	56.5	91.5	59	I		
1.8 16V (88 kW)	2001.03	-	5AT	L	F	Hatchback Engine F4P 770/F4P 773	250590	Drive Shaft	27	26	56.5	92	697			
	2001.03	-	5MT	L	F	Hatchback Engine F4P 770/F4P 773	250208	Drive Shaft	27	29.95	56.5	92	723			
	2001.03	-	5MT	R	F	Hatchback Engine F4P 770/F4P 773	250226	Drive Shaft	27	23	56.5	92	802			
	2001.03	-	5AT	R	F	Hatchback Engine F4P 770/F4P 773	250219	Drive Shaft	27	23	56.5	91.5	793.5			
	2001.03	-	MT	L	F	Hatchback Engine F4P 770/F4P 773	250446	Drive Shaft	27	29.95	56.5	91.5	719			
	2001.03	-	-	-	F	Hatchback Engine F4P 770/F4P 773	850079	Outer Joint	27	32	56.5	92	62.5	I		
	2001.03	-	MT	-	F	Hatchback Engine F4P 770/F4P 773	850083	Outer Joint	27	30	56.5	91.5	59	I		
1.8 16V (89 kW)	2001.03	-	AT	L	F	Hatchback Engine F4P 770/F4P 772	250590	Drive Shaft	27	26	56.5	92	697			
	2001.03	-	AT	L	F	Hatchback Engine F4P 770/F4P 772	250281	Drive Shaft	27	26	56.5	92	700			
	2001.03	-	MT	R	F	Hatchback Engine F4P 770/F4P 772	250226	Drive Shaft	27	23	56.5	92	802			
	2001.03	-	AT	R	F	Hatchback Engine F4P 770/F4P 772	250219	Drive Shaft	27	23	56.5	91.5	793.5			
	2001.03	-	AT	L	F	Hatchback Engine F4P 770/F4P 772	250632	Drive Shaft	27	26	56.7	91	689			
	2001.03	-	MT	L	F	Hatchback Engine F4P 770/F4P 772	250446	Drive Shaft	27	29.95	56.5	91.5	719			
	2001.03	-	MT	-	F	Hatchback Engine F4P 770/F4P 772	850079	Outer Joint	27	32	56.5	92	62.5	I		
	2001.03	-	AT/MT	-	F	Hatchback Engine F4P 770/F4P 772	850083	Outer Joint	27	30	56.5	91.5	59	I		
1.9 dCi (68 kW)	2004.03	-	MT	L	F	Hatchback Engine F9Q 664	250207	Drive Shaft	27	37.1	56.5	91.5	632			
	2004.03	-	MT	R	F	Hatchback Engine F9Q 664	250228	Drive Shaft	27	39	56.5	90.5	967			
	2004.03	-	6MT	-	F	Hatchback Engine F9Q 664	850078	Outer Joint	27	35	56.5	91.5	71	I		
	2004.03	-	5AT	-	F	Hatchback Engine F9Q 664	850083	Outer Joint	27	30	56.5	91.5	59	I		
	2004.03	-	MT	L/R	F	Hatchback Engine F9Q 664	850113	Outer Joint	27	35	56.5	91.5	71	I		
1.9 dCi (74 kW)	2001.10	-	MT	L	F	Hatchback Engine F9Q 754	250207	Drive Shaft	27	37.1	56.5	91.5	632			
	2001.10	-	MT	R	F	Hatchback Engine F9Q 754	250228	Drive Shaft	27	39	56.5	90.5	967			
	2001.10	-	6MT	-	F	Hatchback Engine F9Q 754	850078	Outer Joint	27	35	56.5	91.5	71	I		
	2001.10	-	5AT	-	F	Hatchback Engine F9Q 754	850083	Outer Joint	27	30	56.5	91.5	59	I		
	2001.10	-	MT/6MT	L/R	F	Hatchback Engine F9Q 754	850113	Outer Joint	27	35	56.5	91.5	71	I		
1.9 dCi (77 kW)	2001.06	-	-	R	F	Hatchback Engine F9Q 752	250226	Drive Shaft	27	23	56.5	92	802			
	2001.06	-	-	L	F	Hatchback Engine F9Q 752	250446	Drive Shaft	27	29.95	56.5	91.5	719			
	2001.06	-	MT	-	F	Hatchback Engine F9Q 752	850079	Outer Joint	27	32	56.5	92	62.5	I		
	2001.06	-	-	-	F	Hatchback Engine F9Q 752	850083	Outer Joint	27	30	56.5	91.5	59	I		
1.9 dCi (79 kW)	2001.03	-	MT	L/R	F	Hatchback Engine F9Q 718/F9Q 754	850113	Outer Joint	27	35	56.5	91.5	71	I		
	2001.03	-	-	L	F	Hatchback Engine F9Q 718/F9Q 754	250207	Drive Shaft	27	37.1	56.5	91.5	632			
	2001.03	-	-	R	F	Hatchback Engine F9Q 718/F9Q 754	250228	Drive Shaft	27	39	56.5	90.5	967			
1.9 dCi (81 kW)	2005.01	-	MT	L/R	F	Hatchback Engine F9Q 674/F9Q 758	850113	Outer Joint	27	35	56.5	91.5	71	I		
	2005.01	-	-	L	F	Hatchback Engine F9Q 674/F9Q 758	250207	Drive Shaft	27	37.1	56.5	91.5	632			
	2005.01	-	-	R	F	Hatchback Engine F9Q 674/F9Q 758	250228	Drive Shaft	27	39	56.5	90.5	967			
	2005.01	-	-	R	F	Hatchback Engine F9Q 674/F9Q 758	299266	Drive Shaft	27	39	56.5	91.5	967			

REMARKS	YEAR	TRANSM	L/R	F/R	GSP Ref.	PRODUCT	ABS	Technical Specifications							
								A	B	C	H	L	P		
RENAULT LAGUNA II (BG0/1_)															
1.9 dCi (85 kW)	2005.09-	-	-	L	F	Hatchback Engine F9Q 750	250207	Drive Shaft	27	37.1	56.5	91.5	632		
1.9 dCi (88 kW)	2001.03-	-	5MT	L	F	Hatchback Engine F9Q 650/F9Q 670/F9Q 674/F9Q 750	250207	Drive Shaft	27	37.1	56.5	91.5	632		
	2001.03-	-	5MT	R	F	Hatchback Engine F9Q 650/F9Q 670/F9Q 674/F9Q 750	250228	Drive Shaft	27	39	56.5	90.5	967		
	2001.03-	-	MT	L	F	Hatchback Engine F9Q 650/F9Q 670/F9Q 674/F9Q 750	250237	Drive Shaft	27	37.1	56.5	91.5	632		
	2001.03-	-	-	R	F	Hatchback Engine F9Q 650/F9Q 670/F9Q 674/F9Q 750	299266	Drive Shaft	27	39	56.5	91.5	967		
	2001.03-	-	MT	R	F	Hatchback Engine F9Q 650/F9Q 670/F9Q 674/F9Q 750	250257	Drive Shaft	27	39	56.5	92	968		
	2001.03-	-	-	-	F	Hatchback Engine F9Q 650/F9Q 670/F9Q 674/F9Q 750	850078	Outer Joint	27	35	56.5	91.5	71	I	
	2001.03-	-	MT	L/R	F	Hatchback Engine F9Q 650/F9Q 670/F9Q 674/F9Q 750	850113	Outer Joint	27	35	56.5	91.5	71	I	
1.9 dCi (92 kW)	2005.09-	-	-	L	F	Hatchback Engine F9Q 750	250207	Drive Shaft	27	37.1	56.5	91.5	632		
1.9 dCi (96 kW)	2005.05-	-	MT	L/R	F	Hatchback Engine F9Q 758/F9Q 759	850113	Outer Joint	27	35	56.5	91.5	71	I	
	2005.05-	-	MT	L	F	Hatchback Engine F9Q 758/F9Q 759	250207	Drive Shaft	27	37.1	56.5	91.5	632		
	2005.05-	-	AT	L	F	Hatchback Engine F9Q 758/F9Q 759	250590	Drive Shaft	27	26	56.5	92	697		
	2005.05-	-	AT	L	F	Hatchback Engine F9Q 758/F9Q 759	250281	Drive Shaft	27	26	56.5	92	700		
	2005.05-	-	AT	L	F	Hatchback Engine F9Q 758/F9Q 759	250632	Drive Shaft	27	26	56.7	91	689		
	2005.05-	-	MT	L	F	Hatchback Engine F9Q 758/F9Q 759	250237	Drive Shaft	27	37.1	56.5	91.5	632		
	2005.05-	-	MT	R	F	Hatchback Engine F9Q 758/F9Q 759	250257	Drive Shaft	27	39	56.5	92	968		
2005.05-	-	-	-	F	Hatchback Engine F9Q 758/F9Q 759	850078	Outer Joint	27	35	56.5	91.5	71	I		
2.0 16V (125 kW)	2005.01-	-	MT	L/R	F	Hatchback Engine F4R 784/F4R 786/F4R 787	850113	Outer Joint	27	35	56.5	91.5	71	I	
	2005.01-	-	MT	-	F	Hatchback Engine F4R 784/F4R 786/F4R 787	850080	Outer Joint	27	37	56.5	92	73	I	
	2005.01-	-	6MT	R	F	Hatchback Engine F4R 784/F4R 786/F4R 787	601074	Inner Joint	39	35	30	363	88		
	2005.01-	-	AT	-	-	Hatchback Engine F4R 784/F4R 786/F4R 787	250413	Drive Shaft	27	26	56.5	92	824		
	2005.01-	-	MT	L	F	Hatchback Engine F4R 784/F4R 786/F4R 787	250237	Drive Shaft	27	37.1	56.5	91.5	632		
	2005.01-	-	MT	R	F	Hatchback Engine F4R 784/F4R 786/F4R 787	250257	Drive Shaft	27	39	56.5	92	968		
	2005.01-	-	5AT	-	F	Hatchback Engine F4R 784/F4R 786/F4R 787	850078	Outer Joint	27	35	56.5	91.5	71	I	
	2005.01-	-	AT	R	F	Hatchback Engine F4R 784/F4R 786/F4R 787	250469	Drive Shaft	27	26	56.8	90	982		
	2005.01-	-	AT	R	F	Hatchback Engine F4R 784/F4R 786/F4R 787	250633	Drive Shaft	27	26	56.5	91.5	943		
2.0 16V (150 kW)	2005.01-	-	6MT	R	F	Hatchback Engine F4R 886/F4R 887	601074	Inner Joint	39	35	30	363	88		
	2005.01-	-	AT	-	-	Hatchback Engine F4R 886/F4R 887	250413	Drive Shaft	27	26	56.5	92	824		
	2005.01-	-	-	-	F	Hatchback Engine F4R 886/F4R 887	850078	Outer Joint	27	35	56.5	91.5	71	I	
2.0 16V (98 kW)	2002.08-	-	-	L	F	Hatchback Engine F4R 714	250590	Drive Shaft	27	26	56.5	92	697		
	2002.08-	-	-	L	F	Hatchback Engine F4R 714	250281	Drive Shaft	27	26	56.5	92	700		
	2002.08-	-	-	L	F	Hatchback Engine F4R 714	250208	Drive Shaft	27	29.95	56.5	92	723		
	2002.08-	-	4AT	R	F	Hatchback Engine F4R 714	250509	Drive Shaft	27	26	56.7	91	822		
	2002.08-	-	-	R	F	Hatchback Engine F4R 714	250226	Drive Shaft	27	23	56.5	92	802		
	2002.08-	-	AT	L	F	Hatchback Engine F4R 714	250632	Drive Shaft	27	26	56.7	91	689		
	2002.08-	-	MT	R	F	Hatchback Engine F4R 714	250452	Drive Shaft	27	26	56.7	91	931.5		
	2002.08-	-	-	L	F	Hatchback Engine F4R 714	250460	Drive Shaft	27	26	56.5	92	692		
2.0 16V (99 kW)	2002.08-	-	AT	R	-	Hatchback Engine F4R 712/F4R 713/F4R 714/F4R 715	250413	Drive Shaft	27	26	56.5	92	824		
	2002.08-	-	AT	L	F	Hatchback Engine F4R 712/F4R 713/F4R 714/F4R 715	250590	Drive Shaft	27	26	56.5	92	697		
	2002.08-	-	AT	L	F	Hatchback Engine F4R 712/F4R 713/F4R 714/F4R 715	250281	Drive Shaft	27	26	56.5	92	700		
	2002.08-	-	-	L	F	Hatchback Engine F4R 712/F4R 713/F4R 714/F4R 715	250208	Drive Shaft	27	29.95	56.5	92	723		
	2002.08-	-	4AT	R	F	Hatchback Engine F4R 712/F4R 713/F4R 714/F4R 715	250509	Drive Shaft	27	26	56.7	91	822		
	2002.08-	-	AT	L	F	Hatchback Engine F4R 712/F4R 713/F4R 714/F4R 715	250632	Drive Shaft	27	26	56.7	91	689		
	2002.08-	-	MT	-	F	Hatchback Engine F4R 712/F4R 713/F4R 714/F4R 715	850079	Outer Joint	27	32	56.5	92	62.5	I	
	2002.08-	-	MT	R	F	Hatchback Engine F4R 712/F4R 713/F4R 714/F4R 715	250452	Drive Shaft	27	26	56.7	91	931.5		
	2002.08-	-	MT	R	F	Hatchback Engine F4R 712/F4R 713/F4R 714/F4R 715	250445	Drive Shaft	27	23	56.5	92	791		
	2002.08-	-	MT	L	F	Hatchback Engine F4R 712/F4R 713/F4R 714/F4R 715	250460	Drive Shaft	27	26	56.5	92	692		
2.0 16V IDE (103 kW)	2001.04-	-	-	L	F	Hatchback Engine F5R 700/F5R 701	250590	Drive Shaft	27	26	56.5	92	697		
	2001.04-	-	-	L	F	Hatchback Engine F5R 700/F5R 701	250281	Drive Shaft	27	26	56.5	92	700		
	2001.04-	-	-	R	F	Hatchback Engine F5R 700/F5R 701	250226	Drive Shaft	27	23	56.5	92	802		
	2001.04-	-	AT/MT	-	F	Hatchback Engine F5R 700/F5R 701	850079	Outer Joint	27	32	56.5	92	62.5	I	
	2001.04-	-	AT	L	F	Hatchback Engine F5R 700/F5R 701	250632	Drive Shaft	27	26	56.7	91	689		
	2001.04-	-	-	L	F	Hatchback Engine F5R 700/F5R 701	250446	Drive Shaft	27	29.95	56.5	91.5	719		
	2001.04-	-	-	-	F	Hatchback Engine F5R 700/F5R 701	850083	Outer Joint	27	30	56.5	91.5	59	I	
2.0 16V Turbo (120 kW)	2003.01-	-	MT	-	F	Hatchback Engine F4R 764/F4R 765/F4R 786/F4R 787	850080	Outer Joint	27	37	56.5	92	73	I	
	2003.01-	-	MT	R	F	Hatchback Engine F4R 764/F4R 765/F4R 786/F4R 787	601074	Inner Joint	39	35	30	363	88		
	2003.01-	-	MT	L	F	Hatchback Engine F4R 764/F4R 765/F4R 786/F4R 787	250237	Drive Shaft	27	37.1	56.5	91.5	632		
	2003.01-	-	MT	R	F	Hatchback Engine F4R 764/F4R 765/F4R 786/F4R 787	250257	Drive Shaft	27	39	56.5	92	968		
	2003.01-	-	5AT	-	F	Hatchback Engine F4R 764/F4R 765/F4R 786/F4R 787	850078	Outer Joint	27	35	56.5	91.5	71	I	
	2003.01-	-	AT	R	F	Hatchback Engine F4R 764/F4R 765/F4R 786/F4R 787	250633	Drive Shaft	27	26	56.5	91.5	943		
2.0 dCi (110 kW)	2005.08-	-	-	R	F	Hatchback Engine M9R 740	250518	Drive Shaft	27	39	56.8	90	985		
	2005.08-	-	MT	L/R	F	Hatchback Engine M9R 740	850041	Outer Joint	27	37	56.5	93	72	I	
	2005.08-	-	-	-	F	Hatchback Engine M9R 740	850080	Outer Joint	27	37	56.5	92	73	I	
	2005.08-	-	-	R	F	Hatchback Engine M9R 740	650087	Inner Joint	39	35	30	367	89.5		
	2005.08-	-	-	-	F	Hatchback Engine M9R 740	850078	Outer Joint	27	35	56.5	91.5	71	I	
2.0 dCi (127 kW)	2006.01-	-	MT	L	F	Hatchback Engine M9R 760	650071	Inner Joint	39	35	39	74	102.5		





	 YEAR	TRANSM	L/R	F/R	REMARKS	GSP Ref.	 PRODUCT	 ABS	Technical Specifications					
									A	B	C	H	L	P
RENAULT														
LAGUNA II (BG0/1_)														
2.0 dCi (127 kW)	2006.01-	-	R	F	Hatchback Engine M9R 760	250518	Drive Shaft		27	39	56.8	90	985	
	2006.01-	MT	L/R	F	Hatchback Engine M9R 760	850041	Outer Joint		27	37	56.5	93	72	I
	2006.01-	-	-	F	Hatchback Engine M9R 760	850131	Outer Joint		27	36	56.7	86.5	66	I
	2006.01-	-	R	F	Hatchback Engine M9R 760	650087	Inner Joint		39	35	30	367	89.5	
2.2 dCi (102 kW)	2005.05-	AT/MT	L/R	F	Hatchback Engine G9T 600/G9T 605/G9T 706/G9T 707	850113	Outer Joint		27	35	56.5	91.5	71	I
	2005.05-	-	L	F	Hatchback Engine G9T 600/G9T 605/G9T 706/G9T 707	250256	Drive Shaft		27	37.1	56.5	92	593	
	2005.05-	-	-	F	Hatchback Engine G9T 600/G9T 605/G9T 706/G9T 707	850080	Outer Joint		27	37	56.5	92	73	I
	2005.05-	-	R	F	Hatchback Engine G9T 600/G9T 605/G9T 706/G9T 707	250330	Drive Shaft		27	26	56.5	92	984	
	2005.05-	-	R	F	Hatchback Engine G9T 600/G9T 605/G9T 706/G9T 707	250469	Drive Shaft		27	26	56.8	90	982	
	2005.05-	-	L	F	Hatchback Engine G9T 600/G9T 605/G9T 706/G9T 707	250471	Drive Shaft		27	26	56.8	90	619	
2.2 dCi (110 kW)	2001.10-	MT	L/R	F	Hatchback Engine G9T 700/G9T 702	850041	Outer Joint		27	37	56.5	93	72	I
	2001.10-	-	-	F	Hatchback Engine G9T 700/G9T 702	850080	Outer Joint		27	37	56.5	92	73	I
	2001.10-	-	L	F	Hatchback Engine G9T 700/G9T 702	250256	Drive Shaft		27	37.1	56.5	92	593	
	2001.10-	AT	R	F	Hatchback Engine G9T 700/G9T 702	250330	Drive Shaft		27	26	56.5	92	984	
	2001.10-	AT	R	F	Hatchback Engine G9T 700/G9T 702	250469	Drive Shaft		27	26	56.8	90	982	
	2001.10-	-	L	F	Hatchback Engine G9T 700/G9T 702	250471	Drive Shaft		27	26	56.8	90	619	
2.9 V6 24V (155 kW)	2001.03-2007.08	-	R	F	Hatchback	250330	Drive Shaft		27	26	56.5	92	984	
	2001.03-2007.08	-	L	F	Hatchback	250471	Drive Shaft		27	26	56.8	90	619	
3.0 V6 24V (152 kW)	2001.03-	AT/MT	L/R	F	Hatchback Engine L7X 731	850041	Outer Joint		27	37	56.5	93	72	I
	2001.03-	-	-	F	Hatchback Engine L7X 731	850080	Outer Joint		27	37	56.5	92	73	I
	2001.03-	-	R	F	Hatchback Engine L7X 731	250330	Drive Shaft		27	26	56.5	92	984	
	2001.03-	AT	R	F	Hatchback Engine L7X 731	250469	Drive Shaft		27	26	56.8	90	982	
	2001.03-	-	L	F	Hatchback Engine L7X 731	250471	Drive Shaft		27	26	56.8	90	619	
LAGUNA II Grandtour (KG0/1_)														
1.6 16V (79 kW)	2001.03-	5MT	L	F	Estate Engine K4M 710/K4M 714	250446	Drive Shaft		27	29.95	56.5	91.5	719	
	2001.03-	AT	L	F	Estate Engine K4M 710/K4M 714	250328	Drive Shaft		27	26	56.5	91.5	697	
	2001.03-	AT	R	F	Estate Engine K4M 710/K4M 714	250329	Drive Shaft		27	23	56.5	91.5	824	
	2001.03-	-	-	F	Estate Engine K4M 710/K4M 714	850083	Outer Joint		27	30	56.5	91.5	59	I
1.6 16V (82 kW)	2005.02-	-	-	F	Estate Engine K4M 716	850083	Outer Joint		27	30	56.5	91.5	59	I
1.8 16V (85 kW)	2001.03-	AT	L	F	Estate Engine F4P 770/F4P 771/F4P 774/F4P 775	250590	Drive Shaft		27	26	56.5	92	697	
	2001.03-	AT	L	F	Estate Engine F4P 770/F4P 771/F4P 774/F4P 775	250281	Drive Shaft		27	26	56.5	92	700	
	2001.03-	MT	R	F	Estate Engine F4P 770/F4P 771/F4P 774/F4P 775	250226	Drive Shaft		27	23	56.5	92	802	
	2001.03-	AT	R	F	Estate Engine F4P 770/F4P 771/F4P 774/F4P 775	250219	Drive Shaft		27	23	56.5	91.5	793.5	
	2001.03-	AT	L	F	Estate Engine F4P 770/F4P 771/F4P 774/F4P 775	250632	Drive Shaft		27	26	56.7	91	689	
	2001.03-	AT/MT	-	F	Estate Engine F4P 770/F4P 771/F4P 774/F4P 775	850079	Outer Joint		27	32	56.5	92	62.5	I
	2001.03-	MT	L	F	Estate Engine F4P 770/F4P 771/F4P 774/F4P 775	250446	Drive Shaft		27	29.95	56.5	91.5	719	
1.8 16V (86 kW)	2001.03-	MT	R	F	Estate Engine F4P 770	250226	Drive Shaft		27	23	56.5	92	802	
	2001.03-	MT	L	F	Estate Engine F4P 770	250446	Drive Shaft		27	29.95	56.5	91.5	719	
1.8 16V (88 kW)	2001.03-	AT	R	F	Estate Engine F4P 770/F4P 773	250509	Drive Shaft		27	26	56.7	91	822	
	2001.03-	MT	R	F	Estate Engine F4P 770/F4P 773	250226	Drive Shaft		27	23	56.5	92	802	
	2001.03-	AT/MT	-	F	Estate Engine F4P 770/F4P 773	850079	Outer Joint		27	32	56.5	92	62.5	I
	2001.03-	MT	L	F	Estate Engine F4P 770/F4P 773	250446	Drive Shaft		27	29.95	56.5	91.5	719	
	2001.03-	AT/MT	-	F	Estate Engine F4P 770/F4P 773	850083	Outer Joint		27	30	56.5	91.5	59	I
1.8 16V (89 kW)	2001.03-	AT	R	F	Estate Engine F4P 770/F4P 774	250509	Drive Shaft		27	26	56.7	91	822	
	2001.03-	-	R	F	Estate Engine F4P 770/F4P 774	250226	Drive Shaft		27	23	56.5	92	802	
	2001.03-	-	L	F	Estate Engine F4P 770/F4P 774	250446	Drive Shaft		27	29.95	56.5	91.5	719	
	2001.03-	MT	-	F	Estate Engine F4P 770/F4P 774	850079	Outer Joint		27	32	56.5	92	62.5	I
	2001.03-	-	-	F	Estate Engine F4P 770/F4P 774	850083	Outer Joint		27	30	56.5	91.5	59	I
1.9 dCi (66 kW)	2003.08-2007.09	6MT	-	F	Estate Engine F9Q 664	850078	Outer Joint		27	35	56.5	91.5	71	I
	2003.08-2007.09	5AT	-	F	Estate Engine F9Q 664	850083	Outer Joint		27	30	56.5	91.5	59	I
1.9 dCi (68 kW)	2004.03-	MT	L	F	Estate Engine F9Q 664	250207	Drive Shaft		27	37.1	56.5	91.5	632	
	2004.03-	MT	R	F	Estate Engine F9Q 664	250228	Drive Shaft		27	39	56.5	90.5	967	
	2004.03-	6MT	-	F	Estate Engine F9Q 664	850078	Outer Joint		27	35	56.5	91.5	71	I
	2004.03-	5AT	-	F	Estate Engine F9Q 664	850083	Outer Joint		27	30	56.5	91.5	59	I
	2004.03-	MT	L/R	F	Estate Engine F9Q 664	850113	Outer Joint		27	35	56.5	91.5	71	I
1.9 dCi (74 kW)	2001.10-	4AT/6MT	L	F	Estate Engine F9Q 752	250207	Drive Shaft		27	37.1	56.5	91.5	632	
	2001.10-	4AT/6MT	R	F	Estate Engine F9Q 752	250228	Drive Shaft		27	39	56.5	90.5	967	
	2001.10-	5MT	R	F	Estate Engine F9Q 752	250226	Drive Shaft		27	23	56.5	92	802	
	2001.10-	5MT	L	F	Estate Engine F9Q 752	250446	Drive Shaft		27	29.95	56.5	91.5	719	
	2001.10-	6MT	-	F	Estate Engine F9Q 752	850078	Outer Joint		27	35	56.5	91.5	71	I
	2001.10-	5AT	-	F	Estate Engine F9Q 752	850083	Outer Joint		27	30	56.5	91.5	59	I
	2001.10-	MT/6MT	L/R	F	Estate Engine F9Q 752	850113	Outer Joint		27	35	56.5	91.5	71	I
1.9 dCi (77 kW)	2001.06-	-	R	F	Estate Engine F9Q 752	250226	Drive Shaft		27	23	56.5	92	802	
	2001.06-	-	L	F	Estate Engine F9Q 752	250446	Drive Shaft		27	29.95	56.5	91.5	719	
	2001.06-	MT	-	F	Estate Engine F9Q 752	850079	Outer Joint		27	32	56.5	92	62.5	I
1.9 dCi (79 kW)	2001.03-	MT	L/R	F	Estate Engine F9Q 718/F9Q 754	850113	Outer Joint		27	35	56.5	91.5	71	I

REMARKS	YEAR	TRANSM	L/R	F/R	GSP Ref.	PRODUCT	ABS	Technical Specifications								
								A	B	C	H	L	P			
RENAULT																
LAGUNA II Grandtour (KG0/1)																
1.9 dCi (79 kW)	2001.03-	-	L	F	Estate Engine F9Q 718/F9Q 754	250207	Drive Shaft	27	37.1	56.5	91.5	632				
	2001.03-	-	R	F	Estate Engine F9Q 718/F9Q 754	250228	Drive Shaft	27	39	56.5	90.5	967				
1.9 dCi (81 kW)	2005.01-	MT	L/R	F	Estate Engine F9Q 674/F9Q 758	850113	Outer Joint	27	35	56.5	91.5	71	I			
	2005.01-	MT	L	F	Estate Engine F9Q 674/F9Q 758	250207	Drive Shaft	27	37.1	56.5	91.5	632				
	2005.01-	MT	R	F	Estate Engine F9Q 674/F9Q 758	250228	Drive Shaft	27	39	56.5	90.5	967				
1.9 dCi (85 kW)	2005.08-	2007.09	-	L	F	Estate Engine F9Q 758/F9Q 759	250207	Drive Shaft	27	37.1	56.5	91.5	632			
1.9 dCi (88 kW)	2001.03-	-	5MT	L	F	Estate Engine F9Q 670/F9Q 674/F9Q 750	250207	Drive Shaft	27	37.1	56.5	91.5	632			
	2001.03-	-	5MT	R	F	Estate Engine F9Q 670/F9Q 674/F9Q 750	250228	Drive Shaft	27	39	56.5	90.5	967			
	2001.03-	-	MT	L	F	Estate Engine F9Q 670/F9Q 674/F9Q 750	250237	Drive Shaft	27	37.1	56.5	91.5	632			
	2001.03-	-	-	R	F	Estate Engine F9Q 670/F9Q 674/F9Q 750	299266	Drive Shaft	27	39	56.5	91.5	967			
	2001.03-	-	MT	R	F	Estate Engine F9Q 670/F9Q 674/F9Q 750	250257	Drive Shaft	27	39	56.5	92	968			
	2001.03-	-	-	F	Estate Engine F9Q 670/F9Q 674/F9Q 750	850078	Outer Joint	27	35	56.5	91.5	71	I			
	2001.03-	-	MT	L/R	F	Estate Engine F9Q 670/F9Q 674/F9Q 750	850113	Outer Joint	27	35	56.5	91.5	71	I		
1.9 dCi (92 kW)	2005.09-	-	-	L	F	Estate Engine F9Q 750	250207	Drive Shaft	27	37.1	56.5	91.5	632			
1.9 dCi (96 kW)	2005.05-	-	MT	L/R	F	Estate Engine F9Q 758/F9Q 759	850113	Outer Joint	27	35	56.5	91.5	71	I		
	2005.05-	-	-	L	F	Estate Engine F9Q 758/F9Q 759	250207	Drive Shaft	27	37.1	56.5	91.5	632			
	2005.05-	-	-	L	F	Estate Engine F9Q 758/F9Q 759	250590	Drive Shaft	27	26	56.5	92	697			
	2005.05-	-	-	L	F	Estate Engine F9Q 758/F9Q 759	250281	Drive Shaft	27	26	56.5	92	700			
	2005.05-	-	AT	L	F	Estate Engine F9Q 758/F9Q 759	250632	Drive Shaft	27	26	56.7	91	689			
	2005.05-	-	MT	L	F	Estate Engine F9Q 758/F9Q 759	250237	Drive Shaft	27	37.1	56.5	91.5	632			
	2005.05-	-	MT	R	F	Estate Engine F9Q 758/F9Q 759	250257	Drive Shaft	27	39	56.5	92	968			
	2005.05-	-	MT	-	F	Estate Engine F9Q 758/F9Q 759	850078	Outer Joint	27	35	56.5	91.5	71	I		
2.0 16V (125 kW)	2005.01-	-	AT	R	F	Estate Engine F4R 784/F4R 786/F4R 787	250633	Drive Shaft	27	26	56.5	91.5	943			
	2005.01-	-	MT	L/R	F	Estate Engine F4R 784/F4R 786/F4R 787	850113	Outer Joint	27	35	56.5	91.5	71	I		
	2005.01-	-	MT	-	F	Estate Engine F4R 784/F4R 786/F4R 787	850080	Outer Joint	27	37	56.5	92	73	I		
	2005.01-	-	MT	R	F	Estate Engine F4R 784/F4R 786/F4R 787	601074	Inner Joint	39	35	30	363	88			
	2005.01-	-	AT	-	-	Estate Engine F4R 784/F4R 786/F4R 787	250413	Drive Shaft	27	26	56.5	92	824			
	2005.01-	-	MT	L	F	Estate Engine F4R 784/F4R 786/F4R 787	250237	Drive Shaft	27	37.1	56.5	91.5	632			
	2005.01-	-	MT	R	F	Estate Engine F4R 784/F4R 786/F4R 787	250257	Drive Shaft	27	39	56.5	92	968			
	2005.01-	-	5AT	-	F	Estate Engine F4R 784/F4R 786/F4R 787	850078	Outer Joint	27	35	56.5	91.5	71	I		
2.0 16V (150 kW)	2005.01-	-	MT	R	F	Estate Engine F4R 886/F4R 887	601074	Inner Joint	39	35	30	363	88			
	2005.01-	-	AT	-	-	Estate Engine F4R 886/F4R 887	250413	Drive Shaft	27	26	56.5	92	824			
2.0 16V (98 kW)	2004.10-	2007.09	-	L	F	Estate Engine F4R 714/F4R 715	250208	Drive Shaft	27	29.95	56.5	92	723			
	2004.10-	2007.09	AT	R	F	Estate Engine F4R 714/F4R 715	250509	Drive Shaft	27	26	56.7	91	822			
	2004.10-	2007.09	-	R	F	Estate Engine F4R 714/F4R 715	250226	Drive Shaft	27	23	56.5	92	802			
	2004.10-	2007.09	MT	R	F	Estate Engine F4R 714/F4R 715	250452	Drive Shaft	27	26	56.7	91	931.5			
2.0 16V (99 kW)	2002.08-	-	AT	R	-	Estate Engine F4R 712/F4R 713/F4R 714/F4R 715	250413	Drive Shaft	27	26	56.5	92	824			
	2002.08-	-	-	L	F	Estate Engine F4R 712/F4R 713/F4R 714/F4R 715	250590	Drive Shaft	27	26	56.5	92	697			
	2002.08-	-	-	L	F	Estate Engine F4R 712/F4R 713/F4R 714/F4R 715	250281	Drive Shaft	27	26	56.5	92	700			
	2002.08-	-	-	L	F	Estate Engine F4R 712/F4R 713/F4R 714/F4R 715	250208	Drive Shaft	27	29.95	56.5	92	723			
	2002.08-	-	4AT/AT	R	F	Estate Engine F4R 712/F4R 713/F4R 714/F4R 715	250509	Drive Shaft	27	26	56.7	91	822			
	2002.08-	-	-	R	F	Estate Engine F4R 712/F4R 713/F4R 714/F4R 715	250226	Drive Shaft	27	23	56.5	92	802			
	2002.08-	-	MT	-	F	Estate Engine F4R 712/F4R 713/F4R 714/F4R 715	850079	Outer Joint	27	32	56.5	92	62.5	I		
	2002.08-	-	AT	L	F	Estate Engine F4R 712/F4R 713/F4R 714/F4R 715	250632	Drive Shaft	27	26	56.7	91	689			
	2002.08-	-	MT	R	F	Estate Engine F4R 712/F4R 713/F4R 714/F4R 715	250452	Drive Shaft	27	26	56.7	91	931.5			
2.0 16V IDE (103 kW)	2001.04-	-	-	L	F	Estate Engine F5R 700/F5R 701	250590	Drive Shaft	27	26	56.5	92	697			
	2001.04-	-	-	L	F	Estate Engine F5R 700/F5R 701	250281	Drive Shaft	27	26	56.5	92	700			
	2001.04-	-	-	R	F	Estate Engine F5R 700/F5R 701	250226	Drive Shaft	27	23	56.5	92	802			
	2001.04-	-	MT	-	F	Estate Engine F5R 700/F5R 701	850079	Outer Joint	27	32	56.5	92	62.5	I		
	2001.04-	-	AT	L	F	Estate Engine F5R 700/F5R 701	250632	Drive Shaft	27	26	56.7	91	689			
	2001.04-	-	-	L	F	Estate Engine F5R 700/F5R 701	250446	Drive Shaft	27	29.95	56.5	91.5	719			
	2001.04-	-	-	F	Estate Engine F5R 700/F5R 701	850083	Outer Joint	27	30	56.5	91.5	59	I			
2.0 16V Turbo (120 kW)	2003.01-	-	-	F	Estate Engine F4R 764/F4R 765/F4R 786/F4R 787	850080	Outer Joint	27	37	56.5	92	73	I			
	2003.01-	-	MT	R	F	Estate Engine F4R 764/F4R 765/F4R 786/F4R 787	601074	Inner Joint	39	35	30	363	88			
	2003.01-	-	MT	L	F	Estate Engine F4R 764/F4R 765/F4R 786/F4R 787	250237	Drive Shaft	27	37.1	56.5	91.5	632			
	2003.01-	-	MT	R	F	Estate Engine F4R 764/F4R 765/F4R 786/F4R 787	250257	Drive Shaft	27	39	56.5	92	968			
	2003.01-	-	5AT	-	F	Estate Engine F4R 764/F4R 765/F4R 786/F4R 787	850078	Outer Joint	27	35	56.5	91.5	71	I		
	2003.01-	-	AT	R	F	Estate Engine F4R 764/F4R 765/F4R 786/F4R 787	250633	Drive Shaft	27	26	56.5	91.5	943			
2.0 dCi (110 kW)	2005.08-	-	-	R	F	Estate Engine M9R 740	250518	Drive Shaft	27	39	56.8	90	985			
	2005.08-	-	MT	L/R	F	Estate Engine M9R 740	850041	Outer Joint	27	37	56.5	93	72	I		
	2005.08-	-	-	F	Estate Engine M9R 740	850080	Outer Joint	27	37	56.5	92	73	I			
	2005.08-	-	-	R	F	Estate Engine M9R 740	650087	Inner Joint	39	35	30	367	89.5			
	2005.08-	-	-	F	Estate Engine M9R 740	850078	Outer Joint	27	35	56.5	91.5	71	I			
2.0 dCi (127 kW)	2006.01-	-	-	R	F	Estate Engine M9R 760	250518	Drive Shaft	27	39	56.8	90	985			
	2006.01-	-	MT	L/R	F	Estate Engine M9R 760	850041	Outer Joint	27	37	56.5	93	72	I		
	2006.01-	-	-	F	Estate Engine M9R 760	850080	Outer Joint	27	37	56.5	92	73	I			

REMARKS	YEAR	TRANSM	L/R	F/R	GSP Ref.	PRODUCT	ABS	Technical Specifications						
								A	B	C	H	L	P	
RENAULT														
LAGUNA II Grandtour (KG0/1)														
2.0 dCi (127 kW)	2006.01-	-	-	R	F	Estate Engine M9R 760	650087	Inner Joint	39	35	30	367	89.5	
	2006.01-	-	-	-	F	Estate Engine M9R 760	850078	Outer Joint	27	35	56.5	91.5	71	I
2.2 dCi (102 kW)	2005.05-	-	AT/MT	L/R	F	Estate Engine G9T 600/G9T 706/G9T 707	850113	Outer Joint	27	35	56.5	91.5	71	I
	2005.05-	-	-	L	F	Estate Engine G9T 600/G9T 706/G9T 707	250256	Drive Shaft	27	37.1	56.5	92	593	
	2005.05-	-	-	-	F	Estate Engine G9T 600/G9T 706/G9T 707	850080	Outer Joint	27	37	56.5	92	73	I
	2005.05-	-	-	R	F	Estate Engine G9T 600/G9T 706/G9T 707	250330	Drive Shaft	27	26	56.5	92	984	
	2005.05-	-	AT	R	F	Estate Engine G9T 600/G9T 706/G9T 707	250469	Drive Shaft	27	26	56.8	90	982	
	2005.05-	-	-	L	F	Estate Engine G9T 600/G9T 706/G9T 707	250471	Drive Shaft	27	26	56.8	90	619	
2.2 dCi (110 kW)	2001.10-	-	AT/MT	L/R	F	Estate Engine G9T 702	850041	Outer Joint	27	37	56.5	93	72	I
	2001.10-	-	-	-	F	Estate Engine G9T 702	850080	Outer Joint	27	37	56.5	92	73	I
	2001.10-	-	-	L	F	Estate Engine G9T 702	250256	Drive Shaft	27	37.1	56.5	92	593	
	2001.10-	-	-	R	F	Estate Engine G9T 702	250330	Drive Shaft	27	26	56.5	92	984	
	2001.10-	-	AT	R	F	Estate Engine G9T 702	250469	Drive Shaft	27	26	56.8	90	982	
	2001.10-	-	-	L	F	Estate Engine G9T 702	250471	Drive Shaft	27	26	56.8	90	619	
3.0 V6 24V (152 kW)	2001.03-	-	AT/MT	L/R	F	Estate Engine L7X 731	850041	Outer Joint	27	37	56.5	93	72	I
	2001.03-	-	-	-	F	Estate Engine L7X 731	850080	Outer Joint	27	37	56.5	92	73	I
	2001.03-	-	-	R	F	Estate Engine L7X 731	250330	Drive Shaft	27	26	56.5	92	984	
	2001.03-	-	AT	R	F	Estate Engine L7X 731	250469	Drive Shaft	27	26	56.8	90	982	
	2001.03-	-	-	L	F	Estate Engine L7X 731	250471	Drive Shaft	27	26	56.8	90	619	
LAGUNA III (BT0/1)														
1.5 dCi (81 kW)	2007.10-	-	-	-	F	Hatchback Engine K9K 780/K9K 782	850130	Outer Joint	27	33	56.7	91	61	I
	2007.10-	-	MT	L	F	Hatchback Engine K9K 780/K9K 782	250378	Drive Shaft	27	26	56.7	91	687	
	2007.10-	-	-	R	F	Hatchback Engine K9K 780/K9K 782	250377	Drive Shaft	27	26	56.7	91	940	
1.6 16V (81 kW)	2007.10-	-	-	L/R	F	Hatchback Engine K4M 824	850150	Outer Joint	27	32	56.7	91	61	I
	2007.10-	-	-	L	F	Hatchback Engine K4M 824	250622	Drive Shaft	27	26	56.7	91	690	
2.0 16V (103 kW)	2007.10-	-	-	R	F	Hatchback Engine M4R 704	650110	Inner Joint	26	33	33	346	113	
	2007.10-	-	-	R	F	Hatchback Engine M4R 704	250455	Drive Shaft	27	26	56.7	87	943	
	2007.10-	-	AT	-	-	Hatchback Engine M4R 704	250413	Drive Shaft	27	26	56.5	92	824	
	2007.10-	-	6MT	L	F	Hatchback Engine M4R 704	250451	Drive Shaft	27	26	56.7	87	676	
2.0 16V Hi-Flex (103 kW)	2007.10-	-	-	R	F	Hatchback Engine M4R 726	650110	Inner Joint	26	33	33	346	113	
	2007.10-	-	-	R	F	Hatchback Engine M4R 726	250455	Drive Shaft	27	26	56.7	87	943	
	2007.10-	-	AT	-	-	Hatchback Engine M4R 726	250413	Drive Shaft	27	26	56.5	92	824	
	2007.10-	-	-	L	F	Hatchback Engine M4R 726	250451	Drive Shaft	27	26	56.7	87	676	
2.0 16V Turbo (125 kW)	2007.10-	-	AT	-	-	Hatchback Engine F4R 811	250413	Drive Shaft	27	26	56.5	92	824	
	2007.10-	-	-	L	F	Hatchback Engine F4R 811	250626	Drive Shaft	27	30	56.7	86.5	642	
2.0 dCi (110 kW)	2007.10-	-	-	-	F	Hatchback Engine M9R 802/M9R 805/M9R 814	850131	Outer Joint	27	36	56.7	86.5	66	I
	2007.10-	-	MT	L	F	Hatchback Engine M9R 802/M9R 805/M9R 814	650071	Inner Joint	39	35	39	74	102.5	
	2007.10-	-	MT	R	F	Hatchback Engine M9R 802/M9R 805/M9R 814	250380	Drive Shaft	27	39	56.7	86.5	985	
	2007.10-	-	MT	L	F	Hatchback Engine M9R 802/M9R 805/M9R 814	250496	Drive Shaft	27	39	56.5	90.5	640	
	2007.10-	-	-	L/R	F	Hatchback Engine M9R 802/M9R 805/M9R 814	850161	Outer Joint	27	36	56.7	87	62	I
	2007.10-	-	-	L	F	Hatchback Engine M9R 802/M9R 805/M9R 814	250626	Drive Shaft	27	30	56.7	86.5	642	
	2007.10-	-	AT	R	F	Hatchback Engine M9R 802/M9R 805/M9R 814	250596	Drive Shaft	27	30	56.7	86.5	959	
2.0 dCi (127 kW)	2008.01-	-	-	-	F	Hatchback Engine M9R 800/M9R 809/M9R 815	850131	Outer Joint	27	36	56.7	86.5	66	I
	2008.01-	-	-	R	F	Hatchback Engine M9R 800/M9R 809/M9R 815	250380	Drive Shaft	27	39	56.7	86.5	985	
	2008.01-	-	-	L	F	Hatchback Engine M9R 800/M9R 809/M9R 815	250496	Drive Shaft	27	39	56.5	90.5	640	
	2008.01-	-	MT	L	F	Hatchback Engine M9R 800/M9R 809/M9R 815	650071	Inner Joint	39	35	39	74	102.5	
	2008.01-	-	-	L/R	F	Hatchback Engine M9R 800/M9R 809/M9R 815	850161	Outer Joint	27	36	56.7	87	62	I
	2008.01-	-	-	L	F	Hatchback Engine M9R 800/M9R 809/M9R 815	250626	Drive Shaft	27	30	56.7	86.5	642	
	2008.01-	-	-	R	F	Hatchback Engine M9R 800/M9R 809/M9R 815	250596	Drive Shaft	27	30	56.7	86.5	959	
2.0 dCi (96 kW)	2007.10-	-	-	-	F	Hatchback Engine M9R 742/M9R 744/M9R 802	850131	Outer Joint	27	36	56.7	86.5	66	I
	2007.10-	-	MT	L	F	Hatchback Engine M9R 742/M9R 744/M9R 802	650071	Inner Joint	39	35	39	74	102.5	
	2007.10-	-	-	R	F	Hatchback Engine M9R 742/M9R 744/M9R 802	250380	Drive Shaft	27	39	56.7	86.5	985	
	2007.10-	-	-	L	F	Hatchback Engine M9R 742/M9R 744/M9R 802	250496	Drive Shaft	27	39	56.5	90.5	640	
	2007.10-	-	-	L/R	F	Hatchback Engine M9R 742/M9R 744/M9R 802	850161	Outer Joint	27	36	56.7	87	62	I
2.0 dCi GT (131 kW)	2008.03-	-	-	-	F	Hatchback Engine M9R 816	850131	Outer Joint	27	36	56.7	86.5	66	I
	2008.03-	-	-	-	F	Hatchback Engine M9R 816	850080	Outer Joint	27	37	56.5	92	73	I
	2008.03-	-	-	L	F	Hatchback Engine M9R 816	250496	Drive Shaft	27	39	56.5	90.5	640	
	2008.03-	-	-	L	F	Hatchback Engine M9R 816	650071	Inner Joint	39	35	39	74	102.5	
	2008.03-	-	-	L/R	F	Hatchback Engine M9R 816	850161	Outer Joint	27	36	56.7	87	62	I
2.0 GT (150 kW)	2008.03-	-	-	-	F	Hatchback Engine F4R 800	850131	Outer Joint	27	36	56.7	86.5	66	I
	2008.03-	-	AT	-	-	Hatchback Engine F4R 800	250413	Drive Shaft	27	26	56.5	92	824	
LAGUNA III (BTO/1)														
2.0 Dci (110 kW)	2007.10-	-	-	-	-	-	850108	Outer Joint	27	35	56.5	90.5	71	I
2.0 DCi (127 kW)	2007.10-	-	-	-	-	-	850108	Outer Joint	27	35	56.5	90.5	71	I
LAGUNA III Grandtour (KT0/1)														
1.5 dCi (81 kW)	2007.10-	-	-	-	F	Estate Engine K9K 780/K9K 782	850130	Outer Joint	27	33	56.7	91	61	I

REMARKS	YEAR	TRANSM	L/R	F/R	GSP Ref.	PRODUCT	ABS	Technical Specifications						
								A	B	C	H	L	P	
RENAULT														
LAGUNA III Grandtour (KT0/1)														
1.5 dCi (81 kW)	2007.10-	-	MT	L	F	Estate Engine K9K 780/K9K 782	250378	Drive Shaft	27	26	56.7	91	687	
	2007.10-	-	-	R	F	Estate Engine K9K 780/K9K 782	250377	Drive Shaft	27	26	56.7	91	940	
1.6 16V (81 kW)	2007.10-	-	-	L/R	F	Estate Engine K4M 824	850150	Outer Joint	27	32	56.7	91	61	I
	2007.10-	-	-	L	F	Estate Engine K4M 824	250622	Drive Shaft	27	26	56.7	91	690	
2.0 16V (103 kW)	2007.10-	-	-	R	F	Estate Engine M4R 704	650110	Inner Joint	26	33	33	346	113	
	2007.10-	-	-	R	F	Estate Engine M4R 704	250455	Drive Shaft	27	26	56.7	87	943	
	2007.10-	-	6MT	L	F	Estate Engine M4R 704	250451	Drive Shaft	27	26	56.7	87	676	
2.0 16V Hi-Flex (103 kW)	2007.10-	-	-	R	F	Estate Engine M4R 704/M4R 726	650110	Inner Joint	26	33	33	346	113	
	2007.10-	-	-	R	F	Estate Engine M4R 704/M4R 726	250455	Drive Shaft	27	26	56.7	87	943	
	2007.10-	-	-	L	F	Estate Engine M4R 704/M4R 726	250451	Drive Shaft	27	26	56.7	87	676	
2.0 16V Turbo (125 kW)	2007.10-	-	-	L	F	Estate Engine F4R 811	250626	Drive Shaft	27	30	56.7	86.5	642	
2.0 dCi (110 kW)	2007.10-	-	-	-	F	Estate Engine M9R 802/M9R 805/M9R 814	850131	Outer Joint	27	36	56.7	86.5	66	I
	2007.10-	-	MT	L	F	Estate Engine M9R 802/M9R 805/M9R 814	650071	Inner Joint	39	35	39	74	102.5	
	2007.10-	-	MT	R	F	Estate Engine M9R 802/M9R 805/M9R 814	250380	Drive Shaft	27	39	56.7	86.5	985	
	2007.10-	-	MT	L	F	Estate Engine M9R 802/M9R 805/M9R 814	250496	Drive Shaft	27	39	56.5	90.5	640	
	2007.10-	-	-	L/R	F	Estate Engine M9R 802/M9R 805/M9R 814	850161	Outer Joint	27	36	56.7	87	62	I
	2007.10-	-	-	L	F	Estate Engine M9R 802/M9R 805/M9R 814	250626	Drive Shaft	27	30	56.7	86.5	642	
	2007.10-	-	AT	R	F	Estate Engine M9R 802/M9R 805/M9R 814	250596	Drive Shaft	27	30	56.7	86.5	959	
2.0 dCi (127 kW)	2008.01-	-	-	-	F	Estate Engine M9R 800/M9R 809/M9R 815	850131	Outer Joint	27	36	56.7	86.5	66	I
	2008.01-	-	-	L	F	Estate Engine M9R 800/M9R 809/M9R 815	250496	Drive Shaft	27	39	56.5	90.5	640	
	2008.01-	-	MT	L	F	Estate Engine M9R 800/M9R 809/M9R 815	650071	Inner Joint	39	35	39	74	102.5	
	2008.01-	-	-	L/R	F	Estate Engine M9R 800/M9R 809/M9R 815	850161	Outer Joint	27	36	56.7	87	62	I
	2008.01-	-	-	L	F	Estate Engine M9R 800/M9R 809/M9R 815	250626	Drive Shaft	27	30	56.7	86.5	642	
	2008.01-	-	-	R	F	Estate Engine M9R 800/M9R 809/M9R 815	250596	Drive Shaft	27	30	56.7	86.5	959	
2.0 dCi (96 kW)	2007.10-	-	-	-	F	Estate Engine M9R 742/M9R 744/M9R 802	850131	Outer Joint	27	36	56.7	86.5	66	I
	2007.10-	-	MT	L	F	Estate Engine M9R 742/M9R 744/M9R 802	650071	Inner Joint	39	35	39	74	102.5	
	2007.10-	-	-	R	F	Estate Engine M9R 742/M9R 744/M9R 802	250380	Drive Shaft	27	39	56.7	86.5	985	
	2007.10-	-	-	L	F	Estate Engine M9R 742/M9R 744/M9R 802	250496	Drive Shaft	27	39	56.5	90.5	640	
	2007.10-	-	-	L/R	F	Estate Engine M9R 742/M9R 744/M9R 802	850161	Outer Joint	27	36	56.7	87	62	I
2.0 dCi GT (131 kW)	2008.03-	-	-	-	F	Estate Engine M9R 816/M9R 820	850131	Outer Joint	27	36	56.7	86.5	66	I
	2008.03-	-	-	-	F	Estate Engine M9R 816/M9R 820	850080	Outer Joint	27	37	56.5	92	73	I
	2008.03-	-	-	L	F	Estate Engine M9R 816/M9R 820	250496	Drive Shaft	27	39	56.5	90.5	640	
	2008.03-	-	MT	L	F	Estate Engine M9R 816/M9R 820	650071	Inner Joint	39	35	39	74	102.5	
	2008.03-	-	-	L/R	F	Estate Engine M9R 816/M9R 820	850161	Outer Joint	27	36	56.7	87	62	I
2.0 GT (150 kW)	2008.03-	-	-	-	F	Estate Engine F4R 800	850131	Outer Joint	27	36	56.7	86.5	66	I
LAGUNA MK2														
1.6, 1.8	1998.05-	2001.01	MT	R	-	-	250603	Drive Shaft	23	23	56	84	748	
LOGAN I (KS_/)TONDAR 90														
1.4 (55 kW)	2007.10-	-	-	L	F	Estate Engine K7J 710	211012	Drive Shaft	23	29.95	49	83.5	681	
	2007.10-	-	-	R	F	Estate Engine K7J 710	211014	Drive Shaft	23	23	49	83.5	755	
	2007.10-	-	-	-	F	Estate Engine K7J 710	899085	Outer Joint	23	30	49	86	59	I
1.5 dCi (50 kW)	2007.04-	-	MT	R	F	Estate Engine K9K 792	699169	Inner Joint	26	30	33	326	95	
	2007.04-	-	MT	L	F	Estate Engine K9K 792	250570	Drive Shaft	23	26	49	83.5	647	
	2007.04-	-	MT	R	F	Estate Engine K9K 792	250354	Drive Shaft	23	26	49	86	897	
	2007.04-	-	MT	L	F	Estate Engine K9K 792	250353	Drive Shaft	23	26	49	86	649	
	2007.04-	-	-	-	F	Estate Engine K9K 792	899085	Outer Joint	23	30	49	86	59	I
1.6 (64 kW)	2007.04-	-	-	R	F	Estate Engine K7M 710	699169	Inner Joint	26	30	33	326	95	
	2007.04-	-	-	L	F	Estate Engine K7M 710	211012	Drive Shaft	23	29.95	49	83.5	681	
	2007.04-	-	-	R	F	Estate Engine K7M 710	211014	Drive Shaft	23	23	49	83.5	755	
	2007.04-	-	-	R	F	Estate Engine K7M 710	250354	Drive Shaft	23	26	49	86	897	
	2007.04-	-	-	L	F	Estate Engine K7M 710	250353	Drive Shaft	23	26	49	86	649	
1.6 (77 kW)	2007.04-	-	MT	R	F	Estate Engine K4M 697	699169	Inner Joint	26	30	33	326	95	
	2007.04-	-	MT	L	F	Estate Engine K4M 697	250570	Drive Shaft	23	26	49	83.5	647	
	2007.04-	-	MT	R	F	Estate Engine K4M 697	250354	Drive Shaft	23	26	49	86	897	
	2007.04-	-	MT	L	F	Estate Engine K4M 697	250353	Drive Shaft	23	26	49	86	649	
	2007.04-	-	AT	R	F	Estate Engine K4M 697	250574	Drive Shaft	23	26	49	86	652	
	2007.04-	-	AT	R	F	Estate Engine K4M 697	250443	Drive Shaft	23	23	49	86	789	
LOGAN I (LS_/)TONDAR 90														
1.4 (55 kW)	2004.09-	-	-	R	F	Saloon Engine K7J 710	245085	Drive Shaft	21	23	49	84	763	
	2004.09-	-	-	R	F	Saloon Engine K7J 710	811004	Outer Joint	21	28	49	84	53.5	I
	2004.09-	-	-	R	F	Saloon Engine K7J 710	211023	Drive Shaft	21	23	49	84	761	
	2004.09-	-	-	R	F	Saloon Engine K7J 710	650124	Inner joint	23	28	36.3		115	
	2004.09-	-	-	R	F	Saloon Engine K7J 710	650008	Inner Joint	23	30	36.3	52.2	68.5	
1.5 dCi (48 kW)	2011.06-	-	-	L	F	Saloon Engine K9K 700/K9K 790/K9K 794	211012	Drive Shaft	23	29.95	49	83.5	681	
	2011.06-	-	-	R	F	Saloon Engine K9K 700/K9K 790/K9K 794	211014	Drive Shaft	23	23	49	83.5	755	
1.5 dCi (50 kW)	2007.04-	-	-	L	F	Saloon Engine K9K 792	211012	Drive Shaft	23	29.95	49	83.5	681	

REMARKS	YEAR	TRANSM	L/R	F/R	GSP Ref.	PRODUCT	ABS	Technical Specifications							
								A	B	C	H	L	P		
RENAULT															
LOGAN I (LS_/)TONDAR 90															
1.5 dCi (50 kW)	2007.04-	-	-	R	F	Saloon Engine K9K 792	211014	Drive Shaft		23	23	49	83.5	755	
	2007.04-	-	-	-	F	Saloon Engine K9K 792	899085	Outer Joint		23	30	49	86	59	I
1.6 (64 kW)	2004.09-	-	-	L	F	Saloon Engine K7M 710	245084	Drive Shaft		21	29.95	49	84	681	
	2004.09-	-	-	R	F	Saloon Engine K7M 710	811004	Outer Joint		21	28	49	84	53.5	I
	2004.09-	-	-	R	F	Saloon Engine K7M 710	245085	Drive Shaft		21	23	49	84	763	
	2004.09-	-	-	R	F	Saloon Engine K7M 710	211023	Drive Shaft		21	23	49	84	761	
	2004.09-	-	-	R	F	Saloon Engine K7M 710	650124	Inner joint		23	28	36.3		115	
	2004.09-	-	-	R	F	Saloon Engine K7M 710	650008	Inner Joint		23	30	36.3	52.2	68.5	
1.6 (77 kW)	2007.04-	-	-	L	F	Saloon Engine K4M 690	211012	Drive Shaft		23	29.95	49	83.5	681	
	2007.04-	-	-	R	F	Saloon Engine K4M 690	211014	Drive Shaft		23	23	49	83.5	755	
	2007.04-	-	-	L	F	Saloon Engine K4M 690	250574	Drive Shaft		23	26	49	86	652	
	2007.04-	-	-	R	F	Saloon Engine K4M 690	250443	Drive Shaft		23	23	49	86	789	
LOGAN II (L8_)															
1.2 (55 kW)	2013.11-	-	-	L	F	Saloon Engine D4F 732	211021	Drive Shaft		23	30	49	86	683	
	2013.11-	-	-	L/R	F	Saloon Engine D4F 732	850219	Outer Joint		23	28	49	86	52	I
MAGANE															
2.0 i	-	-	-	-	-	-	850034	Outer Joint		21	22	51.5	83	56.5	O
	-	-	-	-	-	-	850062	Outer Joint	26T	21	22	51.5	83	56.5	O
	-	-	-	-	-	-	850063	Outer Joint	44T	21	22	51.5	83	56.5	O
MASTER I (T__)															
2.2 (67 kW)	1980.08-	1998.07	MT	L/R	F	Bus Engine J7T 782/J7T 788	250003	Drive Shaft		32	27	65	113	825	
MASTER II (ED/HD/UD)															
2.2 dCi 90 (66 kW)	2000.09-	-	MT	R	F	Platform/Chassis Engine G9T 720/G9T 722/G9T 750	250214	Drive Shaft		28	39	65	96	1132	
	2000.09-	-	MT	R	F	Platform/Chassis Engine G9T 720/G9T 722/G9T 750	244016	Drive Shaft	51T	28	39	65	96	1132	
	2000.09-	-	-	L	F	Platform/Chassis Engine G9T 720/G9T 722/G9T 750	250166	Drive Shaft	51T	28	37.1	65	96	663	
	2000.09-	-	-	R	F	Platform/Chassis Engine G9T 720/G9T 722/G9T 750	299151	Drive Shaft	51T	28	39	65	96	1144	
	2000.09-	-	MT	L/R	F	Platform/Chassis Engine G9T 720/G9T 722/G9T 750	844026	Outer Joint	51T	28	36	65	96	71	I
	2000.09-	-	MT	L/R	F	Platform/Chassis Engine G9T 720/G9T 722/G9T 750	844025	Outer Joint		28	36	65	96	71	I
	2000.09-	-	MT	L	F	Platform/Chassis Engine G9T 720/G9T 722/G9T 750	244005	Drive Shaft	51T	28	37.1	65	96	670	
	2000.09-	-	MT	L	F	Platform/Chassis Engine G9T 720/G9T 722/G9T 750	250010	Drive Shaft		28	37.1	67.1	93.5	669	
2.5 D (59 kW)	1998.07-	2001.01	MT	R	F	Platform/Chassis Engine S8U 770	650006	Inner Joint		39	27	35	437	98	
	1998.07-	2001.01	MT	L/R	F	Platform/Chassis Engine S8U 770	844026	Outer Joint	51T	28	36	65	96	71	I
	1998.07-	2001.01	MT	L	F	Platform/Chassis Engine S8U 770	250217	Drive Shaft	51T	28	37.1	67.1	93.5	669	
	1998.07-	2001.01	MT	L/R	F	Platform/Chassis Engine S8U 770	844025	Outer Joint		28	36	65	96	71	I
	1998.07-	2001.01	MT	L	F	Platform/Chassis Engine S8U 770	244005	Drive Shaft	51T	28	37.1	65	96	670	
	1998.07-	2001.01	MT	R	F	Platform/Chassis Engine S8U 770	244004	Drive Shaft	51T	28	39	67.1	93.5	1118	
	1998.07-	2001.01	-	-	F	Platform/Chassis Engine S8U 770	844008	Outer Joint	51T	28	27	67.1	93.5	64.5	I
	1998.07-	2001.01	-	-	F	Platform/Chassis Engine S8U 770	850014	Outer Joint		28	27	67.1	93.5	64.5	I
	1998.07-	2001.01	MT	L	F	Platform/Chassis Engine S8U 770	250010	Drive Shaft		28	37.1	67.1	93.5	669	
	1998.07-	2001.01	MT	R	F	Platform/Chassis Engine S8U 770	250011	Drive Shaft		28	39	67.1	93.5	1118	
2.5 dCi (107 kW)	2006.08-	-	MT	R	F	Platform/Chassis Engine G9U 632	650006	Inner Joint		39	27	35	437	98	
	2006.08-	-	-	R	F	Platform/Chassis Engine G9U 632	250066	Drive Shaft		28	39	65	96	1142	
	2006.08-	-	-	R	F	Platform/Chassis Engine G9U 632	250366	Drive Shaft	51T	28	39	65	96	1116	
	2006.08-	-	-	L	F	Platform/Chassis Engine G9U 632	299286	Drive Shaft	51T	28	39	65	96	700	
2.5 dCi (74 kW)	2006.08-	-	MT	R	F	Platform/Chassis Engine G9U 650/G9U 754	650006	Inner Joint		39	27	35	437	98	
	2006.08-	-	-	L	F	Platform/Chassis Engine G9U 650/G9U 754	250166	Drive Shaft	51T	28	37.1	65	96	663	
	2006.08-	-	-	R	F	Platform/Chassis Engine G9U 650/G9U 754	299151	Drive Shaft	51T	28	39	65	96	1144	
	2006.08-	-	-	R	F	Platform/Chassis Engine G9U 650/G9U 754	250066	Drive Shaft		28	39	65	96	1142	
2.5 dCi (88 kW)	2006.08-	-	MT	R	F	Platform/Chassis Engine G9U 650	650006	Inner Joint		39	27	35	437	98	
	2006.08-	-	-	R	F	Platform/Chassis Engine G9U 650	250066	Drive Shaft		28	39	65	96	1142	
	2006.08-	-	-	R	F	Platform/Chassis Engine G9U 650	250366	Drive Shaft	51T	28	39	65	96	1116	
	2006.08-	-	-	L	F	Platform/Chassis Engine G9U 650	299286	Drive Shaft	51T	28	39	65	96	700	
2.5 dCi 100 (73 kW)	2003.10-	-	MT	L	F	Platform/Chassis Engine G9U 754	244012	Drive Shaft		28	37.1	65	96	663	
	2003.10-	-	MT	R	F	Platform/Chassis Engine G9U 754	250249	Drive Shaft		28	39	65	96	1144	
	2003.10-	-	MT	L	F	Platform/Chassis Engine G9U 754	250166	Drive Shaft	51T	28	37.1	65	96	663	
	2003.10-	-	MT	R	F	Platform/Chassis Engine G9U 754	299151	Drive Shaft	51T	28	39	65	96	1144	
	2003.10-	-	-	R	F	Platform/Chassis Engine G9U 754	250066	Drive Shaft		28	39	65	96	1142	
	2003.10-	-	MT	R	F	Platform/Chassis Engine G9U 754	650006	Inner Joint		39	27	35	437	98	
2.5 dCi 120 (84 kW)	2001.10-	-	MT	L	F	Platform/Chassis Engine G9U 720/G9U 724/G9U 750/G9U 754	244012	Drive Shaft		28	37.1	65	96	663	
	2001.10-	-	MT	R	F	Platform/Chassis Engine G9U 720/G9U 724/G9U 750/G9U 754	250249	Drive Shaft		28	39	65	96	1144	
	2001.10-	-	MT	L	F	Platform/Chassis Engine G9U 720/G9U 724/G9U 750/G9U 754	250166	Drive Shaft	51T	28	37.1	65	96	663	
	2001.10-	-	MT	R	F	Platform/Chassis Engine G9U 720/G9U 724/G9U 750/G9U 754	299151	Drive Shaft	51T	28	39	65	96	1144	
	2001.10-	-	MT	R	F	Platform/Chassis Engine G9U 720/G9U 724/G9U 750/G9U 754	250066	Drive Shaft		28	39	65	96	1142	
	2001.10-	-	MT	R	F	Platform/Chassis Engine G9U 720/G9U 724/G9U 750/G9U 754	650006	Inner Joint		39	27	35	437	98	
2.8 dTi (84 kW)	1998.07-	2001.10	MT	R	F	Platform/Chassis Engine S9W 702	650006	Inner Joint		39	27	35	437	98	
	1998.07-	2001.10	MT	R	F	Platform/Chassis Engine S9W 702	299151	Drive Shaft	51T	28	39	65	96	1144	

		 YEAR	TRANSM	L/R	F/R	REMARKS	GSP Ref.	 PRODUCT	 ABS	Technical Specifications					
										A	B	C	H	L	P
RENAULT															
MASTER II (ED/HD/UD)															
2.8 dTi (84 kW)	1998.07-2001.10	MT	L/R	F	Platform/Chassis Engine S9W 702	844026	Outer Joint	51T	28	36	65	96	71	I	
	1998.07-2001.10	MT	L	F	Platform/Chassis Engine S9W 702	250217	Drive Shaft	51T	28	37.1	67.1	93.5	669		
	1998.07-2001.10	MT	L/R	F	Platform/Chassis Engine S9W 702	844025	Outer Joint		28	36	65	96	71	I	
	1998.07-2001.10	MT	L	F	Platform/Chassis Engine S9W 702	244005	Drive Shaft	51T	28	37.1	65	96	670		
	1998.07-2001.10	MT	R	F	Platform/Chassis Engine S9W 702	244004	Drive Shaft	51T	28	39	67.1	93.5	1118		
	1998.07-2001.10	-	-	F	Platform/Chassis Engine S9W 702	844008	Outer Joint	51T	28	27	67.1	93.5	64.5	I	
	1998.07-2001.10	-	-	F	Platform/Chassis Engine S9W 702	850014	Outer Joint		28	27	67.1	93.5	64.5	I	
	1998.07-2001.10	MT	L	F	Platform/Chassis Engine S9W 702	250010	Drive Shaft		28	37.1	67.1	93.5	669		
3.0 dCi 140 (100 kW)	1998.07-2001.10	MT	R	F	Platform/Chassis Engine S9W 702	250011	Drive Shaft		28	39	67.1	93.5	1118		
	2003.10-	MT	L	F	Platform/Chassis Engine ZD3 200/ZD3 202	250057	Drive Shaft	51T	28	39	65	96	687		
	2003.10-	MT	R	F	Platform/Chassis Engine ZD3 200/ZD3 202	250059	Drive Shaft	51T	28	39	65	96	1126		
MASTER II (FD)															
1.9 dCi 80 (60 kW)	2001.11-	MT	R	F	Box Engine F9Q 772/F9Q 774	244021	Drive Shaft		28	39	65	96	1126		
	2001.11-	-	L	F	Box Engine F9Q 772/F9Q 774	250246	Drive Shaft		28	37.1	65	96	644		
	2001.11-	MT	R	F	Box Engine F9Q 772/F9Q 774	244022	Drive Shaft		28	39	67.1	93.5	1147		
	2001.11-	MT	L/R	F	Box Engine F9Q 772/F9Q 774	844026	Outer Joint	51T	28	36	65	96	71	I	
	2001.11-	MT	L/R	F	Box Engine F9Q 772/F9Q 774	844025	Outer Joint		28	36	65	96	71	I	
	2001.11-	MT	L	F	Box Engine F9Q 772/F9Q 774	244005	Drive Shaft	51T	28	37.1	65	96	670		
	2001.11-	MT	L	F	Box Engine F9Q 772/F9Q 774	250010	Drive Shaft		28	37.1	67.1	93.5	669		
	2001.11-	MT	R	F	Box Engine F9Q 772/F9Q 774	244017	Drive Shaft	51T	28	39	67.1	93.5	1147		
	2001.11-	MT	R	F	Box Engine F9Q 772/F9Q 774	244022	Drive Shaft		28	39	67.1	93.5	1147		
1.9 dTi (59 kW)	2001.11-	MT	R	F	Box Engine F9Q 772/F9Q 774	250060	Drive Shaft	51T	28	39	65	96	1126		
	2000.09-	-	L	F	Box Engine F9Q 770	250246	Drive Shaft		28	37.1	65	96	644		
	2000.09-	MT	R	F	Box Engine F9Q 770	244022	Drive Shaft		28	39	67.1	93.5	1147		
	2000.09-	MT	L/R	F	Box Engine F9Q 770	844026	Outer Joint	51T	28	36	65	96	71	I	
	2000.09-	MT	L/R	F	Box Engine F9Q 770	844025	Outer Joint		28	36	65	96	71	I	
	2000.09-	MT	L	F	Box Engine F9Q 770	244005	Drive Shaft	51T	28	37.1	65	96	670		
	2000.09-	MT	L	F	Box Engine F9Q 770	250010	Drive Shaft		28	37.1	67.1	93.5	669		
	2000.09-	MT	R	F	Box Engine F9Q 770	244017	Drive Shaft	51T	28	39	67.1	93.5	1147		
2.2 dCi 90 (66 kW)	2000.09-	MT	R	F	Box Engine F9Q 770	244022	Drive Shaft		28	39	67.1	93.5	1147		
	2000.09-	MT	R	F	Box Engine F9Q 770	250060	Drive Shaft	51T	28	39	65	96	1126		
	2000.09-	-	L	F	Box Engine F9Q 770	250246	Drive Shaft		28	37.1	65	96	644		
	2000.09-	-	R	F	Box Engine F9Q 770	244022	Drive Shaft		28	39	67.1	93.5	1147		
	2000.09-	MT	L/R	F	Box Engine F9Q 770	844026	Outer Joint	51T	28	36	65	96	71	I	
	2000.09-	MT	L/R	F	Box Engine F9Q 770	844025	Outer Joint		28	36	65	96	71	I	
	2000.09-	MT	L	F	Box Engine F9Q 770	244005	Drive Shaft	51T	28	37.1	65	96	670		
	2000.09-	MT	L	F	Box Engine F9Q 770	250010	Drive Shaft		28	37.1	67.1	93.5	669		
2.5 D (59 kW)	2000.09-	MT	R	F	Box Engine G9T 720/G9T 722/G9T 750	250114	Drive Shaft		28	39	65	96	1132		
	2000.09-	MT	R	F	Box Engine G9T 720/G9T 722/G9T 750	244016	Drive Shaft	51T	28	39	65	96	1132		
	2000.09-	-	L	F	Box Engine G9T 720/G9T 722/G9T 750	250166	Drive Shaft	51T	28	37.1	65	96	663		
	2000.09-	-	R	F	Box Engine G9T 720/G9T 722/G9T 750	299151	Drive Shaft	51T	28	39	65	96	1144		
	2000.09-	MT	L/R	F	Box Engine G9T 720/G9T 722/G9T 750	844026	Outer Joint	51T	28	36	65	96	71	I	
	2000.09-	MT	L/R	F	Box Engine G9T 720/G9T 722/G9T 750	844025	Outer Joint		28	36	65	96	71	I	
	2000.09-	MT	L	F	Box Engine G9T 720/G9T 722/G9T 750	244005	Drive Shaft	51T	28	37.1	65	96	670		
	2000.09-	MT	L	F	Box Engine G9T 720/G9T 722/G9T 750	250010	Drive Shaft		28	37.1	67.1	93.5	669		
2.5 D (59 kW)	1998.07-2001.01	MT	L/R	F	Box Engine S8U 770	844026	Outer Joint	51T	28	36	65	96	71	I	
	1998.07-2001.01	MT	L/R	F	Box Engine S8U 770	844025	Outer Joint		28	36	65	96	71	I	
	1998.07-2001.01	MT	L	F	Box Engine S8U 770	244005	Drive Shaft	51T	28	37.1	65	96	670		
	1998.07-2001.01	MT	R	F	Box Engine S8U 770	244004	Drive Shaft	51T	28	39	67.1	93.5	1118		
	1998.07-2001.01	MT	L	F	Box Engine S8U 770	250010	Drive Shaft		28	37.1	67.1	93.5	669		
	1998.07-2001.01	MT	R	F	Box Engine S8U 770	250011	Drive Shaft		28	39	67.1	93.5	1118		
	1998.07-2001.01	MT	R	F	Box Engine S8U 770	650006	Inner Joint		39	27	35	437	98		
2.5 dCi (107 kW)	2006.08-	MT	R	F	Box Engine G9U 632	650006	Inner Joint		39	27	35	437	98		
	2006.08-	-	R	F	Box Engine G9U 632	250066	Drive Shaft		28	39	65	96	1142		
	2006.08-	-	R	F	Box Engine G9U 632	250366	Drive Shaft	51T	28	39	65	96	1116		
	2006.08-	-	L	F	Box Engine G9U 632	299286	Drive Shaft	51T	28	39	65	96	700		
2.5 dCi (74 kW)	2006.08-	-	L	F	Box Engine G9U 650/G9U 754	250166	Drive Shaft	51T	28	37.1	65	96	663		
	2006.08-	MT	R	F	Box Engine G9U 650/G9U 754	650006	Inner Joint		39	27	35	437	98		
	2006.08-	-	R	F	Box Engine G9U 650/G9U 754	299151	Drive Shaft	51T	28	39	65	96	1144		
	2006.08-	-	R	F	Box Engine G9U 650/G9U 754	250066	Drive Shaft		28	39	65	96	1142		
	2006.08-	-	R	F	Box Engine G9U 650/G9U 754	250366	Drive Shaft	51T	28	39	65	96	1116		
	2006.08-	-	L	F	Box Engine G9U 650/G9U 754	299286	Drive Shaft	51T	28	39	65	96	700		
2.5 dCi (88 kW)	2006.08-	MT	R	F	Box Engine G9U 650	650006	Inner Joint		39	27	35	437	98		
	2006.08-	-	R	F	Box Engine G9U 650	250066	Drive Shaft		28	39	65	96	1142		
	2006.08-	-	R	F	Box Engine G9U 650	250366	Drive Shaft	51T	28	39	65	96	1116		
	2006.08-	-	L	F	Box Engine G9U 650	299286	Drive Shaft	51T	28	39	65	96	700		
2.5 dCi 100 (73 kW)	2003.10-	MT	L	F	Box Engine G9U 754	244012	Drive Shaft		28	37.1	65	96	663		
	2003.10-	MT	R	F	Box Engine G9U 754	250249	Drive Shaft		28	39	65	96	1144		
	2003.10-	MT	L	F	Box Engine G9U 754	250166	Drive Shaft	51T	28	37.1	65	96	663		
	2003.10-	MT	R	F	Box Engine G9U 754	299151	Drive Shaft	51T	28	39	65	96	1144		
	2003.10-	-	R	F	Box Engine G9U 754	250066	Drive Shaft		28	39	65	96	1142		
	2003.10-	-	R	F	Box Engine G9U 754	650006	Inner Joint		39	27	35	437	98		

YEAR	TRANSM	L/R	F/R	REMARKS	GSP Ref.	PRODUCT	ABS	Technical Specifications						
								A	B	C	H	L	P	
RENAULT														
MASTER II (FD)														
2.5 dCi 120 (84 kW)	2001.10-	-	MT	L F	Box Engine G9U 720/G9U 724/G9U 750/G9U 754	244012	Drive Shaft		28	37.1	65	96	663	
	2001.10-	-	MT	R F	Box Engine G9U 720/G9U 724/G9U 750/G9U 754	250249	Drive Shaft		28	39	65	96	1144	
	2001.10-	-	MT	L F	Box Engine G9U 720/G9U 724/G9U 750/G9U 754	250166	Drive Shaft	51T	28	37.1	65	96	663	
	2001.10-	-	MT	R F	Box Engine G9U 720/G9U 724/G9U 750/G9U 754	299151	Drive Shaft	51T	28	39	65	96	1144	
	2001.10-	-	-	L F	Box Engine G9U 720/G9U 724/G9U 750/G9U 754	244005	Drive Shaft	51T	28	37.1	65	96	670	
	2001.10-	-	MT	R F	Box Engine G9U 720/G9U 724/G9U 750/G9U 754	250066	Drive Shaft		28	39	65	96	1142	
	2001.10-	-	MT	R F	Box Engine G9U 720/G9U 724/G9U 750/G9U 754	650006	Inner Joint		39	27	35	437	98	
2.8 dTi (84 kW)	1998.07-	2001.10	MT	R F	Box Engine S9W 702	650006	Inner Joint		39	27	35	437	98	
	1998.07-	2001.10	MT	L/R F	Box Engine S9W 702	844026	Outer Joint	51T	28	36	65	96	71	I
	1998.07-	2001.10	MT	L/R F	Box Engine S9W 702	844025	Outer Joint		28	36	65	96	71	I
	1998.07-	2001.10	MT	L F	Box Engine S9W 702	244005	Drive Shaft	51T	28	37.1	65	96	670	
	1998.07-	2001.10	MT	L F	Box Engine S9W 702	250217	Drive Shaft	51T	28	37.1	67.1	93.5	669	
	1998.07-	2001.10	MT	R F	Box Engine S9W 702	244004	Drive Shaft	51T	28	39	67.1	93.5	1118	
	1998.07-	2001.10	MT	L F	Box Engine S9W 702	250010	Drive Shaft		28	37.1	67.1	93.5	669	
	1998.07-	2001.10	-	- F	Box Engine S9W 702	844008	Outer Joint	51T	28	27	67.1	93.5	64.5	I
	1998.07-	2001.10	-	- F	Box Engine S9W 702	850014	Outer Joint		28	27	67.1	93.5	64.5	I
	1998.07-	2001.10	MT	R F	Box Engine S9W 702	250011	Drive Shaft		28	39	67.1	93.5	1118	
3.0 dCi 140 (100 kW)	2003.10-	-	MT	L F	Box Engine ZD3 202	250057	Drive Shaft	51T	28	39	65	96	687	
	2003.10-	-	MT	R F	Box Engine ZD3 202	250059	Drive Shaft	51T	28	39	65	96	1126	
MASTER II (JD)														
1.9 dCi 80 (60 kW)	2001.11-	-	-	L F	Bus Engine F9Q 772/F9Q 774	250246	Drive Shaft		28	37.1	65	96	644	
	2001.11-	-	MT	L F	Bus Engine F9Q 772/F9Q 774	250058	Drive Shaft	51T	28	37.1	65	96	644	
	2001.11-	-	MT	R F	Bus Engine F9Q 772/F9Q 774	244022	Drive Shaft		28	39	67.1	93.5	1147	
	2001.11-	-	MT	L/R F	Bus Engine F9Q 772/F9Q 774	844026	Outer Joint	51T	28	36	65	96	71	I
	2001.11-	-	MT	L/R F	Bus Engine F9Q 772/F9Q 774	844025	Outer Joint		28	36	65	96	71	I
	2001.11-	-	MT	L F	Bus Engine F9Q 772/F9Q 774	244005	Drive Shaft	51T	28	37.1	65	96	670	
	2001.11-	-	MT	L F	Bus Engine F9Q 772/F9Q 774	250010	Drive Shaft		28	37.1	67.1	93.5	669	
	2001.11-	-	MT	R F	Bus Engine F9Q 772/F9Q 774	244017	Drive Shaft	51T	28	39	67.1	93.5	1147	
	2001.11-	-	MT	R F	Bus Engine F9Q 772/F9Q 774	244022	Drive Shaft		28	39	67.1	93.5	1147	
	2001.11-	-	MT	R F	Bus Engine F9Q 772/F9Q 774	250060	Drive Shaft	51T	28	39	65	96	1126	
	2001.11-	-	MT	R F	Bus Engine F9Q 772/F9Q 774	244021	Drive Shaft		28	39	65	96	1126	
1.9 dTi (59 kW)	2000.09-	-	-	L F	Bus Engine F9Q 770	250246	Drive Shaft		28	37.1	65	96	644	
	2000.09-	-	MT	L F	Bus Engine F9Q 770	250058	Drive Shaft	51T	28	37.1	65	96	644	
	2000.09-	-	MT	R F	Bus Engine F9Q 770	244022	Drive Shaft		28	39	67.1	93.5	1147	
	2000.09-	-	MT	L/R F	Bus Engine F9Q 770	844026	Outer Joint	51T	28	36	65	96	71	I
	2000.09-	-	MT	L/R F	Bus Engine F9Q 770	844025	Outer Joint		28	36	65	96	71	I
	2000.09-	-	MT	L F	Bus Engine F9Q 770	244005	Drive Shaft	51T	28	37.1	65	96	670	
	2000.09-	-	MT	L F	Bus Engine F9Q 770	250010	Drive Shaft		28	37.1	67.1	93.5	669	
	2000.09-	-	MT	R F	Bus Engine F9Q 770	244017	Drive Shaft	51T	28	39	67.1	93.5	1147	
	2000.09-	-	MT	R F	Bus Engine F9Q 770	244022	Drive Shaft		28	39	67.1	93.5	1147	
	2000.09-	-	MT	R F	Bus Engine F9Q 770	250060	Drive Shaft	51T	28	39	65	96	1126	
2.2 dCi 90 (66 kW)	2000.09-	-	MT	R F	Bus Engine G9T 720/G9T 722/G9T 750	250214	Drive Shaft		28	39	65	96	1132	
	2000.09-	-	MT	R F	Bus Engine G9T 720/G9T 722/G9T 750	244016	Drive Shaft	51T	28	39	65	96	1132	
	2000.09-	-	-	L F	Bus Engine G9T 720/G9T 722/G9T 750	250166	Drive Shaft	51T	28	37.1	65	96	663	
	2000.09-	-	-	R F	Bus Engine G9T 720/G9T 722/G9T 750	299151	Drive Shaft	51T	28	39	65	96	1144	
	2000.09-	-	MT	L/R F	Bus Engine G9T 720/G9T 722/G9T 750	844026	Outer Joint	51T	28	36	65	96	71	I
	2000.09-	-	MT	L/R F	Bus Engine G9T 720/G9T 722/G9T 750	844025	Outer Joint		28	36	65	96	71	I
	2000.09-	-	MT	L F	Bus Engine G9T 720/G9T 722/G9T 750	244005	Drive Shaft	51T	28	37.1	65	96	670	
	2000.09-	-	MT	L F	Bus Engine G9T 720/G9T 722/G9T 750	250010	Drive Shaft		28	37.1	67.1	93.5	669	
2.5 D (59 kW)	1998.07-	2001.01	MT	R F	Bus Engine S8U 770	650006	Inner Joint		39	27	35	437	98	
	1998.07-	2001.01	MT	L/R F	Bus Engine S8U 770	844026	Outer Joint	51T	28	36	65	96	71	I
	1998.07-	2001.01	MT	L/R F	Bus Engine S8U 770	844025	Outer Joint		28	36	65	96	71	I
	1998.07-	2001.01	MT	L F	Bus Engine S8U 770	244005	Drive Shaft	51T	28	37.1	65	96	670	
	1998.07-	2001.01	MT	R F	Bus Engine S8U 770	244004	Drive Shaft	51T	28	39	67.1	93.5	1118	
	1998.07-	2001.01	MT	L F	Bus Engine S8U 770	250010	Drive Shaft		28	37.1	67.1	93.5	669	
	1998.07-	2001.01	MT	R F	Bus Engine S8U 770	250011	Drive Shaft		28	39	67.1	93.5	1118	
2.5 dCi (107 kW)	2006.08-	-	-	L F	Bus Engine G9U 632	250166	Drive Shaft	51T	28	37.1	65	96	663	
	2006.08-	-	MT	R F	Bus Engine G9U 632	650006	Inner Joint		39	27	35	437	98	
	2006.08-	-	-	R F	Bus Engine G9U 632	299151	Drive Shaft	51T	28	39	65	96	1144	
	2006.08-	-	-	R F	Bus Engine G9U 632	250066	Drive Shaft		28	39	65	96	1142	
	2006.08-	-	-	R F	Bus Engine G9U 632	250366	Drive Shaft	51T	28	39	65	96	1116	
	2006.08-	-	-	L F	Bus Engine G9U 632	299286	Drive Shaft	51T	28	39	65	96	700	
2.5 dCi (74 kW)	2006.08-	-	MT	R F	Bus Engine G9U 754	650006	Inner Joint		39	27	35	437	98	
	2006.08-	-	-	R F	Bus Engine G9U 754	250066	Drive Shaft		28	39	65	96	1142	
	2006.08-	-	MT	R F	Bus Engine G9U 754	250366	Drive Shaft	51T	28	39	65	96	1116	
	2006.08-	-	MT	L F	Bus Engine G9U 754	299286	Drive Shaft	51T	28	39	65	96	700	





REMARKS	YEAR	TRANSM	L/R	F/R	GSP Ref.	PRODUCT	ABS	Technical Specifications								
								A	B	C	H	L	P			
RENAULT MASTER II (JD)																
2.5 dCi (88 kW)	2006.08-	-	-	L	F	Bus Engine G9U 650	250166	Drive Shaft	51T	28	37.1	65	96	663		
	2006.08-	-	MT	R	F	Bus Engine G9U 650	650006	Inner Joint		39	27	35	437	98		
	2006.08-	-	-	R	F	Bus Engine G9U 650	299151	Drive Shaft	51T	28	39	65	96	1144		
	2006.08-	-	-	R	F	Bus Engine G9U 650	250066	Drive Shaft		28	39	65	96	1142		
	2006.08-	-	-	R	F	Bus Engine G9U 650	250366	Drive Shaft	51T	28	39	65	96	1116		
	2006.08-	-	-	L	F	Bus Engine G9U 650	299286	Drive Shaft	51T	28	39	65	96	700		
2.5 dCi 100 (73 kW)	2003.10-	-	-	R	F	Bus Engine G9U 754	250066	Drive Shaft		28	39	65	96	1142		
	2003.10-	-	MT	R	F	Bus Engine G9U 754	250366	Drive Shaft	51T	28	39	65	96	1116		
	2003.10-	-	MT	R	F	Bus Engine G9U 754	650006	Inner Joint		39	27	35	437	98		
	2003.10-	-	MT	L	F	Bus Engine G9U 754	299286	Drive Shaft	51T	28	39	65	96	700		
2.5 dCi 120 (84 kW)	2001.10-	-	MT	L	F	Bus Engine G9U 720/G9U 750/G9U 754	244012	Drive Shaft		28	37.1	65	96	663		
	2001.10-	-	MT	R	F	Bus Engine G9U 720/G9U 750/G9U 754	250249	Drive Shaft		28	39	65	96	1144		
	2001.10-	-	MT	L	F	Bus Engine G9U 720/G9U 750/G9U 754	250166	Drive Shaft	51T	28	37.1	65	96	663		
	2001.10-	-	MT	R	F	Bus Engine G9U 720/G9U 750/G9U 754	299151	Drive Shaft	51T	28	39	65	96	1144		
	2001.10-	-	-	L	F	Bus Engine G9U 720/G9U 750/G9U 754	244005	Drive Shaft	51T	28	37.1	65	96	670		
	2001.10-	-	MT	R	F	Bus Engine G9U 720/G9U 750/G9U 754	250066	Drive Shaft		28	39	65	96	1142		
	2001.10-	-	MT	R	F	Bus Engine G9U 720/G9U 750/G9U 754	650006	Inner Joint		39	27	35	437	98		
2.8 dTi (84 kW)	1998.07-2001.10	-	MT	R	F	Bus Engine S9W 702	650006	Inner Joint		39	27	35	437	98		
	1998.07-2001.10	-	MT	L/R	F	Bus Engine S9W 702	844026	Outer Joint	51T	28	36	65	96	71	I	
	1998.07-2001.10	-	MT	L/R	F	Bus Engine S9W 702	844025	Outer Joint		28	36	65	96	71	I	
	1998.07-2001.10	-	MT	L	F	Bus Engine S9W 702	244005	Drive Shaft	51T	28	37.1	65	96	670		
	1998.07-2001.10	-	MT	L	F	Bus Engine S9W 702	250217	Drive Shaft	51T	28	37.1	67.1	93.5	669		
	1998.07-2001.10	-	MT	R	F	Bus Engine S9W 702	244004	Drive Shaft	51T	28	39	67.1	93.5	1118		
	1998.07-2001.10	-	MT	L	F	Bus Engine S9W 702	250010	Drive Shaft		28	37.1	67.1	93.5	669		
	1998.07-2001.10	-	-	-	F	Bus Engine S9W 702	844008	Outer Joint	51T	28	27	67.1	93.5	64.5	I	
	1998.07-2001.10	-	-	-	F	Bus Engine S9W 702	850014	Outer Joint		28	27	67.1	93.5	64.5	I	
	1998.07-2001.10	-	MT	R	F	Bus Engine S9W 702	250011	Drive Shaft		28	39	67.1	93.5	1118		
3.0 dCi 140 (100 kW)	2003.10-	-	MT	L	F	Bus Engine ZD3 200/ZD3 202	250057	Drive Shaft	51T	28	39	65	96	687		
	2003.10-	-	MT	R	F	Bus Engine ZD3 200/ZD3 202	250059	Drive Shaft	51T	28	39	65	96	1126		
MASTER III																
2.5 DCi	2009-	-	-	R	F	-	650046	Inner Joint		39	27	30	364	87		
	2009-	-	-	L	F	-	650045	Inner Joint		39	27	39	74	109		
MASTER III (EV HV UV)																
2.3 dCi 100 FWD (74 kW)	2010.02-	-	MT	-	F	Platform/Chassis Engine M9T 670/M9T 672/M9T 676/M9T 870/M9T 890	850132	Outer Joint		31	27	70	100.5	63.5	I	
	2010.02-	-	-	R	F	Platform/Chassis Engine M9T 670/M9T 672/M9T 676/M9T 870/M9T 890	218515	Drive Shaft		31	39	70	101	1077		
	2010.02-	-	-	L	F	Platform/Chassis Engine M9T 670/M9T 672/M9T 676/M9T 870/M9T 890	218247	Drive Shaft		31	39	70	100.5	743		
	2010.02-	-	-	R	F	Platform/Chassis Engine M9T 670/M9T 672/M9T 676/M9T 870/M9T 890	218248	Drive Shaft		31	39	70	100.5	1075		
2.3 dCi 110 FWD (81 kW)	2014.09-	-	MT	L	F	Platform/Chassis Engine M9T 870	218247	Drive Shaft		31	39	70	100.5	743		
	2014.09-	-	MT	R	F	Platform/Chassis Engine M9T 870	218248	Drive Shaft		31	39	70	100.5	1075		
2.3 dCi 125 FWD (92 kW)	2010.02-	-	MT	-	F	Platform/Chassis Engine M9T 670/M9T 672/M9T 676/M9T 870/M9T 890	850132	Outer Joint		31	27	70	100.5	63.5	I	
	2010.02-	-	-	R	F	Platform/Chassis Engine M9T 670/M9T 672/M9T 676/M9T 870/M9T 890	218515	Drive Shaft		31	39	70	101	1077		
	2010.02-	-	-	L	F	Platform/Chassis Engine M9T 670/M9T 672/M9T 676/M9T 870/M9T 890	218247	Drive Shaft		31	39	70	100.5	743		
	2010.02-	-	-	R	F	Platform/Chassis Engine M9T 670/M9T 672/M9T 676/M9T 870/M9T 890	218248	Drive Shaft		31	39	70	100.5	1075		
2.3 dCi 130 FWD/ 2.3 dCi 130 (96 kW)	2012.03-	-	-	L	F	Platform/Chassis	218247	Drive Shaft		31	39	70	100.5	743		
	2012.03-	-	-	R	F	Platform/Chassis	218248	Drive Shaft		31	39	70	100.5	1075		
2.3 dCi 135 FWD (100 kW)	2014.07-	-	MT	L	F	Platform/Chassis Engine M9T 702	218247	Drive Shaft		31	39	70	100.5	743		
2.3 dCi 145 FWD (107 kW)	2010.02-	-	MT	-	F	Platform/Chassis Engine M9T 678/M9T 680/M9T 698/M9T 896	850132	Outer Joint		31	27	70	100.5	63.5	I	
	2010.02-	-	-	R	F	Platform/Chassis Engine M9T 678/M9T 680/M9T 698/M9T 896	218515	Drive Shaft		31	39	70	101	1077		
	2010.02-	-	-	L	F	Platform/Chassis Engine M9T 678/M9T 680/M9T 698/M9T 896	218247	Drive Shaft		31	39	70	100.5	743		
	2010.02-	-	-	R	F	Platform/Chassis Engine M9T 678/M9T 680/M9T 698/M9T 896	218248	Drive Shaft		31	39	70	100.5	1075		
2.3 dCi 150 FWD (110 kW)	2013.03-	-	MT	-	F	Platform/Chassis Engine M9T 880/M9T 898	850132	Outer Joint		31	27	70	100.5	63.5	I	
	2013.03-	-	AT	L	F	Platform/Chassis Engine M9T 880/M9T 898	218247	Drive Shaft		31	39	70	100.5	743		
	2013.03-	-	AT	R	F	Platform/Chassis Engine M9T 880/M9T 898	218248	Drive Shaft		31	39	70	100.5	1075		
2.3 dCi 165 FWD (120 kW)	2014.07-	-	MT	L	F	Platform/Chassis Engine M9T 700/M9T 702	218247	Drive Shaft		31	39	70	100.5	743		
2.3 dCi 170 FWD (125 kW)	2016.06-	-	-	L	F	Platform/Chassis	218247	Drive Shaft		31	39	70	100.5	743		
	2016.06-	-	-	R	F	Platform/Chassis	218248	Drive Shaft		31	39	70	100.5	1075		
MASTER III (FV)																
2.3 dCi 100 FWD (74 kW)	2010.02-	-	-	L	F	Box Engine M9T 670/M9T 672/M9T 676/M9T 870/M9T 890	218247	Drive Shaft		31	39	70	100.5	743		
	2010.02-	-	MT	-	F	Box Engine M9T 670/M9T 672/M9T 676/M9T 870/M9T 890	850132	Outer Joint		31	27	70	100.5	63.5	I	
	2010.02-	-	-	R	F	Box Engine M9T 670/M9T 672/M9T 676/M9T 870/M9T 890	218515	Drive Shaft		31	39	70	101	1077		
	2010.02-	-	-	R	F	Box Engine M9T 670/M9T 672/M9T 676/M9T 870/M9T 890	218248	Drive Shaft		31	39	70	100.5	1075		
2.3 dCi 100 RWD (74 kW)	2010.02-	-	MT	L	F	Box Engine M9T 690/M9T 692/M9T 870/M9T 890	218247	Drive Shaft		31	39	70	100.5	743		
	2010.02-	-	MT	R	F	Box Engine M9T 690/M9T 692/M9T 870/M9T 890	218248	Drive Shaft		31	39	70	100.5	1075		
2.3 dCi 110 FWD (81 kW)	2014.09-	-	MT	L	F	Box Engine M9T 870	218247	Drive Shaft		31	39	70	100.5	743		
	2014.09-	-	MT	R	F	Box Engine M9T 870	218248	Drive Shaft		31	39	70	100.5	1075		
2.3 dCi 125 FWD (92 kW)	2010.02-	-	-	L	F	Box Engine M9T 670/M9T 672/M9T 676/M9T 870/M9T 890	218247	Drive Shaft		31	39	70	100.5	743		

REMARKS	YEAR	TRANSM	L/R	F/R	GSP Ref.	PRODUCT	ABS	Technical Specifications							
								A	B	C	H	L	P		
RENAULT															
MASTER III (FV)															
2.3 dCi 125 FWD (92 kW)	2010.02-	-	MT	-	F	Box Engine M9T 670/M9T 672/M9T 676/M9T 698/M9T 870/M9T 890/M9T 896	850132	Outer Joint		31	27	70	100.5	63.5	I
	2010.02-	-	-	R	F	Box Engine M9T 670/M9T 672/M9T 676/M9T 698/M9T 870/M9T 890/M9T 896	218515	Drive Shaft		31	39	70	101	1077	
	2010.02-	-	-	R	F	Box Engine M9T 670/M9T 672/M9T 676/M9T 698/M9T 870/M9T 890/M9T 896	218248	Drive Shaft		31	39	70	100.5	1075	
2.3 dCi 130 FWD (96 kW)	2016.06-	-	-	L	F	Box Engine M9T 692	218247	Drive Shaft		31	39	70	100.5	743	
	2016.06-	-	-	R	F	Box Engine M9T 692	218248	Drive Shaft		31	39	70	100.5	1075	
2.3 dCi 135 FWD (100 kW)	2014.07-	-	MT	L	F	Box Engine M9T 702	218247	Drive Shaft		31	39	70	100.5	743	
	2014.07-	-	MT	R	F	Box Engine M9T 702	218248	Drive Shaft		31	39	70	100.5	1075	
2.3 dCi 145 FWD (107 kW)	2010.02-	-	-	L	F	Box Engine M9T 678/M9T 680/M9T 694/M9T 696/M9T 698/M9T 896	218247	Drive Shaft		31	39	70	100.5	743	
	2010.02-	-	MT	-	F	Box Engine M9T 678/M9T 680/M9T 694/M9T 696/M9T 698/M9T 896	850132	Outer Joint		31	27	70	100.5	63.5	I
	2010.02-	-	-	R	F	Box Engine M9T 678/M9T 680/M9T 694/M9T 696/M9T 698/M9T 896	218515	Drive Shaft		31	39	70	101	1077	
	2010.02-	-	-	R	F	Box Engine M9T 678/M9T 680/M9T 694/M9T 696/M9T 698/M9T 896	218248	Drive Shaft		31	39	70	100.5	1075	
2.3 dCi 150 FWD (110 kW)	2013.03-	-	MT	L	F	Box Engine M9T 880/M9T 898	218247	Drive Shaft		31	39	70	100.5	743	
	2013.03-	-	MT	-	F	Box Engine M9T 880/M9T 898	850132	Outer Joint		31	27	70	100.5	63.5	I
	2013.03-	-	MT	R	F	Box Engine M9T 880/M9T 898	218248	Drive Shaft		31	39	70	100.5	1075	
2.3 dCi 165 FWD (120 kW)	2014.07-	-	MT	L	F	Box Engine M9T 702	218247	Drive Shaft		31	39	70	100.5	743	
	2014.07-	-	MT	R	F	Box Engine M9T 702	218248	Drive Shaft		31	39	70	100.5	1075	
2.3 dCi 170 FWD (125 kW)	2015.07-	-	-	L	F	Box Engine M9T 706	218247	Drive Shaft		31	39	70	100.5	743	
	2015.07-	-	-	R	F	Box Engine M9T 706	218248	Drive Shaft		31	39	70	100.5	1075	
MASTER III (JV)															
2.3 dCi 100 FWD (74 kW)	2011.02-	-	MT	L	F	Bus Engine M9T 670/M9T 672/M9T 676/M9T 870	218247	Drive Shaft		31	39	70	100.5	743	
	2011.02-	-	MT	-	F	Bus Engine M9T 670/M9T 672/M9T 676/M9T 870	850132	Outer Joint		31	27	70	100.5	63.5	I
	2011.02-	-	-	R	F	Bus Engine M9T 670/M9T 672/M9T 676/M9T 870	218515	Drive Shaft		31	39	70	101	1077	
	2011.02-	-	MT	R	F	Bus Engine M9T 670/M9T 672/M9T 676/M9T 870	218248	Drive Shaft		31	39	70	100.5	1075	
2.3 dCi 110 FWD (81 kW)	2014.09-	-	-	L	F	Bus Engine M9T 870/M9T 890	218247	Drive Shaft		31	39	70	100.5	743	
2.3 dCi 125 FWD (92 kW)	2011.02-	-	MT	L	F	Bus Engine M9T 670/M9T 672/M9T 676/M9T 870	218247	Drive Shaft		31	39	70	100.5	743	
	2011.02-	-	MT	-	F	Bus Engine M9T 670/M9T 672/M9T 676/M9T 870	850132	Outer Joint		31	27	70	100.5	63.5	I
	2011.02-	-	-	R	F	Bus Engine M9T 670/M9T 672/M9T 676/M9T 870	218515	Drive Shaft		31	39	70	101	1077	
	2011.02-	-	MT	R	F	Bus Engine M9T 670/M9T 672/M9T 676/M9T 870	218248	Drive Shaft		31	39	70	100.5	1075	
2.3 dCi 135 FWD (100 kW)	2014.07-	-	MT	L	F	Bus Engine M9T 700/M9T 702	218247	Drive Shaft		31	39	70	100.5	743	
2.3 dCi 145 FWD (107 kW)	2011.02-	-	MT	L	F	Bus Engine M9T 680	218247	Drive Shaft		31	39	70	100.5	743	
	2011.02-	-	MT	-	F	Bus Engine M9T 680	850132	Outer Joint		31	27	70	100.5	63.5	I
	2011.02-	-	-	R	F	Bus Engine M9T 680	218515	Drive Shaft		31	39	70	101	1077	
	2011.02-	-	MT	R	F	Bus Engine M9T 680	218248	Drive Shaft		31	39	70	100.5	1075	
2.3 dCi 150 FWD (110 kW)	2012.10-	-	-	L	F	Bus Engine M9T 880	218247	Drive Shaft		31	39	70	100.5	743	
	2012.10-	-	MT	-	F	Bus Engine M9T 880	850132	Outer Joint		31	27	70	100.5	63.5	I
	2012.10-	-	-	R	F	Bus Engine M9T 880	218248	Drive Shaft		31	39	70	100.5	1075	
2.3 dCi 165 FWD (120 kW)	2014.07-	-	MT	L	F	Bus Engine M9T 700/M9T 702	218247	Drive Shaft		31	39	70	100.5	743	
2.3 dCi 170 FWD (125 kW)	2015.07-	-	MT	L	F	Bus Engine M9T 706	218247	Drive Shaft		31	39	70	100.5	743	
MEGANE															
-	-	-	-	-	-	-	850050	Outer Joint	44T	21	30	51.5	83	56.5	O
	2001-	2007	-	-	-	-	850054	Outer Joint	44T	23	23	57	83	61	M
1.6/1.9 D/2.0 i	-	-	-	-	-	-	850017	Outer Joint		21	22	51.5	83	56.5	I
1.9 DTi	1996-	-	-	R	-	-	250149	Drive Shaft	44T	23	23	57.5	86.5	742	
2.0	1996-	-	-	R	-	-	250149	Drive Shaft	44T	23	23	57.5	86.5	742	
	2009-	2015	-	R	F	-	650135	Inner joint		26	22	33	346	96	
	2009-	2015	-	R	F	-	850212	Outer Joint		25	25	52.6	88.5	58.5	I
2.0 16V	1996-	-	-	R	-	-	250149	Drive Shaft	44T	23	23	57.5	86.5	742	
MEGANE CC (EZ0/1_)															
1.4 Tce (96 kW)	2010.06-	-	-	R	F	Convertible Engine H4J 700	250604	Drive Shaft		25	26	52.6	89	942	
1.5 dCi (81 kW)	2010.06-	-	-	R	F	Convertible Engine K9K 837	250425	Drive Shaft		25	26	52.7	88.5	931	
	2010.06-	-	-	R	F	Convertible Engine K9K 837	850148	Outer Joint		25	35	52.6	89	60	I
	2010.06-	-	-	L	F	Convertible Engine K9K 837	250426	Drive Shaft		25	26	52.7	88.5	680	
	2010.06-	-	-	-	F	Convertible Engine K9K 837	850145	Outer Joint		25	33	52.7	88.5	59.5	I
	2010.06-	-	-	R	F	Convertible Engine K9K 837	250536	Drive Shaft		25	34	52.6	89	984	
	2010.06-	-	-	L	F	Convertible Engine K9K 837	250535	Drive Shaft		25	34	52.7	88.5	632	
	2010.06-	-	-	-	-	Convertible Engine K9K 837	250610	Drive Shaft		25	34	52.7	88.5	1000	
	2010.06-	-	5MT/6MT	-	F	Convertible Engine K9K 837	899213	Outer Joint		25	33	53	88	61.5	I
1.6 16V (81 kW)	2010.06-	-	6MT	-	F	Convertible Engine K4M 858	850163	Outer Joint		25	23	52.4	88.5	61	M
	2010.06-	-	5MT/6MT	-	F	Convertible Engine K4M 858	899213	Outer Joint		25	33	53	88	61.5	I
	2010.06-	-	6MT	R	F	Convertible Engine K4M 858	250510	Drive Shaft		25	26	52.4	88.5	929	
2.0 CVT (103 kW)	2010.06-	-	-	-	F	Convertible Engine M4R 711	899213	Outer Joint		25	33	53	88	61.5	I
2.0 dCi (118 kW)	2010.06-	-	AT	L	F	Convertible Engine M9R 610	218274	Drive Shaft		27	30	56.5	90	624	
2.0 Tce (132 kW)	2010.06-	-	-	L/R	F	Convertible Engine F4R 870	850160	Outer Joint		27	35	56.5	91.5	61	I
	2010.06-	-	-	L	F	Convertible Engine F4R 870	250606	Drive Shaft		27	39	56.5	91.5	686	
MEGANE I															
1.4 16v	1993-	2002	-	-	-	-	850101	Outer Joint	44T	21	30	52.2	85.5	59	I

REMARKS	YEAR	TRANSM	L/R	F/R	GSP Ref.	PRODUCT	ABS	Technical Specifications							
								A	B	C	H	L	P		
RENAULT MEGANE I															
1.6 16v	1996-2002	-	-	-	850101	Outer Joint	44T	21	30	52.2	85.5	59	I		
1.9 TDi	1998.02-1999.04	MT	R	F	250091	Drive Shaft	44T	23	23	56.2	83.5	744			
2.0 16V	1996.04-1999.04	MT	R	F	250091	Drive Shaft	44T	23	23	56.2	83.5	744			
MEGANE I (BA0/1_)															
1.4 16V (70 kW)	1999.03-2003.08	MT	R	F	Hatchback Engine K4J 714/K4J 750	250107	Drive Shaft	44T	21	23	57	84.5	735.9		
	1999.03-2003.08	-	R	F	Hatchback Engine K4J 714/K4J 750	650008	Inner Joint		23	30	36.3	52.2	68.5		
	1999.03-2003.08	MT	L	F	Hatchback Engine K4J 714/K4J 750	250048	Drive Shaft		21	29.95	46.4	81.5	650		
	1999.03-2003.08	MT	R	F	Hatchback Engine K4J 714/K4J 750	250140	Drive Shaft		21	23	49.8	83.5	718		
	1999.03-2003.08	-	L	F	Hatchback Engine K4J 714/K4J 750	250358	Drive Shaft	44T	21	29.95	57	84	646		
	1999.03-2003.08	MT	R	F	Hatchback Engine K4J 714/K4J 750	250173	Drive Shaft		21	23	57	84.5	742.9		
	1999.03-2003.08	-	R	F	Hatchback Engine K4J 714/K4J 750	250284	Drive Shaft	44T	21	23	56.2	83.5	740.5		
	1999.03-2003.08	-	R	F	Hatchback Engine K4J 714/K4J 750	250021	Drive Shaft	44T	21	23	57	84.5	750		
	1999.03-2003.08	-	R	F	Hatchback Engine K4J 714/K4J 750	250054	Drive Shaft		21	23	49.8	83.5	741.5		
	1999.03-2003.08	-	L	F	Hatchback Engine K4J 714/K4J 750	250326	Drive Shaft	44T	21	29.95	57	84.5	648		
1.4 e (55 kW)	1999.03-2003.08	-	R	F	Hatchback Engine K4J 714/K4J 750	250327	Drive Shaft	44T	21	23	57	84.5	740		
	1996.01-2003.08	MT	L	F	Hatchback Engine E7J 626/E7J 764	250009	Drive Shaft	44T	21	29.95	57	84.5	645.7		
	1996.01-2003.08	MT	L	F	Hatchback Engine E7J 626/E7J 764	250055	Drive Shaft		21	29.95	50	84	650		
	1996.01-2003.08	MT	R	F	Hatchback Engine E7J 626/E7J 764	250107	Drive Shaft	44T	21	23	57	84.5	735.9		
	1996.01-2003.08	MT	L	F	Hatchback Engine E7J 626/E7J 764	250048	Drive Shaft		21	29.95	46.4	81.5	650		
	1996.01-2003.08	MT	R	F	Hatchback Engine E7J 626/E7J 764	250140	Drive Shaft		21	23	49.8	83.5	718		
	1996.01-2003.08	MT	R	F	Hatchback Engine E7J 626/E7J 764	250038	Drive Shaft	44T	21	23	52.2	85.5	752		
	1996.01-2003.08	MT	R	F	Hatchback Engine E7J 626/E7J 764	250173	Drive Shaft		21	23	57	84.5	742.9		
	1996.01-2003.08	MT	R	F	Hatchback Engine E7J 626/E7J 764	250316	Drive Shaft		21	23	57	84	741		
	1996.01-2003.08	-	L	F	Hatchback Engine E7J 626/E7J 764	250326	Drive Shaft	44T	21	29.95	57	84.5	648		
1.4 Eco (52 kW)	1996.01-2003.08	-	R	F	Hatchback Engine E7J 626/E7J 764	250327	Drive Shaft	44T	21	23	57	84.5	740		
	1996.01-1999.03	MT	L	F	Hatchback Engine E7J 624	250009	Drive Shaft	44T	21	29.95	57	84.5	645.7		
	1996.01-1999.03	MT	L	F	Hatchback Engine E7J 624	250055	Drive Shaft		21	29.95	50	84	650		
	1996.01-1999.03	MT	R	F	Hatchback Engine E7J 624	250107	Drive Shaft	44T	21	23	57	84.5	735.9		
	1996.01-1999.03	MT	L	F	Hatchback Engine E7J 624	250048	Drive Shaft		21	29.95	46.4	81.5	650		
	1996.01-1999.03	-	L	F	Hatchback Engine E7J 624	250085	Drive Shaft	44T	21	23	57	84.5	746		
	1996.01-1999.03	MT	R	F	Hatchback Engine E7J 624	250140	Drive Shaft		21	23	49.8	83.5	718		
	1996.01-1999.03	MT	R	F	Hatchback Engine E7J 624	250038	Drive Shaft	44T	21	23	52.2	85.5	752		
	1996.01-1999.03	MT	R	F	Hatchback Engine E7J 624	250173	Drive Shaft		21	23	57	84.5	742.9		
	1996.01-1999.03	MT	R	F	Hatchback Engine E7J 624	250316	Drive Shaft		21	23	57	84	741		
1.6 16V (79 kW)	1996.01-1999.03	-	L	F	Hatchback Engine E7J 624	250326	Drive Shaft	44T	21	29.95	57	84.5	648		
	1996.01-1999.03	-	R	F	Hatchback Engine E7J 624	250327	Drive Shaft	44T	21	23	57	84.5	740		
	1999.03-2003.08	MT	L/R	F	Hatchback Engine K4M 700 K4M 701 K4M 704 K4M 708	850069	Outer Joint	44T	23	30	57.5	86.5	58.5	I	
	1999.03-2003.08	-	R	F	Hatchback Engine K4M 700 K4M 701 K4M 704 K4M 708	650008	Inner Joint		23	30	36.3	52.2	68.5		
	1999.03-2003.08	MT	L	F	Hatchback Engine K4M 700 K4M 701 K4M 704 K4M 708	250048	Drive Shaft		21	29.95	46.4	81.5	650		
	1999.03-2003.08	AT	-	F	Hatchback Engine K4M 700 K4M 701 K4M 704 K4M 708	850052	Outer Joint	44T	23	30	57.5	86.5	58.5	I	
	1999.03-2003.08	-	L	F	Hatchback Engine K4M 700 K4M 701 K4M 704 K4M 708	250253	Drive Shaft	44T	23	26	57.5	86.5	634		
	1999.03-2003.08	MT	R	F	Hatchback Engine K4M 700 K4M 701 K4M 704 K4M 708	250140	Drive Shaft		21	23	49.8	83.5	718		
	1999.03-2003.08	-	L	F	Hatchback Engine K4M 700 K4M 701 K4M 704 K4M 708	250358	Drive Shaft	44T	21	29.95	57	84	646		
	1999.03-2003.08	MT	R	F	Hatchback Engine K4M 700 K4M 701 K4M 704 K4M 708	250173	Drive Shaft		21	23	57	84.5	742.9		
1.6 e (66 kW)	1999.03-2003.08	-	R	F	Hatchback Engine K4M 700 K4M 701 K4M 704 K4M 708	250323	Drive Shaft	44T	23	23	57.5	86.5	778		
	1999.03-2003.08	-	R	F	Hatchback Engine K4M 700 K4M 701 K4M 704 K4M 708	250284	Drive Shaft	44T	21	23	56.2	83.5	740.5		
	1996.01-1999.03	MT	L	F	Hatchback Engine K7M 702/K7M 703/K7M 790	250009	Drive Shaft	44T	21	29.95	57	84.5	645.7		
	1996.01-1999.03	MT	L	F	Hatchback Engine K7M 702/K7M 703/K7M 790	250055	Drive Shaft		21	29.95	50	84	650		
	1996.01-1999.03	MT	R	F	Hatchback Engine K7M 702/K7M 703/K7M 790	250107	Drive Shaft	44T	21	23	57	84.5	735.9		
	1996.01-1999.03	MT	L	F	Hatchback Engine K7M 702/K7M 703/K7M 790	250048	Drive Shaft		21	29.95	46.4	81.5	650		
	1996.01-1999.03	MT	R	F	Hatchback Engine K7M 702/K7M 703/K7M 790	250140	Drive Shaft		21	23	49.8	83.5	718		
	1996.01-1999.03	MT	R	F	Hatchback Engine K7M 702/K7M 703/K7M 790	250038	Drive Shaft	44T	21	23	52.2	85.5	752		
	1996.01-1999.03	MT	R	F	Hatchback Engine K7M 702/K7M 703/K7M 790	250173	Drive Shaft		21	23	57	84.5	742.9		
	1996.01-1999.03	MT	R	F	Hatchback Engine K7M 702/K7M 703/K7M 790	250316	Drive Shaft		21	23	57	84	741		
1.6 i (55 kW)	1996.01-1999.03	MT	L	F	Hatchback Engine K7M 720	250009	Drive Shaft	44T	21	29.95	57	84.5	645.7		
	1996.01-1999.03	MT	L	F	Hatchback Engine K7M 720	250055	Drive Shaft		21	29.95	50	84	650		
	1996.01-1999.03	MT	R	F	Hatchback Engine K7M 720	250107	Drive Shaft	44T	21	23	57	84.5	735.9		
	1996.01-1999.03	MT	L	F	Hatchback Engine K7M 720	250048	Drive Shaft		21	29.95	46.4	81.5	650		
	1996.01-1999.03	MT	R	F	Hatchback Engine K7M 720	250140	Drive Shaft		21	23	49.8	83.5	718		
	1996.01-1999.03	MT	R	F	Hatchback Engine K7M 720	250038	Drive Shaft	44T	21	23	52.2	85.5	752		
	1996.01-1999.03	MT	R	F	Hatchback Engine K7M 720	250173	Drive Shaft		21	23	57	84.5	742.9		
	1996.01-1999.03	MT	R	F	Hatchback Engine K7M 720	250316	Drive Shaft		21	23	57	84	741		
	1996.01-1999.03	-	L	F	Hatchback Engine K7M 720	250326	Drive Shaft	44T	21	29.95	57	84.5	648		
	1996.01-1999.03	-	R	F	Hatchback Engine K7M 720	250327	Drive Shaft	44T	21	23	57	84.5	740		
1.6 LPG (80 kW)	2000.10-2002.08	-	R	F	Hatchback Engine K4M 704	650008	Inner Joint		23	30	36.3	52.2	68.5		
	2000.10-2002.08	MT	L	F	Hatchback Engine K4M 704	250048	Drive Shaft		21	29.95	46.4	81.5	650		

REMARKS	YEAR	TRANSM	L/R	F/R	GSP Ref.	PRODUCT	ABS	Technical Specifications							
								A	B	C	H	L	P		
RENAULT MEGANE I (BA0/1_)															
1.6 LPG (80 kW)	2000.10-2002.08	MT	R	F	Hatchback Engine K4M 704	250140	Drive Shaft		21	23	49.8	83.5	718		
	2000.10-2002.08	-	L	F	Hatchback Engine K4M 704	250358	Drive Shaft	44T	21	29.95	57	84	646		
	2000.10-2002.08	MT	R	F	Hatchback Engine K4M 704	250173	Drive Shaft		21	23	57	84.5	742.9		
	2000.10-2002.08	-	R	F	Hatchback Engine K4M 704	250284	Drive Shaft	44T	21	23	56.2	83.5	740.5		
1.8 16V (85 kW)	2001.01-2003.08	-	-	F	Hatchback Engine F4P 720/F4P 722	850058	Outer Joint	44T	23	35	57	87	71	I	
	2001.01-2003.08	-	-	F	Hatchback Engine F4P 720/F4P 722	850052	Outer Joint	44T	23	30	57.5	86.5	58.5	I	
	2001.01-2003.08	-	L	F	Hatchback Engine F4P 720/F4P 722	250160	Drive Shaft	44T	23	29.95	57	87	656.5		
	2001.01-2003.08	-	R	F	Hatchback Engine F4P 720/F4P 722	699131	Inner Joint		23	28	35	142	86		
	2001.01-2003.08	-	R	F	Hatchback Engine F4P 720/F4P 722	250313	Drive Shaft	44T	23	23	57.5	86.5	750		
	2001.01-2003.08	AT/MT	L/R	F	Hatchback Engine F4P 720/F4P 722	850114	Outer Joint	44T	23	35	57.5	87	71	I	
1.9 D Eco (47 kW)	1996.01-2003.08	MT	L	F	Hatchback Engine F8Q 620/F8Q 622/F8Q 624	250009	Drive Shaft	44T	21	29.95	57	84.5	645.7		
	1996.01-2003.08	MT	L	F	Hatchback Engine F8Q 620/F8Q 622/F8Q 624	250055	Drive Shaft		21	29.95	50	84	650		
	1996.01-2003.08	AT/MT	R	F	Hatchback Engine F8Q 620/F8Q 622/F8Q 624	250107	Drive Shaft	44T	21	23	57	84.5	735.9		
	1996.01-2003.08	MT	L	F	Hatchback Engine F8Q 620/F8Q 622/F8Q 624	250048	Drive Shaft		21	29.95	46.4	81.5	650		
	1996.01-2003.08	MT	R	F	Hatchback Engine F8Q 620/F8Q 622/F8Q 624	250038	Drive Shaft	44T	21	23	52.2	85.5	752		
	1996.01-2003.08	MT	R	F	Hatchback Engine F8Q 620/F8Q 622/F8Q 624	250140	Drive Shaft		21	23	49.8	83.5	718		
	1996.01-2003.08	MT	R	F	Hatchback Engine F8Q 620/F8Q 622/F8Q 624	250173	Drive Shaft		21	23	57	84.5	742.9		
	1996.01-2003.08	MT	R	F	Hatchback Engine F8Q 620/F8Q 622/F8Q 624	250316	Drive Shaft		21	23	57	84	741		
	1996.01-2003.08	-	L	F	Hatchback Engine F8Q 620/F8Q 622/F8Q 624	250326	Drive Shaft	44T	21	29.95	57	84.5	648		
	1996.01-2003.08	-	R	F	Hatchback Engine F8Q 620/F8Q 622/F8Q 624	250327	Drive Shaft	44T	21	23	57	85	740		
1.9 dCi (75 kW)	2001.02-2003.08	MT	-	F	Hatchback Engine F9Q 732/F9Q 733	850058	Outer Joint	44T	23	35	57	87	71	I	
	2001.02-2003.08	AT/MT	L/R	F	Hatchback Engine F9Q 732/F9Q 733	850069	Outer Joint	44T	23	30	57.5	86.5	58.5	I	
	2001.02-2003.08	AT/MT	-	F	Hatchback Engine F9Q 732/F9Q 733	850052	Outer Joint	44T	23	30	57.5	86.5	58.5	I	
	2001.02-2003.08	AT	L	F	Hatchback Engine F9Q 732/F9Q 733	250253	Drive Shaft	44T	23	26	57.5	86.5	634		
	2001.02-2003.08	MT	L	F	Hatchback Engine F9Q 732/F9Q 733	250314	Drive Shaft	44T	23	29.95	57.5	86.5	654		
	2001.02-2003.08	MT	R	F	Hatchback Engine F9Q 732/F9Q 733	250156	Drive Shaft	44T	23	23	57.5	86.5	746.5		
1.9 DCi (77 kW)	1999.03-2003.08	MT	-	F	Hatchback Engine F9Q 732/F9Q 738	850058	Outer Joint	44T	23	35	57	87	71	I	
	1999.03-2003.08	MT	R	F	Hatchback Engine F9Q 732/F9Q 738	650008	Inner Joint		23	30	36.3	52.2	68.5		
	1999.03-2003.08	MT	-	F	Hatchback Engine F9Q 732/F9Q 738	850052	Outer Joint	44T	23	30	57.5	86.5	58.5	I	
	1999.03-2003.08	MT	R	F	Hatchback Engine F9Q 732/F9Q 738	250159	Drive Shaft	44T	23	23	57	87	748		
	1999.03-2003.08	MT	R	F	Hatchback Engine F9Q 732/F9Q 738	250156	Drive Shaft	44T	23	23	57.5	86.5	746.5		
1.9 dT (66 kW)	1996.01-2003.08	-	-	-	Hatchback Engine F8Q 784/F8Q 786	850051	Outer Joint	48T	23	25	56.3	80	58	O	
	1996.01-2003.08	MT	L	F	Hatchback Engine F8Q 784/F8Q 786	250029	Drive Shaft	44T	23	29.95	56.8	84	654		
	1996.01-2003.08	MT	L	F	Hatchback Engine F8Q 784/F8Q 786	250048	Drive Shaft		21	29.95	46.4	81.5	650		
	1996.01-2003.08	MT	L/R	F	Hatchback Engine F8Q 784/F8Q 786	850026	Outer Joint		23	25	56.2	83.5	58	O	
	1996.01-2003.08	MT	R	F	Hatchback Engine F8Q 784/F8Q 786	250140	Drive Shaft		21	23	49.8	83.5	718		
	1996.01-2003.08	MT	R	F	Hatchback Engine F8Q 784/F8Q 786	250173	Drive Shaft		21	23	57	84.5	742.9		
	1996.01-2003.08	MT	R	F	Hatchback Engine F8Q 784/F8Q 786	250320	Drive Shaft	44T	23	23	56.8	84	755		
	1996.01-2003.08	MT	R	F	Hatchback Engine F8Q 784/F8Q 786	650079	Inner Joint		23	22	36.3	50	55.5		
	1996.01-2003.08	-	L	F	Hatchback Engine F8Q 784/F8Q 786	250326	Drive Shaft	44T	21	29.95	57	84.5	648		
	1996.01-2003.08	-	R	F	Hatchback Engine F8Q 784/F8Q 786	250054	Drive Shaft		21	23	49.8	83.5	741.5		
1996.01-2003.08	-	R	F	Hatchback Engine F8Q 784/F8Q 786	250327	Drive Shaft	44T	21	23	57	84.5	740			
1.9 dTi (59 kW)	2001.02-2003.08	-	L	F	Hatchback Engine F9Q 744	250311	Drive Shaft	44T	23	29.95	56	82	650		
	2001.02-2003.08	MT	-	F	Hatchback Engine F9Q 744	850058	Outer Joint	44T	23	35	57	87	71	I	
	2001.02-2003.08	AT/MT	L/R	F	Hatchback Engine F9Q 744	850069	Outer Joint	44T	23	30	57.5	86.5	58.5	I	
	2001.02-2003.08	MT	-	F	Hatchback Engine F9Q 744	850052	Outer Joint	44T	23	30	57.5	86.5	58.5	I	
	2001.02-2003.08	MT	R	F	Hatchback Engine F9Q 744	250156	Drive Shaft	44T	23	23	57.5	86.5	746.5		
	2001.02-2003.08	-	R	F	Hatchback Engine F9Q 744	250313	Drive Shaft	44T	23	23	57.5	86.5	750		
1.9 dTi (72 kW)	1997.03-2001.02	-	-	-	Hatchback Engine F9Q 730/F9Q 731/F9Q 734/F9Q 736	850051	Outer Joint	48T	23	25	56.3	80	58	O	
	1997.03-2001.02	MT	L	F	Hatchback Engine F9Q 730/F9Q 731/F9Q 734/F9Q 736	250029	Drive Shaft	44T	23	29.95	56.8	84	654		
	1997.03-2001.02	MT	-	F	Hatchback Engine F9Q 730/F9Q 731/F9Q 734/F9Q 736	850058	Outer Joint	44T	23	35	57	87	71	I	
	1997.03-2001.02	AT/MT	-	F	Hatchback Engine F9Q 730/F9Q 731/F9Q 734/F9Q 736	850052	Outer Joint	44T	23	30	57.5	86.5	58.5	I	
	1997.03-2001.02	AT	L	F	Hatchback Engine F9Q 730/F9Q 731/F9Q 734/F9Q 736	250253	Drive Shaft	44T	23	26	57.5	86.5	634		
	1997.03-2001.02	MT	R	F	Hatchback Engine F9Q 730/F9Q 731/F9Q 734/F9Q 736	250320	Drive Shaft	44T	23	23	56.8	84	755		
	1997.03-2001.02	MT	L/R	F	Hatchback Engine F9Q 730/F9Q 731/F9Q 734/F9Q 736	850026	Outer Joint		23	25	56.2	83.5	58	O	
	1997.03-2001.02	MT	R	F	Hatchback Engine F9Q 730/F9Q 731/F9Q 734/F9Q 736	650079	Inner Joint		23	22	36.3	50	55.5		
	1997.03-2001.02	MT	R	F	Hatchback Engine F9Q 730/F9Q 731/F9Q 734/F9Q 736	250039	Drive Shaft	44T	23	23	57.5	86.5	748		
	1997.03-2001.02	MT	R	F	Hatchback Engine F9Q 730/F9Q 731/F9Q 734/F9Q 736	250159	Drive Shaft	44T	23	23	57	87	748		
	1997.03-2001.02	MT	L	F	Hatchback Engine F9Q 730/F9Q 731/F9Q 734/F9Q 736	250314	Drive Shaft	44T	23	29.95	57.5	86.5	654		
	1997.03-2001.02	MT	R	F	Hatchback Engine F9Q 730/F9Q 731/F9Q 734/F9Q 736	650008	Inner Joint		23	30	36.3	52.2	68.5		
	1997.03-2001.02	-	L	F	Hatchback Engine F9Q 730/F9Q 731/F9Q 734/F9Q 736	250326	Drive Shaft	44T	21	29.95	57	84.5	648		
	1997.03-2001.02	-	R	F	Hatchback Engine F9Q 730/F9Q 731/F9Q 734/F9Q 736	250327	Drive Shaft	44T	21	23	57	84.5	740		
1.9 TDI (69 kW)	1996.09-2003.08	-	-	-	Hatchback Engine F8Q 784	850051	Outer Joint	48T	23	25	56.3	80	58	O	
	1996.09-2003.08	MT	L	F	Hatchback Engine F8Q 784	250029	Drive Shaft	44T	23	29.95	56.8	84	654		
	1996.09-2003.08	-	-	F	Hatchback Engine F8Q 784	850058	Outer Joint	44T	23	35	57	87	71	I	
	1996.09-2003.08	MT	L/R	F	Hatchback Engine F8Q 784	850026	Outer Joint		23	25	56.2	83.5	58	O	

REMARKS	YEAR	TRANSM	L/R	F/R	GSP Ref.	PRODUCT	ABS	Technical Specifications						
								A	B	C	H	L	P	
RENAULT														
MEGANE I (BA0/1_)														
1.9 TDI (69 kW)	1996.09-2003.08	MT	R	F	Hatchback Engine F8Q 784	650008	Inner Joint		23	30	36.3	52.2	68.5	
	1996.09-2003.08	-	-	F	Hatchback Engine F8Q 784	850052	Outer Joint	44T	23	30	57.5	86.5	58.5	I
	1996.09-2003.08	MT	R	F	Hatchback Engine F8Q 784	250320	Drive Shaft	44T	23	23	56.8	84	755	
	1996.09-2003.08	MT	R	F	Hatchback Engine F8Q 784	650079	Inner Joint		23	22	36.3	50	55.5	
	1996.09-2003.08	MT	R	F	Hatchback Engine F8Q 784	250159	Drive Shaft	44T	23	23	57	87	748	
	1996.09-2003.08	MT	R	F	Hatchback Engine F8Q 784	250156	Drive Shaft	44T	23	23	57.5	86.5	746.5	
	1996.09-2003.08	-	L	F	Hatchback Engine F8Q 784	250326	Drive Shaft	44T	21	29.95	57	84.5	648	
	1996.09-2003.08	-	R	F	Hatchback Engine F8Q 784	250327	Drive Shaft	44T	21	23	57	84.5	740	
2.0 (85 kW)	1998.05-2001.05	MT	L	F	Hatchback Engine F3R 750/F3R 751/F3R 791/F3R 796/F3R 797/F3R 798	250009	Drive Shaft	44T	21	29.95	57	84.5	645.7	
	1998.05-2001.05	MT	L	F	Hatchback Engine F3R 750/F3R 751/F3R 791/F3R 796/F3R 797/F3R 798	250055	Drive Shaft		21	29.95	50	84	650	
	1998.05-2001.05	MT	L	F	Hatchback Engine F3R 750/F3R 751/F3R 791/F3R 796/F3R 797/F3R 798	250048	Drive Shaft		21	29.95	46.4	81.5	650	
	1998.05-2001.05	MT	R	F	Hatchback Engine F3R 750/F3R 751/F3R 791/F3R 796/F3R 797/F3R 798	250038	Drive Shaft	44T	21	23	52.2	85.5	752	
	1998.05-2001.05	MT	R	F	Hatchback Engine F3R 750/F3R 751/F3R 791/F3R 796/F3R 797/F3R 798	250140	Drive Shaft		21	23	49.8	83.5	718	
	1998.05-2001.05	MT	R	F	Hatchback Engine F3R 750/F3R 751/F3R 791/F3R 796/F3R 797/F3R 798	250173	Drive Shaft		21	23	57	84.5	742.9	
	1998.05-2001.05	MT	R	F	Hatchback Engine F3R 750/F3R 751/F3R 791/F3R 796/F3R 797/F3R 798	250316	Drive Shaft		21	23	57	84	741	
	1998.05-2001.05	-	L	F	Hatchback Engine F3R 750/F3R 751/F3R 791/F3R 796/F3R 797/F3R 798	250326	Drive Shaft	44T	21	29.95	57	84.5	648	
	1998.05-2001.05	-	R	F	Hatchback Engine F3R 750/F3R 751/F3R 791/F3R 796/F3R 797/F3R 798	250054	Drive Shaft		21	23	49.8	83.5	741.5	
	1998.05-2001.05	-	R	F	Hatchback Engine F3R 750/F3R 751/F3R 791/F3R 796/F3R 797/F3R 798	250327	Drive Shaft	44T	21	23	57	84.5	740	
2.0 16V (108 kW)	1996.07-2003.08	MT	L	F	Hatchback Engine F7R 710/F7R 714	250029	Drive Shaft	44T	23	29.95	56.8	84	650	
	1996.07-2003.08	-	-	F	Hatchback Engine F7R 710/F7R 714	850051	Outer Joint	48T	23	25	56.3	80	58	O
	1996.07-2003.08	-	-	F	Hatchback Engine F7R 710/F7R 714	850058	Outer Joint	44T	23	35	57	87	71	I
	1996.07-2003.08	MT	L/R	F	Hatchback Engine F7R 710/F7R 714	850026	Outer Joint		23	25	56.2	83.5	58	O
	1996.07-2003.08	-	-	F	Hatchback Engine F7R 710/F7R 714	850052	Outer Joint	44T	23	30	57.5	86.5	58.5	I
	1996.07-2003.08	-	R	F	Hatchback Engine F7R 710/F7R 714	650008	Inner Joint		23	30	36.3	52.2	68.5	
	1996.07-2003.08	MT	R	F	Hatchback Engine F7R 710/F7R 714	250320	Drive Shaft	44T	23	23	56.8	84	755	
	1996.07-2003.08	MT	R	F	Hatchback Engine F7R 710/F7R 714	650079	Inner Joint		23	22	36.3	50	55.5	
	1996.07-2003.08	-	R	F	Hatchback Engine F7R 710/F7R 714	250159	Drive Shaft	44T	23	23	57	87	748	
2.0 i (80 kW)	1999.03-2003.08	MT	L	F	Hatchback Engine F3R 750/F3R 751	250009	Drive Shaft	44T	21	29.95	57	84.5	645.7	
	1999.03-2003.08	MT	L	F	Hatchback Engine F3R 750/F3R 751	250055	Drive Shaft		21	29.95	50	84	650	
	1999.03-2003.08	MT	R	F	Hatchback Engine F3R 750/F3R 751	250038	Drive Shaft	44T	21	23	52.2	85.5	752	
	1999.03-2003.08	MT	L	F	Hatchback Engine F3R 750/F3R 751	250048	Drive Shaft		21	29.95	46.4	81.5	650	
	1999.03-2003.08	MT	R	F	Hatchback Engine F3R 750/F3R 751	250316	Drive Shaft		21	23	57	84	741	
	1999.03-2003.08	MT	R	F	Hatchback Engine F3R 750/F3R 751	250140	Drive Shaft		21	23	49.8	83.5	718	
	1999.03-2003.08	MT	R	F	Hatchback Engine F3R 750/F3R 751	250173	Drive Shaft		21	23	57	84.5	742.9	
	1999.03-2003.08	-	L	F	Hatchback Engine F3R 750/F3R 751	250326	Drive Shaft	44T	21	29.95	57	84.5	648	
	1999.03-2003.08	-	R	F	Hatchback Engine F3R 750/F3R 751	250054	Drive Shaft		21	23	49.8	83.5	741.5	
	1999.03-2003.08	-	R	F	Hatchback Engine F3R 750/F3R 751	250327	Drive Shaft	44T	21	23	57	84.5	740	
2.0 i (84 kW)	1996.01-2003.08	MT	L	F	Hatchback Engine F3R 750/F3R 751	250009	Drive Shaft	44T	21	29.95	57	84.5	645.7	
	1996.01-2003.08	MT	L	F	Hatchback Engine F3R 750/F3R 751	250055	Drive Shaft		21	29.95	50	84	650	
	1996.01-2003.08	MT	L	F	Hatchback Engine F3R 750/F3R 751	250048	Drive Shaft		21	29.95	46.4	81.5	650	
	1996.01-2003.08	MT	R	F	Hatchback Engine F3R 750/F3R 751	250140	Drive Shaft		21	23	49.8	83.5	718	
	1996.01-2003.08	MT	R	F	Hatchback Engine F3R 750/F3R 751	250038	Drive Shaft	44T	21	23	52.2	85.5	752	
	1996.01-2003.08	MT	R	F	Hatchback Engine F3R 750/F3R 751	250173	Drive Shaft		21	23	57	84.5	742.9	
	1996.01-2003.08	MT	R	F	Hatchback Engine F3R 750/F3R 751	250027	Drive Shaft	44T	23	23	56.8	84	750.5	
	1996.01-2003.08	MT	R	F	Hatchback Engine F3R 750/F3R 751	250316	Drive Shaft		21	23	57	84	741	
	1996.01-2003.08	-	L	F	Hatchback Engine F3R 750/F3R 751	250326	Drive Shaft	44T	21	29.95	57	84.5	648	
	1996.01-2003.08	-	R	F	Hatchback Engine F3R 750/F3R 751	250054	Drive Shaft		21	23	49.8	83.5	741.5	
	1996.01-2003.08	-	R	F	Hatchback Engine F3R 750/F3R 751	250327	Drive Shaft	44T	21	23	57	84.5	740	
MEGANE I (JA0/1), SCENIC														
2.0 i (84 kW)	1997.01-1998.09	-	-	-	-	850074	Outer Joint		23	22	56.8	84	55.5	I
MEGANE I Cabriolet (EA0/1_)														
1.4 16V (70 kW)	1999.03-2003.08	-	R	F	Convertible Engine K4J 714/K4J 750	650008	Inner Joint		23	30	36.3	52.2	68.5	
	1999.03-2003.08	MT	L	F	Convertible Engine K4J 714/K4J 750	250048	Drive Shaft		21	29.95	46.4	81.5	650	
	1999.03-2003.08	MT	R	F	Convertible Engine K4J 714/K4J 750	250140	Drive Shaft		21	23	49.8	83.5	718	
	1999.03-2003.08	-	L	F	Convertible Engine K4J 714/K4J 750	250358	Drive Shaft	44T	21	29.95	57	84	646	
	1999.03-2003.08	MT	R	F	Convertible Engine K4J 714/K4J 750	250173	Drive Shaft		21	23	57	84.5	742.9	
	1999.03-2003.08	-	R	F	Convertible Engine K4J 714/K4J 750	250284	Drive Shaft	44T	21	23	56.2	83.5	740.5	
1.6 16V (79 kW)	1999.03-2003.08	MT	L/R	F	Convertible Engine K4M 700/K4M 701/K4M 708	850069	Outer Joint	44T	23	30	57.5	86.5	58.5	I
	1999.03-2003.08	-	R	F	Convertible Engine K4M 700/K4M 701/K4M 708	650008	Inner Joint		23	30	36.3	52.2	68.5	
	1999.03-2003.08	MT	L	F	Convertible Engine K4M 700/K4M 701/K4M 708	250048	Drive Shaft		21	29.95	46.4	81.5	650	
	1999.03-2003.08	-	L	F	Convertible Engine K4M 700/K4M 701/K4M 708	250253	Drive Shaft	44T	23	26	57.5	86.5	634	
	1999.03-2003.08	MT	R	F	Convertible Engine K4M 700/K4M 701/K4M 708	250140	Drive Shaft		21	23	49.8	83.5	718	
	1999.03-2003.08	-	L	F	Convertible Engine K4M 700/K4M 701/K4M 708	250358	Drive Shaft	44T	21	29.95	57	84	646	
	1999.03-2003.08	MT	R	F	Convertible Engine K4M 700/K4M 701/K4M 708	250173	Drive Shaft		21	23	57	84.5	742.9	
	1999.03-2003.08	-	R	F	Convertible Engine K4M 700/K4M 701/K4M 708	250323	Drive Shaft	44T	23	23	57.5	86.5	778	
	1999.03-2003.08	-	R	F	Convertible Engine K4M 700/K4M 701/K4M 708	250284	Drive Shaft	44T	21	23	56.2	83.5	740.5	

		 YEAR	TRANSM	L/R	F/R	REMARKS	GSP Ref.	 PRODUCT	 ABS	Technical Specifications					
										A	B	C	H	L	P
RENAULT															
MEGANE I Cabriolet (EA0/1_)															
1.6 e (66 kW)		1996.10-1999.03	MT	L	F	Convertible Engine K7M 702/K7M 703	250009	Drive Shaft	44T	21	29.95	57	84.5	645.7	
		1996.10-1999.03	MT	L	F	Convertible Engine K7M 702/K7M 703	250055	Drive Shaft		21	29.95	50	84	650	
		1996.10-1999.03	MT	R	F	Convertible Engine K7M 702/K7M 703	250107	Drive Shaft	44T	21	23	57	84.5	735.9	
		1996.10-1999.03	MT	L	F	Convertible Engine K7M 702/K7M 703	250048	Drive Shaft		21	29.95	46.4	81.5	650	
		1996.10-1999.03	MT	R	F	Convertible Engine K7M 702/K7M 703	250038	Drive Shaft	44T	21	23	52.2	85.5	752	
		1996.10-1999.03	MT	R	F	Convertible Engine K7M 702/K7M 703	250140	Drive Shaft		21	23	49.8	83.5	718	
		1996.10-1999.03	MT	R	F	Convertible Engine K7M 702/K7M 703	250173	Drive Shaft		21	23	57	84.5	742.9	
		1996.10-1999.03	MT	R	F	Convertible Engine K7M 702/K7M 703	250316	Drive Shaft		21	23	57	84	741	
		1996.10-1999.03	-	L	F	Convertible Engine K7M 702/K7M 703	250326	Drive Shaft	44T	21	29.95	57	84.5	648	
		1996.10-1999.03	-	R	F	Convertible Engine K7M 702/K7M 703	250327	Drive Shaft	44T	21	23	57	84.5	740	
2.0 (84 kW)		1997.04-2003.08	MT	L	F	Convertible Engine F3R 750/F3R 798	250009	Drive Shaft	44T	21	29.95	57	84.5	645.7	
		1997.04-2003.08	MT	L	F	Convertible Engine F3R 750/F3R 798	250055	Drive Shaft		21	29.95	50	84	650	
		1997.04-2003.08	MT	L	F	Convertible Engine F3R 750/F3R 798	250048	Drive Shaft		21	29.95	46.4	81.5	650	
		1997.04-2003.08	MT	R	F	Convertible Engine F3R 750/F3R 798	250038	Drive Shaft	44T	21	23	52.2	85.5	752	
		1997.04-2003.08	MT	L/R	F	Convertible Engine F3R 750/F3R 798	250140	Drive Shaft		21	23	49.8	83.5	718	
		1997.04-2003.08	MT	R	F	Convertible Engine F3R 750/F3R 798	250027	Drive Shaft	44T	23	23	56.8	84	750.5	
		1997.04-2003.08	MT	R	F	Convertible Engine F3R 750/F3R 798	250316	Drive Shaft		21	23	57	84	741	
		1997.04-2003.08	MT	L	F	Convertible Engine F3R 750/F3R 798	250326	Drive Shaft	44T	21	29.95	57	84.5	648	
		1997.04-2003.08	-	R	F	Convertible Engine F3R 750/F3R 798	250021	Drive Shaft	44T	21	23	57	84.5	750	
		1997.04-2003.08	-	R	F	Convertible Engine F3R 750/F3R 798	250054	Drive Shaft		21	23	49.8	83.5	741.5	
		1997.04-2003.08	MT	R	F	Convertible Engine F3R 750/F3R 798	250327	Drive Shaft	44T	21	23	57	84.5	740	
2.0 16V (102 kW)		2002.01-2003.08	-	-	F	Convertible Engine F4R 746/F4R 770	850058	Outer Joint	44T	23	35	57	87	71	I
		2002.01-2003.08	MT	-	F	Convertible Engine F4R 746/F4R 770	850052	Outer Joint	44T	23	30	57.5	86.5	58.5	I
		2002.01-2003.08	MT	R	F	Convertible Engine F4R 746/F4R 770	650008	Inner Joint		23	30	36.3	52.2	68.5	
		2002.01-2003.08	-	L	F	Convertible Engine F4R 746/F4R 770	250160	Drive Shaft	44T	23	29.95	57	87	656.5	
		2002.01-2003.08	MT	R	F	Convertible Engine F4R 746/F4R 770	250159	Drive Shaft	44T	23	23	57	87	748	
		2002.01-2003.08	MT	R	F	Convertible Engine F4R 746/F4R 770	250156	Drive Shaft	44T	23	23	57.5	86.5	746.5	
2.0 16V (108 kW)		1996.10-1999.11	-	-	-	Convertible Engine F7R 710/F7R 714	850051	Outer Joint	48T	23	25	56.3	80	58	O
		1996.10-1999.11	MT	L	F	Convertible Engine F7R 710/F7R 714	250029	Drive Shaft	44T	23	29.95	56.8	84	654	
		1996.10-1999.11	MT	L	F	Convertible Engine F7R 710/F7R 714	250089	Drive Shaft	44T	23	29.95	56.2	83.5	653	
		1996.10-1999.11	-	-	F	Convertible Engine F7R 710/F7R 714	850058	Outer Joint	44T	23	35	57	87	71	I
		1996.10-1999.11	MT	R	F	Convertible Engine F7R 710/F7R 714	650008	Inner Joint		23	30	36.3	52.2	68.5	
		1996.10-1999.11	-	-	F	Convertible Engine F7R 710/F7R 714	850052	Outer Joint	44T	23	30	57.5	86.5	58.5	I
		1996.10-1999.11	MT	R	F	Convertible Engine F7R 710/F7R 714	250320	Drive Shaft	44T	23	23	56.8	84	755	
		1996.10-1999.11	MT	L/R	F	Convertible Engine F7R 710/F7R 714	850026	Outer Joint		23	25	56.2	83.5	58	O
		1996.10-1999.11	-	L	F	Convertible Engine F7R 710/F7R 714	250160	Drive Shaft	44T	23	29.95	57	87	656.5	
		1996.10-1999.11	MT	R	F	Convertible Engine F7R 710/F7R 714	650079	Inner Joint		23	22	36.3	50	55.5	
		1996.10-1999.11	MT	R	F	Convertible Engine F7R 710/F7R 714	250159	Drive Shaft	44T	23	23	57	87	748	
		1996.10-1999.11	-	R	F	Convertible Engine F7R 710/F7R 714	250325	Drive Shaft	44T	23	23	56.3	85	744	
2.0 16V IDE (103 kW)		1999.11-2003.08	-	-	F	Convertible Engine F5R 740	850058	Outer Joint	44T	23	35	57	87	71	I
		1999.11-2003.08	MT	-	F	Convertible Engine F5R 740	850052	Outer Joint	44T	23	30	57.5	86.5	58.5	I
		1999.11-2003.08	MT	R	F	Convertible Engine F5R 740	650008	Inner Joint		23	30	36.3	52.2	68.5	
		1999.11-2003.08	-	L	F	Convertible Engine F5R 740	250160	Drive Shaft	44T	23	29.95	57	87	656.5	
		1999.11-2003.08	MT	R	F	Convertible Engine F5R 740	250159	Drive Shaft	44T	23	23	57	87	748	
		1999.11-2003.08	MT	R	F	Convertible Engine F5R 740	250156	Drive Shaft	44T	23	23	57.5	86.5	746.5	
		1999.11-2003.08	-	L	F	Convertible Engine F5R 740	250404	Drive Shaft	44T	23	29.95	57.5	86	655	
		1999.11-2003.08	-	R	F	Convertible Engine F5R 740	250325	Drive Shaft	44T	23	23	56.3	85	744	
		1999.11-2003.08	MT	L/R	F	Convertible Engine F5R 740	850114	Outer Joint	44T	23	35	57.5	87	71	I
2.0 i (80 kW)		1999.03-2003.08	MT	L	F	Convertible Engine F3R 791/F3R 796	250009	Drive Shaft	44T	21	29.95	57	84.5	645.7	
		1999.03-2003.08	MT	L	F	Convertible Engine F3R 791/F3R 796	250055	Drive Shaft		21	29.95	50	84	650	
		1999.03-2003.08	MT	L	F	Convertible Engine F3R 791/F3R 796	250048	Drive Shaft		21	29.95	46.4	81.5	650	
		1999.03-2003.08	MT	R	F	Convertible Engine F3R 791/F3R 796	250038	Drive Shaft	44T	21	23	52.2	85.5	752	
		1999.03-2003.08	MT	R	F	Convertible Engine F3R 791/F3R 796	250027	Drive Shaft	44T	23	23	56.8	84	750.5	
		1999.03-2003.08	MT	R	F	Convertible Engine F3R 791/F3R 796	250140	Drive Shaft		21	23	49.8	83.5	718	
		1999.03-2003.08	MT	R	F	Convertible Engine F3R 791/F3R 796	250173	Drive Shaft		21	23	57	84.5	742.9	
		1999.03-2003.08	MT	R	F	Convertible Engine F3R 791/F3R 796	250316	Drive Shaft		21	23	57	84	741	
		1999.03-2003.08	-	R	F	Convertible Engine F3R 791/F3R 796	250021	Drive Shaft	44T	21	23	57	84.5	750	
		1999.03-2003.08	-	R	F	Convertible Engine F3R 791/F3R 796	250054	Drive Shaft		21	23	49.8	83.5	741.5	
		1999.03-2003.08	MT	L	F	Convertible Engine F3R 791/F3R 796	250326	Drive Shaft	44T	21	29.95	57	84.5	648	
		1999.03-2003.08	MT	R	F	Convertible Engine F3R 791/F3R 796	250327	Drive Shaft	44T	21	23	57	84.5	740	
MEGANE I Classic (LA0/1_)															
1.4 (55 kW)		1996.09-2003.08	MT	L	F	Saloon Engine E7J 626/E7J 764	250009	Drive Shaft	44T	21	29.95	57	84.5	645.7	
		1996.09-2003.08	MT	L	F	Saloon Engine E7J 626/E7J 764	250055	Drive Shaft		21	29.95	50	84	650	
		1996.09-2003.08	MT	L	F	Saloon Engine E7J 626/E7J 764	250048	Drive Shaft		21	29.95	46.4	81.5	650	
		1996.09-2003.08	MT	R	F	Saloon Engine E7J 626/E7J 764	250038	Drive Shaft	44T	21	23	52.2	85.5	752	
		1996.09-2003.08	MT	R	F	Saloon Engine E7J 626/E7J 764	250140	Drive Shaft		21	23	49.8	83.5	718	

REMARKS	YEAR	TRANSM	L/R	F/R	GSP Ref.	PRODUCT	ABS	Technical Specifications							
								A	B	C	H	L	P		
RENAULT															
MEGANE I Classic (LA0/1_)															
1.4 (55 kW)	1996.09-2003.08	MT	R	F	Saloon Engine E7J 626/E7J 764	250173	Drive Shaft		21	23	57	84.5	742.9		
	1996.09-2003.08	MT	R	F	Saloon Engine E7J 626/E7J 764	250316	Drive Shaft		21	23	57	84	741		
	1996.09-2003.08	-	L	F	Saloon Engine E7J 626/E7J 764	250326	Drive Shaft	44T	21	29.95	57	84.5	648		
	1996.09-2003.08	-	R	F	Saloon Engine E7J 626/E7J 764	250327	Drive Shaft	44T	21	23	57	84.5	740		
1.4 16V (70 kW)	1999.03-2003.08	MT	L	F	Saloon Engine K4J 714/K4J 750	250009	Drive Shaft	44T	21	29.95	57	84.5	645.7		
	1999.03-2003.08	MT	L	F	Saloon Engine K4J 714/K4J 750	250055	Drive Shaft		21	29.95	50	84	650		
	1999.03-2003.08	-	R	F	Saloon Engine K4J 714/K4J 750	650008	Inner Joint		23	30	36.3	52.2	68.5		
	1999.03-2003.08	MT	R	F	Saloon Engine K4J 714/K4J 750	250038	Drive Shaft	44T	21	23	52.2	85.5	752		
	1999.03-2003.08	MT	L	F	Saloon Engine K4J 714/K4J 750	250048	Drive Shaft		21	29.95	46.4	81.5	650		
	1999.03-2003.08	-	L	F	Saloon Engine K4J 714/K4J 750	250358	Drive Shaft	44T	21	29.95	57	84	646		
	1999.03-2003.08	MT	R	F	Saloon Engine K4J 714/K4J 750	250140	Drive Shaft		21	23	49.8	83.5	718		
	1999.03-2003.08	MT	R	F	Saloon Engine K4J 714/K4J 750	250316	Drive Shaft		21	23	57	84	741		
	1999.03-2003.08	MT	R	F	Saloon Engine K4J 714/K4J 750	250173	Drive Shaft		21	23	57	84.5	742.9		
	1999.03-2003.08	-	R	F	Saloon Engine K4J 714/K4J 750	250284	Drive Shaft	44T	21	23	56.2	83.5	740.5		
	1999.03-2003.08	-	R	F	Saloon Engine K4J 714/K4J 750	250021	Drive Shaft	44T	21	23	57	84.5	750		
	1999.03-2003.08	-	R	F	Saloon Engine K4J 714/K4J 750	250054	Drive Shaft		21	23	49.8	83.5	741.5		
1.6 16V (79 kW)	1999.03-2003.08	MT	L/R	F	Saloon Engine K4M 700/K4M 701/K4M 708	850069	Outer Joint	44T	23	30	57.5	86.5	58.5	I	
	1999.03-2003.08	-	R	F	Saloon Engine K4M 700/K4M 701/K4M 708	650008	Inner Joint		23	30	36.3	52.2	68.5		
	1999.03-2003.08	MT	L	F	Saloon Engine K4M 700/K4M 701/K4M 708	250048	Drive Shaft		21	29.95	46.4	81.5	650		
	1999.03-2003.08	-	L	F	Saloon Engine K4M 700/K4M 701/K4M 708	250253	Drive Shaft	44T	23	26	57.5	86.5	634		
	1999.03-2003.08	MT	R	F	Saloon Engine K4M 700/K4M 701/K4M 708	250140	Drive Shaft		21	23	49.8	83.5	718		
	1999.03-2003.08	-	L	F	Saloon Engine K4M 700/K4M 701/K4M 708	250358	Drive Shaft	44T	21	29.95	57	84	646		
	1999.03-2003.08	MT	R	F	Saloon Engine K4M 700/K4M 701/K4M 708	250173	Drive Shaft		21	23	57	84.5	742.9		
	1999.03-2003.08	-	R	F	Saloon Engine K4M 700/K4M 701/K4M 708	250323	Drive Shaft	44T	23	23	57.5	86.5	778		
	1999.03-2003.08	-	R	F	Saloon Engine K4M 700/K4M 701/K4M 708	250284	Drive Shaft	44T	21	23	56.2	83.5	740.5		
1.6 e (66 kW)	1996.09-1999.03	MT	L	F	Saloon Engine K7M 702/K7M 703/K7M 790	250009	Drive Shaft	44T	21	29.95	57	84.5	645.7		
	1996.09-1999.03	MT	L	F	Saloon Engine K7M 702/K7M 703/K7M 790	250055	Drive Shaft		21	29.95	50	84	650		
	1996.09-1999.03	MT	R	F	Saloon Engine K7M 702/K7M 703/K7M 790	250107	Drive Shaft	44T	21	23	57	84.5	735.9		
	1996.09-1999.03	MT	L	F	Saloon Engine K7M 702/K7M 703/K7M 790	250048	Drive Shaft		21	29.95	46.4	81.5	650		
	1996.09-1999.03	MT	R	F	Saloon Engine K7M 702/K7M 703/K7M 790	250038	Drive Shaft	44T	21	23	52.2	85.5	752		
	1996.09-1999.03	MT	R	F	Saloon Engine K7M 702/K7M 703/K7M 790	250140	Drive Shaft		21	23	49.8	83.5	718		
	1996.09-1999.03	MT	R	F	Saloon Engine K7M 702/K7M 703/K7M 790	250173	Drive Shaft		21	23	57	84.5	742.9		
	1996.09-1999.03	MT	R	F	Saloon Engine K7M 702/K7M 703/K7M 790	250316	Drive Shaft		21	23	57	84	741		
	1996.09-1999.03	-	L	F	Saloon Engine K7M 702/K7M 703/K7M 790	250326	Drive Shaft	44T	21	29.95	57	84.5	648		
	1996.09-1999.03	-	R	F	Saloon Engine K7M 702/K7M 703/K7M 790	250327	Drive Shaft	44T	21	23	57	84.5	740		
1.6 i (55 kW)	1996.09-1999.03	MT	L	F	Saloon Engine K7M 720	250009	Drive Shaft	44T	21	29.95	57	84.5	645.7		
	1996.09-1999.03	MT	L	F	Saloon Engine K7M 720	250055	Drive Shaft		21	29.95	50	84	650		
	1996.09-1999.03	MT	L	F	Saloon Engine K7M 720	250048	Drive Shaft		21	29.95	46.4	81.5	650		
	1996.09-1999.03	MT	R	F	Saloon Engine K7M 720	250140	Drive Shaft		21	23	49.8	83.5	718		
	1996.09-1999.03	MT	R	F	Saloon Engine K7M 720	250038	Drive Shaft	44T	21	23	52.2	85.5	752		
	1996.09-1999.03	MT	R	F	Saloon Engine K7M 720	250173	Drive Shaft		21	23	57	84.5	742.9		
	1996.09-1999.03	MT	R	F	Saloon Engine K7M 720	250316	Drive Shaft		21	23	57	84	741		
	1996.09-1999.03	-	L	F	Saloon Engine K7M 720	250326	Drive Shaft	44T	21	29.95	57	84.5	648		
	1996.09-1999.03	-	R	F	Saloon Engine K7M 720	250327	Drive Shaft	44T	21	23	57	84.5	740		
1.8 16V (85 kW)	2001.01-2003.08	-	-	F	Saloon Engine F4P 720/F4P 722	850058	Outer Joint	44T	23	35	57	87	71	I	
	2001.01-2003.08	-	-	F	Saloon Engine F4P 720/F4P 722	850052	Outer Joint	44T	23	30	57.5	86.5	58.5	I	
	2001.01-2003.08	-	R	F	Saloon Engine F4P 720/F4P 722	699131	Inner Joint		23	28	35	142	86		
	2001.01-2003.08	-	L	F	Saloon Engine F4P 720/F4P 722	250160	Drive Shaft	44T	23	29.95	57	87	656.5		
	2001.01-2003.08	-	R	F	Saloon Engine F4P 720/F4P 722	250313	Drive Shaft	44T	23	23	57.5	86.5	750		
	2001.01-2003.08	AT/MT	L/R	F	Saloon Engine F4P 720/F4P 722	850114	Outer Joint	44T	23	35	57.5	87	71	I	
1.9 D (47 kW)	1996.09-2003.08	MT	L	F	Saloon Engine F8Q 620/F8Q 624	250009	Drive Shaft	44T	21	29.95	57	84.5	645.7		
	1996.09-2003.08	MT	L	F	Saloon Engine F8Q 620/F8Q 624	250055	Drive Shaft		21	29.95	50	84	650		
	1996.09-2003.08	AT/MT	R	F	Saloon Engine F8Q 620/F8Q 624	250107	Drive Shaft	44T	21	23	57	84.5	735.9		
	1996.09-2003.08	MT	L	F	Saloon Engine F8Q 620/F8Q 624	250048	Drive Shaft		21	29.95	46.4	81.5	650		
	1996.09-2003.08	MT	R	F	Saloon Engine F8Q 620/F8Q 624	250038	Drive Shaft	44T	21	23	52.2	85.5	752		
	1996.09-2003.08	MT	R	F	Saloon Engine F8Q 620/F8Q 624	250140	Drive Shaft		21	23	49.8	83.5	718		
	1996.09-2003.08	MT	R	F	Saloon Engine F8Q 620/F8Q 624	250173	Drive Shaft		21	23	57	84.5	742.9		
	1996.09-2003.08	MT	R	F	Saloon Engine F8Q 620/F8Q 624	250316	Drive Shaft		21	23	57	84	741		
	1996.09-2003.08	-	L	F	Saloon Engine F8Q 620/F8Q 624	250326	Drive Shaft	44T	21	29.95	57	84.5	648		
	1996.09-2003.08	-	R	F	Saloon Engine F8Q 620/F8Q 624	250327	Drive Shaft	44T	21	23	57	84.5	740		
1.9 dCi (75 kW)	2001.02-2003.08	MT	-	F	Saloon Engine F9Q 732/F9Q 733/F9Q 738	850058	Outer Joint	44T	23	35	57	87	71	I	
	2001.02-2003.08	AT/MT	L/R	F	Saloon Engine F9Q 732/F9Q 733/F9Q 738	850069	Outer Joint	44T	23	30	57.5	86.5	58.5	I	
	2001.02-2003.08	AT/MT	-	F	Saloon Engine F9Q 732/F9Q 733/F9Q 738	850052	Outer Joint	44T	23	30	57.5	86.5	58.5	I	
	2001.02-2003.08	AT	L	F	Saloon Engine F9Q 732/F9Q 733/F9Q 738	250253	Drive Shaft	44T	23	26	57.5	86.5	634		
	2001.02-2003.08	MT	R	F	Saloon Engine F9Q 732/F9Q 733/F9Q 738	250039	Drive Shaft	44T	23	23	57.5	86.5	748		
	2001.02-2003.08	MT	L	F	Saloon Engine F9Q 732/F9Q 733/F9Q 738	250314	Drive Shaft	44T	23	29.95	57.5	86.5	654		



REMARKS	YEAR	TRANSM	L/R	F/R	GSP Ref.	PRODUCT	ABS	Technical Specifications							
								A	B	C	H	L	P		
RENAULT															
MEGANE I Classic (LA0/1_)															
1.9 dCi (75 kW)	2001.02-2003.08	MT	R	F	Saloon Engine F9Q 732/F9Q 733/F9Q 738	650008	Inner Joint		23	30	36.3	52.2	68.5		
	2001.02-2003.08	MT	R	F	Saloon Engine F9Q 732/F9Q 733/F9Q 738	250156	Drive Shaft	44T	23	23	57.5	86.5	746.5		
1.9 dCi (77 kW)	1999.03-2000.09	-	-	F	Saloon Engine F9Q 733	850058	Outer Joint	44T	23	35	57	87	71	I	
	1999.03-2000.09	-	-	F	Saloon Engine F9Q 733	850052	Outer Joint	44T	23	30	57.5	86.5	58.5	I	
	1999.03-2000.09	-	R	F	Saloon Engine F9Q 733	250039	Drive Shaft	44T	23	23	57.5	86.5	748		
	1999.03-2000.09	-	L	F	Saloon Engine F9Q 733	250314	Drive Shaft	44T	23	29.95	57.5	86.5	654		
	1999.03-2000.09	MT	R	F	Saloon Engine F9Q 733	250159	Drive Shaft	44T	23	23	57	87	748		
	1999.03-2000.09	-	R	F	Saloon Engine F9Q 733	650008	Inner Joint		23	30	36.3	52.2	68.5		
1.9 dT (66 kW)	1996.09-2003.08	MT	L	F	Saloon Engine F8Q 784/F8Q 786	250029	Drive Shaft	44T	23	29.95	56.8	84	654		
	1996.09-2003.08	-	-	-	Saloon Engine F8Q 784/F8Q 786	850051	Outer Joint	48T	23	25	56.3	80	58	O	
	1996.09-2003.08	AT/MT	R	F	Saloon Engine F8Q 784/F8Q 786	250107	Drive Shaft	44T	21	23	57	84.5	735.9		
	1996.09-2003.08	MT	L	F	Saloon Engine F8Q 784/F8Q 786	250048	Drive Shaft		21	29.95	46.4	81.5	650		
	1996.09-2003.08	MT	L/R	F	Saloon Engine F8Q 784/F8Q 786	850026	Outer Joint		23	25	56.2	83.5	58	O	
	1996.09-2003.08	MT	R	F	Saloon Engine F8Q 784/F8Q 786	250140	Drive Shaft		21	23	49.8	83.5	718		
	1996.09-2003.08	MT	R	F	Saloon Engine F8Q 784/F8Q 786	250173	Drive Shaft		21	23	57	84.5	742.9		
	1996.09-2003.08	MT	R	F	Saloon Engine F8Q 784/F8Q 786	250320	Drive Shaft	44T	23	23	56.8	84	755		
	1996.09-2003.08	MT	R	F	Saloon Engine F8Q 784/F8Q 786	650079	Inner Joint		23	22	36.3	50	55.5		
	1996.09-2003.08	-	L	F	Saloon Engine F8Q 784/F8Q 786	250326	Drive Shaft	44T	21	29.95	57	84.5	648		
	1996.09-2003.08	-	R	F	Saloon Engine F8Q 784/F8Q 786	250054	Drive Shaft		21	23	49.8	83.5	741.5		
	1996.09-2003.08	-	R	F	Saloon Engine F8Q 784/F8Q 786	250327	Drive Shaft	44T	21	23	57	84.5	740		
1.9 dTi (59 kW)	2001.02-2003.08	-	L	F	Saloon Engine F9Q 744	250311	Drive Shaft	44T	23	29.95	56	82	650		
	2001.02-2003.08	MT	-	F	Saloon Engine F9Q 744	850058	Outer Joint	44T	23	35	57	87	71	I	
	2001.02-2003.08	AT/MT	L/R	F	Saloon Engine F9Q 744	850069	Outer Joint	44T	23	30	57.5	86.5	58.5	I	
	2001.02-2003.08	MT	-	F	Saloon Engine F9Q 744	850052	Outer Joint	44T	23	30	57.5	86.5	58.5	I	
	2001.02-2003.08	MT	R	F	Saloon Engine F9Q 744	250156	Drive Shaft	44T	23	23	57.5	86.5	746.5		
	2001.02-2003.08	-	R	F	Saloon Engine F9Q 744	250313	Drive Shaft	44T	23	23	57.5	86.5	750		
1.9 dTi (72 kW)	1997.03-2001.02	MT	L	F	Saloon Engine F9Q 730/F9Q 731/F9Q 734/F9Q 736	250029	Drive Shaft	44T	23	29.95	56.8	84	654		
	1997.03-2001.02	-	-	-	Saloon Engine F9Q 730/F9Q 731/F9Q 734/F9Q 736	850051	Outer Joint	48T	23	25	56.3	80	58	O	
	1997.03-2001.02	MT	-	F	Saloon Engine F9Q 730/F9Q 731/F9Q 734/F9Q 736	850058	Outer Joint	44T	23	35	57	87	71	I	
	1997.03-2001.02	MT	-	F	Saloon Engine F9Q 730/F9Q 731/F9Q 734/F9Q 736	850052	Outer Joint	44T	23	30	57.5	86.5	58.5	I	
	1997.03-2001.02	MT	L/R	F	Saloon Engine F9Q 730/F9Q 731/F9Q 734/F9Q 736	850026	Outer Joint		23	25	56.2	83.5	58	O	
	1997.03-2001.02	-	L	F	Saloon Engine F9Q 730/F9Q 731/F9Q 734/F9Q 736	250253	Drive Shaft	44T	23	26	57.5	86.5	634		
	1997.03-2001.02	MT	R	F	Saloon Engine F9Q 730/F9Q 731/F9Q 734/F9Q 736	250320	Drive Shaft	44T	23	23	56.8	84	755		
	1997.03-2001.02	MT	R	F	Saloon Engine F9Q 730/F9Q 731/F9Q 734/F9Q 736	650079	Inner Joint		23	22	36.3	50	55.5		
	1997.03-2001.02	-	R	F	Saloon Engine F9Q 730/F9Q 731/F9Q 734/F9Q 736	250039	Drive Shaft	44T	23	23	57.5	86.5	748		
	1997.03-2001.02	-	L	F	Saloon Engine F9Q 730/F9Q 731/F9Q 734/F9Q 736	250314	Drive Shaft	44T	23	29.95	57.5	86.5	654		
	1997.03-2001.02	MT	R	F	Saloon Engine F9Q 730/F9Q 731/F9Q 734/F9Q 736	250159	Drive Shaft	44T	23	23	57	87	748		
	1997.03-2001.02	-	R	F	Saloon Engine F9Q 730/F9Q 731/F9Q 734/F9Q 736	650008	Inner Joint		23	30	36.3	52.2	68.5		
	1997.03-2001.02	-	L	F	Saloon Engine F9Q 730/F9Q 731/F9Q 734/F9Q 736	250326	Drive Shaft	44T	21	29.95	57	84.5	648		
	1997.03-2001.02	-	R	F	Saloon Engine F9Q 730/F9Q 731/F9Q 734/F9Q 736	250327	Drive Shaft	44T	21	23	57	84.5	740		
1.9 TDI (69 kW)	1996.09-2003.08	MT	L	F	Saloon Engine F8Q 784	250029	Drive Shaft	44T	23	29.95	56.8	84	654		
	1996.09-2003.08	-	-	-	Saloon Engine F8Q 784	850051	Outer Joint	48T	23	25	56.3	80	58	O	
	1996.09-2003.08	-	-	F	Saloon Engine F8Q 784	850058	Outer Joint	44T	23	35	57	87	71	I	
	1996.09-2003.08	MT	R	F	Saloon Engine F8Q 784	650008	Inner Joint		23	30	36.3	52.2	68.5		
	1996.09-2003.08	MT	L/R	F	Saloon Engine F8Q 784	850026	Outer Joint		23	25	56.2	83.5	58	O	
	1996.09-2003.08	-	-	F	Saloon Engine F8Q 784	850052	Outer Joint	44T	23	30	57.5	86.5	58.5	I	
	1996.09-2003.08	MT	R	F	Saloon Engine F8Q 784	250320	Drive Shaft	44T	23	23	56.8	84	755		
	1996.09-2003.08	MT	R	F	Saloon Engine F8Q 784	650079	Inner Joint		23	22	36.3	50	55.5		
	1996.09-2003.08	MT	R	F	Saloon Engine F8Q 784	250159	Drive Shaft	44T	23	23	57	87	748		
	1996.09-2003.08	MT	R	F	Saloon Engine F8Q 784	250156	Drive Shaft	44T	23	23	57.5	86.5	746.5		
	1996.09-2003.08	-	L	F	Saloon Engine F8Q 784	250326	Drive Shaft	44T	21	29.95	57	84.5	648		
	1996.09-2003.08	-	R	F	Saloon Engine F8Q 784	250327	Drive Shaft	44T	21	23	57	84.5	740		
2.0 (85 kW)	1998.05-2001.05	MT	L	F	Saloon Engine F3R 750/F3R 752/F3R 791/F3R 796/F3R 797/F3R 798	250009	Drive Shaft	44T	21	29.95	57	84.5	645.7		
	1998.05-2001.05	MT	L	F	Saloon Engine F3R 750/F3R 752/F3R 791/F3R 796/F3R 797/F3R 798	250055	Drive Shaft		21	29.95	50	84	650		
	1998.05-2001.05	MT	L	F	Saloon Engine F3R 750/F3R 752/F3R 791/F3R 796/F3R 797/F3R 798	250048	Drive Shaft		21	29.95	46.4	81.5	650		
	1998.05-2001.05	MT	R	F	Saloon Engine F3R 750/F3R 752/F3R 791/F3R 796/F3R 797/F3R 798	250038	Drive Shaft	44T	21	23	52.2	85.5	752		
	1998.05-2001.05	MT	R	F	Saloon Engine F3R 750/F3R 752/F3R 791/F3R 796/F3R 797/F3R 798	250140	Drive Shaft		21	23	49.8	83.5	718		
	1998.05-2001.05	MT	R	F	Saloon Engine F3R 750/F3R 752/F3R 791/F3R 796/F3R 797/F3R 798	250173	Drive Shaft		21	23	57	84.5	742.9		
	1998.05-2001.05	MT	R	F	Saloon Engine F3R 750/F3R 752/F3R 791/F3R 796/F3R 797/F3R 798	250316	Drive Shaft		21	23	57	84	741		
	1998.05-2001.05	-	R	F	Saloon Engine F3R 750/F3R 752/F3R 791/F3R 796/F3R 797/F3R 798	250054	Drive Shaft		21	23	49.8	83.5	741.5		
	1998.05-2001.05	-	L	F	Saloon Engine F3R 750/F3R 752/F3R 791/F3R 796/F3R 797/F3R 798	250326	Drive Shaft	44T	21	29.95	57	84.5	648		
	1998.05-2001.05	-	R	F	Saloon Engine F3R 750/F3R 752/F3R 791/F3R 796/F3R 797/F3R 798	250327	Drive Shaft	44T	21	23	57	84.5	740		
2.0 i (80 kW)	1999.03-2003.08	MT	L	F	Saloon Engine F3R 750/F3R 751/F3R 752/F3R 791/F3R 796/F3R 797/F3R 798	250009	Drive Shaft	44T	21	29.95	57	84.5	645.7		
	1999.03-2003.08	MT	L	F	Saloon Engine F3R 750/F3R 751/F3R 752/F3R 791/F3R 796/F3R 797/F3R 798	250055	Drive Shaft		21	29.95	50	84	650		
	1999.03-2003.08	MT	L	F	Saloon Engine F3R 750/F3R 751/F3R 752/F3R 791/F3R 796/F3R 797/F3R 798	250048	Drive Shaft		21	29.95	46.4	81.5	650		
	1999.03-2003.08	MT	R	F	Saloon Engine F3R 750/F3R 751/F3R 752/F3R 791/F3R 796/F3R 797/F3R 798	250038	Drive Shaft	44T	21	23	52.2	85.5	752		

REMARKS	YEAR	TRANSM	L/R	F/R	GSP Ref.	PRODUCT	ABS	Technical Specifications						
								A	B	C	H	L	P	
RENAULT														
MEGANE I Classic (LA0/1_)														
2.0 i (80 kW)	1999.03-2003.08	MT	R	F	Saloon Engine F3R 750/F3R 751/F3R 752/F3R 791/F3R 796/F3R 797/F3R 798	250140	Drive Shaft		21	23	49.8	83.5	718	
	1999.03-2003.08	MT	R	F	Saloon Engine F3R 750/F3R 751/F3R 752/F3R 791/F3R 796/F3R 797/F3R 798	250173	Drive Shaft		21	23	57	84.5	742.9	
	1999.03-2003.08	MT	R	F	Saloon Engine F3R 750/F3R 751/F3R 752/F3R 791/F3R 796/F3R 797/F3R 798	250316	Drive Shaft		21	23	57	84	741	
	1999.03-2003.08	-	L	F	Saloon Engine F3R 750/F3R 751/F3R 752/F3R 791/F3R 796/F3R 797/F3R 798	250326	Drive Shaft	44T	21	29.95	57	84.5	648	
	1999.03-2003.08	-	R	F	Saloon Engine F3R 750/F3R 751/F3R 752/F3R 791/F3R 796/F3R 797/F3R 798	250054	Drive Shaft		21	23	49.8	83.5	741.5	
	1999.03-2003.08	-	R	F	Saloon Engine F3R 750/F3R 751/F3R 752/F3R 791/F3R 796/F3R 797/F3R 798	250327	Drive Shaft	44T	21	23	57	84.5	740	
2.0 i (84 kW)	1996.09-2003.08	MT	L	F	Saloon Engine F3R 750/F3R 751/F3R 752/F3R 791/F3R 796/F3R 797/F3R 798	250009	Drive Shaft	44T	21	29.95	57	84.5	645.7	
	1996.09-2003.08	MT	L	F	Saloon Engine F3R 750/F3R 751/F3R 752/F3R 791/F3R 796/F3R 797/F3R 798	250055	Drive Shaft		21	29.95	50	84	650	
	1996.09-2003.08	MT	L	F	Saloon Engine F3R 750/F3R 751/F3R 752/F3R 791/F3R 796/F3R 797/F3R 798	250048	Drive Shaft		21	29.95	46.4	81.5	650	
	1996.09-2003.08	MT	R	F	Saloon Engine F3R 750/F3R 751/F3R 752/F3R 791/F3R 796/F3R 797/F3R 798	250038	Drive Shaft	44T	21	23	52.2	85.5	752	
	1996.09-2003.08	MT	R	F	Saloon Engine F3R 750/F3R 751/F3R 752/F3R 791/F3R 796/F3R 797/F3R 798	250140	Drive Shaft		21	23	49.8	83.5	718	
	1996.09-2003.08	MT	R	F	Saloon Engine F3R 750/F3R 751/F3R 752/F3R 791/F3R 796/F3R 797/F3R 798	250173	Drive Shaft		21	23	57	84.5	742.9	
	1996.09-2003.08	MT	R	F	Saloon Engine F3R 750/F3R 751/F3R 752/F3R 791/F3R 796/F3R 797/F3R 798	250027	Drive Shaft	44T	23	23	56.8	84	750.5	
	1996.09-2003.08	MT	R	F	Saloon Engine F3R 750/F3R 751/F3R 752/F3R 791/F3R 796/F3R 797/F3R 798	250316	Drive Shaft		21	23	57	84	741	
	1996.09-2003.08	-	R	F	Saloon Engine F3R 750/F3R 751/F3R 752/F3R 791/F3R 796/F3R 797/F3R 798	250054	Drive Shaft		21	23	49.8	83.5	741.5	
	1996.09-2003.08	-	L	F	Saloon Engine F3R 750/F3R 751/F3R 752/F3R 791/F3R 796/F3R 797/F3R 798	250326	Drive Shaft	44T	21	29.95	57	84.5	648	
	1996.09-2003.08	-	R	F	Saloon Engine F3R 750/F3R 751/F3R 752/F3R 791/F3R 796/F3R 797/F3R 798	250327	Drive Shaft	44T	21	23	57	84.5	740	
MEGANE I Coach (DA0/1_)														
1.4 16V (70 kW)	1999.03-2003.08	-	R	F	Coupe Engine K4J 714/K4J 750	650008	Inner Joint		23	30	36.3	52.2	68.5	
	1999.03-2003.08	MT	L	F	Coupe Engine K4J 714/K4J 750	250048	Drive Shaft		21	29.95	46.4	81.5	650	
	1999.03-2003.08	MT	R	F	Coupe Engine K4J 714/K4J 750	250140	Drive Shaft		21	23	49.8	83.5	718	
	1999.03-2003.08	-	L	F	Coupe Engine K4J 714/K4J 750	250358	Drive Shaft	44T	21	29.95	57	84	646	
	1999.03-2003.08	MT	R	F	Coupe Engine K4J 714/K4J 750	250173	Drive Shaft		21	23	57	84.5	742.9	
	1999.03-2003.08	-	R	F	Coupe Engine K4J 714/K4J 750	250284	Drive Shaft	44T	21	23	56.2	83.5	740.5	
	1999.03-2003.08	-	L	F	Coupe Engine K4J 714/K4J 750	250326	Drive Shaft	44T	21	29.95	57	84.5	648	
	1999.03-2003.08	-	R	F	Coupe Engine K4J 714/K4J 750	250327	Drive Shaft	44T	21	23	57	84.5	740	
1.6 16V (79 kW)	1999.03-2003.08	-	R	F	Coupe Engine K4M 700/K4M 701/K4M 708	650008	Inner Joint		23	30	36.3	52.2	68.5	
	1999.03-2003.08	MT	L	F	Coupe Engine K4M 700/K4M 701/K4M 708	250048	Drive Shaft		21	29.95	46.4	81.5	650	
	1999.03-2003.08	-	L	F	Coupe Engine K4M 700/K4M 701/K4M 708	250253	Drive Shaft	44T	23	26	57.5	86.5	634	
	1999.03-2003.08	MT	R	F	Coupe Engine K4M 700/K4M 701/K4M 708	250140	Drive Shaft		21	23	49.8	83.5	718	
	1999.03-2003.08	-	L	F	Coupe Engine K4M 700/K4M 701/K4M 708	250358	Drive Shaft	44T	21	29.95	57	84	646	
	1999.03-2003.08	MT	R	F	Coupe Engine K4M 700/K4M 701/K4M 708	250173	Drive Shaft		21	23	57	84.5	742.9	
	1999.03-2003.08	-	R	F	Coupe Engine K4M 700/K4M 701/K4M 708	250323	Drive Shaft	44T	23	23	57.5	86.5	778	
	1999.03-2003.08	-	R	F	Coupe Engine K4M 700/K4M 701/K4M 708	250284	Drive Shaft	44T	21	23	56.2	83.5	740.5	
1.6 e (66 kW)	1996.03-1999.03	MT	L	F	Coupe Engine K7M 702/K7M 703	250009	Drive Shaft	44T	21	29.95	57	84.5	645.7	
	1996.03-1999.03	MT	L	F	Coupe Engine K7M 702/K7M 703	250055	Drive Shaft		21	29.95	50	84	650	
	1996.03-1999.03	MT	L	F	Coupe Engine K7M 702/K7M 703	250048	Drive Shaft		21	29.95	46.4	81.5	650	
	1996.03-1999.03	MT	R	F	Coupe Engine K7M 702/K7M 703	250140	Drive Shaft		21	23	49.8	83.5	718	
	1996.03-1999.03	MT	R	F	Coupe Engine K7M 702/K7M 703	250038	Drive Shaft	44T	21	23	52.2	85.5	752	
	1996.03-1999.03	MT	R	F	Coupe Engine K7M 702/K7M 703	250173	Drive Shaft		21	23	57	84.5	742.9	
	1996.03-1999.03	MT	R	F	Coupe Engine K7M 702/K7M 703	250316	Drive Shaft		21	23	57	84	741	
	1996.03-1999.03	-	L	F	Coupe Engine K7M 702/K7M 703	250326	Drive Shaft	44T	21	29.95	57	84.5	648	
	1996.03-1999.03	-	R	F	Coupe Engine K7M 702/K7M 703	250327	Drive Shaft	44T	21	23	57	84.5	740	
1.9 dCi (75 kW)	2001.02-2003.08	MT	-	F	Coupe Engine F9Q 732/F9Q 733	850058	Outer Joint	44T	23	35	57	87	71	I
	2001.02-2003.08	AT/MT	L/R	F	Coupe Engine F9Q 732/F9Q 733	850069	Outer Joint	44T	23	30	57.5	86.5	58.5	I
	2001.02-2003.08	AT/MT	-	F	Coupe Engine F9Q 732/F9Q 733	850052	Outer Joint	44T	23	30	57.5	86.5	58.5	I
	2001.02-2003.08	AT	L	F	Coupe Engine F9Q 732/F9Q 733	250253	Drive Shaft	44T	23	26	57.5	86.5	634	
	2001.02-2003.08	MT	R	F	Coupe Engine F9Q 732/F9Q 733	250039	Drive Shaft	44T	23	23	57.5	86.5	748	
	2001.02-2003.08	MT	L	F	Coupe Engine F9Q 732/F9Q 733	250314	Drive Shaft	44T	23	29.95	57.5	86.5	654	
	2001.02-2003.08	MT	R	F	Coupe Engine F9Q 732/F9Q 733	650008	Inner Joint		23	30	36.3	52.2	68.5	
	2001.02-2003.08	MT	R	F	Coupe Engine F9Q 732/F9Q 733	250156	Drive Shaft	44T	23	23	57.5	86.5	746.5	
1.9 dTi (72 kW)	1997.03-2001.02	MT	L	F	Coupe Engine F9Q 731/F9Q 734/F9Q 736	250029	Drive Shaft	44T	23	29.95	56.8	84	654	
	1997.03-2001.02	-	-	-	Coupe Engine F9Q 731/F9Q 734/F9Q 736	850051	Outer Joint	48T	23	25	56.3	80	58	O
	1997.03-2001.02	MT	-	F	Coupe Engine F9Q 731/F9Q 734/F9Q 736	850058	Outer Joint	44T	23	35	57	87	71	I
	1997.03-2001.02	AT/MT	-	F	Coupe Engine F9Q 731/F9Q 734/F9Q 736	850052	Outer Joint	44T	23	30	57.5	86.5	58.5	I
	1997.03-2001.02	MT	L/R	F	Coupe Engine F9Q 731/F9Q 734/F9Q 736	850026	Outer Joint		23	25	56.2	83.5	58	O
	1997.03-2001.02	AT	L	F	Coupe Engine F9Q 731/F9Q 734/F9Q 736	250253	Drive Shaft	44T	23	26	57.5	86.5	634	
	1997.03-2001.02	MT	R	F	Coupe Engine F9Q 731/F9Q 734/F9Q 736	250320	Drive Shaft	44T	23	23	56.8	84	755	
	1997.03-2001.02	MT	R	F	Coupe Engine F9Q 731/F9Q 734/F9Q 736	650079	Inner Joint		23	22	36.3	50	55.5	
	1997.03-2001.02	MT	R	F	Coupe Engine F9Q 731/F9Q 734/F9Q 736	250039	Drive Shaft	44T	23	23	57.5	86.5	748	
	1997.03-2001.02	MT	L	F	Coupe Engine F9Q 731/F9Q 734/F9Q 736	250314	Drive Shaft	44T	23	29.95	57.5	86.5	654	
	1997.03-2001.02	MT	R	F	Coupe Engine F9Q 731/F9Q 734/F9Q 736	650008	Inner Joint		23	30	36.3	52.2	68.5	
	1997.03-2001.02	MT	R	F	Coupe Engine F9Q 731/F9Q 734/F9Q 736	250156	Drive Shaft	44T	23	23	57.5	86.5	746.5	
2.0 16V (102 kW)	2002.01-2003.08	-	-	F	Coupe Engine F4R 746	850058	Outer Joint	44T	23	35	57	87	71	I
	2002.01-2003.08	MT	-	F	Coupe Engine F4R 746	850052	Outer Joint	44T	23	30	57.5	86.5	58.5	I
	2002.01-2003.08	MT	R	F	Coupe Engine F4R 746	650008	Inner Joint		23	30	36.3	52.2	68.5	

REMARKS	YEAR	TRANSM	L/R	F/R	GSP Ref.	PRODUCT	ABS	Technical Specifications						
								A	B	C	H	L	P	
RENAULT														
MEGANE I Coach (DA0/1_)														
2.0 16V (102 kW)	2002.01-2003.08	-	L	F	Coupe Engine F4R 746	250160	Drive Shaft	44T	23	29.95	57	87	656.5	
	2002.01-2003.08	MT	R	F	Coupe Engine F4R 746	250159	Drive Shaft	44T	23	23	57	87	748	
	2002.01-2003.08	-	R	F	Coupe Engine F4R 746	250325	Drive Shaft	44T	23	23	56.3	85	744	
	2002.01-2003.08	MT	R	F	Coupe Engine F4R 746	250156	Drive Shaft	44T	23	23	57.5	86.5	746.5	
2.0 16V (108 kW)	1996.03-1999.11	-	-	-	Coupe Engine F7R 710/F7R 714	850043	Outer Joint	44T	21	22	51.5	83	56.5	I
	1996.03-1999.11	MT	L	F	Coupe Engine F7R 710/F7R 714	250029	Drive Shaft	44T	23	29.95	56.8	84	654	
	1996.03-1999.11	-	-	-	Coupe Engine F7R 710/F7R 714	850051	Outer Joint	48T	23	25	56.3	80	58	O
	1996.03-1999.11	MT	L	F	Coupe Engine F7R 710/F7R 714	250089	Drive Shaft	44T	23	29.95	56.2	83.5	653	
	1996.03-1999.11	-	-	-	Coupe Engine F7R 710/F7R 714	850058	Outer Joint	44T	23	35	57	87	71	I
	1996.03-1999.11	MT	R	F	Coupe Engine F7R 710/F7R 714	650008	Inner Joint		23	30	36.3	52.2	68.5	
	1996.03-1999.11	-	-	-	Coupe Engine F7R 710/F7R 714	850052	Outer Joint	44T	23	30	57.5	86.5	58.5	I
	1996.03-1999.11	MT	L/R	F	Coupe Engine F7R 710/F7R 714	850026	Outer Joint		23	25	56.2	83.5	58	O
	1996.03-1999.11	MT	R	F	Coupe Engine F7R 710/F7R 714	250320	Drive Shaft	44T	23	23	56.8	84	755	
	1996.03-1999.11	-	L	F	Coupe Engine F7R 710/F7R 714	250160	Drive Shaft	44T	23	29.95	57	87	656.5	
	1996.03-1999.11	MT	R	F	Coupe Engine F7R 710/F7R 714	650079	Inner Joint		23	22	36.3	50	55.5	
	1996.03-1999.11	MT	R	F	Coupe Engine F7R 710/F7R 714	250159	Drive Shaft	44T	23	23	57	87	748	
	1996.03-1999.11	MT	R	F	Coupe Engine F7R 710/F7R 714	250156	Drive Shaft	44T	23	23	57.5	86.5	746.5	
	1996.03-1999.11	-	R	F	Coupe Engine F7R 710/F7R 714	250325	Drive Shaft	44T	23	23	56.3	85	744	
2.0 16V IDE (103 kW)	1999.11-2003.08	-	-	-	Coupe Engine F5R 740	850058	Outer Joint	44T	23	35	57	87	71	I
	1999.11-2003.08	MT	-	F	Coupe Engine F5R 740	850052	Outer Joint	44T	23	30	57.5	86.5	58.5	I
	1999.11-2003.08	MT	R	F	Coupe Engine F5R 740	650008	Inner Joint		23	30	36.3	52.2	68.5	
	1999.11-2003.08	-	L	F	Coupe Engine F5R 740	250160	Drive Shaft	44T	23	29.95	57	87	656.5	
	1999.11-2003.08	MT	R	F	Coupe Engine F5R 740	250159	Drive Shaft	44T	23	23	57	87	748	
	1999.11-2003.08	MT	R	F	Coupe Engine F5R 740	250156	Drive Shaft	44T	23	23	57.5	86.5	746.5	
	1999.11-2003.08	-	L	F	Coupe Engine F5R 740	250404	Drive Shaft	44T	23	29.95	57.5	86	655	
	1999.11-2003.08	-	R	F	Coupe Engine F5R 740	250325	Drive Shaft	44T	23	23	56.3	85	744	
	1999.11-2003.08	MT	L/R	F	Coupe Engine F5R 740	850114	Outer Joint	44T	23	35	57.5	87	71	I
2.0 i (80 kW)	1999.03-2003.08	MT	L	F	Coupe Engine F3R 791/F3R 796	250009	Drive Shaft	44T	21	29.95	57	84.5	645.7	
	1999.03-2003.08	MT	L	F	Coupe Engine F3R 791/F3R 796	250055	Drive Shaft		21	29.95	50	84	650	
	1999.03-2003.08	MT	L	F	Coupe Engine F3R 791/F3R 796	250048	Drive Shaft		21	29.95	46.4	81.5	650	
	1999.03-2003.08	MT	R	F	Coupe Engine F3R 791/F3R 796	250038	Drive Shaft	44T	21	23	52.2	85.5	752	
	1999.03-2003.08	MT	R	F	Coupe Engine F3R 791/F3R 796	250140	Drive Shaft		21	23	49.8	83.5	718	
	1999.03-2003.08	MT	R	F	Coupe Engine F3R 791/F3R 796	250173	Drive Shaft		21	23	57	84.5	742.9	
	1999.03-2003.08	MT	R	F	Coupe Engine F3R 791/F3R 796	250316	Drive Shaft		21	23	57	84	741	
	1999.03-2003.08	-	L	F	Coupe Engine F3R 791/F3R 796	250404	Drive Shaft	44T	23	29.95	57.5	86	655	
	1999.03-2003.08	MT	L	F	Coupe Engine F3R 791/F3R 796	250326	Drive Shaft	44T	21	29.95	57	84.5	648	
	1999.03-2003.08	-	R	F	Coupe Engine F3R 791/F3R 796	250054	Drive Shaft		21	23	49.8	83.5	741.5	
	1999.03-2003.08	MT	R	F	Coupe Engine F3R 791/F3R 796	250327	Drive Shaft	44T	21	23	57	84.5	740	
2.0 i (84 kW)	1996.03-2003.08	MT	L	F	Coupe Engine F3R 750/F3R 751/F3R 798	250009	Drive Shaft	44T	21	29.95	57	84.5	645.7	
	1996.03-2003.08	MT	L	F	Coupe Engine F3R 750/F3R 751/F3R 798	250055	Drive Shaft		21	29.95	50	84	650	
	1996.03-2003.08	MT	L	F	Coupe Engine F3R 750/F3R 751/F3R 798	250048	Drive Shaft		21	29.95	46.4	81.5	650	
	1996.03-2003.08	MT	R	F	Coupe Engine F3R 750/F3R 751/F3R 798	250140	Drive Shaft		21	23	49.8	83.5	718	
	1996.03-2003.08	MT	R	F	Coupe Engine F3R 750/F3R 751/F3R 798	250038	Drive Shaft	44T	21	23	52.2	85.5	752	
	1996.03-2003.08	MT	R	F	Coupe Engine F3R 750/F3R 751/F3R 798	250173	Drive Shaft		21	23	57	84.5	742.9	
	1996.03-2003.08	MT	R	F	Coupe Engine F3R 750/F3R 751/F3R 798	250027	Drive Shaft	44T	23	23	56.8	84	750.5	
	1996.03-2003.08	MT	R	F	Coupe Engine F3R 750/F3R 751/F3R 798	250316	Drive Shaft		21	23	57	84	741	
	1996.03-2003.08	-	L	F	Coupe Engine F3R 750/F3R 751/F3R 798	250326	Drive Shaft	44T	21	29.95	57	84.5	648	
	1996.03-2003.08	-	R	F	Coupe Engine F3R 750/F3R 751/F3R 798	250054	Drive Shaft		21	23	49.8	83.5	741.5	
	1996.03-2003.08	-	R	F	Coupe Engine F3R 750/F3R 751/F3R 798	250327	Drive Shaft	44T	21	23	57	84.5	740	
MEGANE I Grandtour (KA0/1_)														
1.4 16V (70 kW)	1999.03-2003.08	-	R	F	Estate Engine K4J 714/K4J 750	650008	Inner Joint		23	30	36.3	52.2	68.5	
	1999.03-2003.08	MT	L	F	Estate Engine K4J 714/K4J 750	250048	Drive Shaft		21	29.95	46.4	81.5	650	
	1999.03-2003.08	MT	R	F	Estate Engine K4J 714/K4J 750	250140	Drive Shaft		21	23	49.8	83.5	718	
	1999.03-2003.08	MT	R	F	Estate Engine K4J 714/K4J 750	250173	Drive Shaft		21	23	57	84.5	742.9	
	1999.03-2003.08	-	L	F	Estate Engine K4J 714/K4J 750	250358	Drive Shaft	44T	21	29.95	57	84	646	
	1999.03-2003.08	-	R	F	Estate Engine K4J 714/K4J 750	250284	Drive Shaft	44T	21	23	56.2	83.5	740.5	
	1999.03-2003.08	-	R	F	Estate Engine K4J 714/K4J 750	250021	Drive Shaft	44T	21	23	57	84.5	750	
	1999.03-2003.08	-	R	F	Estate Engine K4J 714/K4J 750	250054	Drive Shaft		21	23	49.8	83.5	741.5	
	1999.03-2003.08	-	L	F	Estate Engine K4J 714/K4J 750	250326	Drive Shaft	44T	21	29.95	57	84.5	648	
	1999.03-2003.08	-	R	F	Estate Engine K4J 714/K4J 750	250327	Drive Shaft	44T	21	23	57	84.5	740	
1.4 e (55 kW)	1999.03-2003.08	MT	L	F	Estate Engine E7J 626	250048	Drive Shaft		21	29.95	46.4	81.5	650	
	1999.03-2003.08	MT	R	F	Estate Engine E7J 626	250140	Drive Shaft		21	23	49.8	83.5	718	
	1999.03-2003.08	MT	R	F	Estate Engine E7J 626	250173	Drive Shaft		21	23	57	84.5	742.9	
	1999.03-2003.08	-	L	F	Estate Engine E7J 626	250326	Drive Shaft	44T	21	29.95	57	84.5	648	
	1999.03-2003.08	-	R	F	Estate Engine E7J 626	250327	Drive Shaft	44T	21	23	57	84.5	740	
1.6 16V (79 kW)	1999.03-2003.08	MT	R	F	Estate Engine K4M 700/K4M 701/K4M 704/K4M 708	650008	Inner Joint		23	30	36.3	52.2	68.5	

REMARKS	YEAR	TRANSM	L/R	F/R	GSP Ref.	PRODUCT	ABS	Technical Specifications						
								A	B	C	H	L	P	
RENAULT														
MEGANE I Grandtour (KA0/1_)														
1.6 16V (79 kW)	1999.03-2003.08	MT	L	F	Estate Engine K4M 700/K4M 701/K4M 704/K4M 708	250048	Drive Shaft		21	29.95	46.4	81.5	650	
	1999.03-2003.08	AT	L	F	Estate Engine K4M 700/K4M 701/K4M 704/K4M 708	250253	Drive Shaft	44T	23	26	57.5	86.5	634	
	1999.03-2003.08	MT	R	F	Estate Engine K4M 700/K4M 701/K4M 704/K4M 708	250140	Drive Shaft		21	23	49.8	83.5	718	
	1999.03-2003.08	MT	R	F	Estate Engine K4M 700/K4M 701/K4M 704/K4M 708	250173	Drive Shaft		21	23	57	84.5	742.9	
	1999.03-2003.08	MT	L	F	Estate Engine K4M 700/K4M 701/K4M 704/K4M 708	250358	Drive Shaft	44T	21	29.95	57	84	646	
	1999.03-2003.08	AT	R	F	Estate Engine K4M 700/K4M 701/K4M 704/K4M 708	250323	Drive Shaft	44T	23	23	57.5	86.5	778	
	1999.03-2003.08	MT	R	F	Estate Engine K4M 700/K4M 701/K4M 704/K4M 708	250284	Drive Shaft	44T	21	23	56.2	83.5	740.5	
1.6 e (66 kW)	1999.03-2003.08	AT	R	F	Estate Engine K7M 702/K7M 703	650008	Inner Joint		23	30	36.3	52.2	68.5	
	1999.03-2003.08	MT	L	F	Estate Engine K7M 702/K7M 703	250048	Drive Shaft		21	29.95	46.4	81.5	650	
	1999.03-2003.08	MT	R	F	Estate Engine K7M 702/K7M 703	250140	Drive Shaft		21	23	49.8	83.5	718	
	1999.03-2003.08	MT	R	F	Estate Engine K7M 702/K7M 703	250173	Drive Shaft		21	23	57	84.5	742.9	
	1999.03-2003.08	AT	R	F	Estate Engine K7M 702/K7M 703	250284	Drive Shaft	44T	21	23	56.2	83.5	740.5	
	1999.03-2003.08	-	L	F	Estate Engine K7M 702/K7M 703	250326	Drive Shaft	44T	21	29.95	57	84.5	648	
	1999.03-2003.08	-	R	F	Estate Engine K7M 702/K7M 703	250327	Drive Shaft	44T	21	23	57	84.5	740	
1.8 16V (85 kW)	2001.01-2003.08	-	-	F	Estate Engine F4P 720/F4P 722	850058	Outer Joint	44T	23	35	57	87	71	I
	2001.01-2003.08	MT	-	F	Estate Engine F4P 720/F4P 722	850052	Outer Joint	44T	23	30	57.5	86.5	58.5	I
	2001.01-2003.08	-	L	F	Estate Engine F4P 720/F4P 722	250160	Drive Shaft	44T	23	29.95	57	87	656.5	
	2001.01-2003.08	-	R	F	Estate Engine F4P 720/F4P 722	699131	Inner Joint		23	28	35	142	86	
	2001.01-2003.08	-	L	F	Estate Engine F4P 720/F4P 722	250220	Drive Shaft	44T	23	29.95	57.5	86.5	655	
	2001.01-2003.08	-	R	F	Estate Engine F4P 720/F4P 722	250313	Drive Shaft	44T	23	23	57.5	86.5	750	
	2001.01-2003.08	AT/MT	L/R	F	Estate Engine F4P 720/F4P 722	850114	Outer Joint	44T	23	35	57.5	87	71	I
1.9 D (47 kW)	1999.04-2003.08	MT	L	F	Estate Engine F8Q 622/F8Q 790	250048	Drive Shaft		21	29.95	46.4	81.5	650	
	1999.04-2003.08	MT	R	F	Estate Engine F8Q 622/F8Q 790	250140	Drive Shaft		21	23	49.8	83.5	718	
	1999.04-2003.08	MT	R	F	Estate Engine F8Q 622/F8Q 790	250173	Drive Shaft		21	23	57	84.5	742.9	
	1999.04-2003.08	-	L	F	Estate Engine F8Q 622/F8Q 790	250326	Drive Shaft	44T	21	29.95	57	84.5	648	
	1999.04-2003.08	-	R	F	Estate Engine F8Q 622/F8Q 790	250327	Drive Shaft	44T	21	23	57	84.5	740	
1.9 dCi (75 kW)	2001.02-2003.08	MT	-	F	Estate Engine F9Q 732/F9Q 733/F9Q 738	850058	Outer Joint	44T	23	35	57	87	71	I
	2001.02-2003.08	AT/MT	L/R	F	Estate Engine F9Q 732/F9Q 733/F9Q 738	850069	Outer Joint	44T	23	30	57.5	86.5	58.5	I
	2001.02-2003.08	AT/MT	-	F	Estate Engine F9Q 732/F9Q 733/F9Q 738	850052	Outer Joint	44T	23	30	57.5	86.5	58.5	I
	2001.02-2003.08	AT	L	F	Estate Engine F9Q 732/F9Q 733/F9Q 738	250253	Drive Shaft	44T	23	26	57.5	86.5	634	
	2001.02-2003.08	-	L	F	Estate Engine F9Q 732/F9Q 733/F9Q 738	250220	Drive Shaft	44T	23	29.95	57.5	86.5	655	
	2001.02-2003.08	MT	L	F	Estate Engine F9Q 732/F9Q 733/F9Q 738	250314	Drive Shaft	44T	23	29.95	57.5	86.5	654	
	2001.02-2003.08	MT	R	F	Estate Engine F9Q 732/F9Q 733/F9Q 738	250156	Drive Shaft	44T	23	23	57.5	86.5	746.5	
	2001.02-2003.08	MT	R	F	Estate Engine F9Q 732/F9Q 733/F9Q 738	250313	Drive Shaft	44T	23	23	57.5	86.5	750	
1.9 dTi (59 kW)	2001.02-2003.08	-	L	F	Estate Engine F9Q 744	250311	Drive Shaft	44T	23	29.95	56	82	650	
	2001.02-2003.08	MT	-	F	Estate Engine F9Q 744	850058	Outer Joint	44T	23	35	57	87	71	I
	2001.02-2003.08	AT/MT	L/R	F	Estate Engine F9Q 744	850069	Outer Joint	44T	23	30	57.5	86.5	58.5	I
	2001.02-2003.08	MT	-	F	Estate Engine F9Q 744	850052	Outer Joint	44T	23	30	57.5	86.5	58.5	I
	2001.02-2003.08	-	L	F	Estate Engine F9Q 744	250220	Drive Shaft	44T	23	29.95	57.5	86.5	655	
	2001.02-2003.08	MT	R	F	Estate Engine F9Q 744	250156	Drive Shaft	44T	23	23	57.5	86.5	746.5	
	2001.02-2003.08	-	R	F	Estate Engine F9Q 744	250313	Drive Shaft	44T	23	23	57.5	86.5	750	
1.9 dTi (72 kW)	1999.03-2001.02	MT	-	F	Estate Engine F9Q 731/F9Q 736	850058	Outer Joint	44T	23	35	57	87	71	I
	1999.03-2001.02	AT/MT	-	F	Estate Engine F9Q 731/F9Q 736	850052	Outer Joint	44T	23	30	57.5	86.5	58.5	I
	1999.03-2001.02	-	L	F	Estate Engine F9Q 731/F9Q 736	250253	Drive Shaft	44T	23	26	57.5	86.5	634	
	1999.03-2001.02	-	R	F	Estate Engine F9Q 731/F9Q 736	250039	Drive Shaft	44T	23	23	57.5	86.5	748	
	1999.03-2001.02	MT	R	F	Estate Engine F9Q 731/F9Q 736	250159	Drive Shaft	44T	23	23	57	87	748	
	1999.03-2001.02	-	L	F	Estate Engine F9Q 731/F9Q 736	250314	Drive Shaft	44T	23	29.95	57.5	86.5	654	
	1999.03-2001.02	-	R	F	Estate Engine F9Q 731/F9Q 736	650008	Inner Joint		23	30	36.3	52.2	68.5	
MEGANE II														
1.8	2000.07-2001.01	MT	R	F	-	250091	Drive Shaft	44T	23	23	56.2	83.5	744	
1.9 DCi/DTi	1999.04-2001.01	MT	R	F	-	250091	Drive Shaft	44T	23	23	56.2	83.5	744	
2.0 16V	1999.04-2003.05	MT	R	F	-	250091	Drive Shaft	44T	23	23	56.2	83.5	744	
MEGANE II (BM0/1_ CM0/1_)														
2.0 (169 kW)	2006.08-2008.02	MT	R	F	Hatchback Engine F4R 774	250554	Drive Shaft		27	39	56.7	88.5	960	
	2006.08-2008.02	MT	R	F	Hatchback Engine F4R 774	250400	Drive Shaft		25	39	53	88	932	
	2006.08-2008.02	MT	L	F	Hatchback Engine F4R 774	699150	Inner Joint		39	32	39	66	104.5	
	2006.08-2008.02	MT	L	F	Hatchback Engine F4R 774	299201	Drive Shaft		25	39	53	88	638	
	2006.08-2008.02	-	L	F	Hatchback Engine F4R 774	218197	Drive Shaft		27	39	57	88	663	
	2006.08-2008.02	MT	-	F	Hatchback Engine F4R 774	899213	Outer Joint		25	33	53	88	61.5	I
	2006.08-2008.02	-	-	F	Hatchback Engine F4R 774	818209	Outer Joint		27	33	57	88	59	I
	2006.08-2008.02	MT	R	F	Hatchback Engine F4R 774	699160	Inner Joint		39	32	33	352	90	
	2006.08-2008.02	-	R	F	Hatchback Engine F4R 774	218366	Drive Shaft		27	39	57	88	961	
2.0 dCi (110 kW)	2005.09-2008.02	-	R	F	Hatchback Engine M9R 700/M9R 722	650087	Inner Joint		39	35	30	367	89.5	
	2005.09-2008.02	-	R	F	Hatchback Engine M9R 700/M9R 722	250453	Drive Shaft		27	39	56.5	90.5	973.5	
	2005.09-2008.02	-	L	F	Hatchback Engine M9R 700/M9R 722	250444	Drive Shaft		27	39	56.5	90.5	626	
2.0 dCi (127 kW)	2007.01-2008.02	-	-	F	Hatchback Engine M9R 724	818209	Outer Joint		27	33	57	88	59	I

REMARKS	YEAR	TRANSM	L/R	F/R	GSP Ref.	PRODUCT	ABS	Technical Specifications							
								A	B	C	H	L	P		
RENAULT															
MEGANE II (BM0/1_, CM0/1_)															
1.4 16V (60 kW)	2003.10-2008.02	5MT	L	F	Hatchback Engine K4J 732	250405	Drive Shaft	23	26	49	86	674			
	2003.10-2008.02	5MT	R	F	Hatchback Engine K4J 732	699169	Inner Joint	26	30	33	326	95			
	2003.10-2008.02	MT	-	F	Hatchback Engine K4J 732	899085	Outer Joint	23	30	49	86	59	I		
	2003.10-2008.02	-	L	F	Hatchback Engine K4J 732	299070	Drive Shaft	23	26	49	86	675			
1.4 16V (72 kW)	2002.11-2008.02	5MT	L	F	Hatchback Engine K4J 730, K4J 740	250405	Drive Shaft	23	26	49	86	674			
	2002.11-2008.02	-	R	F	Hatchback Engine K4J 730, K4J 740	699169	Inner Joint	26	30	33	326	95			
	2002.11-2008.02	MT	-	F	Hatchback Engine K4J 730, K4J 740	899085	Outer Joint	23	30	49	86	59	I		
	2002.11-2008.02	-	L	F	Hatchback Engine K4J 730, K4J 740	299070	Drive Shaft	23	26	49	86	675			
1.5 dCi (60 kW)	2002.09-2008.02	-	L	F	Hatchback Engine K9K 722	250402	Drive Shaft	25	26	53	88	660			
	2002.09-2008.02	-	R	F	Hatchback Engine K9K 722	250348	Drive Shaft	25	26	53	88	905			
	2002.09-2008.02	5MT	R	F	Hatchback Engine K9K 722	699169	Inner Joint	26	30	33	326	95			
	2002.09-2008.02	AT/MT	-	F	Hatchback Engine K9K 722	899085	Outer Joint	23	30	49	86	59	I		
	2002.09-2008.02	-	L	F	Hatchback Engine K9K 722	299070	Drive Shaft	23	26	49	86	675			
1.5 dCi (63 kW)	2005.05-2008.02	5MT	R	F	Hatchback Engine K9K 724	699169	Inner Joint	26	30	33	326	95			
	2005.05-2008.02	5MT	L	F	Hatchback Engine K9K 724	250405	Drive Shaft	23	26	49	86	674			
	2005.05-2008.02	MT	-	F	Hatchback Engine K9K 724	899085	Outer Joint	23	30	49	86	59	I		
	2005.05-2008.02	-	L	F	Hatchback Engine K9K 724	299070	Drive Shaft	23	26	49	86	675			
1.5 dCi (74 kW)	2003.10-2008.02	MT	R	F	Hatchback Engine K9K 728, K9K 729	699169	Inner Joint	26	30	33	326	95			
	2003.10-2008.02	-	L	F	Hatchback Engine K9K 728, K9K 729	250516	Drive Shaft	23	26	49	86	674			
	2003.10-2008.02	AT	L	F	Hatchback Engine K9K 728, K9K 729	250255	Drive Shaft	23	26	49	86	673			
	2003.10-2008.02	AT	R	F	Hatchback Engine K9K 728, K9K 729	250351	Drive Shaft	23	23	49	86	802			
	2003.10-2008.02	-	-	F	Hatchback Engine K9K 728, K9K 729	899085	Outer Joint	23	30	49	86	59	I		
	2003.10-2008.02	MT	R	F	Hatchback Engine K9K 728, K9K 729	299188	Drive Shaft	23	26	49	86	916			
1.5 dCi (76 kW)	2007.01-2009.03	-	R	F	Hatchback Engine K9K 734	699169	Inner Joint	26	30	33	326	95			
	2007.01-2009.03	-	L	F	Hatchback Engine K9K 734	250516	Drive Shaft	23	26	49	86	674			
	2007.01-2009.03	-	R	F	Hatchback Engine K9K 734	299188	Drive Shaft	23	26	49	86	916			
1.5 dCi (78 kW)	2005.05-2008.06	-	L	F	Hatchback Engine K9K 732	250402	Drive Shaft	25	26	53	88	660			
	2005.05-2008.06	-	R	F	Hatchback Engine K9K 732	250348	Drive Shaft	25	26	53	88	905			
	2005.05-2008.06	-	L	F	Hatchback Engine K9K 732	250516	Drive Shaft	23	26	49	86	674			
	2005.05-2008.06	AT	L	F	Hatchback Engine K9K 732	250255	Drive Shaft	23	26	49	86	673			
	2005.05-2008.06	AT	R	F	Hatchback Engine K9K 732	250351	Drive Shaft	23	23	49	86	802			
	2005.05-2008.06	MT	L	F	Hatchback Engine K9K 732	250350	Drive Shaft	25	26	52.6	88	668.5			
	2005.05-2008.06	6MT	-	F	Hatchback Engine K9K 732	899213	Outer Joint	25	33	53	88	61.5	I		
1.6 (77 kW)	2005.06-2008.02	AT	L	F	Hatchback Engine K4M 788	250255	Drive Shaft	23	26	49	86	673			
	2005.06-2008.02	AT	R	F	Hatchback Engine K4M 788	250351	Drive Shaft	23	23	49	86	802			
1.6 16V (82 kW)	2006.01-2008.06	AT	L	F	Hatchback Engine K4M 760, K4M 812, K4M 813	250255	Drive Shaft	23	26	49	86	673			
	2006.01-2008.06	-	R	F	Hatchback Engine K4M 760, K4M 812, K4M 813	699169	Inner Joint	26	30	33	326	95			
	2006.01-2008.06	AT	R	F	Hatchback Engine K4M 760, K4M 812, K4M 813	250351	Drive Shaft	23	23	49	86	802			
	2006.01-2008.06	AT	-	F	Hatchback Engine K4M 760, K4M 812, K4M 813	899085	Outer Joint	23	30	49	86	59	I		
	2006.01-2008.06	-	R	F	Hatchback Engine K4M 760, K4M 812, K4M 813	299071	Drive Shaft	23	26	49	86	911			
1.6 16V (83 kW)	2002.11-2008.02	AT	L	F	Hatchback Engine K4M 760	250255	Drive Shaft	23	26	49	86	673			
	2002.11-2008.02	AT	R	F	Hatchback Engine K4M 760	250351	Drive Shaft	23	23	49	86	802			
	2002.11-2008.02	5MT	R	F	Hatchback Engine K4M 760	699169	Inner Joint	26	30	33	326	95			
	2002.11-2008.02	4AT	R	F	Hatchback Engine K4M 760	250440	Drive Shaft	23	23	49	86	804			
	2002.11-2008.02	AT	-	F	Hatchback Engine K4M 760	899085	Outer Joint	23	30	49	86	59	I		
	2002.11-2008.02	-	L	F	Hatchback Engine K4M 760	250346	Drive Shaft	23	26	49	86	669			
	2002.11-2008.02	5MT	R	F	Hatchback Engine K4M 760	299071	Drive Shaft	23	26	49	86	911			
1.6 Flex-Fuel (77 kW)	2007.01-2008.02	AT	L	F	Hatchback Engine K4M 788	250255	Drive Shaft	23	26	49	86	673			
	2007.01-2008.02	-	R	F	Hatchback Engine K4M 788	699169	Inner Joint	26	30	33	326	95			
	2007.01-2008.02	AT	R	F	Hatchback Engine K4M 788	250351	Drive Shaft	23	23	49	86	802			
	2007.01-2008.02	-	R	F	Hatchback Engine K4M 788	299071	Drive Shaft	23	26	49	86	911			
1.9 dCi (66 kW)	2002.11-2005.12	-	R	F	Hatchback Engine F9Q 808	250400	Drive Shaft	25	39	53	88	932			
	2002.11-2005.12	-	L	F	Hatchback Engine F9Q 808	699150	Inner Joint	39	32	39	66	104.5			
	2002.11-2005.12	-	L	F	Hatchback Engine F9Q 808	299201	Drive Shaft	25	39	53	88	638			
	2002.11-2005.12	-	R	F	Hatchback Engine F9Q 808	699160	Inner Joint	39	32	33	352	90			
1.9 dCi (68 kW)	2004.03-2006.08	MT	R	F	Hatchback Engine F9Q 808	250400	Drive Shaft	25	39	53	88	932			
	2004.03-2006.08	MT	L	F	Hatchback Engine F9Q 808	699150	Inner Joint	39	32	39	66	104.5			
	2004.03-2006.08	MT	L	F	Hatchback Engine F9Q 808	299201	Drive Shaft	25	39	53	88	638			
	2004.03-2006.08	MT	-	F	Hatchback Engine F9Q 808	899213	Outer Joint	25	33	53	88	61.5	I		
	2004.03-2006.08	MT	R	F	Hatchback Engine F9Q 808	699160	Inner Joint	39	32	33	352	90			
1.9 dCi (81 kW)	2005.05-2008.02	MT	R	F	Hatchback Engine F9Q 804, F9Q 818	250400	Drive Shaft	25	39	53	88	932			
	2005.05-2008.02	MT	L	F	Hatchback Engine F9Q 804, F9Q 818	699150	Inner Joint	39	32	39	66	104.5			
	2005.05-2008.02	MT	L	F	Hatchback Engine F9Q 804, F9Q 818	299201	Drive Shaft	25	39	53	88	638			
	2005.05-2008.02	MT	-	F	Hatchback Engine F9Q 804, F9Q 818	899213	Outer Joint	25	33	53	88	61.5	I		
	2005.05-2008.02	MT	R	F	Hatchback Engine F9Q 804, F9Q 818	699160	Inner Joint	39	32	33	352	90			
1.9 dCi (85 kW)	2002.11-2008.02	MT	R	F	Hatchback Engine F9Q 804, F9Q 816, F9Q 818	250400	Drive Shaft	25	39	53	88	932			

REMARKS	GSP Ref.	PRODUCT	ABS	Technical Specifications											
				A	B	C	H	L	P						
		YEAR	TRANSM	L/R	F/R										
RENAULT MEGANE II (BM0/1_, CM0/1_)															
1.9 dCi (85 kW)	2002.11-2008.02	2008.02	MT	L	F	Hatchback Engine F9Q 804, F9Q 816, F9Q 818	699150	Inner Joint		39	32	39	66	104.5	
	2002.11-2008.02	2008.02	AT	L	F	Hatchback Engine F9Q 804, F9Q 816, F9Q 818	299186	Drive Shaft		25	26	52.6	88	669	
	2002.11-2008.02	2008.02	MT	L	F	Hatchback Engine F9Q 804, F9Q 816, F9Q 818	299201	Drive Shaft		25	39	53	88	638	
	2002.11-2008.02	2008.02	MT	R	F	Hatchback Engine F9Q 804, F9Q 816, F9Q 818	699160	Inner Joint		39	32	33	352	90	
1.9 dCi (88 kW)	2002.11-2008.02	2008.02	5MT	R	F	Hatchback Engine F9Q 800	250400	Drive Shaft		25	39	53	88	932	
	2002.11-2008.02	2008.02	5MT	L	F	Hatchback Engine F9Q 800	699150	Inner Joint		39	32	39	66	104.5	
	2002.11-2008.02	2008.02	MT	-	F	Hatchback Engine F9Q 800	899213	Outer Joint		25	33	53	88	61.5	I
	2002.11-2008.02	2008.02	5MT	L	F	Hatchback Engine F9Q 800	299201	Drive Shaft		25	39	53	88	638	
	2002.11-2008.02	2008.02	5MT	R	F	Hatchback Engine F9Q 800	699160	Inner Joint		39	32	33	352	90	
1.9 dCi (96 kW)	2005.05-2009.12	2009.12	AT	-	F	Hatchback Engine F9Q 803, F9Q 804, F9Q 816, F9Q 818	850137	Outer Joint		25	32	52.6	88	58	I
	2005.05-2009.12	2009.12	MT	R	F	Hatchback Engine F9Q 803, F9Q 804, F9Q 816, F9Q 818	250400	Drive Shaft		25	39	53	88	932	
	2005.05-2009.12	2009.12	MT	L	F	Hatchback Engine F9Q 803, F9Q 804, F9Q 816, F9Q 818	699150	Inner Joint		39	32	39	66	104.5	
	2005.05-2009.12	2009.12	MT	L	F	Hatchback Engine F9Q 803, F9Q 804, F9Q 816, F9Q 818	299201	Drive Shaft		25	39	53	88	638	
	2005.05-2009.12	2009.12	MT	-	F	Hatchback Engine F9Q 803, F9Q 804, F9Q 816, F9Q 818	899213	Outer Joint		25	33	53	88	61.5	I
	2005.05-2009.12	2009.12	MT	R	F	Hatchback Engine F9Q 803, F9Q 804, F9Q 816, F9Q 818	699160	Inner Joint		39	32	33	352	90	
2.0 16V (99 kW)	2002.11-2008.02	2008.02	6MT	R	F	Hatchback Engine F4R 770	699160	Inner Joint		39	32	33	352	90	
	2002.11-2008.02	2008.02	AT	L	F	Hatchback Engine F4R 770	250255	Drive Shaft		23	26	49	86	673	
	2002.11-2008.02	2008.02	AT	R	F	Hatchback Engine F4R 770	250351	Drive Shaft		23	23	49	86	802	
	2002.11-2008.02	2008.02	6MT	R	F	Hatchback Engine F4R 770	250447	Drive Shaft		23	39	49	86.5	930	
	2002.11-2008.02	2008.02	-	-	F	Hatchback Engine F4R 770	850117	Outer Joint		23	32	49	86	62	I
	2002.11-2008.02	2008.02	6MT	L	F	Hatchback Engine F4R 770	699150	Inner Joint		39	32	39	66	104.5	
	2002.11-2008.02	2008.02	-	L	F	Hatchback Engine F4R 770	250346	Drive Shaft		23	26	49	86	669	
	2002.11-2008.02	2008.02	AT	R	F	Hatchback Engine F4R 770	250520	Drive Shaft		23	23	49	86	803	
	2002.11-2008.02	2008.02	6MT	L	F	Hatchback Engine F4R 770	250441	Drive Shaft		23	39	49	86.5	636	
	2002.11-2008.02	2008.02	MT	-	F	Hatchback Engine F4R 770	850109	Outer Joint		23	33	49	86.5	61	I
2.0 16V Turbo (120 kW)	2004.05-2008.02	2008.02	MT	R	F	Hatchback Engine F4R 776	250400	Drive Shaft		25	39	53	88	932	
	2004.05-2008.02	2008.02	MT	L	F	Hatchback Engine F4R 776	699150	Inner Joint		39	32	39	66	104.5	
	2004.05-2008.02	2008.02	MT	L	F	Hatchback Engine F4R 776	299201	Drive Shaft		25	39	53	88	638	
	2004.05-2008.02	2008.02	MT	-	F	Hatchback Engine F4R 776	899213	Outer Joint		25	33	53	88	61.5	I
	2004.05-2008.02	2008.02	MT	R	F	Hatchback Engine F4R 776	699160	Inner Joint		39	32	33	352	90	
2.0 Renault Sport (165 kW)	2004.05-2009.10	2009.10	-	R	F	Hatchback Engine F4R 774, F4Rt 774	699160	Inner Joint		39	32	33	352	90	
	2004.05-2009.10	2009.10	-	L	F	Hatchback Engine F4R 774, F4Rt 774	218197	Drive Shaft		27	39	57	88	663	
	2004.05-2009.10	2009.10	-	-	F	Hatchback Engine F4R 774, F4Rt 774	818209	Outer Joint		27	33	57	88	59	I
	2004.05-2009.10	2009.10	-	L	F	Hatchback Engine F4R 774, F4Rt 774	699150	Inner Joint		39	32	39	66	104.5	
	2004.05-2009.10	2009.10	-	R	F	Hatchback Engine F4R 774, F4Rt 774	218366	Drive Shaft		27	39	57	88	961	
	2004.05-2009.10	2009.10	-	R	F	Hatchback Engine F4R 774, F4Rt 774	250554	Drive Shaft		27	39	56.7	88.5	960	
2.0(102 kW)	2006.06-2010.12	2010.12	AT	L	F	Hatchback Engine F4R 770	250255	Drive Shaft		23	26	49	86	673	
	2006.06-2010.12	2010.12	AT	R	F	Hatchback Engine F4R 770	250351	Drive Shaft		23	23	49	86	802	
	2006.06-2010.12	2010.12	-	-	F	Hatchback Engine F4R 770	850117	Outer Joint		23	32	49	86	62	I
	2006.06-2010.12	2010.12	MT	-	F	Hatchback Engine F4R 770	850109	Outer Joint		23	33	49	86.5	61	I
MEGANE II (KM0/1_)															
1.4 (72 kW)	2003.08-2009.07	2009.07	5MT	L	F	Estate Engine K4J 730/K4J 740	250405	Drive Shaft		23	26	49	86	674	
	2003.08-2009.07	2009.07	-	R	F	Estate Engine K4J 730/K4J 740	699169	Inner Joint		26	30	33	326	95	
	2003.08-2009.07	2009.07	MT	-	F	Estate Engine K4J 730/K4J 740	899085	Outer Joint		23	30	49	86	59	I
	2003.08-2009.07	2009.07	-	L	F	Estate Engine K4J 730/K4J 740	299070	Drive Shaft		23	26	49	86	675	
1.5 dCi (60 kW)	2003.08-2006.05	2006.05	5MT	L	F	Estate Engine K9K 722	250405	Drive Shaft		23	26	49	86	674	
	2003.08-2006.05	2006.05	-	R	F	Estate Engine K9K 722	699169	Inner Joint		26	30	33	326	95	
	2003.08-2006.05	2006.05	AT/MT	-	F	Estate Engine K9K 722	899085	Outer Joint		23	30	49	86	59	I
	2003.08-2006.05	2006.05	-	L	F	Estate Engine K9K 722	299070	Drive Shaft		23	26	49	86	675	
1.5 dCi (63 kW)	2005.05-2009.07	2009.07	5MT	L	F	Estate Engine K9K 724	250405	Drive Shaft		23	26	49	86	674	
	2005.05-2009.07	2009.07	-	R	F	Estate Engine K9K 724	699169	Inner Joint		26	30	33	326	95	
	2005.05-2009.07	2009.07	MT	-	F	Estate Engine K9K 724	899213	Outer Joint		25	33	53	88	61.5	I
	2005.05-2009.07	2009.07	-	L	F	Estate Engine K9K 724	299070	Drive Shaft		23	26	49	86	675	
1.5 dCi (74 kW)	2004.02-2006.03	2006.03	-	R	F	Estate Engine K9K 728/K9K 729	699169	Inner Joint		26	30	33	326	95	
	2004.02-2006.03	2006.03	-	L	F	Estate Engine K9K 728/K9K 729	250516	Drive Shaft		23	26	49	86	674	
	2004.02-2006.03	2006.03	AT/MT	-	F	Estate Engine K9K 728/K9K 729	899085	Outer Joint		23	30	49	86	59	I
	2004.02-2006.03	2006.03	-	R	F	Estate Engine K9K 728/K9K 729	299188	Drive Shaft		23	26	49	86	916	
1.5 dCi (76 kW)	2007.01-2009.07	2009.07	-	R	F	Estate Engine K9K 728	699169	Inner Joint		26	30	33	326	95	
	2007.01-2009.07	2009.07	-	L	F	Estate Engine K9K 728	250516	Drive Shaft		23	26	49	86	674	
	2007.01-2009.07	2009.07	MT	-	F	Estate Engine K9K 728	899085	Outer Joint		23	30	49	86	59	I
	2007.01-2009.07	2009.07	-	R	F	Estate Engine K9K 728	299188	Drive Shaft		23	26	49	86	916	
1.5 dCi (78 kW)	2005.05-2008.06	2008.06	-	L	F	Estate Engine K9K 732/K9K 734	250402	Drive Shaft		25	26	53	88	660	
	2005.05-2008.06	2008.06	-	R	F	Estate Engine K9K 732/K9K 734	250348	Drive Shaft		25	26	53	88	905	
	2005.05-2008.06	2008.06	-	L	F	Estate Engine K9K 732/K9K 734	250516	Drive Shaft		23	26	49	86	674	
	2005.05-2008.06	2008.06	MT	-	F	Estate Engine K9K 732/K9K 734	899085	Outer Joint		23	30	49	86	59	I
	2005.05-2008.06	2008.06	MT	L	F	Estate Engine K9K 732/K9K 734	250350	Drive Shaft		25	26	52.6	88	668.5	

REMARKS	GSP Ref.	PRODUCT	ABS	Technical Specifications											
				A	B	C	H	L	P						
RENAULT															
MEGANE II (KM0/1_)															
1.6 (83 kW)	2003.08-2009.07	-	L F	Estate Engine K4M 760/K4M 761	250494	Drive Shaft		25	26	52.6	88	664			
	2003.08-2009.07	AT	L F	Estate Engine K4M 760/K4M 761	250255	Drive Shaft		23	26	49	86	673			
	2003.08-2009.07	-	R F	Estate Engine K4M 760/K4M 761	699169	Inner Joint		26	30	33	326	95			
	2003.08-2009.07	AT	R F	Estate Engine K4M 760/K4M 761	250351	Drive Shaft		23	23	49	86	802			
	2003.08-2009.07	AT	R F	Estate Engine K4M 760/K4M 761	250440	Drive Shaft		23	23	49	86	804			
	2003.08-2009.07	AT	- F	Estate Engine K4M 760/K4M 761	899085	Outer Joint		23	30	49	86	59	I		
	2003.08-2009.07	-	L F	Estate Engine K4M 760/K4M 761	250346	Drive Shaft		23	26	49	86	669			
	2003.08-2009.07	-	R F	Estate Engine K4M 760/K4M 761	299071	Drive Shaft		23	26	49	86	911			
1.6 16V (77 kW)	2005.05-2009.07	-	R F	Estate Engine K4M 762	699169	Inner Joint		26	30	33	326	95			
	2005.05-2009.07	-	R F	Estate Engine K4M 762	299071	Drive Shaft		23	26	49	86	911			
1.6 16V (82 kW)	2006.01-2009.08	AT	L F	Estate Engine K4M 760/K4M 761/K4M 812/K4M 813	250255	Drive Shaft		23	26	49	86	673			
	2006.01-2009.08	-	R F	Estate Engine K4M 760/K4M 761/K4M 812/K4M 813	699169	Inner Joint		26	30	33	326	95			
	2006.01-2009.08	AT	R F	Estate Engine K4M 760/K4M 761/K4M 812/K4M 813	250351	Drive Shaft		23	23	49	86	802			
	2006.01-2009.08	AT	- F	Estate Engine K4M 760/K4M 761/K4M 812/K4M 813	899085	Outer Joint		23	30	49	86	59	I		
	2006.01-2009.08	-	R F	Estate Engine K4M 760/K4M 761/K4M 812/K4M 813	299071	Drive Shaft		23	26	49	86	911			
1.6 16V Hi-Flex (77 kW)	2008.02-2009.07	-	R F	Estate Engine K4M 856	699169	Inner Joint		26	30	33	326	95			
	2008.02-2009.07	-	R F	Estate Engine K4M 856	299071	Drive Shaft		23	26	49	86	911			
1.9 dCi (66 kW)	2004.04-2005.12	-	R F	Estate Engine F9Q 808	250400	Drive Shaft		25	39	53	88	932			
	2004.04-2005.12	-	L F	Estate Engine F9Q 808	699150	Inner Joint		39	32	39	66	104.5			
	2004.04-2005.12	-	L F	Estate Engine F9Q 808	299201	Drive Shaft		25	39	53	88	638			
	2004.04-2005.12	-	R F	Estate Engine F9Q 808	699160	Inner Joint		39	32	33	352	90			
1.9 dCi (68 kW)	2004.03-2007.02	MT	R F	Estate Engine F9Q 808	250400	Drive Shaft		25	39	53	88	932			
	2004.03-2007.02	MT	L F	Estate Engine F9Q 808	699150	Inner Joint		39	32	39	66	104.5			
	2004.03-2007.02	MT	L F	Estate Engine F9Q 808	299201	Drive Shaft		25	39	53	88	638			
	2004.03-2007.02	MT	- F	Estate Engine F9Q 808	899213	Outer Joint		25	33	53	88	61.5	I		
	2004.03-2007.02	MT	R F	Estate Engine F9Q 808	699160	Inner Joint		39	32	33	352	90			
1.9 dCi (81 kW)	2005.05-2009.07	MT	R F	Estate Engine F9Q 804/F9Q 818	250400	Drive Shaft		25	39	53	88	932			
	2005.05-2009.07	MT	L F	Estate Engine F9Q 804/F9Q 818	699150	Inner Joint		39	32	39	66	104.5			
	2005.05-2009.07	AT	L F	Estate Engine F9Q 804/F9Q 818	299186	Drive Shaft		25	26	52.6	88	669			
	2005.05-2009.07	MT	L F	Estate Engine F9Q 804/F9Q 818	299201	Drive Shaft		25	39	53	88	638			
	2005.05-2009.07	MT	- F	Estate Engine F9Q 804/F9Q 818	899213	Outer Joint		25	33	53	88	61.5	I		
	2005.05-2009.07	MT	R F	Estate Engine F9Q 804/F9Q 818	699160	Inner Joint		39	32	33	352	90			
1.9 dCi (85 kW)	2005.05-2009.07	-	R F	Estate Engine F9Q 818	250400	Drive Shaft		25	39	53	88	932			
	2005.05-2009.07	-	L F	Estate Engine F9Q 818	699150	Inner Joint		39	32	39	66	104.5			
	2005.05-2009.07	-	L F	Estate Engine F9Q 818	299201	Drive Shaft		25	39	53	88	638			
	2005.05-2009.07	-	R F	Estate Engine F9Q 818	699160	Inner Joint		39	32	33	352	90			
1.9 dCi (88 kW)	2003.08-2009.07	MT	R F	Estate Engine F9Q 800	250400	Drive Shaft		25	39	53	88	932			
	2003.08-2009.07	6MT	L F	Estate Engine F9Q 800	699150	Inner Joint		39	32	39	66	104.5			
	2003.08-2009.07	MT	- F	Estate Engine F9Q 800	899213	Outer Joint		25	33	53	88	61.5	I		
	2003.08-2009.07	6MT	L F	Estate Engine F9Q 800	299201	Drive Shaft		25	39	53	88	638			
	2003.08-2009.07	MT	R F	Estate Engine F9Q 800	699160	Inner Joint		39	32	33	352	90			
1.9 dCi (96 kW)	2005.05-2009.07	AT	- F	Estate Engine F9Q 803/F9Q 804	850137	Outer Joint		25	32	52.6	88	58	I		
	2005.05-2009.07	MT	R F	Estate Engine F9Q 803/F9Q 804	250400	Drive Shaft		25	39	53	88	932			
	2005.05-2009.07	MT	L F	Estate Engine F9Q 803/F9Q 804	699150	Inner Joint		39	32	39	66	104.5			
	2005.05-2009.07	MT	L F	Estate Engine F9Q 803/F9Q 804	299201	Drive Shaft		25	39	53	88	638			
	2005.05-2009.07	MT	- F	Estate Engine F9Q 803/F9Q 804	899213	Outer Joint		25	33	53	88	61.5	I		
	2005.05-2009.07	MT	R F	Estate Engine F9Q 803/F9Q 804	699160	Inner Joint		39	32	33	352	90			
2.0 (102 kW)	2006.12-2011.01	MT	- F	Estate Engine F4R 770/F4R 771	850109	Outer Joint		23	33	49	86.5	61	I		
	2006.12-2011.01	AT	L F	Estate Engine F4R 770/F4R 771	250255	Drive Shaft		23	26	49	86	673			
	2006.12-2011.01	AT	R F	Estate Engine F4R 770/F4R 771	250351	Drive Shaft		23	23	49	86	802			
	2006.12-2011.01	-	- F	Estate Engine F4R 770/F4R 771	850117	Outer Joint		23	32	49	86	62	I		
2.0 (99 kW)	2003.08-2009.07	AT	L F	Estate Engine F4R 770/F4R 771	250255	Drive Shaft		23	26	49	86	673			
	2003.08-2009.07	AT	R F	Estate Engine F4R 770/F4R 771	250351	Drive Shaft		23	23	49	86	802			
	2003.08-2009.07	MT	R F	Estate Engine F4R 770/F4R 771	250447	Drive Shaft		23	39	49	86.5	930			
	2003.08-2009.07	-	- F	Estate Engine F4R 770/F4R 771	850117	Outer Joint		23	32	49	86	62	I		
	2003.08-2009.07	-	L F	Estate Engine F4R 770/F4R 771	699150	Inner Joint		39	32	39	66	104.5			
	2003.08-2009.07	-	L F	Estate Engine F4R 770/F4R 771	250346	Drive Shaft		23	26	49	86	669			
	2003.08-2009.07	AT	R F	Estate Engine F4R 770/F4R 771	250520	Drive Shaft		23	23	49	86	803			
	2003.08-2009.07	-	L F	Estate Engine F4R 770/F4R 771	250441	Drive Shaft		23	39	49	86.5	636			
	2003.08-2009.07	MT	- F	Estate Engine F4R 770/F4R 771	850109	Outer Joint		23	33	49	86.5	61	I		
	2003.08-2009.07	MT	R F	Estate Engine F4R 770/F4R 771	699160	Inner Joint		39	32	33	352	90			
2.0 dCi (110 kW)	2005.09-2009.07	-	R F	Estate Engine M9R 700/M9R 722	650087	Inner Joint		39	35	30	367	89.5			
	2005.09-2009.07	-	R F	Estate Engine M9R 700/M9R 722	250453	Drive Shaft		27	39	56.5	90.5	973.5			
	2005.09-2009.07	-	L F	Estate Engine M9R 700/M9R 722	650071	Inner Joint		39	35	39	74	102.5			
	2005.09-2009.07	-	L F	Estate Engine M9R 700/M9R 722	250444	Drive Shaft		27	39	56.5	90.5	626			
MEGANE II (LM0/1_)															

REMARKS	YEAR	TRANSM	L/R	F/R	GSP Ref.	PRODUCT	ABS	Technical Specifications							
								A	B	C	H	L	P		
RENAULT MEGANE II (LM0/1_)															
1.4 (60 kW)	2003.09-	-	5MT	R	F	Saloon Engine K4J 732	699169	Inner Joint	26	30	33	326	95		
	2003.09-	-	5MT	L	F	Saloon Engine K4J 732	250405	Drive Shaft	23	26	49	86	674		
	2003.09-	-	MT	-	F	Saloon Engine K4J 732	899085	Outer Joint	23	30	49	86	59	I	
1.4 (72 kW)	2003.09-	-	-	R	F	Saloon Engine K4J 730/K4J 740	699169	Inner Joint	26	30	33	326	95		
	2003.09-	-	5MT	L	F	Saloon Engine K4J 730/K4J 740	250405	Drive Shaft	23	26	49	86	674		
	2003.09-	-	MT	-	F	Saloon Engine K4J 730/K4J 740	899085	Outer Joint	23	30	49	86	59	I	
	2003.09-	-	-	L	F	Saloon Engine K4J 730/K4J 740	299070	Drive Shaft	23	26	49	86	675		
1.5 dCi (60 kW)	2003.09-	-	-	L	F	Saloon Engine K9K 722	250402	Drive Shaft	25	26	53	88	660		
	2003.09-	-	-	R	F	Saloon Engine K9K 722	250348	Drive Shaft	25	26	53	88	905		
	2003.09-	-	-	R	F	Saloon Engine K9K 722	699169	Inner Joint	26	30	33	326	95		
	2003.09-	-	5MT	L	F	Saloon Engine K9K 722	250405	Drive Shaft	23	26	49	86	674		
	2003.09-	-	-	-	F	Saloon Engine K9K 722	899085	Outer Joint	23	30	49	86	59	I	
	2003.09-	-	-	L	F	Saloon Engine K9K 722	299070	Drive Shaft	23	26	49	86	675		
1.5 dCi (63 kW)	2005.05-	-	5MT	L	F	Saloon Engine K9K 724	250405	Drive Shaft	23	26	49	86	674		
	2005.05-	-	-	R	F	Saloon Engine K9K 724	699169	Inner Joint	26	30	33	326	95		
	2005.05-	-	MT	-	F	Saloon Engine K9K 724	899085	Outer Joint	23	30	49	86	59	I	
	2005.05-	-	-	L	F	Saloon Engine K9K 724	299070	Drive Shaft	23	26	49	86	675		
1.5 dCi (74 kW)	2004.02-	-	MT	L	F	Saloon Engine K9K 728/K9K 729	250516	Drive Shaft	23	26	49	86	674		
	2004.02-	-	MT	R	F	Saloon Engine K9K 728/K9K 729	699169	Inner Joint	26	30	33	326	95		
	2004.02-	-	-	-	F	Saloon Engine K9K 728/K9K 729	899085	Outer Joint	23	30	49	86	59	I	
	2004.02-	-	MT	R	F	Saloon Engine K9K 728/K9K 729	299188	Drive Shaft	23	26	49	86	916		
1.5 dCi (76 kW)	2007.01-	-	-	R	F	Saloon Engine K9K 734	699169	Inner Joint	26	30	33	326	95		
	2007.01-	-	-	L	F	Saloon Engine K9K 734	250516	Drive Shaft	23	26	49	86	674		
	2007.01-	-	-	R	F	Saloon Engine K9K 734	299188	Drive Shaft	23	26	49	86	916		
	2007.01-	-	MT	-	F	Saloon Engine K9K 734	899213	Outer Joint	25	33	53	88	61.5	I	
1.5 dCi (78 kW)	2005.05-	-	-	L	F	Saloon Engine K9K 732	250402	Drive Shaft	25	26	53	88	660		
	2005.05-	-	-	R	F	Saloon Engine K9K 732	250348	Drive Shaft	25	26	53	88	905		
	2005.05-	-	-	L	F	Saloon Engine K9K 732	250516	Drive Shaft	23	26	49	86	674		
	2005.05-	-	MT	-	F	Saloon Engine K9K 732	899213	Outer Joint	25	33	53	88	61.5	I	
	2005.05-	-	MT	L	F	Saloon Engine K9K 732	250350	Drive Shaft	25	26	52.6	88	668.5		
1.6 (77 kW)	2005.05-	-	-	R	F	Saloon Engine K4M 762	699169	Inner Joint	26	30	33	326	95		
	2005.05-	-	-	R	F	Saloon Engine K4M 762	299071	Drive Shaft	23	26	49	86	911		
1.6 (83 kW)	2003.09-	-	-	L	F	Saloon Engine K4M 760/K4M 761	250494	Drive Shaft	25	26	52.6	88	664		
	2003.09-	-	AT	L	F	Saloon Engine K4M 760/K4M 761	250255	Drive Shaft	23	26	49	86	673		
	2003.09-	-	-	R	F	Saloon Engine K4M 760/K4M 761	699169	Inner Joint	26	30	33	326	95		
	2003.09-	-	AT	R	F	Saloon Engine K4M 760/K4M 761	250351	Drive Shaft	23	23	49	86	802		
	2003.09-	-	-	R	F	Saloon Engine K4M 760/K4M 761	250440	Drive Shaft	23	23	49	86	804		
	2003.09-	-	-	L	F	Saloon Engine K4M 760/K4M 761	250346	Drive Shaft	23	26	49	86	669		
	2003.09-	-	AT	-	F	Saloon Engine K4M 760/K4M 761	899085	Outer Joint	23	30	49	86	59	I	
	2003.09-	-	-	R	F	Saloon Engine K4M 760/K4M 761	299071	Drive Shaft	23	26	49	86	911		
1.6 16V (82 kW)	2006.01-	-	AT	L	F	Saloon Engine K4M 760/K4M 761/K4M 812/K4M 813	250255	Drive Shaft	23	26	49	86	673		
	2006.01-	-	MT	R	F	Saloon Engine K4M 760/K4M 761/K4M 812/K4M 813	699169	Inner Joint	26	30	33	326	95		
	2006.01-	-	AT	R	F	Saloon Engine K4M 760/K4M 761/K4M 812/K4M 813	250351	Drive Shaft	23	23	49	86	802		
	2006.01-	-	AT	R	F	Saloon Engine K4M 760/K4M 761/K4M 812/K4M 813	250440	Drive Shaft	23	23	49	86	804		
	2006.01-	-	AT	L	F	Saloon Engine K4M 760/K4M 761/K4M 812/K4M 813	250346	Drive Shaft	23	26	49	86	669		
	2006.01-	-	AT	-	F	Saloon Engine K4M 760/K4M 761/K4M 812/K4M 813	899085	Outer Joint	23	30	49	86	59	I	
	2006.01-	-	MT	R	F	Saloon Engine K4M 760/K4M 761/K4M 812/K4M 813	299071	Drive Shaft	23	26	49	86	911		
1.9 dCi (66 kW)	2003.09-2005.12	-	-	-	F	Saloon Engine F9Q 808	899213	Outer Joint	25	33	53	88	61.5	I	
	2003.09-2005.12	-	-	R	F	Saloon Engine F9Q 808	250400	Drive Shaft	25	39	53	88	932		
	2003.09-2005.12	-	-	L	F	Saloon Engine F9Q 808	699150	Inner Joint	39	32	39	66	104.5		
	2003.09-2005.12	-	-	L	F	Saloon Engine F9Q 808	299201	Drive Shaft	25	39	53	88	638		
	2003.09-2005.12	-	-	R	F	Saloon Engine F9Q 808	699160	Inner Joint	39	32	33	352	90		
1.9 dCi (68 kW)	2004.03-	-	MT	R	F	Saloon Engine F9Q 808	250400	Drive Shaft	25	39	53	88	932		
	2004.03-	-	MT	L	F	Saloon Engine F9Q 808	699150	Inner Joint	39	32	39	66	104.5		
	2004.03-	-	MT	L	F	Saloon Engine F9Q 808	299201	Drive Shaft	25	39	53	88	638		
	2004.03-	-	MT	-	F	Saloon Engine F9Q 808	899213	Outer Joint	25	33	53	88	61.5	I	
	2004.03-	-	MT	R	F	Saloon Engine F9Q 808	699160	Inner Joint	39	32	33	352	90		
1.9 dCi (81 kW)	2005.05-	-	MT	R	F	Saloon Engine F9Q 803/F9Q 804/F9Q 816/F9Q 818	250400	Drive Shaft	25	39	53	88	932		
	2005.05-	-	MT	L	F	Saloon Engine F9Q 803/F9Q 804/F9Q 816/F9Q 818	699150	Inner Joint	39	32	39	66	104.5		
	2005.05-	-	MT	L	F	Saloon Engine F9Q 803/F9Q 804/F9Q 816/F9Q 818	299201	Drive Shaft	25	39	53	88	638		
	2005.05-	-	MT	-	F	Saloon Engine F9Q 803/F9Q 804/F9Q 816/F9Q 818	899213	Outer Joint	25	33	53	88	61.5	I	
	2005.05-	-	MT	R	F	Saloon Engine F9Q 803/F9Q 804/F9Q 816/F9Q 818	699160	Inner Joint	39	32	33	352	90		
1.9 dCi (88 kW)	2003.09-	-	MT	R	F	Saloon Engine F9Q 800	250400	Drive Shaft	25	39	53	88	932		
	2003.09-	-	MT	L	F	Saloon Engine F9Q 800	699150	Inner Joint	39	32	39	66	104.5		
	2003.09-	-	MT	L	F	Saloon Engine F9Q 800	299201	Drive Shaft	25	39	53	88	638		
	2003.09-	-	MT	-	F	Saloon Engine F9Q 800	899213	Outer Joint	25	33	53	88	61.5	I	

REMARKS	YEAR	TRANSM	L/R	F/R	GSP Ref.	PRODUCT	ABS	Technical Specifications						
								A	B	C	H	L	P	
RENAULT														
MEGANE II (LM0/1_)														
1.9 dCi (88 kW)	2003.09-	-	MT	R	F	Saloon Engine F9Q 800	699160	Inner Joint	39	32	33	352	90	
1.9 dCi (96 kW)	2005.05-	-	MT	R	F	Saloon Engine F9Q 803/F9Q 804	250400	Drive Shaft	25	39	53	88	932	
	2005.05-	-	AT	-	F	Saloon Engine F9Q 803/F9Q 804	850137	Outer Joint	25	32	52.6	88	58	I
	2005.05-	-	MT	L	F	Saloon Engine F9Q 803/F9Q 804	699150	Inner Joint	39	32	39	66	104.5	
	2005.05-	-	MT	L	F	Saloon Engine F9Q 803/F9Q 804	299201	Drive Shaft	25	39	53	88	638	
	2005.05-	-	MT	-	F	Saloon Engine F9Q 803/F9Q 804	899213	Outer Joint	25	33	53	88	61.5	I
	2005.05-	-	MT	R	F	Saloon Engine F9Q 803/F9Q 804	699160	Inner Joint	39	32	33	352	90	
2.0 (101 kW)	2006.04-2010.11		MT	R	F	Saloon Engine F4R 770	699160	Inner Joint	39	32	33	352	90	
	2006.04-2010.11		MT	R	F	Saloon Engine F4R 770	250447	Drive Shaft	23	39	49	86.5	930	
	2006.04-2010.11		MT	L	F	Saloon Engine F4R 770	699150	Inner Joint	39	32	39	66	104.5	
	2006.04-2010.11		AT	L	F	Saloon Engine F4R 770	250346	Drive Shaft	23	26	49	86	669	
	2006.04-2010.11		MT	L	F	Saloon Engine F4R 770	250441	Drive Shaft	23	39	49	86.5	636	
2.0 (99 kW)	2003.09-	-	AT	L	F	Saloon Engine F4R 770/F4R 771	250255	Drive Shaft	23	26	49	86	673	
	2003.09-	-	AT	R	F	Saloon Engine F4R 770/F4R 771	250351	Drive Shaft	23	23	49	86	802	
	2003.09-	-	MT	R	F	Saloon Engine F4R 770/F4R 771	250447	Drive Shaft	23	39	49	86.5	930	
	2003.09-	-	-	-	F	Saloon Engine F4R 770/F4R 771	850117	Outer Joint	23	32	49	86	62	I
	2003.09-	-	MT	L	F	Saloon Engine F4R 770/F4R 771	699150	Inner Joint	39	32	39	66	104.5	
	2003.09-	-	-	L	F	Saloon Engine F4R 770/F4R 771	250346	Drive Shaft	23	26	49	86	669	
	2003.09-	-	AT	R	F	Saloon Engine F4R 770/F4R 771	250520	Drive Shaft	23	23	49	86	803	
	2003.09-	-	MT	L	F	Saloon Engine F4R 770/F4R 771	250441	Drive Shaft	23	39	49	86.5	636	
	2003.09-	-	MT	-	F	Saloon Engine F4R 770/F4R 771	850109	Outer Joint	23	33	49	86.5	61	I
	2003.09-	-	MT	R	F	Saloon Engine F4R 770/F4R 771	699160	Inner Joint	39	32	33	352	90	
2.0 dCi (110 kW)	2005.09-	-	-	R	F	Saloon Engine M9R 700/M9R 722	650087	Inner Joint	39	35	30	367	89.5	
	2005.09-	-	-	R	F	Saloon Engine M9R 700/M9R 722	250453	Drive Shaft	27	39	56.5	90.5	973.5	
	2005.09-	-	-	L	F	Saloon Engine M9R 700/M9R 722	650071	Inner Joint	39	35	39	74	102.5	
	2005.09-	-	-	L	F	Saloon Engine M9R 700/M9R 722	250444	Drive Shaft	27	39	56.5	90.5	626	
MEGANE II Coupé-Cabriolet (EM0/1_)														
1.5 dCi (78 kW)	2006.03-2008.06		-	-	F	Convertible Engine K9K 732	899213	Outer Joint	25	33	53	88	61.5	I
	2006.03-2008.06		-	L	F	Convertible Engine K9K 732	250402	Drive Shaft	25	26	53	88	660	
	2006.03-2008.06		-	R	F	Convertible Engine K9K 732	250348	Drive Shaft	25	26	53	88	905	
	2006.03-2008.06		MT	L	F	Convertible Engine K9K 732	250350	Drive Shaft	25	26	52.6	88	668.5	
1.5 dCi (76 kW)	2007.01-2009.06		-	L	F	Convertible Engine K9K 734	250402	Drive Shaft	25	26	53	88	660	
	2007.01-2009.06		-	R	F	Convertible Engine K9K 734	250348	Drive Shaft	25	26	53	88	905	
1.6 (83 kW)	2003.09-2009.03		AT	L	F	Convertible Engine K4M 760/K4M 761	250255	Drive Shaft	23	26	49	86	673	
	2003.09-2009.03		-	R	F	Convertible Engine K4M 760/K4M 761	699169	Inner Joint	26	30	33	326	95	
	2003.09-2009.03		AT	R	F	Convertible Engine K4M 760/K4M 761	250351	Drive Shaft	23	23	49	86	802	
	2003.09-2009.03		-	R	F	Convertible Engine K4M 760/K4M 761	250440	Drive Shaft	23	23	49	86	804	
	2003.09-2009.03		-	L	F	Convertible Engine K4M 760/K4M 761	250346	Drive Shaft	23	26	49	86	669	
	2003.09-2009.03		AT	-	F	Convertible Engine K4M 760/K4M 761	899085	Outer Joint	23	30	49	86	59	I
1.6 16V (82 kW)	2006.01-2008.06		AT	L	F	Convertible Engine K4M 760/K4M 761/K4M 812/K4M 813	250255	Drive Shaft	23	26	49	86	673	
	2006.01-2008.06		-	R	F	Convertible Engine K4M 760/K4M 761/K4M 812/K4M 813	699169	Inner Joint	26	30	33	326	95	
	2006.01-2008.06		AT	R	F	Convertible Engine K4M 760/K4M 761/K4M 812/K4M 813	250351	Drive Shaft	23	23	49	86	802	
	2006.01-2008.06		-	R	F	Convertible Engine K4M 760/K4M 761/K4M 812/K4M 813	250440	Drive Shaft	23	23	49	86	804	
	2006.01-2008.06		AT	-	F	Convertible Engine K4M 760/K4M 761/K4M 812/K4M 813	899085	Outer Joint	23	30	49	86	59	I
	2006.01-2008.06		-	L	F	Convertible Engine K4M 760/K4M 761/K4M 812/K4M 813	250346	Drive Shaft	23	26	49	86	669	
1.9 dCi (81 kW)	2005.05-2009.03		MT	R	F	Convertible Engine F9Q 804/F9Q 816/F9Q 818	250400	Drive Shaft	25	39	53	88	932	
	2005.05-2009.03		MT	L	F	Convertible Engine F9Q 804/F9Q 816/F9Q 818	699150	Inner Joint	39	32	39	66	104.5	
	2005.05-2009.03		MT	L	F	Convertible Engine F9Q 804/F9Q 816/F9Q 818	299201	Drive Shaft	25	39	53	88	638	
	2005.05-2009.03		MT	-	F	Convertible Engine F9Q 804/F9Q 816/F9Q 818	899213	Outer Joint	25	33	53	88	61.5	I
	2005.05-2009.03		MT	R	F	Convertible Engine F9Q 804/F9Q 816/F9Q 818	699160	Inner Joint	39	32	33	352	90	
1.9 dCi (85 kW)	2003.09-2009.03		MT	R	F	Convertible Engine F9Q 804/F9Q 816/F9Q 818	250400	Drive Shaft	25	39	53	88	932	
	2003.09-2009.03		MT	L	F	Convertible Engine F9Q 804/F9Q 816/F9Q 818	699150	Inner Joint	39	32	39	66	104.5	
	2003.09-2009.03		AT	L	F	Convertible Engine F9Q 804/F9Q 816/F9Q 818	299186	Drive Shaft	25	26	52.6	88	669	
	2003.09-2009.03		MT	L	F	Convertible Engine F9Q 804/F9Q 816/F9Q 818	299201	Drive Shaft	25	39	53	88	638	
	2003.09-2009.03		MT	R	F	Convertible Engine F9Q 804/F9Q 816/F9Q 818	699160	Inner Joint	39	32	33	352	90	
1.9 dCi (88 kW)	2003.09-2009.03		MT	R	F	Convertible Engine F9Q 800	250400	Drive Shaft	25	39	53	88	932	
	2003.09-2009.03		MT	L	F	Convertible Engine F9Q 800	699150	Inner Joint	39	32	39	66	104.5	
	2003.09-2009.03		MT	-	F	Convertible Engine F9Q 800	899213	Outer Joint	25	33	53	88	61.5	I
	2003.09-2009.03		MT	L	F	Convertible Engine F9Q 800	299201	Drive Shaft	25	39	53	88	638	
	2003.09-2009.03		MT	R	F	Convertible Engine F9Q 800	699160	Inner Joint	39	32	33	352	90	
1.9 dCi (96 kW)	2005.05-2007.02		AT	-	F	Convertible Engine F9Q 803/F9Q 804	850137	Outer Joint	25	32	52.6	88	58	I
	2005.05-2007.02		MT	R	F	Convertible Engine F9Q 803/F9Q 804	250400	Drive Shaft	25	39	53	88	932	
	2005.05-2007.02		MT	L	F	Convertible Engine F9Q 803/F9Q 804	699150	Inner Joint	39	32	39	66	104.5	
	2005.05-2007.02		MT	L	F	Convertible Engine F9Q 803/F9Q 804	299201	Drive Shaft	25	39	53	88	638	

REMARKS	YEAR	TRANSM	L/R	F/R	GSP Ref.	PRODUCT	ABS	Technical Specifications						
								A	B	C	H	L	P	
RENAULT														
MEGANE II Coupé-Cabriolet (EM0/1_)														
1.9 dCi (96 kW)	2005.05-2007.02	MT	-	F	Convertible Engine F9Q 803/F9Q 804	899213	Outer Joint	25	33	53	88	61.5	I	
	2005.05-2007.02	MT	R	F	Convertible Engine F9Q 803/F9Q 804	699160	Inner Joint	39	32	33	352	90		
2.0 (102 kW)	2003.09-2007.02	MT	-	F	Convertible Engine F4R 770	850109	Outer Joint	23	33	49	86.5	61	I	
	2003.09-2007.02	-	R	F	Convertible Engine F4R 770	699160	Inner Joint	39	32	33	352	90		
	2003.09-2007.02	AT	L	F	Convertible Engine F4R 770	250255	Drive Shaft	23	26	49	86	673		
	2003.09-2007.02	AT	R	F	Convertible Engine F4R 770	250351	Drive Shaft	23	23	49	86	802		
	2003.09-2007.02	-	R	F	Convertible Engine F4R 770	250447	Drive Shaft	23	39	49	86.5	930		
	2003.09-2007.02	AT	-	F	Convertible Engine F4R 770	850117	Outer Joint	23	32	49	86	62	I	
	2003.09-2007.02	-	L	F	Convertible Engine F4R 770	699150	Inner Joint	39	32	39	66	104.5		
	2003.09-2007.02	-	L	F	Convertible Engine F4R 770	250441	Drive Shaft	23	39	49	86.5	636		
2.0 (99 kW)	2003.09-2009.12	AT	L	F	Convertible Engine F4R 770/F4R 771	250255	Drive Shaft	23	26	49	86	673		
	2003.09-2009.12	AT	R	F	Convertible Engine F4R 770/F4R 771	250351	Drive Shaft	23	23	49	86	802		
	2003.09-2009.12	MT	R	F	Convertible Engine F4R 770/F4R 771	250447	Drive Shaft	23	39	49	86.5	930		
	2003.09-2009.12	AT	-	F	Convertible Engine F4R 770/F4R 771	850117	Outer Joint	23	32	49	86	62	I	
	2003.09-2009.12	-	L	F	Convertible Engine F4R 770/F4R 771	699150	Inner Joint	39	32	39	66	104.5		
	2003.09-2009.12	-	L	F	Convertible Engine F4R 770/F4R 771	250346	Drive Shaft	23	26	49	86	669		
	2003.09-2009.12	AT	R	F	Convertible Engine F4R 770/F4R 771	250520	Drive Shaft	23	23	49	86	803		
	2003.09-2009.12	-	L	F	Convertible Engine F4R 770/F4R 771	250441	Drive Shaft	23	39	49	86.5	636		
	2003.09-2009.12	MT	-	F	Convertible Engine F4R 770/F4R 771	850109	Outer Joint	23	33	49	86.5	61	I	
	2003.09-2009.12	MT	R	F	Convertible Engine F4R 770/F4R 771	699160	Inner Joint	39	32	33	352	90		
2.0 16V Turbo (120 kW)	2004.05-2009.03	MT	R	F	Convertible Engine F4R 776	250400	Drive Shaft	25	39	53	88	932		
	2004.05-2009.03	MT	L	F	Convertible Engine F4R 776	699150	Inner Joint	39	32	39	66	104.5		
	2004.05-2009.03	MT	L	F	Convertible Engine F4R 776	299201	Drive Shaft	25	39	53	88	638		
	2004.05-2009.03	MT	-	F	Convertible Engine F4R 776	899213	Outer Joint	25	33	53	88	61.5	I	
	2004.05-2009.03	MT	R	F	Convertible Engine F4R 776	699160	Inner Joint	39	32	33	352	90		
2.0 dCi (110 kW)	2005.09-2009.03	-	R	F	Convertible Engine M9R 700/M9R 722	650087	Inner Joint	39	35	30	367	89.5		
	2005.09-2009.03	-	R	F	Convertible Engine M9R 700/M9R 722	250453	Drive Shaft	27	39	56.5	90.5	973.5		
	2005.09-2009.03	-	L	F	Convertible Engine M9R 700/M9R 722	650071	Inner Joint	39	35	39	74	102.5		
	2005.09-2009.03	-	L	F	Convertible Engine M9R 700/M9R 722	250444	Drive Shaft	27	39	56.5	90.5	626		
MEGANE III (BZ0/1_)														
1.4 TCe (96 kW)	2009.04-	-	-	R	Hatchback Engine H4J 700	250604	Drive Shaft	25	26	52.6	89	942		
1.5 dCi (66 kW)	2008.11-	-	-	L	Hatchback Engine K9K 834	250383	Drive Shaft	25	26	52.7	88.5	688		
	2008.11-	-	-	L	Hatchback Engine K9K 834	650096	Inner Joint	26	30	40	64	96		
	2008.11-	-	5MT/6MT	-	F	Hatchback Engine K9K 834	899213	Outer Joint	25	33	53	88	61.5	I
1.5 dCi (81 kW)	2009.02-	-	MT	R	Hatchback Engine K9K 636/K9K 836/K9K 837/K9K 846	250425	Drive Shaft	25	26	52.7	88.5	931		
	2009.02-	-	-	R	Hatchback Engine K9K 636/K9K 836/K9K 837/K9K 846	850148	Outer Joint	25	35	52.6	89	60	I	
	2009.02-	-	MT	L	Hatchback Engine K9K 636/K9K 836/K9K 837/K9K 846	250426	Drive Shaft	25	26	52.7	88.5	680		
	2009.02-	-	-	-	F	Hatchback Engine K9K 636/K9K 836/K9K 837/K9K 846	850145	Outer Joint	25	33	52.7	88.5	59.5	I
	2009.02-	-	-	R	Hatchback Engine K9K 636/K9K 836/K9K 837/K9K 846	250536	Drive Shaft	25	34	52.6	89	984		
	2009.02-	-	-	-	F	Hatchback Engine K9K 636/K9K 836/K9K 837/K9K 846	850163	Outer Joint	25	23	52.4	88.5	61	M
	2009.02-	-	-	L	Hatchback Engine K9K 636/K9K 836/K9K 837/K9K 846	250535	Drive Shaft	25	34	52.7	88.5	632		
	2009.02-	-	-	-	Hatchback Engine K9K 636/K9K 836/K9K 837/K9K 846	250610	Drive Shaft	25	34	52.7	88.5	1000		
	2009.02-	-	5MT/6MT	-	F	Hatchback Engine K9K 636/K9K 836/K9K 837/K9K 846	899213	Outer Joint	25	33	53	88	61.5	I
1.5 dCi (63 kW)	2009.12-	-	-	L	Hatchback Engine K9K 830	250383	Drive Shaft	25	26	52.7	88.5	688		
	2009.12-	-	-	L	Hatchback Engine K9K 830	650096	Inner Joint	26	30	40	64	96		
	2009.12-	-	5MT/6MT	-	F	Hatchback Engine K9K 830	899213	Outer Joint	25	33	53	88	61.5	I
1.5 dCi (70 kW)	2013.11-	-	MT	R	Hatchback Engine K9K 846	250425	Drive Shaft	25	26	52.7	88.5	931		
	2013.11-	-	MT	L	Hatchback Engine K9K 846	250426	Drive Shaft	25	26	52.7	88.5	680		
	2013.11-	-	-	-	F	Hatchback Engine K9K 846	850145	Outer Joint	25	33	52.7	88.5	59.5	I
1.5 dCi (78 kW)	2009.02-	-	-	R	Hatchback Engine K9K 832	250425	Drive Shaft	25	26	52.7	88.5	931		
	2009.02-	-	-	L	Hatchback Engine K9K 832	250426	Drive Shaft	25	26	52.7	88.5	680		
	2009.02-	-	-	-	F	Hatchback Engine K9K 832	850145	Outer Joint	25	33	52.7	88.5	59.5	I
	2009.02-	-	-	-	F	Hatchback Engine K9K 832	850163	Outer Joint	25	23	52.4	88.5	61	M
1.6 16V (74 kW)	2008.11-	-	-	L	Hatchback Engine K4M 848	250383	Drive Shaft	25	26	52.7	88.5	688		
	2008.11-	-	MT	L/R	F	Hatchback Engine K4M 848	850162	Outer Joint	25	23	52.5	88.5	60.5	M
	2008.11-	-	-	-	F	Hatchback Engine K4M 848	850163	Outer Joint	25	23	52.4	88.5	61	M
	2008.11-	-	-	L	F	Hatchback Engine K4M 848	650096	Inner Joint	26	30	40	64	96	
	2008.11-	-	5MT/6MT	-	F	Hatchback Engine K4M 848	899213	Outer Joint	25	33	53	88	61.5	I
1.6 16V (81 kW)	2008.11-	-	MT	R	F	Hatchback Engine K4M 858	250510	Drive Shaft	25	26	52.4	88.5	929	
	2008.11-	-	MT	L/R	F	Hatchback Engine K4M 858	850162	Outer Joint	25	23	52.5	88.5	60.5	M
	2008.11-	-	-	-	F	Hatchback Engine K4M 858	850163	Outer Joint	25	23	52.4	88.5	61	M
	2008.11-	-	5MT/6MT	-	F	Hatchback Engine K4M 858	899213	Outer Joint	25	33	53	88	61.5	I
1.6 16V (82 kW)	2008.11-	-	MT	R	F	Hatchback Engine K4M 858/K4M 866	250510	Drive Shaft	25	26	52.4	88.5	929	
	2008.11-	-	-	-	F	Hatchback Engine K4M 858/K4M 866	850163	Outer Joint	25	23	52.4	88.5	61	M
	2008.11-	-	5MT/6MT	-	F	Hatchback Engine K4M 858/K4M 866	899213	Outer Joint	25	33	53	88	61.5	I
1.6 16V Bifuel (81 kW)	2008.11-	-	MT	R	F	Hatchback Engine K4M 866	250510	Drive Shaft	25	26	52.4	88.5	929	

REMARKS	YEAR	TRANSM	L/R	F/R	GSP Ref.	PRODUCT	ABS	Technical Specifications						
								A	B	C	H	L	P	
RENAULT														
MEGANE III (BZ0/1_)														
1.6 16V Bifuel (81 kW)	2008.11-	-	MT	L/R	F	Hatchback Engine K4M 866	850162	Outer Joint	25	23	52.5	88.5	60.5	M
	2008.11-	-	-	-	F	Hatchback Engine K4M 866	850163	Outer Joint	25	23	52.4	88.5	61	M
	2008.11-	-	5MT	-	F	Hatchback Engine K4M 866	899213	Outer Joint	25	33	53	88	61.5	I
1.6 dCi (96 kW)	2011.04-	-	MT	L	F	Hatchback Engine R9M 402/R9M 404	250428	Drive Shaft	25	39	52.6	89	656	
	2011.04-	-	MT	R	F	Hatchback Engine R9M 402/R9M 404	250427	Drive Shaft	25	39	52.6	89	953	
1.9 dCi (96 kW)	2008.11-	-	-	L	F	Hatchback Engine F9Q 870/F9Q 872	250428	Drive Shaft	25	39	52.6	89	656	
	2008.11-	-	-	R	F	Hatchback Engine F9Q 870/F9Q 872	250427	Drive Shaft	25	39	52.6	89	953	
2.0 dCi (110 kW)	2010.10-	-	AT	L	F	Hatchback Engine M9R 615	218274	Drive Shaft	27	30	56.5	90	624	
2.0 dCi (118 kW)	2009.04-	-	AT	L	F	Hatchback Engine M9R 610	218274	Drive Shaft	27	30	56.5	90	624	
2.0 dCi (120 kW)	2012.07-	-	AT	L	F	Hatchback Engine M9R 610	218274	Drive Shaft	27	30	56.5	90	624	
MEGANE III (DZ0/1_)														
1.4 TCe (96 kW)	2009.04-	-	-	R	F	Coupe Engine H4J 700	250604	Drive Shaft	25	26	52.6	89	942	
1.5 dCi (63 kW)	2008.11-	-	-	L	F	Coupe Engine K9K 830	250383	Drive Shaft	25	26	52.7	88.5	688	
	2008.11-	-	-	L	F	Coupe Engine K9K 830	650096	Inner Joint	26	30	40	64	96	
	2008.11-	-	5MT/6MT	-	F	Coupe Engine K9K 830	899213	Outer Joint	25	33	53	88	61.5	I
1.5 dCi (66 kW)	2008.11-	-	-	L	F	Coupe Engine K9K 834	250383	Drive Shaft	25	26	52.7	88.5	688	
	2008.11-	-	-	L	F	Coupe Engine K9K 834	650096	Inner Joint	26	30	40	64	96	
	2008.11-	-	5MT/6MT	-	F	Coupe Engine K9K 834	899213	Outer Joint	25	33	53	88	61.5	I
1.5 dCi (81 kW)	2009.02-	-	-	R	F	Coupe Engine K9K 636/K9K 836/K9K 837/K9K 846	250425	Drive Shaft	25	26	52.7	88.5	931	
	2009.02-	-	-	R	F	Coupe Engine K9K 636/K9K 836/K9K 837/K9K 846	850148	Outer Joint	25	35	52.6	89	60	I
	2009.02-	-	-	L	F	Coupe Engine K9K 636/K9K 836/K9K 837/K9K 846	250426	Drive Shaft	25	26	52.7	88.5	680	
	2009.02-	-	-	-	F	Coupe Engine K9K 636/K9K 836/K9K 837/K9K 846	850145	Outer Joint	25	33	52.7	88.5	59.5	I
	2009.02-	-	-	R	F	Coupe Engine K9K 636/K9K 836/K9K 837/K9K 846	250536	Drive Shaft	25	34	52.6	89	984	
	2009.02-	-	-	-	F	Coupe Engine K9K 636/K9K 836/K9K 837/K9K 846	850163	Outer Joint	25	23	52.4	88.5	61	M
	2009.02-	-	-	L	F	Coupe Engine K9K 636/K9K 836/K9K 837/K9K 846	250535	Drive Shaft	25	34	52.7	88.5	632	
	2009.02-	-	-	-	-	Coupe Engine K9K 636/K9K 836/K9K 837/K9K 846	250610	Drive Shaft	25	34	52.7	88.5	1000	
	2009.02-	-	5MT/6MT	-	F	Coupe Engine K9K 636/K9K 836/K9K 837/K9K 846	899213	Outer Joint	25	33	53	88	61.5	I
1.5 dCi (70 kW)	2014.07-	-	MT	R	F	Coupe Engine K9K 846	250425	Drive Shaft	25	26	52.7	88.5	931	
	2014.07-	-	MT	L	F	Coupe Engine K9K 846	250426	Drive Shaft	25	26	52.7	88.5	680	
1.5 dCi (78 kW)	2009.02-	-	-	R	F	Coupe Engine K9K 832	250425	Drive Shaft	25	26	52.7	88.5	931	
	2009.02-	-	-	L	F	Coupe Engine K9K 832	250426	Drive Shaft	25	26	52.7	88.5	680	
	2009.02-	-	-	-	F	Coupe Engine K9K 832	850145	Outer Joint	25	33	52.7	88.5	59.5	I
	2009.02-	-	-	-	F	Coupe Engine K9K 832	850163	Outer Joint	25	23	52.4	88.5	61	M
	2009.02-	-	5MT/6MT	-	F	Coupe Engine K9K 832	899213	Outer Joint	25	33	53	88	61.5	I
1.6 16V (74 kW)	2008.11-	-	-	L	F	Coupe Engine K4M 848	250383	Drive Shaft	25	26	52.7	88.5	688	
	2008.11-	-	MT	L/R	F	Coupe Engine K4M 848	850162	Outer Joint	25	23	52.5	88.5	60.5	M
	2008.11-	-	-	-	F	Coupe Engine K4M 848	850163	Outer Joint	25	23	52.4	88.5	61	M
	2008.11-	-	-	L	F	Coupe Engine K4M 848	650096	Inner Joint	26	30	40	64	96	
	2008.11-	-	5MT/6MT	-	F	Coupe Engine K4M 848	899213	Outer Joint	25	33	53	88	61.5	I
1.6 16V (81 kW)	2008.11-	-	6MT	R	F	Coupe Engine K4M 858	250510	Drive Shaft	25	26	52.4	88.5	929	
	2008.11-	-	-	-	F	Coupe Engine K4M 858	850163	Outer Joint	25	23	52.4	88.5	61	M
	2008.11-	-	5MT/6MT	-	F	Coupe Engine K4M 858	899213	Outer Joint	25	33	53	88	61.5	I
1.6 16V Bifuel (81 kW)	2008.11-	-	6MT	R	F	Coupe Engine K4M 866	250510	Drive Shaft	25	26	52.4	88.5	929	
	2008.11-	-	-	-	F	Coupe Engine K4M 866	850163	Outer Joint	25	23	52.4	88.5	61	M
	2008.11-	-	5MT	-	F	Coupe Engine K4M 866	899213	Outer Joint	25	33	53	88	61.5	I
1.6 dCi (96 kW)	2011.04-	-	MT	L	F	Coupe Engine R9M 402	250428	Drive Shaft	25	39	52.6	89	656	
	2011.04-	-	-	R	F	Coupe Engine R9M 402	250427	Drive Shaft	25	39	52.6	89	953	
1.9 dCi (96 kW)	2008.11-	-	-	L	F	Coupe Engine F9Q 870/F9Q 872	250428	Drive Shaft	25	39	52.6	89	656	
	2008.11-	-	-	R	F	Coupe Engine F9Q 870/F9Q 872	250427	Drive Shaft	25	39	52.6	89	953	
2.0 CVT (103 kW)	2009.05-	-	-	-	F	Coupe Engine M4R 711	899213	Outer Joint	25	33	53	88	61.5	I
2.0 dCi (110 kW)	2009.04-	-	AT	L	F	Coupe Engine M9R 615	218274	Drive Shaft	27	30	56.5	90	624	
2.0 dCi (118 kW)	2009.04-	-	AT	L	F	Coupe Engine M9R 610	218274	Drive Shaft	27	30	56.5	90	624	
2.0 dCi (120 kW)	2012.07-	-	AT	L	F	Coupe Engine M9R 610	218274	Drive Shaft	27	30	56.5	90	624	
2.0 R.S. (195 kW)	2008.11-	-	-	L	F	Coupe Engine F4R 874	250606	Drive Shaft	27	39	56.5	91.5	686	
2.0 R.S. (201 kW)	2014.07-	-	-	L	F	Coupe Engine F4R 874	250606	Drive Shaft	27	39	56.5	91.5	686	
MEGANE III Grandtour (KZ0/1)														
1.4 Tce (96 kW)	2009.05-	-	-	R	F	Estate Engine H4J 700	250604	Drive Shaft	25	26	52.6	89	942	
1.5 dCi (66 kW)	2009.05-	-	-	L	F	Estate Engine K9K 834	250383	Drive Shaft	25	26	52.7	88.5	688	
	2009.05-	-	-	L	F	Estate Engine K9K 834	650096	Inner Joint	26	30	40	64	96	
	2009.05-	-	5MT/6MT	-	F	Estate Engine K9K 834	899213	Outer Joint	25	33	53	88	61.5	I
1.5 dCi (81 kW)	2009.02-	-	MT	R	F	Estate Engine K9K 636/K9K 836/K9K 837/K9K 846	250425	Drive Shaft	25	26	52.7	88.5	931	
	2009.02-	-	-	R	F	Estate Engine K9K 636/K9K 836/K9K 837/K9K 846	850148	Outer Joint	25	35	52.6	89	60	I
	2009.02-	-	MT	L	F	Estate Engine K9K 636/K9K 836/K9K 837/K9K 846	250426	Drive Shaft	25	26	52.7	88.5	680	
	2009.02-	-	-	-	F	Estate Engine K9K 636/K9K 836/K9K 837/K9K 846	850145	Outer Joint	25	33	52.7	88.5	59.5	I
	2009.02-	-	-	R	F	Estate Engine K9K 636/K9K 836/K9K 837/K9K 846	250536	Drive Shaft	25	34	52.6	89	984	
	2009.02-	-	-	-	F	Estate Engine K9K 636/K9K 836/K9K 837/K9K 846	850163	Outer Joint	25	23	52.4	88.5	61	M

REMARKS	YEAR	TRANSM	L/R	F/R	GSP Ref.	PRODUCT	ABS	Technical Specifications							
								A	B	C	H	L	P		
RENAULT															
MEGANE III Grandtour (KZ0/1)															
1.5 dCi (81 kW)	2009.02-	-	-	L	F	Estate Engine K9K 636/K9K 836/K9K 837/K9K 846	250535	Drive Shaft		25	34	52.7	88.5	632	
	2009.02-	-	-	-	-	Estate Engine K9K 636/K9K 836/K9K 837/K9K 846	250610	Drive Shaft		25	34	52.7	88.5	1000	
	2009.02-	-	5MT/6MT	-	F	Estate Engine K9K 636/K9K 836/K9K 837/K9K 846	899213	Outer Joint		25	33	53	88	61.5	I
1.5 dCi (63 kW)	2009.03-	-	-	L	F	Estate Engine K9K 830	250383	Drive Shaft		25	26	52.7	88.5	688	
	2009.03-	-	-	L	F	Estate Engine K9K 830	650096	Inner Joint		26	30	40	64	96	
	2009.03-	-	5MT/6MT	-	F	Estate Engine K9K 830	899213	Outer Joint		25	33	53	88	61.5	I
1.5 dCi (70 kW)	2013.11-	-	MT	R	F	Estate Engine K9K 846	250425	Drive Shaft		25	26	52.7	88.5	931	
	2013.11-	-	MT	L	F	Estate Engine K9K 846	250426	Drive Shaft		25	26	52.7	88.5	680	
	2013.11-	-	-	-	F	Estate Engine K9K 846	850145	Outer Joint		25	33	52.7	88.5	59.5	I
1.5 dCi (78 kW)	2009.02-	-	-	R	F	Estate Engine K9K 832/K9K 836/K9K 846	250425	Drive Shaft		25	26	52.7	88.5	931	
	2009.02-	-	-	L	F	Estate Engine K9K 832/K9K 836/K9K 846	250426	Drive Shaft		25	26	52.7	88.5	680	
	2009.02-	-	-	-	F	Estate Engine K9K 832/K9K 836/K9K 846	850145	Outer Joint		25	33	52.7	88.5	59.5	I
	2009.02-	-	-	-	F	Estate Engine K9K 832/K9K 836/K9K 846	850163	Outer Joint		25	23	52.4	88.5	61	M
	2009.02-	-	5MT/6MT	-	F	Estate Engine K9K 832/K9K 836/K9K 846	899213	Outer Joint		25	33	53	88	61.5	I
1.6 16V (74 kW)	2009.05-	-	-	L	F	Estate Engine K4M 848	250383	Drive Shaft		25	26	52.7	88.5	688	
	2009.05-	-	MT	L/R	F	Estate Engine K4M 848	850162	Outer Joint		25	23	52.5	88.5	60.5	M
	2009.05-	-	-	-	F	Estate Engine K4M 848	850163	Outer Joint		25	23	52.4	88.5	61	M
	2009.05-	-	-	L	F	Estate Engine K4M 848	650096	Inner Joint		26	30	40	64	96	
	2009.05-	-	5MT/6MT	-	F	Estate Engine K4M 848	899213	Outer Joint		25	33	53	88	61.5	I
1.6 16V (81 kW)	2009.05-	-	MT	R	F	Estate Engine K4M 858	250510	Drive Shaft		25	26	52.4	88.5	929	
	2009.05-	-	MT	L/R	F	Estate Engine K4M 858	850162	Outer Joint		25	23	52.5	88.5	60.5	M
	2009.05-	-	-	-	F	Estate Engine K4M 858	850163	Outer Joint		25	23	52.4	88.5	61	M
	2009.05-	-	5MT/6MT	-	F	Estate Engine K4M 858	899213	Outer Joint		25	33	53	88	61.5	I
1.6 16V Bifuel (81 kW)	2008.11-	-	MT	R	F	Estate Engine K4M 866	250510	Drive Shaft		25	26	52.4	88.5	929	
	2008.11-	-	-	-	F	Estate Engine K4M 866	850163	Outer Joint		25	23	52.4	88.5	61	M
	2008.11-	-	5MT/6MT	-	F	Estate Engine K4M 866	899213	Outer Joint		25	33	53	88	61.5	I
1.6 dCi (96 kW)	2011.04-	-	MT	L	F	Estate Engine R9M 402	250428	Drive Shaft		25	39	52.6	89	656	
	2011.04-	-	-	R	F	Estate Engine R9M 402	250427	Drive Shaft		25	39	52.6	89	953	
1.9 dCi (96 kW)	2009.05-	-	-	R	F	Estate Engine F9Q 870/F9Q 872	250427	Drive Shaft		25	39	52.6	89	953	
2.0 dCi (110 kW)	2010.10-	-	AT	L	F	Estate Engine M9R 615	218274	Drive Shaft		27	30	56.5	90	624	
2.0 dCi (118 kW)	2009.04-	-	AT	L	F	Estate Engine M9R 610	218274	Drive Shaft		27	30	56.5	90	624	
2.0 dCi (120 kW)	2012.07-	-	AT	L	F	Estate Engine M9R 610	218274	Drive Shaft		27	30	56.5	90	624	
MEGANE SCENIC (JA0/1_)															
1.4 i (55 kW)	1997.01-	1999.09	MT	R	F	MPV Engine E7J 764	250107	Drive Shaft	44T	21	23	57	84.5	735.9	
	1997.01-	1999.09	-	R	F	MPV Engine E7J 764	650008	Inner Joint		23	30	36.3	52.2	68.5	
	1997.01-	1999.09	MT	L	F	MPV Engine E7J 764	250048	Drive Shaft		21	29.95	46.4	81.5	650	
	1997.01-	1999.09	MT	R	F	MPV Engine E7J 764	250140	Drive Shaft		21	23	49.8	83.5	718	
	1997.01-	1999.09	MT	R	F	MPV Engine E7J 764	250173	Drive Shaft		21	23	57	84.5	742.9	
	1997.01-	1999.09	-	L	F	MPV Engine E7J 764	250358	Drive Shaft	44T	21	29.95	57	84	646	
	1997.01-	1999.09	-	R	F	MPV Engine E7J 764	250284	Drive Shaft	44T	21	23	56.2	83.5	740.5	
	1997.01-	1999.09	-	L	F	MPV Engine E7J 764	250326	Drive Shaft	44T	21	29.95	57	84.5	648	
	1997.01-	1999.09	-	R	F	MPV Engine E7J 764	250327	Drive Shaft	44T	21	23	57	84.5	740	
1.6 16V (79 kW)	1998.04-	1999.10	MT	L	F	MPV Engine K4M 700/K4M 701/K4M 704/K4M 708	250311	Drive Shaft	44T	23	29.95	56	82	650	
	1998.04-	1999.10	MT	R	F	MPV Engine K4M 700/K4M 701/K4M 704/K4M 708	250199	Drive Shaft	44T	23	23	57.5	83.5	748	
	1998.04-	1999.10	MT	L	F	MPV Engine K4M 700/K4M 701/K4M 704/K4M 708	250048	Drive Shaft		21	29.95	46.4	81.5	650	
	1998.04-	1999.10	-	R	F	MPV Engine K4M 700/K4M 701/K4M 704/K4M 708	250252	Drive Shaft		23	23	57.5	83.5	748	
	1998.04-	1999.10	AT	L	F	MPV Engine K4M 700/K4M 701/K4M 704/K4M 708	250253	Drive Shaft	44T	23	26	57.5	86.5	634	
	1998.04-	1999.10	MT	R	F	MPV Engine K4M 700/K4M 701/K4M 704/K4M 708	250140	Drive Shaft		21	23	49.8	83.5	718	
	1998.04-	1999.10	MT	R	F	MPV Engine K4M 700/K4M 701/K4M 704/K4M 708	250173	Drive Shaft		21	23	57	84.5	742.9	
	1998.04-	1999.10	MT	L	F	MPV Engine K4M 700/K4M 701/K4M 704/K4M 708	250160	Drive Shaft	44T	23	29.95	57	87	656.5	
	1998.04-	1999.10	AT	R	F	MPV Engine K4M 700/K4M 701/K4M 704/K4M 708	250323	Drive Shaft	44T	23	23	57.5	86.5	778	
	1998.04-	1999.10	MT	R	F	MPV Engine K4M 700/K4M 701/K4M 704/K4M 708	250325	Drive Shaft	44T	23	23	56.3	85	744	
	1998.04-	1999.10	-	R	F	MPV Engine K4M 700/K4M 701/K4M 704/K4M 708	250313	Drive Shaft	44T	23	23	57.5	86.5	750	
1.6 e (66 kW)	1996.10-	1999.10	-	-	-	MPV Engine K7M 702/K7M 703	850043	Outer Joint	44T	21	22	51.5	83	56.5	I
	1996.10-	1999.10	MT	R	F	MPV Engine K7M 702/K7M 703	250107	Drive Shaft	44T	21	23	57	84.5	735.9	
	1996.10-	1999.10	MT	R	F	MPV Engine K7M 702/K7M 703	650008	Inner Joint		23	30	36.3	52.2	68.5	
	1996.10-	1999.10	MT	L	F	MPV Engine K7M 702/K7M 703	250048	Drive Shaft		21	29.95	46.4	81.5	650	
	1996.10-	1999.10	MT	R	F	MPV Engine K7M 702/K7M 703	250140	Drive Shaft		21	23	49.8	83.5	718	
	1996.10-	1999.10	MT	R	F	MPV Engine K7M 702/K7M 703	250173	Drive Shaft		21	23	57	84.5	742.9	
	1996.10-	1999.10	MT	L	F	MPV Engine K7M 702/K7M 703	250358	Drive Shaft	44T	21	29.95	57	84	646	
	1996.10-	1999.10	MT	R	F	MPV Engine K7M 702/K7M 703	250284	Drive Shaft	44T	21	23	56.2	83.5	740.5	
	1996.10-	1999.10	-	R	F	MPV Engine K7M 702/K7M 703	250021	Drive Shaft	44T	21	23	57	84.5	750	
	1996.10-	1999.10	-	R	F	MPV Engine K7M 702/K7M 703	250054	Drive Shaft		21	23	49.8	83.5	741.5	
	1996.10-	1999.10	MT	L	F	MPV Engine K7M 702/K7M 703	250326	Drive Shaft	44T	21	29.95	57	84.5	648	
	1996.10-	1999.10	MT	R	F	MPV Engine K7M 702/K7M 703	250327	Drive Shaft	44T	21	23	57	84.5	740	
1.6 i (55 kW)	1997.01-	1999.09	-	-	-	MPV Engine K7M 720	850043	Outer Joint	44T	21	22	51.5	83	56.5	I

REMARKS	YEAR	TRANSM	L/R	F/R	GSP Ref.	PRODUCT	ABS	Technical Specifications									
								A	B	C	H	L	P				
RENAULT MEGANE SCENIC (JA0/1_)																	
1.6 i (55 kW)	1997.01-1999.09	-	R	F	MPV Engine K7M 720	650008	Inner Joint		23	30	36.3	52.2	68.5				
	1997.01-1999.09	MT	L	F	MPV Engine K7M 720	250048	Drive Shaft		21	29.95	46.4	81.5	650				
	1997.01-1999.09	MT	R	F	MPV Engine K7M 720	250140	Drive Shaft		21	23	49.8	83.5	718				
	1997.01-1999.09	MT	R	F	MPV Engine K7M 720	250173	Drive Shaft		21	23	57	84.5	742.9				
	1997.01-1999.09	MT	R	F	MPV Engine K7M 720	250027	Drive Shaft	44T	23	23	56.8	84	750.5				
	1997.01-1999.09	-	L	F	MPV Engine K7M 720	250358	Drive Shaft	44T	21	29.95	57	84	646				
	1997.01-1999.09	-	R	F	MPV Engine K7M 720	250284	Drive Shaft	44T	21	23	56.2	83.5	740.5				
	1997.01-1999.09	-	L	F	MPV Engine K7M 720	250326	Drive Shaft	44T	21	29.95	57	84.5	648				
	1997.01-1999.09	-	R	F	MPV Engine K7M 720	250021	Drive Shaft	44T	21	23	57	84.5	750				
	1997.01-1999.09	-	R	F	MPV Engine K7M 720	250054	Drive Shaft		21	23	49.8	83.5	741.5				
1997.01-1999.09	-	R	F	MPV Engine K7M 720	250327	Drive Shaft	44T	21	23	57	84.5	740					
1.9 D (47 kW)	1997.03-1999.09	-	-	-	MPV Engine F8Q 790	850051	Outer Joint	48T	23	25	56.3	80	58	O			
	1997.03-1999.09	MT	R	F	MPV Engine F8Q 790	250199	Drive Shaft	44T	23	23	57.5	83.5	748				
	1997.03-1999.09	MT	L	F	MPV Engine F8Q 790	250048	Drive Shaft		21	29.95	46.4	81.5	650				
	1997.03-1999.09	MT	R	F	MPV Engine F8Q 790	250252	Drive Shaft		23	23	57.5	83.5	748				
	1997.03-1999.09	MT	R	F	MPV Engine F8Q 790	250140	Drive Shaft		21	23	49.8	83.5	718				
	1997.03-1999.09	-	R	F	MPV Engine F8Q 790	250320	Drive Shaft	44T	23	23	56.8	84	755				
	1997.03-1999.09	MT	R	F	MPV Engine F8Q 790	250173	Drive Shaft		21	23	57	84.5	742.9				
	1997.03-1999.09	MT	L/R	F	MPV Engine F8Q 790	850026	Outer Joint		23	25	56.2	83.5	58	O			
	1997.03-1999.09	-	R	F	MPV Engine F8Q 790	650079	Inner Joint		23	22	36.3	50	55.5				
	1997.03-1999.09	MT	L	F	MPV Engine F8Q 790	250220	Drive Shaft	44T	23	29.95	57.5	86.5	655				
	1997.03-1999.09	MT	L	F	MPV Engine F8Q 790	250203	Drive Shaft	44T	23	29.95	56.2	83.5	665				
	1997.03-1999.09	-	L	F	MPV Engine F8Q 790	250311	Drive Shaft	44T	23	29.95	56	82	650				
1.9 dT (66 kW)	1997.01-1999.09	MT	L	F	MPV Engine F8Q 784/F8Q 786	250029	Drive Shaft	44T	23	29.95	56.8	84	654				
	1997.01-1999.09	-	-	-	MPV Engine F8Q 784/F8Q 786	850051	Outer Joint	48T	23	25	56.3	80	58	O			
	1997.01-1999.09	-	-	F	MPV Engine F8Q 784/F8Q 786	850058	Outer Joint	44T	23	35	57	87	71	I			
	1997.01-1999.09	MT	R	F	MPV Engine F8Q 784/F8Q 786	250107	Drive Shaft	44T	21	23	57	84.5	735.9				
	1997.01-1999.09	-	-	F	MPV Engine F8Q 784/F8Q 786	850052	Outer Joint	44T	23	30	57.5	86.5	58.5	I			
	1997.01-1999.09	-	R	F	MPV Engine F8Q 784/F8Q 786	650008	Inner Joint		23	30	36.3	52.2	68.5				
	1997.01-1999.09	MT	L/R	F	MPV Engine F8Q 784/F8Q 786	850026	Outer Joint		23	25	56.2	83.5	58	O			
	1997.01-1999.09	MT	R	F	MPV Engine F8Q 784/F8Q 786	250320	Drive Shaft	44T	23	23	56.8	84	755				
	1997.01-1999.09	MT	R	F	MPV Engine F8Q 784/F8Q 786	650079	Inner Joint		23	22	36.3	50	55.5				
	1997.01-1999.09	-	R	F	MPV Engine F8Q 784/F8Q 786	250159	Drive Shaft	44T	23	23	57	87	748				
	1997.01-1999.09	-	R	F	MPV Engine F8Q 784/F8Q 786	250054	Drive Shaft		21	23	49.8	83.5	741.5				
	1997.01-1999.09	MT	L	F	MPV Engine F8Q 784/F8Q 786	250203	Drive Shaft	44T	23	29.95	56.2	83.5	665				
	1997.01-1999.09	-	L	F	MPV Engine F8Q 784/F8Q 786	250311	Drive Shaft	44T	23	29.95	56	82	650				
	1997.01-1999.09	MT	L	F	MPV Engine F8Q 784/F8Q 786	250029	Drive Shaft	44T	23	29.95	56.8	84	654				
	1.9 dTi (72 kW)	1997.04-1999.09	-	-	-	MPV Engine F9Q 730/F9Q 734	850051	Outer Joint	48T	23	25	56.3	80	58	O		
1997.04-1999.09		-	-	F	MPV Engine F9Q 730/F9Q 734	850058	Outer Joint	44T	23	35	57	87	71	I			
1997.04-1999.09		-	-	F	MPV Engine F9Q 730/F9Q 734	850052	Outer Joint	44T	23	30	57.5	86.5	58.5	I			
1997.04-1999.09		MT	R	F	MPV Engine F9Q 730/F9Q 734	250320	Drive Shaft	44T	23	23	56.8	84	755				
1997.04-1999.09		MT	L/R	F	MPV Engine F9Q 730/F9Q 734	850026	Outer Joint		23	25	56.2	83.5	58	O			
1997.04-1999.09		MT	R	F	MPV Engine F9Q 730/F9Q 734	299076	Drive Shaft	44T	23	23	56.2	83.5	742.5				
1997.04-1999.09		MT	R	F	MPV Engine F9Q 730/F9Q 734	650079	Inner Joint		23	22	36.3	50	55.5				
1997.04-1999.09		-	R	F	MPV Engine F9Q 730/F9Q 734	250039	Drive Shaft	44T	23	23	57.5	86.5	748				
1997.04-1999.09		MT	R	F	MPV Engine F9Q 730/F9Q 734	250159	Drive Shaft	44T	23	23	57	87	748				
1997.04-1999.09		-	L	F	MPV Engine F9Q 730/F9Q 734	250314	Drive Shaft	44T	23	29.95	57.5	86.5	654				
1997.04-1999.09		-	R	F	MPV Engine F9Q 730/F9Q 734	650008	Inner Joint		23	30	36.3	52.2	68.5				
1997.04-1999.09		MT	-	F	MPV Engine F9Q 730/F9Q 734	850005	Outer Joint	44T	23	25	56.3	84	61.5	O			
1997.04-1999.09		MT	L	F	MPV Engine F9Q 730/F9Q 734	250203	Drive Shaft	44T	23	29.95	56.2	83.5	665				
2.0 i (80 kW)		1999.01-1999.09	-	-	-	MPV Engine F3R 791/F3R 796	850051	Outer Joint	48T	23	25	56.3	80	58	O		
		1999.01-1999.09	MT	R	F	MPV Engine F3R 791/F3R 796	250199	Drive Shaft	44T	23	23	57.5	83.5	748			
	1999.01-1999.09	-	-	F	MPV Engine F3R 791/F3R 796	850058	Outer Joint	44T	23	35	57	87	71	I			
	1999.01-1999.09	MT	-	F	MPV Engine F3R 791/F3R 796	850052	Outer Joint	44T	23	30	57.5	86.5	58.5	I			
	1999.01-1999.09	MT	R	F	MPV Engine F3R 791/F3R 796	250252	Drive Shaft		23	23	57.5	83.5	748				
	1999.01-1999.09	MT	R	F	MPV Engine F3R 791/F3R 796	650008	Inner Joint		23	30	36.3	52.2	68.5				
	1999.01-1999.09	MT	L/R	F	MPV Engine F3R 791/F3R 796	850026	Outer Joint		23	25	56.2	83.5	58	O			
	1999.01-1999.09	-	L	F	MPV Engine F3R 791/F3R 796	250160	Drive Shaft	44T	23	29.95	57	87	656.5				
	1999.01-1999.09	MT	L	F	MPV Engine F3R 791/F3R 796	250220	Drive Shaft	44T	23	29.95	57.5	86.5	655				
	1999.01-1999.09	MT	R	F	MPV Engine F3R 791/F3R 796	250159	Drive Shaft	44T	23	23	57	87	748				
	1999.01-1999.09	MT	R	F	MPV Engine F3R 791/F3R 796	250156	Drive Shaft	44T	23	23	57.5	86.5	746.5				
	1999.01-1999.09	-	R	F	MPV Engine F3R 791/F3R 796	250325	Drive Shaft	44T	23	23	56.3	85	744				
	1999.01-1999.09	AT	L	F	MPV Engine F3R 791/F3R 796	250073	Drive Shaft	44T	23	26	56.3	84	646				
	1999.01-1999.09	MT	L/R	F	MPV Engine F3R 791/F3R 796	850114	Outer Joint	44T	23	35	57.5	87	71	I			
	2.0 i (84 kW)	1997.01-1999.09	-	-	-	MPV Engine F3R 750/F3R 751	801059	Outer Joint	44T	23	22	56.8	84	55.5	I		
1997.01-1999.09		-	R	F	MPV Engine F3R 750/F3R 751	250199	Drive Shaft	44T	23	23	57.5	83.5	748				

REMARKS	YEAR	TRANSM	L/R	F/R	GSP Ref.	PRODUCT	ABS	Technical Specifications							
								A	B	C	H	L	P		
RENAULT MEGANE SCENIC (JA0/1_)															
2.0 i (84 kW)	1997.01-1999.09	-	-	-	MPV Engine F3R 750/F3R 751	850051	Outer Joint	48T	23	25	56.3	80	58	O	
	1997.01-1999.09	-	-	F	MPV Engine F3R 750/F3R 751	850058	Outer Joint	44T	23	35	57	87	71	I	
	1997.01-1999.09	MT	L/R	F	MPV Engine F3R 750/F3R 751	850026	Outer Joint		23	25	56.2	83.5	58	O	
	1997.01-1999.09	-	R	F	MPV Engine F3R 750/F3R 751	250252	Drive Shaft		23	23	57.5	83.5	748		
	1997.01-1999.09	MT	R	F	MPV Engine F3R 750/F3R 751	650008	Inner Joint		23	30	36.3	52.2	68.5		
	1997.01-1999.09	-	-	F	MPV Engine F3R 750/F3R 751	850052	Outer Joint	44T	23	30	57.5	86.5	58.5	I	
	1997.01-1999.09	-	L	F	MPV Engine F3R 750/F3R 751	250028	Drive Shaft		23	29.95	56.8	84	654		
	1997.01-1999.09	-	R	F	MPV Engine F3R 750/F3R 751	250247	Drive Shaft		23	23	56.8	84	750.5		
	1997.01-1999.09	MT	R	F	MPV Engine F3R 750/F3R 751	250027	Drive Shaft	44T	23	23	56.8	84	750.5		
	1997.01-1999.09	-	L	F	MPV Engine F3R 750/F3R 751	250160	Drive Shaft	44T	23	29.95	57	87	656.5		
	1997.01-1999.09	MT	R	F	MPV Engine F3R 750/F3R 751	250159	Drive Shaft	44T	23	23	57	87	748		
	1997.01-1999.09	MT	L	F	MPV Engine F3R 750/F3R 751	250220	Drive Shaft	44T	23	29.95	57.5	86.5	655		
	1997.01-1999.09	-	R	F	MPV Engine F3R 750/F3R 751	250325	Drive Shaft	44T	23	23	56.3	85	744		
	1997.01-1999.09	AT	L	F	MPV Engine F3R 750/F3R 751	250073	Drive Shaft	44T	23	26	56.3	84	646		
	1997.01-1999.09	MT	L/R	F	MPV Engine F3R 750/F3R 751	850114	Outer Joint	44T	23	35	57.5	87	71	I	
MEGANE SUITE															
-	1995-	-	-	L	-	250239	Drive Shaft	26T	21	29.95	57	84.5	645.7		
	1995-	-	-	R	-	250240	Drive Shaft	26T	21	23	57	84.5	735.9		
MODUS/GRAND MODUS (F/JP0_)															
1.2 (48 kW)	2005.05-	-	-	-	Hatchback Engine D4F 740	850112	Outer Joint		23	28	49	83.5	54.5	I	
	2005.05-	-	-	R	Hatchback Engine D4F 740	250372	Drive Shaft		23	26	49	83.5	890		
	2005.05-	-	-	L	Hatchback Engine D4F 740	250369	Drive Shaft		23	26	49	83.5	651		
1.2 (55 kW)	2004.12-	-	-	-	Hatchback Engine D4F 740	850112	Outer Joint		23	28	49	83.5	54.5	I	
	2004.12-	-	-	R	Hatchback Engine D4F 740	250372	Drive Shaft		23	26	49	83.5	890		
	2004.12-	-	-	L	Hatchback Engine D4F 740	250369	Drive Shaft		23	26	49	83.5	651		
1.2 (58 kW)	2004.12-	-	-	-	Hatchback Engine D4F 764	850112	Outer Joint		23	28	49	83.5	54.5	I	
	2004.12-	-	-	R	Hatchback Engine D4F 764	250372	Drive Shaft		23	26	49	83.5	890		
	2004.12-	-	-	L	Hatchback Engine D4F 764	250369	Drive Shaft		23	26	49	83.5	651		
1.2 (76 kW)	2004.12-	-	-	L	Hatchback Engine D4F 764	250369	Drive Shaft		23	26	49	83.5	651		
1.2 (76 kW)	2011.04-	-	MT	L	Hatchback Engine D4F 786	250568	Drive Shaft		23	26	49	86	648		
	2011.04-	-	-	-	Hatchback Engine D4F 786	850092	Outer Joint		23	29	49	86	57	I	
	2011.04-	-	MT	R	Hatchback Engine D4F 786	250573	Drive Shaft		23	26	49	86	891		
1.2 16V (74 kW)	2007.05-	-	-	R	Hatchback Engine D4F 784	250372	Drive Shaft		23	26	49	83.5	890		
	2007.05-	-	MT	L	Hatchback Engine D4F 784	250568	Drive Shaft		23	26	49	86	648		
	2007.05-	-	-	L	Hatchback Engine D4F 784	250369	Drive Shaft		23	26	49	83.5	651		
	2007.05-	-	-	-	Hatchback Engine D4F 784	850092	Outer Joint		23	29	49	86	57	I	
1.2 16V Hi-Flex (55 kW)	2008.10-	-	-	-	Hatchback Engine D4F 740	850112	Outer Joint		23	28	49	83.5	54.5	I	
	2008.10-	-	MT	R	Hatchback Engine D4F 740	250372	Drive Shaft		23	26	49	83.5	890		
	2008.10-	-	MT	L	Hatchback Engine D4F 740	250369	Drive Shaft		23	26	49	83.5	651		
1.4 (72 kW)	2004.12-	-	-	R	Hatchback Engine K4J 770/K4J 780	250372	Drive Shaft		23	26	49	83.5	890		
	2004.12-	-	-	R	Hatchback Engine K4J 770/K4J 780	699169	Inner Joint		26	30	33	326	95		
	2004.12-	-	-	-	Hatchback Engine K4J 770/K4J 780	899085	Outer Joint		23	30	49	86	59	I	
	2004.12-	-	-	L	Hatchback Engine K4J 770/K4J 780	250278	Drive Shaft		23	26	49	86	653.5		
	2004.12-	-	-	L	Hatchback Engine K4J 770/K4J 780	250369	Drive Shaft		23	26	49	83.5	651		
	2004.12-	-	-	R	Hatchback Engine K4J 770/K4J 780	250277	Drive Shaft		23	26	49	86	898		
1.5 dCi (48 kW)	2004.12-	-	-	R	Hatchback Engine K9K 752	250372	Drive Shaft		23	26	49	83.5	890		
	2004.12-	-	-	R	Hatchback Engine K9K 752	699169	Inner Joint		26	30	33	326	95		
	2004.12-	-	-	L	Hatchback Engine K9K 752	250278	Drive Shaft		23	26	49	86	653.5		
	2004.12-	-	-	L	Hatchback Engine K9K 752	250369	Drive Shaft		23	26	49	83.5	651		
	2004.12-	-	-	R	Hatchback Engine K9K 752	250277	Drive Shaft		23	26	49	86	898		
1.5 dCi (50 kW)	2004.12-	-	MT	R	Hatchback Engine K9K 768/K9K 762	699169	Inner Joint		26	30	33	326	95		
	2004.12-	-	-	R	Hatchback Engine K9K 768/K9K 762	250372	Drive Shaft		23	26	49	83.5	890		
	2004.12-	-	MT	R	Hatchback Engine K9K 768/K9K 762	650148	Inner Joint		26	30	33	326	90		
	2004.12-	-	-	R	Hatchback Engine K9K 768/K9K 762	850168	Outer Joint		23	30	49	83.5	54.5	I	
	2004.12-	-	MT	R	Hatchback Engine K9K 768/K9K 762	250625	Drive Shaft		23	26	49	83.5	893		
	2004.12-	-	MT	L	Hatchback Engine K9K 768/K9K 762	250630	Drive Shaft		23	26	49	83	653		
	2004.12-	-	-	-	Hatchback Engine K9K 768/K9K 762	899085	Outer Joint		23	30	49	86	59	I	
	2004.12-	-	MT	R	Hatchback Engine K9K 768/K9K 762	250354	Drive Shaft		23	26	49	86	897		
	2004.12-	-	MT	L	Hatchback Engine K9K 768/K9K 762	250353	Drive Shaft		23	26	49	86	649		
	2004.12-	-	-	L	Hatchback Engine K9K 768/K9K 762	250278	Drive Shaft		23	26	49	86	653.5		
	2004.12-	-	-	R	Hatchback Engine K9K 768/K9K 762	250277	Drive Shaft		23	26	49	86	898		
	2004.12-	-	-	L	Hatchback Engine K9K 768/K9K 762	250369	Drive Shaft		23	26	49	83.5	651		
1.5 dCi (60 kW)	2004.09-	-	-	R	Hatchback Engine K9K 750	250372	Drive Shaft		23	26	49	83.5	890		
	2004.09-	-	MT	R	Hatchback Engine K9K 750	699169	Inner Joint		26	30	33	326	95		
	2004.09-	-	MT	L	Hatchback Engine K9K 750	250278	Drive Shaft		23	26	49	86	653.5		
	2004.09-	-	MT	R	Hatchback Engine K9K 750	250277	Drive Shaft		23	26	49	86	898		
	2004.09-	-	-	L	Hatchback Engine K9K 750	250369	Drive Shaft		23	26	49	83.5	651		





REMARKS	YEAR	TRANSM	L/R	F/R	GSP Ref.	PRODUCT	ABS	Technical Specifications							
								A	B	C	H	L	P		
RENAULT															
MODUS/GRAND MODUS (F/JP0_)															
1.5 dCi (60 kW)	2004.09-	-	AT	-	F	Hatchback Engine K9K 750	850092	Outer Joint		23	29	49	86	57	I
1.5 dCi (63 kW)	2004.12-	-	-	R	F	Hatchback Engine K9K 760/K9K 766	699169	Inner Joint		26	30	33	326	95	
	2004.12-	-	MT	R	F	Hatchback Engine K9K 760/K9K 766	650148	Inner Joint		26	30	33	326	90	
	2004.12-	-	-	R	F	Hatchback Engine K9K 760/K9K 766	850168	Outer Joint		23	30	49	83.5	54.5	I
	2004.12-	-	MT	R	F	Hatchback Engine K9K 760/K9K 766	250625	Drive Shaft		23	26	49	83.5	893	
	2004.12-	-	MT	-	F	Hatchback Engine K9K 760/K9K 766	850117	Outer Joint		23	32	49	86	62	I
	2004.12-	-	MT	L	F	Hatchback Engine K9K 760/K9K 766	250630	Drive Shaft		23	26	49	83	653	
	2004.12-	-	-	-	F	Hatchback Engine K9K 760/K9K 766	899085	Outer Joint		23	30	49	86	59	I
	2004.12-	-	-	R	F	Hatchback Engine K9K 760/K9K 766	250354	Drive Shaft		23	26	49	86	897	
	2004.12-	-	-	L	F	Hatchback Engine K9K 760/K9K 766	250353	Drive Shaft		23	26	49	86	649	
	2004.12-	-	MT	L	F	Hatchback Engine K9K 760/K9K 766	250278	Drive Shaft		23	26	49	86	653.5	
	2004.12-	-	MT	R	F	Hatchback Engine K9K 760/K9K 766	250277	Drive Shaft		23	26	49	86	898	
	2004.12-	-	AT	-	F	Hatchback Engine K9K 760/K9K 766	850092	Outer Joint		23	29	49	86	57	I
1.5 dCi (76 kW)	2007.05-	-	-	R	F	Hatchback Engine K9K 772	699169	Inner Joint		26	30	33	326	95	
	2007.05-	-	-	L	F	Hatchback Engine K9K 772	250379	Drive Shaft		25	26	52.8	85.5	650	
	2007.05-	-	-	R	F	Hatchback Engine K9K 772	250354	Drive Shaft		23	26	49	86	897	
	2007.05-	-	-	L	F	Hatchback Engine K9K 772	250353	Drive Shaft		23	26	49	86	649	
	2007.05-	-	-	-	F	Hatchback Engine K9K 772	899085	Outer Joint		23	30	49	86	59	I
	2007.05-	-	-	-	F	Hatchback Engine K9K 772	850143	Outer Joint		25	32	52.8	85.5	62.5	I
	2007.05-	-	-	R	F	Hatchback Engine K9K 772	250483	Drive Shaft		25	26	52.8	85.5	891	
1.5 dCi (78 kW)	2005.05-	-	-	R	F	Hatchback Engine K9K 764	699169	Inner Joint		26	30	33	326	95	
	2005.05-	-	MT	L	F	Hatchback Engine K9K 764	250379	Drive Shaft		25	26	52.8	85.5	650	
	2005.05-	-	-	R	F	Hatchback Engine K9K 764	250372	Drive Shaft		23	26	49	83.5	890	
	2005.05-	-	-	-	F	Hatchback Engine K9K 764	899085	Outer Joint		23	30	49	86	59	I
	2005.05-	-	-	R	F	Hatchback Engine K9K 764	250354	Drive Shaft		23	26	49	86	897	
	2005.05-	-	-	-	F	Hatchback Engine K9K 764	850143	Outer Joint		25	32	52.8	85.5	62.5	I
	2005.05-	-	-	L	F	Hatchback Engine K9K 764	250353	Drive Shaft		23	26	49	86	649	
	2005.05-	-	-	L	F	Hatchback Engine K9K 764	250369	Drive Shaft		23	26	49	83.5	651	
2005.05-	-	MT	R	F	Hatchback Engine K9K 764	250483	Drive Shaft		25	26	52.8	85.5	891		
1.5 dCi 75 (55 kW)	2010.10-	-	-	R	F	Hatchback Engine K9K 770	650148	Inner Joint		26	30	33	326	90	
	2010.10-	-	MT	R	F	Hatchback Engine K9K 770	250625	Drive Shaft		23	26	49	83.5	893	
	2010.10-	-	-	R	F	Hatchback Engine K9K 770	699169	Inner Joint		26	30	33	326	95	
	2010.10-	-	MT	L	F	Hatchback Engine K9K 770	250630	Drive Shaft		23	26	49	83	653	
	2010.10-	-	-	L	F	Hatchback Engine K9K 770	250278	Drive Shaft		23	26	49	86	653.5	
	2010.10-	-	MT	L	F	Hatchback Engine K9K 770	250353	Drive Shaft		23	26	49	86	649	
	2010.10-	-	-	R	F	Hatchback Engine K9K 770	250277	Drive Shaft		23	26	49	86	898	
1.5 dCi 90 (65 kW)	2010.10-	-	-	R	F	Hatchback Engine K9K 750	650148	Inner Joint		26	30	33	326	90	
	2010.10-	-	-	R	F	Hatchback Engine K9K 750	250625	Drive Shaft		23	26	49	83.5	893	
	2010.10-	-	MT	R	F	Hatchback Engine K9K 750	699169	Inner Joint		26	30	33	326	95	
	2010.10-	-	MT	L	F	Hatchback Engine K9K 750	250630	Drive Shaft		23	26	49	83	653	
	2010.10-	-	-	-	F	Hatchback Engine K9K 750	850117	Outer Joint		23	32	49	86	62	I
	2010.10-	-	MT	L	F	Hatchback Engine K9K 750	250353	Drive Shaft		23	26	49	86	649	
	2010.10-	-	MT	L	F	Hatchback Engine K9K 750	250278	Drive Shaft		23	26	49	86	653.5	
	2010.10-	-	MT	R	F	Hatchback Engine K9K 750	250277	Drive Shaft		23	26	49	86	898	
1.6 (65 kW)	2004.12-	-	MT	R	F	Hatchback Engine K4M 794	699169	Inner Joint		26	30	33	326	95	
	2004.12-	-	MT	-	F	Hatchback Engine K4M 794	850117	Outer Joint		23	32	49	86	62	I
	2004.12-	-	MT	L	F	Hatchback Engine K4M 794	250278	Drive Shaft		23	26	49	86	653.5	
	2004.12-	-	-	-	F	Hatchback Engine K4M 794	899085	Outer Joint		23	30	49	86	59	I
	2004.12-	-	MT	R	F	Hatchback Engine K4M 794	250277	Drive Shaft		23	26	49	86	898	
	2004.12-	-	MT	L	F	Hatchback Engine K4M 794	250369	Drive Shaft		23	26	49	83.5	651	
	2004.12-	-	AT	L	F	Hatchback Engine K4M 794	250574	Drive Shaft		23	26	49	86	652	
	2004.12-	-	-	R	F	Hatchback Engine K4M 794	250443	Drive Shaft		23	23	49	86	789	
1.6 (82 kW)	2004.12-	-	MT	R	F	Hatchback Engine K4M 790/K4M 791/K4M 800/K4M 801	699169	Inner Joint		26	30	33	326	95	
	2004.12-	-	-	L	F	Hatchback Engine K4M 790/K4M 791/K4M 800/K4M 801	250353	Drive Shaft		23	26	49	86	649	
	2004.12-	-	MT	L	F	Hatchback Engine K4M 790/K4M 791/K4M 800/K4M 801	250278	Drive Shaft		23	26	49	86	653.5	
	2004.12-	-	-	-	F	Hatchback Engine K4M 790/K4M 791/K4M 800/K4M 801	899085	Outer Joint		23	30	49	86	59	I
	2004.12-	-	MT	R	F	Hatchback Engine K4M 790/K4M 791/K4M 800/K4M 801	250277	Drive Shaft		23	26	49	86	898	
	2004.12-	-	MT	L	F	Hatchback Engine K4M 790/K4M 791/K4M 800/K4M 801	250369	Drive Shaft		23	26	49	83.5	651	
	2004.12-	-	AT	L	F	Hatchback Engine K4M 790/K4M 791/K4M 800/K4M 801	250574	Drive Shaft		23	26	49	86	652	
	2004.12-	-	-	R	F	Hatchback Engine K4M 790/K4M 791/K4M 800/K4M 801	250443	Drive Shaft		23	23	49	86	789	
R12 TL															
1.5	1993.11-	-	-	-	-	ARGENTINA (5V)	850009	Outer Joint		20	30	48	107	57.5	I
1.6	1993.11-	-	-	-	-	ARGENTINA (5V)	850009	Outer Joint		20	30	48	107	57.5	I
RAPID															
1.9 D (47 kW)	1994.09-	1998.03	MT	L	F	MPV Engine F8Q 646/F8Q 684/F8Q 724/F8Q 776	250201	Drive Shaft		21	29.95	49.8	83.5	597	
RAPID (F40_G40_)/EXTRA/EXPRESS															

REMARKS	YEAR	TRANSM	L/R	F/R	GSP Ref.	PRODUCT	ABS	Technical Specifications					
								A	B	C	H	L	P
RENAULT													
RAPID (F40_ G40_)/EXTRA/EXPRESS													
1.0 (27 kW)	1986.02-1992.05	MT	R	F	Box Engine C1C 706	250044	Drive Shaft		21	23	46.4	81.5	693.5
	1986.02-1992.05	MT	L	F	Box Engine C1C 706	250024	Drive Shaft		21	29.95	46.4	81.5	599
	1986.02-1992.05	-	R	F	Box Engine C1C 706	250124	Drive Shaft		21	23	46.3	80.5	685
1.1 (33 kW)	1985.07-1995.04	MT	L	F	Box Engine C1E 750/C1E 752/C1E 754/C1E 760/C1E 762/C1E 792	250024	Drive Shaft		21	29.95	46.4	81.5	599
	1985.07-1995.04	-	L	F	Box Engine C1E 750/C1E 752/C1E 754/C1E 760/C1E 762/C1E 792	250118	Drive Shaft		21	29.95	46.3	80.5	604.5
	1985.07-1995.04	-	R	F	Box Engine C1E 750/C1E 752/C1E 754/C1E 760/C1E 762/C1E 792	250124	Drive Shaft		21	23	46.3	80.5	685
	1985.07-1995.04	MT	R	F	Box Engine C1E 750/C1E 752/C1E 754/C1E 760/C1E 762/C1E 792	250044	Drive Shaft		21	23	46.4	81.5	693.5
	1985.07-1995.04	-	L	F	Box Engine C1E 750/C1E 752/C1E 754/C1E 760/C1E 762/C1E 792	250120	Drive Shaft		21	29.95	46.3	80.5	591.5
	1987.06-1991.09	MT	L	F	Box Engine C1E 756	250024	Drive Shaft		21	29.95	46.4	81.5	599
	1987.06-1991.09	-	L	F	Box Engine C1E 756	250118	Drive Shaft		21	29.95	46.3	80.5	604.5
	1987.06-1991.09	-	R	F	Box Engine C1E 756	250124	Drive Shaft		21	23	46.3	80.5	685
	1987.06-1991.09	MT	R	F	Box Engine C1E 756	250044	Drive Shaft		21	23	46.4	81.5	693.5
	1987.06-1991.09	-	L	F	Box Engine C1E 756	250120	Drive Shaft		21	29.95	46.3	80.5	591.5
1.1 (34 kW)	1985.09-1991.08	-	L	F	Box Engine C1E 750	250120	Drive Shaft		21	29.95	46.3	80.5	591.5
	1985.09-1991.08	-	L	F	Box Engine C1E 750	250118	Drive Shaft		21	29.95	46.3	80.5	604.5
1.2 (40 kW)	1991.09-1998.03	MT	L	F	Box Engine C3G 710/C3G 712	250024	Drive Shaft		21	29.95	46.4	81.5	599
	1991.09-1998.03	-	L	F	Box Engine C3G 710/C3G 712	250118	Drive Shaft		21	29.95	46.3	80.5	604.5
	1991.09-1998.03	-	R	F	Box Engine C3G 710/C3G 712	250124	Drive Shaft		21	23	46.3	80.5	685
	1991.09-1998.03	MT	R	F	Box Engine C3G 710/C3G 712	250044	Drive Shaft		21	23	46.4	81.5	693.5
	1991.09-1998.03	-	L	F	Box Engine C3G 710/C3G 712	250120	Drive Shaft		21	29.95	46.3	80.5	591.5
1.4 (43 kW)	1985.07-1991.08	-	L	F	Box Engine C1J 768/C1J 780	250120	Drive Shaft		21	29.95	46.3	80.5	591.5
	1985.07-1991.08	MT	L	F	Box Engine C1J 768/C1J 780	250024	Drive Shaft		21	29.95	46.4	81.5	599
	1985.07-1991.08	-	L	F	Box Engine C1J 768/C1J 780	250118	Drive Shaft		21	29.95	46.3	80.5	604.5
	1985.07-1991.08	-	R	F	Box Engine C1J 768/C1J 780	250124	Drive Shaft		21	23	46.3	80.5	685
	1985.07-1991.08	MT	R	F	Box Engine C1J 768/C1J 780	250044	Drive Shaft		21	23	46.4	81.5	693.5
1.4 (44 kW)	1986.03-1991.08	MT	L	F	Box Engine C2J 784	250024	Drive Shaft		21	29.95	46.4	81.5	599
	1986.03-1991.08	-	L	F	Box Engine C2J 784	250118	Drive Shaft		21	29.95	46.3	80.5	604.5
	1986.03-1991.08	-	R	F	Box Engine C2J 784	250124	Drive Shaft		21	23	46.3	80.5	685
	1986.03-1991.08	MT	R	F	Box Engine C2J 784	250044	Drive Shaft		21	23	46.4	81.5	693.5
	1986.03-1991.08	-	L	F	Box Engine C2J 784	250120	Drive Shaft		21	29.95	46.3	80.5	591.5
1.4 (54 kW)	1991.09-1993.08	AT	L	F	Box Engine E7J 724	250201	Drive Shaft		21	29.95	49.8	83.5	597
1.4 (55 kW)	1991.09-1998.03	MT	R	F	Box Engine E7J 720/E7J 724/E7J 726/E7J 773	250044	Drive Shaft		21	23	46.4	81.5	693.5
	1991.09-1998.03	-	L	F	Box Engine E7J 720/E7J 724/E7J 726/E7J 773	250120	Drive Shaft		21	29.95	46.3	80.5	591.5
	1991.09-1998.03	MT	L	F	Box Engine E7J 720/E7J 724/E7J 726/E7J 773	250024	Drive Shaft		21	29.95	46.4	81.5	599
	1991.09-1998.03	AT	L	F	Box Engine E7J 720/E7J 724/E7J 726/E7J 773	250201	Drive Shaft		21	29.95	49.8	83.5	597
	1991.09-1998.03	-	L	F	Box Engine E7J 720/E7J 724/E7J 726/E7J 773	250118	Drive Shaft		21	29.95	46.3	80.5	604.5
	1991.09-1998.03	-	R	F	Box Engine E7J 720/E7J 724/E7J 726/E7J 773	250124	Drive Shaft		21	23	46.3	80.5	685
1.4 (58 kW)	1994.01-1998.03	-	L	F	Box Engine E7J 728	250120	Drive Shaft		21	29.95	46.3	80.5	591.5
	1994.01-1998.03	MT	L	F	Box Engine E7J 728	250024	Drive Shaft		21	29.95	46.4	81.5	599
	1994.01-1998.03	AT	L	F	Box Engine E7J 728	250201	Drive Shaft		21	29.95	49.8	83.5	597
	1994.01-1998.03	-	L	F	Box Engine E7J 728	250118	Drive Shaft		21	29.95	46.3	80.5	604.5
	1994.01-1998.03	-	R	F	Box Engine E7J 728	250124	Drive Shaft		21	23	46.3	80.5	685
	1994.01-1998.03	MT	R	F	Box Engine E7J 728	250044	Drive Shaft		21	23	46.4	81.5	693.5
1.4 (59 kW)	1995.05-1997.08	MT	L	F	Box Engine E7J 773	250024	Drive Shaft		21	29.95	46.4	81.5	599
	1995.05-1997.08	AT	L	F	Box Engine E7J 773	250201	Drive Shaft		21	29.95	49.8	83.5	597
	1995.05-1997.08	MT	R	F	Box Engine E7J 773	250044	Drive Shaft		21	23	46.4	81.5	693.5
1.4 Cat (43 kW)	1988.08-1998.03	-	L	F	Box Engine C3J 700/C3J 702/C3J 760/C3J 762	250120	Drive Shaft		21	29.95	46.3	80.5	591.5
	1988.08-1998.03	MT	R	F	Box Engine C3J 700/C3J 702/C3J 760/C3J 762	250044	Drive Shaft		21	23	46.4	81.5	693.5
	1988.08-1998.03	MT	L	F	Box Engine C3J 700/C3J 702/C3J 760/C3J 762	250024	Drive Shaft		21	29.95	46.4	81.5	599
	1988.08-1998.03	MT	L	F	Box Engine C3J 700/C3J 702/C3J 760/C3J 762	250201	Drive Shaft		21	29.95	49.8	83.5	597
	1988.08-1998.03	-	L	F	Box Engine C3J 700/C3J 702/C3J 760/C3J 762	250118	Drive Shaft		21	29.95	46.3	80.5	604.5
	1988.08-1998.03	-	R	F	Box Engine C3J 700/C3J 702/C3J 760/C3J 762	250124	Drive Shaft		21	23	46.3	80.5	685
1.6 D (40 kW)	1986.03-1998.08	MT	L	F	Box Engine F8M 720/F8M 730/F8M 736/F8M 760	250024	Drive Shaft		21	29.95	46.4	81.5	599
	1986.03-1998.08	-	L	F	Box Engine F8M 720/F8M 730/F8M 736/F8M 760	250118	Drive Shaft		21	29.95	46.3	80.5	604.5
	1986.03-1998.08	MT	R	F	Box Engine F8M 720/F8M 730/F8M 736/F8M 760	250044	Drive Shaft		21	23	46.4	81.5	693.5
	1986.03-1998.08	-	L	F	Box Engine F8M 720/F8M 730/F8M 736/F8M 760	250120	Drive Shaft		21	29.95	46.3	80.5	591.5
	1993.09-1995.04	-	L	F	Box Engine F8M 736	250120	Drive Shaft		21	29.95	46.3	80.5	591.5
	1993.09-1995.04	MT	L	F	Box Engine F8M 736	250024	Drive Shaft		21	29.95	46.4	81.5	599
	1993.09-1995.04	MT	R	F	Box Engine F8M 736	250044	Drive Shaft		21	23	46.4	81.5	693.5
1.9 D (40 kW)	1994.09-1998.03	-	L	F	Box Engine F8Q 640/F8Q 682	250120	Drive Shaft		21	29.95	46.3	80.5	591.5
	1994.09-1998.03	MT	L	F	Box Engine F8Q 640/F8Q 682	250024	Drive Shaft		21	29.95	46.4	81.5	599
	1994.09-1998.03	MT	L	F	Box Engine F8Q 640/F8Q 682	250201	Drive Shaft		21	29.95	49.8	83.5	597
	1994.09-1998.03	MT	R	F	Box Engine F8Q 640/F8Q 682	250044	Drive Shaft		21	23	46.4	81.5	693.5
1.9 D (47 kW)	1991.09-1998.03	MT	L	F	Box Engine F8Q 646/F8Q 722/F8Q 724/F8Q 774/F8Q 776	250024	Drive Shaft		21	29.95	46.4	81.5	599
	1991.09-1998.03	MT	L	F	Box Engine F8Q 646/F8Q 722/F8Q 724/F8Q 774/F8Q 776	250201	Drive Shaft		21	29.95	49.8	83.5	597
	1991.09-1998.03	MT	R	F	Box Engine F8Q 646/F8Q 722/F8Q 724/F8Q 774/F8Q 776	250044	Drive Shaft		21	23	46.4	81.5	693.5

RENAULT	YEAR	TRANSM	L/R	F/R	REMARKS	GSP Ref.	PRODUCT	ABS	Technical Specifications									
									A	B	C	H	L	P				
RENAULT																		
RAPID (F40_ G40_)/EXTRA/EXPRESS																		
1.9 D (47 kW)	1991.09-	1998.03	-	L	F	Box Engine F8Q 646/F8Q 722/F8Q 724/F8Q 774/F8Q 776	250120	Drive Shaft		21	29.95	46.3	80.5	591.5				
SAFRANE																		
2.5 TD	1993.03-	1996.07	-	-	-	BV PK1	650025	Inner Joint		39	25	30	450.5	76.1				
3.0 I V6	1992-	-	-	-	-	-	850046	Outer Joint	44T	23	29	57.5	83.5	62	O			
SAFRANE I (B54_)																		
2.0 (77 kW)	1992.11-	1996.07	-	-	-	Hatchback Engine J7R 732/J7R 733	850051	Outer Joint	48T	23	25	56.3	80	58	O			
	1992.11-	1996.07	MT	L	F	Hatchback Engine J7R 732/J7R 733	250008	Drive Shaft	30T	23	37.1	56.2	83.5	597.5				
	1992.11-	1996.07	AT/MT	L/R	F	Hatchback Engine J7R 732/J7R 733	850026	Outer Joint		23	25	56.2	83.5	58	O			
	1992.11-	1996.07	-	-	F	Hatchback Engine J7R 732/J7R 733	850045	Outer Joint	30T	23	25	56.2	83.5	58	O			
	1992.11-	1996.07	MT	R	F	Hatchback Engine J7R 732/J7R 733	250105	Drive Shaft	30T	23	37.1	56.2	83.5	540				
2.0 12V (97 kW)	1992.04-	1996.07	-	-	-	Hatchback Engine J7R 734/J7R 735	850051	Outer Joint	48T	23	25	56.3	80	58	O			
	1992.04-	1996.07	MT	L	F	Hatchback Engine J7R 734/J7R 735	250008	Drive Shaft	30T	23	37.1	56.2	83.5	597.5				
	1992.04-	1996.07	AT/MT	L/R	F	Hatchback Engine J7R 734/J7R 735	850026	Outer Joint		23	25	56.2	83.5	58	O			
	1992.04-	1996.07	-	-	F	Hatchback Engine J7R 734/J7R 735	850045	Outer Joint	30T	23	25	56.2	83.5	58	O			
2.1 dT (65 kW)	1992.04-	1996.07	MT	R	F	Hatchback Engine J7R 734/J7R 735	250105	Drive Shaft	30T	23	37.1	56.2	83.5	540				
	1993.11-	1996.07	-	-	-	Hatchback Engine J8S 760	850051	Outer Joint	48T	23	25	56.3	80	58	O			
	1993.11-	1996.07	MT	L	F	Hatchback Engine J8S 760	250008	Drive Shaft	30T	23	37.1	56.2	83.5	597.5				
2.2 (101 kW)	1993.11-	1996.07	MT	L/R	F	Hatchback Engine J8S 760	850026	Outer Joint		23	25	56.2	83.5	58	O			
	1993.11-	1996.07	MT	R	F	Hatchback Engine J8S 760	250105	Drive Shaft	30T	23	37.1	56.2	83.5	540				
	1992.04-	1996.07	-	-	-	Hatchback Engine J7T 760/J7T 761	850051	Outer Joint	48T	23	25	56.3	80	58	O			
	1992.04-	1996.07	MT	L	F	Hatchback Engine J7T 760/J7T 761	250008	Drive Shaft	30T	23	37.1	56.2	83.5	597.5				
2.2 (79 kW)	1992.04-	1996.07	AT/MT	L/R	F	Hatchback Engine J7T 760/J7T 761	850026	Outer Joint		23	25	56.2	83.5	58	O			
	1992.04-	1996.07	-	-	F	Hatchback Engine J7T 760/J7T 761	850045	Outer Joint	30T	23	25	56.2	83.5	58	O			
	1992.04-	1996.07	-	R	F	Hatchback Engine J7T 760/J7T 761	250105	Drive Shaft	30T	23	37.1	56.2	83.5	540				
	1992.04-	1996.07	-	-	-	Hatchback Engine J7T 762	850051	Outer Joint	48T	23	25	56.3	80	58	O			
	1992.04-	1996.07	MT	L	F	Hatchback Engine J7T 762	250008	Drive Shaft	30T	23	37.1	56.2	83.5	597.5				
2.5 dT (83 kW)	1992.04-	1996.07	AT/MT	L/R	F	Hatchback Engine J7T 762	850026	Outer Joint		23	25	56.2	83.5	58	O			
	1992.04-	1996.07	-	-	F	Hatchback Engine J7T 762	850045	Outer Joint	30T	23	25	56.2	83.5	58	O			
	1992.04-	1996.07	MT	R	F	Hatchback Engine J7T 762	250105	Drive Shaft	30T	23	37.1	56.2	83.5	540				
	1992.04-	1996.07	-	-	-	Hatchback Engine S8U 762/S8U 763	850051	Outer Joint	48T	23	25	56.3	80	58	O			
3.0 (125 kW)	1992.12-	1996.07	AT	L	F	Hatchback Engine S8U 762/S8U 763	250008	Drive Shaft	30T	23	37.1	56.2	83.5	597.5				
	1992.12-	1996.07	AT/MT	R	F	Hatchback Engine S8U 762/S8U 763	250171	Drive Shaft	30T	23	39	56.2	83.5	1001				
	1992.12-	1996.07	-	-	F	Hatchback Engine S8U 762/S8U 763	850045	Outer Joint	30T	23	25	56.2	83.5	58	O			
	1992.12-	1996.07	AT	L/R	F	Hatchback Engine S8U 762/S8U 763	850026	Outer Joint		23	25	56.2	83.5	58	O			
	1992.12-	1996.07	AT	L	F	Hatchback Engine Z7X 723	250008	Drive Shaft	30T	23	37.1	56.2	83.5	597.5				
3.0 Biturbo (193 kW)	1993.02-	1996.06	AT	R	F	Hatchback Engine Z7X 723	250171	Drive Shaft	30T	23	39	56.2	83.5	1001				
	1993.02-	1996.06	-	-	F	Hatchback Engine Z7X 723	850045	Outer Joint	30T	23	25	56.2	83.5	58	O			
	1993.02-	1996.07	AT	L	F	All-wheel Drive Hatchback Engine Z7X 726	250008	Drive Shaft	30T	23	37.1	56.2	83.5	597.5				
3.0 V6 (123 kW)	1993.02-	1996.07	AT	R	F	All-wheel Drive Hatchback Engine Z7X 726	250171	Drive Shaft	30T	23	39	56.2	83.5	1001				
	1993.02-	1996.07	-	-	-	All-wheel Drive Hatchback Engine Z7X 726	850045	Outer Joint	30T	23	25	56.2	83.5	58	O			
	1992.12-	1996.07	-	-	-	Hatchback Engine Z7X 721/Z7X 722/Z7X 723/Z7X 753	850051	Outer Joint	48T	23	25	56.3	80	58	O			
	1992.12-	1996.07	-	-	-	All-wheel Drive Hatchback Engine Z7X 721/Z7X 722/Z7X 723	850051	Outer Joint	48T	23	25	56.3	80	58	O			
	1992.12-	1996.07	AT/MT	L	F	Hatchback Engine Z7X 721/Z7X 722/Z7X 723/Z7X 753	250008	Drive Shaft	30T	23	37.1	56.2	83.5	597.5				
	1992.12-	1996.07	AT/MT	L	F	All-wheel Drive Hatchback Engine Z7X 721/Z7X 722/Z7X 723	250008	Drive Shaft	30T	23	37.1	56.2	83.5	597.5				
	1992.12-	1996.07	MT	L/R	F	All-wheel Drive Hatchback Engine Z7X 721/Z7X 722/Z7X 723	850026	Outer Joint		23	25	56.2	83.5	58	O			
SAFRANE II (B54_)	1992.12-	1996.07	AT	R	F	Hatchback Engine Z7X 721/Z7X 722/Z7X 723	250171	Drive Shaft	30T	23	39	56.2	83.5	1001				
	1992.12-	1996.07	AT	R	F	All-wheel Drive Hatchback Engine Z7X 721/Z7X 722/Z7X 723	250171	Drive Shaft	30T	23	39	56.2	83.5	1001				
	1992.12-	1996.07	-	-	F	Hatchback Engine Z7X 721/Z7X 722/Z7X 723/Z7X 753	850045	Outer Joint	30T	23	25	56.2	83.5	58	O			
	1992.12-	1996.07	-	-	-	All-wheel Drive Hatchback Engine Z7X 721/Z7X 722/Z7X 723	850045	Outer Joint	30T	23	25	56.2	83.5	58	O			
	1992.12-	1996.07	-	-	-	All-wheel Drive Hatchback Engine Z7X 721/Z7X 722/Z7X 723	850045	Outer Joint	30T	23	25	56.2	83.5	58	O			
2.0 16V (100 kW)	1996.07-	2000.12	-	L	F	Hatchback Engine N7Q 710/N7Q 711	250271	Drive Shaft	30T	23	26	64	84.5	670				
	1996.07-	2000.12	-	L	F	Hatchback Engine N7Q 710/N7Q 711	250271	Drive Shaft	30T	23	26	64	84.5	670				
	1996.07-	2000.12	-	R	F	Hatchback Engine N7Q 710/N7Q 711	250099	Drive Shaft	30T	23	26	64	84.5	929				
	1996.07-	2000.12	MT	L/R	F	Hatchback Engine N7Q 710/N7Q 711	850056	Outer Joint	30T	23	27	64	84.5	68	I			
2.2 dT (83 kW)	1996.07-	2000.12	MT	L	F	Hatchback Engine G8T 740	250008	Drive Shaft	30T	23	37.1	56.2	83.5	597.5				
	1996.07-	2000.12	-	R	F	Hatchback Engine G8T 740	250296	Drive Shaft	30T	23	39	64	84.5	985				
	1996.07-	2000.12	-	L	F	Hatchback Engine G8T 740	250295	Drive Shaft	30T	23	37.1	64	84.5	598				
	1996.07-	2000.12	MT	L/R	F	Hatchback Engine G8T 740	850056	Outer Joint	30T	23	27	64	84.5	68	I			
2.5 20V (121 kW)	1996.07-	2000.12	-	R	F	Hatchback Engine N7U 700/N7U 701	250074	Drive Shaft	30T	23	26	64	84.5	1020				
	1996.07-	2000.12	MT	L/R	F	Hatchback Engine N7U 700/N7U 701	850056	Outer Joint	30T	23	27	64	84.5	68	I			
	1996.07-	2000.12	MT	L	F	Hatchback Engine N7U 700/N7U 701	250100	Drive Shaft	30T	23	26	64	84.5	594				
3.0 V6 (123 kW)	1996.07-	2000.12	AT	L	F	Hatchback Engine Z7X 755	250008	Drive Shaft	30T	23	37.1	56.2	83.5	597.5				
	1996.07-	2000.12	AT	R	F	Hatchback Engine Z7X 755	250171	Drive Shaft	30T	23	39	56.2	83.5	1001				
SANDERO																		
1.6	2011-	2013	-	-	-	-	811003	Outer Joint		23	30	49	86	59	I			
SANDERO/STEPWAY I (BS_)																		

REMARKS	YEAR	TRANSM	L/R	F/R	GSP Ref.	PRODUCT	ABS	Technical Specifications													
								A	B	C	H	L	P								
RENAULT SANDERO/STEPWAY I (BS_)																					
1.4 (55 kW)	2009.02-	-	-	R	F	Hatchback Engine K7J 710	245085	Drive Shaft		21	23	49	84	763							
	2009.02-	-	-	R	F	Hatchback Engine K7J 710	650008	Inner Joint		23	30	36.3	52.2	68.5							
1.6 (64 kW)	2009.02-	-	MT	L	F	Hatchback Engine K7M 710	245084	Drive Shaft		21	29.95	49	84	681							
	2009.02-	-	MT	R	F	Hatchback Engine K7M 710	245085	Drive Shaft		21	23	49	84	763							
	2009.02-	-	MT	R	F	Hatchback Engine K7M 710	650008	Inner Joint		23	30	36.3	52.2	68.5							
SCENIC																					
-	2001-	2007	-	-	-	-	850054	Outer Joint	44T	23	23	57	83	61	M						
1.6 16V	2001.01-	2006.12	MT	-	-	-	899206	Outer Joint		23	21	56.2	83.5	57	M						
	2001.01-	2006.12	MT	-	-	-	850087	Outer Joint	44T	23	21	56.2	83.5	57	M						
2.0 16V	2001.01-	2006.12	MT	-	-	-	844064	Outer Joint		23	25	57	83.5	58	O						
	2001.01-	2006.12	MT	-	-	-	850086	Outer Joint	44T	23	25	57	83.5	58	O						
SCENIC I																					
1.9 TD/1.9 TDi	1997.05-	1999.04	MT	R	F	-	250091	Drive Shaft	44T	23	23	56.2	83.5	744							
2.0 8V	1997.05-	1998.06	MT	R	F	-	250091	Drive Shaft	44T	23	23	56.2	83.5	744							
SCENIC I (JA0/1_ FA0_)																					
1.4 16V (70 kW)	1999.09-	2003.08	-	R	F	MPV Engine K4J 714/K4J 750	650008	Inner Joint		23	30	36.3	52.2	68.5							
	1999.09-	2003.08	MT	L	F	MPV Engine K4J 714/K4J 750	250048	Drive Shaft		21	29.95	46.4	81.5	650							
	1999.09-	2003.08	MT	R	F	MPV Engine K4J 714/K4J 750	250140	Drive Shaft		21	23	49.8	83.5	718							
	1999.09-	2003.08	-	L	F	MPV Engine K4J 714/K4J 750	250358	Drive Shaft	44T	21	29.95	57	84	646							
	1999.09-	2003.08	MT	R	F	MPV Engine K4J 714/K4J 750	250173	Drive Shaft		21	23	57	84.5	742.9							
	1999.09-	2003.08	-	R	F	MPV Engine K4J 714/K4J 750	250284	Drive Shaft	44T	21	23	56.2	83.5	740.5							
1.6 (75 kW)	2001.03-	2003.08	AT	-	-	MPV Engine K4M 708/K4M 709	250492	Drive Shaft	44T	23	23	57.5	86.5	779							
1.6 (79 kW)	1999.09-	2003.09	MT	L	F	MPV Engine K4M 700/K4M 706	250311	Drive Shaft	44T	23	29.95	56	82	650							
	1999.09-	2003.09	MT	-	F	MPV Engine K4M 700/K4M 706	850058	Outer Joint	44T	23	35	57	87	71	I						
	1999.09-	2003.09	MT	R	F	MPV Engine K4M 700/K4M 706	650008	Inner Joint		23	30	36.3	52.2	68.5							
	1999.09-	2003.09	MT	-	F	MPV Engine K4M 700/K4M 706	850052	Outer Joint	44T	23	30	57.5	86.5	58.5	I						
	1999.09-	2003.09	AT	L	F	MPV Engine K4M 700/K4M 706	250253	Drive Shaft	44T	23	26	57.5	86.5	634							
	1999.09-	2003.09	AT	R	F	MPV Engine K4M 700/K4M 706	250323	Drive Shaft	44T	23	23	57.5	86.5	778							
	1999.09-	2003.09	MT	R	F	MPV Engine K4M 700/K4M 706	250159	Drive Shaft	44T	23	23	57	87	748							
	1999.09-	2003.09	MT	R	F	MPV Engine K4M 700/K4M 706	250325	Drive Shaft	44T	23	23	56.3	85	744							
	1999.09-	2003.09	MT	L	F	MPV Engine K4M 700/K4M 706	250203	Drive Shaft	44T	23	29.95	56.2	83.5	665							
1.6 (81 kW)	2001.06-	2003.09	MT	-	F	MPV Engine K4M 700/K4M 701/K4M 708	850058	Outer Joint	44T	23	35	57	87	71	I						
	2001.06-	2003.09	MT	-	F	MPV Engine K4M 700/K4M 701/K4M 708	850052	Outer Joint	44T	23	30	57.5	86.5	58.5	I						
	2001.06-	2003.09	MT	L	F	MPV Engine K4M 700/K4M 701/K4M 708	250203	Drive Shaft	44T	23	29.95	56.2	83.5	665							
1.6 16V (85 kW)	1999.09-	2003.08	MT	-	F	MPV	850058	Outer Joint	44T	23	35	57	87	71	I						
	1999.09-	2003.08	MT	-	F	MPV	850052	Outer Joint	44T	23	30	57.5	86.5	58.5	I						
	1999.09-	2003.08	MT	R	F	MPV	650008	Inner Joint		23	30	36.3	52.2	68.5							
	1999.09-	2003.08	MT	R	F	MPV	250159	Drive Shaft	44T	23	23	57	87	748							
	1999.09-	2003.08	MT	L	F	MPV	250203	Drive Shaft	44T	23	29.95	56.2	83.5	665							
1.6 BiFuel (79 kW)	1999.09-	2001.04	-	L	F	MPV Engine K4M 704/K4M 712	250311	Drive Shaft	44T	23	29.95	56	82	650							
	1999.09-	2001.04	MT	-	F	MPV Engine K4M 704/K4M 712	850058	Outer Joint	44T	23	35	57	87	71	I						
	1999.09-	2001.04	MT	R	F	MPV Engine K4M 704/K4M 712	650008	Inner Joint		23	30	36.3	52.2	68.5							
	1999.09-	2001.04	MT	-	F	MPV Engine K4M 704/K4M 712	850052	Outer Joint	44T	23	30	57.5	86.5	58.5	I						
	1999.09-	2001.04	MT	R	F	MPV Engine K4M 704/K4M 712	250159	Drive Shaft	44T	23	23	57	87	748							
	1999.09-	2001.04	-	R	F	MPV Engine K4M 704/K4M 712	250325	Drive Shaft	44T	23	23	56.3	85	744							
	1999.09-	2001.04	MT	L	F	MPV Engine K4M 704/K4M 712	250203	Drive Shaft	44T	23	29.95	56.2	83.5	665							
1.8 (85 kW)	2000.07-	2001.04	MT	L	F	All-wheel Drive MPV Engine F4P 722	250160	Drive Shaft	44T	23	29.95	57	87	656.5							
	2000.07-	2001.04	MT	R	F	All-wheel Drive MPV Engine F4P 722	250325	Drive Shaft	44T	23	23	56.3	85	744							
1.8 16V (85 kW)	2001.01-	2003.08	-	-	F	MPV Engine F4P 720/F4P 722	850058	Outer Joint	44T	23	35	57	87	71	I						
	2001.01-	2003.08	-	-	F	MPV Engine F4P 720/F4P 722	850052	Outer Joint	44T	23	30	57.5	86.5	58.5	I						
	2001.01-	2003.08	-	R	F	MPV Engine F4P 720/F4P 722	699131	Inner Joint		23	28	35	142	86							
	2001.01-	2003.08	-	L	F	MPV Engine F4P 720/F4P 722	250160	Drive Shaft	44T	23	29.95	57	87	656.5							
	2001.01-	2003.08	MT	L	F	MPV Engine F4P 720/F4P 722	250203	Drive Shaft	44T	23	29.95	56.2	83.5	665							
	2001.01-	2003.08	-	R	F	MPV Engine F4P 720/F4P 722	250313	Drive Shaft	44T	23	23	57.5	86.5	750							
	2001.01-	2003.08	AT/MT	L/R	F	MPV Engine F4P 720/F4P 722	850114	Outer Joint	44T	23	35	57.5	87	71	I						
1.9 D (47 kW)	1999.09-	2001.03	-	L	F	MPV Engine F8Q 790	250311	Drive Shaft	44T	23	29.95	56	82	650							
	1999.09-	2001.03	-	R	F	MPV Engine F8Q 790	250320	Drive Shaft	44T	23	23	56.8	84	755							
	1999.09-	2001.03	-	R	F	MPV Engine F8Q 790	650079	Inner Joint		23	22	36.3	50	55.5							
	1999.09-	2001.03	MT	L	F	MPV Engine F8Q 790	250203	Drive Shaft	44T	23	29.95	56.2	83.5	665							
1.9 dCi (75 kW)	1999.09-	2003.08	MT	-	F	MPV Engine F9Q 732/F9Q 733	850058	Outer Joint	44T	23	35	57	87	71	I						
	1999.09-	2003.08	MT	L/R	F	MPV Engine F9Q 732/F9Q 733	850069	Outer Joint	44T	23	30	57.5	86.5	58.5	I						
	1999.09-	2003.08	AT/MT	-	F	MPV Engine F9Q 732/F9Q 733	850052	Outer Joint	44T	23	30	57.5	86.5	58.5	I						
	1999.09-	2003.08	MT	R	F	MPV Engine F9Q 732/F9Q 733	650008	Inner Joint		23	30	36.3	52.2	68.5							
	1999.09-	2003.08	AT	L	F	MPV Engine F9Q 732/F9Q 733	250253	Drive Shaft	44T	23	26	57.5	86.5	634							
	1999.09-	2003.08	MT	R	F	MPV Engine F9Q 732/F9Q 733	250159	Drive Shaft	44T	23	23	57	87	748							
	1999.09-	2003.08	-	L	F	MPV Engine F9Q 732/F9Q 733	250220	Drive Shaft	44T	23	29.95	57.5	86.5	655							

REMARKS	YEAR	TRANSM	L/R	F/R	GSP Ref.	PRODUCT	ABS	Technical Specifications						
								A	B	C	H	L	P	
RENAULT														
SCENIC I (JA0/1_ FA0_)														
1.9 dCi (75 kW)	1999.09-2003.08	MT	L	F	MPV Engine F9Q 732/F9Q 733	250314	Drive Shaft	44T	23	29.95	57.5	86.5	654	
	1999.09-2003.08	-	R	F	MPV Engine F9Q 732/F9Q 733	250517	Drive Shaft	44T	23	23	57.5	86	779	
1.9 dCi RX4 (74 kW)	2002.12-2003.08	-	L	F	All-wheel Drive MPV Engine F9Q 732/F9Q 748/F9Q 796	250324	Drive Shaft	44T	23	29.95	58.8	85	681	
	2002.12-2003.08	-	R	F	All-wheel Drive MPV Engine F9Q 732/F9Q 748/F9Q 796	250389	Drive Shaft	44T	23	23	56.2	83.5	778	
	2002.12-2003.08	-	R	F	All-wheel Drive MPV Engine F9Q 732/F9Q 748/F9Q 796	650079	Inner Joint		23	22	36.3	50	55.5	
	2002.12-2003.08	-	-	F	All-wheel Drive MPV Engine F9Q 732/F9Q 748/F9Q 796	899283	Outer Joint	44T	23	23	58.8	85	61	M
	2002.12-2003.08	-	-	F	All-wheel Drive MPV Engine F9Q 732/F9Q 748/F9Q 796	850107	Outer Joint	44T	23	25	56.2	83.5	58	O
	2002.12-2003.08	MT	R	F	All-wheel Drive MPV Engine F9Q 732/F9Q 748/F9Q 796	250254	Drive Shaft	44T	23	23	56.2	83.5	762	
1.9 dCi RX4 (75 kW)	2000.11-2003.08	-	-	R	All-wheel Drive MPV Engine F9Q 740	801059	Outer Joint	44T	23	22	56.8	84	55.5	I
	2000.11-2003.08	-	L	F	All-wheel Drive MPV Engine F9Q 740	250324	Drive Shaft	44T	23	29.95	58.8	85	681	
	2000.11-2003.08	-	R	F	All-wheel Drive MPV Engine F9Q 740	250389	Drive Shaft	44T	23	23	56.2	83.5	778	
	2000.11-2003.08	-	R	F	All-wheel Drive MPV Engine F9Q 740	650079	Inner Joint		23	22	36.3	50	55.5	
	2000.11-2003.08	-	-	F	All-wheel Drive MPV Engine F9Q 740	899283	Outer Joint	44T	23	23	58.8	85	61	M
	2000.11-2003.08	-	-	F	All-wheel Drive MPV Engine F9Q 740	850107	Outer Joint	44T	23	25	56.2	83.5	58	O
	2000.11-2003.08	MT	R	F	All-wheel Drive MPV Engine F9Q 740	250254	Drive Shaft	44T	23	23	56.2	83.5	762	
1.9 dTi (59 kW)	2001.02-2003.08	-	L	F	MPV Engine F9Q 744	250311	Drive Shaft	44T	23	29.95	56	82	650	
	2001.02-2003.08	MT	L/R	F	MPV Engine F9Q 744	850069	Outer Joint	44T	23	30	57.5	86.5	58.5	I
	2001.02-2003.08	-	-	F	MPV Engine F9Q 744	850058	Outer Joint	44T	23	35	57	87	71	I
	2001.02-2003.08	-	-	F	MPV Engine F9Q 744	850052	Outer Joint	44T	23	30	57.5	86.5	58.5	I
	2001.02-2003.08	MT	R	F	MPV Engine F9Q 744	250159	Drive Shaft	44T	23	23	57	87	748	
	2001.02-2003.08	-	R	F	MPV Engine F9Q 744	250039	Drive Shaft	44T	23	23	57.5	86.5	748	
	2001.02-2003.08	-	R	F	MPV Engine F9Q 744	650008	Inner Joint		23	30	36.3	52.2	68.5	
	2001.02-2003.08	MT	L	F	MPV Engine F9Q 744	250203	Drive Shaft	44T	23	29.95	56.2	83.5	665	
	2001.02-2003.08	-	R	F	MPV Engine F9Q 744	250313	Drive Shaft	44T	23	23	57.5	86.5	750	
1.9 dTi (72 kW)	1999.09-2003.08	MT	-	F	MPV Engine F9Q 731/F9Q 734/F9Q 736	850058	Outer Joint	44T	23	35	57	87	71	I
	1999.09-2003.08	-	-	-	MPV Engine F9Q 731/F9Q 734/F9Q 736	850051	Outer Joint	48T	23	25	56.3	80	58	O
	1999.09-2003.08	AT/MT	-	F	MPV Engine F9Q 731/F9Q 734/F9Q 736	850052	Outer Joint	44T	23	30	57.5	86.5	58.5	I
	1999.09-2003.08	MT	L/R	F	MPV Engine F9Q 731/F9Q 734/F9Q 736	850026	Outer Joint		23	25	56.2	83.5	58	O
	1999.09-2003.08	AT	L	F	MPV Engine F9Q 731/F9Q 734/F9Q 736	250253	Drive Shaft	44T	23	26	57.5	86.5	634	
	1999.09-2003.08	MT	R	F	MPV Engine F9Q 731/F9Q 734/F9Q 736	250159	Drive Shaft	44T	23	23	57	87	748	
	1999.09-2003.08	MT	R	F	MPV Engine F9Q 731/F9Q 734/F9Q 736	250039	Drive Shaft	44T	23	23	57.5	86.5	748	
	1999.09-2003.08	MT	L	F	MPV Engine F9Q 731/F9Q 734/F9Q 736	250314	Drive Shaft	44T	23	29.95	57.5	86.5	654	
	1999.09-2003.08	-	L	F	MPV Engine F9Q 731/F9Q 734/F9Q 736	250220	Drive Shaft	44T	23	29.95	57.5	86.5	655	
	1999.09-2003.08	MT	R	F	MPV Engine F9Q 731/F9Q 734/F9Q 736	650008	Inner Joint		23	30	36.3	52.2	68.5	
	1999.09-2003.08	MT	L	F	MPV Engine F9Q 731/F9Q 734/F9Q 736	250203	Drive Shaft	44T	23	29.95	56.2	83.5	665	
	2000.07-2003.08	MT	-	F	MPV Engine F4R 740/F4R 741/F4R 746	850058	Outer Joint	44T	23	35	57	87	71	I
	2000.07-2003.08	AT/MT	-	F	MPV Engine F4R 740/F4R 741/F4R 746	850052	Outer Joint	44T	23	30	57.5	86.5	58.5	I
2000.07-2003.08	MT	R	F	MPV Engine F4R 740/F4R 741/F4R 746	650008	Inner Joint		23	30	36.3	52.2	68.5		
2000.07-2003.08	AT	L	F	MPV Engine F4R 740/F4R 741/F4R 746	250253	Drive Shaft	44T	23	26	57.5	86.5	634		
2000.07-2003.08	MT	L	F	MPV Engine F4R 740/F4R 741/F4R 746	250160	Drive Shaft	44T	23	29.95	57	87	656.5		
2000.07-2003.08	MT	R	F	MPV Engine F4R 740/F4R 741/F4R 746	250159	Drive Shaft	44T	23	23	57	87	748		
2000.07-2003.08	MT	R	F	MPV Engine F4R 740/F4R 741/F4R 746	250325	Drive Shaft	44T	23	23	56.3	85	744		
2000.07-2003.08	-	-	F	MPV Engine F4R 740/F4R 741/F4R 746	850107	Outer Joint	44T	23	25	56.2	83.5	58	O	
2000.07-2003.08	AT/MT	L/R	F	MPV Engine F4R 740/F4R 741/F4R 746	850114	Outer Joint	44T	23	35	57.5	87	71	I	
2.0 16V (102 kW)	1999.09-2003.08	MT	-	F	MPV Engine F4R 740/F4R 741/F4R 744/F4R 747	850058	Outer Joint	44T	23	35	57	87	71	I
	1999.09-2003.08	AT/MT	-	F	MPV Engine F4R 740/F4R 741/F4R 744/F4R 747	850052	Outer Joint	44T	23	30	57.5	86.5	58.5	I
	1999.09-2003.08	MT	R	F	MPV Engine F4R 740/F4R 741/F4R 744/F4R 747	650008	Inner Joint		23	30	36.3	52.2	68.5	
	1999.09-2003.08	AT	L	F	MPV Engine F4R 740/F4R 741/F4R 744/F4R 747	250253	Drive Shaft	44T	23	26	57.5	86.5	634	
	1999.09-2003.08	MT	L	F	MPV Engine F4R 740/F4R 741/F4R 744/F4R 747	250160	Drive Shaft	44T	23	29.95	57	87	656.5	
	1999.09-2003.08	MT	R	F	MPV Engine F4R 740/F4R 741/F4R 744/F4R 747	250159	Drive Shaft	44T	23	23	57	87	748	
	1999.09-2003.08	MT	R	F	MPV Engine F4R 740/F4R 741/F4R 744/F4R 747	250325	Drive Shaft	44T	23	23	56.3	85	744	
	1999.09-2003.08	-	-	F	MPV Engine F4R 740/F4R 741/F4R 744/F4R 747	850107	Outer Joint	44T	23	25	56.2	83.5	58	O
	1999.09-2003.08	AT	L	F	MPV Engine F4R 740/F4R 741/F4R 744/F4R 747	250433	Drive Shaft	44T	23	26	57.5	86	635	
2.0 16V RX4 (102 kW)	2000.06-2003.08	-	-	R	All-wheel Drive MPV Engine F4R 744/F4R 746	801059	Outer Joint	44T	23	22	56.8	84	55.5	I
	2000.06-2003.08	-	L/R	R	All-wheel Drive MPV Engine F4R 744/F4R 746	250634	Drive Shaft	44T	23	24	56.8	84	775	
	2000.06-2003.08	MT	L	F	All-wheel Drive MPV Engine F4R 744/F4R 746	250324	Drive Shaft	44T	23	29.95	58.8	85	681	
	2000.06-2003.08	MT	R	F	All-wheel Drive MPV Engine F4R 744/F4R 746	250389	Drive Shaft	44T	23	23	56.2	83.5	778	
	2000.06-2003.08	MT	R	F	All-wheel Drive MPV Engine F4R 744/F4R 746	650079	Inner Joint		23	22	36.3	50	55.5	
	2000.06-2003.08	-	-	F	All-wheel Drive MPV Engine F4R 744/F4R 746	899283	Outer Joint	44T	23	23	58.8	85	61	M
	2000.06-2003.08	-	-	F	All-wheel Drive MPV Engine F4R 744/F4R 746	850107	Outer Joint	44T	23	25	56.2	83.5	58	O
	2000.06-2003.08	AT	L	F	All-wheel Drive MPV Engine F4R 744/F4R 746	250433	Drive Shaft	44T	23	26	57.5	86	635	
	2000.06-2003.08	AT	L/R	F	All-wheel Drive MPV Engine F4R 744/F4R 746	850114	Outer Joint	44T	23	35	57.5	87	71	I
	2000.06-2003.08	MT	R	F	All-wheel Drive MPV Engine F4R 744/F4R 746	250254	Drive Shaft	44T	23	23	56.2	83.5	762	
	SCENIC II													
1.6	1999.06-2001.03	MT	R	F	-	250091	Drive Shaft	44T	23	23	56.2	83.5	744	
1.8	2000.07-2003.03	MT	R	F	-	250091	Drive Shaft	44T	23	23	56.2	83.5	744	

	 YEAR	TRANSM	L/R	F/R	REMARKS	GSP Ref.	 PRODUCT	 ABS	Technical Specifications					
									A	B	C	H	L	P
RENAULT														
SCENIC II														
1.9 DCi/DTi	1999.06-2001.01	MT	R	F	-	250091	Drive Shaft	44T	23	23	56.2	83.5	744	
2.0 16V	1999.06-2004.02	MT	R	F	-	250091	Drive Shaft	44T	23	23	56.2	83.5	744	
SCENIC II (JM0/1)														
1.4 (72 kW)	2003.06-	-	-	-	-	850124	Outer Joint		25	22	52.6	88	55	I
1.5 DCi (76 kW)	2005.05-	MT	-	-	-	850124	Outer Joint		25	22	52.6	88	55	I
1.5 DCi (78 kW)	2005.05-	MT	-	-	-	850124	Outer Joint		25	22	52.6	88	55	I
1.6 (77 kW)	2006.06-2009	-	-	-	-	850124	Outer Joint		25	22	52.6	88	55	I
1.6 16V (82 kW)	2007.01-	-	-	-	-	850124	Outer Joint		25	22	52.6	88	55	I
SCENIC II (JM0/1_)														
1.4 (72 kW)	2003.06-	5MT	L	F	MPV Engine K4J 730/K4J 740/K4J 770	250494	Drive Shaft		25	26	52.6	88	664	
	2003.06-	MT	-	F	MPV Engine K4J 730/K4J 740/K4J 770	850116	Outer Joint		25	22	52.6	88	55	I
	2003.06-	5MT	R	F	MPV Engine K4J 730/K4J 740/K4J 770	699169	Inner Joint		26	30	33	326	95	
	2003.06-	MT	L	F	MPV Engine K4J 730/K4J 740/K4J 770	250350	Drive Shaft		25	26	52.6	88	668.5	
1.5 dCi (60 kW)	2003.06-	MT	L	F	MPV Engine K9K 722	250402	Drive Shaft		25	26	53	88	660	
	2003.06-	MT	L	F	MPV Engine K9K 722	250403	Drive Shaft		25	26	52.6	88	674	
	2003.06-	MT	R	F	MPV Engine K9K 722	250348	Drive Shaft		25	26	53	88	905	
	2003.06-	MT	R	F	MPV Engine K9K 722	250442	Drive Shaft		25	26	52.6	88	911	
	2003.06-	MT	R	F	MPV Engine K9K 722	250495	Drive Shaft		25	26	52.6	88	914	
	2003.06-	MT	R	F	MPV Engine K9K 722	699169	Inner Joint		26	30	33	326	95	
	2003.06-	MT	L	F	MPV Engine K9K 722	250350	Drive Shaft		25	26	52.6	88	668.5	
	2003.06-	-	-	F	MPV Engine K9K 722	850093	Outer Joint		25	30	52.6	88	58	I
1.5 dCi (74 kW)	2003.11-	MT	L	F	MPV Engine K9K 728/K9K 729	250402	Drive Shaft		25	26	53	88	660	
	2003.11-	MT	L	F	MPV Engine K9K 728/K9K 729	250403	Drive Shaft		25	26	52.6	88	674	
	2003.11-	MT	R	F	MPV Engine K9K 728/K9K 729	250348	Drive Shaft		25	26	53	88	905	
	2003.11-	MT	R	F	MPV Engine K9K 728/K9K 729	250442	Drive Shaft		25	26	52.6	88	911	
	2003.11-	MT	R	F	MPV Engine K9K 728/K9K 729	250495	Drive Shaft		25	26	52.6	88	914	
	2003.11-	MT	R	F	MPV Engine K9K 728/K9K 729	699169	Inner Joint		26	30	33	326	95	
	2003.11-	MT	L	F	MPV Engine K9K 728/K9K 729	250350	Drive Shaft		25	26	52.6	88	668.5	
	2003.11-	-	-	F	MPV Engine K9K 728/K9K 729	850093	Outer Joint		25	30	52.6	88	58	I
1.5 dCi (63 kW)	2005.05-	MT	L	F	MPV Engine K9K 724	250402	Drive Shaft		25	26	53	88	660	
	2005.05-	MT	L	F	MPV Engine K9K 724	250403	Drive Shaft		25	26	52.6	88	674	
	2005.05-	MT	R	F	MPV Engine K9K 724	250348	Drive Shaft		25	26	53	88	905	
	2005.05-	MT	R	F	MPV Engine K9K 724	250442	Drive Shaft		25	26	52.6	88	911	
	2005.05-	MT	R	F	MPV Engine K9K 724	250495	Drive Shaft		25	26	52.6	88	914	
	2005.05-	MT	R	F	MPV Engine K9K 724	699169	Inner Joint		26	30	33	326	95	
	2005.05-	-	-	F	MPV Engine K9K 724	850093	Outer Joint		25	30	52.6	88	58	I
	2005.05-	MT	L	F	MPV Engine K9K 724	250350	Drive Shaft		25	26	52.6	88	668.5	
1.5 dCi (76 kW)	2007.01-	MT	L	F	MPV Engine K9K 734	250402	Drive Shaft		25	26	53	88	660	
	2007.01-	MT	L	F	MPV Engine K9K 734	250403	Drive Shaft		25	26	52.6	88	674	
	2007.01-	MT	R	F	MPV Engine K9K 734	250348	Drive Shaft		25	26	53	88	905	
	2007.01-	MT	R	F	MPV Engine K9K 734	250442	Drive Shaft		25	26	52.6	88	911	
	2007.01-	MT	R	F	MPV Engine K9K 734	250495	Drive Shaft		25	26	52.6	88	914	
	2007.01-	MT	R	F	MPV Engine K9K 734	699169	Inner Joint		26	30	33	326	95	
	2007.01-	MT	-	F	MPV Engine K9K 734	899213	Outer Joint		25	33	53	88	61.5	I
	2007.01-	-	-	F	MPV Engine K9K 734	850093	Outer Joint		25	30	52.6	88	58	I
1.5 dCi (78 kW)	2005.05-	MT	L	F	MPV Engine K9K 732	250402	Drive Shaft		25	26	53	88	660	
	2005.05-	MT	L	F	MPV Engine K9K 732	250403	Drive Shaft		25	26	52.6	88	674	
	2005.05-	MT	R	F	MPV Engine K9K 732	250348	Drive Shaft		25	26	53	88	905	
	2005.05-	MT	R	F	MPV Engine K9K 732	250442	Drive Shaft		25	26	52.6	88	911	
	2005.05-	MT	R	F	MPV Engine K9K 732	250495	Drive Shaft		25	26	52.6	88	914	
	2005.05-	MT	-	F	MPV Engine K9K 732	899213	Outer Joint		25	33	53	88	61.5	I
	2005.05-	MT	R	F	MPV Engine K9K 732	699169	Inner Joint		26	30	33	326	95	
	2005.05-	MT	L	F	MPV Engine K9K 732	250350	Drive Shaft		25	26	52.6	88	668.5	
1.6 (83 kW)	2003.06-	MT	L	F	MPV Engine K4M 761/K4M 782	250494	Drive Shaft		25	26	52.6	88	664	
	2003.06-	MT	-	F	MPV Engine K4M 761/K4M 782	850116	Outer Joint		25	22	52.6	88	55	I
	2003.06-	MT	R	F	MPV Engine K4M 761/K4M 782	699169	Inner Joint		26	30	33	326	95	
	2003.06-	AT	R	F	MPV Engine K4M 761/K4M 782	250386	Drive Shaft		25	23	52.6	88	806	
	2003.06-	MT	L	F	MPV Engine K4M 761/K4M 782	250350	Drive Shaft		25	26	52.6	88	668.5	
	2003.06-	-	-	F	MPV Engine K4M 761/K4M 782	850093	Outer Joint		25	30	52.6	88	58	I
1.6 16V (82 kW)	2005.10-	-	L	F	MPV Engine K4M 706/K4M 766/K4M 812/K4M 813	250494	Drive Shaft		25	26	52.6	88	664	
	2005.10-	MT	-	F	MPV Engine K4M 706/K4M 766/K4M 812/K4M 813	850116	Outer Joint		25	22	52.6	88	55	I
	2005.10-	-	R	F	MPV Engine K4M 706/K4M 766/K4M 812/K4M 813	699169	Inner Joint		26	30	33	326	95	
	2005.10-	-	R	F	MPV Engine K4M 706/K4M 766/K4M 812/K4M 813	250386	Drive Shaft		25	23	52.6	88	806	
	2005.10-	-	F	F	MPV Engine K4M 706/K4M 766/K4M 812/K4M 813	850093	Outer Joint		25	30	52.6	88	58	I
	2005.10-	MT	L	F	MPV Engine K4M 706/K4M 766/K4M 812/K4M 813	250350	Drive Shaft		25	26	52.6	88	668.5	





REMARKS	YEAR	TRANSM	L/R	F/R	GSP Ref.	PRODUCT	ABS	Technical Specifications						
								A	B	C	H	L	P	
RENAULT SCENIC II (JM0/1_)														
1.9 D (85 kW)	2006.06-	-	AT/MT	R	F	MPV Engine F9Q 812/F9Q J 803	250400	Drive Shaft	25	39	53	88	932	
	2006.06-	-	AT/MT	L	F	MPV Engine F9Q 812/F9Q J 803	699150	Inner Joint	39	32	39	66	104.5	
	2006.06-	-	AT/MT	L	F	MPV Engine F9Q 812/F9Q J 803	299201	Drive Shaft	25	39	53	88	638	
	2006.06-	-	AT/MT	R	F	MPV Engine F9Q 812/F9Q J 803	699160	Inner Joint	39	32	33	352	90	
1.9 dCi (81 kW)	2005.05-	-	AT/MT	R	F	MPV Engine F9Q 804	250400	Drive Shaft	25	39	53	88	932	
	2005.05-	-	AT/MT	L	F	MPV Engine F9Q 804	699150	Inner Joint	39	32	39	66	104.5	
	2005.05-	-	AT	L	F	MPV Engine F9Q 804	299186	Drive Shaft	25	26	52.6	88	669	
	2005.05-	-	AT/MT	L	F	MPV Engine F9Q 804	299201	Drive Shaft	25	39	53	88	638	
	2005.05-	-	MT	-	F	MPV Engine F9Q 804	899213	Outer Joint	25	33	53	88	61.5	I
	2005.05-	-	AT/MT	R	F	MPV Engine F9Q 804	699160	Inner Joint	39	32	33	352	90	
1.9 dCi (88 kW)	2003.06-	-	AT	-	F	MPV Engine F9Q 812	850109	Outer Joint	23	33	49	86.5	61	I
	2003.06-	-	AT/MT	R	F	MPV Engine F9Q 812	250400	Drive Shaft	25	39	53	88	932	
	2003.06-	-	AT/MT	L	F	MPV Engine F9Q 812	699150	Inner Joint	39	32	39	66	104.5	
	2003.06-	-	AT/MT	L	F	MPV Engine F9Q 812	299201	Drive Shaft	25	39	53	88	638	
	2003.06-	-	MT	-	F	MPV Engine F9Q 812	899213	Outer Joint	25	33	53	88	61.5	I
	2003.06-	-	AT/MT	R	F	MPV Engine F9Q 812	699160	Inner Joint	39	32	33	352	90	
1.9 dCi (92 kW)	2003.06-	-	AT/MT	R	F	MPV Engine F9Q 804	250400	Drive Shaft	25	39	53	88	932	
	2003.06-	-	AT/MT	L	F	MPV Engine F9Q 804	699150	Inner Joint	39	32	39	66	104.5	
	2003.06-	-	AT/MT	L	F	MPV Engine F9Q 804	299201	Drive Shaft	25	39	53	88	638	
	2003.06-	-	AT/MT	R	F	MPV Engine F9Q 804	699160	Inner Joint	39	32	33	352	90	
1.9 dCi (96 kW)	2005.05-	-	AT/MT	R	F	MPV Engine F9Q 804/F9Q 816/F9Q 818/F9Q J 803	250400	Drive Shaft	25	39	53	88	932	
	2005.05-	-	AT/MT	L	F	MPV Engine F9Q 804/F9Q 816/F9Q 818/F9Q J 803	699150	Inner Joint	39	32	39	66	104.5	
	2005.05-	-	AT/MT	L	F	MPV Engine F9Q 804/F9Q 816/F9Q 818/F9Q J 803	299201	Drive Shaft	25	39	53	88	638	
	2005.05-	-	MT	-	F	MPV Engine F9Q 804/F9Q 816/F9Q 818/F9Q J 803	899213	Outer Joint	25	33	53	88	61.5	I
	2005.05-	-	AT/MT	R	F	MPV Engine F9Q 804/F9Q 816/F9Q 818/F9Q J 803	699160	Inner Joint	39	32	33	352	90	
1.9 dCi 130 (97 kW)	2005.10-2009.12	-	-	R	F	MPV Engine F9Q 804	250400	Drive Shaft	25	39	53	88	932	
	2005.10-2009.12	-	-	L	F	MPV Engine F9Q 804	699150	Inner Joint	39	32	39	66	104.5	
	2005.10-2009.12	-	-	L	F	MPV Engine F9Q 804	299201	Drive Shaft	25	39	53	88	638	
	2005.10-2009.12	-	-	R	F	MPV Engine F9Q 804	699160	Inner Joint	39	32	33	352	90	
2.0 (99 kW)	2003.06-	-	MT	R	F	MPV Engine F4R 770/F4R 771	250400	Drive Shaft	25	39	53	88	932	
	2003.06-	-	AT	-	F	MPV Engine F4R 770/F4R 771	850137	Outer Joint	25	32	52.6	88	58	I
	2003.06-	-	MT	L	F	MPV Engine F4R 770/F4R 771	699150	Inner Joint	39	32	39	66	104.5	
	2003.06-	-	-	L	F	MPV Engine F4R 770/F4R 771	299186	Drive Shaft	25	26	52.6	88	669	
	2003.06-	-	-	R	F	MPV Engine F4R 770/F4R 771	250399	Drive Shaft	25	23	52.6	88	803	
	2003.06-	-	MT	L	F	MPV Engine F4R 770/F4R 771	299201	Drive Shaft	25	39	53	88	638	
	2003.06-	-	MT	-	F	MPV Engine F4R 770/F4R 771	899213	Outer Joint	25	33	53	88	61.5	I
	2003.06-	-	MT	R	F	MPV Engine F4R 770/F4R 771	699160	Inner Joint	39	32	33	352	90	
2.0 16V Turbo (120 kW)	2004.05-	-	AT/MT	R	F	MPV Engine F4R 776	250400	Drive Shaft	25	39	53	88	932	
	2004.05-	-	AT/MT	L	F	MPV Engine F4R 776	699150	Inner Joint	39	32	39	66	104.5	
	2004.05-	-	AT/MT	L	F	MPV Engine F4R 776	299201	Drive Shaft	25	39	53	88	638	
	2004.05-	-	MT	-	F	MPV Engine F4R 776	899213	Outer Joint	25	33	53	88	61.5	I
	2004.05-	-	AT/MT	R	F	MPV Engine F4R 776	699160	Inner Joint	39	32	33	352	90	
2.0 dCi (110 kW)	2005.09-	-	AT/MT	R	F	MPV Engine M9R 700	650087	Inner Joint	39	35	30	367	89.5	
	2005.09-	-	AT/MT	R	F	MPV Engine M9R 700	250453	Drive Shaft	27	39	56.5	90.5	973.5	
	2005.09-	-	AT/MT	L	F	MPV Engine M9R 700	250444	Drive Shaft	27	39	56.5	90.5	626	
SCENIC III (JZ0/1_)														
1.2 TCe (97 kW)	2013.01-	-	-	-	F	MPV Engine H5F 404	850163	Outer Joint	25	23	52.4	88.5	61	M
1.2 TCe (85 kW)	2012.04-	-	-	-	F	MPV Engine H5F 400	850163	Outer Joint	25	23	52.4	88.5	61	M
1.4 16V (96 kW)	2009.02-	-	-	R	F	MPV Engine H4J 700	250604	Drive Shaft	25	26	52.6	89	942	
	2009.02-	-	6MT	-	-	MPV Engine H4J 700	850157	Outer Joint	25	33	52.6	89	60	I
1.5 dCi (63 kW)	2009.04-	-	-	-	F	MPV Engine K9K 830	899213	Outer Joint	25	33	53	88	61.5	I
	2009.04-	-	-	R	F	MPV Engine K9K 830	250425	Drive Shaft	25	26	52.7	88.5	931	
	2009.04-	-	-	L	F	MPV Engine K9K 830	250426	Drive Shaft	25	26	52.7	88.5	680	
1.5 dCi (70 kW)	2010.11-	-	-	R	F	MPV Engine K9K 846	250604	Drive Shaft	25	26	52.6	89	942	
	2010.11-	-	MT	R	F	MPV Engine K9K 846	250425	Drive Shaft	25	26	52.7	88.5	931	
	2010.11-	-	-	L	F	MPV Engine K9K 846	250426	Drive Shaft	25	26	52.7	88.5	680	
	2010.11-	-	MT	-	F	MPV Engine K9K 846	899213	Outer Joint	25	33	53	88	61.5	I
1.5 dCi (78 kW)	2009.02-	-	-	-	F	MPV Engine K9K 832	899213	Outer Joint	25	33	53	88	61.5	I
	2009.02-	-	-	R	F	MPV Engine K9K 832	250604	Drive Shaft	25	26	52.6	89	942	
	2009.02-	-	-	R	F	MPV Engine K9K 832	250425	Drive Shaft	25	26	52.7	88.5	931	
	2009.02-	-	-	L	F	MPV Engine K9K 832	250426	Drive Shaft	25	26	52.7	88.5	680	
	2009.02-	-	-	-	F	MPV Engine K9K 832	850145	Outer Joint	25	33	52.7	88.5	59.5	I
1.5 dCi (81 kW)	2009.04-	-	MT	R	F	MPV Engine K9K 636/K9K 656/K9K 657/K9K 836/K9K 837	250425	Drive Shaft	25	26	52.7	88.5	931	
	2009.04-	-	-	R	F	MPV Engine K9K 636/K9K 656/K9K 657/K9K 836/K9K 837	850148	Outer Joint	25	35	52.6	89	60	I
	2009.04-	-	MT	L	F	MPV Engine K9K 636/K9K 656/K9K 657/K9K 836/K9K 837	250426	Drive Shaft	25	26	52.7	88.5	680	
	2009.04-	-	-	-	F	MPV Engine K9K 636/K9K 656/K9K 657/K9K 836/K9K 837	850145	Outer Joint	25	33	52.7	88.5	59.5	I





RENAULT	YEAR	TRANSM	L/R	F/R	REMARKS	GSP Ref.	PRODUCT	ABS	Technical Specifications							
									A	B	C	H	L	P		
RENAULT																
SCENIC III (JZ0/1_)																
1.5 dCi (81 kW)	2009.04-	-	-	R	F	MPV Engine K9K 636/K9K 656/K9K 657/K9K 836/K9K 837	250536	Drive Shaft		25	34	52.6	89	984		
	2009.04-	-	-	L	F	MPV Engine K9K 636/K9K 656/K9K 657/K9K 836/K9K 837	250535	Drive Shaft		25	34	52.7	88.5	632		
	2009.04-	-	-	-	-	MPV Engine K9K 636/K9K 656/K9K 657/K9K 836/K9K 837	250610	Drive Shaft		25	34	52.7	88.5	1000		
	2009.04-	-	-	-	F	MPV Engine K9K 636/K9K 656/K9K 657/K9K 836/K9K 837	899213	Outer Joint		25	33	53	88	61.5	I	
1.6 16V (81 kW)	2009.02-	-	-	MT	R	F	MPV Engine K4M 858/K4M R 858	250510	Drive Shaft		25	26	52.4	88.5	929	
	2009.02-	-	-	MT	L/R	F	MPV Engine K4M 858/K4M R 858	850162	Outer Joint		25	23	52.5	88.5	60.5	M
	2009.02-	-	-	-	-	F	MPV Engine K4M 858/K4M R 858	850163	Outer Joint		25	23	52.4	88.5	61	M
1.6 16V Bifuel (79 kW)	2012.04-	-	-	MT	R	F	MPV Engine K4M 866	250510	Drive Shaft		25	26	52.4	88.5	929	
	2012.04-	-	-	-	-	F	MPV Engine K4M 866	850157	Outer Joint		25	33	52.6	89	60	I
	2012.04-	-	-	-	-	F	MPV Engine K4M 866	850163	Outer Joint		25	23	52.4	88.5	61	M
1.6 16V Bifuel (81 kW)	2009.02-	-	-	MT	R	F	MPV Engine K4M 866	250510	Drive Shaft		25	26	52.4	88.5	929	
	2009.02-	-	-	-	-	F	MPV Engine K4M 866	850157	Outer Joint		25	33	52.6	89	60	I
	2009.02-	-	-	-	-	F	MPV Engine K4M 866	850163	Outer Joint		25	23	52.4	88.5	61	M
1.6 dCi (96 kW)	2011.04-	-	-	-	R	F	MPV Engine R9M 402/R9M 404	250429	Drive Shaft		27	39	56.5	91.5	956	
	2011.04-	-	-	-	L/R	F	MPV Engine R9M 402/R9M 404	850160	Outer Joint		27	35	56.5	91.5	61	I
	2011.04-	-	-	6MT	-	-	MPV Engine R9M 402/R9M 404	850157	Outer Joint		25	33	52.6	89	60	I
1.6 E85 (81 kW)	2009.02-	-	-	-	-	F	MPV Engine K4M 866	850163	Outer Joint		25	23	52.4	88.5	61	M
	2009.02-	-	-	MT	R	F	MPV Engine K4M 866	250510	Drive Shaft		25	26	52.4	88.5	929	
1.9 dCi (96 kW)	2009.02-	-	-	-	R	F	MPV Engine F9Q 870/F9Q 872	250429	Drive Shaft		27	39	56.5	91.5	956	
	2009.02-	-	-	-	L/R	F	MPV Engine F9Q 870/F9Q 872	850160	Outer Joint		27	35	56.5	91.5	61	I
2.0 16V (103 kW)	2009.02-	-	-	MT	R	F	MPV Engine M4R 710/M4R 711/M4R 713	250604	Drive Shaft		25	26	52.6	89	942	
	2009.02-	-	-	AT	-	-	MPV Engine M4R 710/M4R 711/M4R 713	250433	Drive Shaft	44T	23	26	57.5	86	635	
2.0 dCi (110 kW)	2009.02-	-	-	AT	L	F	MPV Engine M9R 615	218274	Drive Shaft		27	30	56.5	90	624	
2.0 dCi (118 kW)	2009.04-	-	-	AT	L	F	MPV Engine M9R 610	218274	Drive Shaft		27	30	56.5	90	624	
SCENIC/J64																
-	2002-	-	-	AT	-	-	-	850053	Outer Joint		23	23	57	83	61	M
	2002-	-	-	MT	-	-	-	850053	Outer Joint		23	23	57	83	61	M
SUPER 5																
1.0 - 1.4/1.4/1.7	1984.10-	1996.12	-	MT	-	-	gear JB4/5	650059	Inner Joint		23	22	36.3	41	64.5	
SUPER 5 (B/C40_)																
1.1 (33 kW)	1986.01-	1995.03	-	MT	L	F	Hatchback Engine C1E 750/C1E 752/C1E 756/C1E 760	250024	Drive Shaft		21	29.95	46.4	81.5	599	
	1986.01-	1995.03	-	MT	R	F	Hatchback Engine C1E 750/C1E 752/C1E 756/C1E 760	250032	Drive Shaft		21	23	49.8	83.5	690	
	1986.01-	1995.03	-	-	L	F	Hatchback Engine C1E 750/C1E 752/C1E 756/C1E 760	250118	Drive Shaft		21	29.95	46.3	80.5	604.5	
	1986.01-	1995.03	-	-	R	F	Hatchback Engine C1E 750/C1E 752/C1E 756/C1E 760	250124	Drive Shaft		21	23	46.3	80.5	685	
	1986.01-	1995.03	-	MT	L	F	Hatchback Engine C1E 750/C1E 752/C1E 756/C1E 760	250025	Drive Shaft		21	29.95	46.2	82	612	
	1986.01-	1995.03	-	MT	R	F	Hatchback Engine C1E 750/C1E 752/C1E 756/C1E 760	250023	Drive Shaft		21	23	46.2	82	680	
	1986.01-	1995.03	-	-	L	F	Hatchback Engine C1E 750/C1E 752/C1E 756/C1E 760	250120	Drive Shaft		21	29.95	46.3	80.5	591.5	
	1986.01-	1995.03	-	3AT/MT	R	F	Hatchback Engine C1E 750/C1E 752/C1E 756/C1E 760	250044	Drive Shaft		21	23	46.4	81.5	693.5	
1.1 (35 kW)	1989.10-	1990.12	-	-	L	F	Hatchback Engine C1E 750	250120	Drive Shaft		21	29.95	46.3	80.5	591.5	
	1989.10-	1990.12	-	-	L	F	Hatchback Engine C1E 750	250118	Drive Shaft		21	29.95	46.3	80.5	604.5	
1.2 (40 kW)	1987.01-	1990.08	-	3AT/MT	R	F	Hatchback Engine C1G 702/C1G 720/C1G 722	250044	Drive Shaft		21	23	46.4	81.5	693.5	
	1987.01-	1990.08	-	-	L	F	Hatchback Engine C1G 702/C1G 720/C1G 722	250120	Drive Shaft		21	29.95	46.3	80.5	591.5	
	1987.01-	1990.08	-	MT	L	F	Hatchback Engine C1G 702/C1G 720/C1G 722	250024	Drive Shaft		21	29.95	46.4	81.5	599	
	1987.01-	1990.08	-	MT	R	F	Hatchback Engine C1G 702/C1G 720/C1G 722	250032	Drive Shaft		21	23	49.8	83.5	690	
	1987.01-	1990.08	-	-	L	F	Hatchback Engine C1G 702/C1G 720/C1G 722	250118	Drive Shaft		21	29.95	46.3	80.5	604.5	
	1987.01-	1990.08	-	-	R	F	Hatchback Engine C1G 702/C1G 720/C1G 722	250124	Drive Shaft		21	23	46.3	80.5	685	
	1987.01-	1990.08	-	MT	L	F	Hatchback Engine C1G 702/C1G 720/C1G 722	250025	Drive Shaft		21	29.95	46.2	82	612	
	1987.01-	1990.08	-	MT	R	F	Hatchback Engine C1G 702/C1G 720/C1G 722	250023	Drive Shaft		21	23	46.2	82	680	
1.4 (44 kW)	1987.06-	1990.08	-	MT	L	F	Hatchback Engine C2J 784	250024	Drive Shaft		21	29.95	46.4	81.5	599	
	1987.06-	1990.08	-	MT	R	F	Hatchback Engine C2J 784	250032	Drive Shaft		21	23	49.8	83.5	690	
	1987.06-	1990.08	-	-	L	F	Hatchback Engine C2J 784	250118	Drive Shaft		21	29.95	46.3	80.5	604.5	
	1987.06-	1990.08	-	-	R	F	Hatchback Engine C2J 784	250124	Drive Shaft		21	23	46.3	80.5	685	
	1987.06-	1990.08	-	MT	L	F	Hatchback Engine C2J 784	250025	Drive Shaft		21	29.95	46.2	82	612	
	1987.06-	1990.08	-	MT	R	F	Hatchback Engine C2J 784	250023	Drive Shaft		21	23	46.2	82	680	
	1987.06-	1990.08	-	-	L	F	Hatchback Engine C2J 784	250120	Drive Shaft		21	29.95	46.3	80.5	591.5	
	1987.06-	1990.08	-	3AT/MT	R	F	Hatchback Engine C2J 784	250044	Drive Shaft		21	23	46.4	81.5	693.5	
1.4 (49 kW)	1987.06-	1989.07	-	-	R	F	Hatchback Engine C2J 782	250124	Drive Shaft		21	23	46.3	80.5	685	
	1987.06-	1989.07	-	-	L	F	Hatchback Engine C2J 782	250118	Drive Shaft		21	29.95	46.3	80.5	604.5	
	1987.06-	1989.07	-	-	L	F	Hatchback Engine C2J 782	250120	Drive Shaft		21	29.95	46.3	80.5	591.5	
	1987.06-	1989.07	-	MT	L	F	Hatchback Engine C2J 782	250025	Drive Shaft		21	29.95	46.2	82	612	
	1987.06-	1989.07	-	MT	R	F	Hatchback Engine C2J 782	250023	Drive Shaft		21	23	46.2	82	680	
	1987.06-	1989.07	-	3AT/MT	R	F	Hatchback Engine C2J 782	250044	Drive Shaft		21	23	46.4	81.5	693.5	
	1987.06-	1989.07	-	MT	L	F	Hatchback Engine C2J 782	250024	Drive Shaft		21	29.95	46.4	81.5	599	
	1987.06-	1989.07	-	MT	R	F	Hatchback Engine C2J 782	250032	Drive Shaft		21	23	49.8	83.5	690	
1.4 (52 kW)	1984.10-	1989.07	-	-	R	F	Hatchback Engine C2J 700/C2J 780/C2J 781/C2J 788/C2J 789/C2J 798	250124	Drive Shaft		21	23	46.3	80.5	685	
	1984.10-	1989.07	-	-	L	F	Hatchback Engine C2J 700/C2J 780/C2J 781/C2J 788/C2J 789/C2J 798	250118	Drive Shaft		21	29.95	46.3	80.5	604.5	

REMARKS	YEAR	TRANSM	L/R	F/R	GSP Ref.	PRODUCT	ABS	Technical Specifications						
								A	B	C	H	L	P	
RENAULT SUPER 5 (B/C40_)														
1.4 (52 kW)	1984.10-1989.07	-	L	F	Hatchback Engine C2J 700/C2J 780/C2J 781/C2J 788/C2J 789/C2J 798	250120	Drive Shaft		21	29.95	46.3	80.5	591.5	
	1984.10-1989.07	MT	L	F	Hatchback Engine C2J 700/C2J 780/C2J 781/C2J 788/C2J 789/C2J 798	250025	Drive Shaft		21	29.95	46.2	82	612	
	1984.10-1989.07	MT	R	F	Hatchback Engine C2J 700/C2J 780/C2J 781/C2J 788/C2J 789/C2J 798	250023	Drive Shaft		21	23	46.2	82	680	
	1984.10-1989.07	3AT/MT	R	F	Hatchback Engine C2J 700/C2J 780/C2J 781/C2J 788/C2J 789/C2J 798	250044	Drive Shaft		21	23	46.4	81.5	693.5	
	1984.10-1989.07	MT	L	F	Hatchback Engine C2J 700/C2J 780/C2J 781/C2J 788/C2J 789/C2J 798	250024	Drive Shaft		21	29.95	46.4	81.5	599	
	1984.10-1989.07	MT	R	F	Hatchback Engine C2J 700/C2J 780/C2J 781/C2J 788/C2J 789/C2J 798	250032	Drive Shaft		21	23	49.8	83.5	690	
1.4 Cat (43 kW)	1985.10-1996.12	-	L	F	Hatchback Engine C3J 700/C3J 702/C3J 760	250120	Drive Shaft		21	29.95	46.3	80.5	591.5	
	1985.10-1996.12	MT	L	F	Hatchback Engine C3J 700/C3J 702/C3J 760	250024	Drive Shaft		21	29.95	46.4	81.5	599	
	1985.10-1996.12	MT	R	F	Hatchback Engine C3J 700/C3J 702/C3J 760	250032	Drive Shaft		21	23	49.8	83.5	690	
	1985.10-1996.12	-	L	F	Hatchback Engine C3J 700/C3J 702/C3J 760	250118	Drive Shaft		21	29.95	46.3	80.5	604.5	
	1985.10-1996.12	-	R	F	Hatchback Engine C3J 700/C3J 702/C3J 760	250124	Drive Shaft		21	23	46.3	80.5	685	
	1985.10-1996.12	MT	L	F	Hatchback Engine C3J 700/C3J 702/C3J 760	250025	Drive Shaft		21	29.95	46.2	82	612	
	1985.10-1996.12	MT	R	F	Hatchback Engine C3J 700/C3J 702/C3J 760	250023	Drive Shaft		21	23	46.2	82	680	
	1985.10-1996.12	3AT/MT	R	F	Hatchback Engine C3J 700/C3J 702/C3J 760	250044	Drive Shaft		21	23	46.4	81.5	693.5	
1.4 Turbo (88 kW)	1985.04-1990.08	MT	L	F	Hatchback Engine C1J 782/C1J 784/C1J 788	250024	Drive Shaft		21	29.95	46.4	81.5	599	
	1985.04-1990.08	MT	R	F	Hatchback Engine C1J 782/C1J 784/C1J 788	250032	Drive Shaft		21	23	49.8	83.5	690	
	1985.04-1990.08	MT	L	F	Hatchback Engine C1J 782/C1J 784/C1J 788	250201	Drive Shaft		21	29.95	49.8	83.5	597	
	1985.04-1990.08	-	R	F	Hatchback Engine C1J 782/C1J 784/C1J 788	250124	Drive Shaft		21	23	46.3	80.5	685	
	1985.04-1990.08	MT	L	F	Hatchback Engine C1J 782/C1J 784/C1J 788	250025	Drive Shaft		21	29.95	46.2	82	612	
	1985.04-1990.08	MT	R	F	Hatchback Engine C1J 782/C1J 784/C1J 788	250023	Drive Shaft		21	23	46.2	82	680	
	1985.04-1990.08	3AT/MT	R	F	Hatchback Engine C1J 782/C1J 784/C1J 788	250044	Drive Shaft		21	23	46.4	81.5	693.5	
1.6 D (40 kW)	1985.04-1990.12	MT	R	F	Hatchback Engine F8M 730	250044	Drive Shaft		21	23	46.4	81.5	693.5	
	1985.04-1990.12	-	L	F	Hatchback Engine F8M 730	250120	Drive Shaft		21	29.95	46.3	80.5	591.5	
	1985.04-1990.12	MT	L	F	Hatchback Engine F8M 730	250024	Drive Shaft		21	29.95	46.4	81.5	599	
	1985.08-1996.12	MT	R	F	Hatchback Engine F8M 720/F8M 730	250044	Drive Shaft		21	23	46.4	81.5	693.5	
	1985.08-1996.12	MT	L	F	Hatchback Engine F8M 720/F8M 730	250024	Drive Shaft		21	29.95	46.4	81.5	599	
	1985.08-1996.12	-	R	F	Hatchback Engine F8M 720/F8M 730	250124	Drive Shaft		21	23	46.3	80.5	685	
	1985.08-1996.12	-	L	F	Hatchback Engine F8M 720/F8M 730	250120	Drive Shaft		21	29.95	46.3	80.5	591.5	
1.7 (54 kW)	1986.10-1995.03	MT	L	F	Hatchback Engine F3N 716/F3N 717	250024	Drive Shaft		21	29.95	46.4	81.5	599	
	1986.10-1995.03	MT	R	F	Hatchback Engine F3N 716/F3N 717	250032	Drive Shaft		21	23	49.8	83.5	690	
	1986.10-1995.03	-	R	F	Hatchback Engine F3N 716/F3N 717	250124	Drive Shaft		21	23	46.3	80.5	685	
	1986.10-1995.03	MT	L	F	Hatchback Engine F3N 716/F3N 717	250025	Drive Shaft		21	29.95	46.2	82	612	
	1986.10-1995.03	MT	R	F	Hatchback Engine F3N 716/F3N 717	250023	Drive Shaft		21	23	46.2	82	680	
	1986.10-1995.03	3AT/MT	R	F	Hatchback Engine F3N 716/F3N 717	250044	Drive Shaft		21	23	46.4	81.5	693.5	
1.7 (64 kW)	1987.06-1995.03	MT	L	F	Hatchback Engine F2N 740/F2N 742	250024	Drive Shaft		21	29.95	46.4	81.5	599	
	1987.06-1995.03	MT	R	F	Hatchback Engine F2N 740/F2N 742	250032	Drive Shaft		21	23	49.8	83.5	690	
	1987.06-1995.03	MT	L	F	Hatchback Engine F2N 740/F2N 742	250201	Drive Shaft		21	29.95	49.8	83.5	597	
	1987.06-1995.03	-	R	F	Hatchback Engine F2N 740/F2N 742	250124	Drive Shaft		21	23	46.3	80.5	685	
	1987.06-1995.03	MT	L	F	Hatchback Engine F2N 740/F2N 742	250025	Drive Shaft		21	29.95	46.2	82	612	
	1987.06-1995.03	MT	R	F	Hatchback Engine F2N 740/F2N 742	250023	Drive Shaft		21	23	46.2	82	680	
	1987.06-1995.03	3AT/MT	R	F	Hatchback Engine F2N 740/F2N 742	250044	Drive Shaft		21	23	46.4	81.5	693.5	
1.7 (66 kW)	1988.09-1990.09	MT	L	F	Hatchback Engine F2N 740	250201	Drive Shaft		21	29.95	49.8	83.5	597	
1.7 i (69 kW)	1986.10-1991.08	MT	L	F	Hatchback Engine F3N 702/F3N 722	250024	Drive Shaft		21	29.95	46.4	81.5	599	
	1986.10-1991.08	MT	R	F	Hatchback Engine F3N 702/F3N 722	250032	Drive Shaft		21	23	49.8	83.5	690	
	1986.10-1991.08	-	R	F	Hatchback Engine F3N 702/F3N 722	250124	Drive Shaft		21	23	46.3	80.5	685	
	1986.10-1991.08	MT	L	F	Hatchback Engine F3N 702/F3N 722	250025	Drive Shaft		21	29.95	46.2	82	612	
	1986.10-1991.08	MT	R	F	Hatchback Engine F3N 702/F3N 722	250023	Drive Shaft		21	23	46.2	82	680	
	1986.10-1991.08	3AT/MT	R	F	Hatchback Engine F3N 702/F3N 722	250044	Drive Shaft		21	23	46.4	81.5	693.5	
SUPER 5 (S40_)														
1.1 (34 kW)	1984.10-1996.12	-	R	F	Box Engine C1E 750/C1E 752/C1E 754	250124	Drive Shaft		21	23	46.3	80.5	685	
1.2 (44 kW)	1987.01-1996.12	-	R	F	Box Engine C1G 702	250124	Drive Shaft		21	23	46.3	80.5	685	
1.6 D (40 kW)	1984.10-1996.12	-	R	F	Box Engine F8M 720	250124	Drive Shaft		21	23	46.3	80.5	685	
THALIA I (LB_)/SYMBOL														
1.2 16V (55 kW)	2002.04-	-	MT	R	F	Saloon Engine D4F 706/D4F 712	250263	Drive Shaft	44T	21	23	52.2	85.5	723.5
	2002.04-	-	MT	L	F	Saloon Engine D4F 706/D4F 712	250261	Drive Shaft	44T	23	29.95	57.5	86.5	630
	2002.04-	-	MT	L	F	Saloon Engine D4F 706/D4F 712	250401	Drive Shaft	44T	21	29.95	57	84	629
	2002.04-	-	MT	R	F	Saloon Engine D4F 706/D4F 712	650008	Inner Joint		23	30	36.3	52.2	68.5
1.4 (55 kW)	2000.08-	-	-	R	F	Saloon Engine K7J 700	250162	Drive Shaft	26T	21	23	52.2	85.5	723.5
	2000.08-	-	MT	R	F	Saloon Engine K7J 700	250151	Drive Shaft		21	23	49.8	83.5	712
	2000.08-	-	MT	L	F	Saloon Engine K7J 700	250004	Drive Shaft	26T	21	29.95	57	84.5	625.7
	2000.08-	-	MT	R	F	Saloon Engine K7J 700	250017	Drive Shaft	26T	21	23	51.5	83	715
	2000.08-	-	AT	L	F	Saloon Engine K7J 700	250579	Drive Shaft	26T	21	26	52.2	85.5	613
	2000.08-	-	MT	L	F	Saloon Engine K7J 700	250261	Drive Shaft	44T	23	29.95	57.5	86.5	630
	2000.08-	-	AT	R	F	Saloon Engine K7J 700	250588	Drive Shaft	26T	21	23	57	84	739
	2000.08-	-	-	R	F	Saloon Engine K7J 700	650008	Inner Joint		23	30	36.3	52.2	68.5
	2000.08-	-	MT	R	F	Saloon Engine K7J 700	250395	Drive Shaft	26T	21	23	51.5	83	728





RENAULT THALIA I (LB_)/SYMBOL	YEAR	TRANSM	L/R	F/R	REMARKS	GSP Ref.	PRODUCT	ABS	Technical Specifications						
									A	B	C	H	L	P	
1.4 (55 kW)	2000.08-	-	MT	L	F	Saloon Engine K7J 700	250401	Drive Shaft	44T	21	29.95	57	84	629	
	2000.08-	-	MT	R	F	Saloon Engine K7J 700	250437	Drive Shaft		21	23	51.5	83	729	
	2000.08-	-	MT	L	F	Saloon Engine K7J 700	250150	Drive Shaft		21	29.95	49.8	83.5	623	
	2000.08-	-	MT	R	F	Saloon Engine K7J 700	250125	Drive Shaft		21	23	57	84.5	713.5	
1.4 16V (72 kW)	2000.08-	-	MT	R	F	Saloon Engine K4J 712	250162	Drive Shaft	26T	21	23	52.2	85.5	723.5	
	2000.08-	-	MT	R	F	Saloon Engine K4J 712	250151	Drive Shaft		21	23	49.8	83.5	712	
	2000.08-	-	-	R	F	Saloon Engine K4J 712	299150	Drive Shaft	26T	21	23	52.2	85.5	747	
	2000.08-	-	AT	L	F	Saloon Engine K4J 712	250519	Drive Shaft	44T	21	26	52.2	85.5	609	
	2000.08-	-	MT	R	F	Saloon Engine K4J 712	250263	Drive Shaft	44T	21	23	52.2	85.5	723.5	
	2000.08-	-	MT	L	F	Saloon Engine K4J 712	250004	Drive Shaft	26T	21	29.95	57	84.5	625.7	
	2000.08-	-	MT	R	F	Saloon Engine K4J 712	250017	Drive Shaft	26T	21	23	51.5	83	715	
	2000.08-	-	MT	L	F	Saloon Engine K4J 712	250261	Drive Shaft	44T	23	29.95	57.5	86.5	630	
	2000.08-	-	AT	L	F	Saloon Engine K4J 712	250579	Drive Shaft	26T	21	26	52.2	85.5	613	
	2000.08-	-	AT	R	F	Saloon Engine K4J 712	250588	Drive Shaft	26T	21	23	57	84	739	
	2000.08-	-	MT	R	F	Saloon Engine K4J 712	250395	Drive Shaft	26T	21	23	51.5	83	728	
	2000.08-	-	MT	R	F	Saloon Engine K4J 712	250437	Drive Shaft		21	23	51.5	83	729	
	2000.08-	-	MT	L	F	Saloon Engine K4J 712	250401	Drive Shaft	44T	21	29.95	57	84	629	
	2000.08-	-	MT	L	F	Saloon Engine K4J 712	250150	Drive Shaft		21	29.95	49.8	83.5	623	
	2000.08-	-	MT	R	F	Saloon Engine K4J 712	650008	Inner Joint		23	30	36.3	52.2	68.5	
	2000.08-	-	MT	R	F	Saloon Engine K4J 712	250125	Drive Shaft		21	23	57	84.5	713.5	
1.5 dCi (47 kW)	2005.06-	-	MT	L	F	Saloon Engine K9K 740	250280	Drive Shaft	44T	23	26	57.5	86.5	602	
	2005.06-	-	MT	R	F	Saloon Engine K9K 740	250373	Drive Shaft	44T	23	26	57.5	86.5	864	
	2005.06-	-	MT	R	F	Saloon Engine K9K 740	699169	Inner Joint		26	30	33	326	95	
1.5 dCi (48 kW)	2002.04-	-	-	R	F	Saloon Engine K9K 700	250162	Drive Shaft	26T	21	23	52.2	85.5	723.5	
	2002.04-	-	-	L	F	Saloon Engine K9K 700	250004	Drive Shaft	26T	21	29.95	57	84.5	625.7	
	2002.04-	-	-	R	F	Saloon Engine K9K 700	250263	Drive Shaft	44T	21	23	52.2	85.5	723.5	
	2002.04-	-	-	L	F	Saloon Engine K9K 700	250261	Drive Shaft	44T	23	29.95	57.5	86.5	630	
	2002.04-	-	MT	R	F	Saloon Engine K9K 700	250395	Drive Shaft	26T	21	23	51.5	83	728	
	2002.04-	-	MT	L	F	Saloon Engine K9K 700	250397	Drive Shaft		21	29.95	50	84	632	
	2002.04-	-	MT	R	F	Saloon Engine K9K 700	250437	Drive Shaft		21	23	51.5	83	729	
	2002.04-	-	-	L	F	Saloon Engine K9K 700	250401	Drive Shaft	44T	21	29.95	57	84	629	
	2002.04-	-	-	L	F	Saloon Engine K9K 700	250150	Drive Shaft		21	29.95	49.8	83.5	623	
	2002.04-	-	-	R	F	Saloon Engine K9K 700	650008	Inner Joint		23	30	36.3	52.2	68.5	
1.5 dCi (50 kW)	2003.02-	-	MT	L	F	Saloon Engine K9K 700/K9K 714	250280	Drive Shaft	44T	23	26	57.5	86.5	602	
	2003.02-	-	MT	R	F	Saloon Engine K9K 700/K9K 714	250373	Drive Shaft	44T	23	26	57.5	86.5	864	
	2003.02-	-	MT	R	F	Saloon Engine K9K 700/K9K 714	699169	Inner Joint		26	30	33	326	95	
1.5 dCi (60 kW)	2001.06-	-	MT	L	F	Saloon Engine K9K 702	250280	Drive Shaft	44T	23	26	57.5	86.5	602	
	2001.06-	-	MT	R	F	Saloon Engine K9K 702	250373	Drive Shaft	44T	23	26	57.5	86.5	864	
	2001.06-	-	MT	R	F	Saloon Engine K9K 702	699169	Inner Joint		26	30	33	326	95	
THALIA II (LU1/2_)/SYMBOL															
1.5 dCi (62 kW)	2008.09-	-	MT	L	F	Saloon Engine K9K 718	250280	Drive Shaft	44T	23	26	57.5	86.5	602	
	2008.09-	-	MT	R	F	Saloon Engine K9K 718	250373	Drive Shaft	44T	23	26	57.5	86.5	864	
	2008.09-	-	MT	R	F	Saloon Engine K9K 718	699169	Inner Joint		26	30	33	326	95	
1.6 16V (77 kW)	2008.09-	-	AT	L	F	Saloon Engine K4M 743	250519	Drive Shaft	44T	21	26	52.2	85.5	609	
	2008.09-	-	MT	R	F	Saloon Engine K4M 743	250263	Drive Shaft	44T	21	23	52.2	85.5	723.5	
	2008.09-	-	MT	L	F	Saloon Engine K4M 743	250261	Drive Shaft	44T	23	29.95	57.5	86.5	630	
	2008.09-	-	MT	L	F	Saloon Engine K4M 743	250401	Drive Shaft	44T	21	29.95	57	84	629	
	2008.09-	-	MT	R	F	Saloon Engine K4M 743	650008	Inner Joint		23	30	36.3	52.2	68.5	
TRAFIC															
-	-	-	-	-	-	-	650029	Inner Joint		27	27	42	50	62	
2.2	1991.01-	1999.12	MT	-	-	-	899075	Outer Joint		23	27	56.3	110	62	I
	1991.01-	1999.12	MT	-	-	-	899076	Outer Joint		25	27	56.3	110.5	62	I
All Models	1984.11-	1989.12	-	-	-	-	850010	Outer Joint		23	27	56.3	110	62	I
TRAFIC (P6)															
1.4 (35 kW)	1980.03-	1989.04	MT	L/R	F	Platform/Chassis Engine 847 700/C1J 700	250006	Drive Shaft		23	27	56.3	109	712.5	
1.7 (50 kW)	1986.06-	1989.04	MT	L/R	F	Platform/Chassis Engine F1N 722	250006	Drive Shaft		23	27	56.3	109	712.5	
2.0 (59 kW)	1980.03-	1989.04	MT	L/R	R	Platform/Chassis Engine J5R 726	250006	Drive Shaft		23	27	56.3	109	712.5	
2.1 D (43 kW)	1980.03-	1989.04	MT	L/R	R	Platform/Chassis Engine 852 720	250006	Drive Shaft		23	27	56.3	109	712.5	
2.5 D (51 kW)	1980.03-	1989.04	MT	L/R	R	Platform/Chassis Engine 8140.61.240/S8U 720/S8U 722	250006	Drive Shaft		23	27	56.3	109	712.5	
TRAFIC (PXX)															
1.7 (50 kW)	1989.05-	1994.08	MT	L/R	F	Platform/Chassis Engine F1N 722	250183	Drive Shaft		25	27	56.3	110.5	716	
	1989.05-	1994.08	MT	L/R	F	Platform/Chassis Engine F1N 722	244006	Drive Shaft		25	27	56.3	110.5	713.5	
2.0 (60 kW)	1989.03-	1991.12	MT	L/R	F	Platform/Chassis Engine J5R 726	250183	Drive Shaft		25	27	56.3	110.5	716	
2.0 [RWD] (59 kW)	1989.05-	1997.10	MT	L/R	R	Platform/Chassis Engine J5R 726	250006	Drive Shaft		23	27	56.3	109	712.5	
2.1 D [RWD] (43 kW)	1989.05-	1994.06	MT	L/R	R	Platform/Chassis Engine 852 720	250006	Drive Shaft		23	27	56.3	109	712.5	
2.2 (70 kW)	1989.05-	1994.06	MT	L/R	F	Platform/Chassis Engine J7T 780	250183	Drive Shaft		25	27	56.3	110.5	716	





REMARKS	GSP Ref.	PRODUCT	ABS	Technical Specifications								
				A	B	C	H	L	P			
YEAR	TRANSM	L/R	F/R	REMARKS								
RENAULT TRAFIC (PXX)												
2.2 (74 kW)	1994.09-1998.04	MT	-	F	All-wheel Drive Platform/Chassis Engine J7T 600	250183	Drive Shaft	25	27	56.3	110.5	716
	1994.09-1998.04	MT	L/R	F	Platform/Chassis Engine J7T 600	250183	Drive Shaft	25	27	56.3	110.5	716
	1994.09-1998.04	-	L/R	F	All-wheel Drive Platform/Chassis Engine J7T 600	244006	Drive Shaft	25	27	56.3	110.5	713.5
	1994.09-1998.04	-	L/R	F	Platform/Chassis Engine J7T 600	244006	Drive Shaft	25	27	56.3	110.5	713.5
	1994.09-1998.04	-	L/R	F	All-wheel Drive Platform/Chassis Engine J7T 600	250006	Drive Shaft	23	27	56.3	109	712.5
	1994.09-1998.04	-	L/R	F	Platform/Chassis Engine J7T 600	250006	Drive Shaft	23	27	56.3	109	712.5
2.5 D (51 kW)	1989.05-2001.03	MT	L/R	F	Platform/Chassis Engine 8140.61.240/S8U 720/S8U 722	244006	Drive Shaft	25	27	56.3	110.5	713.5
2.5 D (56 kW)	1989.03-1994.08	MT	L/R	F	Platform/Chassis Engine S8U 750	250183	Drive Shaft	25	27	56.3	110.5	716
	1989.03-1994.08	MT	-	F	All-wheel Drive Platform/Chassis Engine S8U 750	250183	Drive Shaft	25	27	56.3	110.5	716
2.5 D (58 kW)	1994.09-1999.01	MT	-	F	All-wheel Drive Platform/Chassis Engine S8U 758	250183	Drive Shaft	25	27	56.3	110.5	716
	1994.09-1998.04	MT	L/R	F	Platform/Chassis Engine S8U 758	250183	Drive Shaft	25	27	56.3	110.5	716
	1994.09-1998.04	-	L/R	F	Platform/Chassis Engine S8U 758	244006	Drive Shaft	25	27	56.3	110.5	713.5
TRAFIC (T1 T3 T4 T2)												
1.4 (35 kW)	1980.03-1989.04	MT	L/R	F	Box Engine 847 700/847 701/C1J 700	250006	Drive Shaft	23	27	56.3	109	712.5
1.7 (50 kW)	1986.06-1989.04	MT	L/R	F	Box Engine F1N 724	250006	Drive Shaft	23	27	56.3	109	712.5
2.0 (59 kW)	1986.06-1989.04	MT	L/R	F	All-wheel Drive Box Engine J5R 716/J5R 722/J5R 726	250006	Drive Shaft	23	27	56.3	109	712.5
	1986.06-1989.04	MT	L/R	F	Box Engine J5R 716/J5R 722/J5R 726	250006	Drive Shaft	23	27	56.3	109	712.5
2.1 D (43 kW)	1980.09-1989.04	MT	L/R	F	Box Engine 852 750	250006	Drive Shaft	23	27	56.3	109	712.5
	1980.09-1989.04	MT	L/R	F	Box Engine 852 750	244006	Drive Shaft	25	27	56.3	110.5	713.5
	1986.11-1989.04	MT	L/R	F	All-wheel Drive Box Engine 852 750	250006	Drive Shaft	23	27	56.3	109	712.5
TRAFIC (T5 T6 T7)												
1.4 (35 kW)	1980.03-1989.04	MT	L/R	F	Bus Engine 847 700/847 701/C1J 700	250006	Drive Shaft	23	27	56.3	109	712.5
1.7 (50 kW)	1986.06-1989.04	MT	L/R	F	Bus Engine F1N 724	250006	Drive Shaft	23	27	56.3	109	712.5
2.0 (59 kW)	1986.06-1989.04	MT	L/R	F	Bus Engine J5R 716/J5R 722/J5R 726	250006	Drive Shaft	23	27	56.3	109	712.5
	1986.06-1989.04	MT	L/R	F	All-wheel Drive Bus Engine J5R 716/J5R 722/J5R 726	250006	Drive Shaft	23	27	56.3	109	712.5
2.1 D (43 kW)	1980.03-1989.04	MT	L/R	F	Bus Engine 852 750	250006	Drive Shaft	23	27	56.3	109	712.5
TRAFIC (TXW)												
1.7 (50 kW)	1992.08-1994.08	MT	L/R	F	Bus Engine F1N 724	244006	Drive Shaft	25	27	56.3	110.5	713.5
1.9 D (44 kW)	1997.06-2001.03	MT	L/R	F	Bus Engine F8Q 606	244006	Drive Shaft	25	27	56.3	110.5	713.5
	1997.06-2001.03	-	L/R	F	Bus Engine F8Q 606	250006	Drive Shaft	23	27	56.3	109	712.5
2.0 (59 kW)	1989.05-1990.08	MT	L/R	F	Bus Engine J5R 726	250183	Drive Shaft	25	27	56.3	110.5	716
	1989.05-1990.08	MT	L/R	F	Bus Engine J5R 726	250006	Drive Shaft	23	27	56.3	109	712.5
2.1 D (43 kW)	1989.05-1994.06	MT	L/R	F	Bus Engine 852 720/852 750	250183	Drive Shaft	25	27	56.3	110.5	716
	1989.05-1994.06	MT	L/R	F	Bus Engine 852 720/852 750	244006	Drive Shaft	25	27	56.3	110.5	713.5
2.1 D (47 kW)	1994.06-1997.10	MT	L/R	F	Bus Engine J8S 620/J8S 758	250183	Drive Shaft	25	27	56.3	110.5	716
	1994.06-1997.10	MT	L/R	F	Bus Engine J8S 620/J8S 758	244006	Drive Shaft	25	27	56.3	110.5	713.5
2.2 (70 kW)	1989.05-1994.06	MT	L/R	F	Bus Engine J7T 780	250183	Drive Shaft	25	27	56.3	110.5	716
	1989.05-1994.06	MT	L/R	F	Bus Engine J7T 780	244006	Drive Shaft	25	27	56.3	110.5	713.5
2.2 (74 kW)	1994.06-1997.10	MT	L/R	F	Bus Engine J7T 600	250183	Drive Shaft	25	27	56.3	110.5	716
	1994.06-1997.10	MT	L/R	F	Bus Engine J7T 600	244006	Drive Shaft	25	27	56.3	110.5	713.5
2.5 D (55 kW)	1989.05-2001.03	MT	L/R	F	Bus Engine 8140.67.2500/8140.67.2550 8140.67.2580/S8U 750/S8U 752/S8U 758	244006	Drive Shaft	25	27	56.3	110.5	713.5
	1989.08-2001.03	MT	L/R	F	All-wheel Drive Bus Engine 8140.67.2500/8140.67.2550/8140.67.2580/S8U 750/S8U 752/S8U 758	244006	Drive Shaft	25	27	56.3	110.5	713.5
TRAFIC (TXX)												
1.4 (35 kW)	1989.05-1991.06	MT	L/R	F	Box Engine C1J 700	250183	Drive Shaft	25	27	56.3	110.5	716
	1989.05-1991.06	MT	L/R	F	Box Engine C1J 700	244006	Drive Shaft	25	27	56.3	110.5	713.5
1.7 (50 kW)	1992.08-1994.08	MT	L/R	F	Box Engine F1N 720	250183	Drive Shaft	25	27	56.3	110.5	716
1.7 (51 kW)	1989.03-1994.08	MT	L/R	F	Box Engine F1N 724	250183	Drive Shaft	25	27	56.3	110.5	716
	1989.03-1994.08	MT	L/R	F	Box Engine F1N 724	244006	Drive Shaft	25	27	56.3	110.5	713.5
1.9 D (44 kW)	1997.06-2001.03	MT	L/R	F	Box Engine F8Q 606	244006	Drive Shaft	25	27	56.3	110.5	713.5
	1997.06-2001.03	-	L/R	F	Box Engine F8Q 606	250006	Drive Shaft	23	27	56.3	109	712.5
2.0 (59 kW)	1989.05-1990.08	MT	L/R	F	Box Engine J5R 716	250183	Drive Shaft	25	27	56.3	110.5	716
	1989.05-1990.08	MT	L/R	F	Box Engine J5R 716	250006	Drive Shaft	23	27	56.3	109	712.5
2.1 D (43 kW)	1989.05-1994.06	MT	L/R	F	Box Engine 852 750	250183	Drive Shaft	25	27	56.3	110.5	716
	1989.05-1994.06	MT	L/R	F	Box Engine 852 750	244006	Drive Shaft	25	27	56.3	110.5	713.5
2.1 D (47 kW)	1994.06-1997.10	MT	L/R	F	Box Engine J8S 620/J8S 758	250183	Drive Shaft	25	27	56.3	110.5	716
	1994.06-1997.10	MT	L/R	F	Box Engine J8S 620/J8S 758	244006	Drive Shaft	25	27	56.3	110.5	713.5
	1994.06-1997.10	-	L/R	F	Box Engine J8S 620/J8S 758	250006	Drive Shaft	23	27	56.3	109	712.5
2.2 (70 kW)	1989.05-1994.06	MT	L/R	F	Box Engine J7T 780	250183	Drive Shaft	25	27	56.3	110.5	716
	1989.05-1994.06	MT	-	F	All-wheel Drive Box Engine J7T 780	250183	Drive Shaft	25	27	56.3	110.5	716
	1989.05-1994.06	MT	L/R	F	Box Engine J7T 780	244006	Drive Shaft	25	27	56.3	110.5	713.5
	1989.05-1994.06	MT	L/R	F	All-wheel Drive Box Engine J7T 780	244006	Drive Shaft	25	27	56.3	110.5	713.5
2.2 (74 kW)	1994.06-1997.10	MT	L/R	F	Box Engine J7T 600	250183	Drive Shaft	25	27	56.3	110.5	716
	1994.06-1997.10	MT	-	F	All-wheel Drive Box Engine J7T 600	250183	Drive Shaft	25	27	56.3	110.5	716
	1994.06-1997.10	MT	L/R	F	Box Engine J7T 600	244006	Drive Shaft	25	27	56.3	110.5	713.5
	1994.06-1997.10	MT	L/R	F	All-wheel Drive Box Engine J7T 600	244006	Drive Shaft	25	27	56.3	110.5	713.5
	1994.06-1997.10	-	L/R	F	Box Engine J7T 600	250006	Drive Shaft	23	27	56.3	109	712.5

	 YEAR	TRANSM	L/R	F/R	REMARKS	GSP Ref.	 PRODUCT	 ABS	Technical Specifications								
									A	B	C	H	L	P			
RENAULT TRAFIC (TXX)																	
2.5 D (55 kW)	1989.05-2001.03	MT	L/R	F	Box Engine 8140.67.2500/8140.67.2550/8140.67.2580/SBU 750/SBU 752/SBU 758	250183	Drive Shaft		25	27	56.3	110.5	716				
	1989.05-2001.03	MT	L/R	F	Box Engine 8140.67.2500/8140.67.2550/8140.67.2580/SBU 750/SBU 752/SBU 758	244006	Drive Shaft		25	27	56.3	110.5	713.5				
2.5 D (56 kW)	1989.03-1994.08	MT	L/R	F	Box Engine S8U 750	250183	Drive Shaft		25	27	56.3	110.5	716				
TRAFIC II (EL)																	
1.9 dCi 100 (74 kW)	2001.03-	-	-	L	F	Platform/Chassis Engine F9Q 760	244003	Drive Shaft		27	37.1	56.5	93.5	676			
	2001.03-	-	-	R	F	Platform/Chassis Engine F9Q 760	244013	Drive Shaft		27	39	56.5	93.5	1020			
	2001.03-	-	AT/MT	L/R	F	Platform/Chassis Engine F9Q 760	818105	Outer Joint		27	26	56.5	93.5	64	M		
1.9 dCi 80 (60 kW)	2001.03-	-	-	L	F	Platform/Chassis Engine F9Q 762	244003	Drive Shaft		27	37.1	56.5	93.5	676			
	2001.03-	-	-	R	F	Platform/Chassis Engine F9Q 762	244013	Drive Shaft		27	39	56.5	93.5	1020			
	2001.03-	-	AT/MT	L/R	F	Platform/Chassis Engine F9Q 762	818105	Outer Joint		27	26	56.5	93.5	64	M		
2.0 (88 kW)	2001.03-	-	-	L	F	Platform/Chassis Engine F4R 720	244003	Drive Shaft		27	37.1	56.5	93.5	676			
	2001.03-	-	-	R	F	Platform/Chassis Engine F4R 720	244013	Drive Shaft		27	39	56.5	93.5	1020			
	2001.03-	-	AT/MT	L/R	F	Platform/Chassis Engine F4R 720	818105	Outer Joint		27	26	56.5	93.5	64	M		
2.0 16V (86 kW)	2006.08-	-	-	L	F	Platform/Chassis Engine F4R 820	244003	Drive Shaft		27	37.1	56.5	93.5	676			
	2006.08-	-	-	R	F	Platform/Chassis Engine F4R 820	244013	Drive Shaft		27	39	56.5	93.5	1020			
2.0 dCi 115 (84 kW)	2006.08-	-	-	L/R	F	Platform/Chassis Engine M9R 780/M9R 782/M9R 786	860005	Outer Joint		27	36	56.6	94	71	I		
	2006.08-	-	-	L	F	Platform/Chassis Engine M9R 780/M9R 782/M9R 786	250578	Drive Shaft		27	39	56.5	93.5	691			
	2006.08-	-	-	L	F	Platform/Chassis Engine M9R 780/M9R 782/M9R 786	260022	Drive Shaft		27	39	56.6	94	694			
	2006.08-	-	-	R	F	Platform/Chassis Engine M9R 780/M9R 782/M9R 786	218271	Drive Shaft		27	39	56.6	94	1013			
2.0 dCi 90 (66 kW)	2006.08-	-	-	L/R	F	Platform/Chassis Engine M9R 780/M9R 782	860005	Outer Joint		27	36	56.6	94	71	I		
	2006.08-	-	-	L	F	Platform/Chassis Engine M9R 780/M9R 782	250578	Drive Shaft		27	39	56.5	93.5	691			
	2006.08-	-	-	L	F	Platform/Chassis Engine M9R 780/M9R 782	260022	Drive Shaft		27	39	56.6	94	694			
	2006.08-	-	MT	R	F	Platform/Chassis Engine M9R 780/M9R 782	218271	Drive Shaft		27	39	56.6	94	1013			
2.5 dCi 135 (99 kW)	2001.03-	-	-	R	F	Platform/Chassis Engine G9U 730	650097	Inner Joint		39	35	30	409	90			
	2001.03-	-	-	-	F	Platform/Chassis Engine G9U 730	850080	Outer Joint		27	37	56.5	92	73	I		
	2001.03-	-	-	L	F	Platform/Chassis Engine G9U 730	250557	Drive Shaft		27	37.1	56.5	92	634			
	2001.03-	-	-	R	F	Platform/Chassis Engine G9U 730	250562	Drive Shaft		27	39	56.5	92	1056			
2.5 dCi 145 (107 kW)	2006.08-	-	-	L	F	Platform/Chassis Engine G9U 630	250497	Drive Shaft		27	39	56.6	94	667			
	2006.08-	-	-	R	F	Platform/Chassis Engine G9U 630	218301	Drive Shaft		27	39	56.6	94	1045			
	2006.08-	-	-	-	F	Platform/Chassis Engine G9U 630	850080	Outer Joint		27	37	56.5	92	73	I		
	2006.08-	-	-	L/R	F	Platform/Chassis Engine G9U 630	860005	Outer Joint		27	36	56.6	94	71	I		
TRAFIC II (FL)																	
1.9 dCi (59 kW)	2001.04-2003.07	-	-	R	F	Box Engine F9Q 762	244013	Drive Shaft		27	39	56.5	93.5	1020			
1.9 dCi (75 kW)	2001.03-	-	-	L	F	Box Engine F9Q 760	244003	Drive Shaft		27	37.1	56.5	93.5	676			
	2001.03-	-	-	R	F	Box Engine F9Q 760	244013	Drive Shaft		27	39	56.5	93.5	1020			
1.9 dCi 100 (74 kW)	2001.03-	-	-	L	F	Box Engine F9Q 760	244003	Drive Shaft		27	37.1	56.5	93.5	676			
	2001.03-	-	-	R	F	Box Engine F9Q 760	244013	Drive Shaft		27	39	56.5	93.5	1020			
	2001.03-	-	-	L/R	F	Box Engine F9Q 760	844034	Outer Joint		27	26	56.5	93.5	64	M		
	2001.03-	-	AT/MT	L/R	F	Box Engine F9Q 760	818105	Outer Joint		27	26	56.5	93.5	64	M		
1.9 dCi 80 (60 kW)	2001.03-	-	-	L	F	Box Engine F9Q 760/F9Q 762	244003	Drive Shaft		27	37.1	56.5	93.5	676			
	2001.03-	-	-	R	F	Box Engine F9Q 760/F9Q 762	244013	Drive Shaft		27	39	56.5	93.5	1020			
	2001.03-	-	-	L/R	F	Box Engine F9Q 760/F9Q 762	844034	Outer Joint		27	26	56.5	93.5	64	M		
	2001.03-	-	AT/MT	L/R	F	Box Engine F9Q 760/F9Q 762	818105	Outer Joint		27	26	56.5	93.5	64	M		
2.0 (88 kW)	2001.03-	-	-	L	F	Box Engine F4R 720/F4R 722	244003	Drive Shaft		27	37.1	56.5	93.5	676			
	2001.03-	-	-	R	F	Box Engine F4R 720/F4R 722	244013	Drive Shaft		27	39	56.5	93.5	1020			
	2001.03-	-	AT/MT	L/R	F	Box Engine F4R 720/F4R 722	818105	Outer Joint		27	26	56.5	93.5	64	M		
	2001.03-	-	-	L/R	F	Box Engine F4R 720/F4R 722	844034	Outer Joint		27	26	56.5	93.5	64	M		
2.0 16V (86 kW)	2006.08-	-	-	L	F	Box Engine F4R 820	244003	Drive Shaft		27	37.1	56.5	93.5	676			
	2006.08-	-	-	R	F	Box Engine F4R 820	244013	Drive Shaft		27	39	56.5	93.5	1020			
	2006.08-	-	AT/MT	L/R	F	Box Engine F4R 820	818105	Outer Joint		27	26	56.5	93.5	64	M		
2.0 dCi 115 (84 kW)	2006.08-	-	-	L/R	F	Box Engine M9R 692/M9R 780/M9R 782/M9R 786	860005	Outer Joint		27	36	56.6	94	71	I		
	2006.08-	-	-	L	F	Box Engine M9R 692/M9R 780/M9R 782/M9R 786	260022	Drive Shaft		27	39	56.6	94	694			
	2006.08-	-	-	R	F	Box Engine M9R 692/M9R 780/M9R 782/M9R 786	218271	Drive Shaft		27	39	56.6	94	1013			
2.0 dCi 90 (66 kW)	2006.08-	-	-	L/R	F	Box Engine M9R 630/M9R 780/M9R 782	860005	Outer Joint		27	36	56.6	94	71	I		
	2006.08-	-	-	L	F	Box Engine M9R 630/M9R 780/M9R 782	250578	Drive Shaft		27	39	56.5	93.5	691			
	2006.08-	-	-	L	F	Box Engine M9R 630/M9R 780/M9R 782	260022	Drive Shaft		27	39	56.6	94	694			
	2006.08-	-	-	R	F	Box Engine M9R 630/M9R 780/M9R 782	218271	Drive Shaft		27	39	56.6	94	1013			
2.5 dCi 135 (99 kW)	2003.05-	-	AT/MT	L/R	F	Box Engine G9U 730	850041	Outer Joint		27	37	56.5	93	72	I		
	2003.05-	-	-	R	F	Box Engine G9U 730	650097	Inner Joint		39	35	30	409	90			
	2003.05-	-	-	-	F	Box Engine G9U 730	850080	Outer Joint		27	37	56.5	92	73	I		
	2003.05-	-	-	L	F	Box Engine G9U 730	250557	Drive Shaft		27	37.1	56.5	92	634			
	2003.05-	-	-	R	F	Box Engine G9U 730	250562	Drive Shaft		27	39	56.5	92	1056			
2.5 dCi 145 (107 kW)	2006.08-	-	-	R	F	Box Engine G9U 630	218301	Drive Shaft		27	39	56.6	94	1045			
	2006.08-	-	-	L/R	F	Box Engine G9U 630	860005	Outer Joint		27	36	56.6	94	71	I		
	2006.08-	-	-	L	F	Box Engine G9U 630	250497	Drive Shaft		27	39	56.6	94	667			
2.5 DTi (99 kW)	2003.03-2003.07	-	-	R	F	Box Engine G9U 730	650097	Inner Joint		39	35	30	409	90			





	 YEAR	TRANSM	L/R	F/R	REMARKS	GSP Ref.	 PRODUCT	 ABS	Technical Specifications						
									A	B	C	H	L	P	
RENAULT															
TRAFIC II (FL)															
2.5 DTi (99 kW)	2003.03-	2003.07	-	-	F	Box Engine G9U 730	850080	Outer Joint		27	37	56.5	92	73	I
	2003.03-	2003.07	-	L	F	Box Engine G9U 730	250557	Drive Shaft		27	37.1	56.5	92	634	
	2003.03-	2003.07	-	R	F	Box Engine G9U 730	250562	Drive Shaft		27	39	56.5	92	1056	
TRAFIC II (JL)															
1.9 dCi (59 kW)	2001.04-	2003.07	-	R	F	Bus Engine F9Q 762	244013	Drive Shaft		27	39	56.5	93.5	1020	
1.9 dCi 100 (74 kW)	2001.03-	-	-	L	F	Bus Engine F9Q 760	244003	Drive Shaft		27	37.1	56.5	93.5	676	
	2001.03-	-	-	R	F	Bus Engine F9Q 760	244013	Drive Shaft		27	39	56.5	93.5	1020	
	2001.03-	-	AT/MT	L/R	F	Bus Engine F9Q 760	818105	Outer Joint		27	26	56.5	93.5	64	M
	2001.03-	-	-	L/R	F	Bus Engine F9Q 760	844034	Outer Joint		27	26	56.5	93.5	64	M
1.9 dCi 80 (60 kW)	2001.03-	-	-	L	F	Bus Engine F9Q 762	244003	Drive Shaft		27	37.1	56.5	93.5	676	
	2001.03-	-	-	R	F	Bus Engine F9Q 762	244013	Drive Shaft		27	39	56.5	93.5	1020	
	2001.03-	-	AT/MT	L/R	F	Bus Engine F9Q 762	818105	Outer Joint		27	26	56.5	93.5	64	M
	2001.03-	-	-	L/R	F	Bus Engine F9Q 762	844034	Outer Joint		27	26	56.5	93.5	64	M
2.0 (88 kW)	2001.03-	-	-	L	F	Bus Engine F4R 720/F4R 722	244003	Drive Shaft		27	37.1	56.5	93.5	676	
	2001.03-	-	-	R	F	Bus Engine F4R 720/F4R 722	244013	Drive Shaft		27	39	56.5	93.5	1020	
	2001.03-	-	AT/MT	L/R	F	Bus Engine F4R 720/F4R 722	818105	Outer Joint		27	26	56.5	93.5	64	M
	2001.03-	-	-	L/R	F	Bus Engine F4R 720/F4R 722	844034	Outer Joint		27	26	56.5	93.5	64	M
2.0 16V (86 kW)	2006.08-	-	-	L	F	Bus Engine F4R 820	244003	Drive Shaft		27	37.1	56.5	93.5	676	
	2006.08-	-	-	R	F	Bus Engine F4R 820	244013	Drive Shaft		27	39	56.5	93.5	1020	
	2006.08-	-	AT/MT	L/R	F	Bus Engine F4R 820	818105	Outer Joint		27	26	56.5	93.5	64	M
2.0 dCi 115 (84 kW)	2006.08-	-	-	L/R	F	Bus Engine M9R 630/M9R 692/M9R 780/M9R 782/M9R 786	860005	Outer Joint		27	36	56.6	94	71	I
	2006.08-	-	-	L	F	Bus Engine M9R 630/M9R 692/M9R 780/M9R 782/M9R 786	250578	Drive Shaft		27	39	56.5	93.5	691	
	2006.08-	-	-	L	F	Bus Engine M9R 630/M9R 692/M9R 780/M9R 782/M9R 786	260022	Drive Shaft		27	39	56.6	94	694	
	2006.08-	-	-	R	F	Bus Engine M9R 630/M9R 692/M9R 780/M9R 782/M9R 786	218271	Drive Shaft		27	39	56.6	94	1013	
2.0 dCi 90 (66 kW)	2006.08-	-	-	L/R	F	Bus Engine M9R 782	860005	Outer Joint		27	36	56.6	94	71	I
	2006.08-	-	-	L	F	Bus Engine M9R 782	250578	Drive Shaft		27	39	56.5	93.5	691	
	2006.08-	-	-	L	F	Bus Engine M9R 782	260022	Drive Shaft		27	39	56.6	94	694	
	2006.08-	-	MT	R	F	Bus Engine M9R 782	218271	Drive Shaft		27	39	56.6	94	1013	
2.5 dCi 115 (84 kW)	2008.02-	-	-	R	F	Bus Engine G9U 630	218301	Drive Shaft		27	39	56.6	94	1045	
	2008.02-	-	-	L/R	F	Bus Engine G9U 630	860005	Outer Joint		27	36	56.6	94	71	I
	2008.02-	-	-	L	F	Bus Engine G9U 630	250497	Drive Shaft		27	39	56.6	94	667	
2.5 dCi 135 (99 kW)	2003.05-	-	AT/MT	L/R	F	Bus Engine G9U 730	850041	Outer Joint		27	37	56.5	93	72	I
	2003.05-	-	-	R	F	Bus Engine G9U 730	650097	Inner Joint		39	35	30	409	90	
	2003.05-	-	-	-	F	Bus Engine G9U 730	850080	Outer Joint		27	37	56.5	92	73	I
	2003.05-	-	-	L	F	Bus Engine G9U 730	250557	Drive Shaft		27	37.1	56.5	92	634	
	2003.05-	-	-	R	F	Bus Engine G9U 730	250562	Drive Shaft		27	39	56.5	92	1056	
2.5 dCi 145 (107 kW)	2006.08-	-	-	R	F	Bus Engine G9U 630	218301	Drive Shaft		27	39	56.6	94	1045	
	2006.08-	-	-	-	F	Bus Engine G9U 630	850080	Outer Joint		27	37	56.5	92	73	I
	2006.08-	-	-	L/R	F	Bus Engine G9U 630	860005	Outer Joint		27	36	56.6	94	71	I
	2006.08-	-	-	L	F	Bus Engine G9U 630	250497	Drive Shaft		27	39	56.6	94	667	
TWINGO															
-	-	-	-	-	-	-	650028	Inner Joint		23	22	36.3	43	57	
	1993-	1996	-	L	-	-	250101	Drive Shaft		21	29.95	57	84.5	625.7	
TWINGO I (C06)															
1.2 (40 kW)	1996.05-	-	-	-	-	-	850066	Outer Joint	44T	21	28	52.5	85	51	I
1.2 (43 kW)	1996.05-	-	-	-	-	-	850066	Outer Joint	44T	21	28	52.5	85	51	I
1.2 16V (44 kW)	2001.01-	-	-	-	-	-	850066	Outer Joint	44T	21	28	52.5	85	51	I
1.2 16V (55 kW)	2001.01-	-	-	-	-	-	850066	Outer Joint	44T	21	28	52.5	85	51	I
TWINGO I (C06_)															
1.2 (40 kW)	1993.03-	1996.10	MT	R	F	Hatchback Engine C3G 700/C3G 702	250359	Drive Shaft	38T	21	23	57	84	739	
	1993.03-	1996.10	MT	L	F	Hatchback Engine C3G 700/C3G 702	250102	Drive Shaft	38T	21	29.95	57	84.5	625.7	
	1993.03-	1996.10	-	L	F	Hatchback Engine C3G 700/C3G 702	250307	Drive Shaft	26T	21	29.95	57	84	623	
	1993.03-	1996.10	MT	R	F	Hatchback Engine C3G 700/C3G 702	250095	Drive Shaft		21	23	46.2	80.5	734	
	1996.05-	2007.03	-	R	F	Hatchback Engine D7F 700/D7F 701	250084	Drive Shaft	38T	21	23	57	84.5	737	
	1996.05-	2007.03	MT	R	F	Hatchback Engine D7F 700/D7F 701	250359	Drive Shaft	38T	21	23	57	84	739	
	1996.05-	2007.03	MT	L	F	Hatchback Engine D7F 700/D7F 701	250102	Drive Shaft	38T	21	29.95	57	84.5	625.7	
	1996.05-	2007.03	MT	L	F	Hatchback Engine D7F 700/D7F 701	250307	Drive Shaft	26T	21	29.95	57	84	623	
	1996.05-	2007.03	MT	R	F	Hatchback Engine D7F 700/D7F 701	250095	Drive Shaft		21	23	46.2	80.5	734	
1.2 (43 kW)	1996.05-	2007.06	MT	R	F	Hatchback Engine D7F 700/D7F 701/D7F 702/D7F 703/D7F 704	650008	Inner Joint		23	30	36.3	52.2	68.5	
	1996.05-	2007.06	-	R	F	Hatchback Engine D7F 700/D7F 701/D7F 702/D7F 703/D7F 704	250084	Drive Shaft	38T	21	23	57	84.5	737	
	1996.05-	2007.06	-	R	F	Hatchback Engine D7F 700/D7F 701/D7F 702/D7F 703/D7F 704	250308	Drive Shaft	26T	21	23	57	84	737	
	1996.05-	2007.06	MT	R	F	Hatchback Engine D7F 700/D7F 701/D7F 702/D7F 703/D7F 704	250359	Drive Shaft	38T	21	23	57	84	739	
	1996.05-	2007.06	MT	L	F	Hatchback Engine D7F 700/D7F 701/D7F 702/D7F 703/D7F 704	250102	Drive Shaft	38T	21	29.95	57	84.5	625.7	
	1996.05-	2007.06	MT	L	F	Hatchback Engine D7F 700/D7F 701/D7F 702/D7F 703/D7F 704	250307	Drive Shaft	26T	21	29.95	57	84	623	
	1996.05-	2007.06	MT	L	F	Hatchback Engine D7F 700/D7F 701/D7F 702/D7F 703/D7F 704	250401	Drive Shaft	44T	21	29.95	57	84	629	
	1996.05-	2007.06	MT	R	F	Hatchback Engine D7F 700/D7F 701/D7F 702/D7F 703/D7F 704	250438	Drive Shaft	44T	21	23	52.3	84.5	740	





RENAULT TWINGO I (C06_)	YEAR	TRANSM	L/R	F/R	REMARKS	GSP Ref.	PRODUCT	ABS	Technical Specifications						
									A	B	C	H	L	P	
1.2 (43 kW)	1996.05-2007.06	MT	R	F	Hatchback Engine D7F 700/D7F 701/D7F 702/D7F 703/D7F 704	250095	Drive Shaft		21	23	46.2	80.5	734		
1.2 16V (44 kW)	2004.08-2007.06	MT	R	F	Hatchback Engine D4F 708	650008	Inner Joint		23	30	36.3	52.2	68.5		
	2004.08-2007.06	MT	R	F	Hatchback Engine D4F 708	250359	Drive Shaft	38T	21	23	57	84	739		
	2004.08-2007.06	MT	L	F	Hatchback Engine D4F 708	250102	Drive Shaft	38T	21	29.95	57	84.5	625.7		
	2004.08-2007.06	MT	L	F	Hatchback Engine D4F 708	250307	Drive Shaft	26T	21	29.95	57	84	623		
	2004.08-2007.06	MT	L	F	Hatchback Engine D4F 708	250401	Drive Shaft	44T	21	29.95	57	84	629		
	2004.08-2007.06	MT	R	F	Hatchback Engine D4F 708	250438	Drive Shaft	44T	21	23	52.3	84.5	740		
	2004.08-2007.06	MT	R	F	Hatchback Engine D4F 708	250095	Drive Shaft		21	23	46.2	80.5	734		
1.2 16V (55 kW)	2001.01-2007.06	MT	R	F	Hatchback Engine D4F 702	650008	Inner Joint		23	30	36.3	52.2	68.5		
	2001.01-2007.06	-	R	F	Hatchback Engine D4F 702	250308	Drive Shaft	26T	21	23	57	84	737		
	2001.01-2007.06	-	L	F	Hatchback Engine D4F 702	250307	Drive Shaft	26T	21	29.95	57	84	623		
	2001.01-2007.06	MT	L	F	Hatchback Engine D4F 702	250401	Drive Shaft	44T	21	29.95	57	84	629		
	2001.01-2007.06	MT	R	F	Hatchback Engine D4F 702	250438	Drive Shaft	44T	21	23	52.3	84.5	740		
TWINGO I (S06_)															
1.2 (43 kW)	1996.05-2004.08	-	R	F	Box Engine D7F 700/D7F 701/D7F 702/D7F 703/D7F 704/D7F 706	250084	Drive Shaft	38T	21	23	57	84.5	737		
TWINGO II (CNO_)															
1.2 (43 kW)	2007.03-	-	-	F	Hatchback Engine D7F 800	850112	Outer Joint		23	28	49	83.5	54.5	I	
	2007.03-	-	-	L	F	Hatchback Engine D7F 800	250544	Drive Shaft		23	30	49	83.5	631	
	2007.03-	-	-	R	F	Hatchback Engine D7F 800	250542	Drive Shaft		23	23	49	83.5	721	
1.2 16V (55 kW)	2007.03-	-	-	F	Hatchback Engine D4F 764/D4F 770/D4F 772	850112	Outer Joint		23	28	49	83.5	54.5	I	
	2007.03-	-	MT	L	F	Hatchback Engine D4F 764/D4F 770/D4F 772	250544	Drive Shaft		23	30	49	83.5	631	
	2007.03-	-	AT/MT	R	F	Hatchback Engine D4F 764/D4F 770/D4F 772	250542	Drive Shaft		23	23	49	83.5	721	
	2007.03-	-	Semi-AT	L	F	Hatchback Engine D4F 764/D4F 770/D4F 772	250591	Drive Shaft		23	30	49	83.5	631	
1.2 16V (56 kW)	2007.03-	-	-	F	Hatchback Engine D4F 772	850112	Outer Joint		23	28	49	83.5	54.5	I	
	2007.03-	-	MT	L	F	Hatchback Engine D4F 772	250544	Drive Shaft		23	30	49	83.5	631	
	2007.03-	-	AT/MT	R	F	Hatchback Engine D4F 772	250542	Drive Shaft		23	23	49	83.5	721	
	2007.03-	-	Semi-AT	L	F	Hatchback Engine D4F 772	250591	Drive Shaft		23	30	49	83.5	631	
1.2 TCe 100 (75 kW)	2011.02-	-	-	L	F	Hatchback Engine D4F 780/D4F 782	250539	Drive Shaft		23	26	49	86	611	
1.2 Turbo (74 kW)	2007.03-	-	-	L	F	Hatchback Engine D4F 780/D4F 782	250539	Drive Shaft		23	26	49	86	611	
1.5 dCi (47 kW)	2007.03-	-	-	R	F	Hatchback Engine K9K 740	699169	Inner Joint		26	30	33	326	95	
	2007.03-	-	-	R	F	Hatchback Engine K9K 740	250538	Drive Shaft		23	26	49	86	868	
	2007.03-	-	-	L	F	Hatchback Engine K9K 740	250539	Drive Shaft		23	26	49	86	611	
TWIZY (MAM_)															
45 (4 kW)	2012.04-	-	AT	L/R	R	Hatchback Engine 3CG 400	201123	Drive Shaft		21	18	47.8	79	467	
VEL SATIS (BJO_)															
2.0 dCi (110 kW)	2005.08-	-	-	L	F	MPV Engine M9R 760	250493	Drive Shaft		27	39	56.8	90	663	
	2005.08-	-	-	R	F	MPV Engine M9R 760	250592	Drive Shaft		27	39	56.8	90	1006	
	2005.08-	-	MT	R	F	MPV Engine M9R 760	250631	Drive Shaft		27	39	56.8	90	1013	
2.0 dCi (127 kW)	2006.01-	-	-	L	F	MPV Engine M9R 760/M9R 762/M9R 763	250493	Drive Shaft		27	39	56.8	90	663	
	2006.01-	-	-	R	F	MPV Engine M9R 760/M9R 762/M9R 763	250592	Drive Shaft		27	39	56.8	90	1006	
	2006.01-	-	MT	R	F	MPV Engine M9R 760/M9R 762/M9R 763	250631	Drive Shaft		27	39	56.8	90	1013	
ROEWE (SAIC) 750															
1.8 Turbo (118 kW)	2008.03-2008.12	AT	-	-	Saloon Engine 18K4G	251032	Drive Shaft		28	26	57.8	83.5	593		
2.5 (135 kW)	2007.01-2015.12	AT	-	-	Saloon Engine 25K4F	251033	Drive Shaft		28	26	57.8	83.5	627		
ROVER 100 (XP)															
111 (44 kW)	1994.04-1997.10	-	-	F	Convertible Engine 11 K2D	851010	Outer Joint		25	22	50	82	56	I	
114 (55 kW)	1994.04-1997.10	-	-	F	Convertible Engine 14 K2A/14 K2D	851010	Outer Joint		25	22	50	82	56	I	
114 (75 kW)	1997.03-1998.10	-	-	F	Convertible Engine 14 K4F	851010	Outer Joint		25	22	50	82	56	I	
100/METRO (XP)															
1.1 (44 kW)	1990.03-1998.12	-	-	F	Hatchback Engine 11 K2A/11 K2D	851010	Outer Joint		25	22	50	82	56	I	
1.4 (55 kW)	1990.03-1998.12	-	-	F	Hatchback Engine 14 K2A/14 K2D	851010	Outer Joint		25	22	50	82	56	I	
1.5 D (42 kW)	1994.12-1998.12	-	-	F	Hatchback Engine TUD 5	851010	Outer Joint		25	22	50	82	56	I	
114 D (38 kW)	1992.10-1994.12	-	-	F	Hatchback Engine TUD 3	851010	Outer Joint		25	22	50	82	56	I	
114 GSi (76 kW)	1994.10-1995.10	-	-	F	Hatchback Engine 14 K4F	851010	Outer Joint		25	22	50	82	56	I	
114 GTI 16V (69 kW)	1990.03-1991.08	-	-	F	Hatchback Engine 14 K4C/14 K4D	851010	Outer Joint		25	22	50	82	56	I	
114 GTI 16V (76 kW)	1991.08-1998.12	-	-	F	Hatchback Engine 14 K4F	851010	Outer Joint		25	22	50	82	56	I	
114 GTI/GT 16V Cat (66 kW)	1990.03-1998.12	-	-	F	Hatchback Engine 14 K4C/14 K4D	851010	Outer Joint		25	22	50	82	56	I	
200 (RF)															
2.2 D/SD (63 kW)	1995.11-2000.03	-	-	F	Hatchback Engine 20 T2R	851006	Outer Joint	27T	26	32	49	78	68.5	I	
	1995.11-2000.03	-	-	F	Hatchback Engine 20 T2R	851005	Outer Joint		26	32	49	78	68.5	I	
	1995.11-2000.03	MT	L	F	Hatchback Engine 20 T2R	251004	Drive Shaft	27T	26	29	49	78	594		
	1995.11-2000.03	MT	R	F	Hatchback Engine 20 T2R	250169	Drive Shaft	27T	26	29	49	78	925		
	1995.11-2000.03	MT	L	F	Hatchback Engine 20 T2R	251011	Drive Shaft		26	29	49	78	594		





	 YEAR	TRANSM	L/R	F/R	REMARKS	GSP Ref.	 PRODUCT	 ABS	Technical Specifications									
									A	B	C	H	L	P				
ROEWE (SAIC)																		
200 (RF)																		
2.2 D/SD (63 kW)	1995.11-2000.03	2000.03	MT	R	F	Hatchback Engine 20 T2R	250168	Drive Shaft		26	29	49	78	925				
	1995.11-2000.03	2000.03	MT	R	F	Hatchback Engine 20 T2R	251027	Drive Shaft	43T	26	29	49	78	936				
	1995.11-2000.03	2000.03	-	L	F	Hatchback Engine 20 T2R	251028	Drive Shaft	43T	26	29	49	78	585				
2.2 SDi (77 kW)	1995.11-2000.03	2000.03	-	-	F	Hatchback Engine 20 T2N	851007	Outer Joint	43T	26	32	49	78	68.5	I			
	1995.11-2000.03	2000.03	-	-	F	Hatchback Engine 20 T2N	851005	Outer Joint		26	32	49	78	68.5	I			
	1995.11-2000.03	2000.03	MT	L	F	Hatchback Engine 20 T2N	251004	Drive Shaft	27T	26	29	49	78	594				
	1995.11-2000.03	2000.03	MT	R	F	Hatchback Engine 20 T2N	250169	Drive Shaft	27T	26	29	49	78	925				
	1995.11-2000.03	2000.03	MT	L	F	Hatchback Engine 20 T2N	251011	Drive Shaft		26	29	49	78	594				
	1995.11-2000.03	2000.03	MT	R	F	Hatchback Engine 20 T2N	250168	Drive Shaft		26	29	49	78	925				
	1995.11-2000.03	2000.03	MT	L	F	Hatchback Engine 20 T2N	251006	Drive Shaft		26	29	49	78	563				
	1995.11-2000.03	2000.03	MT	R	F	Hatchback Engine 20 T2N	251027	Drive Shaft	43T	26	29	49	78	936				
	1995.11-2000.03	2000.03	-	L	F	Hatchback Engine 20 T2N	251028	Drive Shaft	43T	26	29	49	78	585				
211 (44 kW)	1998.01-2000.03	2000.03	MT	R	F	Hatchback Engine 11 K2D	251010	Drive Shaft		26	22	49	78.8	877				
	1998.01-2000.03	2000.03	AT/MT	L/R	F	Hatchback Engine 11 K2D	851003	Outer Joint	43T	26	22	49	78.8	55	I			
	1998.01-2000.03	2000.03	AT/MT	L/R	F	Hatchback Engine 11 K2D	823010	Outer Joint		26	22	49	78.8	55	I			
	1998.01-2000.03	2000.03	MT	L	F	Hatchback Engine 11 K2D	251001	Drive Shaft		26	22	49	78.8	642				
214 i (55 kW)	1995.11-2000.03	2000.03	AT/MT	L/R	F	Hatchback Engine 14 K2F	851003	Outer Joint	43T	26	22	49	78.8	55	I			
	1995.11-2000.03	2000.03	AT/MT	L/R	F	Hatchback Engine 14 K2F	823010	Outer Joint		26	22	49	78.8	55	I			
214 Si (76 kW)	1995.11-2000.03	2000.03	-	-	F	Hatchback Engine 14 K4F	899209	Outer Joint	27T	26	22	49	78.8	55	I			
	1995.11-2000.03	2000.03	AT/MT	L/R	F	Hatchback Engine 14 K4F	851003	Outer Joint	43T	26	22	49	78.8	55	I			
	1995.11-2000.03	2000.03	AT/MT	L/R	F	Hatchback Engine 14 K4F	823010	Outer Joint		26	22	49	78.8	55	I			
216 Si (82 kW)	1995.11-2000.03	2000.03	MT	-	F	Hatchback Engine 16 K4F	899209	Outer Joint	27T	26	22	49	78.8	55	I			
	1995.11-2000.03	2000.03	AT/MT	L/R	F	Hatchback Engine 16 K4F	851003	Outer Joint	43T	26	22	49	78.8	55	I			
	1995.11-2000.03	2000.03	AT/MT	L/R	F	Hatchback Engine 16 K4F	823010	Outer Joint		26	22	49	78.8	55	I			
	1995.11-2000.03	2000.03	CVT	L	F	Hatchback Engine 16 K4F	223020	Drive Shaft	50T	26	25	49	78.8	909				
	1995.11-2000.03	2000.03	CVT	R	F	Hatchback Engine 16 K4F	201010	Drive Shaft	50T	26	25	55	78.5	627				
218 K Vi (107 kW)	1995.11-2000.03	2000.03	-	-	F	Hatchback Engine 18 K4K	899209	Outer Joint	27T	26	22	49	78.8	55	I			
	1995.11-2000.03	2000.03	AT/MT	L/R	F	Hatchback Engine 18 K4K	851003	Outer Joint	43T	26	22	49	78.8	55	I			
	1995.11-2000.03	2000.03	AT/MT	L/R	F	Hatchback Engine 18 K4K	823010	Outer Joint		26	22	49	78.8	55	I			
200 (XH)																		
216 (61 kW)	1985.03-1989.09	1989.09	-	-	F	Saloon Engine 16 H	851012	Outer Joint		23	22	49	79	53.5	I			
216 Vitesse (75 kW)	1985.03-1989.09	1989.09	-	-	F	Saloon Engine 16 H	851012	Outer Joint		23	22	49	79	53.5	I			
200 (XW)																		
1.4 (66 kW)	1992.01-1999.11	1999.11	MT	R	F	Convertible Engine 14 K4C/14 K4D	251010	Drive Shaft		26	22	49	78.8	877				
	1992.01-1999.11	1999.11	MT	L/R	F	Convertible Engine 14 K4C/14 K4D	823010	Outer Joint		26	22	49	78.8	55	I			
	1992.01-1999.11	1999.11	MT	L	F	Convertible Engine 14 K4C/14 K4D	251001	Drive Shaft		26	22	49	78.8	642				
1.4 GSi/Si (70 kW)	1990.01-1995.10	1995.10	MT	R	F	Hatchback Engine 14 K4C	251010	Drive Shaft		26	22	49	78.8	877				
	1990.01-1995.10	1995.10	MT	L	F	Hatchback Engine 14 K4C	251023	Drive Shaft	27T	26	22	49	78.8	642				
	1990.01-1995.10	1995.10	MT	L/R	F	Hatchback Engine 14 K4C	823010	Outer Joint		26	22	49	78.8	55	I			
	1990.01-1995.10	1995.10	MT	L	F	Hatchback Engine 14 K4C	251001	Drive Shaft		26	22	49	78.8	642				
1.4 GSi/Si (76 kW)	1992.12-1995.10	1995.10	MT	R	F	Hatchback Engine 14 K4F	251010	Drive Shaft		26	22	49	78.8	877				
	1992.12-1995.10	1995.10	MT	L	F	Hatchback Engine 14 K4F	251023	Drive Shaft	27T	26	22	49	78.8	642				
	1992.12-1995.10	1995.10	MT	L/R	F	Hatchback Engine 14 K4F	823010	Outer Joint		26	22	49	78.8	55	I			
	1992.12-1995.10	1995.10	MT	L	F	Hatchback Engine 14 K4F	251001	Drive Shaft		26	22	49	78.8	642				
1.4 i 16V (76 kW)	1993.01-1999.11	1999.11	MT	R	F	Convertible Engine 14 K4F	251010	Drive Shaft		26	22	49	78.8	877				
	1993.01-1999.11	1999.11	MT	L/R	F	Convertible Engine 14 K4F	823010	Outer Joint		26	22	49	78.8	55	I			
	1993.01-1999.11	1999.11	MT	L	F	Convertible Engine 14 K4F	251001	Drive Shaft		26	22	49	78.8	642				
1.4 Si/Gsi (66 kW)	1989.10-1995.10	1995.10	MT	R	F	Hatchback Engine 14 K4C/14 K4D	251010	Drive Shaft		26	22	49	78.8	877				
	1989.10-1995.10	1995.10	MT	L	F	Hatchback Engine 14 K4C/14 K4D	251023	Drive Shaft	27T	26	22	49	78.8	642				
	1989.10-1995.10	1995.10	MT	L/R	F	Hatchback Engine 14 K4C/14 K4D	823010	Outer Joint		26	22	49	78.8	55	I			
	1989.10-1995.10	1995.10	MT	L	F	Hatchback Engine 14 K4C/14 K4D	251001	Drive Shaft		26	22	49	78.8	642				
1.6 (82 kW)	1990.04-1996.02	1996.02	AT/MT	L	F	Convertible Engine D 16 Z2	201020	Drive Shaft	50T	26	27	49	78.8	608				
	1990.04-1996.02	1996.02	-	-	F	Convertible Engine D 16 Z2	823007	Outer Joint		26	23	49	78.8	55	I			
	1990.04-1996.02	1996.02	AT/MT	R	F	Convertible Engine D 16 Z2	223040	Drive Shaft	50T	26	27	49	78.8	606				
	1990.04-1996.02	1996.02	AT/MT	L	F	Convertible Engine D 16 Z2	223122	Drive Shaft		26	27	49	78.8	608				
	1990.04-1996.02	1996.02	MT	-	-	Convertible Engine D 16 Z2	823020	Outer Joint		26	23	49	78.5	54.5	M			
	1990.04-1996.02	1996.02	AT/MT	R	F	Convertible Engine D 16 Z2	223078	Drive Shaft		26	27	49	78.8	606				
	1990.04-1996.02	1996.02	AT/MT	L	F	Convertible Engine D 16 Z2	601003	Inner Joint		27	32	40	55	97.5				
1.6 (90 kW)	1992.10-1999.06	1999.06	-	-	F	Coupe Engine D 16 A8	823007	Outer Joint		26	23	49	78.8	55	I			
	1992.10-1999.06	1999.06	AT/MT	L	F	Coupe Engine D 16 A8	201020	Drive Shaft	50T	26	27	49	78.8	608				
	1992.10-1999.06	1999.06	AT/MT	R	F	Coupe Engine D 16 A8	223040	Drive Shaft	50T	26	27	49	78.8	606				
	1992.10-1999.06	1999.06	AT/MT	L	F	Coupe Engine D 16 A8	223122	Drive Shaft		26	27	49	78.8	608				
	1992.10-1999.06	1999.06	AT	-	-	Coupe Engine D 16 A8	823020	Outer Joint		26	23	49	78.5	54.5	M			
	1992.10-1999.06	1999.06	AT/MT	R	F	Coupe Engine D 16 A8	223078	Drive Shaft		26	27	49	78.8	606				
	1992.10-1999.06	1999.06	AT/MT	L	F	Coupe Engine D 16 A8	601003	Inner Joint		27	32	40	55	97.5				
	1992.10-1999.06	1999.06	AT	L	F	Coupe Engine D 16 A8	223020	Drive Shaft	50T	26	25	49	78.8	909				





	 YEAR	TRANSM	L/R	F/R	REMARKS	GSP Ref.	 PRODUCT	 ABS	Technical Specifications					
									A	B	C	H	L	P
ROEWE (SAIC)														
200 (XW)														
1.6 (90 kW)	1992.10-1999.06	AT	R	F	Coupe Engine D 16 A8	201010	Drive Shaft	50T	26	25	55	78.5	627	
	1992.10-1999.06	-	-	-	Coupe Engine D 16 A8	851024	Outer Joint		26	23	49	78.5	55.5	M
1.6 GSi (82 kW)	1989.10-1995.10	-	-	F	Hatchback Engine D 16 Z2	823007	Outer Joint		26	23	49	78.8	55	I
	1989.10-1995.10	-	L	F	Hatchback Engine D 16 Z2	201020	Drive Shaft	50T	26	27	49	78.8	608	
	1989.10-1995.10	-	R	F	Hatchback Engine D 16 Z2	223040	Drive Shaft	50T	26	27	49	78.8	606	
	1989.10-1995.10	MT	-	-	Hatchback Engine D 16 Z2	823020	Outer Joint		26	23	49	78.5	54.5	M
	1989.10-1995.10	-	L	F	Hatchback Engine D 16 Z2	223122	Drive Shaft		26	27	49	78.8	608	
	1989.10-1995.10	-	R	F	Hatchback Engine D 16 Z2	223078	Drive Shaft		26	27	49	78.8	606	
	1989.10-1995.10	-	L	F	Hatchback Engine D 16 Z2	601003	Inner Joint		27	32	40	55	97.5	
	1989.10-1995.10	-	-	-	Hatchback Engine D 16 Z2	851024	Outer Joint		26	23	49	78.5	55.5	M
1.6 GSi (85 kW)	1989.10-1995.10	-	-	F	Hatchback Engine D 16 A7	823007	Outer Joint		26	23	49	78.8	55	I
	1989.10-1995.10	-	L	F	Hatchback Engine D 16 A7	201020	Drive Shaft	50T	26	27	49	78.8	608	
	1989.10-1995.10	-	R	F	Hatchback Engine D 16 A7	223040	Drive Shaft	50T	26	27	49	78.8	606	
	1989.10-1995.10	MT	-	-	Hatchback Engine D 16 A7	823020	Outer Joint		26	23	49	78.5	54.5	M
	1989.10-1995.10	-	L	F	Hatchback Engine D 16 A7	223122	Drive Shaft		26	27	49	78.8	608	
	1989.10-1995.10	-	R	F	Hatchback Engine D 16 A7	223078	Drive Shaft		26	27	49	78.8	606	
	1989.10-1995.10	-	L	F	Hatchback Engine D 16 A7	601003	Inner Joint		27	32	40	55	97.5	
	1989.10-1995.10	-	-	-	Hatchback Engine D 16 A7	851024	Outer Joint		26	23	49	78.5	55.5	M
1.6 GSi (90 kW)	1990.09-1995.10	-	-	F	Hatchback Engine D 16 A8	823007	Outer Joint		26	23	49	78.8	55	I
	1990.09-1995.10	-	L	F	Hatchback Engine D 16 A8	201020	Drive Shaft	50T	26	27	49	78.8	608	
	1990.09-1995.10	-	R	F	Hatchback Engine D 16 A8	223040	Drive Shaft	50T	26	27	49	78.8	606	
	1990.09-1995.10	MT	-	-	Hatchback Engine D 16 A8	823020	Outer Joint		26	23	49	78.5	54.5	M
	1990.09-1995.10	-	L	F	Hatchback Engine D 16 A8	223122	Drive Shaft		26	27	49	78.8	608	
	1990.09-1995.10	-	R	F	Hatchback Engine D 16 A8	223078	Drive Shaft		26	27	49	78.8	606	
	1990.09-1995.10	-	L	F	Hatchback Engine D 16 A8	601003	Inner Joint		27	32	40	55	97.5	
	1990.09-1995.10	-	-	-	Hatchback Engine D 16 A8	851024	Outer Joint		26	23	49	78.5	55.5	M
1.6 GSi (96 kW)	1990.09-1995.10	-	-	F	Hatchback Engine D 16 A9	823007	Outer Joint		26	23	49	78.8	55	I
	1990.09-1995.10	-	L	F	Hatchback Engine D 16 A9	201020	Drive Shaft	50T	26	27	49	78.8	608	
	1990.09-1995.10	-	R	F	Hatchback Engine D 16 A9	223040	Drive Shaft	50T	26	27	49	78.8	606	
	1990.09-1995.10	-	L	F	Hatchback Engine D 16 A9	223122	Drive Shaft		26	27	49	78.8	608	
	1990.09-1995.10	-	R	F	Hatchback Engine D 16 A9	223078	Drive Shaft		26	27	49	78.8	606	
	1990.09-1995.10	-	L	F	Hatchback Engine D 16 A9	601003	Inner Joint		27	32	40	55	97.5	
1.6 i (90 kW)	1992.01-1999.11	-	-	F	Convertible Engine D 16 A8	823007	Outer Joint		26	23	49	78.8	55	I
	1992.01-1999.11	AT/MT	L	F	Convertible Engine D 16 A8	201020	Drive Shaft	50T	26	27	49	78.8	608	
	1992.01-1999.11	AT/MT	R	F	Convertible Engine D 16 A8	223040	Drive Shaft	50T	26	27	49	78.8	606	
	1992.01-1999.11	AT/MT	L	F	Convertible Engine D 16 A8	223122	Drive Shaft		26	27	49	78.8	608	
	1992.01-1999.11	AT	-	-	Convertible Engine D 16 A8	823020	Outer Joint		26	23	49	78.5	54.5	M
	1992.01-1999.11	AT/MT	R	F	Convertible Engine D 16 A8	223078	Drive Shaft		26	27	49	78.8	606	
	1992.01-1999.11	AT/MT	L	F	Convertible Engine D 16 A8	601003	Inner Joint		27	32	40	55	97.5	
1.9 D (52 kW)	1991.09-1995.10	-	-	F	Hatchback Engine XUD9	851006	Outer Joint	27T	26	32	49	78	68.5	I
	1991.09-1995.10	-	-	F	Hatchback Engine XUD9	851005	Outer Joint		26	32	49	78	68.5	I
	1991.09-1995.10	MT	L	F	Hatchback Engine XUD9	251004	Drive Shaft	27T	26	29	49	78	594	
	1991.09-1995.10	MT	R	F	Hatchback Engine XUD9	250169	Drive Shaft	27T	26	29	49	78	925	
	1991.09-1995.10	MT	L	F	Hatchback Engine XUD9	251011	Drive Shaft		26	29	49	78	594	
	1991.09-1995.10	MT	R	F	Hatchback Engine XUD9	250168	Drive Shaft		26	29	49	78	925	
1.9 TD (65 kW)	1991.09-1995.10	-	-	F	Hatchback Engine XUD 7TE	851006	Outer Joint	27T	26	32	49	78	68.5	I
	1991.09-1995.10	-	-	F	Hatchback Engine XUD 7TE	851005	Outer Joint		26	32	49	78	68.5	I
	1991.09-1995.10	MT	L	F	Hatchback Engine XUD 7TE	251004	Drive Shaft	27T	26	29	49	78	594	
	1991.09-1995.10	MT	R	F	Hatchback Engine XUD 7TE	250169	Drive Shaft	27T	26	29	49	78	925	
	1991.09-1995.10	MT	L	F	Hatchback Engine XUD 7TE	251011	Drive Shaft		26	29	49	78	594	
	1991.09-1995.10	MT	R	F	Hatchback Engine XUD 7TE	250168	Drive Shaft		26	29	49	78	925	
	1991.09-1995.10	MT	L	F	Hatchback Engine XUD 7TE	251004	Drive Shaft		26	29	49	78	594	
2.2 GSi (100 kW)	1994.05-1999.06	-	-	F	Coupe Engine 20 T4H	851006	Outer Joint	27T	26	32	49	78	68.5	I
	1994.05-1999.06	-	-	F	Coupe Engine 20 T4H	851005	Outer Joint		26	32	49	78	68.5	I
	1994.05-1999.06	MT	L	F	Coupe Engine 20 T4H	601002	Inner Joint		27	32	40	54	87	
	1994.05-1999.06	MT	L	F	Coupe Engine 20 T4H	210230	Drive Shaft		27	35	56.1	91.5	921	
	1994.05-1999.06	MT	L	F	Coupe Engine 20 T4H	223057	Drive Shaft		26	27	49	79	585.5	
	1994.05-1999.06	MT	L	F	Coupe Engine 20 T4H	223057	Drive Shaft		26	27	49	79	585.5	
2.2 GTi (100 kW)	1993.01-1995.10	-	-	F	Hatchback Engine 20 T4H	851006	Outer Joint	27T	26	32	49	78	68.5	I
	1993.01-1995.10	-	-	F	Hatchback Engine 20 T4H	851005	Outer Joint		26	32	49	78	68.5	I
	1993.01-1995.10	MT	L	F	Hatchback Engine 20 T4H	601002	Inner Joint		27	32	40	54	87	
	1993.01-1995.10	MT	L	F	Hatchback Engine 20 T4H	210230	Drive Shaft		27	35	56.1	91.5	921	
	1993.01-1995.10	MT	L	F	Hatchback Engine 20 T4H	223057	Drive Shaft		26	27	49	79	585.5	
2.2 GTi (103 kW)	1991.09-1995.10	-	-	F	Hatchback Engine 20 M4F	851006	Outer Joint	27T	26	32	49	78	68.5	I
	1991.09-1995.10	-	-	F	Hatchback Engine 20 M4F	851005	Outer Joint		26	32	49	78	68.5	I
	1991.09-1995.10	MT	L	F	Hatchback Engine 20 M4F	601002	Inner Joint		27	32	40	54	87	
	1991.09-1995.10	MT	L	F	Hatchback Engine 20 M4F	210230	Drive Shaft		27	35	56.1	91.5	921	
	1991.09-1995.10	MT	L	F	Hatchback Engine 20 M4F	223057	Drive Shaft		26	27	49	79	585.5	

YEAR	TRANSM	L/R	F/R	REMARKS	GSP Ref.	PRODUCT	ABS	Technical Specifications						
								A	B	C	H	L	P	
ROEWE (SAIC)														
200 (XW)														
2.2 Turbo (147 kW)	1992.10-1999.06	-	-	F	Coupe Engine 20 T4G	851006	Outer Joint	27T	26	32	49	78	68.5	I
	1992.10-1999.06	-	-	F	Coupe Engine 20 T4G	851005	Outer Joint		26	32	49	78	68.5	I
	1992.10-1999.06	MT	L	F	Coupe Engine 20 T4G	601002	Inner Joint		27	32	40	54	87	
	1992.10-1999.06	MT	L	F	Coupe Engine 20 T4G	210230	Drive Shaft		27	35	56.1	91.5	921	
	1992.10-1999.06	MT	L	F	Coupe Engine 20 T4G	223057	Drive Shaft		26	27	49	79	585.5	
	1993.01-1995.10	-	-	F	Hatchback Engine 20 T4G	851006	Outer Joint	27T	26	32	49	78	68.5	I
	1993.01-1995.10	-	-	F	Hatchback Engine 20 T4G	851005	Outer Joint		26	32	49	78	68.5	I
	1993.01-1995.10	MT	L	F	Hatchback Engine 20 T4G	601002	Inner Joint		27	32	40	54	87	
	1993.01-1995.10	-	L	F	Hatchback Engine 20 T4G	251028	Drive Shaft	43T	26	29	49	78	585	
	1993.01-1995.10	MT	L	F	Hatchback Engine 20 T4G	210230	Drive Shaft		27	35	56.1	91.5	921	
1993.01-1995.10	MT	L	F	Hatchback Engine 20 T4G	223057	Drive Shaft		26	27	49	79	585.5		
214 (55 kW)	1993.09-1995.10	MT	R	F	Hatchback Engine 14 K2A/14 K2D	251010	Drive Shaft		26	22	49	78.8	877	
	1993.09-1995.10	MT	L/R	F	Hatchback Engine 14 K2A/14 K2D	823010	Outer Joint		26	22	49	78.8	55	I
	1993.09-1995.10	MT	L	F	Hatchback Engine 14 K2A/14 K2D	251001	Drive Shaft		26	22	49	78.8	642	
214 1.4 (70 kW)	1990.04-1992.09	MT	R	F	Convertible Engine 14 K4C	251010	Drive Shaft		26	22	49	78.8	877	
	1990.04-1992.09	MT	L	F	Convertible Engine 14 K4C	251001	Drive Shaft		26	22	49	78.8	642	
216 1.6i 16V (82 kW)	1996.01-1999.11	AT	L	F	Convertible Engine 16 K4F	223020	Drive Shaft	50T	26	25	49	78.8	909	
	1996.01-1999.11	AT	R	F	Convertible Engine 16 K4F	201010	Drive Shaft	50T	26	25	55	78.5	627	
200 II														
1.6	1989.10-1996.03	MT	-	-	Hatchbackback	651001	Inner Joint		27	22	40	54.5	93.5	
	1992.04-1999.06	MT/AT	-	-	Cabriolet,Coupe	651001	Inner Joint		27	22	40	54.5	93.5	
2.0	1991.06-1996.03	MT	R	F	-	251014	Drive Shaft	27T	26	29	49	78	936	
2.0 TURBO	1991.06-1996.03	MT	R	F	-	251014	Drive Shaft	27T	26	29	49	78	936	
200 SERIES														
218-1.8 TD	1991.03-1996.03	MT	-	-	-	651006	Inner Joint		29	25	40	56.5	96.5	
	1991.03-1996.03	MT	-	-	-	650023	Inner Joint		29	25	31	398	101	
218-1.9 Diesel	1991.03-1996.03	MT	-	-	-	651006	Inner Joint		29	25	40	56.5	96.5	
	1991.03-1996.03	MT	-	-	-	650023	Inner Joint		29	25	31	398	101	
25														
2.0 TD	1999.11-	MT	L	F	-	251017	Drive Shaft	43T	26	29	55	77.5	559	
25 (RF)														
1.1 (44 kW)	1999.11-2005.05	MT	R	F	Hatchback	251010	Drive Shaft		26	22	49	78.8	877	
	1999.11-2005.05	-	-	F	Hatchback	899209	Outer Joint	27T	26	22	49	78.8	55	I
	1999.11-2005.05	MT	L	F	Hatchback	251001	Drive Shaft		26	22	49	78.8	642	
1.1 (55 kW)	1999.09-2001.06	MT	R	F	Hatchback Engine 11 K4F	251010	Drive Shaft		26	22	49	78.8	877	
	1999.09-2001.06	-	-	F	Hatchback Engine 11 K4F	899209	Outer Joint	27T	26	22	49	78.8	55	I
	1999.09-2001.06	MT	L	F	Hatchback Engine 11 K4F	251001	Drive Shaft		26	22	49	78.8	877	
1.1 16V (55 kW)	2004.01-2005.05	MT	R	F	Hatchback Engine 11 K4F	251010	Drive Shaft		26	22	49	78.8	877	
	2004.01-2005.05	-	-	F	Hatchback Engine 11 K4F	899209	Outer Joint	27T	26	22	49	78.8	55	I
	2004.01-2005.05	MT	L	F	Hatchback Engine 11 K4F	251001	Drive Shaft		26	22	49	78.8	642	
1.4 16V (62 kW)	1999.10-2005.05	-	-	F	Hatchback Engine 14 K4M	899209	Outer Joint	27T	26	22	49	78.8	55	I
	1999.10-2005.05	-	R	F	Hatchback Engine 14 K4M	251010	Drive Shaft		26	22	49	78.8	877	
	1999.10-2005.05	AT/MT	L/R	F	Hatchback Engine 14 K4M	851003	Outer Joint	43T	26	22	49	78.8	55	I
	1999.10-2005.05	AT/MT	L/R	F	Hatchback Engine 14 K4M	823010	Outer Joint		26	22	49	78.8	55	I
	1999.10-2005.05	-	L	F	Hatchback Engine 14 K4M	251021	Drive Shaft	43T	26	23	49	78.8	632	
	1999.10-2005.05	-	R	F	Hatchback Engine 14 K4M	251020	Drive Shaft	43T	26	23	49	78.8	903	
	1999.10-2005.05	-	L	F	Hatchback Engine 14 K4M	251001	Drive Shaft		26	22	49	78.8	642	
1.4 16V (76 kW)	1999.10-2005.05	-	-	F	Hatchback Engine 14 K4F	899209	Outer Joint	27T	26	22	49	78.8	55	I
	1999.10-2005.05	-	R	F	Hatchback Engine 14 K4F	251010	Drive Shaft		26	22	49	78.8	877	
	1999.10-2005.05	AT/MT	L/R	F	Hatchback Engine 14 K4F	851003	Outer Joint	43T	26	22	49	78.8	55	I
	1999.10-2005.05	AT/MT	L/R	F	Hatchback Engine 14 K4F	823010	Outer Joint		26	22	49	78.8	55	I
	1999.10-2005.05	-	L	F	Hatchback Engine 14 K4F	251021	Drive Shaft	43T	26	23	49	78.8	632	
	1999.10-2005.05	-	R	F	Hatchback Engine 14 K4F	251020	Drive Shaft	43T	26	23	49	78.8	903	
	1999.10-2005.05	-	L	F	Hatchback Engine 14 K4F	251001	Drive Shaft		26	22	49	78.8	642	
1.6 16V (80 kW)	1999.10-2005.05	-	-	F	Hatchback Engine 16 K4F	899209	Outer Joint	27T	26	22	49	78.8	55	I
	1999.10-2005.05	AT/MT	L/R	F	Hatchback Engine 16 K4F	851003	Outer Joint	43T	26	22	49	78.8	55	I
	1999.10-2005.05	CVT	L	F	Hatchback Engine 16 K4F	251019	Drive Shaft	43T	26	23	49	78.8	630.5	
	1999.10-2005.05	CVT	R	F	Hatchback Engine 16 K4F	251018	Drive Shaft	43T	26	23	49	78.8	887	
	1999.10-2005.05	AT/MT	L/R	F	Hatchback Engine 16 K4F	823010	Outer Joint		26	22	49	78.8	55	I
	1999.10-2005.05	MT	L	F	Hatchback Engine 16 K4F	251021	Drive Shaft	43T	26	23	49	78.8	632	
	1999.10-2005.05	MT	R	F	Hatchback Engine 16 K4F	251020	Drive Shaft	43T	26	23	49	78.8	903	
1.8 16V (107 kW)	2000.02-2005.05	-	-	F	Hatchback Engine 18 K4K	899209	Outer Joint	27T	26	22	49	78.8	55	I
	2000.02-2005.05	AT/MT	L/R	F	Hatchback Engine 18 K4K	851003	Outer Joint	43T	26	22	49	78.8	55	I
	2000.02-2005.05	AT	L	F	Hatchback Engine 18 K4K	251019	Drive Shaft	43T	26	23	49	78.8	630.5	
	2000.02-2005.05	AT	R	F	Hatchback Engine 18 K4K	251018	Drive Shaft	43T	26	23	49	78.8	887	
	2000.02-2005.05	AT/MT	L/R	F	Hatchback Engine 18 K4K	823010	Outer Joint		26	22	49	78.8	55	I





	 YEAR	TRANSM	L/R	F/R	REMARKS	GSP Ref.	 PRODUCT	 ABS	Technical Specifications						
									A	B	C	H	L	P	
ROEWE (SAIC)															
25 (RF)															
1.8 16V (85 kW)	1999.10-2005.05	-	-	F	Hatchback Engine 18 K4F	899209	Outer Joint	27T	26	22	49	78.8	55	I	
	1999.10-2005.05	AT/MT	L/R	F	Hatchback Engine 18 K4F	851003	Outer Joint	43T	26	22	49	78.8	55	I	
	1999.10-2005.05	CVT	L	F	Hatchback Engine 18 K4F	251019	Drive Shaft	43T	26	23	49	78.8	630.5		
	1999.10-2005.05	CVT	R	F	Hatchback Engine 18 K4F	251018	Drive Shaft	43T	26	23	49	78.8	887		
	1999.10-2005.05	AT/MT	L/R	F	Hatchback Engine 18 K4F	823010	Outer Joint		26	22	49	78.8	55	I	
2.0 iDT (74 kW)	1999.10-2005.05	-	-	F	Hatchback Engine 20 T2N	851007	Outer Joint	43T	26	32	49	78	68.5	I	
	1999.10-2005.05	-	-	F	Hatchback Engine 20 T2N	851005	Outer Joint		26	32	49	78	68.5	I	
	1999.10-2005.05	MT	L	F	Hatchback Engine 20 T2N	251006	Drive Shaft		26	29	49	78	563		
	1999.10-2005.05	MT	R	F	Hatchback Engine 20 T2N	251027	Drive Shaft	43T	26	29	49	78	936		
	1999.10-2005.05	-	L	F	Hatchback Engine 20 T2N	251028	Drive Shaft	43T	26	29	49	78	585		
2.0 iDT (83 kW)	2002.01-2004.12	-	-	F	Hatchback Engine 20 T2N	851007	Outer Joint	43T	26	32	49	78	68.5	I	
	2002.01-2004.12	-	-	F	Hatchback Engine 20 T2N	851005	Outer Joint		26	32	49	78	68.5	I	
	2002.01-2004.12	MT	L	F	Hatchback Engine 20 T2N	251006	Drive Shaft		26	29	49	78	563		
	2002.01-2004.12	MT	R	F	Hatchback Engine 20 T2N	251027	Drive Shaft	43T	26	29	49	78	936		
400															
414 (70 kW)	1993.01-1995.04	MT	-	-	-	651003	Inner Joint		22	22	40	59.5	101		
	1993.01-1995.04	MT	-	-	-	651004	Inner Joint		22	22	40	84	101		
400 (RT)															
414 (55 kW)	1996.03-1997.12	-	-	F	Hatchback Engine 14 K2F	851018	Outer Joint		26	22	55	77.5	55.5	I	
	1996.03-1999.12	-	-	F	Saloon Engine 14 K2F	851018	Outer Joint		26	22	55	77.5	55.5	I	
414 Si (76 kW)	1995.05-2000.03	MT	L/R	F	Hatchback Engine 14 K4F	851004	Outer Joint	43T	26	22	55	77.5	55.5	I	
	1995.05-2000.03	MT	L/R	F	Saloon Engine 14 K4F	851004	Outer Joint	43T	26	22	55	77.5	55.5	I	
	1995.05-2000.03	-	-	F	Hatchback Engine 14 K4F	851018	Outer Joint		26	22	55	77.5	55.5	I	
416 Si (82 kW)	1995.05-2000.03	MT	L/R	F	Hatchback Engine 16 K4F	851004	Outer Joint	43T	26	22	55	77.5	55.5	I	
	1995.05-2000.03	MT	L/R	F	Saloon Engine 16 K4F	851004	Outer Joint	43T	26	22	55	77.5	55.5	I	
	1995.05-2000.03	-	-	F	Hatchback Engine 16 K4F	851018	Outer Joint		26	22	55	77.5	55.5	I	
416 Si (83 kW)	1995.05-2000.03	MT	L/R	F	Saloon Engine D 16 Y2	851004	Outer Joint	43T	26	22	55	77.5	55.5	I	
	1995.05-2000.03	MT	-	F	Saloon Engine D 16 Y2	851018	Outer Joint		26	22	55	77.5	55.5	I	
	1995.05-2000.03	AT	L	F	Saloon Engine D 16 Y2	223020	Drive Shaft	50T	26	25	49	78.8	909		
	1995.05-2000.03	AT	R	F	Saloon Engine D 16 Y2	201010	Drive Shaft	50T	26	25	55	78.5	627		
	1995.06-2000.03	MT	L/R	F	Hatchback Engine D 16 Y2	851004	Outer Joint	43T	26	22	55	77.5	55.5	I	
	1995.06-2000.03	-	-	F	Hatchback Engine D 16 Y2	851018	Outer Joint		26	22	55	77.5	55.5	I	
420 D (63 kW)	1995.11-2000.03	-	-	F	Hatchback Engine 20 T2R	851008	Outer Joint		26	32	55	78	68.5	I	
	1995.11-2000.03	-	-	F	Saloon Engine 20 T2R	851008	Outer Joint		26	32	55	78	68.5	I	
	1995.11-2000.03	AT/MT	L/R	F	Hatchback Engine 20 T2R	823002	Outer Joint	43T	26	32	55	78	68.5	I	
	1995.11-2000.03	AT/MT	L/R	F	Saloon Engine 20 T2R	823002	Outer Joint	43T	26	32	55	78	68.5	I	
420 Di (77 kW)	1995.05-2000.03	-	-	F	Hatchback Engine 20 T2N	851008	Outer Joint		26	32	55	78	68.5	I	
	1995.05-2000.03	-	-	F	Saloon Engine 20 T2N	851008	Outer Joint		26	32	55	78	68.5	I	
	1995.05-2000.03	AT/MT	L/R	F	Hatchback Engine 20 T2N	823002	Outer Joint	43T	26	32	55	78	68.5	I	
	1995.05-2000.03	AT/MT	L/R	F	Saloon Engine 20 T2N	823002	Outer Joint	43T	26	32	55	78	68.5	I	
420 Si Lux (100 kW)	1995.12-2000.03	AT/MT	L/R	F	Saloon Engine 20 T4H	823002	Outer Joint	43T	26	32	55	78	68.5	I	
	1995.12-2000.03	AT/MT	L/R	F	Hatchback Engine 20 T4H	823002	Outer Joint	43T	26	32	55	78	68.5	I	
400 (XW)															
414 (70 kW)	1993.01-1995.04	MT	R	F	Saloon Engine 14 K4C	251010	Drive Shaft		26	22	49	78.8	877		
	1993.01-1995.04	MT	L/R	F	Saloon Engine 14 K4C	823010	Outer Joint		26	22	49	78.8	55	I	
	1993.01-1995.04	MT	L	F	Saloon Engine 14 K4C	251001	Drive Shaft		26	22	49	78.8	642		
414 GSI/SI (66 kW)	1990.04-1995.04	MT	R	F	Saloon Engine 14 K4C/14 K4D	251010	Drive Shaft		26	22	49	78.8	877		
	1990.04-1995.04	MT	L	F	Saloon Engine 14 K4C/14 K4D	251023	Drive Shaft	27T	26	22	49	78.8	642		
	1990.04-1995.04	MT	L/R	F	Saloon Engine 14 K4C/14 K4D	823010	Outer Joint		26	22	49	78.8	55	I	
	1990.04-1995.04	MT	L	F	Saloon Engine 14 K4C/14 K4D	251001	Drive Shaft		26	22	49	78.8	642		
	1990.04-1995.04	-	-	-	Saloon Engine 14 K4C/14 K4D	823101	Outer Joint		26	22	49	78.5	55.5	M	
414 GSI/SI Cat (76 kW)	1992.10-1995.04	MT	R	F	Saloon Engine 14 K4F	251010	Drive Shaft		26	22	49	78.8	877		
	1992.10-1995.04	MT	L	F	Saloon Engine 14 K4F	251023	Drive Shaft	27T	26	22	49	78.8	642		
	1992.10-1995.04	MT	L/R	F	Saloon Engine 14 K4F	823010	Outer Joint		26	22	49	78.8	55	I	
	1992.10-1995.04	MT	L	F	Saloon Engine 14 K4F	251001	Drive Shaft		26	22	49	78.8	642		
	1992.10-1995.04	-	-	-	Saloon Engine 14 K4F	823101	Outer Joint		26	22	49	78.5	55.5	M	
416 GSI (82 kW)	1990.04-1995.04	-	-	F	Saloon Engine D 16 Z2	823007	Outer Joint		26	23	49	78.8	55	I	
	1990.04-1995.04	-	L	F	Saloon Engine D 16 Z2	201020	Drive Shaft	50T	26	27	49	78.8	608		
	1990.04-1995.04	-	R	F	Saloon Engine D 16 Z2	223040	Drive Shaft	50T	26	27	49	78.8	606		
	1990.04-1995.04	MT	-	-	Saloon Engine D 16 Z2	823020	Outer Joint		26	23	49	78.5	54.5	M	
	1990.04-1995.04	-	L	F	Saloon Engine D 16 Z2	223122	Drive Shaft		26	27	49	78.8	608		
	1990.04-1995.04	-	R	F	Saloon Engine D 16 Z2	223078	Drive Shaft		26	27	49	78.8	606		
	1990.04-1995.04	-	L	F	Saloon Engine D 16 Z2	601003	Inner Joint		27	32	40	55	97.5		
416 GSI/GSE (85 kW)	1990.04-1995.04	-	-	F	Saloon Engine D 16 A7	823007	Outer Joint		26	23	49	78.8	55	I	
	1990.04-1995.04	-	L	F	Saloon Engine D 16 A7	201020	Drive Shaft	50T	26	27	49	78.8	608		
	1990.04-1995.04	-	R	F	Saloon Engine D 16 A7	223040	Drive Shaft	50T	26	27	49	78.8	606		

	 YEAR	TRANSM	L/R	F/R	REMARKS	GSP Ref.	 PRODUCT	 ABS	Technical Specifications								
									A	B	C	H	L	P			
ROEWE (SAIC)																	
400 (XW)																	
416 GSI/GSE (85 kW)	1990.04-1995.04	MT	-	-	Saloon Engine D 16 A7	823020	Outer Joint		26	23	49	78.5	54.5	M			
	1990.04-1995.04	-	L	F	Saloon Engine D 16 A7	223122	Drive Shaft		26	27	49	78.8	608				
	1990.04-1995.04	-	R	F	Saloon Engine D 16 A7	223078	Drive Shaft		26	27	49	78.8	606				
	1990.04-1995.04	-	L	F	Saloon Engine D 16 A7	601003	Inner Joint		27	32	40	55	97.5				
416 GTI (90 kW)	1990.04-1995.04	-	-	F	Saloon Engine D 16 A8	823007	Outer Joint		26	23	49	78.8	55	I			
	1990.04-1995.04	-	L	F	Saloon Engine D 16 A8	201020	Drive Shaft	50T	26	27	49	78.8	608				
	1990.04-1995.04	-	R	F	Saloon Engine D 16 A8	223040	Drive Shaft	50T	26	27	49	78.8	606				
	1990.04-1995.04	MT	-	-	Saloon Engine D 16 A8	823020	Outer Joint		26	23	49	78.5	54.5	M			
	1990.04-1995.04	-	L	F	Saloon Engine D 16 A8	223122	Drive Shaft		26	27	49	78.8	608				
	1990.04-1995.04	-	R	F	Saloon Engine D 16 A8	223078	Drive Shaft		26	27	49	78.8	606				
416 GTI/GTE (96 kW)	1990.04-1995.04	-	-	F	Saloon Engine D 16 A9	823007	Outer Joint		26	23	49	78.8	55	I			
	1990.04-1995.04	-	L	F	Saloon Engine D 16 A9	201020	Drive Shaft	50T	26	27	49	78.8	608				
	1990.04-1995.04	-	R	F	Saloon Engine D 16 A9	223040	Drive Shaft	50T	26	27	49	78.8	606				
	1990.04-1995.04	MT	-	-	Saloon Engine D 16 A9	823020	Outer Joint		26	23	49	78.5	54.5	M			
	1990.04-1995.04	-	L	F	Saloon Engine D 16 A9	223122	Drive Shaft		26	27	49	78.8	608				
	1990.04-1995.04	-	R	F	Saloon Engine D 16 A9	223078	Drive Shaft		26	27	49	78.8	606				
	1990.04-1995.04	-	L	F	Saloon Engine D 16 A9	601003	Inner Joint		27	32	40	55	97.5				
418 D (49 kW)	1991.09-1995.04	-	-	F	Saloon Engine XUD9	851006	Outer Joint	27T	26	32	49	78	68.5	I			
	1991.09-1995.04	-	-	F	Saloon Engine XUD9	851005	Outer Joint		26	32	49	78	68.5	I			
	1991.09-1995.04	MT	L	F	Saloon Engine XUD9	251004	Drive Shaft	27T	26	29	49	78	594				
	1991.09-1995.04	MT	R	F	Saloon Engine XUD9	250169	Drive Shaft	27T	26	29	49	78	925				
	1991.09-1995.04	MT	L	F	Saloon Engine XUD9	251011	Drive Shaft		26	29	49	78	594				
	1991.09-1995.04	MT	R	F	Saloon Engine XUD9	250168	Drive Shaft		26	29	49	78	925				
	1991.09-1995.04	-	-	F	Saloon Engine XUD 7TE	851006	Outer Joint	27T	26	32	49	78	68.5	I			
418 TD (65 kW)	1991.09-1995.04	-	-	F	Saloon Engine XUD 7TE	851005	Outer Joint		26	32	49	78	68.5	I			
	1991.09-1995.04	MT	L	F	Saloon Engine XUD 7TE	251004	Drive Shaft	27T	26	29	49	78	594				
	1991.09-1995.04	MT	R	F	Saloon Engine XUD 7TE	250169	Drive Shaft	27T	26	29	49	78	925				
	1991.09-1995.04	MT	L	F	Saloon Engine XUD 7TE	251011	Drive Shaft		26	29	49	78	594				
	1991.09-1995.04	MT	R	F	Saloon Engine XUD 7TE	250168	Drive Shaft		26	29	49	78	925				
	1991.09-1995.04	-	-	F	Saloon Engine 20 T4H	851006	Outer Joint	27T	26	32	49	78	68.5	I			
420 GSI/SLI/GTI/Vite (100 kW)	1993.01-1995.04	-	-	F	Saloon Engine 20 T4H	851005	Outer Joint		26	32	49	78	68.5	I			
	1993.01-1995.04	MT	L	F	Saloon Engine 20 T4H	601002	Inner Joint		27	32	40	54	87				
	1993.01-1995.04	-	L	F	Saloon Engine 20 T4H	251028	Drive Shaft	43T	26	29	49	78	585				
	1993.01-1995.04	MT	L	F	Saloon Engine 20 T4H	210230	Drive Shaft		27	35	56.1	91.5	921				
	1993.01-1995.04	MT	L	F	Saloon Engine 20 T4H	223057	Drive Shaft		26	27	49	79	585.5				
	1993.01-1995.04	MT	L	F	Saloon Engine 20 T4H	223057	Drive Shaft		26	27	49	79	585.5				
420 GTI/GSI/Vitesse (103 kW)	1992.02-1995.04	-	-	F	Saloon Engine 20 M4F	851006	Outer Joint	27T	26	32	49	78	68.5	I			
	1992.02-1995.04	-	-	F	Saloon Engine 20 M4F	851005	Outer Joint		26	32	49	78	68.5	I			
	1992.02-1995.04	MT	L	F	Saloon Engine 20 M4F	601002	Inner Joint		27	32	40	54	87				
	1992.02-1995.04	-	L	F	Saloon Engine 20 M4F	251028	Drive Shaft	43T	26	29	49	78	585				
	1992.02-1995.04	MT	L	F	Saloon Engine 20 M4F	210230	Drive Shaft		27	35	56.1	91.5	921				
	1992.02-1995.04	MT	L	F	Saloon Engine 20 M4F	223057	Drive Shaft		26	27	49	79	585.5				
420 Turbo (147 kW)	1993.01-1995.04	-	-	F	Saloon Engine 20 T4G	851006	Outer Joint	27T	26	32	49	78	68.5	I			
	1993.01-1995.04	-	-	F	Saloon Engine 20 T4G	851005	Outer Joint		26	32	49	78	68.5	I			
	1993.01-1995.04	MT	L	F	Saloon Engine 20 T4G	601002	Inner Joint		27	32	40	54	87				
	1993.01-1995.04	MT	L	F	Saloon Engine 20 T4G	210230	Drive Shaft		27	35	56.1	91.5	921				
	1993.01-1995.04	MT	L	F	Saloon Engine 20 T4G	223057	Drive Shaft		26	27	49	79	585.5				
400 I																	
1.6	1990.03-1995.10	MT/AT	-	-	416 Saloon	651001	Inner Joint		27	22	40	54.5	93.5				
	1994.06-1999.06	MT/AT	-	-	416 Saloon	651001	Inner Joint		27	22	40	54.5	93.5				
2.0	1991.11-1995.10	MT	R	F	Saloon	251014	Drive Shaft	27T	26	29	49	78	936				
	1994.06-1996.03	MT	R	F	Tourer	251014	Drive Shaft	27T	26	29	49	78	936				
2.0 TURBO	1991.11-1995.10	MT	R	F	Saloon	251014	Drive Shaft	27T	26	29	49	78	936				
400 SERIES																	
418-1.8 TD	1991.03-1996.03	MT	-	-	-	651006	Inner Joint		29	25	40	56.5	96.5				
	1991.03-1996.03	MT	-	-	-	650023	Inner Joint		29	25	31	398	101				
418-1.9 Diesel	1991.01-1995.11	MT	-	-	-	651006	Inner Joint		29	25	40	56.5	96.5				
	1991.01-1995.11	MT	-	-	-	650023	Inner Joint		29	25	31	398	101				
400 Tourer (XW)																	
1.6 i (82 kW)	1994.05-1998.11	-	-	F	Estate Engine D 16 Z2	823007	Outer Joint		26	23	49	78.8	55	I			
	1994.05-1998.11	AT/MT	L	F	Estate Engine D 16 Z2	201020	Drive Shaft	50T	26	27	49	78.8	608				
	1994.05-1998.11	AT/MT	R	F	Estate Engine D 16 Z2	223040	Drive Shaft	50T	26	27	49	78.8	606				
	1994.05-1998.11	AT/MT	L	F	Estate Engine D 16 Z2	223122	Drive Shaft		26	27	49	78.8	608				
	1994.05-1998.11	AT/MT	R	F	Estate Engine D 16 Z2	223078	Drive Shaft		26	27	49	78.8	606				
	1994.05-1998.11	AT/MT	L	F	Estate Engine D 16 Z2	601003	Inner Joint		27	32	40	55	97.5				





	 YEAR	TRANSM	L/R	F/R	REMARKS	GSP Ref.	 PRODUCT	 ABS	Technical Specifications						
									A	B	C	H	L	P	
ROEWE (SAIC)															
400 Tourer (XW)															
1.6 i (82 kW)	1994.05-1998.11	-	-	F	Estate Engine D 16 Z2	823008	Outer Joint	50T	26	23	49	78.8	55	I	
	1994.05-1998.11	CVT	L	F	Estate Engine D 16 Z2	223020	Drive Shaft	50T	26	25	49	78.8	909		
	1994.05-1998.11	CVT	R	F	Estate Engine D 16 Z2	201010	Drive Shaft	50T	26	25	55	78.5	627		
1.6 i (90 kW)	1994.05-1998.11	-	-	F	Estate Engine D 16 A8	823007	Outer Joint		26	23	49	78.8	55	I	
	1994.05-1998.11	AT/MT	L	F	Estate Engine D 16 A8	201020	Drive Shaft	50T	26	27	49	78.8	608		
	1994.05-1998.11	AT/MT	R	F	Estate Engine D 16 A8	223040	Drive Shaft	50T	26	27	49	78.8	606		
	1994.05-1998.11	AT/MT	L	F	Estate Engine D 16 A8	223122	Drive Shaft		26	27	49	78.8	608		
	1994.05-1998.11	AT/MT	R	F	Estate Engine D 16 A8	223078	Drive Shaft		26	27	49	78.8	606		
	1994.05-1998.11	AT/MT	L	F	Estate Engine D 16 A8	601003	Inner Joint		27	32	40	55	97.5		
	1994.05-1998.11	-	-	F	Estate Engine D 16 A8	823008	Outer Joint	50T	26	23	49	78.8	55	I	
	1994.05-1998.11	AT	L	F	Estate Engine D 16 A8	223020	Drive Shaft	50T	26	25	49	78.8	909		
1.8 TD (65 kW)	1993.09-1998.11	-	-	F	Estate Engine XUD 7TE	851006	Outer Joint	27T	26	32	49	78	68.5	I	
	1993.09-1998.11	-	-	F	Estate Engine XUD 7TE	851005	Outer Joint		26	32	49	78	68.5	I	
	1993.09-1998.11	MT	L	F	Estate Engine XUD 7TE	251004	Drive Shaft	27T	26	29	49	78	594		
	1993.09-1998.11	MT	R	F	Estate Engine XUD 7TE	250169	Drive Shaft	27T	26	29	49	78	925		
	1993.09-1998.11	MT	L	F	Estate Engine XUD 7TE	251011	Drive Shaft		26	29	49	78	594		
	1993.09-1998.11	MT	R	F	Estate Engine XUD 7TE	250168	Drive Shaft		26	29	49	78	925		
2.0 i (100 kW)	1994.05-1998.11	-	-	F	Estate Engine 20 T4H	851006	Outer Joint	27T	26	32	49	78	68.5	I	
	1994.05-1998.11	-	-	F	Estate Engine 20 T4H	851005	Outer Joint		26	32	49	78	68.5	I	
	1994.05-1998.11	MT	L	F	Estate Engine 20 T4H	601002	Inner Joint		27	32	40	54	87		
	1994.05-1998.11	MT	L	F	Estate Engine 20 T4H	210230	Drive Shaft		27	35	56.1	91.5	921		
	1994.05-1998.11	MT	L	F	Estate Engine 20 T4H	223057	Drive Shaft		26	27	49	79	585.5		
45															
2.0 TD	2000.01-	-	MT	L	F	-	251017	Drive Shaft	43T	26	29	55	77.5	559	
45 (RT)															
1.4 (76 kW)	2000.02-2005.05	MT	L/R	F	Hatchback Engine 14 K4F	851004	Outer Joint	43T	26	22	55	77.5	55.5	I	
	2000.02-2005.05	MT	L/R	F	Saloon Engine 14 K4F	851004	Outer Joint	43T	26	22	55	77.5	55.5	I	
	2000.02-2005.05	MT	L	F	Hatchback Engine 14 K4F	251021	Drive Shaft	43T	26	23	49	78.8	632		
	2000.02-2005.05	MT	L	F	Saloon Engine 14 K4F	251021	Drive Shaft	43T	26	23	49	78.8	632		
	2000.02-2005.05	MT	R	F	Hatchback Engine 14 K4F	251020	Drive Shaft	43T	26	23	49	78.8	903		
	2000.02-2005.05	MT	R	F	Saloon Engine 14 K4F	251020	Drive Shaft	43T	26	23	49	78.8	903		
1.6 (80 kW)	2000.02-2005.05	MT	L/R	F	Hatchback Engine 16 K4F	851004	Outer Joint	43T	26	22	55	77.5	55.5	I	
	2000.02-2005.05	MT	L/R	F	Saloon Engine 16 K4F	851004	Outer Joint	43T	26	22	55	77.5	55.5	I	
	2000.02-2005.05	MT	L	F	Hatchback Engine 16 K4F	251021	Drive Shaft	43T	26	23	49	78.8	632		
	2000.02-2005.05	MT	L	F	Saloon Engine 16 K4F	251021	Drive Shaft	43T	26	23	49	78.8	632		
	2000.02-2005.05	MT	R	F	Hatchback Engine 16 K4F	251020	Drive Shaft	43T	26	23	49	78.8	903		
	2000.02-2005.05	MT	R	F	Saloon Engine 16 K4F	251020	Drive Shaft	43T	26	23	49	78.8	903		
1.8 (86 kW)	2000.02-2005.05	MT	L/R	F	Hatchback Engine 18 K4F	851004	Outer Joint	43T	26	22	55	77.5	55.5	I	
	2000.02-2005.05	MT	L/R	F	Saloon Engine 18 K4F	851004	Outer Joint	43T	26	22	55	77.5	55.5	I	
2.0 iDT (74 kW)	2000.02-2005.05	MT	R	F	Hatchback Engine 20 T2N	251072	Drive Shaft	43T	26	29	55	77.5	961		
	2000.02-2005.05	MT	R	F	Saloon Engine 20 T2N	251072	Drive Shaft	43T	26	29	55	77.5	961		
	2000.02-2005.05	-	-	F	Hatchback Engine 20 T2N	851008	Outer Joint		26	32	55	78	68.5	I	
	2000.02-2005.05	-	-	F	Saloon Engine 20 T2N	851008	Outer Joint		26	32	55	78	68.5	I	
	2000.02-2005.05	AT/MT	L/R	F	Hatchback Engine 20 T2N	823002	Outer Joint	43T	26	32	55	78	68.5	I	
	2000.02-2005.05	AT/MT	L/R	F	Saloon Engine 20 T2N	823002	Outer Joint	43T	26	32	55	78	68.5	I	
2.0 iDT (83 kW)	2004.01-2005.05	MT	-	F	Hatchback Engine 20 T2N	851008	Outer Joint		26	32	55	78	68.5	I	
	2004.01-2005.05	MT	-	F	Saloon Engine 20 T2N	851008	Outer Joint		26	32	55	78	68.5	I	
2.0 V6 (110 kW)	2000.02-2005.05	MT	-	F	Hatchback Engine 20 K4F	851008	Outer Joint		26	32	55	78	68.5	I	
	2000.02-2005.05	MT	-	F	Saloon Engine 20 K4F	851008	Outer Joint		26	32	55	78	68.5	I	
	2000.02-2005.05	AT/MT	L/R	F	Hatchback Engine 20 K4F	823002	Outer Joint	43T	26	32	55	78	68.5	I	
	2000.02-2005.05	AT/MT	L/R	F	Saloon Engine 20 K4F	823002	Outer Joint	43T	26	32	55	78	68.5	I	
600 (RH)															
618 i/Si (85 kW)	1996.03-1999.02	-	-	F	Saloon Engine F 18 A3	851017	Outer Joint		28	32	60	89	61	I	
	1996.03-1999.02	MT	L	F	Saloon Engine F 18 A3	223038	Drive Shaft	50T	28	27	60	89	552.5		
	1996.03-1999.02	MT	R	F	Saloon Engine F 18 A3	223039	Drive Shaft	50T	28	27	60	89	602.7		
	1996.03-1999.02	MT	L	F	Saloon Engine F 18 A3	601008	Inner Joint		27	32	40	43	78		
	1996.03-1999.02	MT	R	F	Saloon Engine F 18 A3	623009	Inner Joint		27	32	40	58.5	97		
	1996.03-1999.02	AT/MT	L/R	F	Saloon Engine F 18 A3	851001	Outer Joint	50T	28	32	60	89	61	I	
	1996.03-1999.02	MT	L	F	Saloon Engine F 18 A3	223077	Drive Shaft		28	27	60	89	552.5		
	1996.03-1999.02	MT	R	F	Saloon Engine F 18 A3	251026	Drive Shaft		28	27	60	89	602.7		
620 i (85 kW)	1993.08-1996.06	-	-	F	Saloon Engine F 20 Z2	851017	Outer Joint		28	32	60	89	61	I	
	1993.08-1996.06	MT	L	F	Saloon Engine F 20 Z2	223038	Drive Shaft	50T	28	27	60	89	552.5		
	1993.08-1996.06	MT	R	F	Saloon Engine F 20 Z2	223039	Drive Shaft	50T	28	27	60	89	602.7		
	1993.08-1996.06	MT	L	F	Saloon Engine F 20 Z2	601008	Inner Joint		27	32	40	43	78		
	1993.08-1996.06	MT	R	F	Saloon Engine F 20 Z2	623009	Inner Joint		27	32	40	58.5	97		





	 YEAR	TRANSM	L/R	F/R	REMARKS	GSP Ref.	 PRODUCT	 ABS	Technical Specifications					
									A	B	C	H	L	P
ROEWE (SAIC)														
600 (RH)														
620 i (85 kW)	1993.08-1996.06	AT/MT	L/R	F	Saloon Engine F 20 Z2	851001	Outer Joint	50T	28	32	60	89	61	I
	1993.08-1996.06	MT	L	F	Saloon Engine F 20 Z2	223077	Drive Shaft		28	27	60	89	552.5	
	1993.08-1996.06	MT	R	F	Saloon Engine F 20 Z2	251026	Drive Shaft		28	27	60	89	602.7	
620 Sdi (77 kW)	1994.12-1999.02	-	-	F	Saloon Engine 20 T2N	899208	Outer Joint	45T	28	32	60	89	61	I
	1994.12-1999.02	-	-	F	Saloon Engine 20 T2N	851017	Outer Joint		28	32	60	89	61	I
	1994.12-1999.02	AT/MT	L/R	F	Saloon Engine 20 T2N	851001	Outer Joint	50T	28	32	60	89	61	I
620 Si (96 kW)	1993.08-1999.02	-	-	F	Saloon Engine F 20 Z1	851017	Outer Joint		28	32	60	89	61	I
	1993.08-1999.02	MT	L	F	Saloon Engine F 20 Z1	223038	Drive Shaft	50T	28	27	60	89	552.5	
	1993.08-1999.02	MT	R	F	Saloon Engine F 20 Z1	223039	Drive Shaft	50T	28	27	60	89	602.7	
	1993.08-1999.02	MT	L	F	Saloon Engine F 20 Z1	601008	Inner Joint		27	32	40	43	78	
	1993.08-1999.02	MT	R	F	Saloon Engine F 20 Z1	623009	Inner Joint		27	32	40	58.5	97	
	1993.08-1999.02	AT/MT	L/R	F	Saloon Engine F 20 Z1	851001	Outer Joint	50T	28	32	60	89	61	I
	1993.08-1999.02	MT	L	F	Saloon Engine F 20 Z1	223077	Drive Shaft		28	27	60	89	552.5	
	1993.08-1999.02	MT	R	F	Saloon Engine F 20 Z1	251026	Drive Shaft		28	27	60	89	602.7	
620 Ti Vitesse (147 kW)	1994.07-1999.02	-	-	F	Saloon Engine 20 T4G	899208	Outer Joint	45T	28	32	60	89	61	I
	1994.07-1999.02	AT/MT	L/R	F	Saloon Engine 20 T4G	851001	Outer Joint	50T	28	32	60	89	61	I
623 Si (116 kW)	1993.08-1999.02	-	-	F	Saloon Engine H 23 A3	851017	Outer Joint		28	32	60	89	61	I
	1993.08-1999.02	MT	L	F	Saloon Engine H 23 A3	223038	Drive Shaft	50T	28	27	60	89	552.5	
	1993.08-1999.02	MT	R	F	Saloon Engine H 23 A3	223039	Drive Shaft	50T	28	27	60	89	602.7	
	1993.08-1999.02	MT	L	F	Saloon Engine H 23 A3	601008	Inner Joint		27	32	40	43	78	
	1993.08-1999.02	MT	R	F	Saloon Engine H 23 A3	623009	Inner Joint		27	32	40	58.5	97	
	1993.08-1999.02	AT/MT	L/R	F	Saloon Engine H 23 A3	851001	Outer Joint	50T	28	32	60	89	61	I
	1993.08-1999.02	MT	L	F	Saloon Engine H 23 A3	223077	Drive Shaft		28	27	60	89	552.5	
	1993.08-1999.02	MT	R	F	Saloon Engine H 23 A3	251026	Drive Shaft		28	27	60	89	602.7	
75 (RJ)														
1.8 (88 kW)	1999.02-2005.05	AT	L	F	Saloon Engine K 1.8	638001	Inner Joint		34	23	40	54	97	
	1999.02-2005.05	AT	R	F	Saloon Engine K 1.8	218471	Drive Shaft		28	34	57.8	83.5	948	
	1999.02-2005.05	-	-	F	Saloon Engine K 1.8	851011	Outer Joint		28	23	57.8	83.5	62	M
	1999.02-2005.05	AT	L	F	Saloon Engine K 1.8	251068	Drive Shaft		28	34	57.8	83.5	623	
	1999.02-2005.05	MT	L	F	Saloon Engine K 1.8	251071	Drive Shaft		28	34	57.8	83.5	600	
1.8 Turbo (110 kW)	2003.05-2005.05	-	-	F	Saloon Engine 18 K4G	851011	Outer Joint		28	23	57.8	83.5	62	M
2.0 CDT (85 kW)	1999.02-2005.05	AT	R	F	Saloon Engine M 47 R	218456	Drive Shaft		28	34	57.8	83.5	944	
	1999.02-2005.05	-	-	F	Saloon Engine M 47 R	899151	Outer Joint		28	24	57.8	83.5	62	M
	1999.02-2005.05	MT	R	F	Saloon Engine M 47 R	218457	Drive Shaft		28	34	57.8	83.5	956	
	1999.02-2005.05	MT	L	F	Saloon Engine M 47 R	251069	Drive Shaft		28	34	57.8	83.5	614	
	1999.02-2005.05	AT	L	F	Saloon Engine M 47 R	251070	Drive Shaft		28	34	57.8	83.5	627	
2.0 CDTi (96 kW)	2003.02-2005.05	-	-	F	Saloon Engine 204D2	899151	Outer Joint		28	24	57.8	83.5	62	M
2.0 V6 (110 kW)	1999.02-2005.05	-	-	F	Saloon Engine 20 K4F	899151	Outer Joint		28	24	57.8	83.5	62	M
2.5 V6 (130 kW)	2001.10-2005.05	-	-	F	Saloon Engine 25 K4F	899151	Outer Joint		28	24	57.8	83.5	62	M
75 Tourer (RJ)														
1.8 (88 kW)	2001.08-2005.05	AT	L	F	Estate Engine K 1.8	638001	Inner Joint		34	23	40	54	97	
	2001.08-2005.05	AT	R	F	Estate Engine K 1.8	218471	Drive Shaft		28	34	57.8	83.5	948	
	2001.08-2005.05	-	-	F	Estate Engine K 1.8	851011	Outer Joint		28	23	57.8	83.5	62	M
	2001.08-2005.05	AT	L	F	Estate Engine K 1.8	251068	Drive Shaft		28	34	57.8	83.5	623	
	2001.08-2005.05	MT	L	F	Estate Engine K 1.8	251071	Drive Shaft		28	34	57.8	83.5	600	
1.8 Turbo (110 kW)	2003.05-2005.05	-	-	F	Estate Engine 18 K4G	851011	Outer Joint		28	23	57.8	83.5	62	M
2.0 CDT (85 kW)	2001.08-2005.05	-	-	F	Estate Engine M 47 R	899151	Outer Joint		28	24	57.8	83.5	62	M
	2001.08-2005.05	MT	R	F	Estate Engine M 47 R	218457	Drive Shaft		28	34	57.8	83.5	956	
	2001.08-2005.05	MT	L	F	Estate Engine M 47 R	251069	Drive Shaft		28	34	57.8	83.5	614	
	2001.08-2005.05	AT	L	F	Estate Engine M 47 R	251070	Drive Shaft		28	34	57.8	83.5	627	
2.0 CDTi (96 kW)	2003.02-2005.05	-	-	F	Estate Engine 204D2	899151	Outer Joint		28	24	57.8	83.5	62	M
2.0 V6 (110 kW)	2001.08-2005.05	-	-	F	Estate Engine 20 K4F	899151	Outer Joint		28	24	57.8	83.5	62	M
2.5 V6 (130 kW)	2001.08-2005.05	-	-	F	Estate Engine KV 6	899151	Outer Joint		28	24	57.8	83.5	62	M
800														
825 SD (87 kW)	1993.09-1999.02	-	-	F	Coupe Engine 425 SL1RR/492 4 SHIRG	851002	Outer Joint	45T	28	32	55.6	85	61	I
825 Si (129 kW)	1996.04-1999.02	-	-	F	Coupe Engine 25 K4F	851002	Outer Joint	45T	28	32	55.6	85	61	I
827 24V (124 kW)	1992.08-1999.02	-	-	F	Coupe Engine C 27 A1	851002	Outer Joint	45T	28	32	55.6	85	61	I
800 (XS)														
2.0 (74 kW)	1987.08-1991.10	-	-	F	Hatchback	851002	Outer Joint	45T	28	32	55.6	85	61	I
2.5 (129 kW)	1996.02-1998.10	-	-	F	Hatchback Engine 25 K4F	851002	Outer Joint	45T	28	32	55.6	85	61	I
820 16V Turbo (132 kW)	1992.01-1999.02	-	-	F	Saloon Engine T 16	851002	Outer Joint	45T	28	32	55.6	85	61	I
	1992.01-1999.02	-	-	F	Hatchback Engine T 16	851002	Outer Joint	45T	28	32	55.6	85	61	I
820 I/SI (100 kW)	1992.01-1999.02	-	-	F	Saloon Engine 20 T4H	851002	Outer Joint	45T	28	32	55.6	85	61	I
	1993.01-1999.02	-	-	F	Hatchback Engine 20 T4H	851002	Outer Joint	45T	28	32	55.6	85	61	I
820 i/Si (103 kW)	1988.10-1991.12	-	-	F	Hatchback Engine 20 HD	851002	Outer Joint	45T	28	32	55.6	85	61	I
820 SE/SI (88 kW)	1986.10-1991.12	-	-	F	Saloon Engine 20 HS	851002	Outer Joint	45T	28	32	55.6	85	61	I

YEAR	TRANSM	L/R	F/R	REMARKS	GSP Ref.	PRODUCT	ABS	Technical Specifications										
								A	B	C	H	L	P					
ROEWE (SAIC)																		
800 (XS)																		
820 SE/SI (88 kW)	1986.10-	1991.12	-	-	F	Hatchback Engine 20 HS	851002	Outer Joint	45T	28	32	55.6	85	61	I			
820 SI (98 kW)	1988.10-	1991.12	-	-	F	Hatchback Engine 20 HD M 16	851002	Outer Joint	45T	28	32	55.6	85	61	I			
	1988.10-	1991.12	-	-	F	Saloon Engine 20 HD M 16	851002	Outer Joint	45T	28	32	55.6	85	61	I			
820 Sport (145 kW)	1994.04-	1996.03	-	-	F	Hatchback Engine 20 T4G	851002	Outer Joint	45T	28	32	55.6	85	61	I			
	1994.04-	1996.03	-	-	F	Saloon Engine 20 T4G	851002	Outer Joint	45T	28	32	55.6	85	61	I			
820e (88 kW)	1986.10-	1991.10	-	-	F	Saloon Engine 20 HS	851002	Outer Joint	45T	28	32	55.6	85	61	I			
825 D/SD (87 kW)	1990.01-	1999.02	-	-	F	Saloon Engine 425 SL1RR/492 4 SHIRG	851002	Outer Joint	45T	28	32	55.6	85	61	I			
	1992.01-	1999.02	-	-	F	Hatchback Engine 425 SL1RR/492 4 SHIRG	851002	Outer Joint	45T	28	32	55.6	85	61	I			
825 Si Lux (129 kW)	1996.04-	1999.02	-	-	F	Saloon Engine 25 K4F	851002	Outer Joint	45T	28	32	55.6	85	61	I			
825 SI/Sterling (127 kW)	1987.01-	1991.12	-	-	F	Saloon Engine C 25 A2	851002	Outer Joint	45T	28	32	55.6	85	61	I			
825 SI/Sterling Catalytic-Conv (110 kW)	1986.10-	1991.12	-	-	F	Saloon Engine C 25 A1	851002	Outer Joint	45T	28	32	55.6	85	61	I			
827 24V I/SI Cat (124 kW)	1992.01-	1999.02	-	-	F	Hatchback Engine C 27 A1	851002	Outer Joint	45T	28	32	55.6	85	61	I			
827 SI/Sterling (130 kW)	1988.02-	1991.12	-	-	F	Saloon Engine C 27 A2	851002	Outer Joint	45T	28	32	55.6	85	61	I			
827 SI/Sterling Catalytic-Conv (124 kW)	1988.02-	1999.02	-	-	F	Saloon Engine C 27 A1	851002	Outer Joint	45T	28	32	55.6	85	61	I			
827 Vitesse Catalytic-Conv (124 kW)	1988.10-	1991.12	-	-	F	Hatchback Engine C 27 A1	851002	Outer Joint	45T	28	32	55.6	85	61	I			
827 Vitesse/SLI (130 kW)	1988.10-	1991.12	-	-	F	Hatchback Engine C 27 A2	851002	Outer Joint	45T	28	32	55.6	85	61	I			
COUPE																		
1.6 16 V (82 kW)	1996.03-	1999.11	AT	L	F	Coupe Engine 16 K4F	223020	Drive Shaft	50T	26	25	49	78.8	909				
	1996.03-	1999.11	AT	R	F	Coupe Engine 16 K4F	201010	Drive Shaft	50T	26	25	55	78.5	627				
1.8 16 V (107 kW)	1996.03-	1999.11	CVT/MT	F	F	Coupe Engine 18 K4K	899209	Outer Joint	27T	26	22	49	78.8	55	I			
	1996.03-	1999.11	CVT	L	F	Coupe Engine 18 K4K	251019	Drive Shaft	43T	26	23	49	78.8	630.5				
	1996.03-	1999.11	CVT	R	F	Coupe Engine 18 K4K	251018	Drive Shaft	43T	26	23	49	78.8	887				
MAESTRO																		
1.3 (49 kW)	1990.09-	1995.01	MT	-	F	Hatchback Engine 12 HE	851010	Outer Joint		25	22	50	82	56	I			
1.3 (51 kW)	1990.09-	1995.01	MT	-	F	Hatchback Engine 12 HE	851010	Outer Joint		25	22	50	82	56	I			
1.6 (63 kW)	1990.09-	1995.01	MT	-	F	Hatchback Engine 16 H	851010	Outer Joint		25	22	50	82	56	I			
2.0 D (44 kW)	1990.09-	1992.10	-	-	F	Hatchback	851010	Outer Joint		25	22	50	82	56	I			
MG ZR																		
2.0 TD	2001.07-	-	MT	L	F	-	251017	Drive Shaft	43T	26	29	55	77.5	559				
MG ZS																		
2.0 TD	2001.07-	-	MT	L	F	-	251017	Drive Shaft	43T	26	29	55	77.5	559				
MINI																		
1.0 (30 kW)	1992.01-	1993.06	-	-	F	Hatchback Engine 99 HD 81	851013	Outer Joint		29	19	48	106	57	I			
	1992.01-	1993.06	-	-	F	Hatchback Engine 99 HD 81	699098	Inner Joint		21	19	31.8	46	53				
1.3 (37 kW)	1992.04-	1996.10	-	-	F	Hatchback Engine 12 A2B/12 A2L	699098	Inner Joint		21	19	31.8	46	53				
	1992.10-	2000.11	-	-	F	Hatchback Engine 12 A2B	851013	Outer Joint		29	19	48	106	57	I			
	1992.10-	2000.11	-	-	F	Hatchback Engine 12 A2B	699098	Inner Joint		21	19	31.8	46	53				
1.3 (39 kW)	1992.01-	1995.04	-	-	F	Hatchback Engine 12 A2D	851013	Outer Joint		29	19	48	106	57	I			
	1992.01-	1995.04	-	-	F	Hatchback Engine 12 A2D	699098	Inner Joint		21	19	31.8	46	53				
	1996.05-	1996.10	-	-	F	Hatchback Engine 12 A2L	699098	Inner Joint		21	19	31.8	46	53				
1.3 (45 kW)	1991.01-	1991.12	-	-	F	Hatchback Engine 12 A2A	851013	Outer Joint		29	19	48	106	57	I			
	1991.01-	1991.12	-	-	F	Hatchback Engine 12 A2A	699098	Inner Joint		21	19	31.8	46	53				
1.3 (46 kW)	1992.01-	2000.11	-	-	F	Hatchback Engine 12 A2E/12 A2L	851013	Outer Joint		29	19	48	106	57	I			
	1992.01-	2000.11	-	-	F	Hatchback Engine 12 A2E/12 A2L	699098	Inner Joint		21	19	31.8	46	53				
1.3/Cooper (45 kW)	1991.06-	1994.02	-	-	F	Hatchback Engine 12 A2A	699098	Inner Joint		21	19	31.8	46	53				
MINI (XN)																		
1.3 (46 kW)	1992.09-	1995.04	MT	-	F	Convertible Engine 12 A2E	699098	Inner Joint		21	19	31.8	46	53				
	1992.09-	1995.04	-	-	F	Convertible Engine 12 A2E	851013	Outer Joint		29	19	48	106	57	I			
MINI-MOKE																		
1.0 (26 kW)	1986.09-	1993.09	MT	-	F	Convertible Engine 99 H	699098	Inner Joint		21	19	31.8	46	53				
1.0 (29 kW)	1986.09-	1993.09	MT	-	F	Convertible Engine 99 H	699098	Inner Joint		21	19	31.8	46	53				
MONTEGO																		
1.6 (61 kW)	1990.10-	1992.09	-	-	F	Saloon Engine 16 HL	851010	Outer Joint		25	22	50	82	56	I			
MONTEGO (XE)																		
1.6 (61 kW)	1990.10-	1992.09	-	-	F	Estate Engine 16 HL	851010	Outer Joint		25	22	50	82	56	I			
2.0 GTi (86 kW)	1988.10-	1991.10	-	-	F	Estate Engine 20 H	851010	Outer Joint		25	22	50	82	56	I			
STREETWISE																		
1.4 (62 kW)	2003.08-	2005.05	-	-	F	Hatchback Engine 14 K4M	899209	Outer Joint	27T	26	22	49	78.8	55	I			
	2003.08-	2005.05	-	L	F	Hatchback Engine 14 K4M	251021	Drive Shaft	43T	26	23	49	78.8	632				
	2003.08-	2005.05	-	R	F	Hatchback Engine 14 K4M	251020	Drive Shaft	43T	26	23	49	78.8	903				
1.4 (76 kW)	2003.08-	2005.05	-	-	F	Hatchback Engine 14 K4F	899209	Outer Joint	27T	26	22	49	78.8	55	I			
	2003.08-	2005.05	-	L	F	Hatchback Engine 14 K4F	251021	Drive Shaft	43T	26	23	49	78.8	632				
	2003.08-	2005.05	-	R	F	Hatchback Engine 14 K4F	251020	Drive Shaft	43T	26	23	49	78.8	903				
1.6 (80 kW)	2004.01-	2005.05	MT	R	F	Hatchback Engine 16 K4F	251010	Drive Shaft		26	22	49	78.8	877				
	2004.01-	2005.05	-	-	F	Hatchback Engine 16 K4F	899209	Outer Joint	27T	26	22	49	78.8	55	I			
	2004.01-	2005.05	MT	L/R	F	Hatchback Engine 16 K4F	251019	Drive Shaft	43T	26	23	49	78.8	630.5				





	 YEAR	TRANSM	L/R	F/R	REMARKS	GSP Ref.	 PRODUCT	 ABS	Technical Specifications						
									A	B	C	H	L	P	
ROEWE (SAIC)															
STREETWISE															
1.6 (80 kW)	2004.01-2005.05	MT	R	F	Hatchback Engine 16 K4F	251018	Drive Shaft	43T	26	23	49	78.8	887		
	2004.01-2005.05	MT	L	F	Hatchback Engine 16 K4F	251021	Drive Shaft	43T	26	23	49	78.8	632		
	2004.01-2005.05	MT	R	F	Hatchback Engine 16 K4F	251020	Drive Shaft	43T	26	23	49	78.8	903		
1.8 (86 kW)	2003.08-2005.05	-	-	F	Hatchback Engine 18 K4F	899209	Outer Joint	27T	26	22	49	78.8	55	I	
	2003.08-2005.05	AT	L	F	Hatchback Engine 18 K4F	251019	Drive Shaft	43T	26	23	49	78.8	630.5		
	2003.08-2005.05	AT	R	F	Hatchback Engine 18 K4F	251018	Drive Shaft	43T	26	23	49	78.8	887		
2.0 TD (74 kW)	2003.08-2005.05	-	-	F	Hatchback Engine 20 T2N	851007	Outer Joint	43T	26	32	49	78	68.5	I	
SAAB															
9-3 (YS3D)															
2.0 i (96 kW)	1980.01-2002.09	-	R	F	Hatchback Engine B204I	218199	Drive Shaft	29T	33	34	52	92.5	932		
	1980.01-2002.09	AT/MT	L/R	F	Hatchback Engine B204I	852001	Outer Joint	29T	33	25	52	99	61	O	
	1980.01-2002.09	AT/MT	R	F	Hatchback Engine B204I	252002	Drive Shaft	29T	33	37.1	52	92.5	487		
	1980.01-2002.09	AT	L	F	Hatchback Engine B204I	252001	Drive Shaft	29T	33	34	52	92.5	594		
2.0 SE Turbo (147 kW)	1998.02-2002.09	-	R	F	Hatchback Engine B204R	218199	Drive Shaft	29T	33	34	52	92.5	932		
	1998.02-2002.09	AT/MT	L/R	F	Hatchback Engine B204R	852001	Outer Joint	29T	33	25	52	99	61	O	
	1998.02-2002.09	AT/MT	R	F	Hatchback Engine B204R	252002	Drive Shaft	29T	33	37.1	52	92.5	487		
2.0 Turbo (113 kW)	1998.10-2002.09	AT/MT	L/R	F	Hatchback Engine B204E	852001	Outer Joint	29T	33	25	52	99	61	O	
	1998.10-2002.09	AT/MT	R	F	Hatchback Engine B204E	252002	Drive Shaft	29T	33	37.1	52	92.5	487		
	1998.10-2002.09	AT	L	F	Hatchback Engine B204E	252001	Drive Shaft	29T	33	34	52	92.5	594		
2.0 Turbo (136 kW)	1998.02-2002.09	-	R	F	Hatchback Engine B204L/B205E/B205L	218199	Drive Shaft	29T	33	34	52	92.5	932		
	1998.02-2002.09	AT/MT	L/R	F	Hatchback Engine B204L/B205E/B205L	852001	Outer Joint	29T	33	25	52	99	61	O	
	1998.02-2002.09	AT/MT	R	F	Hatchback Engine B204L/B205E/B205L	252002	Drive Shaft	29T	33	37.1	52	92.5	487		
2.2 TiD (85 kW)	1998.02-2002.09	AT	L	F	Hatchback Engine B204L/B205E/B205L	252001	Drive Shaft	29T	33	34	52	92.5	594		
	1998.02-2000.11	AT/MT	L/R	F	Hatchback Engine D223L/X 22 DTH	852001	Outer Joint	29T	33	25	52	99	61	O	
	1998.02-2000.11	AT/MT	R	F	Hatchback Engine D223L/X 22 DTH	252002	Drive Shaft	29T	33	37.1	52	92.5	487		
2.3 i (110 kW)	1998.02-2000.11	AT	L	F	Hatchback Engine D223L/X 22 DTH	252001	Drive Shaft	29T	33	34	52	92.5	594		
	1998.02-2002.09	-	R	F	Hatchback Engine B234I	218199	Drive Shaft	29T	33	34	52	92.5	932		
	1998.02-2002.09	AT/MT	L/R	F	Hatchback Engine B234I	852001	Outer Joint	29T	33	25	52	99	61	O	
2.3 Turbo (165 kW)	1998.02-2002.09	AT/MT	R	F	Hatchback Engine B234I	252002	Drive Shaft	29T	33	37.1	52	92.5	487		
	1998.02-2002.09	AT	L	F	Hatchback Engine B234I	252001	Drive Shaft	29T	33	34	52	92.5	594		
	1998.10-2002.09	-	-	F	Hatchback Engine B235R	899281	Outer Joint	29T	33	27	59	98	65	I	
1998.10-2002.09	-	L/R	F	Hatchback Engine B235R	252006	Drive Shaft	29T	33	27	59	92	613			
9-3 (YS3F)															
1.8 i (90 kW)	2004.01-2015.02	MT	-	F	Saloon Engine Z 18 XE	852012	Outer Joint		30	25	52	94.5	61	O	
	2005.03-2015.02	MT	L/R	F	Estate Engine Z 18 XE	221036	Drive Shaft		30	27	55.4	100	602		
	2005.03-2015.02	-	-	F	Estate Engine Z 18 XE	852012	Outer Joint		30	25	52	94.5	61	O	
	2005.03-2015.02	-	-	F	Estate Engine Z 18 XE	899023	Outer Joint		30	26	53.8	94.5	65.5	M	
1.8t 2.0 (110 kW)	2005.03-2015.02	-	-	F	Estate Engine B207E	899023	Outer Joint		30	26	53.8	94.5	65.5	M	
	2005.03-2015.02	MT	L/R	F	Estate Engine B207E	221036	Drive Shaft		30	27	55.4	100	602		
1.9 TiD (110 kW)	2004.09-2015.02	-	-	F	Saloon Engine Z 19 DTH	821030	Outer Joint		30	28	55.4	96	65	M	
	2004.09-2015.02	MT	L/R	F	Saloon Engine Z 19 DTH	221036	Drive Shaft		30	27	55.4	100	602		
	2004.09-2015.02	MT	L/R	F	Saloon Engine Z 19 DTH	817051	Outer Joint		30	26	53.8	94.5	65.5	M	
	2004.09-2015.02	AT	L/R	F	Saloon Engine Z 19 DTH	621024	Inner Joint		27	34	35	101	88		
	2004.09-2015.02	-	-	F	Saloon Engine Z 19 DTH	899023	Outer Joint		30	26	53.8	94.5	65.5	M	
	2004.09-2015.02	MT	R	F	Saloon Engine Z 19 DTH	221032	Drive Shaft		30	27	53.8	94.5	605		
	2004.09-2015.02	AT	L/R	F	Saloon Engine Z 19 DTH	244080	Drive Shaft		30	27	53.8	94.5	591		
	2005.03-2015.02	AT	L/R	F	Estate Engine Z 19 DTH	244080	Drive Shaft		30	27	53.8	94.5	591		
	2005.03-2015.02	-	-	F	Estate Engine Z 19 DTH	821030	Outer Joint		30	28	55.4	96	65	M	
	2005.03-2015.02	MT	L/R	F	Estate Engine Z 19 DTH	221036	Drive Shaft		30	27	55.4	100	602		
	2005.03-2015.02	AT/MT	L/R	F	Estate Engine Z 19 DTH	817051	Outer Joint		30	26	53.8	94.5	65.5	M	
	2005.03-2015.02	AT	L/R	F	Estate Engine Z 19 DTH	621024	Inner Joint		27	34	35	101	88		
	2005.03-2015.02	MT	R	F	Estate Engine Z 19 DTH	221032	Drive Shaft		30	27	53.8	94.5	605		
	2006.01-2015.02	AT	L/R	F	Convertible Engine Z 19 DTH	244080	Drive Shaft		30	27	53.8	94.5	591		
	2006.01-2015.02	-	-	F	Convertible Engine Z 19 DTH	821030	Outer Joint		30	28	55.4	96	65	M	
	2006.01-2015.02	MT	L/R	F	Convertible Engine Z 19 DTH	817051	Outer Joint		30	26	53.8	94.5	65.5	M	
	2006.01-2015.02	MT	L/R	F	Convertible Engine Z 19 DTH	221036	Drive Shaft		30	27	55.4	100	602		
2006.01-2015.02	AT	L/R	F	Convertible Engine Z 19 DTH	621024	Inner Joint		27	34	35	101	88			
2006.01-2015.02	MT	R	F	Convertible Engine Z 19 DTH	221032	Drive Shaft		30	27	53.8	94.5	605			
1.9 TiD (88 kW)	2004.09-2015.02	-	-	F	Saloon Engine Z 19 DT	821030	Outer Joint		30	28	55.4	96	65	M	
	2004.09-2015.02	MT	L/R	F	Saloon Engine Z 19 DT	221036	Drive Shaft		30	27	55.4	100	602		
	2004.09-2015.02	MT	L/R	F	Saloon Engine Z 19 DT	817051	Outer Joint		30	26	53.8	94.5	65.5	M	
	2004.09-2015.02	-	-	F	Convertible Engine Z 19 DT	899023	Outer Joint		30	26	53.8	94.5	65.5	M	
	2004.09-2015.02	MT	L/R	F	Convertible Engine Z 19 DT	221036	Drive Shaft		30	27	55.4	100	602		
2004.09-2015.02	-	-	F	Saloon Engine Z 19 DT	899023	Outer Joint		30	26	53.8	94.5	65.5	M		





YEAR	TRANSM	L/R	F/R	REMARKS	GSP Ref.	PRODUCT	ABS	Technical Specifications						
								A	B	C	H	L	P	
SAAB														
9-3 (YS3F)														
1.9 TiD (88 kW)	2004.09-2015.02	MT	L/R	F	Saloon Engine Z 19 DT	221032	Drive Shaft	30	27	53.8	94.5	605		
	2005.03-2015.02	MT	L/R	F	Estate Engine Z 19 DT	221032	Drive Shaft	30	27	53.8	94.5	605		
	2005.03-2015.02	-	-	F	Estate Engine Z 19 DT	821030	Outer Joint	30	28	55.4	96	65	M	
	2005.03-2015.02	MT	L/R	F	Estate Engine Z 19 DT	221036	Drive Shaft	30	27	55.4	100	602		
	2005.03-2015.02	MT	L/R	F	Estate Engine Z 19 DT	817051	Outer Joint	30	26	53.8	94.5	65.5	M	
	2005.03-2015.02	-	-	F	Estate Engine Z 19 DT	899023	Outer Joint	30	26	53.8	94.5	65.5	M	
1.9 TTiD (118 kW)	2007.12-2015.02	MT	-	F	Convertible Engine A 19 DTR	899367	Outer Joint	30	27	58.9	94	64.5	M	
	2007.12-2015.02	MT	-	F	Saloon Engine A 19 DTR	899367	Outer Joint	30	27	58.9	94	64.5	M	
	2007.12-2015.02	MT	-	F	Estate Engine A 19 DTR	899367	Outer Joint	30	27	58.9	94	64.5	M	
	2007.12-2015.02	MT	L/R	F	Convertible Engine A 19 DTR	221036	Drive Shaft	30	27	55.4	100	602		
	2007.12-2015.02	MT	L/R	F	Saloon Engine A 19 DTR	221036	Drive Shaft	30	27	55.4	100	602		
	2007.12-2015.02	MT	L/R	F	Estate Engine A 19 DTR	221036	Drive Shaft	30	27	55.4	100	602		
1.9 TTiD (132 kW)	2007.12-2015.02	MT	L/R	F	Saloon Engine A 19 DTR/Z 19 DTR	221036	Drive Shaft	30	27	55.4	100	602		
	2007.12-2015.02	MT	L/R	F	Convertible Engine A 19 DTR/Z 19 DTR	221036	Drive Shaft	30	27	55.4	100	602		
	2007.12-2015.02	MT	L/R	F	Estate Engine Z 19 DTR	221036	Drive Shaft	30	27	55.4	100	602		
1.9 TTiD (96 kW)	2007.12-2015.02	-	-	F	Estate Engine A 19 DTR	899023	Outer Joint	30	26	53.8	94.5	65.5	M	
	2007.12-2015.02	-	-	F	Saloon Engine A 19 DTR	899023	Outer Joint	30	26	53.8	94.5	65.5	M	
	2007.12-2015.02	-	-	F	Convertible Engine A 19 DTR	899023	Outer Joint	30	26	53.8	94.5	65.5	M	
	2007.12-2015.02	MT	L/R	F	Estate Engine A 19 DTR	221036	Drive Shaft	30	27	55.4	100	602		
	2007.12-2015.02	MT	L/R	F	Saloon Engine A 19 DTR	221036	Drive Shaft	30	27	55.4	100	602		
	2007.12-2015.02	MT	L/R	F	Convertible Engine A 19 DTR	221036	Drive Shaft	30	27	55.4	100	602		
18t BioPower (129 kW)	2009.05-2015.02	MT	L/R	F	Saloon Engine B207L	221036	Drive Shaft	30	27	55.4	100	602		
2.0 (110 kW)	2002.09-2015.02	-	-	F	Saloon Engine B207E	821030	Outer Joint	30	28	55.4	96	65	M	
	2002.09-2015.02	-	-	F	Saloon Engine B207E	899023	Outer Joint	30	26	53.8	94.5	65.5	M	
	2002.09-2015.02	MT	L/R	F	Saloon Engine B207E	221036	Drive Shaft	30	27	55.4	100	602		
	2003.08-2015.02	MT	L/R	F	Convertible Engine B207E	221036	Drive Shaft	30	27	55.4	100	602		
	2003.08-2015.02	-	-	F	Convertible Engine B207E	821030	Outer Joint	30	28	55.4	96	65	M	
	2003.08-2015.02	-	-	F	Convertible Engine B207E	899023	Outer Joint	30	26	53.8	94.5	65.5	M	
2.0 t (129 kW)	2002.09-2015.02	-	-	F	Saloon Engine B207L	821030	Outer Joint	30	28	55.4	96	65	M	
	2002.09-2015.02	MT	L/R	F	Saloon Engine B207L	221036	Drive Shaft	30	27	55.4	100	602		
	2003.08-2015.02	MT	L/R	F	Convertible Engine B207L	221036	Drive Shaft	30	27	55.4	100	602		
	2003.08-2015.02	-	-	F	Convertible Engine B207L	821030	Outer Joint	30	28	55.4	96	65	M	
	2005.03-2015.02	-	-	F	Estate Engine B207L	821030	Outer Joint	30	28	55.4	96	65	M	
	2005.03-2015.02	MT	L/R	F	Estate Engine B207L	221036	Drive Shaft	30	27	55.4	100	602		
2.0 t (147 kW)	2009.02-2015.02	MT	L/R	F	Estate Engine B207M	221036	Drive Shaft	30	27	55.4	100	602		
2.0 t (154 kW)	2002.09-2015.02	-	-	F	Saloon Engine B207R	821030	Outer Joint	30	28	55.4	96	65	M	
	2002.09-2015.02	MT	L/R	F	Saloon Engine B207R	221036	Drive Shaft	30	27	55.4	100	602		
	2003.08-2015.02	MT	L/R	F	Convertible Engine B207R	221036	Drive Shaft	30	27	55.4	100	602		
	2003.08-2015.02	-	-	F	Convertible Engine B207R	821030	Outer Joint	30	28	55.4	96	65	M	
	2005.03-2015.02	-	-	F	Estate Engine B207R	821030	Outer Joint	30	28	55.4	96	65	M	
	2005.03-2015.02	MT	L/R	F	Estate Engine B207R	221036	Drive Shaft	30	27	55.4	100	602		
2.0 t Bio Power (147 kW)	2009.02-2015.02	MT	L/R	F	Estate Engine B207M	221036	Drive Shaft	30	27	55.4	100	602		
2.0 t Bio Power XWD (154 kW)	2008.06-2015.02	MT	L/R	F	All-wheel Drive Estate Engine B207R	221036	Drive Shaft	30	27	55.4	100	602		
2.0 t BioPower (129 kW)	2007.01-2015.02	-	-	F	Estate Engine B207L	821030	Outer Joint	30	28	55.4	96	65	M	
	2007.01-2015.02	-	-	F	Convertible Engine B207L	821030	Outer Joint	30	28	55.4	96	65	M	
	2007.01-2015.02	-	-	F	Saloon Engine B207L	821030	Outer Joint	30	28	55.4	96	65	M	
	2007.01-2015.02	MT	L/R	F	Estate Engine B207L	221036	Drive Shaft	30	27	55.4	100	602		
	2007.01-2015.02	MT	L/R	F	Convertible Engine B207L	221036	Drive Shaft	30	27	55.4	100	602		
	2007.01-2015.02	MT	L/R	F	Saloon Engine B207L	221036	Drive Shaft	30	27	55.4	100	602		
2.0 t BioPower (145 kW)	2007.06-2015.02	-	-	F	Saloon Engine B207R	821030	Outer Joint	30	28	55.4	96	65	M	
	2007.06-2015.02	-	-	F	Estate Engine B207R	821030	Outer Joint	30	28	55.4	96	65	M	
	2007.06-2015.02	MT	L/R	F	Saloon Engine B207R	221036	Drive Shaft	30	27	55.4	100	602		
2.0 t BioPower (147 kW)	2007.06-2015.02	MT	L/R	F	Convertible Engine B207M	221036	Drive Shaft	30	27	55.4	100	602		
	2009.05-2015.02	MT	L/R	F	Saloon Engine B207M	221036	Drive Shaft	30	27	55.4	100	602		
2.0 t BioPower (154 kW)	2002.09-2015.02	MT	L/R	F	Saloon Engine B207R	221036	Drive Shaft	30	27	55.4	100	602		
2.0 t/ 1.8 t (110 kW)	2005.03-2015.02	-	-	F	Estate Engine B207E	821030	Outer Joint	30	28	55.4	96	65	M	
2.2 TiD (92 kW)	2002.09-2015.02	-	-	F	Saloon Engine D223L	821030	Outer Joint	30	28	55.4	96	65	M	
	2002.09-2015.02	MT	L/R	F	Saloon Engine D223L	221036	Drive Shaft	30	27	55.4	100	602		
2.8 Turbo V6 (169 kW)	2005.03-2015.02	MT	L/R	F	Saloon Engine LP9	221036	Drive Shaft	30	27	55.4	100	602		
2.8 Turbo V6 (184 kW)	2005.03-2015.02	-	-	F	Estate Engine LP9	821030	Outer Joint	30	28	55.4	96	65	M	
	2005.03-2015.02	-	-	F	Saloon Engine LP9	821030	Outer Joint	30	28	55.4	96	65	M	
	2005.03-2015.02	MT	L/R	F	Estate Engine LP9	221036	Drive Shaft	30	27	55.4	100	602		
	2005.03-2015.02	MT	L/R	F	Saloon Engine LP9	221036	Drive Shaft	30	27	55.4	100	602		
	2006.02-2015.02	-	-	F	Convertible Engine LP9	821030	Outer Joint	30	28	55.4	96	65	M	
	2006.02-2015.02	MT	L/R	F	Convertible Engine LP9	221036	Drive Shaft	30	27	55.4	100	602		
2.8 Turbo V6 (188 kW)	2007.12-2015.02	MT	L/R	F	Convertible Engine B284L	221036	Drive Shaft	30	27	55.4	100	602		

	 YEAR	TRANSM	L/R	F/R	REMARKS	GSP Ref.	 PRODUCT	 ABS	Technical Specifications						
									A	B	C	H	L	P	
SAAB															
9-3 (YS3F)															
2.8 Turbo V6 (188 kW)	2007.12-2015.02	MT	L/R	F	Saloon Engine B284L	221036	Drive Shaft		30	27	55.4	100	602		
	2007.12-2015.02	MT	L/R	F	Estate Engine B284L	221036	Drive Shaft		30	27	55.4	100	602		
2.8 Turbo V6 (203 kW)	2008.04-2015.02	MT	L/R	F	Saloon Engine B284L	221036	Drive Shaft		30	27	55.4	100	602		
	2008.05-2015.02	MT	L/R	F	Estate Engine B284R	221036	Drive Shaft		30	27	55.4	100	602		
	2009.02-2015.02	MT	L/R	F	Convertible Engine B284R	221036	Drive Shaft		30	27	55.4	100	602		
2.8 Turbo V6 (206 kW)	2009.02-2015.02	MT	L/R	F	Convertible Engine B284R	221036	Drive Shaft		30	27	55.4	100	602		
9-3 Cabriolet (YS3D)															
2.0 i (96 kW)	1998.02-2003.08	-	R	F	Convertible Engine B204I	218199	Drive Shaft	29T	33	34	52	92.5	932		
	1998.02-2003.08	AT/MT	L/R	F	Convertible Engine B204I	852001	Outer Joint	29T	33	25	52	99	61	O	
	1998.02-2003.08	AT/MT	R	F	Convertible Engine B204I	252002	Drive Shaft	29T	33	37.1	52	92.5	487		
	1998.02-2003.08	AT	L	F	Convertible Engine B204I	252001	Drive Shaft	29T	33	34	52	92.5	594		
2.0 SE Turbo (147 kW)	1998.02-2003.08	-	R	F	Convertible Engine B204R	218199	Drive Shaft	29T	33	34	52	92.5	932		
	1998.02-2003.08	AT/MT	L/R	F	Convertible Engine B204R	852001	Outer Joint	29T	33	25	52	99	61	O	
	1998.02-2003.08	AT/MT	R	F	Convertible Engine B204R	252002	Drive Shaft	29T	33	37.1	52	92.5	487		
	1998.02-2003.08	AT	L	F	Convertible Engine B204R	252001	Drive Shaft	29T	33	34	52	92.5	594		
2.0 Turbo (113 kW)	1998.10-2003.08	AT/MT	L/R	F	Convertible Engine B204E	852001	Outer Joint	29T	33	25	52	99	61	O	
	1998.10-2003.08	AT/MT	R	F	Convertible Engine B204E	252002	Drive Shaft	29T	33	37.1	52	92.5	487		
	1998.10-2003.08	AT	L	F	Convertible Engine B204E	252001	Drive Shaft	29T	33	34	52	92.5	594		
2.0 Turbo (136 kW)	1998.02-2003.08	-	R	F	Convertible Engine B204L/B205E/B205L	218199	Drive Shaft	29T	33	34	52	92.5	932		
	1998.02-2003.08	AT/MT	L/R	F	Convertible Engine B204L/B205E/B205L	852001	Outer Joint	29T	33	25	52	99	61	O	
	1998.02-2003.08	AT/MT	R	F	Convertible Engine B204L/B205E/B205L	252002	Drive Shaft	29T	33	37.1	52	92.5	487		
	1998.02-2003.08	AT	L	F	Convertible Engine B204L/B205E/B205L	252001	Drive Shaft	29T	33	34	52	92.5	594		
2.3 i (110 kW)	1998.02-2003.08	-	R	F	Convertible Engine B234I	218199	Drive Shaft	29T	33	34	52	92.5	932		
	1998.02-2003.08	AT/MT	L/R	F	Convertible Engine B234I	852001	Outer Joint	29T	33	25	52	99	61	O	
	1998.02-2003.08	AT/MT	R	F	Convertible Engine B234I	252002	Drive Shaft	29T	33	37.1	52	92.5	487		
	1998.02-2003.08	AT	L	F	Convertible Engine B234I	252001	Drive Shaft	29T	33	34	52	92.5	594		
9-3 II (YS3F)															
1.8 T (110 kW)	2002.09-	-	-	-	-	852014	Outer Joint		30	28	55.4	100	64.5	M	
1.9 TiD (110 kW)	2004.09-	-	-	-	-	699138	Inner Joint		27	28	35	78	83		
1.9 TiD (88 kW)	2004.09-	-	-	-	-	699138	Inner Joint		27	28	35	78	83		
1.9 TTiD (132 kW)	2007.12-	MT	-	-	-	699138	Inner Joint		27	28	35	78	83		
1.9TTiD (132 kW)	2008-	MT	-	-	-	852014	Outer Joint		30	28	55.4	100	64.5	M	
2.0 T (129 kW)	2002.09-	-	-	-	-	852014	Outer Joint		30	28	55.4	100	64.5	M	
2.0 T (154 kW)	2002.09-	-	-	-	-	852014	Outer Joint		30	28	55.4	100	64.5	M	
2.0 T BioPower (129 kW)	2007.01-	-	-	-	-	852014	Outer Joint		30	28	55.4	100	64.5	M	
2.2 TiD (85 kW)	2002.09-	-	-	-	-	852014	Outer Joint		30	28	55.4	100	64.5	M	
2.2 TiD (88 kW)	2002.09-	-	-	-	-	852014	Outer Joint		30	28	55.4	100	64.5	M	
2.2 TiD (92 kW)	2002.09-	-	-	-	-	852014	Outer Joint		30	28	55.4	100	64.5	M	
2.8 T V6 (188 kW)	2007.12-	-	-	-	-	852014	Outer Joint		30	28	55.4	100	64.5	M	
2.8 T V6 XWD (206 kW)	2008.05-	-	-	-	-	852014	Outer Joint		30	28	55.4	100	64.5	M	
9-3 X															
2.0 T (154 kW)	2009.02-	-	-	-	-	852014	Outer Joint		30	28	55.4	100	64.5	M	
2.0 T BioPower (154 kW)	2009.02-	-	-	-	-	852014	Outer Joint		30	28	55.4	100	64.5	M	
9-5 (YS3E)															
1.9 TiD (110 kW)	2006.01-2009.12	-	L/R	F	Saloon Engine Z 19 DTH	299200	Drive Shaft	29T	30	27	59	94	610		
	2006.01-2009.12	-	L/R	F	Estate Engine Z 19 DTH	299200	Drive Shaft	29T	30	27	59	94	610		
	2006.01-2009.12	-	L/R	F	Saloon Engine Z 19 DTH	899254	Outer Joint	29T	30	27	59	94	65	M	
	2006.01-2009.12	-	L/R	F	Estate Engine Z 19 DTH	899254	Outer Joint	29T	30	27	59	94	65	M	
2.0 t (110 kW)	1997.09-2009.12	-	L/R	F	Saloon Engine B205E	899254	Outer Joint	29T	30	27	59	94	65	M	
	1997.09-2009.12	-	-	F	Saloon Engine B205E	852008	Outer Joint	29T	33	27	59	98	65	I	
	1997.09-2009.12	-	-	F	Saloon Engine B205E	899281	Outer Joint	29T	33	27	59	98	65	I	
	1997.09-2009.12	-	L/R	F	Saloon Engine B205E	252006	Drive Shaft	29T	33	27	59	92	613		
	1997.09-2009.12	-	L/R	F	Saloon Engine B205E	299200	Drive Shaft	29T	30	27	59	94	610		
	1998.10-2009.12	-	L/R	F	Estate Engine B205E	899254	Outer Joint	29T	30	27	59	94	65	M	
	1998.10-2009.12	-	-	F	Estate Engine B205E	852008	Outer Joint	29T	33	27	59	98	65	I	
	1998.10-2009.12	-	-	F	Estate Engine B205E	899281	Outer Joint	29T	33	27	59	98	65	I	
	1998.10-2009.12	-	L/R	F	Estate Engine B205E	252006	Drive Shaft	29T	33	27	59	92	613		
	1998.10-2009.12	-	L/R	F	Estate Engine B205E	299200	Drive Shaft	29T	30	27	59	94	610		
2.0 t (136 kW)	2000.07-2009.12	-	L/R	F	Saloon Engine B205L	299200	Drive Shaft	29T	30	27	59	94	610		
	2000.07-2009.12	-	-	F	Saloon Engine B205L	899281	Outer Joint	29T	33	27	59	98	65	I	
	2000.07-2001.07	-	-	F	Estate Engine B205L	899281	Outer Joint	29T	33	27	59	98	65	I	
	2000.07-2009.12	-	L/R	F	Saloon Engine B205L	252006	Drive Shaft	29T	33	27	59	92	613		
	2000.07-2001.07	-	L/R	F	Estate Engine B205L	252006	Drive Shaft	29T	33	27	59	92	613		
2.0 t (141 kW)	1998.10-2000.07	-	-	F	Estate Engine B205E	852008	Outer Joint	29T	33	27	59	98	65	I	
	1998.10-2000.07	-	-	F	Estate Engine B205E	899281	Outer Joint	29T	33	27	59	98	65	I	
	1998.10-2000.07	-	L/R	F	Estate Engine B205E	252006	Drive Shaft	29T	33	27	59	92	613		





	 YEAR	TRANSM	L/R	F/R	REMARKS	GSP Ref.	 PRODUCT	 ABS	Technical Specifications					
									A	B	C	H	L	P
SAAB														
9-5 (YS3E)														
2.0 t Biopower (132 kW)	2005.09-2009.12	-	L/R	F	Saloon Engine B205E	299200	Drive Shaft	29T	30	27	59	94	610	
	2005.09-2009.12	-	L/R	F	Estate Engine B205E	299200	Drive Shaft	29T	30	27	59	94	610	
	2005.09-2009.12	-	L/R	F	Saloon Engine B205E	899254	Outer Joint	29T	30	27	59	94	65	M
	2005.09-2009.12	-	L/R	F	Estate Engine B205E	899254	Outer Joint	29T	30	27	59	94	65	M
2.0 Turbo SE (141 kW)	1998.10-2000.07	-	-	F	Saloon Engine B205E	899281	Outer Joint	29T	33	27	59	98	65	I
	1998.10-2000.07	-	L/R	F	Saloon Engine B205E	252006	Drive Shaft	29T	33	27	59	92	613	
2.2 TiD (88 kW)	2002.03-2009.12	-	L/R	F	Saloon Engine D223L	299200	Drive Shaft	29T	30	27	59	94	610	
	2002.03-2009.12	-	L/R	F	Estate Engine D223L	299200	Drive Shaft	29T	30	27	59	94	610	
	2002.03-2009.12	-	L/R	F	Saloon Engine D223L	899254	Outer Joint	29T	30	27	59	94	65	M
	2002.03-2009.12	-	L/R	F	Estate Engine D223L	899254	Outer Joint	29T	30	27	59	94	65	M
2.3 t (125 kW)	1997.09-2009.12	-	-	F	Saloon Engine B235E	852008	Outer Joint	29T	33	27	59	98	65	I
	1997.09-2009.12	-	-	F	Saloon Engine B235E	899281	Outer Joint	29T	33	27	59	98	65	I
	1997.09-2009.12	-	L/R	F	Saloon Engine B235E	252006	Drive Shaft	29T	33	27	59	92	613	
	1997.09-2009.12	-	L/R	F	Saloon Engine B235E	299200	Drive Shaft	29T	30	27	59	94	610	
	1998.10-2009.12	-	-	F	Estate Engine B235E	852008	Outer Joint	29T	33	27	59	98	65	I
	1998.10-2009.12	-	-	F	Estate Engine B235E	899281	Outer Joint	29T	33	27	59	98	65	I
	1998.10-2009.12	AT/MT	L/R	F	Estate Engine B235E	252006	Drive Shaft	29T	33	27	59	92	613	
2.3 t (136 kW)	2001.01-2009.12	-	L/R	F	Saloon Engine B235E	299200	Drive Shaft	29T	30	27	59	94	610	
	2001.01-2009.12	-	L/R	F	Estate Engine B235E	299200	Drive Shaft	29T	30	27	59	94	610	
	2001.01-2009.12	-	L/R	F	Saloon Engine B235E	899254	Outer Joint	29T	30	27	59	94	65	M
	2001.01-2009.12	-	L/R	F	Estate Engine B235E	899254	Outer Joint	29T	30	27	59	94	65	M
	2001.01-2009.12	-	-	F	Saloon Engine B235E	852008	Outer Joint	29T	33	27	59	98	65	I
	2001.01-2009.12	-	-	F	Estate Engine B235E	852008	Outer Joint	29T	33	27	59	98	65	I
	2001.01-2009.12	-	-	F	Saloon Engine B235E	899281	Outer Joint	29T	33	27	59	98	65	I
	2001.01-2009.12	-	-	F	Estate Engine B235E	899281	Outer Joint	29T	33	27	59	98	65	I
	2001.01-2009.12	-	L/R	F	Saloon Engine B235E	252006	Drive Shaft	29T	33	27	59	92	613	
	2001.01-2009.12	-	L/R	F	Estate Engine B235E	252006	Drive Shaft	29T	33	27	59	92	613	
2.3 t BioPower (152 kW)	2006.11-2009.12	-	L/R	F	Saloon Engine B235R	299200	Drive Shaft	29T	30	27	59	94	610	
	2006.11-2009.12	-	L/R	F	Estate Engine B235R	299200	Drive Shaft	29T	30	27	59	94	610	
	2006.11-2009.12	-	L/R	F	Saloon Engine B235R	899254	Outer Joint	29T	30	27	59	94	65	M
	2006.11-2009.12	-	L/R	F	Estate Engine B235R	899254	Outer Joint	29T	30	27	59	94	65	M
2.3 t BioPower (154 kW)	2006.11-2009.12	-	L/R	F	Estate Engine B235R	299200	Drive Shaft	29T	30	27	59	94	610	
2.3 Turbo (134 kW)	2008.04-2009.12	-	L/R	F	Saloon Engine B235E	299200	Drive Shaft	29T	30	27	59	94	610	
	2008.04-2009.12	-	L/R	F	Saloon Engine B235E	899254	Outer Joint	29T	30	27	59	94	65	M
2.3 Turbo (162 kW)	2003.07-2009.12	-	L/R	F	Saloon Engine B235L	299200	Drive Shaft	29T	30	27	59	94	610	
	2003.07-2009.12	-	L/R	F	Estate Engine B235L	299200	Drive Shaft	29T	30	27	59	94	610	
	2003.07-2009.12	-	L/R	F	Saloon Engine B235L	899254	Outer Joint	29T	30	27	59	94	65	M
	2003.07-2009.12	-	L/R	F	Estate Engine B235L	899254	Outer Joint	29T	30	27	59	94	65	M
2.3 Turbo (169 kW)	1999.10-2001.09	-	-	F	Saloon Engine B235R	852008	Outer Joint	29T	33	27	59	98	65	I
	1999.10-2001.09	-	-	F	Estate Engine B235R	852008	Outer Joint	29T	33	27	59	98	65	I
	1999.10-2001.09	-	-	F	Saloon Engine B235R	899281	Outer Joint	29T	33	27	59	98	65	I
	1999.10-2001.09	-	-	F	Estate Engine B235R	899281	Outer Joint	29T	33	27	59	98	65	I
	1999.10-2001.09	AT/MT	L/R	F	Estate Engine B235R	252006	Drive Shaft	29T	33	27	59	92	613	
2.3 Turbo (184 kW)	2001.09-2009.12	-	L/R	F	Saloon Engine B235R	299200	Drive Shaft	29T	30	27	59	94	610	
	2001.09-2009.12	-	L/R	F	Estate Engine B235R	299200	Drive Shaft	29T	30	27	59	94	610	
	2001.09-2009.12	-	L/R	F	Saloon Engine B235R	899254	Outer Joint	29T	30	27	59	94	65	M
	2001.09-2009.12	-	L/R	F	Estate Engine B235R	899254	Outer Joint	29T	30	27	59	94	65	M
	2001.09-2009.12	-	-	F	Saloon Engine B235R	852008	Outer Joint	29T	33	27	59	98	65	I
	2001.09-2009.12	-	-	F	Estate Engine B235R	852008	Outer Joint	29T	33	27	59	98	65	I
2.3 Turbo (188 kW)	2008.04-2009.12	-	L/R	F	Saloon Engine B235R	299200	Drive Shaft	29T	30	27	59	94	610	
	2008.04-2009.12	-	L/R	F	Estate Engine B235R	299200	Drive Shaft	29T	30	27	59	94	610	
	2008.04-2009.12	-	L/R	F	Saloon Engine B235R	899254	Outer Joint	29T	30	27	59	94	65	M
2.3 Turbo (191 kW)	2005.11-2009.12	-	L/R	F	Saloon Engine B235R	299200	Drive Shaft	29T	30	27	59	94	610	
	2005.11-2009.12	-	L/R	F	Saloon Engine B235R	899254	Outer Joint	29T	30	27	59	94	65	M
	2006.01-2009.12	-	L/R	F	Estate Engine B235R	299200	Drive Shaft	29T	30	27	59	94	610	
	2006.01-2009.12	-	L/R	F	Estate Engine B235R	899254	Outer Joint	29T	30	27	59	94	65	M
2.3 Turbo (224 kW)	2003.06-2005.08	-	L/R	F	Saloon Engine B235R	299200	Drive Shaft	29T	30	27	59	94	610	
3.0 TiD (130 kW)	2001.07-2009.12	-	L/R	F	Saloon Engine D308L	299200	Drive Shaft	29T	30	27	59	94	610	
	2001.07-2009.12	-	L/R	F	Estate Engine D308L	299200	Drive Shaft	29T	30	27	59	94	610	
	2001.07-2009.12	-	L/R	F	Saloon Engine D308L	899254	Outer Joint	29T	30	27	59	94	65	M
	2001.07-2009.12	-	L/R	F	Estate Engine D308L	899254	Outer Joint	29T	30	27	59	94	65	M
	2001.07-2009.12	-	-	F	Saloon Engine D308L	852008	Outer Joint	29T	33	27	59	98	65	I
	2001.07-2009.12	-	-	F	Estate Engine D308L	852008	Outer Joint	29T	33	27	59	98	65	I
3.0 V6t (147 kW)	1998.01-2009.12	-	L/R	F	Saloon Engine B308E	899254	Outer Joint	29T	30	27	59	94	65	M
	1998.01-2009.12	-	-	F	Saloon Engine B308E	852008	Outer Joint	29T	33	27	59	98	65	I

YEAR	TRANSM	L/R	F/R	REMARKS	GSP Ref.	PRODUCT	ABS	Technical Specifications						
								A	B	C	H	L	P	
SAAB														
9-5 (YS3E)														
3.0 V6t (147 kW)	1998.01-2009.12	-	-	F	Saloon Engine B308E	899281	Outer Joint	29T	33	27	59	98	65	I
	1998.01-2009.12	-	L/R	F	Saloon Engine B308E	252006	Drive Shaft	29T	33	27	59	92	613	
	1998.01-2009.12	-	L/R	F	Saloon Engine B308E	299200	Drive Shaft	29T	30	27	59	94	610	
	1998.10-2009.12	-	L/R	F	Estate Engine B308E	299200	Drive Shaft	29T	30	27	59	94	610	
	1998.10-2009.12	-	L/R	F	Estate Engine B308E	899254	Outer Joint	29T	30	27	59	94	65	M
	1998.10-2009.12	-	-	F	Estate Engine B308E	852008	Outer Joint	29T	33	27	59	98	65	I
	1998.10-2009.12	-	-	F	Estate Engine B308E	899281	Outer Joint	29T	33	27	59	98	65	I
	1998.10-2009.12	-	L/R	F	Estate Engine B308E	252006	Drive Shaft	29T	33	27	59	92	613	
9-5 (YS3G)														
1.6 Turbo (132 kW)	2010.05-2012.01	-	-	F	Saloon Engine A 16 LET	821038	Outer Joint		30	24	52	94	64	M
2.0 t BioPower (162 kW)	2010.05-2012.01	-	-	F	Saloon Engine A 20 NFT	899023	Outer Joint		30	26	53.8	94.5	65.5	M
2.0 t BioPower XWD (162 kW)	2010.05-2012.01	-	-	-	All-wheel Drive Saloon Engine A 20 NHT	899367	Outer Joint		30	27	58.9	94	64.5	M
2.0 TiD (118 kW)	2010.05-2012.01	-	-	F	Saloon Engine A 20 DTH	899023	Outer Joint		30	26	53.8	94.5	65.5	M
2.0 TTD (140 kW)	2010.05-2012.01	-	-	F	Saloon Engine A 20 DTR	899023	Outer Joint		30	26	53.8	94.5	65.5	M
2.0 TTD XWD (140 kW)	2010.05-2012.01	-	-	-	All-wheel Drive Saloon Engine A 20 DTR	899367	Outer Joint		30	27	58.9	94	64.5	M
2.0 Turbo (162 kW)	2010.05-2012.01	-	-	F	Saloon Engine A 20 NHT	899023	Outer Joint		30	26	53.8	94.5	65.5	M
2.0 Turbo XWD (162 kW)	2010.05-2012.01	-	-	-	All-wheel Drive Saloon Engine A 20 NHT	899367	Outer Joint		30	27	58.9	94	64.5	M
2.8 Turbo V6 XWD (221 kW)	2010.05-2012.01	-	-	-	All-wheel Drive Saloon Engine A 28 NER	899367	Outer Joint		30	27	58.9	94	64.5	M
9-5 I (YS3E)														
1.9 TiD (110 kW)	2006.01-	-	-	-	-	852013	Outer Joint	29T	30	27	59	94	65	M
2.0 (136 kW)	2000.07-	-	-	-	-	852013	Outer Joint	29T	30	27	59	94	65	M
2.0 T (110 kW)	2001.06-	-	-	-	-	852013	Outer Joint	29T	30	27	59	94	65	M
2.2 TiD (85 kW)	2002-	-	-	-	-	852013	Outer Joint	29T	30	27	59	94	65	M
2.2 TiD (88 kW)	2002-	-	-	-	-	852013	Outer Joint	29T	30	27	59	94	65	M
2.2 TiD (92 kW)	2002-	-	-	-	-	852013	Outer Joint	29T	30	27	59	94	65	M
2.3 T (125 kW)	2001.01-	-	-	-	-	852013	Outer Joint	29T	30	27	59	94	65	M
2.3 T (136 kW)	2001.01-	-	-	-	-	852013	Outer Joint	29T	30	27	59	94	65	M
2.3 T (162 kW)	2001.01-	-	-	-	-	852013	Outer Joint	29T	30	27	59	94	65	M
2.3 T (184 kW)	2001.01-	-	-	-	-	852013	Outer Joint	29T	30	27	59	94	65	M
2.3 T (191 kW)	2001.01-	-	-	-	-	852013	Outer Joint	29T	30	27	59	94	65	M
3.0 T V6 (147 kW)	2001.07-	-	-	-	-	852013	Outer Joint	29T	30	27	59	94	65	M
3.0 TiD (130 kW)	2001.07-	-	-	-	-	852013	Outer Joint	29T	30	27	59	94	65	M
9-7X														
-	2005-	2009	-	-	F	PROPELLER SHAFT	608073	Propshaft CV Joint		17	22	44		119
900 I														
2.0 -16 (93 kW)	1990.01-1994.06	MT	L/R	F	Convertible Engine B202I	852004	Outer Joint		25	25	56.5	86	65	O
	1990.01-1994.06	MT	L/R	F	Convertible Engine B202I	852010	Outer Joint	46T	25	25	56	86	65	O
2.0 S Turbo-16 (104 kW)	1991.09-1994.06	MT	L/R	F	Convertible Engine B202S	852010	Outer Joint	46T	25	25	56	86	65	O
2.1 -16 (100 kW)	1990.08-1994.06	MT	L/R	F	Convertible Engine B212I	852004	Outer Joint		25	25	56.5	86	65	O
	1990.08-1994.06	MT	L/R	F	Convertible Engine B212I	852010	Outer Joint	46T	25	25	56	86	65	O
900 I (AC4 AM4)														
2.0 -16 (93 kW)	1989.01-1993.12	MT	L/R	F	Saloon Engine B202I	852004	Outer Joint		25	25	56.5	86	65	O
	1989.01-1993.12	MT	L/R	F	Saloon Engine B202I	852010	Outer Joint	46T	25	25	56	86	65	O
2.0 i (81 kW)	1985.09-1990.08	MT	L/R	F	Saloon Engine B201	852004	Outer Joint		25	25	56.5	86	65	O
	1985.09-1990.08	MT	L/R	F	Saloon Engine B201	852010	Outer Joint	46T	25	25	56	86	65	O
2.0 i (85 kW)	1980.11-1990.08	MT	L/R	F	Saloon Engine B201XI/BI 20	852004	Outer Joint		25	25	56.5	86	65	O
	1980.11-1990.08	MT	L/R	F	Saloon Engine B201XI/BI 20	852010	Outer Joint	46T	25	25	56	86	65	O
2.0 S Turbo-16 (104 kW)	1991.07-1993.12	MT	L/R	F	Saloon Engine B202S	852010	Outer Joint	46T	25	25	56	86	65	O
2.0 S Turbo-16 (107 kW)	1992.01-1993.12	MT	L/R	F	Saloon Engine B202S	852010	Outer Joint	46T	25	25	56	86	65	O
2.1 -16 (100 kW)	1990.08-1993.12	MT	L/R	F	Saloon Engine B212I	852004	Outer Joint		25	25	56.5	86	65	O
	1990.08-1993.12	MT	L/R	F	Saloon Engine B212I	852010	Outer Joint	46T	25	25	56	86	65	O
900 I Combi														
2.0 (74 kW)	1984.04-1991.10	MT	L/R	F	Hatchback Engine B201	852004	Outer Joint		25	25	56.5	86	65	O
2.0 -16 (93 kW)	1989.01-1992.08	MT	L/R	F	Hatchback Engine B202I	852004	Outer Joint		25	25	56.5	86	65	O
	1989.01-1992.08	MT	L/R	F	Hatchback Engine B202I	852010	Outer Joint	46T	25	25	56	86	65	O
2.0 i (81 kW)	1985.09-1990.08	MT	L/R	F	Hatchback Engine B201	852004	Outer Joint		25	25	56.5	86	65	O
	1985.09-1990.08	MT	L/R	F	Hatchback Engine B201	852010	Outer Joint	46T	25	25	56	86	65	O
2.0 S Turbo-16 (104 kW)	1991.09-1993.07	MT	L/R	F	Hatchback Engine B202S	852010	Outer Joint	46T	25	25	56	86	65	O
2.0 Turbo-16 (132 kW)	1993.01-1994.06	AT/MT	L/R	F	Hatchback Engine B202L	852001	Outer Joint	29T	33	25	52	99	61	O
2.1 -16 (100 kW)	1990.09-1993.07	MT	L/R	F	Hatchback Engine B212I	852010	Outer Joint	46T	25	25	56	86	65	O
900 II														
2.0 -16 Turbo (136 kW)	1993.07-1998.02	AT/MT	L/R	F	Hatchback Engine B204L	852001	Outer Joint	29T	33	25	52	99	61	O
	1993.07-1998.02	-	-	-	Hatchback Engine B204L	852005	Outer Joint		33	25	52	99	61	O
	1993.12-1998.02	AT/MT	L/R	F	Convertible Engine B204L	852001	Outer Joint	29T	33	25	52	99	61	O
	1993.12-1998.02	AT/MT	L/R	F	Coupe Engine B204L	852001	Outer Joint	29T	33	25	52	99	61	O
	1993.12-1998.02	-	-	-	Convertible Engine B204L	852005	Outer Joint		33	25	52	99	61	O

	 YEAR	TRANSM	L/R	F/R	REMARKS	GSP Ref.	 PRODUCT	 ABS	Technical Specifications					
									A	B	C	H	L	P
SAAB														
900 II														
2.0 -16 Turbo (136 kW)	1993.12-1998.02	-	-	-	Coupe Engine B204L	852005	Outer Joint		33	25	52	99	61	O
2.0 i (96 kW)	1993.12-1998.02	AT/MT	L/R	F	Convertible Engine B204I	852001	Outer Joint	29T	33	25	52	99	61	O
	1993.12-1998.02	-	-	-	Convertible Engine B204I	852005	Outer Joint		33	25	52	99	61	O
	1993.12-1998.02	MT	L	F	Convertible Engine B204I	644002	Inner Joint		34	25	35	56.2	85.6	
	1994.08-1998.02	AT/MT	L/R	F	Hatchback Engine B204I	852001	Outer Joint	29T	33	25	52	99	61	O
	1994.08-1998.02	AT/MT	L/R	F	Coupe Engine B204I	852001	Outer Joint	29T	33	25	52	99	61	O
	1994.08-1998.02	-	-	-	Hatchback Engine B204I	852005	Outer Joint		33	25	52	99	61	O
	1994.08-1998.02	-	-	-	Coupe Engine B204I	852005	Outer Joint		33	25	52	99	61	O
	1994.08-1998.02	MT	L	F	Hatchback Engine B204I	644002	Inner Joint		34	25	35	56.2	85.6	
2.0 i (98 kW)	1993.07-1994.07	AT/MT	L/R	F	Hatchback Engine B206I	852001	Outer Joint	29T	33	25	52	99	61	O
	1993.07-1994.07	-	-	-	Hatchback Engine B206I	852005	Outer Joint		33	25	52	99	61	O
	1993.07-1994.07	MT	L	F	Hatchback Engine B206I	644002	Inner Joint		34	25	35	56.2	85.6	
	1993.12-1994.07	AT/MT	L/R	F	Coupe Engine B206I	852001	Outer Joint	29T	33	25	52	99	61	O
	1993.12-1994.07	-	-	-	Coupe Engine B206I	852005	Outer Joint		33	25	52	99	61	O
	1993.12-1994.07	MT	L	F	Coupe Engine B206I	644002	Inner Joint		34	25	35	56.2	85.6	
2.3 -16 (110 kW)	1993.07-1998.02	AT/MT	L/R	F	Hatchback Engine B234I	852001	Outer Joint	29T	33	25	52	99	61	O
	1993.07-1998.02	-	-	-	Hatchback Engine B234I	852005	Outer Joint		33	25	52	99	61	O
	1993.07-1998.02	MT	L	F	Hatchback Engine B234I	644002	Inner Joint		34	25	35	56.2	85.6	
	1993.12-1998.02	AT/MT	L/R	F	Convertible Engine B234I	852001	Outer Joint	29T	33	25	52	99	61	O
	1993.12-1998.02	AT/MT	L/R	F	Coupe Engine B234I	852001	Outer Joint	29T	33	25	52	99	61	O
	1993.12-1998.02	-	-	-	Convertible Engine B234I	852005	Outer Joint		33	25	52	99	61	O
	1993.12-1998.02	-	-	-	Coupe Engine B234I	852005	Outer Joint		33	25	52	99	61	O
	1993.12-1998.02	MT	L	F	Convertible Engine B234I	644002	Inner Joint		34	25	35	56.2	85.6	
2.5 -24 V6 (125 kW)	1993.07-1998.02	AT/MT	L/R	F	Hatchback Engine B258I	852001	Outer Joint	29T	33	25	52	99	61	O
	1993.07-1998.02	-	-	-	Hatchback Engine B258I	852005	Outer Joint		33	25	52	99	61	O
	1993.12-1998.02	AT/MT	L/R	F	Convertible Engine B258I	852001	Outer Joint	29T	33	25	52	99	61	O
	1993.12-1998.02	AT/MT	L/R	F	Coupe Engine B258I	852001	Outer Joint	29T	33	25	52	99	61	O
	1993.12-1998.02	-	-	-	Convertible Engine B258I	852005	Outer Joint		33	25	52	99	61	O
	1993.12-1998.02	-	-	-	Coupe Engine B258I	852005	Outer Joint		33	25	52	99	61	O
9000														
2.0 -16 (94 kW)	1989.01-1993.01	AT/MT	L/R	F	Saloon Engine B202I	899212	Outer Joint	46T	26	25	56	84	61	O
2.0 -16 CD (110 kW)	1993.09-1998.12	AT/MT	L/R	F	Saloon Engine B202S/B204E/B204S	852007	Outer Joint	46T	26	25	56	84	65	O
2.0 -16 CD (96 kW)	1993.09-1998.12	AT/MT	L/R	F	Saloon Engine B202I/B204I	899212	Outer Joint	46T	26	25	56	84	61	O
2.0 -16 CS (94 kW)	1989.01-1998.12	AT/MT	L/R	F	Hatchback Engine B202I	899212	Outer Joint	46T	26	25	56	84	61	O
2.0 -16 CS (96 kW)	1993.09-1998.12	AT/MT	L/R	F	Hatchback Engine B204I	899212	Outer Joint	46T	26	25	56	84	61	O
2.0 -16 ND Turbo (110 kW)	1993.09-1998.12	AT/MT	L/R	F	Hatchback Engine B202S/B204E/B204S	852007	Outer Joint	46T	26	25	56	84	65	O
2.0 -16 Turbo (118 kW)	1984.09-1993.08	AT/MT	L/R	F	Hatchback Engine B202XL	852003	Outer Joint	94T	26	25	56	84	61	O
2.0 -16 Turbo (120 kW)	1988.05-1993.08	AT/MT	L/R	F	Hatchback Engine B202XL	852003	Outer Joint	94T	26	25	56	84	61	O
2.0 -16 Turbo (127 kW)	1989.06-1992.12	AT/MT	L/R	F	Hatchback Engine B202	852003	Outer Joint	94T	26	25	56	84	61	O
2.0 -16 Turbo (129 kW)	1984.09-1991.12	AT/MT	L/R	F	Hatchback Engine B202L/B202XL	852003	Outer Joint	94T	26	25	56	84	61	O
	1985.04-1991.12	AT/MT	L/R	F	Saloon Engine B202XL	852003	Outer Joint	94T	26	25	56	84	61	O
2.0 -16 Turbo CD (136 kW)	1989.09-1998.12	AT/MT	-	-	Saloon Engine B202L	852011	Outer Joint		26	25	56	84	65	O
2.0 -16 Turbo CS (136 kW)	1988.09-1998.12	AT/MT	-	-	Hatchback Engine B202L	852011	Outer Joint		26	25	56	84	65	O
2.3 -16 Aero CS (165 kW)	1993.02-1998.12	AT/MT	L/R	F	Hatchback Engine B234R	852007	Outer Joint	46T	26	25	56	84	65	O
2.3 -16 CD (107 kW)	1989.08-1998.12	AT/MT	L/R	F	Saloon Engine B234I	899212	Outer Joint	46T	26	25	56	84	61	O
	1989.08-1998.12	AT/MT	L/R	F	Saloon Engine B234I	852002	Outer Joint		26	25	56	84	61	O
2.3 -16 CD Turbo (147 kW)	1990.07-1998.12	AT/MT	-	-	Saloon Engine B234L	852011	Outer Joint		26	25	56	84	65	O
	1990.07-1998.12	AT/MT	L/R	F	Saloon Engine B234L	852007	Outer Joint	46T	26	25	56	84	65	O
2.3 -16 CDE (108 kW)	1993.09-1998.12	AT/MT	L/R	F	Saloon Engine B234I	899212	Outer Joint	46T	26	25	56	84	61	O
	1993.09-1998.12	AT/MT	L/R	F	Saloon Engine B234I	852002	Outer Joint		26	25	56	84	61	O
2.3 -16 CS (107 kW)	1989.09-1998.12	AT/MT	L/R	F	Hatchback Engine B234I	899212	Outer Joint	46T	26	25	56	84	61	O
	1989.09-1998.12	AT/MT	L/R	F	Hatchback Engine B234I	852002	Outer Joint		26	25	56	84	61	O
2.3 -16 CSE (108 kW)	1993.09-1998.12	AT/MT	L/R	F	Hatchback Engine B234I	899212	Outer Joint	46T	26	25	56	84	61	O
	1993.09-1998.12	AT/MT	L/R	F	Hatchback Engine B234I	852002	Outer Joint		26	25	56	84	61	O
2.3 -16 Turbo (143 kW)	1990.09-1998.12	AT/MT	-	-	Hatchback Engine B234L	852011	Outer Joint		26	25	56	84	65	O
	1990.09-1993.08	AT/MT	-	-	Saloon Engine B234L	852011	Outer Joint		26	25	56	84	65	O
	1990.09-1998.12	AT/MT	L/R	F	Hatchback Engine B234L	852007	Outer Joint	46T	26	25	56	84	65	O
	1990.09-1993.08	AT/MT	L/R	F	Saloon Engine B234L	852007	Outer Joint	46T	26	25	56	84	65	O
2.3 -16 Turbo CSE (147 kW)	1993.09-1998.12	AT/MT	-	-	Hatchback Engine B234L	852011	Outer Joint		26	25	56	84	65	O
	1993.09-1998.12	AT/MT	L/R	F	Hatchback Engine B234L	852007	Outer Joint	46T	26	25	56	84	65	O
SATURN														
SKY														
-	2007-2009	-	-	R	-	635045	Propshaft CV Joint		24		32			

	 YEAR	TRANSM	L/R	F/R	REMARKS	GSP Ref.	 PRODUCT	 ABS	Technical Specifications					
									A	B	C	H	L	P
SATURN														
VUE														
-	2002-2007	-	-	R	-	699239	Propshaft CV Joint		30	37				
SEAT														
ALHAMBRA														
1.9 TDI	2004-	-	-	R	F	MPV (Diesel)	261255	Stub Axle	37	113.5		381		
	2005-	-	-	R	F	MPV (Diesel)	261255	Stub Axle	37	113.5		381		
	2005-	-	-	R	F	MPV (Diesel)	261255	Stub Axle	37	113.5		381		
	2006-	-	-	R	F	MPV (Diesel)	261255	Stub Axle	37	113.5		381		
	2006-	-	-	R	F	MPV (Diesel)	261255	Stub Axle	37	113.5		381		
	2007-	-	-	R	F	MPV (Diesel)	261255	Stub Axle	37	113.5		381		
	2007-	-	-	R	F	MPV (Diesel)	261255	Stub Axle	37	113.5		381		
	2008-	-	-	R	F	MPV (Diesel)	261255	Stub Axle	37	113.5		381		
1.9 Tdi (66 KW)	1996-	-	-	R	F	MPV (Diesel)	261255	Stub Axle	37	113.5		381		
	1997-	-	-	R	F	MPV (Diesel)	261255	Stub Axle	37	113.5		381		
	1998-	-	-	R	F	MPV (Diesel)	261255	Stub Axle	37	113.5		381		
	1999-	-	-	R	F	MPV (Diesel)	261255	Stub Axle	37	113.5		381		
	2000-	-	-	R	F	MPV (Diesel)	261255	Stub Axle	37	113.5		381		
	2001-	-	-	R	F	MPV (Diesel)	261255	Stub Axle	37	113.5		381		
	2002-	-	-	R	F	MPV (Diesel)	261255	Stub Axle	37	113.5		381		
	2003-	-	-	R	F	MPV (Diesel)	261255	Stub Axle	37	113.5		381		
	2004-	-	-	R	F	MPV (Diesel)	261255	Stub Axle	37	113.5		381		
	2005-	-	-	R	F	MPV (Diesel)	261255	Stub Axle	37	113.5		381		
	2006-	-	-	R	F	MPV (Diesel)	261255	Stub Axle	37	113.5		381		
	2007-	-	-	R	F	MPV (Diesel)	261255	Stub Axle	37	113.5		381		
	2008-	-	-	R	F	MPV (Diesel)	261255	Stub Axle	37	113.5		381		
	2009-	-	-	R	F	MPV (Diesel)	261255	Stub Axle	37	113.5		381		
	2010-	-	-	R	F	MPV (Diesel)	261255	Stub Axle	37	113.5		381		
1.9 TDI (81 KW)	1996-	-	-	R	F	MPV (Diesel)	261255	Stub Axle	37	113.5		381		
	1997-	-	-	R	F	MPV (Diesel)	261255	Stub Axle	37	113.5		381		
	1998-	-	-	R	F	MPV (Diesel)	261255	Stub Axle	37	113.5		381		
	1999-	-	-	R	F	MPV (Diesel)	261255	Stub Axle	37	113.5		381		
	2000-	-	-	R	F	MPV (Diesel)	261255	Stub Axle	37	113.5		381		
1.9 TDI (85 KW)	2000-	-	-	R	F	MPV (Diesel)	261255	Stub Axle	37	113.5		381		
	2001-	-	-	R	F	MPV (Diesel)	261255	Stub Axle	37	113.5		381		
	2002-	-	-	R	F	MPV (Diesel)	261255	Stub Axle	37	113.5		381		
	2003-	-	-	R	F	MPV (Diesel)	261255	Stub Axle	37	113.5		381		
	2004-	-	-	R	F	MPV (Diesel)	261255	Stub Axle	37	113.5		381		
	2005-	-	-	R	F	MPV (Diesel)	261255	Stub Axle	37	113.5		381		
	2006-	-	-	R	F	MPV (Diesel)	261255	Stub Axle	37	113.5		381		
	2007-	-	-	R	F	MPV (Diesel)	261255	Stub Axle	37	113.5		381		
	2008-	-	-	R	F	MPV (Diesel)	261255	Stub Axle	37	113.5		381		
	2009-	-	-	R	F	MPV (Diesel)	261255	Stub Axle	37	113.5		381		
	2010-	-	-	R	F	MPV (Diesel)	261255	Stub Axle	37	113.5		381		
1.9 TDI (96 KW)	2002-	-	-	R	F	MPV (Diesel)	261255	Stub Axle	37	113.5		381		
	2003-	-	-	R	F	MPV (Diesel)	261255	Stub Axle	37	113.5		381		
2.0i (85 KW)	1996-	-	-	R	F	MPV (Petrol)	261255	Stub Axle	37	113.5		381		
	1997-	-	-	R	F	MPV (Petrol)	261255	Stub Axle	37	113.5		381		
	1998-	-	-	R	F	MPV (Petrol)	261255	Stub Axle	37	113.5		381		
	1999-	-	-	R	F	MPV (Petrol)	261255	Stub Axle	37	113.5		381		
	2000-	-	-	R	F	MPV (Petrol)	261255	Stub Axle	37	113.5		381		
	2001-	-	-	R	F	MPV (Petrol)	261255	Stub Axle	37	113.5		381		
	2002-	-	-	R	F	MPV (Petrol)	261255	Stub Axle	37	113.5		381		
	2003-	-	-	R	F	MPV (Petrol)	261255	Stub Axle	37	113.5		381		
	2004-	-	-	R	F	MPV (Petrol)	261255	Stub Axle	37	113.5		381		
	2005-	-	-	R	F	MPV (Petrol)	261255	Stub Axle	37	113.5		381		
	2006-	-	-	R	F	MPV (Petrol)	261255	Stub Axle	37	113.5		381		
	2007-	-	-	R	F	MPV (Petrol)	261255	Stub Axle	37	113.5		381		
	2008-	-	-	R	F	MPV (Petrol)	261255	Stub Axle	37	113.5		381		
	2009-	-	-	R	F	MPV (Petrol)	261255	Stub Axle	37	113.5		381		
	2010-	-	-	R	F	MPV (Petrol)	261255	Stub Axle	37	113.5		381		
ALHAMBRA (710 711)														
1.4 TSI (110 kW)	2010.06-	-	MT	R	F	MPV Engine CAVA/CNWB/CTHA	203366	Drive Shaft	36		59.5	40	794	
	2010.06-	-	-	L	F	MPV Engine CAVA/CNWB/CTHA	261188	Drive Shaft	36		59.5	40	487	
	2010.06-	-	-	-	F	MPV Engine CAVA/CNWB/CTHA	803095	Outer Joint	36	28	59.5	40	66	I
	2010.06-	-	-	L/R	F	MPV Engine CAVA/CNWB/CTHA	801352	Outer Joint	36	28	59.5	40	65	I
	2010.06-	-	MT	L	F	MPV Engine CAVA/CNWB/CTHA	203365	Drive Shaft	36		59.5	40	488	





SEAT	YEAR	TRANSM	L/R	F/R	REMARKS	GSP Ref.	PRODUCT	ABS	Technical Specifications											
									A	B	C	H	L	P						
SEAT ALHAMBRA (710 711)																				
2.0 TDI (100 kW)	2010.06-2011.05	-	L	F	MPV Engine CFFA	261188	Drive Shaft		36		59.5	40	487							
	2010.06-2011.05	AT/MT	L/R	F	MPV Engine CFFA	801352	Outer Joint		36	28	59.5	40	65	I						
	2010.06-2011.05	AT	R	F	MPV Engine CFFA	261330	Drive Shaft		36		59.5	40	760							
	2010.06-2011.05	-	-	F	MPV Engine CFFA	803095	Outer Joint		36	28	59.5	40	66	I						
	2010.06-2011.05	MT	L/R	F	MPV Engine CFFA	261214	Stub Axle		40	37	60		125							
	2010.06-2011.05	MT	L	F	MPV Engine CFFA	203365	Drive Shaft		36		59.5	40	488							
2.0 TDI (103 kW)	2011.05- -	-	L/R	R	All-wheel Drive MPV Engine CFFB	603011	Inner Joint			33		34								
	2011.05- -	-	-	F	All-wheel Drive MPV Engine CFFB	803095	Outer Joint		36	28	59.5	40	66	I						
	2011.05- -	-	L/R	F	All-wheel Drive MPV Engine CFFB	801352	Outer Joint		36	28	59.5	40	65	I						
	2011.05- -	MT	L/R	F	All-wheel Drive MPV Engine CFFB	261214	Stub Axle		40	37	60		125							
2.0 TDI (110 kW)	2015.05- -	MT/DCT	L/R	F	MPV Engine CUVC/DFLA	801352	Outer Joint		36	28	59.5	40	65	I						
	2015.05- -	Semi-AT	R	F	MPV Engine CUVC/DFLA	261330	Drive Shaft		36		59.5	40	760							
	2015.05- -	-	-	F	MPV Engine CUVC/DFLA	803095	Outer Joint		36	28	59.5	40	66	I						
	2015.05- -	MT	L/R	F	MPV Engine CUVC/DFLA	261214	Stub Axle		40	37	60		125							
	2015.05- -	MT	L	F	MPV Engine CUVC/DFLA	203365	Drive Shaft		36		59.5	40	488							
2.0 TDI (125 kW)	2010.06- -	-	L/R	F	MPV Engine CFGB	801352	Outer Joint		36	28	59.5	40	65	I						
	2010.06- -	AT	R	F	MPV Engine CFGB	261330	Drive Shaft		36		59.5	40	760							
	2010.06- -	-	-	F	MPV Engine CFGB	803095	Outer Joint		36	28	59.5	40	66	I						
	2010.06- -	AT	R	F	MPV Engine CFGB	601075	Inner Joint			26		86								
	2010.06- -	MT	L/R	F	MPV Engine CFGB	261214	Stub Axle		40	37	60		125							
2.0 TDI (135 kW)	2015.05- -	MT/DCT	L/R	F	MPV Engine CUWA/DFMA	801352	Outer Joint		36	28	59.5	40	65	I						
	2015.05- -	-	-	F	MPV Engine CUWA/DFMA	803095	Outer Joint		36	28	59.5	40	66	I						
	2015.05- -	MT	L/R	F	MPV Engine CUWA/DFMA	261214	Stub Axle		40	37	60		125							
	2015.05- -	MT	L	F	MPV Engine CUWA/DFMA	203365	Drive Shaft		36		59.5	40	488							
2.0 TDI (85 kW)	2011.05- -	-	L	F	MPV Engine CFFE	261188	Drive Shaft		36		59.5	40	487							
	2011.05- -	-	-	F	MPV Engine CFFE	803095	Outer Joint		36	28	59.5	40	66	I						
	2011.05- -	-	L/R	F	MPV Engine CFFE	801352	Outer Joint		36	28	59.5	40	65	I						
	2011.05- -	MT	L/R	F	MPV Engine CFFE	261214	Stub Axle		40	37	60		125							
	2011.05- -	-	L	F	MPV Engine CFFE	203365	Drive Shaft		36		59.5	40	488							
2.0 TSI (162 kW)	2015.05- -	DCT	L/R	F	MPV Engine DEDA	801352	Outer Joint		36	28	59.5	40	65	I						
	2015.05- -	DCT	L	F	MPV Engine DEDA	203365	Drive Shaft		36		59.5	40	488							
ALHAMBRA (710, 711)																				
1.4 TSI (110 kW)	2015.05- -	MT	R	F	MPV Engine CZDA	203366	Drive Shaft		36		59.5	40	794							
	2015.05- -	-	L	F	MPV Engine CZDA	261188	Drive Shaft		36		59.5	40	487							
	2015.05- -	MT	L/R	F	MPV Engine CZDA	801352	Outer Joint		36	28	59.5	40	65	I						
	2015.05- -	-	-	F	MPV Engine CZDA	803095	Outer Joint		36	28	59.5	40	66	I						
	2015.05- -	MT	L	F	MPV Engine CZDA	203365	Drive Shaft		36		59.5	40	488							
1.8 TSI (118 kW)	2012.11- -	AT	L	F	MPV Engine CDAA	261188	Drive Shaft		36		59.5	40	487							
	2012.11- -	-	-	F	MPV Engine CDAA	803095	Outer Joint		36	28	59.5	40	66	I						
2.0 TDI (103 kW)	2010.06- -	-	L	F	MPV Engine CFFB	261188	Drive Shaft		36		59.5	40	487							
	2010.06- -	AT	R	F	MPV Engine CFFB	261330	Drive Shaft		36		59.5	40	760							
	2010.06- -	-	-	F	MPV Engine CFFB	803095	Outer Joint		36	28	59.5	40	66	I						
	2010.06- -	-	L/R	F	MPV Engine CFFB	801352	Outer Joint		36	28	59.5	40	65	I						
	2010.06- -	MT	L/R	F	MPV Engine CFFB	261214	Stub Axle		40	37	60		125							
	2010.06- -	MT	L	F	MPV Engine CFFB	203365	Drive Shaft		36		59.5	40	488							
2.0 TDI (110 kW)	2015.05- -	MT	L/R	F	All-wheel Drive MPV Engine CUVC, DFLA	801352	Outer Joint		36	28	59.5	40	65	I						
	2015.05- -	-	-	F	All-wheel Drive MPV Engine CUVC, DFLA	803095	Outer Joint		36	28	59.5	40	66	I						
	2015.05- -	MT	L/R	F	All-wheel Drive MPV Engine CUVC, DFLA	261214	Stub Axle		40	37	60		125							
2.0 TDI (130 kW)	2012.11- -	AT	R	F	MPV Engine CFGC	261330	Drive Shaft		36		59.5	40	760							
	2012.11- -	-	L/R	F	MPV Engine CFGC	801352	Outer Joint		36	28	59.5	40	65	I						
	2012.11- -	-	-	F	MPV Engine CFGC	803095	Outer Joint		36	28	59.5	40	66	I						
	2012.11- -	MT	L/R	F	MPV Engine CFGC	261214	Stub Axle		40	37	60		125							
	2012.11- -	-	L	F	MPV Engine CFGC	203365	Drive Shaft		36		59.5	40	488							
2.0 TDI (135 kW)	2016.05- -	MT	L/R	F	All-wheel Drive MPV Engine DFMA	261214	Stub Axle		40	37	60		125							
2.0 TSI (147 kW)	2010.11- -	-	R	F	MPV Engine CCZA	203366	Drive Shaft		36		59.5	40	794							
	2010.11- -	-	L/R	F	MPV Engine CCZA	801352	Outer Joint		36	28	59.5	40	65	I						
	2010.11- -	-	L	F	MPV Engine CCZA	261188	Drive Shaft		36		59.5	40	487							
	2010.11- -	-	-	F	MPV Engine CCZA	803095	Outer Joint		36	28	59.5	40	66	I						
	2010.11- -	-	L	F	MPV Engine CCZA	203365	Drive Shaft		36		59.5	40	488							
ALHAMBRA (7V8 7V9)																				
1.8 T 20V (110 kW)	1997.10-2010.03	-	R	F	MPV Engine AJH/AWC	261193	Stub Axle		37		60		322							
	1997.10-2010.03	MT	L	F	MPV Engine AJH/AWC	218009	Drive Shaft	48W	38	26	60	34.5	620							
	1997.10-2010.03	AT	L/R	F	MPV Engine AJH/AWC	661033	Inner Joint			34		85								
	1997.10-2010.03	MT	R	F	MPV Engine AJH/AWC	218008	Drive Shaft	48W	38	35	60	34.5	559							
	1997.10-2010.03	AT	L/R	F	MPV Engine AJH/AWC	203022	Drive Shaft	48W	38		60	34	486							
	1997.10-2010.03	AT	L/R	F	MPV Engine AJH/AWC	818039	Outer Joint		38	36	60	34	72.5	I						

	 YEAR	TRANSM	L/R	F/R	REMARKS	GSP Ref.	 PRODUCT	 ABS	Technical Specifications					
									A	B	C	H	L	P
SEAT														
ALHAMBRA (7V8 7V9)														
1.8 T 20V (110 kW)	1997.10-2010.03	-	R	F	MPV Engine AJH/AWC	261192	Stub Axle		26	37	60		129.5	
	1997.10-2010.03	AT	L	F	MPV Engine AJH/AWC	261085	Drive Shaft	48W	38		60	34.5	513	
	1997.10-2010.03	AT	R	F	MPV Engine AJH/AWC	261065	Drive Shaft	48W	38		60	34.5	544	
	1997.10-2010.03	MT	L/R	F	MPV Engine AJH/AWC	203023	Drive Shaft	48W	38		60	34	507	
	1997.10-2010.03	AT/MT	L/R	F	MPV Engine AJH/AWC	818026	Outer Joint	48W	38	27	60	34.5	65	I
	1997.10-2010.03	-	L/R	F	MPV Engine AJH/AWC	818025	Outer Joint	48W	38	36	60	34	72.5	I
1.9 TDI (110 kW)	2005.05-2007.05	-	R	F	MPV Engine BTB	261193	Stub Axle		37		60		322	
	2005.05-2007.05	-	R	F	MPV Engine BTB	261192	Stub Axle		26	37	60		129.5	
	2005.05-2007.05	-	L/R	F	MPV Engine BTB	203023	Drive Shaft	48W	38		60	34	507	
	2005.05-2007.05	-	L/R	F	MPV Engine BTB	818025	Outer Joint	48W	38	36	60	34	72.5	I
1.9 TDI (66 kW)	1996.04-2010.03	-	L/R	F	MPV Engine 1Z/AHU/ANU	261087	Drive Shaft	48W	38		60	34.5	506	
	1996.04-2010.03	-	R	F	MPV Engine 1Z/AHU/ANU	261192	Stub Axle		26	37	60		129.5	
	1996.04-2010.03	-	L/R	F	MPV Engine 1Z/AHU/ANU	661032	Inner Joint			27		34		
	1996.04-2010.03	-	-	F	MPV Engine 1Z/AHU/ANU	659006	Inner Joint			34		33.2		
	1996.04-2010.03	MT	L/R	F	MPV Engine 1Z/AHU/ANU	203023	Drive Shaft	48W	38		60	34	507	
	1996.04-2010.03	AT/MT	L/R	F	MPV Engine 1Z/AHU/ANU	818026	Outer Joint	48W	38	27	60	34.5	65	I
	1996.04-2010.03	AT/MT	L/R	F	MPV Engine 1Z/AHU/ANU	818025	Outer Joint	48W	38	36	60	34	72.5	I
1.9 TDI (81 kW)	1996.04-2010.03	MT	R	F	MPV Engine 1Z/AHU/ANU	261245	Stub Axle		26	113.5			290	
	1996.08-2000.06	MT	R	F	MPV Engine AFN/AVG	218008	Drive Shaft	48W	38	35	60	34.5	559	
	1996.08-2000.06	AT	L	F	MPV Engine AFN/AVG	261085	Drive Shaft	48W	38		60	34.5	513	
	1996.08-2000.06	AT	L/R	F	MPV Engine AFN/AVG	661033	Inner Joint			34		85		
	1996.08-2000.06	AT	R	F	MPV Engine AFN/AVG	261065	Drive Shaft	48W	38		60	34.5	544	
	1996.08-2000.06	MT	L	F	MPV Engine AFN/AVG	861022	Outer Joint		38	27	60	34.5	65	M
	1996.08-2000.06	-	-	F	MPV Engine AFN/AVG	818040	Outer Joint		38	27	60	34.5	65	I
	1996.08-2000.06	MT	L	F	MPV Engine AFN/AVG	203024	Drive Shaft	48W	38	26	60	34.5	617	
	1996.08-2000.06	MT	R	F	MPV Engine AFN/AVG	203027	Drive Shaft	48W	38	35	60	34.5	561	
	1996.08-2000.06	AT/MT	L/R	F	MPV Engine AFN/AVG	818026	Outer Joint	48W	38	27	60	34.5	65	I
	1996.08-2000.06	MT	L	F	MPV Engine AFN/AVG	203064	Drive Shaft		38	26	60	34.5	617	
	1996.08-2000.06	MT	R	F	MPV Engine AFN/AVG	203065	Drive Shaft		38	35	60	34.5	561	
	1996.08-2000.06	MT	L/R	F	MPV Engine AFN/AVG	818025	Outer Joint	48W	38	36	60	34	72.5	I
	1996.08-2000.06	AT	R	F	MPV Engine AFN/AVG	261104	Drive Shaft	48W	38		60	34	544	
1.9 TDI (85 kW)	2000.06-2010.03	-	R	F	MPV Engine AUJ/BVK	261193	Stub Axle		37		60		322	
	2000.06-2010.03	5AT	L/R	F	MPV Engine AUJ/BVK	818039	Outer Joint		38	36	60	34	72.5	I
	2000.06-2010.03	5AT	L/R	F	MPV Engine AUJ/BVK	203022	Drive Shaft	48W	38		60	34	486	
	2000.06-2010.03	MT	L/R	F	MPV Engine AUJ/BVK	261087	Drive Shaft	48W	38		60	34.5	506	
	2000.06-2010.03	-	R	F	MPV Engine AUJ/BVK	261192	Stub Axle		26	37	60		129.5	
	2000.06-2010.03	MT	L/R	F	MPV Engine AUJ/BVK	661032	Inner Joint			27		34		
	2000.06-2010.03	MT	L/R	F	MPV Engine AUJ/BVK	203023	Drive Shaft	48W	38		60	34	507	
	2000.06-2010.03	AT/MT	L/R	F	MPV Engine AUJ/BVK	818025	Outer Joint	48W	38	36	60	34	72.5	I
	2000.06-2010.03	MT	R	F	MPV Engine AUJ/BVK	261245	Stub Axle		26	113.5			290	
1.9 TDI (96 kW)	2002.11-2008.11	-	R	F	MPV Engine ASZ	261193	Stub Axle		37		60		322	
	2002.11-2008.11	-	R	F	MPV Engine ASZ	261192	Stub Axle		26	37	60		129.5	
	2002.11-2008.11	MT	L/R	F	MPV Engine ASZ	203023	Drive Shaft	48W	38		60	34	507	
	2002.11-2008.11	AT/MT	L/R	F	MPV Engine ASZ	818025	Outer Joint	48W	38	36	60	34	72.5	I
1.9 TDI 4motion (85 kW)	2000.06-2010.03	-	R	F	All-wheel Drive MPV Engine AUJ/BVK	261193	Stub Axle		37		60		322	
	2000.06-2010.03	5AT	L/R	F	All-wheel Drive MPV Engine AUJ/BVK	203022	Drive Shaft	48W	38		60	34	486	
	2000.06-2010.03	-	R	F	All-wheel Drive MPV Engine AUJ/BVK	261192	Stub Axle		26	37	60		129.5	
	2000.06-2010.03	MT	L/R	F	All-wheel Drive MPV Engine AUJ/BVK	203023	Drive Shaft	48W	38		60	34	507	
	2000.06-2010.03	AT/MT	L/R	F	All-wheel Drive MPV Engine AUJ/BVK	818025	Outer Joint	48W	38	36	60	34	72.5	I
2.0 i (85 kW)	1996.04-2010.03	MT	L	F	MPV Engine ADY/ATM	218009	Drive Shaft	48W	38	26	60	34.5	620	
	1996.04-2010.03	AT	L/R	F	MPV Engine ADY/ATM	661033	Inner Joint			34		85		
	1996.04-2010.03	MT	R	F	MPV Engine ADY/ATM	218008	Drive Shaft	48W	38	35	60	34.5	559	
	1996.04-2010.03	MT	L/R	F	MPV Engine ADY/ATM	203022	Drive Shaft	48W	38		60	34	486	
	1996.04-2010.03	MT	L/R	F	MPV Engine ADY/ATM	261087	Drive Shaft	48W	38		60	34.5	506	
	1996.04-2010.03	-	R	F	MPV Engine ADY/ATM	261192	Stub Axle		26	37	60		129.5	
	1996.04-2010.03	AT	L	F	MPV Engine ADY/ATM	261085	Drive Shaft	48W	38		60	34.5	513	
	1996.04-2010.03	AT	R	F	MPV Engine ADY/ATM	261065	Drive Shaft	48W	38		60	34.5	544	
	1996.04-2010.03	MT	L	F	MPV Engine ADY/ATM	861022	Outer Joint		38	27	60	34.5	65	M
	1996.04-2010.03	MT	-	F	MPV Engine ADY/ATM	659006	Inner Joint			34		33.2		
	1996.04-2010.03	MT	L/R	F	MPV Engine ADY/ATM	661032	Inner Joint			27		34		
	1996.04-2010.03	-	-	F	MPV Engine ADY/ATM	818040	Outer Joint		38	27	60	34.5	65	I
	1996.04-2010.03	MT	L/R	F	MPV Engine ADY/ATM	203023	Drive Shaft	48W	38		60	34	507	
	1996.04-2010.03	MT	L	F	MPV Engine ADY/ATM	203024	Drive Shaft	48W	38	26	60	34.5	617	
	1996.04-2010.03	MT	R	F	MPV Engine ADY/ATM	203027	Drive Shaft	48W	38	35	60	34.5	561	
	1996.04-2010.03	AT/MT	L/R	F	MPV Engine ADY/ATM	818026	Outer Joint	48W	38	27	60	34.5	65	I
	1996.04-2010.03	MT	L	F	MPV Engine ADY/ATM	203064	Drive Shaft		38	26	60	34.5	617	

SEAT	YEAR	TRANSM	L/R	F/R	REMARKS	GSP Ref.	PRODUCT	ABS	Technical Specifications											
									A	B	C	H	L	P						
SEAT ALHAMBRA (7V8 7V9)																				
2.0 i (85 kW)	1996.04-2010.03	MT	R	F	MPV Engine ADY/ATM	203065	Drive Shaft		38	35	60	34.5	561							
	1996.04-2010.03	AT/MT	L/R	F	MPV Engine ADY/ATM	818025	Outer Joint	48W	38	36	60	34	72.5	I						
	1996.04-2010.03	AT	R	F	MPV Engine ADY/ATM	261104	Drive Shaft	48W	38		60	34	544							
	1996.04-2010.03	MT	R	F	MPV Engine ADY/ATM	261245	Stub Axle		26	113.5			290							
	1996.04-2010.03	-	R	F	MPV Engine ADY/ATM	261193	Stub Axle		37		60		322							
2.0 TDI (103 kW)	2005.11-2010.03	-	R	F	MPV Engine BRT	261193	Stub Axle		37		60		322							
	2005.11-2010.03	-	R	F	MPV Engine BRT	261192	Stub Axle		26	37	60		129.5							
	2005.11-2010.03	-	L/R	F	MPV Engine BRT	203023	Drive Shaft	48W	38		60	34	507							
	2005.11-2010.03	-	L/R	F	MPV Engine BRT	818025	Outer Joint	48W	38	36	60	34	72.5	I						
2.8 V6 (150 kW)	2000.06-2010.03	-	R	F	MPV Engine AUE/AYL	261193	Stub Axle		37		60		322							
	2000.06-2010.03	5AT	L	F	MPV Engine AUE/AYL	818039	Outer Joint		38	36	60	34	72.5	I						
	2000.06-2010.03	5AT	L	F	MPV Engine AUE/AYL	203022	Drive Shaft	48W	38		60	34	486							
	2000.06-2010.03	5AT	R	F	MPV Engine AUE/AYL	299120	Drive Shaft	48W	38	30	60	34	561							
	2000.06-2010.03	-	R	F	MPV Engine AUE/AYL	261192	Stub Axle		26	37	60		129.5							
	2000.06-2010.03	MT	L/R	F	MPV Engine AUE/AYL	203023	Drive Shaft	48W	38		60	34	507							
	2000.06-2010.03	AT/MT	L/R	F	MPV Engine AUE/AYL	818025	Outer Joint	48W	38	36	60	34	72.5	I						
2.8 V6 4motion (150 kW)	2000.06-2010.03	-	R	F	All-wheel Drive MPV Engine AUE/AYL	261193	Stub Axle		37		60		322							
	2000.06-2010.03	5AT	L	F	All-wheel Drive MPV Engine AUE/AYL	203022	Drive Shaft	48W	38		60	34	486							
	2000.06-2010.03	5AT	R	F	All-wheel Drive MPV Engine AUE/AYL	299120	Drive Shaft	48W	38	30	60	34	561							
	2000.06-2010.03	-	R	F	All-wheel Drive MPV Engine AUE/AYL	261192	Stub Axle		26	37	60		129.5							
	2000.06-2010.03	MT	L/R	F	All-wheel Drive MPV Engine AUE/AYL	203023	Drive Shaft	48W	38		60	34	507							
	2000.06-2010.03	AT/MT	L/R	F	All-wheel Drive MPV Engine AUE/AYL	818025	Outer Joint	48W	38	36	60	34	72.5	I						
ALHAMBRA (7V8,7V9)																				
1.8 T 20V (110 kW)	1997.10-2000.04	-	L	-	-	699053	Inner Joint		26	28	40	77.5	82.5							
	1997.10-2000.04	-	R	-	-	661028	Inner Joint		35	28	42	48	52							
1.9 TDi (66 kW)	1996.08-2000.04	-	L	-	-	699053	Inner Joint		26	28	40	77.5	82.5							
	1996.08-2000.04	-	R	-	-	661028	Inner Joint		35	28	42	48	52							
1.9 TDi (81 kW)	1996.08-2000.04	-	L	-	-	699053	Inner Joint		26	28	40	77.5	82.5							
	1996.08-2000.04	-	R	-	-	661028	Inner Joint		35	28	42	48	52							
2.0 i (85 kW)	1996.08-2000.04	-	L	-	-	699053	Inner Joint		26	28	40	77.5	82.5							
	1996.08-2000.04	-	R	-	-	661028	Inner Joint		35	28	42	48	52							
ALTEA																				
2.0 (110 kW)	2004.05-2009.03	-	L	F	Engine PS/5P1	261153	Drive Shaft		36	26	59.5	40	583							
ALTEA (5P1)																				
1.2 TSI (77 kW)	2010.04- -	MT	L	F	MPV Engine CBZB	261198	Drive Shaft		36		59.5	40.5	530							
	2010.04- -	MT	-	-	MPV Engine CBZB	603006	Inner Joint			33		34								
	2010.04- -	MT	-	-	MPV Engine CBZB	603016	Inner Joint			28		32								
	2010.04- -	-	L/R	F	MPV Engine CBZB	603011	Inner Joint			33		34								
	2010.04- -	-	L/R	F	MPV Engine CBZB	803037	Outer Joint		36	30	59.5	40.5	55	I						
1.4 16V (63 kW)	2006.05- -	-	L/R	F	MPV Engine BXW/CGGB	603008	Inner Joint			33		32								
	2006.05- -	MT	-	-	MPV Engine BXW/CGGB	603006	Inner Joint			33		34								
	2006.05- -	MT	-	-	MPV Engine BXW/CGGB	603016	Inner Joint			28		32								
	2006.05- -	-	R	F	MPV Engine BXW/CGGB	253008	Drive Shaft		36		59.5	40	782							
	2006.05- -	-	L	F	MPV Engine BXW/CGGB	253007	Drive Shaft		36		59.5	40	559							
	2006.05- -	-	L/R	F	MPV Engine BXW/CGGB	853001	Outer Joint		36	30	59.5	40	49	I						
1.4 TSI (92 kW)	2007.11- -	MT	-	-	MPV Engine CAXC	603006	Inner Joint			33		34								
	2007.11- -	MT	L	F	MPV Engine CAXC	261198	Drive Shaft		36		59.5	40.5	530							
	2007.11- -	MT	R	F	MPV Engine CAXC	201586	Drive Shaft		36		59.5	40	806							
	2007.11- -	5MT	L/R	F	MPV Engine CAXC	603011	Inner Joint			33		34								
	2007.11- -	MT	-	-	MPV Engine CAXC	603016	Inner Joint			28		32								
	2007.11- -	-	L/R	F	MPV Engine CAXC	803037	Outer Joint		36	30	59.5	40.5	55	I						
1.6 (75 kW)	2004.03- -	-	R	F	MPV Engine BGU/BSE/BSF/CCSA/CMXA	261113	Drive Shaft		36		59.5	40	814							
	2004.03- -	MT	L/R	F	MPV Engine BGU/BSE/BSF/CCSA/CMXA	603011	Inner Joint			33		34								
	2004.03- -	-	-	-	MPV Engine BGU/BSE/BSF/CCSA/CMXA	261237	Stub Axle		23	37	54		142.5							
	2004.03- -	5MT	L	F	MPV Engine BGU/BSE/BSF/CCSA/CMXA	261097	Drive Shaft		36		59.5	40.5	543							
	2004.03- -	5MT	R	F	MPV Engine BGU/BSE/BSF/CCSA/CMXA	261096	Drive Shaft		36		59.5	40.5	799							
	2004.03- -	-	L/R	F	MPV Engine BGU/BSE/BSF/CCSA/CMXA	803037	Outer Joint		36	30	59.5	40.5	55	I						
	2004.03- -	5MT	L	F	MPV Engine BGU/BSE/BSF/CCSA/CMXA	203320	Drive Shaft		36		59.5	40	546							
	2004.03- -	7AT	L	F	MPV Engine BGU/BSE/BSF/CCSA/CMXA	803116	Outer Joint		36	30	59.5	38	55	I						
1.6 LPG (75 kW)	2009.09- -	-	L	F	MPV Engine CHGA	261097	Drive Shaft		36		59.5	40.5	543							
	2009.09- -	MT	-	-	MPV Engine CHGA	603006	Inner Joint			33		34								
	2009.09- -	MT	-	-	MPV Engine CHGA	603016	Inner Joint			28		32								
	2009.09- -	5MT	R	F	MPV Engine CHGA	261096	Drive Shaft		36		59.5	40.5	799							
	2009.09- -	-	L	F	MPV Engine CHGA	203320	Drive Shaft		36		59.5	40	546							
	2009.09- -	-	L/R	F	MPV Engine CHGA	603008	Inner Joint			33		32								
	2009.09- -	-	L/R	F	MPV Engine CHGA	603011	Inner Joint			33		34								





SEAT	YEAR	TRANSM	L/R	F/R	REMARKS	GSP Ref.	PRODUCT	ABS	Technical Specifications											
									A	B	C	H	L	P						
SEAT																				
ALTEA (5P1)																				
1.6 LPG (75 kW)	2009.09-	-	-	L/R	F	MPV Engine CHGA	803037	Outer Joint		36	30	59.5	40.5	55	I					
1.6 TDI (66 kW)	2010.11-	-	-	L	F	MPV Engine CAYB	203294	Drive Shaft		36		59.5	38	519						
	2010.11-	-	MT	-	-	MPV Engine CAYB	603006	Inner Joint			33		34							
	2010.11-	-	-	L	F	MPV Engine CAYB	803116	Outer Joint		36	30	59.5	38	55	I					
	2010.11-	-	-	R	F	MPV Engine CAYB	201585	Drive Shaft		36		59.5	40	805						
	2010.11-	-	-	R	F	MPV Engine CAYB	261042	Drive Shaft		36		59.5	40.5	814						
	2010.11-	-	-	L/R	F	MPV Engine CAYB	603011	Inner Joint			33		34							
	2010.11-	-	-	L/R	F	MPV Engine CAYB	803037	Outer Joint		36	30	59.5	40.5	55	I					
1.6 TDI (77 kW)	2009.10-	-	7AT	L/R	F	MPV Engine CAYC	803002	Outer Joint		36	27	59.5	40	66	I					
	2009.10-	-	5MT	L	F	MPV Engine CAYC	203294	Drive Shaft		36		59.5	38	519						
	2009.10-	-	5MT	L	F	MPV Engine CAYC	803116	Outer Joint		36	30	59.5	38	55	I					
	2009.10-	-	5MT	L/R	F	MPV Engine CAYC	803037	Outer Joint		36	30	59.5	40.5	55	I					
	2009.10-	-	5MT	R	F	MPV Engine CAYC	261042	Drive Shaft		36		59.5	40.5	814						
	2009.10-	-	5MT	R	F	MPV Engine CAYC	201585	Drive Shaft		36		59.5	40	805						
	2009.10-	-	-	-	-	MPV Engine CAYC	861059	Outer Joint		36	33	59.5	40	59.5	I					
	2009.10-	-	5MT	L/R	F	MPV Engine CAYC	603011	Inner Joint			33		34							
1.8 TFSI (118 kW)	2007.01-	-	MT	L	F	MPV Engine BYT/BZB/CDA	261100	Drive Shaft		36		59.5	40	513						
	2007.01-	-	MT	L/R	F	MPV Engine BYT/BZB/CDA	861011	Outer Joint		38	29	63	102.5	70	M					
	2007.01-	-	MT	-	F	MPV Engine BYT/BZB/CDA	803100	Outer Joint		36	33	59.5	38	55	I					
	2007.01-	-	MT	L	F	MPV Engine BYT/BZB/CDA	261089	Drive Shaft		36		59.5	40.5	521						
	2007.01-	-	MT	L/R	F	MPV Engine BYT/BZB/CDA	803002	Outer Joint		36	27	59.5	40	66	I					
	2007.01-	-	-	-	-	MPV Engine BYT/BZB/CDA	861059	Outer Joint		36	33	59.5	40	59.5	I					
	2007.01-	-	MT	L	F	MPV Engine BYT/BZB/CDA	261131	Drive Shaft		36		59.5	40	515						
1.9 TDI (66 kW)	2009.08-	-	-	L	F	MPV Engine BXF	803116	Outer Joint		36	30	59.5	38	55	I					
	2009.08-	-	AT	L	F	MPV Engine BXF	654004	Inner Joint			34		85							
	2009.08-	-	MT	-	-	MPV Engine BXF	603006	Inner Joint			33		34							
	2009.08-	-	-	R	F	MPV Engine BXF	261042	Drive Shaft		36		59.5	40.5	814						
	2009.08-	-	MT	-	-	MPV Engine BXF	603016	Inner Joint			28		32							
	2009.08-	-	-	R	F	MPV Engine BXF	201585	Drive Shaft		36		59.5	40	805						
	2009.08-	-	AT	L	F	MPV Engine BXF	203241	Drive Shaft		36		59.5	40	475						
	2009.08-	-	-	L/R	F	MPV Engine BXF	603011	Inner Joint			33		34							
	2009.08-	-	-	L	F	MPV Engine BXF	203294	Drive Shaft		36		59.5	38	519						
1.9 TDI (77 kW)	2009.08-	-	-	L/R	F	MPV Engine BXF	803037	Outer Joint		36	30	59.5	40.5	55	I					
	2004.04-	-	5MT	L/R	F	MPV Engine BJB/BKC/BLS/BXE	803037	Outer Joint		36	30	59.5	40.5	55	I					
	2004.04-	-	5MT	L/R	F	MPV Engine BJB/BKC/BLS/BXE	603011	Inner Joint			33		34							
	2004.04-	-	6AT	L/R	F	MPV Engine BJB/BKC/BLS/BXE	661057	Inner Joint			34		86							
	2004.04-	-	-	-	-	MPV Engine BJB/BKC/BLS/BXE	261237	Stub Axle		23	37	54		142.5						
	2004.04-	-	AT	L	F	MPV Engine BJB/BKC/BLS/BXE	254013	Drive Shaft		36		59.5	40	479.5						
	2004.04-	-	AT	L	F	MPV Engine BJB/BKC/BLS/BXE	654004	Inner Joint			34		85							
	2004.04-	-	AT	L	F	MPV Engine BJB/BKC/BLS/BXE	203241	Drive Shaft		36		59.5	40	475						
	2004.04-	-	MT	L	F	MPV Engine BJB/BKC/BLS/BXE	803116	Outer Joint		36	30	59.5	38	55	I					
	2004.04-	-	6AT	L/R	F	MPV Engine BJB/BKC/BLS/BXE	803002	Outer Joint		36	27	59.5	40	66	I					
	2004.04-	-	MT	R	F	MPV Engine BJB/BKC/BLS/BXE	261042	Drive Shaft		36		59.5	40.5	814						
	2004.04-	-	5MT	R	F	MPV Engine BJB/BKC/BLS/BXE	201585	Drive Shaft		36		59.5	40	805						
	2004.04-	-	6AT	L/R	F	MPV Engine BJB/BKC/BLS/BXE	861045	Outer Joint		36	27	59.5	40	65	M					
2004.04-	-	AT	R	F	MPV Engine BJB/BKC/BLS/BXE	254011	Drive Shaft		36		59.5	40	755							
2004.04-	-	MT	L	F	MPV Engine BJB/BKC/BLS/BXE	203294	Drive Shaft		36		59.5	38	519							
2.0 FSI (110 kW)	2004.05-2009.03	-	-	R	F	MPV Engine BLR/BLY/BVY/BVZ	261113	Drive Shaft		36		59.5	40	814						
	2004.05-2009.03	-	-	-	-	MPV Engine BLR/BLY/BVY/BVZ	261237	Stub Axle		23	37	54		142.5						
	2004.05-2009.03	6AT	R	F	MPV Engine BLR/BLY/BVY/BVZ	261094	Drive Shaft		36	26	59.5	40.5	884							
	2004.05-2009.03	MT	L/R	F	MPV Engine BLR/BLY/BVY/BVZ	603011	Inner Joint			33		34								
	2004.05-2009.03	6MT	R	F	MPV Engine BLR/BLY/BVY/BVZ	201585	Drive Shaft		36		59.5	40	805							
	2004.05-2009.03	AT	L/R	F	MPV Engine BLR/BLY/BVY/BVZ	661011	Inner Joint		26	32	31	68.5	85							
	2004.05-2009.03	-	L/R	F	MPV Engine BLR/BLY/BVY/BVZ	803037	Outer Joint		36	30	59.5	40.5	55	I						
	2004.05-2009.03	6MT	L	F	MPV Engine BLR/BLY/BVY/BVZ	803116	Outer Joint		36	30	59.5	38	55	I						
	2004.05-2009.03	6AT	L	F	MPV Engine BLR/BLY/BVY/BVZ	261093	Drive Shaft		36	26	59.5	40.5	587.5							
2.0 TDI (100 kW)	2004.03-2009.05	MT	L	F	MPV Engine AZV	203295	Drive Shaft		36		59.5	40	491							
	2004.03-2009.05	AT	L/R	F	MPV Engine AZV	661057	Inner Joint			34		86								
	2004.03-2009.05	-	-	-	-	MPV Engine AZV	261237	Stub Axle		23	37	54		142.5						
	2004.03-2009.05	AT	R	F	MPV Engine AZV	203355	Drive Shaft		36	23	59.5	40	799							
	2004.03-2009.05	MT	R	F	MPV Engine AZV	203236	Drive Shaft		36		59.5	40	484							
	2004.03-2009.05	MT	R	F	MPV Engine AZV	203313	Drive Shaft		36		59.5	40	792							
	2004.03-2009.05	AT	L	F	MPV Engine AZV	254013	Drive Shaft		36		59.5	40	479.5							
	2004.03-2009.05	AT	L	F	MPV Engine AZV	654004	Inner Joint			34		85								
	2004.03-2009.05	AT	L	F	MPV Engine AZV	203241	Drive Shaft		36		59.5	40	475							
	2004.03-2009.05	AT/MT	L/R	F	MPV Engine AZV	803002	Outer Joint		36	27	59.5	40	66	I						





SEAT	YEAR	TRANSM	L/R	F/R	REMARKS	GSP Ref.	PRODUCT	ABS	Technical Specifications							
									A	B	C	H	L	P		
SEAT																
ALTEA (5P1)																
2.0 TDI (100 kW)	2004.03-2009.05	6DCT	L/R	F	MPV Engine AZV	861045	Outer Joint		36	27	59.5	40	65	M		
	2004.03-2009.05	AT	R	F	MPV Engine AZV	254011	Drive Shaft		36		59.5	40	755			
2.0 TDI (103 kW)	2005.11-	6MT	L	F	MPV Engine BMM	203265	Drive Shaft		36		59.5	40	487			
	2005.11-	AT	L/R	F	MPV Engine BMM	661057	Inner Joint			34		86				
	2005.11-	-	-	-	MPV Engine BMM	261237	Stub Axle		23	37	54		142.5			
	2005.11-	AT	L	F	MPV Engine BMM	254013	Drive Shaft		36		59.5	40	479.5			
	2005.11-	AT/MT	L/R	F	MPV Engine BMM	803002	Outer Joint		36	27	59.5	40	66	I		
	2005.11-	MT	R	F	MPV Engine BMM	203313	Drive Shaft		36		59.5	40	792			
	2005.11-	AT	L	F	MPV Engine BMM	654004	Inner Joint			34		85				
	2005.11-	AT	L	F	MPV Engine BMM	203241	Drive Shaft		36		59.5	40	475			
	2005.11-	AT	L/R	F	MPV Engine BMM	861045	Outer Joint		36	27	59.5	40	65	M		
	2005.11-	AT	R	F	MPV Engine BMM	254011	Drive Shaft		36		59.5	40	755			
2.0 TDI (125 kW)	2005.11-	MT	L	F	MPV Engine BMM	203295	Drive Shaft		36		59.5	40	491			
	2006.03-	-	-	-	MPV Engine BMN/CEGA	203265	Drive Shaft		36		59.5	40	487			
	2006.03-	-	-	-	MPV Engine BMN/CEGA	261237	Stub Axle		23	37	54		142.5			
	2006.03-	-	R	F	MPV Engine BMN/CEGA	203313	Drive Shaft		36		59.5	40	792			
	2006.03-	-	R	F	MPV Engine BMN/CEGA	261126	Drive Shaft		36		59.5	40	793			
	2006.03-	MT	L/R	F	MPV Engine BMN/CEGA	861045	Outer Joint		36	27	59.5	40	65	M		
2.0 TDI 16V (103 kW)	2006.03-	-	L	F	MPV Engine BMN/CEGA	203295	Drive Shaft		36		59.5	40	491			
	2004.03-	AT	L/R	F	MPV Engine BKD/CFHC	661057	Inner Joint			34		86				
	2004.03-	MT	L	F	MPV Engine BKD/CFHC	203265	Drive Shaft		36		59.5	40	487			
	2004.03-	MT	R	F	MPV Engine BKD/CFHC	203313	Drive Shaft		36		59.5	40	792			
	2004.03-	AT	R	F	MPV Engine BKD/CFHC	203355	Drive Shaft		36	23	59.5	40	799			
	2004.03-	-	-	-	MPV Engine BKD/CFHC	261237	Stub Axle		23	37	54		142.5			
	2004.03-	MT	R	F	MPV Engine BKD/CFHC	203236	Drive Shaft		36		59.5	40	484			
	2004.03-	AT	L	F	MPV Engine BKD/CFHC	254013	Drive Shaft		36		59.5	40	479.5			
	2004.03-	AT	L	F	MPV Engine BKD/CFHC	654004	Inner Joint			34		85				
	2004.03-	AT	L	F	MPV Engine BKD/CFHC	203241	Drive Shaft		36		59.5	40	475			
	2004.03-	MT	L/R	F	MPV Engine BKD/CFHC	803002	Outer Joint		36	27	59.5	40	66	I		
	2004.03-	6DCT	L/R	F	MPV Engine BKD/CFHC	861045	Outer Joint		36	27	59.5	40	65	M		
	2004.03-	MT	R	F	MPV Engine BKD/CFHC	261126	Drive Shaft		36		59.5	40	793			
	2004.03-	AT	R	F	MPV Engine BKD/CFHC	254011	Drive Shaft		36		59.5	40	755			
	2004.03-	MT	L	F	MPV Engine BKD/CFHC	203295	Drive Shaft		36		59.5	40	491			
	2.0 TFSI (147 kW)	2006.04-2009.05	-	L	F	MPV Engine BWA	203295	Drive Shaft		36		59.5	40	491		
		2006.04-2009.05	-	-	-	MPV Engine BWA	261237	Stub Axle		23	37	54		142.5		
		2006.04-2009.05	MT	L/R	F	MPV Engine BWA	803002	Outer Joint		36	27	59.5	40	66	I	
2006.04-2009.05		AT	R	F	MPV Engine BWA	203349	Drive Shaft		36		59.5	40	784			
ALTEA XL																
2.0 (110 KW)	2006.10-2009.03	-	L	F	Engine PS/5P5,5P8	261153	Drive Shaft		36	26	59.5	40	583			
ALTEA XL (5P5 5P8)																
1.2 TSI (77 kW)	2010.04-	MT	L	F	MPV Engine CBZB	261198	Drive Shaft		36		59.5	40.5	530			
	2010.04-	MT	-	-	MPV Engine CBZB	603006	Inner Joint			33		34				
	2010.04-	MT	-	-	MPV Engine CBZB	603016	Inner Joint			28		32				
	2010.04-	-	L/R	F	MPV Engine CBZB	603011	Inner Joint			33		34				
	2010.04-	-	L/R	F	MPV Engine CBZB	803037	Outer Joint		36	30	59.5	40.5	55	I		
1.4 16V (63 kW)	2006.10-	-	L/R	F	MPV Engine BXW/CGGB	603008	Inner Joint			33		32				
	2006.10-	MT	-	-	MPV Engine BXW/CGGB	603006	Inner Joint			33		34				
	2006.10-	MT	-	-	MPV Engine BXW/CGGB	603016	Inner Joint			28		32				
	2006.10-	-	R	F	MPV Engine BXW/CGGB	253008	Drive Shaft		36		59.5	40	782			
	2006.10-	-	L	F	MPV Engine BXW/CGGB	253007	Drive Shaft		36		59.5	40	559			
	2006.10-	-	L/R	F	MPV Engine BXW/CGGB	853001	Outer Joint		36	30	59.5	40	49	I		
1.4 TSI (92 kW)	2007.11-	MT	-	-	MPV Engine CAXC	603006	Inner Joint			33		34				
	2007.11-	MT	L	F	MPV Engine CAXC	261198	Drive Shaft		36		59.5	40.5	530			
	2007.11-	MT	R	F	MPV Engine CAXC	201586	Drive Shaft		36		59.5	40	806			
	2007.11-	-	L/R	F	MPV Engine CAXC	603011	Inner Joint			33		34				
	2007.11-	MT	-	-	MPV Engine CAXC	603016	Inner Joint			28		32				
	2007.11-	-	L/R	F	MPV Engine CAXC	803037	Outer Joint		36	30	59.5	40.5	55	I		
1.6 (75 kW)	2006.10-	-	R	F	MPV Engine BSE/BSF/CCSA/CMXA	261113	Drive Shaft		36		59.5	40	814			
	2006.10-	MT	L/R	F	MPV Engine BSE/BSF/CCSA/CMXA	803037	Outer Joint		36	30	59.5	40.5	55	I		
	2006.10-	MT	L/R	F	MPV Engine BSE/BSF/CCSA/CMXA	603011	Inner Joint			33		34				
	2006.10-	5MT	L	F	MPV Engine BSE/BSF/CCSA/CMXA	261097	Drive Shaft		36		59.5	40.5	543			
	2006.10-	5MT	R	F	MPV Engine BSE/BSF/CCSA/CMXA	261096	Drive Shaft		36		59.5	40.5	799			
	2006.10-	7AT	L	F	MPV Engine BSE/BSF/CCSA/CMXA	803116	Outer Joint		36	30	59.5	38	55	I		
	2006.10-	5MT	L	F	MPV Engine BSE/BSF/CCSA/CMXA	203320	Drive Shaft		36		59.5	40	546			
1.6 LPG (75 kW)	2009.09-	-	L/R	F	MPV Engine CHGA	603008	Inner Joint			33		32				
	2009.09-	-	L	F	MPV Engine CHGA	261097	Drive Shaft		36		59.5	40.5	543			





	 YEAR	TRANSM	L/R	F/R	REMARKS	GSP Ref.	 PRODUCT	 ABS	Technical Specifications					
									A	B	C	H	L	P
SEAT														
ALTEA XL (5P5 5P8)														
1.6 LPG (75 kW)	2009.09-	-	MT	-	-	MPV Engine CHGA	603006	Inner Joint		33		34		
	2009.09-	-	MT	-	-	MPV Engine CHGA	603016	Inner Joint		28		32		
	2009.09-	-	5MT	R	F	MPV Engine CHGA	261096	Drive Shaft	36		59.5	40.5	799	
	2009.09-	-	-	L/R	F	MPV Engine CHGA	603011	Inner Joint		33		34		
	2009.09-	-	-	L	F	MPV Engine CHGA	203320	Drive Shaft	36		59.5	40	546	
	2009.09-	-	-	L/R	F	MPV Engine CHGA	803037	Outer Joint	36	30	59.5	40.5	55	I
1.6 Multifuel (75 kW)	2006.10-	-	MT	-	-	MPV Engine CCSA	603006	Inner Joint		33		34		
	2006.10-	-	5MT	L	F	MPV Engine CCSA	261097	Drive Shaft	36		59.5	40.5	543	
	2006.10-	-	MT	-	-	MPV Engine CCSA	603016	Inner Joint		28		32		
	2006.10-	-	-	L/R	F	MPV Engine CCSA	603011	Inner Joint		33		34		
	2006.10-	-	5MT	R	F	MPV Engine CCSA	261096	Drive Shaft	36		59.5	40.5	799	
	2006.10-	-	5MT	L	F	MPV Engine CCSA	203320	Drive Shaft	36		59.5	40	546	
	2006.10-	-	7AT	L	F	MPV Engine CCSA	803116	Outer Joint	36	30	59.5	38	55	I
1.6 TDI (66 kW)	2006.10-	-	-	L/R	F	MPV Engine CCSA	803037	Outer Joint	36	30	59.5	40.5	55	I
	2010.11-	-	-	L	F	MPV Engine CAYB	203294	Drive Shaft	36		59.5	38	519	
	2010.11-	-	MT	-	-	MPV Engine CAYB	603006	Inner Joint		33		34		
	2010.11-	-	-	L	F	MPV Engine CAYB	803116	Outer Joint	36	30	59.5	38	55	I
	2010.11-	-	-	R	F	MPV Engine CAYB	201585	Drive Shaft	36		59.5	40	805	
	2010.11-	-	-	R	F	MPV Engine CAYB	261042	Drive Shaft	36		59.5	40.5	814	
	2010.11-	-	-	L/R	F	MPV Engine CAYB	603011	Inner Joint		33		34		
1.6 TDI (77 kW)	2010.11-	-	-	L/R	F	MPV Engine CAYB	803037	Outer Joint	36	30	59.5	40.5	55	I
	2009.10-	-	7AT	L/R	F	MPV Engine CAYC	803002	Outer Joint	36	27	59.5	40	66	I
	2009.10-	-	5MT	L	F	MPV Engine CAYC	803116	Outer Joint	36	30	59.5	38	55	I
	2009.10-	-	5MT	R	F	MPV Engine CAYC	261042	Drive Shaft	36		59.5	40.5	814	
	2009.10-	-	5MT	L/R	F	MPV Engine CAYC	603011	Inner Joint		33		34		
	2009.10-	-	5MT	R	F	MPV Engine CAYC	201585	Drive Shaft	36		59.5	40	805	
	2009.10-	-	-	-	-	MPV Engine CAYC	861059	Outer Joint	36	33	59.5	40	59.5	I
	2009.10-	-	5MT	L/R	F	MPV Engine CAYC	803037	Outer Joint	36	30	59.5	40.5	55	I
1.8 TFSI (118 kW)	2009.10-	-	5MT	L	F	MPV Engine CAYC	203294	Drive Shaft	36		59.5	38	519	
	2007.01-	-	MT	-	F	MPV Engine BYT/BZB/CDA	803100	Outer Joint	36	33	59.5	38	55	I
	2007.01-	-	MT	L	F	MPV Engine BYT/BZB/CDA	261089	Drive Shaft	36		59.5	40.5	521	
	2007.01-	-	MT	L/R	F	MPV Engine BYT/BZB/CDA	803002	Outer Joint	36	27	59.5	40	66	I
	2007.01-	-	-	-	-	MPV Engine BYT/BZB/CDA	861059	Outer Joint	36	33	59.5	40	59.5	I
1.9 TDI (66 kW)	2007.01-	-	MT	L	F	MPV Engine BYT/BZB/CDA	261131	Drive Shaft	36		59.5	40	515	
	2009.08-	-	-	L	F	MPV Engine BXF	203294	Drive Shaft	36		59.5	38	519	
	2009.08-	-	-	L/R	F	MPV Engine BXF	803037	Outer Joint	36	30	59.5	40.5	55	I
	2009.08-	-	-	L/R	F	MPV Engine BXF	603011	Inner Joint		33		34		
	2009.08-	-	-	L	F	MPV Engine BXF	803116	Outer Joint	36	30	59.5	38	55	I
	2009.08-	-	MT	-	-	MPV Engine BXF	603006	Inner Joint		33		34		
	2009.08-	-	-	R	F	MPV Engine BXF	261042	Drive Shaft	36		59.5	40.5	814	
	2009.08-	-	MT	-	-	MPV Engine BXF	603016	Inner Joint		28		32		
1.9 TDI (77 kW)	2009.08-	-	-	R	F	MPV Engine BXF	201585	Drive Shaft	36		59.5	40	805	
	2006.10-	-	5MT	L/R	F	MPV Engine BKC/BLS/BXE	803037	Outer Joint	36	30	59.5	40.5	55	I
	2006.10-	-	5MT	L/R	F	MPV Engine BKC/BLS/BXE	603011	Inner Joint		33		34		
	2006.10-	-	6AT	L/R	F	MPV Engine BKC/BLS/BXE	661057	Inner Joint		34		86		
	2006.10-	-	AT	L	F	MPV Engine BKC/BLS/BXE	254013	Drive Shaft	36		59.5	40	479.5	
	2006.10-	-	AT	L	F	MPV Engine BKC/BLS/BXE	654004	Inner Joint		34		85		
	2006.10-	-	MT	L	F	MPV Engine BKC/BLS/BXE	803116	Outer Joint	36	30	59.5	38	55	I
	2006.10-	-	6AT	L/R	F	MPV Engine BKC/BLS/BXE	803002	Outer Joint	36	27	59.5	40	66	I
	2006.10-	-	MT	R	F	MPV Engine BKC/BLS/BXE	261042	Drive Shaft	36		59.5	40.5	814	
	2006.10-	-	AT	L	F	MPV Engine BKC/BLS/BXE	203241	Drive Shaft	36		59.5	40	475	
	2006.10-	-	5MT	R	F	MPV Engine BKC/BLS/BXE	201585	Drive Shaft	36		59.5	40	805	
	2006.10-	-	6AT	L/R	F	MPV Engine BKC/BLS/BXE	861045	Outer Joint	36	27	59.5	40	65	M
	2006.10-	-	AT	R	F	MPV Engine BKC/BLS/BXE	254011	Drive Shaft	36		59.5	40	755	
2006.10-	-	MT	L	F	MPV Engine BKC/BLS/BXE	203294	Drive Shaft	36		59.5	38	519		
2.0 FSI (110 kW)	2006.10-2009.03	-	-	R	F	MPV Engine BVY/BVZ	261113	Drive Shaft	36		59.5	40	814	
	2006.10-2009.03	MT	L/R	F	MPV Engine BVY/BVZ	603011	Inner Joint		33		34			
	2006.10-2009.03	AT/MT	L/R	F	MPV Engine BVY/BVZ	803037	Outer Joint	36	30	59.5	40.5	55	I	
	2006.10-2009.03	6AT	R	F	MPV Engine BVY/BVZ	261094	Drive Shaft	36	26	59.5	40.5	884		
	2006.10-2009.03	6MT	R	F	MPV Engine BVY/BVZ	201585	Drive Shaft	36		59.5	40	805		
	2006.10-2009.03	6MT	L	F	MPV Engine BVY/BVZ	803116	Outer Joint	36	30	59.5	38	55	I	
2.0 TDI (100 kW)	2006.10-2009.03	6AT	L	F	MPV Engine BVY/BVZ	261093	Drive Shaft	36	26	59.5	40.5	587.5		
	2006.11-2009.03	AT	R	F	MPV Engine AZV	254011	Drive Shaft	36		59.5	40	755		
	2006.11-2009.03	MT	L	F	MPV Engine AZV	203295	Drive Shaft	36		59.5	40	491		
	2006.11-2009.03	AT	L/R	F	MPV Engine AZV	661057	Inner Joint		34		86			
2006.11-2009.03	MT	R	F	MPV Engine AZV	203313	Drive Shaft	36		59.5	40	792			





SEAT ALTEA XL (5P5 5P8)	YEAR	TRANSM	L/R	F/R	REMARKS	GSP Ref.	PRODUCT	ABS	Technical Specifications						
									A	B	C	H	L	P	
2.0 TDI (100 kW)	2006.11-2009.03	AT	L	F	MPV Engine AZV	254013	Drive Shaft		36		59.5	40	479.5		
	2006.11-2009.03	AT	L	F	MPV Engine AZV	654004	Inner Joint			34			85		
	2006.11-2009.03	AT/MT	L/R	F	MPV Engine AZV	803002	Outer Joint		36	27	59.5	40	66	I	
	2006.11-2009.03	6DCT	L/R	F	MPV Engine AZV	861045	Outer Joint		36	27	59.5	40	65	M	
2.0 TDI (103 kW)	2006.10-	6MT	L	F	MPV Engine BMM	203265	Drive Shaft		36		59.5	40	487		
	2006.10-	AT	L/R	F	MPV Engine BMM	661057	Inner Joint			34			86		
	2006.10-	AT/MT	L/R	F	MPV Engine BMM	803002	Outer Joint		36	27	59.5	40	66	I	
	2006.10-	AT	L	F	MPV Engine BMM	254013	Drive Shaft		36		59.5	40	479.5		
	2006.10-	MT	R	F	MPV Engine BMM	203313	Drive Shaft		36		59.5	40	792		
	2006.10-	AT	L	F	MPV Engine BMM	654004	Inner Joint			34			85		
	2006.10-	AT	L	F	MPV Engine BMM	203241	Drive Shaft		36		59.5	40	475		
	2006.10-	MT	L	F	MPV Engine BMM	203295	Drive Shaft		36		59.5	40	491		
	2006.10-	AT	L/R	F	MPV Engine BMM	861045	Outer Joint		36	27	59.5	40	65	M	
	2006.10-	AT	R	F	MPV Engine BMM	254011	Drive Shaft		36		59.5	40	755		
	2007.06-	AT	L/R	F	All-wheel Drive MPV Engine BMM	661057	Inner Joint			34			86		
	2007.06-	AT/MT	L/R	F	All-wheel Drive MPV Engine BMM	803002	Outer Joint		36	27	59.5	40	66	I	
	2007.06-	AT	R	F	All-wheel Drive MPV Engine BMM	203266	Drive Shaft		36		59.5	40	601		
	2007.06-	AT	L	F	All-wheel Drive MPV Engine BMM	654004	Inner Joint			34			85		
	2007.06-	-	L/R	R	All-wheel Drive MPV Engine BMM	603011	Inner Joint			33			34		
	2007.06-	AT	L	F	All-wheel Drive MPV Engine BMM	203241	Drive Shaft		36		59.5	40	475		
	2007.06-	-	-	R	All-wheel Drive MPV Engine BMM	635026	Inner Joint		36	33	59.5	40	39		
	2007.06-	AT	L	F	All-wheel Drive MPV Engine BMM	203295	Drive Shaft		36		59.5	40	491		
2.0 TDI (125 kW)	2007.06-	-	L	F	MPV Engine BMN/CEGA	203265	Drive Shaft		36		59.5	40	487		
	2007.06-	MT	-	-	MPV Engine BMN/CEGA	603006	Inner Joint			33			34		
	2007.06-	MT	-	-	All-wheel Drive MPV Engine BMN/CEGA/CFJA	603006	Inner Joint			33			34		
	2007.06-	AT	L/R	F	All-wheel Drive MPV Engine BMN/CEGA/CFJA	803002	Outer Joint		36	27	59.5	40	66	I	
	2007.06-	AT	R	F	All-wheel Drive MPV Engine BMN/CEGA/CFJA	203266	Drive Shaft		36		59.5	40	601		
	2007.06-	MT	-	-	MPV Engine BMN/CEGA	603016	Inner Joint			28			32		
	2007.06-	MT	-	-	All-wheel Drive MPV Engine BMN/CEGA/CFJA	603016	Inner Joint			28			32		
	2007.06-	AT/SMT/7DCT	L/R/F/R	F	All-wheel Drive MPV Engine BMN/CEGA/CFJA	603011	Inner Joint			33			34		
	2007.06-	-	R	F	MPV Engine BMN/CEGA	261126	Drive Shaft		36		59.5	40	793		
	2007.06-	-	-	R	All-wheel Drive MPV Engine BMN/CEGA/CFJA	635026	Inner Joint		36	33	59.5	40	39		
	2007.06-	AT	L	F	All-wheel Drive MPV Engine BMN/CEGA/CFJA	203295	Drive Shaft		36		59.5	40	491		
	2007.06-	MT	L/R	F	MPV Engine BMN/CEGA	861045	Outer Joint		36	27	59.5	40	65	M	
2.0 TDI 16V (103 kW)	2006.10-	AT	R	F	MPV Engine BKD/CFHC	254011	Drive Shaft		36		59.5	40	755		
	2006.10-	MT	L	F	MPV Engine BKD/CFHC	203295	Drive Shaft		36		59.5	40	491		
	2006.10-	6MT	L	F	MPV Engine BKD/CFHC	203265	Drive Shaft		36		59.5	40	487		
	2006.10-	AT	L/R	F	MPV Engine BKD/CFHC	661057	Inner Joint			34			86		
	2006.10-	MT	R	F	MPV Engine BKD/CFHC	203313	Drive Shaft		36		59.5	40	792		
	2006.10-	AT	L	F	MPV Engine BKD/CFHC	254013	Drive Shaft		36		59.5	40	479.5		
	2006.10-	AT	L	F	MPV Engine BKD/CFHC	654004	Inner Joint			34			85		
	2006.10-	AT	L	F	MPV Engine BKD/CFHC	203241	Drive Shaft		36		59.5	40	475		
	2006.10-	AT/MT	L/R	F	MPV Engine BKD/CFHC	803002	Outer Joint		36	27	59.5	40	66	I	
	2006.10-	6DCT	L/R	F	MPV Engine BKD/CFHC	861045	Outer Joint		36	27	59.5	40	65	M	
	2010.10-	AT/MT	L/R	F	All-wheel Drive MPV Engine CFHC	803002	Outer Joint		36	27	59.5	40	66	I	
	2010.10-	-	R	F	All-wheel Drive MPV Engine CFHC	203266	Drive Shaft		36		59.5	40	601		
	2010.10-	AT	L/R	F	All-wheel Drive MPV Engine CFHC	661057	Inner Joint			34			86		
	2010.10-	-	L	F	All-wheel Drive MPV Engine CFHC	203295	Drive Shaft		36		59.5	40	491		
	2010.10-	-	-	R	All-wheel Drive MPV Engine CFHC	635026	Inner Joint		36	33	59.5	40	39		
	2010.10-	-	L/R	R	All-wheel Drive MPV Engine CFHC	603011	Inner Joint			33			34		
2.0 TFSI (147 kW)	2006.10-2009.05	MT/DCT	L/R	F	MPV Engine BWA	803002	Outer Joint		36	27	59.5	40	66	I	
	2006.10-2009.05	-	R	F	MPV Engine BWA	203266	Drive Shaft		36		59.5	40	601		
	2006.10-2009.05	AT	L	F	MPV Engine BWA	654004	Inner Joint			34			85		
	2006.10-2009.05	MT/DCT	L	F	MPV Engine BWA	203295	Drive Shaft		36		59.5	40	491		
	2006.10-2009.05	AT	L	F	MPV Engine BWA	203241	Drive Shaft		36		59.5	40	475		
	2006.10-2009.05	MT/DCT	L/R	F	MPV Engine BWA	603011	Inner Joint			33			34		
	2007.06-2009.05	MT	L/R	F	All-wheel Drive MPV Engine BWA	803002	Outer Joint		36	27	59.5	40	66	I	
	2007.06-2009.05	AT/MT	R	F	All-wheel Drive MPV Engine BWA	261300	Drive Shaft		36		59.5	40	602		
	2007.06-2009.05	-	L/R	R	All-wheel Drive MPV Engine BWA	603011	Inner Joint			33			34		
	2007.06-2009.05	AT/MT	L	F	All-wheel Drive MPV Engine BWA	203295	Drive Shaft		36		59.5	40	491		
	2007.06-2009.05	-	-	R	All-wheel Drive MPV Engine BWA	635026	Inner Joint		36	33	59.5	40	39		
2.0 TFSI (155 kW)	2009.05-	AT/MT	R	F	All-wheel Drive MPV Engine CCZB	261300	Drive Shaft		36		59.5	40	602		
	2009.05-	-	L/R	F	All-wheel Drive MPV Engine CCZB	803002	Outer Joint		36	27	59.5	40	66	I	
	2009.05-	-	-	R	All-wheel Drive MPV Engine CCZB	635026	Inner Joint		36	33	59.5	40	39		
	2009.05-	-	L/R	R	All-wheel Drive MPV Engine CCZB	603011	Inner Joint			33			34		
	2009.05-	AT	-	-	All-wheel Drive MPV Engine CCZB	603016	Inner Joint			28			32		





SEAT	YEAR	TRANSM	L/R	F/R	REMARKS	GSP Ref.	PRODUCT	ABS	Technical Specifications															
									A	B	C	H	L	P										
SEAT																								
ALTEA XL (5P5 5P8)																								
2.0 TFSI (155 kW)	2009.05-	-	AT	-	-	All-wheel Drive MPV Engine CCZB	603006	Inner Joint			33		34											
	2009.05-	-	AT	L	F	All-wheel Drive MPV Engine CCZB	203295	Drive Shaft		36		59.5	40	491										
ARONA (KJ7)																								
1.6 TDI(70 kW)	2017.11-	-	-	L/R	F	Closed Off-Road Vehicle Engine DGTD	603011	Inner Joint			33		34											
1.6 TDI(85 kW)	2017.07-	-	-	L/R	F	Closed Off-Road Vehicle Engine DGTA	603011	Inner Joint			33		34											
AROSA (6H)																								
1.0 (37 kW)	1997.05-2004.06	-	-	R	F	Hatchback Engine AER/ALD/ALL/ANV/AUC	261010	Drive Shaft		22		53	78.5	740										
	1997.05-2004.06	-	-	L	F	Hatchback Engine AER/ALD/ALL/ANV/AUC	261205	Drive Shaft		22	0	53	78.5	525										
	1997.05-2004.06	-	-	R	F	Hatchback Engine AER/ALD/ALL/ANV/AUC	261189	Drive Shaft		22		53	78.5	751										
	1997.05-2004.06	AT/MT	L/R	F	F	Hatchback Engine AER/ALD/ALL/ANV/AUC	653001	Inner Joint			33		32											
	1997.05-2004.06	-	-	L	F	Hatchback Engine AER/ALD/ALL/ANV/AUC	261007	Drive Shaft		22		53	78.5	517										
	1997.05-2004.06	AT/MT	L/R	F	F	Hatchback Engine AER/ALD/ALL/ANV/AUC	853005	Outer Joint		22	30	53	78.5	51	I									
	1998.10-2001.01	-	-	L/R	F	Hatchback Engine AHT	653001	Inner Joint			33		32											
	1998.10-2001.01	-	-	L/R	F	Hatchback Engine AHT	853005	Outer Joint		22	30	53	78.5	51	I									
1.4 (44 kW)	1997.05-2004.06	MT	R	F	F	Hatchback Engine AEX/AKK/AKV/ANW/APQ/AUD	261010	Drive Shaft		22		53	78.5	740										
	1997.05-2004.06	AT/MT	R	F	F	Hatchback Engine AEX/AKK/AKV/ANW/APQ/AUD	261189	Drive Shaft		22		53	78.5	751										
	1997.05-2004.06	AT/MT	L/R	F	F	Hatchback Engine AEX/AKK/AKV/ANW/APQ/AUD	653001	Inner Joint			33		32											
	1997.05-2004.06	MT	L	F	F	Hatchback Engine AEX/AKK/AKV/ANW/APQ/AUD	261007	Drive Shaft		22		53	78.5	517										
	1997.05-2004.06	AT/MT	L/R	F	F	Hatchback Engine AEX/AKK/AKV/ANW/APQ/AUD	853005	Outer Joint		22	30	53	78.5	51	I									
1.4 16V (74 kW)	1997.05-2004.06	AT/MT	L	F	F	Hatchback Engine AEX/AKK/AKV/ANW/APQ/AUD	261205	Drive Shaft		22	0	53	78.5	525										
	2000.01-2004.06	-	-	R	F	Hatchback Engine AFK/AQQ/AUB	261010	Drive Shaft		22		53	78.5	740										
	2000.01-2004.06	AT/MT	R	F	F	Hatchback Engine AFK/AQQ/AUB	261189	Drive Shaft		22		53	78.5	751										
	2000.01-2004.06	-	-	L	F	Hatchback Engine AFK/AQQ/AUB	261007	Drive Shaft		22		53	78.5	517										
	2000.01-2004.06	-	-	L/R	F	Hatchback Engine AFK/AQQ/AUB	653001	Inner Joint			33		32											
	2000.01-2004.06	-	-	L/R	F	Hatchback Engine AFK/AQQ/AUB	853005	Outer Joint		22	30	53	78.5	51	I									
1.4 TDI (55 kW)	2000.01-2004.06	MT	L/R	F	F	Hatchback Engine AMF	653001	Inner Joint			33		32											
	2000.01-2004.06	MT	L/R	F	F	Hatchback Engine AMF	861007	Outer Joint		22	30	53	78.5	60	I									
	2000.01-2004.06	5MT	L	F	F	Hatchback Engine AMF	261075	Drive Shaft		22		53	78.5	525										
	2000.01-2004.06	5MT	R	F	F	Hatchback Engine AMF	261074	Drive Shaft		22		53	78.5	712										
1.7 SDI (44 kW)	1997.08-2004.06	-	-	R	F	Hatchback Engine AKU	261010	Drive Shaft		22		53	78.5	740										
	1997.08-2004.06	AT/MT	L/R	F	F	Hatchback Engine AKU	653001	Inner Joint			33		32											
	1997.08-2004.06	-	-	L	F	Hatchback Engine AKU	261007	Drive Shaft		22		53	78.5	517										
	1997.08-2004.06	AT/MT	L/R	F	F	Hatchback Engine AKU	853005	Outer Joint		22	30	53	78.5	51	I									
CORDOBA (6K1 6K2)																								
1.0 i (37 kW)	1996.09-2002.10	-	-	L	F	Saloon Engine AER/ALD/ANV/AUC	253004	Drive Shaft		22		50	78.5	562										
1.4 16V (55 kW)	2000.05-2002.10	MT	L/R	F	F	Saloon Engine APE/AUA	653001	Inner Joint			33		32											
	2000.05-2002.10	MT	L	F	F	Saloon Engine APE/AUA	253004	Drive Shaft		22		50	78.5	562										
	2000.05-2002.10	-	-	-	F	Saloon Engine APE/AUA	853006	Outer Joint		22	30	50	78.5	52	I									
	2000.05-2002.10	MT	L/R	F	F	Saloon Engine APE/AUA	853008	Outer Joint		22	30	53	78.5	51	I									
1.4 i (44 kW)	1994.06-2002.10	MT	L/R	F	F	Saloon Engine ABD/AEX/AKK AKV/ANW/APQ/AUD	653001	Inner Joint			33		32											
	1994.06-2002.10	-	-	-	F	Saloon Engine ABD/AEX/AKK AKV/ANW/APQ/AUD	853006	Outer Joint		22	30	50	78.5	52	I									
	1994.06-2002.10	MT	L	F	F	Saloon Engine ABD/AEX/AKK AKV/ANW/APQ/AUD	253004	Drive Shaft		22		50	78.5	562										
	1994.06-2002.10	MT	L/R	F	F	Saloon Engine ABD/AEX/AKK AKV/ANW/APQ/AUD	853008	Outer Joint		22	30	53	78.5	51	I									
1.4 i 16V (74 kW)	1996.09-2002.10	-	-	L	F	Saloon Engine AFH/AQQ/AUB	253004	Drive Shaft		22		50	78.5	562										
	1996.09-2002.10	-	-	-	F	Saloon Engine AFH/AQQ/AUB	853006	Outer Joint		22	30	50	78.5	52	I									
1.6 i (55 kW)	1993.02-2002.10	MT	L/R	F	F	Saloon Engine ABU/AEE/ALM	653001	Inner Joint			33		32											
	1993.02-2002.10	MT	L	F	F	Saloon Engine ABU/AEE/ALM	253004	Drive Shaft		22		50	78.5	562										
	1993.02-2002.10	MT	L/R	F	F	Saloon Engine ABU/AEE/ALM	853008	Outer Joint		22	30	53	78.5	51	I									
	1993.02-2002.10	-	-	-	F	Saloon Engine ABU/AEE/ALM	853006	Outer Joint		22	30	50	78.5	52	I									
	1994.05-1999.06	-	-	-	F	Saloon Engine 1F	853006	Outer Joint		22	30	50	78.5	52	I									
1.6 i (74 kW)	1996.07-2002.10	MT	R	F	F	Saloon Engine AEH/AFT/AKL/APF/AUR	253005	Drive Shaft		22		53	78.5	774										
	1996.07-2002.10	AT/MT	L/R	F	F	Saloon Engine AEH/AFT/AKL/APF/AUR	603004	Inner Joint			33		32											
	1996.07-2002.10	AT	L/R	F	F	Saloon Engine AEH/AFT/AKL/APF/AUR	853007	Outer Joint		22	30	53.2	78	61	I									
	1996.07-2002.10	AT/MT	L/R	F	F	Saloon Engine AEH/AFT/AKL/APF/AUR	603005	Inner Joint			33		32											
	1996.07-2002.10	-	-	-	F	Saloon Engine AEH/AFT/AKL/APF/AUR	853006	Outer Joint		22	30	50	78.5	52	I									
	1996.07-2002.10	MT	L/R	F	F	Saloon Engine AEH/AFT/AKL/APF/AUR	853008	Outer Joint		22	30	53	78.5	51	I									
	1996.07-2002.10	MT	L	F	F	Saloon Engine AEH/AFT/AKL/APF/AUR	253003	Drive Shaft		22		53	78.5	539.5										
1.8 i (66 kW)	1993.02-2002.09	AT/MT	L/R	F	F	Saloon Engine ABS/ACC/ADZ	853007	Outer Joint		22	30	53.2	78	61	I									
	1993.02-2002.09	MT	L	F	F	Saloon Engine ABS/ACC/ADZ	253001	Drive Shaft		22		53	78.5	535										
	1993.02-2002.09	AT/MT	R	F	F	Saloon Engine ABS/ACC/ADZ	603009	Inner Joint			33		34											
	1993.02-2002.09	MT	L	F	F	Saloon Engine ABS/ACC/ADZ	261043	Drive Shaft		22		53.2	78	535										
	1993.02-2002.09	MT	R	F	F	Saloon Engine ABS/ACC/ADZ	253002	Drive Shaft		22		53.2	78	769										
	1993.02-2002.09	MT	R	F	F	Saloon Engine ABS/ACC/ADZ	261009	Drive Shaft		22		53.2	78	789										
	1993.02-2002.09	AT/MT	L	F	F	Saloon Engine ABS/ACC/ADZ	603011	Inner Joint			33		34											
	1993.02-2002.09	-	-	-	F	Saloon Engine ABS/ACC/ADZ	853004	Outer Joint		22	30	51	78	61	I									





	 YEAR	TRANSM	L/R	F/R	REMARKS	GSP Ref.	 PRODUCT	 ABS	Technical Specifications					
									A	B	C	H	L	P
SEAT														
CORDOBA (6K1 6K2)														
1.8 i 16V (95 kW)	1993.10-1996.08	MT	L/R	F	Saloon Engine ADL	853007	Outer Joint		22	30	53.2	78	61	I
	1993.10-1996.08	MT	L	F	Saloon Engine ADL	253001	Drive Shaft		22		53	78.5	535	
	1993.10-1996.08	MT	R	F	Saloon Engine ADL	603009	Inner Joint			33		34		
	1993.10-1996.08	MT	L	F	Saloon Engine ADL	261043	Drive Shaft		22		53.2	78	535	
	1993.10-1996.08	MT	R	F	Saloon Engine ADL	253002	Drive Shaft		22		53.2	78	769	
	1993.10-1996.08	MT	-	-	Saloon Engine ADL	603006	Inner Joint			33		34		
	1993.10-1996.08	MT	L	F	Saloon Engine ADL	603011	Inner Joint			33		34		
1.8 T 20V Cupra (115 kW)	1993.10-1996.08	-	-	F	Saloon Engine ADL	853004	Outer Joint		22	30	51	78	61	I
	2000.07-2002.10	MT	-	-	Saloon Engine AQX/AYP	603006	Inner Joint			33		34		
1.9 D (47 kW)	1996.01-1996.08	MT	R	F	Saloon Engine 1Y	253005	Drive Shaft		22		53	78.5	774	
	1996.01-1996.08	MT	L/R	F	Saloon Engine 1Y	603004	Inner Joint			33		32		
	1996.01-1996.08	-	-	F	Saloon Engine 1Y	853006	Outer Joint		22	30	50	78.5	52	I
	1996.01-1996.08	MT	L/R	F	Saloon Engine 1Y	603005	Inner Joint			33		32		
	1996.01-1996.08	MT	L	F	Saloon Engine 1Y	253003	Drive Shaft		22		53	78.5	539.5	
1.9 D (50 kW)	1996.01-1996.08	MT	L/R	F	Saloon Engine 1Y	853008	Outer Joint		22	30	53	78.5	51	I
	1993.02-1996.08	MT	R	F	Saloon Engine 1Y	253005	Drive Shaft		22		53	78.5	774	
	1993.02-1996.08	MT	L/R	F	Saloon Engine 1Y	603004	Inner Joint			33		32		
	1993.02-1996.08	-	-	F	Saloon Engine 1Y	853006	Outer Joint		22	30	50	78.5	52	I
	1993.02-1996.08	MT	L/R	F	Saloon Engine 1Y	603005	Inner Joint			33		32		
	1993.02-1996.08	MT	L	F	Saloon Engine 1Y	253003	Drive Shaft		22		53	78.5	539.5	
1.9 SDI (47 kW)	1996.08-1999.06	MT	R	F	Saloon Engine AEY	253005	Drive Shaft		22		53	78.5	774	
	1996.08-1999.06	MT	L/R	F	Saloon Engine AEY	603004	Inner Joint			33		32		
	1996.08-1999.06	-	-	F	Saloon Engine AEY	853006	Outer Joint		22	30	50	78.5	52	I
	1996.08-1999.06	MT	L/R	F	Saloon Engine AEY	603005	Inner Joint			33		32		
	1996.08-1999.06	MT	L/R	F	Saloon Engine AEY	853008	Outer Joint		22	30	53	78.5	51	I
	1996.08-1999.06	MT	L	F	Saloon Engine AEY	253003	Drive Shaft		22		53	78.5	539.5	
1.9 SDI (50 kW)	1999.06-2002.10	MT	R	F	Saloon Engine AGP/AQM	253005	Drive Shaft		22		53	78.5	774	
	1999.06-2002.10	AT/MT	L/R	F	Saloon Engine AGP/AQM	603004	Inner Joint			33		32		
	1999.06-2002.10	AT/MT	L/R	F	Saloon Engine AGP/AQM	603005	Inner Joint			33		32		
	1999.06-2002.10	MT	L	F	Saloon Engine AGP/AQM	253003	Drive Shaft		22		53	78.5	539.5	
	1999.06-2002.10	MT	L/R	F	Saloon Engine AGP/AQM	853008	Outer Joint		22	30	53	78.5	51	I
1.9 TD (55 kW)	1993.02-1996.08	MT	L/R	F	Saloon Engine AAZ	853007	Outer Joint		22	30	53.2	78	61	I
	1993.02-1996.08	MT	L	F	Saloon Engine AAZ	253001	Drive Shaft		22		53	78.5	535	
	1993.02-1996.08	MT	R	F	Saloon Engine AAZ	603009	Inner Joint			33		34		
	1993.02-1996.08	MT	L	F	Saloon Engine AAZ	261043	Drive Shaft		22		53.2	78	535	
	1993.02-1996.08	MT	R	F	Saloon Engine AAZ	253002	Drive Shaft		22		53.2	78	769	
	1993.02-1996.08	MT	L	F	Saloon Engine AAZ	603011	Inner Joint			33		34		
	1993.02-1996.08	-	-	F	Saloon Engine AAZ	853004	Outer Joint		22	30	51	78	61	I
1.9 TDI (66 kW)	1996.08-2002.10	MT	L	F	Saloon Engine 1Z/AGR/AHU/ALH	261043	Drive Shaft		22		53.2	78	535	
	1996.08-2002.10	MT	R	F	Saloon Engine 1Z/AGR/AHU/ALH	603009	Inner Joint			33		34		
	1996.08-2002.10	-	-	F	Saloon Engine 1Z/AGR/AHU/ALH	853004	Outer Joint		22	30	51	78	61	I
	1996.08-2002.10	MT	L	F	Saloon Engine 1Z/AGR/AHU/ALH	603011	Inner Joint			33		34		
	1996.08-2002.10	MT	L/R	F	Saloon Engine 1Z/AGR/AHU/ALH	861018	Outer Joint		22	30	53	78.5	61	I
1.9 TDI (81 kW)	1997.03-2002.10	MT	L	F	Saloon Engine AFN/ASK/ASV	261043	Drive Shaft		22		53.2	78	535	
	1997.03-2002.10	MT	-	F	Saloon Engine AFN/ASK/ASV	853004	Outer Joint		22	30	51	78	61	I
	1997.03-2002.10	MT	-	-	Saloon Engine AFN/ASK/ASV	603006	Inner Joint			33		34		
	1997.03-2002.10	MT	R	F	Saloon Engine AFN/ASK/ASV	603009	Inner Joint			33		34		
	1997.03-2002.10	MT	L	F	Saloon Engine AFN/ASK/ASV	603011	Inner Joint			33		34		
	1997.03-2002.10	MT	L/R	F	Saloon Engine AFN/ASK/ASV	861018	Outer Joint		22	30	53	78.5	61	I
2.0 i (85 kW)	1993.02-1999.06	MT	L/R	F	Saloon Engine 2E/AGG	853007	Outer Joint		22	30	53.2	78	61	I
	1993.02-1999.06	MT	L	F	Saloon Engine 2E/AGG	253001	Drive Shaft		22		53	78.5	535	
	1993.02-1999.06	MT	R	F	Saloon Engine 2E/AGG	603009	Inner Joint			33		34		
	1993.02-1999.06	MT	L	F	Saloon Engine 2E/AGG	261043	Drive Shaft		22		53.2	78	535	
	1993.02-1999.06	MT	R	F	Saloon Engine 2E/AGG	253002	Drive Shaft		22		53.2	78	769	
	1993.02-1999.06	MT	L	F	Saloon Engine 2E/AGG	603011	Inner Joint			33		34		
2.0 i 16V (110 kW)	1993.02-1999.06	-	-	F	Saloon Engine 2E/AGG	853004	Outer Joint		22	30	51	78	61	I
	1996.08-1999.06	MT	L	F	Saloon Engine ABF	261043	Drive Shaft		22		53.2	78	535	
	1996.08-1999.06	MT	R	F	Saloon Engine ABF	603009	Inner Joint			33		34		
	1996.08-1999.06	-	-	F	Saloon Engine ABF	853004	Outer Joint		22	30	51	78	61	I
	1996.08-1999.06	MT	L	F	Saloon Engine ABF	603011	Inner Joint			33		34		
1996.08-1999.06	MT	L/R	F	Saloon Engine ABF	803036	Outer Joint		36	30	53.2	77.5	61	I	
CORDOBA (6L2)														
1.2 (47 kW)	2002.10-2006.06	5MT	R	F	Saloon Engine AZQ/BME	261063	Drive Shaft		36		50.7	58.5	751	
	2002.10-2006.06	-	-	F	Saloon Engine AZQ/BME	803027	Outer Joint		36	30	50.7	58.5	47.5	I
	2002.10-2006.06	5MT	L	F	Saloon Engine AZQ/BME	203063	Drive Shaft		36		50.7	58.5	501	





	 YEAR	TRANSM	L/R	F/R	REMARKS	GSP Ref.	 PRODUCT	 ABS	Technical Specifications					
									A	B	C	H	L	P
SEAT														
CORDOBA (6L2)														
1.2 12V (51 kW)	2006.05-2009.11	-	L	F	Saloon Engine BXV	203063	Drive Shaft		36		50.7	58.5	501	
	2006.05-2009.11	-	R	F	Saloon Engine BXV	261063	Drive Shaft		36		50.7	58.5	751	
	2006.05-2009.11	-	-	F	Saloon Engine BXV	803027	Outer Joint		36	30	50.7	58.5	47.5	I
1.4 16V (55 kW)	2002.09-2007.12	AT	L/R	F	Saloon Engine BBY/BKY	661005	Inner Joint			30		57.6		
	2002.09-2007.12	5MT	R	F	Saloon Engine BBY/BKY	261063	Drive Shaft		36		50.7	58.5	751	
	2002.09-2007.12	5AT	R	F	Saloon Engine BBY/BKY	261252	Drive Shaft		36		53.7	58.5	730	
	2002.09-2007.12	5AT	R	F	Saloon Engine BBY/BKY	861070	Outer Joint		36	30	53.7	58.5	55	I
	2002.09-2007.12	-	R	F	Saloon Engine BBY/BKY	261077	Drive Shaft		36		50.7	58.5	750	
	2002.09-2007.12	MT	-	F	Saloon Engine BBY/BKY	803027	Outer Joint		36	30	50.7	58.5	47.5	I
	2002.09-2007.12	5MT	L	F	Saloon Engine BBY/BKY	203063	Drive Shaft		36		50.7	58.5	501	
1.4 16V (63 kW)	2006.05-2009.11	-	L	F	Saloon Engine BXW	203063	Drive Shaft		36		50.7	58.5	501	
	2006.05-2009.11	-	R	F	Saloon Engine BXW	261063	Drive Shaft		36		50.7	58.5	751	
	2006.05-2009.11	-	-	F	Saloon Engine BXW	803027	Outer Joint		36	30	50.7	58.5	47.5	I
1.4 16V (74 kW)	2002.10-2009.11	5MT	R	F	Saloon Engine AUB/BBZ	261063	Drive Shaft		36		50.7	58.5	751	
	2002.10-2009.11	-	-	F	Saloon Engine AUB/BBZ	803027	Outer Joint		36	30	50.7	58.5	47.5	I
	2002.10-2009.11	5MT	L	F	Saloon Engine AUB/BBZ	203063	Drive Shaft		36		50.7	58.5	501	
1.4 TDI (51 kW)	2005.05-2009.11	-	-	F	Saloon Engine BNM	803024	Outer Joint		36	30	50.75	59	54.5	I
	2005.05-2009.11	-	R	F	Saloon Engine BNM	261077	Drive Shaft		36		50.7	58.5	750	
	2005.05-2009.11	MT	R	F	Saloon Engine BNM	261223	Drive Shaft		36		52	59	757	
	2005.05-2009.11	MT	L	F	Saloon Engine BNM	261078	Drive Shaft		36		50.7	58.5	501	
	2005.05-2009.11	MT	R	F	Saloon Engine BNM	854006	Outer Joint		36	30	52	59	55.5	I
1.4 TDI (55 kW)	2002.10-2005.12	5MT	L	F	Saloon Engine AMF	261098	Drive Shaft		36		50.5	59	472	
	2002.10-2005.12	-	L	F	Saloon Engine AMF	661062	Inner Joint			30		59		
	2002.10-2005.12	-	L	F	Saloon Engine AMF	854006	Outer Joint		36	30	52	59	55.5	I
	2002.10-2005.12	5MT	R	F	Saloon Engine AMF	261099	Drive Shaft		36		50.5	59	759	
	2002.10-2005.12	-	L	F	Saloon Engine AMF	261135	Drive Shaft		36		52	59	475	
	2002.10-2005.12	-	R	F	Saloon Engine AMF	261136	Drive Shaft		36		52	59	763	
	2002.10-2005.12	-	L/R	F	Saloon Engine AMF	661006	Inner Joint			30		57.6		
1.4 TDI (59 kW)	2005.06-2009.11	-	-	F	Saloon Engine BMS/BNV	803024	Outer Joint		36	30	50.75	59	54.5	I
	2005.06-2009.11	MT	L	F	Saloon Engine BMS/BNV	261098	Drive Shaft		36		50.5	59	472	
	2005.06-2009.11	-	L	F	Saloon Engine BMS/BNV	661062	Inner Joint			30		59		
	2005.06-2009.11	-	L	F	Saloon Engine BMS/BNV	854006	Outer Joint		36	30	52	59	55.5	I
	2005.06-2009.11	MT	R	F	Saloon Engine BMS/BNV	261099	Drive Shaft		36		50.5	59	759	
	2005.06-2009.11	-	L	F	Saloon Engine BMS/BNV	261135	Drive Shaft		36		52	59	475	
	2005.06-2009.11	-	R	F	Saloon Engine BMS/BNV	261136	Drive Shaft		36		52	59	763	
	2005.06-2009.11	-	L/R	F	Saloon Engine BMS/BNV	661006	Inner Joint			30		57.6		
1.6 (74 kW)	2003.04-2009.11	MT	-	-	Saloon Engine BAH	603006	Inner Joint			33		34		
	2003.04-2009.11	-	-	F	Saloon Engine BAH	803024	Outer Joint		36	30	50.75	59	54.5	I
1.6 16V (77 kW)	2006.11-2009.11	MT	L/R	F	Saloon Engine BTS	603011	Inner Joint			33		34		
	2006.11-2009.11	-	-	F	Saloon Engine BTS	803024	Outer Joint		36	30	50.75	59	54.5	I
	2006.11-2009.11	-	L	F	Saloon Engine BTS	261206	Drive Shaft		36	26	52	59	536	
	2006.11-2009.11	AT	R	F	Saloon Engine BTS	261133	Drive Shaft		36	26	52	75	859	
	2006.11-2009.11	-	L	F	Saloon Engine BTS	854006	Outer Joint		36	30	52	59	55.5	I
	2006.11-2009.11	AT	L	F	Saloon Engine BTS	261150	Drive Shaft		36	26	52	75	557	
1.9 SDI (47 kW)	2002.09-2009.11	5MT	R	F	Saloon Engine ASY	261063	Drive Shaft		36		50.7	58.5	751	
	2002.09-2009.11	-	-	F	Saloon Engine ASY	803027	Outer Joint		36	30	50.7	58.5	47.5	I
	2002.09-2009.11	5MT	L	F	Saloon Engine ASY	203063	Drive Shaft		36		50.7	58.5	501	
1.9 TDI (74 kW)	2002.09-2009.11	5MT	L	F	Saloon Engine ATD/AXR/BMT	261098	Drive Shaft		36		50.5	59	472	
	2002.09-2009.11	-	L	F	Saloon Engine ATD/AXR/BMT	661062	Inner Joint			30		59		
	2002.09-2009.11	-	L	F	Saloon Engine ATD/AXR/BMT	854006	Outer Joint		36	30	52	59	55.5	I
	2002.09-2009.11	5MT	R	F	Saloon Engine ATD/AXR/BMT	261099	Drive Shaft		36		50.5	59	759	
	2002.09-2009.11	-	L	F	Saloon Engine ATD/AXR/BMT	261135	Drive Shaft		36		52	59	475	
	2002.09-2009.11	-	R	F	Saloon Engine ATD/AXR/BMT	261136	Drive Shaft		36		52	59	763	
	2002.09-2009.11	-	L/R	F	Saloon Engine ATD/AXR/BMT	661006	Inner Joint			30		57.6		
	2002.09-2009.11	-	-	F	Saloon Engine ATD/AXR/BMT	803024	Outer Joint		36	30	50.75	59	54.5	I
1.9 TDI (96 kW)	2002.10-2009.11	-	L/R	F	Saloon Engine ASZ/BLT	853002	Outer Joint		36	27	50.75	75	65	I
	2002.10-2009.11	MT	R	F	Saloon Engine ASZ/BLT	261183	Drive Shaft		36		50.5	75	769	
	2002.10-2009.11	MT	L	F	Saloon Engine ASZ/BLT	261204	Drive Shaft		36		50.5	75	461	
2.0 (85 kW)	2002.09-2009.11	MT	-	-	Saloon Engine AZL/BBX	603006	Inner Joint			33		34		
	2002.09-2009.11	-	-	F	Saloon Engine AZL/BBX	803024	Outer Joint		36	30	50.75	59	54.5	I
CORDOBA GLX/SXE														
1.8	1995-	-	-	-	-	899136	Outer Joint		22	30	51	78	61	I
CORDOBA I (6K2/C2, 6K5), VARIO														
1.9 TD (50 kW)	1993.02-1996.08	MT	-	-	-	603013	Inner Joint			33		34		





		 YEAR	TRANSM	L/R	F/R	REMARKS	GSP Ref.	 PRODUCT	 ABS	Technical Specifications						
										A	B	C	H	L	P	
SEAT																
CORDOBA I (6K2/C2, 6K5), VARIO																
1.9 TD (55 kW)	1993.02-1996.08		MT	-	-	-	603013	Inner Joint				33		34		
1.9 TDi (66 kW)	1996.08-1999.06		MT	-	-	-	603013	Inner Joint				33		34		
1.9 TDi (81 kW)	1996.08-1999.06		MT	-	-	-	603013	Inner Joint				33		34		
CORDOBA Vario (6K5)																
1.4 16V (55 kW)	1999.06-2002.12		MT	L/R	F	Estate Engine APE/AUA	653001	Inner Joint				33		32		
	1999.06-2002.12		MT	L	F	Estate Engine APE/AUA	253004	Drive Shaft	22			50	78.5	562		
	1999.06-2002.12		MT	L/R	F	Estate Engine APE/AUA	853008	Outer Joint	22	30	53	78.5	51	I		
1.4 i (44 kW)	1996.09-1999.06		MT	L/R	F	Estate Engine AEX/AKV/APQ	653001	Inner Joint				33		32		
	1996.09-1999.06		MT	L	F	Estate Engine AEX/AKV/APQ	253004	Drive Shaft	22			50	78.5	562		
	1996.09-1999.06		MT	-	-	Estate Engine AEX/AKV/APQ	603006	Inner Joint				33		34		
1.6 i (55 kW)	1996.09-1999.06		MT	L/R	F	Estate Engine AEE/ALM	853008	Outer Joint	22	30	53	78.5	51	I		
	1996.09-1999.06		MT	R	F	Estate Engine AEE/ALM	603009	Inner Joint				33		34		
	1996.09-1999.06		MT	L	F	Estate Engine AEE/ALM	253004	Drive Shaft	22			50	78.5	562		
	1996.09-1999.06		MT	L/R	F	Estate Engine AEE/ALM	853008	Outer Joint	22	30	53	78.5	51	I		
	1996.09-1999.06		-	-	F	Estate Engine AEE/ALM	853006	Outer Joint	22	30	50	78.5	52	I		
	1996.09-1999.06		MT	L	F	Estate Engine AEE/ALM	603011	Inner Joint				33		34		
	1997.05-1999.06		-	-	F	Estate Engine 1F	853006	Outer Joint	22	30	50	78.5	52	I		
1.6 i (74 kW)	1996.09-1999.06		AT/MT	L/R	F	Estate Engine AFT	853007	Outer Joint	22	30	53.2	78	61	I		
	1996.09-1999.06		AT/MT	L/R	F	Estate Engine AFT	603004	Inner Joint				33		32		
	1996.09-1999.06		AT/MT	L/R	F	Estate Engine AFT	603009	Inner Joint				33		34		
	1996.09-1999.06		AT/MT	L/R	F	Estate Engine AFT	603005	Inner Joint				33		32		
	1996.09-1999.06		-	-	F	Estate Engine AFT	853006	Outer Joint	22	30	50	78.5	52	I		
	1996.09-1999.06		AT/MT	L/R	F	Estate Engine AFT	853008	Outer Joint	22	30	53	78.5	51	I		
	1996.09-1999.06		-	L	F	Estate Engine AFT	253003	Drive Shaft	22			53	78.5	539.5		
1.9 SDI (47 kW)	1996.09-1999.06		MT	R	F	Estate Engine AFT	253005	Drive Shaft	22			53	78.5	774		
	1996.09-1999.06		MT	L/R	F	Estate Engine AEY	603004	Inner Joint				33		32		
	1996.09-1999.06		MT	L/R	F	Estate Engine AEY	603005	Inner Joint				33		32		
	1996.09-1999.06		MT	L/R	F	Estate Engine AEY	853008	Outer Joint	22	30	53	78.5	51	I		
	1996.09-1999.06		-	-	F	Estate Engine AEY	853006	Outer Joint	22	30	50	78.5	52	I		
	1996.09-1999.06		MT	L	F	Estate Engine AEY	253003	Drive Shaft	22			53	78.5	539.5		
	1996.09-1999.06		MT	R	F	Estate Engine AEY	253005	Drive Shaft	22			53	78.5	774		
1.9 SDI (50 kW)	1999.06-2002.12		AT/MT	R	F	Estate Engine AGP/AQM	603004	Inner Joint				33		32		
	1999.06-2002.12		AT/MT	R	F	Estate Engine AGP/AQM	603005	Inner Joint				33		32		
	1999.06-2002.12		MT	L/R	F	Estate Engine AGP/AQM	853008	Outer Joint	22	30	53	78.5	51	I		
1.9 TDI (66 kW)	1996.08-1999.06		MT	R	F	Estate Engine 1Z/AHU	603009	Inner Joint				33		34		
	1996.08-1999.06		MT	L	F	Estate Engine 1Z/AHU	261043	Drive Shaft	22			53.2	78	535		
	1996.08-1999.06		MT	L	F	Estate Engine 1Z/AHU	603011	Inner Joint				33		34		
	1996.08-1999.06		MT	L/R	F	Estate Engine 1Z/AHU	861018	Outer Joint	22	30	53	78.5	61	I		
	1996.08-1999.06		-	-	F	Estate Engine 1Z/AHU	853004	Outer Joint	22	30	51	78	61	I		
1.9 TDI (81 kW)	1997.07-1999.06		MT	R	F	Estate Engine AFN	603009	Inner Joint				33		34		
	1997.07-1999.06		MT	L	F	Estate Engine AFN	261043	Drive Shaft	22			53.2	78	535		
	1997.07-1999.06		MT	-	F	Estate Engine AFN	853004	Outer Joint	22	30	51	78	61	I		
	1997.07-1999.06		MT	-	-	Estate Engine AFN	603006	Inner Joint				33		34		
	1997.07-1999.06		MT	L	F	Estate Engine AFN	603011	Inner Joint				33		34		
	1997.07-1999.06		MT	L/R	F	Estate Engine AFN	861018	Outer Joint	22	30	53	78.5	61	I		
EXEO (3R2)																
1.6 (75 kW)	2009.03-2010.09		-	L/R	F	Saloon Engine ALZ	803058	Outer Joint	45W	38	33	59.5	34	55	M	
	2009.03-2010.09		-	-	F	Saloon Engine ALZ	803030	Outer Joint		38	33	59.5	34	55	M	
1.8 T (110 kW)	2008.12-2010.05		-	L	F	Saloon Engine CFMA	203352	Drive Shaft	45W	38		59.5	34.5	594		
	2008.12-2010.05		MT	-	-	Saloon Engine CFMA	661044	Inner Joint				34		85		
	2008.12-2010.05		-	L	F	Saloon Engine CFMA	661076	Inner Joint				34		85		
	2008.12-2010.05		-	-	-	Saloon Engine CFMA	803078	Outer Joint	45W	38	27	59.5	34.5	63	M	
	2008.12-2010.05		-	L/R	F	Saloon Engine CFMA	803067	Outer Joint	45W	38	27	59.5	34	68	M	
	2008.12-2010.05		-	-	F	Saloon Engine CFMA	803069	Outer Joint	45W	38	27	59.5	34.5	63	M	
1.8 TSI (118 kW)	2010.05- -		-	L/R	F	Saloon Engine CDHB	803067	Outer Joint	45W	38	27	59.5	34	68	M	
	2010.05- -		-	-	F	Saloon Engine CDHB	803069	Outer Joint	45W	38	27	59.5	34.5	63	M	
	2010.05- -		-	L	F	Saloon Engine CDHB	203352	Drive Shaft	45W	38		59.5	34.5	594		
	2010.05- -		-	L	F	Saloon Engine CDHB	661076	Inner Joint				34		85		
1.8 TSI (88 kW)	2010.09- -		-	L/R	F	Saloon Engine CDHA	803067	Outer Joint	45W	38	27	59.5	34	68	M	
	2010.09- -		-	-	F	Saloon Engine CDHA	803069	Outer Joint	45W	38	27	59.5	34.5	63	M	
	2010.09- -		-	L	F	Saloon Engine CDHA	203352	Drive Shaft	45W	38		59.5	34.5	594		
	2010.09- -		-	L	F	Saloon Engine CDHA	661076	Inner Joint				34		85		
2.0 TDI (105 kW)	2008.12- -		-	-	F	Saloon Engine CAGA/CJCA	803069	Outer Joint	45W	38	27	59.5	34.5	63	M	
	2008.12- -		-	-	L	F	Saloon Engine CAGA/CJCA	203352	Drive Shaft	45W	38		59.5	34.5	594	





	 YEAR	TRANSM	L/R	F/R	REMARKS	GSP Ref.	 PRODUCT	 ABS	Technical Specifications						
									A	B	C	H	L	P	
SEAT															
EXEO (3R2)															
2.0 TDI (105 kW)	2008.12-	-	AT	L/R	F	Saloon Engine CAGA/CJCA	201132	Drive Shaft	45W	38		59.5	34.5	525	
	2008.12-	-	CVT	-	F	Saloon Engine CAGA/CJCA	203052	Drive Shaft	45W	38		59.5	34.5	522	
	2008.12-	-	-	L	F	Saloon Engine CAGA/CJCA	661076	Inner Joint			34		85		
	2008.12-	-	-	-	-	Saloon Engine CAGA/CJCA	803078	Outer Joint	45W	38	27	59.5	34.5	63	M
	2008.12-	-	-	L/R	F	Saloon Engine CAGA/CJCA	803067	Outer Joint	45W	38	27	59.5	34	68	M
2.0 TDI (125 kW)	2009.02-	-	-	L/R	F	Saloon Engine CAHA/CGLB	803067	Outer Joint	45W	38	27	59.5	34	68	M
	2009.02-	-	-	-	F	Saloon Engine CAHA/CGLB	803069	Outer Joint	45W	38	27	59.5	34.5	63	M
	2009.02-	-	-	L	F	Saloon Engine CAHA/CGLB	203352	Drive Shaft	45W	38		59.5	34.5	594	
	2009.02-	-	MT	-	-	Saloon Engine CAHA/CGLB	661044	Inner Joint			34		85		
	2009.02-	-	-	L	F	Saloon Engine CAHA/CGLB	661076	Inner Joint			34		85		
	2009.02-	-	MT	R	F	Saloon Engine CAHA/CGLB	203255	Drive Shaft	45W	38		59.5	34.5	621	
2.0 TDI (88 kW)	2008.12-	-	-	L/R	F	Saloon Engine CAGC/CJCC	803067	Outer Joint	45W	38	27	59.5	34	68	M
	2008.12-	-	-	-	F	Saloon Engine CAGC/CJCC	803069	Outer Joint	45W	38	27	59.5	34.5	63	M
	2008.12-	-	-	L	F	Saloon Engine CAGC/CJCC	203352	Drive Shaft	45W	38		59.5	34.5	594	
	2008.12-	-	MT	-	-	Saloon Engine CAGC/CJCC	661044	Inner Joint			34		85		
	2008.12-	-	-	L	F	Saloon Engine CAGC/CJCC	661076	Inner Joint			34		85		
	2008.12-	-	MT	R	F	Saloon Engine CAGC/CJCC	203255	Drive Shaft	45W	38		59.5	34.5	621	
2.0 TFSI (147 kW)	2009.03-	-	-	-	F	Saloon Engine BWE	803069	Outer Joint	45W	38	27	59.5	34.5	63	M
	2009.03-	-	-	L	F	Saloon Engine BWE	203352	Drive Shaft	45W	38		59.5	34.5	594	
	2009.03-	-	AT/MT	-	-	Saloon Engine BWE	803078	Outer Joint	45W	38	27	59.5	34.5	63	M
	2009.03-	-	AT	L/R	F	Saloon Engine BWE	203052	Drive Shaft	45W	38		59.5	34.5	522	
	2009.03-	-	MT	-	-	Saloon Engine BWE	661044	Inner Joint			34		85		
	2009.03-	-	-	L	F	Saloon Engine BWE	661076	Inner Joint			34		85		
	2009.03-	-	MT	R	F	Saloon Engine BWE	203255	Drive Shaft	45W	38		59.5	34.5	621	
	2009.03-	-	-	L/R	F	Saloon Engine BWE	803067	Outer Joint	45W	38	27	59.5	34	68	M
2.0 TFSI (155 kW)	2010.05-	-	-	L/R	F	Saloon Engine CDND	803067	Outer Joint	45W	38	27	59.5	34	68	M
	2010.05-	-	-	-	F	Saloon Engine CDND	803069	Outer Joint	45W	38	27	59.5	34.5	63	M
	2010.05-	-	-	L	F	Saloon Engine CDND	203352	Drive Shaft	45W	38		59.5	34.5	594	
	2010.05-	-	-	L	F	Saloon Engine CDND	661076	Inner Joint			34		85		
EXEO ST (3R5)															
1.6 (75 kW)	2009.06-	2010.09	-	L/R	F	Estate Engine ALZ	803058	Outer Joint	45W	38	33	59.5	34	55	M
	2009.06-	2010.09	-	-	F	Estate Engine ALZ	803030	Outer Joint		38	33	59.5	34	55	M
1.8 T (110 kW)	2009.06-	2010.05	-	L/R	F	Estate Engine CFMA	803067	Outer Joint	45W	38	27	59.5	34	68	M
	2009.06-	2010.05	-	-	F	Estate Engine CFMA	803069	Outer Joint	45W	38	27	59.5	34.5	63	M
	2009.06-	2010.05	-	L	F	Estate Engine CFMA	203352	Drive Shaft	45W	38		59.5	34.5	594	
	2009.06-	2010.05	MT	-	-	Estate Engine CFMA	661044	Inner Joint			34		85		
	2009.06-	2010.05	-	L	F	Estate Engine CFMA	661076	Inner Joint			34		85		
	2009.06-	2010.05	-	-	-	Estate Engine CFMA	803078	Outer Joint	45W	38	27	59.5	34.5	63	M
1.8 TSI (118 kW)	2010.05-	-	-	L/R	F	Estate Engine CDHB	803067	Outer Joint	45W	38	27	59.5	34	68	M
	2010.05-	-	-	-	F	Estate Engine CDHB	803069	Outer Joint	45W	38	27	59.5	34.5	63	M
	2010.05-	-	-	L	F	Estate Engine CDHB	203352	Drive Shaft	45W	38		59.5	34.5	594	
	2010.05-	-	-	L	F	Estate Engine CDHB	661076	Inner Joint			34		85		
1.8 TSI (88 kW)	2010.09-	-	-	L/R	F	Estate Engine CDHA	803067	Outer Joint	45W	38	27	59.5	34	68	M
	2010.09-	-	-	-	F	Estate Engine CDHA	803069	Outer Joint	45W	38	27	59.5	34.5	63	M
	2010.09-	-	-	L	F	Estate Engine CDHA	203352	Drive Shaft	45W	38		59.5	34.5	594	
	2010.09-	-	-	L	F	Estate Engine CDHA	661076	Inner Joint			34		85		
2.0 TDI (105 kW)	2009.05-	-	-	-	F	Estate Engine CAGA/CJCA	803069	Outer Joint	45W	38	27	59.5	34.5	63	M
	2009.05-	-	MT	L	F	Estate Engine CAGA/CJCA	203352	Drive Shaft	45W	38		59.5	34.5	594	
	2009.05-	-	AT	L/R	F	Estate Engine CAGA/CJCA	201132	Drive Shaft	45W	38		59.5	34.5	525	
	2009.05-	-	CVT	-	F	Estate Engine CAGA/CJCA	203052	Drive Shaft	45W	38		59.5	34.5	522	
	2009.05-	-	MT	L	F	Estate Engine CAGA/CJCA	661076	Inner Joint			34		85		
	2009.05-	-	-	-	-	Estate Engine CAGA/CJCA	803078	Outer Joint	45W	38	27	59.5	34.5	63	M
	2009.05-	-	AT	L/R	F	Estate Engine CAGA/CJCA	803067	Outer Joint	45W	38	27	59.5	34	68	M
	2009.05-	-	-	L/R	F	Estate Engine CAHA/CGLB	803067	Outer Joint	45W	38	27	59.5	34	68	M
2.0 TDI (125 kW)	2009.05-	-	-	-	F	Estate Engine CAHA/CGLB	803069	Outer Joint	45W	38	27	59.5	34.5	63	M
	2009.05-	-	-	L	F	Estate Engine CAHA/CGLB	203352	Drive Shaft	45W	38		59.5	34.5	594	
	2009.05-	-	MT	-	-	Estate Engine CAHA/CGLB	661044	Inner Joint			34		85		
	2009.05-	-	-	L	F	Estate Engine CAHA/CGLB	661076	Inner Joint			34		85		
	2009.05-	-	-	L/R	F	Estate Engine CAGC/CJCC	803067	Outer Joint	45W	38	27	59.5	34	68	M
2.0 TDI (88 kW)	2009.07-	-	-	-	F	Estate Engine CAGC/CJCC	803069	Outer Joint	45W	38	27	59.5	34.5	63	M
	2009.07-	-	-	L	F	Estate Engine CAGC/CJCC	203352	Drive Shaft	45W	38		59.5	34.5	594	
	2009.07-	-	MT	-	-	Estate Engine CAGC/CJCC	661044	Inner Joint			34		85		
	2009.07-	-	-	L	F	Estate Engine CAGC/CJCC	661076	Inner Joint			34		85		
	2009.07-	-	-	L/R	F	Estate Engine CAGC/CJCC	803067	Outer Joint	45W	38	27	59.5	34	68	M
2.0 TFSI (147 kW)	2009.06-	-	-	-	F	Estate Engine BWE	803069	Outer Joint	45W	38	27	59.5	34.5	63	M
	2009.06-	-	MT	L	F	Estate Engine BWE	203352	Drive Shaft	45W	38		59.5	34.5	594	
	2009.06-	-	AT/MT	-	-	Estate Engine BWE	803078	Outer Joint	45W	38	27	59.5	34.5	63	M





	 YEAR	TRANSM	L/R	F/R	REMARKS	GSP Ref.	 PRODUCT	 ABS	Technical Specifications								
									A	B	C	H	L	P			
SEAT																	
EXEO ST (3R5)																	
2.0 TFSI (147 kW)	2009.06-	-	AT	L/R	F	Estate Engine BWE	203052	Drive Shaft	45W	38		59.5	34.5	522			
	2009.06-	-	MT	-	-	Estate Engine BWE	661044	Inner Joint			34		85				
	2009.06-	-	MT	L	F	Estate Engine BWE	661076	Inner Joint			34		85				
	2009.06-	-	MT	L/R	F	Estate Engine BWE	803067	Outer Joint	45W	38	27	59.5	34	68	M		
2.0 TFSI (155 kW)	2010.05-	-	-	L/R	F	Estate Engine CDND	803067	Outer Joint	45W	38	27	59.5	34	68	M		
	2010.05-	-	-	-	F	Estate Engine CDND	803069	Outer Joint	45W	38	27	59.5	34.5	63	M		
	2010.05-	-	-	L	F	Estate Engine CDND	203352	Drive Shaft	45W	38		59.5	34.5	594			
	2010.05-	-	-	L	F	Estate Engine CDND	661076	Inner Joint			34		85				
IBIZA GLX/SXE																	
1.8	1995-	-	-	-	-	-	899136	Outer Joint			22	30	51	78	61	I	
IBIZA I (021A)																	
0.9 (29 kW)	1990.08-	1993.05	-	-	F	Hatchback Engine 09 NCA/146 A 000	817005	Outer Joint			22	20	48.1	90.5	59.5	O	
0.9 (32 kW)	1986.08-	1993.05	-	-	F	Hatchback Engine 146 A 000	817005	Outer Joint			22	20	48.1	90.5	59.5	O	
1.2 (44 kW)	1984.11-	1993.12	-	-	F	Hatchback Engine 021 A 1000	817005	Outer Joint			22	20	48.1	90.5	59.5	O	
1.2 (46 kW)	1984.11-	1993.12	-	-	F	Hatchback Engine 021 A 1000	817005	Outer Joint			22	20	48.1	90.5	59.5	O	
1.2 i (52 kW)	1989.01-	1993.05	-	-	F	Hatchback Engine 021 C.1000	817005	Outer Joint			22	20	48.1	90.5	59.5	O	
1.5 (63 kW)	1984.11-	1993.05	-	-	F	Hatchback Engine 021 A 2000	817005	Outer Joint			22	20	48.1	90.5	59.5	O	
1.5 i (65 kW)	1986.10-	1993.05	-	-	F	Hatchback Engine 021 D.2000	817005	Outer Joint			22	20	48.1	90.5	59.5	O	
1.5 i (74 kW)	1986.10-	1993.05	-	-	F	Hatchback Engine 021 B.2000	817005	Outer Joint			22	20	48.1	90.5	59.5	O	
1.5 i Cat (66 kW)	1986.10-	1993.05	-	-	F	Hatchback Engine 021 C.2000	817005	Outer Joint			22	20	48.1	90.5	59.5	O	
1.7 D (40 kW)	1984.06-	1993.05	-	-	F	Hatchback Engine 022 A.5000	817005	Outer Joint			22	20	48.1	90.5	59.5	O	
1.7 D (42 kW)	1990.08-	1993.05	-	-	F	Hatchback Engine 022 A.5000	817005	Outer Joint			22	20	48.1	90.5	59.5	O	
IBIZA II (6K1)																	
1.0 (33 kW)	1993.03-	1996.09	MT	L/R	F	Hatchback Engine AAU	653001	Inner Joint				33		32			
	1993.03-	1996.09	MT	L	F	Hatchback Engine AAU	253004	Drive Shaft		22		50	78.5	562			
	1993.03-	1996.09	-	-	F	Hatchback Engine AAU	853006	Outer Joint		22	30	50	78.5	52	I		
	1993.03-	1996.09	MT	L/R	F	Hatchback Engine AAU	853008	Outer Joint		22	30	53	78.5	51	I		
1.0 i (37 kW)	1996.09-	1999.08	MT	L/R	F	Hatchback Engine AER	653001	Inner Joint				33					
	1996.09-	1999.08	MT	L	F	Hatchback Engine AER	253004	Drive Shaft		22		50	78.5	562			
	1996.09-	1999.08	-	-	F	Hatchback Engine AER	853006	Outer Joint		22	30	50	78.5	52	I		
	1996.09-	1999.08	MT	L/R	F	Hatchback Engine AER	853008	Outer Joint		22	30	53	78.5	51	I		
1.3 i (40 kW)	1993.03-	1999.08	MT	L/R	F	Hatchback Engine 2G/AAV	653001	Inner Joint				33		32			
	1993.03-	1999.08	MT	L	F	Hatchback Engine 2G/AAV	253004	Drive Shaft		22		50	78.5	562			
	1993.03-	1999.08	-	-	F	Hatchback Engine 2G/AAV	853006	Outer Joint		22	30	50	78.5	52	I		
	1993.03-	1999.08	MT	L/R	F	Hatchback Engine 2G/AAV	853008	Outer Joint		22	30	53	78.5	51	I		
1.4 (40 kW)	1997.12-	1999.04	MT	-	-	Hatchback Engine ANX	603006	Inner Joint				33		34			
	1997.12-	1999.04	-	-	F	Hatchback Engine ANX	853006	Outer Joint		22	30	50	78.5	52	I		
1.4 16V (55 kW)	2000.05-	2002.02	MT	L/R	F	Hatchback Engine APE/AUA	653001	Inner Joint				33					
	2000.05-	2002.02	MT	L	F	Hatchback Engine APE/AUA	253004	Drive Shaft		22		50	78.5	562			
	2000.05-	2002.02	MT	L/R	F	Hatchback Engine APE/AUA	853008	Outer Joint		22	30	53	78.5	51	I		
1.4 i (44 kW)	1993.09-	1999.08	MT	L/R	F	Hatchback Engine ABD/AEX/AKV/APQ	653001	Inner Joint				33		32			
	1993.09-	1999.08	MT	-	-	Hatchback Engine ABD/AEX/AKV/APQ	603006	Inner Joint				33		34			
	1993.09-	1999.08	-	-	F	Hatchback Engine ABD/AEX/AKV/APQ	853006	Outer Joint		22	30	50	78.5	52	I		
	1993.09-	1999.08	MT	L	F	Hatchback Engine ABD/AEX/AKV/APQ	253004	Drive Shaft		22		50	78.5	562			
	1993.09-	1999.08	MT	L/R	F	Hatchback Engine ABD/AEX/AKV/APQ	853008	Outer Joint		22	30	53	78.5	51	I		
1.4 i 16V (74 kW)	1997.06-	1999.08	MT	L/R	F	Hatchback Engine AFH	653001	Inner Joint				33		32			
	1997.06-	1999.08	MT	L	F	Hatchback Engine AFH	253004	Drive Shaft		22		50	78.5	562			
	1997.06-	1999.08	MT	L/R	F	Hatchback Engine AFH	853008	Outer Joint		22	30	53	78.5	51	I		
1.6 i (55 kW)	1993.03-	1999.08	MT	L/R	F	Hatchback Engine ABU/AEE/ALM	653001	Inner Joint				33		32			
	1993.03-	1999.08	-	-	F	Hatchback Engine ABU/AEE/ALM	853006	Outer Joint		22	30	50	78.5	52	I		
	1993.03-	1999.08	MT	L	F	Hatchback Engine ABU/AEE/ALM	253004	Drive Shaft		22		50	78.5	562			
	1993.03-	1999.08	MT	L/R	F	Hatchback Engine ABU/AEE/ALM	853008	Outer Joint		22	30	53	78.5	51	I		
	1994.09-	1999.06	-	-	F	Hatchback Engine 1F	853006	Outer Joint		22	30	50	78.5	52	I		
1.6 i (74 kW)	1996.04-	1999.08	AT	L/R	F	Hatchback Engine AFT/AKL	853007	Outer Joint				22	30	53.2	78	61	I
	1996.04-	1999.08	AT/MT	L/R	F	Hatchback Engine AFT/AKL	603004	Inner Joint				33		32			
	1996.04-	1999.08	-	-	F	Hatchback Engine AFT/AKL	853006	Outer Joint		22	30	50	78.5	52	I		
	1996.04-	1999.08	AT/MT	L/R	F	Hatchback Engine AFT/AKL	603005	Inner Joint				33		32			
1.8 i (66 kW)	1993.03-	1999.08	MT	L	F	Hatchback Engine ABS/ADZ/ACC	261043	Drive Shaft		22		53.2	78	535			
	1993.03-	1999.08	MT	L	F	Hatchback Engine ABS/ADZ/ACC	253001	Drive Shaft		22		53	78.5	535			
	1993.03-	1999.08	AT/MT	L/R	F	Hatchback Engine ABS/ADZ/ACC	853007	Outer Joint		22	30	53.2	78	61	I		
	1993.03-	1999.08	MT	R	F	Hatchback Engine ABS/ADZ/ACC	253002	Drive Shaft		22		53.2	78	769			
	1993.03-	1999.08	MT	R	F	Hatchback Engine ABS/ADZ/ACC	261009	Drive Shaft		22		53.2	78	789			
	1993.03-	1999.08	AT/MT	R	F	Hatchback Engine ABS/ADZ/ACC	603009	Inner Joint				33		34			
	1993.03-	1999.08	-	-	F	Hatchback Engine ABS/ADZ/ACC	853004	Outer Joint		22	30	51	78	61	I		
	1993.03-	1999.08	AT/MT	L	F	Hatchback Engine ABS/ADZ/ACC	603011	Inner Joint				33		34			
1.8 i 16V (95 kW)	1993.11-	1996.08	MT	L/R	F	Hatchback Engine ADL	853007	Outer Joint		22	30	53.2	78	61	I		

	 YEAR	TRANSM	L/R	F/R	REMARKS	GSP Ref.	 PRODUCT	 ABS	Technical Specifications								
									A	B	C	H	L	P			
SEAT																	
IBIZA II (6K1)																	
1.8 i 16V (95 kW)	1993.11-1996.08	MT	L	F	Hatchback Engine ADL	253001	Drive Shaft		22		53	78.5	535				
	1993.11-1996.08	MT	R	F	Hatchback Engine ADL	603009	Inner Joint			33		34					
	1993.11-1996.08	-	L	F	Hatchback Engine ADL	261043	Drive Shaft		22		53.2	78	535				
	1993.11-1996.08	MT	R	F	Hatchback Engine ADL	253002	Drive Shaft		22		53.2	78	769				
	1993.11-1996.08	MT	L	F	Hatchback Engine ADL	603011	Inner Joint				33		34				
	1993.11-1996.08	-	-	F	Hatchback Engine ADL	853004	Outer Joint		22	30	51	78	61	I			
1.8 T 20V Cupra (115 kW)	2000.07-2002.02	MT	L	F	Hatchback Engine AQX/AYP	261043	Drive Shaft		22		53.2	78	535				
	2000.07-2002.02	AT	L	F	Hatchback Engine AQX/AYP	241521	Drive Shaft		29	27	56.1	102	667				
	2000.07-2002.02	-	-	F	Hatchback Engine AQX/AYP	853004	Outer Joint		22	30	51	78	61	I			
	2000.07-2002.02	MT	R	F	Hatchback Engine AQX/AYP	603009	Inner Joint				33		34				
	2000.07-2002.02	MT	L	F	Hatchback Engine AQX/AYP	603011	Inner Joint				33		34				
	2000.07-2002.02	MT	L/R	F	Hatchback Engine AQX/AYP	853008	Outer Joint		22	30	53	78.5	51	I			
1.9 D (47 kW)	1993.04-1996.08	MT	R	F	Hatchback Engine 1Y	253005	Drive Shaft		22		53	78.5	774				
	1993.04-1996.08	MT	L/R	F	Hatchback Engine 1Y	603004	Inner Joint				33		32				
	1993.04-1996.08	-	-	F	Hatchback Engine 1Y	853006	Outer Joint		22	30	50	78.5	52	I			
	1993.04-1996.08	MT	L/R	F	Hatchback Engine 1Y	603005	Inner Joint				33		32				
	1993.04-1996.08	MT	L	F	Hatchback Engine 1Y	253003	Drive Shaft		22		53	78.5	539.5				
	1993.04-1996.08	MT	L/R	F	Hatchback Engine 1Y	853008	Outer Joint		22	30	53	78.5	51	I			
1.9 D (50 kW)	1994.10-1996.08	MT	R	F	Hatchback Engine 1Y	253005	Drive Shaft		22		53	78.5	774				
	1994.10-1996.08	AT/MT	L/R	F	Hatchback Engine 1Y	603004	Inner Joint				33		32				
	1994.10-1996.08	-	-	F	Hatchback Engine 1Y	853006	Outer Joint		22	30	50	78.5	52	I			
	1994.10-1996.08	MT	L/R	F	Hatchback Engine 1Y	603005	Inner Joint				33		32				
	1994.10-1996.08	MT	L/R	F	Hatchback Engine 1Y	853008	Outer Joint		22	30	53	78.5	51	I			
	1994.10-1996.08	MT	L	F	Hatchback Engine 1Y	253003	Drive Shaft		22		53	78.5	539.5				
1.9 SDI (47 kW)	1996.08-1999.08	MT	R	F	Hatchback Engine AEY	253005	Drive Shaft		22		53	78.5	774				
	1996.08-1999.08	MT	L/R	F	Hatchback Engine AEY	603004	Inner Joint				33		32				
	1996.08-1999.08	-	-	F	Hatchback Engine AEY	853006	Outer Joint		22	30	50	78.5	52	I			
	1996.08-1999.08	MT	L/R	F	Hatchback Engine AEY	603005	Inner Joint				33		32				
	1996.08-1999.08	MT	L/R	F	Hatchback Engine AEY	853008	Outer Joint		22	30	53	78.5	51	I			
	1996.08-1999.08	MT	L	F	Hatchback Engine AEY	253003	Drive Shaft		22		53	78.5	539.5				
1.9 SDI (50 kW)	1999.08-2002.02	MT	R	F	Hatchback Engine AGP/AQM	253005	Drive Shaft		22		53	78.5	774				
	1999.08-2002.02	AT/MT	L/R	F	Hatchback Engine AGP/AQM	603004	Inner Joint				33		32				
	1999.08-2002.02	-	-	F	Hatchback Engine AGP/AQM	853006	Outer Joint		22	30	50	78.5	52	I			
	1999.08-2002.02	MT	L/R	F	Hatchback Engine AGP/AQM	603005	Inner Joint				33		32				
	1999.08-2002.02	MT	L	F	Hatchback Engine AGP/AQM	253003	Drive Shaft		22		53	78.5	539.5				
	1999.08-2002.02	MT	L/R	F	Hatchback Engine AGP/AQM	853008	Outer Joint		22	30	53	78.5	51	I			
1.9 TD (55 kW)	1993.03-1996.08	MT	L	F	Hatchback Engine AAZ	253001	Drive Shaft		22		53	78.5	535				
	1993.03-1996.08	MT	L/R	F	Hatchback Engine AAZ	853007	Outer Joint		22	30	53.2	78	61	I			
	1993.03-1996.08	MT	R	F	Hatchback Engine AAZ	253002	Drive Shaft		22		53.2	78	769				
	1993.03-1996.08	-	-	F	Hatchback Engine AAZ	853006	Outer Joint		22	30	50	78.5	52	I			
	1993.03-1996.08	MT	R	F	Hatchback Engine AAZ	603009	Inner Joint				33		34				
	1993.03-1996.08	MT	L	F	Hatchback Engine AAZ	603011	Inner Joint				33		34				
1.9 TDI (66 kW)	1996.08-1999.08	-	L	F	Hatchback Engine 1Z/AHU	261043	Drive Shaft		22		53.2	78	535				
	1996.08-1999.08	MT	L	F	Hatchback Engine 1Z/AHU	603011	Inner Joint				33		34				
	1996.08-1999.08	MT	R	F	Hatchback Engine 1Z/AHU	603009	Inner Joint				33		34				
	1996.08-1999.08	-	-	F	Hatchback Engine 1Z/AHU	853004	Outer Joint		22	30	51	78	61	I			
	1996.08-1999.08	MT	L/R	F	Hatchback Engine 1Z/AHU	861018	Outer Joint		22	30	53	78.5	61	I			
	1996.08-1999.08	MT	L	F	Hatchback Engine 1Z/AHU	261043	Drive Shaft		22		53.2	78	535				
1.9 TDI (81 kW)	1997.02-1999.08	-	L	F	Hatchback Engine AFN	603011	Inner Joint				33		34				
	1997.02-1999.08	MT	L	F	Hatchback Engine AFN	261043	Drive Shaft		22		53.2	78	535				
	1997.02-1999.08	MT	-	F	Hatchback Engine AFN	853004	Outer Joint		22	30	51	78	61	I			
	1997.02-1999.08	MT	R	F	Hatchback Engine AFN	603009	Inner Joint				33		34				
	1997.02-1999.08	MT	L/R	F	Hatchback Engine AFN	861018	Outer Joint		22	30	53	78.5	61	I			
	1997.02-1999.08	MT	L	F	Hatchback Engine AFN	261043	Drive Shaft		22		53.2	78	535				
2.0 i (85 kW)	1993.03-1999.08	MT	L	F	Hatchback Engine 2E/AGG	261043	Drive Shaft		22		53	78	535				
	1993.03-1999.08	MT	L	F	Hatchback Engine 2E/AGG	253001	Drive Shaft		22		53	78.5	535				
	1993.03-1999.08	MT	L/R	F	Hatchback Engine 2E/AGG	853007	Outer Joint		22	30	53.2	78	61	I			
	1993.03-1999.08	MT	R	F	Hatchback Engine 2E/AGG	253002	Drive Shaft		22		53.2	78	769				
	1993.03-1999.08	MT	R	F	Hatchback Engine 2E/AGG	603009	Inner Joint				33		34				
	1993.03-1999.08	-	-	F	Hatchback Engine 2E/AGG	853004	Outer Joint		22	30	51	78	61	I			
2.0 i 16V (110 kW)	1996.08-1999.08	MT	L	F	Hatchback Engine ABF	261043	Drive Shaft		22		53.2	78	535				
	1996.08-1999.08	-	-	F	Hatchback Engine ABF	853004	Outer Joint		22	30	51	78	61	I			
IBIZA III (6L1)																	
1.2 (44 kW)	2007.06-2008.05	-	L	F	Hatchback Engine BBM	203063	Drive Shaft		36		50.7	58.5	501				
	2007.06-2008.05	-	R	F	Hatchback Engine BBM	261063	Drive Shaft		36		50.7	58.5	751				
	2007.06-2008.05	-	-	F	Hatchback Engine BBM	803027	Outer Joint		36	30	50.7	58.5	47.5	I			
1.2 (47 kW)	2002.02-2006.06	5MT	R	F	Hatchback Engine AZQ/BME	261063	Drive Shaft		36		50.7	58.5	751				

	 YEAR	TRANSM	L/R	F/R	REMARKS	GSP Ref.	 PRODUCT	 ABS	Technical Specifications								
									A	B	C	H	L	P			
SEAT																	
IBIZA III (6L1)																	
1.2 (47 kW)	2002.02-2006.06	MT	R	F	Hatchback Engine AZQ/BME	261077	Drive Shaft		36		50.7	58.5	750				
	2002.02-2006.06	MT/5MT	-	F	Hatchback Engine AZQ/BME	803027	Outer Joint		36	30	50.7	58.5	47.5	I			
	2002.02-2006.06	5MT	L	F	Hatchback Engine AZQ/BME	203063	Drive Shaft		36		50.7	58.5	501				
1.2 12V (51 kW)	2006.05-2009.11	-	L	F	Hatchback Engine BXV	203063	Drive Shaft		36		50.7	58.5	501				
	2006.05-2009.11	-	R	F	Hatchback Engine BXV	261063	Drive Shaft		36		50.7	58.5	751				
	2006.05-2009.11	MT	R	F	Hatchback Engine BXV	261077	Drive Shaft		36		50.7	58.5	750				
	2006.05-2009.11	AT	-	-	Hatchback Engine BXV	803078	Outer Joint	45W	38	27	59.5	34.5	63	M			
	2006.05-2009.11	5MT	-	F	Hatchback Engine BXV	803027	Outer Joint		36	30	50.7	58.5	47.5	I			
1.4 16V (55 kW)	2002.02-2007.12	AT	L/R	F	Hatchback Engine BBY/BKY	661005	Inner Joint			30		57.6					
	2002.02-2007.12	5MT	R	F	Hatchback Engine BBY/BKY	261063	Drive Shaft		36		50.7	58.5	751				
	2002.02-2007.12	5AT	R	F	Hatchback Engine BBY/BKY	261252	Drive Shaft		36		53.7	58.5	730				
	2002.02-2007.12	MT	R	F	Hatchback Engine BBY/BKY	261077	Drive Shaft		36		50.7	58.5	750				
	2002.02-2007.12	5AT	R	F	Hatchback Engine BBY/BKY	861070	Outer Joint		36	30	53.7	58.5	55	I			
	2002.02-2007.12	5MT	-	F	Hatchback Engine BBY/BKY	803027	Outer Joint		36	30	50.7	58.5	47.5	I			
	2002.02-2007.12	4AT	-	F	Hatchback Engine BBY/BKY	803024	Outer Joint		36	30	50.75	59	54.5	I			
	2002.02-2007.12	5MT	L	F	Hatchback Engine BBY/BKY	203063	Drive Shaft		36		50.7	58.5	501				
1.4 16V (63 kW)	2006.05-2009.11	-	L	F	Hatchback Engine BXW	203063	Drive Shaft		36		50.7	58.5	501				
	2006.05-2009.11	-	R	F	Hatchback Engine BXW	261063	Drive Shaft		36		50.7	58.5	751				
	2006.05-2009.11	MT	R	F	Hatchback Engine BXW	261077	Drive Shaft		36		50.7	58.5	750				
	2006.05-2009.11	AT	-	-	Hatchback Engine BXW	803078	Outer Joint	45W	38	27	59.5	34.5	63	M			
	2006.05-2009.11	5MT	-	F	Hatchback Engine BXW	803027	Outer Joint		36	30	50.7	58.5	47.5	I			
1.4 16V (74 kW)	2002.02-2009.11	5MT	R	F	Hatchback Engine AUB/BBZ	261063	Drive Shaft		36		50.7	58.5	751				
	2002.02-2009.11	MT	R	F	Hatchback Engine AUB/BBZ	261077	Drive Shaft		36		50.7	58.5	750				
	2002.02-2009.11	-	-	F	Hatchback Engine AUB/BBZ	803027	Outer Joint		36	30	50.7	58.5	47.5	I			
	2002.02-2009.11	5MT	L	F	Hatchback Engine AUB/BBZ	203063	Drive Shaft		36		50.7	58.5	501				
1.4 TDI (51 kW)	2005.05-2009.11	-	-	F	Hatchback Engine BNM	803024	Outer Joint		36	30	50.75	59	54.5	I			
	2005.05-2009.11	MT	L/R	F	Hatchback Engine BNM	603011	Inner Joint			33		34					
	2005.05-2009.11	-	R	F	Hatchback Engine BNM	261077	Drive Shaft		36		50.7	58.5	750				
	2005.05-2009.11	MT	R	F	Hatchback Engine BNM	261223	Drive Shaft		36		52	59	757				
	2005.05-2009.11	MT	L	F	Hatchback Engine BNM	261078	Drive Shaft		36		50.7	58.5	501				
	2005.05-2009.11	MT	R	F	Hatchback Engine BNM	854006	Outer Joint		36	30	52	59	55.5	I			
1.4 TDI (55 kW)	2002.05-2005.12	-	L	F	Hatchback Engine AMF	661062	Inner Joint			30		59					
	2002.05-2005.12	5MT	L	F	Hatchback Engine AMF	261098	Drive Shaft		36		50.5	59	472				
	2002.05-2005.12	-	L	F	Hatchback Engine AMF	854006	Outer Joint		36	30	52	59	55.5	I			
	2002.05-2005.12	5MT	R	F	Hatchback Engine AMF	261099	Drive Shaft		36		50.5	59	759				
	2002.05-2005.12	-	L	F	Hatchback Engine AMF	261135	Drive Shaft		36		52	59	475				
	2002.05-2005.12	-	R	F	Hatchback Engine AMF	261136	Drive Shaft		36		52	59	763				
	2002.05-2005.12	-	L/R	F	Hatchback Engine AMF	661006	Inner Joint			30		57.6					
2002.05-2005.12	-	-	F	Hatchback Engine AMF	803024	Outer Joint		36	30	50.75	59	54.5	I				
1.4 TDI (59 kW)	2005.06-2009.11	-	L	F	Hatchback Engine BMS/BNV	661062	Inner Joint			30		59					
	2005.06-2009.11	-	L	F	Hatchback Engine BMS/BNV	261098	Drive Shaft		36		50.5	59	472				
	2005.06-2009.11	-	L	F	Hatchback Engine BMS/BNV	854006	Outer Joint		36	30	52	59	55.5	I			
	2005.06-2009.11	-	R	F	Hatchback Engine BMS/BNV	261099	Drive Shaft		36		50.5	59	759				
	2005.06-2009.11	AT	-	-	Hatchback Engine BMS/BNV	803078	Outer Joint	45W	38	27	59.5	34.5	63	M			
	2005.06-2009.11	-	L	F	Hatchback Engine BMS/BNV	261135	Drive Shaft		36		52	59	475				
	2005.06-2009.11	-	R	F	Hatchback Engine BMS/BNV	261136	Drive Shaft		36		52	59	763				
	2005.06-2009.11	-	L/R	F	Hatchback Engine BMS/BNV	661006	Inner Joint			30		57.6					
	2005.06-2009.11	5MT	-	F	Hatchback Engine BMS/BNV	803024	Outer Joint		36	30	50.75	59	54.5	I			
1.6 (74 kW)	2003.02-2009.11	MT	-	-	Hatchback Engine BAH	603006	Inner Joint			33		34					
	2003.02-2009.11	5MT	L/R	F	Hatchback Engine BAH	603011	Inner Joint			33		34					
	2003.02-2009.11	-	-	F	Hatchback Engine BAH	803024	Outer Joint		36	30	50.75	59	54.5	I			
1.6 16V (77 kW)	2006.11-2009.11	-	-	-	Hatchback Engine BTS	661050	Inner Joint		26	32	31	68.5	89				
	2006.11-2009.11	-	L	F	Hatchback Engine BTS	661039	Inner Joint		26	22	31	68.5	88.5				
	2006.11-2009.11	MT	L	F	Hatchback Engine BTS	261263	Drive Shaft		36		52	59	514				
	2006.11-2009.11	MT	L/R	F	Hatchback Engine BTS	603011	Inner Joint			33		34					
	2006.11-2009.11	-	-	F	Hatchback Engine BTS	803024	Outer Joint		36	30	50.75	59	54.5	I			
	2006.11-2009.11	MT	L	F	Hatchback Engine BTS	854006	Outer Joint		36	30	52	59	55.5	I			
	2006.11-2009.11	6AT	L	F	Hatchback Engine BTS	261206	Drive Shaft		36	26	52	59	536				
	2006.11-2009.11	6AT	R	F	Hatchback Engine BTS	261133	Drive Shaft		36	26	52	75	859				
	2006.11-2009.11	-	L	F	Hatchback Engine BTS	261274	Drive Shaft		36		50.5	59	514				
	2006.11-2009.11	AT	L	F	Hatchback Engine BTS	261150	Drive Shaft		36	26	52	75	557				
1.8 T Cupra R (132 kW)	2004.01-2008.02	MT	-	-	Hatchback Engine BBU/BLZ	603006	Inner Joint			33		34					
	2004.01-2008.02	MT	L	F	Hatchback Engine BBU/BLZ	661062	Inner Joint			30		59					
	2004.01-2008.02	MT	L	F	Hatchback Engine BBU/BLZ	854006	Outer Joint		36	30	52	59	55.5	I			
	2004.01-2008.02	5MT	L	F	Hatchback Engine BBU/BLZ	261098	Drive Shaft		36		50.5	59	472				
	2004.01-2008.02	5MT	R	F	Hatchback Engine BBU/BLZ	261099	Drive Shaft		36		50.5	59	759				





	 YEAR	TRANSM	L/R	F/R	REMARKS	GSP Ref.	 PRODUCT	 ABS	Technical Specifications					
									A	B	C	H	L	P
SEAT														
IBIZA III (6L1)														
1.8 T Cupra R (132 kW)	2004.01-2008.02	MT	L	F	Hatchback Engine BBU/BLZ	261135	Drive Shaft		36		52	59	475	
	2004.01-2008.02	MT	R	F	Hatchback Engine BBU/BLZ	261136	Drive Shaft		36		52	59	763	
	2004.01-2008.02	-	L/R	F	Hatchback Engine BBU/BLZ	661006	Inner Joint			30		57.6		
	2004.01-2008.02	-	L/R	F	Hatchback Engine BBU/BLZ	603011	Inner Joint				33		34	
	2004.01-2008.02	-	-	-	F	Hatchback Engine BBU/BLZ	803024	Outer Joint	36	30	50.75	59	54.5	I
1.8 T FR (110 kW)	2003.12-2008.05	MT	-	-	Hatchback Engine BJX/BKV	603006	Inner Joint			33		34		
	2003.12-2008.05	MT	L	F	Hatchback Engine BJX/BKV	661062	Inner Joint			30		59		
	2003.12-2008.05	MT	L	F	Hatchback Engine BJX/BKV	854006	Outer Joint	36	30	52	59	55.5	I	
	2003.12-2008.05	5MT	L	F	Hatchback Engine BJX/BKV	261098	Drive Shaft			36		50.5	59	472
	2003.12-2008.05	5MT	R	F	Hatchback Engine BJX/BKV	261099	Drive Shaft			36		50.5	59	759
	2003.12-2008.05	MT	L	F	Hatchback Engine BJX/BKV	261135	Drive Shaft			36		52	59	475
	2003.12-2008.05	MT	L/R	F	Hatchback Engine BJX/BKV	603011	Inner Joint				33		34	
	2003.12-2008.05	MT	R	F	Hatchback Engine BJX/BKV	261136	Drive Shaft			36		52	59	763
	2003.12-2008.05	-	L/R	F	Hatchback Engine BJX/BKV	661006	Inner Joint				30		57.6	
	2003.12-2008.05	-	-	-	F	Hatchback Engine BJX/BKV	803024	Outer Joint	36	30	50.75	59	54.5	I
1.9 SDI (47 kW)	2002.02-2005.12	5MT	R	F	Hatchback Engine ASY	261063	Drive Shaft			36		50.7	58.5	751
	2002.02-2005.12	-	-	-	F	Hatchback Engine ASY	803027	Outer Joint	36	30	50.7	58.5	47.5	I
	2002.02-2005.12	5MT	L	F	Hatchback Engine ASY	203063	Drive Shaft			36		50.7	58.5	501
1.9 TDI (74 kW)	2002.02-2009.11	-	L	F	Hatchback Engine ATD/AXR/BMT	661062	Inner Joint			30		59		
	2002.02-2009.11	5MT	L	F	Hatchback Engine ATD/AXR/BMT	261098	Drive Shaft			36		50.5	59	472
	2002.02-2009.11	-	L	F	Hatchback Engine ATD/AXR/BMT	854006	Outer Joint	36	30	52	59	55.5	I	
	2002.02-2009.11	5MT	R	F	Hatchback Engine ATD/AXR/BMT	261099	Drive Shaft			36		50.5	59	759
	2002.02-2009.11	-	L	F	Hatchback Engine ATD/AXR/BMT	261135	Drive Shaft			36		52	59	475
	2002.02-2009.11	-	R	F	Hatchback Engine ATD/AXR/BMT	261136	Drive Shaft			36		52	59	763
	2002.02-2009.11	5MT	-	F	Hatchback Engine ATD/AXR/BMT	803024	Outer Joint	36	30	50.75	59	54.5	I	
	2002.02-2009.11	-	L/R	F	Hatchback Engine ATD/AXR/BMT	661006	Inner Joint				30		57.6	
1.9 TDI (96 kW)	2002.02-2009.11	-	L/R	F	Hatchback Engine ASZ/BLT	853002	Outer Joint	36	27	50.75	75	65	I	
	2002.02-2009.11	MT	R	F	Hatchback Engine ASZ/BLT	261183	Drive Shaft			36		50.5	75	769
	2002.02-2009.11	MT	L	F	Hatchback Engine ASZ/BLT	261204	Drive Shaft			36		50.5	75	461
1.9 TDI Cupra R (118 kW)	2004.03-2008.02	-	L/R	F	Hatchback Engine BPX/BUK	853002	Outer Joint	36	27	50.75	75	65	I	
	2004.03-2008.02	6MT	R	F	Hatchback Engine BPX/BUK	261183	Drive Shaft			36		50.5	75	769
	2004.03-2008.02	-	L	F	Hatchback Engine BPX/BUK	261204	Drive Shaft			36		50.5	75	461
2.0 (85 kW)	2002.04-2009.11	MT	-	-	Hatchback Engine AZL/BBX	603006	Inner Joint				33		34	
	2002.04-2009.11	-	-	-	F	Hatchback Engine AZL/BBX	803024	Outer Joint	36	30	50.75	59	54.5	I
	2002.04-2009.11	5MT	L/R	F	Hatchback Engine AZL/BBX	603011	Inner Joint				33		34	
IBIZA IV (6J5 6P1)														
1.2 (44 kW)	2009.07- -	-	R	F	Hatchback Engine CGPB	261267	Drive Shaft			36		50.7	58.5	765
	2009.07- -	-	L	F	Hatchback Engine CGPB	203330	Drive Shaft			36		50.7	58.5	515
	2009.07- -	-	L	F	Hatchback Engine CGPB	203372	Drive Shaft			36		50.7	58.5	516
1.2 (51 kW)	2008.03- -	-	R	F	Hatchback Engine BZG/CGPA/CJLB	261267	Drive Shaft			36		50.7	58.5	765
	2008.03- -	-	L	F	Hatchback Engine BZG/CGPA/CJLB	203330	Drive Shaft			36		50.7	58.5	515
	2008.03- -	-	L	F	Hatchback Engine BZG/CGPA/CJLB	203372	Drive Shaft			36		50.7	58.5	516
1.2 TDI (55 kW)	2010.05- -	-	L	F	Hatchback Engine CFWA	261184	Drive Shaft			36		52	59	496
	2010.05- -	-	R	F	Hatchback Engine CFWA	261185	Drive Shaft			36		52	59	785
	2010.05- -	MT	-	-	Hatchback Engine CFWA	603006	Inner Joint				33		34	
	2010.05- -	-	L	F	Hatchback Engine CFWA	854006	Outer Joint	36	30	52	59	55.5	I	
	2010.05- -	-	R	F	Hatchback Engine CFWA	261025	Drive Shaft			36		52	75	773.5
	2010.05- -	-	L/R	F	Hatchback Engine CFWA	603011	Inner Joint				33		34	
	2010.05- -	5MT	-	F	Hatchback Engine CFWA	803024	Outer Joint	36	30	50.75	59	54.5	I	
1.2 TSI (77 kW)	2010.09- -	MT	L	F	Hatchback Engine CBZB	261297	Drive Shaft			36		50.5	59	513
	2010.09- -	MT	R	F	Hatchback Engine CBZB	261301	Drive Shaft			36		50.5	59	771
	2010.09- -	MT	L	F	Hatchback Engine CBZB	261263	Drive Shaft			36		52	59	514
	2010.09- -	MT	L	F	Hatchback Engine CBZB	854006	Outer Joint	36	30	52	59	55.5	I	
	2010.09- -	AT	L	F	Hatchback Engine CBZB	261311	Drive Shaft			36		50.5	59	492
	2010.09- -	MT	L	F	Hatchback Engine CBZB	261308	Drive Shaft			36		50.5	59	786
	2010.09- -	-	L	F	Hatchback Engine CBZB	261274	Drive Shaft			36		50.5	59	514
	2010.09- -	-	L/R	F	Hatchback Engine CBZB	603011	Inner Joint				33		34	
	2010.09- -	7DCT/5MT	-	F	Hatchback Engine CBZB	803024	Outer Joint	36	30	50.75	59	54.5	I	
1.4 (63 kW)	2008.03- -	7AT	-	F	Hatchback Engine BXW/CGGB	803024	Outer Joint	36	30	50.75	59	54.5	I	
	2008.03- -	-	R	F	Hatchback Engine BXW/CGGB	261267	Drive Shaft			36		50.7	58.5	765
	2008.03- -	MT	-	-	Hatchback Engine BXW/CGGB	603006	Inner Joint				33		34	
	2008.03- -	7AT	L	F	Hatchback Engine BXW/CGGB	261206	Drive Shaft			36	26	52	59	536
	2008.03- -	7AT	L	F	Hatchback Engine BXW/CGGB	854006	Outer Joint	36	30	52	59	55.5	I	
	2008.03- -	5MT	-	F	Hatchback Engine BXW/CGGB	803027	Outer Joint	36	30	50.7	58.5	47.5	I	
	2008.03- -	MT	L	F	Hatchback Engine BXW/CGGB	203330	Drive Shaft			36		50.7	58.5	515
	2008.03- -	-	L	F	Hatchback Engine BXW/CGGB	203372	Drive Shaft			36		50.7	58.5	516





	 YEAR	TRANSM	L/R	F/R	REMARKS	GSP Ref.	 PRODUCT	 ABS	Technical Specifications									
									A	B	C	H	L	P				
SEAT																		
IBIZA IV (6J5 6P1)																		
1.4 TDI (55 kW)	2015.05-	-	MT	L/R	F	Hatchback Engine CUSA	603011	Inner Joint			33		34					
1.4 TDI (66 kW)	2015.05-	-	MT	L/R	F	Hatchback Engine CUSB	603011	Inner Joint			33		34					
1.4 TDI (77 kW)	2015.05-	-	MT	L/R	F	Hatchback Engine CUTA	603011	Inner Joint			33		34					
1.4 TSI (110 kW)	2009.06-	-	AT	L	F	Hatchback Engine CAVF/CNUB/CTHF/CTJB	261260	Drive Shaft		36		52	75	498				
	2009.06-	-	AT	-	F	Hatchback Engine CAVF/CNUB/CTHF/CTJB	803041	Outer Joint		36	27	50.5	75	65	I			
	2009.06-	-	AT	R	F	Hatchback Engine CAVF/CNUB/CTHF/CTJB	261261	Drive Shaft		36		52	75	785				
	2009.06-	-	AT	-	-	Hatchback Engine CAVF/CNUB/CTHF/CTJB	603016	Inner Joint			28		32					
1.6 (77 kW)	2008.05-	-	MT	L	F	Hatchback Engine BTS	261297	Drive Shaft		36		50.5	59	513				
	2008.05-	-	MT	L	F	Hatchback Engine BTS	261263	Drive Shaft		36		52	59	514				
	2008.05-	-	MT	R	F	Hatchback Engine BTS	261301	Drive Shaft		36		50.5	59	771				
	2008.05-	-	MT	L	F	Hatchback Engine BTS	854006	Outer Joint		36	30	52	59	55.5	I			
	2008.05-	-	-	L	F	Hatchback Engine BTS	261274	Drive Shaft		36		50.5	59	514				
	2008.05-	-	-	L/R	F	Hatchback Engine BTS	603011	Inner Joint			33		34					
1.6 LPG (60 kW)	2011.05-	-	MT	L	F	Hatchback Engine CNKA	261297	Drive Shaft		36		50.5	59	513				
	2011.05-	-	MT	L	F	Hatchback Engine CNKA	261263	Drive Shaft		36		52	59	514				
	2011.05-	-	MT	R	F	Hatchback Engine CNKA	261301	Drive Shaft		36		50.5	59	771				
	2011.05-	-	-	L/R	F	Hatchback Engine CNKA	603011	Inner Joint			33		34					
	2011.05-	-	MT	L	F	Hatchback Engine CNKA	854006	Outer Joint		36	30	52	59	55.5	I			
	2011.05-	-	-	L	F	Hatchback Engine CNKA	261274	Drive Shaft		36		50.5	59	514				
1.6 TDI (66 kW)	2009.05-	-	-	L	F	Hatchback Engine CAYB	261184	Drive Shaft		36		52	59	496				
	2009.05-	-	-	R	F	Hatchback Engine CAYB	261185	Drive Shaft		36		52	59	785				
	2009.05-	-	MT	-	-	Hatchback Engine CAYB	603006	Inner Joint			33		34					
	2009.05-	-	-	L	F	Hatchback Engine CAYB	854006	Outer Joint		36	30	52	59	55.5	I			
	2009.05-	-	-	L/R	F	Hatchback Engine CAYB	603011	Inner Joint			33		34					
	2009.05-	-	-	R	F	Hatchback Engine CAYB	261025	Drive Shaft		36		52	75	773.5				
1.6 TDI (77 kW)	2009.05-	-	5MT	-	F	Hatchback Engine CAYB	803024	Outer Joint		36	30	50.75	59	54.5	I			
	2009.05-	-	-	L	F	Hatchback Engine CAYC/CLNA	261184	Drive Shaft		36		52	59	496				
	2009.05-	-	-	R	F	Hatchback Engine CAYC/CLNA	261185	Drive Shaft		36		52	59	785				
	2009.05-	-	MT	-	-	Hatchback Engine CAYC/CLNA	603006	Inner Joint			33		34					
	2009.05-	-	-	L	F	Hatchback Engine CAYC/CLNA	854006	Outer Joint		36	30	52	59	55.5	I			
	2009.05-	-	-	L/R	F	Hatchback Engine CAYC/CLNA	603011	Inner Joint			33		34					
	2009.05-	-	-	R	F	Hatchback Engine CAYC/CLNA	261025	Drive Shaft		36		52	75	773.5				
	2009.05-	-	5MT	-	F	Hatchback Engine CAYC/CLNA	803024	Outer Joint		36	30	50.75	59	54.5	I			
1.9 TDI (59 kW)	2008.07-2010.06		MT	L	F	Hatchback Engine BMS	661062	Inner Joint			30		59					
	2008.07-2010.06		MT	L	F	Hatchback Engine BMS	854006	Outer Joint		36	30	52	59	55.5	I			
	2008.07-2010.06		MT	L	F	Hatchback Engine BMS	261135	Drive Shaft		36		52	59	475				
	2008.07-2010.06		MT	R	F	Hatchback Engine BMS	261136	Drive Shaft		36		52	59	763				
	2008.07-2010.06		-	-	F	Hatchback Engine BMS	803027	Outer Joint		36	30	50.7	58.5	47.5	I			
	2008.07-2010.06		-	L/R	F	Hatchback Engine BMS	661006	Inner Joint			30		57.6					
1.9 TDI (66 kW)	2008.07-2010.06		-	-	F	Hatchback Engine BXJ	803024	Outer Joint		36	30	50.75	59	54.5	I			
	2008.07-2010.06		-	L/R	F	Hatchback Engine BXJ	661006	Inner Joint			30		57.6					
1.9 TDI (77 kW)	2008.03-2010.06		-	-	F	Hatchback Engine BLS	803024	Outer Joint		36	30	50.75	59	54.5	I			
	2008.03-2010.06		-	L/R	F	Hatchback Engine BLS	661006	Inner Joint			30		57.6					
2.0 (85 kW)	2008.10-	-	MT	L	F	Hatchback Engine CEKA	261263	Drive Shaft		36		52	59	514				
	2008.10-	-	MT	L/R	F	Hatchback Engine CEKA	603011	Inner Joint			33		34					
	2008.10-	-	MT	L	F	Hatchback Engine CEKA	854006	Outer Joint		36	30	52	59	55.5	I			
	2008.10-	-	MT	-	-	Hatchback Engine CEKA	603006	Inner Joint			33		34					
IBIZA IV (6J5, 6P1)																		
1.2 TSI (63 kW)	2012.08-	-	MT	L	F	Hatchback Engine CBZA	261297	Drive Shaft		36		50.5	59	513				
	2012.08-	-	MT	R	F	Hatchback Engine CBZA	261301	Drive Shaft		36		50.5	59	771				
	2012.08-	-	MT	L	F	Hatchback Engine CBZA	261263	Drive Shaft		36		52	59	514				
	2012.08-	-	MT	L	F	Hatchback Engine CBZA	854006	Outer Joint		36	30	52	59	55.5	I			
	2012.08-	-	MT	L	F	Hatchback Engine CBZA	261308	Drive Shaft		36		50.5	59	786				
	2012.08-	-	AT	L	F	Hatchback Engine CBZA	261311	Drive Shaft		36		50.5	59	492				
	2012.08-	-	-	L	F	Hatchback Engine CBZA	261274	Drive Shaft		36		50.5	59	514				
	2012.08-	-	-	L/R	F	Hatchback Engine CBZA	603011	Inner Joint			33		34					
1.2 TSI (66 kW)	2015.05-	-	MT	L	F	Hatchback Engine CJZC	261263	Drive Shaft		36		52	59	514				
	2015.05-	-	MT	L	F	Hatchback Engine CJZC	854006	Outer Joint		36	30	52	59	55.5	I			
	2015.05-	-	MT	L/R	F	Hatchback Engine CJZC	603011	Inner Joint			33		34					
1.2 TSI (81 kW)	2015.09-	-	MT	L	F	Hatchback Engine CJZD	261263	Drive Shaft		36		52	59	514				
	2015.09-	-	MT	L	F	Hatchback Engine CJZD	854006	Outer Joint		36	30	52	59	55.5	I			
	2015.09-	-	MT	L/R	F	Hatchback Engine CJZD	603011	Inner Joint			33		34					
1.4 TSI (103 kW)	2013.10-	-	-	-	F	Hatchback Engine CPTA	803041	Outer Joint		36	27	50.5	75	65	I			
1.4 TSI (110 kW)	2015.11-	-	7AT/MT	-	F	Hatchback Engine CZEA	803041	Outer Joint		36	27	50.5	75	65	I			
2.0 TDI (105 kW)	2010.01-	-	-	-	F	Hatchback Engine CFHD	803041	Outer Joint		36	27	50.5	75	65	I			





	 YEAR	TRANSM	L/R	F/R	REMARKS	GSP Ref.	 PRODUCT	 ABS	Technical Specifications						
									A	B	C	H	L	P	
SEAT															
IBIZA IV (6J5, 6P1)															
2.0 TDI (105 kW)	2010.01-	-	MT	-	-	Hatchback Engine CFHD	603016	Inner Joint			28		32		
IBIZA IV SPORT (6J1 6P5)															
1.0 TSI (70 kW)	2015.05-	-	7AT	L	F	Coupe Engine CHZB	261206	Drive Shaft		36	26	52	59	536	
	2015.05-	-	7AT	L	F	Coupe Engine CHZB	854006	Outer Joint		36	30	52	59	55.5	I
1.2 TSI (66 kW)	2015.05-	-	MT	L	F	Coupe Engine CJZC	261263	Drive Shaft		36		52	59	514	
	2015.05-	-	MT	L	F	Coupe Engine CJZC	854006	Outer Joint		36	30	52	59	55.5	I
	2015.05-	-	MT	L/R	F	Coupe Engine CJZC	603011	Inner Joint			33		34		
1.2 TSI (77 kW)	2010.09-	-	MT	L	F	Coupe Engine CBZB	261263	Drive Shaft		36		52	59	514	
	2010.09-	-	MT	L	F	Coupe Engine CBZB	854006	Outer Joint		36	30	52	59	55.5	I
	2010.09-	-	7AT	L	F	Coupe Engine CBZB	261198	Drive Shaft		36		59.5	40.5	530	
	2010.09-	-	-	L	F	Coupe Engine CBZB	261274	Drive Shaft		36		50.5	59	514	
	2010.09-	-	-	L/R	F	Coupe Engine CBZB	603011	Inner Joint			33		34		
	2010.09-	-	7DCT/5MT	-	F	Coupe Engine CBZB	803024	Outer Joint		36	30	50.75	59	54.5	I
1.2 TSI (81 kW)	2015.09-	-	MT	L	F	Coupe Engine CJZD	261263	Drive Shaft		36		52	59	514	
	2015.09-	-	MT	L	F	Coupe Engine CJZD	854006	Outer Joint		36	30	52	59	55.5	I
	2015.09-	-	MT	L/R	F	Coupe Engine CJZD	603011	Inner Joint			33		34		
1.4 TDI (55 kW)	2015.05-	-	MT	L/R	F	Coupe Engine CUSA	603011	Inner Joint			33		34		
1.4 TDI (66 kW)	2015.05-	-	MT	L/R	F	Coupe Engine CUSB	603011	Inner Joint			33		34		
1.4 TDI (77 kW)	2015.05-	-	MT	L/R	F	Coupe Engine CUTA	603011	Inner Joint			33		34		
1.4 TSI (103 kW)	2013.10-	-	MT	-	F	Coupe Engine CPTA	803041	Outer Joint		36	27	50.5	75	65	I
1.4 TSI (110 kW)	2015.11-	-	7AT/MT	-	F	Coupe Engine CZEA	803041	Outer Joint		36	27	50.5	75	65	I
1.8 TSI Cupra (141 kW)	2015.11-	-	7AT	L	F	Coupe Engine DAJA	261260	Drive Shaft		36		52	75	498	
	2015.11-	-	7AT	-	F	Coupe Engine DAJA	803041	Outer Joint		36	27	50.5	75	65	I
2.0 (85 kW)	2008.10-	-	-	L	F	Coupe Engine CEKA	261263	Drive Shaft		36		52	59	514	
	2008.10-	-	MT	-	-	Coupe Engine CEKA	603006	Inner Joint			33		34		
	2008.10-	-	-	L	F	Coupe Engine CEKA	854006	Outer Joint		36	30	52	59	55.5	I
2.0 TDI (105 kW)	2010.01-	-	-	-	F	Coupe Engine CFHD	803041	Outer Joint		36	27	50.5	75	65	I
	2010.01-	-	MT	-	-	Coupe Engine CFHD	603016	Inner Joint			28		32		
IBIZA IV ST (6J8 6P8)															
1.2 (44 kW)	2010.05-	-	-	R	F	Estate Engine CGPB	261267	Drive Shaft		36		50.7	58.5	765	
	2010.05-	-	-	L	F	Estate Engine CGPB	203330	Drive Shaft		36		50.7	58.5	515	
	2010.05-	-	-	L	F	Estate Engine CGPB	203372	Drive Shaft		36		50.7	58.5	516	
1.2 (51 kW)	2010.05-	-	-	R	F	Estate Engine BZG/CGPA/CJLB	261267	Drive Shaft		36		50.7	58.5	765	
	2010.05-	-	-	L	F	Estate Engine BZG/CGPA/CJLB	203330	Drive Shaft		36		50.7	58.5	515	
	2010.05-	-	-	L	F	Estate Engine BZG/CGPA/CJLB	203372	Drive Shaft		36		50.7	58.5	516	
1.2 TDI (55 kW)	2010.04-	-	-	L	F	Estate Engine CFWA	261184	Drive Shaft		36		52	59	496	
	2010.04-	-	-	R	F	Estate Engine CFWA	261185	Drive Shaft		36		52	59	785	
	2010.04-	-	MT	-	-	Estate Engine CFWA	603006	Inner Joint			33		34		
	2010.04-	-	-	L	F	Estate Engine CFWA	854006	Outer Joint		36	30	52	59	55.5	I
	2010.04-	-	-	L/R	F	Estate Engine CFWA	603011	Inner Joint			33		34		
	2010.04-	-	-	R	F	Estate Engine CFWA	261025	Drive Shaft		36		52	75	773.5	
	2010.04-	-	5MT	-	F	Estate Engine CFWA	803024	Outer Joint		36	30	50.75	59	54.5	I
1.4 (63 kW)	2010.03-	-	-	R	F	Estate Engine CGGB	261267	Drive Shaft		36		50.7	58.5	765	
	2010.03-	-	-	L	F	Estate Engine CGGB	261311	Drive Shaft		36		50.5	59	492	
	2010.03-	-	-	L	F	Estate Engine CGGB	261308	Drive Shaft		36		50.5	59	786	
	2010.03-	-	MT	-	-	Estate Engine CGGB	603006	Inner Joint			33		34		
	2010.03-	-	MT	L	F	Estate Engine CGGB	203330	Drive Shaft		36		50.7	58.5	515	
	2010.03-	-	-	L	F	Estate Engine CGGB	203372	Drive Shaft		36		50.7	58.5	516	
	2010.03-	-	-	L/R	F	Estate Engine CGGB	603011	Inner Joint			33		34		
1.4 TDI (55 kW)	2015.05-	-	MT	L/R	F	Estate Engine CUSA	603011	Inner Joint			33		34		
1.4 TDI (66 kW)	2015.05-	-	MT	L/R	F	Estate Engine CUSB	603011	Inner Joint			33		34		
1.4 TDI (77 kW)	2015.05-	-	MT	L/R	F	Estate Engine CUTA	603011	Inner Joint			33		34		
1.4 TSI (110 kW)	2012.02-	-	Semi-AT/MT	-	F	Estate Engine CAVF/CNUB/CTHF/CTJB	803041	Outer Joint		36	27	50.5	75	65	I
	2012.02-	-	AT	R	F	Estate Engine CAVF/CNUB/CTHF/CTJB	261261	Drive Shaft		36		52	75	785	
	2012.02-	-	AT	-	-	Estate Engine CAVF/CNUB/CTHF/CTJB	603016	Inner Joint			28		32		
	2012.02-	-	AT	L	F	Estate Engine CAVF/CNUB/CTHF/CTJB	261260	Drive Shaft		36		52	75	498	
	2012.02-	-	AT	L	F	Estate Engine CAVF/CNUB/CTHF/CTJB	261184	Drive Shaft		36		52	59	496	
1.6 TDI (66 kW)	2010.03-	-	MT	L	F	Estate Engine CAYB	261184	Drive Shaft		36		52	59	496	
	2010.03-	-	MT	R	F	Estate Engine CAYB	261185	Drive Shaft		36		52	59	785	
	2010.03-	-	MT	L	F	Estate Engine CAYB	854006	Outer Joint		36	30	52	59	55.5	I
	2010.03-	-	MT	-	-	Estate Engine CAYB	603006	Inner Joint			33		34		
	2010.03-	-	-	L/R	F	Estate Engine CAYB	603011	Inner Joint			33		34		
	2010.03-	-	-	R	F	Estate Engine CAYB	261025	Drive Shaft		36		52	75	773.5	
1.6 TDI (77 kW)	2010.03-	-	MT	L	F	Estate Engine CAYC/CLNA	261184	Drive Shaft		36		52	59	496	
	2010.03-	-	MT	R	F	Estate Engine CAYC/CLNA	261185	Drive Shaft		36		52	59	785	
	2010.03-	-	MT	L	F	Estate Engine CAYC/CLNA	854006	Outer Joint		36	30	52	59	55.5	I
	2010.03-	-	MT	-	-	Estate Engine CAYC/CLNA	603006	Inner Joint			33		34		
	2010.03-	-	-	L/R	F	Estate Engine CAYC/CLNA	603011	Inner Joint			33		34		





SEAT	YEAR	TRANSM	L/R	F/R	REMARKS	GSP Ref.	PRODUCT	ABS	Technical Specifications												
									A	B	C	H	L	P							
SEAT																					
IBIZA IV ST (6J8 6P8)																					
1.6 TDI (77 kW)	2010.03-	-	-	R	F	Estate Engine CAYC/CLNA	261025	Drive Shaft		36		52	75	773.5							
	2010.03-	-	5MT	-	F	Estate Engine CAYC/CLNA	803024	Outer Joint		36	30	50.75	59	54.5	I						
IBIZA IV ST (6J8, 6P8)																					
1.2 TSI (63 kW)	2012.09-	-	MT	L	F	Estate Engine CBZA	261263	Drive Shaft		36		52	59	514							
	2012.09-	-	MT	L	F	Estate Engine CBZA	854006	Outer Joint		36	30	52	59	55.5	I						
	2012.09-	-	AT	R	F	Estate Engine CBZA	261311	Drive Shaft		36		50.5	59	492							
	2012.09-	-	AT	L	F	Estate Engine CBZA	261308	Drive Shaft		36		50.5	59	786							
	2012.09-	-	-	L	F	Estate Engine CBZA	261274	Drive Shaft		36		50.5	59	514							
	2012.09-	-	-	L/R	F	Estate Engine CBZA	603011	Inner Joint			33		34								
1.2 TSI (66 kW)	2015.05-	-	MT	L	F	Estate Engine CJZC	261263	Drive Shaft		36		52	59	514							
	2015.05-	-	MT	L	F	Estate Engine CJZC	854006	Outer Joint		36	30	52	59	55.5	I						
	2015.05-	-	MT	L/R	F	Estate Engine CJZC	603011	Inner Joint			33		34								
1.2 TSI (77 kW)	2010.09-	-	MT	L	F	Estate Engine CBZB	261263	Drive Shaft		36		52	59	514							
	2010.09-	-	MT	L	F	Estate Engine CBZB	854006	Outer Joint		36	30	52	59	55.5	I						
	2010.09-	-	AT	R	F	Estate Engine CBZB	261311	Drive Shaft		36		50.5	59	492							
	2010.09-	-	AT	L	F	Estate Engine CBZB	261308	Drive Shaft		36		50.5	59	786							
	2010.09-	-	-	L	F	Estate Engine CBZB	261274	Drive Shaft		36		50.5	59	514							
	2010.09-	-	-	L/R	F	Estate Engine CBZB	603011	Inner Joint			33		34								
	2010.09-	-	7DCT/5MT	-	F	Estate Engine CBZB	803024	Outer Joint		36	30	50.75	59	54.5	I						
1.2 TSI (81 kW)	2015.09-	-	MT	L	F	Estate Engine CJZD	261263	Drive Shaft		36		52	59	514							
	2015.09-	-	MT	L	F	Estate Engine CJZD	854006	Outer Joint		36	30	52	59	55.5	I						
	2015.09-	-	MT	L/R	F	Estate Engine CJZD	603011	Inner Joint			33		34								
1.4 TSI (103 kW)	2013.10-	-	MT	-	F	Estate Engine CPTA	803041	Outer Joint		36	27	50.5	75	65	I						
1.4 TSI (110 kW)	2015.11-	-	7AT/MT	-	F	Estate Engine CZEA	803041	Outer Joint		36	27	50.5	75	65	I						
IBIZA V (KJ1)																					
1.5 TSI(110 kW)	2017.07-	-	-	L/R	F	Hatchback Engine DADA	603011	Inner Joint			33		34								
1.6 TDI(59 kW)	2017.11-	-	-	L/R	F	Hatchback Engine DGTC	603011	Inner Joint			33		34								
1.6 TDI(70 kW)	2017.09-	-	-	L/R	F	Hatchback Engine DGTD	603011	Inner Joint			33		34								
1.6 TDI(85 kW)	2017.12-	-	-	L/R	F	Hatchback Engine DGTA	603011	Inner Joint			33		34								
IBIZA V SPORTCOUPE (6J1 6P5)																					
1.2 (44 kW)	2009.07-	-	-	R	F	Coupe Engine CGPB	261267	Drive Shaft		36		50.7	58.5	765							
	2009.07-	-	5MT	-	F	Coupe Engine CGPB	803027	Outer Joint		36	30	50.7	58.5	47.5	I						
	2009.07-	-	-	L	F	Coupe Engine CGPB	203330	Drive Shaft		36		50.7	58.5	515							
	2009.07-	-	-	L	F	Coupe Engine CGPB	203372	Drive Shaft		36		50.7	58.5	516							
1.2 (51 kW)	2008.07-	-	-	R	F	Coupe Engine BZG/CGPA/CJLB	261267	Drive Shaft		36		50.7	58.5	765							
	2008.07-	-	5MT	-	F	Coupe Engine BZG/CGPA/CJLB	803027	Outer Joint		36	30	50.7	58.5	47.5	I						
	2008.07-	-	-	L	F	Coupe Engine BZG/CGPA/CJLB	203330	Drive Shaft		36		50.7	58.5	515							
	2008.07-	-	-	L	F	Coupe Engine BZG/CGPA/CJLB	203372	Drive Shaft		36		50.7	58.5	516							
1.2 TDI (55 kW)	2010.05-	-	AT/MT/DC/T	L/R/F	R	Coupe Engine CFWA	603011	Inner Joint			33		34								
	2010.05-	-	-	L	F	Coupe Engine CFWA	261184	Drive Shaft		36		52	59	496							
	2010.05-	-	MT	-	-	Coupe Engine CFWA	603006	Inner Joint			33		34								
	2010.05-	-	-	R	F	Coupe Engine CFWA	261185	Drive Shaft		36		52	59	785							
	2010.05-	-	-	L	F	Coupe Engine CFWA	854006	Outer Joint		36	30	52	59	55.5	I						
	2010.05-	-	-	R	F	Coupe Engine CFWA	261025	Drive Shaft		36		52	75	773.5							
	2010.05-	-	5MT	-	F	Coupe Engine CFWA	803024	Outer Joint		36	30	50.75	59	54.5	I						
1.2 TSI (63 kW)	2012.08-	-	MT	L	F	Coupe Engine CBZA	261263	Drive Shaft		36		52	59	514							
	2012.08-	-	MT	L	F	Coupe Engine CBZA	854006	Outer Joint		36	30	52	59	55.5	I						
	2012.08-	-	MT	L/R	F	Coupe Engine CBZA	603011	Inner Joint			33		34								
	2012.08-	-	AT	L	F	Coupe Engine CBZA	261311	Drive Shaft		36		50.5	59	492							
	2012.08-	-	-	L	F	Coupe Engine CBZA	261274	Drive Shaft		36		50.5	59	514							
1.4 (63 kW)	2008.07-	-	7AT	-	F	Coupe Engine BXW/CGGB	803024	Outer Joint		36	30	50.75	59	54.5	I						
	2008.07-	-	-	R	F	Coupe Engine BXW/CGGB	261267	Drive Shaft		36		50.7	58.5	765							
	2008.07-	-	MT	-	-	Coupe Engine BXW/CGGB	603006	Inner Joint			33		34								
	2008.07-	-	5MT	-	F	Coupe Engine BXW/CGGB	803027	Outer Joint		36	30	50.7	58.5	47.5	I						
	2008.07-	-	MT	L	F	Coupe Engine BXW/CGGB	203330	Drive Shaft		36		50.7	58.5	515							
	2008.07-	-	-	L	F	Coupe Engine BXW/CGGB	203372	Drive Shaft		36		50.7	58.5	516							
1.4 TDI (59 kW)	2008.07-2010.06	-	-	L	F	Coupe Engine BMS	661062	Inner Joint			30		59								
	2008.07-2010.06	-	-	L	F	Coupe Engine BMS	854006	Outer Joint		36	30	52	59	55.5	I						
	2008.07-2010.06	-	-	L	F	Coupe Engine BMS	261135	Drive Shaft		36		52	59	475							
	2008.07-2010.06	-	-	R	F	Coupe Engine BMS	261136	Drive Shaft		36		52	59	763							
	2008.07-2010.06	-	-	L/R	F	Coupe Engine BMS	661006	Inner Joint			30		57.6								
1.4 TSI (110 kW)	2009.06-	-	AT	L	F	Coupe Engine CAVF/CNUB/CTHF/CTJB	261260	Drive Shaft		36		52	75	498							
	2009.06-	-	AT	-	F	Coupe Engine CAVF/CNUB/CTHF/CTJB	803041	Outer Joint		36	27	50.5	75	65	I						
	2009.06-	-	AT	R	F	Coupe Engine CAVF/CNUB/CTHF/CTJB	261261	Drive Shaft		36		52	75	785							
	2009.06-	-	AT	-	-	Coupe Engine CAVF/CNUB/CTHF/CTJB	603016	Inner Joint			28		32								
1.4 TSI Cupra (132 kW)	2009.06-	-	AT	L	F	Coupe Engine CAVE/CTHE/CTJC	261260	Drive Shaft		36		52	75	498							





YEAR	TRANSM	L/R	F/R	REMARKS	GSP Ref.	PRODUCT	ABS	Technical Specifications										
								A	B	C	H	L	P					
SEAT																		
IBIZA V SPORTCOUPE (6J1 6P5)																		
1.4 TSI Cupra (132 kW)	2009.06-	-	AT	-	F	Coupe Engine CAVE/CTHE/CTJC	803041	Outer Joint	36	27	50.5	75	65	I				
	2009.06-	-	AT	R	F	Coupe Engine CAVE/CTHE/CTJC	261261	Drive Shaft	36		52	75	785					
	2009.06-	-	AT	-	-	Coupe Engine CAVE/CTHE/CTJC	603016	Inner Joint		28		32						
1.6 (77 kW)	2008.07-	-	MT	L	F	Coupe Engine BTS	261263	Drive Shaft	36		52	59	514					
	2008.07-	-	MT	L	F	Coupe Engine BTS	854006	Outer Joint	36	30	52	59	55.5	I				
	2008.07-	-	-	L	F	Coupe Engine BTS	261274	Drive Shaft	36		50.5	59	514					
	2008.07-	-	-	L/R	F	Coupe Engine BTS	603011	Inner Joint		33		34						
1.6 LPG (60 kW)	2011.05-	-	MT	L	F	Coupe Engine CNKA	261263	Drive Shaft	36		52	59	514					
	2011.05-	-	-	L/R	F	Coupe Engine CNKA	603011	Inner Joint		33		34						
	2011.05-	-	MT	L	F	Coupe Engine CNKA	854006	Outer Joint	36	30	52	59	55.5	I				
	2011.05-	-	-	L	F	Coupe Engine CNKA	261274	Drive Shaft	36		50.5	59	514					
	2011.05-	-	MT	-	-	Coupe Engine CNKA	603006	Inner Joint		33		34						
1.6 TDI (66 kW)	2009.05-	-	-	L	F	Coupe Engine CAYB	261184	Drive Shaft	36		52	59	496					
	2009.05-	-	-	R	F	Coupe Engine CAYB	261185	Drive Shaft	36		52	59	785					
	2009.05-	-	MT	-	-	Coupe Engine CAYB	603006	Inner Joint		33		34						
	2009.05-	-	-	L	F	Coupe Engine CAYB	854006	Outer Joint	36	30	52	59	55.5	I				
	2009.05-	-	-	L/R	F	Coupe Engine CAYB	603011	Inner Joint		33		34						
	2009.05-	-	-	R	F	Coupe Engine CAYB	261025	Drive Shaft	36		52	75	773.5					
	2009.05-	-	5MT	-	F	Coupe Engine CAYB	803024	Outer Joint	36	30	50.75	59	54.5	I				
1.6 TDI (77 kW)	2009.05-	-	-	L	F	Coupe Engine CAYC/CLNA	261184	Drive Shaft	36		52	59	496					
	2009.05-	-	-	R	F	Coupe Engine CAYC/CLNA	261185	Drive Shaft	36		52	59	785					
	2009.05-	-	MT	-	-	Coupe Engine CAYC/CLNA	603006	Inner Joint		33		34						
	2009.05-	-	-	L	F	Coupe Engine CAYC/CLNA	854006	Outer Joint	36	30	52	59	55.5	I				
	2009.05-	-	-	L/R	F	Coupe Engine CAYC/CLNA	603011	Inner Joint		33		34						
	2009.05-	-	-	R	F	Coupe Engine CAYC/CLNA	261025	Drive Shaft	36		52	75	773.5					
	2009.05-	-	5MT	-	F	Coupe Engine CAYC/CLNA	803024	Outer Joint	36	30	50.75	59	54.5	I				
1.9 TDI (66 kW)	2008.07-2010.06	-	-	-	F	Coupe Engine BXJ	803024	Outer Joint	36	30	50.75	59	54.5	I				
	2008.07-2010.06	-	-	L/R	F	Coupe Engine BXJ	661006	Inner Joint		30		57.6						
1.9 TDI (77 kW)	2008.07-2010.06	-	-	-	F	Coupe Engine BLS	803024	Outer Joint	36	30	50.75	59	54.5	I				
	2008.07-2010.06	-	-	L/R	F	Coupe Engine BLS	661006	Inner Joint		30		57.6						
INCA																		
-	1998-	-	-	-	-	-	899136	Outer Joint	22	30	51	78	61	I				
INCA (6K9)																		
1.4 16V (55 kW)	2000.04-2003.06	MT	L/R	F	Box Engine AUA	653001	Inner Joint		33		32							
	2000.04-2003.06	MT	L	F	Box Engine AUA	253004	Drive Shaft	22		50	78.5	562						
	2000.04-2003.06	MT	L/R	F	Box Engine AUA	853008	Outer Joint	22	30	53	78.5	51	I					
	2000.04-2003.06	-	-	F	Box Engine AUA	853006	Outer Joint	22	30	50	78.5	52	I					
1.4 i (44 kW)	1995.11-2003.06	MT	L/R	F	Box Engine AEX/AKV/APQ/AUD	653001	Inner Joint		33		32							
	1995.11-2003.06	-	-	F	Box Engine AEX/AKV/APQ/AUD	853006	Outer Joint	22	30	50	78.5	52	I					
	1995.11-2003.06	MT	L	F	Box Engine AEX/AKV/APQ/AUD	253004	Drive Shaft	22		50	78.5	562						
	1995.11-2003.06	MT	L/R	F	Box Engine AEX/AKV/APQ/AUD	853008	Outer Joint	22	30	53	78.5	51	I					
1.6 i (55 kW)	1995.11-1998.05	MT	L/R	F	Box Engine 1F	853007	Outer Joint	22	30	53.2	78	61	I					
	1995.11-1998.05	MT	L/R	F	Box Engine 1F	603004	Inner Joint		33		32							
	1995.11-1998.05	MT	R	F	Box Engine 1F	603009	Inner Joint		33		34							
	1995.11-1998.05	MT	L/R	F	Box Engine 1F	603005	Inner Joint		33		32							
	1995.11-1998.05	MT	L/R	F	Box Engine 1F	853008	Outer Joint	22	30	53	78.5	51	I					
	1995.11-1998.05	MT	L	F	Box Engine 1F	253003	Drive Shaft	22		53	78.5	539.5						
	1995.11-1998.05	-	L/R	F	Box Engine 1F	861018	Outer Joint	22	30	53	78.5	61	I					
	1995.11-1998.05	MT	L/R	F	Box Engine 1F	603011	Inner Joint		33		34							
	1997.06-2000.09	MT	L/R	F	Box Engine AEE/ALM	653001	Inner Joint		33		32							
	1997.06-2000.09	MT	L	F	Box Engine AEE/ALM	253004	Drive Shaft	22		50	78.5	562						
	1997.06-2000.09	MT	L/R	F	Box Engine AEE/ALM	853008	Outer Joint	22	30	53	78.5	51	I					
1.7 D (42 kW)	1996.09-2003.06	MT	L/R	F	Box Engine AHB	853007	Outer Joint	22	30	53.2	78	61	I					
	1996.09-2003.06	MT	R	F	Box Engine AHB	603004	Inner Joint		33		32							
	1996.09-2003.06	MT	L/R	F	Box Engine AHB	603005	Inner Joint		33		32							
	1996.09-2003.06	-	L/R	F	Box Engine AHB	853008	Outer Joint	22	30	53	78.5	51	I					
	1996.09-2003.06	MT	L	F	Box Engine AHB	253003	Drive Shaft	22		53	78.5	539.5						
	1996.09-2003.06	MT	L/R	F	Box Engine AHB	861018	Outer Joint	22	30	53	78.5	61	I					
	1996.09-2003.06	MT	R	F	Box Engine AHB	253005	Drive Shaft	22		53	78.5	774						
1.9 D (47 kW)	1995.11-2003.06	MT	R	F	Box Engine 1Y	253005	Drive Shaft	22		53	78.5	774						
	1995.11-2003.06	MT	L/R	F	Box Engine 1Y	603004	Inner Joint		33		32							
	1995.11-2003.06	MT	L/R	F	Box Engine 1Y	853007	Outer Joint	22	30	53.2	78	61	I					
	1995.11-2003.06	-	-	F	Box Engine 1Y	853006	Outer Joint	22	30	50	78.5	52	I					
	1995.11-2003.06	MT	L/R	F	Box Engine 1Y	603005	Inner Joint		33		32							
	1995.11-2003.06	MT	L/R	F	Box Engine 1Y	853008	Outer Joint	22	30	53	78.5	51	I					
	1995.11-2003.06	MT	L	F	Box Engine 1Y	253003	Drive Shaft	22		53	78.5	539.5						





	 YEAR	TRANSM	L/R	F/R	REMARKS	GSP Ref.	 PRODUCT	 ABS	Technical Specifications					
									A	B	C	H	L	P
SEAT														
INCA (6K9)														
1.9 D (47 kW)	1995.11-2003.06	MT	L/R	F	Box Engine 1Y	861018	Outer Joint		22	30	53	78.5	61	I
1.9 SDI (47 kW)	1995.11-2003.06	MT	R	F	Box Engine AEY/AYQ	253005	Drive Shaft		22		53	78.5	774	
	1995.11-2003.06	MT	L/R	F	Box Engine AEY/AYQ	603004	Inner Joint			33		32		
	1995.11-2003.06	MT	L/R	F	Box Engine AEY/AYQ	853007	Outer Joint		22	30	53.2	78	61	I
	1995.11-2003.06	-	-	F	Box Engine AEY/AYQ	853006	Outer Joint		22	30	50	78.5	52	I
	1995.11-2003.06	MT	L/R	F	Box Engine AEY/AYQ	603005	Inner Joint				33		32	
	1995.11-2003.06	MT	L	F	Box Engine AEY/AYQ	253003	Drive Shaft		22		53	78.5	539.5	
	1995.11-2003.06	MT	L/R	F	Box Engine AEY/AYQ	853008	Outer Joint		22	30	53	78.5	51	I
	1995.11-2003.06	MT	L/R	F	Box Engine AEY/AYQ	861018	Outer Joint		22	30	53	78.5	61	I
LEON														
2.0 (110 kW)	2005.07-2010.05	-	L	F	Engine PS/1P1	261153	Drive Shaft		36	26	59.5	40	583	
LEON (1M1)														
1.4 16V (55 kW)	1999.11-2006.06	MT	L	F	Hatchback Engine AHW/APE/AUA/AXP/BCA	261045	Drive Shaft		36		53	78.5	555	
	1999.11-2006.06	MT	R	F	Hatchback Engine AHW/APE/AUA/AXP/BCA	203046	Drive Shaft		36		53	78.5	822	
	1999.11-2006.06	MT	L/R	F	Hatchback Engine AHW/APE/AUA/AXP/BCA	803033	Outer Joint		36	30	53	78.5	51	I
	1999.11-2006.06	-	L/R	F	Hatchback Engine AHW/APE/AUA/AXP/BCA	603008	Inner Joint			33		32		
1.6 (74 kW)	1999.11-2006.06	MT	L/R	F	Hatchback Engine AEH/AKL/APF	603011	Inner Joint			33		34		
	1999.11-2006.06	AT	L	F	Hatchback Engine AEH/AKL/APF	261020	Drive Shaft		36		53.2	77.5	547	
	1999.11-2006.06	MT	L	F	Hatchback Engine AEH/AKL/APF	261045	Drive Shaft		36		53	78.5	555	
	1999.11-2006.06	5MT	R	F	Hatchback Engine AEH/AKL/APF	603009	Inner Joint			33		34		
	1999.11-2006.06	MT	L	F	Hatchback Engine AEH/AKL/APF	261314	Drive Shaft		36		53	78	558	
	1999.11-2006.06	AT	L	F	Hatchback Engine AEH/AKL/APF	261156	Drive Shaft		36		53	78	554.5	
	1999.11-2006.06	-	L/R	F	Hatchback Engine AEH/AKL/APF	803033	Outer Joint		36	30	53	78.5	51	I
	1999.11-2006.06	AT	L	F	Hatchback Engine AEH/AKL/APF	661062	Inner Joint			30		59		
	1999.11-2006.06	-	L/R	F	Hatchback Engine AEH/AKL/APF	603008	Inner Joint			33		32		
	1999.11-2006.06	MT	L/R	F	Hatchback Engine AEH/AKL/APF	803036	Outer Joint		36	30	53.2	77.5	61	I
1.6 (75 kW)	2005.10-2006.06	MT	-	-	Hatchback Engine BFQ/BGU	603006	Inner Joint			33		34		
2005.10-2006.06	MT	-	-	-	Hatchback Engine BFQ/BGU	603016	Inner Joint			28		32		
1.6 16 V (77 kW)	2000.09-2006.06	MT	L/R	F	Hatchback Engine ATN/AUS/AZD/BCB	661005	Inner Joint			30		57.6		
	2000.09-2006.06	AT	L	F	Hatchback Engine ATN/AUS/AZD/BCB	261020	Drive Shaft		36		53.2	77.5	547	
	2000.09-2006.06	MT	L	F	Hatchback Engine ATN/AUS/AZD/BCB	261202	Drive Shaft		36		53.2	77.5	547	
	2000.09-2006.06	MT	R	F	Hatchback Engine ATN/AUS/AZD/BCB	261203	Drive Shaft		36		53.2	77.5	810	
	2000.09-2006.06	-	L/R	F	Hatchback Engine ATN/AUS/AZD/BCB	803036	Outer Joint		36	30	53.2	77.5	61	I
1.8 20V (92 kW)	1999.11-2006.06	MT	L/R	F	Hatchback Engine AGN/APG	803036	Outer Joint		36	30	53.2	77.5	61	I
	1999.11-2006.06	AT	L	F	Hatchback Engine AGN/APG	261020	Drive Shaft		36		53.2	77.5	547	
	1999.11-2006.06	MT	L	F	Hatchback Engine AGN/APG	261314	Drive Shaft		36		53	78	558	
	1999.11-2006.06	MT	L	F	Hatchback Engine AGN/APG	299116	Drive Shaft		36		53.2	77.5	548.5	
	1999.11-2006.06	AT	L	F	Hatchback Engine AGN/APG	261156	Drive Shaft		36		53	78	554.5	
	1999.11-2006.06	AT	L	F	Hatchback Engine AGN/APG	661062	Inner Joint			30		59		
	1999.11-2006.06	MT	R	F	Hatchback Engine AGN/APG	603009	Inner Joint			33		34		
	1999.11-2006.06	MT	L	F	Hatchback Engine AGN/APG	603011	Inner Joint			33		34		
1.8 20V T (132 kW)	1999.11-2006.06	-	L/R	F	Hatchback Engine APP/AUQ	803035	Outer Joint		36	27	53	77.5	65	I
	1999.11-2006.06	MT	L	F	Hatchback Engine APP/AUQ	261123	Drive Shaft		36		53	77.5	520	
	1999.11-2006.06	MT	R	F	Hatchback Engine APP/AUQ	299114	Drive Shaft		36		53	77.5	809	
	1999.11-2006.06	MT	R	F	Hatchback Engine APP/AUQ	261121	Drive Shaft		36		53	77.5	806	
	1999.11-2006.06	AT	L	F	Hatchback Engine APP/AUQ	261156	Drive Shaft		36		53	78	554.5	
	1999.11-2006.06	AT	L	F	Hatchback Engine APP/AUQ	661062	Inner Joint			30		59		
1.8 20V T 4 (132 kW)	1999.11-2006.06	-	R	F	All-wheel Drive Hatchback Engine AJQ/ARY	261186	Drive Shaft		36		53	77.5	653	
	1999.11-2006.06	-	L/R	R	All-wheel Drive Hatchback Engine AJQ/ARY	803033	Outer Joint		36	30	53	78.5	51	I
	1999.11-2006.06	MT	L/R	R	All-wheel Drive Hatchback Engine AJQ/ARY	603011	Inner Joint			33		34		
	1999.11-2006.06	-	L/R	F	All-wheel Drive Hatchback Engine AJQ/ARY	803035	Outer Joint		36	27	53	77.5	65	I
	1999.11-2006.06	-	L	F	All-wheel Drive Hatchback Engine AJQ/ARY	261123	Drive Shaft		36		53	77.5	520	
1.8 T Cupra R (154 kW)	2002.02-2006.06	-	R	F	Hatchback Engine AMK	299114	Drive Shaft		36		53	77.5	809	
	2002.02-2006.06	-	R	F	Hatchback Engine AMK	261121	Drive Shaft		36		53	77.5	806	
	2002.02-2006.06	-	L	F	Hatchback Engine AMK	261123	Drive Shaft		36		53	77.5	520	
	2002.02-2006.06	-	L/R	F	Hatchback Engine AMK	803035	Outer Joint		36	27	53	77.5	65	I
1.8 T Cupra R (165 kW)	2003.07-2006.06	-	R	F	Hatchback Engine BAM	253010	Drive Shaft		36		59.5	40	768	
	2003.07-2006.06	MT	-	-	Hatchback Engine BAM	603016	Inner Joint			28		32		
	2003.07-2006.06	MT	-	-	Hatchback Engine BAM	603006	Inner Joint			33		34		
1.9 SDI (50 kW)	1999.11-2006.06	-	L	F	Hatchback Engine AQM	261045	Drive Shaft		36		53	78.5	555	
	1999.11-2006.06	-	R	F	Hatchback Engine AQM	203046	Drive Shaft		36		53	78.5	822	
	1999.11-2006.06	-	L/R	F	Hatchback Engine AQM	803033	Outer Joint		36	30	53	78.5	51	I
	1999.11-2006.06	-	L/R	F	Hatchback Engine AQM	603008	Inner Joint			33		32		
1.9 TDI (110 kW)	2000.09-2006.06	-	L	F	Hatchback Engine ARL	261123	Drive Shaft		36		53	77.5	520	
	2000.09-2006.06	-	L/R	F	Hatchback Engine ARL	803035	Outer Joint		36	27	53	77.5	65	I
	2000.09-2006.06	MT	R	F	Hatchback Engine ARL	299114	Drive Shaft		36		53	77.5	809	





	 YEAR	TRANSM	L/R	F/R	REMARKS	GSP Ref.	 PRODUCT	 ABS	Technical Specifications								
									A	B	C	H	L	P			
SEAT																	
LEON (1M1)																	
1.9 TDI (110 kW)	2000.09-2006.06	-	R	F	Hatchback Engine ARL	261121	Drive Shaft		36		53	77.5	806				
	2000.09-2006.06	MT	-	-	Hatchback Engine ARL	603016	Inner Joint			28		32					
	2000.09-2006.06	MT	-	-	Hatchback Engine ARL	603006	Inner Joint			33		34					
1.9 TDI (66 kW)	1999.11-2006.06	MT	-	-	Hatchback Engine AGR/ALH	603016	Inner Joint			28		32					
	1999.11-2006.06	MT	R	F	Hatchback Engine AGR/ALH	603009	Inner Joint			33		34					
	1999.11-2006.06	MT	L	F	Hatchback Engine AGR/ALH	203006	Drive Shaft		36		53.2	77.5	557				
	1999.11-2006.06	MT	R	F	Hatchback Engine AGR/ALH	203004	Drive Shaft		36		53.2	77.5	822				
	1999.11-2006.06	MT	-	-	Hatchback Engine AGR/ALH	603006	Inner Joint			33		34					
	1999.11-2006.06	MT	L	F	Hatchback Engine AGR/ALH	261021	Drive Shaft		36		53.2	77.5	564.5				
	1999.11-2006.06	MT	L/R	F	Hatchback Engine AGR/ALH	803036	Outer Joint		36	30	53.2	77.5	61	I			
1.9 TDI (74 kW)	2005.10-2006.06	MT	-	-	Hatchback Engine AXR	603006	Inner Joint			33		34					
	2005.10-2006.06	-	L/R	F	Hatchback Engine AXR	803036	Outer Joint		36	30	53.2	77.5	61	I			
	2005.10-2006.06	-	L	F	Hatchback Engine AXR	603011	Inner Joint			33		34					
	2005.10-2006.06	MT	-	-	Hatchback Engine AXR	603016	Inner Joint			28		32					
	2005.10-2006.06	-	L	F	Hatchback Engine AXR	203006	Drive Shaft		36		53.2	77.5	557				
	2005.10-2006.06	-	R	F	Hatchback Engine AXR	203004	Drive Shaft		36		53.2	77.5	822				
	2005.10-2006.06	-	R	F	Hatchback Engine AXR	603009	Inner Joint			33		34					
1.9 TDI (81 kW)	1999.11-2006.06	MT	R	F	Hatchback Engine AHF/ASV	603009	Inner Joint			33		34					
	1999.11-2006.06	MT	L	F	Hatchback Engine AHF/ASV	203006	Drive Shaft		36		53.2	77.5	557				
	1999.11-2006.06	MT	R	F	Hatchback Engine AHF/ASV	203004	Drive Shaft		36		53.2	77.5	822				
	1999.11-2006.06	MT	L	F	Hatchback Engine AHF/ASV	261021	Drive Shaft		36		53.2	77.5	564.5				
	1999.11-2006.06	MT	L/R	F	Hatchback Engine AHF/ASV	803036	Outer Joint		36	30	53.2	77.5	61	I			
1.9 TDI (96 kW)	2003.05-2006.06	-	L	F	Hatchback Engine ASZ	261123	Drive Shaft		36		53	77.5	520				
	2003.05-2006.06	-	L/R	F	Hatchback Engine ASZ	803035	Outer Joint		36	27	53	77.5	65	I			
	2003.05-2006.06	-	R	F	Hatchback Engine ASZ	299114	Drive Shaft		36		53	77.5	809				
	2003.05-2006.06	-	R	F	Hatchback Engine ASZ	261121	Drive Shaft		36		53	77.5	806				
1.9 TDI Syncro (110 kW)	2002.05-2006.06	-	L	F	All-wheel Drive Hatchback Engine ARL	261123	Drive Shaft		36		53	77.5	520				
	2002.05-2006.06	MT	L/R	R	All-wheel Drive Hatchback Engine ARL	603011	Inner Joint			33		34					
	2002.05-2006.06	-	L/R	F	All-wheel Drive Hatchback Engine ARL	803035	Outer Joint		36	27	53	77.5	65	I			
	2002.05-2006.06	-	R	F	All-wheel Drive Hatchback Engine ARL	261186	Drive Shaft		36		53	77.5	653				
	2002.05-2006.06	MT	-	-	All-wheel Drive Hatchback Engine ARL	603016	Inner Joint			28		32					
	2002.05-2006.06	-	L/R	R	All-wheel Drive Hatchback Engine ARL	803033	Outer Joint		36	30	53	78.5	51	I			
	2002.05-2006.06	MT	-	-	All-wheel Drive Hatchback Engine ARL	603006	Inner Joint			33		34					
2.8 Cupra 4 (150 kW)	2001.02-2006.06	MT	L/R	R	All-wheel Drive Hatchback Engine AUE	603011	Inner Joint			33		34					
	2001.02-2006.06	-	L	F	All-wheel Drive Hatchback Engine AUE	261123	Drive Shaft		36		53	77.5	520				
	2001.02-2006.06	-	L/R	F	All-wheel Drive Hatchback Engine AUE	803035	Outer Joint		36	27	53	77.5	65	I			
	2001.02-2006.06	-	R	F	All-wheel Drive Hatchback Engine AUE	261186	Drive Shaft		36		53	77.5	653				
	2001.02-2006.06	-	L/R	R	All-wheel Drive Hatchback Engine AUE	803033	Outer Joint		36	30	53	78.5	51	I			
LEON (1P1)																	
1.2 TSI (77 kW)	2010.02-2012.12	MT	L	F	Hatchback Engine CBZB	261198	Drive Shaft		36		59.5	40.5	530				
	2010.02-2012.12	MT	-	-	Hatchback Engine CBZB	603006	Inner Joint			33		34					
	2010.02-2012.12	-	L/R	F	Hatchback Engine CBZB	603011	Inner Joint			33		34					
	2010.02-2012.12	-	L/R	F	Hatchback Engine CBZB	803037	Outer Joint		36	30	59.5	40.5	55	I			
	2010.02-2012.12	-	L/R	F	Hatchback Engine CBZB	603008	Inner Joint			33		32					
1.4 16V (63 kW)	2006.06-2012.12	-	L/R	F	Hatchback Engine BXW/CGGB	603008	Inner Joint			33		32					
	2006.06-2012.12	-	R	F	Hatchback Engine BXW/CGGB	253008	Drive Shaft		36		59.5	40	782				
	2006.06-2012.12	MT	L	F	Hatchback Engine BXW/CGGB	253007	Drive Shaft		36		59.5	40	559				
	2006.06-2012.12	-	L/R	F	Hatchback Engine BXW/CGGB	853001	Outer Joint		36	30	59.5	40	49	I			
1.4 TSI (92 kW)	2007.11-2012.12	MT	-	-	Hatchback Engine CAXC	603006	Inner Joint			33		34					
	2007.11-2012.12	MT	L	F	Hatchback Engine CAXC	261198	Drive Shaft		36		59.5	40.5	530				
	2007.11-2012.12	MT	R	F	Hatchback Engine CAXC	201586	Drive Shaft		36		59.5	40	806				
	2007.11-2012.12	-	L/R	F	Hatchback Engine CAXC	603011	Inner Joint			33		34					
	2007.11-2012.12	-	L/R	F	Hatchback Engine CAXC	803037	Outer Joint		36	30	59.5	40.5	55	I			
1.6 (75 kW)	2005.07-2012.12	-	R	F	Hatchback Engine BSE/BSF/CCSA/CMXA	261113	Drive Shaft		36		59.5	40	814				
	2005.07-2012.12	-	L	F	Hatchback Engine BSE/BSF/CCSA/CMXA	261097	Drive Shaft		36		59.5	40.5	543				
	2005.07-2012.12	5MT	R	F	Hatchback Engine BSE/BSF/CCSA/CMXA	261096	Drive Shaft		36		59.5	40.5	799				
	2005.07-2012.12	MT	L/R	F	Hatchback Engine BSE/BSF/CCSA/CMXA	603011	Inner Joint			33		34					
	2005.07-2012.12	-	L	F	Hatchback Engine BSE/BSF/CCSA/CMXA	203320	Drive Shaft		36		59.5	40	546				
	2005.07-2012.12	-	L/R	F	Hatchback Engine BSE/BSF/CCSA/CMXA	803037	Outer Joint		36	30	59.5	40.5	55	I			
	2005.07-2012.12	7DCT	L	F	Hatchback Engine BSE/BSF/CCSA/CMXA	803116	Outer Joint		36	30	59.5	38	55	I			
1.6 LPG (75 kW)	2009.12-2012.12	MT	-	-	Hatchback Engine CHGA	603006	Inner Joint			33		34					
	2009.12-2012.12	-	L	F	Hatchback Engine CHGA	261097	Drive Shaft		36		59.5	40.5	543				
	2009.12-2012.12	-	L/R	F	Hatchback Engine CHGA	603011	Inner Joint			33		34					
	2009.12-2012.12	-	R	F	Hatchback Engine CHGA	261096	Drive Shaft		36		59.5	40.5	799				
	2009.12-2012.12	-	L	F	Hatchback Engine CHGA	203320	Drive Shaft		36		59.5	40	546				
	2009.12-2012.12	-	L/R	F	Hatchback Engine CHGA	803037	Outer Joint		36	30	59.5	40.5	55	I			
1.6 MultiFuel (75 kW)	2010.11-2012.12	MT	-	-	Hatchback Engine BSE/CMXA	603006	Inner Joint			33		34					





	 YEAR	TRANSM	L/R	F/R	REMARKS	GSP Ref.	 PRODUCT	 ABS	Technical Specifications								
									A	B	C	H	L	P			
SEAT																	
LEON (1P1)																	
1.6 MultiFuel (75 kW)	2010.11-2012.12	-	L/R	F	Hatchback Engine BSE/CMXA	603011	Inner Joint			33		34					
	2010.11-2012.12	-	L	F	Hatchback Engine BSE/CMXA	261097	Drive Shaft	36		59.5	40.5	543					
	2010.11-2012.12	-	R	F	Hatchback Engine BSE/CMXA	261096	Drive Shaft	36		59.5	40.5	799					
	2010.11-2012.12	-	L	F	Hatchback Engine BSE/CMXA	203320	Drive Shaft	36		59.5	40	546					
	2010.11-2012.12	-	L/R	F	Hatchback Engine BSE/CMXA	803037	Outer Joint	36	30	59.5	40.5	55	I				
1.6 TDI (66 kW)	2010.11-2012.12	-	L/R	F	Hatchback Engine CAYB	603011	Inner Joint			33		34					
	2010.11-2012.12	-	L	F	Hatchback Engine CAYB	203294	Drive Shaft	36		59.5	38	519					
	2010.11-2012.12	-	L	F	Hatchback Engine CAYB	803116	Outer Joint	36	30	59.5	38	55	I				
1.6 TDI (77 kW)	2010.11-2012.12	-	L/R	F	Hatchback Engine CAYB	803037	Outer Joint	36	30	59.5	40.5	55	I				
	2010.02-2012.12	MT	L	F	Hatchback Engine CAYC	203294	Drive Shaft	36		59.5	38	519					
	2010.02-2012.12	Semi-AT	-	F	Hatchback Engine CAYC	803100	Outer Joint	36	33	59.5	38	55	I				
	2010.02-2012.12	MT	L/R	F	Hatchback Engine CAYC	803037	Outer Joint	36	30	59.5	40.5	55	I				
	2010.02-2012.12	Semi-AT	L	F	Hatchback Engine CAYC	261089	Drive Shaft	36		59.5	40.5	521					
	2010.02-2012.12	AT	L/R	F	Hatchback Engine CAYC	803002	Outer Joint	36	27	59.5	40	66	I				
	2010.02-2012.12	AT/MT	L/R	F	Hatchback Engine CAYC	603011	Inner Joint			33		34					
	2010.02-2012.12	MT	L	F	Hatchback Engine CAYC	803116	Outer Joint	36	30	59.5	38	55	I				
	2010.02-2012.12	MT	R	F	Hatchback Engine CAYC	261042	Drive Shaft	36		59.5	40.5	814					
	2010.02-2012.12	MT	R	F	Hatchback Engine CAYC	201585	Drive Shaft	36		59.5	40	805					
1.8 TSI (118 kW)	2010.02-2012.12	Semi-AT	R	F	Hatchback Engine CAYC	261280	Drive Shaft	36		59.5	40	801					
	2010.02-2012.12	-	-	-	Hatchback Engine CAYC	861059	Outer Joint	36	33	59.5	40	59.5	I				
	2007.06-2012.12	-	-	-	Hatchback Engine BZB/CDA	603006	Inner Joint			33		34					
	2007.06-2012.12	MT	L	F	Hatchback Engine BZB/CDA	261100	Drive Shaft	36		59.5	40	513					
	2007.06-2012.12	-	L/R	F	Hatchback Engine BZB/CDA	603011	Inner Joint			33		34					
	2007.06-2012.12	-	L/R	F	Hatchback Engine BZB/CDA	803002	Outer Joint	36	27	59.5	40	66	I				
	2007.06-2012.12	-	-	-	Hatchback Engine BZB/CDA	861059	Outer Joint	36	33	59.5	40	59.5	I				
1.9 TDI (66 kW)	2007.06-2012.12	MT	L	F	Hatchback Engine BZB/CDA	261131	Drive Shaft	36		59.5	40	515					
	2007.06-2010.12	-	L	F	Hatchback Engine BXF	203294	Drive Shaft	36		59.5	38	519					
	2007.06-2010.12	MT	-	-	Hatchback Engine BXF	603006	Inner Joint			33		34					
	2007.06-2010.12	-	L/R	F	Hatchback Engine BXF	603011	Inner Joint			33		34					
	2007.06-2010.12	-	L	F	Hatchback Engine BXF	803116	Outer Joint	36	30	59.5	38	55	I				
	2007.06-2010.12	-	R	F	Hatchback Engine BXF	261042	Drive Shaft	36		59.5	40.5	814					
1.9 TDI (77 kW)	2007.06-2010.12	-	L/R	F	Hatchback Engine BXF	803037	Outer Joint	36	30	59.5	40.5	55	I				
	2005.07-2010.12	AT	R	F	Hatchback Engine BKC/BLS/BXE	254011	Drive Shaft	36		59.5	40	755					
	2005.07-2010.12	MT	L	F	Hatchback Engine BKC/BLS/BXE	203294	Drive Shaft	36		59.5	38	519					
	2005.07-2010.12	MT	L/R	F	Hatchback Engine BKC/BLS/BXE	603011	Inner Joint			33		34					
	2005.07-2010.12	AT	L/R	F	Hatchback Engine BKC/BLS/BXE	661057	Inner Joint			34		86					
	2005.07-2010.12	MT	L/R	F	Hatchback Engine BKC/BLS/BXE	803037	Outer Joint	36	30	59.5	40.5	55	I				
	2005.07-2010.12	AT	L	F	Hatchback Engine BKC/BLS/BXE	254013	Drive Shaft	36		59.5	40	479.5					
	2005.07-2010.12	AT	L	F	Hatchback Engine BKC/BLS/BXE	654004	Inner Joint			34		85					
	2005.07-2010.12	MT	L	F	Hatchback Engine BKC/BLS/BXE	803116	Outer Joint	36	30	59.5	38	55	I				
	2005.07-2010.12	MT	R	F	Hatchback Engine BKC/BLS/BXE	261042	Drive Shaft	36		59.5	40.5	814					
2.0 Cupra R (195 kW)	2005.07-2010.12	MT	R	F	Hatchback Engine BKC/BLS/BXE	201585	Drive Shaft	36		59.5	40	805					
	2005.07-2010.12	AT	L/R	F	Hatchback Engine BKC/BLS/BXE	803002	Outer Joint	36	27	59.5	40	66	I				
2.0 FSI (110 kW)	2009.09-2012.12	-	L/R	F	Hatchback Engine CDLA	803002	Outer Joint	36	27	59.5	40	66	I				
	2009.09-2012.12	-	L	F	Hatchback Engine CDLA	203295	Drive Shaft	36		59.5	40	491					
	2009.09-2012.12	MT	-	-	Hatchback Engine CDLA	603016	Inner Joint			28		32					
	2005.07-2010.05	MT	R	F	Hatchback Engine BLR/BLY/BVY/BVZ	261113	Drive Shaft	36		59.5	40	814					
	2005.07-2010.05	-	L/R	F	Hatchback Engine BLR/BLY/BVY/BVZ	803037	Outer Joint	36	30	59.5	40.5	55	I				
	2005.07-2010.05	AT	R	F	Hatchback Engine BLR/BLY/BVY/BVZ	261094	Drive Shaft	36	26	59.5	40.5	884					
	2005.07-2010.05	MT	L/R	F	Hatchback Engine BLR/BLY/BVY/BVZ	603011	Inner Joint			33		34					
	2005.07-2010.05	MT	R	F	Hatchback Engine BLR/BLY/BVY/BVZ	201585	Drive Shaft	36		59.5	40	805					
2.0 TDI (100 kW)	2005.07-2010.05	MT	L	F	Hatchback Engine BLR/BLY/BVY/BVZ	803116	Outer Joint	36	30	59.5	38	55	I				
	2005.07-2010.05	AT	L/R	F	Hatchback Engine BLR/BLY/BVY/BVZ	661011	Inner Joint	26	32	31	68.5	85					
	2005.07-2010.05	AT	L	F	Hatchback Engine BLR/BLY/BVY/BVZ	261093	Drive Shaft	36	26	59.5	40.5	587.5					
	2005.07-2010.05	AT	R	F	Hatchback Engine AZV	254011	Drive Shaft	36		59.5	40	755					
	2005.07-2010.05	MT	L	F	Hatchback Engine AZV	203295	Drive Shaft	36		59.5	40	491					
	2005.07-2010.05	-	L/R	F	Hatchback Engine AZV	803002	Outer Joint	36	27	59.5	40	66	I				
	2005.07-2010.05	AT	L/R	F	Hatchback Engine AZV	661057	Inner Joint			34		86					
	2005.07-2010.05	MT	R	F	Hatchback Engine AZV	203236	Drive Shaft	36		59.5	40	484					
	2005.07-2010.05	MT	R	F	Hatchback Engine AZV	203313	Drive Shaft	36		59.5	40	792					
	2005.07-2010.05	AT	L	F	Hatchback Engine AZV	254013	Drive Shaft	36		59.5	40	479.5					
2.0 TDI (103 kW)	2005.07-2010.05	AT	L	F	Hatchback Engine AZV	654004	Inner Joint			34		85					
	2005.07-2010.05	AT	L	F	Hatchback Engine AZV	203241	Drive Shaft	36		59.5	40	475					
	2005.10-2010.10	MT	L	F	Hatchback Engine BMM	203295	Drive Shaft	36		59.5	40	491					
	2005.10-2010.10	Semi-AT	R	F	Hatchback Engine BMM	254011	Drive Shaft	36		59.5	40	755					
	2005.10-2010.10	Semi-AT	L/R	F	Hatchback Engine BMM	661057	Inner Joint			34		86					





	 YEAR	TRANSM	L/R	F/R	REMARKS	GSP Ref.	 PRODUCT	 ABS	Technical Specifications									
									A	B	C	H	L	P				
SEAT																		
LEON (1P1)																		
2.0 TDI (103 kW)	2005.10-2010.10	AT	L	F	Hatchback Engine BMM	203241	Drive Shaft		36		59.5	40	475					
	2005.10-2010.10	MT	R	F	Hatchback Engine BMM	203313	Drive Shaft		36		59.5	40	792					
	2005.10-2010.10	Semi-AT	L	F	Hatchback Engine BMM	254013	Drive Shaft		36		59.5	40	479.5					
	2005.10-2010.10	AT/MT	L/R	F	Hatchback Engine BMM	803002	Outer Joint		36	27	59.5	40	66	I				
	2005.10-2010.10	Semi-AT	L	F	Hatchback Engine BMM	654004	Inner Joint			34		85						
2.0 TDI (125 kW)	2006.05-2012.12	AT	R	F	Hatchback Engine BMN/CEGA/CFJA	254011	Drive Shaft		36		59.5	40	755					
	2006.05-2012.12	MT	L	F	Hatchback Engine BMN/CEGA/CFJA	203265	Drive Shaft		36		59.5	40	487					
	2006.05-2012.12	AT	L	F	Hatchback Engine BMN/CEGA/CFJA	203241	Drive Shaft		36		59.5	40	475					
	2006.05-2012.12	AT	R	F	Hatchback Engine BMN/CEGA/CFJA	654004	Inner Joint			34		85						
	2006.05-2012.12	MT	R	F	Hatchback Engine BMN/CEGA/CFJA	261126	Drive Shaft		36		59.5	40	793					
	2006.05-2012.12	MT	L/R	F	Hatchback Engine BMN/CEGA/CFJA	861045	Outer Joint		36	27	59.5	40	65	M				
2.0 TDI 16V (103 kW)	2005.07-2012.12	AT	R	F	Hatchback Engine BKD/CFHC/CLCB	254011	Drive Shaft		36		59.5	40	755					
	2005.07-2012.12	MT	L	F	Hatchback Engine BKD/CFHC/CLCB	203295	Drive Shaft		36		59.5	40	491					
	2005.07-2012.12	AT	L/R	F	Hatchback Engine BKD/CFHC/CLCB	661057	Inner Joint			34		86						
	2005.07-2012.12	MT	R	F	Hatchback Engine BKD/CFHC/CLCB	203236	Drive Shaft		36		59.5	40	484					
	2005.07-2012.12	MT	R	F	Hatchback Engine BKD/CFHC/CLCB	203313	Drive Shaft		36		59.5	40	792					
	2005.07-2012.12	AT	L	F	Hatchback Engine BKD/CFHC/CLCB	254013	Drive Shaft		36		59.5	40	479.5					
	2005.07-2012.12	AT	L	F	Hatchback Engine BKD/CFHC/CLCB	654004	Inner Joint			34		85						
	2005.07-2012.12	AT	L	F	Hatchback Engine BKD/CFHC/CLCB	203241	Drive Shaft		36		59.5	40	475					
	2005.07-2012.12	AT/MT	L/R	F	Hatchback Engine BKD/CFHC/CLCB	803002	Outer Joint		36	27	59.5	40	66	I				
2.0 TFSI (136 kW)	2005.09-2006.05	-	L/R	F	Hatchback Engine BWA1	803002	Outer Joint		36	27	59.5	40	66	I				
	2005.09-2006.05	-	L	F	Hatchback Engine BWA1	203295	Drive Shaft		36		59.5	40	491					
2.0 TFSI (147 kW)	2005.05-2009.03	-	L	F	Hatchback Engine BWA	203295	Drive Shaft		36		59.5	40	491					
	2005.05-2009.03	MT	L/R	F	Hatchback Engine BWA	803002	Outer Joint		36	27	59.5	40	66	I				
	2005.05-2009.03	AT	R	F	Hatchback Engine BWA	203349	Drive Shaft		36		59.5	40	784					
2.0 TFSI (155 kW)	2009.06-2012.12	-	L/R	F	Hatchback Engine CCZB	803002	Outer Joint		36	27	59.5	40	66	I				
	2009.06-2012.12	AMT	R	F	Hatchback Engine CCZB	203349	Drive Shaft		36		59.5	40	784					
	2009.06-2012.12	AT/MT	L	F	Hatchback Engine CCZB	203295	Drive Shaft		36		59.5	40	491					
2.0 TFSI (177 kW)	2006.11-2011.05	-	L	F	Hatchback Engine BWJ/CDLD	203295	Drive Shaft		36		59.5	40	491					
	2006.11-2011.05	MT	-	-	Hatchback Engine BWJ/CDLD	603016	Inner Joint			28		32						
	2006.11-2011.05	MT	L/R	F	Hatchback Engine BWJ/CDLD	803002	Outer Joint		36	27	59.5	40	66	I				
LEON (5F1)																		
1.0 TSI (85 kW)	2015.05-	-	-	F	Hatchback Engine CHZD	803100	Outer Joint		36	33	59.5	38	55	I				
1.2 TSI (63 kW)	2012.12-	MT	L	F	Hatchback Engine CJZB/CYVA	261277	Drive Shaft		36		59.5	40	516					
	2012.12-	MT	L/R	F	Hatchback Engine CJZB/CYVA	603011	Inner Joint			33		34						
	2012.12-	MT	L/R	F	Hatchback Engine CJZB/CYVA	803037	Outer Joint		36	30	59.5	40.5	55	I				
	2012.12-	-	L	F	Hatchback Engine CJZB/CYVA	203373	Drive Shaft		36		59.5	38	511					
	2012.12-	MT	R	F	Hatchback Engine CJZB/CYVA	261307	Drive Shaft		36		59.5	40	819					
	2012.12-	-	L	F	Hatchback Engine CJZB/CYVA	803116	Outer Joint		36	30	59.5	38	55	I				
1.2 TSI (77 kW)	2013.01-	MT	L	F	Hatchback Engine CJZA	261277	Drive Shaft		36		59.5	40	516					
	2013.01-	AT	-	F	Hatchback Engine CJZA	803100	Outer Joint		36	33	59.5	38	55	I				
	2013.01-	AT	L	F	Hatchback Engine CJZA	261089	Drive Shaft		36		59.5	40.5	521					
	2013.01-	-	L	F	Hatchback Engine CJZA	203373	Drive Shaft		36		59.5	38	511					
	2013.01-	MT	L	F	Hatchback Engine CJZA	261268	Drive Shaft		36		59.5	40	516					
	2013.01-	MT	R	F	Hatchback Engine CJZA	261307	Drive Shaft		36		59.5	40	819					
	2013.01-	-	L/R	F	Hatchback Engine CJZA	603011	Inner Joint			33		34						
	2013.01-	-	L	F	Hatchback Engine CJZA	803116	Outer Joint		36	30	59.5	38	55	I				
	2013.01-	AT	R	F	Hatchback Engine CJZA	261199	Drive Shaft		36		59.5	40.5	800					
	2013.01-	-	L/R	F	Hatchback Engine CJZA	803037	Outer Joint		36	30	59.5	40.5	55	I				
1.2 TSI (81 kW)	2014.04-	-	L/R	F	Hatchback Engine CYVB	803037	Outer Joint		36	30	59.5	40.5	55	I				
	2014.04-	MT	L	F	Hatchback Engine CYVB	261277	Drive Shaft		36		59.5	40	516					
	2014.04-	-	L	F	Hatchback Engine CYVB	203373	Drive Shaft		36		59.5	38	511					
	2014.04-	-	-	F	Hatchback Engine CYVB	803100	Outer Joint		36	33	59.5	38	55	I				
	2014.04-	-	L/R	F	Hatchback Engine CYVB	603011	Inner Joint			33		34						
	2014.04-	-	L	F	Hatchback Engine CYVB	803116	Outer Joint		36	30	59.5	38	55	I				
1.4 TGI (81 kW)	2013.02-	MT	L	F	Hatchback Engine CPWA	261277	Drive Shaft		36		59.5	40	516					
	2013.02-	-	-	F	Hatchback Engine CPWA	803100	Outer Joint		36	33	59.5	38	55	I				
	2013.02-	-	L/R	F	Hatchback Engine CPWA	603011	Inner Joint			33		34						
1.4 TSI (103 kW)	2012.09-	AT	R	F	Hatchback Engine CHPA/CPTA	261303	Drive Shaft		36		59.5	40	795					
	2012.09-	MT	-	F	Hatchback Engine CHPA/CPTA	803100	Outer Joint		36	33	59.5	38	55	I				
	2012.09-	-	-	F	Hatchback Engine CHPA/CPTA	803101	Outer Joint		36	27	59.5	40	65	M				
	2012.09-	MT	L	F	Hatchback Engine CHPA/CPTA	261089	Drive Shaft		36		59.5	40.5	521					
	2012.09-	AT	L	F	Hatchback Engine CHPA/CPTA	261304	Drive Shaft		36		59.5	40	511					
	2012.09-	MT	-	-	Hatchback Engine CHPA/CPTA	603006	Inner Joint			33		34						
	2012.09-	MT	-	-	Hatchback Engine CHPA/CPTA	603016	Inner Joint			28		32						
	2012.09-	MT	R	F	Hatchback Engine CHPA/CPTA	261283	Drive Shaft		36		59.5	40	815					





	 YEAR	TRANSM	L/R	F/R	REMARKS	GSP Ref.	 PRODUCT	 ABS	Technical Specifications					
									A	B	C	H	L	P
SEAT														
LEON (5F1)														
1.4 TSI (103 kW)	2012.09-	-	L/R	F	Hatchback Engine CHPA/CPTA	603011	Inner Joint		33		34			
	2012.09-	MT	-	-	Hatchback Engine CHPA/CPTA	861059	Outer Joint	36	33	59.5	40	59.5	I	
1.4 TSI (110 kW)	2014.05-	AT	R	F	Hatchback Engine CZEA	261303	Drive Shaft	36		59.5	40	795		
	2014.05-	MT	-	F	Hatchback Engine CZEA	803100	Outer Joint	36	33	59.5	38	55	I	
	2014.05-	-	-	F	Hatchback Engine CZEA	803101	Outer Joint	36	27	59.5	40	65	M	
	2014.05-	AT	L	F	Hatchback Engine CZEA	261304	Drive Shaft	36		59.5	40	511		
	2014.05-	-	L/R	F	Hatchback Engine CZEA	603011	Inner Joint		33		34			
1.4 TSI (90 kW)	2012.11-	MT	-	F	Hatchback Engine CMBA/CXSA	803100	Outer Joint	36	33	59.5	38	55	I	
	2012.11-	MT	L/R	F	Hatchback Engine CMBA/CXSA	603011	Inner Joint		33		34			
	2012.11-	MT	L	F	Hatchback Engine CMBA/CXSA	261306	Drive Shaft	36		59.5	40	517		
1.4 TSI (92 kW)	2014.05-	MT	-	F	Hatchback Engine CZCA	803100	Outer Joint	36	33	59.5	38	55	I	
	2014.05-	MT	L/R	F	Hatchback Engine CZCA	603011	Inner Joint		33		34			
1.6 TDI (66 kW)	2012.11-	-	L	F	Hatchback Engine CLHB	203294	Drive Shaft	36		59.5	38	519		
	2012.11-	MT	L/R	F	Hatchback Engine CLHB	603011	Inner Joint		33		34			
	2012.11-	MT	L/R	F	Hatchback Engine CLHB	803037	Outer Joint	36	30	59.5	40.5	55	I	
	2012.11-	-	L	F	Hatchback Engine CLHB	803116	Outer Joint	36	30	59.5	38	55	I	
	2012.11-	-	R	F	Hatchback Engine CLHB	261042	Drive Shaft	36		59.5	40.5	814		
	2012.11-	-	R	F	Hatchback Engine CLHB	201585	Drive Shaft	36		59.5	40	805		
1.6 TDI (77 kW)	2012.11-	MT	-	F	Hatchback Engine CLHA	803100	Outer Joint	36	33	59.5	38	55	I	
	2012.11-	MT	L	F	Hatchback Engine CLHA	261089	Drive Shaft	36		59.5	40.5	521		
	2012.11-	MT	L/R	F	Hatchback Engine CLHA	603011	Inner Joint		33		34			
	2012.11-	-	R	F	Hatchback Engine CLHA	261200	Drive Shaft	36		59.5	40.5	820		
1.6 TDI (81 kW)	2013.09-	MT	L/R	F	Hatchback Engine CRKB/CXXB/DBKA	603011	Inner Joint		33		34			
1.6 TDI (85 kW)	2016.11-	-	L/R	F	Hatchback Engine DDYA	603011	Inner Joint		33		34			
1.8 TSI (132 kW)	2013.02-	-	-	F	Hatchback Engine CJSA	803101	Outer Joint	36	27	59.5	40	65	M	
	2013.02-	MT	L	F	Hatchback Engine CJSA	261304	Drive Shaft	36		59.5	40	511		
2.0 TDI (105 kW)	2013.05-	MT	-	F	Hatchback Engine CRVC	803101	Outer Joint	36	27	59.5	40	65	M	
	2013.05-	AT	L	F	Hatchback Engine CRVC	261285	Drive Shaft	36		59.5	40	472		
	2013.05-	AT	R	F	Hatchback Engine CRVC	203354	Drive Shaft	36		59.5	40	763		
2.0 TDI (110 kW)	2012.10-	AT	L	F	Hatchback Engine CKFC/CRMB	261285	Drive Shaft	36		59.5	40	472		
	2012.10-	AT	R	F	Hatchback Engine CKFC/CRMB	203354	Drive Shaft	36		59.5	40	763		
	2012.10-	AT	-	-	Hatchback Engine CKFC/CRMB	603016	Inner Joint		28		32			
2.0 TDI (135 kW)	2012.09-	MT	-	-	Hatchback Engine CUNA/CUPA	603016	Inner Joint		28		32			
2.0 TDI (81 kW)	2013.05-	MT	L/R	F	Hatchback Engine CRVA	603011	Inner Joint		33		34			
LEON SC (5F5)														
1.0 TSI (85 kW)	2015.05-	-	-	F	Coupe Engine CHZD	803100	Outer Joint	36	33	59.5	38	55	I	
1.2 TSI (63 kW)	2013.01-	-	L/R	F	Coupe Engine CJZB/CYVA	803037	Outer Joint	36	30	59.5	40.5	55	I	
	2013.01-	MT	L	F	Coupe Engine CJZB/CYVA	261277	Drive Shaft	36		59.5	40	516		
	2013.01-	-	L	F	Coupe Engine CJZB/CYVA	203373	Drive Shaft	36		59.5	38	511		
	2013.01-	MT	R	F	Coupe Engine CJZB/CYVA	261307	Drive Shaft	36		59.5	40	819		
	2013.01-	-	L/R	F	Coupe Engine CJZB/CYVA	603011	Inner Joint		33		34			
	2013.01-	-	L	F	Coupe Engine CJZB/CYVA	803116	Outer Joint	36	30	59.5	38	55	I	
1.2 TSI (77 kW)	2013.02-	-	L/R	F	Coupe Engine CJZA	803037	Outer Joint	36	30	59.5	40.5	55	I	
	2013.02-	MT	L	F	Coupe Engine CJZA	261277	Drive Shaft	36		59.5	40	516		
	2013.02-	AT	-	F	Coupe Engine CJZA	803100	Outer Joint	36	33	59.5	38	55	I	
	2013.02-	AT	L	F	Coupe Engine CJZA	261089	Drive Shaft	36		59.5	40.5	521		
	2013.02-	-	L	F	Coupe Engine CJZA	203373	Drive Shaft	36		59.5	38	511		
	2013.02-	MT	L	F	Coupe Engine CJZA	261268	Drive Shaft	36		59.5	40	516		
	2013.02-	MT	R	F	Coupe Engine CJZA	261307	Drive Shaft	36		59.5	40	819		
	2013.02-	-	L/R	F	Coupe Engine CJZA	603011	Inner Joint		33		34			
	2013.02-	-	L	F	Coupe Engine CJZA	803116	Outer Joint	36	30	59.5	38	55	I	
	2013.02-	AT	R	F	Coupe Engine CJZA	261199	Drive Shaft	36		59.5	40.5	800		
1.2 TSI (81 kW)	2014.05-	-	L/R	F	Coupe Engine CYVB	803037	Outer Joint	36	30	59.5	40.5	55	I	
	2014.05-	MT	L	F	Coupe Engine CYVB	261277	Drive Shaft	36		59.5	40	516		
	2014.05-	-	L	F	Coupe Engine CYVB	203373	Drive Shaft	36		59.5	38	511		
	2014.05-	-	-	F	Coupe Engine CYVB	803100	Outer Joint	36	33	59.5	38	55	I	
	2014.05-	-	L/R	F	Coupe Engine CYVB	603011	Inner Joint		33		34			
	2014.05-	-	L	F	Coupe Engine CYVB	803116	Outer Joint	36	30	59.5	38	55	I	
1.4 TSI (103 kW)	2013.02-	AT	R	F	Coupe Engine CHPA/CPTA	261303	Drive Shaft	36		59.5	40	795		
	2013.02-	AT	-	F	Coupe Engine CHPA/CPTA	803101	Outer Joint	36	27	59.5	40	65	M	
	2013.02-	MT	-	F	Coupe Engine CHPA/CPTA	803100	Outer Joint	36	33	59.5	38	55	I	
	2013.02-	MT	L	F	Coupe Engine CHPA/CPTA	261089	Drive Shaft	36		59.5	40.5	521		
	2013.02-	AT	L	F	Coupe Engine CHPA/CPTA	261304	Drive Shaft	36		59.5	40	511		
	2013.02-	MT	-	-	Coupe Engine CHPA/CPTA	603016	Inner Joint		28		32			
	2013.02-	MT	-	-	Coupe Engine CHPA/CPTA	603006	Inner Joint		33		34			
	2013.02-	MT	R	F	Coupe Engine CHPA/CPTA	261283	Drive Shaft	36		59.5	40	815		





	 YEAR	TRANSM	L/R	F/R	REMARKS	GSP Ref.	 PRODUCT	 ABS	Technical Specifications									
									A	B	C	H	L	P				
SEAT																		
LEON SC (5F5)																		
1.4 TSI (103 kW)	2013.02-	-	-	L/R	F	Coupe Engine CHPA/CPTA	603011	Inner Joint			33		34					
	2013.02-	-	MT	-	-	Coupe Engine CHPA/CPTA	861059	Outer Joint	36	33	59.5	40	59.5	I				
1.4 TSI (110 kW)	2014.05-	-	AT	-	F	Coupe Engine CZEA	803101	Outer Joint	36	27	59.5	40	65	M				
	2014.05-	-	MT	-	F	Coupe Engine CZEA	803100	Outer Joint	36	33	59.5	38	55	I				
	2014.05-	-	-	L/R	F	Coupe Engine CZEA	603011	Inner Joint			33		34					
1.4 TSI (90 kW)	2013.02-	-	MT	-	F	Coupe Engine CMBA/CXSA	803100	Outer Joint	36	33	59.5	38	55	I				
	2013.02-	-	MT	L/R	F	Coupe Engine CMBA/CXSA	603011	Inner Joint			33		34					
	2013.02-	-	MT	L	F	Coupe Engine CMBA/CXSA	261306	Drive Shaft	36		59.5	40	517					
1.4 TSI (92 kW)	2014.05-	-	MT	-	F	Coupe Engine CZCA	803100	Outer Joint	36	33	59.5	38	55	I				
	2014.05-	-	MT	L/R	F	Coupe Engine CZCA	603011	Inner Joint			33		34					
1.6 TDI (66 kW)	2013.02-	-	-	L/R	F	Coupe Engine CLHB	803037	Outer Joint	36	30	59.5	40.5	55	I				
	2013.02-	-	-	L	F	Coupe Engine CLHB	203294	Drive Shaft	36		59.5	38	519					
	2013.02-	-	-	L	F	Coupe Engine CLHB	803116	Outer Joint	36	30	59.5	38	55	I				
	2013.02-	-	-	R	F	Coupe Engine CLHB	201585	Drive Shaft	36		59.5	40	805					
	2013.02-	-	-	R	F	Coupe Engine CLHB	261042	Drive Shaft	36		59.5	40.5	814					
1.6 TDI (77 kW)	2013.02-	-	-	L/R	F	Coupe Engine CLHB	603011	Inner Joint			33		34					
	2013.02-	-	MT	-	F	Coupe Engine CLHA	803100	Outer Joint	36	33	59.5	38	55	I				
	2013.02-	-	MT	L	F	Coupe Engine CLHA	261089	Drive Shaft	36		59.5	40.5	521					
	2013.02-	-	MT	R	F	Coupe Engine CLHA	261200	Drive Shaft	36		59.5	40.5	820					
1.6 TDI (81 kW)	2013.02-	-	-	L/R	F	Coupe Engine CLHA	603011	Inner Joint			33		34					
	2013.09-	-	MT/DCT	L/R	F	Coupe Engine CRKB/CXXB/DBKA	603011	Inner Joint			33		34					
1.6 TDI (85 kW)	2016.11-	-	-	L/R	F	Coupe Engine DDYA	603011	Inner Joint			33		34					
1.8 TSI (132 kW)	2013.02-	-	-	-	F	Coupe Engine CJSA	803101	Outer Joint	36	27	59.5	40	65	M				
	2013.02-	-	MT	L	F	Coupe Engine CJSA	261304	Drive Shaft	36		59.5	40	511					
2.0 TDI (105 kW)	2013.05-	-	MT	-	F	Coupe Engine CRVC	803101	Outer Joint	36	27	59.5	40	65	M				
	2013.05-	-	AT	L	F	Coupe Engine CRVC	261285	Drive Shaft	36		59.5	40	472					
	2013.05-	-	AT	R	F	Coupe Engine CRVC	203354	Drive Shaft	36		59.5	40	763					
2.0 TDI (110 kW)	2013.02-	-	MT	-	F	Coupe Engine CKFC/CRMB	803101	Outer Joint	36	27	59.5	40	65	M				
	2013.02-	-	AT	L	F	Coupe Engine CKFC/CRMB	261285	Drive Shaft	36		59.5	40	472					
	2013.02-	-	AT	R	F	Coupe Engine CKFC/CRMB	203354	Drive Shaft	36		59.5	40	763					
	2013.02-	-	AT	-	-	Coupe Engine CKFC/CRMB	603016	Inner Joint			28		32					
2.0 TDI (135 kW)	2013.03-	-	MT	-	-	Coupe Engine CUNA/CUPA	603016	Inner Joint			28		32					
2.0 TDI (81 kW)	2013.02-	-	MT	L/R	F	Coupe Engine CRVA	603011	Inner Joint			33		34					
LEON ST (5F8)																		
1.0 TSI (85 kW)	2015.05-	-	-	-	F	Estate Engine CHZD	803100	Outer Joint	36	33	59.5	38	55	I				
1.2 TSI (63 kW)	2013.11-	-	MT	L/R	F	Estate Engine CJZB/CYVA	603011	Inner Joint			33		34					
	2013.11-	-	MT	L	F	Estate Engine CJZB/CYVA	261277	Drive Shaft	36		59.5	40	516					
	2013.11-	-	MT	L/R	F	Estate Engine CJZB/CYVA	803037	Outer Joint	36	30	59.5	40.5	55	I				
1.2 TSI (77 kW)	2013.08-	-	MT	L	F	Estate Engine CJZA	261277	Drive Shaft	36		59.5	40	516					
	2013.08-	-	MT	L	F	Estate Engine CJZA	203373	Drive Shaft	36		59.5	38	511					
	2013.08-	-	-	L/R	F	Estate Engine CJZA	603011	Inner Joint			33		34					
	2013.08-	-	-	-	F	Estate Engine CJZA	803100	Outer Joint	36	33	59.5	38	55	I				
	2013.08-	-	MT	R	F	Estate Engine CJZA	261307	Drive Shaft	36		59.5	40	819					
	2013.08-	-	-	L/R	F	Estate Engine CJZA	803037	Outer Joint	36	30	59.5	40.5	55	I				
	2013.08-	-	MT	L	F	Estate Engine CJZA	803116	Outer Joint	36	30	59.5	38	55	I				
1.2 TSI (81 kW)	2014.05-	-	-	L/R	F	Estate Engine CYVB	803037	Outer Joint	36	30	59.5	40.5	55	I				
	2014.05-	-	MT	L	F	Estate Engine CYVB	261277	Drive Shaft	36		59.5	40	516					
	2014.05-	-	AT	-	F	Estate Engine CYVB	803100	Outer Joint	36	33	59.5	38	55	I				
	2014.05-	-	AT	L	F	Estate Engine CYVB	261089	Drive Shaft	36		59.5	40.5	521					
	2014.05-	-	-	L	F	Estate Engine CYVB	203373	Drive Shaft	36		59.5	38	511					
	2014.05-	-	MT	L	F	Estate Engine CYVB	261268	Drive Shaft	36		59.5	40	516					
	2014.05-	-	-	L/R	F	Estate Engine CYVB	603011	Inner Joint			33		34					
	2014.05-	-	-	L	F	Estate Engine CYVB	803116	Outer Joint	36	30	59.5	38	55	I				
2014.05-	-	AT	R	F	Estate Engine CYVB	261199	Drive Shaft	36		59.5	40.5	800						
1.4 TGI (81 kW)	2013.10-	-	MT	-	F	Estate Engine CPWA	803100	Outer Joint	36	33	59.5	38	55	I				
	2013.10-	-	-	L/R	F	Estate Engine CPWA	603011	Inner Joint			33		34					
1.4 TSI (103 kW)	2013.10-	-	AT	R	F	Estate Engine CHPA/CPTA	261303	Drive Shaft	36		59.5	40	795					
	2013.10-	-	MT	-	F	Estate Engine CHPA/CPTA	803100	Outer Joint	36	33	59.5	38	55	I				
	2013.10-	-	MT	L	F	Estate Engine CHPA/CPTA	261089	Drive Shaft	36		59.5	40.5	521					
	2013.10-	-	-	-	F	Estate Engine CHPA/CPTA	803101	Outer Joint	36	27	59.5	40	65	M				
	2013.10-	-	-	L/R	F	Estate Engine CHPA/CPTA	603011	Inner Joint			33		34					
	2013.10-	-	AT	L	F	Estate Engine CHPA/CPTA	261304	Drive Shaft	36		59.5	40	511					
	2013.10-	-	MT	R	F	Estate Engine CHPA/CPTA	261283	Drive Shaft	36		59.5	40	815					
1.4 TSI (110 kW)	2014.05-	-	AT	-	F	Estate Engine CZEA	803101	Outer Joint	36	27	59.5	40	65	M				
	2014.05-	-	MT	-	F	Estate Engine CZEA	803100	Outer Joint	36	33	59.5	38	55	I				
	2014.05-	-	-	L/R	F	Estate Engine CZEA	603011	Inner Joint			33		34					





	 YEAR	TRANSM	L/R	F/R	REMARKS	GSP Ref.	 PRODUCT	 ABS	Technical Specifications					
									A	B	C	H	L	P
SEAT														
LEON ST (5F8)														
1.4 TSI (90 kW)	2013.10-	-	MT	-	F Estate Engine CMBA/CXSA	803100	Outer Joint		36	33	59.5	38	55	I
	2013.10-	-	MT	L/R	F Estate Engine CMBA/CXSA	603011	Inner Joint			33		34		
	2013.10-	-	MT	-	F Estate Engine CMBA/CXSA	603006	Inner Joint			33		34		
	2013.10-	-	MT	L	F Estate Engine CMBA/CXSA	261306	Drive Shaft		36		59.5	40	517	
	2013.10-	-	MT	-	F Estate Engine CMBA/CXSA	861059	Outer Joint		36	33	59.5	40	59.5	I
1.4 TSI (92 kW)	2014.05-	-	MT	-	F Estate Engine CZCA	803100	Outer Joint		36	33	59.5	38	55	I
	2014.05-	-	MT	L/R	F Estate Engine CZCA	603011	Inner Joint			33		34		
1.6 TDI (66 kW)	2013.11-	-	MT	L	F Estate Engine CLHB	203294	Drive Shaft		36		59.5	38	519	
	2013.11-	-	MT	L/R	F Estate Engine CLHB	603011	Inner Joint			33		34		
	2013.11-	-	MT	L/R	F Estate Engine CLHB	803037	Outer Joint		36	30	59.5	40.5	55	I
	2013.11-	-	MT	L	F Estate Engine CLHB	803116	Outer Joint		36	30	59.5	38	55	I
	2013.11-	-	MT	R	F Estate Engine CLHB	261042	Drive Shaft		36		59.5	40.5	814	
	2013.11-	-	MT	R	F Estate Engine CLHB	201585	Drive Shaft		36		59.5	40	805	
1.6 TDI (77 kW)	2013.10-	-	AT	-	F Estate Engine CLHA	861059	Outer Joint		36	33	59.5	40	59.5	I
	2013.10-	-	MT	-	F Estate Engine CLHA	803100	Outer Joint		36	33	59.5	38	55	I
	2013.10-	-	MT	L	F Estate Engine CLHA	261089	Drive Shaft		36		59.5	40.5	521	
	2013.10-	-	MT	L/R	F Estate Engine CLHA	603011	Inner Joint			33		34		
	2013.10-	-	MT	R	F Estate Engine CLHA	261200	Drive Shaft		36		59.5	40.5	820	
	2013.10-	-	AT	-	F Estate Engine CLHA	603016	Inner Joint			28		32		
	2013.10-	-	AT	-	F Estate Engine CLHA	603006	Inner Joint			33		34		
1.6 TDI (81 kW)	2013.09-	-	MT	L/R	F Estate Engine CRKB/CXXB/DBKA	603011	Inner Joint			33		34		
1.6 TDI (85 kW)	2016.11-	-	-	L/R	F Estate Engine DDYA	603011	Inner Joint			33		34		
1.8 TSI (132 kW)	2013.10-	-	-	-	F Estate Engine CJSA	803101	Outer Joint		36	27	59.5	40	65	M
	2013.10-	-	MT	L	F Estate Engine CJSA	261304	Drive Shaft		36		59.5	40	511	
	2013.10-	-	AT	-	F Estate Engine CJSA	603016	Inner Joint			28		32		
	2013.10-	-	AT	-	F Box Body/Estate Engine CJSA	603016	Inner Joint			28		32		
1.8 TSI 4Drive (132 kW)	2014.11-	-	-	-	F All-wheel Drive Estate Engine CJSB	803101	Outer Joint		36	27	59.5	40	65	M
2.0 TDI (105 kW)	2013.10-	-	MT	-	F Estate Engine CRVC	803101	Outer Joint		36	27	59.5	40	65	M
	2013.10-	-	AT	L	F Estate Engine CRVC	261285	Drive Shaft		36		59.5	40	472	
	2013.10-	-	AT	R	F Estate Engine CRVC	203354	Drive Shaft		36		59.5	40	763	
2.0 TDI (110 kW)	2013.10-	-	MT	-	F Estate Engine CKFC/CRBC/CRLB/CRMB	803101	Outer Joint		36	27	59.5	40	65	M
	2013.10-	-	AT	L	F Estate Engine CKFC/CRBC/CRLB/CRMB	261285	Drive Shaft		36		59.5	40	472	
	2013.10-	-	AT	R	F Estate Engine CKFC/CRBC/CRLB/CRMB	203354	Drive Shaft		36		59.5	40	763	
2.0 TDI (81 kW)	2013.11-	-	MT	L/R	F Estate Engine CRVA	603011	Inner Joint			33		34		
2.0 TDI 4Drive (135 kW)	2014.11-	-	-	-	F All-wheel Drive Estate Engine CUNA	803101	Outer Joint		36	27	59.5	40	65	M
	2014.11-	-	AT	L	F All-wheel Drive Estate Engine CUNA	261285	Drive Shaft		36		59.5	40	472	
LEON/LEON 4														
-	2000-	2006	-	-	-	201587	Drive Shaft		36		53	78.5	522	
MALAGA (023A)														
1.2 (44 kW)	1985.05-	1993.12	-	-	F Saloon Engine 021 A 1000	817005	Outer Joint		22	20	48.1	90.5	59.5	O
1.2 (47 kW)	1984.11-	1993.12	-	-	F Saloon Engine 021 A 1000	817005	Outer Joint		22	20	48.1	90.5	59.5	O
1.2 i (52 kW)	1989.12-	1993.12	-	-	F Saloon Engine 021 C.1000	817005	Outer Joint		22	20	48.1	90.5	59.5	O
1.5 (63 kW)	1985.05-	1993.12	-	-	F Saloon Engine 021 A 2000	817005	Outer Joint		22	20	48.1	90.5	59.5	O
1.5 i (74 kW)	1987.01-	1993.12	-	-	F Saloon Engine 021 B.2000	817005	Outer Joint		22	20	48.1	90.5	59.5	O
1.5 i Cat (66 kW)	1986.10-	1993.12	-	-	F Saloon Engine 021 A 2000/021 C.2000/021 D.2000	817005	Outer Joint		22	20	48.1	90.5	59.5	O
1.7 D (40 kW)	1985.05-	1993.12	-	-	F Saloon Engine 022 A.5000	817005	Outer Joint		22	20	48.1	90.5	59.5	O
1.7 D (42 kW)	1990.05-	1993.12	-	-	F Saloon Engine 022 A.5000	817005	Outer Joint		22	20	48.1	90.5	59.5	O
Mii (KF1)														
1.0 (44 kW)	2011.10-	-	-	L/R	F Hatchback Engine CHYA	850170	Outer Joint		22	26	46	78	53	M
	2011.10-	-	-	L	F Hatchback Engine CHYA	250567	Drive Shaft		22	28	46	78	650	
	2011.10-	-	-	R	F Hatchback Engine CHYA	250543	Drive Shaft		22	28	46	78	814	
	2011.10-	-	-	-	F Hatchback Engine CHYA	850153	Outer Joint		22	26	46	78	55	M
1.0 (55 kW)	2011.10-	-	-	L/R	F Hatchback Engine CHYB	850170	Outer Joint		22	26	46	78	53	M
	2011.10-	-	-	L	F Hatchback Engine CHYB	250567	Drive Shaft		22	28	46	78	650	
	2011.10-	-	-	R	F Hatchback Engine CHYB	250543	Drive Shaft		22	28	46	78	814	
	2011.10-	-	-	-	F Hatchback Engine CHYB	850153	Outer Joint		22	26	46	78	55	M
1.0 EcoFuel (50 kW)	2012.11-	-	MT	L/R	F Hatchback Engine CPGA	850170	Outer Joint		22	26	46	78	53	M
TOLEDO														
-	1999-	2004	-	-	-	201587	Drive Shaft		36		53	78.5	522	
TOLEDO I (1L)														
1.6 i (52 kW)	1991.05-	1993.12	MT	L	F Hatchback Engine 1F	261043	Drive Shaft		22		53.2	78	535	
	1991.05-	1993.12	MT	L	F Hatchback Engine 1F	253001	Drive Shaft		22		53	78.5	535	
	1991.05-	1993.12	MT	L/R	F Hatchback Engine 1F	853007	Outer Joint		22	30	53.2	78	61	I
	1991.05-	1993.12	MT	R	F Hatchback Engine 1F	253002	Drive Shaft		22		53.2	78	769	
	1991.05-	1993.12	MT	R	F Hatchback Engine 1F	603009	Inner Joint			33		34		
1.6 i (52 kW)	1991.05-	1993.12	-	-	F Hatchback Engine 1F	853004	Outer Joint		22	30	51	78	61	I





	 YEAR	TRANSM	L/R	F/R	REMARKS	GSP Ref.	 PRODUCT	 ABS	Technical Specifications					
									A	B	C	H	L	P
SEAT														
TOLEDO I (1L)														
1.6 i (52 kW)	1991.05-1993.12	MT	L	F	Hatchback Engine 1F	603011	Inner Joint		33		34			
1.6 i (54 kW)	1991.05-1999.03	MT	L	F	Hatchback Engine 1F/ABN/EZ	253001	Drive Shaft	22		53	78.5	535		
	1991.05-1999.03	MT	L/R	F	Hatchback Engine 1F/ABN/EZ	853007	Outer Joint	22	30	53.2	78	61	I	
	1991.05-1999.03	MT	L	F	Hatchback Engine 1F/ABN/EZ	261043	Drive Shaft	22		53.2	78	535		
	1991.05-1999.03	MT	R	F	Hatchback Engine 1F/ABN/EZ	603009	Inner Joint		33		34			
	1991.05-1999.03	MT	R	F	Hatchback Engine 1F/ABN/EZ	253002	Drive Shaft	22		53.2	78	769		
	1991.05-1999.03	MT	-	F	Hatchback Engine 1F/ABN/EZ	853004	Outer Joint	22	30	51	78	61	I	
	1991.05-1999.03	MT	L	F	Hatchback Engine 1F/ABN/EZ	603011	Inner Joint		33		34			
1.6 i (55 kW)	1993.01-1999.03	MT	L	F	Hatchback Engine 1F	261043	Drive Shaft	22		53.2	78	535		
	1993.01-1999.03	MT	L	F	Hatchback Engine 1F	253001	Drive Shaft	22		53	78.5	535		
	1993.01-1999.03	MT	L/R	F	Hatchback Engine 1F	853007	Outer Joint	22	30	53.2	78	61	I	
	1993.01-1999.03	MT	R	F	Hatchback Engine 1F	253002	Drive Shaft	22		53.2	78	769		
	1993.01-1999.03	MT	R	F	Hatchback Engine 1F	603009	Inner Joint		33		34			
	1993.01-1999.03	-	-	F	Hatchback Engine 1F	853004	Outer Joint	22	30	51	78	61	I	
	1993.01-1999.03	MT	L	F	Hatchback Engine 1F	603011	Inner Joint		33		34			
1.6 i (74 kW)	1996.11-1999.03	MT	L	F	Hatchback Engine AFT	261043	Drive Shaft	22		53.2	78	535		
	1996.11-1999.03	MT	-	F	Hatchback Engine AFT	853004	Outer Joint	22	30	51	78	61	I	
	1996.11-1999.03	MT	R	F	Hatchback Engine AFT	603009	Inner Joint		33		34			
	1996.11-1999.03	MT	L	F	Hatchback Engine AFT	603011	Inner Joint		33		34			
	1996.11-1999.03	MT	L/R	F	Hatchback Engine AFT	853008	Outer Joint	22	30	53	78.5	51	I	
	1996.11-1999.03	MT	L	F	Hatchback Engine AFT	253001	Drive Shaft	22		53	78.5	535		
1.8 16V (92 kW)	1991.05-1999.03	MT	L/R	F	Hatchback Engine PL	853007	Outer Joint	22	30	53.2	78	61	I	
	1991.05-1999.03	MT	L	F	Hatchback Engine PL	261043	Drive Shaft	22		53.2	78	535		
	1991.05-1999.03	MT	R	F	Hatchback Engine PL	603009	Inner Joint		33		34			
	1991.05-1999.03	MT	R	F	Hatchback Engine PL	253002	Drive Shaft	22		53.2	78	769		
	1991.05-1999.03	MT	-	-	Hatchback Engine PL	603006	Inner Joint		33		34			
	1991.05-1999.03	MT	-	F	Hatchback Engine PL	853004	Outer Joint	22	30	51	78	61	I	
	1991.05-1999.03	MT	L	F	Hatchback Engine PL	603011	Inner Joint		33		34			
	1991.05-1999.03	MT	L	F	Hatchback Engine PL	253001	Drive Shaft	22		53	78.5	535		
1.8 16V (98 kW)	1991.05-1999.03	MT	L	F	Hatchback Engine KR	261043	Drive Shaft	22		53.2	78	535		
	1991.05-1999.03	MT	-	-	Hatchback Engine KR	603006	Inner Joint		33		34			
	1991.05-1999.03	MT	-	F	Hatchback Engine KR	853004	Outer Joint	22	30	51	78	61	I	
	1991.05-1999.03	MT	L	F	Hatchback Engine KR	253001	Drive Shaft	22		53	78.5	535		
1.8 i (65 kW)	1991.05-1996.12	MT	L	F	Hatchback Engine RP	253001	Drive Shaft	22		53	78.5	535		
	1991.05-1996.12	AT/MT	L/R	F	Hatchback Engine RP	853007	Outer Joint	22	30	53.2	78	61	I	
	1991.05-1996.12	MT	L	F	Hatchback Engine RP	261043	Drive Shaft	22		53.2	78	535		
	1991.05-1996.12	AT/MT	R	F	Hatchback Engine RP	603009	Inner Joint		33		34			
	1991.05-1996.12	MT	R	F	Hatchback Engine RP	253002	Drive Shaft	22		53.2	78	769		
	1991.05-1996.12	-	-	F	Hatchback Engine RP	853004	Outer Joint	22	30	51	78	61	I	
	1991.05-1996.12	AT/MT	L	F	Hatchback Engine RP	603011	Inner Joint		33		34			
1.8 i (66 kW)	1993.11-1996.12	MT	L	F	Hatchback Engine ABS/ADZ/ACC	253001	Drive Shaft	22		53	78.5	535		
	1993.11-1996.12	AT/MT	L/R	F	Hatchback Engine ABS/ADZ/ACC	853007	Outer Joint	22	30	53.2	78	61	I	
	1993.11-1996.12	MT	R	F	Hatchback Engine ABS/ADZ/ACC	253002	Drive Shaft	22		53.2	78	769		
	1993.11-1996.12	MT	R	F	Hatchback Engine ABS/ADZ/ACC	261009	Drive Shaft	22		53.2	78	789		
	1993.11-1996.12	AT/MT	R	F	Hatchback Engine ABS/ADZ/ACC	603009	Inner Joint		33		34			
	1993.11-1996.12	AT/MT	L	F	Hatchback Engine ABS/ADZ/ACC	603011	Inner Joint		33		34			
1.9 D (47 kW)	1995.12-1999.03	MT	R	F	Hatchback Engine 1Y	253005	Drive Shaft	22		53	78.5	774		
	1995.12-1999.03	MT	L	F	Hatchback Engine 1Y	253001	Drive Shaft	22		53	78.5	535		
	1995.12-1999.03	MT	L/R	F	Hatchback Engine 1Y	853007	Outer Joint	22	30	53.2	78	61	I	
	1995.12-1999.03	MT	R	F	Hatchback Engine 1Y	253002	Drive Shaft	22		53.2	78	769		
	1995.12-1999.03	MT	L/R	F	Hatchback Engine 1Y	603004	Inner Joint		33		32			
	1995.12-1999.03	-	-	F	Hatchback Engine 1Y	853006	Outer Joint	22	30	50	78.5	52	I	
	1995.12-1999.03	MT	R	F	Hatchback Engine 1Y	603009	Inner Joint		33		34			
	1995.12-1999.03	MT	L/R	F	Hatchback Engine 1Y	603005	Inner Joint		33		32			
	1995.12-1999.03	MT	L	F	Hatchback Engine 1Y	603011	Inner Joint		33		34			
	1995.12-1999.03	MT	L	F	Hatchback Engine 1Y	253003	Drive Shaft	22		53	78.5	539.5		
	1995.12-1999.03	MT	L/R	F	Hatchback Engine 1Y	853008	Outer Joint	22	30	53	78.5	51	I	
1.9 D (50 kW)	1991.05-1999.03	MT	R	F	Hatchback Engine 1Y	253005	Drive Shaft	22		53	78.5	774		
	1991.05-1999.03	MT	L	F	Hatchback Engine 1Y	253001	Drive Shaft	22		53	78.5	535		
	1991.05-1999.03	MT	L/R	F	Hatchback Engine 1Y	853007	Outer Joint	22	30	53.2	78	61	I	
	1991.05-1999.03	MT	R	F	Hatchback Engine 1Y	253002	Drive Shaft	22		53.2	78	769		
	1991.05-1999.03	MT	L/R	F	Hatchback Engine 1Y	603004	Inner Joint		33		32			
	1991.05-1999.03	-	-	F	Hatchback Engine 1Y	853006	Outer Joint	22	30	50	78.5	52	I	
	1991.05-1999.03	MT	R	F	Hatchback Engine 1Y	603009	Inner Joint		33		34			
	1991.05-1999.03	MT	L	F	Hatchback Engine 1Y	603011	Inner Joint		33		34			
	1991.05-1999.03	MT	L/R	F	Hatchback Engine 1Y	603005	Inner Joint		33		32			
	1991.05-1999.03	MT	L/R	F	Hatchback Engine 1Y	853008	Outer Joint	22	30	53	78.5	51	I	
	1991.05-1999.03	MT	L	F	Hatchback Engine 1Y	253003	Drive Shaft	22		53	78.5	539.5		





	 YEAR	TRANSM	L/R	F/R	REMARKS	GSP Ref.	 PRODUCT	 ABS	Technical Specifications					
									A	B	C	H	L	P
SEAT														
TOLEDO I (1L)														
1.9 TD (55 kW)	1991.05-1999.03	MT	L	F	Hatchback Engine AAZ	253001	Drive Shaft		22		53	78.5	535	
	1991.05-1999.03	MT	L/R	F	Hatchback Engine AAZ	853007	Outer Joint		22	30	53.2	78	61	I
	1991.05-1999.03	MT	L	F	Hatchback Engine AAZ	261043	Drive Shaft		22		53.2	78	535	
	1991.05-1999.03	MT	R	F	Hatchback Engine AAZ	603009	Inner Joint			33		34		
	1991.05-1999.03	MT	R	F	Hatchback Engine AAZ	253002	Drive Shaft		22		53.2	78	769	
	1991.05-1999.03	MT	-	F	Hatchback Engine AAZ	853004	Outer Joint		22	30	51	78	61	I
	1991.05-1999.03	MT	L	F	Hatchback Engine AAZ	603011	Inner Joint			33		34		
1.9 TDI (66 kW)	1995.08-1999.03	MT	L	F	Hatchback Engine 1Z/AHU	261043	Drive Shaft		22		53.2	78	535	
	1995.08-1999.03	MT	-	F	Hatchback Engine 1Z/AHU	853004	Outer Joint		22	30	51	78	61	I
	1995.08-1999.03	MT	R	F	Hatchback Engine 1Z/AHU	603009	Inner Joint			33		34		
	1995.08-1999.03	MT	L	F	Hatchback Engine 1Z/AHU	603011	Inner Joint			33		34		
	1995.08-1999.03	MT	L/R	F	Hatchback Engine 1Z/AHU	861018	Outer Joint		22	30	53	78.5	61	I
1.9 TDI (81 kW)	1996.11-1999.03	MT	L	F	Hatchback Engine AFN	261043	Drive Shaft		22		53.2	78	535	
	1996.11-1999.03	MT	-	F	Hatchback Engine AFN	853004	Outer Joint		22	30	51	78	61	I
	1996.11-1999.03	MT	R	F	Hatchback Engine AFN	603009	Inner Joint			33		34		
	1996.11-1999.03	MT	L	F	Hatchback Engine AFN	603011	Inner Joint			33		34		
	1996.11-1999.03	MT	L/R	F	Hatchback Engine AFN	861018	Outer Joint		22	30	53	78.5	61	I
2.0 i (85 kW)	1991.05-1999.03	MT	L	F	Hatchback Engine 2E/AGG	603011	Inner Joint			33		34		
	1991.05-1999.03	MT	L	F	Hatchback Engine 2E/AGG	253001	Drive Shaft		22		53	78.5	535	
	1991.05-1999.03	MT	L/R	F	Hatchback Engine 2E/AGG	853007	Outer Joint		22	30	53.2	78	61	I
	1991.05-1999.03	MT	L	F	Hatchback Engine 2E/AGG	261043	Drive Shaft		22		53.2	78	535	
	1991.05-1999.03	MT	R	F	Hatchback Engine 2E/AGG	603009	Inner Joint			33		34		
	1991.05-1999.03	MT	R	F	Hatchback Engine 2E/AGG	253002	Drive Shaft		22		53.2	78	769	
	1991.05-1999.03	AT	-	F	Hatchback Engine 2E/AGG	853006	Outer Joint		22	30	50	78.5	52	I
	1991.05-1999.03	MT	-	F	Hatchback Engine 2E/AGG	853004	Outer Joint		22	30	51	78	61	I
2.0 i 16V (110 kW)	1993.11-1999.03	MT	R	F	Hatchback Engine ABF	603009	Inner Joint			33		34		
	1993.11-1999.03	MT	L	F	Hatchback Engine ABF	261043	Drive Shaft		22		53.2	78	535	
	1993.11-1999.03	AT	-	F	Hatchback Engine ABF	853006	Outer Joint		22	30	50	78.5	52	I
	1993.11-1999.03	MT	-	F	Hatchback Engine ABF	853004	Outer Joint		22	30	51	78	61	I
	1993.11-1999.03	MT	R	F	Hatchback Engine ABF	261062	Drive Shaft		36		53.2	77.5	788	
	1993.11-1999.03	MT	L	F	Hatchback Engine ABF	603011	Inner Joint			33		34		
	1993.11-1999.03	MT	L/R	F	Hatchback Engine ABF	803036	Outer Joint		36	30	53.2	77.5	61	I
1.4 16V (55 kW)	2000.01-2002.05	MT	L	F	Saloon Engine AHW/APE/AUA/AXP/BCA	261045	Drive Shaft		36		53	78.5	555	
	2000.01-2002.05	MT	-	-	Saloon Engine AHW/APE/AUA/AXP/BCA	603016	Inner Joint			28		32		
	2000.01-2002.05	MT	R	F	Saloon Engine AHW/APE/AUA/AXP/BCA	203046	Drive Shaft		36		53	78.5	822	
	2000.01-2002.05	MT	L/R	F	Saloon Engine AHW/APE/AUA/AXP/BCA	803033	Outer Joint		36	30	53	78.5	51	I
	2000.01-2002.05	MT	-	-	Saloon Engine AHW/APE/AUA/AXP/BCA	603006	Inner Joint			33		34		
	2000.01-2002.05	-	L/R	F	Saloon Engine AHW/APE/AUA/AXP/BCA	603008	Inner Joint			33		32		
1.6 (74 kW)	1998.10-2004.07	-	R	F	Saloon Engine AEH/AKL/APF	603009	Inner Joint			33		34		
	1998.10-2004.07	MT	L	F	Saloon Engine AEH/AKL/APF	261045	Drive Shaft		36		53	78.5	555	
	1998.10-2004.07	-	L	F	Saloon Engine AEH/AKL/APF	603011	Inner Joint			33		34		
	1998.10-2004.07	MT	L	F	Saloon Engine AEH/AKL/APF	261314	Drive Shaft		36		53	78	558	
	1998.10-2004.07	-	L/R	F	Saloon Engine AEH/AKL/APF	803036	Outer Joint		36	30	53.2	77.5	61	I
	1998.10-2004.07	AT	L	F	Saloon Engine AEH/AKL/APF	261156	Drive Shaft		36		53	78	554.5	
	1998.10-2004.07	-	L/R	F	Saloon Engine AEH/AKL/APF	803033	Outer Joint		36	30	53	78.5	51	I
	1998.10-2004.07	AT	L	F	Saloon Engine AEH/AKL/APF	661062	Inner Joint			30		59		
	1998.10-2004.07	-	L/R	F	Saloon Engine AEH/AKL/APF	603008	Inner Joint			33		32		
1.6 16V (77 kW)	2000.06-2006.05	-	L/R	F	Saloon Engine AUS/AZD/BCB	803036	Outer Joint		36	30	53.2	77.5	61	I
	2000.06-2006.05	MT	L/R	F	Saloon Engine AUS/AZD/BCB	661005	Inner Joint			30		57.6		
1.8 20V (92 kW)	1998.10-2004.07	MT	L/R	F	Saloon Engine AGN/APG	803036	Outer Joint		36	30	53.2	77.5	61	I
	1998.10-2004.07	AT	L	F	Saloon Engine AGN/APG	261020	Drive Shaft		36		53.2	77.5	547	
	1998.10-2004.07	MT	L	F	Saloon Engine AGN/APG	261314	Drive Shaft		36		53	78	558	
	1998.10-2004.07	AT	L	F	Saloon Engine AGN/APG	261156	Drive Shaft		36		53	78	554.5	
	1998.10-2004.07	MT	L	F	Saloon Engine AGN/APG	261021	Drive Shaft		36		53.2	77.5	564.5	
	1998.10-2004.07	AT	L	F	Saloon Engine AGN/APG	661062	Inner Joint			30		59		
	1998.10-2004.07	MT	R	F	Saloon Engine AGN/APG	603009	Inner Joint			33		34		
	1998.10-2004.07	MT	L	F	Saloon Engine AGN/APG	603011	Inner Joint			33		34		
1.8 20VT (132 kW)	2000.09-2004.07	-	L	F	Saloon Engine APP/AUQ	261123	Drive Shaft		36		53	77.5	520	
	2000.09-2004.07	-	L/R	F	Saloon Engine APP/AUQ	803035	Outer Joint		36	27	53	77.5	65	I
	2000.09-2004.07	MT	R	F	Saloon Engine APP/AUQ	299114	Drive Shaft		36		53	77.5	809	
	2000.09-2004.07	-	R	F	Saloon Engine APP/AUQ	261121	Drive Shaft		36		53	77.5	806	
	2000.09-2004.07	AT	L	F	Saloon Engine APP/AUQ	261156	Drive Shaft		36		53	78	554.5	
	2000.09-2004.07	AT	L	F	Saloon Engine APP/AUQ	661062	Inner Joint			30		59		
1.9 TDI (110 kW)	2000.10-2004.07	-	L	F	Saloon Engine ARL	261123	Drive Shaft		36		53	77.5	520	
	2000.10-2004.07	-	L/R	F	Saloon Engine ARL	803035	Outer Joint		36	27	53	77.5	65	I

	 YEAR	TRANSM	L/R	F/R	REMARKS	GSP Ref.	 PRODUCT	 ABS	Technical Specifications					
									A	B	C	H	L	P
SEAT														
TOLEDO I (1L)														
1.9 TDI (110 kW)	2000.10-2004.07	MT	R	F	Saloon Engine ARL	299114	Drive Shaft		36		53	77.5	809	
	2000.10-2004.07	-	R	F	Saloon Engine ARL	261121	Drive Shaft		36		53	77.5	806	
	2000.10-2004.07	MT	-	-	Saloon Engine ARL	603016	Inner Joint			28		32		
	2000.10-2004.07	MT	-	-	Saloon Engine ARL	603006	Inner Joint			33		34		
1.9 TDI (66 kW)	1999.03-2004.07	MT	L/R	F	Saloon Engine AGR/ALH	803036	Outer Joint		36	30	53.2	77.5	61	I
	1999.03-2004.07	MT	L	F	Saloon Engine AGR/ALH	203006	Drive Shaft		36		53.2	77.5	557	
	1999.03-2004.07	MT	R	F	Saloon Engine AGR/ALH	203004	Drive Shaft		36		53.2	77.5	822	
	1999.03-2004.07	MT	R	F	Saloon Engine AGR/ALH	603009	Inner Joint			33		34		
	1999.03-2004.07	MT	L	F	Saloon Engine AGR/ALH	603011	Inner Joint			33		34		
1.9 TDI (81 kW)	1998.10-2004.07	MT	R	F	Saloon Engine AHF/ASV	603009	Inner Joint			33		34		
	1998.10-2004.07	MT	L	F	Saloon Engine AHF/ASV	203006	Drive Shaft		36		53.2	77.5	557	
	1998.10-2004.07	MT	R	F	Saloon Engine AHF/ASV	203004	Drive Shaft		36		53.2	77.5	822	
	1998.10-2004.07	MT	L	F	Saloon Engine AHF/ASV	603011	Inner Joint			33		34		
	1998.10-2004.07	MT	L/R	F	Saloon Engine AHF/ASV	803036	Outer Joint		36	30	53.2	77.5	61	I
1.9 TDI (96 kW)	2003.05-2006.05	-	L	F	Saloon Engine ASZ	261123	Drive Shaft		36		53	77.5	520	
	2003.05-2006.05	-	L/R	F	Saloon Engine ASZ	803035	Outer Joint		36	27	53	77.5	65	I
	2003.05-2006.05	MT	R	F	Saloon Engine ASZ	299114	Drive Shaft		36		53	77.5	809	
	2003.05-2006.05	-	R	F	Saloon Engine ASZ	261121	Drive Shaft		36		53	77.5	806	
2.3 V5 (110 kW)	1998.10-2000.11	MT	L	F	Saloon Engine AGZ	261020	Drive Shaft		36		53.2	77.5	547	
	1998.10-2000.11	-	L/R	F	Saloon Engine AGZ	803036	Outer Joint		36	30	53.2	77.5	61	I
	1998.10-2000.11	-	L	F	Saloon Engine AGZ	261156	Drive Shaft		36		53	78	554.5	
2.3 V5 20V (125 kW)	1998.10-2000.11	-	L	F	Saloon Engine AGZ	661062	Inner Joint			30		59		
	2000.09-2003.11	MT	L	F	Saloon Engine AQN	261020	Drive Shaft		36		53.2	77.5	547	
	2000.09-2003.11	-	L/R	F	Saloon Engine AQN	803036	Outer Joint		36	30	53.2	77.5	61	I
	2000.09-2003.11	MT	-	-	Saloon Engine AQN	603016	Inner Joint			28		32		
	2000.09-2003.11	-	L	F	Saloon Engine AQN	261156	Drive Shaft		36		53	78	554.5	
2.0 (110 KW)	2000.09-2003.11	MT	-	-	Saloon Engine AQN	603006	Inner Joint			33		34		
	2000.09-2003.11	-	L	F	Saloon Engine AQN	661062	Inner Joint			30		59		
	2000.09-2003.11	-	L	F	Saloon Engine AQN	261156	Drive Shaft		36		53	78	554.5	
TOLEDO III														
2.0 (110 KW)	2004.10-2009.05	-	L	F	Engine PS/5P2	261153	Drive Shaft		36	26	59.5	40	583	
TOLEDO III (5P2)														
1.4 16V (63 kW)	2006.05-2009.05	-	L/R	F	MPV Engine BXW	603008	Inner Joint			33		32		
	2006.05-2009.05	-	-	-	MPV Engine BXW	261237	Stub Axle		23	37	54		142.5	
	2006.05-2009.05	MT	-	-	MPV Engine BXW	603016	Inner Joint			28		32		
	2006.05-2009.05	-	R	F	MPV Engine BXW	253008	Drive Shaft		36		59.5	40	782	
	2006.05-2009.05	-	L	F	MPV Engine BXW	253007	Drive Shaft		36		59.5	40	559	
1.4 TSI (92 kW)	2006.05-2009.05	-	L/R	F	MPV Engine BXW	853001	Outer Joint		36	30	59.5	40	49	I
	2007.11-2009.05	-	L/R	F	MPV Engine CAXC	603011	Inner Joint			33		34		
	2007.11-2009.05	-	L/R	F	MPV Engine CAXC	803037	Outer Joint		36	30	59.5	40.5	55	I
	2007.11-2009.05	MT	-	-	MPV Engine CAXC	603016	Inner Joint			28		32		
1.6 (75 kW)	2007.11-2009.05	MT	-	-	MPV Engine CAXC	603006	Inner Joint			33		34		
	2004.10-2009.05	MT	-	-	MPV Engine BGU/BSE/BSF/CCSA	603006	Inner Joint			33		34		
	2004.10-2009.05	-	L/R	F	MPV Engine BGU/BSE/BSF/CCSA	803037	Outer Joint		36	30	59.5	40.5	55	I
	2004.10-2009.05	-	-	-	MPV Engine BGU/BSE/BSF/CCSA	261237	Stub Axle		23	37	54		142.5	
	2004.10-2009.05	MT	L	F	MPV Engine BGU/BSE/BSF/CCSA	261097	Drive Shaft		36		59.5	40.5	543	
	2004.10-2009.05	MT	-	-	MPV Engine BGU/BSE/BSF/CCSA	603016	Inner Joint			28		32		
	2004.10-2009.05	5MT	R	F	MPV Engine BGU/BSE/BSF/CCSA	261096	Drive Shaft		36		59.5	40.5	799	
1.8 TFSI (118 kW)	2004.10-2009.05	MT	L/R	F	MPV Engine BGU/BSE/BSF/CCSA	603011	Inner Joint			33		34		
	2004.10-2009.05	MT	L	F	MPV Engine BGU/BSE/BSF/CCSA	203320	Drive Shaft		36		59.5	40	546	
1.9 TDI (77 kW)	2007.01-2009.05	-	L/R	F	MPV Engine BYT/BZB/CDA	803002	Outer Joint		36	27	59.5	40	66	I
	2004.10-2009.05	MT	L	F	MPV Engine BJB/BKC/BLS/BXE	203294	Drive Shaft		36		59.5	38	519	
2.0 FSI (110 kW)	2004.10-2009.05	AT	L	F	MPV Engine BJB/BKC/BLS/BXE	654004	Inner Joint			34		85		
	2004.10-2009.05	AT	L	F	MPV Engine BJB/BKC/BLS/BXE	203241	Drive Shaft		36		59.5	40	475	
	2004.10-2009.05	MT	L	F	MPV Engine BJB/BKC/BLS/BXE	803116	Outer Joint		36	30	59.5	38	55	I
	2004.10-2009.05	MT	L/R	F	MPV Engine BJB/BKC/BLS/BXE	603011	Inner Joint			33		34		
	2004.10-2009.05	-	R	F	MPV Engine BJB/BKC/BLS/BXE	261042	Drive Shaft		36		59.5	40.5	814	
	2004.10-2009.05	-	L/R	F	MPV Engine BJB/BKC/BLS/BXE	803037	Outer Joint		36	30	59.5	40.5	55	I
	2004.10-2009.05	MT	R	F	MPV Engine BLR/BLY/BVY/BVZ	261113	Drive Shaft		36		59.5	40	814	
1.9 TDI (77 kW)	2004.10-2009.05	-	-	-	MPV Engine BLR/BLY/BVY/BVZ	261237	Stub Axle		23	37	54		142.5	
	2004.10-2009.05	AT	R	F	MPV Engine BLR/BLY/BVY/BVZ	261094	Drive Shaft		36	26	59.5	40.5	884	
	2004.10-2009.05	MT	L/R	F	MPV Engine BLR/BLY/BVY/BVZ	603011	Inner Joint			33		34		
	2004.10-2009.05	MT	R	F	MPV Engine BLR/BLY/BVY/BVZ	201585	Drive Shaft		36		59.5	40	805	
	2004.10-2009.05	MT	L	F	MPV Engine BLR/BLY/BVY/BVZ	803116	Outer Joint		36	30	59.5	38	55	I





	 YEAR	TRANSM	L/R	F/R	REMARKS	GSP Ref.	 PRODUCT	 ABS	Technical Specifications						
									A	B	C	H	L	P	
SEAT															
TOLEDO III (5P2)															
2.0 FSI (110 kW)	2004.10-2009.05	-	L/R	F	MPV Engine BLR/BLY/BVY/BVZ	803037	Outer Joint		36	30	59.5	40.5	55	I	
	2004.10-2009.05	AT	L/R	F	MPV Engine BLR/BLY/BVY/BVZ	661011	Inner Joint		26	32	31	68.5	85		
	2004.10-2009.05	AT	L	F	MPV Engine BLR/BLY/BVY/BVZ	261093	Drive Shaft		36	26	59.5	40.5	587.5		
2.0 TDI (100 kW)	2004.09-2009.05	AT	L/R	F	MPV Engine AZV	661057	Inner Joint			34		86			
	2004.09-2009.05	AT	R	F	MPV Engine AZV	254011	Drive Shaft		36		59.5	40	755		
	2004.09-2009.05	MT	L	F	MPV Engine AZV	203295	Drive Shaft		36		59.5	40	491		
	2004.09-2009.05	-	L/R	F	MPV Engine AZV	803002	Outer Joint		36	27	59.5	40	66	I	
	2004.09-2009.05	-	-	-	MPV Engine AZV	261237	Stub Axle		23	37	54		142.5		
	2004.09-2009.05	MT	R	F	MPV Engine AZV	203236	Drive Shaft		36		59.5	40	484		
	2004.09-2009.05	MT	R	F	MPV Engine AZV	203313	Drive Shaft		36		59.5	40	792		
	2004.09-2009.05	AT	L	F	MPV Engine AZV	254013	Drive Shaft		36		59.5	40	479.5		
	2004.09-2009.05	AT	L	F	MPV Engine AZV	654004	Inner Joint			34		85			
	2004.09-2009.05	AT	L	F	MPV Engine AZV	203241	Drive Shaft		36		59.5	40	475		
2.0 TDI (103 kW)	2004.09-2009.05	AT	L/R	F	MPV Engine AZV	861045	Outer Joint		36	27	59.5	40	65	M	
	2005.11-2009.05	AT	L/R	F	MPV Engine BMM	661057	Inner Joint			34		86			
	2005.11-2009.05	MT	L	F	MPV Engine BMM	203295	Drive Shaft		36		59.5	40	491		
	2005.11-2009.05	-	-	-	MPV Engine BMM	261237	Stub Axle		23	37	54		142.5		
	2005.11-2009.05	AT	L	F	MPV Engine BMM	203241	Drive Shaft		36		59.5	40	475		
	2005.11-2009.05	MT	R	F	MPV Engine BMM	203313	Drive Shaft		36		59.5	40	792		
	2005.11-2009.05	AT	L	F	MPV Engine BMM	254013	Drive Shaft		36		59.5	40	479.5		
	2005.11-2009.05	AT	L	F	MPV Engine BMM	654004	Inner Joint			34		85			
	2005.11-2009.05	MT	L/R	F	MPV Engine BMM	803002	Outer Joint		36	27	59.5	40	66	I	
	2005.11-2009.05	AT	R	F	MPV Engine BMM	254011	Drive Shaft		36		59.5	40	755		
2.0 TDI (125 kW)	2005.11-2009.05	AT	L/R	F	MPV Engine BMM	861045	Outer Joint		36	27	59.5	40	65	M	
	2006.01-2009.05	MT	L	F	MPV Engine BMN/CEGA	203265	Drive Shaft		36		59.5	40	487		
	2006.01-2009.05	-	-	-	MPV Engine BMN/CEGA	261237	Stub Axle		23	37	54		142.5		
	2006.01-2009.05	MT	L/R	F	MPV Engine BMN/CEGA	861045	Outer Joint		36	27	59.5	40	65	M	
	2006.01-2009.05	-	R	F	MPV Engine BMN/CEGA	261126	Drive Shaft		36		59.5	40	793		
	2.0 TDI 16V (103 kW)	2004.04-2009.05	AT	L/R	F	MPV Engine BKD	661057	Inner Joint			34		86		
		2004.04-2009.05	MT	R	F	MPV Engine BKD	203313	Drive Shaft		36		59.5	40	792	
		2004.04-2009.05	AT	R	F	MPV Engine BKD	203355	Drive Shaft		36	23	59.5	40	799	
		2004.04-2009.05	-	-	-	MPV Engine BKD	261237	Stub Axle		23	37	54		142.5	
		2004.04-2009.05	MT	R	F	MPV Engine BKD	203236	Drive Shaft		36		59.5	40	484	
2004.04-2009.05		AT	L	F	MPV Engine BKD	254013	Drive Shaft		36		59.5	40	479.5		
2004.04-2009.05		AT	L	F	MPV Engine BKD	654004	Inner Joint			34		85			
2004.04-2009.05		AT	L	F	MPV Engine BKD	203241	Drive Shaft		36		59.5	40	475		
2004.04-2009.05		MT	L/R	F	MPV Engine BKD	803002	Outer Joint		36	27	59.5	40	66	I	
2004.04-2009.05		MT	L	F	MPV Engine BKD	203295	Drive Shaft		36		59.5	40	491		
2.0 TFSI (147 kW)	2004.04-2009.05	AT	L/R	F	MPV Engine BKD	861045	Outer Joint		36	27	59.5	40	65	M	
	2004.04-2009.05	AT	R	F	MPV Engine BKD	254011	Drive Shaft		36		59.5	40	755		
	2005.11-2009.05	-	L	F	MPV Engine BWA	203295	Drive Shaft		36		59.5	40	491		
	2005.11-2009.05	-	-	-	MPV Engine BWA	261237	Stub Axle		23	37	54		142.5		
TOLEDO IV (KG3)	2005.11-2009.05	MT	L/R	F	MPV Engine BWA	803002	Outer Joint		36	27	59.5	40	66	I	
	2012.07-2012.07	-	-	R	Hatchback Engine CGPC	261267	Drive Shaft		36		50.7	58.5	765		
	2012.07-2012.07	-	-	L	Hatchback Engine CGPC	203330	Drive Shaft		36		50.7	58.5	515		
1.2 TSI (63 kW)	2012.07-2012.07	-	-	L	Hatchback Engine CGPC	203372	Drive Shaft		36		50.7	58.5	516		
	2012.07-2012.07	5MT/6MT	-	F	Hatchback Engine CBZA	803024	Outer Joint		36	30	50.75	59	54.5	I	
	2012.07-2012.07	MT	L	F	Hatchback Engine CBZA	261297	Drive Shaft		36		50.5	59	513		
	2012.07-2012.07	MT	R	F	Hatchback Engine CBZA	261301	Drive Shaft		36		50.5	59	771		
	2012.07-2012.07	-	L/R	F	Hatchback Engine CBZA	603011	Inner Joint			33		34			
	2012.07-2012.07	MT	R	F	Hatchback Engine CBZA	201586	Drive Shaft		36		59.5	40	806		
1.2 TSI (66 kW)	2012.07-2012.07	MT	-	-	Hatchback Engine CBZA	603006	Inner Joint			33		34			
	2015.05-2015.05	MT	L	F	Hatchback Engine CJZC	261263	Drive Shaft		36		52	59	514		
	2015.05-2015.05	MT	L	F	Hatchback Engine CJZC	854006	Outer Joint		36	30	52	59	55.5	I	
	2015.05-2015.05	MT	L/R	F	Hatchback Engine CJZC	603011	Inner Joint			33		34			
1.2 TSI (77 kW)	2012.07-2012.07	5MT/6MT	-	F	Hatchback Engine CBZB	803024	Outer Joint		36	30	50.75	59	54.5	I	
	2012.07-2012.07	MT	L	F	Hatchback Engine CBZB	261297	Drive Shaft		36		50.5	59	513		
	2012.07-2012.07	MT	R	F	Hatchback Engine CBZB	261301	Drive Shaft		36		50.5	59	771		
	2012.07-2012.07	-	L/R	F	Hatchback Engine CBZB	603011	Inner Joint			33		34			
	2012.07-2012.07	MT	R	F	Hatchback Engine CBZB	201586	Drive Shaft		36		59.5	40	806		
	2012.07-2012.07	MT	-	-	Hatchback Engine CBZB	603006	Inner Joint			33		34			
1.2 TSI (81 kW)	2015.05-2015.05	MT	L	F	Hatchback Engine CJZD	261263	Drive Shaft		36		52	59	514		
	2015.05-2015.05	MT	L	F	Hatchback Engine CJZD	854006	Outer Joint		36	30	52	59	55.5	I	
	2015.05-2015.05	MT	L/R	F	Hatchback Engine CJZD	603011	Inner Joint			33		34			
1.4 TDI (66 kW)	2015.05-2015.05	7AT	-	F	Hatchback Engine CUSB	803041	Outer Joint		36	27	50.5	75	65	I	

	 YEAR	TRANSM	L/R	F/R	REMARKS	GSP Ref.	 PRODUCT	 ABS	Technical Specifications						
									A	B	C	H	L	P	
SEAT															
TOLEDO IV (KG3)															
1.4 TDI (66 kW)	2015.05-	-	MT	L/R	F	Hatchback Engine CUSB	603011	Inner Joint			33		34		
1.4 TSI (90 kW)	2012.07-	-	-	L/R	F	Hatchback Engine CAXA	603011	Inner Joint			33		34		
	2012.07-	-	MT	R	F	Hatchback Engine CAXA	201586	Drive Shaft	36		59.5	40	806		
	2012.07-	-	-	R	F	Hatchback Engine CAXA	261311	Drive Shaft	36		50.5	59	492		
	2012.07-	-	AT	-	-	Hatchback Engine CAXA	603006	Inner Joint			33		34		
1.4 TSI (92 kW)	2015.05-	-	-	L/R	F	Hatchback Engine CZCA	603011	Inner Joint			33		34		
1.6 (77 kW)	2013.07-	-	MT	L/R	F	Hatchback Engine CFNA	603011	Inner Joint			33		34		
1.6 TDI (66 kW)	2013.06-	-	-	L	F	Hatchback Engine CAYB	261184	Drive Shaft	36		52	59	496		
	2013.06-	-	-	R	F	Hatchback Engine CAYB	261185	Drive Shaft	36		52	59	785		
	2013.06-	-	MT	L/R	F	Hatchback Engine CAYB	603011	Inner Joint			33		34		
	2013.06-	-	-	L	F	Hatchback Engine CAYB	854006	Outer Joint	36	30	52	59	55.5	I	
	2013.06-	-	MT	R	F	Hatchback Engine CAYB	261025	Drive Shaft	36		52	75	773.5		
1.6 TDI (77 kW)	2012.07-	-	5MT	-	F	Hatchback Engine CAYC/CLNA	803024	Outer Joint	36	30	50.75	59	54.5	I	
	2012.07-	-	-	L	F	Hatchback Engine CAYC/CLNA	261184	Drive Shaft	36		52	59	496		
	2012.07-	-	-	R	F	Hatchback Engine CAYC/CLNA	261185	Drive Shaft	36		52	59	785		
	2012.07-	-	-	L/R	F	Hatchback Engine CAYC/CLNA	603011	Inner Joint			33		34		
	2012.07-	-	-	L	F	Hatchback Engine CAYC/CLNA	854006	Outer Joint	36	30	52	59	55.5	I	
	2012.07-	-	MT	-	-	Hatchback Engine CAYC/CLNA	603006	Inner Joint			33		34		
1.6 TDI (85 kW)	2015.05-	-	-	L	F	Hatchback Engine CXMA	261184	Drive Shaft	36		52	59	496		
	2015.05-	-	-	R	F	Hatchback Engine CXMA	261185	Drive Shaft	36		52	59	785		
	2015.05-	-	-	L	F	Hatchback Engine CXMA	854006	Outer Joint	36	30	52	59	55.5	I	
	2015.05-	-	MT	L/R	F	Hatchback Engine CXMA	603011	Inner Joint			33		34		
	2015.05-	-	MT	R	F	Hatchback Engine CXMA	261025	Drive Shaft	36		52	75	773.5		
SKODA															
CITIGO															
1.0 (44 kW)	2011.10-	-	-	L/R	F	Hatchback Engine CHYA	850170	Outer Joint		22	26	46	78	53	M
	2011.10-	-	-	L	F	Hatchback Engine CHYA	250567	Drive Shaft	22	28	46	78	650		
	2011.10-	-	-	R	F	Hatchback Engine CHYA	250543	Drive Shaft	22	28	46	78	814		
	2011.10-	-	-	-	F	Hatchback Engine CHYA	850153	Outer Joint	22	26	46	78	55	M	
1.0 (55 kW)	2011.10-	-	-	L/R	F	Hatchback Engine CHYB	850170	Outer Joint	22	26	46	78	53	M	
	2011.10-	-	-	L	F	Hatchback Engine CHYB	250567	Drive Shaft	22	28	46	78	650		
	2011.10-	-	-	R	F	Hatchback Engine CHYB	250543	Drive Shaft	22	28	46	78	814		
1.0 CNG (50 kW)	2011.10-	-	-	-	F	Hatchback Engine CHYB	850153	Outer Joint	22	26	46	78	55	M	
	2012.11-	-	MT	L/R	F	Hatchback Engine CPGA	850170	Outer Joint	22	26	46	78	53	M	
	2012.11-	-	-	L	F	Hatchback Engine CPGA	250567	Drive Shaft	22	28	46	78	650		
	2012.11-	-	-	R	F	Hatchback Engine CPGA	250543	Drive Shaft	22	28	46	78	814		
2012.11-	-	-	-	F	Hatchback Engine CPGA	850153	Outer Joint	22	26	46	78	55	M		
FABIA I (6Y2)															
1.0 (37 kW)	1999.12-	2002.08	MT	-	F	Hatchback Engine AQV/ARV	854002	Outer Joint		20	30	52	59.5	49.5	I
1.2 (40 kW)	2002.08-	2008.03	5MT	R	F	Hatchback Engine AWY/BMD	261063	Drive Shaft	36		50.7	58.5	751		
	2002.08-	2008.03	MT	R	F	Hatchback Engine AWY/BMD	261077	Drive Shaft	36		50.7	58.5	750		
	2002.08-	2008.03	MT	-	F	Hatchback Engine AWY/BMD	854002	Outer Joint	20	30	52	59.5	49.5	I	
	2002.08-	2008.03	-	-	F	Hatchback Engine AWY/BMD	803027	Outer Joint	36	30	50.7	58.5	47.5	I	
	2002.08-	2008.03	5MT	L	F	Hatchback Engine AWY/BMD	203063	Drive Shaft	36		50.7	58.5	501		
1.2 (47 kW)	2003.01-	2008.03	5MT	R	F	Hatchback Engine AZQ/BME	261063	Drive Shaft	36		50.7	58.5	751		
	2003.01-	2008.03	MT	R	F	Hatchback Engine AZQ/BME	261077	Drive Shaft	36		50.7	58.5	750		
	2003.01-	2008.03	MT	-	F	Hatchback Engine AZQ/BME	854002	Outer Joint	20	30	52	59.5	49.5	I	
	2003.01-	2008.03	-	-	F	Hatchback Engine AZQ/BME	803027	Outer Joint	36	30	50.7	58.5	47.5	I	
	2003.01-	2008.03	5MT	L	F	Hatchback Engine AZQ/BME	203063	Drive Shaft	36		50.7	58.5	501		
1.4 (44 kW)	2000.08-	2002.08	MT	-	F	Hatchback Engine AZE/AZF	854002	Outer Joint	20	30	52	59.5	49.5	I	
	2000.08-	2002.08	-	-	F	Hatchback Engine AZE/AZF	803027	Outer Joint	36	30	50.7	58.5	47.5	I	
1.4 (50 kW)	1999.08-	2003.05	-	-	F	Hatchback Engine AME/AQW/ATZ	803027	Outer Joint	36	30	50.7	58.5	47.5	I	
1.4 16V (55 kW)	1999.12-	2008.03	AT	L/R	F	Hatchback Engine AUA/BBY/BKY	661005	Inner Joint			30		57.6		
	1999.12-	2008.03	5MT	R	F	Hatchback Engine AUA/BBY/BKY	261063	Drive Shaft	36		50.7	58.5	751		
	1999.12-	2008.03	AT	-	F	Hatchback Engine AUA/BBY/BKY	803024	Outer Joint	36	30	50.75	59	54.5	I	
	1999.12-	2008.03	MT	R	F	Hatchback Engine AUA/BBY/BKY	261077	Drive Shaft	36		50.7	58.5	750		
	1999.12-	2008.03	AT	R	F	Hatchback Engine AUA/BBY/BKY	261252	Drive Shaft	36		53.7	58.5	730		
	1999.12-	2008.03	AT	R	F	Hatchback Engine AUA/BBY/BKY	861070	Outer Joint	36	30	53.7	58.5	55	I	
	1999.12-	2008.03	MT	-	F	Hatchback Engine AUA/BBY/BKY	803027	Outer Joint	36	30	50.7	58.5	47.5	I	
	1999.12-	2008.03	5MT	L	F	Hatchback Engine AUA/BBY/BKY	203063	Drive Shaft	36		50.7	58.5	501		
1.4 16V (74 kW)	1999.12-	2008.03	5MT	R	F	Hatchback Engine AUB/BBZ	261063	Drive Shaft	36		50.7	58.5	751		
	1999.12-	2008.03	MT	R	F	Hatchback Engine AUB/BBZ	261077	Drive Shaft	36		50.7	58.5	750		
	1999.12-	2008.03	-	-	F	Hatchback Engine AUB/BBZ	803027	Outer Joint	36	30	50.7	58.5	47.5	I	
	1999.12-	2008.03	5MT	L	F	Hatchback Engine AUB/BBZ	203063	Drive Shaft	36		50.7	58.5	501		

	 YEAR	TRANSM	L/R	F/R	REMARKS	GSP Ref.	 PRODUCT	 ABS	Technical Specifications						
									A	B	C	H	L	P	
SKODA															
FABIA I (6Y2)															
1.4 TDI (51 kW)	2005.10-2008.03	-	-	F	Hatchback Engine BNM	803024	Outer Joint		36	30	50.75	59	54.5	I	
	2005.10-2008.03	-	R	F	Hatchback Engine BNM	261077	Drive Shaft		36		50.7	58.5	750		
	2005.10-2008.03	MT	R	F	Hatchback Engine BNM	261223	Drive Shaft		36		52	59	757		
	2005.10-2008.03	MT	L	F	Hatchback Engine BNM	261078	Drive Shaft		36		50.7	58.5	501		
	2005.10-2008.03	MT	R	F	Hatchback Engine BNM	854006	Outer Joint		36	30	52	59	55.5	I	
1.4 TDI (55 kW)	2003.04-2008.03	-	-	F	Hatchback Engine AMF	803024	Outer Joint		36	30	50.75	59	54.5	I	
	2003.04-2008.03	MT	L	F	Hatchback Engine AMF	661062	Inner Joint			30		59			
	2003.04-2008.03	5MT	L	F	Hatchback Engine AMF	261098	Drive Shaft		36		50.5	59	472		
	2003.04-2008.03	MT	L	F	Hatchback Engine AMF	854006	Outer Joint		36	30	52	59	55.5	I	
	2003.04-2008.03	5MT	R	F	Hatchback Engine AMF	261099	Drive Shaft		36		50.5	59	759		
	2003.04-2008.03	MT	L	F	Hatchback Engine AMF	261135	Drive Shaft		36		52	59	475		
	2003.04-2008.03	-	L/R	F	Hatchback Engine AMF	661006	Inner Joint			30		57.6			
1.4 TDI (59 kW)	2005.10-2008.03	-	-	F	Hatchback Engine BNV	803024	Outer Joint		36	30	50.75	59	54.5	I	
	2005.10-2008.03	MT	L	F	Hatchback Engine BNV	661062	Inner Joint			30		59			
	2005.10-2008.03	5MT	L	F	Hatchback Engine BNV	261098	Drive Shaft		36		50.5	59	472		
	2005.10-2008.03	MT	L	F	Hatchback Engine BNV	854006	Outer Joint		36	30	52	59	55.5	I	
	2005.10-2008.03	5MT	R	F	Hatchback Engine BNV	261099	Drive Shaft		36		50.5	59	759		
	2005.10-2008.03	MT	L	F	Hatchback Engine BNV	261135	Drive Shaft		36		52	59	475		
	2005.10-2008.03	-	L/R	F	Hatchback Engine BNV	661006	Inner Joint			30		57.6			
1.9 SDI (47 kW)	1999.12-2008.03	5MT	R	F	Hatchback Engine ASY	261063	Drive Shaft		36		50.7	58.5	751		
	1999.12-2008.03	-	R	F	Hatchback Engine ASY	261077	Drive Shaft		36		50.7	58.5	750		
	1999.12-2008.03	MT	-	F	Hatchback Engine ASY	854002	Outer Joint		20	30	52	59.5	49.5	I	
	1999.12-2008.03	-	-	F	Hatchback Engine ASY	803027	Outer Joint		36	30	50.7	58.5	47.5	I	
	1999.12-2008.03	5MT	L	F	Hatchback Engine ASY	203063	Drive Shaft		36		50.7	58.5	501		
	1.9 TDI (74 kW)	2000.01-2008.03	-	-	F	Hatchback Engine ATD/AXR	803024	Outer Joint		36	30	50.75	59	54.5	I
		2000.01-2008.03	MT	L	F	Hatchback Engine ATD/AXR	661062	Inner Joint			30		59		
2000.01-2008.03		5MT	L	F	Hatchback Engine ATD/AXR	261098	Drive Shaft		36		50.5	59	472		
2000.01-2008.03		MT	L	F	Hatchback Engine ATD/AXR	854006	Outer Joint		36	30	52	59	55.5	I	
2000.01-2008.03		5MT	R	F	Hatchback Engine ATD/AXR	261099	Drive Shaft		36		50.5	59	759		
2000.01-2008.03		MT	L	F	Hatchback Engine ATD/AXR	261135	Drive Shaft		36		52	59	475		
2000.01-2008.03		MT	R	F	Hatchback Engine ATD/AXR	261136	Drive Shaft		36		52	59	763		
1.9 TDI RS (96 kW)	2003.06-2008.03	MT	L/R	F	Hatchback Engine ASZ/BLT	853002	Outer Joint		36	27	50.75	75	65	I	
	2003.06-2008.03	MT	R	F	Hatchback Engine ASZ/BLT	261183	Drive Shaft		36		50.5	75	769		
	2003.06-2008.03	MT	-	F	Hatchback Engine ASZ/BLT	854002	Outer Joint		20	30	52	59.5	49.5	I	
	2003.06-2008.03	MT	L	F	Hatchback Engine ASZ/BLT	261204	Drive Shaft		36		50.5	75	461		
2.0 (85 kW)	1999.12-2008.03	-	-	F	Hatchback Engine AZL	803024	Outer Joint		36	30	50.75	59	54.5	I	
	1999.12-2008.03	MT	-	F	Hatchback Engine AZL	854002	Outer Joint		20	30	52	59.5	49.5	I	
FABIA I (6Y3)															
1.2 (40 kW)	2001.07-2007.12	5MT	R	F	Saloon Engine AWY/BMD	261063	Drive Shaft		36		50.7	58.5	751		
	2001.07-2007.12	MT	-	F	Saloon Engine AWY/BMD	854002	Outer Joint		20	30	52	59.5	49.5	I	
	2001.07-2007.12	-	-	F	Saloon Engine AWY/BMD	803027	Outer Joint		36	30	50.7	58.5	47.5	I	
	2001.07-2007.12	5MT	L	F	Saloon Engine AWY/BMD	203063	Drive Shaft		36		50.7	58.5	501		
1.2 (47 kW)	2003.01-2007.12	5MT	R	F	Saloon Engine AZQ/BME	261063	Drive Shaft		36		50.7	58.5	751		
	2003.01-2007.12	-	R	F	Saloon Engine AZQ/BME	261077	Drive Shaft		36		50.7	58.5	750		
	2003.01-2007.12	MT	-	F	Saloon Engine AZQ/BME	854002	Outer Joint		20	30	52	59.5	49.5	I	
	2003.01-2007.12	-	-	F	Saloon Engine AZQ/BME	803027	Outer Joint		36	30	50.7	58.5	47.5	I	
1.4 (44 kW)	2000.04-2002.08	MT	-	F	Saloon Engine AZE/AZF	854002	Outer Joint		20	30	52	59.5	49.5	I	
	2000.04-2002.08	-	-	F	Saloon Engine AZE/AZF	803027	Outer Joint		36	30	50.7	58.5	47.5	I	
1.4 (50 kW)	2001.07-2003.05	-	-	F	Saloon Engine AME/AQW/ATZ	803027	Outer Joint		36	30	50.7	58.5	47.5	I	
1.4 16V (55 kW)	1999.10-2007.12	AT	L/R	F	Saloon Engine AUA/BBY/BKY	661005	Inner Joint			30		57.6			
	1999.10-2007.12	5MT	R	F	Saloon Engine AUA/BBY/BKY	261063	Drive Shaft		36		50.7	58.5	751		
	1999.10-2007.12	AT	-	F	Saloon Engine AUA/BBY/BKY	803024	Outer Joint		36	30	50.75	59	54.5	I	
	1999.10-2007.12	AT	R	F	Saloon Engine AUA/BBY/BKY	261252	Drive Shaft		36		53.7	58.5	730		
	1999.10-2007.12	AT	R	F	Saloon Engine AUA/BBY/BKY	861070	Outer Joint		36	30	53.7	58.5	55	I	
	1999.10-2007.12	-	R	F	Saloon Engine AUA/BBY/BKY	261077	Drive Shaft		36		50.7	58.5	750		
	1999.10-2007.12	MT	-	F	Saloon Engine AUA/BBY/BKY	803027	Outer Joint		36	30	50.7	58.5	47.5	I	
1.4 16V (59 kW)	2006.04-2007.12	-	L	F	Saloon Engine BUD	203063	Drive Shaft		36		50.7	58.5	501		
	2006.04-2007.12	-	R	F	Saloon Engine BUD	261063	Drive Shaft		36		50.7	58.5	751		
	2006.04-2007.12	-	R	F	Saloon Engine BUD	261077	Drive Shaft		36		50.7	58.5	750		
	2006.04-2007.12	MT	-	F	Saloon Engine BUD	803027	Outer Joint		36	30	50.7	58.5	47.5	I	
1.4 16V (74 kW)	1999.12-2007.12	5MT	R	F	Saloon Engine AUB/BBZ	261063	Drive Shaft		36		50.7	58.5	751		





	 YEAR	TRANSM	L/R	F/R	REMARKS	GSP Ref.	 PRODUCT	 ABS	Technical Specifications					
									A	B	C	H	L	P
SKODA														
FABIA I (6Y3)														
1.4 16V (74 kW)	1999.12-2007.12	MT	-	F	Saloon Engine AUB/BBZ	803024	Outer Joint		36	30	50.75	59	54.5	I
	1999.12-2007.12	-	R	F	Saloon Engine AUB/BBZ	261077	Drive Shaft		36		50.7	58.5	750	
	1999.12-2007.12	-	-	F	Saloon Engine AUB/BBZ	803027	Outer Joint		36	30	50.7	58.5	47.5	I
	1999.12-2007.12	5MT	L	F	Saloon Engine AUB/BBZ	203063	Drive Shaft		36		50.7	58.5	501	
1.4 TDI (51 kW)	2005.10-2007.12	-	-	F	Saloon Engine BNM	803024	Outer Joint		36	30	50.75	59	54.5	I
	2005.10-2007.12	-	R	F	Saloon Engine BNM	261077	Drive Shaft		36		50.7	58.5	750	
	2005.10-2007.12	MT	R	F	Saloon Engine BNM	261223	Drive Shaft		36		52	59	757	
	2005.10-2007.12	MT	L	F	Saloon Engine BNM	261078	Drive Shaft		36		50.7	58.5	501	
	2005.10-2007.12	MT	R	F	Saloon Engine BNM	854006	Outer Joint		36	30	52	59	55.5	I
1.4 TDI (55 kW)	2003.04-2007.12	-	-	F	Saloon Engine AMF	803024	Outer Joint		36	30	50.75	59	54.5	I
	2003.04-2007.12	MT	L	F	Saloon Engine AMF	661062	Inner Joint					59		
	2003.04-2007.12	5MT	L	F	Saloon Engine AMF	261098	Drive Shaft		36		50.5	59	472	
	2003.04-2007.12	MT	L	F	Saloon Engine AMF	854006	Outer Joint		36	30	52	59	55.5	I
	2003.04-2007.12	5MT	R	F	Saloon Engine AMF	261099	Drive Shaft		36		50.5	59	759	
	2003.04-2007.12	MT	L	F	Saloon Engine AMF	261135	Drive Shaft		36		52	59	475	
	2003.04-2007.12	-	L/R	F	Saloon Engine AMF	661006	Inner Joint			30		57.6		
	2003.04-2007.12	MT	R	F	Saloon Engine AMF	261136	Drive Shaft		36		52	59	763	
	2003.04-2007.12	-	-	F	Saloon Engine AMF	803024	Outer Joint		36	30	50.75	59	54.5	I
1.4 TDI (59 kW)	2005.10-2007.12	MT	L	F	Saloon Engine BNV	661062	Inner Joint			30		59		
	2005.10-2007.12	5MT	L	F	Saloon Engine BNV	261098	Drive Shaft		36		50.5	59	472	
	2005.10-2007.12	MT	L	F	Saloon Engine BNV	854006	Outer Joint		36	30	52	59	55.5	I
	2005.10-2007.12	5MT	R	F	Saloon Engine BNV	261099	Drive Shaft		36		50.5	59	759	
	2005.10-2007.12	MT	L	F	Saloon Engine BNV	261135	Drive Shaft		36		52	59	475	
	2005.10-2007.12	MT	R	F	Saloon Engine BNV	261136	Drive Shaft		36		52	59	763	
	2005.10-2007.12	-	L/R	F	Saloon Engine BNV	661006	Inner Joint			30		57.6		
	2005.10-2007.12	-	-	F	Saloon Engine BNV	803024	Outer Joint		36	30	50.75	59	54.5	I
1.9 SDI (47 kW)	1999.11-2007.12	5MT	R	F	Saloon Engine ASY	261063	Drive Shaft		36		50.7	58.5	751	
	1999.11-2007.12	-	R	F	Saloon Engine ASY	261077	Drive Shaft		36		50.7	58.5	750	
	1999.11-2007.12	MT	-	F	Saloon Engine ASY	854002	Outer Joint		20	30	52	59.5	49.5	I
	1999.11-2007.12	-	-	F	Saloon Engine ASY	803027	Outer Joint		36	30	50.7	58.5	47.5	I
	1999.11-2007.12	5MT	L	F	Saloon Engine ASY	203063	Drive Shaft		36		50.7	58.5	501	
	1999.11-2007.12	-	-	F	Saloon Engine ASY	803024	Outer Joint		36	30	50.75	59	54.5	I
1.9 TDI (74 kW)	2000.01-2007.12	MT	L	F	Saloon Engine ATD/AXR	661062	Inner Joint			30		59		
	2000.01-2007.12	5MT	L	F	Saloon Engine ATD/AXR	261098	Drive Shaft		36		50.5	59	472	
	2000.01-2007.12	MT	L	F	Saloon Engine ATD/AXR	854006	Outer Joint		36	30	52	59	55.5	I
	2000.01-2007.12	5MT	R	F	Saloon Engine ATD/AXR	261099	Drive Shaft		36		50.5	59	759	
	2000.01-2007.12	MT	L	F	Saloon Engine ATD/AXR	261135	Drive Shaft		36		52	59	475	
	2000.01-2007.12	MT	R	F	Saloon Engine ATD/AXR	261136	Drive Shaft		36		52	59	763	
	2000.01-2007.12	-	L/R	F	Saloon Engine ATD/AXR	661006	Inner Joint			30		57.6		
	2000.01-2007.12	-	-	F	Saloon Engine ATD/AXR	803024	Outer Joint		36	30	50.75	59	54.5	I
2.0 (85 kW)	1999.12-2007.12	-	-	F	Saloon Engine AZL	803024	Outer Joint		36	30	50.75	59	54.5	I
	1999.12-2007.12	MT	-	F	Saloon Engine AZL	854002	Outer Joint		20	30	52	59.5	49.5	I
FABIA I Combi (6Y5)														
1.2 (40 kW)	2001.07-2007.12	5MT	R	F	Estate Engine AWY/BMD	261063	Drive Shaft		36		50.7	58.5	751	
	2001.07-2007.12	MT	-	F	Estate Engine AWY/BMD	854002	Outer Joint		20	30	52	59.5	49.5	I
	2001.07-2007.12	-	-	F	Estate Engine AWY/BMD	803027	Outer Joint		36	30	50.7	58.5	47.5	I
	2001.07-2007.12	5MT	L	F	Estate Engine AWY/BMD	203063	Drive Shaft		36		50.7	58.5	501	
1.2 (47 kW)	2003.01-2007.12	5MT	R	F	Estate Engine AZQ/BME	261063	Drive Shaft		36		50.7	58.5	751	
	2003.01-2007.12	-	R	F	Estate Engine AZQ/BME	261077	Drive Shaft		36		50.7	58.5	750	
	2003.01-2007.12	MT	-	F	Estate Engine AZQ/BME	854002	Outer Joint		20	30	52	59.5	49.5	I
	2003.01-2007.12	-	-	F	Estate Engine AZQ/BME	803027	Outer Joint		36	30	50.7	58.5	47.5	I
1.4 (44 kW)	2000.04-2003.03	MT	-	F	Estate Engine AZE/AZF	854002	Outer Joint		20	30	52	59.5	49.5	I
	2000.04-2003.03	-	-	F	Estate Engine AZE/AZF	803027	Outer Joint		36	30	50.7	58.5	47.5	I
1.4 (50 kW)	2000.04-2003.05	-	-	F	Estate Engine AME/AQW/ATZ	803027	Outer Joint		36	30	50.7	58.5	47.5	I
1.4 16V (55 kW)	2000.05-2007.12	AT	L/R	F	Estate Engine AUA/BBY/BKY	661005	Inner Joint			30		57.6		
	2000.05-2007.12	5MT	R	F	Estate Engine AUA/BBY/BKY	261063	Drive Shaft		36		50.7	58.5	751	
	2000.05-2007.12	AT	-	F	Estate Engine AUA/BBY/BKY	803024	Outer Joint		36	30	50.75	59	54.5	I
	2000.05-2007.12	MT	R	F	Estate Engine AUA/BBY/BKY	261077	Drive Shaft		36		50.7	58.5	750	
	2000.05-2007.12	AT	R	F	Estate Engine AUA/BBY/BKY	261252	Drive Shaft		36		53.7	58.5	730	
	2000.05-2007.12	AT	R	F	Estate Engine AUA/BBY/BKY	861070	Outer Joint		36	30	53.7	58.5	55	I
	2000.05-2007.12	MT	-	F	Estate Engine AUA/BBY/BKY	803027	Outer Joint		36	30	50.7	58.5	47.5	I
	2000.05-2007.12	5MT	L	F	Estate Engine AUA/BBY/BKY	203063	Drive Shaft		36		50.7	58.5	501	
1.4 16V (59 kW)	2006.04-2007.12	-	L	F	Estate Engine BUD	203063	Drive Shaft		36		50.7	58.5	501	
	2006.04-2007.12	-	R	F	Estate Engine BUD	261063	Drive Shaft		36		50.7	58.5	751	
	2006.04-2007.12	-	R	F	Estate Engine BUD	261077	Drive Shaft		36		50.7	58.5	750	
	2006.04-2007.12	-	-	F	Estate Engine BUD	803027	Outer Joint		36	30	50.7	58.5	47.5	I
1.4 16V (74 kW)	2000.04-2007.12	5MT	R	F	Estate Engine AUB/BBZ	261063	Drive Shaft		36		50.7	58.5	751	





	YEAR	TRANSM	L/R	F/R	REMARKS	GSP Ref.	PRODUCT	ABS	Technical Specifications									
									A	B	C	H	L	P				
SKODA																		
FABIA I Combi (6Y5)																		
1.4 16V (74 kW)	2000.04-2007.12	MT	R	F	Estate Engine AUB/BBZ	261077	Drive Shaft		36		50.7	58.5	750					
	2000.04-2007.12	-	-	F	Estate Engine AUB/BBZ	803027	Outer Joint		36	30	50.7	58.5	47.5	I				
	2000.04-2007.12	5MT	L	F	Estate Engine AUB/BBZ	203063	Drive Shaft		36		50.7	58.5	501					
1.4 TDI (51 kW)	2005.10-2007.12	-	-	F	Estate Engine BNM	803024	Outer Joint		36	30	50.75	59	54.5	I				
	2005.10-2007.12	-	R	F	Estate Engine BNM	261077	Drive Shaft		36		50.7	58.5	750					
	2005.10-2007.12	MT	R	F	Estate Engine BNM	261223	Drive Shaft		36		52	59	757					
	2005.10-2007.12	MT	L	F	Estate Engine BNM	261078	Drive Shaft		36		50.7	58.5	501					
	2005.10-2007.12	MT	R	F	Estate Engine BNM	854006	Outer Joint		36	30	52	59	55.5	I				
1.4 TDI (55 kW)	2003.04-2007.12	-	-	F	Estate Engine AMF	803024	Outer Joint		36	30	50.75	59	54.5	I				
	2003.04-2007.12	MT	L	F	Estate Engine AMF	661062	Inner Joint			30		59						
	2003.04-2007.12	5MT	L	F	Estate Engine AMF	261098	Drive Shaft		36		50.5	59	472					
	2003.04-2007.12	MT	L	F	Estate Engine AMF	854006	Outer Joint		36	30	52	59	55.5	I				
	2003.04-2007.12	5MT	R	F	Estate Engine AMF	261099	Drive Shaft		36		50.5	59	759					
	2003.04-2007.12	MT	L	F	Estate Engine AMF	261135	Drive Shaft		36		52	59	475					
	2003.04-2007.12	-	L/R	F	Estate Engine AMF	661006	Inner Joint			30		57.6						
	2003.04-2007.12	MT	R	F	Estate Engine AMF	261136	Drive Shaft		36		52	59	763					
1.4 TDI (59 kW)	2005.10-2007.12	-	-	F	Estate Engine BNV	803024	Outer Joint		36	30	50.75	59	54.5	I				
	2005.10-2007.12	MT	L	F	Estate Engine BNV	661062	Inner Joint			30		59						
	2005.10-2007.12	5MT	L	F	Estate Engine BNV	261098	Drive Shaft		36		50.5	59	472					
	2005.10-2007.12	MT	L	F	Estate Engine BNV	854006	Outer Joint		36	30	52	59	55.5	I				
	2005.10-2007.12	5MT	R	F	Estate Engine BNV	261099	Drive Shaft		36		50.5	59	759					
	2005.10-2007.12	MT	L	F	Estate Engine BNV	261135	Drive Shaft		36		52	59	475					
	2005.10-2007.12	MT	R	F	Estate Engine BNV	261136	Drive Shaft		36		52	59	763					
	2005.10-2007.12	-	L/R	F	Estate Engine BNV	661006	Inner Joint			30		57.6						
1.9 SDI (47 kW)	2000.04-2007.12	5MT	R	F	Estate Engine ASY	261063	Drive Shaft		36		50.7	58.5	751					
	2000.04-2007.12	MT	R	F	Estate Engine ASY	261077	Drive Shaft		36		50.7	58.5	750					
	2000.04-2007.12	MT	-	F	Estate Engine ASY	854002	Outer Joint		20	30	52	59.5	49.5	I				
	2000.04-2007.12	-	-	F	Estate Engine ASY	803027	Outer Joint		36	30	50.7	58.5	47.5	I				
	2000.04-2007.12	5MT	L	F	Estate Engine ASY	203063	Drive Shaft		36		50.7	58.5	501					
1.9 TDI (74 kW)	2000.04-2007.12	-	-	F	Estate Engine ATD/AXR	803024	Outer Joint		36	30	50.75	59	54.5	I				
	2000.04-2007.12	MT	L	F	Estate Engine ATD/AXR	661062	Inner Joint			30		59						
	2000.04-2007.12	5MT	L	F	Estate Engine ATD/AXR	261098	Drive Shaft		36		50.5	59	472					
	2000.04-2007.12	MT	L	F	Estate Engine ATD/AXR	854006	Outer Joint		36	30	52	59	55.5	I				
	2000.04-2007.12	5MT	R	F	Estate Engine ATD/AXR	261099	Drive Shaft		36		50.5	59	759					
	2000.04-2007.12	MT	L	F	Estate Engine ATD/AXR	261135	Drive Shaft		36		52	59	475					
	2000.04-2007.12	MT	R	F	Estate Engine ATD/AXR	261136	Drive Shaft		36		52	59	763					
	2000.04-2007.12	-	L/R	F	Estate Engine ATD/AXR	661006	Inner Joint			30		57.6						
2.0 (85 kW)	2000.04-2007.12	-	-	F	Estate Engine AZL	803024	Outer Joint		36	30	50.75	59	54.5	I				
	2000.04-2007.12	MT	-	F	Estate Engine AZL	854002	Outer Joint		20	30	52	59.5	49.5	I				
FABIA I Praktik (6Y5)																		
1.2 (40 kW)	2001.07-2007.12	5MT	R	F	Box Engine AWY/BMD	261063	Drive Shaft		36		50.7	58.5	751					
	2001.07-2007.12	MT	-	F	Box Engine AWY/BMD	854002	Outer Joint		20	30	52	59.5	49.5	I				
	2001.07-2007.12	-	-	F	Box Engine AWY/BMD	803027	Outer Joint		36	30	50.7	58.5	47.5	I				
	2001.07-2007.12	5MT	L	F	Box Engine AWY/BMD	203063	Drive Shaft		36		50.7	58.5	501					
1.2 (47 kW)	2003.01-2007.12	5MT	R	F	Box Engine AZQ/BME	261063	Drive Shaft		36		50.7	58.5	751					
	2003.01-2007.12	-	R	F	Box Engine AZQ/BME	261077	Drive Shaft		36		50.7	58.5	750					
	2003.01-2007.12	MT	-	F	Box Engine AZQ/BME	854002	Outer Joint		20	30	52	59.5	49.5	I				
	2003.01-2007.12	-	-	F	Box Engine AZQ/BME	803027	Outer Joint		36	30	50.7	58.5	47.5	I				
	2003.01-2007.12	5MT	L	F	Box Engine AZQ/BME	203063	Drive Shaft		36		50.7	58.5	501					
1.4 (50 kW)	2001.07-2003.05	-	-	F	Box Engine AME/AQW/ATZ	803027	Outer Joint		36	30	50.7	58.5	47.5	I				
1.4 TDI (51 kW)	2005.10-2007.12	-	-	F	Box Engine BNM	803024	Outer Joint		36	30	50.75	59	54.5	I				
	2005.10-2007.12	-	R	F	Box Engine BNM	261077	Drive Shaft		36		50.7	58.5	750					
	2005.10-2007.12	MT	R	F	Box Engine BNM	261223	Drive Shaft		36		52	59	757					
	2005.10-2007.12	MT	L	F	Box Engine BNM	261078	Drive Shaft		36		50.7	58.5	501					
	2005.10-2007.12	MT	R	F	Box Engine BNM	854006	Outer Joint		36	30	52	59	55.5	I				
1.9 SDI (47 kW)	2001.07-2007.12	5MT	R	F	Box Engine ASY	261063	Drive Shaft		36		50.7	58.5	751					
	2001.07-2007.12	-	R	F	Box Engine ASY	261077	Drive Shaft		36		50.7	58.5	750					
	2001.07-2007.12	MT	-	F	Box Engine ASY	854002	Outer Joint		20	30	52	59.5	49.5	I				
	2001.07-2007.12	-	-	F	Box Engine ASY	803027	Outer Joint		36	30	50.7	58.5	47.5	I				
	2001.07-2007.12	5MT	L	F	Box Engine ASY	203063	Drive Shaft		36		50.7	58.5	501					
FABIA II (542)																		
1.2 (44 kW)	2006.12-2014.12	MT	R	F	Hatchback Engine BBM/CHFA	261063	Drive Shaft		36		50.7	58.5	751					
	2006.12-2014.12	-	R	F	Hatchback Engine BBM/CHFA	261077	Drive Shaft		36		50.7	58.5	750					
	2006.12-2014.12	MT	-	F	Hatchback Engine BBM/CHFA	803027	Outer Joint		36	30	50.7	58.5	47.5	I				
	2006.12-2014.12	MT	L	F	Hatchback Engine BBM/CHFA	203063	Drive Shaft		36		50.7	58.5	501					
1.2 (51 kW)	2007.01-2014.12	MT	R	F	Hatchback Engine BZG/CEVA/CGPA/CHTA	261063	Drive Shaft		36		50.7	58.5	751					





	 YEAR	TRANSM	L/R	F/R	REMARKS	GSP Ref.	 PRODUCT	 ABS	Technical Specifications									
									A	B	C	H	L	P				
SKODA																		
FABIA II (542)																		
1.2 (51 kW)	2007.01-2014.12	MT	R	F	Hatchback Engine BZG/CEVA/CGPA/CHTA	261077	Drive Shaft		36		50.7	58.5	750					
	2007.01-2014.12	MT	-	F	Hatchback Engine BZG/CEVA/CGPA/CHTA	803027	Outer Joint		36	30	50.7	58.5	47.5	I				
	2007.01-2014.12	MT	L	F	Hatchback Engine BZG/CEVA/CGPA/CHTA	203063	Drive Shaft		36		50.7	58.5	501					
1.2 12V (44 kW)	2011.11-2014.12	-	R	F	Hatchback Engine CGPB	261063	Drive Shaft		36		50.7	58.5	751					
	2011.11-2014.12	-	R	F	Hatchback Engine CGPB	261077	Drive Shaft		36		50.7	58.5	750					
	2011.11-2014.12	-	L	F	Hatchback Engine CGPB	203063	Drive Shaft		36		50.7	58.5	501					
1.2 TDI (55 kW)	2010.05-2014.12	MT	L	F	Hatchback Engine CFWA	854006	Outer Joint		36	30	52	59	55.5	I				
	2010.05-2014.12	5MT	-	F	Hatchback Engine CFWA	803024	Outer Joint		36	30	50.75	59	54.5	I				
	2010.05-2014.12	MT	L	F	Hatchback Engine CFWA	261248	Drive Shaft		36		52	59	480					
	2010.05-2014.12	MT	R	F	Hatchback Engine CFWA	261247	Drive Shaft		36		52	59	765					
	2010.05-2014.12	MT	-	-	Hatchback Engine CFWA	603006	Inner Joint			33		34						
	2010.05-2014.12	MT	L	F	Hatchback Engine CFWA	261302	Drive Shaft		36		50.5	59	479					
	2010.05-2014.12	-	L/R	F	Hatchback Engine CFWA	603011	Inner Joint			33		34						
1.2 TSI (63 kW)	2010.03-2014.12	AT	-	F	Hatchback Engine CBZA	803041	Outer Joint		36	27	50.5	75	65	I				
	2010.03-2014.12	AT	L	F	Hatchback Engine CBZA	854006	Outer Joint		36	30	52	59	55.5	I				
	2010.03-2014.12	AT	L	F	Hatchback Engine CBZA	261264	Drive Shaft		36		52	59	478					
	2010.03-2014.12	-	-	F	Hatchback Engine CBZA	803024	Outer Joint		36	30	50.75	59	54.5	I				
	2010.03-2014.12	MT	-	-	Hatchback Engine CBZA	603006	Inner Joint			33		34						
	2010.03-2014.12	MT	R	F	Hatchback Engine CBZA	261305	Drive Shaft		36		50.5	59	757					
	2010.03-2014.12	-	L/R	F	Hatchback Engine CBZA	603011	Inner Joint			33		34						
1.2 TSI (77 kW)	2010.03-2014.12	AT	-	F	Hatchback Engine CBZB	803041	Outer Joint		36	27	50.5	75	65	I				
	2010.03-2014.12	AT	L	F	Hatchback Engine CBZB	854006	Outer Joint		36	30	52	59	55.5	I				
	2010.03-2014.12	AT/MT	R	F	Hatchback Engine CBZB	261301	Drive Shaft		36		50.5	59	771					
	2010.03-2014.12	AT	L	F	Hatchback Engine CBZB	261264	Drive Shaft		36		52	59	478					
	2010.03-2014.12	-	-	F	Hatchback Engine CBZB	803024	Outer Joint		36	30	50.75	59	54.5	I				
	2010.03-2014.12	-	L/R	F	Hatchback Engine CBZB	603011	Inner Joint			33		34						
	2010.03-2014.12	MT	R	F	Hatchback Engine CBZB	261305	Drive Shaft		36		50.5	59	757					
1.4 (63 kW)	2007.01-2014.12	MT	R	F	Hatchback Engine BXW/CGGB	261063	Drive Shaft		36		50.7	58.5	751					
	2007.01-2014.12	MT	R	F	Hatchback Engine BXW/CGGB	261077	Drive Shaft		36		50.7	58.5	750					
	2007.01-2014.12	MT	-	F	Hatchback Engine BXW/CGGB	803027	Outer Joint		36	30	50.7	58.5	47.5	I				
	2007.01-2014.12	MT	L	F	Hatchback Engine BXW/CGGB	203063	Drive Shaft		36		50.7	58.5	501					
	2007.01-2014.12	MT	L	F	Hatchback Engine BXW/CGGB	203063	Drive Shaft		36		50.7	58.5	501					
1.4 TDI (51 kW)	2007.02-2010.03	MT	-	F	Hatchback Engine BNM	803024	Outer Joint		36	30	50.75	59	54.5	I				
	2007.02-2010.03	-	L	F	Hatchback Engine BNM	661062	Inner Joint			30		59						
	2007.02-2010.03	MT	R	F	Hatchback Engine BNM	261223	Drive Shaft		36		52	59	757					
	2007.02-2010.03	MT	L	F	Hatchback Engine BNM	261078	Drive Shaft		36		50.7	58.5	501					
	2007.02-2010.03	-	L	F	Hatchback Engine BNM	261135	Drive Shaft		36		52	59	475					
	2007.02-2010.03	-	R	F	Hatchback Engine BNM	261136	Drive Shaft		36		52	59	763					
	2007.02-2010.03	MT	R	F	Hatchback Engine BNM	854006	Outer Joint		36	30	52	59	55.5	I				
	2007.02-2010.03	MT	R	F	Hatchback Engine BNM	854006	Outer Joint		36	30	52	59	55.5	I				
1.4 TDI (59 kW)	2007.01-2010.03	-	-	F	Hatchback Engine BMS/BNV	803024	Outer Joint		36	30	50.75	59	54.5	I				
	2007.01-2010.03	MT	L	F	Hatchback Engine BMS/BNV	661062	Inner Joint			30		59						
	2007.01-2010.03	-	L	F	Hatchback Engine BMS/BNV	261098	Drive Shaft		36		50.5	59	472					
	2007.01-2010.03	MT	L	F	Hatchback Engine BMS/BNV	854006	Outer Joint		36	30	52	59	55.5	I				
	2007.01-2010.03	-	R	F	Hatchback Engine BMS/BNV	261099	Drive Shaft		36		50.5	59	759					
	2007.01-2010.03	MT	L	F	Hatchback Engine BMS/BNV	261135	Drive Shaft		36		52	59	475					
	2007.01-2010.03	MT	R	F	Hatchback Engine BMS/BNV	261136	Drive Shaft		36		52	59	763					
	2007.01-2010.03	-	L/R	F	Hatchback Engine BMS/BNV	661006	Inner Joint			30		57.6						
1.4 TSI RS (132 kW)	2010.05-2014.12	-	-	F	Hatchback Engine CAVE/CTHE	803041	Outer Joint		36	27	50.5	75	65	I				
	2010.05-2014.12	AT	-	-	Hatchback Engine CAVE/CTHE	603016	Inner Joint			28		32						
1.6 (77 kW)	2007.04-2014.12	-	-	-	Hatchback Engine BTS/CFNA/CLSA	661050	Inner Joint		26	32	31	68.5	89					
	2007.04-2014.12	-	L	F	Hatchback Engine BTS/CFNA/CLSA	261206	Drive Shaft		36	26	52	59	536					
	2007.04-2014.12	MT	R	F	Hatchback Engine BTS/CFNA/CLSA	261077	Drive Shaft		36		50.7	58.5	750					
	2007.04-2014.12	AT	R	F	Hatchback Engine BTS/CFNA/CLSA	261133	Drive Shaft		36	26	52	75	859					
	2007.04-2014.12	-	L	F	Hatchback Engine BTS/CFNA/CLSA	854006	Outer Joint		36	30	52	59	55.5	I				
	2007.04-2014.12	MT	L/R	F	Hatchback Engine BTS/CFNA/CLSA	603011	Inner Joint			33		34						
	2007.04-2014.12	AT	L/R	F	Hatchback Engine BTS/CFNA/CLSA	861010	Outer Joint		36	30	52	75	54.5	I				
	2007.04-2014.12	6AT/MT/5MT	-	F	Hatchback Engine BTS/CFNA/CLSA	803024	Outer Joint		36	30	50.75	59	54.5	I				
	2007.04-2014.12	AT	L	F	Hatchback Engine BTS/CFNA/CLSA	261150	Drive Shaft		36	26	52	75	557					
1.6 TDI (55 kW)	2010.04-2014.12	5MT	-	F	Hatchback Engine CAYA	803024	Outer Joint		36	30	50.75	59	54.5	I				
	2010.04-2014.12	-	L	F	Hatchback Engine CAYA	854006	Outer Joint		36	30	52	59	55.5	I				
	2010.04-2014.12	-	L	F	Hatchback Engine CAYA	261248	Drive Shaft		36		52	59	480					
	2010.04-2014.12	-	R	F	Hatchback Engine CAYA	261247	Drive Shaft		36		52	59	765					
	2010.04-2014.12	MT	-	-	Hatchback Engine CAYA	603006	Inner Joint			33		34						
	2010.04-2014.12	MT	L/R	F	Hatchback Engine CAYA	603011	Inner Joint			33		34						
	2010.04-2014.12	-	L	F	Hatchback Engine CAYA	261302	Drive Shaft		36		50.5	59	479					
1.6 TDI (66 kW)	2010.03-2014.12	5MT	-	F	Hatchback Engine CAYB	803024	Outer Joint		36	30	50.75	59	54.5	I				
	2010.03-2014.12	-	L	F	Hatchback Engine CAYB	854006	Outer Joint		36	30	52	59	55.5	I				





	YEAR	TRANSM	L/R	F/R	REMARKS	GSP Ref.	PRODUCT	ABS	Technical Specifications											
									A	B	C	H	L	P						
SKODA																				
FABIA II (542)																				
1.6 TDI (66 kW)	2010.03-2014.12	-	L	F	Hatchback Engine CAYB	261248	Drive Shaft		36		52	59	480							
	2010.03-2014.12	-	R	F	Hatchback Engine CAYB	261247	Drive Shaft		36		52	59	765							
	2010.03-2014.12	MT	-	-	Hatchback Engine CAYB	603006	Inner Joint		33		34									
	2010.03-2014.12	MT	L/R	F	Hatchback Engine CAYB	603011	Inner Joint		33		34									
	2010.03-2014.12	-	L	F	Hatchback Engine CAYB	261302	Drive Shaft		36		50.5	59	479							
1.6 TDI (77 kW)	2010.03-2014.12	-	L	F	Hatchback Engine CAYC	854006	Outer Joint		36	30	52	59	55.5	I						
	2010.03-2014.12	-	L	F	Hatchback Engine CAYC	261248	Drive Shaft		36		52	59	480							
	2010.03-2014.12	-	R	F	Hatchback Engine CAYC	261247	Drive Shaft		36		52	59	765							
	2010.03-2014.12	MT	-	-	Hatchback Engine CAYC	603006	Inner Joint		33		34									
	2010.03-2014.12	MT	L/R	F	Hatchback Engine CAYC	603011	Inner Joint		33		34									
	2010.03-2014.12	-	L	F	Hatchback Engine CAYC	261302	Drive Shaft		36		50.5	59	479							
1.9 TDI (77 kW)	2007.04-2010.03	-	-	F	Hatchback Engine BLS/BSW	803024	Outer Joint		36	30	50.75	59	54.5	I						
	2007.04-2010.03	MT	L	F	Hatchback Engine BLS/BSW	661062	Inner Joint		30		59									
	2007.04-2010.03	-	L	F	Hatchback Engine BLS/BSW	261098	Drive Shaft		36		50.5	59	472							
	2007.04-2010.03	MT	L	F	Hatchback Engine BLS/BSW	854006	Outer Joint		36	30	52	59	55.5	I						
	2007.04-2010.03	MT	R	F	Hatchback Engine BLS/BSW	261099	Drive Shaft		36		50.5	59	759							
	2007.04-2010.03	MT	L	F	Hatchback Engine BLS/BSW	261135	Drive Shaft		36		52	59	475							
	2007.04-2010.03	MT	R	F	Hatchback Engine BLS/BSW	261136	Drive Shaft		36		52	59	763							
2007.04-2010.03	-	L/R	F	Hatchback Engine BLS/BSW	661006	Inner Joint		30		57.6										
FABIA II Combi (545)																				
1.2 (44 kW)	2007.10-2014.11	MT	R	F	Estate Engine BBM/CHFA	261063	Drive Shaft		36		50.7	58.5	751							
	2007.10-2014.11	-	R	F	Estate Engine BBM/CHFA	261077	Drive Shaft		36		50.7	58.5	750							
	2007.10-2014.11	MT	-	F	Estate Engine BBM/CHFA	803027	Outer Joint		36	30	50.7	58.5	47.5	I						
	2007.10-2014.11	MT	L	F	Estate Engine BBM/CHFA	203063	Drive Shaft		36		50.7	58.5	501							
1.2 (51 kW)	2007.10-2014.12	MT	R	F	Estate Engine BZG/CEVA/CGPA/CHTA	261063	Drive Shaft		36		50.7	58.5	751							
	2007.10-2014.12	-	R	F	Estate Engine BZG/CEVA/CGPA/CHTA	261077	Drive Shaft		36		50.7	58.5	750							
	2007.10-2014.12	MT	-	F	Estate Engine BZG/CEVA/CGPA/CHTA	803027	Outer Joint		36	30	50.7	58.5	47.5	I						
	2007.10-2014.12	MT	L	F	Estate Engine BZG/CEVA/CGPA/CHTA	203063	Drive Shaft		36		50.7	58.5	501							
1.2 12V (44 kW)	2011.11-2014.12	-	L	F	Estate Engine CGPB	203063	Drive Shaft		36		50.7	58.5	501							
	2011.11-2014.12	-	R	F	Estate Engine CGPB	261063	Drive Shaft		36		50.7	58.5	751							
	2011.11-2014.12	-	R	F	Estate Engine CGPB	261077	Drive Shaft		36		50.7	58.5	750							
1.2 TDI (55 kW)	2010.05-2014.12	MT	L	F	Estate Engine CFWA	854006	Outer Joint		36	30	52	59	55.5	I						
	2010.05-2014.12	5MT	-	F	Estate Engine CFWA	803024	Outer Joint		36	30	50.75	59	54.5	I						
	2010.05-2014.12	MT	L	F	Estate Engine CFWA	261248	Drive Shaft		36		52	59	480							
	2010.05-2014.12	MT	R	F	Estate Engine CFWA	261247	Drive Shaft		36		52	59	765							
	2010.05-2014.12	MT	-	-	Estate Engine CFWA	603006	Inner Joint		33		34									
	2010.05-2014.12	MT	L	F	Estate Engine CFWA	261302	Drive Shaft		36		50.5	59	479							
	2010.05-2014.12	-	L/R	F	Estate Engine CFWA	603011	Inner Joint		33		34									
1.2 TSI (63 kW)	2010.03-2014.12	AT	-	F	Estate Engine CBZA	803041	Outer Joint		36	27	50.5	75	65	I						
	2010.03-2014.12	AT	L	F	Estate Engine CBZA	854006	Outer Joint		36	30	52	59	55.5	I						
	2010.03-2014.12	AT	L	F	Estate Engine CBZA	261264	Drive Shaft		36		52	59	478							
	2010.03-2014.12	-	-	F	Estate Engine CBZA	803024	Outer Joint		36	30	50.75	59	54.5	I						
	2010.03-2014.12	MT	-	-	Estate Engine CBZA	603006	Inner Joint		33		34									
	2010.03-2014.12	MT	R	F	Estate Engine CBZA	261305	Drive Shaft		36		50.5	59	757							
	2010.03-2014.12	-	L/R	F	Estate Engine CBZA	603011	Inner Joint		33		34									
1.2 TSI (77 kW)	2010.03-2014.12	AT	-	F	Estate Engine CBZB	803041	Outer Joint		36	27	50.5	75	65	I						
	2010.03-2014.12	AT	L	F	Estate Engine CBZB	854006	Outer Joint		36	30	52	59	55.5	I						
	2010.03-2014.12	AT/MT	R	F	Estate Engine CBZB	261301	Drive Shaft		36		50.5	59	771							
	2010.03-2014.12	AT	L	F	Estate Engine CBZB	261264	Drive Shaft		36		52	59	478							
	2010.03-2014.12	-	-	F	Estate Engine CBZB	803024	Outer Joint		36	30	50.75	59	54.5	I						
	2010.03-2014.12	-	L/R	F	Estate Engine CBZB	603011	Inner Joint		33		34									
	2010.03-2014.12	MT	R	F	Estate Engine CBZB	261305	Drive Shaft		36		50.5	59	757							
1.4 (63 kW)	2007.10-2014.12	MT	R	F	Estate Engine BXW/CGGB	261063	Drive Shaft		36		50.7	58.5	751							
	2007.10-2014.12	-	R	F	Estate Engine BXW/CGGB	261077	Drive Shaft		36		50.7	58.5	750							
	2007.10-2014.12	MT	-	F	Estate Engine BXW/CGGB	803027	Outer Joint		36	30	50.7	58.5	47.5	I						
	2007.10-2014.12	MT	L	F	Estate Engine BXW/CGGB	203063	Drive Shaft		36		50.7	58.5	501							
1.4 TDI (51 kW)	2007.10-2010.03	MT	-	F	Estate Engine BNM	803024	Outer Joint		36	30	50.75	59	54.5	I						
	2007.10-2010.03	-	R	F	Estate Engine BNM	261077	Drive Shaft		36		50.7	58.5	750							
	2007.10-2010.03	MT	R	F	Estate Engine BNM	261223	Drive Shaft		36		52	59	757							
	2007.10-2010.03	MT	L	F	Estate Engine BNM	261078	Drive Shaft		36		50.7	58.5	501							
	2007.10-2010.03	MT	R	F	Estate Engine BNM	854006	Outer Joint		36	30	52	59	55.5	I						
1.4 TDI (59 kW)	2007.10-2010.03	-	-	F	Estate Engine BMS/BNV	803024	Outer Joint		36	30	50.75	59	54.5	I						
	2007.10-2010.03	MT	L	F	Estate Engine BMS/BNV	661062	Inner Joint		30		59									
	2007.10-2010.03	-	L	F	Estate Engine BMS/BNV	261098	Drive Shaft		36		50.5	59	472							
	2007.10-2010.03	MT	L	F	Estate Engine BMS/BNV	854006	Outer Joint		36	30	52	59	55.5	I						
	2007.10-2010.03	-	R	F	Estate Engine BMS/BNV	261099	Drive Shaft		36		50.5	59	759							





YEAR	TRANSM	L/R	F/R	REMARKS	GSP Ref.	PRODUCT	ABS	Technical Specifications							
								A	B	C	H	L	P		
SKODA															
FABIA II Combi (545)															
1.4 TDI (59 kW)	2007.10-2010.03	MT	L	F	Estate Engine BMS/BNV	261135	Drive Shaft	36		52	59	475			
	2007.10-2010.03	MT	R	F	Estate Engine BMS/BNV	261136	Drive Shaft	36		52	59	763			
	2007.10-2010.03	-	L/R	F	Estate Engine BMS/BNV	661006	Inner Joint		30		57.6				
1.4 TSI RS (132 kW)	2010.05-2014.12	-	-	F	Estate Engine CAVE/CTHE	803041	Outer Joint	36	27	50.5	75	65	I		
	2010.05-2014.12	AT	-	-	Estate Engine CAVE/CTHE	603016	Inner Joint		28		32				
1.6 (77 kW)	2007.10-2014.12	-	-	-	Estate Engine BTS/CFNA	661050	Inner Joint	26	32	31	68.5	89			
	2007.10-2014.12	AT	L	F	Estate Engine BTS/CFNA	261206	Drive Shaft	36	26	52	59	536			
	2007.10-2014.12	MT	R	F	Estate Engine BTS/CFNA	261077	Drive Shaft	36		50.7	58.5	750			
	2007.10-2014.12	AT	L	F	Estate Engine BTS/CFNA	854006	Outer Joint	36	30	52	59	55.5	I		
	2007.10-2014.12	AT	R	F	Estate Engine BTS/CFNA	261133	Drive Shaft	36	26	52	75	859			
	2007.10-2014.12	MT	L/R	F	Estate Engine BTS/CFNA	603011	Inner Joint		33		34				
	2007.10-2014.12	AT	L/R	F	Estate Engine BTS/CFNA	861010	Outer Joint	36	30	52	75	54.5	I		
	2007.10-2014.12	6AT/MT/5MT	-	F	Estate Engine BTS/CFNA	803024	Outer Joint	36	30	50.75	59	54.5	I		
	2007.10-2014.12	AT	L	F	Estate Engine BTS/CFNA	261150	Drive Shaft	36	26	52	75	557			
1.6 TDI (55 kW)	2010.04-2014.12	5MT	-	F	Estate Engine CAYA	803024	Outer Joint	36	30	50.75	59	54.5	I		
	2010.04-2014.12	-	L	F	Estate Engine CAYA	854006	Outer Joint	36	30	52	59	55.5	I		
	2010.04-2014.12	-	L	F	Estate Engine CAYA	261248	Drive Shaft	36		52	59	480			
	2010.04-2014.12	-	R	F	Estate Engine CAYA	261247	Drive Shaft	36		52	59	765			
	2010.04-2014.12	MT	-	-	Estate Engine CAYA	603006	Inner Joint		33		34				
	2010.04-2014.12	MT	L/R	F	Estate Engine CAYA	603011	Inner Joint		33		34				
1.6 TDI (66 kW)	2010.04-2014.12	-	L	F	Estate Engine CAYA	261302	Drive Shaft	36		50.5	59	479			
	2010.03-2014.12	5MT	-	F	Estate Engine CAYB	803024	Outer Joint	36	30	50.75	59	54.5	I		
	2010.03-2014.12	-	L	F	Estate Engine CAYB	854006	Outer Joint	36	30	52	59	55.5	I		
	2010.03-2014.12	-	L	F	Estate Engine CAYB	261248	Drive Shaft	36		52	59	480			
	2010.03-2014.12	-	R	F	Estate Engine CAYB	261247	Drive Shaft	36		52	59	765			
	2010.03-2014.12	MT	-	-	Estate Engine CAYB	603006	Inner Joint		33		34				
1.6 TDI (77 kW)	2010.03-2014.12	MT	L/R	F	Estate Engine CAYB	603011	Inner Joint		33		34				
	2010.03-2014.12	-	L	F	Estate Engine CAYB	261302	Drive Shaft	36		50.5	59	479			
	2010.03-2014.12	-	L	F	Estate Engine CAYC	854006	Outer Joint	36	30	52	59	55.5	I		
	2010.03-2014.12	-	L	F	Estate Engine CAYC	261248	Drive Shaft	36		52	59	480			
	2010.03-2014.12	-	R	F	Estate Engine CAYC	261247	Drive Shaft	36		52	59	765			
	2010.03-2014.12	MT	-	-	Estate Engine CAYC	603006	Inner Joint		33		34				
	2010.03-2014.12	MT	L/R	F	Estate Engine CAYC	603011	Inner Joint		33		34				
	2010.03-2014.12	-	L	F	Estate Engine CAYC	261302	Drive Shaft	36		50.5	59	479			
	2010.03-2014.12	5MT	-	F	Estate Engine CAYC	803024	Outer Joint	36	30	50.75	59	54.5	I		
1.9 TDI (77 kW)	2007.10-2010.03	-	-	F	Estate Engine BLS/BSW	803024	Outer Joint	36	30	50.75	59	54.5	I		
	2007.10-2010.03	MT	L	F	Estate Engine BLS/BSW	661062	Inner Joint		30		59				
	2007.10-2010.03	-	L	F	Estate Engine BLS/BSW	261098	Drive Shaft	36		50.5	59	472			
	2007.10-2010.03	MT	L	F	Estate Engine BLS/BSW	854006	Outer Joint	36	30	52	59	55.5	I		
	2007.10-2010.03	-	R	F	Estate Engine BLS/BSW	261099	Drive Shaft	36		50.5	59	759			
	2007.10-2010.03	MT	L	F	Estate Engine BLS/BSW	261135	Drive Shaft	36		52	59	475			
	2007.10-2010.03	MT	R	F	Estate Engine BLS/BSW	261136	Drive Shaft	36		52	59	763			
	2007.10-2010.03	-	L/R	F	Estate Engine BLS/BSW	661006	Inner Joint		30		57.6				
FABIA III (NJ3)															
1.0 (44 kW)	2014.08-	5MT	-	F	Hatchback Engine CHYA	803027	Outer Joint	36	30	50.7	58.5	47.5	I		
1.0 (55 kW)	2014.08-	5MT	-	F	Hatchback Engine CHYB	803027	Outer Joint	36	30	50.7	58.5	47.5	I		
1.2 TSI (66 kW)	2014.08-	MT	L	F	Hatchback Engine CJZC	261263	Drive Shaft	36		52	59	514			
	2014.08-	MT	L/R	F	Hatchback Engine CJZC	854006	Outer Joint	36	30	52	59	55.5	I		
	2014.08-	MT	L/R	F	Hatchback Engine CJZC	603011	Inner Joint		33		34				
	2014.08-	7DCT/5MT/6MT	-	F	Hatchback Engine CJZC	803024	Outer Joint	36	30	50.75	59	54.5	I		
1.2 TSI (81 kW)	2014.08-	MT	L	F	Hatchback Engine CJZD	261263	Drive Shaft	36		52	59	514			
	2014.08-	MT	L	F	Hatchback Engine CJZD	854006	Outer Joint	36	30	52	59	55.5	I		
	2014.08-	MT	L/R	F	Hatchback Engine CJZD	603011	Inner Joint		33		34				
	2014.08-	7DCT/5MT/6MT	-	F	Hatchback Engine CJZD	803024	Outer Joint	36	30	50.75	59	54.5	I		
2014.08-	AT	-	-	Hatchback Engine CJZD	603006	Inner Joint		33		34					
1.4 TDI (55 kW)	2015.05-	MT	L/R	F	Hatchback Engine CUSA	603011	Inner Joint		33		34				
1.4 TDI (66 kW)	2014.08-	MT	L/R	F	Hatchback Engine CUSB	603011	Inner Joint		33		34				
1.4 TDI (77 kW)	2014.08-	MT	L/R	F	Hatchback Engine CUTA	603011	Inner Joint		33		34				
	2014.08-	MT	-	-	Hatchback Engine CUTA	603006	Inner Joint		33		34				
1.6 (81 kW)	2015.01-	MT	L	F	Hatchback Engine CWVA	261263	Drive Shaft	36		52	59	514			
	2015.01-	MT	L	F	Hatchback Engine CWVA	854006	Outer Joint	36	30	52	59	55.5	I		
	2015.01-	5MT	L/R	F	Hatchback Engine CWVA	603011	Inner Joint		33		34				
	2015.01-	5MT/6MT	-	F	Hatchback Engine CWVA	803024	Outer Joint	36	30	50.75	59	54.5	I		
FABIA III (NJ5)															
1.0 (44 kW)	2014.10-	5MT	-	F	Estate Engine CHYA	803027	Outer Joint	36	30	50.7	58.5	47.5	I		
1.0 (55 kW)	2014.10-	5MT	-	F	Estate Engine CHYB	803027	Outer Joint	36	30	50.7	58.5	47.5	I		
1.2 TSI (66 kW)	2014.10-	MT	L	F	Estate Engine CJZC	261263	Drive Shaft	36		52	59	514			





	 YEAR	TRANSM	L/R	F/R	REMARKS	GSP Ref.	 PRODUCT	 ABS	Technical Specifications					
									A	B	C	H	L	P
SKODA														
FABIA III (NJ5)														
1.2 TSI (66 kW)	2014.10-	-	MT	L	F	Estate Engine CJZC	854006	Outer Joint	36	30	52	59	55.5	I
	2014.10-	-	MT	L/R	F	Estate Engine CJZC	603011	Inner Joint		33		34		
	2014.10-	-	7DCT/5MT/6MT	-	F	Estate Engine CJZC	803024	Outer Joint	36	30	50.75	59	54.5	I
1.2 TSI (81 kW)	2014.10-	-	MT	L	F	Estate Engine CJZD	261263	Drive Shaft	36		52	59	514	
	2014.10-	-	MT	L	F	Estate Engine CJZD	854006	Outer Joint	36	30	52	59	55.5	I
	2014.10-	-	MT	L/R	F	Estate Engine CJZD	603011	Inner Joint		33		34		
	2014.10-	-	7DCT/5MT/6MT	-	F	Estate Engine CJZD	803024	Outer Joint	36	30	50.75	59	54.5	I
	2014.10-	-	AT	-	-	Estate Engine CJZD	603006	Inner Joint		33		34		
1.4 TDI (55 kW)	2015.05-	-	MT	L/R	F	Estate Engine CUSA	603011	Inner Joint		33		34		
1.4 TDI (66 kW)	2014.10-	-	MT	L/R	F	Estate Engine CUSB	603011	Inner Joint		33		34		
1.4 TDI (77 kW)	2014.10-	-	MT	L/R	F	Estate Engine CUTA	603011	Inner Joint		33		34		
	2014.10-	-	MT	-	-	Estate Engine CUTA	603006	Inner Joint		33		34		
1.6 (81 kW)	2015.01-	-	MT	L	F	Estate Engine CWVA	261263	Drive Shaft	36		52	59	514	
	2015.01-	-	MT	L	F	Estate Engine CWVA	854006	Outer Joint	36	30	52	59	55.5	I
	2015.01-	-	5MT	L/R	F	Estate Engine CWVA	603011	Inner Joint		33		34		
	2015.01-	-	5MT/6MT	-	F	Estate Engine CWVA	803024	Outer Joint	36	30	50.75	59	54.5	I
FAVORIT (781)														
1.3 (50 kW)	1994.01-	1994.09	MT	L	F	Hatchback Engine 136B	654002	Inner Joint	22	22	40	60.2	94.5	
	1994.01-	1994.09	MT	L/R	F	Hatchback Engine 136B	854001	Outer Joint	22	22	45	82	53.5	I
	1994.01-	1994.09	MT	-	-	Hatchback Engine 136B	654003	Inner Joint	22	30	40	60.2	94.5	
	1994.01-	1994.09	MT	L	F	Hatchback Engine 136B	254001	Drive Shaft	22	22	45	82	599	
	1994.01-	1994.09	MT	R	F	Hatchback Engine 136B	254002	Drive Shaft	22	22	45	82	861	
1.3 135 (42 kW)	1991.12-	1994.09	MT	L	F	Hatchback Engine 781.135	654002	Inner Joint	22	22	40	60.2	94.5	
	1991.12-	1994.09	MT	L/R	F	Hatchback Engine 781.135	854001	Outer Joint	22	22	45	82	53.5	I
	1991.12-	1994.09	MT	-	-	Hatchback Engine 781.135	654003	Inner Joint	22	30	40	60.2	94.5	
	1991.12-	1994.09	MT	L	F	Hatchback Engine 781.135	254001	Drive Shaft	22	22	45	82	599	
	1991.12-	1994.09	MT	R	F	Hatchback Engine 781.135	254002	Drive Shaft	22	22	45	82	861	
1.3 135 (43 kW)	1991.12-	1994.09	MT	L	F	Hatchback Engine 781.135	654002	Inner Joint	22	22	40	60.2	94.5	
	1991.12-	1994.09	MT	L/R	F	Hatchback Engine 781.135	854001	Outer Joint	22	22	45	82	53.5	I
	1991.12-	1994.09	MT	-	-	Hatchback Engine 781.135	654003	Inner Joint	22	30	40	60.2	94.5	
	1991.12-	1994.09	MT	L	F	Hatchback Engine 781.135	254001	Drive Shaft	22	22	45	82	599	
	1991.12-	1994.09	MT	R	F	Hatchback Engine 781.135	254002	Drive Shaft	22	22	45	82	861	
1.3 135 (44 kW)	1990.10-	1994.09	MT	L	F	Hatchback Engine 781.135	654002	Inner Joint	22	22	40	60.2	94.5	
	1990.10-	1994.09	MT	L/R	F	Hatchback Engine 781.135	854001	Outer Joint	22	22	45	82	53.5	I
	1990.10-	1994.09	MT	-	-	Hatchback Engine 781.135	654003	Inner Joint	22	30	40	60.2	94.5	
	1990.10-	1994.09	MT	L	F	Hatchback Engine 781.135	254001	Drive Shaft	22	22	45	82	599	
	1990.10-	1994.09	MT	R	F	Hatchback Engine 781.135	254002	Drive Shaft	22	22	45	82	861	
1.3 135 XLGLX (40 kW)	1990.01-	1994.09	MT	L	F	Hatchback Engine 781.135E	654002	Inner Joint	22	22	40	60.2	94.5	
	1990.01-	1994.09	MT	L/R	F	Hatchback Engine 781.135E	854001	Outer Joint	22	22	45	82	53.5	I
	1990.01-	1994.09	MT	-	-	Hatchback Engine 781.135E	654003	Inner Joint	22	30	40	60.2	94.5	
	1990.01-	1994.09	MT	L	F	Hatchback Engine 781.135E	254001	Drive Shaft	22	22	45	82	599	
	1990.01-	1994.09	MT	R	F	Hatchback Engine 781.135E	254002	Drive Shaft	22	22	45	82	861	
1.3 135L (43 kW)	1989.05-	1994.09	MT	L	F	Hatchback Engine 781.135	654002	Inner Joint	22	22	40	60.2	94.5	
	1989.05-	1994.09	MT	L/R	F	Hatchback Engine 781.135	854001	Outer Joint	22	22	45	82	53.5	I
	1989.05-	1994.09	MT	-	-	Hatchback Engine 781.135	654003	Inner Joint	22	30	40	60.2	94.5	
	1989.05-	1994.09	MT	L	F	Hatchback Engine 781.135	254001	Drive Shaft	22	22	45	82	599	
	1989.05-	1994.09	MT	R	F	Hatchback Engine 781.135	254002	Drive Shaft	22	22	45	82	861	
1.3 136 (45 kW)	1990.10-	1994.09	MT	L	F	Hatchback Engine 136 L	654002	Inner Joint	22	22	40	60.2	94.5	
	1990.10-	1994.09	MT	L/R	F	Hatchback Engine 136 L	854001	Outer Joint	22	22	45	82	53.5	I
	1990.10-	1994.09	MT	-	-	Hatchback Engine 136 L	654003	Inner Joint	22	30	40	60.2	94.5	
	1990.10-	1994.09	MT	L	F	Hatchback Engine 136 L	254001	Drive Shaft	22	22	45	82	599	
	1990.10-	1994.09	MT	R	F	Hatchback Engine 136 L	254002	Drive Shaft	22	22	45	82	861	
FAVORIT (787)														
1.3 (40 kW)	1992.12-	1997.06	MT	L/R	F	Pickup Engine 135B	854001	Outer Joint	22	22	45	82	53.5	I
	1992.12-	1997.06	MT	-	-	Pickup Engine 135B	654003	Inner Joint	22	30	40	60.2	94.5	
	1992.12-	1997.06	MT	L	F	Pickup Engine 135B	254001	Drive Shaft	22	22	45	82	599	
	1992.12-	1997.06	MT	R	F	Pickup Engine 135B	254002	Drive Shaft	22	22	45	82	861	
	1992.12-	1997.06	MT	L	F	Pickup Engine 135B	654002	Inner Joint	22	22	40	60.2	94.5	
1.3 (42 kW)	1992.12-	1997.06	MT	L/R	F	Pickup Engine 781.135	854001	Outer Joint	22	22	45	82	53.5	I
	1992.12-	1997.06	MT	-	-	Pickup Engine 781.135	654003	Inner Joint	22	30	40	60.2	94.5	
	1992.12-	1997.06	MT	L	F	Pickup Engine 781.135	254001	Drive Shaft	22	22	45	82	599	
	1992.12-	1997.06	MT	R	F	Pickup Engine 781.135	254002	Drive Shaft	22	22	45	82	861	
	1992.12-	1997.06	MT	L	F	Pickup Engine 781.135	654002	Inner Joint	22	22	40	60.2	94.5	
1.3 (50 kW)	1992.12-	1997.06	MT	L/R	F	Pickup Engine 136B	854001	Outer Joint	22	22	45	82	53.5	I
	1992.12-	1997.06	MT	-	-	Pickup Engine 136B	654003	Inner Joint	22	30	40	60.2	94.5	
	1992.12-	1997.06	MT	L	F	Pickup Engine 136B	254001	Drive Shaft	22	22	45	82	599	

	 YEAR	TRANSM	L/R	F/R	REMARKS	GSP Ref.	 PRODUCT	 ABS	Technical Specifications									
									A	B	C	H	L	P				
SKODA																		
FAVORIT (787)																		
1.3 (50 kW)	1992.12-1997.06	MT	R	F	Pickup Engine 136B	254002	Drive Shaft		22	22	45	82	861					
	1992.12-1997.06	MT	L	F	Pickup Engine 136B	654002	Inner Joint		22	22	40	60.2	94.5					
FAVORIT Forman (785)																		
1.3 (40 kW)	1991.09-1995.06	MT	L	F	Estate Engine 781.135E	654002	Inner Joint		22	22	40	60.2	94.5					
	1991.09-1995.06	MT	L/R	F	Estate Engine 781.135E	854001	Outer Joint		22	22	45	82	53.5	I				
	1991.09-1995.06	MT	-	-	Estate Engine 781.135E	654003	Inner Joint		22	30	40	60.2	94.5					
	1991.09-1995.06	MT	L	F	Estate Engine 781.135E	254001	Drive Shaft		22	22	45	82	599					
	1991.09-1995.06	MT	R	F	Estate Engine 781.135E	254002	Drive Shaft		22	22	45	82	861					
1.3 (44 kW)	1991.12-1995.06	MT	L	F	Estate Engine 781.135	654002	Inner Joint		22	22	40	60.2	94.5					
	1991.12-1995.06	MT	L/R	F	Estate Engine 781.135	854001	Outer Joint		22	22	45	82	53.5	I				
	1991.12-1995.06	MT	-	-	Estate Engine 781.135	654003	Inner Joint		22	30	40	60.2	94.5					
	1991.12-1995.06	MT	L	F	Estate Engine 781.135	254001	Drive Shaft		22	22	45	82	599					
1.3 (45 kW)	1991.08-1995.06	MT	L	F	Estate Engine OHC	654002	Inner Joint		22	22	40	60.2	94.5					
	1991.08-1995.06	MT	L/R	F	Estate Engine OHC	854001	Outer Joint		22	22	45	82	53.5	I				
	1991.08-1995.06	MT	-	-	Estate Engine OHC	654003	Inner Joint		22	30	40	60.2	94.5					
	1991.08-1995.06	MT	L	F	Estate Engine OHC	254001	Drive Shaft		22	22	45	82	599					
	1991.08-1995.06	MT	R	F	Estate Engine OHC	254002	Drive Shaft		22	22	45	82	861					
1.3 (50 kW)	1994.01-1995.06	MT	L	F	Estate Engine 136B	654002	Inner Joint		22	22	40	60.2	94.5					
	1994.01-1995.06	MT	L/R	F	Estate Engine 136B	854001	Outer Joint		22	22	45	82	53.5	I				
	1994.01-1995.06	MT	-	-	Estate Engine 136B	654003	Inner Joint		22	30	40	60.2	94.5					
	1994.01-1995.06	MT	L	F	Estate Engine 136B	254001	Drive Shaft		22	22	45	82	599					
	1994.01-1995.06	MT	R	F	Estate Engine 136B	254002	Drive Shaft		22	22	45	82	861					
FELICIA I (6U1)																		
1.3 (40 kW)	1994.10-1998.03	MT	L	F	Hatchback Engine 135B/AMG	654002	Inner Joint		22	22	40	60.2	94.5					
	1994.10-1998.03	MT	L/R	F	Hatchback Engine 135B/AMG	854001	Outer Joint		22	22	45	82	53.5	I				
	1994.10-1998.03	MT	-	-	Hatchback Engine 135B/AMG	654003	Inner Joint		22	30	40	60.2	94.5					
	1994.10-1998.03	MT	L	F	Hatchback Engine 135B/AMG	254001	Drive Shaft		22	22	45	82	599					
	1994.10-1998.03	MT	R	F	Hatchback Engine 135B/AMG	254002	Drive Shaft		22	22	45	82	861					
1.3 (43 kW)	1994.10-1998.03	MT	L	F	Hatchback Engine 135 L/AMJ	654002	Inner Joint		22	22	40	60.2	94.5					
	1994.10-1998.03	MT	L/R	F	Hatchback Engine 135 L/AMJ	854001	Outer Joint		22	22	45	82	53.5	I				
	1994.10-1998.03	MT	-	-	Hatchback Engine 135 L/AMJ	654003	Inner Joint		22	30	40	60.2	94.5					
	1994.10-1998.03	MT	L	F	Hatchback Engine 135 L/AMJ	254001	Drive Shaft		22	22	45	82	599					
	1994.10-1998.03	MT	R	F	Hatchback Engine 135 L/AMJ	254002	Drive Shaft		22	22	45	82	861					
1.3 (50 kW)	1994.10-1998.03	MT	L	F	Hatchback Engine 136B/AMH	654002	Inner Joint		22	22	40	60.2	94.5					
	1994.10-1998.03	MT	L/R	F	Hatchback Engine 136B/AMH	854001	Outer Joint		22	22	45	82	53.5	I				
	1994.10-1998.03	MT	-	-	Hatchback Engine 136B/AMH	654003	Inner Joint		22	30	40	60.2	94.5					
	1994.10-1998.03	MT	L	F	Hatchback Engine 136B/AMH	254001	Drive Shaft		22	22	45	82	599					
	1994.10-1998.03	MT	R	F	Hatchback Engine 136B/AMH	254002	Drive Shaft		22	22	45	82	861					
1.6 LX (55 kW)	1995.08-1998.03	MT	L	F	Hatchback Engine AEE/EA111	654002	Inner Joint		22	22	40	60.2	94.5					
	1995.08-1998.03	MT	L/R	F	Hatchback Engine AEE/EA111	854001	Outer Joint		22	22	45	82	53.5	I				
	1995.08-1998.03	MT	-	-	Hatchback Engine AEE/EA111	654003	Inner Joint		22	30	40	60.2	94.5					
	1995.08-1998.03	MT	L	F	Hatchback Engine AEE/EA111	254001	Drive Shaft		22	22	45	82	599					
	1995.08-1998.03	MT	R	F	Hatchback Engine AEE/EA111	254002	Drive Shaft		22	22	45	82	861					
1.9 D (47 kW)	1995.10-1998.03	MT	L	F	Hatchback Engine AEF	654002	Inner Joint		22	22	40	60.2	94.5					
	1995.10-1998.03	MT	L/R	F	Hatchback Engine AEF	854001	Outer Joint		22	22	45	82	53.5	I				
	1995.10-1998.03	MT	-	-	Hatchback Engine AEF	654003	Inner Joint		22	30	40	60.2	94.5					
	1995.10-1998.03	MT	L	F	Hatchback Engine AEF	254001	Drive Shaft		22	22	45	82	599					
	1995.10-1998.03	MT	R	F	Hatchback Engine AEF	254002	Drive Shaft		22	22	45	82	861					
FELICIA I (6U5)																		
1.3 (43 kW)	1995.08-1998.03	MT	L	F	Estate Engine 135 L/AMJ	654002	Inner Joint		22	22	40	60.2	94.5					
	1995.08-1998.03	MT	L/R	F	Estate Engine 135 L/AMJ	854001	Outer Joint		22	22	45	82	53.5	I				
	1995.08-1998.03	MT	-	-	Estate Engine 135 L/AMJ	654003	Inner Joint		22	30	40	60.2	94.5					
	1995.08-1998.03	MT	L	F	Estate Engine 135 L/AMJ	254001	Drive Shaft		22	22	45	82	599					
	1995.08-1998.03	MT	R	F	Estate Engine 135 L/AMJ	254002	Drive Shaft		22	22	45	82	861					
1.3 LX (40 kW)	1995.08-1998.03	MT	L	F	Estate Engine 135B/AMG	654002	Inner Joint		22	22	40	60.2	94.5					
	1995.08-1998.03	MT	L/R	F	Estate Engine 135B/AMG	854001	Outer Joint		22	22	45	82	53.5	I				
	1995.08-1998.03	MT	-	-	Estate Engine 135B/AMG	654003	Inner Joint		22	30	40	60.2	94.5					
	1995.08-1998.03	MT	L	F	Estate Engine 135B/AMG	254001	Drive Shaft		22	22	45	82	599					
	1995.08-1998.03	MT	R	F	Estate Engine 135B/AMG	254002	Drive Shaft		22	22	45	82	861					
1.3 LXI (50 kW)	1995.08-1998.03	MT	L	F	Estate Engine 136B/AMH	654002	Inner Joint		22	22	40	60.2	94.5					
	1995.08-1998.03	MT	L/R	F	Estate Engine 136B/AMH	854001	Outer Joint		22	22	45	82	53.5	I				
	1995.08-1998.03	MT	-	-	Estate Engine 136B/AMH	654003	Inner Joint		22	30	40	60.2	94.5					
	1995.08-1998.03	MT	L	F	Estate Engine 136B/AMH	254001	Drive Shaft		22	22	45	82	599					
	1995.08-1998.03	MT	R	F	Estate Engine 136B/AMH	254002	Drive Shaft		22	22	45	82	861					
1.6 GLX (55 kW)	1995.08-1998.03	MT	L	F	Estate Engine AEE	654002	Inner Joint		22	22	40	60.2	94.5					





	 YEAR	TRANSM	L/R	F/R	REMARKS	GSP Ref.	 PRODUCT	 ABS	Technical Specifications						
									A	B	C	H	L	P	
SKODA FELICIA I (6U5)															
1.6 GLX (55 kW)	1995.08-1998.03	MT	L/R	F	Estate Engine AEE	854001	Outer Joint		22	22	45	82	53.5	I	
	1995.08-1998.03	MT	-	-	Estate Engine AEE	654003	Inner Joint		22	30	40	60.2	94.5		
	1995.08-1998.03	MT	L	F	Estate Engine AEE	254001	Drive Shaft		22	22	45	82	599		
	1995.08-1998.03	MT	R	F	Estate Engine AEE	254002	Drive Shaft		22	22	45	82	861		
1.9 D (47 kW)	1995.10-1998.03	MT	L	F	Estate Engine AEF	654002	Inner Joint		22	22	40	60.2	94.5		
	1995.10-1998.03	MT	L/R	F	Estate Engine AEF	854001	Outer Joint		22	22	45	82	53.5	I	
	1995.10-1998.03	MT	-	-	Estate Engine AEF	654003	Inner Joint		22	30	40	60.2	94.5		
	1995.10-1998.03	MT	L	F	Estate Engine AEF	254001	Drive Shaft		22	22	45	82	599		
	1995.10-1998.03	MT	R	F	Estate Engine AEF	254002	Drive Shaft		22	22	45	82	861		
FELICIA I (6UF 6U7)															
1.3 (40 kW)	1997.06-2002.04	MT	L/R	F	Pickup Engine 135B/135M/AMG	854001	Outer Joint		22	22	45	82	53.5	I	
	1997.06-2002.04	MT	-	-	Pickup Engine 135B/135M/AMG	654003	Inner Joint		22	30	40	60.2	94.5		
	1997.06-2002.04	MT	L	F	Pickup Engine 135B/135M/AMG	254001	Drive Shaft		22	22	45	82	599		
	1997.06-2002.04	MT	R	F	Pickup Engine 135B/135M/AMG	254002	Drive Shaft		22	22	45	82	861		
	1997.06-2002.04	MT	L	F	Pickup Engine 135B/135M/AMG	654002	Inner Joint		22	22	40	60.2	94.5		
1.3 (50 kW)	1997.06-2002.04	MT	L/R	F	Pickup Engine 136B/136M/AMH	854001	Outer Joint		22	22	45	82	53.5	I	
	1997.06-2002.04	MT	-	-	Pickup Engine 136B/136M/AMH	654003	Inner Joint		22	30	40	60.2	94.5		
	1997.06-2002.04	MT	L	F	Pickup Engine 136B/136M/AMH	254001	Drive Shaft		22	22	45	82	599		
	1997.06-2002.04	MT	R	F	Pickup Engine 136B/136M/AMH	254002	Drive Shaft		22	22	45	82	861		
	1997.06-2002.04	MT	L	F	Pickup Engine 136B/136M/AMH	654002	Inner Joint		22	22	40	60.2	94.5		
1.6 (55 kW)	1997.06-2002.04	MT	L/R	F	Pickup Engine AEE	854001	Outer Joint		22	22	45	82	53.5	I	
	1997.06-2002.04	MT	-	-	Pickup Engine AEE	654003	Inner Joint		22	30	40	60.2	94.5		
	1997.06-2002.04	MT	L	F	Pickup Engine AEE	254001	Drive Shaft		22	22	45	82	599		
	1997.06-2002.04	MT	R	F	Pickup Engine AEE	254002	Drive Shaft		22	22	45	82	861		
	1997.06-2002.04	MT	L	F	Pickup Engine AEE	654002	Inner Joint		22	22	40	60.2	94.5		
1.9 D (47 kW)	1997.06-2002.04	MT	L	F	Pickup Engine AEF	654002	Inner Joint		22	22	40	60.2	94.5		
	1997.06-2002.04	MT	L/R	F	Pickup Engine AEF	854001	Outer Joint		22	22	45	82	53.5	I	
	1997.06-2002.04	MT	-	-	Pickup Engine AEF	654003	Inner Joint		22	30	40	60.2	94.5		
	1997.06-2002.04	MT	L	F	Pickup Engine AEF	254001	Drive Shaft		22	22	45	82	599		
	1997.06-2002.04	MT	R	F	Pickup Engine AEF	254002	Drive Shaft		22	22	45	82	861		
FELICIA II (6U1)															
1.3 (40 kW)	1998.01-2001.06	MT	L	F	Hatchback Engine AMG	654002	Inner Joint		22	22	40	60.2	94.5		
	1998.01-2001.06	MT	L/R	F	Hatchback Engine AMG	854001	Outer Joint		22	22	45	82	53.5	I	
	1998.01-2001.06	MT	L	F	Hatchback Engine AMG	254001	Drive Shaft		22	22	45	82	599		
	1998.01-2001.06	MT	R	F	Hatchback Engine AMG	254002	Drive Shaft		22	22	45	82	861		
1.3 (43 kW)	1998.01-2001.06	MT	L	F	Hatchback Engine AMJ	654002	Inner Joint		22	22	40	60.2	94.5		
	1998.01-2001.06	MT	L/R	F	Hatchback Engine AMJ	854001	Outer Joint		22	22	45	82	53.5	I	
	1998.01-2001.06	MT	L	F	Hatchback Engine AMJ	254001	Drive Shaft		22	22	45	82	599		
1.3 (50 kW)	1998.01-2001.06	MT	R	F	Hatchback Engine AMJ	254002	Drive Shaft		22	22	45	82	861		
	1998.01-2001.06	MT	L	F	Hatchback Engine AMH	654002	Inner Joint		22	22	40	60.2	94.5		
	1998.01-2001.06	MT	L/R	F	Hatchback Engine AMH	854001	Outer Joint		22	22	45	82	53.5	I	
	1998.01-2001.06	MT	L	F	Hatchback Engine AMH	254001	Drive Shaft		22	22	45	82	599		
1.6 (55 kW)	1998.01-2001.06	MT	R	F	Hatchback Engine AMH	254002	Drive Shaft		22	22	45	82	861		
	1998.01-2001.06	MT	L	F	Hatchback Engine AEE	654002	Inner Joint		22	22	40	60.2	94.5		
	1998.01-2001.06	MT	L/R	F	Hatchback Engine AEE	854001	Outer Joint		22	22	45	82	53.5	I	
	1998.01-2001.06	MT	L	F	Hatchback Engine AEE	254001	Drive Shaft		22	22	45	82	599		
1.9 D (47 kW)	1998.01-2001.06	MT	R	F	Hatchback Engine AEE	254002	Drive Shaft		22	22	45	82	861		
	1998.01-2001.06	MT	L	F	Hatchback Engine AEF	654002	Inner Joint		22	22	40	60.2	94.5		
	1998.01-2001.06	MT	L/R	F	Hatchback Engine AEF	854001	Outer Joint		22	22	45	82	53.5	I	
	1998.01-2001.06	MT	L	F	Hatchback Engine AEF	254001	Drive Shaft		22	22	45	82	599		
1998.01-2001.06	MT	R	F	Hatchback Engine AEF	254002	Drive Shaft		22	22	45	82	861			
	FELICIA II (6U5)														
	1.3 (50 kW)	1998.01-2001.06	MT	L	F	Estate Engine AMH	654002	Inner Joint		22	22	40	60.2	94.5	
		1998.01-2001.06	MT	L/R	F	Estate Engine AMH	854001	Outer Joint		22	22	45	82	53.5	I
1998.01-2001.06		MT	L	F	Estate Engine AMH	254001	Drive Shaft		22	22	45	82	599		
1998.01-2001.06		MT	R	F	Estate Engine AMH	254002	Drive Shaft		22	22	45	82	861		
1.6 (55 kW)	1998.01-2001.06	MT	L	F	Estate Engine AEE	654002	Inner Joint		22	22	40	60.2	94.5		
	1998.01-2001.06	MT	L/R	F	Estate Engine AEE	854001	Outer Joint		22	22	45	82	53.5	I	
	1998.01-2001.06	MT	L	F	Estate Engine AEE	254001	Drive Shaft		22	22	45	82	599		
	1998.01-2001.06	MT	R	F	Estate Engine AEE	254002	Drive Shaft		22	22	45	82	861		
1.9 D (47 kW)	1998.01-2001.06	MT	L	F	Estate Engine AEF	654002	Inner Joint		22	22	40	60.2	94.5		
	1998.01-2001.06	MT	L/R	F	Estate Engine AEF	854001	Outer Joint		22	22	45	82	53.5	I	
	1998.01-2001.06	MT	L	F	Estate Engine AEF	254001	Drive Shaft		22	22	45	82	599		
	1998.01-2001.06	MT	R	F	Estate Engine AEF	254002	Drive Shaft		22	22	45	82	861		
OCTAVIA															
-	1997-	2011	-	-	-	201587	Drive Shaft		36		53	78.5	522		





	 YEAR	TRANSM	L/R	F/R	REMARKS	GSP Ref.	 PRODUCT	 ABS	Technical Specifications					
									A	B	C	H	L	P
SKODA OCTAVIA														
1.6	2004-2008	-	-	-	-	201583	Drive Shaft		36	26	59.5	40	873	
	2004-2008	-	-	-	-	201583	Drive Shaft		36	26	59.5	40	873	
1.9 SDi	1999.03-	MT	L	F	-	254003	Drive Shaft		36		53.2	77.5	555	
OCTAVIA I (1U2)														
1.4 (44 kW)	1999.04-2001.03	-	L/R	F	Hatchback Engine AMD	653001	Inner Joint			33		32		
	1999.04-2001.03	MT	L/R	F	Hatchback Engine AMD	803033	Outer Joint		36	30	53	78.5	51	I
	1999.04-2001.03	MT	-	-	Hatchback Engine AMD	603006	Inner Joint			33		34		
1.4 16V (55 kW)	2000.09-2010.12	-	L	F	Hatchback Engine AXP/BCA	261045	Drive Shaft		36		53	78.5	555	
	2000.09-2010.12	-	R	F	Hatchback Engine AXP/BCA	253008	Drive Shaft		36		59.5	40	782	
	2000.09-2010.12	-	R	F	Hatchback Engine AXP/BCA	203046	Drive Shaft		36		53	78.5	822	
	2000.09-2010.12	MT	L/R	F	Hatchback Engine AXP/BCA	803033	Outer Joint		36	30	53	78.5	51	I
	2000.09-2010.12	-	L/R	F	Hatchback Engine AXP/BCA	603008	Inner Joint			33		32		
	2000.09-2010.12	-	L/R	F	Hatchback Engine AXP/BCA	603008	Inner Joint			33		32		
1.6 (55 kW)	1996.09-2004.09	-	L	F	Hatchback Engine AEE	261045	Drive Shaft		36		53	78.5	555	
	1996.09-2004.09	MT	L/R	F	Hatchback Engine AEE	603004	Inner Joint			33		32		
	1996.09-2004.09	-	R	F	Hatchback Engine AEE	203046	Drive Shaft		36		53	78.5	822	
	1996.09-2004.09	MT	L/R	F	Hatchback Engine AEE	803033	Outer Joint		36	30	53	78.5	51	I
	1996.09-2004.09	-	L/R	F	Hatchback Engine AEE	603008	Inner Joint			33		32		
1.6 (74 kW)	1997.02-2007.12	AT	L/R	F	Hatchback Engine AEH/AKL	803036	Outer Joint		36	30	53.2	77.5	61	I
	1997.02-2007.12	MT	L	F	Hatchback Engine AEH/AKL	261045	Drive Shaft		36		53	78.5	555	
	1997.02-2007.12	MT	L/R	F	Hatchback Engine AEH/AKL	603004	Inner Joint			33		32		
	1997.02-2007.12	AT	L	F	Hatchback Engine AEH/AKL	261156	Drive Shaft		36		53	78	554.5	
	1997.02-2007.12	AT	L	F	Hatchback Engine AEH/AKL	661062	Inner Joint			30		59		
	1997.02-2007.12	MT	L/R	F	Hatchback Engine AEH/AKL	803033	Outer Joint		36	30	53	78.5	51	I
	1997.02-2007.12	-	L/R	F	Hatchback Engine AEH/AKL	603008	Inner Joint			33		32		
1.6 (75 kW)	2000.11-2010.12	AT	L/R	F	Hatchback Engine AVU/BFQ	803036	Outer Joint		36	30	53.2	77.5	61	I
	2000.11-2010.12	MT	L	F	Hatchback Engine AVU/BFQ	261045	Drive Shaft		36		53	78.5	555	
	2000.11-2010.12	AT	L	F	Hatchback Engine AVU/BFQ	261156	Drive Shaft		36		53	78	554.5	
	2000.11-2010.12	MT	L/R	F	Hatchback Engine AVU/BFQ	803033	Outer Joint		36	30	53	78.5	51	I
	2000.11-2010.12	AT	L/R	F	Hatchback Engine AVU/BFQ	661006	Inner Joint			30		57.6		
	2000.11-2010.12	AT	L	F	Hatchback Engine AVU/BFQ	661062	Inner Joint			30		59		
	2000.11-2010.12	MT	L/R	F	Hatchback Engine AVU/BFQ	603008	Inner Joint			33		32		
1.8 (92 kW)	1996.09-2000.07	MT	L	F	Hatchback Engine AGN	603011	Inner Joint			33		34		
	1996.09-2000.07	AT	L	F	Hatchback Engine AGN	261020	Drive Shaft		36		53.2	77.5	547	
	1996.09-2000.07	MT	R	F	Hatchback Engine AGN	603009	Inner Joint			33		34		
	1996.09-2000.07	MT	L	F	Hatchback Engine AGN	261314	Drive Shaft		36		53	78	558	
	1996.09-2000.07	AT	L	F	Hatchback Engine AGN	261156	Drive Shaft		36		53	78	554.5	
	1996.09-2000.07	AT	L	F	Hatchback Engine AGN	661062	Inner Joint			30		59		
	1996.09-2000.07	MT	L	F	Hatchback Engine AGN	261021	Drive Shaft		36		53.2	77.5	564.5	
	1996.09-2000.07	AT/MT	L/R	F	Hatchback Engine AGN	803036	Outer Joint		36	30	53.2	77.5	61	I
1.8 T (110 kW)	1997.08-2010.12	AT/MT	L	F	Hatchback Engine AGU/ARX/ARZ/AUM	261020	Drive Shaft		36		53.2	77.5	547	
	1997.08-2010.12	-	R	F	Hatchback Engine AGU/ARX/ARZ/AUM	203011	Drive Shaft		36		53.2	77.5	810.5	
	1997.08-2010.12	-	L	F	Hatchback Engine AGU/ARX/ARZ/AUM	261156	Drive Shaft		36		53	78	554.5	
	1997.08-2010.12	-	L/R	F	Hatchback Engine AGU/ARX/ARZ/AUM	661006	Inner Joint			30		57.6		
	1997.08-2010.12	MT	L	F	Hatchback Engine AGU/ARX/ARZ/AUM	261021	Drive Shaft		36		53.2	77.5	564.5	
	1997.08-2010.12	-	L	F	Hatchback Engine AGU/ARX/ARZ/AUM	661062	Inner Joint			30		59		
	1997.08-2010.12	MT	L/R	F	Hatchback Engine AGU/ARX/ARZ/AUM	603011	Inner Joint			33		34		
	1997.08-2010.12	AT/MT	L/R	F	Hatchback Engine AGU/ARX/ARZ/AUM	803036	Outer Joint		36	30	53.2	77.5	61	I
	2001.05-2006.05	MT	L/R	F	All-wheel Drive Hatchback Engine ARX	803036	Outer Joint		36	30	53.2	77.5	61	I
	2001.05-2006.05	MT	L/R	R	All-wheel Drive Hatchback Engine ARX	603003	Inner Joint			33		32		
	2001.05-2006.05	MT	L	F	All-wheel Drive Hatchback Engine ARX	261314	Drive Shaft		36		53	78	558	
	2001.05-2006.05	MT	L/R	R	All-wheel Drive Hatchback Engine ARX	803033	Outer Joint		36	30	53	78.5	51	I
	2001.05-2006.05	MT	L	F	All-wheel Drive Hatchback Engine ARX	261021	Drive Shaft		36		53.2	77.5	564.5	
	2001.05-2006.05	MT	-	-	All-wheel Drive Hatchback Engine ARX	603006	Inner Joint			33		34		
	2001.05-2006.05	MT	R	F	All-wheel Drive Hatchback Engine ARX	603009	Inner Joint			33		34		
	2001.05-2006.05	MT	L	F	All-wheel Drive Hatchback Engine ARX	603011	Inner Joint			33		34		
1.9 SDI (50 kW)	1997.06-2003.12	MT	L	F	Hatchback Engine AGP/AQM	261045	Drive Shaft		36		53	78.5	555	
	1997.06-2003.12	MT	L/R	F	Hatchback Engine AGP/AQM	603004	Inner Joint			33		32		
	1997.06-2003.12	MT	R	F	Hatchback Engine AGP/AQM	203046	Drive Shaft		36		53	78.5	822	
	1997.06-2003.12	MT	-	-	Hatchback Engine AGP/AQM	603006	Inner Joint			33		34		
	1997.06-2003.12	MT	L/R	F	Hatchback Engine AGP/AQM	803033	Outer Joint		36	30	53	78.5	51	I
	1997.06-2003.12	-	L/R	F	Hatchback Engine AGP/AQM	603008	Inner Joint			33		32		
1.9 TDI (66 kW)	1996.09-2010.03	AT	L	F	Hatchback Engine AGR/ALH	261020	Drive Shaft		36		53.2	77.5	547	
	1996.09-2010.03	MT	R	F	Hatchback Engine AGR/ALH	603009	Inner Joint			33		34		
	1996.09-2010.03	MT	L	F	Hatchback Engine AGR/ALH	203006	Drive Shaft		36		53.2	77.5	557	
	1996.09-2010.03	MT	R	F	Hatchback Engine AGR/ALH	203004	Drive Shaft		36		53.2	77.5	822	
	1996.09-2010.03	MT	L	F	Hatchback Engine AGR/ALH	261021	Drive Shaft		36		53.2	77.5	564.5	

	 YEAR	TRANSM	L/R	F/R	REMARKS	GSP Ref.	 PRODUCT	 ABS	Technical Specifications					
									A	B	C	H	L	P
SKODA														
OCTAVIA I (1U2)														
1.9 TDI (66 kW)	1996.09-2010.03	AT	L/R	F	Hatchback Engine AGR/ALH	661006	Inner Joint		30		57.6			
	1996.09-2010.03	MT	L/R	F	Hatchback Engine AGR/ALH	803036	Outer Joint	36	30	53.2	77.5	61	I	
1.9 TDI (74 kW)	2005.10-2010.12	-	R	F	Hatchback Engine AXR	603009	Inner Joint		33		34			
	2005.10-2010.12	MT	-	-	Hatchback Engine AXR	603006	Inner Joint		33		34			
	2005.10-2010.12	-	L/R	F	Hatchback Engine AXR	803036	Outer Joint	36	30	53.2	77.5	61	I	
	2005.10-2010.12	-	L	F	Hatchback Engine AXR	603011	Inner Joint		33		34			
	2005.10-2010.12	-	L	F	Hatchback Engine AXR	203006	Drive Shaft	36		53.2	77.5	557		
	2005.10-2010.12	-	R	F	Hatchback Engine AXR	203004	Drive Shaft	36		53.2	77.5	822		
	2005.10-2010.12	MT	L	F	Hatchback Engine AXR	261021	Drive Shaft	36		53.2	77.5	564.5		
1.9 TDI (81 kW)	1997.08-2006.01	MT	L	F	Hatchback Engine AHF/ASV	203006	Drive Shaft	36		53.2	77.5	557		
	1997.08-2006.01	MT	R	F	Hatchback Engine AHF/ASV	203004	Drive Shaft	36		53.2	77.5	822		
	1997.08-2006.01	MT	L	F	Hatchback Engine AHF/ASV	261021	Drive Shaft	36		53.2	77.5	564.5		
	1997.08-2006.01	MT	R	F	Hatchback Engine AHF/ASV	603009	Inner Joint		33		34			
1.9 TDI (96 kW)	2002.09-2004.09	MT	L	F	Hatchback Engine ASZ	261123	Drive Shaft	36		53	77.5	520		
	2002.09-2004.09	MT	L/R	F	Hatchback Engine ASZ	803035	Outer Joint	36	27	53	77.5	65	I	
	2002.09-2004.09	-	R	F	Hatchback Engine ASZ	299114	Drive Shaft	36		53	77.5	809		
	2002.09-2004.09	MT	R	F	Hatchback Engine ASZ	261121	Drive Shaft	36		53	77.5	806		
	2002.09-2004.09	MT	-	-	Hatchback Engine ASZ	603016	Inner Joint		28		32			
	2002.09-2004.09	MT	-	-	Hatchback Engine ASZ	603006	Inner Joint		33		34			
2.0 (85 kW)	1999.04-2007.05	AT/MT	L/R	F	Hatchback Engine AEG/APK/AQY/AZH/AZJ	803036	Outer Joint	36	30	53.2	77.5	61	I	
	1999.04-2007.05	AT	L	F	Hatchback Engine AEG/APK/AQY/AZH/AZJ	261020	Drive Shaft	36		53.2	77.5	547		
	1999.04-2007.05	MT	L	F	Hatchback Engine AEG/APK/AQY/AZH/AZJ	261314	Drive Shaft	36		53	78	558		
	1999.04-2007.05	AT	L	F	Hatchback Engine AEG/APK/AQY/AZH/AZJ	261156	Drive Shaft	36		53	78	554.5		
	1999.04-2007.05	AT	L	F	Hatchback Engine AEG/APK/AQY/AZH/AZJ	661062	Inner Joint		30		59			
	1999.04-2007.05	MT	R	F	Hatchback Engine AEG/APK/AQY/AZH/AZJ	203004	Drive Shaft	36		53.2	77.5	822		
	1999.04-2007.05	MT	L	F	Hatchback Engine AEG/APK/AQY/AZH/AZJ	261021	Drive Shaft	36		53.2	77.5	564.5		
	1999.04-2007.05	MT	R	F	Hatchback Engine AEG/APK/AQY/AZH/AZJ	603009	Inner Joint		33		34			
	1999.04-2007.05	MT	L	F	Hatchback Engine AEG/APK/AQY/AZH/AZJ	603011	Inner Joint		33		34			
RS 1.8 T (132 kW)	2001.05-2006.01	MT	L/R	F	Hatchback Engine AUQ	803036	Outer Joint	36	30	53.2	77.5	61	I	
	2001.05-2006.01	MT	L	F	Hatchback Engine AUQ	261020	Drive Shaft	36		53.2	77.5	547		
	2001.05-2006.01	-	L	F	Hatchback Engine AUQ	261156	Drive Shaft	36		53	78	554.5		
	2001.05-2006.01	MT	-	-	Hatchback Engine AUQ	603006	Inner Joint		33		34			
	2001.05-2006.01	-	L/R	F	Hatchback Engine AUQ	661006	Inner Joint		30		57.6			
	2001.05-2006.01	-	L	F	Hatchback Engine AUQ	661062	Inner Joint		30		59			
OCTAVIA I Combi (1U5)														
1.4 16V (55 kW)	2000.08-2010.12	-	L	F	Estate Engine AXP/BCA	261045	Drive Shaft		36		53	78.5	555	
	2000.08-2010.12	MT	R	F	Estate Engine AXP/BCA	203046	Drive Shaft	36		53	78.5	822		
	2000.08-2010.12	-	R	F	Estate Engine AXP/BCA	253008	Drive Shaft	36		59.5	40	782		
	2000.08-2010.12	MT	L/R	F	Estate Engine AXP/BCA	803033	Outer Joint	36	30	53	78.5	51	I	
	2000.08-2010.12	MT	-	-	Estate Engine AXP/BCA	603006	Inner Joint		33		34			
	2000.08-2010.12	-	L/R	F	Estate Engine AXP/BCA	603008	Inner Joint		33		32			
1.6 (55 kW)	1998.07-2004.09	-	L	F	Estate Engine AEE	261045	Drive Shaft	36		53	78.5	555		
	1998.07-2004.09	MT	L/R	F	Estate Engine AEE	603004	Inner Joint		33		32			
	1998.07-2004.09	-	R	F	Estate Engine AEE	203046	Drive Shaft	36		53	78.5	822		
	1998.07-2004.09	MT	L/R	F	Estate Engine AEE	803033	Outer Joint	36	30	53	78.5	51	I	
	1998.07-2004.09	-	L/R	F	Estate Engine AEE	603008	Inner Joint		33		32			
1.6 (74 kW)	1998.07-2007.12	AT	L/R	F	Estate Engine AEH/AKL	803036	Outer Joint	36	30	53.2	77.5	61	I	
	1998.07-2007.12	MT	L	F	Estate Engine AEH/AKL	261045	Drive Shaft	36		53	78.5	555		
	1998.07-2007.12	MT	L/R	F	Estate Engine AEH/AKL	603004	Inner Joint		33		32			
	1998.07-2007.12	AT	L	F	Estate Engine AEH/AKL	261156	Drive Shaft	36		53	78	554.5		
	1998.07-2007.12	MT	L/R	F	Estate Engine AEH/AKL	803033	Outer Joint	36	30	53	78.5	51	I	
	1998.07-2007.12	AT	L	F	Estate Engine AEH/AKL	661062	Inner Joint		30		59			
	1998.07-2007.12	-	L/R	F	Estate Engine AEH/AKL	603008	Inner Joint		33		32			
1.6 (75 kW)	2000.09-2010.12	AT	L/R	F	Estate Engine AVU/BFQ	803036	Outer Joint	36	30	53.2	77.5	61	I	
	2000.09-2010.12	MT	L	F	Estate Engine AVU/BFQ	261045	Drive Shaft	36		53	78.5	555		
	2000.09-2010.12	AT	L	F	Estate Engine AVU/BFQ	261156	Drive Shaft	36		53	78	554.5		
	2000.09-2010.12	AT	L/R	F	Estate Engine AVU/BFQ	661006	Inner Joint		30		57.6			
	2000.09-2010.12	MT	L/R	F	Estate Engine AVU/BFQ	803033	Outer Joint	36	30	53	78.5	51	I	
	2000.09-2010.12	AT	L	F	Estate Engine AVU/BFQ	661062	Inner Joint		30		59			
	2000.09-2010.12	MT	L/R	F	Estate Engine AVU/BFQ	603008	Inner Joint		33		32			
1.8 20V (92 kW)	1998.07-2000.07	MT	L	F	Estate Engine AGN	603011	Inner Joint		33		34			
	1998.07-2000.07	AT	L	F	Estate Engine AGN	261020	Drive Shaft	36		53.2	77.5	547		
	1998.07-2000.07	MT	R	F	Estate Engine AGN	603009	Inner Joint		33		34			
	1998.07-2000.07	MT	L	F	Estate Engine AGN	261314	Drive Shaft	36		53	78	558		
	1998.07-2000.07	AT	L	F	Estate Engine AGN	261156	Drive Shaft	36		53	78	554.5		



	 YEAR	TRANSM	L/R	F/R	REMARKS	GSP Ref.	 PRODUCT	 ABS	Technical Specifications					
									A	B	C	H	L	P
SKODA														
OCTAVIA I Combi (1U5)														
1.8 20V (92 kW)	1998.07-2000.07	AT	L	F	Estate Engine AGN	661062	Inner Joint		30		59			
	1998.07-2000.07	MT	L	F	Estate Engine AGN	261021	Drive Shaft	36		53.2	77.5	564.5		
	1998.07-2000.07	AT/MT	L/R	F	Estate Engine AGN	803036	Outer Joint	36	30	53.2	77.5	61	I	
1.8 T (110 kW)	1998.07-2010.12	AT/MT	L/R	F	Estate Engine AGU/ARX/ARZ/AUM	803036	Outer Joint	36	30	53.2	77.5	61	I	
	1998.07-2010.12	AT/MT	L	F	Estate Engine AGU/ARX/ARZ/AUM	261020	Drive Shaft	36		53.2	77.5	547		
	1998.07-2010.12	-	R	F	Estate Engine AGU/ARX/ARZ/AUM	203011	Drive Shaft	36		53.2	77.5	810.5		
	1998.07-2010.12	MT	L	F	Estate Engine AGU/ARX/ARZ/AUM	261021	Drive Shaft	36		53.2	77.5	564.5		
	1998.07-2010.12	-	L	F	Estate Engine AGU/ARX/ARZ/AUM	261156	Drive Shaft	36		53	78	554.5		
	1998.07-2010.12	-	L	F	Estate Engine AGU/ARX/ARZ/AUM	661062	Inner Joint		30		59			
	1998.07-2010.12	-	L/R	F	Estate Engine AGU/ARX/ARZ/AUM	661006	Inner Joint		30		57.6			
	2001.05-2006.05	MT	L/R	F	All-wheel Drive Estate Engine ARX	803036	Outer Joint	36	30	53.2	77.5	61	I	
	2001.05-2006.05	-	L/R	R	All-wheel Drive Estate Engine ARX	603003	Inner Joint		33		32			
	2001.05-2006.05	MT	L	F	All-wheel Drive Estate Engine ARX	261314	Drive Shaft	36		53	78	558		
	2001.05-2006.05	MT	L	F	All-wheel Drive Estate Engine ARX	261021	Drive Shaft	36		53.2	77.5	564.5		
	2001.05-2006.05	MT	-	-	All-wheel Drive Estate Engine ARX	603006	Inner Joint		33		34			
	2001.05-2006.05	MT	R	F	All-wheel Drive Estate Engine ARX	603009	Inner Joint		33		34			
	2001.05-2006.05	MT	L	F	All-wheel Drive Estate Engine ARX	603011	Inner Joint		33		34			
2001.05-2006.05	-	L/R	R	All-wheel Drive Estate Engine ARX	803033	Outer Joint	36	30	53	78.5	51	I		
1.9 SDI (50 kW)	1998.07-2003.12	MT	L	F	Estate Engine AGP/AQM	261045	Drive Shaft	36		53	78.5	555		
	1998.07-2003.12	MT	L/R	F	Estate Engine AGP/AQM	603004	Inner Joint		33		32			
	1998.07-2003.12	MT	R	F	Estate Engine AGP/AQM	203046	Drive Shaft	36		53	78.5	822		
	1998.07-2003.12	MT	L/R	F	Estate Engine AGP/AQM	803033	Outer Joint	36	30	53	78.5	51	I	
	1998.07-2003.12	-	L/R	F	Estate Engine AGP/AQM	603008	Inner Joint		33		32			
1.9 TDI (66 kW)	1998.07-2010.03	AT	L	F	Estate Engine AGR/ALH	261020	Drive Shaft	36		53.2	77.5	547		
	1998.07-2010.03	MT	R	F	Estate Engine AGR/ALH	603009	Inner Joint		33		34			
	1998.07-2010.03	MT	L	F	Estate Engine AGR/ALH	203006	Drive Shaft	36		53.2	77.5	557		
	1998.07-2010.03	MT	R	F	Estate Engine AGR/ALH	203004	Drive Shaft	36		53.2	77.5	822		
	1998.07-2010.03	MT	L	F	Estate Engine AGR/ALH	261021	Drive Shaft	36		53.2	77.5	564.5		
	1998.07-2010.03	AT	L/R	F	Estate Engine AGR/ALH	661006	Inner Joint		30		57.6			
	1998.07-2010.03	MT	L/R	F	Estate Engine AGR/ALH	803036	Outer Joint	36	30	53.2	77.5	61	I	
	1999.11-2006.02	MT	L/R	R	All-wheel Drive Estate Engine AGR	603003	Inner Joint		33		32			
	1999.11-2006.02	-	L/R	F	All-wheel Drive Estate Engine AGR	803036	Outer Joint	36	30	53.2	77.5	61	I	
	1999.11-2006.02	-	L	F	All-wheel Drive Estate Engine AGR	261314	Drive Shaft	36		53	78	558		
	1999.11-2006.02	-	L/R	R	All-wheel Drive Estate Engine AGR	803033	Outer Joint	36	30	53	78.5	51	I	
	1999.11-2006.02	MT	R	F	All-wheel Drive Estate Engine AGR	603009	Inner Joint		33		34			
	1999.11-2006.02	MT	L	F	All-wheel Drive Estate Engine AGR	603011	Inner Joint		33		34			
	1.9 TDI (74 kW)	2000.08-2010.12	-	R	F	Estate Engine AXR/ATD	603009	Inner Joint		33		34		
2000.08-2010.12		MT	-	-	Estate Engine AXR/ATD	603006	Inner Joint		33		34			
2000.08-2010.12		-	L/R	F	Estate Engine AXR/ATD	803036	Outer Joint	36	30	53.2	77.5	61	I	
2000.08-2010.12		-	L	F	Estate Engine AXR/ATD	603011	Inner Joint		33		34			
2000.08-2010.12		-	L	F	Estate Engine AXR/ATD	203006	Drive Shaft	36		53.2	77.5	557		
2000.08-2010.12		-	R	F	Estate Engine AXR/ATD	203004	Drive Shaft	36		53.2	77.5	822		
2000.08-2010.12		5AT	L	F	Estate Engine AXR/ATD	261021	Drive Shaft	36		53.2	77.5	564.5		
2000.09-2006.01		-	L	F	All-wheel Drive Estate Engine ATD	261123	Drive Shaft	36		53	77.5	520		
2000.09-2006.01		-	L/R	F	All-wheel Drive Estate Engine ATD	803035	Outer Joint	36	27	53	77.5	65	I	
2000.09-2006.01		-	L/R	R	All-wheel Drive Estate Engine ATD	603003	Inner Joint		33		32			
2000.09-2006.01		-	R	F	All-wheel Drive Estate Engine ATD	261186	Drive Shaft	36		53	77.5	653		
2000.09-2006.01	-	L/R	R	All-wheel Drive Estate Engine ATD	803033	Outer Joint	36	30	53	78.5	51	I		
1.9 TDI (81 kW)	1998.07-2006.01	MT	L	F	Estate Engine AHF/ASV	203006	Drive Shaft	36		53.2	77.5	557		
	1998.07-2006.01	MT	R	F	Estate Engine AHF/ASV	203004	Drive Shaft	36		53.2	77.5	822		
	1998.07-2006.01	MT	L	F	Estate Engine AHF/ASV	261021	Drive Shaft	36		53.2	77.5	564.5		
	1998.07-2006.01	MT	R	F	Estate Engine AHF/ASV	603009	Inner Joint		33		34			
	1998.07-2006.01	MT	L/R	F	Estate Engine AHF/ASV	803036	Outer Joint	36	30	53.2	77.5	61	I	
1.9 TDI (96 kW)	2002.09-2004.09	MT	L	F	Estate Engine ASZ	261123	Drive Shaft	36		53	77.5	520		
	2002.09-2004.09	MT	L/R	F	Estate Engine ASZ	803035	Outer Joint	36	27	53	77.5	65	I	
	2002.09-2004.09	MT	R	F	Estate Engine ASZ	299114	Drive Shaft	36		53	77.5	809		
	2002.09-2004.09	MT	R	F	Estate Engine ASZ	261121	Drive Shaft	36		53	77.5	806		
	2002.09-2004.09	MT	-	-	Estate Engine ASZ	603016	Inner Joint		28		32			
	2002.09-2004.09	MT	-	-	Estate Engine ASZ	603006	Inner Joint		33		34			
2.0 (85 kW)	1999.04-2007.05	AT/MT	L/R	F	Estate Engine AEG/APK/AQY/AZH/AZJ	803036	Outer Joint	36	30	53.2	77.5	61	I	
	1999.04-2007.05	MT	L	F	Estate Engine AEG/APK/AQY/AZH/AZJ	261314	Drive Shaft	36		53	78	558		
	1999.04-2007.05	MT	R	F	Estate Engine AEG/APK/AQY/AZH/AZJ	603009	Inner Joint		33		34			
	1999.04-2007.05	AT	L	F	Estate Engine AEG/APK/AQY/AZH/AZJ	261156	Drive Shaft	36		53	78	554.5		
	1999.04-2007.05	AT	L	F	Estate Engine AEG/APK/AQY/AZH/AZJ	661062	Inner Joint		30		59			
	1999.04-2007.05	MT	R	F	Estate Engine AEG/APK/AQY/AZH/AZJ	203004	Drive Shaft	36		53.2	77.5	822		
	1999.04-2007.05	MT	L	F	Estate Engine AEG/APK/AQY/AZH/AZJ	603011	Inner Joint		33		34			





YEAR	TRANSM	L/R	F/R	REMARKS	GSP Ref.	PRODUCT	ABS	Technical Specifications					
								A	B	C	H	L	P
SKODA													
OCTAVIA I Combi (1U5)													
2.0 (85 kW)	1999.04-2007.05	-	L	F	Estate Engine AEG/APK/AQY/AZH/AZJ	261021	Drive Shaft	36		53.2	77.5	564.5	
	2000.08-2004.09	-	L/R	R	All-wheel Drive Estate Engine AZH/AZJ	603003	Inner Joint		33		32		
	2000.08-2004.09	-	L/R	F	All-wheel Drive Estate Engine AZH/AZJ	803036	Outer Joint	36	30	53.2	77.5	61	I
	2000.08-2004.09	-	L	F	All-wheel Drive Estate Engine AZH/AZJ	603011	Inner Joint		33		34		
	2000.08-2004.09	MT	L	F	All-wheel Drive Estate Engine AZH/AZJ	261314	Drive Shaft	36		53	78	558	
	2000.08-2004.09	-	R	F	All-wheel Drive Estate Engine AZH/AZJ	603009	Inner Joint		33		34		
	2000.08-2004.09	-	L/R	F	All-wheel Drive Estate Engine AZH/AZJ	803033	Outer Joint	36	30	53	78.5	51	I
2.0 (88 kW)	2000.01-2010.12	MT	L	F	All-wheel Drive Estate Engine ATF	603011	Inner Joint		33		34		
	2000.01-2010.12	MT	L/R	R	All-wheel Drive Estate Engine ATF	603003	Inner Joint		33		32		
	2000.01-2010.12	MT	R	F	All-wheel Drive Estate Engine ATF	603009	Inner Joint		33		34		
	2000.01-2010.12	-	L	F	All-wheel Drive Estate Engine ATF	261314	Drive Shaft	36		53	78	558	
	2000.01-2010.12	-	L/R	R	All-wheel Drive Estate Engine ATF	803033	Outer Joint	36	30	53	78.5	51	I
	2000.01-2010.12	-	L/R	F	All-wheel Drive Estate Engine ATF	803036	Outer Joint	36	30	53.2	77.5	61	I
RS 1.8 T (132 kW)	2002.08-2006.01	MT	L/R	F	Estate Engine AUQ	803036	Outer Joint	36	30	53.2	77.5	61	I
	2002.08-2006.01	MT	L	F	Estate Engine AUQ	261020	Drive Shaft	36		53.2	77.5	547	
	2002.08-2006.01	-	L	F	Estate Engine AUQ	261156	Drive Shaft	36		53	78	554.5	
	2002.08-2006.01	-	L	F	Estate Engine AUQ	661062	Inner Joint		30		59		
	2002.08-2006.01	-	L/R	F	Estate Engine AUQ	661006	Inner Joint		30		57.6		
	2002.08-2006.01	MT	-	-	Estate Engine AUQ	603006	Inner Joint		33		34		
OCTAVIA II													
2.0 (110 KW)	2004.11-2008.10	-	L	F	Engine PS/1Z3	261153	Drive Shaft	36	26	59.5	40	583	
OCTAVIA II (1U2, 1U5), SW													
1.9 TDi (66 kW)	1996.09-2006.01	MT	-	-	-	603013	Inner Joint			33		34	
1.9 TDi (81 kW)	1996.09-2006.01	MT	-	-	-	603013	Inner Joint			33		34	
OCTAVIA II (1Z3)													
1.2 TSi (77 kW)	2010.02-2013.06	-	L/R	F	Hatchback Engine CBZB	803037	Outer Joint	36	30	59.5	40.5	55	I
	2010.02-2013.06	-	L/R	F	Hatchback Engine CBZB	603011	Inner Joint			33		34	
	2010.02-2013.06	MT	R	F	Hatchback Engine CBZB	201586	Drive Shaft	36		59.5	40	806	
	2010.02-2013.06	-	L	F	Hatchback Engine CBZB	261277	Drive Shaft	36		59.5	40	516	
1.4 (55 kW)	2004.05-2006.05	-	L/R	F	Hatchback Engine BCA	603008	Inner Joint			33		32	
	2004.05-2006.05	MT	-	-	Hatchback Engine BCA	603006	Inner Joint			33		34	
	2004.05-2006.05	-	L	F	Hatchback Engine BCA	261045	Drive Shaft	36		53	78.5	555	
	2004.05-2006.05	-	R	F	Hatchback Engine BCA	203046	Drive Shaft	36		53	78.5	822	
	2004.05-2006.05	-	R	F	Hatchback Engine BCA	253008	Drive Shaft	36		59.5	40	782	
	2004.05-2006.05	-	L	F	Hatchback Engine BCA	253007	Drive Shaft	36		59.5	40	559	
	2004.05-2006.05	MT	L/R	F	Hatchback Engine BCA	853001	Outer Joint	36	30	59.5	40	49	I
1.4 (59 kW)	2004.06-2013.04	MT	-	-	Hatchback Engine BUD/CGGA	603006	Inner Joint			33		34	
	2004.06-2013.04	5MT	R	F	Hatchback Engine BUD/CGGA	253008	Drive Shaft	36		59.5	40	782	
	2004.06-2013.04	MT	L	F	Hatchback Engine BUD/CGGA	253007	Drive Shaft	36		59.5	40	559	
	2004.06-2013.04	-	L/R	F	Hatchback Engine BUD/CGGA	603008	Inner Joint			33		32	
	2004.06-2013.04	-	L/R	F	Hatchback Engine BUD/CGGA	853001	Outer Joint	36	30	59.5	40	49	I
1.4 TSi (90 kW)	2008.11-2013.06	AT	-	F	Hatchback Engine CAXA	803100	Outer Joint	36	33	59.5	38	55	I
	2008.11-2013.06	MT	L/R	F	Hatchback Engine CAXA	803037	Outer Joint	36	30	59.5	40.5	55	I
	2008.11-2013.06	MT	L/R	F	Hatchback Engine CAXA	603011	Inner Joint			33		34	
	2008.11-2013.06	AT	L	F	Hatchback Engine CAXA	261089	Drive Shaft	36		59.5	40.5	521	
	2008.11-2013.06	-	-	-	Hatchback Engine CAXA	603016	Inner Joint			28		32	
	2008.11-2013.06	MT	L	F	Hatchback Engine CAXA	261198	Drive Shaft	36		59.5	40.5	530	
	2008.11-2013.06	MT	R	F	Hatchback Engine CAXA	201586	Drive Shaft	36		59.5	40	806	
	2008.11-2013.06	AT	L	F	Hatchback Engine CAXA	261281	Drive Shaft	36		59.5	40	528	
	2008.11-2013.06	AT	L/R	F	Hatchback Engine CAXA	803002	Outer Joint	36	27	59.5	40	66	I
	2008.11-2013.06	AT	R	F	Hatchback Engine CAXA	261200	Drive Shaft	36		59.5	40.5	820	
	2008.11-2013.06	-	-	-	Hatchback Engine CAXA	861059	Outer Joint	36	33	59.5	40	59.5	I
1.6 (75 kW)	2004.06-2013.06	MT	L	F	Hatchback Engine BGU/BSE/BSF/CCSA/CMXA	261097	Drive Shaft	36		59.5	40.5	543	
	2004.06-2013.06	AT	R	F	Hatchback Engine BGU/BSE/BSF/CCSA/CMXA	261094	Drive Shaft	36	26	59.5	40.5	884	
	2004.06-2013.06	MT	R	F	Hatchback Engine BGU/BSE/BSF/CCSA/CMXA	261096	Drive Shaft	36		59.5	40.5	799	
	2004.06-2013.06	MT	L/R	F	Hatchback Engine BGU/BSE/BSF/CCSA/CMXA	603011	Inner Joint			33		34	
	2004.06-2013.06	AT	L	F	Hatchback Engine BGU/BSE/BSF/CCSA/CMXA	803116	Outer Joint	36	30	59.5	38	55	I
	2004.06-2013.06	AT	L/R	F	Hatchback Engine BGU/BSE/BSF/CCSA/CMXA	661011	Inner Joint	26	32	31	68.5	85	
	2004.06-2013.06	-	L/R	F	Hatchback Engine BGU/BSE/BSF/CCSA/CMXA	803037	Outer Joint	36	30	59.5	40.5	55	I
	2004.06-2013.06	AT	L	F	Hatchback Engine BGU/BSE/BSF/CCSA/CMXA	203318	Drive Shaft	36	26	59.5	38	581	
	2004.06-2013.06	MT	L	F	Hatchback Engine BGU/BSE/BSF/CCSA/CMXA	203320	Drive Shaft	36		59.5	40	546	
1.6 FSI (85 kW)	2004.02-2008.10	MT	L/R	F	Hatchback Engine BLF	603011	Inner Joint			33		34	
	2004.02-2008.10	MT	R	F	Hatchback Engine BLF	261211	Drive Shaft	36		59.5	40.5	784	
	2004.02-2008.10	MT	L	F	Hatchback Engine BLF	803116	Outer Joint	36	30	59.5	38	55	I
	2004.02-2008.10	-	L/R	F	Hatchback Engine BLF	803037	Outer Joint	36	30	59.5	40.5	55	I
	2004.02-2008.10	AT	L	F	Hatchback Engine BLF	201582	Drive Shaft	36	26	59.5	40	597	

	 YEAR	TRANSM	L/R	F/R	REMARKS	GSP Ref.	 PRODUCT	 ABS	Technical Specifications						
									A	B	C	H	L	P	
SKODA															
OCTAVIA II (1Z3)															
1.6 FSI (85 kW)	2004.02-2008.10	AT	L/R	F	Hatchback Engine BLF	661011	Inner Joint		26	32	31	68.5	85		
	2004.02-2008.10	MT	L	F	Hatchback Engine BLF	203319	Drive Shaft		36		59.5	38	557		
1.6 LPG (75 kW)	2009.08-2012.11	-	L/R	F	Hatchback Engine CHGA	603011	Inner Joint			33		34			
	2009.08-2012.11	-	L	F	Hatchback Engine CHGA	261097	Drive Shaft		36		59.5	40.5	543		
	2009.08-2012.11	MT	-	-	Hatchback Engine CHGA	603006	Inner Joint			33		34			
	2009.08-2012.11	-	R	F	Hatchback Engine CHGA	261096	Drive Shaft		36		59.5	40.5	799		
	2009.08-2012.11	-	L/R	F	Hatchback Engine CHGA	803037	Outer Joint		36	30	59.5	40.5	55	I	
	2009.08-2012.11	-	L	F	Hatchback Engine CHGA	203320	Drive Shaft		36		59.5	40	546		
1.6 MultiFuel (75 kW)	2008.01-2013.06	MT	-	-	Hatchback Engine CCSA, CMXA	603006	Inner Joint			33		34			
	2008.01-2013.06	-	L	F	Hatchback Engine CCSA, CMXA	261097	Drive Shaft		36		59.5	40.5	543		
	2008.01-2013.06	-	L/R	F	Hatchback Engine CCSA, CMXA	603011	Inner Joint			33		34			
	2008.01-2013.06	-	R	F	Hatchback Engine CCSA, CMXA	261096	Drive Shaft		36		59.5	40.5	799		
	2008.01-2013.06	-	L	F	Hatchback Engine CCSA, CMXA	203320	Drive Shaft		36		59.5	40	546		
1.6 TDI (77 kW)	2009.06-2013.04	7AT/6MT	-	F	Hatchback Engine CAYC	803100	Outer Joint		36	33	59.5	38	55	I	
	2009.06-2013.04	MT	L	F	Hatchback Engine CAYC	203294	Drive Shaft		36		59.5	38	519		
	2009.06-2013.04	7AT/6MT	L	F	Hatchback Engine CAYC	261089	Drive Shaft		36		59.5	40.5	521		
	2009.06-2013.04	MT	L/R	F	Hatchback Engine CAYC	803037	Outer Joint		36	30	59.5	40.5	55	I	
	2009.06-2013.04	AT	L/R	F	Hatchback Engine CAYC	803002	Outer Joint		36	27	59.5	40	66	I	
	2009.06-2013.04	AT/MT	L/R	F	Hatchback Engine CAYC	603011	Inner Joint			33		34			
	2009.06-2013.04	MT	L	F	Hatchback Engine CAYC	803116	Outer Joint		36	30	59.5	38	55	I	
	2009.06-2013.04	MT	R	F	Hatchback Engine CAYC	261042	Drive Shaft		36		59.5	40.5	814		
	2009.06-2013.04	MT	R	F	Hatchback Engine CAYC	201585	Drive Shaft		36		59.5	40	805		
	2009.06-2013.04	6MT	R	F	Hatchback Engine CAYC	261200	Drive Shaft		36		59.5	40.5	820		
	2009.06-2013.04	7AT	R	F	Hatchback Engine CAYC	261280	Drive Shaft		36		59.5	40	801		
	1.8 TSI (112 kW)	2009.03-2013.06	MT	L	F	Hatchback Engine CDAB	261089	Drive Shaft		36		59.5	40.5	521	
		2009.03-2013.06	-	L/R	F	Hatchback Engine CDAB	803002	Outer Joint		36	27	59.5	40	66	I
2009.03-2013.06		-	-	-	Hatchback Engine CDAB	861059	Outer Joint		36	33	59.5	40	59.5	I	
2009.03-2013.06		-	L/R	F	Hatchback Engine CDAB	603011	Inner Joint			33		34			
2009.03-2013.06		MT	L	F	Hatchback Engine CDAB	261131	Drive Shaft		36		59.5	40	515		
1.8 TSI (118 kW)	2007.06-2013.04	MT	L	F	Hatchback Engine BZB/CDA A	261100	Drive Shaft		36		59.5	40	513		
	2007.06-2013.04	MT	L	F	Hatchback Engine BZB/CDA A	261089	Drive Shaft		36		59.5	40.5	521		
	2007.06-2013.04	MT	L/R	F	Hatchback Engine BZB/CDA A	803002	Outer Joint		36	27	59.5	40	66	I	
	2007.06-2013.04	-	-	-	Hatchback Engine BZB/CDA A	861059	Outer Joint		36	33	59.5	40	59.5	I	
	2007.06-2013.04	MT	L	F	Hatchback Engine BZB/CDA A	261131	Drive Shaft		36		59.5	40	515		
1.9 TDI (77 kW)	2004.06-2010.12	MT	L	F	Hatchback Engine BJB/BKC/BLS/BXE	203294	Drive Shaft		36		59.5	38	519		
	2004.06-2010.12	AT	L/R	F	Hatchback Engine BJB/BKC/BLS/BXE	661057	Inner Joint			34		86			
	2004.06-2010.12	AT	L	F	Hatchback Engine BJB/BKC/BLS/BXE	254013	Drive Shaft		36		59.5	40	479.5		
	2004.06-2010.12	AT	L	F	Hatchback Engine BJB/BKC/BLS/BXE	654004	Inner Joint			34		85			
	2004.06-2010.12	MT	L	F	Hatchback Engine BJB/BKC/BLS/BXE	803116	Outer Joint		36	30	59.5	38	55	I	
	2004.06-2010.12	AT	L	F	Hatchback Engine BJB/BKC/BLS/BXE	203241	Drive Shaft		36		59.5	40	475		
	2004.06-2010.12	MT	R	F	Hatchback Engine BJB/BKC/BLS/BXE	261042	Drive Shaft		36		59.5	40.5	814		
	2004.06-2010.12	AMT	L/R	F	Hatchback Engine BJB/BKC/BLS/BXE	803002	Outer Joint		36	27	59.5	40	66	I	
	2004.06-2010.12	5MT	L/R	F	Hatchback Engine BJB/BKC/BLS/BXE	803037	Outer Joint		36	30	59.5	40.5	55	I	
	2004.06-2010.12	5MT	L/R	F	Hatchback Engine BJB/BKC/BLS/BXE	603011	Inner Joint			33		34			
2.0 FSI (110 kW)	2004.06-2010.12	AT	R	F	Hatchback Engine BJB/BKC/BLS/BXE	254011	Drive Shaft		36		59.5	40	755		
	2004.11-2008.10	MT	R	F	Hatchback Engine BLY/BLR/BVY/BVZ	261113	Drive Shaft		36		59.5	40	814		
	2004.11-2008.10	-	L/R	F	Hatchback Engine BLY/BLR/BVY/BVZ	603011	Inner Joint			33		34			
	2004.11-2008.10	AT	R	F	Hatchback Engine BLY/BLR/BVY/BVZ	261094	Drive Shaft		36	26	59.5	40.5	884		
	2004.11-2008.10	MT	R	F	Hatchback Engine BLY/BLR/BVY/BVZ	201585	Drive Shaft		36		59.5	40	805		
	2004.11-2008.10	MT	L	F	Hatchback Engine BLY/BLR/BVY/BVZ	803116	Outer Joint		36	30	59.5	38	55	I	
	2004.11-2008.10	-	L/R	F	Hatchback Engine BLY/BLR/BVY/BVZ	803037	Outer Joint		36	30	59.5	40.5	55	I	
	2004.11-2008.10	AT	L/R	F	Hatchback Engine BLY/BLR/BVY/BVZ	661011	Inner Joint		26	32	31	68.5	85		
2.0 RS (147 kW)	2005.10-2013.02	-	L	F	Hatchback Engine BWA/CCZA	203295	Drive Shaft		36		59.5	40	491		
	2005.10-2013.02	MT	L/R	F	Hatchback Engine BWA/CCZA	803002	Outer Joint		36	27	59.5	40	66	I	
2.0 TDI (100 kW)	2004.02-2010.05	AT	R	F	Hatchback Engine AZV	254011	Drive Shaft		36		59.5	40	755		
	2004.02-2010.05	MT	L	F	Hatchback Engine AZV	203295	Drive Shaft		36		59.5	40	491		
	2004.02-2010.05	AT	L/R	F	Hatchback Engine AZV	661057	Inner Joint			34		86			
	2004.02-2010.05	MT	R	F	Hatchback Engine AZV	203236	Drive Shaft		36		59.5	40	484		
	2004.02-2010.05	MT	R	F	Hatchback Engine AZV	203313	Drive Shaft		36		59.5	40	792		
	2004.02-2010.05	AT	L	F	Hatchback Engine AZV	254013	Drive Shaft		36		59.5	40	479.5		
	2004.02-2010.05	AT	L	F	Hatchback Engine AZV	654004	Inner Joint			34		85			
	2004.02-2010.05	AT	L	F	Hatchback Engine AZV	203241	Drive Shaft		36		59.5	40	475		
2.0 TDI (103 kW)	2005.11-2010.05	AT	R	F	Hatchback Engine BMM	803002	Outer Joint		36	27	59.5	40	66	I	
2.0 TDI (103 kW)	2005.11-2010.05	AT	R	F	Hatchback Engine BMM	254011	Drive Shaft		36		59.5	40	755		





	 YEAR	TRANSM	L/R	F/R	REMARKS	GSP Ref.	 PRODUCT	 ABS	Technical Specifications					
									A	B	C	H	L	P
SKODA														
OCTAVIA II (1Z3)														
2.0 TDI (103 kW)	2005.11-2010.05	MT	L	F	Hatchback Engine BMM	203295	Drive Shaft		36		59.5	40	491	
	2005.11-2010.05	AT	L/R	F	Hatchback Engine BMM	661057	Inner Joint			34		86		
	2005.11-2010.05	MT	R	F	Hatchback Engine BMM	203313	Drive Shaft		36		59.5	40	792	
	2005.11-2010.05	AT	L	F	Hatchback Engine BMM	254013	Drive Shaft		36		59.5	40	479.5	
	2005.11-2010.05	AT	L	F	Hatchback Engine BMM	654004	Inner Joint			34		85		
	2005.11-2010.05	AT	L	F	Hatchback Engine BMM	203241	Drive Shaft		36		59.5	40	475	
	2005.11-2010.05	MT	L/R	F	Hatchback Engine BMM	803002	Outer Joint		36	27	59.5	40	66	I
2.0 TDI (81 kW)	2010.03-2013.06	-	L	F	Hatchback Engine CFHF	203294	Drive Shaft		36		59.5	38	519	
	2010.03-2013.06	-	L/R	F	Hatchback Engine CFHF	803037	Outer Joint		36	30	59.5	40.5	55	I
	2010.03-2013.06	-	L/R	F	Hatchback Engine CFHF	603011	Inner Joint			33		34		
	2010.03-2013.06	-	L	F	Hatchback Engine CFHF	803116	Outer Joint		36	30	59.5	38	55	I
	2010.03-2013.06	-	R	F	Hatchback Engine CFHF	261042	Drive Shaft		36		59.5	40.5	814	
	2010.03-2013.06	-	R	F	Hatchback Engine CFHF	201585	Drive Shaft		36		59.5	40	805	
2.0 TDI 16V (103 kW)	2004.02-2013.04	MT	L	F	Hatchback Engine BKD/CFHC/CLCB	203295	Drive Shaft		36		59.5	40	491	
	2004.02-2013.04	AT	L/R	F	Hatchback Engine BKD/CFHC/CLCB	661057	Inner Joint			34		86		
	2004.02-2013.04	MT	R	F	Hatchback Engine BKD/CFHC/CLCB	203236	Drive Shaft		36		59.5	40	484	
	2004.02-2013.04	MT	R	F	Hatchback Engine BKD/CFHC/CLCB	203313	Drive Shaft		36		59.5	40	792	
	2004.02-2013.04	AT	L	F	Hatchback Engine BKD/CFHC/CLCB	254013	Drive Shaft		36		59.5	40	479.5	
	2004.02-2013.04	AT	L	F	Hatchback Engine BKD/CFHC/CLCB	654004	Inner Joint			34		85		
	2004.02-2013.04	AT	L	F	Hatchback Engine BKD/CFHC/CLCB	203241	Drive Shaft		36		59.5	40	475	
	2004.02-2013.04	AT/MT	L/R	F	Hatchback Engine BKD/CFHC/CLCB	803002	Outer Joint		36	27	59.5	40	66	I
2.0 TDI RS (125 kW)	2006.04-2013.02	AT	R	F	Hatchback Engine BMN/CEGA	254011	Drive Shaft		36		59.5	40	755	
	2006.04-2013.02	MT	L	F	Hatchback Engine BMN/CEGA	203265	Drive Shaft		36		59.5	40	487	
	2006.04-2013.02	AT	L/R	F	Hatchback Engine BMN/CEGA	661057	Inner Joint			34		86		
	2006.04-2013.02	MT	L/R	F	Hatchback Engine BMN/CEGA	803037	Outer Joint		36	30	59.5	40.5	55	I
	2006.04-2013.02	AT	L	F	Hatchback Engine BMN/CEGA	203241	Drive Shaft		36		59.5	40	475	
	2006.04-2013.02	MT	R	F	Hatchback Engine BMN/CEGA	261126	Drive Shaft		36		59.5	40	793	
2006.04-2013.02	AT	R	F	Hatchback Engine BMN/CEGA	654004	Inner Joint			34		85			
OCTAVIA II COMBI														
2.0 (110 kW)	2004.11-2008.10	-	L	F	Engine PS/1Z5	261153	Drive Shaft		36	26	59.5	40	583	
	2004.11-2008.10	-	L	F	Engine PS/1Z5	261153	Drive Shaft		36	26	59.5	40	583	
OCTAVIA II Combi (1Z5)														
1.2 TSI (77 kW)	2010.02-2013.04	MT	R	F	Estate Engine CBZB	201586	Drive Shaft		36		59.5	40	806	
	2010.02-2013.04	-	L	F	Estate Engine CBZB	261277	Drive Shaft		36		59.5	40	516	
	2010.02-2013.04	-	L/R	F	Estate Engine CBZB	603011	Inner Joint			33		34		
	2010.02-2013.04	-	L/R	F	Estate Engine CBZB	803037	Outer Joint		36	30	59.5	40.5	55	I
1.4 (55 kW)	2004.05-2006.05	MT	-	-	Estate Engine BCA	603006	Inner Joint			33		34		
	2004.05-2006.05	-	R	F	Estate Engine BCA	253008	Drive Shaft		36		59.5	40	782	
	2004.05-2006.05	-	L	F	Estate Engine BCA	253007	Drive Shaft		36		59.5	40	559	
	2004.05-2006.05	-	L/R	F	Estate Engine BCA	853001	Outer Joint		36	30	59.5	40	49	I
	2004.05-2006.05	-	L/R	F	Estate Engine BCA	603008	Inner Joint			33		32		
1.4 (59 kW)	2006.05-2013.06	MT	-	-	Estate Engine BUD/CGGA	603006	Inner Joint			33		34		
	2006.05-2013.06	5MT	R	F	Estate Engine BUD/CGGA	253008	Drive Shaft		36		59.5	40	782	
	2006.05-2013.06	MT	L	F	Estate Engine BUD/CGGA	253007	Drive Shaft		36		59.5	40	559	
	2006.05-2013.06	-	L/R	F	Estate Engine BUD/CGGA	853001	Outer Joint		36	30	59.5	40	49	I
	2006.05-2013.06	-	L/R	F	Estate Engine BUD/CGGA	603008	Inner Joint			33		32		
	2006.05-2013.06	-	-	-	Estate Engine BUD/CGGA	603006	Inner Joint			33		34		
1.4 TSI (90 kW)	2008.11-2013.06	MT	L/R	F	Estate Engine CAXA	803037	Outer Joint		36	30	59.5	40.5	55	I
	2008.11-2013.06	MT	L/R	F	Estate Engine CAXA	603011	Inner Joint			33		34		
	2008.11-2013.06	-	-	-	Estate Engine CAXA	603016	Inner Joint			28		32		
	2008.11-2013.06	MT	L	F	Estate Engine CAXA	261198	Drive Shaft		36		59.5	40.5	530	
	2008.11-2013.06	MT	R	F	Estate Engine CAXA	201586	Drive Shaft		36		59.5	40	806	
	2008.11-2013.06	AT	L/R	F	Estate Engine CAXA	803002	Outer Joint		36	27	59.5	40	66	I
	2008.11-2013.06	-	-	-	Estate Engine CAXA	861059	Outer Joint		36	33	59.5	40	59.5	I
	2008.11-2013.06	-	-	-	Estate Engine CAXA	803037	Outer Joint		36	30	59.5	40.5	55	I
1.6 (75 kW)	2004.09-2013.06	-	L/R	F	Estate/Combi Engine BGU/BSE/BSF/CCSA/CMXA	803037	Outer Joint		36	30	59.5	40.5	55	I
	2004.09-2013.06	MT	L/R	F	Estate/Combi Engine BGU/BSE/BSF/CCSA/CMXA	603011	Inner Joint			33		34		
	2004.09-2013.06	MT	L	F	Estate/Combi Engine BGU/BSE/BSF/CCSA/CMXA	261097	Drive Shaft		36		59.5	40.5	543	
	2004.09-2013.06	AT	R	F	Estate/Combi Engine BGU/BSE/BSF/CCSA/CMXA	261094	Drive Shaft		36	26	59.5	40.5	884	
	2004.09-2013.06	MT	R	F	Estate/Combi Engine BGU/BSE/BSF/CCSA/CMXA	261096	Drive Shaft		36		59.5	40.5	799	
	2004.09-2013.06	AT	L	F	Estate/Combi Engine BGU/BSE/BSF/CCSA/CMXA	803116	Outer Joint		36	30	59.5	38	55	I
	2004.09-2013.06	AT	L/R	F	Estate/Combi Engine BGU/BSE/BSF/CCSA/CMXA	661011	Inner Joint		26	32	31	68.5	85	
	2004.09-2013.06	AT	L	F	Estate/Combi Engine BGU/BSE/BSF/CCSA/CMXA	203318	Drive Shaft		36	26	59.5	38	581	
	2004.09-2013.06	MT	L	F	Estate/Combi Engine BGU/BSE/BSF/CCSA/CMXA	203320	Drive Shaft		36		59.5	40	546	
	2004.09-2013.06	MT	L/R	F	Estate/Combi Engine BLF	603011	Inner Joint			33		34		
1.6 FSI (85 kW)	2004.02-2008.10	MT	R	F	Estate/Combi Engine BLF	261211	Drive Shaft		36		59.5	40.5	784	
	2004.02-2008.10	MT	L	F	Estate/Combi Engine BLF	803116	Outer Joint		36	30	59.5	38	55	I
	2004.02-2008.10	MT	R	F	Estate/Combi Engine BLF	803116	Outer Joint		36	30	59.5	38	55	I





YEAR	TRANSM	L/R	F/R	REMARKS	GSP Ref.	PRODUCT	ABS	Technical Specifications							
								A	B	C	H	L	P		
SKODA															
OCTAVIA II Combi (125)															
1.6 FSI (85 kW)															
2004.02-	2008.10	AT	L	F	Estate/Combi Engine BLF	201582	Drive Shaft	36	26	59.5	40	597			
2004.02-	2008.10	-	L/R	F	Estate/Combi Engine BLF	803037	Outer Joint	36	30	59.5	40.5	55	I		
2004.02-	2008.10	AT	L/R	F	Estate/Combi Engine BLF	661011	Inner Joint	26	32	31	68.5	85			
2004.02-	2008.10	MT	L	F	Estate/Combi Engine BLF	203319	Drive Shaft	36		59.5	38	557			
1.6 LPG (75 kW)															
2009.08-	2012.11	-	L/R	F	Estate Engine CHGA	603011	Inner Joint		33		34				
2009.08-	2012.11	-	L	F	Estate Engine CHGA	261097	Drive Shaft	36		59.5	40.5	543			
2009.08-	2012.11	MT	-	-	Estate Engine CHGA	603006	Inner Joint		33		34				
2009.08-	2012.11	-	R	F	Estate Engine CHGA	261096	Drive Shaft	36		59.5	40.5	799			
2009.08-	2012.11	-	L/R	F	Estate Engine CHGA	803037	Outer Joint	36	30	59.5	40.5	55	I		
2009.08-	2012.11	-	L	F	Estate Engine CHGA	203320	Drive Shaft	36		59.5	40	546			
1.6 MultiFuel (75 kW)															
2008.01-	2013.06	-	L/R	F	Estate Engine CCSA, CMXA	803037	Outer Joint	36	30	59.5	40.5	55	I		
2008.01-	2013.06	MT	L/R	F	Estate Engine CCSA, CMXA	603011	Inner Joint		33		34				
2008.01-	2013.06	MT	-	-	Estate Engine CCSA, CMXA	603006	Inner Joint		33		34				
2008.01-	2013.06	-	L	F	Estate Engine CCSA, CMXA	261097	Drive Shaft	36		59.5	40.5	543			
2008.01-	2013.06	-	R	F	Estate Engine CCSA, CMXA	261096	Drive Shaft	36		59.5	40.5	799			
2008.01-	2013.06	-	L	F	Estate Engine CCSA, CMXA	203320	Drive Shaft	36		59.5	40	546			
1.6 TDI (77 kW)															
2009.06-	2013.02	-	L/R	R	All-wheel Drive Estate Engine CAYC	603011	Inner Joint		33		34				
2009.06-	2013.04	Semi-AT	-	F	Estate Engine CAYC	803100	Outer Joint	36	33	59.5	38	55	I		
2009.06-	2013.02	-	L/R	F	All-wheel Drive Estate Engine CAYC	803002	Outer Joint	36	27	59.5	40	66	I		
2009.06-	2013.04	MT	L	F	Estate Engine CAYC	203294	Drive Shaft	36		59.5	38	519			
2009.06-	2013.04	Semi-AT	L	F	Estate Engine CAYC	261089	Drive Shaft	36		59.5	40.5	521			
2009.06-	2013.02	-	L	F	All-wheel Drive Estate Engine CAYC	203295	Drive Shaft	36		59.5	40	491			
2009.06-	2013.04	MT	L/R	F	Estate Engine CAYC	803037	Outer Joint	36	30	59.5	40.5	55	I		
2009.06-	2013.04	AT	L/R	F	Estate Engine CAYC	803002	Outer Joint	36	27	59.5	40	66	I		
2009.06-	2013.02	-	R	F	All-wheel Drive Estate Engine CAYC	203266	Drive Shaft	36		59.5	40	601			
2009.06-	2013.04	AT/MT	L/R	F	Estate Engine CAYC	603011	Inner Joint		33		34				
2009.06-	2013.04	MT	L	F	Estate Engine CAYC	803116	Outer Joint	36	30	59.5	38	55	I		
2009.06-	2013.04	MT	R	F	Estate Engine CAYC	261042	Drive Shaft	36		59.5	40.5	814			
2009.06-	2013.04	MT	R	F	Estate Engine CAYC	201585	Drive Shaft	36		59.5	40	805			
2009.06-	2013.02	-	-	R	All-wheel Drive Estate Engine CAYC	635026	Inner Joint	36	33	59.5	40	39			
2009.06-	2013.04	Semi-AT	R	F	Estate Engine CAYC	261280	Drive Shaft	36		59.5	40	801			
1.8 TSI (112 kW)															
2009.03-	2013.02	-	L/R	F	All-wheel Drive Estate Engine CDAB	803002	Outer Joint	36	27	59.5	40	66	I		
2009.03-	2013.06	MT	L	F	Estate Engine CDAB	261089	Drive Shaft	36		59.5	40.5	521			
2009.03-	2013.02	-	R	F	All-wheel Drive Estate Engine CDAB	203266	Drive Shaft	36		59.5	40	601			
2009.03-	2013.02	-	L/R	R	All-wheel Drive Estate Engine CDAB	603011	Inner Joint		33		34				
2009.03-	2013.06	-	L/R	F	Estate Engine CDAB	803002	Outer Joint	36	27	59.5	40	66	I		
2009.03-	2013.02	-	L	F	All-wheel Drive Estate Engine CDAB	203295	Drive Shaft	36		59.5	40	491			
2009.03-	2013.02	-	-	-	All-wheel Drive Estate Engine CDAB	861059	Outer Joint	36	33	59.5	40	59.5	I		
2009.03-	2013.06	-	-	-	Estate Engine CDAB	861059	Outer Joint	36	33	59.5	40	59.5	I		
2009.03-	2013.02	-	-	R	All-wheel Drive Estate Engine CDAB	635026	Inner Joint	36	33	59.5	40	39			
2009.03-	2013.06	-	L/R	F	Estate Engine CDAB	603011	Inner Joint		33		34				
2009.03-	2013.06	MT	L	F	Estate Engine CDAB	261131	Drive Shaft	36		59.5	40	515			
1.8 TSI (118 kW)															
2007.06-	2013.04	MT	L	F	Estate Engine BZB/CDA	261100	Drive Shaft	36		59.5	40	513			
2007.06-	2013.04	MT	L	F	Estate Engine BZB/CDA	261089	Drive Shaft	36		59.5	40.5	521			
2007.06-	2013.04	MT	L/R	F	Estate Engine BZB/CDA	803002	Outer Joint	36	27	59.5	40	66	I		
2007.06-	2013.04	MT	L/R	F	Estate Engine BZB/CDA	603011	Inner Joint		33		34				
2007.06-	2013.04	-	-	-	Estate Engine BZB/CDA	861059	Outer Joint	36	33	59.5	40	59.5	I		
2007.06-	2013.04	MT	L	F	Estate Engine BZB/CDA	261131	Drive Shaft	36		59.5	40	515			
2008.11-	2013.02	-	L/R	F	All-wheel Drive Estate Engine CDA	803002	Outer Joint	36	27	59.5	40	66	I		
2008.11-	2013.02	MT	L	F	All-wheel Drive Estate Engine CDA	261100	Drive Shaft	36		59.5	40	513			
2008.11-	2013.02	-	L	F	All-wheel Drive Estate Engine CDA	203295	Drive Shaft	36		59.5	40	491			
2008.11-	2013.02	-	R	F	All-wheel Drive Estate Engine CDA	203266	Drive Shaft	36		59.5	40	601			
2008.11-	2013.02	-	L/R	R	All-wheel Drive Estate Engine CDA	603011	Inner Joint		33		34				
2008.11-	2013.02	-	-	-	All-wheel Drive Estate Engine CDA	861059	Outer Joint	36	33	59.5	40	59.5	I		
2008.11-	2013.02	-	-	R	All-wheel Drive Estate Engine CDA	635026	Inner Joint	36	33	59.5	40	39			
1.9 TDI (77 kW)															
2004.09-	2010.12	AT	R	F	Estate Engine BJB/BKC/BLS/BXE	254011	Drive Shaft	36		59.5	40	755			
2004.09-	2010.12	AMT	L/R	F	Estate Engine BJB/BKC/BLS/BXE	803002	Outer Joint	36	27	59.5	40	66	I		
2004.09-	2010.12	MT	L	F	Estate Engine BJB/BKC/BLS/BXE	203294	Drive Shaft	36		59.5	38	519			
2004.09-	2010.12	AT	L/R	F	Estate Engine BJB/BKC/BLS/BXE	661057	Inner Joint		34		86				
2004.09-	2010.12	AT	L	F	Estate Engine BJB/BKC/BLS/BXE	254013	Drive Shaft	36		59.5	40	479.5			
2004.09-	2010.12	AT	L	F	Estate Engine BJB/BKC/BLS/BXE	654004	Inner Joint		34		85				
2004.09-	2010.12	MT	L	F	Estate Engine BJB/BKC/BLS/BXE	803116	Outer Joint	36	30	59.5	38	55	I		
2004.09-	2010.12	AT	L	F	Estate Engine BJB/BKC/BLS/BXE	203241	Drive Shaft	36		59.5	40	475			
2004.09-	2010.12	MT	R	F	Estate Engine BJB/BKC/BLS/BXE	261042	Drive Shaft	36		59.5	40.5	814			
2004.09-	2010.12	5MT	L/R	F	Estate Engine BJB/BKC/BLS/BXE	803037	Outer Joint	36	30	59.5	40.5	55	I		
2004.09-	2010.12	MT	R	F	Estate Engine BJB/BKC/BLS/BXE	201585	Drive Shaft	36		59.5	40	805			

				TRANSM		L/R F/R		REMARKS		GSP Ref.				ABS		Technical Specifications					
YEAR												PRODUCT				A	B	C	H	L	P
SKODA																					
OCTAVIA II Combi (125)																					
1.9 TDI (77 kW)		2004.09-2010.12	5MT	L/R	F	Estate Engine BJB/BKC/BLS/BXE		603011	Inner Joint					33		34					
		2004.11-2010.12	-	L/R	R	All-wheel Drive Estate Engine BKC/BLS/BXE		803037	Outer Joint		36	30	59.5	40.5	55						I
		2004.11-2010.12	-	L	F	All-wheel Drive Estate Engine BKC/BLS/BXE		203295	Drive Shaft		36		59.5	40	491						
		2004.11-2010.12	-	L/R	R	All-wheel Drive Estate Engine BKC/BLS/BXE		603011	Inner Joint			33		34							
		2004.11-2010.12	-	R	F	All-wheel Drive Estate Engine BKC/BLS/BXE		203266	Drive Shaft		36		59.5	40	601						
		2004.11-2010.12	MT	L/R	F	All-wheel Drive Estate Engine BKC/BLS/BXE		803002	Outer Joint		36	27	59.5	40	66						I
		2004.11-2010.12	-	-	R	All-wheel Drive Estate Engine BKC/BLS/BXE		635026	Inner Joint		36	33	59.5	40	39						
2.0 FSI (110 kW)		2004.11-2008.10	MT	R	F	Estate/Combi Engine BLY/BLR/BVY/BVZ		261113	Drive Shaft		36		59.5	40	814						
		2004.11-2008.10	MT	-	-	All-wheel Drive Estate Engine BLX/BVX		603006	Inner Joint			33		34							
		2004.11-2008.10	MT	L/R	F	Estate/Combi Engine BLY/BLR/BVY/BVZ		603011	Inner Joint			33		34							
		2004.11-2008.10	MT	-	-	All-wheel Drive Estate Engine BLX/BVX		661050	Inner Joint		26	32	31	68.5	89						
		2004.11-2008.10	-	L	F	All-wheel Drive Estate Engine BLX/BVX		803116	Outer Joint		36	30	59.5	38	55						I
		2004.11-2008.10	AT	R	F	Estate/Combi Engine BLY/BLR/BVY/BVZ		261094	Drive Shaft		36	26	59.5	40.5	884						
		2004.11-2008.10	MT	L/R/R	F	All-wheel Drive Estate Engine BLX/BVX		603011	Inner Joint			33		34							
		2004.11-2008.10	MT	R	F	Estate/Combi Engine BLY/BLR/BVY/BVZ		201585	Drive Shaft		36		59.5	40	805						
		2004.11-2008.10	MT	L	F	Estate/Combi Engine BLY/BLR/BVY/BVZ		803116	Outer Joint		36	30	59.5	38	55						I
		2004.11-2008.10	-	-	R	All-wheel Drive Estate Engine BLX/BVX		635026	Inner Joint		36	33	59.5	40	39						
		2004.11-2008.10	-	L/R	F	Estate/Combi Engine BLY/BLR/BVY/BVZ		803037	Outer Joint		36	30	59.5	40.5	55						I
		2004.11-2008.10	AT	L	F	Estate/Combi Engine BLY/BLR/BVY/BVZ		261093	Drive Shaft		36	26	59.5	40.5	587.5						
		2004.11-2008.10	-	L/R/F/R	F	All-wheel Drive Estate Engine BLX/BVX		803037	Outer Joint		36	30	59.5	40.5	55						I
		2004.11-2008.10	-	L	F	All-wheel Drive Estate Engine BLX/BVX		203294	Drive Shaft		36		59.5	38	519						
2.0 RS (147 kW)		2005.10-2013.02	AT/MT	L/R	F	Estate Engine BWA/CCZA		803002	Outer Joint		36	27	59.5	40	66						I
		2005.10-2013.02	AT/MT	L	F	Estate Engine BWA/CCZA		203295	Drive Shaft		36		59.5	40	491						
2.0 TDI (103 kW)		2005.11-2010.05	AT	R	F	Estate Engine BMM		254011	Drive Shaft		36		59.5	40	755						
		2005.11-2010.05	MT	L	F	Estate Engine BMM		203295	Drive Shaft		36		59.5	40	491						
		2005.11-2010.05	AT	L/R	F	Estate Engine BMM		661057	Inner Joint			34		86							
		2005.11-2010.05	MT	R	F	Estate Engine BMM		203313	Drive Shaft		36		59.5	40	792						
		2005.11-2010.05	AT	L	F	Estate Engine BMM		254013	Drive Shaft		36		59.5	40	479.5						
		2005.11-2010.05	AT	L	F	Estate Engine BMM		654004	Inner Joint			34		85							
		2005.11-2010.05	AT	L	F	Estate Engine BMM		203241	Drive Shaft		36		59.5	40	475						
		2005.11-2010.05	AT/MT	L/R	F	Estate Engine BMM		803002	Outer Joint		36	27	59.5	40	66						I
		2006.07-2010.05	-	L/R	F	All-wheel Drive Estate Engine BMM		803002	Outer Joint		36	27	59.5	40	66						I
		2006.07-2010.05	-	R	F	All-wheel Drive Estate Engine BMM		203266	Drive Shaft		36		59.5	40	601						
		2006.07-2010.05	-	L/R	R	All-wheel Drive Estate Engine BMM		603011	Inner Joint			33		34							
		2006.07-2010.05	-	L	F	All-wheel Drive Estate Engine BMM		203295	Drive Shaft		36		59.5	40	491						
		2006.07-2010.05	-	-	R	All-wheel Drive Estate Engine BMM		635026	Inner Joint		36	33	59.5	40	39						
		2006.07-2010.05	-	L/R	R	All-wheel Drive Estate Engine BMM		803037	Outer Joint		36	30	59.5	40.5	55						I
2.0 TDI (81 kW)		2010.03-2013.06	-	L	F	Estate Engine CFHF		203294	Drive Shaft		36		59.5	38	519						
		2010.03-2013.06	-	L/R	F	Estate Engine CFHF		803037	Outer Joint		36	30	59.5	40.5	55						I
		2010.03-2013.06	-	L/R	F	Estate Engine CFHF		603011	Inner Joint			33		34							
		2010.03-2013.06	-	L	F	Estate Engine CFHF		803116	Outer Joint		36	30	59.5	38	55						I
		2010.03-2013.06	-	R	F	Estate Engine CFHF		261042	Drive Shaft		36		59.5	40.5	814						
		2010.03-2013.06	-	R	F	Estate Engine CFHF		201585	Drive Shaft		36		59.5	40	805						
		2011.05-2013.02	-	L/R	R	All-wheel Drive Estate Engine CFHF		603011	Inner Joint			33		34							
		2011.05-2013.02	-	L/R	F	All-wheel Drive Estate Engine CFHF		803002	Outer Joint		36	27	59.5	40	66						I
		2011.05-2013.02	-	L	F	All-wheel Drive Estate Engine CFHF		203295	Drive Shaft		36		59.5	40	491						
		2011.05-2013.02	-	R	F	All-wheel Drive Estate Engine CFHF		203313	Drive Shaft		36		59.5	40	792						
		2011.05-2013.02	-	-	R	All-wheel Drive Estate Engine CFHF		635026	Inner Joint		36	33	59.5	40	39						
2.0 TDI 16V (100 kW)		2004.02-2010.05	AT	L	F	Estate Engine AZV		661057	Inner Joint			34		86							
		2004.02-2010.05	MT	R	F	Estate Engine AZV		203313	Drive Shaft		36		59.5	40	792						
		2004.02-2010.05	AT	L	F	Estate Engine AZV		254013	Drive Shaft		36		59.5	40	479.5						
		2004.02-2010.05	AT	R	F	Estate Engine AZV		203355	Drive Shaft		36	23	59.5	40	799						
		2004.02-2010.05	AT	L	F	Estate Engine AZV		654004	Inner Joint			34		85							
		2004.02-2010.05	AT	L	F	Estate Engine AZV		203241	Drive Shaft		36		59.5	40	475						
		2004.02-2010.05	AT/MT	L/R	F	Estate Engine AZV		803002	Outer Joint		36	27	59.5	40	66						I
		2004.02-2010.05	MT	L/R	F	Estate Engine AZV		203295	Drive Shaft		36		59.5	40	491						
		2004.02-2010.05	AT	R	F	Estate Engine AZV		254011	Drive Shaft		36		59.5	40	755						
2.0 TDI 16V (103 kW)		2004.02-2013.05	AT	L/R	F	Estate Engine BKD/CFHC/CLCB		661057	Inner Joint			34		86							
		2004.02-2013.05	AT	L	F	Estate Engine BKD/CFHC/CLCB		254013	Drive Shaft		36		59.5	40	479.5						
		2004.02-2013.05	AT	L	F	Estate Engine BKD/CFHC/CLCB		654004	Inner Joint			34		85							
		2004.02-2013.05	AT	R	F	Estate Engine BKD/CFHC/CLCB		203355	Drive Shaft		36	23	59.5	40	799						
		2004.02-2013.05	MT	R	F	Estate Engine BKD/CFHC/CLCB		203313	Drive Shaft		36		59.5	40	792						
		2004.02-2013.05	AT	L	F	Estate Engine BKD/CFHC/CLCB		203241	Drive Shaft		36		59.5	40	475						
		2004.02-2013.05	AT/MT	L/R	F	Estate Engine BKD/CFHC/CLCB		803002	Outer Joint		36	27	59.5	40	66						I
		2004.02-2013.05	MT	L	F	Estate Engine BKD/CFHC/CLCB		203295	Drive Shaft		36		59.5	40	491						
		2004.02-2013.05	AT	R	F	Estate Engine BKD/CFHC/CLCB		254011	Drive Shaft		36		59.5	40	755						





		 YEAR	TRANSM	L/R	F/R	REMARKS	GSP Ref.	 PRODUCT	 ABS	Technical Specifications						
										A	B	C	H	L	P	
SKODA																
OCTAVIA II Combi (1Z5)																
2.0 TDI 16V (103 kW)	2010.05-2013.02	MT	L/R	F	All-wheel Drive Estate Engine CFHC	803002	Outer Joint			36	27	59.5	40	66	I	
	2010.05-2013.02	-	L/R	R	All-wheel Drive Estate Engine CFHC	603011	Inner Joint				33		34			
	2010.05-2013.02	MT	R	F	All-wheel Drive Estate Engine CFHC	203266	Drive Shaft			36		59.5	40	601		
	2010.05-2013.02	-	R	F	All-wheel Drive Estate Engine CFHC	203313	Drive Shaft			36		59.5	40	792		
	2010.05-2013.02	AT/MT	L	F	All-wheel Drive Estate Engine CFHC	203295	Drive Shaft			36		59.5	40	491		
	2010.05-2013.02	-	-	R	All-wheel Drive Estate Engine CFHC	635026	Inner Joint			36	33	59.5	40	39		
2.0 TDI RS (125 kW)	2006.04-2013.02	AT	R	F	Estate Engine BMN/CEGA	254011	Drive Shaft			36		59.5	40	755		
	2006.04-2013.02	MT	L	F	Estate Engine BMN/CEGA	203265	Drive Shaft			36		59.5	40	487		
	2006.04-2013.02	AT	L/R	F	Estate Engine BMN/CEGA	661057	Inner Joint				34		86			
	2006.04-2013.02	MT	L/R	F	Estate Engine BMN/CEGA	803037	Outer Joint			36	30	59.5	40.5	55	I	
	2006.04-2013.02	AT	L	F	Estate Engine BMN/CEGA	203241	Drive Shaft			36		59.5	40	475		
	2006.04-2013.02	AT	R	F	Estate Engine BMN/CEGA	654004	Inner Joint				34		85			
	2006.04-2013.02	-	R	F	Estate Engine BMN/CEGA	261126	Drive Shaft			36		59.5	40	793		
	2006.04-2013.02	MT	L/R	F	Estate Engine BMN/CEGA	861045	Outer Joint			36	27	59.5	40	65	M	
OCTAVIA III (5E3 NL3 NR3)																
1.2 TSI (63 kW)	2012.11-	-	L/R	F	Hatchback Engine CJZB	803037	Outer Joint			36	30	59.5	40.5	55	I	
	2012.11-	MT	L	F	Hatchback Engine CJZB	261277	Drive Shaft			36		59.5	40	516		
	2012.11-	MT	-	-	Hatchback Engine CJZB	603006	Inner Joint				33		34			
	2012.11-	-	L/R	F	Hatchback Engine CJZB	603011	Inner Joint				33		34			
1.2 TSI (77 kW)	2012.11-	-	L/R	F	Hatchback Engine CJZA	803037	Outer Joint			36	30	59.5	40.5	55	I	
	2012.11-	MT	L	F	Hatchback Engine CJZA	261277	Drive Shaft			36		59.5	40	516		
	2012.11-	-	L	F	Hatchback Engine CJZA	203373	Drive Shaft			36		59.5	38	511		
	2012.11-	MT	R	F	Hatchback Engine CJZA	261307	Drive Shaft			36		59.5	40	819		
	2012.11-	-	L/R	F	Hatchback Engine CJZA	603011	Inner Joint				33		34			
	2012.11-	-	L	F	Hatchback Engine CJZA	803116	Outer Joint			36	30	59.5	38	55	I	
1.2 TSI (81 kW)	2015.05-	MT	L	F	Hatchback Engine CYVB	261277	Drive Shaft			36		59.5	40	516		
	2015.05-	6MT	L	F	Hatchback Engine CYVB	203373	Drive Shaft			36		59.5	38	511		
	2015.05-	MT	L/R	F	Hatchback Engine CYVB	803037	Outer Joint			36	30	59.5	40.5	55	I	
	2015.05-	MT	L/R	F	Hatchback Engine CYVB	603011	Inner Joint				33		34			
	2015.05-	6MT	L	F	Hatchback Engine CYVB	803116	Outer Joint			36	30	59.5	38	55	I	
1.4 TSI (103 kW)	2012.11-	7AT	R	F	Hatchback Engine CHPA	261303	Drive Shaft			36		59.5	40	795		
	2012.11-	6AT/MT	-	F	Hatchback Engine CHPA	803100	Outer Joint			36	33	59.5	38	55	I	
	2012.11-	7AT	-	F	Hatchback Engine CHPA	803101	Outer Joint			36	27	59.5	40	65	M	
	2012.11-	6AT/MT	L	F	Hatchback Engine CHPA	261089	Drive Shaft			36		59.5	40.5	521		
	2012.11-	MT	L/R	F	Hatchback Engine CHPA	603011	Inner Joint				33		34			
	2012.11-	7AT	L	F	Hatchback Engine CHPA	261304	Drive Shaft			36		59.5	40	511		
	2012.11-	6AT	R	F	Hatchback Engine CHPA	261280	Drive Shaft			36		59.5	40	801		
1.4 TSI (110 kW)	2014.08-	7AT	R	F	Hatchback Engine CHPB/CZDA	261303	Drive Shaft			36		59.5	40	795		
	2014.08-	7AT	-	F	Hatchback Engine CHPB/CZDA	803101	Outer Joint			36	27	59.5	40	65	M	
	2014.08-	6AT/MT	-	F	Hatchback Engine CHPB/CZDA	803100	Outer Joint			36	33	59.5	38	55	I	
	2014.08-	6AT/MT	L	F	Hatchback Engine CHPB/CZDA	261089	Drive Shaft			36		59.5	40.5	521		
	2014.08-	7AT	L	F	Hatchback Engine CHPB/CZDA	261304	Drive Shaft			36		59.5	40	511		
	2014.08-	6AT	R	F	Hatchback Engine CHPB/CZDA	261280	Drive Shaft			36		59.5	40	801		
	2014.08-	6MT	L/R	F	Hatchback Engine CHPB/CZDA	603011	Inner Joint				33		34			
1.4 TSI G-TEC (81 kW)	2013.11-	AT	R	F	Hatchback Engine CPWA	261199	Drive Shaft			36		59.5	40.5	800		
	2013.11-	MT	-	-	Hatchback Engine CPWA	861059	Outer Joint			36	33	59.5	40	59.5	I	
	2013.11-	7AT/MT	L	F	Hatchback Engine CPWA	261089	Drive Shaft			36		59.5	40.5	521		
	2013.11-	-	-	F	Hatchback Engine CPWA	803100	Outer Joint			36	33	59.5	38	55	I	
	2013.11-	MT	-	-	Hatchback Engine CPWA	603006	Inner Joint				33		34			
	2013.11-	AT	L/R	F	Hatchback Engine CPWA	603011	Inner Joint				33		34			
1.6 (81 kW)	2014.01-	-	L/R	F	Hatchback Engine CWVA	803037	Outer Joint			36	30	59.5	40.5	55	I	
	2014.01-	MT	-	F	Hatchback Engine CWVA	803100	Outer Joint			36	33	59.5	38	55	I	
	2014.01-	MT	L	F	Hatchback Engine CWVA	261089	Drive Shaft			36		59.5	40.5	521		
	2014.01-	MT	L/R	F	Hatchback Engine CWVA	603011	Inner Joint				33		34			
	2014.01-	AT	R	F	Hatchback Engine CWVA	261094	Drive Shaft			36	26	59.5	40.5	884		
	2014.01-	AT	L	F	Hatchback Engine CWVA	803116	Outer Joint			36	30	59.5	38	55	I	
	2014.01-	MT	R	F	Hatchback Engine CWVA	261200	Drive Shaft			36		59.5	40.5	820		
	2014.01-	AT	L	F	Hatchback Engine CWVA	203318	Drive Shaft			36	26	59.5	38	581		
1.6 TDI (66 kW)	2012.11-	MT	L	F	Hatchback Engine CLHB/DDYB	203294	Drive Shaft			36		59.5	38	519		
	2012.11-	MT	L/R	F	Hatchback Engine CLHB/DDYB	603011	Inner Joint				33		34			
	2012.11-	MT	L/R	F	Hatchback Engine CLHB/DDYB	803037	Outer Joint			36	30	59.5	40.5	55	I	
	2012.11-	MT	L	F	Hatchback Engine CLHB/DDYB	803116	Outer Joint			36	30	59.5	38	55	I	
	2012.11-	MT	R	F	Hatchback Engine CLHB/DDYB	261042	Drive Shaft			36		59.5	40.5	814		
	2012.11-	MT	-	-	Hatchback Engine CLHB/DDYB	603006	Inner Joint				33		34			
2012.11-	MT	R	F	Hatchback Engine CLHB/DDYB	201585	Drive Shaft			36		59.5	40	805			
1.6 TDI (77 kW)	2012.11-	-	L/R	F	Hatchback Engine CLHA	803037	Outer Joint			36	30	59.5	40.5	55	I	

YEAR	TRANSM	L/R	F/R	REMARKS	GSP Ref.	PRODUCT	ABS	Technical Specifications							
								A	B	C	H	L	P		
SKODA															
OCTAVIA III (5E3 NL3 NR3)															
1.6 TDI (77 kW)	2012.11-	-	L	F	Hatchback Engine CLHA	203294	Drive Shaft	36		59.5	38	519			
	2012.11-	Semi-AT	-	F	Hatchback Engine CLHA	803100	Outer Joint	36	33	59.5	38	55	I		
	2012.11-	Semi-AT	L	F	Hatchback Engine CLHA	261089	Drive Shaft	36		59.5	40.5	521			
	2012.11-	-	L	F	Hatchback Engine CLHA	803116	Outer Joint	36	30	59.5	38	55	I		
	2012.11-	-	R	F	Hatchback Engine CLHA	261042	Drive Shaft	36		59.5	40.5	814			
	2012.11-	-	R	F	Hatchback Engine CLHA	201585	Drive Shaft	36		59.5	40	805			
	2012.11-	-	L/R	F	Hatchback Engine CLHA	603011	Inner Joint		33		34				
	2012.11-	Semi-AT	R	F	Hatchback Engine CLHA	261280	Drive Shaft	36		59.5	40	801			
1.6 TDI (81 kW)	2013.05-	MT	-	-	Hatchback Engine CRKB/CXXB/DBKA	861059	Outer Joint	36	33	59.5	40	59.5	I		
	2013.05-	MT	-	F	Hatchback Engine CRKB/CXXB/DBKA	803100	Outer Joint	36	33	59.5	38	55	I		
	2013.05-	MT	L	F	Hatchback Engine CRKB/CXXB/DBKA	261089	Drive Shaft	36		59.5	40.5	521			
	2013.05-	MT	L/R	F	Hatchback Engine CRKB/CXXB/DBKA	603011	Inner Joint		33		34				
	2013.05-	MT	-	-	Hatchback Engine CRKB/CXXB/DBKA	603006	Inner Joint		33		34				
	2013.05-	MT	R	F	Hatchback Engine CRKB/CXXB/DBKA	261200	Drive Shaft	36		59.5	40.5	820			
1.6 TDI (85 kW)	2017.02-	-	L/R	F	Hatchback Engine DDYA	603011	Inner Joint		33		34				
1.8 TSI (132 kW)	2012.11-	MT	-	F	Hatchback Engine CJSA	803101	Outer Joint	36	27	59.5	40	65	M		
	2012.11-	MT	L	F	Hatchback Engine CJSA	261304	Drive Shaft	36		59.5	40	511			
	2014.09-	AT	-	-	All-wheel Drive Hatchback Engine CJSB	603016	Inner Joint		28		32				
2.0 TDI (105 kW)	2012.11-	-	-	F	Hatchback Engine CKFB/CRVC	803101	Outer Joint	36	27	59.5	40	65	M		
	2012.11-	AT	L	F	Hatchback Engine CKFB/CRVC	261285	Drive Shaft	36		59.5	40	472			
	2012.11-	AT	R	F	Hatchback Engine CKFB/CRVC	203354	Drive Shaft	36		59.5	40	763			
2.0 TDI (110 kW)	2012.11-	-	-	F	Hatchback Engine CKFC/CRMB	803101	Outer Joint	36	27	59.5	40	65	M		
	2012.11-	AT	L	F	Hatchback Engine CKFC/CRMB	261285	Drive Shaft	36		59.5	40	472			
	2012.11-	AT	R	F	Hatchback Engine CKFC/CRMB	203354	Drive Shaft	36		59.5	40	763			
2.0 TDI / TDI RS (135 kW)	2014.09-	AT	-	-	All-wheel Drive Hatchback Engine CUNA/CUPA	603016	Inner Joint		28		32				
2.0 TDI RS (135 kW)	2013.05-	AT	L	F	Hatchback Engine CUNA/CUPA	261285	Drive Shaft	36		59.5	40	472			
	2013.05-	AT	R	F	Hatchback Engine CUNA/CUPA	203354	Drive Shaft	36		59.5	40	763			
	2013.05-	AT	-	-	Hatchback Engine CUNA/CUPA	603016	Inner Joint		28		32				
OCTAVIA III (5E3, NL3, NR3)															
1.0 TSI (85 kW)	2016.05-	MT	-	F	Hatchback Engine CHZD, DKRA	803100	Outer Joint	36	33	59.5	38	55	I		
OCTAVIA III Combi (5E5)															
1.0 TSI (85 kW)	2016.05-	Semi-AT	-	F	Estate Engine CHZD, DKRA	803100	Outer Joint	36	33	59.5	38	55	I		
1.2 TSI (63 kW)	2012.11-	-	L/R	F	Estate Engine CJZB/CYVA	803037	Outer Joint	36	30	59.5	40.5	55	I		
	2012.11-	MT	L	F	Estate Engine CJZB/CYVA	261277	Drive Shaft	36		59.5	40	516			
	2012.11-	MT	-	-	Estate Engine CJZB/CYVA	603006	Inner Joint		33		34				
	2012.11-	-	L/R	F	Estate Engine CJZB/CYVA	603011	Inner Joint		33		34				
	2012.11-	-	L/R	F	Estate Engine CJZA	803037	Outer Joint	36	30	59.5	40.5	55	I		
1.2 TSI (77 kW)	2012.11-	MT	L	F	Estate Engine CJZA	261277	Drive Shaft	36		59.5	40	516			
	2012.11-	-	L	F	Estate Engine CJZA	203373	Drive Shaft	36		59.5	38	511			
	2012.11-	MT	R	F	Estate Engine CJZA	261307	Drive Shaft	36		59.5	40	819			
	2012.11-	-	L/R	F	Estate Engine CJZA	603011	Inner Joint		33		34				
	2012.11-	-	L	F	Estate Engine CJZA	803116	Outer Joint	36	30	59.5	38	55	I		
	2015.05-	MT	L	F	Estate Engine CYVB	261277	Drive Shaft	36		59.5	40	516			
1.2 TSI (81 kW)	2015.05-	6MT	L	F	Estate Engine CYVB	203373	Drive Shaft	36		59.5	38	511			
	2015.05-	MT	L/R	F	Estate Engine CYVB	803037	Outer Joint	36	30	59.5	40.5	55	I		
	2015.05-	MT	L/R	F	Estate Engine CYVB	603011	Inner Joint		33		34				
	2015.05-	6MT	L	F	Estate Engine CYVB	803116	Outer Joint	36	30	59.5	38	55	I		
	2015.05-	6MT	L	F	Estate Engine CHPA	261303	Drive Shaft	36		59.5	40	795			
1.4 TSI (103 kW)	2012.11-	7AT	R	F	Estate Engine CHPA	261303	Drive Shaft	36		59.5	40	795			
	2012.11-	6AT/MT	-	F	Estate Engine CHPA	803100	Outer Joint	36	33	59.5	38	55	I		
	2012.11-	7AT	-	F	Estate Engine CHPA	803101	Outer Joint	36	27	59.5	40	65	M		
	2012.11-	6AT/MT	L	F	Estate Engine CHPA	261089	Drive Shaft	36		59.5	40.5	521			
	2012.11-	MT	L/R	F	Estate Engine CHPA	603011	Inner Joint		33		34				
	2012.11-	7AT	L	F	Estate Engine CHPA	261304	Drive Shaft	36		59.5	40	511			
	2012.11-	6AT	R	F	Estate Engine CHPA	261280	Drive Shaft	36		59.5	40	801			
	2014.08-	7AT	R	F	Estate Engine CHPB, CZDA	261303	Drive Shaft	36		59.5	40	795			
1.4 TSI (110 kW)	2014.08-	7AT	-	F	Estate Engine CHPB, CZDA	803101	Outer Joint	36	27	59.5	40	65	M		
	2014.08-	6AT/MT	-	F	Estate Engine CHPB, CZDA	803100	Outer Joint	36	33	59.5	38	55	I		
	2014.08-	6AT/MT	L	F	Estate Engine CHPB, CZDA	261089	Drive Shaft	36		59.5	40.5	521			
	2014.08-	7AT	L	F	Estate Engine CHPB, CZDA	261304	Drive Shaft	36		59.5	40	511			
	2014.08-	6AT	R	F	Estate Engine CHPB, CZDA	261280	Drive Shaft	36		59.5	40	801			
	2014.08-	6MT	L/R	F	Estate Engine CHPB, CZDA	603011	Inner Joint		33		34				
	2013.11-	AT	R	F	Estate Engine CPWA	261199	Drive Shaft	36		59.5	40.5	800			
1.4 TSI G-TEC (81 kW)	2013.11-	MT	-	-	Estate Engine CPWA	861059	Outer Joint	36	33	59.5	40	59.5	I		
	2013.11-	7AT/MT	L	F	Estate Engine CPWA	261089	Drive Shaft	36		59.5	40.5	521			
	2013.11-	-	-	F	Estate Engine CPWA	803100	Outer Joint	36	33	59.5	38	55	I		
	2013.11-	MT	-	-	Estate Engine CPWA	603006	Inner Joint		33		34				
	2013.11-	MT	-	-	Estate Engine CPWA	603006	Inner Joint		33		34				

	 YEAR	TRANSM	L/R	F/R	REMARKS	GSP Ref.	 PRODUCT	 ABS	Technical Specifications						
									A	B	C	H	L	P	
SKODA															
OCTAVIA III Combi (5E5)															
1.4 TSI G-TEC (81 kW)	2013.11-	-	AT	L/R	F	Estate Engine CPWA	603011	Inner Joint			33		34		
1.6 (81 kW)	2004.01-	-	-	L/R	F	Estate/Combi Engine CWVA	803037	Outer Joint	36	30	59.5	40.5	55	I	
	2004.01-	-	MT	-	F	Estate/Combi Engine CWVA	803100	Outer Joint	36	33	59.5	38	55	I	
	2004.01-	-	MT	L	F	Estate/Combi Engine CWVA	261089	Drive Shaft	36		59.5	40.5	521		
	2004.01-	-	MT	L/R	F	Estate/Combi Engine CWVA	603011	Inner Joint			33		34		
	2004.01-	-	AT	R	F	Estate/Combi Engine CWVA	261094	Drive Shaft	36	26	59.5	40.5	884		
	2004.01-	-	AT	L	F	Estate/Combi Engine CWVA	803116	Outer Joint	36	30	59.5	38	55	I	
	2004.01-	-	MT	R	F	Estate/Combi Engine CWVA	261200	Drive Shaft	36		59.5	40.5	820		
1.6 TDI (66 kW)	2012.11-	-	-	L	F	Estate Engine CLHB, CXXA, DDYB	203294	Drive Shaft	36		59.5	38	519		
	2012.11-	-	MT	L/R	F	Estate Engine CLHB, CXXA, DDYB	603011	Inner Joint			33		34		
	2012.11-	-	MT	L/R	F	Estate Engine CLHB, CXXA, DDYB	803037	Outer Joint	36	30	59.5	40.5	55	I	
	2012.11-	-	MT	R	F	Estate Engine CLHB, CXXA, DDYB	261042	Drive Shaft	36		59.5	40.5	814		
	2012.11-	-	MT	-	-	Estate Engine CLHB, CXXA, DDYB	603006	Inner Joint			33		34		
	2012.11-	-	-	L	F	Estate Engine CLHB, CXXA, DDYB	803116	Outer Joint	36	30	59.5	38	55	I	
	2012.11-	-	MT	R	F	Estate Engine CLHB, CXXA, DDYB	201585	Drive Shaft	36		59.5	40	805		
1.6 TDI (77 kW)	2012.11-	-	-	L	F	Estate Engine CLHA	203294	Drive Shaft	36		59.5	38	519		
	2012.11-	-	MT	L/R	F	Estate Engine CLHA	603011	Inner Joint			33		34		
	2012.11-	-	MT	L/R	F	Estate Engine CLHA	803037	Outer Joint	36	30	59.5	40.5	55	I	
	2012.11-	-	Semi-AT	-	F	Estate Engine CLHA	803100	Outer Joint	36	33	59.5	38	55	I	
	2012.11-	-	Semi-AT	L	F	Estate Engine CLHA	261089	Drive Shaft	36		59.5	40.5	521		
	2012.11-	-	-	L	F	Estate Engine CLHA	803116	Outer Joint	36	30	59.5	38	55	I	
	2012.11-	-	-	R	F	Estate Engine CLHA	261042	Drive Shaft	36		59.5	40.5	814		
	2012.11-	-	-	R	F	Estate Engine CLHA	201585	Drive Shaft	36		59.5	40	805		
	2012.11-	-	Semi-AT	R	F	Estate Engine CLHA	261280	Drive Shaft	36		59.5	40	801		
1.6 TDI (81 kW)	2013.05-	-	MT	-	-	Estate Engine CRKB/CXXB/DBKA	861059	Outer Joint	36	33	59.5	40	59.5	I	
	2013.05-	-	MT	-	F	Estate Engine CRKB/CXXB/DBKA	803100	Outer Joint	36	33	59.5	38	55	I	
	2013.05-	-	MT	L	F	Estate Engine CRKB/CXXB/DBKA	261089	Drive Shaft	36		59.5	40.5	521		
	2013.05-	-	MT	L/R	F	Estate Engine CRKB/CXXB/DBKA	603011	Inner Joint			33		34		
	2013.05-	-	MT	-	-	Estate Engine CRKB/CXXB/DBKA	603006	Inner Joint			33		34		
	2013.05-	-	MT	R	F	Estate Engine CRKB/CXXB/DBKA	261200	Drive Shaft	36		59.5	40.5	820		
1.6 TDI(85 kW)	2017.02-	-	-	L/R	F	Estate/Combi Engine DDYA	603011	Inner Joint			33		34		
1.8 TSI (132 kW)	2012.11-	-	MT	-	F	Estate Engine CJSA	803101	Outer Joint	36	27	59.5	40	65	M	
	2012.11-	-	-	-	-	All-wheel Drive Estate Engine CJSB	803101	Outer Joint	36	27	59.5	40	65	M	
	2012.11-	-	MT	L	F	Estate Engine CJSA	261304	Drive Shaft	36		59.5	40	511		
	2012.11-	-	AT	-	-	All-wheel Drive Estate Engine CJSB	603016	Inner Joint			28		32		
2.0 TDI (105 kW)	2012.11-	-	-	-	F	Estate Engine CKFB/CRVC	803101	Outer Joint	36	27	59.5	40	65	M	
	2012.11-	-	AT	L	F	Estate Engine CKFB/CRVC	261285	Drive Shaft	36		59.5	40	472		
	2012.11-	-	MT	R	F	Estate Engine CKFB/CRVC	203354	Drive Shaft	36		59.5	40	763		
2.0 TDI (110 kW)	2012.11-	-	-	-	F	Estate Engine CKFC/CRMB	803101	Outer Joint	36	27	59.5	40	65	M	
	2012.11-	-	-	-	-	All-wheel Drive Estate Engine CKFC	803101	Outer Joint	36	27	59.5	40	65	M	
	2012.11-	-	AT	L	F	Estate Engine CKFC/CRMB	261285	Drive Shaft	36		59.5	40	472		
	2012.11-	-	AT	R	F	Estate Engine CKFC/CRMB	203354	Drive Shaft	36		59.5	40	763		
2.0 TDI / TDI RS (135 kW)	2014.09-	-	AT	-	-	All-wheel Drive Estate Engine CUNA/CUPA	603016	Inner Joint			28		32		
2.0 TDI RS (135 kW)	2013.05-	-	AT	L	F	Estate Engine CUPA/CUNA	261285	Drive Shaft	36		59.5	40	472		
	2013.05-	-	AT	R	F	Estate Engine CUPA/CUNA	203354	Drive Shaft	36		59.5	40	763		
	2013.05-	-	AT	-	-	Estate Engine CUPA/CUNA	603016	Inner Joint			28		32		
RAPID (NH3)															
1.2 (55 kW)	2012.07-	-	MT	R	F	Hatchback Engine CGPC	261267	Drive Shaft	36		50.7	58.5	765		
	2012.07-	-	-	L	F	Hatchback Engine CGPC	203330	Drive Shaft	36		50.7	58.5	515		
	2012.07-	-	MT	L	F	Hatchback Engine CGPC	203372	Drive Shaft	36		50.7	58.5	516		
1.2 TSI (63 kW)	2012.07-	-	5MT/6MT	-	F	Hatchback Engine CBZA	803024	Outer Joint	36	30	50.75	59	54.5	I	
	2012.07-	-	MT	L	F	Hatchback Engine CBZA	261297	Drive Shaft	36		50.5	59	513		
	2012.07-	-	MT	R	F	Hatchback Engine CBZA	261301	Drive Shaft	36		50.5	59	771		
	2012.07-	-	MT	L/R	F	Hatchback Engine CBZA	603011	Inner Joint			33		34		
	2012.07-	-	MT	-	-	Hatchback Engine CBZA	603006	Inner Joint			33		34		
	2012.07-	-	MT	-	-	Hatchback Engine CBZA	603006	Inner Joint			33		34		
1.2 TSI (66 kW)	2015.05-	-	AT	-	-	Hatchback Engine CJZC	603006	Inner Joint			33		34		
	2015.05-	-	MT	L/R	F	Hatchback Engine CJZC	603011	Inner Joint			33		34		
	2012.07-	-	5MT/6MT	-	F	Hatchback Engine CBZB	803024	Outer Joint	36	30	50.75	59	54.5	I	
	2012.07-	-	MT	L	F	Hatchback Engine CBZB	261297	Drive Shaft	36		50.5	59	513		
	2012.07-	-	MT	R	F	Hatchback Engine CBZB	261301	Drive Shaft	36		50.5	59	771		
1.2 TSI (77 kW)	2012.07-	-	MT	L/R	F	Hatchback Engine CBZB	603011	Inner Joint			33		34		
	2012.07-	-	MT	-	-	Hatchback Engine CBZB	603006	Inner Joint			33		34		
	2015.05-	-	5MT/6MT	-	F	Hatchback Engine CJZD	803024	Outer Joint	36	30	50.75	59	54.5	I	
	2015.05-	-	MT	L/R	F	Hatchback Engine CJZD	603011	Inner Joint			33		34		
	2015.05-	-	AT	-	F	Hatchback Engine CUSB	803041	Outer Joint	36	27	50.5	75	65	I	





	 YEAR	TRANSM	L/R	F/R	REMARKS	GSP Ref.	 PRODUCT	 ABS	Technical Specifications									
									A	B	C	H	L	P				
SKODA																		
RAPID (NH3)																		
1.4 TDI (66 kW)	2015.05-	-	MT	L/R	F	Hatchback Engine CUSB	603011	Inner Joint			33		34					
1.4 TSI (90 kW)	2012.07-	-	AT	L/R	F	Hatchback Engine CAXA	603011	Inner Joint			33		34					
	2012.07-	-	AT	-	-	Hatchback Engine CAXA	603006	Inner Joint			33		34					
1.4 TSI (92 kW)	2015.05-	-	AT	-	-	Hatchback Engine CZCA	603006	Inner Joint			33		34					
	2015.05-	-	AT	L/R	F	Hatchback Engine CZCA	603011	Inner Joint			33		34					
1.6 (77 kW)	2012.07-	-	AT	-	R	Hatchback Engine CFNA	861074	Outer Joint	36	30	52	75	55.5		I			
	2012.07-	-	5MT/6MT	-	F	Hatchback Engine CFNA	803024	Outer Joint	36	30	50.75	59	54.5		I			
	2012.07-	-	AT	L	F	Hatchback Engine CFNA	661039	Inner Joint	26	22	31	68.5	88.5					
	2012.07-	-	MT	L/R	F	Hatchback Engine CFNA	603011	Inner Joint			33		34					
	2012.07-	-	AT	-	-	Hatchback Engine CFNA	603006	Inner Joint			33		34					
1.6 TDI (66 kW)	2013.08-	-	7AT	L	F	Hatchback Engine CAYB	261260	Drive Shaft	36		52	75	498					
	2013.08-	-	7AT	-	F	Hatchback Engine CAYB	803041	Outer Joint	36	27	50.5	75	65		I			
	2013.08-	-	MT	L	F	Hatchback Engine CAYB	261184	Drive Shaft	36		52	59	496					
	2013.08-	-	MT	R	F	Hatchback Engine CAYB	261185	Drive Shaft	36		52	59	785					
	2013.08-	-	7AT	R	F	Hatchback Engine CAYB	261261	Drive Shaft	36		52	75	785					
	2013.08-	-	MT	L/R	F	Hatchback Engine CAYB	603011	Inner Joint			33		34					
	2013.08-	-	MT	L	F	Hatchback Engine CAYB	854006	Outer Joint	36	30	52	59	55.5		I			
	2013.08-	-	MT	R	F	Hatchback Engine CAYB	261025	Drive Shaft	36		52	75	773.5					
1.6 TDI (77 kW)	2012.07-	-	MT	L	F	Hatchback Engine CAYC/CLNA	261184	Drive Shaft	36		52	59	496					
	2012.07-	-	MT	R	F	Hatchback Engine CAYC/CLNA	261185	Drive Shaft	36		52	59	785					
	2012.07-	-	MT	L/R	F	Hatchback Engine CAYC/CLNA	603011	Inner Joint			33		34					
	2012.07-	-	MT	L	F	Hatchback Engine CAYC/CLNA	854006	Outer Joint	36	30	52	59	55.5		I			
	2012.07-	-	MT	-	-	Hatchback Engine CAYC/CLNA	603006	Inner Joint			33		34					
	2012.07-	-	MT	R	F	Hatchback Engine CAYC/CLNA	261025	Drive Shaft	36		52	75	773.5					
1.6 TDI (85 kW)	2015.05-	-	MT	L	F	Hatchback Engine CXMA	261184	Drive Shaft	36		52	59	496					
	2015.05-	-	MT	R	F	Hatchback Engine CXMA	261185	Drive Shaft	36		52	59	785					
	2015.05-	-	MT	L	F	Hatchback Engine CXMA	854006	Outer Joint	36	30	52	59	55.5		I			
	2015.05-	-	MT	L/R	F	Hatchback Engine CXMA	603011	Inner Joint			33		34					
	2015.05-	-	MT	R	F	Hatchback Engine CXMA	261025	Drive Shaft	36		52	75	773.5					
RAPID Spaceback (NH1)																		
1.2 (55 kW)	2012.07-	-	MT	R	F	Hatchback Engine CGPC	261267	Drive Shaft	36		50.7	58.5	765					
	2012.07-	-	-	L	F	Hatchback Engine CGPC	203330	Drive Shaft	36		50.7	58.5	515					
	2012.07-	-	MT	L	F	Hatchback Engine CGPC	203372	Drive Shaft	36		50.7	58.5	516					
1.2 TSI (63 kW)	2012.07-	-	5MT/6MT	-	F	Hatchback Engine CBZA	803024	Outer Joint	36	30	50.75	59	54.5		I			
	2012.07-	-	MT	L/R	F	Hatchback Engine CBZA	603011	Inner Joint			33		34					
	2012.07-	-	MT	-	-	Hatchback Engine CBZA	603006	Inner Joint			33		34					
1.2 TSI (66 kW)	2015.05-	-	AT	-	-	Hatchback Engine CJZC	603006	Inner Joint			33		34					
	2015.05-	-	MT	L/R	F	Hatchback Engine CJZC	603011	Inner Joint			33		34					
1.2 TSI (77 kW)	2012.07-	-	5MT/6MT	-	F	Hatchback Engine CBZB	803024	Outer Joint	36	30	50.75	59	54.5		I			
	2012.07-	-	MT	L	F	Hatchback Engine CBZB	261297	Drive Shaft	36		50.5	59	513					
	2012.07-	-	MT	R	F	Hatchback Engine CBZB	261301	Drive Shaft	36		50.5	59	771					
	2012.07-	-	MT	L/R	F	Hatchback Engine CBZB	603011	Inner Joint			33		34					
	2012.07-	-	MT	-	-	Hatchback Engine CBZB	603006	Inner Joint			33		34					
1.2 TSI (81 kW)	2015.05-	-	5MT/6MT	-	F	Hatchback Engine CJZD	803024	Outer Joint	36	30	50.75	59	54.5		I			
	2015.05-	-	AT/MT	L/R	F	Hatchback Engine CJZD	603011	Inner Joint			33		34					
1.4 TDI (66 kW)	2015.05-	-	AT	-	F	Hatchback Engine CUSB	803041	Outer Joint	36	27	50.5	75	65		I			
	2015.05-	-	MT	L/R	F	Hatchback Engine CUSB	603011	Inner Joint			33		34					
1.4 TSI (90 kW)	2012.07-	-	-	-	F	Hatchback Engine CAXA	803024	Outer Joint	36	30	50.75	59	54.5		I			
	2012.07-	-	AT	L/R	F	Hatchback Engine CAXA	603011	Inner Joint			33		34					
	2012.07-	-	AT	-	-	Hatchback Engine CAXA	603006	Inner Joint			33		34					
1.4 TSI (92 kW)	2015.05-	-	AT	-	-	Hatchback Engine CZCA	603006	Inner Joint			33		34					
	2015.05-	-	AT	L/R	F	Hatchback Engine CZCA	603011	Inner Joint			33		34					
1.6 (77 kW)	2012.07-	-	AT	-	R	Hatchback Engine CFNA	861074	Outer Joint	36	30	52	75	55.5		I			
	2012.07-	-	5MT/6MT	-	F	Hatchback Engine CFNA	803024	Outer Joint	36	30	50.75	59	54.5		I			
	2012.07-	-	AT	L	F	Hatchback Engine CFNA	661039	Inner Joint	26	22	31	68.5	88.5					
	2012.07-	-	MT	L/R	F	Hatchback Engine CFNA	603011	Inner Joint			33		34					
	2012.07-	-	AT	-	-	Hatchback Engine CFNA	603006	Inner Joint			33		34					
1.6 TDI (66 kW)	2013.08-	-	7AT	L	F	Hatchback Engine CAYB	261260	Drive Shaft	36		52	75	498					
	2013.08-	-	7AT	-	F	Hatchback Engine CAYB	803041	Outer Joint	36	27	50.5	75	65		I			
	2013.08-	-	MT	L	F	Hatchback Engine CAYB	261184	Drive Shaft	36		52	59	496					
	2013.08-	-	MT	R	F	Hatchback Engine CAYB	261185	Drive Shaft	36		52	59	785					
	2013.08-	-	MT	L/R	F	Hatchback Engine CAYB	603011	Inner Joint			33		34					
	2013.08-	-	-	-	F	Hatchback Engine CAYB	803024	Outer Joint	36	30	50.75	59	54.5		I			
	2013.08-	-	7AT	R	F	Hatchback Engine CAYB	261261	Drive Shaft	36		52	75	785					
	2013.08-	-	MT	L	F	Hatchback Engine CAYB	854006	Outer Joint	36	30	52	59	55.5		I			
	2013.08-	-	MT	R	F	Hatchback Engine CAYB	261025	Drive Shaft	36		52	75	773.5					





YEAR	TRANS	L/R	F/R	REMARKS	GSP Ref.	PRODUCT	ABS	Technical Specifications					
								A	B	C	H	L	P
SKODA													
RAPID Spaceback (NH1)													
1.6 TDI (77 kW)	2012.07-	-	MT	L F	Hatchback Engine CAYC/CLNA	261184	Drive Shaft	36		52	59	496	
	2012.07-	-	MT	R F	Hatchback Engine CAYC/CLNA	261185	Drive Shaft	36		52	59	785	
	2012.07-	-	MT	L/R F	Hatchback Engine CAYC/CLNA	603011	Inner Joint		33		34		
	2012.07-	-	-	- F	Hatchback Engine CAYC/CLNA	803024	Outer Joint	36	30	50.75	59	54.5	I
	2012.07-	-	MT	L F	Hatchback Engine CAYC/CLNA	854006	Outer Joint	36	30	52	59	55.5	I
	2012.07-	-	MT	- -	Hatchback Engine CAYC/CLNA	603006	Inner Joint		33		34		
	2012.07-	-	MT	R F	Hatchback Engine CAYC/CLNA	261025	Drive Shaft	36		52	75	773.5	
1.6 TDI (85 kW)	2015.05-	-	MT	L F	Hatchback Engine CXMA	261184	Drive Shaft	36		52	59	496	
	2015.05-	-	MT	R F	Hatchback Engine CXMA	261185	Drive Shaft	36		52	59	785	
	2015.05-	-	MT	L F	Hatchback Engine CXMA	854006	Outer Joint	36	30	52	59	55.5	I
	2015.05-	-	MT	R F	Hatchback Engine CXMA	261025	Drive Shaft	36		52	75	773.5	
	2015.05-	-	MT	L/R F	Hatchback Engine CXMA	603011	Inner Joint		33		34		
ROOMSTER (5J)													
1.2 (47 kW)	2006.05-	2007.01	-	L F	MPV Engine BME	203063	Drive Shaft	36		50.7	58.5	501	
	2006.05-	2007.01	-	R F	MPV Engine BME	261063	Drive Shaft	36		50.7	58.5	751	
	2006.05-	2007.01	MT	- F	MPV Engine BME	803027	Outer Joint	36	30	50.7	58.5	47.5	I
1.2 (51 kW)	2007.01-	2015.05	-	L F	MPV Engine BZG/CGPA	203063	Drive Shaft	36		50.7	58.5	501	
	2007.01-	2015.05	-	R F	MPV Engine BZG/CGPA	261063	Drive Shaft	36		50.7	58.5	751	
	2007.01-	2015.05	MT	R F	MPV Engine BZG/CGPA	261077	Drive Shaft	36		50.7	58.5	750	
	2007.01-	2015.05	-	- F	MPV Engine BZG/CGPA	803027	Outer Joint	36	30	50.7	58.5	47.5	I
1.2 TDI (55 kW)	2010.03-	2015.05	MT	L F	MPV Engine CFWA	854006	Outer Joint	36	30	52	59	55.5	I
	2010.03-	2015.05	5MT	- F	MPV Engine CFWA	803024	Outer Joint	36	30	50.75	59	54.5	I
	2010.03-	2015.05	MT	L F	MPV Engine CFWA	261248	Drive Shaft	36		52	59	480	
	2010.03-	2015.05	MT	R F	MPV Engine CFWA	261247	Drive Shaft	36		52	59	765	
	2010.03-	2015.05	-	L/R F	MPV Engine CFWA	603011	Inner Joint		33		34		
	2010.03-	2015.05	MT	- -	MPV Engine CFWA	603006	Inner Joint		33		34		
	2010.03-	2015.05	MT	L F	MPV Engine CFWA	261302	Drive Shaft	36		50.5	59	479	
1.2 TSI (63 kW)	2010.03-	2015.05	AT	- F	MPV Engine CBZA	803041	Outer Joint	36	27	50.5	75	65	I
	2010.03-	2015.05	7DCT/5MT	- F	MPV Engine CBZA	803024	Outer Joint	36	30	50.75	59	54.5	I
	2010.03-	2015.05	AT	L F	MPV Engine CBZA	854006	Outer Joint	36	30	52	59	55.5	I
	2010.03-	2015.05	AT	L F	MPV Engine CBZA	261264	Drive Shaft	36		52	59	478	
	2010.03-	2015.05	MT	- -	MPV Engine CBZA	603006	Inner Joint		33		34		
	2010.03-	2015.05	-	L/R F	MPV Engine CBZA	603011	Inner Joint		33		34		
	2010.03-	2015.05	MT	R F	MPV Engine CBZA	261305	Drive Shaft	36		50.5	59	757	
1.2 TSI (77 kW)	2010.03-	2015.05	AT	- F	MPV Engine CBZB	803041	Outer Joint	36	27	50.5	75	65	I
	2010.03-	2015.05	AT	L F	MPV Engine CBZB	854006	Outer Joint	36	30	52	59	55.5	I
	2010.03-	2015.05	7DCT/5MT	- F	MPV Engine CBZB	803024	Outer Joint	36	30	50.75	59	54.5	I
	2010.03-	2015.05	AT/MT	R F	MPV Engine CBZB	261301	Drive Shaft	36		50.5	59	771	
	2010.03-	2015.05	AT	L F	MPV Engine CBZB	261264	Drive Shaft	36		52	59	478	
	2010.03-	2015.05	-	L/R F	MPV Engine CBZB	603011	Inner Joint		33		34		
	2010.03-	2015.05	MT	R F	MPV Engine CBZB	261305	Drive Shaft	36		50.5	59	757	
1.4 (63 kW)	2006.09-	2015.05	-	R F	MPV Engine BXW/CGGB	261063	Drive Shaft	36		50.7	58.5	751	
	2006.09-	2015.05	MT	R F	MPV Engine BXW/CGGB	261077	Drive Shaft	36		50.7	58.5	750	
	2006.09-	2015.05	MT	- F	MPV Engine BXW/CGGB	803027	Outer Joint	36	30	50.7	58.5	47.5	I
	2006.09-	2015.05	-	L F	MPV Engine BXW/CGGB	203063	Drive Shaft	36		50.7	58.5	501	
1.4 TDI (51 kW)	2006.07-	2010.03	MT	- F	MPV Engine BNM	803024	Outer Joint	36	30	50.75	59	54.5	I
	2006.07-	2010.03	MT	R F	MPV Engine BNM	261077	Drive Shaft	36		50.7	58.5	750	
	2006.07-	2010.03	MT	R F	MPV Engine BNM	261223	Drive Shaft	36		52	59	757	
	2006.07-	2010.03	MT	L F	MPV Engine BNM	261078	Drive Shaft	36		50.7	58.5	501	
	2006.07-	2010.03	MT	R F	MPV Engine BNM	854006	Outer Joint	36	30	52	59	55.5	I
	2006.07-	2010.03	-	L/R F	MPV Engine BNM	661006	Inner Joint		30		57.6		
1.4 TDI (59 kW)	2006.09-	2010.03	MT	- F	MPV Engine BMS/BNV	803024	Outer Joint	36	30	50.75	59	54.5	I
	2006.09-	2010.03	MT	L F	MPV Engine BMS/BNV	261098	Drive Shaft	36		50.5	59	472	
	2006.09-	2010.03	-	L F	MPV Engine BMS/BNV	661062	Inner Joint		30		59		
	2006.09-	2010.03	MT	R F	MPV Engine BMS/BNV	261099	Drive Shaft	36		50.5	59	759	
	2006.09-	2010.03	-	L F	MPV Engine BMS/BNV	854006	Outer Joint	36	30	52	59	55.5	I
	2006.09-	2010.03	-	L/R F	MPV Engine BMS/BNV	661006	Inner Joint		30		57.6		
	2006.09-	2010.03	-	L F	MPV Engine BMS/BNV	261135	Drive Shaft	36		52	59	475	
	2006.09-	2010.03	MT	R F	MPV Engine BMS/BNV	261136	Drive Shaft	36		52	59	763	
1.6 (77 kW)	2006.09-	2015.05	-	- -	MPV Engine BTS/CFNA	661050	Inner Joint	26	32	31	68.5	89	
	2006.09-	2015.05	6AT	L F	MPV Engine BTS/CFNA	261206	Drive Shaft	36	26	52	59	536	
	2006.09-	2015.05	MT	R F	MPV Engine BTS/CFNA	261077	Drive Shaft	36		50.7	58.5	750	
	2006.09-	2015.05	6AT	R F	MPV Engine BTS/CFNA	261133	Drive Shaft	36	26	52	75	859	
	2006.09-	2015.05	6AT	L F	MPV Engine BTS/CFNA	854006	Outer Joint	36	30	52	59	55.5	I
	2006.09-	2015.05	MT	L/R F	MPV Engine BTS/CFNA	603011	Inner Joint		33		34		
	2006.09-	2015.05	6AT/5MT	- F	MPV Engine BTS/CFNA	803024	Outer Joint	36	30	50.75	59	54.5	I
	2006.09-	2015.05	AT	L F	MPV Engine BTS/CFNA	261150	Drive Shaft	36	26	52	75	557	





	 YEAR	TRANSM	L/R	F/R	REMARKS	GSP Ref.	 PRODUCT	 ABS	Technical Specifications					
									A	B	C	H	L	P
SKODA														
ROOMSTER (5J)														
1.6 TDI (66 kW)	2010.03-2015.05	MT	L	F	MPV Engine CAYB	854006	Outer Joint		36	30	52	59	55.5	I
	2010.03-2015.05	5MT	-	F	MPV Engine CAYB	803024	Outer Joint		36	30	50.75	59	54.5	I
	2010.03-2015.05	MT	L	F	MPV Engine CAYB	261248	Drive Shaft		36		52	59	480	
	2010.03-2015.05	MT	R	F	MPV Engine CAYB	261247	Drive Shaft		36		52	59	765	
	2010.03-2015.05	MT	-	-	MPV Engine CAYB	603006	Inner Joint			33		34		
	2010.03-2015.05	-	L/R	F	MPV Engine CAYB	603011	Inner Joint			33		34		
	2010.03-2015.05	MT	L	F	MPV Engine CAYB	261302	Drive Shaft		36		50.5	59	479	
1.6 TDI (77 kW)	2010.03-2015.05	MT	L	F	MPV Engine CAYC	854006	Outer Joint		36	30	52	59	55.5	I
	2010.03-2015.05	5MT	-	F	MPV Engine CAYC	803024	Outer Joint		36	30	50.75	59	54.5	I
	2010.03-2015.05	MT	L	F	MPV Engine CAYC	261248	Drive Shaft		36		52	59	480	
	2010.03-2015.05	MT	R	F	MPV Engine CAYC	261247	Drive Shaft		36		52	59	765	
	2010.03-2015.05	MT	-	-	MPV Engine CAYC	603006	Inner Joint			33		34		
	2010.03-2015.05	-	L/R	F	MPV Engine CAYC	603011	Inner Joint			33		34		
	2010.03-2015.05	MT	L	F	MPV Engine CAYC	261302	Drive Shaft		36		50.5	59	479	
1.9 TDI (74 kW)	2006.03-2006.05	-	L	F	MPV Engine AXR	661062	Inner Joint			30		59		
	2006.03-2006.05	-	L	F	MPV Engine AXR	261098	Drive Shaft		36		50.5	59	472	
	2006.03-2006.05	-	L	F	MPV Engine AXR	854006	Outer Joint		36	30	52	59	55.5	I
	2006.03-2006.05	-	R	F	MPV Engine AXR	261099	Drive Shaft		36		50.5	59	759	
	2006.03-2006.05	-	L	F	MPV Engine AXR	261135	Drive Shaft		36		52	59	475	
	2006.03-2006.05	MT	R	F	MPV Engine AXR	261136	Drive Shaft		36		52	59	763	
	2006.03-2006.05	-	L/R	F	MPV Engine AXR	661006	Inner Joint			30		57.6		
1.9 TDI (77 kW)	2006.09-2010.03	MT	-	F	MPV Engine BLS/BSW	803024	Outer Joint		36	30	50.75	59	54.5	I
	2006.09-2010.03	-	L	F	MPV Engine BLS/BSW	261098	Drive Shaft		36		50.5	59	472	
	2006.09-2010.03	MT	L	F	MPV Engine BLS/BSW	661062	Inner Joint			30		59		
	2006.09-2010.03	MT	L	F	MPV Engine BLS/BSW	854006	Outer Joint		36	30	52	59	55.5	I
	2006.09-2010.03	-	R	F	MPV Engine BLS/BSW	261099	Drive Shaft		36		50.5	59	759	
	2006.09-2010.03	MT	L	F	MPV Engine BLS/BSW	261135	Drive Shaft		36		52	59	475	
	2006.09-2010.03	-	L/R	F	MPV Engine BLS/BSW	661006	Inner Joint			30		57.6		
	2006.09-2010.03	MT	R	F	MPV Engine BLS/BSW	261136	Drive Shaft		36		52	59	763	
ROOMSTER Praktik (5J)														
1.2 (51 kW)	2007.03-2015.05	-	L	F	Box Engine BZG/CGPA	203063	Drive Shaft		36		50.7	58.5	501	
	2007.03-2015.05	-	R	F	Box Engine BZG/CGPA	261063	Drive Shaft		36		50.7	58.5	751	
	2007.03-2015.05	MT	R	F	Box Engine BZG/CGPA	261077	Drive Shaft		36		50.7	58.5	750	
	2007.03-2015.05	-	-	F	Box Engine BZG/CGPA	803027	Outer Joint		36	30	50.7	58.5	47.5	I
1.2 TDI (55 kW)	2010.03-2015.05	MT	L	F	Box Engine CFWA	854006	Outer Joint		36	30	52	59	55.5	I
	2010.03-2015.05	5MT	-	F	Box Engine CFWA	803024	Outer Joint		36	30	50.75	59	54.5	I
	2010.03-2015.05	-	L/R	F	Box Engine CFWA	603011	Inner Joint			33		34		
	2010.03-2015.05	MT	L	F	Box Engine CFWA	261248	Drive Shaft		36		52	59	480	
	2010.03-2015.05	MT	R	F	Box Engine CFWA	261247	Drive Shaft		36		52	59	765	
	2010.03-2015.05	MT	L	F	Box Engine CFWA	261302	Drive Shaft		36		50.5	59	479	
	2010.03-2015.05	MT	-	-	Box Engine CFWA	603006	Inner Joint			33		34		
1.2 TSI (63 kW)	2010.03-2015.05	AT	-	F	Box Engine CBZA	803041	Outer Joint		36	27	50.5	75	65	I
	2010.03-2015.05	7DCT/5MT	-	F	Box Engine CBZA	803024	Outer Joint		36	30	50.75	59	54.5	I
	2010.03-2015.05	AT	L	F	Box Engine CBZA	854006	Outer Joint		36	30	52	59	55.5	I
	2010.03-2015.05	-	L/R/F/R	F	Box Engine CBZA	603011	Inner Joint			33		34		
	2010.03-2015.05	AT	L	F	Box Engine CBZA	261264	Drive Shaft		36		52	59	478	
	2010.03-2015.05	MT	R	F	Box Engine CBZA	261305	Drive Shaft		36		50.5	59	757	
	2010.03-2015.05	MT	-	-	Box Engine CBZA	603006	Inner Joint			33		34		
1.4 (63 kW)	2007.03-2015.05	-	L	F	Box Engine BXW/CGGB	203063	Drive Shaft		36		50.7	58.5	501	
	2007.03-2015.05	-	R	F	Box Engine BXW/CGGB	261063	Drive Shaft		36		50.7	58.5	751	
	2007.03-2015.05	MT	R	F	Box Engine BXW/CGGB	261077	Drive Shaft		36		50.7	58.5	750	
	2007.03-2015.05	-	-	F	Box Engine BXW/CGGB	803027	Outer Joint		36	30	50.7	58.5	47.5	I
1.4 TDI (51 kW)	2007.03-2010.03	-	-	F	Box Engine BNM	803024	Outer Joint		36	30	50.75	59	54.5	I
	2007.03-2010.03	MT	R	F	Box Engine BNM	261077	Drive Shaft		36		50.7	58.5	750	
	2007.03-2010.03	MT	R	F	Box Engine BNM	261223	Drive Shaft		36		52	59	757	
	2007.03-2010.03	MT	L	F	Box Engine BNM	261078	Drive Shaft		36		50.7	58.5	501	
	2007.03-2010.03	MT	R	F	Box Engine BNM	854006	Outer Joint		36	30	52	59	55.5	I
1.4 TDI (59 kW)	2007.03-2010.03	-	-	F	Box Engine BMS/BNV	803024	Outer Joint		36	30	50.75	59	54.5	I
	2007.03-2010.03	MT	L	F	Box Engine BMS/BNV	261098	Drive Shaft		36		50.5	59	472	
	2007.03-2010.03	-	L	F	Box Engine BMS/BNV	661062	Inner Joint			30		59		
	2007.03-2010.03	MT	R	F	Box Engine BMS/BNV	261099	Drive Shaft		36		50.5	59	759	
	2007.03-2010.03	-	L	F	Box Engine BMS/BNV	854006	Outer Joint		36	30	52	59	55.5	I
	2007.03-2010.03	-	L	F	Box Engine BMS/BNV	261135	Drive Shaft		36		52	59	475	
	2007.03-2010.03	MT	R	F	Box Engine BMS/BNV	261136	Drive Shaft		36		52	59	763	
	2007.03-2010.03	-	L/R	F	Box Engine BMS/BNV	661006	Inner Joint			30		57.6		
1.6 TDI (66 kW)	2010.03-2015.05	MT	L	F	Box Engine CAYB	854006	Outer Joint		36	30	52	59	55.5	I





YEAR	TRANSM	L/R	F/R	REMARKS	GSP Ref.	PRODUCT	ABS	Technical Specifications						
								A	B	C	H	L	P	
SKODA														
ROOMSTER Praktik (5J)														
1.6 TDI (66 kW)	2010.03-2015.05	5MT	-	F	Box Engine CAYB	803024	Outer Joint		36	30	50.75	59	54.5	I
	2010.03-2015.05	-	L/R	F	Box Engine CAYB	603011	Inner Joint			33		34		
	2010.03-2015.05	MT	L	F	Box Engine CAYB	261248	Drive Shaft		36		52	59	480	
	2010.03-2015.05	MT	R	F	Box Engine CAYB	261247	Drive Shaft		36		52	59	765	
	2010.03-2015.05	MT	L	F	Box Engine CAYB	261302	Drive Shaft		36		50.5	59	479	
	2010.03-2015.05	MT	-	-	Box Engine CAYB	603006	Inner Joint			33		34		
SUPERB														
2.5 TDi V6	2002.05-	AT	-	F	-	803064	Outer Joint	45T	38	27	60	34	64	I
	2002.05-	MT	-	F	-	803064	Outer Joint	45T	38	27	60	34	64	I
2.8 V6	2002.05-	MT/AT	-	F	-	803064	Outer Joint	45T	38	27	60	34	64	I
SUPERB I (3U4)														
1.8 T (110 kW)	2001.12-2008.03	AT	L	F	Saloon Engine AWT	203015	Drive Shaft	45W	38		59.5	34.5	527	
	2001.12-2008.03	MT	L/R	F	Saloon Engine AWT	861012	Outer Joint	45W	33	30	53	30	62	I
	2001.12-2008.03	AT	L/R	F	Saloon Engine AWT	803019	Outer Joint	45W	38	27	59.5	34.5	63	I
	2001.12-2008.03	AT	R	F	Saloon Engine AWT	203048	Drive Shaft	45W	38		59.5	34.5	502	
	2001.12-2008.03	MT	L	F	Saloon Engine AWT	203010	Drive Shaft	45W	33		53	30	599	
	2001.12-2008.03	MT	R	F	Saloon Engine AWT	203007	Drive Shaft	45W	33		53	30	622	
	2001.12-2008.03	MT	L	F	Saloon Engine AWT	261122	Drive Shaft	45W	33		53	30	602	
	2001.12-2008.03	MT	R	F	Saloon Engine AWT	203009	Drive Shaft	45W	33		53	30	617	
1.9 TDI (74 kW)	2002.08-2005.10	MT	L/R	F	Saloon Engine AVB	803021	Outer Joint	45W	33	27	53	30	63	I
	2002.08-2005.10	MT	L	F	Saloon Engine AVB	261083	Drive Shaft	45W	33		53	30	603	
	2002.08-2005.10	MT	R	F	Saloon Engine AVB	261082	Drive Shaft	45W	33		53	30	620	
	2002.08-2005.10	MT	L/R	F	Saloon Engine AVB	661033	Inner Joint			34		85		
1.9 TDI (77 kW)	2005.10-2007.05	MT	L/R	F	Saloon Engine BSV	803021	Outer Joint	45W	33	27	53	30	63	I
	2005.10-2007.05	MT	L	F	Saloon Engine BSV	261083	Drive Shaft	45W	33		53	30	603	
	2005.10-2007.05	MT	R	F	Saloon Engine BSV	261082	Drive Shaft	45W	33		53	30	620	
1.9 TDI (85 kW)	2007.01-2008.03	-	L/R	F	Saloon Engine BPZ	803021	Outer Joint	45W	33	27	53	30	63	I
	2007.01-2008.03	MT	L	F	Saloon Engine BPZ	261083	Drive Shaft	45W	33		53	30	603	
	2007.01-2008.03	MT	R	F	Saloon Engine BPZ	261082	Drive Shaft	45W	33		53	30	620	
1.9 TDI (96 kW)	2001.12-2008.03	AT	L	F	Saloon Engine AVF/AWX	203015	Drive Shaft	45W	38		59.5	34.5	527	
	2001.12-2008.03	AT	R	F	Saloon Engine AVF/AWX	203048	Drive Shaft	45W	38		59.5	34.5	502	
	2001.12-2008.03	MT	R	F	Saloon Engine AVF/AWX	261019	Drive Shaft	45W	38		59.5	34.5	624	
	2001.12-2008.03	AT/MT	L/R	F	Saloon Engine AVF/AWX	661033	Inner Joint			34		85		
	2001.12-2008.03	AT/MT	L/R	F	Saloon Engine AVF/AWX	803019	Outer Joint	45W	38	27	59.5	34.5	63	I
	2001.12-2008.03	MT	L	F	Saloon Engine AVF/AWX	203008	Drive Shaft	45W	38		59.5	34.5	603	
2.0 (85 kW)	2001.12-2008.03	MT	R	F	Saloon Engine AZM	203001	Drive Shaft	45W	33		53	30	634	
	2001.12-2008.03	MT	L	F	Saloon Engine AZM	203005	Drive Shaft	45W	33		53	30	614	
	2001.12-2008.03	-	L/R	F	Saloon Engine AZM	803018	Outer Joint	45W	33	30	53	30	62	I
	2001.12-2008.03	-	L/R	F	Saloon Engine AZM	603001	Inner Joint			28		32		
	2001.12-2008.03	MT	R	F	Saloon Engine AZM	203013	Drive Shaft	45W	33		53	30	636	
2.0 TDI (103 kW)	2005.10-2008.03	MT	L/R	F	Saloon Engine BSS	803019	Outer Joint	45W	38	27	59.5	34.5	63	I
2.5 TDI (114 kW)	2001.12-2003.08	AT	L	F	Saloon Engine AYM	203015	Drive Shaft	45W	38		59.5	34.5	527	
	2001.12-2003.08	AT/MT	L/R	F	Saloon Engine AYM	803019	Outer Joint	45W	38	27	59.5	34.5	63	I
	2001.12-2003.08	AT	R	F	Saloon Engine AYM	203048	Drive Shaft	45W	38		59.5	34.5	502	
	2001.12-2003.08	MT	R	F	Saloon Engine AYM	261019	Drive Shaft	45W	38		59.5	34.5	624	
	2001.12-2003.08	AT/MT	L/R	F	Saloon Engine AYM	661033	Inner Joint			34		85		
	2001.12-2003.08	MT	L	F	Saloon Engine AYM	203008	Drive Shaft	45W	38		59.5	34.5	603	
2.5 TDI (120 kW)	2003.06-2008.03	AT	L	F	Saloon Engine BDG	203015	Drive Shaft	45W	38		59.5	34.5	527	
	2003.06-2008.03	AT/MT	L/R	F	Saloon Engine BDG	803019	Outer Joint	45W	38	27	59.5	34.5	63	I
	2003.06-2008.03	AT	R	F	Saloon Engine BDG	203048	Drive Shaft	45W	38		59.5	34.5	502	
	2003.06-2008.03	MT	R	F	Saloon Engine BDG	261019	Drive Shaft	45W	38		59.5	34.5	624	
	2003.06-2008.03	MT	L/R	F	Saloon Engine BDG	661033	Inner Joint			34		85		
	2003.06-2008.03	MT	L	F	Saloon Engine BDG	203008	Drive Shaft	45W	38		59.5	34.5	603	
2.8 V6 (142 kW)	2001.12-2008.03	AT	L	F	Saloon Engine AMX	203015	Drive Shaft	45W	38		59.5	34.5	527	
	2001.12-2008.03	AT/MT	L/R	F	Saloon Engine AMX	661033	Inner Joint			34		85		
	2001.12-2008.03	AT/MT	L/R	F	Saloon Engine AMX	803019	Outer Joint	45W	38	27	59.5	34.5	63	I
	2001.12-2008.03	AT	R	F	Saloon Engine AMX	203048	Drive Shaft	45W	38		59.5	34.5	502	
	2001.12-2008.03	MT	R	F	Saloon Engine AMX	261019	Drive Shaft	45W	38		59.5	34.5	624	
	2001.12-2008.03	MT	L	F	Saloon Engine AMX	203008	Drive Shaft	45W	38		59.5	34.5	603	
SUPERB II (3T4)														
1.4 TSI (92 kW)	2008.07-2015.05	MT	-	-	Hatchback Engine CAXC	603006	Inner Joint			33		34		
	2008.07-2015.05	MT	L	F	Hatchback Engine CAXC	261198	Drive Shaft		36		59.5	40.5	530	
	2008.07-2015.05	MT	R	F	Hatchback Engine CAXC	201586	Drive Shaft		36		59.5	40	806	
	2008.07-2015.05	-	L/R	F	Hatchback Engine CAXC	603011	Inner Joint			33		34		
	2008.07-2015.05	-	L/R	F	Hatchback Engine CAXC	803037	Outer Joint		36	30	59.5	40.5	55	I
1.6 TDI (77 kW)	2010.09-2015.05	-	L/R/F	R	Hatchback Engine CAYC	603011	Inner Joint			33		34		

YEAR	TRANSM	L/R	F/R	REMARKS	GSP Ref.	PRODUCT	ABS	Technical Specifications							
								A	B	C	H	L	P		
SKODA SUPERB II (3T4)															
1.6 TDI (77 kW)	2010.09-2015.05	MT	-	F	Hatchback Engine CAYC	803100	Outer Joint	36	33	59.5	38	55	I		
	2010.09-2015.05	MT	L	F	Hatchback Engine CAYC	261089	Drive Shaft	36		59.5	40.5	521			
	2010.09-2015.05	MT	R	F	Hatchback Engine CAYC	261200	Drive Shaft	36		59.5	40.5	820			
1.8 TSI (112 kW)	2009.03-2015.05	-	L/R	R	All-wheel Drive Hatchback Engine CDAB	603011	Inner Joint		33		34				
	2009.03-2015.05	6AT/MT	L/R	F	Hatchback Engine CDAB	803002	Outer Joint	36	27	59.5	40	66	I		
	2009.03-2015.05	-	L/R	F	All-wheel Drive Hatchback Engine CDAB	803002	Outer Joint	36	27	59.5	40	66	I		
	2009.03-2015.05	-	L	F	All-wheel Drive Hatchback Engine CDAB	203295	Drive Shaft	36		59.5	40	491			
	2009.03-2015.05	-	R	F	All-wheel Drive Hatchback Engine CDAB	203266	Drive Shaft	36		59.5	40	601			
	2009.03-2015.05	MT	L	F	Hatchback Engine CDAB	261131	Drive Shaft	36		59.5	40	515			
1.8 TSI (118 kW)	2008.03-2015.05	MT	L	F	Hatchback Engine BZB/CDA	261100	Drive Shaft	36		59.5	40	513			
	2008.03-2015.05	-	L/R	F	Hatchback Engine BZB/CDA	803002	Outer Joint	36	27	59.5	40	66	I		
	2008.03-2015.05	AT	L	F	Hatchback Engine BZB/CDA	661054	Inner Joint	40	28	46.9	51	53			
	2008.03-2015.05	MT	L	F	Hatchback Engine BZB/CDA	261131	Drive Shaft	36		59.5	40	515			
	2008.11-2015.05	-	L/R	F	All-wheel Drive Hatchback Engine CDA	803002	Outer Joint	36	27	59.5	40	66	I		
	2008.11-2015.05	AT	L	F	All-wheel Drive Hatchback Engine CDA	661054	Inner Joint	40	28	46.9	51	53			
	2008.11-2015.05	-	L	F	All-wheel Drive Hatchback Engine CDA	203295	Drive Shaft	36		59.5	40	491			
	2008.11-2015.05	-	L/R	R	All-wheel Drive Hatchback Engine CDA	603011	Inner Joint		33		34				
	2008.11-2015.05	-	R	F	All-wheel Drive Hatchback Engine CDA	203266	Drive Shaft	36		59.5	40	601			
	2008.11-2015.05	MT	L	F	All-wheel Drive Hatchback Engine CDA	261131	Drive Shaft	36		59.5	40	515			
1.9 TDI (77 kW)	2008.03-2010.11	MT	L	F	Hatchback Engine BLS/BXE	203294	Drive Shaft	36		59.5	38	519			
	2008.03-2010.11	MT	-	-	Hatchback Engine BLS/BXE	603006	Inner Joint		33		34				
	2008.03-2010.11	-	L/R	F	Hatchback Engine BLS/BXE	603011	Inner Joint		33		34				
	2008.03-2010.11	MT	L	F	Hatchback Engine BLS/BXE	803116	Outer Joint	36	30	59.5	38	55	I		
	2008.03-2010.11	-	R	F	Hatchback Engine BLS/BXE	261042	Drive Shaft	36		59.5	40.5	814			
	2008.03-2010.11	-	R	F	Hatchback Engine BLS/BXE	201585	Drive Shaft	36		59.5	40	805			
	2008.03-2010.11	-	L/R	F	Hatchback Engine BLS/BXE	803037	Outer Joint	36	30	59.5	40.5	55	I		
	2008.03-2010.11	-	R	F	Hatchback Engine BLS/BXE	261131	Drive Shaft	36		59.5	40	515			
2.0 TDI (103 kW)	2008.03-2010.05	AT	R	F	Hatchback Engine BMP	254011	Drive Shaft	36		59.5	40	755			
	2008.03-2010.05	MT	L	F	Hatchback Engine BMP	203265	Drive Shaft	36		59.5	40	487			
	2008.03-2010.05	MT	R	F	Hatchback Engine BMP	203313	Drive Shaft	36		59.5	40	792			
	2008.03-2010.05	AT	L/R	F	Hatchback Engine BMP	661057	Inner Joint		34		86				
	2008.03-2010.05	AT/MT	L/R	F	Hatchback Engine BMP	803002	Outer Joint	36	27	59.5	40	66	I		
	2008.03-2010.05	AT	L	F	Hatchback Engine BMP	203241	Drive Shaft	36		59.5	40	475			
	2008.03-2010.05	AT	L	F	Hatchback Engine BMP	254013	Drive Shaft	36		59.5	40	479.5			
	2008.03-2010.05	AT	L	F	Hatchback Engine BMP	654004	Inner Joint		34		85				
	2008.03-2010.05	MT	R	F	Hatchback Engine BMP	261126	Drive Shaft	36		59.5	40	793			
	2008.03-2010.05	MT	L	F	Hatchback Engine BMP	203295	Drive Shaft	36		59.5	40	491			
2.0 TDI (125 kW)	2008.07-2015.05	MT	L	F	Hatchback Engine CBBB/CFGB	203265	Drive Shaft	36		59.5	40	487			
	2008.07-2015.05	AT	R	F	Hatchback Engine CBBB/CFGB	254011	Drive Shaft	36		59.5	40	755			
	2008.07-2015.05	AT	L/R	F	Hatchback Engine CBBB/CFGB	661057	Inner Joint		34		86				
	2008.07-2015.05	AT	L	F	Hatchback Engine CBBB/CFGB	203241	Drive Shaft	36		59.5	40	475			
	2008.07-2015.05	AT	R	F	Hatchback Engine CBBB/CFGB	654004	Inner Joint		34		85				
	2008.07-2015.05	MT	R	F	Hatchback Engine CBBB/CFGB	261126	Drive Shaft	36		59.5	40	793			
	2008.09-2015.05	-	L/R	F	All-wheel Drive Hatchback Engine CBBB/CFGB	803002	Outer Joint	36	27	59.5	40	66	I		
	2008.09-2015.05	-	L	F	All-wheel Drive Hatchback Engine CBBB/CFGB	203295	Drive Shaft	36		59.5	40	491			
	2008.09-2015.05	-	L/R	R	All-wheel Drive Hatchback Engine CBBB/CFGB	603011	Inner Joint		33		34				
	2008.09-2015.05	-	R	F	All-wheel Drive Hatchback Engine CBBB/CFGB	203266	Drive Shaft	36		59.5	40	601			
2.0 TDI 16V (103 kW)	2009.01-2015.05	MT	L	F	Hatchback Engine BKD/CFFB/CLJA	203295	Drive Shaft	36		59.5	40	491			
	2009.01-2015.05	AT	R	F	Hatchback Engine BKD/CFFB/CLJA	254011	Drive Shaft	36		59.5	40	755			
	2009.01-2015.05	AT	L/R	F	Hatchback Engine BKD/CFFB/CLJA	661057	Inner Joint		34		86				
	2009.01-2015.05	AT	L	F	Hatchback Engine BKD/CFFB/CLJA	254013	Drive Shaft	36		59.5	40	479.5			
	2009.01-2015.05	AT	L	F	Hatchback Engine BKD/CFFB/CLJA	654004	Inner Joint		34		85				
	2009.01-2015.05	AT	L	F	Hatchback Engine BKD/CFFB/CLJA	203241	Drive Shaft	36		59.5	40	475			
	2009.01-2015.05	AT/MT	L/R	F	Hatchback Engine BKD/CFFB/CLJA	803002	Outer Joint	36	27	59.5	40	66	I		
	2010.11-2015.05	-	L/R	R	All-wheel Drive Hatchback Engine CFFB	603011	Inner Joint		33		34				
	2010.11-2015.05	-	L/R	F	All-wheel Drive Hatchback Engine CFFB	803002	Outer Joint	36	27	59.5	40	66	I		
	2010.11-2015.05	-	L	F	All-wheel Drive Hatchback Engine CFFB	254013	Drive Shaft	36		59.5	40	479.5			
	2010.11-2015.05	-	L	F	All-wheel Drive Hatchback Engine CFFB	654004	Inner Joint		34		85				
	2010.11-2015.05	6AT	L	F	All-wheel Drive Hatchback Engine CFFB	203241	Drive Shaft	36		59.5	40	475			
	2.0 TSI (147 kW)	2010.05-2015.05	AT	-	-	Hatchback Engine CCZA	603016	Inner Joint		28		32			
2010.05-2015.05		AT	-	-	Hatchback Engine CCZA	603006	Inner Joint		33		34				
3.6 FSI (191 kW)	2008.11-2015.05	-	L/R	R	All-wheel Drive Hatchback Engine CDVA	603011	Inner Joint		33		34				
	2008.11-2015.05	AT	-	-	All-wheel Drive Hatchback Engine CDVA	603016	Inner Joint		28		32				
	2008.11-2015.05	AT	-	-	All-wheel Drive Hatchback Engine CDVA	603006	Inner Joint		33		34				
SUPERB II (3T5)															
1.4 TSI (92 kW)	2009.10-2015.05	MT	L	F	Estate Engine CAXC	261198	Drive Shaft	36		59.5	40.5	530			
	2009.10-2015.05	MT	-	-	Estate Engine CAXC	603006	Inner Joint		33		34				





	 YEAR	TRANSM	L/R	F/R	REMARKS	GSP Ref.	 PRODUCT	 ABS	Technical Specifications						
									A	B	C	H	L	P	
SKODA SUPERB II (3T5)															
1.4 TSI (92 kW)	2009.10-2015.05	MT	R	F	Estate Engine CAXC	201586	Drive Shaft		36		59.5	40	806		
	2009.10-2015.05	-	L/R	F	Estate Engine CAXC	603011	Inner Joint			33		34			
	2009.10-2015.05	-	L/R	F	Estate Engine CAXC	803037	Outer Joint		36	30	59.5	40.5	55	I	
1.6 TDI (77 kW)	2010.09-2015.05	-	L/R	F	Estate Engine CAYC	603011	Inner Joint			33		34			
	2010.09-2015.05	MT	-	F	Estate Engine CAYC	803100	Outer Joint		36	33	59.5	38	55	I	
	2010.09-2015.05	MT	L	F	Estate Engine CAYC	261089	Drive Shaft		36		59.5	40.5	521		
	2010.09-2015.05	MT	R	F	Estate Engine CAYC	261200	Drive Shaft		36		59.5	40.5	820		
1.8 TSI (112 kW)	2009.10-2015.05	-	L/R	R	All-wheel Drive Estate Engine CDAB	603011	Inner Joint			33		34			
	2009.10-2015.05	6AT/MT	L/R	F	Estate Engine CDAB	803002	Outer Joint		36	27	59.5	40	66	I	
	2009.10-2015.05	-	L/R	F	All-wheel Drive Estate Engine CDAB	803002	Outer Joint		36	27	59.5	40	66	I	
	2009.10-2015.05	-	L	F	All-wheel Drive Estate Engine CDAB	203295	Drive Shaft		36		59.5	40	491		
	2009.10-2015.05	-	R	F	All-wheel Drive Estate Engine CDAB	203266	Drive Shaft		36		59.5	40	601		
	2009.10-2015.05	MT	L	F	Estate Engine CDAB	261131	Drive Shaft		36		59.5	40	515		
1.8 TSI (118 kW)	2009.10-2015.05	MT	L	F	Estate Engine CDAA	261100	Drive Shaft		36		59.5	40	513		
	2009.10-2015.05	-	L/R	F	All-wheel Drive Estate Engine CDAA	803002	Outer Joint		36	27	59.5	40	66	I	
	2009.10-2015.05	-	L	F	All-wheel Drive Estate Engine CDAA	203295	Drive Shaft		36		59.5	40	491		
	2009.10-2015.05	-	L/R	F	Estate Engine CDAA	803002	Outer Joint		36	27	59.5	40	66	I	
	2009.10-2015.05	-	R	F	All-wheel Drive Estate Engine CDAA	203266	Drive Shaft		36		59.5	40	601		
	2009.10-2015.05	-	L/R	R	All-wheel Drive Estate Engine CDAA	603011	Inner Joint			33		34			
	2009.10-2015.05	MT	L	F	Estate Engine CDAA	261131	Drive Shaft		36		59.5	40	515		
	2009.10-2015.05	MT	L	F	All-wheel Drive Estate Engine CDAA	261131	Drive Shaft		36		59.5	40	515		
1.9 TDI (77 kW)	2009.10-2010.11	-	L	F	Estate Engine BLS/BXE	203294	Drive Shaft		36		59.5	38	519		
	2009.10-2010.11	-	L/R	F	Estate Engine BLS/BXE	603011	Inner Joint			33		34			
	2009.10-2010.11	-	L	F	Estate Engine BLS/BXE	803116	Outer Joint		36	30	59.5	38	55	I	
	2009.10-2010.11	-	R	F	Estate Engine BLS/BXE	261042	Drive Shaft		36		59.5	40.5	814		
	2009.10-2010.11	-	L/R	F	Estate Engine BLS/BXE	803037	Outer Joint		36	30	59.5	40.5	55	I	
	2009.10-2010.11	MT	-	-	Estate Engine BLS/BXE	603006	Inner Joint			33		34			
	2009.10-2010.11	-	R	F	Estate Engine BLS/BXE	201585	Drive Shaft		36		59.5	40	805		
2.0 TDI (103 kW)	2009.10-2010.03	AT	R	F	Estate Engine BMP	254011	Drive Shaft		36		59.5	40	755		
	2009.10-2010.03	MT	L	F	Estate Engine BMP	203265	Drive Shaft		36		59.5	40	487		
	2009.10-2010.03	AT	L/R	F	Estate Engine BMP	661057	Inner Joint			34		86			
	2009.10-2010.03	AT	L	F	Estate Engine BMP	254013	Drive Shaft		36		59.5	40	479.5		
	2009.10-2010.03	AT	L	F	Estate Engine BMP	654004	Inner Joint			34		85			
	2009.10-2010.03	AT	L	F	Estate Engine BMP	203241	Drive Shaft		36		59.5	40	475		
	2009.10-2010.03	MT	R	F	Estate Engine BMP	261126	Drive Shaft		36		59.5	40	793		
	2009.10-2010.03	AT	L/R	F	Estate Engine BMP	803002	Outer Joint		36	27	59.5	40	66	I	
2.0 TDI (125 kW)	2009.10-2015.05	MT	L	F	Estate Engine CBBB	203265	Drive Shaft		36		59.5	40	487		
	2009.10-2015.05	AT	R	F	Estate Engine CBBB	254011	Drive Shaft		36		59.5	40	755		
	2009.10-2015.05	-	L/R	F	All-wheel Drive Estate Engine CBBB	803002	Outer Joint		36	27	59.5	40	66	I	
	2009.10-2015.05	-	L/R	R	All-wheel Drive Estate Engine CBBB	603011	Inner Joint			33		34			
	2009.10-2015.05	AT	L	F	Estate Engine CBBB	203241	Drive Shaft		36		59.5	40	475		
	2009.10-2015.05	AT	R	F	Estate Engine CBBB	654004	Inner Joint			34		85			
	2009.10-2015.05	MT	R	F	Estate Engine CBBB	261126	Drive Shaft		36		59.5	40	793		
2.0 TDI 16V (103 kW)	2009.10-2015.05	AT	R	F	Estate Engine BKD/CFFB/CLJA	254011	Drive Shaft		36		59.5	40	755		
	2009.10-2015.05	AT	L	F	Estate Engine BKD/CFFB/CLJA	254013	Drive Shaft		36		59.5	40	479.5		
	2009.10-2015.05	AT	L	F	Estate Engine BKD/CFFB/CLJA	654004	Inner Joint			34		85			
	2009.10-2015.05	AT	L	F	Estate Engine BKD/CFFB/CLJA	203241	Drive Shaft		36		59.5	40	475		
	2009.10-2015.05	MT	R	F	Estate Engine BKD/CFFB/CLJA	261126	Drive Shaft		36		59.5	40	793		
	2009.10-2015.05	AT	L/R	F	Estate Engine BKD/CFFB/CLJA	803002	Outer Joint		36	27	59.5	40	66	I	
	2010.11-2015.05	-	L/R	R	All-wheel Drive Estate Engine CFFB	603011	Inner Joint			33		34			
	2010.11-2015.05	-	L/R	F	All-wheel Drive Estate Engine CFFB	803002	Outer Joint		36	27	59.5	40	66	I	
	2010.11-2015.05	AT	L	F	All-wheel Drive Estate Engine CFFB	203241	Drive Shaft		36		59.5	40	475		
	2010.11-2015.05	-	L	F	All-wheel Drive Estate Engine CFFB	254013	Drive Shaft		36		59.5	40	479.5		
	2010.11-2015.05	-	L	F	All-wheel Drive Estate Engine CFFB	654004	Inner Joint			34		85			
2.0 TSI (147 kW)	2010.05-2015.05	AT	-	-	Estate Engine CCZA	603016	Inner Joint			28		32			
	2010.05-2015.05	AT	-	-	Estate Engine CCZA	603006	Inner Joint			33		34			
3.6 V6 (191 kW)	2009.10-2015.05	-	L/R	R	All-wheel Drive Estate Engine CDVA	603011	Inner Joint			33		34			
	2009.10-2015.05	AT	-	-	All-wheel Drive Estate Engine CDVA	603016	Inner Joint			28		32			
	2009.10-2015.05	AT	-	-	All-wheel Drive Estate Engine CDVA	603006	Inner Joint			33		34			
SUPERB III (3V3)															
1.4 TSI (110 kW)	2015.03-	-	-	-	Hatchback Engine CZDA/CZEA	803101	Outer Joint		36	27	59.5	40	65	M	
	2015.03-	-	-	-	All-wheel Drive Hatchback Engine CZEA	803101	Outer Joint		36	27	59.5	40	65	M	
1.4 TSI (92 kW)	2015.03-	-	MT	-	Hatchback Engine CZCA	803100	Outer Joint		36	33	59.5	38	55	I	
1.8 TSI (132 kW)	2015.03-	-	MT	L	F	Hatchback Engine CJSJA/CJSC	261131	Drive Shaft		36		59.5	40	515	
2.0 TDI (110 kW)	2015.03-	-	MT	L	F	Hatchback Engine CRLB/DFEA	261131	Drive Shaft		36		59.5	40	515	
	2015.03-	-	6AT	L	F	Hatchback Engine CRLB/DFEA	203381	Drive Shaft		36		59.5	40	486	





	 YEAR	TRANSM	L/R	F/R	REMARKS	GSP Ref.	 PRODUCT	 ABS	Technical Specifications					
									A	B	C	H	L	P
SKODA														
SUPERB III (3V3)														
2.0 TDI (110 kW)	2015.03.-	6AT	L	F	All-wheel Drive Hatchback Engine CRLB/DFEA	203381	Drive Shaft		36		59.5	40	486	
	2015.03.-	-	-	F	Hatchback Engine CRLB/DFEA	803101	Outer Joint		36	27	59.5	40	65	M
2.0 TDI (140 kW)	2015.03.-	MT	L	F	Hatchback Engine DDAA/DFCA	261131	Drive Shaft		36		59.5	40	515	
	2015.03.-	6AT	L	F	Hatchback Engine DDAA/DFCA	203381	Drive Shaft		36		59.5	40	486	
	2015.03.-	6AT	L	F	All-wheel Drive Hatchback Engine DDAA/DFCA	203381	Drive Shaft		36		59.5	40	486	
SUPERB III (3V5)														
1.4 TSI (110 kW)	2015.03.-	-	-	F	Estate Engine CZDA/CZEA	803101	Outer Joint		36	27	59.5	40	65	M
	2015.03.-	-	-	F	All-wheel Drive Estate Engine CZEA	803101	Outer Joint		36	27	59.5	40	65	M
1.6 TDI (88 kW)	2015.03.-	Semi-AT/MT	L	F	Estate Engine DCXA/DCZA	261201	Drive Shaft		36		59.5	40.5	535	
1.8 TSI (132 kW)	2015.03.-	MT	L	F	Estate Engine CJSA/CJSC	261131	Drive Shaft		36		59.5	40	515	
2.0 TDI (110 kW)	2015.03.-	MT	L	F	Estate Engine CRLB/DFEA	261131	Drive Shaft		36		59.5	40	515	
	2015.03.-	6AT	L	F	Estate Engine CRLB/DFEA	203381	Drive Shaft		36		59.5	40	486	
	2015.03.-	6AT	L	F	All-wheel Drive Estate Engine CRLB/DFEA	203381	Drive Shaft		36		59.5	40	486	
	2015.03.-	-	-	F	All-wheel Drive Estate Engine CRLB/DFEA	803101	Outer Joint		36	27	59.5	40	65	M
2.0 TDI (140 kW)	2015.03.-	MT	L	F	Estate Engine DDAA/DFCA	261131	Drive Shaft		36		59.5	40	515	
	2015.03.-	6AT	L	F	Estate Engine DDAA/DFCA	203381	Drive Shaft		36		59.5	40	486	
	2015.03.-	6AT	L	F	All-wheel Drive Estate Engine DDAA/DFCA	203381	Drive Shaft		36		59.5	40	486	
YETI (5L)														
1.2 TSI (77 kW)	2009.09.-	AT	L	F	Closed Off-Road Vehicle Engine CBZB	261201	Drive Shaft		36		59.5	40.5	535	
	2009.09.-	MT	L	F	Closed Off-Road Vehicle Engine CBZB	261198	Drive Shaft		36		59.5	40.5	530	
	2009.09.-	MT	R	F	Closed Off-Road Vehicle Engine CBZB	201586	Drive Shaft		36		59.5	40	806	
	2009.09.-	AT	-	F	Closed Off-Road Vehicle Engine CBZB	803100	Outer Joint		36	33	59.5	38	55	I
	2009.09.-	MT	L/R	F	Closed Off-Road Vehicle Engine CBZB	803037	Outer Joint		36	30	59.5	40.5	55	I
	2009.09.-	-	L/R	F	Closed Off-Road Vehicle Engine CBZB	603011	Inner Joint			33		34		
1.2 TSI (81 kW)	2015.05.-	AT	-	-	Closed Off-Road Vehicle Engine CYVB	603006	Inner Joint			33		34		
	2015.05.-	AT	-	-	Closed Off-Road Vehicle Engine CYVB	861059	Outer Joint		36	33	59.5	40	59.5	I
	2015.05.-	DCT	L/R	F	Closed Off-Road Vehicle Engine CYVB	603011	Inner Joint			33		34		
1.4 TSI (110 kW)	2015.05.-	-	L/R	R	All-wheel Drive Closed Off-Road Vehicle Engine CZDA	603011	Inner Joint			33		34		
	2015.05.-	AT/MT	L	F	All-wheel Drive Closed Off-Road Vehicle Engine CZDA	203295	Drive Shaft		36		59.5	40	491	
	2015.05.-	-	L/R	F	All-wheel Drive Closed Off-Road Vehicle Engine CZDA	803002	Outer Joint		36	27	59.5	40	66	I
1.4 TSI (90 kW)	2010.06.-	MT	-	F	Closed Off-Road Vehicle Engine CAXA	803100	Outer Joint		36	33	59.5	38	55	I
	2010.06.-	MT	L	F	Closed Off-Road Vehicle Engine CAXA	261198	Drive Shaft		36		59.5	40.5	530	
	2010.06.-	MT	R	F	Closed Off-Road Vehicle Engine CAXA	201586	Drive Shaft		36		59.5	40	806	
	2010.06.-	-	L/R	F	Closed Off-Road Vehicle Engine CAXA	603011	Inner Joint			33		34		
	2010.06.-	-	L/R	F	Closed Off-Road Vehicle Engine CAXA	803037	Outer Joint		36	30	59.5	40.5	55	I
1.4 TSI (92 kW)	2015.05.-	AT	-	-	Closed Off-Road Vehicle Engine CZCA	603006	Inner Joint			33		34		
	2015.05.-	AT	-	-	Closed Off-Road Vehicle Engine CZCA	603016	Inner Joint			28		32		
1.6 (81 kW)	2014.04.-	AT	L/R	F	Closed Off-Road Vehicle Engine CWVA	803037	Outer Joint		36	30	59.5	40.5	55	I
	2014.04.-	AT	R	F	Closed Off-Road Vehicle Engine CWVA	261094	Drive Shaft		36	26	59.5	40.5	884	
	2014.04.-	AT	L	F	Closed Off-Road Vehicle Engine CWVA	803116	Outer Joint		36	30	59.5	38	55	I
	2014.04.-	AT	L	F	Closed Off-Road Vehicle Engine CWVA	203318	Drive Shaft		36	26	59.5	38	581	
1.6 TDI (77 kW)	2010.11.-	MT	L/R	F	Closed Off-Road Vehicle Engine CWVA	603011	Inner Joint			33		34		
	2010.11.-	-	L/R	F	Closed Off-Road Vehicle Engine CAYC	603011	Inner Joint			33		34		
	2010.11.-	-	L	F	Closed Off-Road Vehicle Engine CAYC	203294	Drive Shaft		36		59.5	38	519	
	2010.11.-	-	L	F	Closed Off-Road Vehicle Engine CAYC	803116	Outer Joint		36	30	59.5	38	55	I
	2010.11.-	-	R	F	Closed Off-Road Vehicle Engine CAYC	261042	Drive Shaft		36		59.5	40.5	814	
1.6 TDI (77 kW)	2010.11.-	-	L/R	F	Closed Off-Road Vehicle Engine CAYC	803037	Outer Joint		36	30	59.5	40.5	55	I
	2010.11.-	-	R	F	Closed Off-Road Vehicle Engine CAYC	201585	Drive Shaft		36		59.5	40	805	
	2009.11.-	-	L/R	R	All-wheel Drive Closed Off-Road Vehicle Engine CDAB	603011	Inner Joint			33		34		
	2009.11.-	-	L/R	F	All-wheel Drive Closed Off-Road Vehicle Engine CDAB	803002	Outer Joint		36	27	59.5	40	66	I
	2009.11.-	-	L	F	All-wheel Drive Closed Off-Road Vehicle Engine CDAB	203295	Drive Shaft		36		59.5	40	491	
1.8 TSI (118 kW)	2009.05.-	-	L/R	F	All-wheel Drive Closed Off-Road Vehicle Engine CDAA	803002	Outer Joint		36	27	59.5	40	66	I
	2009.05.-	-	L	F	All-wheel Drive Closed Off-Road Vehicle Engine CDAA	203295	Drive Shaft		36		59.5	40	491	
	2009.05.-	MT	-	-	All-wheel Drive Closed Off-Road Vehicle Engine CDAA	603006	Inner Joint			33		34		
	2009.05.-	MT	-	-	All-wheel Drive Closed Off-Road Vehicle Engine CDAA	603016	Inner Joint			28		32		
	2009.05.-	-	L/R	R	All-wheel Drive Closed Off-Road Vehicle Engine CDAA	603011	Inner Joint			33		34		
2.0 TDI (103 kW)	2009.05.-	-	L/R	F	All-wheel Drive Closed Off-Road Vehicle Engine CBDB/CFHC/CLCB	803002	Outer Joint		36	27	59.5	40	66	I
	2009.05.-	MT	R	F	All-wheel Drive Closed Off-Road Vehicle Engine CBDB/CFHC/CLCB	203266	Drive Shaft		36		59.5	40	601	
	2009.05.-	-	L/R	R	All-wheel Drive Closed Off-Road Vehicle Engine CBDB/CFHC/CLCB	603011	Inner Joint			33		34		
	2009.05.-	AT/MT	L	F	All-wheel Drive Closed Off-Road Vehicle Engine CBDB/CFHC/CLCB	203295	Drive Shaft		36		59.5	40	491	
	2011.11.-	-	L	F	Closed Off-Road Vehicle Engine CFHC	203265	Drive Shaft		36		59.5	40	487	
2.0 TDI (110 kW)	2015.05.-	MT	L	F	Closed Off-Road Vehicle Engine CUUB	261188	Drive Shaft		36		59.5	40	487	
	2015.05.-	MT	L	F	All-wheel Drive Closed Off-Road Vehicle Engine CUUB	261188	Drive Shaft		36		59.5	40	487	
	2015.05.-	-	L/R	R	All-wheel Drive Closed Off-Road Vehicle Engine CUUB	603011	Inner Joint			33		34		
	2015.05.-	MT	L	F	Closed Off-Road Vehicle Engine CUUB	203295	Drive Shaft		36		59.5	40	491	
	2015.05.-	MT	L	F	All-wheel Drive Closed Off-Road Vehicle Engine CUUB	203295	Drive Shaft		36		59.5	40	491	





	 YEAR	TRANSM	L/R	F/R	REMARKS	GSP Ref.	 PRODUCT	 ABS	Technical Specifications						
									A	B	C	H	L	P	
SKODA															
YETI (5L)															
2.0 TDI (110 kW)	2015.05-	-	MT	R	F	Closed Off-Road Vehicle Engine CUUB	203266	Drive Shaft		36		59.5	40	601	
	2015.05-	-	MT	R	F	All-wheel Drive Closed Off-Road Vehicle Engine CUUB	203266	Drive Shaft		36		59.5	40	601	
	2015.05-	-	Semi-AT	L	F	Closed Off-Road Vehicle Engine CUUB	654004	Inner Joint			34		85		
	2015.05-	-	Semi-AT	L	F	All-wheel Drive Closed Off-Road Vehicle Engine CUUB	654004	Inner Joint			34		85		
	2015.05-	-	MT	-	-	Closed Off-Road Vehicle Engine CUUB	603016	Inner Joint			28		32		
	2015.05-	-	MT	-	-	All-wheel Drive Closed Off-Road Vehicle Engine CUUB	603016	Inner Joint			28		32		
	2015.05-	-	MT	-	-	Closed Off-Road Vehicle Engine CUUB	603006	Inner Joint			33		34		
	2015.05-	-	MT	-	-	All-wheel Drive Closed Off-Road Vehicle Engine CUUB	603006	Inner Joint			33		34		
	2015.05-	-	MT	L/R	F	Closed Off-Road Vehicle Engine CUUB	803002	Outer Joint	36	27	59.5	40	66	I	
	2015.05-	-	MT	L/R	F	All-wheel Drive Closed Off-Road Vehicle Engine CUUB	803002	Outer Joint	36	27	59.5	40	66	I	
	2015.05-	-	Semi-AT	L	F	Closed Off-Road Vehicle Engine CUUB	203241	Drive Shaft	36		59.5	40	475		
	2015.05-	-	Semi-AT	L	F	All-wheel Drive Closed Off-Road Vehicle Engine CUUB	203241	Drive Shaft	36		59.5	40	475		
2.0 TDI (125 kW)	2009.11-	-	-	L/R	F	All-wheel Drive Closed Off-Road Vehicle Engine CEGA/CFJA	803002	Outer Joint	36	27	59.5	40	66	I	
	2009.11-	-	-	L	F	All-wheel Drive Closed Off-Road Vehicle Engine CEGA/CFJA	203295	Drive Shaft	36		59.5	40	491		
	2009.11-	-	MT	R	F	All-wheel Drive Closed Off-Road Vehicle Engine CEGA/CFJA	203266	Drive Shaft	36		59.5	40	601		
	2009.11-	-	-	L/R	R	All-wheel Drive Closed Off-Road Vehicle Engine CEGA/CFJA	603011	Inner Joint		33		34			
2.0 TDI (81 kW)	2009.11-	-	-	L/R	F	All-wheel Drive Closed Off-Road Vehicle Engine CFHF/CUUA/DFSA	803002	Outer Joint	36	27	59.5	40	66	I	
	2009.11-	-	-	L	F	All-wheel Drive Closed Off-Road Vehicle Engine CFHF/CUUA/DFSA	203295	Drive Shaft	36		59.5	40	491		
	2009.11-	-	MT	-	-	Closed Off-Road Vehicle Engine CFHA/CLCA/CUUA/DFSA	603006	Inner Joint		33		34			
	2009.11-	-	MT	-	-	All-wheel Drive Closed Off-Road Vehicle Engine CFHF/CUUA/DFSA	603006	Inner Joint		33		34			
	2009.11-	-	MT	R	F	All-wheel Drive Closed Off-Road Vehicle Engine CFHF/CUUA/DFSA	203266	Drive Shaft	36		59.5	40	601		
	2009.11-	-	MT	-	-	Closed Off-Road Vehicle Engine CFHA/CLCA/CUUA/DFSA	603016	Inner Joint		28		32			
	2009.11-	-	MT	-	-	All-wheel Drive Closed Off-Road Vehicle Engine CFHF/CUUA/DFSA	603016	Inner Joint		28		32			
	2009.11-	-	-	-	F	Closed Off-Road Vehicle Engine CFHA/CLCA/CUUA/DFSA	803100	Outer Joint	36	33	59.5	38	55	I	
	2009.11-	-	-	L	F	Closed Off-Road Vehicle Engine CFHA/CLCA/CUUA/DFSA	261089	Drive Shaft	36		59.5	40.5	521		
	2009.11-	-	-	L/R	F	Closed Off-Road Vehicle Engine CFHA/CLCA/CUUA/DFSA	603011	Inner Joint		33		34			
	2009.11-	-	-	L/R	R	All-wheel Drive Closed Off-Road Vehicle Engine CFHF/CUUA/DFSA	603011	Inner Joint		33		34			
	2009.11-	-	-	R	F	Closed Off-Road Vehicle Engine CFHA/CLCA/CUUA/DFSA	261200	Drive Shaft	36		59.5	40.5	820		
	2009.11-	-	MT	-	-	Closed Off-Road Vehicle Engine CFHA/CLCA/CUUA/DFSA	861059	Outer Joint	36	33	59.5	40	59.5	I	
	2009.11-	-	MT	-	-	All-wheel Drive Closed Off-Road Vehicle Engine CFHF/CUUA/DFSA	861059	Outer Joint	36	33	59.5	40	59.5	I	
SKODA (SVW)															
OCTAVIA (1Z3)															
1.8 TSI (118 kW)	2007.06-	2014.03	AT	-	-	Hatchback Engine BYJ CEA	254009	Drive Shaft		36	26	59.5	40	584	
SMART															
CABRIO (450)															
0.6 (40 kW)	2000.03-	2004.01	-	R	R	Convertible Engine M 160 E6AL B03	299191	Drive Shaft	42T	24	33	50	25.5	716	
	2000.03-	2004.01	-	L	R	Convertible Engine M 160 E6AL B03	299190	Drive Shaft	42T	24	33	50	25.5	476	
0.6 (45 kW)	2001.01-	2004.01	-	R	R	Convertible Engine M 160 E6AL B05	299191	Drive Shaft	42T	24	33	50	25.5	716	
	2001.01-	2004.01	-	L	R	Convertible Engine M 160 E6AL B05	299190	Drive Shaft	42T	24	33	50	25.5	476	
0.6 (52 kW)	2002.06-	2004.01	Semi-AT	R	R	Convertible Engine M 160.910	299191	Drive Shaft	42T	24	33	50	25.5	716	
	2002.06-	2004.01	Semi-AT	L	R	Convertible Engine M 160.910	299190	Drive Shaft	42T	24	33	50	25.5	476	
0.7 (45 kW)	2003.01-	2004.01	-	R	R	Convertible Engine M 160.920	299191	Drive Shaft	42T	24	33	50	25.5	716	
	2003.01-	2004.01	-	L	R	Convertible Engine M 160.920	299190	Drive Shaft	42T	24	33	50	25.5	476	
0.7 (55 kW)	2003.01-	2004.01	-	R	R	Convertible Engine M 160.920	299191	Drive Shaft	42T	24	33	50	25.5	716	
	2003.01-	2004.01	-	L	R	Convertible Engine M 160.920	299190	Drive Shaft	42T	24	33	50	25.5	476	
0.8 CDI (30 kW)	2001.03-	2004.01	-	R	R	Convertible Engine OM 660.940	299191	Drive Shaft	42T	24	33	50	25.5	716	
	2001.03-	2004.01	-	L	R	Convertible Engine OM 660.940	299190	Drive Shaft	42T	24	33	50	25.5	476	
CITY-COUPÉ (450)															
0.6 (33 kW)	1998.07-	2004.01	-	R	R	Coupe Engine M 160.910	299191	Drive Shaft	42T	24	33	50	25.5	716	
	1998.07-	2004.01	-	L	R	Coupe Engine M 160.910	299190	Drive Shaft	42T	24	33	50	25.5	476	
0.6 (40 kW)	1998.07-	2004.01	-	R	R	Coupe Engine M 160.910	299191	Drive Shaft	42T	24	33	50	25.5	716	
	1998.07-	2004.01	-	L	R	Coupe Engine M 160.910	299190	Drive Shaft	42T	24	33	50	25.5	476	
0.6 (45 kW)	2001.01-	2004.01	-	R	R	Coupe Engine M 160 E6AL B05/M 160.910	299191	Drive Shaft	42T	24	33	50	25.5	716	
	2001.01-	2004.01	-	L	R	Coupe Engine M 160 E6AL B05/M 160.910	299190	Drive Shaft	42T	24	33	50	25.5	476	
0.6 (52 kW)	2002.06-	2004.01	Semi-AT	R	R	Coupe Engine M 160.910	299191	Drive Shaft	42T	24	33	50	25.5	716	
	2002.06-	2004.01	Semi-AT	L	R	Coupe Engine M 160.910	299190	Drive Shaft	42T	24	33	50	25.5	476	
0.7 (37 kW)	2003.01-	2004.01	Semi-AT	R	R	Coupe Engine M 160.920	299191	Drive Shaft	42T	24	33	50	25.5	716	
	2003.01-	2004.01	Semi-AT	L	R	Coupe Engine M 160.920	299190	Drive Shaft	42T	24	33	50	25.5	476	
0.7 (45 kW)	2003.01-	2004.01	-	R	R	Coupe Engine M 160.920	299191	Drive Shaft	42T	24	33	50	25.5	716	
	2003.01-	2004.01	-	L	R	Coupe Engine M 160.920	299190	Drive Shaft	42T	24	33	50	25.5	476	
0.7 (55 kW)	2003.01-	2004.01	-	R	R	Coupe Engine M 160.920	299191	Drive Shaft	42T	24	33	50	25.5	716	
	2003.01-	2004.01	-	L	R	Coupe Engine M 160.920	299190	Drive Shaft	42T	24	33	50	25.5	476	
0.8 CDI (30 kW)	1999.11-	2004.01	-	R	R	Coupe Engine OM 660 DE 8LA/OM 660.940	299191	Drive Shaft	42T	24	33	50	25.5	716	
	1999.11-	2004.01	-	L	R	Coupe Engine OM 660 DE 8LA/OM 660.940	299190	Drive Shaft	42T	24	33	50	25.5	476	
CROSSBLADE (450)															





	 YEAR	TRANSM	L/R	F/R	REMARKS	GSP Ref.	 PRODUCT	 ABS	Technical Specifications					
									A	B	C	H	L	P
SMART														
CROSSBLADE (450)														
0.6 (52 kW)	2002.06-2003.12	-	R	R	Convertible Engine M 160.910	299191	Drive Shaft	42T	24	33	50	25.5	716	
	2002.06-2003.12	-	L	R	Convertible Engine M 160.910	299190	Drive Shaft	42T	24	33	50	25.5	476	
FORFOUR (454)														
1.5 CDI (50 kW)	2004.09-2006.06	-	-	-	Hatchback Engine OM 639.939	839146	Outer Joint		25	23	53	97	61	M
1.5 CDI (70 kW)	2004.09-2006.06	-	-	-	Hatchback Engine OM 639.939	839146	Outer Joint		25	23	53	97	61	M
FORTWO (450)														
0.6 (45 kW)	2004.01-2007.02	AT	R	R	Coupe Engine M 160.910	299191	Drive Shaft	42T	24	33	50	25.5	716	
	2004.01-2007.02	AT	L	R	Coupe Engine M 160.910	299190	Drive Shaft	42T	24	33	50	25.5	476	
0.7 (37 kW)	2004.01-2007.01	AT/MT	R	R	Coupe Engine M 160.920	299191	Drive Shaft	42T	24	33	50	25.5	716	
	2004.01-2007.01	AT/MT	L	R	Coupe Engine M 160.920	299190	Drive Shaft	42T	24	33	50	25.5	476	
0.7 (40 kW)	2004.01-2007.01	-	L	R	Coupe Engine M 160.920	299190	Drive Shaft	42T	24	33	50	25.5	476	
	2004.01-2007.01	-	R	R	Coupe Engine M 160.920	299191	Drive Shaft	42T	24	33	50	25.5	716	
0.7 (45 kW)	2004.01-2007.01	AT	R	R	Coupe Engine M 160.920	299191	Drive Shaft	42T	24	33	50	25.5	716	
	2004.01-2007.01	AT	L	R	Coupe Engine M 160.920	299190	Drive Shaft	42T	24	33	50	25.5	476	
0.7 (55 kW)	2004.01-2007.01	AT	R	R	Coupe Engine M 160.920	299191	Drive Shaft	42T	24	33	50	25.5	716	
	2004.01-2007.01	AT	L	R	Coupe Engine M 160.920	299190	Drive Shaft	42T	24	33	50	25.5	476	
0.8 CDI (30 kW)	2004.01-2007.01	AT/MT	R	R	Coupe Engine OM 660 DE 8LA/OM 660.940	299191	Drive Shaft	42T	24	33	50	25.5	716	
	2004.01-2007.01	AT/MT	L	R	Coupe Engine OM 660 DE 8LA/OM 660.940	299190	Drive Shaft	42T	24	33	50	25.5	476	
FORTWO (451)														
0.8 CDi (33 kW)	2007.01-	AT	L	R	Coupe Engine OM 660.950	235052	Drive Shaft	42T	33	33	56.2	44	521	
	2007.01-	AT	R	R	Coupe Engine OM 660.950	235053	Drive Shaft	42T	33	33	56.2	44	763	
0.8 CDi (40 kW)	2009.08-	AT	L	R	Coupe Engine OM 660.951	235052	Drive Shaft	42T	33	33	56.2	44	521	
	2009.08-	AT	R	R	Coupe Engine OM 660.951	235053	Drive Shaft	42T	33	33	56.2	44	763	
1.0 (45 kW)	2007.01-	-	L	R	Coupe Engine M 132.910	235052	Drive Shaft	42T	33	33	56.2	44	521	
	2007.01-	-	R	R	Coupe Engine M 132.910	235053	Drive Shaft	42T	33	33	56.2	44	763	
1.0 (52 kW)	2007.01-	-	L	R	Coupe Engine M 132.910	235052	Drive Shaft	42T	33	33	56.2	44	521	
	2007.01-	-	R	R	Coupe Engine M 132.910	235053	Drive Shaft	42T	33	33	56.2	44	763	
FORTWO Cabrio (450)														
0.6 Brabus (55 kW)	2004.01-2006.12	-	R	R	Convertible Engine M 160.910	299191	Drive Shaft	42T	24	33	50	25.5	716	
	2004.01-2006.12	-	L	R	Convertible Engine M 160.910	299190	Drive Shaft	42T	24	33	50	25.5	476	
0.7 (45 kW)	2004.01-2007.01	AT	R	R	Convertible Engine M 160.920	299191	Drive Shaft	42T	24	33	50	25.5	716	
	2004.01-2007.01	Semi-AT	L	R	Convertible Engine M 160.920	299190	Drive Shaft	42T	24	33	50	25.5	476	
0.7 (55 kW)	2004.01-2007.01	-	R	R	Convertible Engine M 160.920	299191	Drive Shaft	42T	24	33	50	25.5	716	
	2004.01-2007.01	-	L	R	Convertible Engine M 160.920	299190	Drive Shaft	42T	24	33	50	25.5	476	
0.8 CDI (30 kW)	2004.01-2007.01	-	R	R	Convertible Engine OM 660 DE 8LA/OM 660.940	299191	Drive Shaft	42T	24	33	50	25.5	716	
	2004.01-2007.01	-	L	R	Convertible Engine OM 660 DE 8LA/OM 660.940	299190	Drive Shaft	42T	24	33	50	25.5	476	
FORTWO Cabrio (451)														
0.8 CDi (33 kW)	2007.01-	AT	L	R	Convertible Engine OM 660.950	235052	Drive Shaft	42T	33	33	56.2	44	521	
	2007.01-	AT	R	R	Convertible Engine OM 660.950	235053	Drive Shaft	42T	33	33	56.2	44	763	
1.0 (52 kW)	2007.01-	-	L	R	Convertible Engine M 132.910	235052	Drive Shaft	42T	33	33	56.2	44	521	
	2007.01-	-	R	R	Convertible Engine M 132.910	235053	Drive Shaft	42T	33	33	56.2	44	763	
FORTWO, CABRIO, COUPE														
0.8 CDi (33 kW)	2007.01-	-	-	-	R	-	655001	Inner Joint		33	22	34.9	58	111.5
0.8 CDi (40 kW)	2009.08-	-	-	-	R	-	655001	Inner Joint		33	22	34.9	58	111.5
1.0 (45 kW)	2007.01-	-	-	-	R	-	655001	Inner Joint		33	22	34.9	58	111.5
1.0 (52 kW)	2007.01-	-	-	-	R	-	655001	Inner Joint		33	22	34.9	58	111.5
1.0 Brabus (72 kW)	2008.01-	-	-	-	R	-	655001	Inner Joint		33	22	34.9	58	111.5
1.0 T (62 kW)	2007.01-	-	-	-	R	-	655001	Inner Joint		33	22	34.9	58	111.5
ROADSTER (452)														
0.7 (45 kW)	2003.04-2005.11	-	R	R	Convertible Engine M 160.921	299191	Drive Shaft	42T	24	33	50	25.5	716	
	2003.04-2005.11	-	L	R	Convertible Engine M 160.921	299190	Drive Shaft	42T	24	33	50	25.5	476	
	2003.06-2005.11	-	R	R	Coupe Engine M 160.922	299191	Drive Shaft	42T	24	33	50	25.5	716	
	2003.06-2005.11	-	L	R	Coupe Engine M 160.922	299190	Drive Shaft	42T	24	33	50	25.5	476	
0.7 (60 kW)	2003.04-2005.11	-	R	R	Convertible Engine M 160.922	299191	Drive Shaft	42T	24	33	50	25.5	716	
	2003.04-2005.11	-	R	R	Coupe Engine M 160.921	299191	Drive Shaft	42T	24	33	50	25.5	716	
	2003.04-2005.11	-	L	R	Convertible Engine M 160.922	299190	Drive Shaft	42T	24	33	50	25.5	476	
	2003.04-2005.11	-	L	R	Coupe Engine M 160.921	299190	Drive Shaft	42T	24	33	50	25.5	476	
0.7 Brabus (74 kW)	2003.12-2005.11	-	R	R	Convertible Engine M 160.923	299191	Drive Shaft	42T	24	33	50	25.5	716	
	2003.12-2005.11	-	R	R	Coupe Engine M 160.923	299191	Drive Shaft	42T	24	33	50	25.5	716	
	2003.12-2005.11	-	L	R	Convertible Engine M 160.923	299190	Drive Shaft	42T	24	33	50	25.5	476	
	2003.12-2005.11	-	L	R	Coupe Engine M 160.923	299190	Drive Shaft	42T	24	33	50	25.5	476	
SSANGYONG														
-	-	-	-	-	-	618256	Inner Joint		26	24	40	97	105	
-	-	-	-	-	-	218438	Drive Shaft		28	26	60	110	700	





YEAR	TRANSM	L/R	F/R	REMARKS	GSP Ref.	PRODUCT	ABS	Technical Specifications					
								A	B	C	H	L	P
SSANGYONG													
ACTYON I													
2.0 Xdi (100 kW)	2007.07-	-	-	F	All-wheel Drive MPV Engine D20DT	644022	Inner Joint	27	34	47.7	53.5	77	
2.0 Xdi (104 kW)	2006.10-	-	-	F	All-wheel Drive MPV Engine D20DT	644022	Inner Joint	27	34	47.7	53.5	77	
ACTYON SPORTS I (QJ)													
2.0 Xdi (104 kW)	2007.04-	-	-	F	All-wheel Drive Pickup Engine D20DT	644022	Inner Joint	27	34	47.7	53.5	77	
2.0 Xdi (114 kW)	2011.09-	-	-	F	All-wheel Drive Pickup Engine D20DTR	644022	Inner Joint	27	34	47.7	53.5	77	
FAMILY													
2.2 D	-	-	-	-	-	266001	Drive Shaft	24	23	48	148.5	943	
ISTANA													
2.3 (110 kW)	1995.06-	2003.11	-	-	Bus	835013	Outer Joint	30	35	65	98.5	73 O	
2.9 D (70 kW)	1992.10-	1995.05	-	-	F	Box Engine OM 602.940	699014	Inner Joint	30	35	55	46.4 97	
KORANDO (K4)													
2.2 D (50 kW)	1988.12-	1996.12	-	-	F	All-wheel Drive Closed Off-Road Vehicle Engine DC23	899059	Outer Joint	28	35	53	154 79 O	
KORANDO (KJ)													
2.0 (94 kW)	1997.05-	2002.10	-	-	F	All-wheel Drive Closed Off-Road Vehicle Engine E20	899059	Outer Joint	28	35	53	154 79 O	
2.3 (103 kW)	1997.05-	2000.02	-	-	F	All-wheel Drive Closed Off-Road Vehicle Engine M 111.970	899059	Outer Joint	28	35	53	154 79 O	
2.3 (105 kW)	1999.01-	2006.11	-	-	F	All-wheel Drive Closed Off-Road Vehicle	899059	Outer Joint	28	35	53	154 79 O	
2.3 (110 kW)	2002.01-	2006.06	-	-	F	All-wheel Drive Closed Off-Road Vehicle Engine M 161.970	899059	Outer Joint	28	35	53	154 79 O	
2.3 TDIC (74 kW)	1998.07-	2006.11	-	-	F	All-wheel Drive Closed Off-Road Vehicle	899059	Outer Joint	28	35	53	154 79 O	
2.9 D (72 kW)	1996.12-	2000.10	-	-	F	All-wheel Drive Closed Off-Road Vehicle Engine MB-OM 662	899059	Outer Joint	28	35	53	154 79 O	
2.9 D(73 kW)	1997.06-	2000.10	-	-	F	All-wheel Drive Closed Off-Road Vehicle Engine MB-OM 662	899059	Outer Joint	28	35	53	154 79 O	
2.9 TD (88 kW)	1998.04-	2006.11	-	-	F	All-wheel Drive Closed Off-Road Vehicle	899059	Outer Joint	28	35	53	154 79 O	
3.2 (154 kW)	1996.12-	2002.11	-	-	F	All-wheel Drive Closed Off-Road Vehicle Engine M 104.995 (12.96-J)	899059	Outer Joint	28	35	53	154 79 O	
3.2 (162 kW)	1997.06-	2006.11	-	-	F	All-wheel Drive Closed Off-Road Vehicle Engine M 104.992	899059	Outer Joint	28	35	53	154 79 O	
KORANDO Cabrio (KJ)													
2.3 (103 kW)	1997.11-	2000.02	-	-	F	All-wheel Drive Open Off-Road Vehicle	899059	Outer Joint	28	35	53	154 79 O	
2.3 (105 kW)	1999.02-	2006.11	-	-	F	All-wheel Drive Open Off-Road Vehicle	899059	Outer Joint	28	35	53	154 79 O	
2.3 (110 kW)	2002.01-	2006.06	-	-	F	All-wheel Drive Open Off-Road Vehicle Engine M 161.970	899059	Outer Joint	28	35	53	154 79 O	
2.9 D (72 kW)	1997.11-	2000.10	-	-	F	All-wheel Drive Open Off-Road Vehicle Engine MB-OM 662	899059	Outer Joint	28	35	53	154 79 O	
2.9 TD (88 kW)	1998.04-	2000.02	-	-	F	All-wheel Drive Open Off-Road Vehicle	899059	Outer Joint	28	35	53	154 79 O	
3.2 (156 kW)	1999.01-	2002.11	-	-	F	All-wheel Drive Open Off-Road Vehicle Engine M 104.995	899059	Outer Joint	28	35	53	154 79 O	
3.2 (162 kW)	1997.06-	2006.11	-	-	F	All-wheel Drive Open Off-Road Vehicle Engine M 104.992	899059	Outer Joint	28	35	53	154 79 O	
KYRON													
2.0 Xdi (100 kW)	2010.01-	-	-	-	F	All-wheel Drive Closed Off-Road Vehicle Engine D20DT	644022	Inner Joint	27	34	47.7	53.5 77	
2.0 Xdi (101 kW)	2005.05-	-	-	-	F	All-wheel Drive Closed Off-Road Vehicle Engine D20DT	818247	Outer Joint	28	24	60	110 65 M	
2.0 Xdi (104 kW)	2005.05-	-	-	-	F	All-wheel Drive Closed Off-Road Vehicle Engine D20DT	818247	Outer Joint	28	24	60	110 65 M	
	2005.05-	-	-	-	F	All-wheel Drive Closed Off-Road Vehicle Engine D20DT	644022	Inner Joint	27	34	47.7	53.5 77	
2.3 (110 kW)	2010.01-	-	-	-	F	Closed Off-Road Vehicle Engine M 161.970	644022	Inner Joint	27	34	47.7	53.5 77	
2.7 Xdi (120 kW)	2006.03-	-	-	-	F	All-wheel Drive Closed Off-Road Vehicle Engine D27DT	801408	Outer Joint	40	34	74.5	95 70 O	
2.7 Xdi (121 kW)	2005.05-	-	-	-	F	All-wheel Drive Closed Off-Road Vehicle Engine D27DT	818247	Outer Joint	28	24	60	110 65 M	
MUSSO (FJ)													
2.0 (93 kW)	1996.10-	2005.05	-	-	F	All-wheel Drive Closed Off-Road Vehicle Engine E20	899059	Outer Joint	28	35	53	154 79 O	
2.3 (103 kW)	1996.10-	2002.11	-	-	F	All-wheel Drive Closed Off-Road Vehicle Engine M 111.970	899059	Outer Joint	28	35	53	154 79 O	
2.3 (110 kW)	2003.04-	2006.08	-	-	F	All-wheel Drive Closed Off-Road Vehicle	899059	Outer Joint	28	35	53	154 79 O	
2.3 D (58 kW)	1993.03-	1997.04	-	-	F	All-wheel Drive Closed Off-Road Vehicle Engine OM 661.940	899059	Outer Joint	28	35	53	154 79 O	
2.3 D (59 kW)	1995.10-	1999.04	-	-	F/R	All-wheel Drive Closed Off-Road Vehicle Engine MB-OM 661/OM 601.940	266002	Drive Shaft	28		53	154 480	
	1995.10-	1999.04	-	-	F	All-wheel Drive Closed Off-Road Vehicle Engine MB-OM 661/OM 601.940	899059	Outer Joint	28	35	53	154 79 O	
2.9 D (73 kW)	1996.03-	1998.11	-	-	F/R	All-wheel Drive Closed Off-Road Vehicle Engine MB-OM 662	266002	Drive Shaft	28		53	154 480	
2.9 TD (88 kW)	1998.04-	2007.09	-	-	F	All-wheel Drive Closed Off-Road Vehicle	899059	Outer Joint	28	35	53	154 79 O	
3.2 (162 kW)	1996.06-	2004.09	-	-	F	All-wheel Drive Closed Off-Road Vehicle Engine M 104.992	899059	Outer Joint	28	35	53	154 79 O	
MUSSO SPORTS													
2.9 D (88 kW)	2004.08-	2007.09	-	-	F	Pickup	899059	Outer Joint	28	35	53	154 79 O	
REXTON (GAB_)													
2.3 RX230 (110 kW)	2002.05-	-	-	-	F	All-wheel Drive Closed Off-Road Vehicle Engine G23D	818247	Outer Joint	28	24	60	110 65 M	
	2002.05-	-	-	-	F	All-wheel Drive Closed Off-Road Vehicle Engine G23D	801408	Outer Joint	40	34	74.5	95 70 O	
	2002.05-	-	-	-	R	All-wheel Drive Closed Off-Road Vehicle Engine G23D	605048	Inner Joint		28			
2.7 D (137 kW)	2006.05-	-	-	-	F	All-wheel Drive Closed Off-Road Vehicle Engine D27DTP	818247	Outer Joint	28	24	60	110 65 M	
	2006.05-	-	-	-	F	All-wheel Drive Closed Off-Road Vehicle Engine D27DTP	801408	Outer Joint	40	34	74.5	95 70 O	
	2006.05-	-	-	-	R	All-wheel Drive Closed Off-Road Vehicle Engine D27DTP	605048	Inner Joint		28			
	2006.05-	-	-	-	F	All-wheel Drive Closed Off-Road Vehicle Engine D27DTP	644022	Inner Joint	27	34	47.7	53.5 77	
2.7 Xdi (118 kW)	2011.03-	-	-	-	F	All-wheel Drive Closed Off-Road Vehicle Engine D27DT	644022	Inner Joint	27	34	47.7	53.5 77	
2.7 Xdi (120 kW)	2004.08-	-	-	-	F	All-wheel Drive Closed Off-Road Vehicle Engine D27DT	899158	Outer Joint	28	35	60	111 81 I	
	2004.08-	-	-	-	-	All-wheel Drive Closed Off-Road Vehicle Engine D27DT	644023	Inner Joint	27	35	47.7	56.5 63.5	
	2004.08-	-	-	-	F	All-wheel Drive Closed Off-Road Vehicle Engine D27DT	818247	Outer Joint	28	24	60	110 65 M	
	2004.08-	-	-	-	F	All-wheel Drive Closed Off-Road Vehicle Engine D27DT	801408	Outer Joint	40	34	74.5	95 70 O	
	2004.08-	-	-	-	R	All-wheel Drive Closed Off-Road Vehicle Engine D27DT	605048	Inner Joint		28			





	 YEAR	TRANSM	L/R	F/R	REMARKS	GSP Ref.	 PRODUCT	 ABS	Technical Specifications					
									A	B	C	H	L	P
SSANGYONG														
REXTON (GAB_)														
2.7 Xdi (120 kW)	2004.08-	-	-	-	F All-wheel Drive Closed Off-Road Vehicle Engine D27DT	644022	Inner Joint		27	34	47.7	53.5	77	
2.7 Xdi (121 kW)	2006.03-2012.05	-	-	-	F All-wheel Drive Closed Off-Road Vehicle Engine D27DT	818247	Outer Joint		28	24	60	110	65	M
	2006.03-2012.05	-	-	-	F All-wheel Drive Closed Off-Road Vehicle Engine D27DT	801408	Outer Joint		40	34	74.5	95	70	O
	2006.03-2012.05	-	-	-	R All-wheel Drive Closed Off-Road Vehicle Engine D27DT	605048	Inner Joint			28		28		
2.7 Xdi Turbo (132 kW)	2011.03-	-	-	-	F All-wheel Drive Closed Off-Road Vehicle Engine D27DTP	644022	Inner Joint		27	34	47.7	53.5	77	
2.9 TD (88 kW)	2002.04-	-	-	-	F All-wheel Drive Closed Off-Road Vehicle	818247	Outer Joint		28	24	60	110	65	M
	2002.04-	-	-	-	F All-wheel Drive Closed Off-Road Vehicle	801408	Outer Joint		40	34	74.5	95	70	O
	2002.04-	-	-	-	R All-wheel Drive Closed Off-Road Vehicle	605048	Inner Joint			28		28		
2WD	2002-2006	5MT/4AT	L/R	-	D27DT, E23, E28	266003	Drive Shaft		28	27	53	154	578	
	2002-2006	5MT/4AT	L/R	-	D27DT, E23, E28	866001	Outer Joint		28	34	53	154	79	O
3.2 (162 kW)	2002.04-	-	-	-	F All-wheel Drive Closed Off-Road Vehicle Engine G32D	818247	Outer Joint		28	24	60	110	65	M
	2002.04-	-	-	-	F All-wheel Drive Closed Off-Road Vehicle Engine G32D	801408	Outer Joint		40	34	74.5	95	70	O
	2002.04-	-	-	-	R All-wheel Drive Closed Off-Road Vehicle Engine G32D	605048	Inner Joint			28		28		
	2002.04-	-	-	-	F All-wheel Drive Closed Off-Road Vehicle Engine G32D	644022	Inner Joint		27	34	47.7	53.5	77	
4WD	2002-2006	5MT/4AT	L/R	-	D27DT, E32	266004	Drive Shaft		28	27	60	111	545	
RODIUS														
2.7 Xdi (120 kW)	2005.05-	-	-	-	F All-wheel Drive MPV Engine D27DT	801408	Outer Joint		40	34	74.5	95	70	O
2.7 Xdi (121 kW)	2005.05-	-	-	-	F All-wheel Drive MPV Engine D27DT	801408	Outer Joint		40	34	74.5	95	70	O
3.2 (162 kW)	2007.07-	-	-	-	F All-wheel Drive MPV Engine G32D	801408	Outer Joint		40	34	74.5	95	70	O
STAVIC														
2.7 270 sXDi (121 kW)	2005.02-	-	-	-	F All-wheel Drive Closed Off-Road Vehicle Engine D27DT	801408	Outer Joint		40	34	74.5	95	70	O
3.2 (162 kW)	2005.02-	-	-	-	F All-wheel Drive Closed Off-Road Vehicle	801408	Outer Joint		40	34	74.5	95	70	O
SUBARU														
B13														
2.5	2003-2009	MT/AT	R	-	-	857170	Outer Joint		27	30	52	76.5	54	M
BP5														
1.8	2004.05-2006.02	5MT	R	-	Allwheel Drive Engine EJ20Y	857170	Outer Joint		27	30	52	76.5	54	M
2.0	2003.01-2006.02	5AT	R	-	Allwheel Drive Engine EJ20X	857170	Outer Joint		27	30	52	76.5	54	M
	2003.01-2006.02	5AT	R	-	Allwheel Drive Engine EJ20X	857170	Outer Joint		27	30	52	76.5	54	M
	2003.02-2006.02	4AT	R	-	Allwheel Drive Engine EJ203	857170	Outer Joint		27	30	52	76.5	54	M
	2003.02-2006.02	4AT	R	-	Allwheel Drive Engine EJ203	857170	Outer Joint		27	30	52	76.5	54	M
	2003.12-2006.02	4AT	R	-	Allwheel Drive Engine EJ204	857170	Outer Joint		27	30	52	76.5	54	M
	2003.12-2006.02	4AT	R	-	Allwheel Drive Engine EJ204	857170	Outer Joint		27	30	52	76.5	54	M
	2003.12-2005.04	5MT	R	-	Allwheel Drive Engine EJ204	857170	Outer Joint		27	30	52	76.5	54	M
	2003.12-2005.04	5MT	R	-	Allwheel Drive Engine EJ204	857170	Outer Joint		27	30	52	76.5	54	M
	2004.05-2006.02	5MT	R	-	Allwheel Drive Engine EJ20Y	857170	Outer Joint		27	30	52	76.5	54	M
	2005.03-2006.02	5MT	R	-	Allwheel Drive Engine EJ203	857170	Outer Joint		27	30	52	76.5	54	M
2005.03-2006.02	5MT	R	-	Allwheel Drive Engine EJ203	857170	Outer Joint		27	30	52	76.5	54	M	
BP9														
2.0	2003.06-2006.02	4AT	R	-	Allwheel Drive Engine EJ253	857170	Outer Joint		27	30	52	76.5	54	M
2.5	2003.06-2006.02	4AT	R	-	Allwheel Drive Engine EJ253	857170	Outer Joint		27	30	52	76.5	54	M
BPE														
3.0	2003.06-2006.02	5AT	R	-	Allwheel Drive Engine EZ30D	857170	Outer Joint		27	30	52	76.5	54	M
	2003.06-2006.02	5AT	R	-	Allwheel Drive Engine EZ30D	857170	Outer Joint		27	30	52	76.5	54	M
	2004.07-2006.02	6MT	R	-	Allwheel Drive Engine EZ30D	857170	Outer Joint		27	30	52	76.5	54	M
	2004.07-2006.02	6MT	R	-	Allwheel Drive Engine EZ30D	857170	Outer Joint		27	30	52	76.5	54	M
BRUMBY														
1.8	1990.01-	MT/AT	L/R	R	MY MV	256020	Drive Shaft		23	23	40	41	502.5	
EXIGA (YA_)														
2.0 (109 kW)	2008.05-	-	-	-	Estate Engine EJ204	699215	Inner Joint		25	29	35	77.5	110	
	2008.05-	-	-	-	All-wheel Drive Estate Engine EJ204	699215	Inner Joint		25	29	35	77.5	110	
2.0 (165 kW)	2008.05-	-	-	-	All-wheel Drive Estate Engine EJ20(Turbo)	699215	Inner Joint		25	29	35	77.5	110	
2.5 AWD (125 kW)	2009.12-	-	-	-	All-wheel Drive Estate Engine EJ253	699215	Inner Joint		25	29	35	77.5	110	
2.5 AWD (127 kW)	2012.03-	-	-	-	All-wheel Drive Estate Engine FB25	699215	Inner Joint		25	29	35	77.5	110	
FIORI														
-	1990.01-1992.12	MT/AT	-	-	-	856015	Outer Joint		24	18	50	108	51	M
	1990.01-1992.12	-	L	-	-	256017	Drive Shaft		24	23	50	108	535.5	
	1990.01-1992.12	-	R	-	-	256018	Drive Shaft		24	23	50	108	682.5	
FORESTER														
-	2004-	-	-	-	-	656012	Inner Joint		25	29	35	77.5	110	
	2004-	-	-	-	-	256014	Drive Shaft	44T	27	25	56	86.5	780	
FORESTER (SF_)														
2.0 AWD (90 kW)	1997.08-2002.09	-	-	-	All-wheel Drive Closed Off-Road Vehicle Engine EJ202	656015	Inner Joint		25	29	40	38.5	72	
	1997.08-2002.09	-	-	-	All-wheel Drive Closed Off-Road Vehicle Engine EJ202	656023	Inner Joint		25	29	40.1	38	72.5	





	 YEAR	TRANSM	L/R	F/R	REMARKS	GSP Ref.	 PRODUCT	 ABS	Technical Specifications					
									A	B	C	H	L	P
SUBARU FORESTER (SF_)														
2.0 AWD (90 kW)	1997.08-2002.09	-	-	F	All-wheel Drive Closed Off-Road Vehicle Engine EJ202	856017	Outer Joint		27	30	56	87	58.5	I
	1997.08-2002.09	AT	L/R	F	All-wheel Drive Closed Off-Road Vehicle Engine EJ202	656006	Inner Joint		25	22	40	38.5	72	
	1997.08-2002.09	-	-	-	All-wheel Drive Closed Off-Road Vehicle Engine EJ202	656004	Inner Joint		25	30	40	35.8	75.5	
	1997.08-2002.09	AT	L/R	F	All-wheel Drive Closed Off-Road Vehicle Engine EJ202	256006	Drive Shaft		27	25	56	87	684	
	1997.08-2002.09	-	-	F	All-wheel Drive Closed Off-Road Vehicle Engine EJ202	856040	Outer Joint		27	30	56	86.5	62.7	M
	1997.08-2002.09	-	-	F	All-wheel Drive Closed Off-Road Vehicle Engine EJ202	856009	Outer Joint	44T	27	30	56	86.5	63	M
	1997.08-2002.09	-	-	F	All-wheel Drive Closed Off-Road Vehicle Engine EJ202	856027	Outer Joint	44T	27	23	56	86.5	63	M
	1997.08-2002.09	-	-	F	All-wheel Drive Closed Off-Road Vehicle Engine EJ202	856026	Outer Joint	44T	27	30	56	86.5	63	I
	1997.08-2002.09	-	L/R	F	All-wheel Drive Closed Off-Road Vehicle Engine EJ202	856005	Outer Joint		27	22	56	87	66	M
2.0 AWD (92 kW)	1998.06-2002.09	-	-	-	All-wheel Drive Closed Off-Road Vehicle Engine EJ202	656015	Inner Joint		25	29	40	38.5	72	
	1998.06-2002.09	-	-	-	All-wheel Drive Closed Off-Road Vehicle Engine EJ202	656023	Inner Joint		25	29	40.1	38	72.5	
	1998.06-2002.09	-	-	F	All-wheel Drive Closed Off-Road Vehicle Engine EJ202	856017	Outer Joint		27	30	56	87	58.5	I
	1998.06-2002.09	-	-	-	All-wheel Drive Closed Off-Road Vehicle Engine EJ202	656004	Inner Joint		25	30	40	35.8	75.5	
	1998.06-2002.09	-	-	F	All-wheel Drive Closed Off-Road Vehicle Engine EJ202	856040	Outer Joint		27	30	56	86.5	62.7	M
	1998.06-2002.09	-	-	F	All-wheel Drive Closed Off-Road Vehicle Engine EJ202	856009	Outer Joint	44T	27	30	56	86.5	63	M
	1998.06-2002.09	-	-	F	All-wheel Drive Closed Off-Road Vehicle Engine EJ202	856027	Outer Joint	44T	27	23	56	86.5	63	M
	1998.06-2002.09	-	-	F	All-wheel Drive Closed Off-Road Vehicle Engine EJ202	856026	Outer Joint	44T	27	30	56	86.5	63	I
	1998.06-2002.09	-	L/R	F	All-wheel Drive Closed Off-Road Vehicle Engine EJ202	856005	Outer Joint		27	22	56	87	66	M
2.0 S Turbo AWD (125 kW)	1998.06-2001.04	-	-	-	All-wheel Drive Closed Off-Road Vehicle Engine EJ205	656015	Inner Joint		25	29	40	38.5	72	
	1998.06-2001.04	MT	-	-	All-wheel Drive Closed Off-Road Vehicle Engine EJ205	856017	Outer Joint		27	30	56	87	58.5	I
	1998.06-2001.04	-	-	-	All-wheel Drive Closed Off-Road Vehicle Engine EJ205	656004	Inner Joint		25	30	40	35.8	75.5	
	1998.06-2001.04	-	L/R	F	All-wheel Drive Closed Off-Road Vehicle Engine EJ205	656006	Inner Joint		25	22	40	38.5	72	
	1998.06-2001.04	-	L/R	F	All-wheel Drive Closed Off-Road Vehicle Engine EJ205	256006	Drive Shaft		27	25	56	87	684	
	1998.06-2001.04	-	-	F	All-wheel Drive Closed Off-Road Vehicle Engine EJ205	856009	Outer Joint	44T	27	30	56	86.5	63	M
	1998.06-2001.04	-	L/R	F	All-wheel Drive Closed Off-Road Vehicle Engine EJ205	856005	Outer Joint		27	22	56	87	66	M
2.0 S Turbo AWD (130 kW)	2001.04-2002.09	-	-	-	All-wheel Drive Closed Off-Road Vehicle Engine EJ205	656023	Inner Joint		25	29	40.1	38	72.5	
	2001.04-2002.09	-	-	F	All-wheel Drive Closed Off-Road Vehicle Engine EJ205	856017	Outer Joint		27	30	56	87	58.5	I
	2001.04-2002.09	-	-	-	All-wheel Drive Closed Off-Road Vehicle Engine EJ205	656015	Inner Joint		25	29	40	38.5	72	
	2001.04-2002.09	-	-	-	All-wheel Drive Closed Off-Road Vehicle Engine EJ205	656004	Inner Joint		25	30	40	35.8	75.5	
	2001.04-2002.09	-	-	F	All-wheel Drive Closed Off-Road Vehicle Engine EJ205	856040	Outer Joint		27	30	56	86.5	62.7	M
	2001.04-2002.09	-	-	F	All-wheel Drive Closed Off-Road Vehicle Engine EJ205	856009	Outer Joint	44T	27	30	56	86.5	63	M
	2001.04-2002.09	-	-	F	All-wheel Drive Closed Off-Road Vehicle Engine EJ205	856027	Outer Joint	44T	27	23	56	86.5	63	M
	2001.04-2002.09	-	-	F	All-wheel Drive Closed Off-Road Vehicle Engine EJ205	856026	Outer Joint	44T	27	30	56	86.5	63	I
	2001.04-2002.09	-	L/R	F	All-wheel Drive Closed Off-Road Vehicle Engine EJ205	856005	Outer Joint		27	22	56	87	66	M
2.5 AWD (123 kW)	1997.07-2002.05	-	-	-	All-wheel Drive Closed Off-Road Vehicle Engine EJ25D	656015	Inner Joint		25	29	40	38.5	72	
FORESTER (SG_)														
2.0 AWD (92 kW)	2002.06-2005.05	-	-	-	All-wheel Drive Closed Off-Road Vehicle Engine EJ201	656022	Inner Joint		25	29	35	77.5	110	
	2002.06-2005.05	-	-	-	All-wheel Drive Closed Off-Road Vehicle Engine EJ201	856041	Outer Joint	44T	27	23	56	87	61	M
	2002.06-2005.05	-	-	F	All-wheel Drive Closed Off-Road Vehicle Engine EJ201	856027	Outer Joint	44T	27	23	56	86.5	63	M
	2002.06-2005.05	-	-	-	All-wheel Drive Closed Off-Road Vehicle Engine EJ201	256069	Drive Shaft	44T	27	25	56	87	780	
2.0 S Turbo AWD (130 kW)	2002.09-2005.05	-	-	-	All-wheel Drive Closed Off-Road Vehicle Engine EJ205	656022	Inner Joint		25	29	35	77.5	110	
	2002.09-2005.05	-	-	-	All-wheel Drive Closed Off-Road Vehicle Engine EJ205	856041	Outer Joint	44T	27	23	56	87	61	M
	2002.09-2005.05	-	-	F	All-wheel Drive Closed Off-Road Vehicle Engine EJ205	856026	Outer Joint	44T	27	30	56	86.5	63	I
	2002.09-2005.05	-	-	-	All-wheel Drive Closed Off-Road Vehicle Engine EJ205	256069	Drive Shaft	44T	27	25	56	87	780	
	2002.09-2005.05	-	L/R	F	All-wheel Drive Closed Off-Road Vehicle Engine EJ205	856005	Outer Joint		27	22	56	87	66	M
2.0 X AWD (116 kW)	2005.06-2008.05	-	-	-	All-wheel Drive Closed Off-Road Vehicle Engine EJ204	656022	Inner Joint		25	29	35	77.5	110	
	2005.06-2008.05	-	-	-	All-wheel Drive Closed Off-Road Vehicle Engine EJ204	856041	Outer Joint	44T	27	23	56	87	61	M
	2005.06-2008.05	-	-	F	All-wheel Drive Closed Off-Road Vehicle Engine EJ204	856027	Outer Joint	44T	27	23	56	86.5	63	M
	2005.06-2008.05	-	-	-	All-wheel Drive Closed Off-Road Vehicle Engine EJ204	256069	Drive Shaft	44T	27	25	56	87	780	
2.5 AWD (155 kW)	2003.12-2005.05	-	-	-	All-wheel Drive Closed Off-Road Vehicle Engine EJ25	656022	Inner Joint		25	29	35	77.5	110	
	2003.12-2005.05	-	-	F	All-wheel Drive Closed Off-Road Vehicle Engine EJ25	856027	Outer Joint	44T	27	23	56	86.5	63	M
	2003.12-2005.05	-	-	F	All-wheel Drive Closed Off-Road Vehicle Engine EJ25	856057	Outer Joint	44T	27	32	56	86.5	68.5	I
	2003.12-2005.05	-	-	-	All-wheel Drive Closed Off-Road Vehicle Engine EJ25	256069	Drive Shaft	44T	27	25	56	87	780	
2.5 AWD (171 kW)	2004.01-2009.12	-	-	-	All-wheel Drive Closed Off-Road Vehicle Engine EJ255	656022	Inner Joint		25	29	35	77.5	110	
	2004.01-2009.12	-	-	F	All-wheel Drive Closed Off-Road Vehicle Engine EJ255	856027	Outer Joint	44T	27	23	56	86.5	63	M
	2004.01-2009.12	-	-	F	All-wheel Drive Closed Off-Road Vehicle Engine EJ255	856057	Outer Joint	44T	27	32	56	86.5	68.5	I
2.5 XT AWD (169 kW)	2005.06-2008.05	-	-	-	All-wheel Drive Closed Off-Road Vehicle Engine EJ255	656022	Inner Joint		25	29	35	77.5	110	





	 YEAR	TRANSM	L/R	F/R	REMARKS	GSP Ref.	 PRODUCT	 ABS	Technical Specifications					
									A	B	C	H	L	P
SUBARU														
FORESTER (SG_)														
2.5 XT AWD (169 kW)	2005.06-2008.05	-	-	F	All-wheel Drive Closed Off-Road Vehicle Engine EJ255	856027	Outer Joint	44T	27	23	56	86.5	63	M
	2005.06-2008.05	-	-	F	All-wheel Drive Closed Off-Road Vehicle Engine EJ255	856057	Outer Joint	44T	27	32	56	86.5	68.5	I
	2005.06-2008.05	-	-	-	All-wheel Drive Closed Off-Road Vehicle Engine EJ255	256069	Drive Shaft	44T	27	25	56	87	780	
FORESTER (SH_)														
2.0 AWD (110 kW)	2008.01-2013.09	AT/MT	L/R	F	All-wheel Drive Closed Off-Road Vehicle Engine EJ204	856042	Outer Joint		27	30	52	76	54	M
	2008.01-2013.09	-	-	F	All-wheel Drive Closed Off-Road Vehicle Engine EJ204	899339	Outer Joint		27	32	52	76.5	62.5	I
	2008.01-2013.09	-	-	-	All-wheel Drive Closed Off-Road Vehicle Engine EJ204	699215	Inner Joint		25	29	35	77.5	110	
	2008.01-2013.09	-	-	F	All-wheel Drive Closed Off-Road Vehicle Engine EJ204	856022	Outer Joint		27	30	52	77	54	I
	2010.01-	AT/MT	L/R	F	All-wheel Drive Closed Off-Road Vehicle Engine FB20	856042	Outer Joint		27	30	52	76	54	M
	2010.01-	-	-	-	All-wheel Drive Closed Off-Road Vehicle Engine FB20	699215	Inner Joint		25	29	35	77.5	110	
	2010.01-	-	-	F	All-wheel Drive Closed Off-Road Vehicle Engine FB20	899339	Outer Joint		27	32	52	76.5	62.5	I
	2008.09-2013.09	AT/MT	L/R	F	All-wheel Drive Closed Off-Road Vehicle Engine EE20Z	856042	Outer Joint		27	30	52	76	54	M
	2008.09-2013.09	-	-	F	All-wheel Drive Closed Off-Road Vehicle Engine EE20Z	899339	Outer Joint		27	32	52	76.5	62.5	I
	2008.09-2013.09	-	-	-	All-wheel Drive Closed Off-Road Vehicle Engine EE20Z	699215	Inner Joint		25	29	35	77.5	110	
	2008.09-2013.09	-	-	F	All-wheel Drive Closed Off-Road Vehicle Engine EE20Z	856022	Outer Joint		27	30	52	77	54	I
2.5 (193 kW)	2011.02-2013.09	-	-	-	All-wheel Drive Closed Off-Road Vehicle Engine EJ255	699215	Inner Joint		25	29	35	77.5	110	
2.5 AWD (169 kW)	2008.06-2013.09	AT/MT	L/R	F	All-wheel Drive Closed Off-Road Vehicle Engine EJ255	856042	Outer Joint		27	30	52	76	54	M
	2008.06-2013.09	-	-	-	All-wheel Drive Closed Off-Road Vehicle Engine EJ255	699215	Inner Joint		25	29	35	77.5	110	
2.5 XS (126 kW)	2009.01-2013.09	AT/MT	L/R	F	All-wheel Drive Closed Off-Road Vehicle Engine EJ25	856042	Outer Joint		27	30	52	76	54	M
	2009.01-2013.09	-	-	-	All-wheel Drive Closed Off-Road Vehicle Engine EJ25	699215	Inner Joint		25	29	35	77.5	110	
	2009.01-2013.09	-	-	F	All-wheel Drive Closed Off-Road Vehicle Engine EJ25	899339	Outer Joint		27	32	52	76.5	62.5	I
	2011.03-2013.09	-	-	-	All-wheel Drive Closed Off-Road Vehicle Engine FB25	699215	Inner Joint		25	29	35	77.5	110	
FORESTER(S10)														
2.0	1999.08-2000.08	AT	L	F	ENGINE:EJ202,TRAIN:F4WD,BODY:WAGON	656005	Inner Joint		25	29	40.1	37.5	68	
	2000.05-2001.07	AT	L/R	F	ENGINE:EJ202,TRAIN:F4WD,BODY:WAGON	656005	Inner Joint		25	29	40.1	37.5	68	
	2001.06-2002.05	AT	L/R	F	ENGINE:EJ202,TRAIN:F4WD,BODY:WAGON	656005	Inner Joint		25	29	40.1	37.5	68	
GJ2														
1.6	2011.09-2013.12	CVT	R	-	Engine FB16A	856076	Outer Joint		27	22	52	76.5	54	M
GJ3														
1.6	2011.09-2013.12	CVT	R	-	Allwheel Drive Engine FB16A	856076	Outer Joint		27	22	52	76.5	54	M
	2011.09-2013.12	5MT	R	-	Allwheel Drive Engine FB16A	856076	Outer Joint		27	22	52	76.5	54	M
GJ6														
2.0	2011.09-2013.12	CVT	R	-	Engine FB20A	856076	Outer Joint		27	22	52	76.5	54	M
GJ7														
2.0	2011.09-2013.12	CVT	R	-	Allwheel Drive Engine FB20A	856076	Outer Joint		27	22	52	76.5	54	M
GP2														
1.6	2011.09-2013.12	CVT	R	-	Engine FB16A	856076	Outer Joint		27	22	52	76.5	54	M
GP3														
1.6	2011.09-2013.12	CVT	R	-	Allwheel Drive Engine FB16A	856076	Outer Joint		27	22	52	76.5	54	M
	2011.09-2013.12	5MT	R	-	Allwheel Drive Engine FB16A	856076	Outer Joint		27	22	52	76.5	54	M
GP6														
2.0	2011.09-2013.12	CVT	R	-	Engine FB20A	856076	Outer Joint		27	22	52	76.5	54	M
GP7														
2.0	2011.09-2013.12	CVT	R	-	Allwheel Drive Engine FB20A	856076	Outer Joint		27	22	52	76.5	54	M
IMPREZA														
-	2001-	-	-	-	-	856020	Outer Joint		27	30	56	86.5	63	I
	2004-	-	-	-	-	856021	Outer Joint		27	30	56	86.5	55.5	I
	2004-	-	-	-	-	856021	Outer Joint		27	30	56	86.5	55.5	I
	2004-	-	-	-	-	856024	Outer Joint	44T	27	30	56	86.5	55.5	I
IMPREZA (GC)														
1.6 i (66 kW)	1992.08-2000.12	-	-	-	Saloon Engine EJ16	656015	Inner Joint		25	29	40	38.5	72	
	1992.08-2000.12	-	-	-	Saloon Engine EJ16	656023	Inner Joint		25	29	40.1	38	72.5	
	1992.08-2000.12	-	L/R	F	Saloon Engine EJ16	656006	Inner Joint		25	22	40	38.5	72	
	1992.08-2000.12	-	-	-	Saloon Engine EJ16	656004	Inner Joint		25	30	40	35.8	75.5	
	1992.08-2000.12	-	-	F	Saloon Engine EJ16	856040	Outer Joint		27	30	56	86.5	62.7	M





	 YEAR	TRANSM	L/R	F/R	REMARKS	GSP Ref.	 PRODUCT	 ABS	Technical Specifications					
									A	B	C	H	L	P
SUBARU IMPREZA (GC)														
1.6 i (66 kW)	1992.08-2000.12	-	L/R	F	Saloon Engine EJ16	256006	Drive Shaft		27	25	56	87	684	
	1992.08-2000.12	-	-	F	Saloon Engine EJ16	856009	Outer Joint	44T	27	30	56	86.5	63	M
	1992.08-2000.12	MT	L/R	F	Saloon Engine EJ16	856005	Outer Joint		27	22	56	87	66	M
	1992.08-2000.12	MT	L/R	F	Saloon Engine EJ16	256007	Drive Shaft		27	23	56	87	686.5	
1.6 i (70 kW)	1998.06-2000.12	-	-	-	Saloon Engine EJ161	656023	Inner Joint		25	29	40.1	38	72.5	
	1998.06-2000.12	-	-	-	Saloon Engine EJ161	656015	Inner Joint		25	29	40	38.5	72	
	1998.06-2000.12	-	-	-	Saloon Engine EJ161	656004	Inner Joint		25	30	40	35.8	75.5	
	1998.06-2000.12	-	L/R	F	Saloon Engine EJ161	656006	Inner Joint		25	22	40	38.5	72	
	1998.06-2000.12	-	-	F	Saloon Engine EJ161	856040	Outer Joint		27	30	56	86.5	62.7	M
	1998.06-2000.12	-	L/R	F	Saloon Engine EJ161	256006	Drive Shaft		27	25	56	87	684	
	1998.06-2000.12	-	-	F	Saloon Engine EJ161	856009	Outer Joint	44T	27	30	56	86.5	63	M
	1998.06-2000.12	MT	L/R	F	Saloon Engine EJ161	856005	Outer Joint		27	22	56	87	66	M
1.6 i AWD (66 kW)	1992.08-2000.12	-	-	-	All-wheel Drive Saloon Engine EJ16	656015	Inner Joint		25	29	40	38.5	72	
	1992.08-2000.12	-	-	-	All-wheel Drive Saloon Engine EJ16	656023	Inner Joint		25	29	40.1	38	72.5	
	1992.08-2000.12	-	L/R	F	All-wheel Drive Saloon Engine EJ16	656006	Inner Joint		25	22	40	38.5	72	
	1992.08-2000.12	-	-	-	All-wheel Drive Saloon Engine EJ16	656004	Inner Joint		25	30	40	35.8	75.5	
	1992.08-2000.12	-	-	F	All-wheel Drive Saloon Engine EJ16	856040	Outer Joint		27	30	56	86.5	62.7	M
	1992.08-2000.12	-	L/R	F	All-wheel Drive Saloon Engine EJ16	256006	Drive Shaft		27	25	56	87	684	
	1992.08-2000.12	-	-	F	All-wheel Drive Saloon Engine EJ16	856009	Outer Joint	44T	27	30	56	86.5	63	M
	1992.08-2000.12	MT	L/R	F	All-wheel Drive Saloon Engine EJ16	856008	Outer Joint		27	30	56	87	66	I
1.6 i AWD (70 kW)	1992.08-2000.12	AT/MT	L/R	F	All-wheel Drive Saloon Engine EJ16	856004	Outer Joint		27	30	56	87	68	M
	1992.08-2000.12	AT/MT	L/R	F	All-wheel Drive Saloon Engine EJ16	856005	Outer Joint		27	22	56	87	66	M
	1998.06-2000.12	-	-	-	All-wheel Drive Saloon Engine EJ161	656023	Inner Joint		25	29	40.1	38	72.5	
	1998.06-2000.12	-	-	-	All-wheel Drive Saloon Engine EJ161	656015	Inner Joint		25	29	40	38.5	72	
	1998.06-2000.12	-	-	-	All-wheel Drive Saloon Engine EJ161	656004	Inner Joint		25	30	40	35.8	75.5	
	1998.06-2000.12	-	L/R	F	All-wheel Drive Saloon Engine EJ161	656006	Inner Joint		25	22	40	38.5	72	
	1998.06-2000.12	-	-	F	All-wheel Drive Saloon Engine EJ161	856040	Outer Joint		27	30	56	86.5	62.7	M
	1998.06-2000.12	-	L/R	F	All-wheel Drive Saloon Engine EJ161	256006	Drive Shaft		27	25	56	87	684	
1.8 i AWD (76 kW)	1998.06-2000.12	-	-	-	All-wheel Drive Saloon Engine EJ18	856009	Outer Joint	44T	27	30	56	86.5	63	M
	1992.08-2000.12	-	-	-	All-wheel Drive Saloon Engine EJ18	656015	Inner Joint		25	29	40	38.5	72	
	1992.08-2000.12	-	-	-	All-wheel Drive Saloon Engine EJ18	656023	Inner Joint		25	29	40.1	38	72.5	
	1992.08-2000.12	-	-	-	All-wheel Drive Saloon Engine EJ18	656004	Inner Joint		25	30	40	35.8	75.5	
	1992.08-2000.12	-	-	F	All-wheel Drive Saloon Engine EJ18	856040	Outer Joint		27	30	56	86.5	62.7	M
	1992.08-2000.12	-	-	F	All-wheel Drive Saloon Engine EJ18	856009	Outer Joint	44T	27	30	56	86.5	63	M
	1992.08-2000.12	-	L/R	F	All-wheel Drive Saloon Engine EJ18	856008	Outer Joint		27	30	56	87	66	I
	1992.08-2000.12	AT/MT	L/R	F	All-wheel Drive Saloon Engine EJ18	856004	Outer Joint		27	30	56	87	68	M
2.0 AWD (206 kW)	1998.09-2000.09	-	-	-	All-wheel Drive Saloon Engine EJ205P	856005	Outer Joint		27	22	56	87	66	M
	1998.09-2000.09	-	-	-	All-wheel Drive Saloon Engine EJ205P	656004	Inner Joint		25	30	40	35.8	75.5	
	1998.09-2000.09	-	L/R	F	All-wheel Drive Saloon Engine EJ205P	656006	Inner Joint		25	22	40	38.5	72	
	1998.09-2000.09	-	-	-	All-wheel Drive Saloon Engine EJ205P	656015	Inner Joint		25	29	40	38.5	72	
	1998.09-2000.09	-	L/R	F	All-wheel Drive Saloon Engine EJ205P	256006	Drive Shaft		27	25	56	87	684	
2.0 i AWD (85 kW)	1998.09-2000.09	-	-	F	All-wheel Drive Saloon Engine EJ205P	856009	Outer Joint	44T	27	30	56	86.5	63	M
	1995.10-2000.12	-	-	-	All-wheel Drive Saloon Engine EJ20E	656015	Inner Joint		25	29	40	38.5	72	
	1995.10-2000.12	-	-	-	All-wheel Drive Saloon Engine EJ20E	656023	Inner Joint		25	29	40.1	38	72.5	
	1995.10-2000.12	-	L/R	F	All-wheel Drive Saloon Engine EJ20E	656006	Inner Joint		25	22	40	38.5	72	
	1995.10-2000.12	-	-	-	All-wheel Drive Saloon Engine EJ20E	656004	Inner Joint		25	30	40	35.8	75.5	
	1995.10-2000.12	-	-	F	All-wheel Drive Saloon Engine EJ20E	856040	Outer Joint		27	30	56	86.5	62.7	M
	1995.10-2000.12	-	L/R	F	All-wheel Drive Saloon Engine EJ20E	256006	Drive Shaft		27	25	56	87	684	
	1995.10-2000.12	-	-	F	All-wheel Drive Saloon Engine EJ20E	856009	Outer Joint	44T	27	30	56	86.5	63	M
2.0 i AWD (92 kW)	1995.10-2000.12	-	L/R	F	All-wheel Drive Saloon Engine EJ20E	856008	Outer Joint		27	30	56	87	66	I
	1998.06-2000.12	-	-	-	All-wheel Drive Saloon Engine EJ201	656023	Inner Joint		25	29	40.1	38	72.5	
	1998.06-2000.12	-	-	-	All-wheel Drive Saloon Engine EJ201	656015	Inner Joint		25	29	40	38.5	72	
	1998.06-2000.12	-	-	-	All-wheel Drive Saloon Engine EJ201	656004	Inner Joint		25	30	40	35.8	75.5	
	1998.06-2000.12	-	L/R	F	All-wheel Drive Saloon Engine EJ201	656006	Inner Joint		25	22	40	38.5	72	
	1998.06-2000.12	-	-	F	All-wheel Drive Saloon Engine EJ201	856040	Outer Joint		27	30	56	86.5	62.7	M
	1998.06-2000.12	-	L/R	F	All-wheel Drive Saloon Engine EJ201	256006	Drive Shaft		27	25	56	87	684	
	1998.06-2000.12	-	-	F	All-wheel Drive Saloon Engine EJ201	856009	Outer Joint	44T	27	30	56	86.5	63	M
2.0 Turbo GT AWD (155 kW)	1998.06-2000.12	AT/MT	L/R	F	All-wheel Drive Saloon Engine EJ201	856039	Outer Joint		27	30	56	87.1	58	M
	1994.03-2000.12	-	-	-	All-wheel Drive Saloon Engine EJ20 (Turbo)	656015	Inner Joint		25	29	40	38.5	72	
	1994.03-2000.12	-	-	-	All-wheel Drive Saloon Engine EJ20 (Turbo)	656023	Inner Joint		25	29	40.1	38	72.5	
	1994.03-2000.12	-	L/R	F	All-wheel Drive Saloon Engine EJ20 (Turbo)	656006	Inner Joint		25	22	40	38.5	72	
	1994.03-2000.12	-	-	-	All-wheel Drive Saloon Engine EJ20 (Turbo)	656004	Inner Joint		25	30	40	35.8	75.5	
	1994.03-2000.12	-	-	F	All-wheel Drive Saloon Engine EJ20 (Turbo)	856040	Outer Joint		27	30	56	86.5	62.7	M
1994.03-2000.12	-	L/R	F	All-wheel Drive Saloon Engine EJ20 (Turbo)	256006	Drive Shaft		27	25	56	87	684		





	 YEAR	TRANSM	L/R	F/R	REMARKS	GSP Ref.	 PRODUCT	 ABS	Technical Specifications					
									A	B	C	H	L	P
SUBARU														
IMPREZA (GC)														
2.0 Turbo GT AWD (155 kW)	1994.03-2000.12	-	-	F	All-wheel Drive Saloon Engine EJ20 (Turbo)	856009	Outer Joint	44T	27	30	56	86.5	63	M
	1994.03-2000.12	-	L/R	F	All-wheel Drive Saloon Engine EJ20 (Turbo)	856008	Outer Joint		27	30	56	87	66	I
	1994.03-2000.12	AT/MT	L/R	F	All-wheel Drive Saloon Engine EJ20 (Turbo)	856004	Outer Joint		27	30	56	87	68	M
	1994.03-2000.12	AT	L/R	F	All-wheel Drive Saloon Engine EJ20 (Turbo)	856005	Outer Joint		27	22	56	87	66	M
2.0 Turbo GT AWD (160 kW)	1998.06-2000.12	-	-	-	All-wheel Drive Saloon Engine EJ205	656023	Inner Joint		25	29	40.1	38	72.5	
	1998.06-2000.12	-	-	-	All-wheel Drive Saloon Engine EJ205	656015	Inner Joint		25	29	40	38.5	72	
	1998.06-2000.12	-	-	-	All-wheel Drive Saloon Engine EJ205	656004	Inner Joint		25	30	40	35.8	75.5	
	1998.06-2000.12	-	L/R	F	All-wheel Drive Saloon Engine EJ205	656006	Inner Joint		25	22	40	38.5	72	
	1998.06-2000.12	-	-	F	All-wheel Drive Saloon Engine EJ205	856040	Outer Joint		27	30	56	86.5	62.7	M
	1998.06-2000.12	-	L/R	F	All-wheel Drive Saloon Engine EJ205	256006	Drive Shaft		27	25	56	87	684	
	1998.06-2000.12	-	-	F	All-wheel Drive Saloon Engine EJ205	856009	Outer Joint	44T	27	30	56	86.5	63	M
	1998.06-2000.12	AT/MT	L/R	F	All-wheel Drive Saloon Engine EJ205	856039	Outer Joint		27	30	56	87.1	58	M
2.2 GX AWD (96 kW)	1998.09-2000.09	-	-	-	All-wheel Drive Saloon Engine EJ22E	656015	Inner Joint		25	29	40	38.5	72	
2.2 GX AWD (97 kW)	1995.11-1998.08	-	-	-	All-wheel Drive Saloon Engine EJ22	656015	Inner Joint		25	29	40	38.5	72	
IMPREZA (GD)														
1.5 AWD (77 kW)	2006.05-	-	-	-	All-wheel Drive Saloon Engine EL15	656022	Inner Joint		25	29	35	77.5	110	
1.6 (70 kW)	2001.06-2006.09	-	-	-	Saloon Engine EJ161	656015	Inner Joint		25	29	40	38.5	72	
1.6 AWD (70 kW)	2000.12-	-	-	-	All-wheel Drive Saloon Engine EJ161	656023	Inner Joint		25	29	40.1	38	72.5	
	2000.12-	-	-	-	All-wheel Drive Saloon Engine EJ161	656015	Inner Joint		25	29	40	38.5	72	
	2000.12-	-	-	-	All-wheel Drive Saloon Engine EJ161	656022	Inner Joint		25	29	35	77.5	110	
	2000.12-	-	-	F	All-wheel Drive Saloon Engine EJ161	856009	Outer Joint	44T	27	30	56	86.5	63	M
	2000.12-	-	-	F	All-wheel Drive Saloon Engine EJ161	856026	Outer Joint	44T	27	30	56	86.5	63	I
	2000.12-	-	-	F	All-wheel Drive Saloon Engine EJ161	856067	Outer Joint	44T	27	30	56	86.5	56	M
2.0 (235 kW)	2004.02-	-	-	-	All-wheel Drive Saloon Engine EJ207	656022	Inner Joint		25	29	35	77.5	110	
	2004.02-	-	-	F	All-wheel Drive Saloon Engine EJ207	856048	Outer Joint	44T	27	32	56	86.5	71.5	I
	2004.02-	-	-	F	All-wheel Drive Saloon Engine EJ207	856057	Outer Joint	44T	27	32	56	86.5	68.5	I
	2004.02-	-	-	F	All-wheel Drive Saloon Engine EJ207	856067	Outer Joint	44T	27	30	56	86.5	56	M
	2004.02-	-	-	F	All-wheel Drive Saloon Engine EJ207	856058	Outer Joint	44T	27	32	54.5	86	67	I
	2004.02-	-	-	F	All-wheel Drive Saloon Engine EJ207	856022	Outer Joint		27	30	52	77	54	I
2.0 AWD (184 kW)	2005.10-	-	-	-	All-wheel Drive Saloon Engine EJ20 (Turbo)	656022	Inner Joint		25	29	35	77.5	110	
	2005.10-	-	-	F	All-wheel Drive Saloon Engine EJ20 (Turbo)	856067	Outer Joint	44T	27	30	56	86.5	56	M
	2005.10-	-	-	F	All-wheel Drive Saloon Engine EJ20 (Turbo)	856058	Outer Joint	44T	27	32	54.5	86	67	I
	2005.10-	-	-	F	All-wheel Drive Saloon Engine EJ20 (Turbo)	856022	Outer Joint		27	30	52	77	54	I
2.0 i AWD (92 kW)	2000.12-	-	-	-	All-wheel Drive Saloon Engine EJ201	656023	Inner Joint		25	29	40.1	38	72.5	
	2000.12-	-	-	-	All-wheel Drive Saloon Engine EJ201	656015	Inner Joint		25	29	40	38.5	72	
	2000.12-	-	-	-	All-wheel Drive Saloon Engine EJ201	656022	Inner Joint		25	29	35	77.5	110	
	2000.12-	-	-	F	All-wheel Drive Saloon Engine EJ201	856009	Outer Joint	44T	27	30	56	86.5	63	M
	2000.12-	-	-	F	All-wheel Drive Saloon Engine EJ201	856057	Outer Joint	44T	27	32	56	86.5	68.5	I
	2000.12-	-	-	F	All-wheel Drive Saloon Engine EJ201	856026	Outer Joint	44T	27	30	56	86.5	63	I
	2000.12-	-	-	F	All-wheel Drive Saloon Engine EJ201	856067	Outer Joint	44T	27	30	56	86.5	56	M
	2000.12-	-	-	F	All-wheel Drive Saloon Engine EJ201	856058	Outer Joint	44T	27	32	54.5	86	67	I
	2000.12-	-	-	F	All-wheel Drive Saloon Engine EJ201	856022	Outer Joint		27	30	52	77	54	I
2.0 i R AWD (118 kW)	2005.09-	-	-	-	All-wheel Drive Saloon Engine EJ204	656022	Inner Joint		25	29	35	77.5	110	
	2005.09-	-	-	F	All-wheel Drive Saloon Engine EJ204	856026	Outer Joint	44T	27	30	56	86.5	63	I
	2005.09-	-	-	F	All-wheel Drive Saloon Engine EJ204	856067	Outer Joint	44T	27	30	56	86.5	56	M
	2005.09-	-	-	F	All-wheel Drive Saloon Engine EJ204	856058	Outer Joint	44T	27	32	54.5	86	67	I
	2005.09-	-	-	F	All-wheel Drive Saloon Engine EJ204	856022	Outer Joint		27	30	52	77	54	I
2.0 i WRX AWD (168 kW)	2002.12-2005.09	-	-	-	All-wheel Drive Saloon Engine EJ205	656023	Inner Joint		25	29	40.1	38	72.5	
	2002.12-2005.09	-	-	-	All-wheel Drive Saloon Engine EJ205	656015	Inner Joint		25	29	40	38.5	72	
	2002.12-2005.09	-	-	F	All-wheel Drive Saloon Engine EJ205	856009	Outer Joint	44T	27	30	56	86.5	63	M
	2002.12-2005.09	-	-	F	All-wheel Drive Saloon Engine EJ205	856057	Outer Joint	44T	27	32	56	86.5	68.5	I
	2002.12-2005.09	-	-	F	All-wheel Drive Saloon Engine EJ205	856026	Outer Joint	44T	27	30	56	86.5	63	I
	2002.12-2005.09	-	-	F	All-wheel Drive Saloon Engine EJ205	856058	Outer Joint	44T	27	32	54.5	86	67	I
	2002.12-2005.09	-	-	F	All-wheel Drive Saloon Engine EJ205	856022	Outer Joint		27	30	52	77	54	I
2.0 WRX STi (195 kW)	2001.11-	-	-	-	All-wheel Drive Saloon Engine EJ207	656023	Inner Joint		25	29	40.1	38	72.5	
	2001.11-	-	-	-	All-wheel Drive Saloon Engine EJ207	656015	Inner Joint		25	29	40	38.5	72	
	2001.11-	-	-	-	All-wheel Drive Saloon Engine EJ207	656022	Inner Joint		25	29	35	77.5	110	
	2001.11-	-	-	F	All-wheel Drive Saloon Engine EJ207	856009	Outer Joint	44T	27	30	56	86.5	63	M
	2001.11-	-	-	F	All-wheel Drive Saloon Engine EJ207	856057	Outer Joint	44T	27	32	56	86.5	68.5	I





	 YEAR	TRANSM	L/R	F/R	REMARKS	GSP Ref.	 PRODUCT	 ABS	Technical Specifications					
									A	B	C	H	L	P
SUBARU														
IMPREZA (GD)														
2.0 WRX STi (195 kW)	2001.11-	-	-	-	F All-wheel Drive Saloon Engine EJ207	856067	Outer Joint	44T	27	30	56	86.5	56	M
	2001.11-	-	-	-	F All-wheel Drive Saloon Engine EJ207	856058	Outer Joint	44T	27	32	54.5	86	67	I
	2001.11-	-	-	-	F All-wheel Drive Saloon Engine EJ207	856022	Outer Joint		27	30	52	77	54	I
2.0 WRX Turbo AWD (160 kW)	2000.12-	-	-	-	All-wheel Drive Saloon Engine EJ205	656023	Inner Joint		25	29	40.1	38	72.5	
	2000.12-	-	-	-	All-wheel Drive Saloon Engine EJ205	656015	Inner Joint		25	29	40	38.5	72	
	2000.12-	-	-	-	All-wheel Drive Saloon Engine EJ205	656022	Inner Joint		25	29	35	77.5	110	
	2000.12-	-	-	-	F All-wheel Drive Saloon Engine EJ205	856009	Outer Joint	44T	27	30	56	86.5	63	M
	2000.12-	-	-	-	F All-wheel Drive Saloon Engine EJ205	856057	Outer Joint	44T	27	32	56	86.5	68.5	I
	2000.12-	-	-	-	F All-wheel Drive Saloon Engine EJ205	856026	Outer Joint	44T	27	30	56	86.5	63	I
	2000.12-	-	-	-	F All-wheel Drive Saloon Engine EJ205	856067	Outer Joint	44T	27	30	56	86.5	56	M
	2000.12-	-	-	-	F All-wheel Drive Saloon Engine EJ205	856058	Outer Joint	44T	27	32	54.5	86	67	I
	2000.12-	-	-	-	F All-wheel Drive Saloon Engine EJ205	856022	Outer Joint		27	30	52	77	54	I
2.0 WRX Turbo AWD (165 kW)	2002.12-	-	-	-	All-wheel Drive Saloon Engine EJ205	656023	Inner Joint		25	29	40.1	38	72.5	
	2002.12-	-	-	-	All-wheel Drive Saloon Engine EJ205	656015	Inner Joint		25	29	40	38.5	72	
	2002.12-	-	-	-	All-wheel Drive Saloon Engine EJ205	656022	Inner Joint		25	29	35	77.5	110	
	2002.12-	-	-	-	F All-wheel Drive Saloon Engine EJ205	856009	Outer Joint	44T	27	30	56	86.5	63	M
	2002.12-	-	-	-	F All-wheel Drive Saloon Engine EJ205	856057	Outer Joint	44T	27	32	56	86.5	68.5	I
	2002.12-	-	-	-	F All-wheel Drive Saloon Engine EJ205	856026	Outer Joint	44T	27	30	56	86.5	63	I
	2002.12-	-	-	-	F All-wheel Drive Saloon Engine EJ205	856067	Outer Joint	44T	27	30	56	86.5	56	M
	2002.12-	-	-	-	F All-wheel Drive Saloon Engine EJ205	856058	Outer Joint	44T	27	32	54.5	86	67	I
	2002.12-	-	-	-	F All-wheel Drive Saloon Engine EJ205	856022	Outer Joint		27	30	52	77	54	I
2.5 (206 kW)	2005.09-	-	-	-	All-wheel Drive Saloon Engine EJ257	656022	Inner Joint		25	29	35	77.5	110	
	2005.09-	-	-	-	F All-wheel Drive Saloon Engine EJ257	856048	Outer Joint	44T	27	32	56	86.5	71.5	I
	2005.09-	-	-	-	F All-wheel Drive Saloon Engine EJ257	856067	Outer Joint	44T	27	30	56	86.5	56	M
	2005.09-	-	-	-	F All-wheel Drive Saloon Engine EJ257	856058	Outer Joint	44T	27	32	54.5	86	67	I
	2005.09-	-	-	-	F All-wheel Drive Saloon Engine EJ257	856022	Outer Joint		27	30	52	77	54	I
2.5 AWD (130 kW)	2001.03-	2005.09	-	-	All-wheel Drive Saloon Engine EJ251	656015	Inner Joint		25	29	40	38.5	72	
2.5 AWD (221 kW)	2003.09-	2007.12	-	-	All-wheel Drive Saloon Engine EJ257	656022	Inner Joint		25	29	35	77.5	110	
	2003.09-	2007.12	-	-	F All-wheel Drive Saloon Engine EJ257	856048	Outer Joint	44T	27	32	56	86.5	71.5	I
	2003.09-	2007.12	-	-	F All-wheel Drive Saloon Engine EJ257	856067	Outer Joint	44T	27	30	56	86.5	56	M
	2003.09-	2007.12	-	-	F All-wheel Drive Saloon Engine EJ257	856058	Outer Joint	44T	27	32	54.5	86	67	I
	2003.09-	2007.12	-	-	F All-wheel Drive Saloon Engine EJ257	856022	Outer Joint		27	30	52	77	54	I
2.5 iWRX AWD (169 kW)	2005.09-	-	-	-	All-wheel Drive Saloon Engine EJ255	656022	Inner Joint		25	29	35	77.5	110	
	2005.09-	-	-	-	F All-wheel Drive Saloon Engine EJ255	856048	Outer Joint	44T	27	32	56	86.5	71.5	I
	2005.09-	-	-	-	F All-wheel Drive Saloon Engine EJ255	856067	Outer Joint	44T	27	30	56	86.5	56	M
	2005.09-	-	-	-	F All-wheel Drive Saloon Engine EJ255	856058	Outer Joint	44T	27	32	54.5	86	67	I
	2005.09-	-	-	-	F All-wheel Drive Saloon Engine EJ255	856022	Outer Joint		27	30	52	77	54	I
IMPREZA (GF)														
1.6 (66 kW)	1993.01-	1998.08	-	-	Estate Engine EJ16E	656015	Inner Joint		25	29	40	38.5	72	
1.6 i (70 kW)	1998.06-	2000.12	-	-	Estate Engine EJ161	656023	Inner Joint		25	29	40.1	38	72.5	
	1998.06-	2000.12	-	-	Estate Engine EJ161	656015	Inner Joint		25	29	40	38.5	72	
	1998.06-	2000.12	-	-	Estate Engine EJ161	656004	Inner Joint		25	30	40	35.8	75.5	
	1998.06-	2000.12	-	L/R	F Estate Engine EJ161	656006	Inner Joint		25	22	40	38.5	72	
	1998.06-	2000.12	-	-	F Estate Engine EJ161	856040	Outer Joint		27	30	56	86.5	62.7	M
	1998.06-	2000.12	-	L/R	F Estate Engine EJ161	256006	Drive Shaft		27	25	56	87	684	
	1998.06-	2000.12	-	-	F Estate Engine EJ161	856009	Outer Joint	44T	27	30	56	86.5	63	M
	1998.06-	2000.12	MT	L/R	F Estate Engine EJ161	856005	Outer Joint		27	22	56	87	66	M
	1998.06-	2000.12	MT	L/R	F Estate Engine EJ161	256007	Drive Shaft		27	23	56	87	686.5	
1.6 i AWD (66 kW)	1992.08-	2000.12	-	-	All-wheel Drive Estate Engine EJ16	656015	Inner Joint		25	29	40	38.5	72	
	1992.08-	2000.12	-	-	All-wheel Drive Estate Engine EJ16	656023	Inner Joint		25	29	40.1	38	72.5	
	1992.08-	2000.12	-	L/R	F All-wheel Drive Estate Engine EJ16	656006	Inner Joint		25	22	40	38.5	72	
	1992.08-	2000.12	-	-	All-wheel Drive Estate Engine EJ16	656004	Inner Joint		25	30	40	35.8	75.5	
	1992.08-	2000.12	-	-	F All-wheel Drive Estate Engine EJ16	856040	Outer Joint		27	30	56	86.5	62.7	M
	1992.08-	2000.12	-	L/R	F All-wheel Drive Estate Engine EJ16	256006	Drive Shaft		27	25	56	87	684	
	1992.08-	2000.12	-	-	F All-wheel Drive Estate Engine EJ16	856009	Outer Joint	44T	27	30	56	86.5	63	M
	1992.08-	2000.12	-	L/R	F All-wheel Drive Estate Engine EJ16	856008	Outer Joint		27	30	56	87	66	I
	1992.08-	2000.12	AT/MT	L/R	F All-wheel Drive Estate Engine EJ16	856004	Outer Joint		27	30	56	87	68	M
	1992.08-	2000.12	AT/MT	L/R	F All-wheel Drive Estate Engine EJ16	856005	Outer Joint		27	22	56	87	66	M
	1992.08-	2000.12	MT	L/R	F All-wheel Drive Estate Engine EJ16	256007	Drive Shaft		27	23	56	87	686.5	





	 YEAR	TRANSM	L/R	F/R	REMARKS	GSP Ref.	 PRODUCT	 ABS	Technical Specifications					
									A	B	C	H	L	P
SUBARU IMPREZA (GF)														
1.6 i AWD (70 kW)	1998.06-2000.12	-	-	-	All-wheel Drive Estate Engine EJ161	656023	Inner Joint		25	29	40.1	38	72.5	
	1998.06-2000.12	-	-	-	All-wheel Drive Estate Engine EJ161	656015	Inner Joint		25	29	40	38.5	72	
	1998.06-2000.12	-	-	-	All-wheel Drive Estate Engine EJ161	656004	Inner Joint		25	30	40	35.8	75.5	
	1998.06-2000.12	-	L/R	F	All-wheel Drive Estate Engine EJ161	656006	Inner Joint		25	22	40	38.5	72	
	1998.06-2000.12	-	-	F	All-wheel Drive Estate Engine EJ161	856040	Outer Joint		27	30	56	86.5	62.7	M
	1998.06-2000.12	-	L/R	F	All-wheel Drive Estate Engine EJ161	256006	Drive Shaft		27	25	56	87	684	
	1998.06-2000.12	-	-	F	All-wheel Drive Estate Engine EJ161	856009	Outer Joint	44T	27	30	56	86.5	63	M
	1998.06-2000.12	AT/MT	L/R	F	All-wheel Drive Estate Engine EJ161	856039	Outer Joint		27	30	56	87.1	58	M
1.8 i AWD (76 kW)	1998.06-2000.12	MT	L/R	F	All-wheel Drive Estate Engine EJ161	256007	Drive Shaft		27	23	56	87	686.5	
	1992.08-2000.12	-	-	-	All-wheel Drive Estate Engine EJ18	656015	Inner Joint		25	29	40	38.5	72	
	1992.08-2000.12	-	-	-	All-wheel Drive Estate Engine EJ18	656023	Inner Joint		25	29	40.1	38	72.5	
	1992.08-2000.12	-	L/R	F	All-wheel Drive Estate Engine EJ18	656006	Inner Joint		25	22	40	38.5	72	
	1992.08-2000.12	-	-	-	All-wheel Drive Estate Engine EJ18	656004	Inner Joint		25	30	40	35.8	75.5	
	1992.08-2000.12	-	-	F	All-wheel Drive Estate Engine EJ18	856040	Outer Joint		27	30	56	86.5	62.7	M
	1992.08-2000.12	-	L/R	F	All-wheel Drive Estate Engine EJ18	256006	Drive Shaft		27	25	56	87	684	
	1992.08-2000.12	-	-	F	All-wheel Drive Estate Engine EJ18	856009	Outer Joint	44T	27	30	56	86.5	63	M
	1992.08-2000.12	-	L/R	F	All-wheel Drive Estate Engine EJ18	856008	Outer Joint		27	30	56	87	66	I
	1992.08-2000.12	AT/MT	L/R	F	All-wheel Drive Estate Engine EJ18	856004	Outer Joint		27	30	56	87	68	M
2.0 i 16V AWD (92 kW)	1992.08-2000.12	AT/MT	L/R	F	All-wheel Drive Estate Engine EJ18	856005	Outer Joint		27	22	56	87	66	M
	1992.08-2000.12	-	-	-	All-wheel Drive Estate Engine EJ20E	656023	Inner Joint		25	29	40.1	38	72.5	
	1998.06-2000.12	-	-	-	All-wheel Drive Estate Engine EJ20E	656015	Inner Joint		25	29	40	38.5	72	
	1998.06-2000.12	-	-	-	All-wheel Drive Estate Engine EJ20E	656004	Inner Joint		25	30	40	35.8	75.5	
	1998.06-2000.12	-	L/R	F	All-wheel Drive Estate Engine EJ20E	656006	Inner Joint		25	22	40	38.5	72	
	1998.06-2000.12	-	-	F	All-wheel Drive Estate Engine EJ20E	856040	Outer Joint		27	30	56	86.5	62.7	M
	1998.06-2000.12	-	L/R	F	All-wheel Drive Estate Engine EJ20E	256006	Drive Shaft		27	25	56	87	684	
	1998.06-2000.12	-	-	F	All-wheel Drive Estate Engine EJ20E	856009	Outer Joint	44T	27	30	56	86.5	63	M
2.0 i AWD (85 kW)	1998.06-2000.12	MT	L/R	F	All-wheel Drive Estate Engine EJ20E	856005	Outer Joint		27	22	56	87	66	M
	1995.12-2000.12	-	-	-	All-wheel Drive Estate Engine EJ20E	656023	Inner Joint		25	29	40.1	38	72.5	
	1995.12-2000.12	-	-	-	All-wheel Drive Estate Engine EJ20E	656015	Inner Joint		25	29	40	38.5	72	
	1995.12-2000.12	-	L/R	F	All-wheel Drive Estate Engine EJ20E	656006	Inner Joint		25	22	40	38.5	72	
	1995.12-2000.12	-	-	-	All-wheel Drive Estate Engine EJ20E	656004	Inner Joint		25	30	40	35.8	75.5	
	1995.12-2000.12	-	-	F	All-wheel Drive Estate Engine EJ20E	856040	Outer Joint		27	30	56	86.5	62.7	M
	1995.12-2000.12	-	L/R	F	All-wheel Drive Estate Engine EJ20E	256006	Drive Shaft		27	25	56	87	684	
	1995.12-2000.12	-	-	F	All-wheel Drive Estate Engine EJ20E	856009	Outer Joint	44T	27	30	56	86.5	63	M
2.0 i Turbo AWD (155 kW)	1995.12-2000.12	AT/MT	L/R	F	All-wheel Drive Estate Engine EJ20E	856004	Outer Joint		27	30	56	87	68	M
	1994.03-2000.12	-	-	-	All-wheel Drive Estate Engine EJ20 (Turbo)	656015	Inner Joint		25	29	40	38.5	72	
	1994.03-2000.12	-	-	-	All-wheel Drive Estate Engine EJ20 (Turbo)	656023	Inner Joint		25	29	40.1	38	72.5	
	1994.03-2000.12	-	L/R	F	All-wheel Drive Estate Engine EJ20 (Turbo)	656006	Inner Joint		25	22	40	38.5	72	
	1994.03-2000.12	-	-	-	All-wheel Drive Estate Engine EJ20 (Turbo)	656004	Inner Joint		25	30	40	35.8	75.5	
	1994.03-2000.12	-	-	F	All-wheel Drive Estate Engine EJ20 (Turbo)	856040	Outer Joint		27	30	56	86.5	62.7	M
	1994.03-2000.12	-	L/R	F	All-wheel Drive Estate Engine EJ20 (Turbo)	256006	Drive Shaft		27	25	56	87	684	
	1994.03-2000.12	-	-	F	All-wheel Drive Estate Engine EJ20 (Turbo)	856009	Outer Joint	44T	27	30	56	86.5	63	M
	1994.03-2000.12	-	L/R	F	All-wheel Drive Estate Engine EJ20 (Turbo)	856008	Outer Joint		27	30	56	87	66	I
	1994.03-2000.12	AT/MT	L/R	F	All-wheel Drive Estate Engine EJ20 (Turbo)	856004	Outer Joint		27	30	56	87	68	M
2.0 Turbo GT AWD (160 kW)	1994.03-2000.12	AT	L/R	F	All-wheel Drive Estate Engine EJ20 (Turbo)	856005	Outer Joint		27	22	56	87	66	M
	1998.06-2000.12	-	-	-	All-wheel Drive Estate Engine EJ205	656023	Inner Joint		25	29	40.1	38	72.5	
	1998.06-2000.12	-	-	-	All-wheel Drive Estate Engine EJ205	656015	Inner Joint		25	29	40	38.5	72	
	1998.06-2000.12	-	-	-	All-wheel Drive Estate Engine EJ205	656004	Inner Joint		25	30	40	35.8	75.5	
	1998.06-2000.12	-	L/R	F	All-wheel Drive Estate Engine EJ205	656006	Inner Joint		25	22	40	38.5	72	
	1998.06-2000.12	-	-	F	All-wheel Drive Estate Engine EJ205	856040	Outer Joint		27	30	56	86.5	62.7	M
	1998.06-2000.12	-	L/R	F	All-wheel Drive Estate Engine EJ205	256006	Drive Shaft		27	25	56	87	684	
	1998.06-2000.12	-	-	F	All-wheel Drive Estate Engine EJ205	856009	Outer Joint	44T	27	30	56	86.5	63	M
2.2 GX AWD (96 kW)	1998.06-2000.12	AT/MT	L/R	F	All-wheel Drive Estate Engine EJ205	856039	Outer Joint		27	30	56	87.1	58	M
	1998.09-2000.09	-	-	-	All-wheel Drive Estate Engine EJ22E	656015	Inner Joint		25	29	40	38.5	72	
2.2 GX AWD (97 kW)	1995.11-1998.08	-	-	-	All-wheel Drive Estate Engine EJ22	656015	Inner Joint		25	29	40	38.5	72	
IMPREZA (GFC)														
1.6 (66 kW)	1996.12-2000.12	-	-	-	Coupe Engine EJ16E/EJ16J	656015	Inner Joint		25	29	40	38.5	72	
	1996.12-2000.12	-	-	-	Coupe Engine EJ16E/EJ16J	656023	Inner Joint		25	29	40.1	38	72.5	
	1996.12-2000.12	-	L/R	F	Coupe Engine EJ16E/EJ16J	656006	Inner Joint		25	22	40	38.5	72	
	1996.12-2000.12	-	-	-	Coupe Engine EJ16E/EJ16J	656004	Inner Joint		25	30	40	35.8	75.5	
	1996.12-2000.12	-	L/R	F	Coupe Engine EJ16E/EJ16J	256006	Drive Shaft		27	25	56	87	684	
	1996.12-2000.12	-	-	F	Coupe Engine EJ16E/EJ16J	856040	Outer Joint		27	30	56	86.5	62.7	M
	1996.12-2000.12	-	-	F	Coupe Engine EJ16E/EJ16J	856009	Outer Joint	44T	27	30	56	86.5	63	M
	1996.12-2000.12	MT	L/R	F	Coupe Engine EJ16E/EJ16J	856005	Outer Joint		27	22	56	87	66	M
1.6 AWD (66 kW)	1996.12-2000.12	MT	L/R	F	Coupe Engine EJ16E/EJ16J	256007	Drive Shaft		27	23	56	87	686.5	
	1996.12-2000.12	-	-	-	All-wheel Drive Coupe Engine EJ161	656015	Inner Joint		25	29	40	38.5	72	





	 YEAR	TRANSM	L/R	F/R	REMARKS	GSP Ref.	 PRODUCT	 ABS	Technical Specifications					
									A	B	C	H	L	P
SUBARU														
IMPREZA (GFC)														
1.6 AWD (66 kW)	1996.12-2000.12	-	-	-	All-wheel Drive Coupe Engine EJ161	656023	Inner Joint		25	29	40.1	38	72.5	
	1996.12-2000.12	-	L/R	F	All-wheel Drive Coupe Engine EJ161	656006	Inner Joint		25	22	40	38.5	72	
	1996.12-2000.12	-	-	-	All-wheel Drive Coupe Engine EJ161	656004	Inner Joint		25	30	40	35.8	75.5	
	1996.12-2000.12	-	L/R	F	All-wheel Drive Coupe Engine EJ161	256006	Drive Shaft		27	25	56	87	684	
	1996.12-2000.12	-	-	F	All-wheel Drive Coupe Engine EJ161	856040	Outer Joint		27	30	56	86.5	62.7	M
	1996.12-2000.12	-	-	F	All-wheel Drive Coupe Engine EJ161	856009	Outer Joint	44T	27	30	56	86.5	63	M
2.0 AWD (206 kW)	1998.09-2000.09	-	-	-	All-wheel Drive Coupe Engine EJ205P	656015	Inner Joint		25	29	40	38.5	72	
2.0 AWD (85 kW)	1995.12-2000.12	-	-	-	All-wheel Drive Coupe Engine EJ201	656015	Inner Joint		25	29	40	38.5	72	
	1995.12-2000.12	-	-	-	All-wheel Drive Coupe Engine EJ201	656023	Inner Joint		25	29	40.1	38	72.5	
	1995.12-2000.12	-	L/R	F	All-wheel Drive Coupe Engine EJ201	656006	Inner Joint		25	22	40	38.5	72	
	1995.12-2000.12	-	-	-	All-wheel Drive Coupe Engine EJ201	656004	Inner Joint		25	30	40	35.8	75.5	
	1995.12-2000.12	-	-	F	All-wheel Drive Coupe Engine EJ201	856040	Outer Joint		27	30	56	86.5	62.7	M
	1995.12-2000.12	-	L/R	F	All-wheel Drive Coupe Engine EJ201	256006	Drive Shaft		27	25	56	87	684	
	1995.12-2000.12	-	-	F	All-wheel Drive Coupe Engine EJ201	856009	Outer Joint	44T	27	30	56	86.5	63	M
2.0 AWD (92 kW)	1995.12-2000.12	AT/MT	L/R	F	All-wheel Drive Coupe Engine EJ201	856004	Outer Joint		27	30	56	87	68	M
	1999.03-2000.12	-	-	-	All-wheel Drive Coupe Engine EJ201	656023	Inner Joint		25	29	40.1	38	72.5	
	1999.03-2000.12	-	-	-	All-wheel Drive Coupe Engine EJ201	656004	Inner Joint		25	30	40	35.8	75.5	
	1999.03-2000.12	-	-	F	All-wheel Drive Coupe Engine EJ201	856040	Outer Joint		27	30	56	86.5	62.7	M
	1999.03-2000.12	-	-	F	All-wheel Drive Coupe Engine EJ201	856009	Outer Joint	44T	27	30	56	86.5	63	M
	1999.03-2000.12	-	-	-	All-wheel Drive Coupe Engine EJ201	656015	Inner Joint		25	29	40	38.5	72	
	1999.03-2000.12	-	-	-	Coupe Engine EJ20E	656015	Inner Joint		25	29	40	38.5	72	
2.0 i (85 kW)	1995.11-2000.09	-	-	-	All-wheel Drive Coupe Engine EJ20G	656015	Inner Joint		25	29	40	38.5	72	
	1996.12-2000.12	-	-	-	All-wheel Drive Coupe Engine EJ20G	656023	Inner Joint		25	29	40.1	38	72.5	
	1996.12-2000.12	-	L/R	F	All-wheel Drive Coupe Engine EJ20G	656006	Inner Joint		25	22	40	38.5	72	
	1996.12-2000.12	-	-	-	All-wheel Drive Coupe Engine EJ20G	656004	Inner Joint		25	30	40	35.8	75.5	
	1996.12-2000.12	-	L/R	F	All-wheel Drive Coupe Engine EJ20G	256006	Drive Shaft		27	25	56	87	684	
	1996.12-2000.12	-	-	F	All-wheel Drive Coupe Engine EJ20G	856040	Outer Joint		27	30	56	86.5	62.7	M
	1996.12-2000.12	-	-	F	All-wheel Drive Coupe Engine EJ20G	856009	Outer Joint	44T	27	30	56	86.5	63	M
	1996.12-2000.12	AT/MT	L/R	F	All-wheel Drive Coupe Engine EJ20G	856039	Outer Joint		27	30	56	87.1	58	M
2.2 AWD (96 kW)	1998.09-2000.09	-	-	-	All-wheel Drive Coupe Engine EJ22E	656015	Inner Joint		25	29	40	38.5	72	
2.2(97 kW)	1995.11-1998.08	-	-	-	All-wheel Drive Coupe Engine EJ22E	656015	Inner Joint		25	29	40	38.5	72	
IMPREZA (GG)														
1.6 AWD (70 kW)	2000.12-2000.12	-	-	-	All-wheel Drive Estate Engine EJ161	656023	Inner Joint		25	29	40.1	38	72.5	
	2000.12-2000.12	-	-	-	All-wheel Drive Estate Engine EJ161	656015	Inner Joint		25	29	40	38.5	72	
	2000.12-2000.12	-	-	F	All-wheel Drive Estate Engine EJ161	856009	Outer Joint	44T	27	30	56	86.5	63	M
	2000.12-2000.12	-	-	F	All-wheel Drive Estate Engine EJ161	856026	Outer Joint	44T	27	30	56	86.5	63	I
	2000.12-2000.12	-	-	F	All-wheel Drive Estate Engine EJ161	856067	Outer Joint	44T	27	30	56	86.5	56	M
2.0 AWD (92 kW)	2000.12-2000.12	-	-	-	All-wheel Drive Estate Engine EJ201	656023	Inner Joint		25	29	40.1	38	72.5	
	2000.12-2000.12	-	-	-	All-wheel Drive Estate Engine EJ201	656015	Inner Joint		25	29	40	38.5	72	
	2000.12-2000.12	-	-	F	All-wheel Drive Estate Engine EJ201	856009	Outer Joint	44T	27	30	56	86.5	63	M
	2000.12-2000.12	-	-	F	All-wheel Drive Estate Engine EJ201	856057	Outer Joint	44T	27	32	56	86.5	68.5	I
	2000.12-2000.12	-	-	F	All-wheel Drive Estate Engine EJ201	856026	Outer Joint	44T	27	30	56	86.5	63	I
	2000.12-2000.12	-	-	F	All-wheel Drive Estate Engine EJ201	856067	Outer Joint	44T	27	30	56	86.5	56	M
	2000.12-2000.12	-	-	F	All-wheel Drive Estate Engine EJ201	856022	Outer Joint		27	30	52	77	54	I
2.0 i R AWD (118 kW)	2005.09-2007.06	-	-	F	All-wheel Drive Estate Engine EJ204	856026	Outer Joint	44T	27	30	56	86.5	63	I
	2005.09-2007.06	-	-	F	All-wheel Drive Estate Engine EJ204	856067	Outer Joint	44T	27	30	56	86.5	56	M
	2005.09-2007.06	-	-	F	All-wheel Drive Estate Engine EJ204	856022	Outer Joint		27	30	52	77	54	I
2.0 Turbo AWD (160 kW)	2000.12-2000.12	-	-	-	All-wheel Drive Estate Engine EJ205	656023	Inner Joint		25	29	40.1	38	72.5	
	2000.12-2000.12	-	-	-	All-wheel Drive Estate Engine EJ205	656015	Inner Joint		25	29	40	38.5	72	
	2000.12-2000.12	-	-	F	All-wheel Drive Estate Engine EJ205	856009	Outer Joint	44T	27	30	56	86.5	63	M
	2000.12-2000.12	-	-	F	All-wheel Drive Estate Engine EJ205	856057	Outer Joint	44T	27	32	56	86.5	68.5	I
	2000.12-2000.12	-	-	F	All-wheel Drive Estate Engine EJ205	856026	Outer Joint	44T	27	30	56	86.5	63	I
	2000.12-2000.12	-	-	F	All-wheel Drive Estate Engine EJ205	856067	Outer Joint	44T	27	30	56	86.5	56	M
	2000.12-2000.12	-	-	F	All-wheel Drive Estate Engine EJ205	856022	Outer Joint		27	30	52	77	54	I
2.0 WRX Turbo AWD (165 kW)	2002.12-2002.12	-	-	-	All-wheel Drive Estate Engine EJ205	656023	Inner Joint		25	29	40.1	38	72.5	
	2002.12-2002.12	-	-	-	All-wheel Drive Estate Engine EJ205	656015	Inner Joint		25	29	40	38.5	72	
	2002.12-2002.12	-	-	F	All-wheel Drive Estate Engine EJ205	856009	Outer Joint	44T	27	30	56	86.5	63	M
	2002.12-2002.12	-	-	F	All-wheel Drive Estate Engine EJ205	856067	Outer Joint	44T	27	30	56	86.5	56	M
	2002.12-2002.12	-	-	F	All-wheel Drive Estate Engine EJ205	856026	Outer Joint	44T	27	30	56	86.5	63	I

	 YEAR	TRANSM	L/R	F/R	REMARKS	GSP Ref.	 PRODUCT	 ABS	Technical Specifications						
									A	B	C	H	L	P	
SUBARU															
IMPREZA (GG)															
2.0 WRX Turbo AWD (165 kW)	2002.12-	-	-	-	F All-wheel Drive Estate Engine EJ205	856022	Outer Joint		27	30	52	77	54	I	
2.5 AWD (221 kW)	2005.10-	-	-	-	F All-wheel Drive Estate Engine EJ257	856048	Outer Joint	44T	27	32	56	86.5	71.5	I	
	2005.10-	-	-	-	F All-wheel Drive Estate Engine EJ257	856067	Outer Joint	44T	27	30	56	86.5	56	M	
	2005.10-	-	-	-	F All-wheel Drive Estate Engine EJ257	856022	Outer Joint		27	30	52	77	54	I	
2.5 WRX AWD (169 kW)	2005.09-	-	-	-	F All-wheel Drive Estate Engine EJ255	856048	Outer Joint	44T	27	32	56	86.5	71.5	I	
	2005.09-	-	-	-	F All-wheel Drive Estate Engine EJ255	856067	Outer Joint	44T	27	30	56	86.5	56	M	
	2005.09-	-	-	-	F All-wheel Drive Estate Engine EJ255	856022	Outer Joint		27	30	52	77	54	I	
IMPREZA (GR GH G3)/B3															
2.0 D AWD (110 kW)	2009.01-	-	-	-	F All-wheel Drive Hatchback Engine EE20Z	856022	Outer Joint		27	30	52	77	54	I	
	2009.01-	-	AT/MT	L/R	F All-wheel Drive Hatchback Engine EE20Z	856042	Outer Joint		27	30	52	76	54	M	
2.0 R AWD (110 kW)	2008.01-	-	AT/MT	L/R	F All-wheel Drive Hatchback Engine EJ204	856042	Outer Joint		27	30	52	76	54	M	
	2008.01-	-	-	-	F All-wheel Drive Hatchback Engine EJ204	856022	Outer Joint		27	30	52	77	54	I	
2.5 AWD (169 kW)	2008.01-	-	AT/MT	L/R	F All-wheel Drive Hatchback Engine EJ255	856042	Outer Joint		27	30	52	76	54	M	
	2008.01-	-	-	-	All-wheel Drive Hatchback Engine EJ255	656013	Inner Joint		25	29	35	77.5	110		
	2008.01-	-	-	-	All-wheel Drive Hatchback Engine EJ255	699215	Inner Joint		25	29	35	77.5	110		
	2008.01-	-	-	-	F All-wheel Drive Hatchback Engine EJ255	856022	Outer Joint		27	30	52	77	54	I	
2.5 AWD (227 kW)	2008.01-	-	-	-	All-wheel Drive Hatchback Engine EJ257	699215	Inner Joint		25	29	35	77.5	110		
2.5 STI CS400 AWD (294 kW)	2010.04-	-	-	-	All-wheel Drive Hatchback Engine EJ257	656013	Inner Joint		25	29	35	77.5	110		
	2010.04-	-	-	-	All-wheel Drive Hatchback Engine EJ257	699215	Inner Joint		25	29	35	77.5	110		
2.5 WRX S AWD (188 kW)	2009.02-2010.12	-	-	-	All-wheel Drive Hatchback Engine EJ255	656013	Inner Joint		25	29	35	77.5	110		
	2009.02-2010.12	-	-	-	All-wheel Drive Hatchback Engine EJ255	699215	Inner Joint		25	29	35	77.5	110		
2.5 WRX SE AWD (195 kW)	2008.09-	-	-	-	All-wheel Drive Hatchback Engine EJ255	699215	Inner Joint		25	29	35	77.5	110		
2.5 WRX STI 330S AWD (243 kW)	2009.05-2010.12	-	-	-	All-wheel Drive Hatchback Engine EJ257	656013	Inner Joint		25	29	35	77.5	110		
	2009.05-2010.12	-	-	-	All-wheel Drive Hatchback Engine EJ257	699215	Inner Joint		25	29	35	77.5	110		
2.5 WRX STI AWD (221 kW)	2008.01-	-	-	-	All-wheel Drive Hatchback Engine EJ257	656013	Inner Joint		25	29	35	77.5	110		
	2008.01-	-	-	-	All-wheel Drive Hatchback Engine EJ257	699215	Inner Joint		25	29	35	77.5	110		
	2008.01-	-	-	-	F All-wheel Drive Hatchback Engine EJ257	856022	Outer Joint		27	30	52	77	54	I	
IMPREZA (GR)															
2.5 AWD (169 kW)	2010.01-	-	-	-	All-wheel Drive Saloon Engine EJ255	699215	Inner Joint		25	29	35	77.5	110		
2.5 AWD (199 kW)	2007.07-	-	-	-	All-wheel Drive Saloon Engine EJ257	656013	Inner Joint		25	29	35	77.5	110		
	2007.07-	-	-	-	All-wheel Drive Saloon Engine EJ257	656022	Inner Joint		25	29	35	77.5	110		
	2007.07-	-	-	-	All-wheel Drive Saloon Engine EJ257	699215	Inner Joint		25	29	35	77.5	110		
	2007.07-	-	-	-	F All-wheel Drive Saloon Engine EJ257	856022	Outer Joint		27	30	52	77	54	I	
2.5 WRX STI AWD (221 kW)	2011.01-	-	-	-	All-wheel Drive Saloon Engine EJ257	699215	Inner Joint		25	29	35	77.5	110		
IMPREZA GDBA															
2.0	2000.10-	2001.08	6MT	-	-	Allwheel Drive Engine EJ207 TBO	801050	Outer Joint		27	32	56	86.5	68.5	I
IMPREZA GDBA4WD															
2000	2000.10-	2001.08	6MT	-	-	Allwheel Drive Engine EJ207 TBO	801050	Outer Joint		27	32	56	86.5	68.5	I
IMPREZA GDBB															
2.0	2001.09-	2002.10	6MT	-	-	Allwheel Drive Engine EJ207 TBO	801050	Outer Joint		27	32	56	86.5	68.5	I
2000	2001.09-	2002.10	6MT	-	-	Allwheel Drive Engine EJ207 TBO	801050	Outer Joint		27	32	56	86.5	68.5	I
IMPREZA GDBC															
2.0	2002.11-	2003.08	6MT	-	-	Allwheel Drive Engine EJ207 TBO	801050	Outer Joint		27	32	56	86.5	68.5	I
2000	2002.11-	2003.08	6MT	-	-	Allwheel Drive Engine EJ207 TBO	801050	Outer Joint		27	32	56	86.5	68.5	I
IMPREZA GDBD															
2.0	2003.09-	2004.05	6MT	-	-	Allwheel Drive Engine EJ207 TBO	801050	Outer Joint		27	32	56	86.5	68.5	I
2000	2003.09-	2004.05	6MT	-	-	Allwheel Drive Engine EJ207 TBO	801050	Outer Joint		27	32	56	86.5	68.5	I
IMPREZA(G10)															
1.6	1994.04-	2000.09	AT/MT	L/R	F	ENGINE:EJ161,TRAIN:2WD,BODY:SEDAN/WAGON	656005	Inner Joint		25	29	40.1	37.5	68	
2.0	1994.04-	2000.09	AT/MT	L/R	F	ENGINE:EJ201,TRAIN:F4WD,BODY:WAGON	656005	Inner Joint		25	29	40.1	37.5	68	
	1994.04-	2000.09	AT/MT	L/R	F	ENGINE:EJ201,TRAIN:F4WD,BODY:SEDAN/WAGON	656005	Inner Joint		25	29	40.1	37.5	68	
	1994.04-	2000.09	AT/MT	L/R	F	ENGINE:EJ205,TRAIN:F4WD,BODY:SEDAN/WAGON	656005	Inner Joint		25	29	40.1	37.5	68	
2.0L	1994.04-	2000.09	MT	L/R	F	ENGINE:EJ207,TRAIN:F4WD,BODY:SEDAN/2 DOOR COUPE	656005	Inner Joint		25	29	40.1	37.5	68	
IMPREZA(G11)															
1.6	2000.04-	2001.07	AT/5MT	L/R	F	ENGINE:161,TRAIN:2W,BODY:SEDAN/WAGON	656005	Inner Joint		25	29	40.1	37.5	68	
	2000.04-	2001.07	5MT	L/R	F	ENGINE:161,TRAIN:4W,BODY:SEDAN/WAGON	656005	Inner Joint		25	29	40.1	37.5	68	
	2001.04-	2002.10	AT	L	F	ENGINE:161,TRAIN:2W	656005	Inner Joint		25	29	40.1	37.5	68	
	2001.04-	2002.10	AT	L/R	F	ENGINE:161,TRAIN:4W,BODY:SEDAN/WAGON	656005	Inner Joint		25	29	40.1	37.5	68	
	2002.07-	2003.08	AT/5MT	L	F	ENGINE:161,TRAIN:2W,BODY:SEDAN	656005	Inner Joint		25	29	40.1	37.5	68	
	2002.07-	2003.08	AT/5MT	L/R	F	ENGINE:161,TRAIN:4W,BODY:SEDAN/WAGON	656005	Inner Joint		25	29	40.1	37.5	68	
2.0	2000.04-	2001.07	AT/5MT	L/R	F	ENGINE:201,TRAIN:4W,BODY:SEDAN/WAGON	656005	Inner Joint		25	29	40.1	37.5	68	
	2000.04-	2001.07	5MT	L/R	F	ENGINE:205,TRAIN:4W,BODY:SEDAN/WAGON	656005	Inner Joint		25	29	40.1	37.5	68	





				TRANSM	L/R	F/R	REMARKS	GSP Ref.			Technical Specifications					
YEAR											A	B	C	H	L	P
SUBARU																
IMPREZA(G11)																
2.0	2001.04-2002.10	2002.10	AT/5MT	L	F		ENGINE:201,TRAIN:4W,BODY:SEDAN/WAGON	656005	Inner Joint		25	29	40.1	37.5	68	
	2002.07-2003.08	2003.08	AT/5MT	L/R	F		ENGINE:201,TRAIN:4W,BODY:SEDAN/WAGON	656005	Inner Joint		25	29	40.1	37.5	68	
	2002.07-2003.08	2003.08	-	R	F		ENGINE:205,TRAIN:4W,BODY:SEDAN/WAGON	656005	Inner Joint		25	29	40.1	37.5	68	
	2002.07-2003.08	2003.08	5MT	L/R	F		ENGINE:205,TRAIN:4W,BODY:SEDAN/WAGON	656005	Inner Joint		25	29	40.1	37.5	68	
2.5	2002.07-2003.08	2003.08	AT/5MT	R	F		ENGINE:251,TRAIN:4W,BODY:WAGON	656005	Inner Joint		25	29	40.1	37.5	68	
IMPREZA/WRX/STI																
2.0	1998-	-	MT	-	-		GC8/GF8 EJ207	656005	Inner Joint		25	29	40.1	37.5	68	
JUSTY (KA7)																
1.2	1988.11-1994.02	1994.02	ECVT	-	-		Engine EF12	856060	Outer Joint		27	21	50	108	48.7	M
JUSTY (KA8)																
1.2	1988.11-1994.03	1994.03	MT/AT	-	-		Engine EF12	856060	Outer Joint		27	21	50	108	48.7	M
1.2 4WD	1988.11-1994.02	1994.02	ECVT	-	-		Engine EF12	856060	Outer Joint		27	21	50	108	48.7	M
JUSTY I (KAD)																
1.0 (37 kW)	1987.05-1995.10	1995.10	-	-	-		Hatchback Engine EF10	856014	Outer Joint		24	19	50	108	51	M
	1987.05-1994.11	1994.11	-	-	-		All-wheel Drive Hatchback Engine EF10	856014	Outer Joint		24	19	50	108	51	M
	1987.05-1995.10	1995.10	-	-	-		Hatchback Engine EF10	856031	Outer Joint		24	19	50	108	47	M
	1987.05-1994.11	1994.11	-	-	-		All-wheel Drive Hatchback Engine EF10	856031	Outer Joint		24	19	50	108	47	M
	1987.05-1995.10	1995.10	-	-	-		Hatchback Engine EF10	856033	Outer Joint		24	19	50	108	45	M
	1987.05-1995.10	1995.10	AT/MT	L/R	F		Hatchback Engine EF10	856016	Outer Joint		27	19	50	108.5	51	M
	1987.05-1994.11	1994.11	AT/MT	L/R	F		All-wheel Drive Hatchback Engine EF10	856016	Outer Joint		27	19	50	108.5	51	M
1.0 (40 kW)	1984.11-1990.12	1990.12	-	-	-		All-wheel Drive Hatchback Engine EF10	856014	Outer Joint		24	19	50	108	51	M
	1984.11-1990.12	1990.12	-	-	-		All-wheel Drive Hatchback Engine EF10	856031	Outer Joint		24	19	50	108	47	M
	1984.11-1989.06	1989.06	-	-	-		Hatchback Engine EF10	856014	Outer Joint		24	19	50	108	51	M
	1984.11-1989.06	1989.06	-	-	-		Hatchback Engine EF10	856031	Outer Joint		24	19	50	108	47	M
	1984.11-1989.06	1989.06	-	-	-		Hatchback Engine EF10	856033	Outer Joint		24	19	50	108	45	M
1.2 (49 kW)	1987.05-1995.10	1995.10	-	-	-		Hatchback Engine EF12	856014	Outer Joint		24	19	50	108	51	M
	1987.05-1991.05	1991.05	-	-	-		All-wheel Drive Hatchback Engine EF12	856014	Outer Joint		24	19	50	108	51	M
	1987.05-1991.05	1991.05	-	R	F		All-wheel Drive Hatchback Engine EF12	899255	Outer Joint		24	21	50	108	51	M
	1987.05-1995.10	1995.10	-	-	F		Hatchback Engine EF12	856006	Outer Joint		27	21	50	110	52.5	M
	1987.05-1991.05	1991.05	-	-	F		All-wheel Drive Hatchback Engine EF12	856006	Outer Joint		27	21	50	110	52.5	M
	1987.05-1991.05	1991.05	AT/MT	R	F		All-wheel Drive Hatchback Engine EF12	856030	Outer Joint		24	21	50	106.5	56	M
	1987.05-1995.10	1995.10	AT/MT	L/R	F		Hatchback Engine EF12	856016	Outer Joint		27	19	50	108.5	51	M
1.2 (50 kW)	1986.10-1990.12	1990.12	-	-	-		All-wheel Drive Hatchback Engine EF12	856014	Outer Joint		24	19	50	108	51	M
	1986.10-1990.12	1990.12	-	R	F		All-wheel Drive Hatchback Engine EF12	899255	Outer Joint		24	21	50	108	51	M
	1986.10-1990.12	1990.12	-	-	F		All-wheel Drive Hatchback Engine EF12	856006	Outer Joint		27	21	50	110	52.5	M
1.2 (55 kW)	1990.10-1994.12	1994.12	-	-	F		All-wheel Drive Hatchback Engine EF12	856006	Outer Joint		27	21	50	110	52.5	M
JUSTY II (JMA MS)																
1.3 GX (50 kW)	1995.10-2003.11	2003.11	-	-	F		All-wheel Drive Hatchback Engine EF13	856006	Outer Joint		27	21	50	110	52.5	M
JUSTY KA7																
1.2	1988.11-1994.02	1994.02	ECVT	-	-		Engine EF12	856060	Outer Joint		27	21	50	108	48.7	M
	1988.11-1994.02	1994.02	ECVT	-	-		Engine EF12	856060	Outer Joint		27	21	50	108	48.7	M
1200	1988.11-1994.02	1994.02	ECVT	-	-		Engine EF12	856060	Outer Joint		27	21	50	108	48.7	M
	1988.11-1994.02	1994.02	ECVT	-	-		Engine EF12	856060	Outer Joint		27	21	50	108	48.7	M
JUSTY KA8																
1.2	1988.11-1994.03	1994.03	MT/AT	-	-		Engine EF12	856060	Outer Joint		27	21	50	108	48.7	M
	1988.11-1994.02	1994.02	ECVT	-	-		Allwheel Drive Engine EF12	856060	Outer Joint		27	21	50	108	48.7	M
	1988.11-1994.02	1994.02	ECVT	-	-		Allwheel Drive Engine EF12	856060	Outer Joint		27	21	50	108	48.7	M
1200	1988.11-1994.03	1994.03	MT/AT	-	-		Engine EF12	856060	Outer Joint		27	21	50	108	48.7	M
	1988.11-1994.02	1994.02	ECVT	-	-		Allwheel Drive Engine EF12	856060	Outer Joint		27	21	50	108	48.7	M
	1988.11-1994.02	1994.02	ECVT	-	-		Allwheel Drive Engine EF12	856060	Outer Joint		27	21	50	108	48.7	M
LEGACY																
-	-	-	-	-	R		-	856029	Outer Joint		24	21	50	104	64.5	I
	2001-	-	-	-	-		-	856020	Outer Joint		27	30	56	86.5	63	I
1.6	-	-	-	-	-		-	656009	Inner Joint		23	30	40	35.8	75.5	
2.0	1989-	-	MT/AT	-	-		-	656003	Inner Joint		25	25	40.1	34	83	
2.2	1989-	-	-	-	-		-	656003	Inner Joint		25	25	40.1	34	83	
LEGACY I																
1.8	1989.10-	-	AT	L/R	-		4WD	256002	Drive Shaft		27	25	56	87	686.5	
	1989.10-	-	MT	L/R	-		4WD	256002	Drive Shaft		27	25	56	87	686.5	
2.0	1994.04-1999.10	1999.10	AT	L/R	-		4WD	256002	Drive Shaft		27	25	56	87	686.5	
2.0 T	1991.10-	-	MT	L/R	-		4WD	256002	Drive Shaft		27	25	56	87	686.5	
2.2	1989.10-	-	AT	L/R	-		4WD	256002	Drive Shaft		27	25	56	87	686.5	
	1989.10-	-	MT	L/R	-		4WD	256002	Drive Shaft		27	25	56	87	686.5	
	1994.04-1999.10	1999.10	AT	L/R	-		4WD	256002	Drive Shaft		27	25	56	87	686.5	
2.5	1994.04-1999.10	1999.10	AT	L/R	-		4WD	256002	Drive Shaft		27	25	56	87	686.5	
LEGACY I (BC BJF)																





	 YEAR	TRANSM	L/R	F/R	REMARKS	GSP Ref.	 PRODUCT	 ABS	Technical Specifications					
									A	B	C	H	L	P
SUBARU														
LEGACY I (BC BJF)														
1.8 (76 kW)	1989.01-1994.07	AT/MT	-	R	All-wheel Drive Estate Engine EJ18 SPI	856018	Outer Joint		24	22	50	104	64.5	I
	1989.01-1994.07	-	L/R	F	All-wheel Drive Estate Engine EJ18 SPI	856004	Outer Joint		27	30	56	87	68	M
	1989.01-1994.07	AT/MT	L/R	F	Estate Engine EJ18 SPI	856004	Outer Joint		27	30	56	87	68	M
	1989.01-1994.07	-	L/R	F	All-wheel Drive Estate Engine EJ18 SPI	856005	Outer Joint		27	22	56	87	66	M
	1989.01-1994.07	AT/MT	L/R	F	Estate Engine EJ18 SPI	856003	Outer Joint		27	25	56	87.5	72.5	M
2.0 (85 kW)	1991.09-1994.07	AT/MT	-	R	All-wheel Drive Estate Engine EJ20 EMPI	856018	Outer Joint		24	22	50	104	64.5	I
	1991.09-1994.07	-	L/R	F	All-wheel Drive Estate Engine EJ20 EMPI	856008	Outer Joint		27	30	56	87	66	I
	1991.09-1994.07	MT	L/R	F	All-wheel Drive Estate Engine EJ20 EMPI	856005	Outer Joint		27	22	56	87	66	M
2.0 Turbo Super (147 kW)	1992.05-1994.07	AT/MT	-	R	All-wheel Drive Estate Engine EJ20-GN	856018	Outer Joint		24	22	50	104	64.5	I
	1992.05-1994.07	MT	L/R	F	All-wheel Drive Estate Engine EJ20-GN	856004	Outer Joint		27	30	56	87	68	M
2.2 Super (100 kW)	1989.01-1994.07	MT	L/R	F	All-wheel Drive Estate Engine EJ22 EMPI	856004	Outer Joint		27	30	56	87	68	M
	1989.01-1994.07	AT	L/R	F	All-wheel Drive Estate Engine EJ22 EMPI	856005	Outer Joint		27	22	56	87	66	M
LEGACY I (BC)														
1.8 (76 kW)	1989.01-1993.12	AT/MT	L/R	F	Saloon Engine EJ18 SPI	856004	Outer Joint		27	30	56	87	68	M
	1989.01-1991.09	-	L/R	F	All-wheel Drive Saloon Engine EJ18 SPI	856004	Outer Joint		27	30	56	87	68	M
	1989.01-1991.09	-	L/R	F	All-wheel Drive Saloon Engine EJ18 SPI	856005	Outer Joint		27	22	56	87	66	M
	1989.01-1993.12	AT/MT	L/R	F	Saloon Engine EJ18 SPI	856003	Outer Joint		27	25	56	87.5	72.5	M
2.0 (85 kW)	1991.08-1994.07	MT	L/R	F	All-wheel Drive Saloon Engine EJ20 EMPI	856005	Outer Joint		27	22	56	87	66	M
2.0 Turbo (147 kW)	1992.05-1994.07	AT/MT	-	R	All-wheel Drive Saloon Engine EJ20-GN	856018	Outer Joint		24	22	50	104	64.5	I
	1992.05-1994.07	MT	L/R	F	All-wheel Drive Saloon Engine EJ20-GN	856004	Outer Joint		27	30	56	87	68	M
2.2 (100 kW)	1989.01-1994.07	AT/MT	-	R	All-wheel Drive Saloon Engine EJ22 EMPI	856018	Outer Joint		24	22	50	104	64.5	I
	1989.01-1994.07	MT	L/R	F	All-wheel Drive Saloon Engine EJ22 EMPI	856004	Outer Joint		27	30	56	87	68	M
	1989.01-1994.07	AT	L/R	F	All-wheel Drive Saloon Engine EJ22 EMPI	856005	Outer Joint		27	22	56	87	66	M
LEGACY II (BD)														
2.0 i (85 kW)	1994.09-1999.03	-	-	-	All-wheel Drive Saloon Engine EJ20E	656015	Inner Joint		25	29	40	38.5	72	
	1994.09-1999.03	-	-	-	All-wheel Drive Saloon Engine EJ20E	656023	Inner Joint		25	29	40.1	38	72.5	
	1994.09-1999.03	-	-	-	Saloon Engine EJ20E	656023	Inner Joint		25	29	40.1	38	72.5	
	1994.09-1999.03	-	L/R	F	Saloon Engine EJ20E	656006	Inner Joint		25	22	40	38.5	72	
	1994.09-1999.03	-	L/R	F	All-wheel Drive Saloon Engine EJ20E	656006	Inner Joint		25	22	40	38.5	72	
	1994.09-1999.03	-	-	F	Saloon Engine EJ20E	856040	Outer Joint		27	30	56	86.5	62.7	M
	1994.09-1999.03	-	-	F	All-wheel Drive Saloon Engine EJ20E	856040	Outer Joint		27	30	56	86.5	62.7	M
	1994.09-1999.03	-	L/R	F	Saloon Engine EJ20E	256006	Drive Shaft		27	25	56	87	684	
	1994.09-1999.03	-	L/R	F	All-wheel Drive Saloon Engine EJ20E	256006	Drive Shaft		27	25	56	87	684	
	1994.09-1999.03	-	L/R	F	All-wheel Drive Saloon Engine EJ20E	856008	Outer Joint		27	30	56	87	66	I
	1994.09-1999.03	AT/MT	L/R	F	Saloon Engine EJ20E	856039	Outer Joint		27	30	56	87.1	58	M
	1994.09-1999.03	AT/MT	L/R	F	All-wheel Drive Saloon Engine EJ20E	856039	Outer Joint		27	30	56	87.1	58	M
	1994.09-1999.03	AT/MT	L/R	F	Saloon Engine EJ20E	856005	Outer Joint		27	22	56	87	66	M
	1994.09-1999.03	AT/MT	L/R	F	All-wheel Drive Saloon Engine EJ20E	856005	Outer Joint		27	22	56	87	66	M
	1994.09-1999.03	AT/MT	L/R	F	Saloon Engine EJ20E	856003	Outer Joint		27	25	56	87.5	72.5	M
2.2 (94 kW)	1994.07-1998.11	-	-	-	Saloon Engine EJ22	656015	Inner Joint		25	29	40	38.5	72	
2.2 i (94 kW)	1994.09-1999.03	-	-	-	All-wheel Drive Saloon Engine EJ22 EMPI	656015	Inner Joint		25	29	40	38.5	72	
	1994.09-1999.03	-	-	-	All-wheel Drive Saloon Engine EJ22 EMPI	656023	Inner Joint		25	29	40.1	38	72.5	
	1994.09-1999.03	AT/MT	-	R	All-wheel Drive Saloon Engine EJ22 EMPI	856018	Outer Joint		24	22	50	104	64.5	I
	1994.09-1999.03	-	L/R	F	All-wheel Drive Saloon Engine EJ22 EMPI	656006	Inner Joint		25	22	40	38.5	72	
	1994.09-1999.03	-	-	F	All-wheel Drive Saloon Engine EJ22 EMPI	856040	Outer Joint		27	30	56	86.5	62.7	M
	1994.09-1999.03	-	L/R	F	All-wheel Drive Saloon Engine EJ22 EMPI	256006	Drive Shaft		27	25	56	87	684	
	1994.09-1999.03	-	L/R	F	All-wheel Drive Saloon Engine EJ22 EMPI	856008	Outer Joint		27	30	56	87	66	I
	1994.09-1999.03	AT/MT	L/R	F	All-wheel Drive Saloon Engine EJ22 EMPI	856039	Outer Joint		27	30	56	87.1	58	M
1994.09-1999.03	AT/MT	L/R	F	All-wheel Drive Saloon Engine EJ22 EMPI	856005	Outer Joint		27	22	56	87	66	M	
2.2 i (96 kW)	1996.06-1999.03	-	-	-	All-wheel Drive Saloon Engine EJ22 EMPI	656015	Inner Joint		25	29	40	38.5	72	
	1996.06-1999.03	AT/MT	-	R	All-wheel Drive Saloon Engine EJ22 EMPI	856018	Outer Joint		24	22	50	104	64.5	I
	1996.06-1999.03	-	L/R	F	All-wheel Drive Saloon Engine EJ22 EMPI	656006	Inner Joint		25	22	40	38.5	72	
	1996.06-1999.03	-	-	F	All-wheel Drive Saloon Engine EJ22 EMPI	856040	Outer Joint		27	30	56	86.5	62.7	M
	1996.06-1999.03	-	L/R	F	All-wheel Drive Saloon Engine EJ22 EMPI	256006	Drive Shaft		27	25	56	87	684	
	1996.06-1999.03	-	L/R	F	All-wheel Drive Saloon Engine EJ22 EMPI	856008	Outer Joint		27	30	56	87	66	I
	1996.06-1999.03	-	L/R	F	All-wheel Drive Saloon Engine EJ22 EMPI	856039	Outer Joint		27	30	56	87.1	58	M
2.5 i (110 kW)	1996.06-1999.03	AT/MT	-	R	All-wheel Drive Saloon Engine EJ25D	856018	Outer Joint		24	22	50	104	64.5	I
	1996.06-1999.03	AT	L/R	F	All-wheel Drive Saloon Engine EJ25D	656006	Inner Joint		25	22	40	38.5	72	
	1996.06-1999.03	-	-	F	All-wheel Drive Saloon Engine EJ25D	856040	Outer Joint		27	30	56	86.5	62.7	M
	1996.06-1999.03	AT	L/R	F	All-wheel Drive Saloon Engine EJ25D	256006	Drive Shaft		27	25	56	87	684	
	1996.06-1999.03	-	L/R	F	All-wheel Drive Saloon Engine EJ25D	856039	Outer Joint		27	30	56	87.1	58	M
LEGACY II (BG)														
2.0 i (85 kW)	1994.09-1998.11	-	-	-	Estate Engine EJ20 EMPI	656015	Inner Joint		25	29	40	38.5	72	
	1994.09-1998.11	-	-	-	All-wheel Drive Estate Engine EJ20E	656023	Inner Joint		25	29	40.1	38	72.5	
	1994.09-1998.11	-	-	-	All-wheel Drive Estate Engine EJ20E	656015	Inner Joint		25	29	40	38.5	72	

	 YEAR	TRANSM	L/R	F/R	REMARKS	GSP Ref.	 PRODUCT	 ABS	Technical Specifications					
									A	B	C	H	L	P
SUBARU														
LEGACY II (BG)														
2.0 i (85 kW)	1994.09-1998.11	-	-	-	Estate Engine EJ20 EMPI	656023	Inner Joint		25	29	40.1	38	72.5	
	1994.09-1998.11	AT/MT	-	R	All-wheel Drive Estate Engine EJ20E	856018	Outer Joint		24	22	50	104	64.5	I
	1994.09-1998.11	-	L/R	F	Estate Engine EJ20 EMPI	656006	Inner Joint		25	22	40	38.5	72	
	1994.09-1998.11	-	L/R	F	All-wheel Drive Estate Engine EJ20E	656006	Inner Joint		25	22	40	38.5	72	
	1994.09-1998.11	-	-	F	Estate Engine EJ20 EMPI	856040	Outer Joint		27	30	56	86.5	62.7	M
	1994.09-1998.11	-	-	F	All-wheel Drive Estate Engine EJ20E	856040	Outer Joint		27	30	56	86.5	62.7	M
	1994.09-1998.11	-	L/R	F	Estate Engine EJ20 EMPI	256006	Drive Shaft		27	25	56	87	684	
	1994.09-1998.11	-	L/R	F	All-wheel Drive Estate Engine EJ20E	256006	Drive Shaft		27	25	56	87	684	
	1994.09-1998.11	AT/MT	L/R	F	All-wheel Drive Estate Engine EJ20E	856039	Outer Joint		27	30	56	87.1	58	M
	1994.09-1998.11	AT/MT	L/R	F	Estate Engine EJ20 EMPI	856005	Outer Joint		27	22	56	87	66	M
1994.09-1998.11	AT/MT	L/R	F	All-wheel Drive Estate Engine EJ20E	856005	Outer Joint		27	22	56	87	66	M	
1994.09-1998.11	AT/MT	L/R	F	Estate Engine EJ20 EMPI	856003	Outer Joint		27	25	56	87.5	72.5	M	
2.2 i (94 kW)	1994.02-1998.12	-	-	-	All-wheel Drive Estate Engine EJ22 EMPI	656015	Inner Joint		25	29	40	38.5	72	
	1994.02-1998.12	-	-	-	All-wheel Drive Estate Engine EJ22 EMPI	656023	Inner Joint		25	29	40.1	38	72.5	
	1994.02-1998.12	AT/MT	-	R	All-wheel Drive Estate Engine EJ22 EMPI	856018	Outer Joint		24	22	50	104	64.5	I
	1994.02-1998.12	-	L/R	F	All-wheel Drive Estate Engine EJ22 EMPI	656006	Inner Joint		25	22	40	38.5	72	
	1994.02-1998.12	-	-	F	All-wheel Drive Estate Engine EJ22 EMPI	856040	Outer Joint		27	30	56	86.5	62.7	M
	1994.02-1998.12	-	L/R	F	All-wheel Drive Estate Engine EJ22 EMPI	256006	Drive Shaft		27	25	56	87	684	
	1994.02-1998.12	-	L/R	F	All-wheel Drive Estate Engine EJ22 EMPI	856008	Outer Joint		27	30	56	87	66	I
	1994.02-1998.12	AT/MT	L/R	F	All-wheel Drive Estate Engine EJ22 EMPI	856039	Outer Joint		27	30	56	87.1	58	M
1994.02-1998.12	AT/MT	L/R	F	All-wheel Drive Estate Engine EJ22 EMPI	856005	Outer Joint		27	22	56	87	66	M	
2.2 i (96 kW)	1996.06-1998.11	-	-	-	All-wheel Drive Estate Engine EJ22 EMPI	656023	Inner Joint		25	29	40.1	38	72.5	
	1996.06-1998.11	-	-	-	All-wheel Drive Estate Engine EJ22 EMPI	656015	Inner Joint		25	29	40	38.5	72	
	1996.06-1998.11	AT/MT	-	R	All-wheel Drive Estate Engine EJ22 EMPI	856018	Outer Joint		24	22	50	104	64.5	I
	1996.06-1998.11	-	L/R	F	All-wheel Drive Estate Engine EJ22 EMPI	656006	Inner Joint		25	22	40	38.5	72	
	1996.06-1998.11	-	-	F	All-wheel Drive Estate Engine EJ22 EMPI	856040	Outer Joint		27	30	56	86.5	62.7	M
	1996.06-1998.11	-	L/R	F	All-wheel Drive Estate Engine EJ22 EMPI	256006	Drive Shaft		27	25	56	87	684	
	1996.06-1998.11	-	L/R	F	All-wheel Drive Estate Engine EJ22 EMPI	856008	Outer Joint		27	30	56	87	66	I
	1996.06-1998.11	AT/MT	L/R	F	All-wheel Drive Estate Engine EJ22 EMPI	856039	Outer Joint		27	30	56	87.1	58	M
1996.06-1998.11	-	L/R	F	All-wheel Drive Estate Engine EJ22 EMPI	856005	Outer Joint		27	22	56	87	66	M	
2.5 i (110 kW)	1996.06-1998.11	AT/MT	-	R	All-wheel Drive Estate Engine EJ25D	856018	Outer Joint		24	22	50	104	64.5	I
	1996.06-1998.11	AT	L/R	F	All-wheel Drive Estate Engine EJ25D	656006	Inner Joint		25	22	40	38.5	72	
	1996.06-1998.11	-	-	F	All-wheel Drive Estate Engine EJ25D	856040	Outer Joint		27	30	56	86.5	62.7	M
	1996.06-1998.11	AT	L/R	F	All-wheel Drive Estate Engine EJ25D	256006	Drive Shaft		27	25	56	87	684	
	1996.06-1998.11	-	L/R	F	All-wheel Drive Estate Engine EJ25D	856039	Outer Joint		27	30	56	87.1	58	M
LEGACY III (BE)														
2.0 AWD (206 kW)	2002.06-2003.08	-	-	-	All-wheel Drive Saloon Engine EJ208	656015	Inner Joint		25	29	40	38.5	72	
2.0 AWD (92 kW)	1999.04-2003.08	-	-	-	All-wheel Drive Saloon Engine EJ201	656015	Inner Joint		25	29	40	38.5	72	
	1999.04-2003.08	-	-	-	All-wheel Drive Saloon Engine EJ201	656023	Inner Joint		25	29	40.1	38	72.5	
	1999.04-2003.08	-	-	-	All-wheel Drive Saloon Engine EJ201	656004	Inner Joint		25	30	40	35.8	75.5	
	1999.04-2003.08	-	-	F	All-wheel Drive Saloon Engine EJ201	856040	Outer Joint		27	30	56	86.5	62.7	M
	1999.04-2003.08	-	-	F	All-wheel Drive Saloon Engine EJ201	856009	Outer Joint	44T	27	30	56	86.5	63	M
	1999.04-2003.08	-	-	F	All-wheel Drive Saloon Engine EJ201	856026	Outer Joint	44T	27	30	56	86.5	63	I
	1999.04-2003.08	-	-	F	All-wheel Drive Saloon Engine EJ201	856022	Outer Joint		27	30	52	77	54	I
2.0 RSK AWD (191 kW)	2000.08-2003.08	-	-	-	All-wheel Drive Saloon Engine EJ206	656015	Inner Joint		25	29	40	38.5	72	
2.5 AWD (115 kW)	1998.10-2003.08	-	-	-	All-wheel Drive Saloon Engine EJ25	656015	Inner Joint		25	29	40	38.5	72	
	1998.10-2003.08	-	-	-	All-wheel Drive Saloon Engine EJ25	656023	Inner Joint		25	29	40.1	38	72.5	
	1998.10-2003.08	-	-	-	All-wheel Drive Saloon Engine EJ25	656004	Inner Joint		25	30	40	35.8	75.5	
	1998.10-2003.08	AT	L/R	F	All-wheel Drive Saloon Engine EJ25	656006	Inner Joint		25	22	40	38.5	72	
	1998.10-2003.08	-	-	F	All-wheel Drive Saloon Engine EJ25	856040	Outer Joint		27	30	56	86.5	62.7	M
	1998.10-2003.08	AT	L/R	F	All-wheel Drive Saloon Engine EJ25	256006	Drive Shaft		27	25	56	87	684	
	1998.10-2003.08	-	-	F	All-wheel Drive Saloon Engine EJ25	856009	Outer Joint	44T	27	30	56	86.5	63	M
	1998.10-2003.08	-	-	F	All-wheel Drive Saloon Engine EJ25	856026	Outer Joint	44T	27	30	56	86.5	63	I
3.0 H6 AWD (154 kW)	2000.08-2003.08	-	-	-	All-wheel Drive Saloon Engine EZ30	656015	Inner Joint		25	29	40	38.5	72	
LEGACY III (BH)														
2.0 AWD (206 kW)	2002.06-2003.08	-	-	-	All-wheel Drive Estate Engine EJ208	656023	Inner Joint		25	29	40.1	38	72.5	
	2002.06-2003.08	-	-	-	All-wheel Drive Estate Engine EJ208	656015	Inner Joint		25	29	40	38.5	72	
	2002.06-2003.08	-	-	F	All-wheel Drive Estate Engine EJ208	856009	Outer Joint	44T	27	30	56	86.5	63	M
	2002.06-2003.08	-	-	F	All-wheel Drive Estate Engine EJ208	856022	Outer Joint		27	30	52	77	54	I
2.0 AWD (92 kW)	1998.12-2003.08	-	-	-	All-wheel Drive Estate Engine EJ201	656015	Inner Joint		25	29	40	38.5	72	
	1998.12-2003.08	-	-	-	All-wheel Drive Estate Engine EJ201	656023	Inner Joint		25	29	40.1	38	72.5	
	1998.12-2003.08	-	-	-	All-wheel Drive Estate Engine EJ201	656004	Inner Joint		25	30	40	35.8	75.5	
	1998.12-2003.08	AT	L/R	F	All-wheel Drive Estate Engine EJ201	656006	Inner Joint		25	22	40	38.5	72	
	1998.12-2003.08	-	-	F	All-wheel Drive Estate Engine EJ201	856040	Outer Joint		27	30	56	86.5	62.7	M

	 YEAR	TRANSM	L/R	F/R	REMARKS	GSP Ref.	 PRODUCT	 ABS	Technical Specifications					
									A	B	C	H	L	P
SUBARU														
LEGACY III (BH)														
2.0 AWD (92 kW)	1998.12-2003.08	AT	L/R	F	All-wheel Drive Estate Engine EJ201	256006	Drive Shaft		27	25	56	87	684	
	1998.12-2003.08	-	-	F	All-wheel Drive Estate Engine EJ201	856009	Outer Joint	44T	27	30	56	86.5	63	M
	1998.12-2003.08	-	-	F	All-wheel Drive Estate Engine EJ201	856022	Outer Joint		27	30	52	77	54	I
2.0 RSK AWD (191 kW)	2000.08-2003.08	-	-	-	All-wheel Drive Estate Engine EJ206	656015	Inner Joint		25	29	40	38.5	72	
2.5 AWD (115 kW)	1998.12-2003.08	-	-	-	All-wheel Drive Estate Engine EJ25	656015	Inner Joint		25	29	40	38.5	72	
	1998.12-2003.08	-	-	-	All-wheel Drive Estate Engine EJ25	656023	Inner Joint		25	29	40.1	38	72.5	
	1998.12-2003.08	-	-	-	All-wheel Drive Estate Engine EJ25	656004	Inner Joint		25	30	40	35.8	75.5	
	1998.12-2003.08	AT	L/R	F	All-wheel Drive Estate Engine EJ25	656006	Inner Joint		25	22	40	38.5	72	
	1998.12-2003.08	-	-	F	All-wheel Drive Estate Engine EJ25	856040	Outer Joint		27	30	56	86.5	62.7	M
	1998.12-2003.08	AT	L/R	F	All-wheel Drive Estate Engine EJ25	256006	Drive Shaft		27	25	56	87	684	
	1998.12-2003.08	-	-	F	All-wheel Drive Estate Engine EJ25	856009	Outer Joint	44T	27	30	56	86.5	63	M
3.0 H6 AWD (154 kW)	2000.08-2003.08	-	-	-	All-wheel Drive Estate Engine EZ30	656023	Inner Joint		25	29	40.1	38	72.5	
	2000.08-2003.08	-	-	-	All-wheel Drive Estate Engine EZ30	656004	Inner Joint		25	30	40	35.8	75.5	
	2000.08-2003.08	-	-	-	All-wheel Drive Estate Engine EZ30	656015	Inner Joint		25	29	40	38.5	72	
	2000.08-2003.08	-	-	F	All-wheel Drive Estate Engine EZ30	856009	Outer Joint	44T	27	30	56	86.5	63	M
	2000.08-2003.08	-	-	F	All-wheel Drive Estate Engine EZ30	856026	Outer Joint	44T	27	30	56	86.5	63	I
LEGACY IV (BL)														
2.0 AWD (101 kW)	2003.09-2005.10	AT/MT	L/R	F	All-wheel Drive Saloon Engine EJ202	856042	Outer Joint		27	30	52	76	54	M
	2003.09-2005.10	-	-	-	All-wheel Drive Saloon Engine EJ202	656022	Inner Joint		25	29	35	77.5	110	
	2003.09-2005.10	-	-	F	All-wheel Drive Saloon Engine EJ202	856022	Outer Joint		27	30	52	77	54	I
2.0 AWD (121 kW)	2005.06-2009.04	-	-	-	All-wheel Drive Saloon Engine EJ204	656022	Inner Joint		25	29	35	77.5	110	
	2005.06-2009.04	-	-	F	All-wheel Drive Saloon Engine EJ204	856022	Outer Joint		27	30	52	77	54	I
	2005.06-2009.04	AT/MT	L/R	F	All-wheel Drive Saloon Engine EJ204	856042	Outer Joint		27	30	52	76	54	M
2.0 D AWD (110 kW)	2008.02-2009.12	-	-	F	All-wheel Drive Saloon Engine EE20Z	856022	Outer Joint		27	30	52	77	54	I
	2008.02-2009.12	AT/MT	L/R	F	All-wheel Drive Saloon Engine EE20Z	856042	Outer Joint		27	30	52	76	54	M
2.0 R AWD (110 kW)	2007.09-2009.12	-	-	F	All-wheel Drive Saloon Engine EJ204	856022	Outer Joint		27	30	52	77	54	I
	2007.09-2009.12	AT/MT	L/R	F	All-wheel Drive Saloon Engine EJ204	856042	Outer Joint		27	30	52	76	54	M
2.5 AWD (121 kW)	2003.09-2009.04	-	-	-	All-wheel Drive Saloon Engine EJ25	656022	Inner Joint		25	29	35	77.5	110	
	2003.09-2009.04	-	-	F	All-wheel Drive Saloon Engine EJ25	856022	Outer Joint		27	30	52	77	54	I
	2003.09-2009.04	AT/MT	L/R	F	All-wheel Drive Saloon Engine EJ25	856042	Outer Joint		27	30	52	76	54	M
2.5 i AWD (127 kW)	2007.09-2009.12	-	-	F	All-wheel Drive Saloon Engine EJ25	856022	Outer Joint		27	30	52	77	54	I
	2007.09-2009.12	AT/MT	L/R	F	All-wheel Drive Saloon Engine EJ25	856042	Outer Joint		27	30	52	76	54	M
3.0 R AWD (180 kW)	2003.09-2009.06	AT/MT	L/R	F	All-wheel Drive Saloon Engine EZ30	856042	Outer Joint		27	30	52	76	54	M
	2003.09-2009.06	-	-	-	All-wheel Drive Saloon Engine EZ30	656022	Inner Joint		25	29	35	77.5	110	
	2003.09-2009.06	-	-	F	All-wheel Drive Saloon Engine EZ30	856022	Outer Joint		27	30	52	77	54	I
LEGACY IV (BP)														
2.0 AWD (101 kW)	2003.09-2005.10	AT/MT	L/R	F	All-wheel Drive Estate Engine EJ202	856042	Outer Joint		27	30	52	76	54	M
	2003.09-2005.10	-	-	F	All-wheel Drive Estate Engine EJ202	856022	Outer Joint		27	30	52	77	54	I
2.0 AWD (121 kW)	2005.06-2009.04	-	-	F	All-wheel Drive Estate Engine EJ204	856022	Outer Joint		27	30	52	77	54	I
	2005.06-2009.04	AT/MT	L/R	F	All-wheel Drive Estate Engine EJ204	856042	Outer Joint		27	30	52	76	54	M
2.0 D AWD (110 kW)	2008.02-2009.12	-	-	F	All-wheel Drive Estate Engine EE20Z	856022	Outer Joint		27	30	52	77	54	I
	2008.02-2009.12	AT/MT	L/R	F	All-wheel Drive Estate Engine EE20Z	856042	Outer Joint		27	30	52	76	54	M
2.0 R AWD (110 kW)	2007.09-2009.12	-	-	F	All-wheel Drive Estate Engine EJ204	856022	Outer Joint		27	30	52	77	54	I
	2007.09-2009.12	AT/MT	L/R	F	All-wheel Drive Estate Engine EJ204	856042	Outer Joint		27	30	52	76	54	M
2.5 AWD (121 kW)	2003.09-2009.04	AT/MT	L/R	F	All-wheel Drive Estate Engine EJ25	856042	Outer Joint		27	30	52	76	54	M
	2003.09-2009.04	-	-	F	All-wheel Drive Estate Engine EJ25	856022	Outer Joint		27	30	52	77	54	I
2.5 i AWD (127 kW)	2008.01-2009.12	AT/MT	L/R	F	All-wheel Drive Estate Engine EJ25	856042	Outer Joint		27	30	52	76	54	M
	2008.01-2009.12	-	-	F	All-wheel Drive Estate Engine EJ25	856022	Outer Joint		27	30	52	77	54	I
3.0 R AWD (180 kW)	2003.09-2009.04	AT/MT	L/R	F	All-wheel Drive Estate Engine EZ30	856042	Outer Joint		27	30	52	76	54	M
	2003.09-2009.04	-	-	F	All-wheel Drive Estate Engine EZ30	856022	Outer Joint		27	30	52	77	54	I
LEGACY OUTBACK (BG)														
2.5 (110 kW)	1996.01-1999.12	-	-	-	All-wheel Drive Estate Engine EJ25D	656023	Inner Joint		25	29	40.1	38	72.5	
	1996.01-1999.12	-	-	F	All-wheel Drive Estate Engine EJ25D	856040	Outer Joint		27	30	56	86.5	62.7	M
LEGACY V (BM)														





YEAR	TRANSM	L/R	F/R	REMARKS	GSP Ref.	PRODUCT	ABS	Technical Specifications					
								A	B	C	H	L	P
SUBARU													
LEGACY V (BM)													
2.0 D AWD (110 kW)	2009.09-2014.12	AT/MT	L/R	F	All-wheel Drive Saloon Engine EE20Z	856042	Outer Joint	27	30	52	76	54	M
	2009.09-2014.12	-	-	-	All-wheel Drive Saloon Engine EE20Z	699215	Inner Joint	25	29	35	77.5	110	
2.0 i AWD (110 kW)	2009.09-2014.12	AT/MT	L/R	F	All-wheel Drive Saloon Engine EJ204	856042	Outer Joint	27	30	52	76	54	M
	2009.09-2014.12	-	-	-	All-wheel Drive Saloon Engine EJ204	699215	Inner Joint	25	29	35	77.5	110	
2.0 i LPG AWD (108 kW)	2009.09-2011.12	-	-	-	All-wheel Drive Saloon Engine EJ204	699215	Inner Joint	25	29	35	77.5	110	
2.5 AWD (129 kW)	2013.09-	-	-	-	All-wheel Drive Saloon Engine FB25	699215	Inner Joint	25	29	35	77.5	110	
2.5 GT AWD (195 kW)	2010.07-2014.12	-	-	-	All-wheel Drive Saloon Engine EJ255	699215	Inner Joint	25	29	35	77.5	110	
2.5 GT AWD (210 kW)	2009.05-2014.12	-	-	-	All-wheel Drive Saloon Engine EJ255	699215	Inner Joint	25	29	35	77.5	110	
2.5 i AWD (123 kW)	2009.09-2014.12	AT/MT	L/R	F	All-wheel Drive Saloon Engine EJ253	856042	Outer Joint	27	30	52	76	54	M
	2009.09-2014.12	-	-	-	All-wheel Drive Saloon Engine EJ253	699215	Inner Joint	25	29	35	77.5	110	
2.5 i AWD (127 kW)	2012.07-2014.12	-	-	-	All-wheel Drive Saloon Engine FB25A	699215	Inner Joint	25	29	35	77.5	110	
LEGACY V (BR)													
2.0 AWD (191 kW)	2008.06-2014.12	-	-	-	All-wheel Drive Estate Engine EJ206	699215	Inner Joint	25	29	35	77.5	110	
2.0 AWD (206 kW)	2008.06-2014.12	-	-	-	All-wheel Drive Estate Engine EJ208	699215	Inner Joint	25	29	35	77.5	110	
2.0 D AWD (108 kW)	2013.01-2014.12	-	-	-	All-wheel Drive Estate Engine EE20	699215	Inner Joint	25	29	35	77.5	110	
2.0 D AWD (110 kW)	2009.09-2014.12	AT/MT	L/R	F	All-wheel Drive Estate Engine EE20Z	856042	Outer Joint	27	30	52	76	54	M
	2009.09-2014.12	-	-	-	All-wheel Drive Estate Engine EE20Z	699215	Inner Joint	25	29	35	77.5	110	
2.0 i AWD (110 kW)	2009.09-2014.12	AT/MT	L/R	F	All-wheel Drive Estate Engine EJ204	856042	Outer Joint	27	30	52	76	54	M
	2009.09-2014.12	-	-	-	All-wheel Drive Estate Engine EJ204	699215	Inner Joint	25	29	35	77.5	110	
	2012.06-2014.12	-	-	-	All-wheel Drive Estate Engine FB20	699215	Inner Joint	25	29	35	77.5	110	
2.0 i LPG AWD (108 kW)	2009.09-2011.12	-	-	-	All-wheel Drive Estate Engine EJ204	699215	Inner Joint	25	29	35	77.5	110	
2.5 GT AWD (195 kW)	2010.07-2014.12	-	-	-	All-wheel Drive Estate Engine EJ255	699215	Inner Joint	25	29	35	77.5	110	
2.5 GT AWD (210 kW)	2009.05-2014.12	-	-	-	All-wheel Drive Estate Engine EJ255	699215	Inner Joint	25	29	35	77.5	110	
2.5 i AWD (123 kW)	2009.09-2014.12	AT/MT	L/R	F	All-wheel Drive Estate Engine EJ253	856042	Outer Joint	27	30	52	76	54	M
	2009.09-2014.12	-	-	-	All-wheel Drive Estate Engine EJ253	699215	Inner Joint	25	29	35	77.5	110	
2.5 i AWD (125 kW)	2009.05-2014.12	-	-	-	All-wheel Drive Estate Engine EJ25	699215	Inner Joint	25	29	35	77.5	110	
2.5 i AWD (127 kW)	2012.07-2014.12	-	-	-	All-wheel Drive Estate Engine FB25	699215	Inner Joint	25	29	35	77.5	110	
LEGACY(B12)													
2.0	1999.04-2000.06	AT/MT	L/R	F	ENGINE:EJ201,TRAIN:F4WD,BODY:SEDAN/WAGON	656005	Inner Joint	25	29	40.1	37.5	68	
	2000.02-2001.04	AT/MT	L/R	F	ENGINE:EJ201,TRAIN:F4WD,BODY:SEDAN/WAGON	656005	Inner Joint	25	29	40.1	37.5	68	
	2001.01-2002.04	AT/MT	L/R	F	ENGINE:EJ201,TRAIN:F4WD,BODY:SEDAN/WAGON	656005	Inner Joint	25	29	40.1	37.5	68	
	2001.01-2002.04	MT	R	F	ENGINE:EJ208,TRAIN:F4WD,BODY:SEDAN	656005	Inner Joint	25	29	40.1	37.5	68	
	2002.02-2003.06	AT/MT	L/R	F	ENGINE:EJ201,TRAIN:F4WD,BODY:SEDAN/WAGON	656005	Inner Joint	25	29	40.1	37.5	68	
	2002.02-2003.06	Sport Shift	R	F	ENGINE:EJ206,TRAIN:F4WD,BODY:SEDAN	656005	Inner Joint	25	29	40.1	37.5	68	
	2002.02-2003.06	MT	R	F	ENGINE:EJ208,TRAIN:F4WD,BODY:SEDAN	656005	Inner Joint	25	29	40.1	37.5	68	
2.5	1999.04-2000.06	AT/MT	L/R	F	ENGINE:EJ251,TRAIN:F4WD,BODY:SEDAN/WAGON	656005	Inner Joint	25	29	40.1	37.5	68	
	2000.02-2001.04	AT/MT	L/R	F	ENGINE:EJ251,TRAIN:F4WD,BODY:SEDAN/WAGON	656005	Inner Joint	25	29	40.1	37.5	68	
	2001.01-2002.04	AT/MT	L/R	F	ENGINE:EJ251,TRAIN:F4WD,BODY:SEDAN/WAGON	656005	Inner Joint	25	29	40.1	37.5	68	
	2002.02-2003.06	AT/MT	L/R	F	ENGINE:EJ251,TRAIN:F4WD,BODY:SEDAN/WAGON	656005	Inner Joint	25	29	40.1	37.5	68	
3.0	2000.02-2001.04	AT	L/R	F	ENGINE:EZ30D,TRAIN:F4WD,BODY:WAGON	656005	Inner Joint	25	29	40.1	37.5	68	
	2001.01-2002.04	AT	L/R	F	ENGINE:EZ30D,TRAIN:F4WD,BODY:WAGON	656005	Inner Joint	25	29	40.1	37.5	68	
	2002.02-2003.06	AT	L/R	F	ENGINE:EZ30D,TRAIN:F4WD,BODY:WAGON	656005	Inner Joint	25	29	40.1	37.5	68	
LEGACY/WRX													
-	2001-	-	-	-	4WD	856028	Outer Joint	27	32	56	86.5	71.5	I
LEONE													
-	1985.01-1994.12	MT/AT	L/R	R	-	256019	Drive Shaft	23	23	40	41	536	
1.8	1985.01-1994.12	MT/AT	L/R	F	-	256001	Drive Shaft	30	23	58	137.5	695	
LEONE II													
1.3 (48 kW)	1984.11-1991.09	AT/MT	L/R	F	Saloon Engine EA65	856001	Outer Joint	30	22	58	137.5	56	M
1.6 (55 kW)	1984.11-1991.09	AT/MT	L/R	F	Saloon Engine EA71	856001	Outer Joint	30	22	58	137.5	56	M
1.8 (66 kW)	1984.11-1990.12	AT/MT	L/R	F	All-wheel Drive Saloon Engine EA82	856013	Outer Joint	30	23	58	137.5	56	M
	1984.11-1990.12	AT/MT	L/R	F	All-wheel Drive Estate Engine EA82	856013	Outer Joint	30	23	58	137.5	56	M
1.8 (72 kW)	1988.01-1990.12	-	-	-	All-wheel Drive Saloon Engine EA82	856002	Outer Joint	30	25	58	139	57	M
	1988.01-1990.12	AT/MT	L/R	F	All-wheel Drive Saloon Engine EA82	856013	Outer Joint	30	23	58	137.5	56	M
1.8 (88 kW)	1988.01-1990.12	-	-	F	All-wheel Drive Saloon Engine EA82/EA82T	856046	Outer Joint	30	25	58	138.1	62	M
	1988.01-1990.12	-	-	-	All-wheel Drive Saloon Engine EA82/EA82T	856002	Outer Joint	30	25	58	139	57	M
	1988.01-1990.12	AT/MT	L/R	F	All-wheel Drive Saloon Engine EA82/EA82T	856013	Outer Joint	30	23	58	137.5	56	M
1.8 Cat (70 kW)	1986.07-1991.09	-	-	-	All-wheel Drive Saloon Engine EA82	856002	Outer Joint	30	25	58	139	57	M
1.8 Super (96 kW)	1989.03-1990.12	-	-	F	All-wheel Drive Estate Engine EA82T	856046	Outer Joint	30	25	58	138.1	62	M
	1989.03-1990.12	-	-	-	All-wheel Drive Estate Engine EA82T	856002	Outer Joint	30	25	58	139	57	M
	1989.03-1990.12	AT/MT	L/R	F	All-wheel Drive Estate Engine EA82T	856013	Outer Joint	30	23	58	137.5	56	M
1.8 Super Catalytic-Conv (70 kW)	1986.07-1992.02	-	-	-	All-wheel Drive Estate Engine EA82	856002	Outer Joint	30	25	58	139	57	M
1.8 Super Turbo (100 kW)	1984.11-1990.12	-	-	F	All-wheel Drive Estate Engine EA82T	856046	Outer Joint	30	25	58	138.1	62	M
	1984.11-1990.12	-	-	-	All-wheel Drive Estate Engine EA82T	856002	Outer Joint	30	25	58	139	57	M





	 YEAR	TRANSM	L/R	F/R	REMARKS	GSP Ref.	 PRODUCT	 ABS	Technical Specifications					
									A	B	C	H	L	P
SUBARU														
LEONE II														
1.8 Super Turbo (100 kW)	1984.11-1990.12	AT/MT	L/R	F	All-wheel Drive Estate Engine EA82T	856013	Outer Joint		30	23	58	137.5	56	M
1.8 Turbo (100 kW)	1984.11-1990.12	-	-	F	All-wheel Drive Saloon Engine EA82T	856046	Outer Joint		30	25	58	138.1	62	M
	1984.11-1990.12	-	-	-	All-wheel Drive Saloon Engine EA82T	856002	Outer Joint		30	25	58	139	57	M
	1984.11-1990.12	AT/MT	L/R	F	All-wheel Drive Saloon Engine EA82T	856013	Outer Joint		30	23	58	137.5	56	M
1.8 Turbo (96 kW)	1989.03-1990.12	-	-	F	All-wheel Drive Saloon Engine EA82/EA82T	856046	Outer Joint		30	25	58	138.1	62	M
	1989.03-1990.12	-	-	-	All-wheel Drive Saloon Engine EA82/EA82T	856002	Outer Joint		30	25	58	139	57	M
	1989.03-1990.12	AT/MT	L/R	F	All-wheel Drive Saloon Engine EA82/EA82T	856013	Outer Joint		30	23	58	137.5	56	M
1800 (72 kW)	1986.12-1991.07	AT/MT	L/R	F	All-wheel Drive Estate Engine EA82	856013	Outer Joint		30	23	58	137.5	56	M
1800 (88 kW)	1988.01-1990.12	-	-	F	All-wheel Drive Estate Engine EA82/EA82T	856046	Outer Joint		30	25	58	138.1	62	M
	1988.01-1990.12	AT/MT	L/R	F	All-wheel Drive Estate Engine EA82/EA82T	856013	Outer Joint		30	23	58	137.5	56	M
OUTBACK (BE BH)														
2.5 AWD (115 kW)	2000.10-2003.08	-	-	R	All-wheel Drive Estate Engine EJ25	856018	Outer Joint		24	22	50	104	64.5	I
	2000.10-2003.08	-	-	F	All-wheel Drive Estate Engine EJ25	856026	Outer Joint	44T	27	30	56	86.5	63	I
3.0 H6 AWD (154 kW)	2000.10-2003.08	-	-	F	All-wheel Drive Estate Engine EZ30	856026	Outer Joint	44T	27	30	56	86.5	63	I
OUTBACK (BL BP)														
2.0 D AWD (110 kW)	2008.09-2009.09	AT/MT	L/R	F	All-wheel Drive Estate Engine EE20Z	856042	Outer Joint		27	30	52	76	54	M
2.5 AWD (121 kW)	2003.11-2009.09	AT/MT	L/R	F	All-wheel Drive Estate Engine EJ25D	856042	Outer Joint		27	30	52	76	54	M
3.0 AWD (180 kW)	2003.11-2009.09	AT/MT	L/R	F	All-wheel Drive Estate Engine EZ30	856042	Outer Joint		27	30	52	76	54	M
OUTBACK (BR)														
2.0 D AWD (110 kW)	2009.09-	AT/MT	L/R	F	All-wheel Drive Estate Engine EE20Z	856042	Outer Joint		27	30	52	76	54	M
2.5 (123 kW)	2009.09-	AT/MT	L/R	F	All-wheel Drive Estate Engine EJ253	856042	Outer Joint		27	30	52	76	54	M
PICK UP														
1.8	1981-	-	MT	-	4WD	656002	Inner Joint		23	23	40	35.2	69.2	
PLEO														
1.2	-	-	-	R	RA	256029	Drive Shaft		24	23	50	84	704	
	-	-	-	L	RA	256030	Drive Shaft		24	23	50	84	527	
PLEO (RA1/2)														
660	1998.10-	-	CVT	-	Engine EN07 SPC	856052	Outer Joint		24	19	50	84	50	M
660 4WD	1998.10-	-	CVT	-	Engine EN07 SPC	856052	Outer Joint		24	19	50	84	50	M
PLEO RA1 /2														
660	1998.10-	-	CVT	-	Engine EN07 SPC	856052	Outer Joint		24	19	50	84	50	M
	1998.10-	-	CVT	-	Engine EN07 SPC	856052	Outer Joint		24	19	50	84	50	M
	1998.10-	-	CVT	-	Allwheel Drive Engine EN07 SPC	856052	Outer Joint		24	19	50	84	50	M
	1998.10-	-	CVT	-	Allwheel Drive Engine EN07SPC	856052	Outer Joint		24	19	50	84	50	M
	1998.10-	-	CVT	-	Engine EN07 SPC	856052	Outer Joint		24	19	50	84	50	M
	1998.10-	-	CVT	-	Engine EN07 SPC	856052	Outer Joint		24	19	50	84	50	M
	1998.10-	-	CVT	-	Allwheel Drive Engine EN07 SPC	856052	Outer Joint		24	19	50	84	50	M
	1998.10-	-	CVT	-	Allwheel Drive Engine EN07 SPC	856052	Outer Joint		24	19	50	84	50	M
REX III/M70/80/MINI JUMBO														
0.5 (28 kW)	1989.06-1990.07	-	-	-	Hatchback Engine EN05	856033	Outer Joint		24	19	50	108	45	M
	1989.06-1990.07	-	-	-	All-wheel Drive Hatchback Engine EN05	856033	Outer Joint		24	19	50	108	45	M
	1989.06-1990.07	MT	-	F	Hatchback Engine EN05	856053	Outer Joint		24	18	50	108	49.5	M
	1989.06-1990.07	MT	-	F	All-wheel Drive Hatchback Engine EN05	856053	Outer Joint		24	18	50	108	49.5	M
0.5 Kompressor (45 kW)	1989.06-1990.07	-	-	-	Hatchback Engine EN05	856031	Outer Joint		24	19	50	108	47	M
	1989.06-1990.07	-	-	-	Hatchback Engine EN05	856033	Outer Joint		24	19	50	108	45	M
	1989.06-1990.07	MT	-	F	Hatchback Engine EN05	856053	Outer Joint		24	18	50	108	49.5	M
0.7 (35 kW)	1990.07-1992.03	-	-	-	Hatchback Engine EN07E	856033	Outer Joint		24	19	50	108	45	M
	1990.07-1992.03	-	-	-	All-wheel Drive Hatchback Engine EN07E	856033	Outer Joint		24	19	50	108	45	M
	1990.07-1992.03	MT	-	F	Hatchback Engine EN07E	856053	Outer Joint		24	18	50	108	49.5	M
	1990.07-1992.03	MT	-	F	All-wheel Drive Hatchback Engine EN07E	856053	Outer Joint		24	18	50	108	49.5	M
0.7 Kompressor (47 kW)	1990.07-1992.02	-	-	-	All-wheel Drive Hatchback Engine EN07Z	856031	Outer Joint		24	19	50	108	47	M
	1990.07-1992.02	-	-	-	All-wheel Drive Hatchback Engine EN07Z	856033	Outer Joint		24	19	50	108	45	M
	1990.07-1992.02	MT	-	F	All-wheel Drive Hatchback Engine EN07Z	856053	Outer Joint		24	18	50	108	49.5	M
SAMBAR (KS4)														
660 4WD	1990.03-	-	MT	-	Engine EN07 SPC	856052	Outer Joint		24	19	50	84	50	M
	1990.03-1991.08	MT/AT	-	-	Engine EN07 SPC	856052	Outer Joint		24	19	50	84	50	M
	1990.03-1991.08	MT	-	-	Engine EN07	856052	Outer Joint		24	19	50	84	50	M



		 YEAR	TRANSM	L/R	F/R	REMARKS	GSP Ref.	 PRODUCT	 ABS	Technical Specifications					
										A	B	C	H	L	P
SUBARU															
SAMBAR (KV4)															
660 4WD	1990.03-	-	MT/AT	-	-	Engine EN07 SPC	856052	Outer Joint		24	19	50	84	50	M
SAMBAR KS4															
660	1990.03-	1991.08	MT/AT	-	-	Allwheel Drive Engine EN07 SPC	856052	Outer Joint		24	19	50	84	50	M
	1990.03-	1991.08	MT	-	-	Allwheel Drive Engine EN07	856052	Outer Joint		24	19	50	84	50	M
	1990.03-	-	MT	-	-	Allwheel Drive Engine EN07 SPC	856052	Outer Joint		24	19	50	84	50	M
	1990.03-	1991.08	MT	-	-	Allwheel Drive Engine EN07 SPC	856052	Outer Joint		24	19	50	84	50	M
	1990.03-	-	MT	-	-	Allwheel Drive Engine EN07 SPC	856052	Outer Joint		24	19	50	84	50	M
	1990.03-	1991.08	MT/AT	-	-	Allwheel Drive Engine EN07 SPC	856052	Outer Joint		24	19	50	84	50	M
	1990.03-	1991.08	MT	-	-	Allwheel Drive Engine EN07	856052	Outer Joint		24	19	50	84	50	M
	1990.03-	-	MT	-	-	Allwheel Drive Engine EN07 SPC	856052	Outer Joint		24	19	50	84	50	M
	1990.03-	1991.08	MT	-	-	Allwheel Drive Engine EN07 SPC	856052	Outer Joint		24	19	50	84	50	M
	1990.03-	-	MT	-	-	Allwheel Drive Engine EN07 SPC	856052	Outer Joint		24	19	50	84	50	M
SAMBAR KV4															
660	1990.03-	1991.08	MT/AT	-	-	Allwheel Drive Engine EN07 SPC	856052	Outer Joint		24	19	50	84	50	M
	1990.03-	1991.08	MT/AT	-	-	Allwheel Drive Engine EN07 SPC	856052	Outer Joint		24	19	50	84	50	M
	1990.03-	-	MT/AT	-	-	Allwheel Drive Engine EN07 SPC	856052	Outer Joint		24	19	50	84	50	M
	1990.03-	1991.08	MT/AT	-	-	Allwheel Drive Engine EN07 SPC	856052	Outer Joint		24	19	50	84	50	M
	1990.03-	-	MT/AT	-	-	Allwheel Drive Engine EN07 SPC	856052	Outer Joint		24	19	50	84	50	M
	1990.03-	1991.08	MT/AT	-	-	Allwheel Drive Engine EN07 SPC	856052	Outer Joint		24	19	50	84	50	M
	1990.03-	1991.08	MT/AT	-	-	Allwheel Drive Engine EN07 SPC	856052	Outer Joint		24	19	50	84	50	M
	1990.03-	-	MT/AT	-	-	Allwheel Drive Engine EN07 SPC	856052	Outer Joint		24	19	50	84	50	M
	1990.03-	-	MT/AT	-	-	Allwheel Drive Engine EN07 SPC	856052	Outer Joint		24	19	50	84	50	M
SHERPA															
-	1988-	1989	-	L	-	-	256017	Drive Shaft		24	23	50	108	535.5	
	1988-	1989	-	R	-	-	256018	Drive Shaft		24	23	50	108	682.5	
VIVIO															
0.66 (32 kW)	1992.03-	1995.10	AT/MT	L/R	F	All-wheel Drive Hatchback Engine EN07E	856007	Outer Joint		24	18	50	85.5	45.5	M
0.7 (32 kW)	1992.08-	1998.12	-	-	-	Hatchback Engine EN07E	856032	Outer Joint		24	18	50	108	47	M
VIVIO (KK3)															
660	1992.03-	1996.10	CVT	-	-	Engine EN07	856052	Outer Joint		24	19	50	84	50	M
VIVIO (KK4)															
660 4WD	1992.03-	1996.10	MT/CVT	-	-	Engine EN07 SPC	856052	Outer Joint		24	19	50	84	50	M
VIVIO (KW3)															
660	1994.05-	1995.09	CVT	-	-	Engine EN07	856052	Outer Joint		24	19	50	84	50	M
VIVIO (KW4)															
660 4WD	1992.03-	1993.08	5MT	-	-	Engine EN07	856052	Outer Joint		24	19	50	84	50	M
VIVIO (KY3)															
660	1993.05-	1994.02	CVT	-	-	Engine EN07 SPC	856052	Outer Joint		24	19	50	84	50	M
VIVIO KK3															
660	1992.03-	1996.10	CVT	-	-	Engine EN07	856052	Outer Joint		24	19	50	84	50	M
	1992.03-	1996.10	CVT	-	-	Engine EN07	856052	Outer Joint		24	19	50	84	50	M
	1995.01-	1996.10	CVT	-	-	Engine EN07	856052	Outer Joint		24	19	50	84	50	M
	1995.01-	1996.10	CVT	-	-	Engine EN07	856052	Outer Joint		24	19	50	84	50	M
VIVIO KK4															
660	1992.03-	1995.09	MT/CVT	-	-	Allwheel Drive Engine EN07 SPC	856052	Outer Joint		24	19	50	84	50	M
	1992.03-	1995.09	MT/CVT	-	-	Allwheel Drive Engine EN07 SPC	856052	Outer Joint		24	19	50	84	50	M
	1995.10-	1996.10	MT/CVT	-	-	Allwheel Drive Engine EN07 SPC	856052	Outer Joint		24	19	50	84	50	M
	1995.10-	1996.10	MT/CVT	-	-	Allwheel Drive Engine EN07 SPC	856052	Outer Joint		24	19	50	84	50	M
VIVIO KW3															
660	1994.05-	1995.09	CVT	-	-	Engine EN07	856052	Outer Joint		24	19	50	84	50	M
	1994.05-	1995.09	CVT	-	-	Engine EN07	856052	Outer Joint		24	19	50	84	50	M
	1995.01-	1995.09	CVT	-	-	Engine EN07	856052	Outer Joint		24	19	50	84	50	M
	1995.01-	1995.09	CVT	-	-	Engine EN07	856052	Outer Joint		24	19	50	84	50	M
VIVIO KW4															
660	1992.03-	1993.08	5MT	-	-	Allwheel Drive Engine EN07	856052	Outer Joint		24	19	50	84	50	M
	1992.03-	1993.08	5MT	-	-	Allwheel Drive Engine EN07	856052	Outer Joint		24	19	50	84	50	M
VIVIO KY3															
660	1993.05-	1994.02	CVT	-	-	Engine EN07 SPC	856052	Outer Joint		24	19	50	84	50	M
	1993.05-	1994.02	CVT	-	-	Engine EN07 SPC	856052	Outer Joint		24	19	50	84	50	M
XT (XT)/ALCYONE															
1.8 Turbo (100 kW)	1984.11-	1990.12	-	-	-	All-wheel Drive Coupe Engine EA82/EA82T	856002	Outer Joint		30	25	58	139	57	M
	1984.11-	1990.12	AT/MT	L/R	R	All-wheel Drive Coupe Engine EA82/EA82T	856001	Outer Joint		30	22	58	137.5	56	M





YEAR	TRANSM	L/R	F/R	REMARKS	GSP Ref.	PRODUCT	ABS	Technical Specifications						
								A	B	C	H	L	P	
SUBARU														
XT (XT)/ALCYONE														
1.8 Turbo (88 kW)	1988.01-1990.12	-	-	-	All-wheel Drive Coupe Engine EA82/EA82T	856002	Outer Joint		30	25	58	139	57	M
1.8 Turbo (96 kW)	1987.01-1990.12	-	-	-	All-wheel Drive Coupe Engine EA82/EA82T	856002	Outer Joint		30	25	58	139	57	M
SUZUKI														
ALTO														
0.6 Cl115,Cn11S	1988-1999	AT	-	-	-	857072	Outer Joint		23	18	44	92	48.5	M
0.7 Ha11S,Hc11V	1994-1998	MT	-	-	-	857072	Outer Joint		23	18	44	92	48.5	M
1.0	1994.09-2006.02	MT/AT	-	-	Engine G10B	857173	Outer Joint		23	20	49	92.6	56	M
	1998.01-	MT/AT	-	-	Engine G10B	857153	Outer Joint	43T	23	19	49	78	56	O
1000	1994.09-2006.02	MT/AT	-	-	Engine G10B	857173	Outer Joint		23	20	49	92.6	56	M
	1998.01-	MT/AT	-	-	Engine G10B	857153	Outer Joint	43T	23	19	49	78	56	O
ALTO (EC)														
0.8 (29 kW)	1988.12-1993.11	-	-	-	Hatchback Engine F8B	857051	Outer Joint		23	19	44	91.5	45.5	M
ALTO (EF)														
0.8 (25 kW)	1993.11-1996.06	-	L/R	F	Hatchback Engine F8B	857038	Outer Joint		23	20	49	92	56.5	M
0.8 (29 kW)	1994.11-1996.06	-	L/R	F	Hatchback Engine F8B	857038	Outer Joint		23	20	49	92	56.5	M
1.0 (39 kW)	1994.09-1998.09	-	-	F	Hatchback Engine G10BB	899102	Outer Joint		23	19	49	92	56.5	O
	1994.09-1998.09	MT	L	F	Hatchback Engine G10BB	232006	Drive Shaft		23	22	49	92	589	
	1994.09-1998.09	MT	R	F	Hatchback Engine G10BB	208061	Drive Shaft		23	22	49	92	815	
	1994.09-1998.09	-	-	-	Hatchback Engine G10BB	857008	Outer Joint		23	20	49	92	54.5	O
	1994.09-1998.09	AT	-	F	Hatchback Engine G10BB	857013	Outer Joint		23	20	49	92	56.5	O
	1994.09-1998.09	MT	L/R	F	Hatchback Engine G10BB	857001	Outer Joint		23	20	49	92	56.5	I
	1994.09-1998.09	-	L/R	F	Hatchback Engine G10BB	857038	Outer Joint		23	20	49	92	56.5	M
	1994.09-1998.09	MT	L/R	F	Hatchback Engine G10BB	857048	Outer Joint		23	20	49	92	54.5	O
	1994.09-1998.09	MT	-	F	Hatchback Engine G10BB	857012	Outer Joint		23	20	49	92	56.5	I
	1994.09-1998.09	-	L	F	Hatchback Engine G10BB	257078	Drive Shaft		23	22	49	92	590	
	1994.09-1998.09	-	R	F	Hatchback Engine G10BB	257077	Drive Shaft		23	22	49	92	823	
	1994.09-1998.09	MT	R	F	Hatchback Engine G10BB	608018	Inner Joint		22	19	35	51.9	93.4	
	1994.09-1998.09	MT	L/R	F	Hatchback Engine G10BB	857007	Outer Joint		23	19	49	92	56.5	M
ALTO (FF)														
1.1 (46 kW)	2004.09-2008.12	MT	L	F	Hatchback Engine F10DN	257119	Drive Shaft	43T	23	22	49	77.5	567	
	2004.09-2008.12	MT	R	F	Hatchback Engine F10DN	257120	Drive Shaft	43T	23	22	49	77.5	800	
	2004.09-2008.12	-	-	F	Hatchback Engine F10DN	857083	Outer Joint		23	19	49	77.5	57	O
	2004.09-2008.12	MT	L	F	Hatchback Engine F10DN	232008	Drive Shaft		23	22	49	78	567	
	2004.09-2008.12	-	-	F	Hatchback Engine F10DN	857061	Outer Joint	43T	23	19	49	77.5	57	O
	2004.09-2008.12	-	-	F	Hatchback Engine F10DN	857027	Outer Joint		23	19	49	78	57	O
ALTO (GF)/ALTO K10														
1.0 (50 kW)	2009.01-	MT	L	F	Hatchback Engine K10B	257211	Drive Shaft	43T	23	22	49	81	662	
	2009.01-	-	-	F	Hatchback Engine K10B	857112	Outer Joint	43T	23	19	49	81	56.5	I
ALTO (HA12 HA23)														
1.0 (43 kW)	2000.01-2002.06	-	-	F	Hatchback Engine G10BB	899102	Outer Joint		23	19	49	92	56.5	O
	2000.01-2002.06	MT	L	F	Hatchback Engine G10BB	232006	Drive Shaft		23	22	49	92	589	
	2000.01-2002.06	MT	R	F	Hatchback Engine G10BB	208061	Drive Shaft		23	22	49	92	815	
	2000.01-2002.06	-	-	-	Hatchback Engine G10BB	857008	Outer Joint		23	20	49	92	54.5	O
	2000.01-2002.06	MT	L/R	F	Hatchback Engine G10BB	857001	Outer Joint		23	20	49	92	56.5	I
	2000.01-2002.06	AT	-	F	Hatchback Engine G10BB	857013	Outer Joint		23	20	49	92	56.5	O
	2000.01-2002.06	-	L/R	F	Hatchback Engine G10BB	857038	Outer Joint		23	20	49	92	56.5	M
	2000.01-2002.06	MT	L/R	F	Hatchback Engine G10BB	857048	Outer Joint		23	20	49	92	54.5	O
	2000.01-2002.06	-	L	F	Hatchback Engine G10BB	257078	Drive Shaft		23	22	49	92	590	
	2000.01-2002.06	-	R	F	Hatchback Engine G10BB	257077	Drive Shaft		23	22	49	92	823	
	2000.01-2002.06	MT	R	F	Hatchback Engine G10BB	608018	Inner Joint		22	19	35	51.9	93.4	
	2000.01-2002.06	MT	L/R	F	Hatchback Engine G10BB	857007	Outer Joint		23	19	49	92	56.5	M
	ALTO (HA12S/V)													
0.6	1998.09-2000.12	MT	-	-	Engine F6A	857157	Outer Joint		23	18	49	78	56	M
660	1998.10-2000.12	MT	-	-	Engine F6A	857125	Outer Joint		23	24	49	78	56	I
ALTO (HA21S/V)														
0.6	1998.10-2000.12	AT	-	-	Engine F6A	857157	Outer Joint		23	18	49	78	56	M
ALTO (HA22S)														
0.6	1998.10-2000.12	MT/CVT	-	-	Engine K6A	857157	Outer Joint		23	18	49	78	56	M
660	1998.10-2000.12	MT	-	-	Engine K6A	857125	Outer Joint		23	24	49	78	56	I
	1999.05-2000.12	CVT	-	-	Engine K6A	857125	Outer Joint		23	24	49	78	56	I
ALTO (HA23S/V)														
0.6	2000.12-	MT/AT	-	-	Engine K6A	857157	Outer Joint		23	18	49	78	56	M
660	2000.12-	MT	-	-	Engine K6A	857125	Outer Joint		23	24	49	78	56	I
ALTO (RF410)														
1.1	2006-2010	-	-	-	-	257128	Drive Shaft		23	22	49	77.5	570	

YEAR	TRANS	L/R	F/R	REMARKS	GSP Ref.	PRODUCT	ABS	Technical Specifications						
								A	B	C	H	L	P	
SUZUKI														
ALTO HA11S														
660	1994.11-1998.09	AT	-	-	Engine F6A	801444	Outer Joint		23	17	44	89.6	50.7	M
	1994.11-1998.09	AT	-	-	Engine F6A	801444	Outer Joint		23	17	44	89.6	50.7	M
	1994.11-1998.09	AT	-	-	Engine F6A	801444	Outer Joint		23	17	44	89.6	50.7	M
	1994.11-1998.09	AT	-	-	Engine F6A	801444	Outer Joint		23	17	44	89.6	50.7	M
	1994.11-1998.09	AT	-	-	Engine F6A	801444	Outer Joint		23	17	44	89.6	50.7	M
	1994.11-1998.09	AT	-	-	Engine F6A	801444	Outer Joint		23	17	44	89.6	50.7	M
	1994.11-1998.09	AT	-	-	Engine F6A	801444	Outer Joint		23	17	44	89.6	50.7	M
	1994.11-1998.09	AT	-	-	Engine F6A	801444	Outer Joint		23	17	44	89.6	50.7	M
ALTO HA12S/V														
660	1998.10-1999.09	MT	-	-	Engine F6A	857157	Outer Joint		23	18	49	78	56	M
	1998.10-1999.09	MT	-	-	Engine F6A	857125	Outer Joint		23	24	49	78	56	I
	1999.10-2000.12	MT	-	-	Engine F6A	857157	Outer Joint		23	18	49	78	56	M
	1999.10-	MT	-	-	Engine F6A	857125	Outer Joint		23	24	49	78	56	I
ALTO HA21S/V														
660	1998.10-1999.09	AT	-	-	Engine F6A	857157	Outer Joint		23	18	49	78	56	M
	1998.10-2000.12	AT	-	-	Engine F6A	857157	Outer Joint		23	18	49	78	56	M
ALTO HA22S														
660	1998.10-1999.09	MT	-	-	Engine K6A	857157	Outer Joint		23	18	49	78	56	M
	1998.10-1999.09	MT	-	-	Engine K6A	857125	Outer Joint		23	24	49	78	56	I
	1999.05-1999.09	CVT	-	-	Engine K6A	857125	Outer Joint		23	24	49	78	56	I
	1999.05-1999.09	CVT	-	-	Engine K6A	857125	Outer Joint		23	24	49	78	56	I
	1999.10-2000.12	MT	-	-	Engine K6A	857157	Outer Joint		23	18	49	78	56	M
	1999.10-2000.12	CVT	-	-	Engine K6A	857157	Outer Joint		23	18	49	78	56	M
	1999.10-	MT	-	-	Engine K6A	857125	Outer Joint		23	24	49	78	56	I
	1999.10-	CVT	-	-	Engine K6A	857125	Outer Joint		23	24	49	78	56	I
ALTO HA23S/V														
660	2000.12-	AT	-	-	Engine K6A	857157	Outer Joint		23	18	49	78	56	M
	2000.12-	MT	-	-	Engine K6A	857157	Outer Joint		23	18	49	78	56	M
	2000.12-	MT	-	-	Engine K6A	857125	Outer Joint		23	24	49	78	56	I
ALTO HC11V														
660	1994.11-1998.09	AT	-	-	Engine F6A	801444	Outer Joint		23	17	44	89.6	50.7	M
	1994.11-1998.09	AT	-	-	Engine F6A	801444	Outer Joint		23	17	44	89.6	50.7	M
	1994.11-1998.09	AT	-	-	Engine F6A	801444	Outer Joint		23	17	44	89.6	50.7	M
	1994.11-1998.09	AT	-	-	Engine F6A	801444	Outer Joint		23	17	44	89.6	50.7	M
ALTO IV (FF)														
1.1 (46 kW)	2002.06-	-	-	-	-	857076	Outer Joint		23	19	49	78	57	O
ALTO V (GF)														
1.0 (50 kW)	2002.06-	-	-	-	-	857076	Outer Joint		23	19	49	78	57	O
ALTO(GS)														
-	2002.04-2004.07	-	-	-	Sedan·Van·Hustle	841005	Outer Joint		27	32	56	103	61.5	M
ALTO(SEDAN·VAN·HUSTLE)(HA23S-4)(GS)														
-	2002.04-2004.07	-	-	-	-	841005	Outer Joint		27	32	56	103	61.5	M
BALENO														
1.3 G13B	1995-	MT	-	-	GA11S	657002	Inner Joint		22	19	40	57.5	71	
1.8	1999-	MT	-	-	-	857029	Outer Joint		25	22	49	77	73	I
BALENO (EG)														
1.3 (52 kW)	1996.09-2002.05	-	-	-	Saloon Engine G13BA	857107	Outer Joint		25	21	49	76.5	60.5	M
	1996.09-2002.05	-	-	-	Hatchback Engine G13BA	857107	Outer Joint		25	21	49	76.5	60.5	M
	1996.09-2002.05	AT/MT	L/R	F	Hatchback Engine G13BA	857005	Outer Joint	42T	25	19	49	90	60	M
	1996.09-2002.05	AT/MT	L/R	F	Saloon Engine G13BA	857005	Outer Joint	42T	25	19	49	90	60	M
	1996.09-2002.05	-	-	-	Saloon Engine G13BA	657022	Inner Joint		22	21	35	54	95	
	1996.09-2002.05	-	-	-	Hatchback Engine G13BA	657022	Inner Joint		22	21	35	54	95	
	1996.09-2002.05	-	-	-	Saloon Engine G13BA	657023	Inner Joint		22	21	40	60.5	68	
	1996.09-2002.05	-	-	F	Hatchback Engine G13BA	857160	Outer Joint	42T	25	19	49	76.5	60.5	M
	1996.09-2002.05	-	-	-	Hatchback Engine G13BA	657023	Inner Joint		22	21	40	60.5	68	
	1996.09-2002.05	MT	-	F	Hatchback Engine G13BA	857037	Outer Joint		25	19	49	76	60.5	I
	1996.09-2002.05	MT	-	F	Saloon Engine G13BA	857037	Outer Joint		25	19	49	76	60.5	I
1.3 16V (63 kW)	1997.03-2002.05	-	-	-	Estate Engine G13BB	857107	Outer Joint		25	21	49	76.5	60.5	M
	1997.03-2002.05	AT/MT	L/R	F	Estate Engine G13BB	857005	Outer Joint	42T	25	19	49	90	60	M
	1997.03-2002.05	-	-	-	Estate Engine G13BB	657022	Inner Joint		22	21	35	54	95	
	1997.03-2002.05	-	-	F	Estate Engine G13BB	857160	Outer Joint	42T	25	19	49	76.5	60.5	M
	1997.03-2002.05	-	-	-	Estate Engine G13BB	657023	Inner Joint		22	21	40	60.5	68	
	1997.03-2002.05	MT	-	F	Estate Engine G13BB	857037	Outer Joint		25	19	49	76	60.5	I
1.3 i 16V (63 kW)	1995.07-2002.05	-	-	-	Saloon Engine G13BB	857107	Outer Joint		25	21	49	76.5	60.5	M
	1995.07-2002.05	AT/MT	L/R	F	Hatchback Engine G13BB	857005	Outer Joint	42T	25	19	49	90	60	M

	 YEAR	TRANSM	L/R	F/R	REMARKS	GSP Ref.	 PRODUCT	 ABS	Technical Specifications					
									A	B	C	H	L	P
SUZUKI														
BALENO (EG)														
1.3 i 16V (63 kW)	1995.07-2002.05	AT/MT	L/R	F	Saloon Engine G13BB	857005	Outer Joint	42T	25	19	49	90	60	M
	1995.07-2002.05	-	-	-	Hatchback Engine G13BB	857107	Outer Joint		25	21	49	76.5	60.5	M
	1995.07-2002.05	-	-	-	Saloon Engine G13BB	657022	Inner Joint		22	21	35	54	95	
	1995.07-2002.05	-	-	-	Hatchback Engine G13BB	657022	Inner Joint		22	21	35	54	95	
	1995.07-2002.05	-	-	F	Saloon Engine G13BB	857160	Outer Joint	42T	25	19	49	76.5	60.5	M
	1995.07-2002.05	-	-	-	Saloon Engine G13BB	657023	Inner Joint		22	21	40	60.5	68	
	1995.07-2002.05	-	-	F	Hatchback Engine G13BB	857160	Outer Joint	42T	25	19	49	76.5	60.5	M
	1995.07-2002.05	-	-	-	Hatchback Engine G13BB	657023	Inner Joint		22	21	40	60.5	68	
	1995.07-2002.05	MT	-	F	Hatchback Engine G13BB	857037	Outer Joint		25	19	49	76	60.5	I
	1995.07-2002.05	MT	-	F	Saloon Engine G13BB	857037	Outer Joint		25	19	49	76	60.5	I
1.6 i 16V (72 kW)	1995.07-2002.05	-	-	F	Hatchback Engine G16B	857021	Outer Joint		25	20	49	76	63	M
	1995.07-2002.05	-	-	F	All-wheel Drive Hatchback Engine G16B	857021	Outer Joint		25	20	49	76	63	M
	1995.07-2002.05	-	-	-	Saloon Engine G16B	857107	Outer Joint		25	21	49	76.5	60.5	M
	1995.07-2002.05	-	-	-	All-wheel Drive Saloon Engine G16B	857107	Outer Joint		25	21	49	76.5	60.5	M
	1995.07-2002.05	-	-	-	Hatchback Engine G16B	857107	Outer Joint		25	21	49	76.5	60.5	M
	1995.07-2002.05	-	-	-	All-wheel Drive Hatchback Engine G16B	857107	Outer Joint		25	21	49	76.5	60.5	M
	1995.07-2002.05	-	-	-	Saloon Engine G16B	657022	Inner Joint		22	21	35	54	95	
	1995.07-2002.05	-	-	-	All-wheel Drive Saloon Engine G16B	657022	Inner Joint		22	21	35	54	95	
	1995.07-2002.05	-	-	-	Hatchback Engine G16B	657022	Inner Joint		22	21	35	54	95	
	1995.07-2002.05	-	-	-	All-wheel Drive Hatchback Engine G16B	657022	Inner Joint		22	21	35	54	95	
	1995.07-2002.05	-	-	-	Saloon Engine G16B	657023	Inner Joint		22	21	40	60.5	68	
	1995.07-2002.05	-	-	-	All-wheel Drive Saloon Engine G16B	657023	Inner Joint		22	21	40	60.5	68	
	1995.07-2002.05	-	-	-	All-wheel Drive Hatchback Engine G16B	857016	Outer Joint		25	19	49	76.5	61	M
	1995.07-2002.05	-	-	-	All-wheel Drive Saloon Engine G16B	857016	Outer Joint		25	19	49	76.5	61	M
	1995.07-2002.05	-	-	-	Hatchback Engine G16B	657023	Inner Joint		22	21	40	60.5	68	
	1995.07-2002.05	-	-	-	All-wheel Drive Hatchback Engine G16B	657023	Inner Joint		22	21	40	60.5	68	
	1995.07-2002.05	AT/MT	L/R	F	Hatchback Engine G16B	857014	Outer Joint		25	21	49	76	61	M
	1995.07-2002.05	AT/MT	L/R	F	All-wheel Drive Hatchback Engine G16B	857014	Outer Joint		25	21	49	76	61	M
	1995.07-2002.05	AT/MT	L/R	F	Saloon Engine G16B	857014	Outer Joint		25	21	49	76	61	M
	1995.07-2002.05	AT/MT	L/R	F	All-wheel Drive Saloon Engine G16B	857014	Outer Joint		25	21	49	76	61	M
	1995.07-2002.05	-	-	F	Hatchback Engine G16B	857015	Outer Joint	42T	25	21	49	76	61	M
	1995.07-2002.05	-	-	F	Saloon Engine G16B	857015	Outer Joint	42T	25	21	49	76	61	M
	1995.07-2002.05	AT/MT	L/R	F	Hatchback Engine G16B	899089	Outer Joint		25	20	49	76	61	M
	1995.07-2002.05	AT/MT	L/R	F	All-wheel Drive Hatchback Engine G16B	899089	Outer Joint		25	20	49	76	61	M
	1995.07-2002.05	AT/MT	L/R	F	Saloon Engine G16B	899089	Outer Joint		25	20	49	76	61	M
	1995.07-2002.05	AT/MT	L/R	F	All-wheel Drive Saloon Engine G16B	899089	Outer Joint		25	20	49	76	61	M
	1995.07-2002.05	MT	L/R	F	Hatchback Engine G16B	857002	Outer Joint	42T	25	20	49	76.5	61	I
	1995.07-2002.05	MT	L/R	F	Saloon Engine G16B	857002	Outer Joint	42T	25	20	49	76.5	61	I
	1995.07-2002.05	AT/MT	L/R	F	All-wheel Drive Hatchback Engine G16B	857002	Outer Joint	42T	25	20	49	76.5	61	I
	1995.07-2002.05	AT/MT	L/R	F	All-wheel Drive Saloon Engine G16B	857002	Outer Joint	42T	25	20	49	76.5	61	I
	1996.08-2002.05	-	-	F	Estate Engine G16B	857021	Outer Joint		25	20	49	76	63	M
	1996.08-2002.05	-	-	-	Estate Engine G16B	857107	Outer Joint		25	21	49	76.5	60.5	M
	1996.08-2002.05	-	-	-	All-wheel Drive Estate Engine G16B	857107	Outer Joint		25	21	49	76.5	60.5	M
	1996.08-2002.05	MT	R	F	Estate Engine G16B	257005	Drive Shaft		25	22	49	76	888	
	1996.08-2002.05	-	-	F	Estate Engine G16B	857040	Outer Joint	42T	25	21	49	76.5	61	I
	1996.08-2002.05	-	-	-	Estate Engine G16B	657022	Inner Joint		22	21	35	54	95	
	1996.08-2002.05	-	-	-	All-wheel Drive Estate Engine G16B	657022	Inner Joint		22	21	35	54	95	
	1996.08-2002.05	-	-	-	Estate Engine G16B	657023	Inner Joint		22	21	40	60.5	68	
	1996.08-2002.05	-	-	-	All-wheel Drive Estate Engine G16B	657023	Inner Joint		22	21	40	60.5	68	
	1996.08-2002.05	-	-	-	All-wheel Drive Estate Engine G16B	857016	Outer Joint		25	19	49	76.5	61	M
1996.08-2002.05	AT/MT	L/R	F	Estate Engine G16B	857014	Outer Joint		25	21	49	76	61	M	
1996.08-2002.05	AT/MT	L/R	F	All-wheel Drive Estate Engine G16B	857014	Outer Joint		25	21	49	76	61	M	
1996.08-2002.05	-	-	F	Estate Engine G16B	857015	Outer Joint	42T	25	21	49	76	61	M	
1996.08-2002.05	AT/MT	L/R	F	Estate Engine G16B	899089	Outer Joint		25	20	49	76	61	M	
1996.08-2002.05	AT/MT	L/R	F	All-wheel Drive Estate Engine G16B	899089	Outer Joint		25	20	49	76	61	M	
1996.08-2002.05	MT	L/R	F	Estate Engine G16B	857002	Outer Joint	42T	25	20	49	76.5	61	I	
1996.08-2002.05	AT/MT	L/R	F	All-wheel Drive Estate Engine G16B	857002	Outer Joint	42T	25	20	49	76.5	61	I	
1.6 i 16V (73 kW)	1996.08-2002.05	-	-	F	Estate Engine G16B	857021	Outer Joint		25	20	49	76	63	M
	1996.08-2002.05	-	-	-	Estate Engine G16B	857107	Outer Joint		25	21	49	76.5	60.5	M
	1996.08-2002.05	-	-	-	All-wheel Drive Estate Engine G16B	857107	Outer Joint		25	21	49	76.5	60.5	M
	1996.08-2002.05	MT	R	F	Estate Engine G16B	257005	Drive Shaft		25	22	49	76	888	
	1996.08-2002.05	-	-	-	Estate Engine G16B	657022	Inner Joint		22	21	35	54	95	
	1996.08-2002.05	-	-	-	All-wheel Drive Estate Engine G16B	657022	Inner Joint		22	21	35	54	95	
	1996.08-2002.05	-	-	F	Estate Engine G16B	857040	Outer Joint	42T	25	21	49	76.5	61	I
	1996.08-2002.05	-	-	-	Estate Engine G16B	657023	Inner Joint		22	21	40	60.5	68	
1996.08-2002.05	-	-	-	All-wheel Drive Estate Engine G16B	657023	Inner Joint		22	21	40	60.5	68		

	 YEAR	TRANSM	L/R	F/R	REMARKS	GSP Ref.	 PRODUCT	 ABS	Technical Specifications					
									A	B	C	H	L	P
SUZUKI														
BALENO (EG)														
1.6 i 16V (73 kW)	1996.08-2002.05	AT/MT	L/R	F	All-wheel Drive Estate Engine G16B	857014	Outer Joint		25	21	49	76	61	M
	1996.08-2002.05	AT/MT	L/R	F	All-wheel Drive Estate Engine G16B	899089	Outer Joint		25	20	49	76	61	M
1.8 GTX (89 kW)	1996.03-2002.05	-	-	F	Hatchback Engine J18A	857021	Outer Joint		25	20	49	76	63	M
	1996.03-2002.05	-	-	F	Saloon Engine J18A	857021	Outer Joint		25	20	49	76	63	M
	1996.03-2002.05	-	-	F	Hatchback Engine J18A	857040	Outer Joint	42T	25	21	49	76.5	61	I
	1996.03-2002.05	-	-	F	Saloon Engine J18A	857040	Outer Joint	42T	25	21	49	76.5	61	I
	1996.03-2002.05	-	-	F	Hatchback Engine J18A	857018	Outer Joint		25	22	49	77	73	M
	1996.03-2002.05	-	-	F	Saloon Engine J18A	857018	Outer Joint		25	22	49	77	73	M
	1996.03-2002.05	AT/MT	L/R	F	Hatchback Engine J18A	857014	Outer Joint		25	21	49	76	61	M
	1996.03-2002.05	AT/MT	L/R	F	Saloon Engine J18A	857014	Outer Joint		25	21	49	76	61	M
1.8 i (89 kW)	1996.03-2002.05	-	-	F	All-wheel Drive Hatchback Engine J18A	857021	Outer Joint		25	20	49	76	63	M
	1996.03-2002.05	-	-	F	All-wheel Drive Saloon Engine J18A	857021	Outer Joint		25	20	49	76	63	M
	1996.03-2002.05	-	-	F	All-wheel Drive Hatchback Engine J18A	857040	Outer Joint	42T	25	21	49	76.5	61	I
	1996.03-2002.05	-	-	F	All-wheel Drive Saloon Engine J18A	857040	Outer Joint	42T	25	21	49	76.5	61	I
1.8 i 16V (89 kW)	1996.08-2002.05	-	-	F	Estate Engine J18A	857021	Outer Joint		25	20	49	76	63	M
	1996.08-2002.05	-	-	F	All-wheel Drive Estate Engine J18A	857021	Outer Joint		25	20	49	76	63	M
	1996.08-2002.05	-	-	F	Estate Engine J18A	857040	Outer Joint	42T	25	21	49	76.5	61	I
	1996.08-2002.05	-	-	F	All-wheel Drive Estate Engine J18A	857040	Outer Joint	42T	25	21	49	76.5	61	I
	1996.08-2002.05	-	-	F	Estate Engine J18A	857018	Outer Joint		25	22	49	77	73	M
BALENO/CULTUS														
1.3	1995-	-	MT	-	-	608017	Inner Joint		22	19	35	54.4	86	
CAPPUCINO (EE)														
0.7 (47 kW)	1992.02-1995.08	MT	L/R	R	Convertible Engine F6A	857007	Outer Joint		23	19	49	92	56.5	M
CARRY TRUCK DA63T														
660	2002.05-	5MT	-	-	Allwheel Drive Engine K6A	854011	Outer Joint		23	26	49	78	56	I
	2002.05-	3AT	-	-	Allwheel Drive Engine K6A	854011	Outer Joint		23	26	49	78	56	I
	2002.05-	5MT	-	-	Allwheel Drive Engine K6A	854011	Outer Joint		23	26	49	78	56	I
	2002.05-	3AT	-	-	Allwheel Drive Engine K6A	854011	Outer Joint		23	26	49	78	56	I
CARRY TRUCK DA65T														
660	2005.11-	5MT	-	-	Allwheel Drive Engine K6A	854011	Outer Joint		23	26	49	78	56	I
	2005.11-	5MT	-	-	Allwheel Drive Engine K6A	854011	Outer Joint		23	26	49	78	56	I
CARRY/EVERY(DA62V-5)(GA,PA,PC)														
-	2002.11-2003.10	-	-	-	-	841005	Outer Joint		27	32	56	103	61.5	M
CARRY/EVERY(DA62V-6)(GA,PA,PU,PC)														
-	2003.08-2005.09	-	-	-	-	841005	Outer Joint		27	32	56	103	61.5	M
CARRY/EVERY(DA63T-5)(KC,KCG,KCV)														
-	2002.05-	-	-	-	-	841005	Outer Joint		27	32	56	103	61.5	M
CARRY/EVERY(GA,PA,PC)														
-	2002.11-2003.10	-	-	-	-	841005	Outer Joint		27	32	56	103	61.5	M
CARRY/EVERY(GA,PA,PU,PC)														
-	2003.08-2005.09	-	-	-	-	841005	Outer Joint		27	32	56	103	61.5	M
CARRY/EVERY(KC,KCG,KCV)														
-	2002.05-	-	-	-	-	841005	Outer Joint		27	32	56	103	61.5	M
CERVO MODE														
0.7 Cn22S	1991-1998	MT	-	-	-	857072	Outer Joint		23	18	44	92	48.5	M
CERVO MODE CN22S														
660	1991.09-1998.06	3AT	-	-	Engine F6A	801444	Outer Joint		23	17	44	89.6	50.7	M
	1991.09-1998.06	3AT	-	-	Engine F6A	801444	Outer Joint		23	17	44	89.6	50.7	M
	1991.09-1998.06	3AT	-	-	Engine F6A	801444	Outer Joint		23	17	44	89.6	50.7	M
	1991.09-1998.06	3AT	-	-	Engine F6A	801444	Outer Joint		23	17	44	89.6	50.7	M
	1991.09-1998.06	3AT	-	-	Engine F6A	801444	Outer Joint		23	17	44	89.6	50.7	M
	1991.09-1998.06	3AT	-	-	Engine F6A	801444	Outer Joint		23	17	44	89.6	50.7	M
	1991.09-1998.06	3AT	-	-	Engine F6A	801444	Outer Joint		23	17	44	89.6	50.7	M
	1991.09-1998.06	3AT	-	-	Engine F6A	801444	Outer Joint		23	17	44	89.6	50.7	M
CRESCENT														
1.3	1995-	AT	-	-	GA11S G13B	857023	Outer Joint		25	21	49	76.5	61	I
	1995-	AT	-	-	-	657005	Inner Joint		22	21	40	57.5	71	
CULTUS														
1.3	1995-	AT	-	-	GA11S G13B	857023	Outer Joint		25	21	49	76.5	61	I
	1995-	AT	-	-	-	657005	Inner Joint		22	21	40	57.5	71	
1.3 G13B	1995-	MT	-	-	GA11S	657002	Inner Joint		22	19	40	57.5	71	
1.6	1994-1999	AT	-	-	-	657006	Inner Joint		26	22	40	54	73	
1.8	1999-	MT	-	-	-	857029	Outer Joint		25	22	49	77	73	I
CULTUS BALENO (DG31S)														
1.6 4WD	1996.02-2002.07	5MT	-	-	Engine G16A	857159	Outer Joint	42T	25	21	49	76.5	60.5	M

	 YEAR	TRANSM	L/R	F/R	REMARKS	GSP Ref.	 PRODUCT	 ABS	Technical Specifications					
									A	B	C	H	L	P
SUZUKI														
CULTUS BALENO (DG31S)														
1.6 4WD	1996.02-2002.07	4AT	-	-	Engine G16A	857159	Outer Joint	42T	25	21	49	76.5	60.5	M
CULTUS BALENO (GA11S)														
1.3	1995.01-2002.07	3AT	-	-	Engine G13B	857108	Outer Joint		25	19	49	76.5	60.5	M
	1995.01-2002.07	5MT	-	-	Engine G13B	857108	Outer Joint		25	19	49	76.5	60.5	M
	1996.10-2002.07	CVT	-	-	Engine G13B	857108	Outer Joint		25	19	49	76.5	60.5	M
CULTUS BALENO (GA21S)														
1.5	1995-2002	5MT	-	-	Engine G15A	857159	Outer Joint	42T	25	21	49	76.5	60.5	M
	1995-2002	4AT	-	-	Engine G15A	857159	Outer Joint	42T	25	21	49	76.5	60.5	M
	1995.01-1996.02	4AT	-	-	Engine G15A	857152	Outer Joint		25	20	49	76.5	60.5	M
	1995.01-2002.07	4AT	-	-	Engine G15A	857152	Outer Joint		25	20	49	76.5	60.5	M
CULTUS BALENO (GC21W)														
1.5	1996.02-2002.07	4AT	-	-	Engine G15A	857152	Outer Joint		25	20	49	76.5	60.5	M
CULTUS BALENO DG31S														
1.6	1996.02-2002.07	5MT	-	-	Allwheel Drive Engine G16A	857159	Outer Joint	42T	25	21	49	76.5	60.5	M
1600	1996.02-2002.07	5MT	-	-	Allwheel Drive Engine G16A	857159	Outer Joint	42T	25	21	49	76.5	60.5	M
CULTUS BALENO GA11S														
1.3	1995.01-2002.07	5MT	-	-	Engine G13B	857108	Outer Joint		25	19	49	76.5	60.5	M
	1995.01-2002.07	3AT	-	-	Engine G13B	857108	Outer Joint		25	19	49	76.5	60.5	M
	1995.01-2002.07	3AT	-	-	Engine G13B	857108	Outer Joint		25	19	49	76.5	60.5	M
	1996.10-2002.07	CVT	-	-	Engine G13B	857108	Outer Joint		25	19	49	76.5	60.5	M
	1996.10-2002.07	CVT	-	-	Engine G13B	857108	Outer Joint		25	19	49	76.5	60.5	M
1300	1995.01-2002.07	5MT	-	-	Engine G13B	857108	Outer Joint		25	19	49	76.5	60.5	M
	1995.01-2002.07	3AT	-	-	Engine G13B	857108	Outer Joint		25	19	49	76.5	60.5	M
	1995.01-2002.07	3AT	-	-	Engine G13B	857108	Outer Joint		25	19	49	76.5	60.5	M
	1996.10-2002.07	CVT	-	-	Engine G13B	857108	Outer Joint		25	19	49	76.5	60.5	M
	1996.10-2002.07	CVT	-	-	Engine G13B	857108	Outer Joint		25	19	49	76.5	60.5	M
CULTUS BALENO GA21S														
1.5	1995.01-1996.02	5MT	-	-	Engine G15A	857159	Outer Joint	42T	25	21	49	76.5	60.5	M
	1995.01-1996.02	5MT	-	-	Engine G15A	857159	Outer Joint	42T	25	21	49	76.5	60.5	M
	1995.01-1996.02	5MT	-	-	Engine G15A	857159	Outer Joint	42T	25	21	49	76.5	60.5	M
	1995.01-1996.02	4AT	-	-	Engine G15A	857159	Outer Joint	42T	25	21	49	76.5	60.5	M
	1995.01-1996.02	4AT	-	-	Engine G15A	857159	Outer Joint	42T	25	21	49	76.5	60.5	M
	1995.01-1996.02	4AT	-	-	Engine G15A	857159	Outer Joint	42T	25	21	49	76.5	60.5	M
1500	1995.01-1996.02	5MT	-	-	Engine G15A	857159	Outer Joint	42T	25	21	49	76.5	60.5	M
	1995.01-1996.02	5MT	-	-	Engine G15A	857159	Outer Joint	42T	25	21	49	76.5	60.5	M
	1995.01-1996.02	5MT	-	-	Engine G15A	857159	Outer Joint	42T	25	21	49	76.5	60.5	M
	1995.01-1996.02	4AT	-	-	Engine G15A	857159	Outer Joint	42T	25	21	49	76.5	60.5	M
	1995.01-1996.02	4AT	-	-	Engine G15A	857159	Outer Joint	42T	25	21	49	76.5	60.5	M
CULTUS BALENO GB13S														
1.6	1996.02-2002.07	4AT	-	-	Allwheel Drive Engine G16A	857159	Outer Joint	42T	25	21	49	76.5	60.5	M
1600	1996.02-2002.07	4AT	-	-	Allwheel Drive Engine G16A	857159	Outer Joint	42T	25	21	49	76.5	60.5	M
CULTUS BALENO GB21S														
1.5	1995.01-1996.02	5MT	-	-	Allwheel Drive Engine G15A	857159	Outer Joint	42T	25	21	49	76.5	60.5	M
1500	1995.01-1996.02	5MT	-	-	Allwheel Drive Engine G15A	857159	Outer Joint	42T	25	21	49	76.5	60.5	M
CULTUS BALENO GB31S														
1.6	1996.02-2002.07	4AT	-	-	Allwheel Drive Engine G16A	857159	Outer Joint	42T	25	21	49	76.5	60.5	M
	1996.02-2002.07	5MT	-	-	Allwheel Drive Engine G16A	857159	Outer Joint	42T	25	21	49	76.5	60.5	M
	1996.02-2002.07	5MT	-	-	Allwheel Drive Engine G16A	857159	Outer Joint	42T	25	21	49	76.5	60.5	M
1600	1996.02-2002.07	4AT	-	-	Allwheel Drive Engine G16A	857159	Outer Joint	42T	25	21	49	76.5	60.5	M
	1996.02-2002.07	5MT	-	-	Allwheel Drive Engine G16A	857159	Outer Joint	42T	25	21	49	76.5	60.5	M
	1996.02-2002.07	5MT	-	-	Allwheel Drive Engine G16A	857159	Outer Joint	42T	25	21	49	76.5	60.5	M
CULTUS BALENO GC21S														
1.5	1995.01-2002.07	5MT	-	-	Engine G15A	857159	Outer Joint	42T	25	21	49	76.5	60.5	M
	1995.01-2002.07	5MT	-	-	Engine G15A	857159	Outer Joint	42T	25	21	49	76.5	60.5	M
	1995.01-2002.07	4AT	-	-	Engine G15A	857159	Outer Joint	42T	25	21	49	76.5	60.5	M
	1995.01-2002.07	4AT	-	-	Engine G15A	857159	Outer Joint	42T	25	21	49	76.5	60.5	M
	1995.01-2002.07	4AT	-	-	Engine G15A	857159	Outer Joint	42T	25	21	49	76.5	60.5	M
1500	1995.01-2002.07	5MT	-	-	Engine G15A	857159	Outer Joint	42T	25	21	49	76.5	60.5	M
	1995.01-2002.07	5MT	-	-	Engine G15A	857159	Outer Joint	42T	25	21	49	76.5	60.5	M
	1995.01-2002.07	4AT	-	-	Engine G15A	857159	Outer Joint	42T	25	21	49	76.5	60.5	M
	1995.01-2002.07	4AT	-	-	Engine G15A	857159	Outer Joint	42T	25	21	49	76.5	60.5	M
CULTUS BALENO GC21W														
1.5	1996.02-2002.07	4AT	-	-	Engine G15A	857159	Outer Joint	42T	25	21	49	76.5	60.5	M
	1996.02-2002.07	4AT	-	-	Engine G15A	857159	Outer Joint	42T	25	21	49	76.5	60.5	M
	1996.02-2002.07	5MT	-	-	Engine G15A	857159	Outer Joint	42T	25	21	49	76.5	60.5	M





	 YEAR	TRANSM	L/R	F/R	REMARKS	GSP Ref.	 PRODUCT	 ABS	Technical Specifications						
									A	B	C	H	L	P	
SUZUKI															
CULTUS BALENO GC21W															
1500	1996.02-2002.07	5MT	-	-	Engine G15A	857159	Outer Joint	42T	25	21	49	76.5	60.5	M	
	1996.02-2002.07	4AT	-	-	Engine G15A	857159	Outer Joint	42T	25	21	49	76.5	60.5	M	
CULTUS BALENO GD21S															
1.5	1995.01-1996.02	5MT	-	-	Allwheel Drive Engine G15A	857159	Outer Joint	42T	25	21	49	76.5	60.5	M	
1500	1995.01-1996.02	5MT	-	-	Allwheel Drive Engine G15A	857159	Outer Joint	42T	25	21	49	76.5	60.5	M	
CULTUS BALENO GD31S															
1.6	1996.02-2002.07	5MT	-	-	Allwheel Drive Engine G16A	857159	Outer Joint	42T	25	21	49	76.5	60.5	M	
	1996.02-2002.07	4AT	-	-	Allwheel Drive Engine G16A	857159	Outer Joint	42T	25	21	49	76.5	60.5	M	
	1996.02-2002.07	4AT	-	-	Allwheel Drive Engine G16A	857159	Outer Joint	42T	25	21	49	76.5	60.5	M	
1600	1996.02-2002.07	5MT	-	-	Allwheel Drive Engine G16A	857159	Outer Joint	42T	25	21	49	76.5	60.5	M	
	1996.02-2002.07	4AT	-	-	Allwheel Drive Engine G16A	857159	Outer Joint	42T	25	21	49	76.5	60.5	M	
	1996.02-2002.07	4AT	-	-	Allwheel Drive Engine G16A	857159	Outer Joint	42T	25	21	49	76.5	60.5	M	
CULTUS CRESCENT WAGON GC41W															
1.8	1996.02-1998.05	4AT	-	-	Engine J18A	857159	Outer Joint	42T	25	21	49	76.5	60.5	M	
	1996.02-1998.05	4AT	-	-	Engine J18A	857159	Outer Joint	42T	25	21	49	76.5	60.5	M	
	1996.02-2002.07	4AT	-	-	Engine J18A	857159	Outer Joint	42T	25	21	49	76.5	60.5	M	
	1996.02-2002.07	4AT	-	-	Engine J18A	857159	Outer Joint	42T	25	21	49	76.5	60.5	M	
1800	1996.02-1998.05	4AT	-	-	Engine J18A	857159	Outer Joint	42T	25	21	49	76.5	60.5	M	
	1996.02-1998.05	4AT	-	-	Engine J18A	857159	Outer Joint	42T	25	21	49	76.5	60.5	M	
	1996.02-1998.05	4AT	-	-	Engine J18A	857159	Outer Joint	42T	25	21	49	76.5	60.5	M	
	1996.02-2002.07	4AT	-	-	Engine J18A	857159	Outer Joint	42T	25	21	49	76.5	60.5	M	
	1996.02-2002.07	4AT	-	-	Engine J18A	857159	Outer Joint	42T	25	21	49	76.5	60.5	M	
CULTUS CRESCENT WAGON GD31W															
1.6	1996.02-2002.07	4AT	-	-	Engine G16A	857159	Outer Joint	42T	25	21	49	76.5	60.5	M	
	1996.02-2002.07	4AT	-	-	Allwheel Drive Engine G16A	857159	Outer Joint	42T	25	21	49	76.5	60.5	M	
	1996.02-2002.07	4AT	-	-	Allwheel Drive Engine G16A	857159	Outer Joint	42T	25	21	49	76.5	60.5	M	
	1996.12-2002.07	5MT	-	-	Allwheel Drive Engine G16A	857159	Outer Joint	42T	25	21	49	76.5	60.5	M	
1600	1996.02-2002.07	4AT	-	-	Engine G16A	857159	Outer Joint	42T	25	21	49	76.5	60.5	M	
	1996.02-2002.07	4AT	-	-	Allwheel Drive Engine G16A	857159	Outer Joint	42T	25	21	49	76.5	60.5	M	
	1996.02-2002.07	4AT	-	-	Allwheel Drive Engine G16A	857159	Outer Joint	42T	25	21	49	76.5	60.5	M	
	1996.12-2002.07	5MT	-	-	Allwheel Drive Engine G16A	857159	Outer Joint	42T	25	21	49	76.5	60.5	M	
ESCUDO VITARA (TA02)															
1.6	1997.11-	MT/AT	-	-	Engine G16A	857126	Outer Joint		26	29	48	116	65.5	M	
ESCUDO VITARA (TA11W)															
2.0	1994.12-1997.11	MT/AT	-	-	Engine H20A	857126	Outer Joint		26	29	48	116	65.5	M	
ESCUDO VITARA (TA31W)															
2.0	1994.12-1997.11	4AT	-	-	Engine RF TBO	857126	Outer Joint		26	29	48	116	65.5	M	
ESCUDO VITARA (TA52)															
2.0	1997.11-	4AT	-	-	Engine J20A	857126	Outer Joint		26	29	48	116	65.5	M	
ESCUDO VITARA (TD02)															
1.6	1997.11-	MT/AT	-	-	Engine G16A	857126	Outer Joint		26	29	48	116	65.5	M	
ESCUDO VITARA (TD11W)															
2.0	1994.12-1997.11	MT/AT	-	-	Engine H20A	857126	Outer Joint		26	29	48	116	65.5	M	
ESCUDO VITARA (TD31W)															
2.0	1994.12-1997.11	4AT	-	-	Engine RF TBO	857126	Outer Joint		26	29	48	116	65.5	M	
ESCUDO VITARA (TD52)															
2.0	1997.11-	4AT	-	-	Engine J20A	857126	Outer Joint		26	29	48	116	65.5	M	
ESCUDO VITARA (TD54W)															
2.0 4WD	2005.05-2008.04	MT/AT	-	-	Engine J20A	899322	Outer Joint		28	24	58.3	82	63	M	
	2005.05-2008.04	MT/AT	-	-	Engine J20A	899322	Outer Joint		28	24	58.3	82	63	M	
ESCUDO VITARA (TD94W)															
2.7 4WD	2005.05-2008.04	5AT	-	-	Engine H27A	899322	Outer Joint		28	24	58.3	82	63	M	
	2005.05-2008.04	5AT	-	-	Engine H27A	899322	Outer Joint		28	24	58.3	82	63	M	
ESCUDO VITARA TA02															
1.6	1997.11-	MT/AT	-	-	Engine G16A	857126	Outer Joint		26	29	48	116	65.5	M	
1600	1997.11-	MT/AT	-	-	Engine G16A	857126	Outer Joint		26	29	48	116	65.5	M	
ESCUDO VITARA TA11W															
2.0	1994.12-1997.11	MT/AT	-	-	Engine H20A	857126	Outer Joint		26	29	48	116	65.5	M	
2000	1994.12-1997.11	MT/AT	-	-	Engine H20A	857126	Outer Joint		26	29	48	116	65.5	M	
ESCUDO VITARA TA31W															
2.0	1994.12-1997.11	4AT	-	-	Engine RF TBO	857126	Outer Joint		26	29	48	116	65.5	M	
2000	1994.12-1997.11	4AT	-	-	Engine RF TBO	857126	Outer Joint		26	29	48	116	65.5	M	
ESCUDO VITARA TA52															
2.0	1997.11-	4AT	-	-	Engine J20A	857126	Outer Joint		26	29	48	116	65.5	M	
2000	1997.11-	4AT	-	-	Engine J20A	857126	Outer Joint		26	29	48	116	65.5	M	





		YEAR		TRANSM		L/R F/R		REMARKS		GSP Ref.		PRODUCT		ABS		Technical Specifications					
																A	B	C	H	L	P
SUZUKI																					
ESCUDO VITARA TD02																					
1.6	1997.11-	-	MT/AT	-	-	Engine G16A	857126	Outer Joint		26	29	48	116	65.5	M						
1600	1997.11-	-	MT/AT	-	-	Engine G16A	857126	Outer Joint		26	29	48	116	65.5	M						
ESCUDO VITARA TD11W																					
2.0	1994.12-	1997.11	MT/AT	-	-	Engine H20A	857126	Outer Joint		26	29	48	116	65.5	M						
2000	1994.12-	1997.11	MT/AT	-	-	Engine H20A	857126	Outer Joint		26	29	48	116	65.5	M						
ESCUDO VITARA TD31W																					
2.0	1994.12-	1997.11	4AT	-	-	Engine RF TBO	857126	Outer Joint		26	29	48	116	65.5	M						
2000	1994.12-	1997.11	4AT	-	-	Engine RF TBO	857126	Outer Joint		26	29	48	116	65.5	M						
ESCUDO VITARA TD52																					
2.0	1997.11-	-	4AT	-	-	Engine J20A	857126	Outer Joint		26	29	48	116	65.5	M						
2000	1997.11-	-	4AT	-	-	Engine J20A	857126	Outer Joint		26	29	48	116	65.5	M						
ESCUDO VITARA TD54W																					
2000	2005.05-	2008.04	MT/AT	-	-	Allwheel Drive Engine J20A	899322	Outer Joint		28	24	58.3	82	63	M						
	2005.05-	2008.04	MT/AT	-	-	Allwheel Drive Engine J20A	899322	Outer Joint		28	24	58.3	82	63	M						
ESCUDO VITARA TD94W																					
2700	2005.05-	2008.04	5AT	-	-	Allwheel Drive Engine H27A	899322	Outer Joint		28	24	58.3	82	63	M						
	2005.05-	2008.04	5AT	-	-	Allwheel Drive Engine H27A	899322	Outer Joint		28	24	58.3	82	63	M						
ESTEEM																					
1.3	1995-	-	AT	-	-	GA11S G13B	857023	Outer Joint		25	21	49	76.5	61	I						
	1995-	-	AT	-	-	-	657005	Inner Joint		22	21	40	57.5	71							
EVERY																					
-	2003.08-	-	-	L	R	LE-DA62V	257309	Stub Axle		24	30				419.2						
EVERY DA64V																					
660	2005.08-	-	5MT	-	-	Allwheel Drive Engine K6A	854011	Outer Joint		23	26	49	78	56	I						
	2005.08-	-	3AT	-	-	Allwheel Drive Engine K6A	854011	Outer Joint		23	26	49	78	56	I						
	2005.08-	-	4AT	-	-	Allwheel Drive Engine K6A TBO	854011	Outer Joint		23	26	49	78	56	I						
	2005.08-	-	5MT	-	-	Allwheel Drive Engine K6A TBO	854011	Outer Joint		23	26	49	78	56	I						
	2005.08-	-	4AT	-	-	Allwheel Drive Engine K6A TBO	854011	Outer Joint		23	26	49	78	56	I						
	2005.08-	-	5MT	-	-	Allwheel Drive Engine K6A TBO	854011	Outer Joint		23	26	49	78	56	I						
	2005.08-	-	5MT	-	-	Allwheel Drive Engine K6A	854011	Outer Joint		23	26	49	78	56	I						
	2005.08-	-	3AT	-	-	Allwheel Drive Engine K6A	854011	Outer Joint		23	26	49	78	56	I						
	2005.08-	-	5MT	-	-	Allwheel Drive Engine K6A	854011	Outer Joint		23	26	49	78	56	I						
EVERY WAGON DA64W																					
660	2005.08-	-	3AT	-	-	Allwheel Drive Engine K6A	854011	Outer Joint		23	26	49	78	56	I						
	2005.08-	-	3AT	-	-	Allwheel Drive Engine K6A	854011	Outer Joint		23	26	49	78	56	I						
EVERY WAGON DW64W																					
660	2005.08-	-	4AT	-	-	Allwheel Drive Engine K6A TBO	854011	Outer Joint		23	26	49	78	56	I						
	2005.08-	-	4AT	-	-	Allwheel Drive Engine K6A TBO	854011	Outer Joint		23	26	49	78	56	I						
GRAND VITARA																					
2.4 L4 - Gas	2010-	2013	MT	R	F	Base, Limited, Premium	251049	Drive Shaft		28		58.3	82	601							
	2010-	2013	MT	R	F	Base, Limited, Premium	651017	Inner Joint			26		74								
GRAND VITARA I (FT HT)/GRAND VITARA XL-7/GRAND ESCUDO																					
1.6 (69 kW)	1998.03-	2003.07	MT	-	F	All-wheel Drive Closed Off-Road Vehicle Engine G16B	857009	Outer Joint		26	30	48	116	65.5	I						
2.0 (94 kW)	1998.03-	2003.07	MT	-	F	All-wheel Drive Closed Off-Road Vehicle Engine J20A	857009	Outer Joint		26	30	48	116	65.5	I						
2.0 HDI 110 (80 kW)	2001.07-	2005.09	MT	-	F	All-wheel Drive Closed Off-Road Vehicle Engine RHZ	857009	Outer Joint		26	30	48	116	65.5	I						
2.0 HDI 110 16V (80 kW)	2001.07-	2005.09	MT	-	F	All-wheel Drive Closed Off-Road Vehicle Engine RHW	857009	Outer Joint		26	30	48	116	65.5	I						
2.0 TD (64 kW)	1998.03-	2003.07	MT	-	F	All-wheel Drive Closed Off-Road Vehicle Engine RF	857009	Outer Joint		26	30	48	116	65.5	I						
2.5 V6 24V (106 kW)	1998.04-	2003.07	-	-	F	All-wheel Drive Closed Off-Road Vehicle Engine H 25 A	857017	Outer Joint		26	29	48	116	65.5	I						
	1998.04-	2003.07	-	-	F	All-wheel Drive Closed Off-Road Vehicle Engine H 25 A	857127	Outer Joint		26	30	48	116	65.5	M						
	1998.04-	2003.07	-	R	F	All-wheel Drive Closed Off-Road Vehicle Engine H 25 A	657102	Inner Joint		26	30	35	34	134							
	1998.04-	2003.07	MT	-	F	All-wheel Drive Closed Off-Road Vehicle Engine H 25 A	857009	Outer Joint		26	30	48	116	65.5	I						
2.5 V6 24V (116 kW)	2001.04-	2003.07	MT	-	F	All-wheel Drive Closed Off-Road Vehicle Engine H 25 A	857009	Outer Joint		26	30	48	116	65.5	I						
2.7 (127 kW)	2001.09-	2003.07	-	-	-	All-wheel Drive Closed Off-Road Vehicle Engine H 27 A	854007	Outer Joint		26	32	48	116	65.5	M						
	2001.09-	2003.07	-	-	F	All-wheel Drive Closed Off-Road Vehicle Engine H 27 A	857009	Outer Joint		26	30	48	116	65.5	I						
2.7 (135 kW)	2003.04-	2003.07	-	-	-	All-wheel Drive Closed Off-Road Vehicle Engine H 27 A	854007	Outer Joint		26	32	48	116	65.5	M						
	2003.04-	2003.07	-	-	F	All-wheel Drive Closed Off-Road Vehicle Engine H 27 A	857009	Outer Joint		26	30	48	116	65.5	I						
GRAND VITARA I (FT, GT)																					
1.6 i 16V (69 kW)	1998.03-	-	MT	-	-	-	899107	Outer Joint		26	30	48	116	65.5	I						
1.6 i 16V (73 kW)	1998.03-	-	MT	-	-	-	899107	Outer Joint		26	30	48	116	65.5	I						
2.0 (94 kW)	1998.03-	-	MT	-	-	-	899107	Outer Joint		26	30	48	116	65.5	I						
2.0 HDi (80 kW)	2001.07-	-	MT	-	-	-	899107	Outer Joint		26	30	48	116	65.5	I						
2.0 TD Intercooler (64 kW)	1998.03-	-	MT	-	-	-	899107	Outer Joint		26	30	48	116	65.5	I						
2.5 V6 24V (106 kW)	1998.04-	-	MT	-	-	-	899107	Outer Joint		26	30	48	116	65.5	I						
2.5 V6 24V (116 kW)	1998.04-	-	MT	-	-	-	899107	Outer Joint		26	30	48	116	65.5	I						
2.7 XL-7 (127 kW)	2001.09-	-	-	-	-	-	899107	Outer Joint		26	30	48	116	65.5	I						





YEAR	TRANSM	L/R	F/R	REMARKS	GSP Ref.	PRODUCT	ABS	Technical Specifications							
								A	B	C	H	L	P		
SUZUKI															
GRAND VITARA I (FT, GT)															
2.7 XL-7 (135 kW)	2001.09-	-	-	-	-	899107	Outer Joint		26	30	48	116	65.5	I	
GRAND VITARA I (GT)															
1.6 (69 kW)	1998.03-	2003.07	MT	-	F	All-wheel Drive Convertible Engine G16B	857009	Outer Joint	26	30	48	116	65.5	I	
2.0 (94 kW)	1998.03-	2003.07	MT	-	F	All-wheel Drive Convertible Engine J20A	857009	Outer Joint	26	30	48	116	65.5	I	
GRAND VITARA II															
2.4 L4	2009-	2013	MT	R	-	-	251048	Drive Shaft	28	26	58.3	82	617		
	2009-	2013	MT	R	-	-	651016	Inner Joint	26	24	40	78	98		
2.7 V6	2006-	2008	-	R	-	-	251048	Drive Shaft	28	26	58.3	82	617		
	2006-	2008	-	R	-	-	651016	Inner Joint	26	24	40	78	98		
GRAND VITARA II (JT TE TD)															
1.6 (78 kW)	2005.04-	-	-	R	F	All-wheel Drive Closed Off-Road Vehicle Engine M16A	254014	Drive Shaft	28	26	58.2	82	614		
	2005.04-	-	-	L	F	All-wheel Drive Closed Off-Road Vehicle Engine M16A	257246	Drive Shaft	28		58.2	82	560		
1.9 DDiS (95 kW)	2005.10-	2015.02	-	R	F	All-wheel Drive Closed Off-Road Vehicle Engine F9QB	254014	Drive Shaft	28	26	58.2	82	614		
	2005.10-	2015.02	-	L	F	All-wheel Drive Closed Off-Road Vehicle Engine F9QB	257246	Drive Shaft	28		58.2	82	560		
	2005.10-	2015.02	-	L/R/F/R		All-wheel Drive Closed Off-Road Vehicle Engine F9QB	851030	Outer Joint	28	26	58.3	82	73	I	
2.0 (101 kW)	2013.03-	-	-	L	R	All-wheel Drive Closed Off-Road Vehicle Engine J20A	657162	Inner joint	28	26	40	76	117.5		
2.0 (103 kW)	2005.10-	2015.02	-	R	F	All-wheel Drive Closed Off-Road Vehicle Engine J20A	254014	Drive Shaft	28	26	58.2	82	614		
	2005.10-	2015.02	-	L	F	All-wheel Drive Closed Off-Road Vehicle Engine J20A	257246	Drive Shaft	28		58.2	82	560		
	2005.10-	2015.02	-	L/R/F/R		All-wheel Drive Closed Off-Road Vehicle Engine J20A	851030	Outer Joint	28	26	58.3	82	73	I	
2.4 (122 kW)	2009.01-	-	-	L/R/F/R		All-wheel Drive Closed Off-Road Vehicle Engine J24B	851030	Outer Joint	28	26	58.3	82	73	I	
2.4 (124 kW)	2009.01-	-	-	L/R/F/R		All-wheel Drive Closed Off-Road Vehicle Engine J24B	851030	Outer Joint	28	26	58.3	82	73	I	
	2009.09-	-	MT	L	F	Closed Off-Road Vehicle Engine J24B	657172	Inner joint		24		73			
	2009.09-	-	MT	L	F	Closed Off-Road Vehicle Engine J24B	657172	Inner joint		24		73			
2.7 (138 kW)	2005.04-	2008.08	-	-	F	All-wheel Drive Closed Off-Road Vehicle Engine H 27 A	857067	Outer Joint	28	22	58.2	82	58	I	
	2005.04-	2008.08	-	-	R	All-wheel Drive Closed Off-Road Vehicle Engine H 27 A	851029	Outer Joint	28	24	58.3	82	63	I	
	2005.04-	2008.08	-	L	F	All-wheel Drive Closed Off-Road Vehicle Engine H 27 A	657127	Inner Joint		24		73			
	2005.04-	2008.08	-	R	F	All-wheel Drive Closed Off-Road Vehicle Engine H 27 A	654006	Inner Joint	26	22	40	78.5	96		
	2005.09-	2008.12	AT	-	R	Closed Off-Road Vehicle Engine H 27 A	851029	Outer Joint	28	24	58.3	82	63	I	
3.2 (171 kW)	2009.01-	2015.02	-	L/R/F/R	All-wheel Drive Closed Off-Road Vehicle Engine N32A	851030	Outer Joint	28	26	58.3	82	73	I		
IGNIS I (FH)															
1.3 (61 kW)	2000.10-	2003.09	MT	L/R	F	Closed Off-Road Vehicle Engine M13A	857105	Outer Joint	43T	25	20	49	76	61	M
	2000.10-	2003.09	MT	L	F	Closed Off-Road Vehicle Engine M13A	257062	Drive Shaft		23	22	49	78	609	
	2000.10-	2003.09	MT	L	F	All-wheel Drive Closed Off-Road Vehicle Engine M13A	257062	Drive Shaft		23	22	49	78	609	
	2000.10-	2003.09	MT	R	F	Closed Off-Road Vehicle Engine M13A	257121	Drive Shaft	43T	23	22	49	77.5	847	
	2000.10-	2003.09	MT	R	F	All-wheel Drive Closed Off-Road Vehicle Engine M13A	257121	Drive Shaft	43T	23	22	49	77.5	847	
	2000.10-	2003.09	-	-	F	Closed Off-Road Vehicle Engine M13A	857096	Outer Joint	43T	23	20	49	78	60	M
	2000.10-	2003.09	-	-	F	All-wheel Drive Closed Off-Road Vehicle Engine M13A	857096	Outer Joint	43T	23	20	49	78	60	M
	2000.10-	2003.09	-	-	F	Closed Off-Road Vehicle Engine M13A	857022	Outer Joint		23	19	49	78	57	M
	2000.10-	2003.09	-	-	F	All-wheel Drive Closed Off-Road Vehicle Engine M13A	857022	Outer Joint		23	19	49	78	57	M
	2000.10-	2003.09	MT	L/R	F	All-wheel Drive Closed Off-Road Vehicle Engine M13A	857039	Outer Joint	43T	23	19	49	78	57	M
	2000.10-	2003.09	AT/MT	L/R	F	Closed Off-Road Vehicle Engine M13A	857039	Outer Joint	43T	23	19	49	78	57	M
1.3 4WD (60 kW)	2000.10-	2003.09	-	-	-	-	857104	Outer Joint		23	19	49	78	57	M
1.3 4WD (61 kW)	2000.10-	2003.09	-	-	-	-	857104	Outer Joint		23	19	49	78	57	M
1.3 4WD (66 kW)	2000.10-	2003.09	-	-	-	-	857104	Outer Joint		23	19	49	78	57	M
IGNIS II (MH)															
1.3 (69 kW)	2003.09-	-	-	L/R	F	Closed Off-Road Vehicle Engine M13A	857105	Outer Joint	43T	25	20	49	76	61	M
	2003.09-	-	MT	R	F	Closed Off-Road Vehicle Engine M13A	299185	Drive Shaft	43T	25	22	49	76	644	
	2003.09-	-	MT	R	F	All-wheel Drive Closed Off-Road Vehicle Engine M13A	299185	Drive Shaft	43T	25	22	49	76	644	
	2003.09-	-	-	-	-	Closed Off-Road Vehicle Engine M13A	857081	Outer Joint		25	28	49	76	63	I
	2003.09-	-	-	L	F	Closed Off-Road Vehicle Engine M13A	299184	Drive Shaft	43T	25	22	49	76	610	
	2003.09-	-	-	-	F	Closed Off-Road Vehicle Engine M13A	857062	Outer Joint	43T	25	28	49	76	61	I
	2003.09-	-	-	-	F	All-wheel Drive Closed Off-Road Vehicle Engine M13A	857062	Outer Joint	43T	25	28	49	76	61	I
	2003.09-	-	-	-	F	Closed Off-Road Vehicle Engine M13A	857097	Outer Joint	43T	25	20	49	75	61	M
	2003.09-	-	-	-	F	All-wheel Drive Closed Off-Road Vehicle Engine M13A	857097	Outer Joint	43T	25	20	49	75	61	M
	1.3 DDiS (51 kW)	2003.09-	-	-	-	-	Closed Off-Road Vehicle Engine Z13DT	857079	Outer Joint	43T	25	29	49	76	63
1.5 (73 kW)	2003.09-	-	MT	R	F	Closed Off-Road Vehicle Engine M15A	299185	Drive Shaft	43T	25	22	49	76	644	
	2003.09-	-	MT	L	F	Closed Off-Road Vehicle Engine M15A	299184	Drive Shaft	43T	25	22	49	76	610	
	2003.09-	-	-	-	F	Closed Off-Road Vehicle Engine M15A	857062	Outer Joint	43T	25	28	49	76	61	I
	2003.09-	-	-	-	F	All-wheel Drive Closed Off-Road Vehicle Engine M15A	857062	Outer Joint	43T	25	28	49	76	61	I
1.5 Sport (80 kW)	2003.12-	-	-	-	F	Closed Off-Road Vehicle Engine M15A	857062	Outer Joint	43T	25	28	49	76	61	I
JIMNY (SN)/JIMNY SIERRA															
1.3 16V (59 kW)	1998.09-	-	-	R	F	Closed Off-Road Vehicle Engine G13BB	203264	Drive Shaft		26		44	115.5	555	
	1998.09-	-	-	L	F	Closed Off-Road Vehicle Engine G13BB	214053	Drive Shaft		26		44	115.5	882	
	1998.09-	-	-	R	F	All-wheel Drive Closed Off-Road Vehicle Engine G13BB	203264	Drive Shaft		26		44	115.5	555	
	1998.09-	-	-	L	F	All-wheel Drive Closed Off-Road Vehicle Engine G13BB	214053	Drive Shaft		26		44	115.5	882	
1.3 16V (60 kW)	2001.02-	-	-	-	F	Closed Off-Road Vehicle Engine M13A	859117	Outer Joint		26	19	44	115.5	52	M
	2001.02-	-	-	-	F	All-wheel Drive Closed Off-Road Vehicle Engine M13A	859117	Outer Joint		26	19	44	115.5	52	M

YEAR	TRANS	L/R	F/R	REMARKS	GSP Ref.	PRODUCT	ABS	Technical Specifications						
								A	B	C	H	L	P	
SUZUKI														
JIMNY (SN)/JIMNY SIERRA														
1.3 16V (60 kW)	2001.02-	-	-	R -	Closed Off-Road Vehicle Engine M13A	203264	Drive Shaft		26		44	115.5	555	
	2001.02-	-	-	L -	Closed Off-Road Vehicle Engine M13A	214053	Drive Shaft		26		44	115.5	882	
	2001.02-	-	-	R -	All-wheel Drive Closed Off-Road Vehicle Engine M13A	203264	Drive Shaft		26		44	115.5	555	
	2001.02-	-	-	L -	All-wheel Drive Closed Off-Road Vehicle Engine M13A	214053	Drive Shaft		26		44	115.5	882	
1.3 16V (63 kW)	2005.08-	-	-	R F	All-wheel Drive Closed Off-Road Vehicle Engine M13A	203264	Drive Shaft		26		44	115.5	555	
	2005.08-	-	-	L F	All-wheel Drive Closed Off-Road Vehicle Engine M13A	214053	Drive Shaft		26		44	115.5	882	
	2005.08-	-	-	- F	All-wheel Drive Closed Off-Road Vehicle Engine M13A	859117	Outer Joint		26	19	44	115.5	52	M
JIMNY SIERRA SAMURAI JA51														
1.3	1984.01-	1990.01		MT/AT - -	Engine G13A	814123	Outer Joint		26	22	45	136	51	M
JIMNY SIERRA SAMURAI JB31W														
1.3	1993.05-	1995.11		MT/AT - -	Engine G13B	814123	Outer Joint		26	22	45	136	51	M
1300	1993.05-	1995.11		MT/AT - -	Engine G13B	814123	Outer Joint		26	22	45	136	51	M
JIMNY SIERRA SAMURAI JB43W														
1300	2002.01-	-		4AT - -	Engine M13A	814119	Outer Joint		26	29	44	115.5	52	M
	2002.01-	-		5MT - -	Engine M13A	814119	Outer Joint		26	29	44	115.5	52	M
JIMNY WIDE SAMURAI JA51														
1300	1984.01-	1990.01		MT/AT - -	Engine G13A	814123	Outer Joint		26	22	45	136	51	M
JIMNY/SIERRA/SAMURAI														
1.3 (JB43W)	2002.01-	-		4AT - -	Engine M13A	814119	Outer Joint		26	29	44	115.5	52	M
	2002.01-	-		5MT - -	Engine M13A	814119	Outer Joint		26	29	44	115.5	52	M
KARIMUN														
-	-	-	-	- -	-	657033	Inner Joint		22	19	35	58	100	
	-	-	-	- -	-	857076	Outer Joint		23	19	49	78	57	O
	-	-	-	- -	-	657034	Inner Joint		22	19	35.4	58	107	
KEI (HN11S)														
660	1998.10-	1999.10		3AT - -	Engine F6A TBO	857125	Outer Joint		23	24	49	78	56	I
KEI (HN21S)														
0.6	1998.10-	-		5MT/4AT - -	Engine K6A	857157	Outer Joint		23	18	49	78	56	M
660	1998.10-	2000.10		5MT - -	Engine K6A	857125	Outer Joint		23	24	49	78	56	I
KEI (HN22S)														
0.6	2001.04-	-		5MT/4AT - -	Engine K6A	857157	Outer Joint		23	18	49	78	56	M
660	2001.04-	-		5MT - -	Engine K6A	857125	Outer Joint		23	24	49	78	56	I
KEI HN21S														
660	1998.10-	1999.10		5MT - -	Engine K6A	857125	Outer Joint		23	24	49	78	56	I
	1998.10-	1999.10		5MT - -	Engine K6A	857157	Outer Joint		23	18	49	78	56	M
	2000.10-	-		5MT - -	Engine K6A	857125	Outer Joint		23	24	49	78	56	I
	2000.10-	2000.10		5MT - -	Engine K6A	857157	Outer Joint		23	18	49	78	56	M
	2000.10-	-		4AT - -	Engine K6A	857157	Outer Joint		23	18	49	78	56	M
KEI HN22S														
660	2001.04-	-		5MT - -	Engine K6A	857125	Outer Joint		23	24	49	78	56	I
	2001.04-	-		5MT - -	Engine K6A	857157	Outer Joint		23	18	49	78	56	M
	2001.04-	-		4AT - -	Engine K6A	857157	Outer Joint		23	18	49	78	56	M
KIZASHI (FR)														
2.4 (129 kW)	2010.10-	-		MT/AT L F	Saloon Engine J24B	657171	Inner joint		27	33	40	62	117	
2.4 (131 kW)	2010.10-	-		MT/AT L F	Saloon Engine J24B	657171	Inner joint		27	33	40	62	117	
	2010.10-	-		- R R	All-wheel Drive Saloon Engine J24B	657161	Inner joint		23	28	35	60.5	123	
	2010.10-	-		MT/AT L F	All-wheel Drive Saloon Engine J24B	657171	Inner joint		27	33	40	62	117	
2.4 (138 kW)	2010.10-	-		- R R	All-wheel Drive Saloon Engine J24B	657161	Inner joint		23	28	35	60.5	123	
LIANA (ER RH_)														
1.3 (66 kW)	2002.03-	-		- -	Saloon Engine M13A	657035	Inner Joint		26	21	38	56	103	
	2002.03-	-		- L F	Saloon Engine M13A	699034	Inner Joint		26	21	38	55.5	110.5	
	2002.03-	-		- -	Saloon Engine M13A	657036	Inner Joint		26	21	40	55	70	
	2002.03-	-		- L/R F	Saloon Engine M13A	857041	Outer Joint	42T	25	29	49	76	61	I
1.6 (76 kW)	2002.03-	-		MT L F	Saloon Engine M16A	257060	Drive Shaft	42T	25	26	49	76	611	
	2002.03-	-		MT L F	All-wheel Drive Saloon Engine M16A	257060	Drive Shaft	42T	25	26	49	76	611	
	2002.03-	-		- -	Saloon Engine M16A	857054	Outer Joint	42T	25	29	49	76	61	I
	2002.03-	-		MT R F	Saloon Engine M16A	257061	Drive Shaft	42T	25	26	49	76	591.5	
	2002.03-	-		MT R F	All-wheel Drive Saloon Engine M16A	257061	Drive Shaft	42T	25	26	49	76	591.5	
	2002.03-	-		- -	Saloon Engine M16A	657035	Inner Joint		26	21	38	56	103	
	2002.03-	-		- -	All-wheel Drive Saloon Engine M16A	657035	Inner Joint		26	21	38	56	103	
	2002.03-	-		- L F	Saloon Engine M16A	699034	Inner Joint		26	21	38	55.5	110.5	
	2002.03-	-		- L F	All-wheel Drive Saloon Engine M16A	699034	Inner Joint		26	21	38	55.5	110.5	
	2002.03-	-		- -	Saloon Engine M16A	657036	Inner Joint		26	21	40	55	70	
	2002.03-	-		- -	All-wheel Drive Saloon Engine M16A	657036	Inner Joint		26	21	40	55	70	
	2002.03-	-		- -	F Saloon Engine M16A	824050	Outer Joint	42T	25	29	49	75.5	61	I





YEAR	TRANSM	L/R	F/R	REMARKS	GSP Ref.	PRODUCT	ABS	Technical Specifications							
								A	B	C	H	L	P		
SUZUKI															
LIANA (ER RH_)															
1.6 (76 kW)	2002.03-	-	-	F	All-wheel Drive Saloon Engine M16A	824050	Outer Joint	42T	25	29	49	75.5	61	I	
	2002.03-	-	-	F	Saloon Engine M16A	819003	Outer Joint		25	29	49	75.5	61	I	
	2002.03-	-	-	F	All-wheel Drive Saloon Engine M16A	819003	Outer Joint		25	29	49	75.5	61	I	
	2002.03-	-	-	L/R	Saloon Engine M16A	857041	Outer Joint	42T	25	29	49	76	61	I	
1.6 (78 kW)	2002.04-	-	MT	L	All-wheel Drive Saloon Engine M16A	257060	Drive Shaft	42T	25	26	49	76	611		
	2002.04-	-	MT	R	All-wheel Drive Saloon Engine M16A	257061	Drive Shaft	42T	25	26	49	76	591.5		
	2002.04-	-	-	-	All-wheel Drive Saloon Engine M16A	657035	Inner Joint		26	21	38	56	103		
	2002.04-	-	-	-	All-wheel Drive Saloon Engine M16A	657036	Inner Joint		26	21	40	55	70		
	2002.04-	-	-	L	All-wheel Drive Saloon Engine M16A	699034	Inner Joint		26	21	38	55.5	110.5		
	2002.04-	-	-	F	All-wheel Drive Saloon Engine M16A	824050	Outer Joint	42T	25	29	49	75.5	61	I	
	2002.04-	-	-	F	All-wheel Drive Saloon Engine M16A	819003	Outer Joint		25	29	49	75.5	61	I	
1.6 (79 kW)	2005.01-	-	-	-	Saloon Engine M16A	857054	Outer Joint	42T	25	29	49	76	61	I	
	2005.01-	-	MT	L	Saloon Engine M16A	257060	Drive Shaft	42T	25	26	49	76	611		
	2005.01-2007.12	MT	L	F	All-wheel Drive Saloon Engine M16A	257060	Drive Shaft	42T	25	26	49	76	611		
	2005.01-	-	MT	R	Saloon Engine M16A	257061	Drive Shaft	42T	25	26	49	76	591.5		
	2005.01-2007.12	MT	R	F	All-wheel Drive Saloon Engine M16A	257061	Drive Shaft	42T	25	26	49	76	591.5		
	2005.01-	-	-	-	Saloon Engine M16A	657035	Inner Joint		26	21	38	56	103		
	2005.01-2007.12	-	-	-	All-wheel Drive Saloon Engine M16A	657035	Inner Joint		26	21	38	56	103		
	2005.01-	-	-	-	Saloon Engine M16A	657036	Inner Joint		26	21	40	55	70		
	2005.01-2007.12	-	-	-	All-wheel Drive Saloon Engine M16A	657036	Inner Joint		26	21	40	55	70		
	2005.01-	-	-	F	Saloon Engine M16A	824050	Outer Joint	42T	25	29	49	75.5	61	I	
	2005.01-2007.12	-	-	F	All-wheel Drive Saloon Engine M16A	824050	Outer Joint	42T	25	29	49	75.5	61	I	
	2005.01-	-	-	F	Saloon Engine M16A	819003	Outer Joint		25	29	49	75.5	61	I	
	2005.01-2007.12	-	-	F	All-wheel Drive Saloon Engine M16A	819003	Outer Joint		25	29	49	75.5	61	I	
	2005.01-	-	-	L/R	Saloon Engine M16A	857041	Outer Joint	42T	25	29	49	76	61	I	
	2005.01-	-	-	L	Saloon Engine M16A	699034	Inner Joint		26	21	38	55.5	110.5		
	2005.01-2007.12	-	-	L	All-wheel Drive Saloon Engine M16A	699034	Inner Joint		26	21	38	55.5	110.5		
1.6 i (78 kW)	2002.04-	-	MT	L	Saloon Engine M16A	257060	Drive Shaft	42T	25	26	49	76	611		
	2002.04-	-	-	-	Saloon Engine M16A	857054	Outer Joint	42T	25	29	49	76	61	I	
	2002.04-	-	MT	R	Saloon Engine M16A	257061	Drive Shaft	42T	25	26	49	76	591.5		
	2002.04-	-	-	-	Saloon Engine M16A	657035	Inner Joint		26	21	38	56	103		
	2002.04-	-	-	-	Saloon Engine M16A	657036	Inner Joint		26	21	40	55	70		
	2002.04-	-	-	L	Saloon Engine M16A	699034	Inner Joint		26	21	38	55.5	110.5		
	2002.04-	-	-	F	Saloon Engine M16A	824050	Outer Joint	42T	25	29	49	75.5	61	I	
	2002.04-	-	-	F	Saloon Engine M16A	819003	Outer Joint		25	29	49	75.5	61	I	
	2002.04-	-	-	L/R	Saloon Engine M16A	857041	Outer Joint	42T	25	29	49	76	61	I	
LIANA/ESCUDO															
1.3 (66 kW)	2001.07-2007.12	-	-	L	Estate Engine M13A	699034	Inner Joint		26	21	38	55.5	110.5		
	2001.07-2007.12	-	-	-	Estate Engine M13A	657035	Inner Joint		26	21	38	56	103		
	2001.07-2007.12	-	-	-	Estate Engine M13A	657036	Inner Joint		26	21	40	55	70		
	2001.07-2007.12	-	-	L/R	Estate Engine M13A	857041	Outer Joint	42T	25	29	49	76	61	I	
1.6 (76 kW)	2001.07-2007.12	MT	L	F	Estate Engine M16A	257060	Drive Shaft	42T	25	26	49	76	611		
	2001.07-2007.12	MT	L	F	All-wheel Drive Estate Engine M16A	257060	Drive Shaft	42T	25	26	49	76	611		
	2001.07-2007.12	-	-	-	Estate Engine M16A	857054	Outer Joint	42T	25	29	49	76	61	I	
	2001.07-2007.12	MT	R	F	Estate Engine M16A	257061	Drive Shaft	42T	25	26	49	76	591.5		
	2001.07-2007.12	MT	R	F	All-wheel Drive Estate Engine M16A	257061	Drive Shaft	42T	25	26	49	76	591.5		
	2001.07-2007.12	-	L	F	Estate Engine M16A	699034	Inner Joint		26	21	38	55.5	110.5		
	2001.07-2007.12	-	L	F	All-wheel Drive Estate Engine M16A	699034	Inner Joint		26	21	38	55.5	110.5		
	2001.07-2007.12	-	-	-	Estate Engine M16A	657035	Inner Joint		26	21	38	56	103		
	2001.07-2007.12	-	-	-	All-wheel Drive Estate Engine M16A	657035	Inner Joint		26	21	38	56	103		
	2001.07-2007.12	-	-	F	Estate Engine M16A	824050	Outer Joint	42T	25	29	49	75.5	61	I	
	2001.07-2007.12	-	-	-	Estate Engine M16A	657036	Inner Joint		26	21	40	55	70		
	2001.07-2007.12	-	-	F	All-wheel Drive Estate Engine M16A	824050	Outer Joint	42T	25	29	49	75.5	61	I	
	2001.07-2007.12	-	-	-	All-wheel Drive Estate Engine M16A	657036	Inner Joint		26	21	40	55	70		
	2001.07-2007.12	-	-	F	Estate Engine M16A	819003	Outer Joint		25	29	49	75.5	61	I	
	2001.07-2007.12	-	-	F	All-wheel Drive Estate Engine M16A	819003	Outer Joint		25	29	49	75.5	61	I	
	2001.07-2007.12	-	-	L/R	Estate Engine M16A	857041	Outer Joint	42T	25	29	49	76	61	I	
1.6 (78 kW)	2002.04-2007.12	MT	L	F	All-wheel Drive Estate Engine M16A	257060	Drive Shaft	42T	25	26	49	76	611		
	2002.04-2007.12	MT	R	F	All-wheel Drive Estate Engine M16A	257061	Drive Shaft	42T	25	26	49	76	591.5		
	2002.04-2007.12	-	-	-	All-wheel Drive Estate Engine M16A	657035	Inner Joint		26	21	38	56	103		
	2002.04-2007.12	-	-	-	All-wheel Drive Estate Engine M16A	657036	Inner Joint		26	21	40	55	70		
	2002.04-2007.12	-	L	F	All-wheel Drive Estate Engine M16A	699034	Inner Joint		26	21	38	55.5	110.5		
	2002.04-2007.12	-	-	F	All-wheel Drive Estate Engine M16A	824050	Outer Joint	42T	25	29	49	75.5	61	I	
	2002.04-2007.12	-	-	F	Estate Engine M16A	819003	Outer Joint		25	29	49	75.5	61	I	
	2002.04-2007.12	-	L/R	F	All-wheel Drive Estate Engine M16A	857041	Outer Joint	42T	25	29	49	76	61	I	
1.6 (79 kW)	2005.01-2007.12	-	-	-	Estate Engine M16A	857054	Outer Joint	42T	25	29	49	76	61	I	

			TRANS	L/R	F/R	REMARKS	GSP Ref.			Technical Specifications					
YEAR										A	B	C	H	L	P
SUZUKI															
LIANA/ESCUDO															
1.6 (79 kW)	2005.01-2007.12	2007.12	MT	L	F	All-wheel Drive Estate Engine M16A	257060	Drive Shaft	42T	25	26	49	76	611	
	2005.01-2007.12	2007.12	MT	L	F	Estate Engine M16A	257060	Drive Shaft	42T	25	26	49	76	611	
	2005.01-2007.12	2007.12	MT	R	F	All-wheel Drive Estate Engine M16A	257061	Drive Shaft	42T	25	26	49	76	591.5	
	2005.01-2007.12	2007.12	MT	R	F	Estate Engine M16A	257061	Drive Shaft	42T	25	26	49	76	591.5	
	2005.01-2007.12	2007.12	-	-	-	Estate Engine M16A	657035	Inner Joint		26	21	38	56	103	
	2005.01-2007.12	2007.12	-	-	-	All-wheel Drive Estate Engine M16A	657035	Inner Joint		26	21	38	56	103	
	2005.01-2007.12	2007.12	-	-	-	Estate Engine M16A	657036	Inner Joint		26	21	40	55	70	
	2005.01-2007.12	2007.12	-	-	-	All-wheel Drive Estate Engine M16A	657036	Inner Joint		26	21	40	55	70	
	2005.01-2007.12	2007.12	-	-	F	All-wheel Drive Estate Engine M16A	824050	Outer Joint	42T	25	29	49	75.5	61	I
	2005.01-2007.12	2007.12	-	-	F	Estate Engine M16A	824050	Outer Joint	42T	25	29	49	75.5	61	I
	2005.01-2007.12	2007.12	-	-	F	All-wheel Drive Estate Engine M16A	819003	Outer Joint		25	29	49	75.5	61	I
	2005.01-2007.12	2007.12	-	-	F	Estate Engine M16A	819003	Outer Joint		25	29	49	75.5	61	I
	2005.01-2007.12	2007.12	-	L/R	F	Estate Engine M16A	857041	Outer Joint	42T	25	29	49	76	61	I
	2005.01-2007.12	2007.12	-	L	F	All-wheel Drive Estate Engine M16A	699034	Inner Joint		26	21	38	55.5	110.5	
	2005.01-2007.12	2007.12	-	L	F	Estate Engine M16A	699034	Inner Joint		26	21	38	55.5	110.5	
1.6 i (78 kW)	2002.04-2007.12	2007.12	-	-	-	Estate Engine M16A	857054	Outer Joint	42T	25	29	49	76	61	I
	2002.04-2007.12	2007.12	MT	L	F	Estate Engine M16A	257060	Drive Shaft	42T	25	26	49	76	611	
	2002.04-2007.12	2007.12	MT	R	F	Estate Engine M16A	257061	Drive Shaft	42T	25	26	49	76	591.5	
	2002.04-2007.12	2007.12	-	-	-	Estate Engine M16A	657035	Inner Joint		26	21	38	56	103	
	2002.04-2007.12	2007.12	-	L	F	Estate Engine M16A	699034	Inner Joint		26	21	38	55.5	110.5	
	2002.04-2007.12	2007.12	-	-	-	Estate Engine M16A	657036	Inner Joint		26	21	40	55	70	
	2002.04-2007.12	2007.12	-	-	F	Estate Engine M16A	824050	Outer Joint	42T	25	29	49	75.5	61	I
	2002.04-2007.12	2007.12	-	-	F	Estate Engine M16A	819003	Outer Joint		25	29	49	75.5	61	I
	2002.04-2007.12	2007.12	-	L/R	F	Estate Engine M16A	857041	Outer Joint	42T	25	29	49	76	61	I
MARUTI II															
1.2	1995-	-	-	-	L/R	F	-	657003	Inner Joint		22	18	35	37.5	69
MF33S															
660	2010.10-	-	CVT	R	-	Engine K6A TBO	857188	Outer Joint	43T	23	26	50.3	78.5	56.5	M
	2010.10-	-	CVT	R	-	Engine K6A	857188	Outer Joint	43T	23	26	50.3	78.5	56.5	M
	2010.10-	-	CVT	R	-	Engine K6A	857188	Outer Joint	43T	23	26	50.3	78.5	56.5	M
	2010.10-	-	CVT	R	-	Allwheel Drive Engine K6A TBO	857188	Outer Joint	43T	23	26	50.3	78.5	56.5	M
	2010.10-	-	CVT	R	-	Allwheel Drive Engine K6A TBO	857188	Outer Joint	43T	23	26	50.3	78.5	56.5	M
	2010.10-	-	CVT	R	-	Allwheel Drive Engine K6A	857188	Outer Joint	43T	23	26	50.3	78.5	56.5	M
	2010.10-	-	CVT	R	-	Allwheel Drive Engine K6A	857188	Outer Joint	43T	23	26	50.3	78.5	56.5	M
MH34S															
660	2012.06-	-	CVT	R	-	Engine R06A TBO	857184	Outer Joint		23	26	47	69	56	M
	2012.06-	-	CVT	R	-	Engine R06A	857184	Outer Joint		23	26	47	69	56	M
	2012.06-	-	CVT	R	-	Allwheel Drive Engine R06A TBO	854013	Outer Joint		23	28	47	69	56	M
	2012.06-	-	CVT	R	-	Allwheel Drive Engine R06A	854013	Outer Joint		23	28	47	69	56	M
	2014.06-	-	CVT	R	-	Engine R06A	857184	Outer Joint		23	26	47	69	56	M
	2014.06-	-	CVT	R	-	Engine R06A	857184	Outer Joint		23	26	47	69	56	M
	2014.06-	-	CVT	R	-	Allwheel Drive Engine R06A	854013	Outer Joint		23	28	47	69	56	M
	2014.06-	-	CVT	R	-	Allwheel Drive Engine R06A	854013	Outer Joint		23	28	47	69	56	M
MH44S															
660	2014.06-	-	CVT	R	-	Engine R06A	857184	Outer Joint		23	26	47	69	56	M
	2014.06-	-	CVT	R	-	Engine R06A	857184	Outer Joint		23	26	47	69	56	M
	2014.06-	-	CVT	R	-	Allwheel Drive Engine R06A	854013	Outer Joint		23	28	47	69	56	M
	2014.06-	-	CVT	R	-	Allwheel Drive Engine R06A	854013	Outer Joint		23	28	47	69	56	M
	2014.06-	-	CVT	R	-	Engine R06A	857184	Outer Joint		23	26	47	69	56	M
	2014.06-	-	CVT	R	-	Engine R06A	857184	Outer Joint		23	26	47	69	56	M
	2014.06-	-	CVT	R	-	Allwheel Drive Engine R06A	854013	Outer Joint		23	28	47	69	56	M
	2014.06-	-	CVT	R	-	Allwheel Drive Engine R06A	854013	Outer Joint		23	28	47	69	56	M
MK32S															
660	2013.01-	-	CVT	R	-	Engine R06A TBO	857184	Outer Joint		23	26	47	69	56	M
	2013.01-	-	CVT	R	-	Engine R06A	857184	Outer Joint		23	26	47	69	56	M
	2013.01-	-	CVT	R	-	Allwheel Drive Engine R06A TBO	854013	Outer Joint		23	28	47	69	56	M
	2013.01-	-	CVT	R	-	Allwheel Drive Engine R06A	854013	Outer Joint		23	28	47	69	56	M
SAMURAI (SJ)															
1.0 (33 kW)	1988.11-2004.12	2004.12	AT/MT	L/R	F	All-wheel Drive Closed Off-Road Vehicle Engine F10A	857034	Outer Joint		26	19	45	136.5	51.5	M
1.3 (44 kW)	1988.11-2004.12	2004.12	MT	-	F	All-wheel Drive Closed Off-Road Vehicle Engine G13A	857033	Outer Joint		26	22	44.5	136.5	50.5	M
1.3 (51 kW)	1988.11-2004.12	2004.12	-	L/R	F	All-wheel Drive Closed Off-Road Vehicle Engine G13BA	857020	Outer Joint		26	22	44.5	136.5	50.5	I
	1988.11-2004.12	2004.12	MT	-	F	All-wheel Drive Closed Off-Road Vehicle Engine G13BA	857033	Outer Joint		26	22	44.5	136.5	50.5	M
1.3 (59 kW)	2000.01-2004.12	2004.12	-	L/R	F	All-wheel Drive Closed Off-Road Vehicle Engine G13BA	857020	Outer Joint		26	22	44.5	136.5	50.5	I
	2000.01-2004.12	2004.12	MT	-	F	All-wheel Drive Closed Off-Road Vehicle Engine G13BA	857033	Outer Joint		26	22	44.5	136.5	50.5	M
1.9 D (47 kW)	1998.11-2004.12	2004.12	-	L/R	F	All-wheel Drive Closed Off-Road Vehicle	857020	Outer Joint		26	22	44.5	136.5	50.5	I
1.9 TD (46 kW)	1998.11-2004.12	2004.12	-	L/R	F	All-wheel Drive Closed Off-Road Vehicle Engine XUD9	857020	Outer Joint		26	22	44.5	136.5	50.5	I



	 YEAR	TRANSM	L/R	F/R	REMARKS	GSP Ref.	 PRODUCT	 ABS	Technical Specifications						
									A	B	C	H	L	P	
SUZUKI															
SAMURAI (SJ)															
1.9 TD (46 kW)	1998.11-2004.12	MT	-	F	All-wheel Drive Closed Off-Road Vehicle Engine XUD9	857033	Outer Joint		26	22	44.5	136.5	50.5	M	
SJ 413 (OS)															
1.3 (44 kW)	1986.08-1990.08	MT	-	F	All-wheel Drive Closed Off-Road Vehicle Engine G13A	857033	Outer Joint		26	22	44.5	136.5	50.5	M	
1.3 (47 kW)	1984.09-1990.08	MT	-	F	All-wheel Drive Closed Off-Road Vehicle Engine G13A	857033	Outer Joint		26	22	44.5	136.5	50.5	M	
1.3 (52 kW)	1988.11-1990.08	MT	-	-	Closed Off-Road Vehicle Engine G13BA	857033	Outer Joint		26	22	44.5	136.5	50.5	M	
SPLASH (EX)															
1.0 (48 kW)	2008.01-	-	MT	L/R	F	Hatchback Engine K10B	844085	Outer Joint	25	20	49	81.5	61	M	
	2008.01-	-	MT	L	F	Hatchback Engine K10B	257222	Drive Shaft	25	22	49	81.5	641		
	2008.01-	-	MT	R	F	Hatchback Engine K10B	257221	Drive Shaft	25	22	49	81.5	882		
1.0 (50 kW)	2011.06-	-	MT	L	F	Hatchback Engine K10B	657156	Inner Joint	22	19	40	57	97.5		
1.2 (63 kW)	2008.01-	-	-	L	F	Hatchback Engine K12B	257298	Drive Shaft	25	22	49	82	630		
	2008.01-	-	MT	L/R	F	Hatchback Engine K12B	844085	Outer Joint	25	20	49	81.5	61	M	
	2008.01-	-	MT	L	F	Hatchback Engine K12B	257222	Drive Shaft	25	22	49	81.5	641		
1.2 VVT (66 kW)	2011.06-	-	AT	-	-	Hatchback Engine K12B	857103	Outer Joint	25	28	49	82	61	I	
	2011.06-	-	MT	L	F	Hatchback Engine K12B	657156	Inner Joint	22	19	40	57	97.5		
	2011.06-	-	MT	L	F	Hatchback Engine K12B	257175	Drive Shaft	25	22	49	82	635		
1.2 VVT (67 kW)	2012.08-	-	MT	L	F	Hatchback Engine K12B	657156	Inner Joint	22	19	40	57	97.5		
	2012.08-	-	AT	-	-	Hatchback Engine K12B	857103	Outer Joint	25	28	49	82	61	I	
	2012.08-	-	MT	L	F	Hatchback Engine K12B	257175	Drive Shaft	25	22	49	82	635		
1.2 VVT (69 kW)	2010.09-	-	AT	-	-	Hatchback Engine K12B	857103	Outer Joint	25	28	49	82	61	I	
	2010.09-	-	-	L	F	Hatchback Engine K12B	257298	Drive Shaft	25	22	49	82	630		
	2010.09-	-	MT	L/R	F	Hatchback Engine K12B	844085	Outer Joint	25	20	49	81.5	61	M	
	2010.09-	-	MT	L	F	Hatchback Engine K12B	257222	Drive Shaft	25	22	49	81.5	641		
	2010.09-	-	MT	R	F	Hatchback Engine K12B	257221	Drive Shaft	25	22	49	81.5	882		
1.3 CDTi (55 kW)	2008.01-	-	-	-	F	Hatchback Engine Z 13 DTJ D13A	857100	Outer Joint	25	21	49	82.5	64	M	
	2008.01-	-	MT	L	F	Hatchback Engine Z 13 DTJ D13A	257210	Drive Shaft	25	26	49	81.5	630		
	2008.01-	-	MT	L	F	Hatchback Engine Z 13 DTJ D13A	257223	Drive Shaft	25	26	49	81.5	629		
	2008.01-	-	MT	R	F	Hatchback Engine Z 13 DTJ D13A	257197	Drive Shaft	25	22	49	81.5	614		
SWIFT															
-	1989.01-2000.07	AT	L	-	-		257009	Drive Shaft	23	22	49	92	565		
	1989.01-2000.07	AT	R	-	-		257010	Drive Shaft	23	22	49	92	555		
1.2	2015.08-	-	-	L	R	-	257284	Drive Shaft	24		45	89	649		
1.3	1995-2000	-	-	-	-	-	857043	Outer Joint	42T	23	19	46	92	56.5	I
1.5	1989.03-2001.05	MT/AT	-	-	-	Engine G10A	857173	Outer Joint	23	20	49	92.6	56	M	
1500	1989.03-2001.05	MT/AT	-	-	-	Engine G10A	857173	Outer Joint	23	20	49	92.6	56	M	
RS 415	2006-	-	-	-	-	-	657024	Inner Joint	22	28	38	59.5	85		
SWIFT (HT81S)															
1.5	2003.06-	-	5MT	-	-	Engine M15A	857156	Outer Joint	25	29	49	76	61.5	I	
SWIFT (SF413)															
1.3 i (50 kW)	1991.09-1996.10	-	-	-	-	Convertible Engine G13BA	857052	Outer Joint	23	19	44	92	56.5	M	
	1991.09-1996.10	AT/MT	L/R	F	-	Convertible Engine G13BA	857007	Outer Joint	23	19	49	92	56.5	M	
SWIFT I (AA)															
1.0 (37 kW)	1983.10-1989.03	MT	L/R	F	Hatchback Engine G10A G10	808004	Outer Joint	23	19	44	89	54	M		
	1983.10-1989.03	-	-	-	-	Hatchback Engine G10A G10	857052	Outer Joint	23	19	44	92	56.5	M	
1.0 Turbo (52 kW)	1985.02-1989.12	MT	L/R	F	Hatchback Engine G10T	808004	Outer Joint	23	19	44	89	54	M		
	1985.02-1989.12	-	-	-	-	Hatchback Engine G10T	857006	Outer Joint	23	19	44	89.5	54.5	M	
1.3 (47 kW)	1986.08-1989.03	MT	L/R	F	Hatchback Engine G13A	808004	Outer Joint	23	19	44	89	54	M		
	1986.08-1989.03	-	-	-	-	Hatchback Engine G13A	857006	Outer Joint	23	19	44	89.5	54.5	M	
1.3 (50 kW)	1984.10-1989.03	AT/MT	L/R	F	Hatchback Engine G13A	808004	Outer Joint	23	19	44	89	54	M		
	1984.10-1989.03	-	-	-	-	Hatchback Engine G13A	857052	Outer Joint	23	19	44	92	56.5	M	
1.3 (54 kW)	1984.10-1989.03	AT/MT	L/R	F	Hatchback Engine G13A	808004	Outer Joint	23	19	44	89	54	M		
	1984.10-1989.03	-	-	-	-	Hatchback Engine G13A	857006	Outer Joint	23	19	44	89.5	54.5	M	
1.3 GTi/GXi (74 kW)	1985.08-1989.03	AT/MT	L/R	F	Hatchback Engine G13B	808004	Outer Joint	23	19	44	89	54	M		
	1985.08-1989.03	-	-	-	F	Hatchback Engine G13B	857018	Outer Joint	25	22	49	77	73	M	
SWIFT II (AH AJ)															
1.3 (50 kW)	1991.01-1995.12	-	-	-	-	Saloon Engine G13B	857008	Outer Joint	23	20	49	92	54.5	O	
	1991.01-1995.12	AT/MT	L/R	F	-	Saloon Engine G13B	857007	Outer Joint	23	19	49	92	56.5	M	
1.3 (52 kW)	1989.03-1991.12	-	-	-	-	Saloon Engine G13B	857052	Outer Joint	23	19	44	92	56.5	M	
	1989.03-1991.12	-	-	-	-	Saloon Engine G13B	857006	Outer Joint	23	19	44	89.5	54.5	M	
	1989.03-1991.12	MT	L/R	F	-	Saloon Engine G13B	857007	Outer Joint	23	19	49	92	56.5	M	
1.6 (70 kW)	1989.11-1991.12	-	-	-	F	Saloon Engine G16B	857018	Outer Joint	25	22	49	77	73	M	
	1989.11-1991.12	-	-	-	F	All-wheel Drive Saloon Engine G16B	857018	Outer Joint	25	22	49	77	73	M	
1.6 i (68 kW)	1990.01-2001.05	-	-	-	F	Saloon Engine G16B	857018	Outer Joint	25	22	49	77	73	M	
	1990.01-2001.05	-	-	-	F	All-wheel Drive Saloon Engine G16B	857018	Outer Joint	25	22	49	77	73	M	
	1990.01-2001.05	AT/MT	L/R	F	-	Saloon Engine G16B	857003	Outer Joint	23	22	49	92	67	M	

	 YEAR	TRANSM	L/R	F/R	REMARKS	GSP Ref.	 PRODUCT	 ABS	Technical Specifications					
									A	B	C	H	L	P
SUZUKI														
SWIFT II (EA MA)														
1.0 (37 kW)	1989.03-2001.05	-	-	-	Hatchback Engine G10A	857008	Outer Joint		23	20	49	92	54.5	O
	1989.03-2001.05	-	L	F	Hatchback Engine G10A	257040	Drive Shaft		23	22	49	92	678	
	1989.03-2001.05	-	R	F	Hatchback Engine G10A	257039	Drive Shaft		23	22	49	92	767	
	1989.03-2001.05	MT	L/R	F	Hatchback Engine G10A	699099	Inner Joint		22	19	35	51.5	86.5	
	1989.03-2001.05	MT	L/R	F	Hatchback Engine G10A	857007	Outer Joint		23	19	49	92	56.5	M
1.0 i (39 kW)	1995.01-2005.12	MT	L	F	Hatchback Engine G10A	299096	Drive Shaft		23	22	49	92	678	
	1995.01-2005.12	MT	R	F	Hatchback Engine G10A	299097	Drive Shaft		23	22	49	92	770	
	1995.01-2005.12	-	-	-	Hatchback Engine G10A	857008	Outer Joint		23	20	49	92	54.5	O
	1995.01-2005.12	-	L	F	Hatchback Engine G10A	257040	Drive Shaft		23	22	49	92	678	
	1995.01-2005.12	MT	L/R	F	Hatchback Engine G10A	857001	Outer Joint		23	20	49	92	56.5	I
	1995.01-2005.12	-	R	F	Hatchback Engine G10A	257039	Drive Shaft		23	22	49	92	767	
	1995.01-2005.12	-	L/R	F	Hatchback Engine G10A	857038	Outer Joint		23	20	49	92	56.5	M
	1995.01-2005.12	MT	R	F	Hatchback Engine G10A	608018	Inner Joint		22	19	35	51.9	93.4	
	1995.01-2005.12	MT	L/R	F	Hatchback Engine G10A	699099	Inner Joint		22	19	35	51.5	86.5	
	1995.01-2005.12	MT	L/R	F	Hatchback Engine G10A	857007	Outer Joint		23	19	49	92	56.5	M
1.0 i (40 kW)	1989.03-1991.12	-	-	-	Hatchback Engine G10A	857008	Outer Joint		23	20	49	92	54.5	O
	1989.03-1991.12	-	L	F	Hatchback Engine G10A	257040	Drive Shaft		23	22	49	92	678	
	1989.03-1991.12	MT	L/R	F	Hatchback Engine G10A	857001	Outer Joint		23	20	49	92	56.5	I
	1989.03-1991.12	-	R	F	Hatchback Engine G10A	257039	Drive Shaft		23	22	49	92	767	
	1989.03-1991.12	MT	L/R	F	Hatchback Engine G10A	699099	Inner Joint		22	19	35	51.5	86.5	
	1989.03-1991.12	MT	L/R	F	Hatchback Engine G10A	857007	Outer Joint		23	19	49	92	56.5	M
1.3 (50 kW)	1989.03-2001.05	-	-	-	Hatchback Engine G13A	857008	Outer Joint		23	20	49	92	54.5	O
	1989.03-2001.05	-	-	-	All-wheel Drive Hatchback Engine G13A	857008	Outer Joint		23	20	49	92	54.5	O
	1989.03-2001.05	MT	L/R	F	Hatchback Engine G13A	857001	Outer Joint		23	20	49	92	56.5	I
	1989.03-2001.05	-	L/R	F	Hatchback Engine G13A	857038	Outer Joint		23	20	49	92	56.5	M
	1989.03-2001.05	AT/MT	L/R	F	Hatchback Engine G13A	857007	Outer Joint		23	19	49	92	56.5	M
	1989.03-2001.05	MT	L/R	F	All-wheel Drive Hatchback Engine G13A	857007	Outer Joint		23	19	49	92	56.5	M
1.3 (51 kW)	1989.03-1996.10	MT	R	F	Hatchback Engine G13BA	257032	Drive Shaft		23	22	49	92	586	
	1989.03-1996.10	MT	L	F	Hatchback Engine G13BA	299095	Drive Shaft		23	22	49	92	606	
	1989.03-1996.10	-	L/R	F	Hatchback Engine G13BA	857038	Outer Joint		23	20	49	92	56.5	M
1.3 (52 kW)	1989.03-1991.12	MT	R	F	Hatchback Engine G13A	257032	Drive Shaft		23	22	49	92	586	
	1989.03-1991.12	MT	L	F	Hatchback Engine G13A	299095	Drive Shaft		23	22	49	92	606	
	1989.03-1991.12	-	-	-	Hatchback Engine G13A	857006	Outer Joint		23	19	44	89.5	54.5	M
	1989.03-1991.12	-	L/R	F	Hatchback Engine G13A	857038	Outer Joint		23	20	49	92	56.5	M
	1989.03-1991.12	MT	L/R	F	Hatchback Engine G13A	857007	Outer Joint		23	19	49	92	56.5	M
	1989.10-1991.12	-	-	-	All-wheel Drive Hatchback Engine G13A	857006	Outer Joint		23	19	44	89.5	54.5	M
	1989.10-1991.12	-	-	-	All-wheel Drive Hatchback Engine G13A	857008	Outer Joint		23	20	49	92	54.5	O
	1989.10-1991.12	MT	L/R	F	All-wheel Drive Hatchback Engine G13A	857007	Outer Joint		23	19	49	92	56.5	M
1.3 (63 kW)	2001.06-2003.12	-	L/R	F	Hatchback Engine G13BB	857001	Outer Joint		23	20	49	92	56.5	I
	2001.06-2003.12	-	L/R	F	Hatchback Engine G13BB	857048	Outer Joint		23	20	49	92	54.5	O
1.3 GTi (74 kW)	1989.03-2001.05	AT	-	F	Hatchback Engine G13B	857011	Outer Joint		25	22	49	76.5	73	M
	1989.03-2001.05	-	-	F	Hatchback Engine G13B	857018	Outer Joint		25	22	49	77	73	M
	1989.03-2001.05	-	L/R	F	Hatchback Engine G13B	857038	Outer Joint		23	20	49	92	56.5	M
	1989.03-2001.05	AT	L	F	Hatchback Engine G13B	699099	Inner Joint		22	19	35	51.5	86.5	
	1989.03-2001.05	AT/MT	L/R	F	Hatchback Engine G13B	857007	Outer Joint		23	19	49	92	56.5	M
1.6 (68 kW)	1989.03-1996.10	-	-	F	All-wheel Drive Hatchback Engine G16B	857018	Outer Joint		25	22	49	77	73	M
SWIFT III (MZ EZ)														
1.3 (66 kW)	2006.01-	-	-	-	All-wheel Drive Hatchback Engine M13A	857095	Outer Joint	43T	25	29	49	82.5	57	M
	2006.01-	MT	R	F	All-wheel Drive Hatchback Engine M13A	657085	Inner Joint		22	28	40	54.5	82	
1.3 (67 kW)	2005.02-	MT	L	F	Hatchback Engine M13A	257086	Drive Shaft	43T	25	22	49	82	652	
	2005.02-	MT	R	F	Hatchback Engine M13A	257183	Drive Shaft	43T	25	22	49	82	894	
	2005.02-	MT	R	F	Hatchback Engine M13A	257004	Drive Shaft	43T	25	22	49	82	635	
1.3 (68 kW)	2005.02-	-	-	-	Hatchback Engine M13A	857095	Outer Joint	43T	25	29	49	82.5	57	M
	2005.02-	-	-	-	All-wheel Drive Hatchback Engine M13A	857095	Outer Joint	43T	25	29	49	82.5	57	M
	2005.02-	MT	L	F	Hatchback Engine M13A	257086	Drive Shaft	43T	25	22	49	82	652	
	2005.02-	-	L/R	F	Hatchback Engine M13A	857042	Outer Joint	43T	25	29	49	82	61	I
	2005.02-	MT	R	F	All-wheel Drive Hatchback Engine M13A	657085	Inner Joint		22	28	40	54.5	82	
	2005.02-	MT	R	F	Hatchback Engine M13A	257183	Drive Shaft	43T	25	22	49	82	894	
	2005.02-	MT	R	F	Hatchback Engine M13A	257004	Drive Shaft	43T	25	22	49	82	635	
	2005.02-	MT	L	F	Hatchback Engine M13A	257166	Drive Shaft		25	22	49	82	651	
	2005.02-	MT	R	F	Hatchback Engine M13A	257167	Drive Shaft		25	22	49	82	895	
	2005.02-	Semi-AT	R	F	Hatchback Engine M13A	257169	Drive Shaft		25	22	49	82	641.5	
	2005.02-	Semi-AT	L	F	Hatchback Engine M13A	257168	Drive Shaft		25	22	49	82	630	
	2005.02-	MT	R	F	Hatchback Engine M13A	657085	Inner Joint		22	28	40	54.5	82	
1.3 DDiS (51 kW)	2005.08-	-	-	-	Hatchback Engine Z13DT	857100	Outer Joint		25	21	49	82.5	64	M
	2005.08-	-	-	-	Hatchback Engine Z13DT	857095	Outer Joint	43T	25	29	49	82.5	57	M

YEAR	TRANSM	L/R	F/R	REMARKS	GSP Ref.	PRODUCT	ABS	Technical Specifications						
								A	B	C	H	L	P	
SUZUKI														
SWIFT III (MZ EZ)														
1.3 DDiS (51 kW)	2005.08-	-	MT	L F	Hatchback Engine Z13DT	257210	Drive Shaft		25	26	49	81.5	630	
	2005.08-	-	-	L/R	F Hatchback Engine Z13DT	857042	Outer Joint	43T	25	29	49	82	61	I
	2005.08-	-	-	R	F Hatchback Engine Z13DT	250470	Drive Shaft	43T	25	23	49	82	631	
1.3 DDiS (55 kW)	2005.08-	-	-	-	F Hatchback Engine Z 13 DTJ D13A	857100	Outer Joint		25	21	49	82.5	64	M
	2005.08-	-	-	-	Hatchback Engine Z 13 DTJ D13A	857095	Outer Joint	43T	25	29	49	82.5	57	M
	2005.08-	-	MT	L F	Hatchback Engine Z 13 DTJ D13A	257210	Drive Shaft		25	26	49	81.5	630	
	2005.08-	-	-	L/R	F Hatchback Engine Z 13 DTJ D13A	857042	Outer Joint	43T	25	29	49	82	61	I
	2005.08-	-	-	R	F Hatchback Engine Z 13 DTJ D13A	250470	Drive Shaft	43T	25	23	49	82	631	
1.5 (75 kW)	2005.02-	-	-	-	Hatchback Engine M15A	857095	Outer Joint	43T	25	29	49	82.5	57	M
	2005.02-	-	MT	R F	Hatchback Engine M15A	299080	Drive Shaft	43T	25	22	49	82	641.5	
	2005.02-	-	AT/MT	L/R	F Hatchback Engine M15A	857042	Outer Joint	43T	25	29	49	82	61	I
	2005.02-	-	-	R	F Hatchback Engine M15A	257169	Drive Shaft		25	22	49	82	641.5	
1.6 (92 kW)	2006.05-	-	-	L/R	F Hatchback Engine M16A	857117	Outer Joint		28	29	58	85	62	I
	2006.05-	-	AT/MT	L/R	F Hatchback Engine M16A	857092	Outer Joint		28	29	58	86.5	63	I
SWIFT IV (FZ NZ)														
1.2 (66 kW)	2010.10-	-	MT	- -	Hatchback Engine K12B	857103	Outer Joint		25	28	49	82	61	I
	2010.10-	-	MT	- -	All-wheel Drive Hatchback Engine K12B	857103	Outer Joint		25	28	49	82	61	I
	2010.10-	-	-	R	F Hatchback Engine K12B	257297	Drive Shaft		25	26	49	82	563	
	2010.10-	-	MT	R F	Hatchback Engine K12B	257228	Drive Shaft		25	22	49	82	893	
1.2 (67 kW)	2012.08-	-	MT	- -	Hatchback Engine K12B	857103	Outer Joint		25	28	49	82	61	I
	2012.08-	-	-	R	F Hatchback Engine K12B	257297	Drive Shaft		25	26	49	82	563	
	2012.08-	-	MT	- -	All-wheel Drive Hatchback Engine K12B	857103	Outer Joint		25	28	49	82	61	I
	2012.08-	-	5MT	R F	All-wheel Drive Hatchback Engine K12B	257277	Drive Shaft		25	26	49	82	660	
	2012.08-	-	5MT	L F	All-wheel Drive Hatchback Engine K12B	257275	Drive Shaft		25	26	49	82	641	
	2012.08-	-	MT	R R	All-wheel Drive Hatchback Engine K12B	257283	Drive Shaft		24		45	89	698	
	2012.08-	-	5MT	R F	All-wheel Drive Hatchback Engine K12B	857213	Outer Joint		25	29	49	82	60	I
	2012.08-	-	5MT	R F	All-wheel Drive Hatchback Engine K12B	657151	Inner joint		26	28	40		121	
	2012.08-	-	5MT	L F	All-wheel Drive Hatchback Engine K12B	657152	Inner joint		26	28	38	58.5	102	
1.2 (69 kW)	2012.08-	-	MT	R R	All-wheel Drive Hatchback Engine K12B	657166	Inner joint			23		74.5		
	2010.10-	-	MT	- -	Hatchback Engine K12B	857103	Outer Joint		25	28	49	82	61	I
	2010.10-	-	MT	- -	All-wheel Drive Hatchback Engine K12B	857103	Outer Joint		25	28	49	82	61	I
	2010.10-	-	-	R	F All-wheel Drive Hatchback Engine K12B	257297	Drive Shaft		25	26	49	82	563	
	2010.10-	-	-	L	F Hatchback Engine K12B	257298	Drive Shaft		25	22	49	82	630	
	2010.10-	-	MT	R F	Hatchback Engine K12B	257228	Drive Shaft		25	22	49	82	893	
	2010.10-	-	-	L	F Hatchback Engine K12B	657157	Inner joint		22	28	38	59	110.5	
	2010.10-	-	-	R	F Hatchback Engine K12B	657158	Inner joint		26	28	40		121	
1.3 DDiS (55 kW)	2010.10-	-	MT	- -	Hatchback Engine D13A	857103	Outer Joint		25	28	49	82	61	I
	2010.10-	-	-	R	F Hatchback Engine D13A	257234	Drive Shaft		25	26	49	82	630	
	2010.10-	-	-	R	F Hatchback Engine D13A	654010	Inner Joint		26	22	40		115	
	2010.10-	-	-	R	F Hatchback Engine D13A	857114	Outer Joint		25	22	49	82	64	M
1.6 (100 kW)	2012.01-	-	6MT	L F	Hatchback Engine M16A	257293	Drive Shaft		28	26	58	85	627	
SX4 (EY GY)														
1.5 (73 kW)	2006.06-	2010.07	-	-	F Hatchback Engine M15A	857078	Outer Joint		28	29	58	85	62	I
	2006.06-	2010.07	MT	L F	Hatchback Engine M15A	257247	Drive Shaft		28	26	58	85	612	
1.5 VVT (82 kW)	2010.07-	-	-	-	F Hatchback Engine M15A	857078	Outer Joint		28	29	58	85	62	I
	2010.07-	-	MT	L F	Hatchback Engine M15A	257247	Drive Shaft		28	26	58	85	612	
1.6 VVT (79 kW)	2006.06-	-	5MT	R F	All-wheel Drive Hatchback Engine M16A	257290	Drive Shaft		28	26	58	85	698	
	2006.06-	-	MT	R F	Hatchback Engine M16A	257290	Drive Shaft		28	26	58	85	698	
	2006.06-	-	-	-	F All-wheel Drive Hatchback Engine M16A	857078	Outer Joint		28	29	58	85	62	I
	2006.06-	-	-	-	F Hatchback Engine M16A	857078	Outer Joint		28	29	58	85	62	I
	2006.06-	-	5MT	R R	All-wheel Drive Hatchback Engine M16A	214073	Drive Shaft		24		45	89	731	
	2006.06-	-	5MT	L R	All-wheel Drive Hatchback Engine M16A	214074	Drive Shaft		24		45	89	637	
	2006.06-	-	5MT	R F	All-wheel Drive Hatchback Engine M16A	657137	Inner Joint		26	29	40		116.5	
	2006.06-	-	MT	R F	Hatchback Engine M16A	657137	Inner Joint		26	29	40		116.5	
	2006.06-	-	MT	L F	Hatchback Engine M16A	257247	Drive Shaft		28	26	58	85	612	
	2006.06-	-	MT	R F	Hatchback Engine M16A	257074	Drive Shaft		28	26	58	85	699.5	
	2006.06-	-	AT/MT	L/R	F All-wheel Drive Hatchback Engine M16A	857092	Outer Joint		28	29	58	86.5	63	I
1.6 VVT (82 kW)	2009.07-	-	AT/MT	-	F All-wheel Drive Hatchback Engine M16A	857078	Outer Joint		28	29	58	85	62	I
	2009.07-	-	5MT	R F	All-wheel Drive Hatchback Engine M16A	257290	Drive Shaft		28	26	58	85	698	
	2009.07-	-	5MT	R R	All-wheel Drive Hatchback Engine M16A	214073	Drive Shaft		24		45	89	731	
	2009.07-	-	5MT	L R	All-wheel Drive Hatchback Engine M16A	214074	Drive Shaft		24		45	89	637	
	2009.07-	-	5MT	R F	All-wheel Drive Hatchback Engine M16A	657137	Inner Joint		26	29	40		116.5	
	2009.07-	-	5MT	L F	All-wheel Drive Hatchback Engine M16A	657173	Inner joint		26	29	38	58.5	98.5	
	2009.07-	-	5MT	R F	All-wheel Drive Hatchback Engine M16A	657159	Inner joint		26	29	40		116.5	
	2009.07-	-	5MT	R F	All-wheel Drive Hatchback Engine M16A	257291	Drive Shaft		28	26	58	85	701	





	 YEAR	TRANSM	L/R	F/R	REMARKS	GSP Ref.	 PRODUCT	 ABS	Technical Specifications					
									A	B	C	H	L	P
SUZUKI														
SX4 (EY GY)														
1.6 VVT (82 kW)	2009.07-	-	5MT	L	F	All-wheel Drive Hatchback Engine M16A	257292	Drive Shaft	28	26	58	85	615	
1.6 VVT (88 kW)	2009.07-	-	AT/MT	-	F	All-wheel Drive Hatchback Engine M16A	857078	Outer Joint	28	29	58	85	62	I
	2009.07-	-	5MT	R	F	All-wheel Drive Hatchback Engine M16A	257290	Drive Shaft	28	26	58	85	698	
	2009.07-	-	5MT	R	R	All-wheel Drive Hatchback Engine M16A	214073	Drive Shaft	24		45	89	731	
	2009.07-	-	-	-	F	Hatchback Engine M16A	857078	Outer Joint	28	29	58	85	62	I
	2009.07-	-	5MT	L	R	All-wheel Drive Hatchback Engine M16A	214074	Drive Shaft	24		45	89	637	
	2009.07-	-	5MT	R	F	All-wheel Drive Hatchback Engine M16A	657137	Inner Joint	26	29	40		116.5	
	2009.07-	-	MT	L	F	Hatchback Engine M16A	257247	Drive Shaft	28	26	58	85	612	
	2009.07-	-	MT	R	F	Hatchback Engine M16A	257074	Drive Shaft	28	26	58	85	699.5	
	2009.07-	-	5MT	L	F	Hatchback Engine M16A	657173	Inner joint	26	29	38	58.5	98.5	
	2009.07-	-	5MT	R	F	Hatchback Engine M16A	657159	Inner joint	26	29	40		116.5	
	2009.07-	-	5MT	L	F	All-wheel Drive Hatchback Engine M16A	657173	Inner joint	26	29	38	58.5	98.5	
	2009.07-	-	5MT	R	F	All-wheel Drive Hatchback Engine M16A	657159	Inner joint	26	29	40		116.5	
	2009.07-	-	5MT	R	F	Hatchback Engine M16A	257291	Drive Shaft	28	26	58	85	701	
	2009.07-	-	5MT	L	F	Hatchback Engine M16A	257292	Drive Shaft	28	26	58	85	615	
	2009.07-	-	5MT	R	F	All-wheel Drive Hatchback Engine M16A	257291	Drive Shaft	28	26	58	85	701	
	2009.07-	-	5MT	L	F	All-wheel Drive Hatchback Engine M16A	257292	Drive Shaft	28	26	58	85	615	
2009.07-	-	AT/MT	L/R	F	Hatchback Engine M16A	857092	Outer Joint	28	29	58	86.5	63	I	
2009.07-	-	AT/MT	L/R	F	All-wheel Drive Hatchback Engine M16A	857092	Outer Joint	28	29	58	86.5	63	I	
1.9 DDiS (88 kW)	2006.06-	-	6MT	R	F	Hatchback Engine D19AA	257281	Drive Shaft	28	26	58	85	567	
	2006.06-	-	6MT	R	R	All-wheel Drive Hatchback Engine D19AA	214073	Drive Shaft	24		45	89	731	
	2006.06-	-	6MT	L	R	All-wheel Drive Hatchback Engine D19AA	214074	Drive Shaft	24		45	89	637	
	2006.06-	-	6MT	R	F	Hatchback Engine D19AA	657168	Inner joint	26	33	40		125	
2.0 (107 kW)	2006.06-	-	-	-	F	All-wheel Drive Hatchback Engine J20A	857141	Outer Joint	28	30	58	85	62.5	M
	2006.06-	-	-	-	R	Hatchback Engine J20A	814101	Outer Joint	24	26	45	89	62.5	I
	2006.06-	-	-	-	R	All-wheel Drive Hatchback Engine J20A	814101	Outer Joint	24	26	45	89	62.5	I
2.0 DDiS (99 kW)	2009.07-	-	6MT	R	R	All-wheel Drive Hatchback Engine D20AA	214073	Drive Shaft	24		45	89	731	
	2009.07-	-	-	-	F	Hatchback Engine D20AA	857078	Outer Joint	28	29	58	85	62	I
	2009.07-	-	6MT	L	R	All-wheel Drive Hatchback Engine D20AA	214074	Drive Shaft	24		45	89	637	
	2009.07-	-	-	-	F	All-wheel Drive Hatchback Engine D20AA	857078	Outer Joint	28	29	58	85	62	I
	2009.07-	-	-	L/R	F	Hatchback Engine D20AA	857205	Outer Joint	28	33	58	85	64.5	I
	2009.07-	-	-	L/R	F	All-wheel Drive Hatchback Engine D20AA	857205	Outer Joint	28	33	58	85	64.5	I
	2009.07-	-	-	L	F	Hatchback Engine D20AA	257299	Drive Shaft	28	28	58	85	598	
	2009.07-	-	-	L	F	All-wheel Drive Hatchback Engine D20AA	257299	Drive Shaft	28	28	58	85	598	
	2009.07-	-	-	R	F	Hatchback Engine D20AA	257300	Drive Shaft	28	28	58	85	710	
	2009.07-	-	-	R	F	All-wheel Drive Hatchback Engine D20AA	257300	Drive Shaft	28	28	58	85	710	
	2009.07-	-	-	L	F	Hatchback Engine D20AA	657164	Inner joint	28	33	42	70.5	102.5	
	2009.07-	-	-	L	F	Hatchback Engine D20AA	657163	Inner joint	28	33	42		122.5	
	2009.07-	-	-	L	F	All-wheel Drive Hatchback Engine D20AA	657164	Inner joint	28	33	42	70.5	102.5	
	2009.07-	-	-	L	F	All-wheel Drive Hatchback Engine D20AA	657163	Inner joint	28	33	42		122.5	
	2009.07-	-	MT	L/R	F	Hatchback Engine D20AA	857092	Outer Joint	28	29	58	86.5	63	I
	2009.07-	-	MT	L/R	F	All-wheel Drive Hatchback Engine D20AA	857092	Outer Joint	28	29	58	86.5	63	I
SX4 (GY)														
1.6 (79 kW)	2007.10-	-	-	-	F	Saloon Engine M16A	857078	Outer Joint	28	29	58	85	62	I
	2007.10-	-	MT	L	F	Saloon Engine M16A	257247	Drive Shaft	28	26	58	85	612	
	2007.10-	-	MT	R	F	Saloon Engine M16A	257074	Drive Shaft	28	26	58	85	699.5	
1.6 (88 kW)	2007.10-	-	-	-	F	Saloon Engine M16A	857078	Outer Joint	28	29	58	85	62	I
	2007.10-	-	MT	L	F	Saloon Engine M16A	257247	Drive Shaft	28	26	58	85	612	
	2007.10-	-	MT	R	F	Saloon Engine M16A	257074	Drive Shaft	28	26	58	85	699.5	
SX4 (YA11)														
1.5	2006.05-	-	4AT	-	-	Engine M15A	857149	Outer Joint	28	29	58	85	62.5	I
SX4 (YB11)														
1.5 4WD	2006.05-	-	4AT	-	-	Engine M15A	857149	Outer Joint	28	29	58	85	62.5	I
SX4 S-Cross (JY)/SX4 CROSSOVER														
1.6 (86 kW)	2013.12-	-	-	L/R	F	Hatchback Engine M16A	857208	Outer Joint	28	29	58	85	57	I
1.6 (88 kW)	2013.08-	-	-	L/R	F	Hatchback Engine M16A	857208	Outer Joint	28	29	58	85	57	I
1.6 AllGrip (85 kW)	2013.12-	-	CVT	L	F	All-wheel Drive Hatchback Engine M16A	257289	Drive Shaft	28	28	58	85	651	
	2013.12-	-	5MT	L	F	All-wheel Drive Hatchback Engine M16A	657167	Inner joint	26	29	40	54	104.5	
	2013.12-	-	CVT	L	F	All-wheel Drive Hatchback Engine M16A	657170	Inner joint	28	29	38	58	104.5	
1.6 AllGrip (86 kW)	2013.12-	-	-	R	F	All-wheel Drive Hatchback Engine M16A	257288	Drive Shaft	28	28	58	85	706	
	2013.12-	-	-	L/R	F	All-wheel Drive Hatchback Engine M16A	857208	Outer Joint	28	29	58	85	57	I
	2013.12-	-	5MT	L	F	All-wheel Drive Hatchback Engine M16A	657167	Inner joint	26	29	40	54	104.5	
	2013.12-	-	CVT	L	F	All-wheel Drive Hatchback Engine M16A	657170	Inner joint	28	29	38	58	104.5	
	2013.12-	-	CVT	L	F	All-wheel Drive Hatchback Engine M16A	257289	Drive Shaft	28	28	58	85	651	
1.6 AllGrip (88 kW)	2013.08-	-	-	R	F	All-wheel Drive Hatchback Engine M16A	257288	Drive Shaft	28	28	58	85	706	
	2013.08-	-	-	L/R	F	All-wheel Drive Hatchback Engine M16A	857208	Outer Joint	28	29	58	85	57	I





YEAR	TRANSM	L/R	F/R	REMARKS	GSP Ref.	PRODUCT	ABS	Technical Specifications						
								A	B	C	H	L	P	
SUZUKI														
SX4 S-Cross (JY)/SX4 CROSSOVER														
1.6 AllGrip (88 kW)	2013.08-	-	CVT	L F	All-wheel Drive Hatchback Engine M16A	257289	Drive Shaft		28	28	58	85	651	
	2013.08-	-	5MT	L F	All-wheel Drive Hatchback Engine M16A	657167	Inner joint		26	29	40	54	104.5	
	2013.08-	-	-	R F	All-wheel Drive Hatchback Engine M16A	657165	Inner joint		28	29	42		121.5	
	2013.08-	-	CVT	L F	All-wheel Drive Hatchback Engine M16A	657170	Inner joint		28	29	38	58	104.5	
1.6 DDiS (88 kW)	2013.08-	-	-	L F	Hatchback Engine D16AA	257282	Drive Shaft		28	28	58	85	620	
	2013.08-	-	-	L F	Hatchback Engine D16AA	657169	Inner joint		28	35	42	70.5	104.5	
1.6 DDiS AllGrip (88 kW)	2013.08-	-	-	L F	All-wheel Drive Hatchback Engine D16AA	257282	Drive Shaft		28	28	58	85	620	
	2013.08-	-	-	L F	All-wheel Drive Hatchback Engine D16AA	657169	Inner joint		28	35	42	70.5	104.5	
SX4 YA11														
1500	2006.05-	-	4AT	-	Engine M15A	857149	Outer Joint		28	29	58	85	62.5	I
SX4 YB11														
1500	2006.05-	-	4AT	-	Allwheel Drive Engine M15A	857149	Outer Joint		28	29	58	85	62.5	I
VITARA (ET TA)														
1.6 (54 kW)	1988.10-	1988.12	AT/MT	R F	All-wheel Drive Closed Off-Road Vehicle Engine G16A (8V)	219011	Drive Shaft		26	22	48	116.5	597	
	1988.10-	1988.12	AT/MT	L F	All-wheel Drive Closed Off-Road Vehicle Engine G16A (8V)	219009	Drive Shaft		26		48	116.5	492	
1.6 (59 kW)	1988.07-	1988.03	AT/MT	R F	All-wheel Drive Closed Off-Road Vehicle Engine G16A (8V)	219011	Drive Shaft		26	22	48	116.5	597	
	1988.07-	1988.03	AT/MT	L F	All-wheel Drive Closed Off-Road Vehicle Engine G16A (8V)	219009	Drive Shaft		26		48	116.5	492	
	1988.07-	1988.03	MT	L/R	All-wheel Drive Closed Off-Road Vehicle Engine G16A (8V)	857035	Outer Joint		26	22	48	116.5	65.5	M
1.6 (60 kW)	1988.07-	1991.12	AT/MT	R F	All-wheel Drive Closed Off-Road Vehicle Engine G16A (8V)	219011	Drive Shaft		26	22	48	116.5	597	
	1988.07-	1991.12	AT/MT	L F	All-wheel Drive Closed Off-Road Vehicle Engine G16A (8V)	219009	Drive Shaft		26		48	116.5	492	
	1988.07-	1991.12	MT	L/R	All-wheel Drive Closed Off-Road Vehicle Engine G16A (8V)	857035	Outer Joint		26	22	48	116.5	65.5	M
1.6 (70 kW)	1991.02-	1998.03	AT/MT	R F	All-wheel Drive Closed Off-Road Vehicle Engine G16B	219011	Drive Shaft		26	22	48	116.5	597	
	1991.02-	1998.03	AT/MT	L F	All-wheel Drive Closed Off-Road Vehicle Engine G16B	219009	Drive Shaft		26		48	116.5	492	
1.6 i 16V (71 kW)	1990.07-	1998.03	AT/MT	R F	All-wheel Drive Closed Off-Road Vehicle Engine G16B	219011	Drive Shaft		26	22	48	116.5	597	
	1990.07-	1998.03	-	-	All-wheel Drive Closed Off-Road Vehicle Engine G16B	857017	Outer Joint		26	29	48	116	65.5	I
	1990.07-	1998.03	AT/MT	L F	All-wheel Drive Closed Off-Road Vehicle Engine G16B	219009	Drive Shaft		26		48	116.5	492	
2.0 16V (97 kW)	1996.12-	1998.03	MT	-	All-wheel Drive Closed Off-Road Vehicle Engine J20A	857009	Outer Joint		26	30	48	116	65.5	I
2.0 TD (52 kW)	1994.12-	1998.03	MT	-	All-wheel Drive Closed Off-Road Vehicle Engine RF	857009	Outer Joint		26	30	48	116	65.5	I
2.0 TD Intercooler (64 kW)	1995.12-	1998.03	MT	-	All-wheel Drive Closed Off-Road Vehicle Engine RF	857009	Outer Joint		26	30	48	116	65.5	I
VITARA (ET, TA)														
2.0 16V Cabrio (97 kW)	1996.12-	1998.03	MT	-	-	899107	Outer Joint		26	30	48	116	65.5	I
2.0 TD (52 kW)	1994.12-	1998.03	-	-	-	899107	Outer Joint		26	30	48	116	65.5	I
2.0 TD (64 kW)	1994.12-	1998.03	-	-	-	899107	Outer Joint		26	30	48	116	65.5	I
2.5 V6 24V (118 kW)	1995.12-	1998.03	-	-	-	899107	Outer Joint		26	30	48	116	65.5	I
VITARA (LY)/ESCUDO														
1.6 (88 kW)	2015.02-	-	AT	L F	Closed Off-Road Vehicle Engine M16A	857200	Outer Joint		28	22	58	85	60	M
	2015.02-	-	AT	R F	Closed Off-Road Vehicle Engine M16A	657153	Inner joint		28	22	42		117	
	2015.02-	-	AT	L F	Closed Off-Road Vehicle Engine M16A	657154	Inner joint		26	22	31	87	69	
1.6 AllGrip (88 kW)	2015.02-	-	-	R F	All-wheel Drive Closed Off-Road Vehicle Engine M16A	257288	Drive Shaft		28	28	58	85	706	
1.6 DDiS (88 kW)	2015.02-	-	-	L F	Closed Off-Road Vehicle Engine D16AA	257282	Drive Shaft		28	28	58	85	620	
VITARA Cabrio (ET TA)/SIDEKICK														
1.6 (55 kW)	1990.01-	1993.12	AT/MT	R F	All-wheel Drive Closed Off-Road Vehicle Engine G16A (8V)	219011	Drive Shaft		26	22	48	116.5	597	
	1990.01-	1993.12	AT/MT	L F	All-wheel Drive Closed Off-Road Vehicle Engine G16A (8V)	219009	Drive Shaft		26		48	116.5	492	
1.6 (59 kW)	1988.07-	1995.01	-	R F	Open Off-Road Vehicle Engine G16A (8V)	219011	Drive Shaft		26	22	48	116.5	597	
	1988.07-	1995.01	-	L F	Open Off-Road Vehicle Engine G16A (8V)	219009	Drive Shaft		26		48	116.5	492	
	1988.07-	1995.01	MT	L/R	Open Off-Road Vehicle Engine G16A (8V)	857035	Outer Joint		26	22	48	116.5	65.5	M
1.6 i 16V (71 kW)	1990.07-	1999.03	AT/MT	R F	Open Off-Road Vehicle Engine G16B	219011	Drive Shaft		26	22	48	116.5	597	
	1990.07-	1999.03	-	-	Open Off-Road Vehicle Engine G16B	857017	Outer Joint		26	29	48	116	65.5	I
	1990.07-	1999.03	AT/MT	L F	Open Off-Road Vehicle Engine G16B	219009	Drive Shaft		26		48	116.5	492	
	1990.07-	1999.03	MT	L/R	Open Off-Road Vehicle Engine G16B	857035	Outer Joint		26	22	48	116.5	65.5	M
2.0 16V (97 kW)	1996.12-	1999.03	MT	-	Open Off-Road Vehicle Engine J20A	857009	Outer Joint		26	30	48	116	65.5	I
WAGON														
660	1998.09-	-	AT	-	F -	857031	Outer Joint		23	19	49	78	57	I
WAGON R														
-	-	-	-	L	MC11/MC12	857031	Outer Joint		23	19	49	78	57	I
	-	-	-	R	MC11	257069	Drive Shaft	43T	23	22	49	77.5	821	
	-	-	-	R	MC11/MC12	257070	Drive Shaft	43T	23	22	49	78	811	
	-	-	-	L	MC11	257068	Drive Shaft	43T	23	22	49	77.5	548	
	-	-	-	L	MC11/MC12	257071	Drive Shaft	43T	23	22	49	78	541	
WAGON R (MC11S)														
660	1998.10-	2000.12	MT	-	Engine F6A	857125	Outer Joint		23	24	49	78	56	I
WAGON R (MC21S)														
660	1998.10-	2000.12	CVT	-	Engine K6A	857125	Outer Joint		23	24	49	78	56	I
	1998.12-	2000.12	MT/AT	-	Engine K6A	857125	Outer Joint		23	24	49	78	56	I
WAGON R (MC22S)														





		 YEAR		TRANSM	L/R	F/R	REMARKS	GSP Ref.	 PRODUCT	 ABS	Technical Specifications						
											A	B	C	H	L	P	
SUZUKI																	
WAGON R (MC22S)																	
660	2000.12-	-	MT/AT	-	-	Engine K6A		857125	Outer Joint			23	24	49	78	56	I
	2000.12-	-	CVT	-	-	Engine K6A		857125	Outer Joint			23	24	49	78	56	I
WAGON R+ (EM)/WAGON R WIDE																	
1.0 (48 kW)	1998.02-	2000.05	MT/AT	L/R	F	MPV Engine K10A		857086	Outer Joint			23	19	44	89.6	50.7	M
	1998.02-	2000.05	-	-	-	MPV Engine K10A		857024	Outer Joint			23	19	49	78	57	M
	1998.02-	2000.05	AT	L/R	F	MPV Engine K10A		856010	Outer Joint	41T		23	19	49	78	57	M
1.2 (51 kW)	1998.02-	2000.05	-	-	-	MPV Engine K12A		857006	Outer Joint			23	19	44	89.5	54.5	M
	1998.02-	2000.05	AT/MT	L/R	F	All-wheel Drive MPV Engine K12A		856010	Outer Joint	41T		23	19	49	78	57	M
	1998.02-	2000.05	AT/MT	L/R	F	MPV Engine K12A		856010	Outer Joint	41T		23	19	49	78	57	M
WAGON R+ (MM)/WAGON R SORIO																	
1.3 (56 kW)	2000.05-	2004.12	MT	L	F	MPV Engine G13BB		257066	Drive Shaft	43T		23	22	49	78	593	
1.3 (69 kW)	2003.09-	-	MT	L	F	MPV Engine M13A		257066	Drive Shaft	43T		23	22	49	78	593	
1.3 DDiS (51 kW)	2003.09-	-	MT	L	F	MPV Engine Z13DT		257066	Drive Shaft	43T		23	22	49	78	593	
	2003.09-	-	AT/MT	L/R	F	MPV Engine Z13DT		844080	Outer Joint	43T		25	21	49	76	66.5	M
WAGON R+ I (EM)																	
1.2 (51 kW)	1998.02-	2000.05	MT	-	F	-		857104	Outer Joint			23	19	49	78	57	M
WAGON-R																	
0.7	1993-	1998	MT/AT	-	-	-		857072	Outer Joint			23	18	44	92	48.5	M
WAGON-R (MC11S)																	
0.6	1998.10-	2000.12	MT	-	-	Engine F6A		857157	Outer Joint			23	18	49	78	56	M
WAGON-R (MC21S)																	
0.6	1998.12-	2000.12	MT	-	-	Engine K6A		857157	Outer Joint			23	18	49	78	56	M
WAGON-R (MC22S)																	
0.6	2000.12-	-	MT	-	-	Engine K6A		857157	Outer Joint			23	18	49	78	56	M
WAGON-R MC11S																	
660	1998.10-	2000.12	MT	-	-	Engine F6A		857157	Outer Joint			23	18	49	78	56	M
WAGON-R MC21S																	
660	1998.10-	2000.12	CVT	-	-	Engine K6A		857125	Outer Joint			23	24	49	78	56	I
	1998.12-	2000.12	AT	-	-	Engine K6A		857125	Outer Joint			23	24	49	78	56	I
	1998.12-	1999.10	MT	-	-	Engine K6A		857157	Outer Joint			23	18	49	78	56	M
	1999.10-	2000.12	MT	-	-	Engine K6A		857157	Outer Joint			23	18	49	78	56	M
WAGON-R MC22S																	
660	2000.12-	-	AT	-	-	Engine K6A		857125	Outer Joint			23	24	49	78	56	I
	2000.12-	-	CVT	-	-	Engine K6A		857125	Outer Joint			23	24	49	78	56	I
	2000.12-	-	MT	-	-	Engine K6A		857157	Outer Joint			23	18	49	78	56	M
WAGON-R MH21S																	
660	2003.09-	2004.12	5MT	-	-	Allwheel Drive Engine K6A		854011	Outer Joint			23	26	49	78	56	I
	2003.09-	2004.12	5MT	-	-	Allwheel Drive Engine K6A		854011	Outer Joint			23	26	49	78	56	I
WAGON-R R MC11S																	
660	1998.10-	-	MT	-	-	Engine F6A		857125	Outer Joint			23	24	49	78	56	I
WAGON-R R MC21S																	
660	1998.10-	-	CVT	-	-	Engine K6A		857125	Outer Joint			23	24	49	78	56	I
	1998.12-	-	AT	-	-	Engine K6A		857125	Outer Joint			23	24	49	78	56	I
	1998.12-	1999.10	MT	-	-	Engine K6A		857125	Outer Joint			23	24	49	78	56	I
	1999.10-	-	MT	-	-	Engine K6A		857125	Outer Joint			23	24	49	78	56	I
WAGON-R R MC22S																	
660	2000.12-	-	AT	-	-	Engine K6A		857125	Outer Joint			23	24	49	78	56	I
	2000.12-	-	CVT	-	-	Engine K6A		857125	Outer Joint			23	24	49	78	56	I
	2000.12-	-	CVT	-	-	Engine K6A		857125	Outer Joint			23	24	49	78	56	I
	2000.12-	-	MT	-	-	Engine K6A		857125	Outer Joint			23	24	49	78	56	I
WAGON-R R MH21S																	
660	2003.09-	2004.12	5MT	-	-	Allwheel Drive Engine K6A		854011	Outer Joint			23	26	49	78	56	I
	2003.09-	2004.12	5MT	-	-	Allwheel Drive Engine K6A		854011	Outer Joint			23	26	49	78	56	I
X-90 (EL)																	
1.6 i 16V (71 kW)	1995.09-	1997.12	-	-	-	All-wheel Drive Open Off-Road Vehicle Engine G16B		857010	Outer Joint			26	22	48	116	65.5	I
SUZUKI (CHANGAN)																	
GAZELLE																	
1.3 (63 kW)	2001.01-	2011.12	MT	L	-	Saloon Engine JL474Q5 JL474Q1		257031	Drive Shaft			23	22	49	92	601	
SWIFT (EZ MZ)																	
1.3 (63 kW)	2005.05-	2012.12	MT	L	-	Hatchback Engine G 13 B JL474Q8		218074	Drive Shaft	43T		25	22	49	82	651.5	
	2005.05-	2012.12	MT	R	-	Hatchback Engine G 13 B JL474Q8		218075	Drive Shaft	43T		25	22	49	82	894	
	2005.05-	2012.12	AT	R	-	Hatchback Engine G 13 B JL474Q8		257156	Drive Shaft	43T		25	22	49	82	631	
	2005.05-	2012.12	AT	L	-	Hatchback Engine G 13 B JL474Q8		257157	Drive Shaft	43T		25	22	49	82	625	
1.5 (76 kW)	2007.12-	-	AT	-	-	Hatchback Engine M15A		257157	Drive Shaft	43T		25	22	49	82	625	
SWIFT (NZ FZ)																	

YEAR	TRANSM	L/R	F/R	REMARKS	GSP Ref.	PRODUCT	ABS	Technical Specifications							
								A	B	C	H	L	P		
SUZUKI (CHANGAN)															
SWIFT (NZ FZ)															
1.3 (67 kW)	2013.02-	-	MT	L -	Hatchback Engine G 13 B	218074	Drive Shaft	43T	25	22	49	82	651.5		
	2013.02-	-	MT	R -	Hatchback Engine G 13 B	218075	Drive Shaft	43T	25	22	49	82	894		
	2013.02-	-	AT	R -	Hatchback Engine G 13 B	257156	Drive Shaft	43T	25	22	49	82	631		
	2013.02-	-	AT	L -	Hatchback Engine G 13 B	257157	Drive Shaft	43T	25	22	49	82	625		
WAGON R (CH_)															
1.0 (34 kW)	2002.04-	2004.07	MT	R -	MPV Engine DA465Q-2	257051	Drive Shaft		23	22	49	78	835		
1.0 (48 kW)	2000.06-	2004.07	MT	R -	MPV Engine K10A	257051	Drive Shaft		23	22	49	78	835		
TATA															
INDICA															
1.4 CRDi	2005-	-	-	L/R	F -		857088	Outer Joint	42T	25	28	52.1	95	59.5	O
	2005-	-	-	R	F -		257118	Drive Shaft	42T	25	22	52.1	95	870	
	2005-	-	-	L	F -		258007	Drive Shaft	42T	25	22	52.1	95	601	
INDIGO															
1.4 CRDi	2006-	-	-	L/R	F -		857088	Outer Joint	42T	25	28	52.1	95	59.5	O
	2006-	-	-	R	F -		257118	Drive Shaft	42T	25	22	52.1	95	870	
	2006-	-	-	L	F -		258007	Drive Shaft	42T	25	22	52.1	95	601	
TOYOTA															
-	-	-	-	-	F RH		259235	Drive Shaft	48T	26	24	70	100	968	
	-	-	-	-	F LH		259236	Drive Shaft	48T	26	24	70	100	669	
4 RUNNER															
-	1996-	2002	-	-	-		859072	Outer Joint		30	34	69	123	66.5	I
4 RUNNER (_N18_)															
2.7 (112 kW)	1995.11-	2002.08	-	L/R	F	All-wheel Drive Closed Off-Road Vehicle Engine 3RZ-FE	859034	Outer Joint		30	27	69	122.5	64.5	I
	1995.11-	2002.08	MT	L/R	F	All-wheel Drive Closed Off-Road Vehicle Engine 3RZ-FE	859015	Outer Joint		26	27	60	162	65.5	I
3.0 Turbo-D (92 kW)	1995.11-	2002.11	AT/MT	L/R	F	All-wheel Drive Closed Off-Road Vehicle Engine 1KZ-T	859243	Outer Joint		30	27	69	121	65	I
3.4 (136 kW)	1998.09-	2002.11	-	L/R	F	All-wheel Drive Closed Off-Road Vehicle Engine 5VZ-FE	859034	Outer Joint		30	27	69	122.5	64.5	I
	1998.09-	2002.11	MT	L/R	F	All-wheel Drive Closed Off-Road Vehicle Engine 5VZ-FE	859015	Outer Joint		26	27	60	162	65.5	I
4 RUNNER (_N1_)/HILUX SURF															
2.4 D (66 kW)	1989.08-	1995.11	MT	-	F	All-wheel Drive Closed Off-Road Vehicle Engine 2L-T	859016	Outer Joint		26	27	60	162	65.5	M
2.8 D (61 kW)	1989.10-	1996.03	MT	-	F	All-wheel Drive Closed Off-Road Vehicle Engine 3L	859016	Outer Joint		26	27	60	162	65.5	M
3.0 (105 kW)	1990.07-	1995.11	MT	L/R	F	All-wheel Drive Closed Off-Road Vehicle Engine 3VZ-E	859015	Outer Joint		26	27	60	162	65.5	I
3.0 Turbo-D (92 kW)	1993.10-	1996.03	MT	-	F	All-wheel Drive Closed Off-Road Vehicle Engine 1KZ-T	859016	Outer Joint		26	27	60	162	65.5	M
	1993.10-	1996.03	MT	L/R	F	All-wheel Drive Closed Off-Road Vehicle Engine 1KZ-T	859015	Outer Joint		26	27	60	162	65.5	I
4 RUNNER (_N5_ _N6_ _N7_)/HILUX SURF															
2.4 (82 kW)	1987.08-	1989.07	MT	L/R	F	All-wheel Drive Closed Off-Road Vehicle Engine 22REC	859015	Outer Joint		26	27	60	162	65.5	I
	1987.08-	1989.07	-	-	F	All-wheel Drive Closed Off-Road Vehicle Engine 22REC	859016	Outer Joint		26	27	60	162	65.5	M
AGYA															
1.0	2012.12-	-	MT	R	F	ENGINE:1KRDE/B100RA	214066	Drive Shaft		24	23	47	84.5	841	
	2012.12-	-	AT	R	F	ENGINE:1KRDE/B100RA	214066	Drive Shaft		24	23	47	84.5	841	
	2014.01-	-	MT	R	F	ENGINE:1KRDE/B100LA	214066	Drive Shaft		24	23	47	84.5	841	
	2014.01-	-	AT	R	F	ENGINE:1KRDE/B100LA	214066	Drive Shaft		24	23	47	84.5	841	
ALLION (AZT240)															
2.0	2001-	-	CVT	-	-	Engine 1AZFSE	859294	Outer Joint	48T	26	27	63	97	60	M
ALLION I (_T24_)															
1.8 (100 kW)	2001.06-	2007.06	-	-	-	Saloon Engine 2ZR-FE	859262	Outer Joint	48T	26	24	58	95	51	I
ALLION II (_T26_)															
1.5 (81 kW)	2007.07-	-	-	-	-	F Saloon Engine 1NZ-FE	699046	Inner Joint		23	23	34	60	103.5	
ALLION ZTZ240															
1800	2001.12-	-	4AT	-	-	Engine 1ZZFE	859460	Outer Joint	48T	26	24	58	96	54	I
ALLION ZTZ245															
1800	2001.12-	-	4AT	-	-	Allwheel Drive Engine 1ZZFE	859460	Outer Joint	48T	26	24	58	96	54	I
ALLION, PREMIO															
1.8	2010.04-	-	-	L	F	ENGINE:2ZRFAE/JAPAN	259687	Drive Shaft	48T	26	20	58	95.5	639	
	2010.04-	-	-	L	F	ENGINE:2ZRFAE/JAPAN	859511	Outer Joint		26	25	58	95.5	56.5	I
ALLION, PREMIO															
1.8	2007.05-	2010.03	-	R	F	ENGINE:2ZRFE/ZRT260	259614	Drive Shaft	48T	26	20	58	95.5	907	
	2007.05-	2010.03	-	R	F	ENGINE:2ZRFE/ZRT260	259614	Drive Shaft	48T	26	20	58	95.5	907	
ALPHARD, HV, VELLFIRE															
3.5	2008.04-	2011.09	6AT	R	F	ENGINE:2GRFE/GGH25	259370	Drive Shaft		30	24	61.2	100	994	
	2011.10-	2014.12	6AT	L	F	ENGINE:2GRFE/GGH20	259610	Drive Shaft		30	24	61.2	100	648	
	2011.10-	2014.12	6AT	R	F	ENGINE:2GRFE/GGH20	259608	Drive Shaft		30	24	61.2	100	985	
ALTEZZA GITA (_XE1_)															
2.0 (114 kW)	1999.01-	2001.06	AT	-	R	Estate Engine 1G-GE/1G-FE	639089	Inner Joint				20		68.6	
ALTIS															





YEAR	TRANS	L/R	F/R	REMARKS	GSP Ref.	PRODUCT	ABS	Technical Specifications								
								A	B	C	H	L	P			
TOYOTA																
ALTIS																
-	2008.01-	2010.08	-	R	F	-		259714	Drive Shaft		26	23	58	96	924	
ALTIS,COROLLA																
-	2013.12-	-	MT	L	F	ENGINE:1ZRFE/ZRE171L		859511	Outer Joint		26	25	58	95.5	56.5	I
1.6	2007.12-	2008.10	4AT	R	F	ENGINE:3ZZFE/ZZE141		259617	Drive Shaft		26	20	58	96	926	
	2007.12-	2008.10	4AT	L	F	ENGINE:3ZZFE/ZZE141		259618	Drive Shaft		26	20	58	96	650	
	2010.08-	2013.10	6MT	R	F	ENGINE:1ZRFE/ZRE141		259617	Drive Shaft		26	20	58	96	926	
	2010.08-	2013.10	6MT	L	F	ENGINE:1ZRFE/ZRE141		259618	Drive Shaft		26	20	58	96	650	
	2011.04-	2014.05	4AT	R	F	ENGINE:1ZRFE/ZRE141		259616	Drive Shaft	48T	26	23	58	95.5	922	
	2013.12-	-	MT	L	F	ENGINE:1ZRFE/ZRE171L		259405	Drive Shaft	48T	26	20	58	95.5	646	
	2013.12-	-	4AT	R	F	ENGINE:1ZRFE/ZRE171		259616	Drive Shaft	48T	26	23	58	95.5	922	
	2013.12-	2015.12	6MT	R	F	ENGINE:1ZRFE/ZRE171		259617	Drive Shaft		26	20	58	96	926	
2013.12-	2015.12	6MT	L	F	ENGINE:1ZRFE/ZRE171		259618	Drive Shaft		26	20	58	96	650		
AURION (_V4_)																
3.5 (200 kW)	2006.03-	2011.09	AT	-	F	Saloon Engine 2GR-FE		859290	Outer Joint	48T	26	27	63.3	100	59.5	I
AURIS (_E15_)/COROLLA/BLADE																
1.33 Dual-VVTi (73 kW)	2010.01-	2012.09	-	L	F	Hatchback Engine 1NR-FE		259316	Drive Shaft		26	23	61.2	95.5	662	
	2010.01-	2012.09	-	R	F	Hatchback Engine 1NR-FE		259317	Drive Shaft		26	23	61.2	95.5	941	
	2010.01-	2012.09	-	L/R	F	Hatchback Engine 1NR-FE		859213	Outer Joint		26	23	61.2	95.5	54.5	I
1.33 Dual-VVTi (74 kW)	2009.05-	2012.09	AMT	L	F	Hatchback Engine 1NR-FE		259316	Drive Shaft		26	23	61.2	95.5	662	
	2009.05-	2012.09	AMT	R	F	Hatchback Engine 1NR-FE		259317	Drive Shaft		26	23	61.2	95.5	941	
	2009.05-	2012.09	-	L/R	F	Hatchback Engine 1NR-FE		859213	Outer Joint		26	23	61.2	95.5	54.5	I
1.4 (71 kW)	2007.03-	2012.09	AMT	L	F	Hatchback Engine 4ZZ-FE		259316	Drive Shaft		26	23	61.2	95.5	662	
	2007.03-	2012.09	AMT	R	F	Hatchback Engine 4ZZ-FE		259317	Drive Shaft		26	23	61.2	95.5	941	
	2007.03-	2012.09	-	-	-	Hatchback Engine 4ZZ-FE		699038	Inner Joint		23	23	34	60	113	
	2007.03-	2012.09	-	L/R	F	Hatchback Engine 4ZZ-FE		859213	Outer Joint		26	23	61.2	95.5	54.5	I
1.4 D-4D (66 kW)	2007.03-	2012.09	MT	L	F	Hatchback Engine 1ND-TV		259268	Drive Shaft		26	20	61.2	95.5	665	
	2007.03-	2012.09	MT	R	F	Hatchback Engine 1ND-TV		259447	Drive Shaft		26	20	61.2	95.5	943	
	2007.03-	2012.09	-	L/R	F	Hatchback Engine 1ND-TV		859213	Outer Joint		26	23	61.2	95.5	54.5	I
1.5 (81 kW)	2009.09-	2012.09	-	-	F	Hatchback Engine 1NZ-FE		699046	Inner Joint		23	23	34	60	103.5	
	2009.09-	2012.09	-	-	-	Hatchback Engine 1NZ-FE		859274	Outer Joint		26	23	55.6	96	54	I
1.6 (91 kW)	2007.03-	2012.09	AMT	L	F	Hatchback Engine 1ZR-FE		259316	Drive Shaft		26	23	61.2	95.5	662	
	2007.03-	2012.09	AMT	R	F	Hatchback Engine 1ZR-FE		259317	Drive Shaft		26	23	61.2	95.5	941	
	2007.03-	2012.09	-	L	F	Hatchback Engine 1ZR-FE		259268	Drive Shaft		26	20	61.2	95.5	665	
	2007.03-	2012.09	-	R	F	Hatchback Engine 1ZR-FE		259447	Drive Shaft		26	20	61.2	95.5	943	
	2007.03-	2012.09	-	L/R	F	Hatchback Engine 1ZR-FE		859213	Outer Joint		26	23	61.2	95.5	54.5	I
1.6 (97 kW)	2009.05-	2012.09	AMT	L	F	Hatchback Engine 1ZR-FE		259316	Drive Shaft		26	23	61.2	95.5	662	
	2009.05-	2012.09	AMT	R	F	Hatchback Engine 1ZR-FE		259317	Drive Shaft		26	23	61.2	95.5	941	
	2009.05-	2012.09	-	L	F	Hatchback Engine 1ZR-FE		259268	Drive Shaft		26	20	61.2	95.5	665	
	2009.05-	2012.09	AT	-	-	Hatchback Engine 1ZR-FE		699038	Inner Joint		23	23	34	60	113	
	2009.05-	2012.09	-	R	F	Hatchback Engine 1ZR-FE		259447	Drive Shaft		26	20	61.2	95.5	943	
2009.05-	2012.09	-	L/R	F	Hatchback Engine 1ZR-FE		859213	Outer Joint		26	23	61.2	95.5	54.5	I	
1.8 (100 kW)	2009.02-	2012.09	-	L	F	All-wheel Drive Hatchback Engine 2ZR-FAE		659100	Inner Joint		20	25	35	63.5	118	
1.8 (106 kW)	2009.02-	2012.09	-	L	F	Hatchback Engine 2ZR-FAE		659100	Inner Joint		20	25	35	63.5	118	
1.8 (108 kW)	2009.02-	2012.09	-	L	F	Hatchback Engine 2ZR-FAE		659100	Inner Joint		20	25	35	63.5	118	
	2009.02-	2012.09	-	L	F	Hatchback Engine 2ZR-FAE		259268	Drive Shaft		26	20	61.2	95.5	665	
	2009.02-	2012.09	-	R	F	Hatchback Engine 2ZR-FAE		259447	Drive Shaft		26	20	61.2	95.5	943	
	2009.02-	2012.09	-	L/R	F	Hatchback Engine 2ZR-FAE		859213	Outer Joint		26	23	61.2	95.5	54.5	I
	2009.02-	2012.09	-	L/R	F	Hatchback Engine 2ZR-FAE		859213	Outer Joint		26	23	61.2	95.5	54.5	I
2.0 D-4D (93 kW)	2007.03-	2012.09	6MT	L	F	Hatchback Engine 1AD-FTV		601073	Inner Joint		24	33	50	67	109	
	2007.03-	2012.09	MT	R	F	Hatchback Engine 1AD-FTV		259701	Drive Shaft		30	24	61.4	101	987	
	2007.03-	2012.09	MT	L	F	Hatchback Engine 1AD-FTV		259702	Drive Shaft		30	24	61.4	101	613	
	2007.03-	2012.09	-	L/R	F	Hatchback Engine 1AD-FTV		859318	Outer Joint		30	36	61.4	101	62	I
	2007.03-	2012.09	-	-	F	Hatchback Engine 1AD-FTV		899320	Outer Joint		30	27	61.2	100	64	I
	2007.03-	2012.09	MT	R	F	Hatchback Engine 1AD-FTV		659237	Inner Joint		24	33	40	383	97	
2.2 D (130 kW)	2007.03-	2012.09	6MT	L	F	Hatchback Engine 2AD-FHV		601073	Inner Joint		24	33	50	67	109	
	2007.03-	2012.09	MT	R	F	Hatchback Engine 2AD-FHV		259701	Drive Shaft		30	24	61.4	101	987	
	2007.03-	2012.09	MT	L	F	Hatchback Engine 2AD-FHV		259702	Drive Shaft		30	24	61.4	101	613	
	2007.03-	2012.09	-	L/R	F	Hatchback Engine 2AD-FHV		859318	Outer Joint		30	36	61.4	101	62	I
	2007.03-	2012.09	-	-	F	Hatchback Engine 2AD-FHV		899320	Outer Joint		30	27	61.2	100	64	I
	2007.03-	2012.09	6MT	R	F	Hatchback Engine 2AD-FHV		659237	Inner Joint		24	33	40	383	97	
AURIS (_E18_)																
1.2 (85 kW)	2015.03-	-	-	-	F	Hatchback Engine 8NR-FTS		659139	Inner Joint		20	23	35	63.5	115	
1.3 (73 kW)	2012.10-	-	MT	-	-	Hatchback Engine 1NR-FE		699038	Inner Joint		23	23	34	60	113	
	2012.10-	-	-	R	F	Hatchback Engine 1NR-FE		801143	Outer Joint		26	23	61.2	95.5	54.5	I
	2012.10-	-	-	R	F	Hatchback Engine 1NR-FE		201195	Drive Shaft		26	23	61.2	95.5	942	
	2012.10-	-	-	L	F	Hatchback Engine 1NR-FE		201196	Drive Shaft		26	23	61.2	95.5	662	
1.4 D-4D (66 kW)	2012.10-	-	-	R	F	Hatchback Engine 1ND-TV		259494	Drive Shaft		26	20	61.2	95.5	938	





	 YEAR	TRANSM	L/R	F/R	REMARKS	GSP Ref.	 PRODUCT	 ABS	Technical Specifications						
									A	B	C	H	L	P	
TOYOTA															
AURIS (_E18_)															
1.6 (97 kW)	2012.10-	-	-	F	Hatchback Engine 1ZR-FAE	859427	Outer Joint		26	25	61.2	95.5	61.5	I	
1.8 Hybrid (73 kW)	2012.10-	-	-	L/R	F Hatchback Engine 2ZR-FXE	859528	Outer Joint		26	32	61.2	96.5	54.5	I	
	2012.10-	-	CVT	L	F Hatchback Engine 2ZR-FXE	201236	Drive Shaft		26	24	61.2	96.5	627		
2.0 D-4D (91 kW)	2012.10-	-	-	F	Hatchback Engine 1AD-FTV	899320	Outer Joint		30	27	61.2	100	64	I	
AURIS TOURING SPORTS (_E18_)															
1.2 (85 kW)	2015.03-	-	-	F	Saloon Engine 8NR-FTS	659139	Inner Joint		20	23	35	63.5	115		
1.3 (73 kW)	2013.07-	-	MT	-	Saloon Engine 1NR-FE	699038	Inner Joint		23	23	34	60	113		
1.4 D-4D (66 kW)	2013.07-	-	-	R	F Saloon Engine 1ND-TV	259494	Drive Shaft		26	20	61.2	95.5	938		
1.8 Hybrid (73 kW)	2013.07-	-	-	L/R	F Saloon Engine 2ZR-FXE	859528	Outer Joint		26	32	61.2	96.5	54.5	I	
AURIS VAN (_E18_)															
1.4 D-4D (66 kW)	2013.03-	-	MT	R	F Box Engine 1ND-TV	259494	Drive Shaft		26	20	61.2	95.5	938		
AURIS(HYBRID)															
-	2010.06-	2012.09	AT	L	F ENGINE:2ZRFXE,	659094	Inner Joint		24	25	50	67	105		
1.2	2015.05-	-	6MT	L	F ENGINE: 8NRFTS/NRE185	259507	Drive Shaft		26	20	61.2	95.5	657		
	2015.05-	-	CVT	L	F ENGINE: 8NRFTS/NRE185	259507	Drive Shaft		26	20	61.2	95.5	657		
	2015.05-	-	6MT	R	F ENGINE:8NRFTS/NRE185	259509	Drive Shaft		26	20	61.2	95.5	944		
1.6	2012.10-	2015.04	6MT	L	F ENGINE:1ZRFAE/ZRE185	259507	Drive Shaft		26	20	61.2	95.5	657		
	2012.10-	2015.04	6MT	R	F ENGINE:1ZRFAE/ZRE185	259509	Drive Shaft		26	20	61.2	95.5	944		
	2015.05-	-	CVT	L	F ENGINE:1ZRFAE/ZRE185	259507	Drive Shaft		26	20	61.2	95.5	657		
1.8	2010.06-	2012.09	AT	R	F ENGINE:2ZRFXE	659095	Inner Joint		24	25	40	98	93		
	2010.06-	2012.09	AT	R	F ENGINE:2ZRFXE	259640	Drive Shaft		26	24	55.6	95.5	973		
	2010.06-	2012.09	AT	L	F ENGINE:2ZRFXE,	259639	Drive Shaft		26	24	55.6	95.5	624		
	2015.05-	-	CVT	L	F ENGINE: 2ZRFXE/ZWE186	259673	Drive Shaft		26	24	61.2	96.5	625		
	2015.05-	-	CVT	R	F ENGINE:2ZRFXE/ZWE186	259674	Drive Shaft		26	24	61.2	96.5	973		
AVALON															
-	1995-	1996	-	-	-	859162	Outer Joint	48T	30	34	56	95.5	70	I	
-	1995-	1996	-	-	-	859061	Outer Joint		30	34	56	95.5	70	I	
AVENSIS															
2.2	2008.11-	2011.10	6MT	L	F ENGINE:2ADFTV/ADT271	259661	Drive Shaft		30	24	61.2	100	628		
AVENSIS (ACM20)															
2.0	2001-	-	MT/AT	-	-	Engine 1AZFE	859294	Outer Joint	48T	26	27	63	97	60	M
AVENSIS (T250)															
2.0	2003.07-	2008.12	4AT	-	F Engine 1AZFSE	899302	Outer Joint	48T	26	25	58	95.5	62	M	
AVENSIS (T250W)															
2.0	2003.07-	2008.12	4AT	-	F Engine 1AZFSE	899302	Outer Joint	48T	26	25	58	95.5	62	M	
AVENSIS (T251)															
2.0	2005.06-	2008.12	5AT	-	F Engine 2AZFSE	899302	Outer Joint	48T	26	25	58	95.5	62	M	
AVENSIS (T251W)															
2.0	2005.06-	2008.12	5AT	-	F Engine 2AZFSE	899302	Outer Joint	48T	26	25	58	95.5	62	M	
AVENSIS (_T22_)															
1.6 (74 kW)	1997.09-	2000.10	-	R	F Saloon Engine 4A-FE	859022	Outer Joint	48T	26	23	56	99	61	M	
	1997.09-	2000.10	-	R	F Estate Engine 4A-FE	859022	Outer Joint	48T	26	23	56	99	61	M	
	1997.09-	2000.10	-	-	-	Saloon Engine 4A-FE	699038	Inner Joint		23	23	34	60	113	
	1997.09-	2000.10	-	-	-	Estate Engine 4A-FE	699038	Inner Joint		23	23	34	60	113	
	1997.09-	2000.10	AT/MT	L/R	F Saloon Engine 4A-FE	859028	Outer Joint	48T	26	22	56	99	61	M	
	1997.09-	2000.10	AT/MT	L/R	F Estate Engine 4A-FE	859028	Outer Joint	48T	26	22	56	99	61	M	
1.6 (81 kW)	1997.09-	2000.10	-	R	F Saloon Engine 4A-FE	859022	Outer Joint	48T	26	23	56	99	61	M	
	1997.09-	2000.10	-	R	F Estate Engine 4A-FE	859022	Outer Joint	48T	26	23	56	99	61	M	
	1997.09-	2000.10	-	-	-	Estate Engine 4A-FE	699038	Inner Joint		23	23	34	60	113	
	1997.09-	2000.10	-	-	-	Saloon Engine 4A-FE	699038	Inner Joint		23	23	34	60	113	
	1997.09-	2000.10	AT/MT	L/R	F Estate Engine 4A-FE	859028	Outer Joint	48T	26	22	56	99	61	M	
	1997.09-	2000.10	AT/MT	L/R	F Saloon Engine 4A-FE	859028	Outer Joint	48T	26	22	56	99	61	M	
	2000.10-	2003.02	MT	L	F Estate Engine 3ZZ-FE	259078	Drive Shaft	48T	26	20	58	96	638.5		
	2000.10-	2003.02	MT	R	F Estate Engine 3ZZ-FE	259172	Drive Shaft	48T	26	20	56	99	919		
	2000.10-	2003.02	-	-	-	Estate Engine 3ZZ-FE	699038	Inner Joint		23	23	34	60	113	
1.6 VVT-i (81 kW)	2000.10-	2003.02	AT/MT	L/R	F Estate Engine 3ZZ-FE	859028	Outer Joint	48T	26	22	56	99	61	M	
	2000.10-	2003.02	MT	L	F Saloon Engine 3ZZ-FE	259078	Drive Shaft	48T	26	20	58	96	638.5		
	2000.10-	2003.02	MT	R	F Saloon Engine 3ZZ-FE	259172	Drive Shaft	48T	26	20	56	99	919		
	2000.10-	2003.02	AT/MT	L/R	F Saloon Engine 3ZZ-FE	859028	Outer Joint	48T	26	22	56	99	61	M	
1.8 (81 kW)	1997.09-	2000.10	MT	L	F Estate Engine 7A-FE	299101	Drive Shaft	48T	26	23	56	99	619		
	1997.09-	2000.10	-	L/R	F Saloon Engine 7A-FE	859022	Outer Joint	48T	26	23	56	99	61	M	
	1997.09-	2000.10	-	L/R	F Estate Engine 7A-FE	859022	Outer Joint	48T	26	23	56	99	61	M	
	1997.09-	2000.10	-	-	-	Saloon Engine 7A-FE	699038	Inner Joint		23	23	34	60	113	
	1997.09-	2000.10	-	-	-	Estate Engine 7A-FE	699038	Inner Joint		23	23	34	60	113	
	1997.09-	2000.10	AT/MT	L/R	F Saloon Engine 7A-FE	859028	Outer Joint	48T	26	22	56	99	61	M	





	 YEAR	TRANSM	L/R	F/R	REMARKS	GSP Ref.	 PRODUCT	 ABS	Technical Specifications					
									A	B	C	H	L	P
TOYOTA														
AVENSIS (_T22_)														
1.8 (81 kW)	1997.09-2000.10	AT/MT	L/R	F	Estate Engine 7A-FE	859028	Outer Joint	48T	26	22	56	99	61	M
1.8 (95 kW)	2000.10-2003.02	MT	L	F	Estate Engine 1ZZ-FE	259078	Drive Shaft	48T	26	20	58	96	638.5	
	2000.10-2003.02	MT	R	F	Estate Engine 1ZZ-FE	259172	Drive Shaft	48T	26	20	56	99	919	
	2000.10-2003.02	MT	R	F	Estate Engine 1ZZ-FE	659117	Inner Joint		20	24	35	350.5	102.5	
1.8 VVT-i (95 kW)	2000.10-2003.02	MT	L	F	Saloon Engine 1ZZ-FE	259078	Drive Shaft	48T	26	20	58	96	638.5	
	2000.10-2003.02	MT	R	F	Saloon Engine 1ZZ-FE	259172	Drive Shaft	48T	26	20	56	99	919	
	2000.10-2003.02	MT	R	F	Saloon Engine 1ZZ-FE	659117	Inner Joint		20	24	35	350.5	102.5	
2.0 (110 kW)	2000.10-2003.02	MT	L	F	Estate Engine 1AZ-FSE	259078	Drive Shaft	48T	26	20	58	96	638.5	
	2000.10-2003.02	MT	R	F	Estate Engine 1AZ-FSE	259172	Drive Shaft	48T	26	20	56	99	919	
2.0 (94 kW)	1997.09-2000.10	MT	L	F	Saloon Engine 3S-FE	299101	Drive Shaft	48T	26	23	56	99	619	
	1997.09-2000.10	-	L/R	F	Saloon Engine 3S-FE	859022	Outer Joint	48T	26	23	56	99	61	M
	1997.09-2000.10	-	L/R	F	Estate Engine 3S-FE	859022	Outer Joint	48T	26	23	56	99	61	M
	1997.09-2000.10	-	L	F	Saloon Engine 3S-FE	659046	Inner Joint		20	23	35	63.5	115.5	
2.0 D (61 kW)	1997.09-2000.10	-	L	F	Estate Engine 3S-FE	659046	Inner Joint		20	23	35	63.5	115.5	
	1997.09-2000.10	-	L	F	Estate Engine 3S-FE	659040	Inner Joint		20	23	35	63	118	
2.0 D (85 kW)	1997.10-1998.05	MT	L	F	Estate Engine 2C-T	659040	Inner Joint		20	32	35	63	118	
2.0 D (85 kW)	2002.09-2003.02	MT	L	F	Estate Engine 1CD-FTV	659041	Inner Joint		24	32	50	67	104	
2.0 D-4D (81 kW)	1999.10-2003.02	MT	L	F	Saloon Engine 1CD-FTV	659041	Inner Joint		24	32	50	67	104	
	1999.10-2003.02	MT	L	F	Estate Engine 1CD-FTV	659041	Inner Joint		24	32	50	67	104	
	1999.10-2003.02	MT	L	F	Saloon Engine 1CD-FTV	659111	Inner Joint		24	32	50	99	106	
	1999.10-2003.02	MT	L	F	Estate Engine 1CD-FTV	659111	Inner Joint		24	32	50	99	106	
	1999.10-2003.02	MT	-	F	Saloon Engine 1CD-FTV	859086	Outer Joint		26	24	56	99	61	M
	1999.10-2003.02	MT	-	F	Estate Engine 1CD-FTV	859086	Outer Joint		26	24	56	99	61	M
	1999.10-2003.02	MT	L/R	F	Saloon Engine 1CD-FTV	859024	Outer Joint	48T	26	24	56	99	61	M
	1999.10-2003.02	MT	L/R	F	Estate Engine 1CD-FTV	859024	Outer Joint	48T	26	24	56	99	61	M
2.0 TD (66 kW)	1997.09-2003.02	MT	L	F	Saloon Engine 2C-TE	659040	Inner Joint		20	32	35	63	118	
	1997.09-2003.02	MT	L	F	Estate Engine 2C-TE	659040	Inner Joint		20	32	35	63	118	
	1997.09-2003.02	-	-	F	Saloon Engine 2C-TE	859269	Outer Joint		26	23	56	99	59	M
	1997.09-2003.02	-	-	F	Estate Engine 2C-TE	859269	Outer Joint		26	23	56	99	59	M
	1997.09-2003.02	AT/MT	L/R	F	Saloon Engine 2C-TE	859028	Outer Joint	48T	26	22	56	99	61	M
	1997.09-2003.02	AT/MT	L/R	F	Estate Engine 2C-TE	859028	Outer Joint	48T	26	22	56	99	61	M
2.0 VVT-i (110 kW)	2000.10-2003.02	MT	L	F	Saloon Engine 1AZ-FSE	259078	Drive Shaft	48T	26	20	58	96	638.5	
	2000.10-2003.02	MT	R	F	Saloon Engine 1AZ-FSE	259172	Drive Shaft	48T	26	20	56	99	919	
AVENSIS (_T25_)														
1.6 VVT-i (81 kW)	2003.04-2008.11	-	L/R	F	Hatchback Engine 3ZZ-FE	859037	Outer Joint	48T	26	23	58	95.5	61	M
	2003.04-2008.11	-	L/R	F	Saloon Engine 3ZZ-FE	859037	Outer Joint	48T	26	23	58	95.5	61	M
	2003.04-2008.11	-	L/R	F	Estate Engine 3ZZ-FE	859037	Outer Joint	48T	26	23	58	95.5	61	M
	2003.04-2008.11	MT	L	F	Estate Engine 3ZZ-FE	259078	Drive Shaft	48T	26	20	58	96	638.5	
	2003.04-2008.11	MT	R	F	Estate Engine 3ZZ-FE	259172	Drive Shaft	48T	26	20	56	99	919	
1.8 (95 kW)	2003.04-2008.11	-	L/R	F	Saloon Engine 1ZZ-FE	859037	Outer Joint	48T	26	23	58	95.5	61	M
	2003.04-2008.11	-	L/R	F	Estate Engine 1ZZ-FE	859037	Outer Joint	48T	26	23	58	95.5	61	M
	2003.04-2008.11	-	L/R	F	Hatchback Engine 1ZZ-FE	859037	Outer Joint	48T	26	23	58	95.5	61	M
	2003.04-2008.11	MT	L	F	Saloon Engine 1ZZ-FE	259272	Drive Shaft	48T	26	20	58	95.5	651.5	
	2003.04-2008.11	MT	L	F	Estate Engine 1ZZ-FE	259272	Drive Shaft	48T	26	20	58	95.5	651.5	
	2003.04-2008.11	MT	L	F	Hatchback Engine 1ZZ-FE	259272	Drive Shaft	48T	26	20	58	95.5	651.5	
	2003.04-2008.11	MT	R	F	Saloon Engine 1ZZ-FE	259273	Drive Shaft	48T	26	20	58	95.5	925.5	
	2003.04-2008.11	MT	R	F	Estate Engine 1ZZ-FE	259273	Drive Shaft	48T	26	20	58	95.5	925.5	
	2003.04-2008.11	MT	R	F	Hatchback Engine 1ZZ-FE	259273	Drive Shaft	48T	26	20	58	95.5	925.5	
	2003.04-2008.11	MT	R	F	Hatchback Engine 1ZZ-FE	259273	Drive Shaft	48T	26	20	58	95.5	925.5	
2.0 D-4D (85 kW)	2003.04-2008.11	MT	L	F	Saloon Engine 1CD-FTV	299107	Drive Shaft	48T	26	24	58	95.5	615	
	2003.04-2008.11	MT	L	F	Estate Engine 1CD-FTV	299107	Drive Shaft	48T	26	24	58	95.5	615	
	2003.04-2008.11	MT	L	F	Hatchback Engine 1CD-FTV	299107	Drive Shaft	48T	26	24	58	95.5	615	
	2003.04-2008.11	MT	L	F	Saloon Engine 1CD-FTV	259207	Drive Shaft	48T	26	24	58	95.5	601	
	2003.04-2008.11	5AT	L	F	Estate Engine 1CD-FTV	259207	Drive Shaft	48T	26	24	58	95.5	601	
	2003.04-2008.11	5AT	L	F	Hatchback Engine 1CD-FTV	259207	Drive Shaft	48T	26	24	58	95.5	601	
	2003.04-2008.11	-	R	F	Saloon Engine 1CD-FTV	659045	Inner Joint		24	26	40	369	99.5	
	2003.04-2008.11	-	R	F	Estate Engine 1CD-FTV	659045	Inner Joint		24	26	40	369	99.5	
	2003.04-2008.11	-	R	F	Hatchback Engine 1CD-FTV	659045	Inner Joint		24	26	40	369	99.5	
	2003.04-2008.11	6MT	R	F	Hatchback Engine 1CD-FTV	259519	Drive Shaft	48T	26	24	58	95.5	972	
	2003.04-2008.11	-	R	F	Saloon Engine 1CD-FTV	299106	Drive Shaft	48T	26	24	58	95.5	957.5	
	2003.04-2008.11	-	R	F	Estate Engine 1CD-FTV	299106	Drive Shaft	48T	26	24	58	95.5	957.5	
	2003.04-2008.11	-	R	F	Hatchback Engine 1CD-FTV	299106	Drive Shaft	48T	26	24	58	95.5	957.5	
	2.0 D-4D (93 kW)	2006.03-2008.11	MT	-	F	Hatchback Engine 1AD-FTV	859182	Outer Joint	48T	26	25	58	95.5	61.5
2006.03-2008.11		MT	-	F	Saloon Engine 1AD-FTV	859182	Outer Joint	48T	26	25	58	95.5	61.5	M
2006.03-2008.11		MT	-	F	Estate Engine 1AD-FTV	859182	Outer Joint	48T	26	25	58	95.5	61.5	M
2006.03-2008.11		MT	R	F	Saloon Engine 1AD-FTV	259519	Drive Shaft	48T	26	24	58	95.5	972	
2006.03-2008.11		MT	R	F	Estate Engine 1AD-FTV	259519	Drive Shaft	48T	26	24	58	95.5	972	
2006.03-2008.11		6MT	R	F	Hatchback Engine 1AD-FTV	259519	Drive Shaft	48T	26	24	58	95.5	972	





	 YEAR	TRANSM	L/R	F/R	REMARKS	GSP Ref.	 PRODUCT	 ABS	Technical Specifications					
									A	B	C	H	L	P
TOYOTA														
AVENSIS (_T25_)														
2.2 D-4D (110 kW)	2005.10-2008.11	MT	-	F	Hatchback Engine 2AD-FTV	859233	Outer Joint	48T	30	36	63	99	67	I
	2005.10-2008.11	MT	-	F	Saloon Engine 2AD-FTV	859233	Outer Joint	48T	30	36	63	99	67	I
	2005.10-2008.11	MT	-	F	Estate Engine 2AD-FTV	859233	Outer Joint	48T	30	36	63	99	67	I
	2005.10-2008.11	MT	L	F	Hatchback Engine 2AD-FTV	259445	Drive Shaft	48T	30	24	63	99	600	
	2005.10-2008.11	MT	L	F	Saloon Engine 2AD-FTV	259445	Drive Shaft	48T	30	24	63	99	600	
	2005.10-2008.11	MT	L	F	Estate Engine 2AD-FTV	259445	Drive Shaft	48T	30	24	63	99	600	
	2005.10-2008.11	-	-	F	Hatchback Engine 2AD-FTV	899319	Outer Joint	48T	30	27	63.4	99	64	I
	2005.10-2008.11	-	-	F	Estate Engine 2AD-FTV	899319	Outer Joint	48T	30	27	63.4	99	64	I
2.2 D-CAT (130 kW)	2005.07-2008.11	MT	-	F	Hatchback Engine 2AD-FHV	859233	Outer Joint	48T	30	36	63	99	67	I
	2005.07-2008.11	MT	-	F	Saloon Engine 2AD-FHV	859233	Outer Joint	48T	30	36	63	99	67	I
	2005.07-2008.11	MT	-	F	Estate Engine 2AD-FHV	859233	Outer Joint	48T	30	36	63	99	67	I
	2005.07-2008.11	MT	L	F	Hatchback Engine 2AD-FHV	259445	Drive Shaft	48T	30	24	63	99	600	
	2005.07-2008.11	MT	L	F	Saloon Engine 2AD-FHV	259445	Drive Shaft	48T	30	24	63	99	600	
	2005.07-2008.11	MT	L	F	Estate Engine 2AD-FHV	259445	Drive Shaft	48T	30	24	63	99	600	
	2005.07-2008.11	-	-	F	Hatchback Engine 2AD-FHV	899319	Outer Joint	48T	30	27	63.4	99	64	I
2.4 (120 kW)	2003.10-2008.11	AT	-	F	Saloon Engine 2AZ-FSE	859182	Outer Joint	48T	26	25	58	95.5	61.5	M
	2003.10-2008.11	AT	-	F	Hatchback Engine 2AZ-FSE	859182	Outer Joint	48T	26	25	58	95.5	61.5	M
	2003.10-2008.11	AT	-	F	Estate Engine 2AZ-FSE	859182	Outer Joint	48T	26	25	58	95.5	61.5	M
	2003.09-2008.11	AT	-	F	Saloon Engine 2AZ-FSE	859182	Outer Joint	48T	26	25	58	95.5	61.5	M
2.4 (125 kW)	2003.09-2008.11	AT	-	F	Estate Engine 2AZ-FSE	859182	Outer Joint	48T	26	25	58	95.5	61.5	M
	2003.09-2008.11	AT	-	F	Hatchback Engine 2AZ-FSE	859182	Outer Joint	48T	26	25	58	95.5	61.5	M
AVENSIS (_T27_)														
1.6 (97 kW)	2008.11-	MT	-	F	Saloon Engine 1ZR-FAE	659139	Inner Joint		20	23	35	63.5	115	
	2008.11-	-	-	R	Saloon Engine 1ZR-FAE	259552	Drive Shaft		26	20	61.2	95.5	958	
	2008.11-	-	-	L	Saloon Engine 1ZR-FAE	259553	Drive Shaft		26	20	61.2	95.5	675	
	2009.02-	MT	-	F	Estate Engine 1ZR-FAE	659139	Inner Joint		20	23	35	63.5	115	
	2009.02-	-	-	R	Estate Engine 1ZR-FAE	259552	Drive Shaft		26	20	61.2	95.5	958	
	2009.02-	-	-	L	Estate Engine 1ZR-FAE	259553	Drive Shaft		26	20	61.2	95.5	675	
1.8 (108 kW)	2008.11-	-	-	R	Saloon Engine 2ZR-FAE	259552	Drive Shaft		26	20	61.2	95.5	958	
	2008.11-	-	-	L	Saloon Engine 2ZR-FAE	259553	Drive Shaft		26	20	61.2	95.5	675	
	2009.02-	-	-	R	Estate Engine 2ZR-FAE	259552	Drive Shaft		26	20	61.2	95.5	958	
	2009.02-	-	-	L	Estate Engine 2ZR-FAE	259553	Drive Shaft		26	20	61.2	95.5	675	
2.0 (112 kW)	2008.11-	-	-	R	Saloon Engine 3ZR-FAE	259658	Drive Shaft		26	24	61.2	95.5	958	
	2008.11-	-	-	L	Saloon Engine 3ZR-FAE	259659	Drive Shaft		26	24	61.2	95.5	661	
	2009.02-	-	-	R	Estate Engine 3ZR-FE	259658	Drive Shaft		26	24	61.2	95.5	958	
	2009.02-	-	-	L	Estate Engine 3ZR-FE	259659	Drive Shaft		26	24	61.2	95.5	661	
2.0 D-4D (91 kW)	2011.11-	-	-	F	Saloon Engine 1AD-FTV	859345	Outer Joint		30	25	61.2	99.5	62	M
	2011.11-	-	-	F	Estate Engine 1AD-FTV	859345	Outer Joint		30	25	61.2	99.5	62	M
	2011.11-	-	-	L	Saloon Engine 1AD-FTV	659042	Inner Joint		24	26	50	67	109	
	2011.11-	-	-	L	Estate Engine 1AD-FTV	659042	Inner Joint		24	26	50	67	109	
	2011.11-	-	-	R	Saloon Engine 1AD-FTV	259589	Drive Shaft		30	24	61.2	99.5	1004	
	2011.11-	-	-	R	Estate Engine 1AD-FTV	259589	Drive Shaft		30	24	61.2	99.5	1004	
	2011.11-	-	-	L	Saloon Engine 1AD-FTV	259520	Drive Shaft		30	24	61.2	99.5	620	
2.0 D-4D (93 kW)	2011.11-	-	-	L	Estate Engine 1AD-FTV	259520	Drive Shaft		30	24	61.2	99.5	620	
	2008.11-	-	-	F	Saloon Engine 1AD-FTV	859345	Outer Joint		30	25	61.2	99.5	62	M
	2008.11-	-	-	L	Saloon Engine 1AD-FTV	659042	Inner Joint		24	26	50	67	109	
	2008.11-	-	-	R	Saloon Engine 1AD-FTV	259589	Drive Shaft		30	24	61.2	99.5	1004	
	2008.11-	-	-	L	Saloon Engine 1AD-FTV	259520	Drive Shaft		30	24	61.2	99.5	620	
	2009.02-	-	-	F	Estate Engine 1AD-FTV	859345	Outer Joint		30	25	61.2	99.5	62	M
	2009.02-	-	-	L	Estate Engine 1AD-FTV	659042	Inner Joint		24	26	50	67	109	
2.2 D-4D (110 kW)	2008.11-	-	-	L/R	F Saloon Engine 2AD-FTV	859365	Outer Joint		30	26	61.2	99.5	62	I
	2008.11-	-	-	F	Saloon Engine 2AD-FTV	899319	Outer Joint	48T	30	27	63.4	99	64	I
	2008.11-	-	-	R	Saloon Engine 2AD-FTV	259660	Drive Shaft		30	24	61.2	100	1002	
	2009.02-	-	-	L/R	F Estate Engine 2AD-FHV/2AD-FTV	859365	Outer Joint		30	26	61.2	99.5	62	I
	2009.02-	-	-	F	Estate Engine 2AD-FHV/2AD-FTV	899319	Outer Joint	48T	30	27	63.4	99	64	I
	2009.02-	-	-	R	Estate Engine 2AD-FHV/2AD-FTV	259660	Drive Shaft		30	24	61.2	100	1002	
2.2 D-4D (130 kW)	2008.11-	-	-	L/R	F Saloon Engine 2AD-FHV	859365	Outer Joint		30	26	61.2	99.5	62	I
	2008.11-	-	-	F	Saloon Engine 2AD-FHV	899319	Outer Joint	48T	30	27	63.4	99	64	I
	2008.11-	-	-	R	Saloon Engine 2AD-FHV	259660	Drive Shaft		30	24	61.2	100	1002	
	2009.02-	-	-	L/R	F Estate Engine 2AD-FHV	859365	Outer Joint		30	26	61.2	99.5	62	I
	2009.02-	-	-	R	Estate Engine 2AD-FHV	259660	Drive Shaft		30	24	61.2	100	1002	





TOYOTA	YEAR	TRANSM	L/R	F/R	REMARKS	GSP Ref.	PRODUCT	ABS	Technical Specifications													
									A	B	C	H	L	P								
TOYOTA																						
AVENSIS I (722), SW																						
2.0 VVT-i (110 kW)	2000.10-	2003.02	-	-	-		659070	Inner Joint			27		33.2									
AVENSIS Liftback (_T22_)																						
1.6 (74 kW)	1997.09-	2000.10	MT	L	F	Hatchback Engine 4A-FE	299101	Drive Shaft	48T	26	23	56	99	619								
	1997.09-	2000.10	-	L/R	F	Hatchback Engine 4A-FE	859022	Outer Joint	48T	26	23	56	99	61	M							
	1997.09-	2000.10	-	-	-	Hatchback Engine 4A-FE	699038	Inner Joint		23	23	34	60	113								
	1997.09-	2000.10	AT/MT	L/R	F	Hatchback Engine 4A-FE	859028	Outer Joint	48T	26	22	56	99	61	M							
1.6 (81 kW)	1997.09-	2000.10	-	R	F	Hatchback Engine 4A-FE	859022	Outer Joint	48T	26	23	56	99	61	M							
	1997.09-	2000.10	-	-	-	Hatchback Engine 4A-FE	699038	Inner Joint		23	23	34	60	113								
	1997.09-	2000.10	AT/MT	L/R	F	Hatchback Engine 4A-FE	859028	Outer Joint	48T	26	22	56	99	61	M							
	2000.10-	2003.02	MT	L	F	Hatchback Engine 3ZZ-FE	259078	Drive Shaft	48T	26	20	58	96	638.5								
	2000.10-	2003.02	MT	R	F	Hatchback Engine 3ZZ-FE	259172	Drive Shaft	48T	26	20	56	99	919								
	2000.10-	2003.02	AT/MT	L/R	F	Hatchback Engine 3ZZ-FE	859028	Outer Joint	48T	26	22	56	99	61	M							
1.8 (81 kW)	1997.09-	2000.10	MT	L	F	Hatchback Engine 7A-FE	299101	Drive Shaft	48T	26	23	56	99	619								
	1997.09-	2000.10	-	R	F	Hatchback Engine 7A-FE	859022	Outer Joint	48T	26	23	56	99	61	M							
	1997.09-	2000.10	-	-	-	Hatchback Engine 7A-FE	699038	Inner Joint		23	23	34	60	113								
	1997.09-	2000.10	AT/MT	L/R	F	Hatchback Engine 7A-FE	859028	Outer Joint	48T	26	22	56	99	61	M							
1.8 (95 kW)	2000.10-	2003.02	MT	L	F	Hatchback Engine 1ZZ-FE	259078	Drive Shaft	48T	26	20	58	96	638.5								
	2000.10-	2003.02	MT	R	F	Hatchback Engine 1ZZ-FE	259172	Drive Shaft	48T	26	20	56	99	919								
	2000.10-	2003.02	MT	R	F	Hatchback Engine 1ZZ-FE	659117	Inner Joint		20	24	35	350.5	102.5								
2.0 (110 kW)	2000.10-	2003.02	MT	L	F	Hatchback Engine 1AZ-FSE	259078	Drive Shaft	48T	26	20	58	96	638.5								
	2000.10-	2003.02	MT	R	F	Hatchback Engine 1AZ-FSE	259172	Drive Shaft	48T	26	20	56	99	919								
2.0 (94 kW)	1997.09-	2000.10	MT	L	F	Hatchback Engine 3S-FE	299101	Drive Shaft	48T	26	23	56	99	619								
	1997.09-	2000.10	-	L/R	F	Hatchback Engine 3S-FE	859022	Outer Joint	48T	26	23	56	99	61	M							
	1997.09-	2000.10	-	L	F	Hatchback Engine 3S-FE	659046	Inner Joint		20	23	35	63.5	115.5								
2.0 D (85 kW)	2002.09-	2003.02	MT	L	F	Hatchback Engine 1CD-FTV	659041	Inner Joint		24	32	50	67	104								
2.0 D-4D (81 kW)	1999.10-	2003.02	MT	L	F	Hatchback Engine 1CD-FTV	659041	Inner Joint		24	32	50	67	104								
	1999.10-	2003.02	MT	L	F	Hatchback Engine 1CD-FTV	659111	Inner Joint		24	32	50	99	106								
	1999.10-	2003.02	MT	-	F	Hatchback Engine 1CD-FTV	859086	Outer Joint		26	24	56	99	61	M							
	1999.10-	2003.02	MT	L/R	F	Hatchback Engine 1CD-FTV	859024	Outer Joint	48T	26	24	56	99	61	M							
2.0 TD (66 kW)	1997.09-	2003.02	MT	L	F	Hatchback Engine 2C-TE	659040	Inner Joint		20	32	35	63	118								
	1997.09-	2003.02	-	-	F	Hatchback Engine 2C-TE	859269	Outer Joint		26	23	56	99	59	M							
	1997.09-	2003.02	AT/MT	L/R	F	Hatchback Engine 2C-TE	859028	Outer Joint	48T	26	22	56	99	61	M							
AVENSIS T250																						
2.0	2003.07-	2008.12	4AT	-	-	Engine 1AZFSE	899302	Outer Joint	48T	26	25	58	95.5	62	M							
2000	2003.07-	2008.12	4AT	-	-	Engine 1AZFSE	899302	Outer Joint	48T	26	25	58	95.5	62	M							
AVENSIS T250W																						
2.0	2003.07-	2008.12	4AT	-	-	Engine 1AZFSE	899302	Outer Joint	48T	26	25	58	95.5	62	M							
2000	2003.07-	2008.12	4AT	-	-	Engine 1AZFSE	899302	Outer Joint	48T	26	25	58	95.5	62	M							
AVENSIS T251																						
2.0	2005.06-	2008.12	5AT	-	-	Engine 2AZFSE	899302	Outer Joint	48T	26	25	58	95.5	62	M							
2000	2005.06-	2008.12	5AT	-	-	Engine 2AZFSE	899302	Outer Joint	48T	26	25	58	95.5	62	M							
AVENSIS T251W																						
2.0	2005.06-	2008.12	5AT	-	-	Engine 2AZFSE	899302	Outer Joint	48T	26	25	58	95.5	62	M							
2000	2005.06-	2008.12	5AT	-	-	Engine 2AZFSE	899302	Outer Joint	48T	26	25	58	95.5	62	M							
AVENSIS VERSO (M20)																						
2.0 VVT-i (110 kW)	2001.08-	-	-	-	-		659070	Inner Joint			27		33.2									
AVENSIS VERSO (_M2_)/VERSO SPORTVAN/IPSUM																						
2.0 (110 kW)	2001.08-	2009.11	MT	R	F	MPV Engine 1AZ-FE	259114	Drive Shaft	48T	26	24	63	100	948								
2.0 D (85 kW)	2001.08-	2005.08	MT	-	F	MPV Engine 1CD-FTV	859086	Outer Joint		26	24	56	99	61	M							
	2001.08-	2005.08	-	-	F	MPV Engine 1CD-FTV	859042	Outer Joint	48T	30	27	63	100.5	64.5	I							
	2001.08-	2005.08	MT	L/R	F	MPV Engine 1CD-FTV	859024	Outer Joint	48T	26	24	56	99	61	M							
AYGO (_B1_)																						
1.0 (50 kW)	2005.07-	-	-	L	F	Hatchback Engine 1KR-FE	210232	Drive Shaft		24	23	49.5	91	650								
	2005.07-	-	-	R	F	Hatchback Engine 1KR-FE	210231	Drive Shaft		24	23	49.5	91	841								
	2005.07-	-	-	L/R	F	Hatchback Engine 1KR-FE	899128	Outer Joint		24	19	49.5	91	46	M							
	2005.07-	-	-	-	F	Hatchback Engine 1KR-FE	859268	Outer Joint		24	26	47	85.5	47.5	I							
1.4 HDi (40 kW)	2005.07-	2010.08	-	L	F	Hatchback Engine 2WZ-TV	259495	Drive Shaft		24	23	49.5	91	593								
	2005.07-	2010.08	-	L/R	F	Hatchback Engine 2WZ-TV	845058	Outer Joint		24	20	49.5	91	46	M							
AYGO (_B4_)																						
1.2 (60 kW)	2014.05-	-	MT	L	F	Hatchback Engine 1PP	201194	Drive Shaft		24	22	49.5	88.5	670								
bb I (NCP3_)																						
1.3 (57 kW)	2000.01-	2005.11	-	L/R/F	R	MPV Engine 2NZ-FE	839105	Outer Joint	44T	25	22	52.5	95	58	M							
BLADE																						
2.4	2006.12-	2009.11	-	L	F	ENGINE:2AZFE/AZE154	259583	Drive Shaft		26	24	61.2	100	640								
	2009.12-	2012.03	-	R	F	ENGINE:2AZFE/AZE156	259615	Drive Shaft		26	24	61.2	100	957								





	 YEAR	TRANSM	L/R	F/R	REMARKS	GSP Ref.	 PRODUCT	 ABS	Technical Specifications						
									A	B	C	H	L	P	
TOYOTA															
BREVIS (JCG1_)															
2.5 (147 kW)	1999.10-	2002.09	-	-	F	All-wheel Drive Saloon Engine 1JZ-FSE	859370	Outer Joint	48T	30	30	56	92	59	I
CALDINA (AZT241W)															
2.0	2002-	-	AT	-	-	Engine 1AZFSE	859294	Outer Joint	48T	26	27	63	97	60	M
CALDINA (T241W)															
1.8	2002.09-	2007.06	4AT	-	-	Engine 1ZZFE	859460	Outer Joint	48T	26	24	58	96	54	I
CALDINA (_ T19_)															
2.0 (94 kW)	1992.11-	1997.07	-	R	F	All-wheel Drive Estate Engine 3S-FE	659160	Inner Joint		23	23	36	75	93	
2.0 (99 kW)	1992.11-	1997.08	-	R	F	All-wheel Drive Estate Engine 3S-FE	659160	Inner Joint		23	23	36	75	93	
2.0 TD (54 kW)	1992.11-	1998.04	-	R	F	All-wheel Drive Estate Engine 2C	659160	Inner Joint		23	23	36	75	93	
	1994.06-	1997.09	-	-	F	Estate Engine 2C	859120	Outer Joint	48T	26	24	56	95.5	55	I
2.0 TD (65 kW)	1996.01-	1997.08	MT	R	F	Estate Engine 2C-T	659004	Inner Joint		20	23	35	363	100.5	
CALDINA (_ T21_)															
2.2 TD (67 kW)	1997.10-	2001.09	-	-	F	Estate Engine 3C-TE	859002	Outer Joint	48T	26	25	56	96	62	I
2.2 TD (69 kW)	1997.08-	2002.09	AT	-	F	All-wheel Drive Estate Engine 3C-TE	859002	Outer Joint	48T	26	25	56	96	62	I
	1997.08-	2002.09	AT	L	F	All-wheel Drive Estate Engine 3C-TE	699040	Inner Joint		20	25	35	63.5	112	
	1997.08-	2002.09	AT	-	F	All-wheel Drive Estate Engine 3C-TE	859320	Outer Joint	48T	26	25	56	100	63	M
CALDINA T241W															
1.8	2002.09-	2007.06	4AT	-	-	Engine 1ZZFE	859460	Outer Joint	48T	26	24	58	96	54	I
1800	2002.09-	2007.06	4AT	-	-	Engine 1ZZFE	859460	Outer Joint	48T	26	24	58	96	54	I
CALYA (B401_)															
1.2 (B401RA_)	2016.06-	-	-	L	F	-	201469	Drive Shaft		26	23	55.6	88	640	
	2016.06-	-	-	R	F	-	201468	Drive Shaft		26	23	55.6	88	892	
CAMRY															
-	-	-	-	-	-	-	859371	Outer Joint	48T	30	32	61	100	68.5	O
	-	-	-	R	-	-	259060	Drive Shaft		26	20	56	99.5	940	
	1987-	-	-	-	-	-	899111	Outer Joint		26	24	56	95.5	55	I
	1988-	1991	-	-	-	2WD 4 Cyl	659010	Inner Joint		20	30	35	363	100.5	
	1988.01-	1992.05	-	L/R	-	-	259137	Drive Shaft	48T	26		56	96	515.4	
	1990.01-	1992.12	MT/AT	R	-	SV2122 4 Cyl	259032	Drive Shaft		26	20	56	95.5	913.5	
	1992-	1995	-	-	-	4 Cyl	659007	Inner Joint		20	32	35	63.5	115.3	
	1993-	2002	-	-	-	-	659024	Inner Joint		20	27	35	335	112	
	1993-	2002	-	L	-	-	259059	Drive Shaft		26	20	56	99.5	676.5	
	1993.01-	1997.07	MT/AT	L	-	4 Cyl SDU10	222005	Drive Shaft	48T	26	20	56	99.5	676.5	
	1993.01-	1997.07	MT/AT	R	-	4 Cyl SDU10	222006	Drive Shaft	48T	26	20	56	99.5	940	
	1997.01-	2002.09	MT/AT	L	-	20 Series 4 Cyl	222005	Drive Shaft	48T	26	20	56	99.5	676.5	
	1997.01-	2002.09	MT/AT	R	-	20 Series 4 Cyl	222006	Drive Shaft	48T	26	20	56	99.5	940	
	2002-	2003	-	-	-	6 CYL	859240	Outer Joint		30	26	61	100	67	M
	2002-	-	-	-	-	-	659026	Inner Joint		24	26	50	67	104	
	2002-	-	-	-	-	-	659025	Inner Joint		24	26	40	369	99.5	
	2002-	-	-	-	-	-	859106	Outer Joint		26	26	61	100	67	M
	2002-	-	-	R	-	-	259075	Drive Shaft	48T	26	24	61	100	941	
	2002-	-	-	L	-	-	259074	Drive Shaft	48T	26	24	61	100	667	
2.0	-	-	-	-	-	-	859138	Outer Joint	48T	26	24	61	100	67	M
	-	-	-	R	-	-	259062	Drive Shaft	48T	26	24	70.05	100	955.5	
	-	-	-	L	-	-	259063	Drive Shaft	48T	26	24	70.05	100	658	
2.2	1998-	-	MT	-	-	SXV20 5SFE	659033	Inner Joint		20	24	35	63.5	115.7	
	1998-	-	-	-	-	-	859066	Outer Joint		26	32	56	101	66	I
2.4	2006.02-	2009.02	5AT	R	F	ENGINE: 2AZFE/ACV40	859237	Outer Joint	48T	26	24	61	100	67	M
	2006.02-	2009.02	5AT	L	F	ENGINE: 2AZFE/ACV40	859237	Outer Joint	48T	26	24	61	100	67	M
	2006.02-	2009.02	5AT	R	F	ENGINE: 2AZFE/ACV40	259474	Drive Shaft	48T	26	24	61	100	967	
	2006.02-	2009.02	5AT	L	F	ENGINE: 2AZFE/ACV40	259475	Drive Shaft	48T	26	24	61	100	670	
2.4 (ACV30)	2003-	-	-	R	-	-	259062	Drive Shaft	48T	26	24	70.05	100	955.5	
3.0	2003.01-	2004.05	5AT	L	F	ENGINE: 1MZFE/MCV30	259649	Drive Shaft	48T	30	24	61	100	652	
3.0 V6	1997-	1999	-	-	-	-	831002	Outer Joint		30	26	56	95.5	62	M
3.3	2003.09-	2004.05	5AT	L	F	ENGINE: 3MZFE/MCV31	259649	Drive Shaft	48T	30	24	61	100	652	
CAMRY (ACV30)															
2.4	2001-	-	AT	-	-	Engine 2AZFE	859294	Outer Joint	48T	26	27	63	97	60	M
	2001.09-	2002.09	4AT	-	F	Engine 2AZFE	859138	Outer Joint	48T	26	24	61	100	67	M
CAMRY (_ V1_)/SCEPTER															
2.0 ZX (100 kW)	1991.06-	1997.09	-	R	F	All-wheel Drive Saloon Engine 3S-FE	659160	Inner Joint		23	23	36	75	93	
2.2 (100 kW)	1991.06-	1996.08	AT	L	F	Saloon Engine 5S-FE	699040	Inner Joint		20	25	35	63.5	112	
	1991.06-	1996.08	AT/MT	L/R	F	Saloon Engine 5S-FE	859155	Outer Joint	48T	26	27	56	96	67.5	I
	1991.06-	1996.08	-	-	F	Saloon Engine 5S-FE	859011	Outer Joint		26	27	56	100	63	M
	1991.06-	1996.08	-	-	-	Saloon Engine 5S-FE	859193	Outer Joint		26	32	56	101	66	I
	1992.03-	1996.07	AT	L	F	Estate Engine 5S-FE	699040	Inner Joint		20	25	35	63.5	112	
	1992.03-	1996.07	AT/MT	L/R	F	Estate Engine 5S-FE	859155	Outer Joint	48T	26	27	56	96	67.5	I

	 YEAR	TRANSM	L/R	F/R	REMARKS	GSP Ref.	 PRODUCT	 ABS	Technical Specifications					
									A	B	C	H	L	P
TOYOTA														
CAMRY (_V1_) / SCEPTER														
2.2 (100 kW)	1992.03-1996.07	-	-	F	Estate Engine 5S-FE	859011	Outer Joint		26	27	56	100	63	M
3.0 (136 kW)	1991.06-1995.09	-	-	-	Estate Engine 3VZ-FE	859048	Outer Joint	48T	30	34	56	100.5	66	M
	1991.06-1995.09	-	-	F	Estate Engine 3VZ-FE	859446	Outer Joint	48T	30	27	56	100	66	M
	1993.02-1995.09	-	-	-	Saloon Engine 3VZ-FE	859048	Outer Joint	48T	30	34	56	100.5	66	M
3.0 (138 kW)	1991.06-1996.08	AT/MT	-	-	Saloon Engine 3VZ-FE	859060	Outer Joint		30	34	56	95.5	70	I
	1991.06-1996.08	-	-	-	Saloon Engine 3VZ-FE	859048	Outer Joint	48T	30	34	56	100.5	66	M
	1991.06-1996.08	MT/AT	L/R	F	Saloon Engine 3VZ-FE	859065	Outer Joint		30	27	56	100	67.5	I
	1991.06-1996.08	-	-	F	Saloon Engine 3VZ-FE	859446	Outer Joint	48T	30	27	56	100	66	M
	1992.03-1996.07	AT/MT	-	-	Estate Engine 3VZ-FE	859060	Outer Joint		30	34	56	95.5	70	I
	1992.03-1996.07	-	-	-	Estate Engine 3VZ-FE	859048	Outer Joint	48T	30	34	56	100.5	66	M
	1992.03-1996.07	AT/MT	L/R	F	Estate Engine 3VZ-FE	859161	Outer Joint	48T	30	34	56	95.5	70	I
	1992.03-1996.07	MT/AT	L/R	F	Estate Engine 3VZ-FE	859065	Outer Joint		30	27	56	100	67.5	I
CAMRY (_V2_)														
2.0 (94 kW)	1986.11-1991.05	-	-	F	sedan	899122	Outer Joint		26	24	56	96	56	I
	1986.11-1991.05	-	-	-	Saloon Engine 3S-FE	859062	Outer Joint		26	24	56	95.5	55	I
	1986.11-1991.05	-	-	-	Estate Engine 3S-FE	859062	Outer Joint		26	24	56	95.5	55	I
	1986.11-1991.05	MT	L/R	F	Saloon Engine 3S-FE	859155	Outer Joint	48T	26	27	56	96	67.5	I
	1986.11-1991.05	MT	L/R	F	Estate Engine 3S-FE	859155	Outer Joint	48T	26	27	56	96	67.5	I
	1986.11-1991.05	MT	L/R	F	Saloon Engine 3S-FE	859001	Outer Joint		26	24	56	95.5	55	I
	1986.11-1991.05	MT	L/R	F	Estate Engine 3S-FE	859001	Outer Joint		26	24	56	95.5	55	I
	1986.11-1991.05	-	-	F	Saloon Engine 3S-FE	859011	Outer Joint		26	27	56	100	63	M
	1986.11-1991.05	-	-	F	Estate Engine 3S-FE	859011	Outer Joint		26	27	56	100	63	M
	1988.08-1991.05	MT	-	F	All-wheel Drive Saloon Engine 3S-FE	831001	Outer Joint		26	27	56	99.5	63	I
	1988.08-1991.05	AT	L	F	All-wheel Drive Saloon Engine 3S-FE	659005	Inner Joint		20	23	35	63.5	115.7	
	1988.08-1991.05	-	R	F	All-wheel Drive Saloon Engine 3S-FE	659004	Inner Joint		20	23	35	363	100.5	
	1988.08-1991.05	MT	L	F	All-wheel Drive Saloon Engine 3S-FE	631004	Inner Joint		20	27	35	63.5	123	
	1988.08-1991.05	-	R	F	All-wheel Drive Saloon Engine 3S-FE	659160	Inner Joint		23	23	36	75	93	
	1988.08-1991.05	MT	-	-	All-wheel Drive Saloon Engine 3S-FE	631001	Inner Joint			27		33.2		
	2.0 Gli (94 kW)	1988.08-1991.05	MT	-	F	All-wheel Drive Estate Engine 3S-FE	831001	Outer Joint		26	27	56	99.5	63
1988.08-1991.05		-	-	-	All-wheel Drive Estate Engine 3S-FE	859062	Outer Joint		26	24	56	95.5	55	I
1988.08-1991.05		AT	L	F	All-wheel Drive Estate Engine 3S-FE	659005	Inner Joint		20	23	35	63.5	115.7	
1988.08-1991.05		-	R	F	All-wheel Drive Estate Engine 3S-FE	659004	Inner Joint		20	23	35	363	100.5	
1988.08-1991.05		MT	L	F	All-wheel Drive Estate Engine 3S-FE	631004	Inner Joint		20	27	35	63.5	123	
1988.08-1991.05		-	R	F	All-wheel Drive Estate Engine 3S-FE	659160	Inner Joint		23	23	36	75	93	
1988.08-1991.05		MT	-	-	All-wheel Drive Estate Engine 3S-FE	631001	Inner Joint			27		33.2		
2.0 Gli 16V (89 kW)	1986.11-1991.05	-	-	F	sedan	899122	Outer Joint		26	24	56	96	56	I
	1986.11-1991.05	-	-	-	Saloon Engine 3S-FE	859062	Outer Joint		26	24	56	95.5	55	I
	1986.11-1991.05	-	-	-	Estate Engine 3S-FE	859062	Outer Joint		26	24	56	95.5	55	I
	1986.11-1991.05	MT	L/R	F	Saloon Engine 3S-FE	859155	Outer Joint	48T	26	27	56	96	67.5	I
	1986.11-1991.05	MT	L/R	F	Estate Engine 3S-FE	859155	Outer Joint	48T	26	27	56	96	67.5	I
	1986.11-1991.05	MT	L/R	F	Saloon Engine 3S-FE	859001	Outer Joint		26	24	56	95.5	55	I
	1986.11-1991.05	MT	L/R	F	Estate Engine 3S-FE	859001	Outer Joint		26	24	56	95.5	55	I
2.0 Turbo-D (62 kW)	1986.11-1991.05	-	-	-	Saloon Engine 2C-T	859062	Outer Joint		26	24	56	95.5	55	I
	1986.11-1991.05	-	-	-	Estate Engine 2C-T	859062	Outer Joint		26	24	56	95.5	55	I
	1986.11-1991.05	MT	L/R	F	Saloon Engine 2C-T	859018	Outer Joint		26	24	56	95.5	55	I
	1986.11-1991.05	MT	L/R	F	Estate Engine 2C-T	859018	Outer Joint		26	24	56	95.5	55	I
	1986.11-1991.05	AT/MT	L/R	F	Saloon Engine 2C-T	859001	Outer Joint		26	24	56	95.5	55	I
	1986.11-1991.05	AT/MT	L/R	F	Estate Engine 2C-T	859001	Outer Joint		26	24	56	95.5	55	I
	1986.11-1991.05	-	-	F	Saloon Engine 2C-T	859011	Outer Joint		26	27	56	100	63	M
	1986.11-1991.05	-	-	F	Estate Engine 2C-T	859011	Outer Joint		26	27	56	100	63	M
2.0 Turbo-D (63 kW)	1988.11-1991.05	-	-	-	Saloon Engine 2C-T	859062	Outer Joint		26	24	56	95.5	55	I
	1988.11-1991.05	MT	L/R	F	Saloon Engine 2C-T	859018	Outer Joint		26	24	56	95.5	55	I
	1988.11-1991.05	-	-	-	Estate Engine 2C-T	859062	Outer Joint		26	24	56	95.5	55	I
	1988.11-1991.05	AT/MT	L/R	F	Estate Engine 2C-T	859001	Outer Joint		26	24	56	95.5	55	I
	1988.11-1991.05	-	-	F	Saloon Engine 2C-T	859011	Outer Joint		26	27	56	100	63	M
	1988.11-1991.05	-	-	F	Estate Engine 2C-T	859011	Outer Joint		26	27	56	100	63	M
2.2 (93 kW)	2000.11-2001.11	AT	L	F	Saloon Engine 5S-FE	699040	Inner Joint		20	25	35	63.5	112	
	2000.11-2001.11	-	-	F	Saloon Engine 5S-FE	859011	Outer Joint		26	27	56	100	63	M
2.2 (96 kW)	1996.08-2001.11	-	-	-	Saloon Engine 5S-FE	859014	Outer Joint	48T	26	32	56	101	66	I
	1996.08-2001.11	AT	L	F	Saloon Engine 5S-FE	699040	Inner Joint		20	25	35	63.5	112	
	1996.08-2001.11	AT/MT	L/R	F	Saloon Engine 5S-FE	859155	Outer Joint	48T	26	27	56	96	67.5	I
	1996.08-2001.11	-	-	F	Saloon Engine 5S-FE	859011	Outer Joint		26	27	56	100	63	M
2.5 (118 kW)	1990.01-1991.05	-	-	F	Estate Engine 2VZ-FE	859166	Outer Joint	48T	26	27	56	96	67.5	I
	1990.01-1991.05	-	-	F	Estate Engine 2VZ-FE	859073	Outer Joint		26	27	56	96	67.5	I
	1990.01-1991.05	-	-	-	Estate Engine 2VZ-FE	899115	Outer Joint		26	32	56	97.5	67	I
2.5 (147 kW)	1996.08-2001.07	-	-	F	Estate Engine 2MZ-FE	859446	Outer Joint	48T	30	27	56	100	66	M

	 YEAR	TRANSM	L/R	F/R	REMARKS	GSP Ref.	 PRODUCT	 ABS	Technical Specifications					
									A	B	C	H	L	P
TOYOTA														
CAMRY (_V2_)														
2.5 V6 GXI (118 kW)	1988.02-1991.05	-	-	-	Saloon Engine 2VZ-FE	859058	Outer Joint		26	30	56	95.5	62	I
	1988.02-1991.05	AT/MT	L/R	F	Saloon Engine 2VZ-FE	859012	Outer Joint	48T	26	27	56	100	63	M
	1988.02-1991.05	-	-	F	Saloon Engine 2VZ-FE	859166	Outer Joint	48T	26	27	56	96	67.5	I
	1988.02-1991.05	-	-	F	Saloon Engine 2VZ-FE	859073	Outer Joint		26	27	56	96	67.5	I
3.0 24V (140 kW)	1996.08-2001.11	-	R	F	Saloon Engine 1MZ-FE	659191	Inner Joint		23	26	34	394	124	
	1996.08-2001.11	-	-	-	Saloon Engine 1MZ-FE	859048	Outer Joint	48T	30	34	56	100.5	66	M
3.0 V6 (135 kW)	1996.08-2001.11	AT	-	-	Saloon Engine 1MZ-FE	631001	Inner Joint		27			33.2		
	1996.08-2001.11	AT	-	F	Saloon Engine 1MZ-FE	859009	Outer Joint	48T	30	27	56	100	67.5	I
	1996.08-2001.11	AT	R	F	Saloon Engine 1MZ-FE	659191	Inner Joint		23	26	34	394	124	
CAMRY (_V3_)														
2.4 (112 kW)	2001.11-2006.11	-	L/R	F	Saloon Engine 2AZ-FE	859175	Outer Joint	48T	26	27	63.3	100	59	M
	2001.11-2006.11	-	-	F	Saloon Engine 2AZ-FE	859188	Outer Joint	48T	26	26	61	100	67	M
3.0 (137 kW)	2001.08-2006.11	-	R	F	Saloon Engine 1MZ-FE	659191	Inner Joint		23	26	34	394	124	
	2001.08-2006.11	-	-	F	Saloon Engine 1MZ-FE	859431	Outer Joint	48T	30	27	61.2	100	64.5	M
	2001.08-2006.11	-	-	F	Saloon Engine 1MZ-FE	859225	Outer Joint	48T	30	26	61	99	67	M
CAMRY (_V4_)														
2.4 (116 kW)	2006.01-2011.09	-	-	F	Saloon Engine 2AZ-FE	859290	Outer Joint	48T	26	27	63.3	100	59.5	I
	2006.01-2011.09	-	-	F	Saloon Engine 2AZ-FE	859407	Outer Joint	48T	26	26	61	100	67.5	M
2.4 (123 kW)	2006.01-2011.09	-	-	F	Saloon Engine 2AZ-FE	859290	Outer Joint	48T	26	27	63.3	100	59.5	I
	2006.01-2011.09	-	-	F	Saloon Engine 2AZ-FE	859407	Outer Joint	48T	26	26	61	100	67.5	M
2.4 (127 kW)	2006.10-2011.09	-	-	F	Saloon Engine 2AZ-FE	859290	Outer Joint	48T	26	27	63.3	100	59.5	I
	2006.10-2011.09	-	-	F	Saloon Engine 2AZ-FE	859407	Outer Joint	48T	26	26	61	100	67.5	M
3.5 (204 kW)	2008.01-2011.09	-	-	F	Saloon Engine 2GR-FE	859290	Outer Joint	48T	26	27	63.3	100	59.5	I
3.5(200 kW)	2006.01-2011.12	AT	-	F	Saloon Engine 2GR-FE	859290	Outer Joint	48T	26	27	63.3	100	59.5	I
CAMRY Station Wagon (_V2_)														
2.0 (94 kW)	1986.11-1991.05	-	-	F	wagon	899122	Outer Joint		26	24	56	96	56	I
2.0 GLi 16V (89 kW)	1986.11-1991.05	-	-	F	wagon	899122	Outer Joint		26	24	56	96	56	I
CAMRY VISTA (SV32)														
2.0	1990.07-1994.06	AT	-	-	Engine 3SFE	859203	Outer Joint		26	24	56	95.5	55	M
CAMRY VISTA (SV33)														
2.0	1990.07-1994.06	AT	-	-	Engine 3SFE	859203	Outer Joint		26	24	56	95.5	55	M
CAMRY VISTA (VZV20)														
2.0	1987.04-1990.06	MT	-	-	Engine 1VZFE	859203	Outer Joint		26	24	56	95.5	55	M
CAMRY VISTA (VZV30)														
2.0	1990.07-1992.06	AT	-	-	Engine 1VZFE	859203	Outer Joint		26	24	56	95.5	55	M
CAMRY VISTA (VZV31)														
2.0 4WS	1990.07-1992.06	AT	-	-	Engine 1VZFE	859203	Outer Joint		26	24	56	95.5	55	M
CAMRY VISTA (VZV32)														
2.5	1991.05-1994.06	AT	-	-	Engine 4VZFE	859203	Outer Joint		26	24	56	95.5	55	M
CAMRY VISTA (VZV33)														
2.5 4WS	1991.05-1994.06	AT	-	-	Engine 4VZFE	859203	Outer Joint		26	24	56	95.5	55	M
CAMRY VISTA SV32														
2.0	1990.07-1994.06	AT	-	-	Engine 3SFE	859203	Outer Joint		26	24	56	95.5	55	M
2000	1990.07-1994.06	AT	-	-	Engine 3SFE	859203	Outer Joint		26	24	56	95.5	55	M
CAMRY VISTA VZV20														
2.0	1987.04-1990.06	MT	-	-	Engine 1VZFE	859203	Outer Joint		26	24	56	95.5	55	M
2000	1987.04-1990.06	MT	-	-	Engine 1VZFE	859203	Outer Joint		26	24	56	95.5	55	M
CAMRY VISTA VZV30														
2.0	1990.07-1992.06	AT	-	-	Engine 1VZFE	859203	Outer Joint		26	24	56	95.5	55	M
2000	1990.07-1992.06	AT	-	-	Engine 1VZFE	859203	Outer Joint		26	24	56	95.5	55	M
CAMRY VISTA VZV32														
2.5	1991.05-1994.06	AT	-	-	Engine 4VZFE	859203	Outer Joint		26	24	56	95.5	55	M
	1991.05-1994.06	AT	-	-	Engine 4VZFE	859203	Outer Joint		26	24	56	95.5	55	M
CAMRY(HYBRID)														
-	2011.12-2014.12	-	L	F	ENGINE:5ARFE/ASV50L	859439	Outer Joint		26	27	61.2	100	59.5	I
	2015.01-	-	L	F	ENGINE:5ARFE/ASV50L	859439	Outer Joint		26	27	61.2	100	59.5	I
2.0	2012.08-2014.10	4AT	R	F	ENGINE:1AZFE/ACV51	259594	Drive Shaft	48T	26	24	61	100	970	
	2012.08-2014.10	4AT	L	F	ENGINE:1AZFE/ACV51	259595	Drive Shaft	48T	26	24	61	100	671	
2.5	2011.08-2014.08	6AT	R	F	ENGINE:2ARFE/ASV50	259654	Drive Shaft	48T	26	24	63.3	100	981	
	2011.12-	-	R	F	ENGINE:5ARFE	659232	Inner Joint		24	27	40	378	106	
	2011.12-2014.12	-	L	F	ENGINE:5ARFE/ASV50L	259624	Drive Shaft	48T	26	24	61.2	100	657	
	2011.12-	-	R	F	ENGINE:5ARFE	859439	Outer Joint		26	27	61.2	100	59.5	I
	2011.12-	-	R	F	ENGINE:5ARFE	259625	Drive Shaft	48T	26	24	61.2	100	982	
	2015.01-	-	L	F	ENGINE:5ARFE/ASV50L	259624	Drive Shaft	48T	26	24	61.2	100	657	
3.5	2014.09-	6AT	L	F	ENGINE:2GRFE/GSV50	259324	Drive Shaft	48T	30	24	61	100	659	

	 YEAR	TRANSM	L/R	F/R	REMARKS	GSP Ref.	 PRODUCT	 ABS	Technical Specifications						
									A	B	C	H	L	P	
TOYOTA															
CAMRY(HYBRID)															
3.5	2014.09-	-	6AT	R	F	ENGINE:2GRFE/GSV50	259323	Drive Shaft	48T	30	24	61	100	978	
CAMRY/SOLARA															
-	1989-	1991	-	-	-	4 Cyl	859160	Outer Joint	48T	26	30	56	95.5	62	I
-	1989-	1991	AT	-	-	4 Cyl (2WD)	659009	Inner Joint			24		79		
-	1992-	1996	-	-	-	6 Cyl	859162	Outer Joint	48T	30	34	56	95.5	70	I
-	1992-	1996	-	-	-	6 Cyl	859061	Outer Joint		30	34	56	95.5	70	I
-	1997-	2001	-	-	-	4 Cyl (2WD)	859183	Outer Joint	48T	26	24	56	100	61	M
-	1997-	2001	-	-	-	4 Cyl (2WD)	859215	Outer Joint		26	24	56	100	61	M
CAMRY/VISTA/SCEPTER															
2.2	1998-	-	MT	-	-	-	859095	Outer Joint		26	24	56	99	61	M
CARINA (_T21_)															
2.0 TD (65 kW)	1996.08-	1998.08	-	R	F	All-wheel Drive Saloon Engine 2C-T	659160	Inner Joint		23	23	36	75	93	
CARINA E															
2.0	1993-	1997	-	R	F	-	659105	Inner Joint		20	23	35	363	100.5	
CARINA E (_T19_)															
1.6 (73 kW)	1993.12-	1997.09	-	-	F	Estate Engine 4A-FE	859005	Outer Joint		26	23	56	95.5	55	I
	1993.12-	1997.09	MT	R	F	Estate Engine 4A-FE	208017	Drive Shaft		26	23	56	96.5	910	
	1993.12-	1997.09	-	-	F	Estate Engine 4A-FE	859021	Outer Joint	48T	26	23	56	96.5	55	I
	1993.12-	1997.09	-	-	F	Estate Engine 4A-FE	859128	Outer Joint	48T	26	23	56	95.5	55	I
	1993.12-	1997.09	AT/MT	L/R	F	Estate Engine 4A-FE	859006	Outer Joint	48T	26	23	56	95.5	55	I
	1993.12-	1997.09	AT/MT	L/R	F	Estate Engine 4A-FE	859020	Outer Joint		26	23	56	96.5	55	I
	1993.12-	1997.09	-	-	F	Estate Engine 4A-FE	859059	Outer Joint		26	32	56	101	64	I
	1993.12-	1997.09	MT	R	F	Estate Engine 4A-FE	608015	Inner Joint		23	23	34	61	116	
	1995.01-	1997.09	-	-	F	Saloon Engine 4A-FE	859005	Outer Joint		26	23	56	95.5	55	I
	1995.01-	1997.09	MT	R	F	Saloon Engine 4A-FE	208017	Drive Shaft		26	23	56	96.5	910	
	1995.01-	1997.09	-	-	F	Saloon Engine 4A-FE	859021	Outer Joint	48T	26	23	56	96.5	55	I
	1995.01-	1997.09	-	-	F	Saloon Engine 4A-FE	859128	Outer Joint	48T	26	23	56	95.5	55	I
	1995.01-	1997.09	AT/MT	L/R	F	Saloon Engine 4A-FE	859006	Outer Joint	48T	26	23	56	95.5	55	I
	1995.01-	1997.09	AT/MT	L/R	F	Saloon Engine 4A-FE	859020	Outer Joint		26	23	56	96.5	55	I
	1995.01-	1997.09	-	-	F	Saloon Engine 4A-FE	859059	Outer Joint		26	32	56	101	64	I
	1995.01-	1997.09	MT	R	F	Saloon Engine 4A-FE	608015	Inner Joint		23	23	34	61	116	
1.6 (78 kW)	1995.10-	1997.09	-	-	F	Saloon Engine 4A-FE	859005	Outer Joint		26	23	56	95.5	55	I
	1995.10-	1997.09	MT	R	F	Saloon Engine 4A-FE	208017	Drive Shaft		26	23	56	96.5	910	
	1995.10-	1997.09	-	-	F	Saloon Engine 4A-FE	859021	Outer Joint	48T	26	23	56	96.5	55	I
	1995.10-	1997.09	-	-	F	Saloon Engine 4A-FE	859128	Outer Joint	48T	26	23	56	95.5	55	I
	1995.10-	1997.09	AT/MT	L/R	F	Saloon Engine 4A-FE	859006	Outer Joint	48T	26	23	56	95.5	55	I
	1995.10-	1997.09	AT/MT	L/R	F	Saloon Engine 4A-FE	859020	Outer Joint		26	23	56	96.5	55	I
	1995.10-	1997.09	-	-	F	Saloon Engine 4A-FE	859059	Outer Joint		26	32	56	101	64	I
	1995.10-	1997.09	MT	R	F	Saloon Engine 4A-FE	608015	Inner Joint		23	23	34	61	116	
1.6 (79 kW)	1993.01-	1997.09	-	-	F	Saloon Engine 4A-FE	859005	Outer Joint		26	23	56	95.5	55	I
	1993.01-	1997.09	MT	R	F	Saloon Engine 4A-FE	208017	Drive Shaft		26	23	56	96.5	910	
	1993.01-	1997.09	-	-	F	Saloon Engine 4A-FE	859021	Outer Joint	48T	26	23	56	96.5	55	I
	1993.01-	1997.09	-	-	F	Saloon Engine 4A-FE	859128	Outer Joint	48T	26	23	56	95.5	55	I
	1993.01-	1997.09	AT/MT	L/R	F	Saloon Engine 4A-FE	859006	Outer Joint	48T	26	23	56	95.5	55	I
	1993.01-	1997.09	AT/MT	L/R	F	Saloon Engine 4A-FE	859020	Outer Joint		26	23	56	96.5	55	I
	1993.01-	1997.09	-	-	F	Saloon Engine 4A-FE	859059	Outer Joint		26	32	56	101	64	I
	1993.01-	1997.09	MT	R	F	Saloon Engine 4A-FE	608015	Inner Joint		23	23	34	61	116	
1.6 (85 kW)	1993.12-	1997.09	-	-	F	Estate Engine 4A-FE	859005	Outer Joint		26	23	56	95.5	55	I
	1993.12-	1997.09	MT	R	F	Estate Engine 4A-FE	208017	Drive Shaft		26	23	56	96.5	910	
	1993.12-	1997.09	-	-	F	Estate Engine 4A-FE	859021	Outer Joint	48T	26	23	56	96.5	55	I
	1993.12-	1997.09	-	-	F	Estate Engine 4A-FE	859128	Outer Joint	48T	26	23	56	95.5	55	I
	1993.12-	1997.09	AT/MT	L/R	F	Estate Engine 4A-FE	859006	Outer Joint	48T	26	23	56	95.5	55	I
	1993.12-	1997.09	AT/MT	L/R	F	Estate Engine 4A-FE	859020	Outer Joint		26	23	56	96.5	55	I
	1993.12-	1997.09	-	-	F	Estate Engine 4A-FE	859059	Outer Joint		26	32	56	101	64	I
	1993.12-	1997.09	MT	R	F	Estate Engine 4A-FE	608015	Inner Joint		23	23	34	61	116	
1.6 16V (78 kW)	1995.10-	1997.09	-	-	F	Estate Engine 4A-FE	859005	Outer Joint		26	23	56	95.5	55	I
	1995.10-	1997.09	MT	R	F	Estate Engine 4A-FE	208017	Drive Shaft		26	23	56	96.5	910	
	1995.10-	1997.09	-	-	F	Estate Engine 4A-FE	859128	Outer Joint	48T	26	23	56	95.5	55	I
	1995.10-	1997.09	AT/MT	L/R	F	Estate Engine 4A-FE	859006	Outer Joint	48T	26	23	56	95.5	55	I
	1995.10-	1997.09	AT/MT	L/R	F	Estate Engine 4A-FE	859020	Outer Joint		26	23	56	96.5	55	I
	1995.10-	1997.09	-	-	F	Estate Engine 4A-FE	859059	Outer Joint		26	32	56	101	64	I
	1995.10-	1997.09	MT	R	F	Estate Engine 4A-FE	608015	Inner Joint		23	23	34	61	116	
1.6 16V (85 kW)	1994.12-	1997.09	-	-	F	Saloon Engine 4A-FE	859005	Outer Joint		26	23	56	95.5	55	I
	1994.12-	1997.09	MT	R	F	Saloon Engine 4A-FE	208017	Drive Shaft		26	23	56	96.5	910	
	1994.12-	1997.09	-	-	F	Saloon Engine 4A-FE	859021	Outer Joint	48T	26	23	56	96.5	55	I
	1994.12-	1997.09	-	-	F	Saloon Engine 4A-FE	859128	Outer Joint	48T	26	23	56	95.5	55	I





	 YEAR	TRANSM	L/R	F/R	REMARKS	GSP Ref.	 PRODUCT	 ABS	Technical Specifications					
									A	B	C	H	L	P
TOYOTA														
CARINA E (_T19_)														
1.6 16V (85 kW)	1994.12-1997.09	AT/MT	L/R	F	Saloon Engine 4A-FE	859006	Outer Joint	48T	26	23	56	95.5	55	I
	1994.12-1997.09	AT/MT	L/R	F	Saloon Engine 4A-FE	859020	Outer Joint		26	23	56	96.5	55	I
	1994.12-1997.09	-	-	F	Saloon Engine 4A-FE	859059	Outer Joint		26	32	56	101	64	I
	1994.12-1997.09	MT	R	F	Saloon Engine 4A-FE	608015	Inner Joint		23	23	34	61	116	
1.6 GLI (79 kW)	1992.04-1997.09	-	-	F	Estate Engine 4A-FE	859005	Outer Joint		26	23	56	95.5	55	I
	1992.04-1997.09	MT	R	F	Estate Engine 4A-FE	208017	Drive Shaft		26	23	56	96.5	910	
	1992.04-1997.09	-	-	F	Estate Engine 4A-FE	859021	Outer Joint	48T	26	23	56	96.5	55	I
	1992.04-1997.09	-	-	F	Estate Engine 4A-FE	859128	Outer Joint	48T	26	23	56	95.5	55	I
	1992.04-1997.09	-	-	F	Estate Engine 4A-FE	859004	Outer Joint	48T	26	32	56	101	64	I
	1992.04-1997.09	AT/MT	L/R	F	Estate Engine 4A-FE	859006	Outer Joint	48T	26	23	56	95.5	55	I
	1992.04-1997.09	AT/MT	L/R	F	Estate Engine 4A-FE	859020	Outer Joint		26	23	56	96.5	55	I
	1992.04-1997.09	MT	R	F	Estate Engine 4A-FE	608015	Inner Joint		23	23	34	61	116	
1.8 (79 kW)	1995.01-1997.09	-	-	F	Hatchback Engine 7A-FE	859005	Outer Joint		26	23	56	95.5	55	I
	1995.01-1997.09	-	-	-	Hatchback Engine 7A-FE	859062	Outer Joint		26	24	56	95.5	55	I
	1995.01-1997.09	-	-	F	Hatchback Engine 7A-FE	859021	Outer Joint	48T	26	23	56	96.5	55	I
	1995.01-1997.09	-	-	F	Hatchback Engine 7A-FE	859128	Outer Joint	48T	26	23	56	95.5	55	I
	1995.01-1997.09	AT/MT	L/R	F	Hatchback Engine 7A-FE	859006	Outer Joint	48T	26	23	56	95.5	55	I
	1995.01-1997.09	AT/MT	L/R	F	Hatchback Engine 7A-FE	859020	Outer Joint		26	23	56	96.5	55	I
1.8 i 16V (79 kW)	1995.01-1997.09	-	-	F	Saloon Engine 7A-FE	859005	Outer Joint		26	23	56	95.5	55	I
	1995.01-1997.09	-	-	-	Saloon Engine 7A-FE	859062	Outer Joint		26	24	56	95.5	55	I
	1995.01-1997.09	-	-	F	Saloon Engine 7A-FE	859021	Outer Joint	48T	26	23	56	96.5	55	I
	1995.01-1997.09	-	-	F	Saloon Engine 7A-FE	859128	Outer Joint	48T	26	23	56	95.5	55	I
	1995.01-1997.09	AT/MT	L/R	F	Saloon Engine 7A-FE	859006	Outer Joint	48T	26	23	56	95.5	55	I
	1995.01-1997.09	AT/MT	L/R	F	Saloon Engine 7A-FE	859020	Outer Joint		26	23	56	96.5	55	I
2.0 (98 kW)	1993.01-1997.09	-	-	-	Saloon Engine 3S-FE	859062	Outer Joint		26	24	56	95.5	55	I
	1993.01-1997.09	AT/MT	L/R	F	Saloon Engine 3S-FE	859001	Outer Joint		26	24	56	95.5	55	I
	1993.01-1997.09	-	-	F	Saloon Engine 3S-FE	859059	Outer Joint		26	32	56	101	64	I
2.0 D (54 kW)	1992.04-1996.01	-	-	-	Hatchback Engine 2C	859062	Outer Joint		26	24	56	95.5	55	I
	1992.04-1996.01	AT/MT	L/R	F	Hatchback Engine 2C	859001	Outer Joint		26	24	56	95.5	55	I
	1992.04-1996.01	-	R	F	Hatchback Engine 2C	659004	Inner Joint		20	23	35	363	100.5	
	1992.08-1996.01	-	-	-	Saloon Engine 2C	859062	Outer Joint		26	24	56	95.5	55	I
	1992.08-1996.01	AT/MT	L/R	F	Saloon Engine 2C	859001	Outer Joint		26	24	56	95.5	55	I
2.0 D 54 (kW)	1992.04-1996.01	-	-	F	Sloping back	899122	Outer Joint		26	24	56	96	56	I
	1992.04-1997.09	-	-	F	Sloping back	899122	Outer Joint		26	24	56	96	56	I
2.0 GLI (98 kW)	1992.04-1997.09	-	-	-	Hatchback Engine 3S-FE	859062	Outer Joint		26	24	56	95.5	55	I
	1992.04-1997.09	AT/MT	L/R	F	Hatchback Engine 3S-FE	859001	Outer Joint		26	24	56	95.5	55	I
	1992.04-1997.09	-	-	F	Hatchback Engine 3S-FE	859059	Outer Joint		26	32	56	101	64	I
	1992.04-1997.09	-	-	-	Hatchback Engine 3S-GE	859003	Outer Joint		26	25	56	95.6	61	M
2.0 GTi (116 kW)	1992.04-1994.02	-	-	-	Saloon Engine 3S-GE	859003	Outer Joint		26	25	56	95.6	61	M
	1992.04-1994.02	-	-	-	Saloon Engine 3S-GE	859003	Outer Joint		26	25	56	95.6	61	M
	1992.04-1994.02	MT	L	F	Hatchback Engine 3S-GE	699040	Inner Joint		20	25	35	63.5	112	
	1992.04-1994.02	MT	L	F	Saloon Engine 3S-GE	699040	Inner Joint		20	25	35	63.5	112	
2.0 GTi 16V (129 kW)	1994.03-1997.09	-	-	-	Hatchback Engine 3S-GE	859003	Outer Joint		26	25	56	95.6	61	M
	1994.03-1997.09	-	-	-	Saloon Engine 3S-GE	859003	Outer Joint		26	25	56	95.6	61	M
	1994.03-1997.09	MT	L	F	Saloon Engine 3S-GE	699040	Inner Joint		20	25	35	63.5	112	
	1994.03-1997.09	MT	L	F	Hatchback Engine 3S-GE	699040	Inner Joint		20	25	35	63.5	112	
2.0 i (93 kW)	1992.12-1997.09	-	-	-	Saloon Engine 3S-FE	859062	Outer Joint		26	24	56	95.5	55	I
	1992.12-1997.09	AT/MT	L/R	F	Saloon Engine 3S-FE	859001	Outer Joint		26	24	56	95.5	55	I
	1992.12-1997.09	-	-	F	Saloon Engine 3S-FE	859059	Outer Joint		26	32	56	101	64	I
	1993.12-1997.09	-	-	F	Sloping back	899122	Outer Joint		26	24	56	96	56	I
	1993.12-1997.09	-	-	-	Hatchback Engine 3S-FE	859062	Outer Joint		26	24	56	95.5	55	I
	1993.12-1997.09	AT/MT	L/R	F	Hatchback Engine 3S-FE	859001	Outer Joint		26	24	56	95.5	55	I
2.0 TD (61 kW)	1996.01-1997.09	-	-	F	Hatchback Engine 2C-T	859120	Outer Joint	48T	26	24	56	95.5	55	I
	1996.01-1997.09	-	-	F	Saloon Engine 2C-T	859120	Outer Joint	48T	26	24	56	95.5	55	I
	1996.01-1997.09	-	-	F	Hatchback Engine 2C-T	859021	Outer Joint	48T	26	23	56	96.5	55	I
	1996.01-1997.09	AT/MT	L/R	F	Hatchback Engine 2C-T	859001	Outer Joint		26	24	56	95.5	55	I
	1996.01-1997.09	-	-	F	Saloon Engine 2C-T	859021	Outer Joint	48T	26	23	56	96.5	55	I
	1996.01-1997.09	AT/MT	L/R	F	Saloon Engine 2C-T	859001	Outer Joint		26	24	56	95.5	55	I
	1996.01-1997.09	MT	R	F	Hatchback Engine 2C-T	659004	Inner Joint		20	23	35	363	100.5	
	1996.01-1997.09	MT	R	F	Saloon Engine 2C-T	659004	Inner Joint		20	23	35	363	100.5	
CARINA E Sedan (_T19_)														
2.0 (98 kW)	1993.01-1997.09	-	-	F	sedan	899122	Outer Joint		26	24	56	96	56	I





	 YEAR	TRANSM	L/R	F/R	REMARKS	GSP Ref.	 PRODUCT	 ABS	Technical Specifications						
									A	B	C	H	L	P	
TOYOTA															
CARINA E Sedan (_T19_)															
2.0 D (54 kW)	1992.08-	1996.01	-	-	F sedan	899122	Outer Joint		26	24	56	96	56	I	
2.0 i (93 kW)	1992.12-	1997.09	-	-	F sedan	899122	Outer Joint		26	24	56	96	56	I	
CARINA E Sportswagon (_T19_)															
1.6 (85 kW)	1992.04-	1997.09	MT	R	F Estate Engine 4A-FE	208017	Drive Shaft		26	23	56	96.5	910		
	1992.04-	1997.09	-	-	F Estate Engine 4A-FE	859128	Outer Joint	48T	26	23	56	95.5	55	I	
	1992.04-	1997.09	-	-	F Estate Engine 4A-FE	859059	Outer Joint		26	32	56	101	64	I	
	1992.04-	1997.09	MT	R	F Estate Engine 4A-FE	608015	Inner Joint		23	23	34	61	116		
1.6 GLI (79 kW)	1993.01-	1997.09	-	-	F Estate Engine 4A-FE	859005	Outer Joint		26	23	56	95.5	55	I	
	1993.01-	1997.09	MT	R	F Estate Engine 4A-FE	208017	Drive Shaft		26	23	56	96.5	910		
	1993.01-	1997.09	-	-	F Estate Engine 4A-FE	859021	Outer Joint	48T	26	23	56	96.5	55	I	
	1993.01-	1997.09	-	-	F Estate Engine 4A-FE	859128	Outer Joint	48T	26	23	56	95.5	55	I	
	1993.01-	1997.09	AT/MT	L/R	F Estate Engine 4A-FE	859006	Outer Joint	48T	26	23	56	95.5	55	I	
	1993.01-	1997.09	AT/MT	L/R	F Estate Engine 4A-FE	859020	Outer Joint		26	23	56	96.5	55	I	
	1993.01-	1997.09	-	-	F Estate Engine 4A-FE	859059	Outer Joint		26	32	56	101	64	I	
1.6 i (73 kW)	1993.01-	1997.09	MT	R	F Estate Engine 4A-FE	608015	Inner Joint		23	23	34	61	116		
	1995.02-	1997.09	-	-	F Estate Engine 4A-FE	859005	Outer Joint		26	23	56	95.5	55	I	
	1995.02-	1997.09	MT	R	F Estate Engine 4A-FE	208017	Drive Shaft		26	23	56	96.5	910		
	1995.02-	1997.09	-	-	F Estate Engine 4A-FE	859021	Outer Joint	48T	26	23	56	96.5	55	I	
	1995.02-	1997.09	-	-	F Estate Engine 4A-FE	859128	Outer Joint	48T	26	23	56	95.5	55	I	
	1995.02-	1997.09	AT/MT	L/R	F Estate Engine 4A-FE	859006	Outer Joint	48T	26	23	56	95.5	55	I	
	1995.02-	1997.09	AT/MT	L/R	F Estate Engine 4A-FE	859020	Outer Joint		26	23	56	96.5	55	I	
1.8 i (79 kW)	1995.02-	1997.09	-	-	F Estate Engine 4A-FE	859059	Outer Joint		26	32	56	101	64	I	
	1995.02-	1997.09	MT	R	F Estate Engine 4A-FE	608015	Inner Joint		23	23	34	61	116		
	1995.02-	1997.09	-	-	F Estate Engine 7A-FE	859005	Outer Joint		26	23	56	95.5	55	I	
	1995.02-	1997.09	-	-	Estate Engine 7A-FE	859062	Outer Joint		26	24	56	95.5	55	I	
	1995.02-	1997.09	-	-	F Estate Engine 7A-FE	859021	Outer Joint	48T	26	23	56	96.5	55	I	
	1995.02-	1997.09	-	-	F Estate Engine 7A-FE	859128	Outer Joint	48T	26	23	56	95.5	55	I	
	1995.02-	1997.09	AT/MT	L/R	F Estate Engine 7A-FE	859006	Outer Joint	48T	26	23	56	95.5	55	I	
2.0 D (54 kW)	1995.02-	1997.09	AT/MT	L/R	F Estate Engine 7A-FE	859020	Outer Joint		26	23	56	96.5	55	I	
	1995.02-	1997.09	-	-	F Estate Engine 7A-FE	859059	Outer Joint		26	32	56	101	64	I	
	1993.01-	1996.01	-	-	F wagon	899122	Outer Joint		26	24	56	96	56	I	
	1993.01-	1996.01	-	-	Estate Engine 2C	859062	Outer Joint		26	24	56	95.5	55	I	
	1993.01-	1996.01	AT/MT	L/R	F Estate Engine 2C	859001	Outer Joint		26	24	56	95.5	55	I	
2.0 GLI (98 kW)	1993.01-	1996.01	-	R	F Estate Engine 2C	659004	Inner Joint		20	23	35	363	100.5		
	1993.01-	1997.09	-	-	F wagon	899122	Outer Joint		26	24	56	96	56	I	
	1993.01-	1997.09	-	-	Estate Engine 3S-FE	859062	Outer Joint		26	24	56	95.5	55	I	
	1993.01-	1997.09	AT/MT	L/R	F Estate Engine 3S-FE	859001	Outer Joint		26	24	56	95.5	55	I	
2.0 i (93 kW)	1993.01-	1997.09	-	-	F Estate Engine 3S-FE	859059	Outer Joint		26	32	56	101	64	I	
	1995.05-	1997.09	-	-	F wagon	899122	Outer Joint		26	24	56	96	56	I	
	1995.05-	1997.09	-	-	Estate Engine 3S-FE	859062	Outer Joint		26	24	56	95.5	55	I	
	1995.05-	1997.09	AT/MT	L/R	F Estate Engine 3S-FE	859001	Outer Joint		26	24	56	95.5	55	I	
2.0 TD (61 kW)	1995.05-	1997.09	-	-	F Estate Engine 3S-FE	859059	Outer Joint		26	32	56	101	64	I	
	1996.01-	1997.09	-	-	F Estate Engine 2C-T	859120	Outer Joint	48T	26	24	56	95.5	55	I	
	1996.01-	1997.09	-	-	F Estate Engine 2C-T	859021	Outer Joint	48T	26	23	56	96.5	55	I	
	1996.01-	1997.09	AT/MT	L/R	F Estate Engine 2C-T	859001	Outer Joint		26	24	56	95.5	55	I	
1996.01-	1997.09	MT	R	F Estate Engine 2C-T	659004	Inner Joint		20	23	35	363	100.5			
CARINA E VI															
2.0	1992.05-	1996.01	MT	-	-	859186	Outer Joint	48T	26	25	56	96	61	I	
2.0 TD	1996.02-	1997.11	MT	-	-	859186	Outer Joint	48T	26	25	56	96	61	I	
CARINA II (_T17_)															
1.6 (66 kW)	1987.12-	1990.08	-	-	F Saloon Engine 4A-F	859005	Outer Joint		26	23	56	95.5	55	I	
	1987.12-	1989.11	MT	L/R	F Hatchback Engine 4A-F	859020	Outer Joint		26	23	56	96.5	55	I	
	1987.12-	1989.12	MT	L/R	F Estate Engine 4A-F	859020	Outer Joint		26	23	56	96.5	55	I	
	1987.12-	1989.11	MT	L/R	F Hatchback Engine 4A-F	859006	Outer Joint	48T	26	23	56	95.5	55	I	
	1987.12-	1989.12	MT	L/R	F Estate Engine 4A-F	859006	Outer Joint	48T	26	23	56	95.5	55	I	
	1987.12-	1990.08	MT	L/R	F Saloon Engine 4A-F	859006	Outer Joint	48T	26	23	56	95.5	55	I	
	1987.12-	1990.08	MT	L/R	F Saloon Engine 4A-F	859020	Outer Joint		26	23	56	96.5	55	I	
	1987.12-	1992.03	-	R	F All-wheel Drive Saloon Engine 4A-FE	659160	Inner Joint		23	23	36	75	93		
	1987.12-	1989.11	-	-	F Hatchback Engine 4A-F	859005	Outer Joint		26	23	56	95.5	55	I	
	1987.12-	1989.12	-	-	F Estate Engine 4A-F	859005	Outer Joint		26	23	56	95.5	55	I	
	1.6 (72 kW)	1987.12-	1992.03	-	-	F Hatchback Engine 4A-FE	859005	Outer Joint		26	23	56	95.5	55	I
		1987.12-	1992.03	-	-	F Estate Engine 4A-FE	859005	Outer Joint		26	23	56	95.5	55	I
1987.12-		1992.03	-	-	F Saloon Engine 4A-FE	859005	Outer Joint		26	23	56	95.5	55	I	
1987.12-		1992.03	AT	-	F Saloon Engine 4A-FE	859021	Outer Joint	48T	26	23	56	96.5	55	I	
1987.12-		1992.03	AT	-	F Estate Engine 4A-FE	859021	Outer Joint	48T	26	23	56	96.5	55	I	
1987.12-		1992.03	-	-	Hatchback Engine 4A-FE	859062	Outer Joint		26	24	56	95.5	55	I	

	YEAR	TRANSM	L/R	F/R	REMARKS	GSP Ref.	PRODUCT	ABS	Technical Specifications								
									A	B	C	H	L	P			
TOYOTA																	
CARINA II (_T17_)																	
1.6 (72 kW)	1987.12-1992.03	-	-	-	Estate Engine 4A-FE	859062	Outer Joint		26	24	56	95.5	55	I			
	1987.12-1992.03	-	-	-	Saloon Engine 4A-FE	859062	Outer Joint		26	24	56	95.5	55	I			
	1987.12-1992.03	MT	L/R	F	Saloon Engine 4A-FE	859006	Outer Joint	48T	26	23	56	95.5	55	I			
	1987.12-1992.03	MT	L/R	F	Hatchback Engine 4A-FE	859006	Outer Joint	48T	26	23	56	95.5	55	I			
	1987.12-1992.03	MT	L/R	F	Saloon Engine 4A-FE	859020	Outer Joint		26	23	56	96.5	55	I			
	1987.12-1992.03	MT	L/R	F	Estate Engine 4A-FE	859006	Outer Joint	48T	26	23	56	95.5	55	I			
	1987.12-1992.03	MT	L/R	F	Hatchback Engine 4A-FE	859020	Outer Joint		26	23	56	96.5	55	I			
	1987.12-1992.03	MT	L/R	F	Estate Engine 4A-FE	859020	Outer Joint		26	23	56	96.5	55	I			
1.6 (74 kW)	1988.05-1992.06	-	R	F	All-wheel Drive Saloon Engine 4A-FE	659160	Inner Joint		23	23	36	75	93				
1.6 (75 kW)	1987.12-1992.03	-	-	-	Hatchback Engine 4A-FE	859005	Outer Joint		26	23	56	95.5	55	I			
	1987.12-1992.03	-	-	-	Estate Engine 4A-FE	859005	Outer Joint		26	23	56	95.5	55	I			
	1987.12-1992.03	-	-	-	Saloon Engine 4A-FE	859005	Outer Joint		26	23	56	95.5	55	I			
	1987.12-1992.03	AT	-	F	Saloon Engine 4A-FE	859021	Outer Joint	48T	26	23	56	96.5	55	I			
	1987.12-1992.03	AT	-	F	Estate Engine 4A-FE	859021	Outer Joint	48T	26	23	56	96.5	55	I			
	1987.12-1992.03	-	-	-	Hatchback Engine 4A-FE	859062	Outer Joint		26	24	56	95.5	55	I			
	1987.12-1992.03	-	-	-	Estate Engine 4A-FE	859062	Outer Joint		26	24	56	95.5	55	I			
	1987.12-1992.03	-	-	-	Saloon Engine 4A-FE	859062	Outer Joint		26	24	56	95.5	55	I			
	1987.12-1992.03	MT	L/R	F	Saloon Engine 4A-FE	859006	Outer Joint	48T	26	23	56	95.5	55	I			
	1987.12-1992.03	MT	L/R	F	Hatchback Engine 4A-FE	859006	Outer Joint	48T	26	23	56	95.5	55	I			
	1987.12-1992.03	MT	L/R	F	Saloon Engine 4A-FE	859020	Outer Joint		26	23	56	96.5	55	I			
	1987.12-1992.03	MT	L/R	F	Hatchback Engine 4A-FE	859020	Outer Joint		26	23	56	96.5	55	I			
	1987.12-1992.03	MT	L/R	F	Estate Engine 4A-FE	859006	Outer Joint	48T	26	23	56	95.5	55	I			
	1987.12-1992.03	MT	L/R	F	Estate Engine 4A-FE	859020	Outer Joint		26	23	56	96.5	55	I			
1.6 (77 kW)	1988.06-1992.03	-	R	F	All-wheel Drive Saloon Engine 4A-FE	659160	Inner Joint		23	23	36	75	93				
	1988.06-1992.03	-	R	F	All-wheel Drive Hatchback Engine 4A-FE	659160	Inner Joint		23	23	36	75	93				
1.6 (88 kW)	1987.12-1992.03	-	R	F	All-wheel Drive Saloon Engine 4A-FE	659160	Inner Joint		23	23	36	75	93				
1.6 GX (88 kW)	1987.12-1992.03	-	R	F	All-wheel Drive Estate Engine 4A-FE	659160	Inner Joint		23	23	36	75	93				
2.0 (89 kW)	1987.12-1992.04	-	-	-	Estate Engine 3S-FE	859003	Outer Joint		26	25	56	95.6	61	M			
2.0 (94 kW)	1987.12-1992.03	-	-	-	Saloon Engine 3S-FE	859003	Outer Joint		26	25	56	95.6	61	M			
2.0 D (54 kW)	1987.12-1992.01	MT	L/R	F	Estate Engine 2C-L	859018	Outer Joint		26	24	56	95.5	55	I			
	1987.12-1992.01	-	-	-	Estate Engine 2C-L	859062	Outer Joint		26	24	56	95.5	55	I			
	1987.12-1992.01	MT	L/R	F	Estate Engine 2C-L	859001	Outer Joint		26	24	56	95.5	55	I			
	1988.03-1992.06	-	-	F	Sloping back	899122	Outer Joint		26	24	56	96	56	I			
	1988.03-1992.06	MT	L/R	F	Saloon Engine 2C	859018	Outer Joint		26	24	56	95.5	55	I			
	1988.03-1992.06	MT	L/R	F	Hatchback Engine 2C-L	859018	Outer Joint		26	24	56	95.5	55	I			
	1988.03-1992.06	-	-	-	Hatchback Engine 2C-L	859062	Outer Joint		26	24	56	95.5	55	I			
	1988.03-1992.06	MT	L/R	F	Saloon Engine 2C	859001	Outer Joint		26	24	56	95.5	55	I			
	1988.03-1992.06	MT	L/R	F	Hatchback Engine 2C-L	859001	Outer Joint		26	24	56	95.5	55	I			
	1988.03-1992.06	-	-	-	Saloon Engine 2C	859062	Outer Joint		26	24	56	95.5	55	I			
2.0 GLI (89 kW)	1987.12-1992.03	-	-	-	Hatchback Engine 3S-FE	859003	Outer Joint		26	25	56	95.6	61	M			
	1987.12-1992.03	-	-	-	Saloon Engine 3S-FE	859003	Outer Joint		26	25	56	95.6	61	M			
	1987.12-1992.03	-	-	F	Sloping back	899122	Outer Joint		26	24	56	96	56	I			
2.0 GLi (94 kW)	1987.12-1992.03	-	-	-	Hatchback Engine 3S-FE	859003	Outer Joint		26	25	56	95.6	61	M			
CARINA II Sedan (_T17_)																	
2.0 D (54 kW)	1988.03-1992.06	-	-	F	sedan	899122	Outer Joint		26	24	56	96	56	I			
2.0 GLI (89 kW)	1987.12-1992.03	-	-	F	sedan	899122	Outer Joint		26	24	56	96	56	I			
CARINA II Station Wagon (_T17_)																	
2.0 (89 kW)	1987.12-1992.04	-	-	F	wagon	899122	Outer Joint		26	24	56	96	56	I			
CELICA																	
-	1986-1989	-	-	-	GT&ST	659009	Inner Joint			24		79					
CELICA (ST185)																	
2.0	1989.10-	-	MT	-	Engine 3SGET TBO	859010	Outer Joint		26	27	56	96	67.5	I			
2.0 4WD	1989.10-1993.08	MT	-	-	Engine 3SGTE	859010	Outer Joint		26	27	56	96	67.5	I			
CELICA (_T16_)																	
1.6 (63 kW)	1986.04-1989.08	-	-	-	Saloon Engine 4A-L	859062	Outer Joint		26	24	56	95.5	55	I			
	1986.04-1989.08	-	-	-	Hatchback Engine 4A-L	859062	Outer Joint		26	24	56	95.5	55	I			
	1986.04-1989.08	MT	R	F	Saloon Engine 4A-L	859020	Outer Joint		26	23	56	96.5	55	I			
	1986.04-1989.08	MT	R	F	Hatchback Engine 4A-L	859020	Outer Joint		26	23	56	96.5	55	I			
	1986.04-1989.08	MT	R	F	Saloon Engine 4A-L	859006	Outer Joint	48T	26	23	56	95.5	55	I			
	1986.04-1989.08	MT	R	F	Hatchback Engine 4A-L	859006	Outer Joint	48T	26	23	56	95.5	55	I			
	1986.04-1989.08	-	-	F	Saloon Engine 4A-L	859005	Outer Joint		26	23	56	95.5	55	I			
	1986.04-1989.08	-	-	F	Hatchback Engine 4A-L	859005	Outer Joint		26	23	56	95.5	55	I			
1.6 GT (85 kW)	1987.08-1989.08	-	-	-	Hatchback Engine 4A-GELC	859062	Outer Joint		26	24	56	95.5	55	I			
	1987.08-1989.08	MT	L/R	F	Hatchback Engine 4A-GELC	859001	Outer Joint		26	24	56	95.5	55	I			
1.6 GT 16V (91 kW)	1985.09-1989.08	-	-	-	Hatchback Engine 4A-GEL	859062	Outer Joint		26	24	56	95.5	55	I			
	1985.09-1989.08	MT	L	F	Hatchback Engine 4A-GEL	859001	Outer Joint		26	24	56	95.5	55	I			

	YEAR	TRANSM	L/R	F/R	REMARKS	GSP Ref.	PRODUCT	ABS	Technical Specifications					
									A	B	C	H	L	P
TOYOTA														
CELICA (_T16_)														
1.6 GT 16V (91 kW)	1985.09-1989.08	MT	R	F	Hatchback Engine 4A-GEL	859020	Outer Joint		26	23	56	96.5	55	I
	1985.09-1989.08	MT	R	F	Hatchback Engine 4A-GEL	859006	Outer Joint	48T	26	23	56	95.5	55	I
	1986.04-1989.08	-	-	-	Saloon Engine 4A-GEL	859062	Outer Joint		26	24	56	95.5	55	I
	1986.04-1989.08	MT	L	F	Saloon Engine 4A-GEL	859001	Outer Joint		26	24	56	95.5	55	I
	1986.04-1989.08	MT	R	F	Saloon Engine 4A-GEL	859020	Outer Joint		26	23	56	96.5	55	I
	1986.04-1989.08	MT	R	F	Saloon Engine 4A-GEL	859006	Outer Joint	48T	26	23	56	95.5	55	I
2.0 (103 kW)	1987.08-1989.08	-	-	-	Coupe Engine 3S-GEL	859003	Outer Joint		26	25	56	95.6	61	M
2.0 (110 kW)	1987.01-1989.08	AT	-	F	Saloon Engine 3S-GEL	859056	Outer Joint		26	25	56	96	62	I
	1987.01-1989.08	-	-	-	Saloon Engine 3S-GEL	859003	Outer Joint		26	25	56	95.6	61	M
2.0 GT (103 kW)	1985.08-1989.08	-	-	F	Convertible Engine 3S-GELC	859055	Outer Joint		26	25	56	96	56	M
	1985.08-1989.08	-	-	-	Convertible Engine 3S-GELC	859003	Outer Joint		26	25	56	95.6	61	M
	1985.09-1989.08	-	-	F	Hatchback Engine 3S-GELC	859055	Outer Joint		26	25	56	96	56	M
	1985.09-1989.08	-	-	-	Hatchback Engine 3S-GELC	859003	Outer Joint		26	25	56	95.6	61	M
2.0 GT (110 kW)	1985.08-1989.08	-	-	F	Hatchback Engine 3S-GEL	859055	Outer Joint		26	25	56	96	56	M
	1986.10-1989.08	AT	-	F	Convertible Engine 3S-GEL	859056	Outer Joint		26	25	56	96	62	I
	1986.10-1989.08	-	-	-	Convertible Engine 3S-GEL	859003	Outer Joint		26	25	56	95.6	61	M
2.0 Turbo (136 kW)	1988.03-1989.08	-	-	F	All-wheel Drive Coupe Engine 3S-GTE	859166	Outer Joint	48T	26	27	56	96	67.5	I
	1988.03-1989.08	-	-	F	All-wheel Drive Coupe Engine 3S-GTE	859073	Outer Joint		26	27	56	96	67.5	I
	1988.03-1989.08	MT	L/R	F	All-wheel Drive Coupe Engine 3S-GTE	859012	Outer Joint	48T	26	27	56	100	63	M
	1988.03-1989.08	-	-	-	All-wheel Drive Coupe Engine 3S-GTE	859063	Outer Joint		26	29	56	99.5	62.5	O
	1988.03-1989.08	MT	-	-	All-wheel Drive Coupe Engine 3S-GTE	631001	Inner Joint			27		33.2		
CELICA (_T18_)														
1.6 STi (77 kW)	1989.10-1993.11	AT	L	F	Coupe Engine 4A-FE	659005	Inner Joint		20	23	35	63.5	115.7	
	1989.10-1993.11	MT	L/R	F	Coupe Engine 4A-FE	859006	Outer Joint	48T	26	23	56	95.5	55	I
	1989.10-1993.11	MT	L/R	F	Coupe Engine 4A-FE	859020	Outer Joint		26	23	56	96.5	55	I
2.0 GTi (115 kW)	1989.10-1993.11	AT	-	F	Coupe Engine 3S-GE	859120	Outer Joint	48T	26	24	56	95.5	55	I
	1989.10-1993.11	AT	-	F	Convertible Engine 3S-GE	859120	Outer Joint	48T	26	24	56	95.5	55	I
	1989.10-1993.11	-	-	-	Convertible Engine 3S-GE	859062	Outer Joint		26	24	56	95.5	55	I
	1989.10-1993.11	-	-	-	Coupe Engine 3S-GE	859062	Outer Joint		26	24	56	95.5	55	I
	1989.10-1993.11	MT	-	F	Coupe Engine 3S-GE	859320	Outer Joint	48T	26	25	56	100	63	M
	1989.10-1993.11	MT	-	F	Convertible Engine 3S-GE	859320	Outer Joint	48T	26	25	56	100	63	M
	1989.10-1993.11	AT	L/R	F	Coupe Engine 3S-GE	859001	Outer Joint		26	24	56	95.5	55	I
	1989.10-1993.11	AT	L/R	F	Convertible Engine 3S-GE	859001	Outer Joint		26	24	56	95.5	55	I
	1989.10-1993.11	-	-	F	Coupe Engine 3S-GE	899124	Outer Joint		26	25	56	96	61	I
	1989.10-1993.11	-	-	F	Convertible Engine 3S-GE	899124	Outer Joint		26	25	56	96	61	I
2.0 GTi (118 kW)	1989.10-1993.10	AT	-	F	Coupe Engine 3S-GE	859120	Outer Joint	48T	26	24	56	95.5	55	I
	1989.10-1993.10	MT	-	F	Coupe Engine 3S-GE	859320	Outer Joint	48T	26	25	56	100	63	M
	1989.10-1993.10	-	-	F	Coupe Engine 3S-GE	899124	Outer Joint		26	25	56	96	61	I
2.0 Turbo (150 kW)	1989.10-1993.11	AT/MT	L/R	F	All-wheel Drive Coupe Engine 3S-GTE	859012	Outer Joint	48T	26	27	56	100	63	M
	1989.10-1993.11	-	-	F	All-wheel Drive Coupe Engine 3S-GTE	859166	Outer Joint	48T	26	27	56	96	67.5	I
	1989.10-1993.11	-	-	F	All-wheel Drive Coupe Engine 3S-GTE	859073	Outer Joint		26	27	56	96	67.5	I
	1989.10-1993.11	AT	L/R	F	All-wheel Drive Coupe Engine 3S-GTE	859001	Outer Joint		26	24	56	95.5	55	I
	1989.10-1993.11	-	-	-	All-wheel Drive Coupe Engine 3S-GTE	859063	Outer Joint		26	29	56	99.5	62.5	O
	1989.10-1993.11	MT	-	-	All-wheel Drive Coupe Engine 3S-GTE	631001	Inner Joint			27		33.2		
2.0 Turbo (153 kW)	1989.10-1993.11	MT	L/R	F	All-wheel Drive Coupe Engine 3S-GTE	859012	Outer Joint	48T	26	27	56	100	63	M
	1989.10-1993.11	-	-	F	All-wheel Drive Coupe Engine 3S-GTE	859166	Outer Joint	48T	26	27	56	96	67.5	I
	1989.10-1993.11	-	-	F	All-wheel Drive Coupe Engine 3S-GTE	859073	Outer Joint		26	27	56	96	67.5	I
	1989.10-1993.11	AT	L/R	F	All-wheel Drive Coupe Engine 3S-GTE	859001	Outer Joint		26	24	56	95.5	55	I
	1989.10-1993.11	-	-	-	All-wheel Drive Coupe Engine 3S-GTE	859063	Outer Joint		26	29	56	99.5	62.5	O
	1989.10-1993.11	MT	-	-	All-wheel Drive Coupe Engine 3S-GTE	631001	Inner Joint			27		33.2		
CELICA (_T20_)														
1.8 i 16V (85 kW)	1993.11-1999.11	-	-	F	Coupe Engine 7A-FE	859005	Outer Joint		26	23	56	95.5	55	I
2.0 GTi (129 kW)	1994.08-1999.08	-	-	-	Convertible Engine 3S-GE	859003	Outer Joint		26	25	56	95.6	61	M
	1994.08-1999.08	-	L	F	Convertible Engine 3S-GE	699040	Inner Joint		20	25	35	63.5	112	
2.0 i 16V (125 kW)	1993.11-1999.08	-	-	F	Convertible Engine 3S-GE	859002	Outer Joint	48T	26	25	56	96	62	I
	1993.11-1999.08	-	L	F	Convertible Engine 3S-GE	699040	Inner Joint		20	25	35	63.5	112	
	1996.04-1999.11	-	-	-	Coupe Engine 3S-GE	859003	Outer Joint		26	25	56	95.6	61	M
2.0 i 16V (129 kW)	1993.11-1999.11	-	-	-	Coupe Engine 3S-GE	859003	Outer Joint		26	25	56	95.6	61	M
2.0 i Turbo (178 kW)	1994.02-1999.11	-	-	-	All-wheel Drive Coupe Engine 3S-GTE	859003	Outer Joint		26	25	56	95.6	61	M
CELICA (_T23_)														
1.8 16V TS (141 kW)	1999.08-2005.09	-	-	-	Coupe Engine 2ZZ-GE	859003	Outer Joint		26	25	56	95.6	61	M
	1999.08-2005.09	AT/MT	L/R	F	Coupe Engine 2ZZ-GE	859153	Outer Joint	48T	26	24	58	96	52.5	I
	1999.08-2005.09	-	L/R	F	Coupe Engine 2ZZ-GE	859261	Outer Joint	48T	26	25	56	95	61	I
1.8 16V VT-i (105 kW)	1999.08-2005.07	-	-	-	Coupe Engine 1ZZ-FE	859262	Outer Joint	48T	26	24	58	95	51	I
	1999.08-2005.07	AT/MT	L/R	F	Coupe Engine 1ZZ-FE	859153	Outer Joint	48T	26	24	58	96	52.5	I
	1999.08-2005.07	-	L/R	F	Coupe Engine 1ZZ-FE	859261	Outer Joint	48T	26	25	56	95	61	I



YEAR	TRANSM	L/R	F/R	REMARKS	GSP Ref.	PRODUCT	ABS	Technical Specifications							
								A	B	C	H	L	P		
TOYOTA															
CELICA IV															
2.0	1985.11-1990.01	MT/AT	-	-	-	859186	Outer Joint	48T	26	25	56	96	61	I	
CELICA ST185															
2.0	1989.10-1993.08	MT	-	-	Allwheel Drive Engine 3SGTE	859010	Outer Joint		26	27	56	96	67.5	I	
	1998.10-	MT	-	-	Engine 3SGTE TBO	859010	Outer Joint		26	27	56	96	67.5	I	
2000	1989.10-1993.08	MT	-	-	Allwheel Drive Engine 3SGTE	859010	Outer Joint		26	27	56	96	67.5	I	
	1998.10-	MT	-	-	Engine 3SGTE TBO	859010	Outer Joint		26	27	56	96	67.5	I	
CELICA ST202															
2.0	1993.09-1999.09	MT/AT	-	-	Engine 3SGE	859426	Outer Joint	48T	26	25	56	95.6	61	M	
2000	1993.09-1999.09	MT/AT	-	-	Engine 3SGE	859426	Outer Joint	48T	26	25	56	95.6	61	M	
CHASER (_X10_)															
2.5 VVTi (147 kW)	1996.10-2001.05	-	L/R	R	Saloon Engine 1JZ-GE	859390	Outer Joint	48T	30	27	63	108.5	64	I	
COROLLA															
-	-	-	L	-	ALTIS	259069	Drive Shaft	48T	26	23	58	96	636.5		
	-	-	R	-	ALTIS	259080	Drive Shaft	48T	26	23	58	96	908		
	-	-	R	-	CE110	259195	Drive Shaft	48T	26	20	56	95.5	917		
	-	-	R	-	ZNE10	259191	Drive Shaft	48T	26	20	58	96	912		
	-	-	L	-	CE111	259196	Drive Shaft	48T	26	20	56	95.5	609		
	-	-	L	-	ZNE10	259192	Drive Shaft	48T	26	20	58	96	641		
	1986.01-1994.08	MT/AT	-	-	AE 95 4WD	659012	Inner Joint		23	23	44	49.5	114.5		
	1986.01-1994.08	MT/AT	L	F	-	259044	Drive Shaft		26	23	56	95.5	574		
	1986.01-1994.08	MT/AT	R	F	-	259046	Drive Shaft		26	23	56	95.5	578.5		
	1988-1992	-	L	-	-	259070	Drive Shaft		26	23	56	99.5	599		
	1988-1992	-	R	-	-	259071	Drive Shaft		26	23	56	99.5	908		
	1989.01-1994.08	-	L	-	AE90,AE 92. AE 94	259035	Drive Shaft		26	23	56	96.5	605		
	1989.06-1991.03	-	L	-	AE90 AE92 AE94	222003	Drive Shaft	48T	26	23	56	96.5	605		
	1989.06-1991.03	-	R	-	AE90 AE92 AE94	222004	Drive Shaft	48T	26	23	56	96.5	910		
	1998-	-	-	-	-	699036	Inner Joint		23	29	34	59.5	134		
	1998.11-2000.11	-	R	-	AE 112	222001	Drive Shaft	48T	26	23	56	96.5	920		
	2003-2008	MT	L/R	-	-	859108	Outer Joint		26	29	56	96	63	M	
	2003-	-	-	-	-	859082	Outer Joint		26	23	58	96	54	I	
	2003-	-	R	-	-	259073	Drive Shaft	48T	26	23	58	96	915		
	2003-2008	MT	L/R	-	-	859108	Outer Joint		26	29	56	96	63	M	
	2008.01-2010.08	-	R	F	-	259714	Drive Shaft		26	23	58	96	924		
	2010.07-2014.02	MT	L	F	ENGINE:2ZRFE/ZRE142L	859511	Outer Joint		26	25	58	95.5	56.5	I	
	2010.07-2014.02	AT	L	F	ENGINE:2ZRFE/ZRE142L	859511	Outer Joint		26	25	58	95.5	56.5	I	
	2010.07-2013.10	MT	L	F	ENGINE:1ZZFE,/ZZE142L	859511	Outer Joint		26	25	58	95.5	56.5	I	
1.5	2010.07-2012.12	AT	L	F	ENGINE:1NZFE/NZE141R	659047	Inner Joint		23	23	34	75.5	101.5		
	2010.07-2012.12	AT	L	F	ENGINE:1NZFE/NZE141R	259612	Drive Shaft	48T	26	23	58	96	644		
	2010.07-2012.12	AT	L	F	ENGINE:1NZFE/NZE141R	859083	Outer Joint		26	24	58	96	54	I	
1.6	-	-	-	-	MZE121/ZZE121/1NZFE,3ZZFE	859083	Outer Joint		26	24	58	96	54	I	
	2007.08-2010.06	5MT	R	F	ENGINE:3ZZFE/ZZE141	259616	Drive Shaft	48T	26	23	58	95.5	922		
	2010.07-2014.02	4AT	R	F	ENGINE:1ZRFE/ZRE141	259616	Drive Shaft	48T	26	23	58	95.5	922		
	2014.06-	CVT	L	F	ENGINE:1ZRFE/GENERAL	259228	Drive Shaft		26	20	55.6	95.5	656		
	2014.06-	CVT	L	F	ENGINE:1ZRFE/GENERAL	659064	Inner Joint		20	25	35	63.5	118		
	2014.06-	CVT	R	F	ENGINE:1ZRFE/GENERAL	259688	Drive Shaft		26	20	55.6	95.5	937		
1.8	-	-	R	-	-	859083	Outer Joint		26	24	58	96	54	I	
	-	-	R	-	AE 102	222001	Drive Shaft	48T	26	23	56	96.5	920		
	-	-	L	-	-	259079	Drive Shaft	48T	26	20	58	96	910		
	-	2002	-	-	-	659054	Inner Joint		23	23	34	60	113		
	2002-2008	AT	-	-	-	659143	Inner Joint		23	23	34	60	112		
	2002.04-2004.04	4AT	L	F	ENGINE:1ZZFE/ZZE130	859265	Outer Joint	48T	26	29	56	96	63	M	
	2002.04-2004.04	4AT	L	F	ENGINE:1ZZFE/ZZE130	259274	Drive Shaft	48T	26	20	56	96	636		
	2003.04-2004.04	5MT	L	F	ENGINE:1ZZFE/ZZE130	259018	Drive Shaft		26	20	56	96	636		
	2007.05-2010.08	-	R	F	ENGINE:2ZRFE/GENERAL	259688	Drive Shaft		26	20	55.6	95.5	937		
	2008.02-2010.08	-	R	F	ENGINE:2ZRFE/GENERAL	259688	Drive Shaft		26	20	55.6	95.5	937		
	2010.07-2014.02	MT	R	F	ENGINE:2ZRFE/ZRE142L	259562	Drive Shaft	48T	26	20	58	96	926		
	2010.07-2014.02	MT	L	F	ENGINE:2ZRFE/ZRE142L	259405	Drive Shaft	48T	26	20	58	95.5	646		
	2010.07-2014.02	AT	L	F	ENGINE:2ZRFE/ZRE142L	259405	Drive Shaft	48T	26	20	58	95.5	646		
	2010.07-2013.10	MT	L	F	ENGINE:1ZZFE,/ZZE142L	259405	Drive Shaft	48T	26	20	58	95.5	646		
	2010.09-2014.05	-	R	F	ENGINE:2ZRFE/GENERAL	259688	Drive Shaft		26	20	55.6	95.5	937		
	2010.09-2012.02	-	R	F	ENGINE:2ZRFE/GENERAL	259688	Drive Shaft		26	20	55.6	95.5	937		
	2013.08-	6MT	L	F	ENGINE:2ZRFE/ZRE172	259643	Drive Shaft	48T	26	20	58	96	649		
	2014.06-	CVT	L	F	ENGINE:2ZRFE/GENERAL	259228	Drive Shaft		26	20	55.6	95.5	656		
	2014.06-	CVT	L	F	ENGINE:2ZRFE/GENERAL	659064	Inner Joint		20	25	35	63.5	118		
	2014.06-	6MT	R	F	ENGINE:2ZRFE/GENERAL	259688	Drive Shaft		26	20	55.6	95.5	937		
	2014.06-	CVT	R	F	ENGINE:2ZRFE/GENERAL	259688	Drive Shaft		26	20	55.6	95.5	937		





	 YEAR	TRANSM	L/R	F/R	REMARKS	GSP Ref.	 PRODUCT	 ABS	Technical Specifications					
									A	B	C	H	L	P
TOYOTA														
COROLLA (AE101)														
1.6 i	1992-1997	-	R	F	-	259392	Drive Shaft		26	23	56	96.5	926	
COROLLA (AE92)														
1.6 i	1987-2002	-	R	F	-	259392	Drive Shaft		26	23	56	96.5	926	
COROLLA (E142)														
1.8	2006.09-2008.10	CVT	-	-	Engine 2ZRFE/3ZRFE	859387	Outer Joint	48T	26	25	58	95.5	56.5	M
COROLLA (E144)														
1.8 4WD	2006.09-2008.10	CVT	-	-	Engine 2ZRFE	859387	Outer Joint	48T	26	25	58	95.5	56.5	M
COROLLA (EE90)														
1.3 i	1987-1992	-	R	F	-	259392	Drive Shaft		26	23	56	96.5	926	
COROLLA (NZE121, ZZE121)														
1.6	2004.01-	-	L	-	-	259069	Drive Shaft	48T	26	23	58	96	636.5	
COROLLA (ZZ121)														
1.4 VVT-i	2002-2007	-	L	F	-	259270	Drive Shaft	48T	26	23	56	99	633.5	
	2002-2007	-	R	F	-	259271	Drive Shaft	48T	26	23	56	99	915	
1.6 VVT-i	2002-2007	-	L	F	-	259270	Drive Shaft	48T	26	23	56	99	633.5	
	2002-2007	-	R	F	-	259271	Drive Shaft	48T	26	23	56	99	915	
COROLLA (ZZE122)														
1.8	2000.08-	4AT	-	-	Engine 1ZZFE	859460	Outer Joint	48T	26	24	58	96	54	I
COROLLA (_E10_)														
1.3 12V (53 kW)	1992.07-1997.04	-	-	F	Saloon Engine 2E	699046	Inner Joint		23	23	34	60	103.5	
	1992.07-1995.05	-	-	F	Estate Engine 2E	699046	Inner Joint		23	23	34	60	103.5	
	1992.07-1997.04	-	L	F	Saloon Engine 2E	608015	Inner Joint		23	23	34	61	116	
	1992.07-1995.05	-	L	F	Estate Engine 2E	608015	Inner Joint		23	23	34	61	116	
	1992.07-1997.04	-	L	F	Saloon Engine 2E	208016	Drive Shaft		26	23	56	96.5	599.5	
	1992.07-1995.05	-	L	F	Estate Engine 2E	208016	Drive Shaft		26	23	56	96.5	599.5	
	1992.07-1997.04	-	-	F	Saloon Engine 2E	859005	Outer Joint		26	23	56	95.5	55	I
	1992.07-1995.05	-	-	F	Estate Engine 2E	859005	Outer Joint		26	23	56	95.5	55	I
	1992.07-1997.04	-	R	F	Saloon Engine 2E	208017	Drive Shaft		26	23	56	96.5	910	
	1992.07-1995.05	-	R	F	Estate Engine 2E	208017	Drive Shaft		26	23	56	96.5	910	
	1992.07-1997.04	AT/MT	L/R	F	Saloon Engine 2E	859006	Outer Joint	48T	26	23	56	95.5	55	I
	1992.07-1995.05	MT	L/R	F	Estate Engine 2E	859006	Outer Joint	48T	26	23	56	95.5	55	I
	1992.07-1997.04	AT/MT	L/R	F	Saloon Engine 2E	859020	Outer Joint		26	23	56	96.5	55	I
1992.07-1995.05	MT	L/R	F	Estate Engine 2E	859020	Outer Joint		26	23	56	96.5	55	I	
1.3 XLI (55 kW)	1995.09-1997.04	-	-	F	Saloon Engine 4E-FE	699046	Inner Joint		23	23	34	60	103.5	
	1995.09-1997.04	-	L	F	Estate Engine 4E-FE	608015	Inner Joint		23	23	34	61	116	
	1995.09-1997.04	-	L	F	Saloon Engine 4E-FE	608015	Inner Joint		23	23	34	61	116	
	1995.09-1997.04	-	-	F	Estate Engine 4E-FE	699046	Inner Joint		23	23	34	60	103.5	
	1995.09-1997.04	-	L	F	Estate Engine 4E-FE	208016	Drive Shaft		26	23	56	96.5	599.5	
	1995.09-1997.04	-	L	F	Saloon Engine 4E-FE	208016	Drive Shaft		26	23	56	96.5	599.5	
	1995.09-1997.04	-	-	F	Saloon Engine 4E-FE	859005	Outer Joint		26	23	56	95.5	55	I
	1995.09-1997.04	-	-	F	Estate Engine 4E-FE	859005	Outer Joint		26	23	56	95.5	55	I
	1995.09-1997.04	-	R	F	Estate Engine 4E-FE	208017	Drive Shaft		26	23	56	96.5	910	
	1995.09-1997.04	-	R	F	Saloon Engine 4E-FE	208017	Drive Shaft		26	23	56	96.5	910	
	1995.09-1997.04	-	-	F	Estate Engine 4E-FE	859021	Outer Joint	48T	26	23	56	96.5	55	I
	1995.09-1997.04	-	-	F	Saloon Engine 4E-FE	859021	Outer Joint	48T	26	23	56	96.5	55	I
	1995.09-1997.04	MT	L/R	F	Estate Engine 4E-FE	859006	Outer Joint	48T	26	23	56	95.5	55	I
	1995.09-1997.04	MT	L/R	F	Saloon Engine 4E-FE	859006	Outer Joint	48T	26	23	56	95.5	55	I
	1995.09-1997.04	MT	L/R	F	Estate Engine 4E-FE	859020	Outer Joint		26	23	56	96.5	55	I
	1995.09-1997.04	MT	L/R	F	Saloon Engine 4E-FE	859020	Outer Joint		26	23	56	96.5	55	I
	1.3 XLI 16V (65 kW)	1992.07-1995.09	-	L	F	Saloon Engine 4E-FE	608015	Inner Joint		23	23	34	61	116
1992.07-1995.09		-	L	F	Estate Engine 4E-FE	608015	Inner Joint		23	23	34	61	116	
1992.07-1995.09		-	-	F	Saloon Engine 4E-FE	699046	Inner Joint		23	23	34	60	103.5	
1992.07-1995.09		-	-	F	Estate Engine 4E-FE	699046	Inner Joint		23	23	34	60	103.5	
1992.07-1995.09		-	L	F	Saloon Engine 4E-FE	208016	Drive Shaft		26	23	56	96.5	599.5	
1992.07-1995.09		-	L	F	Estate Engine 4E-FE	208016	Drive Shaft		26	23	56	96.5	599.5	
1992.07-1995.09		-	-	F	Saloon Engine 4E-FE	859005	Outer Joint		26	23	56	95.5	55	I
1992.07-1995.09		-	-	F	Saloon Engine 4E-FE	859021	Outer Joint	48T	26	23	56	96.5	55	I
1992.07-1995.09		-	-	F	Estate Engine 4E-FE	859005	Outer Joint		26	23	56	95.5	55	I
1992.07-1995.09		-	R	F	Saloon Engine 4E-FE	208017	Drive Shaft		26	23	56	96.5	910	
1992.07-1995.09		-	-	F	Estate Engine 4E-FE	859021	Outer Joint	48T	26	23	56	96.5	55	I
1992.07-1995.09		-	R	F	Estate Engine 4E-FE	208017	Drive Shaft		26	23	56	96.5	910	
1992.07-1995.09		MT	L/R	F	Saloon Engine 4E-FE	859006	Outer Joint	48T	26	23	56	95.5	55	I
1992.07-1995.09		MT	L/R	F	Estate Engine 4E-FE	859006	Outer Joint	48T	26	23	56	95.5	55	I
1992.07-1995.09		MT	L/R	F	Saloon Engine 4E-FE	859020	Outer Joint		26	23	56	96.5	55	I
1992.07-1995.09		MT	L/R	F	Estate Engine 4E-FE	859020	Outer Joint		26	23	56	96.5	55	I
1992.07-1995.09		-	-	-	Saloon Engine 4E-FE	659023	Inner Joint		23	23	34	60	113	

	 YEAR	TRANSM	L/R	F/R	REMARKS	GSP Ref.	 PRODUCT	 ABS	Technical Specifications					
									A	B	C	H	L	P
TOYOTA														
COROLLA (E10)														
1.3 XLI 16V (65 kW)	1992.07-1995.09	-	-	-	Estate Engine 4E-FE	659023	Inner Joint		23	23	34	60	113	
1.5(77 kW)	1991.06-1994.08	AT	-	-	Saloon Engine 5A-FE	659023	Inner Joint		23	23	34	60	113	
1.6 (78 kW)	1994.09-1997.12	-	-	F	Saloon Engine 4A-F/4A-FE	859337	Outer Joint		26	29	56	96	54	O
1.6 (85 kW)	1992.05-1995.07	-	-	-	Saloon Engine 4A-FE	619001	Inner Joint		23	29	34	58.5	128.5	
	1992.05-1995.07	-	-	F	Saloon Engine 4A-FE	859337	Outer Joint		26	29	56	96	54	O
1.6 Si (84 kW)	1992.07-1997.04	-	L	F	Estate Engine 4A-FE	608015	Inner Joint		23	23	34	61	116	
	1992.07-1997.04	-	-	-	Estate Engine 4A-FE	619001	Inner Joint		23	29	34	58.5	128.5	
	1992.07-1997.04	-	-	F	Estate Engine 4A-FE	859337	Outer Joint		26	29	56	96	54	O
	1992.07-1997.04	-	L	F	Estate Engine 4A-FE	208016	Drive Shaft		26	23	56	96.5	599.5	
	1992.07-1997.04	-	-	F	Estate Engine 4A-FE	859005	Outer Joint		26	23	56	95.5	55	I
	1992.07-1997.04	-	-	F	Estate Engine 4A-FE	859021	Outer Joint	48T	26	23	56	96.5	55	I
	1992.07-1997.04	-	-	F	Estate Engine 4A-FE	859128	Outer Joint	48T	26	23	56	95.5	55	I
	1992.07-1997.04	-	-	-	Estate Engine 4A-FE	859062	Outer Joint		26	24	56	95.5	55	I
	1992.07-1997.04	MT	L/R	F	Estate Engine 4A-FE	859006	Outer Joint	48T	26	23	56	95.5	55	I
	1992.07-1997.04	MT	L/R	F	Estate Engine 4A-FE	859020	Outer Joint		26	23	56	96.5	55	I
	1995.09-1997.04	-	L	F	Saloon Engine 4A-FE	608015	Inner Joint		23	23	34	61	116	
	1995.09-1997.04	-	L	F	Saloon Engine 4A-FE	208016	Drive Shaft		26	23	56	96.5	599.5	
	1995.09-1997.04	-	-	F	Saloon Engine 4A-FE	859005	Outer Joint		26	23	56	95.5	55	I
	1995.09-1997.04	-	-	F	Saloon Engine 4A-FE	859021	Outer Joint	48T	26	23	56	96.5	55	I
	1995.09-1997.04	-	-	F	Saloon Engine 4A-FE	859128	Outer Joint	48T	26	23	56	95.5	55	I
	1995.09-1997.04	AT/MT	L/R	F	Saloon Engine 4A-FE	859006	Outer Joint	48T	26	23	56	95.5	55	I
1995.09-1997.04	AT/MT	L/R	F	Saloon Engine 4A-FE	859020	Outer Joint		26	23	56	96.5	55	I	
1995.09-1997.04	-	-	-	Saloon Engine 4A-FE	859063	Outer Joint		26	29	56	99.5	62.5	O	
1.8 16V (81 kW)	1995.09-1997.04	MT	-	R	All-wheel Drive Estate Engine 7A-FE	639089	Inner Joint				20		68.6	
	1995.09-1997.04	MT	-	F	All-wheel Drive Estate Engine 7A-FE	859120	Outer Joint	48T	26	24	56	95.5	55	I
	1995.09-1997.04	-	R	F	All-wheel Drive Estate Engine 7A-FE	659160	Inner Joint		23	23	36	75	93	
2.0 D (53 kW)	1992.07-1997.04	-	-	F	Estate Engine 2C	859021	Outer Joint	48T	26	23	56	96.5	55	I
	1992.07-1997.04	-	-	F	Saloon Engine 2C	859021	Outer Joint	48T	26	23	56	96.5	55	I
	1992.07-1997.04	-	-	-	Estate Engine 2C	859062	Outer Joint		26	24	56	95.5	55	I
COROLLA (E11)														
1.3 (55 kW)	1997.05-2001.10	-	-	F	Saloon Engine 2E	699046	Inner Joint		23	23	34	60	103.5	
1.4 (63 kW)	1997.04-2000.02	-	-	F	Saloon Engine 4E-FE	699046	Inner Joint		23	23	34	60	103.5	
	1997.04-2000.02	-	L	F	Estate Engine 4E-FE	608015	Inner Joint		23	23	34	61	116	
	1997.04-2000.02	-	L	F	Saloon Engine 4E-FE	608015	Inner Joint		23	23	34	61	116	
	1997.04-2000.02	-	-	F	Estate Engine 4E-FE	699046	Inner Joint		23	23	34	60	103.5	
	1997.04-2000.02	-	L	F	Estate Engine 4E-FE	208016	Drive Shaft		26	23	56	96.5	599.5	
	1997.04-2000.02	-	L	F	Saloon Engine 4E-FE	208016	Drive Shaft		26	23	56	96.5	599.5	
	1997.04-2000.02	-	-	F	Estate Engine 4E-FE	859005	Outer Joint		26	23	56	95.5	55	I
	1997.04-2000.02	-	-	F	Estate Engine 4E-FE	859021	Outer Joint	48T	26	23	56	96.5	55	I
	1997.04-2000.02	-	-	F	Saloon Engine 4E-FE	859128	Outer Joint	48T	26	23	56	95.5	55	I
	1997.04-2000.02	-	-	F	Saloon Engine 4E-FE	859021	Outer Joint	48T	26	23	56	96.5	55	I
	1997.04-2000.02	MT	L/R	F	Estate Engine 4E-FE	859006	Outer Joint	48T	26	23	56	95.5	55	I
	1997.04-2000.02	MT	L/R	F	Saloon Engine 4E-FE	859006	Outer Joint	48T	26	23	56	95.5	55	I
	1997.04-2000.02	MT	L/R	F	Estate Engine 4E-FE	859020	Outer Joint		26	23	56	96.5	55	I
1.4 16V (71 kW)	2000.02-2001.11	-	L	F	Saloon Engine 4ZZ-FE	608015	Inner Joint		23	23	34	61	116	
	2000.02-2001.10	-	L	F	Estate Engine 4ZZ-FE	608015	Inner Joint		23	23	34	61	116	
	2000.02-2001.11	-	L	F	Saloon Engine 4ZZ-FE	208016	Drive Shaft		26	23	56	96.5	599.5	
	2000.02-2001.10	-	L	F	Estate Engine 4ZZ-FE	208016	Drive Shaft		26	23	56	96.5	599.5	
	2000.02-2001.11	-	-	F	Saloon Engine 4ZZ-FE	859021	Outer Joint	48T	26	23	56	96.5	55	I
	2000.02-2001.10	-	-	F	Estate Engine 4ZZ-FE	859021	Outer Joint	48T	26	23	56	96.5	55	I
	2000.02-2001.10	-	-	F	Estate Engine 4ZZ-FE	859021	Outer Joint	48T	26	23	56	96.5	55	I
1.6 (81 kW)	1997.04-2000.02	-	L	F	Estate Engine 4A-FE	608015	Inner Joint		23	23	34	61	116	
	1997.04-2000.02	-	L	F	Estate Engine 4A-FE	208016	Drive Shaft		26	23	56	96.5	599.5	
	1997.04-2000.02	-	-	F	Estate Engine 4A-FE	859005	Outer Joint		26	23	56	95.5	55	I
	1997.04-2000.02	-	-	F	Estate Engine 4A-FE	859021	Outer Joint	48T	26	23	56	96.5	55	I
	1997.04-2000.02	MT	L/R	F	Estate Engine 4A-FE	859006	Outer Joint	48T	26	23	56	95.5	55	I
	1997.04-2000.02	MT	L/R	F	Estate Engine 4A-FE	859020	Outer Joint		26	23	56	96.5	55	I
	1997.04-2000.02	AT	L	F	Estate Engine 4A-FE	259072	Drive Shaft	48T	26	23	58	96	633.5	
	1997.04-2000.02	MT	L/R	F	Saloon Engine 4A-FE	859006	Outer Joint	48T	26	23	56	95.5	55	I
	1997.04-2000.02	MT	L/R	F	Saloon Engine 4A-FE	859020	Outer Joint		26	23	56	96.5	55	I
1.6 16V (81 kW)	2000.02-2001.11	-	L	F	Saloon Engine 3ZZ-FE	608015	Inner Joint		23	23	34	61	116	
	2000.02-2001.10	-	L	F	Estate Engine 3ZZ-FE	608015	Inner Joint		23	23	34	61	116	
	2000.02-2001.11	-	L	F	Saloon Engine 3ZZ-FE	208016	Drive Shaft		26	23	56	96.5	599.5	
	2000.02-2001.10	-	L	F	Estate Engine 3ZZ-FE	208016	Drive Shaft		26	23	56	96.5	599.5	
	2000.02-2001.11	-	-	F	Saloon Engine 3ZZ-FE	859021	Outer Joint	48T	26	23	56	96.5	55	I
	2000.02-2001.10	-	-	F	Estate Engine 3ZZ-FE	859021	Outer Joint	48T	26	23	56	96.5	55	I





	YEAR	TRANSM	L/R	F/R	REMARKS	GSP Ref.	PRODUCT	ABS	Technical Specifications								
									A	B	C	H	L	P			
TOYOTA																	
COROLLA (_E11_)																	
1.6 16V (81 kW)	2000.02-2001.10	AT	L	F	Estate Engine 3ZZ-FE	259072	Drive Shaft	48T	26	23	58	96	633.5				
	2000.02-2001.11	AT	L	F	Saloon Engine 3ZZ-FE	259072	Drive Shaft	48T	26	23	58	96	633.5				
1.6 Aut. (79 kW)	1997.04-2000.02	-	L	F	Estate Engine 4A-FE	608015	Inner Joint		23	23	34	61	116				
	1997.04-2000.02	-	L	F	Saloon Engine 4A-FE	608015	Inner Joint		23	23	34	61	116				
	1997.04-2000.02	-	L	F	Estate Engine 4A-FE	208016	Drive Shaft		26	23	56	96.5	599.5				
	1997.04-2000.02	-	L	F	Saloon Engine 4A-FE	208016	Drive Shaft		26	23	56	96.5	599.5				
	1997.04-2000.02	-	-	F	Saloon Engine 4A-FE	859005	Outer Joint		26	23	56	95.5	55	I			
	1997.04-2000.02	-	-	F	Estate Engine 4A-FE	859005	Outer Joint		26	23	56	95.5	55	I			
	1997.04-2000.02	-	-	F	Estate Engine 4A-FE	859021	Outer Joint	48T	26	23	56	96.5	55	I			
	1997.04-2000.02	-	-	F	Saloon Engine 4A-FE	859128	Outer Joint	48T	26	23	56	95.5	55	I			
	1997.04-2000.02	-	-	F	Saloon Engine 4A-FE	859021	Outer Joint	48T	26	23	56	96.5	55	I			
	1997.04-2000.02	AT	L	F	Estate Engine 4A-FE	259072	Drive Shaft	48T	26	23	58	96	633.5				
	1997.04-2000.02	AT	L/R	F	Estate Engine 4A-FE	859006	Outer Joint	48T	26	23	56	95.5	55	I			
1997.04-2000.02	AT	L/R	F	Saloon Engine 4A-FE	859006	Outer Joint	48T	26	23	56	95.5	55	I				
1997.04-2000.02	AT	L/R	F	Estate Engine 4A-FE	859020	Outer Joint		26	23	56	96.5	55	I				
1997.04-2000.02	AT	L/R	F	Saloon Engine 4A-FE	859020	Outer Joint		26	23	56	96.5	55	I				
1.8 (81 kW)	1997.04-2001.10	-	L/R	F	All-wheel Drive Estate Engine 7A-FE	859001	Outer Joint		26	24	56	95.5	55	I			
	1997.04-2001.10	-	L/R	F	All-wheel Drive Estate Engine 7A-FE	859006	Outer Joint	48T	26	23	56	95.5	55	I			
	1997.04-2001.10	-	L/R	F	All-wheel Drive Estate Engine 7A-FE	859020	Outer Joint		26	23	56	96.5	55	I			
	1997.04-2001.10	-	R	F	All-wheel Drive Estate Engine 7A-FE	659160	Inner Joint		23	23	36	75	93				
2.0 D (53 kW)	1997.04-2000.02	MT	-	F	Estate Engine 2C-E	859120	Outer Joint	48T	26	24	56	95.5	55	I			
	1997.04-2000.02	MT	-	F	Saloon Engine 2C-E	859120	Outer Joint	48T	26	24	56	95.5	55	I			
	1997.04-2000.02	MT	L	F	Estate Engine 2C-E	659005	Inner Joint		20	23	35	63.5	115.7				
	1997.04-2000.02	MT	L	F	Saloon Engine 2C-E	659005	Inner Joint		20	23	35	63.5	115.7				
2.0 D-4D (66 kW)	2000.09-2001.11	-	-	-	Saloon Engine 1CD-FTV	859003	Outer Joint		26	25	56	95.6	61	M			
	2000.09-2001.10	-	-	-	Estate Engine 1CD-FTV	859003	Outer Joint		26	25	56	95.6	61	M			
COROLLA (_E12_)																	
1.4 D (66 kW)	2004.07-2007.02	-	L/R	F	Hatchback Engine 1ND-TV	859044	Outer Joint	48T	26	25	63	100	62	M			
	2004.07-2007.02	MT	-	F	Hatchback Engine 1ND-TV	859182	Outer Joint	48T	26	25	58	95.5	61.5	M			
	2004.07-2007.02	-	L/R	F	Hatchback Engine 1ND-TV	859226	Outer Joint	48T	26	25	58	93	63.5	M			
1.4 VVT-i (71 kW)	2002.01-2006.12	MT	L/R	F	Hatchback Engine 4ZZ-FE	859037	Outer Joint	48T	26	23	58	95.5	61	M			
	2002.01-2006.12	MT	-	F	Hatchback Engine 4ZZ-FE	859459	Outer Joint	48T	26	23	58	96	54	I			
	2002.01-2006.12	MT	-	F	Hatchback Engine 4ZZ-FE	859131	Outer Joint	48T	26	24	58	96	54	I			
	2002.01-2006.12	MT	L/R	F	Hatchback Engine 4ZZ-FE	859153	Outer Joint	48T	26	24	58	96	52.5	I			
	2002.01-2006.12	MT	-	-	Hatchback Engine 4ZZ-FE	699038	Inner Joint		23	23	34	60	113				
	2002.01-2006.12	MT	R	F	Hatchback Engine 4ZZ-FE	259205	Drive Shaft	48T	26	23	58	95.5	909.5				
	2002.01-2006.12	-	-	-	Hatchback Engine 4ZZ-FE	859130	Outer Joint	48T	26	23	58	96	54	I			
1.6 VVT-i (81 kW)	2002.01-2006.12	MT	L/R	F	Hatchback Engine 3ZZ-FE	859037	Outer Joint	48T	26	23	58	95.5	61	M			
	2002.01-2006.12	AT/MT	L/R	F	Hatchback Engine 3ZZ-FE	859153	Outer Joint	48T	26	24	58	96	52.5	I			
	2002.01-2006.12	AT	L	F	Hatchback Engine 3ZZ-FE	259072	Drive Shaft	48T	26	23	58	96	633.5				
	2002.01-2006.12	MT	R	F	Hatchback Engine 3ZZ-FE	259205	Drive Shaft	48T	26	23	58	95.5	909.5				
	2002.01-2006.12	-	-	-	Hatchback Engine 3ZZ-FE	859130	Outer Joint	48T	26	23	58	96	54	I			
1.8 VVTL-i TS (141 kW)	2002.01-2007.02	-	-	F	Hatchback Engine 2ZZ-GE	859047	Outer Joint		26	24	58	96	52.5	I			
	2002.01-2007.02	-	L/R	F	Hatchback Engine 2ZZ-GE	859044	Outer Joint	48T	26	25	63	100	62	M			
	2002.01-2007.02	MT	-	F	Hatchback Engine 2ZZ-GE	859182	Outer Joint	48T	26	25	58	95.5	61.5	M			
1.8 VVTL-i TS (160 kW)	2005.10-2006.12	MT	-	F	Hatchback Engine 2ZZ-GE	859182	Outer Joint	48T	26	25	58	95.5	61.5	M			
1.8 VVTL-i TS (165 kW)	2005.02-2007.02	-	-	F	Hatchback Engine 2ZZ-GE	859047	Outer Joint		26	24	58	96	52.5	I			
	2005.02-2007.02	MT	-	F	Hatchback Engine 2ZZ-GE	859182	Outer Joint	48T	26	25	58	95.5	61.5	M			
2.0 D-4D (66 kW)	2002.01-2006.12	MT	L	F	Hatchback Engine 1CD-FTV	659073	Inner Joint		24	27	50	67	110				
	2002.01-2006.12	MT	-	F	Hatchback Engine 1CD-FTV	859182	Outer Joint	48T	26	25	58	95.5	61.5	M			
	2002.01-2006.12	-	L/R	F	Hatchback Engine 1CD-FTV	859226	Outer Joint	48T	26	25	58	93	63.5	M			
	2002.01-2006.12	MT	R	F	Hatchback Engine 1CD-FTV	659078	Inner Joint		24	27	40	370	105				
2.0 D-4D (81 kW)	2002.01-2006.12	MT	L	F	Hatchback Engine 1CD-FTV	659073	Inner Joint		24	27	50	67	110				
	2002.01-2006.12	MT	-	F	Hatchback Engine 1CD-FTV	859182	Outer Joint	48T	26	25	58	95.5	61.5	M			
	2002.01-2006.12	-	L/R	F	Hatchback Engine 1CD-FTV	859226	Outer Joint	48T	26	25	58	93	63.5	M			
	2002.01-2006.12	MT	R	F	Hatchback Engine 1CD-FTV	659078	Inner Joint		24	27	40	370	105				
2.0 D-4D (85 kW)	2003.05-2007.02	MT	L	F	Hatchback Engine 1CD-FTV	659073	Inner Joint		24	27	50	67	110				
	2003.05-2007.02	MT	-	F	Hatchback Engine 1CD-FTV	859182	Outer Joint	48T	26	25	58	95.5	61.5	M			
	2003.05-2007.02	-	L/R	F	Hatchback Engine 1CD-FTV	859226	Outer Joint	48T	26	25	58	93	63.5	M			
	2003.05-2007.02	MT	R	F	Hatchback Engine 1CD-FTV	659078	Inner Joint		24	27	40	370	105				
COROLLA (_E12_)/AXIO/ALTIS																	
1.3 (65 kW)	2000.08-2004.03	-	-	F	Saloon Engine 2NZ-FE	699046	Inner Joint		23	23	34	60	103.5				
1.4 D-4D (66 kW)	2004.07-2007.07	-	L/R	F	Saloon Engine 1ND-TV	859044	Outer Joint	48T	26	25	63	100	62	M			
	2004.07-2007.07	MT	-	F	Saloon Engine 1ND-TV	859182	Outer Joint	48T	26	25	58	95.5	61.5	M			
	2004.07-2007.07	-	L/R	F	Saloon Engine 1ND-TV	859226	Outer Joint	48T	26	25	58	93	63.5	M			
1.4 VVT-i (71 kW)	2002.08-2007.07	MT	L/R	F	Saloon Engine 4ZZ-FE	859037	Outer Joint	48T	26	23	58	95.5	61	M			





YEAR	TRANSM	L/R	F/R	REMARKS	GSP Ref.	PRODUCT	ABS	Technical Specifications									
								A	B	C	H	L	P				
TOYOTA																	
COROLLA (_E12_)/AXIO/ALTIS																	
1.4 VVT-i (71 kW)	2002.08-2007.07	2002.07	MT	-	F	Saloon Engine 4ZZ-FE	859459	Outer Joint	48T	26	23	58	96	54	I		
	2002.08-2007.07	2007.07	MT	-	F	Saloon Engine 4ZZ-FE	859131	Outer Joint	48T	26	24	58	96	54	I		
	2002.08-2007.07	2007.07	MT	L/R	F	Saloon Engine 4ZZ-FE	859153	Outer Joint	48T	26	24	58	96	52.5	I		
	2002.08-2007.07	2007.07	MT	-	-	Saloon Engine 4ZZ-FE	699038	Inner Joint		23	23	34	60	113			
	2002.08-2007.07	2007.07	MT	R	F	Saloon Engine 4ZZ-FE	259205	Drive Shaft	48T	26	23	58	95.5	909.5			
	2002.08-2007.07	2007.07	-	-	-	Saloon Engine 4ZZ-FE	859130	Outer Joint	48T	26	23	58	96	54	I		
1.5 (80 kW)	2001.11-2007.07	2007.07	-	-	F	Saloon Engine 1NZ-FE	699046	Inner Joint		23	23	34	60	103.5			
	2001.11-2007.07	2007.07	-	-	F	Saloon Engine 1NZ-FE	859036	Outer Joint		26	23	58	96	52.5	I		
1.5 G (80 kW)	2001.11-2004.05	2004.05	-	-	F	All-wheel Drive Saloon Engine 1NZ-FE	699046	Inner Joint		23	23	34	60	103.5			
	2001.11-2004.05	2004.05	-	-	F	All-wheel Drive Saloon Engine 1NZ-FE	859036	Outer Joint		26	23	58	96	52.5	I		
1.6 VVT-i (81 kW)	2002.08-2007.07	2007.07	MT	L/R	F	Saloon Engine 3ZZ-FE	859037	Outer Joint	48T	26	23	58	95.5	61	M		
	2002.08-2007.07	2007.07	AT/MT	L/R	F	Saloon Engine 3ZZ-FE	859153	Outer Joint	48T	26	24	58	96	52.5	I		
	2002.08-2007.07	2007.07	AT	L	F	Saloon Engine 3ZZ-FE	259072	Drive Shaft	48T	26	23	58	96	633.5			
	2002.08-2007.07	2007.07	MT	R	F	Saloon Engine 3ZZ-FE	259205	Drive Shaft	48T	26	23	58	95.5	909.5			
	2002.08-2007.07	2007.07	-	-	-	Saloon Engine 3ZZ-FE	859130	Outer Joint	48T	26	23	58	96	54	I		
2.0 D-4D (66 kW)	2002.08-2007.07	2007.07	MT	L	F	Saloon Engine 1CD-FTV	659073	Inner Joint		24	27	50	67	110			
	2002.08-2007.07	2007.07	MT	-	F	Saloon Engine 1CD-FTV	859182	Outer Joint	48T	26	25	58	95.5	61.5	M		
	2002.08-2007.07	2007.07	-	L/R	F	Saloon Engine 1CD-FTV	859226	Outer Joint	48T	26	25	58	93	63.5	M		
	2002.08-2007.07	2007.07	MT	R	F	Saloon Engine 1CD-FTV	659078	Inner Joint		24	27	40	370	105			
2.0 D-4D (85 kW)	2004.06-2007.07	2007.07	MT	-	F	Saloon Engine 1CD-FTV	859182	Outer Joint	48T	26	25	58	95.5	61.5	M		
	2004.06-2007.07	2007.07	-	L/R	F	Saloon Engine 1CD-FTV	859226	Outer Joint	48T	26	25	58	93	63.5	M		
COROLLA (_E12_)/COROLLA FIELDER																	
1.4 D4-D (66 kW)	2004.07-2007.02	2007.02	-	L/R	F	Estate Engine 1ND-TV	859044	Outer Joint	48T	26	25	63	100	62	M		
	2004.07-2007.02	2007.02	MT	-	F	Estate Engine 1ND-TV	859182	Outer Joint	48T	26	25	58	95.5	61.5	M		
1.4 VVT-i (71 kW)	2002.01-2007.02	2007.02	MT	L/R	F	Estate Engine 4ZZ-FE	859037	Outer Joint	48T	26	23	58	95.5	61	M		
	2002.01-2007.02	2007.02	MT	-	F	Estate Engine 4ZZ-FE	859459	Outer Joint	48T	26	23	58	96	54	I		
	2002.01-2007.02	2007.02	MT	-	F	Estate Engine 4ZZ-FE	859131	Outer Joint	48T	26	24	58	96	54	I		
	2002.01-2007.02	2007.02	MT	L/R	F	Estate Engine 4ZZ-FE	859153	Outer Joint	48T	26	24	58	96	52.5	I		
	2002.01-2007.02	2007.02	MT	-	-	Estate Engine 4ZZ-FE	699038	Inner Joint		23	23	34	60	113			
	2002.01-2007.02	2007.02	MT	R	F	Estate Engine 4ZZ-FE	259205	Drive Shaft	48T	26	23	58	95.5	909.5			
	2002.01-2007.02	2007.02	-	-	-	Estate Engine 4ZZ-FE	859130	Outer Joint	48T	26	23	58	96	54	I		
1.6 VVT-i (81 kW)	2002.01-2007.02	2007.02	MT	L/R	F	Estate Engine 3ZZ-FE	859037	Outer Joint	48T	26	23	58	95.5	61	M		
	2002.01-2007.02	2007.02	AT/MT	L/R	F	Estate Engine 3ZZ-FE	859153	Outer Joint	48T	26	24	58	96	52.5	I		
	2002.01-2007.02	2007.02	AT	L	F	Estate Engine 3ZZ-FE	259072	Drive Shaft	48T	26	23	58	96	633.5			
	2002.01-2007.02	2007.02	MT	R	F	Estate Engine 3ZZ-FE	259205	Drive Shaft	48T	26	23	58	95.5	909.5			
	2002.01-2007.02	2007.02	-	-	-	Estate Engine 3ZZ-FE	859130	Outer Joint	48T	26	23	58	96	54	I		
2.0 D-4D (66 kW)	2002.01-2007.02	2007.02	MT	L	F	Estate Engine 1CD-FTV	659073	Inner Joint		24	27	50	67	110			
	2002.01-2007.02	2007.02	MT	-	F	Estate Engine 1CD-FTV	859182	Outer Joint	48T	26	25	58	95.5	61.5	M		
	2002.01-2007.02	2007.02	-	L/R	F	Estate Engine 1CD-FTV	859226	Outer Joint	48T	26	25	58	93	63.5	M		
	2002.01-2007.02	2007.02	MT	R	F	Estate Engine 1CD-FTV	659078	Inner Joint		24	27	40	370	105			
2.0 D-4D (85 kW)	2004.04-2007.02	2007.02	MT	L	F	Estate Engine 1CD-FTV	659073	Inner Joint		24	27	50	67	110			
	2004.04-2007.02	2007.02	MT	-	F	Estate Engine 1CD-FTV	859182	Outer Joint	48T	26	25	58	95.5	61.5	M		
	2004.04-2007.02	2007.02	MT	R	F	Estate Engine 1CD-FTV	659078	Inner Joint		24	27	40	370	105			
COROLLA (_E14_)/FIELDER																	
1.5 (81 kW)	2006.09-	-	MT	L	F	Estate Engine 1NZ-FE	201177	Drive Shaft	48T	26	24	58	96	622			
	2006.09-	-	MT	L	F	Estate Engine 1NZ-FE	201178	Drive Shaft		26	24	58	96	622			
1.8 (100 kW)	2006.09-	-	MT	L	F	Estate Engine 2ZR-FE	201177	Drive Shaft	48T	26	24	58	96	622			
	2006.09-	-	MT	L	F	Estate Engine 2ZR-FE	201178	Drive Shaft		26	24	58	96	622			
1.8 (106 kW)	2006.09-	-	MT	L	F	Estate Engine 2ZR-FAE	201177	Drive Shaft	48T	26	24	58	96	622			
	2006.09-	-	MT	L	F	Estate Engine 2ZR-FAE	201178	Drive Shaft		26	24	58	96	622			
COROLLA (_E15_)																	
1.33 (74 kW)	2007.01-	-	-	L	F	Saloon Engine 1NR-FE	259316	Drive Shaft		26	23	61.2	95.5	662			
	2007.01-	-	-	R	F	Saloon Engine 1NR-FE	259317	Drive Shaft		26	23	61.2	95.5	941			
1.4 D-4D (66 kW)	2006.10-	-	-	L	F	Saloon Engine 1ND-TV	259268	Drive Shaft		26	20	61.2	95.5	665			
	2006.10-	-	-	R	F	Saloon Engine 1ND-TV	259447	Drive Shaft		26	20	61.2	95.5	943			
1.4 VVT-i (71 kW)	2007.01-	-	-	L	F	Saloon Engine 4ZZ-FE	259316	Drive Shaft		26	23	61.2	95.5	662			
	2007.01-	-	-	-	-	Saloon Engine 4ZZ-FE	699038	Inner Joint		23	23	34	60	113			
	2007.01-	-	-	R	F	Saloon Engine 4ZZ-FE	259317	Drive Shaft		26	23	61.2	95.5	941			
1.8 VVTi (97 kW)	2008.01-	-	-	-	F	Saloon Engine 2ZR-FE	859428	Outer Joint	48T	26	32	58	96	56.5	I		
1.8 VVTL-i (100 kW)	2007.05-	-	-	-	F	Saloon Engine 2ZR-FAE/2ZR-FE	859428	Outer Joint	48T	26	32	58	96	56.5	I		
2.0 D-4D (93 kW)	2007.01-	-	-	L/R	F	Saloon Engine 1AD-FTV	859318	Outer Joint		30	36	61.4	101	62	I		
	2007.01-	-	6MT	L	F	Saloon Engine 1AD-FTV	601073	Inner Joint		24	33	50	67	109			
	2007.01-	-	6MT	R	F	Saloon Engine 1AD-FTV	659237	Inner Joint		24	33	40	383	97			
2.0(107 kW)	2010.04-	-	AT/CVT	L	F	Saloon Engine 3ZR-FE	659142	Inner Joint		24	32	50	67	104			
	2010.04-	-	AT	L	F	Saloon Engine 3ZR-FE	259572	Drive Shaft	48T	26	24	58	96	622			
	2010.04-	-	CVT	L	F	Saloon Engine 3ZR-FE	259572	Drive Shaft	48T	26	24	58	96	622			

				TRANSM		L/R F/R		REMARKS		GSP Ref.				ABS		Technical Specifications					
YEAR																A	B	C	H	L	P
TOYOTA																					
COROLLA (_E18_ZRE17_)																					
1.3 (73 kW)		2013.06-	-	MT	-	-	-	Saloon Engine 1NR-FE	699038	Inner Joint			23	23	34	60	113				
		2013.06-	-	-	R	F	-	Saloon Engine 1NR-FE	801143	Outer Joint			26	23	61.2	95.5	54.5	I			
		2013.06-	-	-	R	F	-	Saloon Engine 1NR-FE	201195	Drive Shaft			26	23	61.2	95.5	942				
		2013.06-	-	-	L	F	-	Saloon Engine 1NR-FE	201196	Drive Shaft			26	23	61.2	95.5	662				
1.6 (90 kW)		2013.06-	-	CVT	L	F	-	Saloon Engine 1ZR-FE	259689	Drive Shaft			26	20	55.6	95.5	657				
		2013.06-	-	-	L	F	-	Saloon Engine 1ZR-FE	801144	Outer Joint	48T		26	32	58	95.5	56.5	I			
		2013.06-	-	-	L	F	-	Saloon Engine 1ZR-FE	601138	Inner Joint			20	32	35	63.5	119				
		2013.06-	-	AT	R	F	-	Saloon Engine 1ZR-FE	601139	Inner Joint			23	32	34	60.5	116				
		2013.06-	-	-	L	F	-	Saloon Engine 1ZR-FE	201222	Drive Shaft	48T		26	20	58	95.5	649				
		2013.06-	-	-	R	F	-	Saloon Engine 1ZR-FE	201223	Drive Shaft	48T		26	20	58	95.5	922				
		2013.06-	-	AT	R	F	-	Saloon Engine 1ZR-FE	201224	Drive Shaft	48T		26	23	58	95.5	915				
		2013.06-	-	AT	L	F	-	Saloon Engine 1ZR-FE	201225	Drive Shaft	48T		26	23	58	95.5	650				
1.8 VVTi (103 kW)		2013.06-	-	-	-	F	-	Saloon Engine 2ZR-FBE/2ZR-FE	859428	Outer Joint	48T		26	32	58	96	56.5	I			
		2013.06-	-	-	R	F	-	Saloon Engine 2ZR-FBE/2ZR-FE	201223	Drive Shaft	48T		26	20	58	95.5	922				
		2013.06-	-	CVT	R	F	-	Saloon Engine 2ZR-FBE/2ZR-FE	201226	Drive Shaft	48T		26	20	58	95.5	922				
COROLLA (_E8_)																					
1.8 D (47 kW)		1983.06-	1989.06	-	-	-	-	Saloon Engine 1C-L	859062	Outer Joint			26	24	56	95.5	55	I			
		1983.06-	1989.06	MT	L/R	F	-	Saloon Engine 1C-L	859001	Outer Joint			26	24	56	95.5	55	I			
		1983.06-	1989.06	AT/MT	L/R	F	-	Saloon Engine 1C-L	859018	Outer Joint			26	24	56	95.5	55	I			
COROLLA (_E9_)																					
1.3 i (55 kW)		1987.08-	1992.12	-	-	F	-	Saloon Engine 2E/2E-E	859005	Outer Joint			26	23	56	95.5	55	I			
		1987.08-	1992.12	-	-	-	-	Saloon Engine 2E/2E-E	859062	Outer Joint			26	24	56	95.5	55	I			
		1987.08-	1992.12	AT/MT	L/R	F	-	Saloon Engine 2E/2E-E	859006	Outer Joint	48T		26	23	56	95.5	55	I			
		1987.08-	1992.12	AT/MT	L/R	F	-	Saloon Engine 2E/2E-E	859020	Outer Joint			26	23	56	96.5	55	I			
1.6 (66 kW)		1987.08-	1989.12	-	-	-	-	Saloon Engine 4A-F	859062	Outer Joint			26	24	56	95.5	55	I			
		1987.08-	1989.12	MT	R	F	-	Saloon Engine 4A-F	608015	Inner Joint			23	23	34	61	116				
		1987.08-	1989.12	MT	R	F	-	Saloon Engine 4A-F	208017	Drive Shaft			26	23	56	96.5	910				
		1987.08-	1989.12	AT	L/R	F	-	Saloon Engine 4A-F	822001	Outer Joint			26	23	56	96.5	55	I			
		1987.08-	1989.12	MT	L/R	F	-	Saloon Engine 4A-F	859001	Outer Joint			26	24	56	95.5	55	I			
		1987.08-	1989.12	-	-	F	-	Saloon Engine 4A-F	859005	Outer Joint			26	23	56	95.5	55	I			
1.6 GL (70 kW)		1987.10-	1990.08	-	R	F	-	All-wheel Drive Saloon Engine 4A-F	659160	Inner Joint			23	23	36	75	93				
1.6 i (77 kW)		1989.11-	1993.06	-	-	F	-	Saloon Engine 4A-FE	859337	Outer Joint			26	29	56	96	54	O			
		1989.11-	1993.06	-	-	F	-	Saloon Engine 4A-FE	859005	Outer Joint			26	23	56	95.5	55	I			
		1989.11-	1993.06	MT	L/R	F	-	Saloon Engine 4A-FE	859006	Outer Joint	48T		26	23	56	95.5	55	I			
		1989.11-	1993.06	MT	L/R	F	-	Saloon Engine 4A-FE	859020	Outer Joint			26	23	56	96.5	55	I			
1.8 D (47 kW)		1987.07-	1993.06	-	-	F	-	sedan	899122	Outer Joint			26	24	56	96	56	I			
		1987.07-	1993.06	-	-	-	-	Saloon Engine 1C	859062	Outer Joint			26	24	56	95.5	55	I			
		1987.07-	1993.06	-	L	F	-	Saloon Engine 1C	659005	Inner Joint			20	23	35	63.5	115.7				
		1987.07-	1993.06	MT	L/R	F	-	Saloon Engine 1C	859001	Outer Joint			26	24	56	95.5	55	I			
1.8 D (49 kW)		1989.11-	1993.06	-	-	F	-	sedan	899122	Outer Joint			26	24	56	96	56	I			
		1989.11-	1993.06	-	-	-	-	Saloon Engine 1C	859062	Outer Joint			26	24	56	95.5	55	I			
		1989.11-	1993.06	-	L	F	-	Saloon Engine 1C	659005	Inner Joint			20	23	35	63.5	115.7				
		1989.11-	1993.06	MT	L/R	F	-	Saloon Engine 1C	859001	Outer Joint			26	24	56	95.5	55	I			
COROLLA AXIO, FIELDER																					
1.8		2010.05-	2012.03	ATVFC	L	F	-	ENGINE:2ZRFAE/JAPAN	259687	Drive Shaft	48T		26	20	58	95.5	639				
		2010.05-	2012.03	ATVFC	L	F	-	ENGINE:2ZRFAE/JAPAN	859511	Outer Joint			26	25	58	95.5	56.5	I			
COROLLA AXIO, FIELDER																					
1.3		2015.03-	-	CVT	R	F	-	ENGINE:1NRFE/NRE160	259201	Drive Shaft			26	23	55.6	96	896				
		2015.03-	-	CVT	L	F	-	ENGINE:1NRFE/NRE160	259202	Drive Shaft			26	23	55.6	96	653				
1.5		2015.03-	-	5MT	L	F	-	ENGINE:1NZFE/NZE161	259202	Drive Shaft			26	23	55.6	96	653				
		2015.03-	-	CVT	L	F	-	ENGINE:1NZFE/NZE164	259626	Drive Shaft			26	20	55.6	96	651				
		2015.03-	-	CVT	R	F	-	ENGINE:1NZFE/NZE164	259627	Drive Shaft			26	20	55.6	96	897				
1.8		2008.10-	2010.04	AT	R	F	-	ENGINE:2ZRFE/ZRE142	259614	Drive Shaft	48T		26	20	58	95.5	907				
		2008.10-	2010.04	AT	R	F	-	ENGINE:2ZRFE/ZRE142	259614	Drive Shaft	48T		26	20	58	95.5	907				
COROLLA Compact (_E10_)																					
1.3 12V (53 kW)		1992.07-	1995.05	-	-	F	-	Hatchback Engine 2E	699046	Inner Joint			23	23	34	60	103.5				
		1992.07-	1995.05	-	L	F	-	Hatchback Engine 2E	608015	Inner Joint			23	23	34	61	116				
		1992.07-	1995.05	-	L	F	-	Hatchback Engine 2E	208016	Drive Shaft			26	23	56	96.5	599.5				
		1992.07-	1995.05	-	-	F	-	Hatchback Engine 2E	859005	Outer Joint			26	23	56	95.5	55	I			
		1992.07-	1995.05	AT/MT	L/R	F	-	Hatchback Engine 2E	859006	Outer Joint	48T		26	23	56	95.5	55	I			
		1992.07-	1995.05	AT/MT	L/R	F	-	Hatchback Engine 2E	859020	Outer Joint			26	23	56	96.5	55	I			
1.3 XLI (55 kW)		1995.09-	1997.04	-	L	F	-	Hatchback Engine 4E-FE	608015	Inner Joint			23	23	34	61	116				
		1995.09-	1997.04	-	-	F	-	Hatchback Engine 4E-FE	699046	Inner Joint			23	23	34	60	103.5				
		1995.09-	1997.04	-	L	F	-	Hatchback Engine 4E-FE	208016	Drive Shaft			26	23	56	96.5	599.5				
		1995.09-	1997.04	-	-	F	-	Hatchback Engine 4E-FE	859005	Outer Joint			26	23	56	95.5	55	I			
		1995.09-	1997.04	-	R	F	-	Hatchback Engine 4E-FE	208017	Drive Shaft			26	23	56	96.5	910				





	 YEAR	TRANSM	L/R	F/R	REMARKS	GSP Ref.	 PRODUCT	 ABS	Technical Specifications								
									A	B	C	H	L	P			
TOYOTA																	
COROLLA Compact (E10_)																	
1.3 XLI (55 kW)	1995.09-1997.04	-	-	F	Hatchback Engine 4E-FE	859021	Outer Joint	48T	26	23	56	96.5	55	I			
	1995.09-1997.04	MT	L/R	F	Hatchback Engine 4E-FE	859006	Outer Joint	48T	26	23	56	95.5	55	I			
	1995.09-1997.04	MT	L/R	F	Hatchback Engine 4E-FE	859020	Outer Joint		26	23	56	96.5	55	I			
1.3 XLI 16V (65 kW)	1992.07-1995.09	-	L	F	Hatchback Engine 4E-FE	608015	Inner Joint		23	23	34	61	116				
	1992.07-1995.09	-	-	F	Hatchback Engine 4E-FE	699046	Inner Joint		23	23	34	60	103.5				
	1992.07-1995.09	-	L	F	Hatchback Engine 4E-FE	208016	Drive Shaft		26	23	56	96.5	599.5				
	1992.07-1995.09	-	-	F	Hatchback Engine 4E-FE	859005	Outer Joint		26	23	56	95.5	55	I			
	1992.07-1995.09	-	-	F	Hatchback Engine 4E-FE	859021	Outer Joint	48T	26	23	56	96.5	55	I			
	1992.07-1995.09	-	R	F	Hatchback Engine 4E-FE	208017	Drive Shaft		26	23	56	96.5	910				
	1992.07-1995.09	MT	L/R	F	Hatchback Engine 4E-FE	859006	Outer Joint	48T	26	23	56	95.5	55	I			
	1992.07-1995.09	MT	L/R	F	Hatchback Engine 4E-FE	859020	Outer Joint		26	23	56	96.5	55	I			
1.6 i (78 kW)	1994.09-1999.11	-	-	F	Hatchback Engine 4A-FE	859337	Outer Joint		26	29	56	96	54	O			
	1992.07-1997.04	-	L	F	Hatchback Engine 4A-FE	608015	Inner Joint		23	23	34	61	116				
1.6 Si (84 kW)	1992.07-1997.04	-	-	-	Hatchback Engine 4A-FE	619001	Inner Joint		23	29	34	58.5	128.5				
	1992.07-1997.04	-	-	F	Hatchback Engine 4A-FE	859337	Outer Joint		26	29	56	96	54	O			
	1992.07-1997.04	-	L	F	Hatchback Engine 4A-FE	208016	Drive Shaft		26	23	56	96.5	599.5				
	1992.07-1997.04	-	-	F	Hatchback Engine 4A-FE	859021	Outer Joint	48T	26	23	56	96.5	55	I			
	1992.07-1997.04	-	-	F	Hatchback Engine 4A-FE	859128	Outer Joint	48T	26	23	56	95.5	55	I			
	1992.07-1997.04	-	-	-	Hatchback Engine 4A-FE	859062	Outer Joint		26	24	56	95.5	55	I			
	1992.07-1997.04	AT/MT	L/R	F	Hatchback Engine 4A-FE	859006	Outer Joint	48T	26	23	56	95.5	55	I			
	1992.07-1997.04	AT/MT	L/R	F	Hatchback Engine 4A-FE	859020	Outer Joint		26	23	56	96.5	55	I			
2.0 D (53 kW)	1992.07-1997.04	-	-	F	Hatchback Engine 2C	859021	Outer Joint	48T	26	23	56	96.5	55	I			
	1992.07-1997.04	-	-	-	Hatchback Engine 2C	859062	Outer Joint		26	24	56	95.5	55	I			
COROLLA Compact (E11_)																	
1.4 (63 kW)	1997.04-2000.02	-	-	F	Hatchback Engine 4E-FE	699046	Inner Joint		23	23	34	60	103.5				
	1997.04-2000.02	-	L	F	Hatchback Engine 4E-FE	608015	Inner Joint		23	23	34	61	116				
	1997.04-2000.02	-	L	F	Hatchback Engine 4E-FE	208016	Drive Shaft		26	23	56	96.5	599.5				
	1997.04-2000.02	-	-	F	Hatchback Engine 4E-FE	859005	Outer Joint		26	23	56	95.5	55	I			
	1997.04-2000.02	-	-	F	Hatchback Engine 4E-FE	859021	Outer Joint	48T	26	23	56	96.5	55	I			
	1997.04-2000.02	MT	L/R	F	Hatchback Engine 4E-FE	859006	Outer Joint	48T	26	23	56	95.5	55	I			
	1997.04-2000.02	MT	L/R	F	Hatchback Engine 4E-FE	859020	Outer Joint		26	23	56	96.5	55	I			
1.4 (71 kW)	2000.02-2002.01	-	L	F	Hatchback Engine 4ZZ-FE	608015	Inner Joint		23	23	34	61	116				
	2000.02-2002.01	-	L	F	Hatchback Engine 4ZZ-FE	208016	Drive Shaft		26	23	56	96.5	599.5				
	2000.02-2002.01	-	-	F	Hatchback Engine 4ZZ-FE	859021	Outer Joint	48T	26	23	56	96.5	55	I			
1.6 (81 kW)	1997.04-2000.02	-	L	F	Hatchback Engine 4A-FE	608015	Inner Joint		23	23	34	61	116				
	1997.04-2000.02	-	L	F	Hatchback Engine 4A-FE	208016	Drive Shaft		26	23	56	96.5	599.5				
	1997.04-2000.02	-	-	F	Hatchback Engine 4A-FE	859005	Outer Joint		26	23	56	95.5	55	I			
	1997.04-2000.02	-	-	F	Hatchback Engine 4A-FE	859128	Outer Joint	48T	26	23	56	95.5	55	I			
	1997.04-2000.02	-	-	F	Hatchback Engine 4A-FE	859021	Outer Joint	48T	26	23	56	96.5	55	I			
	1997.04-2000.02	MT	L/R	F	Hatchback Engine 4A-FE	859006	Outer Joint	48T	26	23	56	95.5	55	I			
	1997.04-2000.02	MT	L/R	F	Hatchback Engine 4A-FE	859020	Outer Joint		26	23	56	96.5	55	I			
	1997.04-2000.02	MT	L/R	F	Hatchback Engine 4A-FE	859028	Outer Joint	48T	26	22	56	99	61	M			
	2000.02-2002.01	-	L	F	Hatchback Engine 3ZZ-FE	608015	Inner Joint		23	23	34	61	116				
1.6 Aut. (79 kW)	1997.04-2000.02	-	L	F	Hatchback Engine 4A-FE	608015	Inner Joint		23	23	34	61	116				
	1997.04-2000.02	-	L	F	Hatchback Engine 4A-FE	208016	Drive Shaft		26	23	56	96.5	599.5				
	1997.04-2000.02	-	-	F	Hatchback Engine 4A-FE	859005	Outer Joint		26	23	56	95.5	55	I			
	1997.04-2000.02	-	-	F	Hatchback Engine 4A-FE	859128	Outer Joint	48T	26	23	56	95.5	55	I			
	1997.04-2000.02	-	-	F	Hatchback Engine 4A-FE	859021	Outer Joint	48T	26	23	56	96.5	55	I			
2.0 D (53 kW)	1997.04-2000.02	AT	L/R	F	Hatchback Engine 3ZZ-FE	259072	Drive Shaft	48T	26	23	58	96	633.5				
	1997.04-2000.02	AT	L/R	F	Hatchback Engine 4A-FE	859006	Outer Joint	48T	26	23	56	95.5	55	I			
	1997.04-2000.02	AT	L/R	F	Hatchback Engine 4A-FE	859020	Outer Joint		26	23	56	96.5	55	I			
2.0 D (53 kW)	1997.04-2000.02	MT	-	F	Hatchback Engine 2C-E	859120	Outer Joint	48T	26	24	56	95.5	55	I			
	1997.04-2000.02	MT	L	F	Hatchback Engine 2C-E	659005	Inner Joint		20	23	35	63.5	115.7				
2.0 D-4D (66 kW)	2000.09-2002.01	-	-	-	Hatchback Engine 1CD-FTV	859003	Outer Joint		26	25	56	95.6	61	M			
COROLLA Compact (E9_)																	
1.3 (55 kW)	1987.08-1989.12	-	-	-	Hatchback Engine 2E	859062	Outer Joint		26	24	56	95.5	55	I			
	1987.08-1989.12	AT/MT	L/R	F	Hatchback Engine 2E	859020	Outer Joint		26	23	56	96.5	55	I			
	1987.08-1989.12	AT/MT	L/R	F	Hatchback Engine 2E	859006	Outer Joint	48T	26	23	56	95.5	55	I			
	1987.08-1989.12	-	-	F	Hatchback Engine 2E	859005	Outer Joint		26	23	56	95.5	55	I			
1.6 (66 kW)	1987.08-1992.04	MT	R	F	Hatchback Engine 4A-F	208017	Drive Shaft		26	23	56	96.5	910				
	1987.08-1992.04	AT	L/R	F	Hatchback Engine 4A-F	822001	Outer Joint		26	23	56	96.5	55	I			
	1987.08-1992.04	MT	L/R	F	Hatchback Engine 4A-F	859001	Outer Joint		26	24	56	95.5	55	I			
	1987.08-1992.04	-	-	F	Hatchback Engine 4A-F	859005	Outer Joint		26	23	56	95.5	55	I			

YEAR	TRANSM	L/R	F/R	REMARKS	GSP Ref.	PRODUCT	ABS	Technical Specifications							
								A	B	C	H	L	P		
TOYOTA															
COROLLA Compact (E9_)															
1.6 (66 kW)	1987.08-1992.04	-	-	-	Hatchback Engine 4A-F	859062	Outer Joint		26	24	56	95.5	55	I	
	1987.08-1992.04	AT	L/R	F	Hatchback Engine 4A-F	859006	Outer Joint	48T	26	23	56	95.5	55	I	
	1987.08-1992.04	AT	L/R	F	Hatchback Engine 4A-F	859020	Outer Joint		26	23	56	96.5	55	I	
	1987.08-1992.04	MT	R	F	Hatchback Engine 4A-F	608015	Inner Joint		23	23	34	61	116		
1.6 GL (70 kW)	1987.10-1990.08	-	R	F	All-wheel Drive Hatchback Engine 4A-F	659160	Inner Joint		23	23	36	75	93		
1.6 GTi (85 kW)	1987.08-1992.04	-	-	F	Hatchback Engine 4A-GE	859120	Outer Joint	48T	26	24	56	95.5	55	I	
	1987.08-1992.04	-	-	F	Sloping back	899122	Outer Joint		26	24	56	96	56	I	
	1987.08-1992.04	AT	L/R	F	Hatchback Engine 4A-GE	822001	Outer Joint		26	23	56	96.5	55	I	
	1987.08-1992.04	MT	L/R	F	Hatchback Engine 4A-GE	859001	Outer Joint		26	24	56	95.5	55	I	
	1987.08-1992.04	-	-	-	Hatchback Engine 4A-GE	859062	Outer Joint		26	24	56	95.5	55	I	
	1987.08-1992.04	AT	L/R	F	Hatchback Engine 4A-GE	859006	Outer Joint	48T	26	23	56	95.5	55	I	
	1987.08-1992.04	AT	L/R	F	Hatchback Engine 4A-GE	859020	Outer Joint		26	23	56	96.5	55	I	
	1987.08-1992.04	-	-	-	Hatchback Engine 4A-GE	859063	Outer Joint		26	29	56	99.5	62.5	O	
1.6 i (77 kW)	1989.08-1992.04	-	-	F	Hatchback Engine 4A-FE	859337	Outer Joint		26	29	56	96	54	O	
	1989.08-1992.04	AT	L/R	F	Hatchback Engine 4A-FE	822001	Outer Joint		26	23	56	96.5	55	I	
	1989.08-1992.04	MT	L/R	F	Hatchback Engine 4A-FE	859001	Outer Joint		26	24	56	95.5	55	I	
	1989.08-1992.04	-	-	F	Hatchback Engine 4A-FE	859005	Outer Joint		26	23	56	95.5	55	I	
	1989.08-1992.04	AT	L/R	F	Hatchback Engine 4A-FE	859006	Outer Joint	48T	26	23	56	95.5	55	I	
	1989.08-1992.04	AT	L/R	F	Hatchback Engine 4A-FE	859020	Outer Joint		26	23	56	96.5	55	I	
1.6 XL (70 kW)	1989.09-1992.04	MT	R	F	Hatchback Engine 4A-F	208017	Drive Shaft		26	23	56	96.5	910		
	1989.09-1992.04	MT	R	F	Hatchback Engine 4A-F	608015	Inner Joint		23	23	34	61	116		
1.8 D (47 kW)	1987.08-1992.04	-	-	F	Sloping back	899122	Outer Joint		26	24	56	96	56	I	
	1987.08-1992.04	MT	L/R	F	Hatchback Engine 1C	859001	Outer Joint		26	24	56	95.5	55	I	
	1987.08-1992.04	-	L	F	Hatchback Engine 1C	659005	Inner Joint		20	23	35	63.5	115.7		
	1987.08-1992.04	-	-	-	Hatchback Engine 1C	859062	Outer Joint		26	24	56	95.5	55	I	
1.8 D (49 kW)	1989.08-1992.04	-	-	F	Sloping back	899122	Outer Joint		26	24	56	96	56	I	
	1989.08-1992.04	MT	L/R	F	Hatchback Engine 1C	859001	Outer Joint		26	24	56	95.5	55	I	
	1989.08-1992.04	-	L	F	Hatchback Engine 1C	659005	Inner Joint		20	23	35	63.5	115.7		
	1989.08-1992.04	-	-	-	Hatchback Engine 1C	859062	Outer Joint		26	24	56	95.5	55	I	
COROLLA E122															
1800	2001.05-2007.06	4AT	-	-	Engine 1ZZFE	859460	Outer Joint	48T	26	24	58	96	54	I	
COROLLA E124															
1800	2001.08-2007.06	4AT	-	-	Allwheel Drive Engine 1ZZFE	859460	Outer Joint	48T	26	24	58	96	54	I	
COROLLA E142															
1800	2006.09-2008.10	CVT	-	-	Engine 2ZRFE	859387	Outer Joint	48T	26	25	58	95.5	56.5	M	
	2008.10-	CVT	-	-	Engine 3ZRFE	859387	Outer Joint	48T	26	25	58	95.5	56.5	M	
COROLLA E144															
1800	2006.09-2008.10	CVT	-	-	Allwheel Drive Engine 2ZRFE	859387	Outer Joint	48T	26	25	58	95.5	56.5	M	
	2008.10-	CVT	-	-	Allwheel Drive Engine 2ZRFE	859387	Outer Joint	48T	26	25	58	95.5	56.5	M	
COROLLA E152															
1800	2007.10-2009.12	CVT	-	-	Engine 2ZRFE	859386	Outer Joint		26	25	55.6	95.5	57	M	
	2009.12-	CVT	-	-	Engine 2ZRFAE	859386	Outer Joint		26	25	55.6	95.5	57	M	
COROLLA E154															
1800	2007.10-2009.12	CVT	-	-	Allwheel Drive Engine 2ZRFE	859386	Outer Joint		26	25	55.6	95.5	57	M	
	2009.12-	CVT	-	-	Allwheel Drive Engine 2ZRFAE	859386	Outer Joint		26	25	55.6	95.5	57	M	
COROLLA LEVIN (E10_)															
1.5 S (73 kW)	1991.06-1997.08	-	-	-	Coupe Engine 5A-FE	619001	Inner Joint		23	29	34	58.5	128.5		
	1991.06-1997.08	AT	-	F	Coupe Engine 5A-FE	859337	Outer Joint		26	29	56	96	54	O	
	1991.06-1997.08	AT	-	-	Coupe Engine 5A-FE	659023	Inner Joint		23	23	34	60	113		
1.6 GT (85 kW)	1991.06-1997.08	-	-	F	Coupe Engine 4A-FE	859128	Outer Joint	48T	26	23	56	95.5	55	I	
1.6 GT-Z (125 kW)	1991.06-1997.08	-	-	F	Coupe Engine 4A-GZE	859128	Outer Joint	48T	26	23	56	95.5	55	I	
COROLLA LEVIN (E11_)															
1.5(74 kW)	1995.05-1998.04	AT	-	-	Coupe Engine 5A-FE	659023	Inner Joint		23	23	34	60	113		
1.6(121 kW)	1995.05-1998.04	MT	-	F	Coupe Engine 4A-GE	859120	Outer Joint	48T	26	24	56	95.5	55	I	
COROLLA Liftback (E10_)															
1.3 12V (53 kW)	1992.07-1995.05	-	-	F	Hatchback Engine 2E	699046	Inner Joint		23	23	34	60	103.5		
	1992.07-1995.05	-	L	F	Hatchback Engine 2E	608015	Inner Joint		23	23	34	61	116		
	1992.07-1995.05	-	L	F	Hatchback Engine 2E	208016	Drive Shaft		26	23	56	96.5	599.5		
	1992.07-1995.05	-	-	F	Hatchback Engine 2E	859005	Outer Joint		26	23	56	95.5	55	I	
	1992.07-1995.05	-	R	F	Hatchback Engine 2E	208017	Drive Shaft		26	23	56	96.5	910		
	1992.07-1995.05	AT/MT	L/R	F	Hatchback Engine 2E	859006	Outer Joint	48T	26	23	56	95.5	55	I	
	1992.07-1995.05	AT/MT	L/R	F	Hatchback Engine 2E	859020	Outer Joint		26	23	56	96.5	55	I	
1.3 XLI (65 kW)	1992.07-1997.04	-	L	F	Hatchback Engine 4E-FE	608015	Inner Joint		23	23	34	61	116		
	1992.07-1997.04	-	-	F	Hatchback Engine 4E-FE	699046	Inner Joint		23	23	34	60	103.5		
	1992.07-1997.04	-	L	F	Hatchback Engine 4E-FE	208016	Drive Shaft		26	23	56	96.5	599.5		
	1992.07-1997.04	MT	R	F	Hatchback Engine 4E-FE	208017	Drive Shaft		26	23	56	96.5	910		

	 YEAR	TRANSM	L/R	F/R	REMARKS	GSP Ref.	 PRODUCT	 ABS	Technical Specifications					
									A	B	C	H	L	P
TOYOTA														
COROLLA Liftback (_E10_)														
1.3 XLI (65 kW)	1992.07-1997.04	-	-	F	Hatchback Engine 4E-FE	859021	Outer Joint	48T	26	23	56	96.5	55	I
	1992.07-1997.04	-	-	F	Hatchback Engine 4E-FE	859005	Outer Joint		26	23	56	95.5	55	I
	1992.07-1997.04	MT	L/R	F	Hatchback Engine 4E-FE	859006	Outer Joint	48T	26	23	56	95.5	55	I
	1992.07-1997.04	MT	L/R	F	Hatchback Engine 4E-FE	859020	Outer Joint		26	23	56	96.5	55	I
	1992.07-1997.04	-	-	-	Hatchback Engine 4E-FE	659023	Inner Joint		23	23	34	60	113	
1.6 GLI (84 kW)	1992.07-1997.04	-	L	F	Hatchback Engine 4A-FE	608015	Inner Joint		23	23	34	61	116	
	1992.07-1997.04	-	-	-	Hatchback Engine 4A-FE	619001	Inner Joint		23	29	34	58.5	128.5	
	1992.07-1997.04	-	-	F	Hatchback Engine 4A-FE	859337	Outer Joint		26	29	56	96	54	O
	1992.07-1997.04	-	L	F	Hatchback Engine 4A-FE	208016	Drive Shaft		26	23	56	96.5	599.5	
	1992.07-1997.04	-	-	F	Hatchback Engine 4A-FE	859021	Outer Joint	48T	26	23	56	96.5	55	I
	1992.07-1997.04	-	-	F	Hatchback Engine 4A-FE	859128	Outer Joint	48T	26	23	56	95.5	55	I
	1992.07-1997.04	-	-	F	Hatchback Engine 4A-FE	859005	Outer Joint		26	23	56	95.5	55	I
	1992.07-1997.04	-	-	-	Hatchback Engine 4A-FE	859062	Outer Joint		26	24	56	95.5	55	I
	1992.07-1997.04	AT/MT	L/R	F	Hatchback Engine 4A-FE	859006	Outer Joint	48T	26	23	56	95.5	55	I
	1992.07-1997.04	AT/MT	L/R	F	Hatchback Engine 4A-FE	859020	Outer Joint		26	23	56	96.5	55	I
2.0 D (53 kW)	1992.07-1997.04	-	-	F	Sloping back	899122	Outer Joint		26	24	56	96	56	I
	1992.07-1997.04	-	-	F	Hatchback Engine 2C	859021	Outer Joint	48T	26	23	56	96.5	55	I
	1992.07-1997.04	-	-	-	Hatchback Engine 2C	859062	Outer Joint		26	24	56	95.5	55	I
COROLLA Liftback (_E11_)														
1.4 (63 kW)	1997.04-2000.02	-	-	F	Hatchback Engine 4E-FE	699046	Inner Joint		23	23	34	60	103.5	
	1997.04-2000.02	-	L	F	Hatchback Engine 4E-FE	608015	Inner Joint		23	23	34	61	116	
	1997.04-2000.02	-	L	F	Hatchback Engine 4E-FE	208016	Drive Shaft		26	23	56	96.5	599.5	
	1997.04-2000.02	-	-	F	Hatchback Engine 4E-FE	859021	Outer Joint	48T	26	23	56	96.5	55	I
	1997.04-2000.02	MT	L/R	F	Hatchback Engine 4E-FE	859006	Outer Joint	48T	26	23	56	95.5	55	I
	1997.04-2000.02	MT	L/R	F	Hatchback Engine 4E-FE	859020	Outer Joint		26	23	56	96.5	55	I
1.4 (71 kW)	2000.02-2002.01	-	L	F	Hatchback Engine 4ZZ-FE	608015	Inner Joint		23	23	34	61	116	
	2000.02-2002.01	-	L	F	Hatchback Engine 4ZZ-FE	208016	Drive Shaft		26	23	56	96.5	599.5	
	2000.02-2002.01	-	-	F	Hatchback Engine 4ZZ-FE	859021	Outer Joint	48T	26	23	56	96.5	55	I
1.6 (81 kW)	1997.04-2000.02	-	L	F	Hatchback Engine 4A-FE	608015	Inner Joint		23	23	34	61	116	
	1997.04-2000.02	-	L	F	Hatchback Engine 4A-FE	208016	Drive Shaft		26	23	56	96.5	599.5	
	1997.04-2000.02	-	-	F	Hatchback Engine 4A-FE	859005	Outer Joint		26	23	56	95.5	55	I
	1997.04-2000.02	-	-	F	Hatchback Engine 4A-FE	859128	Outer Joint	48T	26	23	56	95.5	55	I
	1997.04-2000.02	-	-	F	Hatchback Engine 4A-FE	859021	Outer Joint	48T	26	23	56	96.5	55	I
	1997.04-2000.02	MT	L/R	F	Hatchback Engine 4A-FE	859006	Outer Joint	48T	26	23	56	95.5	55	I
	1997.04-2000.02	MT	L/R	F	Hatchback Engine 4A-FE	859020	Outer Joint		26	23	56	96.5	55	I
	1997.04-2000.02	MT	L/R	F	Hatchback Engine 4A-FE	859028	Outer Joint	48T	26	22	56	99	61	M
	2000.02-2002.01	-	L	F	Hatchback Engine 3ZZ-FE	608015	Inner Joint		23	23	34	61	116	
	2000.02-2002.01	-	L	F	Hatchback Engine 3ZZ-FE	208016	Drive Shaft		26	23	56	96.5	599.5	
2000.02-2002.01	-	-	F	Hatchback Engine 3ZZ-FE	859021	Outer Joint	48T	26	23	56	96.5	55	I	
2000.02-2002.01	AT	L	F	Hatchback Engine 3ZZ-FE	259072	Drive Shaft	48T	26	23	58	96	633.5		
1.6 Aut. (79 kW)	1997.04-2000.02	-	L	F	Hatchback Engine 4A-FE	608015	Inner Joint		23	23	34	61	116	
	1997.04-2000.02	-	L	F	Hatchback Engine 4A-FE	208016	Drive Shaft		26	23	56	96.5	599.5	
	1997.04-2000.02	-	-	F	Hatchback Engine 4A-FE	859005	Outer Joint		26	23	56	95.5	55	I
	1997.04-2000.02	-	-	F	Hatchback Engine 4A-FE	859128	Outer Joint	48T	26	23	56	95.5	55	I
	1997.04-2000.02	-	-	F	Hatchback Engine 4A-FE	859021	Outer Joint	48T	26	23	56	96.5	55	I
	1997.04-2000.02	AT	L/R	F	Hatchback Engine 4A-FE	859006	Outer Joint	48T	26	23	56	95.5	55	I
2.0 D (53 kW)	1997.04-2000.02	AT	L/R	F	Hatchback Engine 4A-FE	859020	Outer Joint		26	23	56	96.5	55	I
	1997.04-2000.02	MT	-	F	Hatchback Engine 2C-E	859120	Outer Joint	48T	26	24	56	95.5	55	I
2.0 D-4D (66 kW)	1997.04-2000.02	MT	L	F	Hatchback Engine 2C-E	659005	Inner Joint		20	23	35	63.5	115.7	
	2000.09-2002.01	-	-	-	Hatchback Engine 1CD-FTV	859003	Outer Joint		26	25	56	95.6	61	M
COROLLA Liftback (_E9_)														
1.3 i (55 kW)	1987.08-1992.04	-	-	F	Hatchback Engine 2E/2E-E	859005	Outer Joint		26	23	56	95.5	55	I
	1987.08-1992.04	-	-	-	Hatchback Engine 2E/2E-E	859062	Outer Joint		26	24	56	95.5	55	I
	1987.08-1992.04	AT/MT	L/R	F	Hatchback Engine 2E/2E-E	859006	Outer Joint	48T	26	23	56	95.5	55	I
	1987.08-1992.04	AT/MT	L/R	F	Hatchback Engine 2E/2E-E	859020	Outer Joint		26	23	56	96.5	55	I
1.6 (66 kW)	1987.08-1992.04	MT	R	F	Hatchback Engine 4A-F	208017	Drive Shaft		26	23	56	96.5	910	
	1987.08-1992.04	AT	L/R	F	Hatchback Engine 4A-F	822001	Outer Joint		26	23	56	96.5	55	I
	1987.08-1992.04	MT	L/R	F	Hatchback Engine 4A-F	859001	Outer Joint		26	24	56	95.5	55	I
	1987.08-1992.04	-	-	F	Hatchback Engine 4A-F	859005	Outer Joint		26	23	56	95.5	55	I
	1987.08-1992.04	-	-	-	Hatchback Engine 4A-F	859062	Outer Joint		26	24	56	95.5	55	I
	1987.08-1992.04	AT	L/R	F	Hatchback Engine 4A-F	859006	Outer Joint	48T	26	23	56	95.5	55	I
	1987.08-1992.04	AT	L/R	F	Hatchback Engine 4A-F	859020	Outer Joint		26	23	56	96.5	55	I
	1987.08-1992.04	MT	R	F	Hatchback Engine 4A-F	608015	Inner Joint		23	23	34	61	116	
1.6 (70 kW)	1987.08-1992.04	MT	R	F	Hatchback Engine 4A-F	208017	Drive Shaft		26	23	56	96.5	910	
	1987.08-1992.04	AT	L/R	F	Hatchback Engine 4A-F	822001	Outer Joint		26	23	56	96.5	55	I
	1987.08-1992.04	-	-	F	Hatchback Engine 4A-F	859005	Outer Joint		26	23	56	95.5	55	I

	 YEAR	TRANSM	L/R	F/R	REMARKS	GSP Ref.	 PRODUCT	 ABS	Technical Specifications					
									A	B	C	H	L	P
TOYOTA														
COROLLA Liftback (_E9_)														
1.6 (70 kW)	1987.08-1992.04	-	-	-	Hatchback Engine 4A-F	859062	Outer Joint		26	24	56	95.5	55	I
	1987.08-1992.04	MT	L/R	F	Hatchback Engine 4A-F	859001	Outer Joint		26	24	56	95.5	55	I
	1987.08-1992.04	AT	L/R	F	Hatchback Engine 4A-F	859006	Outer Joint	48T	26	23	56	95.5	55	I
	1987.08-1992.04	AT	L/R	F	Hatchback Engine 4A-F	859020	Outer Joint		26	23	56	96.5	55	I
	1987.08-1992.04	MT	R	F	Hatchback Engine 4A-F	608015	Inner Joint		23	23	34	61	116	
1.6 (77 kW)	1989.08-1992.04	-	-	F	Hatchback Engine 4A-FE	859337	Outer Joint		26	29	56	96	54	O
	1989.08-1992.04	MT	R	F	Hatchback Engine 4A-FE	208017	Drive Shaft		26	23	56	96.5	910	
	1989.08-1992.04	AT	L/R	F	Hatchback Engine 4A-FE	822001	Outer Joint		26	23	56	96.5	55	I
	1989.08-1992.04	MT	L/R	F	Hatchback Engine 4A-FE	859001	Outer Joint		26	24	56	95.5	55	I
	1989.08-1992.04	-	-	F	Hatchback Engine 4A-FE	859005	Outer Joint		26	23	56	95.5	55	I
	1989.08-1992.04	AT	L/R	F	Hatchback Engine 4A-FE	859006	Outer Joint	48T	26	23	56	95.5	55	I
	1989.08-1992.04	AT	L/R	F	Hatchback Engine 4A-FE	859020	Outer Joint		26	23	56	96.5	55	I
	1989.08-1992.04	MT	R	F	Hatchback Engine 4A-FE	608015	Inner Joint		23	23	34	61	116	
1.6 GTI (92 kW)	1989.09-1992.05	-	R	F	All-wheel Drive Hatchback Engine 4A-FE	659160	Inner Joint		23	23	36	75	93	
	1987.07-1993.06	-	-	F	Hatchback Engine 4A-GE	859120	Outer Joint	48T	26	24	56	95.5	55	I
	1987.07-1993.06	-	-	F	Sloping back	899122	Outer Joint		26	24	56	96	56	I
	1987.07-1993.06	AT/MT	L/R	F	Hatchback Engine 4A-GE	821001	Outer Joint		26	29	56	96	62	O
	1987.07-1993.06	-	-	-	Hatchback Engine 4A-GE	859062	Outer Joint		26	24	56	95.5	55	I
1.8 D (47 kW)	1987.07-1993.06	-	-	-	Hatchback Engine 4A-GE	859063	Outer Joint		26	29	56	99.5	62.5	O
	1987.08-1992.04	-	-	F	Sloping back	899122	Outer Joint		26	24	56	96	56	I
	1987.08-1992.04	MT	L/R	F	Hatchback Engine 1C	859001	Outer Joint		26	24	56	95.5	55	I
	1987.08-1992.04	-	L	F	Hatchback Engine 1C	659005	Inner Joint		20	23	35	63.5	115.7	
1.8 D (49 kW)	1987.08-1992.04	-	-	-	Hatchback Engine 1C	859062	Outer Joint		26	24	56	95.5	55	I
	1989.08-1992.04	-	-	F	Sloping back	899122	Outer Joint		26	24	56	96	56	I
	1989.08-1992.04	MT	L/R	F	Hatchback Engine 1C	859001	Outer Joint		26	24	56	95.5	55	I
	1989.08-1992.04	-	L	F	Hatchback Engine 1C	659005	Inner Joint		20	23	35	63.5	115.7	
1989.08-1992.04	-	-	-	Hatchback Engine 1C	859062	Outer Joint		26	24	56	95.5	55	I	
COROLLA RUMION E152														
1800	2007.10-2009.12	CVT	-	-	Engine 2ZRFE	859386	Outer Joint		26	25	55.6	95.5	57	M
	2009.12-	CVT	-	-	Engine 2ZRFAE	859386	Outer Joint		26	25	55.6	95.5	57	M
COROLLA RUMION E154														
1800	2007.10-2009.12	CVT	-	-	Allwheel Drive Engine 2ZRFE	859386	Outer Joint		26	25	55.6	95.5	57	M
	2009.12-	CVT	-	-	Allwheel Drive Engine 2ZRFAE	859386	Outer Joint		26	25	55.6	95.5	57	M
COROLLA SPACIO E122														
1800	2001.05-2007.06	4AT	-	-	Engine 1ZZFE	859460	Outer Joint	48T	26	24	58	96	54	I
COROLLA SPACIO E124														
1800	2001.08-2007.06	4AT	-	-	Allwheel Drive Engine 1ZZFE	859460	Outer Joint	48T	26	24	58	96	54	I
COROLLA SPRINTER AE92														
1.6	1987.05-1991.01	MT	-	-	Engine 4AGZE	859070	Outer Joint		26	26	56	100	63	M
	1987.05-1991.01	MT	-	-	Engine 4AGZE	851046	Outer Joint	48T	26	26	56	100	63	M
	1991.01-1991.06	MT	-	-	Engine 4AGZE	859070	Outer Joint		26	26	56	100	63	M
	1991.01-1991.06	MT	-	-	Engine 4AGZE	851046	Outer Joint	48T	26	26	56	100	63	M
1600	1987.05-1991.01	MT	-	-	Engine 4AGZE	859070	Outer Joint		26	26	56	100	63	M
	1987.05-1991.01	MT	-	-	Engine 4AGZE	851046	Outer Joint	48T	26	26	56	100	63	M
	1991.01-1991.06	MT	-	-	Engine 4AGZE	859070	Outer Joint		26	26	56	100	63	M
	1991.01-1991.06	MT	-	-	Engine 4AGZE	851046	Outer Joint	48T	26	26	56	100	63	M
COROLLA Station Wagon (_E9_)														
1.3 (55 kW)	1987.12-1992.06	-	-	F	Estate Engine 2E	859005	Outer Joint		26	23	56	95.5	55	I
	1987.12-1992.06	-	-	-	Estate Engine 2E	859062	Outer Joint		26	24	56	95.5	55	I
	1987.12-1992.06	AT/MT	L/R	F	Estate Engine 2E	859006	Outer Joint	48T	26	23	56	95.5	55	I
	1987.12-1992.06	AT/MT	L/R	F	Estate Engine 2E	859020	Outer Joint		26	23	56	96.5	55	I
1.6 (66 kW)	1988.02-1992.05	MT	R	F	Estate Engine 4A-F	208017	Drive Shaft		26	23	56	96.5	910	
	1988.02-1992.05	-	-	F	Estate Engine 4A-F	859005	Outer Joint		26	23	56	95.5	55	I
	1988.02-1992.05	-	-	-	Estate Engine 4A-F	859062	Outer Joint		26	24	56	95.5	55	I
	1988.02-1992.05	MT	R	F	Estate Engine 4A-F	608015	Inner Joint		23	23	34	61	116	
1.6 (70 kW)	1987.12-1992.04	MT	R	F	Estate Engine 4A-F	208017	Drive Shaft		26	23	56	96.5	910	
	1987.12-1992.04	-	-	F	Estate Engine 4A-F	859005	Outer Joint		26	23	56	95.5	55	I
	1987.12-1992.04	-	-	-	Estate Engine 4A-F	859062	Outer Joint		26	24	56	95.5	55	I
	1987.12-1992.04	MT	R	F	Estate Engine 4A-F	608015	Inner Joint		23	23	34	61	116	
	1988.02-1992.08	-	-	-	All-wheel Drive Estate Engine 4A-F	859062	Outer Joint		26	24	56	95.5	55	I
	1988.02-1992.08	-	R	F	All-wheel Drive Estate Engine 4A-F	659160	Inner Joint		23	23	36	75	93	
1.6 XLI (77 kW)	1988.08-1992.06	-	-	F	All-wheel Drive Estate Engine 4A-FE	859120	Outer Joint	48T	26	24	56	95.5	55	I
	1988.08-1992.06	MT	L/R	F	All-wheel Drive Estate Engine 4A-FE	859006	Outer Joint	48T	26	23	56	95.5	55	I
	1988.08-1992.06	MT	L/R	F	All-wheel Drive Estate Engine 4A-FE	859020	Outer Joint		26	23	56	96.5	55	I
	1988.08-1992.06	-	R	F	All-wheel Drive Estate Engine 4A-FE	659160	Inner Joint		23	23	36	75	93	
	1989.11-1992.06	-	-	F	Estate Engine 4A-FE	859337	Outer Joint		26	29	56	96	54	O

YEAR	TRANSM	L/R	F/R	REMARKS	GSP Ref.	PRODUCT	ABS	Technical Specifications						
								A	B	C	H	L	P	
TOYOTA														
COROLLA Station Wagon (_E9_)														
1.6 XLI (77 kW)	1989.11-1992.06	MT	R	F	Estate Engine 4A-FE	208017	Drive Shaft		26	23	56	96.5	910	
	1989.11-1992.06	MT	L/R	F	Estate Engine 4A-FE	859006	Outer Joint	48T	26	23	56	95.5	55	I
	1989.11-1992.06	MT	L/R	F	Estate Engine 4A-FE	859020	Outer Joint		26	23	56	96.5	55	I
	1989.11-1992.06	MT	R	F	Estate Engine 4A-FE	608015	Inner Joint		23	23	34	61	116	
1.6 XLI (81 kW)	1989.08-1995.07	-	R	F	All-wheel Drive Estate Engine 4A-FE	659160	Inner Joint		23	23	36	75	93	
1.8 D (47 kW)	1987.12-1992.06	-	-	F	wagon	899122	Outer Joint		26	24	56	96	56	I
	1987.12-1992.06	MT	L/R	F	Estate Engine 1C	859001	Outer Joint		26	24	56	95.5	55	I
	1987.12-1992.06	-	L	F	Estate Engine 1C	659005	Inner Joint		20	23	35	63.5	115.7	
	1987.12-1992.06	-	-	-	Estate Engine 1C	859062	Outer Joint		26	24	56	95.5	55	I
1.8 D (49 kW)	1989.08-1992.06	-	-	F	wagon	899122	Outer Joint		26	24	56	96	56	I
	1989.08-1992.06	MT	L/R	F	Estate Engine 1C	859001	Outer Joint		26	24	56	95.5	55	I
	1989.08-1992.06	-	L	F	Estate Engine 1C	659005	Inner Joint		20	23	35	63.5	115.7	
	1989.08-1992.06	-	-	-	Estate Engine 1C	859062	Outer Joint		26	24	56	95.5	55	I
COROLLA Verso (ZER_ ZZE12_ R1_)														
1.6 (81 kW)	2004.04-2009.03	-	R	F	MPV Engine 3ZZ-FE	259531	Drive Shaft	48T	26	20	63	95.5	924	
1.8 (95 kW)	2004.04-2009.03	AT	L/R	F	MPV Engine 1ZZ-FE	859153	Outer Joint	48T	26	24	58	96	52.5	I
	2004.04-2009.03	-	-	-	MPV Engine 1ZZ-FE	859047	Outer Joint		26	24	58	96	52.5	I
	2004.04-2009.03	Semi-AT/MT	R	F	MPV Engine 1ZZ-FE	259531	Drive Shaft	48T	26	20	63	95.5	924	
	2004.04-2009.03	-	L	-	MPV Engine 1ZZ-FE	259505	Drive Shaft	48T	26	20	63	95.5	650	
2.0 D-4D (85 kW)	2004.04-2009.03	-	-	F	MPV Engine 1CD-FTV	859317	Outer Joint	48T	26	26	63	96	65	M
2.2 D-4D (100 kW)	2005.10-2009.03	-	-	F	MPV Engine 2AD-FTV	859233	Outer Joint	48T	30	36	63	99	67	I
	2005.10-2009.03	-	L/R	F	MPV Engine 2AD-FTV	859528	Outer Joint		26	32	61.2	96.5	54.5	I
	2005.10-2009.03	MT	R	F	MPV Engine 2AD-FTV	259446	Drive Shaft	48T	30	24	63	99	976	
	2005.10-2009.03	-	-	F	MPV Engine 2AD-FTV	899319	Outer Joint	48T	30	27	63.4	99	64	I
2.2 D-4D (130 kW)	2005.10-2009.03	-	-	F	MPV Engine 2AD-FHV	859233	Outer Joint	48T	30	36	63	99	67	I
	2005.10-2009.03	-	L/R	F	MPV Engine 2AD-FHV	859528	Outer Joint		26	32	61.2	96.5	54.5	I
	2005.10-2009.03	MT	R	F	MPV Engine 2AD-FHV	259446	Drive Shaft	48T	30	24	63	99	976	
	2005.10-2009.03	-	-	F	MPV Engine 2AD-FHV	899319	Outer Joint	48T	30	27	63.4	99	64	I
COROLLA Verso (_E12_)														
1.6 VVT-i (81 kW)	2002.01-2004.05	MT	L/R	F	MPV Engine 3ZZ-FE	859153	Outer Joint	48T	26	24	58	96	52.5	I
	2002.01-2004.05	-	-	-	MPV Engine 3ZZ-FE	859130	Outer Joint	48T	26	23	58	96	54	I
1.8 VVT-i (99 kW)	2002.01-2004.05	-	-	F	MPV Engine 1ZZ-FE	859459	Outer Joint	48T	26	23	58	96	54	I
	2002.01-2004.05	AT/MT	L/R	F	MPV Engine 1ZZ-FE	859153	Outer Joint	48T	26	24	58	96	52.5	I
	2002.01-2004.05	-	-	F	MPV Engine 1ZZ-FE	859047	Outer Joint		26	24	58	96	52.5	I
	2002.01-2004.05	-	R	F	MPV Engine 1ZZ-FE	659004	Inner Joint		20	23	35	363	100.5	
	2002.01-2004.05	-	-	-	MPV Engine 1ZZ-FE	699038	Inner Joint		23	23	34	60	113	
2.0 D-4D (66 kW)	2002.01-2004.05	MT	L	F	MPV Engine 1CD-FTV	659073	Inner Joint		24	27	50	67	110	
	2002.01-2004.05	MT	-	F	MPV Engine 1CD-FTV	859182	Outer Joint	48T	26	25	58	95.5	61.5	M
	2002.01-2004.05	MT	R	F	MPV Engine 1CD-FTV	659078	Inner Joint		24	27	40	370	105	
COROLLA ZZE122														
1.8	2000.08-2001.02	4AT	-	-	Engine 1ZZFE	859460	Outer Joint	48T	26	24	58	96	54	I
	2000.08-2001.02	4AT	-	-	Engine 1ZZFE	859460	Outer Joint	48T	26	24	58	96	54	I
1800	2000.08-2001.02	4AT	-	-	Engine 1ZZFE	859460	Outer Joint	48T	26	24	58	96	54	I
	2001.02-2001.02	4AT	-	-	Engine 1ZZFE	859460	Outer Joint	48T	26	24	58	96	54	I
COROLLA II TERCEL CORSA EL51														
1300	1994.09-1999.08	MT/AT	-	-	Engine 4EFE	859395	Outer Joint		26	22	56	95.5	53	I
	1994.09-1999.08	MT/AT	-	-	Engine 4EFE	859395	Outer Joint		26	22	56	95.5	53	I
	1994.09-1999.08	MT/AT	-	-	Engine 4EFE	859395	Outer Joint		26	22	56	95.5	53	I
COROLLA II TERCEL CORSA EL53														
1500	1994.09-1999.08	MT/AT	-	-	Engine 4EFE	859395	Outer Joint		26	22	56	95.5	53	I
	1994.09-1999.08	MT/AT	-	-	Engine 5EFE	859395	Outer Joint		26	22	56	95.5	53	I
COROLLA(AE10_,CE10_,EE10_)														
2.0	1991.06-2002.05	AT/MT	L	F	Engine DIESEL,BODY:WAGON	259196	Drive Shaft	48T	26	20	56	95.5	609	
2.2	1991.06-2002.05	AT/MT	L	F	Engine DIESEL EFI,BODY:WAGON/VAN	259196	Drive Shaft	48T	26	20	56	95.5	609	
COROLLA(AE111,CDE110,CE110,EE111,WZE110,ZZE11_)														
2.2	1997.05-2001.10	MT	-	-	Engine DIESEL EFI,BODY:HATCHBACK/LIFTBACK	259196	Drive Shaft	48T	26	20	56	95.5	609	
COROLLA(AE11_,CDE110,CE110,EE11_,WZE110,ZZE11_)														
2.2	1997.05-2001.08	MT	L	F	Engine DIESEL EFI,BODY:SEDAN/WAGON	259196	Drive Shaft	48T	26	20	56	95.5	609	
COROLLA(AE11_,CE11_,EE11_)														
2.0	1995.05-2000.07	AT/MT	L	F	Engine DIESEL,BODY:SEDAN	259196	Drive Shaft	48T	26	20	56	95.5	609	
2.2	1995.05-2000.07	AT/MT	L	F	Engine DIESEL EFI,BODY:SEDAN	259196	Drive Shaft	48T	26	20	56	95.5	609	
COROLLA,MATRIX														
1.8	2002.01-2004.04	5MT	L	F	ENGINE:1ZZFE/ZZE130	259018	Drive Shaft		26	20	56	96	636	
	2004.05-2007.12	4AT	L	F	ENGINE:1ZZFE/ZZE130	859265	Outer Joint	48T	26	29	56	96	63	M
	2004.05-2007.12	4AT	L	F	ENGINE:1ZZFE/ZZE130	259274	Drive Shaft	48T	26	20	56	96	636	

	 YEAR	TRANSM	L/R	F/R	REMARKS	GSP Ref.	 PRODUCT	 ABS	Technical Specifications					
									A	B	C	H	L	P
TOYOTA														
COROLLA/DX/LE/SR5 (2WD)														
-	1993-2000	-	-	-	-	859163	Outer Joint	48T	26	29	56	99.5	62.5	O
COROLLA/SPRINTER (AE92)														
1.6	1987.05-1991.06	MT	-	-	Engine 4AGZE	859070	Outer Joint		26	26	56	100	63	M
COROLLA/SPRINTER (CDE120 DSL)														
2.0	2001-	MT/AT	-	-	Engine 1CDFTV	859294	Outer Joint	48T	26	27	63	97	60	M
COROLLAII TERCEL CORSA II EL51														
1.3	1994.09-1999.08	MT/AT	-	-	Engine 4EFE	859395	Outer Joint		26	22	56	95.5	53	I
	1994.09-1999.08	MT/AT	-	-	Engine 4EFE	859395	Outer Joint		26	22	56	95.5	53	I
	1994.09-1999.08	MT/AT	-	-	Engine 4EFE	859395	Outer Joint		26	22	56	95.5	53	I
COROLLAII TERCEL CORSA II EL53														
1.5	1994.09-1999.08	MT/AT	-	-	Engine 5EFE	859395	Outer Joint		26	22	56	95.5	53	I
	1994.09-1999.08	MT/AT	-	-	Engine 4EFE	859395	Outer Joint		26	22	56	95.5	53	I
CORONA														
-	1987-	-	-	-	-	899111	Outer Joint		26	24	56	95.5	55	I
2.0	1993-1997	-	R	F	-	659105	Inner Joint		20	23	35	363	100.5	
CORONA (_T17_)														
2.0 D (54 kW)	1987.12-1992.01	-	L	F	Saloon Engine 2C	659005	Inner Joint		20	23	35	63.5	115.7	
CORONA (_T19_)														
2.0 (99 kW)	1992.02-1996.01	-	R	F	All-wheel Drive Saloon Engine 3S-FE	659160	Inner Joint		23	23	36	75	93	
2.0 D (54 kW)	1992.08-1996.01	-	L	F	Saloon Engine 2C	659005	Inner Joint		20	23	35	63.5	115.7	
CORONA Saloon (_T19_)														
2.0 D (54 kW)	1992.08-1996.01	MT	-	R	All-wheel Drive Saloon Engine 2C	639089	Inner Joint			20		68.6		
	1992.08-1996.01	MT	-	F	All-wheel Drive Saloon Engine 2C	859120	Outer Joint	48T	26	24	56	95.5	55	I
CORSA														
1.3 (65 kW)	1994.11-1999.09	-	-	F	Hatchback Engine 4E-FE	699046	Inner Joint		23	23	34	60	103.5	
	1994.11-1999.09	-	-	F	Saloon Engine 4E-FE	699046	Inner Joint		23	23	34	60	103.5	
	1994.11-1999.09	-	-	F	Hatchback Engine 4E-FE	859023	Outer Joint		26	23	56	96.5	55	I
	1994.11-1999.09	-	-	F	Hatchback Engine 4E-FE	859017	Outer Joint		26	22	56	95	50	M
	1994.11-1999.09	-	-	F	Saloon Engine 4E-FE	859017	Outer Joint		26	22	56	95	50	M
1.5 (70 kW)	1994.11-1999.09	-	L/R/F/R	F	Hatchback Engine 5E-FE	839105	Outer Joint	44T	25	22	52.5	95	58	M
	1994.11-1999.09	-	L/R/F/R	F	Saloon Engine 5E-FE	839105	Outer Joint	44T	25	22	52.5	95	58	M
	1994.11-1999.09	-	-	F	Hatchback Engine 5E-FE	699046	Inner Joint		23	23	34	60	103.5	
	1994.11-1999.09	-	-	F	Saloon Engine 5E-FE	699046	Inner Joint		23	23	34	60	103.5	
1.5 D (40 kW)	1994.11-1999.09	-	-	F	Hatchback Engine 1N	699046	Inner Joint		23	23	34	60	103.5	
	1994.11-1999.09	-	-	F	Saloon Engine 1N	699046	Inner Joint		23	23	34	60	103.5	
	1994.11-1999.09	-	-	F	Hatchback Engine 1N	859017	Outer Joint		26	22	56	95	50	M
CORSA (_L4_)														
1.3 (65 kW)	1990.10-1994.10	-	-	F	Saloon Engine 4E-FE	699046	Inner Joint		23	23	34	60	103.5	
	1990.10-1994.10	-	-	F	Saloon Engine 4E-FE	859023	Outer Joint		26	23	56	96.5	55	I
	1990.10-1994.10	-	-	F	Saloon Engine 4E-FE	859017	Outer Joint		26	22	56	95	50	M
	1990.10-1994.10	-	-	F	Saloon Engine 4E-FE	859177	Outer Joint	48T	26	23	56	95.5	55	I
	1990.10-1994.10	-	-	-	Saloon Engine 4E-FE	859194	Outer Joint		26	22	56	96.5	55	I
	1990.10-1994.10	-	-	-	Saloon Engine 4E-FE	859197	Outer Joint		26	22	56	100.5	55	I
	1990.10-1994.10	-	-	-	Saloon Engine 4E-FE	659023	Inner Joint		23	23	34	60	113	
CROWN (CRS_ JZS_ GRS18_ UZS_)														
3.0 (188 kW)	2003.09-2008.02	AT	-	F	All-wheel Drive Saloon Engine 3GR-FSE	859453	Outer Joint		30	30	57	82	55.5	I
CURREN (ST20_)														
2.0 (129 kW)	1993.11-1998.10	-	-	F	Coupe Engine 3S-GE	859002	Outer Joint	48T	26	25	56	96	62	I
	1993.11-1998.10	-	L	F	Coupe Engine 3S-GE	699040	Inner Joint		20	25	35	63.5	112	
	1993.11-1996.10	-	R	F	All-wheel Drive Coupe Engine 3S-GE	659160	Inner Joint		23	23	36	75	93	
CURREN ST206														
2.0	1994.01-1998.07	MT/AT	-	-	Engine 3SGE	859426	Outer Joint	48T	26	25	56	95.6	61	M
2000	1994.01-1998.07	MT/AT	-	-	Engine 3SGE	859426	Outer Joint	48T	26	25	56	95.6	61	M
DUET (M101A)														
1.3	2000.05-2004.05	4AT	-	-	Engine K3VE2/K3VE	859423	Outer Joint		24	21	47	85.5	47.5	M
	2000.05-2004.05	5MT	-	-	Engine K3VE2/K3VE	859423	Outer Joint		24	21	47	85.5	47.5	M
DUET M101A														
1300	2000.05-	MT/AT	-	-	Engine K3VE	859423	Outer Joint		24	21	47	85.5	47.5	M
	2000.05-	MT/AT	-	-	Engine K3VE	859423	Outer Joint		24	21	47	85.5	47.5	M
	2000.05-2004.05	5MT	-	-	Engine K3VE2	859423	Outer Joint		24	21	47	85.5	47.5	M
	2000.05-2004.05	5MT	-	-	Engine K3VE2	859423	Outer Joint		24	21	47	85.5	47.5	M
	2000.05-2004.05	5MT	-	-	Engine K3VE2	859423	Outer Joint		24	21	47	85.5	47.5	M
	2000.05-2004.05	4AT	-	-	Engine K3VE2	859423	Outer Joint		24	21	47	85.5	47.5	M
	2000.05-2004.05	4AT	-	-	Engine K3VE2	859423	Outer Joint		24	21	47	85.5	47.5	M
	2000.05-2004.05	4AT	-	-	Engine K3VE2	859423	Outer Joint		24	21	47	85.5	47.5	M
	2001.12-2004.05	5MT	-	-	Engine K3VE	859423	Outer Joint		24	21	47	85.5	47.5	M

TOYOTA	YEAR	TRANSM	L/R	F/R	REMARKS	GSP Ref.	PRODUCT	ABS	Technical Specifications												
									A	B	C	H	L	P							
DUET M101A																					
1300	2001.12-	2004.05	5MT	-	-	Engine K3VE	859423	Outer Joint		24	21	47	85.5	47.5	M						
	2001.12-	2004.05	5MT	-	-	Engine K3VE	859423	Outer Joint		24	21	47	85.5	47.5	M						
	2001.12-	2004.05	4AT	-	-	Engine K3VE	859423	Outer Joint		24	21	47	85.5	47.5	M						
	2001.12-	2004.05	4AT	-	-	Engine K3VE	859423	Outer Joint		24	21	47	85.5	47.5	M						
DUET M111A																					
1300	2000.05-	-	MT/AT	-	-	Allwheel Drive Engine K3VE	859423	Outer Joint		24	21	47	85.5	47.5	M						
	2000.05-	-	MT/AT	-	-	Allwheel Drive Engine K3VE	859423	Outer Joint		24	21	47	85.5	47.5	M						
	2000.05-	2004.05	4AT/5MT	-	-	Allwheel Drive Engine K3VE2	859423	Outer Joint		24	21	47	85.5	47.5	M						
	2000.05-	2004.05	4AT/5MT	-	-	Allwheel Drive Engine K3VE2	859423	Outer Joint		24	21	47	85.5	47.5	M						
	2001.12-	2004.05	4AT/5MT	-	-	Allwheel Drive Engine K3VE	859423	Outer Joint		24	21	47	85.5	47.5	M						
	2001.12-	2004.05	4AT/5MT	-	-	Allwheel Drive Engine K3VE	859423	Outer Joint		24	21	47	85.5	47.5	M						
ECHO (_P1_)																					
1.5 (78 kW)	1999.08-	2005.08	-	-	F	Saloon Engine 1N3-FE	699046	Inner Joint		23	23	34	60	103.5							
ESQUIRE, NOAH, VOXY																					
2.0	2014.01-	-	CVT	L	F	ENGINE:3ZRFAE/JAPAN	259691	Drive Shaft	48T	26	24	61.2	100	620							
	2014.01-	-	CVT	L	F	ENGINE:3ZRFAE/JAPAN	859439	Outer Joint		26	27	61.2	100	59.5	I						
	2014.01-	-	CVT	L	F	ENGINE:3ZRFAE/JAPAN	659125	Inner Joint		24	27	50	67	109.5							
ESQUIRE,NOAH,VOXY																					
2.0	2014.01-	-	CVT	R	F	ENGINE:3ZRFAE/ZRR80	259619	Drive Shaft	48T	26	24	61.2	100	949							
ESTIMA																					
-	-	-	-	R	-	MCR 30	259161	Drive Shaft	48T	30	24	63	100.5	975							
	-	-	-	L	-	MCR 30	259162	Drive Shaft	48T	30	24	63	100.5	655							
2.4	-	-	-	-	-	-	659022	Inner Joint		24	27	50	67	104							
	-	-	-	-	-	-	659027	Inner Joint		24	27	40	369	99.5							
	-	-	-	L	-	-	259051	Drive Shaft	48T	26	24	63	100	662							
	-	-	-	R	-	-	259064	Drive Shaft	48T	26	24	63	100	961							
3.5	2006.01-	2008.11	6AT	L	F	ENGINE:2GRFE/GSR50	259610	Drive Shaft		30	24	61.2	100	648							
	2006.01-	2008.11	6AT	R	F	ENGINE:2GRFE/GSR50	259608	Drive Shaft		30	24	61.2	100	985							
	2012.04-	-	6AT	R	F	ENGINE: 2GRFE/GSR55	259370	Drive Shaft		30	24	61.2	100	994							
ESTIMA (CR50W)																					
2.4	2006.01-	-	CVT	-	-	Engine 2AZFE	859383	Outer Joint		26	27	61.2	100	59.2	M						
	2006.01-	-	CVT	-	-	Engine 2ARFE	859383	Outer Joint		26	27	61.2	100	59.2	M						
ESTIMA (CR55W)																					
2.4 4WD	2006.01-	-	CVT	-	-	Engine 2AZFE	859383	Outer Joint		26	27	61.2	100	59.2	M						
ESTIMA (SR50W)																					
3.5	2006.01-	-	6AT	-	-	Engine 2GRFE	859321	Outer Joint		30	27	61.2	100	64.5	M						
ESTIMA (SR55W)																					
3.5	2006.01-	-	6AT	-	-	Engine 2GRFE	859321	Outer Joint		30	27	61.2	100	64.5	M						
3.5 4WD	2006.01-	-	6AT	-	-	Engine 2GRFE	859321	Outer Joint		30	27	61.2	100	64.5	M						
ESTIMA CR50W																					
2.4	2006.01-	-	CVT	-	-	Engine 2AZFE	859383	Outer Joint		26	27	61.2	100	59.2	M						
2400	2006.01-	-	CVT	-	-	Engine 2AZFE	859383	Outer Joint		26	27	61.2	100	59.2	M						
ESTIMA CR55W																					
2.4	2006.01-	-	CVT	-	-	Engine 2ARFE	859383	Outer Joint		26	27	61.2	100	59.2	M						
	2006.09-	-	CVT	-	-	Allwheel Drive Engine 2AZFE	859383	Outer Joint		26	27	61.2	100	59.2	M						
2400	2006.01-	-	CVT	-	-	Engine 2ARFE	859383	Outer Joint		26	27	61.2	100	59.2	M						
	2006.09-	-	CVT	-	-	Allwheel Drive Engine 2AZFE	859383	Outer Joint		26	27	61.2	100	59.2	M						
ESTIMA EMINA/LUCIDA (_R1_ _R2_)																					
2.4 (99 kW)	1990.05-	1999.12	-	-	F	All-wheel Drive MPV Engine 2TZ-FE	859089	Outer Joint		26	27	56	98	63	M						
ESTIMA EMINA/LUCIDA (_R1_ _R2_)																					
2.4(118 kW)	1993.09-	1999.12	-	L/R	F	All-wheel Drive MPV Engine 2TZ-FZE	899123	Outer Joint		26	27	56	98	68	I						
ESTIMA PREVIA (MCR30W)																					
3.0	1999.12-	-	-	-	-	Engine 1MZFE	859253	Outer Joint	48T	30	34	61	100	67	I						
	1999.12-	-	-	-	-	Engine 1MZFE	859254	Outer Joint	48T	30	27	63	100.5	64.5	I						
ESTIMA PREVIA (MCR40W)																					
3.0 4WD	1999.12-	-	4AT	-	-	Engine 1MZFE	859253	Outer Joint	48T	30	34	61	100	67	I						
	1999.12-	-	4AT	-	-	Engine 1MZFE	859254	Outer Joint	48T	30	27	63	100.5	64.5	I						
ESTIMA SR50W																					
3.5	2006.01-	-	6AT	-	-	Engine 2GRFE	859321	Outer Joint		30	27	61.2	100	64.5	M						
3500	2006.01-	-	6AT	-	-	Engine 2GRFE	859321	Outer Joint		30	27	61.2	100	64.5	M						
ESTIMA SR55W																					
3.5	2006.01-	-	6AT	-	-	Engine 2GRFE	859321	Outer Joint		30	27	61.2	100	64.5	M						
	2006.01-	-	6AT	-	-	Allwheel Drive Engine 2GRFE	859321	Outer Joint		30	27	61.2	100	64.5	M						
3500	2006.01-	-	6AT	-	-	Engine 2GRFE	859321	Outer Joint		30	27	61.2	100	64.5	M						
	2006.01-	-	6AT	-	-	Allwheel Drive Engine 2GRFE	859321	Outer Joint		30	27	61.2	100	64.5	M						

TOYOTA	YEAR	TRANSM	L/R	F/R	REMARKS	GSP Ref.	PRODUCT	ABS	Technical Specifications							
									A	B	C	H	L	P		
TOYOTA ETIOS,LIVA																
1.4	2014.01 -	-	5MT	R	F	ENGINE:1NDTV/NUK10	259588	Drive Shaft		26	20	55.6	95	896		
	2014.01 -	-	5MT	L	F	ENGINE:1NDTV/NUK10	259585	Drive Shaft		26	20	55.6	95	655		
EXIV ED ST202																
2.0	1993.09-1995.08		MT/AT	-	-	Engine 3SGE	859426	Outer Joint	48T	26	25	56	95.6	61	M	
2000	1993.09-1995.08		MT/AT	-	-	Engine 3SGE	859426	Outer Joint	48T	26	25	56	95.6	61	M	
FIELDER																
1.8	2002-2008		AT	-	-	-	659143	Inner Joint		23	23	34	60	112		
FORTUNER																
2.5	2011.09- -		-	R	F	ENGINE:2KDFTV	259534	Drive Shaft		30	30	72.3	116	630		
2.7	2011.07- -		-	R	F	ENGINE:2TRFE	259534	Drive Shaft		30	30	72.3	116	630		
	2013.08- -		-	R	F	ENGINE:2TRFE	259534	Drive Shaft		30	30	72.3	116	630		
3.0	2006.02-2008.09		-	R	F	ENGINE:1KDFTV	259534	Drive Shaft		30	30	72.3	116	630		
	2006.05-2008.09		-	R	F	ENGINE:5LE	259534	Drive Shaft		30	30	72.3	116	630		
	2013.08- -		-	R	F	ENGINE:1KDFTV	259534	Drive Shaft		30	30	72.3	116	630		
4.0	2008.1-2011.07		-	R	F	ENGINE:1GRFE	259534	Drive Shaft		30	30	72.3	116	630		
	2013.08- -		-	R	F	ENGINE:1GRFE	259534	Drive Shaft		30	30	72.3	116	630		
FORTUNER (_N15_ _N16_)																
2.7 (120 kW)	2016.01- -		-	R	F	Closed Off-Road Vehicle Engine 2TR-FE	659238	Inner Joint		30	28	47	76	137		
	2016.01- -		-	R	F	Closed Off-Road Vehicle Engine 2TR-FE	859496	Outer Joint		30	29	70	103.5	82.5	M	
2.7 (122 kW)	2015.05- -		-	R	F	All-wheel Drive Closed Off-Road Vehicle Engine 2TR-FE	659238	Inner Joint		30	28	47	76	137		
	2015.05- -		-	R	F	All-wheel Drive Closed Off-Road Vehicle Engine 2TR-FE	859496	Outer Joint		30	29	70	103.5	82.5	M	
	2015.05- -		-	R	F	Closed Off-Road Vehicle Engine 2TR-FE	659238	Inner Joint		30	28	47	76	137		
	2015.05- -		-	R	F	Closed Off-Road Vehicle Engine 2TR-FE	859496	Outer Joint		30	29	70	103.5	82.5	M	
4.0 (175 kW)	2015.11- -		-	R	F	Closed Off-Road Vehicle Engine 1GR-FE	659238	Inner Joint		30	28	47	76	137		
	2015.11- -		-	R	F	Closed Off-Road Vehicle Engine 1GR-FE	859496	Outer Joint		30	29	70	103.5	82.5	M	
GRANVIA (_H2_ _H1_)																
3.4 (140 kW)	1997.08-2004.12		AT	-	F	All-wheel Drive MPV Engine 5VZ-FE	859016	Outer Joint		26	27	60	162	65.5	M	
GS HYBRID																
3.5	2012.01-2015.09		-	R	F	GEN, LHD, 2GRFSE, ATM, 6FC;RL15LBETQH	631007	Inner Joint		23	30	35	358.5	171		
	2012.01-2015.09		-	R	F	GEN, LHD, 2GRFSE, ATM, 6FC;RL15LBETQH	259686	Drive Shaft		30	23	57	82	995		
	2015.10- -		-	R	F	STD, EUR, LHD, 2GRFKS, ATM;GRL16LBETQHW	631007	Inner Joint		23	30	35	358.5	171		
	2015.10- -		-	R	F	STD, EUR, LHD, 2GRFKS, ATM;GRL16LBETQHW	259686	Drive Shaft		30	23	57	82	995		
HARRIER																
2.2	1998-2003		-	L	-	-	259021	Drive Shaft	48T	26	24	56	99	663		
	1998-2003		-	R	-	-	259022	Drive Shaft	48T	26	24	56	99	957		
	1998-2003		-	L	-	-	859258	Outer Joint	48T	26	25	56	99	62	I	
	1998-2003		-	R	-	-	859258	Outer Joint	48T	26	25	56	99	62	I	
HARRIER (CU10W)																
3.0	1999.04-2003.02		4AT	-	-	Engine 1MZFE	859173	Outer Joint	48T	30	27	63.4	100	64.5	M	
HARRIER (HYBRID)																
2.5	2014.01- -		CVT	R	F	ENGINE:2ARFXE/JAPAN	259685	Drive Shaft		30	24	61.2	100	985		
	2014.01- -		CVT	R	F	ENGINE:2ARFXE/JAPAN	659206	Inner Joint		24	27	40	377	104.5		
HARRIER (SU35W/SU36W)																
3.5 4WD	2007.01-2008.12		5AT	-	F	Engine 2GR-FE	859305	Outer Joint	48T	30	26	61	100	68.5	M	
HARRIER (_U1_)																
3.0 (164 kW)	1998.03-2003.01		-	-	R	All-wheel Drive MPV Engine 1MZ-FE	639089	Inner Joint			20		68.6			
HARRIER (_U3_)																
2.4 (118 kW)	2003.02-2012.06		AT	L/R	F	MPV Engine 2AZ-FE	859175	Outer Joint	48T	26	27	63.3	100	59	M	
	2003.10-2012.06		AT	R	F	All-wheel Drive MPV Engine 2AZ-FE	859175	Outer Joint	48T	26	27	63.3	100	59	M	
3.0 (150 kW)	2003.10-2008.12		-	L	F	All-wheel Drive MPV Engine 1MZ-FE	659084	Inner Joint		23	27	50	62	108.5		
	2003.10-2008.12		-	R	F	All-wheel Drive MPV Engine 1MZ-FE	659079	Inner Joint		23	27	28	394	123		
3.5 (206 kW)	2005.04-2008.12		-	R	F	All-wheel Drive MPV Engine 2GR-FE	659192	Inner Joint		23	26	50	62	108.5		
	2005.04-2008.12		-	R	F	All-wheel Drive MPV Engine 2GR-FE	659191	Inner Joint		23	26	34	394	124		
	2005.04-2008.12		-	R	F	All-wheel Drive MPV Engine 2GR-FE	859175	Outer Joint	48T	26	27	63.3	100	59	M	
HARRIER SU35W																
3500	2007.01-2008.12		5AT	-	-	Allwheel Drive Engine 2GRFE	859305	Outer Joint	48T	30	26	61	100	68.5	M	
HARRIER SU36W																
3500	2007.01-2008.12		5AT	-	-	Allwheel Drive Engine 2GRFE	859305	Outer Joint	48T	30	26	61	100	68.5	M	
HARRIER(HYBRID)																
2.0	2013.12- -		CVT	R	F	ENGINE:3ZRFAE/ZSU65	259672	Drive Shaft		30	24	61.2	100	967		
	2013.12- -		CVT	L	F	ENGINE:3ZRFAE/ZSU60	259678	Drive Shaft		26	24	61.2	100	663		
	2013.12- -		CVT	R	R	ENGINE:3ZRFAE/ZSU65	259656	Drive Shaft		26	20	51.9	99.5	811		
HIACE																
-	2004.08-2013.12		-	-	R	HIACE KDH206V-SRPDY	259728	Stub Axle		30				760		
	2004.08-2013.12		-	-	R	HIACE KDH201V-RBMDY	259728	Stub Axle		30				760		





YEAR	TRANSM	L/R	F/R	REMARKS	GSP Ref.	PRODUCT	ABS	Technical Specifications								
								A	B	C	H	L	P			
TOYOTA																
HIACE																
-	2004.08-	2013.12	-	-	R	HIACE KDH201V-RFPDY	259728	Stub Axle		30					760	
	2004.08-	2013.12	-	-	R	HIACE KDH201K-ERPDI	259728	Stub Axle		30					760	
	2004.08-	2013.12	-	-	R	HIACE KDH206K-ERPDI	259728	Stub Axle		30					760	
	2004.08-	2013.12	-	-	R	HIACE KDH206K-FRPDI	259728	Stub Axle		30					760	
	2004.08-	2013.12	-	-	R	HIACE KDH201V-SRMDI	259728	Stub Axle		30					760	
	2004.08-	2013.12	-	-	R	HIACE KDH206V-SFPDI	259728	Stub Axle		30					760	
	2004.08-	2013.12	-	-	R	HIACE KDH201V-SMMDI	259728	Stub Axle		30					760	
	2004.08-	2013.12	-	-	R	HIACE TRH200K-FRMDK	259728	Stub Axle		30					760	
HIACE III Wagon (_H1_)																
2.4 D (55 kW)	1987.08-	1995.08	MT	-	F	All-wheel Drive Bus Engine 2L	859016	Outer Joint			26	27	60	162	65.5	M
2.4 D (57 kW)	1987.08-	2004.12	-	-	F	Bus Engine 2L	859016	Outer Joint			26	27	60	162	65.5	M
HIACE IV (LXH1_RZH1_LH1_)																
2.4 (85 kW)	1995.08-	1998.04	MT	-	F	All-wheel Drive Box Engine 2RZ-E	859016	Outer Joint			26	27	60	162	65.5	M
2.4 TD (66 kW)	1995.08-	2006.08	MT	-	F	All-wheel Drive Box Engine 2L-T	859016	Outer Joint			26	27	60	162	65.5	M
2.5 D-4D (65 kW)	2001.11-	2006.08	-	L/R	R	Box Engine 2KD-FTV	875002	Outer Joint	48T	30	24	63	108.5	74		I
2.5 D-4D (75 kW)	2001.11-	2006.08	MT	-	F	All-wheel Drive Box Engine 2KD-FTV	859016	Outer Joint		26	27	60	162	65.5		M
	2001.11-	2006.08	-	L/R	R	Box Engine 2KD-FTV	875002	Outer Joint	48T	30	24	63	108.5	74		I
2.5 D-4D (86 kW)	2006.09-	-	MT	-	F	All-wheel Drive Box Engine 2KD-FTV	859016	Outer Joint		26	27	60	162	65.5		M
	2006.09-	-	-	L/R	R	Box Engine 2KD-FTV	875002	Outer Joint	48T	30	24	63	108.5	74		I
2.7 (106 kW)	1998.04-	-	MT	-	F	All-wheel Drive Box Engine 3RZ-FE	859016	Outer Joint		26	27	60	162	65.5		M
HIACE IV (_H1_ _H2_)																
2.4 (85 kW)	1995.08-	1998.04	MT	-	F	All-wheel Drive Bus Engine 2RZ-E	859016	Outer Joint			26	27	60	162	65.5	M
2.4 D (58 kW)	1995.08-	2006.08	-	-	F	Bus Engine 2L	859016	Outer Joint			26	27	60	162	65.5	M
2.4 TD (66 kW)	1995.08-	2006.08	MT	-	F	All-wheel Drive Bus Engine 2L-T	859016	Outer Joint			26	27	60	162	65.5	M
2.5 D-4D (65 kW)	2001.11-	2006.08	-	L/R	R	Bus Engine 2KD-FTV	875002	Outer Joint	48T	30	24	63	108.5	74		I
2.5 D-4D (70 kW)	2001.08-	-	-	L/R	R	Bus Engine 2KD-FTV	875002	Outer Joint	48T	30	24	63	108.5	74		I
2.5 D-4D (75 kW)	2001.08-	2006.07	MT	-	F	All-wheel Drive Bus Engine 2KD-FTV	859016	Outer Joint		26	27	60	162	65.5		M
	2001.11-	2006.08	-	L/R	R	Bus Engine 2KD-FTV	875002	Outer Joint	48T	30	24	63	108.5	74		I
2.5 D-4D (86 kW)	2005.01-	-	MT	-	F	All-wheel Drive Bus Engine 2KD-FTV	859016	Outer Joint		26	27	60	162	65.5		M
	2006.08-	-	-	L/R	R	Bus Engine 2KD-FTV	875002	Outer Joint	48T	30	24	63	108.5	74		I
2.7 (105 kW)	1998.04-	2006.08	MT	-	F	All-wheel Drive Bus Engine 3RZ-FE	859016	Outer Joint		26	27	60	162	65.5		M
2.7 (106 kW)	1999.07-	-	MT	-	F	All-wheel Drive Bus Engine 3RZ-FE	859016	Outer Joint		26	27	60	162	65.5		M
HIACE V (TRH2_KDH2_)																
2.5 D-4D (70 kW)	2006.09-	-	-	L/R	R	Box Engine 2KD-FTV	875002	Outer Joint	48T	30	24	63	108.5	74		I
HIGHLANDER																
-	2012.05-	2015.02	-	R	F	ENGINE:3ARFE	659234	Inner Joint			24	27	40	377	104.5	
2.7	2009.05-	2012.04	-	R	F	ENGINE:1ARFE	859513	Outer Joint			30	27	61	100	65	I
	2009.05-	2012.04	-	L	F	ENGINE:1ARFE	859513	Outer Joint			30	27	61	100	65	I
	2009.05-	2012.04	-	R	F	ENGINE:1ARFE	659234	Inner Joint			24	27	40	377	104.5	
	2009.05-	2012.04	-	R	F	ENGINE:1ARFE	259597	Drive Shaft	48T	30	24	61	100	992		
	2009.05-	2012.04	-	L	F	ENGINE:1ARFE	259598	Drive Shaft	48T	30	24	61	100	673		
	2012.05-	2015.02	-	R	F	ENGINE:3ARFE	259597	Drive Shaft	48T	30	24	61	100	992		
	2012.05-	2015.02	-	L	F	ENGINE:3ARFE	259598	Drive Shaft	48T	30	24	61	100	673		
3.5 L V6	2014-	-	-	L	F	LE Plus Sport Utility 4-Door	259371	Drive Shaft	48T	30	24	61	100	676		
	2014-	-	-	L	F	LE Sport Utility 4-Door	259371	Drive Shaft	48T	30	24	61	100	676		
	2014-	-	-	L	F	Limited Sport Utility 4-Door	259371	Drive Shaft	48T	30	24	61	100	676		
	2014-	-	-	L	F	XLE Sport Utility 4-Door	259371	Drive Shaft	48T	30	24	61	100	676		
	2015-	-	-	L	F	LE Plus Sport Utility 4-Door	259371	Drive Shaft	48T	30	24	61	100	676		
	2015-	-	-	L	F	LE Sport Utility 4-Door	259371	Drive Shaft	48T	30	24	61	100	676		
	2015-	-	-	L	F	Limited Sport Utility 4-Door	259371	Drive Shaft	48T	30	24	61	100	676		
	2015-	-	-	L	F	XLE Sport Utility 4-Door	259371	Drive Shaft	48T	30	24	61	100	676		
	2016-	-	-	L	F	LE Plus Sport Utility 4-Door	259371	Drive Shaft	48T	30	24	61	100	676		
	2016-	-	-	L	F	LE Sport Utility 4-Door	259371	Drive Shaft	48T	30	24	61	100	676		
	2016-	-	-	L	F	Limited Sport Utility 4-Door	259371	Drive Shaft	48T	30	24	61	100	676		
	2016-	-	-	L	F	XLE Sport Utility 4-Door	259371	Drive Shaft	48T	30	24	61	100	676		
HIGHLANDER	2012.05-	2015.02	-	R	F	ENGINE:3ARFE	859513	Outer Joint			30	27	61	100	65	I
	2012.05-	2015.02	-	L	F	ENGINE:3ARFE	859513	Outer Joint			30	27	61	100	65	I
HILUX																
-	-	-	-	-	-	4WD	859092	Outer Joint			26	34	60	162	65.5	I
2.5	2007.08	2008.07	-	R	F	ENGINE:2KDFTV	259534	Drive Shaft			30	30	72.3	116	630	
	2008.08-	2011.06	-	R	F	ENGINE:2KDFTV	259534	Drive Shaft			30	30	72.3	116	630	
	2011.08-	-	5MT	R	F	ENGINE: 2KDFTV/KUN25	259676	Drive Shaft			30	30	72.5	116	632	
	2012.08-	2015.03	-	R	F	ENGINE:2KDFTV	259534	Drive Shaft			30	30	72.3	116	630	
2.7	2007.08	2008.07	-	R	F	ENGINE:2TRFE	259534	Drive Shaft			30	30	72.3	116	630	
	2012.08-	2015.03	-	R	F	ENGINE:2TRFE	259534	Drive Shaft			30	30	72.3	116	630	
3.0	2005.02-	2008.07	-	R	F	ENGINE:1KDFTV	259534	Drive Shaft			30	30	72.3	116	630	

YEAR	TRANS	L/R	F/R	REMARKS	GSP Ref.	PRODUCT	ABS	Technical Specifications						
								A	B	C	H	L	P	
TOYOTA														
HILUX														
3.0	2005.07-2008.09	-	R	F	ENGINE:5LE	259534	Drive Shaft		30	30	72.3	116	630	
	2008.1-2011.07	-	R	F	ENGINE:5LE	259534	Drive Shaft		30	30	72.3	116	630	
4.0	2011.07-2013.10	-	R	F	ENGINE:1GRFE,	259534	Drive Shaft		30	30	72.3	116	630	
HILUX (_N1_)														
2.8 D (65 kW)	1995.08-1998.08	MT	-	F	All-wheel Drive Closed Off-Road Vehicle Engine 3L	859016	Outer Joint		26	27	60	162	65.5	M
3.4 (131 kW)	1995.11-2004.07	AT	-	-	All-wheel Drive Closed Off-Road Vehicle Engine 5VZ-FE	659015	Inner Joint		27	24	47	67	116.5	
HILUX IV (_N5_ _N6_)														
2.2 (69 kW)	1987.01-1989.03	MT	-	F	All-wheel Drive Pickup Engine 4Y	859016	Outer Joint		26	27	60	162	65.5	M
HILUX PICK UP														
-	1992.01-1999.12	MT	L/R	-	4WD	259219	Drive Shaft		26		60	162	527.5	
	2000.01-2006.12	MT	L/R	-	4WD	259219	Drive Shaft		26		60	162	527.5	
	2000.01-2006.12	MT	L/R	-	4WD	259219	Drive Shaft		26		60	162	522	
HILUX V (_N_ KZN1_ VZN1_)/TACOMA														
2.4 D (55 kW)	1994.09-1998.06	MT	-	F	All-wheel Drive Pickup Engine 2L	859016	Outer Joint		26	27	60	162	65.5	M
2.4 D (58 kW)	1994.01-1997.12	MT	-	F	All-wheel Drive Pickup Engine 2L	859016	Outer Joint		26	27	60	162	65.5	M
2.4 D (61 kW)	1988.09-1997.08	MT	-	F	All-wheel Drive Pickup Engine 2L	859016	Outer Joint		26	27	60	162	65.5	M
2.4 i (84 kW)	1989.08-1997.07	MT	L/R	F	All-wheel Drive Pickup Engine 22RE	859015	Outer Joint		26	27	60	162	65.5	I
HILUX VI (_N1_)/TACOMA														
2.4 i (103 kW)	1997.08-2005.10	MT	-	F	All-wheel Drive Pickup Engine 2RZ-FE	859016	Outer Joint		26	27	60	162	65.5	M
	1997.08-2005.10	MT	L/R	F	All-wheel Drive Pickup Engine 2RZ-FE	859015	Outer Joint		26	27	60	162	65.5	I
2.4 TD (66 kW)	1998.08-2002.01	-	-	F	All-wheel Drive Pickup Engine 2L-T	859016	Outer Joint		26	27	60	162	65.5	M
	1998.08-2002.01	MT	L/R	F	All-wheel Drive Pickup Engine 2L-T	859015	Outer Joint		26	27	60	162	65.5	I
2.5 D-4D (65 kW)	2001.11-2005.07	-	L	F	Pickup Engine 2KD-FTV	259036	Drive Shaft		26		60	162	532.5	
	2001.11-2005.07	-	L	F	Pickup Engine 2KD-FTV	659014	Inner Joint			24		83.3		
2.5 D-4D (75 kW)	2001.11-2005.07	MT	-	F	All-wheel Drive Pickup Engine 2KD-FTV	859016	Outer Joint		26	27	60	162	65.5	M
	2001.11-2005.07	-	L	F	All-wheel Drive Pickup Engine 2KD-FTV	259036	Drive Shaft		26		60	162	532.5	
	2001.11-2005.07	-	L	F	All-wheel Drive Pickup Engine 2KD-FTV	659014	Inner Joint			24		83.3		
HILUX VIGO UKN40														
-	-	-	-	-	-	859414	Outer Joint		30	29	72.5	116	73	O
	-	-	-	-	-	659220	Inner Joint		30	29	47	77	116	
HILUX VII (_N1_ _N2_ _N3_)/HILUX (VIGO)														
2.5 D (75 kW)	2005.10-	-	-	F	All-wheel Drive Pickup Engine 2KD-FTV	859199	Outer Joint		30	29	72.5	116	73	M
	2005.10-	MT	L/R	F	All-wheel Drive Pickup Engine 2KD-FTV	859242	Outer Joint		30	29	72.7	116	70	M
	2005.10-	-	-	-	All-wheel Drive Pickup Engine 2KD-FTV	659039	Inner Joint		30	29	47	76	116	
	2005.10-	MT	-	F	All-wheel Drive Pickup Engine 2KD-FTV	259168	Drive Shaft		30	30	72.5	116	630	
	2005.10-	-	L/R	F	All-wheel Drive Pickup Engine 2KD-FTV	259326	Drive Shaft		30	30	72.5	116	629	
2.5 D-4D (106 kW)	2009.09-	-	-	F	All-wheel Drive Pickup Engine 2KD-FTV	859199	Outer Joint		30	29	72.5	116	73	M
	2009.09-	MT	L/R	F	All-wheel Drive Pickup Engine 2KD-FTV	859242	Outer Joint		30	29	72.7	116	70	M
	2009.09-	MT	-	F	All-wheel Drive Pickup Engine 2KD-FTV	259168	Drive Shaft		30	30	72.5	116	630	
	2010.01-	-	-	-	Pickup Engine 2KD-FTV	859199	Outer Joint		30	29	72.5	116	73	M
	2010.01-	MT	-	F	Pickup Engine 2KD-FTV	259168	Drive Shaft		30	30	72.5	116	630	
2.5 D-4D (75 kW)	2005.10-	-	-	-	Pickup Engine 2KD-FTV	859199	Outer Joint		30	29	72.5	116	73	M
	2005.10-	MT	-	F	Pickup Engine 2KD-FTV	259168	Drive Shaft		30	30	72.5	116	630	
2.5 D-4D (88 kW)	2007.12-	-	-	F	All-wheel Drive Pickup Engine 2KD-FTV	859199	Outer Joint		30	29	72.5	116	73	M
	2007.12-	-	-	-	Pickup Engine 2KD-FTV	859199	Outer Joint		30	29	72.5	116	73	M
	2007.12-	MT	L/R	F	All-wheel Drive Pickup Engine 2KD-FTV	859242	Outer Joint		30	29	72.7	116	70	M
	2007.12-	-	-	-	All-wheel Drive Pickup Engine 2KD-FTV	659039	Inner Joint		30	29	47	76	116	
	2007.12-	MT	-	F	All-wheel Drive Pickup Engine 2KD-FTV	259168	Drive Shaft		30	30	72.5	116	630	
	2007.12-	MT	-	F	Pickup Engine 2KD-FTV	259168	Drive Shaft		30	30	72.5	116	630	
	2007.12-	-	L/R	F	All-wheel Drive Pickup Engine 2KD-FTV	259326	Drive Shaft		30	30	72.5	116	629	
2.5 D-4D (94 kW)	2004.11-2005.12	MT	-	F	All-wheel Drive Pickup Engine 2KD-FTV	859016	Outer Joint		26	27	60	162	65.5	M
3.0 D-4D (126 kW)	2007.12-	-	-	F	All-wheel Drive Pickup Engine 1KD-FTV	859199	Outer Joint		30	29	72.5	116	73	M
	2007.12-	MT	L/R	F	All-wheel Drive Pickup Engine 1KD-FTV	859242	Outer Joint		30	29	72.7	116	70	M
	2007.12-	AT/MT	-	F	All-wheel Drive Pickup Engine 1KD-FTV	259168	Drive Shaft		30	30	72.5	116	630	
	2007.12-	-	L/R	F	All-wheel Drive Pickup Engine 1KD-FTV	259326	Drive Shaft		30	30	72.5	116	629	
3.0 D-4D (145 kW)	2008.05-2008.12	-	-	F	All-wheel Drive Pickup Engine 1KD-FTV	859199	Outer Joint		30	29	72.5	116	73	M
	2008.05-2008.12	MT	L/R	F	All-wheel Drive Pickup Engine 1KD-FTV	859242	Outer Joint		30	29	72.7	116	70	M
	2008.05-2008.12	AT/MT	-	F	All-wheel Drive Pickup Engine 1KD-FTV	259168	Drive Shaft		30	30	72.5	116	630	
IPSUM PICNIC (ACM21)														
2.4	2000-	AT	-	-	Engine 2AZFE	859294	Outer Joint	48T	26	27	63	97	60	M
IPSUM PICNIC (ACM26)														
2.4 4WD	2000-	AT	-	-	Engine 2AZFE	859294	Outer Joint	48T	26	27	63	97	60	M
IQ														
1.0	2008.11-	AT	L	F	ENGINE:1KRFE/KGJ10	259667	Drive Shaft		24	23	49.5	92	646	
	2008.11-2014.04	AT	L	F	ENGINE:1KRFE/KGJ10	259667	Drive Shaft		24	23	49.5	92	646	
	2008.11-2012.04	5MT	R	F	ENGINE:1KRFE/KGJ10	259668	Drive Shaft		24	23	49.5	92	903	

	YEAR	TRANSM	L/R	F/R	REMARKS	GSP Ref.	PRODUCT	ABS	Technical Specifications					
									A	B	C	H	L	P
TOYOTA														
IQ														
1.0	2008.11-2012.04	5MT	L	F	ENGINE:1KRFE/KGJ10	259669	Drive Shaft		24	23	49.5	92	650	
1.3	2009.05-2012.04	6MT	L	F	ENGINE:1NRFE/NGJ10	259611	Drive Shaft		26	23	55.6	95	653	
	2009.08-	CVT	-	-	Engine GJ10	859384	Outer Joint		26	29	55.6	96	54	I
	2010.11-	6MT	L	F	ENGINE:1NRFE/NGJ10	259611	Drive Shaft		26	23	55.6	95	653	
IQ (_J1_)														
1.33 (72 kW)	2009.01-	-	-	F	Hatchback Engine 1NR-FE	859219	Outer Joint		26	29	55.6	95	52.5	I
1.4 D-4D (66 kW)	2009.01-	MT	L	F	Hatchback Engine 1ND-TV	659100	Inner Joint		20	25	35	63.5	118	
IQ GJ10														
1300	2009.08-	CVT	-	-	Engine 1NRFE	859384	Outer Joint		26	29	55.6	96	54	I
ISIS														
1.8	2009.09-	-	L	F	ENGINE:2ZRFAE/JAPAN	259687	Drive Shaft	48T	26	20	58	95.5	639	
	2009.09-	-	L	F	ENGINE:2ZRFAE/JAPAN	859511	Outer Joint		26	25	58	95.5	56.5	I
	2009.09-	-	R	F	ENGINE:2ZRFAE/ZGM10G	259614	Drive Shaft	48T	26	20	58	95.5	907	
	2009.09-	-	R	F	ENGINE:2ZRFAE/ZGM10	259614	Drive Shaft	48T	26	20	58	95.5	907	
IST														
1.5	2007.07-	-	R	R	ENGINE:1NZFE/NCP115	259675	Drive Shaft	48T	26	20	51.9	99.5	765	
	2007.07-	-	L	F	ENGINE:1NZFE/NCP115	259626	Drive Shaft		26	20	55.6	96	651	
	2007.07-	-	R	F	ENGINE:1NZFE/NCP115	259627	Drive Shaft		26	20	55.6	96	897	
IST (NCP6_)/XA														
1.3 VVTi (63 kW)	2004.05-2007.07	-	-	F	Hatchback Engine 2NZ-FE	699046	Inner Joint		23	23	34	60	103.5	
1.5 VVTi (80 kW)	2004.05-2007.07	-	-	F	Hatchback Engine 1NZ-FE	699046	Inner Joint		23	23	34	60	103.5	
LAND CRUISER														
-	-	-	R	R	Landcruiser 40 45 60 70 73 75 Series 1/797/99;ZJ75	259731	Stub Axle							
-	-	-	-	-	-	259734	Stub Axle							
1984.10-1990.01	-	L	R	HJ75		259734	Stub Axle							
1984.11-1992.08	-	L	R	FJ75		259734	Stub Axle							
1984.11-1992.08	-	L	R	FJ70		259734	Stub Axle							
1984.11-1991.08	-	L	R	FJ73		259734	Stub Axle							
1990.01-1999.08	-	L	R	HZJ75		259734	Stub Axle							
1990.01-1995.01	-	L	R	HZJ70		259734	Stub Axle							
1990.01-1991.08	-	L	R	HZJ73		259734	Stub Axle							
1990.01-1991.08	-	L	R	PZJ70		259734	Stub Axle							
1990.01-1991.08	-	L	R	PZJ73		259734	Stub Axle							
1990.01-2004.08	-	R	F	-		259735	Stub Axle		27	30			414.5	
1990.01-2004.08	-	L	F	-		259736	Stub Axle		27	30			768	
1992.08-1999.08	-	L	R	FZJ75		259734	Stub Axle							
1992.08-1995.01	-	L	R	FZJ70		259734	Stub Axle							
1999.08-2007.01	-	R	R	HZJ78		259732	Stub Axle							
1999.08-2007.01	-	R	R	HZJ79		259732	Stub Axle							
1999.08-2006.05	-	R	R	FZJ79		259732	Stub Axle							
1999.08-2006.05	-	R	R	HZJ78		259732	Stub Axle							
1999.08-2007.01	-	L	R	HZJ78		259733	Stub Axle							
1999.08-2007.01	-	L	R	HZJ79		259733	Stub Axle							
1999.08-2006.05	-	L	R	HZJ79		259733	Stub Axle							
1999.08-2006.05	-	L	R	HZJ78		259733	Stub Axle							
1999.08-2001.08	-	R	F	-		259729	Stub Axle		24	30			419.2	
1999.08-2006.05	-	R	F	-		259729	Stub Axle		24	30			419.2	
1999.08-2007.01	-	R	F	-		259729	Stub Axle		24	30			419.2	
1999.08-2004.08	-	R	F	-		259729	Stub Axle		24	30			419.2	
1999.08-2001.08	-	L	F	-		259730	Stub Axle		24	30			771.5	
1999.08-2006.05	-	L	F	-		259730	Stub Axle		24	30			771.5	
1999.08-2007.01	-	L	F	-		259730	Stub Axle		24	30			771.5	
1999.08-2004.08	-	L	F	-		259730	Stub Axle		24	30			771.5	
2001.08-2007.01	-	R	R	HDJ79		259732	Stub Axle							
2001.08-2007.01	-	R	R	HZJ78		259732	Stub Axle							
2001.08-2007.01	-	L	R	HZJ79		259733	Stub Axle							
2001.08-2007.01	-	L	R	HZJ78		259733	Stub Axle							
2007.01-2009.07	-	R	F	-		259729	Stub Axle		24	30			419.2	
2007.01-2016.08	-	R	F	-		259729	Stub Axle		24	30			419.2	
2007.01-2012.08	-	R	F	-		259729	Stub Axle		24	30			419.2	
2007.01-2009.07	-	L	F	-		259730	Stub Axle		24	30			771.5	
2007.01-2016.08	-	L	F	-		259730	Stub Axle		24	30			771.5	
2007.01-2012.08	-	L	F	-		259730	Stub Axle		24	30			771.5	
2007.02-	-	R	R	VDJ76		259732	Stub Axle							
2007.02-	-	R	R	HZJ78		259732	Stub Axle							
2007.02-	-	R	R	HDJ79		259732	Stub Axle							

YEAR	TRANSM	L/R	F/R	REMARKS	GSP Ref.	PRODUCT	ABS	Technical Specifications					
								A	B	C	H	L	P
TOYOTA													
LAND CRUISER													
-	2014.08-	2015.07	-	R	F	-	259729	Stub Axle	24	30			419.2
-	2014.08-	2015.07	-	L	F	-	259730	Stub Axle	24	30			771.5
-	2016.08-	-	-	R	F	-	259729	Stub Axle	24	30			419.2
-	2016.08-	-	-	L	F	-	259730	Stub Axle	24	30			771.5
120 Series Prado	2003.01-	-	MT/AT	-	-	-	699045	Inner Joint	30	30	47	75.5	108.5
2.5 D	2003.01-	-	MT/AT	L/R	-	-	259054	Drive Shaft	30	30	70	103.5	647
-	-	-	-	-	-	-	899125	Outer Joint	30	29	72.5	116	73 M
-	-	-	-	L/R	-	-	259004	Drive Shaft	30	30	72.5	116	630
LAND CRUISER 100 (_J1_)/LAND CRUISER AMAZON/PRADO/LAND CRUISER CYGNUS													
4.2 TD (150 kW)	1998.01-	2007.08	-	L/R	F	All-wheel Drive Closed Off-Road Vehicle Engine 1HD-FTE	859085	Outer Joint	30	30	72.58	176	78 I
-	1998.01-	2007.08	-	-	-	All-wheel Drive Closed Off-Road Vehicle Engine 1HD-FTE	659107	Inner Joint	30	30	47	77	133.5
4.7 (173 kW)	1998.01-	2007.08	-	L/R	F	All-wheel Drive Closed Off-Road Vehicle Engine 2UZ-FE	859085	Outer Joint	30	30	72.58	176	78 I
-	1998.01-	2007.08	-	-	-	All-wheel Drive Closed Off-Road Vehicle Engine 2UZ-FE	659107	Inner Joint	30	30	47	77	133.5
4.7 (175 kW)	2002.02-	2007.08	-	L/R	F	All-wheel Drive Closed Off-Road Vehicle Engine 2UZ-FE	859085	Outer Joint	30	30	72.58	176	78 I
-	2002.02-	2007.08	-	-	-	All-wheel Drive Closed Off-Road Vehicle Engine 2UZ-FE	659107	Inner Joint	30	30	47	77	133.5
LAND CRUISER 200 (_J2_)													
4.5 D V8 (210 kW)	2008.01-	-	AT/MT	L/R	F	All-wheel Drive Closed Off-Road Vehicle Engine 1VD-FTV	859336	Outer Joint	36	30	83	120	78 I
4.5 D-4D (195 kW)	2008.01-	-	AT/MT	L/R	F	All-wheel Drive Closed Off-Road Vehicle Engine 1VD-FTV	859336	Outer Joint	36	30	83	120	78 I
4.5 D4-D (200 kW)	2012.01-	-	AT/MT	L/R	F	All-wheel Drive Closed Off-Road Vehicle Engine 1VD-FTV	859336	Outer Joint	36	30	83	120	78 I
4.6 V8 (234 kW)	2012.01-	-	AT/MT	L/R	F	All-wheel Drive Closed Off-Road Vehicle Engine 1UR-FE	859336	Outer Joint	36	30	83	120	78 I
-	2012.01-	-	AT	-	F	All-wheel Drive Closed Off-Road Vehicle Engine 1UR-FE	859303	Outer Joint	36	30	78	121	78 I
-	2012.01-	-	AT	-	-	All-wheel Drive Closed Off-Road Vehicle Engine 1UR-FE	659065	Inner Joint	34	30	47	87	141
4.7 V8 (212 kW)	2008.01-	-	AT/MT	L/R	F	All-wheel Drive Closed Off-Road Vehicle Engine 2UZ-FE	859336	Outer Joint	36	30	83	120	78 I
-	2008.01-	-	-	-	F	All-wheel Drive Closed Off-Road Vehicle Engine 2UZ-FE	859303	Outer Joint	36	30	78	121	78 I
-	2008.01-	-	-	-	-	All-wheel Drive Closed Off-Road Vehicle Engine 2UZ-FE	659065	Inner Joint	34	30	47	87	141
LAND CRUISER 90 (_J9_)/LAND CRUISER PRADO/LAND CRUISER COLORADO													
2.7 (110 kW)	1995.04-	2002.07	-	-	-	All-wheel Drive Closed Off-Road Vehicle Engine 3RZ-FE	659015	Inner Joint	27	24	47	67	116.5
-	1995.04-	2002.07	-	L/R	F	All-wheel Drive Closed Off-Road Vehicle Engine 3RZ-FE	859034	Outer Joint	30	27	69	122.5	64.5 I
3.0 D-4D (120 kW)	2000.08-	2002.08	AT/MT	L/R	F	All-wheel Drive Closed Off-Road Vehicle Engine 1KD-FTV	859243	Outer Joint	30	27	69	121	65 I
-	2000.08-	2002.08	-	L/R	F	All-wheel Drive Closed Off-Road Vehicle Engine 1KD-FTV	859034	Outer Joint	30	27	69	122.5	64.5 I
-	2000.08-	2002.08	-	-	F	All-wheel Drive Closed Off-Road Vehicle Engine 1KD-FTV	259038	Drive Shaft	30	27	69	123	620.5
3.0 TD (92 kW)	1996.04-	2002.12	AT/MT	L/R	F	All-wheel Drive Closed Off-Road Vehicle Engine 1KZ-TE	859243	Outer Joint	30	27	69	121	65 I
-	1996.04-	2002.12	-	L/R	F	All-wheel Drive Closed Off-Road Vehicle Engine 1KZ-TE	859034	Outer Joint	30	27	69	122.5	64.5 I
-	1996.04-	2002.12	-	-	F	All-wheel Drive Closed Off-Road Vehicle Engine 1KZ-TE	259038	Drive Shaft	30	27	69	123	620.5
3.4 i 24V (131 kW)	1996.03-	2002.12	-	-	-	All-wheel Drive Closed Off-Road Vehicle Engine 5VZ-FE	659015	Inner Joint	27	24	47	67	116.5
-	1996.03-	2002.12	AT/MT	L/R	F	All-wheel Drive Closed Off-Road Vehicle Engine 5VZ-FE	859243	Outer Joint	30	27	69	121	65 I
-	1996.03-	2002.12	-	L/R	F	All-wheel Drive Closed Off-Road Vehicle Engine 5VZ-FE	859034	Outer Joint	30	27	69	122.5	64.5 I
LAND CRUISER PRADO (_J12_)													
3.0 D (70 kW)	2002.09-	2009.07	AT/MT	-	F	All-wheel Drive Closed Off-Road Vehicle Engine 5L-E	259015	Drive Shaft	30	30	70	103.5	647
-	2002.09-	2009.07	MT	-	-	All-wheel Drive Closed Off-Road Vehicle Engine 5L-E	659049	Inner Joint	30	30	47	75.5	125.5
3.0 D-4D (120 kW)	2002.09-	2009.07	-	L/R	F	All-wheel Drive Closed Off-Road Vehicle Engine 1KD-FTV	859107	Outer Joint	30	30	70	103.5	82.5 I
-	2002.09-	2009.07	AT/MT	-	F	All-wheel Drive Closed Off-Road Vehicle Engine 1KD-FTV	259015	Drive Shaft	30	30	70	103.5	647
3.0 D-4D (122 kW)	2004.08-	2009.07	-	L/R	F	All-wheel Drive Closed Off-Road Vehicle Engine 1KD-FTV	859107	Outer Joint	30	30	70	103.5	82.5 I
-	2004.08-	2009.07	AT/MT	-	F	All-wheel Drive Closed Off-Road Vehicle Engine 1KD-FTV	259015	Drive Shaft	30	30	70	103.5	647
3.0 D-4D (127 kW)	2002.09-	2009.07	-	L/R	F	All-wheel Drive Closed Off-Road Vehicle Engine 1KD-FTV	859107	Outer Joint	30	30	70	103.5	82.5 I
-	2002.09-	2009.07	AT/MT	-	F	All-wheel Drive Closed Off-Road Vehicle Engine 1KD-FTV	259015	Drive Shaft	30	30	70	103.5	647
3.0 D-4D (150 kW)	2004.08-	2009.07	AT	-	-	All-wheel Drive Closed Off-Road Vehicle Engine 1KD-FTV	659049	Inner Joint	30	30	47	75.5	125.5
3.0 D-4D (92 kW)	2002.09-	2009.07	-	L/R	F	All-wheel Drive Closed Off-Road Vehicle Engine 1KZ-TE	859107	Outer Joint	30	30	70	103.5	82.5 I
-	2002.09-	2009.07	AT/MT	-	F	All-wheel Drive Closed Off-Road Vehicle Engine 1KZ-TE	259015	Drive Shaft	30	30	70	103.5	647
4.0 (183 kW)	2003.01-	2009.07	-	L/R	F	All-wheel Drive Closed Off-Road Vehicle Engine 1GR-FE	859107	Outer Joint	30	30	70	103.5	82.5 I
-	2003.01-	2009.07	AT	-	-	All-wheel Drive Closed Off-Road Vehicle Engine 1GR-FE	659049	Inner Joint	30	30	47	75.5	125.5
-	2003.01-	2009.07	AT	-	F	All-wheel Drive Closed Off-Road Vehicle Engine 1GR-FE	859097	Outer Joint	30	30	70	103.5	82.5 I
4.0 (GRJ12) (179 kW)	2002.09-	2010.08	AT	-	F	All-wheel Drive Closed Off-Road Vehicle Engine 1GR-FE	859097	Outer Joint	30	30	70	103.5	82.5 I
LAND CRUISER PRADO (_J15_)													
3.0 D-4D (127 kW)	2009.08-	-	AT/MT	-	F	All-wheel Drive Closed Off-Road Vehicle Engine 1KD-FTV	259015	Drive Shaft	30	30	70	103.5	647
3.0 D-4D (140 kW)	2009.08-	-	AT/MT	-	F	All-wheel Drive Closed Off-Road Vehicle Engine 1KD-FTV	259015	Drive Shaft	30	30	70	103.5	647
4.0 V6 VVT-i (207 kW)	2009.08-	-	AT	-	-	All-wheel Drive Closed Off-Road Vehicle Engine 1GR-FE	659049	Inner Joint	30	30	47	75.5	125.5
4.0 V6 VVTi (183 kW)	2010.01-	-	AT	-	F	All-wheel Drive Closed Off-Road Vehicle Engine 1GR-FE	859097	Outer Joint	30	30	70	103.5	82.5 I
LAND CRUISER/HI-LUX/4 RUNNER													
2.0	1988-	1993	MT/AT	L/R	-	Truck	259031	Drive Shaft	26		60	162	487
LEVIN (HYBRID)													
1.6	2014.08-	-	CVT	L	F	ENGINE:4ZRFE/GENERAL	259228	Drive Shaft	26	20	55.6	95.5	656
-	2014.08-	-	CVT	L	F	ENGINE:4ZRFE/GENERAL	659064	Inner Joint	20	25	35	63.5	118
-	2014.08-	-	CVT	R	F	ENGINE:4ZRFE/GENERAL	259688	Drive Shaft	26	20	55.6	95.5	937
1.8	2014.08-	-	CVT	L	F	ENGINE:7ZRFE/GENERAL	259228	Drive Shaft	26	20	55.6	95.5	656
-	2014.08-	-	CVT	L	F	ENGINE:7ZRFE/GENERAL	659064	Inner Joint	20	25	35	63.5	118

YEAR	TRANS	L/R	F/R	REMARKS	GSP Ref.	PRODUCT	ABS	Technical Specifications							
								A	B	C	H	L	P		
TOYOTA															
LEVIN (HYBRID)															
1.8	2014.08-	-	6MT	R	F	ENGINE:7ZRFE/GENERAL	259688	Drive Shaft		26	20	55.6	95.5	937	
	2014.08-	-	CVT	R	F	ENGINE:7ZRFE/GENERAL	259688	Drive Shaft		26	20	55.6	95.5	937	
LEXUS (S196)															
3.5 4WD	2007.09-	-	6AT	-	F	Engine 2GR—FSE	859306	Outer Joint		30	30	57	82	55	M
LEXUS GS, TOYOTA GS HYBRID															
3.5	2012.01-	2015.09	AT	L	F	ENGINE:2GRFSE/Europe	259609	Drive Shaft		30	23	57	82	617	
	2012.01-	2015.09	AT	L	F	ENGINE:2GRFSE/Europe	659225	Inner Joint		23	30	35	94	89.5	
	2015.10-	-	AT	L	F	ENGINE:2GRFKS/Europe	259609	Drive Shaft		30	23	57	82	617	
	2015.10-	-	AT	L	F	ENGINE:2GRFKS/Europe	659225	Inner Joint		23	30	35	94	89.5	
LEXUS GS25/3XXX/450H															
3.5	2011.02-	2015.09	6AT	L	F	ENGINE:2GRFSE/JAPAN	259609	Drive Shaft		30	23	57	82	617	
	2011.02-	2015.09	6AT	L	F	ENGINE:2GRFSE/JAPAN	659225	Inner Joint		23	30	35	94	89.5	
LEXUS GS2XX/350/450H															
3.5	2011.12-	2015.09	6AT	L	F	ENGINE:2GRFSE/N. America	259609	Drive Shaft		30	23	57	82	617	
	2011.12-	2015.09	6AT	L	F	ENGINE:2GRFSE/N. America	659225	Inner Joint		23	30	35	94	89.5	
	2015.10-	-	6AT	L	F	ENGINE:2GRFKS,N. America	259609	Drive Shaft		30	23	57	82	617	
	2015.10-	-	6AT	L	F	ENGINE:2GRFKS,N. America	659225	Inner Joint		23	30	35	94	89.5	
LEXUS RC350/300/200T															
3.5	2015.10-	-	6AT	L	F	ENGINE:2GRFSE/N. America	259609	Drive Shaft		30	23	57	82	617	
	2015.10-	-	6AT	L	F	ENGINE:2GRFSE/N. America	659225	Inner Joint		23	30	35	94	89.5	
LEXUS UWXGS S196															
3500	2007.09-	-	6AT	-	-	Allwheel Drive Engine 2GRFSE	859306	Outer Joint		30	30	57	82	55	M
MARK II (_X11_)															
2.5 (147 kW)	2002.10-	2004.11	-	L/R	R	All-wheel Drive Saloon Engine 1JZ-GE	859390	Outer Joint	48T	30	27	63	108.5	64	I
MARK II (_X1_ _V2_)															
2.5 (147 kW)	1996.08-	2001.07	-	-	F	Estate Engine 2MZ-FE	859446	Outer Joint	48T	30	27	56	100	66	M
MARK X ZIO															
2.4	2007.09-	2011.01	-	R	F	ENGINE:2AZFE/ANA10	259615	Drive Shaft		26	24	61.2	100	957	
	2007.09-	2011.01	-	L	F	ENGINE: 2AZFE/ANA10	259583	Drive Shaft		26	24	61.2	100	640	
MATRIX															
-	2003-	2008	MT	L/R	-	-	859108	Outer Joint		26	29	56	96	63	M
	2003-	2008	MT	L/R	-	-	859108	Outer Joint		26	29	56	96	63	M
MATRIX (_E14_)															
1.8 (97 kW)	2008.01-	2014.05	-	-	F	Hatchback Engine 2ZR-FE	859428	Outer Joint	48T	26	32	58	96	56.5	I
MR 2 I (AW1_)															
1.6 16V (85 kW)	1984.11-	1990.06	MT	L/R	F	Coupe Engine 4A-GELC	859018	Outer Joint		26	24	56	95.5	55	I
	1984.11-	1990.06	-	-	-	Coupe Engine 4A-GELC	859062	Outer Joint		26	24	56	95.5	55	I
1.6 16V (91 kW)	1984.11-	1990.06	MT	L/R	F	Coupe Engine 4A-GEL	859018	Outer Joint		26	24	56	95.5	55	I
	1984.11-	1990.06	-	-	-	Coupe Engine 4A-GEL	859062	Outer Joint		26	24	56	95.5	55	I
MR 2 II															
2.0	1990.04-	1999.11	-	-	-	-	859186	Outer Joint	48T	26	25	56	96	61	I
MR 2 II (SW2_)															
2.0 (88 kW)	1989.12-	1992.08	-	-	R	Coupe Engine 3S-FE	859055	Outer Joint		26	25	56	96	56	M
2.0 Turbo (167 kW)	1989.12-	1999.07	-	-	R	Coupe Engine 3S-GTE	859055	Outer Joint		26	25	56	96	56	M
	1989.12-	1999.07	MT	-	-	Coupe Engine 3S-GTE	631001	Inner Joint			27		33.2		
2.0 Turbo (180 kW)	1989.12-	1999.07	MT	-	-	Coupe Engine 3S-GTE	631001	Inner Joint			27		33.2		
MR 2 III (ZZW3_)															
1.8 16V VT-i (103 kW)	1999.10-	2007.06	-	-	F	Convertible Engine 1ZZ-FE	859131	Outer Joint	48T	26	24	58	96	54	I
	1999.10-	2007.06	-	L	F	Convertible Engine 1ZZ-FE	659005	Inner Joint		20	23	35	63.5	115.7	
	1999.10-	2007.06	-	R	F	Convertible Engine 1ZZ-FE	659004	Inner Joint		20	23	35	363	100.5	
NOAH															
2.0	2007.06-	2010.03	-	R	F	ENGINE:3ZRFAE/ZRR70	259619	Drive Shaft	48T	26	24	61.2	100	949	
	2014.01-	-	CVT	L	F	ENGINE:3ZRFAE/GENERAL	659125	Inner Joint		24	27	50	67	109.5	
	2014.01-	-	CVT	L	F	ENGINE:3ZRFAE/GENERAL	259691	Drive Shaft	48T	26	24	61.2	100	620	
	2014.01-	-	CVT	L	F	ENGINE:3ZRFAE/GENERAL	859439	Outer Joint		26	27	61.2	100	59.5	I
NOAH/VOXY (_R7_)															
2.0 (103 kW)	2007.06-	2013.09	AT	R	F	MPV Engine 3ZR-FE	659128	Inner Joint		24	27	40	369.5	105.5	
2.0 (114 kW)	2007.06-	2013.09	AT	R	F	All-wheel Drive MPV Engine 3ZR-FAE	659128	Inner Joint		24	27	40	369.5	105.5	
2.0 (116 kW)	2007.06-	-	AT	R	F	MPV Engine 3ZR-FAE	659128	Inner Joint		24	27	40	369.5	105.5	
NOAH/VOXY (_R8_)															
2.0 (111 kW)	2013.10-	-	AT	R	F	MPV Engine 3ZR-FAE	659128	Inner Joint		24	27	40	369.5	105.5	
OPA (ZCT1_ ACT1_)															
1.8 (100 kW)	2000.04-	2003.08	-	-	F	Estate Engine 1ZZ-FE	859036	Outer Joint		26	23	58	96	52.5	I
	2000.04-	2003.08	-	-	F	Estate Engine 1ZZ-FE	859131	Outer Joint	48T	26	24	58	96	54	I
2.0 (112 kW)	2000.08-	2005.04	-	-	F	Estate Engine 1AZ-FSE	859036	Outer Joint		26	23	58	96	52.5	I





	 YEAR	TRANSM	L/R	F/R	REMARKS	GSP Ref.	 PRODUCT	 ABS	Technical Specifications					
									A	B	C	H	L	P
TOYOTA														
OPA (ZCT1_ ACT1_)														
2.0 (112 kW)	2000.08-2005.04	-	-	F	Estate Engine 1AZ-FSE	859131	Outer Joint	48T	26	24	58	96	54	I
OYOTA VITZ														
1.5	2014.04-	5MT	L	F	ENGINE:1NZFE/JAPAN	259693	Drive Shaft		26	20	55.6	95.5	653	
PASEO (EL44_)/CYNOS														
1.5 (74 kW)	1991.04-1995.08	-	-	F	Coupe Engine 5E-FE	699046	Inner Joint		23	23	34	60	103.5	
1.5 (85 kW)	1988.06-1995.07	-	-	F	Coupe Engine 5E-FE	699046	Inner Joint		23	23	34	60	103.5	
	1988.06-1995.07	-	-	F	Coupe Engine 5E-FE	859023	Outer Joint		26	23	56	96.5	55	I
	1988.06-1995.07	-	-	F	Coupe Engine 5E-FE	859017	Outer Joint		26	22	56	95	50	M
	1988.06-1995.07	-	-	F	Coupe Engine 5E-FE	859177	Outer Joint	48T	26	23	56	95.5	55	I
	1988.06-1995.07	-	-	-	Coupe Engine 5E-FE	659023	Inner Joint		23	23	34	60	113	
PASEO (EL54_)														
1.5 (66 kW)	1996.10-1998.01	-	-	F	Convertible Engine 5E-FE	699046	Inner Joint		23	23	34	60	103.5	
	1996.10-1998.01	-	-	F	Convertible Engine 5E-FE	859023	Outer Joint		26	23	56	96.5	55	I
	1996.10-1998.01	-	-	F	Convertible Engine 5E-FE	859128	Outer Joint	48T	26	23	56	95.5	55	I
1.5 (81 kW)	1996.10-1998.01	-	-	F	Convertible Engine 5E-FE	699046	Inner Joint		23	23	34	60	103.5	
	1996.10-1998.01	-	-	F	Convertible Engine 5E-FE	859023	Outer Joint		26	23	56	96.5	55	I
	1996.10-1998.01	-	-	F	Convertible Engine 5E-FE	859017	Outer Joint		26	22	56	95	50	M
PASEO (EL54_)/CYNOS														
1.5 (81 kW)	1995.08-1999.06	-	-	F	Coupe Engine 5E-FE	699046	Inner Joint		23	23	34	60	103.5	
	1995.08-1999.06	-	-	F	Coupe Engine 5E-FE	859023	Outer Joint		26	23	56	96.5	55	I
	1995.08-1999.06	-	-	F	Coupe Engine 5E-FE	859017	Outer Joint		26	22	56	95	50	M
1.5 (85 kW)	1995.08-1999.06	-	-	F	Coupe Engine 5E-FE	859023	Outer Joint		26	23	56	96.5	55	I
1.5 16V (66 kW)	1995.08-1999.06	-	-	F	Coupe Engine 5E-FE	699046	Inner Joint		23	23	34	60	103.5	
	1995.08-1999.06	-	-	F	Coupe Engine 5E-FE	859023	Outer Joint		26	23	56	96.5	55	I
PASSO (KGC10)														
1.0	2004.05-	4AT	-	-	Engine 1KRFE	859461	Outer Joint		24	26	47	85.5	47.5	I
PASSO (KGC15)														
1.0 4WD	2004.05-	4AT	-	-	Engine 1KRFE	859461	Outer Joint		24	26	47	85.5	47.5	I
PASSO KGC10														
1.0	2004.05-	4AT	-	-	Engine 1KRFE	859461	Outer Joint		24	26	47	85.5	47.5	I
1000	2004.05-	4AT	-	-	Engine 1KRFE	859461	Outer Joint		24	26	47	85.5	47.5	I
PASSO KGC15														
1.0	2004.05-	4AT	-	-	Allwheel Drive Engine 1KRFE	859461	Outer Joint		24	26	47	85.5	47.5	I
1000	2004.05-	4AT	-	-	Allwheel Drive Engine 1KRFE	859461	Outer Joint		24	26	47	85.5	47.5	I
PICNIC (_XM10)														
2.0 (90 kW))	2001.01-2001.12	-	-	F	van	899122	Outer Joint		26	24	56	96	56	I
2.0 16V (94 kW)	1996.05-2001.12	-	-	F	van	899122	Outer Joint		26	24	56	96	56	I
2.2 D (66 kW)	1997.08-2001.12	-	-	F	van	899122	Outer Joint		26	24	56	96	56	I
PICNIC (_XM1_)/IPSUM														
2.0 (90 kW)	2001.01-2001.12	-	-	F	MPV Engine 3S-FE	859120	Outer Joint	48T	26	24	56	95.5	55	I
	2001.01-2001.12	AT/MT	L	F	MPV Engine 3S-FE	259020	Drive Shaft	48T	26	20	56	99	630	
	2001.01-2001.12	-	L/R	F	MPV Engine 3S-FE	859019	Outer Joint	48T	26	24	56	95.5	55	I
2.0 16V (94 kW)	1996.05-2001.12	AT	L	F	MPV Engine 3S-FE	259020	Drive Shaft	48T	26	20	56	99	630	
	1996.05-2001.12	-	L/R	F	MPV Engine 3S-FE	859019	Outer Joint	48T	26	24	56	95.5	55	I
2.0(99 kW)	1996.09-2001.05	-	L/R	F	MPV/MPV Engine 3S-FE	859019	Outer Joint	48T	26	24	56	95.5	55	I
2.2 D (66 kW)	1997.08-2001.12	-	L/R	F	MPV Engine 3C-TE	859019	Outer Joint	48T	26	24	56	95.5	55	I
PLATZ (NCP1_ SCP1_)														
1.3 (63 kW)	1999.08-2005.08	-	-	F	Saloon Engine 2NZ-FE	699046	Inner Joint		23	23	34	60	103.5	
1.5 (78 kW)	1999.04-2005.08	-	-	F	Saloon Engine 1NZ-FE	699046	Inner Joint		23	23	34	60	103.5	
PORTE														
1.3	2012.07-2015.06	CVT	R	F	ENGINE:1NRFE/NSP140	259201	Drive Shaft		26	23	55.6	96	896	
	2012.07-2015.06	CVT	L	F	ENGINE:1NRFE/NSP140	259202	Drive Shaft		26	23	55.6	96	653	
1.5	2015.07-	CVT	L	F	ENGINE:1NZFE/NCP145	259626	Drive Shaft		26	20	55.6	96	651	
	2015.07-	CVT	R	F	ENGINE:1NZFE/NCP145	259627	Drive Shaft		26	20	55.6	96	897	
PORTE (_NNP1_)														
1.3 VVTi (64 kW)	2004.07-2012.07	-	-	F	Hatchback Engine 2NZ-FE	699046	Inner Joint		23	23	34	60	103.5	
1.5 VVTi (81 kW)	2004.07-2012.07	-	-	F	Hatchback Engine 1NZ-FE	699046	Inner Joint		23	23	34	60	103.5	
PREMIO (AZT240)														
2.0	2001-	CVT	-	-	Engine 1AZFSE	859294	Outer Joint	48T	26	27	63	97	60	M
PREMIO ZZT240														
1800	2001.12-	4AT	-	-	Engine 1ZZFE	859460	Outer Joint	48T	26	24	58	96	54	I
PREMIO ZZT245														
1800	2001.12-	4AT	-	-	Allwheel Drive Engine 1ZZFE	859460	Outer Joint	48T	26	24	58	96	54	I
PREVIA (_R1_ _R2_)/ESTIMA														
2.4 (118 kW)	1993.09-1997.12	AT	-	F	All-wheel Drive MPV Engine 2TZ-FZE	859089	Outer Joint		26	27	56	98	63	M





YEAR	TRANSM	L/R	F/R	REMARKS	GSP Ref.	PRODUCT	ABS	Technical Specifications						
								A	B	C	H	L	P	
TOYOTA														
PREVIA (_R1_ _R2_)/ESTIMA														
2.4 (97 kW)	1990.05-2000.08	-	-	-	MPV Engine 2TZ-FE	859201	Outer Joint	48T	26	27	56	98	63	M
	1990.05-2000.08	-	-	-	All-wheel Drive MPV Engine 2TZ-FE	859201	Outer Joint	48T	26	27	56	98	63	M
	1990.05-2000.08	-	-	F	All-wheel Drive MPV Engine 2TZ-FE	859089	Outer Joint		26	27	56	98	63	M
	1990.05-2000.08	AT/MT	L/R	F	MPV Engine 2TZ-FE	859155	Outer Joint	48T	26	27	56	96	67.5	I
	1990.05-2000.08	-	-	F	MPV Engine 2TZ-FE	859011	Outer Joint		26	27	56	100	63	M
	1990.05-2000.08	-	-	F	All-wheel Drive MPV Engine 2TZ-FE	859011	Outer Joint		26	27	56	100	63	M
PREVIA (_R3_)/ESTIMA														
2.0 D-4D (85 kW)	2001.03-2006.01	MT	L	F	MPV Engine 1CD-FTV	659073	Inner Joint		24	27	50	67	110	
	2001.03-2006.01	AT	L/R	F	MPV Engine 1CD-FTV	859175	Outer Joint	48T	26	27	63.3	100	59	M
	2001.03-2006.01	MT	-	F	MPV Engine 1CD-FTV	859154	Outer Joint	48T	30	27	63.4	100	64.5	M
	2001.03-2006.01	MT	L	F	MPV Engine 1CD-FTV	259379	Drive Shaft	48T	30		63.4	99	576	
	2001.03-2006.01	MT	-	-	MPV Engine 1CD-FTV	631001	Inner Joint			27		33.2		
2.4 16V (115 kW)	2000.08-2006.01	AT	L/R	F	MPV Engine 2AZ-FE	859175	Outer Joint	48T	26	27	63.3	100	59	M
	2000.08-2006.01	MT	-	F	MPV Engine 2AZ-FE	859154	Outer Joint	48T	30	27	63.4	100	64.5	M
	2000.08-2006.01	MT	L	F	MPV Engine 2AZ-FE	259379	Drive Shaft	48T	30		63.4	99	576	
	2000.08-2006.01	AT	-	-	MPV Engine 2AZ-FE	859314	Outer Joint	48T	26	27	61.2	100	59.5	I
	2000.08-2006.01	MT	-	-	MPV Engine 2AZ-FE	631001	Inner Joint			27		33.2		
3.0 VVTi (162 kW)	2000.02-2005.12	-	L	F	All-wheel Drive MPV Engine 1MZ-FE	659109	Inner Joint		24	27	50	84	109	
	2000.02-2005.12	-	-	F	All-wheel Drive MPV Engine 1MZ-FE	859089	Outer Joint		26	27	56	98	63	M
	2000.02-2005.12	-	-	F	All-wheel Drive MPV Engine 1MZ-FE	859154	Outer Joint	48T	30	27	63.4	100	64.5	M
	2000.02-2005.12	-	-	F	All-wheel Drive MPV Engine 1MZ-FE	859486	Outer Joint	48T	30	27	61	100	65	I
	2000.02-2005.12	-	-	F	All-wheel Drive MPV Engine 1MZ-FE	859431	Outer Joint	48T	30	27	61.2	100	64.5	M
	2000.02-2005.12	-	-	-	All-wheel Drive MPV Engine 1MZ-FE	631001	Inner Joint			27		33.2		
	2000.08-2005.12	-	L	F	MPV Engine 1MZ-FE	659109	Inner Joint		24	27	50	84	109	
	2000.08-2005.12	-	R	F	MPV Engine 1MZ-FE	659081	Inner Joint		24	27	40	376.5	109	
	2000.08-2005.12	-	-	F	MPV Engine 1MZ-FE	859089	Outer Joint		26	27	56	98	63	M
	2000.08-2005.12	-	-	F	MPV Engine 1MZ-FE	859154	Outer Joint	48T	30	27	63.4	100	64.5	M
	2000.08-2005.12	-	-	F	MPV Engine 1MZ-FE	859486	Outer Joint	48T	30	27	61	100	65	I
	2000.08-2005.12	-	-	F	MPV Engine 1MZ-FE	859431	Outer Joint	48T	30	27	61.2	100	64.5	M
	2000.08-2005.12	-	-	-	MPV Engine 1MZ-FE	631001	Inner Joint			27		33.2		
PREVIA III (_R2_ _R5_)/ESTIMA														
2.4 Hybrid (110 kW)	2012.05-	-	-	R	F	MPV Engine 2AZ-FXE	659226	Inner Joint		24	27	40	377	104.5
PRIUS														
-	2012.03-2015.03	CVT	L	F	ENGINE:2ZRFXE	659094	Inner Joint		24	25	50	67	105	
1.8	2012.03-2015.03	CVT	R	F	ENGINE:2ZRFXE,	659095	Inner Joint		24	25	40	98	93	
	2012.03-2015.03	CVT	R	F	ENGINE:2ZRFXE,	259640	Drive Shaft		26	24	55.6	95.5	973	
	2012.03-2015.03	CVT	L	F	ENGINE:2ZRFXE	259639	Drive Shaft		26	24	55.6	95.5	624	
PRIUS (_W1_)														
1.5 Hybrid (53 kW)	2000.05-2004.01	-	-	F	Saloon Engine 1NZ-FXE	859191	Outer Joint	48T	26	24	56	95.5	55	I
	2000.05-2004.01	AT/MT	L/R	F	Saloon Engine 1NZ-FXE	859153	Outer Joint	48T	26	24	58	96	52.5	I
	2000.05-2004.01	-	L	F	Saloon Engine 1NZ-FXE	259380	Drive Shaft	48T	26	20	58	95.5	671	
PRIUS (_W2_)														
1.5 (57 kW)	2003.08-2009.03	-	L/R	F	Hatchback Engine 1NZ-FXE	859288	Outer Joint	48T	26	23	58	96	52.5	I
	2003.08-2009.03	CVT	L	F	Hatchback Engine 1NZ-FXE	259380	Drive Shaft	48T	26	20	58	95.5	671	
	2003.08-2009.03	-	L/R	F	Hatchback Engine 1NZ-FXE	859136	Outer Joint	48T	26	23	58	96	52.5	I
PRIUS (_W3_)														
1.8 Hybrid (73 kW)	2009.04-	-	-	F	Hatchback Engine 2ZR-FXE	859340	Outer Joint		26	25	55.6	95.5	57	I
	2009.04-	CVT	R	F	Hatchback Engine 2ZR-FXE	259378	Drive Shaft		26	24	55.6	95.5	973	
	2009.04-	-	L/R	F	Hatchback Engine 2ZR-FXE	859244	Outer Joint		26	25	55.6	95.5	57	I
	2009.04-	CVT	L	F	Hatchback Engine 2ZR-FXE	259377	Drive Shaft		26	24	55.6	95.5	623.5	
PRIUS A														
-	2014.11-	CVT	L	F	ENGINE:2ZRFXE	659094	Inner Joint		24	25	50	67	105	
1.8	2014.11-	CVT	R	F	ENGINE:2ZRFXE,	659095	Inner Joint		24	25	40	98	93	
	2014.11-	CVT	R	F	ENGINE:2ZRFXE,	259640	Drive Shaft		26	24	55.6	95.5	973	
	2014.11-	CVT	L	F	ENGINE:2ZRFXE	259639	Drive Shaft		26	24	55.6	95.5	624	
PRIUS ZVW30														
1800	2009.04-	CVT	-	-	Engine 2ZRFXE	859386	Outer Joint		26	25	55.6	95.5	57	M
PRIUS,PRIUS+														
-	2012.03-2014.10	CVT	L	F	ENGINE:2ZRFXE	659094	Inner Joint		24	25	50	67	105	
1.8	2012.03-2014.10	CVT	R	F	ENGINE:2ZRFXE,	659095	Inner Joint		24	25	40	98	93	
	2012.03-2014.10	CVT	R	F	ENGINE:2ZRFXE,	259640	Drive Shaft		26	24	55.6	95.5	973	
	2012.03-2014.10	CVT	L	F	ENGINE:2ZRFXE	259639	Drive Shaft		26	24	55.6	95.5	624	
PROACE (MDX_)														
2.0 D (120 kW)	2013.06-2016.03	-	-	F	Box Body/Estate Engine 4WZ-FHV	810051	Outer Joint		28	39	58.6	94	63	I
2.0 D (94 kW)	2013.06-2016.03	-	-	F	Box Body/Estate Engine 4WZ-FTW	810051	Outer Joint		28	39	58.6	94	63	I





TOYOTA	YEAR	TRANSM	L/R	F/R	REMARKS	GSP Ref.	PRODUCT	ABS	Technical Specifications											
									A	B	C	H	L	P						
PROACE (MDZ_)																				
2.0 D (110 kW)	2016.02-	-	-	-	F	Box Engine 4WZ-FTV	810051	Outer Joint		28	39	58.6	94	63	I					
2.0 D (90 kW)	2016.02-	-	-	-	F	Box Engine 4WZ-FTV	810051	Outer Joint		28	39	58.6	94	63	I					
PROACE (MPY_)																				
2.0 D (110 kW)	2016.02-	-	-	-	F	Bus Engine 4WZ-FTV	810051	Outer Joint		28	39	58.6	94	63	I					
PROBOX,SUCCEED																				
1.3	2014.09-	-	CVT	R	F	ENGINE:1NRFE/NSP160	259201	Drive Shaft		26	23	55.6	96	896						
	2014.09-	-	CVT	L	F	ENGINE:1NRFE/NSP160	259202	Drive Shaft		26	23	55.6	96	653						
1.5	2014.09-	-	CVT	L	F	ENGINE:1NZFE/NCP165	259626	Drive Shaft		26	20	55.6	96	651						
	2014.09-	-	CVT	R	F	ENGINE:1NZFE/NCP165	259627	Drive Shaft		26	20	55.6	96	897						
PROBOX/SUCCEED (_P5_)																				
1.5 VVTi (80 kW)	2002.07-	2014.08	-	L/R	F/R	Estate Engine 1NZ-FE	839105	Outer Joint	44T	25	22	52.5	95	58	M					
	2002.07-	2014.08	-	-	F	Estate Engine 1NZ-FE	699046	Inner Joint		23	23	34	60	103.5						
RACTIS																				
1.3	2010.11-	2014.04	CVT	R	F	ENGINE:1NRFE/NSP120	259201	Drive Shaft		26	23	55.6	96	896						
	2014.05-	-	CVT	R	F	ENGINE:1NRFKE/NSP120	259201	Drive Shaft		26	23	55.6	96	896						
	2014.05-	-	CVT	L	F	ENGINE:1NRFKE/NSP120	259202	Drive Shaft		26	23	55.6	96	653						
1.5	2005.09-	2007.11	AT	L	F	ENGINE:1NZFE/NCP100	259202	Drive Shaft		26	23	55.6	96	653						
	2010.11-	2014.04	CVT	L	F	ENGINE:1NZFE/NCP125	259626	Drive Shaft		26	20	55.6	96	651						
	2010.11-	2014.04	CVT	R	F	ENGINE:1NZFE/NCP125	259627	Drive Shaft		26	20	55.6	96	897						
RACTIS (_P10_)																				
1.3 (64 kW)	2005.09-	2010.08	-	-	F	MPV Engine 2SZ-FE	859449	Outer Joint		26	22	55.6	96	51	I					
RAV 4																				
-	1994.01-	2000.07	MT/AT	-	F	-	659012	Inner Joint		23	23	44	49.5	114.5						
	1994.01-	2000.07	MT/AT	L	-	AE 95 4WD	259044	Drive Shaft		26	23	56	95.5	574						
	1994.01-	2000.07	MT/AT	R	-	AE 95 4WD	259046	Drive Shaft		26	23	56	95.5	578.5						
	2000.01-	-	-	L	F	20 Series	259012	Drive Shaft		26	23	63	100	595						
	2000.01-	-	-	R	F	20 Series	259013	Drive Shaft		26	23	63	100	990.5						
RAV 4 I (SXA1_)																				
2.0 (95 kW)	1994.06-	2000.06	-	-	F	All-terrain vehicle closed	899122	Outer Joint		26	24	56	96	56	I					
RAV 4 I (_A1_)																				
2(94 kW)	1996.07-	2000.06	AT/MT	L/R	F	All-wheel Drive Closed Off-Road Vehicle Engine 3S-FE	859001	Outer Joint		26	24	56	95.5	55	I					
2.0 (95 kW)	1994.06-	2000.06	-	R	F	All-wheel Drive Closed Off-Road Vehicle Engine 3S-FE	659160	Inner Joint		23	23	36	75	93						
	1994.06-	2000.06	-	-	R	All-wheel Drive Closed Off-Road Vehicle Engine 3S-FE	859128	Outer Joint	48T	26	23	56	95.5	55	I					
	1994.06-	2000.06	AT/MT	L/R	F	All-wheel Drive Closed Off-Road Vehicle Engine 3S-FE	859001	Outer Joint		26	24	56	95.5	55	I					
	1994.06-	2000.06	-	-	-	All-wheel Drive Closed Off-Road Vehicle Engine 3S-FE	859062	Outer Joint		26	24	56	95.5	55	I					
1994.06-	2000.06	-	L/R	F	All-wheel Drive Closed Off-Road Vehicle Engine 3S-FE	859289	Outer Joint	48T	26	23	56	96.5	55	I						
RAV 4 I Cabrio (SXA1_)																				
2.0 16V (94 kW)	1997.12-	2000.06	-	-	F	All-terrain vehicle open	899122	Outer Joint		26	24	56	96	56	I					
RAV 4 I Cabrio (_A1_)																				
2.0 16V (94 kW)	1997.12-	2000.06	-	-	R	All-wheel Drive Open Off-Road Vehicle Engine 3S-FE	859128	Outer Joint	48T	26	23	56	95.5	55	I					
	1997.12-	2000.06	AT/MT	L/R	F	All-wheel Drive Open Off-Road Vehicle Engine 3S-FE	859001	Outer Joint		26	24	56	95.5	55	I					
	1997.12-	2000.06	-	-	-	All-wheel Drive Open Off-Road Vehicle Engine 3S-FE	859062	Outer Joint		26	24	56	95.5	55	I					
	1997.12-	2000.06	-	L/R	F	All-wheel Drive Open Off-Road Vehicle Engine 3S-FE	859289	Outer Joint	48T	26	23	56	96.5	55	I					
RAV 4 II (_A2_)																				
1.8 (92 kW)	2000.08-	2005.11	-	-	F	Closed Off-Road Vehicle Engine 1ZZ-FE	859036	Outer Joint		26	23	58	96	52.5	I					
	2000.08-	2005.11	MT	L/R	F	Closed Off-Road Vehicle Engine 1ZZ-FE	859153	Outer Joint	48T	26	24	58	96	52.5	I					
	2000.08-	2005.11	AT	-	F	Closed Off-Road Vehicle Engine 1ZZ-FE	859131	Outer Joint	48T	26	24	58	96	54	I					
	2000.08-	2005.11	AT	L	F	Closed Off-Road Vehicle Engine 1ZZ-FE	659005	Inner Joint		20	23	35	63.5	115.7						
	2000.08-	2005.11	AT	R	F	Closed Off-Road Vehicle Engine 1ZZ-FE	659004	Inner Joint		20	23	35	363	100.5						
2000.08-	2005.11	-	-	F	Closed Off-Road Vehicle Engine 1ZZ-FE	859043	Outer Joint	48T	26	27	58	96	62	I						
2.0 (110 kW)	2000.06-	2005.11	MT	-	-	All-wheel Drive Closed Off-Road Vehicle Engine 1AZ-FE	859081	Outer Joint		26	27	63	100	62	I					
	2000.06-	2005.11	-	-	F	All-wheel Drive Closed Off-Road Vehicle Engine 1AZ-FE	859043	Outer Joint	48T	26	27	58	96	62	I					
	2000.06-	2005.11	AT	-	-	All-wheel Drive Closed Off-Road Vehicle Engine 1AZ-FE	859314	Outer Joint	48T	26	27	61.2	100	59.5	I					
	2000.06-	2005.11	-	L/R	F	All-wheel Drive Closed Off-Road Vehicle Engine 1AZ-FE	859167	Outer Joint	48T	26	27	63	100	62	I					
2.0 D-4D (85 kW)	2001.05-	2005.11	MT	L	F	All-wheel Drive Closed Off-Road Vehicle Engine 1CD-FTV	659084	Inner Joint		23	27	50	62	108.5						
	2001.05-	2005.11	MT	R	F	All-wheel Drive Closed Off-Road Vehicle Engine 1CD-FTV	659079	Inner Joint		23	27	28	394	123						
	2001.05-	2005.11	-	L/R	F	All-wheel Drive Closed Off-Road Vehicle Engine 1CD-FTV	859167	Outer Joint	48T	26	27	63	100	62	I					
RAV 4 III (_A3_)/RAV 4/VANGUARD																				
2.0 (116 kW)	2008.12-	-	MT	R	F	All-wheel Drive Closed Off-Road Vehicle Engine 3ZR-FAE	201234	Drive Shaft		30	24	61.2	100	964						
	2008.12-	-	-	R	F	All-wheel Drive Closed Off-Road Vehicle Engine 3ZR-FAE	659241	Inner joint		20	27	35.5	362	102.5						
	2008.12-	-	MT	L	F	Closed Off-Road Vehicle Engine 3ZR-FAE	659073	Inner Joint		24	27	50	67	110						
	2008.12-	-	-	L	F	All-wheel Drive Closed Off-Road Vehicle Engine 3ZR-FAE	659073	Inner Joint		24	27	50	67	110						
	2008.12-	-	-	-	R	All-wheel Drive Closed Off-Road Vehicle Engine 3ZR-FAE	659213	Inner Joint		20	19	37	60	84						
	2008.12-	-	-	-	R	All-wheel Drive Closed Off-Road Vehicle Engine 3ZR-FAE	859485	Outer Joint		26	18	51.9	99.5	49	I					
	2008.12-	-	-	-	R	All-wheel Drive Closed Off-Road Vehicle Engine 3ZR-FAE	859488	Outer Joint		26	19	51.9	99.5	49	I					





YEAR	TRANSM	L/R	F/R	REMARKS	GSP Ref.	PRODUCT	ABS	Technical Specifications							
								A	B	C	H	L	P		
TOYOTA															
RAV 4 III (_A3_)/RAV 4/VANGUARD															
2.0 (116 kW)	2008.12	-	-	R	-	All-wheel Drive Closed Off-Road Vehicle Engine 3ZR-FAE	859366	Outer Joint	26	18	51.9	99.5	49	M	
	2008.12	-	MT	R	F	Closed Off-Road Vehicle Engine 3ZR-FAE	659078	Inner Joint	24	27	40	370	105		
2.0 VVT-i (112 kW)	2006.03	-	MT	L	F	All-wheel Drive Closed Off-Road Vehicle Engine 1AZ-FE	659073	Inner Joint	24	27	50	67	110		
	2006.03	-	-	-	R	All-wheel Drive Closed Off-Road Vehicle Engine 1AZ-FE	659213	Inner Joint	20	19	37	60	84		
	2006.03	-	AT	L	F	All-wheel Drive Closed Off-Road Vehicle Engine 1AZ-FE	659109	Inner Joint	24	27	50	84	109		
	2006.03	-	-	-	R	All-wheel Drive Closed Off-Road Vehicle Engine 1AZ-FE	859366	Outer Joint	26	18	51.9	99.5	49	M	
	2006.03	-	AT	-	F	All-wheel Drive Closed Off-Road Vehicle Engine 1AZ-FE	859245	Outer Joint	26	27	61.2	100	59	I	
	2006.03	-	-	-	R	All-wheel Drive Closed Off-Road Vehicle Engine 1AZ-FE	859485	Outer Joint	26	18	51.9	99.5	49	I	
	2006.03	-	-	-	R	All-wheel Drive Closed Off-Road Vehicle Engine 1AZ-FE	859488	Outer Joint	26	19	51.9	99.5	49	I	
	2006.03	-	AT	R	F	All-wheel Drive Closed Off-Road Vehicle Engine 1AZ-FE	659108	Inner Joint	24	27	35.5	385	105		
2.2 D-4D (100 kW)	2006.03	-	MT	L	F	All-wheel Drive Closed Off-Road Vehicle Engine 2AD-FTV	659073	Inner Joint	24	27	50	67	110		
	2006.03	-	MT	-	R	All-wheel Drive Closed Off-Road Vehicle Engine 2AD-FTV	659213	Inner Joint	20	19	37	60	84		
	2006.03	-	-	-	R	All-wheel Drive Closed Off-Road Vehicle Engine 2AD-FTV	859366	Outer Joint	26	18	51.9	99.5	49	M	
	2006.03	-	MT	L	F	All-wheel Drive Closed Off-Road Vehicle Engine 2AD-FTV	259622	Drive Shaft	30	24	61.2	100	625		
	2006.03	-	MT	-	R	All-wheel Drive Closed Off-Road Vehicle Engine 2AD-FTV	859485	Outer Joint	26	18	51.9	99.5	49	I	
	2006.03	-	MT	-	R	All-wheel Drive Closed Off-Road Vehicle Engine 2AD-FTV	859488	Outer Joint	26	19	51.9	99.5	49	I	
	2006.03	-	MT	R	F	All-wheel Drive Closed Off-Road Vehicle Engine 2AD-FTV	259518	Drive Shaft	30	24	61.2	100	1006		
2.2 D-4D (110 kW)	2008.12	2013.12	MT	R	F	Closed Off-Road Vehicle Engine 2AD-FTV	201235	Drive Shaft	30	24	61.2	100	1003		
	2008.12	2013.12	6AT	L	F	Closed Off-Road Vehicle Engine 2AD-FTV	259670	Drive Shaft	30	24	61.2	100	636		
	2008.12	2013.12	-	L	F	All-wheel Drive Closed Off-Road Vehicle Engine 2AD-FHV	659073	Inner Joint	24	27	50	67	110		
	2008.12	2013.12	MT	L	F	Closed Off-Road Vehicle Engine 2AD-FTV	659073	Inner Joint	24	27	50	67	110		
	2008.12	2013.12	-	-	R	All-wheel Drive Closed Off-Road Vehicle Engine 2AD-FHV	659213	Inner Joint	20	19	37	60	84		
	2008.12	2013.12	MT	R	F	Closed Off-Road Vehicle Engine 2AD-FTV	659081	Inner Joint	24	27	40	376.5	109		
	2008.12	2013.12	-	-	R	All-wheel Drive Closed Off-Road Vehicle Engine 2AD-FHV	859485	Outer Joint	26	18	51.9	99.5	49	I	
	2008.12	2013.12	-	-	R	All-wheel Drive Closed Off-Road Vehicle Engine 2AD-FHV	859488	Outer Joint	26	19	51.9	99.5	49	I	
	2008.12	2013.12	-	-	R	All-wheel Drive Closed Off-Road Vehicle Engine 2AD-FHV	859366	Outer Joint	26	18	51.9	99.5	49	M	
2.2 D-CAT (130 kW)	2006.03	-	-	L	F	All-wheel Drive Closed Off-Road Vehicle Engine 2AD-FHV	659073	Inner Joint	24	27	50	67	110		
	2006.03	-	-	-	R	All-wheel Drive Closed Off-Road Vehicle Engine 2AD-FHV	659213	Inner Joint	20	19	37	60	84		
	2006.03	-	-	-	R	All-wheel Drive Closed Off-Road Vehicle Engine 2AD-FHV	859366	Outer Joint	26	18	51.9	99.5	49	M	
	2006.03	-	MT	L	F	All-wheel Drive Closed Off-Road Vehicle Engine 2AD-FHV	259622	Drive Shaft	30	24	61.2	100	625		
	2006.03	-	-	-	R	All-wheel Drive Closed Off-Road Vehicle Engine 2AD-FHV	859485	Outer Joint	26	18	51.9	99.5	49	I	
	2006.03	-	-	-	R	All-wheel Drive Closed Off-Road Vehicle Engine 2AD-FHV	859488	Outer Joint	26	19	51.9	99.5	49	I	
	2006.03	-	MT	R	F	All-wheel Drive Closed Off-Road Vehicle Engine 2AD-FHV	259518	Drive Shaft	30	24	61.2	100	1006		
2.4 VVTi (125 kW)	2005.11	-	MT	R	F	Closed Off-Road Vehicle Engine 2AZ-FE	201233	Drive Shaft	30	24	61.2	100	977		
	2005.11	-	MT	R	F	Closed Off-Road Vehicle Engine 2AZ-FE	659128	Inner Joint	24	27	40	369.5	105.5		
3.5 VVTi (201 kW)	2005.11	-	-	R	-	All-wheel Drive Closed Off-Road Vehicle Engine 2GR-FE	859366	Outer Joint	26	18	51.9	99.5	49	M	
RAV 4 IV (_A4_)															
2.0 D-4D (105 kW)	2015.10	-	6MT	L	F	Closed Off-Road Vehicle Engine 2WW	259670	Drive Shaft	30	24	61.2	100	636		
	2015.10	-	MT	L	F	Closed Off-Road Vehicle Engine 2WW	659073	Inner Joint	24	27	50	67	110		
2.0 D4-D (91 kW)	2012.12	-	MT	R	F	Closed Off-Road Vehicle Engine 1AD-FTV	201235	Drive Shaft	30	24	61.2	100	1003		
	2012.12	-	MT	L	F	Closed Off-Road Vehicle Engine 1AD-FTV	659073	Inner Joint	24	27	50	67	110		
	2012.12	-	MT	R	F	Closed Off-Road Vehicle Engine 1AD-FTV	659081	Inner Joint	24	27	40	376.5	109		
	2013.01	-	MT	L	F	All-wheel Drive Closed Off-Road Vehicle Engine 1AD-FTV	659073	Inner Joint	24	27	50	67	110		
	2013.01	-	MT	-	R	All-wheel Drive Closed Off-Road Vehicle Engine 1AD-FTV	659213	Inner Joint	20	19	37	60	84		
	2013.01	-	MT	-	R	All-wheel Drive Closed Off-Road Vehicle Engine 1AD-FTV	859488	Outer Joint	26	19	51.9	99.5	49	I	
2.0 VVT-i (107 kW)	2012.12	-	AT	R	F	Closed Off-Road Vehicle Engine 3ZR-FE	659128	Inner Joint	24	27	40	369.5	105.5		
2.0 VVT-i (111 kW)	2012.12	-	AT	R	F	All-wheel Drive Closed Off-Road Vehicle Engine 3ZR-FAE	659128	Inner Joint	24	27	40	369.5	105.5		
2.0 VVT-i (112 kW)	2015.04	-	MT	R	F	All-wheel Drive Closed Off-Road Vehicle Engine 3ZR-FAE	201234	Drive Shaft	30	24	61.2	100	964		
	2015.04	-	-	-	R	All-wheel Drive Closed Off-Road Vehicle Engine 3ZR-FAE	659241	Inner joint	20	27	35.5	362	102.5		
	2015.04	-	AT	R	F	All-wheel Drive Closed Off-Road Vehicle Engine 3ZR-FAE	659128	Inner Joint	24	27	40	369.5	105.5		
2.2 D4-D (110 kW)	2012.12	-	6AT	L	F	All-wheel Drive Closed Off-Road Vehicle Engine 2AD-FHV	259670	Drive Shaft	30	24	61.2	100	636		
2.5 VVT-i (131 kW)	2012.12	-	MT	R	F	Closed Off-Road Vehicle Engine 2AR-FE	201233	Drive Shaft	30	24	61.2	100	977		
	2012.12	-	MT	R	F	Closed Off-Road Vehicle Engine 2AR-FE	659128	Inner Joint	24	27	40	369.5	105.5		
RAV4															
2.0	2000.08	2003.06	MT	L	F	ENGINE: 1AZFE/ACA26	259647	Drive Shaft	48T	26	24	61.2	100	627	
	2005.11	2008.11	5MT	L	F	ENGINE: 1AZFE/ACA30	259417	Drive Shaft	30	24	61.2	100	656		
	2005.11	2008.11	5MT	R	R	ENGINE: 1AZFE/ACA30	259637	Drive Shaft	26	20	51.9	99.5	810		
	2005.11	2008.11	5MT	R	R	ENGINE: 1AZFE/ACA30	259656	Drive Shaft	26	20	51.9	99.5	811		
	2008.12	2010.01	6MT	L	F	ENGINE: 3ZRFAE/ZSA30	259671	Drive Shaft	30	24	61.2	100	665		
	2008.12	2010.01	6MT	R	F	ENGINE: 3ZRFAE/ZSA30	259672	Drive Shaft	30	24	61.2	100	967		
	2008.12	2010.07	AT	L	F	ENGINE: 3ZRFAE/ZSA30	259678	Drive Shaft	26	24	61.2	100	663		
	2008.12	2010.01	6MT	R	R	ENGINE: 3ZRFAE/ZSA30	259637	Drive Shaft	26	20	51.9	99.5	810		
	2010.02	2012.11	6MT	R	R	ENGINE: 3ZRFAE/ZSA30	259656	Drive Shaft	26	20	51.9	99.5	811		
	2012.12	2015.09	6MT	R	R	ENGINE: 3ZRFAE/ZSA44	259656	Drive Shaft	26	20	51.9	99.5	811		
	2013.11	2015.09	6MT	R	R	ENGINE: 1ADFTV/ALA41	259656	Drive Shaft	26	20	51.9	99.5	811		
	2015.10	-	6MT	L	F	ENGINE: 3ZRFE/ZSA42	259671	Drive Shaft	30	24	61.2	100	665		





YEAR	TRANSM	L/R	F/R	REMARKS	GSP Ref.	PRODUCT	ABS	Technical Specifications							
								A	B	C	H	L	P		
TOYOTA															
RAV4															
2.0	2015.10-	-	6MT	R	F	ENGINE:3ZRFE/ZSA44	259672	Drive Shaft		30	24	61.2	100	967	
	2015.10-	-	CVT	L	F	ENGINE:3ZRFE/ZSA42	259678	Drive Shaft		26	24	61.2	100	663	
	2015.10-	-	6MT	R	R	ENGINE:3ZRFE/ZSA44	259656	Drive Shaft		26	20	51.9	99.5	811	
2.2	2008.12-	2010.01	6MT	R	R	ENGINE:2ADFTV/ALA30	259637	Drive Shaft		26	20	51.9	99.5	810	
	2008.12-	2012.11	6MT	R	R	ENGINE:2ADFTV/ALA30	259656	Drive Shaft		26	20	51.9	99.5	811	
	2009.03-	2010.01	-	R	F	ATYPE, G, EUR, LHD, 2ADFHV, DCRL, ATM, 6FC:ALA30LAWTGXW	659235	Inner Joint		24	27	34	391	102	
	2009.03-	2010.01	-	R	F	ATYPE, G, EUR, LHD, 2ADFHV, DCRL, ATM, 6FC:ALA30LAWTGXW	259696	Drive Shaft		30	24	61.2	100	1000	
	2012.12-	2015.09	6MT	R	R	ENGINE:2ADFTV/ALA49	259656	Drive Shaft		26	20	51.9	99.5	811	
	2012.12-	2015.09	6AT	R	R	ENGINE:2ADFHV/ALA49	259656	Drive Shaft		26	20	51.9	99.5	811	
2.4	2007.01-	2008.11	4AT	R	R	ENGINE:2AZFE/ACA31	259637	Drive Shaft		26	20	51.9	99.5	810	
	2008.08-	2012.11	5MT	L	F	ENGINE:2AZFE/ACA31	259417	Drive Shaft		30	24	61.2	100	656	
	2008.08-	2012.11	5MT	R	R	ENGINE:2AZFE/ACA33	259656	Drive Shaft		26	20	51.9	99.5	811	
2.5	2008.11-	2012.12	4AT	L	F	ENGINE:2ARFE/ASA33	259646	Drive Shaft		26	24	61.2	100	644	
	2009.04-	2012.12	4AT	L	F	ENGINE:2ARFE/ASA38	259645	Drive Shaft		26	24	61.2	100	660	
	2012.12-	2015.09	6AT	R	F	ENGINE:2ARFE/N. America	259685	Drive Shaft		30	24	61.2	100	985	
	2012.12-	2015.09	6AT	R	F	ENGINE:2ARFE/N. America	659206	Inner Joint		24	27	40	377	104.5	
	2015.10-	-	6AT	R	F	ENGINE:2ARFE/N. America	259685	Drive Shaft		30	24	61.2	100	985	
	2015.10-	-	CVT	R	F	ENGINE:2ARFE/N. America	259685	Drive Shaft		30	24	61.2	100	985	
	2015.10-	-	CVT	R	F	ENGINE:2ARFE/EUROPE	259685	Drive Shaft		30	24	61.2	100	985	
	2015.10-	-	6AT	R	F	ENGINE:2ARFE/N. America	659206	Inner Joint		24	27	40	377	104.5	
	2015.10-	-	CVT	R	F	ENGINE:2ARFE/N. America	659206	Inner Joint		24	27	40	377	104.5	
	2015.10-	-	CVT	R	F	ENGINE:2ARFE/EUROPE	659206	Inner Joint		24	27	40	377	104.5	
	2015.10-	-	6AT	L	F	ENGINE:2ARFE/ASA44	259610	Drive Shaft		30	24	61.2	100	648	
	2015.10-	-	6AT	R	F	ENGINE:2ARFE/ASA44	259370	Drive Shaft		30	24	61.2	100	994	
	2015.10-	-	6AT	R	R	ENGINE: 2ARFE/ASA44	259656	Drive Shaft		26	20	51.9	99.5	811	
3.5	2008.08-	2012.11	5AT	R	F	ENGINE:2GRFE/GSA33	259370	Drive Shaft		30	24	61.2	100	994	
	2008.08-	2012.11	5AT	R	R	ENGINE:2GRFE/GSA33	259637	Drive Shaft		26	20	51.9	99.5	810	
	2008.08-	2012.11	5AT	R	R	ENGINE:2GRFE/GSA33	259656	Drive Shaft		26	20	51.9	99.5	811	
RAV4 (ACA2)															
2.0	2000-	-	MT	-	-	-	859294	Outer Joint	48T	26	27	63	97	60	M
2.0 4WD	2000-	-	MT	-	-	-	859294	Outer Joint	48T	26	27	63	97	60	M
RAV4 (ACA20W)															
2.0 4WD	2000-	-	MT/AT	-	-	Engine 1AZFSE	859294	Outer Joint	48T	26	27	63	97	60	M
RAV4 (ACA21W)															
2.0 4WD	2000-	-	MT/AT	-	-	Engine 1AZFSE	859294	Outer Joint	48T	26	27	63	97	60	M
RAV4 4 (ZCA25W)															
1.8	2000.05-	-	4AT	-	-	Engine 1ZZFE	859460	Outer Joint	48T	26	24	58	96	54	I
RAV4 4 (ZCA26W)															
1.8	2000.05-	-	4AT	-	-	Engine 1ZZFE	859460	Outer Joint	48T	26	24	58	96	54	I
RAV4 4 ZCA25W															
1.8	2000.05-	-	4AT	-	-	Engine 1ZZFE	859460	Outer Joint	48T	26	24	58	96	54	I
RAV4 4 ZCA26W															
1.8	2000.05-	-	4AT	-	-	Engine 1ZZFE	859460	Outer Joint	48T	26	24	58	96	54	I
RAV4 J/L															
1.8	2000.05-	2003.06	AT	L	F	ENGINE:1ZZFE/ZCA25	259561	Drive Shaft	48T	26	20	58	96	650	
RAV4 ZCA25W															
1800	2000.05-	-	4AT	-	-	Engine 1ZZFE	859460	Outer Joint	48T	26	24	58	96	54	I
RAV4 ZCA26W															
1800	2000.05-	-	4AT	-	-	Engine 1ZZFE	859460	Outer Joint	48T	26	24	58	96	54	I
RAV4,VANGUARD															
2.4	2008.08-	2012.11	AT	R	R	ENGINE:2AZFE/ACA31	259637	Drive Shaft		26	20	51.9	99.5	810	
	2008.08-	2012.11	AT	R	R	ENGINE:2AZFE/ACA31	259656	Drive Shaft		26	20	51.9	99.5	811	
3.5	2010.02-	2012.11	5AT	R	F	ENGINE:2GRFE,/GSA33	259370	Drive Shaft		30	24	61.2	100	994	
	2010.02-	2012.11	5AT	R	R	ENGINE:2GRFE/GSA33	259637	Drive Shaft		26	20	51.9	99.5	810	
	2010.02-	2012.11	5AT	R	R	ENGINE:2GRFE/GSA33	259656	Drive Shaft		26	20	51.9	99.5	811	
RUSH (J210E)															
1.5 4WD	2006.01-	-	4AT	-	-	Engine 3SZVE	899290	Outer Joint		24	22	52	89.8	81	M
	2006.01-	-	5MT	-	F	Engine 3SZVE	899290	Outer Joint		24	22	52	89.8	81	M
SCEPTER															
2.2	1998-	-	MT	-	-	SXV20 5SFE	659033	Inner Joint		20	24	35	63.5	115.7	
	1998-	-	-	-	-	-	859066	Outer Joint		26	32	56	101	66	I
2.2 (100 kW)	1992.11-	1996.09	-	-	-	Saloon Engine 5S-FE	859193	Outer Joint		26	32	56	101	66	I
	1992.11-	1996.09	-	-	-	Estate Engine 5S-FE	859193	Outer Joint		26	32	56	101	66	I
SCEPTER (SXV10)															
2.2	1992.11-	1996.08	AT	-	-	Engine 5SFE	859087	Outer Joint		26	32	56	100	63	M

	 YEAR	TRANSM	L/R	F/R	REMARKS	GSP Ref.	 PRODUCT	 ABS	Technical Specifications					
									A	B	C	H	L	P
TOYOTA														
SCEPTER (SXV15)														
2.2	1993.10-1994.09	AT	-	-	Engine 5SFE	859087	Outer Joint		26	32	56	100	63	M
SCEPTER (SXV15W)														
2.2	1992.12-1996.09	AT	-	-	Engine 5SFE	859087	Outer Joint		26	32	56	100	63	M
SCEPTER (VCV10)														
3.0	1992.11-1996.08	AT	-	-	Engine 3VZFE	859445	Outer Joint		30	27	56	100	66	M
SCEPTER (VCV15)														
3.0	1992.07-1994.09	AT	-	-	Engine 3VZFE	859445	Outer Joint		30	27	56	100	66	M
SCEPTER (_V15_)														
2.2 (100 kW)	1993.10-1996.06	-	-	-	Coupe Engine 5S-FE	859193	Outer Joint		26	32	56	101	66	I
SCEPTER SXV10														
2.2	1992.11-1996.08	AT	-	-	Engine 5SFE	859087	Outer Joint		26	32	56	100	63	M
	1992.11-1996.08	AT	-	-	Engine 5SFE	851047	Outer Joint	48T	26	32	56	100	63	M
	1992.11-1996.08	AT	-	-	Engine 5SFE	859087	Outer Joint		26	32	56	100	63	M
	1992.11-1996.08	AT	-	-	Engine 5SFE	851047	Outer Joint	48T	26	32	56	100	63	M
SCEPTER SXV15														
2.2	1993.10-1994.09	AT	-	-	Engine 5SFE	859087	Outer Joint		26	32	56	100	63	M
	1993.10-1994.09	AT	-	-	Engine 5SFE	851047	Outer Joint	48T	26	32	56	100	63	M
	1993.10-1994.09	AT	-	-	Engine 5SFE	859087	Outer Joint		26	32	56	100	63	M
	1993.10-1994.09	AT	-	-	Engine 5SFE	851047	Outer Joint	48T	26	32	56	100	63	M
SCEPTER SXV15W														
2.2	1992.12-1996.09	AT	-	-	Engine 5SFE	859087	Outer Joint		26	32	56	100	63	M
	1992.12-1996.09	AT	-	-	Engine 5SFE	851047	Outer Joint	48T	26	32	56	100	63	M
	1992.12-1996.09	AT	-	-	Engine 5SFE	859087	Outer Joint		26	32	56	100	63	M
	1992.12-1996.09	AT	-	-	Engine 5SFE	851047	Outer Joint	48T	26	32	56	100	63	M
SCEPTER VCV10														
3.0	1992.11-1996.08	AT	-	-	Engine 3VZFE	859445	Outer Joint		30	27	56	100	66	M
	1992.11-1996.08	AT	-	-	Engine 3VZFE	859421	Outer Joint		30	34	56	100	66	M
3000	1992.11-1996.08	AT	-	-	Engine 3VZFE	859445	Outer Joint		30	27	56	100	66	M
	1992.11-1996.08	AT	-	-	Engine 3VZFE	859421	Outer Joint		30	34	56	100	66	M
SCEPTER VCV15														
3.0	1992.07-1994.09	AT	-	-	Engine 3VZFE	859445	Outer Joint		30	27	56	100	66	M
	1992.07-1996.06	AT	-	-	Engine 3VZFE	859421	Outer Joint		30	34	56	100	66	M
3000	1992.07-1994.09	AT	-	-	Engine 3VZFE	859445	Outer Joint		30	27	56	100	66	M
	1992.07-1996.06	AT	-	-	Engine 3VZFE	859421	Outer Joint		30	34	56	100	66	M
SEQUOIA														
4.6	2009.04-2012.07	6AT	R	F	ENGINE:1URFE/UPK65	259613	Drive Shaft		36	34	78	121	707	
4.7	2007.11-2009.03	5AT	R	F	ENGINE:2UZFE/UJK65	259613	Drive Shaft		36	34	78	121	707	
5.7	2008.08-	6AT	R	F	ENGINE:3URFBE/USK65	259613	Drive Shaft		36	34	78	121	707	
	2009.11-	6AT	R	F	ENGINE:3URFE/USK65	259613	Drive Shaft		36	34	78	121	707	
SIENNA														
3.3	2005.09-2006.11	AT	L	F	ENGINE:3MZFE/MCL20	259644	Drive Shaft	48T	30	24	61	100	710	
3.5	2006.12-2009.12	AT	L	F	ENGINE:2GRFE/GSL20	259644	Drive Shaft	48T	30	24	61	100	710	
SIENNA (_L2_)														
3.3 (169 kW)	2003.01-2006.12	-	-	F	MPV Engine 3MZ-FE	859234	Outer Joint	48T	30	27	61	100	72.5	M
3.5(198 kW)	2006.1-2010.12	AT	-	F	MPV Engine 2GR-FE	859234	Outer Joint	48T	30	27	61	100	72.5	M
SOLARA														
3.3	2003.07-2006.04	5AT	L	F	ENGINE:3MZFE/MCV31	259649	Drive Shaft	48T	30	24	61	100	652	
SOLARA (_V2_)														
2.2 (100 kW)	1998.06-2001.06	-	-	-	Coupe Engine 5S-FE	859193	Outer Joint		26	32	56	101	66	I
	2000.02-2002.11	-	-	-	Convertible Engine 5S-FE	859193	Outer Joint		26	32	56	101	66	I
SOLARA (_V3_)														
2.4 (117 kW)	2003.07-2008.11	-	L	F	Coupe Engine 2AZ-FE	259184	Drive Shaft	48T	26	24	63	100	667	
	2003.07-2008.11	-	R	F	Coupe Engine 2AZ-FE	259185	Drive Shaft	48T	26	24	63	100	966	
SOLUNA														
1.3	2001.01-	MT/AT	-	-	Engine AL50	859432	Outer Joint		26	22	56	95.5	53	M
	2001.01-	MT/AT	-	-	Engine AL50	859432	Outer Joint		26	22	56	95.5	53	M
1300	2001.01-	MT/AT	-	-	Engine AL50	859432	Outer Joint		26	22	56	95.5	53	M
SPRINTER (_E1_)														
1.5 (74 kW)	1991.06-2002.11	-	-	-	Saloon Engine 5A-FE	619001	Inner Joint		23	29	34	58.5	128.5	
	1991.06-2002.11	-	-	F	Saloon Engine 5A-FE	859337	Outer Joint		26	29	56	96	54	O
	1991.06-2002.11	AT	-	-	Saloon Engine 5A-FE	659023	Inner Joint		23	23	34	60	113	
1.6 (81 kW)	1991.06-2000.12	-	-	F	Saloon Engine 4A-FE	699046	Inner Joint		23	23	34	60	103.5	
1.6 (85 kW)	1991.09-1995.04	-	R	F	All-wheel Drive Saloon Engine 4A-FE	659160	Inner Joint		23	23	36	75	93	
2.0 D (54 kW)	1991.06-2000.11	-	-	F	Saloon Engine 2C	859120	Outer Joint	48T	26	24	56	95.5	55	I
	1991.06-2000.11	-	L	F	Saloon Engine 2C	659005	Inner Joint		20	23	35	63.5	115.7	

	 YEAR	TRANSM	L/R	F/R	REMARKS	GSP Ref.	 PRODUCT	 ABS	Technical Specifications					
									A	B	C	H	L	P
TOYOTA														
SPRINTER (_E1_)														
2.0 D (54 kW)	1995.04-2000.11	-	-	F	Hatchback Engine 2C	859120	Outer Joint	48T	26	24	56	95.5	55	I
	1995.04-2000.11	-	L	F	Hatchback Engine 2C	659005	Inner Joint		20	23	35	63.5	115.7	
2.2 TD (59 kW)	1998.04-2000.07	-	R	F	All-wheel Drive Saloon Engine 3CE	659160	Inner Joint		23	23	36	75	93	
	1998.04-2000.07	-	-	F	Saloon Engine 3CE	859120	Outer Joint	48T	26	24	56	95.5	55	I
	1998.04-2000.07	MT	-	R	All-wheel Drive Saloon Engine 3CE	639089	Inner Joint			20		68.6		
SPRINTER (_E9_)														
1.6 (77 kW)	1988.10-1992.04	-	R	F	All-wheel Drive Hatchback Engine 4A-FE	659160	Inner Joint		23	23	36	75	93	
SPRINTER CARIB (AE11_)														
1.6 (85 kW)	1996.05-2002.05	-	R	F	All-wheel Drive Estate Engine 4A-FE	659160	Inner Joint		23	23	36	75	93	
SPRINTER CARIB (_E9_)														
1.6 (74 kW)	1987.11-1992.05	-	R	F	All-wheel Drive Estate Engine 4A-F	659160	Inner Joint		23	23	36	75	93	
1.6 (82 kW)	1988.09-1995.07	-	R	F	All-wheel Drive Estate Engine 4A-FE	659160	Inner Joint		23	23	36	75	93	
SPRINTER(AE10_,CE10_,EE10_)														
2.2	1991.06-2002.05	AT/MT	L	F	Engine DIESEL EFI,BODY:VAN/WAGON	259196	Drive Shaft	48T	26	20	56	95.5	609	
SPRINTER(AE11_,CE11_,EE11_)														
2.0	1995.05-2000.07	AT/MT	-	-	Engine DIESEL,BODY:SEDAN	259196	Drive Shaft	48T	26	20	56	95.5	609	
2.2	1995.05-2000.07	AT/MT	-	-	Engine DIESEL EFI,BODY:SEDAN	259196	Drive Shaft	48T	26	20	56	95.5	609	
STARLET														
-	1996.01-1999.12	MT/AT	R	-	-	259053	Drive Shaft		23	23	56	90.5	858	
STARLET (EP71)														
1.3	1984-1989	MT/AT	-	-	Engine 2ELU ELU/2ETELU	859462	Outer Joint		23	21	56	88.5	52	M
STARLET (EP76V)														
1.3	1984-1989	4MT	-	-	Engine 2ELJ	859462	Outer Joint		23	21	56	88.5	52	M
STARLET (EP81)														
1.3	1989.01-1995.12	MT/AT	-	-	Engine 4EFE	859227	Outer Joint		23	30	56	88.5	52	M
	1989.01-	MT/AT	-	-	Engine 4EFE	859463	Outer Joint		23	30	56	88.5	52	M
STARLET (EP82)														
1.3	1992.01-1996.01	MT/AT	-	-	Engine 4EFTE TBO	859227	Outer Joint		23	30	56	88.5	52	M
	1992.01-1996.01	MT	-	-	Engine 4EFTE	859227	Outer Joint		23	30	56	88.5	52	M
	1992.01-1996.01	MT/AT	-	-	Engine 4EFTE/4EFTE TBO	859202	Outer Joint	48T	23	30	56	88.5	52	M
	1992.01-1996.01	MT/AT	-	-	Engine 4EFTE TBO	859463	Outer Joint		23	30	56	88.5	52	M
	1992.01-1996.01	MT	-	-	Engine 4EFTE	859463	Outer Joint		23	30	56	88.5	52	M
STARLET (EP91)														
1.3	1996.01-1999.07	MT	-	-	Engine 4EFTE TBO	859463	Outer Joint		23	30	56	88.5	52	M
	1996.01-1999.07	MT	-	-	Engine 4EFTE TBO	859227	Outer Joint		23	30	56	88.5	52	M
	1996.01-1999.07	MT/AT	-	-	Engine 4EFTE	859202	Outer Joint	48T	23	30	56	88.5	52	M
	1996.01-1999.07	MT	-	-	Engine 4EFTE	859202	Outer Joint	48T	23	30	56	88.5	52	M
STARLET (NCP42R)														
1.5	-	MT/AT	-	-	Engine 1NZFE	859196	Outer Joint	48T	24	23	56	90	55	I
STARLET (NP70)														
1.5	1986.12-1989.12	5MT/4AT	-	-	Engine 1N	859462	Outer Joint		23	21	56	88.5	52	M
STARLET (NP76V)														
1.5	1986.12-1989.12	5MT	-	-	Engine 1N	859462	Outer Joint		23	21	56	88.5	52	M
STARLET (_P7_)														
1.0 (40 kW)	1984.10-1989.12	MT	L/R	F	Hatchback Engine 1E-L	859054	Outer Joint		23	23	56	87.5	55	I
1.3 (55 kW)	1984.10-1989.12	MT	L/R	F	Hatchback Engine 2E-LC	859054	Outer Joint		23	23	56	87.5	55	I
1.5 D (40 kW)	1986.12-1989.12	MT	L/R	F	Hatchback Engine 1N	859054	Outer Joint		23	23	56	87.5	55	I
STARLET (_P8_)														
1.0 (40 kW)	1989.12-1992.12	MT	L/R	F	Hatchback Engine 1E	859013	Outer Joint		23	21	56	95	51.5	I
1.3 12V (55 kW)	1989.12-1992.12	-	-	F	Hatchback Engine 2E-E	699046	Inner Joint		23	23	34	60	103.5	
	1989.12-1992.12	MT	-	F	Hatchback Engine 2E-E	859121	Outer Joint	48T	23	23	56	87.5	55	I
	1989.12-1992.12	-	-	-	Hatchback Engine 2E-E	859039	Outer Joint		23	23	56	88.5	52	I
	1989.12-1992.12	-	-	F	Hatchback Engine 2E-E	859100	Outer Joint		23	23	56	90.5	55	I
	1989.12-1992.12	AT/MT	L/R	F	Hatchback Engine 2E-E	859054	Outer Joint		23	23	56	87.5	55	I
1.3 12V Cat (55 kW)	1989.12-1996.03	-	-	F	Hatchback Engine 2E-E	699046	Inner Joint		23	23	34	60	103.5	
	1989.12-1996.03	MT	-	F	Hatchback Engine 2E-E	859121	Outer Joint	48T	23	23	56	87.5	55	I
	1989.12-1996.03	-	-	-	Hatchback Engine 2E-E	859039	Outer Joint		23	23	56	88.5	52	I
	1989.12-1996.03	-	-	F	Hatchback Engine 2E-E	859100	Outer Joint		23	23	56	90.5	55	I
	1989.12-1996.03	AT/MT	L/R	F	Hatchback Engine 2E-E	859054	Outer Joint		23	23	56	87.5	55	I
	1989.12-1996.03	-	-	-	Hatchback Engine 2E-E	659023	Inner Joint		23	23	34	60	113	
1.3 XL (52 kW)	1989.12-1991.12	-	-	F	Hatchback Engine 2E	699046	Inner Joint		23	23	34	60	103.5	
	1989.12-1991.12	MT	-	F	Hatchback Engine 2E	859121	Outer Joint	48T	23	23	56	87.5	55	I
	1989.12-1991.12	-	-	F	Hatchback Engine 2E	859100	Outer Joint		23	23	56	90.5	55	I
1.5 D (40 kW)	1989.12-1996.03	-	-	F	Hatchback Engine 1N	699046	Inner Joint		23	23	34	60	103.5	
	1989.12-1996.03	-	-	-	Hatchback Engine 1N	659023	Inner Joint		23	23	34	60	113	

	 YEAR	TRANSM	L/R	F/R	REMARKS	GSP Ref.	 PRODUCT	 ABS	Technical Specifications					
									A	B	C	H	L	P
TOYOTA														
STARLET (_P9_)														
1.3 (55 kW)	1996.01-1999.10	-	-	F	Hatchback Engine 4E-FE	699046	Inner Joint		23	23	34	60	103.5	
	1996.01-1999.10	-	-	F	Hatchback Engine 4E-FE	859121	Outer Joint	48T	23	23	56	87.5	55	I
	1996.01-1999.10	-	-	F	Hatchback Engine 4E-FE	859040	Outer Joint	48T	23	23	56	90.5	55	I
	1996.01-1999.10	-	-	-	Hatchback Engine 4E-FE	859039	Outer Joint		23	23	56	88.5	52	I
	1996.01-1999.10	AT	L	F	Hatchback Engine 4E-FE	259052	Drive Shaft		23	23	56	90.5	628	
	1996.01-1999.10	AT	R	F	Hatchback Engine 4E-FE	259566	Drive Shaft		23	23	56	90.5	847	
	1996.01-1999.10	AT	L	F	Hatchback Engine 4E-FE	659002	Inner Joint		23	23	34	58.8	102.7	
	1996.01-1999.10	AT/MT	L/R	F	Hatchback Engine 4E-FE	859054	Outer Joint		23	23	56	87.5	55	I
	1996.01-1999.10	-	-	-	Hatchback Engine 4E-FE	659023	Inner Joint		23	23	34	60	113	
STARLET EP71														
1.3	1984.10-1989.12	MT/AT	-	-	Engine 2ELU ELU	859462	Outer Joint		23	21	56	88.5	52	M
	1986.01-1989.12	MT/AT	-	-	Engine 2ETELU	859462	Outer Joint		23	21	56	88.5	52	M
1300	1984.10-1989.12	MT/AT	-	-	Engine 2ELU ELU	859462	Outer Joint		23	21	56	88.5	52	M
	1984.10-1989.12	MT/AT	-	-	Engine 2ELU ELU	859462	Outer Joint		23	21	56	88.5	52	M
	1986.01-1989.12	MT/AT	-	-	Engine 2ETELU	859462	Outer Joint		23	21	56	88.5	52	M
STARLET EP76V														
1.3	1984.10-1989.12	4MT	-	-	Engine 2ELJ	859462	Outer Joint		23	21	56	88.5	52	M
1300	1984.10-1989.12	4MT	-	-	Engine 2ELJ	859462	Outer Joint		23	21	56	88.5	52	M
STARLET EP81														
1.3	1989.01-1995.12	MT/AT	-	-	Engine 4EFE	859463	Outer Joint		23	30	56	88.5	52	M
1300	1989.01-1995.12	MT/AT	-	-	Engine 4EFE	859463	Outer Joint		23	30	56	88.5	52	M
STARLET EP82														
1.3	1992.01-1995.12	MT/AT	-	-	Engine 4EFTE	859472	Outer Joint	48T	23	30	56	88.5	52	M
	1992.01-1996.01	MT/AT	-	-	Engine 4EFTE TBO	859463	Outer Joint		23	30	56	88.5	52	M
	1992.01-1996.01	MT/AT	-	-	Engine 4EFTE TBO	859472	Outer Joint	48T	23	30	56	88.5	52	M
	1992.01-1996.01	MT	-	-	Engine 4EFTE	859463	Outer Joint		23	30	56	88.5	52	M
1300	1992.01-1996.01	MT/AT	-	-	Engine 4EFTE TBO	859463	Outer Joint		23	30	56	88.5	52	M
	1992.01-1996.01	MT	-	-	Engine 4EFTE	859463	Outer Joint		23	30	56	88.5	52	M
	1992.01-1995.12	MT/AT	-	-	Engine 4EFTE	859472	Outer Joint	48T	23	30	56	88.5	52	M
	1992.01-1996.01	MT/AT	-	-	Engine 4EFTE TBO	859472	Outer Joint	48T	23	30	56	88.5	52	M
	1992.01-1996.01	MT/AT	-	-	Engine 4EFTE TBO	859472	Outer Joint	48T	23	30	56	88.5	52	M
STARLET EP91														
1.3	1996.01-1999.07	MT/AT	-	-	Engine 4EFTE	859472	Outer Joint	48T	23	30	56	88.5	52	M
	1996.01-1997.07	MT/AT	-	-	Engine 4EFTE	859472	Outer Joint	48T	23	30	56	88.5	52	M
	1996.01-1999.07	MT	-	-	Engine 4EFTE	859472	Outer Joint	48T	23	30	56	88.5	52	M
	1996.01-1999.07	MT	-	-	Engine 4EFTE TBO	859463	Outer Joint		23	30	56	88.5	52	M
1300	1996.01-1999.07	MT	-	-	Engine 4EFTE TBO	859463	Outer Joint		23	30	56	88.5	52	M
	1996.01-1999.07	MT	-	-	Engine 4EFTE TBO	859463	Outer Joint		23	30	56	88.5	52	M
	1996.01-1999.07	MT/AT	-	-	Engine 4EFTE	859472	Outer Joint	48T	23	30	56	88.5	52	M
	1996.01-1997.07	MT/AT	-	-	Engine 4EFTE	859472	Outer Joint	48T	23	30	56	88.5	52	M
	1996.01-1999.07	MT	-	-	Engine 4EFTE	859472	Outer Joint	48T	23	30	56	88.5	52	M
STARLET NP70														
1.5	1986.12-1989.12	5MT	-	-	Engine 1N	859462	Outer Joint		23	21	56	88.5	52	M
	1986.12-1989.12	4AT	-	-	Engine 1N	859462	Outer Joint		23	21	56	88.5	52	M
1500	1986.12-1989.12	5MT	-	-	Engine 1N	859462	Outer Joint		23	21	56	88.5	52	M
	1986.12-1989.12	4AT	-	-	Engine 1N	859462	Outer Joint		23	21	56	88.5	52	M
STARLET NP76V														
1.5	1986.12-1989.12	5MT	-	-	Engine 1N	859462	Outer Joint		23	21	56	88.5	52	M
1500	1986.12-1989.12	5MT	-	-	Engine 1N	859462	Outer Joint		23	21	56	88.5	52	M
TACOMA														
-	1995-2005	-	-	-	-	859072	Outer Joint		30	34	69	123	66.5	I
2.0 8V (80 KW)	1997.11-2002.01	-	-	-	-	859071	Outer Joint		26	34	69	118.5	66.5	I
TERCEL														
-	1993-1994	-	-	-	-	859134	Outer Joint	48T	26	22	56	100.5	55	I
1.3 (65 kW)	1992.05-1994.10	-	-	-	Saloon Engine 4E-FE	859067	Outer Joint		26	22	56	100.5	55	I
TERCEL (_L3_)														
1.3 (65 kW)	1990.09-1994.10	-	-	-	Hatchback Engine 4E-FE	859067	Outer Joint		26	22	56	100.5	55	I
1.3 12V (53 kW)	1986.05-1990.08	-	-	-	Hatchback Engine 2E	659023	Inner Joint		23	23	34	60	113	
TERCEL (_L5_)														
1.5 (70 kW)	1994.09-1999.09	-	L/R	F/R	Saloon Engine 5E-FE	839105	Outer Joint	44T	25	22	52.5	95	58	M
	1994.09-1999.09	-	-	F	Saloon Engine 5E-FE	699046	Inner Joint		23	23	34	60	103.5	
	1994.09-1999.09	-	-	F	Saloon Engine 5E-FE	859023	Outer Joint		26	23	56	96.5	55	I
	1994.09-1999.09	-	-	F	Saloon Engine 5E-FE	859017	Outer Joint		26	22	56	95	50	M
	1994.09-1999.09	-	-	-	Saloon Engine 5E-FE	859068	Outer Joint		26	22	56	95.5	47.5	I
TOWN ACE														

	 YEAR	TRANSM	L/R	F/R	REMARKS	GSP Ref.	 PRODUCT	 ABS	Technical Specifications					
									A	B	C	H	L	P
TOYOTA														
TOWN ACE														
2.0 (96 kW)	1996.10-2001.10	AT	-	F	All-wheel Drive Bus Engine 3S-FE	859089	Outer Joint		26	27	56	98	63	M
TOWN ACE (_R2_ _R3_)														
2.0 (70 kW)	1985.01-1991.12	-	-	F	All-wheel Drive Bus Engine 3Y-EU	859045	Outer Joint		26	27	60	140	65.5	I
TOYOTA RAV4														
2.5	2012.12-2015.09	6AT	R	F	ENGINE:2ARFE/GENERAL	259685	Drive Shaft		30	24	61.2	100	985	
	2012.12-2015.09	6AT	R	F	ENGINE:2ARFE/GENERAL	659206	Inner Joint		24	27	40	377	104.5	
	2015.10-	6AT	R	F	ENGINE:2ARFE/GENERAL	259685	Drive Shaft		30	24	61.2	100	985	
	2015.10-	CVT	R	F	ENGINE:2ARFXE/GENERAL	259685	Drive Shaft		30	24	61.2	100	985	
	2015.10-	6AT	R	F	ENGINE:2ARFE/GENERAL	659206	Inner Joint		24	27	40	377	104.5	
	2015.10-	CVT	R	F	ENGINE:2ARFXE/GENERAL	659206	Inner Joint		24	27	40	377	104.5	
TUNDRA														
4.6	2009.04-2010.04	6AT	R	F	ENGINE:1URFE/UPK55	259613	Drive Shaft		36	34	78	121	707	
4.7	2006.11-2009.03	5AT	R	F	ENGINE:2UZFE/UJK55	259613	Drive Shaft		36	34	78	121	707	
5.7	2009.04-2013.07	6AT	R	F	ENGINE:3URFBE/USK55	259613	Drive Shaft		36	34	78	121	707	
URBAN CRUISER														
1.3	2009.01-	6MT	R	F	ENGINE:1NRFE/NSP110	259201	Drive Shaft		26	23	55.6	96	896	
	2009.01-2014.04	6MT	L	F	ENGINE:1NRFE/NSP110	259202	Drive Shaft		26	23	55.6	96	853	
1.4	2009.01-2014.04	6MT	R	F	ENGINE:1NDTV, NP110	259677	Drive Shaft		26	20	55.6	95.5	888	
	2009.01-2014.04	6MT	L	F	ENGINE:1NDTV/EUROPE	259693	Drive Shaft		26	20	55.6	95.5	653	
	2009.02-2014.04	6MT	R	R	ENGINE:1NDTV/NP115	259675	Drive Shaft	48T	26	20	51.9	99.5	765	
	2009.02-2014.04	6MT	L	F	ENGINE:1NDTV/EUROPE	259693	Drive Shaft		26	20	55.6	95.5	653	
URBAN CRUISER (_P1_)/IST														
1.33 (73 kW)	2009.01-	-	-	F	Hatchback Engine 1NR-FE	699046	Inner Joint		23	23	34	60	103.5	
	2009.01-	MT	-	F	Hatchback Engine 1NR-FE	859206	Outer Joint		26	23	55.6	96	53	I
	2009.01-	MT	-	-	Hatchback Engine 1NR-FE	659023	Inner Joint		23	23	34	60	113	
1.33 (74 kW)	2009.04-	-	-	F	Hatchback Engine 1NR-FE	699046	Inner Joint		23	23	34	60	103.5	
	2009.04-	MT	-	F	Hatchback Engine 1NR-FE	859206	Outer Joint		26	23	55.6	96	53	I
	2009.04-	MT	-	-	Hatchback Engine 1NR-FE	659023	Inner Joint		23	23	34	60	113	
1.4 D-4D (66 kW)	2009.01-2014.04	-	R	F	Hatchback Engine 1ND-TV	201197	Drive Shaft		26	20	55.6	95.5	900	
	2009.01-2014.04	MT	L	F	Hatchback Engine 1ND-TV	659100	Inner Joint		20	25	35	63.5	118	
	2009.01-2014.04	MT	L	F	All-wheel Drive Hatchback Engine 1ND-TV	659100	Inner Joint		20	25	35	63.5	118	
VAN/WAGON														
4WD	1984-1990	-	-	F	-	859103	Outer Joint		26	27	60	140	65.5	I
VECTRA														
2.0	1997-2006	-	-	-	-	821035	Outer Joint	29T	33	25	52	103.5	61	O
2.2	1997-2006	-	-	-	-	821035	Outer Joint	29T	33	25	52	103.5	61	O
VENZA (_V1_)														
2.7 (136 kW)	2008.11-	AT	R	F	Estate Engine 1AR-FE	201229	Drive Shaft	48T	30	24	61	100	994	
	2008.11-	AT	R	F	All-wheel Drive Estate Engine 1AR-FE	201229	Drive Shaft	48T	30	24	61	100	994	
	2008.11-	AT	L	F	Estate Engine 1AR-FE	201230	Drive Shaft	48T	30	24	61	100	675	
	2008.11-	AT	L	F	All-wheel Drive Estate Engine 1AR-FE	201230	Drive Shaft	48T	30	24	61	100	675	
	2008.11-	AT	R	F	Estate Engine 1AR-FE	201231	Drive Shaft	48T	30	24	61	100	992	
VEROSSA (_X11_)														
2.0 VVTi (118 kW)	2000.10-2003.11	-	-	F	All-wheel Drive Saloon Engine 1G-FE	859370	Outer Joint	48T	30	30	56	92	59	I
	2000.10-2003.11	AT	-	R	Saloon Engine 1G-FE	639089	Inner Joint			20		68.6		
VERSO														
2.2	2009.02-2010.06	6MT	R	F	ENGINE:2ADFHV/AUR21	259679	Drive Shaft		30	24	61.2	100.5	989	
VERSO (_R2_)														
1.6 (97 kW)	2009.04-	-	L	F	MPV Engine 1ZR-FAE	259621	Drive Shaft		26	20	61.2	95.5	661	
	2009.04-	MT	-	F	MPV Engine 1ZR-FAE	659139	Inner Joint		20	23	35	63.5	115	
	2009.04-	MT	R	F	MPV Engine 1ZR-FAE	259633	Drive Shaft		26	20	61.2	95.5	945	
1.8 (108 kW)	2009.04-	CVT	L	F	MPV Engine 2ZR-FAE	259621	Drive Shaft		26	20	61.2	95.5	661	
	2009.04-	MT	L	F	MPV Engine 2ZR-FAE	259493	Drive Shaft		26	20	61.2	95.5	658	
	2009.04-	CVT	R	F	MPV Engine 2ZR-FAE	259633	Drive Shaft		26	20	61.2	95.5	945	
	2009.04-	MT	R	F	MPV Engine 2ZR-FAE	259494	Drive Shaft		26	20	61.2	95.5	938	
2.0 D-4D (91 kW)	2012.11-	-	-	F	MPV Engine 1AD-FTV	859345	Outer Joint		30	25	61.2	99.5	62	M
	2012.11-	MT	R	F	MPV Engine 1AD-FTV	259662	Drive Shaft		30	24	61.2	99.5	993	
	2012.11-	MT	L	F	MPV Engine 1AD-FTV	259657	Drive Shaft		30	24	61.2	99.5	613	
2.0 D-4D (93 kW)	2009.04-	-	-	F	MPV Engine 1AD-FTV	859345	Outer Joint		30	25	61.2	99.5	62	M
	2009.04-	-	R	F	MPV Engine 1AD-FTV	259662	Drive Shaft		30	24	61.2	99.5	993	
	2009.04-	-	L	F	MPV Engine 1AD-FTV	259657	Drive Shaft		30	24	61.2	99.5	613	
2.2 D-4D (110 kW)	2009.04-	MT/AT	L	F	MPV Engine 2AD-FHV	801083	Outer Joint		30	33	61.2	100.5	56	I
	2009.04-	MT/AT	L	F	MPV Engine 2AD-FHV	601145	Inner Joint		24	33	50	67	109	
	2009.04-	MT/AT	L	F	MPV Engine 2AD-FHV	201237	Drive Shaft		30	24	61.2	100.5	613	
2.2 D-CAT (130 kW)	2009.04-	MT/AT	L	F	MPV Engine 2AD-FHV	801083	Outer Joint		30	33	61.2	100.5	56	I
	2009.04-	MT/AT	L	F	MPV Engine 2AD-FHV	601145	Inner Joint		24	33	50	67	109	

	 YEAR	TRANSM	L/R	F/R	REMARKS	GSP Ref.	 PRODUCT	 ABS	Technical Specifications									
									A	B	C	H	L	P				
TOYOTA																		
VERSO (_R2_)																		
2.2 D-CAT (130 kW)	2009.04-		MT/AT	L	F	MPV Engine 2AD-FHV	201237	Drive Shaft		30	24	61.2	100.5	613				
VERSO S (_P12_)/RACTIS																		
1.33 (73 kW)	2010.11-2016.10	-	-	-	F	MPV Engine 1NR-FE	699046	Inner Joint		23	23	34	60	103.5				
	2010.11-2016.10	MT	-	-	F	MPV Engine 1NR-FE	859206	Outer Joint		26	23	55.6	96	53	I			
	2010.11-2016.10	-	-	-	-	MPV Engine 1NR-FE	659023	Inner Joint		23	23	34	60	113				
1.4 D4-D (66 kW)	2010.11-2016.10	MT	L	F	MPV Engine 1ND-TV	659100	Inner Joint		20	25	35	63.5	118					
VERSO-S																		
1.3	2010.11-2014.04	6MT	R	F	ENGINE:1NRFE/NSP120	259201	Drive Shaft		26	23	55.6	96	896					
	2010.11-2014.04	CVT	R	F	ENGINE:1NRFE/NSP120	259201	Drive Shaft		26	23	55.6	96	896					
	2010.11-2014.04	CVT	L	F	ENGINE:1NRFE/NSP120	259202	Drive Shaft		26	23	55.6	96	653					
	2010.11-2014.04	6MT	L	F	ENGINE:1NRFE/NSP120	259202	Drive Shaft		26	23	55.6	96	653					
1.4	2010.11-2014.04	6MT	R	F	ENGINE:1NDTV/NP121	259677	Drive Shaft		26	20	55.6	95.5	888					
	2010.11-2014.04	6MT	L	F	ENGINE:1NDTV/EUROPE	259693	Drive Shaft		26	20	55.6	95.5	653					
	2014.05-	6MT	L	F	ENGINE:1NDTV/EUROPE	259693	Drive Shaft		26	20	55.6	95.5	653					
VIOS																		
-	-	-	R	-	-		259076	Drive Shaft	48T	24	23	56	90.5	637.5				
1.5	-	-	MT/AT	-	-	Engine 1NZFE	859207	Outer Joint		24	23	56	90	55	I			
VIOS (THAILAND)																		
1.5	2003.01-	-	MT/AT	-	-	Engine NCP92	859207	Outer Joint		24	23	56	90	55	I			
1500	2003.01-	-	MT/AT	-	-	Engine NCP92	859207	Outer Joint		24	23	56	90	55	I			
VIOS/YARIS (_P9_)/BELTA																		
1.5 (80 kW)	2007.08-	-	-	-	F	Saloon Engine 1NZ-FE	699046	Inner Joint		23	23	34	60	103.5				
	2007.08-	-	-	-	-	Saloon Engine 1NZ-FE	859274	Outer Joint		26	23	55.6	96	54	I			
VISTA																		
2.2	1998-	-	MT	-	-	SXV20 5SFE	659033	Inner Joint		20	24	35	63.5	115.7				
	1998-	-	-	-	-	-	859066	Outer Joint		26	32	56	101	66	I			
VISTA (_V5_)																		
2.0 (107 kW)	1998.06-2003.08	-	-	-	F	Saloon Engine 3S-FSE	859131	Outer Joint	48T	26	24	58	96	54	I			
VISTA/CAMRY (_V3_/_V4_)																		
2.0 (96 kW)	1994.01-1998.05	-	R	F	All-wheel Drive Saloon Engine 3S-FE	659160	Inner Joint		23	23	36	75	93					
	1994.01-1998.05	-	-	F	All-wheel Drive Saloon Engine 3S-FE	859120	Outer Joint	48T	26	24	56	95.5	55	I				
	1994.01-1998.05	-	-	F	Saloon Engine 3S-FE	859120	Outer Joint	48T	26	24	56	95.5	55	I				
	1994.01-1998.05	-	R	F	All-wheel Drive Saloon Engine 3S-FE	639089	Inner Joint		20		68.6							
	1994.01-1998.05	-	-	F	Saloon Engine 3S-FE	831001	Outer Joint		26	27	56	99.5	63	I				
	1994.01-1998.05	-	-	F	Saloon Engine 3S-FE	859125	Outer Joint	48T	26	27	56	99.5	63	I				
	1994.01-1998.05	-	L	F	Saloon Engine 3S-FE	631004	Inner Joint		20	27	35	63.5	123					
2.0 (99 kW)	1994.06-1998.06	-	R	F	All-wheel Drive Saloon Engine 3S-FE	659160	Inner Joint		23	23	36	75	93					
2.0 TD (66 kW)	1990.07-1994.12	-	-	F	Saloon Engine 2C-T	831001	Outer Joint		26	27	56	99.5	63	I				
	1990.07-1994.12	-	-	F	Saloon Engine 2C-T	859125	Outer Joint	48T	26	27	56	99.5	63	I				
	1990.07-1994.12	-	R	F	Saloon Engine 2C-T	659004	Inner Joint		20	23	35	363	100.5					
	1990.07-1994.12	-	L	F	Saloon Engine 2C-T	631004	Inner Joint		20	27	35	63.5	123					
2.2 TD (66 kW)	1994.01-1998.05	-	-	F	Saloon Engine 3C-T	831001	Outer Joint		26	27	56	99.5	63	I				
	1994.01-1998.05	-	-	F	Saloon Engine 3C-T	859125	Outer Joint	48T	26	27	56	99.5	63	I				
	1994.01-1998.05	-	R	F	Saloon Engine 3C-T	659004	Inner Joint		20	23	35	363	100.5					
	1994.01-1998.05	-	L	F	Saloon Engine 3C-T	631004	Inner Joint		20	27	35	63.5	123					
VITZ																		
1.3	2014.04-	-	CVT	L	F	ENGINE:1NRFKE/NSP130	259295	Drive Shaft		26	23	55.6	96	656.5				
	2014.04-	-	CVT	L	F	ENGINE:1NRFKE/NSP135	259626	Drive Shaft		26	20	55.6	96	651				
1.5	2007.08-2008.08	5MT	L	F	ENGINE:1NZFE/NCP91	259202	Drive Shaft		26	23	55.6	96	653					
	2014.04-	-	5MT	R	F	ENGINE:1NZFE/NCP131	259677	Drive Shaft		26	20	55.6	95.5	888				
	2014.04-	-	5MT	L	F	ENGINE:1NZFE/NCP131	259202	Drive Shaft		26	23	55.6	96	653				
VITZ YARIS ECHO																		
1.0	2001.01-2003.12	MT/AT	-	-	Engine	859326	Outer Joint		24	28	56	90.5	54.2	O				
	2008.01-	-	MT/AT	-	-	Engine	859384	Outer Joint		26	29	55.6	96	54	I			
1.3	-	-	MT/AT	-	-	Engine	859190	Outer Joint		24	22	58	90	47	I			
1000	2001.01-2003.12	MT/AT	-	-	Engine	859326	Outer Joint		24	28	56	90.5	54.2	O				
	2008.01-	-	MT/AT	-	-	Engine	859384	Outer Joint		26	29	55.6	96	54	I			
1300	-	-	MT/AT	-	-	Engine	859190	Outer Joint		24	22	58	90	47	I			
VITZ YARIS ECHO CP90																		
1.0	2007.08-2008.09	CVT	-	-	Engine 1KRFE	859308	Outer Joint		26	20	55.6	96	54	M				
1000	2007.08-2008.09	CVT	-	-	Engine 1KRFE	859308	Outer Joint		26	20	55.6	96	54	M				
VITZ YARIS ECHO NCP11																		
1.0	2002.06-	-	MT/AT	-	-	Engine 2NZFE	859190	Outer Joint		24	22	58	90	47	I			
	2002.06-	-	MT/AT	-	-	Engine 2NZFE	859190	Outer Joint		24	22	58	90	47	I			
	2002.06-	-	MT/AT	-	-	Engine 2NZFE	859190	Outer Joint		24	22	58	90	47	I			

YEAR	TRANSM	L/R	F/R	REMARKS	GSP Ref.	PRODUCT	ABS	Technical Specifications							
								A	B	C	H	L	P		
TOYOTA															
VITZ YARIS ECHO NCP11															
1000	2002.06-	-	MT/AT	-	-	Engine 2NZFE	859190	Outer Joint		24	22	58	90	47	I
	2002.06-	-	MT/AT	-	-	Engine 2NZFE	859190	Outer Joint		24	22	58	90	47	I
	2002.06-	-	MT/AT	-	-	Engine 2NZFE	859190	Outer Joint		24	22	58	90	47	I
VITZ YARIS ECHO SCP10															
1.0	2000.01-	-	MT/AT	-	-	Engine 1SZFE	859334	Outer Joint	48T	24	19	58	90.7	46.7	I
1000	2000.01-	-	MT/AT	-	-	Engine 1SZFE	859334	Outer Joint	48T	24	19	58	90.7	46.7	I
VITZ YARIS ECHO SP90															
1.0	2005.01-2007.08	-	CVT	-	-	Engine 1KRFE	859308	Outer Joint		26	20	55.6	96	54	M
	2008.09-	-	CVT	-	-	Engine 1KRFE	859308	Outer Joint		26	20	55.6	96	54	M
1000	2005.01-2007.08	-	CVT	-	-	Engine 1KRFE	859308	Outer Joint		26	20	55.6	96	54	M
	2007.08-2008.09	-	CVT	-	-	Engine 1KRFE	859308	Outer Joint		26	20	55.6	96	54	M
	2008.08-	-	CVT	-	-	Engine 1KRFE	859308	Outer Joint		26	20	55.6	96	54	M
	2008.09-	-	CVT	-	-	Engine 1KRFE	859308	Outer Joint		26	20	55.6	96	54	M
VITZ/YARIS/ECHO															
1.0	2001.01-2003.12	-	MT/AT	-	-	-	859326	Outer Joint		24	28	56	90.5	54.2	O
	2007.08-2008.09	-	-	-	-	CVT/F	859308	Outer Joint		26	20	55.6	96	54	M
1.3	-	-	MT/AT	-	-	-	859190	Outer Joint		24	22	58	90	47	I
VITZ/YARIS/ECHO (NCP11)															
1.0	2002.06-	-	MT/AT	-	-	Engine 2NZFE	859190	Outer Joint		24	22	58	90	47	I
VITZ/YARIS/ECHO (SCP10)															
1.0	2000.01-	-	MT/AT	-	-	Engine 1SZFE	859255	Outer Joint	48T	24	19	57.8	91	44.5	M
VOXY															
-	-	-	-	R	-	AZR60	259193	Drive Shaft	48T	26	20	63	100	930	
	-	-	-	L	-	AZR60	259194	Drive Shaft	48T	26	20	63	100	634	
WILL CYPHA (NCP7_)															
1.3 VVTi (62 kW)	2001.05-2005.07	-	-	-	F	Hatchback Engine 2NZ-FE	699046	Inner Joint		23	23	34	60	103.5	
	2001.05-2005.07	-	AT	-	F	Hatchback Engine 2NZ-FE	859035	Outer Joint	48T	24	22	58	91	47	I
	2001.05-2005.07	-	AT	-	-	Hatchback Engine 2NZ-FE	659023	Inner Joint		23	23	34	60	113	
WILL VS (_E12_)															
1.5 VVTi (81 kW)	2001.03-2004.04	-	-	-	F	All-wheel Drive Hatchback Engine 1NZ-FE	699046	Inner Joint		23	23	34	60	103.5	
WINDOM (_V1_)															
3.0 (138 kW)	1991.07-1996.09	-	-	-	F	Saloon Engine 3VZ-FE	859048	Outer Joint	48T	30	34	56	100.5	66	M
	1991.07-1996.09	-	-	-	F	Saloon Engine 3VZ-FE	859446	Outer Joint	48T	30	27	56	100	66	M
WINDOM (_V2_)															
2.5 (147 kW)	1996.10-2001.07	-	-	-	F	Saloon Engine 2MZ-FE	859446	Outer Joint	48T	30	27	56	100	66	M
3.0 (155 kW)	1996.10-2001.07	-	-	-	F	Saloon Engine 1MZ-FE	859446	Outer Joint	48T	30	27	56	100	66	M
WINDOM LEXUS ES300 (VCV10)															
3.0	1991.10-1996.08	-	AT	-	-	Engine 3VZFE	859445	Outer Joint		30	27	56	100	66	M
WINDOM LEXUS ES300 (VCV11)															
2.5	1993.08-1996.08	-	AT	-	-	Engine 4VZFE	859445	Outer Joint		30	27	56	100	66	M
WINDOM LEXUS ES300 VCV10															
3.0	1991.10-1996.08	-	AT	-	-	Engine 3VZFE	859445	Outer Joint		30	27	56	100	66	M
WINDOM LEXUS ES300 VCV11															
2.5	1993.08-1996.08	-	AT	-	-	Engine 4VZFE	859445	Outer Joint		30	27	56	100	66	M
WINDOM LEXUS ES302 VCV11															
2.5	1993.08-1996.08	-	AT	-	-	Engine 4VZFE	859445	Outer Joint		30	27	56	100	66	M
WINDOM LEXUS ES306 VCV10															
3000	1991.10-1996.08	-	AT	-	-	Engine 3VZFE	859445	Outer Joint		30	27	56	100	66	M
WISH															
-	-	-	-	-	-	-	859083	Outer Joint		26	24	58	96	54	I
1.8	2010.06-2012.03	-	ATVFC	L	F	ENGINE:2ZRFAE/GENERAL	259687	Drive Shaft	48T	26	20	58	95.5	639	
	2010.06-2012.03	-	ATVFC	L	F	ENGINE:2ZRFAE/GENERAL	859511	Outer Joint		26	25	58	95.5	56.5	I
	2012.04-	-	CVFC	L	F	ENGINE:2ZRFAE/JAPAN	259687	Drive Shaft	48T	26	20	58	95.5	639	
	2012.04-	-	CVFC	L	F	ENGINE:2ZRFAE/JAPAN	859511	Outer Joint		26	25	58	95.5	56.5	I
	2012.04-	-	-	R	F	ENGINE:2ZRFAE/	259404	Drive Shaft	48T	26	20	58	95.5	922	
	2012.04-	-	-	R	F	ENGINE:2ZRFAE/ZGE20G	259614	Drive Shaft	48T	26	20	58	95.5	907	
	2012.04-	-	-	R	F	ENGINE:2ZRFAE/ZGE20	259614	Drive Shaft	48T	26	20	58	95.5	907	
2.0	2004.08-2007.02	-	4FC	L	F	ENGINE:1AZFE/GENERAL	259691	Drive Shaft	48T	26	24	61.2	100	620	
	2004.08-2007.02	-	4FC	L	F	ENGINE:1AZFE/GENERAL	859439	Outer Joint		26	27	61.2	100	59.5	I
	2004.08-2007.02	-	4FC	L	F	ENGINE:1AZFE/GENERAL	659125	Inner Joint		24	27	50	67	109.5	
	2007.03-2009.08	-	4FC	L	F	ENGINE:1AZFE/GENERAL	259691	Drive Shaft	48T	26	24	61.2	100	620	
	2007.03-2009.08	-	4FC	L	F	ENGINE:1AZFE/GENERAL	859439	Outer Joint		26	27	61.2	100	59.5	I
	2007.03-2009.08	-	4FC	L	F	ENGINE:1AZFE/GENERAL	659125	Inner Joint		24	27	50	67	109.5	
	2009.09-2010.04	-	4AT	L	F	ENGINE:3ZRFE/GENERAL	259691	Drive Shaft	48T	26	24	61.2	100	620	
	2009.09-2010.04	-	4AT	L	F	ENGINE:3ZRFE/GENERAL	859439	Outer Joint		26	27	61.2	100	59.5	I

YEAR	TRANSM	L/R	F/R	REMARKS	GSP Ref.	PRODUCT	ABS	Technical Specifications					
								A	B	C	H	L	P
TOYOTA WISH													
2.0	2009.09-2010.04	4AT	L	F	ENGINE:3ZRFE/GENERAL	659125	Inner Joint	24	27	50	67	109.5	
	2012.04-	-	R	F	ENGINE:3ZRFAE/ZGE22	259619	Drive Shaft	48T	26	24	61.2	100	
WISH (ANE10G,ANE11W)													
2.0	2003-	AT	-	-	Engine 1AZFSE	859294	Outer Joint	48T	26	27	63	97	
WISH (ZNE10G)													
1.8	2003.01-	4AT	-	-	Engine 1ZZFE	859460	Outer Joint	48T	26	24	58	96	
1.8 4WD	2003.01-	4AT	-	-	Engine 1ZZFE	859460	Outer Joint	48T	26	24	58	96	
WISH (E2_)													
1.8 (106 kW)	2009.04-	AT/CVFC	L	F	MPV Engine 2ZR-FAE	859357	Outer Joint	48T	26	25	58	95.5	
1.8 (98 kW)	2009.04-	AT/CVFC	L	F	All-wheel Drive MPV Engine 2ZR-FAE	859357	Outer Joint	48T	26	25	58	95.5	
2.0 (116 kW)	2009.04-	AT	R	F	MPV Engine 3ZR-FAE	659128	Inner Joint	24	27	40	369.5	105.5	
	2009.04-	AT	R	F	All-wheel Drive MPV Engine 3ZR-FAE	659128	Inner Joint	24	27	40	369.5	105.5	
2.0(107 kW)	2009.04-	AT	R	F	MPV/MPV Engine 3ZR-FAE, 3ZR-FE	659128	Inner Joint	24	27	40	369.5	105.5	
WISH ZNE10G													
1.8	2003.01-	4AT	-	-	Engine 1ZZFE	859460	Outer Joint	48T	26	24	58	96	
1800	2003.01-	4AT	-	-	Engine 1ZZFE	859460	Outer Joint	48T	26	24	58	96	
WISH ZNE14G													
1.8	2003.01-	4AT	-	-	Allwheel Drive Engine 1ZZFE	859460	Outer Joint	48T	26	24	58	96	
1800	2003.01-	4AT	-	-	Allwheel Drive Engine 1ZZFE	859460	Outer Joint	48T	26	24	58	96	
YARIS													
1.0	2008.01-	MT/AT	-	-	-	859384	Outer Joint	26	29	55.6	96	54	
	2011.08-2012.07	5MT	R	F	ENGINE:1KRFE/KSP130	259665	Drive Shaft	26	23	55.6	96	886	
	2011.08-2012.07	5MT	L	F	ENGINE:1KRFE/KSP130	259680	Drive Shaft	26	23	55.6	96	670	
1.3	2006.01-2008.07	MT	R	F	ENGINE:2NZFE/NCP92L	659003	Inner Joint	23	22	34	60.4	103	
	2006.01-2008.07	MT	R	F	ENGINE:2NZFE/NCP92L	259294	Drive Shaft	26	23	55.6	96	897.5	
	2008.08-2011.07	AT	R	F	ENGINE:2NZFE/NCP90L	659003	Inner Joint	23	22	34	60.4	103	
	2008.08-2011.07	MT	R	F	ENGINE:2NZFE/NCP90L	659003	Inner Joint	23	22	34	60.4	103	
	2008.08-2013.06	MT	R	F	ENGINE:2NZFE/NCP92L	659003	Inner Joint	23	22	34	60.4	103	
	2008.08-2013.06	AT	R	F	ENGINE:2NZFE/NCP92L	659003	Inner Joint	23	22	34	60.4	103	
	2008.08-2013.06	MT	R	F	ENGINE:2NZFE/NCP92L	659003	Inner Joint	23	22	34	60.4	103	
	2008.08-2011.07	AT	R	F	ENGINE:2NZFE/NCP90L	259294	Drive Shaft	26	23	55.6	96	897.5	
	2008.08-2011.07	MT	R	F	ENGINE:2NZFE/NCP90L	259294	Drive Shaft	26	23	55.6	96	897.5	
	2008.08-2013.06	MT	R	F	ENGINE:2NZFE/NCP92L	259294	Drive Shaft	26	23	55.6	96	897.5	
	2008.08-2013.06	AT	R	F	ENGINE:2NZFE/NCP92L	259294	Drive Shaft	26	23	55.6	96	897.5	
	2008.08-2013.06	MT	R	F	ENGINE:2NZFE/NCP92L	259294	Drive Shaft	26	23	55.6	96	897.5	
	2011.08-2014.06	MT	R	F	ENGINE:2NZFE/NCP130L	659003	Inner Joint	23	22	34	60.4	103	
	2011.08-2014.06	AT	R	F	ENGINE:2NZFE/NCP130L	659003	Inner Joint	23	22	34	60.4	103	
	2011.08-2014.06	MT	R	F	ENGINE:2NZFE/NCP130L	259294	Drive Shaft	26	23	55.6	96	897.5	
	2011.08-2014.06	AT	R	F	ENGINE:2NZFE/NCP130L	259294	Drive Shaft	26	23	55.6	96	897.5	
1.4	2008.11-2011.06	6MT	L	F	ENGINE:1NDTV/N. America/EUROPE	259700	Drive Shaft	26	20	55.6	95	657	
	2008.11-2011.06	6MT	L	F	ENGINE:1NDTV/N. America/EUROPE	659077	Inner Joint	20	23	35	63.5	115.7	
	2008.11-2011.06	6MT	R	F	ENGINE:1NDTV/EUROPE	259699	Drive Shaft	26	20	55.6	95	897	
	2008.11-2011.06	6MT	R	F	ENGINE:1NDTV/EUROPE	659077	Inner Joint	20	23	35	63.5	115.7	
	2009.02-2011.06	6MT	L	F	ENGINE:1NDTV/N. America/EUROPE	259700	Drive Shaft	26	20	55.6	95	657	
	2009.02-2011.06	6MT	L	F	ENGINE:1NDTV/N. America/EUROPE	659077	Inner Joint	20	23	35	63.5	115.7	
	2009.02-2011.06	6MT	R	F	ENGINE:1NDTV/EUROPE	259699	Drive Shaft	26	20	55.6	95	897	
	2009.02-2011.06	6MT	R	F	ENGINE:1NDTV/EUROPE	659077	Inner Joint	20	23	35	63.5	115.7	
1.5	2007.01-2009.02	MT	L	F	ENGINE:1NZFE/NCP91	259611	Drive Shaft	26	23	55.6	95	653	
YARIS (HYBRID)													
1.4	2011.07-2014.06	6MT	L	F	ENGINE:1NDTV/EUROPE	259700	Drive Shaft	26	20	55.6	95	657	
	2011.07-2014.06	6MT	L	F	ENGINE:1NDTV/EUROPE	659077	Inner Joint	20	23	35	63.5	115.7	
	2011.07-2014.06	6MT	R	F	ENGINE:1NDTV/EUROPE	259699	Drive Shaft	26	20	55.6	95	897	
	2011.07-2014.06	6MT	R	F	ENGINE:1NDTV/EUROPE	659077	Inner Joint	20	23	35	63.5	115.7	
	2014.07-2015.10	6MT	L	F	ENGINE:1NDTV/EUROPE	259700	Drive Shaft	26	20	55.6	95	657	
	2014.07-	6MT	L	F	ENGINE:1NDTV/EUROPE	259700	Drive Shaft	26	20	55.6	95	657	
	2014.07-2015.10	6MT	L	F	ENGINE:1NDTV/EUROPE	659077	Inner Joint	20	23	35	63.5	115.7	
	2014.07-	6MT	L	F	ENGINE:1NDTV/EUROPE	659077	Inner Joint	20	23	35	63.5	115.7	
	2014.07-2015.10	6MT	R	F	ENGINE:1NDTV/EUROPE	259699	Drive Shaft	26	20	55.6	95	897	
	2014.07-	6MT	R	F	ENGINE:1NDTV/EUROPE	259699	Drive Shaft	26	20	55.6	95	897	
	2014.07-2015.10	6MT	R	F	ENGINE:1NDTV/EUROPE	659077	Inner Joint	20	23	35	63.5	115.7	
	2014.07-	6MT	R	F	ENGINE:1NDTV/EUROPE	659077	Inner Joint	20	23	35	63.5	115.7	
1.5	2012.04-2014.06	AT	L	F	ENGINE:1NZFXE/EUROPE	259698	Drive Shaft	26	20	55.6	95	633	
	2012.04-2014.06	AT	L	F	ENGINE:1NZFXE/EUROPE	659077	Inner Joint	20	23	35	63.5	115.7	
	2012.04-2014.06	AT	R	F	ENGINE:1NZFXE/EUROPE	259697	Drive Shaft	26	20	55.6	95	917	
	2012.04-2014.06	AT	R	F	ENGINE:1NZFXE/EUROPE	659236	Inner Joint	20	23	35	63.5	121	
	2014.07-	CVT	L	F	ENGINE:1NZFXE/EUROPE	259698	Drive Shaft	26	20	55.6	95	633	

YEAR	TRANS	L/R	F/R	REMARKS	GSP Ref.	PRODUCT	ABS	Technical Specifications										
								A	B	C	H	L	P					
TOYOTA																		
YARIS (HYBRID)																		
1.5	2014.07-	-	CVT	L F	ENGINE:1NZFXE/EUROPE	659077	Inner Joint		20	23	35	63.5	115.7					
	2014.07-	-	CVT	R F	ENGINE:1NZFXE/EUROPE	259697	Drive Shaft		26	20	55.6	95	917					
	2014.07-	-	CVT	R F	ENGINE:1NZFXE/EUROPE	659236	Inner Joint		20	23	35	63.5	121					
YARIS (_P13_)/YARIS/VITZ/VITZ																		
1.0 (51 kW)	2010.12-	-	MT	- -	Hatchback Engine 1KR-FE	659092	Inner Joint		23	20	34	60	101					
1.3 (73 kW)	2011.09-	-	AT/MT	L F	Hatchback Engine 1NR-FE	259343	Drive Shaft		26	23	55.6	95	658					
	2011.09-	-	AT/MT	R F	Hatchback Engine 1NR-FE	259345	Drive Shaft		26	23	55.6	95	897					
YARIS (_P1_)/YARIS/VITZ/VITZ/ECHO/ECHO																		
1.0 (48 kW)	2003.03-2005.09		MT	L F	Hatchback Engine 1SZ-FE	659017	Inner Joint		23	22	34	58.8	102.7					
	2003.03-2005.09		MT	L/R F	Hatchback Engine 1SZ-FE	899282	Outer Joint	48T	24	28	56	90	53	O				
	2003.03-2005.09		-	- F	Hatchback Engine 1SZ-FE	859152	Outer Joint	48T	24	19	58	91	46.5	I				
	2003.03-2005.09		-	L/R F	Hatchback Engine 1SZ-FE	859026	Outer Joint	48T	24	26	58	90.5	46.5	I				
	2003.03-2005.09		-	- F	Hatchback Engine 1SZ-FE	899127	Outer Joint		24	28	56	90	53	O				
	2003.03-2005.09		MT	L F	Hatchback Engine 1SZ-FE	259057	Drive Shaft		24	23	56	90	635					
	2003.03-2005.09		MT	L F	Hatchback Engine 1SZ-FE	259209	Drive Shaft	48T	24	23	56	90	635					
	2003.03-2005.09		MT	- F	Hatchback Engine 1SZ-FE	859271	Outer Joint	48T	24	28	56	90.5	54.2	O				
	2003.03-2005.09		-	L F	Hatchback Engine 1SZ-FE	299181	Drive Shaft	48T	24	23	58	91	650					
	2003.03-2005.09		-	R F	Hatchback Engine 1SZ-FE	299180	Drive Shaft	48T	24	23	58	91	864					
1.0 (50 kW)	1999.04-2005.09		MT	L F	Hatchback Engine 1SZ-FE	659017	Inner Joint		23	22	34	58.8	102.7					
	1999.04-2005.09		-	R F	Hatchback Engine 1SZ-FE	859263	Outer Joint		26	20	55.6	95	46	M				
	1999.04-2005.09		MT	L/R F	Hatchback Engine 1SZ-FE	899282	Outer Joint	48T	24	28	56	90	53	O				
	1999.04-2005.09		-	- F	Hatchback Engine 1SZ-FE	859152	Outer Joint	48T	24	19	58	91	46.5	I				
	1999.04-2005.09		-	L/R F	Hatchback Engine 1SZ-FE	859026	Outer Joint	48T	24	26	58	90.5	46.5	I				
	1999.04-2005.09		AT/MT	L/R F	Hatchback Engine 1SZ-FE	859025	Outer Joint		24	26	58	90.5	46.5	I				
	1999.04-2005.09		-	R F	Hatchback Engine 1SZ-FE	259208	Drive Shaft		26	23	55.6	95	884					
	1999.04-2005.09		-	- F	Hatchback Engine 1SZ-FE	899127	Outer Joint		24	28	56	90	53	O				
	1999.04-2005.09		MT	L F	Hatchback Engine 1SZ-FE	259057	Drive Shaft		24	23	56	90	635					
	1999.04-2005.09		MT	L F	Hatchback Engine 1SZ-FE	259209	Drive Shaft	48T	24	23	56	90	635					
	1999.04-2005.09		MT	- F	Hatchback Engine 1SZ-FE	859271	Outer Joint	48T	24	28	56	90.5	54.2	O				
	1999.04-2005.09		-	- -	Hatchback Engine 1SZ-FE	659063	Inner Joint		23	19	38	59	99					
	1999.04-2005.09		-	L F	Hatchback Engine 1SZ-FE	299181	Drive Shaft	48T	24	23	58	91	650					
1999.04-2005.09		-	R F	Hatchback Engine 1SZ-FE	299180	Drive Shaft	48T	24	23	58	91	864						
1.3 (63 kW)	1999.11-2005.10		-	- F	Hatchback Engine 2SZ-FE	699046	Inner Joint		23	23	34	60	103.5					
	1999.11-2005.10		-	- -	Hatchback Engine 2SZ-FE	859029	Outer Joint		24	22	56	90	48.5	M				
	1999.11-2005.10		AT/MT	R F	Hatchback Engine 2SZ-FE	259011	Drive Shaft	48T	24	23	58	91	881.5					
	1999.11-2005.10		AT/MT	L/R F	Hatchback Engine 2SZ-FE	859091	Outer Joint		24	22	58	91	47	I				
	1999.11-2005.10		AT/MT	R F	Hatchback Engine 2SZ-FE	259077	Drive Shaft	48T	24	23	56	90.5	876.5					
	1999.11-2005.10		AT/MT	R F	Hatchback Engine 2SZ-FE	659002	Inner Joint		23	23	34	58.8	102.7					
	1999.11-2005.10		-	- F	Hatchback Engine 2SZ-FE	859271	Outer Joint	48T	24	28	56	90.5	54.2	O				
	1999.11-2005.10		-	- F	Hatchback Engine 2SZ-FE	859129	Outer Joint	48T	24	22	56	90	48.5	I				
1.3 (64 kW)	1999.08-2005.09		MT	L/R F	Hatchback Engine 2SZ-FE	899282	Outer Joint	48T	24	28	56	90	53	O				
	1999.08-2005.09		-	- -	Hatchback Engine 2SZ-FE	859029	Outer Joint		24	22	56	90	48.5	M				
	1999.08-2005.09		AT/MT	R F	Hatchback Engine 2SZ-FE	259011	Drive Shaft	48T	24	23	58	91	881.5					
	1999.08-2005.09		AT/MT	R F	Hatchback Engine 2SZ-FE	259077	Drive Shaft	48T	24	23	56	90.5	876.5					
	1999.08-2005.09		AT/MT	R F	Hatchback Engine 2SZ-FE	659002	Inner Joint		23	23	34	58.8	102.7					
	1999.08-2005.09		-	- F	Hatchback Engine 2SZ-FE	859129	Outer Joint	48T	24	22	56	90	48.5	I				
1.4 D-4D (55 kW)	2001.10-2005.09		MT	L/R F	Hatchback Engine 1ND-TV	859137	Outer Joint	48T	24	23	58	91	52.5	I				
	2001.10-2005.09		-	- F	Hatchback Engine 1ND-TV	699046	Inner Joint		23	23	34	60	103.5					
	2001.10-2005.09		-	- -	Hatchback Engine 1ND-TV	859038	Outer Joint		24	23	58	91	52.5	I				
	2001.10-2005.09		MT	L/R F	Hatchback Engine 1ND-TV	899282	Outer Joint	48T	24	28	56	90	53	O				
	2001.10-2005.09		AT/MT	R F	Hatchback Engine 1ND-TV	259011	Drive Shaft	48T	24	23	58	91	881.5					
	2001.10-2005.09		MT	R F	Hatchback Engine 1ND-TV	259077	Drive Shaft	48T	24	23	56	90.5	876.5					
	2001.10-2005.09		AT/MT	R F	Hatchback Engine 1ND-TV	659002	Inner Joint		23	23	34	58.8	102.7					
	2001.10-2005.09		-	- F	Hatchback Engine 1ND-TV	859271	Outer Joint	48T	24	28	56	90.5	54.2	O				
	2001.10-2005.09		-	- F	Hatchback Engine 1ND-TV	859135	Outer Joint	48T	24	23	56	90.5	55	I				
	2001.10-2005.09		-	- F	Hatchback Engine 1ND-TV	859137	Outer Joint	48T	24	23	58	91	52.5	I				
1.5 (110 kW)	2000.03-2005.07		MT	L/R F	Hatchback Engine 1NZ-FE	859137	Outer Joint	48T	24	23	58	91	52.5	I				
	2000.03-2005.07		-	- F	Hatchback Engine 1NZ-FE	699046	Inner Joint		23	23	34	60	103.5					
	2000.03-2005.07		-	- F	Hatchback Engine 1NZ-FE	859135	Outer Joint	48T	24	23	56	90.5	55	I				
1.5 (77 kW)	2003.01-2005.11		MT	L/R F	Hatchback Engine 1NZ-FE	859137	Outer Joint	48T	24	23	58	91	52.5	I				
	2003.01-2005.11		-	- F	Hatchback Engine 1NZ-FE	699046	Inner Joint		23	23	34	60	103.5					
	2003.01-2005.11		MT	L/R F	Hatchback Engine 1NZ-FE	899282	Outer Joint	48T	24	28	56	90	53	O				
	2003.01-2005.11		AT/MT	R F	Hatchback Engine 1NZ-FE	259011	Drive Shaft	48T	24	23	58	91	881.5					
	2003.01-2005.11		AT/MT	R F	Hatchback Engine 1NZ-FE	659002	Inner Joint		23	23	34	58.8	102.7					
	2003.01-2005.11		-	- F	Hatchback Engine 1NZ-FE	859135	Outer Joint	48T	24	23	56	90.5	55	I				
1.5 (78 kW)	2001.04-2005.09		MT	L/R F	Hatchback Engine 1NZ-FE	859137	Outer Joint	48T	24	23	58	91	52.5	I				
	2001.04-2005.09		-	- F	Hatchback Engine 1NZ-FE	699046	Inner Joint		23	23	34	60	103.5					

YEAR	TRANSM	L/R	F/R	REMARKS	GSP Ref.	PRODUCT	ABS	Technical Specifications							
								A	B	C	H	L	P		
TOYOTA															
YARIS (_P1_)YARIS/VITZ/VITZ/ECHO/ECHO															
1.5 (78 kW)	2001.04-2005.09	AT/MT	R	F	Hatchback Engine 1NZ-FE	259011	Drive Shaft	48T	24	23	58	91	881.5		
	2001.04-2005.09	AT/MT	R	F	Hatchback Engine 1NZ-FE	659002	Inner Joint		23	23	34	58.8	102.7		
YARIS (_P9_)YARIS/VITZ/VITZ															
1.0 VVT-i (51 kW)	2005.01-2011.11	-	R	F	Hatchback Engine 1KR-FE	859263	Outer Joint		26	20	55.6	95	46	M	
	2005.01-2011.11	-	-	F	Hatchback Engine 1KR-FE	859231	Outer Joint		26	19	55.6	96	46.5	I	
	2005.01-2011.11	MT	-	-	Hatchback Engine 1KR-FE	659092	Inner Joint		23	20	34	60	101		
	2005.01-2011.11	-	R	F	Hatchback Engine 1KR-FE	259208	Drive Shaft		26	23	55.6	95	884		
	2005.01-2011.11	-	-	-	Hatchback Engine 1KR-FE	859297	Outer Joint		26	20	55.6	95	46	I	
	2005.01-2011.11	-	-	-	Hatchback Engine 1KR-FE	859222	Outer Joint		26	19	55.6	95.5	46.5	I	
	2005.01-2011.11	MT	L	F	Hatchback Engine 1KR-FE	259206	Drive Shaft		26	23	55.6	95	670		
	2005.01-2011.11	-	-	F	Hatchback Engine 1KR-FE	859232	Outer Joint		26	20	55.6	95	46	M	
	2005.01-2011.11	-	-	-	Hatchback Engine 1KR-FE	859332	Outer Joint		26	19	55.6	95	46	M	
2005.01-2011.11	-	L/R	F	Hatchback Engine 1KR-FE	859168	Outer Joint	48T	24	22	56	90	48.5	M		
1.3 (64 kW)	2007.08-	-	-	-	All-wheel Drive Hatchback Engine 2NZ-FE	859274	Outer Joint		26	23	55.6	96	54	I	
1.3 VVT-i (63 kW)	2005.01-	-	-	F	Hatchback Engine 2NZ-FE	859449	Outer Joint		26	22	55.6	96	51	I	
	2005.01-	Semi-AT/MT	L	F	Hatchback Engine 2NZ-FE	859263	Outer Joint		26	20	55.6	95	46	M	
	2005.01-	-	-	F	Hatchback Engine 2NZ-FE	699046	Inner Joint		23	23	34	60	103.5		
	2005.01-	MT	-	-	Hatchback Engine 2NZ-FE	659092	Inner Joint		23	20	34	60	101		
	2005.01-	-	-	-	Hatchback Engine 2NZ-FE	859274	Outer Joint		26	23	55.6	96	54	I	
	2005.01-	-	-	F	Hatchback Engine 2NZ-FE	859206	Outer Joint		26	23	55.6	96	53	I	
	2005.01-	MT	-	F	Hatchback Engine 2NZ-FE	859232	Outer Joint		26	20	55.6	95	46	M	
	2005.01-	Semi-AT/MT	L	F	Hatchback Engine 2NZ-FE	259206	Drive Shaft		26	23	55.6	95	670		
	2005.01-	-	-	F	Hatchback Engine 2NZ-FE	859238	Outer Joint		26	22	55.6	96	46.5	I	
	2005.01-	AT	-	F	Hatchback Engine 2NZ-FE	859385	Outer Joint		26	22	55.6	96	54	I	
2005.01-	-	-	-	Hatchback Engine 2NZ-FE	659023	Inner Joint		23	23	34	60	113			
1.3 VVT-i (64 kW)	2005.08-	-	R	F	Hatchback Engine 2SZ-FE	859263	Outer Joint		26	20	55.6	95	46	M	
	2005.08-	MT	-	-	Hatchback Engine 2SZ-FE	659092	Inner Joint		23	20	34	60	101		
	2005.08-	-	-	-	Hatchback Engine 2SZ-FE	859274	Outer Joint		26	23	55.6	96	54	I	
	2005.08-	-	-	-	Hatchback Engine 2SZ-FE	859029	Outer Joint		24	22	56	90	48.5	M	
	2005.08-	-	-	F	Hatchback Engine 2SZ-FE	859449	Outer Joint		26	22	55.6	96	51	I	
	2005.08-	-	-	F	Hatchback Engine 2SZ-FE	859206	Outer Joint		26	23	55.6	96	53	I	
	2005.08-	-	R	F	Hatchback Engine 2SZ-FE	259208	Drive Shaft		26	23	55.6	95	884		
	2005.08-	MT	-	F	Hatchback Engine 2SZ-FE	859232	Outer Joint		26	20	55.6	95	46	M	
	2005.08-	Semi-AT/MT	L	F	Hatchback Engine 2SZ-FE	259206	Drive Shaft		26	23	55.6	95	670		
	2005.08-	-	-	F	Hatchback Engine 2SZ-FE	859238	Outer Joint		26	22	55.6	96	46.5	I	
	2005.08-	AT	-	F	Hatchback Engine 2SZ-FE	859385	Outer Joint		26	22	55.6	96	54	I	
	2005.08-	-	-	-	Hatchback Engine 2SZ-FE	659023	Inner Joint		23	23	34	60	113		
	2005.08-	-	L/R	F	Hatchback Engine 2SZ-FE	859168	Outer Joint	48T	24	22	56	90	48.5	M	
1.33 VVT-i (73 kW)	2010.07-	Semi-AT/MT	L	F	Hatchback Engine 1NR-FE	859263	Outer Joint		26	20	55.6	95	46	M	
	2010.07-	MT	-	-	Hatchback Engine 1NR-FE	659092	Inner Joint		23	20	34	60	101		
	2010.07-	Semi-AT/MT	L	F	Hatchback Engine 1NR-FE	259206	Drive Shaft		26	23	55.6	95	670		
	2010.07-	MT	-	F	Hatchback Engine 1NR-FE	859270	Outer Joint		26	24	55.6	95	56	M	
1.33 VVT-i (74 kW)	2008.11-	Semi-AT/MT	L	F	Hatchback Engine 1NR-FE	859263	Outer Joint		26	20	55.6	95	46	M	
	2008.11-	MT	-	-	Hatchback Engine 1NR-FE	659092	Inner Joint		23	20	34	60	101		
	2008.11-	Semi-AT/MT	L	F	Hatchback Engine 1NR-FE	259206	Drive Shaft		26	23	55.6	95	670		
	2008.11-	MT	-	F	Hatchback Engine 1NR-FE	859270	Outer Joint		26	24	55.6	95	56	M	
1.4 D-4D (66 kW)	2005.08-	-	-	F	Hatchback Engine 1ND-TV	699046	Inner Joint		23	23	34	60	103.5		
	2005.08-	-	L	F	Hatchback Engine 1ND-TV	259635	Drive Shaft		26	20	55.6	95	655		
	2005.08-	-	R	F	Hatchback Engine 1ND-TV	259636	Drive Shaft		26	20	55.6	95	896		
	2005.08-	-	R	F	Hatchback Engine 1ND-TV	259354	Drive Shaft		26		55.6	95	787		
	2005.08-	-	L	F	Hatchback Engine 1ND-TV	259352	Drive Shaft		26		55.6	95	546		
1.5 (80 kW)	2005.11-	-	-	F	Hatchback Engine 1NZ-FE	699046	Inner Joint		23	23	34	60	103.5		
1.8 VVTi (98 kW)	2007.01-	-	MT	L	F	Hatchback Engine 2ZR-FE	659100	Inner Joint		20	25	35	63.5	118	
YARIS VERSO (_P2_)FUN CARGO															
1.3 (62 kW)	2002.11-2005.09	-	L/R	F/R	MPV Engine 2NZ-FE	839105	Outer Joint	44T	25	22	52.5	95	58	M	
	2002.11-2005.09	-	L/R	F	MPV Engine 2NZ-FE	859137	Outer Joint	48T	24	23	58	91	52.5	I	
	2002.11-2005.09	-	-	-	MPV Engine 2NZ-FE	859038	Outer Joint		24	23	58	91	52.5	I	
	2002.11-2005.09	-	-	F	MPV Engine 2NZ-FE	699046	Inner Joint		23	23	34	60	103.5		
	2002.11-2005.09	-	-	-	MPV Engine 2NZ-FE	859029	Outer Joint		24	22	56	90	48.5	M	
	2002.11-2005.09	-	-	F	MPV Engine 2NZ-FE	859115	Outer Joint		24	22	56	90	48.5	I	
	2002.11-2005.09	AT/MT	R	F	MPV Engine 2NZ-FE	259011	Drive Shaft	48T	24	23	58	91	881.5		
	2002.11-2005.09	AT/MT	R	F	MPV Engine 2NZ-FE	259077	Drive Shaft	48T	24	23	56	90.5	876.5		
	2002.11-2005.09	AT/MT	R	F	MPV Engine 2NZ-FE	659002	Inner Joint		23	23	34	58.8	102.7		
	2002.11-2005.09	-	-	F	MPV Engine 2NZ-FE	859129	Outer Joint	48T	24	22	56	90	48.5	I	
	2002.11-2005.09	-	-	F	MPV Engine 2NZ-FE	859135	Outer Joint	48T	24	23	56	90.5	55	I	
1.3 (63 kW)	1999.08-2002.10	-	L/R	F/R	MPV Engine 2NZ-FE	839105	Outer Joint	44T	25	22	52.5	95	58	M	

	YEAR	TRANSM	L/R	F/R	REMARKS	GSP Ref.	PRODUCT	ABS	Technical Specifications						
									A	B	C	H	L	P	
TOYOTA															
YARIS VERSO (P2)/FUN CARGO															
1.3 (63 kW)	1999.08-2002.10	-	L/R	F	MPV Engine 2NZ-FE	859137	Outer Joint	48T	24	23	58	91	52.5	I	
	1999.08-2002.10	-	-	-	MPV Engine 2NZ-FE	859038	Outer Joint		24	23	58	91	52.5	I	
	1999.08-2002.10	-	-	F	MPV Engine 2NZ-FE	699046	Inner Joint		23	23	34	60	103.5		
	1999.08-2002.10	-	-	-	MPV Engine 2NZ-FE	859029	Outer Joint		24	22	56	90	48.5	M	
	1999.08-2002.10	AT/MT	R	F	MPV Engine 2NZ-FE	259011	Drive Shaft	48T	24	23	58	91	881.5		
	1999.08-2002.10	-	-	F	MPV Engine 2NZ-FE	859115	Outer Joint		24	22	56	90	48.5	I	
	1999.08-2002.10	AT/MT	R	F	MPV Engine 2NZ-FE	259077	Drive Shaft	48T	24	23	56	90.5	876.5		
	1999.08-2002.10	AT/MT	R	F	MPV Engine 2NZ-FE	659002	Inner Joint		23	23	34	58.8	102.7		
	1999.08-2002.10	-	-	F	MPV Engine 2NZ-FE	859129	Outer Joint	48T	24	22	56	90	48.5	I	
	1999.08-2002.10	-	-	F	MPV Engine 2NZ-FE	859135	Outer Joint	48T	24	23	56	90.5	55	I	
1.4 D-4D (55 kW)	2001.12-2005.09	-	L/R/F/R		MPV Engine 1ND-TV	839105	Outer Joint	44T	25	22	52.5	95	58	M	
	2001.12-2005.09	MT	L/R	F	MPV Engine 1ND-TV	859137	Outer Joint	48T	24	23	58	91	52.5	I	
	2001.12-2005.09	-	-	-	MPV Engine 1ND-TV	859038	Outer Joint		24	23	58	91	52.5	I	
	2001.12-2005.09	-	-	F	MPV Engine 1ND-TV	699046	Inner Joint		23	23	34	60	103.5		
	2001.12-2005.09	MT	R	F	MPV Engine 1ND-TV	259011	Drive Shaft	48T	24	23	58	91	881.5		
	2001.12-2005.09	MT	R	F	MPV Engine 1ND-TV	259077	Drive Shaft	48T	24	23	56	90.5	876.5		
	2001.12-2005.09	MT	R	F	MPV Engine 1ND-TV	659002	Inner Joint		23	23	34	58.8	102.7		
	2001.12-2005.09	-	-	F	MPV Engine 1ND-TV	859129	Outer Joint	48T	24	22	56	90	48.5	I	
	2001.12-2005.09	-	-	F	MPV Engine 1ND-TV	859135	Outer Joint	48T	24	23	56	90.5	55	I	
1.5 (77 kW)	2003.05-2005.09	-	L/R/F/R		MPV Engine 1NZ-FE	839105	Outer Joint	44T	25	22	52.5	95	58	M	
	2003.05-2005.09	MT	L/R	F	MPV Engine 1NZ-FE	859137	Outer Joint	48T	24	23	58	91	52.5	I	
	2003.05-2005.09	-	-	-	MPV Engine 1NZ-FE	859038	Outer Joint		24	23	58	91	52.5	I	
	2003.05-2005.09	-	-	F	MPV Engine 1NZ-FE	699046	Inner Joint		23	23	34	60	103.5		
	2003.05-2005.09	AT/MT	R	F	MPV Engine 1NZ-FE	259011	Drive Shaft	48T	24	23	58	91	881.5		
	2003.05-2005.09	AT/MT	R	F	MPV Engine 1NZ-FE	659002	Inner Joint		23	23	34	58.8	102.7		
1.5 (78 kW)	2000.03-2005.09	-	L/R/F/R		MPV Engine 1NZ-FE	839105	Outer Joint	44T	25	22	52.5	95	58	M	
	2000.03-2005.09	MT	L/R	F	MPV Engine 1NZ-FE	859137	Outer Joint	48T	24	23	58	91	52.5	I	
	2000.03-2005.09	-	-	-	MPV Engine 1NZ-FE	859038	Outer Joint		24	23	58	91	52.5	I	
	2000.03-2005.09	-	-	F	MPV Engine 1NZ-FE	699046	Inner Joint		23	23	34	60	103.5		
	2000.03-2005.09	AT/MT	R	F	MPV Engine 1NZ-FE	259011	Drive Shaft	48T	24	23	58	91	881.5		
	2000.03-2005.09	AT/MT	R	F	MPV Engine 1NZ-FE	659002	Inner Joint		23	23	34	58.8	102.7		
1.5 (80 kW)	2002.08-2005.09	-	L/R/F/R		MPV Engine 1NZ-FE	839105	Outer Joint	44T	25	22	52.5	95	58	M	
YARIS(HYBRID)															
1.0	2011.07-2014.06	5MT	R	F	ENGINE:1KRFE/KSP130	259665	Drive Shaft		26	23	55.6	96	886		
	2011.07-2014.06	5MT	L	F	ENGINE:1KRFE/KSP130	259680	Drive Shaft		26	23	55.6	96	670		
	2014.07-2015.10	5MT	R	F	ENGINE:1KRFE/KSP130	259665	Drive Shaft		26	23	55.6	96	886		
	2014.07-2015.10	5MT	L	F	ENGINE:1KRFE/KSP130	259680	Drive Shaft		26	23	55.6	96	670		
1.3	2011.07-2014.06	6MT	R	F	ENGINE:1NRFE/NSP130	259666	Drive Shaft		26	23	55.6	96	899		
	2011.07-2014.06	MT	L	F	ENGINE:1NRFE/NSP130L	859510	Outer Joint		26	21	55.6	96	51.5	M	
	2011.07-2014.06	MT	L	F	ENGINE:1NRFE/NSP130L	259681	Drive Shaft		26	23	55.6	96	657		
TOYOTA (FAW)															
COROLLA (E120)															
1.8 (101 kW)	2004.02-2007.01	MT/AT	L	-	Saloon Engine 2ZR-FE	259170	Drive Shaft	48T	26	20	58	96	642		
	2004.02-2007.01	MT/AT	R	-	Saloon Engine 2ZR-FE	259171	Drive Shaft	48T	26	20	58	96	914		
1.8 (93 kW)	2004.02-2007.01	MT/AT	L	-	Saloon Engine 1ZZ-FE	259170	Drive Shaft	48T	26	20	58	96	642		
	2004.02-2007.01	MT/AT	R	-	Saloon Engine 1ZZ-FE	259171	Drive Shaft	48T	26	20	58	96	914		
COROLLA (E140)															
1.6 (90 kW)	2010.10-2014.12	MT/AT	R	-	Saloon Engine 1ZR-FE	259218	Drive Shaft		26	20	55.6	95.5	938		
	2010.10-2014.12	MT	R	-	Saloon Engine 1ZR-FE	259221	Drive Shaft	48T	26	23	58	96	906		
	2010.10-2014.12	-	R	-	Saloon Engine 1ZR-FE	259537	Drive Shaft		26	23	55.6	95.5	935		
	2010.10-2014.12	-	L	-	Saloon Engine 1ZR-FE	259538	Drive Shaft		26	23	55.6	95.5	655		
	2010.10-2014.12	MT/AT	L	-	Saloon Engine 1ZR-FE	259170	Drive Shaft	48T	26	20	58	96	642		
	2010.10-2014.12	MT/AT	R	-	Saloon Engine 1ZR-FE	259171	Drive Shaft	48T	26	20	58	96	914		
	2010.10-2014.12	MT	L	-	Saloon Engine 1ZR-FE	259222	Drive Shaft	48T	26	23	58	96	639		
1.8 (103 kW)	2010.10-2014.12	MT/AT	L	-	Saloon Engine 2ZR-FE	259170	Drive Shaft	48T	26	20	58	96	642		
	2010.10-2014.12	MT/AT	R	-	Saloon Engine 2ZR-FE	259171	Drive Shaft	48T	26	20	58	96	914		
	2010.10-2014.12	MT/AT	R	-	Saloon Engine 2ZR-FE	259218	Drive Shaft		26	20	55.6	95.5	938		
COROLLA EX (E120)															
1.6 (90 kW)	2007.05-2014.12	MT/AT	R	-	Saloon Engine 1ZR-FE	259218	Drive Shaft		26	20	55.6	95.5	938		
	2007.05-2014.12	MT	R	-	Saloon Engine 1ZR-FE	259221	Drive Shaft	48T	26	23	58	96	906		
	2007.05-2014.12	-	R	-	Saloon Engine 1ZR-FE	259537	Drive Shaft		26	23	55.6	95.5	935		
	2007.05-2014.12	-	L	-	Saloon Engine 1ZR-FE	259538	Drive Shaft		26	23	55.6	95.5	655		
	2007.05-2014.12	MT/AT	L	-	Saloon Engine 1ZR-FE	259170	Drive Shaft	48T	26	20	58	96	642		
	2007.05-2014.12	MT/AT	R	-	Saloon Engine 1ZR-FE	259171	Drive Shaft	48T	26	20	58	96	914		
	2007.05-2014.12	MT	L	-	Saloon Engine 1ZR-FE	259222	Drive Shaft	48T	26	23	58	96	639		

YEAR	TRANS	L/R	F/R	REMARKS	GSP Ref.	PRODUCT	ABS	Technical Specifications							
								A	B	C	H	L	P		
TOYOTA (FAW)															
CROWN ROYAL (S180)															
2.5 (145 kW)	2005.02-2010.12	-	R	-	Saloon Engine 5GR-FE	259291	Drive Shaft	30	30	58.6	115.5	816			
	2005.02-2010.12	-	L	-	Saloon Engine 5GR-FE	259292	Drive Shaft	30	30	58.6	115.5	770			
3.0 (170 kW)	2005.02-2010.12	-	R	-	Saloon Engine 3GR-FE	259291	Drive Shaft	30	30	58.6	115.5	816			
	2005.02-2010.12	-	L	-	Saloon Engine 3GR-FE	259292	Drive Shaft	30	30	58.6	115.5	770			
RAV4 (A30)															
2.0 (110 kW)	2009.04-2013.08	AT	R	F	All-wheel Drive Closed Off-Road Vehicle Engine 1AZ-FE	259523	Drive Shaft	26	24	61.2	100	988			
	2009.04-2013.08	AT	L	F	All-wheel Drive Closed Off-Road Vehicle Engine 1AZ-FE	259524	Drive Shaft	26	24	61.2	100	643			
	2009.04-2013.08	MT	R	F	All-wheel Drive Closed Off-Road Vehicle Engine 1AZ-FE	259536	Drive Shaft	30	24	61.2	100	980			
	2009.04-2013.08	MT	L	F	All-wheel Drive Closed Off-Road Vehicle Engine 1AZ-FE	259541	Drive Shaft	30	24	61.2	100	655			
	2009.04-2013.08	4AT	R	F	Closed Off-Road Vehicle Engine 1AZ-FE	259523	Drive Shaft	26	24	61.2	100	988			
	2009.04-2013.08	4AT	L	F	Closed Off-Road Vehicle Engine 1AZ-FE	259524	Drive Shaft	26	24	61.2	100	643			
	2009.04-2013.08	5MT	R	F	Closed Off-Road Vehicle Engine 1AZ-FE	259536	Drive Shaft	30	24	61.2	100	980			
	2009.04-2013.08	4AT	L	F	Closed Off-Road Vehicle Engine 1AZ-FE	259539	Drive Shaft	26	24	61.2	100	656			
	2009.04-2013.08	4AT	R	F	Closed Off-Road Vehicle Engine 1AZ-FE	259540	Drive Shaft	26	24	61.2	100	972			
	2009.04-2013.08	5MT	L	F	Closed Off-Road Vehicle Engine 1AZ-FE	259541	Drive Shaft	30	24	61.2	100	655			
	2009.04-2013.08	5MT	R	F	Closed Off-Road Vehicle Engine 1AZ-FE	259542	Drive Shaft	30	24	61.2	100	977			
2.4 (125 kW)	2009.04-2013.08	AT	R	-	All-wheel Drive Closed Off-Road Vehicle Engine 2AZ-FE	259523	Drive Shaft	26	24	61.2	100	988			
	2009.04-2013.08	AT	L	-	All-wheel Drive Closed Off-Road Vehicle Engine 2AZ-FE	259524	Drive Shaft	26	24	61.2	100	643			
	2009.04-2013.08	MT	R	-	All-wheel Drive Closed Off-Road Vehicle Engine 2AZ-FE	259536	Drive Shaft	30	24	61.2	100	980			
	2009.04-2013.08	MT	L	-	All-wheel Drive Closed Off-Road Vehicle Engine 2AZ-FE	259541	Drive Shaft	30	24	61.2	100	655			
REIZ (X120)															
2.5 (145 kW)	2005.10-2010.09	-	R	-	Saloon Engine 5GR-FE	259291	Drive Shaft	30	30	58.6	115.5	816			
	2005.10-2010.09	-	L	-	Saloon Engine 5GR-FE	259292	Drive Shaft	30	30	58.6	115.5	770			
3.0 (170 kW)	2005.10-2010.09	-	R	-	Saloon Engine 3GR-FE	259291	Drive Shaft	30	30	58.6	115.5	816			
	2005.10-2010.09	-	L	-	Saloon Engine 3GR-FE	259292	Drive Shaft	30	30	58.6	115.5	770			
VIOS (P40)															
1.3 (64 kW)	2005.10-2008.02	MT	R	-	Saloon Engine 2SZ-FE	259262	Drive Shaft								
	2005.10-2008.02	MT	L	-	Saloon Engine 2SZ-FE	259263	Drive Shaft								
1.5 (68 kW)	2002.11-2005.10	AT	L	-	Saloon Engine 5A-FE	259264	Drive Shaft								
	2002.11-2005.10	AT	R	-	Saloon Engine 5A-FE	259265	Drive Shaft								
	2005.10-2008.02	AT	L	-	Saloon Engine 3SZ-FE	259264	Drive Shaft								
	2005.10-2008.02	AT	R	-	Saloon Engine 3SZ-FE	259265	Drive Shaft								
VIOS (P90)															
1.6 (87 kW)	2008.10-2013.05	AT	-	-	Saloon Engine 1ZR-FE	259318	Drive Shaft	26	23	55.6	95.5	904			
TOYOTA (GAC)															
CAMRY (ACV4_)															
200 (108 kW)	2006.06-2015.12	-	-	-	Saloon Engine 1AZ-FE	259185	Drive Shaft	48T	26	24	63	100	966		
240 (123 kW)	2006.06-2011.12	-	L	-	Saloon Engine 2AZ-FE	259184	Drive Shaft	48T	26	24	63	100	667		
	2006.06-2011.12	-	R	-	Saloon Engine 2AZ-FE	259185	Drive Shaft	48T	26	24	63	100	966		
CAMRY (V50)															
2.0 (109 kW)	2012.03-	-	-	-	Saloon Engine 1AZ-FE	259185	Drive Shaft	48T	26	24	63	100	966		
HIGHLANDER (ASU4_ GSU4_)															
2.7 (138 kW)	2011.01-	-	L	-	Closed Off-Road Vehicle Engine 3AR-FE	259296	Drive Shaft	48T	30	24	63	100.5	673		
	2011.01-	-	R	-	Closed Off-Road Vehicle Engine 3AR-FE	259297	Drive Shaft	48T	30	24	63	100.5	992		
2.7 (140 kW)	2009.05-2012.12	-	L	F	Closed Off-Road Vehicle Engine 1AR-FE	259296	Drive Shaft	48T	30	24	63	100.5	673		
	2009.05-2012.12	-	R	F	Closed Off-Road Vehicle Engine 1AR-FE	259297	Drive Shaft	48T	30	24	63	100.5	992		
3.5 (201 kW)	2009.05-2015.12	-	L	F	All-wheel Drive Closed Off-Road Vehicle Engine 2GR-FE	259521	Drive Shaft	48T	26	23	61	100	653		
	2009.05-2015.12	-	R	F	All-wheel Drive Closed Off-Road Vehicle Engine 2GR-FE	259522	Drive Shaft	48T	26	23	61	100	1027		
VAUXHALL															
ADAM (M13)															
1.2 (51 kW)	2012.10-	-	MT	L	F	Hatchback Engine A 12 XEL	644013	Inner Joint	22	21	35	57.5	93		
	2012.10-	-	-	L	F	Hatchback Engine A 12 XEL	817089	Outer Joint	22	20	51	79.5	51	M	
	2012.10-	-	MT	L	F	Hatchback Engine A 12 XEL	260023	Drive Shaft	22	22	51.2	79.5	615		
1.4 (64 kW)	2012.10-	-	MT	L	F	Hatchback Engine A 14 XEL	644013	Inner Joint	22	21	35	57.5	93		
	2012.10-	-	-	R	F	Hatchback Engine A 14 XEL	244078	Drive Shaft	22	22	51	79.5	918		
	2012.10-	-	-	R	F	Hatchback Engine A 14 XEL	817089	Outer Joint	22	20	51	79.5	51	M	
	2012.10-	-	-	L	F	Hatchback Engine A 14 XEL	244079	Drive Shaft	22	22	51	79.5	615		
	2012.10-	-	-	L/R	F	Hatchback Engine A 14 XEL	817052	Outer Joint	22	21	51.2	79.5	54	M	
	2012.10-	-	MT	L	F	Hatchback Engine A 14 XEL	260023	Drive Shaft	22	22	51.2	79.5	615		
1.4 (74 kW)	2012.10-	-	MT	L	F	Hatchback Engine A 14 XER	644013	Inner Joint	22	21	35	57.5	93		
	2012.10-	-	-	R	F	Hatchback Engine A 14 XER	244078	Drive Shaft	22	22	51	79.5	918		
	2012.10-	-	-	R	F	Hatchback Engine A 14 XER	817089	Outer Joint	22	20	51	79.5	51	M	
	2012.10-	-	-	L	F	Hatchback Engine A 14 XER	244079	Drive Shaft	22	22	51	79.5	615		
	2012.10-	-	-	L/R	F	Hatchback Engine A 14 XER	817052	Outer Joint	22	21	51.2	79.5	54	M	
	2012.10-	-	MT	L	F	Hatchback Engine A 14 XER	260023	Drive Shaft	22	22	51.2	79.5	615		

YEAR	TRANSM	L/R	F/R	REMARKS	GSP Ref.	PRODUCT	ABS	Technical Specifications							
								A	B	C	H	L	P		
VAUXHALL															
ADAM (M13)															
1.4 S (110 kW)	2014.11-	-	-	F	Hatchback Engine B 14 NEH	817027	Outer Joint		25	23	51	84.5	60	M	
	2014.11-	-	MT	L	F	Hatchback Engine B 14 NEH	217070	Drive Shaft		25	25	51	84.5	576	
AGILA Mk I (A) (H00)															
1.0 12V (43 kW)	2000.09-	2005.08	-	L/R	F	Hatchback Engine Z 10 XE	844001	Outer Joint	43T	23	20	49	78	61	M
	2000.09-	2005.08	-	-	-	Hatchback Engine Z 10 XE	899110	Outer Joint		23	20	49	78	61	M
	2000.09-	2005.08	MT	L	F	Hatchback Engine Z 10 XE	257087	Drive Shaft	43T	23	22	49	78	638	
	2000.09-	2005.08	MT	R	F	Hatchback Engine Z 10 XE	244043	Drive Shaft	43T	23	22	49	78	853	
1.0 12V (44 kW)	2000.02-	2006.11	-	L/R	F	Hatchback Engine Z 10 XEP	844001	Outer Joint	43T	23	20	49	78	61	M
	2000.02-	2006.11	MT	L	F	Hatchback Engine Z 10 XEP	257087	Drive Shaft	43T	23	22	49	78	638	
	2000.02-	2006.11	MT	R	F	Hatchback Engine Z 10 XEP	244043	Drive Shaft	43T	23	22	49	78	853	
1.2 16V (55 kW)	2000.09-	2008.03	-	L/R	F	Hatchback Engine Z 12 XE	844001	Outer Joint	43T	23	20	49	78	61	M
	2000.09-	2008.03	-	-	-	Hatchback Engine Z 12 XE	899110	Outer Joint		23	20	49	78	61	M
1.2 16V Twinport (59 kW)	2004.07-	2006.11	-	L/R	F	Hatchback Engine Z 12 XEP	844001	Outer Joint	43T	23	20	49	78	61	M
AGILA Mk II (B) (H08)															
1.0 12V (48 kW)	2008.01-	2014.11	MT	L	F	Hatchback Engine K10B	657156	Inner Joint		22	19	40	57	97.5	
	2008.01-	2014.11	MT	L/R	F	Hatchback Engine K10B	844085	Outer Joint		25	20	49	81.5	61	M
	2008.01-	2014.11	MT	L	F	Hatchback Engine K10B	257175	Drive Shaft		25	22	49	82	635	
	2008.01-	2014.11	MT	L	F	Hatchback Engine K10B	257222	Drive Shaft		25	22	49	81.5	641	
	2008.01-	2014.11	MT	R	F	Hatchback Engine K10B	257221	Drive Shaft		25	22	49	81.5	882	
1.0 i (50 kW)	2011.08-	2014.11	MT	L	F	Hatchback Engine K10B	657156	Inner Joint		22	19	40	57	97.5	
	2011.08-	2014.11	MT	L	F	Hatchback Engine K10B	257175	Drive Shaft		25	22	49	82	635	
1.2 i 16V (63 kW)	2008.01-	2014.11	MT	L	F	Hatchback Engine K12B	657156	Inner Joint		22	19	40	57	97.5	
	2008.01-	2014.11	MT	L/R	F	Hatchback Engine K12B	844085	Outer Joint		25	20	49	81.5	61	M
	2008.01-	2014.11	MT	L	F	Hatchback Engine K12B	257175	Drive Shaft		25	22	49	82	635	
	2008.01-	2014.11	MT	L	F	Hatchback Engine K12B	257222	Drive Shaft		25	22	49	81.5	641	
	2008.01-	2014.11	MT	R	F	Hatchback Engine K12B	257221	Drive Shaft		25	22	49	81.5	882	
1.2 i 16V (69 kW)	2008.01-	2014.11	AT	-	-	Hatchback Engine K12B	857103	Outer Joint		25	28	49	82	61	I
	2008.01-	2014.11	MT	L/R	F	Hatchback Engine K12B	844085	Outer Joint		25	20	49	81.5	61	M
	2008.01-	2014.11	MT	L	F	Hatchback Engine K12B	657156	Inner Joint		22	19	40	57	97.5	
	2008.01-	2014.11	MT	L	F	Hatchback Engine K12B	257175	Drive Shaft		25	22	49	82	635	
	2008.01-	2014.11	MT	L	F	Hatchback Engine K12B	257222	Drive Shaft		25	22	49	81.5	641	
	2008.01-	2014.11	MT	R	F	Hatchback Engine K12B	257221	Drive Shaft		25	22	49	81.5	882	
1.3 CDTI (55 kW)	2008.01-	2014.11	-	-	F	Hatchback Engine D13A	857100	Outer Joint		25	21	49	82.5	64	M
	2008.01-	2014.11	MT	-	F	Hatchback Engine D13A	257210	Drive Shaft		25	26	49	81.5	630	
	2008.01-	2014.11	MT	L	F	Hatchback Engine D13A	257223	Drive Shaft		25	26	49	81.5	629	
	2008.01-	2014.11	MT	R	F	Hatchback Engine D13A	257197	Drive Shaft		25	22	49	81.5	614	
ANTARA (L07)															
2.0 CDTI (110 kW)	2006.08-	2015.04	5AT/5AT	-	F	All-wheel Drive Closed Off-Road Vehicle Engine Z 20 DMH	822009	Outer Joint		30	34	54	105.5	64.5	O
	2006.08-	2015.04	5AT	R	F	All-wheel Drive Closed Off-Road Vehicle Engine Z 20 DMH	608035	Inner Joint		27	34	43.3	51	77	
2.2 CDTI (120 kW)	2010.12-	-	MT	L	F	All-wheel Drive Closed Off-Road Vehicle Engine A 22 DM	208093	Drive Shaft		30	27	54	105.5	618.5	
	2010.12-	-	MT	R	F	All-wheel Drive Closed Off-Road Vehicle Engine A 22 DM	208094	Drive Shaft		30	27	54	105.5	542	
	2010.12-	-	5AT/5AT	-	F	All-wheel Drive Closed Off-Road Vehicle Engine A 22 DM	822009	Outer Joint		30	34	54	105.5	64.5	O
	2010.12-	-	MT	L	F	All-wheel Drive Closed Off-Road Vehicle Engine A 22 DM	608034	Inner Joint		27	34	35	68.5	111.5	
	2010.12-	-	MT	R	F	All-wheel Drive Closed Off-Road Vehicle Engine A 22 DM	608035	Inner Joint		27	34	43.3	51	77	
2.2 CDTI (135 kW)	2010.12-	-	MT	L	F	All-wheel Drive Closed Off-Road Vehicle Engine A 22 DMH	208093	Drive Shaft		30	27	54	105.5	618.5	
	2010.12-	-	MT	R	F	All-wheel Drive Closed Off-Road Vehicle Engine A 22 DMH	208094	Drive Shaft		30	27	54	105.5	542	
	2010.12-	-	5AT/5AT	-	F	All-wheel Drive Closed Off-Road Vehicle Engine A 22 DMH	822009	Outer Joint		30	34	54	105.5	64.5	O
	2010.12-	-	MT	L	F	All-wheel Drive Closed Off-Road Vehicle Engine A 22 DMH	608034	Inner Joint		27	34	35	68.5	111.5	
	2010.12-	-	MT	R	F	All-wheel Drive Closed Off-Road Vehicle Engine A 22 DMH	608035	Inner Joint		27	34	43.3	51	77	
2.2 CDTI FWD (120 kW)	2010.12-	-	MT	L	F	Closed Off-Road Vehicle Engine A 22 DM	208093	Drive Shaft		30	27	54	105.5	618.5	
	2010.12-	-	MT	R	F	Closed Off-Road Vehicle Engine A 22 DM	208094	Drive Shaft		30	27	54	105.5	542	
	2010.12-	-	5AT/5AT	-	F	Closed Off-Road Vehicle Engine A 22 DM	822009	Outer Joint		30	34	54	105.5	64.5	O
	2010.12-	-	MT	L	F	Closed Off-Road Vehicle Engine A 22 DM	608034	Inner Joint		27	34	35	68.5	111.5	
	2010.12-	-	MT	R	F	Closed Off-Road Vehicle Engine A 22 DM	608035	Inner Joint		27	34	43.3	51	77	
2.4 (103 kW)	2006.08-	2015.04	5AT	-	F	All-wheel Drive Closed Off-Road Vehicle Engine Z 24 XED	822009	Outer Joint		30	34	54	105.5	64.5	O
	2006.08-	2015.04	5AT	R	F	All-wheel Drive Closed Off-Road Vehicle Engine Z 24 XED	608035	Inner Joint		27	34	43.3	51	77	
2.4 (123 kW)	2010.12-	2015.04	MT	-	-	All-wheel Drive Closed Off-Road Vehicle Engine A 24 XE	822009	Outer Joint		30	34	54	105.5	64.5	O
	2010.12-	2015.04	6MT	-	F	Closed Off-Road Vehicle Engine A 24 XE	822009	Outer Joint		30	34	54	105.5	64.5	O
	2010.12-	2015.04	MT	R	F	All-wheel Drive Closed Off-Road Vehicle Engine A 24 XE	608035	Inner Joint		27	34	43.3	51	77	
	2010.12-	2015.04	6MT	R	F	Closed Off-Road Vehicle Engine A 24 XE	608035	Inner Joint		27	34	43.3	51	77	
2.4 (126 kW)	2010.11-	2015.04	MT	-	-	All-wheel Drive Closed Off-Road Vehicle Engine A 24 XE	822009	Outer Joint		30	34	54	105.5	64.5	O
	2010.11-	2015.04	MT	-	F	Closed Off-Road Vehicle Engine A 24 XE	822009	Outer Joint		30	34	54	105.5	64.5	O
	2010.11-	2015.04	MT	R	F	Closed Off-Road Vehicle Engine A 24 XE	608035	Inner Joint		27	34	43.3	51	77	
	2010.11-	2015.04	MT	R	F	All-wheel Drive Closed Off-Road Vehicle Engine A 24 XE	608035	Inner Joint		27	34	43.3	51	77	
3.0 (188 kW)	2010.11-	2015.04	AT	-	-	All-wheel Drive Closed Off-Road Vehicle Engine A 30 XH	822009	Outer Joint		30	34	54	105.5	64.5	O
ARENA Combi (A97)															

YEAR	TRANSM	L/R	F/R	REMARKS	GSP Ref.	PRODUCT	ABS	Technical Specifications							
								A	B	C	H	L	P		
VAUXHALL															
ARENA Combi (A97)															
1.9 D (44 kW)	1998.03-2001.08	MT	-	F	BUS Engine F8Q 600	250183	Drive Shaft		25	27	56.3	110.5	716		
	1998.03-2001.08	MT	L/R	F	BUS Engine F8Q 600	244006	Drive Shaft		25	27	56.3	110.5	713.5		
2.5 D (55 kW)	1998.03-2001.08	MT	L/R	F	BUS Engine S8U 780	244006	Drive Shaft		25	27	56.3	110.5	713.5		
ARENA Van (A97)															
1.9 D (44 kW)	1998.03-2001.08	MT	-	F	Box Engine F8Q 600	250183	Drive Shaft		25	27	56.3	110.5	716		
	1998.03-2001.08	MT	L/R	F	Box Engine F8Q 600	244006	Drive Shaft		25	27	56.3	110.5	713.5		
2.5 D (55 kW)	1998.03-2001.08	MT	L/R	F	Box Engine S8U 780	244006	Drive Shaft		25	27	56.3	110.5	713.5		
ASTRA															
1.3(66kW)	2004-2012	-	R	F	Estate	644011	Inner Joint		34	25	37.5	46	55		
	2004-2012	-	R	F	Hatchback	644011	Inner Joint		34	25	37.5	46	55		
	2004-2012	-	R	F	Estate	644011	Inner Joint		34	25	37.5	46	55		
	2004-2012	-	R	F	Hatchback	644011	Inner Joint		34	25	37.5	46	55		
	2004-2012	-	R	F	Estate	644011	Inner Joint		34	25	37.5	46	55		
	2004-2012	-	R	F	Hatchback	644011	Inner Joint		34	25	37.5	46	55		
	2004-2012	-	R	F	Estate	644011	Inner Joint		34	25	37.5	46	55		
	2004-2012	-	R	F	Hatchback	644011	Inner Joint		34	25	37.5	46	55		
	2004-2012	-	R	F	Estate	644011	Inner Joint		34	25	37.5	46	55		
	2004-2012	-	R	F	Hatchback	644011	Inner Joint		34	25	37.5	46	55		
	2004-2012	-	-	-	Hatchback	644011	Inner Joint		34	25	37.5	46	55		
ASTRA F															
1.4/1.6	1991-1998	MT	L	F	-	260010	Drive Shaft		22	22	52.2	97	587		
	1991-1998	MT	R	F	-	260011	Drive Shaft		22	22	52	95	920		
1.7 TD	1992.04-1998.03	MT	L	F	All	260012	Drive Shaft	29T	33	34	52	103.5	586		
1.8	1993.06-1994.08	MT	L	F	All	260012	Drive Shaft	29T	33	34	52	103.5	586		
2.0 16v	1991.10-1998.03	MT	L	F	All	260012	Drive Shaft	29T	33	34	52	103.5	586		
2.0 8v	1991.10-1994.08	MT	L	F	All	260012	Drive Shaft	29T	33	34	52	103.5	586		
ASTRA F (56, 57), SW															
1.4 (53 kW)	1999.09-	-	-	-	-	844060	Outer Joint	29T	22	22	52	98	51	O	
1.4 (55 kW)	1999.09-	-	-	-	-	844060	Outer Joint	29T	22	22	52	98	51	O	
1.4 i 16V Cabrio (66 kW)	1996.02-1998.09	-	-	-	-	844060	Outer Joint	29T	22	22	52	98	51	O	
1.4 Si (60 kW)	1992.03-1998.09	-	-	-	-	844060	Outer Joint	29T	22	22	52	98	51	O	
1.6 i (55 kW)	1992.03-1998.09	-	-	-	-	844060	Outer Joint	29T	22	22	52	98	51	O	
1.6 i 16V (74 kW)	1994.08-1998.09	-	-	-	ChP2732834	844060	Outer Joint	29T	22	22	52	98	51	O	
1.6 Si (74 kW)	1992.05-1994.12	-	-	-	-	844060	Outer Joint	29T	22	22	52	98	51	O	
1.7 D (44 kW)	1992.03-1992.09	MT	-	-	-	844060	Outer Joint	29T	22	22	52	98	51	O	
ASTRA F CLASSIC, SW															
1.4 i (44 kW)	1998-2004	-	-	-	ChP2732834	844060	Outer Joint	29T	22	22	52	98	51	O	
1.4 i (46 kW)	1998-2004	-	-	-	ChP2732834	844060	Outer Joint	29T	22	22	52	98	51	O	
1.7 TD (50 kW)	1998-2000	-	-	-	ChP8202126	844060	Outer Joint	29T	22	22	52	98	51	O	
2.0 i (100 kW)	1998-2000	-	-	-	ChP8202126	844060	Outer Joint	29T	22	22	52	98	51	O	
ASTRA G															
1.4 16V	1998.04-2004.12	MT	R	F	-	260014	Drive Shaft		33	22	52	108	964		
1.6 8V/16V	1998.04-2004.12	MT/AT	R	F	-	260014	Drive Shaft		33	22	52	108	964		
1.7 TD	1998.04-2000.01	MT	R	F	-	260014	Drive Shaft		33	22	52	108	964		
ASTRA G,SW															
Classic	1998-	-	-	-	ChYG039154/1G043744	844060	Outer Joint	29T	22	22	52	98	51	O	
-	1998-	-	-	-	Classic Ch.No YG039154/ 1G043744,Exc.Italy	844033	Outer Joint		22	22	52	98	51	O	
Classic	1998-	-	-	-	Ch.No YG039154 / 1G043744	844060	Outer Joint	29T	22	22	52	98	51	O	
ASTRA III VAN															
1.4	1991.11-1998.10	MT	L	F	LCV	260010	Drive Shaft		22	22	52.2	97	587		
	1991.11-1998.10	MT	R	F	LCV	260011	Drive Shaft		22	22	52	95	920		
ASTRA IV VAN															
1.6	1998.10-	MT	R	F	LCV	260014	Drive Shaft		33	22	52	108	964		
1.7 TD	1998.10-2000.02	MT	R	F	LCV	260014	Drive Shaft		33	22	52	108	964		
ASTRA Mk II (T85)															
1.2 (40 kW)	1984.09-1991.08	-	-	F	Hatchback Engine 12 S	844023	Outer Joint		22	22	52	95	50	O	
1.2 (44 kW)	1984.09-1991.08	MT	L/R	F	Hatchback Engine 12 S	844051	Outer Joint	29T	22	22	52	95	50.5	O	
	1984.09-1991.08	MT	L/R	F	Hatchback Engine 12 S	844041	Outer Joint		22	22	52	95	50	O	
	1984.09-1991.08	MT	L/R	F	Hatchback Engine 12 S	644004	Inner Joint		22	22	34.95	57.5	72.5		
	1984.09-1991.08	-	-	F	Hatchback Engine 12 S	844023	Outer Joint		22	22	52	95	50	O	
1.3 (55 kW)	1984.09-1991.08	MT	L/R	F	Hatchback Engine 13 S	844051	Outer Joint	29T	22	22	52	95	50.5	O	
	1984.09-1991.08	MT	L/R	F	Estate Engine 13 S	844051	Outer Joint	29T	22	22	52	95	50.5	O	
	1984.09-1991.08	AT/MT	L/R	F	Hatchback Engine 13 S	844041	Outer Joint		22	22	52	95	50	O	
	1984.09-1991.08	AT/MT	L/R	F	Estate Engine 13 S	844041	Outer Joint		22	22	52	95	50	O	
	1984.09-1991.08	MT	L/R	F	Hatchback Engine 13 S	644004	Inner Joint		22	22	34.95	57.5	72.5		
	1984.09-1991.08	MT	L/R	F	Estate Engine 13 S	644004	Inner Joint		22	22	34.95	57.5	72.5		

YEAR	TRANSM	L/R	F/R	REMARKS	GSP Ref.	PRODUCT	ABS	Technical Specifications							
								A	B	C	H	L	P		
VAUXHALL															
ASTRA Mk II (T85)															
1.3 (55 kW)	1984.09-1991.08	-	-	-	Hatchback Engine 13 S	844024	Outer Joint		22	22	52.2	97	50	O	
	1984.09-1991.08	-	-	F	Hatchback Engine 13 S	844023	Outer Joint		22	22	52	95	50	O	
	1984.09-1991.08	-	-	F	Estate Engine 13 S	844023	Outer Joint		22	22	52	95	50	O	
1.4 i (44 kW)	1990.01-1991.08	MT	L/R	F	Hatchback Engine C 14 NZ	644004	Inner Joint		22	22	34.95	57.5	72.5		
	1990.01-1991.08	-	-	F	Hatchback Engine C 14 NZ	844023	Outer Joint		22	22	52	95	50	O	
	1990.01-1991.08	MT	L/R	F	Hatchback Engine C 14 NZ	844051	Outer Joint	29T	22	22	52	95	50.5	O	
	1990.01-1991.08	MT	L/R	F	Hatchback Engine C 14 NZ	844041	Outer Joint		22	22	52	95	50	O	
	1990.01-1991.08	-	-	-	Hatchback Engine C 14 NZ	844024	Outer Joint		22	22	52.2	97	50	O	
1.4 S (55 kW)	1989.01-1991.08	-	-	F	Estate Engine 14 NV	844018	Outer Joint		22	28	52.2	97.5	55	O	
	1989.01-1991.08	-	-	F	Estate Engine 14 NV	844019	Outer Joint	29T	22	28	52	97.5	57.5	O	
	1990.01-1991.08	MT	L/R	F	Hatchback Engine 14 NV	844051	Outer Joint	29T	22	22	52	95	50.5	O	
	1990.01-1991.08	MT	L/R	F	Hatchback Engine 14 NV	844041	Outer Joint		22	22	52	95	50	O	
	1990.01-1991.08	-	-	-	Hatchback Engine 14 NV	644004	Inner Joint		22	22	34.95	57.5	72.5		
	1990.01-1991.08	-	-	F	Hatchback Engine 14 NV	844023	Outer Joint		22	22	52	95	50	O	
1.6 (60 kW)	1984.09-1991.08	MT	-	F	Hatchback Engine 16 SV	808003	Outer Joint		33	25	52	109	61	O	
	1984.09-1991.08	MT	-	F	Estate Engine 16 SV	808003	Outer Joint		33	25	52	109	61	O	
	1984.09-1991.08	MT	L/R	F	Hatchback Engine 16 SV	899205	Outer Joint		33	25	52	109	61	O	
	1984.09-1991.08	MT	L/R	F	Estate Engine 16 SV	899205	Outer Joint		33	25	52	109	61	O	
	1984.09-1991.08	AT	-	F	Hatchback Engine 16 SV	844023	Outer Joint		22	22	52	95	50	O	
	1984.09-1991.08	AT	-	F	Estate Engine 16 SV	844023	Outer Joint		22	22	52	95	50	O	
	1984.09-1991.08	MT	-	F	Hatchback Engine 16 SV	644001	Inner Joint		34	22	35	56.2	76		
	1984.09-1991.08	MT	-	F	Estate Engine 16 SV	644001	Inner Joint		34	22	35	56.2	76		
1.6 D (40 kW)	1984.09-1989.12	MT	L/R	F	Hatchback Engine 16 DA	899205	Outer Joint		33	25	52	109	61	O	
	1984.09-1989.12	MT	L/R	F	Estate Engine 16 DA	899205	Outer Joint		33	25	52	109	61	O	
	1984.09-1989.12	MT	L/R	F	Hatchback Engine 16 DA	844056	Outer Joint	29T	33	25	52	109	61	O	
	1984.09-1989.12	MT	L/R	F	Estate Engine 16 DA	844056	Outer Joint	29T	33	25	52	109	61	O	
	1984.09-1989.12	MT	L/R	F	Hatchback Engine 16 DA	644004	Inner Joint		22	22	34.95	57.5	72.5		
	1984.09-1989.12	MT	L/R	F	Estate Engine 16 DA	644004	Inner Joint		22	22	34.95	57.5	72.5		
	1984.09-1989.12	MT	L/R	F	Hatchback Engine 16 DA	844057	Outer Joint	43T	33	25	52	109	61	O	
	1984.09-1989.12	MT	L/R	F	Estate Engine 16 DA	844057	Outer Joint	43T	33	25	52	109	61	O	
1.6 i (60 kW)	1987.01-1991.12	MT	-	F	Convertible Engine 16 SV	808003	Outer Joint		33	25	52	109	61	O	
	1987.01-1991.12	MT	L/R	F	Convertible Engine 16 SV	899205	Outer Joint		33	25	52	109	61	O	
	1987.01-1991.12	AT	-	F	Convertible Engine 16 SV	844023	Outer Joint		22	22	52	95	50	O	
	1987.01-1991.12	MT	-	F	Convertible Engine 16 SV	644001	Inner Joint		34	22	35	56.2	76		
1.7 D (42 kW)	1989.01-1991.08	MT	L/R	F	Hatchback Engine 17 DR	644002	Inner Joint		34	25	35	56.2	85.6		
	1989.01-1991.08	-	-	F	Hatchback Engine 17 DR	808003	Outer Joint		33	25	52	109	61	O	
	1989.01-1991.08	MT	L/R	F	Hatchback Engine 17 DR	899205	Outer Joint		33	25	52	109	61	O	
	1989.01-1991.08	MT	L/R	F	Hatchback Engine 17 DR	844057	Outer Joint	43T	33	25	52	109	61	O	
	1989.01-1991.08	MT	L/R	F	Hatchback Engine 17 DR	844056	Outer Joint	29T	33	25	52	109	61	O	
	1989.02-1991.08	MT	L/R	F	Estate Engine 17 D	644002	Inner Joint		34	25	35	56.2	85.6		
	1989.02-1991.08	-	-	F	Estate Engine 17 D	808003	Outer Joint		33	25	52	109	61	O	
	1989.02-1991.08	MT	L/R	F	Estate Engine 17 D	899205	Outer Joint		33	25	52	109	61	O	
	1989.02-1991.08	MT	L/R	F	Estate Engine 17 D	844057	Outer Joint	43T	33	25	52	109	61	O	
	1989.02-1991.08	MT	L/R	F	Estate Engine 17 D	844056	Outer Joint	29T	33	25	52	109	61	O	
1.8 GTE (82 kW)	1984.09-1991.08	MT	L/R	F	Hatchback Engine 18 E	644002	Inner Joint		34	25	35	56.2	85.6		
	1984.09-1991.08	AT/MT	L/R	F	Hatchback Engine 18 E	621011	Inner Joint		34	25	35	78	64		
	1984.09-1991.08	-	-	F	Hatchback Engine 18 E	808003	Outer Joint		33	25	52	109	61	O	
	1984.09-1991.08	MT	L/R	F	Hatchback Engine 18 E	899205	Outer Joint		33	25	52	109	61	O	
	1984.09-1991.08	MT	L/R	F	Hatchback Engine 18 E	844056	Outer Joint	29T	33	25	52	109	61	O	
1.8 i (83 kW)	1990.01-1991.08	MT	L/R	F	Estate Engine 18 E	644002	Inner Joint		34	25	35	56.2	85.6		
	1990.01-1991.08	AT/MT	L/R	F	Estate Engine 18 E	621011	Inner Joint		34	25	35	78	64		
	1990.01-1991.08	-	-	F	Estate Engine 18 E	808003	Outer Joint		33	25	52	109	61	O	
	1990.01-1991.08	MT	L/R	F	Estate Engine 18 E	899205	Outer Joint		33	25	52	109	61	O	
	1990.01-1991.08	MT	L/R	F	Estate Engine 18 E	844057	Outer Joint	43T	33	25	52	109	61	O	
	1990.01-1991.08	MT	L/R	F	Estate Engine 18 E	844056	Outer Joint	29T	33	25	52	109	61	O	
2.0 GTE (95 kW)	1986.09-1991.08	-	-	F	Hatchback Engine 20 SEH	808003	Outer Joint		33	25	52	109	61	O	
2.0 GTE 16V (115 kW)	1988.05-1991.08	AT/MT	L/R	F	Hatchback Engine 20 XE	621011	Inner Joint		34	25	35	78	64		
	1988.05-1991.08	-	-	F	Hatchback Engine 20 XE	808003	Outer Joint		33	25	52	109	61	O	
2.0 i (85 kW)	1987.01-1991.12	MT	L/R	F	Convertible Engine 20 NE	644002	Inner Joint		34	25	35	56.2	85.6		
	1987.01-1991.12	-	-	F	Convertible Engine 20 NE	808003	Outer Joint		33	25	52	109	61	O	
	1987.01-1991.12	MT	L/R	F	Convertible Engine 20 NE	899205	Outer Joint		33	25	52	109	61	O	
	1987.01-1991.12	MT	L/R	F	Convertible Engine 20 NE	844057	Outer Joint	43T	33	25	52	109	61	O	
	1987.01-1991.12	MT	L/R	F	Convertible Engine 20 NE	844056	Outer Joint	29T	33	25	52	109	61	O	
2.0 i Cat (85 kW)	1991.01-1993.08	-	-	L	Convertible Engine C 20 NE	244014	Drive Shaft	43T	33	34	52	103.5	587		
	1991.01-1993.08	-	-	R	Convertible Engine C 20 NE	244048	Drive Shaft		33	34	52	109	938		
	1991.01-1993.08	MT	L/R	F	Convertible Engine C 20 NE	644002	Inner Joint		34	25	35	56.2	85.6		

YEAR	TRANS	L/R	F/R	REMARKS	GSP Ref.	PRODUCT	ABS	Technical Specifications							
								A	B	C	H	L	P		
VAUXHALL															
ASTRA Mk II (T85)															
2.0 i Cat (85 kW)	1991.01-1993.08	-	-	F	Convertible Engine C 20 NE	808003	Outer Joint		33	25	52	109	61	O	
	1991.01-1993.08	MT	L/R	F	Convertible Engine C 20 NE	899205	Outer Joint		33	25	52	109	61	O	
	1991.01-1993.08	MT	L/R	F	Convertible Engine C 20 NE	844057	Outer Joint	43T	33	25	52	109	61	O	
	1991.01-1993.08	MT	L/R	F	Convertible Engine C 20 NE	844056	Outer Joint	29T	33	25	52	109	61	O	
ASTRA Mk II Belmont (T85)															
1.3 (55 kW)	1985.09-1991.08	-	-	F	Saloon Engine 13 S	844023	Outer Joint		22	22	52	95	50	O	
1.4 i (44 kW)	1990.01-1991.12	-	-	F	Saloon Engine C 14 NZ	844023	Outer Joint		22	22	52	95	50	O	
1.6 (66 kW)	1985.09-1991.08	MT	-	F	Saloon Engine 16 SH	808003	Outer Joint		33	25	52	109	61	O	
	1985.09-1991.08	AT	-	F	Saloon Engine 16 SH	844023	Outer Joint		22	22	52	95	50	O	
	1985.09-1991.08	MT	-	F	Saloon Engine 16 SH	644001	Inner Joint		34	22	35	56.2	76		
1.6 S (60 kW)	1989.01-1991.12	MT	-	F	Saloon Engine 16 SV	808003	Outer Joint		33	25	52	109	61	O	
	1989.01-1991.12	AT	-	F	Saloon Engine 16 SV	844023	Outer Joint		22	22	52	95	50	O	
	1989.01-1991.12	MT	-	F	Saloon Engine 16 SV	644001	Inner Joint		34	22	35	56.2	76		
1.7 D (42 kW)	1989.01-1991.12	-	-	F	Saloon Engine 17 D	844018	Outer Joint		22	28	52.2	97.5	55	O	
	1989.01-1991.12	-	-	F	Saloon Engine 17 D	844019	Outer Joint	29T	22	28	52	97.5	57.5	O	
1.8 (82 kW)	1986.01-1990.12	AT/MT	L/R	F	Saloon Engine 18 SE	621011	Inner Joint		34	25	35	78	64		
	1986.01-1990.12	-	-	F	Saloon Engine 18 SE	808003	Outer Joint		33	25	52	109	61	O	
1.8 i (85 kW)	1985.09-1991.08	AT/MT	L/R	F	Saloon Engine 18 SE	621011	Inner Joint		34	25	35	78	64		
	1985.09-1991.08	-	-	F	Saloon Engine 18 SE	808003	Outer Joint		33	25	52	109	61	O	
ASTRA Mk III (F) (T92)															
1.4 i (44 kW)	1991.09-1998.02	MT	L/R	F	Hatchback Engine C 14 NZ	844051	Outer Joint	29T	22	22	52	95	50.5	O	
	1991.09-1998.02	MT	L/R	F	Estate Engine C 14 NZ	844051	Outer Joint	29T	22	22	52	95	50.5	O	
	1991.09-1998.02	MT	L	F	Hatchback Engine C 14 NZ	244002	Drive Shaft	29T	22	22	52	95	585		
	1991.09-1998.02	MT	L	F	Estate Engine C 14 NZ	244002	Drive Shaft	29T	22	22	52	95	585		
	1991.09-1998.02	MT	L/R	F	Hatchback Engine C 14 NZ	644004	Inner Joint		22	22	34.95	57.5	72.5		
	1991.09-1998.02	MT	L/R	F	Estate Engine C 14 NZ	644004	Inner Joint		22	22	34.95	57.5	72.5		
	1991.09-1998.02	-	-	F	Hatchback Engine C 14 NZ	844023	Outer Joint		22	22	52	95	50	O	
	1991.09-1998.02	-	-	F	Estate Engine C 14 NZ	844023	Outer Joint		22	22	52	95	50	O	
	1991.09-1998.02	MT	R	F	Hatchback Engine C 14 NZ	260002	Drive Shaft	29T	22	22	52	95	926		
	1991.09-1998.02	MT	L/R	F	Hatchback Engine C 14 NZ	844007	Outer Joint	29T	22	22	52	94.5	50	O	
	1991.09-1998.02	MT	R	F	Estate Engine C 14 NZ	260002	Drive Shaft	29T	22	22	52	95	926		
	1991.09-1998.02	MT	L/R	F	Estate Engine C 14 NZ	844007	Outer Joint	29T	22	22	52	94.5	50	O	
	1992.04-1998.09	-	-	F	Saloon Engine C 14 NZ	844023	Outer Joint		22	22	52	95	50	O	
	1992.04-1998.09	MT	L/R	F	Saloon Engine C 14 NZ	844051	Outer Joint	29T	22	22	52	95	50.5	O	
	1992.04-1998.09	MT	L/R	F	Saloon Engine C 14 NZ	844007	Outer Joint	29T	22	22	52	94.5	50	O	
	1992.04-1998.09	MT	L	F	Saloon Engine C 14 NZ	244002	Drive Shaft	29T	22	22	52	95	585		
	1992.04-1998.09	MT	R	F	Saloon Engine C 14 NZ	260002	Drive Shaft	29T	22	22	52	95	926		
	1992.04-1998.09	MT	L/R	F	Saloon Engine C 14 NZ	644004	Inner Joint		22	22	34.95	57.5	72.5		
	1.4 i (60 kW)	1991.03-1998.02	MT	L	F	Estate Engine C 14 SE	244002	Drive Shaft	29T	22	22	52	95	585	
		1991.03-1998.02	MT	L/R	F	Estate Engine C 14 SE	644004	Inner Joint		22	22	34.95	57.5	72.5	
1991.03-1998.02		MT	R	F	Estate Engine C 14 SE	260002	Drive Shaft	29T	22	22	52	95	926		
1991.03-1998.02		MT	L/R	F	Estate Engine C 14 SE	844051	Outer Joint	29T	22	22	52	95	50.5	O	
1991.03-1998.02		MT	L/R	F	Estate Engine C 14 SE	844007	Outer Joint	29T	22	22	52	94.5	50	O	
1991.03-1998.02		-	-	F	Estate Engine C 14 SE	844023	Outer Joint		22	22	52	95	50	O	
1992.03-1998.02		MT	L	F	Hatchback Engine C 14 SE	244002	Drive Shaft	29T	22	22	52	95	585		
1992.03-1998.02		MT	L/R	F	Hatchback Engine C 14 SE	644004	Inner Joint		22	22	34.95	57.5	72.5		
1992.03-1998.02		MT	R	F	Hatchback Engine C 14 SE	260002	Drive Shaft	29T	22	22	52	95	926		
1992.03-1998.02		-	-	F	Hatchback Engine C 14 SE	844023	Outer Joint		22	22	52	95	50	O	
1992.03-1998.02		MT	L/R	F	Hatchback Engine C 14 SE	844007	Outer Joint	29T	22	22	52	94.5	50	O	
1992.03-1998.02		MT	L/R	F	Hatchback Engine C 14 SE	844051	Outer Joint	29T	22	22	52	95	50.5	O	
1992.04-1998.09		-	-	F	Saloon Engine C 14 SE	844023	Outer Joint		22	22	52	95	50	O	
1992.04-1998.09		MT	L	F	Saloon Engine C 14 SE	244002	Drive Shaft	29T	22	22	52	95	585		
1992.04-1998.09		MT	L/R	F	Saloon Engine C 14 SE	644004	Inner Joint		22	22	34.95	57.5	72.5		
1992.04-1998.09		MT	R	F	Saloon Engine C 14 SE	260002	Drive Shaft	29T	22	22	52	95	926		
1992.04-1998.09		MT	L/R	F	Saloon Engine C 14 SE	844007	Outer Joint	29T	22	22	52	94.5	50	O	
1992.04-1998.09		MT	L/R	F	Saloon Engine C 14 SE	844051	Outer Joint	29T	22	22	52	95	50.5	O	
1.4 i 16V (66 kW)		1996.02-1998.01	AT/MT	L/R	F	Estate Engine X 14 XE	844007	Outer Joint	29T	22	22	52	94.5	50	O
		1996.02-1998.02	-	-	F	Hatchback Engine X 14 XE	844023	Outer Joint		22	22	52	95	50	O
	1996.02-1998.01	-	-	F	Estate Engine X 14 XE	844023	Outer Joint		22	22	52	95	50	O	
	1996.02-1998.02	AT/MT	L/R	F	Hatchback Engine X 14 XE	844007	Outer Joint	29T	22	22	52	94.5	50	O	
1.4 S (55 kW)	1991.09-1998.02	-	-	F	Hatchback Engine 14 NV	844023	Outer Joint		22	22	52	95	50	O	
	1993.02-1996.12	AT/MT	L/R	F	Hatchback Engine X 16 SZ	844007	Outer Joint	29T	22	22	52	94.5	50	O	
1.6 i (52 kW)	1993.02-1996.12	MT	L/R	F	Hatchback Engine X 16 SZ	644004	Inner Joint		22	22	34.95	57.5	72.5		
	1993.02-1996.12	-	-	-	Hatchback Engine X 16 SZ	844068	Outer Joint	29T	22	30	52	94.5	55	I	
	1993.02-1996.12	-	-	F	Hatchback Engine X 16 SZ	844023	Outer Joint		22	22	52	95	50	O	
	1993.03-1996.08	AT/MT	L/R	F	Convertible Engine X 16 SZ	844007	Outer Joint	29T	22	22	52	94.5	50	O	

YEAR	TRANSM	L/R	F/R	REMARKS	GSP Ref.	PRODUCT	ABS	Technical Specifications								
								A	B	C	H	L	P			
VAUXHALL																
ASTRA Mk III (F) (T92)																
1.6 i (52 kW)	1993.03-1996.08	-	-	F	Convertible Engine X 16 SZ	844023	Outer Joint		22	22	52	95	50	O		
	1993.03-1996.08	MT	L/R	F	Convertible Engine X 16 SZ	644004	Inner Joint		22	22	34.95	57.5	72.5			
	1993.03-1996.08	-	-	-	Convertible Engine X 16 SZ	844068	Outer Joint	29T	22	30	52	94.5	55	I		
	1994.07-1998.02	AT/MT	L/R	F	Estate Engine X 16 SZ	844007	Outer Joint	29T	22	22	52	94.5	50	O		
	1994.07-1998.02	MT	L/R	F	Estate Engine X 16 SZ	644004	Inner Joint		22	22	34.95	57.5	72.5			
	1994.07-1998.02	-	-	-	Estate Engine X 16 SZ	844068	Outer Joint	29T	22	30	52	94.5	55	I		
	1994.07-1998.02	-	-	F	Estate Engine X 16 SZ	844023	Outer Joint		22	22	52	95	50	O		
	1994.08-1996.07	-	-	F	Saloon Engine X 16 SZ	844023	Outer Joint		22	22	52	95	50	O		
	1994.08-1996.07	AT/MT	L/R	F	Saloon Engine X 16 SZ	844007	Outer Joint	29T	22	22	52	94.5	50	O		
	1994.08-1996.07	-	-	-	Saloon Engine X 16 SZ	844068	Outer Joint	29T	22	30	52	94.5	55	I		
	1994.08-1996.07	MT	L/R	F	Saloon Engine X 16 SZ	644004	Inner Joint		22	22	34.95	57.5	72.5			
1.6 i (55 kW)	1991.09-1998.02	AT/MT	L/R	F	Hatchback Engine E 16 NZ	844007	Outer Joint	29T	22	22	52	94.5	50	O		
	1991.09-1998.02	AT/MT	L/R	F	Hatchback Engine E 16 NZ	844051	Outer Joint	29T	22	22	52	95	50.5	O		
	1991.09-1998.02	AT/MT	L/R	F	Estate Engine C 16 NZ	844007	Outer Joint	29T	22	22	52	94.5	50	O		
	1991.09-1998.02	AT/MT	L/R	F	Estate Engine C 16 NZ	844051	Outer Joint	29T	22	22	52	95	50.5	O		
	1991.09-1998.02	MT	L	F	Hatchback Engine E 16 NZ	244002	Drive Shaft	29T	22	22	52	95	585			
	1991.09-1998.02	MT	L	F	Estate Engine C 16 NZ	244002	Drive Shaft	29T	22	22	52	95	585			
	1991.09-1998.02	MT	L/R	F	Hatchback Engine E 16 NZ	644004	Inner Joint		22	22	34.95	57.5	72.5			
	1991.09-1998.02	MT	L/R	F	Estate Engine C 16 NZ	644004	Inner Joint		22	22	34.95	57.5	72.5			
	1991.09-1998.02	-	-	-	Estate Engine C 16 NZ	844068	Outer Joint	29T	22	30	52	94.5	55	I		
	1991.09-1998.02	-	-	-	Hatchback Engine E 16 NZ	844068	Outer Joint	29T	22	30	52	94.5	55	I		
	1991.09-1998.02	-	-	F	Hatchback Engine E 16 NZ	844023	Outer Joint		22	22	52	95	50	O		
	1991.09-1998.02	-	-	F	Estate Engine C 16 NZ	844023	Outer Joint		22	22	52	95	50	O		
	1991.09-1998.02	MT	R	F	Hatchback Engine E 16 NZ	260002	Drive Shaft	29T	22	22	52	95	926			
	1991.09-1998.02	MT	R	F	Estate Engine C 16 NZ	260002	Drive Shaft	29T	22	22	52	95	926			
	1992.03-1998.09	-	-	F	Saloon Engine C 16 NZ	844023	Outer Joint		22	22	52	95	50	O		
	1992.03-1998.09	AT/MT	L/R	F	Saloon Engine C 16 NZ	844051	Outer Joint	29T	22	22	52	95	50.5	O		
	1992.03-1998.09	AT/MT	L/R	F	Saloon Engine C 16 NZ	844007	Outer Joint	29T	22	22	52	94.5	50	O		
	1992.03-1998.09	MT	L	F	Saloon Engine C 16 NZ	244002	Drive Shaft	29T	22	22	52	95	585			
	1992.03-1998.09	-	-	-	Saloon Engine C 16 NZ	844068	Outer Joint	29T	22	30	52	94.5	55	I		
	1992.03-1998.09	MT	R	F	Saloon Engine C 16 NZ	260002	Drive Shaft	29T	22	22	52	95	926			
	1992.03-1998.09	MT	L/R	F	Saloon Engine C 16 NZ	644004	Inner Joint		22	22	34.95	57.5	72.5			
	1996.01-2001.03	AT/MT	L/R	F	Convertible Engine X 16 SZR	844007	Outer Joint	29T	22	22	52	94.5	50	O		
	1996.01-2001.03	-	-	-	Convertible Engine X 16 SZR	844068	Outer Joint	29T	22	30	52	94.5	55	I		
1.6 i (74 kW)	1992.03-1998.02	-	-	-	Hatchback Engine C 16 SE	844068	Outer Joint	29T	22	30	52	94.5	55	I		
	1992.03-1998.02	-	-	F	Hatchback Engine C 16 SE	844023	Outer Joint		22	22	52	95	50	O		
	1992.05-1994.12	-	-	F	Saloon Engine C 16 SE	844023	Outer Joint		22	22	52	95	50	O		
	1992.05-1994.12	MT	L	F	Saloon Engine C 16 SE	244002	Drive Shaft	29T	22	22	52	95	585			
	1992.05-1994.12	MT	L/R	F	Saloon Engine C 16 SE	644004	Inner Joint		22	22	34.95	57.5	72.5			
	1992.05-1994.12	MT	R	F	Saloon Engine C 16 SE	260002	Drive Shaft	29T	22	22	52	95	926			
	1992.05-1994.12	-	-	-	Saloon Engine C 16 SE	844068	Outer Joint	29T	22	30	52	94.5	55	I		
	1992.05-1994.12	MT	L/R	F	Saloon Engine C 16 SE	844007	Outer Joint	29T	22	22	52	94.5	50	O		
	1992.05-1994.12	MT	L/R	F	Saloon Engine C 16 SE	844051	Outer Joint	29T	22	22	52	95	50.5	O		
1.6 i 16V (74 kW)	1994.01-1998.02	AT/MT	L/R	F	Estate Engine X 16 XEL	844007	Outer Joint	29T	22	22	52	94.5	50	O		
	1994.01-1998.02	MT	L/R	F	Hatchback Engine X 16 XEL	844051	Outer Joint	29T	22	22	52	95	50.5	O		
	1994.01-1998.02	-	-	F	Estate Engine X 16 XEL	844023	Outer Joint		22	22	52	95	50	O		
	1994.01-1998.02	MT	L	F	Hatchback Engine X 16 XEL	244002	Drive Shaft	29T	22	22	52	95	585			
	1994.01-1998.02	MT	L/R	F	Estate Engine X 16 XEL	644004	Inner Joint		22	22	34.95	57.5	72.5			
	1994.01-1998.02	AT/MT	L/R	F	Hatchback Engine X 16 XEL	844007	Outer Joint	29T	22	22	52	94.5	50	O		
	1994.01-1998.02	-	-	-	Estate Engine X 16 XEL	844068	Outer Joint	29T	22	30	52	94.5	55	I		
	1994.01-1998.02	-	-	-	Hatchback Engine X 16 XEL	844068	Outer Joint	29T	22	30	52	94.5	55	I		
	1994.01-1998.02	MT	L/R	F	Hatchback Engine X 16 XEL	644004	Inner Joint		22	22	34.95	57.5	72.5			
	1994.01-1998.02	MT	R	F	Hatchback Engine X 16 XEL	260002	Drive Shaft	29T	22	22	52	95	926			
	1994.01-1998.02	-	-	F	Hatchback Engine X 16 XEL	844023	Outer Joint		22	22	52	95	50	O		
	1994.08-1998.09	-	-	F	Saloon Engine X 16 XEL	844023	Outer Joint		22	22	52	95	50	O		
	1994.08-1998.09	AT/MT	L/R	F	Saloon Engine X 16 XEL	844007	Outer Joint	29T	22	22	52	94.5	50	O		
	1994.08-1998.09	MT	L/R	F	Saloon Engine X 16 XEL	644004	Inner Joint		22	22	34.95	57.5	72.5			
	1994.08-1998.09	-	-	-	Saloon Engine X 16 XEL	844068	Outer Joint	29T	22	30	52	94.5	55	I		
1.6 Si (74 kW)	1991.03-1994.12	MT	L	F	Estate Engine C 16 SE	244002	Drive Shaft	29T	22	22	52	95	585			
	1991.03-1994.12	-	-	F	Estate Engine C 16 SE	844023	Outer Joint		22	22	52	95	50	O		
	1991.03-1994.12	MT	L/R	F	Estate Engine C 16 SE	644004	Inner Joint		22	22	34.95	57.5	72.5			
	1991.03-1994.12	MT	R	F	Estate Engine C 16 SE	260002	Drive Shaft	29T	22	22	52	95	926			
	1991.03-1994.12	-	-	-	Estate Engine C 16 SE	844068	Outer Joint	29T	22	30	52	94.5	55	I		
	1991.03-1994.12	MT	L/R	F	Estate Engine C 16 SE	844051	Outer Joint	29T	22	22	52	95	50.5	O		
	1991.03-1994.12	MT	L/R	F	Estate Engine C 16 SE	844007	Outer Joint	29T	22	22	52	94.5	50	O		
1.7 D (42 kW)	1991.12-1998.02	MT	L/R	F	Estate Engine 17 D	644004	Inner Joint		22	22	34.95	57.5	72.5			

YEAR	TRANSM	L/R	F/R	REMARKS	GSP Ref.	PRODUCT	ABS	Technical Specifications								
								A	B	C	H	L	P			
VAUXHALL																
ASTRA Mk III (F) (T92)																
1.7 D (42 kW)	1991.12-1998.02	AT/MT	L/R	F	Estate Engine 17 D	844056	Outer Joint	29T	33	25	52	109	61	O		
	1991.12-1998.02	AT/MT	L/R	F	Hatchback Engine 17 D	844056	Outer Joint	29T	33	25	52	109	61	O		
	1991.12-1998.02	MT	L/R	F	Hatchback Engine 17 D	644004	Inner Joint		22	22	34.95	57.5	72.5			
	1991.12-1998.02	-	-	F	Hatchback Engine 17 D	844023	Outer Joint		22	22	52	95	50	O		
	1991.12-1998.02	-	-	F	Estate Engine 17 D	844023	Outer Joint		22	22	52	95	50	O		
	1992.03-1992.09	-	-	F	Saloon Engine 17 D	844023	Outer Joint		22	22	52	95	50	O		
	1992.03-1992.09	AT/MT	L/R	F	Saloon Engine 17 D	844056	Outer Joint	29T	33	25	52	109	61	O		
	1992.03-1992.09	MT	L/R	F	Saloon Engine 17 D	644004	Inner Joint		22	22	34.95	57.5	72.5			
1.7 D (44 kW)	1991.03-1994.12	-	-	F	Estate Engine 17 DR	844023	Outer Joint		22	22	52	95	50	O		
	1991.03-1994.12	MT	L/R	F	Estate Engine 17 DR	644004	Inner Joint		22	22	34.95	57.5	72.5			
	1991.03-1994.12	AT/MT	L/R	F	Estate Engine 17 DR	844056	Outer Joint	29T	33	25	52	109	61	O		
	1991.03-1994.12	AT/MT	L/R	F	Estate Engine 17 DR	844007	Outer Joint	29T	22	22	52	94.5	50	O		
	1991.09-1994.12	MT	L/R	F	Hatchback Engine 17 DR	644004	Inner Joint		22	22	34.95	57.5	72.5			
	1991.09-1994.12	AT/MT	L/R	F	Hatchback Engine 17 DR	844056	Outer Joint	29T	33	25	52	109	61	O		
	1991.09-1994.12	-	-	F	Hatchback Engine 17 DR	808003	Outer Joint		33	25	52	109	61	O		
	1991.09-1994.12	AT/MT	L/R	F	Hatchback Engine 17 DR	844007	Outer Joint	29T	22	22	52	94.5	50	O		
	1992.07-1998.09	-	-	F	Saloon Engine 17 DR	844023	Outer Joint		22	22	52	95	50	O		
	1992.07-1998.09	AT/MT	L/R	F	Saloon Engine 17 DR	844056	Outer Joint	29T	33	25	52	109	61	O		
	1992.07-1998.09	AT/MT	L/R	F	Saloon Engine 17 DR	844007	Outer Joint	29T	22	22	52	94.5	50	O		
	1992.07-1998.09	MT	L/R	F	Saloon Engine 17 DR	644004	Inner Joint		22	22	34.95	57.5	72.5			
1.7 TD (50 kW)	1994.01-1998.02	AT/MT	L/R	F	Estate Engine X 17 DTL	621011	Inner Joint		34	25	35	78	64			
	1994.01-1998.02	-	-	F	Estate Engine X 17 DTL	844023	Outer Joint		22	22	52	95	50	O		
	1994.01-1998.02	AT/MT	L/R	F	Estate Engine X 17 DTL	844056	Outer Joint	29T	33	25	52	109	61	O		
	1994.08-1998.09	-	-	F	Saloon Engine X 17 DTL	844023	Outer Joint		22	22	52	95	50	O		
	1994.08-1998.09	AT/MT	L/R	F	Saloon Engine X 17 DTL	621011	Inner Joint		34	25	35	78	64			
	1994.08-1998.02	AT/MT	L/R	F	Hatchback Engine X 17 DTL	621011	Inner Joint		34	25	35	78	64			
	1994.08-1998.09	AT/MT	L/R	F	Saloon Engine X 17 DTL	844056	Outer Joint	29T	33	25	52	109	61	O		
	1994.08-1998.02	-	-	F	Hatchback Engine X 17 DTL	808003	Outer Joint		33	25	52	109	61	O		
	1994.08-1998.02	AT/MT	L/R	F	Hatchback Engine X 17 DTL	844056	Outer Joint	29T	33	25	52	109	61	O		
1.7 TD (60 kW)	1991.12-1998.02	MT	L/R	F	Hatchback Engine 17 DT (TC4EE1)	644002	Inner Joint		34	25	35	56.2	85.6			
	1991.12-1998.02	MT	L/R	F	Estate Engine 17 DT (TC4EE1)	644002	Inner Joint		34	25	35	56.2	85.6			
	1991.12-1998.09	MT	L/R	F	Saloon Engine 17 DT (TC4EE1)	644002	Inner Joint		34	25	35	56.2	85.6			
	1991.12-1998.02	MT	L	F	Hatchback Engine 17 DT (TC4EE1)	244011	Drive Shaft	29T	33	34	52	109	594.5			
	1991.12-1998.02	MT	L	F	Estate Engine 17 DT (TC4EE1)	244011	Drive Shaft	29T	33	34	52	109	594.5			
	1991.12-1998.09	MT	L	F	Saloon Engine 17 DT (TC4EE1)	244011	Drive Shaft	29T	33	34	52	109	594.5			
	1991.12-1998.02	AT/MT	L/R	F	Hatchback Engine 17 DT (TC4EE1)	621011	Inner Joint		34	25	35	78	64			
	1991.12-1998.02	AT/MT	L/R	F	Estate Engine 17 DT (TC4EE1)	621011	Inner Joint		34	25	35	78	64			
	1991.12-1998.02	-	-	F	Hatchback Engine 17 DT (TC4EE1)	808003	Outer Joint		33	25	52	109	61	O		
	1991.12-1998.02	-	-	F	Estate Engine 17 DT (TC4EE1)	808003	Outer Joint		33	25	52	109	61	O		
	1991.12-1998.02	MT	R	F	Hatchback Engine 17 DT (TC4EE1)	244059	Drive Shaft	29T	33	34	52	109	938			
	1991.12-1998.02	MT	R	F	Estate Engine 17 DT (TC4EE1)	244059	Drive Shaft	29T	33	34	52	109	938			
	1991.12-1998.09	AT/MT	L/R	F	Saloon Engine 17 DT (TC4EE1)	621011	Inner Joint		34	25	35	78	64			
	1991.12-1998.09	MT	R	F	Saloon Engine 17 DT (TC4EE1)	244059	Drive Shaft	29T	33	34	52	109	938			
	1991.12-1998.09	-	-	F	Saloon Engine 17 DT (TC4EE1)	808003	Outer Joint		33	25	52	109	61	O		
	1991.12-1998.02	AT/MT	L/R	F	Hatchback Engine 17 DT (TC4EE1)	844056	Outer Joint	29T	33	25	52	109	61	O		
	1991.12-1998.02	AT/MT	L/R	F	Estate Engine 17 DT (TC4EE1)	844056	Outer Joint	29T	33	25	52	109	61	O		
	1991.12-1998.09	AT/MT	L/R	F	Saloon Engine 17 DT (TC4EE1)	844056	Outer Joint	29T	33	25	52	109	61	O		
1.8 (92 kW)	1994.09-1996.08	-	-	F	Convertible Engine C 18 XE	808003	Outer Joint		33	25	52	109	61	O		
1.8 16V (85 kW)	1994.11-2001.03	MT	L/R	F	Convertible Engine X 18 XE	644002	Inner Joint		34	25	35	56.2	85.6			
	1994.11-2001.03	AT/MT	L/R	F	Convertible Engine X 18 XE	621011	Inner Joint		34	25	35	78	64			
1.8 i 16V (82 kW)	1995.09-1998.02	-	-	F	Saloon Engine 18 SE	808003	Outer Joint		33	25	52	109	61	O		
1.8 i 16V (85 kW)	1994.01-1996.12	MT	L/R	F	Saloon Engine C 18 XEL	644002	Inner Joint		34	25	35	56.2	85.6			
	1994.01-1996.12	AT/MT	L	F	Saloon Engine C 18 XEL	621011	Inner Joint		34	25	35	78	64			
	1994.01-1996.12	-	-	F	Saloon Engine C 18 XEL	808003	Outer Joint		33	25	52	109	61	O		
	1994.09-1998.02	MT	L/R	F	Hatchback Engine C 18 XEL	644002	Inner Joint		34	25	35	56.2	85.6			
	1994.09-1998.02	MT	L/R	F	Estate Engine X 18 XE	644002	Inner Joint		34	25	35	56.2	85.6			
	1994.09-1998.02	AT/MT	L	F	Hatchback Engine C 18 XEL	621011	Inner Joint		34	25	35	78	64			
	1994.09-1998.02	AT/MT	L	F	Estate Engine X 18 XE	621011	Inner Joint		34	25	35	78	64			
	1994.09-1998.02	-	-	F	Hatchback Engine C 18 XEL	808003	Outer Joint		33	25	52	109	61	O		
	1994.09-1998.02	-	-	F	Estate Engine X 18 XE	808003	Outer Joint		33	25	52	109	61	O		
1.8 i 16V (92 kW)	1993.06-1994.10	MT	L/R	F	Saloon Engine C 18 XE	644002	Inner Joint		34	25	35	56.2	85.6			
	1993.06-1994.10	AT/MT	L	F	Saloon Engine C 18 XE	621011	Inner Joint		34	25	35	78	64			
	1994.09-1998.02	MT	L/R	F	Hatchback Engine C 18 XE	644002	Inner Joint		34	25	35	56.2	85.6			
	1994.09-1998.02	MT	L/R	F	Estate Engine C 18 XE	644002	Inner Joint		34	25	35	56.2	85.6			
	1994.09-1998.02	AT/MT	L	F	Hatchback Engine C 18 XE	621011	Inner Joint		34	25	35	78	64			
	1994.09-1998.02	AT/MT	L	F	Estate Engine C 18 XE	621011	Inner Joint		34	25	35	78	64			

YEAR	TRANSM	L/R	F/R	REMARKS	GSP Ref.	PRODUCT	ABS	Technical Specifications							
								A	B	C	H	L	P		
VAUXHALL															
ASTRA Mk III (F) (T92)															
1.8 i 16V (92 kW)	1994.09-1998.02	-	-	F	Hatchback Engine C 18 XE	808003	Outer Joint		33	25	52	109	61	O	
	1994.09-1998.02	-	-	F	Estate Engine C 18 XE	808003	Outer Joint		33	25	52	109	61	O	
2.0 i (85 kW)	1991.09-1998.02	MT	L/R	F	Estate Engine C 20 NE	644002	Inner Joint		34	25	35	56.2	85.6		
	1991.09-1998.02	MT	L/R	F	Hatchback Engine C 20 NE	644002	Inner Joint		34	25	35	56.2	85.6		
	1991.09-1998.02	MT	L	F	Estate Engine C 20 NE	244011	Drive Shaft	29T	33	34	52	109	594.5		
	1991.09-1998.02	MT	L	F	Hatchback Engine C 20 NE	244011	Drive Shaft	29T	33	34	52	109	594.5		
	1991.09-1998.02	AT/MT	L/R	F	Estate Engine C 20 NE	621011	Inner Joint		34	25	35	78	64		
	1991.09-1998.02	AT/MT	L/R	F	Hatchback Engine C 20 NE	621011	Inner Joint		34	25	35	78	64		
	1991.09-1998.02	-	-	F	Estate Engine C 20 NE	808003	Outer Joint		33	25	52	109	61	O	
	1991.09-1998.02	-	-	F	Hatchback Engine C 20 NE	808003	Outer Joint		33	25	52	109	61	O	
	1991.09-1998.02	MT	R	F	Estate Engine C 20 NE	244059	Drive Shaft	29T	33	34	52	109	938		
	1991.09-1998.02	MT	R	F	Hatchback Engine C 20 NE	244059	Drive Shaft	29T	33	34	52	109	938		
	1991.09-1998.02	AT/MT	L/R	F	Estate Engine C 20 NE	844056	Outer Joint	29T	33	25	52	109	61	O	
	1991.09-1998.02	AT/MT	L/R	F	Hatchback Engine C 20 NE	844056	Outer Joint	29T	33	25	52	109	61	O	
	1992.03-1998.09	MT	L/R	F	Saloon Engine C 20 NE	644002	Inner Joint		34	25	35	56.2	85.6		
	1992.03-1998.09	MT	L	F	Saloon Engine C 20 NE	244011	Drive Shaft	29T	33	34	52	109	594.5		
	1992.03-1998.09	AT/MT	L/R	F	Saloon Engine C 20 NE	621011	Inner Joint		34	25	35	78	64		
	1992.03-1998.09	-	-	F	Saloon Engine C 20 NE	808003	Outer Joint		33	25	52	109	61	O	
	1992.03-1998.09	MT	R	F	Saloon Engine C 20 NE	244059	Drive Shaft	29T	33	34	52	109	938		
	1992.03-1998.09	AT/MT	L/R	F	Saloon Engine C 20 NE	844056	Outer Joint	29T	33	25	52	109	61	O	
	1993.03-1994.10	MT	L	F	Convertible Engine C 20 NE	244011	Drive Shaft	29T	33	34	52	109	594.5		
	1993.03-1994.10	AT/MT	L/R	F	Convertible Engine C 20 NE	844056	Outer Joint	29T	33	25	52	109	61	O	
	1993.03-1994.10	MT	L/R	F	Convertible Engine C 20 NE	644002	Inner Joint		34	25	35	56.2	85.6		
	1993.03-1994.10	MT	R	F	Convertible Engine C 20 NE	244059	Drive Shaft	29T	33	34	52	109	938		
	1993.03-1994.10	AT/MT	L/R	F	Convertible Engine C 20 NE	621011	Inner Joint		34	25	35	78	64		
	1993.03-1994.10	-	-	F	Convertible Engine C 20 NE	808003	Outer Joint		33	25	52	109	61	O	
2.0 i 16V (100 kW)	1994.01-1998.02	AT/MT	L/R	F	Hatchback Engine X 20 XEV	844056	Outer Joint	29T	33	25	52	109	61	O	
	1994.01-1998.02	AT/MT	L/R	F	Estate Engine X 20 XEV	844056	Outer Joint	29T	33	25	52	109	61	O	
	1994.01-1998.02	-	-	F	Convertible Engine X 20 XEV	808003	Outer Joint		33	25	52	109	61	O	
	1994.01-1998.02	AT/MT	L	F	Hatchback Engine X 20 XEV	621011	Inner Joint		34	25	35	78	64		
	1994.01-1998.02	AT/MT	L	F	Estate Engine X 20 XEV	621011	Inner Joint		34	25	35	78	64		
	1994.01-1998.02	-	-	F	Hatchback Engine X 20 XEV	808003	Outer Joint		33	25	52	109	61	O	
	1994.01-1998.02	-	-	F	Estate Engine X 20 XEV	808003	Outer Joint		33	25	52	109	61	O	
	1995.02-1998.09	AT/MT	L	F	Saloon Engine X 20 XEV	621011	Inner Joint		34	25	35	78	64		
	1995.02-1998.09	-	-	F	Saloon Engine X 20 XEV	808003	Outer Joint		33	25	52	109	61	O	
	1995.02-1998.09	AT/MT	L/R	F	Saloon Engine X 20 XEV	844056	Outer Joint	29T	33	25	52	109	61	O	
2.0 i 16V (110 kW)	1991.09-1998.02	MT	L/R	F	Hatchback Engine C 20 XE	644002	Inner Joint		34	25	35	56.2	85.6		
	1991.09-1998.02	MT	L	F	Hatchback Engine C 20 XE	244011	Drive Shaft	29T	33	34	52	109	594.5		
	1991.09-1998.02	AT/MT	L/R	F	Hatchback Engine C 20 XE	621011	Inner Joint		34	25	35	78	64		
	1991.09-1998.02	-	-	F	Hatchback Engine C 20 XE	808003	Outer Joint		33	25	52	109	61	O	
	1991.09-1998.02	MT	R	F	Hatchback Engine C 20 XE	244059	Drive Shaft	29T	33	34	52	109	938		
	1991.09-1998.02	MT	L/R	F	Hatchback Engine C 20 XE	844056	Outer Joint	29T	33	25	52	109	61	O	
ASTRA Mk IV (G) (T98)															
1.2 16V (55 kW)	2000.09-2005.05	-	-	F	Hatchback Engine Z 12 XE	844012	Outer Joint		33	28	52	104	54.5	O	
	2000.09-2005.05	-	-	F	Saloon Engine Z 12 XE	844012	Outer Joint		33	28	52	104	54.5	O	
	2000.09-2005.05	-	-	F	Estate Engine Z 12 XE	844012	Outer Joint		33	28	52	104	54.5	O	
1.4 16V (66 kW)	1998.02-2005.05	-	L/R	F	Hatchback Engine Z 14 XE	644004	Inner Joint		22	22	34.95	57.5	72.5		
	1998.02-2005.05	-	L/R	F	Estate Engine Z 14 XE	644004	Inner Joint		22	22	34.95	57.5	72.5		
	1998.02-2005.05	MT	L	F	Hatchback Engine Z 14 XE	260013	Drive Shaft		33	22	52	103	595		
	1998.02-2005.05	MT	L	F	Estate Engine Z 14 XE	260013	Drive Shaft		33	22	52	103	595		
	1998.02-2005.05	-	-	F	Hatchback Engine Z 14 XE	844010	Outer Joint	29T	33	22	52	103	50.5	O	
	1998.02-2005.05	MT	R	F	Hatchback Engine Z 14 XE	244033	Drive Shaft		33	22	52	103	950.5		
	1998.02-2005.05	MT	R	F	Estate Engine Z 14 XE	244033	Drive Shaft		33	22	52	103	950.5		
	1998.02-2005.05	MT	L	F	Hatchback Engine Z 14 XE	621014	Inner Joint		22	22	35	57.5	75		
	1998.02-2005.05	MT	L	F	Estate Engine Z 14 XE	621014	Inner Joint		22	22	35	57.5	75		
	1998.02-2005.05	AT/MT	L/R	F	Hatchback Engine Z 14 XE	844030	Outer Joint		33	22	52	103	50.5	O	
	1998.02-2005.05	AT/MT	L/R	F	Estate Engine Z 14 XE	844030	Outer Joint		33	22	52	103	50.5	O	
	1998.09-2005.05	-	L/R	F	Saloon Engine X 14 XE	644004	Inner Joint		22	22	34.95	57.5	72.5		
	1998.09-2005.05	MT	L	F	Saloon Engine X 14 XE	260013	Drive Shaft		33	22	52	103	595		
	1998.09-2005.05	-	-	F	Saloon Engine X 14 XE	844010	Outer Joint	29T	33	22	52	103	50.5	O	
	1998.09-2005.05	MT	R	F	Saloon Engine X 14 XE	244033	Drive Shaft		33	22	52	103	950.5		
	1998.09-2005.05	MT	L	F	Saloon Engine X 14 XE	621014	Inner Joint		22	22	35	57.5	75		
	1998.09-2005.05	AT/MT	L/R	F	Saloon Engine X 14 XE	844030	Outer Joint		33	22	52	103	50.5	O	
1.4 16V Dualfuel (66 kW)	1999.09-2003.06	MT	L/R	F	Hatchback/CC Engine X 14 XE, Z 14 XE	644004	Inner Joint		22	22	34.95	57.5	72.5		
	1999.09-2003.06	MT	L	F	Hatchback/CC Engine X 14 XE, Z 14 XE	260013	Drive Shaft		33	22	52	103	595		
	1999.09-2003.06	MT	R	F	Hatchback/CC Engine X 14 XE, Z 14 XE	244033	Drive Shaft		33	22	52	103	950.5		

YEAR	TRANSM	L/R	F/R	REMARKS	GSP Ref.	PRODUCT	ABS	Technical Specifications								
								A	B	C	H	L	P			
VAUXHALL																
ASTRA Mk IV (G) (T98)																
1.4 16V Dualfuel (66 kW)	1999.09-2003.06	MT	L	F	Hatchback/CC Engine X 14 XE, Z 14 XE	621014	Inner Joint		22	22	35	57.5	75			
1.4 16V Dualfuel(66 kW)	1999.09-2003.06	MT	L/R	F	Estate Engine X 14 XE, Z 14 XE	644004	Inner Joint		22	22	34.95	57.5	72.5			
	1999.09-2003.06	MT	L	F	Estate Engine X 14 XE, Z 14 XE	260013	Drive Shaft		33	22	52	103	595			
	1999.09-2003.06	MT	R	F	Estate Engine X 14 XE, Z 14 XE	244033	Drive Shaft		33	22	52	103	950.5			
	1999.09-2003.06	MT	L	F	Estate Engine X 14 XE, Z 14 XE	621014	Inner Joint		22	22	35	57.5	75			
1.6 (55 kW)	1998.02-2000.09	-	L/R	F	Hatchback Engine X 16 SZR	644004	Inner Joint		22	22	34.95	57.5	72.5			
	1998.02-2000.09	MT	L	F	Hatchback Engine X 16 SZR	260013	Drive Shaft		33	22	52	103	595			
	1998.02-2000.09	-	-	F	Hatchback Engine X 16 SZR	844010	Outer Joint	29T	33	22	52	103	50.5	O		
	1998.02-2000.09	MT	R	F	Hatchback Engine X 16 SZR	244033	Drive Shaft		33	22	52	103	950.5			
	1998.02-2000.09	MT	L	F	Hatchback Engine X 16 SZR	621014	Inner Joint		22	22	35	57.5	75			
	1998.02-2000.09	AT/MT	L/R	F	Hatchback Engine X 16 SZR	844030	Outer Joint		33	22	52	103	50.5	O		
	1998.03-2004.04	MT	L	F	Estate Engine X 16 SZR	260013	Drive Shaft		33	22	52	103	595			
	1998.03-2004.04	MT	R	F	Estate Engine X 16 SZR	244033	Drive Shaft		33	22	52	103	950.5			
	1998.03-2004.04	-	L/R	F	Estate Engine X 16 SZR	644004	Inner Joint		22	22	34.95	57.5	72.5			
	1998.03-2004.04	MT	L	F	Estate Engine X 16 SZR	621014	Inner Joint		22	22	35	57.5	75			
	1998.03-2004.04	AT/MT	L/R	F	Estate Engine X 16 SZR	844030	Outer Joint		33	22	52	103	50.5	O		
	1998.09-2000.09	-	L/R	F	Saloon Engine X 16 SZR	644004	Inner Joint		22	22	34.95	57.5	72.5			
	1998.09-2000.09	MT	L	F	Saloon Engine X 16 SZR	260013	Drive Shaft		33	22	52	103	595			
	1998.09-2000.09	MT	R	F	Saloon Engine X 16 SZR	244033	Drive Shaft		33	22	52	103	950.5			
	1998.09-2000.09	MT	L	F	Saloon Engine X 16 SZR	621014	Inner Joint		22	22	35	57.5	75			
	1998.09-2000.09	AT/MT	L/R	F	Saloon Engine X 16 SZR	844030	Outer Joint		33	22	52	103	50.5	O		
1.6 (62 kW)	1998.03-2004.04	MT	L	F	Estate Engine Z 16 SE	260013	Drive Shaft		33	22	52	103	595			
	1998.03-2004.04	-	-	F	Estate Engine Z 16 SE	844010	Outer Joint	29T	33	22	52	103	50.5	O		
	1998.03-2004.04	MT	R	F	Estate Engine Z 16 SE	244033	Drive Shaft		33	22	52	103	950.5			
	1998.03-2004.04	-	L/R	F	Estate Engine Z 16 SE	644004	Inner Joint		22	22	34.95	57.5	72.5			
	1998.03-2004.04	MT	L	F	Estate Engine Z 16 SE	621014	Inner Joint		22	22	35	57.5	75			
	1998.03-2004.04	AT/MT	L/R	F	Estate Engine Z 16 SE	844030	Outer Joint		33	22	52	103	50.5	O		
	2000.09-2005.05	-	L/R	F	Hatchback Engine Z 16 SE	644004	Inner Joint		22	22	34.95	57.5	72.5			
	2000.09-2005.05	-	L/R	F	Saloon Engine Z 16 SE	644004	Inner Joint		22	22	34.95	57.5	72.5			
	2000.09-2005.05	MT	L	F	Hatchback Engine Z 16 SE	260013	Drive Shaft		33	22	52	103	595			
	2000.09-2005.05	MT	L	F	Saloon Engine Z 16 SE	260013	Drive Shaft		33	22	52	103	595			
	2000.09-2005.05	-	-	F	Hatchback Engine Z 16 SE	844010	Outer Joint	29T	33	22	52	103	50.5	O		
	2000.09-2005.05	-	-	F	Saloon Engine Z 16 SE	844010	Outer Joint	29T	33	22	52	103	50.5	O		
	2000.09-2005.05	MT	R	F	Hatchback Engine Z 16 SE	244033	Drive Shaft		33	22	52	103	950.5			
	2000.09-2005.05	MT	R	F	Saloon Engine Z 16 SE	244033	Drive Shaft		33	22	52	103	950.5			
	2000.09-2005.05	MT	L	F	Hatchback Engine Z 16 SE	621014	Inner Joint		22	22	35	57.5	75			
	2000.09-2005.05	MT	L	F	Saloon Engine Z 16 SE	621014	Inner Joint		22	22	35	57.5	75			
2000.09-2005.05	AT/MT	L/R	F	Hatchback Engine Z 16 SE	844030	Outer Joint		33	22	52	103	50.5	O			
2000.09-2005.05	AT/MT	L/R	F	Saloon Engine Z 16 SE	844030	Outer Joint		33	22	52	103	50.5	O			
1.6 (76 kW)	2002.12-2005.05	-	L	F	Estate Engine Z 16 XEP	260013	Drive Shaft		33	22	52	103	595			
	2002.12-2005.05	-	L/R	F	Hatchback Engine Z 16 XEP	644004	Inner Joint		22	22	34.95	57.5	72.5			
	2002.12-2005.05	-	-	F	Estate Engine Z 16 XEP	844010	Outer Joint	29T	33	22	52	103	50.5	O		
	2002.12-2005.05	-	L	F	Hatchback Engine Z 16 XEP	260013	Drive Shaft		33	22	52	103	595			
	2002.12-2005.05	-	R	F	Estate Engine Z 16 XEP	244033	Drive Shaft		33	22	52	103	950.5			
	2002.12-2005.05	-	L/R	F	Estate Engine Z 16 XEP	644004	Inner Joint		22	22	34.95	57.5	72.5			
	2002.12-2005.05	-	R	F	Hatchback Engine Z 16 XEP	244033	Drive Shaft		33	22	52	103	950.5			
	2002.12-2005.05	-	L	F	Estate Engine Z 16 XEP	621014	Inner Joint		22	22	35	57.5	75			
	2002.12-2005.05	-	L/R	F	Estate Engine Z 16 XEP	844030	Outer Joint		33	22	52	103	50.5	O		
	2002.12-2005.05	-	L	F	Hatchback Engine Z 16 XEP	621014	Inner Joint		22	22	35	57.5	75			
1.6 16V (74 kW)	1998.02-2005.05	-	L/R	F	Hatchback Engine Z 16 XE	644004	Inner Joint		22	22	34.95	57.5	72.5			
	1998.02-2005.05	MT	L	F	Hatchback Engine Z 16 XE	260013	Drive Shaft		33	22	52	103	595			
	1998.02-2005.05	-	-	F	Hatchback Engine Z 16 XE	844010	Outer Joint	29T	33	22	52	103	50.5	O		
	1998.02-2005.05	MT	R	F	Hatchback Engine Z 16 XE	244033	Drive Shaft		33	22	52	103	950.5			
	1998.02-2005.05	MT	L	F	Hatchback Engine Z 16 XE	621014	Inner Joint		22	22	35	57.5	75			
	1998.02-2005.05	AT/MT	L/R	F	Hatchback Engine Z 16 XE	844030	Outer Joint		33	22	52	103	50.5	O		
	1998.03-2004.04	-	L/R	F	Estate Engine X 16 XEL	644004	Inner Joint		22	22	34.95	57.5	72.5			
	1998.03-2004.04	MT	L	F	Estate Engine X 16 XEL	260013	Drive Shaft		33	22	52	103	595			
	1998.03-2004.04	-	-	F	Estate Engine X 16 XEL	844010	Outer Joint	29T	33	22	52	103	50.5	O		
	1998.03-2004.04	MT	R	F	Estate Engine X 16 XEL	244033	Drive Shaft		33	22	52	103	950.5			
	1998.03-2004.04	MT	L	F	Estate Engine X 16 XEL	621014	Inner Joint		22	22	35	57.5	75			
	1998.03-2004.04	AT/MT	L/R	F	Estate Engine X 16 XEL	844030	Outer Joint		33	22	52	103	50.5	O		
	1998.09-2005.05	-	L/R	F	Saloon Engine X 16 XEL	644004	Inner Joint		22	22	34.95	57.5	72.5			
	1998.09-2005.05	MT	L	F	Saloon Engine X 16 XEL	260013	Drive Shaft		33	22	52	103	595			
	1998.09-2005.05	MT	R	F	Saloon Engine X 16 XEL	244033	Drive Shaft		33	22	52	103	950.5			
	1998.09-2005.05	MT	L	F	Saloon Engine X 16 XEL	621014	Inner Joint		22	22	35	57.5	75			
1998.09-2005.05	AT/MT	L/R	F	Saloon Engine X 16 XEL	844030	Outer Joint		33	22	52	103	50.5	O			

	YEAR	TRANSM	L/R	F/R	REMARKS	GSP Ref.	PRODUCT	ABS	Technical Specifications								
									A	B	C	H	L	P			
VAUXHALL																	
ASTRA Mk IV (G) (T98)																	
1.6 16V (74 kW)	2001.03-2005.10	MT	L	F	Convertible Engine Z 16 XE	260013	Drive Shaft		33	22	52	103	595				
	2001.03-2005.10	-	-	F	Convertible Engine Z 16 XE	844010	Outer Joint	29T	33	22	52	103	50.5	O			
	2001.03-2005.10	MT	R	F	Convertible Engine Z 16 XE	244033	Drive Shaft		33	22	52	103	950.5				
	2001.03-2005.10	-	L/R	F	Convertible Engine Z 16 XE	644004	Inner Joint		22	22	34.95	57.5	72.5				
	2001.03-2005.10	MT	L	F	Convertible Engine Z 16 XE	621014	Inner Joint		22	22	35	57.5	75				
	2001.03-2005.10	AT/MT	L/R	F	Convertible Engine Z 16 XE	844030	Outer Joint		33	22	52	103	50.5	O			
1.6 16V (76 kW)	2000.03-2005.08	-	L/R	F	Coupe Engine Z 16 XEP	644004	Inner Joint		22	22	34.95	57.5	72.5				
	2000.03-2005.08	-	-	F	Coupe Engine Z 16 XEP	844010	Outer Joint	29T	33	22	52	103	50.5	O			
	2000.03-2005.08	-	L	F	Coupe Engine Z 16 XEP	260013	Drive Shaft		33	22	52	103	595				
	2000.03-2005.08	-	R	F	Coupe Engine Z 16 XEP	244033	Drive Shaft		33	22	52	103	950.5				
	2000.03-2005.08	-	L	F	Coupe Engine Z 16 XEP	621014	Inner Joint		22	22	35	57.5	75				
	2003.03-2005.10	-	L/R	F	Convertible Engine Z 16 XEP	644004	Inner Joint		22	22	34.95	57.5	72.5				
	2003.03-2005.10	-	-	F	Convertible Engine Z 16 XEP	844010	Outer Joint	29T	33	22	52	103	50.5	O			
	2003.03-2005.10	-	L	F	Convertible Engine Z 16 XEP	260013	Drive Shaft		33	22	52	103	595				
	2003.03-2005.10	-	R	F	Convertible Engine Z 16 XEP	244033	Drive Shaft		33	22	52	103	950.5				
	2003.03-2005.10	-	L	F	Convertible Engine Z 16 XEP	621014	Inner Joint		22	22	35	57.5	75				
1.6 Dualfuel (55 kW)	1998.02-2000.12	-	L/R	F	Hatchback/CC Engine X 16 SZR	644004	Inner Joint		22	22	34.95	57.5	72.5				
	1998.02-2000.12	-	L	F	Hatchback/CC Engine X 16 SZR	260013	Drive Shaft		33	22	52	103	595				
	1998.02-2000.12	-	R	F	Hatchback/CC Engine X 16 SZR	244033	Drive Shaft		33	22	52	103	950.5				
	1998.02-2000.12	-	L	F	Hatchback/CC Engine X 16 SZR	621014	Inner Joint		22	22	35	57.5	75				
1.6 Dualfuel (62 kW)	2000.07-2005.05	MT	L/R	F	Saloon Engine Z 16 SE	644004	Inner Joint		22	22	34.95	57.5	72.5				
	2000.07-2005.05	MT	L/R	F	Hatchback Engine Z 16 SE	644004	Inner Joint		22	22	34.95	57.5	72.5				
	2000.07-2005.05	MT	L	F	Estate Engine Z 16 SE	260013	Drive Shaft		33	22	52	103	595				
	2000.07-2005.05	MT	L	F	Saloon Engine Z 16 SE	260013	Drive Shaft		33	22	52	103	595				
	2000.07-2005.05	MT	L	F	Hatchback Engine Z 16 SE	260013	Drive Shaft		33	22	52	103	595				
	2000.07-2005.05	-	-	F	Saloon Engine Z 16 SE	844010	Outer Joint	29T	33	22	52	103	50.5	O			
	2000.07-2005.05	-	-	F	Hatchback Engine Z 16 SE	844010	Outer Joint	29T	33	22	52	103	50.5	O			
	2000.07-2005.05	MT	R	F	Estate Engine Z 16 SE	244033	Drive Shaft		33	22	52	103	950.5				
	2000.07-2005.05	MT	R	F	Saloon Engine Z 16 SE	244033	Drive Shaft		33	22	52	103	950.5				
	2000.07-2005.05	MT	R	F	Hatchback Engine Z 16 SE	244033	Drive Shaft		33	22	52	103	950.5				
	2000.07-2005.05	MT	L/R	F	Estate Engine Z 16 SE	644004	Inner Joint		22	22	34.95	57.5	72.5				
	2000.07-2005.05	MT	L	F	Estate Engine Z 16 SE	621014	Inner Joint		22	22	35	57.5	75				
	2000.07-2005.05	MT	L	F	Saloon Engine Z 16 SE	621014	Inner Joint		22	22	35	57.5	75				
	2000.07-2005.05	MT	L	F	Hatchback Engine Z 16 SE	621014	Inner Joint		22	22	35	57.5	75				
1.6 Dualfuel (63 kW)	1998.03-2004.04	-	L/R	F	Estate Engine Z 16 XE	644004	Inner Joint		22	22	34.95	57.5	72.5				
	1998.03-2004.04	-	L	F	Estate Engine Z 16 XE	260013	Drive Shaft		33	22	52	103	595				
	1998.03-2004.04	-	-	F	Estate Engine Z 16 XE	844010	Outer Joint	29T	33	22	52	103	50.5	O			
	1998.03-2004.04	-	R	F	Estate Engine Z 16 XE	244033	Drive Shaft		33	22	52	103	950.5				
	1998.03-2004.04	-	L	F	Estate Engine Z 16 XE	621014	Inner Joint		22	22	35	57.5	75				
	2002.09-2005.05	5MT	L/R	F	Hatchback Engine Z 16 XE	644004	Inner Joint		22	22	34.95	57.5	72.5				
	2002.09-2005.05	-	L/R	F	Saloon Engine Z 16 XE	644004	Inner Joint		22	22	34.95	57.5	72.5				
	2002.09-2005.05	5MT	L	F	Hatchback Engine Z 16 XE	260013	Drive Shaft		33	22	52	103	595				
	2002.09-2005.05	-	L	F	Saloon Engine Z 16 XE	260013	Drive Shaft		33	22	52	103	595				
	2002.09-2005.05	-	-	F	Saloon Engine Z 16 XE	844010	Outer Joint	29T	33	22	52	103	50.5	O			
	2002.09-2005.05	-	-	F	Hatchback Engine Z 16 XE	844010	Outer Joint	29T	33	22	52	103	50.5	O			
	2002.09-2005.05	5MT	R	F	Hatchback Engine Z 16 XE	244033	Drive Shaft		33	22	52	103	950.5				
	2002.09-2005.05	-	R	F	Saloon Engine Z 16 XE	244033	Drive Shaft		33	22	52	103	950.5				
	2002.09-2005.05	5MT	L	F	Hatchback Engine Z 16 XE	621014	Inner Joint		22	22	35	57.5	75				
	2002.09-2005.05	-	L	F	Saloon Engine Z 16 XE	621014	Inner Joint		22	22	35	57.5	75				
	1.6 Dualfuel (74 kW)	1999.09-2004.08	MT	L/R	F	Saloon Engine Z 16 XE	644004	Inner Joint		22	22	34.95	57.5	72.5			
1999.09-2004.08		MT	L/R	F	Hatchback Engine Z 16 XE	644004	Inner Joint		22	22	34.95	57.5	72.5				
1999.09-2004.08		5MT	L/R	F	Estate Engine Z 16 XE	644004	Inner Joint		22	22	34.95	57.5	72.5				
1999.09-2004.08		MT	L	F	Saloon Engine Z 16 XE	260013	Drive Shaft		33	22	52	103	595				
1999.09-2004.08		MT	L	F	Hatchback Engine Z 16 XE	260013	Drive Shaft		33	22	52	103	595				
1999.09-2004.08		5MT	L	F	Estate Engine Z 16 XE	260013	Drive Shaft		33	22	52	103	595				
1999.09-2004.08		MT	R	F	Saloon Engine Z 16 XE	244033	Drive Shaft		33	22	52	103	950.5				
1999.09-2004.08		MT	R	F	Hatchback Engine Z 16 XE	244033	Drive Shaft		33	22	52	103	950.5				
1999.09-2004.08		5MT	R	F	Estate Engine Z 16 XE	244033	Drive Shaft		33	22	52	103	950.5				
1999.09-2004.08		MT	L	F	Saloon Engine Z 16 XE	621014	Inner Joint		22	22	35	57.5	75				
1999.09-2004.08		MT	L	F	Hatchback Engine Z 16 XE	621014	Inner Joint		22	22	35	57.5	75				
1999.09-2004.08		5MT	L	F	Estate Engine Z 16 XE	621014	Inner Joint		22	22	35	57.5	75				
1.6 Dualfuel(55 kW)	1998.02-2000.12	MT	L/R	F	Estate Engine X 16 SZR	644004	Inner Joint		22	22	34.95	57.5	72.5				
	1998.02-2000.12	-	L/R	F	Saloon	644004	Inner Joint		22	22	34.95	57.5	72.5				
	1998.02-2000.12	MT	L	F	Estate Engine X 16 SZR	260013	Drive Shaft		33	22	52	103	595				
	1998.02-2000.12	-	L	F	Saloon	260013	Drive Shaft		33	22	52	103	595				
	1998.02-2000.12	MT	R	F	Estate Engine X 16 SZR	244033	Drive Shaft		33	22	52	103	950.5				

YEAR	TRANS	L/R	F/R	REMARKS	GSP Ref.	PRODUCT	ABS	Technical Specifications										
								A	B	C	H	L	P					
VAUXHALL																		
ASTRA Mk IV (G) (T98)																		
1.6 Dualfuel(55 kW)	1998.02-2000.12	-	R	F	Saloon	244033	Drive Shaft		33	22	52	103	950.5					
	1998.02-2000.12	MT	L	F	Estate Engine X 16 SZR	621014	Inner Joint		22	22	35	57.5	75					
	1998.02-2000.12	-	L	F	Saloon	621014	Inner Joint		22	22	35	57.5	75					
1.7 CDTI 16V (59 kW)	2003.04-2005.05	-	-	F	Hatchback Engine Z 17 DTL	844049	Outer Joint		33	25	52	109	61	O				
	2003.04-2005.05	-	-	F	Saloon Engine Z 17 DTL	844049	Outer Joint		33	25	52	109	61	O				
	2003.04-2005.05	-	-	F	Estate Engine Z 17 DTL	844049	Outer Joint		33	25	52	109	61	O				
	2003.04-2005.05	MT	R	F	Hatchback Engine Z 17 DTL	699026	Inner Joint		22	25	35	57	82.5					
	2003.04-2005.05	MT	R	F	Saloon Engine Z 17 DTL	699026	Inner Joint		22	25	35	57	82.5					
	2003.04-2005.05	MT	R	F	Estate Engine Z 17 DTL	699026	Inner Joint		22	25	35	57	82.5					
	2003.04-2005.05	AT/MT	L/R	F	Hatchback Engine Z 17 DTL	844006	Outer Joint	29T	33	25	52	103.5	61	O				
	2003.04-2005.05	AT/MT	L/R	F	Saloon Engine Z 17 DTL	844006	Outer Joint	29T	33	25	52	103.5	61	O				
	2003.04-2005.05	AT/MT	L/R	F	Estate Engine Z 17 DTL	844006	Outer Joint	29T	33	25	52	103.5	61	O				
	2003.04-2005.05	MT	R	F	Hatchback Engine Z 17 DTL	260035	Drive Shaft		33	22	52	109	961					
	2003.04-2005.05	MT	R	F	Saloon Engine Z 17 DTL	260035	Drive Shaft		33	22	52	109	961					
	2003.04-2005.05	MT	R	F	Estate Engine Z 17 DTL	260035	Drive Shaft		33	22	52	109	961					
1.7 DTI 16V (55 kW)	2000.02-2005.05	AT/MT	L/R	F	Hatchback Engine Y 17 DT	844006	Outer Joint	29T	33	25	52	103.5	61	O				
	2000.02-2005.05	AT/MT	L/R	F	Estate Engine Y 17 DT	844006	Outer Joint	29T	33	25	52	103.5	61	O				
	2000.02-2005.05	AT/MT	L/R	F	Saloon Engine Y 17 DT	844006	Outer Joint	29T	33	25	52	103.5	61	O				
	2000.02-2005.05	MT	R	F	Hatchback Engine Y 17 DT	260035	Drive Shaft		33	22	52	109	961					
	2000.02-2005.05	MT	R	F	Estate Engine Y 17 DT	260035	Drive Shaft		33	22	52	109	961					
	2000.02-2005.05	MT	R	F	Saloon Engine Y 17 DT	260035	Drive Shaft		33	22	52	109	961					
	2000.02-2005.05	-	-	F	Hatchback Engine Y 17 DT	844049	Outer Joint		33	25	52	109	61	O				
	2000.02-2005.05	-	-	F	Estate Engine Y 17 DT	844049	Outer Joint		33	25	52	109	61	O				
	2000.02-2005.05	-	-	F	Saloon Engine Y 17 DT	844049	Outer Joint		33	25	52	109	61	O				
	2000.02-2005.05	MT	R	F	Hatchback Engine Y 17 DT	699026	Inner Joint		22	25	35	57	82.5					
	2000.02-2005.05	MT	R	F	Estate Engine Y 17 DT	699026	Inner Joint		22	25	35	57	82.5					
	2000.02-2005.05	MT	R	F	Saloon Engine Y 17 DT	699026	Inner Joint		22	25	35	57	82.5					
1.7 TD (50 kW)	1998.02-2000.08	MT	L	F	Hatchback Engine X 17 DTL	260013	Drive Shaft		33	22	52	103	595					
	1998.02-2000.08	MT	L	F	Estate Engine X 17 DTL	260013	Drive Shaft		33	22	52	103	595					
	1998.02-2000.08	-	-	F	Hatchback Engine X 17 DTL	844010	Outer Joint	29T	33	22	52	103	50.5	O				
	1998.02-2000.08	-	-	F	Estate Engine X 17 DTL	844010	Outer Joint	29T	33	22	52	103	50.5	O				
	1998.02-2000.08	MT	R	F	Hatchback Engine X 17 DTL	244033	Drive Shaft		33	22	52	103	950.5					
	1998.02-2000.08	MT	R	F	Estate Engine X 17 DTL	244033	Drive Shaft		33	22	52	103	950.5					
	1998.02-2000.08	MT	L	F	Hatchback Engine X 17 DTL	621014	Inner Joint		22	22	35	57.5	75					
	1998.02-2000.08	MT	L	F	Estate Engine X 17 DTL	621014	Inner Joint		22	22	35	57.5	75					
	1998.02-2000.08	AT/MT	L/R	F	Hatchback Engine X 17 DTL	844030	Outer Joint		33	22	52	103	50.5	O				
	1998.02-2000.08	AT/MT	L/R	F	Estate Engine X 17 DTL	844030	Outer Joint		33	22	52	103	50.5	O				
	1998.09-2000.08	MT	L	F	Saloon Engine X 17 DTL	260013	Drive Shaft		33	22	52	103	595					
	1998.09-2000.08	MT	R	F	Saloon Engine X 17 DTL	244033	Drive Shaft		33	22	52	103	950.5					
	1998.09-2000.08	MT	L	F	Saloon Engine X 17 DTL	621014	Inner Joint		22	22	35	57.5	75					
	1998.09-2000.08	AT/MT	L/R	F	Saloon Engine X 17 DTL	844030	Outer Joint		33	22	52	103	50.5	O				
1.8 16V (85 kW)	1998.02-2000.09	MT	R	F	Hatchback Engine X 18 XE1	699026	Inner Joint		22	25	35	57	82.5					
	1998.02-2000.08	MT	R	F	Estate Engine X 18 XE1	699026	Inner Joint		22	25	35	57	82.5					
	1998.02-2004.07	AT/MT	L/R	F	Saloon Engine X 18 XE1	844006	Outer Joint	29T	33	25	52	103.5	61	O				
	1998.02-2000.09	AT/MT	L/R	F	Hatchback Engine X 18 XE1	844006	Outer Joint	29T	33	25	52	103.5	61	O				
	1998.02-2000.08	AT/MT	L/R	F	Estate Engine X 18 XE1	844006	Outer Joint	29T	33	25	52	103.5	61	O				
	1998.02-2004.07	MT	R	F	Saloon Engine X 18 XE1	260035	Drive Shaft		33	22	52	109	961					
	1998.02-2000.09	MT	R	F	Hatchback Engine X 18 XE1	260035	Drive Shaft		33	22	52	109	961					
	1998.02-2000.08	MT	R	F	Estate Engine X 18 XE1	260035	Drive Shaft		33	22	52	109	961					
	1998.02-2000.09	-	-	F	Hatchback Engine X 18 XE1	844049	Outer Joint		33	25	52	109	61	O				
	1998.02-2004.07	-	-	F	Saloon Engine X 18 XE1	844049	Outer Joint		33	25	52	109	61	O				
	1998.02-2000.08	-	-	F	Estate Engine X 18 XE1	844049	Outer Joint		33	25	52	109	61	O				
	1998.02-2004.07	MT	R	F	Saloon Engine X 18 XE1	699026	Inner Joint		22	25	35	57	82.5					
	2000.03-2005.08	MT	R	F	Coupe Engine X 18 XE1	699026	Inner Joint		22	25	35	57	82.5					
	2000.03-2005.08	AT/MT	L/R	F	Coupe Engine X 18 XE1	844006	Outer Joint	29T	33	25	52	103.5	61	O				
	2000.03-2005.08	MT	R	F	Coupe Engine X 18 XE1	260035	Drive Shaft		33	22	52	109	961					
	2000.03-2005.08	-	-	F	Coupe Engine X 18 XE1	844049	Outer Joint		33	25	52	109	61	O				
1.8 16V (92 kW)	1998.02-2004.07	AT/MT	L/R	F	Saloon Engine Z 18 XE	844006	Outer Joint	29T	33	25	52	103.5	61	O				
	1998.02-2004.07	MT	R	F	Saloon Engine Z 18 XE	260035	Drive Shaft		33	22	52	109	961					
	1998.02-2004.07	-	-	F	Saloon Engine Z 18 XE	844049	Outer Joint		33	25	52	109	61	O				
	1998.02-2004.07	MT	R	F	Saloon Engine Z 18 XE	699026	Inner Joint		22	25	35	57	82.5					
	2000.09-2005.05	MT	R	F	Estate Engine Z 18 XE	699026	Inner Joint		22	25	35	57	82.5					
	2000.09-2005.08	MT	R	F	Coupe Engine Z 18 XE	699026	Inner Joint		22	25	35	57	82.5					
	2000.09-2005.05	MT	R	F	Hatchback Engine Z 18 XE	699026	Inner Joint		22	25	35	57	82.5					
	2000.09-2005.05	AT/MT	L/R	F	Estate Engine Z 18 XE	844006	Outer Joint	29T	33	25	52	103.5	61	O				
	2000.09-2005.08	AT/MT	L/R	F	Coupe Engine Z 18 XE	844006	Outer Joint	29T	33	25	52	103.5	61	O				

	YEAR	TRANSM	L/R	F/R	REMARKS	GSP Ref.	PRODUCT	ABS	Technical Specifications								
									A	B	C	H	L	P			
VAUXHALL																	
ASTRA Mk IV (G) (T98)																	
1.8 16V (92 kW)	2000.09-2005.05	AT/MT	L/R	F	Hatchback Engine Z 18 XE	844006	Outer Joint	29T	33	25	52	103.5	61	O			
	2000.09-2005.05	MT	R	F	Estate Engine Z 18 XE	260035	Drive Shaft		33	22	52	109	961				
	2000.09-2005.08	MT	R	F	Coupe Engine Z 18 XE	260035	Drive Shaft		33	22	52	109	961				
	2000.09-2005.05	MT	R	F	Hatchback Engine Z 18 XE	260035	Drive Shaft		33	22	52	109	961				
	2000.09-2005.08	-	-	F	Coupe Engine Z 18 XE	844049	Outer Joint		33	25	52	109	61	O			
	2000.09-2005.05	-	-	F	Hatchback Engine Z 18 XE	844049	Outer Joint		33	25	52	109	61	O			
	2000.09-2005.05	-	-	F	Estate Engine Z 18 XE	844049	Outer Joint		33	25	52	109	61	O			
	2001.03-2005.10	-	-	F	Convertible Engine Z 18 XE	844049	Outer Joint		33	25	52	109	61	O			
	2001.03-2005.10	MT	R	F	Convertible Engine Z 18 XE	699026	Inner Joint		22	25	35	57	82.5				
	2001.03-2005.10	AT/MT	L/R	F	Convertible Engine Z 18 XE	844006	Outer Joint	29T	33	25	52	103.5	61	O			
	2001.03-2005.10	MT	R	F	Convertible Engine Z 18 XE	260035	Drive Shaft		33	22	52	109	961				
1.8 16V Dualfuel (87 kW)	1998.02-2004.07	-	-	F	Saloon Engine Z 18 XE	844049	Outer Joint		33	25	52	109	61	O			
	1998.02-2004.07	AT/MT	L/R	F	Saloon Engine Z 18 XE	844006	Outer Joint	29T	33	25	52	103.5	61	O			
	1998.02-2004.07	-	R	F	Saloon Engine Z 18 XE	260035	Drive Shaft		33	22	52	109	961				
	1998.02-2004.07	-	R	F	Saloon Engine Z 18 XE	699026	Inner Joint		22	25	35	57	82.5				
	2002.09-2005.08	-	R	F	Coupe Engine Z 18 XE	699026	Inner Joint		22	25	35	57	82.5				
	2002.09-2005.05	-	-	F	Hatchback Engine Z 18 XE	844049	Outer Joint		33	25	52	109	61	O			
	2002.09-2005.05	-	-	F	Estate Engine Z 18 XE	844049	Outer Joint		33	25	52	109	61	O			
	2002.09-2005.08	-	-	F	Coupe Engine Z 18 XE	844049	Outer Joint		33	25	52	109	61	O			
	2002.09-2005.05	-	R	F	Hatchback Engine Z 18 XE	699026	Inner Joint		22	25	35	57	82.5				
	2002.09-2005.05	-	R	F	Estate Engine Z 18 XE	699026	Inner Joint		22	25	35	57	82.5				
	2002.09-2005.08	AT/MT	L/R	F	Coupe Engine Z 18 XE	844006	Outer Joint	29T	33	25	52	103.5	61	O			
	2002.09-2005.05	AT/MT	L/R	F	Estate Engine Z 18 XE	844006	Outer Joint	29T	33	25	52	103.5	61	O			
	2002.09-2005.08	-	R	F	Coupe Engine Z 18 XE	260035	Drive Shaft		33	22	52	109	961				
	2002.09-2005.05	-	R	F	Hatchback Engine Z 18 XE	260035	Drive Shaft		33	22	52	109	961				
	2002.09-2005.05	-	R	F	Estate Engine Z 18 XE	260035	Drive Shaft		33	22	52	109	961				
1.8 16V Dualfuel (92 kW)	2002.07-2003.12	MT	R	F	Hatchback/CC Engine Z 18 XE	699026	Inner Joint		22	25	35	57	82.5				
	2002.07-2003.12	MT	L/R	F	Hatchback/CC Engine Z 18 XE	844006	Outer Joint	29T	33	25	52	103.5	61	O			
	2002.07-2003.12	MT	R	F	Hatchback/CC Engine Z 18 XE	260035	Drive Shaft		33	22	52	109	961				
1.8 16V Dualfuel(92 kW)	2002.07-2004.08	MT	R	F	Coupe Engine Z 18 XE	699026	Inner Joint		22	25	35	57	82.5				
	2002.07-2003.12	MT	R	F	Estate Engine Z 18 XE	699026	Inner Joint		22	25	35	57	82.5				
	2002.07-2003.12	MT	R	F	Saloon	699026	Inner Joint		22	25	35	57	82.5				
	2002.07-2004.08	MT	L/R	F	Coupe Engine Z 18 XE	844006	Outer Joint	29T	33	25	52	103.5	61	O			
	2002.07-2003.12	MT	L/R	F	Estate Engine Z 18 XE	844006	Outer Joint	29T	33	25	52	103.5	61	O			
	2002.07-2003.12	MT	L/R	F	Saloon	844006	Outer Joint	29T	33	25	52	103.5	61	O			
	2002.07-2004.08	MT	R	F	Coupe Engine Z 18 XE	260035	Drive Shaft		33	22	52	109	961				
	2002.07-2003.12	MT	R	F	Estate Engine Z 18 XE	260035	Drive Shaft		33	22	52	109	961				
	2002.07-2003.12	MT	R	F	Saloon	260035	Drive Shaft		33	22	52	109	961				
2.0 (147 kW)	2002.09-2005.10	MT	R	F	Convertible Engine Z 20 LET	244082	Drive Shaft		33	34	55	104	663				
	2002.09-2005.10	MT	-	F	Convertible Engine Z 20 LET	899061	Outer Joint		33	35	55	104	67.5	I			
	2002.09-2005.10	MT	L	F	Convertible Engine Z 20 LET	644018	Inner Joint		34	35	35	56	119.5				
	2002.09-2005.10	MT	L	F	Convertible Engine Z 20 LET	244025	Drive Shaft		33	34	55	104	593				
2.0 16V (100 kW)	1998.02-2005.05	-	L/R	F	Hatchback Engine X 20 XEV	844006	Outer Joint	29T	33	25	52	103.5	61	O			
	1998.02-2005.05	MT	L/R	F	Hatchback Engine X 20 XEV	621011	Inner Joint		34	25	35	78	64				
	1998.02-2005.05	-	L/R	F	Hatchback Engine X 20 XEV	644002	Inner Joint		34	25	35	56.2	85.6				
	1998.02-2005.05	-	-	F	Hatchback Engine X 20 XEV	844049	Outer Joint		33	25	52	109	61	O			
	1998.02-2005.05	-	L	F	Hatchback Engine X 20 XEV	244044	Drive Shaft		33	34	52	103.5	595				
	1998.09-2005.05	-	L	F	Saloon Engine X 20 XEV	244044	Drive Shaft		33	34	52	103.5	595				
	1998.09-2005.05	MT	L/R	F	Saloon Engine X 20 XEV	621011	Inner Joint		34	25	35	78	64				
	1998.09-2005.05	-	L/R	F	Saloon Engine X 20 XEV	644002	Inner Joint		34	25	35	56.2	85.6				
	1998.09-2005.05	AT/MT	L/R	F	Saloon Engine X 20 XEV	844006	Outer Joint	29T	33	25	52	103.5	61	O			
	1998.09-2005.05	-	-	F	Saloon Engine X 20 XEV	844049	Outer Joint		33	25	52	109	61	O			
2.0 16V Turbo (140 kW)	2000.09-2005.08	MT	-	F	Coupe Engine Z 20 LET	899061	Outer Joint		33	35	55	104	67.5	I			
	2000.09-2005.08	MT	L	F	Coupe Engine Z 20 LET	644018	Inner Joint		34	35	35	56	119.5				
	2000.09-2005.08	MT	L	F	Coupe Engine Z 20 LET	244025	Drive Shaft		33	34	55	104	593				
	2000.09-2005.08	MT	R	F	Coupe Engine Z 20 LET	244082	Drive Shaft		33	34	55	104	663				
2.0 DI (60 kW)	1998.02-2005.05	MT	L/R	F	Hatchback Engine X 20 DTL	621011	Inner Joint		34	25	35	78	64				
	1998.02-2004.07	MT	L/R	F	Saloon Engine Y 20 DTL	621011	Inner Joint		34	25	35	78	64				
	1998.02-2005.05	-	L/R	F	Hatchback Engine X 20 DTL	644002	Inner Joint		34	25	35	56.2	85.6				
	1998.02-2004.07	-	L/R	F	Saloon Engine Y 20 DTL	644002	Inner Joint		34	25	35	56.2	85.6				
	1998.02-2005.05	AT/MT	L/R	F	Hatchback Engine X 20 DTL	844006	Outer Joint	29T	33	25	52	103.5	61	O			
	1998.02-2004.07	AT/MT	L/R	F	Saloon Engine Y 20 DTL	844006	Outer Joint	29T	33	25	52	103.5	61	O			
	1998.02-2005.05	-	-	F	Hatchback Engine X 20 DTL	844049	Outer Joint		33	25	52	109	61	O			
	1998.02-2004.07	-	-	F	Saloon Engine Y 20 DTL	844049	Outer Joint		33	25	52	109	61	O			
	1998.02-2004.07	-	L	F	Saloon Engine Y 20 DTL	244044	Drive Shaft		33	34	52	103.5	595				
	1998.02-2005.05	-	L	F	Hatchback Engine X 20 DTL	244044	Drive Shaft		33	34	52	103.5	595				





YEAR	TRANS	L/R	F/R	REMARKS	GSP Ref.	PRODUCT	ABS	Technical Specifications								
								A	B	C	H	L	P			
VAUXHALL																
ASTRA Mk IV (G) (T98)																
2.0 DI (60 kW)	1998.03-2004.04	-	L/R	F	Estate Engine Y 20 DTL	844006	Outer Joint	29T	33	25	52	103.5	61	O		
	1998.03-2004.04	MT	L/R	F	Estate Engine Y 20 DTL	621011	Inner Joint		34	25	35	78	64			
	1998.03-2004.04	-	L/R	F	Estate Engine Y 20 DTL	644002	Inner Joint		34	25	35	56.2	85.6			
	1998.03-2004.04	-	-	F	Estate Engine Y 20 DTL	844049	Outer Joint		33	25	52	109	61	O		
	1998.03-2004.04	-	L	F	Estate Engine Y 20 DTL	244044	Drive Shaft		33	34	52	103.5	595			
2.0 DTI 16V (74 kW)	1998.02-2004.07	MT	L/R	F	Saloon Engine X 20 DTH	621011	Inner Joint		34	25	35	78	64			
	1998.02-2004.07	AT/MT	L/R	F	Saloon Engine X 20 DTH	844006	Outer Joint	29T	33	25	52	103.5	61	O		
	1998.02-2004.07	-	L/R	F	Saloon Engine X 20 DTH	644002	Inner Joint		34	25	35	56.2	85.6			
	1998.02-2004.07	-	-	F	Saloon Engine X 20 DTH	844049	Outer Joint		33	25	52	109	61	O		
	1998.02-2004.07	-	L	F	Saloon Engine X 20 DTH	244044	Drive Shaft		33	34	52	103.5	595			
	1998.03-2004.04	MT	L/R	F	Estate Engine X 20 DTH	621011	Inner Joint		34	25	35	78	64			
	1998.03-2004.04	AT/MT	L/R	F	Estate Engine X 20 DTH	844006	Outer Joint	29T	33	25	52	103.5	61	O		
	1998.03-2004.04	-	L/R	F	Estate Engine X 20 DTH	644002	Inner Joint		34	25	35	56.2	85.6			
	1998.03-2004.04	-	-	F	Estate Engine X 20 DTH	844049	Outer Joint		33	25	52	109	61	O		
	1998.03-2004.04	-	L	F	Estate Engine X 20 DTH	244044	Drive Shaft		33	34	52	103.5	595			
	1999.08-2005.05	AT/MT	L/R	F	Hatchback Engine Y 20 DTH	844006	Outer Joint	29T	33	25	52	103.5	61	O		
	1999.08-2005.05	MT	L/R	F	Hatchback Engine Y 20 DTH	621011	Inner Joint		34	25	35	78	64			
	1999.08-2005.05	-	L/R	F	Hatchback Engine Y 20 DTH	644002	Inner Joint		34	25	35	56.2	85.6			
	1999.08-2005.05	-	-	F	Hatchback Engine Y 20 DTH	844049	Outer Joint		33	25	52	109	61	O		
	1999.08-2005.05	-	L	F	Hatchback Engine Y 20 DTH	244044	Drive Shaft		33	34	52	103.5	595			
2.0 SRI Turbo (141 kW)	2001.11-2005.05	MT	R	F	Hatchback Engine Z 20 LET	244082	Drive Shaft		33	34	55	104	663			
	2001.11-2005.05	MT	-	F	Hatchback Engine Z 20 LET	899061	Outer Joint		33	35	55	104	67.5	I		
	2001.11-2005.05	MT	L	F	Hatchback Engine Z 20 LET	644018	Inner Joint		34	35	35	56	119.5			
	2001.11-2005.05	MT	L	F	Hatchback Engine Z 20 LET	244025	Drive Shaft		33	34	55	104	593			
2.0 Turbo (141 kW)	2002.03-2005.10	MT	-	F	Convertible Engine Z 20 LET	899061	Outer Joint		33	35	55	104	67.5	I		
	2002.03-2005.10	MT	L	F	Convertible Engine Z 20 LET	644018	Inner Joint		34	35	35	56	119.5			
	2002.03-2005.10	MT	L	F	Convertible Engine Z 20 LET	244025	Drive Shaft		33	34	55	104	593			
	2002.03-2005.10	MT	R	F	Convertible Engine Z 20 LET	244082	Drive Shaft		33	34	55	104	663			
2.2 16V (108 kW)	2000.03-2005.08	AT/MT	L/R	F	Coupe Engine Z 22 SE	844006	Outer Joint	29T	33	25	52	103.5	61	O		
	2000.03-2005.08	MT	L/R	F	Coupe Engine Z 22 SE	621011	Inner Joint		34	25	35	78	64			
	2000.03-2005.08	-	L/R	F	Coupe Engine Z 22 SE	644002	Inner Joint		34	25	35	56.2	85.6			
	2000.03-2005.08	-	-	F	Coupe Engine Z 22 SE	844049	Outer Joint		33	25	52	109	61	O		
	2000.03-2005.08	-	L	F	Coupe Engine Z 22 SE	244044	Drive Shaft		33	34	52	103.5	595			
	2001.03-2005.05	-	-	F	Hatchback Engine Z 22 SE	844049	Outer Joint		33	25	52	109	61	O		
	2001.03-2005.05	-	-	F	Saloon Engine Z 22 SE	844049	Outer Joint		33	25	52	109	61	O		
	2001.03-2005.05	-	-	F	Estate Engine Z 22 SE	844049	Outer Joint		33	25	52	109	61	O		
	2001.03-2005.10	-	-	F	Convertible Engine Z 22 SE	844049	Outer Joint		33	25	52	109	61	O		
	2001.03-2005.05	-	L	F	Hatchback Engine Z 22 SE	244044	Drive Shaft		33	34	52	103.5	595			
	2001.03-2005.05	-	L	F	Estate Engine Z 22 SE	244044	Drive Shaft		33	34	52	103.5	595			
	2001.03-2005.10	-	L	F	Convertible Engine Z 22 SE	244044	Drive Shaft		33	34	52	103.5	595			
	2001.03-2005.05	MT	L/R	F	Hatchback Engine Z 22 SE	621011	Inner Joint		34	25	35	78	64			
	2001.03-2005.05	MT	L/R	F	Saloon Engine Z 22 SE	621011	Inner Joint		34	25	35	78	64			
	2001.03-2005.05	MT	L/R	F	Estate Engine Z 22 SE	621011	Inner Joint		34	25	35	78	64			
	2001.03-2005.10	MT	L/R	F	Convertible Engine Z 22 SE	621011	Inner Joint		34	25	35	78	64			
	2001.03-2005.05	-	L/R	F	Hatchback Engine Z 22 SE	644002	Inner Joint		34	25	35	56.2	85.6			
	2001.03-2005.05	-	L/R	F	Estate Engine Z 22 SE	644002	Inner Joint		34	25	35	56.2	85.6			
	2001.03-2005.10	-	L/R	F	Convertible Engine Z 22 SE	644002	Inner Joint		34	25	35	56.2	85.6			
	2001.03-2005.05	AT/MT	L/R	F	Hatchback Engine Z 22 SE	844006	Outer Joint	29T	33	25	52	103.5	61	O		
	2001.03-2005.05	AT/MT	L/R	F	Estate Engine Z 22 SE	844006	Outer Joint	29T	33	25	52	103.5	61	O		
	2001.03-2005.10	AT/MT	L/R	F	Convertible Engine Z 22 SE	844006	Outer Joint	29T	33	25	52	103.5	61	O		
ASTRA Mk V (H) (A04)																
1.3 CDTI (66 kW)	2004.01-2009.05	-	R	F	Hatchback Engine Z 13 DTH	244051	Drive Shaft		33	34	53	93.5	570			
	2004.01-2009.05	-	L	F	Hatchback Engine Z 13 DTH	244052	Drive Shaft		33	25	53	93.5	573			
	2004.01-2009.05	MT	L	F	Hatchback Engine Z 13 DTH	260020	Drive Shaft		33	25	52.5	94	561			
	2004.01-2009.05	-	L/R	F	Hatchback Engine Z 13 DTH	844028	Outer Joint		33	24	53	93.5	63.5	M		
	2004.01-2009.05	MT	L	F	Hatchback Engine Z 13 DTH	621018	Inner Joint		25	34	35	58	116			
	2004.08-2009.03	-	R	F	Estate Engine Z 13 DTH	244051	Drive Shaft		33	34	53	93.5	570			
	2004.08-2009.03	-	L	F	Estate Engine Z 13 DTH	244052	Drive Shaft		33	25	53	93.5	573			
	2004.08-2009.03	MT	L	F	Estate Engine Z 13 DTH	260020	Drive Shaft		33	25	52.5	94	561			
	2004.08-2009.03	-	L/R	F	Estate Engine Z 13 DTH	844028	Outer Joint		33	24	53	93.5	63.5	M		
	2004.08-2009.03	MT	L	F	Estate Engine Z 13 DTH	621018	Inner Joint		25	34	35	58	116			
1.4 (66 kW)	2004.01-2009.05	MT	L	F	Hatchback Engine Z 14 XEP	244028	Drive Shaft		33	22	53	95	590			
	2004.01-2009.05	MT	L	F	Hatchback Engine Z 14 XEP	621014	Inner Joint		22	22	35	57.5	75			
	2004.01-2009.05	MT	L/R	F	Hatchback Engine Z 14 XEP	844003	Outer Joint		33	22	53	95	54.5	M		
	2004.01-2009.05	MT	R	F	Hatchback Engine Z 14 XEP	244030	Drive Shaft		33	22	53	95	952			
	2004.08-2009.03	MT	L	F	Estate Engine Z 14 XEP	244028	Drive Shaft		33	22	53	95	590			

YEAR	TRANSM	L/R	F/R	REMARKS	GSP Ref.	PRODUCT	ABS	Technical Specifications								
								A	B	C	H	L	P			
VAUXHALL																
ASTRA Mk V (H) (A04)																
1.4 (66 kW)	2004.08-2009.03	MT	L	F	Estate Engine Z 14 XEP	621014	Inner Joint	22	22	35	57.5	75				
	2004.08-2009.03	MT	L/R	F	Estate Engine Z 14 XEP	844003	Outer Joint	33	22	53	95	54.5	M			
	2004.08-2009.03	MT	R	F	Estate Engine Z 14 XEP	244030	Drive Shaft	33	22	53	95	952				
1.6 (132 kW)	2004.08-2009.03	-	L/R	F	Estate Engine Z 16 LET	844028	Outer Joint	33	24	53	93.5	63.5	M			
1.6 (77 kW)	2004.01-2009.05	MT	L	F	Hatchback Engine Z 16 XEP	244028	Drive Shaft	33	22	53	95	590				
	2004.01-2009.05	MT	L	F	Hatchback Engine Z 16 XEP	621014	Inner Joint	22	22	35	57.5	75				
	2004.01-2009.05	MT	L/R	F	Hatchback Engine Z 16 XEP	844003	Outer Joint	33	22	53	95	54.5	M			
	2004.01-2009.05	MT	R	F	Hatchback Engine Z 16 XEP	244030	Drive Shaft	33	22	53	95	952				
	2004.08-2009.03	MT	L	F	Estate Engine Z 16 XEP	244028	Drive Shaft	33	22	53	95	590				
	2004.08-2009.03	MT	L	F	Estate Engine Z 16 XEP	621014	Inner Joint	22	22	35	57.5	75				
	2004.08-2009.03	MT	L/R	F	Estate Engine Z 16 XEP	844003	Outer Joint	33	22	53	95	54.5	M			
	2004.08-2009.03	MT	R	F	Estate Engine Z 16 XEP	244030	Drive Shaft	33	22	53	95	952				
1.6 (85 kW)	2004.01-2009.05	-	L	F	Hatchback Engine Z 16 XER	244028	Drive Shaft	33	22	53	95	590				
	2004.01-2009.05	-	L	F	Hatchback Engine Z 16 XER	621014	Inner Joint	22	22	35	57.5	75				
	2004.01-2009.05	-	R	F	Hatchback Engine Z 16 XER	244030	Drive Shaft	33	22	53	95	952				
	2004.01-2009.05	-	L/R	F	Hatchback Engine Z 16 XER	844003	Outer Joint	33	22	53	95	54.5	M			
	2004.08-2009.03	-	L	F	Estate Engine A 16 XER	244028	Drive Shaft	33	22	53	95	590				
	2004.08-2009.03	-	L	F	Estate Engine A 16 XER	621014	Inner Joint	22	22	35	57.5	75				
	2004.08-2009.03	-	L/R	F	Estate Engine A 16 XER	844003	Outer Joint	33	22	53	95	54.5	M			
	2004.08-2009.03	-	R	F	Estate Engine A 16 XER	244030	Drive Shaft	33	22	53	95	952				
1.6 Turbo (132 kW)	2006.09-2009.09	-	L/R	F	Hatchback Engine Z 16 LET	844028	Outer Joint	33	24	53	93.5	63.5	M			
1.7 CDTI (59 kW)	2004.01-2009.05	MT	L	F	Hatchback Engine Z 17 DTL	699026	Inner Joint	22	25	35	57	82.5				
	2004.01-2009.05	MT	L	F	Hatchback Engine Z 17 DTL	221063	Drive Shaft	33	22	53	93.5	586				
	2004.01-2009.05	MT	R	F	Hatchback Engine Z 17 DTL	221055	Drive Shaft	33	22	53	93.5	950				
	2004.01-2009.05	MT	L/R	F	Hatchback Engine Z 17 DTL	844028	Outer Joint	33	24	53	93.5	63.5	M			
	2004.08-2009.05	-	L	F	Estate Engine Z 17 DTL	699026	Inner Joint	22	25	35	57	82.5				
	2004.08-2009.05	-	R	F	Estate Engine Z 17 DTL	644005	Inner Joint	34	25	35	54	47				
	2004.08-2009.05	-	L	F	Estate Engine Z 17 DTL	221063	Drive Shaft	33	22	53	93.5	586				
	2004.08-2009.05	-	L/R	F	Estate Engine Z 17 DTL	844028	Outer Joint	33	24	53	93.5	63.5	M			
	2004.08-2009.05	MT	R	F	Estate Engine Z 17 DTL	221055	Drive Shaft	33	22	53	93.5	950				
1.7 CDTI (74 kW)	2004.01-2009.05	5MT	L	F	Hatchback Engine Z 17 DTH	244029	Drive Shaft	33	34	53	93.5	594				
	2004.01-2009.05	5MT	R	F	Hatchback Engine Z 17 DTH	244031	Drive Shaft	33	34	53	93.5	559				
	2004.01-2009.05	6MT	L	F	Hatchback Engine Z 17 DTH	244052	Drive Shaft	33	25	53	93.5	573				
	2004.01-2009.05	MT	R	F	Hatchback Engine Z 17 DTH	644005	Inner Joint	34	25	35	54	47				
	2004.01-2009.05	MT/5MT	L	F	Hatchback Engine Z 17 DTH	621011	Inner Joint	34	25	35	78	64				
	2004.01-2009.05	5MT	L	F	Hatchback Engine Z 17 DTH	644002	Inner Joint	34	25	35	56.2	85.6				
	2004.01-2009.05	5AT	L	F	Hatchback Engine Z 17 DTH	244024	Drive Shaft	33	34	53	93.5	589				
	2004.01-2009.05	AT/MT	L/R	F	Hatchback Engine Z 17 DTH	844028	Outer Joint	33	24	53	93.5	63.5	M			
	2004.08-2009.03	5MT	L	F	Estate Engine Z 17 DTH	244029	Drive Shaft	33	34	53	93.5	594				
	2004.08-2009.03	5MT	R	F	Estate Engine Z 17 DTH	244031	Drive Shaft	33	34	53	93.5	559				
	2004.08-2009.03	6MT	L	F	Estate Engine Z 17 DTH	244052	Drive Shaft	33	25	53	93.5	573				
	2004.08-2009.03	MT	R	F	Estate Engine Z 17 DTH	644005	Inner Joint	34	25	35	54	47				
	2004.08-2009.03	MT/5MT	L	F	Estate Engine Z 17 DTH	621011	Inner Joint	34	25	35	78	64				
	2004.08-2009.03	5MT	L	F	Estate Engine Z 17 DTH	644002	Inner Joint	34	25	35	56.2	85.6				
	2004.08-2009.03	5AT	L	F	Estate Engine Z 17 DTH	244024	Drive Shaft	33	34	53	93.5	589				
	2004.08-2009.03	AT/MT	L/R	F	Estate Engine Z 17 DTH	844028	Outer Joint	33	24	53	93.5	63.5	M			
1.7 CDTI (81 kW)	2004.01-2009.05	-	L/R	F	Hatchback Engine Z 17 DTJ	844027	Outer Joint	33	26	52.5	94	65.5	M			
	2004.01-2009.05	-	R	F	Hatchback Engine Z 17 DTJ	644016	Inner Joint	34	28	37.5	46	54				
	2004.01-2009.05	-	R	F	Hatchback Engine Z 17 DTJ	244099	Drive Shaft	33	34	52.5	94	563				
	2004.01-2009.05	-	L	F	Hatchback Engine Z 17 DTJ	699186	Inner Joint	25	28	35	57.5	81.5				
	2004.01-2009.05	-	R	F	Hatchback Engine Z 17 DTJ	644005	Inner Joint	34	25	35	54	47				
	2004.01-2009.05	-	-	F	Hatchback Engine Z 17 DTJ	899024	Outer Joint	33	26	52.5	94	65.5	M			
	2004.01-2009.05	-	L	F	Hatchback Engine Z 17 DTJ	221051	Drive Shaft	33	25	52.5	94	579				
	2004.08-2012.10	-	R	F	Estate Engine A 17 DTJ	644016	Inner Joint	34	28	37.5	46	54				
	2004.08-2012.10	MT	R	F	Estate Engine A 17 DTJ	644005	Inner Joint	34	25	35	54	47				
	2004.08-2012.10	-	R	F	Estate Engine A 17 DTJ	244099	Drive Shaft	33	34	52.5	94	563				
	2004.08-2012.10	-	L	F	Estate Engine A 17 DTJ	699186	Inner Joint	25	28	35	57.5	81.5				
	2004.08-2012.10	-	L	F	Estate Engine A 17 DTJ	221051	Drive Shaft	33	25	52.5	94	579				
	2004.08-2012.10	-	-	F	Estate Engine A 17 DTJ	899024	Outer Joint	33	26	52.5	94	65.5	M			
	2004.08-2012.10	-	L/R	F	Estate Engine A 17 DTJ	844027	Outer Joint	33	26	52.5	94	65.5	M			
1.8 (103 kW)	2004.01-2009.05	MT	L	F	Hatchback Engine A 18 XER	699026	Inner Joint	22	25	35	57	82.5				
	2004.01-2009.05	MT	L	F	Hatchback Engine A 18 XER	221063	Drive Shaft	33	22	53	93.5	586				
	2004.01-2009.05	-	L/R	F	Hatchback Engine A 18 XER	844028	Outer Joint	33	24	53	93.5	63.5	M			
	2004.01-2009.05	AT/MT	R	F	Hatchback Engine A 18 XER	221055	Drive Shaft	33	22	53	93.5	950				
	2004.01-2009.05	AT	L	F	Hatchback Engine A 18 XER	244097	Drive Shaft	33	22	53	93.5	588				
	2004.01-2009.05	AT	R	F	Hatchback Engine A 18 XER	244098	Drive Shaft	33	22	53	93.5	950				

	YEAR		TRANSM	L/R	F/R	REMARKS	GSP Ref.	PRODUCT	ABS	Technical Specifications						
	A	B								C	H	L	P			
VAUXHALL																
ASTRA Mk V (H) (A04)																
1.8 (103 kW)	2005.12-	2010.10	MT	L	F	Estate Engine Z 18 XER	699026	Inner Joint		22	25	35	57	82.5		
	2005.12-	2010.10	MT	L	F	Estate Engine Z 18 XER	221063	Drive Shaft		33	22	53	93.5	586		
	2005.12-	2010.10	-	L/R	F	Estate Engine Z 18 XER	844028	Outer Joint		33	24	53	93.5	63.5	M	
	2005.12-	2010.10	AT/MT	R	F	Estate Engine Z 18 XER	221055	Drive Shaft		33	22	53	93.5	950		
	2005.12-	2010.10	AT	L	F	Estate Engine Z 18 XER	244097	Drive Shaft		33	22	53	93.5	588		
	2005.12-	2010.10	AT	R	F	Estate Engine Z 18 XER	244098	Drive Shaft		33	22	53	93.5	950		
1.8 (92 kW)	2004.01-	2009.05	MT	L	F	Hatchback Engine Z 18 XE	699026	Inner Joint		22	25	35	57	82.5		
	2004.01-	2009.05	MT	L	F	Hatchback Engine Z 18 XE	221063	Drive Shaft		33	22	53	93.5	586		
	2004.01-	2009.05	AT/MT	R	F	Hatchback Engine Z 18 XE	221055	Drive Shaft		33	22	53	93.5	950		
	2004.01-	2009.05	AT/MT	L/R	F	Hatchback Engine Z 18 XE	844028	Outer Joint		33	24	53	93.5	63.5	M	
	2004.01-	2009.05	AT	L	F	Hatchback Engine Z 18 XE	244097	Drive Shaft		33	22	53	93.5	588		
	2004.01-	2009.05	AT	R	F	Hatchback Engine Z 18 XE	244098	Drive Shaft		33	22	53	93.5	950		
	2004.10-	2009.03	MT	L	F	Estate Engine Z 18 XE	699026	Inner Joint		22	25	35	57	82.5		
	2004.10-	2009.03	MT	L	F	Estate Engine Z 18 XE	221063	Drive Shaft		33	22	53	93.5	586		
	2004.10-	2009.03	AT/MT	R	F	Estate Engine Z 18 XE	221055	Drive Shaft		33	22	53	93.5	950		
	2004.10-	2009.03	AT/MT	L/R	F	Estate Engine Z 18 XE	844028	Outer Joint		33	24	53	93.5	63.5	M	
	2004.10-	2009.03	AT	L	F	Estate Engine Z 18 XE	244097	Drive Shaft		33	22	53	93.5	588		
	2004.10-	2009.03	AT	R	F	Estate Engine Z 18 XE	244098	Drive Shaft		33	22	53	93.5	950		
1.9 CDTi (110 kW)	2004.01-	2009.05	MT	L/R	F	Hatchback Engine Z 19 DTH	817051	Outer Joint		30	26	53.8	94.5	65.5	M	
	2004.01-	2009.05	-	L	F	Hatchback Engine Z 19 DTH	221035	Drive Shaft		30	25	53.8	94.5	581		
	2004.01-	2009.05	-	L	F	Hatchback Engine Z 19 DTH	699186	Inner Joint		25	28	35	57.5	81.5		
	2004.01-	2009.05	MT	L	F	Hatchback Engine Z 19 DTH	621018	Inner Joint		25	34	35	58	116		
	2004.01-	2009.05	MT	L	F	Hatchback Engine Z 19 DTH	221071	Drive Shaft		30	25	53.8	94.5	576		
	2004.01-	2009.05	-	-	F	Hatchback Engine Z 19 DTH	899023	Outer Joint		30	26	53.8	94.5	65.5	M	
	2004.01-	2009.05	MT	R	F	Hatchback Engine Z 19 DTH	221062	Drive Shaft		30	34	53.8	94.5	595		
	2004.01-	2009.05	-	R	F	Hatchback Engine Z 19 DTH	260016	Drive Shaft		30	34	52.5	105	588		
	2004.08-	2009.03	MT	L/R	F	Estate Engine Z 19 DTH	817051	Outer Joint		30	26	53.8	94.5	65.5	M	
	2004.08-	2009.03	-	L	F	Estate Engine Z 19 DTH	221035	Drive Shaft		30	25	53.8	94.5	581		
	2004.08-	2009.03	-	L	F	Estate Engine Z 19 DTH	699186	Inner Joint		25	28	35	57.5	81.5		
	2004.08-	2009.03	MT	L	F	Estate Engine Z 19 DTH	621018	Inner Joint		25	34	35	58	116		
	2004.08-	2009.03	MT	L	F	Estate Engine Z 19 DTH	221071	Drive Shaft		30	25	53.8	94.5	576		
	2004.08-	2009.03	MT	R	F	Estate Engine Z 19 DTH	221062	Drive Shaft		30	34	53.8	94.5	595		
	2004.08-	2009.03	-	R	F	Estate Engine Z 19 DTH	260016	Drive Shaft		30	34	52.5	105	588		
	2004.08-	2009.03	-	-	F	Estate Engine Z 19 DTH	899023	Outer Joint		30	26	53.8	94.5	65.5	M	
	1.9 CDTi (88 kW)	2004.01-	2009.05	-	R	F	Hatchback Engine Z 19 DT	221056	Drive Shaft		33	34	52.5	94	595	
		2004.01-	2009.05	-	L	F	Hatchback Engine Z 19 DT	221073	Drive Shaft		33	25	52.5	94	578	
		2004.01-	2009.05	-	L	F	Hatchback Engine Z 19 DT	699186	Inner Joint		25	28	35	57.5	81.5	
		2004.01-	2009.05	MT	L	F	Hatchback Engine Z 19 DT	621018	Inner Joint		25	34	35	58	116	
2004.01-		2009.05	MT	L	F	Hatchback Engine Z 19 DT	221071	Drive Shaft		30	25	53.8	94.5	576		
2004.01-		2009.05	AT	L	F	Hatchback Engine Z 19 DT	221111	Drive Shaft		33	27	52.5	94	562		
2004.01-		2009.05	MT	R	F	Hatchback Engine Z 19 DT	221062	Drive Shaft		30	34	53.8	94.5	595		
2004.01-		2009.05	-	-	F	Hatchback Engine Z 19 DT	899024	Outer Joint		33	26	52.5	94	65.5	M	
2004.01-		2009.05	AT	R	F	Hatchback Engine Z 19 DT	221110	Drive Shaft		33	27	52.5	94	576		
2004.01-		2009.05	MT	L/R	F	Hatchback Engine Z 19 DT	844027	Outer Joint		33	26	52.5	94	65.5	M	
2004.08-		2009.03	-	R	F	Estate Engine Z 19 DT	221056	Drive Shaft		33	34	52.5	94	595		
2004.08-		2009.03	-	L	F	Estate Engine Z 19 DT	221073	Drive Shaft		33	25	52.5	94	578		
2004.08-		2009.03	-	L	F	Estate Engine Z 19 DT	699186	Inner Joint		25	28	35	57.5	81.5		
2004.08-		2009.03	MT	L	F	Estate Engine Z 19 DT	621018	Inner Joint		25	34	35	58	116		
2004.08-		2009.03	MT	L	F	Estate Engine Z 19 DT	221071	Drive Shaft		30	25	53.8	94.5	576		
2004.08-		2009.03	AT	L	F	Estate Engine Z 19 DT	221111	Drive Shaft		33	27	52.5	94	562		
2004.08-		2009.03	MT	R	F	Estate Engine Z 19 DT	221062	Drive Shaft		30	34	53.8	94.5	595		
2004.08-		2009.03	-	-	F	Estate Engine Z 19 DT	899024	Outer Joint		33	26	52.5	94	65.5	M	
2004.08-		2009.03	AT	R	F	Estate Engine Z 19 DT	221110	Drive Shaft		33	27	52.5	94	576		
2004.08-		2009.03	-	L/R	F	Estate Engine Z 19 DT	844027	Outer Joint		33	26	52.5	94	65.5	M	
1.9 CDTi 16V (88 kW)	2004.01-	2009.05	-	R	F	Hatchback Engine Z 19 DTJ	221056	Drive Shaft		33	34	52.5	94	595		
	2004.01-	2009.05	-	L	F	Hatchback Engine Z 19 DTJ	221073	Drive Shaft		33	25	52.5	94	578		
	2004.01-	2009.05	-	L	F	Hatchback Engine Z 19 DTJ	699186	Inner Joint		25	28	35	57.5	81.5		
	2004.01-	2009.05	MT	L	F	Hatchback Engine Z 19 DTJ	621018	Inner Joint		25	34	35	58	116		
	2004.01-	2009.05	MT	L	F	Hatchback Engine Z 19 DTJ	221071	Drive Shaft		30	25	53.8	94.5	576		
	2004.01-	2009.05	AT	L	F	Hatchback Engine Z 19 DTJ	221111	Drive Shaft		33	27	52.5	94	562		
	2004.01-	2009.05	MT	R	F	Hatchback Engine Z 19 DTJ	221062	Drive Shaft		30	34	53.8	94.5	595		
	2004.01-	2009.05	-	-	F	Hatchback Engine Z 19 DTJ	899024	Outer Joint		33	26	52.5	94	65.5	M	
	2004.01-	2009.05	AT	R	F	Hatchback Engine Z 19 DTJ	221110	Drive Shaft		33	27	52.5	94	576		
	2004.01-	2009.05	-	L/R	F	Hatchback Engine Z 19 DTJ	844027	Outer Joint		33	26	52.5	94	65.5	M	
2004.08-	2009.03	MT	R	F	Estate Engine Z 19 DTJ	221056	Drive Shaft		33	34	52.5	94	595			
2004.08-	2009.03	MT	L	F	Estate Engine Z 19 DTJ	221073	Drive Shaft		33	25	52.5	94	578			

YEAR	TRANSM	L/R	F/R	REMARKS	GSP Ref.	PRODUCT	ABS	Technical Specifications									
								A	B	C	H	L	P				
VAUXHALL																	
ASTRA Mk V (H) (A04)																	
1.9 CDTi 16V (88 kW)	2004.08-2009.03	MT	L	F	Estate Engine Z 19 DTJ	621018	Inner Joint	25	34	35	58	116					
	2004.08-2009.03	MT	L	F	Estate Engine Z 19 DTJ	699186	Inner Joint	25	28	35	57.5	81.5					
	2004.08-2009.03	MT	L/R	F	Estate Engine Z 19 DTJ	844027	Outer Joint	33	26	52.5	94	65.5	M				
2.0 Turbo (125 kW)	2004.01-2009.05	-	R	F	Hatchback Engine Z 20 LEL	221056	Drive Shaft	33	34	52.5	94	595					
	2004.01-2009.05	-	-	F	Hatchback Engine Z 20 LEL	899024	Outer Joint	33	26	52.5	94	65.5	M				
	2004.01-2009.05	-	L/R	F	Hatchback Engine Z 20 LEL	844027	Outer Joint	33	26	52.5	94	65.5	M				
	2004.08-2010.10	-	-	F	Estate Engine Z 20 LEL	899024	Outer Joint	33	26	52.5	94	65.5	M				
	2004.08-2010.10	-	L/R	F	Estate Engine Z 20 LEL	844027	Outer Joint	33	26	52.5	94	65.5	M				
2.0 Turbo (147 kW)	2004.01-2009.05	-	-	F	Hatchback Engine Z 20 LER	899024	Outer Joint	33	26	52.5	94	65.5	M				
	2004.01-2009.05	-	L/R	F	Hatchback Engine Z 20 LER	844027	Outer Joint	33	26	52.5	94	65.5	M				
	2004.01-2009.05	MT	R	F	Hatchback Engine Z 20 LER	221056	Drive Shaft	33	34	52.5	94	595					
	2004.08-2010.10	-	R	F	Estate Engine Z 20 LER	221056	Drive Shaft	33	34	52.5	94	595					
	2004.08-2010.10	-	-	F	Estate Engine Z 20 LER	899024	Outer Joint	33	26	52.5	94	65.5	M				
2.0 Turbo (177 kW)	2004.08-2010.10	-	L/R	F	Estate Engine Z 20 LER	844027	Outer Joint	33	26	52.5	94	65.5	M				
	2004.01-2009.05	-	L/R	F	Hatchback Engine Z 20 LEH	817051	Outer Joint	30	26	53.8	94.5	65.5	M				
	2004.01-2009.05	-	R	F	Hatchback Engine Z 20 LEH	221062	Drive Shaft	30	34	53.8	94.5	595					
	2004.01-2009.05	-	R	F	Hatchback Engine Z 20 LEH	260016	Drive Shaft	30	34	52.5	105	588					
	2004.01-2009.05	-	-	F	Hatchback Engine Z 20 LEH	899023	Outer Joint	30	26	53.8	94.5	65.5	M				
ASTRA Mk V (H) Sport Hatch (A04)																	
1.3 CDTi (66 kW)	2005.04-2010.11	-	R	F	Hatchback Engine Z 13 DTH	244051	Drive Shaft	33	34	53	93.5	570					
	2005.04-2010.11	-	L	F	Hatchback Engine Z 13 DTH	244052	Drive Shaft	33	25	53	93.5	573					
	2005.04-2010.11	MT	L	F	Hatchback Engine Z 13 DTH	260020	Drive Shaft	33	25	52.5	94	561					
	2005.04-2010.11	-	L/R	F	Hatchback Engine Z 13 DTH	844028	Outer Joint	33	24	53	93.5	63.5	M				
	2005.04-2010.11	MT	L	F	Hatchback Engine Z 13 DTH	621018	Inner Joint	25	34	35	58	116					
1.4 i 16V (66 kW)	2005.03-2010.11	-	L	F	Hatchback Engine Z 14 XEP	244028	Drive Shaft	33	22	53	95	590					
	2005.03-2010.11	-	L	F	Hatchback Engine Z 14 XEP	621014	Inner Joint	22	22	35	57.5	75					
	2005.03-2010.11	-	R	F	Hatchback Engine Z 14 XEP	244030	Drive Shaft	33	22	53	95	952					
	2005.03-2010.11	-	L/R	F	Hatchback Engine Z 14 XEP	844003	Outer Joint	33	22	53	95	54.5	M				
1.6 (132 kW)	2006.10-2010.11	-	L/R	F	Hatchback Engine Z 16 LET	844028	Outer Joint	33	24	53	93.5	63.5	M				
1.6 (77 kW)	2005.02-2010.11	-	L	F	Hatchback Engine Z 16 XEP	244028	Drive Shaft	33	22	53	95	590					
	2005.02-2010.11	-	L	F	Hatchback Engine Z 16 XEP	621014	Inner Joint	22	22	35	57.5	75					
	2005.02-2010.11	-	L/R	F	Hatchback Engine Z 16 XEP	844003	Outer Joint	33	22	53	95	54.5	M				
	2005.02-2010.11	-	R	F	Hatchback Engine Z 16 XEP	244030	Drive Shaft	33	22	53	95	952					
1.6 i 16V (85 kW)	2006.12-2010.11	-	L	F	Hatchback Engine Z 16 XER	244028	Drive Shaft	33	22	53	95	590					
	2006.12-2010.11	-	L	F	Hatchback Engine Z 16 XER	621014	Inner Joint	22	22	35	57.5	75					
	2006.12-2010.11	-	L/R	F	Hatchback Engine Z 16 XER	844003	Outer Joint	33	22	53	95	54.5	M				
1.7 CDTi (74 kW)	2005.02-2010.11	5MT	L	F	Hatchback Engine Z 17 DTH	244029	Drive Shaft	33	34	53	93.5	594					
	2005.02-2010.11	-	R	F	Hatchback Engine Z 17 DTH	244031	Drive Shaft	33	34	53	93.5	559					
	2005.02-2010.11	6MT	L	F	Hatchback Engine Z 17 DTH	244052	Drive Shaft	33	25	53	93.5	573					
	2005.02-2010.11	MT	R	F	Hatchback Engine Z 17 DTH	644005	Inner Joint	34	25	35	54	47					
	2005.02-2010.11	5MT	L	F	Hatchback Engine Z 17 DTH	644002	Inner Joint	34	25	35	56.2	85.6					
	2005.02-2010.11	5AT	L	F	Hatchback Engine Z 17 DTH	244024	Drive Shaft	33	34	53	93.5	589					
	2005.02-2010.11	-	L/R	F	Hatchback Engine Z 17 DTH	844028	Outer Joint	33	24	53	93.5	63.5	M				
1.7 CDTi (81 kW)	2007.02-2010.11	-	R	F	Hatchback Engine A 17 DTJ	644016	Inner Joint	34	28	37.5	46	54					
	2007.02-2010.11	-	R	F	Hatchback Engine A 17 DTJ	244099	Drive Shaft	33	34	52.5	94	563					
	2007.02-2010.11	-	L	F	Hatchback Engine A 17 DTJ	699186	Inner Joint	25	28	35	57.5	81.5					
	2007.02-2010.11	5AT	R	F	Hatchback Engine A 17 DTJ	644005	Inner Joint	34	25	35	54	47					
	2007.02-2010.11	-	L	F	Hatchback Engine A 17 DTJ	221051	Drive Shaft	33	25	52.5	94	579					
	2007.02-2010.11	-	L/R	F	Hatchback Engine A 17 DTJ	844027	Outer Joint	33	26	52.5	94	65.5	M				
1.8 (92 kW)	2005.02-2010.11	5MT	L	F	Hatchback Engine Z 18 XE	699026	Inner Joint	22	25	35	57	82.5					
	2005.02-2010.11	5MT	L	F	Hatchback Engine Z 18 XE	221063	Drive Shaft	33	22	53	93.5	586					
	2005.02-2010.11	AT/MT	R	F	Hatchback Engine Z 18 XE	221055	Drive Shaft	33	22	53	93.5	950					
	2005.02-2010.11	-	L/R	F	Hatchback Engine Z 18 XE	844028	Outer Joint	33	24	53	93.5	63.5	M				
	2005.02-2010.11	4AT	L	F	Hatchback Engine Z 18 XE	244097	Drive Shaft	33	22	53	93.5	588					
	2005.02-2010.11	4AT	R	F	Hatchback Engine Z 18 XE	244098	Drive Shaft	33	22	53	93.5	950					
1.8 i 16V (103 kW)	2007.03-2010.11	5MT	L	F	Hatchback Engine Z 18 XER	699026	Inner Joint	22	25	35	57	82.5					
	2007.03-2010.11	AT/MT	R	F	Hatchback Engine Z 18 XER	221055	Drive Shaft	33	22	53	93.5	950					
	2007.03-2010.11	5MT	L	F	Hatchback Engine Z 18 XER	221063	Drive Shaft	33	22	53	93.5	586					
	2007.03-2010.11	4AT	L	F	Hatchback Engine Z 18 XER	244097	Drive Shaft	33	22	53	93.5	588					
	2007.03-2010.11	-	L/R	F	Hatchback Engine Z 18 XER	844028	Outer Joint	33	24	53	93.5	63.5	M				
	2007.03-2010.11	4AT	R	F	Hatchback Engine Z 18 XER	244098	Drive Shaft	33	22	53	93.5	950					
1.9 CDTi (110 kW)	2005.02-2010.11	-	L	F	Hatchback Engine Z 19 DTH	221035	Drive Shaft	30	25	53.8	94.5	581					
	2005.02-2010.11	-	L	F	Hatchback Engine Z 19 DTH	699186	Inner Joint	25	28	35	57.5	81.5					
	2005.02-2010.11	-	L	F	Hatchback Engine Z 19 DTH	621018	Inner Joint	25	34	35	58	116					
	2005.02-2010.11	-	L/R	F	Hatchback Engine Z 19 DTH	817051	Outer Joint	30	26	53.8	94.5	65.5	M				

YEAR	TRANS	L/R	F/R	REMARKS	GSP Ref.	PRODUCT	ABS	Technical Specifications					
								A	B	C	H	L	P
VAUXHALL													
ASTRA Mk V (H) Sport Hatch (A04)													
1.9 CDTI (110 kW)	2005.02-2010.11	-	L	F	Hatchback Engine Z 19 DTH	221071	Drive Shaft	30	25	53.8	94.5	576	
	2005.02-2010.11	-	R	F	Hatchback Engine Z 19 DTH	221062	Drive Shaft	30	34	53.8	94.5	595	
	2005.02-2010.11	-	R	F	Hatchback Engine Z 19 DTH	260016	Drive Shaft	30	34	52.5	105	588	
	2005.02-2010.11	-	-	F	Hatchback Engine Z 19 DTH	899023	Outer Joint	30	26	53.8	94.5	65.5	M
1.9 CDTI (74 kW)	2005.08-2010.11	-	L/R	F	Hatchback Engine Z 19 DTL	844027	Outer Joint	33	26	52.5	94	65.5	M
	2005.08-2010.11	-	R	F	Hatchback Engine Z 19 DTL	221056	Drive Shaft	33	34	52.5	94	595	
	2005.08-2010.11	-	L	F	Hatchback Engine Z 19 DTL	221073	Drive Shaft	33	25	52.5	94	578	
	2005.08-2010.11	-	L	F	Hatchback Engine Z 19 DTL	621018	Inner Joint	25	34	35	58	116	
	2005.08-2010.11	-	L	F	Hatchback Engine Z 19 DTL	699186	Inner Joint	25	28	35	57.5	81.5	
	2005.08-2010.11	AT	L	F	Hatchback Engine Z 19 DTL	221111	Drive Shaft	33	27	52.5	94	562	
	2005.08-2010.11	-	-	F	Hatchback Engine Z 19 DTL	899024	Outer Joint	33	26	52.5	94	65.5	M
1.9 CDTI (88 kW)	2005.02-2010.11	-	R	F	Hatchback Engine Z 19 DT	221056	Drive Shaft	33	34	52.5	94	595	
	2005.02-2010.11	-	L	F	Hatchback Engine Z 19 DT	221073	Drive Shaft	33	25	52.5	94	578	
	2005.02-2010.11	-	L	F	Hatchback Engine Z 19 DT	699186	Inner Joint	25	28	35	57.5	81.5	
	2005.02-2010.11	MT	L	F	Hatchback Engine Z 19 DT	621018	Inner Joint	25	34	35	58	116	
	2005.02-2010.11	MT	L	F	Hatchback Engine Z 19 DT	221071	Drive Shaft	30	25	53.8	94.5	576	
	2005.02-2010.11	MT	R	F	Hatchback Engine Z 19 DT	221062	Drive Shaft	30	34	53.8	94.5	595	
	2005.02-2010.11	AT	L	F	Hatchback Engine Z 19 DT	221111	Drive Shaft	33	27	52.5	94	562	
	2005.02-2010.11	-	-	F	Hatchback Engine Z 19 DT	899024	Outer Joint	33	26	52.5	94	65.5	M
	2005.02-2010.11	AT	R	F	Hatchback Engine Z 19 DT	221110	Drive Shaft	33	27	52.5	94	576	
	2005.02-2010.11	MT	L/R	F	Hatchback Engine Z 19 DT	844027	Outer Joint	33	26	52.5	94	65.5	M
2.0 Turbo (125 kW)	2005.02-2010.11	-	R	F	Hatchback Engine Z 20 LEL	221056	Drive Shaft	33	34	52.5	94	595	
	2005.02-2010.11	-	-	F	Hatchback Engine Z 20 LEL	899024	Outer Joint	33	26	52.5	94	65.5	M
	2005.02-2010.11	-	L/R	F	Hatchback Engine Z 20 LEL	844027	Outer Joint	33	26	52.5	94	65.5	M
2.0 VXR (176 kW)	2009.02-2010.11	-	-	F	Hatchback Engine Z 20 LEH	899023	Outer Joint	30	26	53.8	94.5	65.5	M
	2009.02-2010.11	-	L/R	F	Hatchback Engine Z 20 LEH	817051	Outer Joint	30	26	53.8	94.5	65.5	M
	2009.02-2010.11	-	R	F	Hatchback Engine Z 20 LEH	260016	Drive Shaft	30	34	52.5	105	588	
ASTRA Mk V (H) TwinTop (A04)													
1.6 (77 kW)	2005.09-2010.11	MT	L	F	Convertible Engine Z 16 XEP	244028	Drive Shaft	33	22	53	95	590	
	2005.09-2010.11	MT	L	F	Convertible Engine Z 16 XEP	621014	Inner Joint	22	22	35	57.5	75	
	2005.09-2010.11	MT	L/R	F	Convertible Engine Z 16 XEP	844003	Outer Joint	33	22	53	95	54.5	M
	2005.09-2010.11	MT	R	F	Convertible Engine Z 16 XEP	244030	Drive Shaft	33	22	53	95	952	
1.6 i 16V (85 kW)	2006.10-2010.11	-	L	F	Convertible Engine Z 16 XER	244028	Drive Shaft	33	22	53	95	590	
	2006.10-2010.11	-	L	F	Convertible Engine Z 16 XER	621014	Inner Joint	22	22	35	57.5	75	
	2006.10-2010.11	-	R	F	Convertible Engine Z 16 XER	244030	Drive Shaft	33	22	53	95	952	
	2006.10-2010.11	-	L/R	F	Convertible Engine Z 16 XER	844003	Outer Joint	33	22	53	95	54.5	M
1.8 (103 kW)	2008.05-2010.11	MT	L	F	Convertible Engine Z 18 XER	699026	Inner Joint	22	25	35	57	82.5	
	2008.05-2010.11	AT/MT	R	F	Convertible Engine Z 18 XER	221055	Drive Shaft	33	22	53	93.5	950	
	2008.05-2010.11	MT	L	F	Convertible Engine Z 18 XER	221063	Drive Shaft	33	22	53	93.5	586	
	2008.05-2010.11	AT	L	F	Convertible Engine Z 18 XER	244097	Drive Shaft	33	22	53	93.5	588	
	2008.05-2010.11	-	L/R	F	Convertible Engine Z 18 XER	844028	Outer Joint	33	24	53	93.5	63.5	M
	2008.05-2010.11	AT	R	F	Convertible Engine Z 18 XER	244098	Drive Shaft	33	22	53	93.5	950	
1.9 CDTI (110 kW)	2006.01-2010.11	-	-	F	Convertible Engine Z 19 DTH	899023	Outer Joint	30	26	53.8	94.5	65.5	M
	2006.01-2010.11	-	L	F	Convertible Engine Z 19 DTH	221035	Drive Shaft	30	25	53.8	94.5	581	
	2006.01-2010.11	-	L/R	F	Convertible Engine Z 19 DTH	817051	Outer Joint	30	26	53.8	94.5	65.5	M
	2006.01-2010.11	-	L	F	Convertible Engine Z 19 DTH	699186	Inner Joint	25	28	35	57.5	81.5	
	2006.01-2010.11	-	L	F	Convertible Engine Z 19 DTH	621018	Inner Joint	25	34	35	58	116	
	2006.01-2010.11	-	L	F	Convertible Engine Z 19 DTH	221071	Drive Shaft	30	25	53.8	94.5	576	
	2006.01-2010.11	-	R	F	Convertible Engine Z 19 DTH	221062	Drive Shaft	30	34	53.8	94.5	595	
	2006.01-2010.11	-	R	F	Convertible Engine Z 19 DTH	260016	Drive Shaft	30	34	52.5	105	588	
2.0 (125 kW)	2006.02-2010.11	-	R	F	Convertible Engine Z 20 LEL	221056	Drive Shaft	33	34	52.5	94	595	
	2006.02-2010.11	-	R	F	Convertible Engine Z 20 LEL	844027	Outer Joint	33	26	52.5	94	65.5	M
	2006.02-2010.11	-	-	F	Convertible Engine Z 20 LEL	899024	Outer Joint	33	26	52.5	94	65.5	M
2.0 Turbo (147 kW)	2006.01-2010.11	-	R	F	Convertible Engine Z 20 LER	221056	Drive Shaft	33	34	52.5	94	595	
	2006.01-2010.11	-	L/R	F	Convertible Engine Z 20 LER	844027	Outer Joint	33	26	52.5	94	65.5	M
	2006.01-2010.11	-	-	F	Convertible Engine Z 20 LER	899024	Outer Joint	33	26	52.5	94	65.5	M
ASTRA Mk VI (J) (P10)													
1.3 CDTI (70 kW)	2009.12-	-	-	-	F Hatchback Engine A 13 DTE	808047	Outer Joint	33	23	52.5	94	59.5	M
	2010.10-	-	-	-	F Estate Engine A 13 DTE	808047	Outer Joint	33	23	52.5	94	59.5	M
	2012.06-	-	-	-	F Saloon Engine A 13 DTE	808047	Outer Joint	33	23	52.5	94	59.5	M
1.4 (64 kW)	2009.12-	-	-	L	F Hatchback Engine A 14 XEL	244064	Drive Shaft	33	22	53	95	618	
	2009.12-	-	-	R	F Hatchback Engine A 14 XEL	244065	Drive Shaft	33	22	53	95	983	
	2009.12-	-	-	L	F Hatchback Engine A 14 XEL	621014	Inner Joint	22	22	35	57.5	75	
	2010.10-	-	-	L	F Estate Engine A 14 XEL	244064	Drive Shaft	33	22	53	95	618	
	2010.10-	-	-	R	F Estate Engine A 14 XEL	244065	Drive Shaft	33	22	53	95	983	

	 YEAR	TRANSM	L/R	F/R	REMARKS	GSP Ref.	 PRODUCT	 ABS	Technical Specifications								
									A	B	C	H	L	P			
VAUXHALL																	
ASTRA Mk VI (J) (P10)																	
1.4 (64 kW)	2010.10-	-	-	L	F	Estate Engine A 14 XEL	621014	Inner Joint		22	22	35	57.5	75			
1.4 (74 kW)	2009.12-	-	-	L	F	Hatchback Engine A 14 XER	244064	Drive Shaft		33	22	53	95	618			
	2009.12-	-	-	R	F	Hatchback Engine A 14 XER	244065	Drive Shaft		33	22	53	95	983			
	2009.12-	-	-	L	F	Hatchback Engine A 14 XER	621014	Inner Joint		22	22	35	57.5	75			
	2010.10-	-	-	L	F	Estate Engine A 14 XER	244064	Drive Shaft		33	22	53	95	618			
	2010.10-	-	-	R	F	Estate Engine A 14 XER	244065	Drive Shaft		33	22	53	95	983			
	2010.10-	-	-	L	F	Estate Engine A 14 XER	621014	Inner Joint		22	22	35	57.5	75			
	2012.06-	-	MT	L	F	Saloon Engine A 14 XER	244064	Drive Shaft		33	22	53	95	618			
	2012.06-	-	MT	R	F	Saloon Engine A 14 XER	244065	Drive Shaft		33	22	53	95	983			
1.4 Turbo (103 kW)	2012.06-	-	MT	L	F	Saloon Engine A 14 XER	621014	Inner Joint		22	22	35	57.5	75			
	2009.12-	-	MT	R	F	Hatchback Engine A 14 NET	644005	Inner Joint		34	25	35	54	47			
	2009.12-	-	AT	-	F	Hatchback Engine A 14 NET	808047	Outer Joint		33	23	52.5	94	59.5	M		
	2009.12-	-	MT	R	F	Hatchback Engine A 14 NET	221109	Drive Shaft		33	34	53	93.5	588			
	2010.10-	-	MT	R	F	Estate Engine A 14 NET	644005	Inner Joint		34	25	35	54	47			
	2010.10-	-	AT	-	F	Estate Engine A 14 NET	808047	Outer Joint		33	23	52.5	94	59.5	M		
	2010.10-	-	MT	R	F	Estate Engine A 14 NET	221109	Drive Shaft		33	34	53	93.5	588			
	2012.06-	-	MT	R	F	Saloon Engine A 14 NET	644005	Inner Joint		34	25	35	54	47			
1.4 Turbo (88 kW)	2012.06-	-	AT	-	F	Saloon Engine A 14 NET	808047	Outer Joint		33	23	52.5	94	59.5	M		
	2012.06-	-	MT	R	F	Saloon Engine A 14 NET	221109	Drive Shaft		33	34	53	93.5	588			
	2010.10-	-	MT	R	F	Estate Engine A 14 NEL	644005	Inner Joint		34	25	35	54	47			
	2010.10-	-	AT	-	F	Estate Engine A 14 NEL	808047	Outer Joint		33	23	52.5	94	59.5	M		
	2010.10-	-	MT	R	F	Estate Engine A 14 NEL	221109	Drive Shaft		33	34	53	93.5	588			
	2011.08-	-	MT	R	F	Hatchback Engine A 14 NEL	644005	Inner Joint		34	25	35	54	47			
	2011.08-	-	AT	-	F	Hatchback Engine A 14 NEL	808047	Outer Joint		33	23	52.5	94	59.5	M		
	2011.08-	-	MT	R	F	Hatchback Engine A 14 NEL	221109	Drive Shaft		33	34	53	93.5	588			
1.6 (85 kW)	2009.12-	-	AT	R	F	Hatchback Engine A 16 XER	208077	Drive Shaft		33	34	52.5	94	95.1			
	2009.12-	-	AT	R	F	Hatchback Engine A 16 XER	621029	Inner Joint		22	23	35	57.5	103			
	2009.12-	-	AT	R	F	Hatchback Engine A 16 XER	844088	Outer Joint		33	23	52.3	94	59.5	M		
	2009.12-	-	AT	-	F	Hatchback Engine A 16 XER	808047	Outer Joint		33	23	52.5	94	59.5	M		
	2009.12-	-	MT	L	F	Hatchback Engine A 16 XER	244064	Drive Shaft		33	22	53	95	618			
	2009.12-	-	MT	R	F	Hatchback Engine A 16 XER	244065	Drive Shaft		33	22	53	95	983			
	2009.12-	-	AT	R	F	Hatchback Engine A 16 XER	221072	Drive Shaft		33	22	52.3	94	95.7			
	2009.12-	-	MT	L	F	Hatchback Engine A 16 XER	621014	Inner Joint		22	22	35	57.5	75			
	2010.10-	-	AT	R	F	Estate Engine B 16 XER	208077	Drive Shaft		33	34	52.5	94	95.1			
	2010.10-	-	AT	R	F	Estate Engine B 16 XER	621029	Inner Joint		22	23	35	57.5	103			
	2010.10-	-	AT	R	F	Estate Engine B 16 XER	844088	Outer Joint		33	23	52.3	94	59.5	M		
	2010.10-	-	AT	-	F	Estate Engine B 16 XER	808047	Outer Joint		33	23	52.5	94	59.5	M		
	2010.10-	-	MT	L	F	Estate Engine B 16 XER	244064	Drive Shaft		33	22	53	95	618			
	2010.10-	-	MT	R	F	Estate Engine B 16 XER	244065	Drive Shaft		33	22	53	95	983			
	2010.10-	-	AT	R	F	Estate Engine B 16 XER	221072	Drive Shaft		33	22	52.3	94	95.7			
	2010.10-	-	MT	L	F	Estate Engine B 16 XER	621014	Inner Joint		22	22	35	57.5	75			
	2012.06-	-	AT	R	F	Saloon Engine A 16 XER	208077	Drive Shaft		33	34	52.5	94	95.1			
	2012.06-	-	AT	R	F	Saloon Engine A 16 XER	621029	Inner Joint		22	23	35	57.5	103			
	2012.06-	-	AT	R	F	Saloon Engine A 16 XER	844088	Outer Joint		33	23	52.3	94	59.5	M		
	2012.06-	-	AT	-	F	Saloon Engine A 16 XER	808047	Outer Joint		33	23	52.5	94	59.5	M		
	2012.06-	-	MT	L	F	Saloon Engine A 16 XER	244064	Drive Shaft		33	22	53	95	618			
	2012.06-	-	MT	R	F	Saloon Engine A 16 XER	244065	Drive Shaft		33	22	53	95	983			
	2012.06-	-	AT	R	F	Saloon Engine A 16 XER	221072	Drive Shaft		33	22	52.3	94	95.7			
	2012.06-	-	MT	L	F	Saloon Engine A 16 XER	621014	Inner Joint		22	22	35	57.5	75			
1.6 CDTI (100 kW)	2013.11-	-	-	-	F	Hatchback Engine B 16 DTH	899023	Outer Joint		30	26	53.8	94.5	65.5	M		
	2013.11-	-	MT	L/R	F	Hatchback Engine B 16 DTH	817051	Outer Joint		30	26	53.8	94.5	65.5	M		
	2014.01-	-	-	-	F	Estate Engine B 16 DTH	899023	Outer Joint		30	26	53.8	94.5	65.5	M		
	2014.01-	-	MT	L/R	F	Estate Engine B 16 DTH	817051	Outer Joint		30	26	53.8	94.5	65.5	M		
1.6 CDTI (81 kW)	2013.11-	-	-	-	F	Hatchback Engine B 16 DTL	899023	Outer Joint		30	26	53.8	94.5	65.5	M		
	2013.11-	-	-	L/R	F	Hatchback Engine B 16 DTL	817051	Outer Joint		30	26	53.8	94.5	65.5	M		
	2014.01-	-	-	-	F	Estate Engine B 16 DTL	899023	Outer Joint		30	26	53.8	94.5	65.5	M		
	2014.01-	-	-	L/R	F	Estate Engine B 16 DTL	817051	Outer Joint		30	26	53.8	94.5	65.5	M		
1.6 Turbo (132 kW)	2009.12-	-	-	-	F	Hatchback Engine A 16 LET	899023	Outer Joint		30	26	53.8	94.5	65.5	M		
	2009.12-	-	MT	L	F	Hatchback Engine A 16 LET	821049	Outer Joint		30	26	52.5	94	65.5	M		
	2009.12-	-	-	L/R	F	Hatchback Engine A 16 LET	817051	Outer Joint		30	26	53.8	94.5	65.5	M		
	2010.10-	-	MT	R	F	Estate Engine A 16 LET	821049	Outer Joint		30	26	52.5	94	65.5	M		
	2010.10-	-	-	-	F	Estate Engine A 16 LET	899023	Outer Joint		30	26	53.8	94.5	65.5	M		
	2010.10-	-	-	L/R	F	Estate Engine A 16 LET	817051	Outer Joint		30	26	53.8	94.5	65.5	M		
	2010.10-	-	MT	R	F	Estate Engine A 16 LET	221074	Drive Shaft		30	34	52.5	94	589			
	2012.06-	-	MT	R	F	Saloon Engine A 16 LET	821049	Outer Joint		30	26	52.5	94	65.5	M		
2012.06-	-	-	-	-	F	Saloon Engine A 16 LET	899023	Outer Joint		30	26	53.8	94.5	65.5	M		

YEAR	TRANSM	L/R	F/R	REMARKS	GSP Ref.	PRODUCT	ABS	Technical Specifications							
								A	B	C	H	L	P		
VAUXHALL															
ASTRA Mk VI (J) (P10)															
1.6 Turbo (132 kW)	2012.06-	-	-	L/R	F	Saloon Engine A 16 LET	817051	Outer Joint	30	26	53.8	94.5	65.5	M	
	2012.06-	-	MT	R	F	Saloon Engine A 16 LET	221074	Drive Shaft	30	34	52.5	94	589		
1.7 CDTI (74 kW)	2010.10-	-	-	R	F	Hatchback Engine A 17 DTL	821049	Outer Joint	30	26	52.5	94	65.5	M	
	2010.10-	-	MT	L	F	Estate Engine A 17 DTL	821049	Outer Joint	30	26	52.5	94	65.5	M	
	2010.10-	-	-	-	F	Estate Engine A 17 DTL	899023	Outer Joint	30	26	53.8	94.5	65.5	M	
	2010.10-	-	-	-	F	Hatchback Engine A 17 DTL	899023	Outer Joint	30	26	53.8	94.5	65.5	M	
	2010.10-	-	MT	L	F	Estate Engine A 17 DTL	221076	Drive Shaft	30	25	52.5	94	601		
	2010.10-	-	MT	L	F	Hatchback Engine A 17 DTL	221076	Drive Shaft	30	25	52.5	94	601		
	2010.10-	-	-	R	F	Hatchback Engine A 17 DTL	221074	Drive Shaft	30	34	52.5	94	589		
	2010.10-	-	-	L/R	F	Hatchback Engine A 17 DTL	817051	Outer Joint	30	26	53.8	94.5	65.5	M	
1.7 CDTI (81 kW)	2009.12-	-	-	-	F	Hatchback Engine A 17 DTE	899023	Outer Joint	30	26	53.8	94.5	65.5	M	
	2009.12-	-	MT	L	F	Hatchback Engine A 17 DTE	821049	Outer Joint	30	26	52.5	94	65.5	M	
	2009.12-	-	MT	L	F	Hatchback Engine A 17 DTE	221076	Drive Shaft	30	25	52.5	94	601		
	2009.12-	-	-	L/R	F	Hatchback Engine A 17 DTE	817051	Outer Joint	30	26	53.8	94.5	65.5	M	
	2010.10-	-	MT	L	F	Estate Engine A 17 DTC	821049	Outer Joint	30	26	52.5	94	65.5	M	
	2010.10-	-	-	-	F	Estate Engine A 17 DTC	899023	Outer Joint	30	26	53.8	94.5	65.5	M	
	2010.10-	-	MT	L	F	Estate Engine A 17 DTC	221076	Drive Shaft	30	25	52.5	94	601		
	2010.10-	-	-	L/R	F	Estate Engine A 17 DTC	817051	Outer Joint	30	26	53.8	94.5	65.5	M	
	2012.06-	-	-	-	F	Saloon Engine A 17 DTE	899023	Outer Joint	30	26	53.8	94.5	65.5	M	
	2012.06-	-	MT	L	F	Saloon Engine A 17 DTE	821049	Outer Joint	30	26	52.5	94	65.5	M	
	2012.06-	-	MT	L	F	Saloon Engine A 17 DTE	221076	Drive Shaft	30	25	52.5	94	601		
	2012.06-	-	MT	L/R	F	Saloon Engine A 17 DTE	817051	Outer Joint	30	26	53.8	94.5	65.5	M	
	1.7 CDTI (92 kW)	2009.12-	-	-	-	F	Hatchback Engine A 17 DTR	899023	Outer Joint	30	26	53.8	94.5	65.5	M
		2009.12-	-	-	R	F	Hatchback Engine A 17 DTR	821049	Outer Joint	30	26	52.5	94	65.5	M
2009.12-		-	MT	L	F	Hatchback Engine A 17 DTR	221076	Drive Shaft	30	25	52.5	94	601		
2009.12-		-	-	L/R	F	Hatchback Engine A 17 DTR	817051	Outer Joint	30	26	53.8	94.5	65.5	M	
2009.12-		-	-	R	F	Hatchback Engine A 17 DTR	221074	Drive Shaft	30	34	52.5	94	589		
2010.10-		-	-	R	F	Estate Engine A 17 DTR	821049	Outer Joint	30	26	52.5	94	65.5	M	
2010.10-		-	-	-	F	Estate Engine A 17 DTR	899023	Outer Joint	30	26	53.8	94.5	65.5	M	
2010.10-		-	MT	L	F	Estate Engine A 17 DTR	221076	Drive Shaft	30	25	52.5	94	601		
2010.10-		-	-	L/R	F	Estate Engine A 17 DTR	817051	Outer Joint	30	26	53.8	94.5	65.5	M	
2010.10-		-	-	R	F	Estate Engine A 17 DTR	221074	Drive Shaft	30	34	52.5	94	589		
1.7 CDTI (96 kW)		2011.06-	-	-	R	F	Hatchback Engine A 17 DTF	821049	Outer Joint	30	26	52.5	94	65.5	M
		2011.06-	2014.05	-	R	F	Estate Engine A 17 DTS	821049	Outer Joint	30	26	52.5	94	65.5	M
		2011.06-	-	MT	L	F	Hatchback Engine A 17 DTF	221076	Drive Shaft	30	25	52.5	94	601	
		2011.06-	2014.05	MT	L	F	Estate Engine A 17 DTS	221076	Drive Shaft	30	25	52.5	94	601	
	2011.06-	-	-	-	F	Hatchback Engine A 17 DTF	899023	Outer Joint	30	26	53.8	94.5	65.5	M	
	2011.06-	2014.05	-	-	F	Estate Engine A 17 DTS	899023	Outer Joint	30	26	53.8	94.5	65.5	M	
	2011.06-	-	-	L/R	F	Hatchback Engine A 17 DTF	817051	Outer Joint	30	26	53.8	94.5	65.5	M	
	2011.06-	-	-	R	F	Hatchback Engine A 17 DTF	221074	Drive Shaft	30	34	52.5	94	589		
	2011.06-	2014.05	-	R	F	Estate Engine A 17 DTS	221074	Drive Shaft	30	34	52.5	94	589		
	2011.06-	2014.05	-	L/R	F	Estate Engine A 17 DTS	817051	Outer Joint	30	26	53.8	94.5	65.5	M	
	2012.06-	-	-	-	F	Saloon Engine A 17 DTF	899023	Outer Joint	30	26	53.8	94.5	65.5	M	
	2012.06-	-	MT	L	F	Saloon Engine A 17 DTF	821049	Outer Joint	30	26	52.5	94	65.5	M	
	2012.06-	-	MT	L	F	Saloon Engine A 17 DTF	221076	Drive Shaft	30	25	52.5	94	601		
	2012.06-	-	MT	L/R	F	Saloon Engine A 17 DTF	817051	Outer Joint	30	26	53.8	94.5	65.5	M	
	2.0 CDTI (118 kW)	2009.12-	-	-	-	F	Hatchback Engine A 20 DTH	899023	Outer Joint	30	26	53.8	94.5	65.5	M
		2009.12-	-	-	L/R	F	Hatchback Engine A 20 DTH	817051	Outer Joint	30	26	53.8	94.5	65.5	M
		2010.10-	-	-	-	F	Estate Engine A 20 DTH	899023	Outer Joint	30	26	53.8	94.5	65.5	M
		2010.10-	-	-	L/R	F	Estate Engine A 20 DTH	817051	Outer Joint	30	26	53.8	94.5	65.5	M
2.0 CDTI (121 kW)	2011.08-	-	-	-	F	Hatchback Engine A 20 DTH	899023	Outer Joint	30	26	53.8	94.5	65.5	M	
	2011.08-	-	-	-	F	Estate Engine A 20 DTH	899023	Outer Joint	30	26	53.8	94.5	65.5	M	
	2011.08-	-	-	L/R	F	Hatchback Engine A 20 DTH	817051	Outer Joint	30	26	53.8	94.5	65.5	M	
	2011.08-	-	-	L/R	F	Estate Engine A 20 DTH	817051	Outer Joint	30	26	53.8	94.5	65.5	M	
ASTRA Mk VI (J) GTC (P10)															
1.4 (103 kW)	2011.10-	-	MT	R	F	Hatchback Engine B 14 NET	644005	Inner Joint	34	25	35	54	47		
	2011.10-	-	AT	-	F	Hatchback Engine B 14 NET	808047	Outer Joint	33	23	52.5	94	59.5	M	
	2011.10-	-	MT	L/R	F	Hatchback Engine B 14 NET	817051	Outer Joint	30	26	53.8	94.5	65.5	M	
	2011.10-	-	MT	R	F	Hatchback Engine B 14 NET	221109	Drive Shaft	33	34	53	93.5	588		
1.4 (88 kW)	2011.10-	-	MT	R	F	Hatchback Engine A 14 NEL	644005	Inner Joint	34	25	35	54	47		
	2011.10-	-	AT	-	F	Hatchback Engine A 14 NEL	808047	Outer Joint	33	23	52.5	94	59.5	M	
	2011.10-	-	MT	L/R	F	Hatchback Engine A 14 NEL	817051	Outer Joint	30	26	53.8	94.5	65.5	M	
1.6 (132 kW)	2011.10-	-	-	-	F	Hatchback Engine A 16 LET	899023	Outer Joint	30	26	53.8	94.5	65.5	M	
	2011.10-	-	MT	L/R	F	Hatchback Engine A 16 LET	817051	Outer Joint	30	26	53.8	94.5	65.5	M	
1.6 CDTI (100 kW)	2014.07-	-	-	-	F	Hatchback Engine B 16 DTH	899023	Outer Joint	30	26	53.8	94.5	65.5	M	

YEAR	TRANSM	L/R	F/R	REMARKS	GSP Ref.	PRODUCT	ABS	Technical Specifications						
								A	B	C	H	L	P	
VAUXHALL														
ASTRA Mk VI (J) GTC (P10)														
1.6 CDTI (100 kW)	2014.07-	-	MT	L F	Hatchback Engine B 16 DTH	817051	Outer Joint		30	26	53.8	94.5	65.5	M
1.6 CDTI (81 kW)	2014.07-	-	-	-	F Hatchback Engine B 16 DTL	899023	Outer Joint		30	26	53.8	94.5	65.5	M
	2014.07-	-	MT	L F	Hatchback Engine B 16 DTL	817051	Outer Joint		30	26	53.8	94.5	65.5	M
1.6 SIDI (147 kW)	2013.09-	-	MT	L F	Hatchback Engine A 16 SHT	821049	Outer Joint		30	26	52.5	94	65.5	M
	2013.09-	-	-	-	F Hatchback Engine A 16 SHT	899023	Outer Joint		30	26	53.8	94.5	65.5	M
	2013.09-	-	MT	L F	Hatchback Engine A 16 SHT	817051	Outer Joint		30	26	53.8	94.5	65.5	M
1.7 CDTI (81 kW)	2011.10-	-	-	-	F Hatchback Engine A 17 DTJ	899023	Outer Joint		30	26	53.8	94.5	65.5	M
	2011.10-	-	MT	L/R	F Hatchback Engine A 17 DTJ	817051	Outer Joint		30	26	53.8	94.5	65.5	M
1.7 CDTI (96 kW)	2011.10-	-	-	-	F Hatchback Engine A 17 DTS	899023	Outer Joint		30	26	53.8	94.5	65.5	M
	2011.10-	-	MT	L/R	F Hatchback Engine A 17 DTS	817051	Outer Joint		30	26	53.8	94.5	65.5	M
2.0 BiTurbo CDTI (143 kW)	2012.12-	-	-	-	F Hatchback Engine A 20 DTR	899023	Outer Joint		30	26	53.8	94.5	65.5	M
2.0 CDTI (121 kW)	2011.10-	-	-	-	F Hatchback Engine A 20 DTH	899023	Outer Joint		30	26	53.8	94.5	65.5	M
	2011.10-	-	AT	L F	Hatchback Engine A 20 DTH	817051	Outer Joint		30	26	53.8	94.5	65.5	M
2.0 VXR (206 kW)	2012.04-	-	-	-	F Hatchback Engine B 20 NFT	899367	Outer Joint		30	27	58.9	94	64.5	M
ASTRAMAX														
1.4 i/1.6	1991.10-	1994.02	MT	L F	LCV	260010	Drive Shaft		22	22	52.2	97	587	
	1991.10-	1994.02	MT	R F	LCV	260011	Drive Shaft		22	22	52	95	920	
ASTRAMAX (T85)														
1.4 S (55 kW)	1989.07-	1991.08	-	-	F Box Engine 14 NV	844023	Outer Joint		22	22	52	95	50	O
1.6 (60 kW)	1985.09-	1991.12	MT	-	F Box Engine 16 SV	808003	Outer Joint		33	25	52	109	61	O
	1985.09-	1991.12	AT	-	F Box Engine 16 SV	844023	Outer Joint		22	22	52	95	50	O
	1985.09-	1991.12	MT	-	F Box Engine 16 SV	644001	Inner Joint		34	22	35	56.2	76	
ASTRAVAN														
1.3(66kW)	2005-	2012	-	R F	Box	644011	Inner Joint		34	25	37.5	46	55	
	2005-	2012	-	R F	Box	644011	Inner Joint		34	25	37.5	46	55	
	2005-	2012	-	R F	Box	644011	Inner Joint		34	25	37.5	46	55	
	2005-	2012	-	R F	Box	644011	Inner Joint		34	25	37.5	46	55	
	2005-	2012	-	R F	Box	644011	Inner Joint		34	25	37.5	46	55	
	2005-	2012	-	R F	Box	644011	Inner Joint		34	25	37.5	46	55	
ASTRAVAN Mk III (F) (T92)														
1.4 i (44 kW)	1991.01-	1994.10	MT	L F	Box Engine C 14 NZ	244002	Drive Shaft	29T	22	22	52	95	585	
	1991.01-	1994.10	-	-	F Box Engine C 14 NZ	844023	Outer Joint		22	22	52	95	50	O
	1991.01-	1994.10	MT	L/R	F Box Engine C 14 NZ	644004	Inner Joint		22	22	34.95	57.5	72.5	
	1991.01-	1994.10	MT	R F	Box Engine C 14 NZ	260002	Drive Shaft	29T	22	22	52	95	926	
	1991.01-	1994.10	MT	L/R	F Box Engine C 14 NZ	844051	Outer Joint	29T	22	22	52	95	50.5	O
1.6 i (52 kW)	1994.02-	1996.10	-	-	F Box Engine X 16 SZ	844023	Outer Joint		22	22	52	95	50	O
	1994.02-	1996.10	MT	L/R	F Box Engine X 16 SZ	644004	Inner Joint		22	22	34.95	57.5	72.5	
1.6 i (55 kW)	1991.01-	1998.08	-	-	F Box Engine C 16 NZ	844023	Outer Joint		22	22	52	95	50	O
	1991.01-	1998.08	MT	L/R	F Box Engine C 16 NZ	644004	Inner Joint		22	22	34.95	57.5	72.5	
1.7 D (44 kW)	1991.01-	1994.08	-	-	F Box Engine 17 DR	844023	Outer Joint		22	22	52	95	50	O
	1991.01-	1994.08	MT	L/R	F Box Engine 17 DR	644004	Inner Joint		22	22	34.95	57.5	72.5	
	1991.01-	1994.08	AT/MT	L/R	F Box Engine 17 DR	844056	Outer Joint	29T	33	25	52	109	61	O
1.7 TD (50 kW)	1994.01-	1998.08	AT/MT	L/R	F Box Engine X 17 DTL	621011	Inner Joint		34	25	35	78	64	
	1994.01-	1998.08	-	-	F Box Engine X 17 DTL	808003	Outer Joint		33	25	52	109	61	O
ASTRAVAN Mk IV (G) (T98)														
1.4 16V (66 kW)	2000.09-	2005.05	-	L/R	F Box Engine Z 14 XE	644004	Inner Joint		22	22	34.95	57.5	72.5	
	2000.09-	2005.05	-	L F	Box Engine Z 14 XE	260013	Drive Shaft		33	22	52	103	595	
	2000.09-	2005.05	-	R F	Box Engine Z 14 XE	244033	Drive Shaft		33	22	52	103	950.5	
	2000.09-	2005.05	-	L F	Box Engine Z 14 XE	621014	Inner Joint		22	22	35	57.5	75	
1.6 Dualfuel 16V (77 kW)	2004.10-	2005.12	MT	L/R	F Box Engine Z 16 XEP	644004	Inner Joint		22	22	34.95	57.5	72.5	
	2004.10-	2005.12	MT	L F	Box Engine Z 16 XEP	260013	Drive Shaft		33	22	52	103	595	
	2004.10-	2005.12	MT	R F	Box Engine Z 16 XEP	244033	Drive Shaft		33	22	52	103	950.5	
	2004.10-	2005.12	MT	L F	Box Engine Z 16 XEP	621014	Inner Joint		22	22	35	57.5	75	
1.6 Dualfuel(55 kW)	1998.02-	2000.12	-	L/R	F Box Engine X 16 SZR	644004	Inner Joint		22	22	34.95	57.5	72.5	
	1998.02-	2000.12	-	L F	Box Engine X 16 SZR	260013	Drive Shaft		33	22	52	103	595	
	1998.02-	2000.12	-	R F	Box Engine X 16 SZR	244033	Drive Shaft		33	22	52	103	950.5	
	1998.02-	2000.12	-	L F	Box Engine X 16 SZR	621014	Inner Joint		22	22	35	57.5	75	
1.6 Dualfuel(62 kW)	2000.09-	2004.10	MT	L/R	F Box Engine Z 16 SE	644004	Inner Joint		22	22	34.95	57.5	72.5	
	2000.09-	2004.10	MT	L F	Box Engine Z 16 SE	260013	Drive Shaft		33	22	52	103	595	
	2000.09-	2004.10	MT	R F	Box Engine Z 16 SE	244033	Drive Shaft		33	22	52	103	950.5	
	2000.09-	2004.10	MT	L F	Box Engine Z 16 SE	621014	Inner Joint		22	22	35	57.5	75	
1.6 i (55 kW)	1998.08-	2000.09	-	L/R	F Box Engine X 16 SZR	644004	Inner Joint		22	22	34.95	57.5	72.5	
	1998.08-	2000.09	-	L F	Box Engine X 16 SZR	260013	Drive Shaft		33	22	52	103	595	
	1998.08-	2000.09	-	R F	Box Engine X 16 SZR	244033	Drive Shaft		33	22	52	103	950.5	
	1998.08-	2000.09	-	L F	Box Engine X 16 SZR	621014	Inner Joint		22	22	35	57.5	75	
1.6 i (62 kW)	2000.09-	2006.08	-	L F	Box Engine Z 16 SE	260013	Drive Shaft		33	22	52	103	595	

YEAR	TRANSM	L/R	F/R	REMARKS	GSP Ref.	PRODUCT	ABS	Technical Specifications									
								A	B	C	H	L	P				
VAUXHALL																	
ASTRAVAN Mk IV (G) (T98)																	
1.6 i (62 kW)	2000.09-2006.08	-	-	F	Box Engine Z 16 SE	844010	Outer Joint	29T	33	22	52	103	50.5	O			
	2000.09-2006.08	-	R	F	Box Engine Z 16 SE	244033	Drive Shaft		33	22	52	103	950.5				
	2000.09-2006.08	-	L/R	F	Box Engine Z 16 SE	644004	Inner Joint		22	22	34.95	57.5	72.5				
	2000.09-2006.08	-	L	F	Box Engine Z 16 SE	621014	Inner Joint		22	22	35	57.5	75				
1.7 CDTI (59 kW)	2004.04-2006.08	-	R	F	Box Engine Z 17 DTL	699026	Inner Joint		22	25	35	57	82.5				
	2004.04-2006.08	AT/MT	L/R	F	Box Engine Z 17 DTL	844006	Outer Joint	29T	33	25	52	103.5	61	O			
	2004.04-2006.08	-	R	F	Box Engine Z 17 DTL	260035	Drive Shaft		33	22	52	109	961				
1.7 DTI 16V (55 kW)	2001.04-2006.08	-	R	F	Box Engine Y 17 DT	699026	Inner Joint		22	25	35	57	82.5				
	2001.04-2006.08	AT/MT	L/R	F	Box Engine Y 17 DT	844006	Outer Joint	29T	33	25	52	103.5	61	O			
	2001.04-2006.08	-	R	F	Box Engine Y 17 DT	260035	Drive Shaft		33	22	52	109	961				
1.7 TD (50 kW)	1998.08-2006.08	-	L	F	Box Engine X 17 DTL	260013	Drive Shaft		33	22	52	103	595				
	1998.08-2006.08	-	-	F	Box Engine X 17 DTL	844010	Outer Joint	29T	33	22	52	103	50.5	O			
	1998.08-2006.08	-	R	F	Box Engine X 17 DTL	244033	Drive Shaft		33	22	52	103	950.5				
	1998.08-2006.08	-	L	F	Box Engine X 17 DTL	621014	Inner Joint		22	22	35	57.5	75				
2.0 DI (60 kW)	1998.08-2006.08	AT/MT	L/R	F	Box Engine X 20 DTL	844006	Outer Joint	29T	33	25	52	103.5	61	O			
	1998.08-2006.08	-	L/R	F	Box Engine X 20 DTL	644002	Inner Joint		34	25	35	56.2	85.6				
	1998.08-2006.08	-	-	F	Box Engine X 20 DTL	844049	Outer Joint		33	25	52	109	61	O			
	1998.08-2006.08	-	L	F	Box Engine X 20 DTL	244044	Drive Shaft		33	34	52	103.5	595				
2.0 DTI (74 kW)	2004.04-2006.08	AT/MT	L/R	F	Box Engine Y 20 DTH	844006	Outer Joint	29T	33	25	52	103.5	61	O			
	2004.04-2006.08	MT	L/R	F	Box Engine Y 20 DTH	621011	Inner Joint		34	25	35	78	64				
	2004.04-2006.08	-	L/R	F	Box Engine Y 20 DTH	644002	Inner Joint		34	25	35	56.2	85.6				
	2004.04-2006.08	-	L	F	Box Engine Y 20 DTH	244044	Drive Shaft		33	34	52	103.5	595				
ASTRAVAN Mk V (H) (A04)																	
1.3 CDTI (66 kW)	2005.08-	-	-	R	F	Box Engine Z 13 DTH	244051	Drive Shaft		33	34	53	93.5	570			
	2005.08-	-	-	L	F	Box Engine Z 13 DTH	244052	Drive Shaft		33	25	53	93.5	573			
	2005.08-	MT	L	F	Box Engine Z 13 DTH	260020	Drive Shaft		33	25	52.5	94	561				
	2005.08-	-	L/R	F	Box Engine Z 13 DTH	844028	Outer Joint		33	24	53	93.5	63.5	M			
	2005.08-	MT	L	F	Box Engine Z 13 DTH	621018	Inner Joint		25	34	35	58	116				
1.4 i (66 kW)	2005.03-	-	-	L	F	Box Engine Z 14 XEP	244028	Drive Shaft		33	22	53	95	590			
	2005.03-	-	-	L	F	Box Engine Z 14 XEP	621014	Inner Joint		22	22	35	57.5	75			
	2005.03-	-	L/R	F	Box Engine Z 14 XEP	844003	Outer Joint		33	22	53	95	54.5	M			
	2005.03-	-	-	R	F	Box Engine Z 14 XEP	244030	Drive Shaft		33	22	53	95	952			
1.6 (76 kW)	2005.03-	-	-	L	F	Box Engine Z 16 XE1	244028	Drive Shaft		33	22	53	95	590			
	2005.03-	-	-	L	F	Box Engine Z 16 XE1	621014	Inner Joint		22	22	35	57.5	75			
	2005.03-	-	L/R	F	Box Engine Z 16 XE1	844003	Outer Joint		33	22	53	95	54.5	M			
	2005.03-	-	-	R	F	Box Engine Z 16 XE1	244030	Drive Shaft		33	22	53	95	952			
1.7 CDTI (59 kW)	2005.03-2006.07	-	R	F	Box Engine Z 17 DTL	644005	Inner Joint		34	25	35	54	47				
	2005.03-2006.07	-	L	F	Box Engine Z 17 DTL	699026	Inner Joint		22	25	35	57	82.5				
	2005.03-2006.07	MT	R	F	Box Engine Z 17 DTL	221055	Drive Shaft		33	22	53	93.5	950				
	2005.03-2006.07	-	L	F	Box Engine Z 17 DTL	221063	Drive Shaft		33	22	53	93.5	586				
	2005.03-2006.07	-	L/R	F	Box Engine Z 17 DTL	844028	Outer Joint		33	24	53	93.5	63.5	M			
1.7 CDTI (74 kW)	2005.03-2011.11	-	L/R	F	Box Engine Z 17 DTH	844027	Outer Joint		33	26	52.5	94	65.5	M			
	2005.03-2011.11	-	R	F	Box Engine Z 17 DTH	244031	Drive Shaft		33	34	53	93.5	559				
	2005.03-2011.11	-	R	F	Box Engine Z 17 DTH	221056	Drive Shaft		33	34	52.5	94	595				
	2005.03-2011.11	-	L	F	Box Engine Z 17 DTH	244052	Drive Shaft		33	25	53	93.5	573				
	2005.03-2011.11	5AT	R	F	Box Engine Z 17 DTH	644005	Inner Joint		34	25	35	54	47				
	2005.03-2011.11	-	L	F	Box Engine Z 17 DTH	221073	Drive Shaft		33	25	52.5	94	578				
	2005.03-2011.11	-	L	F	Box Engine Z 17 DTH	621018	Inner Joint		25	34	35	58	116				
	2005.03-2011.11	-	L	F	Box Engine Z 17 DTH	699186	Inner Joint		25	28	35	57.5	81.5				
	2005.03-2011.11	5AT	L	F	Box Engine Z 17 DTH	244024	Drive Shaft		33	34	53	93.5	589				
	2005.03-2011.11	-	L/R	F	Box Engine Z 17 DTH	844028	Outer Joint		33	24	53	93.5	63.5	M			
1.7 CDTI (81 kW)	2011.06-2013.12	MT	R	F	Box Engine Z 17 DTJ	644016	Inner Joint		34	28	37.5	46	54				
	2011.06-2013.12	MT	R	F	Box Engine Z 17 DTJ	244099	Drive Shaft		33	34	52.5	94	563				
	2011.06-2013.12	MT	L	F	Box Engine Z 17 DTJ	699186	Inner Joint		25	28	35	57.5	81.5				
	2011.06-2013.12	-	R	F	Box Engine Z 17 DTJ	644005	Inner Joint		34	25	35	54	47				
	2011.06-2013.12	-	-	F	Box Engine Z 17 DTJ	899024	Outer Joint		33	26	52.5	94	65.5	M			
	2011.06-2013.12	MT	L	F	Box Engine Z 17 DTJ	221051	Drive Shaft		33	25	52.5	94	579				
	2011.06-2013.12	MT	L/R	F	Box Engine Z 17 DTJ	844027	Outer Joint		33	26	52.5	94	65.5	M			
1.7 CDTI (92 kW)	2011.11-	MT	R	F	Box Engine Z 17 DTR	644016	Inner Joint		34	28	37.5	46	54				
	2011.11-	MT	R	F	Box Engine Z 17 DTR	244099	Drive Shaft		33	34	52.5	94	563				
	2011.11-	MT	L	F	Box Engine Z 17 DTR	699186	Inner Joint		25	28	35	57.5	81.5				
	2011.11-	-	R	F	Box Engine Z 17 DTR	644005	Inner Joint		34	25	35	54	47				
	2011.11-	-	-	F	Box Engine Z 17 DTR	899024	Outer Joint		33	26	52.5	94	65.5	M			
	2011.11-	MT	L	F	Box Engine Z 17 DTR	221051	Drive Shaft		33	25	52.5	94	579				
	2011.11-	MT	L/R	F	Box Engine Z 17 DTR	844027	Outer Joint		33	26	52.5	94	65.5	M			
1.9 CDTI (110 kW)	2005.03-2011.11	-	-	F	Box Engine Z 19 DTH	899023	Outer Joint		30	26	53.8	94.5	65.5	M			

YEAR	TRANS	L/R	F/R	REMARKS	GSP Ref.	PRODUCT	ABS	Technical Specifications						
								A	B	C	H	L	P	
VAUXHALL														
ASTRAVAN Mk V (H) (A04)														
1.9 CDTI (110 kW)	2005.03-2011.11	-	L	F	Box Engine Z 19 DTH	221035	Drive Shaft		30	25	53.8	94.5	581	
	2005.03-2011.11	-	L/R	F	Box Engine Z 19 DTH	817051	Outer Joint		30	26	53.8	94.5	65.5	M
	2005.03-2011.11	-	L	F	Box Engine Z 19 DTH	699186	Inner Joint		25	28	35	57.5	81.5	
	2005.03-2011.11	-	L	F	Box Engine Z 19 DTH	621018	Inner Joint		25	34	35	58	116	
	2005.03-2011.11	-	L	F	Box Engine Z 19 DTH	221071	Drive Shaft		30	25	53.8	94.5	576	
	2005.03-2011.11	-	R	F	Box Engine Z 19 DTH	221062	Drive Shaft		30	34	53.8	94.5	595	
	2005.03-2011.11	-	R	F	Box Engine Z 19 DTH	260016	Drive Shaft		30	34	52.5	105	588	
1.9 CDTI (88 kW)	2005.03-2011.11	-	L/R	F	Box Engine Z 19 DT	844027	Outer Joint		33	26	52.5	94	65.5	M
	2005.03-2011.11	-	R	F	Box Engine Z 19 DT	221056	Drive Shaft		33	34	52.5	94	595	
	2005.03-2011.11	-	L	F	Box Engine Z 19 DT	221073	Drive Shaft		33	25	52.5	94	578	
	2005.03-2011.11	-	L	F	Box Engine Z 19 DT	621018	Inner Joint		25	34	35	58	116	
	2005.03-2011.11	-	L	F	Box Engine Z 19 DT	699186	Inner Joint		25	28	35	57.5	81.5	
	2005.03-2011.11	AT	L	F	Box Engine Z 19 DT	221111	Drive Shaft		33	27	52.5	94	562	
	2005.03-2011.11	-	-	F	Box Engine Z 19 DT	899024	Outer Joint		33	26	52.5	94	65.5	M
	2005.03-2011.11	AT	R	F	Box Engine Z 19 DT	221110	Drive Shaft		33	27	52.5	94	576	
CALIBRA														
2.0 16v	1991.08-1998.08	MT	L	F	All Incl. 4WD	260012	Drive Shaft	29T	33	34	52	103.5	586	
2.0 8v	1991.08-1996.12	MT	L	F	All	260012	Drive Shaft	29T	33	34	52	103.5	586	
2.0 Turbo	1991.08-1998.08	MT	L	F	All Incl. 4WD	260012	Drive Shaft	29T	33	34	52	103.5	586	
CALIBRA (C89)														
2.0 i (85 kW)	1990.06-1997.07	AT/MT	L/R	F	Coupe Engine C 20 NE	621011	Inner Joint		34	25	35	78	64	
	1990.06-1997.07	MT	L/R	F	All-wheel Drive Coupe Engine C 20 NE	621011	Inner Joint		34	25	35	78	64	
	1990.06-1997.07	MT	L	F	Coupe Engine C 20 NE	244011	Drive Shaft	29T	33	34	52	109	594.5	
	1990.06-1997.07	MT	L	F	All-wheel Drive Coupe Engine C 20 NE	244011	Drive Shaft	29T	33	34	52	109	594.5	
	1990.06-1997.07	-	R	F	Coupe Engine C 20 NE	644005	Inner Joint		34	25	35	54	47	
	1990.06-1997.07	-	R	F	All-wheel Drive Coupe Engine C 20 NE	644005	Inner Joint		34	25	35	54	47	
	1990.06-1997.07	AT/MT	L/R	F	Coupe Engine C 20 NE	844056	Outer Joint	29T	33	25	52	109	61	O
	1990.06-1997.07	MT	L/R	F	All-wheel Drive Coupe Engine C 20 NE	844056	Outer Joint	29T	33	25	52	109	61	O
	1990.06-1997.07	MT	R	F	Coupe Engine C 20 NE	244059	Drive Shaft	29T	33	34	52	109	938	
	1990.06-1997.07	MT	L	F	All-wheel Drive Coupe Engine C 20 NE	644002	Inner Joint		34	25	35	56.2	85.6	
	1990.06-1997.07	AT/MT	L/R	F	Coupe Engine C 20 NE	844057	Outer Joint	43T	33	25	52	109	61	O
	1990.06-1997.07	MT	L/R	F	All-wheel Drive Coupe Engine C 20 NE	844057	Outer Joint	43T	33	25	52	109	61	O
	1990.06-1997.07	-	-	-	All-wheel Drive Coupe Engine C 20 NE	808003	Outer Joint		33	25	52	109	61	O
	1990.06-1997.07	MT	L/R	F	Coupe Engine C 20 NE	644002	Inner Joint		34	25	35	56.2	85.6	
2.0 i 16V (100 kW)	1990.06-1997.07	-	R	F	Coupe Engine X 20 XEV	644005	Inner Joint		34	25	35	54	47	
	1990.06-1997.07	MT	L/R	F	Coupe Engine X 20 XEV	844056	Outer Joint	29T	33	25	52	109	61	O
	1990.06-1997.07	MT	L/R	F	Coupe Engine X 20 XEV	844057	Outer Joint	43T	33	25	52	109	61	O
	1990.06-1997.07	MT	L/R	F	Coupe Engine X 20 XEV	621011	Inner Joint		34	25	35	78	64	
	1994.02-1997.07	MT	L	F	All-wheel Drive Coupe Engine X 20 XEV	621011	Inner Joint		34	25	35	78	64	
	1994.02-1997.07	-	R	F	All-wheel Drive Coupe Engine X 20 XEV	644005	Inner Joint		34	25	35	54	47	
	1994.02-1997.07	MT	L/R	F	All-wheel Drive Coupe Engine X 20 XEV	844057	Outer Joint	43T	33	25	52	109	61	O
	1994.02-1997.07	MT	L/R	F	All-wheel Drive Coupe Engine X 20 XEV	844056	Outer Joint	29T	33	25	52	109	61	O
2.0 i 16V (110 kW)	1990.06-1994.02	MT	L	F	All-wheel Drive Coupe Engine C 20 XE	244011	Drive Shaft	29T	33	34	52	109	594.5	
	1990.06-1994.02	-	R	F	Coupe Engine C 20 XE	644005	Inner Joint		34	25	35	54	47	
	1990.06-1994.02	MT	L	F	Coupe Engine C 20 XE	244011	Drive Shaft	29T	33	34	52	109	594.5	
	1990.06-1994.02	-	R	F	All-wheel Drive Coupe Engine C 20 XE	644005	Inner Joint		34	25	35	54	47	
	1990.06-1994.02	MT	L/R	F	All-wheel Drive Coupe Engine C 20 XE	844056	Outer Joint	29T	33	25	52	109	61	O
	1990.06-1994.02	MT	L	F	All-wheel Drive Coupe Engine C 20 XE	644002	Inner Joint		34	25	35	56.2	85.6	
	1990.06-1994.02	MT	L/R	F	All-wheel Drive Coupe Engine C 20 XE	844057	Outer Joint	43T	33	25	52	109	61	O
	1990.06-1994.02	MT	L/R	F	Coupe Engine C 20 XE	844057	Outer Joint	43T	33	25	52	109	61	O
	1990.06-1994.02	MT	L/R	F	Coupe Engine C 20 XE	621011	Inner Joint		34	25	35	78	64	
	1990.06-1994.02	MT	L	F	Coupe Engine C 20 XE	644002	Inner Joint		34	25	35	56.2	85.6	
2.0 i Turbo (150 kW)	1992.03-1997.07	MT	L/R	F	All-wheel Drive Coupe Engine C 20 LET	621011	Inner Joint		34	25	35	78	64	
	1992.03-1997.07	MT	L	F	All-wheel Drive Coupe Engine C 20 LET	244011	Drive Shaft	29T	33	34	52	109	594.5	
	1992.03-1997.07	-	R	F	All-wheel Drive Coupe Engine C 20 LET	644005	Inner Joint		34	25	35	54	47	
	1992.03-1997.07	MT	L/R	F	All-wheel Drive Coupe Engine C 20 LET	844056	Outer Joint	29T	33	25	52	109	61	O
	1992.03-1997.07	MT	L	F	All-wheel Drive Coupe Engine C 20 LET	644002	Inner Joint		34	25	35	56.2	85.6	
2.5 i V6 (125 kW)	1993.04-1997.07	-	R	F	Coupe Engine C 25 XE	644005	Inner Joint		34	25	35	54	47	
	1993.04-1997.07	MT	L	F	Coupe Engine C 25 XE	644002	Inner Joint		34	25	35	56.2	85.6	
	1993.04-1997.07	AT/MT	L	F	Coupe Engine C 25 XE	621011	Inner Joint		34	25	35	78	64	
CARLTON Mk III (V87)														
2.3 TD Interc. (74 kW)	1988.08-1994.03	AT/MT	L/R	R	Saloon Engine 23 DTR	648002	Inner Joint				28		32	
	1988.09-1994.03	AT/MT	L/R	R	Estate Engine 23 DTR	648002	Inner Joint				28		32	
2.6 i (110 kW)	1990.09-1994.03	AT/MT	L/R	R	Saloon Engine C 26 NE	648002	Inner Joint				28		32	
	1990.09-1994.03	AT/MT	L/R	R	Estate Engine C 26 NE	648002	Inner Joint				28		32	

YEAR	TRANSM	L/R	F/R	REMARKS	GSP Ref.	PRODUCT	ABS	Technical Specifications						
								A	B	C	H	L	P	
VAUXHALL														
CARLTON Mk III (V87)														
3.0 (130 kW)	1987.03-1994.03	AT/MT	L/R	R	Estate Engine C 30 NE	648002	Inner Joint			28		32		
3.0 24V (147 kW)	1989.09-1994.03	AT/MT	L/R	R	Estate Engine C 30 SEJ	648002	Inner Joint			28		32		
3.0 3000 (130 kW)	1987.03-1990.09	AT/MT	L/R	R	Saloon Engine 30 NE	648002	Inner Joint			28		32		
3.0 3000 24V (150 kW)	1989.09-1994.03	AT/MT	L/R	R	Saloon Engine C 30 SE	648002	Inner Joint			28		32		
3000 24V (147 kW)	1989.09-1994.03	AT/MT	L/R	R	Saloon Engine C 30 SEJ	648002	Inner Joint			28		32		
3000 Cat (130 kW)	1988.03-1994.03	AT/MT	L/R	R	Saloon Engine C 30 NE	648002	Inner Joint			28		32		
CASCADA (W13)														
1.4 (103 kW)	2013.02-	-	-	F	Convertible Engine A 14 NET	899023	Outer Joint	30	26	53.8	94.5	65.5	M	
1.6 (125 kW)	2013.02-	-	-	F	Convertible Engine A 16 XHT	899023	Outer Joint	30	26	53.8	94.5	65.5	M	
1.6 (147 kW)	2013.11-	-	-	F	Convertible Engine A 16 SHT	899023	Outer Joint	30	26	53.8	94.5	65.5	M	
2.0 CDTI (121 kW)	2013.02-	AT	-	F	Convertible Engine A 20 DTH	899023	Outer Joint	30	26	53.8	94.5	65.5	M	
	2013.02-	MT	L	F	Convertible Engine A 20 DTH	899367	Outer Joint	30	27	58.9	94	64.5	M	
	2013.02-	-	L/R	F	Convertible Engine A 20 DTH	817051	Outer Joint	30	26	53.8	94.5	65.5	M	
2.0 CDTI (125 kW)	2015.07-	AT	-	F	Convertible Engine B 20 DTH	899023	Outer Joint	30	26	53.8	94.5	65.5	M	
	2015.07-	MT	L	F	Convertible Engine B 20 DTH	899367	Outer Joint	30	27	58.9	94	64.5	M	
2.0 CDTI (143 kW)	2013.02-	AT	-	F	Convertible Engine A 20 DTR	899023	Outer Joint	30	26	53.8	94.5	65.5	M	
	2013.02-	MT	L	F	Convertible Engine A 20 DTR	899367	Outer Joint	30	27	58.9	94	64.5	M	
	2013.02-	-	L/R	F	Convertible Engine A 20 DTR	817051	Outer Joint	30	26	53.8	94.5	65.5	M	
CAVALIER III														
1.4/1.6	1988-1995	MT	L	F	-	260010	Drive Shaft		22	22	52.2	97	587	
	1988-1995	MT	R	F	-	260011	Drive Shaft		22	22	52	95	920	
1.7 TD	1992.03-1995.10	MT	L	F	All	260012	Drive Shaft	29T	33	34	52	103.5	586	
1.8	1991.08-1995.10	MT	L	F	All Incl. 4WD	260012	Drive Shaft	29T	33	34	52	103.5	586	
2.0 16v	1991.08-1995.10	MT	L	F	All Incl. 4WD	260012	Drive Shaft	29T	33	34	52	103.5	586	
2.0 8v	1991.08-1995.10	MT	L	F	All Incl. 4WD	260012	Drive Shaft	29T	33	34	52	103.5	586	
2.0 Turbo	1992.10-1994.08	MT	L	F	4WD	260012	Drive Shaft	29T	33	34	52	103.5	586	
CAVALIER Mk III (J89)														
1.4 S (55 kW)	1988.09-1995.11	MT	L/R	F	Saloon Engine 14 NV	844051	Outer Joint	29T	22	22	52	95	50.5	O
	1988.09-1995.11	MT	L/R	F	Hatchback Engine 14 NV	844051	Outer Joint	29T	22	22	52	95	50.5	O
	1988.09-1995.11	MT	L	F	Saloon Engine 14 NV	244002	Drive Shaft	29T	22	22	52	95	585	
	1988.09-1995.11	MT	L	F	Hatchback Engine 14 NV	244002	Drive Shaft	29T	22	22	52	95	585	
	1988.09-1995.11	MT	L/R	F	Saloon Engine 14 NV	644004	Inner Joint		22	22	34.95	57.5	72.5	
	1988.09-1995.11	MT	R	F	Saloon Engine 14 NV	260002	Drive Shaft	29T	22	22	52	95	926	
	1988.09-1995.11	MT	R	F	Hatchback Engine 14 NV	260002	Drive Shaft	29T	22	22	52	95	926	
	1988.09-1995.11	-	-	F	Saloon Engine 14 NV	844023	Outer Joint		22	22	52	95	50	O
	1988.09-1995.11	MT	L/R	F	Hatchback Engine 14 NV	644004	Inner Joint		22	22	34.95	57.5	72.5	
	1988.09-1995.11	-	-	F	Hatchback Engine 14 NV	844023	Outer Joint		22	22	52	95	50	O
1.6 (60 kW)	1988.09-1993.05	AT/MT	L/R	F	Saloon Engine 16 SV	844051	Outer Joint	29T	22	22	52	95	50.5	O
	1988.09-1993.05	AT/MT	L/R	F	Hatchback Engine 16 SV	844051	Outer Joint	29T	22	22	52	95	50.5	O
	1988.09-1993.05	MT	L	F	Saloon Engine 16 SV	244002	Drive Shaft	29T	22	22	52	95	585	
	1988.09-1993.05	MT	L	F	Hatchback Engine 16 SV	244002	Drive Shaft	29T	22	22	52	95	585	
	1988.09-1993.05	MT	L/R	F	Saloon Engine 16 SV	644004	Inner Joint		22	22	34.95	57.5	72.5	
	1988.09-1993.05	MT	R	F	Saloon Engine 16 SV	260002	Drive Shaft	29T	22	22	52	95	926	
	1988.09-1993.05	MT	R	F	Hatchback Engine 16 SV	260002	Drive Shaft	29T	22	22	52	95	926	
	1988.09-1993.05	-	-	F	Saloon Engine 16 SV	844023	Outer Joint		22	22	52	95	50	O
	1988.09-1993.05	MT	L/R	F	Hatchback Engine 16 SV	644004	Inner Joint		22	22	34.95	57.5	72.5	
	1988.09-1993.05	-	-	F	Hatchback Engine 16 SV	844023	Outer Joint		22	22	52	95	50	O
1.6 i (52 kW)	1993.09-1995.11	-	-	F	Hatchback Engine X 16 SZ	844023	Outer Joint		22	22	52	95	50	O
	1993.09-1995.11	MT	L/R	F	Saloon Engine X 16 SZ	644004	Inner Joint		22	22	34.95	57.5	72.5	
	1993.09-1995.11	MT	L/R	F	Hatchback Engine X 16 SZ	644004	Inner Joint		22	22	34.95	57.5	72.5	
	1993.09-1995.11	-	-	F	Saloon Engine X 16 SZ	844023	Outer Joint		22	22	52	95	50	O
1.6 i (55 kW)	1988.09-1995.11	MT	L	F	Saloon Engine E 16 NZ	244002	Drive Shaft	29T	22	22	52	95	585	
	1988.09-1995.11	MT	L	F	Hatchback Engine E 16 NZ	244002	Drive Shaft	29T	22	22	52	95	585	
	1988.09-1995.11	-	-	F	Saloon Engine E 16 NZ	844023	Outer Joint		22	22	52	95	50	O
	1988.09-1995.11	-	-	F	Hatchback Engine E 16 NZ	844023	Outer Joint		22	22	52	95	50	O
	1988.09-1995.11	MT	L/R	F	Saloon Engine E 16 NZ	644004	Inner Joint		22	22	34.95	57.5	72.5	
	1988.09-1995.11	MT	L/R	F	Hatchback Engine E 16 NZ	644004	Inner Joint		22	22	34.95	57.5	72.5	
	1988.09-1995.11	MT	R	F	Saloon Engine E 16 NZ	260002	Drive Shaft	29T	22	22	52	95	926	
	1988.09-1995.11	MT	R	F	Hatchback Engine E 16 NZ	260002	Drive Shaft	29T	22	22	52	95	926	
	1988.09-1995.11	AT/MT	L/R	F	Saloon Engine E 16 NZ	844051	Outer Joint	29T	22	22	52	95	50.5	O
	1988.09-1995.11	AT/MT	L/R	F	Hatchback Engine E 16 NZ	844051	Outer Joint	29T	22	22	52	95	50.5	O
1.7 D (42 kW)	1988.09-1992.09	-	R	F	Saloon Engine 17 D	244048	Drive Shaft		33	34	52	109	938	
	1988.09-1992.09	-	R	F	Hatchback Engine 17 D	244048	Drive Shaft		33	34	52	109	938	
	1988.09-1992.09	-	-	F	Saloon Engine 17 D	808003	Outer Joint		33	25	52	109	61	O
	1988.09-1992.09	AT/MT	L/R	F	Saloon Engine 17 D	844057	Outer Joint	43T	33	25	52	109	61	O
	1988.09-1992.09	AT/MT	L/R	F	Hatchback Engine 17 D	844057	Outer Joint	43T	33	25	52	109	61	O

YEAR	TRANSM	L/R	F/R	REMARKS	GSP Ref.	PRODUCT	ABS	Technical Specifications								
								A	B	C	H	L	P			
VAUXHALL																
CAVALIER Mk III (J89)																
1.7 D (42 kW)	1988.09-1992.09	-	-	F	Hatchback Engine 17 D	808003	Outer Joint		33	25	52	109	61	O		
	1988.09-1992.09	AT/MT	L/R	F	Saloon Engine 17 D	844056	Outer Joint	29T	33	25	52	109	61	O		
	1988.09-1992.09	AT/MT	L/R	F	Hatchback Engine 17 D	844056	Outer Joint	29T	33	25	52	109	61	O		
	1988.09-1992.09	MT	L/R	F	Saloon Engine 17 D	644004	Inner Joint		22	22	34.95	57.5	72.5			
	1988.09-1992.09	MT	L/R	F	Hatchback Engine 17 D	644004	Inner Joint		22	22	34.95	57.5	72.5			
	1988.09-1992.09	-	L	F	Saloon Engine 17 D	244014	Drive Shaft	43T	33	34	52	103.5	587			
	1988.09-1992.09	-	L	F	Hatchback Engine 17 D	244014	Drive Shaft	43T	33	34	52	103.5	587			
1.7 D (44 kW)	1992.07-1995.11	-	L	F	Saloon Engine 17 DR	244014	Drive Shaft	43T	33	34	52	103.5	587			
	1992.07-1995.11	-	R	F	Hatchback Engine 17 DR	244048	Drive Shaft		33	34	52	109	938			
	1992.07-1995.11	-	R	F	Saloon Engine 17 DR	244048	Drive Shaft		33	34	52	109	938			
	1992.07-1995.11	AT/MT	L/R	F	Hatchback Engine 17 DR	844056	Outer Joint	29T	33	25	52	109	61	O		
	1992.07-1995.11	AT/MT	L/R	F	Saloon Engine 17 DR	844056	Outer Joint	29T	33	25	52	109	61	O		
	1992.07-1995.11	MT	L/R	F	Hatchback Engine 17 DR	644004	Inner Joint		22	22	34.95	57.5	72.5			
	1992.07-1995.11	MT	L/R	F	Saloon Engine 17 DR	644004	Inner Joint		22	22	34.95	57.5	72.5			
	1992.07-1995.11	-	-	F	Hatchback Engine 17 DR	808003	Outer Joint		33	25	52	109	61	O		
	1992.07-1995.11	-	-	F	Saloon Engine 17 DR	808003	Outer Joint		33	25	52	109	61	O		
	1992.07-1995.11	-	L	F	Hatchback Engine 17 DR	244014	Drive Shaft	43T	33	34	52	103.5	587			
1.7 TD (60 kW)	1988.09-1995.11	MT	L/R	F	Saloon Engine 17 DT (TC4EE1)	621011	Inner Joint		34	25	35	78	64			
	1988.09-1995.11	MT	L/R	F	Hatchback Engine 17 DT (TC4EE1)	621011	Inner Joint		34	25	35	78	64			
	1988.09-1995.11	MT	L	F	Saloon Engine 17 DT (TC4EE1)	244011	Drive Shaft	29T	33	34	52	109	594.5			
	1988.09-1995.11	MT	L	F	Hatchback Engine 17 DT (TC4EE1)	244011	Drive Shaft	29T	33	34	52	109	594.5			
	1988.09-1995.11	AT/MT	L/R	F	Saloon Engine 17 DT (TC4EE1)	844056	Outer Joint	29T	33	25	52	109	61	O		
	1988.09-1995.11	MT	L/R	F	Saloon Engine 17 DT (TC4EE1)	644002	Inner Joint		34	25	35	56.2	85.6			
	1988.09-1995.11	AT/MT	L/R	F	Hatchback Engine 17 DT (TC4EE1)	844056	Outer Joint	29T	33	25	52	109	61	O		
	1988.09-1995.11	MT	R	F	Saloon Engine 17 DT (TC4EE1)	244059	Drive Shaft	29T	33	34	52	109	938			
	1988.09-1995.11	MT	R	F	Hatchback Engine 17 DT (TC4EE1)	244059	Drive Shaft	29T	33	34	52	109	938			
	1988.09-1995.11	AT/MT	L/R	F	Saloon Engine 17 DT (TC4EE1)	844057	Outer Joint	43T	33	25	52	109	61	O		
	1988.09-1995.11	MT	L/R	F	Hatchback Engine 17 DT (TC4EE1)	644002	Inner Joint		34	25	35	56.2	85.6			
	1988.09-1995.11	AT/MT	L/R	F	Hatchback Engine 17 DT (TC4EE1)	844057	Outer Joint	43T	33	25	52	109	61	O		
	1988.09-1995.11	-	-	F	Saloon Engine 17 DT (TC4EE1)	808003	Outer Joint		33	25	52	109	61	O		
	1988.09-1995.11	-	-	F	Hatchback Engine 17 DT (TC4EE1)	808003	Outer Joint		33	25	52	109	61	O		
1.8 (65 kW)	1989.09-1992.08	-	L	F	Saloon Engine E 18 NVR	244014	Drive Shaft	43T	33	34	52	103.5	587			
	1989.09-1992.08	-	R	F	Saloon Engine E 18 NVR	244048	Drive Shaft		33	34	52	109	938			
1.8 (66 kW)	1988.09-1995.08	MT	L/R	F	Saloon Engine C 18 NZ	644002	Inner Joint		34	25	35	56.2	85.6			
	1988.09-1990.10	MT	L/R	F	Hatchback Engine 18 SV	621011	Inner Joint		34	25	35	78	64			
	1988.09-1990.10	MT	L/R	F	Hatchback Engine 18 SV	644002	Inner Joint		34	25	35	56.2	85.6			
	1988.09-1995.08	MT	L/R	F	Saloon Engine C 18 NZ	621011	Inner Joint		34	25	35	78	64			
	1988.09-1995.08	MT	L	F	Saloon Engine C 18 NZ	244011	Drive Shaft	29T	33	34	52	109	594.5			
	1988.09-1990.10	MT	L	F	Hatchback Engine 18 SV	244011	Drive Shaft	29T	33	34	52	109	594.5			
	1988.09-1995.08	AT/MT	L/R	F	Saloon Engine C 18 NZ	844056	Outer Joint	29T	33	25	52	109	61	O		
	1988.09-1990.10	AT/MT	L/R	F	Hatchback Engine 18 SV	844056	Outer Joint	29T	33	25	52	109	61	O		
	1988.09-1995.08	MT	R	F	Saloon Engine C 18 NZ	244059	Drive Shaft	29T	33	34	52	109	938			
	1988.09-1995.08	AT/MT	L/R	F	Saloon Engine C 18 NZ	844057	Outer Joint	43T	33	25	52	109	61	O		
	1988.09-1990.10	MT	R	F	Hatchback Engine 18 SV	244059	Drive Shaft	29T	33	34	52	109	938			
	1988.09-1990.10	AT/MT	L/R	F	Hatchback Engine 18 SV	844057	Outer Joint	43T	33	25	52	109	61	O		
	1988.09-1995.08	-	-	F	Saloon Engine C 18 NZ	808003	Outer Joint		33	25	52	109	61	O		
	1988.09-1990.10	-	-	F	Hatchback Engine 18 SV	808003	Outer Joint		33	25	52	109	61	O		
1.8 i Cat (66 kW)	1990.03-1995.11	MT	L/R	F	Saloon Engine C 18 NZ	621011	Inner Joint		34	25	35	78	64			
	1990.03-1995.11	MT	L/R	F	Hatchback Engine C 18 NZ	621011	Inner Joint		34	25	35	78	64			
	1990.03-1995.11	MT	L/R	F	Saloon Engine C 18 NZ	644002	Inner Joint		34	25	35	56.2	85.6			
	1990.03-1995.11	MT	L/R	F	Hatchback Engine C 18 NZ	644002	Inner Joint		34	25	35	56.2	85.6			
	1990.03-1995.11	MT	L	F	Saloon Engine C 18 NZ	244011	Drive Shaft	29T	33	34	52	109	594.5			
	1990.03-1995.11	MT	L	F	Hatchback Engine C 18 NZ	244011	Drive Shaft	29T	33	34	52	109	594.5			
	1990.03-1995.11	AT/MT	L/R	F	Saloon Engine C 18 NZ	844056	Outer Joint	29T	33	25	52	109	61	O		
	1990.03-1995.11	AT/MT	L/R	F	Hatchback Engine C 18 NZ	844056	Outer Joint	29T	33	25	52	109	61	O		
	1990.03-1995.11	MT	R	F	Saloon Engine C 18 NZ	244059	Drive Shaft	29T	33	34	52	109	938			
	1990.03-1995.11	AT/MT	L/R	F	Saloon Engine C 18 NZ	844057	Outer Joint	43T	33	25	52	109	61	O		
	1990.03-1995.11	MT	R	F	Hatchback Engine C 18 NZ	244059	Drive Shaft	29T	33	34	52	109	938			
	1990.03-1995.11	AT/MT	L/R	F	Hatchback Engine C 18 NZ	844057	Outer Joint	43T	33	25	52	109	61	O		
	1990.03-1995.11	-	-	F	Hatchback Engine C 18 NZ	808003	Outer Joint		33	25	52	109	61	O		
	2.0 i (85 kW)	1988.09-1990.10	MT	L/R	F	Saloon Engine 20 NE	621011	Inner Joint		34	25	35	78	64		
1988.09-1990.10		MT	L/R	F	Saloon Engine 20 NE	644002	Inner Joint		34	25	35	56.2	85.6			
1988.09-1992.10		MT	L/R	F	Hatchback Engine 20 NE	621011	Inner Joint		34	25	35	78	64			
1988.09-1992.10		MT	L/R	F	Hatchback Engine 20 NE	644002	Inner Joint		34	25	35	56.2	85.6			
1988.09-1990.10		MT	L	F	Saloon Engine 20 NE	244011	Drive Shaft	29T	33	34	52	109	594.5			
1988.09-1992.10		MT	L	F	Hatchback Engine 20 NE	244011	Drive Shaft	29T	33	34	52	109	594.5			

YEAR	TRANS	L/R	F/R	REMARKS	GSP Ref.	PRODUCT	ABS	Technical Specifications									
								A	B	C	H	L	P				
VAUXHALL																	
CAVALIER Mk III (J89)																	
2.0 i (85 kW)																	
1988.09-1990.10	AT/MT	L/R	F	Saloon Engine 20 NE	844056	Outer Joint	29T	33	25	52	109	61	O				
1988.09-1992.10	AT/MT	L/R	F	Hatchback Engine 20 NE	844056	Outer Joint	29T	33	25	52	109	61	O				
1988.09-1990.10	MT	-	F	Saloon Engine 20 NE	808003	Outer Joint		33	25	52	109	61	O				
1988.09-1990.10	MT	R	F	Saloon Engine 20 NE	244059	Drive Shaft	29T	33	34	52	109	938					
1988.09-1990.10	AT/MT	L/R	F	Saloon Engine 20 NE	844057	Outer Joint	43T	33	25	52	109	61	O				
1988.09-1992.10	MT	R	F	Hatchback Engine 20 NE	244059	Drive Shaft	29T	33	34	52	109	938					
1988.09-1992.10	AT/MT	L/R	F	Hatchback Engine 20 NE	844057	Outer Joint	43T	33	25	52	109	61	O				
1988.09-1992.10	-	-	F	Hatchback Engine 20 NE	808003	Outer Joint		33	25	52	109	61	O				
1991.01-1992.10	MT	L/R	F	All-wheel Drive Saloon Engine 20 NE	621011	Inner Joint		34	25	35	78	64					
1991.01-1992.10	MT	L/R	F	All-wheel Drive Hatchback Engine 20 NE	621011	Inner Joint		34	25	35	78	64					
1991.01-1992.10	-	R	F	All-wheel Drive Saloon Engine 20 NE	644005	Inner Joint		34	25	35	54	47					
1991.01-1992.10	-	R	F	All-wheel Drive Hatchback Engine 20 NE	644005	Inner Joint		34	25	35	54	47					
1991.01-1992.10	MT	L/R	F	All-wheel Drive Saloon Engine 20 NE	844056	Outer Joint	29T	33	25	52	109	61	O				
1991.01-1992.10	MT	L/R	F	All-wheel Drive Hatchback Engine 20 NE	844056	Outer Joint	29T	33	25	52	109	61	O				
1991.01-1992.10	MT	L/R	F	All-wheel Drive Saloon Engine 20 NE	844057	Outer Joint	43T	33	25	52	109	61	O				
1991.01-1992.10	MT	L/R	F	All-wheel Drive Hatchback Engine 20 NE	844057	Outer Joint	43T	33	25	52	109	61	O				
1991.01-1992.10	MT	L	F	All-wheel Drive Saloon Engine 20 NE	644002	Inner Joint		34	25	35	56.2	85.6					
1991.01-1992.10	MT	L	F	All-wheel Drive Hatchback Engine 20 NE	644002	Inner Joint		34	25	35	56.2	85.6					
2.0 i (95 kW)																	
1988.09-1992.09	MT	L/R	F	All-wheel Drive Saloon Engine 20 SEH	621011	Inner Joint		34	25	35	78	64					
1988.09-1992.09	-	R	F	All-wheel Drive Saloon Engine 20 SEH	644005	Inner Joint		34	25	35	54	47					
1988.09-1992.09	MT	L/R	F	All-wheel Drive Saloon Engine 20 SEH	844056	Outer Joint	29T	33	25	52	109	61	O				
1988.09-1992.09	MT	L	F	All-wheel Drive Saloon Engine 20 SEH	644002	Inner Joint		34	25	35	56.2	85.6					
1988.09-1992.09	MT	L/R	F	All-wheel Drive Saloon Engine 20 SEH	844057	Outer Joint	43T	33	25	52	109	61	O				
2.0 i 16V (100 kW)																	
1993.09-1995.11	-	R	F	Hatchback Engine X 20 XEV	644005	Inner Joint		34	25	35	54	47					
1993.09-1995.11	MT	L	F	Hatchback Engine X 20 XEV	644002	Inner Joint		34	25	35	56.2	85.6					
1993.09-1995.11	MT	L/R	F	Hatchback Engine X 20 XEV	621011	Inner Joint		34	25	35	78	64					
2.0 i 16V (110 kW)																	
1988.09-1995.11	MT	R	F	Saloon Engine C 20 XE	644005	Inner Joint		34	25	35	54	47					
1988.09-1995.11	MT	L	F	Hatchback Engine C 20 XE	621011	Inner Joint		34	25	35	78	64					
1988.09-1995.11	-	R	F	All-wheel Drive Saloon Engine C 20 XE	644005	Inner Joint		34	25	35	54	47					
1988.09-1995.11	MT	L	F	Saloon Engine C 20 XE	244011	Drive Shaft	29T	33	34	52	109	594.5					
1988.09-1995.11	MT	L	F	Hatchback Engine C 20 XE	244011	Drive Shaft	29T	33	34	52	109	594.5					
1988.09-1995.11	MT	L/R	F	All-wheel Drive Saloon Engine C 20 XE	844056	Outer Joint	29T	33	25	52	109	61	O				
1988.09-1995.11	MT	L	F	All-wheel Drive Saloon Engine C 20 XE	644002	Inner Joint		34	25	35	56.2	85.6					
1988.09-1995.11	MT	L/R	F	All-wheel Drive Saloon Engine C 20 XE	844057	Outer Joint	43T	33	25	52	109	61	O				
1988.09-1995.11	-	-	F	Saloon Engine C 20 XE	808003	Outer Joint		33	25	52	109	61	O				
1988.09-1995.11	MT	L/R	F	Saloon Engine C 20 XE	844057	Outer Joint	43T	33	25	52	109	61	O				
1988.09-1995.11	MT	L/R	F	Hatchback Engine C 20 XE	844057	Outer Joint	43T	33	25	52	109	61	O				
1988.09-1995.11	-	-	F	Saloon Engine C 20 XE	808003	Outer Joint		33	25	52	109	61	O				
1988.09-1995.11	MT	L/R	F	Saloon Engine C 20 XE	844056	Outer Joint	29T	33	25	52	109	61	O				
1988.09-1995.11	MT	L/R	F	Hatchback Engine C 20 XE	844056	Outer Joint	29T	33	25	52	109	61	O				
1988.09-1995.11	MT	L/R	F	Saloon Engine C 20 XE	621011	Inner Joint		34	25	35	78	64					
1988.09-1995.11	MT	L/R	F	All-wheel Drive Saloon Engine C 20 XE	621011	Inner Joint		34	25	35	78	64					
1988.09-1995.11	MT	L	F	Saloon Engine C 20 XE	644002	Inner Joint		34	25	35	56.2	85.6					
1988.09-1995.11	MT	L	F	Hatchback Engine C 20 XE	644002	Inner Joint		34	25	35	56.2	85.6					
1992.01-1993.11	-	R	F	All-wheel Drive Hatchback Engine C 20 XE	644005	Inner Joint		34	25	35	54	47					
1992.01-1993.11	MT	L/R	F	All-wheel Drive Hatchback Engine C 20 XE	844056	Outer Joint	29T	33	25	52	109	61	O				
1992.01-1993.11	MT	L	F	All-wheel Drive Hatchback Engine C 20 XE	644002	Inner Joint		34	25	35	56.2	85.6					
1992.01-1993.11	MT	L/R	F	All-wheel Drive Hatchback Engine C 20 XE	844057	Outer Joint	43T	33	25	52	109	61	O				
1992.01-1993.11	MT	L/R	F	All-wheel Drive Hatchback Engine C 20 XE	621011	Inner Joint		34	25	35	78	64					
2.0 i Cat (85 kW)																	
1990.09-1995.11	MT	R	F	Saloon Engine C 20 NE	644005	Inner Joint		34	25	35	54	47					
1990.09-1995.11	MT	L/R	F	Hatchback Engine C 20 NE	621011	Inner Joint		34	25	35	78	64					
1990.09-1995.11	MT	L/R	F	Saloon Engine C 20 NE	621011	Inner Joint		34	25	35	78	64					
1990.09-1995.11	MT	L/R	F	Hatchback Engine C 20 NE	644002	Inner Joint		34	25	35	56.2	85.6					
1990.09-1995.11	MT	L/R	F	Saloon Engine C 20 NE	644002	Inner Joint		34	25	35	56.2	85.6					
1990.09-1995.11	MT	L	F	Hatchback Engine C 20 NE	244011	Drive Shaft	29T	33	34	52	109	594.5					
1990.09-1995.11	MT	L	F	Saloon Engine C 20 NE	244011	Drive Shaft	29T	33	34	52	109	594.5					
1990.09-1995.11	AT/MT	L/R	F	Hatchback Engine C 20 NE	844056	Outer Joint	29T	33	25	52	109	61	O				
1990.09-1995.11	AT/MT	L/R	F	Saloon Engine C 20 NE	844056	Outer Joint	29T	33	25	52	109	61	O				
1990.09-1995.11	MT	R	F	Hatchback Engine C 20 NE	244059	Drive Shaft	29T	33	34	52	109	938					
1990.09-1995.11	AT/MT	L/R	F	Hatchback Engine C 20 NE	844057	Outer Joint	43T	33	25	52	109	61	O				
1990.09-1995.11	MT	R	F	Saloon Engine C 20 NE	244059	Drive Shaft	29T	33	34	52	109	938					
1990.09-1995.11	AT/MT	L/R	F	Saloon Engine C 20 NE	844057	Outer Joint	43T	33	25	52	109	61	O				
1990.09-1995.11	-	-	F	Hatchback Engine C 20 NE	808003	Outer Joint		33	25	52	109	61	O				
1990.09-1995.11	-	-	F	Saloon Engine C 20 NE	808003	Outer Joint		33	25	52	109	61	O				
2.0 i Turbo (150 kW)																	
1992.06-1994.11	MT	R	F	All-wheel Drive Saloon Engine C 20 LET	644005	Inner Joint		34	25	35	54	47					
2.0 SRi (95 kW)																	
1988.09-1992.09	MT	L/R	F	Saloon Engine 20 SEH	621011	Inner Joint		34	25	35	78	64					

YEAR	TRANSM	L/R	F/R	REMARKS	GSP Ref.	PRODUCT	ABS	Technical Specifications						
								A	B	C	H	L	P	
VAUXHALL														
CAVALIER Mk III (J89)														
2.0 SRi (95 kW)	1988.09-1992.09	MT	L/R	F	Saloon Engine 20 SEH	644002	Inner Joint		34	25	35	56.2	85.6	
	1988.09-1992.09	MT	L/R	F	Hatchback Engine 20 SEH	621011	Inner Joint		34	25	35	78	64	
	1988.09-1992.09	MT	R	F	Hatchback Engine 20 SEH	644005	Inner Joint		34	25	35	54	47	
	1988.09-1992.09	MT	L/R	F	Hatchback Engine 20 SEH	644002	Inner Joint		34	25	35	56.2	85.6	
	1988.09-1992.09	MT	L	F	Saloon Engine 20 SEH	244011	Drive Shaft	29T	33	34	52	109	594.5	
	1988.09-1992.09	MT	L	F	Hatchback Engine 20 SEH	244011	Drive Shaft	29T	33	34	52	109	594.5	
	1988.09-1992.09	AT/MT	L/R	F	Saloon Engine 20 SEH	844057	Outer Joint	43T	33	25	52	109	61	O
	1988.09-1992.09	AT/MT	L/R	F	Hatchback Engine 20 SEH	844057	Outer Joint	43T	33	25	52	109	61	O
	1988.09-1992.09	MT	R	F	Saloon Engine 20 SEH	244059	Drive Shaft	29T	33	34	52	109	938	
	1988.09-1992.09	MT	R	F	Hatchback Engine 20 SEH	244059	Drive Shaft	29T	33	34	52	109	938	
	1988.09-1992.09	-	-	F	Hatchback Engine 20 SEH	808003	Outer Joint		33	25	52	109	61	O
	1988.09-1992.09	AT/MT	L/R	F	Saloon Engine 20 SEH	844056	Outer Joint	29T	33	25	52	109	61	O
	1988.09-1992.09	AT/MT	L/R	F	Hatchback Engine 20 SEH	844056	Outer Joint	29T	33	25	52	109	61	O
2.0 SRi 16V (100 kW)	1993.09-1995.11	-	R	F	Saloon Engine X 20 XEV	644005	Inner Joint		34	25	35	54	47	
	1993.09-1995.11	MT	L/R	F	Saloon Engine X 20 XEV	621011	Inner Joint		34	25	35	78	64	
	1993.09-1995.11	MT	L	F	Saloon Engine X 20 XEV	644002	Inner Joint		34	25	35	56.2	85.6	
2.5 V6 (125 kW)	1988.08-1994.06	MT	R	F	Saloon Engine C 25 XE	644005	Inner Joint		34	25	35	54	47	
	1988.08-1994.06	MT	L	F	Saloon Engine C 25 XE	644002	Inner Joint		34	25	35	56.2	85.6	
	1988.09-1994.06	-	R	F	Hatchback Engine C 25 XE	644005	Inner Joint		34	25	35	54	47	
	1988.09-1994.06	MT	L	F	Hatchback Engine C 25 XE	644002	Inner Joint		34	25	35	56.2	85.6	
COMBO I														
1.4/1.7 TD	1993.10-2001.09	MT	L	F	LCV	260007	Drive Shaft		22	22	52	97	563	
COMBO II														
1.6/1.7 Di	2001.10-	MT	L	F	LCV	260018	Drive Shaft		22	22	52	97.5	587	
COMBO Mk I (B) (S93)														
1.4 (44 kW)	1994.07-2001.10	-	-	F	Box Engine C 14 NZ	644003	Inner Joint		22	28	34.95	57.5	83.5	
	1994.07-2001.10	-	-	F	Box Engine C 14 NZ	844018	Outer Joint		22	28	52.2	97.5	55	O
	1994.07-2001.10	MT	L/R	F	Box Engine C 14 NZ	844020	Outer Joint	29T	22	28	52	97.5	57.5	O
	1994.07-2001.10	MT	L	F	Box Engine C 14 NZ	299139	Drive Shaft		22	22	52	98	570.5	
	1994.07-2001.10	MT	L	F	Box Engine C 14 NZ	244001	Drive Shaft	29T	22	22	52	95	573	
	1994.07-2001.10	MT	R	F	Box Engine C 14 NZ	299138	Drive Shaft		22	22	52	98	916.5	
	1994.07-2001.10	-	R	F	Box Engine C 14 NZ	208005	Drive Shaft	29T	22	22	52	98	916.5	
	1994.07-2001.10	-	-	F	Box Engine C 14 NZ	844019	Outer Joint	29T	22	28	52	97.5	57.5	O
1.7 D (44 kW)	1994.07-2001.10	-	-	F	Box Engine X 17 D (4EE1)	644003	Inner Joint		22	28	34.95	57.5	83.5	
	1994.07-2001.10	-	-	F	Box Engine X 17 D (4EE1)	844018	Outer Joint		22	28	52.2	97.5	55	O
	1994.07-2001.10	MT	L/R	F	Box Engine X 17 D (4EE1)	844020	Outer Joint	29T	22	28	52	97.5	57.5	O
	1994.07-2001.10	MT	L	F	Box Engine X 17 D (4EE1)	299139	Drive Shaft		22	22	52	98	570.5	
	1994.07-2001.10	MT	L	F	Box Engine X 17 D (4EE1)	244001	Drive Shaft	29T	22	22	52	95	573	
	1994.07-2001.10	MT	R	F	Box Engine X 17 D (4EE1)	299138	Drive Shaft		22	22	52	98	916.5	
	1994.07-2001.10	-	R	F	Box Engine X 17 D (4EE1)	208005	Drive Shaft	29T	22	22	52	98	916.5	
	1994.07-2001.10	-	-	F	Box Engine X 17 D (4EE1)	844019	Outer Joint	29T	22	28	52	97.5	57.5	O
COMBO Mk II (C) (F25)														
1.3 CDTi 16V (51 kW)	2004.09-2012.02	-	R	F	Box Body/Estate Engine Z 13 DT	244075	Drive Shaft	29T	22	22	52	97.5	926	
	2004.09-2012.02	AT/MT	L	F	Box Body/Estate Engine Z 13 DT	299069	Drive Shaft	29T	22	22	52	97.5	584	
	2004.09-2012.02	-	L	F	Box Body/Estate Engine Z 13 DT	244027	Drive Shaft	29T	22	22	52	98	580	
	2004.09-2012.02	-	R	F	Box Body/Estate Engine Z 13 DT	244026	Drive Shaft	29T	22	22	52	98	930	
	2004.09-2012.02	-	L/R	F	Box Body/Estate Engine Z 13 DT	844002	Outer Joint	29T	22	23	52	97.5	61	M
	2004.09-2012.02	-	L	F	Box Body/Estate Engine Z 13 DT	244045	Drive Shaft	29T	22	22	52	97	579	
1.3 CDTi 16V (55 kW)	2005.10-2011.11	-	R	F	Box Body/Estate Engine Z 13 DTJ	244075	Drive Shaft	29T	22	22	52	97.5	926	
	2005.10-2011.11	AT/MT	L	F	Box Body/Estate Engine Z 13 DTJ	299069	Drive Shaft	29T	22	22	52	97.5	584	
	2005.10-2011.11	-	L	F	Box Body/Estate Engine Z 13 DTJ	244027	Drive Shaft	29T	22	22	52	98	580	
	2005.10-2011.11	-	R	F	Box Body/Estate Engine Z 13 DTJ	244026	Drive Shaft	29T	22	22	52	98	930	
	2005.10-2011.11	-	L	F	Box Body/Estate Engine Z 13 DTJ	244045	Drive Shaft	29T	22	22	52	97	579	
	2005.10-2011.11	-	L/R	F	Box Body/Estate Engine Z 13 DTJ	844002	Outer Joint	29T	22	23	52	97.5	61	M
1.4 i 16V (66 kW)	2004.01-2011.11	-	R	F	Box Body/Estate Engine Z 14 XEP	299205	Drive Shaft		22	22	52	97.5	930	
	2004.01-2011.11	-	L	F	Box Body/Estate Engine Z 14 XEP	244027	Drive Shaft	29T	22	22	52	98	580	
	2004.01-2011.11	-	R	F	Box Body/Estate Engine Z 14 XEP	844043	Outer Joint		22	28	52	97.5	57.5	O
	2004.01-2011.11	MT	L	F	Box Body/Estate Engine Z 14 XEP	299069	Drive Shaft	29T	22	22	52	97.5	584	
	2004.01-2011.11	-	L/R	F	Box Body/Estate Engine Z 14 XEP	844020	Outer Joint	29T	22	28	52	97.5	57.5	O
	2004.01-2011.11	-	R	F	Box Body/Estate Engine Z 14 XEP	244026	Drive Shaft	29T	22	22	52	98	930	
	2004.01-2011.11	-	L	F	Box Body/Estate Engine Z 14 XEP	244045	Drive Shaft	29T	22	22	52	97	579	
	2004.01-2011.11	-	R	F	Box Body/Estate Engine Z 14 XEP	244075	Drive Shaft	29T	22	22	52	97.5	926	
1.6 (62 kW)	2001.09-2004.10	-	R	F	Box Body/Estate Engine Z 16 SE	244075	Drive Shaft	29T	22	22	52	97.5	926	
	2001.09-2004.10	MT	L	F	Box Body/Estate Engine Z 16 SE	299069	Drive Shaft	29T	22	22	52	97.5	584	
	2001.09-2004.10	-	L	F	Box Body/Estate Engine Z 16 SE	244027	Drive Shaft	29T	22	22	52	98	580	
	2001.09-2004.10	-	L/R	F	Box Body/Estate Engine Z 16 SE	844020	Outer Joint	29T	22	28	52	97.5	57.5	O

YEAR	TRANSM	L/R	F/R	REMARKS	GSP Ref.	PRODUCT	ABS	Technical Specifications									
								A	B	C	H	L	P				
VAUXHALL																	
COMBO Mk II (C) (F25)																	
1.6 (62 kW)	2001.09-2004.10	-	R	F	Box Body/Estate Engine Z 16 SE	244026	Drive Shaft	29T	22	22	52	98	930				
	2001.09-2004.10	-	L	F	Box Body/Estate Engine Z 16 SE	244045	Drive Shaft	29T	22	22	52	97	579				
1.6 (64 kW)	2001.10-2011.11	MT	L	F	Box Body/Estate Engine Z 16 SE	299069	Drive Shaft	29T	22	22	52	97.5	584				
	2001.10-2011.11	-	R	F	Box Body/Estate Engine Z 16 SE	844043	Outer Joint		22	28	52	97.5	57.5	O			
	2001.10-2011.11	-	L	F	Box Body/Estate Engine Z 16 SE	244027	Drive Shaft	29T	22	22	52	98	580				
	2001.10-2011.11	-	L/R	F	Box Body/Estate Engine Z 16 SE	844020	Outer Joint	29T	22	28	52	97.5	57.5	O			
	2001.10-2011.11	-	R	F	Box Body/Estate Engine Z 16 SE	244026	Drive Shaft	29T	22	22	52	98	930				
	2001.10-2011.11	-	L	F	Box Body/Estate Engine Z 16 SE	244045	Drive Shaft	29T	22	22	52	97	579				
	2001.10-2011.11	-	R	F	Box Body/Estate Engine Z 16 SE	244075	Drive Shaft	29T	22	22	52	97.5	926				
	2001.10-2011.11	-	R	F	Box Body/Estate Engine Z 16 SE	299205	Drive Shaft		22	22	52	97.5	930				
1.6 CNG 16V (69 kW)	2006.06-2012.02	-	R	F	Box Body/Estate Engine Z 16 YNG	244075	Drive Shaft	29T	22	22	52	97.5	926				
	2006.06-2012.02	MT	L	F	Box Body/Estate Engine Z 16 YNG	299069	Drive Shaft	29T	22	22	52	97.5	584				
	2006.06-2012.02	-	L	F	Box Body/Estate Engine Z 16 YNG	244027	Drive Shaft	29T	22	22	52	98	580				
	2006.06-2012.02	-	R	F	Box Body/Estate Engine Z 16 YNG	244026	Drive Shaft	29T	22	22	52	98	930				
	2006.06-2012.02	-	L/R	F	Box Body/Estate Engine Z 16 YNG	844020	Outer Joint	29T	22	28	52	97.5	57.5	O			
	2006.06-2012.02	-	L	F	Box Body/Estate Engine Z 16 YNG	244045	Drive Shaft	29T	22	22	52	97	579				
1.6 CNG 16V (71 kW)	2005.04-2012.02	-	R	F	Box Body/Estate Engine Z 16 YNG	244075	Drive Shaft	29T	22	22	52	97.5	926				
	2005.04-2012.02	MT	L	F	Box Body/Estate Engine Z 16 YNG	299069	Drive Shaft	29T	22	22	52	97.5	584				
	2005.04-2012.02	-	L	F	Box Body/Estate Engine Z 16 YNG	244027	Drive Shaft	29T	22	22	52	98	580				
	2005.04-2012.02	-	R	F	Box Body/Estate Engine Z 16 YNG	244026	Drive Shaft	29T	22	22	52	98	930				
	2005.04-2012.02	-	L/R	F	Box Body/Estate Engine Z 16 YNG	844020	Outer Joint	29T	22	28	52	97.5	57.5	O			
	2005.04-2012.02	-	L	F	Box Body/Estate Engine Z 16 YNG	244045	Drive Shaft	29T	22	22	52	97	579				
1.7 CDTI 16V (74 kW)	2004.12-2011.11	-	R	F	Box Body/Estate Engine Z 17 DTH	244092	Drive Shaft	29T	33	34	52	104	609				
	2004.12-2011.11	-	L	F	Box Body/Estate Engine Z 17 DTH	244032	Drive Shaft	29T	33	34	52	104	587.5				
	2004.12-2011.11	-	R	F	Box Body/Estate Engine Z 17 DTH	660003	Inner Joint		34	24	35.5	47	70.5				
	2004.12-2011.11	-	L	F	Box Body/Estate Engine Z 17 DTH	621034	Inner Joint		34	24	35	56.5	102				
	2004.12-2011.11	-	L/R	F	Box Body/Estate Engine Z 17 DTH	844004	Outer Joint	29T	33	24	52	104	64	M			
	2004.12-2011.11	-	R	F	Box Body/Estate Engine Z 17 DTH	260021	Drive Shaft	29T	33	34	52	104	612				
1.7 DI 16V (48 kW)	2001.09-2011.11	MT	L	F	Box Body/Estate Engine Y 17 DTL	299069	Drive Shaft	29T	22	22	52	97.5	584				
	2001.09-2011.11	-	R	F	Box Body/Estate Engine Y 17 DTL	844043	Outer Joint		22	28	52	97.5	57.5	O			
	2001.09-2011.11	-	L	F	Box Body/Estate Engine Y 17 DTL	244027	Drive Shaft	29T	22	22	52	98	580				
	2001.09-2011.11	-	L	F	Box Body/Estate Engine Y 17 DTL	299204	Drive Shaft		22	22	52	97.5	584				
	2001.09-2011.11	-	-	-	Box Body/Estate Engine Y 17 DTL	844044	Outer Joint		22	28	52	97.5	57.5	O			
	2001.09-2011.11	-	L/R	F	Box Body/Estate Engine Y 17 DTL	844020	Outer Joint	29T	22	28	52	97.5	57.5	O			
	2001.09-2011.11	-	R	F	Box Body/Estate Engine Y 17 DTL	244026	Drive Shaft	29T	22	22	52	98	930				
	2001.09-2011.11	-	L	F	Box Body/Estate Engine Y 17 DTL	244045	Drive Shaft	29T	22	22	52	97	579				
	2001.09-2011.11	-	R	F	Box Body/Estate Engine Y 17 DTL	244075	Drive Shaft	29T	22	22	52	97.5	926				
1.7 DTI 16V (55 kW)	2001.09-2011.11	-	R	F	Box Body/Estate Engine Y 17 DTL	299205	Drive Shaft		22	22	52	97.5	930				
	2001.10-2011.11	MT	L	F	Box Body/Estate Engine Y 17 DT	299069	Drive Shaft	29T	22	22	52	97.5	584				
	2001.10-2011.11	-	L	F	Box Body/Estate Engine Y 17 DT	244027	Drive Shaft	29T	22	22	52	98	580				
	2001.10-2011.11	-	R	F	Box Body/Estate Engine Y 17 DT	244026	Drive Shaft	29T	22	22	52	98	930				
	2001.10-2011.11	-	L	F	Box Body/Estate Engine Y 17 DT	244045	Drive Shaft	29T	22	22	52	97	579				
	2001.10-2011.11	-	L/R	F	Box Body/Estate Engine Y 17 DT	844002	Outer Joint	29T	22	23	52	97.5	61	M			
2001.10-2011.11	-	R	F	Box Body/Estate Engine Y 17 DT	244075	Drive Shaft	29T	22	22	52	97.5	926					
COMBO TOUR Mk II (C) (F25)																	
1.3 CDTI 16V (51 kW)	2004.09-2006.09	MT	R	F	MPV Engine Y 13 DT	244075	Drive Shaft	29T	22	22	52	97.5	926				
	2004.09-2006.09	AT/MT	L	F	MPV Engine Y 13 DT	299069	Drive Shaft	29T	22	22	52	97.5	584				
	2004.09-2006.09	MT	L	F	MPV Engine Y 13 DT	244027	Drive Shaft	29T	22	22	52	98	580				
	2004.09-2006.09	MT	R	F	MPV Engine Y 13 DT	244026	Drive Shaft	29T	22	22	52	98	930				
	2004.09-2006.09	MT	L	F	MPV Engine Y 13 DT	244045	Drive Shaft	29T	22	22	52	97	579				
	2004.09-2006.09	MT	L/R	F	MPV Engine Y 13 DT	844002	Outer Joint	29T	22	23	52	97.5	61	M			
	2004.09-2006.09	MT	R	F	MPV Engine Y 13 DT	244026	Drive Shaft	29T	22	22	52	98	930				
1.3 CDTI 16V (55 kW)	2006.07-2012.02	MT	L	F	MPV Engine Z 13 DTJ	244027	Drive Shaft	29T	22	22	52	98	580				
	2006.07-2012.02	AT/MT	L	F	MPV Engine Z 13 DTJ	299069	Drive Shaft	29T	22	22	52	97.5	584				
	2006.07-2012.02	MT	R	F	MPV Engine Z 13 DTJ	244026	Drive Shaft	29T	22	22	52	98	930				
	2006.07-2012.02	MT	L	F	MPV Engine Z 13 DTJ	244045	Drive Shaft	29T	22	22	52	97	579				
	2006.07-2012.02	MT	L/R	F	MPV Engine Z 13 DTJ	844002	Outer Joint	29T	22	23	52	97.5	61	M			
	2006.07-2012.02	MT	R	F	MPV Engine Z 13 DTJ	244075	Drive Shaft	29T	22	22	52	97.5	926				
1.4 (66 kW)	2004.10-2010.09	-	R	F	MPV Engine Z 14 XEP	244075	Drive Shaft	29T	22	22	52	97.5	926				
	2004.10-2010.09	MT	L	F	MPV Engine Z 14 XEP	299069	Drive Shaft	29T	22	22	52	97.5	584				
	2004.10-2010.09	-	L	F	MPV Engine Z 14 XEP	244027	Drive Shaft	29T	22	22	52	98	580				
	2004.10-2010.09	-	L/R	F	MPV Engine Z 14 XEP	844020	Outer Joint	29T	22	28	52	97.5	57.5	O			
	2004.10-2010.09	-	R	F	MPV Engine Z 14 XEP	244026	Drive Shaft	29T	22	22	52	98	930				
	2004.10-2010.09	-	L	F	MPV Engine Z 14 XEP	244045	Drive Shaft	29T	22	22	52	97	579				
1.6 (64 kW)	2001.10-2004.06	MT	R	F	MPV Engine Z 16 SE	244075	Drive Shaft	29T	22	22	52	97.5	926				
	2001.10-2004.06	MT	L	F	MPV Engine Z 16 SE	299069	Drive Shaft	29T	22	22	52	97.5	584				
	2001.10-2004.06	MT	L	F	MPV Engine Z 16 SE	244027	Drive Shaft	29T	22	22	52	98	580				

YEAR	TRANSM	L/R	F/R	REMARKS	GSP Ref.	PRODUCT	ABS	Technical Specifications										
								A	B	C	H	L	P					
VAUXHALL																		
COMBO TOUR Mk II (C) (F25)																		
1.6 (64 kW)	2001.10-2004.06	MT	R	F	MPV Engine Z 16 SE	244026	Drive Shaft	29T	22	22	52	98	930					
	2001.10-2004.06	-	L/R	F	MPV Engine Z 16 SE	844020	Outer Joint	29T	22	28	52	97.5	57.5	O				
	2001.10-2004.06	MT	L	F	MPV Engine Z 16 SE	244045	Drive Shaft	29T	22	22	52	97	579					
1.7 CDTI 16V (74 kW)	2004.12-2010.09	-	R	F	MPV Engine Z 17 DTH	244092	Drive Shaft	29T	33	34	52	104	609					
	2004.12-2010.09	-	L	F	MPV Engine Z 17 DTH	244032	Drive Shaft	29T	33	34	52	104	587.5					
	2004.12-2010.09	-	R	F	MPV Engine Z 17 DTH	660003	Inner Joint		34	24	35.5	47	70.5					
	2004.12-2010.09	-	L	F	MPV Engine Z 17 DTH	621034	Inner Joint		34	24	35	56.5	102					
	2004.12-2010.09	-	L/R	F	MPV Engine Z 17 DTH	844004	Outer Joint	29T	33	24	52	104	64	M				
	2004.12-2010.09	MT	R	F	MPV Engine Z 17 DTH	260021	Drive Shaft	29T	33	34	52	104	612					
1.7 DI 16V (48 kW)	2001.09-2004.06	MT	R	F	MPV Engine Y 17 DTL	244075	Drive Shaft	29T	22	22	52	97.5	926					
	2001.09-2004.06	MT	L	F	MPV Engine Y 17 DTL	299069	Drive Shaft	29T	22	22	52	97.5	584					
	2001.09-2004.06	-	L	F	MPV Engine Y 17 DTL	299204	Drive Shaft		22	22	52	97.5	584					
	2001.09-2004.06	MT	L	F	MPV Engine Y 17 DTL	244027	Drive Shaft	29T	22	22	52	98	580					
	2001.09-2004.06	-	L	F	MPV Engine Y 17 DTL	844043	Outer Joint		22	28	52	97.5	57.5	O				
	2001.09-2004.06	MT	R	F	MPV Engine Y 17 DTL	244026	Drive Shaft	29T	22	22	52	98	930					
	2001.09-2004.06	MT	L/R	F	MPV Engine Y 17 DTL	844020	Outer Joint	29T	22	28	52	97.5	57.5	O				
	2001.09-2004.06	MT	L	F	MPV Engine Y 17 DTL	244045	Drive Shaft	29T	22	22	52	97	579					
1.7 DTI 16V (55 kW)	2001.10-2012.02	MT	R	F	MPV Engine Y 17 DT	244075	Drive Shaft	29T	22	22	52	97.5	926					
	2001.10-2012.02	MT	L	F	MPV Engine Y 17 DT	299069	Drive Shaft	29T	22	22	52	97.5	584					
	2001.10-2012.02	MT	L	F	MPV Engine Y 17 DT	244027	Drive Shaft	29T	22	22	52	98	580					
	2001.10-2012.02	MT	R	F	MPV Engine Y 17 DT	244026	Drive Shaft	29T	22	22	52	98	930					
	2001.10-2012.02	MT	L	F	MPV Engine Y 17 DT	244045	Drive Shaft	29T	22	22	52	97	579					
	2001.10-2012.02	MT	L/R	F	MPV Engine Y 17 DT	844002	Outer Joint	29T	22	23	52	97.5	61	M				
CORSA B																		
1.2/1.4	1993.04-2000.09	MT	L	F	-	260007	Drive Shaft		22	22	52	97	563					
1.5 D/1.5 TD	1993.04-2000.09	MT	L	F	-	260007	Drive Shaft		22	22	52	97	563					
1.7 D	1996.02-2000.09	MT	L	F	-	260007	Drive Shaft		22	22	52	97	563					
CORSA B (73, 78, 79, F35)																		
1.5 D (37 kW)	1993.03-2000.09	MT	-	-	-	844060	Outer Joint	29T	22	22	52	98	51	O				
1.6 GSi 16V (80 kW)	1993.03-2000.09	-	-	-	-	844060	Outer Joint	29T	22	22	52	98	51	O				
1.6 i 16V (78 kW)	1994.09-2000.09	-	-	-	-	844060	Outer Joint	29T	22	22	52	98	51	O				
CORSA C																		
1.0	2000.10-	-	-	L	F	-	260009	Drive Shaft	29T	22	22	52	97.5	559				
	2000.10-	-	-	-	-	-	860001	Outer Joint		22	28	52	97.5	54.5	O			
	2000.10-	-	-	-	-	-	844053	Outer Joint	29T	22	28	52	97.5	54.5	O			
1.2	2000.10-	-	-	L	F	-	260004	Drive Shaft	29T	22	22	52	97.5	575				
	2000.10-	-	-	-	-	-	860001	Outer Joint		22	28	52	97.5	54.5	O			
	2000.10-	-	-	-	-	-	844053	Outer Joint	29T	22	28	52	97.5	54.5	O			
1.4	2000.10-	-	-	L	F	-	260006	Drive Shaft	29T	22	22	52	97.5	587				
1.7 Di	2000.10-2003.10	MT	L	F	-	260006	Drive Shaft	29T	22	22	52	97.5	587					
1.7 DTi	2000.10-2003.10	MT	L	F	-	260006	Drive Shaft	29T	22	22	52	97.5	587					
CORSA C (F08, F68)																		
1.0 12V (43 kW)	2000.09-	-	-	-	-	-	860001	Outer Joint		22	28	52	97.5	54.5	O			
1.0 12V (44 kW)	2000.09-	-	-	-	-	-	860001	Outer Joint		22	28	52	97.5	54.5	O			
1.2 16V (55 kW)	2000.09-	-	-	-	-	-	860001	Outer Joint		22	28	52	97.5	54.5	O			
1.2 Twinport (59 kW)	2004.07-	-	-	-	-	-	860001	Outer Joint		22	28	52	97.5	54.5	O			
1.4 16V (66 kW)	2000.09-	-	-	-	-	-	860001	Outer Joint		22	28	52	97.5	54.5	O			
1.4 Twinport (66 kW)	2003.06-	-	-	-	-	-	860001	Outer Joint		22	28	52	97.5	54.5	O			
CORSA C VAN (F08, W5L)																		
1.2 (59 kW)	2005.07-	-	-	-	-	LCV	860001	Outer Joint		22	28	52	97.5	54.5	O			
1.2 16V (55 kW)	2000.09-	-	-	-	-	LCV	860001	Outer Joint		22	28	52	97.5	54.5	O			
1.4 (66 kW)	2003.08-	-	-	-	-	LCV	860001	Outer Joint		22	28	52	97.5	54.5	O			
CORSA C VAN(F08,W5L)																		
1.2 16V(55KW)	2000.09-	-	-	-	-	LCV	844053	Outer Joint	29T	22	28	52	97.5	54.5	O			
1.2(59KW)	2005.07-	-	-	-	-	LCV	844053	Outer Joint	29T	22	28	52	97.5	54.5	O			
1.4(66KW)	2003.08-	-	-	-	-	LCV	844053	Outer Joint	29T	22	28	52	97.5	54.5	O			
CORSA C(F08,F68)																		
1.0 12V(43-44)KW	2000.09-	-	-	-	-	-	844053	Outer Joint	29T	22	28	52	97.5	54.5	O			
1.2 16V(55KW)	2000.09-	-	-	-	-	-	844053	Outer Joint	29T	22	28	52	97.5	54.5	O			
1.2 TWINPORT(59KW)	2004.07-	-	-	-	-	-	844053	Outer Joint	29T	22	28	52	97.5	54.5	O			
1.4 16V(66KW)	2000.09-	-	-	-	-	-	844053	Outer Joint	29T	22	28	52	97.5	54.5	O			
1.4 TWINPORT(66KW)	2003.06-	-	-	-	-	-	844053	Outer Joint	29T	22	28	52	97.5	54.5	O			
CORSA I																		
1.0	1997.04-2000.09	MT	L	F	-	260007	Drive Shaft		22	22	52	97	563					
CORSA I VAN																		
1.4/1.7 D	1994.02-2001.02	MT	L	F	LCV	260007	Drive Shaft		22	22	52	97	563					

YEAR	TRANSM	L/R	F/R	REMARKS	GSP Ref.	PRODUCT	ABS	Technical Specifications									
								A	B	C	H	L	P				
VAUXHALL																	
CORSA II																	
1.2	2000.10-	-	MT/AT	-	-	-	660001	Inner Joint		22	28	34.9	57.5	96.5			
CORSA Mk I (B) (S93)																	
1.0 i (12V (40 kW))	1996.11-2000.09	-	L/R	F	Hatchback Engine X 10 XE	844014	Outer Joint	29T	22	28	52	98	60	I			
	1996.11-2000.09	-	-	F	Hatchback Engine X 10 XE	844031	Outer Joint		22	28	52	95.5	57.5	I			
	1996.11-2000.09	-	-	-	Hatchback Engine X 10 XE	844078	Outer Joint		22	28	52	98	60	I			
	1996.11-2000.09	-	L	F	Hatchback Engine X 10 XE	244036	Drive Shaft	29T	22	22	52	95	565				
	1996.11-2000.09	AT/MT	L	F	Hatchback Engine X 10 XE	299139	Drive Shaft		22	22	52	98	570.5				
	1996.11-2000.09	-	R	F	Hatchback Engine X 10 XE	244037	Drive Shaft	29T	22	22	52	97	921				
	1996.11-2000.09	AT/MT	R	F	Hatchback Engine X 10 XE	299138	Drive Shaft		22	22	52	98	916.5				
	1996.11-2000.09	-	R	F	Hatchback Engine X 10 XE	208005	Drive Shaft	29T	22	22	52	98	916.5				
1.2 i (33 kW)	1996.11-2000.09	-	L/R	F	Hatchback Engine X 10 XE	844013	Outer Joint	29T	22	28	52	98	52	O			
	1993.03-2000.09	-	-	F	Hatchback Engine C 12 NZ	844018	Outer Joint		22	28	52.2	97.5	55	O			
	1993.03-2000.09	MT	L/R	F	Hatchback Engine C 12 NZ	844020	Outer Joint	29T	22	28	52	97.5	57.5	O			
	1993.03-2000.09	MT	L	F	Hatchback Engine C 12 NZ	299139	Drive Shaft		22	22	52	98	570.5				
	1993.03-2000.09	MT	L	F	Hatchback Engine C 12 NZ	244001	Drive Shaft	29T	22	22	52	95	573				
	1993.03-2000.09	MT	R	F	Hatchback Engine C 12 NZ	299138	Drive Shaft		22	22	52	98	916.5				
	1993.03-2000.09	-	R	F	Hatchback Engine C 12 NZ	208005	Drive Shaft	29T	22	22	52	98	916.5				
	1993.03-2000.09	-	-	F	Hatchback Engine C 12 NZ	844019	Outer Joint	29T	22	28	52	97.5	57.5	O			
1.2 i 16V (48 kW)	1993.03-2000.09	-	-	F	Hatchback Engine C 12 NZ	644003	Inner Joint		22	28	34.95	57.5	83.5				
	1998.03-2000.09	-	-	F	Hatchback Engine X 12 XE	644003	Inner Joint		22	28	34.95	57.5	83.5				
	1998.03-2000.09	-	-	F	Hatchback Engine X 12 XE	844018	Outer Joint		22	28	52.2	97.5	55	O			
	1998.03-2000.09	MT	L/R	F	Hatchback Engine X 12 XE	844020	Outer Joint	29T	22	28	52	97.5	57.5	O			
	1998.03-2000.09	MT	L	F	Hatchback Engine X 12 XE	244001	Drive Shaft	29T	22	22	52	95	573				
	1998.03-2000.09	AT/MT	L	F	Hatchback Engine X 12 XE	299139	Drive Shaft		22	22	52	98	570.5				
	1998.03-2000.09	AT/MT	R	F	Hatchback Engine X 12 XE	299138	Drive Shaft		22	22	52	98	916.5				
	1998.03-2000.09	-	R	F	Hatchback Engine X 12 XE	208005	Drive Shaft	29T	22	22	52	98	916.5				
1.4 i (44 kW)	1998.03-2000.09	-	-	F	Hatchback Engine X 12 XE	844019	Outer Joint	29T	22	28	52	97.5	57.5	O			
	1993.03-2000.09	-	-	F	Hatchback Engine C 14 NZ	844018	Outer Joint		22	28	52.2	97.5	55	O			
	1993.03-2000.09	MT	L/R	F	Hatchback Engine C 14 NZ	844020	Outer Joint	29T	22	28	52	97.5	57.5	O			
	1993.03-2000.09	AT/MT	L	F	Hatchback Engine C 14 NZ	299139	Drive Shaft		22	22	52	98	570.5				
	1993.03-2000.09	MT	L	F	Hatchback Engine C 14 NZ	244001	Drive Shaft	29T	22	22	52	95	573				
	1993.03-2000.09	AT/MT	R	F	Hatchback Engine C 14 NZ	299138	Drive Shaft		22	22	52	98	916.5				
	1993.03-2000.09	-	R	F	Hatchback Engine C 14 NZ	208005	Drive Shaft	29T	22	22	52	98	916.5				
	1993.03-2000.09	-	-	F	Hatchback Engine C 14 NZ	844019	Outer Joint	29T	22	28	52	97.5	57.5	O			
1.4 i 16V (66 kW)	1994.09-2000.09	MT	L/R	F	Hatchback Engine X 14 XE	844020	Outer Joint	29T	22	28	52	97.5	57.5	O			
	1994.09-2000.09	MT	L	F	Hatchback Engine X 14 XE	244001	Drive Shaft	29T	22	22	52	95	573				
	1994.09-2000.09	-	R	F	Hatchback Engine X 14 XE	208005	Drive Shaft	29T	22	22	52	98	916.5				
	1994.09-2000.09	-	-	F	Hatchback Engine X 14 XE	844018	Outer Joint		22	28	52.2	97.5	55	O			
1.4 i S (60 kW)	1993.03-2000.09	-	-	F	Hatchback Engine C 14 SE	844018	Outer Joint		22	28	52.2	97.5	55	O			
	1993.03-2000.09	MT	L/R	F	Hatchback Engine C 14 SE	844020	Outer Joint	29T	22	28	52	97.5	57.5	O			
	1993.03-2000.09	MT	L	F	Hatchback Engine C 14 SE	244001	Drive Shaft	29T	22	22	52	95	573				
	1993.03-2000.09	MT	L	F	Hatchback Engine C 14 SE	299139	Drive Shaft		22	22	52	98	570.5				
	1993.03-2000.09	MT	R	F	Hatchback Engine C 14 SE	299138	Drive Shaft		22	22	52	98	916.5				
	1993.03-2000.09	-	R	F	Hatchback Engine C 14 SE	208005	Drive Shaft	29T	22	22	52	98	916.5				
	1993.03-2000.09	-	-	F	Hatchback Engine C 14 SE	844019	Outer Joint	29T	22	28	52	97.5	57.5	O			
	1993.03-2000.09	-	-	F	Hatchback Engine C 14 SE	644003	Inner Joint		22	28	34.95	57.5	83.5				
1.5 D (37 kW)	1992.12-1996.12	-	-	F	Hatchback Engine 15 D	644003	Inner Joint		22	28	34.95	57.5	83.5				
	1992.12-1996.12	-	-	F	Hatchback Engine 15 D	844018	Outer Joint		22	28	52.2	97.5	55	O			
	1992.12-1996.12	MT	L/R	F	Hatchback Engine 15 D	844020	Outer Joint	29T	22	28	52	97.5	57.5	O			
	1992.12-1996.12	MT	L	F	Hatchback Engine 15 D	244001	Drive Shaft	29T	22	22	52	95	573				
	1992.12-1996.12	MT	L	F	Hatchback Engine 15 D	299139	Drive Shaft		22	22	52	98	570.5				
	1992.12-1996.12	MT	R	F	Hatchback Engine 15 D	299138	Drive Shaft		22	22	52	98	916.5				
	1992.12-1996.12	-	R	F	Hatchback Engine 15 D	208005	Drive Shaft	29T	22	22	52	98	916.5				
	1992.12-1996.12	-	-	F	Hatchback Engine 15 D	844019	Outer Joint	29T	22	28	52	97.5	57.5	O			
1.5 TD (49 kW)	1993.03-1996.10	-	-	F	Hatchback Engine X 15 DT (T4EC1)	644003	Inner Joint		22	28	34.95	57.5	83.5				
	1993.03-1996.10	-	-	F	Hatchback Engine X 15 DT (T4EC1)	844018	Outer Joint		22	28	52.2	97.5	55	O			
	1993.03-1996.10	MT	L/R	F	Hatchback Engine X 15 DT (T4EC1)	844020	Outer Joint	29T	22	28	52	97.5	57.5	O			
	1993.03-1996.10	MT	L	F	Hatchback Engine X 15 DT (T4EC1)	299139	Drive Shaft		22	22	52	98	570.5				
	1993.03-1996.10	MT	L	F	Hatchback Engine X 15 DT (T4EC1)	244001	Drive Shaft	29T	22	22	52	95	573				
	1993.03-1996.10	MT	R	F	Hatchback Engine X 15 DT (T4EC1)	299138	Drive Shaft		22	22	52	98	916.5				
	1993.03-1996.10	-	R	F	Hatchback Engine X 15 DT (T4EC1)	208005	Drive Shaft	29T	22	22	52	98	916.5				
	1993.03-1996.10	-	-	F	Hatchback Engine X 15 DT (T4EC1)	844019	Outer Joint	29T	22	28	52	97.5	57.5	O			
1.6 GSI 16V (80 kW)	1993.03-2000.09	MT	L/R	F	Hatchback Engine C 16 XE	644004	Inner Joint		22	22	34.95	57.5	72.5				
	1993.03-2000.09	-	-	F	Hatchback Engine C 16 XE	644003	Inner Joint		22	28	34.95	57.5	83.5				
1.6 i 16V (78 kW)	1994.09-2000.09	MT	L/R	F	Hatchback Engine X 16 XE	644004	Inner Joint		22	22	34.95	57.5	72.5				
	1994.09-2000.09	-	-	F	Hatchback Engine X 16 XE	644003	Inner Joint		22	28	34.95	57.5	83.5				
1.7 D (44 kW)	1996.02-2000.09	-	-	F	Hatchback Engine X 17 D (4EE1)	644003	Inner Joint		22	28	34.95	57.5	83.5				





YEAR	TRANSM	L/R	F/R	REMARKS	GSP Ref.	PRODUCT	ABS	Technical Specifications									
								A	B	C	H	L	P				
VAUXHALL																	
CORSA Mk I (B) (S93)																	
1.7 D (44 kW)	1996.02-2000.09	-	-	F	Hatchback Engine X 17 D (4EE1)	844018	Outer Joint		22	28	52.2	97.5	55	O			
	1996.02-2000.09	MT	L/R	F	Hatchback Engine X 17 D (4EE1)	844020	Outer Joint	29T	22	28	52	97.5	57.5	O			
	1996.02-2000.09	MT	L	F	Hatchback Engine X 17 D (4EE1)	244001	Drive Shaft	29T	22	22	52	95	57.3				
	1996.02-2000.09	MT	L	F	Hatchback Engine X 17 D (4EE1)	299139	Drive Shaft		22	22	52	98	570.5				
	1996.02-2000.09	MT	R	F	Hatchback Engine X 17 D (4EE1)	299138	Drive Shaft		22	22	52	98	916.5				
	1996.02-2000.09	-	R	F	Hatchback Engine X 17 D (4EE1)	208005	Drive Shaft	29T	22	22	52	98	916.5				
	1996.02-2000.09	-	-	F	Hatchback Engine X 17 D (4EE1)	844019	Outer Joint	29T	22	28	52	97.5	57.5	O			
CORSA Mk II (C) (X01)																	
1.0 12V (43 kW)	2000.09-2003.10	AT/MT	R	F	Hatchback Engine Z 10 XE	244075	Drive Shaft	29T	22	22	52	97.5	926				
	2000.09-2003.10	MT	L	F	Hatchback Engine Z 10 XE	299069	Drive Shaft	29T	22	22	52	97.5	584				
	2000.09-2003.10	AT/MT	L	F	Hatchback Engine Z 10 XE	244027	Drive Shaft	29T	22	22	52	98	580				
	2000.09-2003.10	AT/MT	R	F	Hatchback Engine Z 10 XE	244026	Drive Shaft	29T	22	22	52	98	930				
	2000.09-2003.10	-	-	-	Hatchback Engine Z 10 XE	844071	Outer Joint		22	28	52	98	52	O			
	2000.09-2003.10	AT/MT	L	F	Hatchback Engine Z 10 XE	244045	Drive Shaft	29T	22	22	52	97	579				
	2000.09-2003.10	-	L/R	F	Hatchback Engine Z 10 XE	844013	Outer Joint	29T	22	28	52	98	52	O			
1.0 12V (44 kW)	2003.11-2006.10	-	R	F	Hatchback Engine Z 10 XEP	244075	Drive Shaft	29T	22	22	52	97.5	926				
	2003.11-2006.10	-	L/R	F	Hatchback Engine Z 10 XEP	844014	Outer Joint	29T	22	28	52	98	60	I			
	2003.11-2006.10	Semi-AT/MT	L	F	Hatchback Engine Z 10 XEP	299069	Drive Shaft	29T	22	22	52	97.5	584				
	2003.11-2006.10	-	L	F	Hatchback Engine Z 10 XEP	244027	Drive Shaft	29T	22	22	52	98	580				
	2003.11-2006.10	-	R	F	Hatchback Engine Z 10 XEP	244026	Drive Shaft	29T	22	22	52	98	930				
	2003.11-2006.10	-	L	F	Hatchback Engine Z 10 XEP	244036	Drive Shaft	29T	22	22	52	95	565				
	2003.11-2006.10	-	L	F	Hatchback Engine Z 10 XEP	244045	Drive Shaft	29T	22	22	52	97	579				
	2003.11-2006.10	-	R	F	Hatchback Engine Z 10 XEP	244037	Drive Shaft	29T	22	22	52	97	921				
	2003.11-2006.10	-	L/R	F	Hatchback Engine Z 10 XEP	844013	Outer Joint	29T	22	28	52	98	52	O			
1.2 16V (55 kW)	2000.09-2006.10	Semi-AT/MT	L	F	Hatchback Engine Z 12 XE	299069	Drive Shaft	29T	22	22	52	97.5	584				
	2000.09-2006.10	-	L	F	Hatchback Engine Z 12 XE	244027	Drive Shaft	29T	22	22	52	98	580				
	2000.09-2006.10	-	R	F	Hatchback Engine Z 12 XE	244026	Drive Shaft	29T	22	22	52	98	930				
	2000.09-2006.10	AT/MT	L	F	Hatchback Engine Z 12 XE	244095	Drive Shaft	29T	22	22	52	97	566				
	2000.09-2006.10	AT/MT	R	F	Hatchback Engine Z 12 XE	244096	Drive Shaft	29T	22	22	52	97	917				
	2000.09-2006.10	AT/MT	L	F	Hatchback Engine Z 12 XE	244045	Drive Shaft	29T	22	22	52	97	579				
	2000.09-2006.10	-	-	-	Hatchback Engine Z 12 XE	844071	Outer Joint		22	28	52	98	52	O			
	2000.09-2006.10	AT/MT	R	F	Hatchback Engine Z 12 XE	244075	Drive Shaft	29T	22	22	52	97.5	926				
	2000.09-2006.10	-	L/R	F	Hatchback Engine Z 12 XE	844013	Outer Joint	29T	22	28	52	98	52	O			
1.2 16V Dualfuel (55 kW)	2001.08-2006.10	-	L	F	Hatchback Engine Z 12 XE	244027	Drive Shaft	29T	22	22	52	98	580				
	2001.08-2006.10	Semi-AT/MT	L	F	Hatchback Engine Z 12 XE	299069	Drive Shaft	29T	22	22	52	97.5	584				
	2001.08-2006.10	-	R	F	Hatchback Engine Z 12 XE	244026	Drive Shaft	29T	22	22	52	98	930				
	2001.08-2006.10	-	L	F	Hatchback Engine Z 12 XE	244095	Drive Shaft	29T	22	22	52	97	566				
	2001.08-2006.10	-	R	F	Hatchback Engine Z 12 XE	244096	Drive Shaft	29T	22	22	52	97	917				
	2001.08-2006.10	-	L	F	Hatchback Engine Z 12 XE	244045	Drive Shaft	29T	22	22	52	97	579				
	2001.08-2006.10	-	-	-	Hatchback Engine Z 12 XE	844071	Outer Joint		22	28	52	98	52	O			
	2001.08-2006.10	-	R	F	Hatchback Engine Z 12 XE	244075	Drive Shaft	29T	22	22	52	97.5	926				
	2001.08-2006.10	-	L/R	F	Hatchback Engine Z 12 XE	844013	Outer Joint	29T	22	28	52	98	52	O			
1.2 Twinport (59 kW)	2004.07-2006.10	-	R	F	Hatchback Engine Z 12 XEP	244075	Drive Shaft	29T	22	22	52	97.5	926				
	2004.07-2006.10	-	L	F	Hatchback Engine Z 12 XEP	244027	Drive Shaft	29T	22	22	52	98	580				
	2004.07-2006.10	Semi-AT/MT	L	F	Hatchback Engine Z 12 XEP	299069	Drive Shaft	29T	22	22	52	97.5	584				
	2004.07-2006.10	-	R	F	Hatchback Engine Z 12 XEP	244026	Drive Shaft	29T	22	22	52	98	930				
	2004.07-2006.10	-	L	F	Hatchback Engine Z 12 XEP	244045	Drive Shaft	29T	22	22	52	97	579				
	2004.07-2006.10	-	L/R	F	Hatchback Engine Z 12 XEP	844013	Outer Joint	29T	22	28	52	98	52	O			
1.3 CDTI 16V (52 kW)	2000.08-2006.09	-	R	F	Hatchback Engine Z 13 DT	299205	Drive Shaft		22	22	52	97.5	930				
	2000.08-2006.09	-	L	F	Hatchback Engine Z 13 DT	244027	Drive Shaft	29T	22	22	52	98	580				
	2000.08-2006.09	-	R	F	Hatchback Engine Z 13 DT	844043	Outer Joint		22	28	52	97.5	57.5	O			
	2000.08-2006.09	AT/MT	L	F	Hatchback Engine Z 13 DT	299069	Drive Shaft	29T	22	22	52	97.5	584				
	2000.08-2006.09	-	L/R	F	Hatchback Engine Z 13 DT	844020	Outer Joint	29T	22	28	52	97.5	57.5	O			
	2000.08-2006.09	-	R	F	Hatchback Engine Z 13 DT	244026	Drive Shaft	29T	22	22	52	98	930				
	2000.08-2006.09	-	L	F	Hatchback Engine Z 13 DT	244045	Drive Shaft	29T	22	22	52	97	579				
	2000.08-2006.09	-	R	F	Hatchback Engine Z 13 DT	244075	Drive Shaft	29T	22	22	52	97.5	926				
1.4 16V (66 kW)	2000.09-2006.10	-	R	F	Hatchback Engine Z 14 XE	244075	Drive Shaft	29T	22	22	52	97.5	926				
	2000.09-2006.10	Semi-AT/MT	L	F	Hatchback Engine Z 14 XE	299069	Drive Shaft	29T	22	22	52	97.5	584				
	2000.09-2006.10	-	R	F	Hatchback Engine Z 14 XE	844043	Outer Joint		22	28	52	97.5	57.5	O			
	2000.09-2006.10	-	L	F	Hatchback Engine Z 14 XE	244027	Drive Shaft	29T	22	22	52	98	580				
	2000.09-2006.10	-	-	-	Hatchback Engine Z 14 XE	844044	Outer Joint		22	28	52	97.5	57.5	O			
	2000.09-2006.10	-	R	F	Hatchback Engine Z 14 XE	244026	Drive Shaft	29T	22	22	52	98	930				
	2000.09-2006.10	MT	L/R	F	Hatchback Engine Z 14 XE	844020	Outer Joint	29T	22	28	52	97.5	57.5	O			
	2000.09-2006.10	-	L	F	Hatchback Engine Z 14 XE	244045	Drive Shaft	29T	22	22	52	97	579				
	2000.09-2006.10	-	L	F	Hatchback Engine Z 14 XE	244001	Drive Shaft	29T	22	22	52	95	573				
	2000.09-2006.10	-	R	F	Hatchback Engine Z 14 XE	299205	Drive Shaft		22	22	52	97.5	930				

	YEAR	TRANSM	L/R	F/R	REMARKS	GSP Ref.	PRODUCT	ABS	Technical Specifications									
									A	B	C	H	L	P				
VAUXHALL																		
CORSA Mk II (C) (X01)																		
1.4 Twinport (66 kW)	2003.06-2006.10	-	L	F	Hatchback Engine Z 14 XEP	244027	Drive Shaft	29T	22	22	52	98	580					
	2003.06-2006.10	Semi-AT/MT	L	F	Hatchback Engine Z 14 XEP	299069	Drive Shaft	29T	22	22	52	97.5	584					
	2003.06-2006.10	-	L/R	F	Hatchback Engine Z 14 XEP	844020	Outer Joint	29T	22	28	52	97.5	57.5	O				
	2003.06-2006.10	-	R	F	Hatchback Engine Z 14 XEP	244026	Drive Shaft	29T	22	22	52	98	930					
	2003.06-2006.10	-	L	F	Hatchback Engine Z 14 XEP	244045	Drive Shaft	29T	22	22	52	97	579					
	2003.06-2006.10	-	R	F	Hatchback Engine Z 14 XEP	244075	Drive Shaft	29T	22	22	52	97.5	926					
1.7 CDTI 16V (74 kW)	2000.08-2006.09	-	R	F	Hatchback Engine Z 17 DTH	244060	Drive Shaft		22	22	52	98	930					
	2000.08-2006.09	-	R	F	Hatchback Engine Z 17 DTH	244092	Drive Shaft	29T	33	34	52	104	609					
	2000.08-2006.09	-	L	F	Hatchback Engine Z 17 DTH	299204	Drive Shaft		22	22	52	97.5	584					
	2000.08-2006.09	-	L	F	Hatchback Engine Z 17 DTH	244032	Drive Shaft	29T	33	34	52	104	587.5					
	2000.08-2006.09	-	R	F	Hatchback Engine Z 17 DTH	660003	Inner Joint		34	24	35.5	47	70.5					
	2000.08-2006.09	-	L	F	Hatchback Engine Z 17 DTH	621034	Inner Joint		34	24	35	56.5	102					
	2000.08-2006.09	-	L	F	Hatchback Engine Z 17 DTH	844043	Outer Joint		22	28	52	97.5	57.5	O				
	2000.08-2006.09	-	L/R	F	Hatchback Engine Z 17 DTH	844004	Outer Joint	29T	33	24	52	104	64	M				
1.7 DI 16V (48 kW)	2000.08-2006.09	MT	L	F	Hatchback Engine Y 17 DTL	299069	Drive Shaft	29T	22	22	52	97.5	584					
	2000.08-2006.09	-	R	F	Hatchback Engine Y 17 DTL	844043	Outer Joint		22	28	52	97.5	57.5	O				
	2000.08-2006.09	-	L	F	Hatchback Engine Y 17 DTL	244027	Drive Shaft	29T	22	22	52	98	580					
	2000.08-2006.09	-	R	F	Hatchback Engine Y 17 DTL	244060	Drive Shaft		22	22	52	98	930					
	2000.08-2006.09	-	L	F	Hatchback Engine Y 17 DTL	299204	Drive Shaft		22	22	52	97.5	584					
	2000.08-2006.09	-	-	-	Hatchback Engine Y 17 DTL	844044	Outer Joint		22	28	52	97.5	57.5	O				
	2000.08-2006.09	-	R	F	Hatchback Engine Y 17 DTL	244026	Drive Shaft	29T	22	22	52	98	930					
	2000.08-2006.09	-	L/R	F	Hatchback Engine Y 17 DTL	844020	Outer Joint	29T	22	28	52	97.5	57.5	O				
	2000.08-2006.09	-	L	F	Hatchback Engine Y 17 DTL	244045	Drive Shaft	29T	22	22	52	97	579					
	2000.08-2006.09	-	R	F	Hatchback Engine Y 17 DTL	244075	Drive Shaft	29T	22	22	52	97.5	926					
	2000.08-2006.09	-	R	F	Hatchback Engine Y 17 DTL	299205	Drive Shaft		22	22	52	97.5	930					
	1.7 DTI 16V (55 kW)	2000.08-2006.09	MT	L	F	Hatchback Engine Y 17 DT	299069	Drive Shaft	29T	22	22	52	97.5	584				
2000.08-2006.09		-	R	F	Hatchback Engine Y 17 DT	844043	Outer Joint		22	28	52	97.5	57.5	O				
2000.08-2006.09		-	L	F	Hatchback Engine Y 17 DT	244027	Drive Shaft	29T	22	22	52	98	580					
2000.08-2006.09		-	R	F	Hatchback Engine Y 17 DT	244060	Drive Shaft		22	22	52	98	930					
2000.08-2006.09		-	L	F	Hatchback Engine Y 17 DT	299204	Drive Shaft		22	22	52	97.5	584					
2000.08-2006.09		-	-	-	Hatchback Engine Y 17 DT	844044	Outer Joint		22	28	52	97.5	57.5	O				
2000.08-2006.09		-	R	F	Hatchback Engine Y 17 DT	244026	Drive Shaft	29T	22	22	52	98	930					
2000.08-2006.09		-	L/R	F	Hatchback Engine Y 17 DT	844020	Outer Joint	29T	22	28	52	97.5	57.5	O				
2000.08-2006.09		-	L	F	Hatchback Engine Y 17 DT	244045	Drive Shaft	29T	22	22	52	97	579					
2000.08-2006.09		-	R	F	Hatchback Engine Y 17 DT	244075	Drive Shaft	29T	22	22	52	97.5	926					
1.8 16V (92 kW)	2000.08-2006.09	MT	L	F	Hatchback Engine Z 18 XE	299069	Drive Shaft	29T	22	22	52	97.5	584					
	2000.08-2006.09	-	L	F	Hatchback Engine Z 18 XE	244027	Drive Shaft	29T	22	22	52	98	580					
	2000.08-2006.09	-	R	F	Hatchback Engine Z 18 XE	244026	Drive Shaft	29T	22	22	52	98	930					
	2000.08-2006.09	-	L	F	Hatchback Engine Z 18 XE	244045	Drive Shaft	29T	22	22	52	97	579					
	2000.08-2006.09	-	L/R	F	Hatchback Engine Z 18 XE	844002	Outer Joint	29T	22	23	52	97.5	61	M				
	2000.08-2006.09	-	R	F	Hatchback Engine Z 18 XE	244075	Drive Shaft	29T	22	22	52	97.5	926					
	CORSA Mk III (D) (S07)																	
	1.0 (44 kW)	2006.11-2014.08	-	-	F	Hatchback Engine Z 10 XEP	899018	Outer Joint		22	27	51	79.5	54	O			
2006.11-2014.08		MT	R	F	Hatchback Engine Z 10 XEP	644013	Inner Joint		22	21	35	57.5	93					
2006.11-2014.08		MT	L	F	Hatchback Engine Z 10 XEP	244079	Drive Shaft		22	22	51	79.5	615					
2006.11-2014.08		MT	L	F	Hatchback Engine Z 10 XEP	817089	Outer Joint		22	20	51	79.5	51	M				
2006.11-2014.08		-	L/R	F	Hatchback Engine Z 10 XEP	817052	Outer Joint		22	21	51.2	79.5	54	M				
2006.11-2014.08		MT	L	F	Hatchback Engine Z 10 XEP	260023	Drive Shaft		22	22	51.2	79.5	615					
2006.11-2014.08		MT	R	F	Hatchback Engine Z 10 XEP	217044	Drive Shaft		22	22	51.2	79.5	919					
1.0 i 12V (48 kW)	2010.06-2014.08	MT	L	F	Hatchback Engine A 10 XEP	817089	Outer Joint		22	20	51	79.5	51	M				
	2010.06-2014.08	MT	L	F	Hatchback Engine A 10 XEP	260023	Drive Shaft		22	22	51.2	79.5	615					
	2010.06-2014.08	MT	L	F	Hatchback Engine A 10 XEP	644013	Inner Joint		22	21	35	57.5	93					
1.2 (51 kW)	2010.06-2014.08	AT/MT	L	F	Hatchback Engine A 12 XEL	644013	Inner Joint		22	21	35	57.5	93					
	2010.06-2014.08	-	L	F	Hatchback Engine A 12 XEL	817089	Outer Joint		22	20	51	79.5	51	M				
	2010.06-2014.08	AT/MT	L	F	Hatchback Engine A 12 XEL	260023	Drive Shaft		22	22	51.2	79.5	615					
1.2 (59 kW)	2006.11-2014.08	-	-	F	Hatchback Engine Z 12 XEP	899018	Outer Joint		22	27	51	79.5	54	O				
	2006.11-2014.08	MT	R	F	Hatchback Engine Z 12 XEP	644013	Inner Joint		22	21	35	57.5	93					
	2006.11-2014.08	MT	R	F	Hatchback Engine Z 12 XEP	244078	Drive Shaft		22	22	51	79.5	918					
	2006.11-2014.08	MT	R	F	Hatchback Engine Z 12 XEP	817089	Outer Joint		22	20	51	79.5	51	M				
	2006.11-2014.08	MT	L	F	Hatchback Engine Z 12 XEP	244079	Drive Shaft		22	22	51	79.5	615					
	2006.11-2014.08	-	L/R	F	Hatchback Engine Z 12 XEP	817052	Outer Joint		22	21	51.2	79.5	54	M				
	2006.11-2014.08	AT/MT	L	F	Hatchback Engine Z 12 XEP	260023	Drive Shaft		22	22	51.2	79.5	615					
	2006.11-2014.08	MT	R	F	Hatchback Engine Z 12 XEP	217044	Drive Shaft		22	22	51.2	79.5	919					
1.2 i 16V (63 kW)	2006.11-2014.08	MT	L	F	Hatchback Engine A 12 XER	644013	Inner Joint		22	21	35	57.5	93					

YEAR	TRANSM	L/R	F/R	REMARKS	GSP Ref.	PRODUCT	ABS	Technical Specifications										
								A	B	C	H	L	P					
VAUXHALL																		
CORSA Mk III (D) (S07)																		
1.2 i 16V (63 kW)	2006.11-2014.08	MT	L	F	Hatchback Engine A 12 XER	817089	Outer Joint	22	20	51	79.5	51	M					
	2006.11-2014.08	MT	L	F	Hatchback Engine A 12 XER	260023	Drive Shaft	22	22	51.2	79.5	615						
1.2 LPG (59 kW)	2009.09-2014.08	-	R	F	Hatchback Engine Z 12 XEP	644013	Inner Joint	22	21	35	57.5	93						
	2009.09-2014.08	-	R	F	Hatchback Engine Z 12 XEP	244078	Drive Shaft	22	22	51	79.5	918						
	2009.09-2014.08	-	R	F	Hatchback Engine Z 12 XEP	817089	Outer Joint	22	20	51	79.5	51	M					
	2009.09-2014.08	-	L	F	Hatchback Engine Z 12 XEP	244079	Drive Shaft	22	22	51	79.5	615						
	2009.09-2014.08	-	L/R	F	Hatchback Engine Z 12 XEP	817052	Outer Joint	22	21	51.2	79.5	54	M					
	2009.09-2014.08	AT/MT	L	F	Hatchback Engine Z 12 XEP	260023	Drive Shaft	22	22	51.2	79.5	615						
	2009.09-2014.08	-	R	F	Hatchback Engine Z 12 XEP	217044	Drive Shaft	22	22	51.2	79.5	919						
1.2 LPG (63 kW)	2011.08-2014.08	MT	L	F	Hatchback Engine A 12 XER	644013	Inner Joint	22	21	35	57.5	93						
	2011.08-2014.08	-	L	F	Hatchback Engine A 12 XER	817089	Outer Joint	22	20	51	79.5	51	M					
	2011.08-2014.08	MT	L	F	Hatchback Engine A 12 XER	260023	Drive Shaft	22	22	51.2	79.5	615						
1.3 CDTI (55 kW)	2006.07-2014.08	-	L/R	F	Hatchback Engine A 13 DTC	817053	Outer Joint	25	23	51	84.5	60	M					
	2006.07-2014.08	-	-	F	Hatchback Engine A 13 DTC	817067	Outer Joint	25	22	51	84	57.5	M					
	2006.07-2014.08	MT	L	F	Hatchback Engine A 13 DTC	244040	Drive Shaft	25	22	51	84.5	616						
	2006.07-2014.08	MT	R	F	Hatchback Engine A 13 DTC	244042	Drive Shaft	25	22	51	84.5	920						
	2006.07-2014.08	-	-	F	Hatchback Engine A 13 DTC	817027	Outer Joint	25	23	51	84.5	60	M					
1.3 CDTI (66 kW)	2006.07-2014.08	MT	R	F	Hatchback Engine Z 13 DTH	217071	Drive Shaft	25	25	51	84.5	952						
	2006.07-2014.08	-	L/R	F	Hatchback Engine Z 13 DTH	817053	Outer Joint	25	23	51	84.5	60	M					
	2006.07-2014.08	MT	L	F	Hatchback Engine Z 13 DTH	217070	Drive Shaft	25	25	51	84.5	576						
	2006.07-2014.08	-	-	F	Hatchback Engine Z 13 DTH	817067	Outer Joint	25	22	51	84	57.5	M					
	2006.07-2014.08	-	-	F	Hatchback Engine Z 13 DTH	817027	Outer Joint	25	23	51	84.5	60	M					
1.3 CDTI (70 kW)	2010.06-2014.08	-	L/R	F	Hatchback Engine A 13 DTR	817053	Outer Joint	25	23	51	84.5	60	M					
	2010.06-2014.08	-	-	F	Hatchback Engine A 13 DTR	817067	Outer Joint	25	22	51	84	57.5	M					
	2010.06-2014.08	-	-	F	Hatchback Engine A 13 DTR	817027	Outer Joint	25	23	51	84.5	60	M					
1.4 (64 kW)	2009.09-2014.08	MT	L	F	Hatchback Engine A 14 XEL	260023	Drive Shaft	22	22	51.2	79.5	615						
	2009.09-2014.08	MT	L	F	Hatchback Engine A 14 XEL	644013	Inner Joint	22	21	35	57.5	93						
1.4 (66 kW)	2006.07-2014.08	AT/MT	L	F	Hatchback Engine Z 14 XEP	644013	Inner Joint	22	21	35	57.5	93						
	2006.07-2014.08	MT	R	F	Hatchback Engine Z 14 XEP	244078	Drive Shaft	22	22	51	79.5	918						
	2006.07-2014.08	MT	R	F	Hatchback Engine Z 14 XEP	817089	Outer Joint	22	20	51	79.5	51	M					
	2006.07-2014.08	MT	L	F	Hatchback Engine Z 14 XEP	244079	Drive Shaft	22	22	51	79.5	615						
	2006.07-2014.08	-	L/R	F	Hatchback Engine Z 14 XEP	817052	Outer Joint	22	21	51.2	79.5	54	M					
	2006.07-2014.08	AT/MT	L	F	Hatchback Engine Z 14 XEP	260023	Drive Shaft	22	22	51.2	79.5	615						
	2006.07-2014.08	AT/MT	L	F	Hatchback Engine Z 14 XEP	260023	Drive Shaft	22	22	51.2	79.5	615						
1.4 (74 kW)	2010.07-2014.08	AT/MT	L	F	Hatchback Engine A 14 XER	644013	Inner Joint	22	21	35	57.5	93						
	2010.07-2014.08	MT	R	F	Hatchback Engine A 14 XER	244078	Drive Shaft	22	22	51	79.5	918						
	2010.07-2014.08	MT	R	F	Hatchback Engine A 14 XER	817089	Outer Joint	22	20	51	79.5	51	M					
	2010.07-2014.08	MT	L	F	Hatchback Engine A 14 XER	244079	Drive Shaft	22	22	51	79.5	615						
	2010.07-2014.08	-	L/R	F	Hatchback Engine A 14 XER	817052	Outer Joint	22	21	51.2	79.5	54	M					
1.4 (88 kW)	2010.07-2014.08	AT/MT	L	F	Hatchback Engine A 14 XER	260023	Drive Shaft	22	22	51.2	79.5	615						
	2012.07-2014.08	MT	L/R	F	Hatchback Engine A 14 NEL	817053	Outer Joint	25	23	51	84.5	60	M					
	2012.07-2014.08	MT	R	F	Hatchback Engine A 14 NEL	244042	Drive Shaft	25	22	51	84.5	920						
	2012.07-2014.08	MT	-	F	Hatchback Engine A 14 NEL	817027	Outer Joint	25	23	51	84.5	60	M					
	2012.07-2014.08	MT	-	F	Hatchback Engine A 14 NEL	817027	Outer Joint	25	23	51	84.5	60	M					
1.4 LPG (66 kW)	2006.07-2014.08	AT/MT	L	F	Hatchback Engine Z 14 XEP	644013	Inner Joint	22	21	35	57.5	93						
	2006.07-2014.08	-	R	F	Hatchback Engine Z 14 XEP	244078	Drive Shaft	22	22	51	79.5	918						
	2006.07-2014.08	-	R	F	Hatchback Engine Z 14 XEP	817089	Outer Joint	22	20	51	79.5	51	M					
	2006.07-2014.08	-	L	F	Hatchback Engine Z 14 XEP	244079	Drive Shaft	22	22	51	79.5	615						
	2006.07-2014.08	-	L/R	F	Hatchback Engine Z 14 XEP	817052	Outer Joint	22	21	51.2	79.5	54	M					
	2006.07-2014.08	AT/MT	L	F	Hatchback Engine Z 14 XEP	260023	Drive Shaft	22	22	51.2	79.5	615						
1.6 SRi (110 kW)	2007.05-2014.08	-	-	F	Hatchback Engine A 16 LEL	860006	Outer Joint	25	35	51	84.5	63	I					
	2007.05-2014.08	MT	L	F	Hatchback Engine A 16 LEL	260025	Drive Shaft	25	25	51	84.5	579.5						
	2007.05-2014.08	MT	R	F	Hatchback Engine A 16 LEL	260024	Drive Shaft	25	34	51	84.5	608						
1.6 VXR (141 kW)	2007.02-2014.08	-	-	F	Hatchback Engine Z 16 LER	860006	Outer Joint	25	35	51	84.5	63	I					
	2007.02-2014.08	MT	L	F	Hatchback Engine Z 16 LER	260025	Drive Shaft	25	25	51	84.5	579.5						
	2007.02-2014.08	MT	R	F	Hatchback Engine Z 16 LER	260024	Drive Shaft	25	34	51	84.5	608						
1.6 VXR (150 kW)	2011.06-2014.08	-	-	F	Hatchback Engine Z 16 LER	860006	Outer Joint	25	35	51	84.5	63	I					
	2011.06-2014.08	MT	L	F	Hatchback Engine Z 16 LER	260025	Drive Shaft	25	25	51	84.5	579.5						
	2011.06-2014.08	MT	R	F	Hatchback Engine Z 16 LER	260024	Drive Shaft	25	34	51	84.5	608						
1.7 CDTI (92 kW)	2006.11-2014.08	-	-	F	Hatchback Engine Z 17 DTR	860006	Outer Joint	25	35	51	84.5	63	I					
1.7 CDTI (96 kW)	2006.11-2014.08	-	-	F	Hatchback Engine A 17 DTS	860006	Outer Joint	25	35	51	84.5	63	I					
CORSA Mk IV (E) (X15)																		
1.2 (51 kW)	2014.08-2014.08	-	MT	L	F	Hatchback Engine B 12 XER	644013	Inner Joint	22	21	35	57.5	93					
	2014.08-2014.08	-	MT	L	F	Hatchback Engine B 12 XER	817089	Outer Joint	22	20	51	79.5	51	M				
	2014.08-2014.08	-	MT	L	F	Hatchback Engine B 12 XER	260023	Drive Shaft	22	22	51.2	79.5	615					
1.4 (110 kW)	2015.07-2015.07	-	MT	L	F	Hatchback Engine B 14 NEH	217070	Drive Shaft	25	25	51	84.5	576					
1.4 (55 kW)	2014.09-2014.09	-	MT	L	F	Hatchback Engine B 14 XER	644013	Inner Joint	22	21	35	57.5	93					
	2014.09-2014.09	-	MT	R	F	Hatchback Engine B 14 XER	244078	Drive Shaft	22	22	51	79.5	918					

YEAR	TRANSM	L/R	F/R	REMARKS	GSP Ref.	PRODUCT	ABS	Technical Specifications						
								A	B	C	H	L	P	
VAUXHALL														
CORSA Mk IV (E) (X15)														
1.4 (55 kW)	2014.09-	-	MT	R F	Hatchback Engine B 14 XER	817089	Outer Joint		22	20	51	79.5	51	M
	2014.09-	-	MT	L F	Hatchback Engine B 14 XER	244079	Drive Shaft		22	22	51	79.5	615	
	2014.09-	-	MT	L F	Hatchback Engine B 14 XER	260023	Drive Shaft		22	22	51.2	79.5	615	
1.4 (66 kW)	2014.08-	-	MT	L F	Hatchback Engine B 14 XEJ	644013	Inner Joint		22	21	35	57.5	93	
	2014.08-	-	MT	R F	Hatchback Engine B 14 XEJ	244078	Drive Shaft		22	22	51	79.5	918	
	2014.08-	-	MT	R F	Hatchback Engine B 14 XEJ	817089	Outer Joint		22	20	51	79.5	51	M
	2014.08-	-	MT	L F	Hatchback Engine B 14 XEJ	244079	Drive Shaft		22	22	51	79.5	615	
	2014.08-	-	MT	L F	Hatchback Engine B 14 XEJ	260023	Drive Shaft		22	22	51.2	79.5	615	
1.4 (74 kW)	2014.08-	-	MT	L F	Hatchback Engine B 14 NEJ	217070	Drive Shaft		25	25	51	84.5	576	
1.6 VXR (151 kW)	2015.04-	-	-	L F	Hatchback Engine B 16 LES	860006	Outer Joint		25	35	51	84.5	63	I
	2015.04-	-	MT	L F	Hatchback Engine B 16 LES	260025	Drive Shaft		25	25	51	84.5	579.5	
CORSA VAN II														
1.2	2001.03-	-	-	-	LCV	860001	Outer Joint		22	28	52	97.5	54.5	O
	2001.03-	-	MT	-	-	660001	Inner Joint		22	28	34.9	57.5	96.5	
1.7 Di/DTi	2001.03-	-	MT	L F	LCV	260018	Drive Shaft		22	22	52	97.5	587	
CORSAVAN Mk I (B) (S93)														
1.4 i (44 kW)	1994.01-2000.09	-	-	F	Box Engine C 14 NZ	644003	Inner Joint		22	28	34.95	57.5	83.5	
	1994.01-2000.09	-	-	F	Box Engine C 14 NZ	844018	Outer Joint		22	28	52.2	97.5	55	O
	1994.01-2000.09	AT/MT	L F	F	Box Engine C 14 NZ	299139	Drive Shaft		22	22	52	98	570.5	
	1994.01-2000.09	AT/MT	R F	F	Box Engine C 14 NZ	299138	Drive Shaft		22	22	52	98	916.5	
	1994.01-2000.09	-	R F	F	Box Engine C 14 NZ	208005	Drive Shaft	29T	22	22	52	98	916.5	
	1994.01-2000.09	-	-	F	Box Engine C 14 NZ	844019	Outer Joint	29T	22	28	52	97.5	57.5	O
1.5 D (37 kW)	1994.08-1995.12	-	-	F	Box Engine 15 D	644003	Inner Joint		22	28	34.95	57.5	83.5	
	1994.08-1995.12	-	-	F	Box Engine 15 D	844018	Outer Joint		22	28	52.2	97.5	55	O
	1994.08-1995.12	MT	L F	F	Box Engine 15 D	299139	Drive Shaft		22	22	52	98	570.5	
	1994.08-1995.12	MT	R F	F	Box Engine 15 D	299138	Drive Shaft		22	22	52	98	916.5	
	1994.08-1995.12	-	-	F	Box Engine 15 D	844019	Outer Joint	29T	22	28	52	97.5	57.5	O
1.7 D (44 kW)	1994.01-2000.09	-	-	F	Box Engine X 17 D (4EE1)	644003	Inner Joint		22	28	34.95	57.5	83.5	
	1994.01-2000.09	-	-	F	Box Engine X 17 D (4EE1)	844018	Outer Joint		22	28	52.2	97.5	55	O
	1994.01-2000.09	MT	L F	F	Box Engine X 17 D (4EE1)	299139	Drive Shaft		22	22	52	98	570.5	
	1994.01-2000.09	MT	R F	F	Box Engine X 17 D (4EE1)	299138	Drive Shaft		22	22	52	98	916.5	
	1994.01-2000.09	-	R F	F	Box Engine X 17 D (4EE1)	208005	Drive Shaft	29T	22	22	52	98	916.5	
	1994.01-2000.09	-	-	F	Box Engine X 17 D (4EE1)	844019	Outer Joint	29T	22	28	52	97.5	57.5	O
CORSAVAN Mk II (C) (X01)														
1.2 16V (55 kW)	2000.09-2006.06	AT/MT	R F	F	Box Engine Z 12 XE	244075	Drive Shaft	29T	22	22	52	97.5	926	
	2000.09-2006.06	-	L F	F	Box Engine Z 12 XE	244027	Drive Shaft	29T	22	22	52	98	580	
	2000.09-2006.06	Semi-AT/MT	L F	F	Box Engine Z 12 XE	299069	Drive Shaft	29T	22	22	52	97.5	584	
	2000.09-2006.06	-	R F	F	Box Engine Z 12 XE	244026	Drive Shaft	29T	22	22	52	98	930	
	2000.09-2006.06	AT/MT	L F	F	Box Engine Z 12 XE	244095	Drive Shaft	29T	22	22	52	97	566	
	2000.09-2006.06	AT/MT	R F	F	Box Engine Z 12 XE	244096	Drive Shaft	29T	22	22	52	97	917	
	2000.09-2006.06	-	-	-	Box Engine Z 12 XE	844071	Outer Joint		22	28	52	98	52	O
	2000.09-2006.06	AT/MT	L F	F	Box Engine Z 12 XE	244045	Drive Shaft	29T	22	22	52	97	579	
	2000.09-2006.06	-	L/R F	F	Box Engine Z 12 XE	844013	Outer Joint	29T	22	28	52	98	52	O
1.2 16V (59 kW)	2004.07-2006.11	MT	R F	F	Box Engine Z 12 XEP	244075	Drive Shaft	29T	22	22	52	97.5	926	
	2004.07-2006.11	MT	L F	F	Box Engine Z 12 XEP	244027	Drive Shaft	29T	22	22	52	98	580	
	2004.07-2006.11	MT	R F	F	Box Engine Z 12 XEP	244026	Drive Shaft	29T	22	22	52	98	930	
	2004.07-2006.11	MT	L F	F	Box Engine Z 12 XEP	244045	Drive Shaft	29T	22	22	52	97	579	
	2004.07-2006.11	MT	L/R F	F	Box Engine Z 12 XEP	844013	Outer Joint	29T	22	28	52	98	52	O
1.2 16V Dualfuel (55 kW)	2001.08-2006.06	Semi-AT/MT	L F	F	Box Engine Z 12 XE	299069	Drive Shaft	29T	22	22	52	97.5	584	
	2001.08-2006.06	-	L F	F	Box Engine Z 12 XE	244027	Drive Shaft	29T	22	22	52	98	580	
	2001.08-2006.06	-	R F	F	Box Engine Z 12 XE	244026	Drive Shaft	29T	22	22	52	98	930	
	2001.08-2006.06	-	L F	F	Box Engine Z 12 XE	244095	Drive Shaft	29T	22	22	52	97	566	
	2001.08-2006.06	-	R F	F	Box Engine Z 12 XE	244096	Drive Shaft	29T	22	22	52	97	917	
	2001.08-2006.06	-	L F	F	Box Engine Z 12 XE	244045	Drive Shaft	29T	22	22	52	97	579	
	2001.08-2006.06	-	-	-	Box Engine Z 12 XE	844071	Outer Joint		22	28	52	98	52	O
	2001.08-2006.06	-	R F	F	Box Engine Z 12 XE	244075	Drive Shaft	29T	22	22	52	97.5	926	
	2001.08-2006.06	-	L/R F	F	Box Engine Z 12 XE	844013	Outer Joint	29T	22	28	52	98	52	O
1.2 16V Dualfuel (59 kW)	2004.07-2005.12	-	R F	F	Box Engine Z 12 XEP	244075	Drive Shaft	29T	22	22	52	97.5	926	
	2004.07-2005.12	-	L F	F	Box Engine Z 12 XEP	244027	Drive Shaft	29T	22	22	52	98	580	
	2004.07-2005.12	-	R F	F	Box Engine Z 12 XEP	244026	Drive Shaft	29T	22	22	52	98	930	
	2004.07-2005.12	-	L F	F	Box Engine Z 12 XEP	244045	Drive Shaft	29T	22	22	52	97	579	
	2004.07-2005.12	-	L/R F	F	Box Engine Z 12 XEP	844013	Outer Joint	29T	22	28	52	98	52	O
1.3 CDT1 16V (52 kW)	2004.04-2006.06	-	R F	F	Box Engine Z 13 DT	299205	Drive Shaft		22	22	52	97.5	930	
	2004.04-2006.06	-	R F	F	Box Engine Z 13 DT	244075	Drive Shaft	29T	22	22	52	97.5	926	
	2004.04-2006.06	-	R F	F	Box Engine Z 13 DT	844043	Outer Joint		22	28	52	97.5	57.5	O
	2004.04-2006.06	-	L F	F	Box Engine Z 13 DT	244027	Drive Shaft	29T	22	22	52	98	580	

YEAR	TRANSM	L/R	F/R	REMARKS	GSP Ref.	PRODUCT	ABS	Technical Specifications									
								A	B	C	H	L	P				
VAUXHALL																	
CORSAVAN Mk II (C) (X01)																	
1.3 CDTI 16V (52 kW)	2004.04-2006.06	AT/MT	L	F	Box Engine Z 13 DT	299069	Drive Shaft	29T	22	22	52	97.5	584				
	2004.04-2006.06	-	L/R	F	Box Engine Z 13 DT	844020	Outer Joint	29T	22	28	52	97.5	57.5	O			
	2004.04-2006.06	-	R	F	Box Engine Z 13 DT	244026	Drive Shaft	29T	22	22	52	98	930				
	2004.04-2006.06	-	L	F	Box Engine Z 13 DT	244045	Drive Shaft	29T	22	22	52	97	579				
1.4 (66 kW)	2003.11-2006.06	-	R	F	Box Engine Z 14 XEP	244075	Drive Shaft	29T	22	22	52	97.5	926				
	2003.11-2006.06	MT	L	F	Box Engine Z 14 XEP	299069	Drive Shaft	29T	22	22	52	97.5	584				
	2003.11-2006.06	-	L	F	Box Engine Z 14 XEP	244027	Drive Shaft	29T	22	22	52	98	580				
	2003.11-2006.06	-	L/R	F	Box Engine Z 14 XEP	844020	Outer Joint	29T	22	28	52	97.5	57.5	O			
	2003.11-2006.06	-	R	F	Box Engine Z 14 XEP	244026	Drive Shaft	29T	22	22	52	98	930				
	2003.11-2006.06	-	L	F	Box Engine Z 14 XEP	244045	Drive Shaft	29T	22	22	52	97	579				
1.7 DI 16V (48 kW)	2000.09-2006.06	MT	L	F	Box Engine Y 17 DTL	299069	Drive Shaft	29T	22	22	52	97.5	584				
	2000.09-2006.06	-	L	F	Box Engine Y 17 DTL	244027	Drive Shaft	29T	22	22	52	98	580				
	2000.09-2006.06	-	R	F	Box Engine Y 17 DTL	844043	Outer Joint		22	28	52	97.5	57.5	O			
	2000.09-2006.06	-	R	F	Box Engine Y 17 DTL	244060	Drive Shaft		22	22	52	98	930				
	2000.09-2006.06	-	L	F	Box Engine Y 17 DTL	299204	Drive Shaft		22	22	52	97.5	584				
	2000.09-2006.06	-	-	-	Box Engine Y 17 DTL	844044	Outer Joint		22	28	52	97.5	57.5	O			
	2000.09-2006.06	-	R	F	Box Engine Y 17 DTL	244026	Drive Shaft	29T	22	22	52	98	930				
	2000.09-2006.06	-	L/R	F	Box Engine Y 17 DTL	844020	Outer Joint	29T	22	28	52	97.5	57.5	O			
	2000.09-2006.06	-	L	F	Box Engine Y 17 DTL	244045	Drive Shaft	29T	22	22	52	97	579				
	2000.09-2006.06	-	R	F	Box Engine Y 17 DTL	244075	Drive Shaft	29T	22	22	52	97.5	926				
	2000.09-2006.06	-	R	F	Box Engine Y 17 DTL	299205	Drive Shaft		22	22	52	97.5	930				
1.7 DTI 16V (55 kW)	2000.09-2006.06	MT	L	F	Box Engine Y 17 DT	299069	Drive Shaft	29T	22	22	52	97.5	584				
	2000.09-2006.06	-	L	F	Box Engine Y 17 DT	244027	Drive Shaft	29T	22	22	52	98	580				
	2000.09-2006.06	-	R	F	Box Engine Y 17 DT	844043	Outer Joint		22	28	52	97.5	57.5	O			
	2000.09-2006.06	-	R	F	Box Engine Y 17 DT	244060	Drive Shaft		22	22	52	98	930				
	2000.09-2006.06	-	L	F	Box Engine Y 17 DT	299204	Drive Shaft		22	22	52	97.5	584				
	2000.09-2006.06	-	-	-	Box Engine Y 17 DT	844044	Outer Joint		22	28	52	97.5	57.5	O			
	2000.09-2006.06	-	R	F	Box Engine Y 17 DT	244026	Drive Shaft	29T	22	22	52	98	930				
	2000.09-2006.06	-	L/R	F	Box Engine Y 17 DT	844020	Outer Joint	29T	22	28	52	97.5	57.5	O			
	2000.09-2006.06	-	L	F	Box Engine Y 17 DT	244045	Drive Shaft	29T	22	22	52	97	579				
	2000.09-2006.06	-	L/R	F	Box Engine Y 17 DT	844020	Outer Joint	29T	22	28	52	97.5	57.5	O			
	2000.09-2006.06	-	R	F	Box Engine Y 17 DT	244075	Drive Shaft	29T	22	22	52	97.5	926				
	2000.09-2006.06	-	R	F	Box Engine Y 17 DT	299205	Drive Shaft		22	22	52	97.5	930				
CORSAVAN Mk III (D) (S07)																	
1.2 (51 kW)	2010.01-	-	L	F	Box Engine A 12 XEL	817089	Outer Joint		22	20	51	79.5	51	M			
	2010.01-	AT/MT	L	F	Box Engine A 12 XEL	260023	Drive Shaft		22	22	51.2	79.5	615				
	2010.01-	AT/MT	L	F	Box Engine A 12 XEL	644013	Inner Joint		22	21	35	57.5	93				
1.2 (59 kW)	2009.07-	-	R	F	Box Engine Z 12 XEP	644013	Inner Joint		22	21	35	57.5	93				
	2009.07-	5MT	R	F	Box Engine Z 12 XEP	244078	Drive Shaft		22	22	51	79.5	918				
	2009.07-	5MT	R	F	Box Engine Z 12 XEP	817089	Outer Joint		22	20	51	79.5	51	M			
	2009.07-	-	L	F	Box Engine Z 12 XEP	244079	Drive Shaft		22	22	51	79.5	615				
	2009.07-	5MT	L/R	F	Box Engine Z 12 XEP	817052	Outer Joint		22	21	51.2	79.5	54	M			
	2009.07-	AT/MT	L	F	Box Engine Z 12 XEP	260023	Drive Shaft		22	22	51.2	79.5	615				
	2009.07-	-	R	F	Box Engine Z 12 XEP	217044	Drive Shaft		22	22	51.2	79.5	919				
1.3 CDTI (55 kW)	2006.07-	-	-	F	Box Engine Z 13 DTJ	817027	Outer Joint		25	23	51	84.5	60	M			
	2006.07-	-	L/R	F	Box Engine Z 13 DTJ	817053	Outer Joint		25	23	51	84.5	60	M			
	2006.07-	-	L	F	Box Engine Z 13 DTJ	244040	Drive Shaft		25	22	51	84.5	616				
	2006.07-	-	R	F	Box Engine Z 13 DTJ	244042	Drive Shaft		25	22	51	84.5	920				
1.3 CDTI (66 kW)	2006.07-	-	L/R	F	Box Engine Z 13 DTH	817053	Outer Joint		25	23	51	84.5	60	M			
	2006.07-	-	R	F	Box Engine Z 13 DTH	217071	Drive Shaft		25	25	51	84.5	952				
	2006.07-	-	L	F	Box Engine Z 13 DTH	217070	Drive Shaft		25	25	51	84.5	576				
	2006.07-	-	-	F	Box Engine Z 13 DTH	817027	Outer Joint		25	23	51	84.5	60	M			
1.3 CDTI (70 kW)	2006.07-	-	L/R	F	Box Engine A 13 DTE	817053	Outer Joint		25	23	51	84.5	60	M			
	2006.07-	-	-	F	Box Engine A 13 DTE	817027	Outer Joint		25	23	51	84.5	60	M			
CORSAVAN Mk IV (E) (X15)																	
1.2 (51 kW)	2014.10-	-	MT	L	F	Box Engine B 12 XEL	817089	Outer Joint		22	20	51	79.5	51	M		
FRONTERA Mk I (A) (U92)																	
2.2 i (100 kW)	1995.03-1998.10	-	-	F	All-wheel Drive Closed Off-Road Vehicle Engine X 22 XE	826004	Outer Joint		17	33	53	144	69.5	I			
2.3 TD (74 kW)	1991.09-1998.06	-	-	F	All-wheel Drive Closed Off-Road Vehicle Engine 23 DTR	826004	Outer Joint		17	33	53	144	69.5	I			
2.5 TDS (85 kW)	1991.11-1998.06	-	-	F	All-wheel Drive Closed Off-Road Vehicle Engine 25TDS (VM41B)	826004	Outer Joint		17	33	53	144	69.5	I			
2.8 TD (83 kW)	1995.01-1996.12	-	-	F	All-wheel Drive Closed Off-Road Vehicle Engine 28 TDI (4JB1T)	826004	Outer Joint		17	33	53	144	69.5	I			
FRONTERA Mk I (A) Sport (U92)																	
2.5 TDS (85 kW)	1996.09-1998.10	-	-	F	All-wheel Drive Open Off-Road Vehicle Engine 25TDS (VM41B)	826004	Outer Joint		17	33	53	144	69.5	I			
2.8 TD (83 kW)	1995.01-1996.12	-	-	F	All-wheel Drive Open Off-Road Vehicle Engine 28 TDI (4JB1T)	826004	Outer Joint		17	33	53	144	69.5	I			
FRONTERA Mk II (B) (U99)																	
2.2 DTI (85 kW)	1998.10-2004.09	-	-	F	All-wheel Drive Closed Off-Road Vehicle Engine Y 22 DTH	826004	Outer Joint		17	33	53	144	69.5	I			
2.2 i (100 kW)	1998.10-2004.10	-	-	F	All-wheel Drive Closed Off-Road Vehicle Engine X 22 SE	826004	Outer Joint		17	33	53	144	69.5	I			



	 YEAR	TRANSM	L/R	F/R	REMARKS	GSP Ref.	 PRODUCT	 ABS	Technical Specifications						
									A	B	C	H	L	P	
VAUXHALL															
FRONTERA Mk II (B) (U99)															
3.2 i (151 kW)	1998.10-	2004.10	-	-	F	All-wheel Drive Closed Off-Road Vehicle Engine 6 VD1	826004	Outer Joint		17	33	53	144	69.5	I
INSIGNIA Mk I (A) (G09)															
1.4 (103 kW)	2011.04-	2017.05	-	-	F	Hatchback Engine B 14 NET	899023	Outer Joint		30	26	53.8	94.5	65.5	M
	2011.04-	2017.05	-	-	F	Saloon Engine A 14 NET	899023	Outer Joint		30	26	53.8	94.5	65.5	M
1.4 LPG (103 kW)	2012.07-	2017.05	-	-	F	Saloon Engine A 14 NET	899023	Outer Joint		30	26	53.8	94.5	65.5	M
	2012.07-	2017.05	-	-	F	Hatchback Engine A 14 NET	899023	Outer Joint		30	26	53.8	94.5	65.5	M
	2012.07-	2017.05	MT	L/R	F	Saloon Engine A 14 NET	817051	Outer Joint		30	26	53.8	94.5	65.5	M
	2012.07-	2017.05	MT	L/R	F	Hatchback Engine A 14 NET	817051	Outer Joint		30	26	53.8	94.5	65.5	M
1.6 CDTi (100 kW)	2015.07-	2017.05	MT	R	F	Hatchback Engine B 16 DTH	260027	Drive Shaft		30	27	52.5	94.5	619	
	2015.07-	2017.05	MT	R	F	Estate/Country Tourer Engine B 16 DTH	260027	Drive Shaft		30	27	52.5	94.5	619	
	2015.07-	2017.05	6MT	R	F	Saloon Engine B 16 DTH	260027	Drive Shaft		30	27	52.5	94.5	619	
	2015.07-	2017.05	-	-	F	Hatchback Engine B 16 DTH	899023	Outer Joint		30	26	53.8	94.5	65.5	M
	2015.07-	2017.05	-	-	F	Estate/Country Tourer Engine B 16 DTH	899023	Outer Joint		30	26	53.8	94.5	65.5	M
	2015.07-	2017.05	-	-	F	Saloon Engine B 16 DTH	899023	Outer Joint		30	26	53.8	94.5	65.5	M
	2015.07-	2017.05	-	L/R	F	Hatchback Engine B 16 DTH	817051	Outer Joint		30	26	53.8	94.5	65.5	M
	2015.07-	2017.05	-	L/R	F	Estate/Country Tourer Engine B 16 DTH	817051	Outer Joint		30	26	53.8	94.5	65.5	M
	2015.07-	2017.05	-	L/R	F	Saloon Engine B 16 DTH	817051	Outer Joint		30	26	53.8	94.5	65.5	M
	2015.07-	2017.05	AT	R	F	Hatchback Engine B 16 DTH	221045	Drive Shaft		30	27	52.5	94.5	615	
	2015.07-	2017.05	AT	R	F	Estate/Country Tourer Engine B 16 DTH	221045	Drive Shaft		30	27	52.5	94.5	615	
1.6 CDTi (88 kW)	2015.07-	2017.05	-	-	F	Hatchback Engine B 16 DTJ	899023	Outer Joint		30	26	53.8	94.5	65.5	M
	2015.07-	2017.05	-	-	F	Saloon Engine B 16 DTJ	899023	Outer Joint		30	26	53.8	94.5	65.5	M
1.6 Turbo (125 kW)	2013.07-	2017.05	MT	R	F	Hatchback Engine A 16 XHT	260027	Drive Shaft		30	27	52.5	94.5	619	
	2013.07-	2017.05	MT	R	F	Estate/Country Tourer Engine A 16 XHT	260027	Drive Shaft		30	27	52.5	94.5	619	
	2013.07-	2017.05	-	-	F	Hatchback Engine A 16 XHT	899023	Outer Joint		30	26	53.8	94.5	65.5	M
	2013.07-	2017.05	AT/MT	L/R	F	Estate/Country Tourer Engine A 16 XHT	817051	Outer Joint		30	26	53.8	94.5	65.5	M
	2013.07-	2017.05	AT/MT	L/R	F	Hatchback Engine A 16 XHT	817051	Outer Joint		30	26	53.8	94.5	65.5	M
	2013.07-	2017.05	-	-	F	Estate/Country Tourer Engine A 16 XHT	899023	Outer Joint		30	26	53.8	94.5	65.5	M
	2013.07-	2017.05	AT	R	F	Hatchback Engine A 16 XHT	221045	Drive Shaft		30	27	52.5	94.5	615	
1.6 Turbo (132 kW)	2009.01-	2017.05	MT	L/R	F	Hatchback Engine A 16 LET	817051	Outer Joint		30	26	53.8	94.5	65.5	M
	2009.01-	2017.05	MT	L/R	F	Saloon Engine A 16 LET	817051	Outer Joint		30	26	53.8	94.5	65.5	M
	2009.01-	2017.05	MT	R	F	Hatchback Engine A 16 LET	899023	Outer Joint		30	26	53.8	94.5	65.5	M
	2009.01-	2017.05	MT	R	F	Saloon Engine A 16 LET	899023	Outer Joint		30	26	53.8	94.5	65.5	M
1.6(85 kW)	2008.07-	2012.07	MT	L/R	F	Saloon Engine A 16 XER	621011	Inner Joint		34	25	35	78	64	
1.8 (103 kW)	2008.07-	2017.05	-	-	F	Saloon Engine A 18 XER	821038	Outer Joint		30	24	52	94	64	M
	2008.07-	2017.05	-	-	F	Hatchback Engine A 18 XER	821038	Outer Joint		30	24	52	94	64	M
	2008.07-	2017.05	MT	L/R	F	Saloon Engine A 18 XER	621011	Inner Joint		34	25	35	78	64	
	2008.07-	2017.05	MT	L/R	F	Hatchback Engine A 18 XER	621011	Inner Joint		34	25	35	78	64	
	2008.07-	2017.05	MT	L	F	Saloon Engine A 18 XER	221050	Drive Shaft		30	25	52	94	622	
	2008.07-	2017.05	MT	L	F	Hatchback Engine A 18 XER	221050	Drive Shaft		30	25	52	94	622	
	2008.07-	2017.05	MT	R	F	Saloon Engine A 18 XER	221054	Drive Shaft		30	25	52	94	1008	
	2008.07-	2017.05	MT	R	F	Hatchback Engine A 18 XER	221054	Drive Shaft		30	25	52	94	1008	
2.0 Biturbo CDTi (143 kW)	2012.03-	2017.05	MT	L/R	F	All-wheel Drive Hatchback Engine A 20 DTR	260027	Drive Shaft		30	27	52.5	94.5	619	
	2012.03-	2017.05	MT	L/R	F	All-wheel Drive Saloon Engine A 20 DTR	260027	Drive Shaft		30	27	52.5	94.5	619	
	2012.03-	2017.05	AT	L/R	F	Hatchback Engine A 20 DTR	817051	Outer Joint		30	26	53.8	94.5	65.5	M
	2012.03-	2017.05	AT	L/R	F	Saloon Engine A 20 DTR	817051	Outer Joint		30	26	53.8	94.5	65.5	M
	2012.03-	2017.05	-	-	F	Hatchback Engine A 20 DTR	899367	Outer Joint		30	27	58.9	94	64.5	M
	2012.03-	2017.05	-	-	F	Saloon Engine A 20 DTR	899367	Outer Joint		30	27	58.9	94	64.5	M
	2012.03-	2017.05	-	-	F	All-wheel Drive Hatchback Engine A 20 DTR	899023	Outer Joint		30	26	53.8	94.5	65.5	M
	2012.03-	2017.05	-	-	F	All-wheel Drive Saloon Engine A 20 DTR	899023	Outer Joint		30	26	53.8	94.5	65.5	M
	2012.03-	2017.05	AT	R	F	Hatchback Engine A 20 DTR	221045	Drive Shaft		30	27	52.5	94.5	615	
	2012.03-	2017.05	AT	R	F	All-wheel Drive Hatchback Engine A 20 DTR	221045	Drive Shaft		30	27	52.5	94.5	615	
	2012.03-	2017.05	AT	R	F	Saloon Engine A 20 DTR	221045	Drive Shaft		30	27	52.5	94.5	615	
	2012.03-	2017.05	AT	R	F	All-wheel Drive Saloon Engine A 20 DTR	221045	Drive Shaft		30	27	52.5	94.5	615	
	2012.03-	2017.05	MT	L/R	F	All-wheel Drive Hatchback Engine A 20 DTR	817051	Outer Joint		30	26	53.8	94.5	65.5	M
	2012.03-	2017.05	MT	L/R	F	All-wheel Drive Saloon Engine A 20 DTR	817051	Outer Joint		30	26	53.8	94.5	65.5	M
	2013.09-	2017.05	-	-	F	All-wheel Drive Estate/Country Tourer Engine A 20 DTR	899023	Outer Joint		30	26	53.8	94.5	65.5	M
	2013.09-	2017.05	-	L/R	F	All-wheel Drive Estate/Country Tourer Engine A 20 DTR	817051	Outer Joint		30	26	53.8	94.5	65.5	M
2013.09-	2017.05	-	R	F	All-wheel Drive Estate/Country Tourer Engine A 20 DTR	221045	Drive Shaft		30	27	52.5	94.5	615		
2.0 CDTi (103 kW)	2013.07-	2017.05	MT	L/R	F	Hatchback Engine A 20 DTE	260027	Drive Shaft		30	27	52.5	94.5	619	
	2013.07-	2017.05	AT/MT	L/R	F	Hatchback Engine A 20 DTE	817051	Outer Joint		30	26	53.8	94.5	65.5	M
	2013.07-	2017.05	-	L/R	F	Saloon Engine A 20 DTE	260027	Drive Shaft		30	27	52.5	94.5	619	
	2013.07-	2017.05	-	L/R	F	Saloon Engine A 20 DTE	817051	Outer Joint		30	26	53.8	94.5	65.5	M
	2013.07-	2017.05	-	-	F	Saloon Engine A 20 DTE	899023	Outer Joint		30	26	53.8	94.5	65.5	M
	2013.07-	2017.05	-	-	F	Hatchback Engine A 20 DTE	899023	Outer Joint		30	26	53.8	94.5	65.5	M
2.0 CDTi (118 kW)	2008.07-	2017.05	MT	L/R	F	Saloon Engine A 20 DTH	260027	Drive Shaft		30	27	52.5	94.5	619	

YEAR	TRANSM	L/R	F/R	REMARKS	GSP Ref.	PRODUCT	ABS	Technical Specifications							
								A	B	C	H	L	P		
VAUXHALL															
INSIGNIA Mk I (A) (G09)															
2.0 CDTI (118 kW)	2008.07-2017.05	MT	L/R	F	Hatchback Engine A 20 DTH	260027	Drive Shaft	30	27	52.5	94.5	619			
	2008.07-2017.05	MT	L/R	F	All-wheel Drive Hatchback Engine A 20 DTH	260027	Drive Shaft	30	27	52.5	94.5	619			
	2008.07-2017.05	MT	L/R	F	All-wheel Drive Saloon Engine A 20 DTH	260027	Drive Shaft	30	27	52.5	94.5	619			
	2008.07-2017.05	AT/MT	L/R	F	Saloon Engine A 20 DTH	817051	Outer Joint	30	26	53.8	94.5	65.5	M		
	2008.07-2017.05	AT/MT	L/R	F	Hatchback Engine A 20 DTH	817051	Outer Joint	30	26	53.8	94.5	65.5	M		
	2008.07-2017.05	AT	-	F	All-wheel Drive Hatchback Engine A 20 DTH	899023	Outer Joint	30	26	53.8	94.5	65.5	M		
	2008.07-2017.05	AT	-	F	All-wheel Drive Saloon Engine A 20 DTH	899023	Outer Joint	30	26	53.8	94.5	65.5	M		
	2008.07-2017.05	-	L	F	All-wheel Drive Hatchback Engine A 20 DTH	817051	Outer Joint	30	26	53.8	94.5	65.5	M		
	2008.07-2017.05	-	L	F	All-wheel Drive Saloon Engine A 20 DTH	817051	Outer Joint	30	26	53.8	94.5	65.5	M		
	2008.07-2017.05	AT	L/R	F	Saloon Engine A 20 DTH	221045	Drive Shaft	30	27	52.5	94.5	615			
	2008.07-2017.05	AT	L/R	F	Hatchback Engine A 20 DTH	221045	Drive Shaft	30	27	52.5	94.5	615			
	2008.07-2017.05	AT	L/R	F	All-wheel Drive Hatchback Engine A 20 DTH	221045	Drive Shaft	30	27	52.5	94.5	615			
	2008.07-2017.05	AT	L/R	F	All-wheel Drive Saloon Engine A 20 DTH	221045	Drive Shaft	30	27	52.5	94.5	615			
	2008.07-2017.05	-	-	F	Saloon Engine A 20 DTH	899023	Outer Joint	30	26	53.8	94.5	65.5	M		
	2008.07-2017.05	-	-	F	Hatchback Engine A 20 DTH	899023	Outer Joint	30	26	53.8	94.5	65.5	M		
2.0 CDTI (120 kW)	2013.07-2017.05	MT	L/R	F	Hatchback Engine A 20 DTH	260027	Drive Shaft	30	27	52.5	94.5	619			
	2013.07-2017.05	MT	L/R	F	Saloon Engine A 20 DTH	260027	Drive Shaft	30	27	52.5	94.5	619			
	2013.07-2017.05	AT/MT	L/R	F	Saloon Engine A 20 DTH	817051	Outer Joint	30	26	53.8	94.5	65.5	M		
	2013.07-2017.05	-	-	F	Hatchback Engine A 20 DTH	899023	Outer Joint	30	26	53.8	94.5	65.5	M		
	2013.07-2017.05	-	-	F	Estate/Country Tourer Engine A 20 DTH	899023	Outer Joint	30	26	53.8	94.5	65.5	M		
	2013.07-2017.05	-	L/R	F	Estate/Country Tourer Engine A 20 DTH	817051	Outer Joint	30	26	53.8	94.5	65.5	M		
	2013.07-2017.05	AT	L/R	F	Hatchback Engine A 20 DTH	221045	Drive Shaft	30	27	52.5	94.5	615			
	2013.07-2017.05	AT	L/R	F	Saloon Engine A 20 DTH	221045	Drive Shaft	30	27	52.5	94.5	615			
	2013.07-2017.05	-	L/R	F	Estate/Country Tourer Engine A 20 DTH	221045	Drive Shaft	30	27	52.5	94.5	615			
	2013.07-2017.05	-	-	F	Saloon Engine A 20 DTH	899023	Outer Joint	30	26	53.8	94.5	65.5	M		
	2013.07-2017.05	AT/MT	L/R	F	Hatchback Engine A 20 DTH	817051	Outer Joint	30	26	53.8	94.5	65.5	M		
2.0 CDTI (125 kW)	2014.11-2017.05	6AT	L/R	F	Hatchback Engine B 20 DTH	817051	Outer Joint	30	26	53.8	94.5	65.5	M		
	2014.11-2017.05	-	-	F	Hatchback Engine B 20 DTH	899023	Outer Joint	30	26	53.8	94.5	65.5	M		
	2014.11-2017.05	-	-	F	All-wheel Drive Hatchback Engine B 20 DTH	899023	Outer Joint	30	26	53.8	94.5	65.5	M		
	2014.11-2017.05	-	-	F	Saloon Engine B 20 DTH	899023	Outer Joint	30	26	53.8	94.5	65.5	M		
	2014.11-2017.05	-	-	F	All-wheel Drive Saloon Engine B 20 DTH	899023	Outer Joint	30	26	53.8	94.5	65.5	M		
	2014.11-2017.05	6AT	L/R	F	Hatchback Engine B 20 DTH	221045	Drive Shaft	30	27	52.5	94.5	615			
	2014.11-2017.05	-	-	F	Estate/Country Tourer Engine B 20 DTH	899023	Outer Joint	30	26	53.8	94.5	65.5	M		
	2014.11-2017.05	-	-	F	All-wheel Drive Estate/Country Tourer Engine B 20 DTH	899023	Outer Joint	30	26	53.8	94.5	65.5	M		
2.0 CDTI (140 kW)	2008.10-2017.05	-	-	F	Hatchback Engine A 20 DTR	899367	Outer Joint	30	27	58.9	94	64.5	M		
	2008.10-2017.05	AT	L/R	F	Hatchback Engine A 20 DTR	221045	Drive Shaft	30	27	52.5	94.5	615			
	2008.10-2017.05	AT	L/R	F	Hatchback Engine A 20 DTR	817051	Outer Joint	30	26	53.8	94.5	65.5	M		
	2008.11-2017.05	-	-	F	Saloon Engine A 20 DTR	899367	Outer Joint	30	27	58.9	94	64.5	M		
	2008.11-2017.05	AT	L/R	F	Saloon Engine A 20 DTR	221045	Drive Shaft	30	27	52.5	94.5	615			
	2008.11-2017.05	AT	L/R	F	Saloon Engine A 20 DTR	817051	Outer Joint	30	26	53.8	94.5	65.5	M		
	2009.05-2017.05	-	-	F	All-wheel Drive Hatchback Engine A 20 DTR	899023	Outer Joint	30	26	53.8	94.5	65.5	M		
	2009.05-2017.05	-	-	F	All-wheel Drive Saloon Engine A 20 DTR	899023	Outer Joint	30	26	53.8	94.5	65.5	M		
	2009.05-2017.05	AT	L/R	F	All-wheel Drive Hatchback Engine A 20 DTR	221045	Drive Shaft	30	27	52.5	94.5	615			
	2009.05-2017.05	AT	L/R	F	All-wheel Drive Saloon Engine A 20 DTR	221045	Drive Shaft	30	27	52.5	94.5	615			
	2009.05-2017.05	MT	L/R	F	All-wheel Drive Hatchback Engine A 20 DTR	817051	Outer Joint	30	26	53.8	94.5	65.5	M		
	2009.05-2017.05	MT	L/R	F	All-wheel Drive Saloon Engine A 20 DTR	817051	Outer Joint	30	26	53.8	94.5	65.5	M		
	2009.05-2017.05	MT	L/R	F	All-wheel Drive Hatchback Engine A 20 DTR	260027	Drive Shaft	30	27	52.5	94.5	619			
	2009.05-2017.05	MT	L/R	F	All-wheel Drive Saloon Engine A 20 DTR	260027	Drive Shaft	30	27	52.5	94.5	619			
2.0 CDTI (88 kW)	2012.03-2016.03	MT	L/R	F	Hatchback Engine A 20 DTE	260027	Drive Shaft	30	27	52.5	94.5	619			
	2012.03-2016.03	-	-	F	Hatchback Engine A 20 DTE	899023	Outer Joint	30	26	53.8	94.5	65.5	M		
	2012.03-2014.12	-	-	F	Saloon Engine A 20 DTE	899023	Outer Joint	30	26	53.8	94.5	65.5	M		
	2012.03-2016.03	AT/MT	L/R	F	Hatchback Engine A 20 DTE	817051	Outer Joint	30	26	53.8	94.5	65.5	M		
2.0 CDTI (96 kW)	2008.07-2014.12	AT/MT	L/R	F	Saloon Engine A 20 DTJ	817051	Outer Joint	30	26	53.8	94.5	65.5	M		
	2008.07-2014.12	AT/MT	L/R	F	Hatchback Engine A 20 DT	817051	Outer Joint	30	26	53.8	94.5	65.5	M		
	2008.07-2014.12	MT	L	F	Saloon Engine A 20 DTJ	260026	Drive Shaft	30	25	52.5	94.5	631			
	2008.07-2014.12	MT	L	F	Hatchback Engine A 20 DT	260026	Drive Shaft	30	25	52.5	94.5	631			
	2008.07-2014.12	AT	L/R	F	Saloon Engine A 20 DTJ	221045	Drive Shaft	30	27	52.5	94.5	615			
	2008.07-2014.12	AT	L/R	F	Hatchback Engine A 20 DT	221045	Drive Shaft	30	27	52.5	94.5	615			
	2008.07-2014.12	MT	R	F	Saloon Engine A 20 DTJ	260027	Drive Shaft	30	27	52.5	94.5	619			
	2008.07-2014.12	MT	R	F	Hatchback Engine A 20 DT	260027	Drive Shaft	30	27	52.5	94.5	619			
	2008.07-2014.12	-	-	F	Saloon Engine A 20 DTJ	899023	Outer Joint	30	26	53.8	94.5	65.5	M		
	2008.07-2014.12	-	-	F	Hatchback Engine A 20 DT	899023	Outer Joint	30	26	53.8	94.5	65.5	M		
2.0 CDTI(88 kW)	2012.03-2016.03	MT	L/R	F	Estate/Country Tourer	260027	Drive Shaft	30	27	52.5	94.5	619			
	2012.03-2016.03	AT/MT	L/R	F	Estate/Country Tourer	817051	Outer Joint	30	26	53.8	94.5	65.5	M		
	2012.03-2016.03	-	-	F	Estate/Country Tourer	899023	Outer Joint	30	26	53.8	94.5	65.5	M		
2.0 E85 Turbo (162 kW)	2010.09-2017.05	AT/MT	L/R	F	Estate/Sports Tourer Engine A 20 NFT, A 20 NHT	817051	Outer Joint	30	26	53.8	94.5	65.5	M		

YEAR	TRANSM	L/R	F/R	REMARKS	GSP Ref.	PRODUCT	ABS	Technical Specifications						
								A	B	C	H	L	P	
VAUXHALL														
INSIGNIA Mk I (A) (G09)														
2.0 E85 Turbo (162 kW)	2010.09-2017.05	AT/MT	L/R	F	Hatchback Engine A 20 NFT	817051	Outer Joint	30	26	53.8	94.5	65.5	M	
	2010.09-2017.05	AT	L/R	F	Estate/Sports Tourer Engine A 20 NFT, A 20 NHT	221045	Drive Shaft	30	27	52.5	94.5	615		
	2010.09-2017.05	AT	L/R	F	Hatchback Engine A 20 NFT	221045	Drive Shaft	30	27	52.5	94.5	615		
	2010.09-2017.05	-	-	F	Saloon Engine A 20 NHT	899023	Outer Joint	30	26	53.8	94.5	65.5	M	
	2010.09-2017.05	MT	L/R	F	Estate/Sports Tourer Engine A 20 NFT, A 20 NHT	260027	Drive Shaft	30	27	52.5	94.5	619		
	2010.09-2017.05	MT	L/R	F	Hatchback Engine A 20 NFT	260027	Drive Shaft	30	27	52.5	94.5	619		
2.0 Turbo (162 kW)	2008.07-2017.05	MT	L/R	F	All-wheel Drive Saloon Engine A 20 NFT	260027	Drive Shaft	30	27	52.5	94.5	619		
	2008.07-2017.05	MT	L/R	F	All-wheel Drive Hatchback Engine A 20 NHT	260027	Drive Shaft	30	27	52.5	94.5	619		
	2008.07-2017.05	AT/MT	L/R	F	Saloon Engine A 20 NFT	817051	Outer Joint	30	26	53.8	94.5	65.5	M	
	2008.07-2017.05	AT/MT	L/R	F	Hatchback Engine A 20 NHT	817051	Outer Joint	30	26	53.8	94.5	65.5	M	
	2008.07-2017.05	AT/MT	L/R	F	All-wheel Drive Saloon Engine A 20 NFT	817051	Outer Joint	30	26	53.8	94.5	65.5	M	
	2008.07-2017.05	AT/MT	L/R	F	All-wheel Drive Hatchback Engine A 20 NHT	817051	Outer Joint	30	26	53.8	94.5	65.5	M	
	2008.07-2017.05	AT	L/R	F	Saloon Engine A 20 NFT	221045	Drive Shaft	30	27	52.5	94.5	615		
	2008.07-2017.05	AT	L/R	F	Hatchback Engine A 20 NHT	221045	Drive Shaft	30	27	52.5	94.5	615		
	2008.07-2017.05	AT	L/R	F	All-wheel Drive Saloon Engine A 20 NFT	221045	Drive Shaft	30	27	52.5	94.5	615		
	2008.07-2017.05	AT	L/R	F	All-wheel Drive Hatchback Engine A 20 NHT	221045	Drive Shaft	30	27	52.5	94.5	615		
	2008.07-2017.05	MT	L/R	F	Saloon Engine A 20 NFT	260027	Drive Shaft	30	27	52.5	94.5	619		
	2008.07-2017.05	MT	L/R	F	Hatchback Engine A 20 NHT	260027	Drive Shaft	30	27	52.5	94.5	619		
	2008.07-2017.05	-	-	F	Saloon Engine A 20 NFT	899023	Outer Joint	30	26	53.8	94.5	65.5	M	
	2008.07-2017.05	-	-	F	Hatchback Engine A 20 NHT	899023	Outer Joint	30	26	53.8	94.5	65.5	M	
	2008.07-2017.05	-	-	F	All-wheel Drive Saloon Engine A 20 NFT	899023	Outer Joint	30	26	53.8	94.5	65.5	M	
	2008.07-2017.05	-	-	F	All-wheel Drive Hatchback Engine A 20 NHT	899023	Outer Joint	30	26	53.8	94.5	65.5	M	
2.0 Turbo (184 kW)	2011.09-2017.05	-	-	-	All-wheel Drive Hatchback Engine A 20 NHT	899023	Outer Joint	30	26	53.8	94.5	65.5	M	
	2011.09-2017.05	-	-	-	All-wheel Drive Saloon Engine A 20 NFT	899023	Outer Joint	30	26	53.8	94.5	65.5	M	
	2011.09-2017.05	MT	L/R	F	All-wheel Drive Saloon Engine A 20 NFT	260027	Drive Shaft	30	27	52.5	94.5	619		
	2011.09-2017.05	MT	L/R	F	Saloon Engine A 20 NHT	260027	Drive Shaft	30	27	52.5	94.5	619		
	2011.09-2017.05	-	-	F	Saloon Engine A 20 NHT	899023	Outer Joint	30	26	53.8	94.5	65.5	M	
	2011.09-2017.05	-	-	F	All-wheel Drive Estate/Country Tourer Engine A 20 NFT, A 20 NHT, B 20 NHT	899023	Outer Joint	30	26	53.8	94.5	65.5	M	
	2011.09-2017.05	-	L/R	F	All-wheel Drive Saloon Engine A 20 NFT	817051	Outer Joint	30	26	53.8	94.5	65.5	M	
	2011.09-2017.05	-	L/R	F	Saloon Engine A 20 NHT	817051	Outer Joint	30	26	53.8	94.5	65.5	M	
	2011.09-2017.05	AT	L/R	F	All-wheel Drive Saloon Engine A 20 NFT	221045	Drive Shaft	30	27	52.5	94.5	615		
	2011.09-2017.05	AT	L/R	F	Saloon Engine A 20 NHT	221045	Drive Shaft	30	27	52.5	94.5	615		
	2014.04-2017.05	MT	L/R	F	Hatchback Engine A 20 NFT	260027	Drive Shaft	30	27	52.5	94.5	619		
	2014.04-2017.05	-	-	F	Hatchback Engine A 20 NFT	899023	Outer Joint	30	26	53.8	94.5	65.5	M	
	2014.04-2017.05	-	L/R	F	Hatchback Engine A 20 NFT	817051	Outer Joint	30	26	53.8	94.5	65.5	M	
	2014.04-2017.05	AT	R	F	Hatchback Engine A 20 NFT	221045	Drive Shaft	30	27	52.5	94.5	615		
2.8 V6 Turbo (191 kW)	2008.07-2017.05	-	-	F	All-wheel Drive Saloon Engine A 28 NET	899023	Outer Joint	30	26	53.8	94.5	65.5	M	
	2008.07-2017.05	-	-	F	All-wheel Drive Hatchback Engine A 28 NET	899023	Outer Joint	30	26	53.8	94.5	65.5	M	
	2008.07-2017.05	AT	R	F	All-wheel Drive Saloon Engine A 28 NET	817051	Outer Joint	30	26	53.8	94.5	65.5	M	
	2008.07-2017.05	AT	R	F	All-wheel Drive Hatchback Engine A 28 NET	817051	Outer Joint	30	26	53.8	94.5	65.5	M	
	2008.07-2017.05	AT	L/R	F	All-wheel Drive Saloon Engine A 28 NET	221045	Drive Shaft	30	27	52.5	94.5	615		
	2008.07-2017.05	AT	L/R	F	All-wheel Drive Hatchback Engine A 28 NET	221045	Drive Shaft	30	27	52.5	94.5	615		
	2008.07-2017.05	-	-	F	All-wheel Drive Saloon Engine A 28 NET	899367	Outer Joint	30	27	58.9	94	64.5	M	
	2008.07-2017.05	-	-	F	All-wheel Drive Hatchback Engine A 28 NET	899367	Outer Joint	30	27	58.9	94	64.5	M	
2.8 VXR (239 kW)	2009.07-2017.05	-	-	F	All-wheel Drive Saloon Engine A 28 NER	899367	Outer Joint	30	27	58.9	94	64.5	M	
	2009.07-2017.05	-	-	F	All-wheel Drive Hatchback Engine A 28 NER	899367	Outer Joint	30	27	58.9	94	64.5	M	
INSIGNIA Mk I (A) Country Tourer (G09)														
2.0 CDTI (47) (120 kW)	2013.07-2017.05	MT	L/R	F	All-wheel Drive Estate Engine A 20 DTH	260027	Drive Shaft	30	27	52.5	94.5	619		
	2013.07-2017.05	AT/MT	L/R	F	All-wheel Drive Estate Engine A 20 DTH	817051	Outer Joint	30	26	53.8	94.5	65.5	M	
	2013.07-2017.05	-	-	F	All-wheel Drive Estate Engine A 20 DTH	899023	Outer Joint	30	26	53.8	94.5	65.5	M	
	2013.07-2017.05	AT	L/R	F	All-wheel Drive Estate Engine A 20 DTH	221045	Drive Shaft	30	27	52.5	94.5	615		
INSIGNIA Mk I (A) Sports Tourer (G09)														
1.4 (103 kW)	2011.04-2017.05	-	-	F	Estate Engine B 14 NET	899023	Outer Joint	30	26	53.8	94.5	65.5	M	
1.4 LPG (103 kW)	2012.07-2017.05	-	-	F	Estate Engine A 14 NET	899023	Outer Joint	30	26	53.8	94.5	65.5	M	
	2012.07-2017.05	MT	L/R	F	Estate Engine A 14 NET	817051	Outer Joint	30	26	53.8	94.5	65.5	M	
1.6 CDTI (100 kW)	2015.07-2017.05	MT	R	F	Estate Engine B 16 DTH	260027	Drive Shaft	30	27	52.5	94.5	619		
	2015.07-2017.05	-	-	F	Estate Engine B 16 DTH	899023	Outer Joint	30	26	53.8	94.5	65.5	M	
	2015.07-2017.05	-	L/R	F	Estate Engine B 16 DTH	817051	Outer Joint	30	26	53.8	94.5	65.5	M	
	2015.07-2017.05	AT	R	F	Estate Engine B 16 DTH	221045	Drive Shaft	30	27	52.5	94.5	615		
1.6 Turbo (125 kW)	2013.07-2017.05	MT	R	F	Estate Engine A 16 XHT	260027	Drive Shaft	30	27	52.5	94.5	619		
	2013.07-2017.05	-	-	F	Estate Engine A 16 XHT	899023	Outer Joint	30	26	53.8	94.5	65.5	M	
	2013.07-2017.05	AT/MT	L/R	F	Estate Engine A 16 XHT	817051	Outer Joint	30	26	53.8	94.5	65.5	M	
	2013.07-2017.05	AT	R	F	Estate Engine A 16 XHT	221045	Drive Shaft	30	27	52.5	94.5	615		
1.6 Turbo (132 kW)	2009.01-2017.05	MT	L/R	F	Estate Engine A 16 LET	817051	Outer Joint	30	26	53.8	94.5	65.5	M	
	2009.01-2017.05	MT	R	F	Estate Engine A 16 LET	899023	Outer Joint	30	26	53.8	94.5	65.5	M	
1.8 (103 kW)	2008.07-2017.05	MT	-	F	Estate Engine A 18 XER	821038	Outer Joint	30	24	52	94	64	M	





	YEAR	TRANSM	L/R	F/R	REMARKS	GSP Ref.	PRODUCT	ABS	Technical Specifications								
									A	B	C	H	L	P			
VAUXHALL																	
INSIGNIA Mk I (A) Sports Tourer (G09)																	
1.8 (103 kW)	2008.07-2017.05	MT	L/R	F	Estate Engine A 18 XER	621011	Inner Joint		34	25	35	78	64				
	2008.07-2017.05	MT	L	F	Estate Engine A 18 XER	221050	Drive Shaft		30	25	52	94	622				
	2008.07-2017.05	MT	R	F	Estate Engine A 18 XER	221054	Drive Shaft		30	25	52	94	1008				
2.0 Biturbo CDTI (143 kW)	2012.03-2017.05	AT	L/R	F	Estate Engine A 20 DTR	817051	Outer Joint		30	26	53.8	94.5	65.5	M			
	2012.03-2017.05	-	L/R	F	All-wheel Drive Estate Engine A 20 DTR	817051	Outer Joint		30	26	53.8	94.5	65.5	M			
	2012.03-2017.05	-	-	F	Estate Engine A 20 DTR	899367	Outer Joint		30	27	58.9	94	64.5	M			
	2012.03-2017.05	-	-	F	All-wheel Drive Estate Engine A 20 DTR	899023	Outer Joint		30	26	53.8	94.5	65.5	M			
	2012.03-2017.05	AT	R	F	Estate Engine A 20 DTR	221045	Drive Shaft		30	27	52.5	94.5	615				
	2012.03-2017.05	AT	R	F	All-wheel Drive Estate Engine A 20 DTR	221045	Drive Shaft		30	27	52.5	94.5	615				
2.0 CDTI (103 kW)	2013.07-2017.05	MT	L/R	F	Estate Engine A 20 DTE	260027	Drive Shaft		30	27	52.5	94.5	619				
	2013.07-2017.05	-	-	F	Estate Engine A 20 DTE	899023	Outer Joint		30	26	53.8	94.5	65.5	M			
	2013.07-2017.05	AT/MT	L/R	F	Estate Engine A 20 DTE	817051	Outer Joint		30	26	53.8	94.5	65.5	M			
2.0 CDTI (118 kW)	2008.07-2017.05	MT	L/R	F	Estate Engine A 20 DTH	260027	Drive Shaft		30	27	52.5	94.5	619				
	2008.07-2017.05	MT	L/R	F	All-wheel Drive Estate Engine A 20 DTH	260027	Drive Shaft		30	27	52.5	94.5	619				
	2008.07-2017.05	AT/MT	L/R	F	Estate Engine A 20 DTH	817051	Outer Joint		30	26	53.8	94.5	65.5	M			
	2008.07-2017.05	AT	-	F	All-wheel Drive Estate Engine A 20 DTH	899023	Outer Joint		30	26	53.8	94.5	65.5	M			
	2008.07-2017.05	-	L	F	All-wheel Drive Estate Engine A 20 DTH	817051	Outer Joint		30	26	53.8	94.5	65.5	M			
	2008.07-2017.05	AT	L/R	F	Estate Engine A 20 DTH	221045	Drive Shaft		30	27	52.5	94.5	615				
	2008.07-2017.05	AT	L/R	F	All-wheel Drive Estate Engine A 20 DTH	221045	Drive Shaft		30	27	52.5	94.5	615				
	2008.07-2017.05	-	-	F	Estate Engine A 20 DTH	899023	Outer Joint		30	26	53.8	94.5	65.5	M			
2.0 CDTI (120 kW)	2013.07-2017.05	MT	L/R	F	Estate Engine A 20 DTH	260027	Drive Shaft		30	27	52.5	94.5	619				
	2013.07-2017.05	-	L/R	F	Estate Engine A 20 DTH	817051	Outer Joint		30	26	53.8	94.5	65.5	M			
	2013.07-2017.05	AT	L/R	F	Estate Engine A 20 DTH	221045	Drive Shaft		30	27	52.5	94.5	615				
	2013.07-2017.05	-	-	F	Estate Engine A 20 DTH	899023	Outer Joint		30	26	53.8	94.5	65.5	M			
2.0 CDTI (125 kW)	2014.11-2017.05	6AT	L/R	F	Estate Engine B 20 DTH	817051	Outer Joint		30	26	53.8	94.5	65.5	M			
	2014.11-2017.05	-	-	F	Estate Engine B 20 DTH	899023	Outer Joint		30	26	53.8	94.5	65.5	M			
	2014.11-2017.05	-	-	F	All-wheel Drive Estate Engine B 20 DTH	899023	Outer Joint		30	26	53.8	94.5	65.5	M			
	2014.11-2017.05	6AT	L	F	Estate Engine B 20 DTH	221045	Drive Shaft		30	27	52.5	94.5	615				
2.0 CDTI (140 kW)	2008.11-2017.05	-	-	F	Estate Engine A 20 DTR	899367	Outer Joint		30	27	58.9	94	64.5	M			
	2008.11-2017.05	AT	L/R	F	Estate Engine A 20 DTR	221045	Drive Shaft		30	27	52.5	94.5	615				
	2008.11-2017.05	AT	L/R	F	Estate Engine A 20 DTR	817051	Outer Joint		30	26	53.8	94.5	65.5	M			
	2009.05-2017.05	-	-	F	All-wheel Drive Estate Engine A 20 DTR	899023	Outer Joint		30	26	53.8	94.5	65.5	M			
	2009.05-2017.05	AT	L/R	F	All-wheel Drive Estate Engine A 20 DTR	221045	Drive Shaft		30	27	52.5	94.5	615				
	2009.05-2017.05	MT	L/R	F	All-wheel Drive Estate Engine A 20 DTR	817051	Outer Joint		30	26	53.8	94.5	65.5	M			
	2009.05-2017.05	MT	L/R	F	All-wheel Drive Estate Engine A 20 DTR	260027	Drive Shaft		30	27	52.5	94.5	619				
2.0 CDTI (81 kW)	2008.07-2017.05	-	L	F	Estate Engine A 20 DTL	260026	Drive Shaft		30	25	52.5	94.5	631				
	2008.07-2017.05	-	-	F	Estate Engine A 20 DTL	899023	Outer Joint		30	26	53.8	94.5	65.5	M			
	2008.07-2017.05	-	L/R	F	Estate Engine A 20 DTL	817051	Outer Joint		30	26	53.8	94.5	65.5	M			
	2008.07-2017.05	-	R	F	Estate Engine A 20 DTL	260027	Drive Shaft		30	27	52.5	94.5	619				
2.0 CDTI (88 kW)	2012.03-2016.03	MT	L/R	F	Estate Engine A 20 DTE	260027	Drive Shaft		30	27	52.5	94.5	619				
	2012.03-2016.03	-	-	F	Estate Engine A 20 DTE	899023	Outer Joint		30	26	53.8	94.5	65.5	M			
	2012.03-2016.03	AT/MT	L/R	F	Estate Engine A 20 DTE	817051	Outer Joint		30	26	53.8	94.5	65.5	M			
2.0 CDTI (96 kW)	2008.07-2014.12	AT/MT	L/R	F	Estate Engine A 20 DT	817051	Outer Joint		30	26	53.8	94.5	65.5	M			
	2008.07-2014.12	MT	L	F	Estate Engine A 20 DT	260026	Drive Shaft		30	25	52.5	94.5	631				
	2008.07-2014.12	AT	L/R	F	Estate Engine A 20 DT	221045	Drive Shaft		30	27	52.5	94.5	615				
	2008.07-2014.12	MT	R	F	Estate Engine A 20 DT	260027	Drive Shaft		30	27	52.5	94.5	619				
	2008.07-2014.12	-	-	F	Estate Engine A 20 DT	899023	Outer Joint		30	26	53.8	94.5	65.5	M			
2.0 Turbo (162 kW)	2008.07-2017.05	MT	L/R	F	All-wheel Drive Estate Engine A 20 NHT	260027	Drive Shaft		30	27	52.5	94.5	619				
	2008.07-2017.05	AT/MT	L/R	F	Estate Engine A 20 NFT	817051	Outer Joint		30	26	53.8	94.5	65.5	M			
	2008.07-2017.05	AT/MT	L/R	F	All-wheel Drive Estate Engine A 20 NHT	817051	Outer Joint		30	26	53.8	94.5	65.5	M			
	2008.07-2017.05	AT	L/R	F	Estate Engine A 20 NFT	221045	Drive Shaft		30	27	52.5	94.5	615				
	2008.07-2017.05	AT	L/R	F	All-wheel Drive Estate Engine A 20 NHT	221045	Drive Shaft		30	27	52.5	94.5	615				
	2008.07-2017.05	MT	L/R	F	Estate Engine A 20 NFT	260027	Drive Shaft		30	27	52.5	94.5	619				
	2008.07-2017.05	-	-	F	Estate Engine A 20 NFT	899023	Outer Joint		30	26	53.8	94.5	65.5	M			
	2008.07-2017.05	-	-	F	All-wheel Drive Estate Engine A 20 NHT	899023	Outer Joint		30	26	53.8	94.5	65.5	M			
2.0 Turbo (184 kW)	2011.09-2017.05	-	-	F	All-wheel Drive Estate Engine B 20 NHT	899023	Outer Joint		30	26	53.8	94.5	65.5	M			
	2014.04-2017.05	MT	L/R	F	Estate Engine B 20 NHT	260027	Drive Shaft		30	27	52.5	94.5	619				
	2014.04-2017.05	AT/MT	L/R	F	Estate Engine B 20 NHT	817051	Outer Joint		30	26	53.8	94.5	65.5	M			
	2014.04-2017.05	-	-	F	Estate Engine B 20 NHT	899023	Outer Joint		30	26	53.8	94.5	65.5	M			
	2014.04-2017.05	AT	L/R	F	Estate Engine B 20 NHT	221045	Drive Shaft		30	27	52.5	94.5	615				
2.8 V6 Turbo (191 kW)	2008.08-2017.05	-	-	F	All-wheel Drive Estate Engine A 28 NET	899023	Outer Joint		30	26	53.8	94.5	65.5	M			
	2008.08-2017.05	AT	L/R	F	All-wheel Drive Estate Engine A 28 NET	221045	Drive Shaft		30	27	52.5	94.5	615				
	2008.08-2017.05	-	-	F	All-wheel Drive Estate Engine A 28 NET	899367	Outer Joint		30	27	58.9	94	64.5	M			
	2008.08-2017.05	-	R	F	All-wheel Drive Estate Engine A 28 NET	817051	Outer Joint		30	26	53.8	94.5	65.5	M			
2.8 VXR (239 kW)	2009.07-2017.05	-	-	F	All-wheel Drive Estate Engine A 28 NER	899367	Outer Joint		30	27	58.9	94	64.5	M			
MERIVA Mk I (A) (X03)																	





	YEAR	TRANSM	L/R	F/R	REMARKS	GSP Ref.	PRODUCT	ABS	Technical Specifications								
									A	B	C	H	L	P			
VAUXHALL																	
MERIVA Mk I (A) (X03)																	
1.3 CDTi (51 kW)	2005.04-2010.06	MT	L	F	MPV Engine Z 13 DT	299069	Drive Shaft	29T	22	22	52	97.5	584				
	2005.04-2010.06	-	L/R	F	MPV Engine Z 13 DT	844002	Outer Joint	29T	22	23	52	97.5	61	M			
1.3 CDTi (55 kW)	2003.01-2009.10	MT	L	F	MPV Engine Z 13 DTJ	299069	Drive Shaft	29T	22	22	52	97.5	584				
	2003.01-2009.10	-	L/R	F	MPV Engine Z 13 DTJ	844002	Outer Joint	29T	22	23	52	97.5	61	M			
1.4 16V Twinport (66 kW)	2003.01-2010.06	MT	L	F	MPV Engine Z 14 XEP	299069	Drive Shaft	29T	22	22	52	97.5	584				
	2003.01-2010.06	-	L/R	F	MPV Engine Z 14 XEP	844020	Outer Joint	29T	22	28	52	97.5	57.5	O			
	2003.01-2010.06	-	-	F	MPV Engine Z 14 XEP	822007	Outer Joint	29T	22	22	52	98	51	M			
1.6 i (64 kW)	2003.01-2010.06	MT	L	F	MPV Engine Z 16 SE	299069	Drive Shaft	29T	22	22	52	97.5	584				
	2003.01-2010.06	-	L	F	MPV Engine Z 16 SE	244100	Drive Shaft	29T	22	22	52	97.5	590				
	2003.01-2010.06	-	R	F	MPV Engine Z 16 SE	299157	Drive Shaft	29T	22	22	52	97.5	930				
	2003.01-2010.06	-	L/R	F	MPV Engine Z 16 SE	844020	Outer Joint	29T	22	28	52	97.5	57.5	O			
	2003.01-2010.06	-	L/R	F	MPV Engine Z 16 SE	844005	Outer Joint	29T	22	22	52	97.5	58.5	M			
	2003.01-2010.06	-	-	F	MPV Engine Z 16 SE	822007	Outer Joint	29T	22	22	52	98	51	M			
1.6 i 16V (74 kW)	2003.01-2005.09	AT/MT	L	F	MPV Engine Z 16 XE	299069	Drive Shaft	29T	22	22	52	97.5	584				
	2003.01-2005.09	-	L	F	MPV Engine Z 16 XE	244100	Drive Shaft	29T	22	22	52	97.5	590				
	2003.01-2005.09	-	R	F	MPV Engine Z 16 XE	299157	Drive Shaft	29T	22	22	52	97.5	930				
	2003.01-2005.09	-	L/R	F	MPV Engine Z 16 XE	844020	Outer Joint	29T	22	28	52	97.5	57.5	O			
	2003.01-2005.09	-	L/R	F	MPV Engine Z 16 XE	844005	Outer Joint	29T	22	22	52	97.5	58.5	M			
	2003.01-2005.09	-	-	F	MPV Engine Z 16 XE	822007	Outer Joint	29T	22	22	52	98	51	M			
1.6 i 16V Twinport (77 kW)	2003.05-2010.06	Semi-AT/MT	L	F	MPV Engine Z 16 XEP	299069	Drive Shaft	29T	22	22	52	97.5	584				
	2003.05-2010.06	-	L/R	F	MPV Engine Z 16 XEP	844020	Outer Joint	29T	22	28	52	97.5	57.5	O			
	2003.05-2010.06	-	-	F	MPV Engine Z 16 XEP	822007	Outer Joint	29T	22	22	52	98	51	M			
1.6 Turbo (132 kW)	2006.05-2010.06	-	R	F	MPV Engine Z 16 LET	244093	Drive Shaft	29T	33	34	52	104	619				
	2006.05-2010.06	-	R	F	MPV Engine Z 16 LET	660003	Inner Joint		34	24	35.5	47	70.5				
	2006.05-2010.06	-	L/R	F	MPV Engine Z 16 LET	844004	Outer Joint	29T	33	24	52	104	64	M			
	2006.05-2010.06	-	R	F	MPV Engine Z 16 LET	260021	Drive Shaft	29T	33	34	52	104	612				
1.7 CDTi (74 kW)	2003.09-2010.06	-	R	F	MPV Engine Z 17 DTH	244093	Drive Shaft	29T	33	34	52	104	619				
	2003.09-2010.06	-	L	F	MPV Engine Z 17 DTH	244094	Drive Shaft	29T	33	34	52	104	599				
	2003.09-2010.06	-	R	F	MPV Engine Z 17 DTH	660003	Inner Joint		34	24	35.5	47	70.5				
	2003.09-2010.06	-	L	F	MPV Engine Z 17 DTH	621034	Inner Joint		34	24	35	56.5	102				
	2003.09-2010.06	-	L/R	F	MPV Engine Z 17 DTH	844004	Outer Joint	29T	33	24	52	104	64	M			
	2003.09-2010.06	-	R	F	MPV Engine Z 17 DTH	260021	Drive Shaft	29T	33	34	52	104	612				
1.7 DTi (55 kW)	2003.06-2010.06	MT	L	F	MPV Engine Y 17 DT	299069	Drive Shaft	29T	22	22	52	97.5	584				
	2003.06-2010.06	-	R	F	MPV Engine Y 17 DT	244093	Drive Shaft	29T	33	34	52	104	619				
	2003.06-2010.06	-	R	F	MPV Engine Y 17 DT	660003	Inner Joint		34	24	35.5	47	70.5				
	2003.06-2010.06	-	L/R	F	MPV Engine Y 17 DT	844002	Outer Joint	29T	22	23	52	97.5	61	M			
1.8 i 16V (92 kW)	2003.05-2010.06	AT/MT	L	F	MPV Engine Z 18 XE	299069	Drive Shaft	29T	22	22	52	97.5	584				
	2003.05-2010.06	-	L/R	F	MPV Engine Z 18 XE	844002	Outer Joint	29T	22	23	52	97.5	61	M			
MERIVA Mk II (B) (S10)																	
1.3 CDTi (55 kW)	2010.06-	MT	R	F	MPV Engine A 13 DTC	844093	Outer Joint		33	23	52	103.5	60	M			
	2010.06-	-	-	F	MPV Engine A 13 DTC	808047	Outer Joint		33	23	52.5	94	59.5	M			
	2010.06-	MT	R	F	MPV Engine A 13 DTC	244088	Drive Shaft		33	22	52	103.5	953				
1.3 CDTi (70 kW)	2010.06-	MT	R	F	MPV Engine A 13 DTE	844093	Outer Joint		33	23	52	103.5	60	M			
	2010.06-	-	-	F	MPV Engine A 13 DTE	808047	Outer Joint		33	23	52.5	94	59.5	M			
	2010.06-	MT	R	F	MPV Engine A 13 DTE	244088	Drive Shaft		33	22	52	103.5	953				
1.4 (88 kW)	2010.06-	-	-	F	MPV Engine A 14 NEL	808047	Outer Joint		33	23	52.5	94	59.5	M			
1.4 LPG (88 kW)	2011.06-	-	-	F	MPV Engine B 14 NEL	808047	Outer Joint		33	23	52.5	94	59.5	M			
1.6 CDTi (100 kW)	2013.08-	-	-	F	MPV Engine B 16 DTH	899024	Outer Joint		33	26	52.5	94	65.5	M			
1.6 CDTi (70 kW)	2014.01-	-	-	F	MPV Engine B 16 DTC	899024	Outer Joint		33	26	52.5	94	65.5	M			
1.6 CDTi (81 kW)	2014.07-	-	-	F	MPV Engine B 16 DTL	899024	Outer Joint		33	26	52.5	94	65.5	M			
1.7 CDTi (74 kW)	2010.06-	-	-	F	MPV Engine A 17 DT	808047	Outer Joint		33	23	52.5	94	59.5	M			
1.7 CDTi (81 kW)	2010.06-	-	-	F	MPV Engine A 17 DTC	899024	Outer Joint		33	26	52.5	94	65.5	M			
1.7 CDTi (96 kW)	2010.06-	-	-	F	MPV Engine A 17 DTS	899024	Outer Joint		33	26	52.5	94	65.5	M			
MOVANO Mk I (A) Chassis/Cab (X70)																	
2.2 DTi (66 kW)	2000.09-2010.05	MT	R	F	Platform/Chassis Engine G9T 722	250214	Drive Shaft		28	39	65	96	1132				
	2000.09-2010.05	MT	R	F	Platform/Chassis Engine G9T 722	244016	Drive Shaft	51T	28	39	65	96	1132				
	2000.09-2010.05	MT	L	F	Platform/Chassis Engine G9T 722	244005	Drive Shaft	51T	28	37.1	65	96	670				
	2000.09-2010.05	MT	L	F	Platform/Chassis Engine G9T 722	250010	Drive Shaft		28	37.1	67.1	93.5	669				
2.5 CDTi (107 kW)	2006.08-2010.05	MT	R	F	Platform/Chassis Engine G9U 632	650006	Inner Joint		39	27	35	437	98				
	2006.08-2010.05	-	R	F	Platform/Chassis Engine G9U 632	250066	Drive Shaft		28	39	65	96	1142				
	2006.08-2010.05	-	L	F	Platform/Chassis Engine G9U 632	299286	Drive Shaft	51T	28	39	65	96	700				
2.5 CDTi (74 kW)	2004.04-2010.05	-	R	F	Platform/Chassis Engine G9U 754	250066	Drive Shaft		28	39	65	96	1142				
	2004.04-2010.05	MT	R	F	Platform/Chassis Engine G9U 754	650006	Inner Joint		39	27	35	437	98				
	2004.04-2010.05	-	L	F	Platform/Chassis Engine G9U 754	299286	Drive Shaft	51T	28	39	65	96	700				
2.5 CDTi (88 kW)	2006.08-2010.05	MT	R	F	Platform/Chassis Engine G9U 650	650006	Inner Joint		39	27	35	437	98				
	2006.08-2010.05	-	R	F	Platform/Chassis Engine G9U 650	250066	Drive Shaft		28	39	65	96	1142				





				TRANSM		L/R F/R		REMARKS		GSP Ref.				ABS		Technical Specifications					
YEAR																A	B	C	H	L	P
VAUXHALL																					
MOVANO Mk I (A) Chassis/Cab (X70)																					
2.5 CDTI (88 kW)	2006.08-	2010.05	-	L	F	Platform/Chassis Engine G9U 650		299286	Drive Shaft	51T	28	39	65	96	700						
2.5 D (59 kW)	1998.10-	2002.08	MT	L	F	Platform/Chassis Engine S8U 770		250217	Drive Shaft	51T	28	37.1	67.1	93.5	669						
	1998.10-	2002.08	MT	L	F	Platform/Chassis Engine S8U 770		244005	Drive Shaft	51T	28	37.1	65	96	670						
	1998.10-	2002.08	MT	R	F	Platform/Chassis Engine S8U 770		650006	Inner Joint		39	27	35	437	98						
	1998.10-	2002.08	MT	R	F	Platform/Chassis Engine S8U 770		244004	Drive Shaft	51T	28	39	67.1	93.5	1118						
	1998.10-	2002.08	-	-	F	Platform/Chassis Engine S8U 770		844008	Outer Joint	51T	28	27	67.1	93.5	64.5	I					
	1998.10-	2002.08	MT	L	F	Platform/Chassis Engine S8U 770		250010	Drive Shaft		28	37.1	67.1	93.5	669						
	1998.10-	2002.08	-	-	F	Platform/Chassis Engine S8U 770		850014	Outer Joint		28	27	67.1	93.5	64.5	I					
	1998.10-	2002.08	MT	R	F	Platform/Chassis Engine S8U 770		250011	Drive Shaft		28	39	67.1	93.5	1118						
2.5 DTI (84 kW)	2001.10-	2010.05	MT	L	F	Platform/Chassis Engine G9U 720		244012	Drive Shaft		28	37.1	65	96	663						
	2001.10-	2010.05	MT	R	F	Platform/Chassis Engine G9U 720		250249	Drive Shaft		28	39	65	96	1144						
	2001.10-	2010.05	MT	L	F	Platform/Chassis Engine G9U 720		250166	Drive Shaft	51T	28	37.1	65	96	663						
	2001.10-	2010.05	MT	R	F	Platform/Chassis Engine G9U 720		299151	Drive Shaft	51T	28	39	65	96	1144						
	2001.10-	2010.05	MT	R	F	Platform/Chassis Engine G9U 720		250066	Drive Shaft		28	39	65	96	1142						
	2001.10-	2010.05	MT	R	F	Platform/Chassis Engine G9U 720		650006	Inner Joint		39	27	35	437	98						
2.8 DTI (84 kW)	1998.10-	2001.10	MT	R	F	Platform/Chassis Engine S9W 702		250011	Drive Shaft		28	39	67.1	93.5	1118						
	1998.10-	2001.10	MT	L	F	Platform/Chassis Engine S9W 702		250217	Drive Shaft	51T	28	37.1	67.1	93.5	669						
	1998.10-	2001.10	MT	R	F	Platform/Chassis Engine S9W 702		650006	Inner Joint		39	27	35	437	98						
	1998.10-	2001.10	MT	L	F	Platform/Chassis Engine S9W 702		244005	Drive Shaft	51T	28	37.1	65	96	670						
	1998.10-	2001.10	MT	R	F	Platform/Chassis Engine S9W 702		244004	Drive Shaft	51T	28	39	67.1	93.5	1118						
	1998.10-	2001.10	-	-	F	Platform/Chassis Engine S9W 702		844008	Outer Joint	51T	28	27	67.1	93.5	64.5	I					
	1998.10-	2001.10	-	-	F	Platform/Chassis Engine S9W 702		850014	Outer Joint		28	27	67.1	93.5	64.5	I					
	1998.10-	2001.10	MT	L	F	Platform/Chassis Engine S9W 702		250010	Drive Shaft		28	37.1	67.1	93.5	669						
MOVANO Mk I (A) Combi (X70)																					
1.9 DTI (60 kW)	2001.10-	2010.05	MT	R	F	BUS Engine F9Q 774		250060	Drive Shaft	51T	28	39	65	96	1126						
	2001.10-	2010.05	MT	L	F	BUS Engine F9Q 774		250246	Drive Shaft		28	37.1	65	96	644						
	2001.10-	2010.05	MT	L	F	BUS Engine F9Q 774		244005	Drive Shaft	51T	28	37.1	65	96	670						
	2001.10-	2010.05	MT	L	F	BUS Engine F9Q 774		250010	Drive Shaft		28	37.1	67.1	93.5	669						
2.2 DTI (66 kW)	2000.09-	2010.05	MT	R	F	BUS Engine G9T 720		250214	Drive Shaft		28	39	65	96	1132						
	2000.09-	2010.05	MT	R	F	BUS Engine G9T 720		244016	Drive Shaft	51T	28	39	65	96	1132						
	2000.09-	2010.05	MT	L	F	BUS Engine G9T 720		244005	Drive Shaft	51T	28	37.1	65	96	670						
2.5 CDTI (107 kW)	2000.09-	2010.05	MT	L	F	BUS Engine G9T 720		250010	Drive Shaft		28	37.1	67.1	93.5	669						
	2006.08-	2010.05	MT	R	F	BUS Engine G9U 632		650006	Inner Joint		39	27	35	437	98						
	2006.08-	2010.05	-	R	F	BUS Engine G9U 632		250066	Drive Shaft		28	39	65	96	1142						
2.5 CDTI (74 kW)	2006.08-	2010.05	-	L	F	BUS Engine G9U 632		299286	Drive Shaft	51T	28	39	65	96	700						
	2001.10-	2009.08	MT	R	F	BUS Engine G9U 650		250066	Drive Shaft		28	39	65	96	1142						
	2001.10-	2009.08	MT	R	F	BUS Engine G9U 650		650006	Inner Joint		39	27	35	437	98						
2.5 CDTI (88 kW)	2001.10-	2009.08	-	L	F	BUS Engine G9U 650		299286	Drive Shaft	51T	28	39	65	96	700						
	2003.02-	2009.08	MT	R	F	BUS Engine G9U 650		650006	Inner Joint		39	27	35	437	98						
	2003.02-	2009.08	-	R	F	BUS Engine G9U 650		250066	Drive Shaft		28	39	65	96	1142						
2.5 D (59 kW)	2003.02-	2009.08	-	L	F	BUS Engine G9U 650		299286	Drive Shaft	51T	28	39	65	96	700						
	1998.10-	2000.09	MT	R	F	BUS Engine S8U 770		250011	Drive Shaft		28	39	67.1	93.5	1118						
	1998.10-	2000.09	MT	R	F	BUS Engine S8U 770		650006	Inner Joint		39	27	35	437	98						
	1998.10-	2000.09	MT	L	F	BUS Engine S8U 770		244005	Drive Shaft	51T	28	37.1	65	96	670						
2.5 DTI (84 kW)	1998.10-	2000.09	MT	R	F	BUS Engine S8U 770		244004	Drive Shaft	51T	28	39	67.1	93.5	1118						
	1998.10-	2000.09	MT	R	F	BUS Engine S8U 770		250010	Drive Shaft		28	37.1	67.1	93.5	669						
	1998.10-	2000.09	MT	L	F	BUS Engine S8U 770		250010	Drive Shaft		28	37.1	67.1	93.5	669						
	1998.10-	2000.09	MT	R	F	BUS Engine S8U 770		244004	Drive Shaft	51T	28	39	67.1	93.5	1118						
2.5 DTI (84 kW)	2001.10-	2009.08	-	R	F	BUS Engine G9U 750		250066	Drive Shaft		28	39	65	96	1142						
	2001.10-	2009.08	MT	L	F	BUS Engine G9U 750		244005	Drive Shaft	51T	28	37.1	65	96	670						
	2001.10-	2009.08	MT	R	F	BUS Engine G9U 750		244004	Drive Shaft	51T	28	39	67.1	93.5	1118						
	2001.10-	2009.08	MT	R	F	BUS Engine G9U 750		650006	Inner Joint		39	27	35	437	98						
	2001.10-	2009.08	MT	L	F	BUS Engine G9U 750		250010	Drive Shaft		28	37.1	67.1	93.5	669						
	2001.10-	2009.08	MT	R	F	BUS Engine G9U 750		250011	Drive Shaft		28	39	67.1	93.5	1118						
2.8 DTI (84 kW)	1998.10-	2001.10	MT	R	F	BUS Engine S9W 702		250011	Drive Shaft		28	39	67.1	93.5	1118						
	1998.10-	2001.10	MT	R	F	BUS Engine S9W 702		650006	Inner Joint		39	27	35	437	98						
	1998.10-	2001.10	MT	L	F	BUS Engine S9W 702		244005	Drive Shaft	51T	28	37.1	65	96	670						
	1998.10-	2001.10	MT	R	F	BUS Engine S9W 702		244004	Drive Shaft	51T	28	39	67.1	93.5	1118						
	1998.10-	2001.10	MT	L	F	BUS Engine S9W 702		250010	Drive Shaft		28	37.1	67.1	93.5	669						
MOVANO Mk I (A) Van (X70)																					
1.9 DTI (59 kW)	2000.09-	2001.10	MT	L	F	Box Engine F9Q 770		250058	Drive Shaft	51T	28	37.1	65	96	644						
1.9 DTI (60 kW)	2001.10-	2010.05	MT	R	F	Box Engine F9Q 774		250060	Drive Shaft	51T	28	39	65	96	1126						
	2001.10-	2010.05	-	L	F	Box Engine F9Q 774		250246	Drive Shaft		28	37.1	65	96	644						
	2001.10-	2010.05	MT	L	F	Box Engine F9Q 774		250058	Drive Shaft	51T	28	37.1	65	96	644						
	2001.10-	2010.05	MT	L	F	Box Engine F9Q 774		244005	Drive Shaft	51T	28	37.1	65	96	670						
	2001.10-	2010.05	MT	L	F	Box Engine F9Q 774		250010	Drive Shaft		28	37.1	67.1	93.5	669						
2.2 DTI (66 kW)	2000.09-	2010.05	MT	R	F	Box Engine G9T 750		250214	Drive Shaft		28	39	65	96	1132						
	2000.09-	2010.05	MT	R	F	Box Engine G9T 750		244016	Drive Shaft	51T	28	39	65	96</							

YEAR	TRANSM	L/R	F/R	REMARKS	GSP Ref.	PRODUCT	ABS	Technical Specifications									
								A	B	C	H	L	P				
VAUXHALL																	
MOVANO Mk I (A) Van (X70)																	
2.2 DTI (66 kW)	2000.09-2010.05	MT	L	F	Box Engine G9T 750	244005	Drive Shaft	51T	28	37.1	65	96	670				
	2000.09-2010.05	MT	L	F	Box Engine G9T 750	250010	Drive Shaft		28	37.1	67.1	93.5	669				
2.5 CDTI (107 kW)	2006.08-2010.05	MT	R	F	Box Engine G9U 632	650006	Inner Joint		39	27	35	437	98				
	2006.08-2010.05	-	R	F	Box Engine G9U 632	250066	Drive Shaft		28	39	65	96	1142				
	2006.08-2010.05	-	L	F	Box Engine G9U 632	299286	Drive Shaft	51T	28	39	65	96	700				
2.5 CDTI (74 kW)	2004.04-2010.05	-	R	F	Box Engine G9U 754	250066	Drive Shaft		28	39	65	96	1142				
	2004.04-2010.05	MT	R	F	Box Engine G9U 754	650006	Inner Joint		39	27	35	437	98				
	2004.04-2010.05	-	L	F	Box Engine G9U 754	299286	Drive Shaft	51T	28	39	65	96	700				
2.5 CDTI (88 kW)	2006.08-2010.05	MT	R	F	Box Engine G9U 650	650006	Inner Joint		39	27	35	437	98				
	2006.08-2010.05	-	R	F	Box Engine G9U 650	250066	Drive Shaft		28	39	65	96	1142				
	2006.08-2010.05	-	L	F	Box Engine G9U 650	299286	Drive Shaft	51T	28	39	65	96	700				
2.5 D (59 kW)	1998.10-2000.09	-	L	F	Box Engine S8U 770	250217	Drive Shaft	51T	28	37.1	67.1	93.5	669				
	1998.10-2000.09	MT	R	F	Box Engine S8U 770	650006	Inner Joint		39	27	35	437	98				
	1998.10-2000.09	MT	L	F	Box Engine S8U 770	244005	Drive Shaft	51T	28	37.1	65	96	670				
	1998.10-2000.09	MT	R	F	Box Engine S8U 770	244004	Drive Shaft	51T	28	39	67.1	93.5	1118				
	1998.10-2000.09	-	-	F	Box Engine S8U 770	844008	Outer Joint	51T	28	27	67.1	93.5	64.5	I			
	1998.10-2000.09	-	-	F	Box Engine S8U 770	850014	Outer Joint		28	27	67.1	93.5	64.5	I			
	1998.10-2000.09	MT	L	F	Box Engine S8U 770	250010	Drive Shaft		28	37.1	67.1	93.5	669				
	1998.10-2000.09	MT	R	F	Box Engine S8U 770	250011	Drive Shaft		28	39	67.1	93.5	1118				
2.5 DTI (84 kW)	2001.10-2010.05	MT	L	F	Box Engine G9U 754	244012	Drive Shaft		28	37.1	65	96	663				
	2001.10-2010.05	MT	R	F	Box Engine G9U 754	250249	Drive Shaft		28	39	65	96	1144				
	2001.10-2010.05	MT	L	F	Box Engine G9U 754	250166	Drive Shaft	51T	28	37.1	65	96	663				
	2001.10-2010.05	MT	R	F	Box Engine G9U 754	299151	Drive Shaft	51T	28	39	65	96	1144				
	2001.10-2010.05	MT	R	F	Box Engine G9U 754	250066	Drive Shaft		28	39	65	96	1142				
2.8 TDI (84 kW)	1998.10-2001.10	MT	R	F	Box Engine S9W 702	250011	Drive Shaft		28	39	67.1	93.5	1118				
	1998.10-2001.10	MT	R	F	Box Engine S9W 702	650006	Inner Joint		39	27	35	437	98				
	1998.10-2001.10	MT	L	F	Box Engine S9W 702	244005	Drive Shaft	51T	28	37.1	65	96	670				
	1998.10-2001.10	MT	R	F	Box Engine S9W 702	244004	Drive Shaft	51T	28	39	67.1	93.5	1118				
	1998.10-2001.10	MT	L	F	Box Engine S9W 702	250010	Drive Shaft		28	37.1	67.1	93.5	669				
MOVANO Mk II (B) Chassis/Cab (X62)																	
2.3 CDTI FWD (100 kW)	2014.05- -	MT	L	F	Platform/Chassis Engine M9T 702	218247	Drive Shaft		31	39	70	100.5	743				
	2014.05- -	MT	R	F	Platform/Chassis Engine M9T 702	218248	Drive Shaft		31	39	70	100.5	1075				
2.3 CDTI FWD (107 kW)	2010.05- -	MT	-	F	Platform/Chassis Engine M9T 678	850132	Outer Joint		31	27	70	100.5	63.5	I			
	2010.05- -	-	L	F	Platform/Chassis Engine M9T 678	218247	Drive Shaft		31	39	70	100.5	743				
	2010.05- -	-	R	F	Platform/Chassis Engine M9T 678	218248	Drive Shaft		31	39	70	100.5	1075				
2.3 CDTI FWD (74 kW)	2010.05- -	MT	-	F	Platform/Chassis Engine M9T 676	850132	Outer Joint		31	27	70	100.5	63.5	I			
	2010.05- -	-	L	F	Platform/Chassis Engine M9T 676	218247	Drive Shaft		31	39	70	100.5	743				
	2010.05- -	-	R	F	Platform/Chassis Engine M9T 676	218248	Drive Shaft		31	39	70	100.5	1075				
2.3 CDTI FWD (92 kW)	2010.05- -	MT	-	F	Platform/Chassis Engine M9T 676	850132	Outer Joint		31	27	70	100.5	63.5	I			
	2010.05- -	-	L	F	Platform/Chassis Engine M9T 676	218247	Drive Shaft		31	39	70	100.5	743				
	2010.05- -	-	R	F	Platform/Chassis Engine M9T 676	218248	Drive Shaft		31	39	70	100.5	1075				
MOVANO Mk II (B) Combi (X62)																	
2.3 CDTI FWD (100 kW)	2014.05- -	MT	R	F	BUS Engine M9T 702	218248	Drive Shaft		31	39	70	100.5	1075				
2.3 CDTI FWD (107 kW)	2010.05- -	MT	-	F	BUS Engine M9T 680	850132	Outer Joint		31	27	70	100.5	63.5	I			
	2010.05- -	-	L	F	BUS Engine M9T 680	218247	Drive Shaft		31	39	70	100.5	743				
	2010.05- -	-	R	F	BUS Engine M9T 680	218248	Drive Shaft		31	39	70	100.5	1075				
2.3 CDTI FWD (120 kW)	2014.05- -	MT	L	F	BUS Engine M9T 702	218247	Drive Shaft		31	39	70	100.5	743				
	2014.05- -	MT	R	F	BUS Engine M9T 702	218248	Drive Shaft		31	39	70	100.5	1075				
2.3 CDTI FWD (125 kW)	2015.07- -	MT	L	F	BUS Engine M9T 706	218247	Drive Shaft		31	39	70	100.5	743				
2.3 CDTI FWD (74 kW)	2010.05- -	MT	-	F	BUS Engine M9T 670	850132	Outer Joint		31	27	70	100.5	63.5	I			
	2010.05- -	-	L	F	BUS Engine M9T 670	218247	Drive Shaft		31	39	70	100.5	743				
	2010.05- -	-	R	F	BUS Engine M9T 670	218248	Drive Shaft		31	39	70	100.5	1075				
2.3 CDTI FWD (81 kW)	2014.05- -	MT	L	F	BUS Engine M9T 870	218247	Drive Shaft		31	39	70	100.5	743				
2.3 CDTI FWD (92 kW)	2010.05- -	MT	-	F	BUS Engine M9T 876	850132	Outer Joint		31	27	70	100.5	63.5	I			
	2010.05- -	-	L	F	BUS Engine M9T 876	218247	Drive Shaft		31	39	70	100.5	743				
	2010.05- -	-	R	F	BUS Engine M9T 876	218248	Drive Shaft		31	39	70	100.5	1075				
MOVANO Mk II (B) VAN (X62)																	
2.3 CDTI FWD (100 kW)	2014.05- -	MT	L	F	Box Engine M9T 702	218247	Drive Shaft		31	39	70	100.5	743				
	2014.05- -	MT	R	F	Box Engine M9T 702	218248	Drive Shaft		31	39	70	100.5	1075				
2.3 CDTI FWD (107 kW)	2010.05- -	MT	-	F	Box Engine M9T 680	850132	Outer Joint		31	27	70	100.5	63.5	I			
	2010.05- -	-	L	F	Box Engine M9T 680	218247	Drive Shaft		31	39	70	100.5	743				
	2010.05- -	-	R	F	Box Engine M9T 680	218248	Drive Shaft		31	39	70	100.5	1075				
2.3 CDTI FWD (120 kW)	2014.05- -	MT	L	F	Box Engine M9T 700	218247	Drive Shaft		31	39	70	100.5	743				
	2014.05- -	MT	R	F	Box Engine M9T 700	218248	Drive Shaft		31	39	70	100.5	1075				
2.3 CDTI FWD (125 kW)	2016.11- -	6MT	L	F	Box Engine M9T 706	218247	Drive Shaft		31	39	70	100.5	743				
2.3 CDTI FWD (74 kW)	2010.05- -	MT	-	F	Box Engine M9T 870	850132	Outer Joint		31	27	70	100.5	63.5	I			





YEAR	TRANSM	L/R	F/R	REMARKS	GSP Ref.	PRODUCT	ABS	Technical Specifications						
								A	B	C	H	L	P	
VAUXHALL														
MOVANO Mk II (B) VAN (X62)														
2.3 CDTI FWD (74 kW)	2010.05-	-	-	L	F	Box Engine M9T 870	218247	Drive Shaft	31	39	70	100.5	743	
	2010.05-	-	-	R	F	Box Engine M9T 870	218248	Drive Shaft	31	39	70	100.5	1075	
2.3 CDTI FWD (81 kW)	2012.02-	-	MT	L	F	Box Engine M9T 870	218247	Drive Shaft	31	39	70	100.5	743	
	2012.02-	-	MT	R	F	Box Engine M9T 870	218248	Drive Shaft	31	39	70	100.5	1075	
2.3 CDTI FWD (92 kW)	2010.05-	-	MT	-	F	Box Engine M9T 676	850132	Outer Joint	31	27	70	100.5	63.5	I
	2010.05-	-	-	L	F	Box Engine M9T 676	218247	Drive Shaft	31	39	70	100.5	743	
	2010.05-	-	-	R	F	Box Engine M9T 676	218248	Drive Shaft	31	39	70	100.5	1075	
2.3 CDTI FWD (96 kW)	2016.10-	-	6MT	L	F	Box Engine M9T 704	218247	Drive Shaft	31	39	70	100.5	743	
NOVA (S83)														
1.0 (33 kW)	1983.05-	1993.03	MT	L/R	F	Hatchback Engine 10 S	844046	Outer Joint	22	28	52.2	97.5	55	O
	1983.05-	1993.03	-	-	F	Hatchback Engine 10 S	644003	Inner Joint	22	28	34.95	57.5	83.5	
	1983.05-	1993.03	-	-	F	Hatchback Engine 10 S	844018	Outer Joint	22	28	52.2	97.5	55	O
1.2 i Cat (33 kW)	1989.09-	1993.03	MT	L/R	F	Hatchback Engine C 12 NZ	844046	Outer Joint	22	28	52.2	97.5	55	O
	1989.09-	1993.03	-	-	F	Hatchback Engine C 12 NZ	644003	Inner Joint	22	28	34.95	57.5	83.5	
	1989.09-	1993.03	-	-	F	Hatchback Engine C 12 NZ	844018	Outer Joint	22	28	52.2	97.5	55	O
1.2 N (38 kW)	1990.01-	1993.03	MT	L/R	F	Hatchback Engine 12 NV	844046	Outer Joint	22	28	52.2	97.5	55	O
	1990.01-	1993.03	-	-	F	Hatchback Engine 12 NV	644003	Inner Joint	22	28	34.95	57.5	83.5	
	1990.01-	1993.03	-	-	F	Hatchback Engine 12 NV	844018	Outer Joint	22	28	52.2	97.5	55	O
1.2 S (40 kW)	1983.05-	1990.02	MT	L/R	F	Hatchback Engine 12 ST	844046	Outer Joint	22	28	52.2	97.5	55	O
	1983.05-	1990.02	-	-	F	Hatchback Engine 12 ST	644003	Inner Joint	22	28	34.95	57.5	83.5	
	1983.05-	1990.02	-	-	F	Hatchback Engine 12 ST	844018	Outer Joint	22	28	52.2	97.5	55	O
1.2 S (43 kW)	1988.01-	1990.02	-	-	F	Hatchback Engine 12 S	644003	Inner Joint	22	28	34.95	57.5	83.5	
	1988.01-	1990.02	-	-	F	Hatchback Engine 12 S	844018	Outer Joint	22	28	52.2	97.5	55	O
1.3 S (51 kW)	1983.05-	1989.10	MT	L/R	F	Hatchback Engine 13 SB	844046	Outer Joint	22	28	52.2	97.5	55	O
	1983.05-	1989.10	-	-	F	Hatchback Engine 13 SB	844018	Outer Joint	22	28	52.2	97.5	55	O
	1983.05-	1989.10	-	-	F	Hatchback Engine 13 SB	644003	Inner Joint	22	28	34.95	57.5	83.5	
1.4 (44 kW)	1990.10-	1992.08	-	-	F	Saloon Engine C 14 NZ	644003	Inner Joint	22	28	34.95	57.5	83.5	
	1990.10-	1992.08	-	-	F	Saloon Engine C 14 NZ	844018	Outer Joint	22	28	52.2	97.5	55	O
1.4 (60 kW)	1990.09-	1992.08	-	-	F	Saloon Engine C 14 SE	644003	Inner Joint	22	28	34.95	57.5	83.5	
	1990.09-	1992.08	-	-	F	Saloon Engine C 14 SE	844018	Outer Joint	22	28	52.2	97.5	55	O
1.4 i (44 kW)	1990.01-	1993.03	MT	L/R	F	Hatchback Engine C 14 NZ	844046	Outer Joint	22	28	52.2	97.5	55	O
	1990.01-	1993.03	-	-	F	Hatchback Engine C 14 NZ	644003	Inner Joint	22	28	34.95	57.5	83.5	
	1990.01-	1993.03	-	-	F	Hatchback Engine C 14 NZ	844018	Outer Joint	22	28	52.2	97.5	55	O
1.4 i S (60 kW)	1991.09-	1993.03	MT	L/R	F	Hatchback Engine C 14 SE	844046	Outer Joint	22	28	52.2	97.5	55	O
	1991.09-	1993.03	-	-	F	Hatchback Engine C 14 SE	644003	Inner Joint	22	28	34.95	57.5	83.5	
	1991.09-	1993.03	-	-	F	Hatchback Engine C 14 SE	844018	Outer Joint	22	28	52.2	97.5	55	O
1.4 S (55 kW)	1990.01-	1993.02	-	-	F	Saloon Engine 14 NV	644003	Inner Joint	22	28	34.95	57.5	83.5	
	1990.01-	1993.02	-	-	F	Saloon Engine 14 NV	844018	Outer Joint	22	28	52.2	97.5	55	O
	1990.01-	1993.02	MT	L/R	F	Saloon Engine 14 NV	844046	Outer Joint	22	28	52.2	97.5	55	O
	1990.01-	1993.03	MT	L/R	F	Hatchback Engine 14 NV	844046	Outer Joint	22	28	52.2	97.5	55	O
	1990.01-	1993.03	-	-	F	Hatchback Engine 14 NV	644003	Inner Joint	22	28	34.95	57.5	83.5	
	1990.01-	1993.03	-	-	F	Hatchback Engine 14 NV	844018	Outer Joint	22	28	52.2	97.5	55	O
1.5 D (37 kW)	1987.09-	1993.03	-	-	F	Hatchback Engine 15 D	844018	Outer Joint	22	28	52.2	97.5	55	O
	1987.09-	1993.03	MT	L/R	F	Hatchback Engine 15 D	844046	Outer Joint	22	28	52.2	97.5	55	O
	1987.09-	1993.03	-	-	F	Hatchback Engine 15 D	644003	Inner Joint	22	28	34.95	57.5	83.5	
1.5 TD (49 kW)	1990.01-	1993.02	MT	L/R	F	Saloon Engine 15 DT (T4EC1)	644004	Inner Joint	22	22	34.95	57.5	72.5	
	1990.01-	1993.02	-	-	F	Saloon Engine 15 DT (T4EC1)	844023	Outer Joint	22	22	52	95	50	O
	1990.01-	1993.03	MT	L/R	F	Hatchback Engine 15 DT (T4EC1)	844041	Outer Joint	22	22	52	95	50	O
	1990.01-	1993.02	MT	L/R	F	Saloon Engine 15 DT (T4EC1)	844041	Outer Joint	22	22	52	95	50	O
	1990.01-	1993.03	-	-	-	Hatchback Engine 15 DT (T4EC1)	844024	Outer Joint	22	22	52.2	97	50	O
	1990.01-	1993.02	-	-	-	Saloon Engine 15 DT (T4EC1)	844024	Outer Joint	22	22	52.2	97	50	O
	1990.01-	1993.03	MT	L/R	F	Hatchback Engine 15 DT (T4EC1)	644004	Inner Joint	22	22	34.95	57.5	72.5	
	1990.01-	1993.03	-	-	F	Hatchback Engine 15 DT (T4EC1)	844023	Outer Joint	22	22	52	95	50	O
1.6 GSI (72 kW)	1989.09-	1993.03	MT	L/R	F	Hatchback Engine C 16 SEI	844041	Outer Joint	22	22	52	95	50	O
	1989.09-	1993.03	-	-	-	Hatchback Engine C 16 SEI	844024	Outer Joint	22	22	52.2	97	50	O
	1989.09-	1993.03	MT	L/R	F	Hatchback Engine C 16 SEI	644004	Inner Joint	22	22	34.95	57.5	72.5	
	1989.09-	1993.03	-	-	F	Hatchback Engine C 16 SEI	844023	Outer Joint	22	22	52	95	50	O
1.6 GSI (74 kW)	1988.05-	1992.03	MT	L/R	F	Hatchback Engine E 16 SE	844041	Outer Joint	22	22	52	95	50	O
	1988.05-	1992.03	MT	L/R	F	Hatchback Engine E 16 SE	644004	Inner Joint	22	22	34.95	57.5	72.5	
	1988.05-	1992.03	-	-	F	Hatchback Engine E 16 SE	844023	Outer Joint	22	22	52	95	50	O
1.6 GSI Cat (74 kW)	1992.02-	1993.03	MT	L/R	F	Hatchback Engine C 16 SE	844041	Outer Joint	22	22	52	95	50	O
	1992.02-	1993.03	-	-	-	Hatchback Engine C 16 SE	844024	Outer Joint	22	22	52.2	97	50	O
	1992.02-	1993.03	MT	L/R	F	Hatchback Engine C 16 SE	644004	Inner Joint	22	22	34.95	57.5	72.5	
	1992.02-	1993.03	-	-	F	Hatchback Engine C 16 SE	844023	Outer Joint	22	22	52	95	50	O
NOVAVAN (S83)														
1.2 (38 kW)	1990.01-	1994.10	-	-	F	Box Engine 12 NV	644003	Inner Joint	22	28	34.95	57.5	83.5	

	 YEAR	TRANSM	L/R	F/R	REMARKS	GSP Ref.	 PRODUCT	 ABS	Technical Specifications					
									A	B	C	H	L	P
VAUXHALL														
NOVAVAN (S83)														
1.2 (38 kW)	1990.01-1994.10	-	-	F	Box Engine 12 NV	844018	Outer Joint		22	28	52.2	97.5	55	O
1.4 (55 kW)	1990.11-1993.03	-	-	F	Box Engine 14 NV	644003	Inner Joint		22	28	34.95	57.5	83.5	
	1990.11-1993.03	-	-	F	Box Engine 14 NV	844018	Outer Joint		22	28	52.2	97.5	55	O
1.5 D (37 kW)	1991.01-1994.10	-	-	F	Box Engine 15 D	644003	Inner Joint		22	28	34.95	57.5	83.5	
	1991.01-1994.10	-	-	F	Box Engine 15 D	844018	Outer Joint		22	28	52.2	97.5	55	O
SENATOR Mk II (B) (V88)														
2.5 i (103 kW)	1987.09-1990.10	AT/MT	L/R	R	Saloon Engine 25 E	648002	Inner Joint			28		32		
2.6 i (110 kW)	1990.09-1993.09	AT/MT	L/R	R	Saloon Engine C 26 NE	648002	Inner Joint			28		32		
3.0 (130 kW)	1988.01-1990.09	AT/MT	L/R	R	Saloon Engine 30 NE	648002	Inner Joint			28		32		
3.0 24V (150 kW)	1989.09-1993.09	AT/MT	L/R	R	Saloon Engine C 30 SE	648002	Inner Joint			28		32		
3.0 i Cat (130 kW)	1988.01-1993.09	AT/MT	L/R	R	Saloon Engine C 30 NE	648002	Inner Joint			28		32		
SIGNUM														
1.9 CDTi (110 kW)	2004.04-	-	-	-	-	699138	Inner Joint		27	28	35	78	83	
1.9 CDTi (74 kW)	2004.04-	-	-	-	-	699138	Inner Joint		27	28	35	78	83	
1.9 CDTi (88 kW)	2004.04-	-	-	-	-	699138	Inner Joint		27	28	35	78	83	
2.0 Turbo 16V (129 kW)	2003.05-	-	-	-	-	699138	Inner Joint		27	28	35	78	83	
2.2 DTi 16V (92 kW)	2003.05-	-	-	-	-	699138	Inner Joint		27	28	35	78	83	
2.8 V6 Turbo (169 kW)	2005.09-	MT	-	-	-	852014	Outer Joint		30	28	55.4	100	64.5	M
	2005.09-	MT	-	-	-	699138	Inner Joint		27	28	35	78	83	
2.8 V6 Turbo (184 kW)	2005.09-	MT	-	-	-	852014	Outer Joint		30	28	55.4	100	64.5	M
	2005.09-	MT	-	-	-	699138	Inner Joint		27	28	35	78	83	
3.0 V6 CDTi (130 kW)	2003.05-	-	-	-	-	699138	Inner Joint		27	28	35	78	83	
3.0 V6 CDTi (135 kW)	2005-	MT	-	-	-	852014	Outer Joint		30	28	55.4	100	64.5	M
	2005.09-	MT	-	-	-	699138	Inner Joint		27	28	35	78	83	
3.2 V6 (155 kW)	2003.05-	-	-	-	-	699138	Inner Joint		27	28	35	78	83	
SIGNUM (Z03)														
1.8 (103 kW)	2005.08-2008.05	MT	L	F	Hatchback Engine Z 18 XER	699026	Inner Joint		22	25	35	57	82.5	
	2005.08-2008.05	MT	L	F	Hatchback Engine Z 18 XER	244020	Drive Shaft		30	22	52.5	105	617.5	
	2005.08-2008.05	MT	R	F	Hatchback Engine Z 18 XER	217040	Drive Shaft		30	22	52.5	105	987	
	2005.08-2008.05	-	L/R	F	Hatchback Engine Z 18 XER	817007	Outer Joint		30	25	52.5	105	62	O
	2005.08-2008.05	-	L	F	Hatchback Engine Z 18 XER	217223	Drive Shaft		30	22	52	94	609	
1.8 (90 kW)	2003.06-2005.07	MT	L	F	Hatchback Engine Z 18 XE	699026	Inner Joint		22	25	35	57	82.5	
	2003.06-2005.07	MT	L	F	Hatchback Engine Z 18 XE	244020	Drive Shaft		30	22	52.5	105	617.5	
	2003.06-2005.07	MT	R	F	Hatchback Engine Z 18 XE	217040	Drive Shaft		30	22	52.5	105	987	
	2003.06-2005.07	-	L/R	F	Hatchback Engine Z 18 XE	817007	Outer Joint		30	25	52.5	105	62	O
	2003.06-2005.07	-	L	F	Hatchback Engine Z 18 XE	217223	Drive Shaft		30	22	52	94	609	
1.9 CDTi (88 kW)	2004.04-2008.03	MT	L/R	F	Hatchback Engine Z 19 DT	817051	Outer Joint		30	26	53.8	94.5	65.5	M
	2004.04-2008.03	MT	L/R	F	Hatchback Engine Z 19 DT	221036	Drive Shaft		30	27	55.4	100	602	
	2004.04-2008.03	-	R	F	Hatchback Engine Z 19 DT	221053	Drive Shaft		30	34	53.8	94.5	617	
	2004.04-2008.03	-	L	F	Hatchback Engine Z 19 DT	221092	Drive Shaft		30	25	53.8	94.5	604	
	2004.04-2008.03	-	R	F	Hatchback Engine Z 19 DT	644016	Inner Joint		34	28	37.5	46	54	
	2004.04-2008.03	-	L	F	Hatchback Engine Z 19 DT	699186	Inner Joint		25	28	35	57.5	81.5	
	2004.04-2008.03	MT	R	F	Hatchback Engine Z 19 DT	221032	Drive Shaft		30	27	53.8	94.5	605	
1.9 CDTi 16V (110 kW)	2004.04-2008.03	AT/MT	L/R	F	Hatchback Engine Z 19 DTH	817051	Outer Joint		30	26	53.8	94.5	65.5	M
	2004.04-2008.03	-	L/R	F	Hatchback Engine Z 19 DTH	221036	Drive Shaft		30	27	55.4	100	602	
	2004.04-2008.03	MT	R	F	Hatchback Engine Z 19 DTH	221053	Drive Shaft		30	34	53.8	94.5	617	
	2004.04-2008.03	MT	L	F	Hatchback Engine Z 19 DTH	221092	Drive Shaft		30	25	53.8	94.5	604	
	2004.04-2008.03	MT	R	F	Hatchback Engine Z 19 DTH	644016	Inner Joint		34	28	37.5	46	54	
	2004.04-2008.03	AT	L/R	F	Hatchback Engine Z 19 DTH	621024	Inner Joint		27	34	35	101	88	
	2004.04-2008.03	MT	L	F	Hatchback Engine Z 19 DTH	699186	Inner Joint		25	28	35	57.5	81.5	
	2004.04-2008.03	-	-	F	Hatchback Engine Z 19 DTH	899023	Outer Joint		30	26	53.8	94.5	65.5	M
	2004.04-2008.03	MT	R	F	Hatchback Engine Z 19 DTH	221032	Drive Shaft		30	27	53.8	94.5	605	
	2004.04-2008.03	AT	L/R	F	Hatchback Engine Z 19 DTH	244080	Drive Shaft		30	27	53.8	94.5	591	
2.0 DTi (74 kW)	2003.05-2008.05	MT	L/R	F	Hatchback Engine Y 20 DTH	817007	Outer Joint		30	25	52.5	105	62	O
	2003.05-2008.05	-	L	F	Hatchback Engine Y 20 DTH	644002	Inner Joint		34	25	35	56.2	85.6	
2.0 i Turbo (129 kW)	2003.05-2008.05	MT	R	F	Hatchback Engine Y 20 DTH	221061	Drive Shaft		30	34	52.5	105	968	
	2003.03-2008.10	-	L/R	F	Hatchback Engine Z 20 NET	221036	Drive Shaft		30	27	55.4	100	602	
	2003.03-2008.10	MT	L/R	F	Hatchback Engine Z 20 NET	817051	Outer Joint		30	26	53.8	94.5	65.5	M
	2003.03-2008.10	-	-	F	Hatchback Engine Z 20 NET	899023	Outer Joint		30	26	53.8	94.5	65.5	M
2.2 DTi (92 kW)	2003.03-2008.10	MT	L/R	F	Hatchback Engine Z 20 NET	221032	Drive Shaft		30	27	53.8	94.5	605	
	2003.05-2008.05	-	L/R	F	Hatchback Engine Y 22 DTR	221036	Drive Shaft		30	27	55.4	100	602	
	2003.05-2008.05	MT	L/R	F	Hatchback Engine Y 22 DTR	817051	Outer Joint		30	26	53.8	94.5	65.5	M
	2003.05-2008.05	-	-	F	Hatchback Engine Y 22 DTR	899023	Outer Joint		30	26	53.8	94.5	65.5	M
	2003.05-2008.05	MT	L/R	F	Hatchback Engine Y 22 DTR	221032	Drive Shaft		30	27	53.8	94.5	605	
2.2 i (114 kW)	2003.05-2008.05	-	-	F	Hatchback Engine Z 22 YH	899023	Outer Joint		30	26	53.8	94.5	65.5	M
	2003.05-2008.05	-	L/R	F	Hatchback Engine Z 22 YH	817007	Outer Joint		30	25	52.5	105	62	O

	 YEAR	TRANSM	L/R	F/R	REMARKS	GSP Ref.	 PRODUCT	 ABS	Technical Specifications					
									A	B	C	H	L	P
VAUXHALL														
SIGNUM (Z03)														
2.2 i (114 kW)	2003.05-2008.05	-	-	F	Hatchback Engine Z 22 YH	821038	Outer Joint		30	24	52	94	64	M
	2003.05-2008.05	-	L	F	Hatchback Engine Z 22 YH	644002	Inner Joint		34	25	35	56.2	85.6	
2.8 V6 Turbo (169 kW)	2005.07-2008.05	-	L/R	F	Hatchback Engine Z 28 NEL	221036	Drive Shaft		30	27	55.4	100	602	
	2005.07-2008.05	-	-	F	Hatchback Engine Z 28 NEL	899023	Outer Joint		30	26	53.8	94.5	65.5	M
3.0 CDTI (130 kW)	2003.05-2008.05	-	L/R	F	Hatchback Engine Y 30 DT	221036	Drive Shaft		30	27	55.4	100	602	
	2003.05-2008.05	MT	L/R	F	Hatchback Engine Y 30 DT	817051	Outer Joint		30	26	53.8	94.5	65.5	M
	2003.05-2008.05	-	-	F	Hatchback Engine Y 30 DT	899023	Outer Joint		30	26	53.8	94.5	65.5	M
	2003.05-2008.05	MT	L/R	F	Hatchback Engine Y 30 DT	221032	Drive Shaft		30	27	53.8	94.5	605	
3.0 V6 CDTI (135 kW)	2005.07-2008.06	-	-	F	Hatchback Engine Z 30 DT	899023	Outer Joint		30	26	53.8	94.5	65.5	M
	2005.07-2008.06	-	L/R	F	Hatchback Engine Z 30 DT	221036	Drive Shaft		30	27	55.4	100	602	
3.2 V6 (155 kW)	2003.05-2008.05	-	L/R	F	Hatchback Engine Z 32 SE	221036	Drive Shaft		30	27	55.4	100	602	
	2003.05-2008.05	MT	L/R	F	Hatchback Engine Z 32 SE	817051	Outer Joint		30	26	53.8	94.5	65.5	M
	2003.05-2008.05	-	-	F	Hatchback Engine Z 32 SE	899023	Outer Joint		30	26	53.8	94.5	65.5	M
	2003.05-2008.05	MT	L/R	F	Hatchback Engine Z 32 SE	221032	Drive Shaft		30	27	53.8	94.5	605	
SINTRA (APV)														
2.2 DTI (85 kW)	1997.07-1999.04	-	-	F	MPV Engine X 22 DTH	806005	Outer Joint		33	34	50	105	62.5	O
2.2 i 16 V (104 kW)	1996.11-1999.04	-	-	F	MPV Engine X 22 XE	899020	Outer Joint		33	25	50	105	61	O
	1996.11-1999.04	-	L/R	F	MPV Engine X 22 XE	644002	Inner Joint		34	25	35	56.2	85.6	
3.0 i 24V (148 kW)	1996.11-1999.04	-	-	F	MPV Engine X 30 XE	806005	Outer Joint		33	34	50	105	62.5	O
TIGRA														
1.4 16V	1994.11-2000.06	MT	L	F	-	260007	Drive Shaft		22	22	52	97	563	
TIGRA A														
1.6 i 16V (78 kW)	1994.07-1998.08	MT	-	-	-	844060	Outer Joint	29T	22	22	52	98	51	O
TIGRA Mk I (S93)														
1.4 16V (66 kW)	1994.07-2000.12	-	-	F	Coupe Engine X 14 XE	644003	Inner Joint		22	28	34.95	57.5	83.5	
	1994.07-2000.12	-	-	F	Coupe Engine X 14 XE	844018	Outer Joint		22	28	52.2	97.5	55	O
	1994.07-2000.12	-	L/R	F	Coupe Engine X 14 XE	844020	Outer Joint	29T	22	28	52	97.5	57.5	O
	1994.07-2000.12	AT/MT	L	F	Coupe Engine X 14 XE	299139	Drive Shaft		22	22	52	98	570.5	
	1994.07-2000.12	MT	L	F	Coupe Engine X 14 XE	244001	Drive Shaft	29T	22	22	52	95	573	
	1994.07-2000.12	AT/MT	R	F	Coupe Engine X 14 XE	299138	Drive Shaft		22	22	52	98	916.5	
	1994.07-2000.12	-	R	F	Coupe Engine X 14 XE	208005	Drive Shaft	29T	22	22	52	98	916.5	
	1994.07-2000.12	-	-	F	Coupe Engine X 14 XE	844019	Outer Joint	29T	22	28	52	97.5	57.5	O
1.6 16V (78 kW)	1994.07-2000.12	-	-	F	Coupe Engine X 16 XE	644003	Inner Joint		22	28	34.95	57.5	83.5	
	1994.07-2000.12	-	L/R	F	Coupe Engine X 16 XE	844007	Outer Joint	29T	22	22	52	94.5	50	O
	1994.07-2000.12	MT	L/R	F	Coupe Engine X 16 XE	644004	Inner Joint		22	22	34.95	57.5	72.5	
TIGRA TwinTop (X04)														
1.3 CDTI (51 kW)	2004.06-2009.08	-	R	F	Convertible Engine Z 13 DT	299205	Drive Shaft		22	22	52	97.5	930	
	2004.06-2009.08	-	R	F	Convertible Engine Z 13 DT	244075	Drive Shaft	29T	22	22	52	97.5	926	
	2004.06-2009.08	-	R	F	Convertible Engine Z 13 DT	844043	Outer Joint		22	28	52	97.5	57.5	O
	2004.06-2009.08	MT	L	F	Convertible Engine Z 13 DT	299069	Drive Shaft	29T	22	22	52	97.5	584	
	2004.06-2009.08	-	L	F	Convertible Engine Z 13 DT	244027	Drive Shaft	29T	22	22	52	98	580	
	2004.06-2009.08	-	L/R	F	Convertible Engine Z 13 DT	844020	Outer Joint	29T	22	28	52	97.5	57.5	O
	2004.06-2009.08	-	R	F	Convertible Engine Z 13 DT	244026	Drive Shaft	29T	22	22	52	98	930	
	2004.06-2009.08	-	L	F	Convertible Engine Z 13 DT	244045	Drive Shaft	29T	22	22	52	97	579	
1.4 (66 kW)	2004.06-2009.08	-	R	F	Convertible Engine Z 14 XEP	299205	Drive Shaft		22	22	52	97.5	930	
	2004.06-2009.08	-	R	F	Convertible Engine Z 14 XEP	244075	Drive Shaft	29T	22	22	52	97.5	926	
	2004.06-2009.08	-	R	F	Convertible Engine Z 14 XEP	844043	Outer Joint		22	28	52	97.5	57.5	O
	2004.06-2009.08	-	L	F	Convertible Engine Z 14 XEP	244027	Drive Shaft	29T	22	22	52	98	580	
	2004.06-2009.08	AT/MT	L	F	Convertible Engine Z 14 XEP	299069	Drive Shaft	29T	22	22	52	97.5	584	
	2004.06-2009.08	-	L/R	F	Convertible Engine Z 14 XEP	844020	Outer Joint	29T	22	28	52	97.5	57.5	O
	2004.06-2009.08	-	R	F	Convertible Engine Z 14 XEP	244026	Drive Shaft	29T	22	22	52	98	930	
	2004.06-2009.08	-	L	F	Convertible Engine Z 14 XEP	244045	Drive Shaft	29T	22	22	52	97	579	
1.8 (92 kW)	2004.06-2009.08	-	R	F	Convertible Engine Z 18 XE	244075	Drive Shaft	29T	22	22	52	97.5	926	
	2004.06-2009.08	MT	L	F	Convertible Engine Z 18 XE	299069	Drive Shaft	29T	22	22	52	97.5	584	
	2004.06-2009.08	-	L	F	Convertible Engine Z 18 XE	244027	Drive Shaft	29T	22	22	52	98	580	
	2004.06-2009.08	-	R	F	Convertible Engine Z 18 XE	244026	Drive Shaft	29T	22	22	52	98	930	
	2004.06-2009.08	-	L	F	Convertible Engine Z 18 XE	244045	Drive Shaft	29T	22	22	52	97	579	
	2004.06-2009.08	-	L/R	F	Convertible Engine Z 18 XE	844002	Outer Joint	29T	22	23	52	97.5	61	M
VECTRA (B) (J96)														
1.6 i (55 kW)	1995.08-2001.10	AT/MT	L/R	F	Hatchback Engine X 16 SZR	844007	Outer Joint	29T	22	22	52	94.5	50	O
	1995.08-2001.10	AT/MT	L/R	F	Saloon Engine X 16 SZR	844007	Outer Joint	29T	22	22	52	94.5	50	O
	1995.08-2001.10	-	-	-	Saloon Engine X 16 SZR	844039	Outer Joint		22	22	52	95	50.5	O
	1995.08-2001.10	-	-	-	Hatchback Engine X 16 SZR	844039	Outer Joint		22	22	52	95	50.5	O
	1995.08-2001.10	AT/MT	L/R	F	Hatchback Engine X 16 SZR	844011	Outer Joint	29T	33	22	52	103	50.5	O
	1995.08-2001.10	AT/MT	L/R	F	Saloon Engine X 16 SZR	844011	Outer Joint	29T	33	22	52	103	50.5	O
	1995.08-2001.10	-	-	F	Saloon Engine X 16 SZR	844010	Outer Joint	29T	33	22	52	103	50.5	O

	 YEAR	TRANSM	L/R	F/R	REMARKS	GSP Ref.	 PRODUCT	 ABS	Technical Specifications						
									A	B	C	H	L	P	
VAUXHALL															
VECTRA (B) (J96)															
1.6 i (55 kW)	1995.08-2001.10	-	-	F	Hatchback Engine X 16 SZR	844010	Outer Joint	29T	33	22	52	103	50.5	O	
	1995.08-2001.10	-	L/R	F	Hatchback Engine X 16 SZR	644004	Inner Joint		22	22	34.95	57.5	72.5		
	1995.08-2001.10	-	L/R	F	Saloon Engine X 16 SZR	644004	Inner Joint		22	22	34.95	57.5	72.5		
1.6 i 16V (74 kW)	1995.08-2001.10	-	-	-	Saloon Engine Y 16 XE	844039	Outer Joint		22	22	52	95	50.5	O	
	1995.08-2001.10	AT/MT	L/R	F	Saloon Engine Y 16 XE	844007	Outer Joint	29T	22	22	52	94.5	50	O	
	1995.08-2001.10	-	-	-	Hatchback Engine X 16 XEL	844039	Outer Joint		22	22	52	95	50.5	O	
	1995.08-2001.10	AT/MT	L/R	F	Hatchback Engine X 16 XEL	844007	Outer Joint	29T	22	22	52	94.5	50	O	
	1995.08-2001.10	-	L/R	F	Saloon Engine Y 16 XE	644004	Inner Joint		22	22	34.95	57.5	72.5		
	1995.08-2001.10	-	L/R	F	Hatchback Engine X 16 XEL	644004	Inner Joint		22	22	34.95	57.5	72.5		
	1995.08-2001.10	AT/MT	L/R	F	Saloon Engine Y 16 XE	844011	Outer Joint	29T	33	22	52	103	50.5	O	
	1995.08-2001.10	AT/MT	L/R	F	Hatchback Engine X 16 XEL	844011	Outer Joint	29T	33	22	52	103	50.5	O	
	1995.08-2001.10	-	-	F	Saloon Engine Y 16 XE	844010	Outer Joint	29T	33	22	52	103	50.5	O	
	1995.08-2001.10	-	-	F	Hatchback Engine X 16 XEL	844010	Outer Joint	29T	33	22	52	103	50.5	O	
1.7 TD (60 kW)	1995.10-1996.11	5MT	R	F	Saloon Engine X 17 DT (TC4EE1)	244039	Drive Shaft	29T	33	34	52	103.5	959		
	1995.10-1996.11	5MT	R	F	Hatchback Engine X 17 DT (TC4EE1)	244039	Drive Shaft	29T	33	34	52	103.5	959		
	1995.10-1996.11	-	L/R	F	Saloon Engine X 17 DT (TC4EE1)	644002	Inner Joint		34	25	35	56.2	85.6		
	1995.10-1996.11	-	L/R	F	Hatchback Engine X 17 DT (TC4EE1)	644002	Inner Joint		34	25	35	56.2	85.6		
	1995.10-1996.11	AT/MT	L/R	F	Saloon Engine X 17 DT (TC4EE1)	844006	Outer Joint	29T	33	25	52	103.5	61	O	
	1995.10-1996.11	AT/MT	L/R	F	Hatchback Engine X 17 DT (TC4EE1)	844006	Outer Joint	29T	33	25	52	103.5	61	O	
	1995.10-1996.11	AT/MT	L/R	F	Saloon Engine X 17 DT (TC4EE1)	621011	Inner Joint		34	25	35	78	64		
	1995.10-1996.11	AT/MT	L/R	F	Hatchback Engine X 17 DT (TC4EE1)	621011	Inner Joint		34	25	35	78	64		
	1995.10-1996.11	5MT	L	F	Saloon Engine X 17 DT (TC4EE1)	244038	Drive Shaft	29T	33	34	52	103.5	595		
	1995.10-1996.11	5MT	L	F	Hatchback Engine X 17 DT (TC4EE1)	244038	Drive Shaft	29T	33	34	52	103.5	595		
1.8 i 16V (85 kW)	1995.09-2000.09	-	R	F	Hatchback/CC Engine X 18 XE	244039	Drive Shaft	29T	33	34	52	103.5	959		
	1995.09-2000.09	-	L/R	F	Hatchback/CC Engine X 18 XE	644002	Inner Joint		34	25	35	56.2	85.6		
	1995.09-2000.09	AT/MT	L/R	F	Hatchback/CC Engine X 18 XE	844006	Outer Joint	29T	33	25	52	103.5	61	O	
	1995.09-2000.09	-	L	F	Hatchback/CC Engine X 18 XE	244038	Drive Shaft	29T	33	34	52	103.5	595		
	1995.10-2000.09	-	R	F	Saloon Engine X 18 XE	244039	Drive Shaft	29T	33	34	52	103.5	959		
	1995.10-2000.09	-	L/R	F	Saloon Engine X 18 XE	644002	Inner Joint		34	25	35	56.2	85.6		
	1995.10-2000.09	-	L/R	F	Hatchback Engine X 18 XE1	644002	Inner Joint		34	25	35	56.2	85.6		
	1995.10-2000.09	AT/MT	L/R	F	Saloon Engine X 18 XE	844006	Outer Joint	29T	33	25	52	103.5	61	O	
	1995.10-2000.09	AT/MT	L/R	F	Hatchback Engine X 18 XE1	844006	Outer Joint	29T	33	25	52	103.5	61	O	
	1995.10-2000.09	-	L/R	F	Saloon Engine X 18 XE1	644002	Inner Joint		34	25	35	56.2	85.6		
	1995.10-2000.09	AT/MT	L/R	F	Saloon Engine X 18 XE1	844006	Outer Joint	29T	33	25	52	103.5	61	O	
	1995.10-2000.09	AT/MT	L/R	F	Hatchback Engine X 18 XE1	621011	Inner Joint		34	25	35	78	64		
	1995.10-2000.09	4AT/5MT	L	F	Hatchback Engine X 18 XE1	244038	Drive Shaft	29T	33	34	52	103.5	595		
	1995.10-2000.09	4AT/5MT	L	F	Saloon Engine X 18 XE1	244038	Drive Shaft	29T	33	34	52	103.5	595		
	1995.10-2000.09	-	L	F	Saloon Engine X 18 XE	244038	Drive Shaft	29T	33	34	52	103.5	595		
	1995.10-2000.09	4AT/5MT	R	F	Hatchback Engine X 18 XE1	244039	Drive Shaft	29T	33	34	52	103.5	959		
	1995.10-2000.09	4AT/5MT	R	F	Saloon Engine X 18 XE1	244039	Drive Shaft	29T	33	34	52	103.5	959		
	1996.09-2000.09	-	R	F	Estate Engine X 18 XE	244039	Drive Shaft	29T	33	34	52	103.5	959		
	1996.09-2000.09	-	L/R	F	Estate Engine X 18 XE	644002	Inner Joint		34	25	35	56.2	85.6		
	1996.09-2000.09	AT/MT	L/R	F	Estate Engine X 18 XE	844006	Outer Joint	29T	33	25	52	103.5	61	O	
	1996.09-2000.09	-	L	F	Estate Engine X 18 XE	244038	Drive Shaft	29T	33	34	52	103.5	595		
	1996.11-2000.09	-	L/R	F	Estate Engine X 18 XE1	644002	Inner Joint		34	25	35	56.2	85.6		
	1996.11-2000.09	AT/MT	L/R	F	Estate Engine X 18 XE1	844006	Outer Joint	29T	33	25	52	103.5	61	O	
	1996.11-2000.09	AT/MT	L/R	F	Estate Engine X 18 XE1	621011	Inner Joint		34	25	35	78	64		
	1996.11-2000.09	4AT/5MT	L	F	Estate Engine X 18 XE1	244038	Drive Shaft	29T	33	34	52	103.5	595		
	1996.11-2000.09	4AT/5MT	R	F	Estate Engine X 18 XE1	244039	Drive Shaft	29T	33	34	52	103.5	959		
1.8 i 16V (92 kW)	2000.09-2003.07	AT/MT	L/R	F	Hatchback Engine Z 18 XE	844006	Outer Joint	29T	33	25	52	103.5	61	O	
	2000.09-2002.03	-	L/R	F	Saloon Engine Z 18 XE	644002	Inner Joint		34	25	35	56.2	85.6		
	2000.09-2002.03	-	L/R	F	Estate Engine Z 18 XE	644002	Inner Joint		34	25	35	56.2	85.6		
	2000.09-2002.03	AT/MT	L/R	F	Saloon Engine Z 18 XE	844006	Outer Joint	29T	33	25	52	103.5	61	O	
	2000.09-2002.03	AT/MT	L/R	F	Estate Engine Z 18 XE	844006	Outer Joint	29T	33	25	52	103.5	61	O	
	2000.09-2003.07	-	L/R	F	Hatchback Engine Z 18 XE	644002	Inner Joint		34	25	35	56.2	85.6		
	2000.09-2003.07	AT/MT	L/R	F	Hatchback Engine Z 18 XE	621011	Inner Joint		34	25	35	78	64		
	2000.09-2002.03	AT/MT	L/R	F	Saloon Engine Z 18 XE	621011	Inner Joint		34	25	35	78	64		
	2000.09-2002.03	AT/MT	L/R	F	Estate Engine Z 18 XE	621011	Inner Joint		34	25	35	78	64		
2.0 DI 16V (60 kW)	1995.08-2001.10	AT/MT	L/R	F	Saloon Engine X 20 DTL	844006	Outer Joint	29T	33	25	52	103.5	61	O	
	1995.08-2001.10	AT/MT	L/R	F	Hatchback Engine X 20 DTL	844006	Outer Joint	29T	33	25	52	103.5	61	O	
	1995.08-2001.10	AT/MT	L/R	F	Estate Engine X 20 DTL	844006	Outer Joint	29T	33	25	52	103.5	61	O	
	1995.08-2001.10	-	L/R	F	Saloon Engine X 20 DTL	644002	Inner Joint		34	25	35	56.2	85.6		
	1995.08-2001.10	-	L/R	F	Hatchback Engine X 20 DTL	644002	Inner Joint		34	25	35	56.2	85.6		
	1995.08-2001.10	-	L/R	F	Estate Engine X 20 DTL	644002	Inner Joint		34	25	35	56.2	85.6		
	1995.08-2001.10	AT/MT	L/R	F	Saloon Engine X 20 DTL	621011	Inner Joint		34	25	35	78	64		
	1995.08-2001.10	5MT	L	F	Saloon Engine X 20 DTL	244038	Drive Shaft	29T	33	34	52	103.5	595		





YEAR	TRANSM	L/R	F/R	REMARKS	GSP Ref.	PRODUCT	ABS	Technical Specifications									
								A	B	C	H	L	P				
VAUXHALL																	
VECTRA (B) (J96)																	
2.0 DI 16V (60 kW)																	
1995.08-	2001.10	AT/MT	L/R	F	Hatchback Engine X 20 DTL	621011	Inner Joint		34	25	35	78	64				
1995.08-	2001.10	5MT	L	F	Hatchback Engine X 20 DTL	244038	Drive Shaft	29T	33	34	52	103.5	595				
1995.08-	2001.10	5MT	L	F	Estate Engine X 20 DTL	244038	Drive Shaft	29T	33	34	52	103.5	595				
1995.08-	2001.10	AT/MT	L/R	F	Estate Engine X 20 DTL	621011	Inner Joint		34	25	35	78	64				
1995.08-	2001.10	5MT	R	F	Saloon Engine X 20 DTL	244039	Drive Shaft	29T	33	34	52	103.5	959				
1995.08-	2001.10	5MT	R	F	Hatchback Engine X 20 DTL	244039	Drive Shaft	29T	33	34	52	103.5	959				
1995.08-	2001.10	5MT	R	F	Estate Engine X 20 DTL	244039	Drive Shaft	29T	33	34	52	103.5	959				
2.0 DTi 16V (74 kW)																	
1995.08-	2001.10	5MT	R	F	Saloon Engine Y 20 DTH	244039	Drive Shaft	29T	33	34	52	103.5	959				
1995.08-	2001.10	5MT	R	F	Estate Engine X 20 DTH	244039	Drive Shaft	29T	33	34	52	103.5	959				
1995.08-	2001.10	-	L/R	F	Saloon Engine Y 20 DTH	644002	Inner Joint		34	25	35	56.2	85.6				
1995.08-	2001.10	-	L/R	F	Estate Engine X 20 DTH	644002	Inner Joint		34	25	35	56.2	85.6				
1995.08-	2001.10	AT/MT	L/R	F	Saloon Engine Y 20 DTH	844006	Outer Joint	29T	33	25	52	103.5	61	O			
1995.08-	2001.10	AT/MT	L/R	F	Estate Engine X 20 DTH	844006	Outer Joint	29T	33	25	52	103.5	61	O			
1995.08-	2001.10	AT/MT	L/R	F	Saloon Engine Y 20 DTH	621011	Inner Joint		34	25	35	78	64				
1995.08-	2001.10	AT/MT	L/R	F	Estate Engine X 20 DTH	621011	Inner Joint		34	25	35	78	64				
1995.08-	2001.10	5MT	L	F	Saloon Engine Y 20 DTH	244038	Drive Shaft	29T	33	34	52	103.5	595				
1995.08-	2001.10	5MT	L	F	Estate Engine X 20 DTH	244038	Drive Shaft	29T	33	34	52	103.5	595				
1997.06-	2001.10	AT/MT	L/R	F	Hatchback Engine Y 20 DTH	621011	Inner Joint		34	25	35	78	64				
1997.06-	2001.10	5MT	R	F	Hatchback Engine Y 20 DTH	244039	Drive Shaft	29T	33	34	52	103.5	959				
1997.06-	2001.10	-	L/R	F	Hatchback Engine Y 20 DTH	644002	Inner Joint		34	25	35	56.2	85.6				
1997.06-	2001.10	AT/MT	L/R	F	Hatchback Engine Y 20 DTH	844006	Outer Joint	29T	33	25	52	103.5	61	O			
1997.06-	2001.10	5MT	L	F	Hatchback Engine Y 20 DTH	244038	Drive Shaft	29T	33	34	52	103.5	595				
2.0 i 16V (100 kW)																	
1995.10-	2001.01	AT/MT	L/R	F	Estate Engine X 20 XEV	844006	Outer Joint	29T	33	25	52	103.5	61	O			
1995.10-	2001.01	AT/MT	L/R	F	Saloon Engine X 20 XEV	844006	Outer Joint	29T	33	25	52	103.5	61	O			
1995.10-	2001.01	AT/MT	L/R	F	Hatchback Engine X 20 XEV	844006	Outer Joint	29T	33	25	52	103.5	61	O			
1995.10-	2001.01	-	L/R	F	Estate Engine X 20 XEV	644002	Inner Joint		34	25	35	56.2	85.6				
1995.10-	2001.01	AT/MT	L/R	F	Saloon Engine X 20 XEV	621011	Inner Joint		34	25	35	78	64				
1995.10-	2001.01	AT/MT	L/R	F	Hatchback Engine X 20 XEV	621011	Inner Joint		34	25	35	78	64				
1995.10-	2001.01	4AT/5MT	L	F	Estate Engine X 20 XEV	244038	Drive Shaft	29T	33	34	52	103.5	595				
1995.10-	2001.01	AT/MT	L/R	F	Estate Engine X 20 XEV	621011	Inner Joint		34	25	35	78	64				
1995.10-	2001.01	-	L/R	F	Saloon Engine X 20 XEV	644002	Inner Joint		34	25	35	56.2	85.6				
1995.10-	2001.01	-	L/R	F	Hatchback Engine X 20 XEV	644002	Inner Joint		34	25	35	56.2	85.6				
1995.10-	2001.01	4AT/5MT	L	F	Saloon Engine X 20 XEV	244038	Drive Shaft	29T	33	34	52	103.5	595				
1995.10-	2001.01	4AT/5MT	L	F	Hatchback Engine X 20 XEV	244038	Drive Shaft	29T	33	34	52	103.5	595				
1995.10-	2001.01	4AT/5MT	R	F	Estate Engine X 20 XEV	244039	Drive Shaft	29T	33	34	52	103.5	959				
1995.10-	2001.01	4AT/5MT	R	F	Saloon Engine X 20 XEV	244039	Drive Shaft	29T	33	34	52	103.5	959				
1995.10-	2001.01	4AT/5MT	R	F	Hatchback Engine X 20 XEV	244039	Drive Shaft	29T	33	34	52	103.5	959				
1995.10-	2001.01	4AT/5MT	L	F	Hatchback Engine X 20 XEV	244038	Drive Shaft	29T	33	34	52	103.5	595				
2.2 DTi 16V (92 kW)																	
1995.08-	2001.10	MT	L	F	Hatchback Engine Y 22 DTR	244058	Drive Shaft	29T	33	27	55	104	586				
1995.08-	2001.10	MT	L	F	Saloon Engine Y 22 DTR	244058	Drive Shaft	29T	33	27	55	104	586				
1995.08-	2001.10	-	-	F	Hatchback Engine Y 22 DTR	844065	Outer Joint	29T	33	35	55	104	67.5	I			
1995.08-	2001.10	MT	L	F	Estate Engine Y 22 DTR	244058	Drive Shaft	29T	33	27	55	104	586				
1995.08-	2001.10	-	-	F	Saloon Engine Y 22 DTR	844065	Outer Joint	29T	33	35	55	104	67.5	I			
1995.08-	2001.10	-	-	F	Estate Engine Y 22 DTR	844065	Outer Joint	29T	33	35	55	104	67.5	I			
1995.08-	2001.10	MT	L/R	F	Hatchback Engine Y 22 DTR	817051	Outer Joint		30	26	53.8	94.5	65.5	M			
1995.08-	2001.10	MT	L/R	F	Estate Engine Y 22 DTR	817051	Outer Joint		30	26	53.8	94.5	65.5	M			
1995.08-	2001.10	MT	L/R	F	Hatchback Engine Y 22 DTR	221032	Drive Shaft		30	27	53.8	94.5	605				
1995.08-	2001.10	MT	L/R	F	Estate Engine Y 22 DTR	221032	Drive Shaft		30	27	53.8	94.5	605				
2.2 i 16V (108 kW)																	
1995.08-	2001.10	4AT/5MT	R	F	Saloon Engine Z 22 SE	244039	Drive Shaft	29T	33	34	52	103.5	959				
1995.08-	2001.10	AT/MT	L/R	F	Estate Engine Z 22 SE	844006	Outer Joint	29T	33	25	52	103.5	61	O			
1995.08-	2001.10	-	L/R	F	Saloon Engine Z 22 SE	644002	Inner Joint		34	25	35	56.2	85.6				
1995.08-	2001.10	AT/MT	L/R	F	Saloon Engine Z 22 SE	844006	Outer Joint	29T	33	25	52	103.5	61	O			
1995.08-	2001.10	-	L/R	F	Estate Engine Z 22 SE	644002	Inner Joint		34	25	35	56.2	85.6				
1995.08-	2001.10	4AT/5MT	L	F	Estate Engine Z 22 SE	244038	Drive Shaft	29T	33	34	52	103.5	595				
1995.08-	2001.10	4AT/5MT	L	F	Saloon Engine Z 22 SE	244038	Drive Shaft	29T	33	34	52	103.5	595				
1995.08-	2001.10	4AT/5MT	R	F	Estate Engine Z 22 SE	244039	Drive Shaft	29T	33	34	52	103.5	959				
2000.09-	2003.07	AT/MT	L/R	F	Hatchback Engine Z 22 SE	844006	Outer Joint	29T	33	25	52	103.5	61	O			
2000.09-	2003.07	-	L/R	F	Hatchback Engine Z 22 SE	644002	Inner Joint		34	25	35	56.2	85.6				
2000.09-	2003.07	4AT/5MT	L	F	Hatchback Engine Z 22 SE	244038	Drive Shaft	29T	33	34	52	103.5	595				
2000.09-	2003.07	4AT/5MT	R	F	Hatchback Engine Z 22 SE	244039	Drive Shaft	29T	33	34	52	103.5	959				
2.5 i GSi (143 kW)																	
1998.03-	2000.07	-	R	F	Saloon Engine X 25 XE	644005	Inner Joint		34	25	35	54	47				
1998.03-	2000.07	-	R	F	Hatchback Engine X 25 XE	644005	Inner Joint		34	25	35	54	47				
1998.03-	2000.07	-	L	F	Saloon Engine X 25 XE	644002	Inner Joint		34	25	35	56.2	85.6				
1998.03-	2000.07	-	L	F	Hatchback Engine X 25 XE	644002	Inner Joint		34	25	35	56.2	85.6				
1998.03-	2000.07	AT/MT	L/R	F	Saloon Engine X 25 XE	844006	Outer Joint	29T	33	25	52	103.5	61	O			
1998.03-	2000.07	AT/MT	L/R	F	Hatchback Engine X 25 XE	844006	Outer Joint	29T	33	25	52	103.5	61	O			
1998.03-	2000.07	-	L	F	Saloon Engine X 25 XE	244038	Drive Shaft	29T	33	34	52	103.5	595				

	 YEAR	TRANSM	L/R	F/R	REMARKS	GSP Ref.	 PRODUCT	 ABS	Technical Specifications						
									A	B	C	H	L	P	
VAUXHALL															
VECTRA (B) (J96)															
2.5 i GSi (143 kW)	1998.03-2000.07	-	L	F	Hatchback Engine X 25 XE	244038	Drive Shaft	29T	33	34	52	103.5	595		
	1998.05-1999.09	-	R	F	Estate Engine X 25 XE	644005	Inner Joint		34	25	35	54	47		
	1998.05-1999.09	-	L	F	Estate Engine X 25 XE	644002	Inner Joint		34	25	35	56.2	85.6		
	1998.05-1999.09	AT/MT	L/R	F	Estate Engine X 25 XE	844006	Outer Joint	29T	33	25	52	103.5	61	O	
	1998.05-1999.09	-	L	F	Estate Engine X 25 XE	244038	Drive Shaft	29T	33	34	52	103.5	595		
2.5 i V6 (125 kW)	1995.09-2000.08	4AT/5MT	R	F	Saloon Engine X 25 XE	244039	Drive Shaft	29T	33	34	52	103.5	959		
	1995.09-2000.08	4AT/5MT	R	F	Hatchback Engine X 25 XE	244039	Drive Shaft	29T	33	34	52	103.5	959		
	1995.09-2000.08	-	L/R	F	Saloon Engine X 25 XE	644002	Inner Joint		34	25	35	56.2	85.6		
	1995.09-2000.08	-	L/R	F	Hatchback Engine X 25 XE	644002	Inner Joint		34	25	35	56.2	85.6		
	1995.09-2000.08	-	R	F	Saloon Engine X 25 XE	644005	Inner Joint		34	25	35	54	47		
	1995.09-2000.08	-	R	F	Hatchback Engine X 25 XE	644005	Inner Joint		34	25	35	54	47		
	1995.09-2000.08	AT/MT	L/R	F	Saloon Engine X 25 XE	844006	Outer Joint	29T	33	25	52	103.5	61	O	
	1995.09-2000.08	AT/MT	L/R	F	Hatchback Engine X 25 XE	844006	Outer Joint	29T	33	25	52	103.5	61	O	
	1995.09-2000.08	4AT/5MT	L	F	Saloon Engine X 25 XE	244038	Drive Shaft	29T	33	34	52	103.5	595		
	1995.09-2000.08	4AT/5MT	L	F	Hatchback Engine X 25 XE	244038	Drive Shaft	29T	33	34	52	103.5	595		
	1996.11-2000.08	4AT/5MT	R	F	Estate Engine X 25 XE	244039	Drive Shaft	29T	33	34	52	103.5	959		
	1996.11-2000.08	-	L/R	F	Estate Engine X 25 XE	644002	Inner Joint		34	25	35	56.2	85.6		
	1996.11-2000.08	-	R	F	Estate Engine X 25 XE	644005	Inner Joint		34	25	35	54	47		
	1996.11-2000.08	AT/MT	L/R	F	Estate Engine X 25 XE	844006	Outer Joint	29T	33	25	52	103.5	61	O	
	1996.11-2000.08	4AT/5MT	L	F	Estate Engine X 25 XE	244038	Drive Shaft	29T	33	34	52	103.5	595		
2.6 i V6 (125 kW)	2000.09-2003.07	-	-	F	Hatchback Engine Y 26 SE	844065	Outer Joint	29T	33	35	55	104	67.5	I	
	2000.09-2002.03	-	-	F	Saloon Engine Y 26 SE	844065	Outer Joint	29T	33	35	55	104	67.5	I	
	2000.09-2002.03	-	-	F	Estate Engine Y 26 SE	844065	Outer Joint	29T	33	35	55	104	67.5	I	
	2000.09-2002.03	-	R	F	Estate Engine Y 26 SE	644005	Inner Joint		34	25	35	54	47		
	2000.09-2003.07	-	R	F	Hatchback Engine Y 26 SE	644005	Inner Joint		34	25	35	54	47		
	2000.09-2002.03	-	R	F	Saloon Engine Y 26 SE	644005	Inner Joint		34	25	35	54	47		
VECTRA A (86, 87)															
1.4 S (55 kW)	1988.09-1992.06	-	-	-	ChP1175250	844060	Outer Joint	29T	22	22	52	98	51	O	
1.6 (60 kW)	1988.09-1993.05	-	-	-	-	844060	Outer Joint	29T	22	22	52	98	51	O	
1.6 i (52 kW)	1993.09-1995.11	-	-	-	-	844060	Outer Joint	29T	22	22	52	98	51	O	
1.6 i (55 kW)	1993.09-1995.11	-	-	-	-	844060	Outer Joint	29T	22	22	52	98	51	O	
VECTRA B															
1.7 TD	1995.10-1996.08	MT	L	F	-	260012	Drive Shaft	29T	33	34	52	103.5	586		
1.8 16V X18XE	1995.10-2000.01	MT/AT	L	F	-	260012	Drive Shaft	29T	33	34	52	103.5	586		
2.0 Di	1996.08-2002.05	MT	L	F	-	260012	Drive Shaft	29T	33	34	52	103.5	586		
2.2 16V	2000.09-2002.05	MT/AT	L	F	-	260012	Drive Shaft	29T	33	34	52	103.5	586		
2.5 V6	1995.10-2000.10	MT/AT	L	F	-	260012	Drive Shaft	29T	33	34	52	103.5	586		
VECTRA B (36), SW															
1.6 i (55 kW)	1995.10-2002.04	-	-	-	ChW1285446	844060	Outer Joint	29T	22	22	52	98	51	O	
1.6 i 16V (74 kW)	1995.10-2002.04	-	-	-	ChW1285446	844060	Outer Joint	29T	22	22	52	98	51	O	
VECTRA C, SW															
1.9 CDTi (110 kW)	2004.04-	MT	-	-	-	699138	Inner Joint		27	28	35	78	83		
1.9 CDTi (74 kW)	2004.04-	MT	-	-	-	699138	Inner Joint		27	28	35	78	83		
1.9 CDTi (88 kW)	2004.04-	MT	-	-	-	699138	Inner Joint		27	28	35	78	83		
2.0 T 16V (129 kW)	2003.03-	-	-	-	-	699138	Inner Joint		27	28	35	78	83		
2.2 DTi 16V (92 kW)	2002.04-	-	-	-	-	699138	Inner Joint		27	28	35	78	83		
2.8 T V6 (163 kW)	2005.08-	MT	-	-	-	852014	Outer Joint		30	28	55.4	100	64.5	M	
2.8 T V6 (188 kW)	2005.08-	MT	-	-	-	852014	Outer Joint		30	28	55.4	100	64.5	M	
3.0 CDTi (130 kW)	2005.08-	-	-	-	-	699138	Inner Joint		27	28	35	78	83		
3.0 CDTi (135 kW)	2005-	MT	-	-	-	852014	Outer Joint		30	28	55.4	100	64.5	M	
3.2 V6 (155 kW)	2002.08-	MT	-	-	-	699138	Inner Joint		27	28	35	78	83		
VECTRA Mk II (C) (Z02)															
1.8 (103 kW)	2006.01-2008.07	MT	L	F	Saloon Engine Z 18 XER	699026	Inner Joint		22	25	35	57	82.5		
	2006.01-2008.07	MT	L	F	Estate Engine Z 18 XER	699026	Inner Joint		22	25	35	57	82.5		
	2006.01-2008.07	MT	L	F	Saloon Engine Z 18 XER	244020	Drive Shaft		30	22	52.5	105	617.5		
	2006.01-2008.07	MT	L	F	Estate Engine Z 18 XER	244020	Drive Shaft		30	22	52.5	105	617.5		
	2006.01-2008.07	-	-	F	Estate Engine Z 18 XER	821038	Outer Joint		30	24	52	94	64	M	
	2006.01-2008.07	MT	R	F	Saloon Engine Z 18 XER	217040	Drive Shaft		30	22	52.5	105	987		
	2006.01-2008.07	MT	R	F	Estate Engine Z 18 XER	217040	Drive Shaft		30	22	52.5	105	987		
	2006.01-2008.07	-	L/R	F	Saloon Engine Z 18 XER	817007	Outer Joint		30	25	52.5	105	62	O	
	2006.01-2008.07	-	L/R	F	Estate Engine Z 18 XER	817007	Outer Joint		30	25	52.5	105	62	O	
	2006.01-2008.07	-	-	F	Saloon Engine Z 18 XER	821038	Outer Joint		30	24	52	94	64	M	
	2006.01-2008.07	-	L	F	Saloon Engine Z 18 XER	217223	Drive Shaft		30	22	52	94	609		
	2006.01-2008.07	-	L	F	Estate Engine Z 18 XER	217223	Drive Shaft		30	22	52	94	609		
1.8 16V (90 kW)	2002.04-2008.07	MT	L	F	Saloon Engine Z 18 XE	699026	Inner Joint		22	25	35	57	82.5		
	2002.04-2008.07	MT	L	F	Saloon Engine Z 18 XE	244020	Drive Shaft		30	22	52.5	105	617.5		

	YEAR	TRANSM	L/R	F/R	REMARKS	GSP Ref.	PRODUCT	ABS	Technical Specifications									
									A	B	C	H	L	P				
VAUXHALL																		
VECTRA Mk II (C) (Z02)																		
1.8 16V (90 kW)	2002.04-2008.07	-	-	F	Saloon Engine Z 18 XE	821038	Outer Joint		30	24	52	94	64	M				
	2002.04-2008.07	MT	R	F	Saloon Engine Z 18 XE	217040	Drive Shaft		30	22	52.5	105	987					
	2002.04-2008.07	MT	L/R	F	Saloon Engine Z 18 XE	817007	Outer Joint		30	25	52.5	105	62	O				
	2002.04-2008.07	-	L	F	Saloon Engine Z 18 XE	217223	Drive Shaft		30	22	52	94	609					
	2003.10-2005.08	MT	L	F	Estate Engine Z 18 XE	699026	Inner Joint		22	25	35	57	82.5					
	2003.10-2005.08	MT	L	F	Estate Engine Z 18 XE	244020	Drive Shaft		30	22	52.5	105	617.5					
	2003.10-2005.08	-	-	F	Estate Engine Z 18 XE	821038	Outer Joint		30	24	52	94	64	M				
	2003.10-2005.08	MT	R	F	Estate Engine Z 18 XE	217040	Drive Shaft		30	22	52.5	105	987					
1.8 16V Dualfuel (90 kW)	2002.04-2008.07	MT	L	F	Saloon Engine Z 18 XE	699026	Inner Joint		22	25	35	57	82.5					
	2002.04-2008.07	MT	L	F	Saloon Engine Z 18 XE	244020	Drive Shaft		30	22	52.5	105	617.5					
	2002.04-2008.07	-	-	F	Saloon Engine Z 18 XE	821038	Outer Joint		30	24	52	94	64	M				
	2002.04-2008.07	MT	R	F	Saloon Engine Z 18 XE	217040	Drive Shaft		30	22	52.5	105	987					
	2002.04-2008.07	MT	L/R	F	Saloon Engine Z 18 XE	817007	Outer Joint		30	25	52.5	105	62	O				
	2002.04-2008.07	-	L	F	Saloon Engine Z 18 XE	217223	Drive Shaft		30	22	52	94	609					
	1.9 CDTI (88 kW)	2002.04-2008.09	MT	L/R	F	Saloon Engine Z 19 DT	221036	Drive Shaft		30	27	55.4	100	602				
		2002.04-2008.09	MT	L/R	F	Saloon Engine Z 19 DT	817051	Outer Joint		30	26	53.8	94.5	65.5	M			
2002.04-2008.09		-	R	F	Saloon Engine Z 19 DT	221053	Drive Shaft		30	34	53.8	94.5	617					
2002.04-2008.09		-	L	F	Saloon Engine Z 19 DT	221092	Drive Shaft		30	25	53.8	94.5	604					
2002.04-2008.09		-	R	F	Saloon Engine Z 19 DT	644016	Inner Joint		34	28	37.5	46	54					
2002.04-2008.09		-	L	F	Saloon Engine Z 19 DT	699186	Inner Joint		25	28	35	57.5	81.5					
2002.04-2008.09		MT	R	F	Saloon Engine Z 19 DT	221032	Drive Shaft		30	27	53.8	94.5	605					
2004.04-2008.07		MT	L/R	F	Estate Engine Z 19 DT	221036	Drive Shaft		30	27	55.4	100	602					
2004.04-2008.07		MT	L/R	F	Estate Engine Z 19 DT	817051	Outer Joint		30	26	53.8	94.5	65.5	M				
2004.04-2008.07		MT	-	F	Estate Engine Z 19 DT	899023	Outer Joint		30	26	53.8	94.5	65.5	M				
2004.04-2008.07		-	R	F	Estate Engine Z 19 DT	221053	Drive Shaft		30	34	53.8	94.5	617					
2004.04-2008.07		-	L	F	Estate Engine Z 19 DT	221092	Drive Shaft		30	25	53.8	94.5	604					
2004.04-2008.07		-	R	F	Estate Engine Z 19 DT	644016	Inner Joint		34	28	37.5	46	54					
2004.04-2008.07		-	L	F	Estate Engine Z 19 DT	699186	Inner Joint		25	28	35	57.5	81.5					
2004.04-2008.07	MT	R	F	Estate Engine Z 19 DT	221032	Drive Shaft		30	27	53.8	94.5	605						
1.9 CDTI 16V (110 kW)	2004.04-2008.08	Semi-AT	L/R	F	Saloon Engine Z 19 DTH	244080	Drive Shaft		30	27	53.8	94.5	591					
	2004.04-2008.07	Semi-AT	L/R	F	Estate Engine Z 19 DTH	244080	Drive Shaft		30	27	53.8	94.5	591					
	2004.04-2008.08	AT/MT	L/R	F	Saloon Engine Z 19 DTH	817051	Outer Joint		30	26	53.8	94.5	65.5	M				
	2004.04-2008.08	AT/MT	L/R	F	Saloon Engine Z 19 DTH	221036	Drive Shaft		30	27	55.4	100	602					
	2004.04-2008.07	AT/MT	L/R	F	Estate Engine Z 19 DTH	221036	Drive Shaft		30	27	55.4	100	602					
	2004.04-2008.07	AT/MT	L/R	F	Estate Engine Z 19 DTH	817051	Outer Joint		30	26	53.8	94.5	65.5	M				
	2004.04-2008.08	AT/MT	-	F	Saloon Engine Z 19 DTH	899023	Outer Joint		30	26	53.8	94.5	65.5	M				
	2004.04-2008.07	AT/MT	-	F	Estate Engine Z 19 DTH	899023	Outer Joint		30	26	53.8	94.5	65.5	M				
	2004.04-2008.08	AMT	L/R	F	Saloon Engine Z 19 DTH	621024	Inner Joint		27	34	35	101	88					
	2004.04-2008.07	AMT	L/R	F	Estate Engine Z 19 DTH	621024	Inner Joint		27	34	35	101	88					
2004.04-2008.08	MT	R	F	Saloon Engine Z 19 DTH	221032	Drive Shaft		30	27	53.8	94.5	605						
2004.04-2008.07	MT	R	F	Estate Engine Z 19 DTH	221032	Drive Shaft		30	27	53.8	94.5	605						
2.0 16V Turbo (129 kW)	2000.01-2008.10	-	L/R	F	Saloon Engine Z 20 NET	221036	Drive Shaft		30	27	55.4	100	602					
	2000.01-2008.10	MT	L/R	F	Saloon Engine Z 20 NET	817051	Outer Joint		30	26	53.8	94.5	65.5	M				
	2000.01-2008.10	-	-	F	Saloon Engine Z 20 NET	899023	Outer Joint		30	26	53.8	94.5	65.5	M				
	2000.01-2008.10	-	L/R	F	Saloon Engine Z 20 NET	221032	Drive Shaft		30	27	53.8	94.5	605					
	2003.10-2008.07	MT	L/R	F	Estate Engine Z 20 NET	817051	Outer Joint		30	26	53.8	94.5	65.5	M				
	2003.10-2008.07	-	L/R	F	Estate Engine Z 20 NET	221036	Drive Shaft		30	27	55.4	100	602					
	2003.10-2008.07	-	-	F	Estate Engine Z 20 NET	899023	Outer Joint		30	26	53.8	94.5	65.5	M				
	2003.10-2008.07	MT	R	F	Estate Engine Z 20 NET	221032	Drive Shaft		30	27	53.8	94.5	605					
2.0 DTI 16V (74 kW)	2002.04-2008.10	MT	L/R	F	Saloon Engine Y 20 DTH	817007	Outer Joint		30	25	52.5	105	62	O				
	2002.04-2008.10	MT	L	F	Saloon Engine Y 20 DTH	260015	Drive Shaft		30	34	52.5	105	628					
	2002.04-2008.10	-	L/R	F	Saloon Engine Y 20 DTH	644002	Inner Joint		34	25	35	56.2	85.6					
	2002.04-2008.10	AT/MT	L	F	Saloon Engine Y 20 DTH	621011	Inner Joint		34	25	35	78	64					
	2002.04-2008.10	MT	R	F	Saloon Engine Y 20 DTH	221061	Drive Shaft		30	34	52.5	105	968					
	2003.10-2008.07	AT/MT	L	F	Estate Engine Y 20 DTH	621011	Inner Joint		34	25	35	78	64					
	2003.10-2008.07	MT	L/R	F	Estate Engine Y 20 DTH	817007	Outer Joint		30	25	52.5	105	62	O				
	2003.10-2008.07	MT	L	F	Estate Engine Y 20 DTH	260015	Drive Shaft		30	34	52.5	105	628					
	2003.10-2008.07	-	L/R	F	Estate Engine Y 20 DTH	644002	Inner Joint		34	25	35	56.2	85.6					
2003.10-2008.07	MT	R	F	Estate Engine Y 20 DTH	221061	Drive Shaft		30	34	52.5	105	968						
2.2 16V (108 kW)	2002.01-2008.10	-	-	F	Saloon Engine Z 22 SE	821038	Outer Joint		30	24	52	94	64	M				
	2002.01-2008.10	MT	L/R	F	Saloon Engine Z 22 SE	817007	Outer Joint		30	25	52.5	105	62	O				
	2002.01-2008.10	MT	L	F	Saloon Engine Z 22 SE	260015	Drive Shaft		30	34	52.5	105	628					
	2002.01-2008.10	-	L/R	F	Saloon Engine Z 22 SE	644002	Inner Joint		34	25	35	56.2	85.6					
	2002.01-2008.10	AT/MT	L	F	Saloon Engine Z 22 SE	621011	Inner Joint		34	25	35	78	64					





YEAR	TRANSM	L/R	F/R	REMARKS	GSP Ref.	PRODUCT	ABS	Technical Specifications					
								A	B	C	H	L	P
VAUXHALL													
VECTRA Mk II (C) (Z02)													
2.2 direct (114 kW)	2002.01-2008.10	MT	L/R	F	Saloon Engine Z 22 YH	817007	Outer Joint	30	25	52.5	105	62	O
	2002.01-2008.10	-	-	F	Saloon Engine Z 22 YH	821038	Outer Joint	30	24	52	94	64	M
	2002.01-2008.10	MT	L	F	Saloon Engine Z 22 YH	260015	Drive Shaft	30	34	52.5	105	628	
	2002.01-2008.10	-	L/R	F	Saloon Engine Z 22 YH	644002	Inner Joint	34	25	35	56.2	85.6	
	2003.10-2008.07	-	-	F	Estate Engine Z 22 YH	821038	Outer Joint	30	24	52	94	64	M
	2003.10-2008.07	MT	L/R	F	Estate Engine Z 22 YH	817007	Outer Joint	30	25	52.5	105	62	O
	2003.10-2008.07	MT	L	F	Estate Engine Z 22 YH	260015	Drive Shaft	30	34	52.5	105	628	
	2003.10-2008.07	-	L/R	F	Estate Engine Z 22 YH	644002	Inner Joint	34	25	35	56.2	85.6	
	2003.10-2008.07	AT/MT	L	F	Estate Engine Z 22 YH	621011	Inner Joint	34	25	35	78	64	
2.2 DTI 16V (92 kW)	2002.04-2008.10	5AT/5AT	L/R	F	Saloon Engine Y 22 DTR	221036	Drive Shaft	30	27	55.4	100	602	
	2002.04-2008.10	5AT/5AT	-	F	Saloon Engine Y 22 DTR	899023	Outer Joint	30	26	53.8	94.5	65.5	M
	2002.04-2008.10	MT	L/R	F	Saloon Engine Y 22 DTR	817051	Outer Joint	30	26	53.8	94.5	65.5	M
	2002.04-2008.10	MT	L/R	F	Saloon Engine Y 22 DTR	221032	Drive Shaft	30	27	53.8	94.5	605	
	2003.10-2008.07	-	L/R	F	Estate Engine Y 22 DTR	221032	Drive Shaft	30	27	53.8	94.5	605	
	2003.10-2008.07	MT	L/R	F	Estate Engine Y 22 DTR	817051	Outer Joint	30	26	53.8	94.5	65.5	M
	2003.10-2008.07	-	L/R	F	Estate Engine Y 22 DTR	221036	Drive Shaft	30	27	55.4	100	602	
	2003.10-2008.07	-	-	F	Estate Engine Y 22 DTR	899023	Outer Joint	30	26	53.8	94.5	65.5	M
2.8 V6 Turbo (169 kW)	2005.08-2008.07	MT	L/R	F	Estate Engine Z 28 NEL	221036	Drive Shaft	30	27	55.4	100	602	
2.8 V6 Turbo (206 kW)	2006.10-2008.07	-	L/R	F	Estate Engine Z 28 NET	221036	Drive Shaft	30	27	55.4	100	602	
3.0 CDTI (135 kW)	2005.08-2008.07	-	L/R	F	Saloon Engine Z 30 DT	221036	Drive Shaft	30	27	55.4	100	602	
	2005.08-2008.07	-	L/R	F	Estate Engine Z 30 DT	221036	Drive Shaft	30	27	55.4	100	602	
	2005.08-2008.07	-	-	F	Saloon Engine Z 30 DT	899023	Outer Joint	30	26	53.8	94.5	65.5	M
	2005.08-2008.07	-	-	F	Estate Engine Z 30 DT	899023	Outer Joint	30	26	53.8	94.5	65.5	M
3.0 V6 CDTI (130 kW)	2003.06-2005.08	-	L/R	F	Saloon Engine Y 30 DT	221032	Drive Shaft	30	27	53.8	94.5	605	
	2003.06-2005.08	MT	L/R	F	Saloon Engine Y 30 DT	817051	Outer Joint	30	26	53.8	94.5	65.5	M
	2003.06-2005.08	-	L/R	F	Saloon Engine Y 30 DT	221036	Drive Shaft	30	27	55.4	100	602	
	2003.06-2005.08	-	-	F	Saloon Engine Y 30 DT	899023	Outer Joint	30	26	53.8	94.5	65.5	M
	2003.10-2005.08	-	L/R	F	Estate Engine Y 30 DT	221032	Drive Shaft	30	27	53.8	94.5	605	
	2003.10-2005.08	MT	L/R	F	Estate Engine Y 30 DT	817051	Outer Joint	30	26	53.8	94.5	65.5	M
	2003.10-2005.08	-	L/R	F	Estate Engine Y 30 DT	221036	Drive Shaft	30	27	55.4	100	602	
	2003.10-2005.08	-	-	F	Estate Engine Y 30 DT	899023	Outer Joint	30	26	53.8	94.5	65.5	M
3.2 V6 (155 kW)	2003.06-2008.07	-	L/R	F	Saloon Engine Z 32 SE	221036	Drive Shaft	30	27	55.4	100	602	
	2003.06-2008.07	MT	L/R	F	Saloon Engine Z 32 SE	817051	Outer Joint	30	26	53.8	94.5	65.5	M
	2003.06-2008.07	-	-	F	Saloon Engine Z 32 SE	899023	Outer Joint	30	26	53.8	94.5	65.5	M
	2003.06-2008.07	MT	L/R	F	Saloon Engine Z 32 SE	221032	Drive Shaft	30	27	53.8	94.5	605	
	2003.10-2005.08	MT	L/R	F	Estate Engine Z 32 SE	221032	Drive Shaft	30	27	53.8	94.5	605	
	2003.10-2005.08	MT	L/R	F	Estate Engine Z 32 SE	817051	Outer Joint	30	26	53.8	94.5	65.5	M
	2003.10-2005.08	-	L/R	F	Estate Engine Z 32 SE	221036	Drive Shaft	30	27	55.4	100	602	
	2003.10-2005.08	-	-	F	Estate Engine Z 32 SE	899023	Outer Joint	30	26	53.8	94.5	65.5	M
VECTRA Mk II (C) GTS (Z02)													
1.8 (103 kW)	2006.01-2008.07	MT	L	F	Hatchback Engine Z 18 XER	699026	Inner Joint	22	25	35	57	82.5	
	2006.01-2008.07	MT	L	F	Hatchback Engine Z 18 XER	244020	Drive Shaft	30	22	52.5	105	617.5	
	2006.01-2008.07	MT	R	F	Hatchback Engine Z 18 XER	217040	Drive Shaft	30	22	52.5	105	987	
	2006.01-2008.07	-	L/R	F	Hatchback Engine Z 18 XER	817007	Outer Joint	30	25	52.5	105	62	O
	2006.01-2008.07	-	-	F	Hatchback Engine Z 18 XER	821038	Outer Joint	30	24	52	94	64	M
	2006.01-2008.07	-	L	F	Hatchback Engine Z 18 XER	217223	Drive Shaft	30	22	52	94	609	
1.8 16V (90 kW)	2002.08-2008.07	MT	L	F	Hatchback Engine Z 18 XE	699026	Inner Joint	22	25	35	57	82.5	
	2002.08-2008.07	MT	L	F	Hatchback Engine Z 18 XE	244020	Drive Shaft	30	22	52.5	105	617.5	
	2002.08-2008.07	-	-	F	Hatchback Engine Z 18 XE	821038	Outer Joint	30	24	52	94	64	M
	2002.08-2008.07	MT	R	F	Hatchback Engine Z 18 XE	217040	Drive Shaft	30	22	52.5	105	987	
	2002.08-2008.07	MT	L/R	F	Hatchback Engine Z 18 XE	817007	Outer Joint	30	25	52.5	105	62	O
	2002.08-2008.07	-	L	F	Hatchback Engine Z 18 XE	217223	Drive Shaft	30	22	52	94	609	
1.8 16V Dualfuel (90 kW)	2002.08-2008.07	MT	L	F	Hatchback Engine Z 18 XE	699026	Inner Joint	22	25	35	57	82.5	
	2002.08-2008.07	MT	L	F	Hatchback Engine Z 18 XE	244020	Drive Shaft	30	22	52.5	105	617.5	
	2002.08-2008.07	-	-	F	Hatchback Engine Z 18 XE	821038	Outer Joint	30	24	52	94	64	M
	2002.08-2008.07	MT	R	F	Hatchback Engine Z 18 XE	217040	Drive Shaft	30	22	52.5	105	987	
	2002.08-2008.07	MT	L/R	F	Hatchback Engine Z 18 XE	817007	Outer Joint	30	25	52.5	105	62	O
	2002.08-2008.07	-	L	F	Hatchback Engine Z 18 XE	217223	Drive Shaft	30	22	52	94	609	
1.9 CDTI (88 kW)	2002.08-2008.07	MT	L/R	F	Hatchback Engine Z 19 DT	221036	Drive Shaft	30	27	55.4	100	602	
	2002.08-2008.07	MT	L/R	F	Hatchback Engine Z 19 DT	817051	Outer Joint	30	26	53.8	94.5	65.5	M
	2002.08-2008.07	-	R	F	Hatchback Engine Z 19 DT	221053	Drive Shaft	30	34	53.8	94.5	617	
	2002.08-2008.07	-	L	F	Hatchback Engine Z 19 DT	221092	Drive Shaft	30	25	53.8	94.5	604	
	2002.08-2008.07	-	R	F	Hatchback Engine Z 19 DT	644016	Inner Joint	34	28	37.5	46	54	
	2002.08-2008.07	-	L	F	Hatchback Engine Z 19 DT	699186	Inner Joint	25	28	35	57.5	81.5	
	2002.08-2008.07	-	-	F	Hatchback Engine Z 19 DT	899023	Outer Joint	30	26	53.8	94.5	65.5	M
	2002.08-2008.07	MT	R	F	Hatchback Engine Z 19 DT	221032	Drive Shaft	30	27	53.8	94.5	605	





YEAR	TRANS	L/R	F/R	REMARKS	GSP Ref.	PRODUCT	ABS	Technical Specifications						
								A	B	C	H	L	P	
VAUXHALL														
VECTRA Mk II (C) GTS (Z02)														
1.9 CDTI 16V (110 kW)	2004.04-2008.07	Semi-AT	L/R	F	Hatchback Engine Z 19 DTH	244080	Drive Shaft		30	27	53.8	94.5	591	
	2004.04-2008.07	AT/MT	L/R	F	Hatchback Engine Z 19 DTH	817051	Outer Joint		30	26	53.8	94.5	65.5	M
	2004.04-2008.07	AT/MT	L/R	F	Hatchback Engine Z 19 DTH	221036	Drive Shaft		30	27	55.4	100	602	
	2004.04-2008.07	AT/MT	-	F	Hatchback Engine Z 19 DTH	899023	Outer Joint		30	26	53.8	94.5	65.5	M
	2004.04-2008.07	AMT	L/R	F	Hatchback Engine Z 19 DTH	621024	Inner Joint		27	34	35	101	88	
	2004.04-2008.07	MT	R	F	Hatchback Engine Z 19 DTH	221032	Drive Shaft		30	27	53.8	94.5	605	
2.0 16V Turbo (129 kW)	2003.03-2008.07	MT	L/R	F	Hatchback Engine Z 20 NET	221032	Drive Shaft		30	27	53.8	94.5	605	
	2003.03-2008.07	MT	L/R	F	Hatchback Engine Z 20 NET	817051	Outer Joint		30	26	53.8	94.5	65.5	M
	2003.03-2008.07	-	L/R	F	Hatchback Engine Z 20 NET	221036	Drive Shaft		30	27	55.4	100	602	
	2003.03-2008.07	-	-	F	Hatchback Engine Z 20 NET	899023	Outer Joint		30	26	53.8	94.5	65.5	M
2.0 DTI 16V (74 kW)	2002.08-2008.07	MT	L/R	F	Hatchback Engine Y 20 DTH	817007	Outer Joint		30	25	52.5	105	62	O
	2002.08-2008.07	MT	L	F	Hatchback Engine Y 20 DTH	260015	Drive Shaft		30	34	52.5	105	628	
	2002.08-2008.07	-	L/R	F	Hatchback Engine Y 20 DTH	644002	Inner Joint		34	25	35	56.2	85.6	
	2002.08-2008.07	AT/MT	L	F	Hatchback Engine Y 20 DTH	621011	Inner Joint		34	25	35	78	64	
	2002.08-2008.07	MT	R	F	Hatchback Engine Y 20 DTH	221061	Drive Shaft		30	34	52.5	105	968	
2.2 16V (108 kW)	2002.08-2008.07	MT	L/R	F	Hatchback Engine Z 22 SE	817007	Outer Joint		30	25	52.5	105	62	O
	2002.08-2008.07	MT	L	F	Hatchback Engine Z 22 SE	260015	Drive Shaft		30	34	52.5	105	628	
	2002.08-2008.07	-	L/R	F	Hatchback Engine Z 22 SE	644002	Inner Joint		34	25	35	56.2	85.6	
	2002.08-2008.07	AT/MT	L	F	Hatchback Engine Z 22 SE	621011	Inner Joint		34	25	35	78	64	
2.2 direct (114 kW)	2003.10-2005.08	MT	L/R	F	Hatchback Engine Z 22 YH	817007	Outer Joint		30	25	52.5	105	62	O
	2003.10-2005.08	-	-	F	Hatchback Engine Z 22 YH	821038	Outer Joint		30	24	52	94	64	M
	2003.10-2005.08	MT	L	F	Hatchback Engine Z 22 YH	260015	Drive Shaft		30	34	52.5	105	628	
	2003.10-2005.08	-	L/R	F	Hatchback Engine Z 22 YH	644002	Inner Joint		34	25	35	56.2	85.6	
	2003.10-2005.08	AT/MT	L	F	Hatchback Engine Z 22 YH	621011	Inner Joint		34	25	35	78	64	
2.2 DTI 16V (92 kW)	2002.08-2008.07	5AT/5AT	L/R	F	Hatchback Engine Y 22 DTR	221036	Drive Shaft		30	27	55.4	100	602	
	2002.08-2008.07	5AT/5AT	-	F	Hatchback Engine Y 22 DTR	899023	Outer Joint		30	26	53.8	94.5	65.5	M
	2002.08-2008.07	MT	L/R	F	Hatchback Engine Y 22 DTR	221032	Drive Shaft		30	27	53.8	94.5	605	
	2002.08-2008.07	MT	L/R	F	Hatchback Engine Y 22 DTR	817051	Outer Joint		30	26	53.8	94.5	65.5	M
2.8 V6 Turbo (169 kW)	2005.08-2008.07	-	L/R	F	Hatchback Engine Z 28 NEL	221036	Drive Shaft		30	27	55.4	100	602	
2.8 V6 Turbo (184 kW)	2006.08-2008.07	-	L/R	F	Hatchback Engine Z 28 NET	221036	Drive Shaft		30	27	55.4	100	602	
2.8 V6 Turbo (188 kW)	2005.08-2008.07	MT	L/R	F	Hatchback Engine Z 28 NET	221036	Drive Shaft		30	27	55.4	100	602	
2.8 V6 Turbo (206 kW)	2006.08-2008.07	-	L/R	F	Hatchback Engine Z 28 NET	221036	Drive Shaft		30	27	55.4	100	602	
3.0 CDTI (135 kW)	2005.08-2008.07	-	L/R	F	Hatchback Engine Z 30 DT	221036	Drive Shaft		30	27	55.4	100	602	
	2005.08-2008.07	-	-	F	Hatchback Engine Z 30 DT	899023	Outer Joint		30	26	53.8	94.5	65.5	M
3.0 V6 CDTI (130 kW)	2003.06-2005.08	-	L/R	F	Hatchback Engine Y 30 DT	221032	Drive Shaft		30	27	53.8	94.5	605	
	2003.06-2005.08	MT	L/R	F	Hatchback Engine Y 30 DT	817051	Outer Joint		30	26	53.8	94.5	65.5	M
	2003.06-2005.08	-	L/R	F	Hatchback Engine Y 30 DT	221036	Drive Shaft		30	27	55.4	100	602	
	2003.06-2005.08	-	-	F	Hatchback Engine Y 30 DT	899023	Outer Joint		30	26	53.8	94.5	65.5	M
3.2 V6 (155 kW)	2002.08-2008.07	MT	L/R	F	Hatchback Engine Z 32 SE	817051	Outer Joint		30	26	53.8	94.5	65.5	M
	2002.08-2008.07	-	-	F	Hatchback Engine Z 32 SE	899023	Outer Joint		30	26	53.8	94.5	65.5	M
	2002.08-2008.07	MT	L/R	F	Hatchback Engine Z 32 SE	221032	Drive Shaft		30	27	53.8	94.5	605	
	2002.08-2008.07	AT/MT	L/R	F	Hatchback Engine Z 32 SE	221036	Drive Shaft		30	27	55.4	100	602	
VIVA (C16)														
1.0 (55 kW)	2015.01-	-	L	F	Hatchback Engine B 10 XE	201616	Drive Shaft	48T	25	22	52.5	59	625	
	2015.01-	-	R	F	Hatchback Engine B 10 XE	201621	Drive Shaft	44T	28	26	56	90	785	
1.0 LPG(54 kW)	2015.06-	-	L	F	Hatchback Engine B 10 XL, D 10 XE	201616	Drive Shaft	48T	25	22	52.5	59	625	
	2015.06-	-	R	F	Hatchback Engine B 10 XL, D 10 XE	201621	Drive Shaft	44T	28	26	56	90	785	
VIVARO (X83)														
1.9 DI (59 kW)	2001.08-2006.12	-	L	F	Box Engine F9Q 762	244003	Drive Shaft		27	37.1	56.5	93.5	676	
	2001.08-2006.12	-	R	F	Box Engine F9Q 762	244013	Drive Shaft		27	39	56.5	93.5	1020	
	2003.04-2014.07	MT	L	F	Platform/Chassis Engine F9Q 762	244003	Drive Shaft		27	37.1	56.5	93.5	676	
	2003.04-2014.07	MT	R	F	Platform/Chassis Engine F9Q 762	244013	Drive Shaft		27	39	56.5	93.5	1020	
1.9 DTI (74 kW)	2001.08-2006.12	-	L	F	Box Engine F9Q 760	244003	Drive Shaft		27	37.1	56.5	93.5	676	
	2001.08-2006.12	-	R	F	Box Engine F9Q 760	244013	Drive Shaft		27	39	56.5	93.5	1020	
	2001.08-2006.12	AT/MT	L/R	F	Box Engine F9Q 760	818105	Outer Joint		27	26	56.5	93.5	64	M
2.0 16V (88 kW)	2001.08-2006.12	-	L	F	Box Engine F4R 720	244003	Drive Shaft		27	37.1	56.5	93.5	676	
	2001.08-2006.12	-	R	F	Box Engine F4R 720	244013	Drive Shaft		27	39	56.5	93.5	1020	
	2003.04-2014.07	-	L	F	Platform/Chassis Engine F4R 720	244003	Drive Shaft		27	37.1	56.5	93.5	676	
	2003.04-2014.07	-	R	F	Platform/Chassis Engine F4R 720	244013	Drive Shaft		27	39	56.5	93.5	1020	
2.0 CDTI (66 kW)	2006.01-2014.07	-	L	F	Platform/Chassis Engine M9R 782	260022	Drive Shaft		27	39	56.6	94	694	
	2006.01-2014.07	-	L	F	Box Engine M9R 780	260022	Drive Shaft		27	39	56.6	94	694	
	2006.01-2014.07	-	R	F	Platform/Chassis Engine M9R 782	218271	Drive Shaft		27	39	56.6	94	1013	
	2006.01-2014.07	-	R	F	Box Engine M9R 780	218271	Drive Shaft		27	39	56.6	94	1013	
2.0 CDTI (84 kW)	2006.08-2014.07	-	L	F	Platform/Chassis Engine M9R 780	260022	Drive Shaft		27	39	56.6	94	694	
	2006.08-2014.07	-	L	F	Box Engine M9R 780	260022	Drive Shaft		27	39	56.6	94	694	
	2006.08-2014.07	-	R	F	Platform/Chassis Engine M9R 780	218271	Drive Shaft		27	39	56.6	94	1013	





	 YEAR	TRANSM	L/R	F/R	REMARKS	GSP Ref.	 PRODUCT	 ABS	Technical Specifications						
									A	B	C	H	L	P	
VAUXHALL															
VIVARO (X83)															
2.0 CDTI (84 kW)	2006.08-	2014.07	-	R	F	Box Engine M9R 780	218271	Drive Shaft		27	39	56.6	94	1013	
2.0 ECOTEC (86 kW)	2006.08-	2014.07	-	L	F	Box Engine F4R 820	244003	Drive Shaft		27	37.1	56.5	93.5	676	
	2006.08-	2014.07	-	L	F	Platform/Chassis Engine F4R 820	244003	Drive Shaft		27	37.1	56.5	93.5	676	
	2006.08-	2014.07	AT/MT	L/R	F	Box Engine F4R 820	818105	Outer Joint		27	26	56.5	93.5	64	M
	2006.08-	2014.07	AT/MT	L/R	F	Platform/Chassis Engine F4R 820	818105	Outer Joint		27	26	56.5	93.5	64	M
	2006.08-	2014.07	-	R	F	Box Engine F4R 820	244013	Drive Shaft		27	39	56.5	93.5	1020	
	2006.08-	2014.07	-	R	F	Platform/Chassis Engine F4R 820	244013	Drive Shaft		27	39	56.5	93.5	1020	
2.5 CDTI (107 kW)	2006.08-	2014.07	-	R	F	Platform/Chassis Engine G9U 630	218301	Drive Shaft		27	39	56.6	94	1045	
	2006.08-	2014.07	-	R	F	Box Engine G9U 630	218301	Drive Shaft		27	39	56.6	94	1045	
	2006.08-	2014.07	-	R	F	Platform/Chassis Engine G9U 630	650097	Inner Joint		39	35	30	409	90	
	2006.08-	2014.07	-	R	F	Box Engine G9U 630	650097	Inner Joint		39	35	30	409	90	
	2006.08-	2014.07	-	L	F	Platform/Chassis Engine G9U 630	250557	Drive Shaft		27	37.1	56.5	92	634	
	2006.08-	2014.07	-	L	F	Box Engine G9U 630	250557	Drive Shaft		27	37.1	56.5	92	634	
	2006.08-	2014.07	-	R	F	Platform/Chassis Engine G9U 630	250562	Drive Shaft		27	39	56.5	92	1056	
	2006.08-	2014.07	-	R	F	Box Engine G9U 630	250562	Drive Shaft		27	39	56.5	92	1056	
	2006.08-	2014.07	-	L	F	Platform/Chassis Engine G9U 630	250497	Drive Shaft		27	39	56.6	94	667	
	2006.08-	2014.07	-	L	F	Box Engine G9U 630	250497	Drive Shaft		27	39	56.6	94	667	
2.5 CDTI (99 kW)	2003.04-	2006.07	-	R	F	Platform/Chassis Engine G9U 730	650097	Inner Joint		39	35	30	409	90	
	2003.04-	2006.07	-	-	F	Platform/Chassis Engine G9U 730	850080	Outer Joint		27	37	56.5	92	73	I
	2003.04-	2006.07	-	L	F	Platform/Chassis Engine G9U 730	250557	Drive Shaft		27	37.1	56.5	92	634	
	2003.04-	2006.07	-	R	F	Platform/Chassis Engine G9U 730	250562	Drive Shaft		27	39	56.5	92	1056	
2.5 DTI (99 kW)	2003.07-	2014.07	AT/MT	L/R	F	Box Engine G9U 730	850041	Outer Joint		27	37	56.5	93	72	I
	2003.07-	2014.07	-	-	F	Box Engine G9U 730	850080	Outer Joint		27	37	56.5	92	73	I
	2003.07-	2014.07	-	R	F	Box Engine G9U 730	650097	Inner Joint		39	35	30	409	90	
	2003.07-	2014.07	-	L	F	Box Engine G9U 730	250557	Drive Shaft		27	37.1	56.5	92	634	
	2003.07-	2014.07	-	R	F	Box Engine G9U 730	250562	Drive Shaft		27	39	56.5	92	1056	
VIVARO Combi (X83)															
1.9 DI (59 kW)	2001.08-	2006.12	-	L	F	BUS Engine F9Q 762	244003	Drive Shaft		27	37.1	56.5	93.5	676	
	2001.08-	2006.12	-	R	F	BUS Engine F9Q 762	244013	Drive Shaft		27	39	56.5	93.5	1020	
1.9 DTI (74 kW)	2001.08-	2006.12	-	L	F	BUS Engine F9Q 760	244003	Drive Shaft		27	37.1	56.5	93.5	676	
	2001.08-	2006.12	-	R	F	BUS Engine F9Q 760	244013	Drive Shaft		27	39	56.5	93.5	1020	
2.0 16V (88 kW)	2001.08-	2006.12	-	L	F	BUS Engine F4R 720	244003	Drive Shaft		27	37.1	56.5	93.5	676	
	2001.08-	2006.12	-	R	F	BUS Engine F4R 720	244013	Drive Shaft		27	39	56.5	93.5	1020	
2.0 CDTI (66 kW)	2006.01-	2014.07	-	L	F	BUS Engine M9R 780	260022	Drive Shaft		27	39	56.6	94	694	
	2006.01-	2014.07	-	R	F	BUS Engine M9R 780	218271	Drive Shaft		27	39	56.6	94	1013	
2.0 CDTI (84 kW)	2006.08-	2014.07	-	L	F	BUS Engine M9R 780	260022	Drive Shaft		27	39	56.6	94	694	
	2006.08-	2014.07	-	R	F	BUS Engine M9R 780	218271	Drive Shaft		27	39	56.6	94	1013	
2.0 ECOTEC (86 kW)	2006.08-	2014.07	-	L	F	BUS Engine F4R 820	244003	Drive Shaft		27	37.1	56.5	93.5	676	
	2006.08-	2014.07	AT/MT	L/R	F	BUS Engine F4R 820	818105	Outer Joint		27	26	56.5	93.5	64	M
	2006.08-	2014.07	-	R	F	BUS Engine F4R 820	244013	Drive Shaft		27	39	56.5	93.5	1020	
2.5 CDTI (107 kW)	2006.01-	2014.07	-	R	F	BUS Engine G9U 630	218301	Drive Shaft		27	39	56.6	94	1045	
	2006.01-	2014.07	-	R	F	BUS Engine G9U 630	650097	Inner Joint		39	35	30	409	90	
	2006.01-	2014.07	-	L	F	BUS Engine G9U 630	250557	Drive Shaft		27	37.1	56.5	92	634	
	2006.01-	2014.07	-	R	F	BUS Engine G9U 630	250562	Drive Shaft		27	39	56.5	92	1056	
	2006.01-	2014.07	-	L	F	BUS Engine G9U 630	250497	Drive Shaft		27	39	56.6	94	667	
2.5 DTI (99 kW)	2003.07-	2014.07	AT/MT	L/R	F	BUS Engine G9U 730	850041	Outer Joint		27	37	56.5	93	72	I
	2003.07-	2014.07	-	-	F	BUS Engine G9U 730	850080	Outer Joint		27	37	56.5	92	73	I
	2003.07-	2014.07	-	R	F	BUS Engine G9U 730	650097	Inner Joint		39	35	30	409	90	
	2003.07-	2014.07	-	L	F	BUS Engine G9U 730	250557	Drive Shaft		27	37.1	56.5	92	634	
	2003.07-	2014.07	-	R	F	BUS Engine G9U 730	250562	Drive Shaft		27	39	56.5	92	1056	
ZAFIRA Mk I (A) (T98)															
1.6 16V (74 kW)	1999.04-	2005.08	MT	R	F	MPV Engine X 16 XEL	699026	Inner Joint		22	25	35	57	82.5	
	1999.04-	2005.08	-	L	F	MPV Engine X 16 XEL	260013	Drive Shaft		33	22	52	103	595	
	1999.04-	2005.08	-	L/R	F	MPV Engine X 16 XEL	644004	Inner Joint		22	22	34.95	57.5	72.5	
	1999.04-	2005.08	-	-	F	MPV Engine X 16 XEL	844010	Outer Joint	29T	33	22	52	103	50.5	O
	1999.04-	2005.08	AT/MT	L/R	F	MPV Engine X 16 XEL	844006	Outer Joint	29T	33	25	52	103.5	61	O
	1999.04-	2005.08	-	R	F	MPV Engine X 16 XEL	244033	Drive Shaft		33	22	52	103	950.5	
	1999.04-	2005.08	-	L	F	MPV Engine X 16 XEL	621014	Inner Joint		22	22	35	57.5	75	
	1999.04-	2005.08	-	-	F	MPV Engine X 16 XEL	844049	Outer Joint		33	25	52	109	61	O
	1999.04-	2005.08	MT	R	F	MPV Engine X 16 XEL	260035	Drive Shaft		33	22	52	109	961	
	1999.04-	2005.08	AT	-	F	MPV Engine Z 16 YNG	844010	Outer Joint	29T	33	22	52	103	50.5	O
1.6 CNG (71 kW)	2001.09-	2005.06	-	L	F	MPV Engine Z 16 YNG	244028	Drive Shaft		33	22	53	95	590	
	2001.09-	2005.06	-	L	F	MPV Engine Z 16 YNG	621014	Inner Joint		22	22	35	57.5	75	
	2001.09-	2005.06	-	R	F	MPV Engine Z 16 YNG	244030	Drive Shaft		33	22	53	95	952	
	2001.09-	2005.06	-	L/R	F	MPV Engine Z 16 YNG	844003	Outer Joint		33	22	53	95	54.5	M
	2001.09-	2005.06	-	R	F	MPV Engine Z 16 XE	699026	Inner Joint		22	25	35	57	82.5	





YEAR	TRANSM	L/R	F/R	REMARKS	GSP Ref.	PRODUCT	ABS	Technical Specifications							
								A	B	C	H	L	P		
VAUXHALL															
ZAFIRA Mk I (A) (T98)															
1.6 Dualfuel (74 kW)	1998.11-2005.08	MT	L	F	MPV Engine Z 16 XE	260013	Drive Shaft		33	22	52	103	595		
	1998.11-2005.08	-	-	F	MPV Engine Z 16 XE	844010	Outer Joint	29T	33	22	52	103	50.5	O	
	1998.11-2005.08	MT	R	F	MPV Engine Z 16 XE	244033	Drive Shaft		33	22	52	103	950.5		
	1998.11-2005.08	MT	L/R	F	MPV Engine Z 16 XE	644004	Inner Joint		22	22	34.95	57.5	72.5		
	1998.11-2005.08	MT	L/R	F	MPV Engine Z 16 XE	844006	Outer Joint	29T	33	25	52	103.5	61	O	
	1998.11-2005.08	MT	L	F	MPV Engine Z 16 XE	621014	Inner Joint		22	22	35	57.5	75		
1.8 16V (85 kW)	1999.05-2000.08	MT	R	F	MPV Engine X 18 XE1	699026	Inner Joint		22	25	35	57	82.5		
	1999.05-2000.08	AT/MT	L/R	F	MPV Engine X 18 XE1	844006	Outer Joint	29T	33	25	52	103.5	61	O	
	1999.05-2000.08	MT	R	F	MPV Engine X 18 XE1	260035	Drive Shaft		33	22	52	109	961		
	1999.05-2000.08	-	-	F	MPV Engine X 18 XE1	844049	Outer Joint		33	25	52	109	61	O	
1.8 16V (92 kW)	2000.09-2005.08	MT	R	F	MPV Engine Z 18 XE	699026	Inner Joint		22	25	35	57	82.5		
	2000.09-2005.08	AT/MT	L/R	F	MPV Engine Z 18 XE	844006	Outer Joint	29T	33	25	52	103.5	61	O	
	2000.09-2005.08	MT	R	F	MPV Engine Z 18 XE	260035	Drive Shaft		33	22	52	109	961		
	2000.09-2005.08	-	-	F	MPV Engine Z 18 XE	844049	Outer Joint		33	25	52	109	61	O	
1.8 Dualfuel (92 kW)	2000.09-2005.08	-	R	F	MPV Engine Z 18 XE	699026	Inner Joint		22	25	35	57	82.5		
	2000.09-2005.08	-	R	F	MPV Engine Z 18 XE	260035	Drive Shaft		33	22	52	109	961		
2.0 (147 kW)	2002.06-2005.06	MT	R	F	MPV Engine Z 20 LET	244082	Drive Shaft		33	34	55	104	663		
	2002.06-2005.06	MT	-	F	MPV Engine Z 20 LET	899061	Outer Joint		33	35	55	104	67.5	I	
	2002.06-2005.06	MT	L	F	MPV Engine Z 20 LET	644018	Inner Joint		34	35	35	56	119.5		
	2002.06-2005.06	MT	L	F	MPV Engine Z 20 LET	244025	Drive Shaft		33	34	55	104	593		
2.0 DI 16V (60 kW)	1999.10-2005.08	AT/MT	L/R	F	MPV Engine X 20 DTL	844006	Outer Joint	29T	33	25	52	103.5	61	O	
	1999.10-2005.08	MT	L/R	F	MPV Engine X 20 DTL	621011	Inner Joint		34	25	35	78	64		
	1999.10-2005.08	-	L/R	F	MPV Engine X 20 DTL	644002	Inner Joint		34	25	35	56.2	85.6		
	1999.10-2005.08	-	-	F	MPV Engine X 20 DTL	844049	Outer Joint		33	25	52	109	61	O	
	1999.10-2005.08	-	L	F	MPV Engine X 20 DTL	244044	Drive Shaft		33	34	52	103.5	595		
2.0 DTI 16V (74 kW)	1999.04-2005.08	AT/MT	L/R	F	MPV Engine Y 20 DTH	844006	Outer Joint	29T	33	25	52	103.5	61	O	
	1999.04-2005.08	MT	L/R	F	MPV Engine Y 20 DTH	621011	Inner Joint		34	25	35	78	64		
	1999.04-2005.08	-	L/R	F	MPV Engine Y 20 DTH	644002	Inner Joint		34	25	35	56.2	85.6		
	1999.04-2005.08	-	L	F	MPV Engine Y 20 DTH	244044	Drive Shaft		33	34	52	103.5	595		
	1999.04-2005.08	-	-	F	MPV Engine Y 20 DTH	844049	Outer Joint		33	25	52	109	61	O	
2.0 GSI Turbo (141 kW)	2001.09-2005.06	MT	-	F	MPV Engine Z 20 LET	899061	Outer Joint		33	35	55	104	67.5	I	
	2001.09-2005.06	MT	L	F	MPV Engine Z 20 LET	644018	Inner Joint		34	35	35	56	119.5		
	2001.09-2005.06	MT	L	F	MPV Engine Z 20 LET	244025	Drive Shaft		33	34	55	104	593		
	2001.09-2005.06	MT	R	F	MPV Engine Z 20 LET	244082	Drive Shaft		33	34	55	104	663		
2.2 16V (108 kW)	1998.11-2004.08	AT/MT	L/R	F	MPV Engine Z 22 SE	844006	Outer Joint	29T	33	25	52	103.5	61	O	
	1998.11-2004.08	MT	L/R	F	MPV Engine Z 22 SE	621011	Inner Joint		34	25	35	78	64		
	1998.11-2004.08	-	L/R	F	MPV Engine Z 22 SE	644002	Inner Joint		34	25	35	56.2	85.6		
	1998.11-2004.08	-	L	F	MPV Engine Z 22 SE	244044	Drive Shaft		33	34	52	103.5	595		
	1998.11-2004.08	-	-	F	MPV Engine Z 22 SE	844049	Outer Joint		33	25	52	109	61	O	
ZAFIRA Mk II (B) (A05)															
1.6 (77 kW)	2005.07-2014.11	MT	L	F	MPV Engine Z 16 XEP	244028	Drive Shaft		33	22	53	95	590		
	2005.07-2014.11	MT	L	F	MPV Engine Z 16 XEP	621014	Inner Joint		22	22	35	57.5	75		
	2005.07-2014.11	MT	L/R	F	MPV Engine Z 16 XEP	844003	Outer Joint		33	22	53	95	54.5	M	
	2005.07-2014.11	MT	R	F	MPV Engine Z 16 XEP	244030	Drive Shaft		33	22	53	95	952		
1.6 (85 kW)	2007.12-2014.11	-	L	F	MPV Engine A 16 XER	244028	Drive Shaft		33	22	53	95	590		
	2007.12-2014.11	-	L	F	MPV Engine A 16 XER	621014	Inner Joint		22	22	35	57.5	75		
	2007.12-2014.11	-	L/R	F	MPV Engine A 16 XER	844003	Outer Joint		33	22	53	95	54.5	M	
1.7 CDTI (81 kW)	2009.04-2014.11	-	L/R	F	MPV Engine A 17 DTJ	844027	Outer Joint		33	26	52.5	94	65.5	M	
	2009.04-2014.11	-	R	F	MPV Engine A 17 DTJ	644016	Inner Joint		34	28	37.5	46	54		
	2009.04-2014.11	-	R	F	MPV Engine A 17 DTJ	244099	Drive Shaft		33	34	52.5	94	563		
	2009.04-2014.11	-	L	F	MPV Engine A 17 DTJ	699186	Inner Joint		25	28	35	57.5	81.5		
	2009.04-2014.11	MT	-	F	MPV Engine A 17 DTJ	899024	Outer Joint		33	26	52.5	94	65.5	M	
	2009.04-2014.11	-	L	F	MPV Engine A 17 DTJ	221051	Drive Shaft		33	25	52.5	94	579		
1.7 CDTI (92 kW)	2008.01-2014.11	-	R	F	MPV Engine A 17 DTR	644016	Inner Joint		34	28	37.5	46	54		
	2008.01-2014.11	-	R	F	MPV Engine A 17 DTR	244099	Drive Shaft		33	34	52.5	94	563		
	2008.01-2014.11	-	L	F	MPV Engine A 17 DTR	699186	Inner Joint		25	28	35	57.5	81.5		
	2008.01-2014.11	MT	-	F	MPV Engine A 17 DTR	899024	Outer Joint		33	26	52.5	94	65.5	M	
	2008.01-2014.11	-	L	F	MPV Engine A 17 DTR	221051	Drive Shaft		33	25	52.5	94	579		
	2008.01-2014.11	-	L/R	F	MPV Engine A 17 DTR	844027	Outer Joint		33	26	52.5	94	65.5	M	
1.8 (103 kW)	2005.04-2014.11	-	L	F	MPV Engine Z 18 XER	699026	Inner Joint		22	25	35	57	82.5		
	2005.04-2014.11	-	L	F	MPV Engine Z 18 XER	221063	Drive Shaft		33	22	53	93.5	586		
	2005.04-2014.11	-	R	F	MPV Engine Z 18 XER	221055	Drive Shaft		33	22	53	93.5	950		
	2005.04-2014.11	-	L/R	F	MPV Engine Z 18 XER	844028	Outer Joint		33	24	53	93.5	63.5	M	
1.8 (88 kW)	2013.04-2014.11	MT	L	F	MPV Engine A 18 XEL	699026	Inner Joint		22	25	35	57	82.5		
	2013.04-2014.11	MT	L	F	MPV Engine A 18 XEL	221063	Drive Shaft		33	22	53	93.5	586		

YEAR	TRANSM	L/R	F/R	REMARKS	GSP Ref.	PRODUCT	ABS	Technical Specifications						
								A	B	C	H	L	P	
VAUXHALL														
ZAFIRA Mk II (B) (A05)														
1.8 (88 kW)	2013.04-2014.11	MT	L/R	F	MPV Engine A 18 XEL	844028	Outer Joint	33	24	53	93.5	63.5	M	
1.9 CDTI (110 kW)	2005.07-2014.11	MT	L	F	MPV Engine Z 19 DTH	221035	Drive Shaft	30	25	53.8	94.5	581		
	2005.07-2014.11	-	L/R	F	MPV Engine Z 19 DTH	817051	Outer Joint	30	26	53.8	94.5	65.5	M	
	2005.07-2014.11	MT	L	F	MPV Engine Z 19 DTH	699186	Inner Joint	25	28	35	57.5	81.5		
	2005.07-2014.11	MT	L	F	MPV Engine Z 19 DTH	621018	Inner Joint	25	34	35	58	116		
	2005.07-2014.11	MT	L	F	MPV Engine Z 19 DTH	221071	Drive Shaft	30	25	53.8	94.5	576		
	2005.07-2014.11	MT	R	F	MPV Engine Z 19 DTH	221062	Drive Shaft	30	34	53.8	94.5	595		
	2005.07-2014.11	MT	R	F	MPV Engine Z 19 DTH	260016	Drive Shaft	30	34	52.5	105	588		
	2005.07-2014.11	-	-	F	MPV Engine Z 19 DTH	899023	Outer Joint	30	26	53.8	94.5	65.5	M	
1.9 CDTI (74 kW)	2005.07-2014.11	-	-	F	MPV Engine Z 19 DTL	899024	Outer Joint	33	26	52.5	94	65.5	M	
	2005.07-2014.11	AT	L	F	MPV Engine Z 19 DTL	221111	Drive Shaft	33	27	52.5	94	562		
	2005.07-2014.11	AT	R	F	MPV Engine Z 19 DTL	221110	Drive Shaft	33	27	52.5	94	576		
1.9 CDTI (88 kW)	2005.07-2014.11	-	L/R	F	MPV Engine Z 19 DT	844027	Outer Joint	33	26	52.5	94	65.5	M	
	2005.07-2014.11	MT	R	F	MPV Engine Z 19 DT	221056	Drive Shaft	33	34	52.5	94	595		
	2005.07-2014.11	MT	L	F	MPV Engine Z 19 DT	221073	Drive Shaft	33	25	52.5	94	578		
	2005.07-2014.11	MT	L	F	MPV Engine Z 19 DT	621018	Inner Joint	25	34	35	58	116		
	2005.07-2014.11	MT	L	F	MPV Engine Z 19 DT	699186	Inner Joint	25	28	35	57.5	81.5		
	2005.07-2014.11	AT	L	F	MPV Engine Z 19 DT	221111	Drive Shaft	33	27	52.5	94	562		
	2005.07-2014.11	-	-	F	MPV Engine Z 19 DT	899024	Outer Joint	33	26	52.5	94	65.5	M	
	2005.07-2014.11	AT	R	F	MPV Engine Z 19 DT	221110	Drive Shaft	33	27	52.5	94	576		
2.0 (147 kW)	2005.07-2014.11	-	L/R	F	MPV Engine Z 20 LER	844027	Outer Joint	33	26	52.5	94	65.5	M	
	2005.07-2014.11	-	R	F	MPV Engine Z 20 LER	221056	Drive Shaft	33	34	52.5	94	595		
	2005.07-2014.11	-	-	F	MPV Engine Z 20 LER	899024	Outer Joint	33	26	52.5	94	65.5	M	
2.0 (176 kW)	2006.01-2014.11	MT	-	F	MPV Engine Z 20 LEH	899023	Outer Joint	30	26	53.8	94.5	65.5	M	
	2006.01-2014.11	-	L/R	F	MPV Engine Z 20 LEH	817051	Outer Joint	30	26	53.8	94.5	65.5	M	
	2006.01-2014.11	-	R	F	MPV Engine Z 20 LEH	221062	Drive Shaft	30	34	53.8	94.5	595		
	2006.01-2014.11	-	R	F	MPV Engine Z 20 LEH	260016	Drive Shaft	30	34	52.5	105	588		
2.2 (110 kW)	2005.07-2014.11	MT	R	F	MPV Engine Z 22 YH	244051	Drive Shaft	33	34	53	93.5	570		
	2005.07-2014.11	-	L/R	F	MPV Engine Z 22 YH	844028	Outer Joint	33	24	53	93.5	63.5	M	
ZAFIRA Mk III (P12)														
1.6 CDTI (100 kW)	2013.03-2014.11	MT	L	F	MPV Engine B 16 DTH	260027	Drive Shaft	30	27	52.5	94.5	619		
	2013.03-2014.11	-	-	F	MPV Engine B 16 DTH	899023	Outer Joint	30	26	53.8	94.5	65.5	M	
1.6 CDTI (99 kW)	2016.10-2017.12	-	L	F	MPV Engine B 16 DTH	260027	Drive Shaft	30	27	52.5	94.5	619		
1.6 CNG (110 kW)	2011.10-2012.12	-	L/R	F	MPV Engine A 16 XNT	817051	Outer Joint	30	26	53.8	94.5	65.5	M	
	2011.10-2012.12	-	-	F	MPV Engine A 16 XNT	899023	Outer Joint	30	26	53.8	94.5	65.5	M	
2.0 BiTurbo CDTI (143 kW)	2013.01-2014.11	MT	L	F	MPV Engine A 20 DTR	260027	Drive Shaft	30	27	52.5	94.5	619		
2.0 CDTI (121 kW)	2011.10-2012.12	6AT	L/R	F	MPV Engine A 20 DTH	817051	Outer Joint	30	26	53.8	94.5	65.5	M	
	2011.10-2012.12	-	-	F	MPV Engine A 20 DTH	899023	Outer Joint	30	26	53.8	94.5	65.5	M	
	2011.10-2012.12	MT	L	F	MPV Engine A 20 DTH	260027	Drive Shaft	30	27	52.5	94.5	619		
2.0 CDTI (125 kW)	2015.01-2016.12	MT	R	F	MPV Engine B 20 DTH	260027	Drive Shaft	30	27	52.5	94.5	619		
	2015.01-2016.12	6AT	L	F	MPV Engine B 20 DTH	817051	Outer Joint	30	26	53.8	94.5	65.5	M	
	2015.01-2016.12	-	-	F	MPV Engine B 20 DTH	899023	Outer Joint	30	26	53.8	94.5	65.5	M	
2.0 CDTI (81 kW)	2011.10-2012.12	-	L	F	MPV Engine A 20 DTL	260027	Drive Shaft	30	27	52.5	94.5	619		
	2011.10-2012.12	-	-	F	MPV Engine A 20 DTL	899023	Outer Joint	30	26	53.8	94.5	65.5	M	
2.0 CDTI (96 kW)	2011.10-2012.12	-	-	F	MPV Engine A 20 DT	899023	Outer Joint	30	26	53.8	94.5	65.5	M	
	2011.10-2012.12	MT	L	F	MPV Engine A 20 DT	260027	Drive Shaft	30	27	52.5	94.5	619		
VOLVO														
340-360 (343 345)														
1.6 Diesel (40 kW)	1984.08-1991.07	-	-	R	Hatchback Engine D 16	818290	Outer Joint	36	29	56.5	49.5	64	I	
	1984.08-1991.07	-	L	F	Hatchback Engine D 16	618044	Inner Joint	26	23	40	68.5	99.5		
	1984.08-1991.07	-	-	F	Hatchback Engine D 16	862031	Outer Joint	48T	36	27	56.5	55	65	M
	1984.08-1991.07	-	-	F	Hatchback Engine D 16	859285	Outer Joint	40	27	57.4	52	63.5	M	
	1984.08-1991.07	-	-	F	Hatchback Engine D 16	862045	Outer Joint	40	26	57.4	52	62.5	M	
	1984.08-1991.07	-	L	F	Hatchback Engine D 16	801424	Outer Joint	31	27	36.2	70	62	M	
	1984.08-1991.07	-	-	R	Hatchback Engine D 16	618187	Inner Joint	26	29	35	69.5	107.5		
	1984.08-1991.07	-	-	R	Hatchback Engine D 16	818290	Outer Joint	36	29	56.5	49.5	64	I	
1.7 (59 kW)	1985.08-1991.07	-	-	R	Hatchback Engine B 17 2 K	818290	Outer Joint	36	29	56.5	49.5	64	I	
	1985.08-1991.07	-	L	F	Hatchback Engine B 17 2 K	618044	Inner Joint	26	23	40	68.5	99.5		
	1985.08-1991.07	-	-	F	Hatchback Engine B 17 2 K	859285	Outer Joint	40	27	57.4	52	63.5	M	
	1985.08-1991.07	-	-	F	Hatchback Engine B 17 2 K	862031	Outer Joint	48T	36	27	56.5	55	65	M
	1985.08-1991.07	-	-	F	Hatchback Engine B 17 2 K	862045	Outer Joint	40	26	57.4	52	62.5	M	
	1985.08-1991.07	-	-	R	Hatchback Engine B 17 2 K	618187	Inner Joint	26	29	35	69.5	107.5		
	1985.08-1991.07	-	L	F	Hatchback Engine B 17 2 K	801424	Outer Joint	31	27	36.2	70	62	M	
	1985.08-1991.07	-	-	R	Hatchback Engine B 17 2 K	818290	Outer Joint	36	29	56.5	49.5	64	I	
340-360 (344)														
1.6 Diesel (40 kW)	1984.08-1991.07	-	-	R	Saloon Engine D 16	818290	Outer Joint	36	29	56.5	49.5	64	I	
	1984.08-1991.07	-	L	F	Saloon Engine D 16	618044	Inner Joint	26	23	40	68.5	99.5		

	 YEAR	TRANSM	L/R	F/R	REMARKS	GSP Ref.	 PRODUCT	 ABS	Technical Specifications								
									A	B	C	H	L	P			
VOLVO																	
340-360 (344)																	
1.6 Diesel (40 kW)	1984.08-1991.07	-	-	F	Saloon Engine D 16	862031	Outer Joint	48T	36	27	56.5	55	65	M			
	1984.08-1991.07	-	-	F	Saloon Engine D 16	859285	Outer Joint		40	27	57.4	52	63.5	M			
	1984.08-1991.07	-	-	F	Saloon Engine D 16	862045	Outer Joint		40	26	57.4	52	62.5	M			
	1984.08-1991.07	-	L	F	Saloon Engine D 16	801424	Outer Joint		31	27	36.2	70	62	M			
	1984.08-1991.07	-	-	R	Saloon Engine D 16	618187	Inner Joint		26	29	35	69.5	107.5				
1.7 (59 kW)	1985.08-1991.07	-	-	R	Saloon Engine B 17 2 K	818290	Outer Joint		36	29	56.5	49.5	64	I			
	1985.08-1991.07	-	L	F	Saloon Engine B 17 2 K	618044	Inner Joint		26	23	40	68.5	99.5				
	1985.08-1991.07	-	-	F	Saloon Engine B 17 2 K	859285	Outer Joint		40	27	57.4	52	63.5	M			
	1985.08-1991.07	-	-	F	Saloon Engine B 17 2 K	862031	Outer Joint	48T	36	27	56.5	55	65	M			
	1985.08-1991.07	-	-	F	Saloon Engine B 17 2 K	862045	Outer Joint		40	26	57.4	52	62.5	M			
	1985.08-1991.07	-	-	R	Saloon Engine B 17 2 K	618187	Inner Joint		26	29	35	69.5	107.5				
2.0 (75 kW)	1984.08-1990.07	-	-	R	Saloon Engine B 200 K	818290	Outer Joint		36	29	56.5	49.5	64	I			
	1984.08-1990.07	-	L	F	Saloon Engine B 200 K	618044	Inner Joint		26	23	40	68.5	99.5				
	1984.08-1990.07	-	-	F	Saloon Engine B 200 K	862031	Outer Joint	48T	36	27	56.5	55	65	M			
	1984.08-1990.07	-	-	F	Saloon Engine B 200 K	859285	Outer Joint		40	27	57.4	52	63.5	M			
	1984.08-1990.07	-	-	F	Saloon Engine B 200 K	862045	Outer Joint		40	26	57.4	52	62.5	M			
	1984.08-1990.07	-	L	F	Saloon Engine B 200 K	801424	Outer Joint		31	27	36.2	70	62	M			
1984.08-1990.07	-	-	R	Saloon Engine B 200 K	618187	Inner Joint		26	29	35	69.5	107.5					
440 K (445)																	
1.6 (61 kW)	1988.09-1996.12	-	-	F	Hatchback Engine B 16 F	862007	Outer Joint	44T	22	22	50	83	52	O			
	1988.09-1996.12	-	-	F	Hatchback Engine B 16 F	862006	Outer Joint		22	22	50	83	52	O			
1.7 (58 kW)	1988.09-1992.08	-	-	F	Hatchback Engine B 18 KD	862007	Outer Joint	44T	22	22	50	83	52	O			
	1988.09-1992.08	-	-	F	Hatchback Engine B 18 KD	862006	Outer Joint		22	22	50	83	52	O			
1.7 Turbo (88 kW)	1988.08-1996.07	MT	-	F	Hatchback Engine B 18 FT	862005	Outer Joint	44T	22	25	50	83	61	O			
	1988.08-1996.07	-	-	F	Hatchback Engine B 18 FT	862004	Outer Joint		22	25	50	83	61	O			
1.7 Turbo (90 kW)	1991.01-1996.12	MT	-	F	Hatchback Engine B 18 FT	862005	Outer Joint	44T	22	25	50	83	61	O			
	1991.01-1996.12	-	-	F	Hatchback Engine B 18 FT	862004	Outer Joint		22	25	50	83	61	O			
1.8 (66 kW)	1991.08-1996.07	-	-	F	Hatchback Engine B 18 U	862007	Outer Joint	44T	22	22	50	83	52	O			
	1991.08-1996.07	-	-	F	Hatchback Engine B 18 U	862006	Outer Joint		22	22	50	83	52	O			
1.9 Turbo-Diesel (66 kW)	1994.07-1996.12	MT	-	F	Hatchback Engine D 19 T	862005	Outer Joint	44T	22	25	50	83	61	O			
460 L (464)																	
1.7 Turbo (88 kW)	1989.08-1996.07	MT	-	F	Saloon Engine B 18 FT	862005	Outer Joint	44T	22	25	50	83	61	O			
	1989.08-1996.07	-	-	F	Saloon Engine B 18 FT	862004	Outer Joint		22	25	50	83	61	O			
1.7 Turbo (90 kW)	1991.01-1996.07	MT	-	F	Saloon Engine B 18 FT	862005	Outer Joint	44T	22	25	50	83	61	O			
	1991.01-1996.07	-	-	F	Saloon Engine B 18 FT	862004	Outer Joint		22	25	50	83	61	O			
1.9 Turbo-Diesel (66 kW)	1994.07-1996.07	MT	-	F	Saloon Engine D 19 T	862005	Outer Joint	44T	22	25	50	83	61	O			
2.0 (80 kW)	1993.08-1996.07	MT	-	F	Saloon Engine B 20 F	862005	Outer Joint	44T	22	25	50	83	61	O			
2.0 (81 kW)	1992.08-1995.07	MT	-	F	Saloon Engine B 20 F	862005	Outer Joint	44T	22	25	50	83	61	O			
480 E (482)																	
1.7 (70 kW)	1987.08-1989.07	-	-	F	Coupe Engine B 18 F	862006	Outer Joint		22	22	50	83	52	O			
1.7 (75 kW)	1989.08-1996.07	-	-	F	Coupe Engine B 18 EP	862006	Outer Joint		22	22	50	83	52	O			
1.7 (78 kW)	1986.04-1989.07	-	-	F	Coupe Engine B 18 E	862006	Outer Joint		22	22	50	83	52	O			
1.7 Turbo (88 kW)	1987.08-1996.07	MT	-	F	Coupe Engine B 18 FT	862005	Outer Joint	44T	22	25	50	83	61	O			
1.7 Turbo (90 kW)	1991.01-1996.07	MT	-	F	Coupe Engine B 18 FT	862005	Outer Joint	44T	22	25	50	83	61	O			
	1991.01-1996.07	-	-	F	Coupe Engine B 18 FT	862004	Outer Joint		22	25	50	83	61	O			
2.0 (81 kW)	1992.08-1995.09	MT	-	F	Coupe Engine B 20 F	862005	Outer Joint	44T	22	25	50	83	61	O			
760 (704 764)																	
2.4 D (60 kW)	1982.01-1992.07	-	-	R	Saloon Engine D 24	818290	Outer Joint		36	29	56.5	49.5	64	I			
	1982.01-1992.07	-	L	F	Saloon Engine D 24	618044	Inner Joint		26	23	40	68.5	99.5				
	1982.01-1992.07	-	-	F	Saloon Engine D 24	859285	Outer Joint		40	27	57.4	52	63.5	M			
	1982.01-1992.07	-	-	F	Saloon Engine D 24	862031	Outer Joint	48T	36	27	56.5	55	65	M			
	1982.01-1992.07	-	-	F	Saloon Engine D 24	862045	Outer Joint		40	26	57.4	52	62.5	M			
	1982.01-1992.07	-	-	R	Saloon Engine D 24	618187	Inner Joint		26	29	35	69.5	107.5				
	1982.01-1992.07	-	L	F	Saloon Engine D 24	801424	Outer Joint		31	27	36.2	70	62	M			
760 Kombi (704 765)																	
2.4 D (60 kW)	1982.01-1992.07	-	-	R	Estate Engine D 24	818290	Outer Joint		36	29	56.5	49.5	64	I			
	1982.01-1992.07	-	L	F	Estate Engine D 24	618044	Inner Joint		26	23	40	68.5	99.5				
	1982.01-1992.07	-	-	F	Estate Engine D 24	859285	Outer Joint		40	27	57.4	52	63.5	M			
	1982.01-1992.07	-	-	F	Estate Engine D 24	862031	Outer Joint	48T	36	27	56.5	55	65	M			
	1982.01-1992.07	-	-	F	Estate Engine D 24	862045	Outer Joint		40	26	57.4	52	62.5	M			
	1982.01-1992.07	-	-	R	Estate Engine D 24	618187	Inner Joint		26	29	35	69.5	107.5				
1982.01-1992.07	-	L	F	Estate Engine D 24	801424	Outer Joint		31	27	36.2	70	62	M				
850																	
-	1993-1997	-	-	-	-	862015	Outer Joint		26	25	56.5	98	58	O			
850 (854)																	

	 YEAR	TRANSM	L/R	F/R	REMARKS	GSP Ref.	 PRODUCT	 ABS	Technical Specifications					
									A	B	C	H	L	P
VOLVO														
850 (854)														
2.0 (105 kW)	1991.06-1996.12	MT	R	F	Saloon Engine B 5204 F	662015	Inner Joint		26	25	40	531.5	66.5	
	1991.06-1996.12	AT	L	F	Saloon Engine B 5204 F	262001	Drive Shaft	48T	26	26	56.5	98.5	574.5	
	1991.06-1996.12	AT	R	F	Saloon Engine B 5204 F	262002	Drive Shaft	48T	26	26	56.5	98.5	1028	
	1991.06-1996.12	-	-	-	Saloon Engine B 5204 F	862014	Outer Joint		26	25	56.5	98.5	56	O
	1991.06-1996.12	AT/MT	L/R	F	Saloon Engine B 5204 F	862001	Outer Joint	48T	26	25	56.5	98.5	56	O
2.0 (93 kW)	1994.08-1996.12	MT	R	F	Saloon Engine B 5202 S	662015	Inner Joint		26	25	40	531.5	66.5	
	1994.08-1996.12	AT	L	F	Saloon Engine B 5202 S	262001	Drive Shaft	48T	26	26	56.5	98.5	574.5	
	1994.08-1996.12	AT	R	F	Saloon Engine B 5202 S	262002	Drive Shaft	48T	26	26	56.5	98.5	1028	
	1994.08-1996.12	-	-	-	Saloon Engine B 5202 S	862014	Outer Joint		26	25	56.5	98.5	56	O
	1994.08-1996.12	AT/MT	L/R	F	Saloon Engine B 5202 S	862001	Outer Joint	48T	26	25	56.5	98.5	56	O
2.0 Turbo (155 kW)	1993.08-1996.12	AT/MT	L/R	F	Saloon Engine B 5204 T/B 5204 FT	862016	Outer Joint		26	28	56.5	97.5	66	O
	1993.08-1996.12	AT/MT	L/R	F	Saloon Engine B 5204 T/B 5204 FT	862002	Outer Joint	48T	26	28	56.5	97.5	66	O
2.3 T5 (166 kW)	1993.08-1996.07	AT/MT	L/R	F	Saloon Engine B 5234 FT	862016	Outer Joint		26	28	56.5	97.5	66	O
	1993.08-1996.07	AT/MT	L/R	F	Saloon Engine B 5234 FT	862002	Outer Joint	48T	26	28	56.5	97.5	66	O
2.3 T5-R (184 kW)	1995.08-1996.12	MT	L/R	F	Saloon Engine B 5234 T4	862016	Outer Joint		26	28	56.5	97.5	66	O
	1995.08-1996.12	MT	L/R	F	Saloon Engine B 5234 T4	862002	Outer Joint	48T	26	28	56.5	97.5	66	O
2.4 (103 kW)	1991.06-1994.07	MT	R	F	Saloon Engine B 5252	662015	Inner Joint		26	25	40	531.5	66.5	
	1991.06-1994.07	AT	L	F	Saloon Engine B 5252	262001	Drive Shaft	48T	26	26	56.5	98.5	574.5	
	1991.06-1994.07	AT	R	F	Saloon Engine B 5252	262002	Drive Shaft	48T	26	26	56.5	98.5	1028	
	1991.06-1994.07	-	-	-	Saloon Engine B 5252	862014	Outer Joint		26	25	56.5	98.5	56	O
	1991.06-1994.07	AT/MT	L/R	F	Saloon Engine B 5252	862001	Outer Joint	48T	26	25	56.5	98.5	56	O
2.4 (106 kW)	1994.08-1996.12	MT	R	F	Saloon Engine B 5252 FS	662015	Inner Joint		26	25	40	531.5	66.5	
	1994.08-1996.12	AT	L	F	Saloon Engine B 5252 FS	262001	Drive Shaft	48T	26	26	56.5	98.5	574.5	
	1994.08-1996.12	AT	R	F	Saloon Engine B 5252 FS	262002	Drive Shaft	48T	26	26	56.5	98.5	1028	
	1994.08-1996.12	-	-	-	Saloon Engine B 5252 FS	862014	Outer Joint		26	25	56.5	98.5	56	O
	1994.08-1996.12	AT/MT	L/R	F	Saloon Engine B 5252 FS	862001	Outer Joint	48T	26	25	56.5	98.5	56	O
2.4 (125 kW)	1991.08-1996.12	MT	R	F	Saloon Engine B 5254 S	662015	Inner Joint		26	25	40	531.5	66.5	
	1991.08-1996.12	AT	L	F	Saloon Engine B 5254 S	262001	Drive Shaft	48T	26	26	56.5	98.5	574.5	
	1991.08-1996.12	AT	R	F	Saloon Engine B 5254 S	262002	Drive Shaft	48T	26	26	56.5	98.5	1028	
	1991.08-1996.12	-	-	-	Saloon Engine B 5254 S	862014	Outer Joint		26	25	56.5	98.5	56	O
	1991.08-1996.12	AT/MT	L/R	F	Saloon Engine B 5254 S	862001	Outer Joint	48T	26	25	56.5	98.5	56	O
2.4 GLE (142 kW)	1993.09-1997.10	-	-	-	Saloon Engine B 5254 T	862014	Outer Joint		26	25	56.5	98.5	56	O
2.5 TDI (103 kW)	1995.08-1996.12	AT	L	F	Saloon Engine D 5252 T	262001	Drive Shaft	48T	26	26	56.5	98.5	574.5	
	1995.08-1996.12	AT/MT	L/R	F	Saloon Engine D 5252 T	862016	Outer Joint		26	28	56.5	97.5	66	O
	1995.08-1996.12	AT/MT	L/R	F	Saloon Engine D 5252 T	862002	Outer Joint	48T	26	28	56.5	97.5	66	O
850 (855)														
2.0 (105 kW)	1993.02-1996.12	MT	R	F	Estate Engine B 5204 F	662015	Inner Joint		26	25	40	531.5	66.5	
	1993.02-1996.12	AT	R	F	Estate Engine B 5204 F	262002	Drive Shaft	48T	26	26	56.5	98.5	1028	
	1993.02-1996.12	AT	L	F	Estate Engine B 5204 F	262001	Drive Shaft	48T	26	26	56.5	98.5	574.5	
	1993.02-1996.12	-	-	-	Estate Engine B 5204 F	862014	Outer Joint		26	25	56.5	98.5	56	O
	1993.02-1996.12	AT/MT	L/R	F	Estate Engine B 5204 F	862001	Outer Joint	48T	26	25	56.5	98.5	56	O
2.0 (93 kW)	1994.08-1996.12	MT	R	F	Estate Engine B 5202 S	662015	Inner Joint		26	25	40	531.5	66.5	
	1994.08-1996.12	AT	R	F	Estate Engine B 5202 S	262002	Drive Shaft	48T	26	26	56.5	98.5	1028	
	1994.08-1996.12	AT	L	F	Estate Engine B 5202 S	262001	Drive Shaft	48T	26	26	56.5	98.5	574.5	
	1994.08-1996.12	-	-	-	Estate Engine B 5202 S	862014	Outer Joint		26	25	56.5	98.5	56	O
	1994.08-1996.12	AT/MT	L/R	F	Estate Engine B 5202 S	862001	Outer Joint	48T	26	25	56.5	98.5	56	O
2.0 Turbo (155 kW)	1993.02-1996.12	AT	L	F	Estate Engine B 5204 T/B 5204 FT	262139	Drive Shaft	48T	26	26	56.5	97.5	580	
	1993.02-1996.12	AT	L	F	Estate Engine B 5204 T/B 5204 FT	262001	Drive Shaft	48T	26	26	56.5	98.5	574.5	
	1993.02-1996.12	AT/MT	L/R	F	Estate Engine B 5204 T/B 5204 FT	862016	Outer Joint		26	28	56.5	97.5	66	O
	1993.02-1996.12	AT/MT	L/R	F	Estate Engine B 5204 T/B 5204 FT	862002	Outer Joint	48T	26	28	56.5	97.5	66	O
2.3 T5 (166 kW)	1993.02-1996.12	AT	L	F	Estate Engine B 5234 FT	262001	Drive Shaft	48T	26	26	56.5	98.5	574.5	
	1993.02-1996.12	AT/MT	L/R	F	Estate Engine B 5234 FT	862016	Outer Joint		26	28	56.5	97.5	66	O
	1993.02-1996.12	AT/MT	L/R	F	Estate Engine B 5234 FT	862002	Outer Joint	48T	26	28	56.5	97.5	66	O
2.3 T5-R (184 kW)	1995.08-1996.12	MT	L/R	F	Estate Engine B 5234 T4	862016	Outer Joint		26	28	56.5	97.5	66	O
	1995.08-1996.12	MT	L/R	F	Estate Engine B 5234 T4	862002	Outer Joint	48T	26	28	56.5	97.5	66	O
2.4 (103 kW)	1992.08-1994.07	MT	R	F	Estate Engine B 5252	662015	Inner Joint		26	25	40	531.5	66.5	
	1992.08-1994.07	AT	L	F	Estate Engine B 5252	262001	Drive Shaft	48T	26	26	56.5	98.5	574.5	
	1992.08-1994.07	AT	R	F	Estate Engine B 5252	262002	Drive Shaft	48T	26	26	56.5	98.5	1028	
	1992.08-1994.07	-	-	-	Estate Engine B 5252	862014	Outer Joint		26	25	56.5	98.5	56	O
	1992.08-1994.07	AT/MT	L/R	F	Estate Engine B 5252	862001	Outer Joint	48T	26	25	56.5	98.5	56	O
2.4 (106 kW)	1994.08-1996.12	MT	R	F	Estate Engine B 5252 FS	662015	Inner Joint		26	25	40	531.5	66.5	
	1994.08-1996.12	AT	L	F	Estate Engine B 5252 FS	262001	Drive Shaft	48T	26	26	56.5	98.5	574.5	
	1994.08-1996.12	AT	R	F	Estate Engine B 5252 FS	262002	Drive Shaft	48T	26	26	56.5	98.5	1028	
	1994.08-1996.12	-	-	-	Estate Engine B 5252 FS	862014	Outer Joint		26	25	56.5	98.5	56	O
	1994.08-1996.12	AT/MT	L/R	F	Estate Engine B 5252 FS	862001	Outer Joint	48T	26	25	56.5	98.5	56	O
2.4 (125 kW)	1992.09-1996.12	MT	R	F	Estate Engine B 5252 S	662015	Inner Joint		26	25	40	531.5	66.5	

	 YEAR	TRANSM	L/R	F/R	REMARKS	GSP Ref.	 PRODUCT	 ABS	Technical Specifications					
									A	B	C	H	L	P
VOLVO														
850 (855)														
2.4 (125 kW)	1992.09-1996.12	AT	L	F	Estate Engine B 5252 S	262001	Drive Shaft	48T	26	26	56.5	98.5	574.5	
	1992.09-1996.12	AT	R	F	Estate Engine B 5252 S	262002	Drive Shaft	48T	26	26	56.5	98.5	1028	
	1992.09-1996.12	-	-	-	Estate Engine B 5252 S	862014	Outer Joint		26	25	56.5	98.5	56	O
	1992.09-1996.12	AT/MT	L/R	F	Estate Engine B 5252 S	862001	Outer Joint	48T	26	25	56.5	98.5	56	O
2.4 AWD (142 kW)	1996.04-1996.12	-	L/R	R	All-wheel Drive Estate Engine B 5254 T	201128	Drive Shaft	48T	26	26	60.5	81	751	
	1996.04-1996.12	AT/MT	L/R	F	All-wheel Drive Estate Engine B 5254 T	862016	Outer Joint		26	28	56.5	97.5	66	O
	1996.04-1996.12	AT/MT	L/R	F	All-wheel Drive Estate Engine B 5254 T	862002	Outer Joint	48T	26	28	56.5	97.5	66	O
2.4 GLE (142 kW)	1993.09-1997.10	-	-	-	Estate Engine B 5254 T	862014	Outer Joint		26	25	56.5	98.5	56	O
2.5 TDI (103 kW)	1995.08-1996.12	AT	L	F	Estate Engine D 5252 T	262001	Drive Shaft	48T	26	26	56.5	98.5	574.5	
	1995.08-1996.12	AT/MT	L/R	F	Estate Engine D 5252 T	862016	Outer Joint		26	28	56.5	97.5	66	O
	1995.08-1996.12	AT/MT	L/R	F	Estate Engine D 5252 T	862002	Outer Joint	48T	26	28	56.5	97.5	66	O
960 (964)														
2.4 TD Interc. (85 kW)	1991.09-1994.07	MT/AT	L/R	R	Saloon Engine D 24 TIC	201126	Drive Shaft		26	26	60.5	81	745	
960 II (964)														
2.5 (125 kW)	1994.07-1996.12	MT/AT	L/R	R	Saloon Engine B 6254 S	201126	Drive Shaft		26	26	60.5	81	745	
960 II (965)														
2.5 (125 kW)	1994.08-1996.12	MT/AT	L/R	R	Estate Engine B 6254 S	201126	Drive Shaft		26	26	60.5	81	745	
960 Kombi (965)														
2.4 TD Interc. (85 kW)	1991.09-1994.07	MT/AT	L/R	R	Estate Engine D 24 TIC	201126	Drive Shaft		26	26	60.5	81	745	
C30 (533)														
1.6 (74 kW)	2006.10-2012.12	MT	R	F	Hatchback Engine B 4164 S3	218337	Drive Shaft		36	23	51.6	48	908	
	2006.10-2012.12	MT	L	F	Hatchback Engine B 4164 S3	218189	Drive Shaft		36	23	56	48	601	
	2006.10-2012.12	-	L	F	Hatchback Engine B 4164 S3	618044	Inner Joint		26	23	40	68.5	99.5	
	2006.10-2012.12	MT	R	F	Hatchback Engine B 4164 S3	218206	Drive Shaft		36	23	56	48	906	
	2006.10-2012.12	-	-	F	Hatchback Engine B 4164 S3	862031	Outer Joint	48T	36	27	56.5	55	65	M
	2006.10-2012.12	-	-	F	Hatchback Engine B 4164 S3	859285	Outer Joint		40	27	57.4	52	63.5	M
	2006.10-2012.12	MT	L	F	Hatchback Engine B 4164 S3	818264	Outer Joint		36	25	51.6	48	58	O
	2006.10-2012.12	-	-	F	Hatchback Engine B 4164 S3	862045	Outer Joint		40	26	57.4	52	62.5	M
	2006.10-2012.12	-	L	F	Hatchback Engine B 4164 S3	801424	Outer Joint		31	27	36.2	70	62	M
	2006.10-2012.12	-	-	R	Hatchback Engine B 4164 S3	618187	Inner Joint		26	29	35	69.5	107.5	
	2006.10-2012.12	MT	L	F	Hatchback Engine B 4164 S3	618168	Inner Joint		23	22	40	61	90	
	2006.10-2012.12	-	-	R	Hatchback Engine B 4164 S3	818290	Outer Joint		36	29	56.5	49.5	64	I
1.6 D (80 kW)	2006.10-2012.12	-	L	F	Hatchback Engine D 4164 T	618044	Inner Joint		26	23	40	68.5	99.5	
	2006.10-2012.12	-	-	F	Hatchback Engine D 4164 T	862031	Outer Joint	48T	36	27	56.5	55	65	M
	2006.10-2012.12	-	-	F	Hatchback Engine D 4164 T	859285	Outer Joint		40	27	57.4	52	63.5	M
	2006.10-2012.12	-	-	F	Hatchback Engine D 4164 T	862045	Outer Joint		40	26	57.4	52	62.5	M
	2006.10-2012.12	-	L	F	Hatchback Engine D 4164 T	801424	Outer Joint		31	27	36.2	70	62	M
	2006.10-2012.12	-	-	R	Hatchback Engine D 4164 T	618187	Inner Joint		26	29	35	69.5	107.5	
	2006.10-2012.12	-	R	F	Hatchback Engine D 4164 T	218219	Drive Shaft		36	26	56.3	48	921	
	2006.10-2012.12	-	-	R	Hatchback Engine D 4164 T	818290	Outer Joint		36	29	56.5	49.5	64	I
1.6 D2 (84 kW)	2010.10-2012.12	MT	L	F	Hatchback Engine D 4162 T	662052	Inner Joint		26	28	40	61	112.5	
	2010.10-2012.12	-	L	F	Hatchback Engine D 4162 T	618044	Inner Joint		26	23	40	68.5	99.5	
	2010.10-2012.12	-	-	F	Hatchback Engine D 4162 T	862031	Outer Joint	48T	36	27	56.5	55	65	M
	2010.10-2012.12	-	-	F	Hatchback Engine D 4162 T	859285	Outer Joint		40	27	57.4	52	63.5	M
	2010.10-2012.12	MT	L	F	Hatchback Engine D 4162 T	262078	Drive Shaft		36	26	56.3	48	583	
	2010.10-2012.12	-	-	F	Hatchback Engine D 4162 T	862045	Outer Joint		40	26	57.4	52	62.5	M
	2010.10-2012.12	-	L	F	Hatchback Engine D 4162 T	801424	Outer Joint		31	27	36.2	70	62	M
	2010.10-2012.12	-	-	R	Hatchback Engine D 4162 T	618187	Inner Joint		26	29	35	69.5	107.5	
	2010.10-2012.12	-	-	R	Hatchback Engine D 4162 T	818290	Outer Joint		36	29	56.5	49.5	64	I
	2010.10-2012.12	6MT	R	F	Hatchback Engine D 4162 T	262053	Drive Shaft		36	26	56.3	48	917	
1.8 (92 kW)	2006.10-2012.12	-	L	F	Hatchback Engine B 4184 S11	618044	Inner Joint		26	23	40	68.5	99.5	
	2006.10-2012.12	-	-	F	Hatchback Engine B 4184 S11	862031	Outer Joint	48T	36	27	56.5	55	65	M
	2006.10-2012.12	-	-	F	Hatchback Engine B 4184 S11	859285	Outer Joint		40	27	57.4	52	63.5	M
	2006.10-2012.12	-	L/R	F	Hatchback Engine B 4184 S11	818203	Outer Joint		36	23	56	48	57	I
	2006.10-2012.12	-	-	F	Hatchback Engine B 4184 S11	862045	Outer Joint		40	26	57.4	52	62.5	M
	2006.10-2012.12	-	L	F	Hatchback Engine B 4184 S11	801424	Outer Joint		31	27	36.2	70	62	M
	2006.10-2012.12	-	-	R	Hatchback Engine B 4184 S11	618187	Inner Joint		26	29	35	69.5	107.5	
	2006.10-2012.12	5MT	L	F	Hatchback Engine B 4184 S11	218328	Drive Shaft		36	26	55.3	48	580	
	2006.10-2012.12	MT	R	F	Hatchback Engine B 4184 S11	899130	Outer Joint		36	26	56.3	48	61	M
	2006.10-2012.12	-	-	R	Hatchback Engine B 4184 S11	818290	Outer Joint		36	29	56.5	49.5	64	I
	2006.10-2012.12	5MT	R	F	Hatchback Engine B 4184 S11	218329	Drive Shaft		36	26	55.3	48	920	
1.8 FlexFuel (92 kW)	2007.01-2012.12	5MT	R	F	Hatchback Engine B 4184 S8	218329	Drive Shaft		36	26	55.3	48	920	
	2007.01-2012.12	-	L	F	Hatchback Engine B 4184 S8	618044	Inner Joint		26	23	40	68.5	99.5	
	2007.01-2012.12	-	-	F	Hatchback Engine B 4184 S8	862031	Outer Joint	48T	36	27	56.5	55	65	M
	2007.01-2012.12	-	-	F	Hatchback Engine B 4184 S8	859285	Outer Joint		40	27	57.4	52	63.5	M
	2007.01-2012.12	-	L/R	F	Hatchback Engine B 4184 S8	818203	Outer Joint		36	23	56	48	57	I

	 YEAR	TRANSM	L/R	F/R	REMARKS	GSP Ref.	 PRODUCT	 ABS	Technical Specifications					
									A	B	C	H	L	P
VOLVO														
C30 (533)														
1.8 FlexFuel (92 kW)	2007.01-2012.12	-	-	F	Hatchback Engine B 4184 S8	862045	Outer Joint		40	26	57.4	52	62.5	M
	2007.01-2012.12	-	L	F	Hatchback Engine B 4184 S8	801424	Outer Joint		31	27	36.2	70	62	M
	2007.01-2012.12	-	-	R	Hatchback Engine B 4184 S8	618187	Inner Joint		26	29	35	69.5	107.5	
	2007.01-2012.12	5MT	L	F	Hatchback Engine B 4184 S8	218328	Drive Shaft		36	26	55.3	48	580	
	2007.01-2012.12	MT	R	F	Hatchback Engine B 4184 S8	899130	Outer Joint		36	26	56.3	48	61	M
	2007.01-2012.12	-	-	R	Hatchback Engine B 4184 S8	818290	Outer Joint		36	29	56.5	49.5	64	I
2.0 (107 kW)	2006.10-2012.12	5MT	R	F	Hatchback Engine B 4204 S3	218329	Drive Shaft		36	26	55.3	48	920	
	2006.10-2012.12	AT	R	F	Hatchback Engine B 4204 S3	662017	Inner Joint		28	26	34	371.5	92	
	2006.10-2012.12	-	L	F	Hatchback Engine B 4204 S3	618044	Inner Joint		26	23	40	68.5	99.5	
	2006.10-2012.12	-	-	F	Hatchback Engine B 4204 S3	862031	Outer Joint	48T	36	27	56.5	55	65	M
	2006.10-2012.12	-	-	F	Hatchback Engine B 4204 S3	859285	Outer Joint		40	27	57.4	52	63.5	M
	2006.10-2012.12	-	L/R	F	Hatchback Engine B 4204 S3	818203	Outer Joint		36	23	56	48	57	I
	2006.10-2012.12	-	-	F	Hatchback Engine B 4204 S3	862045	Outer Joint		40	26	57.4	52	62.5	M
	2006.10-2012.12	-	L	F	Hatchback Engine B 4204 S3	801424	Outer Joint		31	27	36.2	70	62	M
	2006.10-2012.12	-	-	R	Hatchback Engine B 4204 S3	618187	Inner Joint		26	29	35	69.5	107.5	
	2006.10-2012.12	AT	R	F	Hatchback Engine B 4204 S3	262024	Drive Shaft		36	28	56	48	908	
	2006.10-2012.12	5MT	L	F	Hatchback Engine B 4204 S3	218328	Drive Shaft		36	26	55.3	48	580	
	2006.10-2012.12	MT	R	F	Hatchback Engine B 4204 S3	899130	Outer Joint		36	26	56.3	48	61	M
	2006.10-2012.12	-	-	R	Hatchback Engine B 4204 S3	818290	Outer Joint		36	29	56.5	49.5	64	I
	2.0 D (100 kW)	2006.10-2012.12	AT	R	F	Hatchback Engine D 4204 T	662017	Inner Joint		28	26	34	371.5	92
2006.10-2012.12		-	L	F	Hatchback Engine D 4204 T	618044	Inner Joint		26	23	40	68.5	99.5	
2006.10-2012.12		MT	-	F	Hatchback Engine D 4204 T	862048	Outer Joint		36	26	56	48	64	I
2006.10-2012.12		-	-	F	Hatchback Engine D 4204 T	862031	Outer Joint	48T	36	27	56.5	55	65	M
2006.10-2012.12		-	-	F	Hatchback Engine D 4204 T	859285	Outer Joint		40	27	57.4	52	63.5	M
2006.10-2012.12		MT	L	F	Hatchback Engine D 4204 T	218194	Drive Shaft		36	26	56	48	568	
2006.10-2012.12		MT	R	F	Hatchback Engine D 4204 T	218280	Drive Shaft		36	26	56	48	918	
2006.10-2012.12		-	-	F	Hatchback Engine D 4204 T	862045	Outer Joint		40	26	57.4	52	62.5	M
2006.10-2012.12		MT	L	F	Hatchback Engine D 4204 T	218198	Drive Shaft		36	26	56	48	580	
2006.10-2012.12		-	L	F	Hatchback Engine D 4204 T	801424	Outer Joint		31	27	36.2	70	62	M
2006.10-2012.12		-	-	R	Hatchback Engine D 4204 T	618187	Inner Joint		26	29	35	69.5	107.5	
2006.10-2012.12		AT	R	F	Hatchback Engine D 4204 T	262024	Drive Shaft		36	28	56	48	908	
2006.10-2012.12		MT	R	F	Hatchback Engine D 4204 T	899130	Outer Joint		36	26	56.3	48	61	M
2006.10-2012.12		AT	L	F	Hatchback Engine D 4204 T	218367	Drive Shaft		36	28	56	48	570	
2006.10-2012.12	-	-	R	Hatchback Engine D 4204 T	818290	Outer Joint		36	29	56.5	49.5	64	I	
2.0 FlexFuel (107 kW)	2010.01-2012.12	-	-	R	Hatchback Engine B 4204 S4	818290	Outer Joint		36	29	56.5	49.5	64	I
	2010.01-2012.12	-	R	F	Hatchback Engine B 4204 S4	218329	Drive Shaft		36	26	55.3	48	920	
	2010.01-2012.12	-	L	F	Hatchback Engine B 4204 S4	618044	Inner Joint		26	23	40	68.5	99.5	
	2010.01-2012.12	-	-	F	Hatchback Engine B 4204 S4	862031	Outer Joint	48T	36	27	56.5	55	65	M
	2010.01-2012.12	-	-	F	Hatchback Engine B 4204 S4	859285	Outer Joint		40	27	57.4	52	63.5	M
	2010.01-2012.12	-	-	F	Hatchback Engine B 4204 S4	862045	Outer Joint		40	26	57.4	52	62.5	M
	2010.01-2012.12	-	L	F	Hatchback Engine B 4204 S4	801424	Outer Joint		31	27	36.2	70	62	M
	2010.01-2012.12	-	-	R	Hatchback Engine B 4204 S4	618187	Inner Joint		26	29	35	69.5	107.5	
2010.01-2012.12	-	L	F	Hatchback Engine B 4204 S4	218328	Drive Shaft		36	26	55.3	48	580		
2.4 i (125 kW)	2006.10-2012.12	MT	L	F	Hatchback Engine B 5244 S4	618159	Inner joint		26	26	40	67	96.5	
	2006.10-2012.12	-	L	F	Hatchback Engine B 5244 S4	618044	Inner Joint		26	23	40	68.5	99.5	
	2006.10-2012.12	MT	L	F	Hatchback Engine B 5244 S4	262097	Drive Shaft		36	26	56	48	532	
	2006.10-2012.12	AT	R	F	Hatchback Engine B 5244 S4	899132	Outer Joint		36	24	56	48	57	I
	2006.10-2012.12	MT	-	F	Hatchback Engine B 5244 S4	862048	Outer Joint		36	26	56	48	64	I
	2006.10-2012.12	-	-	F	Hatchback Engine B 5244 S4	862031	Outer Joint	48T	36	27	56.5	55	65	M
	2006.10-2012.12	-	-	F	Hatchback Engine B 5244 S4	859285	Outer Joint		40	27	57.4	52	63.5	M
	2006.10-2012.12	Semi-AT	L	F	Hatchback Engine B 5244 S4	262060	Drive Shaft		36	26	56	48	519	
	2006.10-2012.12	-	-	F	Hatchback Engine B 5244 S4	862045	Outer Joint		40	26	57.4	52	62.5	M
	2006.10-2012.12	Semi-AT	R	F	Hatchback Engine B 5244 S4	262063	Drive Shaft		36	26	56	48	947	
	2006.10-2012.12	AMT	L/R	F	Hatchback Engine B 5244 S4	862033	Outer Joint		36	24	56	48	59	I
	2006.10-2012.12	-	L	F	Hatchback Engine B 5244 S4	801424	Outer Joint		31	27	36.2	70	62	M
	2006.10-2012.12	-	-	R	Hatchback Engine B 5244 S4	618187	Inner Joint		26	29	35	69.5	107.5	
	2006.10-2012.12	AT	L	F	Hatchback Engine B 5244 S4	262027	Drive Shaft		36	26	56	48	515.5	
2006.10-2012.12	AT	R	F	Hatchback Engine B 5244 S4	218192	Drive Shaft		36	26	56	48	949		
2006.10-2012.12	-	-	R	Hatchback Engine B 5244 S4	818290	Outer Joint		36	29	56.5	49.5	64	I	
2.5 (120 kW)	2006.10-2012.12	MT	L	F	Hatchback Engine D 5244 T9	618159	Inner joint		26	26	40	67	96.5	
	2006.10-2012.12	-	L	F	Hatchback Engine D 5244 T9	618044	Inner Joint		26	23	40	68.5	99.5	
	2006.10-2012.12	AT	R	F	Hatchback Engine D 5244 T9	899132	Outer Joint		36	24	56	48	57	I
	2006.10-2012.12	-	-	F	Hatchback Engine D 5244 T9	899155	Outer Joint		36	26	56	48	64	I
	2006.10-2012.12	-	-	F	Hatchback Engine D 5244 T9	862031	Outer Joint	48T	36	27	56.5	55	65	M
	2006.10-2012.12	-	-	F	Hatchback Engine D 5244 T9	859285	Outer Joint		40	27	57.4	52	63.5	M
2006.10-2012.12	-	L	F	Hatchback Engine D 5244 T9	262060	Drive Shaft		36	26	56	48	519		

YEAR	TRANSM	L/R	F/R	REMARKS	GSP Ref.	PRODUCT	ABS	Technical Specifications							
								A	B	C	H	L	P		
VOLVO															
C30 (533)															
2.5 (120 kW)	2006.10-2012.12	-	R	F	Hatchback Engine D 5244 T9	262063	Drive Shaft		36	26	56	48	947		
	2006.10-2012.12	-	-	F	Hatchback Engine D 5244 T9	862045	Outer Joint		40	26	57.4	52	62.5	M	
	2006.10-2012.12	-	L/R	F	Hatchback Engine D 5244 T9	862033	Outer Joint		36	24	56	48	59	I	
	2006.10-2012.12	-	L	F	Hatchback Engine D 5244 T9	801424	Outer Joint		31	27	36.2	70	62	M	
	2006.10-2012.12	-	-	R	Hatchback Engine D 5244 T9	618187	Inner Joint		26	29	35	69.5	107.5		
	2006.10-2012.12	AT	L	F	Hatchback Engine D 5244 T9	262027	Drive Shaft		36	26	56	48	515.5		
	2006.10-2012.12	-	-	R	Hatchback Engine D 5244 T9	818290	Outer Joint		36	29	56.5	49.5	64	I	
	2006.10-2012.12	AT	R	F	Hatchback Engine D 5244 T9	218192	Drive Shaft		36	26	56	48	949		
2.5 (132 kW)	2006.10-2012.12	MT	L	F	Hatchback Engine D 5244 T8	618159	Inner joint		26	26	40	67	96.5		
	2006.10-2012.12	-	L	F	Hatchback Engine D 5244 T8	618044	Inner Joint		26	23	40	68.5	99.5		
	2006.10-2012.12	MT	L	F	Hatchback Engine D 5244 T8	262097	Drive Shaft		36	26	56	48	532		
	2006.10-2012.12	AT	R	F	Hatchback Engine D 5244 T8	899132	Outer Joint		36	24	56	48	57	I	
	2006.10-2012.12	MT	-	F	Hatchback Engine D 5244 T8	899155	Outer Joint		36	26	56	48	64	I	
	2006.10-2012.12	MT	-	F	Hatchback Engine D 5244 T8	862048	Outer Joint		36	26	56	48	64	I	
	2006.10-2012.12	-	-	F	Hatchback Engine D 5244 T8	862031	Outer Joint	48T	36	27	56.5	55	65	M	
	2006.10-2012.12	-	-	F	Hatchback Engine D 5244 T8	859285	Outer Joint		40	27	57.4	52	63.5	M	
	2006.10-2012.12	AT	L	F	Hatchback Engine D 5244 T8	262060	Drive Shaft		36	26	56	48	519		
	2006.10-2012.12	AT	R	F	Hatchback Engine D 5244 T8	262063	Drive Shaft		36	26	56	48	947		
	2006.10-2012.12	-	-	F	Hatchback Engine D 5244 T8	862045	Outer Joint		40	26	57.4	52	62.5	M	
	2006.10-2012.12	AT	L/R	F	Hatchback Engine D 5244 T8	862033	Outer Joint		36	24	56	48	59	I	
	2006.10-2012.12	-	L	F	Hatchback Engine D 5244 T8	801424	Outer Joint		31	27	36.2	70	62	M	
	2006.10-2012.12	-	-	R	Hatchback Engine D 5244 T8	618187	Inner Joint		26	29	35	69.5	107.5		
	2006.10-2012.12	AT	L	F	Hatchback Engine D 5244 T8	262027	Drive Shaft		36	26	56	48	515.5		
	2006.10-2012.12	AT	R	F	Hatchback Engine D 5244 T8	218192	Drive Shaft		36	26	56	48	949		
	2006.10-2012.12	-	-	R	Hatchback Engine D 5244 T8	818290	Outer Joint		36	29	56.5	49.5	64	I	
2.5 (162 kW)	2006.10-2012.12	Semi-AT	L	F	Hatchback Engine B 5254 T3	862033	Outer Joint		36	24	56	48	59	I	
	2006.10-2012.12	MT	L	F	Hatchback Engine B 5254 T3	618159	Inner joint		26	26	40	67	96.5		
	2006.10-2012.12	-	L	F	Hatchback Engine B 5254 T3	618044	Inner Joint		26	23	40	68.5	99.5		
	2006.10-2012.12	MT	L	F	Hatchback Engine B 5254 T3	262097	Drive Shaft		36	26	56	48	532		
	2006.10-2012.12	AT	R	F	Hatchback Engine B 5254 T3	899132	Outer Joint		36	24	56	48	57	I	
	2006.10-2012.12	-	-	F	Hatchback Engine B 5254 T3	862048	Outer Joint		36	26	56	48	64	I	
	2006.10-2012.12	-	-	F	Hatchback Engine B 5254 T3	862031	Outer Joint	48T	36	27	56.5	55	65	M	
	2006.10-2012.12	-	-	F	Hatchback Engine B 5254 T3	859285	Outer Joint		40	27	57.4	52	63.5	M	
	2006.10-2012.12	Semi-AT	L	F	Hatchback Engine B 5254 T3	262060	Drive Shaft		36	26	56	48	519		
	2006.10-2012.12	Semi-AT	R	F	Hatchback Engine B 5254 T3	262063	Drive Shaft		36	26	56	48	947		
	2006.10-2012.12	-	-	F	Hatchback Engine B 5254 T3	862045	Outer Joint		40	26	57.4	52	62.5	M	
	2006.10-2012.12	-	L	F	Hatchback Engine B 5254 T3	801424	Outer Joint		31	27	36.2	70	62	M	
	2006.10-2012.12	-	-	R	Hatchback Engine B 5254 T3	618187	Inner Joint		26	29	35	69.5	107.5		
	2006.10-2012.12	AT	L	F	Hatchback Engine B 5254 T3	262027	Drive Shaft		36	26	56	48	515.5		
	2006.10-2012.12	AT	R	F	Hatchback Engine B 5254 T3	218192	Drive Shaft		36	26	56	48	949		
	2006.10-2012.12	-	-	R	Hatchback Engine B 5254 T3	818290	Outer Joint		36	29	56.5	49.5	64	I	
2.5 (169 kW)	2007.03-2012.12	MT	L	F	Hatchback Engine B 5254 T7	618159	Inner joint		26	26	40	67	96.5		
	2007.03-2012.12	-	L	F	Hatchback Engine B 5254 T7	862033	Outer Joint		36	24	56	48	59	I	
	2007.03-2012.12	-	L	F	Hatchback Engine B 5254 T7	618044	Inner Joint		26	23	40	68.5	99.5		
	2007.03-2012.12	MT	L	F	Hatchback Engine B 5254 T7	262097	Drive Shaft		36	26	56	48	532		
	2007.03-2012.12	AT	R	F	Hatchback Engine B 5254 T7	899132	Outer Joint		36	24	56	48	57	I	
	2007.03-2012.12	-	-	F	Hatchback Engine B 5254 T7	862048	Outer Joint		36	26	56	48	64	I	
	2007.03-2012.12	-	-	F	Hatchback Engine B 5254 T7	862031	Outer Joint	48T	36	27	56.5	55	65	M	
	2007.03-2012.12	Semi-AT	L	F	Hatchback Engine B 5254 T7	262060	Drive Shaft		36	26	56	48	519		
	2007.03-2012.12	-	-	F	Hatchback Engine B 5254 T7	859285	Outer Joint		40	27	57.4	52	63.5	M	
	2007.03-2012.12	Semi-AT	R	F	Hatchback Engine B 5254 T7	262063	Drive Shaft		36	26	56	48	947		
	2007.03-2012.12	-	-	F	Hatchback Engine B 5254 T7	862045	Outer Joint		40	26	57.4	52	62.5	M	
	2007.03-2012.12	-	L	F	Hatchback Engine B 5254 T7	801424	Outer Joint		31	27	36.2	70	62	M	
	2007.03-2012.12	-	-	R	Hatchback Engine B 5254 T7	618187	Inner Joint		26	29	35	69.5	107.5		
	2007.03-2012.12	AT	L	F	Hatchback Engine B 5254 T7	262027	Drive Shaft		36	26	56	48	515.5		
	2007.03-2012.12	AT	R	F	Hatchback Engine B 5254 T7	218192	Drive Shaft		36	26	56	48	949		
	2007.03-2012.12	-	-	R	Hatchback Engine B 5254 T7	818290	Outer Joint		36	29	56.5	49.5	64	I	
D3 (110 kW)	2010.10-2012.12	-	L	F	Hatchback Engine D 5204 T5	618044	Inner Joint		26	23	40	68.5	99.5		
	2010.10-2012.12	-	-	F	Hatchback Engine D 5204 T5	899155	Outer Joint		36	26	56	48	64	I	
	2010.10-2012.12	-	-	F	Hatchback Engine D 5204 T5	862031	Outer Joint	48T	36	27	56.5	55	65	M	
	2010.10-2012.12	-	-	F	Hatchback Engine D 5204 T5	859285	Outer Joint		40	27	57.4	52	63.5	M	
	2010.10-2012.12	-	-	F	Hatchback Engine D 5204 T5	862045	Outer Joint		40	26	57.4	52	62.5	M	
	2010.10-2012.12	-	L	F	Hatchback Engine D 5204 T5	801424	Outer Joint		31	27	36.2	70	62	M	
	2010.10-2012.12	-	-	R	Hatchback Engine D 5204 T5	618187	Inner Joint		26	29	35	69.5	107.5		
	2010.10-2012.12	-	-	R	Hatchback Engine D 5204 T5	818290	Outer Joint		36	29	56.5	49.5	64	I	
D4 (130 kW)	2010.10-2012.12	-	L	F	Hatchback Engine D 5204 T	618044	Inner Joint		26	23	40	68.5	99.5		

VOLVO	YEAR	TRANSM	L/R	F/R	REMARKS	GSP Ref.	PRODUCT	ABS	Technical Specifications											
									A	B	C	H	L	P						
VOLVO																				
C30 (533)																				
D4 (130 kW)	2010.10-	2012.12	-	-	F	Hatchback Engine D 5204 T	899155	Outer Joint		36	26	56	48	64	I					
	2010.10-	2012.12	-	-	F	Hatchback Engine D 5204 T	862031	Outer Joint	48T	36	27	56.5	55	65	M					
	2010.10-	2012.12	-	-	F	Hatchback Engine D 5204 T	859285	Outer Joint		40	27	57.4	52	63.5	M					
	2010.10-	2012.12	-	-	F	Hatchback Engine D 5204 T	862045	Outer Joint		40	26	57.4	52	62.5	M					
	2010.10-	2012.12	-	L	F	Hatchback Engine D 5204 T	801424	Outer Joint		31	27	36.2	70	62	M					
	2010.10-	2012.12	-	-	R	Hatchback Engine D 5204 T	618187	Inner Joint		26	29	35	69.5	107.5						
	2010.10-	2012.12	-	-	R	Hatchback Engine D 5204 T	818290	Outer Joint		36	29	56.5	49.5	64	I					
Electric (82 kW)	2010.12-	2012.12	-	-	R	Hatchback Engine E400V1	818290	Outer Joint		36	29	56.5	49.5	64	I					
	2010.12-	2012.12	-	L	F	Hatchback Engine E400V1	618044	Inner Joint		26	23	40	68.5	99.5						
	2010.12-	2012.12	-	-	F	Hatchback Engine E400V1	862031	Outer Joint	48T	36	27	56.5	55	65	M					
	2010.12-	2012.12	-	-	F	Hatchback Engine E400V1	859285	Outer Joint		40	27	57.4	52	63.5	M					
	2010.12-	2012.12	-	-	F	Hatchback Engine E400V1	862045	Outer Joint		40	26	57.4	52	62.5	M					
	2010.12-	2012.12	-	L	F	Hatchback Engine E400V1	801424	Outer Joint		31	27	36.2	70	62	M					
	2010.12-	2012.12	-	-	R	Hatchback Engine E400V1	618187	Inner Joint		26	29	35	69.5	107.5						
Electric (89 kW)	2010.12-	2012.12	-	-	R	Hatchback Engine MRS7701	818290	Outer Joint		36	29	56.5	49.5	64	I					
	2010.12-	2012.12	-	L	F	Hatchback Engine MRS7701	618044	Inner Joint		26	23	40	68.5	99.5						
	2010.12-	2012.12	-	-	F	Hatchback Engine MRS7701	862031	Outer Joint	48T	36	27	56.5	55	65	M					
	2010.12-	2012.12	-	-	F	Hatchback Engine MRS7701	859285	Outer Joint		40	27	57.4	52	63.5	M					
	2010.12-	2012.12	-	-	F	Hatchback Engine MRS7701	862045	Outer Joint		40	26	57.4	52	62.5	M					
	2010.12-	2012.12	-	L	F	Hatchback Engine MRS7701	801424	Outer Joint		31	27	36.2	70	62	M					
	2010.12-	2012.12	-	-	R	Hatchback Engine MRS7701	618187	Inner Joint		26	29	35	69.5	107.5						
C70 I (872)																				
2.0 (132 kW)	1997.03-	2002.09	MT	R	F	Coupe Engine B 5204 T2	662015	Inner Joint		26	25	40	531.5	66.5						
	1997.03-	2002.09	AT	R	F	Coupe Engine B 5204 T2	262002	Drive Shaft	48T	26	26	56.5	98.5	1028						
	1997.03-	2002.09	-	-	-	Coupe Engine B 5204 T2	862014	Outer Joint		26	25	56.5	98.5	56	O					
	1997.03-	2002.09	AT/MT	L/R	F	Coupe Engine B 5204 T2	862001	Outer Joint	48T	26	25	56.5	98.5	56	O					
2.0 T (120 kW)	2000.03-	2002.09	MT	L	F	Coupe Engine B 5204 T4	862009	Outer Joint	48T	36	27	56.5	48	66	M					
	2000.03-	2002.09	AT/MT	L/R	F	Coupe Engine B 5204 T4	862010	Outer Joint	48T	36	33	56.5	48	58	M					
2.0 T (166 kW)	1997.03-	2002.09	AT	L	F	Coupe Engine B 5204 T3	262001	Drive Shaft	48T	26	26	56.5	98.5	574.5						
	1997.03-	2002.09	AT/MT	L/R	F	Coupe Engine B 5204 T3	862016	Outer Joint		26	28	56.5	97.5	66	O					
	1997.03-	2002.09	AT/MT	L/R	F	Coupe Engine B 5204 T3	862002	Outer Joint	48T	26	28	56.5	97.5	66	O					
	1997.03-	2002.09	MT	L	F	Coupe Engine B 5204 T3	862009	Outer Joint	48T	36	27	56.5	48	66	M					
2.3 T-5 (176 kW)	1997.03-	2002.09	AT/MT	L/R	F	Coupe Engine B 5234 T3	862016	Outer Joint		26	28	56.5	97.5	66	O					
	1997.03-	2002.09	AT/MT	L/R	F	Coupe Engine B 5234 T3	862002	Outer Joint	48T	26	28	56.5	97.5	66	O					
	1997.03-	2002.09	MT	L	F	Coupe Engine B 5234 T3	862009	Outer Joint	48T	36	27	56.5	48	66	M					
2.4 (121 kW)	1999.03-	2002.09	AT	L	F	Coupe Engine B 5254 S	262001	Drive Shaft	48T	26	26	56.5	98.5	574.5						
	1999.03-	2002.09	AT/MT	L/R	F	Coupe Engine B 5254 S	862010	Outer Joint	48T	36	33	56.5	48	58	M					
2.4 (125 kW)	1999.05-	2002.09	-	-	-	Coupe Engine B 5254 S	862014	Outer Joint		26	25	56.5	98.5	56	O					
	1999.05-	2002.09	AT/MT	L/R	F	Coupe Engine B 5254 S	862010	Outer Joint	48T	36	33	56.5	48	58	M					
2.4 T (142 kW)	1997.03-	2002.09	AT	L	F	Coupe Engine B 5254 T	262001	Drive Shaft	48T	26	26	56.5	98.5	574.5						
	1997.03-	2002.09	AT/MT	L/R	F	Coupe Engine B 5254 T	862016	Outer Joint		26	28	56.5	97.5	66	O					
	1997.03-	2002.09	AT/MT	L/R	F	Coupe Engine B 5254 T	862002	Outer Joint	48T	26	28	56.5	97.5	66	O					
	1997.03-	2002.09	MT	L	F	Coupe Engine B 5254 T	862009	Outer Joint	48T	36	27	56.5	48	66	M					
C70 I (873)																				
2.0 (132 kW)	1998.03-	2005.10	-	-	-	Convertible Engine B 5204 T2	862014	Outer Joint		26	25	56.5	98.5	56	O					
	1998.03-	2005.10	AT/MT	L/R	F	Convertible Engine B 5204 T2	862001	Outer Joint	48T	26	25	56.5	98.5	56	O					
2.0 T (120 kW)	2000.03-	2005.10	MT	L	F	Convertible Engine B 5204 T4	862009	Outer Joint	48T	36	27	56.5	48	66	M					
	2000.03-	2005.10	AT/MT	L/R	F	Convertible Engine B 5204 T4	862010	Outer Joint	48T	36	33	56.5	48	58	M					
2.0 T (166 kW)	1998.03-	2005.10	AT	L	F	Convertible Engine B 5204 T3	262001	Drive Shaft	48T	26	26	56.5	98.5	574.5						
	1998.03-	2005.10	AT/MT	L/R	F	Convertible Engine B 5204 T3	862016	Outer Joint		26	28	56.5	97.5	66	O					
	1998.03-	2005.10	AT/MT	L/R	F	Convertible Engine B 5204 T3	862002	Outer Joint	48T	26	28	56.5	97.5	66	O					
	1998.03-	2005.10	MT	L	F	Convertible Engine B 5204 T3	862009	Outer Joint	48T	36	27	56.5	48	66	M					
2.3 T5 (176 kW)	1998.03-	2005.10	AT/MT	L/R	F	Convertible Engine B 5234 T3	862016	Outer Joint		26	28	56.5	97.5	66	O					
	1998.03-	2005.10	AT/MT	L/R	F	Convertible Engine B 5234 T3	862002	Outer Joint	48T	26	28	56.5	97.5	66	O					
	1998.03-	2005.10	MT	L	F	Convertible Engine B 5234 T3	862009	Outer Joint	48T	36	27	56.5	48	66	M					
2.3 T5 (180 kW)	2002.07-	2005.10	MT	L	F	Convertible Engine B 5234 T9	862009	Outer Joint	48T	36	27	56.5	48	66	M					
2.4 (125 kW)	1998.06-	2005.10	-	-	-	Convertible Engine B 5254 S	862014	Outer Joint		26	25	56.5	98.5	56	O					
	1998.06-	2005.10	AT/MT	L/R	F	Convertible Engine B 5254 S	862010	Outer Joint	48T	36	33	56.5	48	58	M					
	1998.06-	2005.10	MT	L	F	Convertible Engine B 5254 S	862009	Outer Joint	48T	36	27	56.5	48	66	M					
	1998.06-	2005.10	AT/MT	L/R	F	Convertible Engine B 5254 S	862001	Outer Joint	48T	26	25	56.5	98.5	56	O					
2.4 T (142 kW)	1998.03-	2005.10	MT	L	F	Convertible Engine B 5254 T	862009	Outer Joint	48T	36	27	56.5	48	66	M					
	1998.03-	2005.10	AT	L	F	Convertible Engine B 5254 T	262001	Drive Shaft	48T	26	26	56.5	98.5	574.5						
	1998.03-	2005.10	AT/MT	L/R	F	Convertible Engine B 5254 T	862016	Outer Joint		26	28	56.5	97.5	66	O					
2.4 T (147 kW)	2002.07-	2005.10	MT	L	F	Convertible Engine B 5244 T7	862009	Outer Joint	48T	36	27	56.5	48	66	M					
C70 II (542)																				
2.0 D (100 kW)	2008.01-	2009.10	AT	R	F	Convertible Engine D 4204 T	662017	Inner Joint		28	26	34	371.5	92						

VOLVO	YEAR	TRANSM	L/R	F/R	REMARKS	GSP Ref.	PRODUCT	ABS	Technical Specifications										
									A	B	C	H	L	P					
VOLVO																			
C70 II (542)																			
2.0 D (100 kW)	2008.01-2009.10	MT	L	F	Convertible Engine D 4204 T	218194	Drive Shaft		36	26	56	48	568						
	2008.01-2009.10	MT	R	F	Convertible Engine D 4204 T	218280	Drive Shaft		36	26	56	48	918						
	2008.01-2009.10	MT	L	F	Convertible Engine D 4204 T	218198	Drive Shaft		36	26	56	48	580						
	2008.01-2009.10	AT	R	F	Convertible Engine D 4204 T	262024	Drive Shaft		36	28	56	48	908						
	2008.01-2009.10	AT	L	F	Convertible Engine D 4204 T	218367	Drive Shaft		36	28	56	48	570						
	2008.01-2009.10	MT	R	F	Convertible Engine D 4204 T	899130	Outer Joint		36	26	56.3	48	61	M					
2.4 (103 kW)	2006.03-2009.10	MT	L	F	Convertible Engine B 5244 S5	618159	Inner joint		26	26	40	67	96.5						
	2006.03-2009.10	MT	L	F	Convertible Engine B 5244 S5	262097	Drive Shaft		36	26	56	48	532						
	2006.03-2009.10	AT	R	F	Convertible Engine B 5244 S5	899132	Outer Joint		36	24	56	48	57	I					
	2006.03-2009.10	MT	-	F	Convertible Engine B 5244 S5	862048	Outer Joint		36	26	56	48	64	I					
	2006.03-2009.10	Semi-AT	L	F	Convertible Engine B 5244 S5	262060	Drive Shaft		36	26	56	48	519						
	2006.03-2009.10	Semi-AT	R	F	Convertible Engine B 5244 S5	262063	Drive Shaft		36	26	56	48	947						
	2006.03-2009.10	AMT	L/R	F	Convertible Engine B 5244 S5	862033	Outer Joint		36	24	56	48	59	I					
	2006.03-2009.10	AT	L	F	Convertible Engine B 5244 S5	262027	Drive Shaft		36	26	56	48	515.5						
	2006.03-2009.10	AT	R	F	Convertible Engine B 5244 S5	218192	Drive Shaft		36	26	56	48	949						
2.4 D (120 kW)	2007.03-2013.06	AT	R	F	Convertible Engine D 5244 T9	218192	Drive Shaft		36	26	56	48	949						
	2007.03-2013.06	MT	L	F	Convertible Engine D 5244 T9	618159	Inner joint		26	26	40	67	96.5						
	2007.03-2013.06	AT	R	F	Convertible Engine D 5244 T9	899132	Outer Joint		36	24	56	48	57	I					
	2007.03-2013.06	-	L	F	Convertible Engine D 5244 T9	262060	Drive Shaft		36	26	56	48	519						
	2007.03-2013.06	-	R	F	Convertible Engine D 5244 T9	262063	Drive Shaft		36	26	56	48	947						
	2007.03-2013.06	-	L/R	F	Convertible Engine D 5244 T9	862033	Outer Joint		36	24	56	48	59	I					
	2007.03-2013.06	AT	L	F	Convertible Engine D 5244 T9	262027	Drive Shaft		36	26	56	48	515.5						
2.4 i (125 kW)	2006.03-2009.10	MT	L	F	Convertible Engine B 5244 S4	618159	Inner joint		26	26	40	67	96.5						
	2006.03-2009.10	MT	L	F	Convertible Engine B 5244 S4	262097	Drive Shaft		36	26	56	48	532						
	2006.03-2009.10	AT	R	F	Convertible Engine B 5244 S4	899132	Outer Joint		36	24	56	48	57	I					
	2006.03-2009.10	MT	-	F	Convertible Engine B 5244 S4	899155	Outer Joint		36	26	56	48	64	I					
	2006.03-2009.10	MT	-	F	Convertible Engine B 5244 S4	862048	Outer Joint		36	26	56	48	64	I					
	2006.03-2009.10	Semi-AT	L	F	Convertible Engine B 5244 S4	262060	Drive Shaft		36	26	56	48	519						
	2006.03-2009.10	Semi-AT	R	F	Convertible Engine B 5244 S4	262063	Drive Shaft		36	26	56	48	947						
	2006.03-2009.10	AMT	L/R	F	Convertible Engine B 5244 S4	862033	Outer Joint		36	24	56	48	59	I					
	2006.03-2009.10	AT	L	F	Convertible Engine B 5244 S4	262027	Drive Shaft		36	26	56	48	515.5						
	2006.03-2009.10	AT	R	F	Convertible Engine B 5244 S4	218192	Drive Shaft		36	26	56	48	949						
2.5 (132 kW)	2006.03-2013.06	MT	L	F	Convertible Engine D 5244 T8	618159	Inner joint		26	26	40	67	96.5						
	2006.03-2013.06	AT	R	F	Convertible Engine D 5244 T8	899132	Outer Joint		36	24	56	48	57	I					
	2006.03-2013.06	MT	L	F	Convertible Engine D 5244 T8	262097	Drive Shaft		36	26	56	48	532						
	2006.03-2013.06	MT	-	F	Convertible Engine D 5244 T8	862048	Outer Joint		36	26	56	48	64	I					
	2006.03-2013.06	-	L	F	Convertible Engine D 5244 T8	262060	Drive Shaft		36	26	56	48	519						
	2006.03-2013.06	-	R	F	Convertible Engine D 5244 T8	262063	Drive Shaft		36	26	56	48	947						
	2006.03-2013.06	-	L/R	F	Convertible Engine D 5244 T8	862033	Outer Joint		36	24	56	48	59	I					
	2006.03-2013.06	AT	L	F	Convertible Engine D 5244 T8	262027	Drive Shaft		36	26	56	48	515.5						
	2006.03-2013.06	AT	R	F	Convertible Engine D 5244 T8	218192	Drive Shaft		36	26	56	48	949						
2.5 (162 kW)	2006.03-2007.02	MT	L	F	Convertible Engine B 5254 T3	618159	Inner joint		26	26	40	67	96.5						
	2006.03-2007.02	MT	L	F	Convertible Engine B 5254 T3	262097	Drive Shaft		36	26	56	48	532						
	2006.03-2007.02	AT	R	F	Convertible Engine B 5254 T3	899132	Outer Joint		36	24	56	48	57	I					
	2006.03-2007.02	Semi-AT	L	F	Convertible Engine B 5254 T3	262060	Drive Shaft		36	26	56	48	519						
	2006.03-2007.02	Semi-AT	R	F	Convertible Engine B 5254 T3	262063	Drive Shaft		36	26	56	48	947						
	2006.03-2007.02	MT	L/R	F	Convertible Engine B 5254 T3	862033	Outer Joint		36	24	56	48	59	I					
	2006.03-2007.02	AT	L	F	Convertible Engine B 5254 T3	262027	Drive Shaft		36	26	56	48	515.5						
	2006.03-2007.02	AT	R	F	Convertible Engine B 5254 T3	218192	Drive Shaft		36	26	56	48	949						
2.5 (169 kW)	2007.03-2009.10	MT	L	F	Convertible Engine B 5254 T7	618159	Inner joint		26	26	40	67	96.5						
	2007.03-2009.10	MT	L	F	Convertible Engine B 5254 T7	262097	Drive Shaft		36	26	56	48	532						
	2007.03-2009.10	AT	R	F	Convertible Engine B 5254 T7	899132	Outer Joint		36	24	56	48	57	I					
	2007.03-2009.10	Semi-AT	L	F	Convertible Engine B 5254 T7	262060	Drive Shaft		36	26	56	48	519						
	2007.03-2009.10	Semi-AT	R	F	Convertible Engine B 5254 T7	262063	Drive Shaft		36	26	56	48	947						
	2007.03-2009.10	AMT	L/R	F	Convertible Engine B 5254 T7	862033	Outer Joint		36	24	56	48	59	I					
	2007.03-2009.10	AT	L	F	Convertible Engine B 5254 T7	262027	Drive Shaft		36	26	56	48	515.5						
	2007.03-2009.10	AT	R	F	Convertible Engine B 5254 T7	218192	Drive Shaft		36	26	56	48	949						
D3 (110 kW)	2010.10-2013.06	MT	L	F	Convertible Engine D 5204 T5	262097	Drive Shaft		36	26	56	48	532						
	2010.10-2013.06	-	-	F	Convertible Engine D 5204 T5	899155	Outer Joint		36	26	56	48	64	I					
D4 (130 kW)	2010.10-2013.06	MT	L	F	Convertible Engine D 5204 T	262097	Drive Shaft		36	26	56	48	532						
	2010.10-2013.06	6AT	L	F	Convertible Engine D 5204 T	262108	Drive Shaft		36	31	56	48	506						
	2010.10-2013.06	-	-	F	Convertible Engine D 5204 T	899155	Outer Joint		36	26	56	48	64	I					
S40																			
1.6 (80 kW)	1999-2003	-	-	-	-	862024	Outer Joint	43T	26	27	56.5	98	66.5	M					
S40 I (644)																			
1.6 (77 kW)	1995.09-1999.08	-	-	F	Saloon Engine B 4164 S	839100	Outer Joint	43T	25	23	54	95.5	64	M					

VOLVO	YEAR	TRANSM	L/R	F/R	REMARKS	GSP Ref.	PRODUCT	ABS	Technical Specifications											
									A	B	C	H	L	P						
VOLVO																				
S40 I (644)																				
1.6 (77 kW)	1995.09-1999.08	-	-	F	Saloon Engine B 4164 S	899230	Outer Joint	43T	25	29	54	95	60	O						
	1995.09-1999.08	MT	L	F	Saloon Engine B 4164 S	239097	Drive Shaft	43T	25	25	54	95.5	614							
	1995.09-1999.08	MT	R	F	Saloon Engine B 4164 S	239096	Drive Shaft	43T	25	25	54	95.5	937							
	1995.09-1999.08	AT/MT	L/R	F	Saloon Engine B 4164 S	862003	Outer Joint	43T	25	25	54	95	61	O						
	1995.09-1999.08	-	L	F	Saloon Engine B 4164 S	862009	Outer Joint	48T	36	27	56.5	48	66	M						
1.6 (80 kW)	1999.03-2003.12	-	-	F	Saloon Engine B 4164 S2	839100	Outer Joint	43T	25	23	54	95.5	64	M						
	1999.03-2003.12	-	-	F	Saloon Engine B 4164 S2	899230	Outer Joint	43T	25	29	54	95	60	O						
	1999.03-2003.12	MT	L	F	Saloon Engine B 4164 S2	239097	Drive Shaft	43T	25	25	54	95.5	614							
	1999.03-2003.12	MT	R	F	Saloon Engine B 4164 S2	239096	Drive Shaft	43T	25	25	54	95.5	937							
	1999.03-2003.12	AT/MT	L/R	F	Saloon Engine B 4164 S2	862008	Outer Joint	43T	25	33	54	95	61	M						
1.8 (85 kW)	1995.07-1999.08	MT	L	F	Saloon Engine B 4184 S	862009	Outer Joint	48T	36	27	56.5	48	66	M						
	1995.07-1999.08	MT	-	F	Saloon Engine B 4184 S	839100	Outer Joint	43T	25	23	54	95.5	64	M						
	1995.07-1999.08	MT	-	F	Saloon Engine B 4184 S	899230	Outer Joint	43T	25	29	54	95	60	O						
	1995.07-1999.08	MT	L	F	Saloon Engine B 4184 S	239097	Drive Shaft	43T	25	25	54	95.5	614							
	1995.07-1999.08	MT	R	F	Saloon Engine B 4184 S	239096	Drive Shaft	43T	25	25	54	95.5	937							
	1995.07-1999.08	AT	L	F	Saloon Engine B 4184 S	262072	Drive Shaft	43T	25	26	54	95	599							
	1995.07-1999.08	AT	L/R	F	Saloon Engine B 4184 S	862003	Outer Joint	43T	25	25	54	95	61	O						
	1995.07-1999.08	AT	R	F	Saloon Engine B 4184 S	262035	Drive Shaft	43T	25	26	54	95	948							
	1995.07-1999.08	AT	-	F	Saloon Engine B 4184 S	899262	Outer Joint	43T	25	25	54	95	61	O						
	2001.06-2003.08	MT	-	F	Saloon Engine B 4184 S2	839100	Outer Joint	43T	25	23	54	95.5	64	M						
	2001.06-2003.08	MT	-	F	Saloon Engine B 4184 S2	899230	Outer Joint	43T	25	29	54	95	60	O						
	2001.06-2003.08	MT	L	F	Saloon Engine B 4184 S2	239097	Drive Shaft	43T	25	25	54	95.5	614							
	2001.06-2003.08	MT	R	F	Saloon Engine B 4184 S2	239096	Drive Shaft	43T	25	25	54	95.5	937							
	2001.06-2003.08	AT	L	F	Saloon Engine B 4184 S2	262072	Drive Shaft	43T	25	26	54	95	599							
	2001.06-2003.08	AT	-	F	Saloon Engine B 4184 S2	899262	Outer Joint	43T	25	25	54	95	61	O						
	2001.06-2003.08	AT	R	F	Saloon Engine B 4184 S2	262035	Drive Shaft	43T	25	26	54	95	948							
1.8 (90 kW)	1999.03-2003.12	MT	-	F	Saloon Engine B 4184 S2	839100	Outer Joint	43T	25	23	54	95.5	64	M						
	1999.03-2003.12	MT	-	F	Saloon Engine B 4184 S2	899230	Outer Joint	43T	25	29	54	95	60	O						
	1999.03-2003.12	MT	L	F	Saloon Engine B 4184 S2	239097	Drive Shaft	43T	25	25	54	95.5	614							
	1999.03-2003.12	MT	R	F	Saloon Engine B 4184 S2	239096	Drive Shaft	43T	25	25	54	95.5	937							
	1999.03-2003.12	MT	L	F	Saloon Engine B 4184 S2	262023	Drive Shaft	43T	25	29.95	54	95	628.7							
	1999.03-2003.12	AT/MT	L/R	F	Saloon Engine B 4184 S2	862008	Outer Joint	43T	25	33	54	95	61	M						
	1999.03-2003.12	AT	L	F	Saloon Engine B 4184 S2	262072	Drive Shaft	43T	25	26	54	95	599							
	1999.03-2003.12	MT	R	F	Saloon Engine B 4184 S2	250421	Drive Shaft	43T	25	23	54	94.5	813							
	1999.03-2003.12	AT	R	F	Saloon Engine B 4184 S2	262035	Drive Shaft	43T	25	26	54	95	948							
	1999.03-2003.12	AT	-	F	Saloon Engine B 4184 S2	899262	Outer Joint	43T	25	25	54	95	61	O						
1.8 i (90 kW)	2001.06-2003.12	MT	-	F	Saloon Engine B 4184 SJ	839100	Outer Joint	43T	25	23	54	95.5	64	M						
	2001.06-2003.12	MT	-	F	Saloon Engine B 4184 SJ	899230	Outer Joint	43T	25	29	54	95	60	O						
	2001.06-2003.12	MT	L	F	Saloon Engine B 4184 SJ	239097	Drive Shaft	43T	25	25	54	95.5	614							
	2001.06-2003.12	MT	R	F	Saloon Engine B 4184 SJ	239096	Drive Shaft	43T	25	25	54	95.5	937							
	2001.06-2003.12	AT	L	F	Saloon Engine B 4184 SJ	262072	Drive Shaft	43T	25	26	54	95	599							
	2001.06-2003.12	AT	R	F	Saloon Engine B 4184 SJ	262035	Drive Shaft	43T	25	26	54	95	948							
	2001.06-2003.12	AT	-	F	Saloon Engine B 4184 SJ	899262	Outer Joint	43T	25	25	54	95	61	O						
	2001.06-2003.12	AT/MT	L/R	F	Saloon Engine B 4184 SJ	862011	Outer Joint	43T	25	33	56.3	99	61.5	M						
1.8 i (92 kW)	1998.03-2003.12	MT	-	F	Saloon Engine B 4184 SM	839100	Outer Joint	43T	25	23	54	95.5	64	M						
	1998.03-2003.12	MT	-	F	Saloon Engine B 4184 SM	899230	Outer Joint	43T	25	29	54	95	60	O						
	1998.03-2003.12	MT	L	F	Saloon Engine B 4184 SM	239097	Drive Shaft	43T	25	25	54	95.5	614							
	1998.03-2003.12	MT	R	F	Saloon Engine B 4184 SM	239096	Drive Shaft	43T	25	25	54	95.5	937							
	1998.03-2003.12	AT/MT	L/R	F	Saloon Engine B 4184 SM	862008	Outer Joint	43T	25	33	54	95	61	M						
	1998.03-2003.12	AT	L	F	Saloon Engine B 4184 SM	262072	Drive Shaft	43T	25	26	54	95	599							
	1998.03-2003.12	AT	R	F	Saloon Engine B 4184 SM	262035	Drive Shaft	43T	25	26	54	95	948							
	1998.03-2003.12	AT	-	F	Saloon Engine B 4184 SM	899262	Outer Joint	43T	25	25	54	95	61	O						
1.9 DI (70 kW)	1999.03-2000.07	-	-	F	Saloon Engine D 4192 T2	899230	Outer Joint	43T	25	29	54	95	60	O						
	1999.03-2000.07	MT	L	F	Saloon Engine D 4192 T2	262023	Drive Shaft	43T	25	29.95	54	95	628.7							
	1999.03-2000.07	AT/MT	L/R	F	Saloon Engine D 4192 T2	862012	Outer Joint	43T	26	27	56.5	98	66.5	M						
	1999.03-2000.07	MT	R	F	Saloon Engine D 4192 T2	250421	Drive Shaft	43T	25	23	54	94.5	813							
1.9 DI (75 kW)	2000.07-2003.12	MT	L	F	Saloon Engine D 4192 T4	262064	Drive Shaft	43T	26	26	56.5	98	607							
	2000.07-2003.12	MT	L	F	Saloon Engine D 4192 T4	262023	Drive Shaft	43T	25	29.95	54	95	628.7							
	2000.07-2003.12	MT	R	F	Saloon Engine D 4192 T4	250421	Drive Shaft	43T	25	23	54	94.5	813							
	2000.07-2003.12	AT/MT	L/R	F	Saloon Engine D 4192 T4	862012	Outer Joint	43T	26	27	56.5	98	66.5	M						
1.9 DI (85 kW)	2000.07-2003.12	MT	L	F	Saloon Engine D 4192 T3	262064	Drive Shaft	43T	26	26	56.5	98	607							
	2000.07-2003.12	AT/MT	L/R	F	Saloon Engine D 4192 T3	862012	Outer Joint	43T	26	27	56.5	98	66.5	M						
1.9 T4 (147 kW)	1997.05-2000.07	MT	L	F	Saloon Engine B 4194 T	262089	Drive Shaft	43T	26	26	56.5	98	593							
	1997.05-2000.07	-	L/R	F	Saloon Engine B 4194 T	862003	Outer Joint	43T	25	25	54	95	61	O						
	1997.05-2000.07	AT/MT	L/R	F	Saloon Engine B 4194 T	862012	Outer Joint	43T	26	27	56.5	98	66.5	M						
1.9 TD (66 kW)	1995.07-1999.08	-	-	F	Saloon Engine D 4192 T	899230	Outer Joint	43T	25	29	54	95	60	O						

VOLVO	YEAR	TRANSM	L/R	F/R	REMARKS	GSP Ref.	PRODUCT	ABS	Technical Specifications					
									A	B	C	H	L	P
VOLVO														
S40 I (644)														
1.9 TD (66 kW)	1995.07-1999.08	MT	L	F	Saloon Engine D 4192 T	262023	Drive Shaft	43T	25	29.95	54	95	628.7	
	1995.07-1999.08	MT	R	F	Saloon Engine D 4192 T	250421	Drive Shaft	43T	25	23	54	94.5	813	
	1995.07-1999.08	-	L	F	Saloon Engine D 4192 T	862009	Outer Joint	48T	36	27	56.5	48	66	M
2.0 (100 kW)	1995.07-2003.12	-	-	F	Saloon Engine B 4204 S	899230	Outer Joint	43T	25	29	54	95	60	O
	1995.07-2003.12	MT	R	F	Saloon Engine B 4204 S	262021	Drive Shaft	43T	25	26	54	95	945	
	1995.07-2003.12	AT/MT	L/R	F	Saloon Engine B 4204 S	862003	Outer Joint	43T	25	25	54	95	61	O
	1995.07-2003.12	AT	L	F	Saloon Engine B 4204 S	262072	Drive Shaft	43T	25	26	54	95	599	
	1995.07-2003.12	AT	R	F	Saloon Engine B 4204 S	262035	Drive Shaft	43T	25	26	54	95	948	
	1995.07-2003.12	-	-	F	Saloon Engine B 4204 S	899262	Outer Joint	43T	25	25	54	95	61	O
2.0 (103 kW)	1995.07-1999.08	-	-	F	Saloon Engine B 4204 S	899230	Outer Joint	43T	25	29	54	95	60	O
	1995.07-1999.08	MT	R	F	Saloon Engine B 4204 S	262021	Drive Shaft	43T	25	26	54	95	945	
	1995.07-1999.08	AT	L/R	F	Saloon Engine B 4204 S	862003	Outer Joint	43T	25	25	54	95	61	O
	1995.07-1999.08	AT	L	F	Saloon Engine B 4204 S	262072	Drive Shaft	43T	25	26	54	95	599	
	1995.07-1999.08	AT	R	F	Saloon Engine B 4204 S	262035	Drive Shaft	43T	25	26	54	95	948	
	1995.07-1999.08	-	-	F	Saloon Engine B 4204 S	899262	Outer Joint	43T	25	25	54	95	61	O
2.0 T (118 kW)	1995.07-1999.08	MT	L	F	Saloon Engine B 4204 S	862009	Outer Joint	48T	36	27	56.5	48	66	M
	1997.10-2003.12	MT	L	F	Saloon Engine B 4204 T	262089	Drive Shaft	43T	26	26	56.5	98	593	
	1997.10-2003.12	-	L/R	F	Saloon Engine B 4204 T	862003	Outer Joint	43T	25	25	54	95	61	O
	1997.10-2003.12	AT/MT	L/R	F	Saloon Engine B 4204 T	862012	Outer Joint	43T	26	27	56.5	98	66.5	M
	2001.06-2003.12	MT	L	F	Saloon Engine B 4204 T3	262089	Drive Shaft	43T	26	26	56.5	98	593	
2.0 T (120 kW)	2001.06-2003.12	MT	L	F	Saloon Engine B 4204 T3	262089	Drive Shaft	43T	26	26	56.5	98	593	
2.0 T (121 kW)	2000.07-2001.06	MT	L	F	Saloon Engine B 4204 T3	262089	Drive Shaft	43T	26	26	56.5	98	593	
	2000.07-2001.06	AT/MT	L/R	F	Saloon Engine B 4204 T3	862012	Outer Joint	43T	26	27	56.5	98	66.5	M
2.0 T4 (147 kW)	2000.07-2003.12	MT	L	F	Saloon Engine B 4204 T5	262089	Drive Shaft	43T	26	26	56.5	98	593	
	2000.07-2003.12	AT/MT	L/R	F	Saloon Engine B 4204 T5	862012	Outer Joint	43T	26	27	56.5	98	66.5	M
S40 II (544)														
1.6 (74 kW)	2005.01-2012.12	MT	R	F	Saloon Engine B 4164 S3	218337	Drive Shaft		36	23	51.6	48	908	
	2005.01-2012.12	MT	L	F	Saloon Engine B 4164 S3	218189	Drive Shaft		36	23	56	48	601	
	2005.01-2012.12	MT	R	F	Saloon Engine B 4164 S3	218206	Drive Shaft		36	23	56	48	906	
	2005.01-2012.12	MT	L	F	Saloon Engine B 4164 S3	818264	Outer Joint		36	25	51.6	48	58	O
	2005.01-2012.12	MT	L	F	Saloon Engine B 4164 S3	618168	Inner Joint		23	22	40	61	90	
1.6 D (81 kW)	2005.01-2012.12	-	R	F	Saloon Engine D 4164 T	218219	Drive Shaft		36	26	56.3	48	921	
	2005.01-2012.12	MT	R	F	Saloon Engine D 4164 T	899130	Outer Joint		36	26	56.3	48	61	M
1.6 D2 (84 kW)	2010.10-2012.12	MT	L	F	Saloon Engine D 4162 T	662052	Inner Joint		26	28	40	61	112.5	
	2010.10-2012.12	MT	L	F	Saloon Engine D 4162 T	262078	Drive Shaft		36	26	56.3	48	583	
	2010.10-2012.12	-	R	F	Saloon Engine D 4162 T	262053	Drive Shaft		36	26	56.3	48	917	
1.8 (92 kW)	2004.04-2010.12	-	L/R	F	Saloon Engine B 4184 S11	818203	Outer Joint		36	23	56	48	57	I
	2004.04-2010.12	MT	R	F	Saloon Engine B 4184 S11	899130	Outer Joint		36	26	56.3	48	61	M
	2004.04-2010.12	5MT	L	F	Saloon Engine B 4184 S11	218328	Drive Shaft		36	26	55.3	48	580	
	2004.04-2010.12	5MT	R	F	Saloon Engine B 4184 S11	218329	Drive Shaft		36	26	55.3	48	920	
1.8 FlexFuel (92 kW)	2006.01-2010.12	-	L/R	F	Saloon Engine B 4184 S8	818203	Outer Joint		36	23	56	48	57	I
	2006.01-2010.12	5MT	L	F	Saloon Engine B 4184 S8	218328	Drive Shaft		36	26	55.3	48	580	
	2006.01-2010.12	5MT	R	F	Saloon Engine B 4184 S8	218329	Drive Shaft		36	26	55.3	48	920	
	2006.01-2010.12	MT	R	F	Saloon Engine B 4184 S8	899130	Outer Joint		36	26	56.3	48	61	M
2.0 (107 kW)	2006.10-2012.12	AT	R	F	Saloon Engine B 4204 S3	662017	Inner Joint		28	26	34	371.5	92	
	2006.10-2012.12	-	L/R	F	Saloon Engine B 4204 S3	818203	Outer Joint		36	23	56	48	57	I
	2006.10-2012.12	AT	R	F	Saloon Engine B 4204 S3	262024	Drive Shaft		36	28	56	48	908	
	2006.10-2012.12	5MT	L	F	Saloon Engine B 4204 S3	218328	Drive Shaft		36	26	55.3	48	580	
	2006.10-2012.12	MT	R	F	Saloon Engine B 4204 S3	899130	Outer Joint		36	26	56.3	48	61	M
	2006.10-2012.12	5MT	R	F	Saloon Engine B 4204 S3	218329	Drive Shaft		36	26	55.3	48	920	
2.0 CDI (98 kW)	2005.07-2006.12	-	L	F	Saloon Engine D 4204 T2	218194	Drive Shaft		36	26	56	48	568	
	2005.07-2006.12	-	R	F	Saloon Engine D 4204 T2	218280	Drive Shaft		36	26	56	48	918	
2.0 D (100 kW)	2004.01-2010.12	AT	R	F	Saloon Engine D 4204 T	662017	Inner Joint		28	26	34	371.5	92	
	2004.01-2010.12	MT	-	F	Saloon Engine D 4204 T	862048	Outer Joint		36	26	56	48	64	I
	2004.01-2010.12	MT	L	F	Saloon Engine D 4204 T	218194	Drive Shaft		36	26	56	48	568	
	2004.01-2010.12	MT	R	F	Saloon Engine D 4204 T	218280	Drive Shaft		36	26	56	48	918	
	2004.01-2010.12	MT	L	F	Saloon Engine D 4204 T	218198	Drive Shaft		36	26	56	48	580	
	2004.01-2010.12	AT	R	F	Saloon Engine D 4204 T	262024	Drive Shaft		36	28	56	48	908	
	2004.01-2010.12	MT	R	F	Saloon Engine D 4204 T	899130	Outer Joint		36	26	56.3	48	61	M
	2004.01-2010.12	AT	L	F	Saloon Engine D 4204 T	218367	Drive Shaft		36	28	56	48	570	
2.0 D4 (96 kW)	2005.07-2006.12	AT	R	F	Saloon Engine D 4204 T2	662017	Inner Joint		28	26	34	371.5	92	
2.0 F (107 kW)	2009.10-2012.12	MT	R	F	Saloon Engine B 4204 S4	899130	Outer Joint		36	26	56.3	48	61	M
	2009.10-2012.12	-	L	F	Saloon Engine B 4204 S4	218328	Drive Shaft		36	26	55.3	48	580	
	2009.10-2012.12	-	R	F	Saloon Engine B 4204 S4	218329	Drive Shaft		36	26	55.3	48	920	
2.4 (103 kW)	2004.01-2010.12	MT	L	F	Saloon Engine B 5244 S5	262097	Drive Shaft		36	26	56	48	532	
	2004.01-2010.12	AT	R	F	Saloon Engine B 5244 S5	899132	Outer Joint		36	24	56	48	57	I
	2004.01-2010.12	MT	L	F	Saloon Engine B 5244 S5	618159	Inner joint		26	26	40	67	96.5	

VOLVO	YEAR	TRANSM	L/R	F/R	REMARKS	GSP Ref.	PRODUCT	ABS	Technical Specifications							
									A	B	C	H	L	P		
VOLVO																
S40 II (544)																
2.4 (103 kW)	2004.01-2010.12	MT	-	F	Saloon Engine B 5244 S5	862048	Outer Joint		36	26	56	48	64	I		
	2004.01-2010.12	Semi-AT	L	F	Saloon Engine B 5244 S5	262060	Drive Shaft		36	26	56	48	519			
	2004.01-2010.12	Semi-AT	R	F	Saloon Engine B 5244 S5	262063	Drive Shaft		36	26	56	48	947			
	2004.01-2010.12	AMT	L/R	F	Saloon Engine B 5244 S5	862033	Outer Joint		36	24	56	48	59	I		
	2004.01-2010.12	AT	L	F	Saloon Engine B 5244 S5	262027	Drive Shaft		36	26	56	48	515.5			
	2004.01-2010.12	AT	R	F	Saloon Engine B 5244 S5	218192	Drive Shaft		36	26	56	48	949			
2.4 (125 kW)	2004.01-2010.12	MT	L	F	Saloon Engine B 5244 S4	262097	Drive Shaft		36	26	56	48	532			
	2004.01-2010.12	AT	R	F	Saloon Engine B 5244 S4	899132	Outer Joint		36	24	56	48	57	I		
	2004.01-2010.12	MT	-	F	Saloon Engine B 5244 S4	862048	Outer Joint		36	26	56	48	64	I		
	2004.01-2010.12	Semi-AT	L	F	Saloon Engine B 5244 S4	262060	Drive Shaft		36	26	56	48	519			
	2004.01-2010.12	Semi-AT	R	F	Saloon Engine B 5244 S4	262063	Drive Shaft		36	26	56	48	947			
	2004.01-2010.12	AMT	L/R	F	Saloon Engine B 5244 S4	862033	Outer Joint		36	24	56	48	59	I		
	2004.01-2010.12	AT	L	F	Saloon Engine B 5244 S4	262027	Drive Shaft		36	26	56	48	515.5			
	2004.01-2010.12	AT	R	F	Saloon Engine B 5244 S4	218192	Drive Shaft		36	26	56	48	949			
2.4 AWD (125 kW)	2006.08-2012.12	MT	L	F	All-wheel Drive Saloon Engine B 5244 S4	618159	Inner joint		26	26	40	67	96.5			
2.4 CDI (120 kW)	2007.03-2010.12	-	L	F	Saloon Engine D 5244 T9	262060	Drive Shaft		36	26	56	48	519			
	2007.03-2010.12	-	R	F	Saloon Engine D 5244 T9	262063	Drive Shaft		36	26	56	48	947			
2.4 D5 (132 kW)	2006.03-2010.12	MT	L	F	Saloon Engine D 5244 T8	618159	Inner joint		26	26	40	67	96.5			
	2006.03-2010.12	MT	L	F	Saloon Engine D 5244 T8	262097	Drive Shaft		36	26	56	48	532			
	2006.03-2010.12	AT	R	F	Saloon Engine D 5244 T8	899132	Outer Joint		36	24	56	48	57	I		
	2006.03-2010.12	MT	-	F	Saloon Engine D 5244 T8	899155	Outer Joint		36	26	56	48	64	I		
	2006.03-2010.12	MT	-	F	Saloon Engine D 5244 T8	862048	Outer Joint		36	26	56	48	64	I		
	2006.03-2010.12	-	L	F	Saloon Engine D 5244 T8	262060	Drive Shaft		36	26	56	48	519			
	2006.03-2010.12	-	R	F	Saloon Engine D 5244 T8	262063	Drive Shaft		36	26	56	48	947			
	2006.03-2010.12	-	L/R	F	Saloon Engine D 5244 T8	862033	Outer Joint		36	24	56	48	59	I		
	2006.03-2010.12	AT	L	F	Saloon Engine D 5244 T8	262027	Drive Shaft		36	26	56	48	515.5			
	2006.03-2010.12	AT	R	F	Saloon Engine D 5244 T8	218192	Drive Shaft		36	26	56	48	949			
2.5 (162 kW)	2004.01-2007.12	MT	L	F	Saloon Engine B 5254 T3	262097	Drive Shaft		36	26	56	48	532			
	2004.01-2007.12	AT	R	F	Saloon Engine B 5254 T3	899132	Outer Joint		36	24	56	48	57	I		
	2004.01-2007.12	MT	R	F	Saloon Engine B 5254 T3	662046	Inner joint		26	26	28	513.5	93			
	2004.01-2007.12	-	-	F	Saloon Engine B 5254 T3	862048	Outer Joint		36	26	56	48	64	I		
	2004.01-2007.12	Semi-AT	L	F	Saloon Engine B 5254 T3	262060	Drive Shaft		36	26	56	48	519			
	2004.01-2007.12	MT	R	F	Saloon Engine B 5254 T3	262100	Drive Shaft		36	26	56	48	954			
	2004.01-2007.12	Semi-AT	R	F	Saloon Engine B 5254 T3	262063	Drive Shaft		36	26	56	48	947			
	2004.01-2007.12	AMT	L/R	F	Saloon Engine B 5254 T3	862033	Outer Joint		36	24	56	48	59	I		
	2004.01-2007.12	AT	L	F	Saloon Engine B 5254 T3	262027	Drive Shaft		36	26	56	48	515.5			
	2004.01-2007.12	AT	R	F	Saloon Engine B 5254 T3	218192	Drive Shaft		36	26	56	48	949			
2.5 (169 kW)	2007.03-2012.12	MT	L	F	Saloon Engine B 5254 T7	618159	Inner joint		26	26	40	67	96.5			
	2007.03-2012.12	MT	L	F	Saloon Engine B 5254 T7	262097	Drive Shaft		36	26	56	48	532			
	2007.03-2012.12	AT	R	F	Saloon Engine B 5254 T7	899132	Outer Joint		36	24	56	48	57	I		
	2007.03-2012.12	AT	L	F	Saloon Engine B 5254 T7	262060	Drive Shaft		36	26	56	48	519			
	2007.03-2012.12	AT	R	F	Saloon Engine B 5254 T7	262063	Drive Shaft		36	26	56	48	947			
	2007.03-2012.12	AT	L/R	F	Saloon Engine B 5254 T7	862033	Outer Joint		36	24	56	48	59	I		
	2007.03-2012.12	AT	L	F	Saloon Engine B 5254 T7	262027	Drive Shaft		36	26	56	48	515.5			
	2007.03-2012.12	AT	R	F	Saloon Engine B 5254 T7	218192	Drive Shaft		36	26	56	48	949			
2.5 AWD (162 kW)	2004.04-2007.12	MT	L	F	All-wheel Drive Saloon Engine B 5254 T3	618159	Inner joint		26	26	40	67	96.5			
	2004.04-2007.12	-	-	F	All-wheel Drive Saloon Engine B 5254 T3	862048	Outer Joint		36	26	56	48	64	I		
	2004.04-2007.12	AT/MT	-	-	All-wheel Drive Saloon Engine B 5254 T3	635008	Inner Joint			24		23.5				
	2004.04-2007.12	-	L	F	All-wheel Drive Saloon Engine B 5254 T3	262060	Drive Shaft		36	26	56	48	519			
	2004.04-2007.12	-	R	F	All-wheel Drive Saloon Engine B 5254 T3	262063	Drive Shaft		36	26	56	48	947			
	2004.04-2007.12	-	L/R	F	All-wheel Drive Saloon Engine B 5254 T3	862033	Outer Joint		36	24	56	48	59	I		
2.5 AWD (169 kW)	2007.03-2010.12	MT	R	F	All-wheel Drive Saloon Engine B 5254 T7	662045	Inner joint		26	26	28	528	93			
	2007.03-2010.12	-	R	F	All-wheel Drive Saloon Engine B 5254 T7	662047	Inner joint		26	26	28	513.5	93			
	2007.03-2010.12	-	-	F	All-wheel Drive Saloon Engine B 5254 T7	862048	Outer Joint		36	26	56	48	64	I		
	2007.03-2010.12	AT/MT	-	-	All-wheel Drive Saloon Engine B 5254 T7	635008	Inner Joint			24		23.5				
D3 (110 kW)	2010.10-2012.12	6AT	L	F	Saloon Engine D 5204 T5	262108	Drive Shaft		36	31	56	48	506			
	2010.10-2012.12	6AT	R	F	Saloon Engine D 5204 T5	662048	Inner joint		28	26	33	520	100.5			
	2010.10-2012.12	-	-	F	Saloon Engine D 5204 T5	899155	Outer Joint		36	26	56	48	64	I		
D4 (130 kW)	2010.10-2012.12	6AT	L	F	Saloon Engine D 5204 T	262108	Drive Shaft		36	31	56	48	506			
	2010.10-2012.12	-	-	F	Saloon Engine D 5204 T	899155	Outer Joint		36	26	56	48	64	I		
S40I/V40 (VS, VW), SW																
1.9 Di (85 kW)	2000.07-2003.12	-	-	-	-	862024	Outer Joint	43T	26	27	56.5	98	66.5	M		
2.0 T (120 kW)	2000-2003	-	-	-	-	862024	Outer Joint	43T	26	27	56.5	98	66.5	M		
2.0 T (121 kW)	2000-2003	-	-	-	-	862024	Outer Joint	43T	26	27	56.5	98	66.5	M		
2.0 T4 (147 kW)	1997.05-2000.12	-	-	-	-	862024	Outer Joint	43T	26	27	56.5	98	66.5	M		
S60																





YEAR	TRANSM	L/R	F/R	REMARKS	GSP Ref.	PRODUCT	ABS	Technical Specifications										
								A	B	C	H	L	P					
VOLVO																		
S60																		
2.0 2L	2014.01-2015.12	-	-	F	-	262124	Drive Shaft		40	28	57.5	52	954					
2.4	2002-2003	-	-	-	5 cylinder Turbo	699195	Propshaft CV Joint			19		22.6						
2.5	2003-2009	-	-	-	5 cylinder Turbo	699195	Propshaft CV Joint			19		22.6						
	2003-2009	-	-	-	5 cylinder Turbo (T5)	699195	Propshaft CV Joint			19		22.6						
S60 I (384)																		
2.0 T (132 kW)	2000.07-2010.04	AT/MT	L/R	F	Saloon Engine B 5204 T5	862009	Outer Joint	48T	36	27	56.5	48	66	M				
	2000.07-2010.04	AT	R	F	Saloon Engine B 5204 T5	262015	Drive Shaft	48T	36	26	56.5	48	974					
	2000.07-2010.04	AT	R	F	Saloon Engine B 5204 T5	662029	Inner Joint		26	26	31	513	93.5					
	2000.07-2010.04	MT	L	F	Saloon Engine B 5204 T5	862038	Outer Joint		36	25	56.5	48	58	M				
	2000.07-2010.04	AT	L	F	Saloon Engine B 5204 T5	862019	Outer Joint		36	27	56.5	48	66	M				
	2000.07-2010.04	MT	R	F	Saloon Engine B 5204 T5	262031	Drive Shaft	48T	36	26	56.5	48	992					
	2000.07-2010.04	AT	L	F	Saloon Engine B 5204 T5	262022	Drive Shaft	48T	36	26	56.5	48	527					
	2000.07-2010.04	AT	R	F	Saloon Engine B 5204 T5	262017	Drive Shaft	48T	36	26	56.5	48	978.5					
	2000.07-2010.04	AT	L	F	Saloon Engine B 5204 T5	262012	Drive Shaft	48T	36	26	56.5	48	526					
2.4 (103 kW)	2000.07-2010.04	MT	R	F	Saloon Engine B 5244 S2	662030	Inner Joint		26	25	40	526	92.5					
	2000.07-2010.04	MT	L	F	Saloon Engine B 5244 S2	862038	Outer Joint		36	25	56.5	48	58	M				
	2000.07-2010.04	MT	R	F	Saloon Engine B 5244 S2	862040	Outer Joint	48T	36	25	56.5	48	58	M				
	2000.07-2010.04	AT/MT	L/R	F	Saloon Engine B 5244 S2	862010	Outer Joint	48T	36	33	56.5	48	58	M				
	2000.07-2010.04	MT	R	F	Saloon Engine B 5244 S2	262028	Drive Shaft	48T	36	26	56.5	48	990					
	2000.07-2010.04	AT	L	F	Saloon Engine B 5244 S2	262012	Drive Shaft	48T	36	26	56.5	48	526					
	2000.07-2010.04	AT	R	F	Saloon Engine B 5244 S2	262015	Drive Shaft	48T	36	26	56.5	48	974					
2.4 (125 kW)	2000.11-2010.04	5AT	R	F	Saloon Engine B 5244 S	262015	Drive Shaft	48T	36	26	56.5	48	974					
	2000.11-2010.04	5MT	R	F	Saloon Engine B 5244 S	662030	Inner Joint		26	25	40	526	92.5					
	2000.11-2010.04	MT	L	F	Saloon Engine B 5244 S	862038	Outer Joint		36	25	56.5	48	58	M				
	2000.11-2010.04	5MT	R	F	Saloon Engine B 5244 S	862040	Outer Joint	48T	36	25	56.5	48	58	M				
	2000.11-2010.04	AT/MT	L/R	F	Saloon Engine B 5244 S	862010	Outer Joint	48T	36	33	56.5	48	58	M				
	2000.11-2010.04	5MT	R	F	Saloon Engine B 5244 S	262028	Drive Shaft	48T	36	26	56.5	48	990					
	2000.11-2010.04	5AT	L	F	Saloon Engine B 5244 S	262012	Drive Shaft	48T	36	26	56.5	48	526					
2.4 Bifuel (103 kW)	2001.07-2010.04	AT	R	F	Saloon Engine B 5244 SG	262015	Drive Shaft	48T	36	26	56.5	48	974					
	2001.07-2010.04	AT	R	F	Saloon Engine B 5244 SG2	262015	Drive Shaft	48T	36	26	56.5	48	974					
	2001.07-2010.04	MT	R	F	Saloon Engine B 5244 SG	662030	Inner Joint		26	25	40	526	92.5					
	2001.07-2010.04	MT	R	F	Saloon Engine B 5244 SG2	662030	Inner Joint		26	25	40	526	92.5					
	2001.07-2010.04	AT	R	F	Saloon Engine B 5244 SG	662029	Inner Joint		26	26	31	513	93.5					
	2001.07-2010.04	AT	R	F	Saloon Engine B 5244 SG2	662029	Inner Joint		26	26	31	513	93.5					
	2001.07-2010.04	MT	L	F	Saloon Engine B 5244 SG	862038	Outer Joint		36	25	56.5	48	58	M				
	2001.07-2010.04	MT	L	F	Saloon Engine B 5244 SG2	862038	Outer Joint		36	25	56.5	48	58	M				
	2001.07-2010.04	MT	R	F	Saloon Engine B 5244 SG	862040	Outer Joint	48T	36	25	56.5	48	58	M				
	2001.07-2010.04	MT	R	F	Saloon Engine B 5244 SG2	862040	Outer Joint	48T	36	25	56.5	48	58	M				
	2001.07-2010.04	AT/MT	L/R	F	Saloon Engine B 5244 SG2	862010	Outer Joint	48T	36	33	56.5	48	58	M				
	2001.07-2010.04	AT	R	F	Saloon Engine B 5244 SG	262017	Drive Shaft	48T	36	26	56.5	48	978.5					
	2001.07-2010.04	AT	R	F	Saloon Engine B 5244 SG2	262017	Drive Shaft	48T	36	26	56.5	48	978.5					
	2001.07-2010.04	MT	R	F	Saloon Engine B 5244 SG	262028	Drive Shaft	48T	36	26	56.5	48	990					
	2001.07-2010.04	MT	R	F	Saloon Engine B 5244 SG2	262028	Drive Shaft	48T	36	26	56.5	48	990					
	2001.07-2010.04	AT	L	F	Saloon Engine B 5244 SG	262012	Drive Shaft	48T	36	26	56.5	48	526					
	2001.07-2010.04	AT	L	F	Saloon Engine B 5244 SG2	262012	Drive Shaft	48T	36	26	56.5	48	526					
2.4 CDI (85 kW)	2003.10-2005.12	MT	R	F	Saloon Engine D 5244 T3	262031	Drive Shaft	48T	36	26	56.5	48	992					
2.4 D (120 kW)	2005.07-2009.12	5AT	R	F	Saloon Engine D 5244 T5	662029	Inner Joint		26	26	31	513	93.5					
	2005.07-2009.12	MT	L	F	Saloon Engine D 5244 T5	862038	Outer Joint		36	25	56.5	48	58	M				
	2005.07-2009.12	MT	R	F	Saloon Engine D 5244 T5	262031	Drive Shaft	48T	36	26	56.5	48	992					
	2005.07-2009.12	6AT/6MT	-	F	Saloon Engine D 5244 T5	862037	Outer Joint	48T	36	27	56.5	48	66	M				
	2005.07-2009.12	5AT	R	F	Saloon Engine D 5244 T5	262017	Drive Shaft	48T	36	26	56.5	48	978.5					
	2005.07-2009.12	AT	L	F	Saloon Engine D 5244 T5	262141	Drive Shaft	48T	36	28	56.5	48	521					
2.4 D (93 kW)	2005.03-2010.04	-	R	F	Saloon Engine D 5244 T7	262031	Drive Shaft	48T	36	26	56.5	48	992					
	2005.03-2010.04	6MT	-	F	Saloon Engine D 5244 T7	862037	Outer Joint	48T	36	27	56.5	48	66	M				
2.4 D (96 kW)	2001.05-2010.04	AT	R	F	Saloon Engine D 5244 T2	262015	Drive Shaft	48T	36	26	56.5	48	974					
	2001.05-2010.04	AT	L	F	Saloon Engine D 5244 T2	862019	Outer Joint		36	27	56.5	48	66	M				
	2001.05-2010.04	MT	R	F	Saloon Engine D 5244 T2	262031	Drive Shaft	48T	36	26	56.5	48	992					
	2001.05-2010.04	AT	L	F	Saloon Engine D 5244 T2	262022	Drive Shaft	48T	36	26	56.5	48	527					
	2001.05-2010.04	6MT	-	F	Saloon Engine D 5244 T2	862037	Outer Joint	48T	36	27	56.5	48	66	M				
	2001.05-2010.04	AT/MT	L/R	F	Saloon Engine D 5244 T2	862009	Outer Joint	48T	36	27	56.5	48	66	M				
	2001.05-2010.04	AT	L	F	Saloon Engine D 5244 T2	262012	Drive Shaft	48T	36	26	56.5	48	526					
2.4 D5 (120 kW)	2001.01-2010.04	AT	R	F	Saloon Engine D 5244 T	262015	Drive Shaft	48T	36	26	56.5	48	974					
	2001.01-2010.04	5AT	R	F	Saloon Engine D 5244 T	662029	Inner Joint		26	26	31	513	93.5					
	2001.01-2010.04	MT	L	F	Saloon Engine D 5244 T	862038	Outer Joint		36	25	56.5	48	58	M				
	2001.01-2010.04	AT	L	F	Saloon Engine D 5244 T	862019	Outer Joint		36	27	56.5	48	66	M				
	2001.01-2010.04	MT	R	F	Saloon Engine D 5244 T	262031	Drive Shaft	48T	36	26	56.5	48	992					

VOLVO	YEAR	TRANSM	L/R	F/R	REMARKS	GSP Ref.	PRODUCT	ABS	Technical Specifications						
									A	B	C	H	L	P	
VOLVO															
S60 I (384)															
2.4 D5 (120 kW)	2001.01-2010.04	AT	L	F	Saloon Engine D 5244 T	262022	Drive Shaft	48T	36	26	56.5	48	527		
	2001.01-2010.04	6AT/6MT	-	F	Saloon Engine D 5244 T	862037	Outer Joint	48T	36	27	56.5	48	66	M	
	2001.01-2010.04	5AT	R	F	Saloon Engine D 5244 T	262017	Drive Shaft	48T	36	26	56.5	48	978.5		
	2001.01-2010.04	AT	L	F	Saloon Engine D 5244 T	262141	Drive Shaft	48T	36	28	56.5	48	521		
	2001.01-2010.04	AT	L	F	Saloon Engine D 5244 T	262012	Drive Shaft	48T	36	26	56.5	48	526		
2.4 D5 (136 kW)	2005.03-2010.04	5AT	R	F	Saloon Engine D 5244 T4	662029	Inner Joint		26	26	31	513	93.5		
	2005.03-2010.04	MT	L	F	Saloon Engine D 5244 T4	862038	Outer Joint		36	25	56.5	48	58	M	
	2005.03-2010.04	6AT/6MT	-	F	Saloon Engine D 5244 T4	862037	Outer Joint	48T	36	27	56.5	48	66	M	
	2005.03-2010.04	5AT	R	F	Saloon Engine D 5244 T4	262017	Drive Shaft	48T	36	26	56.5	48	978.5		
	2005.03-2010.04	AT	L	F	Saloon Engine D 5244 T4	262141	Drive Shaft	48T	36	28	56.5	48	521		
2.4 T (147 kW)	2000.07-2010.04	AT	R	F	Saloon Engine B 5244 T3	262015	Drive Shaft	48T	36	26	56.5	48	974		
	2000.07-2010.04	AT	R	F	Saloon Engine B 5244 T3	662029	Inner Joint		26	26	31	513	93.5		
	2000.07-2010.04	MT	R	F	Saloon Engine B 5244 T3	262031	Drive Shaft	48T	36	26	56.5	48	992		
	2000.07-2010.04	MT	L	F	Saloon Engine B 5244 T3	862038	Outer Joint		36	25	56.5	48	58	M	
	2000.07-2010.04	AT	L	F	Saloon Engine B 5244 T3	862019	Outer Joint		36	27	56.5	48	66	M	
	2000.07-2010.04	AT	L	F	Saloon Engine B 5244 T3	262022	Drive Shaft	48T	36	26	56.5	48	527		
	2000.07-2010.04	AT	R	F	Saloon Engine B 5244 T3	262017	Drive Shaft	48T	36	26	56.5	48	978.5		
	2000.07-2010.04	AT/MT	L/R	F	Saloon Engine B 5244 T3	862009	Outer Joint	48T	36	27	56.5	48	66	M	
	2000.07-2010.04	AT	L	F	Saloon Engine B 5244 T3	262012	Drive Shaft	48T	36	26	56.5	48	526		
	2000.07-2010.04	AT	L	F	Saloon Engine B 5244 T3	862009	Outer Joint	48T	36	27	56.5	48	66	M	
2.4 T AWD (147 kW)	2001.06-2010.04	AT/MT	L/R	F	All-wheel Drive Saloon Engine B 5244 T3	862009	Outer Joint	48T	36	27	56.5	48	66	M	
	2001.06-2010.04	AT	R	F	All-wheel Drive Saloon Engine B 5244 T3	262015	Drive Shaft	48T	36	26	56.5	48	974		
	2001.06-2010.04	AT	L	F	All-wheel Drive Saloon Engine B 5244 T3	862019	Outer Joint		36	27	56.5	48	66	M	
	2001.06-2010.04	MT	R	F	All-wheel Drive Saloon Engine B 5244 T3	262031	Drive Shaft	48T	36	26	56.5	48	992		
	2001.06-2010.04	AT/MT	-	-	All-wheel Drive Saloon Engine B 5244 T3	635008	Inner Joint			24		23.5			
	2001.06-2010.04	AT	L	F	All-wheel Drive Saloon Engine B 5244 T3	262022	Drive Shaft	48T	36	26	56.5	48	527		
	2001.06-2010.04	AT	R	F	All-wheel Drive Saloon Engine B 5244 T3	262140	Drive Shaft	48T	36	26	56.5	48	977		
2.4 T5 (191 kW)	2004.04-2010.04	AT	R	F	Saloon Engine B 5244 T5	262015	Drive Shaft	48T	36	26	56.5	48	974		
	2004.04-2010.04	AT/MT	L/R	F	Saloon Engine B 5244 T5	862009	Outer Joint	48T	36	27	56.5	48	66	M	
	2004.04-2010.04	AT	R	F	Saloon Engine B 5244 T5	662029	Inner Joint		26	26	31	513	93.5		
	2004.04-2010.04	MT	L	F	Saloon Engine B 5244 T5	862038	Outer Joint		36	25	56.5	48	58	M	
	2004.04-2010.04	AT	L	F	Saloon Engine B 5244 T5	862019	Outer Joint		36	27	56.5	48	66	M	
	2004.04-2010.04	MT	R	F	Saloon Engine B 5244 T5	262031	Drive Shaft	48T	36	26	56.5	48	992		
	2004.04-2010.04	AT	L	F	Saloon Engine B 5244 T5	262022	Drive Shaft	48T	36	26	56.5	48	527		
	2004.04-2010.04	AT	R	F	Saloon Engine B 5244 T5	262017	Drive Shaft	48T	36	26	56.5	48	978.5		
	2004.04-2010.04	AT	L	F	Saloon Engine B 5244 T5	262012	Drive Shaft	48T	36	26	56.5	48	526		
	2004.04-2010.04	AT	R	F	Saloon Engine B 5244 T5	262015	Drive Shaft	48T	36	26	56.5	48	974		
2.5 (184 kW)	2000.07-2010.04	AT	R	F	Saloon Engine B 5234 T3	262015	Drive Shaft	48T	36	26	56.5	48	974		
	2000.07-2010.04	AT	R	F	Saloon Engine B 5234 T3	662029	Inner Joint		26	26	31	513	93.5		
	2000.07-2010.04	MT	R	F	Saloon Engine B 5234 T3	262031	Drive Shaft	48T	36	26	56.5	48	992		
	2000.07-2010.04	MT	L	F	Saloon Engine B 5234 T3	862038	Outer Joint		36	25	56.5	48	58	M	
	2000.07-2010.04	AT	L	F	Saloon Engine B 5234 T3	862019	Outer Joint		36	27	56.5	48	66	M	
	2000.07-2010.04	AT	L	F	Saloon Engine B 5234 T3	262022	Drive Shaft	48T	36	26	56.5	48	527		
	2000.07-2010.04	AT	R	F	Saloon Engine B 5234 T3	262017	Drive Shaft	48T	36	26	56.5	48	978.5		
	2000.07-2010.04	AT/MT	L/R	F	Saloon Engine B 5234 T3	862009	Outer Joint	48T	36	27	56.5	48	66	M	
	2000.07-2010.04	AT	L	F	Saloon Engine B 5234 T3	262012	Drive Shaft	48T	36	26	56.5	48	526		
	2000.07-2010.04	AT	L	F	Saloon Engine B 5234 T3	862009	Outer Joint	48T	36	27	56.5	48	66	M	
2.5 T (154 kW)	2003.01-2010.04	AT/MT	L/R	F	Saloon Engine B 5254 T2	862009	Outer Joint	48T	36	27	56.5	48	66	M	
	2003.01-2010.04	6AT	R	F	Saloon Engine B 5254 T2	262015	Drive Shaft	48T	36	26	56.5	48	974		
	2003.01-2010.04	AT	L	F	Saloon Engine B 5254 T2	662029	Inner Joint		26	26	31	513	93.5		
	2003.01-2010.04	MT	L	F	Saloon Engine B 5254 T2	862038	Outer Joint		36	25	56.5	48	58	M	
	2003.01-2010.04	MT	R	F	Saloon Engine B 5254 T2	262031	Drive Shaft	48T	36	26	56.5	48	992		
	2003.01-2010.04	AT	L	F	Saloon Engine B 5254 T2	262022	Drive Shaft	48T	36	26	56.5	48	527		
	2003.01-2010.04	AT	L	F	Saloon Engine B 5254 T2	262017	Drive Shaft	48T	36	26	56.5	48	978.5		
	2003.01-2010.04	5AT	L	F	Saloon Engine B 5254 T2	262012	Drive Shaft	48T	36	26	56.5	48	526		
2.5 T AWD (154 kW)	2002.07-2010.04	AT/MT	L/R	F	All-wheel Drive Saloon Engine B 5254 T2	862009	Outer Joint	48T	36	27	56.5	48	66	M	
	2002.07-2010.04	MT/AT	L	F	All-wheel Drive Saloon Engine B 5254 T2	862019	Outer Joint		36	27	56.5	48	66	M	
	2002.07-2010.04	AT/MT	L	F	All-wheel Drive Saloon Engine B 5254 T2	262022	Drive Shaft	48T	36	26	56.5	48	527		
	2002.07-2010.04	AT/MT	-	-	All-wheel Drive Saloon Engine B 5254 T2	635008	Inner Joint			24		23.5			
	2002.07-2010.04	AT	R	F	All-wheel Drive Saloon Engine B 5254 T2	262140	Drive Shaft	48T	36	26	56.5	48	977		
2.5 T AWD (221 kW)	2003.01-2010.04	AT/MT	L/R	F	All-wheel Drive Saloon Engine B 5254 T4	862009	Outer Joint	48T	36	27	56.5	48	66	M	
	2003.01-2010.04	MT	L	F	All-wheel Drive Saloon Engine B 5254 T4	862038	Outer Joint		36	25	56.5	48	58	M	
	2003.01-2010.04	AT/MT	-	-	All-wheel Drive Saloon Engine B 5254 T4	635008	Inner Joint			24		23.5			
	2003.01-2010.04	AT	R	F	All-wheel Drive Saloon Engine B 5254 T4	262140	Drive Shaft	48T	36	26	56.5	48	977		
	2003.01-2010.04	AT	R	F	All-wheel Drive Saloon Engine B 5254 T4	262140	Drive Shaft	48T	36	26	56.5	48	977		
S60 II															
-	2011-	2018	-	L	F	-	262127	Drive Shaft		40	28	57.4	52	602	
S60 II (134)															





VOLVO	YEAR	TRANSM	L/R	F/R	REMARKS	GSP Ref.	PRODUCT	ABS	Technical Specifications					
									A	B	C	H	L	P
VOLVO														
S60 II (134)														
2.0 (177 kW)	2010.04-2014.12	AT	R	F	Saloon Engine B 4204 T7	262112	Drive Shaft		40	26	57.4	52	962	
	2010.04-2014.12	6AT	R	F	Saloon Engine B 4204 T7	262114	Drive Shaft		40	28	57.4	52	952	
	2010.04-2014.12	6AT	L	F	Saloon Engine B 4204 T7	262113	Drive Shaft		40	28	57.4	52	590	
	2010.04-2014.12	AT	L	F	Saloon Engine B 4204 T7	262134	Drive Shaft		40	26	57.4	52	599	
	2010.04-2014.12	6AT	-	-	Saloon Engine B 4204 T7	818269	Outer Joint		40	26	57.4	52	63.5	I
2.0 T (149 kW)	2010.04-2011.12	AT	R	F	Saloon Engine B 4204 T6	262112	Drive Shaft		40	26	57.4	52	962	
	2010.04-2011.12	AT	L	F	Saloon Engine B 4204 T6	262134	Drive Shaft		40	26	57.4	52	599	
	2010.04-2011.12	6AT	-	-	Saloon Engine B 4204 T6	818269	Outer Joint		40	26	57.4	52	63.5	I
2.4 D4 AWD (140 kW)	2015.03-	AT	L/R	R	All-wheel Drive Saloon Engine D 5244 T21	201129	Drive Shaft		36	26	56.5	49.5	756	
2.5 (151 kW)	2010.04-2011.12	AT	-	F	Saloon Engine D 5244 T10	859344	Outer Joint		40	26	57.4	52	63.5	M
	2010.04-2011.12	MT	R	F	Saloon Engine D 5244 T10	601076	Inner Joint		26	28	40	522.5	94.5	
	2010.04-2011.12	AT	L	F	Saloon Engine D 5244 T10	262109	Drive Shaft		40	31	57.4	52	524	
2.5 (158 kW)	2011.04-2015.12	AT	-	F	Saloon Engine D 5244 T11	859344	Outer Joint		40	26	57.4	52	63.5	M
	2011.04-2015.12	MT	R	F	Saloon Engine D 5244 T11	601076	Inner Joint		26	28	40	522.5	94.5	
	2011.04-2015.12	AT	L	F	Saloon Engine D 5244 T11	262109	Drive Shaft		40	31	57.4	52	524	
2.5 AWD (151 kW)	2010.04-2011.12	AT	-	-	All-wheel Drive Saloon Engine D 5244 T10	859344	Outer Joint		40	26	57.4	52	63.5	M
	2010.04-2011.12	AT	L	F	All-wheel Drive Saloon Engine D 5244 T10	259443	Drive Shaft		40	31	57.4	52	528	
	2010.04-2011.12	-	L/R	R	All-wheel Drive Saloon Engine D 5244 T10	201129	Drive Shaft		36	26	56.5	49.5	756	
	2010.04-2011.12	AT	L	F	All-wheel Drive Saloon Engine D 5244 T10	262109	Drive Shaft		40	31	57.4	52	524	
2.5 AWD (158 kW)	2011.04-2015.12	AT	L	F	All-wheel Drive Saloon Engine D 5244 T11	259443	Drive Shaft		40	31	57.4	52	528	
	2011.04-2015.12	AT	-	-	All-wheel Drive Saloon Engine D 5244 T11	859344	Outer Joint		40	26	57.4	52	63.5	M
	2011.04-2015.12	6AT	R	F	All-wheel Drive Saloon Engine D 5244 T11	662033	Inner Joint		28	27	30	521	102.5	
	2011.04-2015.12	AT	L/R	R	All-wheel Drive Saloon Engine D 5244 T11	201129	Drive Shaft		36	26	56.5	49.5	756	
3.0 T AWD (258 kW)	2011.04-2015.12	AT	L	F	All-wheel Drive Saloon Engine D 5244 T11	262109	Drive Shaft		40	31	57.4	52	524	
	2014.04-	AT	L/R	R	All-wheel Drive Saloon Engine B 6304 T5	201129	Drive Shaft		36	26	56.5	49.5	756	
D3 (100 kW)	2012.05-2015.12	MT	R	F	Saloon Engine D 5204 T7	601076	Inner Joint		26	28	40	522.5	94.5	
D3 (120 kW)	2010.04-2014.12	AT	L	F	Saloon Engine D 5204 T2	259443	Drive Shaft		40	31	57.4	52	528	
	2010.04-2014.12	AT	R	F	Saloon Engine D 5204 T2	259444	Drive Shaft		40	28	57.4	52	994	
	2010.04-2014.12	MT	R	F	Saloon Engine D 5204 T2	601076	Inner Joint		26	28	40	522.5	94.5	
	2010.04-2014.12	AT	L	F	Saloon Engine D 5204 T2	262109	Drive Shaft		40	31	57.4	52	524	
D4 (120 kW)	2010.04-2014.12	AT	L	F	Saloon Engine D 5204 T3	259443	Drive Shaft		40	31	57.4	52	528	
	2010.04-2014.12	AT	R	F	Saloon Engine D 5204 T3	259444	Drive Shaft		40	28	57.4	52	994	
	2010.04-2014.12	MT	R	F	Saloon Engine D 5204 T3	601076	Inner Joint		26	28	40	522.5	94.5	
	2010.04-2014.12	AT	L	F	Saloon Engine D 5204 T3	262109	Drive Shaft		40	31	57.4	52	524	
D5 AWD (169 kW)	2014.04-2015.12	AT	L/R	R	All-wheel Drive Saloon Engine D 5244 T15	201129	Drive Shaft		36	26	56.5	49.5	756	
T3 (110 kW)	2010.04-2015.12	MT	R	F	Saloon Engine B 4164 T3	662041	Inner joint		26	28	40	447	95.5	
T4 (132 kW)	2010.04-2015.12	6AT	R	F	Saloon Engine B 4164 T	601078	Inner Joint		28	28	34	446.5	95.5	
	2010.04-2015.12	6AT	L	F	Saloon Engine B 4164 T	601077	Inner Joint		28	28	42.5	80	95.5	
T6 AWD (224 kW)	2010.04-2015.12	-	L/R	R	All-wheel Drive Saloon Engine B 6304 T4	201129	Drive Shaft		36	26	56.5	49.5	756	
	2010.04-2015.12	AT	L/R	F	All-wheel Drive Saloon Engine B 6304 T4	862042	Outer Joint		40	27	57.4	52	63.5	M
T6 AWD (242 kW)	2014.04-2015.12	AT	L/R	R	All-wheel Drive Saloon Engine B 6304 T4	201129	Drive Shaft		36	26	56.5	49.5	756	
S70														
-	1999-	2000	-	-	-	699195	Propshaft CV Joint			19		22.6		
S70 (874)														
2.0 (105 kW)	1997.01-2000.11	MT	R	F	Saloon Engine B 5204 F	662015	Inner Joint		26	25	40	531.5	66.5	
	1997.01-2000.11	AT	R	F	Saloon Engine B 5204 F	262002	Drive Shaft	48T	26	26	56.5	98.5	1028	
	1997.01-2000.11	-	-	-	Saloon Engine B 5204 F	862014	Outer Joint		26	25	56.5	98.5	56	O
	1997.01-2000.11	AT/MT	L/R	F	Saloon Engine B 5204 F	862001	Outer Joint	48T	26	25	56.5	98.5	56	O
2.0 (120 kW)	1997.01-2000.11	-	-	-	Saloon Engine B 5204 T4	862014	Outer Joint		26	25	56.5	98.5	56	O
	1997.01-2000.11	MT	L	F	Saloon Engine B 5204 T4	862009	Outer Joint	48T	36	27	56.5	48	66	M
2.0 (132 kW)	1997.01-2000.11	MT	R	F	Saloon Engine B 5204 T2	662015	Inner Joint		26	25	40	531.5	66.5	
	1997.01-2000.11	AT	R	F	Saloon Engine B 5204 T2	262002	Drive Shaft	48T	26	26	56.5	98.5	1028	
	1997.01-2000.11	-	-	-	Saloon Engine B 5204 T2	862014	Outer Joint		26	25	56.5	98.5	56	O
	1997.01-2000.11	AT/MT	L/R	F	Saloon Engine B 5204 T2	862001	Outer Joint	48T	26	25	56.5	98.5	56	O
2.0 (93 kW)	1997.01-2000.11	MT	R	F	Saloon Engine B 5202 FS	662015	Inner Joint		26	25	40	531.5	66.5	
	1997.01-2000.11	AT	R	F	Saloon Engine B 5202 FS	262002	Drive Shaft	48T	26	26	56.5	98.5	1028	
	1997.01-2000.11	-	-	-	Saloon Engine B 5202 FS	862014	Outer Joint		26	25	56.5	98.5	56	O
	1997.01-2000.11	AT/MT	L/R	F	Saloon Engine B 5202 FS	862010	Outer Joint	48T	36	33	56.5	48	58	M
2.0 Turbo (155 kW)	1997.01-2000.11	AT/MT	L/R	F	Saloon Engine B 5204 T	862016	Outer Joint		26	28	56.5	97.5	66	O
	1997.01-2000.11	AT/MT	L/R	F	Saloon Engine B 5204 T	862002	Outer Joint	48T	26	28	56.5	97.5	66	O
2.0 Turbo (166 kW)	1997.01-2000.11	AT	L	F	Saloon Engine B 5204 T3	262001	Drive Shaft	48T	26	26	56.5	98.5	574.5	
	1997.01-2000.11	AT/MT	L/R	F	Saloon Engine B 5204 T3	862016	Outer Joint		26	28	56.5	97.5	66	O
	1997.01-2000.11	AT/MT	L/R	F	Saloon Engine B 5204 T3	862002	Outer Joint	48T	26	28	56.5	97.5	66	O
	1997.01-2000.11	MT	L	F	Saloon Engine B 5204 T3	862009	Outer Joint	48T	36	27	56.5	48	66	M
2.3 (177 kW)	1996.11-2000.11	-	-	R	Saloon Engine B 5234 T3	818290	Outer Joint		36	29	56.5	49.5	64	I

YEAR	TRANSM	L/R	F/R	REMARKS	GSP Ref.	PRODUCT	ABS	Technical Specifications						
								A	B	C	H	L	P	
VOLVO														
S70 (874)														
2.3 (177 kW)	1996.11-2000.11	-	L	F	Saloon Engine B 5234 T3	618044	Inner Joint		26	23	40	68.5	99.5	
	1996.11-2000.11	-	-	F	Saloon Engine B 5234 T3	862031	Outer Joint	48T	36	27	56.5	55	65	M
	1996.11-2000.11	-	-	F	Saloon Engine B 5234 T3	859285	Outer Joint		40	27	57.4	52	63.5	M
	1996.11-2000.11	-	-	F	Saloon Engine B 5234 T3	862045	Outer Joint		40	26	57.4	52	62.5	M
	1996.11-2000.11	-	L	F	Saloon Engine B 5234 T3	801424	Outer Joint		31	27	36.2	70	62	M
	1996.11-2000.11	-	-	R	Saloon Engine B 5234 T3	618187	Inner Joint		26	29	35	69.5	107.5	
2.3 T-5 (176 kW)	1997.01-2000.11	AT/MT	L/R	F	Saloon Engine B 5234 T3	862016	Outer Joint		26	28	56.5	97.5	66	O
	1997.01-2000.11	AT/MT	L/R	F	Saloon Engine B 5234 T3	862002	Outer Joint	48T	26	28	56.5	97.5	66	O
	1997.01-2000.11	AT/MT	L/R	F	Saloon Engine B 5234 T3	862009	Outer Joint	48T	36	27	56.5	48	66	M
2.3 Turbo (184 kW)	1997.01-2000.11	AT/MT	L/R	F	Saloon Engine B 5234 FT+	862016	Outer Joint		26	28	56.5	97.5	66	O
	1997.01-2000.11	AT/MT	L/R	F	Saloon Engine B 5234 FT+	862002	Outer Joint	48T	26	28	56.5	97.5	66	O
	1997.01-2000.11	AT/MT	L/R	F	Saloon Engine B 5234 FT+	862009	Outer Joint	48T	36	27	56.5	48	66	M
2.4 (103 kW)	1999.08-2000.11	AT	L	F	Saloon Engine B 5244 S2	262001	Drive Shaft	48T	26	26	56.5	98.5	574.5	
	1999.08-2000.11	-	-	-	Saloon Engine B 5244 S2	862014	Outer Joint		26	25	56.5	98.5	56	O
	1999.08-2000.11	AT/MT	L/R	F	Saloon Engine B 5244 S2	862010	Outer Joint	48T	36	33	56.5	48	58	M
2.4 (106 kW)	1997.01-2000.11	MT	R	F	Saloon Engine B 5252 FS	662015	Inner Joint		26	25	40	531.5	66.5	
	1997.01-2000.11	AT	R	F	Saloon Engine B 5252 FS	262002	Drive Shaft	48T	26	26	56.5	98.5	1028	
	1997.01-2000.11	-	-	-	Saloon Engine B 5252 FS	862014	Outer Joint		26	25	56.5	98.5	56	O
	1997.01-2000.11	AT/MT	L/R	F	Saloon Engine B 5252 FS	862010	Outer Joint	48T	36	33	56.5	48	58	M
	1997.01-2000.11	AT/MT	L/R	F	Saloon Engine B 5252 FS	862001	Outer Joint	48T	26	25	56.5	98.5	56	O
2.4 (121 kW)	1998.06-2000.11	AT	L	F	Saloon Engine B 5254 S	262001	Drive Shaft	48T	26	26	56.5	98.5	574.5	
	1998.06-2000.11	-	-	-	Saloon Engine B 5254 S	862014	Outer Joint		26	25	56.5	98.5	56	O
	1998.06-2000.11	AT/MT	L/R	F	Saloon Engine B 5254 S	862010	Outer Joint	48T	36	33	56.5	48	58	M
	1998.06-2000.11	AT/MT	L/R	F	Saloon Engine B 5254 S	862001	Outer Joint	48T	26	25	56.5	98.5	56	O
2.4 (125 kW)	1997.01-2000.11	MT	R	F	Saloon Engine B 5254 S	662015	Inner Joint		26	25	40	531.5	66.5	
	1997.01-2000.11	AT	L	F	Saloon Engine B 5254 S	262001	Drive Shaft	48T	26	26	56.5	98.5	574.5	
	1997.01-2000.11	AT	R	F	Saloon Engine B 5254 S	262002	Drive Shaft	48T	26	26	56.5	98.5	1028	
	1997.01-2000.11	-	-	-	Saloon Engine B 5254 S	862014	Outer Joint		26	25	56.5	98.5	56	O
	1997.01-2000.11	AT/MT	L/R	F	Saloon Engine B 5254 S	862010	Outer Joint	48T	36	33	56.5	48	58	M
	1997.01-2000.11	AT/MT	L/R	F	Saloon Engine B 5254 S	862001	Outer Joint	48T	26	25	56.5	98.5	56	O
2.4 Bifuel (103 kW)	1999.07-2000.11	AT/MT	L/R	F	Saloon Engine B 5244 SG	862010	Outer Joint	48T	36	33	56.5	48	58	M
2.4 Bifuel (106 kW)	1998.10-2000.11	AT/MT	L/R	F	Saloon Engine GB 5252 S	862010	Outer Joint	48T	36	33	56.5	48	58	M
	1998.10-2000.11	AT/MT	L/R	F	Saloon Engine GB 5252 S	862016	Outer Joint		26	28	56.5	97.5	66	O
	1998.10-2000.11	AT/MT	L/R	F	Saloon Engine GB 5252 S	862001	Outer Joint	48T	26	25	56.5	98.5	56	O
2.4 Turbo (142 kW)	1997.01-2000.11	AT/MT	L/R	F	Saloon Engine B 5244 T	862016	Outer Joint		26	28	56.5	97.5	66	O
	1997.01-2000.11	AT/MT	L/R	F	Saloon Engine B 5244 T	862002	Outer Joint	48T	26	28	56.5	97.5	66	O
	1997.01-2000.11	MT	L	F	Saloon Engine B 5244 T	862009	Outer Joint	48T	36	27	56.5	48	66	M
2.5 TDI (103 kW)	1997.01-2000.11	AT/MT	L/R	F	Saloon Engine D 5252 T	862016	Outer Joint		26	28	56.5	97.5	66	O
	1997.01-2000.11	AT/MT	L/R	F	Saloon Engine D 5252 T	862002	Outer Joint	48T	26	28	56.5	97.5	66	O
	1997.01-2000.11	MT	L	F	Saloon Engine D 5252 T	862009	Outer Joint	48T	36	27	56.5	48	66	M
S80														
-	2005-2006	AT	-	F	-	262033	Drive Shaft	48T	36	26	56.5	48	535	
	2007-	-	L	F	-	262127	Drive Shaft		40	28	57.4	52	602	
	2014-	-	L	F	-	262126	Drive Shaft		40	31	57.5	52	576	
2.0 (103 kW)	1999.01-2006.07	-	L	F	-	262137	Drive Shaft	48T	36	26	56.5	48	551	
2.4	2008-2012	-	-	-	5 cylinder Turbo (Diesel)	699195	Propshaft CV Joint		19		22.6			
3.0	2008-2012	-	-	-	6 cylinder Turbo (t6).	699195	Propshaft CV Joint		19		22.6			
3.2	2007-2011	-	-	-	6 cylinder..	699195	Propshaft CV Joint		19		22.6			
4.4	2007-2011	-	-	-	8 cylinde	699195	Propshaft CV Joint		19		22.6			
S80 I (184)														
2.0 (120 kW)	1998.06-2006.07	AT/MT	L/R	F	Saloon Engine B 5204 T4	862010	Outer Joint	48T	36	33	56.5	48	58	M
	1998.06-2006.07	AT/MT	L/R	F	Saloon Engine B 5204 T4	862001	Outer Joint	48T	26	25	56.5	98.5	56	O
2.0 T (132 kW)	1999.12-2006.07	AT	R	F	Saloon Engine B 5204 T5	662029	Inner Joint		26	26	31	513	93.5	
	1999.12-2006.07	MT	L	F	Saloon Engine B 5204 T5	862038	Outer Joint		36	25	56.5	48	58	M
	1999.12-2006.07	AT/MT	L/R	F	Saloon Engine B 5204 T5	862010	Outer Joint	48T	36	33	56.5	48	58	M
	1999.12-2006.07	AT	R	F	Saloon Engine B 5204 T5	262017	Drive Shaft	48T	36	26	56.5	48	978.5	
2.0 T (166 kW)	1998.06-2006.07	AT/MT	L/R	F	Saloon Engine B 5204 T3	862009	Outer Joint	48T	36	27	56.5	48	66	M
2.4 (103 kW)	1999.01-2006.07	AT	L	F	Saloon Engine B 5244 S2	862040	Outer Joint	48T	36	25	56.5	48	58	M
	1999.01-2006.07	AT	R	F	Saloon Engine B 5244 S2	662029	Inner Joint		26	26	31	513	93.5	
	1999.01-2006.07	AT	R	F	Saloon Engine B 5244 S2	662012	Inner Joint		26	24	31	513	85	
	1999.01-2006.07	AT	L	F	Saloon Engine B 5244 S2	662028	Inner Joint		26	25	40	67.5	94	
	1999.01-2006.07	AT/MT	L/R	F	Saloon Engine B 5244 S2	862010	Outer Joint	48T	36	33	56.5	48	58	M
	1999.01-2006.07	AT	R	F	Saloon Engine B 5244 S2	262017	Drive Shaft	48T	36	26	56.5	48	978.5	
	1999.01-2006.07	AT	L	F	Saloon Engine B 5244 S2	262029	Drive Shaft	48T	36	26	56.5	48	540	
	1999.01-2006.07	AT	R	F	Saloon Engine B 5244 S2	262034	Drive Shaft	48T	36	26	56.5	48	987	
2.4 (125 kW)	1999.01-2006.07	AT	L	F	Saloon Engine B 5244 S	862040	Outer Joint	48T	36	25	56.5	48	58	M





VOLVO	YEAR	TRANSM	L/R	F/R	REMARKS	GSP Ref.	PRODUCT	ABS	Technical Specifications							
									A	B	C	H	L	P		
VOLVO																
S80 I (184)																
2.4 (125 kW)	1999.01-2006.07	AT	R	F	Saloon Engine B 5244 S	662029	Inner Joint		26	26	31	513	93.5			
	1999.01-2006.07	AT	R	F	Saloon Engine B 5244 S	662012	Inner Joint		26	24	31	513	85			
	1999.01-2006.07	AT	L	F	Saloon Engine B 5244 S	662028	Inner Joint		26	25	40	67.5	94			
	1999.01-2006.07	AT/MT	L/R	F	Saloon Engine B 5244 S	862010	Outer Joint	48T	36	33	56.5	48	58	M		
	1999.01-2006.07	AT	R	F	Saloon Engine B 5244 S	262017	Drive Shaft	48T	36	26	56.5	48	978.5			
	1999.01-2006.07	AT	L	F	Saloon Engine B 5244 S	262029	Drive Shaft	48T	36	26	56.5	48	540			
2.4 Bifuel (103 kW)	2001.09-2006.07	AT	L	F	Saloon Engine B 5244 SG2	862040	Outer Joint	48T	36	25	56.5	48	58	M		
	2001.09-2006.07	AT	L	F	Saloon Engine B 5244 SG	862040	Outer Joint	48T	36	25	56.5	48	58	M		
	2001.09-2006.07	AT	R	F	Saloon Engine B 5244 SG2	662029	Inner Joint		26	26	31	513	93.5			
	2001.09-2006.07	AT	R	F	Saloon Engine B 5244 SG	662029	Inner Joint		26	26	31	513	93.5			
	2001.09-2006.07	MT	L	F	Saloon Engine B 5244 SG2	862038	Outer Joint		36	25	56.5	48	58	M		
	2001.09-2006.07	MT	L	F	Saloon Engine B 5244 SG	862038	Outer Joint		36	25	56.5	48	58	M		
	2001.09-2006.07	AT	R	F	Saloon Engine B 5244 SG	662012	Inner Joint		26	24	31	513	85			
	2001.09-2006.07	AT	L	F	Saloon Engine B 5244 SG2	662028	Inner Joint		26	25	40	67.5	94			
	2001.09-2006.07	AT	L	F	Saloon Engine B 5244 SG	662028	Inner Joint		26	25	40	67.5	94			
	2001.09-2006.07	AT/MT	L/R	F	Saloon Engine B 5244 SG	862010	Outer Joint	48T	36	33	56.5	48	58	M		
	2001.09-2006.07	AT	R	F	Saloon Engine B 5244 SG2	262017	Drive Shaft	48T	36	26	56.5	48	978.5			
	2001.09-2006.07	AT	R	F	Saloon Engine B 5244 SG	262017	Drive Shaft	48T	36	26	56.5	48	978.5			
	2001.09-2006.07	AT	L	F	Saloon Engine B 5244 SG2	262029	Drive Shaft	48T	36	26	56.5	48	540			
	2001.09-2006.07	AT	L	F	Saloon Engine B 5244 SG	262029	Drive Shaft	48T	36	26	56.5	48	540			
	2.4 D (96 kW)	2001.10-2006.07	AT/MT	L/R	F	Saloon Engine D 5244 T2	862009	Outer Joint	48T	36	27	56.5	48	66	M	
2001.10-2006.07		AT	R	F	Saloon Engine D 5244 T2	662029	Inner Joint		26	26	31	513	93.5			
2.4 D5 (120 kW)	2001.08-2006.07	AT/MT	L/R	F	Saloon Engine D 5244 T	862009	Outer Joint	48T	36	27	56.5	48	66	M		
	2001.08-2006.07	AT	R	F	Saloon Engine D 5244 T	662029	Inner Joint		26	26	31	513	93.5			
	2001.08-2006.07	MT	L	F	Saloon Engine D 5244 T	862038	Outer Joint		36	25	56.5	48	58	M		
	2001.08-2006.07	AT	R	F	Saloon Engine D 5244 T	262017	Drive Shaft	48T	36	26	56.5	48	978.5			
2.4 T (147 kW)	2000.06-2006.07	AT	R	F	Saloon Engine B 5244 T3	662029	Inner Joint		26	26	31	513	93.5			
	2000.06-2006.07	MT	L	F	Saloon Engine B 5244 T3	862038	Outer Joint		36	25	56.5	48	58	M		
	2000.06-2006.07	AT	R	F	Saloon Engine B 5244 T3	262017	Drive Shaft	48T	36	26	56.5	48	978.5			
	2000.06-2006.07	AT/MT	L/R	F	Saloon Engine B 5244 T3	862009	Outer Joint	48T	36	27	56.5	48	66	M		
2.4 T5 AWD (147 kW)	2000.04-2003.09	AT	R	F	All-wheel Drive Saloon Engine B 5244 T3	662029	Inner Joint		26	26	31	513	93.5			
	2000.04-2003.09	MT	L	F	All-wheel Drive Saloon Engine B 5244 T3	862038	Outer Joint		36	25	56.5	48	58	M		
	2000.04-2003.09	AT	R	F	All-wheel Drive Saloon Engine B 5244 T3	262017	Drive Shaft	48T	36	26	56.5	48	978.5			
2.5 T (154 kW)	2003.03-2006.07	AT	R	F	Saloon Engine B 5254 T2	662029	Inner Joint		26	26	31	513	93.5			
	2003.03-2006.07	MT	L	F	Saloon Engine B 5254 T2	862038	Outer Joint		36	25	56.5	48	58	M		
	2003.03-2006.07	AT	R	F	Saloon Engine B 5254 T2	262017	Drive Shaft	48T	36	26	56.5	48	978.5			
2.5 T AWD (154 kW)	2003.07-2006.07	AT/MT	L/R	F	All-wheel Drive Saloon Engine B 5254 T2	862009	Outer Joint	48T	36	27	56.5	48	66	M		
	2003.07-2006.07	AT	R	F	All-wheel Drive Saloon Engine B 5254 T2	262140	Drive Shaft	48T	36	26	56.5	48	977			
2.5 TDI (103 kW)	1999.01-2006.07	MT	L	F	Saloon Engine D 5252 T	862038	Outer Joint		36	25	56.5	48	58	M		
	1999.01-2006.07	AT/MT	L/R	F	Saloon Engine D 5252 T	862009	Outer Joint	48T	36	27	56.5	48	66	M		
2.8 T6 (200 kW)	1998.05-2006.07	-	L	F	Saloon Engine B 6284 T	262025	Drive Shaft	48T	36	35	56.5	48	430			
	1998.05-2006.07	-	R	F	Saloon Engine B 6284 T	262026	Drive Shaft	48T	36	39	56.5	48	662			
	1998.05-2006.07	AT/MT	L/R	F	Saloon Engine B 6284 T	862009	Outer Joint	48T	36	27	56.5	48	66	M		
	1999.03-2006.07	-	L	F	Saloon Engine B 6294 S	262025	Drive Shaft	48T	36	35	56.5	48	430			
2.9 (147 kW)	1999.03-2006.07	MT	L	F	Saloon Engine B 6294 S	862038	Outer Joint		36	25	56.5	48	58	M		
	1999.03-2006.07	AT/MT	L/R	F	Saloon Engine B 6294 S	862009	Outer Joint	48T	36	27	56.5	48	66	M		
	1998.05-2006.07	-	L	F	Saloon Engine B 6304 S3	262025	Drive Shaft	48T	36	35	56.5	48	430			
2.9 (150 kW)	1998.05-2006.07	MT	L	F	Saloon Engine B 6304 S3	862038	Outer Joint		36	25	56.5	48	58	M		
	1998.05-2006.07	AT	L	F	Saloon Engine B 6304 S3	262138	Drive Shaft	48T	36	26	56.5	48	488			
	1998.05-2006.07	AT/MT	L/R	F	Saloon Engine B 6304 S3	862009	Outer Joint	48T	36	27	56.5	48	66	M		
	2001.06-2006.07	-	L	F	Saloon Engine B 6294 S2	262025	Drive Shaft	48T	36	35	56.5	48	430			
3.0 (144 kW)	2001.06-2006.07	-	R	F	Saloon Engine B 6294 S2	262026	Drive Shaft	48T	36	39	56.5	48	662			
	2001.06-2006.07	AT/MT	L/R	F	Saloon Engine B 6294 S2	862009	Outer Joint	48T	36	27	56.5	48	66	M		
	2001.06-2006.07	-	L	F	Saloon Engine B 6294 T	262025	Drive Shaft	48T	36	35	56.5	48	430			
3.0 T6 (200 kW)	2001.06-2006.07	-	R	F	Saloon Engine B 6294 T	262026	Drive Shaft	48T	36	39	56.5	48	662			
	2001.06-2006.07	AT/MT	L/R	F	Saloon Engine B 6294 T	862009	Outer Joint	48T	36	27	56.5	48	66	M		
	2001.06-2006.07	-	L	F	Saloon Engine B 6294 T	262025	Drive Shaft	48T	36	35	56.5	48	430			
S80 II (124)																
2.0 (177 kW)	2010.10-	6AT	-	-	Saloon Engine B 4204 T7	818269	Outer Joint		40	26	57.4	52	63.5	I		
	2010.10-	AT	R	F	Saloon Engine B 4204 T7	262112	Drive Shaft		40	26	57.4	52	962			
	2010.10-	AT	L	F	Saloon Engine B 4204 T7	262134	Drive Shaft		40	26	57.4	52	599			
2.0 FlexFuel (107 kW)	2008.01-	6AT	-	-	Saloon Engine B 4204 S4	818269	Outer Joint		40	26	57.4	52	63.5	I		





	 YEAR	TRANSM	L/R	F/R	REMARKS	GSP Ref.	 PRODUCT	 ABS	Technical Specifications					
									A	B	C	H	L	P
VOLVO														
S80 II (124)														
2.0 T (149 kW)	2010.01-	-	AT	R	F	Saloon Engine B 4204 T6	262112	Drive Shaft	40	26	57.4	52	962	
	2010.01-	-	AT	L	F	Saloon Engine B 4204 T6	262134	Drive Shaft	40	26	57.4	52	599	
	2010.01-	-	6AT	-	-	Saloon Engine B 4204 T6	818269	Outer Joint	40	26	57.4	52	63.5	I
2.4 D (120 kW)	2006.03-	-	AT	-	F	Saloon Engine D 5244 T	859344	Outer Joint	40	26	57.4	52	63.5	M
	2006.03-	-	MT	R	F	Saloon Engine D 5244 T	601076	Inner Joint	26	28	40	522.5	94.5	
2.4 D (129 kW)	2010.01-	-	AT	L	F	Saloon Engine D 5244 T14	259443	Drive Shaft	40	31	57.4	52	528	
	2010.01-	-	AT	R	F	Saloon Engine D 5244 T14	259444	Drive Shaft	40	28	57.4	52	994	
	2010.01-	-	AT	-	F	Saloon Engine D 5244 T14	859344	Outer Joint	40	26	57.4	52	63.5	M
	2010.01-	-	MT	R	F	Saloon Engine D 5244 T14	601076	Inner Joint	26	28	40	522.5	94.5	
	2010.01-	-	AT	L	F	Saloon Engine D 5244 T14	262109	Drive Shaft	40	31	57.4	52	524	
2.5 (136 kW)	2006.03-	-	AT	L	F	Saloon Engine D 5244 T4	259443	Drive Shaft	40	31	57.4	52	528	
	2006.03-	-	AT	-	F	Saloon Engine D 5244 T4	859344	Outer Joint	40	26	57.4	52	63.5	M
	2006.03-	-	AT	R	F	Saloon Engine D 5244 T4	259444	Drive Shaft	40	28	57.4	52	994	
	2006.03-	-	MT	R	F	Saloon Engine D 5244 T4	601076	Inner Joint	26	28	40	522.5	94.5	
	2006.03-	-	AT	L	F	Saloon Engine D 5244 T4	262109	Drive Shaft	40	31	57.4	52	524	
2.5 (151 kW)	2010.01-	-	AT	L	F	Saloon Engine D 5244 T10	259443	Drive Shaft	40	31	57.4	52	528	
	2010.01-	-	AT	R	F	Saloon Engine D 5244 T10	259444	Drive Shaft	40	28	57.4	52	994	
	2010.01-	-	MT	R	F	Saloon Engine D 5244 T10	601076	Inner Joint	26	28	40	522.5	94.5	
	2010.01-	-	AT	L	F	Saloon Engine D 5244 T10	262109	Drive Shaft	40	31	57.4	52	524	
	2010.01-	-	AT	-	F	Saloon Engine D 5244 T10	859344	Outer Joint	40	26	57.4	52	63.5	M
2.5 (158 kW)	2011.06-	-	AT	L	F	Saloon Engine D 5244 T11	259443	Drive Shaft	40	31	57.4	52	528	
	2011.06-	-	AT	R	F	Saloon Engine D 5244 T11	259444	Drive Shaft	40	28	57.4	52	994	
	2011.06-	-	MT	R	F	Saloon Engine D 5244 T11	601076	Inner Joint	26	28	40	522.5	94.5	
	2011.06-	-	AT	L	F	Saloon Engine D 5244 T11	262109	Drive Shaft	40	31	57.4	52	524	
2.5 AWD (136 kW)	2007.01-	-	AT	L	F	All-wheel Drive Saloon Engine D 5244 T4	259443	Drive Shaft	40	31	57.4	52	528	
	2007.01-	-	AT	-	-	All-wheel Drive Saloon Engine D 5244 T4	859344	Outer Joint	40	26	57.4	52	63.5	M
	2007.01-	-	MT	L/R	R	All-wheel Drive Saloon Engine D 5244 T4	201129	Drive Shaft	36	26	56.5	49.5	756	
	2007.01-	-	AT	L	F	All-wheel Drive Saloon Engine D 5244 T4	262109	Drive Shaft	40	31	57.4	52	524	
2.5 AWD (151 kW)	2010.01-	-	AT	L	F	All-wheel Drive Saloon Engine D 5244 T10	259443	Drive Shaft	40	31	57.4	52	528	
	2010.01-	-	AT/MT	L/R	R	All-wheel Drive Saloon Engine D 5244 T10	201129	Drive Shaft	36	26	56.5	49.5	756	
	2010.01-	-	AT	L	F	All-wheel Drive Saloon Engine D 5244 T10	262109	Drive Shaft	40	31	57.4	52	524	
2.5 AWD (158 kW)	2011.06-	-	AT	L	F	All-wheel Drive Saloon Engine D 5244 T15	259443	Drive Shaft	40	31	57.4	52	528	
	2011.06-	-	-	L/R	R	All-wheel Drive Saloon Engine D 5244 T15	201129	Drive Shaft	36	26	56.5	49.5	756	
	2011.06-	-	6AT	R	F	All-wheel Drive Saloon Engine D 5244 T15	662033	Inner Joint	28	27	30	521	102.5	
	2011.06-	-	AT	L	F	All-wheel Drive Saloon Engine D 5244 T15	262109	Drive Shaft	40	31	57.4	52	524	
2.5 T (147 kW)	2006.03-	-	-	-	F	Saloon Engine B 5254 T6	859344	Outer Joint	40	26	57.4	52	63.5	M
	2006.03-	-	MT	R	F	Saloon Engine B 5254 T6	601076	Inner Joint	26	28	40	522.5	94.5	
	2006.03-	-	AT	L	F	Saloon Engine B 5254 T6	262109	Drive Shaft	40	31	57.4	52	524	
2.5 T (170 kW)	2010.01-	-	-	-	F	Saloon Engine B 5254 T10	859344	Outer Joint	40	26	57.4	52	63.5	M
	2010.01-	-	MT	R	F	Saloon Engine B 5254 T10	601076	Inner Joint	26	28	40	522.5	94.5	
	2010.01-	-	AT	L	F	Saloon Engine B 5254 T10	262109	Drive Shaft	40	31	57.4	52	524	
2.5 T AWD (147 kW)	2006.10-	-	-	-	All-wheel Drive Saloon Engine B 5254 T6	859344	Outer Joint	40	26	57.4	52	63.5	M	
2.5 T FlexFuel (147 kW)	2008.05-	-	-	-	F	Saloon Engine B 5254 T8	859344	Outer Joint	40	26	57.4	52	63.5	M
	2008.05-	-	MT	R	F	Saloon Engine B 5254 T8	601076	Inner Joint	26	28	40	522.5	94.5	
	2008.05-	-	AT	L	F	Saloon Engine B 5254 T8	262109	Drive Shaft	40	31	57.4	52	524	
2.5 T FlexFuel (170 kW)	2010.01-	-	-	-	F	Saloon Engine B 5254 T11	859344	Outer Joint	40	26	57.4	52	63.5	M
	2010.01-	-	MT	R	F	Saloon Engine B 5254 T11	601076	Inner Joint	26	28	40	522.5	94.5	
	2010.01-	-	AT	L	F	Saloon Engine B 5254 T11	262109	Drive Shaft	40	31	57.4	52	524	
3.2 (175 kW)	2006.03-	-	AT	L/R	F	Saloon Engine B 6324 S	862042	Outer Joint	40	27	57.4	52	63.5	M
3.2 (179 kW)	2010.01-	-	AT	L/R	F	Saloon Engine B 6324 S5	862042	Outer Joint	40	27	57.4	52	63.5	M
3.2 AWD (175 kW)	2007.01-	-	-	L/R	R	All-wheel Drive Saloon Engine B 6324 S	201129	Drive Shaft	36	26	56.5	49.5	756	
	2007.01-	-	AT	L/R	F	All-wheel Drive Saloon Engine B 6324 S	862042	Outer Joint	40	27	57.4	52	63.5	M
3.2 AWD (179 kW)	2010.01-	-	-	L/R	R	All-wheel Drive Saloon Engine B 6324 S5	201129	Drive Shaft	36	26	56.5	49.5	756	
	2010.01-	-	AT	L/R	F	All-wheel Drive Saloon Engine B 6324 S5	862042	Outer Joint	40	27	57.4	52	63.5	M
4.4 V8 (232 kW)	2006.03-	-	-	-	-	All-wheel Drive Saloon Engine B 8444 S	859344	Outer Joint	40	26	57.4	52	63.5	M
	2006.03-	-	-	L/R	R	All-wheel Drive Saloon Engine B 8444 S	201129	Drive Shaft	36	26	56.5	49.5	756	
D3 (100 kW)	2012.05-	-	MT	R	F	Saloon Engine D 5204 T7	601076	Inner Joint	26	28	40	522.5	94.5	
D3/D4 (120 kW)	2010.01-	-	MT	R	F	Saloon Engine D 5204 T2	601076	Inner Joint	26	28	40	522.5	94.5	
	2010.01-	-	AT	L	F	Saloon Engine D 5204 T2	262109	Drive Shaft	40	31	57.4	52	524	
T6 AWD (210 kW)	2007.01-	-	-	L/R	R	All-wheel Drive Saloon Engine B 6304 T2	201129	Drive Shaft	36	26	56.5	49.5	756	
	2007.01-	-	AT	L/R	F	All-wheel Drive Saloon Engine B 6304 T2	862042	Outer Joint	40	27	57.4	52	63.5	M
T6 AWD (224 kW)	2010.10-	-	-	L/R	R	All-wheel Drive Saloon Engine B 6304 T4	201129	Drive Shaft	36	26	56.5	49.5	756	
	2010.10-	-	AT	L/R	F	All-wheel Drive Saloon Engine B 6304 T4	862042	Outer Joint	40	27	57.4	52	63.5	M
S80 II (AS)														
4.4 V8 4WD (232 kW)	2006.03-	-	-	-	-	Transmission Cardanic	635009	Inner Joint			20	21		
	2006.03-	-	-	-	-	Transmission Cardanic	635009	Propshaft CV Joint			20	21		
S90														





VOLVO S90	YEAR	TRANSM	L/R	F/R	REMARKS	GSP Ref.	PRODUCT	ABS	Technical Specifications						
									A	B	C	H	L	P	
-	1997- 1998	-	-	R	-	201125	Drive Shaft		26	26	61	81	743		
V40															
-	2013-	-	-	R	F	Hatchback	262110	Drive Shaft		36	26	56.1	48	921	
	2013- 2016	-	-	R	F	-	262135	Drive Shaft		36	28	56.1	48	930	
	2013-	-	-	L	F	-	262121	Drive Shaft		36	31	56.1	48	562	
	2013-	-	-	R	F	-	262130	Drive Shaft		36	28	56.1	48	936	
	2014-	-	-	R	F	Hatchback	262128	Drive Shaft		36	28	56.1	48	913	
	2015- 2016	-	-	L	F	Hatchback	262122	Drive Shaft		36	31	56.1	48	586	
	2016-	-	-	R	F	Hatchback	262131	Drive Shaft		36	28	56.1	48	936	
1.6 (80 kW)	1999- 2003	-	-	-	-	-	862024	Outer Joint	43T	26	27	56.5	98	66.5 M	
1.9 Di (70 kW)	1999- 2000	-	-	-	-	-	862024	Outer Joint	43T	26	27	56.5	98	66.5 M	
1.9 Di (75 kW)	2000-	-	-	-	-	-	862024	Outer Joint	43T	26	27	56.5	98	66.5 M	
1.9 Di (85 kW)	2000-	-	-	-	-	-	862024	Outer Joint	43T	26	27	56.5	98	66.5 M	
2.0 TDi	2013- 2015	-	-	R	F	Hatchback	262120	Drive Shaft		36	26	56.1	48	966	
V40 (525 526)															
D2 (84 kW)	2012.03-	-	AT	L	F	Hatchback Engine D 4162 T	262111	Drive Shaft		36	28	56.1	48	578	
	2012.03-	-	MT	R	F	Hatchback Engine D 4162 T	634150	Inner Joint		26	24	40	381	98	
	2012.03-	-	MT	L	F	Hatchback Engine D 4162 T	662052	Inner Joint		26	28	40	61	112.5	
	2012.03-	-	MT	L	F	Hatchback Engine D 4162 T	262078	Drive Shaft		36	26	56.3	48	583	
	2012.03-	-	AT	R	F	Hatchback Engine D 4162 T	262024	Drive Shaft		36	28	56	48	908	
	2012.03-	-	MT	L	F	Hatchback Engine D 4162 T	234224	Drive Shaft		36	26	56.1	48	581	
	2012.03-	-	MT	R	F	Hatchback Engine D 4162 T	234270	Drive Shaft		36	26	56.1	48	918	
D3 (110 kW)	2012.03- 2015.03	6MT	L	F	Hatchback Engine D 5204 T6	662050	Inner joint		26	26	40	67	104		
	2012.03- 2015.03	6MT	L	F	Hatchback Engine D 5204 T6	862049	Outer Joint		36	26	56.1	48	64	M	
	2012.03- 2015.03	6AT	L	F	Hatchback Engine D 5204 T6	262116	Drive Shaft		36	31	56.1	48	517		
	2012.03- 2015.03	6AT	R	F	Hatchback Engine D 5204 T6	262132	Drive Shaft		36	28	56.1	48	968		
D4 (130 kW)	2012.03-	-	6MT	L	F	Hatchback Engine D 5204 T4	662050	Inner joint		26	26	40	67	104	
	2012.03-	-	6MT	L	F	Hatchback Engine D 5204 T4	862049	Outer Joint		36	26	56.1	48	64	M
	2012.03-	-	6AT	L	F	Hatchback Engine D 5204 T4	262116	Drive Shaft		36	31	56.1	48	517	
	2012.03-	-	6AT	R	F	Hatchback Engine D 5204 T4	262132	Drive Shaft		36	28	56.1	48	968	
T2 GTDi (88 kW)	2013.03- 2015.12	MT	-	-	Hatchback Engine B 4164 T4	834194	Outer Joint		36	24	56.1	48	59	M	
T3 GTDi (110 kW)	2012.03-	-	MT	R	F	Hatchback Engine B 4164 T3	634150	Inner Joint		26	24	40	381	98	
	2012.03-	-	MT	L	F	Hatchback Engine B 4164 T3	234224	Drive Shaft		36	26	56.1	48	581	
	2012.03-	-	MT	R	F	Hatchback Engine B 4164 T3	234270	Drive Shaft		36	26	56.1	48	918	
T4 AWD (132 kW)	2013.07-	-	6AT	L	F	All-wheel Drive Hatchback Engine B 5204 T8	262116	Drive Shaft		36	31	56.1	48	517	
	2013.07-	-	6AT	R	F	All-wheel Drive Hatchback Engine B 5204 T8	262132	Drive Shaft		36	28	56.1	48	968	
T4 GTDi (132 kW)	2012.03-	-	AT	R	F	Hatchback Engine B 4164 T	262129	Drive Shaft		36	28	56.1	48	920	
	2012.03-	-	MT	R	F	Hatchback Engine B 4164 T	634150	Inner Joint		26	24	40	381	98	
	2012.03-	-	MT	L	F	Hatchback Engine B 4164 T	234224	Drive Shaft		36	26	56.1	48	581	
	2012.03-	-	MT	R	F	Hatchback Engine B 4164 T	234270	Drive Shaft		36	26	56.1	48	918	
V40 (645)															
1.6 (77 kW)	1995.12- 1999.08	-	-	F	Estate Engine B 4164 S	839100	Outer Joint	43T	25	23	54	95.5	64	M	
	1995.12- 1999.08	-	-	F	Estate Engine B 4164 S	899230	Outer Joint	43T	25	29	54	95	60	O	
	1995.12- 1999.08	MT	L	F	Estate Engine B 4164 S	239097	Drive Shaft	43T	25	25	54	95.5	614		
	1995.12- 1999.08	MT	R	F	Estate Engine B 4164 S	239096	Drive Shaft	43T	25	25	54	95.5	937		
	1995.12- 1999.08	AT/MT	L/R	F	Estate Engine B 4164 S	862003	Outer Joint	43T	25	25	54	95	61	O	
	1995.12- 1999.08	-	-	L	F	Estate Engine B 4164 S	862009	Outer Joint	48T	36	27	56.5	48	66	M
1.6 (80 kW)	1999.03- 2004.06	-	-	F	Estate Engine B 4164 S2	839100	Outer Joint	43T	25	23	54	95.5	64	M	
	1999.03- 2004.06	-	-	F	Estate Engine B 4164 S2	899230	Outer Joint	43T	25	29	54	95	60	O	
	1999.03- 2004.06	MT	L	F	Estate Engine B 4164 S2	239097	Drive Shaft	43T	25	25	54	95.5	614		
	1999.03- 2004.06	MT	R	F	Estate Engine B 4164 S2	239096	Drive Shaft	43T	25	25	54	95.5	937		
	1999.03- 2004.06	AT/MT	L/R	F	Estate Engine B 4164 S2	862008	Outer Joint	43T	25	33	54	95	61	M	
1.8 (85 kW)	1995.07- 1999.08	MT	L	F	Estate Engine B 4184 S3	862009	Outer Joint	48T	36	27	56.5	48	66	M	
	1995.07- 1999.08	-	-	F	Estate Engine B 4184 S3	839100	Outer Joint	43T	25	23	54	95.5	64	M	
	1995.07- 1999.08	MT	L	F	Estate Engine B 4184 S3	899230	Outer Joint	43T	25	29	54	95	60	O	
	1995.07- 1999.08	MT	L	F	Estate Engine B 4184 S3	239097	Drive Shaft	43T	25	25	54	95.5	614		
	1995.07- 1999.08	MT	R	F	Estate Engine B 4184 S3	239096	Drive Shaft	43T	25	25	54	95.5	937		
	1995.07- 1999.08	AT	L/R	F	Estate Engine B 4184 S3	862003	Outer Joint	43T	25	25	54	95	61	O	
	1995.07- 1999.08	AT	L	F	Estate Engine B 4184 S3	262072	Drive Shaft	43T	25	26	54	95	599		
	1995.07- 1999.08	MT	L	F	Estate Engine B 4184 S3	262023	Drive Shaft	43T	25	29.95	54	95	628.7		
	1995.07- 1999.08	MT	R	F	Estate Engine B 4184 S3	250421	Drive Shaft	43T	25	23	54	94.5	813		
	1995.07- 1999.08	AT	R	F	Estate Engine B 4184 S3	262035	Drive Shaft	43T	25	26	54	95	948		
1.8 (90 kW)	1999.03- 2004.06	-	-	F	Estate Engine B 4184 S2	839100	Outer Joint	43T	25	23	54	95.5	64	M	
	1999.03- 2004.06	MT	-	F	Estate Engine B 4184 S2	899230	Outer Joint	43T	25	29	54	95	60	O	
	1999.03- 2004.06	MT	L	F	Estate Engine B 4184 S2	239097	Drive Shaft	43T	25	25	54	95.5	614		
	1999.03- 2004.06	MT	R	F	Estate Engine B 4184 S2	239096	Drive Shaft	43T	25	25	54	95.5	937		





	 YEAR	TRANSM	L/R	F/R	REMARKS	GSP Ref.	 PRODUCT	 ABS	Technical Specifications						
									A	B	C	H	L	P	
VOLVO															
V40 (645)															
1.8 (90 kW)	1999.03-2004.06	-	L	F	Estate Engine B 4184 S2	262023	Drive Shaft	43T	25	29.95	54	95	628.7		
	1999.03-2004.06	AT/MT	L/R	F	Estate Engine B 4184 S2	862008	Outer Joint	43T	25	33	54	95	61	M	
	1999.03-2004.06	AT	L	F	Estate Engine B 4184 S2	262072	Drive Shaft	43T	25	26	54	95	599		
	1999.03-2004.06	-	R	F	Estate Engine B 4184 S2	250421	Drive Shaft	43T	25	23	54	94.5	813		
	1999.03-2004.06	AT	R	F	Estate Engine B 4184 S2	262035	Drive Shaft	43T	25	26	54	95	948		
1.8 i (90 kW)	2001.06-2004.06	-	-	F	Estate Engine B 4184 SJ	839100	Outer Joint	43T	25	23	54	95.5	64	M	
	2001.06-2004.06	MT	-	F	Estate Engine B 4184 SJ	899230	Outer Joint	43T	25	29	54	95	60	O	
	2001.06-2004.06	MT	L	F	Estate Engine B 4184 SJ	239097	Drive Shaft	43T	25	25	54	95.5	614		
	2001.06-2004.06	MT	R	F	Estate Engine B 4184 SJ	239096	Drive Shaft	43T	25	25	54	95.5	937		
	2001.06-2004.06	AT	L	F	Estate Engine B 4184 SJ	262072	Drive Shaft	43T	25	26	54	95	599		
	2001.06-2004.06	AT	R	F	Estate Engine B 4184 SJ	262035	Drive Shaft	43T	25	26	54	95	948		
	2001.06-2004.06	AT/MT	L/R	F	Estate Engine B 4184 SJ	862011	Outer Joint	43T	25	33	56.3	99	61.5	M	
1.8 i (92 kW)	1998.03-2004.06	-	-	F	Estate Engine B 4184 SM	839100	Outer Joint	43T	25	23	54	95.5	64	M	
	1998.03-2004.06	MT	-	F	Estate Engine B 4184 SM	899230	Outer Joint	43T	25	29	54	95	60	O	
	1998.03-2004.06	MT	L	F	Estate Engine B 4184 SM	239097	Drive Shaft	43T	25	25	54	95.5	614		
	1998.03-2004.06	MT	R	F	Estate Engine B 4184 SM	239096	Drive Shaft	43T	25	25	54	95.5	937		
	1998.03-2004.06	AT/MT	L/R	F	Estate Engine B 4184 SM	862008	Outer Joint	43T	25	33	54	95	61	M	
	1998.03-2004.06	AT	L	F	Estate Engine B 4184 SM	262072	Drive Shaft	43T	25	26	54	95	599		
	1998.03-2004.06	AT	R	F	Estate Engine B 4184 SM	262035	Drive Shaft	43T	25	26	54	95	948		
1.9 DI (70 kW)	1999.03-2000.07	MT	L	F	Estate Engine D 4192 T2	262004	Drive Shaft	43T	25	29.95	54	95	628.7		
	1999.03-2000.07	-	-	F	Estate Engine D 4192 T2	899230	Outer Joint	43T	25	29	54	95	60	O	
	1999.03-2000.07	MT	L	F	Estate Engine D 4192 T2	262023	Drive Shaft	43T	25	29.95	54	95	628.7		
	1999.03-2000.07	AT/MT	L/R	F	Estate Engine D 4192 T2	862012	Outer Joint	43T	26	27	56.5	98	66.5	M	
	1999.03-2000.07	MT	R	F	Estate Engine D 4192 T2	250421	Drive Shaft	43T	25	23	54	94.5	813		
1.9 DI (75 kW)	2000.07-2004.06	MT	L	F	Estate Engine D 4192 T4	262064	Drive Shaft	43T	26	26	56.5	98	607		
	2000.07-2004.06	AT/MT	L/R	F	Estate Engine D 4192 T4	862012	Outer Joint	43T	26	27	56.5	98	66.5	M	
1.9 DI (85 kW)	2000.07-2004.06	MT	L	F	Estate Engine D 4192 T3	262064	Drive Shaft	43T	26	26	56.5	98	607		
	2000.07-2004.06	AT/MT	L/R	F	Estate Engine D 4192 T3	862012	Outer Joint	43T	26	27	56.5	98	66.5	M	
1.9 T4 (147 kW)	1997.05-2000.07	AT	L	F	Estate Engine B 4194 T	618171	Inner Joint		26	26	40	429.5	93		
	1997.05-2000.07	MT	L	F	Estate Engine B 4194 T	262089	Drive Shaft	43T	26	26	56.5	98	593		
	1997.05-2000.07	AT	L	F	Estate Engine B 4194 T	262118	Drive Shaft	43T	26	26	56.5	98	600		
	1997.05-2000.07	-	L/R	F	Estate Engine B 4194 T	862003	Outer Joint	43T	25	25	54	95	61	O	
	1997.05-2000.07	AT/MT	L/R	F	Estate Engine B 4194 T	862012	Outer Joint	43T	26	27	56.5	98	66.5	M	
1.9 TD (66 kW)	1995.07-1999.08	MT	L	F	Estate Engine D 4192 T	262004	Drive Shaft	43T	25	29.95	54	95	628.7		
	1995.07-1999.08	-	-	F	Estate Engine D 4192 T	899230	Outer Joint	43T	25	29	54	95	60	O	
	1995.07-1999.08	MT	L	F	Estate Engine D 4192 T	262023	Drive Shaft	43T	25	29.95	54	95	628.7		
	1995.07-1999.08	MT	R	F	Estate Engine D 4192 T	250421	Drive Shaft	43T	25	23	54	94.5	813		
	1995.07-1999.08	-	L	F	Estate Engine D 4192 T	862009	Outer Joint	48T	36	27	56.5	48	66	M	
2.0 (100 kW)	1995.07-2004.06	MT	L	F	Estate Engine B 4204 S	262004	Drive Shaft	43T	25	29.95	54	95	628.7		
	1995.07-2004.06	MT	-	F	Estate Engine B 4204 S	899230	Outer Joint	43T	25	29	54	95	60	O	
	1995.07-2004.06	MT	R	F	Estate Engine B 4204 S	262021	Drive Shaft	43T	25	26	54	95	945		
	1995.07-2004.06	AT	L/R	F	Estate Engine B 4204 S	862003	Outer Joint	43T	25	25	54	95	61	O	
	1995.07-2004.06	MT	L/R	F	Estate Engine B 4204 S	862008	Outer Joint	43T	25	33	54	95	61	M	
	1995.07-2004.06	AT	L	F	Estate Engine B 4204 S	262072	Drive Shaft	43T	25	26	54	95	599		
	1995.07-2004.06	AT	R	F	Estate Engine B 4204 S	262035	Drive Shaft	43T	25	26	54	95	948		
	1995.07-2004.06	AT	-	F	Estate Engine B 4204 S	899262	Outer Joint	43T	25	25	54	95	61	O	
	1995.07-2004.06	AT/MT	L/R	F	Estate Engine B 4204 S	862011	Outer Joint	43T	25	33	56.3	99	61.5	M	
2.0 (103 kW)	1995.07-1999.08	MT	L	F	Estate Engine B 4204 S	262004	Drive Shaft	43T	25	29.95	54	95	628.7		
	1995.07-1999.08	MT	-	F	Estate Engine B 4204 S	899230	Outer Joint	43T	25	29	54	95	60	O	
	1995.07-1999.08	MT	R	F	Estate Engine B 4204 S	262021	Drive Shaft	43T	25	26	54	95	945		
	1995.07-1999.08	AT/MT	L/R	F	Estate Engine B 4204 S	862003	Outer Joint	43T	25	25	54	95	61	O	
	1995.07-1999.08	AT	L	F	Estate Engine B 4204 S	262072	Drive Shaft	43T	25	26	54	95	599		
	1995.07-1999.08	AT	R	F	Estate Engine B 4204 S	262035	Drive Shaft	43T	25	26	54	95	948		
	1995.07-1999.08	AT	-	F	Estate Engine B 4204 S	899262	Outer Joint	43T	25	25	54	95	61	O	
2.0 T (118 kW)	1997.10-2000.07	MT	L	F	Estate Engine B 4204 T	262089	Drive Shaft	43T	26	26	56.5	98	593		
	1997.10-2000.07	-	L/R	F	Estate Engine B 4204 T	862003	Outer Joint	43T	25	25	54	95	61	O	
	1997.10-2000.07	AT/MT	L/R	F	Estate Engine B 4204 T	862012	Outer Joint	43T	26	27	56.5	98	66.5	M	
2.0 T (120 kW)	2001.06-2004.06	MT	L	F	Estate Engine B 4204 T3	262089	Drive Shaft	43T	26	26	56.5	98	593		
2.0 T (121 kW)	1999.07-2004.06	MT	L	F	Estate Engine B 4204 T2	262089	Drive Shaft	43T	26	26	56.5	98	593		
	1999.07-2004.06	AT/MT	L/R	F	Estate Engine B 4204 T2	862012	Outer Joint	43T	26	27	56.5	98	66.5	M	
2.0 T4 (147 kW)	2000.07-2004.06	MT	L	F	Estate Engine B 4204 T5	262089	Drive Shaft	43T	26	26	56.5	98	593		
	2000.07-2004.06	AT/MT	L/R	F	Estate Engine B 4204 T5	862012	Outer Joint	43T	26	27	56.5	98	66.5	M	
V40 CROSS COUNTRY															
-	2013-	-	-	L	F	-	262121	Drive Shaft		36	31	56.1	48	562	
2.0 T4	-	-	-	R	R	Hinten	262107	Drive Shaft	44NS	36	23	56.5	50	742	
V40 XC															

VOLVO	YEAR	TRANSM	L/R	F/R	REMARKS	GSP Ref.	PRODUCT	ABS	Technical Specifications									
									A	B	C	H	L	P				
V40 XC																		
-	2013-	-	-	L	F	-	262121	Drive Shaft		36	31	56.1	48	562				
-	2013-	-	-	R	F	-	262130	Drive Shaft		36	28	56.1	48	936				
V50 (545)																		
1.6 (74 kW)	2005.01-	2012.12	MT	R	F	Estate Engine B 4164 S3	218337	Drive Shaft		36	23	51.6	48	908				
	2005.01-	2012.12	MT	L	F	Estate Engine B 4164 S3	218189	Drive Shaft		36	23	56	48	601				
	2005.01-	2012.12	MT	R	F	Estate Engine B 4164 S3	218206	Drive Shaft		36	23	56	48	906				
	2005.01-	2012.12	MT	L	F	Estate Engine B 4164 S3	818264	Outer Joint		36	25	51.6	48	58	O			
	2005.01-	2012.12	MT	L	F	Estate Engine B 4164 S3	618168	Inner Joint		23	22	40	61	90				
1.6 D (80 kW)	2005.03-	-	-	L	F	Estate	618044	Inner Joint		26	23	40	68.5	99.5				
1.6 D (81 kW)	2005.01-	2011.12	-	R	F	Estate Engine D 4164 T	218219	Drive Shaft		36	26	56.3	48	921				
	2005.01-	2011.12	MT	R	F	Estate Engine D 4164 T	899130	Outer Joint		36	26	56.3	48	61	M			
1.6 D2 (84 kW)	2010.01-	2012.12	MT	L	F	Estate Engine D 4162 T	662052	Inner Joint		26	28	40	61	112.5				
	2010.01-	2012.12	MT	L	F	Estate Engine D 4162 T	262078	Drive Shaft		36	26	56.3	48	583				
	2010.01-	2012.12	-	R	F	Estate Engine D 4162 T	262053	Drive Shaft		36	26	56.3	48	917				
1.8 (92 kW)	2004.04-	2010.12	-	L	F	Estate Engine B 4184 S11	618044	Inner Joint		26	23	40	68.5	99.5				
	2004.04-	2010.12	-	L/R	F	Estate Engine B 4184 S11	818203	Outer Joint		36	23	56	48	57	I			
	2004.04-	2010.12	MT	R	F	Estate Engine B 4184 S11	899130	Outer Joint		36	26	56.3	48	61	M			
	2004.04-	2010.12	5MT	L	F	Estate Engine B 4184 S11	218328	Drive Shaft		36	26	55.3	48	580				
	2004.04-	2010.12	5MT	R	F	Estate Engine B 4184 S11	218329	Drive Shaft		36	26	55.3	48	920				
1.8 FlexFuel (92 kW)	2005.01-	2010.12	-	L	F	Estate Engine B 4184 S8	618044	Inner Joint		26	23	40	68.5	99.5				
	2005.01-	2010.12	-	L/R	F	Estate Engine B 4184 S8	818203	Outer Joint		36	23	56	48	57	I			
	2005.01-	2010.12	5MT	L	F	Estate Engine B 4184 S8	218328	Drive Shaft		36	26	55.3	48	580				
	2005.01-	2010.12	5MT	R	F	Estate Engine B 4184 S8	218329	Drive Shaft		36	26	55.3	48	920				
	2005.01-	2010.12	MT	R	F	Estate Engine B 4184 S8	899130	Outer Joint		36	26	56.3	48	61	M			
2.0 (107 kW)	2006.10-	2012.12	-	L	F	Estate Engine B 4204 S3	618044	Inner Joint		26	23	40	68.5	99.5				
	2006.10-	2012.12	AT	R	F	Estate Engine B 4204 S3	662017	Inner Joint		28	26	34	371.5	92				
	2006.10-	2012.12	-	L/R	F	Estate Engine B 4204 S3	818203	Outer Joint		36	23	56	48	57	I			
	2006.10-	2012.12	AT	R	F	Estate Engine B 4204 S3	262024	Drive Shaft		36	28	56	48	908				
	2006.10-	2012.12	5MT	L	F	Estate Engine B 4204 S3	218328	Drive Shaft		36	26	55.3	48	580				
	2006.10-	2012.12	MT	R	F	Estate Engine B 4204 S3	899130	Outer Joint		36	26	56.3	48	61	M			
	2006.10-	2012.12	5MT	R	F	Estate Engine B 4204 S3	218329	Drive Shaft		36	26	55.3	48	920				
2.0 CDI (98 kW)	2003.12-	2006.12	-	L	F	Estate Engine D 4204 T2	218194	Drive Shaft		36	26	56	48	568				
	2003.12-	2006.12	-	R	F	Estate Engine D 4204 T2	218280	Drive Shaft		36	26	56	48	918				
	2003.12-	2006.12	MT	L	F	Estate Engine D 4204 T2	218198	Drive Shaft		36	26	56	48	580				
	2003.12-	2006.12	MT	R	F	Estate Engine D 4204 T2	899130	Outer Joint		36	26	56.3	48	61	M			
	2003.12-	2006.12	Semi-AT	L	F	Estate Engine D 4204 T2	218367	Drive Shaft		36	28	56	48	570				
2.0 D (100 kW)	2004.04-	2010.12	MT	-	F	Estate Engine D 4204 T	862048	Outer Joint		36	26	56	48	64	I			
	2004.04-	2010.12	AT	R	F	Estate Engine D 4204 T	662017	Inner Joint		28	26	34	371.5	92				
	2004.04-	2010.12	-	R	F	Estate Engine D 4204 T	262105	Drive Shaft		36	26	56	48	911				
	2004.04-	2010.12	MT	L	F	Estate Engine D 4204 T	218194	Drive Shaft		36	26	56	48	568				
	2004.04-	2010.12	MT	R	F	Estate Engine D 4204 T	218280	Drive Shaft		36	26	56	48	918				
	2004.04-	2010.12	MT	L	F	Estate Engine D 4204 T	218198	Drive Shaft		36	26	56	48	580				
	2004.04-	2010.12	AT	R	F	Estate Engine D 4204 T	262024	Drive Shaft		36	28	56	48	908				
	2004.04-	2010.12	MT	R	F	Estate Engine D 4204 T	899130	Outer Joint		36	26	56.3	48	61	M			
	2004.04-	2010.12	AT	L	F	Estate Engine D 4204 T	218367	Drive Shaft		36	28	56	48	570				
2.0 FlexFuel (107 kW)	2010.01-	2012.12	-	L	F	Estate Engine B 4204 S4	618044	Inner Joint		26	23	40	68.5	99.5				
	2010.01-	2012.12	-	L	F	Estate Engine B 4204 S4	218328	Drive Shaft		36	26	55.3	48	580				
	2010.01-	2012.12	-	R	F	Estate Engine B 4204 S4	218329	Drive Shaft		36	26	55.3	48	920				
	2010.01-	2012.12	MT	R	F	Estate Engine B 4204 S4	899130	Outer Joint		36	26	56.3	48	61	M			
2.4 (103 kW)	2004.04-	2010.12	MT	L	F	Estate Engine B 5244 S5	262097	Drive Shaft		36	26	56	48	532				
	2004.04-	2010.12	AT	R	F	Estate Engine B 5244 S5	899132	Outer Joint		36	24	56	48	57	I			
	2004.04-	2010.12	MT	-	F	Estate Engine B 5244 S5	862048	Outer Joint		36	26	56	48	64	I			
	2004.04-	2010.12	Semi-AT	L	F	Estate Engine B 5244 S5	262060	Drive Shaft		36	26	56	48	519				
	2004.04-	2010.12	Semi-AT	R	F	Estate Engine B 5244 S5	262063	Drive Shaft		36	26	56	48	947				
	2004.04-	2010.12	AMT	L/R	F	Estate Engine B 5244 S5	862033	Outer Joint		36	24	56	48	59	I			
	2004.04-	2010.12	AT	L	F	Estate Engine B 5244 S5	262027	Drive Shaft		36	26	56	48	515.5				
	2004.04-	2010.12	AT	R	F	Estate Engine B 5244 S5	218192	Drive Shaft		36	26	56	48	949				
2.4 (125 kW)	2004.04-	2010.12	MT	L	F	Estate Engine B 5244 S4	262097	Drive Shaft		36	26	56	48	532				
	2004.04-	2010.12	AT	R	F	Estate Engine B 5244 S4	899132	Outer Joint		36	24	56	48	57	I			
	2004.04-	2010.12	MT	-	F	Estate Engine B 5244 S4	862048	Outer Joint		36	26	56	48	64	I			
	2004.04-	2010.12	MT	L	F	Estate Engine B 5244 S4	618159	Inner joint		26	26	40	67	96.5				
	2004.04-	2010.12	Semi-AT	L	F	Estate Engine B 5244 S4	262060	Drive Shaft		36	26	56	48	519				
	2004.04-	2010.12	Semi-AT	R	F	Estate Engine B 5244 S4	262063	Drive Shaft		36	26	56	48	947				
	2004.04-	2010.12	AMT	L/R	F	Estate Engine B 5244 S4	862033	Outer Joint		36	24	56	48	59	I			
	2004.04-	2010.12	AT	L	F	Estate Engine B 5244 S4	262027	Drive Shaft		36	26	56	48	515.5				
	2004.04-	2010.12	AT	R	F	Estate Engine B 5244 S4	218192	Drive Shaft		36	26	56	48	949				





	 YEAR	TRANSM	L/R	F/R	REMARKS	GSP Ref.	 PRODUCT	 ABS	Technical Specifications									
									A	B	C	H	L	P				
VOLVO																		
V50 (545)																		
2.4 AWD (125 kW)	2006.08-2009.12	MT	L	F	All-wheel Drive Estate Engine B 5244 S4	618159	Inner joint		26	26	40	67	96.5					
2.4 D5 (132 kW)	2006.03-2010.12	MT	L	F	Estate Engine D 5244 T8	262097	Drive Shaft		36	26	56	48	532					
	2006.03-2010.12	AT	R	F	Estate Engine D 5244 T8	899132	Outer Joint		36	24	56	48	57	I				
	2006.03-2010.12	MT	-	F	Estate Engine D 5244 T8	862048	Outer Joint		36	26	56	48	64	I				
	2006.03-2010.12	AT	L	F	Estate Engine D 5244 T8	262060	Drive Shaft		36	26	56	48	519					
	2006.03-2010.12	AT	R	F	Estate Engine D 5244 T8	262063	Drive Shaft		36	26	56	48	947					
	2006.03-2010.12	AT	L/R	F	Estate Engine D 5244 T8	862033	Outer Joint		36	24	56	48	59	I				
	2006.03-2010.12	AT	L	F	Estate Engine D 5244 T8	262027	Drive Shaft		36	26	56	48	515.5					
2.4 Tdi (120 kW)	2007.05-2010.12	MT	L	F	Estate Engine D 5244 T9	618159	Inner joint		26	26	40	67	96.5					
	2007.05-2010.12	-	L	F	Estate Engine D 5244 T9	262060	Drive Shaft		36	26	56	48	519					
	2007.05-2010.12	-	R	F	Estate Engine D 5244 T9	262063	Drive Shaft		36	26	56	48	947					
	2007.05-2010.12	-	L/R	F	Estate Engine D 5244 T9	862033	Outer Joint		36	24	56	48	59	I				
2.5 (162 kW)	2004.04-2007.12	MT	L	F	Estate Engine B 5254 T3	262097	Drive Shaft		36	26	56	48	532					
	2004.04-2007.12	AT	R	F	Estate Engine B 5254 T3	899132	Outer Joint		36	24	56	48	57	I				
	2004.04-2007.12	MT	-	F	Estate Engine B 5254 T3	862048	Outer Joint		36	26	56	48	64	I				
	2004.04-2007.12	Semi-AT	L	F	Estate Engine B 5254 T3	262060	Drive Shaft		36	26	56	48	519					
	2004.04-2007.12	Semi-AT	R	F	Estate Engine B 5254 T3	262063	Drive Shaft		36	26	56	48	947					
	2004.04-2007.12	AMT	L/R	F	Estate Engine B 5254 T3	862033	Outer Joint		36	24	56	48	59	I				
	2004.04-2007.12	AT	L	F	Estate Engine B 5254 T3	262027	Drive Shaft		36	26	56	48	515.5					
2.5 (169 kW)	2004.04-2007.12	AT	R	F	Estate Engine B 5254 T3	218192	Drive Shaft		36	26	56	48	949					
	2007.03-2012.12	MT	L	F	Estate Engine B 5254 T7	262097	Drive Shaft		36	26	56	48	532					
	2007.03-2012.12	MT	L	F	Estate Engine B 5254 T7	618159	Inner joint		26	26	40	67	96.5					
	2007.03-2012.12	Semi-AT	L	F	Estate Engine B 5254 T7	262060	Drive Shaft		36	26	56	48	519					
	2007.03-2012.12	AT	R	F	Estate Engine B 5254 T7	262063	Drive Shaft		36	26	56	48	947					
2.5 AWD (162 kW)	2007.03-2012.12	AMT/AT	L/R	F	Estate Engine B 5254 T7	862033	Outer Joint		36	24	56	48	59	I				
	2004.04-2007.12	MT	-	F	All-wheel Drive Estate Engine B 5254 T3	862048	Outer Joint		36	26	56	48	64	I				
	2004.04-2007.12	AT/MT	-	-	All-wheel Drive Estate Engine B 5254 T3	635008	Inner Joint			24		23.5						
	2004.04-2007.12	6MT	L	F	All-wheel Drive Estate Engine B 5254 T3	262106	Drive Shaft		36	26	56	48	539					
	2004.04-2007.12	MT	L	F	All-wheel Drive Estate Engine B 5254 T3	618159	Inner joint		26	26	40	67	96.5					
	2004.04-2007.12	MT	R	F	All-wheel Drive Estate Engine B 5254 T3	662046	Inner joint		26	26	28	513.5	93					
	2004.04-2007.12	MT	R	F	All-wheel Drive Estate Engine B 5254 T3	262100	Drive Shaft		36	26	56	48	954					
2.5 AWD (169 kW)	2007.03-2010.12	-	-	F	All-wheel Drive Estate Engine B 5254 T7	862048	Outer Joint		36	26	56	48	64	I				
	2007.03-2010.12	-	L	R	All-wheel Drive Estate Engine B 5254 T7	201131	Drive Shaft	44NS	36	26	56.5	50	727					
	2007.03-2010.12	MT	L	F	All-wheel Drive Estate Engine B 5254 T7	618159	Inner joint		26	26	40	67	96.5					
	2007.03-2010.12	MT	R	F	All-wheel Drive Estate Engine B 5254 T7	662045	Inner joint		26	26	28	528	93					
	2007.03-2010.12	-	R	F	All-wheel Drive Estate Engine B 5254 T7	662047	Inner joint		26	26	28	513.5	93					
D3 (110 kW)	2010.10-2012.12	-	-	F	Estate Engine D 5204 T5	899155	Outer Joint		36	26	56	48	64	I				
	2010.10-2012.12	6AT	L	F	Estate Engine D 5204 T5	262108	Drive Shaft		36	31	56	48	506					
	2010.10-2012.12	6AT	R	F	Estate Engine D 5204 T5	662048	Inner joint		28	26	33	520	100.5					
D4 (130 kW)	2010.10-2012.12	-	-	F	Estate Engine D 5204 T	899155	Outer Joint		36	26	56	48	64	I				
	2010.10-2012.12	6AT	L	F	Estate Engine D 5204 T	262108	Drive Shaft		36	31	56	48	506					
V60																		
-	2011-2018	-	L	F	-	262127	Drive Shaft		40	28	57.4	52	602					
-	2016-	-	L	F	-	262126	Drive Shaft		40	31	57.5	52	576					
V60 (155 157)																		
1.5 T2 (90 kW)	2015.10-	-	-	L	F	Estate Engine B 4154 T5	801424	Outer Joint		31	27	36.2	70	62	M			
	2015.10-	-	-	R	F	Estate Engine B 4154 T5	618187	Inner Joint		26	29	35	69.5	107.5				
	2015.10-	-	-	R	F	Estate Engine B 4154 T5	818290	Outer Joint		36	29	56.5	49.5	64	I			
	2015.10-	-	-	L	F	Estate Engine B 4154 T5	618044	Inner Joint		26	23	40	68.5	99.5				
	2015.10-	-	-	-	F	Estate Engine B 4154 T5	859285	Outer Joint		40	27	57.4	52	63.5	M			
	2015.10-	-	-	-	F	Estate Engine B 4154 T5	862031	Outer Joint	48T	36	27	56.5	55	65	M			
	2015.10-	-	-	-	F	Estate Engine B 4154 T5	862045	Outer Joint		40	26	57.4	52	62.5	M			
1.6 DRiVe (84 kW)	2011.02-2015.12	6AT	R	F	Estate Engine D 4162 T	262133	Drive Shaft		40	28	57.4	52	934					
2.0 AWD (270 kW)	2015.06-	-	-	L	F	All-wheel Drive Estate Engine B4204 T43	801424	Outer Joint		31	27	36.2	70	62	M			
	2015.06-	-	-	R	F	All-wheel Drive Estate Engine B4204 T43	618187	Inner Joint		26	29	35	69.5	107.5				
	2015.06-	-	-	R	F	All-wheel Drive Estate Engine B4204 T43	818290	Outer Joint		36	29	56.5	49.5	64	I			
	2015.06-	-	-	L	F	All-wheel Drive Estate Engine B4204 T43	618044	Inner Joint		26	23	40	68.5	99.5				
	2015.06-	-	-	-	F	All-wheel Drive Estate Engine B4204 T43	859285	Outer Joint		40	27	57.4	52	63.5	M			
	2015.06-	-	-	-	F	All-wheel Drive Estate Engine B4204 T43	862031	Outer Joint	48T	36	27	56.5	55	65	M			
2.0 D2 (88 kW)	2015.03-	-	-	-	F	All-wheel Drive Estate Engine B4204 T43	862045	Outer Joint		40	26	57.4	52	62.5	M			
	2015.03-	-	-	R	F	Estate Engine D 4204 T8	818290	Outer Joint		36	29	56.5	49.5	64	I			
	2015.03-	-	-	L	F	Estate Engine D 4204 T8	618044	Inner Joint		26	23	40	68.5	99.5				
	2015.03-	-	-	-	F	Estate Engine D 4204 T8	859285	Outer Joint		40	27	57.4	52	63.5	M			
	2015.03-	-	-	-	F	Estate Engine D 4204 T8	862031	Outer Joint	48T	36	27	56.5	55	65	M			
2015.03-	-	-	-	F	Estate Engine D 4204 T8	862045	Outer Joint		40	26	57.4	52	62.5	M				





	 YEAR	TRANSM	L/R	F/R	REMARKS	GSP Ref.	 PRODUCT	 ABS	Technical Specifications						
									A	B	C	H	L	P	
VOLVO															
V60 (155 157)															
2.0 D2 (88 kW)	2015.03-	-	-	L	F	Estate Engine D 4204 T8	801424	Outer Joint	31	27	36.2	70	62	M	
	2015.03-	-	-	-	R	Estate Engine D 4204 T8	618187	Inner Joint	26	29	35	69.5	107.5		
2.0 D3 (110 kW)	2015.03-	-	-	-	R	Estate Engine D 4204 T4	818290	Outer Joint	36	29	56.5	49.5	64	I	
	2015.03-	-	-	L	F	Estate Engine D 4204 T4	618044	Inner Joint	26	23	40	68.5	99.5		
	2015.03-	-	-	-	F	Estate Engine D 4204 T4	859285	Outer Joint	40	27	57.4	52	63.5	M	
	2015.03-	-	-	-	F	Estate Engine D 4204 T4	862031	Outer Joint	48T	36	27	56.5	55	65	M
	2015.03-	-	-	-	F	Estate Engine D 4204 T4	862045	Outer Joint	40	26	57.4	52	62.5	M	
	2015.03-	-	-	L	F	Estate Engine D 4204 T4	801424	Outer Joint	31	27	36.2	70	62	M	
2.0 D4 (140 kW)	2015.03-	-	-	-	R	Estate Engine D 4204 T4	618187	Inner Joint	26	29	35	69.5	107.5		
	2015.03-	-	-	L	F	Estate Engine D 4204 T14	618044	Inner Joint	26	23	40	68.5	99.5		
	2015.03-	-	-	-	F	Estate Engine D 4204 T14	859285	Outer Joint	40	27	57.4	52	63.5	M	
	2015.03-	-	-	-	F	Estate Engine D 4204 T14	862031	Outer Joint	48T	36	27	56.5	55	65	M
	2015.03-	-	-	-	F	Estate Engine D 4204 T14	862045	Outer Joint	40	26	57.4	52	62.5	M	
	2015.03-	-	-	L	F	Estate Engine D 4204 T14	801424	Outer Joint	31	27	36.2	70	62	M	
2.0 T (132 kW)	2015.03-	-	-	-	R	Estate Engine D 4204 T14	618187	Inner Joint	26	29	35	69.5	107.5		
	2014.01-	-	-	-	R	Estate Engine B 5204 T8	818290	Outer Joint	36	29	56.5	49.5	64	I	
	2014.01-	-	-	-	F	Estate Engine B 5204 T8	862045	Outer Joint	40	26	57.4	52	62.5	M	
	2014.01-	-	-	L	F	Estate Engine B 5204 T8	618044	Inner Joint	26	23	40	68.5	99.5		
	2014.01-	-	-	-	F	Estate Engine B 5204 T8	859285	Outer Joint	40	27	57.4	52	63.5	M	
	2014.01-	-	-	-	F	Estate Engine B 5204 T8	862031	Outer Joint	48T	36	27	56.5	55	65	M
2.0 T (149 kW)	2014.01-	-	-	L	F	Estate Engine B 5204 T8	801424	Outer Joint	31	27	36.2	70	62	M	
	2014.01-	-	-	-	R	Estate Engine B 5204 T8	618187	Inner Joint	26	29	35	69.5	107.5		
	2010.07-	2012.12	AT	R	F	Estate Engine B 4204 T6	259444	Drive Shaft	40	28	57.4	52	994		
	2010.07-	2012.12	6AT	R	F	Estate Engine B 4204 T6	262114	Drive Shaft	40	28	57.4	52	952		
	2010.07-	2012.12	6AT	L	F	Estate Engine B 4204 T6	262113	Drive Shaft	40	28	57.4	52	590		
	2.0 T4 (140 kW)	2015.03-	-	-	L	F	Estate Engine B 4204 T19	801424	Outer Joint	31	27	36.2	70	62	M
2015.03-		-	-	-	R	Estate Engine B 4204 T19	618187	Inner Joint	26	29	35	69.5	107.5		
2015.03-		-	-	-	R	Estate Engine B 4204 T19	818290	Outer Joint	36	29	56.5	49.5	64	I	
2015.03-		-	-	L	F	Estate Engine B 4204 T19	618044	Inner Joint	26	23	40	68.5	99.5		
2015.03-		-	-	-	F	Estate Engine B 4204 T19	859285	Outer Joint	40	27	57.4	52	63.5	M	
2015.03-		-	-	-	F	Estate Engine B 4204 T19	862031	Outer Joint	48T	36	27	56.5	55	65	M
2.0 T5 (162 kW)	2015.03-	-	-	-	F	Estate Engine B 4204 T19	862045	Outer Joint	40	26	57.4	52	62.5	M	
	2014.01-	-	-	-	R	Estate Engine B4204 T15	818290	Outer Joint	36	29	56.5	49.5	64	I	
	2014.01-	-	-	L	F	Estate Engine B4204 T15	618044	Inner Joint	26	23	40	68.5	99.5		
	2014.01-	-	-	-	F	Estate Engine B4204 T15	862031	Outer Joint	48T	36	27	56.5	55	65	M
	2014.01-	-	-	-	F	Estate Engine B4204 T15	859285	Outer Joint	40	27	57.4	52	63.5	M	
	2014.01-	-	-	-	F	Estate Engine B4204 T15	862045	Outer Joint	40	26	57.4	52	62.5	M	
2.4 D5 (158 kW)	2014.01-	-	-	L	F	Estate Engine B4204 T15	801424	Outer Joint	31	27	36.2	70	62	M	
	2014.01-	-	-	-	R	Estate Engine B4204 T15	618187	Inner Joint	26	29	35	69.5	107.5		
	2011.04-	2015.12	AT	-	F	Estate Engine D 5244 T11	859344	Outer Joint	40	26	57.4	52	63.5	M	
	2011.04-	2015.12	AT	R	F	Estate Engine D 5244 T11	259444	Drive Shaft	40	28	57.4	52	994		
	2011.04-	2015.12	-	-	F	Estate Engine D 5244 T11	859285	Outer Joint	40	27	57.4	52	63.5	M	
	2011.04-	2015.12	MT	R	F	Estate Engine D 5244 T11	601076	Inner Joint	26	28	40	522.5	94.5		
2.4 D5 AWD (158 kW)	2011.04-	2015.12	AT	L	F	Estate Engine D 5244 T11	262109	Drive Shaft	40	31	57.4	52	524		
	2011.04-	2015.12	-	-	R	Estate Engine D 5244 T11	618187	Inner Joint	26	29	35	69.5	107.5		
	2011.04-	2015.12	-	-	R	Estate Engine D 5244 T11	818290	Outer Joint	36	29	56.5	49.5	64	I	
	2011.04-	2015.12	-	-	F	All-wheel Drive Estate Engine D 5244 T11	859344	Outer Joint	40	26	57.4	52	63.5	M	
	2011.04-	2015.12	AT	L/R	R	All-wheel Drive Estate Engine D 5244 T11	201129	Drive Shaft	36	26	56.5	49.5	756		
	2011.04-	2015.12	-	-	F	All-wheel Drive Estate Engine D 5244 T11	859285	Outer Joint	40	27	57.4	52	63.5	M	
2.4 D5 Hybrid AWD (120 kW)	2011.04-	2015.12	AT/MT	L	F	All-wheel Drive Estate Engine D 5244 T11	262109	Drive Shaft	40	31	57.4	52	524		
	2011.04-	2015.12	-	-	R	All-wheel Drive Estate Engine D 5244 T11	618187	Inner Joint	26	29	35	69.5	107.5		
	2011.04-	2015.12	-	-	R	All-wheel Drive Estate Engine D 5244 T11	818290	Outer Joint	36	29	56.5	49.5	64	I	
	2015.03-	-	-	L	F	All-wheel Drive Estate Engine D87PHEV	801424	Outer Joint	31	27	36.2	70	62	M	
	2015.03-	-	-	-	R	All-wheel Drive Estate Engine D87PHEV	618187	Inner Joint	26	29	35	69.5	107.5		
	2015.03-	-	-	-	R	All-wheel Drive Estate Engine D87PHEV	818290	Outer Joint	36	29	56.5	49.5	64	I	
2.4 Hybrid D6 AWD (158 kW)	2015.03-	-	AT	L	F	All-wheel Drive Estate Engine D87PHEV	262125	Drive Shaft	40	31	57.5	52	529		
	2015.03-	-	AT	R	F	All-wheel Drive Estate Engine D87PHEV	262123	Drive Shaft	40	28	57.5	52	994		
	2015.03-	-	-	-	R	All-wheel Drive Estate Engine D87PHEV	201122	Drive Shaft	44NS	36	32	56.2	49.5	592	
	2015.03-	-	-	L	F	All-wheel Drive Estate Engine D87PHEV	618044	Inner Joint	26	23	40	68.5	99.5		
	2015.03-	-	-	-	F	All-wheel Drive Estate Engine D87PHEV	859285	Outer Joint	40	27	57.4	52	63.5	M	
	2015.03-	-	-	-	F	All-wheel Drive Estate Engine D87PHEV	862031	Outer Joint	48T	36	27	56.5	55	65	M
	2015.03-	-	-	-	F	All-wheel Drive Estate Engine D87PHEV	862045	Outer Joint	40	26	57.4	52	62.5	M	
	2012.06-	2015.12	-	-	R	All-wheel Drive Estate Engine D82PHEV	818290	Outer Joint	36	29	56.5	49.5	64	I	
2012.06-	2015.12	-	-	-	All-wheel Drive Estate Engine D82PHEV	859344	Outer Joint	40	26	57.4	52	63.5	M		
2012.06-	2015.12	-	L	F	All-wheel Drive Estate Engine D82PHEV	618044	Inner Joint	26	23	40	68.5	99.5			

		 YEAR	TRANSM	L/R	F/R	REMARKS	GSP Ref.	 PRODUCT	 ABS	Technical Specifications						
										A	B	C	H	L	P	
VOLVO																
V60 (155 157)																
2.4 Hybrid D6 AWD (158 kW)		2012.06-2015.12	-	-	F	All-wheel Drive Estate Engine D82PHEV	862031	Outer Joint	48T	36	27	56.5	55	65	M	
		2012.06-2015.12	-	-	F	All-wheel Drive Estate Engine D82PHEV	859285	Outer Joint		40	27	57.4	52	63.5	M	
		2012.06-2015.12	-	-	R	All-wheel Drive Estate Engine D82PHEV	201122	Drive Shaft	44NS	36	32	56.2	49.5	592		
		2012.06-2015.12	-	-	F	All-wheel Drive Estate Engine D82PHEV	862045	Outer Joint		40	26	57.4	52	62.5	M	
		2012.06-2015.12	-	-	L	F	All-wheel Drive Estate Engine D82PHEV	801424	Outer Joint		31	27	36.2	70	62	M
		2012.06-2015.12	-	-	R	All-wheel Drive Estate Engine D82PHEV	618187	Inner Joint		26	29	35	69.5	107.5		
2.5 (151 kW)		2010.07-2011.12	AT	L	F	Estate Engine D 5244 T10	259443	Drive Shaft		40	31	57.4	52	528		
		2010.07-2011.12	AT/AT	R	F	Estate Engine D 5244 T10	259444	Drive Shaft		40	28	57.4	52	994		
		2010.07-2011.12	-	-	F	Estate Engine D 5244 T10	859285	Outer Joint		40	27	57.4	52	63.5	M	
		2010.07-2011.12	MT	R	F	Estate Engine D 5244 T10	601076	Inner Joint		26	28	40	522.5	94.5		
		2010.07-2011.12	AT	L	F	Estate Engine D 5244 T10	262109	Drive Shaft		40	31	57.4	52	524		
		2010.07-2011.12	-	-	R	Estate Engine D 5244 T10	618187	Inner Joint		26	29	35	69.5	107.5		
2.5 AWD (151 kW)		2010.07-2011.12	-	-	-	All-wheel Drive Estate Engine D 5244 T10	859344	Outer Joint		40	26	57.4	52	63.5	M	
		2010.07-2011.12	-	L/R	R	All-wheel Drive Estate Engine D 5244 T10	201129	Drive Shaft		36	26	56.5	49.5	756		
		2010.07-2011.12	-	-	F	All-wheel Drive Estate Engine D 5244 T10	859285	Outer Joint		40	27	57.4	52	63.5	M	
		2010.07-2011.12	AT	L	F	All-wheel Drive Estate Engine D 5244 T10	262109	Drive Shaft		40	31	57.4	52	524		
		2010.07-2011.12	-	-	R	All-wheel Drive Estate Engine D 5244 T10	618187	Inner Joint		26	29	35	69.5	107.5		
		2010.07-2011.12	-	-	R	All-wheel Drive Estate Engine D 5244 T10	818290	Outer Joint		36	29	56.5	49.5	64	I	
3.0 T AWD (258 kW)		2014.04-	-	-	L	F	All-wheel Drive Estate Engine B 6304 T5	618044	Inner Joint		26	23	40	68.5	99.5	
		2014.04-	AT	L/R	R	All-wheel Drive Estate Engine B 6304 T5	201129	Drive Shaft		36	26	56.5	49.5	756		
		2014.04-	-	-	F	All-wheel Drive Estate Engine B 6304 T5	862031	Outer Joint	48T	36	27	56.5	55	65	M	
		2014.04-	-	-	F	All-wheel Drive Estate Engine B 6304 T5	859285	Outer Joint		40	27	57.4	52	63.5	M	
		2014.04-	-	-	F	All-wheel Drive Estate Engine B 6304 T5	862045	Outer Joint		40	26	57.4	52	62.5	M	
		2014.04-	-	-	R	All-wheel Drive Estate Engine B 6304 T5	618187	Inner Joint		26	29	35	69.5	107.5		
		2014.04-	-	-	R	All-wheel Drive Estate Engine B 6304 T5	818290	Outer Joint		36	29	56.5	49.5	64	I	
		2014.04-	-	-	L	F	All-wheel Drive Estate Engine B 6304 T5	801424	Outer Joint		31	27	36.2	70	62	M
D3 (100 kW)		2012.05-2015.12	AT	R	F	Estate Engine D 5204 T7	259444	Drive Shaft		40	28	57.4	52	994		
		2012.05-2015.12	-	-	R	Estate Engine D 5204 T7	818290	Outer Joint		36	29	56.5	49.5	64	I	
		2012.05-2015.12	-	-	F	Estate Engine D 5204 T7	862045	Outer Joint		40	26	57.4	52	62.5	M	
		2012.05-2015.12	-	-	F	Estate Engine D 5204 T7	859285	Outer Joint		40	27	57.4	52	63.5	M	
		2012.05-2015.12	-	-	L	F	Estate Engine D 5204 T7	618044	Inner Joint		26	23	40	68.5	99.5	
		2012.05-2015.12	MT	R	F	Estate Engine D 5204 T7	601076	Inner Joint		26	28	40	522.5	94.5		
		2012.05-2015.12	-	-	F	Estate Engine D 5204 T7	862031	Outer Joint	48T	36	27	56.5	55	65	M	
		2012.05-2015.12	-	-	L	F	Estate Engine D 5204 T7	801424	Outer Joint		31	27	36.2	70	62	M
		2012.05-2015.12	-	-	R	Estate Engine D 5204 T7	618187	Inner Joint		26	29	35	69.5	107.5		
D3/D4 (120 kW)		2010.07-2014.12	AT	R	F	Estate Engine D 5204 T2	259444	Drive Shaft		40	28	57.4	52	994		
		2010.07-2014.12	-	-	F	Estate Engine D 5204 T2	862045	Outer Joint		40	26	57.4	52	62.5	M	
		2010.07-2014.12	-	-	F	Estate Engine D 5204 T2	859285	Outer Joint		40	27	57.4	52	63.5	M	
		2010.07-2014.12	MT	R	F	Estate Engine D 5204 T2	601076	Inner Joint		26	28	40	522.5	94.5		
		2010.07-2014.12	6AT	R	F	Estate Engine D 5204 T2	662043	Inner joint		28	26	33	521	100		
		2010.07-2014.12	AT	L	F	Estate Engine D 5204 T2	262109	Drive Shaft		40	31	57.4	52	524		
D4 (133 kW)		2013.10-2015.12	-	-	R	Estate Engine D 4204 T5	818290	Outer Joint		36	29	56.5	49.5	64	I	
		2013.10-2015.12	-	-	L	F	Estate Engine D 4204 T5	618044	Inner Joint		26	23	40	68.5	99.5	
		2013.10-2015.12	6MT	L	F	Estate Engine D 4204 T5	262119	Drive Shaft		40	31	57.4	52	599		
		2013.10-2015.12	6MT	R	F	Estate Engine D 4204 T5	262117	Drive Shaft		40	28	57.4	52	949		
		2013.10-2015.12	-	-	F	Estate Engine D 4204 T5	859285	Outer Joint		40	27	57.4	52	63.5	M	
		2013.10-2015.12	-	-	F	Estate Engine D 4204 T5	862031	Outer Joint	48T	36	27	56.5	55	65	M	
		2013.10-2015.12	-	-	F	Estate Engine D 4204 T5	862045	Outer Joint		40	26	57.4	52	62.5	M	
		2013.10-2015.12	-	-	L	F	Estate Engine D 4204 T5	801424	Outer Joint		31	27	36.2	70	62	M
		2013.10-2015.12	-	-	R	Estate Engine D 4204 T5	618187	Inner Joint		26	29	35	69.5	107.5		
D4 AWD (120 kW)		2012.05-	-	-	L/R	R	All-wheel Drive Estate Engine D 5244 T17	201129	Drive Shaft		36	26	56.5	49.5	756	
		2012.05-	-	-	L	F	All-wheel Drive Estate Engine D 5244 T17	618044	Inner Joint		26	23	40	68.5	99.5	
		2012.05-	-	-	F	All-wheel Drive Estate Engine D 5244 T17	859285	Outer Joint		40	27	57.4	52	63.5	M	
		2012.05-	-	-	F	All-wheel Drive Estate Engine D 5244 T17	862031	Outer Joint	48T	36	27	56.5	55	65	M	
		2012.05-	-	-	F	All-wheel Drive Estate Engine D 5244 T17	862045	Outer Joint		40	26	57.4	52	62.5	M	
		2012.05-	-	-	R	All-wheel Drive Estate Engine D 5244 T17	618187	Inner Joint		26	29	35	69.5	107.5		
		2012.05-	-	-	L	F	All-wheel Drive Estate Engine D 5244 T17	801424	Outer Joint		31	27	36.2	70	62	M
		2012.05-	-	-	R	All-wheel Drive Estate Engine D 5244 T17	818290	Outer Joint		36	29	56.5	49.5	64	I	
D4 AWD (133 kW)		2013.10-2015.12	-	-	F	All-wheel Drive Estate Engine D 5244 T12	859285	Outer Joint		40	27	57.4	52	63.5	M	
		2013.10-2015.12	-	-	L	F	All-wheel Drive Estate Engine D 5244 T12	618044	Inner Joint		26	23	40	68.5	99.5	
		2013.10-2015.12	-	-	F	All-wheel Drive Estate Engine D 5244 T12	862031	Outer Joint	48T	36	27	56.5	55	65	M	
		2013.10-2015.12	-	-	F	All-wheel Drive Estate Engine D 5244 T12	862045	Outer Joint		40	26	57.4	52	62.5	M	
		2013.10-2015.12	-	-	R	All-wheel Drive Estate Engine D 5244 T12	618187	Inner Joint		26	29	35	69.5	107.5		
		2013.10-2015.12	-	-	R	All-wheel Drive Estate Engine D 5244 T12	818290	Outer Joint		36	29	56.5	49.5	64	I	
		2013.10-2015.12	-	-	L	F	All-wheel Drive Estate Engine D 5244 T12	801424	Outer Joint		31	27	36.2	70	62	M

	 YEAR	TRANSM	L/R	F/R	REMARKS	GSP Ref.	 PRODUCT	 ABS	Technical Specifications					
									A	B	C	H	L	P
VOLVO														
V60 (155 157)														
D4 AWD (140 kW)	2015.03-	-	-	R	All-wheel Drive Estate Engine D 5244 T21	818290	Outer Joint		36	29	56.5	49.5	64	I
	2015.03-	-	-	L	All-wheel Drive Estate Engine D 5244 T21	618044	Inner Joint		26	23	40	68.5	99.5	
	2015.03-	-	-	F	All-wheel Drive Estate Engine D 5244 T21	859285	Outer Joint		40	27	57.4	52	63.5	M
	2015.03-	-	-	F	All-wheel Drive Estate Engine D 5244 T21	862031	Outer Joint	48T	36	27	56.5	55	65	M
	2015.03-	-	-	F	All-wheel Drive Estate Engine D 5244 T21	862045	Outer Joint		40	26	57.4	52	62.5	M
	2015.03-	-	-	L	All-wheel Drive Estate Engine D 5244 T21	801424	Outer Joint		31	27	36.2	70	62	M
	2015.03-	-	-	R	All-wheel Drive Estate Engine D 5244 T21	618187	Inner Joint		26	29	35	69.5	107.5	
D5 (165 kW)	2015.03-	-	-	R	Estate Engine D 4204 T11	818290	Outer Joint		36	29	56.5	49.5	64	I
	2015.03-	-	-	L	Estate Engine D 4204 T11	618044	Inner Joint		26	23	40	68.5	99.5	
	2015.03-	-	-	F	Estate Engine D 4204 T11	859285	Outer Joint		40	27	57.4	52	63.5	M
	2015.03-	-	-	F	Estate Engine D 4204 T11	862031	Outer Joint	48T	36	27	56.5	55	65	M
	2015.03-	-	-	F	Estate Engine D 4204 T11	862045	Outer Joint		40	26	57.4	52	62.5	M
	2015.03-	-	-	L	Estate Engine D 4204 T11	801424	Outer Joint		31	27	36.2	70	62	M
	2015.03-	-	-	R	Estate Engine D 4204 T11	618187	Inner Joint		26	29	35	69.5	107.5	
D5 (169 kW)	2014.04-2015.12	-	-	R	Estate Engine D 5244 T23	818290	Outer Joint		36	29	56.5	49.5	64	I
	2014.04-2015.12	-	-	F	Estate Engine D 5244 T23	859285	Outer Joint		40	27	57.4	52	63.5	M
	2014.04-2015.12	-	L	F	Estate Engine D 5244 T23	618044	Inner Joint		26	23	40	68.5	99.5	
	2014.04-2015.12	-	-	F	Estate Engine D 5244 T23	862031	Outer Joint	48T	36	27	56.5	55	65	M
	2014.04-2015.12	-	-	F	Estate Engine D 5244 T23	862045	Outer Joint		40	26	57.4	52	62.5	M
	2014.04-2015.12	-	-	R	Estate Engine D 5244 T23	618187	Inner Joint		26	29	35	69.5	107.5	
	2014.04-2015.12	-	L	F	Estate Engine D 5244 T23	801424	Outer Joint		31	27	36.2	70	62	M
D5 AWD (169 kW)	2014.04-2015.12	-	-	R	All-wheel Drive Estate Engine D 5244 T15	818290	Outer Joint		36	29	56.5	49.5	64	I
	2014.04-2015.12	-	-	F	All-wheel Drive Estate Engine D 5244 T15	859285	Outer Joint		40	27	57.4	52	63.5	M
	2014.04-2015.12	AT	L/R	R	All-wheel Drive Estate Engine D 5244 T15	201129	Drive Shaft		36	26	56.5	49.5	756	
	2014.04-2015.12	-	L	F	All-wheel Drive Estate Engine D 5244 T15	618044	Inner Joint		26	23	40	68.5	99.5	
	2014.04-2015.12	-	-	F	All-wheel Drive Estate Engine D 5244 T15	862031	Outer Joint	48T	36	27	56.5	55	65	M
	2014.04-2015.12	-	-	F	All-wheel Drive Estate Engine D 5244 T15	862045	Outer Joint		40	26	57.4	52	62.5	M
	2014.04-2015.12	-	-	R	All-wheel Drive Estate Engine D 5244 T15	618187	Inner Joint		26	29	35	69.5	107.5	
D6 Hybrid AWD (162 kW)	2015.03-	-	-	L	All-wheel Drive Estate Engine D97PHEV	801424	Outer Joint		31	27	36.2	70	62	M
	2015.03-	-	-	R	All-wheel Drive Estate Engine D97PHEV	618187	Inner Joint		26	29	35	69.5	107.5	
	2015.03-	-	-	R	All-wheel Drive Estate Engine D97PHEV	818290	Outer Joint		36	29	56.5	49.5	64	I
	2015.03-	-	-	L	All-wheel Drive Estate Engine D97PHEV	618044	Inner Joint		26	23	40	68.5	99.5	
	2015.03-	-	-	F	All-wheel Drive Estate Engine D97PHEV	859285	Outer Joint		40	27	57.4	52	63.5	M
	2015.03-	-	-	F	All-wheel Drive Estate Engine D97PHEV	862031	Outer Joint	48T	36	27	56.5	55	65	M
	2015.03-	-	-	R	All-wheel Drive Estate Engine D97PHEV	201122	Drive Shaft	44NS	36	32	56.2	49.5	592	
T3 (110 kW)	2015.03-	-	-	F	All-wheel Drive Estate Engine D97PHEV	862045	Outer Joint		40	26	57.4	52	62.5	M
	2015.03-	-	-	L	All-wheel Drive Estate Engine D97PHEV	801424	Outer Joint		31	27	36.2	70	62	M
	2010.09-2015.12	-	-	R	Estate Engine B 4164 T3	818290	Outer Joint		36	29	56.5	49.5	64	I
	2010.09-2015.12	-	L	F	Estate Engine B 4164 T3	618044	Inner Joint		26	23	40	68.5	99.5	
	2010.09-2015.12	MT	R	F	Estate Engine B 4164 T3	662041	Inner joint		26	28	40	447	95.5	
	2010.09-2015.12	-	-	F	Estate Engine B 4164 T3	862031	Outer Joint	48T	36	27	56.5	55	65	M
	2010.09-2015.12	-	-	F	Estate Engine B 4164 T3	859285	Outer Joint		40	27	57.4	52	63.5	M
T3 (112 kW)	2010.09-2015.12	-	-	F	Estate Engine B 4164 T3	862045	Outer Joint		40	26	57.4	52	62.5	M
	2010.09-2015.12	-	L	F	Estate Engine B 4164 T3	801424	Outer Joint		31	27	36.2	70	62	M
	2015.03-	-	-	R	Estate Engine B 4164 T3	618187	Inner Joint		26	29	35	69.5	107.5	
	2015.03-	-	-	L	Estate Engine B 4164 T3	618187	Inner Joint		26	29	35	69.5	107.5	
	2015.03-	-	-	R	Estate Engine B 4154 T4	818290	Outer Joint		36	29	56.5	49.5	64	I
	2015.03-	-	-	R	Estate Engine B 4204 T37	818290	Outer Joint		36	29	56.5	49.5	64	I
	2015.03-	-	-	L	Estate Engine B 4154 T4	618044	Inner Joint		26	23	40	68.5	99.5	
	2015.03-	-	-	L	Estate Engine B 4204 T37	618044	Inner Joint		26	23	40	68.5	99.5	
	2015.03-	-	-	F	Estate Engine B 4154 T4	859285	Outer Joint		40	27	57.4	52	63.5	M
	2015.03-	-	-	F	Estate Engine B 4204 T37	859285	Outer Joint		40	27	57.4	52	63.5	M
	2015.03-	-	-	F	Estate Engine B 4154 T4	862031	Outer Joint	48T	36	27	56.5	55	65	M
	2015.03-	-	-	F	Estate Engine B 4204 T37	862031	Outer Joint	48T	36	27	56.5	55	65	M
	2015.03-	-	-	F	Estate Engine B 4154 T4	862045	Outer Joint		40	26	57.4	52	62.5	M
	2015.03-	-	-	F	Estate Engine B 4204 T37	862045	Outer Joint		40	26	57.4	52	62.5	M
	2015.03-	-	-	L	Estate Engine B 4154 T4	801424	Outer Joint		31	27	36.2	70	62	M
T4 (132 kW)	2010.09-2015.12	-	-	R	Estate Engine B 4164 T	818290	Outer Joint		36	29	56.5	49.5	64	I
	2010.09-2015.12	-	L	F	Estate Engine B 4164 T	618044	Inner Joint		26	23	40	68.5	99.5	
	2010.09-2015.12	6AT	R	F	Estate Engine B 4164 T	601078	Inner Joint		28	28	34	446.5	95.5	
	2010.09-2015.12	6AT	L	F	Estate Engine B 4164 T	601077	Inner Joint		28	28	42.5	80	95.5	
	2010.09-2015.12	-	-	F	Estate Engine B 4164 T	862031	Outer Joint	48T	36	27	56.5	55	65	M
	2010.09-2015.12	-	-	F	Estate Engine B 4164 T	859285	Outer Joint		40	27	57.4	52	63.5	M
	2010.09-2015.12	-	-	F	Estate Engine B 4164 T	862045	Outer Joint		40	26	57.4	52	62.5	M

VOLVO	YEAR	TRANSM	L/R	F/R	REMARKS	GSP Ref.	PRODUCT	ABS	Technical Specifications							
									A	B	C	H	L	P		
VOLVO																
V60 (155 157)																
T4 (132 kW)	2010.09-2015.12	-	L	F	Estate Engine B 4164 T	801424	Outer Joint		31	27	36.2	70	62	M		
	2010.09-2015.12	-	R	F	Estate Engine B 4164 T	618187	Inner Joint		26	29	35	69.5	107.5			
T4F (132 kW)	2011.04-2015.12	MT	R	F	Estate Engine B 4164 T2	662041	Inner joint		26	28	40	447	95.5			
T5 (157 kW)	2013.10-	-	R	F	Estate Engine B 5204 T9	818290	Outer Joint		36	29	56.5	49.5	64	I		
	2013.10-	-	L	F	Estate Engine B 5204 T9	618044	Inner Joint		26	23	40	68.5	99.5			
	2013.10-	-	F	F	Estate Engine B 5204 T9	862045	Outer Joint		40	26	57.4	52	62.5	M		
	2013.10-	-	F	F	Estate Engine B 5204 T9	859285	Outer Joint		40	27	57.4	52	63.5	M		
	2013.10-	-	F	F	Estate Engine B 5204 T9	862031	Outer Joint	48T	36	27	56.5	55	65	M		
	2013.10-	-	L	F	Estate Engine B 5204 T9	801424	Outer Joint		31	27	36.2	70	62	M		
T5 (176 kW)	2013.10-	-	R	F	Estate Engine B 5204 T9	618187	Inner Joint		26	29	35	69.5	107.5			
	2012.08-	-	R	F	Estate Engine B 4204 T7	818290	Outer Joint		36	29	56.5	49.5	64	I		
	2012.08-	-	L	F	Estate Engine B 4204 T7	618044	Inner Joint		26	23	40	68.5	99.5			
	2012.08-	-	F	F	Estate Engine B 4204 T7	862031	Outer Joint	48T	36	27	56.5	55	65	M		
	2012.08-	-	F	F	Estate Engine B 4204 T7	859285	Outer Joint		40	27	57.4	52	63.5	M		
	2012.08-	-	F	F	Estate Engine B 4204 T7	862045	Outer Joint		40	26	57.4	52	62.5	M		
T5 (177 kW)	2012.08-	-	L	F	Estate Engine B 4204 T7	801424	Outer Joint		31	27	36.2	70	62	M		
	2012.08-	-	R	F	Estate Engine B 4204 T7	618187	Inner Joint		26	29	35	69.5	107.5			
	2010.09-2014.12	6AT	R	F	Estate Engine B 4204 T7	262114	Drive Shaft		40	28	57.4	52	952			
	2010.09-2014.12	6AT	L	F	Estate Engine B 4204 T7	262113	Drive Shaft		40	28	57.4	52	590			
T5 (180 kW)	2013.10-	-	R	F	Estate Engine B 4204 T11	818290	Outer Joint		36	29	56.5	49.5	64	I		
	2013.10-	-	L	F	Estate Engine B 4204 T11	618044	Inner Joint		26	23	40	68.5	99.5			
	2013.10-	-	F	F	Estate Engine B 4204 T11	862031	Outer Joint	48T	36	27	56.5	55	65	M		
	2013.10-	-	F	F	Estate Engine B 4204 T11	859285	Outer Joint		40	27	57.4	52	63.5	M		
	2013.10-	-	F	F	Estate Engine B 4204 T11	862045	Outer Joint		40	26	57.4	52	62.5	M		
	2013.10-	-	L	F	Estate Engine B 4204 T11	801424	Outer Joint		31	27	36.2	70	62	M		
T5 AWD (180 kW)	2013.10-	-	R	F	Estate Engine B 4204 T11	618187	Inner Joint		26	29	35	69.5	107.5			
	2014.07-	-	R	F	All-wheel Drive Estate Engine B 4204 T11	818290	Outer Joint		36	29	56.5	49.5	64	I		
	2014.07-	-	L	F	All-wheel Drive Estate Engine B 4204 T11	618044	Inner Joint		26	23	40	68.5	99.5			
	2014.07-	-	F	F	All-wheel Drive Estate Engine B 4204 T11	862031	Outer Joint	48T	36	27	56.5	55	65	M		
	2014.07-	-	F	F	All-wheel Drive Estate Engine B 4204 T11	859285	Outer Joint		40	27	57.4	52	63.5	M		
	2014.07-	-	F	F	All-wheel Drive Estate Engine B 4204 T11	862045	Outer Joint		40	26	57.4	52	62.5	M		
T6 (187 kW)	2014.07-	-	L	F	All-wheel Drive Estate Engine B 4204 T11	801424	Outer Joint		31	27	36.2	70	62	M		
	2015.04-	-	R	F	All-wheel Drive Estate Engine B 4204 T11	618187	Inner Joint		26	29	35	69.5	107.5			
	2015.04-	-	L	F	All-wheel Drive Estate Engine B 5254 T12	801424	Outer Joint		31	27	36.2	70	62	M		
	2015.04-	-	R	F	All-wheel Drive Estate Engine B 5254 T12	618187	Inner Joint		26	29	35	69.5	107.5			
	2015.04-	-	R	F	All-wheel Drive Estate Engine B 5254 T12	818290	Outer Joint		36	29	56.5	49.5	64	I		
	2015.04-	-	F	F	All-wheel Drive Estate Engine B 5254 T12	862045	Outer Joint		40	26	57.4	52	62.5	M		
T6 (225 kW)	2015.04-	-	L	F	All-wheel Drive Estate Engine B 5254 T12	618044	Inner Joint		26	23	40	68.5	99.5			
	2015.04-	-	F	F	All-wheel Drive Estate Engine B 5254 T12	859285	Outer Joint		40	27	57.4	52	63.5	M		
	2015.04-	-	F	F	All-wheel Drive Estate Engine B 5254 T12	862031	Outer Joint	48T	36	27	56.5	55	65	M		
	2013.10-	-	R	F	Estate Engine B 4204 T9	818290	Outer Joint		36	29	56.5	49.5	64	I		
	2013.10-	-	L	F	Estate Engine B 4204 T9	618044	Inner Joint		26	23	40	68.5	99.5			
	2013.10-	-	F	F	Estate Engine B 4204 T9	862031	Outer Joint	48T	36	27	56.5	55	65	M		
T6 AWD (224 kW)	2013.10-	-	F	F	Estate Engine B 4204 T9	859285	Outer Joint		40	27	57.4	52	63.5	M		
	2013.10-	-	F	F	Estate Engine B 4204 T9	862045	Outer Joint		40	26	57.4	52	62.5	M		
	2013.10-	-	L	F	Estate Engine B 4204 T9	801424	Outer Joint		31	27	36.2	70	62	M		
	2013.10-	-	R	F	Estate Engine B 4204 T9	618187	Inner Joint		26	29	35	69.5	107.5			
	2010.07-2015.12	-	L/R	R	All-wheel Drive Estate Engine B 6304 T4	201129	Drive Shaft		36	26	56.5	49.5	756			
	2010.07-2015.12	-	L	F	All-wheel Drive Estate Engine B 6304 T4	618044	Inner Joint		26	23	40	68.5	99.5			
	2010.07-2015.12	-	F	F	All-wheel Drive Estate Engine B 6304 T4	862031	Outer Joint	48T	36	27	56.5	55	65	M		
	2010.07-2015.12	-	F	F	All-wheel Drive Estate Engine B 6304 T4	859285	Outer Joint		40	27	57.4	52	63.5	M		
	2010.07-2015.12	AT	R	F	All-wheel Drive Estate Engine B 6304 T4	262112	Drive Shaft		40	26	57.4	52	962			
	2010.07-2015.12	AT	L	F	All-wheel Drive Estate Engine B 6304 T4	262134	Drive Shaft		40	26	57.4	52	599			
	2010.07-2015.12	-	R	F	All-wheel Drive Estate Engine B 6304 T4	618187	Inner Joint		26	29	35	69.5	107.5			
	2010.07-2015.12	-	F	F	All-wheel Drive Estate Engine B 6304 T4	862045	Outer Joint		40	26	57.4	52	62.5	M		
T6 AWD (225 kW)	2010.07-2015.12	AT	L/R	F	All-wheel Drive Estate Engine B 6304 T4	862042	Outer Joint		40	27	57.4	52	63.5	M		
	2010.07-2015.12	-	R	F	All-wheel Drive Estate Engine B 6304 T4	818290	Outer Joint		36	29	56.5	49.5	64	I		
	2010.07-2015.12	-	L	F	All-wheel Drive Estate Engine B 6304 T4	801424	Outer Joint		31	27	36.2	70	62	M		
	2013.10-	-	R	F	All-wheel Drive Estate Engine B 4204 T9	818290	Outer Joint		36	29	56.5	49.5	64	I		
	2013.10-	-	L	F	All-wheel Drive Estate Engine B 4204 T9	618044	Inner Joint		26	23	40	68.5	99.5			
	2013.10-	-	F	F	All-wheel Drive Estate Engine B 4204 T9	862031	Outer Joint	48T	36	27	56.5	55	65	M		
T6 AWD (242 kW)	2013.10-	-	F	F	All-wheel Drive Estate Engine B 4204 T9	859285	Outer Joint		40	27	57.4	52	63.5	M		
	2013.10-	-	F	F	All-wheel Drive Estate Engine B 4204 T9	862045	Outer Joint		40	26	57.4	52	62.5	M		
	2013.10-	-	L	F	All-wheel Drive Estate Engine B 4204 T9	801424	Outer Joint		31	27	36.2	70	62	M		
	2013.10-	-	R	F	All-wheel Drive Estate Engine B 4204 T9	618187	Inner Joint		26	29	35	69.5	107.5			
	2014.04-2015.12	AT	L/R	R	All-wheel Drive Estate Engine B 6304 T4	201129	Drive Shaft		36	26	56.5	49.5	756			

		 YEAR		TRANSM	L/R	F/R	REMARKS	GSP Ref.	 PRODUCT	 ABS	Technical Specifications					
											A	B	C	H	L	P
VOLVO																
V60 (155 157)																
T6 AWD (242 kW)	2014.04-2015.12	-	L	F	All-wheel Drive Estate Engine B 6304 T4	618044	Inner Joint		26	23	40	68.5	99.5			
	2014.04-2015.12	-	-	F	All-wheel Drive Estate Engine B 6304 T4	859285	Outer Joint		40	27	57.4	52	63.5	M		
	2014.04-2015.12	-	-	F	All-wheel Drive Estate Engine B 6304 T4	862031	Outer Joint	48T	36	27	56.5	55	65	M		
	2014.04-2015.12	-	-	R	All-wheel Drive Estate Engine B 6304 T4	618187	Inner Joint		26	29	35	69.5	107.5			
	2014.04-2015.12	-	-	F	All-wheel Drive Estate Engine B 6304 T4	862045	Outer Joint		40	26	57.4	52	62.5	M		
	2014.04-2015.12	-	-	R	All-wheel Drive Estate Engine B 6304 T4	818290	Outer Joint		36	29	56.5	49.5	64	I		
	2014.04-2015.12	-	L	F	All-wheel Drive Estate Engine B 6304 T4	801424	Outer Joint		31	27	36.2	70	62	M		
V70																
-	1997-2010	-	-	-	-	699195	Propshaft CV Joint				19	22.6				
-	2003-2007	-	-	-	-	699195	Propshaft CV Joint				19	22.6				
2.3	2001-2004	-	-	-	5 cylinder Turbo XC	699195	Propshaft CV Joint				19	22.6				
2.4	-	-	-	-	5 cylinder Turbo XC	699195	Propshaft CV Joint				19	22.6				
	2000-2002	-	-	-	5 cylinder Turbo	699195	Propshaft CV Joint				19	22.6				
	2003-2007	-	-	-	5 cylinder Turbo (Diesel).	699195	Propshaft CV Joint				19	22.6				
	2003-2007	-	-	-	5 cylinder Turbo (Diesel) XC.	699195	Propshaft CV Joint				19	22.6				
2.5	2003-2007	-	-	-	5 cylinder Turbo	699195	Propshaft CV Joint				19	22.6				
	2003-2007	-	-	-	5 cylinder Turbo XC	699195	Propshaft CV Joint				19	22.6				
V70 I (875 876)																
2.0 (105 kW)	1995.12-2000.03	MT	R	F	Estate Engine B 5204 F	662015	Inner Joint		26	25	40	531.5	66.5			
	1995.12-2000.03	AT	R	F	Estate Engine B 5204 F	262002	Drive Shaft	48T	26	26	56.5	98.5	1028			
	1995.12-2000.03	-	-	-	Estate Engine B 5204 F	862014	Outer Joint		26	25	56.5	98.5	56	O		
	1995.12-2000.03	AT/MT	L/R	F	Estate Engine B 5204 F	862001	Outer Joint	48T	26	25	56.5	98.5	56	O		
2.0 (120 kW)	1997.01-2000.12	-	-	-	Estate Engine B 5204 T4	862014	Outer Joint		26	25	56.5	98.5	56	O		
	1997.01-2000.12	-	L	F	Estate Engine B 5204 T4	862009	Outer Joint	48T	36	27	56.5	48	66	M		
2.0 (132 kW)	1996.11-2000.03	MT	R	F	Estate Engine B 5204 T2	662015	Inner Joint		26	25	40	531.5	66.5			
	1996.11-2000.03	AT	R	F	Estate Engine B 5204 T2	262002	Drive Shaft	48T	26	26	56.5	98.5	1028			
	1996.11-2000.03	-	-	-	Estate Engine B 5204 T2	862014	Outer Joint		26	25	56.5	98.5	56	O		
	1996.11-2000.03	AT/MT	L/R	F	Estate Engine B 5204 T2	862001	Outer Joint	48T	26	25	56.5	98.5	56	O		
2.0 (93 kW)	1995.12-2000.03	MT	R	F	Estate Engine B 5202 S	662015	Inner Joint		26	25	40	531.5	66.5			
	1995.12-2000.03	AT	R	F	Estate Engine B 5202 S	262002	Drive Shaft	48T	26	26	56.5	98.5	1028			
	1995.12-2000.03	MT	L	F	Estate Engine B 5202 S	862038	Outer Joint		36	25	56.5	48	58	M		
	1995.12-2000.03	-	-	-	Estate Engine B 5202 S	862014	Outer Joint		26	25	56.5	98.5	56	O		
	1995.12-2000.03	AT/MT	L/R	F	Estate Engine B 5202 S	862010	Outer Joint	48T	36	33	56.5	48	58	M		
	1995.12-2000.03	AT/MT	L/R	F	Estate Engine B 5202 S	862001	Outer Joint	48T	26	25	56.5	98.5	56	O		
2.0 Turbo (155 kW)	1995.12-2000.03	AT/MT	L/R	F	Estate Engine B 5204 T	862016	Outer Joint		26	28	56.5	97.5	66	O		
	1995.12-2000.03	AT/MT	L/R	F	Estate Engine B 5204 T	862002	Outer Joint	48T	26	28	56.5	97.5	66	O		
2.0 Turbo (166 kW)	1996.11-2000.12	AT	L	F	Estate Engine B 5204 T3	262001	Drive Shaft	48T	26	26	56.5	98.5	574.5			
	1996.11-2000.12	AT/MT	L/R	F	Estate Engine B 5204 T3	862016	Outer Joint		26	28	56.5	97.5	66	O		
	1996.11-2000.12	AT/MT	L/R	F	Estate Engine B 5204 T3	862002	Outer Joint	48T	26	28	56.5	97.5	66	O		
	1996.11-2000.12	MT	L	F	Estate Engine B 5204 T3	862009	Outer Joint	48T	36	27	56.5	48	66	M		
2.0 Turbo AWD (166 kW)	1996.11-2000.12	AT/MT	-	-	All-wheel Drive Estate Engine B 5204 T3	635008	Inner Joint			24	23.5					
	1996.11-2000.12	AT/MT	L/R	F	All-wheel Drive Estate Engine B 5204 T3	862016	Outer Joint		26	28	56.5	97.5	66	O		
	1996.11-2000.12	AT/MT	L/R	F	All-wheel Drive Estate Engine B 5204 T3	862002	Outer Joint	48T	26	28	56.5	97.5	66	O		
	1996.11-2000.12	MT	L	F	All-wheel Drive Estate Engine B 5204 T3	862009	Outer Joint	48T	36	27	56.5	48	66	M		
2.3 T AWD (184 kW)	1997.04-2000.03	AT/MT	-	-	All-wheel Drive Estate Engine B 5234 FT+	635008	Inner Joint			24	23.5					
	1997.04-2000.03	AT/MT	L/R	F	All-wheel Drive Estate Engine B 5234 FT+	862016	Outer Joint		26	28	56.5	97.5	66	O		
	1997.04-2000.03	AT/MT	L/R	F	All-wheel Drive Estate Engine B 5234 FT+	862002	Outer Joint	48T	26	28	56.5	97.5	66	O		
	1997.04-2000.03	AT/MT	L/R	F	All-wheel Drive Estate Engine B 5234 FT+	862009	Outer Joint	48T	36	27	56.5	48	66	M		
2.3 T-5 (176 kW)	1996.11-2000.12	AT	R	F	Estate Engine B 5234 T3	662029	Inner Joint		26	26	31	513	93.5			
	1996.11-2000.12	AT/MT	L/R	F	Estate Engine B 5234 T3	862016	Outer Joint		26	28	56.5	97.5	66	O		
	1996.11-2000.12	AT	R	F	Estate Engine B 5234 T3	262017	Drive Shaft	48T	36	26	56.5	48	978.5			
	1996.11-2000.12	AT/MT	L/R	F	Estate Engine B 5234 T3	862002	Outer Joint	48T	26	28	56.5	97.5	66	O		
	1996.11-2000.12	AT/MT	L/R	F	Estate Engine B 5234 T3	862009	Outer Joint	48T	36	27	56.5	48	66	M		
2.3 T-5 AWD (176 kW)	1997.01-2000.12	AT/MT	-	-	All-wheel Drive Estate Engine B 5234 T3	635008	Inner Joint			24	23.5					
	1997.01-2000.12	AT/MT	L/R	F	All-wheel Drive Estate Engine B 5234 T3	862016	Outer Joint		26	28	56.5	97.5	66	O		
	1997.01-2000.12	AT/MT	L/R	F	All-wheel Drive Estate Engine B 5234 T3	862002	Outer Joint	48T	26	28	56.5	97.5	66	O		
	1997.01-2000.12	AT/MT	L/R	F	All-wheel Drive Estate Engine B 5234 T3	862009	Outer Joint	48T	36	27	56.5	48	66	M		
2.3 Turbo (184 kW)	1995.12-2000.03	AT	R	F	Estate Engine B 5234 FT+	662029	Inner Joint		26	26	31	513	93.5			
	1995.12-2000.03	AT/MT	L/R	F	Estate Engine B 5234 FT+	862016	Outer Joint		26	28	56.5	97.5	66	O		
	1995.12-2000.03	AT	R	F	Estate Engine B 5234 FT+	262017	Drive Shaft	48T	36	26	56.5	48	978.5			
	1995.12-2000.03	AT/MT	L/R	F	Estate Engine B 5234 FT+	862002	Outer Joint	48T	26	28	56.5	97.5	66	O		
	1995.12-2000.03	AT/MT	L/R	F	Estate Engine B 5234 FT+	862009	Outer Joint	48T	36	27	56.5	48	66	M		
2.4 (103 kW)	1999.03-2000.12	AT	R	F	Estate Engine B 5244 S2	662029	Inner Joint		26	26	31	513	93.5			
	1999.03-2000.12	AT/MT	L/R	F	Estate Engine B 5244 S2	862010	Outer Joint	48T	36	33	56.5	48	58	M		
	1999.03-2000.12	AT	L	F	Estate Engine B 5244 S2	262143	Drive Shaft	48T	36	26	56.5	48	506			
2.4 (106 kW)	1995.12-2000.03	MT	R	F	Estate Engine B 5252 FS	662015	Inner Joint		26	25	40	531.5	66.5			





	 YEAR	TRANSM	L/R	F/R	REMARKS	GSP Ref.	 PRODUCT	 ABS	Technical Specifications								
									A	B	C	H	L	P			
VOLVO																	
V70 I (875 876)																	
2.4 (106 kW)	1995.12-2000.03	AT	R	F	Estate Engine B 5252 FS	262002	Drive Shaft	48T	26	26	56.5	98.5	1028				
	1995.12-2000.03	-	-	-	Estate Engine B 5252 FS	862014	Outer Joint		26	25	56.5	98.5	56	O			
	1995.12-2000.03	AT/MT	L/R	F	Estate Engine B 5252 FS	862010	Outer Joint	48T	36	33	56.5	48	58	M			
	1995.12-2000.03	AT/MT	L/R	F	Estate Engine B 5252 FS	862001	Outer Joint	48T	26	25	56.5	98.5	56	O			
2.4 (121 kW)	1998.06-1999.12	AT	L	F	Estate Engine B 5254 S	262001	Drive Shaft	48T	26	26	56.5	98.5	574.5				
	1998.06-1999.12	-	-	-	Estate Engine B 5254 S	862014	Outer Joint		26	25	56.5	98.5	56	O			
	1998.06-1999.12	AT/MT	L/R	F	Estate Engine B 5254 S	862010	Outer Joint	48T	36	33	56.5	48	58	M			
	1998.06-1999.12	AT/MT	L/R	F	Estate Engine B 5254 S	862001	Outer Joint	48T	26	25	56.5	98.5	56	O			
2.4 (125 kW)	1995.12-2000.05	MT	R	F	Estate Engine B 5254 S	662015	Inner Joint		26	25	40	531.5	66.5				
	1995.12-2000.05	AT	R	F	Estate Engine B 5254 S	262002	Drive Shaft	48T	26	26	56.5	98.5	1028				
	1995.12-2000.05	AT	L	F	Estate Engine B 5254 S	262001	Drive Shaft	48T	26	26	56.5	98.5	574.5				
	1995.12-2000.05	AT/MT	L/R	F	Estate Engine B 5254 S	862010	Outer Joint	48T	36	33	56.5	48	58	M			
	1995.12-2000.05	AT	L	F	Estate Engine B 5254 S	262143	Drive Shaft	48T	36	26	56.5	48	506				
	1995.12-2000.05	AT/MT	L/R	F	Estate Engine B 5254 S	862001	Outer Joint	48T	26	25	56.5	98.5	56	O			
2.4 Bifuel (103 kW)	1999.08-2000.12	AT/MT	L/R	F	Estate Engine B 5244 SG	862010	Outer Joint	48T	36	33	56.5	48	58	M			
2.4 Bifuel (106 kW)	1998.05-1999.12	AT/MT	L/R	F	Estate Engine GB 5252 S	862010	Outer Joint	48T	36	33	56.5	48	58	M			
	1998.05-1999.12	AT/MT	L/R	F	Estate Engine GB 5252 S	862016	Outer Joint		26	28	56.5	97.5	66	O			
	1998.05-1999.12	AT/MT	L/R	F	Estate Engine GB 5252 S	862001	Outer Joint	48T	26	25	56.5	98.5	56	O			
2.4 Turbo (142 kW)	1996.04-2000.12	AT	R	F	Estate Engine B 5244 T	662029	Inner Joint		26	26	31	513	93.5				
	1996.04-2000.12	AT/MT	L/R	F	Estate Engine B 5244 T	862016	Outer Joint		26	28	56.5	97.5	66	O			
	1996.04-2000.12	AT/MT	L/R	F	Estate Engine B 5244 T	862002	Outer Joint	48T	26	28	56.5	97.5	66	O			
	1996.04-2000.12	MT	L	F	Estate Engine B 5244 T	862009	Outer Joint	48T	36	27	56.5	48	66	M			
2.4 Turbo AWD (142 kW)	1996.04-2000.12	AT/MT	-	-	All-wheel Drive Estate Engine B 5254 T	635008	Inner Joint			24		23.5					
	1996.04-2000.12	AT/MT	L/R	F	All-wheel Drive Estate Engine B 5254 T	862016	Outer Joint		26	28	56.5	97.5	66	O			
	1996.04-2000.12	AT/MT	L/R	F	All-wheel Drive Estate Engine B 5254 T	862002	Outer Joint	48T	26	28	56.5	97.5	66	O			
	1996.04-2000.12	AT/MT	L	F	All-wheel Drive Estate Engine B 5254 T	862009	Outer Joint	48T	36	27	56.5	48	66	M			
2.4 Turbo AWD (195 kW)	1999.03-2000.12	AT/MT	L/R	F	All-wheel Drive Estate Engine B 5244 T2	862009	Outer Joint	48T	36	27	56.5	48	66	M			
2.5 TDI (103 kW)	1995.12-2000.12	AT	R	F	Estate Engine D 5252 T	662029	Inner Joint		26	26	31	513	93.5				
	1995.12-2000.12	AT/MT	L/R	F	Estate Engine D 5252 T	862016	Outer Joint		26	28	56.5	97.5	66	O			
	1995.12-2000.12	AT	R	F	Estate Engine D 5252 T	262017	Drive Shaft	48T	36	26	56.5	48	978.5				
	1995.12-2000.12	AT/MT	L/R	F	Estate Engine D 5252 T	862002	Outer Joint	48T	26	28	56.5	97.5	66	O			
	1995.12-2000.12	MT	L	F	Estate Engine D 5252 T	862009	Outer Joint	48T	36	27	56.5	48	66	M			
V70 II																	
2.0	2015-	-	-	-	F -	262124	Drive Shaft		40	28	57.5	52	954				
V70 II (285)																	
2.0 T (132 kW)	1999.11-2007.08	AT	R	F	Estate Engine B 5204 T5	262015	Drive Shaft	48T	36	26	56.5	48	974				
	1999.11-2007.08	AT	R	F	Estate Engine B 5204 T5	662029	Inner Joint		26	26	31	513	93.5				
	1999.11-2007.08	MT	R	F	Estate Engine B 5204 T5	262031	Drive Shaft	48T	36	26	56.5	48	992				
	1999.11-2007.08	AT	L	F	Estate Engine B 5204 T5	262022	Drive Shaft	48T	36	26	56.5	48	527				
	1999.11-2007.08	MT	L	F	Estate Engine B 5204 T5	862038	Outer Joint		36	25	56.5	48	58	M			
	1999.11-2007.08	AT	L	F	Estate Engine B 5204 T5	862019	Outer Joint		36	27	56.5	48	66	M			
	1999.11-2007.08	AT	R	F	Estate Engine B 5204 T5	262017	Drive Shaft	48T	36	26	56.5	48	978.5				
	1999.11-2007.08	AT/MT	L/R	F	Estate Engine B 5204 T5	862009	Outer Joint	48T	36	27	56.5	48	66	M			
	1999.11-2007.08	AT	L	F	Estate Engine B 5204 T5	262012	Drive Shaft	48T	36	26	56.5	48	526				
	2.3 (195 kW)	2000.10-2004.09	-	L	F	Estate Engine B 5234 T7	862019	Outer Joint		36	27	56.5	48	66	M		
2.3 T5 (184 kW)	2000.10-2004.09	-	L	F	Estate Engine B 5234 T7	262022	Drive Shaft	48T	36	26	56.5	48	527				
	1999.11-2004.12	AT	R	F	Estate Engine B 5234 T3	262015	Drive Shaft	48T	36	26	56.5	48	974				
	1999.11-2004.12	AT	R	F	Estate Engine B 5234 T3	662029	Inner Joint		26	26	31	513	93.5				
	1999.11-2004.12	MT	R	F	Estate Engine B 5234 T3	262031	Drive Shaft	48T	36	26	56.5	48	992				
	1999.11-2004.12	AT	L	F	Estate Engine B 5234 T3	262022	Drive Shaft	48T	36	26	56.5	48	527				
	1999.11-2004.12	AT	L	F	Estate Engine B 5234 T3	862019	Outer Joint		36	27	56.5	48	66	M			
	1999.11-2004.12	AT	R	F	Estate Engine B 5234 T3	262017	Drive Shaft	48T	36	26	56.5	48	978.5				
	1999.11-2004.12	AT/MT	L/R	F	Estate Engine B 5234 T3	862009	Outer Joint	48T	36	27	56.5	48	66	M			
	1999.11-2004.12	AT	L	F	Estate Engine B 5234 T3	262012	Drive Shaft	48T	36	26	56.5	48	526				
2.4 (103 kW)	2000.03-2007.08	MT	R	F	Estate Engine B 5244 S2	662030	Inner Joint		26	25	40	526	92.5				
	2000.03-2007.08	MT	R	F	Estate Engine B 5244 S2	862040	Outer Joint	48T	36	25	56.5	48	58	M			
	2000.03-2007.08	MT	L	F	Estate Engine B 5244 S2	862038	Outer Joint		36	25	56.5	48	58	M			
	2000.03-2007.08	AT/MT	L/R	F	Estate Engine B 5244 S2	862010	Outer Joint	48T	36	33	56.5	48	58	M			
	2000.03-2007.08	MT	R	F	Estate Engine B 5244 S2	262028	Drive Shaft	48T	36	26	56.5	48	990				
	2000.03-2007.08	AT	L	F	Estate Engine B 5244 S2	262012	Drive Shaft	48T	36	26	56.5	48	526				
	2000.03-2007.08	AT	R	F	Estate Engine B 5244 S2	262015	Drive Shaft	48T	36	26	56.5	48	974				
2.4 (125 kW)	2000.03-2007.08	MT	R	F	Estate Engine B 5244 S	662030	Inner Joint		26	25	40	526	92.5				
	2000.03-2007.08	MT	R	F	Estate Engine B 5244 S	862040	Outer Joint	48T	36	25	56.5	48	58	M			
	2000.03-2007.08	MT	L	F	Estate Engine B 5244 S	862038	Outer Joint		36	25	56.5	48	58	M			
	2000.03-2007.08	MT	R	F	Estate Engine B 5244 S	262028	Drive Shaft	48T	36	26	56.5	48	990				
	2000.03-2007.08	AT	L	F	Estate Engine B 5244 S	262012	Drive Shaft	48T	36	26	56.5	48	526				

	YEAR	TRANSM	L/R	F/R	REMARKS	GSP Ref.	PRODUCT	ABS	Technical Specifications						
									A	B	C	H	L	P	
VOLVO															
V70 II (285)															
2.4 (125 kW)	2000.03-	2007.08	AT	R	F	Estate Engine B 5244 S	262015	Drive Shaft	48T	36	26	56.5	48	974	
2.4 Bifuel (103 kW)	2001.09-	2007.08	AT	R	F	Estate Engine B 5244 SG	262015	Drive Shaft	48T	36	26	56.5	48	974	
	2001.09-	2007.08	AT	R	F	Estate Engine B 5244 SG2	262015	Drive Shaft	48T	36	26	56.5	48	974	
	2001.09-	2007.08	MT	R	F	Estate Engine B 5244 SG	662030	Inner Joint		26	25	40	526	92.5	
	2001.09-	2007.08	MT	R	F	Estate Engine B 5244 SG2	662030	Inner Joint		26	25	40	526	92.5	
	2001.09-	2007.08	AT	R	F	Estate Engine B 5244 SG	662029	Inner Joint		26	26	31	513	93.5	
	2001.09-	2007.08	AT	R	F	Estate Engine B 5244 SG2	662029	Inner Joint		26	26	31	513	93.5	
	2001.09-	2007.08	MT	R	F	Estate Engine B 5244 SG	862040	Outer Joint	48T	36	25	56.5	48	58	M
	2001.09-	2007.08	MT	R	F	Estate Engine B 5244 SG2	862040	Outer Joint	48T	36	25	56.5	48	58	M
	2001.09-	2007.08	MT	L	F	Estate Engine B 5244 SG	862038	Outer Joint		36	25	56.5	48	58	M
	2001.09-	2007.08	MT	L	F	Estate Engine B 5244 SG2	862038	Outer Joint		36	25	56.5	48	58	M
	2001.09-	2007.08	AT/MT	L/R	F	Estate Engine B 5244 SG2	862010	Outer Joint	48T	36	33	56.5	48	58	M
	2001.09-	2007.08	MT	R	F	Estate Engine B 5244 SG	262028	Drive Shaft	48T	36	26	56.5	48	990	
	2001.09-	2007.08	MT	R	F	Estate Engine B 5244 SG2	262028	Drive Shaft	48T	36	26	56.5	48	990	
	2001.09-	2007.08	AT	L	F	Estate Engine B 5244 SG	262012	Drive Shaft	48T	36	26	56.5	48	526	
2001.09-	2007.08	AT	L	F	Estate Engine B 5244 SG2	262012	Drive Shaft	48T	36	26	56.5	48	526		
2.4 CDI (90 kW)	2005.07-	2008.12	-	R	F	Estate Engine D 5244 T6	262031	Drive Shaft	48T	36	26	56.5	48	992	
2.4 D (93 kW)	2005.04-	2008.12	-	L/R	F	Estate Engine D 5244 T7	862009	Outer Joint	48T	36	27	56.5	48	66	M
	2005.04-	2008.12	AT	R	F	Estate Engine D 5244 T7	662029	Inner Joint		26	26	31	513	93.5	
	2005.04-	2008.12	-	R	F	Estate Engine D 5244 T7	262031	Drive Shaft	48T	36	26	56.5	48	992	
	2005.04-	2008.12	MT	L	F	Estate Engine D 5244 T7	862038	Outer Joint		36	25	56.5	48	58	M
	2005.04-	2008.12	AT	R	F	Estate Engine D 5244 T7	262017	Drive Shaft	48T	36	26	56.5	48	978.5	
2.4 D (96 kW)	2001.07-	2007.08	AT	R	F	Estate Engine D 5244 T2	262015	Drive Shaft	48T	36	26	56.5	48	974	
	2001.07-	2007.08	AT	R	F	Estate Engine D 5244 T2	662029	Inner Joint		26	26	31	513	93.5	
	2001.07-	2007.08	MT	R	F	Estate Engine D 5244 T2	262031	Drive Shaft	48T	36	26	56.5	48	992	
	2001.07-	2007.08	AT	L	F	Estate Engine D 5244 T2	262022	Drive Shaft	48T	36	26	56.5	48	527	
	2001.07-	2007.08	MT	L	F	Estate Engine D 5244 T2	862038	Outer Joint		36	25	56.5	48	58	M
	2001.07-	2007.08	AT	L	F	Estate Engine D 5244 T2	862019	Outer Joint		36	27	56.5	48	66	M
	2001.07-	2007.08	AT	R	F	Estate Engine D 5244 T2	262017	Drive Shaft	48T	36	26	56.5	48	978.5	
	2001.07-	2007.08	AT	L	F	Estate Engine D 5244 T2	262012	Drive Shaft	48T	36	26	56.5	48	526	
2001.07-	2007.08	AT/MT	L/R	F	Estate Engine D 5244 T2	862009	Outer Joint	48T	36	27	56.5	48	66	M	
2.4 D5 (120 kW)	2001.01-	2008.12	5AT	R	F	Estate Engine D 5244 T	662029	Inner Joint		26	26	31	513	93.5	
	2001.01-	2008.12	MT	R	F	Estate Engine D 5244 T	262031	Drive Shaft	48T	36	26	56.5	48	992	
	2001.01-	2008.12	AT	L	F	Estate Engine D 5244 T	262022	Drive Shaft	48T	36	26	56.5	48	527	
	2001.01-	2008.12	AT	L	F	Estate Engine D 5244 T	862019	Outer Joint		36	27	56.5	48	66	M
	2001.01-	2008.12	6AT/6MT	-	F	Estate Engine D 5244 T	862037	Outer Joint	48T	36	27	56.5	48	66	M
	2001.01-	2008.12	5AT	R	F	Estate Engine D 5244 T	262017	Drive Shaft	48T	36	26	56.5	48	978.5	
	2001.01-	2008.12	AT	L	F	Estate Engine D 5244 T	262141	Drive Shaft	48T	36	28	56.5	48	521	
	2001.01-	2008.12	AT	L	F	Estate Engine D 5244 T	262012	Drive Shaft	48T	36	26	56.5	48	526	
	2001.01-	2008.12	AT/MT	L/R	F	Estate Engine D 5244 T	862009	Outer Joint	48T	36	27	56.5	48	66	M
	2001.01-	2008.12	AT	R	F	Estate Engine D 5244 T	262015	Drive Shaft	48T	36	26	56.5	48	974	
2005.08-	2007.07	MT	R	F	Estate Engine D 5244 T5	262031	Drive Shaft	48T	36	26	56.5	48	992		
2005.08-	2007.07	6AT/6MT	-	F	Estate Engine D 5244 T5	862037	Outer Joint	48T	36	27	56.5	48	66	M	
2.4 D5 (136 kW)	2005.04-	2008.12	5AT	R	F	Estate Engine D 5244 T4	662029	Inner Joint		26	26	31	513	93.5	
	2005.04-	2008.12	MT	L	F	Estate Engine D 5244 T4	862038	Outer Joint		36	25	56.5	48	58	M
	2005.04-	2008.12	6AT/6MT	-	F	Estate Engine D 5244 T4	862037	Outer Joint	48T	36	27	56.5	48	66	M
	2005.04-	2008.12	5AT	R	F	Estate Engine D 5244 T4	262017	Drive Shaft	48T	36	26	56.5	48	978.5	
	2005.04-	2008.12	AT	L	F	Estate Engine D 5244 T4	262141	Drive Shaft	48T	36	28	56.5	48	521	
2.4 D5 AWD (120 kW)	2002.07-	2007.08	AT	R	F	All-wheel Drive Estate Engine D 5244 T	662029	Inner Joint		26	26	31	513	93.5	
	2002.07-	2007.08	MT	R	F	All-wheel Drive Estate Engine D 5244 T	262031	Drive Shaft	48T	36	26	56.5	48	992	
	2002.07-	2007.08	AT	L	F	All-wheel Drive Estate Engine D 5244 T	262022	Drive Shaft	48T	36	26	56.5	48	527	
	2002.07-	2007.08	AT/MT	-	-	All-wheel Drive Estate Engine D 5244 T	635008	Inner Joint		24		23.5			
	2002.07-	2007.08	MT	L	F	All-wheel Drive Estate Engine D 5244 T	862038	Outer Joint		36	25	56.5	48	58	M
	2002.07-	2007.08	AT	L	F	All-wheel Drive Estate Engine D 5244 T	862019	Outer Joint		36	27	56.5	48	66	M
	2002.07-	2007.08	6AT/6MT	-	F	All-wheel Drive Estate Engine D 5244 T	862037	Outer Joint	48T	36	27	56.5	48	66	M
	2002.07-	2007.08	AT	R	F	All-wheel Drive Estate Engine D 5244 T	262140	Drive Shaft	48T	36	26	56.5	48	977	
	2002.07-	2007.08	AT/MT	L/R	F	All-wheel Drive Estate Engine D 5244 T	862009	Outer Joint	48T	36	27	56.5	48	66	M
	2002.07-	2007.08	AT	L	F	All-wheel Drive Estate Engine D 5244 T	262012	Drive Shaft	48T	36	26	56.5	48	526	
2.4 D5 AWD (136 kW)	2005.07-	2008.12	AT	R	F	All-wheel Drive Estate Engine D 5244 T4	662029	Inner Joint		26	26	31	513	93.5	
	2005.07-	2008.12	MT	L	F	All-wheel Drive Estate Engine D 5244 T4	862038	Outer Joint		36	25	56.5	48	58	M
	2005.07-	2008.12	6AT/6MT	-	F	All-wheel Drive Estate Engine D 5244 T4	862037	Outer Joint	48T	36	27	56.5	48	66	M
2.4 T (147 kW)	1999.11-	2003.08	5AT	R	F	Estate Engine B 5244 T3	262015	Drive Shaft	48T	36	26	56.5	48	974	
	1999.11-	2003.08	AT	R	F	Estate Engine B 5244 T3	662029	Inner Joint		26	26	31	513	93.5	
	1999.11-	2003.08	MT	R	F	Estate Engine B 5244 T3	262031	Drive Shaft	48T	36	26	56.5	48	992	
	1999.11-	2003.08	AT	L	F	Estate Engine B 5244 T3	262022	Drive Shaft	48T	36	26	56.5	48	527	
	1999.11-	2003.08	MT	L	F	Estate Engine B 5244 T3	862038	Outer Joint		36	25	56.5	48	58	M





VOLVO	YEAR	TRANSM	L/R	F/R	REMARKS	GSP Ref.	PRODUCT	ABS	Technical Specifications					
									A	B	C	H	L	P
V70 II (285)														
2.4 T (147 kW)	1999.11-2003.08	AT	L	F	Estate Engine B 5244 T3	862019	Outer Joint		36	27	56.5	48	66	M
	1999.11-2003.08	5AT	L	F	Estate Engine B 5244 T3	262012	Drive Shaft	48T	36	26	56.5	48	526	
	1999.11-2003.08	AT/MT	L/R	F	Estate Engine B 5244 T3	862009	Outer Joint	48T	36	27	56.5	48	66	M
2.4 T AWD (147 kW)	2001.09-2002.08	AT/MT	L/R	F	All-wheel Drive Estate Engine B 5244 T3	862009	Outer Joint	48T	36	27	56.5	48	66	M
	2001.09-2002.08	AT/MT	-	-	All-wheel Drive Estate Engine B 5244 T3	635008	Inner Joint			24		23.5		
	2001.09-2002.08	AT	L	F	All-wheel Drive Estate Engine B 5244 T3	262022	Drive Shaft	48T	36	26	56.5	48	527	
	2001.09-2002.08	MT	L	F	All-wheel Drive Estate Engine B 5244 T3	862038	Outer Joint		36	25	56.5	48	58	M
	2001.09-2002.08	AT	L	F	All-wheel Drive Estate Engine B 5244 T3	862019	Outer Joint		36	27	56.5	48	66	M
	2001.09-2002.08	AT	R	F	All-wheel Drive Estate Engine B 5244 T3	262140	Drive Shaft	48T	36	26	56.5	48	977	
	2001.09-2002.08	AT	L	F	All-wheel Drive Estate Engine B 5244 T3	262012	Drive Shaft	48T	36	26	56.5	48	526	
2.4 T5 (191 kW)	2004.04-2007.08	AT	R	F	Estate Engine B 5244 T5	262015	Drive Shaft	48T	36	26	56.5	48	974	
	2004.04-2007.08	AT/MT	L/R	F	Estate Engine B 5244 T5	862009	Outer Joint	48T	36	27	56.5	48	66	M
	2004.04-2007.08	AT	R	F	Estate Engine B 5244 T5	662029	Inner Joint		26	26	31	513	93.5	
	2004.04-2007.08	MT	R	F	Estate Engine B 5244 T5	262031	Drive Shaft	48T	36	26	56.5	48	992	
	2004.04-2007.08	AT	L	F	Estate Engine B 5244 T5	262022	Drive Shaft	48T	36	26	56.5	48	527	
	2004.04-2007.08	MT	L	F	Estate Engine B 5244 T5	862038	Outer Joint		36	25	56.5	48	58	M
	2004.04-2007.08	AT	L	F	Estate Engine B 5244 T5	862019	Outer Joint		36	27	56.5	48	66	M
	2004.04-2007.08	AT	L	F	Estate Engine B 5244 T5	262012	Drive Shaft	48T	36	26	56.5	48	526	
2.5 R Sport (221 kW)	2002.12-2007.08	MT	L	F	Estate Engine B 5254 T4	862038	Outer Joint		36	25	56.5	48	58	M
2.5 T (154 kW)	2001.07-2007.08	5AT	R	F	Estate Engine B 5254 T2	262015	Drive Shaft	48T	36	26	56.5	48	974	
	2001.07-2007.08	AT	R	F	Estate Engine B 5254 T2	662029	Inner Joint		26	26	31	513	93.5	
	2001.07-2007.08	MT	R	F	Estate Engine B 5254 T2	262031	Drive Shaft	48T	36	26	56.5	48	992	
	2001.07-2007.08	AT	L	F	Estate Engine B 5254 T2	262022	Drive Shaft	48T	36	26	56.5	48	527	
	2001.07-2007.08	MT	L	F	Estate Engine B 5254 T2	862038	Outer Joint		36	25	56.5	48	58	M
	2001.07-2007.08	AT	L	F	Estate Engine B 5254 T2	862019	Outer Joint		36	27	56.5	48	66	M
	2001.07-2007.08	AT	R	F	Estate Engine B 5254 T2	262017	Drive Shaft	48T	36	26	56.5	48	978.5	
	2001.07-2007.08	5AT	L	F	Estate Engine B 5254 T2	262012	Drive Shaft	48T	36	26	56.5	48	526	
	2001.07-2007.08	AT/MT	L/R	F	Estate Engine B 5254 T2	862009	Outer Joint	48T	36	27	56.5	48	66	M
2.5 T AWD (154 kW)	2002.07-2007.08	AT/MT	L/R	F	All-wheel Drive Estate Engine B 5254 T2	862009	Outer Joint	48T	36	27	56.5	48	66	M
	2002.07-2007.08	AT/MT	-	-	All-wheel Drive Estate Engine B 5254 T2	635008	Inner Joint			24		23.5		
	2002.07-2007.08	AT	L	F	All-wheel Drive Estate Engine B 5254 T2	262022	Drive Shaft	48T	36	26	56.5	48	527	
	2002.07-2007.08	AT	L	F	All-wheel Drive Estate Engine B 5254 T2	862019	Outer Joint		36	27	56.5	48	66	M
	2002.07-2007.08	AT	L	F	All-wheel Drive Estate Engine B 5254 T2	862038	Outer Joint		36	25	56.5	48	58	M
	2002.07-2007.08	AT	R	F	All-wheel Drive Estate Engine B 5254 T2	262140	Drive Shaft	48T	36	26	56.5	48	977	
	2002.07-2007.08	AT	L	F	All-wheel Drive Estate Engine B 5254 T2	262012	Drive Shaft	48T	36	26	56.5	48	526	
2.5 TDI (103 kW)	1999.11-2007.08	-	R	F	Estate Engine D 5252 T	262031	Drive Shaft	48T	36	26	56.5	48	992	
	1999.11-2007.08	MT	L	F	Estate Engine D 5252 T	862038	Outer Joint		36	25	56.5	48	58	M
	1999.11-2007.08	AT/MT	L/R	F	Estate Engine D 5252 T	862009	Outer Joint	48T	36	27	56.5	48	66	M
R 2,5 T AWD (221 kW)	2003.03-2007.08	AT/MT	L/R	F	All-wheel Drive Estate Engine B 5254 T4	862009	Outer Joint	48T	36	27	56.5	48	66	M
	2003.03-2007.08	AT/MT	-	-	All-wheel Drive Estate Engine B 5254 T4	635008	Inner Joint			24		23.5		
	2003.03-2007.08	AT	L	F	All-wheel Drive Estate Engine B 5254 T4	262022	Drive Shaft	48T	36	26	56.5	48	527	
	2003.03-2007.08	MT	L	F	All-wheel Drive Estate Engine B 5254 T4	862038	Outer Joint		36	25	56.5	48	58	M
	2003.03-2007.08	AT	L	F	All-wheel Drive Estate Engine B 5254 T4	862019	Outer Joint		36	27	56.5	48	66	M
	2003.03-2007.08	AT	R	F	All-wheel Drive Estate Engine B 5254 T4	262140	Drive Shaft	48T	36	26	56.5	48	977	
	2003.03-2007.08	AT	L	F	All-wheel Drive Estate Engine B 5254 T4	262012	Drive Shaft	48T	36	26	56.5	48	526	
V70 III (135)														
1.6 DRiVe / D2 (84 kW)	2011.04-2015.12	6AT	R	F	Estate Engine D 4162 T	262133	Drive Shaft		40	28	57.4	52	934	
1.6 T4F (132 kW)	2011.01-2015.12	MT	R	F	Estate Engine B 4164 T2	662041	Inner joint		26	28	40	447	95.5	
2.0 D (100 kW)	2007.10-2015.12	MT	R	F	Estate Engine D 4204 T	299212	Drive Shaft		40	26	57.4	51	945	
2.0 FlexiFuel (107 kW)	2008.01-2011.12	6AT	-	-	Estate Engine B 4204 S4	818269	Outer Joint		40	26	57.4	52	63.5	I
2.0 T (149 kW)	2009.09-2011.12	6AT	-	-	Estate Engine B 4204 T6	818269	Outer Joint		40	26	57.4	52	63.5	I
	2009.09-2011.12	AT	R	F	Estate Engine B 4204 T6	262112	Drive Shaft		40	26	57.4	52	962	
	2009.09-2011.12	6AT	R	F	Estate Engine B 4204 T6	262114	Drive Shaft		40	28	57.4	52	952	
	2009.09-2011.12	6AT	L	F	Estate Engine B 4204 T6	262113	Drive Shaft		40	28	57.4	52	590	
	2009.09-2011.12	AT	L	F	Estate Engine B 4204 T6	262134	Drive Shaft		40	26	57.4	52	599	
2.4 (158 kW)	2011.04-2015.12	-	L/R	R	All-wheel Drive Estate Engine D 5244 T11	201129	Drive Shaft		36	26	56.5	49.5	756	
	2011.04-2015.12	MT	R	F	Estate Engine D 5244 T11	601076	Inner Joint		26	28	40	522.5	94.5	
	2011.04-2015.12	AT	L	F	Estate Engine D 5244 T11	262109	Drive Shaft		40	31	57.4	52	524	
	2011.04-2015.12	AT	L	F	All-wheel Drive Estate Engine D 5244 T11	262109	Drive Shaft		40	31	57.4	52	524	
2.4 AWD (151 kW)	2009.12-2011.12	-	L/R	R	All-wheel Drive Estate Engine D 5244 T10	201129	Drive Shaft		36	26	56.5	49.5	756	
	2009.12-2011.12	6AT	R	F	All-wheel Drive Estate Engine D 5244 T10	662033	Inner Joint		28	27	30	521	102.5	
	2009.12-2011.12	AT	L	F	All-wheel Drive Estate Engine D 5244 T10	262109	Drive Shaft		40	31	57.4	52	524	
2.4 D (120 kW)	2007.04-2010.12	MT	R	F	Estate Engine D 5244 T5	601076	Inner Joint		26	28	40	522.5	94.5	
2.4 D (129 kW)	2009.04-2010.12	MT	R	F	Estate Engine D 5244 T14	601076	Inner Joint		26	28	40	522.5	94.5	
	2009.04-2010.12	AT	L	F	Estate Engine D 5244 T14	262109	Drive Shaft		40	31	57.4	52	524	
2.5 (136 kW)	2007.04-2009.12	MT	R	F	Estate Engine D 5244 T4	601076	Inner Joint		26	28	40	522.5	94.5	



YEAR	TRANSM	L/R	F/R	REMARKS	GSP Ref.	PRODUCT	ABS	Technical Specifications							
								A	B	C	H	L	P		
VOLVO															
V70 III (135)															
2.5 (136 kW)	2007.04-2009.12	AT	L	F	Estate Engine D 5244 T4	262109	Drive Shaft		40	31	57.4	52	524		
2.5 (151 kW)	2008.10-2011.12	MT	R	F	Estate Engine D 5244 T10	601076	Inner Joint		26	28	40	522.5	94.5		
	2008.10-2011.12	AT	L	F	Estate Engine D 5244 T10	262109	Drive Shaft		40	31	57.4	52	524		
2.5 (177 kW)	2010.01-2014.12	6AT	-	-	Estate Engine B 4204 T7	818269	Outer Joint		40	26	57.4	52	63.5	I	
	2010.01-2014.12	6AT	R	F	Estate Engine B 4204 T7	262114	Drive Shaft		40	28	57.4	52	952		
	2010.01-2014.12	6AT	L	F	Estate Engine B 4204 T7	262113	Drive Shaft		40	28	57.4	52	590		
2.5 AWD (136 kW)	2007.04-2009.12	MT	L/R	R	All-wheel Drive Estate Engine D 5244 T4	201129	Drive Shaft		36	26	56.5	49.5	756		
	2007.04-2009.12	6MT	L	F	All-wheel Drive Estate Engine D 5244 T4	662040	Inner joint		31	28	44	65	82		
	2007.04-2009.12	AT	L	F	All-wheel Drive Estate Engine D 5244 T4	262109	Drive Shaft		40	31	57.4	52	524		
2.5 T (147 kW)	2007.08-2009.12	AT	-	F	Estate Engine B 5254 T6	859344	Outer Joint		40	26	57.4	52	63.5	M	
	2007.08-2009.12	AT	R	F	Estate Engine B 5254 T6	259444	Drive Shaft		40	28	57.4	52	994		
	2007.08-2009.12	MT	R	F	Estate Engine B 5254 T6	601076	Inner Joint		26	28	40	522.5	94.5		
	2007.08-2009.12	AT	L	F	Estate Engine B 5254 T6	262109	Drive Shaft		40	31	57.4	52	524		
	2007.08-2009.12	MT	L/R	F	Estate Engine B 5254 T6	862042	Outer Joint		40	27	57.4	52	63.5	M	
2.5 T (170 kW)	2009.04-2012.12	AT	R	F	Estate Engine B 5254 T10	259444	Drive Shaft		40	28	57.4	52	994		
	2009.04-2012.12	-	-	F	Estate Engine B 5254 T10	859344	Outer Joint		40	26	57.4	52	63.5	M	
	2009.04-2012.12	AT	L	F	Estate Engine B 5254 T10	262109	Drive Shaft		40	31	57.4	52	524		
	2009.04-2012.12	MT	R	F	Estate Engine B 5254 T10	601076	Inner Joint		26	28	40	522.5	94.5		
	2009.04-2012.12	MT	L/R	F	Estate Engine B 5254 T10	862042	Outer Joint		40	27	57.4	52	63.5	M	
2.5 T FlexiFuel (147 kW)	2008.05-2009.12	AT	R	F	Estate Engine B 5254 T8	259444	Drive Shaft		40	28	57.4	52	994		
	2008.05-2009.12	MT	R	F	Estate Engine B 5254 T8	601076	Inner Joint		26	28	40	522.5	94.5		
	2008.05-2009.12	AT	L	F	Estate Engine B 5254 T8	262109	Drive Shaft		40	31	57.4	52	524		
	2008.05-2009.12	MT	L/R	F	Estate Engine B 5254 T8	862042	Outer Joint		40	27	57.4	52	63.5	M	
2.5 T FlexiFuel (170 kW)	2009.04-2011.12	AT	R	F	Estate Engine B 5254 T11	259444	Drive Shaft		40	28	57.4	52	994		
	2009.04-2011.12	MT	R	F	Estate Engine B 5254 T11	601076	Inner Joint		26	28	40	522.5	94.5		
	2009.04-2011.12	AT	L	F	Estate Engine B 5254 T11	262109	Drive Shaft		40	31	57.4	52	524		
	2009.04-2011.12	MT	L/R	F	Estate Engine B 5254 T11	862042	Outer Joint		40	27	57.4	52	63.5	M	
3.2 (179 kW)	2010.04-2014.12	AT	L/R	F	Estate Engine B 6324 S5	862042	Outer Joint		40	27	57.4	52	63.5	M	
3.2 AWD (175 kW)	2007.04-2010.12	-	L/R	R	All-wheel Drive Estate Engine B 6324 S	201129	Drive Shaft		36	26	56.5	49.5	756		
	2007.04-2010.12	AT	L/R	F	All-wheel Drive Estate Engine B 6324 S	862042	Outer Joint		40	27	57.4	52	63.5	M	
3.2 AWD (179 kW)	2010.04-2015.12	-	L/R	R	All-wheel Drive Estate Engine B 6324 S5	201129	Drive Shaft		36	26	56.5	49.5	756		
	2010.04-2015.12	AT	L/R	F	All-wheel Drive Estate Engine B 6324 S5	862042	Outer Joint		40	27	57.4	52	63.5	M	
D3 (100 kW)	2007.10-2015.12	MT	R	F	Estate Engine D 5204 T7	601076	Inner Joint		26	28	40	522.5	94.5		
	2007.10-2015.12	AT	L	F	Estate Engine D 5204 T7	262109	Drive Shaft		40	31	57.4	52	524		
	2007.10-2015.12	MT	R	F	Estate Engine D 5204 T7	299212	Drive Shaft		40	26	57.4	51	945		
D3/D4 (120 kW)	2010.03-2015.12	AT	L	F	Estate Engine D 5204 T2	259443	Drive Shaft		40	31	57.4	52	528		
	2010.03-2015.12	AT	R	F	Estate Engine D 5204 T2	259444	Drive Shaft		40	28	57.4	52	994		
	2010.03-2015.12	AT	L	F	Estate Engine D 5204 T2	262109	Drive Shaft		40	31	57.4	52	524		
	2010.03-2015.12	MT	R	F	Estate Engine D 5204 T2	601076	Inner Joint		26	28	40	522.5	94.5		
D4 (133 kW)	2013.10-2015.12	6MT	L	F	Estate Engine D 4204 T5	262119	Drive Shaft		40	31	57.4	52	599		
	2013.10-2015.12	6MT	R	F	Estate Engine D 4204 T5	262117	Drive Shaft		40	28	57.4	52	949		
D4 AWD (120 kW)	2007.10-2015.12	AT	L/R	R	All-wheel Drive Estate Engine D 5244 T17	201129	Drive Shaft		36	26	56.5	49.5	756		
	2007.10-2015.12	6AT	R	F	All-wheel Drive Estate Engine D 5244 T17	662033	Inner Joint		28	27	30	521	102.5		
D4 AWD (133 kW)	2013.10-2015.12	AT	L/R	R	All-wheel Drive Estate Engine D 5244 T12	201129	Drive Shaft		36	26	56.5	49.5	756		
T6 AWD (210 kW)	2007.08-2010.12	-	L/R	R	All-wheel Drive Estate Engine B 6304 T2	201129	Drive Shaft		36	26	56.5	49.5	756		
T6 AWD (224 kW)	2007.08-2010.12	AT	L/R	F	All-wheel Drive Estate Engine B 6304 T2	862042	Outer Joint		40	27	57.4	52	63.5	M	
	2010.01-2015.12	-	L/R	R	All-wheel Drive Estate Engine B 6304 T4	201129	Drive Shaft		36	26	56.5	49.5	756		
V70 III (BW)															
-	2008-2013	-	-	L	F	-	262127	Drive Shaft		40	28	57.4	52	602	
	2013-2015	-	AT	L	-	Engine: B4164T2	262081	Drive Shaft		40	28	57.4	51	591	
	2013-2015	-	AT	R	-	Engine: B4164T2	262082	Drive Shaft		40	28	57.4	51	950	
2.0 (107kW)	2008-2015	-	-	L	R	-	262115	Drive Shaft		40	28	57.4	52	602	
2.0 T5	2015-2017	-	-	L	F	-	262126	Drive Shaft		40	31	57.5	52	576	
V70 XC															
-	1998-2000	-	-	-	-	-	699195	Propshaft CV Joint			19		22.6		
2.3	2001-2004	-	-	-	5 cylinder Turbo		699195	Propshaft CV Joint			19		22.6		
2.4	2001-2006	-	-	-	5 cylinder Turbo		699195	Propshaft CV Joint			19		22.6		
2.5	2003-2007	-	-	-	5 cylinder Turbo (T5)		699195	Propshaft CV Joint			19		22.6		
XC60 (156)															
2.0 T (149 kW)	2009.12-2012.12	-	L	F	Estate Engine B 4204 T6	618044	Inner Joint		26	23	40	68.5	99.5		
	2009.12-2012.12	-	L/R	R	Estate Engine B 4204 T6	201129	Drive Shaft		36	26	56.5	49.5	756		
	2009.12-2012.12	-	-	F	Estate Engine B 4204 T6	862031	Outer Joint	48T	36	27	56.5	55	65	M	
	2009.12-2012.12	-	-	F	Estate Engine B 4204 T6	859285	Outer Joint		40	27	57.4	52	63.5	M	
	2009.12-2012.12	-	-	F	Estate Engine B 4204 T6	862045	Outer Joint		40	26	57.4	52	62.5	M	
	2009.12-2012.12	AT	L/R	F	Estate Engine B 4204 T6	862042	Outer Joint		40	27	57.4	52	63.5	M	
2009.12-2012.12	-	L	F	Estate Engine B 4204 T6	801424	Outer Joint		31	27	36.2	70	62	M		





VOLVO XC60 (156)	YEAR	TRANSM	L/R	F/R	REMARKS	GSP Ref.	PRODUCT	ABS	Technical Specifications					
									A	B	C	H	L	P
2.0 T (149 kW)	2009.12-2012.12	-	-	R	Estate Engine B 4204 T6	618187	Inner Joint		26	29	35	69.5	107.5	
	2009.12-2012.12	-	-	R	Estate Engine B 4204 T6	818290	Outer Joint		36	29	56.5	49.5	64	I
2.4 D (129 kW)	2009.04-2010.12	-	-	R	Estate Engine D 5244 T14	818290	Outer Joint		36	29	56.5	49.5	64	I
	2009.04-2010.12	-	L	F	Estate Engine D 5244 T14	618044	Inner Joint		26	23	40	68.5	99.5	
	2009.04-2010.12	-	-	F	Estate Engine D 5244 T14	859285	Outer Joint		40	27	57.4	52	63.5	M
	2009.04-2010.12	-	-	F	Estate Engine D 5244 T14	862031	Outer Joint	48T	36	27	56.5	55	65	M
	2009.04-2010.12	AT	L/R	F	Estate Engine D 5244 T14	862042	Outer Joint		40	27	57.4	52	63.5	M
	2009.04-2010.12	-	-	F	Estate Engine D 5244 T14	862045	Outer Joint		40	26	57.4	52	62.5	M
	2009.04-2010.12	-	L	F	Estate Engine D 5244 T14	801424	Outer Joint		31	27	36.2	70	62	M
2.4 D / D3 / D4 AWD (120 kW)	2008.05-2010.12	-	-	R	Estate Engine D 5244 T14	618187	Inner Joint		26	29	35	69.5	107.5	
	2008.05-2010.12	-	-	F	Estate Engine D 5244 T14	818290	Outer Joint		36	29	56.5	49.5	64	I
	2008.05-2010.12	-	L	F	All-wheel Drive Estate Engine D 5244 T5	618044	Inner Joint		26	23	40	68.5	99.5	
	2008.05-2010.12	-	-	F	All-wheel Drive Estate Engine D 5244 T5	859285	Outer Joint		40	27	57.4	52	63.5	M
	2008.05-2010.12	-	L/R	R	All-wheel Drive Estate Engine D 5244 T5	201129	Drive Shaft		36	26	56.5	49.5	756	
	2008.05-2010.12	-	-	F	All-wheel Drive Estate Engine D 5244 T5	862031	Outer Joint	48T	36	27	56.5	55	65	M
	2008.05-2010.12	AT	L	F	All-wheel Drive Estate Engine D 5244 T5	201385	Drive Shaft		40	31	56	52	547	
	2008.05-2010.12	AT	R	F	All-wheel Drive Estate Engine D 5244 T5	201388	Drive Shaft		40	28	57.4	52	1024	
	2008.05-2010.12	-	-	F	All-wheel Drive Estate Engine D 5244 T5	862045	Outer Joint		40	26	57.4	52	62.5	M
	2008.05-2010.12	-	L	F	All-wheel Drive Estate Engine D 5244 T5	801424	Outer Joint		31	27	36.2	70	62	M
2.4 D AWD (129 kW)	2008.05-2010.12	-	-	R	All-wheel Drive Estate Engine D 5244 T5	618187	Inner Joint		26	29	35	69.5	107.5	
	2008.05-2010.12	AT/MT	L/R	F	All-wheel Drive Estate Engine D 5244 T5	862042	Outer Joint		40	27	57.4	52	63.5	M
	2008.05-2010.12	-	-	R	All-wheel Drive Estate Engine D 5244 T5	818290	Outer Joint		36	29	56.5	49.5	64	I
	2009.06-2010.12	-	-	R	All-wheel Drive Estate Engine D 5244 T14	818290	Outer Joint		36	29	56.5	49.5	64	I
	2009.06-2010.12	-	L	F	All-wheel Drive Estate Engine D 5244 T14	618044	Inner Joint		26	23	40	68.5	99.5	
	2009.06-2010.12	-	-	F	All-wheel Drive Estate Engine D 5244 T14	859285	Outer Joint		40	27	57.4	52	63.5	M
	2009.06-2010.12	-	-	F	All-wheel Drive Estate Engine D 5244 T14	862031	Outer Joint	48T	36	27	56.5	55	65	M
	2009.06-2010.12	-	-	F	All-wheel Drive Estate Engine D 5244 T14	862045	Outer Joint		40	26	57.4	52	62.5	M
	2009.06-2010.12	-	L	F	All-wheel Drive Estate Engine D 5244 T14	801424	Outer Joint		31	27	36.2	70	62	M
	2009.06-2010.12	AT	L/R	F	All-wheel Drive Estate Engine D 5244 T14	862042	Outer Joint		40	27	57.4	52	63.5	M
2.5 (158 kW)	2011.06-2011.06	-	-	F	Estate Engine D 5244 T15	859285	Outer Joint		40	27	57.4	52	63.5	M
	2011.06-2011.06	AT	L/R	F	Estate Engine D 5244 T15	862042	Outer Joint		40	27	57.4	52	63.5	M
	2011.06-2011.06	-	-	R	Estate Engine D 5244 T15	618187	Inner Joint		26	29	35	69.5	107.5	
	2011.06-2011.06	-	L	F	Estate Engine D 5244 T15	801424	Outer Joint		31	27	36.2	70	62	M
	2011.06-2011.06	-	-	R	Estate Engine D 5244 T15	818290	Outer Joint		36	29	56.5	49.5	64	I
2.5 AWD (136 kW)	2008.05-2009.12	-	-	F	All-wheel Drive Estate Engine D 5244 T4	859285	Outer Joint		40	27	57.4	52	63.5	M
	2008.05-2009.12	-	L/R	R	All-wheel Drive Estate Engine D 5244 T4	201129	Drive Shaft		36	26	56.5	49.5	756	
	2008.05-2009.12	-	L	F	All-wheel Drive Estate Engine D 5244 T4	801424	Outer Joint		31	27	36.2	70	62	M
	2008.05-2009.12	AT/MT	L/R	F	All-wheel Drive Estate Engine D 5244 T4	862042	Outer Joint		40	27	57.4	52	63.5	M
	2008.05-2009.12	-	-	R	All-wheel Drive Estate Engine D 5244 T4	618187	Inner Joint		26	29	35	69.5	107.5	
	2008.05-2009.12	-	-	R	All-wheel Drive Estate Engine D 5244 T4	818290	Outer Joint		36	29	56.5	49.5	64	I
2.5 AWD (151 kW)	2009.07-2011.06	-	L	F	All-wheel Drive Estate Engine D 5244 T10	618044	Inner Joint		26	23	40	68.5	99.5	
	2009.07-2011.06	-	-	F	All-wheel Drive Estate Engine D 5244 T10	859285	Outer Joint		40	27	57.4	52	63.5	M
	2009.07-2011.06	-	-	F	All-wheel Drive Estate Engine D 5244 T10	862031	Outer Joint	48T	36	27	56.5	55	65	M
	2009.07-2011.06	-	L/R	R	All-wheel Drive Estate Engine D 5244 T10	201129	Drive Shaft		36	26	56.5	49.5	756	
	2009.07-2011.06	-	-	F	All-wheel Drive Estate Engine D 5244 T10	862045	Outer Joint		40	26	57.4	52	62.5	M
	2009.07-2011.06	-	L	F	All-wheel Drive Estate Engine D 5244 T10	801424	Outer Joint		31	27	36.2	70	62	M
	2009.07-2011.06	-	-	R	All-wheel Drive Estate Engine D 5244 T10	618187	Inner Joint		26	29	35	69.5	107.5	
	2009.07-2011.06	AT/MT	L/R	F	All-wheel Drive Estate Engine D 5244 T10	862042	Outer Joint		40	27	57.4	52	63.5	M
	2009.07-2011.06	-	-	R	All-wheel Drive Estate Engine D 5244 T10	818290	Outer Joint		36	29	56.5	49.5	64	I
2.5 AWD (158 kW)	2011.04-2015.12	-	L/R	R	All-wheel Drive Estate Engine D 5244 T11	201129	Drive Shaft		36	26	56.5	49.5	756	
	2011.04-2015.12	-	-	F	All-wheel Drive Estate Engine D 5244 T11	859285	Outer Joint		40	27	57.4	52	63.5	M
	2011.04-2015.12	AT	L	F	All-wheel Drive Estate Engine D 5244 T11	201385	Drive Shaft		40	31	56	52	547	
	2011.04-2015.12	AT	R	F	All-wheel Drive Estate Engine D 5244 T11	201388	Drive Shaft		40	28	57.4	52	1024	
	2011.04-2015.12	AT	L/R	F	All-wheel Drive Estate Engine D 5244 T11	862042	Outer Joint		40	27	57.4	52	63.5	M
	2011.04-2015.12	-	-	R	All-wheel Drive Estate Engine D 5244 T11	618187	Inner Joint		26	29	35	69.5	107.5	
	2011.04-2015.12	-	L	F	All-wheel Drive Estate Engine D 5244 T11	801424	Outer Joint		31	27	36.2	70	62	M
	2011.04-2015.12	-	-	R	All-wheel Drive Estate Engine D 5244 T11	818290	Outer Joint		36	29	56.5	49.5	64	I
3.2 AWD (175 kW)	2009.07-2010.12	-	R	F	All-wheel Drive Estate Engine B 6324 S	201387	Drive Shaft		40	28	57.4	52	1030	
	2009.07-2010.12	-	-	F	All-wheel Drive Estate Engine B 6324 S	859285	Outer Joint		40	27	57.4	52	63.5	M
	2009.07-2010.12	-	L/R	R	All-wheel Drive Estate Engine B 6324 S	201129	Drive Shaft		36	26	56.5	49.5	756	
	2009.07-2010.12	-	L	F	All-wheel Drive Estate Engine B 6324 S	618044	Inner Joint		26	23	40	68.5	99.5	
	2009.07-2010.12	-	-	F	All-wheel Drive Estate Engine B 6324 S	862031	Outer Joint	48T	36	27	56.5	55	65	M
	2009.07-2010.12	-	-	F	All-wheel Drive Estate Engine B 6324 S	862045	Outer Joint		40	26	57.4	52	62.5	M
	2009.07-2010.12	-	-	R	All-wheel Drive Estate Engine B 6324 S	618187	Inner Joint		26	29	35	69.5	107.5	
	2009.07-2010.12	-	L	F	All-wheel Drive Estate Engine B 6324 S	801424	Outer Joint		31	27	36.2	70	62	M
	2009.07-2010.12	AT	L/R	F	All-wheel Drive Estate Engine B 6324 S	862042	Outer Joint		40	27	57.4	52	63.5	M





	 YEAR	TRANSM	L/R	F/R	REMARKS	GSP Ref.	 PRODUCT	 ABS	Technical Specifications							
									A	B	C	H	L	P		
VOLVO																
XC60 (156)																
3.2 AWD (175 kW)	2009.07-2010.12	-	-	R	All-wheel Drive Estate Engine B 6324 S	818290	Outer Joint		36	29	56.5	49.5	64	I		
3.2 AWD (179 kW)	2010.03-2015.12	-	R	F	All-wheel Drive Estate Engine B 6324 S5	201387	Drive Shaft		40	28	57.4	52	1030			
	2010.03-2015.12	-	-	F	All-wheel Drive Estate Engine B 6324 S5	859285	Outer Joint		40	27	57.4	52	63.5	M		
	2010.03-2015.12	-	L/R	R	All-wheel Drive Estate Engine B 6324 S5	201129	Drive Shaft		36	26	56.5	49.5	756			
	2010.03-2015.12	-	L	F	All-wheel Drive Estate Engine B 6324 S5	618044	Inner Joint		26	23	40	68.5	99.5			
	2010.03-2015.12	-	-	F	All-wheel Drive Estate Engine B 6324 S5	862031	Outer Joint	48T	36	27	56.5	55	65	M		
	2010.03-2015.12	AT	L	F	All-wheel Drive Estate Engine B 6324 S5	201385	Drive Shaft		40	31	56	52	547			
	2010.03-2015.12	-	-	R	All-wheel Drive Estate Engine B 6324 S5	618187	Inner Joint		26	29	35	69.5	107.5			
	2010.03-2015.12	-	L	F	All-wheel Drive Estate Engine B 6324 S5	801424	Outer Joint		31	27	36.2	70	62	M		
	2010.03-2015.12	AT	L/R	F	All-wheel Drive Estate Engine B 6324 S5	862042	Outer Joint		40	27	57.4	52	63.5	M		
	2010.03-2015.12	-	-	F	All-wheel Drive Estate Engine B 6324 S5	862045	Outer Joint		40	26	57.4	52	62.5	M		
D3 (100 kW)	2010.03-2015.12	-	-	R	All-wheel Drive Estate Engine B 6324 S5	818290	Outer Joint		36	29	56.5	49.5	64	I		
	2012.04-2015.12	-	-	F	Estate Engine D 5204 T7	859285	Outer Joint		40	27	57.4	52	63.5	M		
	2012.04-2015.12	-	L	F	Estate Engine D 5204 T7	801424	Outer Joint		31	27	36.2	70	62	M		
D3/D4 (120 kW)	2012.04-2015.12	AT	L/R	F	Estate Engine D 5204 T7	862042	Outer Joint		40	27	57.4	52	63.5	M		
	2010.03-2014.12	-	-	R	Estate Engine D 5204 T2	818290	Outer Joint		36	29	56.5	49.5	64	I		
	2010.03-2014.12	-	-	F	Estate Engine D 5204 T2	859285	Outer Joint		40	27	57.4	52	63.5	M		
D4 (133 kW)	2010.03-2014.12	-	L	F	Estate Engine D 5204 T2	618044	Inner Joint		26	23	40	68.5	99.5			
	2010.03-2014.12	-	-	F	Estate Engine D 5204 T2	862031	Outer Joint	48T	36	27	56.5	55	65	M		
	2010.03-2014.12	AT	L	F	Estate Engine D 5204 T2	201385	Drive Shaft		40	31	56	52	547			
	2010.03-2014.12	MT	R	F	Estate Engine D 5204 T2	201389	Drive Shaft		40	28	57.4	52	1030			
	2010.03-2014.12	-	L	F	Estate Engine D 5204 T2	801424	Outer Joint		31	27	36.2	70	62	M		
	2010.03-2014.12	AT	L/R	F	Estate Engine D 5204 T2	862042	Outer Joint		40	27	57.4	52	63.5	M		
	2010.03-2014.12	-	-	F	Estate Engine D 5204 T2	862045	Outer Joint		40	26	57.4	52	62.5	M		
	2010.03-2014.12	-	-	R	Estate Engine D 5204 T2	618187	Inner Joint		26	29	35	69.5	107.5			
	D4 AWD (133 kW)	2013.10-2015.12	6AT	L	F	Estate Engine D 4204 T5	201375	Drive Shaft		40	31	66	52	596		
		2013.10-2015.12	MT	L	F	Estate Engine D 4204 T5	201377	Drive Shaft		40	31	66	52	623		
2013.10-2015.12		AT	R	F	Estate Engine D 4204 T5	201378	Drive Shaft		40	28	66	52	976			
2013.10-2015.12		MT	R	F	Estate Engine D 4204 T5	201379	Drive Shaft		40	28	66	52	977			
D4 AWD (169 kW)	2013.10-2015.12	AT	L/R	R	All-wheel Drive Estate Engine D 5244 T12	201129	Drive Shaft		36	26	56.5	49.5	756			
	2013.10-2015.12	-	-	F	All-wheel Drive Estate Engine D 5244 T12	859285	Outer Joint		40	27	57.4	52	63.5	M		
	2013.10-2015.12	-	L	F	All-wheel Drive Estate Engine D 5244 T12	801424	Outer Joint		31	27	36.2	70	62	M		
	2013.10-2015.12	-	-	R	All-wheel Drive Estate Engine D 5244 T12	618187	Inner Joint		26	29	35	69.5	107.5			
	2013.10-2015.12	-	-	R	All-wheel Drive Estate Engine D 5244 T12	818290	Outer Joint		36	29	56.5	49.5	64	I		
D5 AWD (169 kW)	2014.04-2015.12	AT/MT	L/R	R	All-wheel Drive Estate Engine D 5244 T23	201129	Drive Shaft		36	26	56.5	49.5	756			
	2014.04-2015.12	-	-	F	All-wheel Drive Estate Engine D 5244 T23	859285	Outer Joint		40	27	57.4	52	63.5	M		
	2014.04-2015.12	-	L	F	All-wheel Drive Estate Engine D 5244 T23	801424	Outer Joint		31	27	36.2	70	62	M		
	2014.04-2015.12	-	-	R	All-wheel Drive Estate Engine D 5244 T23	618187	Inner Joint		26	29	35	69.5	107.5			
	2014.04-2015.12	-	-	R	All-wheel Drive Estate Engine D 5244 T23	818290	Outer Joint		36	29	56.5	49.5	64	I		
T5 (177 kW)	2010.09-2014.12	-	-	R	Estate Engine B 4204 T7	818290	Outer Joint		36	29	56.5	49.5	64	I		
	2010.09-2014.12	-	L	F	Estate Engine B 4204 T7	201386	Drive Shaft		40	31	57.4	52	624			
	2010.09-2014.12	-	R	F	Estate Engine B 4204 T7	201390	Drive Shaft		40	28	57.4	52	978			
	2010.09-2014.12	-	L	F	Estate Engine B 4204 T7	618044	Inner Joint		26	23	40	68.5	99.5			
	2010.09-2014.12	-	-	F	Estate Engine B 4204 T7	859285	Outer Joint		40	27	57.4	52	63.5	M		
	2010.09-2014.12	-	-	F	Estate Engine B 4204 T7	862031	Outer Joint	48T	36	27	56.5	55	65	M		
	2010.09-2014.12	-	-	F	Estate Engine B 4204 T7	862045	Outer Joint		40	26	57.4	52	62.5	M		
	2010.09-2014.12	AT	L/R	F	Estate Engine B 4204 T7	862042	Outer Joint		40	27	57.4	52	63.5	M		
	2010.09-2014.12	-	-	R	Estate Engine B 4204 T7	618187	Inner Joint		26	29	35	69.5	107.5			
	2010.09-2014.12	-	L	F	Estate Engine B 4204 T7	801424	Outer Joint		31	27	36.2	70	62	M		
T5 (180 kW)	2013.10-	AT	R	F	Estate Engine B 4204 T11	201378	Drive Shaft		40	28	66	52	976			
T5 AWD (180 kW)	2015.10-	6AT	L	F	All-wheel Drive Estate Engine B 4204 T11	201375	Drive Shaft		40	31	66	52	596			
T5 AWD (187 kW)	2014.04-	-	-	F	All-wheel Drive Estate Engine B 5254 T12	859285	Outer Joint		40	27	57.4	52	63.5	M		
	2014.04-	-	-	L	All-wheel Drive Estate Engine B 5254 T12	801424	Outer Joint		31	27	36.2	70	62	M		
T6 (225 kW)	2013.10-	AT	R	F	Estate Engine B 4204 T9	201378	Drive Shaft		40	28	66	52	976			
T6 AWD (210 kW)	2008.05-2010.12	-	R	F	All-wheel Drive Estate Engine B 6304 T2	201387	Drive Shaft		40	28	57.4	52	1030			
	2008.05-2010.12	-	L/R	R	All-wheel Drive Estate Engine B 6304 T2	201129	Drive Shaft		36	26	56.5	49.5	756			
	2008.05-2010.12	-	-	F	All-wheel Drive Estate Engine B 6304 T2	859285	Outer Joint		40	27	57.4	52	63.5	M		
	2008.05-2010.12	-	L	F	All-wheel Drive Estate Engine B 6304 T2	618044	Inner Joint		26	23	40	68.5	99.5			
	2008.05-2010.12	-	-	F	All-wheel Drive Estate Engine B 6304 T2	862031	Outer Joint	48T	36	27	56.5	55	65	M		
	2008.05-2010.12	-	-	R	All-wheel Drive Estate Engine B 6304 T2	618187	Inner Joint		26	29	35	69.5	107.5			
	2008.05-2010.12	-	L	F	All-wheel Drive Estate Engine B 6304 T2	801424	Outer Joint		31	27	36.2	70	62	M		
	2008.05-2010.12	-	-	F	All-wheel Drive Estate Engine B 6304 T2	862045	Outer Joint		40	26	57.4	52	62.5	M		
	2008.05-2010.12	AT	L/R	F	All-wheel Drive Estate Engine B 6304 T2	862042	Outer Joint		40	27	57.4	52	63.5	M		
	2008.05-2010.12	-	-	R	All-wheel Drive Estate Engine B 6304 T2	818290	Outer Joint		36	29	56.5	49.5	64	I		
T6 AWD (224 kW)	2010.03-2015.12	-	R	F	All-wheel Drive Estate Engine B 6304 T4	201387	Drive Shaft		40	28	57.4	52	1030			
	2010.03-2015.12	-	-	F	All-wheel Drive Estate Engine B 6304 T4	859285	Outer Joint		40	27	57.4	52	63.5	M		





VOLVO	YEAR	TRANSM	L/R	F/R	REMARKS	GSP Ref.	PRODUCT	ABS	Technical Specifications							
									A	B	C	H	L	P		
VOLVO																
XC60 (156)																
T6 AWD (224 kW)	2010.03-2015.12	-	L/R	R	All-wheel Drive Estate Engine B 6304 T4	201129	Drive Shaft		36	26	56.5	49.5	756			
	2010.03-2015.12	-	L	F	All-wheel Drive Estate Engine B 6304 T4	618044	Inner Joint		26	23	40	68.5	99.5			
	2010.03-2015.12	-	-	F	All-wheel Drive Estate Engine B 6304 T4	862031	Outer Joint	48T	36	27	56.5	55	65	M		
	2010.03-2015.12	-	-	R	All-wheel Drive Estate Engine B 6304 T4	618187	Inner Joint		26	29	35	69.5	107.5			
	2010.03-2015.12	-	L	F	All-wheel Drive Estate Engine B 6304 T4	801424	Outer Joint		31	27	36.2	70	62	M		
	2010.03-2015.12	AT	L	F	All-wheel Drive Estate Engine B 6304 T4	201385	Drive Shaft		40	31	56	52	547			
	2010.03-2015.12	AT	L/R	F	All-wheel Drive Estate Engine B 6304 T4	862042	Outer Joint		40	27	57.4	52	63.5	M		
	2010.03-2015.12	-	-	F	All-wheel Drive Estate Engine B 6304 T4	862045	Outer Joint		40	26	57.4	52	62.5	M		
	2010.03-2015.12	-	-	R	All-wheel Drive Estate Engine B 6304 T4	818290	Outer Joint		36	29	56.5	49.5	64	I		
	2013.10-	-	6AT	L	F	All-wheel Drive Estate Engine B 4204 T9	201375	Drive Shaft		40	31	66	52	596		
T6 AWD (242 kW)	2014.04-2015.12	AT	R	F	All-wheel Drive Estate Engine B 6304 T4	201387	Drive Shaft		40	28	57.4	52	1030			
	2014.04-2015.12	-	-	F	All-wheel Drive Estate Engine B 6304 T4	859285	Outer Joint		40	27	57.4	52	63.5	M		
	2014.04-2015.12	-	L	F	All-wheel Drive Estate Engine B 6304 T4	801424	Outer Joint		31	27	36.2	70	62	M		
	2014.04-2015.12	AT	L/R	F	All-wheel Drive Estate Engine B 6304 T4	862042	Outer Joint		40	27	57.4	52	63.5	M		
XC70																
-	2008-	2011	-	-	-	699195	Propshaft CV Joint				19		22.6			
XC70 CROSS COUNTRY (295)/V70 XC																
2.4 D5 AWD (136 kW)	2005.12-	2007.08	6AT/6MT	-	F	All-wheel Drive Estate Engine D 5244 T4	862037	Outer Joint	48T	36	27	56.5	48	66	M	
2.4 D5 XC AWD (120 kW)	2002.09-	2007.08	AT/MT	-	-	All-wheel Drive Estate Engine D 5244 T	635008	Inner Joint			24		23.5			
	2002.09-	2007.08	6AT/6MT	-	-	All-wheel Drive Estate Engine D 5244 T	862037	Outer Joint	48T	36	27	56.5	48	66	M	
	2002.09-	2007.08	-	L	F	All-wheel Drive Estate Engine D 5244 T	262039	Drive Shaft	48T	36	26	56.5	48	558.5		
2.4 T XC AWD (142 kW)	1997.11-	2002.09	AT/MT	-	-	All-wheel Drive Estate Engine B 5254 T	635008	Inner Joint			24		23.5			
	1997.11-	2002.09	-	L/R	F	All-wheel Drive Estate Engine B 5254 T	862002	Outer Joint	48T	26	28	56.5	97.5	66	O	
2.4 T XC AWD (147 kW)	2000.03-	2002.09	MT	R	F	All-wheel Drive Estate Engine B 5244 T3	262031	Drive Shaft	48T	36	26	56.5	48	992		
	2000.03-	2002.09	AT/MT	-	-	All-wheel Drive Estate Engine B 5244 T3	635008	Inner Joint			24		23.5			
	2000.03-	2002.09	AT	L	F	All-wheel Drive Estate Engine B 5244 T3	262022	Drive Shaft	48T	36	26	56.5	48	527		
	2000.03-	2002.09	AT	L	F	All-wheel Drive Estate Engine B 5244 T3	862019	Outer Joint		36	27	56.5	48	66	M	
	2000.03-	2002.09	-	L	R	All-wheel Drive Estate Engine B 5244 T3	201130	Drive Shaft		36	26	56.5	50	764		
	2000.03-	2002.09	AT	L	F	All-wheel Drive Estate Engine B 5244 T3	262012	Drive Shaft	48T	36	26	56.5	48	526		
	2000.03-	2002.09	AT	L	F	All-wheel Drive Estate Engine B 5244 T3	262039	Drive Shaft	48T	36	26	56.5	48	558.5		
	2000.03-	2002.09	AT	L	F	All-wheel Drive Estate Engine B 5244 T3	262039	Drive Shaft	48T	36	26	56.5	48	558.5		
2.5 T XC AWD (154 kW)	2002.09-	2007.08	AT/MT	-	-	All-wheel Drive Estate Engine B 5254 T2	635008	Inner Joint			24		23.5			
	2002.09-	2007.08	AT	L	F	All-wheel Drive Estate Engine B 5254 T2	262039	Drive Shaft	48T	36	26	56.5	48	558.5		
XC70 II																
-	2014-	-	AT	R	R	-	662035	Inner Joint		23	29	28	64	110		
-	2014-	-	AT	R	R	-	262077	Drive Shaft	44NS	36	23	56.5	49.5	762		
XC70 II (136)																
2.4 D (129 kW)	2009.06-	2010.12	AT	L/R	F	Estate Engine D 5244 T14	862042	Outer Joint		40	27	57.4	52	63.5	M	
2.4 D / D4 AWD (120 kW)	2007.08-	-	-	L/R	R	All-wheel Drive Estate Engine D 5244 T5	218364	Drive Shaft		36	26	56.5	49.5	750		
	2007.08-	-	AT/MT	L/R	R	All-wheel Drive Estate Engine D 5244 T5	201129	Drive Shaft		36	26	56.5	49.5	756		
	2007.08-	-	AT	L/R	F	All-wheel Drive Estate Engine D 5244 T5	862042	Outer Joint		40	27	57.4	52	63.5	M	
	2007.08-	-	AT	L	F	All-wheel Drive Estate Engine D 5244 T5	201369	Drive Shaft		40	31	57.4	52	537		
	2007.08-	-	AT	L	F	All-wheel Drive Estate Engine D 5244 T5	601210	Inner Joint		22	23	35	81.5	134.5		
	2007.08-	-	6AT	R	F	All-wheel Drive Estate Engine D 5244 T5	201370	Drive Shaft		40	28	57.4	52	1008		
	2007.08-	-	MT	L	F	All-wheel Drive Estate Engine D 5244 T5	201380	Drive Shaft		40	31	57.4	52	566		
	2007.08-	-	AT	L	F	All-wheel Drive Estate Engine D 5244 T5	201381	Drive Shaft		40	31	57.4	52	537		
	2007.08-	-	MT	R	F	All-wheel Drive Estate Engine D 5244 T5	201382	Drive Shaft		40	28	57.4	52	1011		
	2007.08-	-	AT	R	F	All-wheel Drive Estate Engine D 5244 T5	201384	Drive Shaft		40	28	57.4	52	1008		
2.5 AWD (136 kW)	2007.04-	2009.12	-	L/R	R	All-wheel Drive Estate Engine D 5244 T4	218364	Drive Shaft		36	26	56.5	49.5	750		
	2007.04-	2009.12	-	L/R	R	All-wheel Drive Estate Engine D 5244 T4	201129	Drive Shaft		36	26	56.5	49.5	756		
	2007.04-	2009.12	AT	L	F	All-wheel Drive Estate Engine D 5244 T4	201369	Drive Shaft		40	31	57.4	52	537		
	2007.04-	2009.12	AT	L	F	All-wheel Drive Estate Engine D 5244 T4	601210	Inner Joint		22	23	35	81.5	134.5		
	2007.04-	2009.12	AT	L	F	All-wheel Drive Estate Engine D 5244 T4	201381	Drive Shaft		40	31	57.4	52	537		
	2007.04-	2009.12	AT	R	F	All-wheel Drive Estate Engine D 5244 T4	201384	Drive Shaft		40	28	57.4	52	1008		
	2007.04-	2009.12	AT	L/R	F	All-wheel Drive Estate Engine D 5244 T4	862042	Outer Joint		40	27	57.4	52	63.5	M	
	2007.04-	2009.12	AT	L/R	F	All-wheel Drive Estate Engine D 5244 T4	201384	Drive Shaft		40	28	57.4	52	1008		
2.5 AWD (151 kW)	2009.04-	2011.12	-	L/R	R	All-wheel Drive Estate Engine D 5244 T10	218364	Drive Shaft		36	26	56.5	49.5	750		
	2009.04-	2011.12	AT/MT	L/R	R	All-wheel Drive Estate Engine D 5244 T10	201129	Drive Shaft		36	26	56.5	49.5	756		
	2009.04-	2011.12	AT	L	F	All-wheel Drive Estate Engine D 5244 T10	201369	Drive Shaft		40	31	57.4	52	537		
	2009.04-	2011.12	AT	L	F	All-wheel Drive Estate Engine D 5244 T10	601210	Inner Joint		22	23	35	81.5	134.5		
	2009.04-	2011.12	AT	L	F	All-wheel Drive Estate Engine D 5244 T10	201381	Drive Shaft		40	31	57.4	52	537		
	2009.04-	2011.12	AT	R	F	All-wheel Drive Estate Engine D 5244 T10	201384	Drive Shaft		40	28	57.4	52	1008		
	2009.04-	2011.12	AT	L/R	F	All-wheel Drive Estate Engine D 5244 T10	862042	Outer Joint		40	27	57.4	52	63.5	M	
	2009.04-	2011.12	AT	L/R	F	All-wheel Drive Estate Engine D 5244 T10	201384	Drive Shaft		40	28	57.4	52	1008		
2.5 AWD (158 kW)	2011.04-	2015.12	-	L/R	R	All-wheel Drive Estate Engine D 5244 T11	218364	Drive Shaft		36	26	56.5	49.5	750		
	2011.04-	2015.12	-	L/R	R	All-wheel Drive Estate Engine D 5244 T11	201129	Drive Shaft		36	26	56.5	49.5	756		
	2011.04-	2015.12	AT	L	F	All-wheel Drive Estate Engine D 5244 T11	201369	Drive Shaft		40	31	57.4	52	537		
	2011.04-	2015.12	AT	L	F	All-wheel Drive Estate Engine D 5244 T11	601210	Inner Joint		22	23	35	81.5	134.5		
	2011.04-	2015.12	6AT	R	F	All-wheel Drive Estate Engine D 5244 T11	201370	Drive Shaft		40	28	57.4	52	1008		





	 YEAR	TRANSM	L/R	F/R	REMARKS	GSP Ref.	 PRODUCT	 ABS	Technical Specifications						
									A	B	C	H	L	P	
VOLVO															
XC70 II (136)															
2.5 AWD (158 kW)	2011.04-2015.12	MT	L	F	All-wheel Drive Estate Engine D 5244 T11	201380	Drive Shaft		40	31	57.4	52	566		
	2011.04-2015.12	AT	L	F	All-wheel Drive Estate Engine D 5244 T11	201381	Drive Shaft		40	31	57.4	52	537		
	2011.04-2015.12	MT	R	F	All-wheel Drive Estate Engine D 5244 T11	201382	Drive Shaft		40	28	57.4	52	1011		
	2011.04-2015.12	AT	R	F	All-wheel Drive Estate Engine D 5244 T11	201384	Drive Shaft		40	28	57.4	52	1008		
	2011.04-2015.12	AT	L/R	F	All-wheel Drive Estate Engine D 5244 T11	862042	Outer Joint		40	27	57.4	52	63.5	M	
3.2 AWD (175 kW)	2007.08-	-	L/R	R	All-wheel Drive Estate Engine B 6324 S	218364	Drive Shaft		36	26	56.5	49.5	750		
	2007.08-	-	L/R	R	All-wheel Drive Estate Engine B 6324 S	201129	Drive Shaft		36	26	56.5	49.5	756		
	2007.08-	-	AT	L	F	All-wheel Drive Estate Engine B 6324 S	201369	Drive Shaft		40	31	57.4	52	537	
	2007.08-	-	AT	L	F	All-wheel Drive Estate Engine B 6324 S	601210	Inner Joint		22	23	35	81.5	134.5	
	2007.08-	-	AT	L	F	All-wheel Drive Estate Engine B 6324 S	201381	Drive Shaft		40	31	57.4	52	537	
	2007.08-	-	AT	L/R	F	All-wheel Drive Estate Engine B 6324 S	862042	Outer Joint		40	27	57.4	52	63.5	M
3.2 AWD (179 kW)	2007.08-	-	L/R	R	All-wheel Drive Estate Engine B 6324 S5	218364	Drive Shaft		36	26	56.5	49.5	750		
	2007.08-	-	L/R	R	All-wheel Drive Estate Engine B 6324 S5	201129	Drive Shaft		36	26	56.5	49.5	756		
	2007.08-	-	AT	L	F	All-wheel Drive Estate Engine B 6324 S5	201369	Drive Shaft		40	31	57.4	52	537	
	2007.08-	-	AT	L/R	F	All-wheel Drive Estate Engine B 6324 S5	862042	Outer Joint		40	27	57.4	52	63.5	M
	2007.08-	-	AT	L	F	All-wheel Drive Estate Engine B 6324 S5	601210	Inner Joint		22	23	35	81.5	134.5	
	2007.08-	-	AT	L	F	All-wheel Drive Estate Engine B 6324 S5	201381	Drive Shaft		40	31	57.4	52	537	
D3 (120 kW)	2010.04-2015.12	AT	L/R	F	Estate Engine D 5204 T2	862042	Outer Joint		40	27	57.4	52	63.5	M	
D4 (133 kW)	2013.10-	6AT	L	F	Estate Engine D 4204 T5	201373	Drive Shaft		40	31	66	52	581		
	2013.10-	6AT	R	F	Estate Engine D 4204 T5	201374	Drive Shaft		40	28	66	52	961		
	2013.10-	MT	R	F	Estate Engine D 4204 T5	201376	Drive Shaft		40	28	66	52	962		
	2013.10-	-	L/R	R	All-wheel Drive Estate Engine D 5244 T12	218364	Drive Shaft		36	26	56.5	49.5	750		
D4 AWD (133 kW)	2013.10-	AT/MT	L/R	R	All-wheel Drive Estate Engine D 5244 T12	201129	Drive Shaft		36	26	56.5	49.5	756		
	2013.10-	6AT	R	F	All-wheel Drive Estate Engine D 5244 T12	201370	Drive Shaft		40	28	57.4	52	1008		
	2013.10-	MT	L	F	All-wheel Drive Estate Engine D 5244 T12	201380	Drive Shaft		40	31	57.4	52	566		
	2013.10-	MT	R	F	All-wheel Drive Estate Engine D 5244 T12	201382	Drive Shaft		40	28	57.4	52	1011		
	2013.10-	-	L/R	R	All-wheel Drive Estate Engine D 5244 T12	218364	Drive Shaft		36	26	56.5	49.5	750		
D5 AWD (162 kW)	2015.03-	-	L/R	R	All-wheel Drive Estate Engine D 5244 T20	218364	Drive Shaft		36	26	56.5	49.5	750		
	2015.03-	AT	L/R	R	All-wheel Drive Estate Engine D 5244 T20	201129	Drive Shaft		36	26	56.5	49.5	756		
T5 (180 kW)	2013.10-	6AT	L	F	Estate Engine B 4204 T11	201373	Drive Shaft		40	31	66	52	581		
T6 AWD (210 kW)	2008.01-	-	L/R	R	All-wheel Drive Estate Engine B 6304 T2	218364	Drive Shaft		36	26	56.5	49.5	750		
	2008.01-	-	L/R	R	All-wheel Drive Estate Engine B 6304 T2	201129	Drive Shaft		36	26	56.5	49.5	756		
	2008.01-	AT	L/R	F	All-wheel Drive Estate Engine B 6304 T2	862042	Outer Joint		40	27	57.4	52	63.5	M	
	2008.01-	AT	L	F	All-wheel Drive Estate Engine B 6304 T2	201369	Drive Shaft		40	31	57.4	52	537		
	2008.01-	AT	L	F	All-wheel Drive Estate Engine B 6304 T2	601210	Inner Joint		22	23	35	81.5	134.5		
	2008.01-	AT	L	F	All-wheel Drive Estate Engine B 6304 T2	201381	Drive Shaft		40	31	57.4	52	537		
T6 AWD (224 kW)	2010.01-	-	L/R	R	All-wheel Drive Estate Engine B 6304 T4	218364	Drive Shaft		36	26	56.5	49.5	750		
	2010.01-	-	L/R	R	All-wheel Drive Estate Engine B 6304 T4	201129	Drive Shaft		36	26	56.5	49.5	756		
	2010.01-	AT	R	F	All-wheel Drive Estate Engine B 6304 T4	201383	Drive Shaft		40	28	57.4	52	1014		
XC90															
2.4	2006-2014	-	-	-	5 cylinder Turbo (Diesel)	699195	Propshaft CV Joint			19		22.6			
2.4 D5 (120 kW)	2002-	-	-	-	Transmission Cardanic	635009	Inner Joint			20		21			
	2002-	-	-	-	Transmission Cardanic	635009	Propshaft CV Joint			20		21			
2.4 D5 (136 kW)	2002-	-	-	-	Transmission Cardanic	635009	Propshaft CV Joint			20		21			
	2002-	-	-	-	Transmission Cardanic	635009	Inner Joint			20		21			
2.5	2003-2011	-	-	-	5 cylinder Turbo (T5)	699195	Propshaft CV Joint			19		22.6			
2.9	2003-2006	-	-	-	6 cylinder Turbo (T6)	699195	Propshaft CV Joint			19		22.6			
3.2	2007-2014	-	-	-	6 cylinder	699195	Propshaft CV Joint			19		22.6			
3.2 24V AWD (175 kW)	2002.09-	-	-	-	Transmission Cardanic	635009	Propshaft CV Joint			20		21			
	2002.09-	-	-	-	Transmission Cardanic	635009	Inner Joint			20		21			
4.4	2005-2011	-	-	-	8 cylinder	699195	Propshaft CV Joint			19		22.6			
4.4 V8 AWD (232 kW)	2002.09-	-	-	-	Transmission Cardanic	635009	Propshaft CV Joint			20		21			
	2002.09-	-	-	-	Transmission Cardanic	635009	Inner Joint			20		21			
XC90 I (275)															
2.5 AWD (120 kW)	2002.10-2006.12	-	L/R	R	All-wheel Drive Estate Engine D 5244 T	244068	Drive Shaft		36	26	56.5	50	797		
	2002.10-2006.12	AT	L	F	All-wheel Drive Estate Engine D 5244 T	262046	Drive Shaft	48T	36	26	56.5	55	584		
	2002.10-2006.12	Semi-AT	L	F	All-wheel Drive Estate Engine D 5244 T	201402	Drive Shaft	48T	36	26	56.5	55	580		
	2002.10-2006.12	Semi-AT	R	F	All-wheel Drive Estate Engine D 5244 T	262136	Drive Shaft	48T	36	26	56.5	55	1031		
	2002.10-2006.12	AT/MT	-	-	All-wheel Drive Estate Engine D 5244 T	635008	Inner Joint			24		23.5			
	2002.10-2006.12	-	-	F	All-wheel Drive Estate Engine D 5244 T	862031	Outer Joint	48T	36	27	56.5	55	65	M	
	2002.10-2006.12	AT	L	F	All-wheel Drive Estate Engine D 5244 T	262083	Drive Shaft	48T	40	26	72	52	580		
	2002.10-2006.12	-	-	R	All-wheel Drive Estate Engine D 5244 T	618187	Inner Joint		26	29	35	69.5	107.5		
	2002.10-2006.12	-	-	R	All-wheel Drive Estate Engine D 5244 T	818290	Outer Joint		36	29	56.5	49.5	64	I	
	2002.10-2006.12	MT	L	F	All-wheel Drive Estate Engine D 5244 T	262142	Drive Shaft	48T	36	26	56.5	55	588		
	2002.10-2010.12	-	L/R	R	All-wheel Drive Estate Engine D 5244 T5	244068	Drive Shaft		36	26	56.5	50	797		
	2007.10-2010.12	AT	L	F	All-wheel Drive Estate Engine D 5244 T5	262046	Drive Shaft	48T	36	26	56.5	55	584		
	2007.10-2010.12	MT	L	F	All-wheel Drive Estate Engine D 5244 T5	262142	Drive Shaft	48T	36	26	56.5	55	588		

				TRANSM		L/R F/R		REMARKS		GSP Ref.				ABS		Technical Specifications					
YEAR												PRODUCT				A	B	C	H	L	P
VOLVO																					
XC90 I (275)																					
2.5 AWD (136 kW)		2005.04-2010.12	-	L/R	R	All-wheel Drive Estate Engine D 5244 T4				244068	Drive Shaft		36	26	56.5	50	797				
		2005.04-2010.12	AT	L	F	All-wheel Drive Estate Engine D 5244 T4				262046	Drive Shaft	48T	36	26	56.5	55	584				
		2005.04-2010.12	AT/MT	-	-	All-wheel Drive Estate Engine D 5244 T4				635008	Inner Joint			24		23.5					
		2005.04-2010.12	-	-	F	All-wheel Drive Estate Engine D 5244 T4				862035	Outer Joint	48T	40	27	72	52	63.5	M			
		2005.04-2010.12	AT	L	F	All-wheel Drive Estate Engine D 5244 T4				201371	Drive Shaft	48T	40	31	72	52	552				
		2005.04-2010.12	AT	L	F	All-wheel Drive Estate Engine D 5244 T4				201391	Drive Shaft	48T	40	28	72	52	554				
		2005.04-2010.12	MT	R	F	All-wheel Drive Estate Engine D 5244 T4				201392	Drive Shaft	48T	36	28	56.5	55	1050				
		2005.04-2010.12	AT	R	F	All-wheel Drive Estate Engine D 5244 T4				201404	Drive Shaft	48T	36	28	56.5	55	1033				
		2005.04-2010.12	MT	L	F	All-wheel Drive Estate Engine D 5244 T4				262142	Drive Shaft	48T	36	26	56.5	55	588				
2.5 AWD (147 kW)		2011.01-2014.12	AT	L	F	All-wheel Drive Estate Engine D 5244 T18				262046	Drive Shaft	48T	36	26	56.5	55	584				
		2011.01-2014.12	-	L	F	All-wheel Drive Estate Engine D 5244 T18				618044	Inner Joint		26	23	40	68.5	99.5				
		2011.01-2014.12	AT/MT	-	-	All-wheel Drive Estate Engine D 5244 T18				635008	Inner Joint			24		23.5					
		2011.01-2014.12	-	-	F	All-wheel Drive Estate Engine D 5244 T18				862031	Outer Joint	48T	36	27	56.5	55	65	M			
		2011.01-2014.12	-	-	F	All-wheel Drive Estate Engine D 5244 T18				859285	Outer Joint		40	27	57.4	52	63.5	M			
		2011.01-2014.12	AT	L	F	All-wheel Drive Estate Engine D 5244 T18				201371	Drive Shaft	48T	40	31	72	52	552				
		2011.01-2014.12	-	-	F	All-wheel Drive Estate Engine D 5244 T18				862045	Outer Joint		40	26	57.4	52	62.5	M			
		2011.01-2014.12	-	L	F	All-wheel Drive Estate Engine D 5244 T18				801424	Outer Joint		31	27	36.2	70	62	M			
		2011.01-2014.12	-	-	R	All-wheel Drive Estate Engine D 5244 T18				618187	Inner Joint		26	29	35	69.5	107.5				
		2011.01-2014.12	MT	L	F	All-wheel Drive Estate Engine D 5244 T18				262142	Drive Shaft	48T	36	26	56.5	55	588				
		2011.01-2014.12	-	-	R	All-wheel Drive Estate Engine D 5244 T18				818290	Outer Joint		36	29	56.5	49.5	64	I			
		2011.01-2014.12	-	L/R	R	All-wheel Drive Estate Engine D 5244 T18				244068	Drive Shaft		36	26	56.5	50	797				
2.5 T (154 kW)		2002.10-2006.12	-	L/R	R	All-wheel Drive Estate Engine B 5254 T2				244068	Drive Shaft		36	26	56.5	50	797				
		2002.10-2006.12	Semi-AT	L	F	All-wheel Drive Estate Engine B 5254 T2				201402	Drive Shaft	48T	36	26	56.5	55	580				
		2002.10-2006.12	Semi-AT	R	F	All-wheel Drive Estate Engine B 5254 T2				262136	Drive Shaft	48T	36	26	56.5	55	1031				
		2002.10-2006.12	-	L	F	All-wheel Drive Estate Engine B 5254 T2				618044	Inner Joint		26	23	40	68.5	99.5				
		2002.10-2006.12	AT/MT	-	-	All-wheel Drive Estate Engine B 5254 T2				635008	Inner Joint			24		23.5					
		2002.10-2006.12	-	-	F	All-wheel Drive Estate Engine B 5254 T2				862031	Outer Joint	48T	36	27	56.5	55	65	M			
		2002.10-2006.12	-	-	F	All-wheel Drive Estate Engine B 5254 T2				859285	Outer Joint		40	27	57.4	52	63.5	M			
		2002.10-2006.12	AT	L	F	All-wheel Drive Estate Engine B 5254 T2				262083	Drive Shaft	48T	40	26	72	52	580				
		2002.10-2006.12	-	-	F	All-wheel Drive Estate Engine B 5254 T2				862045	Outer Joint		40	26	57.4	52	62.5	M			
		2002.10-2006.12	-	-	R	All-wheel Drive Estate Engine B 5254 T2				618187	Inner Joint		26	29	35	69.5	107.5				
		2002.10-2006.12	-	-	R	All-wheel Drive Estate Engine B 5254 T2				818290	Outer Joint		36	29	56.5	49.5	64	I			
		2002.10-2006.12	-	L	F	All-wheel Drive Estate Engine B 5254 T2				801424	Outer Joint		31	27	36.2	70	62	M			
		2002.10-2006.12	MT	R	F	All-wheel Drive Estate Engine B 5254 T2				201404	Drive Shaft	48T	36	28	56.5	55	1033				
		2002.10-2006.12	MT	L	F	All-wheel Drive Estate Engine B 5254 T2				262142	Drive Shaft	48T	36	26	56.5	55	588				
2.5 T AWD (154 kW)		2012.10-2014.09	-	-	R	All-wheel Drive Estate Engine B 5254 T9				818290	Outer Joint		36	29	56.5	49.5	64	I			
		2012.10-2014.09	-	L	F	All-wheel Drive Estate Engine B 5254 T9				618044	Inner Joint		26	23	40	68.5	99.5				
		2012.10-2014.09	-	-	F	All-wheel Drive Estate Engine B 5254 T9				862031	Outer Joint	48T	36	27	56.5	55	65	M			
		2012.10-2014.09	-	-	F	All-wheel Drive Estate Engine B 5254 T9				859285	Outer Joint		40	27	57.4	52	63.5	M			
		2012.10-2014.09	-	-	F	All-wheel Drive Estate Engine B 5254 T9				862045	Outer Joint		40	26	57.4	52	62.5	M			
		2012.10-2014.09	-	L	F	All-wheel Drive Estate Engine B 5254 T9				801424	Outer Joint		31	27	36.2	70	62	M			
		2012.10-2014.09	-	-	R	All-wheel Drive Estate Engine B 5254 T9				618187	Inner Joint		26	29	35	69.5	107.5				
3.2 AWD (175 kW)		2006.03-2010.12	-	L/R	R	All-wheel Drive Estate Engine B 6324 S				244068	Drive Shaft		36	26	56.5	50	797				
		2006.03-2010.12	AT	L	F	All-wheel Drive Estate Engine B 6324 S				262046	Drive Shaft	48T	36	26	56.5	55	584				
		2006.03-2010.12	AT/MT	-	-	All-wheel Drive Estate Engine B 6324 S				635008	Inner Joint			24		23.5					
		2006.03-2010.12	-	-	F	All-wheel Drive Estate Engine B 6324 S				862031	Outer Joint	48T	36	27	56.5	55	65	M			
		2006.03-2010.12	AT	L	F	All-wheel Drive Estate Engine B 6324 S				201371	Drive Shaft	48T	40	31	72	52	552				
		2006.03-2010.12	-	-	R	All-wheel Drive Estate Engine B 6324 S				618187	Inner Joint		26	29	35	69.5	107.5				
		2006.03-2010.12	-	L	F	All-wheel Drive Estate Engine B 6324 S				801424	Outer Joint		31	27	36.2	70	62	M			
		2006.03-2010.12	-	-	R	All-wheel Drive Estate Engine B 6324 S				818290	Outer Joint		36	29	56.5	49.5	64	I			
		2006.03-2010.12	AT	L	F	All-wheel Drive Estate Engine B 6324 S				201391	Drive Shaft	48T	40	28	72	52	554				
3.2 AWD (179 kW)		2010.04-2012.12	-	L/R	R	All-wheel Drive Estate Engine B 6324 S5				244068	Drive Shaft		36	26	56.5	50	797				
		2010.04-2012.12	AT	L	F	All-wheel Drive Estate Engine B 6324 S5				262046	Drive Shaft	48T	36	26	56.5	55	584				
		2010.04-2012.12	AT/MT	-	-	All-wheel Drive Estate Engine B 6324 S5				635008	Inner Joint			24		23.5					
		2010.04-2012.12	AT	L	F	All-wheel Drive Estate Engine B 6324 S5				201371	Drive Shaft	48T	40	31	72	52	552				
		2010.04-2012.12	AT	R	F	All-wheel Drive Estate Engine B 6324 S5				201403	Drive Shaft	48T	36	28	56.5	55	1033				
D3/2.5 (120 kW)		2009.04-2014.12	-	-	R	Estate Engine D 5244 T5				818290	Outer Joint		36	29	56.5	49.5	64	I			
		2009.04-2014.12	AT	L	F	Estate Engine D 5244 T5				262046	Drive Shaft	48T	36	26	56.5	55	584				
		2009.04-2014.12	-	L	F	Estate Engine D 5244 T5				618044	Inner Joint		26	23	40	68.5	99.5				
		2009.04-2014.12	AT/MT	-	-	Estate Engine D 5244 T5				635008	Inner Joint			24		23.5					
		2009.04-2014.12	-	-	F	Estate Engine D 5244 T5				862035	Outer Joint	48T	40	27	72	52	63.5	M			
		2009.04-2014.12	-	-	F	Estate Engine D 5244 T5				862031	Outer Joint	48T	36	27	56.5	55	65	M			
		2009.04-2014.12	-	-	F	Estate Engine D 5244 T5				859285	Outer Joint		40	27	57.4	52	63.5	M			
		2009.04-2014.12	AT	L	F	Estate Engine D 5244 T5				201371	Drive Shaft	48T	40	31	72	52	552				
		2009.04-2014.12	-	-	F	Estate Engine D 5244 T5				862045	Outer Joint		40	26	57.4	52	62.5	M			
		2009.04-2014.12	-	L	F	Estate Engine D 5244 T5				801424	Outer Joint		31	27	36.2	70	62	M			

	 YEAR	TRANSM	L/R	F/R	REMARKS	GSP Ref.	 PRODUCT	 ABS	Technical Specifications					
									A	B	C	H	L	P
VOLVO														
XC90 I (275)														
D3/2.5 (120 kW)	2009.04-2014.12	-	-	R	Estate Engine D 5244 T5	618187	Inner Joint		26	29	35	69.5	107.5	
	2009.04-2014.12	6AT	R	F	Estate Engine D 5244 T5	201372	Drive Shaft	48T	40	28	72	52	1028	
	2009.04-2014.12	MT	L	F	Estate Engine D 5244 T5	262142	Drive Shaft	48T	36	26	56.5	55	588	
D5(155 kW)	2013.11-2014.09	-	-	R	All-wheel Drive Closed Off-Road Vehicle Engine D 5244 T18	818290	Outer Joint		36	29	56.5	49.5	64	I
	2013.11-2014.09	-	-	F	All-wheel Drive Closed Off-Road Vehicle Engine D 5244 T18	859285	Outer Joint		40	27	57.4	52	63.5	M
	2013.11-2014.09	-	L	F	All-wheel Drive Closed Off-Road Vehicle Engine D 5244 T18	618044	Inner Joint		26	23	40	68.5	99.5	
	2013.11-2014.09	-	-	F	All-wheel Drive Closed Off-Road Vehicle Engine D 5244 T18	862031	Outer Joint	48T	36	27	56.5	55	65	M
	2013.11-2014.09	-	-	F	All-wheel Drive Closed Off-Road Vehicle Engine D 5244 T18	862045	Outer Joint		40	26	57.4	52	62.5	M
	2013.11-2014.09	-	L	F	All-wheel Drive Closed Off-Road Vehicle Engine D 5244 T18	801424	Outer Joint		31	27	36.2	70	62	M
	2013.11-2014.09	-	-	R	All-wheel Drive Closed Off-Road Vehicle Engine D 5244 T18	618187	Inner Joint		26	29	35	69.5	107.5	
T6 AWD (200 kW)	2002.10-2006.12	-	L/R	R	All-wheel Drive Estate Engine B 6294 T	244068	Drive Shaft		36	26	56.5	50	797	
	2002.10-2006.12	AT/MT	-	-	All-wheel Drive Estate Engine B 6294 T	635008	Inner Joint			24		23.5		
	2002.10-2006.12	-	-	F	All-wheel Drive Estate Engine B 6294 T	862031	Outer Joint	48T	36	27	56.5	55	65	M
	2002.10-2006.12	-	-	R	All-wheel Drive Estate Engine B 6294 T	618187	Inner Joint		26	29	35	69.5	107.5	
	2002.10-2006.12	-	-	R	All-wheel Drive Estate Engine B 6294 T	818290	Outer Joint		36	29	56.5	49.5	64	I
V8 AWD (232 kW)	2005.01-2010.12	-	L/R	R	All-wheel Drive Estate Engine B 8444 S	244068	Drive Shaft		36	26	56.5	50	797	
	2005.01-2010.12	AT	L	F	All-wheel Drive Estate Engine B 8444 S	262046	Drive Shaft	48T	36	26	56.5	55	584	
	2005.01-2010.12	AT/MT	-	-	All-wheel Drive Estate Engine B 8444 S	635008	Inner Joint			24		23.5		
	2005.01-2010.12	AT	L	F	All-wheel Drive Estate Engine B 8444 S	201371	Drive Shaft	48T	40	31	72	52	552	
	2005.01-2010.12	AT	L	F	All-wheel Drive Estate Engine B 8444 S	201391	Drive Shaft	48T	40	28	72	52	554	
	2005.01-2010.12	AT	R	F	All-wheel Drive Estate Engine B 8444 S	201404	Drive Shaft	48T	36	28	56.5	55	1033	
VOLVO (CHANGAN)														
S40 (MS)														
2.0 (107 kW)	2009.01-2011.12	AT	L	-	Saloon Engine CAF488Q1/CAF488Q3	262047	Drive Shaft		36	26	55.2	48.5	520	
	2009.01-2011.12	AT	R	-	Saloon Engine CAF488Q1/CAF488Q3	262048	Drive Shaft		36	26	55.2	48.5	950	
2.4 (125 kW)	2006.06-2011.12	AT	L	-	Saloon Engine B 5244 S4	262047	Drive Shaft		36	26	55.2	48.5	520	
	2006.06-2011.12	AT	R	-	Saloon Engine B 5244 S4	262048	Drive Shaft		36	26	55.2	48.5	950	
2.5 (162 kW)	2006.06-2010.12	AT	L	-	Saloon Engine B 5254 T6/B 5254 T3	262047	Drive Shaft		36	26	55.2	48.5	520	
	2006.06-2010.12	AT	R	-	Saloon Engine B 5254 T6/B 5254 T3	262048	Drive Shaft		36	26	55.2	48.5	950	
VW														
AMAROK (2HA 2HB S1B S6B S7A S7B)														
2.0 BiTDI (120 kW)	2010.09-2010.09	MT	L	F	Pickup Engine CDCA	261173	Drive Shaft		28		64.8	44.5	65.9	
	2010.09-2010.09	MT	-	F	Pickup Engine CDCA	861062	Outer Joint		28	27	64.8	44.5	66.5	M
2.0 BiTDI (132 kW)	2011.11-2011.11	MT	L	F	Pickup Engine CNEA	261173	Drive Shaft		28		64.8	44.5	65.9	
	2011.11-2011.11	AT/MT	L/R	F	Pickup Engine CNEA	699148	Inner Joint			28		34		
2.0 BiTDI 4motion (120 kW)	2010.09-2010.09	MT	L	F	All-wheel Drive Pickup Engine CDCA	261173	Drive Shaft		28		64.8	44.5	65.9	
	2010.09-2010.09	-	L/R	F	All-wheel Drive Pickup Engine CDCA	699148	Inner Joint			28		34		
	2010.09-2010.09	MT	-	F	All-wheel Drive Pickup Engine CDCA	861062	Outer Joint		28	27	64.8	44.5	66.5	M
2.0 BiTDI 4motion (132 kW)	2011.11-2011.11	MT	L	F	All-wheel Drive Pickup Engine CNEA	261173	Drive Shaft		28		64.8	44.5	65.9	
	2011.11-2011.11	-	L/R	F	All-wheel Drive Pickup Engine CNEA	699148	Inner Joint			28		34		
2.0 TDI (103 kW)	2012.07-2012.07	MT	L	F	Pickup Engine CNFB	261173	Drive Shaft		28		64.8	44.5	65.9	
2.0 TDI (90 kW)	2010.09-2010.09	MT	L	F	Pickup Engine CDBA/CNFA	261173	Drive Shaft		28		64.8	44.5	65.9	
	2010.09-2010.09	MT	-	F	Pickup Engine CDBA/CNFA	861062	Outer Joint		28	27	64.8	44.5	66.5	M
2.0 TDI 4motion (103 kW)	2012.06-2012.06	MT	L	F	All-wheel Drive Pickup Engine CNFB	261173	Drive Shaft		28		64.8	44.5	65.9	
	2012.06-2012.06	MT	L/R	F	All-wheel Drive Pickup Engine CNFB	699148	Inner Joint			28		34		
2.0 TDI 4motion (90 kW)	2010.09-2010.09	MT	L	F	All-wheel Drive Pickup Engine CDBA/CNFA	261173	Drive Shaft		28		64.8	44.5	65.9	
	2010.09-2010.09	-	L/R	F	All-wheel Drive Pickup Engine CDBA/CNFA	699148	Inner Joint			28		34		
	2010.09-2010.09	MT	-	F	All-wheel Drive Pickup Engine CDBA/CNFA	861062	Outer Joint		28	27	64.8	44.5	66.5	M
2.0 TSI (118 kW)	2010.12-2010.12	MT	L	F	Pickup Engine CFPA	261173	Drive Shaft		28		64.8	44.5	65.9	
	2010.12-2010.12	MT	-	F	Pickup Engine CFPA	861062	Outer Joint		28	27	64.8	44.5	66.5	M
3.0 TDI 4motion (150 kW)	2016.06-2016.06	8AT	L/R	F	All-wheel Drive Pickup Engine DDXB	699148	Inner Joint			28		34		
3.0 TDI 4motion (165 kW)	2016.06-2016.06	8AT	L/R	F	All-wheel Drive Pickup Engine DDXC	699148	Inner Joint			28		34		
AMAROK (2HA, 2HB, S1B, S6B, S7A, S7B)														
3.0 TDI 4motion(120 kW)	2016.06-2016.06	-	L/R	F	All-wheel Drive Pickup Engine DDXA	699148	Inner Joint			28		34		
APOLLO														
1.8	1990.01-1992.11	MT	-	-	-	818044	Outer Joint		23	30	55	91.5	54.5	I
ARTEON (3H7)														
2.0 TDI 4motion (176 kW)	2017.04-2017.04	-	L/R	R	All-wheel Drive Hatchback Engine CUAA	603011	Inner Joint			33		34		
BEETLE														
-	1998-2001	-	-	-	-	201587	Drive Shaft		36		53	78.5	522	
2.0	2008-2011	AT	L/R	-	-	661034	Inner Joint		26	32	31	68.5	88.5	
2.5	2012-	-	L/R	-	-	661034	Inner Joint		26	32	31	68.5	88.5	
BEETLE (5C1 5C2)/BJALLA														
1.2 TSI (77 kW)	2011.07-2011.07	-	-	-	Hatchback Engine CBZB	261235	Drive Shaft		36	0	59.5	40	600	
	2011.07-2011.07	AT	L/R	F	Hatchback Engine CBZB	803037	Outer Joint		36	30	59.5	40.5	55	I

		 YEAR	TRANSM	L/R	F/R	REMARKS	GSP Ref.	 PRODUCT	 ABS	Technical Specifications						
										A	B	C	H	L	P	
VW																
BEETLE (5C1 5C2)/BJALLA																
1.4 TSI (118 kW)	2011.10-	-	-	-	-	Hatchback Engine CTHD	261235	Drive Shaft		36	0	59.5	40	600		
	2011.10-	-	MT	L/R	F	Hatchback Engine CTHD	803037	Outer Joint		36	30	59.5	40.5	55	I	
1.6 TDI (77 kW)	2011.10-	-	-	L/R	F	Hatchback Engine CAYC	803037	Outer Joint		36	30	59.5	40.5	55	I	
2.0 TDI (81 kW)	2014.06-	-	MT	L/R	F	Hatchback Engine CUUA	803037	Outer Joint		36	30	59.5	40.5	55	I	
2.0 TSI (147 kW)	2011.04-	-	MT	L/R	F	Hatchback Engine CBFA	803037	Outer Joint		36	30	59.5	40.5	55	I	
2.0 TSI (155 kW)	2012.12-	-	-	-	-	Hatchback Engine CPLA	261235	Drive Shaft		36	0	59.5	40	600		
2.0 TSI (162 kW)	2014.12-	-	MT	L/R	F	Hatchback Engine CULC	803037	Outer Joint		36	30	59.5	40.5	55	I	
2.5 (125 kW)	2011.04-	-	-	L/R	F	Hatchback Engine CCCA	803037	Outer Joint		36	30	59.5	40.5	55	I	
BEETLE (5C7 5C8)																
1.2 TSI (77 kW)	2011.12-	-	AT	L/R	F	Convertible Engine CBZB/CYVD	803037	Outer Joint		36	30	59.5	40.5	55	I	
1.4 TSI (118 kW)	2011.12-	-	MT	L/R	F	Convertible Engine CAVD	803037	Outer Joint		36	30	59.5	40.5	55	I	
1.6 TDI (77 kW)	2011.12-	-	-	L/R	F	Convertible Engine CAYC	803037	Outer Joint		36	30	59.5	40.5	55	I	
2.0 TDI (81 kW)	2014.06-	-	MT	L/R	F	Convertible Engine CUUA	803037	Outer Joint		36	30	59.5	40.5	55	I	
2.0 TSI (147 kW)	2011.12-	-	MT	L/R	F	Convertible Engine CCTA	803037	Outer Joint		36	30	59.5	40.5	55	I	
2.0 TSI (155 kW)	2012.12-	-	MT	L/R	F	Convertible Engine CPPA	803037	Outer Joint		36	30	59.5	40.5	55	I	
2.0 TSI (162 kW)	2014.12-	-	MT	L/R	F	Convertible Engine CULC	803037	Outer Joint		36	30	59.5	40.5	55	I	
BORA (1J2)																
1.4 16V (55 kW)	2000.03-	2005.05	AT	L/R	F	Saloon Engine AKQ/AHW/ASP	803036	Outer Joint		36	30	53.2	77.5	61	I	
	2000.03-	2005.05	-	L	F	Saloon Engine AKQ/AHW/ASP	261045	Drive Shaft		36		53	78.5	555		
	2000.03-	2005.05	-	R	F	Saloon Engine AKQ/AHW/ASP	203046	Drive Shaft		36		53	78.5	822		
	2000.03-	2005.05	MT	-	-	Saloon Engine AKQ/AHW/ASP	603006	Inner Joint			33		34			
	2000.03-	2005.05	MT	L/R	F	Saloon Engine AKQ/AHW/ASP	803033	Outer Joint		36	30	53	78.5	51	I	
	2000.03-	2005.05	-	L/R	F	Saloon Engine AKQ/AHW/ASP	603008	Inner Joint			33		32			
1.6 (74 kW)	1998.10-	2005.05	AT	L/R	F	Saloon Engine AEH/AKL/APF	803036	Outer Joint		36	30	53.2	77.5	61	I	
	1998.10-	2005.05	AT	L	F	Saloon Engine AEH/AKL/APF	261020	Drive Shaft		36		53.2	77.5	547		
	1998.10-	2005.05	MT	L	F	Saloon Engine AEH/AKL/APF	261045	Drive Shaft		36		53	78.5	555		
	1998.10-	2005.05	AT	L	F	Saloon Engine AEH/AKL/APF	261156	Drive Shaft		36		53	78	554.5		
	1998.10-	2005.05	AT	L	F	Saloon Engine AEH/AKL/APF	661062	Inner Joint			30		59			
	1998.10-	2005.05	MT	L/R	F	Saloon Engine AEH/AKL/APF	803033	Outer Joint		36	30	53	78.5	51	I	
	1998.10-	2005.05	AT	L/R	F	Saloon Engine AEH/AKL/APF	661006	Inner Joint			30		57.6			
	1998.10-	2005.05	MT	L/R	F	Saloon Engine AEH/AKL/APF	603008	Inner Joint			33		32			
1.6 (75 kW)	2000.08-	2005.05	AT	L/R	F	Saloon Engine AVU/BFQ/BJH	803036	Outer Joint		36	30	53.2	77.5	61	I	
	2000.08-	2005.05	AT	L	F	Saloon Engine AVU/BFQ/BJH	261020	Drive Shaft		36		53.2	77.5	547		
	2000.08-	2005.05	MT	L	F	Saloon Engine AVU/BFQ/BJH	261045	Drive Shaft		36		53	78.5	555		
	2000.08-	2005.05	AT	L	F	Saloon Engine AVU/BFQ/BJH	261156	Drive Shaft		36		53	78	554.5		
	2000.08-	2005.05	MT	L/R	F	Saloon Engine AVU/BFQ/BJH	803033	Outer Joint		36	30	53	78.5	51	I	
	2000.08-	2005.05	AT	L/R	F	Saloon Engine AVU/BFQ/BJH	661006	Inner Joint			30		57.6			
	2000.08-	2005.05	AT	L	F	Saloon Engine AVU/BFQ/BJH	661062	Inner Joint			30		59			
	2000.08-	2005.05	MT	L/R	F	Saloon Engine AVU/BFQ/BJH	603008	Inner Joint			33		32			
1.6 16V (77 kW)	2000.05-	2005.05	MT	L	F	Saloon Engine AUS/AZD/ATN/BCB	261202	Drive Shaft		36		53.2	77.5	547		
	2000.05-	2005.05	MT	-	-	Saloon Engine AUS/AZD/ATN/BCB	603006	Inner Joint			33		34			
	2000.05-	2005.05	MT	R	F	Saloon Engine AUS/AZD/ATN/BCB	261203	Drive Shaft		36		53.2	77.5	810		
	2000.05-	2005.05	AT/MT	L/R	F	Saloon Engine AUS/AZD/ATN/BCB	803036	Outer Joint		36	30	53.2	77.5	61	I	
	2000.05-	2005.05	MT	L/R	F	Saloon Engine AUS/AZD/ATN/BCB	661005	Inner Joint			30		57.6			
1.6 FSI (81 kW)	2002.01-	2005.05	MT	L/R	F	Saloon Engine BAD	661005	Inner Joint			30		57.6			
	2002.01-	2005.05	-	L/R	F	Saloon Engine BAD	803036	Outer Joint		36	30	53.2	77.5	61	I	
	2002.01-	2005.05	MT	-	-	Saloon Engine BAD	603006	Inner Joint			33		34			
1.8 (92 kW)	1998.10-	2005.05	5MT	R	F	Saloon Engine AGN	603009	Inner Joint			33		34			
	1998.10-	2005.05	5MT	L	F	Saloon Engine AGN	261314	Drive Shaft		36		53	78	558		
	1998.10-	2005.05	-	L/R	R	Saloon Engine AGN	803033	Outer Joint		36	30	53	78.5	51	I	
	1998.10-	2005.05	5MT	L/R/R	F	Saloon Engine AGN	603011	Inner Joint			33		34			
	1998.10-	2005.05	5MT	L/R	F	Saloon Engine AGN	803036	Outer Joint		36	30	53.2	77.5	61	I	
1.8 4motion (92 kW)	1999.02-	2005.05	-	L/R/R	F	All-wheel Drive Saloon Engine AGN	603011	Inner Joint			33		34			
	1999.02-	2005.05	-	R	F	All-wheel Drive Saloon Engine AGN	603009	Inner Joint			33		34			
	1999.02-	2005.05	-	L	F	All-wheel Drive Saloon Engine AGN	261314	Drive Shaft		36		53	78	558		
	1999.02-	2005.05	-	L/R	R	All-wheel Drive Saloon Engine AGN	803033	Outer Joint		36	30	53	78.5	51	I	
	1999.02-	2005.05	MT	L/R	F	All-wheel Drive Saloon Engine AGN	803036	Outer Joint		36	30	53.2	77.5	61	I	
1.8 T (110 kW)	2000.05-	2005.05	AT	R	F	Saloon Engine AGU	261243	Drive Shaft		36		53	77.5	813		
	2000.05-	2005.05	MT	L	F	Saloon Engine AGU	261020	Drive Shaft		36		53.2	77.5	547		
	2000.05-	2005.05	5AT	L/R	F	Saloon Engine AGU	803035	Outer Joint		36	27	53	77.5	65	I	
	2000.05-	2005.05	4AT/MT	L/R	F	Saloon Engine AGU	661006	Inner Joint			30		57.6			
	2000.05-	2005.05	5MT	L	F	Saloon Engine AGU	261156	Drive Shaft		36		53	78	554.5		
	2000.05-	2005.05	5MT	L	F	Saloon Engine AGU	661062	Inner Joint			30		59			
	2000.05-	2005.05	4AT/MT	L/R	F	Saloon Engine AGU	803036	Outer Joint		36	30	53.2	77.5	61	I	
	2000.05-	2005.05	5AT	L	F	Saloon Engine AGU	203374	Drive Shaft		36		53	77.5	521		
1.8 T (132 kW)	2002.03-	2005.05	-	L	F	Saloon Engine AUQ	261123	Drive Shaft		36		53	77.5	520		

	 YEAR	TRANSM	L/R	F/R	REMARKS	GSP Ref.	 PRODUCT	 ABS	Technical Specifications					
									A	B	C	H	L	P
VW														
BORA (1J2)														
1.8 T (132 kW)	2002.03-2005.05	MT	L/R	F	Saloon Engine AUQ	803035	Outer Joint		36	27	53	77.5	65	I
	2002.03-2005.05	MT	-	-	Saloon Engine AUQ	603016	Inner Joint			28		32		
	2002.03-2005.05	-	R	F	Saloon Engine AUQ	299114	Drive Shaft		36		53	77.5	809	
	2002.03-2005.05	-	R	F	Saloon Engine AUQ	261121	Drive Shaft		36		53	77.5	806	
	2002.03-2005.05	MT	-	-	Saloon Engine AUQ	603006	Inner Joint			33		34		
1.9 SDI (50 kW)	1998.10-2005.05	AT	L/R	F	Saloon Engine AQM	803036	Outer Joint		36	30	53.2	77.5	61	I
	1998.10-2005.05	-	L	F	Saloon Engine AQM	261045	Drive Shaft		36		53	78.5	555	
	1998.10-2005.05	-	R	F	Saloon Engine AQM	203046	Drive Shaft		36		53	78.5	822	
	1998.10-2005.05	MT	-	-	Saloon Engine AQM	603006	Inner Joint			33		34		
	1998.10-2005.05	MT	L/R	F	Saloon Engine AQM	803033	Outer Joint		36	30	53	78.5	51	I
1.9 TDI (110 kW)	1998.10-2005.05	-	L/R	F	Saloon Engine AQM	603008	Inner Joint			33		32		
	2000.05-2005.05	MT	-	-	Saloon Engine ARL	603016	Inner Joint			28		32		
	2000.05-2005.05	-	R	F	Saloon Engine ARL	299114	Drive Shaft		36		53	77.5	809	
	2000.05-2005.05	-	R	F	Saloon Engine ARL	261121	Drive Shaft		36		53	77.5	806	
	2000.05-2005.05	MT	-	-	Saloon Engine ARL	603006	Inner Joint			33		34		
1.9 TDI (66 kW)	2000.05-2005.05	MT	L/R	F	Saloon Engine ARL	803035	Outer Joint		36	27	53	77.5	65	I
	2000.05-2005.05	-	L	F	Saloon Engine ARL	261123	Drive Shaft		36		53	77.5	520	
	1998.10-2005.05	AT/MT	L/R	F	Saloon Engine ALH	803036	Outer Joint		36	30	53.2	77.5	61	I
	1998.10-2005.05	AT	L	F	Saloon Engine ALH	261020	Drive Shaft		36		53.2	77.5	547	
	1998.10-2005.05	MT	L	F	Saloon Engine ALH	203006	Drive Shaft		36		53.2	77.5	557	
	1998.10-2005.05	MT	R	F	Saloon Engine ALH	203004	Drive Shaft		36		53.2	77.5	822	
	1998.10-2005.05	MT	L	F	Saloon Engine ALH	261021	Drive Shaft		36		53.2	77.5	564.5	
	1998.10-2005.05	AT	L/R	F	Saloon Engine ALH	661006	Inner Joint			30		57.6		
1.9 TDI (74 kW)	1998.10-2005.05	MT	R	F	Saloon Engine ALH	603009	Inner Joint			33		34		
	2000.09-2005.05	AT	L	F	Saloon Engine ATD	203374	Drive Shaft		36		53	77.5	521	
	2000.09-2005.05	-	-	-	Saloon Engine ATD	603016	Inner Joint			28		32		
	2000.09-2005.05	AT	L/R	F	Saloon Engine ATD	803035	Outer Joint		36	27	53	77.5	65	I
	2000.09-2005.05	MT	L/R	F	Saloon Engine ATD	803036	Outer Joint		36	30	53.2	77.5	61	I
	2000.09-2005.05	AT	R	F	Saloon Engine ATD	261243	Drive Shaft		36		53	77.5	813	
	2000.09-2005.05	AT	L	F	Saloon Engine ATD	261244	Drive Shaft		36		53	77.5	523	
	2000.09-2005.05	MT	L	F	Saloon Engine ATD	203006	Drive Shaft		36		53.2	77.5	557	
	2000.09-2005.05	MT	R	F	Saloon Engine ATD	203004	Drive Shaft		36		53.2	77.5	822	
	2000.09-2005.05	MT	L	F	Saloon Engine ATD	261021	Drive Shaft		36		53.2	77.5	564.5	
1.9 TDI (81 kW)	2000.09-2005.05	MT	R	F	Saloon Engine ATD	603009	Inner Joint			33		34		
	2000.09-2005.05	MT	L	F	Saloon Engine ATD	603011	Inner Joint			33		34		
	1998.10-2001.06	AT/MT	L/R	F	Saloon Engine AHF	803036	Outer Joint		36	30	53.2	77.5	61	I
	1998.10-2001.06	MT	L	F	Saloon Engine AHF	203006	Drive Shaft		36		53.2	77.5	557	
	1998.10-2001.06	MT	R	F	Saloon Engine AHF	203004	Drive Shaft		36		53.2	77.5	822	
	1998.10-2001.06	MT	L	F	Saloon Engine AHF	261021	Drive Shaft		36		53.2	77.5	564.5	
1.9 TDI (85 kW)	1998.10-2001.06	AT	L/R	F	Saloon Engine AHF	661006	Inner Joint			30		57.6		
	1998.10-2001.06	MT	R	F	Saloon Engine AHF	603009	Inner Joint			33		34		
	1998.12-2002.01	MT	L	F	Saloon Engine AUY	261123	Drive Shaft		36		53	77.5	520	
	1998.12-2002.01	AT	R	F	Saloon Engine AUY	261243	Drive Shaft		36		53	77.5	813	
	1998.12-2002.01	AT	L	F	Saloon Engine AUY	261244	Drive Shaft		36		53	77.5	523	
1.9 TDI (96 kW)	1998.12-2002.01	MT	R	F	Saloon Engine AUY	299114	Drive Shaft		36		53	77.5	809	
	1998.12-2002.01	MT	R	F	Saloon Engine AUY	261121	Drive Shaft		36		53	77.5	806	
	1998.12-2002.01	AT/MT	L/R	F	Saloon Engine AUY	803035	Outer Joint		36	27	53	77.5	65	I
	1998.12-2002.01	AT	L	F	Saloon Engine AUY	203374	Drive Shaft		36		53	77.5	521	
	2000.11-2005.05	AT	L	F	Saloon Engine ASZ	203374	Drive Shaft		36		53	77.5	521	
	2000.11-2005.05	AT	R	F	Saloon Engine ASZ	261243	Drive Shaft		36		53	77.5	813	
	2000.11-2005.05	-	-	-	Saloon Engine ASZ	603016	Inner Joint			28		32		
	2000.11-2005.05	AT/MT	L/R	F	Saloon Engine ASZ	803035	Outer Joint		36	27	53	77.5	65	I
1.9 TDI 4motion (110 kW)	2000.11-2005.05	MT	L	F	Saloon Engine ASZ	261123	Drive Shaft		36		53	77.5	520	
	2000.11-2005.05	AT	L	F	Saloon Engine ASZ	261244	Drive Shaft		36		53	77.5	523	
	2000.11-2005.05	MT	R	F	Saloon Engine ASZ	299114	Drive Shaft		36		53	77.5	809	
	2000.11-2005.05	MT	R	F	Saloon Engine ASZ	261121	Drive Shaft		36		53	77.5	806	
	2000.11-2005.05	MT	R	F	Saloon Engine ASZ	261121	Drive Shaft		36		53	77.5	806	
	2000.05-2005.05	MT	-	-	All-wheel Drive Saloon Engine ARL	603016	Inner Joint			28		32		
	2000.05-2005.05	6MT	R	F	All-wheel Drive Saloon Engine ARL	261186	Drive Shaft		36		53	77.5	653	
	2000.05-2005.05	-	R	F	All-wheel Drive Saloon Engine ARL	261121	Drive Shaft		36		53	77.5	806	
1.9 TDI 4motion (66 kW)	2000.05-2005.05	-	L/R	R	All-wheel Drive Saloon Engine ARL	803033	Outer Joint		36	30	53	78.5	51	I
	2000.05-2005.05	-	L/R	R	All-wheel Drive Saloon Engine ARL	603011	Inner Joint			33		34		
	2000.05-2005.05	MT	-	-	All-wheel Drive Saloon Engine ARL	603006	Inner Joint			33		34		
	2000.05-2005.05	MT	L/R	F	All-wheel Drive Saloon Engine ARL	803035	Outer Joint		36	27	53	77.5	65	I
	2000.05-2005.05	-	L	F	All-wheel Drive Saloon Engine ARL	261123	Drive Shaft		36		53	77.5	520	
	1998.11-2002.04	MT	L/R	F	All-wheel Drive Saloon Engine AGR	803036	Outer Joint		36	30	53.2	77.5	61	I

	 YEAR	TRANSM	L/R	F/R	REMARKS	GSP Ref.	 PRODUCT	 ABS	Technical Specifications								
									A	B	C	H	L	P			
VW																	
BORA (1J2)																	
1.9 TDI 4motion (66 kW)	1998.11-2002.04	-	L/R/F/R		All-wheel Drive Saloon Engine AGR	603011	Inner Joint			33		34					
	1998.11-2002.04	-	L	F	All-wheel Drive Saloon Engine AGR	261314	Drive Shaft	36		53	78	558					
	1998.11-2002.04	-	L/R	R	All-wheel Drive Saloon Engine AGR	803033	Outer Joint	36	30	53	78.5	51		I			
	1998.11-2002.04	-	R	F	All-wheel Drive Saloon Engine AGR	603009	Inner Joint			33		34					
1.9 TDI 4motion (74 kW)	2000.09-2005.05	MT	L/R	F	All-wheel Drive Saloon Engine ATD	803035	Outer Joint	36	27	53	77.5	65		I			
	2000.09-2005.05	6MT	L	F	All-wheel Drive Saloon Engine ATD	261123	Drive Shaft	36		53	77.5	520					
	2000.09-2005.05	-	L/R	R	All-wheel Drive Saloon Engine ATD	603011	Inner Joint			33		34					
	2000.09-2005.05	-	-	-	All-wheel Drive Saloon Engine ATD	603016	Inner Joint			28		32					
	2000.09-2005.05	AT	L	F	All-wheel Drive Saloon Engine ATD	261244	Drive Shaft	36		53	77.5	523					
	2000.09-2005.05	6MT	R	F	All-wheel Drive Saloon Engine ATD	261186	Drive Shaft	36		53	77.5	653					
	2000.09-2005.05	-	L/R	R	All-wheel Drive Saloon Engine ATD	803033	Outer Joint	36	30	53	78.5	51		I			
	2000.09-2005.05	MT	L	F	All-wheel Drive Saloon Engine ATD	261021	Drive Shaft	36		53.2	77.5	564.5					
1.9 TDI 4motion (85 kW)	1999.02-2001.06	-	L	F	All-wheel Drive Saloon Engine AJM	261123	Drive Shaft	36		53	77.5	520					
	1999.02-2001.06	-	L/R	R	All-wheel Drive Saloon Engine AJM	603011	Inner Joint			33		34					
	1999.02-2001.06	-	R	F	All-wheel Drive Saloon Engine AJM	261186	Drive Shaft	36		53	77.5	653					
	1999.02-2001.06	AT/MT	L/R	F	All-wheel Drive Saloon Engine AJM	803035	Outer Joint	36	27	53	77.5	65		I			
	1999.02-2001.06	-	L/R	R	All-wheel Drive Saloon Engine AJM	803033	Outer Joint	36	30	53	78.5	51		I			
1.9 TDI 4motion (96 kW)	2000.11-2005.05	-	-	-	All-wheel Drive Saloon Engine ASZ	603016	Inner Joint			28		32					
	2000.11-2005.05	-	R	F	All-wheel Drive Saloon Engine ASZ	261186	Drive Shaft	36		53	77.5	653					
	2000.11-2005.05	MT	R	F	All-wheel Drive Saloon Engine ASZ	299114	Drive Shaft	36		53	77.5	809					
	2000.11-2005.05	-	L/R	R	All-wheel Drive Saloon Engine ASZ	803033	Outer Joint	36	30	53	78.5	51		I			
	2000.11-2005.05	-	L/R	R	All-wheel Drive Saloon Engine ASZ	603011	Inner Joint			33		34					
	2000.11-2005.05	MT	L/R	F	All-wheel Drive Saloon Engine ASZ	803035	Outer Joint	36	27	53	77.5	65		I			
	2000.11-2005.05	-	L	F	All-wheel Drive Saloon Engine ASZ	261123	Drive Shaft	36		53	77.5	520					
	2000.11-2005.05	-	-	-	All-wheel Drive Saloon Engine ASZ	603016	Inner Joint			28		32					
2.0 (85 kW)	1998.10-2005.05	AT/MT	L/R	F	Saloon Engine AQY	803036	Outer Joint	36	30	53.2	77.5	61		I			
	1998.10-2005.05	AT	L	F	Saloon Engine AQY	261020	Drive Shaft	36		53.2	77.5	547					
	1998.10-2005.05	MT	L	F	Saloon Engine AQY	261314	Drive Shaft	36		53	78	558					
	1998.10-2005.05	AT	L	F	Saloon Engine AQY	261156	Drive Shaft	36		53	78	554.5					
	1998.10-2005.05	AT	L	F	Saloon Engine AQY	661062	Inner Joint			30		59					
	1998.10-2005.05	MT	R	F	Saloon Engine AQY	203004	Drive Shaft	36		53.2	77.5	822					
	1998.10-2005.05	MT	L	F	Saloon Engine AQY	261021	Drive Shaft	36		53.2	77.5	564.5					
	1998.10-2005.05	AT	L/R	F	Saloon Engine AQY	661006	Inner Joint			30		57.6					
	1998.10-2005.05	MT	R	F	Saloon Engine AQY	603009	Inner Joint			33		34					
	1998.10-2005.05	MT	L	F	Saloon Engine AQY	603011	Inner Joint			33		34					
2.0 4motion (85 kW)	2000.04-2005.05	-	L/R/F/R		All-wheel Drive Saloon Engine AZH	603011	Inner Joint			33		34					
	2000.04-2005.05	-	R	F	All-wheel Drive Saloon Engine AZH	603009	Inner Joint			33		34					
	2000.04-2005.05	-	L	F	All-wheel Drive Saloon Engine AZH	261314	Drive Shaft	36		53	78	558					
	2000.04-2005.05	-	L/R	R	All-wheel Drive Saloon Engine AZH	803033	Outer Joint	36	30	53	78.5	51		I			
	2000.04-2005.05	MT	L/R	F	All-wheel Drive Saloon Engine AZH	803036	Outer Joint	36	30	53.2	77.5	61		I			
	2000.04-2005.05	MT	L	F	All-wheel Drive Saloon Engine AZH	261021	Drive Shaft	36		53.2	77.5	564.5					
2.3 V5 (110 kW)	1998.10-2000.10	-	L/R	F	Saloon Engine AGZ	803036	Outer Joint	36	30	53.2	77.5	61		I			
	1998.10-2000.10	-	L	F	Saloon Engine AGZ	261020	Drive Shaft	36		53.2	77.5	547					
	1998.10-2000.10	MT	R	F	Saloon Engine AGZ	203011	Drive Shaft	36		53.2	77.5	810.5					
	1998.10-2000.10	-	L	F	Saloon Engine AGZ	261156	Drive Shaft	36		53	78	554.5					
	1998.10-2000.10	-	L	F	Saloon Engine AGZ	261312	Drive Shaft	36		53	78	546					
	1998.10-2000.10	-	L	F	Saloon Engine AGZ	661062	Inner Joint			30		59					
	1998.10-2000.10	-	L/R	F	Saloon Engine AGZ	661006	Inner Joint			30		57.6					
	1998.10-2000.10	-	-	-	Saloon Engine AGZ	603016	Inner Joint			28		32					
2.3 V5 (125 kW)	2000.10-2005.05	AT	L	F	Saloon Engine AQN	203374	Drive Shaft	36		53	77.5	521					
	2000.10-2005.05	AT	R	F	Saloon Engine AQN	261243	Drive Shaft	36		53	77.5	813					
	2000.10-2005.05	MT	L/R	F	Saloon Engine AQN	803036	Outer Joint	36	30	53.2	77.5	61		I			
	2000.10-2005.05	-	-	-	Saloon Engine AQN	603016	Inner Joint			28		32					
	2000.10-2005.05	MT	L	F	Saloon Engine AQN	261020	Drive Shaft	36		53.2	77.5	547					
	2000.10-2005.05	AT	L	F	Saloon Engine AQN	261244	Drive Shaft	36		53	77.5	523					
	2000.10-2005.05	AT	L/R	F	Saloon Engine AQN	803035	Outer Joint	36	27	53	77.5	65		I			
	2000.10-2005.05	MT	L/R	F	Saloon Engine AQN	661006	Inner Joint			30		57.6					
	2000.10-2005.05	MT	L	F	Saloon Engine AQN	261156	Drive Shaft	36		53	78	554.5					
	2000.10-2005.05	MT	L	F	Saloon Engine AQN	661062	Inner Joint			30		59					
2.3 V5 4motion (110 kW)	1998.12-2000.10	MT	L/R	F	All-wheel Drive Saloon Engine AGZ	803035	Outer Joint	36	27	53	77.5	65		I			
	1998.12-2000.10	-	L	F	All-wheel Drive Saloon Engine AGZ	261123	Drive Shaft	36		53	77.5	520					
	1998.12-2000.10	-	L/R	R	All-wheel Drive Saloon Engine AGZ	603011	Inner Joint			33		34					
	1998.12-2000.10	-	R	F	All-wheel Drive Saloon Engine AGZ	261186	Drive Shaft	36		53	77.5	653					
	1998.12-2000.10	-	L/R	R	All-wheel Drive Saloon Engine AGZ	803033	Outer Joint	36	30	53	78.5	51		I			
2.3 V5 4motion (125 kW)	2000.10-2005.05	-	-	-	All-wheel Drive Saloon Engine AQN	603016	Inner Joint			28		32					
	2000.10-2005.05	MT	L/R	F	All-wheel Drive Saloon Engine AQN	803035	Outer Joint	36	27	53	77.5	65		I			
	2000.10-2005.05	-	L	F	All-wheel Drive Saloon Engine AQN	261123	Drive Shaft	36		53	77.5	520					
	2000.10-2005.05	-	L/R	R	All-wheel Drive Saloon Engine AQN	603011	Inner Joint			33		34					





YEAR	TRANSM	L/R	F/R	REMARKS	GSP Ref.	PRODUCT	ABS	Technical Specifications					
								A	B	C	H	L	P
VW													
BORA (1J2)													
2.3 V5 4motion (125 kW)	2000.10-2005.05	-	R	F	All-wheel Drive Saloon Engine AQN	261186	Drive Shaft	36		53	77.5	653	
	2000.10-2005.05	-	L/R	R	All-wheel Drive Saloon Engine AQN	803033	Outer Joint	36	30	53	78.5	51	I
2.8 V6 4motion (150 kW)	1999.03-2005.05	MT	L/R	F	All-wheel Drive Saloon Engine AQP	803035	Outer Joint	36	27	53	77.5	65	I
	1999.03-2005.05	-	L/R	R	All-wheel Drive Saloon Engine AQP	603011	Inner Joint		33		34		
	1999.03-2005.05	-	-	-	All-wheel Drive Saloon Engine AQP	603016	Inner Joint		28		32		
	1999.03-2005.05	-	R	F	All-wheel Drive Saloon Engine AQP	261186	Drive Shaft	36		53	77.5	653	
	1999.03-2005.05	-	L/R	R	All-wheel Drive Saloon Engine AQP	803033	Outer Joint	36	30	53	78.5	51	I
	1999.03-2005.05	-	L	F	All-wheel Drive Saloon Engine AQP	261123	Drive Shaft	36		53	77.5	520	
BORA (1J2, 1J6) SW													
1.9 TDi (66 kW)	1998-	-	MT	-	-	603013	Inner Joint		33		34		
1.9 TDi (74 kW)	2000.05-	2005.05	AT	R	-	603013	Inner Joint		33		34		
1.9 TDi (81 kW)	1998-	-	MT	-	-	603013	Inner Joint		33		34		
BORA Variant (1J6)													
1.4 16V (55 kW)	2001.09-2005.05	-	L/R	F	Estate Engine AHW/ASP/BCA	603008	Inner Joint		33		32		
	2001.09-2005.05	MT	-	-	Estate Engine AHW/ASP/BCA	603006	Inner Joint		33		34		
	2001.09-2005.05	AT	L/R	F	Estate Engine AHW/ASP/BCA	803036	Outer Joint	36	30	53.2	77.5	61	I
	2001.09-2005.05	-	L	F	Estate Engine AHW/ASP/BCA	261045	Drive Shaft	36		53	78.5	555	
	2001.09-2005.05	-	R	F	Estate Engine AHW/ASP/BCA	203046	Drive Shaft	36		53	78.5	822	
	2001.09-2005.05	MT	L/R	F	Estate Engine AHW/ASP/BCA	803033	Outer Joint	36	30	53	78.5	51	I
1.6 (74 kW)	1999.05-2005.05	MT	L	F	Estate Engine APF/AEH/AKL	261020	Drive Shaft	36		53.2	77.5	547	
	1999.05-2005.05	MT	L	F	Estate Engine APF/AEH/AKL	261045	Drive Shaft	36		53	78.5	555	
	1999.05-2005.05	AT	L	F	Estate Engine APF/AEH/AKL	261156	Drive Shaft	36		53	78	554.5	
	1999.05-2005.05	AT	L/R	F	Estate Engine APF/AEH/AKL	661006	Inner Joint		30		57.6		
	1999.05-2005.05	MT	L/R	F	Estate Engine APF/AEH/AKL	803033	Outer Joint	36	30	53	78.5	51	I
	1999.05-2005.05	AT	L	F	Estate Engine APF/AEH/AKL	661062	Inner Joint		30		59		
	1999.05-2005.05	AT	L/R	F	Estate Engine APF/AEH/AKL	803036	Outer Joint	36	30	53.2	77.5	61	I
	1999.05-2005.05	MT	L/R	F	Estate Engine APF/AEH/AKL	603008	Inner Joint		33		32		
	1999.05-2005.05	MT	L/R	F	Estate Engine APF/AEH/AKL	803033	Outer Joint	36	30	53	78.5	51	I
1.6 (75 kW)	2000.08-2005.05	AT	L/R	F	Estate Engine AVU/BFQ	803036	Outer Joint	36	30	53.2	77.5	61	I
	2000.08-2005.05	AT	L	F	Estate Engine AVU/BFQ	261020	Drive Shaft	36		53.2	77.5	547	
	2000.08-2005.05	MT	L	F	Estate Engine AVU/BFQ	261045	Drive Shaft	36		53	78.5	555	
	2000.08-2005.05	AT	L	F	Estate Engine AVU/BFQ	261156	Drive Shaft	36		53	78	554.5	
	2000.08-2005.05	MT	L/R	F	Estate Engine AVU/BFQ	803033	Outer Joint	36	30	53	78.5	51	I
	2000.08-2005.05	AT	L/R	F	Estate Engine AVU/BFQ	661006	Inner Joint		30		57.6		
	2000.08-2005.05	AT	L	F	Estate Engine AVU/BFQ	661062	Inner Joint		30		59		
	2000.08-2005.05	MT	L/R	F	Estate Engine AVU/BFQ	603008	Inner Joint		33		32		
	2000.08-2005.05	MT	L/R	F	Estate Engine AVU/BFQ	803033	Outer Joint	36	30	53	78.5	51	I
1.6 16V (77 kW)	2000.02-2005.05	MT	L	F	Estate Engine AUS/AZD/ATN/BCB	261202	Drive Shaft	36		53.2	77.5	547	
	2000.02-2005.05	MT	-	-	Estate Engine AUS/AZD/ATN/BCB	603006	Inner Joint		33		34		
	2000.02-2005.05	MT	R	F	Estate Engine AUS/AZD/ATN/BCB	261203	Drive Shaft	36		53.2	77.5	810	
	2000.02-2005.05	AT/MT	L/R	F	Estate Engine AUS/AZD/ATN/BCB	803036	Outer Joint	36	30	53.2	77.5	61	I
	2000.02-2005.05	MT	L/R	F	Estate Engine AUS/AZD/ATN/BCB	661005	Inner Joint		30		57.6		
1.6 FSI (81 kW)	2002.01-2005.05	-	L/R	F	Estate Engine BAD	803036	Outer Joint	36	30	53.2	77.5	61	I
	2002.01-2005.05	MT	-	-	Estate Engine BAD	603006	Inner Joint		33		34		
1.8 4motion (92 kW)	1999.05-2005.05	-	L/R/F	R	All-wheel Drive Estate Engine AGN	603011	Inner Joint		33		34		
	1999.05-2005.05	-	R	F	All-wheel Drive Estate Engine AGN	603009	Inner Joint		33		34		
	1999.05-2005.05	-	L	F	All-wheel Drive Estate Engine AGN	261314	Drive Shaft	36		53	78	558	
	1999.05-2005.05	-	L/R	R	All-wheel Drive Estate Engine AGN	803033	Outer Joint	36	30	53	78.5	51	I
	1999.05-2005.05	-	L/R	F	All-wheel Drive Estate Engine AGN	803036	Outer Joint	36	30	53.2	77.5	61	I
	1999.05-2005.05	-	L	F	All-wheel Drive Estate Engine AGN	261123	Drive Shaft	36		53	77.5	520	
1.8 T (110 kW)	2000.05-2005.05	5AT	R	F	Estate Engine AGU	261243	Drive Shaft	36		53	77.5	813	
	2000.05-2005.05	MT	L/R	F	Estate Engine AGU	803036	Outer Joint	36	30	53.2	77.5	61	I
	2000.05-2005.05	MT	L	F	Estate Engine AGU	261020	Drive Shaft	36		53.2	77.5	547	
	2000.05-2005.05	5AT	L/R	F	Estate Engine AGU	803035	Outer Joint	36	27	53	77.5	65	I
	2000.05-2005.05	MT	L/R	F	Estate Engine AGU	661006	Inner Joint		30		57.6		
	2000.05-2005.05	4AT/MT	L	F	Estate Engine AGU	261156	Drive Shaft	36		53	78	554.5	
	2000.05-2005.05	4AT/MT	L	F	Estate Engine AGU	661062	Inner Joint		30		59		
	2000.05-2005.05	5AT	L	F	Estate Engine AGU	203374	Drive Shaft	36		53	77.5	521	
	2000.05-2005.05	5AT	L	F	Estate Engine AGU	261123	Drive Shaft	36		53	77.5	520	
1.8 T (132 kW)	2002.05-2005.05	-	L	F	Estate Engine AUQ	261123	Drive Shaft	36		53	77.5	520	
	2002.05-2005.05	MT	L/R	F	Estate Engine AUQ	803035	Outer Joint	36	27	53	77.5	65	I
	2002.05-2005.05	MT	-	-	Estate Engine AUQ	603016	Inner Joint		28		32		
	2002.05-2005.05	-	R	F	Estate Engine AUQ	299114	Drive Shaft	36		53	77.5	809	
	2002.05-2005.05	-	R	F	Estate Engine AUQ	261121	Drive Shaft	36		53	77.5	806	
	2002.05-2005.05	MT	-	-	Estate Engine AUQ	603006	Inner Joint		33		34		
1.9 TDI (110 kW)	2001.05-2005.05	MT	L/R	F	Estate Engine ARL	803035	Outer Joint	36	27	53	77.5	65	I
	2001.05-2005.05	MT	-	-	Estate Engine ARL	603016	Inner Joint		28		32		
	2001.05-2005.05	-	L	F	Estate Engine ARL	261123	Drive Shaft	36		53	77.5	520	
	2001.05-2005.05	-	R	F	Estate Engine ARL	299114	Drive Shaft	36		53	77.5	809	
	2001.05-2005.05	-	R	F	Estate Engine ARL	261121	Drive Shaft	36		53	77.5	806	
	2001.05-2005.05	-	R	F	Estate Engine ARL	261121	Drive Shaft	36		53	77.5	806	





YEAR	TRANSM	L/R	F/R	REMARKS	GSP Ref.	PRODUCT	ABS	Technical Specifications						
								A	B	C	H	L	P	
VW														
BORA Variant (1J6)														
1.9 TDI (110 kW)	2001.05-2005.05	MT	-	-	Estate Engine ARL	603006	Inner Joint			33		34		
1.9 TDI (66 kW)	2004.07-2005.05	AT/MT	L/R	F	Estate Engine ALH	803036	Outer Joint	36	30	53.2	77.5	61	I	
	2004.07-2005.05	-	L	F	Estate Engine ALH	603011	Inner Joint			33		34		
	2004.07-2005.05	AT	L	F	Estate Engine ALH	261020	Drive Shaft	36		53.2	77.5	547		
	2004.07-2005.05	-	L	F	Estate Engine ALH	261314	Drive Shaft	36		53	78	558		
	2004.07-2005.05	MT	-	-	Estate Engine ALH	603006	Inner Joint			33		34		
	2004.07-2005.05	MT	L	F	Estate Engine ALH	261021	Drive Shaft	36		53.2	77.5	564.5		
	2004.07-2005.05	MT	R	F	Estate Engine ALH	603009	Inner Joint			33		34		
1.9 TDI (74 kW)	2000.09-2005.05	AT	L	F	Estate Engine ATD	203374	Drive Shaft	36		53	77.5	521		
	2000.09-2005.05	AT	L/R	F	Estate Engine ATD	803035	Outer Joint	36	27	53	77.5	65	I	
	2000.09-2005.05	-	-	-	Estate Engine ATD	603016	Inner Joint			28		32		
	2000.09-2005.05	MT	L/R	F	Estate Engine ATD	803036	Outer Joint	36	30	53.2	77.5	61	I	
	2000.09-2005.05	AT	R	F	Estate Engine ATD	261243	Drive Shaft	36		53	77.5	813		
	2000.09-2005.05	AT	L	F	Estate Engine ATD	261244	Drive Shaft	36		53	77.5	523		
	2000.09-2005.05	MT	L	F	Estate Engine ATD	203006	Drive Shaft	36		53.2	77.5	557		
	2000.09-2005.05	MT	R	F	Estate Engine ATD	203004	Drive Shaft	36		53.2	77.5	822		
	2000.09-2005.05	MT	L	F	Estate Engine ATD	261021	Drive Shaft	36		53.2	77.5	564.5		
	2000.09-2005.05	MT	R	F	Estate Engine ATD	603009	Inner Joint			33		34		
2000.09-2005.05	MT	L	F	Estate Engine ATD	603011	Inner Joint			33		34			
1.9 TDI (81 kW)	1999.05-2001.06	AT/MT	L/R	F	Estate Engine AHF	803036	Outer Joint	36	30	53.2	77.5	61	I	
	1999.05-2001.06	4AT	L	F	Estate Engine AHF	261244	Drive Shaft	36		53	77.5	523		
	1999.05-2001.06	MT	L	F	Estate Engine AHF	203006	Drive Shaft	36		53.2	77.5	557		
	1999.05-2001.06	MT	R	F	Estate Engine AHF	203004	Drive Shaft	36		53.2	77.5	822		
	1999.05-2001.06	MT	L	F	Estate Engine AHF	261021	Drive Shaft	36		53.2	77.5	564.5		
	1999.05-2001.06	AT	L/R	F	Estate Engine AHF	661006	Inner Joint			30		57.6		
	1999.05-2001.06	MT	R	F	Estate Engine AHF	603009	Inner Joint			33		34		
1.9 TDI (85 kW)	1999.05-2001.06	AT	R	F	Estate Engine AJM	261243	Drive Shaft	36		53	77.5	813		
	1999.05-2001.06	AT	L	F	Estate Engine AJM	261244	Drive Shaft	36		53	77.5	523		
	1999.05-2001.06	MT	L	F	Estate Engine AJM	261123	Drive Shaft	36		53	77.5	520		
	1999.05-2001.06	MT	R	F	Estate Engine AJM	299114	Drive Shaft	36		53	77.5	809		
	1999.05-2001.06	MT	R	F	Estate Engine AJM	261121	Drive Shaft	36		53	77.5	806		
	1999.05-2001.06	AT/MT	L/R	F	Estate Engine AJM	803035	Outer Joint	36	27	53	77.5	65	I	
	1999.05-2001.06	AT	L	F	Estate Engine AJM	203374	Drive Shaft	36		53	77.5	521		
	1999.05-2001.06	AT	R	F	Estate Engine ASZ	261243	Drive Shaft	36		53	77.5	813		
1.9 TDI (96 kW)	2000.11-2005.05	AT	R	F	Estate Engine ASZ	261243	Drive Shaft	36		53	77.5	813		
	2000.11-2005.05	-	-	-	Estate Engine ASZ	603016	Inner Joint			28		32		
	2000.11-2005.05	AT	L	F	Estate Engine ASZ	261244	Drive Shaft	36		53	77.5	523		
	2000.11-2005.05	MT	R	F	Estate Engine ASZ	299114	Drive Shaft	36		53	77.5	809		
	2000.11-2005.05	MT	R	F	Estate Engine ASZ	261121	Drive Shaft	36		53	77.5	806		
	2000.11-2005.05	AT	L	F	Estate Engine ASZ	203374	Drive Shaft	36		53	77.5	521		
	2000.11-2005.05	AT/MT	L/R	F	Estate Engine ASZ	803035	Outer Joint	36	27	53	77.5	65	I	
	2000.11-2005.05	MT	L	F	Estate Engine ASZ	261123	Drive Shaft	36		53	77.5	520		
1.9 TDI 4motion (110 kW)	2001.05-2005.05	MT	L/R	F	All-wheel Drive Estate Engine ARL	803035	Outer Joint	36	27	53	77.5	65	I	
	2001.05-2005.05	MT	-	-	All-wheel Drive Estate Engine ARL	603016	Inner Joint			28		32		
	2001.05-2005.05	-	L	F	All-wheel Drive Estate Engine ARL	261123	Drive Shaft	36		53	77.5	520		
	2001.05-2005.05	6MT	R	F	All-wheel Drive Estate Engine ARL	261186	Drive Shaft	36		53	77.5	653		
	2001.05-2005.05	MT	R	F	All-wheel Drive Estate Engine ARL	299114	Drive Shaft	36		53	77.5	809		
	2001.05-2005.05	-	L/R	R	All-wheel Drive Estate Engine ARL	603011	Inner Joint			33		34		
	2001.05-2005.05	-	R	F	All-wheel Drive Estate Engine ARL	261121	Drive Shaft	36		53	77.5	806		
	2001.05-2005.05	MT	-	-	All-wheel Drive Estate Engine ARL	603006	Inner Joint			33		34		
	2001.05-2005.05	-	L/R	R	All-wheel Drive Estate Engine ARL	803033	Outer Joint	36	30	53	78.5	51	I	
1.9 TDI 4motion (74 kW)	2000.09-2005.05	MT	L/R	F	All-wheel Drive Estate Engine ATD	803035	Outer Joint	36	27	53	77.5	65	I	
	2000.09-2005.05	-	L	F	All-wheel Drive Estate Engine ATD	261123	Drive Shaft	36		53	77.5	520		
	2000.09-2005.05	-	L/R	R	All-wheel Drive Estate Engine ATD	603011	Inner Joint			33		34		
	2000.09-2005.05	-	-	-	All-wheel Drive Estate Engine ATD	603016	Inner Joint			28		32		
	2000.09-2005.05	-	R	F	All-wheel Drive Estate Engine ATD	261186	Drive Shaft	36		53	77.5	653		
	2000.09-2005.05	-	L/R	R	All-wheel Drive Estate Engine ATD	803033	Outer Joint	36	30	53	78.5	51	I	
1.9 TDI 4motion (85 kW)	2000.09-2005.05	MT	L	F	All-wheel Drive Estate Engine ATD	261021	Drive Shaft	36		53.2	77.5	564.5		
	1999.05-2001.06	-	L	F	All-wheel Drive Estate Engine AJM	261123	Drive Shaft	36		53	77.5	520		
	1999.05-2001.06	-	L/R	R	All-wheel Drive Estate Engine AJM	603011	Inner Joint			33		34		
	1999.05-2001.06	-	R	F	All-wheel Drive Estate Engine AJM	299114	Drive Shaft	36		53	77.5	809		
	1999.05-2001.06	-	R	F	All-wheel Drive Estate Engine AJM	261186	Drive Shaft	36		53	77.5	653		
	1999.05-2001.06	AT/MT	L/R	F	All-wheel Drive Estate Engine AJM	803035	Outer Joint	36	27	53	77.5	65	I	
1.9 TDI 4motion (96 kW)	2000.11-2005.05	-	-	-	All-wheel Drive Estate Engine ASZ	603016	Inner Joint			28		32		
	2000.11-2005.05	AT	L	F	All-wheel Drive Estate Engine ASZ	261244	Drive Shaft	36		53	77.5	523		
	2000.11-2005.05	6MT	R	F	All-wheel Drive Estate Engine ASZ	261186	Drive Shaft	36		53	77.5	653		

YEAR	TRANSM	L/R	F/R	REMARKS	GSP Ref.	PRODUCT	ABS	Technical Specifications							
								A	B	C	H	L	P		
VW															
BORA Variant (1J6)															
1.9 TDI 4motion (96 kW)	2000.11-2005.05	MT	R	F	All-wheel Drive Estate Engine ASZ	299114	Drive Shaft	36		53	77.5	809			
	2000.11-2005.05	-	R	F	All-wheel Drive Estate Engine ASZ	261121	Drive Shaft	36		53	77.5	806			
	2000.11-2005.05	-	L/R	R	All-wheel Drive Estate Engine ASZ	803033	Outer Joint	36	30	53	78.5	51	I		
	2000.11-2005.05	-	L/R	R	All-wheel Drive Estate Engine ASZ	603011	Inner Joint		33		34				
	2000.11-2005.05	MT	L/R	F	All-wheel Drive Estate Engine ASZ	803035	Outer Joint	36	27	53	77.5	65	I		
	2000.11-2005.05	-	L	F	All-wheel Drive Estate Engine ASZ	261123	Drive Shaft	36		53	77.5	520			
2.0 (85 kW)	1999.05-2005.05	AT/MT	L/R	F	Estate Engine APK	803036	Outer Joint	36	30	53.2	77.5	61	I		
	1999.05-2005.05	AT	L	F	Estate Engine APK	261020	Drive Shaft	36		53.2	77.5	547			
	1999.05-2005.05	MT	L	F	Estate Engine APK	261314	Drive Shaft	36		53	78	558			
	1999.05-2005.05	AT	L	F	Estate Engine APK	261156	Drive Shaft	36		53	78	554.5			
	1999.05-2005.05	AT	L	F	Estate Engine APK	661062	Inner Joint		30		59				
	1999.05-2005.05	MT	R	F	Estate Engine APK	203004	Drive Shaft	36		53.2	77.5	822			
	1999.05-2005.05	MT	L	F	Estate Engine APK	261021	Drive Shaft	36		53.2	77.5	564.5			
	1999.05-2005.05	AT	L/R	F	Estate Engine APK	661006	Inner Joint		30		57.6				
	1999.05-2005.05	MT	R	F	Estate Engine APK	603009	Inner Joint		33		34				
	1999.05-2005.05	MT	L	F	Estate Engine APK	603011	Inner Joint		33		34				
2.0 4motion (85 kW)	2000.04-2005.05	MT	L/R	F	All-wheel Drive Estate Engine AZH	803036	Outer Joint	36	30	53.2	77.5	61	I		
	2000.04-2005.05	-	L/R/F/R	F	All-wheel Drive Estate Engine AZH	603011	Inner Joint		33		34				
	2000.04-2005.05	-	L	F	All-wheel Drive Estate Engine AZH	261314	Drive Shaft	36		53	78	558			
	2000.04-2005.05	MT	L	F	All-wheel Drive Estate Engine AZH	261021	Drive Shaft	36		53.2	77.5	564.5			
	2000.04-2005.05	-	L/R	R	All-wheel Drive Estate Engine AZH	803033	Outer Joint	36	30	53	78.5	51	I		
	2000.04-2005.05	-	R	F	All-wheel Drive Estate Engine AZH	603009	Inner Joint		33		34				
2.0 4motion (88 kW)	1999.12-2003.05	MT	L	F	All-wheel Drive Estate Engine ATF	261314	Drive Shaft	36		53	78	558			
	1999.12-2003.05	AT/MT	L/R	R	All-wheel Drive Estate Engine ATF	803033	Outer Joint	36	30	53	78.5	51	I		
	1999.12-2003.05	-	L/R	F	All-wheel Drive Estate Engine ATF	603011	Inner Joint		33		34				
	1999.12-2003.05	AT/MT	L/R	F	All-wheel Drive Estate Engine ATF	803036	Outer Joint	36	30	53.2	77.5	61	I		
2.3 V5 (110 kW)	1999.05-2000.10	-	L/R	F	Estate Engine AGZ	803036	Outer Joint	36	30	53.2	77.5	61	I		
	1999.05-2000.10	-	L	F	Estate Engine AGZ	261020	Drive Shaft	36		53.2	77.5	547			
	1999.05-2000.10	MT	R	F	Estate Engine AGZ	203011	Drive Shaft	36		53.2	77.5	810.5			
	1999.05-2000.10	-	L	F	Estate Engine AGZ	261156	Drive Shaft	36		53	78	554.5			
	1999.05-2000.10	MT	L	F	Estate Engine AGZ	261312	Drive Shaft	36		53	78	546			
	1999.05-2000.10	-	L	F	Estate Engine AGZ	661062	Inner Joint		30		59				
	1999.05-2000.10	-	L/R	F	Estate Engine AGZ	661006	Inner Joint		30		57.6				
2.3 V5 (125 kW)	2000.10-2005.05	AT	L	F	Estate Engine AQN	203374	Drive Shaft	36		53	77.5	521			
	2000.10-2005.05	AT	R	F	Estate Engine AQN	261243	Drive Shaft	36		53	77.5	813			
	2000.10-2005.05	MT	L/R	F	Estate Engine AQN	803036	Outer Joint	36	30	53.2	77.5	61	I		
	2000.10-2005.05	-	-	-	Estate Engine AQN	603016	Inner Joint		28		32				
	2000.10-2005.05	MT	L	F	Estate Engine AQN	261020	Drive Shaft	36		53.2	77.5	547			
	2000.10-2005.05	AT	L	F	Estate Engine AQN	261244	Drive Shaft	36		53	77.5	523			
	2000.10-2005.05	AT	L/R	F	Estate Engine AQN	803035	Outer Joint	36	27	53	77.5	65	I		
	2000.10-2005.05	MT	L/R	F	Estate Engine AQN	661006	Inner Joint		30		57.6				
	2000.10-2005.05	MT	L	F	Estate Engine AQN	261156	Drive Shaft	36		53	78	554.5			
	2000.10-2005.05	MT	L	F	Estate Engine AQN	661062	Inner Joint		30		59				
2.3 V5 4motion (110 kW)	1999.05-2000.10	AT/MT	L	F	All-wheel Drive Estate Engine AGZ	261020	Drive Shaft	36		53.2	77.5	547			
	1999.05-2000.10	MT	L/R	F	All-wheel Drive Estate Engine AGZ	803035	Outer Joint	36	27	53	77.5	65	I		
	1999.05-2000.10	-	L	F	All-wheel Drive Estate Engine AGZ	261123	Drive Shaft	36		53	77.5	520			
	1999.05-2000.10	-	L/R	R	All-wheel Drive Estate Engine AGZ	603011	Inner Joint		33		34				
	1999.05-2000.10	-	R	F	All-wheel Drive Estate Engine AGZ	261186	Drive Shaft	36		53	77.5	653			
	1999.05-2000.10	-	L/R	R	All-wheel Drive Estate Engine AGZ	803033	Outer Joint	36	30	53	78.5	51	I		
2.3 V5 4motion (125 kW)	2000.10-2005.05	MT	L/R	F	All-wheel Drive Estate Engine AQN	803035	Outer Joint	36	27	53	77.5	65	I		
	2000.10-2005.05	-	L	F	All-wheel Drive Estate Engine AQN	261123	Drive Shaft	36		53	77.5	520			
	2000.10-2005.05	-	L/R	R	All-wheel Drive Estate Engine AQN	603011	Inner Joint		33		34				
	2000.10-2005.05	-	-	-	All-wheel Drive Estate Engine AQN	603016	Inner Joint		28		32				
	2000.10-2005.05	-	R	F	All-wheel Drive Estate Engine AQN	261186	Drive Shaft	36		53	77.5	653			
	2000.10-2005.05	-	L/R	R	All-wheel Drive Estate Engine AQN	803033	Outer Joint	36	30	53	78.5	51	I		
2.8 V6 4motion (150 kW)	1999.05-2005.05	MT	L/R	F	All-wheel Drive Estate Engine AQP	803035	Outer Joint	36	27	53	77.5	65	I		
	1999.05-2005.05	-	L/R	R	All-wheel Drive Estate Engine AQP	603011	Inner Joint		33		34				
	1999.05-2005.05	-	-	-	All-wheel Drive Estate Engine AQP	603016	Inner Joint		28		32				
	1999.05-2005.05	-	R	F	All-wheel Drive Estate Engine AQP	261186	Drive Shaft	36		53	77.5	653			
	1999.05-2005.05	-	L/R	R	All-wheel Drive Estate Engine AQP	803033	Outer Joint	36	30	53	78.5	51	I		
	1999.05-2005.05	-	L	F	All-wheel Drive Estate Engine AQP	261123	Drive Shaft	36		53	77.5	520			
BORA/VARIANT/4MOTION															
-	1999-2005	-	-	-	-	201587	Drive Shaft	36		53	78.5	522			
CADDY ALLTRACK (SAA)															
1.0 TSI (75 kW)	2015.11-	-	-	-	F	Box Engine CHZG	803100	Outer Joint	36	33	59.5	38	55	I	
1.2 TSI (62 kW)	2015.06-	-	-	-	F	Box Engine CYVC	803100	Outer Joint	36	33	59.5	38	55	I	

YEAR	TRANSM	L/R	F/R	REMARKS	GSP Ref.	PRODUCT	ABS	Technical Specifications							
								A	B	C	H	L	P		
VW															
CADDY ALLTRACK (SAA)															
1.2 TSI (62 kW)	2015.06-	-	MT	L/R	F	Box Engine CYVC	603011	Inner Joint			33		34		
1.4 TGI CNG (81 kW)	2015.06-	-	-	L	F	Box Engine CPWA	261131	Drive Shaft	36		59.5	40	515		
	2015.06-	-	-	-	F	Box Engine CPWA	803101	Outer Joint	36	27	59.5	40	65	M	
1.4 TSI (92 kW)	2015.05-	-	7AT/MT	L	F	Box Engine CZCB	261131	Drive Shaft	36		59.5	40	515		
	2015.05-	-	AT	-	-	Box Engine CZCB	603016	Inner Joint			28		32		
	2015.05-	-	-	-	F	Box Engine CZCB	803101	Outer Joint	36	27	59.5	40	65	M	
2.0 TDI (110 kW)	2015.05-	-	6MT	L	F	Box Engine CUUB	203265	Drive Shaft	36		59.5	40	487		
	2015.05-	-	6DCT	L	F	Box Engine CUUB	654004	Inner Joint			34		85		
	2015.05-	-	CVT	L	F	Box Engine CUUB	203241	Drive Shaft	36		59.5	40	475		
	2015.05-	-	CVT	R	F	Box Engine CUUB	203354	Drive Shaft	36		59.5	40	763		
2.0 TDI (55 kW)	2015.05-	-	MT	-	-	Box Engine CUUF	861059	Outer Joint	36	33	59.5	40	59.5	I	
	2015.05-	-	MT	L	F	Box Engine CUUF	261131	Drive Shaft	36		59.5	40	515		
	2015.05-	-	MT	L/R	F	Box Engine CUUF	603011	Inner Joint			33		34		
	2015.05-	-	MT	L	F	Box Engine CUUF	261089	Drive Shaft	36		59.5	40.5	521		
	2015.05-	-	-	-	F	Box Engine CUUF	803101	Outer Joint	36	27	59.5	40	65	M	
	2015.05-	-	MT	-	-	Box Engine CUUF	603016	Inner Joint			28		32		
	2015.05-	-	-	-	F	Box Engine CUUF	803100	Outer Joint	36	33	59.5	38	55	I	
	2015.05-	-	MT	-	-	Box Engine CUUF	603006	Inner Joint			33		34		
2.0 TDI (75 kW)	2015.05-	-	MT	L	F	Box Engine CUUD	261200	Drive Shaft	36		59.5	40.5	820		
	2015.05-	-	MT	-	F	Box Engine CUUD	261131	Drive Shaft	36		59.5	40	515		
	2015.05-	-	DCT	L	F	Box Engine CUUD	803101	Outer Joint	36	27	59.5	40	65	M	
	2015.05-	-	DCT	L	F	Box Engine CUUD	654004	Inner Joint			34		85		
	2015.05-	-	MT	-	-	Box Engine CUUD	603016	Inner Joint			28		32		
	2015.05-	-	CVT	L	F	Box Engine CUUD	203241	Drive Shaft	36		59.5	40	475		
2015.05-	-	CVT	R	F	Box Engine CUUD	203354	Drive Shaft	36		59.5	40	763			
CADDY ALLTRACK (SAB)															
1.0 TSI (75 kW)	2015.11-	-	-	-	F	Estate Engine CHZG	803100	Outer Joint	36	33	59.5	38	55	I	
1.2 TSI (62 kW)	2015.06-	-	-	-	F	Estate Engine CYVC	803100	Outer Joint	36	33	59.5	38	55	I	
	2015.06-	-	MT	L/R	F	Estate Engine CYVC	603011	Inner Joint			33		34		
1.4 TGI CNG (81 kW)	2015.06-	-	-	L	F	Estate Engine CPWA	261131	Drive Shaft	36		59.5	40	515		
	2015.06-	-	-	-	F	Estate Engine CPWA	803101	Outer Joint	36	27	59.5	40	65	M	
1.4 TSI (92 kW)	2015.05-	-	AT	-	-	Estate Engine CZCB	603016	Inner Joint			28		32		
	2015.05-	-	-	L	F	Estate Engine CZCB	261131	Drive Shaft	36		59.5	40	515		
	2015.05-	-	-	-	F	Estate Engine CZCB	803101	Outer Joint	36	27	59.5	40	65	M	
2.0 TDI (110 kW)	2015.05-	-	6MT	L	F	Estate Engine DFSB	203265	Drive Shaft	36		59.5	40	487		
	2015.05-	-	6DCT	L	F	Estate Engine DFSB	654004	Inner Joint			34		85		
	2015.05-	-	CVT	L	F	Estate Engine DFSB	203241	Drive Shaft	36		59.5	40	475		
	2015.05-	-	CVT	R	F	Estate Engine DFSB	203354	Drive Shaft	36		59.5	40	763		
2.0 TDI (55 kW)	2015.05-	-	MT	-	-	Estate Engine DFSF	861059	Outer Joint	36	33	59.5	40	59.5	I	
	2015.05-	-	MT	L	F	Estate Engine DFSF	261131	Drive Shaft	36		59.5	40	515		
	2015.05-	-	MT	L/R	F	Estate Engine DFSF	603011	Inner Joint			33		34		
	2015.05-	-	MT	L	F	Estate Engine DFSF	261089	Drive Shaft	36		59.5	40.5	521		
	2015.05-	-	-	-	F	Estate Engine DFSF	803101	Outer Joint	36	27	59.5	40	65	M	
	2015.05-	-	MT	-	-	Estate Engine DFSF	603016	Inner Joint			28		32		
	2015.05-	-	-	-	F	Estate Engine DFSF	803100	Outer Joint	36	33	59.5	38	55	I	
	2015.05-	-	MT	-	-	Estate Engine DFSF	603006	Inner Joint			33		34		
2.0 TDI (75 kW)	2015.05-	-	MT	R	F	Estate Engine DFSF	261200	Drive Shaft	36		59.5	40.5	820		
	2015.05-	-	MT	L	F	Estate Engine CUUD	261131	Drive Shaft	36		59.5	40	515		
	2015.05-	-	MT	-	F	Estate Engine CUUD	803101	Outer Joint	36	27	59.5	40	65	M	
	2015.05-	-	DCT	L	F	Estate Engine CUUD	654004	Inner Joint			34		85		
	2015.05-	-	MT	-	-	Estate Engine CUUD	603016	Inner Joint			28		32		
	2015.05-	-	CVT	L	F	Estate Engine CUUD	203241	Drive Shaft	36		59.5	40	475		
2015.05-	-	CVT	R	F	Estate Engine CUUD	203354	Drive Shaft	36		59.5	40	763			
CADDY I (14)															
1.6 (55 kW)	1983.01-	1992.07	MT	L/R	F	Pickup Engine EW	603004	Inner Joint			33		32		
	1983.01-	1992.07	-	L	F	Pickup Engine EW	253006	Drive Shaft	22		50	78.5	526		
	1983.01-	1992.07	MT	L/R	F	Pickup Engine EW	603005	Inner Joint			33		32		
	1983.01-	1992.07	MT	L/R	F	Pickup Engine EW	861013	Outer Joint	22	30	50	77.5	51	I	
1.6 D (40 kW)	1982.08-	1992.07	-	L	F	Pickup Engine JK	253006	Drive Shaft	22		50	78.5	526		
	1982.08-	1992.07	MT	L/R	F	Pickup Engine JK	603004	Inner Joint			33		32		
	1982.08-	1992.07	MT	L/R	F	Pickup Engine JK	861013	Outer Joint	22	30	50	77.5	51	I	
	1982.08-	1992.07	MT	L/R	F	Pickup Engine JK	603005	Inner Joint			33		32		
1.8 (70 kW)	1985.08-	1992.07	-	L	F	Pickup Engine JH	253006	Drive Shaft	22		50	78.5	526		
	1985.08-	1992.07	MT	L/R	F	Pickup Engine JH	603004	Inner Joint			33		32		
	1985.08-	1992.07	MT	L/R	F	Pickup Engine JH	861013	Outer Joint	22	30	50	77.5	51	I	
	1985.08-	1992.07	MT	L/R	F	Pickup Engine JH	603005	Inner Joint			33		32		

YEAR	TRANSM	L/R	F/R	REMARKS	GSP Ref.	PRODUCT	ABS	Technical Specifications						
								A	B	C	H	L	P	
VW														
CADDY II														
1.9 SDi	1996.04-	-	MT	L F	LCV	261030	Drive Shaft		22		50	77.5	539.7	
	1996.04-	-	-	R -	LCV	261066	Drive Shaft		22		51	78.7	772	
CADDY II (9K9A)														
1.4 (44 kW)	1995.11-	2004.01	MT	L/R F	Box Engine AEX/AUD/APQ	653001	Inner Joint			33		32		
	1995.11-	2004.01	MT	- -	Box Engine AEX/AUD/APQ	603006	Inner Joint			33		34		
	1995.11-	2004.01	MT	L F	Box Engine AEX/AUD/APQ	253004	Drive Shaft	22		50	78.5	562		
	1995.11-	2004.01	MT	L/R F	Box Engine AEX/AUD/APQ	853008	Outer Joint	22	30	53	78.5	51	I	
1.4 (55 kW)	2000.08-	2004.01	-	L/R F	Box Engine AUA	653001	Inner Joint			33		32		
	2000.08-	2004.01	-	L F	Box Engine AUA	253004	Drive Shaft	22		50	78.5	562		
	2000.08-	2004.01	-	L/R F	Box Engine AUA	853008	Outer Joint	22	30	53	78.5	51	I	
	2000.08-	2004.01	MT	- -	Box Engine AUA	603006	Inner Joint			33		34		
1.9 D (47 kW)	1995.11-	2004.01	MT	R F	Box Engine 1Y	253005	Drive Shaft	22		53	78.5	774		
	1995.11-	2004.01	MT	L/R F	Box Engine 1Y	603004	Inner Joint			33		32		
	1995.11-	2004.01	MT	L/R F	Box Engine 1Y	603005	Inner Joint			33		32		
	1995.11-	2004.01	MT	L F	Box Engine 1Y	253003	Drive Shaft	22		53	78.5	539.5		
	1995.11-	2004.01	MT	- -	Box Engine 1Y	603006	Inner Joint			33		34		
1.9 SDI (47 kW)	1995.11-	2004.01	MT	L/R F	Box Engine 1Y	853008	Outer Joint	22	30	53	78.5	51	I	
	1995.11-	2004.01	MT	R F	Box Engine AYQ	253005	Drive Shaft	22		53	78.5	774		
	1995.11-	2004.01	MT	L/R F	Box Engine AYQ	603004	Inner Joint			33		32		
	1995.11-	2004.01	MT	- -	Box Engine AYQ	603006	Inner Joint			33		34		
	1995.11-	2004.01	MT	L/R F	Box Engine AYQ	603005	Inner Joint			33		32		
1.9 SDI (47 kW)	1995.11-	2004.01	MT	L F	Box Engine AYQ	253003	Drive Shaft	22		53	78.5	539.5		
	1995.11-	2004.01	MT	L/R F	Box Engine AYQ	853008	Outer Joint	22	30	53	78.5	51	I	
	1995.11-	2004.01	MT	R F	Box Engine AYQ	253005	Drive Shaft	22		53	78.5	774		
	1995.11-	2004.01	MT	L/R F	Box Engine AYQ	603004	Inner Joint			33		32		
	1995.11-	2004.01	MT	L/R F	Box Engine AYQ	603005	Inner Joint			33		32		
1.9 TDI (66 kW)	1996.09-	2004.01	MT	L F	Box Engine IZ/AHU/AIH	603011	Inner Joint			33		34		
	1996.09-	2004.01	-	L/R F	Box Engine IZ/AHU/AIH	853007	Outer Joint	22	30	53.2	78	61	I	
	1996.09-	2004.01	-	L F	Box Engine IZ/AHU/AIH	261043	Drive Shaft	22		53.2	78	535		
	1996.09-	2004.01	MT	R F	Box Engine IZ/AHU/AIH	253002	Drive Shaft	22		53.2	78	769		
	1996.09-	2004.01	MT	R F	Box Engine IZ/AHU/AIH	603009	Inner Joint			33		34		
	1996.09-	2004.01	MT	- -	Box Engine IZ/AHU/AIH	603006	Inner Joint			33		34		
	1996.09-	2004.01	-	- F	Box Engine IZ/AHU/AIH	853004	Outer Joint	22	30	51	78	61	I	
75 1.6 (55 kW)	1995.11-	1997.05	-	L/R F	Box Engine 1F	853008	Outer Joint	22	30	53	78.5	51	I	
	1995.11-	1997.05	MT	- -	Box Engine 1F	603006	Inner Joint			33		34		
	1995.11-	2000.09	MT	L/R F	Box Engine AEE	653001	Inner Joint			33		32		
	1995.11-	1997.05	-	L F	Box Engine 1F	603011	Inner Joint			33		34		
	1995.11-	2000.09	MT	L F	Box Engine AEE	253004	Drive Shaft	22		50	78.5	562		
	1995.11-	2000.09	MT	- -	Box Engine AEE	603006	Inner Joint			33		34		
	1995.11-	2000.09	MT	L/R F	Box Engine AEE	853008	Outer Joint	22	30	53	78.5	51	I	
	1995.11-	1997.05	-	L/R F	Box Engine 1F	603004	Inner Joint			33		32		
	1995.11-	1997.05	-	L F	Box Engine 1F	253003	Drive Shaft	22		53	78.5	539.5		
1995.11-	1997.05	-	R F	Box Engine 1F	603009	Inner Joint			33		34			
CADDY II (9K9B)														
1.4 (44 kW)	1995.11-	2004.01	MT	- -	Estate Engine AEX/AKV/AUD/APQ	603006	Inner Joint			33		34		
	1995.11-	2004.01	-	L/R F	Estate Engine AEX/AKV/AUD/APQ	653001	Inner Joint			33		32		
	1995.11-	2004.01	-	L F	Estate Engine AEX/AKV/AUD/APQ	253004	Drive Shaft	22		50	78.5	562		
	1995.11-	2004.01	-	L/R F	Estate Engine AEX/AKV/AUD/APQ	853008	Outer Joint	22	30	53	78.5	51	I	
1.4 16V (55 kW)	2000.08-	2004.01	MT	- -	Estate Engine AUA	603006	Inner Joint			33		34		
	2000.08-	2004.01	-	L/R F	Estate Engine AUA	653001	Inner Joint			33		32		
	2000.08-	2004.01	-	L F	Estate Engine AUA	253004	Drive Shaft	22		50	78.5	562		
1.6 (55 kW)	2000.08-	2004.01	-	L/R F	Estate Engine AUA	853008	Outer Joint	22	30	53	78.5	51	I	
	1995.11-	1997.05	-	L/R F	Estate Engine 1F	853008	Outer Joint	22	30	53	78.5	51	I	
	1995.11-	1997.05	MT	- -	Estate Engine 1F	603006	Inner Joint			33		34		
	1995.11-	1997.05	-	L/R F	Estate Engine 1F	603004	Inner Joint			33		32		
	1995.11-	1997.05	-	L F	Estate Engine 1F	253003	Drive Shaft	22		53	78.5	539.5		
	1997.06-	2000.09	-	L/R F	Estate Engine AEE	853008	Outer Joint	22	30	53	78.5	51	I	
	1997.06-	2000.09	MT	- -	Estate Engine AEE	603006	Inner Joint			33		34		
1.9 D (47 kW)	1997.06-	2000.09	-	L/R F	Estate Engine AEE	653001	Inner Joint			33		32		
	1997.06-	2000.09	-	L F	Estate Engine AEE	253004	Drive Shaft	22		50	78.5	562		
	1995.11-	2004.01	MT	R F	Estate Engine 1Y	253005	Drive Shaft	22		53	78.5	774		
	1995.11-	2004.01	MT	- -	Estate Engine 1Y	603006	Inner Joint			33		34		
	1995.11-	2004.01	-	L/R F	Estate Engine 1Y	603004	Inner Joint			33		32		
1.9 SDI (47 kW)	1995.11-	2004.01	MT	L F	Estate Engine 1Y	253003	Drive Shaft	22		53	78.5	539.5		
	1995.11-	2004.01	MT	L/R F	Estate Engine 1Y	853008	Outer Joint	22	30	53	78.5	51	I	
	1995.11-	2004.01	MT	R F	Estate Engine AEY	253005	Drive Shaft	22		53	78.5	774		
	1995.11-	2004.01	MT	- -	Estate Engine AEY	603006	Inner Joint			33		34		
1995.11-	2004.01	-	L/R F	Estate Engine AEY	603004	Inner Joint			33		32			

	 YEAR	TRANSM	L/R	F/R	REMARKS	GSP Ref.	 PRODUCT	 ABS	Technical Specifications					
									A	B	C	H	L	P
VW														
CADDY II (9K9B)														
1.9 SDI (47 kW)	1995.11-2004.01	MT	L	F	Estate Engine AEY	253003	Drive Shaft		22		53	78.5	539.5	
	1995.11-2004.01	MT	L/R	F	Estate Engine AEY	853008	Outer Joint		22	30	53	78.5	51	I
1.9 TDI (66 kW)	1996.10-2004.01	MT	-	-	Estate Engine AHU/ALH/ALE	603006	Inner Joint			33		34		
	1996.10-2004.01	MT	L/R	F	Estate Engine AHU/ALH/ALE	603011	Inner Joint			33		34		
	1996.10-2004.01	-	L/R	F	Estate Engine AHU/ALH/ALE	853007	Outer Joint		22	30	53.2	78	61	I
	1996.10-2004.01	-	L	F	Estate Engine AHU/ALH/ALE	261043	Drive Shaft		22		53.2	78	535	
	1996.10-2004.01	-	R	F	Estate Engine AHU/ALH/ALE	253002	Drive Shaft		22		53.2	78	769	
	1996.10-2004.01	-	-	F	Estate Engine AHU/ALH/ALE	853004	Outer Joint		22	30	51	78	61	I
	1996.10-2004.01	-	L/R	F	Estate Engine AHU/ALH/ALE	861018	Outer Joint		22	30	53	78.5	61	I
CADDY II (9U7)														
1.6 (55 kW)	1996.06-2000.12	MT	L/R	F	Pickup Engine AEE	854001	Outer Joint		22	22	45	82	53.5	I
	1996.06-2000.12	MT	L	F	Pickup Engine AEE	254001	Drive Shaft		22	22	45	82	599	
	1996.06-2000.12	MT	R	F	Pickup Engine AEE	254002	Drive Shaft		22	22	45	82	861	
	1996.06-2000.12	MT	L	F	Pickup Engine AEE	654002	Inner Joint		22	22	40	60.2	94.5	
1.9 D (47 kW)	1996.06-2000.12	MT	L/R	F	Pickup Engine AEF	854001	Outer Joint		22	22	45	82	53.5	I
	1996.06-2000.12	MT	L	F	Pickup Engine AEF	254001	Drive Shaft		22	22	45	82	599	
	1996.06-2000.12	MT	R	F	Pickup Engine AEF	254002	Drive Shaft		22	22	45	82	861	
	1996.06-2000.12	MT	L	F	Pickup Engine AEF	654002	Inner Joint		22	22	40	60.2	94.5	
CADDY III (2KA 2KH 2CA 2CH)														
1.2 TSI (63 kW)	2010.09-2015.05	-	L	F	Box Engine CBZA	261131	Drive Shaft		36		59.5	40	515	
	2010.09-2015.05	-	L	F	Box Engine CBZA	803002	Outer Joint		36	27	59.5	40	66	I
	2010.09-2015.05	MT	-	-	Box Engine CBZA	603006	Inner Joint			33		34		
	2010.09-2015.05	MT	-	-	Box Engine CBZA	603016	Inner Joint			28		32		
	2010.09-2015.05	-	R	F	Box Engine CBZA	803100	Outer Joint		36	33	59.5	38	55	I
	2010.09-2015.05	-	R	F	Box Engine CBZA	603011	Inner Joint			33		34		
	2010.09-2015.05	MT	-	-	Box Engine CBZA	861059	Outer Joint		36	33	59.5	40	59.5	I
	2010.09-2015.05	-	L	F	Box Engine CBZA	261131	Drive Shaft		36		59.5	40	515	
1.2 TSI (77 kW)	2010.09-2015.05	-	L	F	Box Engine CBZB	803002	Outer Joint		36	27	59.5	40	66	I
	2010.09-2015.05	-	L	F	Box Engine CBZB	603011	Inner Joint			33		34		
	2010.09-2015.05	MT	-	-	Box Engine CBZB	603006	Inner Joint			33		34		
	2010.09-2015.05	MT	-	-	Box Engine CBZB	603016	Inner Joint			28		32		
	2010.09-2015.05	-	R	F	Box Engine CBZB	803100	Outer Joint		36	33	59.5	38	55	I
	2010.09-2015.05	MT	-	-	Box Engine CBZB	861059	Outer Joint		36	33	59.5	40	59.5	I
	2010.09-2015.05	-	L	F	Box Engine CBZB	261131	Drive Shaft		36		59.5	40	515	
	2010.09-2015.05	-	L	F	Box Engine CBZB	261277	Drive Shaft		36		59.5	40	516	
1.4 (55 kW)	2004.03-2006.05	MT	-	-	Box Engine BCA	603006	Inner Joint			33		34		
	2004.03-2006.05	-	L	F	Box Engine BCA	261198	Drive Shaft		36		59.5	40.5	530	
	2004.03-2006.05	5MT	L/R	F	Box Engine BCA	803037	Outer Joint		36	30	59.5	40.5	55	I
	2004.03-2006.05	5MT	L/R	F	Box Engine BCA	603011	Inner Joint			33		34		
1.4 (59 kW)	2006.05-2010.08	MT	-	-	Box Engine BUD	603006	Inner Joint			33		34		
	2006.05-2010.08	-	L	F	Box Engine BUD	261198	Drive Shaft		36		59.5	40.5	530	
	2006.05-2010.08	-	L/R	F	Box Engine BUD	603011	Inner Joint			33		34		
	2006.05-2010.08	5MT	L/R	F	Box Engine BUD	803037	Outer Joint		36	30	59.5	40.5	55	I
1.6 (75 kW)	2004.04-2015.05	MT	-	-	Box Engine BGU	603006	Inner Joint			33		34		
	2004.04-2015.05	-	L	F	Box Engine BGU	803002	Outer Joint		36	27	59.5	40	66	I
	2004.04-2015.05	-	L	F	Box Engine BGU	261277	Drive Shaft		36		59.5	40	516	
	2004.04-2015.05	-	L	F	Box Engine BGU	203373	Drive Shaft		36		59.5	38	511	
	2004.04-2015.05	5MT	L/R	F	Box Engine BGU	603011	Inner Joint			33		34		
	2004.04-2015.05	AT	L/R	F	Box Engine BGU	661011	Inner Joint		26	32	31	68.5	85	
	2004.04-2015.05	-	R	F	Box Engine BGU	201585	Drive Shaft		36		59.5	40	805	
	2004.04-2015.05	-	L	F	Box Engine BGU	803116	Outer Joint		36	30	59.5	38	55	I
	2004.04-2015.05	MT	-	-	Box Engine BGU	861059	Outer Joint		36	33	59.5	40	59.5	I
	2004.04-2015.05	-	R	F	Box Engine BGU	803037	Outer Joint		36	30	59.5	40.5	55	I
	2004.04-2015.05	-	R	F	Box Engine BGU	261113	Drive Shaft		36		59.5	40	814	
	1.6 BiFuel (75 kW)	2011.05-2015.05	-	L/R	F	Box Engine CHGA	803002	Outer Joint		36	27	59.5	40	66
2011.05-2015.05		-	L/R	F	Box Engine CHGA	603011	Inner Joint			33		34		
2011.05-2015.05		MT	-	-	Box Engine CHGA	603006	Inner Joint			33		34		
2011.05-2015.05		-	R	F	Box Engine CHGA	201585	Drive Shaft		36		59.5	40	805	
2011.05-2015.05		MT	-	-	Box Engine CHGA	861059	Outer Joint		36	33	59.5	40	59.5	I
2011.05-2015.05		-	R	F	Box Engine CHGA	261113	Drive Shaft		36		59.5	40	814	
1.6 TDI (55 kW)	2010.08-2015.05	MT	-	-	Box Engine CAYE	603006	Inner Joint			33		34		
	2010.08-2015.05	MT	R	F	Box Engine CAYE	261101	Drive Shaft		36		59.5	40	803	
	2010.08-2015.05	MT	L	F	Box Engine CAYE	261100	Drive Shaft		36		59.5	40	513	
	2010.08-2015.05	MT	L/R	F	Box Engine CAYE	803002	Outer Joint		36	27	59.5	40	66	I
	2010.08-2015.05	MT	-	-	Box Engine CAYE	603016	Inner Joint			28		32		
	2010.08-2015.05	MT	L/R	F	Box Engine CAYE	603011	Inner Joint			33		34		
	2010.08-2015.05	MT	-	-	Box Engine CAYE	861059	Outer Joint		36	33	59.5	40	59.5	I
	2010.08-2015.05	MT	L	F	Box Engine CAYE	261131	Drive Shaft		36		59.5	40	515	





			TRANSM	L/R	F/R	REMARKS	GSP Ref.			Technical Specifications					
YEAR										A	B	C	H	L	P
VW															
CADDY III (2KA 2KH 2CA 2CH)															
1.6 TDI (75 kW)		2010.08-2015.05	-	R	F	Box Engine CAYD	803002	Outer Joint		36	27	59.5	40	66	I
		2010.08-2015.05	MT	L	F	Box Engine CAYD	261131	Drive Shaft		36		59.5	40	515	
		2010.08-2015.05	MT	R	F	Box Engine CAYD	261101	Drive Shaft		36		59.5	40	803	
		2010.08-2015.05	MT	L	F	Box Engine CAYD	261100	Drive Shaft		36		59.5	40	513	
1.9 TDI (55 kW)		2005.09-2010.08	MT	L	F	Box Engine BSU	261100	Drive Shaft		36		59.5	40	513	
		2005.09-2010.08	MT	R	F	Box Engine BSU	261101	Drive Shaft		36		59.5	40	803	
		2005.09-2010.08	-	L/R	F	Box Engine BSU	803002	Outer Joint		36	27	59.5	40	66	I
		2005.09-2010.08	AT	L	F	Box Engine BSU	654004	Inner Joint			34		85		
		2005.09-2010.08	MT	-	-	Box Engine BSU	603016	Inner Joint			28		32		
		2005.09-2010.08	AT	L	F	Box Engine BSU	203241	Drive Shaft		36		59.5	40	475	
		2005.09-2010.08	MT	L	F	Box Engine BSU	261131	Drive Shaft		36		59.5	40	515	
1.9 TDI (77 kW)		2004.04-2010.08	AT	L/R	F	Box Engine BJB	661057	Inner Joint			34		86		
		2004.04-2010.08	MT	L	F	Box Engine BJB	261100	Drive Shaft		36		59.5	40	513	
		2004.04-2010.08	MT	R	F	Box Engine BJB	261101	Drive Shaft		36		59.5	40	803	
		2004.04-2010.08	AT/MT	L/R	F	Box Engine BJB	803002	Outer Joint		36	27	59.5	40	66	I
		2004.04-2010.08	AT	L	F	Box Engine BJB	254013	Drive Shaft		36		59.5	40	479.5	
		2004.04-2010.08	AT	L	F	Box Engine BJB	654004	Inner Joint			34		85		
		2004.04-2010.08	AT	L	F	Box Engine BJB	203241	Drive Shaft		36		59.5	40	475	
		2004.04-2010.08	AT	R	F	Box Engine BJB	254011	Drive Shaft		36		59.5	40	755	
		2004.04-2010.08	MT	L	F	Box Engine BJB	261131	Drive Shaft		36		59.5	40	515	
1.9 TDI 4motion (77 kW)		2008.11-2010.08	-	L/R	F	All-wheel Drive Box Engine BLS	803002	Outer Joint		36	27	59.5	40	66	I
		2008.11-2010.08	-	R	F	All-wheel Drive Box Engine BLS	203266	Drive Shaft		36		59.5	40	601	
		2008.11-2010.08	-	L	F	All-wheel Drive Box Engine BLS	203295	Drive Shaft		36		59.5	40	491	
2.0 EcoFuel (80 kW)		2006.04-2015.05	MT	-	-	Box Engine BSX	603006	Inner Joint			33		34		
		2006.04-2015.05	-	L	F	Box Engine BSX	803002	Outer Joint		36	27	59.5	40	66	I
		2006.04-2015.05	-	R	F	Box Engine BSX	201585	Drive Shaft		36		59.5	40	805	
		2006.04-2015.05	MT	-	-	Box Engine BSX	861059	Outer Joint		36	33	59.5	40	59.5	I
		2006.04-2015.05	5MT	L/R	F	Box Engine BSX	803037	Outer Joint		36	30	59.5	40.5	55	I
		2006.04-2015.05	-	L/R	F	Box Engine BSX	603011	Inner Joint			33		34		
		2006.04-2015.05	-	R	F	Box Engine BSX	261113	Drive Shaft		36		59.5	40	814	
2.0 SDI (51 kW)		2004.03-2010.08	MT	-	-	Box Engine BDJ	603006	Inner Joint			33		34		
		2004.03-2010.08	-	L/R	F	Box Engine BDJ	603011	Inner Joint			33		34		
		2004.03-2010.08	-	L	F	Box Engine BDJ	803002	Outer Joint		36	27	59.5	40	66	I
		2004.03-2010.08	-	L	F	Box Engine BDJ	203373	Drive Shaft		36		59.5	38	511	
		2004.03-2010.08	-	L	F	Box Engine BDJ	261277	Drive Shaft		36		59.5	40	516	
		2004.03-2010.08	-	R	F	Box Engine BDJ	261042	Drive Shaft		36		59.5	40.5	814	
		2004.03-2010.08	-	L	F	Box Engine BDJ	261268	Drive Shaft		36		59.5	40	516	
		2004.03-2010.08	-	R	F	Box Engine BDJ	201585	Drive Shaft		36		59.5	40	805	
		2004.03-2010.08	-	L	F	Box Engine BDJ	803116	Outer Joint		36	30	59.5	38	55	I
		2004.03-2010.08	-	L/R	F	Box Engine BDJ	803037	Outer Joint		36	30	59.5	40.5	55	I
2.0 TDI (103 kW)		2007.09-2010.08	MT	-	-	Box Engine BMM	603016	Inner Joint			28		32		
2.0 TDI (125 kW)		2012.05-2015.05	-	L/R	F	Box Engine CFJA	661057	Inner Joint			34		86		
		2012.05-2015.05	-	L	F	Box Engine CFJA	654004	Inner Joint			34		85		
		2012.05-2015.05	-	L/R	F	Box Engine CFJA	861045	Outer Joint		36	27	59.5	40	65	M
		2012.05-2015.05	Semi-AT	L	F	Box Engine CFJA	203241	Drive Shaft		36		59.5	40	475	
2.0 TDI (62 kW)		2010.11-2015.05	MT	-	-	Box Engine CFHE	603016	Inner Joint			28		32		
2.0 TDI (81 kW)		2010.08-2015.05	-	R	F	Box Engine CLCA	803002	Outer Joint		36	27	59.5	40	66	I
		2010.08-2015.05	-	R	F	Box Engine CLCA	261101	Drive Shaft		36		59.5	40	803	
		2010.08-2015.05	MT	-	-	Box Engine CLCA	603016	Inner Joint			28		32		
2.0 TDI 16V (103 kW)		2010.11-2015.05	6AT	L/R	F	Box Engine CFHC	661057	Inner Joint			34		86		
		2010.11-2015.05	6AT	L/R	F	Box Engine CFHC	861045	Outer Joint		36	27	59.5	40	65	M
		2010.11-2015.05	6AT	R	F	Box Engine CFHC	654004	Inner Joint			34		85		
		2010.11-2015.05	6AT	R	F	Box Engine CFHC	254011	Drive Shaft		36		59.5	40	755	
		2010.11-2015.05	Semi-AT	L	F	Box Engine CFHC	203241	Drive Shaft		36		59.5	40	475	
2.0 TDI 16V 4motion (103 kW)		2010.11-2015.05	DCT	L	F	All-wheel Drive Box Engine CFHC	654004	Inner Joint			34		85		
		2010.11-2015.05	DCT	L	F	All-wheel Drive Box Engine CFHC	203241	Drive Shaft		36		59.5	40	475	
2.0 TDI 4motion (62 kW)		2010.12-2015.05	MT	-	-	All-wheel Drive Box Engine CFHE	603016	Inner Joint			28		32		
2.0 TDI 4motion (81 kW)		2010.08-2015.05	-	L/R	F	All-wheel Drive Box Engine CFHF	803002	Outer Joint		36	27	59.5	40	66	I
		2010.08-2015.05	-	R	F	All-wheel Drive Box Engine CFHF	203266	Drive Shaft		36		59.5	40	601	
		2010.08-2015.05	MT	-	-	All-wheel Drive Box Engine CFHF	603016	Inner Joint			28		32		
		2010.08-2015.05	-	L	F	All-wheel Drive Box Engine CFHF	203295	Drive Shaft		36		59.5	40	491	
CADDY III (2KB 2KJ 2CB 2CJ)															
1.2 TSI (63 kW)		2010.09-2015.05	-	L	F	Estate Engine CBZA	261131	Drive Shaft		36		59.5	40	515	
		2010.09-2015.05	-	L	F	Estate Engine CBZA	803002	Outer Joint		36	27	59.5	40	66	I
		2010.09-2015.05	MT	-	-	Estate Engine CBZA	603006	Inner Joint			33		34		
		2010.09-2015.05	MT	-	-	Estate Engine CBZA	603016	Inner Joint			28		32		

YEAR	TRANSM	L/R	F/R	REMARKS	GSP Ref.	PRODUCT	ABS	Technical Specifications							
								A	B	C	H	L	P		
VW															
CADDY III (2KB 2KJ 2CB 2CJ)															
1.2 TSI (63 kW)	2010.09-2015.05	-	R	F	Estate Engine CBZA	803100	Outer Joint	36	33	59.5	38	55	I		
	2010.09-2015.05	-	R	F	Estate Engine CBZA	603011	Inner Joint		33		34				
	2010.09-2015.05	MT	-	-	Estate Engine CBZA	861059	Outer Joint	36	33	59.5	40	59.5	I		
1.2 TSI (77 kW)	2010.09-2015.05	-	L	F	Estate Engine CBZB	261131	Drive Shaft	36		59.5	40	515			
	2010.09-2015.05	-	L	F	Estate Engine CBZB	803002	Outer Joint	36	27	59.5	40	66	I		
	2010.09-2015.05	-	R	F	Estate Engine CBZB	603011	Inner Joint		33		34				
	2010.09-2015.05	MT	-	-	Estate Engine CBZB	603006	Inner Joint		33		34				
	2010.09-2015.05	MT	-	-	Estate Engine CBZB	603016	Inner Joint		28		32				
	2010.09-2015.05	-	R	F	Estate Engine CBZB	803100	Outer Joint	36	33	59.5	38	55	I		
	2010.09-2015.05	MT	-	-	Estate Engine CBZB	861059	Outer Joint	36	33	59.5	40	59.5	I		
1.4 (55 kW)	2004.03-2006.05	MT	-	-	Estate Engine BCA	603006	Inner Joint		33		34				
	2004.03-2006.05	-	L	F	Estate Engine BCA	261198	Drive Shaft	36		59.5	40.5	530			
	2004.03-2006.05	5MT	L/R	F	Estate Engine BCA	803037	Outer Joint	36	30	59.5	40.5	55	I		
	2004.03-2006.05	5MT	L/R	F	Estate Engine BCA	603011	Inner Joint		33		34				
1.4 (59 kW)	2006.05-2010.08	MT	-	-	Estate Engine BUD	603006	Inner Joint		33		34				
	2006.05-2010.08	-	L	F	Estate Engine BUD	261198	Drive Shaft	36		59.5	40.5	530			
	2006.05-2010.08	-	L/R	F	Estate Engine BUD	603011	Inner Joint		33		34				
	2006.05-2010.08	5MT	L/R	F	Estate Engine BUD	803037	Outer Joint	36	30	59.5	40.5	55	I		
1.6 (75 kW)	2004.04-2015.05	-	R	F	Estate Engine BGU	261113	Drive Shaft	36		59.5	40	814			
	2004.04-2015.05	MT	-	-	Estate Engine BGU	603006	Inner Joint		33		34				
	2004.04-2015.05	-	L/R	F	Estate Engine BGU	803002	Outer Joint	36	27	59.5	40	66	I		
	2004.04-2015.05	-	L	F	Estate Engine BGU	203373	Drive Shaft	36		59.5	38	511			
	2004.04-2015.05	-	L	F	Estate Engine BGU	261277	Drive Shaft	36		59.5	40	516			
	2004.04-2015.05	5MT	L/R	F	Estate Engine BGU	603011	Inner Joint		33		34				
	2004.04-2015.05	AT	L/R	F	Estate Engine BGU	661011	Inner Joint	26	32	31	68.5	85			
	2004.04-2015.05	-	R	F	Estate Engine BGU	201585	Drive Shaft	36		59.5	40	805			
	2004.04-2015.05	-	L	F	Estate Engine BGU	803116	Outer Joint	36	30	59.5	38	55	I		
	2004.04-2015.05	MT	-	-	Estate Engine BGU	861059	Outer Joint	36	33	59.5	40	59.5	I		
	2004.04-2015.05	5MT	L/R	F	Estate Engine BGU	803037	Outer Joint	36	30	59.5	40.5	55	I		
1.6 BiFuel (75 kW)	2011.05-2015.05	-	L/R	F	Estate Engine CHGA	803002	Outer Joint	36	27	59.5	40	66	I		
	2011.05-2015.05	-	L/R	F	Estate Engine CHGA	603011	Inner Joint		33		34				
	2011.05-2015.05	MT	-	-	Estate Engine CHGA	603006	Inner Joint		33		34				
	2011.05-2015.05	-	R	F	Estate Engine CHGA	201585	Drive Shaft	36		59.5	40	805			
	2011.05-2015.05	MT	-	-	Estate Engine CHGA	861059	Outer Joint	36	33	59.5	40	59.5	I		
	2011.05-2015.05	-	R	F	Estate Engine CHGA	261113	Drive Shaft	36		59.5	40	814			
1.6 TDI (55 kW)	2010.08-2015.05	MT	-	-	Estate Engine CAYE	603006	Inner Joint		33		34				
	2010.08-2015.05	MT	R	F	Estate Engine CAYE	261101	Drive Shaft	36		59.5	40	803			
	2010.08-2015.05	MT	L	F	Estate Engine CAYE	261100	Drive Shaft	36		59.5	40	513			
	2010.08-2015.05	-	L/R	F	Estate Engine CAYE	803002	Outer Joint	36	27	59.5	40	66	I		
	2010.08-2015.05	MT	-	-	Estate Engine CAYE	603016	Inner Joint		28		32				
	2010.08-2015.05	MT	-	-	Estate Engine CAYE	861059	Outer Joint	36	33	59.5	40	59.5	I		
1.6 TDI (75 kW)	2010.08-2015.05	-	R	F	Estate Engine CAYD	803002	Outer Joint	36	27	59.5	40	66	I		
	2010.08-2015.05	MT	L	F	Estate Engine CAYD	261131	Drive Shaft	36		59.5	40	515			
	2010.08-2015.05	MT	R	F	Estate Engine CAYD	261101	Drive Shaft	36		59.5	40	803			
	2010.08-2015.05	MT	L	F	Estate Engine CAYD	261100	Drive Shaft	36		59.5	40	513			
1.9 TDI (55 kW)	2005.09-2010.08	-	L/R	F	Estate Engine BSU	803002	Outer Joint	36	27	59.5	40	66	I		
	2005.09-2010.08	MT	L	F	Estate Engine BSU	261100	Drive Shaft	36		59.5	40	513			
	2005.09-2010.08	MT	R	F	Estate Engine BSU	261101	Drive Shaft	36		59.5	40	803			
	2005.09-2010.08	AT	L	F	Estate Engine BSU	654004	Inner Joint		34		85				
	2005.09-2010.08	MT	-	-	Estate Engine BSU	603016	Inner Joint		28		32				
	2005.09-2010.08	AT	L	F	Estate Engine BSU	203241	Drive Shaft	36		59.5	40	475			
	2005.09-2010.08	MT	L	F	Estate Engine BSU	261131	Drive Shaft	36		59.5	40	515			
1.9 TDI (77 kW)	2004.04-2010.08	AT	L/R	F	Estate Engine BJB	661057	Inner Joint		34		86				
	2004.04-2010.08	MT	L	F	Estate Engine BJB	261100	Drive Shaft	36		59.5	40	513			
	2004.04-2010.08	MT	R	F	Estate Engine BJB	261101	Drive Shaft	36		59.5	40	803			
	2004.04-2010.08	AT/MT	L/R	F	Estate Engine BJB	803002	Outer Joint	36	27	59.5	40	66	I		
	2004.04-2010.08	AT	L	F	Estate Engine BJB	254013	Drive Shaft	36		59.5	40	479.5			
	2004.04-2010.08	AT	L	F	Estate Engine BJB	654004	Inner Joint		34		85				
	2004.04-2010.08	AT	L	F	Estate Engine BJB	203241	Drive Shaft	36		59.5	40	475			
	2004.04-2010.08	AT	R	F	Estate Engine BJB	254011	Drive Shaft	36		59.5	40	755			
	2004.04-2010.08	MT	L	F	Estate Engine BJB	261131	Drive Shaft	36		59.5	40	515			
1.9 TDI 4motion (77 kW)	2008.05-2010.08	-	L/R	F	All-wheel Drive Estate Engine BLS	803002	Outer Joint	36	27	59.5	40	66	I		
	2008.05-2010.08	MT	R	F	All-wheel Drive Estate Engine BLS	203266	Drive Shaft	36		59.5	40	601			
	2008.05-2010.08	-	L	F	All-wheel Drive Estate Engine BLS	203295	Drive Shaft	36		59.5	40	491			
2.0 EcoFuel (80 kW)	2006.04-2015.05	MT	-	-	Estate Engine BSX	603006	Inner Joint		33		34				
	2006.04-2015.05	-	L	F	Estate Engine BSX	803002	Outer Joint	36	27	59.5	40	66	I		





YEAR	TRANSM	L/R	F/R	REMARKS	GSP Ref.	PRODUCT	ABS	Technical Specifications						
								A	B	C	H	L	P	
VW														
CADDY III (2KB 2KJ 2CB 2CJ)														
2.0 EcoFuel (80 kW)	2006.04-2015.05	-	R	F	Estate Engine BSX	201585	Drive Shaft	36		59.5	40	805		
	2006.04-2015.05	MT	-	-	Estate Engine BSX	861059	Outer Joint	36	33	59.5	40	59.5	I	
	2006.04-2015.05	5MT	L/R	F	Estate Engine BSX	803037	Outer Joint	36	30	59.5	40.5	55	I	
	2006.04-2015.05	-	L/R	F	Estate Engine BSX	603011	Inner Joint		33		34			
	2006.04-2015.05	-	R	F	Estate Engine BSX	261113	Drive Shaft	36		59.5	40	814		
2.0 SDI (51 kW)	2004.03-2010.08	MT	-	-	Estate Engine BDJ	603006	Inner Joint		33		34			
	2004.03-2010.08	-	L/R	F	Estate Engine BDJ	603011	Inner Joint		33		34			
	2004.03-2010.08	-	L	F	Estate Engine BDJ	803002	Outer Joint	36	27	59.5	40	66	I	
	2004.03-2010.08	-	L	F	Estate Engine BDJ	203373	Drive Shaft	36		59.5	38	511		
	2004.03-2010.08	-	L	F	Estate Engine BDJ	261277	Drive Shaft	36		59.5	40	516		
	2004.03-2010.08	-	R	F	Estate Engine BDJ	261042	Drive Shaft	36		59.5	40.5	814		
	2004.03-2010.08	-	L	F	Estate Engine BDJ	261268	Drive Shaft	36		59.5	40	516		
	2004.03-2010.08	-	R	F	Estate Engine BDJ	201585	Drive Shaft	36		59.5	40	805		
	2004.03-2010.08	-	L	F	Estate Engine BDJ	803116	Outer Joint	36	30	59.5	38	55	I	
	2004.03-2010.08	-	L/R	F	Estate Engine BDJ	803037	Outer Joint	36	30	59.5	40.5	55	I	
2.0 TDI (103 kW)	2007.09-2010.08	MT	-	-	Estate Engine BMM	603016	Inner Joint		28		32			
2.0 TDI (125 kW)	2012.05-2015.05	-	L/R	F	Estate Engine CFJA	661057	Inner Joint		34		86			
	2012.05-2015.05	-	L	F	Estate Engine CFJA	654004	Inner Joint		34		85			
	2012.05-2015.05	-	L/R	F	Estate Engine CFJA	861045	Outer Joint	36	27	59.5	40	65	M	
	2012.05-2015.05	Semi-AT	L	F	Estate Engine CFJA	203241	Drive Shaft	36		59.5	40	475		
2.0 TDI (81 kW)	2010.08-2015.05	-	R	F	Estate Engine CLCA	803002	Outer Joint	36	27	59.5	40	66	I	
	2010.08-2015.05	MT	R	F	Estate Engine CLCA	261101	Drive Shaft	36		59.5	40	803		
	2010.08-2015.05	MT	-	-	Estate Engine CLCA	603016	Inner Joint		28		32			
2.0 TDI 16V (103 kW)	2010.11-2015.05	6AT	L/R	F	Estate Engine CFHC	661057	Inner Joint		34		86			
	2010.11-2015.05	6AT	L/R	F	Estate Engine CFHC	861045	Outer Joint	36	27	59.5	40	65	M	
	2010.11-2015.05	6AT	R	F	Estate Engine CFHC	654004	Inner Joint		34		85			
	2010.11-2015.05	6AT	R	F	Estate Engine CFHC	254011	Drive Shaft	36		59.5	40	755		
	2010.11-2015.05	Semi-AT	L	F	Estate Engine CFHC	203241	Drive Shaft	36		59.5	40	475		
2.0 TDI 16V 4motion (103 kW)	2010.11-2015.05	DCT	L	F	All-wheel Drive Estate Engine CFHC	654004	Inner Joint		34		85			
	2010.11-2015.05	DCT	L	F	All-wheel Drive Estate Engine CFHC	203241	Drive Shaft	36		59.5	40	475		
2.0 TDI 4motion (81 kW)	2010.08-2015.05	-	R	F	All-wheel Drive Estate Engine CFHF	261101	Drive Shaft	36		59.5	40	803		
	2010.08-2015.05	-	L/R	F	All-wheel Drive Estate Engine CFHF	803002	Outer Joint	36	27	59.5	40	66	I	
	2010.08-2015.05	-	R	F	All-wheel Drive Estate Engine CFHF	203266	Drive Shaft	36		59.5	40	601		
	2010.08-2015.05	MT	-	-	All-wheel Drive Estate Engine CFHF	603016	Inner Joint		28		32			
	2010.08-2015.05	-	L	F	All-wheel Drive Estate Engine CFHF	203295	Drive Shaft	36		59.5	40	491		
CADDY III (2KB, 2KJ, 2CB, 2CJ)														
1.9 TDI	2004-	-	-	L/R	F	-	661017	Inner Joint		33		31.8		
CADDY IV (SAA SAH)														
1.0 TSI (75 kW)	2015.11-	-	-	-	F	Box Engine CHZG	803100	Outer Joint	36	33	59.5	38	55	I
1.2 TSI (62 kW)	2015.06-	-	-	-	F	Box Engine CYVC	803100	Outer Joint	36	33	59.5	38	55	I
	2015.06-	MT	L/R	F	Box Engine CYVC	603011	Inner Joint		33		34			
1.4 TGI CNG (81 kW)	2015.06-	6DCT	L	F	Box Engine CPWA	203265	Drive Shaft	36		59.5	40	487		
	2015.06-	-	L	F	Box Engine CPWA	261131	Drive Shaft	36		59.5	40	515		
	2015.06-	-	-	-	F	Box Engine CPWA	803101	Outer Joint	36	27	59.5	40	65	M
1.4 TSI (92 kW)	2015.05-	AT	-	-	Box Engine CZCB	603016	Inner Joint		28		32			
	2015.05-	-	L	F	Box Engine CZCB	261131	Drive Shaft	36		59.5	40	515		
	2015.05-	-	-	-	F	Box Engine CZCB	803101	Outer Joint	36	27	59.5	40	65	M
1.6 (81 kW)	2015.11-	-	-	R	F	Box Engine CWVA	803037	Outer Joint	36	30	59.5	40.5	55	I
	2015.11-	MT	L/R	F	Box Engine CWVA	603011	Inner Joint		33		34			
1.6 TDI (55 kW)	2015.05-	MT	L	F	Box Engine CAYE	261131	Drive Shaft	36		59.5	40	515		
	2015.05-	MT	-	-	Box Engine CAYE	861059	Outer Joint	36	33	59.5	40	59.5	I	
	2015.05-	-	-	-	F	Box Engine CAYE	803101	Outer Joint	36	27	59.5	40	65	M
	2015.05-	MT	L	F	Box Engine CAYE	261089	Drive Shaft	36		59.5	40.5	521		
	2015.05-	MT	L/R	F	Box Engine CAYE	603011	Inner Joint		33		34			
	2015.05-	-	-	-	F	Box Engine CAYE	803100	Outer Joint	36	33	59.5	38	55	I
	2015.05-	MT	-	-	Box Engine CAYE	603016	Inner Joint		28		32			
	2015.05-	MT	-	-	Box Engine CAYE	603006	Inner Joint		33		34			
	2015.05-	MT	R	F	Box Engine CAYE	261200	Drive Shaft	36		59.5	40.5	820		
1.6 TDI (75 kW)	2015.05-	7AT/MT	L	F	Box Engine CAYD	261131	Drive Shaft	36		59.5	40	515		
	2015.05-	-	-	-	F	Box Engine CAYD	803101	Outer Joint	36	27	59.5	40	65	M
2.0 TDI (103 kW)	2015.05-	6MT	L	F	Box Engine CFHC	203265	Drive Shaft	36		59.5	40	487		
	2015.05-	DCT	L	F	Box Engine CFHC	654004	Inner Joint		34		85			
	2015.05-	CVT	L	F	Box Engine CFHC	203241	Drive Shaft	36		59.5	40	475		
	2015.05-	CVT	R	F	Box Engine CFHC	203354	Drive Shaft	36		59.5	40	763		
2.0 TDI (110 kW)	2015.05-	6MT	L	F	Box Engine CUUB	203265	Drive Shaft	36		59.5	40	487		
	2015.05-	6DCT	L	F	Box Engine CUUB	654004	Inner Joint		34		85			





YEAR	TRANSM	L/R	F/R	REMARKS	GSP Ref.	PRODUCT	ABS	Technical Specifications							
								A	B	C	H	L	P		
VW															
CADDY IV (SAA SAH)															
2.0 TDI (110 kW)	2015.05-	-	CVT	L	F	Box Engine CUUB	203241	Drive Shaft		36		59.5	40	475	
	2015.05-	-	CVT	R	F	Box Engine CUUB	203354	Drive Shaft		36		59.5	40	763	
2.0 TDI (55 kW)	2015.05-	-	MT	L	F	Box Engine CUUF	261131	Drive Shaft		36		59.5	40	515	
	2015.05-	-	MT	-	-	Box Engine CUUF	861059	Outer Joint		36	33	59.5	40	59.5	I
	2015.05-	-	6MT	L	F	Box Engine CUUF	203265	Drive Shaft		36		59.5	40	487	
	2015.05-	-	MT	L	F	Box Engine CUUF	261089	Drive Shaft		36		59.5	40.5	521	
	2015.05-	-	-	-	F	Box Engine CUUF	803101	Outer Joint		36	27	59.5	40	65	M
	2015.05-	-	MT	L/R	F	Box Engine CUUF	603011	Inner Joint			33		34		
	2015.05-	-	-	-	F	Box Engine CUUF	803100	Outer Joint		36	33	59.5	38	55	I
	2015.05-	-	MT	-	-	Box Engine CUUF	603016	Inner Joint			28		32		
	2015.05-	-	MT	-	-	Box Engine CUUF	603006	Inner Joint			33		34		
	2015.05-	-	MT	R	F	Box Engine CUUF	261200	Drive Shaft		36		59.5	40.5	820	
2.0 TDI (75 kW)	2015.05-	-	MT	L	F	Box Engine CUUD	261131	Drive Shaft		36		59.5	40	515	
	2015.05-	-	MT	-	F	Box Engine CUUD	803101	Outer Joint		36	27	59.5	40	65	M
	2015.05-	-	MT	L	F	Box Engine CUUD	654004	Inner Joint			34		85		
	2015.05-	-	MT	-	-	Box Engine CUUD	603016	Inner Joint			28		32		
	2015.05-	-	CVT	L	F	Box Engine CUUD	203241	Drive Shaft		36		59.5	40	475	
	2015.05-	-	CVT	R	F	Box Engine CUUD	203354	Drive Shaft		36		59.5	40	763	
2.0 TDI 4motion (103 kW)	2015.05-	-	DCT	L	F	All-wheel Drive Box Engine CFHC	654004	Inner Joint			34		85		
CADDY IV (SAB SAJ)															
1.0 TSI (75 kW)	2015.11-	-	-	-	F	Estate Engine CHZG	803100	Outer Joint		36	33	59.5	38	55	I
1.2 TSI (62 kW)	2015.06-	-	-	-	F	Estate Engine CYVC	803100	Outer Joint		36	33	59.5	38	55	I
	2015.06-	-	MT	L/R	F	Estate Engine CYVC	603011	Inner Joint			33		34		
1.4 TGI CNG (81 kW)	2015.06-	-	-	L	F	Estate Engine CPWA	203265	Drive Shaft		36		59.5	40	487	
	2015.06-	-	-	L	F	Estate Engine CPWA	261131	Drive Shaft		36		59.5	40	515	
	2015.06-	-	-	-	F	Estate Engine CPWA	803101	Outer Joint		36	27	59.5	40	65	M
1.4 TSI (92 kW)	2015.05-	-	AT	-	-	Estate Engine CZCB	603016	Inner Joint			28		32		
	2015.05-	-	-	L	F	Estate Engine CZCB	261131	Drive Shaft		36		59.5	40	515	
	2015.05-	-	-	-	F	Estate Engine CZCB	803101	Outer Joint		36	27	59.5	40	65	M
1.6 (81 kW)	2015.11-	-	-	R	F	Estate Engine CWVA	803037	Outer Joint		36	30	59.5	40.5	55	I
	2015.11-	-	MT	L/R	F	Estate Engine CWVA	603011	Inner Joint			33		34		
1.6 TDI (55 kW)	2015.05-	-	MT	L	F	Estate Engine CAYE	261131	Drive Shaft		36		59.5	40	515	
	2015.05-	-	MT	-	-	Estate Engine CAYE	861059	Outer Joint		36	33	59.5	40	59.5	I
	2015.05-	-	-	-	F	Estate Engine CAYE	803101	Outer Joint		36	27	59.5	40	65	M
	2015.05-	-	MT	L	F	Estate Engine CAYE	261089	Drive Shaft		36		59.5	40.5	521	
	2015.05-	-	MT	L/R	F	Estate Engine CAYE	603011	Inner Joint			33		34		
	2015.05-	-	-	-	F	Estate Engine CAYE	803100	Outer Joint		36	33	59.5	38	55	I
	2015.05-	-	MT	-	-	Estate Engine CAYE	603016	Inner Joint			28		32		
	2015.05-	-	MT	-	-	Estate Engine CAYE	603006	Inner Joint			33		34		
	2015.05-	-	MT	R	F	Estate Engine CAYE	261200	Drive Shaft		36		59.5	40.5	820	
1.6 TDI (75 kW)	2015.05-	-	7AT/MT	L	F	Estate Engine CAYD	261131	Drive Shaft		36		59.5	40	515	
	2015.05-	-	-	-	F	Estate Engine CAYD	803101	Outer Joint		36	27	59.5	40	65	M
2.0 TDI (103 kW)	2015.05-	-	6MT	L	F	Estate Engine CFHC	203265	Drive Shaft		36		59.5	40	487	
	2015.05-	-	DCT	L	F	Estate Engine CFHC	654004	Inner Joint			34		85		
	2015.05-	-	CVT	L	F	Estate Engine CFHC	203241	Drive Shaft		36		59.5	40	475	
	2015.05-	-	CVT	R	F	Estate Engine CFHC	203354	Drive Shaft		36		59.5	40	763	
2.0 TDI (110 kW)	2015.05-	-	6MT	L	F	Estate Engine CUUB	203265	Drive Shaft		36		59.5	40	487	
	2015.05-	-	6DCT	L	F	Estate Engine CUUB	654004	Inner Joint			34		85		
	2015.05-	-	CVT	L	F	Estate Engine CUUB	203241	Drive Shaft		36		59.5	40	475	
	2015.05-	-	CVT	R	F	Estate Engine CUUB	203354	Drive Shaft		36		59.5	40	763	
2.0 TDI (55 kW)	2015.05-	-	MT	L	F	Estate Engine CUUF	261131	Drive Shaft		36		59.5	40	515	
	2015.05-	-	MT	-	-	Estate Engine CUUF	861059	Outer Joint		36	33	59.5	40	59.5	I
	2015.05-	-	-	-	F	Estate Engine CUUF	803101	Outer Joint		36	27	59.5	40	65	M
	2015.05-	-	MT	L	F	Estate Engine CUUF	261089	Drive Shaft		36		59.5	40.5	521	
	2015.05-	-	MT	L/R	F	Estate Engine CUUF	603011	Inner Joint			33		34		
	2015.05-	-	-	-	F	Estate Engine CUUF	803100	Outer Joint		36	33	59.5	38	55	I
	2015.05-	-	MT	-	-	Estate Engine CUUF	603016	Inner Joint			28		32		
	2015.05-	-	MT	-	-	Estate Engine CUUF	603006	Inner Joint			33		34		
	2015.05-	-	MT	R	F	Estate Engine CUUF	261200	Drive Shaft		36		59.5	40.5	820	
2.0 TDI (75 kW)	2015.05-	-	MT	L	F	Estate Engine CUUD	261131	Drive Shaft		36		59.5	40	515	
	2015.05-	-	MT	-	F	Estate Engine CUUD	803101	Outer Joint		36	27	59.5	40	65	M
	2015.05-	-	MT/DCT	L	F	Estate Engine CUUD	654004	Inner Joint			34		85		
	2015.05-	-	MT	-	-	Estate Engine CUUD	603016	Inner Joint			28		32		
	2015.05-	-	CVT	L	F	Estate Engine CUUD	203241	Drive Shaft		36		59.5	40	475	
	2015.05-	-	CVT	R	F	Estate Engine CUUD	203354	Drive Shaft		36		59.5	40	763	
2.0 TDI 4motion (103 kW)	2015.05-	-	DCT	L	F	All-wheel Drive Estate Engine CFHC	654004	Inner Joint			34		85		

VW CAMP MOB. (TYP2/TRANSP./LT)	YEAR	2012-2016	TRANSM	L/R	F/R	REMARKS	GSP Ref.	PRODUCT	ABS	Technical Specifications					
										A	B	C	H	L	P
2.0	2012-2016	-	-	-	-		201666	Drive Shaft		38	26	63	102.5	616	
	2012-2016	-	-	-	-		201665	Drive Shaft		38	26	63	102.5	614	
CC															
-	2012-2016	-	-	-	-		201594	Drive Shaft		36		59.5	40	800	
2.0T	2009-		AT	R	F		261152	Drive Shaft		36	26	59.5	40	873	
CC (358)															
1.4 TSI (110 kW)	2015.05-		MT	L/R	F	Coupe Engine CZDA	603011	Inner Joint			33		34		
1.4 TSI (118 kW)	2011.11-		MT	L/R	F	Coupe Engine CTHD	603011	Inner Joint			33		34		
	2011.11-		AT	L	F	Coupe Engine CTHD	261281	Drive Shaft		36		59.5	40	528	
	2011.11-		MT	L/R	F	Coupe Engine CTHD	803037	Outer Joint		36	30	59.5	40.5	55	I
	2011.11-		AT	L/R	F	Coupe Engine CTHD	803002	Outer Joint		36	27	59.5	40	66	I
1.4 TSI MultiFuel (118 kW)	2011.11-		AT	L/R	F	Coupe Engine CKMA	803002	Outer Joint		36	27	59.5	40	66	I
	2011.11-		MT	L/R	F	Coupe Engine CKMA	803037	Outer Joint		36	30	59.5	40.5	55	I
	2011.11-		MT	L/R	F	Coupe Engine CKMA	603011	Inner Joint			33		34		
1.8 TSI (118 kW)	2011.11-		MT	L	F	Coupe Engine CDAA	261100	Drive Shaft		36		59.5	40	513	
	2011.11-		MT	L/R	F	Coupe Engine CDAA	803002	Outer Joint		36	27	59.5	40	66	I
	2011.11-		AT	L/R	F	Coupe Engine CDAA	661011	Inner Joint		26	32	31	68.5	85	
	2011.11-		MT	L	F	Coupe Engine CDAA	261131	Drive Shaft		36		59.5	40	515	
2.0 TDI (100 kW)	2011.11-		MT	L	F	Coupe Engine CFFA	203295	Drive Shaft		36		59.5	40	491	
	2011.11-		AT	R	F	Coupe Engine CFFA	254011	Drive Shaft		36		59.5	40	755	
	2011.11-		-	L/R	F	Coupe Engine CFFA	803002	Outer Joint		36	27	59.5	40	66	I
	2011.11-		MT	R	F	Coupe Engine CFFA	203313	Drive Shaft		36		59.5	40	792	
	2011.11-		AT	L	F	Coupe Engine CFFA	254013	Drive Shaft		36		59.5	40	479.5	
	2011.11-		AT	L	F	Coupe Engine CFFA	654004	Inner Joint			34		85		
	2011.11-		AT	-	-	Coupe Engine CFFA	603016	Inner Joint			28		32		
	2011.11-		AT	-	-	Coupe Engine CFFA	603006	Inner Joint			33		34		
2.0 TDI (103 kW)	2011.11-		AT	R	F	Coupe Engine CFFB	254011	Drive Shaft		36		59.5	40	755	
	2011.11-		MT	L	F	Coupe Engine CFFB	203295	Drive Shaft		36		59.5	40	491	
	2011.11-		-	L/R	F	Coupe Engine CFFB	803002	Outer Joint		36	27	59.5	40	66	I
	2011.11-		MT	R	F	Coupe Engine CFFB	203313	Drive Shaft		36		59.5	40	792	
	2011.11-		AT	L	F	Coupe Engine CFFB	254013	Drive Shaft		36		59.5	40	479.5	
	2011.11-		AT	L	F	Coupe Engine CFFB	654004	Inner Joint			34		85		
	2011.11-		AT	L	F	Coupe Engine CFFB	203241	Drive Shaft		36		59.5	40	475	
	2011.11-		AT	-	-	Coupe Engine CFFB	603016	Inner Joint			28		32		
	2011.11-		AT	-	-	Coupe Engine CFFB	603006	Inner Joint			33		34		
2.0 TDI (125 kW)	2011.11-		AT	L	F	Coupe Engine CFGB	254013	Drive Shaft		36		59.5	40	479.5	
	2011.11-		AT	L	F	Coupe Engine CFGB	654004	Inner Joint			34		85		
	2011.11-		AT	L	F	Coupe Engine CFGB	203241	Drive Shaft		36		59.5	40	475	
	2011.11-		AT	-	-	Coupe Engine CFGB	603006	Inner Joint			33		34		
	2011.11-		-	L/R	F	Coupe Engine CFGB	861045	Outer Joint		36	27	59.5	40	65	M
	2011.11-		AT	R	F	Coupe Engine CFGB	254011	Drive Shaft		36		59.5	40	755	
2.0 TDI (130 kW)	2012.12-		6DCT	L	F	Coupe Engine CFGC	254013	Drive Shaft		36		59.5	40	479.5	
	2012.12-		6DCT	L	F	Coupe Engine CFGC	654004	Inner Joint			34		85		
	2012.12-		MT	L/R	F	Coupe Engine CFGC	861045	Outer Joint		36	27	59.5	40	65	M
	2012.12-		6DCT	R	F	Coupe Engine CFGC	254011	Drive Shaft		36		59.5	40	755	
	2012.12-		AT	-	-	Coupe Engine CFGC	603006	Inner Joint			33		34		
2.0 TDI 4motion (103 kW)	2011.11-		-	L	F	All-wheel Drive Coupe Engine CFFB	203295	Drive Shaft		36		59.5	40	491	
	2011.11-		-	L/R	F	All-wheel Drive Coupe Engine CFFB	803002	Outer Joint		36	27	59.5	40	66	I
	2011.11-		AT	R	F	All-wheel Drive Coupe Engine CFFB	654004	Inner Joint			34		85		
	2011.11-		-	R	F	All-wheel Drive Coupe Engine CFFB	203266	Drive Shaft		36		59.5	40	601	
	2011.11-		AT	R	F	All-wheel Drive Coupe Engine CFFB	203241	Drive Shaft		36		59.5	40	475	
	2011.11-		-	L/R	R	All-wheel Drive Coupe Engine CFFB	603011	Inner Joint			33		34		
	2011.11-		AT	-	-	All-wheel Drive Coupe Engine CFFB	603016	Inner Joint			28		32		
	2011.11-		AT	-	-	All-wheel Drive Coupe Engine CFFB	603006	Inner Joint			33		34		
2.0 TDI 4motion (125 kW)	2011.11-		-	L/R	F	All-wheel Drive Coupe Engine CFGB	803002	Outer Joint		36	27	59.5	40	66	I
	2011.11-		-	L	F	All-wheel Drive Coupe Engine CFGB	254013	Drive Shaft		36		59.5	40	479.5	
	2011.11-		AT	R	F	All-wheel Drive Coupe Engine CFGB	203241	Drive Shaft		36		59.5	40	475	
	2011.11-		-	L	F	All-wheel Drive Coupe Engine CFGB	654004	Inner Joint			34		85		
	2011.11-		-	L/R	R	All-wheel Drive Coupe Engine CFGB	603011	Inner Joint			33		34		
	2011.11-		AT	-	-	All-wheel Drive Coupe Engine CFGB	603006	Inner Joint			33		34		
2.0 TDI 4motion (130 kW)	2012.12-		AT	L/R	F	All-wheel Drive Coupe Engine CFGC	803002	Outer Joint		36	27	59.5	40	66	I
	2012.12-		AT	L	F	All-wheel Drive Coupe Engine CFGC	254013	Drive Shaft		36		59.5	40	479.5	
	2012.12-		AT	L	F	All-wheel Drive Coupe Engine CFGC	654004	Inner Joint			34		85		
	2012.12-		AT	L/R	R	All-wheel Drive Coupe Engine CFGC	603011	Inner Joint			33		34		
	2012.12-		AT	-	-	All-wheel Drive Coupe Engine CFGC	603006	Inner Joint			33		34		
2.0 TSI (155 kW)	2011.11-		AT	-	-	Coupe Engine CCZB	603016	Inner Joint			28		32		





	 YEAR	TRANSM	L/R	F/R	REMARKS	GSP Ref.	 PRODUCT	 ABS	Technical Specifications						
									A	B	C	H	L	P	
VW															
CC (358)															
2.0 TSI (155 kW)	2011.11-	-	AT	-	-	Coupe Engine CCZB	603006	Inner Joint			33		34		
	2011.11-	-	-	L/R	F	Coupe Engine CCZB	861045	Outer Joint	36	27	59.5	40	65	M	
3.6 FSI 4motion (220 kW)	2011.11-	-	-	L/R	F	All-wheel Drive Coupe Engine BWS	603011	Inner Joint			33		34		
	2011.11-	-	AT	-	-	All-wheel Drive Coupe Engine BWS	603006	Inner Joint			33		34		
CORRADO (53I)															
1.8 16V (100 kW)	1989.04-	1992.07	MT	L/R	F	Coupe Engine KR	853007	Outer Joint		22	30	53.2	78	61	I
	1989.04-	1992.07	MT	L	F	Coupe Engine KR	253001	Drive Shaft	22		53	78.5	535		
	1989.04-	1992.07	-	L	F	Coupe Engine KR	261043	Drive Shaft	22		53.2	78	535		
	1989.04-	1992.07	MT	R	F	Coupe Engine KR	603009	Inner Joint			33		34		
	1989.04-	1992.07	-	-	F	Coupe Engine KR	853004	Outer Joint	22	30	51	78	61	I	
	1989.04-	1992.07	MT	L	F	Coupe Engine KR	603011	Inner Joint			33		34		
1.8 G60 (118 kW)	1988.09-	1993.09	AT/MT	L	F	Coupe Engine PG	253001	Drive Shaft	22		53	78.5	535		
	1988.09-	1993.09	AT/MT	L/R	F	Coupe Engine PG	853007	Outer Joint	22	30	53.2	78	61	I	
	1988.09-	1993.09	AT/MT	R	F	Coupe Engine PG	603009	Inner Joint			33		34		
	1988.09-	1993.09	-	-	F	Coupe Engine PG	853004	Outer Joint	22	30	51	78	61	I	
	1988.09-	1993.09	AT/MT	L	F	Coupe Engine PG	603011	Inner Joint			33		34		
2.0 i (85 kW)	1993.04-	1995.12	AT/MT	L/R	F	Coupe Engine 2E	853007	Outer Joint	22	30	53.2	78	61	I	
	1993.04-	1995.12	AT/MT	R	F	Coupe Engine 2E	603009	Inner Joint			33		34		
	1993.04-	1995.12	MT	R	F	Coupe Engine 2E	261009	Drive Shaft	22		53.2	78	789		
	1993.04-	1995.12	AT/MT	L	F	Coupe Engine 2E	603011	Inner Joint			33		34		
2.0 i 16V (100 kW)	1991.08-	1995.12	AT/MT	L/R	F	Coupe Engine 9A	853007	Outer Joint	22	30	53.2	78	61	I	
	1991.08-	1995.12	AT/MT	L	F	Coupe Engine 9A	253001	Drive Shaft	22		53	78.5	535		
	1991.08-	1995.12	MT	L	F	Coupe Engine 9A	261043	Drive Shaft	22		53.2	78	535		
	1991.08-	1995.12	AT/MT	R	F	Coupe Engine 9A	603009	Inner Joint			33		34		
	1991.08-	1995.12	-	-	F	Coupe Engine 9A	853004	Outer Joint	22	30	51	78	61	I	
	1991.08-	1995.12	AT/MT	L	F	Coupe Engine 9A	603011	Inner Joint			33		34		
2.9 VR6 (140 kW)	1991.08-	1995.12	AT/MT	R	F	Coupe Engine ABV	603009	Inner Joint			33		34		
	1991.08-	1995.12	MT	R	F	Coupe Engine ABV	261062	Drive Shaft	36		53.2	77.5	788		
	1991.08-	1995.12	MT	L	F	Coupe Engine ABV	299116	Drive Shaft	36		53.2	77.5	548.5		
	1991.08-	1995.12	AT/MT	L/R	F	Coupe Engine ABV	803036	Outer Joint	36	30	53.2	77.5	61	I	
	1991.08-	1995.12	AT/MT	L	F	Coupe Engine ABV	603011	Inner Joint			33		34		
CRAFTER															
2.5 TDI	2006.04-	2011.07	-	-	R	-	261354	Stub Axle	29	26			840		
	2006.04-	2013.05	-	-	R	-	261354	Stub Axle	29	26			840		
CRAFTER 30-50 (2F_)															
2.0 TDI (105 kW)	2011.10-	2016.12	MT	-	F	Platform/Chassis Engine CKUC	839232	Outer Joint	25	22	52.5	95	58	M	
CROSS FOX															
1.6 8V	2005.01-	2011.12	-	-	-	EA111	854003	Outer Joint	36	30	52	75	56	I	
	2005.01-	2011.06	MT	-	-	EA111	861037	Outer Joint	22	30	51	78	61	I	
CROSSFOX															
-	2011-	-	MT	L/R	-	-	861046	Outer Joint	22	24	51	78	62	M	
EOS (1F7 1F8)															
1.4 TSI (118 kW)	2008.05-	2015.08	-	L	F	Convertible Engine CTHD	261224	Drive Shaft	36		59.5	40	536		
	2008.05-	2015.08	MT	-	-	Convertible Engine CTHD	603006	Inner Joint			33		34		
	2008.05-	2015.08	-	L/R	F	Convertible Engine CTHD	603011	Inner Joint			33		34		
	2008.05-	2015.08	-	L/R	F	Convertible Engine CTHD	803037	Outer Joint	36	30	59.5	40.5	55	I	
1.4 TSI (90 kW)	2007.11-	2015.08	MT	L	F	Convertible Engine CAXA	261198	Drive Shaft	36		59.5	40.5	530		
	2007.11-	2015.08	MT	-	-	Convertible Engine CAXA	603006	Inner Joint			33		34		
	2007.11-	2015.08	-	L/R	F	Convertible Engine CAXA	603011	Inner Joint			33		34		
	2007.11-	2015.08	-	L/R	F	Convertible Engine CAXA	803037	Outer Joint	36	30	59.5	40.5	55	I	
	2007.11-	2015.08	MT	-	-	Convertible Engine CAXA	861059	Outer Joint	36	33	59.5	40	59.5	I	
1.6 FSI (85 kW)	2006.06-	2008.05	MT	-	-	Convertible Engine BLF	603006	Inner Joint			33		34		
	2006.06-	2008.05	MT	L/R	F	Convertible Engine BLF	603011	Inner Joint			33		34		
	2006.06-	2008.05	6MT	L/R	F	Convertible Engine BLF	803037	Outer Joint	36	30	59.5	40.5	55	I	
	2006.06-	2008.05	AT	L/R	F	Convertible Engine BLF	661011	Inner Joint	26	32	31	68.5	85		
2.0 FSI (110 kW)	2006.03-	2008.05	MT	-	-	Convertible Engine BVY	603006	Inner Joint			33		34		
	2006.03-	2008.05	MT	L/R	F	Convertible Engine BVY	603011	Inner Joint			33		34		
	2006.03-	2008.05	6MT	L/R	F	Convertible Engine BVY	803037	Outer Joint	36	30	59.5	40.5	55	I	
	2006.03-	2008.05	AT	L/R	F	Convertible Engine BVY	661011	Inner Joint	26	32	31	68.5	85		
2.0 TDI (100 kW)	2010.11-	2015.08	MT	L	F	Convertible Engine CFFA	203295	Drive Shaft	36		59.5	40	491		
	2010.11-	2015.08	-	-	-	Convertible Engine CFFA	603016	Inner Joint			28		32		
	2010.11-	2015.08	MT	R	F	Convertible Engine CFFA	203313	Drive Shaft	36		59.5	40	792		
	2010.11-	2015.08	AT	L	F	Convertible Engine CFFA	254013	Drive Shaft	36		59.5	40	479.5		
	2010.11-	2015.08	AT	L	F	Convertible Engine CFFA	203241	Drive Shaft	36		59.5	40	475		
	2010.11-	2015.08	AT	L	F	Convertible Engine CFFA	654004	Inner Joint			34		85		
	2010.11-	2015.08	MT	L/R	F	Convertible Engine CFFA	803002	Outer Joint	36	27	59.5	40	66	I	





YEAR	TRANSM	L/R	F/R	REMARKS	GSP Ref.	PRODUCT	ABS	Technical Specifications						
								A	B	C	H	L	P	
VW														
EOS (1F7 1F8)														
2.0 TDI (100 kW)	2010.11-	2015.08	AT	R	F	Convertible Engine CFFA	254011	Drive Shaft	36		59.5	40	755	
2.0 TDI (103 kW)	2006.06-	2008.05	AT	R	F	Convertible Engine BMM	254011	Drive Shaft	36		59.5	40	755	
	2006.06-	2008.05	MT	L	F	Convertible Engine BMM	203295	Drive Shaft	36		59.5	40	491	
	2006.06-	2008.05	AT	L/R	F	Convertible Engine BMM	661057	Inner Joint		34		86		
	2006.06-	2008.05	MT	R	F	Convertible Engine BMM	203313	Drive Shaft	36		59.5	40	792	
	2006.06-	2008.05	AT	L	F	Convertible Engine BMM	254013	Drive Shaft	36		59.5	40	479.5	
	2006.06-	2008.05	AT	L	F	Convertible Engine BMM	654004	Inner Joint		34		85		
	2006.06-	2008.05	AT	L	F	Convertible Engine BMM	203241	Drive Shaft	36		59.5	40	475	
	2006.06-	2008.05	AT/MT	L/R	F	Convertible Engine BMM	803002	Outer Joint	36	27	59.5	40	66	I
2.0 TDI 16V (103 kW)	2008.05-	2015.08	AT	L/R	F	Convertible Engine CFFB	661057	Inner Joint		34		86		
	2008.05-	2015.08	MT	L	F	Convertible Engine CFFB	203295	Drive Shaft	36		59.5	40	491	
	2008.05-	2015.08	AT	R	F	Convertible Engine CFFB	254011	Drive Shaft	36		59.5	40	755	
	2008.05-	2015.08	MT	R	F	Convertible Engine CFFB	203313	Drive Shaft	36		59.5	40	792	
	2008.05-	2015.08	AT	L	F	Convertible Engine CFFB	254013	Drive Shaft	36		59.5	40	479.5	
	2008.05-	2015.08	AT	L	F	Convertible Engine CFFB	654004	Inner Joint		34		85		
	2008.05-	2015.08	AT	L	F	Convertible Engine CFFB	203241	Drive Shaft	36		59.5	40	475	
	2008.05-	2015.08	AT/MT	L/R	F	Convertible Engine CFFB	803002	Outer Joint	36	27	59.5	40	66	I
2.0 TFSI (147 kW)	2006.03-	2015.08	-	L/R	F	Convertible Engine CCTA	803002	Outer Joint	36	27	59.5	40	66	I
	2006.03-	2015.08	-	L/R	F	Convertible Engine CCTA	861045	Outer Joint	36	27	59.5	40	65	M
	2006.03-	2015.08	AT/MT	L	F	Convertible Engine CCTA	203295	Drive Shaft	36		59.5	40	491	
	2009.11-	2015.08	-	L/R	F	Convertible Engine CCZB	803002	Outer Joint	36	27	59.5	40	66	I
2.0 TSI (155 kW)	2009.11-	2015.08	-	L/R	F	Convertible Engine CCZB	861045	Outer Joint	36	27	59.5	40	65	M
	2009.11-	2015.08	-	L	F	Convertible Engine CCZB	203295	Drive Shaft	36		59.5	40	491	
	2009.11-	2015.08	-	L/R	F	Convertible Engine CCZB	803002	Outer Joint	36	27	59.5	40	66	I
3.2 V6 (184 kW)	2006.06-	2009.05	-	L/R	F	Convertible Engine BUB	661057	Inner Joint		34		86		
3.6 V6 (191 kW)	2009.05-	2010.11	AT	-	-	Convertible Engine CDVA	603016	Inner Joint		28		32		
FOX														
1.6 8V (EA111)	2004.01-	2011.06	MT	-	-	-	861037	Outer Joint	22	30	51	78	61	I
FOX (5Z1 5Z3)														
1.2 (40 kW)	2005.04-	-	MT	L	F	Hatchback Engine CHFB	261262	Drive Shaft	36		52	75.5	525	
	2005.04-	-	MT	R	F	Hatchback Engine CHFB	261040	Drive Shaft	36		52	75.5	770	
	2005.04-	-	-	L/R	F	Hatchback Engine CHFB	854004	Outer Joint	36	30	52	75.5	47.5	I
	2005.04-	-	MT	-	F	Hatchback Engine CHFB	854002	Outer Joint	20	30	52	59.5	49.5	I
1.2 (44 kW)	2010.09-	-	-	R	F	Hatchback Engine CHFA	261040	Drive Shaft	36		52	75.5	770	
	2010.09-	-	-	L/R	F	Hatchback Engine CHFA	854004	Outer Joint	36	30	52	75.5	47.5	I
1.4 (55 kW)	2005.04-	-	MT	L	F	Hatchback Engine BKR	261262	Drive Shaft	36		52	75.5	525	
	2005.04-	-	MT	R	F	Hatchback Engine BKR	261040	Drive Shaft	36		52	75.5	770	
	2005.04-	-	MT	L/R	F	Hatchback Engine BKR	854004	Outer Joint	36	30	52	75.5	47.5	I
1.4 TDI (51 kW)	2005.04-	-	-	-	F	Hatchback Engine BNM	803024	Outer Joint	36	30	50.75	59	54.5	I
	2005.04-	-	MT	R	F	Hatchback Engine BNM	261223	Drive Shaft	36		52	59	757	
	2005.04-	-	MT	L	F	Hatchback Engine BNM	261078	Drive Shaft	36		50.7	58.5	501	
	2005.04-	-	-	L/R	F	Hatchback Engine BNM	854004	Outer Joint	36	30	52	75.5	47.5	I
	2005.04-	-	MT	L/R	F	Hatchback Engine BNM	861010	Outer Joint	36	30	52	75	54.5	I
	2005.04-	-	MT	R	F	Hatchback Engine BNM	854006	Outer Joint	36	30	52	59	55.5	I
GOL														
-	-	-	-	-	-	-	861014	Outer Joint	22	30	51	78	61	I
	2009-	2013	MT	L/R	-	-	661068	Inner Joint		33		32		
	2009-	2013	MT	L/R	-	-	861046	Outer Joint	22	24	51	78	62	M
1.0	-	-	-	-	-	-	861019	Outer Joint	22	28	51	78.7	51.5	O+M
	1997-	-	-	-	-	-	861031	Outer Joint	22	28	51	78.7	51.1	M
1.0 16V	1997-	-	-	L	-	-	299118	Drive Shaft	22		51	78.7	634	
1.0 8V	1992.10-	1996.12	MT	-	-	-	618019	Inner Joint		33		32		
	1992.10-	1996.12	MT	-	-	-	861033	Outer Joint	22	30	51	77.5	52	I
	1997-	-	-	R	-	-	299117	Drive Shaft	22		51	78.7	598	
	1997-	-	-	R	-	-	299117	Drive Shaft	22		51	78.7	598	
	1997-	-	-	L	-	-	299118	Drive Shaft	22		51	78.7	634	
1.0 EA111 16V	1997.01-	2001.11	MT	-	-	-	699057	Inner Joint		28		32		
	1997.01-	2001.11	MT	-	-	-	618019	Inner Joint		33		32		
1.0 EA111 16V Power	1997.01-	2006.12	MT	L/R	-	-	861031	Outer Joint	22	28	51	78.7	51.1	M
	1997.01-	2006.12	MT	R	-	-	261080	Drive Shaft	22		51	78.7	605	
	1997.01-	2006.12	MT	L	-	-	261079	Drive Shaft	22		51	78.7	634	
	1997.01-	2006.12	MT	-	-	-	699057	Inner Joint		28		32		
	1997.01-	2001.11	MT	-	-	-	618019	Inner Joint		33		32		
	1997.01-	2006.12	MT	-	-	-	861030	Outer Joint	22	28	51	77.5	50	M
1.0 EA111 8V	1997.01-	2001.11	MT	-	-	-	699057	Inner Joint		28		32		
	1997.01-	2001.11	MT	-	-	-	618019	Inner Joint		33		32		
1.0 EA111 8V Power	1997.01-	2006.12	MT	L/R	-	-	861031	Outer Joint	22	28	51	78.7	51.1	M

	 YEAR	TRANSM	L/R	F/R	REMARKS	GSP Ref.	 PRODUCT	 ABS	Technical Specifications					
									A	B	C	H	L	P
VW														
GOL														
1.0 EA111 8V Power	1997.01-2006.12	MT	R	-	-	261080	Drive Shaft		22		51	78.7	605	
	1997.01-2006.12	MT	L	-	-	261079	Drive Shaft		22		51	78.7	634	
	1997.01-2006.12	MT	-	-	-	699057	Inner Joint			28		32		
	1997.01-2001.11	MT	-	-	-	618019	Inner Joint			33		32		
	1997.01-2006.12	MT	-	-	-	861030	Outer Joint		22	28	51	77.5	50	M
1.0 Mi 8V/16V/Power 16V	1997-2001.11	-	L/R	-	-	861031	Outer Joint		22	28	51	78.7	51.1	M
	1997-2001.11	-	L	-	-	261117	Drive Shaft		22		51	78.7	634	
	1997-2001.11	-	R	-	-	261118	Drive Shaft		22		51	78.7	605	
1.0 Turbo	2000.01-2006.12	MT	-	-	-	861028	Outer Joint		22	30	51	78	61	I
1.6 8V	1986.01-1994.10	MT	-	-	-	618019	Inner Joint			33		32		
1.6 8V AE	1989.11-1994.10	MT	-	-	-	618019	Inner Joint			33		32		
2.0 16V	1995.01-2006.12	MT	-	-	-	861034	Outer Joint		33	30	64	33.5	61	I
	1995.01-2006.12	MT	-	-	-	861023	Outer Joint	43T	33	30	64	33.5	61	I
2.0 8V	1994.10-1995.12	MT	-	-	-	899134	Outer Joint	43T	22	30	51	78	61	I
	1994.10-1995.12	MT	-	-	-	861028	Outer Joint		22	30	51	78	61	I
	1995.01-2006.12	MT	-	-	-	899134	Outer Joint	43T	22	30	51	78	61	I
	1996.01-2006.12	MT	-	-	-	861028	Outer Joint		22	30	51	78	61	I
GOL G IV														
1.0 8V (EA111)	2005.01-2006.12	MT	L/R	-	-	861031	Outer Joint		22	28	51	78.7	51.1	M
	2005.01-2006.12	MT	R	-	-	261080	Drive Shaft		22		51	78.7	605	
	2005.01-2006.12	MT	L	-	-	261079	Drive Shaft		22		51	78.7	634	
	2005.01-2006.12	MT	-	-	-	699057	Inner Joint			28		32		
	2005.01-2006.12	MT	-	-	-	861030	Outer Joint		22	28	51	77.5	50	M
GOL IV														
1.0 16V	2005-2006	-	R	-	-	299117	Drive Shaft		22		51	78.7	598	
	2005-2006	-	L	-	-	299118	Drive Shaft		22		51	78.7	634	
1.0 8V	2005-2006	-	R	-	-	299117	Drive Shaft		22		51	78.7	598	
	2005-2006	-	L	-	-	299118	Drive Shaft		22		51	78.7	634	
GOL MI														
1.0 8/16V	1997.01-2006.12	MT	L/R	-	-	861031	Outer Joint		22	28	51	78.7	51.1	M
	1997.01-2006.12	MT	R	-	-	261080	Drive Shaft		22		51	78.7	605	
	1997.01-2006.12	MT	L	-	-	261079	Drive Shaft		22		51	78.7	634	
	1997.01-2001.11	MT	-	-	-	699057	Inner Joint			28		32		
	1997.01-2006.12	MT	-	-	-	699057	Inner Joint			28		32		
	1997.01-2001.11	MT	-	-	-	618019	Inner Joint			33		32		
	1997.01-2006.12	MT	-	-	-	861030	Outer Joint		22	28	51	77.5	50	M
GOLF														
-	1998-2001	-	-	-	-	201587	Drive Shaft		36		53	78.5	522	
	2006-2014	-	-	-	-	201594	Drive Shaft		36		59.5	40	800	
1.2 TSI	2012-	-	L	R	Hatchback	661103	Inner Joint			33		32		
	2012-	-	L	R	Hatchback	261286	Drive Shaft		36		59.5	79	587	
1.4 TGI CNG	2013-	-	L	R	Hatchback	661103	Inner Joint			33		32		
	2013-	-	L	R	Hatchback	261286	Drive Shaft		36		59.5	79	587	
1.4 TSI	2012-	-	L	R	Hatchback	661103	Inner Joint			33		32		
	2012-	-	L	R	Hatchback	261286	Drive Shaft		36		59.5	79	587	
	2013-	-	L	R	Hatchback	661103	Inner Joint			33		32		
	2013-	-	L	R	Hatchback	261286	Drive Shaft		36		59.5	79	587	
1.4 TSI MultiFuel	2013-	-	L	R	Hatchback	661103	Inner Joint			33		32		
	2013-	-	L	R	Hatchback	261286	Drive Shaft		36		59.5	79	587	
1.6 8V	1999.01-2005.12	MT/AT	-	-	-	803070	Outer Joint		36	30	53	78	60	I
1.6 TDI	2012-	-	L	R	Hatchback	661103	Inner Joint			33		32		
	2012-	-	L	R	Hatchback	261286	Drive Shaft		36		59.5	79	587	
	2013-	-	L	R	Hatchback	661103	Inner Joint			33		32		
	2013-	-	L	R	Hatchback	261286	Drive Shaft		36		59.5	79	587	
1.6 TDI 4motion	2012-	-	L	R	Hatchback	661103	Inner Joint			33		32		
	2012-	-	L	R	Hatchback	261286	Drive Shaft		36		59.5	79	587	
	2013-	-	L	R	Hatchback	661103	Inner Joint			33		32		
	2013-	-	L	R	Hatchback	261286	Drive Shaft		36		59.5	79	587	
1.8	2016-	-	L	-	-	261153	Drive Shaft		36	26	59.5	40	583	
	2016-	-	L	-	-	261153	Drive Shaft		36	26	59.5	40	583	
	2017-	-	L	-	-	261153	Drive Shaft		36	26	59.5	40	583	
	2017-	-	L	-	-	261153	Drive Shaft		36	26	59.5	40	583	
	2018-	-	L	-	-	261153	Drive Shaft		36	26	59.5	40	583	
	2018-	-	L	-	-	261153	Drive Shaft		36	26	59.5	40	583	
1.8 8V	1994.01-1998.12	MT/AT	-	-	-	661022	Inner Joint			33		34		
2.0 8V	1994.01-1998.12	AT	-	-	-	661022	Inner Joint			33		34		





	 YEAR	TRANSM	L/R	F/R	REMARKS	GSP Ref.	 PRODUCT	 ABS	Technical Specifications					
									A	B	C	H	L	P
VW														
GOLF														
2.0 8V	1994.01-1998.12	MT	-	-	-	661022	Inner Joint		33		34			
	1999.01-2005.12	MT/AT	-	-	-	803070	Outer Joint	36	30	53	78	60	I	
2.0 R 4motion	2013-	-	L	R	Hatchback	661103	Inner Joint		33		32			
	2013-	-	L	R	Hatchback	261286	Drive Shaft	36		59.5	79	587		
2.0 TDI	2012-	-	L	R	Hatchback	661103	Inner Joint		33		32			
	2012-	-	L	R	Hatchback	261286	Drive Shaft	36		59.5	79	587		
	2013-	-	L	R	Hatchback	661103	Inner Joint		33		32			
	2013-	-	L	R	Hatchback	261286	Drive Shaft	36		59.5	79	587		
2.0 TDI 4motion	2012-	-	L	R	Hatchback	661103	Inner Joint		33		32			
	2012-	-	L	R	Hatchback	261286	Drive Shaft	36		59.5	79	587		
GOLF -14														
1.6 TDI 6V	-	-	L	R	-	661103	Inner Joint		33		32			
	-	-	R	R	-	661103	Inner Joint		33		32			
	-	-	L	R	-	261286	Drive Shaft	36		59.5	79	587		
	-	-	R	R	-	261287	Drive Shaft	36		59.5	79	630		
GOLF 7														
2.0	2014-	-	R	R	4MOTION (ALLWHEEL)	661103	Inner Joint		33		32			
	2014-	-	R	R	4MOTION (ALLWHEEL)	261287	Drive Shaft	36		59.5	79	630		
GOLF ALLTRACK														
1.8	2017-	-	L	-	-	261153	Drive Shaft	36	26	59.5	40	583		
	2017-	-	L	-	-	261153	Drive Shaft	36	26	59.5	40	583		
	2018-	-	L	-	-	261153	Drive Shaft	36	26	59.5	40	583		
	2018-	-	L	-	-	261153	Drive Shaft	36	26	59.5	40	583		
GOLF ALLTRACK (BA5)														
1.6 TDI 4motion (81 kW)	2014.12-	-	AT	-	F All-wheel Drive Estate Engine CRKB/CXXB	803101	Outer Joint	36	27	59.5	40	65	M	
	2014.12-	-	MT	-	F All-wheel Drive Estate Engine CRKB/CXXB	803100	Outer Joint	36	33	59.5	38	55	I	
	2014.12-	-	MT	L	F All-wheel Drive Estate Engine CRKB/CXXB	261089	Drive Shaft	36		59.5	40.5	521		
	2014.12-	-	MT	R	F All-wheel Drive Estate Engine CRKB/CXXB	261200	Drive Shaft	36		59.5	40.5	820		
1.8 TSI 4motion (132 kW)	2014.12-	-	AT	-	- All-wheel Drive Estate Engine CJSB	603016	Inner Joint		28		32			
2.0 TDI 4motion (110 kW)	2014.12-	-	AT	-	F All-wheel Drive Estate Engine CRLB/CRBC/DCYA	803101	Outer Joint	36	27	59.5	40	65	M	
	2014.12-	-	MT	-	F All-wheel Drive Estate Engine CRLB/CRBC/DCYA	803100	Outer Joint	36	33	59.5	38	55	I	
	2014.12-	-	MT	L	F All-wheel Drive Estate Engine CRLB/CRBC/DCYA	261089	Drive Shaft	36		59.5	40.5	521		
	2014.12-	-	MT	R	F All-wheel Drive Estate Engine CRLB/CRBC/DCYA	261200	Drive Shaft	36		59.5	40.5	820		
2.0 TDI 4motion (135 kW)	2014.12-	-	AT	-	- All-wheel Drive Estate Engine CUNA/DGCA	603016	Inner Joint		28		32			
GOLF GTI														
2.0 8V	1994.01-1998.12	AT	-	-	-	661022	Inner Joint		33		34			
	1994.01-1998.12	MT	-	-	-	661022	Inner Joint		33		34			
	1999.01-2005.12	MT/AT	-	-	-	803070	Outer Joint	36	30	53	78	60	I	
GOLF I Cabriolet (155)														
1.6 (53 kW)	1986.04-1990.02	MT	L	F	Convertible Engine RE	253001	Drive Shaft	22		53	78.5	535		
	1986.04-1990.02	MT	L/R	F	Convertible Engine RE	853007	Outer Joint	22	30	53.2	78	61	I	
	1986.04-1990.02	MT	R	F	Convertible Engine RE	261006	Drive Shaft	22		53.2	78	747		
	1986.04-1990.02	AT/MT	L/R	F	Convertible Engine RE	603004	Inner Joint		33		32			
	1986.04-1990.02	MT	R	F	Convertible Engine RE	603009	Inner Joint		33		34			
	1986.04-1990.02	MT	L	F	Convertible Engine RE	603011	Inner Joint		33		34			
	1986.04-1990.02	AT/MT	L/R	F	Convertible Engine RE	603005	Inner Joint		33		32			
	1986.04-1990.02	AT/MT	L/R	F	Convertible Engine RE	853008	Outer Joint	22	30	53	78.5	51	I	
	1986.04-1990.02	AT/MT	L	F	Convertible Engine RE	253003	Drive Shaft	22		53	78.5	539.5		
1.6 (55 kW)	1983.08-1992.04	MT	L	F	Convertible Engine EW	253001	Drive Shaft	22		53	78.5	535		
	1983.08-1992.04	MT	L/R	F	Convertible Engine EW	853007	Outer Joint	22	30	53.2	78	61	I	
	1983.08-1992.04	AT/MT	L/R	F	Convertible Engine EW	603004	Inner Joint		33		32			
	1983.08-1992.04	MT	R	F	Convertible Engine EW	603009	Inner Joint		33		34			
	1983.08-1992.04	MT	R	F	Convertible Engine EW	261006	Drive Shaft	22		53.2	78	747		
	1983.08-1992.04	AT/MT	L/R	F	Convertible Engine EW	603005	Inner Joint		33		32			
	1983.08-1992.04	-	R	F	Convertible Engine EW	261054	Drive Shaft	22		53	78.5	749		
	1983.08-1992.04	-	-	F	Convertible Engine EW	853006	Outer Joint	22	30	50	78.5	52	I	
	1983.08-1992.04	AT/MT	L/R	F	Convertible Engine EW	853008	Outer Joint	22	30	53	78.5	51	I	
	1983.08-1992.04	AT/MT	L	F	Convertible Engine EW	253003	Drive Shaft	22		53	78.5	539.5		
	1983.08-1992.04	MT	L	F	Convertible Engine EW	603011	Inner Joint		33		34			
1.8 (66 kW)	1983.08-1992.09	MT	L	F	Convertible Engine EX	253001	Drive Shaft	22		53	78.5	535		
	1983.08-1992.09	MT	L	F	Convertible Engine EX	261043	Drive Shaft	22		53.2	78	535		
	1983.08-1992.09	MT	L/R	F	Convertible Engine EX	853007	Outer Joint	22	30	53.2	78	61	I	
	1983.08-1992.09	MT	R	F	Convertible Engine EX	261006	Drive Shaft	22		53.2	78	747		
	1983.08-1992.09	AT/MT	L/R	F	Convertible Engine EX	603004	Inner Joint		33		32			
	1983.08-1992.09	MT	R	F	Convertible Engine EX	603009	Inner Joint		33		34			
	1983.08-1992.09	MT	L	F	Convertible Engine EX	603011	Inner Joint		33		34			





YEAR	TRANSM	L/R	F/R	REMARKS	GSP Ref.	PRODUCT	ABS	Technical Specifications								
								A	B	C	H	L	P			
VW																
GOLF I Cabriolet (155)																
1.8 (66 kW)	1983.08-1992.09	AT/MT	L/R	F	Convertible Engine EX	603005	Inner Joint			33		32				
	1983.08-1992.09	-	-	F	Convertible Engine EX	853004	Outer Joint	22	30	51	78	61	I			
	1983.08-1992.09	AT/MT	L/R	F	Convertible Engine EX	853008	Outer Joint	22	30	53	78.5	51	I			
	1983.08-1992.09	AT/MT	L	F	Convertible Engine EX	253003	Drive Shaft	22		53	78.5	539.5				
	1983.08-1992.09	-	R	F	Convertible Engine EX	203014	Drive Shaft	22		51	78.7	608.7				
1.8 (70 kW)	1983.08-1993.04	MT	L	F	Convertible Engine JH	253001	Drive Shaft	22		53	78.5	535				
	1983.08-1993.04	MT	L	F	Convertible Engine JH	261043	Drive Shaft	22		53.2	78	535				
	1983.08-1993.04	MT	L/R	F	Convertible Engine JH	853007	Outer Joint	22	30	53.2	78	61	I			
	1983.08-1993.04	MT	R	F	Convertible Engine JH	261006	Drive Shaft	22		53.2	78	747				
	1983.08-1993.04	AT/MT	L/R	F	Convertible Engine JH	603004	Inner Joint			33		32				
	1983.08-1993.04	MT	R	F	Convertible Engine JH	603009	Inner Joint			33		34				
	1983.08-1993.04	MT	L	F	Convertible Engine JH	603011	Inner Joint			33		34				
	1983.08-1993.04	AT/MT	L/R	F	Convertible Engine JH	603005	Inner Joint			33		32				
	1983.08-1993.04	-	-	F	Convertible Engine JH	853004	Outer Joint	22	30	51	78	61	I			
	1983.08-1993.04	AT/MT	L/R	F	Convertible Engine JH	853008	Outer Joint	22	30	53	78.5	51	I			
	1983.08-1993.04	AT/MT	L	F	Convertible Engine JH	253003	Drive Shaft	22		53	78.5	539.5				
	1.8 (72 kW)	1989.08-1993.03	MT	L	F	Convertible Engine 2H	261043	Drive Shaft	22		53.2	78	535			
		1989.08-1993.03	MT	L	F	Convertible Engine 2H	253001	Drive Shaft	22		53	78.5	535			
1989.08-1993.03		MT	R	F	Convertible Engine 2H	261006	Drive Shaft	22		53.2	78	747				
1989.08-1993.03		MT	L/R	F	Convertible Engine 2H	853007	Outer Joint	22	30	53.2	78	61	I			
1989.08-1993.03		AT	L/R	F	Convertible Engine 2H	603004	Inner Joint			33		32				
1989.08-1993.03		MT	R	F	Convertible Engine 2H	603009	Inner Joint			33		34				
1989.08-1993.03		-	-	F	Convertible Engine 2H	853004	Outer Joint	22	30	51	78	61	I			
1989.08-1993.03		MT	L	F	Convertible Engine 2H	603011	Inner Joint			33		34				
1989.08-1993.03		AT	L/R	F	Convertible Engine 2H	603005	Inner Joint			33		32				
1989.08-1993.03		AT	L	F	Convertible Engine 2H	253003	Drive Shaft	22		53	78.5	539.5				
1989.08-1993.03		AT	L/R	F	Convertible Engine 2H	853008	Outer Joint	22	30	53	78.5	51	I			
1.8 (82 kW)		1982.08-1989.12	-	L	F	Convertible Engine DX/EV/PB/KT	253006	Drive Shaft	22		50	78.5	526			
		1982.08-1989.12	MT	L/R	F	Convertible Engine DX/EV/PB/KT	603004	Inner Joint			33		32			
	1982.08-1989.12	MT	L/R	F	Convertible Engine DX/EV/PB/KT	861013	Outer Joint	22	30	50	77.5	51	I			
	1982.08-1989.12	MT	L/R	F	Convertible Engine DX/EV/PB/KT	853007	Outer Joint	22	30	53.2	78	61	I			
	1982.08-1989.12	AT	-	F	Convertible Engine DX/EV/PB/KT	853006	Outer Joint	22	30	50	78.5	52	I			
	1982.08-1989.12	MT	L	F	Convertible Engine DX/EV/PB/KT	261043	Drive Shaft	22		53.2	78	535				
	1982.08-1989.12	-	-	F	Convertible Engine DX/EV/PB/KT	853004	Outer Joint	22	30	51	78	61	I			
	1982.08-1989.12	MT	L	F	Convertible Engine DX/EV/PB/KT	603011	Inner Joint			33		34				
	1982.08-1989.12	MT	R	F	Convertible Engine DX/EV/PB/KT	603009	Inner Joint			33		34				
	1982.08-1989.12	MT	R	F	Convertible Engine DX/EV/PB/KT	261006	Drive Shaft	22		53.2	78	747				
	1982.08-1989.12	MT	L	F	Convertible Engine DX/EV/PB/KT	253001	Drive Shaft	22		53	78.5	535				
	1982.08-1989.12	MT	-	-	Convertible Engine DX/EV/PB/KT	603006	Inner Joint			33		34				
	1982.08-1989.12	MT	L/R	F	Convertible Engine DX/EV/PB/KT	603005	Inner Joint			33		32				
	1983.08-1992.12	MT	L	F	Convertible Engine DX	253001	Drive Shaft	22		53	78.5	535				
	1983.08-1992.12	MT	L/R	F	Convertible Engine DX	853007	Outer Joint	22	30	53.2	78	61	I			
	1983.08-1992.12	MT	-	-	Convertible Engine DX	603006	Inner Joint			33		34				
	1983.08-1992.12	MT	L/R	F	Convertible Engine DX	603004	Inner Joint			33		32				
	1983.08-1992.12	MT	R	F	Convertible Engine DX	603009	Inner Joint			33		34				
	1983.08-1992.12	MT	R	F	Convertible Engine DX	261006	Drive Shaft	22		53.2	78	747				
	1983.08-1992.12	MT	L/R	F	Convertible Engine DX	603005	Inner Joint			33		32				
	1983.08-1992.12	MT	L/R	F	Convertible Engine DX	861013	Outer Joint	22	30	50	77.5	51	I			
1983.08-1992.12	-	-	F	Convertible Engine DX	853006	Outer Joint	22	30	50	78.5	52	I				
1983.08-1992.12	MT	L	F	Convertible Engine DX	603011	Inner Joint			33		34					
GOLF II (19E 1G1)																
1.0 (37 kW)	1985.08-1991.10	MT	L/R	F	Hatchback Engine HZ	653001	Inner Joint			33		32				
	1985.08-1991.10	MT	R	F	Hatchback Engine HZ	261008	Drive Shaft	22		53	78.5	774				
	1985.08-1991.10	MT	L	F	Hatchback Engine HZ	253004	Drive Shaft	22		50	78.5	562				
	1985.08-1991.10	MT	L/R	F	Hatchback Engine HZ	853008	Outer Joint	22	30	53	78.5	51	I			
	1985.08-1991.10	MT	-	-	Hatchback Engine HZ	603006	Inner Joint			33		34				
1.3 Cat (40 kW)	1986.06-1992.12	MT	L/R	F	Hatchback Engine MH	653001	Inner Joint			33		32				
	1986.06-1992.12	MT	-	-	Hatchback Engine MH	603006	Inner Joint			33		34				
	1986.06-1992.12	MT	L	F	Hatchback Engine MH	253004	Drive Shaft	22		50	78.5	562				
	1986.06-1992.12	-	-	F	Hatchback Engine MH	853006	Outer Joint	22	30	50	78.5	52	I			
	1986.06-1992.12	MT	L/R	F	Hatchback Engine MH	853008	Outer Joint	22	30	53	78.5	51	I			
1.6 (51 kW)	1986.10-1992.12	AT/MT	R	F	Hatchback Engine PN	253005	Drive Shaft	22		53	78.5	774				
	1986.10-1992.12	AT/MT	L/R	F	Hatchback Engine PN	603004	Inner Joint			33		32				
	1986.10-1992.12	-	-	F	Hatchback Engine PN	853006	Outer Joint	22	30	50	78.5	52	I			
	1986.10-1992.12	AT/MT	L/R	F	Hatchback Engine PN	603005	Inner Joint			33		32				
	1986.10-1992.12	AT/MT	L/R	F	Hatchback Engine PN	853008	Outer Joint	22	30	53	78.5	51	I			

	 YEAR	TRANSM	L/R	F/R	REMARKS	GSP Ref.	 PRODUCT	 ABS	Technical Specifications									
									A	B	C	H	L	P				
VW																		
GOLF II (19E 1G1)																		
1.6 (51 kW)	1986.10-	1992.12	AT/MT	L	F	Hatchback Engine PN	253003	Drive Shaft		22		53	78.5	539.5				
1.6 (53 kW)	1986.02-	1991.10	AT/MT	R	F	Hatchback Engine RF	253005	Drive Shaft		22		53	78.5	774				
	1986.02-	1991.10	AT/MT	L/R	F	Hatchback Engine RF	603004	Inner Joint			33		32					
	1986.02-	1991.10	-	-	F	Hatchback Engine RF	853006	Outer Joint	22	30	50	78.5	52	I				
	1986.02-	1991.10	AT/MT	L/R	F	Hatchback Engine RF	603005	Inner Joint			33		32					
	1986.02-	1991.10	AT/MT	L/R	F	Hatchback Engine RF	853008	Outer Joint	22	30	53	78.5	51	I				
	1986.02-	1991.10	AT/MT	L	F	Hatchback Engine RF	253003	Drive Shaft	22		53	78.5	539.5					
1.6 (55 kW)	1983.08-	1992.07	AT/MT	R	F	Hatchback Engine HM	253005	Drive Shaft	22		53	78.5	774					
	1983.08-	1992.07	AT/MT	L/R	F	Hatchback Engine HM	603004	Inner Joint			33		32					
	1983.08-	1992.07	-	-	F	Hatchback Engine HM	853006	Outer Joint	22	30	50	78.5	52	I				
	1983.08-	1992.07	AT/MT	L/R	F	Hatchback Engine HM	603005	Inner Joint			33		32					
	1983.08-	1992.07	AT/MT	L/R	F	Hatchback Engine HM	853008	Outer Joint	22	30	53	78.5	51	I				
	1983.08-	1992.07	AT/MT	L	F	Hatchback Engine HM	253003	Drive Shaft	22		53	78.5	539.5					
1.6 D (40 kW)	1983.08-	1991.10	AT/MT	L/R	F	Hatchback Engine ME	603004	Inner Joint			33		32					
	1983.08-	1991.10	-	-	F	Hatchback Engine ME	853006	Outer Joint	22	30	50	78.5	52	I				
	1983.08-	1991.10	AT/MT	L/R	F	Hatchback Engine ME	603005	Inner Joint			33		32					
	1983.08-	1991.10	AT/MT	L/R	F	Hatchback Engine ME	853008	Outer Joint	22	30	53	78.5	51	I				
	1983.08-	1991.10	AT/MT	L	F	Hatchback Engine ME	253003	Drive Shaft	22		53	78.5	539.5					
	1983.08-	1991.10	AT/MT	R	F	Hatchback Engine ME	253005	Drive Shaft	22		53	78.5	774					
1.6 TD (44 kW)	1989.08-	1991.10	MT	R	F	Hatchback Engine 1V	253005	Drive Shaft	22		53	78.5	774					
	1989.08-	1991.10	MT	-	-	Hatchback Engine 1V	603006	Inner Joint			33		34					
	1989.08-	1991.10	MT	L/R	F	Hatchback Engine 1V	603004	Inner Joint			33		32					
	1989.08-	1991.10	MT	-	F	Hatchback Engine 1V	853006	Outer Joint	22	30	50	78.5	52	I				
	1989.08-	1991.10	MT	L/R	F	Hatchback Engine 1V	603005	Inner Joint			33		32					
	1989.08-	1991.10	MT	L/R	F	Hatchback Engine 1V	853008	Outer Joint	22	30	53	78.5	51	I				
1.6 TD (51 kW)	1983.08-	1991.10	MT	L/R	F	Hatchback Engine JR	603004	Inner Joint			33		32					
	1983.08-	1991.10	MT	-	-	Hatchback Engine JR	603006	Inner Joint			33		34					
	1983.08-	1991.10	-	-	F	Hatchback Engine JR	853006	Outer Joint	22	30	50	78.5	52	I				
	1983.08-	1991.10	MT	L/R	F	Hatchback Engine JR	603005	Inner Joint			33		32					
	1983.08-	1991.10	MT	L/R	F	Hatchback Engine JR	853008	Outer Joint	22	30	53	78.5	51	I				
	1983.08-	1991.10	MT	L	F	Hatchback Engine JR	253003	Drive Shaft	22		53	78.5	539.5					
1.6 TD (59 kW)	1983.08-	1991.10	MT	R	F	Hatchback Engine JR	253005	Drive Shaft	22		53	78.5	774					
	1989.04-	1991.10	MT	L/R	F	Hatchback Engine RA/SB	603004	Inner Joint			33		32					
	1989.04-	1991.10	MT	-	-	Hatchback Engine RA/SB	603006	Inner Joint			33		34					
	1989.04-	1991.10	MT	-	F	Hatchback Engine RA/SB	853006	Outer Joint	22	30	50	78.5	52	I				
	1989.04-	1991.10	MT	L/R	F	Hatchback Engine RA/SB	603005	Inner Joint			33		32					
	1989.04-	1991.10	MT	L/R	F	Hatchback Engine RA/SB	853008	Outer Joint	22	30	53	78.5	51	I				
1.8 (62 kW)	1986.08-	1990.01	MT	L	F	Hatchback Engine RH	253001	Drive Shaft	22		53	78.5	535					
	1986.08-	1990.01	MT	L/R	F	Hatchback Engine RH	853007	Outer Joint	22	30	53.2	78	61	I				
	1986.08-	1990.01	AT/MT	L/R	F	Hatchback Engine RH	603004	Inner Joint			33		32					
	1986.08-	1990.01	MT	R	F	Hatchback Engine RH	253002	Drive Shaft	22		53.2	78	769					
	1986.08-	1990.01	MT	R	F	Hatchback Engine RH	603009	Inner Joint			33		34					
	1986.08-	1990.01	-	-	F	Hatchback Engine RH	853006	Outer Joint	22	30	50	78.5	52	I				
	1986.08-	1990.01	MT	L	F	Hatchback Engine RH	603011	Inner Joint			33		34					
	1986.08-	1990.01	AT/MT	L/R	F	Hatchback Engine RH	603005	Inner Joint			33		32					
	1986.08-	1990.01	AT/MT	L/R	F	Hatchback Engine RH	853008	Outer Joint	22	30	53	78.5	51	I				
	1986.08-	1990.01	AT/MT	L	F	Hatchback Engine RH	253003	Drive Shaft	22		53	78.5	539.5					
	1986.08-	1990.01	AT/MT	R	F	Hatchback Engine RH	253005	Drive Shaft	22		53	78.5	774					
	1.8 (66 kW)	1984.08-	1991.10	AT/MT	R	F	Hatchback Engine HV	253005	Drive Shaft	22		53	78.5	774				
1984.08-		1991.10	MT	L	F	Hatchback Engine HV	253001	Drive Shaft	22		53	78.5	535					
1984.08-		1991.10	MT	L/R	F	Hatchback Engine HV	853007	Outer Joint	22	30	53.2	78	61	I				
1984.08-		1991.10	AT/MT	L/R	F	Hatchback Engine HV	603004	Inner Joint			33		32					
1984.08-		1991.10	MT	R	F	Hatchback Engine HV	253002	Drive Shaft	22		53.2	78	769					
1984.08-		1991.10	MT	R	F	Hatchback Engine HV	603009	Inner Joint			33		34					
1984.08-		1991.10	MT	L/R	F	Hatchback Engine HV	603011	Inner Joint			33		34					
1984.08-		1991.10	AT/MT	L/R	F	Hatchback Engine HV	603005	Inner Joint			33		32					
1984.08-		1991.10	-	-	F	Hatchback Engine HV	853006	Outer Joint	22	30	50	78.5	52	I				
1984.08-		1991.10	AT/MT	L/R	F	Hatchback Engine HV	853008	Outer Joint	22	30	53	78.5	51	I				
1.8 GTI (82 kW)	1983.08-	1991.10	MT	L/R	F	Hatchback Engine EV	253003	Drive Shaft	22		53	78.5	539.5					
	1983.08-	1991.10	MT	L	F	Hatchback Engine EV	853007	Outer Joint	22	30	53.2	78	61	I				
	1983.08-	1991.10	MT	L	F	Hatchback Engine EV	253001	Drive Shaft	22		53	78.5	535					
	1983.08-	1991.10	MT	R	F	Hatchback Engine EV	603009	Inner Joint			33		34					
	1983.08-	1991.10	MT	L	F	Hatchback Engine EV	261043	Drive Shaft	22		53.2	78	535					

	 YEAR	TRANSM	L/R	F/R	REMARKS	GSP Ref.	 PRODUCT	 ABS	Technical Specifications						
									A	B	C	H	L	P	
VW															
GOLF II (19E 1G1)															
1.8 GTI (82 kW)	1983.08-1991.10	MT	R	F	Hatchback Engine EV	253002	Drive Shaft		22		53.2	78	769		
	1983.08-1991.10	MT	L	F	Hatchback Engine EV	603011	Inner Joint			33		34			
	1983.08-1991.10	-	-	F	Hatchback Engine EV	853004	Outer Joint		22	30	51	78	61	I	
1.8 GTI 16V (102 kW)	1986.02-1990.06	MT	L	F	Hatchback Engine KR	261043	Drive Shaft		22		53.2	78	535		
	1986.02-1990.06	MT	L	F	Hatchback Engine KR	253001	Drive Shaft		22		53	78.5	535		
	1986.02-1990.06	MT	L/R	F	Hatchback Engine KR	853007	Outer Joint		22	30	53.2	78	61	I	
	1986.02-1990.06	MT	-	-	Hatchback Engine KR	603006	Inner Joint			33		34			
	1986.02-1990.06	MT	R	F	Hatchback Engine KR	253002	Drive Shaft		22		53.2	78	769		
	1986.02-1990.06	MT	R	F	Hatchback Engine KR	603009	Inner Joint			33		34			
	1986.02-1990.06	-	-	F	Hatchback Engine KR	853004	Outer Joint		22	30	51	78	61	I	
	1986.02-1990.06	MT	L	F	Hatchback Engine KR	603011	Inner Joint			33		34			
1.8 GTI 16V (95 kW)	1986.02-1991.10	MT	L	F	Hatchback Engine PL	261043	Drive Shaft		22		53.2	78	535		
	1986.02-1991.10	MT	L	F	Hatchback Engine PL	253001	Drive Shaft		22		53	78.5	535		
	1986.02-1991.10	MT	L/R	F	Hatchback Engine PL	853007	Outer Joint		22	30	53.2	78	61	I	
	1986.02-1991.10	MT	-	-	Hatchback Engine PL	603006	Inner Joint			33		34			
	1986.02-1991.10	MT	R	F	Hatchback Engine PL	253002	Drive Shaft		22		53.2	78	769		
	1986.02-1991.10	MT	R	F	Hatchback Engine PL	603009	Inner Joint			33		34			
	1986.02-1991.10	-	-	F	Hatchback Engine PL	853004	Outer Joint		22	30	51	78	61	I	
	1986.02-1991.10	MT	L	F	Hatchback Engine PL	603011	Inner Joint			33		34			
1.8 GTI Cat (79 kW)	1987.01-1991.10	MT	L	F	Hatchback Engine PF	261043	Drive Shaft		22		53.2	78	535		
	1987.01-1991.10	MT	L	F	Hatchback Engine PF	253001	Drive Shaft		22		53	78.5	535		
	1987.01-1991.10	MT	L/R	F	Hatchback Engine PF	853007	Outer Joint		22	30	53.2	78	61	I	
	1987.01-1991.10	MT	R	F	Hatchback Engine PF	253002	Drive Shaft		22		53.2	78	769		
	1987.01-1991.10	MT	R	F	Hatchback Engine PF	603009	Inner Joint			33		34			
	1987.01-1991.10	-	-	F	Hatchback Engine PF	853004	Outer Joint		22	30	51	78	61	I	
	1987.01-1991.10	MT	L	F	Hatchback Engine PF	603011	Inner Joint			33		34			
1.8 GTI G60 (118 kW)	1990.04-1991.07	MT	L	F	Hatchback Engine PG	261043	Drive Shaft		22		53.2	78	535		
	1990.04-1991.07	AT/MT	L/R	F	Hatchback Engine PG	853007	Outer Joint		22	30	53.2	78	61	I	
	1990.04-1991.07	MT	-	-	Hatchback Engine PG	603006	Inner Joint			33		34			
	1990.04-1991.07	AT/MT	R	F	Hatchback Engine PG	603009	Inner Joint			33		34			
	1990.04-1991.07	-	-	F	Hatchback Engine PG	853004	Outer Joint		22	30	51	78	61	I	
	1990.04-1991.07	AT/MT	L	F	Hatchback Engine PG	603011	Inner Joint			33		34			
1.8 GTI G60 Syncro (118 kW)	1988.08-1991.12	MT	L	F	All-wheel Drive Hatchback Engine 1H	261043	Drive Shaft		22		53.2	78	535		
	1988.08-1991.12	AT/MT	L/R	F	All-wheel Drive Hatchback Engine 1H	853007	Outer Joint		22	30	53.2	78	61	I	
	1988.08-1991.12	AT/MT	R	F	All-wheel Drive Hatchback Engine 1H	603009	Inner Joint			33		34			
	1988.08-1991.12	MT	-	-	All-wheel Drive Hatchback Engine 1H	603006	Inner Joint			33		34			
	1988.08-1991.12	-	-	-	All-wheel Drive Hatchback Engine 1H	853004	Outer Joint		22	30	51	78	61	I	
	1988.08-1991.12	AT/MT	L	F	All-wheel Drive Hatchback Engine 1H	603011	Inner Joint			33		34			
1.8 i Cat (66 kW)	1987.08-1991.10	MT	L	F	Hatchback Engine RP	253001	Drive Shaft		22		53	78.5	535		
	1987.08-1991.10	MT	L/R	F	Hatchback Engine RP	853007	Outer Joint		22	30	53.2	78	61	I	
	1987.08-1991.10	AT/MT	L/R	F	Hatchback Engine RP	603004	Inner Joint			33		32			
	1987.08-1991.10	MT	R	F	Hatchback Engine RP	253002	Drive Shaft		22		53.2	78	769		
	1987.08-1991.10	MT	R	F	Hatchback Engine RP	603009	Inner Joint			33		34			
	1987.08-1991.10	-	-	F	Hatchback Engine RP	853006	Outer Joint		22	30	50	78.5	52	I	
	1987.08-1991.10	MT	L/R	F	Hatchback Engine RP	603011	Inner Joint			33		34			
	1987.08-1991.10	AT/MT	L/R	F	Hatchback Engine RP	603005	Inner Joint			33		32			
	1987.08-1991.10	AT/MT	L/R	F	Hatchback Engine RP	853008	Outer Joint		22	30	53	78.5	51	I	
	1987.08-1991.10	AT/MT	L	F	Hatchback Engine RP	253003	Drive Shaft		22		53	78.5	539.5		
	1987.08-1991.10	AT/MT	R	F	Hatchback Engine RP	253005	Drive Shaft		22		53	78.5	774		
	1987.08-1991.10	MT	L/R	F	All-wheel Drive Hatchback Engine RP	853007	Outer Joint		22	30	53.2	78	61	I	
	1987.08-1991.10	MT	L/R/F/R	F	All-wheel Drive Hatchback Engine RP	603004	Inner Joint			33		32			
1.8 i Cat Syncro (66 kW)	1987.08-1991.10	MT	L/R/F/R	F	All-wheel Drive Hatchback Engine RP	603005	Inner Joint			33		32			
	1987.08-1991.10	MT	R	F	All-wheel Drive Hatchback Engine RP	603009	Inner Joint			33		34			
	1987.08-1991.10	MT	L	F	All-wheel Drive Hatchback Engine RP	603011	Inner Joint			33		34			
	1987.08-1991.10	-	-	-	All-wheel Drive Hatchback Engine RP	853006	Outer Joint		22	30	50	78.5	52	I	
	1987.08-1991.10	MT	L	F	All-wheel Drive Hatchback Engine RP	853008	Outer Joint		22	30	53	78.5	51	I	
	1987.08-1991.10	MT	L	F	All-wheel Drive Hatchback Engine RP	253003	Drive Shaft		22		53	78.5	539.5		
	1987.08-1991.10	MT	L/R	R	All-wheel Drive Hatchback Engine RP	803007	Outer Joint		22	30	51	78.7	51.1	I	
	1.8 Syncro (66 kW)	1986.02-1991.07	MT	L/R	F	All-wheel Drive Hatchback Engine GU	853007	Outer Joint		22	30	53.2	78	61	I
		1986.02-1991.07	MT	L/R/F/R	F	All-wheel Drive Hatchback Engine GU	603004	Inner Joint			33		32		
		1986.02-1991.07	MT	L/R/F/R	F	All-wheel Drive Hatchback Engine GU	603005	Inner Joint			33		32		
		1986.02-1991.07	MT	R	F	All-wheel Drive Hatchback Engine GU	603009	Inner Joint			33		34		
		1986.02-1991.07	-	-	-	All-wheel Drive Hatchback Engine GU	853006	Outer Joint		22	30	50	78.5	52	I
		1986.02-1991.07	MT	L	F	All-wheel Drive Hatchback Engine GU	603011	Inner Joint			33		34		
1986.02-1991.07		MT	L	F	All-wheel Drive Hatchback Engine GU	853008	Outer Joint		22	30	53	78.5	51	I	
1986.02-1991.07	MT	L	F	All-wheel Drive Hatchback Engine GU	253003	Drive Shaft		22		53	78.5	539.5			

YEAR	TRANSM	L/R	F/R	REMARKS	GSP Ref.	PRODUCT	ABS	Technical Specifications						
								A	B	C	H	L	P	
VW														
GOLF II (19E 1G1)														
1.8 Syncro (66 kW)	1986.02-1991.07	MT	L/R	R	All-wheel Drive Hatchback Engine GU	803007	Outer Joint		22	30	51	78.7	51.1	I
	1986.02-1991.07	-	R	F	All-wheel Drive Hatchback Engine GU	203014	Drive Shaft		22		51	78.7	608.7	
1.8 Syncro (72 kW)	1988.08-1991.07	MT	L/R	F	All-wheel Drive Hatchback Engine 1P	853007	Outer Joint		22	30	53.2	78	61	I
	1988.08-1991.07	MT	-	-	All-wheel Drive Hatchback Engine 1P	603006	Inner Joint			33		34		
	1988.08-1991.07	MT	L/R	F/R	All-wheel Drive Hatchback Engine 1P	603004	Inner Joint			33		32		
	1988.08-1991.07	MT	R	F	All-wheel Drive Hatchback Engine 1P	603009	Inner Joint			33		34		
	1988.08-1991.07	-	-	-	All-wheel Drive Hatchback Engine 1P	853006	Outer Joint		22	30	50	78.5	52	I
	1988.08-1991.07	MT	L	F	All-wheel Drive Hatchback Engine 1P	603011	Inner Joint			33		34		
	1988.08-1991.07	MT	L/R	F/R	All-wheel Drive Hatchback Engine 1P	603005	Inner Joint			33		32		
	1988.08-1991.07	MT	L	F	All-wheel Drive Hatchback Engine 1P	853008	Outer Joint		22	30	53	78.5	51	I
	1988.08-1991.07	MT	L	F	All-wheel Drive Hatchback Engine 1P	253003	Drive Shaft		22		53	78.5	539.5	
	1988.08-1991.07	MT	L/R	R	All-wheel Drive Hatchback Engine 1P	803007	Outer Joint		22	30	51	78.7	51.1	I
	1988.08-1991.07	-	R	F	All-wheel Drive Hatchback Engine 1P	203014	Drive Shaft		22		51	78.7	608.7	
GOLF III														
-	1993-	-	-	-	-	661004	Inner Joint			34		59.2		
GOLF III (1H1)														
1.4 (40 kW)	1991.11-1997.08	MT	L/R	F	Hatchback Engine AEX	653001	Inner Joint			33		32		
	1991.11-1997.08	MT	-	-	Hatchback Engine AEX	603006	Inner Joint			33		34		
	1991.11-1997.08	-	-	F	Hatchback Engine AEX	853006	Outer Joint		22	30	50	78.5	52	I
	1991.11-1997.08	MT	L	F	Hatchback Engine AEX	261172	Drive Shaft		22		53	78	584.5	
	1991.11-1997.08	MT	R	F	Hatchback Engine AEX	261067	Drive Shaft		22		51	78.7	781	
	1991.11-1997.08	MT	L/R	F	Hatchback Engine AEX	853008	Outer Joint		22	30	53	78.5	51	I
	1991.11-1997.08	MT	R	F	Hatchback Engine AEX	261055	Drive Shaft		22		53	78.5	796	
1.4 (44 kW)	1991.10-1997.08	MT	L/R	F	Hatchback Engine ABD	653001	Inner Joint			33		32		
	1991.10-1997.08	MT	L/R	F	Hatchback Engine ABD	603004	Inner Joint			33		32		
	1991.10-1997.08	MT	-	-	Hatchback Engine ABD	603006	Inner Joint			33		34		
	1991.10-1997.08	-	-	F	Hatchback Engine ABD	853006	Outer Joint		22	30	50	78.5	52	I
	1991.10-1997.08	MT	L	F	Hatchback Engine ABD	253004	Drive Shaft		22		50	78.5	562	
	1991.10-1997.08	MT	L/R	F	Hatchback Engine ABD	603005	Inner Joint			33		32		
	1991.10-1997.08	MT	L	F	Hatchback Engine ABD	261172	Drive Shaft		22		53	78	584.5	
	1991.10-1997.08	MT	R	F	Hatchback Engine ABD	261067	Drive Shaft		22		51	78.7	781	
	1991.10-1997.08	MT	R	F	Hatchback Engine ABD	261055	Drive Shaft		22		53	78.5	796	
	1991.10-1997.08	MT	L/R	F	Hatchback Engine ABD	853008	Outer Joint		22	30	53	78.5	51	I
1.6 (55 kW)	1992.09-1997.08	MT	L/R	F	Hatchback Engine ABU	653001	Inner Joint			33		32		
	1992.09-1997.08	MT	L/R	F	Hatchback Engine ABU	603004	Inner Joint			33		32		
	1992.09-1997.08	MT	-	-	Hatchback Engine ABU	603006	Inner Joint			33		34		
	1992.09-1997.08	-	-	F	Hatchback Engine ABU	853006	Outer Joint		22	30	50	78.5	52	I
	1992.09-1997.08	MT	L	F	Hatchback Engine ABU	253004	Drive Shaft		22		50	78.5	562	
	1992.09-1997.08	MT	L/R	F	Hatchback Engine ABU	603005	Inner Joint			33		32		
	1992.09-1997.08	MT	L	F	Hatchback Engine ABU	261172	Drive Shaft		22		53	78	584.5	
	1992.09-1997.08	MT	R	F	Hatchback Engine ABU	261067	Drive Shaft		22		51	78.7	781	
	1992.09-1997.08	MT	R	F	Hatchback Engine ABU	261055	Drive Shaft		22		53	78.5	796	
	1992.09-1997.08	MT	L/R	F	Hatchback Engine ABU	853008	Outer Joint		22	30	53	78.5	51	I
1.6 (74 kW)	1995.07-1997.08	MT	-	F	Hatchback Engine AKS	853006	Outer Joint		22	30	50	78.5	52	I
	1995.07-1997.08	AT	L/R	F	Hatchback Engine AKS	853007	Outer Joint		22	30	53.2	78	61	I
	1995.07-1997.08	MT	L/R	F	Hatchback Engine AKS	603004	Inner Joint			33		32		
	1995.07-1997.08	AT	L	F	Hatchback Engine AKS	261011	Drive Shaft		22		53.2	78	547	
	1995.07-1997.08	AT	-	F	Hatchback Engine AKS	853004	Outer Joint		22	30	51	78	61	I
	1995.07-1997.08	MT	L	F	Hatchback Engine AKS	253004	Drive Shaft		22		50	78.5	562	
	1995.07-1997.08	AT	R	F	Hatchback Engine AKS	261028	Drive Shaft		22		53.2	78	767	
	1995.07-1997.08	MT	R	F	Hatchback Engine AKS	261055	Drive Shaft		22		53	78.5	796	
	1995.07-1997.08	MT	L/R	F	Hatchback Engine AKS	603005	Inner Joint			33		32		
	1995.07-1997.08	MT	L/R	F	Hatchback Engine AKS	853008	Outer Joint		22	30	53	78.5	51	I
1.8 (55 kW)	1991.11-1997.08	MT	R	F	Hatchback Engine AAM	261012	Drive Shaft		22		50	78	792	
	1991.11-1997.08	AT/MT	L/R	F	Hatchback Engine AAM	853007	Outer Joint		22	30	53.2	78	61	I
	1991.11-1997.08	MT	R	F	Hatchback Engine AAM	261009	Drive Shaft		22		53.2	78	789	
	1991.11-1997.08	AT	L	F	Hatchback Engine AAM	261011	Drive Shaft		22		53.2	78	547	
	1991.11-1997.08	AT/MT	L	F	Hatchback Engine AAM	261001	Drive Shaft		22		53.2	78	557	
	1991.11-1997.08	AT/MT	R	F	Hatchback Engine AAM	603009	Inner Joint			33		34		
	1991.11-1997.08	AT	R	F	Hatchback Engine AAM	261028	Drive Shaft		22		53.2	78	767	
	1991.11-1997.08	AT/MT	L	F	Hatchback Engine AAM	603011	Inner Joint			33		34		
	1991.11-1997.08	-	-	F	Hatchback Engine AAM	853004	Outer Joint		22	30	51	78	61	I
1.8 (66 kW)	1991.11-1997.08	MT	R	F	Hatchback Engine ACC	261012	Drive Shaft		22		50	78	792	
	1991.11-1997.08	AT/MT	L/R	F	Hatchback Engine ACC	853007	Outer Joint		22	30	53.2	78	61	I
	1991.11-1997.08	MT	R	F	Hatchback Engine ACC	261009	Drive Shaft		22		53.2	78	789	
	1991.11-1997.08	AT	L	F	Hatchback Engine ACC	261011	Drive Shaft		22		53.2	78	547	





	 YEAR	TRANSM	L/R	F/R	REMARKS	GSP Ref.	 PRODUCT	 ABS	Technical Specifications							
									A	B	C	H	L	P		
VW																
GOLF III (1H1)																
1.8 (66 kW)	1991.11-1997.08	AT/MT	L	F	Hatchback Engine ACC	261001	Drive Shaft		22		53.2	78	557			
	1991.11-1997.08	AT/MT	R	F	Hatchback Engine ACC	603009	Inner Joint			33		34				
	1991.11-1997.08	AT	R	F	Hatchback Engine ACC	261028	Drive Shaft		22		53.2	78	767			
	1991.11-1997.08	AT/MT	L	F	Hatchback Engine ACC	603011	Inner Joint			33		34				
	1991.11-1997.08	-	-	F	Hatchback Engine ACC	853004	Outer Joint		22	30	51	78	61	I		
1.8 Syncro (66 kW)	1993.01-1997.08	MT	R	F	All-wheel Drive Hatchback Engine ABS	261012	Drive Shaft		22		50	78	792			
	1993.01-1997.08	MT	L/R	F	All-wheel Drive Hatchback Engine ABS	853007	Outer Joint		22	30	53.2	78	61	I		
	1993.01-1997.08	MT	L/R	R	All-wheel Drive Hatchback Engine ABS	603004	Inner Joint			33		32				
	1993.01-1997.08	MT	R	F	All-wheel Drive Hatchback Engine ABS	261009	Drive Shaft		22		53.2	78	789			
	1993.01-1997.08	MT	R	F	All-wheel Drive Hatchback Engine ABS	603009	Inner Joint			33		34				
	1993.01-1997.08	-	-	F	All-wheel Drive Hatchback Engine ABS	853004	Outer Joint		22	30	51	78	61	I		
	1993.01-1997.08	MT	L	F	All-wheel Drive Hatchback Engine ABS	603011	Inner Joint			33		34				
1.9 D (48 kW)	1991.11-1997.08	MT	-	-	Hatchback Engine 1Y	603006	Inner Joint			33		34				
	1991.11-1997.08	MT	L/R	F	Hatchback Engine 1Y	603004	Inner Joint			33		32				
	1991.11-1997.08	-	-	F	Hatchback Engine 1Y	853006	Outer Joint		22	30	50	78.5	52	I		
	1991.11-1997.08	MT	L	F	Hatchback Engine 1Y	253004	Drive Shaft		22		50	78.5	562			
	1991.11-1997.08	MT	R	F	Hatchback Engine 1Y	261055	Drive Shaft		22		53	78.5	796			
	1991.11-1997.08	MT	L/R	F	Hatchback Engine 1Y	603005	Inner Joint			33		32				
	1991.11-1997.08	MT	L/R	F	Hatchback Engine 1Y	853008	Outer Joint		22	30	53	78.5	51	I		
1.9 SDI (47 kW)	1995.07-1997.08	MT	L/R	F	Hatchback Engine AEY	603004	Inner Joint			33		32				
	1995.07-1997.08	MT	L	F	Hatchback Engine AEY	253004	Drive Shaft		22		50	78.5	562			
	1995.07-1997.08	MT	-	-	Hatchback Engine AEY	603006	Inner Joint			33		34				
	1995.07-1997.08	-	-	F	Hatchback Engine AEY	853006	Outer Joint		22	30	50	78.5	52	I		
	1995.07-1997.08	MT	R	F	Hatchback Engine AEY	261055	Drive Shaft		22		53	78.5	796			
	1995.07-1997.08	MT	L/R	F	Hatchback Engine AEY	603005	Inner Joint			33		32				
	1995.07-1997.08	MT	L/R	F	Hatchback Engine AEY	853008	Outer Joint		22	30	53	78.5	51	I		
1.9 TD,GTD (55 kW)	1991.11-1997.08	MT	R	F	Hatchback Engine AAZ	261012	Drive Shaft		22		50	78	792			
	1991.11-1997.08	AT/MT	L/R	F	Hatchback Engine AAZ	853007	Outer Joint		22	30	53.2	78	61	I		
	1991.11-1997.08	MT	-	-	Hatchback Engine AAZ	603006	Inner Joint			33		34				
	1991.11-1997.08	MT	R	F	Hatchback Engine AAZ	261009	Drive Shaft		22		53.2	78	789			
	1991.11-1997.08	AT	L	F	Hatchback Engine AAZ	261011	Drive Shaft		22		53.2	78	547			
	1991.11-1997.08	AT/MT	L	F	Hatchback Engine AAZ	261001	Drive Shaft		22		53.2	78	557			
	1991.11-1997.08	AT/MT	R	F	Hatchback Engine AAZ	603009	Inner Joint			33		34				
	1991.11-1997.08	AT	R	F	Hatchback Engine AAZ	261028	Drive Shaft		22		53.2	78	767			
	1991.11-1997.08	AT/MT	L	F	Hatchback Engine AAZ	603011	Inner Joint			33		34				
	1991.11-1997.08	-	-	F	Hatchback Engine AAZ	853004	Outer Joint		22	30	51	78	61	I		
1.9 TDI (66 kW)	1993.09-1997.08	MT	R	F	Hatchback Engine 1Z	261012	Drive Shaft		22		50	78	792			
	1993.09-1997.08	MT	R	F	Hatchback Engine 1Z	603009	Inner Joint			33		34				
	1993.09-1997.08	MT	L	F	Hatchback Engine 1Z	261001	Drive Shaft		22		53.2	78	557			
	1993.09-1997.08	-	-	F	Hatchback Engine 1Z	853004	Outer Joint		22	30	51	78	61	I		
	1993.09-1997.08	MT	L	F	Hatchback Engine 1Z	603011	Inner Joint			33		34				
	1993.09-1997.08	MT	R	F	Hatchback Engine 1Z	261002	Drive Shaft		22		53	78.5	793			
	1993.09-1997.08	MT	L/R	F	Hatchback Engine 1Z	861018	Outer Joint		22	30	53	78.5	61	I		
1.9 TDI (81 kW)	1996.04-1997.08	AT	L	F	Hatchback Engine AFN	261020	Drive Shaft		36		53.2	77.5	547			
	1996.04-1997.08	MT	L	F	Hatchback Engine AFN	261001	Drive Shaft		22		53.2	78	557			
	1996.04-1997.08	MT	L	F	Hatchback Engine AFN	261021	Drive Shaft		36		53.2	77.5	564.5			
	1996.04-1997.08	MT	R	F	Hatchback Engine AFN	603009	Inner Joint			33		34				
	1996.04-1997.08	MT	L	F	Hatchback Engine AFN	603011	Inner Joint			33		34				
	1996.04-1997.08	MT	R	F	Hatchback Engine AFN	261002	Drive Shaft		22		53	78.5	793			
	1996.04-1997.08	-	L/R	F	Hatchback Engine AFN	803036	Outer Joint		36	30	53.2	77.5	61	I		
	1996.04-1997.08	AT/MT	L/R	F	Hatchback Engine AFN	861018	Outer Joint		22	30	53	78.5	61	I		
2.0 (85 kW)	1991.11-1997.08	MT	R	F	Hatchback Engine 2E	261012	Drive Shaft		22		50	78	792			
	1991.11-1997.08	AT	L/R	F	Hatchback Engine 2E	853007	Outer Joint		22	30	53.2	78	61	I		
	1991.11-1997.08	AT	R	F	Hatchback Engine 2E	261009	Drive Shaft		22		53.2	78	789			
	1991.11-1997.08	AT	L	F	Hatchback Engine 2E	261011	Drive Shaft		22		53.2	78	547			
	1991.11-1997.08	MT	R	F	Hatchback Engine 2E	261062	Drive Shaft		36		53.2	77.5	788			
	1991.11-1997.08	AT/MT	R	F	Hatchback Engine 2E	603009	Inner Joint			33		34				
	1991.11-1997.08	AT	R	F	Hatchback Engine 2E	261028	Drive Shaft		22		53.2	78	767			
	1991.11-1997.08	AT/MT	L	F	Hatchback Engine 2E	603011	Inner Joint			33		34				
	1991.11-1997.08	AT	L	F	Hatchback Engine 2E	261001	Drive Shaft		22		53.2	78	557			
	1991.11-1997.08	-	-	F	Hatchback Engine 2E	853004	Outer Joint		22	30	51	78	61	I		
	1991.11-1997.08	MT	L/R	F	Hatchback Engine 2E	803036	Outer Joint		36	30	53.2	77.5	61	I		
2.0 GL (79 kW)	1995.08-1997.09	MT	R	F	Hatchback Engine AEP	261012	Drive Shaft		22		50	78	792			
	1995.08-1997.09	-	-	F	Hatchback Engine AEP	853004	Outer Joint		22	30	51	78	61	I		
2.0 GTI 16V (110 kW)	1992.08-1997.08	MT	-	-	Hatchback Engine ABF	603006	Inner Joint			33		34				





	 YEAR	TRANSM	L/R	F/R	REMARKS	GSP Ref.	 PRODUCT	 ABS	Technical Specifications					
									A	B	C	H	L	P
VW														
GOLF III (1H1)														
2.0 GTI 16V (110 kW)	1992.08-1997.08	AT/MT	R	F	Hatchback Engine ABF	603009	Inner Joint		33		34			
	1992.08-1997.08	AT/MT	L	F	Hatchback Engine ABF	603011	Inner Joint		33		34			
	1992.08-1997.08	MT	R	F	Hatchback Engine ABF	261062	Drive Shaft	36		53.2	77.5	788		
	1992.08-1997.08	MT	L	F	Hatchback Engine ABF	299116	Drive Shaft	36		53.2	77.5	548.5		
	1992.08-1997.08	AT/MT	L/R	F	Hatchback Engine ABF	803036	Outer Joint	36	30	53.2	77.5	61	I	
2.0 Syncro (85 kW)	1995.08-1997.08	MT	R	F	All-wheel Drive Hatchback Engine AGG	261012	Drive Shaft	22		50	78	792		
	1995.08-1997.08	-	-	-	All-wheel Drive Hatchback Engine AGG	853004	Outer Joint	22	30	51	78	61	I	
2.8 VR6 (128 kW)	1992.01-1997.08	AT/MT	R	F	Hatchback Engine AAA	603009	Inner Joint		33		34			
	1992.01-1997.08	AT/MT	L	F	Hatchback Engine AAA	603011	Inner Joint		33		34			
	1992.01-1997.08	MT	R	F	Hatchback Engine AAA	261062	Drive Shaft	36		53.2	77.5	788		
	1992.01-1997.08	MT	L	F	Hatchback Engine AAA	299116	Drive Shaft	36		53.2	77.5	548.5		
	1992.01-1997.08	AT/MT	L/R	F	Hatchback Engine AAA	803036	Outer Joint	36	30	53.2	77.5	61	I	
2.9 VR6 Syncro (140 kW)	1994.10-1997.08	MT	-	-	All-wheel Drive Hatchback Engine ABV	603006	Inner Joint		33		34			
GOLF III Cabriolet (1E7)														
1.6 (74 kW)	1994.10-1998.05	MT	-	F	Convertible Engine AEK/AFT/AKS	853006	Outer Joint	22	30	50	78.5	52	I	
	1994.10-1998.05	AT	L	F	Convertible Engine AEK/AFT/AKS	261011	Drive Shaft	22		53.2	78	547		
	1994.10-1998.05	AT	-	F	Convertible Engine AEK/AFT/AKS	853004	Outer Joint	22	30	51	78	61	I	
1.8 (55 kW)	1993.07-1998.05	MT	L/R	F	Convertible Engine AAM	853007	Outer Joint	22	30	53.2	78	61	I	
	1993.07-1998.05	MT	R	F	Convertible Engine AAM	603009	Inner Joint		33		34			
	1993.07-1998.05	MT	R	F	Convertible Engine AAM	261012	Drive Shaft	22		50	78	792		
	1993.07-1998.05	MT	-	-	Convertible Engine AAM	603006	Inner Joint		33		34			
	1993.07-1998.05	MT	R	F	Convertible Engine AAM	261009	Drive Shaft	22		53.2	78	789		
	1993.07-1998.05	AT/MT	-	F	Convertible Engine AAM	853004	Outer Joint	22	30	51	78	61	I	
	1993.07-1998.05	MT	L	F	Convertible Engine AAM	261001	Drive Shaft	22		53.2	78	557		
	1993.07-1998.05	MT	L	F	Convertible Engine AAM	603011	Inner Joint		33		34			
1.8 (66 kW)	1993.07-1998.05	AT/MT	L/R	F	Convertible Engine ABS	853007	Outer Joint	22	30	53.2	78	61	I	
	1993.07-1998.05	MT	R	F	Convertible Engine ABS	261012	Drive Shaft	22		50	78	792		
	1993.07-1998.05	MT	R	F	Convertible Engine ABS	261009	Drive Shaft	22		53.2	78	789		
	1993.07-1998.05	AT/MT	-	F	Convertible Engine ABS	853004	Outer Joint	22	30	51	78	61	I	
	1993.07-1998.05	AT	L	F	Convertible Engine ABS	261011	Drive Shaft	22		53.2	78	547		
	1993.07-1998.05	AT/MT	R	F	Convertible Engine ABS	603009	Inner Joint		33		34			
	1993.07-1998.05	AT/MT	L	F	Convertible Engine ABS	261001	Drive Shaft	22		53.2	78	557		
	1993.07-1998.05	AT/MT	L	F	Convertible Engine ABS	603011	Inner Joint		33		34			
1.9 TDI (66 kW)	1995.08-1998.05	MT	R	F	Convertible Engine ALE	261012	Drive Shaft	22		50	78	792		
	1995.08-1998.05	MT	L	F	Convertible Engine ALE	261001	Drive Shaft	22		53.2	78	557		
	1995.08-1998.05	MT	R	F	Convertible Engine ALE	603009	Inner Joint		33		34			
	1995.08-1998.05	-	-	F	Convertible Engine ALE	853004	Outer Joint	22	30	51	78	61	I	
	1995.08-1998.05	MT	L	F	Convertible Engine ALE	603011	Inner Joint		33		34			
	1995.08-1998.05	MT	R	F	Convertible Engine ALE	261002	Drive Shaft	22		53	78.5	793		
	1995.08-1998.05	MT	L/R	F	Convertible Engine ALE	861018	Outer Joint	22	30	53	78.5	61	I	
1.9 TDI (81 kW)	1996.07-1998.05	MT	R	F	Convertible Engine AFN	603009	Inner Joint		33		34			
	1996.07-1998.05	MT	R	F	Convertible Engine AFN	261012	Drive Shaft	22		50	78	792		
	1996.07-1998.05	MT	L	F	Convertible Engine AFN	261001	Drive Shaft	22		53.2	78	557		
	1996.07-1998.05	MT	L	F	Convertible Engine AFN	603011	Inner Joint		33		34			
	1996.07-1998.05	MT	R	F	Convertible Engine AFN	261002	Drive Shaft	22		53	78.5	793		
	1996.07-1998.05	MT	L/R	F	Convertible Engine AFN	861018	Outer Joint	22	30	53	78.5	61	I	
	1996.07-1998.05	-	-	F	Convertible Engine AFN	853004	Outer Joint	22	30	51	78	61	I	
2.0 (85 kW)	1993.07-1998.05	AT/MT	L/R	F	Convertible Engine ADY	853007	Outer Joint	22	30	53.2	78	61	I	
	1993.07-1998.05	AT/MT	R	F	Convertible Engine ADY	603009	Inner Joint		33		34			
	1993.07-1998.05	MT	R	F	Convertible Engine ADY	261012	Drive Shaft	22		50	78	792		
	1993.07-1998.05	MT	R	F	Convertible Engine ADY	261009	Drive Shaft	22		53.2	78	789		
	1993.07-1998.05	AT/MT	-	F	Convertible Engine ADY	853004	Outer Joint	22	30	51	78	61	I	
	1993.07-1998.05	AT	L	F	Convertible Engine ADY	261011	Drive Shaft	22		53.2	78	547		
	1993.07-1998.05	AT/MT	L	F	Convertible Engine ADY	261001	Drive Shaft	22		53.2	78	557		
	1993.07-1998.05	AT/MT	L	F	Convertible Engine ADY	603011	Inner Joint		33		34			
GOLF III Variant (1H5)														
1.4 (40 kW)	1993.07-1999.04	MT	L/R	F	Estate Engine ABD	653001	Inner Joint		33		32			
	1993.07-1999.04	-	-	F	Estate Engine ABD	853006	Outer Joint	22	30	50	78.5	52	I	
	1993.07-1999.04	MT	L	F	Estate Engine ABD	261172	Drive Shaft	22		53	78	584.5		
	1993.07-1999.04	MT	R	F	Estate Engine ABD	261067	Drive Shaft	22		51	78.7	781		
	1993.07-1999.04	MT	L/R	F	Estate Engine ABD	853008	Outer Joint	22	30	53	78.5	51	I	
1.4 (44 kW)	1993.07-1999.04	MT	L/R	F	Estate Engine ABD	653001	Inner Joint		33		32			
	1993.07-1999.04	MT	L/R	F	Estate Engine ABD	603004	Inner Joint		33		32			
	1993.07-1999.04	MT	-	-	Estate Engine ABD	603006	Inner Joint		33		34			
	1993.07-1999.04	-	-	F	Estate Engine ABD	853006	Outer Joint	22	30	50	78.5	52	I	
	1993.07-1999.04	MT	L	F	Estate Engine ABD	253004	Drive Shaft	22		50	78.5	562		

YEAR	TRANSM	L/R	F/R	REMARKS	GSP Ref.	PRODUCT	ABS	Technical Specifications							
								A	B	C	H	L	P		
VW															
GOLF III Variant (1H5)															
1.4 (44 kW)	1993.07-1999.04	MT	L/R	F	Estate Engine ABD	603005	Inner Joint			33		32			
	1993.07-1999.04	MT	L	F	Estate Engine ABD	261172	Drive Shaft	22		53	78	584.5			
	1993.07-1999.04	MT	R	F	Estate Engine ABD	261067	Drive Shaft	22		51	78.7	781			
	1993.07-1999.04	MT	L/R	F	Estate Engine ABD	853008	Outer Joint	22	30	53	78.5	51	I		
1.6 (74 kW)	1994.07-1999.04	AT	L/R	F	Estate Engine AFT	853007	Outer Joint	22	30	53.2	78	61	I		
	1994.07-1999.04	MT	L/R	F	Estate Engine AFT	603004	Inner Joint			33		32			
	1994.07-1999.04	MT	R	F	Estate Engine AFT	603009	Inner Joint			33		34			
	1994.07-1999.04	MT	L/R	F	Estate Engine AFT	603005	Inner Joint			33		32			
	1994.07-1999.04	MT	L	F	Estate Engine AFT	253004	Drive Shaft	22		50	78.5	562			
	1994.07-1999.04	MT	L/R	F	Estate Engine AFT	853008	Outer Joint	22	30	53	78.5	51	I		
	1994.07-1999.04	AT	R	F	Estate Engine AFT	261028	Drive Shaft	22		53.2	78	767			
	1994.07-1999.04	AT	L	F	Estate Engine AFT	261011	Drive Shaft	22		53.2	78	547			
	1994.07-1999.04	-	-	F	Estate Engine AFT	853006	Outer Joint	22	30	50	78.5	52	I		
	1994.07-1999.04	AT	-	F	Estate Engine AFT	853004	Outer Joint	22	30	51	78	61	I		
	1994.07-1999.04	MT	R	F	Estate Engine AFT	261055	Drive Shaft	22		53	78.5	796			
	1994.07-1999.04	MT	L	F	Estate Engine AFT	603011	Inner Joint			33		34			
1.8 (55 kW)	1993.07-1999.04	AT/MT	L/R	F	Estate Engine AAM	853007	Outer Joint	22	30	53.2	78	61	I		
	1993.07-1999.04	MT	R	F	Estate Engine AAM	261012	Drive Shaft	22		50	78	792			
	1993.07-1999.04	MT	R	F	Estate Engine AAM	261009	Drive Shaft	22		53.2	78	789			
	1993.07-1999.04	AT	L	F	Estate Engine AAM	261011	Drive Shaft	22		53.2	78	547			
	1993.07-1999.04	AT	R	F	Estate Engine AAM	261028	Drive Shaft	22		53.2	78	767			
	1993.07-1999.04	MT	R	F	Estate Engine AAM	603009	Inner Joint			33		34			
	1993.07-1999.04	MT	L	F	Estate Engine AAM	261001	Drive Shaft	22		53.2	78	557			
	1993.07-1999.04	-	-	F	Estate Engine AAM	853004	Outer Joint	22	30	51	78	61	I		
1993.07-1999.04	MT	L	F	Estate Engine AAM	603011	Inner Joint			33		34				
1.8 (66 kW)	1993.07-1999.04	AT/MT	L/R	F	Estate Engine ANP	853007	Outer Joint	22	30	53.2	78	61	I		
	1993.07-1999.04	MT	R	F	Estate Engine ANP	261012	Drive Shaft	22		50	78	792			
	1993.07-1999.04	MT	R	F	Estate Engine ANP	261009	Drive Shaft	22		53.2	78	789			
	1993.07-1999.04	AT	L	F	Estate Engine ANP	261011	Drive Shaft	22		53.2	78	547			
	1993.07-1999.04	AT/MT	L	F	Estate Engine ANP	261001	Drive Shaft	22		53.2	78	557			
	1993.07-1999.04	AT/MT	R	F	Estate Engine ANP	603009	Inner Joint			33		34			
	1993.07-1999.04	AT	R	F	Estate Engine ANP	261028	Drive Shaft	22		53.2	78	767			
	1993.07-1999.04	AT/MT	L	F	Estate Engine ANP	603011	Inner Joint			33		34			
1993.07-1999.04	-	-	F	Estate Engine ANP	853004	Outer Joint	22	30	51	78	61	I			
1.8 Syncro (66 kW)	1994.10-1999.04	MT	L/R	F	All-wheel Drive Estate Engine ADZ	853007	Outer Joint	22	30	53.2	78	61	I		
	1994.10-1999.04	MT	R	F	All-wheel Drive Estate Engine ADZ	261012	Drive Shaft	22		50	78	792			
	1994.10-1999.04	MT	R	F	All-wheel Drive Estate Engine ADZ	261009	Drive Shaft	22		53.2	78	789			
	1994.10-1999.04	MT	L	F	All-wheel Drive Estate Engine ADZ	261001	Drive Shaft	22		53.2	78	557			
	1994.10-1999.04	MT	R	F	All-wheel Drive Estate Engine ADZ	603009	Inner Joint			33		34			
	1994.10-1999.04	-	-	F	All-wheel Drive Estate Engine ADZ	853004	Outer Joint	22	30	51	78	61	I		
1994.10-1999.04	MT	L	F	All-wheel Drive Estate Engine ADZ	603011	Inner Joint			33		34				
1.9 D (48 kW)	1993.07-1999.04	MT	-	-	Estate Engine 1Y	603006	Inner Joint			33		34			
	1993.07-1999.04	MT	L/R	F	Estate Engine 1Y	603004	Inner Joint			33		32			
	1993.07-1999.04	-	-	F	Estate Engine 1Y	853006	Outer Joint	22	30	50	78.5	52	I		
	1993.07-1999.04	MT	L	F	Estate Engine 1Y	253004	Drive Shaft	22		50	78.5	562			
	1993.07-1999.04	MT	R	F	Estate Engine 1Y	261055	Drive Shaft	22		53	78.5	796			
	1993.07-1999.04	MT	L/R	F	Estate Engine 1Y	603005	Inner Joint			33		32			
	1993.07-1999.04	MT	L/R	F	Estate Engine 1Y	853008	Outer Joint	22	30	53	78.5	51	I		
1.9 SDI (47 kW)	1995.07-1999.04	MT	L/R	F	Estate Engine AEY	603004	Inner Joint			33		32			
	1995.07-1999.04	MT	L	F	Estate Engine AEY	253004	Drive Shaft	22		50	78.5	562			
	1995.07-1999.04	MT	-	-	Estate Engine AEY	603006	Inner Joint			33		34			
	1995.07-1999.04	-	-	F	Estate Engine AEY	853006	Outer Joint	22	30	50	78.5	52	I		
	1995.07-1999.04	MT	R	F	Estate Engine AEY	261055	Drive Shaft	22		53	78.5	796			
	1995.07-1999.04	MT	L/R	F	Estate Engine AEY	603005	Inner Joint			33		32			
	1995.07-1999.04	MT	L/R	F	Estate Engine AEY	853008	Outer Joint	22	30	53	78.5	51	I		
1.9 TD (55 kW)	1993.07-1999.04	AT/MT	L/R	F	Estate Engine AAZ	853007	Outer Joint	22	30	53.2	78	61	I		
	1993.07-1999.04	MT	R	F	Estate Engine AAZ	261012	Drive Shaft	22		50	78	792			
	1993.07-1999.04	MT	-	-	Estate Engine AAZ	603006	Inner Joint			33		34			
	1993.07-1999.04	MT	R	F	Estate Engine AAZ	261009	Drive Shaft	22		53.2	78	789			
	1993.07-1999.04	AT	L	F	Estate Engine AAZ	261011	Drive Shaft	22		53.2	78	547			
	1993.07-1999.04	AT/MT	L	F	Estate Engine AAZ	261001	Drive Shaft	22		53.2	78	557			
	1993.07-1999.04	AT/MT	R	F	Estate Engine AAZ	603009	Inner Joint			33		34			
	1993.07-1999.04	AT	R	F	Estate Engine AAZ	261028	Drive Shaft	22		53.2	78	767			
	1993.07-1999.04	AT/MT	L	F	Estate Engine AAZ	603011	Inner Joint			33		34			
	1993.07-1999.04	-	-	F	Estate Engine AAZ	853004	Outer Joint	22	30	51	78	61	I		
1.9 TDI (66 kW)	1994.03-1999.04	MT	R	F	Estate Engine AHU	261012	Drive Shaft	22		50	78	792			





	YEAR		TRANSM	L/R	F/R	REMARKS	GSP Ref.	PRODUCT	ABS	Technical Specifications										
										A	B	C	H	L	P					
VW																				
GOLF III Variant (1H5)																				
1.9 TDI (66 kW)	1994.03-	1999.04	MT	L	F	Estate Engine AHU	261011	Drive Shaft		22		53.2	78	547						
	1994.03-	1999.04	MT	L	F	Estate Engine AHU	261001	Drive Shaft		22		53.2	78	557						
	1994.03-	1999.04	MT	R	F	Estate Engine AHU	603009	Inner Joint			33		34							
	1994.03-	1999.04	-	-	F	Estate Engine AHU	853004	Outer Joint		22	30	51	78	61	I					
	1994.03-	1999.04	MT	L	F	Estate Engine AHU	603011	Inner Joint			33		34							
	1994.03-	1999.04	MT	R	F	Estate Engine AHU	261002	Drive Shaft		22		53	78.5	793						
	1994.03-	1999.04	MT	L/R	F	Estate Engine AHU	861018	Outer Joint		22	30	53	78.5	61	I					
1.9 TDI (81 kW)	1996.04-	1999.04	MT	R	F	Estate Engine AFN	261012	Drive Shaft		22		50	78	792						
	1996.04-	1999.04	MT	L	F	Estate Engine AFN	261001	Drive Shaft		22		53.2	78	557						
	1996.04-	1999.04	MT	R	F	Estate Engine AFN	603009	Inner Joint			33		34							
	1996.04-	1999.04	-	-	F	Estate Engine AFN	853004	Outer Joint		22	30	51	78	61	I					
	1996.04-	1999.04	MT	L	F	Estate Engine AFN	603011	Inner Joint			33		34							
	1996.04-	1999.04	MT	R	F	Estate Engine AFN	261002	Drive Shaft		22		53	78.5	793						
	1996.04-	1999.04	MT	L/R	F	Estate Engine AFN	861018	Outer Joint		22	30	53	78.5	61	I					
1.9 TDI Syncro (66 kW)	1995.07-	1999.04	-	R	F	All-wheel Drive Estate Engine 1Z	603009	Inner Joint			33		34							
	1995.07-	1999.04	-	L	F	All-wheel Drive Estate Engine 1Z	603011	Inner Joint			33		34							
	1995.07-	1999.04	-	L/R	R	All-wheel Drive Estate Engine 1Z	603004	Inner Joint			33		32							
2.0 (79 kW)	1995.08-	1996.04	MT	R	F	Estate Engine AEP	261012	Drive Shaft		22		50	78	792						
	1995.08-	1996.04	-	-	F	Estate Engine AEP	853004	Outer Joint		22	30	51	78	61	I					
2.0 (85 kW)	1993.07-	1999.04	AT/MT	L/R	F	Estate Engine 2E	853007	Outer Joint		22	30	53.2	78	61	I					
	1993.07-	1999.04	MT	R	F	Estate Engine 2E	261012	Drive Shaft		22		50	78	792						
	1993.07-	1999.04	AT	L	F	Estate Engine 2E	261011	Drive Shaft		22		53.2	78	547						
	1993.07-	1999.04	AT/MT	L	F	Estate Engine 2E	261001	Drive Shaft		22		53.2	78	557						
	1993.07-	1999.04	AT/MT	R	F	Estate Engine 2E	603009	Inner Joint			33		34							
	1993.07-	1999.04	AT/MT	R	F	Estate Engine 2E	261062	Drive Shaft		36		53.2	77.5	788						
	1993.07-	1999.04	AT	R	F	Estate Engine 2E	261028	Drive Shaft		22		53.2	78	767						
	1993.07-	1999.04	AT/MT	L	F	Estate Engine 2E	603011	Inner Joint			33		34							
	1993.07-	1999.04	-	-	F	Estate Engine 2E	853004	Outer Joint		22	30	51	78	61	I					
1993.07-	1999.04	MT	L/R	F	Estate Engine 2E	803036	Outer Joint		36	30	53.2	77.5	61	I						
2.9 VR6 Syncro (140 kW)	1994.10-	1999.04	MT	-	-	All-wheel Drive Estate Engine ABV	603006	Inner Joint			33		34							
GOLF IV (1J1)																				
1.4 16V (55 kW)	1997.08-	2005.06	MT	L	F	Hatchback Engine AHW/AKQ/APE	261045	Drive Shaft		36		53	78.5	555						
	1997.08-	2005.06	MT	R	F	Hatchback Engine AHW/AKQ/APE	203046	Drive Shaft		36		53	78.5	822						
	1997.08-	2005.06	MT	-	-	Hatchback Engine AHW/AKQ/APE	603006	Inner Joint			33		34							
	1997.08-	2005.06	AT	L/R	F	Hatchback Engine AHW/AKQ/APE	661006	Inner Joint			30		57.6							
	1997.08-	2005.06	AT	L	F	Hatchback Engine AHW/AKQ/APE	261156	Drive Shaft		36		53	78	554.5						
	1997.08-	2005.06	MT	L/R	F	Hatchback Engine AHW/AKQ/APE	803033	Outer Joint		36	30	53	78.5	51	I					
	1997.08-	2005.06	AT	L	F	Hatchback Engine AHW/AKQ/APE	661062	Inner Joint			30		59							
	1997.08-	2005.06	AT	L/R	F	Hatchback Engine AHW/AKQ/APE	803036	Outer Joint		36	30	53.2	77.5	61	I					
	1997.08-	2005.06	MT	L/R	F	Hatchback Engine AHW/AKQ/APE	603008	Inner Joint			33		32							
1.6 (74 kW)	1997.08-	2004.05	AT	L/R	F	Hatchback Engine AKL/AEH/APF	803036	Outer Joint		36	30	53.2	77.5	61	I					
	1997.08-	2004.05	AT	L	F	Hatchback Engine AKL/AEH/APF	261020	Drive Shaft		36		53.2	77.5	547						
	1997.08-	2004.05	MT	L	F	Hatchback Engine AKL/AEH/APF	261045	Drive Shaft		36		53	78.5	555						
	1997.08-	2004.05	AT	L	F	Hatchback Engine AKL/AEH/APF	261156	Drive Shaft		36		53	78	554.5						
	1997.08-	2004.05	AT	L	F	Hatchback Engine AKL/AEH/APF	661062	Inner Joint			30		59							
	1997.08-	2004.05	MT	L/R	F	Hatchback Engine AKL/AEH/APF	803033	Outer Joint		36	30	53	78.5	51	I					
	1997.08-	2004.05	AT	L/R	F	Hatchback Engine AKL/AEH/APF	661006	Inner Joint			30		57.6							
	1997.08-	2004.05	MT	L/R	F	Hatchback Engine AKL/AEH/APF	603008	Inner Joint			33		32							
1.6 (75 kW)	2000.08-	2005.06	AT	L	F	Hatchback Engine AVU/BFQ/BJH	261020	Drive Shaft		36		53.2	77.5	547						
	2000.08-	2005.06	MT	L	F	Hatchback Engine AVU/BFQ/BJH	261045	Drive Shaft		36		53	78.5	555						
	2000.08-	2005.06	AT	L/R	F	Hatchback Engine AVU/BFQ/BJH	661006	Inner Joint			30		57.6							
	2000.08-	2005.06	AT	L	F	Hatchback Engine AVU/BFQ/BJH	261156	Drive Shaft		36		53	78	554.5						
	2000.08-	2005.06	MT	L/R	F	Hatchback Engine AVU/BFQ/BJH	803033	Outer Joint		36	30	53	78.5	51	I					
	2000.08-	2005.06	AT	L	F	Hatchback Engine AVU/BFQ/BJH	661062	Inner Joint			30		59							
	2000.08-	2005.06	AT	L/R	F	Hatchback Engine AVU/BFQ/BJH	803036	Outer Joint		36	30	53.2	77.5	61	I					
	2000.08-	2005.06	MT	L/R	F	Hatchback Engine AVU/BFQ/BJH	603008	Inner Joint			33		32							
1.6 16V (77 kW)	2000.02-	2005.06	AT	L	F	Hatchback Engine ATN	261020	Drive Shaft		36		53.2	77.5	547						
	2000.02-	2005.06	MT	L	F	Hatchback Engine ATN	261202	Drive Shaft		36		53.2	77.5	547						
	2000.02-	2005.06	MT	R	F	Hatchback Engine ATN	261203	Drive Shaft		36		53.2	77.5	810						
	2000.02-	2005.06	AT/MT	L/R	F	Hatchback Engine ATN	803036	Outer Joint		36	30	53.2	77.5	61	I					
	2000.02-	2005.06	MT	L/R	F	Hatchback Engine ATN	661005	Inner Joint			30		57.6							
1.6 FSI (81 kW)	2002.01-	2005.06	MT	L/R	F	Hatchback Engine BAD	803036	Outer Joint		36	30	53.2	77.5	61	I					
	2002.01-	2005.06	MT	-	-	Hatchback Engine BAD	603006	Inner Joint			33		34							
	2002.01-	2005.06	MT	L/R	F	Hatchback Engine BAD	661005	Inner Joint			30		57.6							
1.8 (92 kW)	1997.08-	2005.06	MT	L	F	Hatchback Engine AGN	603011	Inner Joint			33		34							
	1997.08-	2005.06	AT	L	F	Hatchback Engine AGN	261020	Drive Shaft		36		53.2	77.5	547						



	YEAR	TRANSM	L/R	F/R	REMARKS	GSP Ref.	PRODUCT	ABS	Technical Specifications					
									A	B	C	H	L	P
VW														
GOLF IV (1J1)														
1.8 (92 kW)	1997.08-2005.06	MT	L	F	Hatchback Engine AGN	261314	Drive Shaft		36		53	78	558	
	1997.08-2005.06	AT	L	F	Hatchback Engine AGN	261156	Drive Shaft		36		53	78	554.5	
	1997.08-2005.06	AT	L/R	F	Hatchback Engine AGN	661006	Inner Joint			30		57.6		
	1997.08-2005.06	AT	L	F	Hatchback Engine AGN	661062	Inner Joint			30		59		
	1997.08-2005.06	MT	L	F	Hatchback Engine AGN	261021	Drive Shaft		36		53.2	77.5	564.5	
	1997.08-2005.06	AT/MT	L/R	F	Hatchback Engine AGN	803036	Outer Joint		36	30	53.2	77.5	61	I
1.8 4motion (92 kW)	1998.05-2005.06	-	L/R/F/R		All-wheel Drive Hatchback Engine AGN	603011	Inner Joint			33		34		
	1998.05-2005.06	MT	L/R	F	All-wheel Drive Hatchback Engine AGN	603004	Inner Joint			33		32		
	1998.05-2005.06	-	R	F	All-wheel Drive Hatchback Engine AGN	603009	Inner Joint			33		34		
	1998.05-2005.06	-	L	F	All-wheel Drive Hatchback Engine AGN	261314	Drive Shaft		36		53	78	558	
	1998.05-2005.06	-	L/R	R	All-wheel Drive Hatchback Engine AGN	803033	Outer Joint		36	30	53	78.5	51	I
	1998.05-2005.06	MT	L/R	F	All-wheel Drive Hatchback Engine AGN	803036	Outer Joint		36	30	53.2	77.5	61	I
1.8 T (110 kW)	1997.08-2005.06	5AT	R	F	Hatchback Engine AWD	261243	Drive Shaft		36		53	77.5	813	
	1997.08-2005.06	MT	L	F	Hatchback Engine AWD	261020	Drive Shaft		36		53.2	77.5	547	
	1997.08-2005.06	5AT	L/R	F	Hatchback Engine AWD	803035	Outer Joint		36	27	53	77.5	65	I
	1997.08-2005.06	5MT	R	F	Hatchback Engine AWD	203011	Drive Shaft		36		53.2	77.5	810.5	
	1997.08-2005.06	4AT/MT	L	F	Hatchback Engine AWD	261156	Drive Shaft		36		53	78	554.5	
	1997.08-2005.06	5MT	L	F	Hatchback Engine AWD	261312	Drive Shaft		36		53	78	546	
	1997.08-2005.06	4AT/MT	L	F	Hatchback Engine AWD	661062	Inner Joint			30		59		
	1997.08-2005.06	MT	L	F	Hatchback Engine AWD	261202	Drive Shaft		36		53.2	77.5	547	
	1997.08-2005.06	MT	R	F	Hatchback Engine AWD	261203	Drive Shaft		36		53.2	77.5	810	
	1997.08-2005.06	-	L/R	F	Hatchback Engine AWD	661006	Inner Joint			30		57.6		
	1997.08-2005.06	MT	L/R	F	Hatchback Engine AWD	803036	Outer Joint		36	30	53.2	77.5	61	I
	1997.08-2005.06	5AT	L	F	Hatchback Engine AWD	203374	Drive Shaft		36		53	77.5	521	
	1.8 T GTI (132 kW)	2001.08-2005.06	-	L/R	F	Hatchback Engine AUQ	803035	Outer Joint		36	27	53	77.5	65
2001.08-2005.06		-	L	F	Hatchback Engine AUQ	261123	Drive Shaft		36		53	77.5	520	
2001.08-2005.06		-	-	-	Hatchback Engine AUQ	603016	Inner Joint			28		32		
2001.08-2005.06		-	R	F	Hatchback Engine AUQ	299114	Drive Shaft		36		53	77.5	809	
2001.08-2005.06		-	R	F	Hatchback Engine AUQ	261121	Drive Shaft		36		53	77.5	806	
2001.08-2005.06		-	R	F	Hatchback Engine AUQ	253010	Drive Shaft		36		59.5	40	768	
1.9 SDI (50 kW)	1997.08-2005.06	-	L	F	Hatchback Engine AGP	261045	Drive Shaft		36		53	78.5	555	
	1997.08-2005.06	MT	L/R	F	Hatchback Engine AGP	603004	Inner Joint			33		32		
	1997.08-2005.06	MT	R	F	Hatchback Engine AGP	203046	Drive Shaft		36		53	78.5	822	
	1997.08-2005.06	MT	-	-	Hatchback Engine AGP	603006	Inner Joint			33		34		
	1997.08-2005.06	MT	L/R	F	Hatchback Engine AGP	803033	Outer Joint		36	30	53	78.5	51	I
	1997.08-2005.06	AT	L/R	F	Hatchback Engine AGP	803036	Outer Joint		36	30	53.2	77.5	61	I
	1997.08-2005.06	-	L/R	F	Hatchback Engine AGP	603008	Inner Joint			33		32		
	1997.08-2005.06	-	L/R	F	Hatchback Engine AGP	603016	Inner Joint			28		32		
1.9 TDI (110 kW)	2000.05-2005.06	MT	-	-	Hatchback Engine ARL	603016	Inner Joint			28		32		
	2000.05-2005.06	-	R	F	Hatchback Engine ARL	261186	Drive Shaft		36		53	77.5	653	
	2000.05-2005.06	-	R	F	Hatchback Engine ARL	299114	Drive Shaft		36		53	77.5	809	
	2000.05-2005.06	-	R	F	Hatchback Engine ARL	261121	Drive Shaft		36		53	77.5	806	
	2000.05-2005.06	-	R	F	Hatchback Engine ARL	253010	Drive Shaft		36		59.5	40	768	
	2000.05-2005.06	MT	-	-	Hatchback Engine ARL	603006	Inner Joint			33		34		
	2000.05-2005.06	MT	L/R	F	Hatchback Engine ARL	803035	Outer Joint		36	27	53	77.5	65	I
	2000.05-2005.06	-	L	F	Hatchback Engine ARL	261123	Drive Shaft		36		53	77.5	520	
1.9 TDI (66 kW)	1997.10-2004.05	AT	L	F	Hatchback Engine AGR	261020	Drive Shaft		36		53.2	77.5	547	
	1997.10-2004.05	MT	L	F	Hatchback Engine AGR	203006	Drive Shaft		36		53.2	77.5	557	
	1997.10-2004.05	MT	R	F	Hatchback Engine AGR	203004	Drive Shaft		36		53.2	77.5	822	
	1997.10-2004.05	MT	L	F	Hatchback Engine AGR	261021	Drive Shaft		36		53.2	77.5	564.5	
	1997.10-2004.05	AT	L/R	F	Hatchback Engine AGR	661006	Inner Joint			30		57.6		
	1997.10-2004.05	MT	R	F	Hatchback Engine AGR	603009	Inner Joint			33		34		
	1997.10-2004.05	AT/MT	L/R	F	Hatchback Engine AGR	803036	Outer Joint		36	30	53.2	77.5	61	I
	1997.10-2004.05	AT	L/R	F	Hatchback Engine AGR	803035	Outer Joint		36	27	53	77.5	65	I
1.9 TDI (74 kW)	2000.09-2005.06	MT	L/R	F	Hatchback Engine AXR	803036	Outer Joint		36	30	53.2	77.5	61	I
	2000.09-2005.06	AT	L	F	Hatchback Engine AXR	261244	Drive Shaft		36		53	77.5	523	
	2000.09-2005.06	-	-	-	Hatchback Engine AXR	603016	Inner Joint			28		32		
	2000.09-2005.06	MT	L	F	Hatchback Engine AXR	603011	Inner Joint			33		34		
	2000.09-2005.06	MT	L	F	Hatchback Engine AXR	203006	Drive Shaft		36		53.2	77.5	557	
	2000.09-2005.06	MT	R	F	Hatchback Engine AXR	203004	Drive Shaft		36		53.2	77.5	822	
	2000.09-2005.06	MT	L	F	Hatchback Engine AXR	261021	Drive Shaft		36		53.2	77.5	564.5	
	2000.09-2005.06	-	R	F	Hatchback Engine AXR	603009	Inner Joint			33		34		
	2000.09-2005.06	AT	L/R	F	Hatchback Engine AXR	803035	Outer Joint		36	27	53	77.5	65	I
1.9 TDI (81 kW)	1997.08-2004.05	AT	L	F	Hatchback Engine AHF	261020	Drive Shaft		36		53.2	77.5	547	
	1997.08-2004.05	MT	L	F	Hatchback Engine AHF	203006	Drive Shaft		36		53.2	77.5	557	
	1997.08-2004.05	MT	R	F	Hatchback Engine AHF	203004	Drive Shaft		36		53.2	77.5	822	
	1997.08-2004.05	MT	L	F	Hatchback Engine AHF	261021	Drive Shaft		36		53.2	77.5	564.5	
	1997.08-2004.05	AT	L/R	F	Hatchback Engine AHF	661006	Inner Joint			30		57.6		

	 YEAR	TRANSM	L/R	F/R	REMARKS	GSP Ref.	 PRODUCT	 ABS	Technical Specifications						
									A	B	C	H	L	P	
VW															
GOLF IV (1J1)															
1.9 TDI (81 kW)	1997.08-2004.05	MT	R	F	Hatchback Engine AHF	603009	Inner Joint			33		34			
	1997.08-2004.05	AT/MT	L/R	F	Hatchback Engine AHF	803036	Outer Joint	36	30	53.2	77.5	61	I		
1.9 TDI (85 kW)	1998.12-2001.06	AT	R	F	Hatchback Engine AUJ	261243	Drive Shaft	36		53	77.5	813			
	1998.12-2001.06	AT	L	F	Hatchback Engine AUJ	261244	Drive Shaft	36		53	77.5	523			
	1998.12-2001.06	6MT	R	F	Hatchback Engine AUJ	299114	Drive Shaft	36		53	77.5	809			
	1998.12-2001.06	MT	R	F	Hatchback Engine AUJ	261121	Drive Shaft	36		53	77.5	806			
	1998.12-2001.06	5AT	L	F	Hatchback Engine AUJ	261021	Drive Shaft	36		53.2	77.5	564.5			
	1998.12-2001.06	AT/MT	L/R	F	Hatchback Engine AUJ	803035	Outer Joint	36	27	53	77.5	65	I		
	1998.12-2001.06	MT	L	F	Hatchback Engine AUJ	261123	Drive Shaft	36		53	77.5	520			
	1998.12-2001.06	AT	L	F	Hatchback Engine AUJ	203374	Drive Shaft	36		53	77.5	521			
1.9 TDI (96 kW)	2000.11-2005.06	AT	R	F	Hatchback Engine ASZ	261243	Drive Shaft	36		53	77.5	813			
	2000.11-2005.06	AT	L	F	Hatchback Engine ASZ	261244	Drive Shaft	36		53	77.5	523			
	2000.11-2005.06	-	-	-	Hatchback Engine ASZ	603016	Inner Joint		28		32				
	2000.11-2005.06	MT	R	F	Hatchback Engine ASZ	299114	Drive Shaft	36		53	77.5	809			
	2000.11-2005.06	MT	R	F	Hatchback Engine ASZ	261121	Drive Shaft	36		53	77.5	806			
	2000.11-2005.06	AT	L	F	Hatchback Engine ASZ	203374	Drive Shaft	36		53	77.5	521			
	2000.11-2005.06	AT/MT	L/R	F	Hatchback Engine ASZ	803035	Outer Joint	36	27	53	77.5	65	I		
	2000.11-2005.06	MT	L	F	Hatchback Engine ASZ	261123	Drive Shaft	36		53	77.5	520			
1.9 TDI 4motion (110 kW)	2000.02-2005.06	MT	-	-	All-wheel Drive Hatchback Engine ARL	603016	Inner Joint		28		32				
	2000.02-2005.06	-	R	F	All-wheel Drive Hatchback Engine ARL	261186	Drive Shaft	36		53	77.5	653			
	2000.02-2005.06	-	L/R	R	All-wheel Drive Hatchback Engine ARL	803033	Outer Joint	36	30	53	78.5	51	I		
	2000.02-2005.06	-	L/R	R	All-wheel Drive Hatchback Engine ARL	603011	Inner Joint		33		34				
	2000.02-2005.06	MT	-	-	All-wheel Drive Hatchback Engine ARL	603006	Inner Joint		33		34				
	2000.02-2005.06	MT	L/R	F	All-wheel Drive Hatchback Engine ARL	803035	Outer Joint	36	27	53	77.5	65	I		
	2000.02-2005.06	-	L	F	All-wheel Drive Hatchback Engine ARL	261123	Drive Shaft	36		53	77.5	520			
1.9 TDI 4motion (66 kW)	1998.07-2002.04	-	L/R	F/R	All-wheel Drive Hatchback Engine AGR	603011	Inner Joint		33		34				
	1998.07-2002.04	-	L	F	All-wheel Drive Hatchback Engine AGR	261314	Drive Shaft	36		53	78	558			
	1998.07-2002.04	-	L/R	R	All-wheel Drive Hatchback Engine AGR	803033	Outer Joint	36	30	53	78.5	51	I		
	1998.07-2002.04	-	R	F	All-wheel Drive Hatchback Engine AGR	603009	Inner Joint		33		34				
	1998.07-2002.04	MT	L/R	F	All-wheel Drive Hatchback Engine AGR	803036	Outer Joint	36	30	53.2	77.5	61	I		
1.9 TDI 4motion (74 kW)	2000.09-2005.06	MT	L	F	All-wheel Drive Hatchback Engine ATD	261123	Drive Shaft	36		53	77.5	520			
	2000.09-2005.06	MT	L/R	F	All-wheel Drive Hatchback Engine ATD	803035	Outer Joint	36	27	53	77.5	65	I		
	2000.09-2005.06	-	-	-	All-wheel Drive Hatchback Engine ATD	603016	Inner Joint		28		32				
	2000.09-2005.06	-	L/R	R	All-wheel Drive Hatchback Engine ATD	603011	Inner Joint		33		34				
	2000.09-2005.06	MT	R	F	All-wheel Drive Hatchback Engine ATD	261186	Drive Shaft	36		53	77.5	653			
	2000.09-2005.06	-	L/R	R	All-wheel Drive Hatchback Engine ATD	803033	Outer Joint	36	30	53	78.5	51	I		
1.9 TDI 4motion (85 kW)	1999.09-2001.06	-	R	F	All-wheel Drive Hatchback Engine AJM	261186	Drive Shaft	36		53	77.5	653			
	1999.09-2001.06	-	L/R	R	All-wheel Drive Hatchback Engine AJM	803033	Outer Joint	36	30	53	78.5	51	I		
	1999.09-2001.06	-	L/R	R	All-wheel Drive Hatchback Engine AJM	603011	Inner Joint		33		34				
	1999.09-2001.06	MT	L/R	F	All-wheel Drive Hatchback Engine AJM	803035	Outer Joint	36	27	53	77.5	65	I		
	1999.09-2001.06	-	L	F	All-wheel Drive Hatchback Engine AJM	261123	Drive Shaft	36		53	77.5	520			
1.9 TDI 4motion (96 kW)	2000.11-2005.06	-	-	-	All-wheel Drive Hatchback Engine ASZ	603016	Inner Joint		28		32				
	2000.11-2005.06	-	R	F	All-wheel Drive Hatchback Engine ASZ	261186	Drive Shaft	36		53	77.5	653			
	2000.11-2005.06	-	L/R	R	All-wheel Drive Hatchback Engine ASZ	803033	Outer Joint	36	30	53	78.5	51	I		
	2000.11-2005.06	-	L/R	R	All-wheel Drive Hatchback Engine ASZ	603011	Inner Joint		33		34				
	2000.11-2005.06	MT	L/R	F	All-wheel Drive Hatchback Engine ASZ	803035	Outer Joint	36	27	53	77.5	65	I		
	2000.11-2005.06	-	L	F	All-wheel Drive Hatchback Engine ASZ	261123	Drive Shaft	36		53	77.5	520			
2.0 (85 kW)	1998.07-2004.05	AT/MT	L/R	F	Hatchback Engine BER	803036	Outer Joint	36	30	53.2	77.5	61	I		
	1998.07-2004.05	-	L	F	Hatchback Engine BER	603011	Inner Joint		33		34				
	1998.07-2004.05	AT	L	F	Hatchback Engine BER	261020	Drive Shaft	36		53.2	77.5	547			
	1998.07-2004.05	MT	L	F	Hatchback Engine BER	261314	Drive Shaft	36		53	78	558			
	1998.07-2004.05	AT	L	F	Hatchback Engine BER	261156	Drive Shaft	36		53	78	554.5			
	1998.07-2004.05	AT	L	F	Hatchback Engine BER	661062	Inner Joint		30		59				
	1998.07-2004.05	MT	R	F	Hatchback Engine BER	203004	Drive Shaft	36		53.2	77.5	822			
	1998.07-2004.05	MT	L	F	Hatchback Engine BER	261021	Drive Shaft	36		53.2	77.5	564.5			
	1998.07-2004.05	AT	L/R	F	Hatchback Engine BER	661006	Inner Joint		30		57.6				
	1998.07-2004.05	MT	R	F	Hatchback Engine BER	603009	Inner Joint		33		34				
2.0 4motion (85 kW)	2000.10-2005.06	MT	L/R	F	All-wheel Drive Hatchback Engine AZJ	803036	Outer Joint	36	30	53.2	77.5	61	I		
	2000.10-2005.06	-	L/R	F/R	All-wheel Drive Hatchback Engine AZJ	603011	Inner Joint		33		34				
	2000.10-2005.06	-	L	F	All-wheel Drive Hatchback Engine AZJ	261314	Drive Shaft	36		53	78	558			
	2000.10-2005.06	-	L	F	All-wheel Drive Hatchback Engine AZJ	261021	Drive Shaft	36		53.2	77.5	564.5			
	2000.10-2005.06	-	L/R	R	All-wheel Drive Hatchback Engine AZJ	803033	Outer Joint	36	30	53	78.5	51	I		
	2000.10-2005.06	-	R	F	All-wheel Drive Hatchback Engine AZJ	603009	Inner Joint		33		34				
2.3 V5 (110 kW)	1997.08-2000.10	AT/MT	L	F	Hatchback Engine AGZ	261020	Drive Shaft	36		53.2	77.5	547			
	1997.08-2000.10	-	L/R	F	Hatchback Engine AGZ	803036	Outer Joint	36	30	53.2	77.5	61	I		
	1997.08-2000.10	5MT	R	F	Hatchback Engine AGZ	203011	Drive Shaft	36		53.2	77.5	810.5			





	 YEAR	TRANSM	L/R	F/R	REMARKS	GSP Ref.	 PRODUCT	 ABS	Technical Specifications								
									A	B	C	H	L	P			
VW																	
GOLF IV (1J1)																	
2.3 V5 (110 kW)	1997.08-2000.10	AT/MT	L	F	Hatchback Engine AGZ	261156	Drive Shaft		36		53	78	554.5				
	1997.08-2000.10	5MT	L	F	Hatchback Engine AGZ	261312	Drive Shaft		36		53	78	546				
	1997.08-2000.10	AT/MT	L	F	Hatchback Engine AGZ	661062	Inner Joint			30		59					
	1997.08-2000.10	MT	L	F	Hatchback Engine AGZ	261202	Drive Shaft		36		53.2	77.5	547				
	1997.08-2000.10	MT	R	F	Hatchback Engine AGZ	261203	Drive Shaft		36		53.2	77.5	810				
	1997.08-2000.10	-	L/R	F	Hatchback Engine AGZ	661006	Inner Joint			30		57.6					
	1997.08-2000.10	AT/MT	L/R	F	Hatchback Engine AGZ	661005	Inner Joint			30		57.6					
2.3 V5 (125 kW)	2000.10-2005.06	AT	L/R	F	Hatchback Engine AQN	803035	Outer Joint		36	27	53	77.5	65	I			
	2000.10-2005.06	5AT	R	F	Hatchback Engine AQN	261243	Drive Shaft		36		53	77.5	813				
	2000.10-2005.06	MT	L	F	Hatchback Engine AQN	261020	Drive Shaft		36		53.2	77.5	547				
	2000.10-2005.06	AT	L	F	Hatchback Engine AQN	261244	Drive Shaft		36		53	77.5	523				
	2000.10-2005.06	-	-	-	Hatchback Engine AQN	603016	Inner Joint			28		32					
	2000.10-2005.06	MT	L	F	Hatchback Engine AQN	261156	Drive Shaft		36		53	78	554.5				
	2000.10-2005.06	MT	L/R	F	Hatchback Engine AQN	661006	Inner Joint			30		57.6					
	2000.10-2005.06	MT	L	F	Hatchback Engine AQN	661062	Inner Joint			30		59					
	2000.10-2005.06	MT	L/R	F	Hatchback Engine AQN	803036	Outer Joint		36	30	53.2	77.5	61	I			
	2000.10-2005.06	AT	L	F	Hatchback Engine AQN	203374	Drive Shaft		36		53	77.5	521				
2.3 V5 4motion (110 kW)	1998.12-2000.10	-	L	F	All-wheel Drive Hatchback Engine AGZ	261123	Drive Shaft		36		53	77.5	520				
	1998.12-2000.10	MT	L/R	F	All-wheel Drive Hatchback Engine AGZ	803035	Outer Joint		36	27	53	77.5	65	I			
	1998.12-2000.10	-	L/R	R	All-wheel Drive Hatchback Engine AGZ	603011	Inner Joint			33		34					
	1998.12-2000.10	AT/MT	L	F	All-wheel Drive Hatchback Engine AGZ	261020	Drive Shaft		36		53.2	77.5	547				
	1998.12-2000.10	-	R	F	All-wheel Drive Hatchback Engine AGZ	261186	Drive Shaft		36		53	77.5	653				
2.3 V5 4motion (125 kW)	1998.12-2000.10	-	L/R	R	All-wheel Drive Hatchback Engine AGZ	803033	Outer Joint		36	30	53	78.5	51	I			
	2000.10-2005.06	-	L	F	All-wheel Drive Hatchback Engine AQN	261123	Drive Shaft		36		53	77.5	520				
	2000.10-2005.06	MT	L/R	F	All-wheel Drive Hatchback Engine AQN	803035	Outer Joint		36	27	53	77.5	65	I			
	2000.10-2005.06	-	-	-	All-wheel Drive Hatchback Engine AQN	603016	Inner Joint			28		32					
	2000.10-2005.06	-	R	F	All-wheel Drive Hatchback Engine AQN	261186	Drive Shaft		36		53	77.5	653				
	2000.10-2005.06	-	L/R	R	All-wheel Drive Hatchback Engine AQN	603011	Inner Joint			33		34					
	2000.10-2005.06	-	L/R	R	All-wheel Drive Hatchback Engine AQN	803033	Outer Joint		36	30	53	78.5	51	I			
2.8 V6 4motion (150 kW)	1999.03-2005.06	-	L	F	All-wheel Drive Hatchback Engine AUE	261123	Drive Shaft		36		53	77.5	520				
	1999.03-2005.06	-	-	-	All-wheel Drive Hatchback Engine AUE	603016	Inner Joint			28		32					
	1999.03-2005.06	-	L/R	R	All-wheel Drive Hatchback Engine AUE	603011	Inner Joint			33		34					
	1999.03-2005.06	-	L/R	F	All-wheel Drive Hatchback Engine AUE	803035	Outer Joint		36	27	53	77.5	65	I			
	1999.03-2005.06	-	R	F	All-wheel Drive Hatchback Engine AUE	261186	Drive Shaft		36		53	77.5	653				
3.2 R32 4motion (177 kW)	1999.03-2005.06	-	L/R	R	All-wheel Drive Hatchback Engine AUE	803033	Outer Joint		36	30	53	78.5	51	I			
	2002.09-2005.06	-	L/R	R	All-wheel Drive Hatchback Engine BFH	603011	Inner Joint			33		34					
	2002.09-2005.06	MT	L/R	F	All-wheel Drive Hatchback Engine BFH	861021	Outer Joint		36	27	53	40	65	I			
2002.09-2005.06	-	L/R	R	All-wheel Drive Hatchback Engine BFH	803033	Outer Joint		36	30	53	78.5	51	I				
GOLF IV Cabriolet (1E7)																	
1.6 (74 kW)	1998.06-2002.06	-	L/R	F	Convertible Engine AFT/AKS	603004	Inner Joint			33		32					
	1998.06-2002.06	MT	-	F	Convertible Engine AFT/AKS	853006	Outer Joint		22	30	50	78.5	52	I			
	1998.06-2002.06	AT	L	F	Convertible Engine AFT/AKS	261011	Drive Shaft		22		53.2	78	547				
	1998.06-2002.06	AT	-	F	Convertible Engine AFT/AKS	853004	Outer Joint		22	30	51	78	61	I			
	1998.06-2002.06	5MT	L	F	Convertible Engine AFT/AKS	253004	Drive Shaft		22		50	78.5	562				
	1998.06-2002.06	-	L/R	F	Convertible Engine AFT/AKS	853008	Outer Joint		22	30	53	78.5	51	I			
	1998.06-2002.06	MT	L	F	Convertible Engine AFT/AKS	603011	Inner Joint			33		34					
1.8 (55 kW)	1998.06-2002.06	-	L/R	F	Convertible Engine AAM/ANN	853007	Outer Joint		22	30	53.2	78	61	I			
	1998.06-2002.06	MT	R	F	Convertible Engine AAM/ANN	603009	Inner Joint			33		34					
	1998.06-2002.06	MT	R	F	Convertible Engine AAM/ANN	261012	Drive Shaft		22		50	78	792				
	1998.06-2002.06	AT/MT	-	F	Convertible Engine AAM/ANN	853004	Outer Joint		22	30	51	78	61	I			
	1998.06-2002.06	-	L	F	Convertible Engine AAM/ANN	261001	Drive Shaft		22		53.2	78	557				
	1998.06-2002.06	MT	-	-	Convertible Engine AAM/ANN	603006	Inner Joint			33		34					
	1998.06-2002.06	-	R	F	Convertible Engine AAM/ANN	261002	Drive Shaft		22		53	78.5	793				
	1998.06-2002.06	-	L/R	F	Convertible Engine AAM/ANN	861018	Outer Joint		22	30	53	78.5	61	I			
	1998.06-2002.06	MT	L	F	Convertible Engine ANP	603011	Inner Joint			33		34					
	1998.06-2002.06	-	L/R	F	Convertible Engine ANP	853007	Outer Joint		22	30	53.2	78	61	I			
1.8 (66 kW)	1998.06-2002.06	MT	R	F	Convertible Engine ANP	603009	Inner Joint			33		34					
	1998.06-2002.06	MT	R	F	Convertible Engine ANP	261012	Drive Shaft		22		50	78	792				
	1998.06-2002.06	AT	L	F	Convertible Engine ANP	261011	Drive Shaft		22		53.2	78	547				
	1998.06-2002.06	AT/MT	-	F	Convertible Engine ANP	853004	Outer Joint		22	30	51	78	61	I			
	1998.06-2002.06	-	L	F	Convertible Engine ANP	261001	Drive Shaft		22		53.2	78	557				
	1998.06-2002.06	-	R	F	Convertible Engine ANP	261002	Drive Shaft		22		53	78.5	793				
	1998.06-2002.06	-	L/R	F	Convertible Engine ANP	861018	Outer Joint		22	30	53	78.5	61	I			
	1998.06-2002.06	-	L	F	Convertible Engine AHU	603011	Inner Joint			33		34					
	1998.06-2002.06	MT	L/R	F	Convertible Engine AHU	853007	Outer Joint		22	30	53.2	78	61	I			
	1998.06-2002.06	-	L	F	Convertible Engine AHU	261001	Drive Shaft		22		53.2	78	557				

YEAR	TRANS	L/R	F/R	REMARKS	GSP Ref.	PRODUCT	ABS	Technical Specifications					
								A	B	C	H	L	P
VW													
GOLF IV Cabriolet (1E7)													
1.9 TDI (66 kW)	1998.06-2002.06	-	R	F	Convertible Engine AHU	261002	Drive Shaft	22		53	78.5	793	
	1998.06-2002.06	-	L	F	Convertible Engine AHU	261021	Drive Shaft	36		53.2	77.5	564.5	
	1998.06-2002.06	-	R	F	Convertible Engine AHU	603009	Inner Joint		33		34		
	1998.06-2002.06	MT	L/R	F	Convertible Engine AHU	861018	Outer Joint	22	30	53	78.5	61	I
1.9 TDI (81 kW)	1998.06-2002.06	-	L/R	F	Convertible Engine AFN/AVG	861018	Outer Joint	22	30	53	78.5	61	I
	1998.06-2002.06	-	L	F	Convertible Engine AFN/AVG	603011	Inner Joint		33		34		
	1998.06-2002.06	-	L/R	F	Convertible Engine AFN/AVG	853007	Outer Joint	22	30	53.2	78	61	I
	1998.06-2002.06	-	L	F	Convertible Engine AFN/AVG	261001	Drive Shaft	22		53.2	78	557	
	1998.06-2002.06	-	R	F	Convertible Engine AFN/AVG	261002	Drive Shaft	22		53	78.5	793	
	1998.06-2002.06	-	L	F	Convertible Engine AFN/AVG	261021	Drive Shaft	36		53.2	77.5	564.5	
	1998.06-2002.06	-	R	F	Convertible Engine AFN/AVG	603009	Inner Joint		33		34		
2.0 (85 kW)	1998.06-2002.06	MT	R	F	Convertible Engine AGG	261012	Drive Shaft	22		50	78	792	
	1998.06-2002.06	-	L/R	F	Convertible Engine AGG	853007	Outer Joint	22	30	53.2	78	61	I
	1998.06-2002.06	AT	L	F	Convertible Engine AGG	261011	Drive Shaft	22		53.2	78	547	
	1998.06-2002.06	4AT	R	F	Convertible Engine AGG	261028	Drive Shaft	22		53.2	78	767	
	1998.06-2002.06	AT	-	F	Convertible Engine AGG	853004	Outer Joint	22	30	51	78	61	I
	1998.06-2002.06	5MT	L	F	Convertible Engine AGG	261001	Drive Shaft	22		53.2	78	557	
	1998.06-2002.06	5MT	R	F	Convertible Engine AGG	261002	Drive Shaft	22		53	78.5	793	
	1998.06-2002.06	MT	L	F	Convertible Engine AGG	603009	Inner Joint		33		34		
	1998.06-2002.06	MT	R	F	Convertible Engine AGG	603011	Inner Joint		33		34		
	1998.06-2002.06	-	L/R	F	Convertible Engine AGG	861018	Outer Joint	22	30	53	78.5	61	I
GOLF IV Variant (1J5)													
1.4 16V (55 kW)	1999.05-2006.06	AT	L/R	F	Estate Engine AHW/AKQ/APE	803036	Outer Joint	36	30	53.2	77.5	61	I
	1999.05-2006.06	MT	L	F	Estate Engine AHW/AKQ/APE	261045	Drive Shaft	36		53	78.5	555	
	1999.05-2006.06	MT	L/R	F	Estate Engine AHW/AKQ/APE	603004	Inner Joint		33		32		
	1999.05-2006.06	MT	R	F	Estate Engine AHW/AKQ/APE	203046	Drive Shaft	36		53	78.5	822	
	1999.05-2006.06	MT	-	-	Estate Engine AHW/AKQ/APE	603006	Inner Joint		33		34		
	1999.05-2006.06	MT	L/R	F	Estate Engine AHW/AKQ/APE	803033	Outer Joint	36	30	53	78.5	51	I
	1999.05-2006.06	MT	L/R	F	Estate Engine AHW/AKQ/APE	603008	Inner Joint		33		32		
1.6 (74 kW)	1999.05-2002.04	AT	L/R	F	Estate Engine AEH/AKL/APF	803036	Outer Joint	36	30	53.2	77.5	61	I
	1999.05-2002.04	AT	L	F	Estate Engine AEH/AKL/APF	261020	Drive Shaft	36		53.2	77.5	547	
	1999.05-2002.04	MT	L	F	Estate Engine AEH/AKL/APF	261045	Drive Shaft	36		53	78.5	555	
	1999.05-2002.04	AT	L	F	Estate Engine AEH/AKL/APF	261156	Drive Shaft	36		53	78	554.5	
	1999.05-2002.04	AT	L	F	Estate Engine AEH/AKL/APF	661062	Inner Joint		30		59		
	1999.05-2002.04	MT	L/R	F	Estate Engine AEH/AKL/APF	803033	Outer Joint	36	30	53	78.5	51	I
	1999.05-2002.04	AT	L/R	F	Estate Engine AEH/AKL/APF	661006	Inner Joint		30		57.6		
	1999.05-2002.04	MT	L/R	F	Estate Engine AEH/AKL/APF	603008	Inner Joint		33		32		
1.6 (75 kW)	2000.08-2006.06	AT	L/R	F	Estate Engine AVU/BFQ	803036	Outer Joint	36	30	53.2	77.5	61	I
	2000.08-2006.06	AT	L	F	Estate Engine AVU/BFQ	261020	Drive Shaft	36		53.2	77.5	547	
	2000.08-2006.06	MT	L	F	Estate Engine AVU/BFQ	261045	Drive Shaft	36		53	78.5	555	
	2000.08-2006.06	AT	L	F	Estate Engine AVU/BFQ	261156	Drive Shaft	36		53	78	554.5	
	2000.08-2006.06	MT	L/R	F	Estate Engine AVU/BFQ	803033	Outer Joint	36	30	53	78.5	51	I
	2000.08-2006.06	AT	L/R	F	Estate Engine AVU/BFQ	661006	Inner Joint		30		57.6		
	2000.08-2006.06	AT	L	F	Estate Engine AVU/BFQ	661062	Inner Joint		30		59		
	2000.08-2006.06	MT	L/R	F	Estate Engine AVU/BFQ	603008	Inner Joint		33		32		
1.6 16V (77 kW)	2000.02-2006.06	AT/MT	L/R	F	Estate Engine ATN/AUS/AZD/BCB	803036	Outer Joint	36	30	53.2	77.5	61	I
	2000.02-2006.06	AT	L	F	Estate Engine ATN/AUS/AZD/BCB	261202	Drive Shaft	36		53.2	77.5	547	
	2000.02-2006.06	MT	-	-	Estate Engine ATN/AUS/AZD/BCB	603006	Inner Joint		33		34		
	2000.02-2006.06	MT	L	F	Estate Engine ATN/AUS/AZD/BCB	261021	Drive Shaft	36		53.2	77.5	564.5	
	2000.02-2006.06	AT	R	F	Estate Engine ATN/AUS/AZD/BCB	261203	Drive Shaft	36		53.2	77.5	810	
	2000.02-2006.06	MT	L/R	F	Estate Engine ATN/AUS/AZD/BCB	661005	Inner Joint		30		57.6		
1.6 FSI (81 kW)	2002.01-2006.06	MT	L/R	F	Estate Engine BAD	803036	Outer Joint	36	30	53.2	77.5	61	I
	2002.01-2006.06	MT	-	-	Estate Engine BAD	603006	Inner Joint		33		34		
	2002.01-2006.06	MT	L/R	F	Estate Engine BAD	661005	Inner Joint		30		57.6		
1.8 4motion (92 kW)	1999.05-2006.06	-	L/R/F/R		All-wheel Drive Estate Engine AGN	603011	Inner Joint		33		34		
	1999.05-2006.06	-	R	F	All-wheel Drive Estate Engine AGN	603009	Inner Joint		33		34		
	1999.05-2006.06	-	L	F	All-wheel Drive Estate Engine AGN	261314	Drive Shaft	36		53	78	558	
	1999.05-2006.06	-	L/R	R	All-wheel Drive Estate Engine AGN	803033	Outer Joint	36	30	53	78.5	51	I
	1999.05-2006.06	-	L/R	F	All-wheel Drive Estate Engine AGN	803036	Outer Joint	36	30	53.2	77.5	61	I
1.8 T (110 kW)	2000.05-2006.06	AT	R	F	Estate Engine ARZ	261243	Drive Shaft	36		53	77.5	813	
	2000.05-2006.06	-	L	F	Estate Engine ARZ	261020	Drive Shaft	36		53.2	77.5	547	
	2000.05-2006.06	AT/MT	L	F	Estate Engine ARZ	261156	Drive Shaft	36		53	78	554.5	
	2000.05-2006.06	5AT/MT	L/R	F	Estate Engine ARZ	661006	Inner Joint		30		57.6		
	2000.05-2006.06	AT/MT	L	F	Estate Engine ARZ	661062	Inner Joint		30		59		
	2000.05-2006.06	AT/MT	L/R	F	Estate Engine ARZ	803036	Outer Joint	36	30	53.2	77.5	61	I
	2000.05-2006.06	5AT	L/R	F	Estate Engine ARZ	803035	Outer Joint	36	27	53	77.5	65	I

	 YEAR	TRANSM	L/R	F/R	REMARKS	GSP Ref.	 PRODUCT	 ABS	Technical Specifications					
									A	B	C	H	L	P
VW														
GOLF IV Variant (1J5)														
1.8 T (110 kW)	2000.05-2006.06	AT	L	F	Estate Engine ARZ	203374	Drive Shaft		36		53	77.5	521	
1.9 SDI (50 kW)	1999.05-2006.06	AT	L/R	F	Estate Engine AGP	803036	Outer Joint		36	30	53.2	77.5	61	I
	1999.05-2006.06	-	L	F	Estate Engine AGP	261045	Drive Shaft		36		53	78.5	555	
	1999.05-2006.06	MT	L/R	F	Estate Engine AGP	603004	Inner Joint			33		32		
	1999.05-2006.06	-	R	F	Estate Engine AGP	203046	Drive Shaft		36		53	78.5	822	
	1999.05-2006.06	MT	-	-	Estate Engine AGP	603006	Inner Joint			33		34		
	1999.05-2006.06	MT	L/R	F	Estate Engine AGP	803033	Outer Joint		36	30	53	78.5	51	I
	1999.05-2006.06	-	L/R	F	Estate Engine AGP	603008	Inner Joint			33		32		
1.9 TDI (110 kW)	2001.06-2006.06	MT	-	-	Estate Engine ARL	603006	Inner Joint			33		34		
	2001.06-2006.06	MT	-	-	Estate Engine ARL	603016	Inner Joint			28		32		
	2001.06-2006.06	MT	R	F	Estate Engine ARL	299114	Drive Shaft		36		53	77.5	809	
	2001.06-2006.06	-	R	F	Estate Engine ARL	261121	Drive Shaft		36		53	77.5	806	
	2001.06-2006.06	-	L	F	Estate Engine ARL	261123	Drive Shaft		36		53	77.5	520	
	2001.06-2006.06	-	L/R	F	Estate Engine ARL	803035	Outer Joint		36	27	53	77.5	65	I
1.9 TDI (66 kW)	1999.05-2006.05	AT/MT	L/R	F	Estate Engine AGR	803036	Outer Joint		36	30	53.2	77.5	61	I
	1999.05-2006.05	MT	L	F	Estate Engine AGR	203006	Drive Shaft		36		53.2	77.5	557	
	1999.05-2006.05	MT	R	F	Estate Engine AGR	203004	Drive Shaft		36		53.2	77.5	822	
	1999.05-2006.05	MT	L	F	Estate Engine AGR	261021	Drive Shaft		36		53.2	77.5	564.5	
	1999.05-2006.05	AT	L/R	F	Estate Engine AGR	661006	Inner Joint			30		57.6		
	1999.05-2006.05	MT	R	F	Estate Engine AGR	603009	Inner Joint			33		34		
1.9 TDI (74 kW)	2000.09-2006.06	AT	L/R	F	Estate Engine ATD	803035	Outer Joint		36	27	53	77.5	65	I
	2000.09-2006.06	MT	L/R	F	Estate Engine ATD	803036	Outer Joint		36	30	53.2	77.5	61	I
	2000.09-2006.06	AT	L	F	Estate Engine ATD	261244	Drive Shaft		36		53	77.5	523	
	2000.09-2006.06	-	-	-	Estate Engine ATD	603016	Inner Joint			28		32		
	2000.09-2006.06	MT	L	F	Estate Engine ATD	603011	Inner Joint			33		34		
	2000.09-2006.06	MT	L	F	Estate Engine ATD	203006	Drive Shaft		36		53.2	77.5	557	
	2000.09-2006.06	MT	R	F	Estate Engine ATD	203004	Drive Shaft		36		53.2	77.5	822	
	2000.09-2006.06	MT	L	F	Estate Engine ATD	261021	Drive Shaft		36		53.2	77.5	564.5	
1.9 TDI (81 kW)	1999.05-2001.06	AT	L	F	Estate Engine ASV	261020	Drive Shaft		36		53.2	77.5	547	
	1999.05-2001.06	MT	L	F	Estate Engine ASV	203006	Drive Shaft		36		53.2	77.5	557	
	1999.05-2001.06	AT/MT	L/R	F	Estate Engine ASV	803036	Outer Joint		36	30	53.2	77.5	61	I
	1999.05-2001.06	MT	R	F	Estate Engine ASV	203004	Drive Shaft		36		53.2	77.5	822	
	1999.05-2001.06	MT	L	F	Estate Engine ASV	261021	Drive Shaft		36		53.2	77.5	564.5	
	1999.05-2001.06	AT	L/R	F	Estate Engine ASV	661006	Inner Joint			30		57.6		
	1999.05-2001.06	MT	R	F	Estate Engine ASV	603009	Inner Joint			33		34		
1.9 TDI (85 kW)	1999.08-2001.06	AT	R	F	Estate Engine AJM	261243	Drive Shaft		36		53	77.5	813	
	1999.08-2001.06	MT	L/R	F	Estate Engine AJM	803035	Outer Joint		36	27	53	77.5	65	I
	1999.08-2001.06	AT	L	F	Estate Engine AJM	261244	Drive Shaft		36		53	77.5	523	
	1999.08-2001.06	MT	L	F	Estate Engine AJM	261123	Drive Shaft		36		53	77.5	520	
	1999.08-2001.06	6MT	R	F	Estate Engine AJM	299114	Drive Shaft		36		53	77.5	809	
	1999.08-2001.06	MT	R	F	Estate Engine AJM	261121	Drive Shaft		36		53	77.5	806	
	1999.08-2001.06	AT	L	F	Estate Engine AJM	203374	Drive Shaft		36		53	77.5	521	
1.9 TDI (96 kW)	2000.11-2006.06	AT	R	F	Estate Engine ASZ	261243	Drive Shaft		36		53	77.5	813	
	2000.11-2006.06	AT	L	F	Estate Engine ASZ	261244	Drive Shaft		36		53	77.5	523	
	2000.11-2006.06	-	-	-	Estate Engine ASZ	603016	Inner Joint			28		32		
	2000.11-2006.06	MT	R	F	Estate Engine ASZ	299114	Drive Shaft		36		53	77.5	809	
	2000.11-2006.06	MT	R	F	Estate Engine ASZ	261121	Drive Shaft		36		53	77.5	806	
	2000.11-2006.06	AT	L	F	Estate Engine ASZ	203374	Drive Shaft		36		53	77.5	521	
	2000.11-2006.06	AT/MT	L/R	F	Estate Engine ASZ	803035	Outer Joint		36	27	53	77.5	65	I
	2000.11-2006.06	MT	L	F	Estate Engine ASZ	261123	Drive Shaft		36		53	77.5	520	
1.9 TDI 4motion (110 kW)	2002.05-2005.06	MT	L/R	F	All-wheel Drive Estate Engine ARL	803035	Outer Joint		36	27	53	77.5	65	I
	2002.05-2005.06	MT	-	-	All-wheel Drive Estate Engine ARL	603016	Inner Joint			28		32		
	2002.05-2005.06	MT	R	F	All-wheel Drive Estate Engine ARL	261186	Drive Shaft		36		53	77.5	653	
	2002.05-2005.06	-	R	F	All-wheel Drive Estate Engine ARL	299114	Drive Shaft		36		53	77.5	809	
	2002.05-2005.06	MT	L/R	R	All-wheel Drive Estate Engine ARL	603011	Inner Joint			33		34		
	2002.05-2005.06	MT	-	-	All-wheel Drive Estate Engine ARL	603006	Inner Joint			33		34		
	2002.05-2005.06	MT	L/R	R	All-wheel Drive Estate Engine ARL	803033	Outer Joint		36	30	53	78.5	51	I
	2002.05-2005.06	MT	L	F	All-wheel Drive Estate Engine ARL	261123	Drive Shaft		36		53	77.5	520	
1.9 TDI 4motion (66 kW)	1999.05-2002.04	MT	L/R	F	All-wheel Drive Estate Engine AGR	803036	Outer Joint		36	30	53.2	77.5	61	I
	1999.05-2002.04	-	L/R/F/R	-	All-wheel Drive Estate Engine AGR	603011	Inner Joint			33		34		
	1999.05-2002.04	-	L	F	All-wheel Drive Estate Engine AGR	261314	Drive Shaft		36		53	78	558	
	1999.05-2002.04	-	L/R	R	All-wheel Drive Estate Engine AGR	803033	Outer Joint		36	30	53	78.5	51	I
	1999.05-2002.04	-	R	F	All-wheel Drive Estate Engine AGR	603009	Inner Joint			33		34		
1.9 TDI 4motion (74 kW)	2000.09-2006.06	MT	L/R	F	All-wheel Drive Estate Engine ATD	803035	Outer Joint		36	27	53	77.5	65	I
	2000.09-2006.06	MT	L	F	All-wheel Drive Estate Engine ATD	261123	Drive Shaft		36		53	77.5	520	

				TRANSM		L/R F/R		REMARKS		GSP Ref.				ABS		Technical Specifications					
YEAR																A	B	C	H	L	P
VW																					
GOLF IV Variant (1J5)																					
1.9 TDI 4motion (74 kW)		2000.09-2006.06	-	L/R	R	All-wheel Drive Estate Engine ATD		603011	Inner Joint					33		34					
		2000.09-2006.06	AT	L	F	All-wheel Drive Estate Engine ATD		261244	Drive Shaft		36		53	77.5	523						
		2000.09-2006.06	-	-	-	All-wheel Drive Estate Engine ATD		603016	Inner Joint			28		32							
		2000.09-2006.06	6MT	R	F	All-wheel Drive Estate Engine ATD		261186	Drive Shaft		36		53	77.5	653						
		2000.09-2006.06	-	L/R	R	All-wheel Drive Estate Engine ATD		803033	Outer Joint		36	30	53	78.5	51	I					
		2000.09-2006.06	MT	L	F	All-wheel Drive Estate Engine ATD		261021	Drive Shaft		36		53.2	77.5	564.5						
1.9 TDI 4motion (85 kW)		1999.05-2001.06	-	R	F	All-wheel Drive Estate Engine AJM		261186	Drive Shaft		36		53	77.5	653						
		1999.05-2001.06	-	L/R	R	All-wheel Drive Estate Engine AJM		803033	Outer Joint		36	30	53	78.5	51	I					
		1999.05-2001.06	-	L/R	R	All-wheel Drive Estate Engine AJM		603011	Inner Joint				33		34						
		1999.05-2001.06	MT	-	-	All-wheel Drive Estate Engine AJM		603006	Inner Joint				33		34						
		1999.05-2001.06	MT	L/R	F	All-wheel Drive Estate Engine AJM		803035	Outer Joint		36	27	53	77.5	65	I					
		1999.05-2001.06	-	L	F	All-wheel Drive Estate Engine AJM		261123	Drive Shaft		36		53	77.5	520						
1.9 TDI 4motion (96 kW)		2000.11-2006.06	AT	R	F	All-wheel Drive Estate Engine ASZ		261243	Drive Shaft		36		53	77.5	813						
		2000.11-2006.06	AT	L	F	All-wheel Drive Estate Engine ASZ		261244	Drive Shaft		36		53	77.5	523						
		2000.11-2006.06	-	-	-	All-wheel Drive Estate Engine ASZ		603016	Inner Joint			28		32							
		2000.11-2006.06	6MT	R	F	All-wheel Drive Estate Engine ASZ		261186	Drive Shaft		36		53	77.5	653						
		2000.11-2006.06	MT	R	F	All-wheel Drive Estate Engine ASZ		299114	Drive Shaft		36		53	77.5	809						
		2000.11-2006.06	-	R	F	All-wheel Drive Estate Engine ASZ		261121	Drive Shaft		36		53	77.5	806						
		2000.11-2006.06	-	L/R	R	All-wheel Drive Estate Engine ASZ		803033	Outer Joint		36	30	53	78.5	51	I					
		2000.11-2006.06	-	L/R	R	All-wheel Drive Estate Engine ASZ		603011	Inner Joint				33		34						
		2000.11-2006.06	AT	L	F	All-wheel Drive Estate Engine ASZ		203374	Drive Shaft		36		53	77.5	521						
		2000.11-2006.06	MT	L/R	F	All-wheel Drive Estate Engine ASZ		803035	Outer Joint		36	27	53	77.5	65	I					
		2000.11-2006.06	-	L	F	All-wheel Drive Estate Engine ASZ		261123	Drive Shaft		36		53	77.5	520						
2.0 (85 kW)		1999.05-2006.06	AT/MT	L/R	F	Estate Engine APK		803036	Outer Joint		36	30	53.2	77.5	61	I					
		1999.05-2006.06	AT	L	F	Estate Engine APK		261020	Drive Shaft		36		53.2	77.5	547						
		1999.05-2006.06	MT	L	F	Estate Engine APK		261314	Drive Shaft		36		53	78	558						
		1999.05-2006.06	MT	R	F	Estate Engine APK		203004	Drive Shaft		36		53.2	77.5	822						
		1999.05-2006.06	AT	L	F	Estate Engine APK		261156	Drive Shaft		36		53	78	554.5						
		1999.05-2006.06	MT	L	F	Estate Engine APK		261021	Drive Shaft		36		53.2	77.5	564.5						
		1999.05-2006.06	AT	L/R	F	Estate Engine APK		661006	Inner Joint				30		57.6						
		1999.05-2006.06	AT	L	F	Estate Engine APK		661062	Inner Joint				30		59						
		1999.05-2006.06	MT	R	F	Estate Engine APK		603009	Inner Joint				33		34						
		1999.05-2006.06	MT	L	F	Estate Engine APK		603011	Inner Joint				33		34						
2.0 4motion (85 kW)		2000.10-2006.06	-	L/R/F/R		All-wheel Drive Estate Engine AZJ		603011	Inner Joint				33		34						
		2000.10-2006.06	-	R	F	All-wheel Drive Estate Engine AZJ		603009	Inner Joint				33		34						
		2000.10-2006.06	-	L	F	All-wheel Drive Estate Engine AZJ		261314	Drive Shaft		36		53	78	558						
		2000.10-2006.06	-	L/R	R	All-wheel Drive Estate Engine AZJ		803033	Outer Joint		36	30	53	78.5	51	I					
		2000.10-2006.06	MT	L/R	F	All-wheel Drive Estate Engine AZJ		803036	Outer Joint		36	30	53.2	77.5	61	I					
2.0 4motion (88 kW)		1999.12-2006.06	MT	R	F	All-wheel Drive Estate Engine ATF		603009	Inner Joint				33		34						
		1999.12-2006.06	MT	L	F	All-wheel Drive Estate Engine ATF		261314	Drive Shaft		36		53	78	558						
		1999.12-2006.06	MT	L/R	R	All-wheel Drive Estate Engine ATF		803033	Outer Joint		36	30	53	78.5	51	I					
		1999.12-2006.06	MT	L/R/F/R		All-wheel Drive Estate Engine ATF		603011	Inner Joint				33		34						
		1999.12-2006.06	MT	L/R	F	All-wheel Drive Estate Engine ATF		803036	Outer Joint		36	30	53.2	77.5	61	I					
2.0 Bi-Fuel (85 kW)		2002.02-2006.06	-	R	F	Estate Engine BEH		603009	Inner Joint				33		34						
		2002.02-2006.06	-	L	F	Estate Engine BEH		261314	Drive Shaft		36		53	78	558						
		2002.02-2006.06	-	R	F	Estate Engine BEH		203004	Drive Shaft		36		53.2	77.5	822						
		2002.02-2006.06	MT	L/R	F	Estate Engine BEH		803036	Outer Joint		36	30	53.2	77.5	61	I					
		2002.02-2006.06	-	L	F	Estate Engine BEH		603011	Inner Joint				33		34						
		2002.02-2006.06	MT	-	-	Estate Engine BEH		603006	Inner Joint				33		34						
2.3 V5 (110 kW)		1999.05-2006.06	AT/MT	L	F	Estate Engine AGZ		261020	Drive Shaft		36		53.2	77.5	547						
		1999.05-2006.06	AT/MT	L	F	Estate Engine AGZ		261156	Drive Shaft		36		53	78	554.5						
		1999.05-2006.06	AT/MT	L/R	F	Estate Engine AGZ		661006	Inner Joint				30		57.6						
		1999.05-2006.06	AT/MT	L	F	Estate Engine AGZ		661062	Inner Joint				30		59						
		1999.05-2006.06	AT/MT	L/R	F	Estate Engine AGZ		803036	Outer Joint		36	30	53.2	77.5	61	I					
2.3 V5 (125 kW)		2000.10-2006.06	AT	R	F	Estate Engine AQN		261243	Drive Shaft		36		53	77.5	813						
		2000.10-2006.06	MT	L/R	F	Estate Engine AQN		803036	Outer Joint		36	30	53.2	77.5	61	I					
		2000.10-2006.06	MT	L	F	Estate Engine AQN		261020	Drive Shaft		36		53.2	77.5	547						
		2000.10-2006.06	AT	L/R	F	Estate Engine AQN		803035	Outer Joint		36	27	53	77.5	65	I					
		2000.10-2006.06	AT	L	F	Estate Engine AQN		261244	Drive Shaft		36		53	77.5	523						
		2000.10-2006.06	-	-	-	Estate Engine AQN		603016	Inner Joint			28		32							
		2000.10-2006.06	MT	L	F	Estate Engine AQN		261156	Drive Shaft		36		53	78	554.5						
		2000.10-2006.06	MT	L/R	F	Estate Engine AQN		661006	Inner Joint				30		57.6						
		2000.10-2006.06	MT	L	F	Estate Engine AQN		661062	Inner Joint				30		59						
		2000.10-2006.06	AT	L	F	Estate Engine AQN		203374	Drive Shaft		36		53	77.5	521						
2.3 V5 4motion (110 kW)		1999.05-2006.06	-	L	F	All-wheel Drive Estate Engine AGZ		261123	Drive Shaft		36		53	77.5	520						
		1999.05-2006.06	MT	L/R	F	All-wheel Drive Estate Engine AGZ		803035	Outer Joint		36	27	53	77.5	65	I					





YEAR	TRANSM	L/R	F/R	REMARKS	GSP Ref.	PRODUCT	ABS	Technical Specifications						
								A	B	C	H	L	P	
VW														
GOLF IV Variant (1J5)														
2.3 V5 4motion (110 kW)	1999.05-2006.06	-	L/R	R	All-wheel Drive Estate Engine AGZ	603011	Inner Joint			33		34		
	1999.05-2006.06	-	R	F	All-wheel Drive Estate Engine AGZ	261186	Drive Shaft	36		53	77.5	653		
	1999.05-2006.06	-	L/R	R	All-wheel Drive Estate Engine AGZ	803033	Outer Joint	36	30	53	78.5	51	I	
2.3 V5 4motion (125 kW)	2000.10-2006.06	-	L	F	All-wheel Drive Estate Engine AQN	261123	Drive Shaft	36		53	77.5	520		
	2000.10-2006.06	MT	L/R	F	All-wheel Drive Estate Engine AQN	803035	Outer Joint	36	27	53	77.5	65	I	
	2000.10-2006.06	-	L/R	R	All-wheel Drive Estate Engine AQN	603011	Inner Joint			33		34		
	2000.10-2006.06	MT	L	F	All-wheel Drive Estate Engine AQN	261020	Drive Shaft	36		53.2	77.5	547		
	2000.10-2006.06	AT	L	F	All-wheel Drive Estate Engine AQN	261244	Drive Shaft	36		53	77.5	523		
	2000.10-2006.06	-	-	-	All-wheel Drive Estate Engine AQN	603016	Inner Joint			28		32		
	2000.10-2006.06	-	R	F	All-wheel Drive Estate Engine AQN	261186	Drive Shaft	36		53	77.5	653		
	2000.10-2006.06	-	L/R	R	All-wheel Drive Estate Engine AQN	803033	Outer Joint	36	30	53	78.5	51	I	
2.8 V6 4motion (150 kW)	1999.05-2006.06	-	L	F	All-wheel Drive Estate Engine BDE	261123	Drive Shaft	36		53	77.5	520		
	1999.05-2006.06	MT	L/R	F	All-wheel Drive Estate Engine BDE	803035	Outer Joint	36	27	53	77.5	65	I	
	1999.05-2006.06	-	L/R	R	All-wheel Drive Estate Engine BDE	603011	Inner Joint			33		34		
	1999.05-2006.06	-	-	-	All-wheel Drive Estate Engine BDE	603016	Inner Joint			28		32		
	1999.05-2006.06	-	R	F	All-wheel Drive Estate Engine BDE	261186	Drive Shaft	36		53	77.5	653		
	1999.05-2006.06	-	L/R	R	All-wheel Drive Estate Engine BDE	803033	Outer Joint	36	30	53	78.5	51	I	
GOLF MK6														
2.5L	2010-	2014	AT	R	F	-	261152	Drive Shaft		36	26	59.5	40	873
GOLF PLUS														
-	2005-	2007	-	-	-	-	201594	Drive Shaft		36		59.5	40	800
1.6	2005-	2009	-	-	-	-	201583	Drive Shaft		36	26	59.5	40	873
	2005-	2007	-	-	-	-	201583	Drive Shaft		36	26	59.5	40	873
GOLF PLUS (5M1 521)														
1.2 TSI (63 kW)	2010.05-2013.12	-	L/R	F	Hatchback Engine CBZA	603011	Inner Joint			33		34		
	2010.05-2013.12	AT	L	F	Hatchback Engine CBZA	261201	Drive Shaft	36		59.5	40.5	535		
	2010.05-2013.12	MT	L	F	Hatchback Engine CBZA	261198	Drive Shaft	36		59.5	40.5	530		
	2010.05-2013.12	MT	L/R	F	Hatchback Engine CBZA	803037	Outer Joint	36	30	59.5	40.5	55	I	
	2010.05-2013.12	MT	R	F	Hatchback Engine CBZA	201586	Drive Shaft	36		59.5	40	806		
	2010.05-2013.12	AT	-	F	Hatchback Engine CBZA	803100	Outer Joint	36	33	59.5	38	55	I	
1.2 TSI (77 kW)	2009.11-2013.12	AT	L	F	Hatchback Engine CBZB	261201	Drive Shaft	36		59.5	40.5	535		
	2009.11-2013.12	AT	L	F	Hatchback Engine CBZB	261198	Drive Shaft	36		59.5	40.5	530		
	2009.11-2013.12	MT	R	F	Hatchback Engine CBZB	201586	Drive Shaft	36		59.5	40	806		
	2009.11-2013.12	AT	-	F	Hatchback Engine CBZB	803100	Outer Joint	36	33	59.5	38	55	I	
	2009.11-2013.12	MT	L/R	F	Hatchback Engine CBZB	803037	Outer Joint	36	30	59.5	40.5	55	I	
	2009.11-2013.12	-	L/R	F	Hatchback Engine CBZB	603011	Inner Joint			33		34		
1.4 16V (55 kW)	2005.01-2006.11	5MT	R	F	Hatchback Engine BCA	253008	Drive Shaft	36		59.5	40	782		
	2005.01-2006.11	MT	L	F	Hatchback Engine BCA	253007	Drive Shaft	36		59.5	40	559		
	2005.01-2006.11	MT	L/R	F	Hatchback Engine BCA	853001	Outer Joint	36	30	59.5	40	49	I	
	2005.01-2006.11	-	L/R	F	Hatchback Engine BCA	603008	Inner Joint			33		32		
1.4 16V (59 kW)	2006.05-2013.12	-	L/R	F	Hatchback Engine BUD	603008	Inner Joint			33		32		
	2006.05-2013.12	5MT	R	F	Hatchback Engine BUD	253008	Drive Shaft	36		59.5	40	782		
	2006.05-2013.12	MT	L	F	Hatchback Engine BUD	253007	Drive Shaft	36		59.5	40	559		
	2006.05-2013.12	5MT	L/R	F	Hatchback Engine BUD	853001	Outer Joint	36	30	59.5	40	49	I	
1.4 FSI (66 kW)	2005.07-2006.11	MT	L	F	Hatchback Engine BLN	253007	Drive Shaft	36		59.5	40	559		
	2005.07-2006.11	5MT	L/R	F	Hatchback Engine BLN	853001	Outer Joint	36	30	59.5	40	49	I	
	2005.07-2006.11	-	L/R	F	Hatchback Engine BLN	603008	Inner Joint			33		32		
1.4 TSI (103 kW)	2006.05-2008.06	MT	L	F	Hatchback Engine BMY	261224	Drive Shaft	36		59.5	40	536		
	2006.05-2008.06	MT	L/R	F	Hatchback Engine BMY	603011	Inner Joint			33		34		
	2006.05-2008.06	MT	L	F	Hatchback Engine BMY	203302	Drive Shaft	36		59.5	40	528		
	2006.05-2008.06	MT	R	F	Hatchback Engine BMY	201586	Drive Shaft	36		59.5	40	806		
	2006.05-2008.06	MT	L/R	F	Hatchback Engine BMY	803037	Outer Joint	36	30	59.5	40.5	55	I	
	2006.05-2008.06	AT	R	F	Hatchback Engine BMY	261342	Drive Shaft	36		59.5	40	764		
	2006.05-2008.06	AT	L/R	F	Hatchback Engine BMY	803002	Outer Joint	36	27	59.5	40	66	I	
	2006.05-2008.06	7AT	L/R	F	Hatchback Engine CAVD	803002	Outer Joint	36	27	59.5	40	66	I	
1.4 TSI (118 kW)	2008.06-2013.12	MT	L	F	Hatchback Engine CAVD	261224	Drive Shaft	36		59.5	40	536		
	2008.06-2013.12	MT	L/R	F	Hatchback Engine CAVD	603011	Inner Joint			33		34		
	2008.06-2013.12	-	L	F	Hatchback Engine CAVD	661054	Inner Joint			40	28	46.9	51	53
	2008.06-2013.12	MT	L/R	F	Hatchback Engine CAVD	803037	Outer Joint	36	30	59.5	40.5	55	I	
	2008.06-2013.12	Semi-AT	L	F	Hatchback Engine CAVD	261281	Drive Shaft	36		59.5	40	528		
	2006.05-2008.06	6AT	L/R	F	Hatchback Engine BLG	803002	Outer Joint	36	27	59.5	40	66	I	
	2006.05-2008.06	MT	L	F	Hatchback Engine BLG	203302	Drive Shaft	36		59.5	40	528		
	2006.05-2008.06	AT	R	F	Hatchback Engine BLG	261342	Drive Shaft	36		59.5	40	764		
1.4 TSI (90 kW)	2007.06-2013.12	Semi-AT	L/R	F	Hatchback Engine CAXA	803002	Outer Joint	36	27	59.5	40	66	I	
	2007.06-2013.12	MT	L/R	F	Hatchback Engine CAXA	603011	Inner Joint			33		34		
	2007.06-2013.12	MT	L	F	Hatchback Engine CAXA	261198	Drive Shaft	36		59.5	40.5	530		

	 YEAR	TRANSM	L/R	F/R	REMARKS	GSP Ref.	 PRODUCT	 ABS	Technical Specifications					
									A	B	C	H	L	P
VW														
GOLF PLUS (5M1 521)														
1.4 TSI (90 kW)	2007.06-2013.12	-	L	F	Hatchback Engine CAXA	661054	Inner Joint		40	28	46.9	51	53	
	2007.06-2013.12	MT	R	F	Hatchback Engine CAXA	201586	Drive Shaft		36		59.5	40	806	
	2007.06-2013.12	Semi-AT	L	F	Hatchback Engine CAXA	261281	Drive Shaft		36		59.5	40	528	
	2007.06-2013.12	6MT	L/R	F	Hatchback Engine CAXA	803037	Outer Joint		36	30	59.5	40.5	55	I
	2007.06-2013.12	-	-	-	Hatchback Engine CAXA	861059	Outer Joint		36	33	59.5	40	59.5	I
1.6 (75 kW)	2005.05-2013.12	MT	L/R	F	Hatchback Engine BSE	603011	Inner Joint			33		34		
	2005.05-2013.12	MT	L	F	Hatchback Engine BSE	261097	Drive Shaft		36		59.5	40.5	543	
	2005.05-2013.12	5MT	R	F	Hatchback Engine BSE	261096	Drive Shaft		36		59.5	40.5	799	
	2005.05-2013.12	AT	L	F	Hatchback Engine BSE	803116	Outer Joint		36	30	59.5	38	55	I
	2005.05-2013.12	-	L/R	F	Hatchback Engine BSE	803037	Outer Joint		36	30	59.5	40.5	55	I
	2005.05-2013.12	AT	L	F	Hatchback Engine BSE	203318	Drive Shaft		36	26	59.5	38	581	
	2005.05-2013.12	MT	L	F	Hatchback Engine BSE	203320	Drive Shaft		36		59.5	40	546	
	2005.05-2013.12	AT	L/R	F	Hatchback Engine BSE	661011	Inner Joint		26	32	31	68.5	85	
1.6 BiFuel (75 kW)	2009.05-2013.12	-	L/R	F	Hatchback Engine CHGA	603011	Inner Joint			33		34		
	2009.05-2013.12	-	L	F	Hatchback Engine CHGA	261097	Drive Shaft		36		59.5	40.5	543	
	2009.05-2013.12	MT	-	-	Hatchback Engine CHGA	603006	Inner Joint			33		34		
	2009.05-2013.12	-	R	F	Hatchback Engine CHGA	261096	Drive Shaft		36		59.5	40.5	799	
	2009.05-2013.12	-	L/R	F	Hatchback Engine CHGA	803037	Outer Joint		36	30	59.5	40.5	55	I
	2009.05-2013.12	-	L	F	Hatchback Engine CHGA	203320	Drive Shaft		36		59.5	40	546	
1.6 FSI (85 kW)	2005.01-2008.05	MT	L/R	F	Hatchback Engine BLF	603011	Inner Joint			33		34		
	2005.01-2008.05	6MT	R	F	Hatchback Engine BLF	261211	Drive Shaft		36		59.5	40.5	784	
	2005.01-2008.05	AT	L/R	F	Hatchback Engine BLF	661011	Inner Joint		26	32	31	68.5	85	
	2005.01-2008.05	6MT	L	F	Hatchback Engine BLF	803116	Outer Joint		36	30	59.5	38	55	I
	2005.01-2008.05	AT	L	F	Hatchback Engine BLF	201582	Drive Shaft		36	26	59.5	40	597	
	2005.01-2008.05	-	L/R	F	Hatchback Engine BLF	803037	Outer Joint		36	30	59.5	40.5	55	I
1.6 MultiFuel (75 kW)	2007.11-2013.12	MT	L/R	F	Hatchback Engine CMXA	603011	Inner Joint			33		34		
	2007.11-2013.12	MT	-	-	Hatchback Engine CMXA	603006	Inner Joint			33		34		
	2007.11-2013.12	-	L	F	Hatchback Engine CMXA	261097	Drive Shaft		36		59.5	40.5	543	
	2007.11-2013.12	MT	R	F	Hatchback Engine CMXA	261096	Drive Shaft		36		59.5	40.5	799	
	2007.11-2013.12	6AT	L	F	Hatchback Engine CMXA	803116	Outer Joint		36	30	59.5	38	55	I
	2007.11-2013.12	6AT	L	F	Hatchback Engine CMXA	203318	Drive Shaft		36	26	59.5	38	581	
	2007.11-2013.12	-	L/R	F	Hatchback Engine CMXA	803037	Outer Joint		36	30	59.5	40.5	55	I
	2007.11-2013.12	-	L	F	Hatchback Engine CMXA	203320	Drive Shaft		36		59.5	40	546	
1.6 TDI (66 kW)	2009.02-2013.12	-	L/R	F	Hatchback Engine CAYB	603011	Inner Joint			33		34		
	2009.02-2013.12	-	L	F	Hatchback Engine CAYB	203294	Drive Shaft		36		59.5	38	519	
	2009.02-2013.12	MT	-	-	Hatchback Engine CAYB	603006	Inner Joint			33		34		
	2009.02-2013.12	-	L	F	Hatchback Engine CAYB	803116	Outer Joint		36	30	59.5	38	55	I
	2009.02-2013.12	-	R	F	Hatchback Engine CAYB	261042	Drive Shaft		36		59.5	40.5	814	
	2009.02-2013.12	-	L/R	F	Hatchback Engine CAYB	803037	Outer Joint		36	30	59.5	40.5	55	I
	2009.02-2013.12	-	R	F	Hatchback Engine CAYB	201585	Drive Shaft		36		59.5	40	805	
1.6 TDI (77 kW)	2009.03-2013.12	AT	-	F	Hatchback Engine CAYC	803100	Outer Joint		36	33	59.5	38	55	I
	2009.03-2013.12	MT	L	F	Hatchback Engine CAYC	203294	Drive Shaft		36		59.5	38	519	
	2009.03-2013.12	AT	L	F	Hatchback Engine CAYC	261089	Drive Shaft		36		59.5	40.5	521	
	2009.03-2013.12	MT	L/R	F	Hatchback Engine CAYC	603011	Inner Joint			33		34		
	2009.03-2013.12	MT	L/R	F	Hatchback Engine CAYC	803037	Outer Joint		36	30	59.5	40.5	55	I
	2009.03-2013.12	MT	L	F	Hatchback Engine CAYC	803116	Outer Joint		36	30	59.5	38	55	I
	2009.03-2013.12	MT	R	F	Hatchback Engine CAYC	261042	Drive Shaft		36		59.5	40.5	814	
	2009.03-2013.12	MT	R	F	Hatchback Engine CAYC	201585	Drive Shaft		36		59.5	40	805	
	2009.03-2013.12	AT	R	F	Hatchback Engine CAYC	261280	Drive Shaft		36		59.5	40	801	
	2009.03-2013.12	-	-	-	Hatchback Engine CAYC	861059	Outer Joint		36	33	59.5	40	59.5	I
	2009.03-2013.12	AT	L	F	Hatchback Engine CAYC	261282	Drive Shaft		36		59.5	40	523	
	2009.03-2013.12	AT	L/R	F	Hatchback Engine CAYC	803002	Outer Joint		36	27	59.5	40	66	I
1.9 TDI (66 kW)	2005.05-2008.12	-	L	F	Hatchback Engine BRU	203294	Drive Shaft		36		59.5	38	519	
	2005.05-2008.12	MT	-	-	Hatchback Engine BRU	603006	Inner Joint			33		34		
	2005.05-2008.12	-	L/R	F	Hatchback Engine BRU	803037	Outer Joint		36	30	59.5	40.5	55	I
	2005.05-2008.12	-	L	F	Hatchback Engine BRU	803116	Outer Joint		36	30	59.5	38	55	I
	2005.05-2008.12	MT	L/R	F	Hatchback Engine BRU	603011	Inner Joint			33		34		
	2005.05-2008.12	-	R	F	Hatchback Engine BRU	261042	Drive Shaft		36		59.5	40.5	814	
1.9 TDI (77 kW)	2005.01-2009.01	6AT	L/R	F	Hatchback Engine BKC	803002	Outer Joint		36	27	59.5	40	66	I
	2005.01-2009.01	MT	L/R	F	Hatchback Engine BKC	603011	Inner Joint			33		34		
	2005.01-2009.01	5MT	L	F	Hatchback Engine BKC	203294	Drive Shaft		36		59.5	38	519	
	2005.01-2009.01	AT	-	-	Hatchback Engine BKC	603016	Inner Joint			28		32		

	YEAR	TRANSM	L/R	F/R	REMARKS	GSP Ref.	PRODUCT	ABS	Technical Specifications					
									A	B	C	H	L	P
VW														
GOLF PLUS (5M1 521)														
1.9 TDI (77 kW)	2005.01-2009.01	6AT	R	F	Hatchback Engine BKC	254011	Drive Shaft		36		59.5	40	755	
	2005.01-2009.01	-	L	F	Hatchback Engine BKC	661054	Inner Joint		40	28	46.9	51	53	
	2005.01-2009.01	6AT	L	F	Hatchback Engine BKC	254013	Drive Shaft		36		59.5	40	479.5	
	2005.01-2009.01	6AT	L	F	Hatchback Engine BKC	654004	Inner Joint			34		85		
	2005.01-2009.01	MT	L/R	F	Hatchback Engine BKC	803037	Outer Joint		36	30	59.5	40.5	55	I
	2005.01-2009.01	6AT	L/R	F	Hatchback Engine BKC	661057	Inner Joint			34		86		
	2005.01-2009.01	5MT	R	F	Hatchback Engine BKC	261042	Drive Shaft		36		59.5	40.5	814	
	2005.01-2009.01	AT	L	F	Hatchback Engine BKC	203241	Drive Shaft		36		59.5	40	475	
	2005.01-2009.01	5MT	L	F	Hatchback Engine BKC	803116	Outer Joint		36	30	59.5	38	55	I
	2005.01-2009.01	6AT	L/R	F	Hatchback Engine BKC	861045	Outer Joint		36	27	59.5	40	65	M
2005.01-2009.01	5MT	R	F	Hatchback Engine BKC	201585	Drive Shaft		36		59.5	40	805		
2.0 FSI (110 kW)	2005.05-2008.06	-	R	F	Hatchback Engine BLR	261113	Drive Shaft		36		59.5	40	814	
	2005.05-2008.06	-	L/R	F	Hatchback Engine BLR	803037	Outer Joint		36	30	59.5	40.5	55	I
	2005.05-2008.06	AT	R	F	Hatchback Engine BLR	261094	Drive Shaft		36	26	59.5	40.5	884	
	2005.05-2008.06	MT	L/R	F	Hatchback Engine BLR	603011	Inner Joint			33		34		
	2005.05-2008.06	6MT	L	F	Hatchback Engine BLR	803116	Outer Joint		36	30	59.5	38	55	I
	2005.05-2008.06	6MT	R	F	Hatchback Engine BLR	201585	Drive Shaft		36		59.5	40	805	
	2005.05-2008.06	AT	L/R	F	Hatchback Engine BLR	661011	Inner Joint		26	32	31	68.5	85	
	2005.05-2008.06	6AT	L	F	Hatchback Engine BLR	261093	Drive Shaft		36	26	59.5	40.5	587.5	
2.0 TDI (100 kW)	2005.05-2013.12	AT	R	F	Hatchback Engine CFHB	254011	Drive Shaft		36		59.5	40	755	
	2005.05-2013.12	6MT	L	F	Hatchback Engine CFHB	203265	Drive Shaft		36		59.5	40	487	
	2005.05-2013.12	AT	L/R	F	Hatchback Engine CFHB	661057	Inner Joint			34		86		
	2005.05-2013.12	6AT	L	F	Hatchback Engine CFHB	254013	Drive Shaft		36		59.5	40	479.5	
	2005.05-2013.12	6MT	R	F	Hatchback Engine CFHB	203313	Drive Shaft		36		59.5	40	792	
	2005.05-2013.12	6AT	L	F	Hatchback Engine CFHB	654004	Inner Joint			34		85		
	2005.05-2013.12	MT	R	F	Hatchback Engine CFHB	203236	Drive Shaft		36		59.5	40	484	
	2005.05-2013.12	AT	L	F	Hatchback Engine CFHB	203241	Drive Shaft		36		59.5	40	475	
	2005.05-2013.12	AT/MT	L/R	F	Hatchback Engine CFHB	861045	Outer Joint		36	27	59.5	40	65	M
	2005.05-2013.12	AT/MT	L/R	F	Hatchback Engine CFHB	803002	Outer Joint		36	27	59.5	40	66	I
2005.05-2013.12	6MT	R	F	Hatchback Engine CFHB	261126	Drive Shaft		36		59.5	40	793		
2005.05-2013.12	6MT	L	F	Hatchback Engine CFHB	203295	Drive Shaft		36		59.5	40	491		
2.0 TDI (103 kW)	2005.12-2011.05	AT	L/R	F	Hatchback Engine BMM	661057	Inner Joint			34		86		
	2005.12-2011.05	MT	L	F	Hatchback Engine BMM	203265	Drive Shaft		36		59.5	40	487	
	2005.12-2011.05	AT	L	F	Hatchback Engine BMM	254013	Drive Shaft		36		59.5	40	479.5	
	2005.12-2011.05	MT	R	F	Hatchback Engine BMM	203313	Drive Shaft		36		59.5	40	792	
	2005.12-2011.05	AT	L	F	Hatchback Engine BMM	654004	Inner Joint			34		85		
	2005.12-2011.05	MT	R	F	Hatchback Engine BMM	203236	Drive Shaft		36		59.5	40	484	
	2005.12-2011.05	AT/MT	L/R	F	Hatchback Engine BMM	803002	Outer Joint		36	27	59.5	40	66	I
	2005.12-2011.05	AT	L	F	Hatchback Engine BMM	203241	Drive Shaft		36		59.5	40	475	
	2005.12-2011.05	AT/MT	L/R	F	Hatchback Engine BMM	861045	Outer Joint		36	27	59.5	40	65	M
	2005.12-2011.05	MT	R	F	Hatchback Engine BMM	261126	Drive Shaft		36		59.5	40	793	
2005.12-2011.05	AT	R	F	Hatchback Engine BMM	254011	Drive Shaft		36		59.5	40	755		
2005.12-2011.05	MT	L	F	Hatchback Engine BMM	203295	Drive Shaft		36		59.5	40	491		
2.0 TDI (81 kW)	2009.01-2013.12	MT	L	F	Hatchback Engine CLCA	203294	Drive Shaft		36		59.5	38	519	
	2009.01-2013.12	MT	L/R	F	Hatchback Engine CLCA	803037	Outer Joint		36	30	59.5	40.5	55	I
	2009.01-2013.12	AT	L	F	Hatchback Engine CLCA	254013	Drive Shaft		36		59.5	40	479.5	
	2009.01-2013.12	AT	L	F	Hatchback Engine CLCA	654004	Inner Joint			34		85		
	2009.01-2013.12	MT	L	F	Hatchback Engine CLCA	803116	Outer Joint		36	30	59.5	38	55	I
	2009.01-2013.12	MT	R	F	Hatchback Engine CLCA	261042	Drive Shaft		36		59.5	40.5	814	
	2009.01-2013.12	AT	L/R	F	Hatchback Engine CLCA	803002	Outer Joint		36	27	59.5	40	66	I
	2009.01-2013.12	MT	L/R	F	Hatchback Engine CLCA	603011	Inner Joint			33		34		
	2009.01-2013.12	MT	R	F	Hatchback Engine CLCA	201585	Drive Shaft		36		59.5	40	805	
2009.01-2013.12	AT	R	F	Hatchback Engine CLCA	254011	Drive Shaft		36		59.5	40	755		
2.0 TDI (96 kW)	2005.05-2007.05	-	L	F	Hatchback Engine BEE	203265	Drive Shaft		36		59.5	40	487	
	2005.05-2007.05	-	L/R	F	Hatchback Engine BEE	803002	Outer Joint		36	27	59.5	40	66	I
	2005.05-2007.05	-	R	F	Hatchback Engine BEE	203313	Drive Shaft		36		59.5	40	792	
	2005.05-2007.05	-	L	F	Hatchback Engine BEE	203295	Drive Shaft		36		59.5	40	491	
	2005.05-2007.05	-	L/R	F	Hatchback Engine BEE	861045	Outer Joint		36	27	59.5	40	65	M
	2005.05-2007.05	-	R	F	Hatchback Engine BEE	261126	Drive Shaft		36		59.5	40	793	
2.0 TDI 16V (103 kW)	2005.01-2013.12	AT	R	F	Hatchback Engine BKB/CBDB/CFHC	254011	Drive Shaft		36		59.5	40	755	
	2005.01-2013.12	MT	L	F	Hatchback Engine BKB/CBDB/CFHC	203295	Drive Shaft		36		59.5	40	491	
	2005.01-2013.12	AT	L/R	F	Hatchback Engine BKB/CBDB/CFHC	661057	Inner Joint			34		86		
	2005.01-2013.12	MT	L	F	Hatchback Engine BKB/CBDB/CFHC	203265	Drive Shaft		36		59.5	40	487	
	2005.01-2013.12	MT	R	F	Hatchback Engine BKB/CBDB/CFHC	203313	Drive Shaft		36		59.5	40	792	
	2005.01-2013.12	AT	L	F	Hatchback Engine BKB/CBDB/CFHC	254013	Drive Shaft		36		59.5	40	479.5	
	2005.01-2013.12	AT	L	F	Hatchback Engine BKB/CBDB/CFHC	654004	Inner Joint			34		85		

YEAR	TRANSM	L/R	F/R	REMARKS	GSP Ref.	PRODUCT	ABS	Technical Specifications						
								A	B	C	H	L	P	
VW														
GOLF PLUS (5M1 521)														
2.0 TDI 16V (103 kW)	2005.01-2013.12	AT	L	F	Hatchback Engine BKB/CBDB/CFHC	203241	Drive Shaft		36		59.5	40	475	
	2005.01-2013.12	AT/MT	L/R	F	Hatchback Engine BKB/CBDB/CFHC	803002	Outer Joint		36	27	59.5	40	66	I
	2005.01-2013.12	AT/MT	L/R	F	Hatchback Engine BKB/CBDB/CFHC	861045	Outer Joint		36	27	59.5	40	65	M
	2005.01-2013.12	MT	R	F	Hatchback Engine BKB/CBDB/CFHC	261126	Drive Shaft		36		59.5	40	793	
GOLF SERIE III														
1.8	1991-1997.06	-	R	-		861015	Outer Joint		22	30	50	78	61	I
2.0	1991-1997.06	-	R	-		861015	Outer Joint		22	30	50	78	61	I
GOLF SPORTSVAN (AM1)														
1.0 TSI (85 kW)	2015.05-	AT	-	-	Hatchback Engine CHZD	861059	Outer Joint		36	33	59.5	40	59.5	I
1.2 TSI (63 kW)	2014.05-	-	L/R	F	Hatchback Engine CYVA	803037	Outer Joint		36	30	59.5	40.5	55	I
	2014.05-	MT	L	F	Hatchback Engine CYVA	261277	Drive Shaft		36		59.5	40	516	
	2014.05-	-	L	F	Hatchback Engine CYVA	203373	Drive Shaft		36		59.5	38	511	
	2014.05-	-	L/R	F	Hatchback Engine CYVA	603011	Inner Joint			33		34		
	2014.05-	-	L	F	Hatchback Engine CYVA	803116	Outer Joint		36	30	59.5	38	55	I
1.2 TSI (81 kW)	2014.04-	-	L/R	F	Hatchback Engine CYVB	803037	Outer Joint		36	30	59.5	40.5	55	I
	2014.04-	MT	L	F	Hatchback Engine CYVB	203373	Drive Shaft		36		59.5	38	511	
	2014.04-	MT	L	F	Hatchback Engine CYVB	803116	Outer Joint		36	30	59.5	38	55	I
	2014.04-	-	L/R	F	Hatchback Engine CYVB	603011	Inner Joint			33		34		
1.4 TSI (110 kW)	2014.02-	AT	R	F	Hatchback Engine CZDA	261303	Drive Shaft		36		59.5	40	795	
	2014.02-	AT	-	F	Hatchback Engine CZDA	803101	Outer Joint		36	27	59.5	40	65	M
	2014.02-	MT	-	F	Hatchback Engine CZDA	803100	Outer Joint		36	33	59.5	38	55	I
	2014.02-	MT	L	F	Hatchback Engine CZDA	261089	Drive Shaft		36		59.5	40.5	521	
	2014.02-	MT	L/R	F	Hatchback Engine CZDA	603011	Inner Joint			33		34		
	2014.02-	AT	L	F	Hatchback Engine CZDA	261304	Drive Shaft		36		59.5	40	511	
1.4 TSI (92 kW)	2014.04-	AT/MT	-	F	Hatchback Engine CPVB	803100	Outer Joint		36	33	59.5	38	55	I
	2014.04-	7AT	L	F	Hatchback Engine CPVB	261089	Drive Shaft		36		59.5	40.5	521	
	2014.04-	7AT	R	F	Hatchback Engine CPVB	261200	Drive Shaft		36		59.5	40.5	820	
	2014.04-	MT	L	F	Hatchback Engine CPVB	261306	Drive Shaft		36		59.5	40	517	
	2014.04-	-	L/R	F	Hatchback Engine CPVB	603011	Inner Joint			33		34		
1.4 TSI MultiFuel (92 kW)	2014.04-	MT	-	-	Hatchback Engine CPVB	861059	Outer Joint		36	33	59.5	40	59.5	I
	2014.04-	AT/MT	-	F	Hatchback Engine CPVB	803100	Outer Joint		36	33	59.5	38	55	I
	2014.04-	MT	L/R	F	Hatchback Engine CPVB	603011	Inner Joint			33		34		
	2014.04-	7AT	L	F	Hatchback Engine CPVB	261089	Drive Shaft		36		59.5	40.5	521	
	2014.04-	MT	-	-	Hatchback Engine CPVB	603006	Inner Joint			33		34		
	2014.04-	7AT	R	F	Hatchback Engine CPVB	261200	Drive Shaft		36		59.5	40.5	820	
	2014.04-	MT	L	F	Hatchback Engine CPVB	261306	Drive Shaft		36		59.5	40	517	
1.6 (81 kW)	2014.05-	-	L/R	F	Hatchback Engine CWVA	803037	Outer Joint		36	30	59.5	40.5	55	I
	2014.05-	MT	L	F	Hatchback Engine CWVA	261277	Drive Shaft		36		59.5	40	516	
	2014.05-	MT	L/R	F	Hatchback Engine CWVA	603011	Inner Joint			33		34		
	2014.05-	AT	L	F	Hatchback Engine CWVA	803116	Outer Joint		36	30	59.5	38	55	I
	2014.05-	AT	L	F	Hatchback Engine CWVA	203318	Drive Shaft		36	26	59.5	38	581	
1.6 TDI (66 kW)	2014.02-	MT	L	F	Hatchback Engine CRKA	203294	Drive Shaft		36		59.5	38	519	
	2014.02-	MT	L/R	F	Hatchback Engine CRKA	603011	Inner Joint			33		34		
	2014.02-	MT	L/R	F	Hatchback Engine CRKA	803037	Outer Joint		36	30	59.5	40.5	55	I
	2014.02-	MT	L	F	Hatchback Engine CRKA	803116	Outer Joint		36	30	59.5	38	55	I
	2014.02-	MT	R	F	Hatchback Engine CRKA	261042	Drive Shaft		36		59.5	40.5	814	
	2014.02-	MT	-	-	Hatchback Engine CRKA	603006	Inner Joint			33		34		
1.6 TDI (81 kW)	2014.02-	AT	-	F	Hatchback Engine CRKB	803100	Outer Joint		36	33	59.5	38	55	I
	2014.02-	AT	L	F	Hatchback Engine CRKB	261089	Drive Shaft		36		59.5	40.5	521	
	2014.02-	AT	R	F	Hatchback Engine CRKB	261280	Drive Shaft		36		59.5	40	801	
	2014.02-	MT	L	F	Hatchback Engine CRKB	261282	Drive Shaft		36		59.5	40	523	
	2014.02-	-	L/R	F	Hatchback Engine CRKB	603011	Inner Joint			33		34		
1.6 TDI (85 kW)	2016.11-	7DCT/5MT	L/R	F	Hatchback Engine DDYA	603011	Inner Joint			33		34		
2.0 TDI (110 kW)	2014.02-	MT	-	F	Hatchback Engine CRLB/DCYA	803101	Outer Joint		36	27	59.5	40	65	M
	2014.02-	AT	-	F	Hatchback Engine CRLB/DCYA	803100	Outer Joint		36	33	59.5	38	55	I
	2014.02-	-	L	F	Hatchback Engine CRLB/DCYA	261285	Drive Shaft		36		59.5	40	472	
	2014.02-	AT	R	F	Hatchback Engine CRLB/DCYA	203354	Drive Shaft		36		59.5	40	763	
	2014.02-	AT	-	-	Hatchback Engine CRLB/DCYA	603016	Inner Joint			28		32		
2.0 TDI (81 kW)	2014.05-	AT/MT	L	F	Hatchback Engine CRVA/CRLD	261089	Drive Shaft		36		59.5	40.5	521	
	2014.05-	-	-	F	Hatchback Engine CRVA/CRLD	803100	Outer Joint		36	33	59.5	38	55	I
	2014.05-	MT	R	F	Hatchback Engine CRVA/CRLD	261200	Drive Shaft		36		59.5	40.5	820	
	2014.05-	AT	R	F	Hatchback Engine CRVA/CRLD	261280	Drive Shaft		36		59.5	40	801	
	2014.05-	-	L/R	F	Hatchback Engine CRVA/CRLD	603011	Inner Joint			33		34		
GOLF SPORTWAGEN														
1.8	2015-	-	-	L	-	261153	Drive Shaft		36	26	59.5	40	583	
	2015-	-	-	L	-	261153	Drive Shaft		36	26	59.5	40	583	

YEAR	TRANSM	L/R	F/R	REMARKS	GSP Ref.	PRODUCT	ABS	Technical Specifications						
								A	B	C	H	L	P	
VW														
GOLF SPORTWAGEN														
1.8	2016-	-	-	L	-	261153	Drive Shaft	36	26	59.5	40	583		
	2016-	-	-	L	-	261153	Drive Shaft	36	26	59.5	40	583		
	2017-	-	-	L	-	261153	Drive Shaft	36	26	59.5	40	583		
	2017-	-	-	L	-	261153	Drive Shaft	36	26	59.5	40	583		
	2018-	-	-	L	-	261153	Drive Shaft	36	26	59.5	40	583		
	2018-	-	-	L	-	261153	Drive Shaft	36	26	59.5	40	583		
GOLF V (1K1)														
1.4 16V (55 kW)	2003.10-	2006.05	-	-	-	Hatchback Engine BCA	261237	Stub Axle	23	37	54		142.5	
	2003.10-	2006.05	5MT	R	F	Hatchback Engine BCA	253008	Drive Shaft	36		59.5	40	782	
	2003.10-	2006.05	MT	L	F	Hatchback Engine BCA	253007	Drive Shaft	36		59.5	40	559	
	2003.10-	2006.05	MT	L/R	F	Hatchback Engine BCA	853001	Outer Joint	36	30	59.5	40	49	I
	2003.10-	2006.05	MT	-	-	Hatchback Engine BCA	603006	Inner Joint		33		34		
	2003.10-	2006.05	-	L/R	F	Hatchback Engine BCA	603008	Inner Joint		33		32		
1.4 16V (59 kW)	2006.05-	2008.11	-	L/R	F	Hatchback Engine BUD	603008	Inner Joint		33		32		
	2006.05-	2008.11	MT	-	-	Hatchback Engine BUD	603006	Inner Joint		33		34		
	2006.05-	2008.11	5MT	R	F	Hatchback Engine BUD	253008	Drive Shaft	36		59.5	40	782	
	2006.05-	2008.11	5MT	L	F	Hatchback Engine BUD	253007	Drive Shaft	36		59.5	40	559	
	2006.05-	2008.11	5MT	L/R	F	Hatchback Engine BUD	853001	Outer Joint	36	30	59.5	40	49	I
1.4 FSI (66 kW)	2003.10-	2006.07	-	-	-	Hatchback Engine BKG	261237	Stub Axle	23	37	54		142.5	
	2003.10-	2006.07	5MT	L	F	Hatchback Engine BKG	253007	Drive Shaft	36		59.5	40	559	
	2003.10-	2006.07	MT	L/R	F	Hatchback Engine BKG	853001	Outer Joint	36	30	59.5	40	49	I
	2003.10-	2006.07	MT	-	-	Hatchback Engine BKG	603006	Inner Joint		33		34		
	2003.10-	2006.07	-	L/R	F	Hatchback Engine BKG	603008	Inner Joint		33		32		
1.4 TSI (103 kW)	2006.05-	2008.11	6MT	L	F	Hatchback Engine BMY	261224	Drive Shaft	36		59.5	40	536	
	2006.05-	2008.11	MT	L/R	F	Hatchback Engine BMY	603011	Inner Joint		33		34		
	2006.05-	2008.11	6MT	L/R	F	Hatchback Engine BMY	803037	Outer Joint	36	30	59.5	40.5	55	I
	2006.05-	2008.11	MT	R	F	Hatchback Engine BMY	201586	Drive Shaft	36		59.5	40	806	
	2006.05-	2008.11	6AT	L/R	F	Hatchback Engine BMY	803002	Outer Joint	36	27	59.5	40	66	I
	2006.05-	2008.11	AT	R	F	Hatchback Engine BMY	261342	Drive Shaft	36		59.5	40	764	
1.4 TSI (125 kW)	2005.11-	2008.11	MT	L	F	Hatchback Engine BLG	203302	Drive Shaft	36		59.5	40	528	
	2005.11-	2008.11	6AT/6MT	L/R	F	Hatchback Engine BLG	803002	Outer Joint	36	27	59.5	40	66	I
	2005.11-	2008.11	AT	R	F	Hatchback Engine BLG	261342	Drive Shaft	36		59.5	40	764	
	2005.11-	2008.11	MT	R	F	Hatchback Engine BLG	201653	Drive Shaft	36		59.5	40	785	
1.4 TSI (90 kW)	2007.05-	2008.11	Semi-AT	L/R	F	Hatchback Engine CAXA	803002	Outer Joint	36	27	59.5	40	66	I
	2007.05-	2008.11	MT	L/R	F	Hatchback Engine CAXA	603011	Inner Joint		33		34		
	2007.05-	2008.11	MT	L	F	Hatchback Engine CAXA	261198	Drive Shaft	36		59.5	40.5	530	
	2007.05-	2008.11	MT	R	F	Hatchback Engine CAXA	201586	Drive Shaft	36		59.5	40	806	
	2007.05-	2008.11	6MT	L/R	F	Hatchback Engine CAXA	803037	Outer Joint	36	30	59.5	40.5	55	I
1.6 (75 kW)	2004.01-	2008.11	AT	R	F	Hatchback Engine BGU	203346	Drive Shaft	36	26	59.5	38	879	
	2004.01-	2008.11	MT	L/R	F	Hatchback Engine BGU	603011	Inner Joint		33		34		
	2004.01-	2008.11	-	-	-	Hatchback Engine BGU	261237	Stub Axle	23	37	54		142.5	
	2004.01-	2008.11	MT	L	F	Hatchback Engine BGU	261097	Drive Shaft	36		59.5	40.5	543	
	2004.01-	2008.11	AT	R	F	Hatchback Engine BGU	261094	Drive Shaft	36	26	59.5	40.5	884	
	2004.01-	2008.11	5MT	R	F	Hatchback Engine BGU	261096	Drive Shaft	36		59.5	40.5	799	
	2004.01-	2008.11	AT	L	F	Hatchback Engine BGU	803116	Outer Joint	36	30	59.5	38	55	I
	2004.01-	2008.11	-	L/R	F	Hatchback Engine BGU	803037	Outer Joint	36	30	59.5	40.5	55	I
	2004.01-	2008.11	AT	L/R	F	Hatchback Engine BGU	661011	Inner Joint	26	32	31	68.5	85	
	2004.01-	2008.11	AT	L	F	Hatchback Engine BGU	203318	Drive Shaft	36	26	59.5	38	581	
	2004.01-	2008.11	MT	L	F	Hatchback Engine BGU	203320	Drive Shaft	36		59.5	40	546	
1.6 FSI (85 kW)	2003.10-	2008.07	MT	L/R	F	Hatchback Engine BAG	603011	Inner Joint		33		34		
	2003.10-	2008.07	-	-	-	Hatchback Engine BAG	261237	Stub Axle	23	37	54		142.5	
	2003.10-	2008.07	MT	R	F	Hatchback Engine BAG	261211	Drive Shaft	36		59.5	40.5	784	
	2003.10-	2008.07	MT	L	F	Hatchback Engine BAG	803116	Outer Joint	36	30	59.5	38	55	I
	2003.10-	2008.07	-	L/R	F	Hatchback Engine BAG	803037	Outer Joint	36	30	59.5	40.5	55	I
	2003.10-	2008.07	AT	L	F	Hatchback Engine BAG	201582	Drive Shaft	36	26	59.5	40	597	
	2003.10-	2008.07	AT	L/R	F	Hatchback Engine BAG	661011	Inner Joint	26	32	31	68.5	85	
	2003.10-	2008.07	MT	L	F	Hatchback Engine BAG	203319	Drive Shaft	36		59.5	38	557	
1.6 MultiFuel (75 kW)	2007.10-	2008.11	-	L	F	Hatchback Engine CCSA	203320	Drive Shaft	36		59.5	40	546	
1.9 TDI (66 kW)	2004.05-	2008.11	MT	-	-	Hatchback Engine BRU	603006	Inner Joint		33		34		
	2004.05-	2008.11	-	L	F	Hatchback Engine BRU	203294	Drive Shaft	36		59.5	38	519	
	2004.05-	2008.11	5MT	L/R	F	Hatchback Engine BRU	803037	Outer Joint	36	30	59.5	40.5	55	I
	2004.05-	2008.11	-	-	-	Hatchback Engine BRU	261237	Stub Axle	23	37	54		142.5	
	2004.05-	2008.11	AT	L	F	Hatchback Engine BRU	654004	Inner Joint		34		85		
	2004.05-	2008.11	AT	L	F	Hatchback Engine BRU	203241	Drive Shaft	36		59.5	40	475	
	2004.05-	2008.11	-	L	F	Hatchback Engine BRU	803116	Outer Joint	36	30	59.5	38	55	I
	2004.05-	2008.11	MT	L/R	F	Hatchback Engine BRU	603011	Inner Joint		33		34		

	 YEAR	TRANSM	L/R	F/R	REMARKS	GSP Ref.	 PRODUCT	 ABS	Technical Specifications							
									A	B	C	H	L	P		
VW																
GOLF V (1K1)																
1.9 TDI (66 kW)	2004.05-2008.11	-	R	F	Hatchback Engine BRU	261042	Drive Shaft		36		59.5	40.5	814			
	2004.05-2008.11	-	R	F	Hatchback Engine BRU	201585	Drive Shaft		36		59.5	40	805			
1.9 TDI (77 kW)	2003.10-2008.11	MT	L/R	F	Hatchback Engine BLS	603011	Inner Joint		33		34					
	2003.10-2008.11	5MT	L	F	Hatchback Engine BLS	203294	Drive Shaft		36		59.5	38	519			
	2003.10-2008.11	AT	L	F	Hatchback Engine BLS	254013	Drive Shaft		36		59.5	40	479.5			
	2003.10-2008.11	AT	L	F	Hatchback Engine BLS	654004	Inner Joint		34		85					
	2003.10-2008.11	MT	L/R	F	Hatchback Engine BLS	803037	Outer Joint		36	30	59.5	40.5	55	I		
	2003.10-2008.11	6AT	L/R	F	Hatchback Engine BLS	661057	Inner Joint		34		86					
	2003.10-2008.11	-	-	-	Hatchback Engine BLS	261237	Stub Axle		23	37	54		142.5			
	2003.10-2008.11	AT	L	F	Hatchback Engine BLS	203241	Drive Shaft		36		59.5	40	475			
	2003.10-2008.11	5MT	L	F	Hatchback Engine BLS	803116	Outer Joint		36	30	59.5	38	55	I		
	2003.10-2008.11	5MT	R	F	Hatchback Engine BLS	261042	Drive Shaft		36		59.5	40.5	814			
	2003.10-2008.11	6AT	L/R	F	Hatchback Engine BLS	861045	Outer Joint		36	27	59.5	40	65	M		
	2003.10-2008.11	AT	L/R	F	Hatchback Engine BLS	803002	Outer Joint		36	27	59.5	40	66	I		
	2003.10-2008.11	5MT	R	F	Hatchback Engine BLS	201585	Drive Shaft		36		59.5	40	805			
	2003.10-2008.11	AT	R	F	Hatchback Engine BLS	254011	Drive Shaft		36		59.5	40	755			
1.9 TDI 4motion (77 kW)	2004.08-2008.11	6AT	L/R	F	All-wheel Drive Hatchback Engine BKC	803037	Outer Joint		36	30	59.5	40.5	55	I		
	2004.08-2008.11	MT	L/R	F	All-wheel Drive Hatchback Engine BKC	603011	Inner Joint		33		34					
	2004.08-2008.11	6MT	L/R	F	All-wheel Drive Hatchback Engine BKC	803002	Outer Joint		36	27	59.5	40	66	I		
	2004.08-2008.11	-	-	-	All-wheel Drive Hatchback Engine BKC	261237	Stub Axle		23	37	54		142.5			
	2004.08-2008.11	-	R	F	All-wheel Drive Hatchback Engine BKC	203266	Drive Shaft		36		59.5	40	601			
	2004.08-2008.11	-	L	F	All-wheel Drive Hatchback Engine BKC	203295	Drive Shaft		36		59.5	40	491			
2.0 FSI (110 kW)	2004.01-2008.11	MT	R	F	Hatchback Engine BLY	261113	Drive Shaft		36		59.5	40	814			
	2004.01-2008.11	MT	L/R	F	Hatchback Engine BLY	603011	Inner Joint		33		34					
	2004.01-2008.11	-	-	-	Hatchback Engine BLY	261237	Stub Axle		23	37	54		142.5			
	2004.01-2008.11	AT	R	F	Hatchback Engine BLY	261094	Drive Shaft		36	26	59.5	40.5	884			
	2004.01-2008.11	-	L/R	F	Hatchback Engine BLY	803037	Outer Joint		36	30	59.5	40.5	55	I		
	2004.01-2008.11	MT	L	F	Hatchback Engine BLY	803116	Outer Joint		36	30	59.5	38	55	I		
	2004.01-2008.11	AT	L/R	F	Hatchback Engine BLY	661011	Inner Joint		26	32	31	68.5	85			
	2004.01-2008.11	MT	R	F	Hatchback Engine BLY	201585	Drive Shaft		36		59.5	40	805			
	2004.01-2008.11	AT	L	F	Hatchback Engine BLY	261093	Drive Shaft		36	26	59.5	40.5	587.5			
2.0 FSI 4motion (110 kW)	2004.08-2008.11	-	-	-	All-wheel Drive Hatchback Engine BLX	261237	Stub Axle		23	37	54		142.5			
	2004.08-2008.11	-	L	F	All-wheel Drive Hatchback Engine BLX	803116	Outer Joint		36	30	59.5	38	55	I		
	2004.08-2008.11	MT	L/R	F	All-wheel Drive Hatchback Engine BLX	603011	Inner Joint		33		34					
	2004.08-2008.11	AT	L/R	F	All-wheel Drive Hatchback Engine BLX	661011	Inner Joint		26	32	31	68.5	85			
	2004.08-2008.11	-	L/R	F	All-wheel Drive Hatchback Engine BLX	803037	Outer Joint		36	30	59.5	40.5	55	I		
	2004.08-2008.11	-	L	F	All-wheel Drive Hatchback Engine BLX	203294	Drive Shaft		36		59.5	38	519			
2.0 GTI (147 kW)	2004.10-2009.02	-	L/R	F	Hatchback Engine CBFA	803002	Outer Joint		36	27	59.5	40	66	I		
	2004.10-2009.02	AT	L/R	F	Hatchback Engine CBFA	661057	Inner Joint		34		86					
	2004.10-2009.02	-	-	-	Hatchback Engine CBFA	261237	Stub Axle		23	37	54		142.5			
	2004.10-2009.02	AT	L	F	Hatchback Engine CBFA	254013	Drive Shaft		36		59.5	40	479.5			
	2004.10-2009.02	AT	L	F	Hatchback Engine CBFA	654004	Inner Joint		34		85					
	2004.10-2009.02	AT/MT	L	F	Hatchback Engine CBFA	203295	Drive Shaft		36		59.5	40	491			
2.0 GTI (169 kW)	2006.09-2008.12	-	L	F	Hatchback Engine BYD	203295	Drive Shaft		36		59.5	40	491			
	2006.09-2008.12	MT	L/R	F	Hatchback Engine BYD	803002	Outer Joint		36	27	59.5	40	66	I		
2.0 SDI (55 kW)	2004.01-2008.11	MT	-	-	Hatchback Engine BDK	603006	Inner Joint		33		34					
	2004.01-2008.11	MT	L/R	F	Hatchback Engine BDK	603011	Inner Joint		33		34					
	2004.01-2008.11	-	-	-	Hatchback Engine BDK	261237	Stub Axle		23	37	54		142.5			
	2004.01-2008.11	-	L/R	F	Hatchback Engine BDK	803037	Outer Joint		36	30	59.5	40.5	55	I		
2.0 TDI (100 kW)	2003.10-2008.11	MT	L	F	Hatchback Engine AZV	203295	Drive Shaft		36		59.5	40	491			
	2003.10-2008.11	AT	L/R	F	Hatchback Engine AZV	661057	Inner Joint		34		86					
	2003.10-2008.11	MT	L	F	Hatchback Engine AZV	203265	Drive Shaft		36		59.5	40	487			
	2003.10-2008.11	-	L/R	F	Hatchback Engine AZV	803002	Outer Joint		36	27	59.5	40	66	I		
	2003.10-2008.11	MT	R	F	Hatchback Engine AZV	203313	Drive Shaft		36		59.5	40	792			
	2003.10-2008.11	AT	R	F	Hatchback Engine AZV	203355	Drive Shaft		36	23	59.5	40	799			
	2003.10-2008.11	MT	R	F	Hatchback Engine AZV	203236	Drive Shaft		36		59.5	40	484			
	2003.10-2008.11	-	-	-	Hatchback Engine AZV	261237	Stub Axle		23	37	54		142.5			
	2003.10-2008.11	AT	L	F	Hatchback Engine AZV	254013	Drive Shaft		36		59.5	40	479.5			
	2003.10-2008.11	AT	L	F	Hatchback Engine AZV	654004	Inner Joint		34		85					
	2003.10-2008.11	AT	L	F	Hatchback Engine AZV	203241	Drive Shaft		36		59.5	40	475			
	2003.10-2008.11	-	L/R	F	Hatchback Engine AZV	861045	Outer Joint		36	27	59.5	40	65	M		
	2003.10-2008.11	MT	R	F	Hatchback Engine AZV	261126	Drive Shaft		36		59.5	40	793			
	2003.10-2008.11	AT	R	F	Hatchback Engine AZV	254011	Drive Shaft		36		59.5	40	755			
2.0 TDI (103 kW)	2004.12-2008.11	AT	R	F	Hatchback Engine BMM	254011	Drive Shaft		36		59.5	40	755			
	2004.12-2008.11	AT	L/R	F	Hatchback Engine BMM	661057	Inner Joint		34		86					
	2004.12-2008.11	MT	L	F	Hatchback Engine BMM	203265	Drive Shaft		36		59.5	40	487			





YEAR	TRANSM	L/R	F/R	REMARKS	GSP Ref.	PRODUCT	ABS	Technical Specifications					
								A	B	C	H	L	P
VW													
GOLF V (1K1)													
2.0 TDI (103 kW)	2004.12-2008.11	-	L/R	F	Hatchback Engine BMM	803002	Outer Joint	36	27	59.5	40	66	I
	2004.12-2008.11	-	-	-	Hatchback Engine BMM	261237	Stub Axle	23	37	54		142.5	
	2004.12-2008.11	MT	R	F	Hatchback Engine BMM	203313	Drive Shaft	36		59.5	40	792	
	2004.12-2008.11	AT	L	F	Hatchback Engine BMM	254013	Drive Shaft	36		59.5	40	479.5	
	2004.12-2008.11	AT	L	F	Hatchback Engine BMM	654004	Inner Joint		34		85		
	2004.12-2008.11	AT	L	F	Hatchback Engine BMM	203241	Drive Shaft	36		59.5	40	475	
	2004.12-2008.11	MT	L	F	Hatchback Engine BMM	203295	Drive Shaft	36		59.5	40	491	
	2004.12-2008.11	-	L/R	F	Hatchback Engine BMM	861045	Outer Joint	36	27	59.5	40	65	M
2.0 TDI (125 kW)	2005.11-2008.11	AT	R	F	Hatchback Engine BMN	254011	Drive Shaft	36		59.5	40	755	
	2005.11-2008.11	MT	L	F	Hatchback Engine BMN	203265	Drive Shaft	36		59.5	40	487	
	2005.11-2008.11	AT	L/R	F	Hatchback Engine BMN	661057	Inner Joint		34		86		
	2005.11-2008.11	AT	L	F	Hatchback Engine BMN	203241	Drive Shaft	36		59.5	40	475	
	2005.11-2008.11	MT	R	F	Hatchback Engine BMN	261126	Drive Shaft	36		59.5	40	793	
	2005.11-2008.11	AT	R	F	Hatchback Engine BMN	654004	Inner Joint		34		85		
	2005.11-2008.11	-	L/R	F	Hatchback Engine BMN	861045	Outer Joint	36	27	59.5	40	65	M
	2005.11-2008.11	MT	R	F	Hatchback Engine BMN	261126	Drive Shaft	36		59.5	40	793	
2.0 TDI 16V (103 kW)	2003.10-2008.11	AT	L/R	F	Hatchback Engine BKD	661057	Inner Joint		34		86		
	2003.10-2008.11	-	L/R	F	Hatchback Engine BKD	803002	Outer Joint	36	27	59.5	40	66	I
	2003.10-2008.11	MT	L	F	Hatchback Engine BKD	203265	Drive Shaft	36		59.5	40	487	
	2003.10-2008.11	MT	R	F	Hatchback Engine BKD	203313	Drive Shaft	36		59.5	40	792	
	2003.10-2008.11	6AT	R	F	Hatchback Engine BKD	203355	Drive Shaft	36	23	59.5	40	799	
	2003.10-2008.11	MT	R	F	Hatchback Engine BKD	203236	Drive Shaft	36		59.5	40	484	
	2003.10-2008.11	-	-	-	Hatchback Engine BKD	261237	Stub Axle	23	37	54		142.5	
	2003.10-2008.11	AT	L	F	Hatchback Engine BKD	254013	Drive Shaft	36		59.5	40	479.5	
	2003.10-2008.11	AT	L	F	Hatchback Engine BKD	654004	Inner Joint		34		85		
	2003.10-2008.11	-	L/R	F	Hatchback Engine BKD	861045	Outer Joint	36	27	59.5	40	65	M
	2003.10-2008.11	MT	R	F	Hatchback Engine BKD	261126	Drive Shaft	36		59.5	40	793	
	2003.10-2008.11	MT	L/R	F	Hatchback Engine BKD	203295	Drive Shaft	36		59.5	40	491	
	2003.10-2008.11	AT	R	F	Hatchback Engine BKD	254011	Drive Shaft	36		59.5	40	755	
	2003.10-2008.11	DCT	L	F	Hatchback Engine BKD	203241	Drive Shaft	36		59.5	40	475	
2.0 TDI 16V 4motion (103 kW)	2004.08-2008.11	-	L/R	F	All-wheel Drive Hatchback Engine BKD	803002	Outer Joint	36	27	59.5	40	66	I
	2004.08-2008.11	-	L	F	All-wheel Drive Hatchback Engine BKD	203295	Drive Shaft	36		59.5	40	491	
	2004.08-2008.11	-	L/R	R	All-wheel Drive Hatchback Engine BKD	603011	Inner Joint		33		34		
	2004.08-2008.11	-	-	-	All-wheel Drive Hatchback Engine BKD	261237	Stub Axle	23	37	54		142.5	
	2004.08-2008.11	-	R	F	All-wheel Drive Hatchback Engine BKD	203266	Drive Shaft	36		59.5	40	601	
	2004.08-2008.11	-	L/R	R	All-wheel Drive Hatchback Engine BKD	803037	Outer Joint	36	30	59.5	40.5	55	I
2.0 TDI 4motion (103 kW)	2004.08-2008.11	-	L/R	F	All-wheel Drive Hatchback Engine BMM	803002	Outer Joint	36	27	59.5	40	66	I
	2004.08-2008.11	-	R	F	All-wheel Drive Hatchback Engine BMM	203266	Drive Shaft	36		59.5	40	601	
	2004.08-2008.11	-	-	-	All-wheel Drive Hatchback Engine BMM	261237	Stub Axle	23	37	54		142.5	
	2004.08-2008.11	-	L/R	R	All-wheel Drive Hatchback Engine BMM	603011	Inner Joint		33		34		
	2004.08-2008.11	-	L	F	All-wheel Drive Hatchback Engine BMM	203295	Drive Shaft	36		59.5	40	491	
	2004.08-2008.11	-	L/R	R	All-wheel Drive Hatchback Engine BMM	803037	Outer Joint	36	30	59.5	40.5	55	I
3.2 (184 kW)	2005.09-2008.11	-	L/R	R	Hatchback Engine BUB	803037	Outer Joint	36	30	59.5	40.5	55	I
	2005.09-2008.11	-	L/R	F	Hatchback Engine BUB	803002	Outer Joint	36	27	59.5	40	66	I
	2005.09-2008.11	AT	R	F	Hatchback Engine BUB	203266	Drive Shaft	36		59.5	40	601	
	2005.09-2008.11	-	L/R	R	Hatchback Engine BUB	603011	Inner Joint		33		34		
	2005.09-2008.11	AT/MT	L	F	Hatchback Engine BUB	203295	Drive Shaft	36		59.5	40	491	
3.2 R32 4motion (184 kW)	2005.11-2008.11	-	L/R	R	All-wheel Drive Hatchback Engine BUB	803037	Outer Joint	36	30	59.5	40.5	55	I
	2005.11-2008.11	-	L/R	F	All-wheel Drive Hatchback Engine BUB	803002	Outer Joint	36	27	59.5	40	66	I
	2005.11-2008.11	-	L/R	R	All-wheel Drive Hatchback Engine BUB	603011	Inner Joint		33		34		
	2005.11-2008.11	AT	R	F	All-wheel Drive Hatchback Engine BUB	203266	Drive Shaft	36		59.5	40	601	
	2005.11-2008.11	AT/MT	L	F	All-wheel Drive Hatchback Engine BUB	203295	Drive Shaft	36		59.5	40	491	
GOLF V Variant (1K5)													
1.4 (59 kW)	2007.06-2009.07	-	L/R	F	Estate Engine BUD	603008	Inner Joint		33		32		
	2007.06-2009.07	MT	-	-	Estate Engine BUD	603006	Inner Joint		33		34		
	2007.06-2009.07	5MT	R	F	Estate Engine BUD	253008	Drive Shaft	36		59.5	40	782	
	2007.06-2009.07	-	L	F	Estate Engine BUD	253007	Drive Shaft	36		59.5	40	559	
	2007.06-2009.07	5MT	L/R	F	Estate Engine BUD	853001	Outer Joint	36	30	59.5	40	49	I
1.4 TSI (103 kW)	2007.06-2009.07	MT	L/R	F	Estate Engine BMY	803037	Outer Joint	36	30	59.5	40.5	55	I
	2007.06-2009.07	MT	L/R	F	Estate Engine BMY	603011	Inner Joint		33		34		
	2007.06-2009.07	MT	L	F	Estate Engine BMY	203302	Drive Shaft	36		59.5	40	528	
	2007.06-2009.07	MT	R	F	Estate Engine BMY	201586	Drive Shaft	36		59.5	40	806	
	2007.06-2009.07	AT	L/R	F	Estate Engine BMY	803002	Outer Joint	36	27	59.5	40	66	I
	2007.06-2009.07	AT	R	F	Estate Engine BMY	261342	Drive Shaft	36		59.5	40	764	
1.4 TSI (118 kW)	2008.07-2009.07	Semi-AT	L	F	Estate Engine CAVD	203302	Drive Shaft	36		59.5	40	528	
	2008.07-2009.07	MT	L/R	F	Estate Engine CAVD	603011	Inner Joint		33		34		

YEAR	TRANSM	L/R	F/R	REMARKS	GSP Ref.	PRODUCT	ABS	Technical Specifications								
								A	B	C	H	L	P			
VW																
GOLF V Variant (1K5)																
1.4 TSI (118 kW)	2008.07-2009.07	-	-	-	Estate Engine CAVD	603016	Inner Joint			28		32				
	2008.07-2009.07	-	L	F	Estate Engine CAVD	661054	Inner Joint	40	28	46.9	51	53				
	2008.07-2009.07	MT	L/R	F	Estate Engine CAVD	803037	Outer Joint	36	30	59.5	40.5	55	I			
	2008.07-2009.07	AT	L/R	F	Estate Engine CAVD	803002	Outer Joint	36	27	59.5	40	66	I			
1.4 TSI (125 kW)	2007.06-2009.07	MT	L	F	Estate Engine BLG	203302	Drive Shaft	36		59.5	40	528				
	2007.06-2009.07	6AT/6MT	L/R	F	Estate Engine BLG	803002	Outer Joint	36	27	59.5	40	66	I			
	2007.06-2009.07	AT	R	F	Estate Engine BLG	261342	Drive Shaft	36		59.5	40	764				
	2007.06-2009.07	MT	R	F	Estate Engine BLG	201653	Drive Shaft	36		59.5	40	785				
1.4 TSI (90 kW)	2007.06-2009.07	MT	L/R	F	Estate Engine CAXA	603011	Inner Joint			33		34				
	2007.06-2009.07	MT	L	F	Estate Engine CAXA	261198	Drive Shaft	36		59.5	40.5	530				
	2007.06-2009.07	-	-	-	Estate Engine CAXA	603016	Inner Joint			28		32				
	2007.06-2009.07	-	L	F	Estate Engine CAXA	661054	Inner Joint	40	28	46.9	51	53				
	2007.06-2009.07	MT	R	F	Estate Engine CAXA	201586	Drive Shaft	36		59.5	40	806				
	2007.06-2009.07	MT	L/R	F	Estate Engine CAXA	803037	Outer Joint	36	30	59.5	40.5	55	I			
	2007.06-2009.07	AT	L/R	F	Estate Engine CAXA	803002	Outer Joint	36	27	59.5	40	66	I			
	2007.06-2009.07	AT	R	F	Estate Engine CAXA	203346	Drive Shaft	36	26	59.5	38	879				
1.6 (75 kW)	2007.06-2009.07	AT	-	-	Estate Engine BGU	661050	Inner Joint	26	32	31	68.5	89				
	2007.06-2009.07	6AT/5MT	L/R	F	Estate Engine BGU	803037	Outer Joint	36	30	59.5	40.5	55	I			
	2007.06-2009.07	MT	L	F	Estate Engine BGU	261097	Drive Shaft	36		59.5	40.5	543				
	2007.06-2009.07	AT	R	F	Estate Engine BGU	803116	Outer Joint	36	30	59.5	38	55	I			
	2007.06-2009.07	5MT	R	F	Estate Engine BGU	261096	Drive Shaft	36		59.5	40.5	799				
	2007.06-2009.07	MT	L/R	F	Estate Engine BGU	603011	Inner Joint			33		34				
	2007.06-2009.07	MT	L	F	Estate Engine BGU	203320	Drive Shaft	36		59.5	40	546				
	2007.06-2009.07	AT	L	F	Estate Engine BGU	261093	Drive Shaft	36	26	59.5	40.5	587.5				
	1.6 MultiFuel (75 kW)	2007.11-2009.07	MT	-	-	Estate Engine CCSA	603006	Inner Joint			33		34			
		2007.11-2009.07	-	L	F	Estate Engine CCSA	261097	Drive Shaft	36		59.5	40.5	543			
2007.11-2009.07		-	L/R	F	Estate Engine CCSA	603011	Inner Joint			33		34				
2007.11-2009.07		-	R	F	Estate Engine CCSA	261096	Drive Shaft	36		59.5	40.5	799				
2007.11-2009.07		-	L	F	Estate Engine CCSA	203320	Drive Shaft	36		59.5	40	546				
2007.11-2009.07		-	L/R	F	Estate Engine CCSA	803037	Outer Joint	36	30	59.5	40.5	55	I			
1.9 TDI (77 kW)	2007.06-2009.07	MT	L	F	Estate Engine BLS	203294	Drive Shaft	36		59.5	38	519				
	2007.06-2009.07	MT	L/R	F	Estate Engine BLS	603011	Inner Joint			33		34				
	2007.06-2009.07	6AT	R	F	Estate Engine BLS	254011	Drive Shaft	36		59.5	40	755				
	2007.06-2009.07	-	L	F	Estate Engine BLS	661054	Inner Joint	40	28	46.9	51	53				
	2007.06-2009.07	-	R	F	Estate Engine BLS	203313	Drive Shaft	36		59.5	40	792				
	2007.06-2009.07	MT	L/R	F	Estate Engine BLS	803037	Outer Joint	36	30	59.5	40.5	55	I			
	2007.06-2009.07	6AT	L/R	F	Estate Engine BLS	661057	Inner Joint			34		86				
	2007.06-2009.07	MT	L	F	Estate Engine BLS	803116	Outer Joint	36	30	59.5	38	55	I			
	2007.06-2009.07	MT	R	F	Estate Engine BLS	261042	Drive Shaft	36		59.5	40.5	814				
	2007.06-2009.07	AT	L	F	Estate Engine BLS	203241	Drive Shaft	36		59.5	40	475				
	2007.06-2009.07	6AT	L	F	Estate Engine BLS	254013	Drive Shaft	36		59.5	40	479.5				
	2007.06-2009.07	6AT	L	F	Estate Engine BLS	654004	Inner Joint			34		85				
	2007.06-2009.07	MT	R	F	Estate Engine BLS	201585	Drive Shaft	36		59.5	40	805				
	2007.06-2009.07	AT	L/R	F	Estate Engine BLS	803002	Outer Joint	36	27	59.5	40	66	I			
2007.06-2009.07	AT	L/R	F	Estate Engine BLS	603008	Inner Joint			33		32					
1.9 TDI 4motion (77 kW)	2008.01-2009.07	AT	R	F	All-wheel Drive Estate Engine BLS	254011	Drive Shaft	36		59.5	40	755				
	2008.01-2009.07	MT	L	F	All-wheel Drive Estate Engine BLS	203295	Drive Shaft	36		59.5	40	491				
	2008.01-2009.07	MT	L/R	R	All-wheel Drive Estate Engine BLS	603011	Inner Joint			33		34				
	2008.01-2009.07	-	L	F	All-wheel Drive Estate Engine BLS	661054	Inner Joint	40	28	46.9	51	53				
	2008.01-2009.07	AT	L/R	F	All-wheel Drive Estate Engine BLS	661057	Inner Joint			34		86				
	2008.01-2009.07	MT	R	F	All-wheel Drive Estate Engine BLS	203266	Drive Shaft	36		59.5	40	601				
	2008.01-2009.07	AT	L	F	All-wheel Drive Estate Engine BLS	254013	Drive Shaft	36		59.5	40	479.5				
	2008.01-2009.07	AT	L	F	All-wheel Drive Estate Engine BLS	654004	Inner Joint			34		85				
	2008.01-2009.07	AT/MT	L/R	F	All-wheel Drive Estate Engine BLS	803002	Outer Joint	36	27	59.5	40	66	I			
	2008.01-2009.07	6AT	L	F	All-wheel Drive Estate Engine BLS	203241	Drive Shaft	36		59.5	40	475				
2.0 (147 kW)	2007.06-2009.07	AT	L	F	Estate Engine BWA	203295	Drive Shaft	36		59.5	40	491				
	2007.06-2009.07	6AT/6MT	L/R	F	Estate Engine BWA	803002	Outer Joint	36	27	59.5	40	66	I			
2.0 TDI (100 kW)	2007.06-2009.07	MT	L	F	Estate Engine AZV	203295	Drive Shaft	36		59.5	40	491				
	2007.06-2009.07	-	L/R	F	Estate Engine AZV	803002	Outer Joint	36	27	59.5	40	66	I			
	2007.06-2009.07	MT	-	-	Estate Engine AZV	603006	Inner Joint			33		34				
	2007.06-2009.07	AT	L	F	Estate Engine AZV	654004	Inner Joint			34		85				
	2007.06-2009.07	MT	R	F	Estate Engine AZV	203313	Drive Shaft	36		59.5	40	792				
	2007.06-2009.07	MT	-	-	Estate Engine AZV	603016	Inner Joint			28		32				
	2007.06-2009.07	AT	L	F	Estate Engine AZV	203241	Drive Shaft	36		59.5	40	475				
2.0 TDI (103 kW)	2007.06-2009.07	AT	R	F	Estate Engine BMM	254011	Drive Shaft	36		59.5	40	755				
	2007.06-2009.07	MT	L	F	Estate Engine BMM	203295	Drive Shaft	36		59.5	40	491				

	YEAR		TRANSM	L/R	F/R	REMARKS	GSP Ref.	PRODUCT	ABS	Technical Specifications					
	A	B								C	H	L	P		
VW															
GOLF V Variant (1K5)															
2.0 TDI (103 kW)	2007.06-	2009.07	AT	L/R	F	Estate Engine BMM	661057	Inner Joint		34		86			
	2007.06-	2009.07	-	R	F	Estate Engine BMM	203236	Drive Shaft	36		59.5	40	484		
	2007.06-	2009.07	MT	R	F	Estate Engine BMM	203313	Drive Shaft	36		59.5	40	792		
	2007.06-	2009.07	AT	L	F	Estate Engine BMM	254013	Drive Shaft	36		59.5	40	479.5		
	2007.06-	2009.07	AT	L	F	Estate Engine BMM	654004	Inner Joint		34		85			
	2007.06-	2009.07	AT	L	F	Estate Engine BMM	203241	Drive Shaft	36		59.5	40	475		
	2007.06-	2009.07	AT/MT	L/R	F	Estate Engine BMM	803002	Outer Joint	36	27	59.5	40	66	I	
2.0 TDI 16V (103 kW)	2007.06-	2009.07	AT	R	F	Estate Engine CBDB	254011	Drive Shaft	36		59.5	40	755		
	2007.06-	2009.07	MT	L	F	Estate Engine CBDB	203295	Drive Shaft	36		59.5	40	491		
	2007.06-	2009.07	AT	L/R	F	Estate Engine CBDB	661057	Inner Joint		34		86			
	2007.06-	2009.07	MT	R	F	Estate Engine CBDB	203313	Drive Shaft	36		59.5	40	792		
	2007.06-	2009.07	AT	L	F	Estate Engine CBDB	254013	Drive Shaft	36		59.5	40	479.5		
	2007.06-	2009.07	AT	L	F	Estate Engine CBDB	654004	Inner Joint		34		85			
	2007.06-	2009.07	AT	L	F	Estate Engine CBDB	203241	Drive Shaft	36		59.5	40	475		
2007.06-	2009.07	AT/MT	L/R	F	Estate Engine CBDB	803002	Outer Joint	36	27	59.5	40	66	I		
GOLF VARIANT (BA5)															
-	2013-	-	-	L	R	-	661103	Inner Joint		33		32			
	2013-	-	-	R	R	-	661103	Inner Joint		33		32			
	2013-	-	-	L	R	-	261286	Drive Shaft	36		59.5	79	587		
	2013-	-	-	R	R	-	261287	Drive Shaft	36		59.5	79	630		
GOLF VARIANT(685)															
-	2010-	2014	-	L	-	-	261153	Drive Shaft	36	26	59.5	40	583		
	2010-	2014	-	L	-	-	261153	Drive Shaft	36	26	59.5	40	583		
GOLF VI (517)															
1.2 TSI (77 kW)	2011.03-	-	DCT	L	F	Convertible Engine CBZB	261201	Drive Shaft	36		59.5	40.5	535		
	2011.03-	-	MT	L/R	F	Convertible Engine CBZB	803037	Outer Joint	36	30	59.5	40.5	55	I	
	2011.03-	-	MT	L	F	Convertible Engine CBZB	261198	Drive Shaft	36		59.5	40.5	530		
	2011.03-	-	MT	R	F	Convertible Engine CBZB	201586	Drive Shaft	36		59.5	40	806		
	2011.03-	-	AT/MT	L/R	F	Convertible Engine CBZB	603011	Inner Joint		33		34			
	2011.03-	-	DCT	-	F	Convertible Engine CBZB	803100	Outer Joint	36	33	59.5	38	55	I	
	2011.03-	-	MT	-	-	Convertible Engine CBZB	603006	Inner Joint		33		34			
1.2 TSI 16V (77 kW)	2013.11-	-	MT	L/R	F	Convertible Engine CYVD	803037	Outer Joint	36	30	59.5	40.5	55	I	
	2013.11-	-	MT	L/R	F	Convertible Engine CYVD	603011	Inner Joint		33		34			
	2013.11-	-	MT	L	F	Convertible Engine CYVD	203373	Drive Shaft	36		59.5	38	511		
	2013.11-	-	MT	-	-	Convertible Engine CYVD	603006	Inner Joint		33		34			
	2013.11-	-	MT	L	F	Convertible Engine CYVD	803116	Outer Joint	36	30	59.5	38	55	I	
1.4 TSI (110 kW)	2013.11-	-	MT	L/R	F	Convertible Engine CZDA	603011	Inner Joint		33		34			
1.4 TSI (118 kW)	2011.03-	-	MT	L	F	Convertible Engine CAVD	261224	Drive Shaft	36		59.5	40	536		
	2011.03-	-	MT	L/R	F	Convertible Engine CAVD	803037	Outer Joint	36	30	59.5	40.5	55	I	
	2011.03-	-	MT	L/R	F	Convertible Engine CAVD	603011	Inner Joint		33		34			
	2011.03-	-	7AT	L	F	Convertible Engine CAVD	261281	Drive Shaft	36		59.5	40	528		
	2011.03-	-	AT	L/R	F	Convertible Engine CAVD	803002	Outer Joint	36	27	59.5	40	66	I	
1.4 TSI (90 kW)	2011.11-	-	7AT	R	F	Convertible Engine CAXA	261199	Drive Shaft	36		59.5	40.5	800		
	2011.11-	-	DCT	L	F	Convertible Engine CAXA	261201	Drive Shaft	36		59.5	40.5	535		
	2011.11-	-	MT	L/R	F	Convertible Engine CAXA	803037	Outer Joint	36	30	59.5	40.5	55	I	
	2011.11-	-	MT	R	F	Convertible Engine CAXA	201586	Drive Shaft	36		59.5	40	806		
	2011.11-	-	AT/MT	L/R	F	Convertible Engine CAXA	603011	Inner Joint		33		34			
	2011.11-	-	-	-	F	Convertible Engine CAXA	803100	Outer Joint	36	33	59.5	38	55	I	
1.6 TDI (77 kW)	2011.03-	-	-	L	F	Convertible Engine CAYC	203294	Drive Shaft	36		59.5	38	519		
	2011.03-	-	-	L/R	F	Convertible Engine CAYC	803037	Outer Joint	36	30	59.5	40.5	55	I	
	2011.03-	-	-	L/R	F	Convertible Engine CAYC	603011	Inner Joint		33		34			
	2011.03-	-	-	L	F	Convertible Engine CAYC	803116	Outer Joint	36	30	59.5	38	55	I	
	2011.03-	-	-	R	F	Convertible Engine CAYC	261042	Drive Shaft	36		59.5	40.5	814		
	2011.03-	-	-	R	F	Convertible Engine CAYC	201585	Drive Shaft	36		59.5	40	805		
2.0 GTI (155 kW)	2011.11-	-	AT	-	-	Convertible Engine CCZB	603016	Inner Joint		28		32			
2.0 R (195 kW)	2013.01-	-	AT	-	-	Convertible Engine CDLA	603016	Inner Joint		28		32			
2.0 TDI (103 kW)	2011.11-	-	MT	R	F	Convertible Engine CFHC	203313	Drive Shaft	36		59.5	40	792		
	2011.11-	-	AT	L	F	Convertible Engine CFHC	254013	Drive Shaft	36		59.5	40	479.5		
	2011.11-	-	AT	L	F	Convertible Engine CFHC	654004	Inner Joint		34		85			
	2011.11-	-	-	L/R	F	Convertible Engine CFHC	803002	Outer Joint	36	27	59.5	40	66	I	
	2011.11-	-	AT	-	-	Convertible Engine CFHC	603016	Inner Joint		28		32			
	2011.11-	-	AT	R	F	Convertible Engine CFHC	254011	Drive Shaft	36		59.5	40	755		
	2011.11-	-	MT	L	F	Convertible Engine CFHC	203295	Drive Shaft	36		59.5	40	491		
2.0 TDI (110 kW)	2013.11-	-	MT	L	F	Convertible Engine CUUB	203265	Drive Shaft	36		59.5	40	487		
	2013.11-	-	MT	R	F	Convertible Engine CUUB	203313	Drive Shaft	36		59.5	40	792		
	2013.11-	-	AT	L/R	F	Convertible Engine CUUB	603011	Inner Joint		33		34			





YEAR	TRANSM	L/R	F/R	REMARKS	GSP Ref.	PRODUCT	ABS	Technical Specifications						
								A	B	C	H	L	P	
VW														
GOLF VI (517)														
2.0 TDI (110 kW)	2013.11-	-	MT	L/R	F	Convertible Engine CUUB	803002	Outer Joint	36	27	59.5	40	66	I
	2013.11-	-	MT	R	F	Convertible Engine CUUB	261126	Drive Shaft	36		59.5	40	793	
	2013.11-	-	DCT	R	F	Convertible Engine CUUB	654004	Inner Joint		34		85		
	2013.11-	-	DCT	R	F	Convertible Engine CUUB	254011	Drive Shaft	36		59.5	40	755	
	2013.11-	-	MT	L	F	Convertible Engine CUUB	203295	Drive Shaft	36		59.5	40	491	
2.0 TDI (81 kW)	2013.11-	-	MT	L	F	Convertible Engine CUUA	203294	Drive Shaft	36		59.5	38	519	
	2013.11-	-	MT	L/R	F	Convertible Engine CUUA	803037	Outer Joint	36	30	59.5	40.5	55	I
	2013.11-	-	MT	L/R	F	Convertible Engine CUUA	603011	Inner Joint		33		34		
	2013.11-	-	MT	L	F	Convertible Engine CUUA	803116	Outer Joint	36	30	59.5	38	55	I
	2013.11-	-	MT	R	F	Convertible Engine CUUA	261042	Drive Shaft	36		59.5	40.5	814	
2013.11-	-	MT	-	-	Convertible Engine CUUA	603006	Inner Joint		33		34			
GOLF VI (5K1)														
1.2 TSI (63 kW)	2010.05-	2012.11	-	L/R	F	Hatchback Engine CBZA	603011	Inner Joint		33		34		
	2010.05-	2012.11	AT	L	F	Hatchback Engine CBZA	261201	Drive Shaft	36		59.5	40.5	535	
	2010.05-	2012.11	MT	L	F	Hatchback Engine CBZA	261198	Drive Shaft	36		59.5	40.5	530	
	2010.05-	2012.11	MT	L/R	F	Hatchback Engine CBZA	803037	Outer Joint	36	30	59.5	40.5	55	I
	2010.05-	2012.11	MT	R	F	Hatchback Engine CBZA	201586	Drive Shaft	36		59.5	40	806	
	2010.05-	2012.11	AT	-	F	Hatchback Engine CBZA	803100	Outer Joint	36	33	59.5	38	55	I
1.2 TSI (77 kW)	2008.11-	2012.11	AT	L	F	Hatchback Engine CBZB	261201	Drive Shaft	36		59.5	40.5	535	
	2008.11-	2012.11	MT	L	F	Hatchback Engine CBZB	261198	Drive Shaft	36		59.5	40.5	530	
	2008.11-	2012.11	MT	R	F	Hatchback Engine CBZB	201586	Drive Shaft	36		59.5	40	806	
	2008.11-	2012.11	AT	-	F	Hatchback Engine CBZB	803100	Outer Joint	36	33	59.5	38	55	I
	2008.11-	2012.11	-	L/R	F	Hatchback Engine CBZB	603011	Inner Joint		33		34		
	2008.11-	2012.11	MT	L/R	F	Hatchback Engine CBZB	803037	Outer Joint	36	30	59.5	40.5	55	I
1.4 (59 kW)	2008.10-	2012.11	-	L/R	F	Hatchback Engine CGGA	603008	Inner Joint		33		32		
	2008.10-	2012.11	MT	-	-	Hatchback Engine CGGA	603006	Inner Joint		33		34		
	2008.10-	2012.11	MT	R	F	Hatchback Engine CGGA	253008	Drive Shaft	36		59.5	40	782	
	2008.10-	2012.11	MT	L	F	Hatchback Engine CGGA	253007	Drive Shaft	36		59.5	40	559	
	2008.10-	2012.11	-	L/R	F	Hatchback Engine CGGA	853001	Outer Joint	36	30	59.5	40	49	I
1.4 TSI (118 kW)	2008.10-	2012.11	MT	L	F	Hatchback Engine CAVD	261224	Drive Shaft	36		59.5	40	536	
	2008.10-	2012.11	-	-	-	Hatchback Engine CAVD	603016	Inner Joint		28		32		
	2008.10-	2012.11	MT	L/R	F	Hatchback Engine CAVD	603011	Inner Joint		33		34		
	2008.10-	2012.11	MT	L/R	F	Hatchback Engine CAVD	803037	Outer Joint	36	30	59.5	40.5	55	I
	2008.10-	2012.11	Semi-AT	L	F	Hatchback Engine CAVD	261281	Drive Shaft	36		59.5	40	528	
	2008.10-	2012.11	AT	L/R	F	Hatchback Engine CAVD	803002	Outer Joint	36	27	59.5	40	66	I
1.4 TSI (90 kW)	2008.10-	2012.11	MT	L	F	Hatchback Engine CAXA	261224	Drive Shaft	36		59.5	40	536	
	2008.10-	2012.11	-	-	-	Hatchback Engine CAXA	603016	Inner Joint		28		32		
	2008.10-	2012.11	MT	L/R	F	Hatchback Engine CAXA	603011	Inner Joint		33		34		
	2008.10-	2012.11	MT	R	F	Hatchback Engine CAXA	201586	Drive Shaft	36		59.5	40	806	
	2008.10-	2012.11	MT	L/R	F	Hatchback Engine CAXA	803037	Outer Joint	36	30	59.5	40.5	55	I
	2008.10-	2012.11	Semi-AT	L	F	Hatchback Engine CAXA	261281	Drive Shaft	36		59.5	40	528	
	2008.10-	2012.11	-	-	-	Hatchback Engine CAXA	861059	Outer Joint	36	33	59.5	40	59.5	I
	2008.10-	2012.11	AT	L/R	F	Hatchback Engine CAXA	803002	Outer Joint	36	27	59.5	40	66	I
1.6 (75 kW)	2008.10-	2012.11	AT	R	F	Hatchback Engine BSE	261113	Drive Shaft	36		59.5	40	814	
	2008.10-	2012.11	MT	L	F	Hatchback Engine BSE	261097	Drive Shaft	36		59.5	40.5	543	
	2008.10-	2012.11	MT	L/R	F	Hatchback Engine BSE	803037	Outer Joint	36	30	59.5	40.5	55	I
	2008.10-	2012.11	-	L/R	F	Hatchback Engine BSE	603011	Inner Joint		33		34		
	2008.10-	2012.11	MT	R	F	Hatchback Engine BSE	261096	Drive Shaft	36		59.5	40.5	799	
	2008.10-	2012.11	AT	L	F	Hatchback Engine BSE	803116	Outer Joint	36	30	59.5	38	55	I
	2008.10-	2012.11	MT	L	F	Hatchback Engine BSE	203320	Drive Shaft	36		59.5	40	546	
	2008.10-	2012.11	AT	L/R	F	Hatchback Engine BSE	661011	Inner Joint	26	32	31	68.5	85	
1.6 BiFuel (75 kW)	2009.03-	2012.11	MT	-	-	Hatchback Engine CHGA	603006	Inner Joint		33		34		
	2009.03-	2012.11	-	L	F	Hatchback Engine CHGA	261097	Drive Shaft	36		59.5	40.5	543	
	2009.03-	2012.11	-	L/R	F	Hatchback Engine CHGA	603011	Inner Joint		33		34		
	2009.03-	2012.11	5MT	R	F	Hatchback Engine CHGA	261096	Drive Shaft	36		59.5	40.5	799	
	2009.03-	2012.11	-	L/R	F	Hatchback Engine CHGA	803037	Outer Joint	36	30	59.5	40.5	55	I
	2009.03-	2012.11	-	L	F	Hatchback Engine CHGA	203320	Drive Shaft	36		59.5	40	546	
1.6 MultiFuel (75 kW)	2008.10-	2012.11	-	L/R	F	Hatchback Engine CCSA	603011	Inner Joint		33		34		
	2008.10-	2012.11	-	L	F	Hatchback Engine CCSA	261097	Drive Shaft	36		59.5	40.5	543	
	2008.10-	2012.11	MT	-	-	Hatchback Engine CCSA	603006	Inner Joint		33		34		
	2008.10-	2012.11	-	R	F	Hatchback Engine CCSA	261096	Drive Shaft	36		59.5	40.5	799	
	2008.10-	2012.11	-	L/R	F	Hatchback Engine CCSA	803037	Outer Joint	36	30	59.5	40.5	55	I
	2008.10-	2012.11	-	L	F	Hatchback Engine CCSA	203320	Drive Shaft	36		59.5	40	546	
1.6 TDI (66 kW)	2009.02-	2012.11	-	L	F	Hatchback Engine CAYB	203294	Drive Shaft	36		59.5	38	519	
	2009.02-	2012.11	MT	-	-	Hatchback Engine CAYB	603006	Inner Joint		33		34		
	2009.02-	2012.11	-	-	F	Hatchback Engine CAYB	803100	Outer Joint	36	33	59.5	38	55	I





YEAR	TRANSM	L/R	F/R	REMARKS	GSP Ref.	PRODUCT	ABS	Technical Specifications						
								A	B	C	H	L	P	
VW														
GOLF VI (5K1)														
1.6 TDI (66 kW)	2009.02-2012.11	-	L	F	Hatchback Engine CAYB	803116	Outer Joint	36	30	59.5	38	55	I	
	2009.02-2012.11	-	L/R	F	Hatchback Engine CAYB	603011	Inner Joint		33		34			
	2009.02-2012.11	-	R	F	Hatchback Engine CAYB	261042	Drive Shaft	36		59.5	40.5	814		
	2009.02-2012.11	-	R	F	Hatchback Engine CAYB	201585	Drive Shaft	36		59.5	40	805		
	2009.02-2012.11	-	L/R	F	Hatchback Engine CAYB	803037	Outer Joint	36	30	59.5	40.5	55	I	
1.6 TDI (77 kW)	2009.02-2012.11	Semi-AT	-	F	Hatchback Engine CAYC	803100	Outer Joint	36	33	59.5	38	55	I	
	2009.02-2012.11	Semi-AT	L	F	Hatchback Engine CAYC	261089	Drive Shaft	36		59.5	40.5	521		
	2009.02-2012.11	-	L/R	F	Hatchback Engine CAYC	803002	Outer Joint	36	27	59.5	40	66	I	
	2009.02-2012.11	MT	L	F	Hatchback Engine CAYC	803116	Outer Joint	36	30	59.5	38	55	I	
	2009.02-2012.11	MT	R	F	Hatchback Engine CAYC	261042	Drive Shaft	36		59.5	40.5	814		
	2009.02-2012.11	-	L/R	F	Hatchback Engine CAYC	603011	Inner Joint		33		34			
	2009.02-2012.11	Semi-AT	R	F	Hatchback Engine CAYC	261280	Drive Shaft	36		59.5	40	801		
	2009.02-2012.11	-	-	-	Hatchback Engine CAYC	861059	Outer Joint	36	33	59.5	40	59.5	I	
	2009.02-2012.11	MT	R	F	Hatchback Engine CAYC	201585	Drive Shaft	36		59.5	40	805		
	2009.02-2012.11	-	L/R	F	Hatchback Engine CAYC	803037	Outer Joint	36	30	59.5	40.5	55	I	
	2009.02-2012.11	MT	L	F	Hatchback Engine CAYC	203294	Drive Shaft	36		59.5	38	519		
1.8 TSI (118 kW)	2009.06-2011.01	MT	L	F	Hatchback Engine CDAA	261100	Drive Shaft	36		59.5	40	513		
	2009.06-2011.01	MT	L/R	F	Hatchback Engine CDAA	803002	Outer Joint	36	27	59.5	40	66	I	
	2009.06-2011.01	AT	L/R	F	Hatchback Engine CDAA	661011	Inner Joint	26	32	31	68.5	85		
	2009.06-2011.01	MT	L	F	Hatchback Engine CDAA	261131	Drive Shaft	36		59.5	40	515		
2.0 GTi (155 kW)	2009.04-2012.11	AT/MT	L/R	F	Hatchback Engine CCZB	803002	Outer Joint	36	27	59.5	40	66	I	
	2009.04-2012.11	MT	L	F	Hatchback Engine CCZB	203295	Drive Shaft	36		59.5	40	491		
2.0 R 4motion (188 kW)	2009.11-2013.11	-	L/R	R	All-wheel Drive Hatchback Engine CDLC	603011	Inner Joint		33		34			
	2009.11-2013.11	-	-	R	All-wheel Drive Hatchback Engine CDLC	635026	Inner Joint	36	33	59.5	40	39		
2.0 R 4motion (195 kW)	2009.11-2011.05	-	-	R	All-wheel Drive Hatchback Engine CDLA	635026	Inner Joint	36	33	59.5	40	39		
2.0 R 4motion (199 kW)	2009.11-2012.11	-	L/R	R	All-wheel Drive Hatchback Engine CDLF	603011	Inner Joint		33		34			
	2009.11-2012.11	-	-	R	All-wheel Drive Hatchback Engine CDLF	635026	Inner Joint	36	33	59.5	40	39		
2.0 TDI (100 kW)	2008.10-2012.11	-	L/R	F	Hatchback Engine CBAA	803002	Outer Joint	36	27	59.5	40	66	I	
	2008.10-2012.11	-	L	F	Hatchback Engine CBAA	203295	Drive Shaft	36		59.5	40	491		
	2008.10-2012.11	MT	-	-	Hatchback Engine CBAA	603006	Inner Joint		33		34			
	2008.10-2012.11	AT	L	F	Hatchback Engine CBAA	654004	Inner Joint		34		85			
	2008.10-2012.11	MT	-	-	Hatchback Engine CBAA	603016	Inner Joint		28		32			
	2008.10-2012.11	-	R	F	Hatchback Engine CBAA	203313	Drive Shaft	36		59.5	40	792		
	2008.10-2012.11	AT	L	F	Hatchback Engine CBAA	203241	Drive Shaft	36		59.5	40	475		
2.0 TDI (103 kW)	2008.10-2013.05	AT	L/R	F	Hatchback Engine CBAB	661057	Inner Joint		34		86			
	2008.10-2013.05	MT	R	F	Hatchback Engine CBAB	203313	Drive Shaft	36		59.5	40	792		
	2008.10-2013.05	AT	L	F	Hatchback Engine CBAB	254013	Drive Shaft	36		59.5	40	479.5		
	2008.10-2013.05	AT	L	F	Hatchback Engine CBAB	654004	Inner Joint		34		85			
	2008.10-2013.05	AT/MT	L/R	F	Hatchback Engine CBAB	803002	Outer Joint	36	27	59.5	40	66	I	
	2008.10-2013.05	AT	L	F	Hatchback Engine CBAB	203241	Drive Shaft	36		59.5	40	475		
	2008.10-2013.05	AT	R	F	Hatchback Engine CBAB	254011	Drive Shaft	36		59.5	40	755		
	2008.10-2013.05	MT	L	F	Hatchback Engine CBAB	203295	Drive Shaft	36		59.5	40	491		
	2008.10-2013.05	AT	L	F	Hatchback Engine CBAB	203241	Drive Shaft	36		59.5	40	475		
2.0 TDI (125 kW)	2009.04-2012.11	AT	R	F	Hatchback Engine CBBB	254011	Drive Shaft	36		59.5	40	755		
	2009.04-2012.11	MT	L	F	Hatchback Engine CBBB	203265	Drive Shaft	36		59.5	40	487		
	2009.04-2012.11	AT	R	F	Hatchback Engine CBBB	654004	Inner Joint		34		85			
	2009.04-2012.11	MT	R	F	Hatchback Engine CBBB	261126	Drive Shaft	36		59.5	40	793		
	2009.04-2012.11	Semi-AT	L	F	Hatchback Engine CBBB	203241	Drive Shaft	36		59.5	40	475		
2.0 TDI (81 kW)	2008.10-2012.11	MT	L	F	Hatchback Engine CBDC	203294	Drive Shaft	36		59.5	38	519		
	2008.10-2012.11	MT	L/R	F	Hatchback Engine CBDC	803037	Outer Joint	36	30	59.5	40.5	55	I	
	2008.10-2012.11	AT	L/R	F	Hatchback Engine CBDC	661057	Inner Joint		34		86			
	2008.10-2012.11	MT	L/R	F	Hatchback Engine CBDC	603011	Inner Joint		33		34			
	2008.10-2012.11	AT	L	F	Hatchback Engine CBDC	254013	Drive Shaft	36		59.5	40	479.5		
	2008.10-2012.11	AT	L	F	Hatchback Engine CBDC	654004	Inner Joint		34		85			
	2008.10-2012.11	MT	L	F	Hatchback Engine CBDC	803116	Outer Joint	36	30	59.5	38	55	I	
	2008.10-2012.11	AT	L/R	F	Hatchback Engine CBDC	803002	Outer Joint	36	27	59.5	40	66	I	
	2008.10-2012.11	MT	R	F	Hatchback Engine CBDC	261042	Drive Shaft	36		59.5	40.5	814		
	2008.10-2012.11	AT	R	F	Hatchback Engine CBDC	254011	Drive Shaft	36		59.5	40	755		
	2008.10-2012.11	MT	R	F	Hatchback Engine CBDC	201585	Drive Shaft	36		59.5	40	805		
	2.0 TDI 4motion (103 kW)	2009.05-2012.11	MT	L	F	All-wheel Drive Hatchback Engine CBAB	203295	Drive Shaft	36		59.5	40	491	
		2009.05-2012.11	-	L/R	F	All-wheel Drive Hatchback Engine CBAB	803002	Outer Joint	36	27	59.5	40	66	I
2009.05-2012.11		AT	L	F	All-wheel Drive Hatchback Engine CBAB	654004	Inner Joint		34		85			
2009.05-2012.11		MT	R	F	All-wheel Drive Hatchback Engine CBAB	203266	Drive Shaft	36		59.5	40	601		
2009.05-2012.11		-	L/R	R	All-wheel Drive Hatchback Engine CBAB	603011	Inner Joint		33		34			
2009.05-2012.11		AT	L	F	All-wheel Drive Hatchback Engine CBAB	203241	Drive Shaft	36		59.5	40	475		
GOLF VI Variant (AJ5)														
1.2 TSI (63 kW)	2010.07-2013.07	AT	L	F	Estate Engine CBZA	261201	Drive Shaft	36		59.5	40.5	535		

	 YEAR	TRANSM	L/R	F/R	REMARKS	GSP Ref.	 PRODUCT	 ABS	Technical Specifications					
									A	B	C	H	L	P
VW														
GOLF VI Variant (AJ5)														
1.2 TSI (63 kW)	2010.07-2013.07	MT	L	F	Estate Engine CBZA	261198	Drive Shaft		36		59.5	40.5	530	
	2010.07-2013.07	MT	R	F	Estate Engine CBZA	201586	Drive Shaft		36		59.5	40	806	
	2010.07-2013.07	AT	-	F	Estate Engine CBZA	803100	Outer Joint		36	33	59.5	38	55	I
	2010.07-2013.07	MT	-	-	Estate Engine CBZA	603006	Inner Joint			33		34		
1.2 TSI (77 kW)	2009.07-2013.07	AT	L	F	Estate Engine CBZB	261201	Drive Shaft		36		59.5	40.5	535	
	2009.07-2013.07	MT	L	F	Estate Engine CBZB	261198	Drive Shaft		36		59.5	40.5	530	
	2009.07-2013.07	MT	R	F	Estate Engine CBZB	201586	Drive Shaft		36		59.5	40	806	
	2009.07-2013.07	AT	-	F	Estate Engine CBZB	803100	Outer Joint		36	33	59.5	38	55	I
	2009.07-2013.07	6MT	L/R	F	Estate Engine CBZB	803037	Outer Joint		36	30	59.5	40.5	55	I
	2009.07-2013.07	6MT	L/R	F	Estate Engine CBZB	603011	Inner Joint			33		34		
1.4 (59 kW)	2009.07-2013.07	-	L/R	F	Estate Engine BUD	603008	Inner Joint			33		32		
	2009.07-2013.07	MT	-	-	Estate Engine BUD	603006	Inner Joint			33		34		
	2009.07-2013.07	5MT	R	F	Estate Engine BUD	253008	Drive Shaft		36		59.5	40	782	
	2009.07-2013.07	-	L	F	Estate Engine BUD	253007	Drive Shaft		36		59.5	40	559	
	2009.07-2013.07	-	L/R	F	Estate Engine BUD	853001	Outer Joint		36	30	59.5	40	49	I
1.4 TSI (118 kW)	2009.07-2013.07	MT	L	F	Estate Engine CNWA	261224	Drive Shaft		36		59.5	40	536	
	2009.07-2013.07	MT	L/R	F	Estate Engine CNWA	603011	Inner Joint			33		34		
	2009.07-2013.07	MT	L/R	F	Estate Engine CNWA	803037	Outer Joint		36	30	59.5	40.5	55	I
	2009.07-2013.07	7AT	L	F	Estate Engine CNWA	261281	Drive Shaft		36		59.5	40	528	
	2009.07-2013.07	AT	L/R	F	Estate Engine CNWA	803002	Outer Joint		36	27	59.5	40	66	I
1.4 TSI (90 kW)	2009.07-2013.07	MT	L	F	Estate Engine CAXA	261198	Drive Shaft		36		59.5	40.5	530	
	2009.07-2013.07	MT	L/R	F	Estate Engine CAXA	603011	Inner Joint			33		34		
	2009.07-2013.07	MT	R	F	Estate Engine CAXA	201586	Drive Shaft		36		59.5	40	806	
	2009.07-2013.07	MT	L/R	F	Estate Engine CAXA	803037	Outer Joint		36	30	59.5	40.5	55	I
	2009.07-2013.07	7AT	L	F	Estate Engine CAXA	261281	Drive Shaft		36		59.5	40	528	
	2009.07-2013.07	AT	L/R	F	Estate Engine CAXA	803002	Outer Joint		36	27	59.5	40	66	I
1.6 (75 kW)	2009.07-2013.07	MT	-	-	Estate Engine BSE	661050	Inner Joint		26	32	31	68.5	89	
	2009.07-2013.07	MT	-	-	Estate Engine BSE	603006	Inner Joint			33		34		
	2009.07-2013.07	-	L	F	Estate Engine BSE	261097	Drive Shaft		36		59.5	40.5	543	
	2009.07-2013.07	-	L/R	F	Estate Engine BSE	603011	Inner Joint			33		34		
	2009.07-2013.07	-	R	F	Estate Engine BSE	261096	Drive Shaft		36		59.5	40.5	799	
	2009.07-2013.07	-	L	F	Estate Engine BSE	203320	Drive Shaft		36		59.5	40	546	
	2009.07-2013.07	-	L/R	F	Estate Engine BSE	803037	Outer Joint		36	30	59.5	40.5	55	I
1.6 MultiFuel (75 kW)	2010.07-2013.07	-	L/R	F	Estate Engine CMXA	603011	Inner Joint			33		34		
	2010.07-2013.07	-	L	F	Estate Engine CMXA	261097	Drive Shaft		36		59.5	40.5	543	
	2010.07-2013.07	MT	-	-	Estate Engine CMXA	603006	Inner Joint			33		34		
	2010.07-2013.07	-	R	F	Estate Engine CMXA	261096	Drive Shaft		36		59.5	40.5	799	
	2010.07-2013.07	-	L/R	F	Estate Engine CMXA	803037	Outer Joint		36	30	59.5	40.5	55	I
	2010.07-2013.07	-	L	F	Estate Engine CMXA	203320	Drive Shaft		36		59.5	40	546	
1.6 TDI (66 kW)	2009.12-2013.07	-	L	F	Estate Engine CAYB	203294	Drive Shaft		36		59.5	38	519	
	2009.12-2013.07	MT	-	-	Estate Engine CAYB	603006	Inner Joint			33		34		
	2009.12-2013.07	MT	-	-	Estate Engine CAYB	603016	Inner Joint			28		32		
	2009.12-2013.07	-	-	F	Estate Engine CAYB	803100	Outer Joint		36	33	59.5	38	55	I
	2009.12-2013.07	-	L	F	Estate Engine CAYB	803116	Outer Joint		36	30	59.5	38	55	I
	2009.12-2013.07	-	L/R	F	Estate Engine CAYB	603011	Inner Joint			33		34		
	2009.12-2013.07	-	R	F	Estate Engine CAYB	261042	Drive Shaft		36		59.5	40.5	814	
	2009.12-2013.07	-	R	F	Estate Engine CAYB	201585	Drive Shaft		36		59.5	40	805	
	2009.12-2013.07	-	L/R	F	Estate Engine CAYB	803037	Outer Joint		36	30	59.5	40.5	55	I
	2009.12-2013.07	-	L/R	F	Estate Engine CAYB	803037	Outer Joint		36	30	59.5	40.5	55	I
1.6 TDI (77 kW)	2009.07-2013.07	Semi-AT	-	F	Estate Engine CAYC	803100	Outer Joint		36	33	59.5	38	55	I
	2009.07-2013.07	MT	L	F	Estate Engine CAYC	203294	Drive Shaft		36		59.5	38	519	
	2009.07-2013.07	Semi-AT	L	F	Estate Engine CAYC	261089	Drive Shaft		36		59.5	40.5	521	
	2009.07-2013.07	MT	L/R	F	Estate Engine CAYC	603011	Inner Joint			33		34		
	2009.07-2013.07	MT	L/R	F	Estate Engine CAYC	803037	Outer Joint		36	30	59.5	40.5	55	I
	2009.07-2013.07	AT	R	F	Estate Engine CAYC	203313	Drive Shaft		36		59.5	40	792	
	2009.07-2013.07	MT	L	F	Estate Engine CAYC	803116	Outer Joint		36	30	59.5	38	55	I
	2009.07-2013.07	AT	R	F	Estate Engine CAYC	261042	Drive Shaft		36		59.5	40.5	814	
	2009.07-2013.07	Semi-AT	R	F	Estate Engine CAYC	261280	Drive Shaft		36		59.5	40	801	
	2009.07-2013.07	-	-	-	Estate Engine CAYC	261282	Drive Shaft		36		59.5	40	523	
	2009.07-2013.07	AT	R	F	Estate Engine CAYC	201585	Drive Shaft		36		59.5	40	805	
	2009.07-2013.07	AT	L/R	F	Estate Engine CAYC	803002	Outer Joint		36	27	59.5	40	66	I
	1.6 TDI 4motion (77 kW)	2009.07-2013.07	-	L/R	F	All-wheel Drive Estate Engine CAYC	803002	Outer Joint		36	27	59.5	40	66
2009.07-2013.07		-	R	F	All-wheel Drive Estate Engine CAYC	203266	Drive Shaft		36		59.5	40	601	
2009.07-2013.07		-	L/R	R	All-wheel Drive Estate Engine CAYC	603011	Inner Joint			33		34		
2009.07-2013.07		-	L	F	All-wheel Drive Estate Engine CAYC	203295	Drive Shaft		36		59.5	40	491	
2.0 TDI (100 kW)	2009.07-2013.07	-	L/R	F	Estate Engine CBDA/CFHB	803002	Outer Joint		36	27	59.5	40	66	I

YEAR	TRANSM	L/R	F/R	REMARKS	GSP Ref.	PRODUCT	ABS	Technical Specifications							
								A	B	C	H	L	P		
VW															
GOLF VI Variant (AJ5)															
2.0 TDI (100 kW)	2009.07-	2013.07	MT	-	-	Estate Engine CBDA/CFHB	603006	Inner Joint			33		34		
	2009.07-	2013.07	-	R	F	Estate Engine CBDA/CFHB	203313	Drive Shaft	36		59.5	40	792		
	2009.07-	2013.07	MT	-	-	Estate Engine CBDA/CFHB	603016	Inner Joint		28		32			
	2009.07-	2013.07	-	L	F	Estate Engine CBDA/CFHB	203295	Drive Shaft	36		59.5	40	491		
2.0 TDI (103 kW)	2009.07-	2013.07	AT	R	F	Estate Engine CBDB/CJAA/CFHC/CLCB	254011	Drive Shaft	36		59.5	40	755		
	2009.07-	2013.07	-	L/R	F	Estate Engine CBDB/CJAA/CFHC/CLCB	803002	Outer Joint	36	27	59.5	40	66	I	
	2009.07-	2013.07	AT	L/R	F	Estate Engine CBDB/CJAA/CFHC/CLCB	661057	Inner Joint		34		86			
	2009.07-	2013.07	MT	R	F	Estate Engine CBDB/CJAA/CFHC/CLCB	203313	Drive Shaft	36		59.5	40	792		
	2009.07-	2013.07	AT	L	F	Estate Engine CBDB/CJAA/CFHC/CLCB	254013	Drive Shaft	36		59.5	40	479.5		
	2009.07-	2013.07	AT	L	F	Estate Engine CBDB/CJAA/CFHC/CLCB	654004	Inner Joint		34		85			
	2009.07-	2013.07	AT	L	F	Estate Engine CBDB/CJAA/CFHC/CLCB	203241	Drive Shaft	36		59.5	40	475		
	2009.07-	2013.07	MT	L	F	Estate Engine CBDB/CJAA/CFHC/CLCB	203295	Drive Shaft	36		59.5	40	491		
2.0 TDI (81 kW)	2010.01-	2013.07	-	L/R	F	Estate Engine CLCA	803037	Outer Joint	36	30	59.5	40.5	55	I	
	2010.01-	2013.07	-	L	F	Estate Engine CLCA	203294	Drive Shaft	36		59.5	38	519		
	2010.01-	2013.07	MT	-	-	Estate Engine CLCA	603006	Inner Joint		33		34			
	2010.01-	2013.07	-	L	F	Estate Engine CLCA	803116	Outer Joint	36	30	59.5	38	55	I	
	2010.01-	2013.07	-	R	F	Estate Engine CLCA	261042	Drive Shaft	36		59.5	40.5	814		
	2010.01-	2013.07	-	L/R	F	Estate Engine CLCA	603011	Inner Joint		33		34			
	2010.01-	2013.07	-	R	F	Estate Engine CLCA	201585	Drive Shaft	36		59.5	40	805		
2.0 TSI (147 kW)	2009.07-	2013.07	AT	L	F	Estate Engine CCZA	203295	Drive Shaft	36		59.5	40	491		
	2009.07-	2013.07	-	L/R	F	Estate Engine CCZA	803002	Outer Joint	36	27	59.5	40	66	I	
GOLF VII (5G1 BQ1 BE1 BE2)															
1.0 TSI (85 kW)	2015.05-	-	AT	-	-	Hatchback Engine CHZD	861059	Outer Joint	36	33	59.5	40	59.5	I	
	2015.05-	-	MT	-	F	Hatchback Engine CHZD	803100	Outer Joint	36	33	59.5	38	55	I	
1.2 TSI (63 kW)	2012.08-	-	-	L	F	Hatchback Engine CJZB	203373	Drive Shaft	36		59.5	38	511		
	2012.08-	-	MT	-	-	Hatchback Engine CJZB	603006	Inner Joint		33		34			
	2012.08-	-	-	L/R	F	Hatchback Engine CJZB	603011	Inner Joint		33		34			
	2012.08-	-	MT	R	F	Hatchback Engine CJZB	261307	Drive Shaft	36		59.5	40	819		
	2012.08-	-	-	L	F	Hatchback Engine CJZB	803116	Outer Joint	36	30	59.5	38	55	I	
	2012.08-	-	-	L/R	F	Hatchback Engine CJZB	803037	Outer Joint	36	30	59.5	40.5	55	I	
1.2 TSI (77 kW)	2012.11-	-	AT	-	F	Hatchback Engine CJZA	803100	Outer Joint	36	33	59.5	38	55	I	
	2012.11-	-	MT	L	F	Hatchback Engine CJZA	203373	Drive Shaft	36		59.5	38	511		
	2012.11-	-	AT	L	F	Hatchback Engine CJZA	261089	Drive Shaft	36		59.5	40.5	521		
	2012.11-	-	-	L/R	F	Hatchback Engine CJZA	603011	Inner Joint		33		34			
	2012.11-	-	MT	L	F	Hatchback Engine CJZA	803116	Outer Joint	36	30	59.5	38	55	I	
	2012.11-	-	AT	R	F	Hatchback Engine CJZA	261199	Drive Shaft	36		59.5	40.5	800		
	2012.11-	-	-	L/R	F	Hatchback Engine CJZA	803037	Outer Joint	36	30	59.5	40.5	55	I	
1.2 TSI (81 kW)	2014.04-	-	-	L/R	F	Hatchback Engine CYVB	803037	Outer Joint	36	30	59.5	40.5	55	I	
	2014.04-	-	MT	L	F	Hatchback Engine CYVB	261277	Drive Shaft	36		59.5	40	516		
	2014.04-	-	6MT	L	F	Hatchback Engine CYVB	203373	Drive Shaft	36		59.5	38	511		
	2014.04-	-	6MT	L	F	Hatchback Engine CYVB	803116	Outer Joint	36	30	59.5	38	55	I	
	2014.04-	-	-	L/R	F	Hatchback Engine CYVB	603011	Inner Joint		33		34			
1.4 GTE Hybrid (110 kW)	2014.05-	-	AT	R	F	Hatchback Engine CUKB	261303	Drive Shaft	36		59.5	40	795		
	2014.05-	-	AT	-	F	Hatchback Engine CUKB	803101	Outer Joint	36	27	59.5	40	65	M	
	2014.05-	-	MT	-	F	Hatchback Engine CUKB	803100	Outer Joint	36	33	59.5	38	55	I	
	2014.05-	-	MT	L	F	Hatchback Engine CUKB	261089	Drive Shaft	36		59.5	40.5	521		
	2014.05-	-	AT	L	F	Hatchback Engine CUKB	261304	Drive Shaft	36		59.5	40	511		
1.4 TGI CNG (81 kW)	2013.06-	-	7AT/MT	L	F	Hatchback Engine CPWA	261089	Drive Shaft	36		59.5	40.5	521		
	2013.06-	-	-	-	F	Hatchback Engine CPWA	803100	Outer Joint	36	33	59.5	38	55	I	
	2013.06-	-	AT	L/R	F	Hatchback Engine CPWA	603011	Inner Joint		33		34			
	2013.06-	-	AT	R	F	Hatchback Engine CPWA	261199	Drive Shaft	36		59.5	40.5	800		
1.4 TSI (103 kW)	2012.11-	-	MT	-	F	Hatchback Engine CHPA	803100	Outer Joint	36	33	59.5	38	55	I	
	2012.11-	-	AT	-	F	Hatchback Engine CHPA	803101	Outer Joint	36	27	59.5	40	65	M	
	2012.11-	-	MT	L	F	Hatchback Engine CHPA	261089	Drive Shaft	36		59.5	40.5	521		
	2012.11-	-	MT	L/R	F	Hatchback Engine CHPA	603011	Inner Joint		33		34			
1.4 TSI (110 kW)	2014.05-	-	AT	R	F	Hatchback Engine CZDA	261303	Drive Shaft	36		59.5	40	795		
	2014.05-	-	AT	-	F	Hatchback Engine CZDA	803101	Outer Joint	36	27	59.5	40	65	M	
	2014.05-	-	MT	-	F	Hatchback Engine CZDA	803100	Outer Joint	36	33	59.5	38	55	I	
	2014.05-	-	MT	L	F	Hatchback Engine CZDA	261089	Drive Shaft	36		59.5	40.5	521		
	2014.05-	-	MT	L/R	F	Hatchback Engine CZDA	603011	Inner Joint		33		34			
	2014.05-	-	AT	L	F	Hatchback Engine CZDA	261304	Drive Shaft	36		59.5	40	511		
1.4 TSI (90 kW)	2012.11-	-	AT	L	F	Hatchback Engine CMBA	261201	Drive Shaft	36		59.5	40.5	535		
	2012.11-	-	AT/MT	-	F	Hatchback Engine CMBA	803100	Outer Joint	36	33	59.5	38	55	I	
	2012.11-	-	-	L/R	F	Hatchback Engine CMBA	603011	Inner Joint		33		34			
	2012.11-	-	AT	L	F	Hatchback Engine CMBA	261306	Drive Shaft	36		59.5	40	517		
1.4 TSI (92 kW)	2014.05-	-	AT/MT	L/R	F	Hatchback Engine CPVB	803037	Outer Joint	36	30	59.5	40.5	55	I	

YEAR	TRANSM	L/R	F/R	REMARKS	GSP Ref.	PRODUCT	ABS	Technical Specifications						
								A	B	C	H	L	P	
VW														
GOLF VII (5G1 BQ1 BE1 BE2)														
1.4 TSI (92 kW)	2014.05-	-	7AT/MT	L	F	Hatchback Engine CPVB	261089	Drive Shaft	36		59.5	40.5	521	
	2014.05-	-	-	-	F	Hatchback Engine CPVB	803100	Outer Joint	36	33	59.5	38	55	I
	2014.05-	-	-	L/R	F	Hatchback Engine CPVB	603011	Inner Joint		33		34		
	2014.05-	-	AT	R	F	Hatchback Engine CPVB	261199	Drive Shaft	36		59.5	40.5	800	
1.4 TSI MultiFuel (90 kW)	2013.04-	-	AT	L	F	Hatchback Engine CPVA	261201	Drive Shaft	36		59.5	40.5	535	
	2013.04-	-	AT/MT	-	F	Hatchback Engine CPVA	803100	Outer Joint	36	33	59.5	38	55	I
	2013.04-	-	MT	L/R	F	Hatchback Engine CPVA	603011	Inner Joint		33		34		
	2013.04-	-	MT	-	-	Hatchback Engine CPVA	603006	Inner Joint		33		34		
	2013.04-	-	AT	L	F	Hatchback Engine CPVA	261306	Drive Shaft	36		59.5	40	517	
	2013.04-	-	MT	-	-	Hatchback Engine CPVA	861059	Outer Joint	36	33	59.5	40	59.5	I
1.4 TSI MultiFuel (92 kW)	2013.12-	-	MT	-	-	Hatchback Engine CPVB	861059	Outer Joint	36	33	59.5	40	59.5	I
	2013.12-	-	7AT/MT	L	F	Hatchback Engine CPVB	261089	Drive Shaft	36		59.5	40.5	521	
	2013.12-	-	-	-	F	Hatchback Engine CPVB	803100	Outer Joint	36	33	59.5	38	55	I
	2013.12-	-	MT	-	-	Hatchback Engine CPVB	603006	Inner Joint		33		34		
	2013.12-	-	MT	L/R	F	Hatchback Engine CPVB	603011	Inner Joint		33		34		
	2013.12-	-	AT	R	F	Hatchback Engine CPVB	261199	Drive Shaft	36		59.5	40.5	800	
1.6 (81 kW)	2014.05-	-	MT	L	F	Hatchback Engine CWVA	261277	Drive Shaft	36		59.5	40	516	
	2014.05-	-	AT/MT	L/R	F	Hatchback Engine CWVA	803037	Outer Joint	36	30	59.5	40.5	55	I
	2014.05-	-	MT	L/R	F	Hatchback Engine CWVA	603011	Inner Joint		33		34		
	2014.05-	-	AT	L	F	Hatchback Engine CWVA	803116	Outer Joint	36	30	59.5	38	55	I
	2014.05-	-	AT	L	F	Hatchback Engine CWVA	203318	Drive Shaft	36	26	59.5	38	581	
1.6 TDI (66 kW)	2013.04-	-	-	L/R	F	Hatchback Engine CLHB	803037	Outer Joint	36	30	59.5	40.5	55	I
	2013.04-	-	-	L	F	Hatchback Engine CLHB	203294	Drive Shaft	36		59.5	38	519	
	2013.04-	-	MT	L	F	Hatchback Engine CLHB	261089	Drive Shaft	36		59.5	40.5	521	
	2013.04-	-	MT	-	-	Hatchback Engine CLHB	603006	Inner Joint		33		34		
	2013.04-	-	-	L	F	Hatchback Engine CLHB	803116	Outer Joint	36	30	59.5	38	55	I
	2013.04-	-	-	R	F	Hatchback Engine CLHB	261042	Drive Shaft	36		59.5	40.5	814	
	2013.04-	-	-	L/R	F	Hatchback Engine CLHB	603011	Inner Joint		33		34		
	2013.04-	-	-	R	F	Hatchback Engine CLHB	201585	Drive Shaft	36		59.5	40	805	
	2013.04-	-	MT	L	F	Hatchback Engine CLHB	261282	Drive Shaft	36		59.5	40	523	
1.6 TDI (77 kW)	2012.08-	-	AT/MT	-	F	Hatchback Engine CLHA	803100	Outer Joint	36	33	59.5	38	55	I
	2012.08-	-	AT	L	F	Hatchback Engine CLHA	261089	Drive Shaft	36		59.5	40.5	521	
	2012.08-	-	-	L/R	F	Hatchback Engine CLHA	603011	Inner Joint		33		34		
	2012.08-	-	AT	R	F	Hatchback Engine CLHA	261280	Drive Shaft	36		59.5	40	801	
	2012.08-	-	-	L	F	Hatchback Engine CLHA	261282	Drive Shaft	36		59.5	40	523	
1.6 TDI (81 kW)	2013.01-	-	AT/MT	-	F	Hatchback Engine CXXB	803100	Outer Joint	36	33	59.5	38	55	I
	2013.01-	-	AT	L	F	Hatchback Engine CXXB	261089	Drive Shaft	36		59.5	40.5	521	
	2013.01-	-	AT	R	F	Hatchback Engine CXXB	261280	Drive Shaft	36		59.5	40	801	
	2013.01-	-	-	L/R	F	Hatchback Engine CXXB	603011	Inner Joint		33		34		
	2013.01-	-	MT	L	F	Hatchback Engine CXXB	261282	Drive Shaft	36		59.5	40	523	
1.6 TDI (85 kW)	2016.11-	-	5MT	L/R	F	Hatchback Engine DDYA	603011	Inner Joint		33		34		
1.6 TDI 4motion (77 kW)	2012.11-	-	MT	-	-	All-wheel Drive Hatchback Engine CLHA	803101	Outer Joint	36	27	59.5	40	65	M
1.6 TDI 4motion (81 kW)	2013.01-	-	-	-	F	All-wheel Drive Hatchback Engine CRKB	803101	Outer Joint	36	27	59.5	40	65	M
	2013.01-	-	6MT	L/R	F	All-wheel Drive Hatchback Engine CRKB	603011	Inner Joint		33		34		
2.0 GTD (135 kW)	2013.04-	-	AT	L	F	Hatchback Engine CUNA/DGCA	261285	Drive Shaft	36		59.5	40	472	
	2013.04-	-	AT	R	F	Hatchback Engine CUNA/DGCA	203354	Drive Shaft	36		59.5	40	763	
	2013.04-	-	AT	-	-	Hatchback Engine CUNA/DGCA	603016	Inner Joint		28		32		
2.0 GTI (162 kW)	2013.04-	-	AT	-	-	Hatchback Engine CXDA	603016	Inner Joint		28		32		
2.0 GTI Clubsport (195 kW)	2016.02-	-	AT	-	-	Hatchback Engine CJXE	603016	Inner Joint		28		32		
2.0 TDI (105 kW)	2012.08-	-	-	-	F	Hatchback Engine CRBB/CRVC	803101	Outer Joint	36	27	59.5	40	65	M
	2012.08-	-	AT	L	F	Hatchback Engine CRBB/CRVC	261285	Drive Shaft	36		59.5	40	472	
	2012.08-	-	AT	R	F	Hatchback Engine CRBB/CRVC	203354	Drive Shaft	36		59.5	40	763	
2.0 TDI (110 kW)	2012.11-	-	-	-	F	Hatchback Engine CRLB/CRUA/CRMB/CRBC/DCYA/DEJA	803101	Outer Joint	36	27	59.5	40	65	M
	2012.11-	-	AT	L	F	Hatchback Engine CRLB/CRUA/CRMB/CRBC/DCYA/DEJA	261285	Drive Shaft	36		59.5	40	472	
	2012.11-	-	AT	R	F	Hatchback Engine CRLB/CRUA/CRMB/CRBC/DCYA/DEJA	203354	Drive Shaft	36		59.5	40	763	
2.0 TDI (81 kW)	2012.11-	-	MT	L/R	F	Hatchback Engine CRVA/CYKB/CRLD/DEJB	603011	Inner Joint		33		34		
	2012.11-	-	7AT/MT	L	F	Hatchback Engine CRVA/CYKB/CRLD/DEJB	261089	Drive Shaft	36		59.5	40.5	521	
	2012.11-	-	-	-	F	Hatchback Engine CRVA/CYKB/CRLD/DEJB	803100	Outer Joint	36	33	59.5	38	55	I
	2012.11-	-	MT	R	F	Hatchback Engine CRVA/CYKB/CRLD/DEJB	261200	Drive Shaft	36		59.5	40.5	820	
	2012.11-	-	7AT	R	F	Hatchback Engine CRVA/CYKB/CRLD/DEJB	261280	Drive Shaft	36		59.5	40	801	
2.0 TDI 4motion (110 kW)	2012.11-	-	MT	-	F	All-wheel Drive Hatchback Engine CRLB/CKFC/CRMB/CRBC/DCYA	803101	Outer Joint	36	27	59.5	40	65	M
e-Golf (85 kW)	2014.03-	2017.02	-	-	-	Hatchback Engine EAGA	803101	Outer Joint	36	27	59.5	40	65	M
GOLF VII (5G1, BQ1, BE1, BE2)														
1.5 TSI (110 kW)	2017.04-	-	6MT	L/R	F	Hatchback Engine DADA	603011	Inner Joint		33		34		
1.5 TSI(96 kW)	2017.07-	-	-	L/R	F	Hatchback Engine DACA	603011	Inner Joint		33		34		
GOLF VII (BA5, BV5)														

	 YEAR	TRANSM	L/R	F/R	REMARKS	GSP Ref.	 PRODUCT	 ABS	Technical Specifications										
									A	B	C	H	L	P					
VW																			
GOLF VII (BA5, BV5)																			
1.5 TSI(96 kW)	2017.07-	-	L/R	F	Estate/Estate/Variant Engine DACA	603011	Inner Joint			33		34							
GOLF VII Variant (BA5 BV5)																			
1.0 TSI (85 kW)	2015.05-	AT	-	-	Estate Engine CHZD	861059	Outer Joint		36	33	59.5	40	59.5		I				
	2015.05-	MT	-	F	Estate Engine CHZD	803100	Outer Joint		36	33	59.5	38	55		I				
1.2 TSI (63 kW)	2013.05-	MT	L/R	F	Estate Engine CJZB	803037	Outer Joint		36	30	59.5	40.5	55		I				
	2013.05-	AT/MT	L/R	F	Estate Engine CJZB	603011	Inner Joint			33		34							
	2013.05-	MT	L	F	Estate Engine CJZB	203373	Drive Shaft		36		59.5	38	511						
	2013.05-	MT	L	F	Estate Engine CJZB	803116	Outer Joint		36	30	59.5	38	55		I				
1.2 TSI (77 kW)	2013.05-	MT	L/R	F	Estate Engine CJZA	803037	Outer Joint		36	30	59.5	40.5	55		I				
	2013.05-	AT/MT	L/R	F	Estate Engine CJZA	603011	Inner Joint			33		34							
	2013.05-	MT	L	F	Estate Engine CJZA	203373	Drive Shaft		36		59.5	38	511						
	2013.05-	AT	-	F	Estate Engine CJZA	803100	Outer Joint		36	33	59.5	38	55		I				
	2013.05-	AT	L	F	Estate Engine CJZA	261089	Drive Shaft		36		59.5	40.5	521						
	2013.05-	MT	L	F	Estate Engine CJZA	803116	Outer Joint		36	30	59.5	38	55		I				
	2013.05-	AT	R	F	Estate Engine CJZA	261199	Drive Shaft		36		59.5	40.5	800						
1.2 TSI (81 kW)	2014.04-	MT	L/R	F	Estate Engine CYVB	803037	Outer Joint		36	30	59.5	40.5	55		I				
	2014.04-	MT	L/R	F	Estate Engine CYVB	603011	Inner Joint			33		34							
	2014.04-	6MT	L	F	Estate Engine CYVB	203373	Drive Shaft		36		59.5	38	511						
	2014.04-	6MT	L	F	Estate Engine CYVB	803116	Outer Joint		36	30	59.5	38	55		I				
1.4 TGI CNG (81 kW)	2013.09-	-	L/R	F	Estate Engine CPWA	603011	Inner Joint			33		34							
	2013.09-	-	-	F	Estate Engine CPWA	803100	Outer Joint		36	33	59.5	38	55		I				
	2013.09-	7AT/MT	L	F	Estate Engine CPWA	261089	Drive Shaft		36		59.5	40.5	521						
	2013.09-	AT	R	F	Estate Engine CPWA	261199	Drive Shaft		36		59.5	40.5	800						
1.4 TSI (103 kW)	2013.05-	AT	R	F	Estate Engine CHPA	261303	Drive Shaft		36		59.5	40	795						
	2013.05-	MT	-	F	Estate Engine CHPA	803100	Outer Joint		36	33	59.5	38	55		I				
	2013.05-	AT	-	F	Estate Engine CHPA	803101	Outer Joint		36	27	59.5	40	65		M				
	2013.05-	MT	L	F	Estate Engine CHPA	261089	Drive Shaft		36		59.5	40.5	521						
	2013.05-	MT	L/R	F	Estate Engine CHPA	603011	Inner Joint			33		34							
	2013.05-	AT	L	F	Estate Engine CHPA	261304	Drive Shaft		36		59.5	40	511						
1.4 TSI (110 kW)	2014.05-	AT	R	F	Estate Engine CZDA	261303	Drive Shaft		36		59.5	40	795						
	2014.05-	AT	-	F	Estate Engine CZDA	803101	Outer Joint		36	27	59.5	40	65		M				
	2014.05-	MT	-	F	Estate Engine CZDA	803100	Outer Joint		36	33	59.5	38	55		I				
	2014.05-	MT	L	F	Estate Engine CZDA	261089	Drive Shaft		36		59.5	40.5	521						
	2014.05-	MT	L/R	F	Estate Engine CZDA	603011	Inner Joint			33		34							
	2014.05-	AT	L	F	Estate Engine CZDA	261304	Drive Shaft		36		59.5	40	511						
1.4 TSI (90 kW)	2013.05-	AT	L	F	Estate Engine CXSA	261201	Drive Shaft		36		59.5	40.5	535						
	2013.05-	AT/MT	-	F	Estate Engine CXSA	803100	Outer Joint		36	33	59.5	38	55		I				
	2013.05-	-	L/R	F	Estate Engine CXSA	603011	Inner Joint			33		34							
	2013.05-	AT	L	F	Estate Engine CXSA	261306	Drive Shaft		36		59.5	40	517						
1.4 TSI (92 kW)	2014.05-	MT	L/R	F	Estate Engine CPVB	603011	Inner Joint			33		34							
	2014.05-	7AT/MT	L	F	Estate Engine CPVB	261089	Drive Shaft		36		59.5	40.5	521						
	2014.05-	-	-	F	Estate Engine CPVB	803100	Outer Joint		36	33	59.5	38	55		I				
	2014.05-	AT	-	-	Estate Engine CPVB	603016	Inner Joint			28		32							
	2014.05-	AT	R	F	Estate Engine CPVB	261199	Drive Shaft		36		59.5	40.5	800						
1.4 TSI MultiFuel (90 kW)	2013.04-	MT	L/R	F	Estate Engine CPVA	603011	Inner Joint			33		34							
	2013.04-	7AT/MT	L	F	Estate Engine CPVA	261089	Drive Shaft		36		59.5	40.5	521						
	2013.04-	-	-	F	Estate Engine CPVA	803100	Outer Joint		36	33	59.5	38	55		I				
	2013.04-	MT	-	-	Estate Engine CPVA	603006	Inner Joint			33		34							
	2013.04-	AT	R	F	Estate Engine CPVA	261199	Drive Shaft		36		59.5	40.5	800						
	2013.04-	MT	-	-	Estate Engine CPVA	861059	Outer Joint		36	33	59.5	40	59.5		I				
1.4 TSI MultiFuel (92 kW)	2014.05-	AT	R	F	Estate Engine CPVB	261199	Drive Shaft		36		59.5	40.5	800						
	2014.05-	MT	-	-	Estate Engine CPVB	861059	Outer Joint		36	33	59.5	40	59.5		I				
	2014.05-	MT	L/R	F	Estate Engine CPVB	603011	Inner Joint			33		34							
	2014.05-	7AT/MT	L	F	Estate Engine CPVB	261089	Drive Shaft		36		59.5	40.5	521						
	2014.05-	-	-	F	Estate Engine CPVB	803100	Outer Joint		36	33	59.5	38	55		I				
	2014.05-	MT	-	-	Estate Engine CPVB	603006	Inner Joint			33		34							
1.6 (81 kW)	2014.05-	AT	L	F	Estate Engine CWVA	203294	Drive Shaft		36		59.5	38	519						
	2014.05-	-	L/R	F	Estate Engine CWVA	803037	Outer Joint		36	30	59.5	40.5	55		I				
	2014.05-	MT	L	F	Estate Engine CWVA	261277	Drive Shaft		36		59.5	40	516						
	2014.05-	AT	L	F	Estate Engine CWVA	803116	Outer Joint		36	30	59.5	38	55		I				
	2014.05-	-	L/R	F	Estate Engine CWVA	603011	Inner Joint			33		34							
	2014.05-	AT	R	F	Estate Engine CWVA	261042	Drive Shaft		36		59.5	40.5	814						
	2014.05-	6AT	L	F	Estate Engine CWVA	203318	Drive Shaft		36	26	59.5	38	581						
1.6 TDI (66 kW)	2013.05-	MT	L	F	Estate Engine CLHB	203294	Drive Shaft		36		59.5	38	519						
	2013.05-	MT	-	-	Estate Engine CLHB	603006	Inner Joint			33		34							
	2013.05-	MT	L/R	F	Estate Engine CLHB	803037	Outer Joint		36	30	59.5	40.5	55		I				

	 YEAR	TRANSM	L/R	F/R	REMARKS	GSP Ref.	 PRODUCT	 ABS	Technical Specifications						
									A	B	C	H	L	P	
VW															
GOLF VII Variant (BA5 BV5)															
1.6 TDI (66 kW)	2013.05-	-	MT	L	F	Estate Engine CLHB	803116	Outer Joint	36	30	59.5	38	55	I	
	2013.05-	-	MT	R	F	Estate Engine CLHB	261042	Drive Shaft	36		59.5	40.5	814		
	2013.05-	-	MT	L/R	F	Estate Engine CLHB	603011	Inner Joint		33		34			
	2013.05-	-	MT	R	F	Estate Engine CLHB	201585	Drive Shaft	36		59.5	40	805		
1.6 TDI (77 kW)	2013.05-	-	AT/MT	-	F	Estate Engine CLHA	803100	Outer Joint	36	33	59.5	38	55	I	
	2013.05-	-	AT/MT	L	F	Estate Engine CLHA	261089	Drive Shaft	36		59.5	40.5	521		
	2013.05-	-	-	L/R	F	Estate Engine CLHA	603011	Inner Joint		33		34			
	2013.05-	-	MT	R	F	Estate Engine CLHA	261200	Drive Shaft	36		59.5	40.5	820		
	2013.05-	-	AT	R	F	Estate Engine CLHA	261280	Drive Shaft	36		59.5	40	801		
1.6 TDI (81 kW)	2013.05-	-	MT	R	F	Estate Engine CLHA	261282	Drive Shaft	36		59.5	40	523		
	2013.05-	-	6MT	L/R	F	Estate Engine CLHA	803100	Outer Joint	36	33	59.5	38	55	I	
	2013.05-	-	AT/MT	L	F	Estate Engine CRKB	261089	Drive Shaft	36		59.5	40.5	521		
	2013.05-	-	-	L/R	F	Estate Engine CRKB	603011	Inner Joint		33		34			
	2013.05-	-	MT	R	F	Estate Engine CRKB	261200	Drive Shaft	36		59.5	40.5	820		
1.6 TDI (85 kW)	2013.05-	-	AT	R	F	Estate Engine CRKB	261280	Drive Shaft	36		59.5	40	801		
	2013.05-	-	AT	R	F	Estate Engine CRKB	261282	Drive Shaft	36		59.5	40	523		
	2016.11-	-	7DCT/5MT	L/R	F	Estate Engine DDYA	603011	Inner Joint		33		34			
	2013.05-	-	-	L/R	F	All-wheel Drive Estate Engine CLHA	603011	Inner Joint		33		34			
	2013.05-	-	-	-	F	All-wheel Drive Estate Engine CLHA	803101	Outer Joint	36	27	59.5	40	65	M	
1.6 TDI 4motion (81 kW)	2013.05-	-	6MT	L/R	F	All-wheel Drive Estate Engine CXXB	603011	Inner Joint		33		34			
	2013.05-	-	-	-	F	All-wheel Drive Estate Engine CXXB	803101	Outer Joint	36	27	59.5	40	65	M	
2.0 GTD (135 kW)	2015.01-	-	AT	-	-	Estate Engine CUNA/DGCA	603016	Inner Joint		28		32			
	2015.01-	-	AT	L	F	Estate Engine CUNA/DGCA	261285	Drive Shaft	36		59.5	40	472		
	2015.01-	-	AT	R	F	Estate Engine CUNA/DGCA	203354	Drive Shaft	36		59.5	40	763		
2.0 TDI (110 kW)	2013.04-	-	MT	-	F	Estate Engine CRLB/CRUA/CRMB/CRBC/DCYA/DEJA	803101	Outer Joint	36	27	59.5	40	65	M	
	2013.04-	-	AT	L	F	Estate Engine CRLB/CRUA/CRMB/CRBC/DCYA/DEJA	261285	Drive Shaft	36		59.5	40	472		
	2013.04-	-	AT	R	F	Estate Engine CRLB/CRUA/CRMB/CRBC/DCYA/DEJA	203354	Drive Shaft	36		59.5	40	763		
2.0 TDI (81 kW)	2013.05-	-	MT	L/R	F	Estate Engine CRVA/CYKB/CRLD/DCYB/DEJB	603011	Inner Joint		33		34			
	2013.05-	-	-	-	F	Estate Engine CRVA/CYKB/CRLD/DCYB/DEJB	803100	Outer Joint	36	33	59.5	38	55	I	
	2013.05-	-	7AT/MT	L	F	Estate Engine CRVA/CYKB/CRLD/DCYB/DEJB	261089	Drive Shaft	36		59.5	40.5	521		
	2013.05-	-	MT	R	F	Estate Engine CRVA/CYKB/CRLD/DCYB/DEJB	261200	Drive Shaft	36		59.5	40.5	820		
	2013.05-	-	7AT	R	F	Estate Engine CRVA/CYKB/CRLD/DCYB/DEJB	261280	Drive Shaft	36		59.5	40	801		
2.0 TDI 4motion (110 kW)	2013.04-	-	MT	-	-	All-wheel Drive Estate Engine CRLB/CRBC/DCYA	803101	Outer Joint	36	27	59.5	40	65	M	
GOLF VII Variant (BA5, BV5)															
1.5 TSI (110 kW)	2017.04-	-	6MT	L/R	F	Estate Engine DADA	603011	Inner Joint		33		34			
GOLF/GLX/GTI															
-	1995-	1998.07	-	-	-	-	899136	Outer Joint		22	30	51	78	61	I
GOLF/GOLF R32															
-	1998-	2006	-	-	-	-	201587	Drive Shaft	36		53	78.5	522		
-	2006-	2014	-	-	-	-	201594	Drive Shaft	36		59.5	40	800		
1.6	2006-	2009	-	-	-	-	201583	Drive Shaft	36	26	59.5	40	873		
GOLF/R32/GTI/RABBIT															
-	1998-	2006	-	-	-	-	201587	Drive Shaft	36		53	78.5	522		
1.6	2006-	2009	-	-	-	-	201583	Drive Shaft	36	26	59.5	40	873		
GOLF/R32/GTI/RABBIT(474)															
-	2006-	2007	-	L	-	-	261153	Drive Shaft	36	26	59.5	40	583		
-	2006-	2007	-	L	-	-	261153	Drive Shaft	36	26	59.5	40	583		
GOLF/VARIANT															
1.6	2004-	2005	-	-	-	-	201583	Drive Shaft	36	26	59.5	40	873		
GOLF/VARIANT/4MOTION															
1.4	2007-	2014	-	-	-	-	201584	Drive Shaft	36		59.5	40	530		
1.6	2004-	2005	-	-	-	-	201583	Drive Shaft	36	26	59.5	40	873		
JETTA															
-	1999-	2006	-	-	-	-	201587	Drive Shaft	36		53	78.5	522		
-	2009-	2010	-	-	-	-	201594	Drive Shaft	36		59.5	40	800		
1.4	2006-	2016	-	-	-	-	201584	Drive Shaft	36		59.5	40	530		
	2018-	-	-	L	-	-	261153	Drive Shaft	36	26	59.5	40	583		
1.4/1.8	2018-	-	-	L	-	-	261153	Drive Shaft	36	26	59.5	40	583		
	2016-	-	-	L	-	-	261153	Drive Shaft	36	26	59.5	40	583		
	2016-	-	-	L	-	-	261153	Drive Shaft	36	26	59.5	40	583		
	2017-	-	-	L	-	-	261153	Drive Shaft	36	26	59.5	40	583		
1.8	2017-	-	-	L	-	-	261153	Drive Shaft	36	26	59.5	40	583		
	2002-	-	-	L	F	Turbo Gas 5 Speed	261060	Drive Shaft	36		53.2	77.5	520		
	2003-	-	-	L	F	5 Speed	261060	Drive Shaft	36		53.2	77.5	520		
	2004-	-	-	L	F	5 Speed	261060	Drive Shaft	36		53.2	77.5	520		
2005-	-	-	L	F	(Vin "J" or "M" 8th Digit) 5 Speed	261060	Drive Shaft	36		53.2	77.5	520			

YEAR	TRANS	L/R	F/R	REMARKS	GSP Ref.	PRODUCT	ABS	Technical Specifications						
								A	B	C	H	L	P	
VW														
JETTA														
1.8	2015-	-	-	L - -		261153	Drive Shaft		36	26	59.5	40	583	
	2015-	-	-	L - -		261153	Drive Shaft		36	26	59.5	40	583	
1.8/2.5	2014-	-	-	L - -		261153	Drive Shaft		36	26	59.5	40	583	
	2014-	-	-	L - -		261153	Drive Shaft		36	26	59.5	40	583	
1.9	2004-	-	-	L F	SW w/Eng Code BEW	261060	Drive Shaft		36		53.2	77.5	520	
	2005-	-	-	L F	(Vin "J" or "M" 8th Digit) SW w/Eng Code BEW	261060	Drive Shaft		36		53.2	77.5	520	
2.0/2.5	2012-	-	-	L - -		261153	Drive Shaft		36	26	59.5	40	583	
	2012-	-	-	L - -		261153	Drive Shaft		36	26	59.5	40	583	
	2013-	-	-	L - -		261153	Drive Shaft		36	26	59.5	40	583	
	2013-	-	-	L - -		261153	Drive Shaft		36	26	59.5	40	583	
2.5	2008-	-	-	L - -		261153	Drive Shaft		36	26	59.5	40	583	
	2008-	-	-	L - -		261153	Drive Shaft		36	26	59.5	40	583	
	2009-	-	-	L - -		261153	Drive Shaft		36	26	59.5	40	583	
	2009-	-	-	L - -		261153	Drive Shaft		36	26	59.5	40	583	
	2010-	-	-	L - -		261153	Drive Shaft		36	26	59.5	40	583	
	2010-	-	-	L - -		261153	Drive Shaft		36	26	59.5	40	583	
	2011-	-	-	L - -		261153	Drive Shaft		36	26	59.5	40	583	
	2011-	-	-	L - -		261153	Drive Shaft		36	26	59.5	40	583	
2.8	2004-	-	-	L F	5 Speed	261060	Drive Shaft		36		53.2	77.5	520	
	2005-	-	-	L F	(Vin "J" or "M" 8th Digit) 5 Speed	261060	Drive Shaft		36		53.2	77.5	520	
JETTA A4														
2.0	2008-	2010		AT	L/R - -	661034	Inner Joint		26	32	31	68.5	88.5	
JETTA II (19E 1G2 165)														
1.3 Cat (40 kW)	1987.06-	1991.12		MT	L/R F	Saloon Engine MH/NZ/2G	653001	Inner Joint			33		32	
	1987.06-	1991.12		MT	- -	Saloon Engine MH/NZ/2G	603006	Inner Joint			33		34	
	1987.06-	1991.12		MT	L F	Saloon Engine MH/NZ/2G	253004	Drive Shaft	22		50	78.5	562	
	1987.06-	1991.12		MT	L/R F	Saloon Engine MH/NZ/2G	853008	Outer Joint	22	30	53	78.5	51	I
1.6 (51 kW)	1986.10-	1991.10		AT/MT	L/R F	Saloon Engine PN	603004	Inner Joint			33		32	
	1986.10-	1991.10		AT/MT	L/R F	Saloon Engine PN	603005	Inner Joint			33		32	
	1986.10-	1991.10		AT/MT	L/R F	Saloon Engine PN	853008	Outer Joint	22	30	53	78.5	51	I
	1986.10-	1991.10		AT/MT	L F	Saloon Engine PN	253003	Drive Shaft	22		53	78.5	539.5	
	1986.10-	1991.10		AT/MT	R F	Saloon Engine PN	253005	Drive Shaft	22		53	78.5	774	
1.6 (53 kW)	1986.03-	1991.10		AT/MT	R F	Saloon Engine RF	253005	Drive Shaft	22		53	78.5	774	
	1986.03-	1991.10		AT/MT	L/R F	Saloon Engine RF	603004	Inner Joint			33		32	
	1986.03-	1991.10		AT/MT	L/R F	Saloon Engine RF	603005	Inner Joint			33		32	
	1986.03-	1991.10		AT/MT	L/R F	Saloon Engine RF	853008	Outer Joint	22	30	53	78.5	51	I
	1986.03-	1991.10		AT/MT	R F	Saloon Engine RF	253003	Drive Shaft	22		53	78.5	539.5	
1.6 (55 kW)	1984.01-	1992.07		AT/MT	L F	Saloon Engine EZ/ABN/HM	253005	Drive Shaft	22		53	78.5	774	
	1984.01-	1992.07		AT/MT	L/R F	Saloon Engine EZ/ABN/HM	603004	Inner Joint			33		32	
	1984.01-	1992.07		-	-	F Saloon Engine EZ/ABN/HM	853006	Outer Joint	22	30	50	78.5	52	I
	1984.01-	1992.07		AT/MT	L/R F	Saloon Engine EZ/ABN/HM	603005	Inner Joint			33		32	
	1984.01-	1992.07		AT/MT	L/R F	Saloon Engine EZ/ABN/HM	853008	Outer Joint	22	30	53	78.5	51	I
	1984.01-	1992.07		AT/MT	L F	Saloon Engine EZ/ABN/HM	253003	Drive Shaft	22		53	78.5	539.5	
1.6 D (40 kW)	1984.01-	1991.10		AT/MT	R F	Saloon Engine ME	253005	Drive Shaft	22		53	78.5	774	
	1984.01-	1991.10		AT/MT	L/R F	Saloon Engine ME	603004	Inner Joint			33		32	
	1984.01-	1991.10		AT/MT	L/R F	Saloon Engine ME	603005	Inner Joint			33		32	
	1984.01-	1991.10		AT/MT	L/R F	Saloon Engine ME	853008	Outer Joint	22	30	53	78.5	51	I
	1984.01-	1991.10		AT/MT	L F	Saloon Engine ME	253003	Drive Shaft	22		53	78.5	539.5	
1.6 TD (44 kW)	1990.01-	1991.10		MT	R F	Saloon Engine 1V	253005	Drive Shaft	22		53	78.5	774	
	1990.01-	1991.10		MT	- -	Saloon Engine 1V	603006	Inner Joint			33		34	
	1990.01-	1991.10		MT	L/R F	Saloon Engine 1V	603004	Inner Joint			33		32	
	1990.01-	1991.10		MT	L/R F	Saloon Engine 1V	603005	Inner Joint			33		32	
	1990.01-	1991.10		MT	L/R F	Saloon Engine 1V	853008	Outer Joint	22	30	53	78.5	51	I
	1990.01-	1991.10		MT	L F	Saloon Engine 1V	253003	Drive Shaft	22		53	78.5	539.5	
1.6 TD (51 kW)	1984.01-	1991.10		MT	R F	Saloon Engine MF/JR	253005	Drive Shaft	22		53	78.5	774	
	1984.01-	1991.10		MT	- -	Saloon Engine MF/JR	603006	Inner Joint			33		34	
	1984.01-	1991.10		MT	L/R F	Saloon Engine MF/JR	603004	Inner Joint			33		32	
	1984.01-	1991.10		MT	L/R F	Saloon Engine MF/JR	603005	Inner Joint			33		32	
	1984.01-	1991.10		MT	L/R F	Saloon Engine MF/JR	853008	Outer Joint	22	30	53	78.5	51	I
	1984.01-	1991.10		MT	L F	Saloon Engine MF/JR	253003	Drive Shaft	22		53	78.5	539.5	
1.6 TD (59 kW)	1989.04-	1991.10		MT	R F	Saloon Engine RA/SB	253005	Drive Shaft	22		53	78.5	774	
	1989.04-	1991.10		MT	- -	Saloon Engine RA/SB	603006	Inner Joint			33		34	
	1989.04-	1991.10		MT	L/R F	Saloon Engine RA/SB	603004	Inner Joint			33		32	
	1989.04-	1991.10		MT	L/R F	Saloon Engine RA/SB	603005	Inner Joint			33		32	
	1989.04-	1991.10		MT	L/R F	Saloon Engine RA/SB	853008	Outer Joint	22	30	53	78.5	51	I
	1989.04-	1991.10		MT	L F	Saloon Engine RA/SB	253003	Drive Shaft	22		53	78.5	539.5	

YEAR	TRANSM	L/R	F/R	REMARKS	GSP Ref.	PRODUCT	ABS	Technical Specifications						
								A	B	C	H	L	P	
VW														
JETTA II (19E 1G2 16S)														
1.8 (62 kW)	1986.08-1990.01	MT	L	F	Saloon Engine RH	253001	Drive Shaft		22		53	78.5	535	
	1986.08-1990.01	MT	L/R	F	Saloon Engine RH	853007	Outer Joint		22	30	53.2	78	61	I
	1986.08-1990.01	AT/MT	L/R	F	Saloon Engine RH	603004	Inner Joint			33		32		
	1986.08-1990.01	MT	R	F	Saloon Engine RH	253002	Drive Shaft		22		53.2	78	769	
	1986.08-1990.01	MT	R	F	Saloon Engine RH	603009	Inner Joint			33		34		
	1986.08-1990.01	-	-	F	Saloon Engine RH	853006	Outer Joint		22	30	50	78.5	52	I
	1986.08-1990.01	MT	L	F	Saloon Engine RH	603011	Inner Joint			33		34		
	1986.08-1990.01	AT/MT	L/R	F	Saloon Engine RH	603005	Inner Joint			33		32		
	1986.08-1990.01	AT/MT	L/R	F	Saloon Engine RH	853008	Outer Joint		22	30	53	78.5	51	I
	1986.08-1990.01	AT/MT	L	F	Saloon Engine RH	253003	Drive Shaft		22		53	78.5	539.5	
1.8 (66 kW)	1984.08-1991.10	AT/MT	R	F	Saloon Engine GX	253005	Drive Shaft		22		53	78.5	774	
	1984.08-1991.10	MT	L	F	Saloon Engine GX	253001	Drive Shaft		22		53	78.5	535	
	1984.08-1991.10	AT/MT	L/R	F	Saloon Engine GX	603004	Inner Joint			33		32		
	1984.08-1991.10	MT	L/R	F	Saloon Engine GX	853007	Outer Joint		22	30	53.2	78	61	I
	1984.08-1991.10	MT	R	F	Saloon Engine GX	253002	Drive Shaft		22		53.2	78	769	
	1984.08-1991.10	MT	R	F	Saloon Engine GX	603009	Inner Joint			33		34		
	1984.08-1991.10	MT	L	F	Saloon Engine GX	603011	Inner Joint			33		34		
	1984.08-1991.10	AT/MT	L/R	F	Saloon Engine GX	603005	Inner Joint			33		32		
	1984.08-1991.10	-	-	F	Saloon Engine GX	853006	Outer Joint		22	30	50	78.5	52	I
	1984.08-1991.10	AT/MT	L/R	F	Saloon Engine GX	853008	Outer Joint		22	30	53	78.5	51	I
1984.08-1991.10	AT/MT	L	F	Saloon Engine GX	253003	Drive Shaft		22		53	78.5	539.5		
1.8 (82 kW)	1984.01-1991.10	MT	L	F	Saloon Engine EV/GZ/PB	261043	Drive Shaft		22		53.2	78	535	
	1984.01-1991.10	MT	L	F	Saloon Engine EV/GZ/PB	253001	Drive Shaft		22		53	78.5	535	
	1984.01-1991.10	MT	L/R	F	Saloon Engine EV/GZ/PB	853007	Outer Joint		22	30	53.2	78	61	I
	1984.01-1991.10	MT	-	-	Saloon Engine EV/GZ/PB	603006	Inner Joint			33		34		
	1984.01-1991.10	MT	R	F	Saloon Engine EV/GZ/PB	253002	Drive Shaft		22		53.2	78	769	
	1984.01-1991.10	MT	R	F	Saloon Engine EV/GZ/PB	603009	Inner Joint			33		34		
	1984.01-1991.10	-	-	F	Saloon Engine EV/GZ/PB	853004	Outer Joint		22	30	51	78	61	I
1984.01-1991.10	MT	L	F	Saloon Engine EV/GZ/PB	603011	Inner Joint			33		34			
1.8 16V (102 kW)	1987.06-1989.12	MT	L/R	F	Saloon Engine KR	853007	Outer Joint		22	30	53.2	78	61	I
	1987.06-1989.12	MT	L	F	Saloon Engine KR	261043	Drive Shaft		22		53.2	78	535	
	1987.06-1989.12	-	-	F	Saloon Engine KR	853004	Outer Joint		22	30	51	78	61	I
	1987.06-1989.12	MT	L	F	Saloon Engine KR	603011	Inner Joint			33		34		
	1987.06-1989.12	MT	R	F	Saloon Engine KR	603009	Inner Joint			33		34		
	1987.06-1989.12	MT	R	F	Saloon Engine KR	253002	Drive Shaft		22		53.2	78	769	
	1987.06-1989.12	MT	L	F	Saloon Engine KR	253001	Drive Shaft		22		53	78.5	535	
	1987.06-1989.12	MT	-	-	Saloon Engine KR	603006	Inner Joint			33		34		
1.8 16V (95 kW)	1986.08-1991.10	MT	L	F	Saloon Engine PL	261043	Drive Shaft		22		53.2	78	535	
	1986.08-1991.10	MT	L	F	Saloon Engine PL	253001	Drive Shaft		22		53	78.5	535	
	1986.08-1991.10	MT	L/R	F	Saloon Engine PL	853007	Outer Joint		22	30	53.2	78	61	I
	1986.08-1991.10	MT	-	-	Saloon Engine PL	603006	Inner Joint			33		34		
	1986.08-1991.10	MT	R	F	Saloon Engine PL	253002	Drive Shaft		22		53.2	78	769	
	1986.08-1991.10	MT	R	F	Saloon Engine PL	603009	Inner Joint			33		34		
	1986.08-1991.10	-	-	F	Saloon Engine PL	853004	Outer Joint		22	30	51	78	61	I
	1986.08-1991.10	MT	L	F	Saloon Engine PL	603011	Inner Joint			33		34		
1.8 Cat (66 kW)	1987.08-1991.10	AT/MT	R	F	Saloon Engine RP	253005	Drive Shaft		22		53	78.5	774	
	1987.08-1991.10	MT	L	F	Saloon Engine RP	253001	Drive Shaft		22		53	78.5	535	
	1987.08-1991.10	MT	L/R	F	Saloon Engine RP	853007	Outer Joint		22	30	53.2	78	61	I
	1987.08-1991.10	AT/MT	L/R	F	Saloon Engine RP	603004	Inner Joint			33		32		
	1987.08-1991.10	MT	R	F	Saloon Engine RP	253002	Drive Shaft		22		53.2	78	769	
	1987.08-1991.10	MT	R	F	Saloon Engine RP	603009	Inner Joint			33		34		
	1987.08-1991.10	-	-	F	Saloon Engine RP	853006	Outer Joint		22	30	50	78.5	52	I
	1987.08-1991.10	MT	L	F	Saloon Engine RP	603011	Inner Joint			33		34		
	1987.08-1991.10	AT/MT	L/R	F	Saloon Engine RP	603005	Inner Joint			33		32		
	1987.08-1991.10	AT/MT	L/R	F	Saloon Engine RP	853008	Outer Joint		22	30	53	78.5	51	I
1987.08-1991.10	AT/MT	L	F	Saloon Engine RP	253003	Drive Shaft		22		53	78.5	539.5		
1.8 Cat (79 kW)	1987.01-1991.10	MT	L	F	Saloon Engine PF	261043	Drive Shaft		22		53.2	78	535	
	1987.01-1991.10	MT	L	F	Saloon Engine PF	253001	Drive Shaft		22		53	78.5	535	
	1987.01-1991.10	MT	L/R	F	Saloon Engine PF	853007	Outer Joint		22	30	53.2	78	61	I
	1987.01-1991.10	MT	R	F	Saloon Engine PF	253002	Drive Shaft		22		53.2	78	769	
	1987.01-1991.10	MT	R	F	Saloon Engine PF	603009	Inner Joint			33		34		
	1987.01-1991.10	-	-	F	Saloon Engine PF	853004	Outer Joint		22	30	51	78	61	I
1987.01-1991.10	MT	L	F	Saloon Engine PF	603011	Inner Joint			33		34			
1.8 Syncro (72 kW)	1988.08-1991.07	MT	L/R	F	All-wheel Drive Saloon Engine 1P	853007	Outer Joint		22	30	53.2	78	61	I
	1988.08-1991.07	MT	L/R/R	F	All-wheel Drive Saloon Engine 1P	603004	Inner Joint			33		32		

	YEAR		TRANSM	L/R	F/R	REMARKS	GSP Ref.	PRODUCT	ABS	Technical Specifications										
	A	B								C	H	L	P							
VW																				
JETTA II (19E 1G2 165)																				
1.8 Syncro (72 kW)	1988.08-1991.07	-	-	-	-	All-wheel Drive Saloon Engine 1P	853006	Outer Joint		22	30	50	78.5	52	I					
	1988.08-1991.07	MT	R	F	-	All-wheel Drive Saloon Engine 1P	603009	Inner Joint			33		34							
	1988.08-1991.07	MT	-	-	-	All-wheel Drive Saloon Engine 1P	603006	Inner Joint			33		34							
	1988.08-1991.07	-	-	-	-	All-wheel Drive Saloon Engine 1P	853004	Outer Joint		22	30	51	78	61	I					
	1988.08-1991.07	MT	L	F	-	All-wheel Drive Saloon Engine 1P	603011	Inner Joint			33		34							
	1988.08-1991.07	MT	L/R/F/R	-	-	All-wheel Drive Saloon Engine 1P	603005	Inner Joint			33		32							
	1988.08-1991.07	MT	L	F	-	All-wheel Drive Saloon Engine 1P	853008	Outer Joint		22	30	53	78.5	51	I					
	1988.08-1991.07	MT	L	F	-	All-wheel Drive Saloon Engine 1P	253003	Drive Shaft		22		53	78.5	539.5						
1988.08-1991.07	MT	L/R	R	-	All-wheel Drive Saloon Engine 1P	803007	Outer Joint		22	30	51	78.7	51.1	I						
JETTA III (1K2)																				
1.4 TSI (103 kW)	2006.07-2010.10	6MT	L	F	-	Saloon Engine BMY	261224	Drive Shaft		36		59.5	40	536						
	2006.07-2010.10	6MT	L/R	F	-	Saloon Engine BMY	803037	Outer Joint		36	30	59.5	40.5	55	I					
	2006.07-2010.10	MT	L/R	F	-	Saloon Engine BMY	603011	Inner Joint			33		34							
	2006.07-2010.10	MT	R	F	-	Saloon Engine BMY	201586	Drive Shaft		36		59.5	40	806						
	2006.07-2010.10	AT	L/R	F	-	Saloon Engine BMY	803002	Outer Joint		36	27	59.5	40	66	I					
	2006.07-2010.10	AT	R	F	-	Saloon Engine BMY	261342	Drive Shaft		36		59.5	40	764						
1.4 TSI (118 kW)	2008.07-2010.10	MT	L/R	F	-	Saloon Engine CAVD	603011	Inner Joint			33		34							
	2008.07-2010.10	AT	L	F	-	Saloon Engine CAVD	661054	Inner Joint		40	28	46.9	51	53						
	2008.07-2010.10	-	L/R	F	-	Saloon Engine CAVD	803037	Outer Joint		36	30	59.5	40.5	55	I					
	2008.07-2010.10	AT	L/R	F	-	Saloon Engine CAVD	803002	Outer Joint		36	27	59.5	40	66	I					
1.4 TSI (125 kW)	2006.07-2010.10	MT	L	F	-	Saloon Engine BLG	203302	Drive Shaft		36		59.5	40	528						
	2006.07-2010.10	6MT	L/R	F	-	Saloon Engine BLG	803002	Outer Joint		36	27	59.5	40	66	I					
	2006.07-2010.10	AT	R	F	-	Saloon Engine BLG	261342	Drive Shaft		36		59.5	40	764						
1.4 TSI (90 kW)	2007.05-2010.10	Semi-AT	L/R	F	-	Saloon Engine CAXA	803002	Outer Joint		36	27	59.5	40	66	I					
	2007.05-2010.10	MT	L/R	F	-	Saloon Engine CAXA	603011	Inner Joint			33		34							
	2007.05-2010.10	MT	L	F	-	Saloon Engine CAXA	261198	Drive Shaft		36		59.5	40.5	530						
	2007.05-2010.10	6MT	L/R	F	-	Saloon Engine CAXA	803037	Outer Joint		36	30	59.5	40.5	55	I					
1.6 (75 kW)	2005.10-2010.10	-	R	F	-	Saloon Engine BGU	261113	Drive Shaft		36		59.5	40	814						
	2005.10-2010.10	MT	L	F	-	Saloon Engine BGU	261097	Drive Shaft		36		59.5	40.5	543						
	2005.10-2010.10	5MT	L/R	F	-	Saloon Engine BGU	803037	Outer Joint		36	30	59.5	40.5	55	I					
	2005.10-2010.10	5MT	R	F	-	Saloon Engine BGU	261096	Drive Shaft		36		59.5	40.5	799						
	2005.10-2010.10	MT	L/R	F	-	Saloon Engine BGU	603011	Inner Joint			33		34							
	2005.10-2010.10	AT	-	-	-	Saloon Engine BGU	603016	Inner Joint			28		32							
	2005.10-2010.10	7AT	L	F	-	Saloon Engine BGU	803116	Outer Joint		36	30	59.5	38	55	I					
	2005.10-2010.10	AT	L/R	F	-	Saloon Engine BGU	661011	Inner Joint		26	32	31	68.5	85						
	2005.10-2010.10	MT	L	F	-	Saloon Engine BGU	203320	Drive Shaft		36		59.5	40	546						
	2005.10-2010.10	6AT	L	F	-	Saloon Engine BGU	261093	Drive Shaft		36	26	59.5	40.5	587.5						
1.6 FSI (85 kW)	2005.09-2010.10	6MT	L/R	F	-	Saloon Engine BLF	803037	Outer Joint		36	30	59.5	40.5	55	I					
	2005.09-2010.10	MT	L/R	F	-	Saloon Engine BLF	603011	Inner Joint			33		34							
	2005.09-2010.10	6MT	R	F	-	Saloon Engine BLF	261211	Drive Shaft		36		59.5	40.5	784						
	2005.09-2010.10	6MT	L	F	-	Saloon Engine BLF	803116	Outer Joint		36	30	59.5	38	55	I					
	2005.09-2010.10	AT	L/R	F	-	Saloon Engine BLF	661011	Inner Joint		26	32	31	68.5	85						
	2005.09-2010.10	6MT	L	F	-	Saloon Engine BLF	203319	Drive Shaft		36		59.5	38	557						
1.6 MultiFuel (75 kW)	2008.01-2010.10	MT	-	-	-	Saloon Engine CCSA	661050	Inner Joint		26	32	31	68.5	89						
	2008.01-2010.10	MT	-	-	-	Saloon Engine CCSA	603006	Inner Joint			33		34							
	2008.01-2010.10	-	L	F	-	Saloon Engine CCSA	261097	Drive Shaft		36		59.5	40.5	543						
	2008.01-2010.10	-	L/R	F	-	Saloon Engine CCSA	603011	Inner Joint			33		34							
	2008.01-2010.10	-	R	F	-	Saloon Engine CCSA	261096	Drive Shaft		36		59.5	40.5	799						
	2008.01-2010.10	-	L	F	-	Saloon Engine CCSA	203320	Drive Shaft		36		59.5	40	546						
	2008.01-2010.10	-	L/R	F	-	Saloon Engine CCSA	803037	Outer Joint		36	30	59.5	40.5	55	I					
1.6 TDI (66 kW)	2009.12-2010.10	-	L	F	-	Saloon Engine CAYB	203294	Drive Shaft		36		59.5	38	519						
	2009.12-2010.10	-	L/R	F	-	Saloon Engine CAYB	603011	Inner Joint			33		34							
	2009.12-2010.10	MT	-	-	-	Saloon Engine CAYB	603016	Inner Joint			28		32							
	2009.12-2010.10	-	L	F	-	Saloon Engine CAYB	803116	Outer Joint		36	30	59.5	38	55	I					
	2009.12-2010.10	-	R	F	-	Saloon Engine CAYB	261042	Drive Shaft		36		59.5	40.5	814						
	2009.12-2010.10	-	L/R	F	-	Saloon Engine CAYB	803037	Outer Joint		36	30	59.5	40.5	55	I					
	2009.12-2010.10	-	R	F	-	Saloon Engine CAYB	201585	Drive Shaft		36		59.5	40	805						
1.6 TDI (77 kW)	2009.06-2010.10	5MT	L	F	-	Saloon Engine CAYC	203294	Drive Shaft		36		59.5	38	519						
	2009.06-2010.10	MT	L/R	F	-	Saloon Engine CAYC	603011	Inner Joint			33		34							
	2009.06-2010.10	MT	L/R	F	-	Saloon Engine CAYC	803037	Outer Joint		36	30	59.5	40.5	55	I					
	2009.06-2010.10	7DCT	R	F	-	Saloon Engine CAYC	203313	Drive Shaft		36		59.5	40	792						
	2009.06-2010.10	5MT	L	F	-	Saloon Engine CAYC	803116	Outer Joint		36	30	59.5	38	55	I					
	2009.06-2010.10	MT	R	F	-	Saloon Engine CAYC	261042	Drive Shaft		36		59.5	40.5	814						
	2009.06-2010.10	MT	R	F	-	Saloon Engine CAYC	201585	Drive Shaft		36		59.5	40	805						
	2009.06-2010.10	AT	L/R	F	-	Saloon Engine CAYC	803002	Outer Joint		36	27	59.5	40	66	I					
1.9 TDI (77 kW)	2005.08-2010.10	MT	L	F	-	Saloon Engine BKC	203294	Drive Shaft		36		59.5	38	519						

YEAR	TRANSM	L/R	F/R	REMARKS	GSP Ref.	PRODUCT	ABS	Technical Specifications						
								A	B	C	H	L	P	
VW														
JETTA III (1K2)														
1.9 TDI (77 kW)	2005.08-2010.10	MT	L/R	F	Saloon Engine BKC	603011	Inner Joint			33		34		
	2005.08-2010.10	7DCT	R	F	Saloon Engine BKC	203313	Drive Shaft	36		59.5	40	792		
	2005.08-2010.10	MT	L/R	F	Saloon Engine BKC	803037	Outer Joint	36	30	59.5	40.5	55	I	
	2005.08-2010.10	6AT	L/R	F	Saloon Engine BKC	661057	Inner Joint			34		86		
	2005.08-2010.10	MT	L	F	Saloon Engine BKC	803116	Outer Joint	36	30	59.5	38	55	I	
	2005.08-2010.10	MT	R	F	Saloon Engine BKC	261042	Drive Shaft	36		59.5	40.5	814		
	2005.08-2010.10	6AT	L	F	Saloon Engine BKC	254013	Drive Shaft	36		59.5	40	479.5		
	2005.08-2010.10	6AT	L	F	Saloon Engine BKC	654004	Inner Joint			34		85		
	2005.08-2010.10	6AT	L	F	Saloon Engine BKC	203241	Drive Shaft	36		59.5	40	475		
	2005.08-2010.10	6AT	R	F	Saloon Engine BKC	254011	Drive Shaft	36		59.5	40	755		
	2005.08-2010.10	AT	L/R	F	Saloon Engine BKC	803002	Outer Joint	36	27	59.5	40	66	I	
	2005.08-2010.10	MT	R	F	Saloon Engine BKC	201585	Drive Shaft	36		59.5	40	805		
2.0 FSI (110 kW)	2005.08-2010.10	-	R	F	Saloon Engine BLR	261113	Drive Shaft	36		59.5	40	814		
	2005.08-2010.10	6AT/6MT	L/R	F	Saloon Engine BLR	803037	Outer Joint	36	30	59.5	40.5	55	I	
	2005.08-2010.10	MT	L/R	F	Saloon Engine BLR	603011	Inner Joint			33		34		
	2005.08-2010.10	AT	R	F	Saloon Engine BLR	261094	Drive Shaft	36	26	59.5	40.5	884		
	2005.08-2010.10	AT	L/R	F	Saloon Engine BLR	661011	Inner Joint	26	32	31	68.5	85		
	2005.08-2010.10	MT	L	F	Saloon Engine BLR	803116	Outer Joint	36	30	59.5	38	55	I	
	2005.08-2010.10	AT	L	F	Saloon Engine BLR	261093	Drive Shaft	36	26	59.5	40.5	587.5		
2.0 TDI (100 kW)	2005.09-2010.10	AT	R	F	Saloon Engine AZV	254011	Drive Shaft	36		59.5	40	755		
	2005.09-2010.10	MT	L	F	Saloon Engine AZV	203295	Drive Shaft	36		59.5	40	491		
	2005.09-2010.10	AT	L/R	F	Saloon Engine AZV	661057	Inner Joint			34		86		
	2005.09-2010.10	MT	R	F	Saloon Engine AZV	203313	Drive Shaft	36		59.5	40	792		
	2005.09-2010.10	AT	L	F	Saloon Engine AZV	254013	Drive Shaft	36		59.5	40	479.5		
	2005.09-2010.10	AT	L	F	Saloon Engine AZV	654004	Inner Joint			34		85		
	2005.09-2010.10	AT	L	F	Saloon Engine AZV	203241	Drive Shaft	36		59.5	40	475		
	2005.09-2010.10	AT/MT	L/R	F	Saloon Engine AZV	803002	Outer Joint	36	27	59.5	40	66	I	
2.0 TDI (103 kW)	2005.10-2010.10	AT	L/R	F	Saloon Engine BMM	661057	Inner Joint			34		86		
	2005.10-2010.10	AT	L	F	Saloon Engine BMM	254013	Drive Shaft	36		59.5	40	479.5		
	2005.10-2010.10	6MT	R	F	Saloon Engine BMM	203313	Drive Shaft	36		59.5	40	792		
	2005.10-2010.10	AT	L	F	Saloon Engine BMM	654004	Inner Joint			34		85		
	2005.10-2010.10	AT/MT	L/R	F	Saloon Engine BMM	803002	Outer Joint	36	27	59.5	40	66	I	
	2005.10-2010.10	AT	L	F	Saloon Engine BMM	203241	Drive Shaft	36		59.5	40	475		
	2005.10-2010.10	AT	R	F	Saloon Engine BMM	254011	Drive Shaft	36		59.5	40	755		
	2005.10-2010.10	MT	L	F	Saloon Engine BMM	203295	Drive Shaft	36		59.5	40	491		
2.0 TDI (125 kW)	2006.10-2010.10	AT	R	F	Saloon Engine BMN/CEGA	254011	Drive Shaft	36		59.5	40	755		
	2006.10-2010.10	MT	-	-	Saloon Engine BMN/CEGA	603016	Inner Joint			28		32		
	2006.10-2010.10	AT	L	F	Saloon Engine BMN/CEGA	254013	Drive Shaft	36		59.5	40	479.5		
	2006.10-2010.10	AT	L	F	Saloon Engine BMN/CEGA	654004	Inner Joint			34		85		
	2006.10-2010.10	-	L/R	F	Saloon Engine BMN/CEGA	861045	Outer Joint	36	27	59.5	40	65	M	
2.0 TDI 16V (103 kW)	2005.08-2010.10	AT	R	F	Saloon Engine BKD/CBDB/CJAA/CBEA	254011	Drive Shaft	36		59.5	40	755		
	2005.08-2010.10	MT	L	F	Saloon Engine BKD/CBDB/CJAA/CBEA	203295	Drive Shaft	36		59.5	40	491		
	2005.08-2010.10	AT	L/R	F	Saloon Engine BKD/CBDB/CJAA/CBEA	661057	Inner Joint			34		86		
	2005.08-2010.10	MT	R	F	Saloon Engine BKD/CBDB/CJAA/CBEA	203313	Drive Shaft	36		59.5	40	792		
	2005.08-2010.10	AT	L	F	Saloon Engine BKD/CBDB/CJAA/CBEA	254013	Drive Shaft	36		59.5	40	479.5		
	2005.08-2010.10	AT	L	F	Saloon Engine BKD/CBDB/CJAA/CBEA	654004	Inner Joint			34		85		
	2005.08-2010.10	AT	L	F	Saloon Engine BKD/CBDB/CJAA/CBEA	203241	Drive Shaft	36		59.5	40	475		
	2005.08-2010.10	AT/MT	L/R	F	Saloon Engine BKD/CBDB/CJAA/CBEA	803002	Outer Joint	36	27	59.5	40	66	I	
2.0 TFSI (147 kW)	2005.10-2010.10	6AT/6MT	L/R	F	Saloon Engine CAWB	803002	Outer Joint	36	27	59.5	40	66	I	
	2005.10-2010.10	MT	L	F	Saloon Engine CAWB	203295	Drive Shaft	36		59.5	40	491		
	2005.10-2010.10	AT	R	F	Saloon Engine CAWB	203349	Drive Shaft	36		59.5	40	784		
	2005.10-2010.10	6DCT	L/R	F	Saloon Engine CAWB	861045	Outer Joint	36	27	59.5	40	65	M	
	2005.10-2010.10	6DCT	L/R	F	Saloon Engine CAWB	861045	Outer Joint	36	27	59.5	40	65	M	
2.5 (110 kW)	2006.01-2010.10	5MT	L/R	F	Saloon Engine BTK	803037	Outer Joint	36	30	59.5	40.5	55	I	
	2006.01-2010.10	MT	L/R	F	Saloon Engine BTK	603011	Inner Joint			33		34		
	2006.01-2010.10	AT	L/R	F	Saloon Engine BTK	803002	Outer Joint	36	27	59.5	40	66	I	
	2006.01-2010.10	5MT	L	F	Saloon Engine BTK	803116	Outer Joint	36	30	59.5	38	55	I	
	2006.01-2010.10	5MT	L	F	Saloon Engine BTK	203294	Drive Shaft	36		59.5	38	519		
2.5 (125 kW)	2008.07-2010.10	-	L/R	F	Saloon Engine CCCA	803002	Outer Joint	36	27	59.5	40	66	I	
JETTA IV (162 163)														
1.2 TSI (77 kW)	2010.10-2010.10	-	-	L/R	F	Saloon Engine CBZB	603011	Inner Joint			33		34	
	2010.10-2010.10	-	MT	L	F	Saloon Engine CBZB	261198	Drive Shaft	36		59.5	40.5	530	
	2010.10-2010.10	-	DCT	L/R	F	Saloon Engine CBZB	803002	Outer Joint	36	27	59.5	40	66	I
	2010.10-2010.10	-	-	L/R	F	Saloon Engine CBZB	803037	Outer Joint	36	30	59.5	40.5	55	I
	2010.10-2010.10	-	-	L/R	F	Saloon Engine CBZB	803037	Outer Joint	36	30	59.5	40.5	55	I
1.4 TSI (110 kW)	2011.04-2014.07	-	L/R	F	Saloon Engine CAVA	803002	Outer Joint	36	27	59.5	40	66	I	
	2011.04-2014.07	MT	L/R	F	Saloon Engine CAVA	803037	Outer Joint	36	30	59.5	40.5	55	I	
1.4 TSI (118 kW)	2011.04-2014.07	MT	L/R	F	Saloon Engine CAVD	803037	Outer Joint	36	30	59.5	40.5	55	I	



YEAR	TRANSM	L/R	F/R	REMARKS	GSP Ref.	PRODUCT	ABS	Technical Specifications						
								A	B	C	H	L	P	
VW														
JETTA IV (162 163)														
1.4 TSI (118 kW)	2011.04-	-	AT	L/R	F	Saloon Engine CAVD	803002	Outer Joint	36	27	59.5	40	66	I
	2011.04-	-	MT	L/R	F	Saloon Engine CAVD	603011	Inner Joint		33		34		
1.4 TSI (90 kW)	2011.05-	-	MT	L/R	F	Saloon Engine CAXA	603011	Inner Joint		33		34		
	2011.05-	-	MT	L	F	Saloon Engine CAXA	261198	Drive Shaft	36		59.5	40.5	530	
	2011.05-	-	MT	L/R	F	Saloon Engine CAXA	803037	Outer Joint	36	30	59.5	40.5	55	I
	2011.05-	-	AT	L/R	F	Saloon Engine CAXA	803002	Outer Joint	36	27	59.5	40	66	I
1.4 TSI Hybrid (110 kW)	2011.04-	-	AT	L/R	F	Saloon Engine CRJA	803002	Outer Joint	36	27	59.5	40	66	I
1.6 (77 kW)	2011.12-	-	MT	L/R	F	Saloon Engine CLRA	603011	Inner Joint		33		34		
	2011.12-	-	MT	L/R	F	Saloon Engine CLRA	803037	Outer Joint	36	30	59.5	40.5	55	I
	2011.12-	-	MT	R	F	Saloon Engine CLRA	261211	Drive Shaft	36		59.5	40.5	784	
	2011.12-	-	MT	L	F	Saloon Engine CLRA	803116	Outer Joint	36	30	59.5	38	55	I
	2011.12-	-	MT	L	F	Saloon Engine CLRA	203319	Drive Shaft	36		59.5	38	557	
1.6 TDI (77 kW)	2011.02-	-	AT	L/R	F	Saloon Engine CAYC	803002	Outer Joint	36	27	59.5	40	66	I
	2011.02-	-	MT	R	F	Saloon Engine CAYC	261042	Drive Shaft	36		59.5	40.5	814	
	2011.02-	-	MT	L/R	F	Saloon Engine CAYC	603011	Inner Joint		33		34		
	2011.02-	-	MT	R	F	Saloon Engine CAYC	201585	Drive Shaft	36		59.5	40	805	
	2011.02-	-	MT	L/R	F	Saloon Engine CAYC	803037	Outer Joint	36	30	59.5	40.5	55	I
1.8 TSI (125 kW)	2014.07-	-	AT	L/R	F	Saloon Engine CPKA	803002	Outer Joint	36	27	59.5	40	66	I
2.0 (85 kW)	2010.06-	-	MT	L/R	F	Saloon Engine CBPA	603011	Inner Joint		33		34		
	2010.06-	-	MT/DCT	L/R	F	Saloon Engine CBPA	803037	Outer Joint	36	30	59.5	40.5	55	I
	2010.06-	-	DCT	R	F	Saloon Engine CBPA	261094	Drive Shaft	36	26	59.5	40.5	884	
	2010.06-	-	DCT	L	F	Saloon Engine CBPA	803116	Outer Joint	36	30	59.5	38	55	I
	2010.06-	-	DCT	L	F	Saloon Engine CBPA	203318	Drive Shaft	36	26	59.5	38	581	
2.0 TDI (103 kW)	2011.02-	-	-	L/R	F	Saloon Engine CFFB	803002	Outer Joint	36	27	59.5	40	66	I
	2011.02-	-	AT	L/R	F	Saloon Engine CFFB	661057	Inner Joint		34		86		
	2011.02-	-	AT	L	F	Saloon Engine CFFB	254013	Drive Shaft	36		59.5	40	479.5	
	2011.02-	-	AT	L	F	Saloon Engine CFFB	203241	Drive Shaft	36		59.5	40	475	
	2011.02-	-	AT	L	F	Saloon Engine CFFB	654004	Inner Joint		34		85		
	2011.02-	-	AT	R	F	Saloon Engine CFFB	254011	Drive Shaft	36		59.5	40	755	
2.0 TDI (110 kW)	2014.08-	-	AT	L/R	F	Saloon Engine CUUB	661057	Inner Joint		34		86		
	2014.08-	-	AT	R	F	Saloon Engine CUUB	254011	Drive Shaft	36		59.5	40	755	
	2014.08-	-	MT	L/R	F	Saloon Engine CUUB	803037	Outer Joint	36	30	59.5	40.5	55	I
	2014.08-	-	MT	L/R	F	Saloon Engine CUUB	603011	Inner Joint		33		34		
	2014.08-	-	AT	L	F	Saloon Engine CUUB	254013	Drive Shaft	36		59.5	40	479.5	
	2014.08-	-	AT	L	F	Saloon Engine CUUB	654004	Inner Joint		34		85		
	2014.08-	-	MT	L/R	F	Saloon Engine CUUB	803002	Outer Joint	36	27	59.5	40	66	I
	2014.08-	-	AT	-	-	Saloon Engine CUUB	603006	Inner Joint		33		34		
	2014.08-	-	AT	-	-	Saloon Engine CUUB	603016	Inner Joint		28		32		
2.0 TDI (81 kW)	2010.10-	-	MT	L/R	F	Saloon Engine CLCA	603011	Inner Joint		33		34		
	2010.10-	-	DCT	L/R	F	Saloon Engine CLCA	803002	Outer Joint	36	27	59.5	40	66	I
	2010.10-	-	MT	L/R	F	Saloon Engine CLCA	803037	Outer Joint	36	30	59.5	40.5	55	I
	2010.10-	-	-	R	F	Saloon Engine CLCA	261042	Drive Shaft	36		59.5	40.5	814	
	2010.10-	-	MT	-	-	Saloon Engine CLCA	603006	Inner Joint		33		34		
	2010.10-	-	-	R	F	Saloon Engine CLCA	201585	Drive Shaft	36		59.5	40	805	
2.0 TSI (147 kW)	2010.12-	-	MT/DCT	L/R	F	Saloon Engine CBFA	861045	Outer Joint	36	27	59.5	40	65	M
	2010.12-	-	6DCT	L	F	Saloon Engine CBFA	203295	Drive Shaft	36		59.5	40	491	
2.0 TSI (155 kW)	2012.12-	-	DCT	L	F	Saloon Engine CPLA	203295	Drive Shaft	36		59.5	40	491	
	2012.12-	-	MT/DCT	L/R	F	Saloon Engine CPLA	861045	Outer Joint	36	27	59.5	40	65	M
2.5 (125 kW)	2010.04-	-	MT	L/R	F	Saloon Engine CBUA	803037	Outer Joint	36	30	59.5	40.5	55	I
	2010.04-	-	AT	L/R	F	Saloon Engine CBUA	803002	Outer Joint	36	27	59.5	40	66	I
	2010.04-	-	DCT	L/R	F	Saloon Engine CBUA	861045	Outer Joint	36	27	59.5	40	65	M
	2010.04-	-	MT	L/R	F	Saloon Engine CBUA	603011	Inner Joint		33		34		
JETTA MK5														
1.8T	2014-	2015	AT	R	F	-	261152	Drive Shaft	36	26	59.5	40	873	
2.5L	2005-	2014	AT	R	F	-	261152	Drive Shaft	36	26	59.5	40	873	
JETTA VARIANT														
-	2001-	2006	-	-	-	-	201587	Drive Shaft	36		53	78.5	522	
JETTA/SYNCRO														
-	2006-	2011	-	-	-	-	201594	Drive Shaft	36		59.5	40	800	
KOMBI														
1.6	1998.01-	2006.12	MT	-	-	-	661013	Inner Joint		33		32		
LOAD UP (121122 BL1 BL2)														
1.0 (44 kW)	2014.12-	-	MT	L/R	F	Box Engine CHYA	850170	Outer Joint	22	26	46	78	53	M
1.0 EcoFuel (50 kW)	2014.12-	-	MT	L/R	F	Box Engine CPGA	850170	Outer Joint	22	26	46	78	53	M
LOGUS														
1.6	1993.01-	1996.12	MT	-	-	-	899154	Outer Joint	25	30	56.5	89	52	I

YEAR	TRANS	L/R	F/R	REMARKS	GSP Ref.	PRODUCT	ABS	Technical Specifications						
								A	B	C	H	L	P	
VW LOGUS														
1.8	1993.01-1996.12	MT	-	-	-	818100	Outer Joint		25	30	56.5	89	56.5	I
	1993.01-1996.12	MT	-	-	-	618018	Inner Joint			33		32		
2.0	1993.01-1996.12	MT	-	-	-	818100	Outer Joint		25	30	56.5	89	56.5	I
	1993.01-1996.12	MT	-	-	-	618018	Inner Joint			33		32		
LUPO														
-	2005-2009	MT	L/R	-	-	861046	Outer Joint		22	24	51	78	62	M
LUPO (6X1 6E1)														
1.0 (37 kW)	1998.09-2005.07	-	L/R	F	Hatchback Engine ALD	653001	Inner Joint			33		32		
	1998.09-2005.07	MT	L/R	F	Hatchback Engine ALD	853005	Outer Joint	22	30	53	78.5	51	I	
	1998.10-2000.05	-	L/R	F	Hatchback Engine AHT	653001	Inner Joint			33		32		
	1998.10-2000.05	-	L/R	F	Hatchback Engine AHT	853005	Outer Joint	22	30	53	78.5	51	I	
1.2 TDI 3L (45 kW)	1999.07-2005.07	AT/MT	L/R	F	Hatchback Engine ANY	899268	Outer Joint	20	26	43	56	45	M	
1.4 (44 kW)	2000.10-2005.07	-	L/R	F	Hatchback Engine AUD	653001	Inner Joint			33		32		
	2000.10-2005.07	AT/MT	L/R	F	Hatchback Engine AUD	853005	Outer Joint	22	30	53	78.5	51	I	
1.4 16V (55 kW)	1998.09-2005.07	MT	L/R	F	Hatchback Engine BBY	653001	Inner Joint			33		32		
	1998.09-2005.07	AT/MT	L/R	F	Hatchback Engine BBY	853005	Outer Joint	22	30	53	78.5	51	I	
	1998.09-2005.07	AT	L/R	F	Hatchback Engine BBY	661005	Inner Joint			30		57.6		
1.4 16V (74 kW)	1999.08-2005.07	MT	R	F	Hatchback Engine AFK	261189	Drive Shaft	22		53	78.5	751		
	1999.08-2005.07	-	L/R	F	Hatchback Engine AFK	653001	Inner Joint			33		32		
	1999.08-2005.07	AT/MT	L/R	F	Hatchback Engine AFK	853005	Outer Joint	22	30	53	78.5	51	I	
	1999.08-2005.07	MT	L	F	Hatchback Engine AFK	261205	Drive Shaft	22	0	53	78.5	525		
1.4 FSI (77 kW)	2001.02-2005.07	MT	L	F	Hatchback Engine ARR	261205	Drive Shaft	22	0	53	78.5	525		
	2001.02-2005.07	MT	R	F	Hatchback Engine ARR	261189	Drive Shaft	22		53	78.5	751		
	2001.02-2005.07	-	L/R	F	Hatchback Engine ARR	653001	Inner Joint			33		32		
	2001.02-2005.07	-	L/R	F	Hatchback Engine ARR	853005	Outer Joint	22	30	53	78.5	51	I	
1.4 TDI (55 kW)	1999.01-2005.07	-	-	-	Hatchback Engine AMF	653002	Inner Joint			33		34		
	1999.01-2005.07	MT	L/R	F	Hatchback Engine AMF	861007	Outer Joint	22	30	53	78.5	60	I	
	1999.01-2005.07	-	L/R	F	Hatchback Engine AMF	661006	Inner Joint			30		57.6		
	1999.01-2005.07	5MT	L	F	Hatchback Engine AMF	261075	Drive Shaft	22		53	78.5	525		
	1999.01-2005.07	5MT	R	F	Hatchback Engine AMF	261074	Drive Shaft	22		53	78.5	712		
1.6 GTI (92 kW)	2000.09-2005.07	MT	L/R	F	Hatchback Engine AVY	861007	Outer Joint	22	30	53	78.5	60	I	
1.7 SDI (44 kW)	1998.09-2005.07	-	L/R	F	Hatchback Engine AKU	653001	Inner Joint			33		32		
	1998.09-2005.07	-	L/R	F	Hatchback Engine AKU	853005	Outer Joint	22	30	53	78.5	51	I	
MULTIVAN V (7HM 7HN 7HF 7EF 7EM 7EN)														
1.9 TDI (62 kW)	2006.01-2009.11	-	L	F	MPV Engine BRR	261105	Drive Shaft	38		63	102.5	645		
	2006.01-2009.11	-	L/R	F	MPV Engine BRR	861009	Outer Joint	38	27	63	102	66	M	
	2006.01-2009.11	-	R	F	MPV Engine BRR	203246	Drive Shaft	38	26	63	102.5	858		
	2006.01-2009.11	5MT	-	F	MPV Engine BRR	261190	Stub Axle	26	37	50		136.5		
	2006.01-2009.11	MT	R	F	MPV Engine BRR	261084	Drive Shaft	38	26	63	102.5	613		
	2006.01-2009.11	6AT	-	F	MPV Engine BRR	261238	Stub Axle	26	30	62		114.5		
	2006.01-2009.11	AT	R	F	MPV Engine BRR	203267	Drive Shaft	38	26	63	102.5	925		
	2006.01-2009.11	6MT	-	F	MPV Engine BRR	261191	Stub Axle	26	42	60		135.5		
	2006.01-2009.11	-	R	F	MPV Engine BRR	661020	Inner Joint	26	28	50	205.5	63		
	2006.01-2009.11	-	L	F	MPV Engine BRR	661041	Inner Joint			28		32		
1.9 TDI (63 kW)	2003.04-2009.11	-	R	F	MPV Engine AXC	203246	Drive Shaft	38	26	63	102.5	858		
	2003.04-2009.11	5MT	-	F	MPV Engine AXC	261190	Stub Axle	26	37	50		136.5		
	2003.04-2009.11	MT	R	F	MPV Engine AXC	261084	Drive Shaft	38	26	63	102.5	613		
	2003.04-2009.11	-	-	F	MPV Engine AXC	261215	Stub Axle	26	42	60		143.5		
	2003.04-2009.11	6AT	-	F	MPV Engine AXC	261238	Stub Axle	26	30	62		114.5		
	2003.04-2009.11	-	-	F	MPV Engine AXC	261213	Stub Axle	42	42	60		135.5		
	2003.04-2009.11	AT	R	F	MPV Engine AXC	203267	Drive Shaft	38	26	63	102.5	925		
	2003.04-2009.11	6MT	-	F	MPV Engine AXC	261191	Stub Axle	26	42	60		135.5		
	2003.04-2009.11	MT	R	F	MPV Engine AXC	661020	Inner Joint	26	28	50	205.5	63		
	2003.04-2009.11	-	L/R	F	MPV Engine AXC	861009	Outer Joint	38	27	63	102	66	M	
1.9 TDI (75 kW)	2006.06-2009.11	-	L	F	MPV Engine BRS	261105	Drive Shaft	38		63	102.5	645		
	2006.06-2009.11	5MT	-	F	MPV Engine BRS	203246	Drive Shaft	38	26	63	102.5	858		
	2006.06-2009.11	-	-	-	MPV Engine BRS	261190	Stub Axle	26	37	50		136.5		
	2006.06-2009.11	-	-	-	MPV Engine BRS	661010	Inner Joint			28		32		
	2006.06-2009.11	MT	R	F	MPV Engine BRS	261084	Drive Shaft	38	26	63	102.5	613		
	2006.06-2009.11	6AT	-	F	MPV Engine BRS	261238	Stub Axle	26	30	62		114.5		
	2006.06-2009.11	AT	R	F	MPV Engine BRS	203267	Drive Shaft	38	26	63	102.5	925		
	2006.06-2009.11	6MT	-	F	MPV Engine BRS	261191	Stub Axle	26	42	60		135.5		
	2006.06-2009.11	MT	R	F	MPV Engine BRS	661020	Inner Joint	26	28	50	205.5	63		
	2006.06-2009.11	MT	L	F	MPV Engine BRS	661041	Inner Joint			28		32		
2006.06-2009.11	-	L	F	MPV Engine BRS	261105	Drive Shaft	38		63	102.5	645			





YEAR	TRANS	L/R	F/R	REMARKS	GSP Ref.	PRODUCT	ABS	Technical Specifications						
								A	B	C	H	L	P	
VW														
MULTIVAN V (7HM 7HN 7HF 7EF 7EM 7EN)														
1.9 TDI (75 kW)	2006.06-	2009.11	-	L/R	F	MPV Engine BRS	861009	Outer Joint	38	27	63	102	66	M
1.9 TDI (77 kW)	2003.04-	2009.11	5MT	R	F	MPV Engine AXB	203246	Drive Shaft	38	26	63	102.5	858	
	2003.04-	2009.11	5MT	-	F	MPV Engine AXB	261190	Stub Axle	26	37	50		136.5	
	2003.04-	2009.11	-	-	-	MPV Engine AXB	661010	Inner Joint		28		32		
	2003.04-	2009.11	MT	R	F	MPV Engine AXB	261084	Drive Shaft	38	26	63	102.5	613	
	2003.04-	2009.11	6AT	-	F	MPV Engine AXB	261238	Stub Axle	26	30	62		114.5	
	2003.04-	2009.11	AT	R	F	MPV Engine AXB	203267	Drive Shaft	38	26	63	102.5	925	
	2003.04-	2009.11	6MT	-	F	MPV Engine AXB	261191	Stub Axle	26	42	60		135.5	
	2003.04-	2009.11	MT	R	F	MPV Engine AXB	661020	Inner Joint	26	28	50	205.5	63	
	2003.04-	2009.11	MT	L	F	MPV Engine AXB	661041	Inner Joint		28		32		
	2003.04-	2009.11	5MT	L	F	MPV Engine AXB	261105	Drive Shaft	38		63	102.5	645	
2003.04-	2009.11	MT	L/R	F	MPV Engine AXB	861009	Outer Joint	38	27	63	102	66	M	
2.0 (85 kW)	2003.11-	-	5MT	R	F	MPV Engine AXA	203246	Drive Shaft	38	26	63	102.5	858	
	2003.11-	-	5MT	-	F	MPV Engine AXA	261190	Stub Axle	26	37	50		136.5	
	2003.11-	-	-	-	-	MPV Engine AXA	661010	Inner Joint		28		32		
	2003.11-	-	MT	R	F	MPV Engine AXA	261084	Drive Shaft	38	26	63	102.5	613	
	2003.11-	-	6AT	-	F	MPV Engine AXA	261238	Stub Axle	26	30	62		114.5	
	2003.11-	-	6MT	-	F	MPV Engine AXA	261191	Stub Axle	26	42	60		135.5	
	2003.11-	-	MT	L	F	MPV Engine AXA	203278	Drive Shaft	38		63	102	643	
	2003.11-	-	MT	R	F	MPV Engine AXA	661020	Inner Joint	26	28	50	205.5	63	
	2003.11-	-	MT	R	F	MPV Engine AXA	203279	Drive Shaft	38	26	63	102	856	
	2003.11-	-	MT	L	F	MPV Engine AXA	661041	Inner Joint		28		32		
	2003.11-	-	-	R	F	MPV Engine AXA	261216	Stub Axle	26	37	50		145	
	2003.11-	-	5MT	L	F	MPV Engine AXA	261105	Drive Shaft	38		63	102.5	645	
	2003.11-	-	MT	L/R	F	MPV Engine AXA	861009	Outer Joint	38	27	63	102	66	M
2.0 BiTDI (132 kW)	2009.09-	-	-	-	F	MPV Engine CFCA	801467	Outer Joint	38	30	63	102.5	67.5	I
	2009.09-	-	AT	L/R	F	MPV Engine CFCA	861011	Outer Joint	38	29	63	102.5	70	M
	2009.09-	-	MT	L	F	MPV Engine CFCA	203360	Drive Shaft	38	42	63	102.5	617	
	2009.09-	-	MT	L	F	MPV Engine CFCA	261269	Drive Shaft						
	2009.09-	-	5MT	-	F	MPV Engine CFCA	261190	Stub Axle	26	37	50		136.5	
	2009.09-	-	6AT	-	F	MPV Engine CFCA	261238	Stub Axle	26	30	62		114.5	
	2009.09-	-	AT	L	F	MPV Engine CFCA	203293	Drive Shaft	38	37	63	102.5	645	
	2009.09-	-	MT	R	F	MPV Engine CFCA	203296	Drive Shaft	38	26	63	102.5	880	
	2009.09-	-	6MT	-	F	MPV Engine CFCA	261191	Stub Axle	26	42	60		135.5	
	2009.09-	-	AT	R	F	MPV Engine CFCA	203353	Drive Shaft	38	37	63	102.5	1027	
	2009.09-	-	-	R	F	MPV Engine CFCA	261216	Stub Axle	26	37	50		145	
	2009.09-	-	MT	L/R	F	MPV Engine CFCA	861009	Outer Joint	38	27	63	102	66	M
	2.0 BiTDI 4motion (132 kW)	2009.09-	-	-	-	F	All-wheel Drive MPV Engine CFCA	801467	Outer Joint	38	30	63	102.5	67.5
2009.09-		-	5MT	-	F	All-wheel Drive MPV Engine CFCA	261190	Stub Axle	26	37	50		136.5	
2009.09-		-	-	L	R	All-wheel Drive MPV Engine CFCA	661075	Inner Joint		28		26		
2009.09-		-	-	L/R	F	All-wheel Drive MPV Engine CFCA	861011	Outer Joint	38	29	63	102.5	70	M
2009.09-		-	MT	R	F	All-wheel Drive MPV Engine CFCA	203360	Drive Shaft	38	42	63	102.5	617	
2009.09-		-	MT	R	F	All-wheel Drive MPV Engine CFCA	261269	Drive Shaft						
2009.09-		-	-	-	F	All-wheel Drive MPV Engine CFCA	261215	Stub Axle	26	42	60		143.5	
2009.09-		-	6AT	-	F	All-wheel Drive MPV Engine CFCA	261238	Stub Axle	26	30	62		114.5	
2009.09-		-	-	-	F	All-wheel Drive MPV Engine CFCA	261213	Stub Axle	42	42	60		135.5	
2009.09-		-	6MT	-	F	All-wheel Drive MPV Engine CFCA	261191	Stub Axle	26	42	60		135.5	
2009.09-		-	AT	R	F	All-wheel Drive MPV Engine CFCA	203353	Drive Shaft	38	37	63	102.5	1027	
2009.09-		-	-	R	F	All-wheel Drive MPV Engine CFCA	261216	Stub Axle	26	37	50		145	
2.0 TDI (100 kW)		2010.05-	-	5MT	-	F	MPV Engine CAAE	261190	Stub Axle	26	37	50		136.5
	2010.05-	-	-	L/R	F	MPV Engine CAAE	861011	Outer Joint	38	29	63	102.5	70	M
	2010.05-	-	MT	L	F	MPV Engine CAAE	203360	Drive Shaft	38	42	63	102.5	617	
	2010.05-	-	MT	L	F	MPV Engine CAAE	261269	Drive Shaft						
	2010.05-	-	6AT	-	F	MPV Engine CAAE	261238	Stub Axle	26	30	62		114.5	
	2010.05-	-	AT	L	F	MPV Engine CAAE	203293	Drive Shaft	38	37	63	102.5	645	
	2010.05-	-	6MT	-	F	MPV Engine CAAE	261191	Stub Axle	26	42	60		135.5	
	2010.05-	-	MT	R	F	MPV Engine CAAE	203296	Drive Shaft	38	26	63	102.5	880	
	2010.05-	-	-	-	F	MPV Engine CAAE	801467	Outer Joint	38	30	63	102.5	67.5	I
	2010.05-	-	-	R	F	MPV Engine CAAE	261216	Stub Axle	26	37	50		145	
2.0 TDI (103 kW)	2009.09-	-	-	-	F	MPV Engine CAAC/CCHA	801467	Outer Joint	38	30	63	102.5	67.5	I
	2009.09-	-	AT/MT	L/R	F	MPV Engine CAAC/CCHA	861011	Outer Joint	38	29	63	102.5	70	M
	2009.09-	-	MT	L	F	MPV Engine CAAC/CCHA	203360	Drive Shaft	38	42	63	102.5	617	
	2009.09-	-	MT	L	F	MPV Engine CAAC/CCHA	261269	Drive Shaft						
	2009.09-	-	5MT	-	F	MPV Engine CAAC/CCHA	261190	Stub Axle	26	37	50		136.5	
	2009.09-	-	6AT	-	F	MPV Engine CAAC/CCHA	261238	Stub Axle	26	30	62		114.5	
	2009.09-	-	AT	L	F	MPV Engine CAAC/CCHA	203293	Drive Shaft	38	37	63	102.5	645	





YEAR	TRANSM	L/R	F/R	REMARKS	GSP Ref.	PRODUCT	ABS	Technical Specifications						
								A	B	C	H	L	P	
VW														
MULTIVAN V (7HM 7HN 7HF 7EF 7EM 7EN)														
2.0 TDI (103 kW)	2009.09.-	-	AT	R	F	MPV Engine CAAC/CCHA	203353	Drive Shaft	38	37	63	102.5	1027	
	2009.09.-	-	MT	R	F	MPV Engine CAAC/CCHA	203296	Drive Shaft	38	26	63	102.5	880	
	2009.09.-	-	6MT	-	F	MPV Engine CAAC/CCHA	261191	Stub Axle	26	42	60		135.5	
	2009.09.-	-	-	R	F	MPV Engine CAAC/CCHA	261216	Stub Axle	26	37	50		145	
2.0 TDI (62 kW)	2009.09.-	-	5MT	-	F	MPV Engine CAAA	261190	Stub Axle	26	37	50		136.5	
	2009.09.-	-	6AT	-	F	MPV Engine CAAA	261238	Stub Axle	26	30	62		114.5	
	2009.09.-	-	-	L	F	MPV Engine CAAA	203278	Drive Shaft	38		63	102	643	
	2009.09.-	-	-	R	F	MPV Engine CAAA	203261	Drive Shaft	38	26	63	102	857	
	2009.09.-	-	6MT	-	F	MPV Engine CAAA	261191	Stub Axle	26	42	60		135.5	
	2009.09.-	-	-	L/R	F	MPV Engine CAAA	861009	Outer Joint	38	27	63	102	66	M
	2009.09.-	-	-	R	F	MPV Engine CAAA	261216	Stub Axle	26	37	50		145	
2.0 TDI (75 kW)	2009.09.-	-	5MT	-	F	MPV Engine CAAB	261190	Stub Axle	26	37	50		136.5	
	2009.09.-	-	6AT	-	F	MPV Engine CAAB	261238	Stub Axle	26	30	62		114.5	
	2009.09.-	-	-	L	F	MPV Engine CAAB	203278	Drive Shaft	38		63	102	643	
	2009.09.-	-	-	R	F	MPV Engine CAAB	203261	Drive Shaft	38	26	63	102	857	
	2009.09.-	-	6MT	-	F	MPV Engine CAAB	261191	Stub Axle	26	42	60		135.5	
	2009.09.-	-	-	L/R	F	MPV Engine CAAB	861009	Outer Joint	38	27	63	102	66	M
	2009.09.-	-	-	R	F	MPV Engine CAAB	261216	Stub Axle	26	37	50		145	
2.0 TDI (84 kW)	2011.05.-	-	-	L/R	F	MPV Engine CAAD	861009	Outer Joint	38	27	63	102	66	M
	2011.05.-	-	5MT	-	F	MPV Engine CAAD	261190	Stub Axle	26	37	50		136.5	
	2011.05.-	-	6AT	-	F	MPV Engine CAAD	261238	Stub Axle	26	30	62		114.5	
	2011.05.-	-	-	L	F	MPV Engine CAAD	203278	Drive Shaft	38		63	102	643	
	2011.05.-	-	6MT	-	F	MPV Engine CAAD	261191	Stub Axle	26	42	60		135.5	
	2011.05.-	-	MT	R	F	MPV Engine CAAD	203261	Drive Shaft	38	26	63	102	857	
	2011.05.-	-	-	R	F	MPV Engine CAAD	203279	Drive Shaft	38	26	63	102	856	
	2011.05.-	-	-	R	F	MPV Engine CAAD	261216	Stub Axle	26	37	50		145	
2.0 TDI 4motion (100 kW)	2010.05.-	-	5MT	-	F	All-wheel Drive MPV Engine CAAE	261190	Stub Axle	26	37	50		136.5	
	2010.05.-	-	-	L	R	All-wheel Drive MPV Engine CAAE	661075	Inner Joint		28	26			
	2010.05.-	-	-	L/R	F	All-wheel Drive MPV Engine CAAE	861011	Outer Joint	38	29	63	102.5	70	M
	2010.05.-	-	MT	R	F	All-wheel Drive MPV Engine CAAE	203360	Drive Shaft	38	42	63	102.5	617	
	2010.05.-	-	MT	R	F	All-wheel Drive MPV Engine CAAE	261269	Drive Shaft						
	2010.05.-	-	6AT	-	F	All-wheel Drive MPV Engine CAAE	261238	Stub Axle	26	30	62		114.5	
	2010.05.-	-	6MT	-	F	All-wheel Drive MPV Engine CAAE	261191	Stub Axle	26	42	60		135.5	
	2010.05.-	-	-	-	F	All-wheel Drive MPV Engine CAAE	801467	Outer Joint	38	30	63	102.5	67.5	I
	2010.05.-	-	-	R	F	All-wheel Drive MPV Engine CAAE	261216	Stub Axle	26	37	50		145	
	2010.05.-	-	-	-	F	All-wheel Drive MPV Engine CAAC/CCHA	801467	Outer Joint	38	30	63	102.5	67.5	I
2.0 TDI 4motion (103 kW)	2009.09.-	-	-	L/R	F	All-wheel Drive MPV Engine CAAC/CCHA	861011	Outer Joint	38	29	63	102.5	70	M
	2009.09.-	-	-	L	R	All-wheel Drive MPV Engine CAAC/CCHA	661075	Inner Joint		28	26			
	2009.09.-	-	5MT	-	F	All-wheel Drive MPV Engine CAAC/CCHA	261190	Stub Axle	26	37	50		136.5	
	2009.09.-	-	MT	R	F	All-wheel Drive MPV Engine CAAC/CCHA	203360	Drive Shaft	38	42	63	102.5	617	
	2009.09.-	-	MT	R	F	All-wheel Drive MPV Engine CAAC/CCHA	261269	Drive Shaft						
	2009.09.-	-	6AT	-	F	All-wheel Drive MPV Engine CAAC/CCHA	261238	Stub Axle	26	30	62		114.5	
	2009.09.-	-	6MT	-	F	All-wheel Drive MPV Engine CAAC/CCHA	261191	Stub Axle	26	42	60		135.5	
	2009.09.-	-	AT	R	F	All-wheel Drive MPV Engine CAAC/CCHA	203353	Drive Shaft	38	37	63	102.5	1027	
	2009.09.-	-	-	R	F	All-wheel Drive MPV Engine CAAC/CCHA	261216	Stub Axle	26	37	50		145	
	2012.07.-	-	-	-	F	MPV Engine CJKB	801467	Outer Joint	38	30	63	102.5	67.5	I
	2012.07.-	-	MT	L/R	F	MPV Engine CJKB	861011	Outer Joint	38	29	63	102.5	70	M
2.0 TSI (110 kW)	2012.07.-	-	5MT	-	F	MPV Engine CJKB	261190	Stub Axle	26	37	50		136.5	
	2012.07.-	-	6AT	-	F	MPV Engine CJKB	261238	Stub Axle	26	30	62		114.5	
	2012.07.-	-	MT	R	F	MPV Engine CJKB	203296	Drive Shaft	38	26	63	102.5	880	
	2012.07.-	-	6MT	-	F	MPV Engine CJKB	261191	Stub Axle	26	42	60		135.5	
	2012.07.-	-	-	R	F	MPV Engine CJKB	261216	Stub Axle	26	37	50		145	
	2011.05.-	-	AT/MT	L/R	F	MPV Engine CJKB	861011	Outer Joint	38	29	63	102.5	70	M
	2011.05.-	-	5MT	-	F	MPV Engine CJKB	261190	Stub Axle	26	37	50		136.5	
2.0 TSI (150 kW)	2011.05.-	-	6AT	-	F	MPV Engine CJKB	261238	Stub Axle	26	30	62		114.5	
	2011.05.-	-	6MT	-	F	MPV Engine CJKB	261191	Stub Axle	26	42	60		135.5	
	2011.05.-	-	MT	R	F	MPV Engine CJKB	203296	Drive Shaft	38	26	63	102.5	880	
	2011.05.-	-	-	R	F	MPV Engine CJKB	261216	Stub Axle	26	37	50		145	
	2011.07.-	-	-	L	R	All-wheel Drive MPV Engine CJKB	661075	Inner Joint		28	26			
	2011.07.-	-	5MT	-	F	All-wheel Drive MPV Engine CJKB	261190	Stub Axle	26	37	50		136.5	
2.0 TSI 4motion (150 kW)	2011.07.-	-	-	L/R	F	All-wheel Drive MPV Engine CJKB	861011	Outer Joint	38	29	63	102.5	70	M
	2011.07.-	-	6AT	-	F	All-wheel Drive MPV Engine CJKB	261238	Stub Axle	26	30	62		114.5	
	2011.07.-	-	AT	L	F	All-wheel Drive MPV Engine CJKB	203293	Drive Shaft	38	37	63	102.5	645	
	2011.07.-	-	6MT	-	F	All-wheel Drive MPV Engine CJKB	261191	Stub Axle	26	42	60		135.5	
	2011.07.-	-	-	-	F	All-wheel Drive MPV Engine CJKB	801467	Outer Joint	38	30	63	102.5	67.5	I
	2011.07.-	-	-	R	F	All-wheel Drive MPV Engine CJKB	261216	Stub Axle	26	37	50		145	





YEAR	TRANSM	L/R	F/R	REMARKS	GSP Ref.	PRODUCT	ABS	Technical Specifications						
								A	B	C	H	L	P	
VW														
MULTIVAN V (7HM 7HN 7HF 7EF 7EM 7EN)														
2.5 TDI (120 kW)	2003.11-2009.11	MT	R	F	MPV Engine BLJ	661021	Inner Joint	26	30	50	288	78		
	2003.11-2009.11	-	L	F	MPV Engine BLJ	661029	Inner Joint	26	30	46.8		79		
	2003.11-2009.11	-	R	F	MPV Engine BLJ	261140	Drive Shaft	38	26	63	102.5	873		
	2003.11-2009.11	-	R	F	MPV Engine BLJ	261084	Drive Shaft	38	26	63	102.5	613		
	2003.11-2009.11	5MT	-	F	MPV Engine BLJ	261190	Stub Axle	26	37	50		136.5		
	2003.11-2009.11	-	L/R	F	MPV Engine BLJ	861011	Outer Joint	38	29	63	102.5	70	M	
	2003.11-2009.11	6AT	-	F	MPV Engine BLJ	261238	Stub Axle	26	30	62		114.5		
	2003.11-2009.11	6MT	-	F	MPV Engine BLJ	261191	Stub Axle	26	42	60		135.5		
2.5 TDI (128 kW)	2003.04-2009.11	MT	L	F	MPV Engine AXE	661029	Inner Joint	26	30	46.8		79		
	2003.04-2009.11	5MT	-	F	MPV Engine AXE	261190	Stub Axle	26	37	50		136.5		
	2003.04-2009.11	6MT	R	F	MPV Engine AXE	261140	Drive Shaft	38	26	63	102.5	873		
	2003.04-2009.11	6AT	R	F	MPV Engine AXE	261210	Drive Shaft	38	26	63	102.5	925		
	2003.04-2009.11	-	L/R	F	MPV Engine AXE	861011	Outer Joint	38	29	63	102.5	70	M	
	2003.04-2009.11	6AT	-	F	MPV Engine AXE	261238	Stub Axle	26	30	62		114.5		
	2003.04-2009.11	AT	R	F	MPV Engine AXE	203267	Drive Shaft	38	26	63	102.5	925		
	2003.04-2009.11	6MT	-	F	MPV Engine AXE	261191	Stub Axle	26	42	60		135.5		
2.5 TDI (96 kW)	2003.04-2009.11	MT	L	F	MPV Engine AXD	661029	Inner Joint	26	30	46.8		79		
	2003.04-2009.11	5MT	-	F	MPV Engine AXD	261190	Stub Axle	26	37	50		136.5		
	2003.04-2009.11	6MT	R	F	MPV Engine AXD	261140	Drive Shaft	38	26	63	102.5	873		
	2003.04-2009.11	6AT	R	F	MPV Engine AXD	261210	Drive Shaft	38	26	63	102.5	925		
	2003.04-2009.11	-	L/R	F	MPV Engine AXD	861011	Outer Joint	38	29	63	102.5	70	M	
	2003.04-2009.11	6AT	-	F	MPV Engine AXD	261238	Stub Axle	26	30	62		114.5		
	2003.04-2009.11	AT	R	F	MPV Engine AXD	203267	Drive Shaft	38	26	63	102.5	925		
	2003.04-2009.11	6MT	-	F	MPV Engine AXD	261191	Stub Axle	26	42	60		135.5		
2.5 TDI 4motion (128 kW)	2003.04-2009.11	MT	R	F	MPV Engine AXD	661021	Inner Joint	26	30	50	288	78		
	2004.07-2009.11	MT	L	F	All-wheel Drive MPV Engine AXE/BPC	661029	Inner Joint	26	30	46.8		79		
	2004.07-2009.11	5MT	-	F	All-wheel Drive MPV Engine AXE/BPC	261190	Stub Axle	26	37	50		136.5		
	2004.07-2009.11	-	L/R	F	All-wheel Drive MPV Engine AXE/BPC	861011	Outer Joint	38	29	63	102.5	70	M	
	2004.07-2009.11	6MT	R	F	All-wheel Drive MPV Engine AXE/BPC	261084	Drive Shaft	38	26	63	102.5	613		
	2004.07-2009.11	6AT	-	F	All-wheel Drive MPV Engine AXE/BPC	261238	Stub Axle	26	30	62		114.5		
	2004.07-2009.11	AT	R	F	All-wheel Drive MPV Engine AXE/BPC	203267	Drive Shaft	38	26	63	102.5	925		
	2004.07-2009.11	AT/MT	L	R	All-wheel Drive MPV Engine AXE/BPC	261257	Drive Shaft	38		59	100	683		
2.5 TDI 4motion (96 kW)	2004.07-2009.11	AT/MT	L	R	All-wheel Drive MPV Engine AXE/BPC	661075	Inner Joint		28		26			
	2004.07-2009.11	6MT	-	F	All-wheel Drive MPV Engine AXE/BPC	261191	Stub Axle	26	42	60		135.5		
	2004.07-2009.11	-	L	F	All-wheel Drive MPV Engine AXD	661029	Inner Joint	26	30	46.8		79		
	2004.07-2009.11	5MT	-	F	All-wheel Drive MPV Engine AXD	261190	Stub Axle	26	37	50		136.5		
	2004.07-2009.11	-	L/R	F	All-wheel Drive MPV Engine AXD	861011	Outer Joint	38	29	63	102.5	70	M	
	2004.07-2009.11	6MT	R	F	All-wheel Drive MPV Engine AXD	261084	Drive Shaft	38	26	63	102.5	613		
	2004.07-2009.11	6AT	-	F	All-wheel Drive MPV Engine AXD	261238	Stub Axle	26	30	62		114.5		
	2004.07-2009.11	AT	R	F	All-wheel Drive MPV Engine AXD	203267	Drive Shaft	38	26	63	102.5	925		
3.2 V6 (170 kW)	2004.02-2009.11	AT/MT	L	R	All-wheel Drive MPV Engine AXD	261257	Drive Shaft	38		59	100	683		
	2004.07-2009.11	6MT	-	F	All-wheel Drive MPV Engine AXD	261191	Stub Axle	26	42	60		135.5		
	2004.02-2004.06	5MT	-	F	MPV Engine BDL	261190	Stub Axle	26	37	50		136.5		
	2004.02-2004.06	AT	L/R	F	MPV Engine BDL	861011	Outer Joint	38	29	63	102.5	70	M	
	2004.02-2004.06	6AT	-	F	MPV Engine BDL	261238	Stub Axle	26	30	62		114.5		
	2004.02-2004.06	6MT	-	F	MPV Engine BDL	261191	Stub Axle	26	42	60		135.5		
	3.2 V6 (173 kW)	2004.02-2009.11	5MT	-	F	MPV Engine BKK	261190	Stub Axle	26	37	50		136.5	
		2004.02-2009.11	AT	L/R	F	MPV Engine BKK	861011	Outer Joint	38	29	63	102.5	70	M
2004.02-2009.11		6AT	-	F	MPV Engine BKK	261238	Stub Axle	26	30	62		114.5		
2004.02-2009.11		6MT	-	F	MPV Engine BKK	261191	Stub Axle	26	42	60		135.5		
3.2 V6 4motion (173 kW)	2004.07-2009.11	5MT	-	F	All-wheel Drive MPV Engine BKK	261190	Stub Axle	26	37	50		136.5		
	2004.07-2009.11	-	L/R	F	All-wheel Drive MPV Engine BKK	861011	Outer Joint	38	29	63	102.5	70	M	
	2004.07-2009.11	6AT	-	F	All-wheel Drive MPV Engine BKK	261238	Stub Axle	26	30	62		114.5		
	2004.07-2009.11	AT/MT	L	R	All-wheel Drive MPV Engine BKK	261257	Drive Shaft	38		59	100	683		
	2004.07-2009.11	AT/MT	R	R	All-wheel Drive MPV Engine BKK	261258	Drive Shaft	38		59	100	743		
	2004.07-2009.11	AT/MT	L	R	All-wheel Drive MPV Engine BKK	661075	Inner Joint		28		26			
MULTIVAN VI (SGF SGM SGN)														
2.0 TDI (103 kW)	2015.04-	-	-	L/R	F	MPV Engine CAAC	261216	Stub Axle	26	37	50		145	
2.0 TDI (110 kW)	2015.04-	-	-	R	F	MPV Engine CXHA	261216	Stub Axle	26	37	50		145	
2.0 TDI (132 kW)	2015.04-	-	-	R	F	MPV Engine CFCA	261216	Stub Axle	26	37	50		145	
2.0 TDI (150 kW)	2015.06-	-	-	L/R	F	MPV Engine CXEB	261216	Stub Axle	26	37	50		145	
	2015.06-	-	7DCT	L	F	MPV Engine CXEB	203278	Drive Shaft	38		63	102	643	
2.0 TDI (75 kW)	2015.04-	-	MT	L	F	MPV Engine CXGB	203278	Drive Shaft	38		63	102	643	





				TRANSM		L/R F/R		REMARKS		GSP Ref.				ABS		Technical Specifications					
YEAR																A	B	C	H	L	P
VW																					
MULTIVAN VI (SGF SGM SGN)																					
2.0 TDI (75 kW)		2015.04-	-	-	R	F	MPV Engine CXGB			261216	Stub Axle			26	37	50			145		
2.0 TDI 4motion (103 kW)		2015.06-	-	-	R	F	All-wheel Drive MPV Engine CAAC			261216	Stub Axle			26	37	50			145		
		2015.06-	-	-	L	R	All-wheel Drive MPV Engine CAAC			661075	Inner Joint				28		26				
2.0 TDI 4motion (110 kW)		2015.08-	-	-	L	R	All-wheel Drive MPV Engine CXFA			661075	Inner Joint				28		26				
2.0 TDI 4motion (132 kW)		2015.06-	-	-	L/R	F	All-wheel Drive MPV Engine CFCA			261216	Stub Axle			26	37	50			145		
		2015.06-	-	-	L	R	All-wheel Drive MPV Engine CFCA			661075	Inner Joint				28		26				
2.0 TDI 4motion (150 kW)		2015.06-	-	-	L/R	F	All-wheel Drive MPV Engine CXEB			261216	Stub Axle			26	37	50			145		
		2015.06-	-	-	L	R	All-wheel Drive MPV Engine CXEB			661075	Inner Joint				28		26				
2.0 TSI (110 kW)		2015.04-	-	-	R	F	MPV Engine CJKB			261216	Stub Axle			26	37	50			145		
2.0 TSI (150 kW)		2015.04-	-	-	R	F	MPV Engine CJKA			261216	Stub Axle			26	37	50			145		
2.0 TSI 4motion (150 kW)		2015.06-	-	-	R	F	All-wheel Drive MPV Engine CJKA			261216	Stub Axle			26	37	50			145		
		2015.06-	-	-	L	R	All-wheel Drive MPV Engine CJKA			661075	Inner Joint				28		26				
NEW BEETLE (1Y7)																					
1.4 (55 kW)		2003.01-	2010.09	-	L/R	F	Convertible Engine BCA			803033	Outer Joint			36	30	53	78.5	51	I		
		2003.01-	2010.09	-	L/R	F	Convertible Engine BCA			603008	Inner Joint				33		32				
1.6 (75 kW)		2003.01-	2010.09	-	L/R	F	Convertible Engine BFS			803036	Outer Joint			36	30	53.2	77.5	61	I		
		2003.01-	2010.09	-	L/R	F	Convertible Engine BFS			603011	Inner Joint				33		34				
		2003.01-	2010.09	5MT	R	F	Convertible Engine BFS			603009	Inner Joint				33		34				
		2003.01-	2010.09	MT	L	F	Convertible Engine BFS			261021	Drive Shaft			36		53.2	77.5	564.5			
1.8 T (110 kW)		2003.01-	2010.09	MT	L/R	F	Convertible Engine AWW			803036	Outer Joint			36	30	53.2	77.5	61	I		
		2003.01-	2010.09	MT	L	F	Convertible Engine AWW			261020	Drive Shaft			36		53.2	77.5	547			
1.9 TDI (74 kW)		2003.06-	2010.09	-	L/R	F	Convertible Engine AXR			603011	Inner Joint				33		34				
		2003.06-	2010.09	MT	L	F	Convertible Engine AXR			203006	Drive Shaft			36		53.2	77.5	557			
		2003.06-	2010.09	-	L/R	F	Convertible Engine AXR			803036	Outer Joint			36	30	53.2	77.5	61	I		
		2003.06-	2010.09	MT	L	F	Convertible Engine AXR			261021	Drive Shaft			36		53.2	77.5	564.5			
		2003.06-	2010.09	MT	-	-	-	Convertible Engine AXR			603006	Inner Joint				33		34			
1.9 TDI (77 kW)		2005.07-	2010.09	-	L/R	F	Convertible Engine BSW			803036	Outer Joint			36	30	53.2	77.5	61	I		
		2005.07-	2010.09	MT	L	F	Convertible Engine BSW			261021	Drive Shaft			36		53.2	77.5	564.5			
		2005.07-	2010.09	-	R	F	Convertible Engine BSW			603009	Inner Joint				33		34				
2.0 (85 kW)		2002.09-	2010.10	MT	L/R	F	Convertible Engine BEV			603011	Inner Joint				33		34				
		2002.09-	2010.10	AT	L/R	F	Convertible Engine BEV			803036	Outer Joint			36	30	53.2	77.5	61	I		
		2002.09-	2010.10	MT	L	F	Convertible Engine BEV			261314	Drive Shaft			36		53	78	558			
		2002.09-	2010.10	MT	L	F	Convertible Engine BEV			261021	Drive Shaft			36		53.2	77.5	564.5			
2.5 (110 kW)		2005.07-	2010.09	MT	L/R	F	Convertible Engine BPS			803036	Outer Joint			36	30	53.2	77.5	61	I		
NEW BEETLE (9C1 1C1)																					
1.4 (55 kW)		2001.11-	2010.09	MT	-	-	Hatchback Engine BCA			603006	Inner Joint				33		34				
		2001.11-	2010.09	-	L/R	F	Hatchback Engine BCA			603008	Inner Joint				33		32				
		2001.11-	2010.09	-	L/R	F	Hatchback Engine BCA			803033	Outer Joint			36	30	53	78.5	51	I		
1.6 (74 kW)		1999.10-	2000.09	MT	L/R	F	Hatchback Engine AWH			803036	Outer Joint			36	30	53.2	77.5	61	I		
		1999.10-	2000.09	-	L	F	Hatchback Engine AWH			603011	Inner Joint				33		34				
		1999.10-	2000.09	-	L	F	Hatchback Engine AWH			261314	Drive Shaft			36		53	78	558			
		1999.10-	2000.09	MT	R	F	Hatchback Engine AWH			603009	Inner Joint				33		34				
1.6 (75 kW)		2000.06-	2010.09	MT	L/R	F	Hatchback Engine BFS			803036	Outer Joint			36	30	53.2	77.5	61	I		
		2000.06-	2010.09	-	L/R	F	Hatchback Engine BFS			603011	Inner Joint				33		34				
		2000.06-	2010.09	MT	L	F	Hatchback Engine BFS			261314	Drive Shaft			36		53	78	558			
		2000.06-	2010.09	AT	L	F	Hatchback Engine BFS			261156	Drive Shaft			36		53	78	554.5			
		2000.06-	2010.09	MT	L	F	Hatchback Engine BFS			261021	Drive Shaft			36		53.2	77.5	564.5			
		2000.06-	2010.09	AT	L	F	Hatchback Engine BFS			661062	Inner Joint				30		59				
		2000.06-	2010.09	MT	R	F	Hatchback Engine BFS			603009	Inner Joint				33		34				
1.8 T (110 kW)		1999.10-	2010.09	MT	L/R	F	Hatchback Engine AVC			803036	Outer Joint			36	30	53.2	77.5	61	I		
		1999.10-	2010.09	MT	L	F	Hatchback Engine AVC			261020	Drive Shaft			36		53.2	77.5	547			
		1999.10-	2010.09	-	L	F	Hatchback Engine AVC			261156	Drive Shaft			36		53	78	554.5			
		1999.10-	2010.09	-	L	F	Hatchback Engine AVC			661062	Inner Joint				30		59				
1.8 T (132 kW)		2001.11-	2005.06	MT	-	-	Hatchback Engine AWP			603006	Inner Joint				33		34				
		2001.11-	2005.06	-	L/R	F	Hatchback Engine AWP			803035	Outer Joint			36	27	53	77.5	65	I		
1.9 TDI (66 kW)		1998.01-	2004.06	MT	L	F	Hatchback Engine ALH			203006	Drive Shaft			36		53.2	77.5	557			
		1998.01-	2004.06	MT	R	F	Hatchback Engine ALH			203004	Drive Shaft			36		53.2	77.5	822			
		1998.01-	2004.06	MT	R	F	Hatchback Engine ALH			603009	Inner Joint				33		34				
		1998.01-	2004.06	AT/MT	L/R	F	Hatchback Engine ALH			803036	Outer Joint			36	30	53.2	77.5	61	I		
1.9 TDI (74 kW)		2001.02-	2010.09	MT	L	F	Hatchback Engine BEW			603011	Inner Joint				33		34				
		2001.02-	2010.09	MT	L/R	F	Hatchback Engine BEW			803036	Outer Joint			36	30	53.2	77.5	61	I		
		2001.02-	2010.09	MT	L	F	Hatchback Engine BEW			203006	Drive Shaft			36		53.2	77.5	557			
		2001.02-	2010.09	MT	R	F	Hatchback Engine BEW			603009	Inner Joint				33		34				
		2001.02-	2010.09	MT	L	F	Hatchback Engine BEW			261021	Drive Shaft			36		53.2	77.5	564.5			
1.9 TDI (77 kW)		2005.07-	2010.09	-	L/R	F	Hatchback Engine BSW			803036	Outer Joint			36	30	53.2	77.5	61	I		
		2005.07-	2010.09	-	L	F	Hatchback Engine BSW			261021	Drive Shaft			36		53.2	77.5	564.5			

YEAR	TRANS	L/R	F/R	REMARKS	GSP Ref.	PRODUCT	ABS	Technical Specifications						
								A	B	C	H	L	P	
VW														
NEW BEETLE (9C1 1C1)														
1.9 TDI (77 kW)	2005.07-	2010.09	-	R F	Hatchback Engine BSW	603009	Inner Joint		33		34			
2.0 (85 kW)	1998.01-	2010.09	-	L F	Hatchback Engine AQY	603011	Inner Joint		33		34			
	1998.01-	2010.09	MT	L F	Hatchback Engine AQY	603003	Inner Joint		33		32			
	1998.01-	2010.09	MT	L F	Hatchback Engine AQY	261314	Drive Shaft	36		53	78	558		
	1998.01-	2010.09	MT	L F	Hatchback Engine AQY	261021	Drive Shaft	36		53.2	77.5	564.5		
	1998.01-	2010.09	AT	L F	Hatchback Engine AQY	261156	Drive Shaft	36		53	78	554.5		
	1998.01-	2010.09	MT	R F	Hatchback Engine AQY	603009	Inner Joint		33		34			
	1998.01-	2010.09	AT	L F	Hatchback Engine AQY	661062	Inner Joint		30		59			
	1998.01-	2010.09	AT/MT	L/R F	Hatchback Engine AQY	803036	Outer Joint	36	30	53.2	77.5	61	I	
2.3 V5 (125 kW)	2000.10-	2010.09	MT	L F	Hatchback Engine AQN	261020	Drive Shaft	36		53.2	77.5	547		
	2000.10-	2010.09	-	L F	Hatchback Engine AQN	261156	Drive Shaft	36		53	78	554.5		
	2000.10-	2010.09	-	L F	Hatchback Engine AQN	661062	Inner Joint		30		59			
	2000.10-	2010.09	MT	L/R F	Hatchback Engine AQN	803036	Outer Joint	36	30	53.2	77.5	61	I	
	2000.10-	2010.09	MT	- -	Hatchback Engine AQN	603006	Inner Joint		33		34			
2.5 (110 kW)	2005.07-	2010.09	MT	L/R F	Hatchback Engine BPR	803036	Outer Joint	36	30	53.2	77.5	61	I	
RSI 3.2 4motion (165 kW)	2000.04-	2001.05	-	L/R R	All-wheel Drive Hatchback Engine AXJ	803033	Outer Joint	36	30	53	78.5	51	I	
	2000.04-	2001.05	MT	L/R F	All-wheel Drive Hatchback Engine AXJ	861021	Outer Joint	36	27	53	40	65	I	
	2000.04-	2001.05	-	L/R R	All-wheel Drive Hatchback Engine AXJ	603011	Inner Joint		33		34			
NEW BEETLE (9C1, 1C1, 1Y7)														
1.9 TDi (66 kW)	1998.01-	2004.06	-	R - -		603013	Inner Joint		33		34			
1.9 TDi (74 kW)	1998.01-	2004.06	-	R - -		603013	Inner Joint		33		34			
PARATI														
1.0	1997-	-	-	- - -		861031	Outer Joint	22	28	51	78.7	51.1	M	
1.0 16V	1997-	-	-	R - -		299117	Drive Shaft	22		51	78.7	598		
	1997-	-	-	L - -		299118	Drive Shaft	22		51	78.7	634		
1.0 Mi 16V	1997-	2001.11	-	L/R - -		861031	Outer Joint	22	28	51	78.7	51.1	M	
	1997-	2001.11	-	L - -		261117	Drive Shaft	22		51	78.7	634		
	1997-	2001.11	-	R - -		261118	Drive Shaft	22		51	78.7	605		
1.0 Turbo	2000.01-	2006.12	MT	- - -		861028	Outer Joint	22	30	51	78	61	I	
1.6 8V	1986.01-	1996.12	MT	- - -		618019	Inner Joint		33		32			
2.0 16V	1996.01-	2006.12	MT	- - -		861034	Outer Joint	33	30	64	33.5	61	I	
	1996.01-	2006.12	MT	- - -		861023	Outer Joint	43T	33	30	64	33.5	61	I
2.0 8V	1996.01-	2006.12	MT	- - -		899134	Outer Joint	43T	22	30	51	78	61	I
	1996.01-	2006.12	MT	- - -		861028	Outer Joint	22	30	51	78	61	I	
PARATI MI														
1.0 16V	1997.01-	2006.12	MT	L/R - -		861031	Outer Joint	22	28	51	78.7	51.1	M	
	1997.01-	2006.12	MT	R - -		261080	Drive Shaft	22		51	78.7	605		
	1997.01-	2006.12	MT	L - -		261079	Drive Shaft	22		51	78.7	634		
	1997.01-	2001.11	MT	- - -		699057	Inner Joint		28		32			
	1997.01-	2001.11	MT	- - -		618019	Inner Joint		33		32			
	1997.01-	2006.12	MT	- - -		618019	Inner Joint		33		32			
	1997.01-	2006.12	MT	- - -		861030	Outer Joint	22	28	51	77.5	50	M	
PASSAT														
-	-	-	-	- - -		803050	Outer Joint	33	27	53	30	63	I	
-	-	-	MT	L - B5		203031	Drive Shaft	33		53	30	614		
1.6	-	-	MT/AT	- - -		803045	Outer Joint	33	30	53	30	62	I	
1.8	-	-	MT/AT	- - -		803045	Outer Joint	33	30	53	30	62	I	
1.9	-	-	MT/AT	- - -		803045	Outer Joint	33	30	53	30	62	I	
2.0	2006-	-	-	R - -		261152	Drive Shaft	36	26	59.5	40	873		
	2006-	-	-	R - -		261152	Drive Shaft	36	26	59.5	40	873		
	2007-	-	-	R - -		261152	Drive Shaft	36	26	59.5	40	873		
	2007-	-	-	R - -		261152	Drive Shaft	36	26	59.5	40	873		
	2008-	-	-	R - -		261152	Drive Shaft	36	26	59.5	40	873		
	2008-	-	-	R - -		261152	Drive Shaft	36	26	59.5	40	873		
	2009-	-	-	R - -		261152	Drive Shaft	36	26	59.5	40	873		
	2009-	-	-	R - -		261152	Drive Shaft	36	26	59.5	40	873		
	2010-	-	-	R - -		261152	Drive Shaft	36	26	59.5	40	873		
	2010-	-	-	R - -		261152	Drive Shaft	36	26	59.5	40	873		
PASSAT (362)														
1.4 TSI (118 kW)	2012.11-	2014.12	MT	L F	Saloon Engine CTHD	261224	Drive Shaft	36		59.5	40	536		
	2012.11-	2014.12	MT	L/R F	Saloon Engine CTHD	603011	Inner Joint		33		34			
	2012.11-	2014.12	MT	L/R F	Saloon Engine CTHD	803037	Outer Joint	36	30	59.5	40.5	55	I	
	2012.11-	2014.12	7AT	L F	Saloon Engine CTHD	261281	Drive Shaft	36		59.5	40	528		
	2012.11-	2014.12	AT	L/R F	Saloon Engine CTHD	803002	Outer Joint	36	27	59.5	40	66	I	
1.4 TSI (90 kW)	2010.08-	2014.12	AT/MT	- F	Saloon Engine CAXA	803100	Outer Joint	36	33	59.5	38	55	I	
	2010.08-	2014.12	AT	L F	Saloon Engine CAXA	261201	Drive Shaft	36		59.5	40.5	535		

	 YEAR	TRANSM	L/R	F/R	REMARKS	GSP Ref.	 PRODUCT	 ABS	Technical Specifications									
									A	B	C	H	L	P				
VW																		
PASSAT (362)																		
1.4 TSI (90 kW)	2010.08-2014.12	MT	L	F	Saloon Engine CAXA	261198	Drive Shaft		36		59.5	40.5	530					
	2010.08-2014.12	MT	R	F	Saloon Engine CAXA	201586	Drive Shaft		36		59.5	40	806					
	2010.08-2014.12	-	L/R	F	Saloon Engine CAXA	603011	Inner Joint			33		34						
1.4 TSI EcoFuel (110 kW)	2010.08-2014.12	MT	L	F	Saloon Engine CDGA	261224	Drive Shaft		36		59.5	40	536					
	2010.08-2014.12	MT	L/R	F	Saloon Engine CDGA	803037	Outer Joint		36	30	59.5	40.5	55	I				
	2010.08-2014.12	AT	L	F	Saloon Engine CDGA	261281	Drive Shaft		36		59.5	40	528					
	2010.08-2014.12	AT	L/R	F	Saloon Engine CDGA	803002	Outer Joint		36	27	59.5	40	66	I				
	2010.08-2014.12	MT	L/R/F/R	F	Saloon Engine CDGA	603011	Inner Joint			33		34						
1.4 TSI MultiFuel (118 kW)	2010.11-2014.12	MT	L/R	F	Saloon Engine CKMA	603011	Inner Joint			33		34						
	2010.11-2014.12	MT	L	F	Saloon Engine CKMA	261224	Drive Shaft		36		59.5	40	536					
	2010.11-2014.12	MT	L/R	F	Saloon Engine CKMA	803037	Outer Joint		36	30	59.5	40.5	55	I				
	2010.11-2014.12	AT	L	F	Saloon Engine CKMA	261281	Drive Shaft		36		59.5	40	528					
1.6 TDI (77 kW)	2010.08-2014.12	MT	-	F	Saloon Engine CAYC	803100	Outer Joint		36	33	59.5	38	55	I				
	2010.08-2014.12	MT	L	F	Saloon Engine CAYC	261089	Drive Shaft		36		59.5	40.5	521					
	2010.08-2014.12	MT	R	F	Saloon Engine CAYC	261200	Drive Shaft		36		59.5	40.5	820					
	2010.08-2014.12	-	L/R	F	Saloon Engine CAYC	603011	Inner Joint			33		34						
1.8 TSI (118 kW)	2010.08-2014.12	-	L/R	F	Saloon Engine CDAA	803002	Outer Joint		36	27	59.5	40	66	I				
	2010.08-2014.12	MT	L	F	Saloon Engine CDAA	261100	Drive Shaft		36		59.5	40	513					
	2010.08-2014.12	AT	L/R	F	Saloon Engine CDAA	661011	Inner Joint		26	32	31	68.5	85					
	2010.08-2014.12	MT	L	F	Saloon Engine CDAA	261131	Drive Shaft		36		59.5	40	515					
2.0 TDI (100 kW)	2010.08-2014.12	-	L/R	F	Saloon Engine CFFA	803002	Outer Joint		36	27	59.5	40	66	I				
	2010.08-2014.12	-	L	F	Saloon Engine CFFA	203295	Drive Shaft		36		59.5	40	491					
	2010.08-2014.12	MT	-	-	Saloon Engine CFFA	603016	Inner Joint			28		32						
	2010.08-2014.12	-	R	F	Saloon Engine CFFA	203313	Drive Shaft		36		59.5	40	792					
	2010.08-2014.12	MT	-	-	Saloon Engine CFFA	603006	Inner Joint			33		34						
2.0 TDI (103 kW)	2010.08-2014.12	MT	L	F	Saloon Engine CFFB	203295	Drive Shaft		36		59.5	40	491					
	2010.08-2014.12	-	L/R	F	Saloon Engine CFFB	803002	Outer Joint		36	27	59.5	40	66	I				
	2010.08-2014.12	MT	R	F	Saloon Engine CFFB	203313	Drive Shaft		36		59.5	40	792					
	2010.08-2014.12	AT	L	F	Saloon Engine CFFB	254013	Drive Shaft		36		59.5	40	479.5					
	2010.08-2014.12	AT	L	F	Saloon Engine CFFB	654004	Inner Joint			34		85						
	2010.08-2014.12	Semi-AT	L	F	Saloon Engine CFFB	203241	Drive Shaft		36		59.5	40	475					
2.0 TDI (125 kW)	2010.08-2014.12	AT	R	F	Saloon Engine CFFB	254011	Drive Shaft		36		59.5	40	755					
	2010.08-2014.12	AT	L	F	Saloon Engine CFGB	254013	Drive Shaft		36		59.5	40	479.5					
	2010.08-2014.12	AT	L	F	Saloon Engine CFGB	654004	Inner Joint			34		85						
	2010.08-2014.12	Semi-AT	L	F	Saloon Engine CFGB	203241	Drive Shaft		36		59.5	40	475					
	2010.08-2014.12	-	L/R	F	Saloon Engine CFGB	861045	Outer Joint		36	27	59.5	40	65	M				
2.0 TDI (125 kW)	2010.08-2014.12	AT	R	F	Saloon Engine CFGB	254011	Drive Shaft		36		59.5	40	755					
	2010.08-2014.12	AT	L	F	Saloon Engine CFGB	654004	Inner Joint			34		85						
	2010.08-2014.12	Semi-AT	L	F	Saloon Engine CFGB	203241	Drive Shaft		36		59.5	40	475					
	2010.08-2014.12	-	L/R	F	Saloon Engine CFGB	861045	Outer Joint		36	27	59.5	40	65	M				
	2010.08-2014.12	AT	R	F	Saloon Engine CFGB	254011	Drive Shaft		36		59.5	40	755					
2.0 TDI 4motion (103 kW)	2010.08-2014.12	MT/Semi-AT	L/R	F	All-wheel Drive Saloon Engine CFFB	803002	Outer Joint		36	27	59.5	40	66	I				
	2010.08-2014.12	MT	R	F	All-wheel Drive Saloon Engine CFFB	203266	Drive Shaft		36		59.5	40	601					
	2010.08-2014.12	Semi-AT	L	F	All-wheel Drive Saloon Engine CFFB	654004	Inner Joint			34		85						
	2010.08-2014.12	Semi-AT	L	F	All-wheel Drive Saloon Engine CFFB	203241	Drive Shaft		36		59.5	40	475					
	2010.08-2014.12	AT/MT	L/R/F/R	F	All-wheel Drive Saloon Engine CFFB	603011	Inner Joint			33		34						
	2010.08-2014.12	MT	L	F	All-wheel Drive Saloon Engine CFFB	203295	Drive Shaft		36		59.5	40	491					
2.0 TDI 4motion (125 kW)	2010.08-2013.01	AT	L	F	All-wheel Drive Saloon Engine CFGB	254013	Drive Shaft		36		59.5	40	479.5					
	2010.08-2013.01	AT	L	F	All-wheel Drive Saloon Engine CFGB	654004	Inner Joint			34		85						
	2010.08-2013.01	-	L/R	F	All-wheel Drive Saloon Engine CFGB	803002	Outer Joint		36	27	59.5	40	66	I				
	2010.08-2013.01	Semi-AT	L	F	All-wheel Drive Saloon Engine CFGB	203241	Drive Shaft		36		59.5	40	475					
	2010.08-2013.01	MT	L/R/F/R	F	All-wheel Drive Saloon Engine CFGB	603011	Inner Joint			33		34						
2.0 TDI 4motion (130 kW)	2013.01-2014.12	AT	L/R	F	All-wheel Drive Saloon Engine CFGC	803002	Outer Joint		36	27	59.5	40	66	I				
	2013.01-2014.12	AT	L	F	All-wheel Drive Saloon Engine CFGC	254013	Drive Shaft		36		59.5	40	479.5					
	2013.01-2014.12	AT	L	F	All-wheel Drive Saloon Engine CFGC	654004	Inner Joint			34		85						
	2013.01-2014.12	-	L/R	R	All-wheel Drive Saloon Engine CFGC	603011	Inner Joint			33		34						
3.6 FSI 4motion (220 kW)	2011.01-2014.12	-	L/R	R	All-wheel Drive Saloon Engine BWS	603011	Inner Joint			33		34						
	2011.01-2014.12	AT	-	-	All-wheel Drive Saloon Engine BWS	603016	Inner Joint			28		32						
	2011.01-2014.12	AT	-	-	All-wheel Drive Saloon Engine BWS	603006	Inner Joint			33		34						
PASSAT (3A2 351)																		
1.6 (53 kW)	1988.02-1991.09	MT	L/R	F	Saloon Engine 1F/EZ	603004	Inner Joint			33		32						
	1988.02-1991.09	-	-	F	Saloon Engine 1F/EZ	853004	Outer Joint		22	30	51	78	61	I				
	1988.02-1991.09	MT	L/R	F	Saloon Engine 1F/EZ	603005	Inner Joint			33		32						
	1988.02-1991.09	MT	L/R	F	Saloon Engine 1F/EZ	853008	Outer Joint		22	30	53	78.5	51	I				
	1988.02-1991.09	-	-	-	Saloon Engine 1F/EZ	661007	Inner Joint			33		32						
1.6 (74 kW)	1994.10-1996.08	MT	L	F	Saloon Engine AFT/AEK	261001	Drive Shaft		22		53.2	78	557					
	1994.10-1996.08	MT	R	F	Saloon Engine AFT/AEK	603009	Inner Joint			33		34						
	1994.10-1996.08	-	-	F	Saloon Engine AFT/AEK	853004	Outer Joint		22	30	51	78	61	I				
	1994.10-1996.08	MT	L	F	Saloon Engine AFT/AEK	603011	Inner Joint			33		34						

	 YEAR	TRANSM	L/R	F/R	REMARKS	GSP Ref.	 PRODUCT	 ABS	Technical Specifications										
									A	B	C	H	L	P					
VW																			
PASSAT (3A2 35I)																			
1.6 (74 kW)	1994.10-1996.08	MT	R	F	Saloon Engine AFT/AEK	261002	Drive Shaft		22		53	78.5	793						
	1994.10-1996.08	AT/MT	L/R	F	Saloon Engine AFT/AEK	861018	Outer Joint		22	30	53	78.5	61	I					
1.6 TD (59 kW)	1988.08-1993.09	MT	L/R	F	Saloon Engine RA	603004	Inner Joint			33		32							
	1988.08-1993.09	MT	R	F	Saloon Engine RA	603009	Inner Joint			33		34							
	1988.08-1993.09	MT	L	F	Saloon Engine RA	603011	Inner Joint			33		34							
	1988.08-1993.09	MT	L	F	Saloon Engine RA	261001	Drive Shaft	22			53.2	78	557						
	1988.08-1993.09	MT	L/R	F	Saloon Engine RA	603005	Inner Joint			33		32							
	1988.08-1993.09	MT	L/R	F	Saloon Engine RA	853008	Outer Joint	22	30	53	78.5	51	I						
	1988.08-1993.09	MT	R	F	Saloon Engine RA	261002	Drive Shaft	22			53	78.5	793						
	1988.08-1993.09	MT	L/R	F	Saloon Engine RA	861018	Outer Joint	22	30	53	78.5	61	I						
1.8 (55 kW)	1990.08-1996.08	MT	R	F	Saloon Engine AAM	603009	Inner Joint			33		34							
	1990.08-1996.08	MT	L	F	Saloon Engine AAM	603011	Inner Joint			33		34							
	1990.08-1996.08	MT	L	F	Saloon Engine AAM	261001	Drive Shaft	22			53.2	78	557						
	1990.08-1996.08	MT	R	F	Saloon Engine AAM	261002	Drive Shaft	22			53	78.5	793						
	1990.08-1996.08	AT/MT	L/R	F	Saloon Engine AAM	861018	Outer Joint	22	30	53	78.5	61	I						
1.8 (66 kW)	1988.02-1996.08	MT	R	F	Saloon Engine ABS	603009	Inner Joint			33		34							
	1988.02-1996.08	MT	L	F	Saloon Engine ABS	603011	Inner Joint			33		34							
	1988.02-1996.08	MT	L	F	Saloon Engine ABS	261001	Drive Shaft	22			53.2	78	557						
	1988.02-1996.08	MT	R	F	Saloon Engine ABS	261002	Drive Shaft	22			53	78.5	793						
	1988.02-1996.08	AT/MT	L/R	F	Saloon Engine ABS	861018	Outer Joint	22	30	53	78.5	61	I						
1.8 (79 kW)	1988.04-1993.07	AT/MT	R	F	Saloon Engine PF	603009	Inner Joint			33		34							
	1988.04-1993.07	AT/MT	L	F	Saloon Engine PF	261001	Drive Shaft	22			53.2	78	557						
	1988.04-1993.07	AT/MT	R	F	Saloon Engine PF	261002	Drive Shaft	22			53	78.5	793						
	1988.04-1993.07	AT/MT	L	F	Saloon Engine PF	603011	Inner Joint			33		34							
1.8 (82 kW)	1988.04-1992.07	AT/MT	R	F	Saloon Engine PB	603009	Inner Joint			33		34							
	1988.04-1992.07	AT/MT	L	F	Saloon Engine PB	261001	Drive Shaft	22			53.2	78	557						
	1988.04-1992.07	AT/MT	L	F	Saloon Engine PB	603011	Inner Joint			33		34							
	1988.04-1992.07	AT/MT	R	F	Saloon Engine PB	261002	Drive Shaft	22			53	78.5	793						
1.8 16V (100 kW)	1988.04-1989.12	AT/MT	L	F	Saloon Engine KR	603011	Inner Joint			33		34							
	1988.04-1989.12	AT/MT	R	F	Saloon Engine KR	603009	Inner Joint			33		34							
	1988.04-1989.12	AT/MT	L	F	Saloon Engine KR	261001	Drive Shaft	22			53.2	78	557						
	1988.04-1989.12	AT/MT	R	F	Saloon Engine KR	261002	Drive Shaft	22			53	78.5	793						
1.8 G60 Syncro (118 kW)	1988.08-1996.08	MT	L/R	R	All-wheel Drive Saloon Engine PG	603004	Inner Joint			33		32							
	1988.08-1996.08	MT	R	F	All-wheel Drive Saloon Engine PG	603009	Inner Joint			33		34							
	1988.08-1996.08	MT	L/R	R	All-wheel Drive Saloon Engine PG	603005	Inner Joint			33		32							
	1988.08-1996.08	MT	L/R	F	All-wheel Drive Saloon Engine PG	861018	Outer Joint	22	30	53	78.5	61	I						
	1988.08-1996.08	MT	L	F	All-wheel Drive Saloon Engine PG	603011	Inner Joint			33		34							
1.9 D (50 kW)	1989.05-1993.10	MT	R	F	Saloon Engine 1Y	603009	Inner Joint			33		34							
	1989.05-1993.10	MT	L	F	Saloon Engine 1Y	261001	Drive Shaft	22			53.2	78	557						
	1989.05-1993.10	MT	L	F	Saloon Engine 1Y	603011	Inner Joint			33		34							
	1989.05-1993.10	MT	R	F	Saloon Engine 1Y	261002	Drive Shaft	22			53	78.5	793						
	1989.05-1993.10	MT	L/R	F	Saloon Engine 1Y	861018	Outer Joint	22	30	53	78.5	61	I						
1.9 TD (55 kW)	1991.03-1996.08	AT/MT	R	F	Saloon Engine AAZ	603009	Inner Joint			33		34							
	1991.03-1996.08	AT/MT	L	F	Saloon Engine AAZ	603011	Inner Joint			33		34							
	1991.03-1996.08	AT/MT	L	F	Saloon Engine AAZ	261001	Drive Shaft	22			53.2	78	557						
	1991.03-1996.08	AT/MT	R	F	Saloon Engine AAZ	261002	Drive Shaft	22			53	78.5	793						
	1991.03-1996.08	AT/MT	L/R	F	Saloon Engine AAZ	861018	Outer Joint	22	30	53	78.5	61	I						
1.9 TDI (81 kW)	1996.03-1996.08	MT	L	F	Saloon Engine AFN	261021	Drive Shaft	36			53.2	77.5	564.5						
	1996.03-1996.08	MT	R	F	Saloon Engine AFN	603009	Inner Joint			33		34							
	1996.03-1996.08	AT/MT	L/R	F	Saloon Engine AFN	803036	Outer Joint	36	30	53.2	77.5	61	I						
2.0 (79 kW)	1995.03-1996.08	MT	L	F	Saloon Engine AEP	261001	Drive Shaft	22			53.2	78	557						
	1995.03-1996.08	MT	R	F	Saloon Engine AEP	603009	Inner Joint			33		34							
	1995.03-1996.08	MT	R	F	Saloon Engine AEP	261002	Drive Shaft	22			53	78.5	793						
	1995.03-1996.08	MT	L	F	Saloon Engine AEP	603011	Inner Joint			33		34							
	1995.03-1996.08	AT/MT	L/R	F	Saloon Engine AEP	861018	Outer Joint	22	30	53	78.5	61	I						
2.0 (85 kW)	1990.02-1996.08	MT	R	F	Saloon Engine AGG	603009	Inner Joint			33		34							
	1990.02-1996.08	MT	L	F	Saloon Engine AGG	603011	Inner Joint			33		34							
	1990.02-1996.08	AT	-	F	Saloon Engine AGG	853004	Outer Joint	22	30	51	78	61	I						
	1990.02-1996.08	MT	L	F	Saloon Engine AGG	261001	Drive Shaft	22			53.2	78	557						
	1990.02-1996.08	MT	R	F	Saloon Engine AGG	261002	Drive Shaft	22			53	78.5	793						
	1990.02-1996.08	AT/MT	L/R	F	Saloon Engine AGG	861018	Outer Joint	22	30	53	78.5	61	I						
2.0 16V (100 kW)	1988.08-1993.09	AT/MT	R	F	Saloon Engine 9A	603009	Inner Joint			33		34							
	1988.08-1993.09	AT/MT	L	F	Saloon Engine 9A	261001	Drive Shaft	22			53.2	78	557						
	1988.08-1993.09	AT/MT	L	F	Saloon Engine 9A	603011	Inner Joint			33		34							
	1988.08-1993.09	AT/MT	R	F	Saloon Engine 9A	261002	Drive Shaft	22			53	78.5	793						
	1988.08-1993.09	AT/MT	L/R	F	Saloon Engine 9A	861018	Outer Joint	22	30	53	78.5	61	I						

	 YEAR	TRANSM	L/R	F/R	REMARKS	GSP Ref.	 PRODUCT	 ABS	Technical Specifications						
									A	B	C	H	L	P	
VW															
PASSAT (3A2 35I)															
2.0 16V (110 kW)	1994.01-1996.08	MT	L	F	Saloon Engine ABF	261021	Drive Shaft		36		53.2	77.5	564.5		
	1994.01-1996.08	MT	R	F	Saloon Engine ABF	603009	Inner Joint			33		34			
	1994.01-1996.08	MT	L/R	F	Saloon Engine ABF	803036	Outer Joint		36	30	53.2	77.5	61	I	
2.0 Syncro (85 kW)	1990.10-1996.08	MT	L/R	R	All-wheel Drive Saloon Engine ADY	603004	Inner Joint			33		32			
	1990.10-1996.08	MT	R	F	All-wheel Drive Saloon Engine ADY	603009	Inner Joint			33		34			
	1990.10-1996.08	MT	L/R	F	All-wheel Drive Saloon Engine ADY	603011	Inner Joint			33		34			
	1990.10-1996.08	AT	-	-	All-wheel Drive Saloon Engine ADY	853004	Outer Joint		22	30	51	78	61	I	
	1990.10-1996.08	MT	L/R	R	All-wheel Drive Saloon Engine ADY	603005	Inner Joint			33		32			
	1990.10-1996.08	MT	L/R	F	All-wheel Drive Saloon Engine ADY	861018	Outer Joint		22	30	53	78.5	61	I	
2.8 VR6 (128 kW)	1991.06-1996.08	MT	R	F	Saloon Engine AAA	261062	Drive Shaft		36		53.2	77.5	788		
	1991.06-1996.08	MT	R	F	Saloon Engine AAA	603009	Inner Joint			33		34			
	1991.06-1996.08	AT/MT	L	F	Saloon Engine AAA	261021	Drive Shaft		36		53.2	77.5	564.5		
	1991.06-1996.08	MT	L/R	F	Saloon Engine AAA	803036	Outer Joint		36	30	53.2	77.5	61	I	
PASSAT (3B2)															
1.6 (74 kW)	1996.10-2000.11	AT/MT	L/R	F	Saloon Engine AHL/ADP/ANA	861012	Outer Joint	45W	33	30	53	30	62	I	
	1996.10-2000.11	MT	L	F	Saloon Engine AHL/ADP/ANA	203002	Drive Shaft	45W	33		53	30	614		
	1996.10-2000.11	AT/MT	L/R	F	Saloon Engine AHL/ADP/ANA	803018	Outer Joint	45W	33	30	53	30	62	I	
	1996.10-2000.11	AT	R	F	Saloon Engine AHL/ADP/ANA	299108	Drive Shaft	45W	33		53	30	586		
	1996.10-2000.11	AT	L	F	Saloon Engine AHL/ADP/ANA	203012	Drive Shaft	45W	33		53	30	498		
	1996.10-2000.11	MT	R	F	Saloon Engine AHL/ADP/ANA	299111	Drive Shaft	45W	33		53	30	636		
1.8 (92 kW)	1996.10-2000.11	AT	L/R	F	Saloon Engine APT	861012	Outer Joint	45W	33	30	53	30	62	I	
	1996.10-2000.11	MT	R	F	Saloon Engine APT	203001	Drive Shaft	45W	33		53	30	634		
	1996.10-2000.11	MT	L/R	F	Saloon Engine APT	803018	Outer Joint	45W	33	30	53	30	62	I	
	1996.10-2000.11	MT	L	F	Saloon Engine APT	203005	Drive Shaft	45W	33		53	30	614		
	1996.10-2000.11	MT	L/R	F	Saloon Engine APT	603001	Inner Joint			28		32			
	1996.10-2000.11	AT	R	F	Saloon Engine APT	299108	Drive Shaft	45W	33		53	30	586		
	1996.10-2000.11	AT	L	F	Saloon Engine APT	203012	Drive Shaft	45W	33		53	30	498		
	1996.10-2000.11	MT	R	F	Saloon Engine APT	203013	Drive Shaft	45W	33		53	30	636		
1.8 Syncro/4motion (92 kW)	1996.10-2000.11	-	L	F	All-wheel Drive Saloon Engine ARG	203002	Drive Shaft	45W	33		53	30	614		
	1996.10-2000.11	MT	L/R	F	All-wheel Drive Saloon Engine ARG	861012	Outer Joint	45W	33	30	53	30	62	I	
	1996.10-2000.11	-	R	F	All-wheel Drive Saloon Engine ARG	299111	Drive Shaft	45W	33		53	30	636		
1.8 T (110 kW)	1996.10-2000.11	MT	R	F	Saloon Engine AEB	203001	Drive Shaft	45W	33		53	30	634		
	1996.10-2000.11	-	L/R	F	Saloon Engine AEB	861012	Outer Joint	45W	33	30	53	30	62	I	
	1996.10-2000.11	MT	L	F	Saloon Engine AEB	203005	Drive Shaft	45W	33		53	30	614		
	1996.10-2000.11	-	L/R	F	Saloon Engine AEB	803018	Outer Joint	45W	33	30	53	30	62	I	
	1996.10-2000.11	5AT	L	F	Saloon Engine AEB	203036	Drive Shaft	45W	33		53	30	524		
	1996.10-2000.11	MT	R	F	Saloon Engine AEB	203007	Drive Shaft	45W	33		53	30	622		
	1996.10-2000.11	-	L/R	F	Saloon Engine AEB	603001	Inner Joint			28		32			
	1996.10-2000.11	MT	L	F	Saloon Engine AEB	261122	Drive Shaft	45W	33		53	30	602		
	1996.10-2000.11	AT	R	F	Saloon Engine AEB	203012	Drive Shaft	45W	33		53	30	498		
	1996.10-2000.11	MT	R	F	Saloon Engine AEB	203013	Drive Shaft	45W	33		53	30	636		
	1.9 TDI (66 kW)	1996.10-2000.11	5MT	L	F	Saloon Engine AHU	603011	Inner Joint			33		34		
		1996.10-2000.11	-	L/R	F	Saloon Engine AHU	861012	Outer Joint	45W	33	30	53	30	62	I
1996.10-2000.11		-	L/R	F	Saloon Engine AHU	803018	Outer Joint	45W	33	30	53	30	62	I	
1996.10-2000.11		-	L/R	F	Saloon Engine AHU	853007	Outer Joint		22	30	53.2	78	61	I	
1996.10-2000.11		MT	L	F	Saloon Engine AHU	203010	Drive Shaft	45W	33		53	30	599		
1996.10-2000.11		5MT	R	F	Saloon Engine AHU	603009	Inner Joint			33		34			
1996.10-2000.11		MT	R	F	Saloon Engine AHU	203007	Drive Shaft	45W	33		53	30	622		
1996.10-2000.11		AT/MT	L/R	F	Saloon Engine AHU	661033	Inner Joint			34		85			
1996.10-2000.11		MT	L	F	Saloon Engine AHU	261122	Drive Shaft	45W	33		53	30	602		
1996.10-2000.11		AT	R	F	Saloon Engine AHU	299108	Drive Shaft	45W	33		53	30	586		
1996.10-2000.11		5MT	R	F	Saloon Engine AHU	261002	Drive Shaft		22		53	78.5	793		
1996.10-2000.11		-	L/R	F	Saloon Engine AHU	861018	Outer Joint		22	30	53	78.5	61	I	
1996.10-2000.11		AT	L	F	Saloon Engine AHU	203012	Drive Shaft	45W	33		53	30	498		
1996.10-2000.11		MT	R	F	Saloon Engine AHU	203009	Drive Shaft	45W	33		53	30	617		
1.9 TDI (74 kW)		2000.02-2000.11	MT	L/R	F	Saloon Engine AVB	803021	Outer Joint	45W	33	27	53	30	63	I
	2000.02-2000.11	AT	L/R	F	Saloon Engine AVB	803019	Outer Joint	45W	38	27	59.5	34.5	63	I	
	2000.02-2000.11	MT	L	F	Saloon Engine AVB	261083	Drive Shaft	45W	33		53	30	603		
	2000.02-2000.11	MT	R	F	Saloon Engine AVB	261082	Drive Shaft	45W	33		53	30	620		
	2000.02-2000.11	AT/MT	L/R	F	Saloon Engine AVB	661033	Inner Joint			34		85			
	2000.02-2000.11	AT	R	F	Saloon Engine AVB	299108	Drive Shaft	45W	33		53	30	586		
1.9 TDI (81 kW)	1996.10-2000.11	AT	R	F	Saloon Engine AFN	650019	Inner Joint			34		59.5			
	1996.10-2000.11	MT	L/R	F	Saloon Engine AFN	661033	Inner Joint			34		85			
	1996.10-2000.11	AT	L	F	Saloon Engine AFN	203048	Drive Shaft	45W	38		59.5	34.5	502		
	1996.10-2000.11	MT	R	F	Saloon Engine AFN	261019	Drive Shaft	45W	38		59.5	34.5	624		
	1996.10-2000.11	-	R	F	Saloon Engine AFN	603009	Inner Joint			33		34			

	 YEAR	TRANSM	L/R	F/R	REMARKS	GSP Ref.	 PRODUCT	 ABS	Technical Specifications									
									A	B	C	H	L	P				
VW																		
PASSAT (3B2)																		
1.9 TDI (81 kW)	1996.10-2000.11	5MT	L	F	Saloon Engine AFN	261314	Drive Shaft		36		53	78	558					
	1996.10-2000.11	MT	L	F	Saloon Engine AFN	203008	Drive Shaft	45W	38		59.5	34.5	603					
	1996.10-2000.11	-	L/R	F	Saloon Engine AFN	803036	Outer Joint		36	30	53.2	77.5	61	I				
	1996.10-2000.11	AT/MT	L/R	F	Saloon Engine AFN	803019	Outer Joint	45W	38	27	59.5	34.5	63	I				
1.9 TDI (85 kW)	1998.08-2000.11	AT	L	F	Saloon Engine AJM	203015	Drive Shaft	45W	38		59.5	34.5	527					
	1998.08-2000.11	MT	-	F	Saloon Engine AJM	650019	Inner Joint			34		59.5						
	1998.08-2000.11	MT	L	F	Saloon Engine AJM	261083	Drive Shaft	45W	33		53	30	603					
	1998.08-2000.11	AT	R	F	Saloon Engine AJM	203048	Drive Shaft	45W	38		59.5	34.5	502					
	1998.08-2000.11	MT	R	F	Saloon Engine AJM	261019	Drive Shaft	45W	38		59.5	34.5	624					
	1998.08-2000.11	MT	R	F	Saloon Engine AJM	261082	Drive Shaft	45W	33		53	30	620					
	1998.08-2000.11	AT/MT	L/R	F	Saloon Engine AJM	661033	Inner Joint			34		85						
	1998.08-2000.11	MT	L	F	Saloon Engine AJM	203008	Drive Shaft	45W	38		59.5	34.5	603					
	1998.08-2000.11	AT/MT	L/R	F	Saloon Engine AJM	803019	Outer Joint	45W	38	27	59.5	34.5	63	I				
	1998.08-2000.11	6MT	L	F	Saloon Engine AJM	261157	Drive Shaft	45W	38		59.5	34.5	601					
1.9 TDI 4motion (85 kW)	1998.08-2000.11	AT/MT	L/R	F	Saloon Engine AJM	803021	Outer Joint	45W	33	27	53	30	63	I				
	1999.08-2000.11	AT/MT	L/R	F	All-wheel Drive Saloon Engine ATJ	803021	Outer Joint	45W	33	27	53	30	63	I				
	1999.08-2000.11	6MT	L/R	F	All-wheel Drive Saloon Engine ATJ	861012	Outer Joint	45W	33	30	53	30	62	I				
	1999.08-2000.11	AT	R	F	All-wheel Drive Saloon Engine ATJ	650019	Inner Joint			34		59.5						
	1999.08-2000.11	AT/AT	L	F	All-wheel Drive Saloon Engine ATJ	203048	Drive Shaft	45W	38		59.5	34.5	502					
	1999.08-2000.11	5MT	R	F	All-wheel Drive Saloon Engine ATJ	261019	Drive Shaft	45W	38		59.5	34.5	624					
	1999.08-2000.11	5MT	L/R	F	All-wheel Drive Saloon Engine ATJ	803019	Outer Joint	45W	38	27	59.5	34.5	63	I				
1.9 TDI Syncro/4motion (81 kW)	1999.08-2000.11	5MT	L	F	All-wheel Drive Saloon Engine ATJ	203008	Drive Shaft	45W	38		59.5	34.5	603					
	1999.08-2000.11	6MT	L	F	All-wheel Drive Saloon Engine ATJ	261157	Drive Shaft	45W	38		59.5	34.5	601					
	1996.10-2000.11	AT	R	F	All-wheel Drive Saloon Engine AFN	650019	Inner Joint			34		59.5						
	1996.10-2000.11	MT	L/R	F	All-wheel Drive Saloon Engine AFN	661033	Inner Joint			34		85						
	1996.10-2000.11	AT	L	F	All-wheel Drive Saloon Engine AFN	203048	Drive Shaft	45W	38		59.5	34.5	502					
	1996.10-2000.11	MT	R	F	All-wheel Drive Saloon Engine AFN	203007	Drive Shaft	45W	33		53	30	622					
	1996.10-2000.11	MT	L	F	All-wheel Drive Saloon Engine AFN	261122	Drive Shaft	45W	33		53	30	602					
2.3 VR5 (110 kW)	1996.10-2000.11	MT	L/R	F	All-wheel Drive Saloon Engine AFN	861012	Outer Joint	45W	33	30	53	30	62	I				
	1996.10-2000.11	MT	L/R	F	Saloon Engine AGZ	861012	Outer Joint	45W	33	30	53	30	62	I				
	1996.10-2000.11	MT	L/R	F	Saloon Engine AGZ	661033	Inner Joint			34		85						
	1996.10-2000.11	MT	L	F	Saloon Engine AGZ	203010	Drive Shaft	45W	33		53	30	599					
	1996.10-2000.11	MT	R	F	Saloon Engine AGZ	203007	Drive Shaft	45W	33		53	30	622					
	1996.10-2000.11	MT	L	F	Saloon Engine AGZ	261122	Drive Shaft	45W	33		53	30	602					
	1996.10-2000.11	AT	L/R	F	Saloon Engine AGZ	803020	Outer Joint	45W	38	30	59.5	34	59.5	I				
2.3 VR5 Syncro/4motion (110 kW)	1996.10-2000.11	MT	R	F	Saloon Engine AGZ	203009	Drive Shaft	45W	33		53	30	617					
	1997.10-2000.11	MT	L/R	F	All-wheel Drive Saloon Engine AGZ	861012	Outer Joint	45W	33	30	53	30	62	I				
	1997.10-2000.11	MT	L	F	All-wheel Drive Saloon Engine AGZ	203010	Drive Shaft	45W	33		53	30	599					
	1997.10-2000.11	-	R	F	All-wheel Drive Saloon Engine AGZ	203007	Drive Shaft	45W	33		53	30	622					
	1997.10-2000.11	-	L	F	All-wheel Drive Saloon Engine AGZ	261122	Drive Shaft	45W	33		53	30	602					
	1997.10-2000.11	MT	R	F	All-wheel Drive Saloon Engine AGZ	203009	Drive Shaft	45W	33		53	30	617					
	1997.10-2000.11	MT	L/R	F	All-wheel Drive Saloon Engine AGZ	861012	Outer Joint	45W	33	30	53	30	62	I				
2.5 TDI (110 kW)	1997.10-2000.11	MT	L	F	All-wheel Drive Saloon Engine AGZ	203010	Drive Shaft	45W	33		53	30	599					
	1998.07-2000.11	AT	L	F	Saloon Engine AFB/AKN	203015	Drive Shaft	45W	38		59.5	34.5	527					
	1998.07-2000.11	AT	R	F	Saloon Engine AFB/AKN	203048	Drive Shaft	45W	38		59.5	34.5	502					
	1998.07-2000.11	MT	R	F	Saloon Engine AFB/AKN	261019	Drive Shaft	45W	38		59.5	34.5	624					
	1998.07-2000.11	AT/MT	L/R	F	Saloon Engine AFB/AKN	661033	Inner Joint			34		85						
	1998.07-2000.11	AT/MT	L/R	F	Saloon Engine AFB/AKN	803019	Outer Joint	45W	38	27	59.5	34.5	63	I				
	1998.07-2000.11	MT	L	F	Saloon Engine AFB/AKN	203008	Drive Shaft	45W	38		59.5	34.5	603					
2.5 TDI Syncro/4motion (110 kW)	1998.12-2000.11	AT	R	F	Saloon Engine AFB/AKN	203008	Drive Shaft	45W	38		59.5	34.5	603					
	1998.12-2000.11	MT	L/R	F	All-wheel Drive Saloon Engine AFB	261019	Drive Shaft	45W	38		59.5	34.5	624					
	1998.12-2000.11	MT	L/R	F	All-wheel Drive Saloon Engine AFB	661033	Inner Joint			34		85						
	1998.12-2000.11	AT	L/R	F	All-wheel Drive Saloon Engine AFB	803020	Outer Joint	45W	38	30	59.5	34	59.5	I				
	1998.12-2000.11	MT	L	F	All-wheel Drive Saloon Engine AFB	203008	Drive Shaft	45W	38		59.5	34.5	603					
2.8 V6 (132 kW)	1998.12-2000.11	MT	L/R	F	All-wheel Drive Saloon Engine AFB	803019	Outer Joint	45W	38	27	59.5	34.5	63	I				
	1997.05-1999.09	AT	L	F	Saloon Engine AGE	203015	Drive Shaft	45W	38		59.5	34.5	527					
	1997.05-1999.09	AT/MT	L/R	F	Saloon Engine AGE	803019	Outer Joint	45W	38	27	59.5	34.5	63	I				
	1997.05-1999.09	AT	R	F	Saloon Engine AGE	203048	Drive Shaft	45W	38		59.5	34.5	502					
	1997.05-1999.09	MT	R	F	Saloon Engine AGE	261019	Drive Shaft	45W	38		59.5	34.5	624					
	1997.05-1999.09	MT	L	F	Saloon Engine AGE	203008	Drive Shaft	45W	38		59.5	34.5	603					
2.8 V6 (142 kW)	1998.08-2000.11	AT	L	F	Saloon Engine AGE	203008	Drive Shaft	45W	38		59.5	34.5	603					
	1996.08-2000.11	AT	L	F	Saloon Engine AHA	203015	Drive Shaft	45W	38		59.5	34.5	527					
	1996.08-2000.11	AT	R	F	Saloon Engine AHA	203048	Drive Shaft	45W	38		59.5	34.5	502					
	1996.08-2000.11	MT	R	F	Saloon Engine AHA	261019	Drive Shaft	45W	38		59.5	34.5	624					
	1996.08-2000.11	MT	L/R	F	Saloon Engine AHA	661033	Inner Joint			34		85						
	1996.08-2000.11	MT	L	F	Saloon Engine AHA	203008	Drive Shaft	45W	38		59.5	34.5	603					
2.8 V6 Syncro/4motion (142 kW)	1996.08-2000.11	AT/MT	L/R	F	Saloon Engine AHA	803019	Outer Joint	45W	38	27	59.5	34.5	63	I				
	1996.10-2000.11	AT	L	F	All-wheel Drive Saloon Engine ALG	203015	Drive Shaft	45W	38		59.5	34.5	527					
	1996.10-2000.11	AT	R	F	All-wheel Drive Saloon Engine ALG	203048	Drive Shaft	45W	38		59.5	34.5	502					

YEAR	TRANSM	L/R	F/R	REMARKS	GSP Ref.	PRODUCT	ABS	Technical Specifications									
								A	B	C	H	L	P				
VW																	
PASSAT (3B2)																	
2.8 V6 Syncro/4motion (142 kW)	1996.10-2000.11	MT	R	F	All-wheel Drive Saloon Engine ALG	261019	Drive Shaft	45W	38		59.5	34.5	624				
	1996.10-2000.11	MT	L/R	F	All-wheel Drive Saloon Engine ALG	661033	Inner Joint			34		85					
	1996.10-2000.11	AT/MT	L/R	F	All-wheel Drive Saloon Engine ALG	803020	Outer Joint	45W	38	30	59.5	34	59.5	I			
	1996.10-2000.11	MT	L	F	All-wheel Drive Saloon Engine ALG	203008	Drive Shaft	45W	38		59.5	34.5	603				
	1996.10-2000.11	MT	L/R	F	All-wheel Drive Saloon Engine ALG	803019	Outer Joint	45W	38	27	59.5	34.5	63	I			
PASSAT (3B3)																	
1.6 (75 kW)	2000.11-2005.05	-	R	F	Saloon Engine ALZ	299111	Drive Shaft	45W	33		53	30	636				
	2000.11-2005.05	-	L	F	Saloon Engine ALZ	203002	Drive Shaft	45W	33		53	30	614				
	2000.11-2005.05	MT	L/R	F	Saloon Engine ALZ	861012	Outer Joint	45W	33	30	53	30	62	I			
1.8 T 20V (110 kW)	2000.11-2005.05	5MT	L/R	F	Saloon Engine AWT	861012	Outer Joint	45W	33	30	53	30	62	I			
	2000.11-2005.05	AT	L	F	Saloon Engine AWT	203015	Drive Shaft	45W	38		59.5	34.5	527				
	2000.11-2005.05	5MT	R	F	Saloon Engine AWT	203001	Drive Shaft	45W	33		53	30	634				
	2000.11-2005.05	5MT	L	F	Saloon Engine AWT	203005	Drive Shaft	45W	33		53	30	614				
	2000.11-2005.05	5AT	L/R	F	Saloon Engine AWT	803019	Outer Joint	45W	38	27	59.5	34.5	63	I			
	2000.11-2005.05	5MT	L/R	F	Saloon Engine AWT	803018	Outer Joint	45W	33	30	53	30	62	I			
	2000.11-2005.05	AT	R	F	Saloon Engine AWT	203048	Drive Shaft	45W	38		59.5	34.5	502				
	2000.11-2005.05	MT	L	F	Saloon Engine AWT	203010	Drive Shaft	45W	33		53	30	599				
	2000.11-2005.05	AT	L/R	F	Saloon Engine AWT	661033	Inner Joint			34		85					
	2000.11-2005.05	5MT	R	F	Saloon Engine AWT	203007	Drive Shaft	45W	33		53	30	622				
	2000.11-2005.05	5MT	L/R	F	Saloon Engine AWT	603001	Inner Joint			28		32					
	2000.11-2005.05	5MT	L	F	Saloon Engine AWT	261122	Drive Shaft	45W	33		53	30	602				
	2000.11-2005.05	MT	R	F	Saloon Engine AWT	203009	Drive Shaft	45W	33		53	30	617				
1.9 TDI (74 kW)	2000.11-2005.05	5MT	L/R	F	Saloon Engine AVB	803021	Outer Joint	45W	33	27	53	30	63	I			
	2000.11-2005.05	5MT	L	F	Saloon Engine AVB	261083	Drive Shaft	45W	33		53	30	603				
	2000.11-2005.05	AT	R	F	Saloon Engine AVB	650019	Inner Joint			34		59.5					
	2000.11-2005.05	5MT	R	F	Saloon Engine AVB	261082	Drive Shaft	45W	33		53	30	620				
	2000.11-2005.05	AT	L	F	Saloon Engine AVB	203048	Drive Shaft	45W	38		59.5	34.5	502				
	2000.11-2005.05	AT/MT	L/R	F	Saloon Engine AVB	661033	Inner Joint			34		85					
	2000.11-2005.05	4AT	L/R	F	Saloon Engine AVB	803019	Outer Joint	45W	38	27	59.5	34.5	63	I			
1.9 TDI (96 kW)	2000.11-2005.05	AT	L	F	Saloon Engine AVF	203015	Drive Shaft	45W	38		59.5	34.5	527				
	2000.11-2005.05	AT	R	F	Saloon Engine AVF	203048	Drive Shaft	45W	38		59.5	34.5	502				
	2000.11-2005.05	MT	R	F	Saloon Engine AVF	261019	Drive Shaft	45W	38		59.5	34.5	624				
	2000.11-2005.05	AT/MT	L/R	F	Saloon Engine AVF	661033	Inner Joint			34		85					
	2000.11-2005.05	MT	L	F	Saloon Engine AVF	203008	Drive Shaft	45W	38		59.5	34.5	603				
	2000.11-2005.05	-	L/R	F	Saloon Engine AVF	803019	Outer Joint	45W	38	27	59.5	34.5	63	I			
	2000.11-2005.05	MT	L	F	Saloon Engine AVF	261157	Drive Shaft	45W	38		59.5	34.5	601				
1.9 TDI 4motion (96 kW)	2000.11-2005.05	6MT	L	F	All-wheel Drive Saloon Engine AVF	261157	Drive Shaft	45W	38		59.5	34.5	601				
	2000.11-2005.05	AT	L	F	All-wheel Drive Saloon Engine AVF	203015	Drive Shaft	45W	38		59.5	34.5	527				
	2000.11-2005.05	6MT	R	F	All-wheel Drive Saloon Engine AVF	261019	Drive Shaft	45W	38		59.5	34.5	624				
	2000.11-2005.05	AT	R	F	All-wheel Drive Saloon Engine AVF	203048	Drive Shaft	45W	38		59.5	34.5	502				
	2000.11-2005.05	MT	L/R	F	All-wheel Drive Saloon Engine AVF	661033	Inner Joint			34		85					
	2000.11-2005.05	6MT	L	F	All-wheel Drive Saloon Engine AVF	203008	Drive Shaft	45W	38		59.5	34.5	603				
	2000.11-2005.05	-	L/R	F	All-wheel Drive Saloon Engine AVF	803019	Outer Joint	45W	38	27	59.5	34.5	63	I			
2.0 (85 kW)	2000.11-2005.05	MT	R	F	Saloon Engine AZM	203001	Drive Shaft	45W	33		53	30	634				
	2000.11-2005.05	AT	L/R	F	Saloon Engine AZM	861012	Outer Joint	45W	33	30	53	30	62	I			
	2000.11-2005.05	MT	L	F	Saloon Engine AZM	203005	Drive Shaft	45W	33		53	30	614				
	2000.11-2005.05	MT	L/R	F	Saloon Engine AZM	803018	Outer Joint	45W	33	30	53	30	62	I			
	2000.11-2005.05	AT	L/R	F	Saloon Engine AZM	661033	Inner Joint			34		85					
	2000.11-2005.05	AT/MT	L/R	F	Saloon Engine AZM	603001	Inner Joint			28		32					
	2000.11-2005.05	AT	R	F	Saloon Engine AZM	299108	Drive Shaft	45W	33		53	30	586				
	2000.11-2005.05	AT	L	F	Saloon Engine AZM	203012	Drive Shaft	45W	33		53	30	498				
	2000.11-2005.05	MT	R	F	Saloon Engine AZM	203013	Drive Shaft	45W	33		53	30	636				
2.0 (96 kW)	2001.11-2005.05	MT	R	F	Saloon Engine ALT	203009	Drive Shaft	45W	33		53	30	617				
	2001.11-2005.05	MT	L/R	F	Saloon Engine ALT	861012	Outer Joint	45W	33	30	53	30	62	I			
	2001.11-2005.05	MT	L	F	Saloon Engine ALT	203010	Drive Shaft	45W	33		53	30	599				
	2001.11-2005.05	MT	R	F	Saloon Engine ALT	203007	Drive Shaft	45W	33		53	30	622				
	2001.11-2005.05	MT	L	F	Saloon Engine ALT	261122	Drive Shaft	45W	33		53	30	602				
	2001.11-2005.05	AT/MT	L/R	F	Saloon Engine ALT	661033	Inner Joint			34		85					
2.0 4motion (85 kW)	2000.11-2005.05	MT	L	F	All-wheel Drive Saloon Engine AZM	203002	Drive Shaft	45W	33		53	30	614				
	2000.11-2005.05	MT	L/R	F	All-wheel Drive Saloon Engine AZM	861012	Outer Joint	45W	33	30	53	30	62	I			
	2000.11-2005.05	AT	R	F	All-wheel Drive Saloon Engine AZM	299108	Drive Shaft	45W	33		53	30	586				
	2000.11-2005.05	AT	L	F	All-wheel Drive Saloon Engine AZM	203012	Drive Shaft	45W	33		53	30	498				
	2000.11-2005.05	MT	R	F	All-wheel Drive Saloon Engine AZM	203013	Drive Shaft	45W	33		53	30	636				
	2000.11-2005.05	MT	R	F	All-wheel Drive Saloon Engine AZM	299111	Drive Shaft	45W	33		53	30	636				
2.0 TDI (100 kW)	2003.12-2005.05	-	L/R	F	Saloon Engine BGW	803019	Outer Joint	45W	38	27	59.5	34.5	63	I			
	2003.12-2005.05	MT	L/R	F	Saloon Engine BGW	661033	Inner Joint			34		85					





YEAR	TRANSM	L/R	F/R	REMARKS	GSP Ref.	PRODUCT	ABS	Technical Specifications							
								A	B	C	H	L	P		
VW															
PASSAT (3B3)															
2.0 TDI (100 kW)	2003.12-2005.05	6MT	R	F	Saloon Engine BGW	261019	Drive Shaft	45W	38		59.5	34.5	624		
	2003.12-2005.05	6MT	L	F	Saloon Engine BGW	203008	Drive Shaft	45W	38		59.5	34.5	603		
2.3 V5 (125 kW)	2000.11-2005.05	AT/MT	L/R	F	Saloon Engine AZX	803019	Outer Joint	45W	38	27	59.5	34.5	63	I	
	2000.11-2005.05	AT	L	F	Saloon Engine AZX	203015	Drive Shaft	45W	38		59.5	34.5	527		
	2000.11-2005.05	AT	R	F	Saloon Engine AZX	203048	Drive Shaft	45W	38		59.5	34.5	502		
	2000.11-2005.05	MT	R	F	Saloon Engine AZX	261019	Drive Shaft	45W	38		59.5	34.5	624		
	2000.11-2005.05	AT/MT	L/R	F	Saloon Engine AZX	661033	Inner Joint			34		85			
	2000.11-2005.05	MT	L	F	Saloon Engine AZX	203008	Drive Shaft	45W	38		59.5	34.5	603		
2.3 V5 4motion (125 kW)	2000.11-2005.05	MT	L/R	F	All-wheel Drive Saloon Engine AZX	803019	Outer Joint	45W	38	27	59.5	34.5	63	I	
	2000.11-2005.05	AT	L	F	All-wheel Drive Saloon Engine AZX	203015	Drive Shaft	45W	38		59.5	34.5	527		
	2000.11-2005.05	AT	R	F	All-wheel Drive Saloon Engine AZX	203048	Drive Shaft	45W	38		59.5	34.5	502		
	2000.11-2005.05	MT	L/R	F	All-wheel Drive Saloon Engine AZX	661033	Inner Joint			34		85			
	2000.11-2005.05	MT	R	F	All-wheel Drive Saloon Engine AZX	261019	Drive Shaft	45W	38		59.5	34.5	624		
	2000.11-2005.05	MT	L	F	All-wheel Drive Saloon Engine AZX	203008	Drive Shaft	45W	38		59.5	34.5	603		
2.5 TDI (110 kW)	2000.11-2005.05	AT	L	F	Saloon Engine AKN	203015	Drive Shaft	45W	38		59.5	34.5	527		
	2000.11-2005.05	AT	R	F	Saloon Engine AKN	203048	Drive Shaft	45W	38		59.5	34.5	502		
	2000.11-2005.05	6MT	R	F	Saloon Engine AKN	261019	Drive Shaft	45W	38		59.5	34.5	624		
	2000.11-2005.05	AT/MT	L/R	F	Saloon Engine AKN	661033	Inner Joint			34		85			
	2000.11-2005.05	5AT/6MT	L/R	F	Saloon Engine AKN	803019	Outer Joint	45W	38	27	59.5	34.5	63	I	
	2000.11-2005.05	6MT	L	F	Saloon Engine AKN	203008	Drive Shaft	45W	38		59.5	34.5	603		
2.5 TDI (120 kW)	2003.05-2005.05	AT	L	F	Saloon Engine BDG	203015	Drive Shaft	45W	38		59.5	34.5	527		
	2003.05-2005.05	AT/MT	L/R	F	Saloon Engine BDG	803019	Outer Joint	45W	38	27	59.5	34.5	63	I	
	2003.05-2005.05	AT	R	F	Saloon Engine BDG	203048	Drive Shaft	45W	38		59.5	34.5	502		
	2003.05-2005.05	MT	R	F	Saloon Engine BDG	261019	Drive Shaft	45W	38		59.5	34.5	624		
	2003.05-2005.05	AT/MT	L/R	F	Saloon Engine BDG	661033	Inner Joint			34		85			
	2003.05-2005.05	MT	L	F	Saloon Engine BDG	203008	Drive Shaft	45W	38		59.5	34.5	603		
2.5 TDI 4motion (110 kW)	2000.11-2005.05	AT	L	F	All-wheel Drive Saloon Engine AKN	203015	Drive Shaft	45W	38		59.5	34.5	527		
	2000.11-2005.05	6MT	R	F	All-wheel Drive Saloon Engine AKN	261019	Drive Shaft	45W	38		59.5	34.5	624		
	2000.11-2005.05	AT	R	F	All-wheel Drive Saloon Engine AKN	203048	Drive Shaft	45W	38		59.5	34.5	502		
	2000.11-2005.05	MT	L/R	F	All-wheel Drive Saloon Engine AKN	661033	Inner Joint			34		85			
	2000.11-2005.05	5AT	L/R	F	All-wheel Drive Saloon Engine AKN	803020	Outer Joint	45W	38	30	59.5	34	59.5	I	
	2000.11-2005.05	6MT	L	F	All-wheel Drive Saloon Engine AKN	203008	Drive Shaft	45W	38		59.5	34.5	603		
	2000.11-2005.05	6MT	L/R	F	All-wheel Drive Saloon Engine AKN	803019	Outer Joint	45W	38	27	59.5	34.5	63	I	
2.5 TDI 4motion (132 kW)	2003.01-2005.05	MT	L/R	F	All-wheel Drive Saloon Engine BAU/BDH	661033	Inner Joint			34		85			
	2003.01-2005.05	AT/MT	L/R	F	All-wheel Drive Saloon Engine BAU/BDH	803019	Outer Joint	45W	38	27	59.5	34.5	63	I	
	2003.01-2005.05	MT	R	F	All-wheel Drive Saloon Engine BAU/BDH	261019	Drive Shaft	45W	38		59.5	34.5	624		
	2003.01-2005.05	AT/MT	L/R	R	All-wheel Drive Saloon Engine BAU/BDH	603001	Inner Joint			28		32			
	2003.01-2005.05	MT	L	F	All-wheel Drive Saloon Engine BAU/BDH	203008	Drive Shaft	45W	38		59.5	34.5	603		
2.8 4motion (142 kW)	2000.11-2005.05	AT	L	F	All-wheel Drive Saloon Engine AMX/ATQ	203015	Drive Shaft	45W	38		59.5	34.5	527		
	2000.11-2005.05	AT	R	F	All-wheel Drive Saloon Engine AMX/ATQ	203048	Drive Shaft	45W	38		59.5	34.5	502		
	2000.11-2005.05	MT	L/R	F	All-wheel Drive Saloon Engine AMX/ATQ	661033	Inner Joint			34		85			
	2000.11-2005.05	5MT	R	F	All-wheel Drive Saloon Engine AMX/ATQ	261019	Drive Shaft	45W	38		59.5	34.5	624		
	2000.11-2005.05	5AT/5MT	L/R	F	All-wheel Drive Saloon Engine AMX/ATQ	803019	Outer Joint	45W	38	27	59.5	34.5	63	I	
	2000.11-2005.05	5MT	L	F	All-wheel Drive Saloon Engine AMX/ATQ	203008	Drive Shaft	45W	38		59.5	34.5	603		
4.0 W8 4motion (202 kW)	2001.09-2004.09	AT	L	F	All-wheel Drive Saloon Engine BDN/BDP	203015	Drive Shaft	45W	38		59.5	34.5	527		
	2001.09-2004.09	AT	L/R	F	All-wheel Drive Saloon Engine BDN/BDP	803019	Outer Joint	45W	38	27	59.5	34.5	63	I	
	2001.09-2004.09	AT	R	F	All-wheel Drive Saloon Engine BDN/BDP	203048	Drive Shaft	45W	38		59.5	34.5	502		
	2001.09-2004.09	MT	R	F	All-wheel Drive Saloon Engine BDN/BDP	261019	Drive Shaft	45W	38		59.5	34.5	624		
	2001.09-2004.09	MT	L/R	F	All-wheel Drive Saloon Engine BDN/BDP	661033	Inner Joint			34		85			
	2001.09-2004.09	AT/MT	L/R	R	All-wheel Drive Saloon Engine BDN/BDP	603001	Inner Joint			28		32			
	2001.09-2004.09	MT	L	F	All-wheel Drive Saloon Engine BDN/BDP	203008	Drive Shaft	45W	38		59.5	34.5	603		
PASSAT (3C2)/PASSAT/Magotan															
1.4 TSI (90 kW)	2007.05-2010.07	Semi-AT	L/R	F	Saloon Engine CAXA	803002	Outer Joint			36	27	59.5	40	66	I
	2007.05-2010.07	-	-	-	Saloon Engine CAXA	603016	Inner Joint				28		32		
	2007.05-2010.07	MT	L	F	Saloon Engine CAXA	261198	Drive Shaft		36		59.5	40.5	530		
	2007.05-2010.07	MT	R	F	Saloon Engine CAXA	201586	Drive Shaft		36		59.5	40	806		
	2007.05-2010.07	-	-	-	Saloon Engine CAXA	803100	Outer Joint		36	33	59.5	38	55	I	
	2007.05-2010.07	6MT	L/R	F	Saloon Engine CAXA	803037	Outer Joint		36	30	59.5	40.5	55	I	
	2007.05-2010.07	MT	L/R	F	Saloon Engine CAXA	603011	Inner Joint			33		34			
1.4 TSI EcoFuel (110 kW)	2009.01-2010.07	MT	L	F	Saloon Engine CDGA	261224	Drive Shaft		36		59.5	40	536		
	2009.01-2010.07	MT	L/R	F	Saloon Engine CDGA	603011	Inner Joint			33		34			
	2009.01-2010.07	MT	L/R	F	Saloon Engine CDGA	803037	Outer Joint		36	30	59.5	40.5	55	I	
	2009.01-2010.07	AT	L	F	Saloon Engine CDGA	261281	Drive Shaft		36		59.5	40	528		
	2009.01-2010.07	AT	L/R	F	Saloon Engine CDGA	803002	Outer Joint		36	27	59.5	40	66	I	
1.6 (75 kW)	2005.05-2010.07	-	R	F	Saloon Engine BSE	261113	Drive Shaft		36		59.5	40	814		
	2005.05-2010.07	MT	-	-	Saloon Engine BSE	603006	Inner Joint			33		34			

YEAR	TRANSM	L/R	F/R	REMARKS	GSP Ref.	PRODUCT	ABS	Technical Specifications								
								A	B	C	H	L	P			
VW																
PASSAT (3C2)/PASSAT/Magotan																
1.6 (75 kW)	2005.05-2010.07	-	L/R	F	Saloon Engine BSE	603011	Inner Joint			33		34				
	2005.05-2010.07	-	L	F	Saloon Engine BSE	203373	Drive Shaft	36		59.5	38	511				
	2005.05-2010.07	5MT	L/R	F	Saloon Engine BSE	803037	Outer Joint	36	30	59.5	40.5	55	I			
	2005.05-2010.07	AT	L/R	F	Saloon Engine BSE	661011	Inner Joint	26	32	31	68.5	85				
	2005.05-2010.07	-	L	F	Saloon Engine BSE	803116	Outer Joint	36	30	59.5	38	55	I			
	2005.05-2010.07	-	R	F	Saloon Engine BSE	201585	Drive Shaft	36		59.5	40	805				
1.6 FSI (85 kW)	2005.03-2008.06	MT	L	F	Saloon Engine BLF	261198	Drive Shaft	36		59.5	40.5	530				
	2005.03-2008.06	6AT/6MT	L/R	F	Saloon Engine BLF	803037	Outer Joint	36	30	59.5	40.5	55	I			
	2005.03-2008.06	AT	L	F	Saloon Engine BLF	201582	Drive Shaft	36	26	59.5	40	597				
	2005.03-2008.06	AT	L/R	F	Saloon Engine BLF	661011	Inner Joint	26	32	31	68.5	85				
1.6 TDI (77 kW)	2009.08-2010.07	MT	-	F	Saloon Engine CAYC	803100	Outer Joint	36	33	59.5	38	55	I			
	2009.08-2010.07	MT	L	F	Saloon Engine CAYC	261089	Drive Shaft	36		59.5	40.5	521				
	2009.08-2010.07	MT	-	-	Saloon Engine CAYC	603006	Inner Joint			33		34				
	2009.08-2010.07	-	L/R	F	Saloon Engine CAYC	803002	Outer Joint	36	27	59.5	40	66	I			
	2009.08-2010.07	-	L/R	F	Saloon Engine CAYC	603011	Inner Joint			33		34				
	2009.08-2010.07	MT	R	F	Saloon Engine CAYC	261200	Drive Shaft	36		59.5	40.5	820				
	2009.08-2010.07	MT	-	-	Saloon Engine CAYC	861059	Outer Joint	36	33	59.5	40	59.5	I			
1.8 TSI (118 kW)	2007.05-2010.07	MT	L	F	Saloon Engine BZB	203295	Drive Shaft	36		59.5	40	491				
	2007.05-2010.07	6AT/MT	L/R	F	Saloon Engine BZB	803002	Outer Joint	36	27	59.5	40	66	I			
	2007.05-2010.07	MT	L	F	Saloon Engine BZB	261100	Drive Shaft	36		59.5	40	513				
	2007.05-2010.07	AT	L/R	F	Saloon Engine BZB	661011	Inner Joint	26	32	31	68.5	85				
1.9 TDI (77 kW)	2005.03-2008.11	AT	R	F	Saloon Engine BLS	254011	Drive Shaft	36		59.5	40	755				
	2005.03-2008.11	MT	L	F	Saloon Engine BLS	203294	Drive Shaft	36		59.5	38	519				
	2005.03-2008.11	MT	L/R	F	Saloon Engine BLS	603011	Inner Joint			33		34				
	2005.03-2008.11	AT	L/R	F	Saloon Engine BLS	661057	Inner Joint			34		86				
	2005.03-2008.11	MT	L/R	F	Saloon Engine BLS	803037	Outer Joint	36	30	59.5	40.5	55	I			
	2005.03-2008.11	AT	L	F	Saloon Engine BLS	254013	Drive Shaft	36		59.5	40	479.5				
	2005.03-2008.11	AT	L	F	Saloon Engine BLS	654004	Inner Joint			34		85				
	2005.03-2008.11	MT	L	F	Saloon Engine BLS	803116	Outer Joint	36	30	59.5	38	55	I			
	2005.03-2008.11	MT	R	F	Saloon Engine BLS	261042	Drive Shaft	36		59.5	40.5	814				
	2005.03-2008.11	AT	L/R	F	Saloon Engine BLS	803002	Outer Joint	36	27	59.5	40	66	I			
	2005.03-2008.11	-	R	F	Saloon Engine BLS	201585	Drive Shaft	36		59.5	40	805				
2.0 BlueTDI (105 kW)	2009.01-2010.11	AT	R	F	Saloon Engine CBAC	254011	Drive Shaft	36		59.5	40	755				
	2009.01-2010.11	-	L/R	F	Saloon Engine CBAC	803002	Outer Joint	36	27	59.5	40	66	I			
	2009.01-2010.11	MT	R	F	Saloon Engine CBAC	203313	Drive Shaft	36		59.5	40	792				
	2009.01-2010.11	AT	L	F	Saloon Engine CBAC	254013	Drive Shaft	36		59.5	40	479.5				
	2009.01-2010.11	AT	L	F	Saloon Engine CBAC	654004	Inner Joint			34		85				
	2009.01-2010.11	MT	L	F	Saloon Engine CBAC	203295	Drive Shaft	36		59.5	40	491				
	2009.01-2010.11	Semi-AT	L	F	Saloon Engine CBAC	203241	Drive Shaft	36		59.5	40	475				
2.0 FSI (110 kW)	2005.03-2010.07	MT	L/R	F	Saloon Engine BVZ	603011	Inner Joint			33		34				
	2005.03-2010.07	6AT/6MT	L/R	F	Saloon Engine BVZ	803037	Outer Joint	36	30	59.5	40.5	55	I			
	2005.03-2010.07	AT	R	F	Saloon Engine BVZ	261094	Drive Shaft	36	26	59.5	40.5	884				
	2005.03-2010.07	AT	L/R/F/R	F	Saloon Engine BVZ	661011	Inner Joint	26	32	31	68.5	85				
	2005.03-2010.07	AT	L	F	Saloon Engine BVZ	261093	Drive Shaft	36	26	59.5	40.5	587.5				
2.0 FSI (125 kW)	2007.08-2010.07	AT	L	F	Saloon Engine CCTB	661038	Inner Joint	26	34	31	68.5	88.5				
	2007.08-2010.07	AT	-	-	Saloon Engine CCTB	603006	Inner Joint			33		34				
2.0 FSI (147 kW)	2005.07-2010.07	AT/MT	L/R	F	Saloon Engine BPY	803002	Outer Joint	36	27	59.5	40	66	I			
	2005.07-2010.07	AT/MT	L/R	F	Saloon Engine BPY	861045	Outer Joint	36	27	59.5	40	65	M			
	2005.07-2010.07	AT/MT	L	F	Saloon Engine BPY	203295	Drive Shaft	36		59.5	40	491				
2.0 FSI 4motion (110 kW)	2005.09-2010.07	MT	L	F	All-wheel Drive Saloon Engine BLX	203294	Drive Shaft	36		59.5	38	519				
	2005.09-2010.07	-	L/R/F/R	F	All-wheel Drive Saloon Engine BLX	603011	Inner Joint			33		34				
	2005.09-2010.07	MT	L	F	All-wheel Drive Saloon Engine BLX	803116	Outer Joint	36	30	59.5	38	55	I			
	2005.09-2010.07	AT	R	F	All-wheel Drive Saloon Engine BLX	261094	Drive Shaft	36	26	59.5	40.5	884				
	2005.09-2010.07	6AT/6MT	L/R	F	All-wheel Drive Saloon Engine BLX	803037	Outer Joint	36	30	59.5	40.5	55	I			
	2005.09-2010.07	AT	L	F	All-wheel Drive Saloon Engine BLX	261093	Drive Shaft	36	26	59.5	40.5	587.5				
	2005.09-2010.07	AT	L/R	F	All-wheel Drive Saloon Engine BLX	661011	Inner Joint	26	32	31	68.5	85				
2.0 TDI (100 kW)	2005.03-2010.11	AT	L/R	F	Saloon Engine BMA	661057	Inner Joint			34		86				
	2005.03-2010.11	MT	L	F	Saloon Engine BMA	203265	Drive Shaft	36		59.5	40	487				
	2005.03-2010.11	-	L/R	F	Saloon Engine BMA	803002	Outer Joint	36	27	59.5	40	66	I			
	2005.03-2010.11	MT	R	F	Saloon Engine BMA	203313	Drive Shaft	36		59.5	40	792				
	2005.03-2010.11	AT	L	F	Saloon Engine BMA	254013	Drive Shaft	36		59.5	40	479.5				
	2005.03-2010.11	AT	L	F	Saloon Engine BMA	654004	Inner Joint			34		85				
	2005.03-2010.11	MT	R	F	Saloon Engine BMA	203236	Drive Shaft	36		59.5	40	484				
	2005.03-2010.11	MT	R	F	Saloon Engine BMA	261126	Drive Shaft	36		59.5	40	793				
	2005.03-2010.11	MT	L	F	Saloon Engine BMA	203295	Drive Shaft	36		59.5	40	491				
	2005.03-2010.11	-	L/R	F	Saloon Engine BMA	861045	Outer Joint	36	27	59.5	40	65	M			





YEAR	TRANSM	L/R	F/R	REMARKS	GSP Ref.	PRODUCT	ABS	Technical Specifications							
								A	B	C	H	L	P		
VW															
PASSAT (3C2)/PASSAT/Magotan															
2.0 TDI (100 kW)	2005.03-2010.11	AT	R	F	Saloon Engine BMA	254011	Drive Shaft	36		59.5	40	755			
	2005.03-2010.11	Semi-AT	L	F	Saloon Engine BMA	203241	Drive Shaft	36		59.5	40	475			
2.0 TDI (103 kW)	2005.03-2009.05	AT	L/R	F	Saloon Engine BMP	661057	Inner Joint		34		86				
	2005.03-2009.05	MT	L	F	Saloon Engine BMP	203265	Drive Shaft	36		59.5	40	487			
	2005.03-2009.05	-	L/R	F	Saloon Engine BMP	803002	Outer Joint	36	27	59.5	40	66	I		
	2005.03-2009.05	MT	R	F	Saloon Engine BMP	203313	Drive Shaft	36		59.5	40	792			
	2005.03-2009.05	AT	L	F	Saloon Engine BMP	254013	Drive Shaft	36		59.5	40	479.5			
	2005.03-2009.05	AT	L	F	Saloon Engine BMP	654004	Inner Joint		34		85				
	2005.03-2009.05	MT	R	F	Saloon Engine BMP	261126	Drive Shaft	36		59.5	40	793			
	2005.03-2009.05	MT	L	F	Saloon Engine BMP	203295	Drive Shaft	36		59.5	40	491			
	2005.03-2009.05	-	L/R	F	Saloon Engine BMP	861045	Outer Joint	36	27	59.5	40	65	M		
	2005.03-2009.05	AT	R	F	Saloon Engine BMP	254011	Drive Shaft	36		59.5	40	755			
	2005.03-2009.05	Semi-AT	L	F	Saloon Engine BMP	203241	Drive Shaft	36		59.5	40	475			
2.0 TDI (120 kW)	2005.08-2009.05	AT	R	F	Saloon Engine BUZ	254011	Drive Shaft	36		59.5	40	755			
	2005.08-2009.05	AT	L	F	Saloon Engine BUZ	254013	Drive Shaft	36		59.5	40	479.5			
	2005.08-2009.05	AT	L	F	Saloon Engine BUZ	654004	Inner Joint		34		85				
	2005.08-2009.05	Semi-AT	L	F	Saloon Engine BUZ	203241	Drive Shaft	36		59.5	40	475			
	2005.08-2009.05	6AT/6MT	L/R	F	Saloon Engine BUZ	861045	Outer Joint	36	27	59.5	40	65	M		
2.0 TDI (125 kW)	2005.08-2010.07	AT	L	F	Saloon Engine BMR	254013	Drive Shaft	36		59.5	40	479.5			
	2005.08-2010.07	AT	L	F	Saloon Engine BMR	654004	Inner Joint		34		85				
	2005.08-2010.07	6AT/6MT	L/R	F	Saloon Engine BMR	861045	Outer Joint	36	27	59.5	40	65	M		
	2005.08-2010.07	Semi-AT	L	F	Saloon Engine BMR	203241	Drive Shaft	36		59.5	40	475			
	2005.08-2010.07	AT	R	F	Saloon Engine BMR	254011	Drive Shaft	36		59.5	40	755			
2.0 TDI (81 kW)	2008.11-2010.07	-	-	F	Saloon Engine CBDC	803100	Outer Joint	36	33	59.5	38	55	I		
	2008.11-2010.07	MT	L	F	Saloon Engine CBDC	261089	Drive Shaft	36		59.5	40.5	521			
	2008.11-2010.07	-	L/R	F	Saloon Engine CBDC	803002	Outer Joint	36	27	59.5	40	66	I		
	2008.11-2010.07	MT	-	-	Saloon Engine CBDC	603006	Inner Joint		33		34				
	2008.11-2010.07	-	L/R	F	Saloon Engine CBDC	603011	Inner Joint		33		34				
	2008.11-2010.07	MT	R	F	Saloon Engine CBDC	261200	Drive Shaft	36		59.5	40.5	820			
	2008.11-2010.07	MT	-	-	Saloon Engine CBDC	861059	Outer Joint	36	33	59.5	40	59.5	I		
2.0 TDI (88 kW)	2005.11-2007.05	AT	R	F	Saloon Engine BWV	254011	Drive Shaft	36		59.5	40	755			
	2005.11-2007.05	MT	L	F	Saloon Engine BWV	203295	Drive Shaft	36		59.5	40	491			
	2005.11-2007.05	AT	L/R	F	Saloon Engine BWV	661057	Inner Joint		34		86				
	2005.11-2007.05	MT	R	F	Saloon Engine BWV	203236	Drive Shaft	36		59.5	40	484			
	2005.11-2007.05	MT	R	F	Saloon Engine BWV	203313	Drive Shaft	36		59.5	40	792			
	2005.11-2007.05	AT	L	F	Saloon Engine BWV	254013	Drive Shaft	36		59.5	40	479.5			
	2005.11-2007.05	AT	L	F	Saloon Engine BWV	654004	Inner Joint		34		85				
	2005.11-2007.05	AT/MT	L/R	F	Saloon Engine BWV	803002	Outer Joint	36	27	59.5	40	66	I		
	2005.11-2007.05	Semi-AT	L	F	Saloon Engine BWV	203241	Drive Shaft	36		59.5	40	475			
2.0 TDI (90 kW)	2005.08-2006.07	AT	R	F	Saloon Engine BVE	254011	Drive Shaft	36		59.5	40	755			
	2005.08-2006.07	MT	L	F	Saloon Engine BVE	203295	Drive Shaft	36		59.5	40	491			
	2005.08-2006.07	AT	L/R	F	Saloon Engine BVE	661057	Inner Joint		34		86				
	2005.08-2006.07	MT	R	F	Saloon Engine BVE	203313	Drive Shaft	36		59.5	40	792			
	2005.08-2006.07	AT	L	F	Saloon Engine BVE	254013	Drive Shaft	36		59.5	40	479.5			
	2005.08-2006.07	AT	L	F	Saloon Engine BVE	654004	Inner Joint		34		85				
	2005.08-2006.07	AT/MT	L/R	F	Saloon Engine BVE	803002	Outer Joint	36	27	59.5	40	66	I		
	2005.08-2006.07	Semi-AT	L	F	Saloon Engine BVE	203241	Drive Shaft	36		59.5	40	475			
2.0 TDI 16V (103 kW)	2005.03-2010.07	AT	L/R	F	Saloon Engine BKP	661057	Inner Joint		34		86				
	2005.03-2010.07	MT	L	F	Saloon Engine BKP	203265	Drive Shaft	36		59.5	40	487			
	2005.03-2010.07	-	L/R	F	Saloon Engine BKP	803002	Outer Joint	36	27	59.5	40	66	I		
	2005.03-2010.07	MT	R	F	Saloon Engine BKP	203313	Drive Shaft	36		59.5	40	792			
	2005.03-2010.07	AT	L	F	Saloon Engine BKP	254013	Drive Shaft	36		59.5	40	479.5			
	2005.03-2010.07	AT	L	F	Saloon Engine BKP	654004	Inner Joint		34		85				
	2005.03-2010.07	MT	R	F	Saloon Engine BKP	261126	Drive Shaft	36		59.5	40	793			
	2005.03-2010.07	MT	L	F	Saloon Engine BKP	203295	Drive Shaft	36		59.5	40	491			
	2005.03-2010.07	-	L/R	F	Saloon Engine BKP	861045	Outer Joint	36	27	59.5	40	65	M		
	2005.03-2010.07	AT	R	F	Saloon Engine BKP	254011	Drive Shaft	36		59.5	40	755			
	2005.03-2010.07	Semi-AT	L	F	Saloon Engine BKP	203241	Drive Shaft	36		59.5	40	475			
2.0 TDI 16V 4motion (103 kW)	2005.03-2010.08	6AT/6MT	L/R	F	All-wheel Drive Saloon Engine BKP	803002	Outer Joint	36	27	59.5	40	66	I		
	2005.03-2010.08	-	L/R	R	All-wheel Drive Saloon Engine BKP	803037	Outer Joint	36	30	59.5	40.5	55	I		
	2005.03-2010.08	-	L	F	All-wheel Drive Saloon Engine BKP	203295	Drive Shaft	36		59.5	40	491			
	2005.03-2010.08	-	L/R	R	All-wheel Drive Saloon Engine BKP	603011	Inner Joint		33		34				
	2005.03-2010.08	MT	R	F	All-wheel Drive Saloon Engine BKP	203266	Drive Shaft	36		59.5	40	601			
2.0 TDI 4motion (103 kW)	2005.03-2009.05	-	L/R	R	All-wheel Drive Saloon Engine BMP	803037	Outer Joint	36	30	59.5	40.5	55	I		
	2005.03-2009.05	-	L/R	R	All-wheel Drive Saloon Engine BMP	603011	Inner Joint		33		34				
	2005.03-2009.05	6AT/6MT	L/R	F	All-wheel Drive Saloon Engine BMP	803002	Outer Joint	36	27	59.5	40	66	I		

YEAR	TRANSM	L/R	F/R	REMARKS	GSP Ref.	PRODUCT	ABS	Technical Specifications						
								A	B	C	H	L	P	
VW														
PASSAT (3C2)/PASSAT/Magotan														
2.0 TDI 4motion (103 kW)	2005.03-2009.05	-	R	F	All-wheel Drive Saloon Engine BMP	203266	Drive Shaft	36		59.5	40	601		
	2005.03-2009.05	-	L	F	All-wheel Drive Saloon Engine BMP	203295	Drive Shaft	36		59.5	40	491		
2.0 TDI 4motion (125 kW)	2009.05-2010.07	-	L/R	F	All-wheel Drive Saloon Engine CBBB	803002	Outer Joint	36	27	59.5	40	66	I	
	2009.05-2010.07	-	L/R	R	All-wheel Drive Saloon Engine CBBB	603011	Inner Joint		33		34			
	2009.05-2010.07	-	L	F	All-wheel Drive Saloon Engine CBBB	254013	Drive Shaft	36		59.5	40	479.5		
	2009.05-2010.07	-	L	F	All-wheel Drive Saloon Engine CBBB	654004	Inner Joint		34		85			
	2009.05-2010.07	Semi-AT	L	F	All-wheel Drive Saloon Engine CBBB	203241	Drive Shaft	36		59.5	40	475		
3.2 FSI 4motion (184 kW)	2005.11-2010.07	AT/MT	L/R	R	All-wheel Drive Saloon Engine AXZ	803037	Outer Joint	36	30	59.5	40.5	55	I	
	2005.11-2010.07	AT/MT	L/R	F	All-wheel Drive Saloon Engine AXZ	661057	Inner Joint		34		86			
	2005.11-2010.07	AT/MT	L/R	R	All-wheel Drive Saloon Engine AXZ	603011	Inner Joint		33		34			
	2005.11-2010.07	-	L	F	All-wheel Drive Saloon Engine AXZ	254013	Drive Shaft	36		59.5	40	479.5		
	2005.11-2010.07	-	L	F	All-wheel Drive Saloon Engine AXZ	654004	Inner Joint		34		85			
	2005.11-2010.07	-	R	F	All-wheel Drive Saloon Engine AXZ	203266	Drive Shaft	36		59.5	40	601		
	2005.11-2010.07	AT	L	F	All-wheel Drive Saloon Engine AXZ	203241	Drive Shaft	36		59.5	40	475		
	2005.11-2010.07	AT/MT	L/R	F	All-wheel Drive Saloon Engine AXZ	803002	Outer Joint	36	27	59.5	40	66	I	
	2005.11-2010.07	AT	-	-	All-wheel Drive Saloon Engine AXZ	603016	Inner Joint		28		32			
	2005.11-2010.07	AT	-	-	All-wheel Drive Saloon Engine AXZ	603006	Inner Joint		33		34			
3.6 R36 4motion (220 kW)	2007.04-2010.07	-	L/R	R	All-wheel Drive Saloon Engine BWS	603011	Inner Joint		33		34			
	2007.04-2010.07	AT	-	-	All-wheel Drive Saloon Engine BWS	603016	Inner Joint		28		32			
	2007.04-2010.07	AT	-	-	All-wheel Drive Saloon Engine BWS	603006	Inner Joint		33		34			
PASSAT (3G2)														
1.4 TSI (110 kW)	2014.11-	-	-	-	Saloon Engine CZDA	803101	Outer Joint	36	27	59.5	40	65	M	
1.4 TSI 4motion (110 kW)	2015.02-	-	-	-	All-wheel Drive Saloon Engine CZEA	803101	Outer Joint	36	27	59.5	40	65	M	
1.6 TDI (88 kW)	2014.08-	-	Semi-AT/MT	L	Saloon Engine DCXA	261201	Drive Shaft	36		59.5	40.5	535		
1.8 TSI (132 kW)	2015.02-	-	AT	-	Saloon Engine CJSA	603016	Inner Joint		28		32			
	2015.02-	-	MT	L	Saloon Engine CJSA	261131	Drive Shaft	36		59.5	40	515		
2.0 TDI (110 kW)	2014.11-	-	6AT	L	Saloon Engine DFGA	203381	Drive Shaft	36		59.5	40	486		
	2014.11-	-	AT	-	Saloon Engine DFGA	603006	Inner Joint		33		34			
	2014.11-	-	AT	-	Saloon Engine DFGA	603016	Inner Joint		28		32			
	2014.11-	-	MT	L	Saloon Engine DFGA	261131	Drive Shaft	36		59.5	40	515		
2.0 TDI (135 kW)	2015.07-	-	AT	-	Saloon Engine CUPA	603006	Inner Joint		33		34			
2.0 TDI (140 kW)	2014.11-	-	6AT	L	Saloon Engine DDAA	203381	Drive Shaft	36		59.5	40	486		
	2014.11-	-	AT	-	Saloon Engine DDAA	603006	Inner Joint		33		34			
	2014.11-	-	MT	L	Saloon Engine DDAA	261131	Drive Shaft	36		59.5	40	515		
	2014.11-	-	AT	-	Saloon Engine DDAA	603016	Inner Joint		28		32			
2.0 TDI 4motion (110 kW)	2015.02-	-	AT	-	All-wheel Drive Saloon Engine DFEA	603006	Inner Joint		33		34			
	2015.02-	-	AT	-	All-wheel Drive Saloon Engine DFEA	603016	Inner Joint		28		32			
	2015.02-	-	6AT	L	All-wheel Drive Saloon Engine DFEA	203381	Drive Shaft	36		59.5	40	486		
	2015.02-	-	-	-	All-wheel Drive Saloon Engine DFEA	803101	Outer Joint	36	27	59.5	40	65	M	
2.0 TDI 4motion (140 kW)	2014.11-	-	AT	-	All-wheel Drive Saloon Engine DDAA	603016	Inner Joint		28		32			
	2014.11-	-	6AT	L	All-wheel Drive Saloon Engine DDAA	203381	Drive Shaft	36		59.5	40	486		
	2014.11-	-	AT	L/R	All-wheel Drive Saloon Engine DDAA	603011	Inner Joint		33		34			
	2014.11-	-	AT	-	All-wheel Drive Saloon Engine DDAA	603006	Inner Joint		33		34			
2.0 TDI 4motion (176 kW)	2014.08-	-	6AT	L	All-wheel Drive Saloon Engine CUAA	203381	Drive Shaft	36		59.5	40	486		
	2014.08-	-	AT	R	All-wheel Drive Saloon Engine CUAA	661048	Inner Joint	40	34	46.9	47	80.5		
	2014.08-	-	AT	L/R	All-wheel Drive Saloon Engine CUAA	603011	Inner Joint		33		34			
	2014.08-	-	AT	-	All-wheel Drive Saloon Engine CUAA	603006	Inner Joint		33		34			
2.0 TSI (162 kW)	2015.02-	-	AT	-	Saloon Engine CHHB	603016	Inner Joint		28		32			
	2015.02-	-	AT	R	Saloon Engine CHHB	661048	Inner Joint	40	34	46.9	47	80.5		
PASSAT 3G														
1.6 Tdi DCX (88 KW)	2006-	2011	AT	L	F	-	261153	Drive Shaft	36	26	59.5	40	583	
PASSAT ALEMAO														
2.0	1988.01-	1997.12	MT/AT	-	-	-	661022	Inner Joint		33		34		
2.0 16V	1988.01-	1997.12	MT	-	-	-	803070	Outer Joint	36	30	53	78	60	I
	1988.01-	1997.12	MT	-	-	-	661022	Inner Joint		33		34		
	1990.01-	1997.12	AT	-	-	-	803070	Outer Joint	36	30	53	78	60	I
	1990.01-	1997.12	AT	-	-	-	661022	Inner Joint		33		34		
2.8	1988.01-	1997.12	MT/AT	-	-	-	803070	Outer Joint	36	30	53	78	60	I
	1988.01-	1997.12	MT/AT	-	-	-	661022	Inner Joint		33		34		
PASSAT ALLTRACK (365)														
1.8 TSI (112 kW)	2012.01-	2014.12	MT	L	F	Estate Engine CDAB	261131	Drive Shaft	36		59.5	40	515	
1.8 TSI (118 kW)	2012.01-	2014.12	MT	L	F	Estate Engine CDAA	261100	Drive Shaft	36		59.5	40	513	
	2012.01-	2014.12	-	L/R	F	Estate Engine CDAA	803002	Outer Joint	36	27	59.5	40	66	I
	2012.01-	2014.12	AT	L/R	F	Estate Engine CDAA	661011	Inner Joint	26	32	31	68.5	85	
	2012.01-	2014.12	MT	L	F	Estate Engine CDAA	261131	Drive Shaft	36		59.5	40	515	





YEAR	TRANSM	L/R	F/R	REMARKS	GSP Ref.	PRODUCT	ABS	Technical Specifications					
								A	B	C	H	L	P
VW													
PASSAT ALLTRACK (365)													
2.0 TDI (103 kW)	2012.01-2014.12	-	L	F	Estate Engine CFFB	203295	Drive Shaft	36		59.5	40	491	
	2012.01-2014.12	-	L/R	F	Estate Engine CFFB	803002	Outer Joint	36	27	59.5	40	66	I
	2012.01-2014.12	-	R	F	Estate Engine CFFB	203313	Drive Shaft	36		59.5	40	792	
2.0 TDI 4motion (103 kW)	2012.01-2014.12	MT	R	F	All-wheel Drive Estate Engine CFFB	261300	Drive Shaft	36		59.5	40	602	
	2012.01-2014.12	-	L	F	All-wheel Drive Estate Engine CFFB	203295	Drive Shaft	36		59.5	40	491	
	2012.01-2014.12	-	L/R	F	All-wheel Drive Estate Engine CFFB	803002	Outer Joint	36	27	59.5	40	66	I
	2012.01-2014.12	-	L/R	R	All-wheel Drive Estate Engine CFFB	603011	Inner Joint		33		34		
2.0 TDI 4motion (125 kW)	2012.01-2014.12	-	L/R	R	All-wheel Drive Estate Engine CFGB	603011	Inner Joint		33		34		
	2012.01-2014.12	-	L	F	All-wheel Drive Estate Engine CFGB	254013	Drive Shaft	36		59.5	40	479.5	
	2012.01-2014.12	-	L	F	All-wheel Drive Estate Engine CFGB	654004	Inner Joint		34		85		
	2012.01-2014.12	-	L/R	F	All-wheel Drive Estate Engine CFGB	803002	Outer Joint	36	27	59.5	40	66	I
	2012.01-2014.12	Semi-AT	L	F	All-wheel Drive Estate Engine CFGB	203241	Drive Shaft	36		59.5	40	475	
	2012.01-2014.12	AT	L	F	All-wheel Drive Estate Engine CFGB	261295	Drive Shaft	36		59.5	40	555	
2.0 TDI 4motion (130 kW)	2013.01-2014.12	AT	L	F	All-wheel Drive Estate Engine CFGC	254013	Drive Shaft	36		59.5	40	479.5	
	2013.01-2014.12	AT	L	F	All-wheel Drive Estate Engine CFGC	654004	Inner Joint		34		85		
	2013.01-2014.12	-	L/R	R	All-wheel Drive Estate Engine CFGC	603011	Inner Joint		33		34		
	2013.01-2014.12	Semi-AT	L	F	All-wheel Drive Estate Engine CFGC	203241	Drive Shaft	36		59.5	40	475	
	2013.01-2014.12	AT	L	F	All-wheel Drive Estate Engine CFGC	261294	Drive Shaft	36		59.5	40	555	
2.0 TSI 4motion (155 kW)	2012.01-2014.12	-	L/R	R	All-wheel Drive Estate Engine CCZB	603011	Inner Joint		33		34		
PASSAT ALLTRACK (3G5)													
1.4 TSI 4motion (110 kW)	2015.05-	-	-	F	All-wheel Drive Estate Engine CZEZ	803101	Outer Joint	36	27	59.5	40	65	M
2.0 TDI 4motion (110 kW)	2015.05-	AT	-	-	All-wheel Drive Estate Engine DFEA	603006	Inner Joint		33		34		
	2015.05-	AT	-	-	All-wheel Drive Estate Engine DFEA	603016	Inner Joint		28		32		
	2015.05-	-	-	F	All-wheel Drive Estate Engine DFEA	803101	Outer Joint	36	27	59.5	40	65	M
	2015.05-	MT	L/R	R	All-wheel Drive Estate Engine DFEA	603011	Inner Joint		33		34		
2.0 TDI 4motion (135 kW)	2015.07-	AT	-	-	All-wheel Drive Estate Engine CUPA	603006	Inner Joint		33		34		
	2015.07-	DCT	L/R	F	All-wheel Drive Estate Engine CUPA	603011	Inner Joint		33		34		
2.0 TDI 4motion (140 kW)	2015.05-	AT	-	-	All-wheel Drive Estate Engine DFCA	603006	Inner Joint		33		34		
	2015.05-	AT	-	-	All-wheel Drive Estate Engine DFCA	603016	Inner Joint		28		32		
	2015.05-	AT	L/R	R	All-wheel Drive Estate Engine DFCA	603011	Inner Joint		33		34		
2.0 TDI 4motion (176 kW)	2015.05-	AT	-	-	All-wheel Drive Estate Engine CUAA	603006	Inner Joint		33		34		
	2015.05-	AT	R	F	All-wheel Drive Estate Engine CUAA	661048	Inner Joint	40	34	46.9	47	80.5	
	2015.05-	AT	L/R	R	All-wheel Drive Estate Engine CUAA	603011	Inner Joint		33		34		
380TSI (162 kW)	2015.07-	AT	-	-	All-wheel Drive Estate Engine CHHB	603016	Inner Joint		28		32		
	2015.07-	AT	R	F	All-wheel Drive Estate Engine CHHB	661048	Inner Joint	40	34	46.9	47	80.5	
PASSAT B6													
2.0T	2006-	2009	AT	R	F	-	261152	Drive Shaft	36	26	59.5	40	873
PASSAT CC													
2.0	2009-	-	-	R	-	-	261152	Drive Shaft	36	26	59.5	40	873
	2009-	-	-	R	-	-	261152	Drive Shaft	36	26	59.5	40	873
PASSAT CC (357)													
1.4 TSI MultiFuel (118 kW)	2011.01-2012.01	MT	L/R	F	Coupe Engine CKMA	603011	Inner Joint		33		34		
	2011.01-2012.01	MT	L/R	F	Coupe Engine CKMA	803037	Outer Joint	36	30	59.5	40.5	55	I
	2011.01-2012.01	AT	L	F	Coupe Engine CKMA	261281	Drive Shaft	36		59.5	40	528	
	2011.01-2012.01	AT	L/R	F	Coupe Engine CKMA	803002	Outer Joint	36	27	59.5	40	66	I
1.8 TSI (118 kW)	2008.06-2012.01	MT	L	F	Coupe Engine BZB	203295	Drive Shaft	36		59.5	40	491	
	2008.06-2012.01	MT	L	F	Coupe Engine BZB	261100	Drive Shaft	36		59.5	40	513	
	2008.06-2012.01	MT	L/R	F	Coupe Engine BZB	803002	Outer Joint	36	27	59.5	40	66	I
	2008.06-2012.01	AT	L/R	F	Coupe Engine BZB	661011	Inner Joint	26	32	31	68.5	85	
	2008.06-2012.01	MT	L	F	Coupe Engine BZB	261131	Drive Shaft	36		59.5	40	515	
2.0 BlueTDI (105 kW)	2009.05-2010.11	MT	L	F	Coupe Engine CBAC	203295	Drive Shaft	36		59.5	40	491	
	2009.05-2010.11	AT	R	F	Coupe Engine CBAC	254011	Drive Shaft	36		59.5	40	755	
	2009.05-2010.11	-	L/R	F	Coupe Engine CBAC	803002	Outer Joint	36	27	59.5	40	66	I
	2009.05-2010.11	MT	R	F	Coupe Engine CBAC	203313	Drive Shaft	36		59.5	40	792	
	2009.05-2010.11	AT	L	F	Coupe Engine CBAC	254013	Drive Shaft	36		59.5	40	479.5	
	2009.05-2010.11	AT	L	F	Coupe Engine CBAC	654004	Inner Joint		34		85		
	2009.05-2010.11	Semi-AT	L	F	Coupe Engine CBAC	203241	Drive Shaft	36		59.5	40	475	
2.0 TDI (100 kW)	2008.06-2011.05	AT	L/R	F	Coupe Engine CBAA	661057	Inner Joint		34		86		
	2008.06-2011.05	AT	R	F	Coupe Engine CBAA	254011	Drive Shaft	36		59.5	40	755	
	2008.06-2011.05	MT	L	F	Coupe Engine CBAA	203295	Drive Shaft	36		59.5	40	491	
	2008.06-2011.05	MT	R	F	Coupe Engine CBAA	203313	Drive Shaft	36		59.5	40	792	
	2008.06-2011.05	AT	L	F	Coupe Engine CBAA	254013	Drive Shaft	36		59.5	40	479.5	
	2008.06-2011.05	AT	L	F	Coupe Engine CBAA	654004	Inner Joint		34		85		
	2008.06-2011.05	AT/MT	L/R	F	Coupe Engine CBAA	803002	Outer Joint	36	27	59.5	40	66	I
	2008.06-2011.05	AT	R	F	Coupe Engine CFFB	254011	Drive Shaft	36		59.5	40	755	
2.0 TDI (103 kW)	2008.06-2012.01	MT	L	F	Coupe Engine CFFB	203295	Drive Shaft	36		59.5	40	491	





	 YEAR	TRANSM	L/R	F/R	REMARKS	GSP Ref.	 PRODUCT	 ABS	Technical Specifications					
									A	B	C	H	L	P
VW														
PASSAT CC (357)														
2.0 TDI (103 kW)	2008.06-2012.01	AT	L/R	F	Coupe Engine CFFB	661057	Inner Joint		34		86			
	2008.06-2012.01	MT	R	F	Coupe Engine CFFB	203313	Drive Shaft	36		59.5	40	792		
	2008.06-2012.01	AT	L	F	Coupe Engine CFFB	254013	Drive Shaft	36		59.5	40	479.5		
	2008.06-2012.01	AT	L	F	Coupe Engine CFFB	654004	Inner Joint		34		85			
	2008.06-2012.01	AT/MT	L/R	F	Coupe Engine CFFB	803002	Outer Joint	36	27	59.5	40	66	I	
	2008.06-2012.01	Semi-AT	L	F	Coupe Engine CFFB	203241	Drive Shaft	36		59.5	40	475		
2.0 TDI (120 kW)	2008.05-2011.05	Semi-AT	L	F	Coupe Engine CBBA	654004	Inner Joint		34		85			
	2008.05-2011.05	AT	-	-	Coupe Engine CBBA	603006	Inner Joint		33		34			
	2008.05-2011.05	Semi-AT	L	F	Coupe Engine CBBA	203241	Drive Shaft	36		59.5	40	475		
2.0 TDI (125 kW)	2008.06-2012.01	AT	R	F	Coupe Engine CBBB	254011	Drive Shaft	36		59.5	40	755		
	2008.06-2012.01	AT	L	F	Coupe Engine CBBB	254013	Drive Shaft	36		59.5	40	479.5		
	2008.06-2012.01	AT	L	F	Coupe Engine CBBB	654004	Inner Joint		34		85			
	2008.06-2012.01	Semi-AT	L	F	Coupe Engine CBBB	203241	Drive Shaft	36		59.5	40	475		
	2008.06-2012.01	-	L/R	F	Coupe Engine CBBB	861045	Outer Joint	36	27	59.5	40	65	M	
2.0 TDI 4motion (103 kW)	2009.08-2012.01	-	L/R	F	All-wheel Drive Coupe Engine CFFB	803002	Outer Joint	36	27	59.5	40	66	I	
	2009.08-2012.01	-	L	F	All-wheel Drive Coupe Engine CFFB	203295	Drive Shaft	36		59.5	40	491		
	2009.08-2012.01	Semi-AT	L	F	All-wheel Drive Coupe Engine CFFB	654004	Inner Joint		34		85			
	2009.08-2012.01	-	R	F	All-wheel Drive Coupe Engine CFFB	203266	Drive Shaft	36		59.5	40	601		
	2009.08-2012.01	-	L/R	R	All-wheel Drive Coupe Engine CFFB	603011	Inner Joint		33		34			
	2009.08-2012.01	Semi-AT	L	F	All-wheel Drive Coupe Engine CFFB	203241	Drive Shaft	36		59.5	40	475		
2.0 TDI 4motion (125 kW)	2009.11-2012.01	-	L/R	F	All-wheel Drive Coupe Engine CBBB/CFGB	803002	Outer Joint	36	27	59.5	40	66	I	
	2009.11-2012.01	-	L/R	R	All-wheel Drive Coupe Engine CBBB/CFGB	603011	Inner Joint		33		34			
	2009.11-2012.01	-	L	F	All-wheel Drive Coupe Engine CBBB/CFGB	254013	Drive Shaft	36		59.5	40	479.5		
	2009.11-2012.01	-	L	F	All-wheel Drive Coupe Engine CBBB/CFGB	654004	Inner Joint		34		85			
	2009.11-2012.01	Semi-AT	L	F	All-wheel Drive Coupe Engine CBBB/CFGB	203241	Drive Shaft	36		59.5	40	475		
2.0 TSI (147 kW)	2008.06-2012.01	-	L	F	Coupe Engine CCTA	661038	Inner Joint	26	34	31	68.5	88.5		
	2008.06-2012.01	AT/MT	L/R	F	Coupe Engine CCTA	803002	Outer Joint	36	27	59.5	40	66	I	
	2008.06-2012.01	AT/MT	L/R	F	Coupe Engine CCTA	861045	Outer Joint	36	27	59.5	40	65	M	
	2008.06-2012.01	AT/MT	L	F	Coupe Engine CCTA	203295	Drive Shaft	36		59.5	40	491		
2.0 TSI (155 kW)	2010.11-2012.01	-	L/R	F	Coupe Engine CCZB	861045	Outer Joint	36	27	59.5	40	65	M	
3.6 FSI 4motion (220 kW)	2008.06-2010.05	-	L/R	R	All-wheel Drive Coupe Engine BWS	603011	Inner Joint		33		34			
	2008.06-2010.05	AT	-	-	All-wheel Drive Coupe Engine BWS	603016	Inner Joint		28		32			
	2008.06-2010.05	AT	-	-	All-wheel Drive Coupe Engine BWS	603006	Inner Joint		33		34			
PASSAT CC (COUPE)														
-	2009-2012	-	-	-	-	201594	Drive Shaft		36		59.5	40	800	
PASSAT II (32B)														
1.8 Syncro (66 kW)	1988.03-	-	-	F	-	603013	Inner Joint		33		34			
2.2 (85 kW)	1988.03-	MT/AT	L	-	Ch32B00000132J299999	603013	Inner Joint		33		34			
PASSAT IV														
1.6	1997.02-1999.05	MT	-	F	All	603013	Inner Joint		33		34			
1.9 TDi	1998.05-2000.12	AT	-	F	-	803064	Outer Joint	45T	38	27	60	34	64	I
	1998.05-2000.12	MT	-	F	-	803064	Outer Joint	45T	38	27	60	34	64	I
2.5 TDi V6	1999.09-	AT	-	F	-	803064	Outer Joint	45T	38	27	60	34	64	I
	1999.09-	MT	-	F	-	803064	Outer Joint	45T	38	27	60	34	64	I
2.8 V6	1997.04-	MT/AT	-	F	Syncro 4WD	803064	Outer Joint	45T	38	27	60	34	64	I
PASSAT VARIANT (365)														
2.0 TDI	2013-	AT	L	F	ENGINE:CFGB	261289	Drive Shaft		36		59.5	40	481	
PASSAT Variant (365)/PASSAT/Magotan														
1.4 TSI (118 kW)	2012.11-2014.12	AT	L/R	F	Estate Engine CTHD	803002	Outer Joint	36	27	59.5	40	66	I	
	2012.11-2014.12	MT	L	F	Estate Engine CTHD	261224	Drive Shaft	36		59.5	40	536		
	2012.11-2014.12	MT	L/R	F	Estate Engine CTHD	603011	Inner Joint		33		34			
	2012.11-2014.12	MT	L/R	F	Estate Engine CTHD	803037	Outer Joint	36	30	59.5	40.5	55	I	
1.4 TSI (90 kW)	2010.08-2014.12	MT	L/R	F	Estate Engine CAXA	603011	Inner Joint		33		34			
	2010.08-2014.12	MT	L	F	Estate Engine CAXA	261198	Drive Shaft	36		59.5	40.5	530		
	2010.08-2014.12	MT	R	F	Estate Engine CAXA	201586	Drive Shaft	36		59.5	40	806		
	2010.08-2014.12	-	-	F	Estate Engine CAXA	803100	Outer Joint	36	33	59.5	38	55	I	
1.4 TSI EcoFuel (110 kW)	2010.08-2014.12	MT	L	F	Estate Engine CDGA	261224	Drive Shaft	36		59.5	40	536		
	2010.08-2014.12	MT	L/R	F	Estate Engine CDGA	803037	Outer Joint	36	30	59.5	40.5	55	I	
	2010.08-2014.12	AT	L	F	Estate Engine CDGA	261281	Drive Shaft	36		59.5	40	528		
	2010.08-2014.12	AT	L/R	F	Estate Engine CDGA	803002	Outer Joint	36	27	59.5	40	66	I	
	2010.08-2014.12	MT	L/R	F	Estate Engine CDGA	603011	Inner Joint		33		34			
1.4 TSI MultiFuel (118 kW)	2010.11-2014.12	MT	L/R	F	Estate Engine CKMA	603011	Inner Joint		33		34			
	2010.11-2014.12	MT	L	F	Estate Engine CKMA	261224	Drive Shaft	36		59.5	40	536		
	2010.11-2014.12	MT	L/R	F	Estate Engine CKMA	803037	Outer Joint	36	30	59.5	40.5	55	I	
	2010.11-2014.12	AT	L	F	Estate Engine CKMA	261281	Drive Shaft	36		59.5	40	528		
	2010.11-2014.12	AT	L/R	F	Estate Engine CKMA	803002	Outer Joint	36	27	59.5	40	66	I	

YEAR	TRANSM	L/R	F/R	REMARKS	GSP Ref.	PRODUCT	ABS	Technical Specifications						
								A	B	C	H	L	P	
VW														
PASSAT Variant (365)/PASSAT/Magotan														
1.6 TDI (77 kW)	2010.08-2014.12	MT	L/R	F	Estate Engine CAYC	603011	Inner Joint			33		34		
	2010.08-2014.12	MT	-	F	Estate Engine CAYC	803100	Outer Joint	36	33	59.5	38	55	I	
	2010.08-2014.12	MT	L	F	Estate Engine CAYC	261089	Drive Shaft	36		59.5	40.5	521		
	2010.08-2014.12	MT	R	F	Estate Engine CAYC	261200	Drive Shaft	36		59.5	40.5	820		
1.8 TSI (118 kW)	2010.08-2014.12	-	L/R	F	Estate Engine CDAA	803002	Outer Joint	36	27	59.5	40	66	I	
	2010.08-2014.12	MT	L	F	Estate Engine CDAA	261100	Drive Shaft	36		59.5	40	513		
	2010.08-2014.12	AT	L/R	F	Estate Engine CDAA	661011	Inner Joint	26	32	31	68.5	85		
	2010.08-2014.12	MT	L	F	Estate Engine CDAA	261131	Drive Shaft	36		59.5	40	515		
2.0 TDI (100 kW)	2010.08-2014.12	-	L/R	F	Estate Engine CFFA	803002	Outer Joint	36	27	59.5	40	66	I	
	2010.08-2014.12	-	L	F	Estate Engine CFFA	203295	Drive Shaft	36		59.5	40	491		
	2010.08-2014.12	MT	-	F	Estate Engine CFFA	603016	Inner Joint		28		32			
	2010.08-2014.12	-	R	F	Estate Engine CFFA	203313	Drive Shaft	36		59.5	40	792		
	2010.08-2014.12	MT	-	F	Estate Engine CFFA	603006	Inner Joint		33		34			
2.0 TDI (103 kW)	2010.08-2014.12	MT	L	F	Estate Engine CFFB	203295	Drive Shaft	36		59.5	40	491		
	2010.08-2014.12	-	L/R	F	Estate Engine CFFB	803002	Outer Joint	36	27	59.5	40	66	I	
	2010.08-2014.12	MT	R	F	Estate Engine CFFB	203313	Drive Shaft	36		59.5	40	792		
	2010.08-2014.12	AT	L	F	Estate Engine CFFB	254013	Drive Shaft	36		59.5	40	479.5		
	2010.08-2014.12	AT	L	F	Estate Engine CFFB	654004	Inner Joint		34		85			
	2010.08-2014.12	Semi-AT	L	F	Estate Engine CFFB	203241	Drive Shaft	36		59.5	40	475		
	2010.08-2014.12	AT	R	F	Estate Engine CFFB	254011	Drive Shaft	36		59.5	40	755		
2.0 TDI (125 kW)	2010.08-2014.12	AT	L	F	Estate Engine CFGB	254013	Drive Shaft	36		59.5	40	479.5		
	2010.08-2014.12	AT	L	F	Estate Engine CFGB	654004	Inner Joint		34		85			
	2010.08-2014.12	Semi-AT	L	F	Estate Engine CFGB	203241	Drive Shaft	36		59.5	40	475		
	2010.08-2014.12	-	L/R	F	Estate Engine CFGB	861045	Outer Joint	36	27	59.5	40	65	M	
	2010.08-2014.12	AT	R	F	Estate Engine CFGB	254011	Drive Shaft	36		59.5	40	755		
2.0 TDI 4motion (103 kW)	2010.08-2014.12	MT	L/R	F	All-wheel Drive Estate Engine CFFB	803002	Outer Joint	36	27	59.5	40	66	I	
	2010.08-2014.12	MT	R	F	All-wheel Drive Estate Engine CFFB	203266	Drive Shaft	36		59.5	40	601		
	2010.08-2014.12	AT	L	F	All-wheel Drive Estate Engine CFFB	654004	Inner Joint		34		85			
	2010.08-2014.12	CVT/Semi-AT	L	F	All-wheel Drive Estate Engine CFFB	203241	Drive Shaft	36		59.5	40	475		
	2010.08-2014.12	MT	L/R/F/R	F	All-wheel Drive Estate Engine CFFB	603011	Inner Joint		33		34			
	2010.08-2014.12	MT	L	F	All-wheel Drive Estate Engine CFFB	203295	Drive Shaft	36		59.5	40	491		
2.0 TDI 4motion (125 kW)	2010.08-2013.01	MT	L/R/F/R	F	All-wheel Drive Estate Engine CFGB	603011	Inner Joint		33		34			
	2010.08-2013.01	MT	L/R	F	All-wheel Drive Estate Engine CFGB	803002	Outer Joint	36	27	59.5	40	66	I	
	2010.08-2013.01	AT	L	F	All-wheel Drive Estate Engine CFGB	254013	Drive Shaft	36		59.5	40	479.5		
	2010.08-2013.01	AT/Semi-AT	L	F	All-wheel Drive Estate Engine CFGB	203241	Drive Shaft	36		59.5	40	475		
	2010.08-2013.01	AT	L	F	All-wheel Drive Estate Engine CFGB	654004	Inner Joint		34		85			
2.0 TDI 4motion (130 kW)	2013.01-2014.12	AT	L/R	F	All-wheel Drive Estate Engine CFGC	803002	Outer Joint	36	27	59.5	40	66	I	
	2013.01-2014.12	AT	L	F	All-wheel Drive Estate Engine CFGC	254013	Drive Shaft	36		59.5	40	479.5		
	2013.01-2014.12	AT	L	F	All-wheel Drive Estate Engine CFGC	654004	Inner Joint		34		85			
	2013.01-2014.12	-	L/R	R	All-wheel Drive Estate Engine CFGC	603011	Inner Joint		33		34			
3.6 FSI 4motion (220 kW)	2011.01-2014.12	-	L/R	R	All-wheel Drive Estate Engine BWS	603011	Inner Joint		33		34			
	2011.01-2014.12	AT	-	-	All-wheel Drive Estate Engine BWS	603016	Inner Joint		28		32			
	2011.01-2014.12	AT	-	-	All-wheel Drive Estate Engine BWS	603006	Inner Joint		33		34			
PASSAT Variant (3A5 35I)														
1.6 (53 kW)	1988.04-1991.09	-	-	F	Estate Engine 1F/EZ	853004	Outer Joint	22	30	51	78	61	I	
1.6 (74 kW)	1994.07-1995.12	MT	R	F	Estate Engine AEK	603009	Inner Joint		33		34			
	1994.07-1995.12	MT	L	F	Estate Engine AEK	261001	Drive Shaft	22		53.2	78	557		
	1994.07-1995.12	MT	L	F	Estate Engine AEK	603011	Inner Joint		33		34			
	1994.07-1995.12	MT	R	F	Estate Engine AEK	261002	Drive Shaft	22		53	78.5	793		
	1994.07-1995.12	-	-	F	Estate Engine AEK	853004	Outer Joint	22	30	51	78	61	I	
	1994.07-1995.12	AT/MT	L/R	F	Estate Engine AEK	861018	Outer Joint	22	30	53	78.5	61	I	
1.6 TD (59 kW)	1988.08-1993.09	MT	R	F	Estate Engine RA	603009	Inner Joint		33		34			
	1988.08-1993.09	MT	L/R	F	Estate Engine RA	603004	Inner Joint		33		32			
	1988.08-1993.09	MT	L/R	F	Estate Engine RA	603005	Inner Joint		33		32			
	1988.08-1993.09	MT	L/R	F	Estate Engine RA	853008	Outer Joint	22	30	53	78.5	51	I	
	1988.08-1993.09	MT	L	F	Estate Engine RA	261001	Drive Shaft	22		53.2	78	557		
	1988.08-1993.09	MT	L	F	Estate Engine RA	603011	Inner Joint		33		34			
	1988.08-1993.09	MT	R	F	Estate Engine RA	261002	Drive Shaft	22		53	78.5	793		
	1988.08-1993.09	MT	L/R	F	Estate Engine RA	861018	Outer Joint	22	30	53	78.5	61	I	
1.8 (55 kW)	1990.08-1997.05	MT	R	F	Estate Engine AAM	603009	Inner Joint		33		34			
	1990.08-1997.05	MT	L	F	Estate Engine AAM	261001	Drive Shaft	22		53.2	78	557		
	1990.08-1997.05	MT	R	F	Estate Engine AAM	261002	Drive Shaft	22		53	78.5	793		
	1990.08-1997.05	AT/MT	L/R	F	Estate Engine AAM	861018	Outer Joint	22	30	53	78.5	61	I	
	1990.08-1997.05	MT	L	F	Estate Engine AAM	603011	Inner Joint		33		34			
1.8 (66 kW)	1988.02-1997.05	MT	R	F	Estate Engine RP	603009	Inner Joint		33		34			
	1988.02-1997.05	MT	L	F	Estate Engine RP	261001	Drive Shaft	22		53.2	78	557		





	 YEAR	TRANSM	L/R	F/R	REMARKS	GSP Ref.	 PRODUCT	 ABS	Technical Specifications					
									A	B	C	H	L	P
VW														
PASSAT Variant (3A5 35I)														
1.8 (66 kW)	1988.02-1997.05	MT	R	F	Estate Engine RP	261002	Drive Shaft		22		53	78.5	793	
	1988.02-1997.05	AT/MT	L/R	F	Estate Engine RP	861018	Outer Joint		22	30	53	78.5	61	I
	1988.02-1997.05	MT	L	F	Estate Engine RP	603011	Inner Joint			33		34		
1.8 (79 kW)	1988.04-1990.07	AT/MT	R	F	Estate Engine PF	603009	Inner Joint			33		34		
	1988.04-1990.07	AT/MT	L	F	Estate Engine PF	261001	Drive Shaft		22		53.2	78	557	
	1988.04-1990.07	AT/MT	L	F	Estate Engine PF	603011	Inner Joint			33		34		
	1988.04-1990.07	AT/MT	R	F	Estate Engine PF	261002	Drive Shaft		22		53	78.5	793	
1.8 (82 kW)	1988.04-1992.07	AT/MT	R	F	Estate Engine PB	603009	Inner Joint			33		34		
	1988.04-1992.07	AT/MT	L	F	Estate Engine PB	261001	Drive Shaft		22		53.2	78	557	
	1988.04-1992.07	AT/MT	L	F	Estate Engine PB	603011	Inner Joint			33		34		
	1988.04-1992.07	AT/MT	R	F	Estate Engine PB	261002	Drive Shaft		22		53	78.5	793	
1.8 16V (100 kW)	1988.04-1989.12	AT/MT	L	F	Estate Engine KR	603011	Inner Joint			33		34		
	1988.04-1989.12	AT/MT	R	F	Estate Engine KR	603009	Inner Joint			33		34		
	1988.04-1989.12	AT/MT	L	F	Estate Engine KR	261001	Drive Shaft		22		53.2	78	557	
	1988.04-1989.12	AT/MT	R	F	Estate Engine KR	261002	Drive Shaft		22		53	78.5	793	
1.8 G60 Syncro (118 kW)	1988.08-1997.05	MT	L/R	R	All-wheel Drive Estate Engine PG	603004	Inner Joint			33		32		
	1988.08-1997.05	MT	R	F	All-wheel Drive Estate Engine PG	603009	Inner Joint			33		34		
	1988.08-1997.05	MT	L/R	R	All-wheel Drive Estate Engine PG	603005	Inner Joint			33		32		
	1988.08-1997.05	MT	L/R	F	All-wheel Drive Estate Engine PG	861018	Outer Joint		22	30	53	78.5	61	I
	1988.08-1997.05	MT	L	F	All-wheel Drive Estate Engine PG	603011	Inner Joint			33		34		
1.9 D (50 kW)	1989.05-1993.10	MT	R	F	Estate Engine 1Y	603009	Inner Joint			33		34		
	1989.05-1993.10	MT	L	F	Estate Engine 1Y	261001	Drive Shaft		22		53.2	78	557	
	1989.05-1993.10	MT	L	F	Estate Engine 1Y	603011	Inner Joint			33		34		
	1989.05-1993.10	MT	R	F	Estate Engine 1Y	261002	Drive Shaft		22		53	78.5	793	
	1989.05-1993.10	MT	L/R	F	Estate Engine 1Y	861018	Outer Joint		22	30	53	78.5	61	I
1.9 TD (55 kW)	1991.03-1997.05	AT/MT	R	F	Estate Engine AAZ	603009	Inner Joint			33		34		
	1991.03-1997.05	AT/MT	L	F	Estate Engine AAZ	261001	Drive Shaft		22		53.2	78	557	
	1991.03-1997.05	AT/MT	R	F	Estate Engine AAZ	261002	Drive Shaft		22		53	78.5	793	
	1991.03-1997.05	AT/MT	L/R	F	Estate Engine AAZ	861018	Outer Joint		22	30	53	78.5	61	I
	1991.03-1997.05	AT/MT	L	F	Estate Engine AAZ	603011	Inner Joint			33		34		
1.9 TDI (81 kW)	1996.03-1997.05	MT	R	F	Estate Engine AFN	603009	Inner Joint			33		34		
	1996.03-1997.05	MT	L	F	Estate Engine AFN	261021	Drive Shaft		36		53.2	77.5	564.5	
	1996.03-1997.05	AT/MT	L/R	F	Estate Engine AFN	803036	Outer Joint		36	30	53.2	77.5	61	I
2.0 (79 kW)	1995.03-1996.08	MT	L	F	Estate Engine AEP	261001	Drive Shaft		22		53.2	78	557	
	1995.03-1996.08	MT	R	F	Estate Engine AEP	603009	Inner Joint			33		34		
	1995.03-1996.08	MT	R	F	Estate Engine AEP	261002	Drive Shaft		22		53	78.5	793	
	1995.03-1996.08	MT	L	F	Estate Engine AEP	603011	Inner Joint			33		34		
	1995.03-1996.08	AT/MT	L/R	F	Estate Engine AEP	861018	Outer Joint		22	30	53	78.5	61	I
2.0 (85 kW)	1990.02-1997.05	MT	R	F	Estate Engine 2E	603009	Inner Joint			33		34		
	1990.02-1997.05	MT	-	-	Estate Engine 2E	603006	Inner Joint			33		34		
	1990.02-1997.05	MT	L	F	Estate Engine 2E	261001	Drive Shaft		22		53.2	78	557	
	1990.02-1997.05	-	-	F	Estate Engine 2E	853004	Outer Joint		22	30	51	78	61	I
	1990.02-1997.05	MT	R	F	Estate Engine 2E	261002	Drive Shaft		22		53	78.5	793	
	1990.02-1997.05	AT/MT	L/R	F	Estate Engine 2E	861018	Outer Joint		22	30	53	78.5	61	I
	1990.02-1997.05	MT	L	F	Estate Engine 2E	603011	Inner Joint			33		34		
	1993.10-1996.10	MT	-	-	Estate Engine 2E	603006	Inner Joint			33		34		
	1993.10-1996.10	MT	R	F	Estate Engine 2E	603009	Inner Joint			33		34		
	1993.10-1996.10	MT	L	F	Estate Engine 2E	603011	Inner Joint			33		34		
	1993.10-1996.10	MT	L	F	Estate Engine 2E	261001	Drive Shaft		22		53.2	78	557	
	1993.10-1996.10	MT	R	F	Estate Engine 2E	261002	Drive Shaft		22		53	78.5	793	
	1993.10-1996.10	-	-	F	Estate Engine 2E	853004	Outer Joint		22	30	51	78	61	I
1993.10-1996.10	AT/MT	L/R	F	Estate Engine 2E	861018	Outer Joint		22	30	53	78.5	61	I	
2.0 16V (100 kW)	1988.08-1993.09	AT/MT	R	F	Estate Engine 9A	603009	Inner Joint			33		34		
	1988.08-1993.09	AT/MT	L	F	Estate Engine 9A	261001	Drive Shaft		22		53.2	78	557	
	1988.08-1993.09	AT/MT	L	F	Estate Engine 9A	603011	Inner Joint			33		34		
	1988.08-1993.09	AT/MT	R	F	Estate Engine 9A	261002	Drive Shaft		22		53	78.5	793	
	1988.08-1993.09	AT/MT	L/R	F	Estate Engine 9A	861018	Outer Joint		22	30	53	78.5	61	I
2.0 16V (110 kW)	1994.01-1997.05	MT	L	F	Estate Engine ABF	603009	Inner Joint			33		34		
	1994.01-1997.05	MT	L	F	Estate Engine ABF	261021	Drive Shaft		36		53.2	77.5	564.5	
	1994.01-1997.05	MT	L/R	F	Estate Engine ABF	803036	Outer Joint		36	30	53.2	77.5	61	I
2.0 Syncro (85 kW)	1990.10-1997.05	MT	L/R	R	All-wheel Drive Estate Engine 2E	603004	Inner Joint			33		32		
	1990.10-1997.05	MT	R	F	All-wheel Drive Estate Engine 2E	603009	Inner Joint			33		34		
	1990.10-1997.05	MT	L/R	R	All-wheel Drive Estate Engine 2E	603005	Inner Joint			33		32		
	1990.10-1997.05	MT	-	-	All-wheel Drive Estate Engine 2E	603006	Inner Joint			33		34		
	1990.10-1997.05	MT	L/R	F	All-wheel Drive Estate Engine 2E	861018	Outer Joint		22	30	53	78.5	61	I
1990.10-1997.05	MT	L/R	F	All-wheel Drive Estate Engine 2E	603011	Inner Joint			33		34			





YEAR	TRANSM	L/R	F/R	REMARKS	GSP Ref.	PRODUCT	ABS	Technical Specifications							
								A	B	C	H	L	P		
VW															
PASSAT Variant (3A5 35I)															
2.8 VR6 (128 kW)	1991.06-1997.05	MT	R	F	Estate Engine AAA	603009	Inner Joint			33		34			
	1991.06-1997.05	MT	R	F	Estate Engine AAA	261062	Drive Shaft	36		53.2	77.5	788			
	1991.06-1997.05	AT/MT	L	F	Estate Engine AAA	261021	Drive Shaft	36		53.2	77.5	564.5			
	1991.06-1997.05	MT	L/R	F	Estate Engine AAA	803036	Outer Joint	36	30	53.2	77.5	61	I		
2.9 VR6 Syncro (135 kW)	1994.01-1997.05	MT	L/R	R	All-wheel Drive Estate Engine ABV	603004	Inner Joint			33		32			
	1994.01-1997.05	MT	-	-	All-wheel Drive Estate Engine ABV	603006	Inner Joint			33		34			
	1994.01-1997.05	MT	R	F	All-wheel Drive Estate Engine ABV	261062	Drive Shaft	36		53.2	77.5	788			
	1994.01-1997.05	MT	L/R	F	All-wheel Drive Estate Engine ABV	803036	Outer Joint	36	30	53.2	77.5	61	I		
PASSAT Variant (3B5)															
1.6 (74 kW)	1997.06-2000.11	MT	L	F	Estate Engine AHL	203002	Drive Shaft	45W	33		53	30	614		
	1997.06-2000.11	AT/MT	L/R	F	Estate Engine AHL	861012	Outer Joint	45W	33	30	53	30	62	I	
	1997.06-2000.11	AT	R	F	Estate Engine AHL	299108	Drive Shaft	45W	33		53	30	586		
	1997.06-2000.11	AT	L	F	Estate Engine AHL	203012	Drive Shaft	45W	33		53	30	498		
	1997.06-2000.11	MT	R	F	Estate Engine AHL	299111	Drive Shaft	45W	33		53	30	636		
1.8 (92 kW)	1997.06-2000.11	AT	L/R	F	Estate Engine ARG	861012	Outer Joint	45W	33	30	53	30	62	I	
	1997.06-2000.11	MT	R	F	Estate Engine ARG	203001	Drive Shaft	45W	33		53	30	634		
	1997.06-2000.11	MT	L/R	F	Estate Engine ARG	803018	Outer Joint	45W	33	30	53	30	62	I	
	1997.06-2000.11	MT	L	F	Estate Engine ARG	203005	Drive Shaft	45W	33		53	30	614		
	1997.06-2000.11	-	L/R	F	Estate Engine ARG	603001	Inner Joint			28		32			
	1997.06-2000.11	AT/MT	R	F	Estate Engine ARG	299108	Drive Shaft	45W	33		53	30	586		
	1997.06-2000.11	AT	L	F	Estate Engine ARG	203012	Drive Shaft	45W	33		53	30	498		
1.8 Syncro/4motion (92 kW)	1997.06-2000.11	-	L	F	All-wheel Drive Estate Engine ADR	203002	Drive Shaft	45W	33		53	30	614		
	1997.06-2000.11	MT	L/R	F	All-wheel Drive Estate Engine ADR	861012	Outer Joint	45W	33	30	53	30	62	I	
	1997.06-2000.11	-	R	F	All-wheel Drive Estate Engine ADR	299111	Drive Shaft	45W	33		53	30	636		
1.8 T (110 kW)	1997.06-2000.11	MT	L/R	F	Estate Engine AEB	803019	Outer Joint	45W	38	27	59.5	34.5	63	I	
	1997.06-2000.11	AT/MT	L/R	F	Estate Engine AEB	861012	Outer Joint	45W	33	30	53	30	62	I	
	1997.06-2000.11	MT	R	F	Estate Engine AEB	203001	Drive Shaft	45W	33		53	30	634		
	1997.06-2000.11	MT	L	F	Estate Engine AEB	203005	Drive Shaft	45W	33		53	30	614		
	1997.06-2000.11	-	L/R	F	Estate Engine AEB	803018	Outer Joint	45W	33	30	53	30	62	I	
	1997.06-2000.11	5AT	L	F	Estate Engine AEB	203036	Drive Shaft	45W	33		53	30	524		
	1997.06-2000.11	MT	R	F	Estate Engine AEB	203007	Drive Shaft	45W	33		53	30	622		
	1997.06-2000.11	-	L/R	F	Estate Engine AEB	603001	Inner Joint			28		32			
	1997.06-2000.11	MT	L	F	Estate Engine AEB	261122	Drive Shaft	45W	33		53	30	602		
	1997.06-2000.11	AT	R	F	Estate Engine AEB	203012	Drive Shaft	45W	33		53	30	498		
	1997.06-2000.11	MT	R	F	Estate Engine AEB	203013	Drive Shaft	45W	33		53	30	636		
	1.9 TDI (66 kW)	1997.06-2000.11	5MT	L	F	Estate Engine AHU	603011	Inner Joint			33		34		
		1997.06-2000.11	-	L/R	F	Estate Engine AHU	861012	Outer Joint	45W	33	30	53	30	62	I
1997.06-2000.11		-	L/R	F	Estate Engine AHU	803018	Outer Joint	45W	33	30	53	30	62	I	
1997.06-2000.11		-	L/R	F	Estate Engine AHU	853007	Outer Joint		22	30	53.2	78	61	I	
1997.06-2000.11		MT	L	F	Estate Engine AHU	203010	Drive Shaft	45W	33		53	30	599		
1997.06-2000.11		5MT	R	F	Estate Engine AHU	603009	Inner Joint			33		34			
1997.06-2000.11		MT	R	F	Estate Engine AHU	203007	Drive Shaft	45W	33		53	30	622		
1997.06-2000.11		AT/MT	L/R	F	Estate Engine AHU	661033	Inner Joint			34		85			
1997.06-2000.11		MT	L	F	Estate Engine AHU	261122	Drive Shaft	45W	33		53	30	602		
1997.06-2000.11		AT	R	F	Estate Engine AHU	299108	Drive Shaft	45W	33		53	30	586		
1997.06-2000.11		5MT	R	F	Estate Engine AHU	261002	Drive Shaft		22	53	78.5	793			
1997.06-2000.11		-	L/R	F	Estate Engine AHU	861018	Outer Joint		22	30	53	78.5	61	I	
1997.06-2000.11		AT	L	F	Estate Engine AHU	203012	Drive Shaft	45W	33		53	30	498		
1997.06-2000.11		MT	R	F	Estate Engine AHU	203009	Drive Shaft	45W	33		53	30	617		
1.9 TDI (74 kW)		2000.02-2000.11	MT	L/R	F	Estate Engine AVB	803021	Outer Joint	45W	33	27	53	30	63	I
		2000.02-2000.11	MT	L	F	Estate Engine AVB	203048	Drive Shaft	45W	38		59.5	34.5	502	
	2000.02-2000.11	AT	L/R	F	Estate Engine AVB	803019	Outer Joint	45W	38	27	59.5	34.5	63	I	
	2000.02-2000.11	AT	R	F	Estate Engine AVB	650019	Inner Joint			34		59.5			
	2000.02-2000.11	MT	L	F	Estate Engine AVB	261083	Drive Shaft	45W	33		53	30	603		
	2000.02-2000.11	MT	R	F	Estate Engine AVB	261082	Drive Shaft	45W	33		53	30	620		
	2000.02-2000.11	AT/MT	L/R	F	Estate Engine AVB	661033	Inner Joint			34		85			
	2000.02-2000.11	AT	R	F	Estate Engine AVB	299108	Drive Shaft	45W	33		53	30	586		
1.9 TDI (81 kW)	1997.06-2000.11	AT	L	F	Estate Engine AVG	203015	Drive Shaft	45W	38		59.5	34.5	527		
	1997.06-2000.11	MT	L/R	F	Estate Engine AVG	661033	Inner Joint			34		85			
	1997.06-2000.11	-	-	F	Estate Engine AVG	650019	Inner Joint			34		59.5			
	1997.06-2000.11	AT	R	F	Estate Engine AVG	203048	Drive Shaft	45W	38		59.5	34.5	502		
	1997.06-2000.11	MT	R	F	Estate Engine AVG	261019	Drive Shaft	45W	38		59.5	34.5	624		
	1997.06-2000.11	-	R	F	Estate Engine AVG	603009	Inner Joint			33		34			
	1997.06-2000.11	MT	L	F	Estate Engine AVG	261314	Drive Shaft		36		53	78	558		
	1997.06-2000.11	MT	L	F	Estate Engine AVG	203008	Drive Shaft	45W	38		59.5	34.5	603		
1997.06-2000.11	AT/MT	L/R	F	Estate Engine AVG	803036	Outer Joint		36	30	53.2	77.5	61	I		

	 YEAR	TRANSM	L/R	F/R	REMARKS	GSP Ref.	 PRODUCT	 ABS	Technical Specifications								
									A	B	C	H	L	P			
VW																	
PASSAT Variant (3B5)																	
1.9 TDI (81 kW)	1997.06-2000.11	AT/MT	L/R	F	Estate Engine AVG	803019	Outer Joint	45W	38	27	59.5	34.5	63	I			
1.9 TDI (85 kW)	1998.08-2000.11	6MT	L	F	Estate Engine AJM	261157	Drive Shaft	45W	38		59.5	34.5	601				
	1998.08-2000.11	AT	L	F	Estate Engine AJM	203015	Drive Shaft	45W	38		59.5	34.5	527				
	1998.08-2000.11	MT	-	F	Estate Engine AJM	650019	Inner Joint			34		59.5					
	1998.08-2000.11	MT	L	F	Estate Engine AJM	261083	Drive Shaft	45W	33		53	30	603				
	1998.08-2000.11	AT	R	F	Estate Engine AJM	203048	Drive Shaft	45W	38		59.5	34.5	502				
	1998.08-2000.11	MT	R	F	Estate Engine AJM	261019	Drive Shaft	45W	38		59.5	34.5	624				
	1998.08-2000.11	MT	R	F	Estate Engine AJM	261082	Drive Shaft	45W	33		53	30	620				
	1998.08-2000.11	AT/MT	L/R	F	Estate Engine AJM	661033	Inner Joint			34		85					
	1998.08-2000.11	MT	L	F	Estate Engine AJM	203008	Drive Shaft	45W	38		59.5	34.5	603				
	1998.08-2000.11	AT/MT	L/R	F	Estate Engine AJM	803019	Outer Joint	45W	38	27	59.5	34.5	63	I			
1.9 TDI 4motion (85 kW)	1998.08-2000.11	6MT	L	F	All-wheel Drive Estate Engine ATJ	261157	Drive Shaft	45W	38		59.5	34.5	601				
	1998.08-2000.11	6MT	L/R	F	All-wheel Drive Estate Engine ATJ	861012	Outer Joint	45W	33	30	53	30	62	I			
	1998.08-2000.11	6MT	L/R	F	All-wheel Drive Estate Engine ATJ	661030	Inner Joint			30		32					
	1998.08-2000.11	MT	L	F	All-wheel Drive Estate Engine ATJ	203048	Drive Shaft	45W	38		59.5	34.5	502				
	1998.08-2000.11	MT	L	F	All-wheel Drive Estate Engine ATJ	261083	Drive Shaft	45W	33		53	30	603				
	1998.08-2000.11	AT	R	F	All-wheel Drive Estate Engine ATJ	650019	Inner Joint			34		59.5					
	1998.08-2000.11	MT	R	F	All-wheel Drive Estate Engine ATJ	261082	Drive Shaft	45W	33		53	30	620				
	1998.08-2000.11	MT	R	F	All-wheel Drive Estate Engine ATJ	261019	Drive Shaft	45W	38		59.5	34.5	624				
	1998.08-2000.11	AT/MT	L/R	F	All-wheel Drive Estate Engine ATJ	661033	Inner Joint			34		85					
	1998.08-2000.11	MT	L	F	All-wheel Drive Estate Engine ATJ	203008	Drive Shaft	45W	38		59.5	34.5	603				
1.9 TDI Syncro/4motion (81 kW)	1998.08-2000.11	6MT	L/R	F	All-wheel Drive Estate Engine ATJ	803019	Outer Joint	45W	38	27	59.5	34.5	63	I			
	1998.08-2000.11	MT	L/R	F	All-wheel Drive Estate Engine ATJ	803021	Outer Joint	45W	33	27	53	30	63	I			
	1997.06-2000.11	-	L/R	F	All-wheel Drive Estate Engine AVG/AFN	861012	Outer Joint	45W	33	30	53	30	62	I			
	1997.06-2000.11	MT	L	F	All-wheel Drive Estate Engine AVG/AFN	203048	Drive Shaft	45W	38		59.5	34.5	502				
	1997.06-2000.11	AT	R	F	All-wheel Drive Estate Engine AVG/AFN	650019	Inner Joint			34		59.5					
	1997.06-2000.11	MT	L/R	F	All-wheel Drive Estate Engine AVG/AFN	661033	Inner Joint			34		85					
	1997.06-2000.11	MT	R	F	All-wheel Drive Estate Engine AVG/AFN	203007	Drive Shaft	45W	33		53	30	622				
	1997.06-2000.11	MT	L	F	All-wheel Drive Estate Engine AVG/AFN	261122	Drive Shaft	45W	33		53	30	602				
	1997.06-2000.11	MT	L	F	All-wheel Drive Estate Engine AVG/AFN	203010	Drive Shaft	45W	33		53	30	599				
	1997.06-2000.11	MT	R	F	All-wheel Drive Estate Engine AVG/AFN	203007	Drive Shaft	45W	33		53	30	622				
2.3 VR5 (110 kW)	1997.06-2000.11	MT	L	F	Estate Engine AGZ	261122	Drive Shaft	45W	33		53	30	602				
	1997.06-2000.11	AT	R	F	Estate Engine AGZ	203020	Outer Joint	45W	38	30	59.5	34	59.5	I			
	1997.06-2000.11	MT	L/R	F	Estate Engine AGZ	861012	Outer Joint	45W	33	30	53	30	62	I			
	1997.06-2000.11	MT	L/R	F	Estate Engine AGZ	661033	Inner Joint			34		85					
	1997.06-2000.11	MT	L	F	Estate Engine AGZ	203010	Drive Shaft	45W	33		53	30	599				
	1997.06-2000.11	MT	R	F	Estate Engine AGZ	203007	Drive Shaft	45W	33		53	30	622				
	1997.06-2000.11	MT	L	F	Estate Engine AGZ	261122	Drive Shaft	45W	33		53	30	602				
	1997.06-2000.11	AT	R	F	Estate Engine AGZ	203020	Outer Joint	45W	38	30	59.5	34	59.5	I			
2.3 VR5 Syncro/4motion (110 kW)	1997.10-2000.11	MT	L/R	F	All-wheel Drive Estate Engine AGZ	203009	Drive Shaft	45W	33		53	30	617				
	1997.10-2000.11	-	R	F	All-wheel Drive Estate Engine AGZ	861012	Outer Joint	45W	33	30	53	30	62	I			
	1997.10-2000.11	-	L	F	All-wheel Drive Estate Engine AGZ	203007	Drive Shaft	45W	33		53	30	622				
2.5 TDI (110 kW)	1997.10-2000.11	-	L	F	All-wheel Drive Estate Engine AGZ	261122	Drive Shaft	45W	33		53	30	602				
	1998.07-2000.11	AT	L	F	Estate Engine AFB/AKN	203015	Drive Shaft	45W	38		59.5	34.5	527				
	1998.07-2000.11	MT	R	F	Estate Engine AFB/AKN	261019	Drive Shaft	45W	38		59.5	34.5	624				
	1998.07-2000.11	AT	R	F	Estate Engine AFB/AKN	203048	Drive Shaft	45W	38		59.5	34.5	502				
	1998.07-2000.11	AT/MT	L/R	F	Estate Engine AFB/AKN	661033	Inner Joint			34		85					
	1998.07-2000.11	AT/MT	L/R	F	Estate Engine AFB/AKN	803019	Outer Joint	45W	38	27	59.5	34.5	63	I			
2.5 TDI Syncro/4motion (110 kW)	1998.07-2000.11	MT	L	F	Estate Engine AFB/AKN	203008	Drive Shaft	45W	38		59.5	34.5	603				
	1998.12-2000.11	MT	R	F	All-wheel Drive Estate Engine AFB/AKN	261019	Drive Shaft	45W	38		59.5	34.5	624				
	1998.12-2000.11	MT	L/R	F	All-wheel Drive Estate Engine AFB/AKN	661033	Inner Joint			34		85					
	1998.12-2000.11	AT	L/R	F	All-wheel Drive Estate Engine AFB/AKN	803020	Outer Joint	45W	38	30	59.5	34	59.5	I			
	1998.12-2000.11	MT	L	F	All-wheel Drive Estate Engine AFB/AKN	203008	Drive Shaft	45W	38		59.5	34.5	603				
2.8 V6 (142 kW)	1998.12-2000.11	MT	L/R	F	All-wheel Drive Estate Engine AFB/AKN	803019	Outer Joint	45W	38	27	59.5	34.5	63	I			
	1997.06-2000.11	AT	L	F	Estate Engine ACK/APR	203015	Drive Shaft	45W	38		59.5	34.5	527				
	1997.06-2000.11	MT	R	F	Estate Engine ACK/APR	261019	Drive Shaft	45W	38		59.5	34.5	624				
	1997.06-2000.11	MT	L/R	F	Estate Engine ACK/APR	661033	Inner Joint			34		85					
	1997.06-2000.11	AT	R	F	Estate Engine ACK/APR	203048	Drive Shaft	45W	38		59.5	34.5	502				
	1997.06-2000.11	MT	L	F	Estate Engine ACK/APR	203008	Drive Shaft	45W	38		59.5	34.5	603				
2.8 V6 Syncro/4motion (142 kW)	1997.06-2000.11	AT/MT	L/R	F	Estate Engine ACK/APR	803019	Outer Joint	45W	38	27	59.5	34.5	63	I			
	1997.06-2000.11	MT	L/R	F	All-wheel Drive Estate Engine AHA	803019	Outer Joint	45W	38	27	59.5	34.5	63	I			
	1997.06-2000.11	AT	L	F	All-wheel Drive Estate Engine AHA	203015	Drive Shaft	45W	38		59.5	34.5	527				
	1997.06-2000.11	MT	L/R	F	All-wheel Drive Estate Engine AHA	661033	Inner Joint			34		85					
	1997.06-2000.11	AT	R	F	All-wheel Drive Estate Engine AHA	203048	Drive Shaft	45W	38		59.5	34.5	502				
	1997.06-2000.11	MT	R	F	All-wheel Drive Estate Engine AHA	261019	Drive Shaft	45W	38		59.5	34.5	624				
	1997.06-2000.11	AT/MT	L/R	F	All-wheel Drive Estate Engine AHA	803020	Outer Joint	45W	38	30	59.5	34	59.5	I			
1997.06-2000.11	MT	L	F	All-wheel Drive Estate Engine AHA	203008	Drive Shaft	45W	38		59.5	34.5	603					
PASSAT Variant (3B6)																	





	 YEAR	TRANSM	L/R	F/R	REMARKS	GSP Ref.	 PRODUCT	 ABS	Technical Specifications					
									A	B	C	H	L	P
VW														
PASSAT Variant (3B6)														
1.6 (75 kW)	2000.11-2005.05	-	R	F	Saloon Engine ALZ	299111	Drive Shaft	45W	33		53	30	636	
	2000.11-2005.05	-	L	F	Saloon Engine ALZ	203002	Drive Shaft	45W	33		53	30	614	
	2000.11-2005.05	MT	L/R	F	Saloon Engine ALZ	861012	Outer Joint	45W	33	30	53	30	62	I
1.8 T 20V (110 kW)	2000.11-2005.05	5MT	L/R	F	Saloon Engine AWT	861012	Outer Joint	45W	33	30	53	30	62	I
	2000.11-2005.05	AT	L	F	Saloon Engine AWT	203015	Drive Shaft	45W	38		59.5	34.5	527	
	2000.11-2005.05	5MT	R	F	Saloon Engine AWT	203001	Drive Shaft	45W	33		53	30	634	
	2000.11-2005.05	5MT	L	F	Saloon Engine AWT	203005	Drive Shaft	45W	33		53	30	614	
	2000.11-2005.05	5AT	L/R	F	Saloon Engine AWT	803019	Outer Joint	45W	38	27	59.5	34.5	63	I
	2000.11-2005.05	5MT	L/R	F	Saloon Engine AWT	803018	Outer Joint	45W	33	30	53	30	62	I
	2000.11-2005.05	AT	R	F	Saloon Engine AWT	203048	Drive Shaft	45W	38		59.5	34.5	502	
	2000.11-2005.05	MT	L	F	Saloon Engine AWT	203010	Drive Shaft	45W	33		53	30	599	
	2000.11-2005.05	AT	L/R	F	Saloon Engine AWT	661033	Inner Joint			34		85		
	2000.11-2005.05	5MT	R	F	Saloon Engine AWT	203007	Drive Shaft	45W	33		53	30	622	
	2000.11-2005.05	5MT	L/R	F	Saloon Engine AWT	603001	Inner Joint			28		32		
	2000.11-2005.05	5MT	L	F	Saloon Engine AWT	261122	Drive Shaft	45W	33		53	30	602	
	2000.11-2005.05	MT	R	F	Saloon Engine AWT	203009	Drive Shaft	45W	33		53	30	617	
1.9 TDI (74 kW)	2000.11-2005.05	5MT	L/R	F	Saloon Engine AVB	803021	Outer Joint	45W	33	27	53	30	63	I
	2000.11-2005.05	5MT	L	F	Saloon Engine AVB	261083	Drive Shaft	45W	33		53	30	603	
	2000.11-2005.05	AT	-	F	Saloon Engine AVB	650019	Inner Joint			34		59.5		
	2000.11-2005.05	5MT	R	F	Saloon Engine AVB	261082	Drive Shaft	45W	33		53	30	620	
	2000.11-2005.05	AT	L	F	Saloon Engine AVB	203048	Drive Shaft	45W	38		59.5	34.5	502	
	2000.11-2005.05	AT/MT	L/R	F	Saloon Engine AVB	661033	Inner Joint			34		85		
	2000.11-2005.05	4AT	L/R	F	Saloon Engine AVB	803019	Outer Joint	45W	38	27	59.5	34.5	63	I
1.9 TDI (96 kW)	2000.11-2005.05	MT	L	F	Saloon Engine AVF	261157	Drive Shaft	45W	38		59.5	34.5	601	
	2000.11-2005.05	AT	L	F	Saloon Engine AVF	203015	Drive Shaft	45W	38		59.5	34.5	527	
	2000.11-2005.05	MT	R	F	Saloon Engine AVF	261019	Drive Shaft	45W	38		59.5	34.5	624	
	2000.11-2005.05	AT	R	F	Saloon Engine AVF	203048	Drive Shaft	45W	38		59.5	34.5	502	
	2000.11-2005.05	AT/MT	L/R	F	Saloon Engine AVF	661033	Inner Joint			34		85		
	2000.11-2005.05	MT	L	F	Saloon Engine AVF	203008	Drive Shaft	45W	38		59.5	34.5	603	
	2000.11-2005.05	-	L/R	F	Saloon Engine AVF	803019	Outer Joint	45W	38	27	59.5	34.5	63	I
1.9 TDI 4motion (96 kW)	2000.11-2005.05	6MT	L	F	All-wheel Drive Saloon Engine AVF	261157	Drive Shaft	45W	38		59.5	34.5	601	
	2000.11-2005.05	AT	L	F	All-wheel Drive Saloon Engine AVF	203015	Drive Shaft	45W	38		59.5	34.5	527	
	2000.11-2005.05	6MT	R	F	All-wheel Drive Saloon Engine AVF	261019	Drive Shaft	45W	38		59.5	34.5	624	
	2000.11-2005.05	AT	R	F	All-wheel Drive Saloon Engine AVF	203048	Drive Shaft	45W	38		59.5	34.5	502	
	2000.11-2005.05	MT	L/R	F	All-wheel Drive Saloon Engine AVF	661033	Inner Joint			34		85		
	2000.11-2005.05	6MT	L	F	All-wheel Drive Saloon Engine AVF	203008	Drive Shaft	45W	38		59.5	34.5	603	
	2000.11-2005.05	-	L/R	F	All-wheel Drive Saloon Engine AVF	803019	Outer Joint	45W	38	27	59.5	34.5	63	I
2.0 (85 kW)	2000.11-2005.05	MT	R	F	Saloon Engine AZM	203001	Drive Shaft	45W	33		53	30	634	
	2000.11-2005.05	AT	L/R	F	Saloon Engine AZM	861012	Outer Joint	45W	33	30	53	30	62	I
	2000.11-2005.05	MT	L	F	Saloon Engine AZM	203005	Drive Shaft	45W	33		53	30	614	
	2000.11-2005.05	MT	L/R	F	Saloon Engine AZM	803018	Outer Joint	45W	33	30	53	30	62	I
	2000.11-2005.05	AT	L/R	F	Saloon Engine AZM	661033	Inner Joint			34		85		
	2000.11-2005.05	MT	L/R	F	Saloon Engine AZM	603001	Inner Joint			28		32		
	2000.11-2005.05	AT	R	F	Saloon Engine AZM	299108	Drive Shaft	45W	33		53	30	586	
	2000.11-2005.05	AT	L	F	Saloon Engine AZM	203012	Drive Shaft	45W	33		53	30	498	
	2000.11-2005.05	MT	R	F	Saloon Engine AZM	203013	Drive Shaft	45W	33		53	30	636	
2.0 (96 kW)	2001.11-2005.05	MT	R	F	Saloon Engine ALT	203009	Drive Shaft	45W	33		53	30	617	
	2001.11-2005.05	MT	L/R	F	Saloon Engine ALT	861012	Outer Joint	45W	33	30	53	30	62	I
	2001.11-2005.05	MT	L	F	Saloon Engine ALT	203010	Drive Shaft	45W	33		53	30	599	
	2001.11-2005.05	MT	R	F	Saloon Engine ALT	203007	Drive Shaft	45W	33		53	30	622	
	2001.11-2005.05	MT	L	F	Saloon Engine ALT	261122	Drive Shaft	45W	33		53	30	602	
	2001.11-2005.05	AT/MT	L/R	F	Saloon Engine ALT	661033	Inner Joint			34		85		
	2001.11-2005.05	MT	R	F	Saloon Engine ALT	203013	Drive Shaft	45W	33		53	30	636	
2.0 4motion (85 kW)	2000.11-2005.05	-	R	F	All-wheel Drive Saloon Engine AZM	299111	Drive Shaft	45W	33		53	30	636	
	2000.11-2005.05	-	L	F	All-wheel Drive Saloon Engine AZM	203002	Drive Shaft	45W	33		53	30	614	
	2000.11-2005.05	MT	L/R	F	All-wheel Drive Saloon Engine AZM	861012	Outer Joint	45W	33	30	53	30	62	I
	2000.11-2005.05	MT	L/R	R	All-wheel Drive Saloon Engine AZM	603001	Inner Joint			28		32		
	2000.11-2005.05	MT	R	F	All-wheel Drive Saloon Engine AZM	203013	Drive Shaft	45W	33		53	30	636	
2.0 TDI (100 kW)	2003.12-2005.05	-	L/R	F	Saloon Engine BGW	803019	Outer Joint	45W	38	27	59.5	34.5	63	I
	2003.12-2005.05	MT	L/R	F	Saloon Engine BGW	661033	Inner Joint			34		85		
	2003.12-2005.05	6MT	R	F	Saloon Engine BGW	261019	Drive Shaft	45W	38		59.5	34.5	624	
	2003.12-2005.05	6MT	L	F	Saloon Engine BGW	203008	Drive Shaft	45W	38		59.5	34.5	603	
2.3 VR5 (125 kW)	2000.11-2005.05	AT/MT	L/R	F	Saloon Engine AZX	803019	Outer Joint	45W	38	27	59.5	34.5	63	I
	2000.11-2005.05	AT	L	F	Saloon Engine AZX	203015	Drive Shaft	45W	38		59.5	34.5	527	
	2000.11-2005.05	AT	R	F	Saloon Engine AZX	203048	Drive Shaft	45W	38		59.5	34.5	502	
	2000.11-2005.05	-	R	F	Saloon Engine AZX	261019	Drive Shaft	45W	38		59.5	34.5	624	
	2000.11-2005.05	AT/MT	L/R	F	Saloon Engine AZX	661033	Inner Joint			34		85		





YEAR	TRANSM	L/R	F/R	REMARKS	GSP Ref.	PRODUCT	ABS	Technical Specifications						
								A	B	C	H	L	P	
VW														
PASSAT Variant (3B6)														
2.3 VR5 (125 kW)	2000.11-2005.05	MT	L	F	Saloon Engine AZX	203008	Drive Shaft	45W	38		59.5	34.5	603	
2.3 VR5 4motion (125 kW)	2000.11-2005.05	AT	L	F	All-wheel Drive Saloon Engine AZX	203015	Drive Shaft	45W	38		59.5	34.5	527	
	2000.11-2005.05	MT	L/R	F	All-wheel Drive Saloon Engine AZX	803019	Outer Joint	45W	38	27	59.5	34.5	63	I
	2000.11-2005.05	AT	R	F	All-wheel Drive Saloon Engine AZX	203048	Drive Shaft	45W	38		59.5	34.5	502	
	2000.11-2005.05	MT	L/R	F	All-wheel Drive Saloon Engine AZX	661033	Inner Joint			34		85		
	2000.11-2005.05	5MT	R	F	All-wheel Drive Saloon Engine AZX	261019	Drive Shaft	45W	38		59.5	34.5	624	
	2000.11-2005.05	5MT	L	F	All-wheel Drive Saloon Engine AZX	203008	Drive Shaft	45W	38		59.5	34.5	603	
2.5 TDI (110 kW)	2000.11-2005.05	AT	L	F	Saloon Engine AKN	203015	Drive Shaft	45W	38		59.5	34.5	527	
	2000.11-2005.05	6MT	R	F	Saloon Engine AKN	261019	Drive Shaft	45W	38		59.5	34.5	624	
	2000.11-2005.05	AT	R	F	Saloon Engine AKN	203048	Drive Shaft	45W	38		59.5	34.5	502	
	2000.11-2005.05	AT/MT	L/R	F	Saloon Engine AKN	661033	Inner Joint			34		85		
	2000.11-2005.05	5AT/6MT	L/R	F	Saloon Engine AKN	803019	Outer Joint	45W	38	27	59.5	34.5	63	I
	2000.11-2005.05	6MT	L	F	Saloon Engine AKN	203008	Drive Shaft	45W	38		59.5	34.5	603	
2.5 TDI (120 kW)	2003.05-2005.05	AT	L	F	Saloon Engine BDG	203015	Drive Shaft	45W	38		59.5	34.5	527	
	2003.05-2005.05	AT/MT	L/R	F	Saloon Engine BDG	803019	Outer Joint	45W	38	27	59.5	34.5	63	I
	2003.05-2005.05	AT	R	F	Saloon Engine BDG	203048	Drive Shaft	45W	38		59.5	34.5	502	
	2003.05-2005.05	MT	R	F	Saloon Engine BDG	261019	Drive Shaft	45W	38		59.5	34.5	624	
	2003.05-2005.05	MT	L	F	Saloon Engine BDG	203008	Drive Shaft	45W	38		59.5	34.5	603	
2.5 TDI 4motion (110 kW)	2000.11-2005.05	AT	L	F	All-wheel Drive Saloon Engine AKN	203015	Drive Shaft	45W	38		59.5	34.5	527	
	2000.11-2005.05	6MT	R	F	All-wheel Drive Saloon Engine AKN	261019	Drive Shaft	45W	38		59.5	34.5	624	
	2000.11-2005.05	AT	R	F	All-wheel Drive Saloon Engine AKN	203048	Drive Shaft	45W	38		59.5	34.5	502	
	2000.11-2005.05	MT	L/R	F	All-wheel Drive Saloon Engine AKN	661033	Inner Joint			34		85		
	2000.11-2005.05	5AT	L/R	F	All-wheel Drive Saloon Engine AKN	803020	Outer Joint	45W	38	30	59.5	34	59.5	I
	2000.11-2005.05	6MT	L	F	All-wheel Drive Saloon Engine AKN	203008	Drive Shaft	45W	38		59.5	34.5	603	
	2000.11-2005.05	6MT	L/R	F	All-wheel Drive Saloon Engine AKN	803019	Outer Joint	45W	38	27	59.5	34.5	63	I
	2000.11-2005.05	6MT	L/R	F	All-wheel Drive Saloon Engine AKN	803019	Outer Joint	45W	38	27	59.5	34.5	63	I
2.5 TDI 4motion (132 kW)	2003.01-2005.05	AT/MT	L/R	F	All-wheel Drive Saloon Engine BAU/BDH	803019	Outer Joint	45W	38	27	59.5	34.5	63	I
	2003.01-2005.05	MT	L/R	F	All-wheel Drive Saloon Engine BAU/BDH	661033	Inner Joint			34		85		
	2003.01-2005.05	MT	R	F	All-wheel Drive Saloon Engine BAU/BDH	261019	Drive Shaft	45W	38		59.5	34.5	624	
	2003.01-2005.05	AT/MT	L/R	R	All-wheel Drive Saloon Engine BAU/BDH	603001	Inner Joint			28		32		
	2003.01-2005.05	MT	L	F	All-wheel Drive Saloon Engine BAU/BDH	203008	Drive Shaft	45W	38		59.5	34.5	603	
2.8 4motion (142 kW)	2000.11-2005.05	MT	L/R	F	All-wheel Drive Saloon Engine AMX/ATQ	661033	Inner Joint			34		85		
	2000.11-2005.05	AT	L	F	All-wheel Drive Saloon Engine AMX/ATQ	203015	Drive Shaft	45W	38		59.5	34.5	527	
	2000.11-2005.05	AT	R	F	All-wheel Drive Saloon Engine AMX/ATQ	203048	Drive Shaft	45W	38		59.5	34.5	502	
	2000.11-2005.05	5MT	R	F	All-wheel Drive Saloon Engine AMX/ATQ	261019	Drive Shaft	45W	38		59.5	34.5	624	
	2000.11-2005.05	5AT/5MT	L/R	F	All-wheel Drive Saloon Engine AMX/ATQ	803019	Outer Joint	45W	38	27	59.5	34.5	63	I
	2000.11-2005.05	5MT	L	F	All-wheel Drive Saloon Engine AMX/ATQ	203008	Drive Shaft	45W	38		59.5	34.5	603	
4.0 W8 4motion (202 kW)	2001.09-2004.09	AT	L	F	All-wheel Drive Saloon Engine BDN	203015	Drive Shaft	45W	38		59.5	34.5	527	
	2001.09-2004.09	AT	L/R	F	All-wheel Drive Saloon Engine BDN	803019	Outer Joint	45W	38	27	59.5	34.5	63	I
	2001.09-2004.09	AT	R	F	All-wheel Drive Saloon Engine BDN	203048	Drive Shaft	45W	38		59.5	34.5	502	
	2001.09-2004.09	MT	R	F	All-wheel Drive Saloon Engine BDN	261019	Drive Shaft	45W	38		59.5	34.5	624	
	2001.09-2004.09	AT/MT	L/R	R	All-wheel Drive Saloon Engine BDN	603001	Inner Joint			28		32		
	2001.09-2004.09	MT	L	F	All-wheel Drive Saloon Engine BDN	203008	Drive Shaft	45W	38		59.5	34.5	603	
PASSAT Variant (3C5)														
1.4 TSI (90 kW)	2007.05-2010.11	Semi-AT	L/R	F	Estate Engine CAXA	803002	Outer Joint		36	27	59.5	40	66	I
	2007.05-2010.11	AT	L	F	Estate Engine CAXA	261201	Drive Shaft		36		59.5	40.5	535	
	2007.05-2010.11	-	-	-	Estate Engine CAXA	603016	Inner Joint			28		32		
	2007.05-2010.11	MT	L/R	F	Estate Engine CAXA	603011	Inner Joint			33		34		
	2007.05-2010.11	MT	L	F	Estate Engine CAXA	261198	Drive Shaft		36		59.5	40.5	530	
	2007.05-2010.11	MT	R	F	Estate Engine CAXA	201586	Drive Shaft		36		59.5	40	806	
	2007.05-2010.11	-	-	-	Estate Engine CAXA	803100	Outer Joint		36	33	59.5	38	55	I
	2007.05-2010.11	6MT	L/R	F	Estate Engine CAXA	803037	Outer Joint		36	30	59.5	40.5	55	I
1.4 TSI EcoFuel (110 kW)	2009.01-2010.11	MT	L	F	Estate Engine CDGA	261224	Drive Shaft		36		59.5	40	536	
	2009.01-2010.11	MT	L/R	F	Estate Engine CDGA	603011	Inner Joint			33		34		
	2009.01-2010.11	MT	L/R	F	Estate Engine CDGA	803037	Outer Joint		36	30	59.5	40.5	55	I
	2009.01-2010.11	AT	L	F	Estate Engine CDGA	261281	Drive Shaft		36		59.5	40	528	
	2009.01-2010.11	AT	L/R	F	Estate Engine CDGA	803002	Outer Joint		36	27	59.5	40	66	I
	2009.01-2010.11	AT	R	F	Estate Engine CDGA	261113	Drive Shaft		36		59.5	40	814	
1.6 (75 kW)	2005.08-2010.11	-	R	F	Estate Engine BSE	261113	Drive Shaft		36		59.5	40	814	
	2005.08-2010.11	MT	-	-	Estate Engine BSE	603006	Inner Joint			33		34		
	2005.08-2010.11	-	L/R	F	Estate Engine BSE	603011	Inner Joint			33		34		
	2005.08-2010.11	-	L	F	Estate Engine BSE	203373	Drive Shaft		36		59.5	38	511	
	2005.08-2010.11	5MT	L/R	F	Estate Engine BSE	803037	Outer Joint		36	30	59.5	40.5	55	I
	2005.08-2010.11	AT	L/R	F	Estate Engine BSE	661011	Inner Joint		26	32	31	68.5	85	
	2005.08-2010.11	-	L	F	Estate Engine BSE	803116	Outer Joint		36	30	59.5	38	55	I
	2005.08-2010.11	-	R	F	Estate Engine BSE	201585	Drive Shaft		36		59.5	40	805	
1.6 FSI (85 kW)	2005.08-2008.06	MT	L	F	Estate Engine BLF	261198	Drive Shaft		36		59.5	40.5	530	
	2005.08-2008.06	6AT/6MT	L/R	F	Estate Engine BLF	803037	Outer Joint		36	30	59.5	40.5	55	I





	 YEAR	TRANSM	L/R	F/R	REMARKS	GSP Ref.	 PRODUCT	 ABS	Technical Specifications						
									A	B	C	H	L	P	
VW															
PASSAT Variant (3C5)															
1.6 FSI (85 kW)	2005.08-2008.06	AT	L	F	Estate Engine BLF	201582	Drive Shaft		36	26	59.5	40	597		
	2005.08-2008.06	AT	L/R	F	Estate Engine BLF	661011	Inner Joint		26	32	31	68.5	85		
1.6 TDI (77 kW)	2009.08-2010.11	MT	-	F	Estate Engine CAYC	803100	Outer Joint		36	33	59.5	38	55	I	
	2009.08-2010.11	MT	L	F	Estate Engine CAYC	261089	Drive Shaft		36		59.5	40.5	521		
	2009.08-2010.11	MT	-	-	Estate Engine CAYC	603006	Inner Joint			33		34			
	2009.08-2010.11	-	L/R	F	Estate Engine CAYC	803002	Outer Joint		36	27	59.5	40	66	I	
	2009.08-2010.11	-	L/R	F	Estate Engine CAYC	603011	Inner Joint			33		34			
	2009.08-2010.11	MT	R	F	Estate Engine CAYC	261200	Drive Shaft		36		59.5	40.5	820		
	2009.08-2010.11	MT	-	-	Estate Engine CAYC	861059	Outer Joint		36	33	59.5	40	59.5	I	
1.8 TSI (118 kW)	2007.05-2011.10	MT	L	F	Estate Engine BZB/CDA	261100	Drive Shaft		36		59.5	40	513		
	2007.05-2011.10	6AT/MT	L/R	F	Estate Engine BZB/CDA	803002	Outer Joint		36	27	59.5	40	66	I	
	2007.05-2011.10	AT	L/R	F	Estate Engine BZB/CDA	661011	Inner Joint		26	32	31	68.5	85		
	2007.05-2011.10	MT	L	F	Estate Engine BZB/CDA	261131	Drive Shaft		36		59.5	40	515		
	2007.05-2011.10	MT	L	F	Estate Engine BZB/CDA	203295	Drive Shaft		36		59.5	40	491		
1.9 TDI (77 kW)	2005.08-2008.11	AT	R	F	Estate Engine BKC/BLS/BSE	254011	Drive Shaft		36		59.5	40	755		
	2005.08-2008.11	MT	L	F	Estate Engine BKC/BLS/BSE	203294	Drive Shaft		36		59.5	38	519		
	2005.08-2008.11	MT	L/R	F	Estate Engine BKC/BLS/BSE	603011	Inner Joint			33		34			
	2005.08-2008.11	AT	L/R	F	Estate Engine BKC/BLS/BSE	661057	Inner Joint			34		86			
	2005.08-2008.11	MT	L/R	F	Estate Engine BKC/BLS/BSE	803037	Outer Joint		36	30	59.5	40.5	55	I	
	2005.08-2008.11	AT	L	F	Estate Engine BKC/BLS/BSE	254013	Drive Shaft		36		59.5	40	479.5		
	2005.08-2008.11	AT	L	F	Estate Engine BKC/BLS/BSE	654004	Inner Joint			34		85			
	2005.08-2008.11	MT	L	F	Estate Engine BKC/BLS/BSE	803116	Outer Joint		36	30	59.5	38	55	I	
	2005.08-2008.11	AT	L	F	Estate Engine BKC/BLS/BSE	203241	Drive Shaft		36		59.5	40	475		
	2005.08-2008.11	MT	R	F	Estate Engine BKC/BLS/BSE	261042	Drive Shaft		36		59.5	40.5	814		
	2005.08-2008.11	AT	L/R	F	Estate Engine BKC/BLS/BSE	803002	Outer Joint		36	27	59.5	40	66	I	
	2005.08-2008.11	MT	R	F	Estate Engine BKC/BLS/BSE	201585	Drive Shaft		36		59.5	40	805		
	2.0 BlueTDI (105 kW)	2009.01-2010.11	AT	R	F	Estate Engine CBAC	254011	Drive Shaft		36		59.5	40	755	
		2009.01-2010.11	-	L/R	F	Estate Engine CBAC	803002	Outer Joint		36	27	59.5	40	66	I
2009.01-2010.11		MT	R	F	Estate Engine CBAC	203313	Drive Shaft		36		59.5	40	792		
2009.01-2010.11		AT	L	F	Estate Engine CBAC	254013	Drive Shaft		36		59.5	40	479.5		
2009.01-2010.11		AT	L	F	Estate Engine CBAC	654004	Inner Joint			34		85			
2009.01-2010.11		MT	L	F	Estate Engine CBAC	203295	Drive Shaft		36		59.5	40	491		
2009.01-2010.11		Semi-AT	L	F	Estate Engine CBAC	203241	Drive Shaft		36		59.5	40	475		
2.0 FSI (110 kW)	2005.08-2010.11	MT	L/R	F	Estate Engine BLR	603011	Inner Joint			33		34			
	2005.08-2010.11	AT	R	F	Estate Engine BLR	261094	Drive Shaft		36	26	59.5	40.5	884		
	2005.08-2010.11	6AT/6MT	L/R	F	Estate Engine BLR	803037	Outer Joint		36	30	59.5	40.5	55	I	
	2005.08-2010.11	AT	L/R	F	Estate Engine BLR	661011	Inner Joint		26	32	31	68.5	85		
	2005.08-2010.11	AT	L	F	Estate Engine BLR	261093	Drive Shaft		36	26	59.5	40.5	587.5		
2.0 FSI (147 kW)	2005.08-2010.11	MT	L	F	Estate Engine AXX	203295	Drive Shaft		36		59.5	40	491		
	2005.08-2010.11	AT/MT	L/R	F	Estate Engine AXX	803002	Outer Joint		36	27	59.5	40	66	I	
	2005.08-2010.11	AT/MT	L/R	F	Estate Engine AXX	861045	Outer Joint		36	27	59.5	40	65	M	
2.0 FSI 4motion (110 kW)	2005.09-2010.11	MT	L	F	All-wheel Drive Estate Engine BLX	203294	Drive Shaft		36		59.5	38	519		
	2005.09-2010.11	-	L/R/F/R		All-wheel Drive Estate Engine BLX	603011	Inner Joint			33		34			
	2005.09-2010.11	MT	L	F	All-wheel Drive Estate Engine BLX	803116	Outer Joint		36	30	59.5	38	55	I	
	2005.09-2010.11	AT	R	F	All-wheel Drive Estate Engine BLX	261094	Drive Shaft		36	26	59.5	40.5	884		
	2005.09-2010.11	6AT/6MT	L/R	F	All-wheel Drive Estate Engine BLX	803037	Outer Joint		36	30	59.5	40.5	55	I	
	2005.09-2010.11	AT	L	F	All-wheel Drive Estate Engine BLX	261093	Drive Shaft		36	26	59.5	40.5	587.5		
	2005.09-2010.11	AT	L/R	F	All-wheel Drive Estate Engine BLX	661011	Inner Joint		26	32	31	68.5	85		
2.0 TDI (100 kW)	2005.08-2010.11	AT	L/R	F	Estate Engine BMA	661057	Inner Joint			34		86			
	2005.08-2010.11	MT	L	F	Estate Engine BMA	203265	Drive Shaft		36		59.5	40	487		
	2005.08-2010.11	-	L/R	F	Estate Engine BMA	803002	Outer Joint		36	27	59.5	40	66	I	
	2005.08-2010.11	MT	R	F	Estate Engine BMA	203313	Drive Shaft		36		59.5	40	792		
	2005.08-2010.11	AT	L	F	Estate Engine BMA	254013	Drive Shaft		36		59.5	40	479.5		
	2005.08-2010.11	AT	L	F	Estate Engine BMA	654004	Inner Joint			34		85			
	2005.08-2010.11	AT	L	F	Estate Engine BMA	203241	Drive Shaft		36		59.5	40	475		
	2005.08-2010.11	MT	R	F	Estate Engine BMA	261126	Drive Shaft		36		59.5	40	793		
	2005.08-2010.11	MT	L	F	Estate Engine BMA	203295	Drive Shaft		36		59.5	40	491		
	2005.08-2010.11	-	L/R	F	Estate Engine BMA	861045	Outer Joint		36	27	59.5	40	65	M	
	2005.08-2010.11	AT	R	F	Estate Engine BMA	254011	Drive Shaft		36		59.5	40	755		
	2.0 TDI (103 kW)	2005.08-2009.05	AT	L/R	F	Estate Engine BMP	661057	Inner Joint			34		86		
2005.08-2009.05		MT	L	F	Estate Engine BMP	203265	Drive Shaft		36		59.5	40	487		
2005.08-2009.05		-	L/R	F	Estate Engine BMP	803002	Outer Joint		36	27	59.5	40	66	I	
2005.08-2009.05		MT	R	F	Estate Engine BMP	203313	Drive Shaft		36		59.5	40	792		
2005.08-2009.05		AT	L	F	Estate Engine BMP	254013	Drive Shaft		36		59.5	40	479.5		
2005.08-2009.05		AT	L	F	Estate Engine BMP	654004	Inner Joint			34		85			
2005.08-2009.05		MT	R	F	Estate Engine BMP	261126	Drive Shaft		36		59.5	40	793		

	 YEAR	TRANSM	L/R	F/R	REMARKS	GSP Ref.	 PRODUCT	 ABS	Technical Specifications					
									A	B	C	H	L	P
VW														
PASSAT Variant (3C5)														
2.0 TDI (103 kW)	2005.08-2009.05	MT	L	F	Estate Engine BMP	203295	Drive Shaft		36		59.5	40	491	
	2005.08-2009.05	-	L/R	F	Estate Engine BMP	861045	Outer Joint		36	27	59.5	40	65	M
	2005.08-2009.05	AT	R	F	Estate Engine BMP	254011	Drive Shaft		36		59.5	40	755	
	2005.08-2009.05	Semi-AT	L	F	Estate Engine BMP	203241	Drive Shaft		36		59.5	40	475	
2.0 TDI (120 kW)	2005.08-2009.05	AT	R	F	Estate Engine BUZ	254011	Drive Shaft		36		59.5	40	755	
	2005.08-2009.05	AT	L	F	Estate Engine BUZ	254013	Drive Shaft		36		59.5	40	479.5	
	2005.08-2009.05	AT	L	F	Estate Engine BUZ	654004	Inner Joint			34		85		
	2005.08-2009.05	Semi-AT	L	F	Estate Engine BUZ	203241	Drive Shaft		36		59.5	40	475	
	2005.08-2009.05	-	L/R	F	Estate Engine BUZ	861045	Outer Joint		36	27	59.5	40	65	M
2.0 TDI (125 kW)	2005.08-2010.11	AT	L	F	Estate Engine BMR	254013	Drive Shaft		36		59.5	40	479.5	
	2005.08-2010.11	AT	L	F	Estate Engine BMR	654004	Inner Joint			34		85		
	2005.08-2010.11	6AT/6MT	L/R	F	Estate Engine BMR	861045	Outer Joint		36	27	59.5	40	65	M
	2005.08-2010.11	Semi-AT	L	F	Estate Engine BMR	203241	Drive Shaft		36		59.5	40	475	
	2005.08-2010.11	AT	R	F	Estate Engine BMR	254011	Drive Shaft		36		59.5	40	755	
2.0 TDI (81 kW)	2008.11-2010.11	MT	-	F	Estate Engine CBDC	803100	Outer Joint		36	33	59.5	38	55	I
	2008.11-2010.11	MT	L	F	Estate Engine CBDC	261089	Drive Shaft		36		59.5	40.5	521	
	2008.11-2010.11	-	L/R	F	Estate Engine CBDC	803002	Outer Joint		36	27	59.5	40	66	I
	2008.11-2010.11	MT	-	-	Estate Engine CBDC	603006	Inner Joint				33		34	
	2008.11-2010.11	-	L/R	F	Estate Engine CBDC	603011	Inner Joint				33		34	
	2008.11-2010.11	MT	R	F	Estate Engine CBDC	261200	Drive Shaft		36		59.5	40.5	820	
	2008.11-2010.11	MT	-	-	Estate Engine CBDC	861059	Outer Joint		36	33	59.5	40	59.5	I
2.0 TDI (88 kW)	2005.11-2007.05	MT	L	F	Estate Engine BWV	203295	Drive Shaft		36		59.5	40	491	
	2005.11-2007.05	AT	L/R	F	Estate Engine BWV	661057	Inner Joint			34		86		
	2005.11-2007.05	MT	R	F	Estate Engine BWV	203313	Drive Shaft		36		59.5	40	792	
	2005.11-2007.05	AT	L	F	Estate Engine BWV	254013	Drive Shaft		36		59.5	40	479.5	
	2005.11-2007.05	AT	L	F	Estate Engine BWV	654004	Inner Joint			34		85		
	2005.11-2007.05	AT/MT	L/R	F	Estate Engine BWV	803002	Outer Joint		36	27	59.5	40	66	I
	2005.11-2007.05	AT	R	F	Estate Engine BWV	254011	Drive Shaft		36		59.5	40	755	
2.0 TDI (90 kW)	2005.08-2006.02	AT	R	F	Estate Engine BVE	254011	Drive Shaft		36		59.5	40	755	
	2005.08-2006.02	MT	L	F	Estate Engine BVE	203295	Drive Shaft		36		59.5	40	491	
	2005.08-2006.02	AT	L/R	F	Estate Engine BVE	661057	Inner Joint			34		86		
	2005.08-2006.02	MT	R	F	Estate Engine BVE	203313	Drive Shaft		36		59.5	40	792	
	2005.08-2006.02	AT	L	F	Estate Engine BVE	254013	Drive Shaft		36		59.5	40	479.5	
	2005.08-2006.02	AT	L	F	Estate Engine BVE	654004	Inner Joint			34		85		
	2005.08-2006.02	AT/MT	L/R	F	Estate Engine BVE	803002	Outer Joint		36	27	59.5	40	66	I
2.0 TDI 16V (103 kW)	2005.08-2010.11	AT	L/R	F	Estate Engine BKP/CBAB	661057	Inner Joint			34		86		
	2005.08-2010.11	MT	L	F	Estate Engine BKP/CBAB	203265	Drive Shaft		36		59.5	40	487	
	2005.08-2010.11	-	L/R	F	Estate Engine BKP/CBAB	803002	Outer Joint		36	27	59.5	40	66	I
	2005.08-2010.11	MT	R	F	Estate Engine BKP/CBAB	203313	Drive Shaft		36		59.5	40	792	
	2005.08-2010.11	AT	L	F	Estate Engine BKP/CBAB	254013	Drive Shaft		36		59.5	40	479.5	
	2005.08-2010.11	AT	L	F	Estate Engine BKP/CBAB	654004	Inner Joint			34		85		
	2005.08-2010.11	AT	L	F	Estate Engine BKP/CBAB	203241	Drive Shaft		36		59.5	40	475	
	2005.08-2010.11	MT	R	F	Estate Engine BKP/CBAB	261126	Drive Shaft		36		59.5	40	793	
	2005.08-2010.11	-	L/R	F	Estate Engine BKP/CBAB	861045	Outer Joint		36	27	59.5	40	65	M
	2005.08-2010.11	MT	L	F	Estate Engine BKP/CBAB	203295	Drive Shaft		36		59.5	40	491	
2005.08-2010.11	AT	R	F	Estate Engine BKP/CBAB	254011	Drive Shaft		36		59.5	40	755		
2.0 TDI 16V 4motion (103 kW)	2005.08-2010.11	6AT/6MT	L/R	F	All-wheel Drive Estate Engine BKP	803002	Outer Joint		36	27	59.5	40	66	I
	2005.08-2010.11	-	L/R	R	All-wheel Drive Estate Engine BKP	803037	Outer Joint		36	30	59.5	40.5	55	I
	2005.08-2010.11	-	L	F	All-wheel Drive Estate Engine BKP	203295	Drive Shaft		36		59.5	40	491	
	2005.08-2010.11	-	L/R	R	All-wheel Drive Estate Engine BKP	603011	Inner Joint			33		34		
	2005.08-2010.11	-	R	F	All-wheel Drive Estate Engine BKP	203266	Drive Shaft		36		59.5	40	601	
2.0 TDI 4motion (103 kW)	2005.08-2009.05	-	L/R	R	All-wheel Drive Estate Engine BMP	803037	Outer Joint		36	30	59.5	40.5	55	I
	2005.08-2009.05	-	L/R	R	All-wheel Drive Estate Engine BMP	603011	Inner Joint			33		34		
	2005.08-2009.05	6AT/6MT	L/R	F	All-wheel Drive Estate Engine BMP	803002	Outer Joint		36	27	59.5	40	66	I
	2005.08-2009.05	MT	R	F	All-wheel Drive Estate Engine BMP	203266	Drive Shaft		36		59.5	40	601	
	2005.08-2009.05	Semi-AT	L	F	All-wheel Drive Estate Engine BMP	654004	Inner Joint			34		85		
	2005.08-2009.05	Semi-AT	L	F	All-wheel Drive Estate Engine BMP	203241	Drive Shaft		36		59.5	40	475	
	2005.08-2009.05	-	L	F	All-wheel Drive Estate Engine BMP	203295	Drive Shaft		36		59.5	40	491	
	2005.08-2009.05	-	L	F	All-wheel Drive Estate Engine BMP	254013	Drive Shaft		36		59.5	40	479.5	
2.0 TDI 4motion (125 kW)	2009.05-2010.11	-	L	F	All-wheel Drive Estate Engine CBBB	254013	Drive Shaft		36		59.5	40	479.5	
	2009.05-2010.11	-	L	F	All-wheel Drive Estate Engine CBBB	654004	Inner Joint			34		85		
	2009.05-2010.11	-	L/R	F	All-wheel Drive Estate Engine CBBB	803002	Outer Joint		36	27	59.5	40	66	I
	2009.05-2010.11	-	L/R	R	All-wheel Drive Estate Engine CBBB	603011	Inner Joint			33		34		
	2009.05-2010.11	Semi-AT	L	F	All-wheel Drive Estate Engine CBBB	203241	Drive Shaft		36		59.5	40	475	
3.2 FSI 4motion (184 kW)	2005.11-2010.11	AT/MT	L/R	R	All-wheel Drive Estate Engine AXZ	803037	Outer Joint		36	30	59.5	40.5	55	I
	2005.11-2010.11	AT/MT	L/R	F	All-wheel Drive Estate Engine AXZ	661057	Inner Joint			34		86		
	2005.11-2010.11	AT/MT	L/R	R	All-wheel Drive Estate Engine AXZ	603011	Inner Joint			33		34		

YEAR	TRANS	L/R	F/R	REMARKS	GSP Ref.	PRODUCT	ABS	Technical Specifications					
								A	B	C	H	L	P
VW													
PASSAT Variant (3C5)													
3.2 FSI 4motion (184 kW)	2005.11-2010.11	-	L	F	All-wheel Drive Estate Engine AXZ	254013	Drive Shaft	36		59.5	40	479.5	
	2005.11-2010.11	AT	L	F	All-wheel Drive Estate Engine AXZ	203241	Drive Shaft	36		59.5	40	475	
	2005.11-2010.11	-	L	F	All-wheel Drive Estate Engine AXZ	654004	Inner Joint		34		85		
	2005.11-2010.11	MT	R	F	All-wheel Drive Estate Engine AXZ	203266	Drive Shaft	36		59.5	40	601	
	2005.11-2010.11	AT/MT	L/R	F	All-wheel Drive Estate Engine AXZ	803002	Outer Joint	36	27	59.5	40	66	I
	2005.11-2010.11	AT	-	-	All-wheel Drive Estate Engine AXZ	603016	Inner Joint		28		32		
	2005.11-2010.11	AT	-	-	All-wheel Drive Estate Engine AXZ	603006	Inner Joint		33		34		
	2005.11-2010.11	-	L	F	All-wheel Drive Estate Engine AXZ	203295	Drive Shaft	36		59.5	40	491	
3.6 R36 4motion (220 kW)	2007.04-2010.11	-	L/R	R	All-wheel Drive Estate Engine BWS	603011	Inner Joint		33		34		
	2007.04-2010.11	AT	-	-	All-wheel Drive Estate Engine BWS	603016	Inner Joint		28		32		
	2007.04-2010.11	AT	-	-	All-wheel Drive Estate Engine BWS	603006	Inner Joint		33		34		
PASSAT Variant (3G5)													
1.4 TSI 4motion (110 kW)	2015.02-	-	-	F	All-wheel Drive Estate Engine CZEA	803101	Outer Joint	36	27	59.5	40	65	M
1.6 TDI (88 kW)	2014.08-	-	Semi-AT/MT	L	Estate Engine DCZA	261201	Drive Shaft	36		59.5	40.5	535	
1.8 TSI (132 kW)	2015.02-	-	AT	-	Estate Engine CJSA	603016	Inner Joint		28		32		
	2015.02-	-	MT	L	Estate Engine CJSA	261131	Drive Shaft	36		59.5	40	515	
2.0 TDI (110 kW)	2014.11-	-	6AT	L	Estate Engine CRLB/DBG/DFGA	203381	Drive Shaft	36		59.5	40	486	
	2014.11-	-	AT	-	Estate Engine CRLB/DBG/DFGA	603006	Inner Joint		33		34		
	2014.11-	-	6AT	R	Estate Engine CRLB/DBG/DFGA	261345	Drive Shaft	36		59.5	40	774	
	2014.11-	-	AT	-	Estate Engine CRLB/DBG/DFGA	603016	Inner Joint		28		32		
	2014.11-	-	MT	L	Estate Engine CRLB/DBG/DFGA	261131	Drive Shaft	36		59.5	40	515	
2.0 TDI (135 kW)	2015.07-	-	AT	-	Estate Engine CUPA	603006	Inner Joint		33		34		
2.0 TDI (140 kW)	2014.11-	-	AT	-	Estate Engine DDAA/DFCA	603016	Inner Joint		28		32		
	2014.11-	-	6AT	L	Estate Engine DDAA/DFCA	203381	Drive Shaft	36		59.5	40	486	
	2014.11-	-	AT	-	Estate Engine DDAA/DFCA	603006	Inner Joint		33		34		
	2014.11-	-	MT	L	Estate Engine DDAA/DFCA	261131	Drive Shaft	36		59.5	40	515	
2.0 TDI 4motion (110 kW)	2015.02-	-	AT	-	All-wheel Drive Estate Engine DFEA	603006	Inner Joint		33		34		
	2015.02-	-	AT	-	All-wheel Drive Estate Engine DFEA	603016	Inner Joint		28		32		
	2015.02-	-	6AT	L	All-wheel Drive Estate Engine DFEA	203381	Drive Shaft	36		59.5	40	486	
	2015.02-	-	-	F	All-wheel Drive Estate Engine DFEA	803101	Outer Joint	36	27	59.5	40	65	M
	2015.02-	-	MT	L/R	All-wheel Drive Estate Engine DFEA	603011	Inner Joint		33		34		
2.0 TDI 4motion (140 kW)	2014.11-	-	AT	-	All-wheel Drive Estate Engine DDAA	603016	Inner Joint		28		32		
	2014.11-	-	6AT	L	All-wheel Drive Estate Engine DDAA	203381	Drive Shaft	36		59.5	40	486	
	2014.11-	-	AT	L/R	All-wheel Drive Estate Engine DDAA	603011	Inner Joint		33		34		
	2014.11-	-	6AT	R	All-wheel Drive Estate Engine DDAA	261346	Drive Shaft	36		59.5	40	589	
	2014.11-	-	AT	-	All-wheel Drive Estate Engine DDAA	603006	Inner Joint		33		34		
2.0 TDI 4motion (176 kW)	2014.08-	-	AT	R	All-wheel Drive Estate Engine CUAA	661048	Inner Joint	40	34	46.9	47	80.5	
	2014.08-	-	AT	L/R	All-wheel Drive Estate Engine CUAA	603011	Inner Joint		33		34		
	2014.08-	-	AT	-	All-wheel Drive Estate Engine CUAA	603006	Inner Joint		33		34		
280TSI (110 kW)	2014.11-	-	-	F	Estate Engine CZEA	803101	Outer Joint	36	27	59.5	40	65	M
380TSI (162 kW)	2015.02-	-	AT	-	Estate Engine CHHB	603016	Inner Joint		28		32		
	2015.02-	-	AT	R	Estate Engine CHHB	661048	Inner Joint	40	34	46.9	47	80.5	
PASSAT/VARIANT													
-	2006-2007	-	-	-	-	201597	Drive Shaft	36		59.5	40	652	
	2009-2015	-	-	-	-	201594	Drive Shaft	36		59.5	40	800	
1.6	2006-2011	-	-	-	-	201583	Drive Shaft	36	26	59.5	40	873	
PHAETON													
-	2002-2016	-	-	-	-	201595	Drive Shaft	38		59.5	34	535	
PHAETON (3D1 3D2 3D3 3D4 3D6 3D7 3D8 3D9)													
3.0 V6 TDI 4motion (165 kW)	2004.09-2007.05	-	-	-	All-wheel Drive Saloon Engine BMK	803099	Outer Joint	38	27	59.5	34.5	64	M
3.0 V6 TDI 4motion (171 kW)	2007.06-2008.11	-	-	-	All-wheel Drive Saloon Engine CARA	803099	Outer Joint	38	27	59.5	34.5	64	M
3.0 V6 TDI 4motion (176 kW)	2008.11-2016.03	-	-	-	All-wheel Drive Saloon Engine CEXA	803099	Outer Joint	38	27	59.5	34.5	64	M
3.2 V6 (177 kW)	2002.04-2005.05	-	-	F	Saloon Engine AYT	650019	Inner Joint		34		59.5		
	2002.04-2005.05	-	-	F	Saloon Engine AYT	899351	Outer Joint	38	29	59.5	34	70	M
3.2 V6 4motion (177 kW)	2004.02-2008.11	-	-	-	All-wheel Drive Saloon Engine BRK	650019	Inner Joint		34		59.5		
	2004.02-2008.11	-	-	-	All-wheel Drive Saloon Engine BRK	899351	Outer Joint	38	29	59.5	34	70	M
4.2 V8 4motion (246 kW)	2003.05-2016.03	-	-	-	All-wheel Drive Saloon Engine BGJ	803099	Outer Joint	38	27	59.5	34.5	64	M
POINTER													
1.8	1993.01-1996.12	MT	-	-	-	818100	Outer Joint	25	30	56.5	89	56.5	I
	1993.01-1996.12	MT	-	-	-	618018	Inner Joint		33		32		
2.0	1993.01-1996.12	MT	-	-	-	818100	Outer Joint	25	30	56.5	89	56.5	I
	1993.01-1996.12	MT	-	-	-	618018	Inner Joint		33		32		
POLO													
1.4	-	-	AT	L	-	261022	Drive Shaft	36		52	75	513	
	-	-	AT	R	-	261023	Drive Shaft	36		52	75	747	
1.6	-	-	AT	L	-	261024	Drive Shaft	36		52	75	517.5	





	 YEAR	TRANSM	L/R	F/R	REMARKS	GSP Ref.	 PRODUCT	 ABS	Technical Specifications					
									A	B	C	H	L	P
VW														
POLO														
1.6 8V (EA111)	2003.01-2011.06	MT	-	-	-	861037	Outer Joint		22	30	51	78	61	I
1.6/2.0 8V	2003.01-2011.12	-	-	-	-	854003	Outer Joint		36	30	52	75	56	I
2.0 8V	2003.01-2011.06	MT	-	-	-	861037	Outer Joint		22	30	51	78	61	I
POLO (6N1)														
1.0 (33 kW)	1994.10-1996.09	MT	R	F	Hatchback Engine AEV	261010	Drive Shaft		22		53	78.5	740	
	1994.10-1996.09	MT	L/R	F	Hatchback Engine AEV	653001	Inner Joint			33		32		
	1994.10-1996.09	MT	L	F	Hatchback Engine AEV	261007	Drive Shaft		22		53	78.5	517	
	1994.10-1996.09	MT	L/R	F	Hatchback Engine AEV	853005	Outer Joint		22	30	53	78.5	51	I
1.0 (37 kW)	1996.09-1999.10	-	R	F	Hatchback Engine AER/ALL	261010	Drive Shaft		22		53	78.5	740	
	1996.09-1999.10	MT	L/R	F	Hatchback Engine AER/ALL	653001	Inner Joint			33		32		
	1996.09-1999.10	-	L	F	Hatchback Engine AER/ALL	261007	Drive Shaft		22		53	78.5	517	
	1996.09-1999.10	AT/MT	L/R	F	Hatchback Engine AER/ALL	853005	Outer Joint		22	30	53	78.5	51	I
1.3 (40 kW)	1994.10-1995.07	MT	R	F	Hatchback Engine ADX	261010	Drive Shaft		22		53	78.5	740	
	1994.10-1995.07	MT	L/R	F	Hatchback Engine ADX	653001	Inner Joint			33		32		
	1994.10-1995.07	MT	L	F	Hatchback Engine ADX	261007	Drive Shaft		22		53	78.5	517	
	1994.10-1995.07	MT	L/R	F	Hatchback Engine ADX	853005	Outer Joint		22	30	53	78.5	51	I
1.4 (40 kW)	1995.08-1999.10	MT	R	F	Hatchback Engine AEX	261010	Drive Shaft		22		53	78.5	740	
	1995.08-1999.10	MT	L/R	F	Hatchback Engine AEX	653001	Inner Joint			33		32		
	1995.08-1999.10	MT	L	F	Hatchback Engine AEX	261007	Drive Shaft		22		53	78.5	517	
	1995.08-1999.10	AT/MT	L/R	F	Hatchback Engine AEX	853005	Outer Joint		22	30	53	78.5	51	I
1.4 (44 kW)	1995.07-1999.10	MT	R	F	Hatchback Engine AEX	261010	Drive Shaft		22		53	78.5	740	
	1995.07-1999.10	AT/MT	L/R	F	Hatchback Engine AEX	653001	Inner Joint			33		32		
	1995.07-1999.10	MT	L	F	Hatchback Engine AEX	261007	Drive Shaft		22		53	78.5	517	
	1995.07-1999.10	AT/MT	L/R	F	Hatchback Engine AEX	853005	Outer Joint		22	30	53	78.5	51	I
1.4 16V (74 kW)	1996.04-1999.10	-	R	F	Hatchback Engine AFH	261010	Drive Shaft		22		53	78.5	740	
	1996.04-1999.10	MT	L/R	F	Hatchback Engine AFH	653001	Inner Joint			33		32		
	1996.04-1999.10	-	L	F	Hatchback Engine AFH	261007	Drive Shaft		22		53	78.5	517	
	1996.04-1999.10	AT/MT	L/R	F	Hatchback Engine AFH	853005	Outer Joint		22	30	53	78.5	51	I
1.6 (55 kW)	1994.10-1999.10	MT	R	F	Hatchback Engine AEE	261010	Drive Shaft		22		53	78.5	740	
	1994.10-1999.10	MT	L/R	F	Hatchback Engine AEE	653001	Inner Joint			33		32		
	1994.10-1999.10	MT	L	F	Hatchback Engine AEE	261007	Drive Shaft		22		53	78.5	517	
	1994.10-1999.10	MT	L/R	F	Hatchback Engine AEE	853005	Outer Joint		22	30	53	78.5	51	I
1.7 SDI (42 kW)	1997.04-1999.10	-	R	F	Hatchback Engine AHG	261010	Drive Shaft		22		53	78.5	740	
	1997.04-1999.10	MT	L/R	F	Hatchback Engine AHG	653001	Inner Joint			33		32		
	1997.04-1999.10	-	L	F	Hatchback Engine AHG	261007	Drive Shaft		22		53	78.5	517	
	1997.04-1999.10	-	L/R	F	Hatchback Engine AHG	853005	Outer Joint		22	30	53	78.5	51	I
1.7 SDI (44 kW)	1997.08-1999.10	MT	R	F	Hatchback Engine AKU	261010	Drive Shaft		22		53	78.5	740	
	1997.08-1999.10	MT	L/R	F	Hatchback Engine AKU	653001	Inner Joint			33		32		
	1997.08-1999.10	MT	L	F	Hatchback Engine AKU	261007	Drive Shaft		22		53	78.5	517	
	1997.08-1999.10	AT/MT	L/R	F	Hatchback Engine AKU	853005	Outer Joint		22	30	53	78.5	51	I
1.9 D (47 kW)	1994.10-1999.10	MT	R	F	Hatchback Engine AEF	261010	Drive Shaft		22		53	78.5	740	
	1994.10-1999.10	MT	L/R	F	Hatchback Engine AEF	653001	Inner Joint			33		32		
	1994.10-1999.10	MT	L/R	F	Hatchback Engine AEF	853005	Outer Joint		22	30	53	78.5	51	I
	1994.10-1999.10	MT	L	F	Hatchback Engine AEF	261007	Drive Shaft		22		53	78.5	517	
1.9 SDI (47 kW)	1996.07-1999.10	MT	L/R	F	Hatchback Engine AGD	653001	Inner Joint			33		32		
	1996.07-1999.10	MT	R	F	Hatchback Engine AGD	261010	Drive Shaft		22		53	78.5	740	
	1996.07-1999.10	MT	L/R	F	Hatchback Engine AGD	853005	Outer Joint		22	30	53	78.5	51	I
	1996.07-1999.10	MT	L	F	Hatchback Engine AGD	261007	Drive Shaft		22		53	78.5	517	
120 1.6 16V GTI (88 kW)	1998.09-1999.10	-	L	F	Hatchback Engine AJV	261043	Drive Shaft		22		53.2	78	535	
	1998.09-1999.10	-	L/R	F	Hatchback Engine AJV	653001	Inner Joint			33		32		
	1998.09-1999.10	MT	L/R	F	Hatchback Engine AJV	861007	Outer Joint		22	30	53	78.5	60	I
POLO (6N2)														
1.0 (37 kW)	1999.10-2001.09	MT	L	F	Hatchback Engine ALD/AUC	261205	Drive Shaft		22	0	53	78.5	525	
	1999.10-2001.09	-	R	F	Hatchback Engine ALD/AUC	261010	Drive Shaft		22		53	78.5	740	
	1999.10-2001.09	MT	R	F	Hatchback Engine ALD/AUC	261189	Drive Shaft		22		53	78.5	751	
	1999.10-2001.09	MT	L/R	F	Hatchback Engine ALD/AUC	653001	Inner Joint			33		32		
	1999.10-2001.09	-	L	F	Hatchback Engine ALD/AUC	261007	Drive Shaft		22		53	78.5	517	
	1999.10-2001.09	AT/MT	L/R	F	Hatchback Engine ALD/AUC	853005	Outer Joint		22	30	53	78.5	51	I
1.4 (40 kW)	1999.10-2001.09	MT	L	F	Hatchback Engine ANX	261205	Drive Shaft		22	0	53	78.5	525	
	1999.10-2001.09	MT	R	F	Hatchback Engine ANX	261010	Drive Shaft		22		53	78.5	740	
	1999.10-2001.09	MT	R	F	Hatchback Engine ANX	261189	Drive Shaft		22		53	78.5	751	
	1999.10-2001.09	MT	L/R	F	Hatchback Engine ANX	653001	Inner Joint			33		32		
	1999.10-2001.09	MT	L	F	Hatchback Engine ANX	261007	Drive Shaft		22		53	78.5	517	
	1999.10-2001.09	AT/MT	L/R	F	Hatchback Engine ANX	853005	Outer Joint		22	30	53	78.5	51	I
	1999.10-2001.09	AT	L/R	F	Hatchback Engine ANX	661005	Inner Joint			30		57.6		
	1999.10-2001.09	MT	L	F	Hatchback Engine ANX	261205	Drive Shaft		22	0	53	78.5	525	

	 YEAR	TRANSM	L/R	F/R	REMARKS	GSP Ref.	 PRODUCT	 ABS	Technical Specifications					
									A	B	C	H	L	P
VW														
POLO (6N2)														
1.4 (44 kW)	1999.10-2001.09	MT	R	F	Hatchback Engine AKK	261189	Drive Shaft		22		53	78.5	751	
	1999.10-2001.09	AT/MT	L/R	F	Hatchback Engine AKK	653001	Inner Joint			33		32		
	1999.10-2001.09	AT/MT	L/R	F	Hatchback Engine AKK	853005	Outer Joint	22	30	53	78.5	51	I	
	1999.10-2001.09	AT	L/R	F	Hatchback Engine AKK	661005	Inner Joint			30		57.6		
1.4 16V (55 kW)	1999.10-2001.09	MT	R	F	Hatchback Engine APE	261189	Drive Shaft		22		53	78.5	751	
	1999.10-2001.09	MT	L/R	F	Hatchback Engine APE	653001	Inner Joint			33		32		
	1999.10-2001.09	AT/MT	L/R	F	Hatchback Engine APE	853005	Outer Joint	22	30	53	78.5	51	I	
	1999.10-2001.09	AT	L/R	F	Hatchback Engine APE	661005	Inner Joint			30		57.6		
	1999.10-2001.09	MT	L	F	Hatchback Engine APE	261205	Drive Shaft		22	0	53	78.5	525	
1.4 16V (74 kW)	1999.10-2001.09	MT	L	F	Hatchback Engine AFK	261205	Drive Shaft		22	0	53	78.5	525	
	1999.10-2001.09	MT	R	F	Hatchback Engine AFK	261189	Drive Shaft		22		53	78.5	751	
	1999.10-2001.09	-	R	F	Hatchback Engine AFK	261010	Drive Shaft		22		53	78.5	740	
	1999.10-2001.09	MT	L/R	F	Hatchback Engine AFK	653001	Inner Joint			33		32		
	1999.10-2001.09	-	L	F	Hatchback Engine AFK	261007	Drive Shaft		22		53	78.5	517	
	1999.10-2001.09	AT/MT	L/R	F	Hatchback Engine AFK	853005	Outer Joint	22	30	53	78.5	51	I	
1.4 TDI (55 kW)	1999.10-2001.09	-	-	-	Hatchback Engine AMF	653002	Inner Joint			33		34		
	1999.10-2001.09	MT	L/R	F	Hatchback Engine AMF	861007	Outer Joint	22	30	53	78.5	60	I	
	1999.10-2001.09	-	L/R	F	Hatchback Engine AMF	661006	Inner Joint			30		57.6		
	1999.10-2001.09	-	L	F	Hatchback Engine AMF	261075	Drive Shaft		22		53	78.5	525	
	1999.10-2001.09	-	R	F	Hatchback Engine AMF	261074	Drive Shaft		22		53	78.5	712	
1.6 16V GTI (92 kW)	1999.10-2001.09	MT	R	F	Hatchback Engine ARC	261189	Drive Shaft		22		53	78.5	751	
	1999.10-2001.09	MT	L/R	F	Hatchback Engine ARC	653001	Inner Joint			33		32		
	1999.10-2001.09	MT	L/R	F	Hatchback Engine ARC	861007	Outer Joint	22	30	53	78.5	60	I	
	1999.10-2001.09	MT	L	F	Hatchback Engine ARC	261205	Drive Shaft		22	0	53	78.5	525	
1.7 SDI (44 kW)	1999.10-2001.09	MT	R	F	Hatchback Engine AKU	261010	Drive Shaft		22		53	78.5	740	
	1999.10-2001.09	MT	L/R	F	Hatchback Engine AKU	653001	Inner Joint			33		32		
	1999.10-2001.09	MT	L	F	Hatchback Engine AKU	261007	Drive Shaft		22		53	78.5	517	
	1999.10-2001.09	AT/MT	L/R	F	Hatchback Engine AKU	853005	Outer Joint	22	30	53	78.5	51	I	
1.9 D (47 kW)	1999.10-2001.09	MT	L	F	Hatchback Engine AEF	261205	Drive Shaft		22	0	53	78.5	525	
	1999.10-2001.09	MT	R	F	Hatchback Engine AEF	261189	Drive Shaft		22		53	78.5	751	
	1999.10-2001.09	MT	L/R	F	Hatchback Engine AEF	653001	Inner Joint			33		32		
	1999.10-2001.09	MT	L/R	F	Hatchback Engine AEF	853005	Outer Joint	22	30	53	78.5	51	I	
1.9 SDI (47 kW)	1999.10-2001.09	MT	L	F	Hatchback Engine AGD/ASX	261205	Drive Shaft		22	0	53	78.5	525	
	1999.10-2001.09	MT	R	F	Hatchback Engine AGD/ASX	261189	Drive Shaft		22		53	78.5	751	
	1999.10-2001.09	MT	L/R	F	Hatchback Engine AGD/ASX	653001	Inner Joint			33		32		
	1999.10-2001.09	MT	L/R	F	Hatchback Engine AGD/ASX	853005	Outer Joint	22	30	53	78.5	51	I	
POLO (6NF)														
1.0 (33 kW)	1994.10-1999.12	MT	R	F	Box Engine AEV	261010	Drive Shaft		22		53	78.5	740	
	1994.10-1999.12	MT	L/R	F	Box Engine AEV	653001	Inner Joint			33		32		
	1994.10-1999.12	MT	L	F	Box Engine AEV	261007	Drive Shaft		22		53	78.5	517	
	1994.10-1999.12	MT	L/R	F	Box Engine AEV	853005	Outer Joint	22	30	53	78.5	51	I	
1.4 (44 kW)	1998.05-1999.12	-	L/R	F	Box Engine AEX	853008	Outer Joint	22	30	53	78.5	51	I	
	1998.05-1999.12	MT	R	F	Box Engine AEX	261010	Drive Shaft		22		53	78.5	740	
	1998.05-1999.12	AT/MT	L/R	F	Box Engine AEX	653001	Inner Joint			33		32		
	1998.05-1999.12	MT	L	F	Box Engine AEX	261007	Drive Shaft		22		53	78.5	517	
	1998.05-1999.12	AT/MT	L/R	F	Box Engine AEX	853005	Outer Joint	22	30	53	78.5	51	I	
	1998.05-1999.12	-	L	F	Box Engine AEX	253004	Drive Shaft		22		50	78.5	562	
1.7 SDI (44 kW)	1997.08-1999.12	MT	R	F	Box Engine AKU	261010	Drive Shaft		22		53	78.5	740	
	1997.08-1999.12	MT	L/R	F	Box Engine AKU	653001	Inner Joint			33		32		
	1997.08-1999.12	MT	L	F	Box Engine AKU	261007	Drive Shaft		22		53	78.5	517	
	1997.08-1999.12	MT	L/R	F	Box Engine AKU	853005	Outer Joint	22	30	53	78.5	51	I	
1.9 D (47 kW)	1994.10-1999.12	MT	R	F	Box Engine AEF	261010	Drive Shaft		22		53	78.5	740	
	1994.10-1999.12	MT	L/R	F	Box Engine AEF	653001	Inner Joint			33		32		
	1994.10-1999.12	-	L/R	F	Box Engine AEF	603004	Inner Joint			33		32		
	1994.10-1999.12	MT	L	F	Box Engine AEF	261007	Drive Shaft		22		53	78.5	517	
	1994.10-1999.12	MT	L/R	F	Box Engine AEF	853005	Outer Joint	22	30	53	78.5	51	I	
	1994.10-1999.12	-	L/R	F	Box Engine AEF	853008	Outer Joint	22	30	53	78.5	51	I	
	1994.10-1999.12	-	L	F	Box Engine AEF	253003	Drive Shaft		22		53	78.5	539.5	
	1994.10-1999.12	-	R	F	Box Engine AEF	253005	Drive Shaft		22		53	78.5	774	
1.9 SDI (47 kW)	1996.07-1999.12	MT	R	F	Box Engine AGD	261010	Drive Shaft		22		53	78.5	740	
	1996.07-1999.12	MT	L/R	F	Box Engine AGD	653001	Inner Joint			33		32		
	1996.07-1999.12	-	L/R	F	Box Engine AGD	603004	Inner Joint			33		32		
	1996.07-1999.12	MT	L	F	Box Engine AGD	261007	Drive Shaft		22		53	78.5	517	
	1996.07-1999.12	MT	L/R	F	Box Engine AGD	853005	Outer Joint	22	30	53	78.5	51	I	
	1996.07-1999.12	-	L/R	F	Box Engine AGD	853008	Outer Joint	22	30	53	78.5	51	I	
	1996.07-1999.12	-	L	F	Box Engine AGD	253003	Drive Shaft		22		53	78.5	539.5	

	 YEAR	TRANSM	L/R	F/R	REMARKS	GSP Ref.	 PRODUCT	 ABS	Technical Specifications										
									A	B	C	H	L	P					
VW																			
POLO (6NF)																			
1.9 SDI (47 kW)	1996.07-1999.12	-	R	F	Box Engine AGD	253005	Drive Shaft		22		53	78.5	774						
POLO (6R1 6C1)																			
1.0 (55 kW)	2014.01-	5MT	-	F	Hatchback Engine CHYB	803027	Outer Joint		36	30	50.7	58.5	47.5	I					
1.2 (44 kW)	2009.06-	-	R	F	Hatchback Engine CGPB	261267	Drive Shaft		36		50.7	58.5	765						
	2009.06-	-	L	F	Hatchback Engine CGPB	203330	Drive Shaft		36		50.7	58.5	515						
	2009.06-	-	L	F	Hatchback Engine CGPB	203372	Drive Shaft		36		50.7	58.5	516						
1.2 (51 kW)	2009.06-	-	R	F	Hatchback Engine CGPA	261267	Drive Shaft		36		50.7	58.5	765						
	2009.06-	-	L	F	Hatchback Engine CGPA	203330	Drive Shaft		36		50.7	58.5	515						
	2009.06-	-	L	F	Hatchback Engine CGPA	203372	Drive Shaft		36		50.7	58.5	516						
1.2 TDI (55 kW)	2009.10-	-	L	F	Hatchback Engine CFWA	261184	Drive Shaft		36		52	59	496						
	2009.10-	-	L/R	F	Hatchback Engine CFWA	603011	Inner Joint			33		34							
	2009.10-	-	R	F	Hatchback Engine CFWA	261185	Drive Shaft		36		52	59	785						
	2009.10-	MT	-	-	Hatchback Engine CFWA	603006	Inner Joint			33		34							
	2009.10-	-	L	F	Hatchback Engine CFWA	854006	Outer Joint		36	30	52	59	55.5	I					
	2009.10-	-	R	F	Hatchback Engine CFWA	261025	Drive Shaft		36		52	75	773.5						
	2009.10-	-	-	-	F	Hatchback Engine CFWA	803024	Outer Joint		36	30	50.75	59	54.5	I				
1.2 TSI (66 kW)	2011.05-2014.05	-	L/R	F	Hatchback Engine CBZC	603011	Inner Joint			33		34							
	2011.05-2014.05	-	-	F	Hatchback Engine CBZC	803024	Outer Joint		36	30	50.75	59	54.5	I					
	2011.05-2014.05	-	L	F	Hatchback Engine CBZC	261263	Drive Shaft		36		52	59	514						
	2011.05-2014.05	-	L	F	Hatchback Engine CBZC	854006	Outer Joint		36	30	52	59	55.5	I					
	2011.05-2014.05	-	L	F	Hatchback Engine CBZC	261274	Drive Shaft		36		50.5	59	514						
1.2 TSI (77 kW)	2009.11-	MT	L	F	Hatchback Engine CBZB	261297	Drive Shaft		36		50.5	59	513						
	2009.11-	MT	L	F	Hatchback Engine CBZB	261263	Drive Shaft		36		52	59	514						
	2009.11-	MT	R	F	Hatchback Engine CBZB	261301	Drive Shaft		36		50.5	59	771						
	2009.11-	6MT	-	F	Hatchback Engine CBZB	803024	Outer Joint		36	30	50.75	59	54.5	I					
	2009.11-	-	L/R	F	Hatchback Engine CBZB	603011	Inner Joint			33		34							
	2009.11-	MT	L	F	Hatchback Engine CBZB	854006	Outer Joint		36	30	52	59	55.5	I					
	2009.11-	-	L	F	Hatchback Engine CBZB	261274	Drive Shaft		36		50.5	59	514						
1.2 TSI (81 kW)	2014.01-	MT	L	F	Hatchback Engine CJZD	261263	Drive Shaft		36		52	59	514						
	2014.01-	MT	L	F	Hatchback Engine CJZD	854006	Outer Joint		36	30	52	59	55.5	I					
	2014.01-	7AT	L	F	Hatchback Engine CJZD	261206	Drive Shaft		36	26	52	59	536						
	2014.01-	AT/MT	L/R	F	Hatchback Engine CJZD	603011	Inner Joint			33		34							
	2014.01-	AT	-	-	Hatchback Engine CJZD	603006	Inner Joint			33		34							
1.2 TSI 16V (66 kW)	2014.02-	-	L	F	Hatchback Engine CJZC	261263	Drive Shaft		36		52	59	514						
	2014.02-	-	-	F	Hatchback Engine CJZC	803024	Outer Joint		36	30	50.75	59	54.5	I					
	2014.02-	-	L	F	Hatchback Engine CJZC	854006	Outer Joint		36	30	52	59	55.5	I					
	2014.02-	-	L	F	Hatchback Engine CJZC	261274	Drive Shaft		36		50.5	59	514						
	2014.02-	AT/MT	L/R	F	Hatchback Engine CJZC	603011	Inner Joint			33		34							
2014.02-	AT	-	-	Hatchback Engine CJZC	603006	Inner Joint			33		34								
1.4 (63 kW)	2009.06-	-	-	F	Hatchback Engine CGGB	803024	Outer Joint		36	30	50.75	59	54.5	I					
	2009.06-	MT	R	F	Hatchback Engine CGGB	261267	Drive Shaft		36		50.7	58.5	765						
	2009.06-	MT	L	F	Hatchback Engine CGGB	203330	Drive Shaft		36		50.7	58.5	515						
	2009.06-	MT	L	F	Hatchback Engine CGGB	203372	Drive Shaft		36		50.7	58.5	516						
	2009.06-	AT	L/R	F	Hatchback Engine CGGB	603011	Inner Joint			33		34							
1.4 BiFuel (60 kW)	2010.03-2011.01	-	R	F	Hatchback Engine CMAA	261267	Drive Shaft		36		50.7	58.5	765						
	2010.03-2011.01	-	L	F	Hatchback Engine CMAA	203330	Drive Shaft		36		50.7	58.5	515						
	2010.03-2011.01	-	L	F	Hatchback Engine CMAA	203372	Drive Shaft		36		50.7	58.5	516						
1.4 GTI (132 kW)	2010.05-	AT	L	F	Hatchback Engine CAVE	261260	Drive Shaft		36		52	75	498						
	2010.05-	AT	-	F	Hatchback Engine CAVE	803041	Outer Joint		36	27	50.5	75	65	I					
	2010.05-	AT	R	F	Hatchback Engine CAVE	261261	Drive Shaft		36		52	75	785						
	2010.05-	AT	-	-	Hatchback Engine CAVE	603016	Inner Joint			28		32							
	2010.05-	AT	L/R	F	Hatchback Engine CAVE	603011	Inner Joint			33		34							
1.4 TDI (55 kW)	2014.03-	MT	L/R	F	Hatchback Engine CYZB	603011	Inner Joint			33		34							
	2014.03-	MT	-	-	Hatchback Engine CYZB	603006	Inner Joint			33		34							
	2014.03-	5MT	-	F	Hatchback Engine CYZB	803024	Outer Joint		36	30	50.75	59	54.5	I					
1.4 TDI (66 kW)	2014.02-	MT	L/R	F	Hatchback Engine CUSB	603011	Inner Joint			33		34							
	2014.02-	5MT	-	F	Hatchback Engine CUSB	803024	Outer Joint		36	30	50.75	59	54.5	I					
1.4 TDI (77 kW)	2014.05-	MT	L/R	F	Hatchback Engine CYZA	603011	Inner Joint			33		34							
	2014.05-	MT	-	-	Hatchback Engine CYZA	603006	Inner Joint			33		34							
1.4 TSI (103 kW)	2012.10-	AT	L	F	Hatchback Engine CPTA	261260	Drive Shaft		36		52	75	498						
	2012.10-	-	-	F	Hatchback Engine CPTA	803041	Outer Joint		36	27	50.5	75	65	I					
	2012.10-	AT	R	F	Hatchback Engine CPTA	261261	Drive Shaft		36		52	75	785						
1.4 TSI (110 kW)	2014.05-	Semi-AT/MT	-	F	Hatchback Engine CZEA	803041	Outer Joint		36	27	50.5	75	65	I					
	2014.05-	AT	-	-	Hatchback Engine CZEA	603016	Inner Joint			28		32							
1.6 (66 kW)	2014.07-	MT	L	F	Hatchback Engine CWVB	261263	Drive Shaft		36		52	59	514						
	2014.07-	MT	L	F	Hatchback Engine CWVB	854006	Outer Joint		36	30	52	59	55.5	I					
	2014.07-	MT	L/R	F	Hatchback Engine CWVB	603011	Inner Joint			33		34							

YEAR	TRANSM	L/R	F/R	REMARKS	GSP Ref.	PRODUCT	ABS	Technical Specifications						
								A	B	C	H	L	P	
VW														
POLO (6R1 6C1)														
1.6 (81 kW)	2014.07-	-	L	F	Hatchback Engine CWVA	261263	Drive Shaft	36		52	59	514		
	2014.07-	-	L	F	Hatchback Engine CWVA	854006	Outer Joint	36	30	52	59	55.5	I	
	2014.07-	-	L	F	Hatchback Engine CWVA	261274	Drive Shaft	36		50.5	59	514		
	2014.07-	-	MT	L/R	F	Hatchback Engine CWVA	603011	Inner Joint		33		34		
	2014.07-	-	MT	-	-	Hatchback Engine CWVA	603006	Inner Joint		33		34		
1.6 BiFuel (60 kW)	2011.01-	-	L/R	F	Hatchback Engine CNKA	603011	Inner Joint		33		34			
	2011.01-	-	L	F	Hatchback Engine CNKA	261263	Drive Shaft	36		52	59	514		
	2011.01-	-	L	F	Hatchback Engine CNKA	854006	Outer Joint	36	30	52	59	55.5	I	
	2011.01-	-	L	F	Hatchback Engine CNKA	261274	Drive Shaft	36		50.5	59	514		
	2011.01-	-	MT	-	-	Hatchback Engine CNKA	603006	Inner Joint		33		34		
1.6 TDI (55 kW)	2009.06-	-	MT	L	F	Hatchback Engine CAYA	261184	Drive Shaft	36		52	59	496	
	2009.06-	-	MT	-	F	Hatchback Engine CAYA	803024	Outer Joint	36	30	50.75	59	54.5	I
	2009.06-	-	MT	R	F	Hatchback Engine CAYA	261185	Drive Shaft	36		52	59	785	
	2009.06-	-	-	L/R	F	Hatchback Engine CAYA	603011	Inner Joint		33		34		
	2009.06-	-	MT	-	-	Hatchback Engine CAYA	603006	Inner Joint		33		34		
	2009.06-	-	MT	L	F	Hatchback Engine CAYA	854006	Outer Joint	36	30	52	59	55.5	I
	2009.06-	-	-	R	F	Hatchback Engine CAYA	261025	Drive Shaft	36		52	75	773.5	
1.6 TDI (66 kW)	2009.06-	-	Semi-AT	L	F	Hatchback Engine CAYB	261260	Drive Shaft	36		52	75	498	
	2009.06-	-	Semi-AT	-	F	Hatchback Engine CAYB	803041	Outer Joint	36	27	50.5	75	65	I
	2009.06-	-	MT	L	F	Hatchback Engine CAYB	261184	Drive Shaft	36		52	59	496	
	2009.06-	-	MT	-	F	Hatchback Engine CAYB	803024	Outer Joint	36	30	50.75	59	54.5	I
	2009.06-	-	MT	R	F	Hatchback Engine CAYB	261185	Drive Shaft	36		52	59	785	
	2009.06-	-	MT	L/R	F	Hatchback Engine CAYB	603011	Inner Joint		33		34		
	2009.06-	-	Semi-AT	R	F	Hatchback Engine CAYB	261261	Drive Shaft	36		52	75	785	
	2009.06-	-	MT	L	F	Hatchback Engine CAYB	854006	Outer Joint	36	30	52	59	55.5	I
	2009.06-	-	MT	R	F	Hatchback Engine CAYB	261025	Drive Shaft	36		52	75	773.5	
1.6 TDI (77 kW)	2009.06-	-	-	L	F	Hatchback Engine CAYC/CLNA	261184	Drive Shaft	36		52	59	496	
	2009.06-	-	MT	-	F	Hatchback Engine CAYC/CLNA	803024	Outer Joint	36	30	50.75	59	54.5	I
	2009.06-	-	-	L/R	F	Hatchback Engine CAYC/CLNA	603011	Inner Joint		33		34		
	2009.06-	-	-	R	F	Hatchback Engine CAYC/CLNA	261185	Drive Shaft	36		52	59	785	
	2009.06-	-	MT	-	-	Hatchback Engine CAYC/CLNA	603006	Inner Joint		33		34		
	2009.06-	-	-	L	F	Hatchback Engine CAYC/CLNA	854006	Outer Joint	36	30	52	59	55.5	I
	2009.06-	-	-	R	F	Hatchback Engine CAYC/CLNA	261025	Drive Shaft	36		52	75	773.5	
1.8 GTI (141 kW)	2014.11-	-	AT	-	-	Hatchback Engine DAJB	603016	Inner Joint		28		32		
	2014.11-	-	7AT	L	F	Hatchback Engine DAJB	261260	Drive Shaft	36		52	75	498	
	2014.11-	-	7AT	-	F	Hatchback Engine DAJB	803041	Outer Joint	36	27	50.5	75	65	I
	2014.11-	-	AT	L	F	Hatchback Engine DAJB	661054	Inner Joint	40	28	46.9	51	53	
2.0 R WRC (162 kW)	2013.08-	-	MT	-	-	Hatchback Engine CDLJ	603016	Inner Joint		28		32		
POLO (86C 80)														
1.0 (33 kW)	1985.08-	1992.01	MT	L	F	Hatchback Engine HZ	653001	Inner Joint		33		32		
	1985.08-	1992.01	MT	L	F	Coupe Engine HZ	653001	Inner Joint		33		32		
	1985.08-	1992.01	-	-	F	Hatchback Engine HZ	803022	Outer Joint	20	25	45.5	74	49	I
	1985.08-	1992.01	-	-	F	Coupe Engine HZ	803022	Outer Joint	20	25	45.5	74	49	I
	1985.08-	1992.01	MT	L/R	F	Hatchback Engine HZ	861002	Outer Joint	20	30	45.5	73.5	51	I
	1985.08-	1992.01	MT	L/R	F	Coupe Engine HZ	861002	Outer Joint	20	30	45.5	73.5	51	I
1.0 Cat (33 kW)	1989.08-	1994.09	MT	L	F	Hatchback Engine AAU	653001	Inner Joint		33		32		
	1989.08-	1994.09	MT	L	F	Coupe Engine AAK	653001	Inner Joint		33		32		
	1989.08-	1994.09	-	-	F	Hatchback Engine AAU	803022	Outer Joint	20	25	45.5	74	49	I
	1989.08-	1994.09	-	-	F	Coupe Engine AAK	803022	Outer Joint	20	25	45.5	74	49	I
	1989.08-	1994.09	MT	L/R	F	Hatchback Engine AAU	861002	Outer Joint	20	30	45.5	73.5	51	I
	1989.08-	1994.09	MT	L/R	F	Coupe Engine AAK	861002	Outer Joint	20	30	45.5	73.5	51	I
1.1 (37 kW)	1981.10-	1989.09	-	-	F	Hatchback Engine HB	803022	Outer Joint	20	25	45.5	74	49	I
1.3 (55 kW)	1982.09-	1989.09	-	-	F	Coupe Engine GK	803022	Outer Joint	20	25	45.5	74	49	I
	1982.09-	1989.09	-	-	F	Hatchback Engine GK	803022	Outer Joint	20	25	45.5	74	49	I
	1982.09-	1989.09	MT	L/R	F	Coupe Engine GK	861002	Outer Joint	20	30	45.5	73.5	51	I
	1982.09-	1989.09	MT	L/R	F	Hatchback Engine GK	861002	Outer Joint	20	30	45.5	73.5	51	I
	1982.09-	1989.09	MT	L	F	Coupe Engine GK	653001	Inner Joint		33		32		
	1982.09-	1989.09	MT	L	F	Hatchback Engine GK	653001	Inner Joint		33		32		
1.3 Cat (40 kW)	1987.07-	1994.09	MT	L	F	Hatchback Engine AAV	653001	Inner Joint		33		32		
	1987.07-	1994.08	MT	L	F	Coupe Engine AAV	653001	Inner Joint		33		32		
	1987.07-	1994.09	-	-	F	Hatchback Engine AAV	803022	Outer Joint	20	25	45.5	74	49	I
	1987.07-	1994.08	-	-	F	Coupe Engine AAV	803022	Outer Joint	20	25	45.5	74	49	I
	1987.07-	1994.09	MT	L/R	F	Hatchback Engine AAV	861002	Outer Joint	20	30	45.5	73.5	51	I
	1987.07-	1994.08	MT	L/R	F	Coupe Engine AAV	861002	Outer Joint	20	30	45.5	73.5	51	I
1.3 Cat (55 kW)	1989.10-	1991.03	MT	L	F	Hatchback Engine 3F	653001	Inner Joint		33		32		
	1989.10-	1994.09	MT	L	F	Coupe Engine 3F	653001	Inner Joint		33		32		

YEAR	TRANSM	L/R	F/R	REMARKS	GSP Ref.	PRODUCT	ABS	Technical Specifications							
								A	B	C	H	L	P		
VW															
POLO (86C 80)															
1.3 Cat (55 kW)	1989.10-1991.03	-	-	F	Hatchback Engine 3F	803022	Outer Joint		20	25	45.5	74	49	I	
	1989.10-1994.09	-	-	F	Coupe Engine 3F	803022	Outer Joint		20	25	45.5	74	49	I	
	1989.10-1991.03	MT	L/R	F	Hatchback Engine 3F	861002	Outer Joint		20	30	45.5	73.5	51	I	
	1989.10-1994.09	MT	L/R	F	Coupe Engine 3F	861002	Outer Joint		20	30	45.5	73.5	51	I	
1.3 D (33 kW)	1986.08-1990.07	MT	L/R	F	Hatchback Engine MN	653001	Inner Joint			33		32			
	1986.08-1990.08	MT	L/R	F	Coupe Engine MN	653001	Inner Joint			33		32			
	1986.08-1990.07	-	-	F	Hatchback Engine MN	803022	Outer Joint		20	25	45.5	74	49	I	
	1986.08-1990.08	-	-	F	Coupe Engine MN	803022	Outer Joint		20	25	45.5	74	49	I	
1.3 G40 (83 kW)	1990.08-1994.09	MT	L	F	Coupe Engine PY	653001	Inner Joint			33		32			
	1990.08-1994.09	MT	R	F	Coupe Engine PY	861002	Outer Joint		20	30	45.5	73.5	51	I	
1.3 G40 (85 kW)	1987.01-1990.08	MT	L	F	Coupe Engine PY	653001	Inner Joint			33		32			
	1987.01-1990.08	-	-	F	Coupe Engine PY	803022	Outer Joint		20	25	45.5	74	49	I	
	1987.01-1990.08	MT	L/R	F	Coupe Engine PY	861002	Outer Joint		20	30	45.5	73.5	51	I	
1.4 D (35 kW)	1990.08-1994.09	MT	L/R	F	Coupe Engine 1W	653001	Inner Joint			33		32			
	1990.08-1994.09	-	-	F	Coupe Engine 1W	803022	Outer Joint		20	25	45.5	74	49	I	
	1990.10-1994.09	MT	L/R	F	Hatchback Engine 1W	653001	Inner Joint			33		32			
POLO (86CF)															
1.0 (33 kW)	1992.08-1994.07	MT	L	F	Box Engine AAU	653001	Inner Joint			33		32			
	1992.08-1994.07	MT	R	F	Box Engine AAU	861002	Outer Joint		20	30	45.5	73.5	51	I	
1.3 (40 kW)	1992.08-1994.07	MT	L	F	Box Engine AAV	653001	Inner Joint			33		32			
	1992.08-1994.07	MT	R	F	Box Engine AAV	861002	Outer Joint		20	30	45.5	73.5	51	I	
1.4 D (35 kW)	1992.08-1994.07	MT	L/R	F	Box Engine 1W	653001	Inner Joint			33		32			
POLO (9A4)															
1.4 (55 kW)	2003.07-	-	AT	L/R	F	Saloon Engine BBY/BKY	661005	Inner Joint			30		57.6		
	2003.07-	-	MT	R	F	Saloon Engine BBY/BKY	261063	Drive Shaft		36		50.7	58.5	751	
	2003.07-	-	AT	R	F	Saloon Engine BBY/BKY	261252	Drive Shaft		36		53.7	58.5	730	
	2003.07-	-	MT	R	F	Saloon Engine BBY/BKY	261077	Drive Shaft		36		50.7	58.5	750	
	2003.07-	-	AT	R	F	Saloon Engine BBY/BKY	861070	Outer Joint		36	30	53.7	58.5	55	I
	2003.07-	-	MT	-	F	Saloon Engine BBY/BKY	803027	Outer Joint		36	30	50.7	58.5	47.5	I
	2003.07-	-	MT	L	F	Saloon Engine BBY/BKY	203063	Drive Shaft		36		50.7	58.5	501	
	2003.07-	-	AT	-	F	Saloon Engine BBY/BKY	803024	Outer Joint		36	30	50.75	59	54.5	I
1.4 (74 kW)	2003.11-	-	-	R	F	Saloon Engine BBZ	261063	Drive Shaft		36		50.7	58.5	751	
	2003.11-	-	-	R	F	Saloon Engine BBZ	261077	Drive Shaft		36		50.7	58.5	750	
	2003.11-	-	-	F	Saloon Engine BBZ	803027	Outer Joint		36	30	50.7	58.5	47.5	I	
	2003.11-	-	-	L	F	Saloon Engine BBZ	203063	Drive Shaft		36		50.7	58.5	501	
1.4 TDI (55 kW)	2003.07-	-	MT	L	F	Saloon Engine BAY	261098	Drive Shaft		36		50.5	59	472	
	2003.07-	-	-	L	F	Saloon Engine BAY	661062	Inner Joint			30		59		
	2003.07-	-	MT	R	F	Saloon Engine BAY	261099	Drive Shaft		36		50.5	59	759	
	2003.07-	-	-	L	F	Saloon Engine BAY	854006	Outer Joint		36	30	52	59	55.5	I
	2003.07-	-	-	L	F	Saloon Engine BAY	261135	Drive Shaft		36		52	59	475	
	2003.07-	-	-	L/R	F	Saloon Engine BAY	661006	Inner Joint			30		57.6		
	2003.07-	-	-	R	F	Saloon Engine BAY	261136	Drive Shaft		36		52	59	763	
	2003.07-	-	MT	-	F	Saloon Engine BAY	803024	Outer Joint		36	30	50.75	59	54.5	I
1.9 SDI (47 kW)	2002.09-	-	-	R	F	Saloon Engine ASY	261063	Drive Shaft		36		50.7	58.5	751	
	2002.09-	-	-	R	F	Saloon Engine ASY	261077	Drive Shaft		36		50.7	58.5	750	
	2002.09-	-	-	-	F	Saloon Engine ASY	803027	Outer Joint		36	30	50.7	58.5	47.5	I
	2002.09-	-	-	L/R	F	Saloon Engine ASY	854004	Outer Joint		36	30	52	75.5	47.5	I
	2002.09-	-	-	L	F	Saloon Engine ASY	203063	Drive Shaft		36		50.7	58.5	501	
POLO (9N_)															
1.2 (40 kW)	2002.01-2007.05	5MT	R	F	Hatchback Engine AWY/BMD	261063	Drive Shaft		36		50.7	58.5	751		
	2002.01-2007.05	MT	R	F	Hatchback Engine AWY/BMD	261077	Drive Shaft		36		50.7	58.5	750		
	2002.01-2007.05	MT	-	F	Hatchback Engine AWY/BMD	803027	Outer Joint		36	30	50.7	58.5	47.5	I	
	2002.01-2007.05	MT	-	F	Hatchback Engine AWY/BMD	854002	Outer Joint		20	30	52	59.5	49.5	I	
	2002.01-2007.05	5MT	L	F	Hatchback Engine AWY/BMD	203063	Drive Shaft		36		50.7	58.5	501		
1.2 (44 kW)	2007.05-2009.11	MT	R	F	Hatchback Engine BBM	261063	Drive Shaft		36		50.7	58.5	751		
	2007.05-2009.11	-	R	F	Hatchback Engine BBM	261077	Drive Shaft		36		50.7	58.5	750		
	2007.05-2009.11	MT	-	F	Hatchback Engine BBM	803027	Outer Joint		36	30	50.7	58.5	47.5	I	
	2007.05-2009.11	MT	-	F	Hatchback Engine BBM	854002	Outer Joint		20	30	52	59.5	49.5	I	
	2007.05-2009.11	MT	L	F	Hatchback Engine BBM	203063	Drive Shaft		36		50.7	58.5	501		
1.2 12V (47 kW)	2001.10-2007.07	-	L	F	Hatchback Engine AZQ	203063	Drive Shaft		36		50.7	58.5	501		
	2001.10-2007.07	-	R	F	Hatchback Engine AZQ	261063	Drive Shaft		36		50.7	58.5	751		
	2001.10-2007.07	-	R	F	Hatchback Engine AZQ	261077	Drive Shaft		36		50.7	58.5	750		
	2001.10-2007.07	MT	-	F	Hatchback Engine AZQ	803027	Outer Joint		36	30	50.7	58.5	47.5	I	
1.2 12V (51 kW)	2007.05-2009.11	MT	R	F	Hatchback Engine BZG	261063	Drive Shaft		36		50.7	58.5	751		
	2007.05-2009.11	-	R	F	Hatchback Engine BZG	261077	Drive Shaft		36		50.7	58.5	750		
	2007.05-2009.11	MT	-	F	Hatchback Engine BZG	803027	Outer Joint		36	30	50.7	58.5	47.5	I	

	 YEAR	TRANSM	L/R	F/R	REMARKS	GSP Ref.	 PRODUCT	 ABS	Technical Specifications								
									A	B	C	H	L	P			
VW																	
POLO (9N_)																	
1.2 12V (51 kW)	2007.05-2009.11	MT	L	F	Hatchback Engine BZG	203063	Drive Shaft		36		50.7	58.5	501				
1.4 (61 kW)	2002.08-2009.11	-	R	F	Hatchback Engine BLM	261077	Drive Shaft		36		50.7	58.5	750				
1.4 16V (55 kW)	2001.10-2008.05	AT	L/R	F	Hatchback Engine BBY	661005	Inner Joint		30		57.6						
	2001.10-2008.05	5MT	R	F	Hatchback Engine BBY	261063	Drive Shaft		36		50.7	58.5	751				
	2001.10-2008.05	MT	R	F	Hatchback Engine BBY	261077	Drive Shaft		36		50.7	58.5	750				
	2001.10-2008.05	AT	R	F	Hatchback Engine BBY	261252	Drive Shaft		36		53.7	58.5	730				
	2001.10-2008.05	AT	R	F	Hatchback Engine BBY	861070	Outer Joint		36	30	53.7	58.5	55	I			
	2001.10-2008.05	MT	-	F	Hatchback Engine BBY	803027	Outer Joint		36	30	50.7	58.5	47.5	I			
	2001.10-2008.05	AT	-	F	Hatchback Engine BBY	803024	Outer Joint		36	30	50.75	59	54.5	I			
	2001.10-2008.05	5MT	L	F	Hatchback Engine BBY	203063	Drive Shaft		36		50.7	58.5	501				
1.4 16V (59 kW)	2006.05-2009.11	AT	-	F	Hatchback Engine BUD	803024	Outer Joint		36	30	50.75	59	54.5	I			
	2006.05-2009.11	MT	R	F	Hatchback Engine BUD	261063	Drive Shaft		36		50.7	58.5	751				
	2006.05-2009.11	AT	L	F	Hatchback Engine BUD	261206	Drive Shaft		36	26	52	59	536				
	2006.05-2009.11	MT	R	F	Hatchback Engine BUD	261077	Drive Shaft		36		50.7	58.5	750				
	2006.05-2009.11	AT	R	F	Hatchback Engine BUD	261133	Drive Shaft		36	26	52	75	859				
	2006.05-2009.11	AT	L	F	Hatchback Engine BUD	854006	Outer Joint		36	30	52	59	55.5	I			
	2006.05-2009.11	MT	-	F	Hatchback Engine BUD	803027	Outer Joint		36	30	50.7	58.5	47.5	I			
	2006.05-2009.11	MT	L	F	Hatchback Engine BUD	203063	Drive Shaft		36		50.7	58.5	501				
1.4 16V (74 kW)	2006.05-2009.11	AT	L	F	Hatchback Engine BUD	261150	Drive Shaft		36	26	52	75	557				
	2001.10-2008.05	5MT	R	F	Hatchback Engine AUB	261063	Drive Shaft		36		50.7	58.5	751				
	2001.10-2008.05	-	R	F	Hatchback Engine AUB	261077	Drive Shaft		36		50.7	58.5	750				
	2001.10-2008.05	MT	-	F	Hatchback Engine AUB	803027	Outer Joint		36	30	50.7	58.5	47.5	I			
	2001.10-2008.05	5MT	L	F	Hatchback Engine AUB	203063	Drive Shaft		36		50.7	58.5	501				
	2001.10-2008.05	-	R	F	Hatchback Engine AUB	261077	Drive Shaft		36		50.7	58.5	750				
	2001.10-2008.05	MT	-	F	Hatchback Engine AUB	803027	Outer Joint		36	30	50.7	58.5	47.5	I			
	2001.10-2008.05	5MT	L	F	Hatchback Engine AUB	203063	Drive Shaft		36		50.7	58.5	501				
1.4 FSI (63 kW)	2002.02-2006.07	5MT	R	F	Hatchback Engine AXU	261063	Drive Shaft		36		50.7	58.5	751				
	2002.02-2006.07	MT	R	F	Hatchback Engine AXU	261077	Drive Shaft		36		50.7	58.5	750				
	2002.02-2006.07	MT	-	F	Hatchback Engine AXU	803027	Outer Joint		36	30	50.7	58.5	47.5	I			
	2002.02-2006.07	5MT	L	F	Hatchback Engine AXU	203063	Drive Shaft		36		50.7	58.5	501				
1.4 TDI (51 kW)	2005.04-2009.11	-	L	F	Hatchback Engine BNM	261098	Drive Shaft		36		50.5	59	472				
	2005.04-2009.11	-	R	F	Hatchback Engine BNM	261099	Drive Shaft		36		50.5	59	759				
	2005.04-2009.11	-	R	F	Hatchback Engine BNM	261077	Drive Shaft		36		50.7	58.5	750				
	2005.04-2009.11	MT	R	F	Hatchback Engine BNM	261223	Drive Shaft		36		52	59	757				
	2005.04-2009.11	MT	L	F	Hatchback Engine BNM	261078	Drive Shaft		36		50.7	58.5	501				
	2005.04-2009.11	-	L/R	F	Hatchback Engine BNM	661006	Inner Joint		30		57.6						
	2005.04-2009.11	MT	R	F	Hatchback Engine BNM	854006	Outer Joint		36	30	52	59	55.5	I			
	2005.04-2009.11	MT	-	F	Hatchback Engine BNM	803024	Outer Joint		36	30	50.75	59	54.5	I			
1.4 TDI (55 kW)	2001.10-2005.06	5MT	L	F	Hatchback Engine AMF	261098	Drive Shaft		36		50.5	59	472				
	2001.10-2005.06	-	L	F	Hatchback Engine AMF	661062	Inner Joint		30		59						
	2001.10-2005.06	-	L	F	Hatchback Engine AMF	854006	Outer Joint		36	30	52	59	55.5	I			
	2001.10-2005.06	5MT	R	F	Hatchback Engine AMF	261099	Drive Shaft		36		50.5	59	759				
	2001.10-2005.06	-	L/R	F	Hatchback Engine AMF	861007	Outer Joint		22	30	53	78.5	60	I			
	2001.10-2005.06	-	L	F	Hatchback Engine AMF	261135	Drive Shaft		36		52	59	475				
	2001.10-2005.06	-	R	F	Hatchback Engine AMF	261136	Drive Shaft		36		52	59	763				
	2001.10-2005.06	MT	-	F	Hatchback Engine AMF	803024	Outer Joint		36	30	50.75	59	54.5	I			
1.4 TDI (59 kW)	2001.10-2005.06	-	L/R	F	Hatchback Engine AMF	661006	Inner Joint		30		57.6						
	2005.04-2009.11	MT	L	F	Hatchback Engine BMS	261098	Drive Shaft		36		50.5	59	472				
	2005.04-2009.11	-	L	F	Hatchback Engine BMS	661062	Inner Joint		30		59						
	2005.04-2009.11	MT	R	F	Hatchback Engine BMS	261099	Drive Shaft		36		50.5	59	759				
	2005.04-2009.11	-	L	F	Hatchback Engine BMS	854006	Outer Joint		36	30	52	59	55.5	I			
	2005.04-2009.11	-	L	F	Hatchback Engine BMS	261135	Drive Shaft		36		52	59	475				
	2005.04-2009.11	-	R	F	Hatchback Engine BMS	261136	Drive Shaft		36		52	59	763				
	2005.04-2009.11	-	L/R	F	Hatchback Engine BMS	661006	Inner Joint		30		57.6						
1.6 16V (77 kW)	2005.04-2009.11	MT	-	F	Hatchback Engine BMS	803024	Outer Joint		36	30	50.75	59	54.5	I			
	2006.05-2009.11	AT/MT	-	F	Hatchback Engine BTS	803024	Outer Joint		36	30	50.75	59	54.5	I			
	2006.05-2009.11	MT	L/R	F	Hatchback Engine BTS	603011	Inner Joint		33		34						
	2006.05-2009.11	AT	L	F	Hatchback Engine BTS	261206	Drive Shaft		36	26	52	59	536				
	2006.05-2009.11	AT	R	F	Hatchback Engine BTS	261133	Drive Shaft		36	26	52	75	859				
	2006.05-2009.11	AT	L	F	Hatchback Engine BTS	854006	Outer Joint		36	30	52	59	55.5	I			
	2006.05-2009.11	AT	L/R	F	Hatchback Engine BTS	861010	Outer Joint		36	30	52	75	54.5	I			
	2006.05-2009.11	AT	L	F	Hatchback Engine BTS	261150	Drive Shaft		36	26	52	75	557				
1.8 GTI (110 kW)	2005.09-2009.11	MT	L	F	Hatchback Engine BJX	854006	Outer Joint		36	30	52	59	55.5	I			
	2005.09-2009.11	MT	-	-	Hatchback Engine BJX	603006	Inner Joint		33		34						
	2005.09-2009.11	MT	L/R	F	Hatchback Engine BJX	603011	Inner Joint		33		34						
	2005.09-2009.11	MT	L	F	Hatchback Engine BJX	261248	Drive Shaft		36		52	59	480				
	2005.09-2009.11	MT	R	F	Hatchback Engine BJX	261247	Drive Shaft		36		52	59	765				
	2005.09-2009.11	MT	L	F	Hatchback Engine BJX	261302	Drive Shaft		36		50.5	59	479				
	2005.09-2009.11	-	-	F	Hatchback Engine BJX	803024	Outer Joint		36	30	50.75	59	54.5	I			





YEAR	TRANSM	L/R	F/R	REMARKS	GSP Ref.	PRODUCT	ABS	Technical Specifications							
								A	B	C	H	L	P		
VW															
POLO (9N_)															
1.8 GTi Cup Edition (132 kW)	2006.05-2009.11	-	L	F	Hatchback Engine BBU	854006	Outer Joint	36	30	52	59	55.5	I		
	2006.05-2009.11	MT	-	-	Hatchback Engine BBU	603006	Inner Joint		33		34				
	2006.05-2009.11	-	L	F	Hatchback Engine BBU	261248	Drive Shaft	36		52	59	480			
	2006.05-2009.11	MT	L/R	F	Hatchback Engine BBU	603011	Inner Joint		33		34				
	2006.05-2009.11	-	R	F	Hatchback Engine BBU	261247	Drive Shaft	36		52	59	765			
	2006.05-2009.11	-	L	F	Hatchback Engine BBU	261302	Drive Shaft	36		50.5	59	479			
	2006.05-2009.11	-	-	F	Hatchback Engine BBU	803024	Outer Joint	36	30	50.75	59	54.5	I		
1.9 SDI (47 kW)	2001.10-2009.11	5MT	R	F	Hatchback Engine ASY	261063	Drive Shaft	36		50.7	58.5	751			
	2001.10-2009.11	MT	R	F	Hatchback Engine ASY	261077	Drive Shaft	36		50.7	58.5	750			
	2001.10-2009.11	-	-	F	Hatchback Engine ASY	803027	Outer Joint	36	30	50.7	58.5	47.5	I		
	2001.10-2009.11	5MT	L	F	Hatchback Engine ASY	203063	Drive Shaft	36		50.7	58.5	501			
1.9 TDI (74 kW)	2001.10-2009.11	MT	L	F	Hatchback Engine AXR	661062	Inner Joint		30		59				
	2001.10-2009.11	5MT	L	F	Hatchback Engine AXR	261098	Drive Shaft	36		50.5	59	472			
	2001.10-2009.11	MT	L	F	Hatchback Engine AXR	854006	Outer Joint	36	30	52	59	55.5	I		
	2001.10-2009.11	5MT	R	F	Hatchback Engine AXR	261099	Drive Shaft	36		50.5	59	759			
	2001.10-2009.11	MT	L	F	Hatchback Engine AXR	261135	Drive Shaft	36		52	59	475			
	2001.10-2009.11	MT	R	F	Hatchback Engine AXR	261136	Drive Shaft	36		52	59	763			
	2001.10-2009.11	-	L/R	F	Hatchback Engine AXR	661006	Inner Joint		30		57.6				
	2001.10-2009.11	MT	-	F	Hatchback Engine AXR	803024	Outer Joint	36	30	50.75	59	54.5	I		
1.9 TDI (96 kW)	2003.11-2009.11	-	L	F	Hatchback Engine ASZ/BLT	853002	Outer Joint	36	27	50.75	75	65	I		
	2003.11-2009.11	-	R	F	Hatchback Engine ASZ/BLT	261183	Drive Shaft	36		50.5	75	769			
	2003.11-2009.11	-	L	F	Hatchback Engine ASZ/BLT	261204	Drive Shaft	36		50.5	75	461			
POLO (AW1, BZ1)															
1.6 TDI(59 kW)	2017.11-	-	L/R	F	Hatchback Engine DGTC	603011	Inner Joint		33		34				
1.6 TDI(70 kW)	2017.11-	-	L/R	F	Hatchback Engine DGTD	603011	Inner Joint		33		34				
POLO CLASSIC															
-	1996-	-	-	-	-	899136	Outer Joint	22	30	51	78	61	I		
1.8	1997-2002	-	L	-	-	299118	Drive Shaft	22		51	78.7	634			
POLO CLASSIC (6V2)/FLIGHT															
1.6 (74 kW)	1995.12-2001.09	MT	R	F	Saloon Engine AFT	253005	Drive Shaft	22		53	78.5	774			
	1995.12-2001.09	MT	L/R	F	Saloon Engine AFT	853007	Outer Joint	22	30	53.2	78	61	I		
	1995.12-2001.09	MT	R	F	Saloon Engine AFT	253002	Drive Shaft	22		53.2	78	769			
	1995.12-2001.09	MT	L/R	F	Saloon Engine AFT	603004	Inner Joint		33		32				
	1995.12-2001.09	MT	R	F	Saloon Engine AFT	603009	Inner Joint		33		34				
	1995.12-2001.09	MT	L	F	Saloon Engine AFT	603011	Inner Joint		33		34				
	1995.12-2001.09	-	L/R	F	Saloon Engine AFT	853008	Outer Joint	22	30	53	78.5	51	I		
	1995.12-2001.09	MT	L/R	F	Saloon Engine AFT	603005	Inner Joint		33		32				
	1995.12-2001.09	MT	L	F	Saloon Engine AFT	253003	Drive Shaft	22		53	78.5	539.5			
1.9 SDI (47 kW)	1995.12-1999.08	MT	R	F	Saloon Engine AEY	253005	Drive Shaft	22		53	78.5	774			
	1995.12-1999.08	MT	L/R	F	Saloon Engine AEY	603004	Inner Joint		33		32				
	1995.12-1999.08	MT	-	-	Saloon Engine AEY	603006	Inner Joint		33		34				
	1995.12-1999.08	MT	L	F	Saloon Engine AEY	253003	Drive Shaft	22		53	78.5	539.5			
	1995.12-1999.08	MT	L/R	F	Saloon Engine AEY	603005	Inner Joint		33		32				
	1995.12-1999.08	MT	L/R	F	Saloon Engine AEY	853008	Outer Joint	22	30	53	78.5	51	I		
1.9 SDI (48 kW)	1996.06-2001.09	MT	-	-	Saloon Engine AEY	603006	Inner Joint		33		34				
1.9 SDI (50 kW)	1999.08-2002.01	-	R	F	Saloon Engine AQM	603004	Inner Joint		33		32				
	1999.08-2002.01	-	L/R	F	Saloon Engine AQM	853008	Outer Joint	22	30	53	78.5	51	I		
1.9 TDI (67 kW)	1997.01-1999.08	MT	-	-	Saloon Engine AHU	603006	Inner Joint		33		34				
1.9 TDI (81 kW)	1998.06-2002.01	-	L	F	Saloon Engine AFN/ASV	603011	Inner Joint		33		34				
	1998.06-2002.01	-	L/R	F	Saloon Engine AFN/ASV	853007	Outer Joint	22	30	53.2	78	61	I		
	1998.06-2002.01	-	R	F	Saloon Engine AFN/ASV	603009	Inner Joint		33		34				
	1998.06-2002.01	MT	-	-	Saloon Engine AFN/ASV	603006	Inner Joint		33		34				
	1998.06-2002.01	-	L/R	F	Saloon Engine AFN/ASV	861018	Outer Joint	22	30	53	78.5	61	I		
54 1.4 (40 kW)	1998.01-1999.08	-	L/R	F	Saloon Engine ANX	853008	Outer Joint	22	30	53	78.5	51	I		
	1998.01-1999.08	MT	L	F	Saloon Engine ANX	261205	Drive Shaft	22	0	53	78.5	525			
	1998.01-1999.08	MT	R	F	Saloon Engine ANX	261189	Drive Shaft	22		53	78.5	751			
	1998.01-1999.08	MT	-	-	Saloon Engine ANX	603006	Inner Joint		33		34				
	1998.01-1999.08	MT	L/R	F	Saloon Engine ANX	653001	Inner Joint		33		32				
	1998.01-1999.08	-	L	F	Saloon Engine ANX	253004	Drive Shaft	22		50	78.5	562			
57 1.7 SDI (42 kW)	1997.07-2001.09	-	L/R	F	Saloon Engine AKW	603004	Inner Joint		33		32				
	1997.07-2001.09	-	L/R	F	Saloon Engine AKW	853008	Outer Joint	22	30	53	78.5	51	I		
	1997.07-2001.09	MT	-	-	Saloon Engine AKW	603006	Inner Joint		33		34				
	1997.07-2001.09	-	R	F	Saloon Engine AKW	253005	Drive Shaft	22		53	78.5	774			
60 1.4 (44 kW)	1995.12-2001.09	MT	L/R	F	Saloon Engine AKK	653001	Inner Joint		33		32				
	1995.12-2001.09	MT	-	-	Saloon Engine AKK	603006	Inner Joint		33		34				
	1995.12-2001.09	MT	L	F	Saloon Engine AKK	253004	Drive Shaft	22		50	78.5	562			

YEAR	TRANSM	L/R	F/R	REMARKS	GSP Ref.	PRODUCT	ABS	Technical Specifications						
								A	B	C	H	L	P	
VW														
POLO CLASSIC (6V2)/FLIGHT														
60 1.4 (44 kW)	1995.12-2001.09	MT	L/R	F	Saloon Engine AKK	853008	Outer Joint		22	30	53	78.5	51	I
75 1.4 16V (55 kW)	1999.10-2001.09	MT	L/R	F	Saloon Engine APE	653001	Inner Joint			33		32		
	1999.10-2001.09	-	L	F	Saloon Engine APE	253004	Drive Shaft	22			50	78.5	562	
	1999.10-2001.09	-	L/R	F	Saloon Engine APE	853008	Outer Joint	22	30	53	78.5	51	I	
75 1.6 (55 kW)	1995.11-1997.09	MT	-	-	Saloon Engine 1F	603006	Inner Joint			33		34		
	1995.11-2001.09	MT	L/R	F	Saloon Engine ALM	653001	Inner Joint			33		32		
	1995.11-2001.09	MT	L/R	F	Saloon Engine ALM	853007	Outer Joint	22	30	53.2	78	61	I	
	1995.11-2001.09	MT	R	F	Saloon Engine ALM	603009	Inner Joint			33		34		
	1995.11-2001.09	MT	R	F	Saloon Engine ALM	253002	Drive Shaft	22			53.2	78	769	
	1995.11-1997.09	-	R	F	Saloon Engine 1F	253002	Drive Shaft	22			53.2	78	769	
	1995.11-1997.09	-	L/R	F	Saloon Engine 1F	853007	Outer Joint	22	30	53.2	78	61	I	
	1995.11-2001.09	MT	L	F	Saloon Engine ALM	253004	Drive Shaft	22			50	78.5	562	
	1995.11-2001.09	MT	-	-	Saloon Engine ALM	603006	Inner Joint			33		34		
	1995.11-2001.09	MT	L/R	F	Saloon Engine ALM	853008	Outer Joint	22	30	53	78.5	51	I	
	1995.11-2001.09	MT	L	F	Saloon Engine ALM	603011	Inner Joint			33		34		
	1995.11-1997.09	MT	R	F	Saloon Engine 1F	603009	Inner Joint			33		34		
	1995.11-1997.09	MT	L	F	Saloon Engine 1F	603011	Inner Joint			33		34		
90 1.8 (66 kW)	1997.01-2001.09	MT	-	-	Saloon Engine ABS/ADD/ADZ	603006	Inner Joint			33		34		
90 1.9 TDI (66 kW)	1996.09-2001.09	MT	L/R	F	Saloon Engine AGR	853007	Outer Joint	22	30	53.2	78	61	I	
	1996.09-2001.09	MT	R	F	Saloon Engine AGR	603009	Inner Joint			33		34		
	1996.09-2001.09	MT	R	F	Saloon Engine AGR	253002	Drive Shaft	22			53.2	78	769	
	1996.09-2001.09	MT	-	-	Saloon Engine AGR	603006	Inner Joint			33		34		
	1996.09-2001.09	MT	L/R	F	Saloon Engine AGR	603011	Inner Joint			33		34		
	1996.09-2001.09	-	L/R	F	Saloon Engine AGR	861018	Outer Joint	22	30	53	78.5	61	I	
POLO CLASSIC (86C 80)														
1.0 (33 kW)	1985.01-1994.09	MT	L	F	Saloon Engine HZ	653001	Inner Joint			33		32		
	1985.01-1994.09	-	-	F	Saloon Engine HZ	803022	Outer Joint	20	25	45.5	74	49	I	
	1985.01-1994.09	MT	L/R	F	Saloon Engine HZ	861002	Outer Joint	20	30	45.5	73.5	51	I	
1.3 Cat (40 kW)	1987.07-1994.09	MT	L	F	Saloon Engine NZ	653001	Inner Joint			33		32		
	1987.07-1994.09	-	-	F	Saloon Engine NZ	803022	Outer Joint	20	25	45.5	74	49	I	
	1987.07-1994.09	MT	L/R	F	Saloon Engine NZ	861002	Outer Joint	20	30	45.5	73.5	51	I	
1.4 D (35 kW)	1990.10-1994.09	MT	L/R	F	Saloon Engine 1W	653001	Inner Joint			33		32		
	1990.10-1994.09	-	-	F	Saloon Engine 1W	803022	Outer Joint	20	25	45.5	74	49	I	
POLO SEDAN														
1.6 8V (EA111)	2003.01-2011.06	MT	-	-	-	861037	Outer Joint	22	30	51	78	61	I	
1.6/2.0 8V	2003.01-2011.12	-	-	-	-	854003	Outer Joint	36	30	52	75	56	I	
2.0 8V	2003.01-2011.06	MT	-	-	-	861037	Outer Joint	22	30	51	78	61	I	
POLO Van (6R)/POLO CityVan														
1.2 TSI (81 kW)	2014.01- -	-	L/R	F	Box Body/Hatchback Engine CJZD	603011	Inner Joint			33		34		
	2014.01- -	MT	L	F	Box Body/Hatchback Engine CJZD	261263	Drive Shaft	36			52	59	514	
	2014.01- -	MT	L	F	Box Body/Hatchback Engine CJZD	854006	Outer Joint	36	30	52	59	55.5	I	
1.4 TDI (55 kW)	2014.03- -	AT	L/R	F	Box Body/Hatchback Engine CYZB	603011	Inner Joint			33		34		
1.4 TDI (66 kW)	2014.02- -	5MT	L/R	F	Box Body/Hatchback Engine CUSB	603011	Inner Joint			33		34		
1.4 TSI (110 kW)	2014.05- -	Semi-AT/MT	-	F	Box Body/Hatchback Engine CZEA	803041	Outer Joint	36	27	50.5	75	65	I	
POLO Variant (6V5)														
1.4 (40 kW)	1998.12-2001.09	-	L/R	F	Estate Engine AKP	853008	Outer Joint	22	30	53	78.5	51	I	
	1998.12-2001.09	-	L/R	F	Estate Engine AKP	653001	Inner Joint			33		32		
	1998.12-2001.09	AT/MT	L/R	F	Estate Engine AKP	853005	Outer Joint	22	30	53	78.5	51	I	
	1998.12-2001.09	-	L	F	Estate Engine AKP	253004	Drive Shaft	22			50	78.5	562	
	1998.12-2001.09	AT	L/R	F	Estate Engine AKP	661005	Inner Joint			30		57.6		
1.4 (44 kW)	1997.05-2001.09	-	L/R	F	Estate Engine ANW	853008	Outer Joint	22	30	53	78.5	51	I	
	1997.05-2001.09	MT	L/R	F	Estate Engine ANW	653001	Inner Joint			33		32		
	1997.05-2001.09	MT	L	F	Estate Engine ANW	253004	Drive Shaft	22			50	78.5	562	
	1997.05-2001.09	MT	-	-	Estate Engine ANW	603006	Inner Joint			33		34		
1.4 16V (55 kW)	1999.10-2001.09	-	L/R	F	Estate Engine APE/AUA	653001	Inner Joint			33		32		
	1999.10-2001.09	AT/MT	L/R	F	Estate Engine APE/AUA	853005	Outer Joint	22	30	53	78.5	51	I	
	1999.10-2001.09	-	L	F	Estate Engine APE/AUA	253004	Drive Shaft	22			50	78.5	562	
	1999.10-2001.09	-	L/R	F	Estate Engine APE/AUA	853008	Outer Joint	22	30	53	78.5	51	I	
1.6 (55 kW)	1997.05-2001.09	-	L/R	F	Estate Engine AEE	853008	Outer Joint	22	30	53	78.5	51	I	
	1997.05-2001.09	-	L/R	F	Estate Engine AEE	653001	Inner Joint			33		32		
	1997.05-2001.09	MT	L/R	F	Estate Engine AEE	853007	Outer Joint	22	30	53.2	78	61	I	
	1997.05-2001.09	MT	R	F	Estate Engine AEE	253002	Drive Shaft	22			53.2	78	769	
	1997.05-2001.09	-	L	F	Estate Engine AEE	253004	Drive Shaft	22			50	78.5	562	
	1997.05-2001.09	MT	-	-	Estate Engine AEE	603006	Inner Joint			33		34		
	1997.05-2001.09	MT	R	F	Estate Engine AEE	603009	Inner Joint			33		34		
	1997.05-2001.09	MT	L	F	Estate Engine AEE	603011	Inner Joint			33		34		

YEAR	TRANSM	L/R	F/R	REMARKS	GSP Ref.	PRODUCT	ABS	Technical Specifications						
								A	B	C	H	L	P	
VW														
POLO Variant (6V5)														
1.6 (74 kW)	1997.05-2001.09	MT	R	F	Estate Engine AEH/AFL/AKL/APF/AUR	253005	Drive Shaft		22		53	78.5	774	
	1997.05-2001.09	MT	L/R	F	Estate Engine AEH/AFL/AKL/APF/AUR	853007	Outer Joint		22	30	53.2	78	61	I
	1997.05-2001.09	MT	R	F	Estate Engine AEH/AFL/AKL/APF/AUR	253002	Drive Shaft		22		53.2	78	769	
	1997.05-2001.09	MT	L/R	F	Estate Engine AEH/AFL/AKL/APF/AUR	603004	Inner Joint			33		32		
	1997.05-2001.09	MT	R	F	Estate Engine AEH/AFL/AKL/APF/AUR	603009	Inner Joint			33		34		
	1997.05-2001.09	MT	L/R	F	Estate Engine AEH/AFL/AKL/APF/AUR	603011	Inner Joint			33		34		
	1997.05-2001.09	-	L/R	F	Estate Engine AEH/AFL/AKL/APF/AUR	853008	Outer Joint		22	30	53	78.5	51	I
	1997.05-2001.09	MT	L/R	F	Estate Engine AEH/AFL/AKL/APF/AUR	603005	Inner Joint			33		32		
1.7 SDI (42 kW)	1997.05-2001.09	MT	L	F	Estate Engine AEH/AFL/AKL/APF/AUR	253003	Drive Shaft		22		53	78.5	539.5	
	1997.08-2001.09	-	L/R	F	Estate Engine AKW	603004	Inner Joint			33		32		
	1997.08-2001.09	-	L/R	F	Estate Engine AKW	853008	Outer Joint		22	30	53	78.5	51	I
	1997.08-2001.09	MT	-	-	Estate Engine AKW	603006	Inner Joint			33		34		
1.9 SDI (47 kW)	1997.06-2001.09	MT	L/R	F	Estate Engine AEY	603004	Inner Joint			33		32		
	1997.06-2001.09	MT	L/R	F	Estate Engine AEY	603005	Inner Joint			33		32		
	1997.06-2001.09	MT	L/R	F	Estate Engine AEY	853008	Outer Joint		22	30	53	78.5	51	I
	1997.06-2001.09	MT	L	F	Estate Engine AEY	253003	Drive Shaft		22		53	78.5	539.5	
	1997.06-2001.09	MT	R	F	Estate Engine AEY	253005	Drive Shaft		22		53	78.5	774	
1.9 SDI (50 kW)	1999.08-2001.09	-	R	F	Estate Engine AGP	603004	Inner Joint			33		32		
	1999.08-2001.09	-	L/R	F	Estate Engine AGP	853008	Outer Joint		22	30	53	78.5	51	I
1.9 TDI (66 kW)	1997.05-2001.09	MT	L/R	F	Estate Engine ALH	853007	Outer Joint		22	30	53.2	78	61	I
	1997.05-2001.09	MT	R	F	Estate Engine ALH	253002	Drive Shaft		22		53.2	78	769	
	1997.05-2001.09	MT	-	-	Estate Engine ALH	603006	Inner Joint			33		34		
	1997.05-2001.09	MT	R	F	Estate Engine ALH	603009	Inner Joint			33		34		
	1997.05-2001.09	MT	L	F	Estate Engine ALH	603011	Inner Joint			33		34		
1.9 TDI (81 kW)	1997.05-2001.09	-	L/R	F	Estate Engine ALH	861018	Outer Joint		22	30	53	78.5	61	I
	1998.06-2001.09	-	L/R	F	Estate Engine AFN/ASV	861018	Outer Joint		22	30	53	78.5	61	I
	1998.06-2001.09	-	L/R	F	Estate Engine AFN/ASV	853007	Outer Joint		22	30	53.2	78	61	I
	1998.06-2001.09	MT	-	-	Estate Engine AFN/ASV	603006	Inner Joint			33		34		
	1998.06-2001.09	MT	R	F	Estate Engine AFN/ASV	603009	Inner Joint			33		34		
1998.06-2001.09	MT	L	F	Estate Engine AFN/ASV	603011	Inner Joint			33		34			
QUANTUM														
1.8	1991.11-1992.11	MT	-	-	-	861024	Outer Joint	43T	22	30	64	78	51	I
	1992.11-1995.12	MT/AT	-	-	-	899134	Outer Joint	43T	22	30	51	78	61	I
	1992.11-2002.12	MT/AT	-	-	-	861028	Outer Joint		22	30	51	78	61	I
	1992.11-1995.12	MT/AT	-	-	-	618018	Inner Joint			33		32		
	1992.11-2002.12	MT/AT	-	-	-	618018	Inner Joint			33		32		
	1993.01-2002.12	MT/AT	-	-	-	899134	Outer Joint	43T	22	30	51	78	61	I
	1993.01-2002.12	MT/AT	-	-	-	618018	Inner Joint			33		32		
	1996.01-2002.12	MT/AT	-	-	-	899134	Outer Joint	43T	22	30	51	78	61	I
2.0 8V	1991.11-1992.11	MT	-	-	-	861024	Outer Joint	43T	22	30	64	78	51	I
	1992.11-1995.12	MT/AT	-	-	-	899134	Outer Joint	43T	22	30	51	78	61	I
	1992.11-2002.12	MT/AT	-	-	-	861028	Outer Joint		22	30	51	78	61	I
	1992.11-1995.12	MT/AT	-	-	-	618018	Inner Joint			33		32		
	1992.11-2002.12	MT/AT	-	-	-	618018	Inner Joint			33		32		
	1993.01-2002.12	MT/AT	-	-	-	899134	Outer Joint	43T	22	30	51	78	61	I
	1993.01-2002.12	MT/AT	-	-	-	618018	Inner Joint			33		32		
	1996.01-2002.12	MT/AT	-	-	-	899134	Outer Joint	43T	22	30	51	78	61	I
1996.01-2002.12	MT/AT	-	-	-	861028	Outer Joint		22	30	51	78	61	I	
RABBIT MK5														
2.5L	2006-	2009	AT	R	F	-	261152	Drive Shaft		36	26	59.5	40	873
SAGITAR														
-	2006-	2012	-	-	-	-	201594	Drive Shaft		36		59.5	40	800
SANTANA														
1.8	1991.11-1992.11	MT	-	-	-	861024	Outer Joint	43T	22	30	64	78	51	I
	1992.11-1995.12	MT/AT	-	-	-	861028	Outer Joint		22	30	51	78	61	I
	1992.11-1995.12	MT/AT	-	-	-	618018	Inner Joint			33		32		
	1992.12-1995.12	MT/AT	-	-	-	899134	Outer Joint	43T	22	30	51	78	61	I
	1992.12-1995.12	MT/AT	-	-	-	618018	Inner Joint			33		32		
	1996.01-2006.12	MT/AT	-	-	-	899134	Outer Joint	43T	22	30	51	78	61	I
2.0	1996.01-2006.12	MT/AT	-	-	-	861028	Outer Joint		22	30	51	78	61	I
	1991.11-1992.11	MT	-	-	-	861024	Outer Joint	43T	22	30	64	78	51	I
	1992.11-1995.12	MT/AT	-	-	-	861028	Outer Joint		22	30	51	78	61	I
	1992.11-1995.12	MT/AT	-	-	-	618018	Inner Joint			33		32		
1992.12-1995.12	MT/AT	-	-	-	899134	Outer Joint	43T	22	30	51	78	61	I	





YEAR	TRANSM	L/R	F/R	REMARKS	GSP Ref.	PRODUCT	ABS	Technical Specifications							
								A	B	C	H	L	P		
VW SANTANA															
2.0	1992.12-1995.12	MT/AT	-	-	-	618018	Inner Joint			33		32			
	1996.01-2006.12	MT/AT	-	-	-	899134	Outer Joint	43T	22	30	51	78	61	I	
	1996.01-2006.12	MT/AT	-	-	-	861028	Outer Joint		22	30	51	78	61	I	
SAVEIRO															
-	2009-2013	MT	L/R	-	-	861046	Outer Joint		22	24	51	78	62	M	
	2010-2013	MT	L/R	-	-	661068	Inner Joint			33		32			
1.6 AE	1987.01-1995.12	MT	-	-	-	618019	Inner Joint			33		32			
2.0	1996.01-2006.12	MT	-	-	-	861028	Outer Joint		22	30	51	78	61	I	
SCIROCCO (137 138)															
1.4 TSI (110 kW)	2015.07-	7AT	L	F	Coupe Engine CZDA	261131	Drive Shaft		36		59.5	40	515		
1.4 TSI (118 kW)	2008.05-	MT	L	F	Coupe Engine CAVD	261201	Drive Shaft		36		59.5	40.5	535		
	2008.05-	MT	-	F	Coupe Engine CAVD	803100	Outer Joint		36	33	59.5	38	55	I	
	2008.05-	MT	L/R	F	Coupe Engine CAVD	603011	Inner Joint			33		34			
	2008.05-	MT	L/R	F	Coupe Engine CAVD	803037	Outer Joint		36	30	59.5	40.5	55	I	
	2008.05-	7AT	L	F	Coupe Engine CAVD	261281	Drive Shaft		36		59.5	40	528		
	2008.05-	AT	L/R	F	Coupe Engine CAVD	803002	Outer Joint		36	27	59.5	40	66	I	
1.4 TSI (90 kW)	2008.08-	-	-	F	Coupe Engine CAXA/CMSB	803100	Outer Joint		36	33	59.5	38	55	I	
	2008.08-	-	L/R	F	Coupe Engine CAXA/CMSB	803037	Outer Joint		36	30	59.5	40.5	55	I	
	2008.08-	MT	L	F	Coupe Engine CAXA/CMSB	261198	Drive Shaft		36		59.5	40.5	530		
	2008.08-	-	L/R	F	Coupe Engine CAXA/CMSB	603011	Inner Joint			33		34			
1.4 TSI (92 kW)	2013.11-	MT	-	-	Coupe Engine CXSB	861059	Outer Joint		36	33	59.5	40	59.5	I	
	2013.11-	MT	L/R	F	Coupe Engine CXSB	603011	Inner Joint			33		34			
	2013.11-	-	-	F	Coupe Engine CXSB	803100	Outer Joint		36	33	59.5	38	55	I	
	2013.11-	MT	-	-	Coupe Engine CXSB	603006	Inner Joint			33		34			
2.0 TDI (100 kW)	2010.11-	-	-	-	Coupe Engine CFHB	603016	Inner Joint			28		32			
	2010.11-	MT	R	F	Coupe Engine CFHB	203313	Drive Shaft		36		59.5	40	792		
	2010.11-	AT	L	F	Coupe Engine CFHB	254013	Drive Shaft		36		59.5	40	479.5		
	2010.11-	AT	L	F	Coupe Engine CFHB	654004	Inner Joint			34		85			
	2010.11-	AT	L	F	Coupe Engine CFHB	203241	Drive Shaft		36		59.5	40	475		
	2010.11-	-	L/R	F	Coupe Engine CFHB	803002	Outer Joint		36	27	59.5	40	66	I	
	2010.11-	AT	R	F	Coupe Engine CFHB	254011	Drive Shaft		36		59.5	40	755		
	2010.11-	MT	L	F	Coupe Engine CFHB	203295	Drive Shaft		36		59.5	40	491		
2.0 TDI (103 kW)	2008.08-	AT	L/R	F	Coupe Engine CBDB	661057	Inner Joint			34		86			
	2008.08-	-	-	-	Coupe Engine CBDB	603016	Inner Joint			28		32			
	2008.08-	MT	R	F	Coupe Engine CBDB	203313	Drive Shaft		36		59.5	40	792		
	2008.08-	AT	L	F	Coupe Engine CBDB	254013	Drive Shaft		36		59.5	40	479.5		
	2008.08-	AT	L	F	Coupe Engine CBDB	654004	Inner Joint			34		85			
	2008.08-	-	L/R	F	Coupe Engine CBDB	803002	Outer Joint		36	27	59.5	40	66	I	
	2008.08-	AT	L	F	Coupe Engine CBDB	203241	Drive Shaft		36		59.5	40	475		
	2008.08-	AT	R	F	Coupe Engine CBDB	254011	Drive Shaft		36		59.5	40	755		
	2008.08-	MT	L	F	Coupe Engine CBDB	203295	Drive Shaft		36		59.5	40	491		
2.0 TDI (110 kW)	2013.11-	MT	L	F	Coupe Engine CUUB	261188	Drive Shaft		36		59.5	40	487		
	2013.11-	Semi-AT	L	F	Coupe Engine CUUB	654004	Inner Joint			34		85			
	2013.11-	Semi-AT	L	F	Coupe Engine CUUB	203241	Drive Shaft		36		59.5	40	475		
2.0 TDI (125 kW)	2009.05-	MT	L	F	Coupe Engine CBBB	203265	Drive Shaft		36		59.5	40	487		
	2009.05-	MT	R	F	Coupe Engine CBBB	261126	Drive Shaft		36		59.5	40	793		
	2009.05-	AT	R	F	Coupe Engine CBBB	654004	Inner Joint			34		85			
	2009.05-	AT	R	F	Coupe Engine CBBB	254011	Drive Shaft		36		59.5	40	755		
	2009.05-	Semi-AT	L	F	Coupe Engine CBBB	203241	Drive Shaft		36		59.5	40	475		
2.0 TDI (130 kW)	2013.01-	MT	R	F	Coupe Engine CFGC	203313	Drive Shaft		36		59.5	40	792		
	2013.01-	AT	L	F	Coupe Engine CFGC	254013	Drive Shaft		36		59.5	40	479.5		
	2013.01-	AT	L	F	Coupe Engine CFGC	654004	Inner Joint			34		85			
	2013.01-	AT	L/R	F	Coupe Engine CFGC	803002	Outer Joint		36	27	59.5	40	66	I	
	2013.01-	AT	R	F	Coupe Engine CFGC	254011	Drive Shaft		36		59.5	40	755		
	2013.01-	MT	L	F	Coupe Engine CFGC	203295	Drive Shaft		36		59.5	40	491		
2.0 TDI (135 kW)	2014.05-	MT	L	F	Coupe Engine CUWA/CUXA	261188	Drive Shaft		36		59.5	40	487		
	2014.05-	AT	R	F	Coupe Engine CUWA/CUXA	254011	Drive Shaft		36		59.5	40	755		
	2014.05-	MT	L	F	Coupe Engine CUWA/CUXA	203265	Drive Shaft		36		59.5	40	487		
	2014.05-	AT	R	F	Coupe Engine CUWA/CUXA	654004	Inner Joint			34		85			
	2014.05-	MT	R	F	Coupe Engine CUWA/CUXA	261126	Drive Shaft		36		59.5	40	793		
	2014.05-	MT	L/R	F	Coupe Engine CUWA/CUXA	861045	Outer Joint		36	27	59.5	40	65	M	
	2014.05-	Semi-AT	L	F	Coupe Engine CUWA/CUXA	203241	Drive Shaft		36		59.5	40	475		
2.0 TSI (132 kW)	2013.11-	AT	-	-	Coupe Engine CULA	603016	Inner Joint			28		32			
2.0 TSI (147 kW)	2008.05-2009.11	MT	L	F	Coupe Engine CAWB	203295	Drive Shaft		36		59.5	40	491		
	2008.05-2009.11	-	L/R	F	Coupe Engine CAWB	803002	Outer Joint		36	27	59.5	40	66	I	
2.0 TSI (155 kW)	2009.11-	AT	L/R	F	Coupe Engine CCZB	803002	Outer Joint		36	27	59.5	40	66	I	





YEAR	TRANSM	L/R	F/R	REMARKS	GSP Ref.	PRODUCT	ABS	Technical Specifications						
								A	B	C	H	L	P	
VW														
SCIROCCO (137 138)														
2.0 TSI (155 kW)	2009.11-	-	AT	L F	Coupe Engine CCZB	203295	Drive Shaft		36		59.5	40	491	
2.0 TSI (162 kW)	2013.11-	-	AT	- -	Coupe Engine CULC	603016	Inner Joint		28		32			
SCIROCCO (53B)														
1.6 (53 kW)	1986.04-	1990.07	MT	L/R F	Coupe Engine RE	603004	Inner Joint		33		32			
	1986.04-	1990.07	MT	L/R F	Coupe Engine RE	603005	Inner Joint		33		32			
	1986.04-	1990.07	MT	L/R F	Coupe Engine RE	853008	Outer Joint	22	30	53	78.5	51	I	
	1986.04-	1990.07	MT	L F	Coupe Engine RE	253003	Drive Shaft	22		53	78.5	539.5		
1.6 (55 kW)	1983.01-	1989.12	MT	L/R F	Coupe Engine EW	603004	Inner Joint		33		32			
	1983.01-	1989.12	MT	L/R F	Coupe Engine EW	853008	Outer Joint	22	30	53	78.5	51	I	
	1983.01-	1989.12	MT	L F	Coupe Engine EW	253003	Drive Shaft	22		53	78.5	539.5		
	1983.01-	1989.12	MT	L/R F	Coupe Engine EW	603005	Inner Joint		33		32			
1.8 (66 kW)	1983.08-	1992.07	MT	L F	Coupe Engine EX	253001	Drive Shaft	22		53	78.5	535		
	1983.08-	1992.07	AT/MT	L/R F	Coupe Engine EX	853007	Outer Joint	22	30	53.2	78	61	I	
	1983.08-	1992.07	AT/MT	L/R F	Coupe Engine EX	603004	Inner Joint		33		32			
	1983.08-	1992.07	AT/MT	R F	Coupe Engine EX	603009	Inner Joint		33		34			
	1983.08-	1992.07	MT	R F	Coupe Engine EX	261006	Drive Shaft	22		53.2	78	747		
	1983.08-	1992.07	AT/MT	L/R F	Coupe Engine EX	603005	Inner Joint		33		32			
	1983.08-	1992.07	AT	L/R F	Coupe Engine EX	861013	Outer Joint	22	30	50	77.5	51	I	
	1983.08-	1992.07	AT/MT	L/R F	Coupe Engine EX	853008	Outer Joint	22	30	53	78.5	51	I	
	1983.08-	1992.07	AT/MT	L F	Coupe Engine EX	253003	Drive Shaft	22		53	78.5	539.5		
1.8 (70 kW)	1985.11-	1992.07	MT	L F	Coupe Engine JH	253001	Drive Shaft	22		53	78.5	535		
	1985.11-	1992.07	MT	L/R F	Coupe Engine JH	853007	Outer Joint	22	30	53.2	78	61	I	
	1985.11-	1992.07	MT	R F	Coupe Engine JH	261006	Drive Shaft	22		53.2	78	747		
	1985.11-	1992.07	MT	L/R F	Coupe Engine JH	603004	Inner Joint		33		32			
	1985.11-	1992.07	-	L F	Coupe Engine JH	253006	Drive Shaft	22		50	78.5	526		
	1985.11-	1992.07	MT	L/R F	Coupe Engine JH	861013	Outer Joint	22	30	50	77.5	51	I	
	1985.11-	1992.07	MT	R F	Coupe Engine JH	603009	Inner Joint		33		34			
	1985.11-	1992.07	MT	L F	Coupe Engine JH	603011	Inner Joint		33		34			
	1985.11-	1992.07	MT	L/R F	Coupe Engine JH	603005	Inner Joint		33		32			
1.8 (82 kW)	1982.08-	1989.12	-	L F	Coupe Engine JJ	253006	Drive Shaft	22		50	78.5	526		
	1982.08-	1989.12	MT	L/R F	Coupe Engine JJ	603004	Inner Joint		33		32			
	1982.08-	1989.12	MT	L/R F	Coupe Engine JJ	861013	Outer Joint	22	30	50	77.5	51	I	
	1982.08-	1989.12	MT	L/R F	Coupe Engine JJ	853007	Outer Joint	22	30	53.2	78	61	I	
	1982.08-	1989.12	MT	L F	Coupe Engine JJ	603011	Inner Joint		33		34			
	1982.08-	1989.12	MT	R F	Coupe Engine JJ	603009	Inner Joint		33		34			
	1982.08-	1989.12	MT	R F	Coupe Engine JJ	261006	Drive Shaft	22		53.2	78	747		
	1982.08-	1989.12	MT	L F	Coupe Engine JJ	253001	Drive Shaft	22		53	78.5	535		
	1982.08-	1989.12	MT	L/R F	Coupe Engine JJ	603005	Inner Joint		33		32			
1.8 16V (102 kW)	1985.10-	1989.07	MT	L/R F	Coupe Engine KR	853007	Outer Joint	22	30	53.2	78	61	I	
	1985.10-	1989.07	MT	L F	Coupe Engine KR	603011	Inner Joint		33		34			
	1985.10-	1989.07	MT	R F	Coupe Engine KR	603009	Inner Joint		33		34			
	1985.10-	1989.07	MT	R F	Coupe Engine KR	261006	Drive Shaft	22		53.2	78	747		
	1985.10-	1989.07	MT	L F	Coupe Engine KR	253001	Drive Shaft	22		53	78.5	535		
1.8 16V (95 kW)	1986.03-	1992.07	MT	L F	Coupe Engine PL	253001	Drive Shaft	22		53	78.5	535		
	1986.03-	1992.07	MT	R F	Coupe Engine PL	261006	Drive Shaft	22		53.2	78	747		
	1986.03-	1992.07	MT	L/R F	Coupe Engine PL	853007	Outer Joint	22	30	53.2	78	61	I	
	1986.03-	1992.07	MT	R F	Coupe Engine PL	603009	Inner Joint		33		34			
	1986.03-	1992.07	MT	L F	Coupe Engine PL	603011	Inner Joint		33		34			
SHARAN														
1.9 TDI (110 KW)	2005-	-	-	R F	MPV (Diesel)	261255	Stub Axle	37	113.5			381		
	2006-	-	-	R F	MPV (Diesel)	261255	Stub Axle	37	113.5			381		
	2007-	-	-	R F	MPV (Diesel)	261255	Stub Axle	37	113.5			381		
	2008-	-	-	R F	MPV (Diesel)	261255	Stub Axle	37	113.5			381		
	2009-	-	-	R F	MPV (Diesel)	261255	Stub Axle	37	113.5			381		
	2010-	-	-	R F	MPV (Diesel)	261255	Stub Axle	37	113.5			381		
	2011-	-	-	R F	MPV (Diesel)	261255	Stub Axle	37	113.5			381		
1.9 Tdi (66 KW)	1995-	-	-	R F	MPV (Diesel)	261255	Stub Axle	37	113.5			381		
	1996-	-	-	R F	MPV (Diesel)	261255	Stub Axle	37	113.5			381		
	1997-	-	-	R F	MPV (Diesel)	261255	Stub Axle	37	113.5			381		
	1998-	-	-	R F	MPV (Diesel)	261255	Stub Axle	37	113.5			381		
	1999-	-	-	R F	MPV (Diesel)	261255	Stub Axle	37	113.5			381		
	2000-	-	-	R F	MPV (Diesel)	261255	Stub Axle	37	113.5			381		
	2001-	-	-	R F	MPV (Diesel)	261255	Stub Axle	37	113.5			381		
	2002-	-	-	R F	MPV (Diesel)	261255	Stub Axle	37	113.5			381		
	2003-	-	-	R F	MPV (Diesel)	261255	Stub Axle	37	113.5			381		
	2004-	-	-	R F	MPV (Diesel)	261255	Stub Axle	37	113.5			381		

	 YEAR	TRANSM	L/R	F/R	REMARKS	GSP Ref.	 PRODUCT	 ABS	Technical Specifications						
									A	B	C	H	L	P	
VW SHARAN															
1.9 Tdi (66 KW)	2005-	-	-	R F	MPV (Diesel)	261255	Stub Axle		37	113.5			381		
	2006-	-	-	R F	MPV (Diesel)	261255	Stub Axle		37	113.5			381		
	2007-	-	-	R F	MPV (Diesel)	261255	Stub Axle		37	113.5			381		
	2008-	-	-	R F	MPV (Diesel)	261255	Stub Axle		37	113.5			381		
	2009-	-	-	R F	MPV (Diesel)	261255	Stub Axle		37	113.5			381		
	2010-	-	-	R F	MPV (Diesel)	261255	Stub Axle		37	113.5			381		
1.9 TDI (81 KW)	1996-	-	-	R F	MPV (Diesel)	261255	Stub Axle		37	113.5			381		
	1997-	-	-	R F	MPV (Diesel)	261255	Stub Axle		37	113.5			381		
	1998-	-	-	R F	MPV (Diesel)	261255	Stub Axle		37	113.5			381		
	1999-	-	-	R F	MPV (Diesel)	261255	Stub Axle		37	113.5			381		
	2000-	-	-	R F	MPV (Diesel)	261255	Stub Axle		37	113.5			381		
1.9 TDI (85 KW)	2000-	-	-	R F	MPV (Diesel)	261255	Stub Axle		37	113.5			381		
	2001-	-	-	R F	MPV (Diesel)	261255	Stub Axle		37	113.5			381		
	2002-	-	-	R F	MPV (Diesel)	261255	Stub Axle		37	113.5			381		
	2003-	-	-	R F	MPV (Diesel)	261255	Stub Axle		37	113.5			381		
	2004-	-	-	R F	MPV (Diesel)	261255	Stub Axle		37	113.5			381		
	2005-	-	-	R F	MPV (Diesel)	261255	Stub Axle		37	113.5			381		
	2006-	-	-	R F	MPV (Diesel)	261255	Stub Axle		37	113.5			381		
	2007-	-	-	R F	MPV (Diesel)	261255	Stub Axle		37	113.5			381		
	2008-	-	-	R F	MPV (Diesel)	261255	Stub Axle		37	113.5			381		
	2009-	-	-	R F	MPV (Diesel)	261255	Stub Axle		37	113.5			381		
1.9 TDI (96 KW)	2002-	-	-	R F	MPV (Diesel)	261255	Stub Axle		37	113.5			381		
	2003-	-	-	R F	MPV (Diesel)	261255	Stub Axle		37	113.5			381		
	2004-	-	-	R F	MPV (Diesel)	261255	Stub Axle		37	113.5			381		
	2005-	-	-	R F	MPV (Diesel)	261255	Stub Axle		37	113.5			381		
	2006-	-	-	R F	MPV (Diesel)	261255	Stub Axle		37	113.5			381		
	2007-	-	-	R F	MPV (Diesel)	261255	Stub Axle		37	113.5			381		
	2008-	-	-	R F	MPV (Diesel)	261255	Stub Axle		37	113.5			381		
	2009-	-	-	R F	MPV (Diesel)	261255	Stub Axle		37	113.5			381		
SHARAN (7M8 7M9 7M6)															
1.8 T 20V (110 kW)	1997.09-	2010.03	MT	L F	MPV Engine AJH	218009	Drive Shaft	48W	38	26	60	34.5	620		
	1997.09-	2010.03	MT	R F	MPV Engine AJH	218008	Drive Shaft	48W	38	35	60	34.5	559		
	1997.09-	2010.03	AT	L/R F	MPV Engine AJH	203022	Drive Shaft	48W	38		60	34	486		
	1997.09-	2010.03	-	R F	MPV Engine AJH	261192	Stub Axle		26	37	60		129.5		
	1997.09-	2010.03	AT	L F	MPV Engine AJH	261085	Drive Shaft	48W	38		60	34.5	513		
	1997.09-	2010.03	AT	R F	MPV Engine AJH	261065	Drive Shaft	48W	38		60	34.5	544		
	1997.09-	2010.03	AT	L/R F	MPV Engine AJH	818039	Outer Joint		38	36	60	34	72.5	I	
	1997.09-	2010.03	MT	L F	MPV Engine AJH	203024	Drive Shaft	48W	38	26	60	34.5	617		
	1997.09-	2010.03	MT	L/R F	MPV Engine AJH	203023	Drive Shaft	48W	38		60	34	507		
	1997.09-	2010.03	MT	R F	MPV Engine AJH	203027	Drive Shaft	48W	38	35	60	34.5	561		
	1997.09-	2010.03	AT/MT	L/R F	MPV Engine AJH	818026	Outer Joint	48W	38	27	60	34.5	65	I	
	1997.09-	2010.03	AT	R F	MPV Engine AJH	261104	Drive Shaft	48W	38		60	34	544		
	1997.09-	2010.03	AT/MT	L/R F	MPV Engine AJH	818025	Outer Joint	48W	38	36	60	34	72.5	I	
1.9 TDI (110 kW)	2005.06-	2010.03	-	R F	MPV Engine BTB	261193	Stub Axle		37		60		322		
	2005.06-	2010.03	-	R F	MPV Engine BTB	261192	Stub Axle		26	37	60		129.5		
	2005.06-	2010.03	-	L/R F	MPV Engine BTB	203023	Drive Shaft	48W	38		60	34	507		
	2005.06-	2010.03	-	L/R F	MPV Engine BTB	818025	Outer Joint	48W	38	36	60	34	72.5	I	
1.9 TDI (66 kW)	1995.09-	2010.03	6MT	L/R F	MPV Engine 1Z/ANU/AHU	203022	Drive Shaft	48W	38		60	34	486		
	1995.09-	2010.03	6MT	L/R F	MPV Engine 1Z/ANU/AHU	261087	Drive Shaft	48W	38		60	34.5	506		
	1995.09-	2010.03	-	R F	MPV Engine 1Z/ANU/AHU	261192	Stub Axle		26	37	60		129.5		
	1995.09-	2010.03	MT	L F	MPV Engine 1Z/ANU/AHU	861022	Outer Joint		38	27	60	34.5	65	M	
	1995.09-	2010.03	-	F	MPV Engine 1Z/ANU/AHU	659006	Inner Joint			34		33.2			
	1995.09-	2010.03	6MT	L/R F	MPV Engine 1Z/ANU/AHU	661032	Inner Joint			27		34			
	1995.09-	2010.03	-	-	F	MPV Engine 1Z/ANU/AHU	818040	Outer Joint		38	27	60	34.5	65	I
	1995.09-	2010.03	MT	L/R F	MPV Engine 1Z/ANU/AHU	203023	Drive Shaft	48W	38		60	34	507		
	1995.09-	2010.03	MT	L F	MPV Engine 1Z/ANU/AHU	203024	Drive Shaft	48W	38	26	60	34.5	617		
	1995.09-	2010.03	MT	R F	MPV Engine 1Z/ANU/AHU	203027	Drive Shaft	48W	38	35	60	34.5	561		
	1995.09-	2010.03	MT	L/R F	MPV Engine 1Z/ANU/AHU	818026	Outer Joint	48W	38	27	60	34.5	65	I	
	1995.09-	2010.03	MT	L F	MPV Engine 1Z/ANU/AHU	203064	Drive Shaft		38	26	60	34.5	617		
	1995.09-	2010.03	MT	R F	MPV Engine 1Z/ANU/AHU	203065	Drive Shaft		38	35	60	34.5	561		
	1995.09-	2010.03	MT	L/R F	MPV Engine 1Z/ANU/AHU	818025	Outer Joint	48W	38	36	60	34	72.5	I	
	1995.09-	2010.03	AT	R F	MPV Engine 1Z/ANU/AHU	261104	Drive Shaft	48W	38		60	34	544		
1995.09-	2010.03	MT	R F	MPV Engine 1Z/ANU/AHU	261245	Stub Axle		26	113.5			290			

YEAR	TRANSM	L/R	F/R	REMARKS	GSP Ref.	PRODUCT	ABS	Technical Specifications					
								A	B	C	H	L	P
VW SHARAN (7M8 7M9 7M6)													
1.9 TDI (81 kW)													
1996.09-2000.04	AT	L/R	F	MPV Engine AFN	661033	Inner Joint			34		85		
1996.09-2000.04	MT	R	F	MPV Engine AFN	218008	Drive Shaft	48W	38	35	60	34.5	559	
1996.09-2000.04	AT	L	F	MPV Engine AFN	261085	Drive Shaft	48W	38		60	34.5	513	
1996.09-2000.04	AT	R	F	MPV Engine AFN	261065	Drive Shaft	48W	38		60	34.5	544	
1996.09-2000.04	MT	L	F	MPV Engine AFN	861022	Outer Joint		38	27	60	34.5	65	
1996.09-2000.04	-	-	F	MPV Engine AFN	818040	Outer Joint		38	27	60	34.5	65	
1996.09-2000.04	MT	L	F	MPV Engine AFN	203024	Drive Shaft	48W	38	26	60	34.5	617	
1996.09-2000.04	AT/MT	L/R	F	MPV Engine AFN	818026	Outer Joint	48W	38	27	60	34.5	65	
1996.09-2000.04	MT	R	F	MPV Engine AFN	203027	Drive Shaft	48W	38	35	60	34.5	561	
1996.09-2000.04	MT	L	F	MPV Engine AFN	203064	Drive Shaft		38	26	60	34.5	617	
1996.09-2000.04	MT	R	F	MPV Engine AFN	203065	Drive Shaft		38	35	60	34.5	561	
1996.09-2000.04	AT/MT	L/R	F	MPV Engine AFN	818025	Outer Joint	48W	38	36	60	34	72.5	
1996.09-2000.04	AT	R	F	MPV Engine AFN	261104	Drive Shaft	48W	38		60	34	544	
1.9 TDI (85 kW)													
2000.04-2010.03	-	R	F	MPV Engine AUU	261193	Stub Axle		37		60		322	
2000.04-2010.03	5AT	L/R	F	MPV Engine AUU	203022	Drive Shaft	48W	38		60	34	486	
2000.04-2010.03	MT	L/R	F	MPV Engine AUU	261087	Drive Shaft	48W	38		60	34.5	506	
2000.04-2010.03	-	R	F	MPV Engine AUU	261192	Stub Axle		26	37	60		129.5	
2000.04-2010.03	MT	-	F	MPV Engine AUU	659006	Inner Joint			34		33.2		
2000.04-2010.03	MT	L/R	F	MPV Engine AUU	661032	Inner Joint			27		34		
2000.04-2010.03	MT	L/R	F	MPV Engine AUU	203023	Drive Shaft	48W	38		60	34	507	
2000.04-2010.03	5AT	L/R	F	MPV Engine AUU	818039	Outer Joint		38	36	60	34	72.5	
2000.04-2010.03	AT/MT	L/R	F	MPV Engine AUU	818025	Outer Joint	48W	38	36	60	34	72.5	
2000.04-2010.03	MT	R	F	MPV Engine AUU	261245	Stub Axle		26	113.5			290	
1.9 TDI (96 kW)													
2002.11-2010.03	-	R	F	MPV Engine ASZ	261193	Stub Axle		37		60		322	
2002.11-2010.03	-	R	F	MPV Engine ASZ	261192	Stub Axle		26	37	60		129.5	
2002.11-2010.03	MT	L/R	F	MPV Engine ASZ	203023	Drive Shaft	48W	38		60	34	507	
2002.11-2010.03	AT/MT	L/R	F	MPV Engine ASZ	818025	Outer Joint	48W	38	36	60	34	72.5	
1.9 TDI 4motion (85 kW)													
2000.04-2010.03	-	R	F	All-wheel Drive MPV Engine AUU	261193	Stub Axle		37		60		322	
2000.04-2010.03	5AT	L/R	F	All-wheel Drive MPV Engine AUU	203022	Drive Shaft	48W	38		60	34	486	
2000.04-2010.03	-	R	F	All-wheel Drive MPV Engine AUU	261192	Stub Axle		26	37	60		129.5	
2000.04-2010.03	MT	-	F	All-wheel Drive MPV Engine AUU	659006	Inner Joint			34		33.2		
2000.04-2010.03	MT	L/R	F	All-wheel Drive MPV Engine AUU	203023	Drive Shaft	48W	38		60	34	507	
2000.04-2010.03	AT/MT	L/R	F	All-wheel Drive MPV Engine AUU	818025	Outer Joint	48W	38	36	60	34	72.5	
2.0 (85 kW)													
1995.09-2010.03	MT	L	F	MPV Engine ADY	218009	Drive Shaft	48W	38	26	60	34.5	620	
1995.09-2010.03	MT	R	F	MPV Engine ADY	218008	Drive Shaft	48W	38	35	60	34.5	559	
1995.09-2010.03	MT	L/R	F	MPV Engine ADY	203022	Drive Shaft	48W	38		60	34	486	
1995.09-2010.03	MT	L/R	F	MPV Engine ADY	261087	Drive Shaft	48W	38		60	34.5	506	
1995.09-2010.03	AT	L	F	MPV Engine ADY	261085	Drive Shaft	48W	38		60	34.5	513	
1995.09-2010.03	-	R	F	MPV Engine ADY	261192	Stub Axle		26	37	60		129.5	
1995.09-2010.03	AT	R	F	MPV Engine ADY	261065	Drive Shaft	48W	38		60	34.5	544	
1995.09-2010.03	MT	L	F	MPV Engine ADY	861022	Outer Joint		38	27	60	34.5	65	
1995.09-2010.03	MT	-	F	MPV Engine ADY	659006	Inner Joint			34		33.2		
1995.09-2010.03	MT	L/R	F	MPV Engine ADY	661032	Inner Joint			27		34		
1995.09-2010.03	-	-	F	MPV Engine ADY	818040	Outer Joint		38	27	60	34.5	65	
1995.09-2010.03	MT	L/R	F	MPV Engine ADY	203023	Drive Shaft	48W	38		60	34	507	
1995.09-2010.03	MT	L	F	MPV Engine ADY	203024	Drive Shaft	48W	38	26	60	34.5	617	
1995.09-2010.03	MT	R	F	MPV Engine ADY	203027	Drive Shaft	48W	38	35	60	34.5	561	
1995.09-2010.03	MT	L/R	F	MPV Engine ADY	818026	Outer Joint	48W	38	27	60	34.5	65	
1995.09-2010.03	MT	L	F	MPV Engine ADY	203064	Drive Shaft		38	26	60	34.5	617	
1995.09-2010.03	MT	R	F	MPV Engine ADY	203065	Drive Shaft		38	35	60	34.5	561	
1995.09-2010.03	AT/MT	L/R	F	MPV Engine ADY	818025	Outer Joint	48W	38	36	60	34	72.5	
1995.09-2010.03	AT	R	F	MPV Engine ADY	261104	Drive Shaft	48W	38		60	34	544	
1995.09-2010.03	-	R	F	MPV Engine ADY	261193	Stub Axle		37		60		322	
2.0 16V (110 kW)													
1995.09-2000.02	-	R	F	MPV	261193	Stub Axle		37		60		322	
1995.09-2000.02	MT	L	F	MPV	861022	Outer Joint		38	27	60	34.5	65	
1995.09-2000.02	MT	-	F	MPV	659006	Inner Joint			34		33.2		
1995.09-2000.02	-	-	F	MPV	818040	Outer Joint		38	27	60	34.5	65	
1995.09-2000.02	MT	L	F	MPV	203024	Drive Shaft	48W	38	26	60	34.5	617	
1995.09-2000.02	MT	R	F	MPV	203027	Drive Shaft	48W	38	35	60	34.5	561	
1995.09-2000.02	MT	L	F	MPV	203064	Drive Shaft		38	26	60	34.5	617	
1995.09-2000.02	MT	R	F	MPV	203065	Drive Shaft		38	35	60	34.5	561	
1995.09-2000.02	AT	R	F	MPV	261104	Drive Shaft	48W	38		60	34	544	
2.0 LPG (85 kW)													
2006.04-2010.03	-	R	F	MPV Engine ATM	261193	Stub Axle		37		60		322	
2006.04-2010.03	MT	L/R	F	MPV Engine ATM	261087	Drive Shaft	48W	38		60	34.5	506	
2006.04-2010.03	AT	-	F	MPV Engine ATM	650019	Inner Joint			34		59.5		
2006.04-2010.03	-	R	F	MPV Engine ATM	261192	Stub Axle		26	37	60		129.5	





YEAR	TRANSM	L/R	F/R	REMARKS	GSP Ref.	PRODUCT	ABS	Technical Specifications						
								A	B	C	H	L	P	
VW														
SHARAN (7M8 7M9 7M6)														
2.0 LPG (85 kW)	2006.04-2010.03	MT	L/R	F	MPV Engine ATM	661032	Inner Joint			27		34		
	2006.04-2010.03	MT	L/R	F	MPV Engine ATM	818025	Outer Joint	48W	38	36	60	34	72.5	I
2.0 TDI (100 kW)	2005.11-2010.03	-	R	F	MPV Engine BVH	261192	Stub Axle		26	37	60		129.5	
	2005.11-2010.03	-	L/R	F	MPV Engine BVH	203023	Drive Shaft	48W	38		60	34	507	
	2005.11-2010.03	-	L/R	F	MPV Engine BVH	818025	Outer Joint	48W	38	36	60	34	72.5	I
2.0 TDI (103 kW)	2005.11-2010.03	-	R	F	MPV Engine BRT	261193	Stub Axle		37		60		322	
	2005.11-2010.03	-	R	F	MPV Engine BRT	261192	Stub Axle		26	37	60		129.5	
	2005.11-2010.03	-	L/R	F	MPV Engine BRT	203023	Drive Shaft	48W	38		60	34	507	
	2005.11-2010.03	-	L/R	F	MPV Engine BRT	818025	Outer Joint	48W	38	36	60	34	72.5	I
2.8 V6 24V (150 kW)	2000.04-2010.03	5AT	L	F	MPV Engine AYL	203022	Drive Shaft	48W	38		60	34	486	
	2000.04-2010.03	5AT	R	F	MPV Engine AYL	299120	Drive Shaft	48W	38	30	60	34	561	
	2000.04-2010.03	-	R	F	MPV Engine AYL	261192	Stub Axle		26	37	60		129.5	
	2000.04-2010.03	MT	L/R	F	MPV Engine AYL	203023	Drive Shaft	48W	38		60	34	507	
	2000.04-2010.03	5AT	L	F	MPV Engine AYL	818039	Outer Joint		38	36	60	34	72.5	I
	2000.04-2010.03	AT/MT	L/R	F	MPV Engine AYL	818025	Outer Joint	48W	38	36	60	34	72.5	I
	2000.04-2010.03	-	-	R	MPV Engine AYL	602006	Inner Joint			25		32		
2.8 V6 24V 4motion (150 kW)	2000.04-2010.03	5AT	L	F	All-wheel Drive MPV Engine AYL	203022	Drive Shaft	48W	38		60	34	486	
	2000.04-2010.03	5AT	R	F	All-wheel Drive MPV Engine AYL	299120	Drive Shaft	48W	38	30	60	34	561	
	2000.04-2010.03	-	R	F	All-wheel Drive MPV Engine AYL	261192	Stub Axle		26	37	60		129.5	
	2000.04-2010.03	MT	L/R	F	All-wheel Drive MPV Engine AYL	203023	Drive Shaft	48W	38		60	34	507	
	2000.04-2010.03	AT/MT	L/R	F	All-wheel Drive MPV Engine AYL	818025	Outer Joint	48W	38	36	60	34	72.5	I
	2000.04-2010.03	-	-	R	All-wheel Drive MPV Engine AYL	602006	Inner Joint			25		32		
2.8 VR6 (128 kW)	1995.09-2000.04	MT	L	F	MPV Engine AAA	218009	Drive Shaft	48W	38	26	60	34.5	620	
	1995.09-2000.04	MT	R	F	MPV Engine AAA	218106	Drive Shaft	48W	38	35	60	34.5	634	
	1995.09-2000.04	AT	L/R	F	MPV Engine AAA	218010	Drive Shaft	48W	38		60	34.5	550	
	1995.09-2000.04	-	-	F	MPV Engine AAA	818040	Outer Joint		38	27	60	34.5	65	I
	1995.09-2000.04	AT/MT	L/R	F	MPV Engine AAA	818026	Outer Joint	48W	38	27	60	34.5	65	I
	1995.09-2000.04	AT/MT	L/R	F	MPV Engine AAA	818025	Outer Joint	48W	38	36	60	34	72.5	I
2.8 VR6 Syncro (128 kW)	1996.11-2000.04	MT	L	F	All-wheel Drive MPV Engine AAA	218009	Drive Shaft	48W	38	26	60	34.5	620	
	1996.11-2000.04	MT	R	F	All-wheel Drive MPV Engine AAA	218106	Drive Shaft	48W	38	35	60	34.5	634	
	1996.11-2000.04	AT	L/R	F	All-wheel Drive MPV Engine AAA	218010	Drive Shaft	48W	38		60	34.5	550	
	1996.11-2000.04	-	-	-	All-wheel Drive MPV Engine AAA	818040	Outer Joint		38	27	60	34.5	65	I
	1996.11-2000.04	AT/MT	L/R	F	All-wheel Drive MPV Engine AAA	818026	Outer Joint	48W	38	27	60	34.5	65	I
	1996.11-2000.04	AT	L/R	F	All-wheel Drive MPV Engine AAA	818025	Outer Joint	48W	38	36	60	34	72.5	I
SHARAN (7N1 7N2)														
1.4 TSI (110 kW)	2010.05-	MT	R	F	MPV Engine CAVA/CNWB/CTHA	203366	Drive Shaft		36		59.5	40	794	
	2010.05-	AT/MT	L	F	MPV Engine CAVA/CNWB/CTHA	261188	Drive Shaft		36		59.5	40	487	
	2010.05-	AT/MT	L/R	F	MPV Engine CAVA/CNWB/CTHA	801352	Outer Joint		36	28	59.5	40	65	I
	2010.05-	-	-	F	MPV Engine CAVA/CNWB/CTHA	803095	Outer Joint		36	28	59.5	40	66	I
	2010.05-	MT	L	F	MPV Engine CAVA/CNWB/CTHA	203365	Drive Shaft		36		59.5	40	488	
	2015.05-	MT/DCT	R	F	MPV Engine CZDA	203366	Drive Shaft		36		59.5	40	794	
	2015.05-	MT/DCT	L/R	F	MPV Engine CZDA	801352	Outer Joint		36	28	59.5	40	65	I
	2015.05-	MT/DCT	L	F	MPV Engine CZDA	203365	Drive Shaft		36		59.5	40	488	
2.0 TDI (100 kW)	2010.05-	MT	L	F	MPV Engine CFFA	261188	Drive Shaft		36		59.5	40	487	
	2010.05-	AT/MT	L/R	F	MPV Engine CFFA	801352	Outer Joint		36	28	59.5	40	65	I
	2010.05-	AT	R	F	MPV Engine CFFA	261330	Drive Shaft		36		59.5	40	760	
	2010.05-	-	-	F	MPV Engine CFFA	803095	Outer Joint		36	28	59.5	40	66	I
	2010.05-	MT	L/R	F	MPV Engine CFFA	261214	Stub Axle		40	37	60		125	
	2010.05-	6MT	L	F	MPV Engine CFFA	203365	Drive Shaft		36		59.5	40	488	
	2010.05-	AT	R	F	MPV Engine CFFA	601075	Inner Joint			26		86		
2.0 TDI (103 kW)	2010.05-	MT	L	F	MPV Engine CFFB	261188	Drive Shaft		36		59.5	40	487	
	2010.05-	AT/MT	L/R	F	MPV Engine CFFB	801352	Outer Joint		36	28	59.5	40	65	I
	2010.05-	AT	R	F	MPV Engine CFFB	261330	Drive Shaft		36		59.5	40	760	
	2010.05-	-	-	F	MPV Engine CFFB	803095	Outer Joint		36	28	59.5	40	66	I
	2010.05-	MT	L/R	F	MPV Engine CFFB	261214	Stub Axle		40	37	60		125	
	2010.05-	6MT	L	F	MPV Engine CFFB	203365	Drive Shaft		36		59.5	40	488	
	2010.05-	AT	R	F	MPV Engine CFFB	601075	Inner Joint			26		86		
2.0 TDI (110 kW)	2015.05-	MT	L/R	F	MPV Engine DFLA	801352	Outer Joint		36	28	59.5	40	65	I
	2015.05-	MT	L/R	F	MPV Engine DFLA	261214	Stub Axle		40	37	60		125	
	2015.05-	MT	L	F	MPV Engine DFLA	203365	Drive Shaft		36		59.5	40	488	
2.0 TDI (125 kW)	2010.08-	AT/MT	L/R	F	MPV Engine CFGB	801352	Outer Joint		36	28	59.5	40	65	I
	2010.08-	AT	R	F	MPV Engine CFGB	261330	Drive Shaft		36		59.5	40	760	
	2010.08-	-	-	F	MPV Engine CFGB	803095	Outer Joint		36	28	59.5	40	66	I
	2010.08-	MT	L/R	F	MPV Engine CFGB	261214	Stub Axle		40	37	60		125	
	2010.08-	AT	R	F	MPV Engine CFGB	601075	Inner Joint			26		86		
2.0 TDI (130 kW)	2013.01-	AT/MT	L/R	F	MPV Engine CFGC	801352	Outer Joint		36	28	59.5	40	65	I





	 YEAR	TRANSM	L/R	F/R	REMARKS	GSP Ref.	 PRODUCT	 ABS	Technical Specifications						
									A	B	C	H	L	P	
VW															
SHARAN (7N1 7N2)															
2.0 TDI (130 kW)	2013.01-	-	AT	R	F	MPV Engine CFGC	261330	Drive Shaft		36		59.5	40	760	
	2013.01-	-	-	-	F	MPV Engine CFGC	803095	Outer Joint		36	28	59.5	40	66	I
	2013.01-	-	MT	L/R	F	MPV Engine CFGC	261214	Stub Axle		40	37	60		125	
	2013.01-	-	AT	R	F	MPV Engine CFGC	601075	Inner Joint			26		86		
2.0 TDI (135 kW)	2015.05-	-	MT/DCT	L/R	F	MPV Engine DFMA	801352	Outer Joint		36	28	59.5	40	65	I
	2015.05-	-	MT	L/R	F	MPV Engine DFMA	261214	Stub Axle		40	37	60		125	
2.0 TDI (85 kW)	2011.05-	-	MT	L	F	MPV Engine CFFE	261188	Drive Shaft		36		59.5	40	487	
	2011.05-	-	MT	L/R	F	MPV Engine CFFE	801352	Outer Joint		36	28	59.5	40	65	I
	2011.05-	-	-	-	F	MPV Engine CFFE	803095	Outer Joint		36	28	59.5	40	66	I
	2011.05-	-	MT	L/R	F	MPV Engine CFFE	261214	Stub Axle		40	37	60		125	
2.0 TDI 4motion (103 kW)	2011.05-	-	MT	L/R	F	All-wheel Drive MPV Engine CFFB	203365	Drive Shaft		36		59.5	40	488	
	2011.05-	-	-	-	F	All-wheel Drive MPV Engine CFFB	801352	Outer Joint		36	28	59.5	40	65	I
2.0 TDI 4motion (110 kW)	2011.05-	-	MT	L/R	F	All-wheel Drive MPV Engine CFFB	803095	Outer Joint		36	28	59.5	40	66	I
	2011.05-	-	MT	L/R	F	All-wheel Drive MPV Engine CFFB	261214	Stub Axle		40	37	60		125	
	2015.05-	-	MT	L/R	F	All-wheel Drive MPV Engine CUVC	801352	Outer Joint		36	28	59.5	40	65	I
2.0 TDI 4motion (135 kW)	2015.05-	-	MT	L/R	F	All-wheel Drive MPV Engine CUVC	261214	Stub Axle		40	37	60		125	
2.0 TDI 4motion (147 kW)	2016.05-	-	MT	L/R	F	All-wheel Drive MPV Engine DFMA	261214	Stub Axle		40	37	60		125	
2.0 TSI (147 kW)	2010.12-	-	AT	L	F	MPV Engine CCZA	261188	Drive Shaft		36		59.5	40	487	
	2010.12-	-	AT	L/R	F	MPV Engine CCZA	801352	Outer Joint		36	28	59.5	40	65	I
	2010.12-	-	-	-	F	MPV Engine CCZA	803095	Outer Joint		36	28	59.5	40	66	I
	2010.12-	-	-	L	F	MPV Engine CCZA	203365	Drive Shaft		36		59.5	40	488	
2.0 TSI (162 kW)	2015.05-	-	MT	L/R	F	MPV Engine DEDA	801352	Outer Joint		36	28	59.5	40	65	I
	2015.05-	-	DCT	L	F	MPV Engine DEDA	203365	Drive Shaft		36		59.5	40	488	
SHARAN I (7M8, 7M9, 7M6)															
1.9 TDi (66 kW)	1995.09-	2000.05	-	L	-	-	699053	Inner Joint		26	28	40	77.5	82.5	
	1995.09-	2000.05	-	R	-	-	661028	Inner Joint		35	28	42	48	52	
2.0 (85 kW)	1995.09-	2000.09	-	L	-	-	699053	Inner Joint		26	28	40	77.5	82.5	
	1995.09-	2000.04	-	R	-	-	661028	Inner Joint		35	28	42	48	52	
2.8 VR6 (128 kW)	1995.05-	2000.09	-	L	-	-	699053	Inner Joint		26	28	40	77.5	82.5	
	1995.05-	2000.04	-	R	-	-	661028	Inner Joint		35	28	42	48	52	
SPACEFOX															
1.6 8V (EA111)	2007.01-	2011.06	MT	-	-	-	861037	Outer Joint		22	30	51	78	61	I
SYNCRO															
-	1989-	1992	-	-	-	4WD	861017	Outer Joint		26	25	65	104	69.5	O
SYNCRO(462)															
-	2006-	2008	-	L	-	-	261153	Drive Shaft		36	26	59.5	40	583	
	2006-	2008	-	L	-	-	261153	Drive Shaft		36	26	59.5	40	583	
SYNCRO(665)															
-	2009-	2010	-	L	-	-	261153	Drive Shaft		36	26	59.5	40	583	
	2009-	2010	-	L	-	-	261153	Drive Shaft		36	26	59.5	40	583	
TIGUAN (5N_)															
1.4 TSI (110 kW)	2008.05-	-	MT	L	F	Closed Off-Road Vehicle Engine BWK	261146	Drive Shaft		36		59.5	40	490	
	2008.05-	-	MT	R	F	Closed Off-Road Vehicle Engine BWK	261147	Drive Shaft		36		59.5	40	795	
	2015.05-	-	AT	-	-	Closed Off-Road Vehicle Engine CZDA	603006	Inner Joint			33		34		
	2015.05-	-	AT	-	-	Closed Off-Road Vehicle Engine CZDA	603016	Inner Joint			28		32		
1.4 TSI (118 kW)	2011.05-	-	AT	L	F	Closed Off-Road Vehicle Engine CAVD	661054	Inner Joint		40	28	46.9	51	53	
	2011.05-	-	MT	L	F	Closed Off-Road Vehicle Engine CAVD	261146	Drive Shaft		36		59.5	40	490	
	2011.05-	-	MT	R	F	Closed Off-Road Vehicle Engine CAVD	261147	Drive Shaft		36		59.5	40	795	
	2011.05-	-	AT	-	-	Closed Off-Road Vehicle Engine CAVD	603016	Inner Joint			28		32		
	2011.05-	-	AT	-	-	Closed Off-Road Vehicle Engine CAVD	603006	Inner Joint			33		34		
1.4 TSI (90 kW)	2010.08-	-	MT	L	F	Closed Off-Road Vehicle Engine CAXA	261146	Drive Shaft		36		59.5	40	490	
	2010.08-	-	MT	R	F	Closed Off-Road Vehicle Engine CAXA	261147	Drive Shaft		36		59.5	40	795	
	2010.08-	-	MT	-	-	Closed Off-Road Vehicle Engine CAXA	603006	Inner Joint			33		34		
	2010.08-	-	MT	-	-	Closed Off-Road Vehicle Engine CAXA	603016	Inner Joint			28		32		
1.4 TSI 4motion (110 kW)	2007.09-	-	-	L	F	All-wheel Drive Closed Off-Road Vehicle Engine BWK	661090	Inner Joint		40	28	46.9		104	
	2007.09-	-	-	L/R	R	All-wheel Drive Closed Off-Road Vehicle Engine BWK	603011	Inner Joint			33		34		
	2007.09-	-	-	L	F	All-wheel Drive Closed Off-Road Vehicle Engine BWK	261296	Drive Shaft		36	40	59.5	40	500	
	2007.09-	-	-	R	F	All-wheel Drive Closed Off-Road Vehicle Engine BWK	203369	Drive Shaft		36	40	59.5	40	598	
	2007.09-	-	MT	L/R	F	All-wheel Drive Closed Off-Road Vehicle Engine BWK	803002	Outer Joint		36	27	59.5	40	66	I
	2007.09-	-	-	-	R	All-wheel Drive Closed Off-Road Vehicle Engine BWK	635026	Inner Joint		36	33	59.5	40	39	
1.4 TSI 4motion (118 kW)	2011.05-	-	-	L	F	All-wheel Drive Closed Off-Road Vehicle Engine CAVD	661090	Inner Joint		40	28	46.9		104	
	2011.05-	-	AT	L	F	All-wheel Drive Closed Off-Road Vehicle Engine CAVD	661054	Inner Joint		40	28	46.9	51	53	
	2011.05-	-	-	L	F	All-wheel Drive Closed Off-Road Vehicle Engine CAVD	261296	Drive Shaft		36	40	59.5	40	500	
	2011.05-	-	-	L/R	F	All-wheel Drive Closed Off-Road Vehicle Engine CAVD	803002	Outer Joint		36	27	59.5	40	66	I
	2011.05-	-	-	R	F	All-wheel Drive Closed Off-Road Vehicle Engine CAVD	203369	Drive Shaft		36	40	59.5	40	598	
	2011.05-	-	-	L/R	R	All-wheel Drive Closed Off-Road Vehicle Engine CAVD	603011	Inner Joint			33		34		

	 YEAR	TRANSM	L/R	F/R	REMARKS	GSP Ref.	 PRODUCT	 ABS	Technical Specifications					
									A	B	C	H	L	P
VW														
TIGUAN (5N_)														
1.4 TSI 4motion (118 kW)	2011.05-	-	-	R	All-wheel Drive Closed Off-Road Vehicle Engine CAVD	635026	Inner Joint		36	33	59.5	40	39	
	2011.05-	-	AT	-	All-wheel Drive Closed Off-Road Vehicle Engine CAVD	603016	Inner Joint			28		32		
	2011.05-	-	AT	-	All-wheel Drive Closed Off-Road Vehicle Engine CAVD	603006	Inner Joint			33		34		
2.0 TDI (103 kW)	2008.03-	-	MT	L	F	Closed Off-Road Vehicle Engine CFFB	261146	Drive Shaft	36		59.5	40	490	
	2008.03-	-	MT	R	F	Closed Off-Road Vehicle Engine CFFB	261147	Drive Shaft	36		59.5	40	795	
2.0 TDI (81 kW)	2010.05-	-	MT	L	F	Closed Off-Road Vehicle Engine CFFD	261146	Drive Shaft	36		59.5	40	490	
	2010.05-	-	MT	-	-	Closed Off-Road Vehicle Engine CFFD	603006	Inner Joint		33		34		
	2010.05-	-	MT	-	-	Closed Off-Road Vehicle Engine CFFD	603016	Inner Joint		28		32		
2.0 TDI 4motion (100 kW)	2007.11-	-	AT/MT	L/R	F	All-wheel Drive Closed Off-Road Vehicle Engine CBAA	803002	Outer Joint	36	27	59.5	40	66	I
	2007.11-	-	-	-	-	All-wheel Drive Closed Off-Road Vehicle Engine CBAA	603016	Inner Joint		28		32		
	2007.11-	-	AT	R	F	All-wheel Drive Closed Off-Road Vehicle Engine CBAA	203270	Drive Shaft	36	40	59.5	40	593	
	2007.11-	-	-	L/R	R	All-wheel Drive Closed Off-Road Vehicle Engine CBAA	603011	Inner Joint		33		34		
	2007.11-	-	MT	L	F	All-wheel Drive Closed Off-Road Vehicle Engine CBAA	261296	Drive Shaft	36	40	59.5	40	500	
	2007.11-	-	MT	R	F	All-wheel Drive Closed Off-Road Vehicle Engine CBAA	203369	Drive Shaft	36	40	59.5	40	598	
	2007.11-	-	MT	L	F	All-wheel Drive Closed Off-Road Vehicle Engine CBAA	661090	Inner Joint	40	28	46.9		104	
	2007.11-	-	-	-	R	All-wheel Drive Closed Off-Road Vehicle Engine CBAA	635026	Inner Joint	36	33	59.5	40	39	
	2007.11-	-	AT	R	F	All-wheel Drive Closed Off-Road Vehicle Engine CBAA	603025	Inner Joint	40	34	46.9	47	80.5	
2.0 TDI 4motion (103 kW)	2007.09-	-	MT	L	F	All-wheel Drive Closed Off-Road Vehicle Engine CLJA	661090	Inner Joint	40	28	46.9		104	
	2007.09-	-	6AT/MT	L/R	F	All-wheel Drive Closed Off-Road Vehicle Engine CLJA	803002	Outer Joint	36	27	59.5	40	66	I
	2007.09-	-	AT	R	F	All-wheel Drive Closed Off-Road Vehicle Engine CLJA	203270	Drive Shaft	36	40	59.5	40	593	
	2007.09-	-	-	L/R	R	All-wheel Drive Closed Off-Road Vehicle Engine CLJA	603011	Inner Joint		33		34		
	2007.09-	-	MT	L	F	All-wheel Drive Closed Off-Road Vehicle Engine CLJA	261296	Drive Shaft	36	40	59.5	40	500	
	2007.09-	-	MT	R	F	All-wheel Drive Closed Off-Road Vehicle Engine CLJA	203369	Drive Shaft	36	40	59.5	40	598	
	2007.09-	-	-	-	R	All-wheel Drive Closed Off-Road Vehicle Engine CLJA	635026	Inner Joint	36	33	59.5	40	39	
	2007.09-	-	AT	R	F	All-wheel Drive Closed Off-Road Vehicle Engine CLJA	603025	Inner Joint	40	34	46.9	47	80.5	
	2007.09-	-	MT	L/R	F	All-wheel Drive Closed Off-Road Vehicle Engine CLJA	261214	Stub Axle	40	37	60		125	
2.0 TDI 4motion (110 kW)	2015.05-	-	AT/MT	L/R	F	All-wheel Drive Closed Off-Road Vehicle Engine CUVC	603011	Inner Joint		33		34		
2.0 TDI 4motion (120 kW)	2008.02-2009.08	-	L/R	R	All-wheel Drive Closed Off-Road Vehicle Engine CBBA	603011	Inner Joint		33		34			
	2008.02-2009.08	2009.08	MT	L	F	All-wheel Drive Closed Off-Road Vehicle Engine CBBA	661054	Inner Joint	40	28	46.9	51	53	
	2008.02-2009.08	2009.08	MT	R	F	All-wheel Drive Closed Off-Road Vehicle Engine CBBA	203269	Drive Shaft	36	40	59.5	40	605	
	2008.02-2009.08	2009.08	MT	-	-	All-wheel Drive Closed Off-Road Vehicle Engine CBBA	603006	Inner Joint		33		34		
	2008.02-2009.08	2009.08	-	-	R	All-wheel Drive Closed Off-Road Vehicle Engine CBBA	635026	Inner Joint	36	33	59.5	40	39	
2.0 TDI 4motion (125 kW)	2007.09-	-	MT	-	-	All-wheel Drive Closed Off-Road Vehicle Engine CBBB	603006	Inner Joint		33		34		
	2007.09-	-	MT	L	F	All-wheel Drive Closed Off-Road Vehicle Engine CBBB	661054	Inner Joint	40	28	46.9	51	53	
	2007.09-	-	MT	R	F	All-wheel Drive Closed Off-Road Vehicle Engine CBBB	203269	Drive Shaft	36	40	59.5	40	605	
	2007.09-	-	-	-	R	All-wheel Drive Closed Off-Road Vehicle Engine CBBB	635026	Inner Joint	36	33	59.5	40	39	
	2007.09-	-	-	L/R	R	All-wheel Drive Closed Off-Road Vehicle Engine CBBB	603011	Inner Joint		33		34		
	2007.09-	-	MT	L/R	F	All-wheel Drive Closed Off-Road Vehicle Engine CBBB	261214	Stub Axle	40	37	60		125	
2.0 TDI 4motion (130 kW)	2012.11-	-	MT	R	F	All-wheel Drive Closed Off-Road Vehicle Engine CFGC	203269	Drive Shaft	36	40	59.5	40	605	
	2012.11-	-	AT/MT	L/R	F	All-wheel Drive Closed Off-Road Vehicle Engine CFGC	603011	Inner Joint		33		34		
	2012.11-	-	-	-	R	All-wheel Drive Closed Off-Road Vehicle Engine CFGC	635026	Inner Joint	36	33	59.5	40	39	
2.0 TDI 4motion (135 kW)	2015.05-	-	AT	L/R	R	All-wheel Drive Closed Off-Road Vehicle Engine CUWA	603011	Inner Joint		33		34		
2.0 TFSI 4motion (125 kW)	2007.09-	-	6AT/MT	L/R	F	All-wheel Drive Closed Off-Road Vehicle Engine CAWA	803002	Outer Joint	36	27	59.5	40	66	I
	2007.09-	-	MT	L	F	All-wheel Drive Closed Off-Road Vehicle Engine CAWA	661090	Inner Joint	40	28	46.9		104	
	2007.09-	-	MT	L	F	All-wheel Drive Closed Off-Road Vehicle Engine CAWA	261296	Drive Shaft	36	40	59.5	40	500	
	2007.09-	-	AT	R	F	All-wheel Drive Closed Off-Road Vehicle Engine CAWA	261347	Drive Shaft	36	40	59.5	40	593	
	2007.09-	-	-	-	R	All-wheel Drive Closed Off-Road Vehicle Engine CAWA	635026	Inner Joint	36	33	59.5	40	39	
	2007.09-	-	-	L/R	R	All-wheel Drive Closed Off-Road Vehicle Engine CAWA	603011	Inner Joint		33		34		
	2007.09-	-	-	R	F	All-wheel Drive Closed Off-Road Vehicle Engine CAWA	603025	Inner Joint	40	34	46.9	47	80.5	
	2007.09-	-	AT	L	F	All-wheel Drive Closed Off-Road Vehicle Engine CAWA	201265	Drive Shaft	36	37	59.5	40	557	
2.0 TFSI 4motion (147 kW)	2007.09-	-	6AT/MT	L/R	F	All-wheel Drive Closed Off-Road Vehicle Engine CAWB	803002	Outer Joint	36	27	59.5	40	66	I
	2007.09-	-	-	L	F	All-wheel Drive Closed Off-Road Vehicle Engine CAWB	661090	Inner Joint	40	28	46.9		104	
	2007.09-	-	-	-	-	All-wheel Drive Closed Off-Road Vehicle Engine CAWB	603016	Inner Joint		28		32		
	2007.09-	-	-	L/R	R	All-wheel Drive Closed Off-Road Vehicle Engine CAWB	603011	Inner Joint		33		34		
	2007.09-	-	MT	L	F	All-wheel Drive Closed Off-Road Vehicle Engine CAWB	261296	Drive Shaft	36	40	59.5	40	500	
	2007.09-	-	AT	R	F	All-wheel Drive Closed Off-Road Vehicle Engine CAWB	261347	Drive Shaft	36	40	59.5	40	593	
	2007.09-	-	-	-	R	All-wheel Drive Closed Off-Road Vehicle Engine CAWB	635026	Inner Joint	36	33	59.5	40	39	
	2007.09-	-	-	R	F	All-wheel Drive Closed Off-Road Vehicle Engine CAWB	603025	Inner Joint	40	34	46.9	47	80.5	
	2007.09-	-	AT	L	F	All-wheel Drive Closed Off-Road Vehicle Engine CAWB	201265	Drive Shaft	36	37	59.5	40	557	
2.0 TSI 4motion (132 kW)	2011.05-	-	-	L/R	R	All-wheel Drive Closed Off-Road Vehicle Engine CCZD	603011	Inner Joint		33		34		
	2011.05-	-	AT	L	F	All-wheel Drive Closed Off-Road Vehicle Engine CCZD	661038	Inner Joint	26	34	31	68.5	88.5	
	2011.05-	-	-	L/R	F	All-wheel Drive Closed Off-Road Vehicle Engine CCZD	803002	Outer Joint	36	27	59.5	40	66	I
	2011.05-	-	AT	R	F	All-wheel Drive Closed Off-Road Vehicle Engine CCZD	661048	Inner Joint	40	34	46.9	47	80.5	
	2011.05-	-	-	L	F	All-wheel Drive Closed Off-Road Vehicle Engine CCZD	661090	Inner Joint	40	28	46.9		104	
	2011.05-	-	AT	L	F	All-wheel Drive Closed Off-Road Vehicle Engine CCZD	661054	Inner Joint	40	28	46.9	51	53	
2011.05-	-	MT	L	F	All-wheel Drive Closed Off-Road Vehicle Engine CCZD	261296	Drive Shaft	36	40	59.5	40	500		

YEAR	TRANSM	L/R	F/R	REMARKS	GSP Ref.	PRODUCT	ABS	Technical Specifications						
								A	B	C	H	L	P	
VW														
TIGUAN (5N_)														
2.0 TSI 4motion (132 kW)	2011.05-	-	AT	R F	All-wheel Drive Closed Off-Road Vehicle Engine CCZD	261347	Drive Shaft		36	40	59.5	40	593	
	2011.05-	-	-	R	All-wheel Drive Closed Off-Road Vehicle Engine CCZD	635026	Inner Joint		36	33	59.5	40	39	
	2011.05-	-	AT	-	All-wheel Drive Closed Off-Road Vehicle Engine CCZD	603006	Inner Joint			33		34		
	2011.05-	-	-	R F	All-wheel Drive Closed Off-Road Vehicle Engine CCZD	603025	Inner Joint		40	34	46.9	47	80.5	
	2011.05-	-	AT	L F	All-wheel Drive Closed Off-Road Vehicle Engine CCZD	201265	Drive Shaft		36	37	59.5	40	557	
2.0 TSI 4motion (155 kW)	2011.05-	-	-	L/R R	All-wheel Drive Closed Off-Road Vehicle Engine CCZB	603011	Inner Joint			33		34		
	2011.05-	-	-	L/R F	All-wheel Drive Closed Off-Road Vehicle Engine CCZB	803002	Outer Joint		36	27	59.5	40	66	I
	2011.05-	-	AT	R F	All-wheel Drive Closed Off-Road Vehicle Engine CCZB	661048	Inner Joint		40	34	46.9	47	80.5	
	2011.05-	-	-	L F	All-wheel Drive Closed Off-Road Vehicle Engine CCZB	661090	Inner Joint		40	28	46.9		104	
	2011.05-	-	AT	L F	All-wheel Drive Closed Off-Road Vehicle Engine CCZB	661054	Inner Joint		40	28	46.9	51	53	
	2011.05-	-	MT	L F	All-wheel Drive Closed Off-Road Vehicle Engine CCZB	261296	Drive Shaft		36	40	59.5	40	500	
	2011.05-	-	AT	R F	All-wheel Drive Closed Off-Road Vehicle Engine CCZB	261347	Drive Shaft		36	40	59.5	40	593	
	2011.05-	-	-	R	All-wheel Drive Closed Off-Road Vehicle Engine CCZB	635026	Inner Joint		36	33	59.5	40	39	
	2011.05-	-	AT	-	All-wheel Drive Closed Off-Road Vehicle Engine CCZB	603006	Inner Joint			33		34		
	2011.05-	-	-	R F	All-wheel Drive Closed Off-Road Vehicle Engine CCZB	603025	Inner Joint		40	34	46.9	47	80.5	
	2011.05-	-	AT	L F	All-wheel Drive Closed Off-Road Vehicle Engine CCZB	201265	Drive Shaft		36	37	59.5	40	557	
TIGUAN (AD1)														
1.4 TSI 4motion (110 kW)	2016.05-	-	6MT	L/R R	All-wheel Drive Closed Off-Road Vehicle Engine CZDA	603011	Inner Joint			33		34		
2.0 TDI 4motion (110 kW)	2016.01-	-	MT/DCT	L/R R	All-wheel Drive Closed Off-Road Vehicle Engine DFGA	603011	Inner Joint			33		34		
2.0 TDI 4motion (140 kW)	2016.04-	-	7DCT	L/R R	All-wheel Drive Closed Off-Road Vehicle Engine DFHA	603011	Inner Joint			33		34		
2.0 TDI 4motion (176 kW)	2016.05-	-	7DCT	L/R R	All-wheel Drive Closed Off-Road Vehicle Engine CUAA	603011	Inner Joint			33		34		
330 TSI (132 kW)	2016.01-	-	7DCT	L/R R	All-wheel Drive Closed Off-Road Vehicle Engine CZPA	603011	Inner Joint			33		34		
380 TSI (162 kW)	2016.06-	-	-	L/R R	All-wheel Drive Closed Off-Road Vehicle Engine CHHB	603011	Inner Joint			33		34		
TIGUAN ALLSPACE (BW2)														
2.0 TDI 4motion (110 kW)	2017.06-	-	-	L/R R	All-wheel Drive Closed Off-Road Vehicle Engine DBGC, DFGA	603011	Inner Joint			33		34		
2.0 TDI 4motion (140 kW)	2017.06-	-	-	L/R R	All-wheel Drive Closed Off-Road Vehicle Engine DFHA	603011	Inner Joint			33		34		
2.0 TDI 4motion (176 kW)	2017.06-	-	-	L/R R	All-wheel Drive Closed Off-Road Vehicle Engine CUAA	603011	Inner Joint			33		34		
2.0 TSI 4motion (132 kW)	2017.03-	-	-	L/R R	All-wheel Drive Closed Off-Road Vehicle Engine DGVA	603011	Inner Joint			33		34		
2.0 TSI 4motion (162 kW)	2017.07-	-	-	L/R R	All-wheel Drive Closed Off-Road Vehicle Engine CXDA	603011	Inner Joint			33		34		
TOUAREG (7LA 7L6 7L7)														
2.5 R5 TDI (120 kW)	2003.08-	2010.05	-	L/R R	All-wheel Drive Closed Off-Road Vehicle Engine BLK	261323	Drive Shaft		38		63	102.5	734	
	2003.08-	2010.05	-	L/R F	All-wheel Drive Closed Off-Road Vehicle Engine BLK	203300	Drive Shaft		38		63.9	102.5	523	
	2003.08-	2010.05	-	L/R F	All-wheel Drive Closed Off-Road Vehicle Engine BLK	699148	Inner Joint			28		34		
	2003.08-	2010.05	-	L/R R	All-wheel Drive Closed Off-Road Vehicle Engine BLK	661066	Inner Joint			28		28		
	2003.08-	2010.05	-	L/R R	All-wheel Drive Closed Off-Road Vehicle Engine BLK	603027	Inner Joint			28		28		
2.5 R5 TDI (128 kW)	2003.01-	2010.05	-	-	F	All-wheel Drive Closed Off-Road Vehicle Engine BPE	861042	Outer Joint	38	27	63.9	102.5	63	M
	2003.01-	2010.05	6AT/6MT	L/R F	All-wheel Drive Closed Off-Road Vehicle Engine BPE	699148	Inner Joint			28		34		
	2003.01-	2010.05	6AT/6MT	L/R R	All-wheel Drive Closed Off-Road Vehicle Engine BPE	261323	Drive Shaft		38		63	102.5	734	
	2003.01-	2010.05	6AT/6MT	L/R F	All-wheel Drive Closed Off-Road Vehicle Engine BPE	203300	Drive Shaft		38		63.9	102.5	523	
	2003.01-	2010.05	AT/MT	L/R R	All-wheel Drive Closed Off-Road Vehicle Engine BPE	235087	Drive Shaft		38		63	102	723	
	2003.01-	2010.05	6AT/6MT	L/R R	All-wheel Drive Closed Off-Road Vehicle Engine BPE	603027	Inner Joint			28		28		
	2003.01-	2010.05	6AT/6MT	L/R R	All-wheel Drive Closed Off-Road Vehicle Engine BPE	661066	Inner Joint			28		28		
	2003.01-	2010.05	AT/MT	L/R R	All-wheel Drive Closed Off-Road Vehicle Engine BPE	635051	Inner Joint			30		30.5		
3.0 TDI (155 kW)	2006.04-	2010.05	-	L/R F	All-wheel Drive Closed Off-Road Vehicle Engine BUN	699148	Inner Joint			28		34		
	2006.04-	2010.05	-	L/R F	All-wheel Drive Closed Off-Road Vehicle Engine BUN	299213	Drive Shaft		30		64	103.5	523	
	2006.04-	2010.05	-	L/R F	All-wheel Drive Closed Off-Road Vehicle Engine BUN	861050	Outer Joint		30	27	64	103.5	63.5	M
	2006.04-	2010.05	-	L/R F	All-wheel Drive Closed Off-Road Vehicle Engine BUN	603027	Inner Joint			28		28		
	2006.04-	2010.05	-	L/R R	All-wheel Drive Closed Off-Road Vehicle Engine BUN	261236	Drive Shaft		30		64	103.5	734	
	2006.04-	2010.05	-	L/R R	All-wheel Drive Closed Off-Road Vehicle Engine BUN	661066	Inner Joint			28		28		
3.0 V6 TDI (165 kW)	2004.11-	2010.05	6AT/6MT	L/R R	All-wheel Drive Closed Off-Road Vehicle Engine BKS	661066	Inner Joint			28		28		
	2004.11-	2010.05	-	-	-	All-wheel Drive Closed Off-Road Vehicle Engine BKS	661064	Inner Joint	30	28	64	103.5	64	
	2004.11-	2010.05	-	-	F	All-wheel Drive Closed Off-Road Vehicle Engine BKS	235043	Drive Shaft	30		64	103.5	535	
	2004.11-	2010.05	6AT/6MT	L/R F	All-wheel Drive Closed Off-Road Vehicle Engine BKS	299213	Drive Shaft		30		64	103.5	523	
	2004.11-	2010.05	6AT/6MT	L/R F	All-wheel Drive Closed Off-Road Vehicle Engine BKS	699148	Inner Joint			28		34		
	2004.11-	2010.05	6AT/6MT	L/R F	All-wheel Drive Closed Off-Road Vehicle Engine BKS	861050	Outer Joint		30	27	64	103.5	63.5	M
	2004.11-	2010.05	6AT/6MT	L/R R	All-wheel Drive Closed Off-Road Vehicle Engine BKS	603027	Inner Joint			28		28		
	2004.11-	2010.05	6AT/6MT	L/R R	All-wheel Drive Closed Off-Road Vehicle Engine BKS	261236	Drive Shaft		30		64	103.5	734	
3.0 V6 TDI (176 kW)	2007.11-	2010.05	-	L/R R	All-wheel Drive Closed Off-Road Vehicle Engine CASA	661066	Inner Joint			28		28		
	2007.11-	2010.05	-	-	F	All-wheel Drive Closed Off-Road Vehicle Engine CASA	235043	Drive Shaft	30		64	103.5	535	
	2007.11-	2010.05	-	L/R F	All-wheel Drive Closed Off-Road Vehicle Engine CASA	299213	Drive Shaft		30		64	103.5	523	
	2007.11-	2010.05	-	L/R F	All-wheel Drive Closed Off-Road Vehicle Engine CASA	699148	Inner Joint			28		34		
	2007.11-	2010.05	-	L/R F	All-wheel Drive Closed Off-Road Vehicle Engine CASA	861050	Outer Joint		30	27	64	103.5	63.5	M
	2007.11-	2010.05	-	L/R R	All-wheel Drive Closed Off-Road Vehicle Engine CASA	603027	Inner Joint			28		28		
	2007.11-	2010.05	-	L/R R	All-wheel Drive Closed Off-Road Vehicle Engine CASA	261236	Drive Shaft		30		64	103.5	734	
3.2 V6 (162 kW)	2002.10-	2006.11	6AT/6MT	L/R R	All-wheel Drive Closed Off-Road Vehicle Engine AZZ/BAA/BKJ/BMV/BMX/BRJ	661066	Inner Joint			28		28		
	2002.10-	2006.11	-	-	-	All-wheel Drive Closed Off-Road Vehicle Engine AZZ/BAA/BKJ/BMV/BMX/BRJ	661064	Inner Joint	30	28	64	103.5	64	

YEAR	TRANSM	L/R	F/R	REMARKS	GSP Ref.	PRODUCT	ABS	Technical Specifications						
								A	B	C	H	L	P	
VW														
TOUAREG (7LA 7L6 7L7)														
3.2 V6 (162 kW)	2002.10-2006.11	-	-	F	All-wheel Drive Closed Off-Road Vehicle Engine AZZ/BAA/BKJ/BMV/BMX/BRJ	235043	Drive Shaft	30		64	103.5	535		
	2002.10-2006.11	6AT/6MT	L/R	F	All-wheel Drive Closed Off-Road Vehicle Engine AZZ/BAA/BKJ/BMV/BMX/BRJ	699148	Inner Joint		28		34			
	2002.10-2006.11	6AT/6MT	L/R	F	All-wheel Drive Closed Off-Road Vehicle Engine AZZ/BAA/BKJ/BMV/BMX/BRJ	299213	Drive Shaft	30		64	103.5	523		
	2002.10-2006.11	6AT/6MT	L/R	F	All-wheel Drive Closed Off-Road Vehicle Engine AZZ/BAA/BKJ/BMV/BMX/BRJ	861050	Outer Joint	30	27	64	103.5	63.5	M	
	2002.10-2006.11	6AT/6MT	L/R	R	All-wheel Drive Closed Off-Road Vehicle Engine AZZ/BAA/BKJ/BMV/BMX/BRJ	603027	Inner Joint		28		28			
	2002.10-2006.11	6AT/6MT	L/R	R	All-wheel Drive Closed Off-Road Vehicle Engine AZZ/BAA/BKJ/BMV/BMX/BRJ	261236	Drive Shaft	30		64	103.5	734		
3.2 V6 (177 kW)	2004.11-2006.11	AT/MT	L/R	R	All-wheel Drive Closed Off-Road Vehicle Engine BMV	661066	Inner Joint		28		28			
	2004.11-2006.11	-	-	F	All-wheel Drive Closed Off-Road Vehicle Engine BMV	235043	Drive Shaft	30		64	103.5	535		
	2004.11-2006.11	AT/MT	L/R	F	All-wheel Drive Closed Off-Road Vehicle Engine BMV	699148	Inner Joint		28		34			
	2004.11-2006.11	AT/MT	L/R	F	All-wheel Drive Closed Off-Road Vehicle Engine BMV	299213	Drive Shaft	30		64	103.5	523		
	2004.11-2006.11	AT/MT	L/R	F	All-wheel Drive Closed Off-Road Vehicle Engine BMV	861050	Outer Joint	30	27	64	103.5	63.5	M	
	2004.11-2006.11	AT/MT	L/R	R	All-wheel Drive Closed Off-Road Vehicle Engine BMV	603027	Inner Joint		28		28			
	2004.11-2006.11	AT/MT	L/R	R	All-wheel Drive Closed Off-Road Vehicle Engine BMV	261236	Drive Shaft	30		64	103.5	734		
3.6 V6 FSI (206 kW)	2005.10-2010.05	-	-	-	All-wheel Drive Closed Off-Road Vehicle Engine BHL	661064	Inner Joint	30	28	64	103.5	64		
	2005.10-2010.05	-	-	F	All-wheel Drive Closed Off-Road Vehicle Engine BHL	235043	Drive Shaft	30		64	103.5	535		
4.2 V8 (228 kW)	2002.12-2006.11	-	L/R	R	All-wheel Drive Closed Off-Road Vehicle Engine AXQ	661066	Inner Joint		28		28			
	2002.12-2006.11	-	L/R	F	All-wheel Drive Closed Off-Road Vehicle Engine AXQ	299213	Drive Shaft	30		64	103.5	523		
	2002.12-2006.11	-	L/R	F	All-wheel Drive Closed Off-Road Vehicle Engine AXQ	699148	Inner Joint		28		34			
	2002.12-2006.11	-	L/R	F	All-wheel Drive Closed Off-Road Vehicle Engine AXQ	861050	Outer Joint	30	27	64	103.5	63.5	M	
	2002.12-2006.11	-	L/R	R	All-wheel Drive Closed Off-Road Vehicle Engine AXQ	603027	Inner Joint		28		28			
	2002.12-2006.11	-	L/R	R	All-wheel Drive Closed Off-Road Vehicle Engine AXQ	261236	Drive Shaft	30		64	103.5	734		
4.2 V8 FSI (257 kW)	2006.06-2010.05	-	L/R	R	All-wheel Drive Closed Off-Road Vehicle Engine BAR	661066	Inner Joint		28		28			
	2006.06-2010.05	AT	L/R	F	All-wheel Drive Closed Off-Road Vehicle Engine BAR	699148	Inner Joint		28		34			
	2006.06-2010.05	-	L/R	F	All-wheel Drive Closed Off-Road Vehicle Engine BAR	299213	Drive Shaft	30		64	103.5	523		
	2006.06-2010.05	AT	L/R	F	All-wheel Drive Closed Off-Road Vehicle Engine BAR	861050	Outer Joint	30	27	64	103.5	63.5	M	
	2006.06-2010.05	AT	L/R	R	All-wheel Drive Closed Off-Road Vehicle Engine BAR	603027	Inner Joint		28		28			
	2006.06-2010.05	-	L/R	R	All-wheel Drive Closed Off-Road Vehicle Engine BAR	261236	Drive Shaft	30		64	103.5	734		
5.0 R50 TDI (257 kW)	2007.08-2010.05	-	L/R	F	All-wheel Drive Closed Off-Road Vehicle Engine CBWA	803085	Outer Joint	30	29	64	103	72.5	M	
	2007.08-2010.05	6AT	L/R	F	All-wheel Drive Closed Off-Road Vehicle Engine CBWA	201127	Drive Shaft	30		64	103	522		
5.0 V10 TDI (230 kW)	2002.10-2010.05	6AT/6MT	L/R	R	All-wheel Drive Closed Off-Road Vehicle Engine BWF	661066	Inner Joint		28		28			
	2002.10-2010.05	-	-	-	All-wheel Drive Closed Off-Road Vehicle Engine BWF	661064	Inner Joint	30	28	64	103.5	64		
	2002.10-2010.05	-	L/R	F	All-wheel Drive Closed Off-Road Vehicle Engine BWF	803085	Outer Joint	30	29	64	103	72.5	M	
	2002.10-2010.05	6AT	L/R	F	All-wheel Drive Closed Off-Road Vehicle Engine BWF	201127	Drive Shaft	30		64	103	522		
	2002.10-2010.05	-	L/R	R	All-wheel Drive Closed Off-Road Vehicle Engine BWF	603027	Inner Joint		28		28			
	2002.10-2010.05	6AT/6MT	L/R	R	All-wheel Drive Closed Off-Road Vehicle Engine BWF	261236	Drive Shaft	30		64	103.5	734		
6.0 W12 (331 kW)	2004.08-2010.05	6AT/6MT	L/R	R	All-wheel Drive Closed Off-Road Vehicle Engine BJN/CFRA	661066	Inner Joint		28		28			
	2004.08-2010.05	-	-	-	All-wheel Drive Closed Off-Road Vehicle Engine BJN/CFRA	661064	Inner Joint	30	28	64	103.5	64		
	2004.08-2010.05	-	L/R	F	All-wheel Drive Closed Off-Road Vehicle Engine BJN/CFRA	803085	Outer Joint	30	29	64	103	72.5	M	
	2004.08-2010.05	-	L/R	F	All-wheel Drive Closed Off-Road Vehicle Engine BJN/CFRA	699148	Inner Joint		28		34			
	2004.08-2010.05	-	L/R	F	All-wheel Drive Closed Off-Road Vehicle Engine BJN/CFRA	299213	Drive Shaft	30		64	103.5	523		
	2004.08-2010.05	6AT	L/R	F	All-wheel Drive Closed Off-Road Vehicle Engine BJN/CFRA	201127	Drive Shaft	30		64	103	522		
	2004.08-2010.05	-	L/R	F	All-wheel Drive Closed Off-Road Vehicle Engine BJN/CFRA	861050	Outer Joint	30	27	64	103.5	63.5	M	
	2004.08-2010.05	-	L/R	R	All-wheel Drive Closed Off-Road Vehicle Engine BJN/CFRA	603027	Inner Joint		28		28			
	2004.08-2010.05	6AT/6MT	L/R	R	All-wheel Drive Closed Off-Road Vehicle Engine BJN/CFRA	261236	Drive Shaft	30		64	103.5	734		
TOUAREG (7P5 7P6)														
3.0 V6 TDI (150 kW)	2010.01-2010.01	-	-	L/R	F	All-wheel Drive Closed Off-Road Vehicle Engine CRCD	235085	Drive Shaft	30		64.4	103.5	525	
	2010.01-2010.01	AT/6MT	L/R	F	All-wheel Drive Closed Off-Road Vehicle Engine CRCD	699148	Inner Joint		28		34			
	2010.01-2010.01	AT	-	F	All-wheel Drive Closed Off-Road Vehicle Engine CRCD	835045	Outer Joint	30	28	64.4	103.5	62.5	I	
	2010.01-2010.01	-	L/R	R	All-wheel Drive Closed Off-Road Vehicle Engine CRCD	261298	Drive Shaft	30	37	64	103.5	863		
	2010.01-2010.01	-	-	F	All-wheel Drive Closed Off-Road Vehicle Engine CRCD	803117	Outer Joint	30	28	64.4	103.5	62.5	I	
3.0 V6 TDI (165 kW)	2010.06-2010.06	-	L/R	F	All-wheel Drive Closed Off-Road Vehicle Engine CATA	235085	Drive Shaft	30		64.4	103.5	525		
	2010.06-2010.06	-	L/R	F	All-wheel Drive Closed Off-Road Vehicle Engine CATA	699148	Inner Joint		28		34			
	2010.06-2010.06	AT	-	F	All-wheel Drive Closed Off-Road Vehicle Engine CATA	835045	Outer Joint	30	28	64.4	103.5	62.5	I	
	2010.06-2010.06	-	L/R	R	All-wheel Drive Closed Off-Road Vehicle Engine CATA	261298	Drive Shaft	30	37	64	103.5	863		
	2010.06-2010.06	-	-	F	All-wheel Drive Closed Off-Road Vehicle Engine CATA	803117	Outer Joint	30	28	64.4	103.5	62.5	I	
3.0 V6 TDI (176 kW)	2010.01-2010.01	-	-	F	All-wheel Drive Closed Off-Road Vehicle Engine CASA	803117	Outer Joint	30	28	64.4	103.5	62.5	I	
	2010.01-2010.01	-	L/R	F	All-wheel Drive Closed Off-Road Vehicle Engine CASA	235085	Drive Shaft	30		64.4	103.5	525		
	2010.01-2010.01	-	L/R	F	All-wheel Drive Closed Off-Road Vehicle Engine CASA	699148	Inner Joint		28		34			
	2010.01-2010.01	AT	-	F	All-wheel Drive Closed Off-Road Vehicle Engine CASA	835045	Outer Joint	30	28	64.4	103.5	62.5	I	
	2010.01-2010.01	-	L/R	R	All-wheel Drive Closed Off-Road Vehicle Engine CASA	261298	Drive Shaft	30	37	64	103.5	863		
3.0 V6 TDI (180 kW)	2011.05-2011.05	-	-	F	All-wheel Drive Closed Off-Road Vehicle Engine CRCA	803117	Outer Joint	30	28	64.4	103.5	62.5	I	
	2011.05-2011.05	-	L/R	F	All-wheel Drive Closed Off-Road Vehicle Engine CRCA	235085	Drive Shaft	30		64.4	103.5	525		
	2011.05-2011.05	-	L/R	F	All-wheel Drive Closed Off-Road Vehicle Engine CRCA	699148	Inner Joint		28		34			
	2011.05-2011.05	AT	-	F	All-wheel Drive Closed Off-Road Vehicle Engine CRCA	835045	Outer Joint	30	28	64.4	103.5	62.5	I	
	2011.05-2011.05	-	L/R	R	All-wheel Drive Closed Off-Road Vehicle Engine CRCA	261298	Drive Shaft	30	37	64	103.5	863		
3.0 V6 TDI (193 kW)	2014.09-2014.09	-	-	L/R	R	All-wheel Drive Closed Off-Road Vehicle Engine CVVA	235085	Drive Shaft	30		64.4	103.5	525	

	 YEAR	TRANSM	L/R	F/R	REMARKS	GSP Ref.	 PRODUCT	 ABS	Technical Specifications						
									A	B	C	H	L	P	
VW															
TOUAREG (7P5 7P6)															
3.0 V6 TDI (193 kW)	2014.09-	-	AT	L/R	F	All-wheel Drive Closed Off-Road Vehicle Engine CVVA	699148	Inner Joint			28		34		
	2014.09-	-	-	L/R	R	All-wheel Drive Closed Off-Road Vehicle Engine CVVA	261298	Drive Shaft	30	37	64	103.5	863		
3.0 V6 TSI (213 kW)	2010.08-	-	-	-	F	All-wheel Drive Closed Off-Road Vehicle Engine CJTA	803117	Outer Joint	30	28	64.4	103.5	62.5	I	
	2010.08-	-	AT	-	F	All-wheel Drive Closed Off-Road Vehicle Engine CJTA	835045	Outer Joint	30	28	64.4	103.5	62.5	I	
3.0 V6 TSI Hybrid (245 kW)	2010.04-	-	-	-	F	All-wheel Drive Closed Off-Road Vehicle Engine CGEA	803117	Outer Joint	30	28	64.4	103.5	62.5	I	
	2010.04-	-	-	L/R	F	All-wheel Drive Closed Off-Road Vehicle Engine CGEA	235085	Drive Shaft	30		64.4	103.5	525		
	2010.04-	-	-	L/R	F	All-wheel Drive Closed Off-Road Vehicle Engine CGEA	699148	Inner Joint		28		34			
	2010.04-	-	AT	-	F	All-wheel Drive Closed Off-Road Vehicle Engine CGEA	835045	Outer Joint	30	28	64.4	103.5	62.5	I	
	2010.04-	-	-	L/R	R	All-wheel Drive Closed Off-Road Vehicle Engine CGEA	261298	Drive Shaft	30	37	64	103.5	863		
3.6 V6 FSI (183 kW)	2010.08-	-	-	-	F	All-wheel Drive Closed Off-Road Vehicle Engine CMTA	803117	Outer Joint	30	28	64.4	103.5	62.5	I	
3.6 V6 FSI (206 kW)	2010.04-	-	-	-	F	All-wheel Drive Closed Off-Road Vehicle Engine CGRA	803117	Outer Joint	30	28	64.4	103.5	62.5	I	
	2010.04-	-	-	L/R	F	All-wheel Drive Closed Off-Road Vehicle Engine CGRA	235085	Drive Shaft	30		64.4	103.5	525		
	2010.04-	-	-	L/R	F	All-wheel Drive Closed Off-Road Vehicle Engine CGRA	699148	Inner Joint		28		34			
	2010.04-	-	AT	-	F	All-wheel Drive Closed Off-Road Vehicle Engine CGRA	835045	Outer Joint	30	28	64.4	103.5	62.5	I	
	2010.04-	-	-	L/R	R	All-wheel Drive Closed Off-Road Vehicle Engine CGRA	261298	Drive Shaft	30	37	64	103.5	863		
4.2 V8 FSI (265 kW)	2011.01-	-	-	-	F	All-wheel Drive Closed Off-Road Vehicle Engine CGNA	803117	Outer Joint	30	28	64.4	103.5	62.5	I	
	2011.01-	-	-	L/R	F	All-wheel Drive Closed Off-Road Vehicle Engine CGNA	235085	Drive Shaft	30		64.4	103.5	525		
	2011.01-	-	-	L/R	F	All-wheel Drive Closed Off-Road Vehicle Engine CGNA	699148	Inner Joint		28		34			
	2011.01-	-	AT	-	F	All-wheel Drive Closed Off-Road Vehicle Engine CGNA	835045	Outer Joint	30	28	64.4	103.5	62.5	I	
	2011.01-	-	-	L/R	R	All-wheel Drive Closed Off-Road Vehicle Engine CGNA	261298	Drive Shaft	30	37	64	103.5	863		
4.2 V8 TDI (250 kW)	2010.01-	-	-	-	F	All-wheel Drive Closed Off-Road Vehicle Engine CKDA	803117	Outer Joint	30	28	64.4	103.5	62.5	I	
	2010.01-	-	-	L/R	F	All-wheel Drive Closed Off-Road Vehicle Engine CKDA	235085	Drive Shaft	30		64.4	103.5	525		
	2010.01-	-	-	L/R	F	All-wheel Drive Closed Off-Road Vehicle Engine CKDA	699148	Inner Joint		28		34			
	2010.01-	-	AT	-	F	All-wheel Drive Closed Off-Road Vehicle Engine CKDA	835045	Outer Joint	30	28	64.4	103.5	62.5	I	
TOURAN															
-	2006-	2016	-	-	-	-	201594	Drive Shaft	36		59.5	40	800		
1.6	2003-	2005	-	-	-	-	201583	Drive Shaft	36	26	59.5	40	873		
	2006-	2008	-	-	-	-	201583	Drive Shaft	36	26	59.5	40	873		
TOURAN (1T1 1T2)															
1.4 FSI (125 kW)	2006.11-	2010.05	-	L/R	F	MPV Engine BLG	803002	Outer Joint	36	27	59.5	40	66	I	
	2006.11-	2010.05	MT	L	F	MPV Engine BLG	203302	Drive Shaft	36		59.5	40	528		
	2006.11-	2010.05	AT	-	-	MPV Engine BLG	603016	Inner Joint		28		32			
	2006.11-	2010.05	AT	R	F	MPV Engine BLG	261342	Drive Shaft	36		59.5	40	764		
1.4 TSI (103 kW)	2006.02-	2010.05	MT	L	F	MPV Engine BMY/CAVC	261224	Drive Shaft	36		59.5	40	536		
	2006.02-	2010.05	MT	L/R	F	MPV Engine BMY/CAVC	603011	Inner Joint		33		34			
	2006.02-	2010.05	MT	R	F	MPV Engine BMY/CAVC	201586	Drive Shaft	36		59.5	40	806		
	2006.02-	2010.05	6MT	L/R	F	MPV Engine BMY/CAVC	803037	Outer Joint	36	30	59.5	40.5	55	I	
	2006.02-	2010.05	AT	R	F	MPV Engine BMY/CAVC	261342	Drive Shaft	36		59.5	40	764		
	2006.02-	2010.05	AT	L/R	F	MPV Engine BMY/CAVC	803002	Outer Joint	36	27	59.5	40	66	I	
1.4 TSI EcoFuel (110 kW)	2009.05-	2010.05	MT	L	F	MPV Engine CDGA	261224	Drive Shaft	36		59.5	40	536		
	2009.05-	2010.05	MT	L/R	F	MPV Engine CDGA	603011	Inner Joint		33		34			
	2009.05-	2010.05	MT	L/R	F	MPV Engine CDGA	803037	Outer Joint	36	30	59.5	40.5	55	I	
	2009.05-	2010.05	AT	L/R	F	MPV Engine CDGA	803002	Outer Joint	36	27	59.5	40	66	I	
1.6 (75 kW)	2003.07-	2010.05	-	R	F	MPV Engine BGU	261113	Drive Shaft	36		59.5	40	814		
	2003.07-	2010.05	MT	L	F	MPV Engine BGU	261089	Drive Shaft	36		59.5	40.5	521		
	2003.07-	2010.05	-	L/R	F	MPV Engine BGU	603011	Inner Joint		33		34			
	2003.07-	2010.05	-	-	-	MPV Engine BGU	261237	Stub Axle	23	37	54		142.5		
	2003.07-	2010.05	-	L	F	MPV Engine BGU	203373	Drive Shaft	36		59.5	38	511		
	2003.07-	2010.05	MT	R	F	MPV Engine BGU	261200	Drive Shaft	36		59.5	40.5	820		
	2003.07-	2010.05	-	L/R	F	MPV Engine BGU	803037	Outer Joint	36	30	59.5	40.5	55	I	
	2003.07-	2010.05	AT	L/R	F	MPV Engine BGU	661011	Inner Joint	26	32	31	68.5	85		
	2003.07-	2010.05	-	L	F	MPV Engine BGU	803116	Outer Joint	36	30	59.5	38	55	I	
	2003.07-	2010.05	MT	-	-	MPV Engine BGU	603006	Inner Joint		33		34			
1.6 FSI (85 kW)	2003.02-	2007.01	-	L/R	F	MPV Engine BAG	603011	Inner Joint		33		34			
	2003.02-	2007.01	-	-	-	MPV Engine BAG	261237	Stub Axle	23	37	54		142.5		
	2003.02-	2007.01	AT	L/R	F	MPV Engine BAG	661011	Inner Joint	26	32	31	68.5	85		
	2003.02-	2007.01	-	L/R	F	MPV Engine BAG	803037	Outer Joint	36	30	59.5	40.5	55	I	
	2003.02-	2007.01	AT	L	F	MPV Engine BAG	201582	Drive Shaft	36	26	59.5	40	597		
1.9 TDI (66 kW)	2004.11-	2010.05	MT	-	-	MPV Engine BRU	603006	Inner Joint		33		34			
	2004.11-	2010.05	-	L/R	F	MPV Engine BRU	803037	Outer Joint	36	30	59.5	40.5	55	I	
	2004.11-	2010.05	-	R	F	MPV Engine BRU	203313	Drive Shaft	36		59.5	40	792		
	2004.11-	2010.05	-	L/R	F	MPV Engine BRU	803002	Outer Joint	36	27	59.5	40	66	I	
	2004.11-	2010.05	-	L	F	MPV Engine BRU	803116	Outer Joint	36	30	59.5	38	55	I	
	2004.11-	2010.05	MT	-	-	MPV Engine BRU	603016	Inner Joint		28		32			
	2004.11-	2010.05	-	L/R	F	MPV Engine BRU	603011	Inner Joint		33		34			
2004.11-	2010.05	-	R	F	MPV Engine BRU	261042	Drive Shaft	36		59.5	40.5	814			

	 YEAR	TRANSM	L/R	F/R	REMARKS	GSP Ref.	 PRODUCT	 ABS	Technical Specifications							
									A	B	C	H	L	P		
VW																
TOURAN (1T1 1T2)																
1.9 TDI (66 kW)	2004.11-2010.05	MT	-	-	MPV Engine BRU	861059	Outer Joint		36	33	59.5	40	59.5		I	
	2004.11-2010.05	-	L	F	MPV Engine BRU	203295	Drive Shaft		36		59.5	40	491			
	2004.11-2010.05	-	R	F	MPV Engine BRU	201585	Drive Shaft		36		59.5	40	805			
	2004.11-2010.05	-	L	F	MPV Engine BRU	203294	Drive Shaft		36		59.5	38	519			
1.9 TDI (74 kW)	2003.02-2004.05	-	L	F	MPV Engine AVQ	203294	Drive Shaft		36		59.5	38	519			
	2003.02-2004.05	-	L/R	F	MPV Engine AVQ	603011	Inner Joint			33		34				
	2003.02-2004.05	AT	L	F	MPV Engine AVQ	654004	Inner Joint			34		85				
	2003.02-2004.05	-	-	-	MPV Engine AVQ	261237	Stub Axle		23	37	54		142.5			
	2003.02-2004.05	AT	L	F	MPV Engine AVQ	203241	Drive Shaft		36		59.5	40	475			
	2003.02-2004.05	-	L	F	MPV Engine AVQ	803116	Outer Joint		36	30	59.5	38	55	I		
	2003.02-2004.05	-	R	F	MPV Engine AVQ	261042	Drive Shaft		36		59.5	40.5	814			
	2003.02-2004.05	-	L/R	F	MPV Engine AVQ	803037	Outer Joint		36	30	59.5	40.5	55	I		
	2003.02-2004.05	MT	-	-	MPV Engine AVQ	603006	Inner Joint			33		34				
	2003.02-2004.05	-	R	F	MPV Engine AVQ	201585	Drive Shaft		36		59.5	40	805			
1.9 TDI (77 kW)	2003.08-2010.05	MT	-	F	MPV Engine BKC	803100	Outer Joint		36	33	59.5	38	55	I		
	2003.08-2010.05	AT	L/R	F	MPV Engine BKC	661057	Inner Joint			34		86				
	2003.08-2010.05	MT	L	F	MPV Engine BKC	261089	Drive Shaft		36		59.5	40.5	521			
	2003.08-2010.05	AT	L	F	MPV Engine BKC	254013	Drive Shaft		36		59.5	40	479.5			
	2003.08-2010.05	AT	L	F	MPV Engine BKC	654004	Inner Joint			34		85				
	2003.08-2010.05	AT/MT	L/R	F	MPV Engine BKC	803002	Outer Joint		36	27	59.5	40	66	I		
	2003.08-2010.05	MT	R	F	MPV Engine BKC	203313	Drive Shaft		36		59.5	40	792			
	2003.08-2010.05	MT	L	F	MPV Engine BKC	803116	Outer Joint		36	30	59.5	38	55	I		
	2003.08-2010.05	-	-	-	MPV Engine BKC	261237	Stub Axle		23	37	54		142.5			
	2003.08-2010.05	AT	L	F	MPV Engine BKC	203241	Drive Shaft		36		59.5	40	475			
	2003.08-2010.05	MT	R	F	MPV Engine BKC	261042	Drive Shaft		36		59.5	40.5	814			
	2003.08-2010.05	MT	R	F	MPV Engine BKC	261200	Drive Shaft		36		59.5	40.5	820			
	2003.08-2010.05	MT	L/R	F	MPV Engine BKC	603011	Inner Joint			33		34				
	2003.08-2010.05	6AT	L/R	F	MPV Engine BKC	861045	Outer Joint		36	27	59.5	40	65	M		
	2003.08-2010.05	AT	R	F	MPV Engine BKC	254011	Drive Shaft		36		59.5	40	755			
	2003.08-2010.05	-	-	-	MPV Engine BKC	861059	Outer Joint		36	33	59.5	40	59.5	I		
	2003.08-2010.05	MT	L	F	MPV Engine BKC	203295	Drive Shaft		36		59.5	40	491			
	2003.08-2010.05	MT	L/R	F	MPV Engine BKC	803037	Outer Joint		36	30	59.5	40.5	55	I		
	2003.08-2010.05	MT	L	F	MPV Engine BKC	203294	Drive Shaft		36		59.5	38	519			
	2003.08-2010.05	MT	R	F	MPV Engine BKC	201585	Drive Shaft		36		59.5	40	805			
2.0 EcoFuel (80 kW)	2006.02-2009.05	-	R	F	MPV Engine BSX	261113	Drive Shaft		36		59.5	40	814			
	2006.02-2009.05	MT	-	-	MPV Engine BSX	603006	Inner Joint			33		34				
	2006.02-2009.05	-	L/R	F	MPV Engine BSX	603011	Inner Joint			33		34				
	2006.02-2009.05	-	L	F	MPV Engine BSX	203373	Drive Shaft		36		59.5	38	511			
	2006.02-2009.05	5MT	L/R	F	MPV Engine BSX	803037	Outer Joint		36	30	59.5	40.5	55	I		
	2006.02-2009.05	-	L	F	MPV Engine BSX	803116	Outer Joint		36	30	59.5	38	55	I		
2.0 FSI (110 kW)	2003.10-2007.01	MT	R	F	MPV Engine BLX	261113	Drive Shaft		36		59.5	40	814			
	2003.10-2007.01	MT	L/R	F	MPV Engine BLX	603011	Inner Joint			33		34				
	2003.10-2007.01	-	-	-	MPV Engine BLX	261237	Stub Axle		23	37	54		142.5			
	2003.10-2007.01	AT	R	F	MPV Engine BLX	261094	Drive Shaft		36	26	59.5	40.5	884			
	2003.10-2007.01	-	L/R	F	MPV Engine BLX	803037	Outer Joint		36	30	59.5	40.5	55	I		
	2003.10-2007.01	MT	L	F	MPV Engine BLX	803116	Outer Joint		36	30	59.5	38	55	I		
	2003.10-2007.01	AT	L/R	F	MPV Engine BLX	661011	Inner Joint		26	32	31	68.5	85			
	2003.10-2007.01	AT	L	F	MPV Engine BLX	261093	Drive Shaft		36	26	59.5	40.5	587.5			
	2003.10-2007.01	MT	R	F	MPV Engine BLX	201585	Drive Shaft		36		59.5	40	805			
2.0 FSI (85 kW)	2004.10-2010.05	-	-	-	MPV Engine BJZ	261237	Stub Axle		23	37	54		142.5			
2.0 TDI (100 kW)	2003.02-2010.05	-	L	F	MPV Engine AZV	203265	Drive Shaft		36		59.5	40	487			
	2003.02-2010.05	-	L/R	F	MPV Engine AZV	803002	Outer Joint		36	27	59.5	40	66	I		
	2003.02-2010.05	-	R	F	MPV Engine AZV	203313	Drive Shaft		36		59.5	40	792			
	2003.02-2010.05	MT	R	F	MPV Engine AZV	203236	Drive Shaft		36		59.5	40	484			
	2003.02-2010.05	MT	-	-	MPV Engine AZV	603016	Inner Joint			28		32				
	2003.02-2010.05	-	-	-	MPV Engine AZV	261237	Stub Axle		23	37	54		142.5			
	2003.02-2010.05	Semi-AT	L	F	MPV Engine AZV	654004	Inner Joint			34		85				
	2003.02-2010.05	-	R	F	MPV Engine AZV	261126	Drive Shaft		36		59.5	40	793			
	2003.02-2010.05	-	L/R	F	MPV Engine AZV	203295	Drive Shaft		36		59.5	40	491			
	2003.02-2010.05	-	L/R	F	MPV Engine AZV	861045	Outer Joint		36	27	59.5	40	65	M		
	2003.02-2010.05	Semi-AT	L	F	MPV Engine AZV	203241	Drive Shaft		36		59.5	40	475			
2.0 TDI (103 kW)	2005.12-2010.05	AT	R	F	MPV Engine BMM	254011	Drive Shaft		36		59.5	40	755			
	2005.12-2010.05	MT	L	F	MPV Engine BMM	203295	Drive Shaft		36		59.5	40	491			
	2005.12-2010.05	MT	L	F	MPV Engine BMM	203265	Drive Shaft		36		59.5	40	487			
	2005.12-2010.05	-	L/R	F	MPV Engine BMM	803002	Outer Joint		36	27	59.5	40	66	I		
	2005.12-2010.05	MT	R	F	MPV Engine BMM	203313	Drive Shaft		36		59.5	40	792			

YEAR	TRANSM	L/R	F/R	REMARKS	GSP Ref.	PRODUCT	ABS	Technical Specifications					
								A	B	C	H	L	P
VW													
TOURAN (1T1 1T2)													
2.0 TDI (103 kW)	2005.12-2010.05	AT	L	F	MPV Engine BMM	254013	Drive Shaft		36		59.5	40	479.5
	2005.12-2010.05	AT	L	F	MPV Engine BMM	654004	Inner Joint			34		85	
	2005.12-2010.05	MT	R	F	MPV Engine BMM	261126	Drive Shaft		36		59.5	40	793
	2005.12-2010.05	-	L/R	F	MPV Engine BMM	861045	Outer Joint		36	27	59.5	40	65 M
	2005.12-2010.05	Semi-AT	L	F	MPV Engine BMM	203241	Drive Shaft		36		59.5	40	475
2.0 TDI (125 kW)	2005.12-2010.05	AT	R	F	MPV Engine BMN	254011	Drive Shaft		36		59.5	40	755
	2005.12-2010.05	AT	L/R	F	MPV Engine BMN	661057	Inner Joint			34		86	
	2005.12-2010.05	MT	L	F	MPV Engine BMN	203265	Drive Shaft		36		59.5	40	487
	2005.12-2010.05	AT	R	F	MPV Engine BMN	654004	Inner Joint			34		85	
	2005.12-2010.05	MT	R	F	MPV Engine BMN	261126	Drive Shaft		36		59.5	40	793
	2005.12-2010.05	-	L/R	F	MPV Engine BMN	861045	Outer Joint		36	27	59.5	40	65 M
	2005.12-2010.05	Semi-AT	L	F	MPV Engine BMN	203241	Drive Shaft		36		59.5	40	475
2.0 TDI 16V (103 kW)	2003.08-2010.05	AT	L/R	F	MPV Engine BKD	661057	Inner Joint			34		86	
	2003.08-2010.05	MT	L	F	MPV Engine BKD	203265	Drive Shaft		36		59.5	40	487
	2003.08-2010.05	AT	L	F	MPV Engine BKD	254013	Drive Shaft		36		59.5	40	479.5
	2003.08-2010.05	AT/MT	L/R	F	MPV Engine BKD	803002	Outer Joint		36	27	59.5	40	66 I
	2003.08-2010.05	MT	R	F	MPV Engine BKD	203313	Drive Shaft		36		59.5	40	792
	2003.08-2010.05	AT	L	F	MPV Engine BKD	654004	Inner Joint			34		85	
	2003.08-2010.05	AT	R	F	MPV Engine BKD	203355	Drive Shaft		36	23	59.5	40	799
	2003.08-2010.05	MT	R	F	MPV Engine BKD	203236	Drive Shaft		36		59.5	40	484
	2003.08-2010.05	-	-	-	MPV Engine BKD	261237	Stub Axle		23	37	54		142.5
	2003.08-2010.05	MT	R	F	MPV Engine BKD	261126	Drive Shaft		36		59.5	40	793
	2003.08-2010.05	AT/MT	L/R	F	MPV Engine BKD	861045	Outer Joint		36	27	59.5	40	65 M
	2003.08-2010.05	MT	L/R	F	MPV Engine BKD	203295	Drive Shaft		36		59.5	40	491
	2003.08-2010.05	AT	R	F	MPV Engine BKD	254011	Drive Shaft		36		59.5	40	755
	2003.08-2010.05	Semi-AT	L	F	MPV Engine BKD	203241	Drive Shaft		36		59.5	40	475
TOURAN (1T3)/GOLF TOURAN													
1.2 TSI (77 kW)	2010.05-2015.05	-	L/R	F	MPV Engine CBZB	603011	Inner Joint			33		34	
	2010.05-2015.05	MT	L	F	MPV Engine CBZB	261198	Drive Shaft		36		59.5	40.5	530
	2010.05-2015.05	MT	-	-	MPV Engine CBZB	603006	Inner Joint			33		34	
	2010.05-2015.05	-	L/R	F	MPV Engine CBZB	803037	Outer Joint		36	30	59.5	40.5	55 I
1.4 TSI (103 kW)	2010.05-2015.05	MT	L	F	MPV Engine CTHC	261224	Drive Shaft		36		59.5	40	536
	2010.05-2015.05	MT	L/R	F	MPV Engine CTHC	603011	Inner Joint			33		34	
	2010.05-2015.05	MT	R	F	MPV Engine CTHC	201586	Drive Shaft		36		59.5	40	806
	2010.05-2015.05	MT	L/R	F	MPV Engine CTHC	803037	Outer Joint		36	30	59.5	40.5	55 I
	2010.05-2015.05	-	-	-	MPV Engine CTHC	861059	Outer Joint		36	33	59.5	40	59.5 I
	2010.05-2015.05	AT	L/R	F	MPV Engine CTHC	803002	Outer Joint		36	27	59.5	40	66 I
1.4 TSI (125 kW)	2010.05-2015.05	MT	L	F	MPV Engine CTHB	203302	Drive Shaft		36		59.5	40	528
	2010.05-2015.05	-	L/R	F	MPV Engine CTHB	803002	Outer Joint		36	27	59.5	40	66 I
	2010.05-2015.05	AT	-	-	MPV Engine CTHB	603016	Inner Joint			28		32	
1.4 TSI EcoFuel (110 kW)	2010.05-2015.05	MT	L/R	F	MPV Engine CDGA	603011	Inner Joint			33		34	
	2010.05-2015.05	MT	L/R	F	MPV Engine CDGA	803037	Outer Joint		36	30	59.5	40.5	55 I
	2010.05-2015.05	-	-	-	MPV Engine CDGA	861059	Outer Joint		36	33	59.5	40	59.5 I
	2010.05-2015.05	AT	L/R	F	MPV Engine CDGA	803002	Outer Joint		36	27	59.5	40	66 I
1.6 TDI (66 kW)	2010.05-2015.05	MT	-	F	MPV Engine CAYB	803100	Outer Joint		36	33	59.5	38	55 I
	2010.05-2015.05	MT	L	F	MPV Engine CAYB	261089	Drive Shaft		36		59.5	40.5	521
	2010.05-2015.05	MT	-	-	MPV Engine CAYB	603006	Inner Joint			33		34	
	2010.05-2015.05	MT	R	F	MPV Engine CAYB	261200	Drive Shaft		36		59.5	40.5	820
	2010.05-2015.05	-	L/R	F	MPV Engine CAYB	603011	Inner Joint			33		34	
	2010.05-2015.05	MT	-	-	MPV Engine CAYB	861059	Outer Joint		36	33	59.5	40	59.5 I
1.6 TDI (77 kW)	2010.05-2015.05	DCT/MT	-	F	MPV Engine CAYC	803100	Outer Joint		36	33	59.5	38	55 I
	2010.05-2015.05	DCT/MT	L	F	MPV Engine CAYC	261089	Drive Shaft		36		59.5	40.5	521
	2010.05-2015.05	-	-	-	MPV Engine CAYC	603016	Inner Joint			28		32	
	2010.05-2015.05	MT	L/R	F	MPV Engine CAYC	603011	Inner Joint			33		34	
	2010.05-2015.05	DCT/MT	R	F	MPV Engine CAYC	261200	Drive Shaft		36		59.5	40.5	820
	2010.05-2015.05	AT	L/R	F	MPV Engine CAYC	803002	Outer Joint		36	27	59.5	40	66 I
2.0 TDI (103 kW)	2010.05-2015.05	MT	L	F	MPV Engine CFHC	203295	Drive Shaft		36		59.5	40	491
	2010.05-2015.05	AT	R	F	MPV Engine CFHC	254011	Drive Shaft		36		59.5	40	755
	2010.05-2015.05	-	-	-	MPV Engine CFHC	603016	Inner Joint			28		32	
	2010.05-2015.05	MT	R	F	MPV Engine CFHC	203313	Drive Shaft		36		59.5	40	792
	2010.05-2015.05	AT	L	F	MPV Engine CFHC	254013	Drive Shaft		36		59.5	40	479.5
	2010.05-2015.05	AT	L	F	MPV Engine CFHC	654004	Inner Joint			34		85	
	2010.05-2015.05	AT/MT	L/R	F	MPV Engine CFHC	803002	Outer Joint		36	27	59.5	40	66 I
	2010.05-2015.05	DCT	L	F	MPV Engine CFHC	203241	Drive Shaft		36		59.5	40	475
2.0 TDI (125 kW)	2010.05-2013.01	-	R	F	MPV Engine CFJA	254011	Drive Shaft		36		59.5	40	755
	2010.05-2013.01	AT	L	F	MPV Engine CFJA	203241	Drive Shaft		36		59.5	40	475

YEAR	TRANSM	L/R	F/R	REMARKS	GSP Ref.	PRODUCT	ABS	Technical Specifications							
								A	B	C	H	L	P		
VW															
TOURAN (1T3)/GOLF TOURAN															
2.0 TDI (125 kW)	2010.05-	2013.01	-	R	F	MPV Engine CFJA	654004	Inner Joint			34		85		
2.0 TDI (81 kW)	2010.11-	2015.05	MT	L	F	MPV Engine CLCA	203294	Drive Shaft	36		59.5	38	519		
	2010.11-	2015.05	MT	L/R	F	MPV Engine CLCA	803037	Outer Joint	36	30	59.5	40.5	55	I	
	2010.11-	2015.05	AT	L	F	MPV Engine CLCA	254013	Drive Shaft	36		59.5	40	479.5		
	2010.11-	2015.05	AT	L	F	MPV Engine CLCA	203241	Drive Shaft	36		59.5	40	475		
	2010.11-	2015.05	AT	L	F	MPV Engine CLCA	654004	Inner Joint			34		85		
	2010.11-	2015.05	MT	L	F	MPV Engine CLCA	803116	Outer Joint	36	30	59.5	38	55	I	
	2010.11-	2015.05	MT	R	F	MPV Engine CLCA	261042	Drive Shaft	36		59.5	40.5	814		
	2010.11-	2015.05	AT	L/R	F	MPV Engine CLCA	803002	Outer Joint	36	27	59.5	40	66	I	
	2010.11-	2015.05	AT	R	F	MPV Engine CLCA	254011	Drive Shaft	36		59.5	40	755		
	2010.11-	2015.05	MT	R	F	MPV Engine CLCA	201585	Drive Shaft	36		59.5	40	805		
2010.11-	2015.05	MT	L/R	F	MPV Engine CLCA	603011	Inner Joint		33		34				
TOURAN (5T1)															
1.4 TSI (110 kW)	2015.05-	-	-	-	F	MPV Engine CZDA	803101	Outer Joint	36	27	59.5	40	65	M	
1.6 TDI (81 kW)	2015.05-	2016.05	Semi-AT/MT	L	F	MPV Engine CRKB	261201	Drive Shaft	36		59.5	40.5	535		
1.6 TDI (85 kW)	2016.05-	-	Semi-AT/MT	L	F	MPV Engine DGDA	261201	Drive Shaft	36		59.5	40.5	535		
1.8 TSI (132 kW)	2015.11-	-	MT	L	F	MPV Engine CJSA	261131	Drive Shaft	36		59.5	40	515		
	2015.11-	-	AT	-	-	MPV Engine CJSA	603016	Inner Joint		28		32			
2.0 TDI (110 kW)	2015.05-	-	MT	L	F	MPV Engine DFEA	261131	Drive Shaft	36		59.5	40	515		
2.0 TDI (140 kW)	2015.11-	-	6AT	L	F	MPV Engine DFHA	203381	Drive Shaft	36		59.5	40	486		
TRANSPORTER															
2.0	2012-	2016	-	-	-	-	201666	Drive Shaft	38	26	63	102.5	616		
	2012-	2016	-	-	-	-	201665	Drive Shaft	38	26	63	102.5	614		
TRANSPORTER III															
1.6 TD (51 kW)	1984.10-	1992.07	MT	L/R	R	Platform/Chassis Engine JX	261005	Drive Shaft				32	540		
	1984.10-	1992.07	MT	L/R	R	Box Engine JX	261005	Drive Shaft				32	540		
1.6 TD Syncro (51 kW)	1986.03-	1992.07	MT	L/R	F	All-wheel Drive Platform/Chassis Engine JX	661003	Inner Joint		33		32			
	1986.03-	1992.07	MT	L/R	F	All-wheel Drive Box Engine JX	661003	Inner Joint		33		32			
	1986.03-	1992.07	MT	L/R	R	All-wheel Drive Platform/Chassis Engine JX	603001	Inner Joint		28		32			
	1986.03-	1992.07	MT	L/R	R	All-wheel Drive Box Engine JX	603001	Inner Joint		28		32			
	1986.03-	1992.07	MT	L/R	F	All-wheel Drive Platform/Chassis Engine JX	261092	Drive Shaft	26		65	104	712		
	1986.03-	1992.07	MT	L/R	F	All-wheel Drive Box Engine JX	261092	Drive Shaft	26		65	104	712		
	1986.03-	1992.07	MT	L/R	R	All-wheel Drive Platform/Chassis Engine JX	261005	Drive Shaft				32	540		
	1986.03-	1992.07	MT	L/R	R	All-wheel Drive Box Engine JX	261005	Drive Shaft				32	540		
1.7 D (42 kW)	1989.07-	1992.07	MT	L/R	R	Platform/Chassis Engine KY	261005	Drive Shaft				32	540		
	1989.07-	1992.07	MT	L/R	R	Box Engine KY	261005	Drive Shaft				32	540		
1.9 (44 kW)	1982.09-	1992.07	MT	L/R	R	Platform/Chassis Engine DF	261005	Drive Shaft				32	540		
	1982.10-	1992.07	MT	L/R	R	Box Engine DF	261005	Drive Shaft				32	540		
1.9 (57 kW)	1982.08-	1992.07	MT	L/R	R	Platform/Chassis Engine DG	261005	Drive Shaft				32	540		
	1982.10-	1992.07	MT	L/R	R	Box Engine DG	261005	Drive Shaft				32	540		
1.9 (61 kW)	1984.10-	1989.02	MT	L/R	R	Box Engine DH	261005	Drive Shaft				32	540		
	1984.10-	1989.02	MT	L/R	R	Platform/Chassis Engine DH	261005	Drive Shaft				32	540		
1.9 (66 kW)	1983.08-	1989.02	MT	L/R	R	Box Engine GW	261005	Drive Shaft				32	540		
1.9 Syncro (57 kW)	1984.11-	1992.07	MT	L/R	F	All-wheel Drive Box Engine DG	661003	Inner Joint		33		32			
	1984.11-	1992.07	MT	L/R	R	All-wheel Drive Box Engine DG	603001	Inner Joint		28		32			
	1984.11-	1992.07	MT	L/R	F	All-wheel Drive Box Engine DG	261092	Drive Shaft	26		65	104	712		
	1984.11-	1992.07	MT	L/R	R	All-wheel Drive Box Engine DG	261005	Drive Shaft				32	540		
	1984.12-	1992.07	MT	L/R	F	All-wheel Drive Platform/Chassis Engine DG	661003	Inner Joint		33		32			
	1984.12-	1992.07	MT	L/R	R	All-wheel Drive Platform/Chassis Engine DG	603001	Inner Joint		28		32			
	1984.12-	1992.07	MT	L/R	F	All-wheel Drive Platform/Chassis Engine DG	261092	Drive Shaft	26		65	104	712		
	1984.12-	1992.07	MT	L/R	R	All-wheel Drive Platform/Chassis Engine DG	261005	Drive Shaft				32	540		
2.1 (70 kW)	1985.08-	1992.07	MT	L/R	R	Box Engine MV	261005	Drive Shaft				32	540		
	1985.08-	1992.07	MT	L/R	R	Platform/Chassis Engine MV	261005	Drive Shaft				32	540		
2.1 (82 kW)	1986.03-	1992.07	MT	L/R	R	Platform/Chassis Engine DJ	261005	Drive Shaft				32	540		
	1986.03-	1992.07	MT	L/R	R	Box Engine DJ	261005	Drive Shaft				32	540		
2.1 i (68 kW)	1989.07-	1992.07	MT	L/R	R	Platform/Chassis Engine SS	261005	Drive Shaft				32	540		
	1989.07-	1992.07	MT	L/R	R	Box Engine SS	261005	Drive Shaft				32	540		
2.1 Syncro (70 kW)	1985.08-	1992.07	MT	L/R	F	All-wheel Drive Box Engine MV	661003	Inner Joint		33		32			
	1985.08-	1992.07	MT	L/R	F	All-wheel Drive Platform/Chassis Engine MV	661003	Inner Joint		33		32			
	1985.08-	1992.07	MT	L/R	R	All-wheel Drive Box Engine MV	603001	Inner Joint		28		32			
	1985.08-	1992.07	MT	L/R	F	All-wheel Drive Box Engine MV	261092	Drive Shaft	26		65	104	712		
	1985.08-	1992.07	MT	L/R	R	All-wheel Drive Platform/Chassis Engine MV	603001	Inner Joint		28		32			
	1985.08-	1992.07	MT	L/R	F	All-wheel Drive Platform/Chassis Engine MV	261092	Drive Shaft	26		65	104	712		
	1985.08-	1992.07	MT	L/R	R	All-wheel Drive Box Engine MV	261005	Drive Shaft				32	540		
	1985.08-	1992.07	MT	L/R	R	All-wheel Drive Platform/Chassis Engine MV	261005	Drive Shaft				32	540		
2.1 Syncro (82 kW)	1986.03-	1992.07	MT	L/R	F	All-wheel Drive Platform/Chassis Engine DJ	661003	Inner Joint		33		32			

YEAR	TRANSM	L/R	F/R	REMARKS	GSP Ref.	PRODUCT	ABS	Technical Specifications						
								A	B	C	H	L	P	
VW														
TRANSPORTER III														
2.1 Syncro (82 kW)	1986.03-1992.07	MT	L/R	F	All-wheel Drive Box Engine DJ	661003	Inner Joint			33		32		
	1986.03-1992.07	MT	L/R	R	All-wheel Drive Platform/Chassis Engine DJ	603001	Inner Joint			28		32		
	1986.03-1992.07	MT	L/R	R	All-wheel Drive Box Engine DJ	603001	Inner Joint			28		32		
	1986.03-1992.07	MT	L/R	F	All-wheel Drive Platform/Chassis Engine DJ	261092	Drive Shaft	26		65	104	712		
	1986.03-1992.07	MT	L/R	F	All-wheel Drive Box Engine DJ	261092	Drive Shaft	26		65	104	712		
	1986.03-1992.07	MT	L/R	R	All-wheel Drive Platform/Chassis Engine DJ	261005	Drive Shaft					32	540	
	1986.03-1992.07	MT	L/R	R	All-wheel Drive Box Engine DJ	261005	Drive Shaft					32	540	
TRANSPORTER III/TRANSPORTER/CARAVELLE														
1.6 TD (51 kW)	1984.08-1992.07	MT	L/R	R	Bus Engine JX	261005	Drive Shaft					32	540	
1.6 TD Syncro (51 kW)	1986.03-1992.07	MT	L/R	F	All-wheel Drive Bus Engine JX	661003	Inner Joint			33		32		
	1986.03-1992.07	MT	L/R	R	All-wheel Drive Bus Engine JX	603001	Inner Joint			28		32		
	1986.03-1992.07	MT	L/R	F	All-wheel Drive Bus Engine JX	261092	Drive Shaft	26		65	104	712		
	1986.03-1992.07	MT	L/R	R	All-wheel Drive Bus Engine JX	261005	Drive Shaft					32	540	
1.7 D (42 kW)	1986.10-1992.07	MT	L/R	R	Bus Engine KY	261005	Drive Shaft					32	540	
1.9 (44 kW)	1982.08-1992.07	MT	L/R	R	Bus Engine DF	261005	Drive Shaft					32	540	
1.9 (57 kW)	1982.08-1992.07	MT	L/R	R	Bus Engine DG	261005	Drive Shaft					32	540	
1.9 Syncro (57 kW)	1985.02-1992.07	MT	L/R	F	All-wheel Drive Bus Engine DG	661003	Inner Joint			33		32		
	1985.02-1992.07	MT	L/R	R	All-wheel Drive Bus Engine DG	603001	Inner Joint			28		32		
	1985.02-1992.07	MT	L/R	F	All-wheel Drive Bus Engine DG	261092	Drive Shaft	26		65	104	712		
	1985.02-1992.07	MT	L/R	R	All-wheel Drive Bus Engine DG	261005	Drive Shaft					32	540	
2.1 (64 kW)	1986.10-1992.07	5AT	L	F	Bus Engine SR	261020	Drive Shaft	36		53.2	77.5	547		
	1986.10-1992.07	MT	L/R	R	Bus Engine SR	261005	Drive Shaft					32	540	
2.1 (70 kW)	1985.08-1992.07	MT	L/R	R	Bus Engine MV	261005	Drive Shaft					32	540	
2.1 (82 kW)	1984.08-1992.07	MT	L/R	R	Bus Engine DJ	261005	Drive Shaft					32	540	
2.1 i (68 kW)	1989.07-1992.07	MT	L/R	R	Bus Engine SS	261005	Drive Shaft					32	540	
2.1 Syncro (64 kW)	1986.10-1992.07	MT	L/R	F	All-wheel Drive Bus Engine SR	661003	Inner Joint			33		32		
	1986.10-1992.07	MT	L/R	R	All-wheel Drive Bus Engine SR	603001	Inner Joint			28		32		
	1986.10-1992.07	MT	L/R	F	All-wheel Drive Bus Engine SR	261092	Drive Shaft	26		65	104	712		
	1986.10-1992.07	MT	L/R	R	All-wheel Drive Bus Engine SR	261005	Drive Shaft					32	540	
2.1 Syncro (70 kW)	1985.08-1992.07	MT	L/R	F	All-wheel Drive Bus Engine MV	661003	Inner Joint			33		32		
	1985.08-1992.07	MT	L/R	R	All-wheel Drive Bus Engine MV	603001	Inner Joint			28		32		
	1985.08-1992.07	MT	L/R	F	All-wheel Drive Bus Engine MV	261092	Drive Shaft	26		65	104	712		
	1985.08-1992.07	MT	L/R	R	All-wheel Drive Bus Engine MV	261005	Drive Shaft					32	540	
2.1 Syncro (82 kW)	1986.01-1992.07	MT	L/R	F	All-wheel Drive Bus Engine DJ	661003	Inner Joint			33		32		
	1986.01-1992.07	MT	L/R	R	All-wheel Drive Bus Engine DJ	603001	Inner Joint			28		32		
	1986.01-1992.07	MT	L/R	F	All-wheel Drive Bus Engine DJ	261092	Drive Shaft	26		65	104	712		
	1986.01-1992.07	MT	L/R	R	All-wheel Drive Bus Engine DJ	261005	Drive Shaft					32	540	
TRANSPORTER IV (70A 70H 7DA 7DH)														
1.9 D (44 kW)	1990.09-1995.12	MT	L/R	F	Box Engine 1X	261003	Drive Shaft		38		60.2	34.5	540.8	
	1990.09-1995.12	MT	L/R	F	Box Engine 1X	661001	Inner Joint			33		31.8		
	1990.09-1995.12	MT	L/R	F	Box Engine 1X	261052	Drive Shaft	48T	38		60.2	34.5	529	
	1990.09-1995.12	MT	L/R	F	Box Engine 1X	861005	Outer Joint		38	27	60.2	34.5	65	I
	1990.09-1995.12	MT	L/R	F	Box Engine 1X	861006	Outer Joint	48T	38	27	60.2	34.5	65	I
	1990.09-1995.12	MT	L/R	F	Box Engine 1X	261119	Drive Shaft		38		60.2	34.5	527	
	1990.09-1995.12	MT	L/R	F	Box Engine 1X	261120	Drive Shaft		38		60.2	34.5	529	
	1990.09-1995.12	MT	L/R	F	Box Engine 1X	661002	Inner Joint			28		31.8		
	1990.09-1995.12	MT	L/R	F	Box Engine 1X	861003	Outer Joint		38	33	60.2	34.5	65	I
	1990.09-1995.12	MT	L/R	F	Box Engine 1X	261004	Drive Shaft	48T	38		60.2	34.5	540.8	
	1990.09-1995.12	MT	L/R	F	Box Engine 1X	861004	Outer Joint	48T	38	33	60.2	34.5	65	I
1.9 D (45 kW)	1990.07-1995.12	MT	L/R	F	Box Engine 1X	261003	Drive Shaft		38		60.2	34.5	540.8	
	1990.07-1995.12	MT	L/R	F	Box Engine 1X	661001	Inner Joint			33		31.8		
	1990.07-1995.12	MT	L/R	F	Box Engine 1X	261052	Drive Shaft	48T	38		60.2	34.5	529	
	1990.07-1995.12	MT	L/R	F	Box Engine 1X	861005	Outer Joint		38	27	60.2	34.5	65	I
	1990.07-1995.12	MT	L/R	F	Box Engine 1X	661036	Inner Joint			28		31.8		
	1990.07-1995.12	MT	L/R	F	Box Engine 1X	861006	Outer Joint	48T	38	27	60.2	34.5	65	I
	1990.07-1995.12	MT	L/R	F	Box Engine 1X	261119	Drive Shaft		38		60.2	34.5	527	
	1990.07-1995.12	MT	L/R	F	Box Engine 1X	261120	Drive Shaft		38		60.2	34.5	529	
	1990.07-1995.12	MT	L/R	F	Box Engine 1X	661002	Inner Joint			28		31.8		
	1990.07-1995.12	MT	L/R	F	Box Engine 1X	261004	Drive Shaft	48T	38		60.2	34.5	540.8	
	1990.07-1995.12	MT	L/R	F	Box Engine 1X	861003	Outer Joint		38	33	60.2	34.5	65	I
	1990.07-1995.12	MT	L/R	F	Box Engine 1X	861004	Outer Joint	48T	38	33	60.2	34.5	65	I
1.9 TD (50 kW)	1992.10-2003.04	MT	L/R	F	Box Engine ABL	861004	Outer Joint	48T	38	33	60.2	34.5	65	I
	1992.10-2003.04	MT	L/R	F	Box Engine ABL	261003	Drive Shaft		38		60.2	34.5	540.8	
	1992.10-2003.04	MT	L/R	F	Box Engine ABL	661001	Inner Joint			33		31.8		
	1992.10-2003.04	MT	L/R	F	Box Engine ABL	261052	Drive Shaft	48T	38		60.2	34.5	529	
	1992.10-2003.04	MT	L/R	F	Box Engine ABL	861005	Outer Joint		38	27	60.2	34.5	65	I

	YEAR	TRANSM	L/R	F/R	REMARKS	GSP Ref.	PRODUCT	ABS	Technical Specifications								
									A	B	C	H	L	P			
VW																	
TRANSPORTER IV (70A 70H 7DA 7DH)																	
1.9 TD (50 kW)	1992.10-2003.04	MT	L/R	F	Box Engine ABL	661036	Inner Joint			28		31.8					
	1992.10-2003.04	MT	L/R	F	Box Engine ABL	861006	Outer Joint	48T	38	27	60.2	34.5	65	I			
	1992.10-2003.04	MT	L/R	F	Box Engine ABL	261119	Drive Shaft		38		60.2	34.5	527				
	1992.10-2003.04	MT	L/R	F	Box Engine ABL	261120	Drive Shaft		38		60.2	34.5	529				
	1992.10-2003.04	MT	R	F	Box Engine ABL	261225	Stub Axle		37	113.5			394				
	1992.10-2003.04	MT	L/R	F	Box Engine ABL	661002	Inner Joint			28		31.8					
	1992.10-2003.04	MT	L/R	F	Box Engine ABL	261004	Drive Shaft	48T	38		60.2	34.5	540.8				
2.0 (62 kW)	1992.10-2003.04	MT	L/R	F	Box Engine ABL	861003	Outer Joint		38	33	60.2	34.5	65	I			
	1990.07-2003.04	MT	L/R	F	Box Engine AAC	261003	Drive Shaft		38		60.2	34.5	540.8				
	1990.07-2003.04	MT	L/R	F	Box Engine AAC	661001	Inner Joint			33		31.8					
	1990.07-2003.04	MT	L/R	F	Box Engine AAC	261052	Drive Shaft	48T	38		60.2	34.5	529				
	1990.07-2003.04	MT	L/R	F	Box Engine AAC	861005	Outer Joint		38	27	60.2	34.5	65	I			
	1990.07-2003.04	MT	L/R	F	Box Engine AAC	661036	Inner Joint			28		31.8					
	1990.07-2003.04	MT	L/R	F	Box Engine AAC	861006	Outer Joint	48T	38	27	60.2	34.5	65	I			
	1990.07-2003.04	MT	L/R	F	Box Engine AAC	261119	Drive Shaft		38		60.2	34.5	527				
	1990.07-2003.04	MT	L/R	F	Box Engine AAC	261120	Drive Shaft		38		60.2	34.5	529				
	1990.07-2003.04	MT	R	F	Box Engine AAC	261225	Stub Axle		37	113.5			394				
	1990.07-2003.04	MT	L/R	F	Box Engine AAC	661002	Inner Joint			28		31.8					
	1990.07-2003.04	MT	L/R	F	Box Engine AAC	861003	Outer Joint		38	33	60.2	34.5	65	I			
	1990.07-2003.04	MT	L/R	F	Box Engine AAC	261004	Drive Shaft	48T	38		60.2	34.5	540.8				
	1990.07-2003.04	MT	L/R	F	Box Engine AAC	861004	Outer Joint	48T	38	33	60.2	34.5	65	I			
2.4 D (55 kW)	1997.08-2003.04	AT/MT	L/R	F	Box Engine AJA	261003	Drive Shaft		38		60.2	34.5	540.8				
	1997.08-2003.04	AT/MT	L/R	F	Box Engine AJA	861005	Outer Joint		38	27	60.2	34.5	65	I			
	1997.08-2003.04	AT/MT	L/R	F	Box Engine AJA	861006	Outer Joint	48T	38	27	60.2	34.5	65	I			
	1997.08-2003.04	MT/AT	L/R	F	Box Engine AJA	661036	Inner Joint			28		31.8					
	1997.08-2003.04	MT	R	F	Box Engine AJA	261225	Stub Axle		37	113.5			394				
	1997.08-2003.04	AT/MT	L/R	F	Box Engine AJA	261004	Drive Shaft	48T	38		60.2	34.5	540.8				
2.4 D (57 kW)	1997.08-2003.04	AT/MT	L/R	F	Box Engine AJA	661002	Inner Joint			28		31.8					
	1990.07-1998.04	AT/MT	L/R	F	Box Engine AAB	661001	Inner Joint			33		31.8					
	1990.07-1998.04	AT/MT	L/R	F	Box Engine AAB	261052	Drive Shaft	48T	38		60.2	34.5	529				
	1990.07-1998.04	AT/MT	L/R	F	Box Engine AAB	861005	Outer Joint		38	27	60.2	34.5	65	I			
	1990.07-1998.04	AT/MT	L/R	F	Box Engine AAB	861006	Outer Joint	48T	38	27	60.2	34.5	65	I			
	1990.07-1998.04	AT/MT	L/R	F	Box Engine AAB	261119	Drive Shaft		38		60.2	34.5	527				
	1990.07-1998.04	AT/MT	L/R	F	Box Engine AAB	261120	Drive Shaft		38		60.2	34.5	529				
	1990.07-1998.04	MT	R	F	Box Engine AAB	261225	Stub Axle		37	113.5			394				
	1990.07-1998.04	MT/AT	L/R	F	Box Engine AAB	661036	Inner Joint			28		31.8					
	1990.07-1998.04	AT/MT	R	F	Box Engine AAB	261004	Drive Shaft	48T	38		60.2	34.5	540.8				
	1990.07-1998.04	AT/MT	L/R	F	Box Engine AAB	661002	Inner Joint			28		31.8					
	1990.07-1998.04	AT/MT	L/R	F	Box Engine AAB	861003	Outer Joint		38	33	60.2	34.5	65	I			
	1990.07-1998.04	AT/MT	L/R	F	Box Engine AAB	861004	Outer Joint	48T	38	33	60.2	34.5	65	I			
	1990.07-1998.04	AT/MT	L/R	F	Box Engine AAB	261003	Drive Shaft		38		60.2	34.5	540.8				
2.4 D Syncro (57 kW)	1992.10-1998.09	MT	L/R	F	All-wheel Drive Box Engine AAB	261052	Drive Shaft	48T	38		60.2	34.5	529				
	1992.10-1998.09	AT/MT	L/R	F	All-wheel Drive Box Engine AAB	861005	Outer Joint		38	27	60.2	34.5	65	I			
	1992.10-1998.09	AT/MT	L/R	F	All-wheel Drive Box Engine AAB	861006	Outer Joint	48T	38	27	60.2	34.5	65	I			
	1992.10-1998.09	AT/MT	L/R	F	All-wheel Drive Box Engine AAB	661002	Inner Joint			28		31.8					
2.5 (81 kW)	1990.11-2003.04	AT/MT	L/R	F	Box Engine ACU	661001	Inner Joint			33		31.8					
	1990.11-2003.04	AT/MT	L/R	F	Box Engine ACU	261052	Drive Shaft	48T	38		60.2	34.5	529				
	1990.11-2003.04	AT/MT	L/R	F	Box Engine ACU	861005	Outer Joint		38	27	60.2	34.5	65	I			
	1990.11-2003.04	AT/MT	L/R	F	Box Engine ACU	861006	Outer Joint	48T	38	27	60.2	34.5	65	I			
	1990.11-2003.04	AT/MT	L/R	F	Box Engine ACU	261119	Drive Shaft		38		60.2	34.5	527				
	1990.11-2003.04	AT/MT	L/R	F	Box Engine ACU	261120	Drive Shaft		38		60.2	34.5	529				
	1990.11-2003.04	MT	R	F	Box Engine ACU	261225	Stub Axle		37	113.5			394				
	1990.11-2003.04	MT/AT	L/R	F	Box Engine ACU	661036	Inner Joint			28		31.8					
	1990.11-2003.04	AT/MT	L/R	F	Box Engine ACU	261004	Drive Shaft	48T	38		60.2	34.5	540.8				
	1990.11-2003.04	AT/MT	L/R	F	Box Engine ACU	661002	Inner Joint			28		31.8					
	1990.11-2003.04	AT/MT	L/R	F	Box Engine ACU	861003	Outer Joint		38	33	60.2	34.5	65	I			
	1990.11-2003.04	AT/MT	L/R	F	Box Engine ACU	861004	Outer Joint	48T	38	33	60.2	34.5	65	I			
	1990.11-2003.04	AT/MT	L/R	F	Box Engine ACU	261003	Drive Shaft		38		60.2	34.5	540.8				
	2.5 (85 kW)	1996.08-2003.04	MT	L/R	F	Box Engine APL	261003	Drive Shaft		38		60.2	34.5	540.8			
1996.08-2003.04		AT/MT	L/R	F	Box Engine APL	861005	Outer Joint		38	27	60.2	34.5	65	I			
1996.08-2003.04		AT/MT	L/R	F	Box Engine APL	861006	Outer Joint	48T	38	27	60.2	34.5	65	I			
1996.08-2003.04		MT	L/R	F	Box Engine APL	661036	Inner Joint			28		31.8					
1996.08-2003.04		MT	R	F	Box Engine APL	261225	Stub Axle		37	113.5			394				
1996.08-2003.04		MT	L/R	F	Box Engine APL	261004	Drive Shaft	48T	38		60.2	34.5	540.8				
2.5 Syncro (81 kW)	1992.10-2003.04	AT/MT	L/R	F	All-wheel Drive Box Engine ACU	861004	Outer Joint	48T	38	33	60.2	34.5	65	I			

YEAR	TRANSM	L/R	F/R	REMARKS	GSP Ref.	PRODUCT	ABS	Technical Specifications						
								A	B	C	H	L	P	
VW														
TRANSPORTER IV (70A 70H 7DA 7DH)														
2.5 Syncro (81 kW)	1992.10-2003.04	AT/MT	L/R	F	All-wheel Drive Box Engine ACU	861005	Outer Joint		38	27	60.2	34.5	65	I
	1992.10-2003.04	MT	L/R	F	All-wheel Drive Box Engine ACU	261052	Drive Shaft	48T	38		60.2	34.5	529	
	1992.10-2003.04	AT/MT	L/R	F	All-wheel Drive Box Engine ACU	861006	Outer Joint	48T	38	27	60.2	34.5	65	I
	1992.10-2003.04	AT/MT	L/R	F	All-wheel Drive Box Engine ACU	661002	Inner Joint			28		31.8		
	1992.10-2003.04	AT/MT	L/R	F	All-wheel Drive Box Engine ACU	861003	Outer Joint		38	33	60.2	34.5	65	I
2.5 Syncro (85 kW)	1996.08-2003.04	AT/MT	L/R	F	All-wheel Drive Box Engine AET	861005	Outer Joint		38	27	60.2	34.5	65	I
	1996.08-2003.04	AT/MT	L/R	F	All-wheel Drive Box Engine AET	861006	Outer Joint	48T	38	27	60.2	34.5	65	I
	1996.08-2003.04	AT/MT	L/R	F	All-wheel Drive Box Engine AET	661002	Inner Joint			28		31.8		
2.5 TDI (111 kW)	2000.09-2003.04	-	L/R	F	Box Engine AXG	661030	Inner Joint			30		32		
	2000.09-2003.04	MT	L/R	F	Box Engine AXG	261033	Drive Shaft	48T	38		60.2	34.5	545	
2.5 TDI (65 kW)	1998.12-2003.04	MT	L/R	F	Box Engine AJT	261003	Drive Shaft		38		60.2	34.5	540.8	
	1998.12-2003.04	MT	L/R	F	Box Engine AJT	861005	Outer Joint		38	27	60.2	34.5	65	I
	1998.12-2003.04	MT	L/R	F	Box Engine AJT	861006	Outer Joint	48T	38	27	60.2	34.5	65	I
	1998.12-2003.04	MT	L/R	F	Box Engine AJT	661036	Inner Joint			28		31.8		
	1998.12-2003.04	MT	R	F	Box Engine AJT	261225	Stub Axle		37	113.5			394	
	1998.12-2003.04	MT	L/R	F	Box Engine AJT	261004	Drive Shaft	48T	38		60.2	34.5	540.8	
2.5 TDI (75 kW)	1995.09-2003.04	AT/MT	L/R	F	Box Engine AUF	861005	Outer Joint		38	27	60.2	34.5	65	I
	1995.09-2003.04	AT/MT	L/R	F	Box Engine AUF	861006	Outer Joint	48T	38	27	60.2	34.5	65	I
	1995.09-2003.04	AT	R	F	Box Engine AUF	261120	Drive Shaft		38		60.2	34.5	529	
	1995.09-2003.04	MT	L/R	F	Box Engine AUF	261034	Drive Shaft		38		60.2	34.5	529	
	1995.09-2003.04	MT	R	F	Box Engine AUF	261225	Stub Axle		37	113.5			394	
	1995.09-2003.04	MT/AT	L/R	F	Box Engine AUF	661036	Inner Joint			28		31.8		
	1995.09-2003.04	AT/MT	L/R	F	Box Engine AUF	261004	Drive Shaft	48T	38		60.2	34.5	540.8	
	1995.09-2003.04	AT/MT	L/R	F	Box Engine AUF	661002	Inner Joint			28		31.8		
2.5 TDI Syncro (75 kW)	1995.09-2003.04	AT/MT	L/R	F	All-wheel Drive Box Engine ACV	861005	Outer Joint		38	27	60.2	34.5	65	I
	1995.09-2003.04	AT/MT	L/R	F	All-wheel Drive Box Engine ACV	861006	Outer Joint	48T	38	27	60.2	34.5	65	I
	1995.09-2003.04	AT/MT	L/R	F	All-wheel Drive Box Engine ACV	661002	Inner Joint			28		31.8		
2.8 VR6 (103 kW)	1996.05-2000.05	MT	R	F	Box Engine AES	261225	Stub Axle		37	113.5			394	
2.8 VR6 (150 kW)	2000.06-2003.04	MT	L/R	F	Box Engine AMV	261003	Drive Shaft		38		60.2	34.5	540.8	
	2000.06-2003.04	AT	R	F	Box Engine AMV	261033	Drive Shaft	48T	38		60.2	34.5	545	
	2000.06-2003.04	MT	L/R	F	Box Engine AMV	661036	Inner Joint			28		31.8		
	2000.06-2003.04	MT	L/R	F	Box Engine AMV	261004	Drive Shaft	48T	38		60.2	34.5	540.8	
TRANSPORTER IV (70B 70C 7DB 7DK 70J 70K 7DC 7DJ)/TRANSPORTER/CARAVELLE														
1.8 (49 kW)	1990.12-1992.07	MT	L/R	F	Bus Engine PD	861004	Outer Joint	48T	38	33	60.2	34.5	65	I
	1990.12-1992.07	MT	L/R	F	Bus Engine PD	661001	Inner Joint					31.8		
	1990.12-1992.07	MT	L/R	F	Bus Engine PD	261052	Drive Shaft	48T	38		60.2	34.5	529	
	1990.12-1992.07	MT	L/R	F	Bus Engine PD	261119	Drive Shaft		38		60.2	34.5	527	
	1990.12-1992.07	MT	L/R	F	Bus Engine PD	861003	Outer Joint		38	33	60.2	34.5	65	I
1.9 D (44 kW)	1990.09-1995.12	MT	L/R	F	Bus Engine 1X	661001	Inner Joint			33		31.8		
	1990.09-1995.12	MT	L/R	F	Bus Engine 1X	261052	Drive Shaft	48T	38		60.2	34.5	529	
	1990.09-1995.12	MT	L/R	F	Bus Engine 1X	861005	Outer Joint		38	27	60.2	34.5	65	I
	1990.09-1995.12	MT	L/R	F	Bus Engine 1X	861006	Outer Joint	48T	38	27	60.2	34.5	65	I
	1990.09-1995.12	MT	L/R	F	Bus Engine 1X	261119	Drive Shaft		38		60.2	34.5	527	
	1990.09-1995.12	MT	L/R	F	Bus Engine 1X	261120	Drive Shaft		38		60.2	34.5	529	
	1990.09-1995.12	MT	L/R	F	Bus Engine 1X	661002	Inner Joint			28		31.8		
	1990.09-1995.12	MT	L/R	F	Bus Engine 1X	261004	Drive Shaft	48T	38		60.2	34.5	540.8	
	1990.09-1995.12	MT	L/R	F	Bus Engine 1X	861003	Outer Joint		38	33	60.2	34.5	65	I
	1990.09-1995.12	MT	L/R	F	Bus Engine 1X	661036	Inner Joint			28		31.8		
1990.09-1995.12	MT	L/R	F	Bus Engine 1X	861004	Outer Joint	48T	38	33	60.2	34.5	65	I	
1.9 D (45 kW)	1990.09-1995.12	MT	L/R	F	Bus Engine 1X	261003	Drive Shaft		38		60.2	34.5	540.8	
	1990.09-1995.12	MT	L/R	F	Bus Engine 1X	661001	Inner Joint			33		31.8		
	1990.09-1995.12	MT	L/R	F	Bus Engine 1X	261052	Drive Shaft	48T	38		60.2	34.5	529	
	1990.09-1995.12	MT	L/R	F	Bus Engine 1X	861005	Outer Joint		38	27	60.2	34.5	65	I
	1990.09-1995.12	MT	L/R	F	Bus Engine 1X	861006	Outer Joint	48T	38	27	60.2	34.5	65	I
	1990.09-1995.12	MT	L/R	F	Bus Engine 1X	261119	Drive Shaft		38		60.2	34.5	527	
	1990.09-1995.12	MT	L/R	F	Bus Engine 1X	261120	Drive Shaft		38		60.2	34.5	529	
	1990.09-1995.12	MT	L/R	F	Bus Engine 1X	661002	Inner Joint			28		31.8		
	1990.09-1995.12	MT	L/R	F	Bus Engine 1X	261004	Drive Shaft	48T	38		60.2	34.5	540.8	
	1990.09-1995.12	MT	L/R	F	Bus Engine 1X	861003	Outer Joint		38	33	60.2	34.5	65	I
1.9 TD (50 kW)	1992.10-2003.04	MT	L/R	F	Bus Engine ABL	861004	Outer Joint		48T	38	60.2	34.5	529	
	1992.10-2003.04	MT	L/R	F	Bus Engine ABL	261052	Drive Shaft	48T	38		60.2	34.5	529	
	1992.10-2003.04	MT	L/R	F	Bus Engine ABL	861005	Outer Joint		38	27	60.2	34.5	65	I
	1992.10-2003.04	MT	L/R	F	Bus Engine ABL	661001	Inner Joint					31.8		

	YEAR	TRANSM	L/R	F/R	REMARKS	GSP Ref.	PRODUCT	ABS	Technical Specifications								
									A	B	C	H	L	P			
VW																	
TRANSPORTER IV (70B 70C 7DB 7DK 70J 70K 7DC 7DJ)/TRANSPORTER/CARAVELLE																	
1.9 TD (50 kW)	1992.10-2003.04	MT	L/R	F	Bus Engine ABL	861006	Outer Joint	48T	38	27	60.2	34.5	65	I			
	1992.10-2003.04	MT	L/R	F	Bus Engine ABL	261119	Drive Shaft		38		60.2	34.5	527				
	1992.10-2003.04	MT	L/R	F	Bus Engine ABL	261120	Drive Shaft		38		60.2	34.5	529				
	1992.10-2003.04	MT	R	F	Bus Engine ABL	261225	Stub Axle		37	113.5			394				
	1992.10-2003.04	MT	L/R	F	Bus Engine ABL	661002	Inner Joint			28		31.8					
	1992.10-2003.04	MT	L/R	F	Bus Engine ABL	261004	Drive Shaft	48T	38		60.2	34.5	540.8				
	1992.10-2003.04	MT	L/R	F	Bus Engine ABL	861003	Outer Joint		38	33	60.2	34.5	65	I			
	1992.10-2003.04	MT	L/R	F	Bus Engine ABL	661036	Inner Joint			28		31.8					
	1992.10-2003.04	MT	L/R	F	Bus Engine ABL	861004	Outer Joint	48T	38	33	60.2	34.5	65	I			
	1992.10-2003.04	MT	L/R	F	Bus Engine ABL	261003	Drive Shaft		38		60.2	34.5	540.8				
2.0 (62 kW)	1990.09-2003.04	MT	L/R	F	Bus Engine AAC	861004	Outer Joint	48T	38	33	60.2	34.5	65	I			
	1990.09-2003.04	MT	L/R	F	Bus Engine AAC	261003	Drive Shaft		38		60.2	34.5	540.8				
	1990.09-2003.04	MT	L/R	F	Bus Engine AAC	661001	Inner Joint			33		31.8					
	1990.09-2003.04	MT	L/R	F	Bus Engine AAC	261052	Drive Shaft	48T	38		60.2	34.5	529				
	1990.09-2003.04	MT	L/R	F	Bus Engine AAC	861005	Outer Joint		38	27	60.2	34.5	65	I			
	1990.09-2003.04	MT	L/R	F	Bus Engine AAC	861006	Outer Joint	48T	38	27	60.2	34.5	65	I			
	1990.09-2003.04	MT	L/R	F	Bus Engine AAC	261119	Drive Shaft		38		60.2	34.5	527				
	1990.09-2003.04	MT	L/R	F	Bus Engine AAC	261120	Drive Shaft		38		60.2	34.5	529				
	1990.09-2003.04	MT	R	F	Bus Engine AAC	261225	Stub Axle		37	113.5			394				
	1990.09-2003.04	MT	L/R	F	Bus Engine AAC	661002	Inner Joint			28		31.8					
	1990.09-2003.04	MT	L/R	F	Bus Engine AAC	861003	Outer Joint		38	33	60.2	34.5	65	I			
	1990.09-2003.04	MT	L/R	F	Bus Engine AAC	661036	Inner Joint			28		31.8					
	1990.09-2003.04	MT	L/R	F	Bus Engine AAC	261004	Drive Shaft	48T	38		60.2	34.5	540.8				
	2.4 D (55 kW)	1997.08-2003.04	AT/MT	L/R	F	Bus Engine AJA	261003	Drive Shaft		38		60.2	34.5	540.8			
1997.08-2003.04		AT/MT	L/R	F	Bus Engine AJA	861005	Outer Joint		38	27	60.2	34.5	65	I			
1997.08-2003.04		AT/MT	L/R	F	Bus Engine AJA	861006	Outer Joint	48T	38	27	60.2	34.5	65	I			
1997.08-2003.04		MT/AT	L/R	F	Bus Engine AJA	661036	Inner Joint			28		31.8					
1997.08-2003.04		MT	R	F	Bus Engine AJA	261225	Stub Axle		37	113.5			394				
1997.08-2003.04		AT/MT	L/R	F	Bus Engine AJA	261004	Drive Shaft	48T	38		60.2	34.5	540.8				
1997.08-2003.04		AT/MT	L/R	F	Bus Engine AJA	661002	Inner Joint			28		31.8					
2.4 D (57 kW)	1990.09-1998.04	AT/MT	L/R	F	Bus Engine AAB	261003	Drive Shaft		38		60.2	34.5	540.8				
	1990.09-1998.04	AT/MT	L/R	F	Bus Engine AAB	661001	Inner Joint			33		31.8					
	1990.09-1998.04	AT/MT	L/R	F	Bus Engine AAB	261052	Drive Shaft	48T	38		60.2	34.5	529				
	1990.09-1998.04	AT/MT	L/R	F	Bus Engine AAB	861005	Outer Joint		38	27	60.2	34.5	65	I			
	1990.09-1998.04	AT/MT	L/R	F	Bus Engine AAB	861006	Outer Joint	48T	38	27	60.2	34.5	65	I			
	1990.09-1998.04	AT/MT	L/R	F	Bus Engine AAB	261119	Drive Shaft		38		60.2	34.5	527				
	1990.09-1998.04	AT/MT	L/R	F	Bus Engine AAB	261120	Drive Shaft		38		60.2	34.5	529				
	1990.09-1998.04	MT/AT	L/R	F	Bus Engine AAB	661036	Inner Joint			28		31.8					
	1990.09-1998.04	MT	R	F	Bus Engine AAB	261225	Stub Axle		37	113.5			394				
	1990.09-1998.04	AT/MT	R	F	Bus Engine AAB	261004	Drive Shaft	48T	38		60.2	34.5	540.8				
	1990.09-1998.04	AT/MT	L/R	F	Bus Engine AAB	661002	Inner Joint			28		31.8					
	1990.09-1998.04	AT/MT	L/R	F	Bus Engine AAB	861003	Outer Joint		38	33	60.2	34.5	65	I			
	1990.09-1998.04	AT/MT	L/R	F	Bus Engine AAB	861004	Outer Joint	48T	38	33	60.2	34.5	65	I			
2.4 D Syncro (57 kW)	1992.10-1998.09	MT	L/R	F	All-wheel Drive Bus Engine AAB	261052	Drive Shaft	48T	38		60.2	34.5	529				
	1992.10-1998.09	AT/MT	L/R	F	All-wheel Drive Bus Engine AAB	861005	Outer Joint		38	27	60.2	34.5	65	I			
	1992.10-1998.09	AT/MT	L/R	F	All-wheel Drive Bus Engine AAB	861006	Outer Joint	48T	38	27	60.2	34.5	65	I			
	1992.10-1998.09	AT/MT	L/R	F	All-wheel Drive Bus Engine AAB	661002	Inner Joint			28		31.8					
2.5 (81 kW)	1990.11-2003.04	AT/MT	L/R	F	Bus Engine AAF	661001	Inner Joint			33		31.8					
	1990.11-2003.04	AT/MT	L/R	F	Bus Engine AAF	261052	Drive Shaft	48T	38		60.2	34.5	529				
	1990.11-2003.04	AT/MT	L/R	F	Bus Engine AAF	861005	Outer Joint		38	27	60.2	34.5	65	I			
	1990.11-2003.04	AT/MT	L/R	F	Bus Engine AAF	861006	Outer Joint	48T	38	27	60.2	34.5	65	I			
	1990.11-2003.04	AT/MT	L/R	F	Bus Engine AAF	261119	Drive Shaft		38		60.2	34.5	527				
	1990.11-2003.04	AT/MT	L/R	F	Bus Engine AAF	261120	Drive Shaft		38		60.2	34.5	529				
	1990.11-2003.04	MT/AT	L/R	F	Bus Engine AAF	661036	Inner Joint			28		31.8					
	1990.11-2003.04	MT	R	F	Bus Engine AAF	261225	Stub Axle		37	113.5			394				
	1990.11-2003.04	AT/MT	L/R	F	Bus Engine AAF	661002	Inner Joint			28		31.8					
	1990.11-2003.04	AT/MT	L/R	F	Bus Engine AAF	261004	Drive Shaft	48T	38		60.2	34.5	540.8				
	1990.11-2003.04	AT/MT	L/R	F	Bus Engine AAF	861003	Outer Joint		38	33	60.2	34.5	65	I			
	1990.11-2003.04	AT/MT	L/R	F	Bus Engine AAF	861004	Outer Joint	48T	38	33	60.2	34.5	65	I			
	1990.11-2003.04	AT/MT	L/R	F	Bus Engine AAF	261003	Drive Shaft		38		60.2	34.5	540.8				
	2.5 (85 kW)	1996.08-2003.04	MT	L/R	F	Bus Engine AET/APL/AVT	261003	Drive Shaft		38		60.2	34.5	540.8			
1996.08-2003.04		AT/MT	L/R	F	Bus Engine AET/APL/AVT	861005	Outer Joint		38	27	60.2	34.5	65	I			
1996.08-2003.04		MT	L/R	F	Bus Engine AET/APL/AVT	661036	Inner Joint			28		31.8					
1996.08-2003.04		AT/MT	L/R	F	Bus Engine AET/APL/AVT	861006	Outer Joint	48T	38	27	60.2	34.5	65	I			
1996.08-2003.04		MT	R	F	Bus Engine AET/APL/AVT	261225	Stub Axle		37	113.5			394				
1996.08-2003.04		MT	L/R	F	Bus Engine AET/APL/AVT	261004	Drive Shaft	48T	38		60.2	34.5	540.8				

YEAR	TRANSM	L/R	F/R	REMARKS	GSP Ref.	PRODUCT	ABS	Technical Specifications						
								A	B	C	H	L	P	
VW														
TRANSPORTER IV (70B 70C 7DB 7DK 70J 70K 7DC 7DJ)/TRANSPORTER/CARAVELLE														
2.5 (85 kW)	1996.08-2003.04	AT/MT	L/R	F	Bus Engine AET/APL/AVT	661002	Inner Joint			28		31.8		
2.5 Syncro (81 kW)	1992.11-2003.04	MT	L/R	F	All-wheel Drive Bus Engine AAF	261052	Drive Shaft	48T	38		60.2	34.5	529	
	1992.11-2003.04	AT/MT	L/R	F	All-wheel Drive Bus Engine AAF	861005	Outer Joint		38	27	60.2	34.5	65	I
	1992.11-2003.04	AT/MT	L/R	F	All-wheel Drive Bus Engine AAF	861006	Outer Joint	48T	38	27	60.2	34.5	65	I
	1992.11-2003.04	AT/MT	L/R	F	All-wheel Drive Bus Engine AAF	661002	Inner Joint			28		31.8		
	1992.11-2003.04	AT/MT	L/R	F	All-wheel Drive Bus Engine AAF	861003	Outer Joint		38	33	60.2	34.5	65	I
	1992.11-2003.04	AT/MT	L/R	F	All-wheel Drive Bus Engine AAF	861004	Outer Joint	48T	38	33	60.2	34.5	65	I
2.5 Syncro (85 kW)	1996.07-2003.04	AT/MT	L/R	F	All-wheel Drive Bus Engine AET/APL/AVT	861005	Outer Joint		38	27	60.2	34.5	65	I
	1996.07-2003.04	AT/MT	L/R	F	All-wheel Drive Bus Engine AET/APL/AVT	861006	Outer Joint	48T	38	27	60.2	34.5	65	I
	1996.07-2003.04	AT/MT	L/R	F	All-wheel Drive Bus Engine AET/APL/AVT	661002	Inner Joint			28		31.8		
2.5 TDI (111 kW)	1998.05-2003.04	-	L/R	F	Bus Engine AHY/AXG	661030	Inner Joint			30		32		
	1998.05-2003.04	MT	L/R	F	Bus Engine AHY/AXG	261033	Drive Shaft	48T	38		60.2	34.5	545	
2.5 TDI (65 kW)	1998.05-2003.04	MT	L/R	F	Bus Engine AJT/AYY	261003	Drive Shaft		38		60.2	34.5	540.8	
	1998.05-2003.04	MT	L/R	F	Bus Engine AJT/AYY	661036	Inner Joint			28		31.8		
	1998.05-2003.04	MT	L/R	F	Bus Engine AJT/AYY	861005	Outer Joint		38	27	60.2	34.5	65	I
	1998.05-2003.04	MT	L/R	F	Bus Engine AJT/AYY	861006	Outer Joint	48T	38	27	60.2	34.5	65	I
	1998.05-2003.04	MT	R	F	Bus Engine AJT/AYY	261225	Stub Axle		37	113.5			394	
	1998.05-2003.04	MT	L/R	F	Bus Engine AJT/AYY	261004	Drive Shaft	48T	38		60.2	34.5	540.8	
	1998.05-2003.04	MT	L/R	F	Bus Engine AJT/AYY	661002	Inner Joint			28		31.8		
2.5 TDI (75 kW)	1995.09-2003.04	AT/MT	L/R	F	Bus Engine ACV	261003	Drive Shaft		38		60.2	34.5	540.8	
	1995.09-2003.04	AT/MT	L/R	F	Bus Engine ACV	861005	Outer Joint		38	27	60.2	34.5	65	I
	1995.09-2003.04	AT/MT	L/R	F	Bus Engine ACV	861006	Outer Joint	48T	38	27	60.2	34.5	65	I
	1995.09-2003.04	AT	R	F	Bus Engine ACV	261120	Drive Shaft		38		60.2	34.5	529	
	1995.09-2003.04	MT	L/R	F	Bus Engine ACV	261034	Drive Shaft		38		60.2	34.5	529	
	1995.09-2003.04	MT	R	F	Bus Engine ACV	261225	Stub Axle		37	113.5			394	
	1995.09-2003.04	MT/AT	L/R	F	Bus Engine ACV	661036	Inner Joint			28		31.8		
2.5 TDI Syncro (75 kW)	1995.09-2003.04	AT/MT	L/R	F	Bus Engine ACV	261004	Drive Shaft	48T	38		60.2	34.5	540.8	
	1995.09-2003.04	AT/MT	L/R	F	Bus Engine ACV	661002	Inner Joint			28		31.8		
	1996.01-2003.04	AT/MT	L/R	F	All-wheel Drive Bus Engine ACV	861005	Outer Joint		38	27	60.2	34.5	65	I
	1996.01-2003.04	AT/MT	L/R	F	All-wheel Drive Bus Engine ACV	861006	Outer Joint	48T	38	27	60.2	34.5	65	I
	1996.01-2003.04	AT/MT	L/R	F	All-wheel Drive Bus Engine ACV	661002	Inner Joint			28		31.8		
2.8 VR 6 (103 kW)	1995.11-2000.04	AT/MT	L/R	F	Bus Engine AES	261003	Drive Shaft		38		60.2	34.5	540.8	
	1995.11-2000.04	AT/MT	L/R	F	Bus Engine AES	861005	Outer Joint		38	27	60.2	34.5	65	I
	1995.11-2000.04	AT/MT	L/R	F	Bus Engine AES	861006	Outer Joint	48T	38	27	60.2	34.5	65	I
	1995.11-2000.04	MT	R	F	Bus Engine AES	261225	Stub Axle		37	113.5			394	
	1995.11-2000.04	MT/AT	L/R	F	Bus Engine AES	661036	Inner Joint			28		31.8		
	1995.11-2000.04	AT/MT	L/R	F	Bus Engine AES	261004	Drive Shaft	48T	38		60.2	34.5	540.8	
	1995.11-2000.04	AT/MT	L/R	F	Bus Engine AES	661002	Inner Joint			28		31.8		
2.8 VR6 (150 kW)	2000.04-2003.04	-	L/R	F	Bus Engine AMV	661030	Inner Joint			30		32		
	2000.04-2003.04	AT	R	F	Bus Engine AMV	261033	Drive Shaft	48T	38		60.2	34.5	545	
TRANSPORTER IV (70E 70L 70M 7DE 7DL 7D)														
1.9 D (44 kW)	1990.09-1995.12	MT	L/R	F	Platform/Chassis Engine 1X	661001	Inner Joint			33		31.8		
	1990.09-1995.12	MT	L/R	F	Platform/Chassis Engine 1X	261052	Drive Shaft	48T	38		60.2	34.5	529	
	1990.09-1995.12	MT	L/R	F	Platform/Chassis Engine 1X	861005	Outer Joint		38	27	60.2	34.5	65	I
	1990.09-1995.12	MT	L/R	F	Platform/Chassis Engine 1X	861006	Outer Joint	48T	38	27	60.2	34.5	65	I
	1990.09-1995.12	MT	L/R	F	Platform/Chassis Engine 1X	261119	Drive Shaft		38		60.2	34.5	527	
	1990.09-1995.12	MT	L/R	F	Platform/Chassis Engine 1X	261120	Drive Shaft		38		60.2	34.5	529	
	1990.09-1995.12	MT	L/R	F	Platform/Chassis Engine 1X	661002	Inner Joint			28		31.8		
	1990.09-1995.12	MT	L/R	F	Platform/Chassis Engine 1X	261004	Drive Shaft	48T	38		60.2	34.5	540.8	
	1990.09-1995.12	MT	L/R	F	Platform/Chassis Engine 1X	861003	Outer Joint		38	33	60.2	34.5	65	I
	1990.09-1995.12	MT	L/R	F	Platform/Chassis Engine 1X	861004	Outer Joint	48T	38	33	60.2	34.5	65	I
	1990.09-1995.12	MT	L/R	F	Platform/Chassis Engine 1X	261003	Drive Shaft		38		60.2	34.5	540.8	
1.9 D (45 kW)	1990.07-1995.12	MT	L/R	F	Platform/Chassis Engine 1X	661001	Inner Joint			33		31.8		
	1990.07-1995.12	MT	L/R	F	Platform/Chassis Engine 1X	261052	Drive Shaft	48T	38		60.2	34.5	529	
	1990.07-1995.12	MT	L/R	F	Platform/Chassis Engine 1X	861005	Outer Joint		38	27	60.2	34.5	65	I
	1990.07-1995.12	MT	L/R	F	Platform/Chassis Engine 1X	661036	Inner Joint			28		31.8		
	1990.07-1995.12	MT	L/R	F	Platform/Chassis Engine 1X	861006	Outer Joint	48T	38	27	60.2	34.5	65	I
	1990.07-1995.12	MT	L/R	F	Platform/Chassis Engine 1X	261119	Drive Shaft		38		60.2	34.5	527	
	1990.07-1995.12	MT	L/R	F	Platform/Chassis Engine 1X	261120	Drive Shaft		38		60.2	34.5	529	
	1990.07-1995.12	MT	L/R	F	Platform/Chassis Engine 1X	661002	Inner Joint			28		31.8		
	1990.07-1995.12	MT	L/R	F	Platform/Chassis Engine 1X	261004	Drive Shaft	48T	38		60.2	34.5	540.8	
	1990.07-1995.12	MT	L/R	F	Platform/Chassis Engine 1X	861003	Outer Joint		38	33	60.2	34.5	65	I
	1990.07-1995.12	MT	L/R	F	Platform/Chassis Engine 1X	861004	Outer Joint	48T	38	33	60.2	34.5	65	I
1.9 TD (50 kW)	1992.10-2003.04	MT	L/R	F	Platform/Chassis Engine ABL	861004	Outer Joint	48T	38	33	60.2	34.5	65	I
	1992.10-2003.04	MT	L/R	F	Platform/Chassis Engine ABL	261003	Drive Shaft		38		60.2	34.5	540.8	

	YEAR	TRANSM	L/R	F/R	REMARKS	GSP Ref.	PRODUCT	ABS	Technical Specifications					
									A	B	C	H	L	P
VW														
TRANSPORTER IV (70E 70L 70M 7DE 7DL 7D)														
1.9 TD (50 kW)	1992.10-2003.04	MT	L/R	F	Platform/Chassis Engine ABL	661001	Inner Joint			33		31.8		
	1992.10-2003.04	MT	L/R	F	Platform/Chassis Engine ABL	261052	Drive Shaft	48T	38		60.2	34.5	529	
	1992.10-2003.04	MT	L/R	F	Platform/Chassis Engine ABL	861005	Outer Joint		38	27	60.2	34.5	65	I
	1992.10-2003.04	MT	L/R	F	Platform/Chassis Engine ABL	661036	Inner Joint			28		31.8		
	1992.10-2003.04	MT	L/R	F	Platform/Chassis Engine ABL	861006	Outer Joint	48T	38	27	60.2	34.5	65	I
	1992.10-2003.04	MT	L/R	F	Platform/Chassis Engine ABL	261119	Drive Shaft		38		60.2	34.5	527	
	1992.10-2003.04	MT	L/R	F	Platform/Chassis Engine ABL	261120	Drive Shaft		38		60.2	34.5	529	
	1992.10-2003.04	MT	L/R	F	Platform/Chassis Engine ABL	661002	Inner Joint			28		31.8		
	1992.10-2003.04	MT	L/R	F	Platform/Chassis Engine ABL	261004	Drive Shaft	48T	38		60.2	34.5	540.8	
	1992.10-2003.04	MT	L/R	F	Platform/Chassis Engine ABL	861003	Outer Joint		38	33	60.2	34.5	65	I
2.0 (62 kW)	1990.07-2003.04	MT	L/R	F	Platform/Chassis Engine AAC	261003	Drive Shaft		38		60.2	34.5	540.8	
	1990.07-2003.04	MT	L/R	F	Platform/Chassis Engine AAC	661001	Inner Joint			33		31.8		
	1990.07-2003.04	MT	L/R	F	Platform/Chassis Engine AAC	261052	Drive Shaft	48T	38		60.2	34.5	529	
	1990.07-2003.04	MT	L/R	F	Platform/Chassis Engine AAC	861005	Outer Joint		38	27	60.2	34.5	65	I
	1990.07-2003.04	MT	L/R	F	Platform/Chassis Engine AAC	861006	Outer Joint	48T	38	27	60.2	34.5	65	I
	1990.07-2003.04	MT	L/R	F	Platform/Chassis Engine AAC	661036	Inner Joint			28		31.8		
	1990.07-2003.04	MT	L/R	F	Platform/Chassis Engine AAC	261119	Drive Shaft		38		60.2	34.5	527	
	1990.07-2003.04	MT	L/R	F	Platform/Chassis Engine AAC	261120	Drive Shaft		38		60.2	34.5	529	
	1990.07-2003.04	MT	L/R	F	Platform/Chassis Engine AAC	661002	Inner Joint			28		31.8		
	1990.07-2003.04	MT	L/R	F	Platform/Chassis Engine AAC	261004	Drive Shaft	48T	38		60.2	34.5	540.8	
	1990.07-2003.04	MT	L/R	F	Platform/Chassis Engine AAC	861003	Outer Joint		38	33	60.2	34.5	65	I
	1990.07-2003.04	MT	L/R	F	Platform/Chassis Engine AAC	861004	Outer Joint	48T	38	33	60.2	34.5	65	I
	2.4 D (55 kW)	1997.08-2003.04	AT/MT	L/R	F	Platform/Chassis Engine AJA	861005	Outer Joint		38	27	60.2	34.5	65
1997.08-2003.04		MT	L/R	F	Platform/Chassis Engine AJA	661036	Inner Joint			28		31.8		
1997.08-2003.04		AT/MT	L/R	F	Platform/Chassis Engine AJA	861006	Outer Joint	48T	38	27	60.2	34.5	65	I
1997.08-2003.04		AT/MT	L/R	F	Platform/Chassis Engine AJA	661002	Inner Joint			28		31.8		
1997.08-2003.04		AT/MT	L/R	F	Platform/Chassis Engine AJA	261004	Drive Shaft	48T	38		60.2	34.5	540.8	
2.4 D (57 kW)	1990.09-1998.04	AT/MT	L/R	F	Platform/Chassis Engine AAB	261003	Drive Shaft		38		60.2	34.5	540.8	
	1990.09-1998.04	AT/MT	L/R	F	Platform/Chassis Engine AAB	661001	Inner Joint			33		31.8		
	1990.09-1998.04	AT/MT	L/R	F	Platform/Chassis Engine AAB	261052	Drive Shaft	48T	38		60.2	34.5	529	
	1990.09-1998.04	AT/MT	L/R	F	Platform/Chassis Engine AAB	861005	Outer Joint		38	27	60.2	34.5	65	I
	1990.09-1998.04	AT/MT	L/R	F	Platform/Chassis Engine AAB	861006	Outer Joint	48T	38	27	60.2	34.5	65	I
	1990.09-1998.04	AT/MT	L/R	F	Platform/Chassis Engine AAB	261119	Drive Shaft		38		60.2	34.5	527	
	1990.09-1998.04	AT/MT	L/R	F	Platform/Chassis Engine AAB	261120	Drive Shaft		38		60.2	34.5	529	
	1990.09-1998.04	MT/AT	L/R	F	Platform/Chassis Engine AAB	661036	Inner Joint			28		31.8		
	1990.09-1998.04	AT/MT	R	F	Platform/Chassis Engine AAB	261004	Drive Shaft	48T	38		60.2	34.5	540.8	
	1990.09-1998.04	AT/MT	L/R	F	Platform/Chassis Engine AAB	661002	Inner Joint			28		31.8		
	1990.09-1998.04	AT/MT	L/R	F	Platform/Chassis Engine AAB	861003	Outer Joint		38	33	60.2	34.5	65	I
	1990.09-1998.04	AT/MT	L/R	F	Platform/Chassis Engine AAB	861004	Outer Joint	48T	38	33	60.2	34.5	65	I
	1990.09-1998.04	AT/MT	L/R	F	Platform/Chassis Engine AAB	261003	Drive Shaft		38		60.2	34.5	540.8	
2.4 D Syncro (57 kW)	1992.10-1998.09	MT	L/R	F	All-wheel Drive Platform/Chassis Engine AAB	261052	Drive Shaft	48T	38		60.2	34.5	529	
	1992.10-1998.09	AT/MT	L/R	F	All-wheel Drive Platform/Chassis Engine AAB	861005	Outer Joint		38	27	60.2	34.5	65	I
	1992.10-1998.09	AT/MT	L/R	F	All-wheel Drive Platform/Chassis Engine AAB	861006	Outer Joint	48T	38	27	60.2	34.5	65	I
	1992.10-1998.09	AT/MT	L/R	F	All-wheel Drive Platform/Chassis Engine AAB	661002	Inner Joint			28		31.8		
2.5 (81 kW)	1990.11-2003.04	AT/MT	L/R	F	Platform/Chassis Engine AEN	661001	Inner Joint			33		31.8		
	1990.11-2003.04	AT/MT	L/R	F	Platform/Chassis Engine AEN	261052	Drive Shaft	48T	38		60.2	34.5	529	
	1990.11-2003.04	AT/MT	L/R	F	Platform/Chassis Engine AEN	861005	Outer Joint		38	27	60.2	34.5	65	I
	1990.11-2003.04	AT/MT	L/R	F	Platform/Chassis Engine AEN	861006	Outer Joint	48T	38	27	60.2	34.5	65	I
	1990.11-2003.04	AT/MT	L/R	F	Platform/Chassis Engine AEN	261119	Drive Shaft		38		60.2	34.5	527	
	1990.11-2003.04	AT/MT	L/R	F	Platform/Chassis Engine AEN	261120	Drive Shaft		38		60.2	34.5	529	
	1990.11-2003.04	MT/AT	L/R	F	Platform/Chassis Engine AEN	661036	Inner Joint			28		31.8		
	1990.11-2003.04	AT/MT	L/R	F	Platform/Chassis Engine AEN	661002	Inner Joint			28		31.8		
	1990.11-2003.04	AT/MT	L/R	F	Platform/Chassis Engine AEN	261004	Drive Shaft	48T	38		60.2	34.5	540.8	
	1990.11-2003.04	AT/MT	L/R	F	Platform/Chassis Engine AEN	861003	Outer Joint		38	33	60.2	34.5	65	I
2.5 (85 kW)	1996.08-2003.04	AT/MT	L/R	F	Platform/Chassis Engine AET	861004	Outer Joint	48T	38	33	60.2	34.5	65	I
	1996.08-2003.04	AT/MT	L/R	F	Platform/Chassis Engine AET	261003	Drive Shaft		38		60.2	34.5	540.8	
	1996.08-2003.04	AT/MT	L/R	F	Platform/Chassis Engine AET	861005	Outer Joint		38	27	60.2	34.5	65	I
	1996.08-2003.04	AT/MT	L/R	F	Platform/Chassis Engine AET	861006	Outer Joint	48T	38	27	60.2	34.5	65	I
	1996.08-2003.04	MT	L/R	F	Platform/Chassis Engine AET	661036	Inner Joint			28		31.8		
	1996.08-2003.04	MT	L/R	F	Platform/Chassis Engine AET	261004	Drive Shaft	48T	38		60.2	34.5	540.8	
2.5 Syncro (81 kW)	1992.10-2003.04	AT/MT	L/R	F	All-wheel Drive Platform/Chassis Engine AAF	661002	Inner Joint			28		31.8		
	1992.10-2003.04	AT/MT	L/R	F	All-wheel Drive Platform/Chassis Engine AAF	861004	Outer Joint	48T	38	33	60.2	34.5	65	I
	1992.10-2003.04	AT/MT	L/R	F	All-wheel Drive Platform/Chassis Engine AAF	861005	Outer Joint		38	27	60.2	34.5	65	I
	1992.10-2003.04	MT	L/R	F	All-wheel Drive Platform/Chassis Engine AAF	261052	Drive Shaft	48T	38		60.2	34.5	529	
1992.10-2003.04	AT/MT	L/R	F	All-wheel Drive Platform/Chassis Engine AAF	861006	Outer Joint	48T	38	27	60.2	34.5	65	I	

YEAR	TRANSM	L/R	F/R	REMARKS	GSP Ref.	PRODUCT	ABS	Technical Specifications						
								A	B	C	H	L	P	
VW														
TRANSPORTER IV (70E 70L 70M 7DE 7DL 7D)														
2.5 Syncro (81 kW)	1992.10-2003.04	AT/MT	L/R	F	All-wheel Drive Platform/Chassis Engine AAF	661002	Inner Joint			28		31.8		
	1992.10-2003.04	AT/MT	L/R	F	All-wheel Drive Platform/Chassis Engine AAF	861003	Outer Joint	38	33	60.2	34.5	65	I	
2.5 Syncro (85 kW)	1996.08-2003.04	AT/MT	L/R	F	All-wheel Drive Platform/Chassis Engine APL	861005	Outer Joint	38	27	60.2	34.5	65	I	
	1996.08-2003.04	AT/MT	L/R	F	All-wheel Drive Platform/Chassis Engine APL	861006	Outer Joint	48T	38	27	60.2	34.5	65	I
	1996.08-2003.04	AT/MT	L/R	F	All-wheel Drive Platform/Chassis Engine APL	661002	Inner Joint			28		31.8		
2.5 TDI (65 kW)	1998.05-2003.04	MT	L/R	F	Platform/Chassis Engine AJT	261003	Drive Shaft	38		60.2	34.5	540.8		
	1998.05-2003.04	MT	L/R	F	Platform/Chassis Engine AJT	861005	Outer Joint	38	27	60.2	34.5	65	I	
	1998.05-2003.04	MT	L/R	F	Platform/Chassis Engine AJT	861006	Outer Joint	48T	38	27	60.2	34.5	65	I
	1998.05-2003.04	MT	L/R	F	Platform/Chassis Engine AJT	661036	Inner Joint			28		31.8		
	1998.05-2003.04	MT	L/R	F	Platform/Chassis Engine AJT	261004	Drive Shaft	48T	38		60.2	34.5	540.8	
2.5 TDI (75 kW)	1995.09-2003.04	AT/MT	L/R	F	Platform/Chassis Engine AYC	261003	Drive Shaft	38		60.2	34.5	540.8		
	1995.09-2003.04	AT/MT	L/R	F	Platform/Chassis Engine AYC	861005	Outer Joint	38	27	60.2	34.5	65	I	
	1995.09-2003.04	AT/MT	L/R	F	Platform/Chassis Engine AYC	861006	Outer Joint	48T	38	27	60.2	34.5	65	I
	1995.09-2003.04	AT	R	F	Platform/Chassis Engine AYC	261120	Drive Shaft	38		60.2	34.5	529		
	1995.09-2003.04	MT	L/R	F	Platform/Chassis Engine AYC	261034	Drive Shaft	38		60.2	34.5	529		
	1995.09-2003.04	MT/AT	L/R	F	Platform/Chassis Engine AYC	661036	Inner Joint			28		31.8		
2.5 TDI Syncro (75 kW)	1995.09-2003.04	AT/MT	L/R	F	Platform/Chassis Engine AYC	261004	Drive Shaft	48T	38		60.2	34.5	540.8	
	1995.09-2003.04	AT/MT	L/R	F	Platform/Chassis Engine AYC	661002	Inner Joint			28		31.8		
	1998.05-2003.04	-	R	F	All-wheel Drive Platform/Chassis Engine ACV/AXL	261003	Drive Shaft	38		60.2	34.5	540.8		
	1998.05-2003.04	AT/MT	L/R	F	All-wheel Drive Platform/Chassis Engine ACV/AXL	861005	Outer Joint	38	27	60.2	34.5	65	I	
	1998.05-2003.04	AT/MT	L/R	F	All-wheel Drive Platform/Chassis Engine ACV/AXL	861006	Outer Joint	48T	38	27	60.2	34.5	65	I
TRANSPORTER T5														
2.5 TDI	2006-	-	-	-	-	661094	Propshaft CV Joint			25		29		
TRANSPORTER T5 T6														
2.0TDI	-	-	-	-	-	803118	Outer Joint	38	30	63	102.5	68	I	
	-	-	-	-	-	203361	Drive Shaft	38	26	63	102.5	883		
	-	-	-	-	-	661086	Inner Joint	26	30	50	281.5	78		
TRANSPORTER V (7HA 7HH 7EA 7EH)														
1.9 TDI (62 kW)	2006.01-2009.11	-	L/R	F	Box Engine BRR	861009	Outer Joint	38	27	63	102	66	M	
	2006.01-2009.11	-	R	F	Box Engine BRR	203246	Drive Shaft	38	26	63	102.5	858		
	2006.01-2009.11	5MT	-	F	Box Engine BRR	261190	Stub Axle	26	37	50		136.5		
	2006.01-2009.11	-	-	-	Box Engine BRR	661010	Inner Joint			28		32		
	2006.01-2009.11	MT	R	F	Box Engine BRR	261084	Drive Shaft	38	26	63	102.5	613		
	2006.01-2009.11	6AT	-	F	Box Engine BRR	261238	Stub Axle	26	30	62		114.5		
	2006.01-2009.11	AT	R	F	Box Engine BRR	203267	Drive Shaft	38	26	63	102.5	925		
	2006.01-2009.11	6MT	-	F	Box Engine BRR	261191	Stub Axle	26	42	60		135.5		
	2006.01-2009.11	MT	R	F	Box Engine BRR	661020	Inner Joint	26	28	50	205.5	63		
	2006.01-2009.11	MT	L	F	Box Engine BRR	661041	Inner Joint			28		32		
	2006.01-2009.11	-	L	F	Box Engine BRR	261105	Drive Shaft	38		63	102.5	645		
1.9 TDI (63 kW)	2003.04-2009.11	5MT	R	F	Box Engine AXC	203246	Drive Shaft	38	26	63	102.5	858		
	2003.04-2009.11	5MT	-	F	Box Engine AXC	261190	Stub Axle	26	37	50		136.5		
	2003.04-2009.11	-	-	-	Box Engine AXC	661010	Inner Joint			28		32		
	2003.04-2009.11	MT	R	F	Box Engine AXC	261084	Drive Shaft	38	26	63	102.5	613		
	2003.04-2009.11	6AT	-	F	Box Engine AXC	261238	Stub Axle	26	30	62		114.5		
	2003.04-2009.11	AT	R	F	Box Engine AXC	203267	Drive Shaft	38	26	63	102.5	925		
	2003.04-2009.11	6MT	-	F	Box Engine AXC	261191	Stub Axle	26	42	60		135.5		
	2003.04-2009.11	MT	R	F	Box Engine AXC	661020	Inner Joint	26	28	50	205.5	63		
	2003.04-2009.11	MT	L	F	Box Engine AXC	661041	Inner Joint			28		32		
	2003.04-2009.11	5MT	L	F	Box Engine AXC	261105	Drive Shaft	38		63	102.5	645		
1.9 TDI (75 kW)	2006.06-2009.11	-	R	F	Box Engine BRS	203246	Drive Shaft	38	26	63	102.5	858		
	2006.06-2009.11	5MT	-	F	Box Engine BRS	261190	Stub Axle	26	37	50		136.5		
	2006.06-2009.11	-	-	-	Box Engine BRS	661010	Inner Joint			28		32		
	2006.06-2009.11	MT	R	F	Box Engine BRS	261084	Drive Shaft	38	26	63	102.5	613		
	2006.06-2009.11	6AT	-	F	Box Engine BRS	261238	Stub Axle	26	30	62		114.5		
	2006.06-2009.11	AT	R	F	Box Engine BRS	203267	Drive Shaft	38	26	63	102.5	925		
	2006.06-2009.11	6MT	-	F	Box Engine BRS	261191	Stub Axle	26	42	60		135.5		
	2006.06-2009.11	MT	R	F	Box Engine BRS	661020	Inner Joint	26	28	50	205.5	63		
	2006.06-2009.11	MT	L	F	Box Engine BRS	661041	Inner Joint			28		32		
	2006.06-2009.11	-	L	F	Box Engine BRS	261105	Drive Shaft	38		63	102.5	645		
1.9 TDI (77 kW)	2003.04-2009.11	5MT	R	F	Box Engine AXB	203246	Drive Shaft	38	26	63	102.5	858		
	2003.04-2009.11	5MT	-	F	Box Engine AXB	261190	Stub Axle	26	37	50		136.5		

	YEAR	TRANSM	L/R	F/R	REMARKS	GSP Ref.	PRODUCT	ABS	Technical Specifications												
									A	B	C	H	L	P							
VW																					
TRANSPORTER V (7HA 7HH 7EA 7EH)																					
1.9 TDI (77 kW)	2003.04-2009.11	-	-	-	Box Engine AXB	661010	Inner Joint			28		32									
	2003.04-2009.11	MT	R	F	Box Engine AXB	261084	Drive Shaft		38	26	63	102.5	613								
	2003.04-2009.11	6AT	-	F	Box Engine AXB	261238	Stub Axle		26	30	62		114.5								
	2003.04-2009.11	AT	R	F	Box Engine AXB	203267	Drive Shaft		38	26	63	102.5	925								
	2003.04-2009.11	6MT	-	F	Box Engine AXB	261191	Stub Axle		26	42	60		135.5								
	2003.04-2009.11	MT	R	F	Box Engine AXB	661020	Inner Joint		26	28	50	205.5	63								
	2003.04-2009.11	MT	L	F	Box Engine AXB	661041	Inner Joint			28		32									
	2003.04-2009.11	5MT	L	F	Box Engine AXB	261105	Drive Shaft		38		63	102.5	645								
2.0 (85 kW)	2003.11-	MT	R	F	Box Engine AXA	861009	Outer Joint		38	27	63	102	66	M							
	2003.11-	-	R	F	Box Engine AXA	203246	Drive Shaft		38	26	63	102.5	858								
	2003.11-	5MT	-	F	Box Engine AXA	261190	Stub Axle		26	37	50		145								
	2003.11-	5MT	-	F	Box Engine AXA	261190	Stub Axle		26	37	50		136.5								
	2003.11-	MT	R	F	Box Engine AXA	261084	Drive Shaft		38	26	63	102.5	613								
	2003.11-	-	-	-	Box Engine AXA	661010	Inner Joint			28		32									
	2003.11-	6AT	-	F	Box Engine AXA	261238	Stub Axle		26	30	62		114.5								
	2003.11-	MT	L	F	Box Engine AXA	203278	Drive Shaft		38		63	102	643								
	2003.11-	6MT	-	F	Box Engine AXA	261191	Stub Axle		26	42	60		135.5								
	2003.11-	MT	R	F	Box Engine AXA	661020	Inner Joint		26	28	50	205.5	63								
	2003.11-	MT	R	F	Box Engine AXA	203279	Drive Shaft		38	26	63	102	856								
	2003.11-	MT	L	F	Box Engine AXA	661041	Inner Joint			28		32									
	2003.11-	MT	L	F	Box Engine AXA	261105	Drive Shaft		38		63	102.5	645								
	2003.11-	MT	L/R	F	Box Engine AXA	861009	Outer Joint		38	27	63	102	66	M							
2.0 BiTDI (132 kW)	2009.09-	-	R	F	Box Engine CFCA	261216	Stub Axle		26	37	50		145								
	2009.09-	-	-	F	Box Engine CFCA	801467	Outer Joint		38	30	63	102.5	67.5	I							
	2009.09-	AT	L/R	F	Box Engine CFCA	861011	Outer Joint		38	29	63	102.5	70	M							
	2009.09-	MT	L	F	Box Engine CFCA	203360	Drive Shaft		38	42	63	102.5	617								
	2009.09-	MT	L	F	Box Engine CFCA	261269	Drive Shaft														
	2009.09-	5MT	-	F	Box Engine CFCA	261190	Stub Axle		26	37	50		136.5								
	2009.09-	6AT	-	F	Box Engine CFCA	261238	Stub Axle		26	30	62		114.5								
	2009.09-	AT	L	F	Box Engine CFCA	203293	Drive Shaft		38	37	63	102.5	645								
	2009.09-	MT	L	F	Box Engine CFCA	203278	Drive Shaft		38		63	102	643								
	2009.09-	MT	R	F	Box Engine CFCA	203261	Drive Shaft		38	26	63	102	857								
	2009.09-	MT	R	F	Box Engine CFCA	203296	Drive Shaft		38	26	63	102.5	880								
	2009.09-	6MT	-	F	Box Engine CFCA	261191	Stub Axle		26	42	60		135.5								
	2009.09-	AT	R	F	Box Engine CFCA	203353	Drive Shaft		38	37	63	102.5	1027								
	2009.09-	MT	L/R	F	Box Engine CFCA	861009	Outer Joint		38	27	63	102	66	M							
2.0 BiTDI 4motion (132 kW)	2009.09-	-	R	F	All-wheel Drive Box Engine CFCA	261216	Stub Axle		26	37	50		145								
	2009.09-	-	-	F	All-wheel Drive Box Engine CFCA	801467	Outer Joint		38	30	63	102.5	67.5	I							
	2009.09-	5MT	-	F	All-wheel Drive Box Engine CFCA	261190	Stub Axle		26	37	50		136.5								
	2009.09-	-	L	R	All-wheel Drive Box Engine CFCA	661075	Inner Joint			28		26									
	2009.09-	-	L/R	F	All-wheel Drive Box Engine CFCA	861011	Outer Joint		38	29	63	102.5	70	M							
	2009.09-	MT	R	F	All-wheel Drive Box Engine CFCA	203360	Drive Shaft		38	42	63	102.5	617								
	2009.09-	MT	R	F	All-wheel Drive Box Engine CFCA	261269	Drive Shaft														
	2009.09-	-	-	F	All-wheel Drive Box Engine CFCA	261215	Stub Axle		26	42	60		143.5								
	2009.09-	6AT	-	F	All-wheel Drive Box Engine CFCA	261238	Stub Axle		26	30	62		114.5								
	2009.09-	-	-	F	All-wheel Drive Box Engine CFCA	261213	Stub Axle		42	42	60		135.5								
	2009.09-	6MT	-	F	All-wheel Drive Box Engine CFCA	261191	Stub Axle		26	42	60		135.5								
	2009.09-	AT	R	F	All-wheel Drive Box Engine CFCA	203353	Drive Shaft		38	37	63	102.5	1027								
	2.0 TDI (100 kW)	2010.05-	-	R	F	Box Engine CAAE	261216	Stub Axle		26	37	50		145							
		2010.05-	AT/MT	L/R	F	Box Engine CAAE	861011	Outer Joint		38	29	63	102.5	70	M						
2010.05-		MT	L	F	Box Engine CAAE	203360	Drive Shaft		38	42	63	102.5	617								
2010.05-		5MT	-	F	Box Engine CAAE	261190	Stub Axle		26	37	50		136.5								
2010.05-		MT	L	F	Box Engine CAAE	261269	Drive Shaft														
2010.05-		6AT	-	F	Box Engine CAAE	261238	Stub Axle		26	30	62		114.5								
2010.05-		AT	L	F	Box Engine CAAE	203293	Drive Shaft		38	37	63	102.5	645								
2010.05-		6MT	-	F	Box Engine CAAE	261191	Stub Axle		26	42	60		135.5								
2010.05-		MT	R	F	Box Engine CAAE	203296	Drive Shaft		38	26	63	102.5	880								
2010.05-		-	-	F	Box Engine CAAE	801467	Outer Joint		38	30	63	102.5	67.5	I							
2.0 TDI (103 kW)		2009.09-	-	-	F	Box Engine CCHA	801467	Outer Joint		38	30	63	102.5	67.5	I						
	2009.09-	-	R	F	Box Engine CCHA	261216	Stub Axle		26	37	50		145								
	2009.09-	-	L/R	F	Box Engine CCHA	861011	Outer Joint		38	29	63	102.5	70	M							
	2009.09-	MT	L	F	Box Engine CCHA	203360	Drive Shaft		38	42	63	102.5	617								
	2009.09-	MT	L	F	Box Engine CCHA	261269	Drive Shaft														
	2009.09-	5MT	-	F	Box Engine CCHA	261190	Stub Axle		26	37	50		136.5								
	2009.09-	6AT	-	F	Box Engine CCHA	261238	Stub Axle		26	30	62		114.5								
	2009.09-	AT	L	F	Box Engine CCHA	203293	Drive Shaft		38	37	63	102.5	645								

YEAR	TRANSM	L/R	F/R	REMARKS	GSP Ref.	PRODUCT	ABS	Technical Specifications						
								A	B	C	H	L	P	
VW														
TRANSPORTER V (7HA 7HH 7EA 7EH)														
2.0 TDI (103 kW)	2009.09.-	-	AT	R	F	Box Engine CCHA	203353	Drive Shaft	38	37	63	102.5	1027	
	2009.09.-	-	6MT	-	F	Box Engine CCHA	261191	Stub Axle	26	42	60		135.5	
	2009.09.-	-	MT	R	F	Box Engine CCHA	203296	Drive Shaft	38	26	63	102.5	880	
2.0 TDI (62 kW)	2009.09.-	-	-	R	F	Box Engine CAAA	261216	Stub Axle	26	37	50		145	
	2009.09.-	-	5MT	-	F	Box Engine CAAA	261190	Stub Axle	26	37	50		136.5	
	2009.09.-	-	6AT	-	F	Box Engine CAAA	261238	Stub Axle	26	30	62		114.5	
	2009.09.-	-	-	L	F	Box Engine CAAA	203278	Drive Shaft	38		63	102	643	
	2009.09.-	-	-	R	F	Box Engine CAAA	203261	Drive Shaft	38	26	63	102	857	
	2009.09.-	-	6MT	-	F	Box Engine CAAA	261191	Stub Axle	26	42	60		135.5	
	2009.09.-	-	-	L/R	F	Box Engine CAAA	861009	Outer Joint	38	27	63	102	66	M
2.0 TDI (75 kW)	2009.09.-	-	-	R	F	Box Engine CAAB	261216	Stub Axle	26	37	50		145	
	2009.09.-	-	5MT	-	F	Box Engine CAAB	261190	Stub Axle	26	37	50		136.5	
	2009.09.-	-	6AT	-	F	Box Engine CAAB	261238	Stub Axle	26	30	62		114.5	
	2009.09.-	-	-	L	F	Box Engine CAAB	203278	Drive Shaft	38		63	102	643	
	2009.09.-	-	-	R	F	Box Engine CAAB	203261	Drive Shaft	38	26	63	102	857	
	2009.09.-	-	6MT	-	F	Box Engine CAAB	261191	Stub Axle	26	42	60		135.5	
	2009.09.-	-	-	L/R	F	Box Engine CAAB	861009	Outer Joint	38	27	63	102	66	M
2.0 TDI (84 kW)	2011.05.-	-	-	L/R	F	Box Engine CAAD	861009	Outer Joint	38	27	63	102	66	M
	2011.05.-	-	-	R	F	Box Engine CAAD	261216	Stub Axle	26	37	50		145	
	2011.05.-	-	5MT	-	F	Box Engine CAAD	261190	Stub Axle	26	37	50		136.5	
	2011.05.-	-	6AT	-	F	Box Engine CAAD	261238	Stub Axle	26	30	62		114.5	
	2011.05.-	-	MT	L	F	Box Engine CAAD	203278	Drive Shaft	38		63	102	643	
	2011.05.-	-	6MT	-	F	Box Engine CAAD	261191	Stub Axle	26	42	60		135.5	
	2011.05.-	-	MT	R	F	Box Engine CAAD	203261	Drive Shaft	38	26	63	102	857	
2.0 TDI 4motion (100 kW)	2010.05.-	-	-	R	F	All-wheel Drive Box Engine CAAE	261216	Stub Axle	26	37	50		145	
	2010.05.-	-	-	L	R	All-wheel Drive Box Engine CAAE	661075	Inner Joint		28		26		
	2010.05.-	-	-	L/R	F	All-wheel Drive Box Engine CAAE	861011	Outer Joint	38	29	63	102.5	70	M
	2010.05.-	-	5MT	-	F	All-wheel Drive Box Engine CAAE	261190	Stub Axle	26	37	50		136.5	
	2010.05.-	-	MT	R	F	All-wheel Drive Box Engine CAAE	203360	Drive Shaft	38	42	63	102.5	617	
	2010.05.-	-	MT	R	F	All-wheel Drive Box Engine CAAE	261269	Drive Shaft						
	2010.05.-	-	6AT	-	F	All-wheel Drive Box Engine CAAE	261238	Stub Axle	26	30	62		114.5	
	2010.05.-	-	6MT	-	F	All-wheel Drive Box Engine CAAE	261191	Stub Axle	26	42	60		135.5	
	2010.05.-	-	-	-	F	All-wheel Drive Box Engine CAAE	801467	Outer Joint	38	30	63	102.5	67.5	I
2.0 TDI 4motion (103 kW)	2009.09.-	-	-	-	F	All-wheel Drive Box Engine CCHA	801467	Outer Joint	38	30	63	102.5	67.5	I
	2009.09.-	-	-	R	F	All-wheel Drive Box Engine CCHA	261216	Stub Axle	26	37	50		145	
	2009.09.-	-	-	L/R	F	All-wheel Drive Box Engine CCHA	861011	Outer Joint	38	29	63	102.5	70	M
	2009.09.-	-	-	L	R	All-wheel Drive Box Engine CCHA	661075	Inner Joint		28		26		
	2009.09.-	-	5MT	-	F	All-wheel Drive Box Engine CCHA	261190	Stub Axle	26	37	50		136.5	
	2009.09.-	-	MT	R	F	All-wheel Drive Box Engine CCHA	203360	Drive Shaft	38	42	63	102.5	617	
	2009.09.-	-	MT	R	F	All-wheel Drive Box Engine CCHA	261269	Drive Shaft						
	2009.09.-	-	6AT	-	F	All-wheel Drive Box Engine CCHA	261238	Stub Axle	26	30	62		114.5	
	2009.09.-	-	6MT	-	F	All-wheel Drive Box Engine CCHA	261191	Stub Axle	26	42	60		135.5	
	2009.09.-	-	AT	R	F	All-wheel Drive Box Engine CCHA	203353	Drive Shaft	38	37	63	102.5	1027	
	2.0 TSI (110 kW)	2012.07.-	-	-	-	F	Box Engine CJKB	801467	Outer Joint	38	30	63	102.5	67.5
2012.07.-		-	-	R	F	Box Engine CJKB	261216	Stub Axle	26	37	50		145	
2012.07.-		-	MT	L/R	F	Box Engine CJKB	861011	Outer Joint	38	29	63	102.5	70	M
2012.07.-		-	MT	L	F	Box Engine CJKB	203360	Drive Shaft	38	42	63	102.5	617	
2012.07.-		-	MT	L	F	Box Engine CJKB	261269	Drive Shaft						
2012.07.-		-	5MT	-	F	Box Engine CJKB	261190	Stub Axle	26	37	50		136.5	
2012.07.-		-	6AT	-	F	Box Engine CJKB	261238	Stub Axle	26	30	62		114.5	
2012.07.-		-	MT	R	F	Box Engine CJKB	203296	Drive Shaft	38	26	63	102.5	880	
2012.07.-		-	6MT	-	F	Box Engine CJKB	261191	Stub Axle	26	42	60		135.5	
2012.07.-		-	AT	R	F	Box Engine CJKB	203353	Drive Shaft	38	37	63	102.5	1027	
2.0 TSI (150 kW)		2011.05.-	-	-	R	F	Box Engine CJKB	261216	Stub Axle	26	37	50		145
	2011.05.-	-	AT/MT	L/R	F	Box Engine CJKB	861011	Outer Joint	38	29	63	102.5	70	M
	2011.05.-	-	5MT	-	F	Box Engine CJKB	261190	Stub Axle	26	37	50		136.5	
	2011.05.-	-	MT	L	F	Box Engine CJKB	203360	Drive Shaft	38	42	63	102.5	617	
	2011.05.-	-	MT	L	F	Box Engine CJKB	261269	Drive Shaft						
	2011.05.-	-	6AT	-	F	Box Engine CJKB	261238	Stub Axle	26	30	62		114.5	
	2011.05.-	-	6MT	-	F	Box Engine CJKB	261191	Stub Axle	26	42	60		135.5	
	2011.05.-	-	AT	R	F	Box Engine CJKB	203353	Drive Shaft	38	37	63	102.5	1027	
	2011.05.-	-	MT	R	F	Box Engine CJKB	203296	Drive Shaft	38	26	63	102.5	880	
	2011.05.-	-	-	-	F	Box Engine CJKB	801467	Outer Joint	38	30	63	102.5	67.5	I
	2.0 TSI 4motion (150 kW)	2011.07.-	-	-	R	F	All-wheel Drive Box Engine CJKB	261216	Stub Axle	26	37	50		145
2011.07.-		-	-	L	R	All-wheel Drive Box Engine CJKB	661075	Inner Joint		28		26		
2011.07.-		-	5MT	-	F	All-wheel Drive Box Engine CJKB	261190	Stub Axle	26	37	50		136.5	

YEAR	TRANSM	L/R	F/R	REMARKS	GSP Ref.	PRODUCT	ABS	Technical Specifications					
								A	B	C	H	L	P
VW													
TRANSPORTER V (7HA 7HH 7EA 7EH)													
2.0 TSI 4motion (150 kW)	2011.07.-	-	L/R	F	All-wheel Drive Box Engine CJKA	861011	Outer Joint	38	29	63	102.5	70	M
	2011.07.-	MT	R	F	All-wheel Drive Box Engine CJKA	203360	Drive Shaft	38	42	63	102.5	617	
	2011.07.-	MT	R	F	All-wheel Drive Box Engine CJKA	261269	Drive Shaft						
	2011.07.-	6AT	-	F	All-wheel Drive Box Engine CJKA	261238	Stub Axle	26	30	62		114.5	
	2011.07.-	6MT	-	F	All-wheel Drive Box Engine CJKA	261191	Stub Axle	26	42	60		135.5	
	2011.07.-	AT	R	F	All-wheel Drive Box Engine CJKA	203353	Drive Shaft	38	37	63	102.5	1027	
	2011.07.-	-	-	F	All-wheel Drive Box Engine CJKA	801467	Outer Joint	38	30	63	102.5	67.5	I
2.5 TDI (128 kW)	2003.04-2009.11	MT	R	F	Box Engine AXE/BPC	661021	Inner Joint	26	30	50	288	78	
	2003.04-2009.11	MT	L	F	Box Engine AXE/BPC	661029	Inner Joint	26	30	46.8		79	
	2003.04-2009.11	MT	R	F	Box Engine AXE/BPC	261140	Drive Shaft	38	26	63	102.5	873	
	2003.04-2009.11	AT	R	F	Box Engine AXE/BPC	261210	Drive Shaft	38	26	63	102.5	925	
	2003.04-2009.11	5MT	-	F	Box Engine AXE/BPC	261190	Stub Axle	26	37	50		136.5	
	2003.04-2009.11	-	L/R	F	Box Engine AXE/BPC	861011	Outer Joint	38	29	63	102.5	70	M
	2003.04-2009.11	6AT	-	F	Box Engine AXE/BPC	261238	Stub Axle	26	30	62		114.5	
	2003.04-2009.11	AT	R	F	Box Engine AXE/BPC	203267	Drive Shaft	38	26	63	102.5	925	
	2003.04-2009.11	6MT	-	F	Box Engine AXE/BPC	261191	Stub Axle	26	42	60		135.5	
2.5 TDI (96 kW)	2003.04-2009.11	MT	R	F	Box Engine AXD	661021	Inner Joint	26	30	50	288	78	
	2003.04-2009.11	MT	L	F	Box Engine AXD	661029	Inner Joint	26	30	46.8		79	
	2003.04-2009.11	6MT	R	F	Box Engine AXD	261140	Drive Shaft	38	26	63	102.5	873	
	2003.04-2009.11	5MT	-	F	Box Engine AXD	261190	Stub Axle	26	37	50		136.5	
	2003.04-2009.11	6AT	R	F	Box Engine AXD	261210	Drive Shaft	38	26	63	102.5	925	
	2003.04-2009.11	-	L/R	F	Box Engine AXD	861011	Outer Joint	38	29	63	102.5	70	M
	2003.04-2009.11	6AT	-	F	Box Engine AXD	261238	Stub Axle	26	30	62		114.5	
	2003.04-2009.11	AT	R	F	Box Engine AXD	203267	Drive Shaft	38	26	63	102.5	925	
	2003.04-2009.11	6MT	-	F	Box Engine AXD	261191	Stub Axle	26	42	60		135.5	
2.5 TDI 4motion (128 kW)	2004.07-2009.11	MT	L	F	All-wheel Drive Box Engine AXE/BPC	661029	Inner Joint	26	30	46.8		79	
	2004.07-2009.11	5MT	-	F	All-wheel Drive Box Engine AXE/BPC	261190	Stub Axle	26	37	50		136.5	
	2004.07-2009.11	-	L/R	F	All-wheel Drive Box Engine AXE/BPC	861011	Outer Joint	38	29	63	102.5	70	M
	2004.07-2009.11	6MT	R	F	All-wheel Drive Box Engine AXE/BPC	261084	Drive Shaft	38	26	63	102.5	613	
	2004.07-2009.11	6AT	-	F	All-wheel Drive Box Engine AXE/BPC	261238	Stub Axle	26	30	62		114.5	
	2004.07-2009.11	AT	R	F	All-wheel Drive Box Engine AXE/BPC	203267	Drive Shaft	38	26	63	102.5	925	
	2004.07-2009.11	AT/MT	L	R	All-wheel Drive Box Engine AXE/BPC	261257	Drive Shaft	38		59	100	683	
	2004.07-2009.11	AT/MT	R	R	All-wheel Drive Box Engine AXE/BPC	261258	Drive Shaft	38		59	100	743	
	2004.07-2009.11	AT/MT	L	R	All-wheel Drive Box Engine AXE/BPC	661075	Inner Joint		28		26		
2.5 TDI 4motion (96 kW)	2004.07-2009.11	MT	L	F	All-wheel Drive Box Engine BNZ	661029	Inner Joint	26	30	46.8		79	
	2004.07-2009.11	5MT	-	F	All-wheel Drive Box Engine BNZ	261190	Stub Axle	26	37	50		136.5	
	2004.07-2009.11	-	L/R	F	All-wheel Drive Box Engine BNZ	861011	Outer Joint	38	29	63	102.5	70	M
	2004.07-2009.11	6MT	R	F	All-wheel Drive Box Engine BNZ	261084	Drive Shaft	38	26	63	102.5	613	
	2004.07-2009.11	6AT	-	F	All-wheel Drive Box Engine BNZ	261238	Stub Axle	26	30	62		114.5	
	2004.07-2009.11	AT/MT	L	R	All-wheel Drive Box Engine BNZ	261257	Drive Shaft	38		59	100	683	
	2004.07-2009.11	AT/MT	R	R	All-wheel Drive Box Engine BNZ	261258	Drive Shaft	38		59	100	743	
	2004.07-2009.11	AT/MT	L	R	All-wheel Drive Box Engine BNZ	661075	Inner Joint		28		26		
	2004.07-2009.11	6MT	-	F	All-wheel Drive Box Engine BNZ	261191	Stub Axle	26	42	60		135.5	
3.2 4motion (173 kW)	2003.11-2009.11	5MT	-	F	All-wheel Drive Box Engine BKK	261190	Stub Axle	26	37	50		136.5	
	2003.11-2009.11	-	L/R	F	All-wheel Drive Box Engine BKK	861011	Outer Joint	38	29	63	102.5	70	M
	2003.11-2009.11	-	-	F	All-wheel Drive Box Engine BKK	261215	Stub Axle	26	42	60		143.5	
	2003.11-2009.11	6AT	-	F	All-wheel Drive Box Engine BKK	261238	Stub Axle	26	30	62		114.5	
	2003.11-2009.11	AT	R	F	All-wheel Drive Box Engine BKK	203267	Drive Shaft	38	26	63	102.5	925	
	2003.11-2009.11	-	-	F	All-wheel Drive Box Engine BKK	261213	Stub Axle	42	42	60		135.5	
	2003.11-2009.11	-	L	R	All-wheel Drive Box Engine BKK	261257	Drive Shaft	38		59	100	683	
	2003.11-2009.11	6MT	-	F	All-wheel Drive Box Engine BKK	261191	Stub Axle	26	42	60		135.5	
	2003.11-2009.11	-	L	R	All-wheel Drive Box Engine BKK	661075	Inner Joint		28		26		
3.2 V6 (170 kW)	2003.04-2004.06	5MT	-	F	Box Engine BDL	261190	Stub Axle	26	37	50		136.5	
	2003.04-2004.06	AT	L/R	F	Box Engine BDL	861011	Outer Joint	38	29	63	102.5	70	M
	2003.04-2004.06	-	-	F	Box Engine BDL	261215	Stub Axle	26	42	60		143.5	
	2003.04-2004.06	6AT	-	F	Box Engine BDL	261238	Stub Axle	26	30	62		114.5	
	2003.04-2004.06	-	-	F	Box Engine BDL	261213	Stub Axle	42	42	60		135.5	
	2003.04-2004.06	AT	R	F	Box Engine BDL	203267	Drive Shaft	38	26	63	102.5	925	
	2003.04-2004.06	6MT	-	F	Box Engine BDL	261191	Stub Axle	26	42	60		135.5	
3.2 V6 (173 kW)	2004.02-2009.11	5MT	-	F	Box Engine BKK/CFLA	261190	Stub Axle	26	37	50		136.5	
	2004.02-2009.11	AT	L/R	F	Box Engine BKK/CFLA	861011	Outer Joint	38	29	63	102.5	70	M
	2004.02-2009.11	6AT	-	F	Box Engine BKK/CFLA	261238	Stub Axle	26	30	62		114.5	
	2004.02-2009.11	AT	R	F	Box Engine BKK/CFLA	203267	Drive Shaft	38	26	63	102.5	925	
	2004.02-2009.11	6MT	-	F	Box Engine BKK/CFLA	261191	Stub Axle	26	42	60		135.5	

	YEAR	TRANSM	L/R	F/R	REMARKS	GSP Ref.	PRODUCT	ABS	Technical Specifications					
									A	B	C	H	L	P
VW														
TRANSPORTER V (7HB 7HJ 7EB 7EJ 7EF 7EG 7HF 7EC)/TRANSPORTER/CARAVELLE														
1.9 TDI (62 kW)	2006.01-2009.11	MT	R	F	Bus Engine BRR	203246	Drive Shaft		38	26	63	102.5	858	
	2006.01-2009.11	-	-	-	Bus Engine BRR	661010	Inner Joint			28		32		
	2006.01-2009.11	MT	R	F	Bus Engine BRR	261084	Drive Shaft		38	26	63	102.5	613	
	2006.01-2009.11	5MT	-	F	Bus Engine BRR	261190	Stub Axle		26	37	50		136.5	
	2006.01-2009.11	-	-	F	Bus Engine BRR	261215	Stub Axle		26	42	60		143.5	
	2006.01-2009.11	-	-	F	Bus Engine BRR	261213	Stub Axle		42	42	60		135.5	
	2006.01-2009.11	AT	R	F	Bus Engine BRR	203267	Drive Shaft		38	26	63	102.5	925	
	2006.01-2009.11	6AT	-	F	Bus Engine BRR	261238	Stub Axle		26	30	62		114.5	
	2006.01-2009.11	MT	R	F	Bus Engine BRR	661020	Inner Joint		26	28	50	205.5	63	
	2006.01-2009.11	MT	L/R	F	Bus Engine BRR	861009	Outer Joint		38	27	63	102	66	M
	2006.01-2009.11	MT	L	F	Bus Engine BRR	661041	Inner Joint			28		32		
	2006.01-2009.11	MT	L	F	Bus Engine BRR	261105	Drive Shaft		38		63	102.5	645	
	2006.01-2009.11	6MT	-	F	Bus Engine BRR	261191	Stub Axle		26	42	60		135.5	
	1.9 TDI (63 kW)	2003.04-2009.11	MT	R	F	Bus Engine AXC	203246	Drive Shaft		38	26	63	102.5	858
2003.04-2009.11		MT	R	F	Bus Engine AXC	261084	Drive Shaft		38	26	63	102.5	613	
2003.04-2009.11		-	-	-	Bus Engine AXC	661010	Inner Joint			28		32		
2003.04-2009.11		-	-	F	Bus Engine AXC	261215	Stub Axle		26	42	60		143.5	
2003.04-2009.11		6AT	-	F	Bus Engine AXC	261238	Stub Axle		26	30	62		114.5	
2003.04-2009.11		-	-	F	Bus Engine AXC	261213	Stub Axle		42	42	60		135.5	
2003.04-2009.11		AT	R	F	Bus Engine AXC	203267	Drive Shaft		38	26	63	102.5	925	
2003.04-2009.11		6MT	-	F	Bus Engine AXC	261191	Stub Axle		26	42	60		135.5	
2003.04-2009.11		MT	R	F	Bus Engine AXC	661020	Inner Joint		26	28	50	205.5	63	
2003.04-2009.11		MT	L/R	F	Bus Engine AXC	861009	Outer Joint		38	27	63	102	66	M
2003.04-2009.11		MT	L	F	Bus Engine AXC	661041	Inner Joint			28		32		
2003.04-2009.11		MT	L	F	Bus Engine AXC	261105	Drive Shaft		38		63	102.5	645	
2003.04-2009.11		5MT	-	F	Bus Engine AXC	261190	Stub Axle		26	37	50		136.5	
1.9 TDI (75 kW)		2006.06-2009.11	MT	R	F	Bus Engine BRS	203246	Drive Shaft		38	26	63	102.5	858
	2006.06-2009.11	MT	R	F	Bus Engine BRS	261084	Drive Shaft		38	26	63	102.5	613	
	2006.06-2009.11	-	-	-	Bus Engine BRS	661010	Inner Joint			28		32		
	2006.06-2009.11	5MT	-	F	Bus Engine BRS	261190	Stub Axle		26	37	50		136.5	
	2006.06-2009.11	-	-	F	Bus Engine BRS	261215	Stub Axle		26	42	60		143.5	
	2006.06-2009.11	-	-	F	Bus Engine BRS	261213	Stub Axle		42	42	60		135.5	
	2006.06-2009.11	AT	R	F	Bus Engine BRS	203267	Drive Shaft		38	26	63	102.5	925	
	2006.06-2009.11	6AT	-	F	Bus Engine BRS	261238	Stub Axle		26	30	62		114.5	
	2006.06-2009.11	MT	R	F	Bus Engine BRS	661020	Inner Joint		26	28	50	205.5	63	
	2006.06-2009.11	MT	L/R	F	Bus Engine BRS	861009	Outer Joint		38	27	63	102	66	M
	2006.06-2009.11	MT	L	F	Bus Engine BRS	661041	Inner Joint			28		32		
	2006.06-2009.11	MT	L	F	Bus Engine BRS	261105	Drive Shaft		38		63	102.5	645	
	2006.06-2009.11	6MT	-	F	Bus Engine BRS	261191	Stub Axle		26	42	60		135.5	
	1.9 TDI (77 kW)	2003.04-2009.11	MT	R	F	Bus Engine AXB	203246	Drive Shaft		38	26	63	102.5	858
2003.04-2009.11		MT	R	F	Bus Engine AXB	261084	Drive Shaft		38	26	63	102.5	613	
2003.04-2009.11		-	-	-	Bus Engine AXB	661010	Inner Joint			28		32		
2003.04-2009.11		-	-	F	Bus Engine AXB	261215	Stub Axle		26	42	60		143.5	
2003.04-2009.11		6AT	-	F	Bus Engine AXB	261238	Stub Axle		26	30	62		114.5	
2003.04-2009.11		-	-	F	Bus Engine AXB	261213	Stub Axle		42	42	60		135.5	
2003.04-2009.11		AT	R	F	Bus Engine AXB	203267	Drive Shaft		38	26	63	102.5	925	
2003.04-2009.11		6MT	-	F	Bus Engine AXB	261191	Stub Axle		26	42	60		135.5	
2003.04-2009.11		MT	R	F	Bus Engine AXB	661020	Inner Joint		26	28	50	205.5	63	
2003.04-2009.11		MT	L/R	F	Bus Engine AXB	861009	Outer Joint		38	27	63	102	66	M
2003.04-2009.11		MT	L	F	Bus Engine AXB	661041	Inner Joint			28		32		
2003.04-2009.11		MT	L	F	Bus Engine AXB	261105	Drive Shaft		38		63	102.5	645	
2003.04-2009.11		5MT	-	F	Bus Engine AXB	261190	Stub Axle		26	37	50		136.5	
2.0 (85 kW)		2003.11-2009.11	5MT	-	F	Bus Engine AXA	261190	Stub Axle		26	37	50		136.5
	2003.11-2009.11	MT	R	F	Bus Engine AXA	203246	Drive Shaft		38	26	63	102.5	858	
	2003.11-2009.11	-	-	R	Bus Engine AXA	261216	Stub Axle		26	37	50		145	
	2003.11-2009.11	MT	R	F	Bus Engine AXA	261084	Drive Shaft		38	26	63	102.5	613	
	2003.11-2009.11	-	-	-	Bus Engine AXA	661010	Inner Joint			28		32		
	2003.11-2009.11	6AT	-	F	Bus Engine AXA	261238	Stub Axle		26	30	62		114.5	
	2003.11-2009.11	-	-	F	Bus Engine AXA	261215	Stub Axle		26	42	60		143.5	
	2003.11-2009.11	-	-	F	Bus Engine AXA	261213	Stub Axle		42	42	60		135.5	
	2003.11-2009.11	6MT	-	F	Bus Engine AXA	261191	Stub Axle		26	42	60		135.5	
	2003.11-2009.11	MT	L	F	Bus Engine AXA	203278	Drive Shaft		38		63	102	643	
	2003.11-2009.11	MT	R	F	Bus Engine AXA	203261	Drive Shaft		38	26	63	102	857	
	2003.11-2009.11	MT	R	F	Bus Engine AXA	661020	Inner Joint		26	28	50	205.5	63	
	2003.11-2009.11	MT	R	F	Bus Engine AXA	203279	Drive Shaft		38	26	63	102	856	
	2003.11-2009.11	MT	L/R	F	Bus Engine AXA	861009	Outer Joint		38	27	63	102	66	M





	YEAR	TRANSM	L/R	F/R	REMARKS	GSP Ref.	PRODUCT	ABS	Technical Specifications												
									A	B	C	H	L	P							
VW																					
TRANSPORTER V (7HB 7HJ 7EB 7EJ 7EF 7EG 7HF 7EC)/TRANSPORTER/CARAVELLE																					
2.0 (85 kW)	2003.11-	-	MT	L	F	Bus Engine AXA	661041	Inner Joint			28		32								
	2003.11-	-	5MT	L	F	Bus Engine AXA	261105	Drive Shaft	38		63	102.5	645								
2.0 BiTDI (132 kW)	2009.09-	-	-	-	F	Bus Engine CFCA	801467	Outer Joint	38	30	63	102.5	67.5	I							
	2009.09-	-	AT/MT	L/R	F	Bus Engine CFCA	861011	Outer Joint	38	29	63	102.5	70	M							
	2009.09-	-	-	R	F	Bus Engine CFCA	261216	Stub Axle	26	37	50		145								
	2009.09-	-	MT	L	F	Bus Engine CFCA	203360	Drive Shaft	38	42	63	102.5	617								
	2009.09-	-	MT	L	F	Bus Engine CFCA	261269	Drive Shaft													
	2009.09-	-	-	-	F	Bus Engine CFCA	261215	Stub Axle	26	42	60		143.5								
	2009.09-	-	5MT	-	F	Bus Engine CFCA	261190	Stub Axle	26	37	50		136.5								
	2009.09-	-	-	-	F	Bus Engine CFCA	261213	Stub Axle	42	42	60		135.5								
	2009.09-	-	6AT	-	F	Bus Engine CFCA	261238	Stub Axle	26	30	62		114.5								
	2009.09-	-	AT	L	F	Bus Engine CFCA	203293	Drive Shaft	38	37	63	102.5	645								
	2009.09-	-	MT	L	F	Bus Engine CFCA	203278	Drive Shaft	38		63	102	643								
	2009.09-	-	MT	R	F	Bus Engine CFCA	203296	Drive Shaft	38	26	63	102.5	880								
	2009.09-	-	AT	R	F	Bus Engine CFCA	203353	Drive Shaft	38	37	63	102.5	1027								
	2009.09-	-	MT	L/R	F	Bus Engine CFCA	861009	Outer Joint	38	27	63	102	66	M							
	2009.09-	-	6MT	-	F	Bus Engine CFCA	261191	Stub Axle	26	42	60		135.5								
2.0 BiTDI 4motion (132 kW)	2009.09-	-	5MT	-	F	All-wheel Drive Bus Engine CFCA	261190	Stub Axle	26	37	50		136.5								
	2009.09-	-	-	-	F	All-wheel Drive Bus Engine CFCA	801467	Outer Joint	38	30	63	102.5	67.5	I							
	2009.09-	-	AT/MT	L	R	All-wheel Drive Bus Engine CFCA	661075	Inner Joint			28		26								
	2009.09-	-	AT/MT	L/R	F	All-wheel Drive Bus Engine CFCA	861011	Outer Joint	38	29	63	102.5	70	M							
	2009.09-	-	-	R	F	All-wheel Drive Bus Engine CFCA	261216	Stub Axle	26	37	50		145								
	2009.09-	-	-	-	F	All-wheel Drive Bus Engine CFCA	261215	Stub Axle	26	42	60		143.5								
	2009.09-	-	MT	R	F	All-wheel Drive Bus Engine CFCA	203360	Drive Shaft	38	42	63	102.5	617								
	2009.09-	-	6AT	-	F	All-wheel Drive Bus Engine CFCA	261238	Stub Axle	26	30	62		114.5								
	2009.09-	-	MT	R	F	All-wheel Drive Bus Engine CFCA	261269	Drive Shaft													
	2009.09-	-	-	-	F	All-wheel Drive Bus Engine CFCA	261213	Stub Axle	42	42	60		135.5								
	2009.09-	-	6MT	-	F	All-wheel Drive Bus Engine CFCA	261191	Stub Axle	26	42	60		135.5								
	2009.09-	-	AT	R	F	All-wheel Drive Bus Engine CFCA	203353	Drive Shaft	38	37	63	102.5	1027								
	2.0 TDI (100 kW)	2010.05-	-	AT/MT	L/R	F	Bus Engine CAAE	861011	Outer Joint	38	29	63	102.5	70	M						
		2010.05-	-	-	R	F	Bus Engine CAAE	261216	Stub Axle	26	37	50		145							
		2010.05-	-	MT	L	F	Bus Engine CAAE	203360	Drive Shaft	38	42	63	102.5	617							
2010.05-		-	MT	L	F	Bus Engine CAAE	261269	Drive Shaft													
2010.05-		-	5MT	-	F	Bus Engine CAAE	261190	Stub Axle	26	37	50		136.5								
2010.05-		-	-	-	F	Bus Engine CAAE	261215	Stub Axle	26	42	60		143.5								
2010.05-		-	-	-	F	Bus Engine CAAE	261213	Stub Axle	42	42	60		135.5								
2010.05-		-	6AT	-	F	Bus Engine CAAE	261238	Stub Axle	26	30	62		114.5								
2010.05-		-	AT	L	F	Bus Engine CAAE	203293	Drive Shaft	38	37	63	102.5	645								
2010.05-		-	MT	R	F	Bus Engine CAAE	203296	Drive Shaft	38	26	63	102.5	880								
2010.05-		-	-	-	F	Bus Engine CAAE	801467	Outer Joint	38	30	63	102.5	67.5	I							
2010.05-		-	6MT	-	F	Bus Engine CAAE	261191	Stub Axle	26	42	60		135.5								
2.0 TDI (103 kW)		2009.09-	-	5MT	-	F	Bus Engine CAAC	261190	Stub Axle	26	37	50		136.5							
		2009.09-	-	AT/MT	L/R	F	Bus Engine CAAC	861011	Outer Joint	38	29	63	102.5	70	M						
		2009.09-	-	-	R	F	Bus Engine CAAC	261216	Stub Axle	26	37	50		145							
	2009.09-	-	MT	L	F	Bus Engine CAAC	203360	Drive Shaft	38	42	63	102.5	617								
	2009.09-	-	MT	L	F	Bus Engine CAAC	261269	Drive Shaft													
	2009.09-	-	-	-	F	Bus Engine CAAC	261215	Stub Axle	26	42	60		143.5								
	2009.09-	-	6AT	-	F	Bus Engine CAAC	261238	Stub Axle	26	30	62		114.5								
	2009.09-	-	-	-	F	Bus Engine CAAC	261213	Stub Axle	42	42	60		135.5								
	2009.09-	-	6MT	-	F	Bus Engine CAAC	261191	Stub Axle	26	42	60		135.5								
	2009.09-	-	AT	L	F	Bus Engine CAAC	203293	Drive Shaft	38	37	63	102.5	645								
	2009.09-	-	MT	L	F	Bus Engine CAAC	203278	Drive Shaft	38		63	102	643								
	2009.09-	-	MT	R	F	Bus Engine CAAC	203261	Drive Shaft	38	26	63	102	857								
	2009.09-	-	MT	R	F	Bus Engine CAAC	203296	Drive Shaft	38	26	63	102.5	880								
	2009.09-	-	AT	R	F	Bus Engine CAAC	203353	Drive Shaft	38	37	63	102.5	1027								
	2009.09-	-	MT	L/R	F	Bus Engine CAAC	861009	Outer Joint	38	27	63	102	66	M							
2.0 TDI (62 kW)	2009.09-	-	5MT	-	F	Bus Engine CAAA	261190	Stub Axle	26	37	50		136.5								
	2009.09-	-	-	R	F	Bus Engine CAAA	261216	Stub Axle	26	37	50		145								
	2009.09-	-	-	-	F	Bus Engine CAAA	261215	Stub Axle	26	42	60		143.5								
	2009.09-	-	6AT	-	F	Bus Engine CAAA	261238	Stub Axle	26	30	62		114.5								
	2009.09-	-	-	-	F	Bus Engine CAAA	261213	Stub Axle	42	42	60		135.5								
	2009.09-	-	6MT	-	F	Bus Engine CAAA	261191	Stub Axle	26	42	60		135.5								
	2009.09-	-	MT	L	F	Bus Engine CAAA	203278	Drive Shaft	38		63	102	643								
	2009.09-	-	MT	R	F	Bus Engine CAAA	203261	Drive Shaft	38	26	63	102	857								
	2009.09-	-	MT	R	F	Bus Engine CAAA	203296	Drive Shaft	38	26	63	102.5	880								
2.0 TDI (75 kW)	2009.09-	-	5MT	-	F	Bus Engine CAAB	261190	Stub Axle	26	37	50		136.5								

YEAR	TRANSM	L/R	F/R	REMARKS	GSP Ref.	PRODUCT	ABS	Technical Specifications							
								A	B	C	H	L	P		
VW															
TRANSPORTER V (7HB 7HJ 7EB 7EJ 7EF 7EG 7HF 7EC)/TRANSPORTER/CARAVELLE															
2.0 TDI (75 kW)	2009.09-	-	-	R F	Bus Engine CAAB	261216	Stub Axle	26	37	50		145			
	2009.09-	-	-	F	Bus Engine CAAB	261215	Stub Axle	26	42	60		143.5			
	2009.09-	6AT	-	F	Bus Engine CAAB	261238	Stub Axle	26	30	62		114.5			
	2009.09-	-	-	F	Bus Engine CAAB	261213	Stub Axle	42	42	60		135.5			
	2009.09-	6MT	-	F	Bus Engine CAAB	261191	Stub Axle	26	42	60		135.5			
	2009.09-	MT	L	F	Bus Engine CAAB	203278	Drive Shaft	38		63	102	643			
	2009.09-	MT	R	F	Bus Engine CAAB	203261	Drive Shaft	38	26	63	102	857			
	2009.09-	MT	L/R	F	Bus Engine CAAB	861009	Outer Joint	38	27	63	102	66	M		
2.0 TDI (84 kW)	2011.05-	-	-	R F	Bus Engine CAAD	261216	Stub Axle	26	37	50		145			
	2011.05-	-	-	F	Bus Engine CAAD	261215	Stub Axle	26	42	60		143.5			
	2011.05-	6AT	-	F	Bus Engine CAAD	261238	Stub Axle	26	30	62		114.5			
	2011.05-	-	-	F	Bus Engine CAAD	261213	Stub Axle	42	42	60		135.5			
	2011.05-	6MT	-	F	Bus Engine CAAD	261191	Stub Axle	26	42	60		135.5			
	2011.05-	MT	L	F	Bus Engine CAAD	203278	Drive Shaft	38		63	102	643			
	2011.05-	MT	R	F	Bus Engine CAAD	203261	Drive Shaft	38	26	63	102	857			
	2011.05-	MT	L/R	F	Bus Engine CAAD	861009	Outer Joint	38	27	63	102	66	M		
2.0 TDI 4motion (100 kW)	2010.05-	MT	L/R	F	All-wheel Drive Bus Engine CCHB	861011	Outer Joint	38	29	63	102.5	70	M		
	2010.05-	MT	L	R	All-wheel Drive Bus Engine CCHB	661075	Inner Joint		28		26				
	2010.05-	-	R	F	All-wheel Drive Bus Engine CCHB	261216	Stub Axle	26	37	50		145			
	2010.05-	MT	R	F	All-wheel Drive Bus Engine CCHB	203360	Drive Shaft	38	42	63	102.5	617			
	2010.05-	MT	R	F	All-wheel Drive Bus Engine CCHB	261269	Drive Shaft								
	2010.05-	5MT	-	F	All-wheel Drive Bus Engine CCHB	261190	Stub Axle	26	37	50		136.5			
	2010.05-	-	-	F	All-wheel Drive Bus Engine CCHB	261215	Stub Axle	26	42	60		143.5			
	2010.05-	-	-	F	All-wheel Drive Bus Engine CCHB	261213	Stub Axle	42	42	60		135.5			
	2010.05-	6AT	-	F	All-wheel Drive Bus Engine CCHB	261238	Stub Axle	26	30	62		114.5			
	2010.05-	-	-	F	All-wheel Drive Bus Engine CCHB	801467	Outer Joint	38	30	63	102.5	67.5	I		
	2010.05-	6MT	-	F	All-wheel Drive Bus Engine CCHB	261191	Stub Axle	26	42	60		135.5			
	2.0 TDI 4motion (103 kW)	2009.09-	-	-	F	All-wheel Drive Bus Engine CCHA	801467	Outer Joint	38	30	63	102.5	67.5	I	
2009.09-		5MT	-	F	All-wheel Drive Bus Engine CCHA	261190	Stub Axle	26	37	50		136.5			
2009.09-		MT	L	R	All-wheel Drive Bus Engine CCHA	661075	Inner Joint		28		26				
2009.09-		MT	L/R	F	All-wheel Drive Bus Engine CCHA	861011	Outer Joint	38	29	63	102.5	70	M		
2009.09-		-	R	F	All-wheel Drive Bus Engine CCHA	261216	Stub Axle	26	37	50		145			
2009.09-		MT	R	F	All-wheel Drive Bus Engine CCHA	203360	Drive Shaft	38	42	63	102.5	617			
2009.09-		-	-	F	All-wheel Drive Bus Engine CCHA	261215	Stub Axle	26	42	60		143.5			
2009.09-		MT	R	F	All-wheel Drive Bus Engine CCHA	261269	Drive Shaft								
2009.09-		6AT	-	F	All-wheel Drive Bus Engine CCHA	261238	Stub Axle	26	30	62		114.5			
2009.09-		-	-	F	All-wheel Drive Bus Engine CCHA	261213	Stub Axle	42	42	60		135.5			
2009.09-		6MT	-	F	All-wheel Drive Bus Engine CCHA	261191	Stub Axle	26	42	60		135.5			
2009.09-		AT	R	F	All-wheel Drive Bus Engine CCHA	203353	Drive Shaft	38	37	63	102.5	1027			
2.0 TSI (110 kW)		2012.07-	-	-	F	Bus Engine CJKB	801467	Outer Joint	38	30	63	102.5	67.5	I	
		2012.07-	MT	L/R	F	Bus Engine CJKB	861011	Outer Joint	38	29	63	102.5	70	M	
	2012.07-	-	R	F	Bus Engine CJKB	261216	Stub Axle	26	37	50		145			
	2012.07-	MT	L	F	Bus Engine CJKB	203360	Drive Shaft	38	42	63	102.5	617			
	2012.07-	MT	L	F	Bus Engine CJKB	261269	Drive Shaft								
	2012.07-	5MT	-	F	Bus Engine CJKB	261190	Stub Axle	26	37	50		136.5			
	2012.07-	-	-	F	Bus Engine CJKB	261215	Stub Axle	26	42	60		143.5			
	2012.07-	-	-	F	Bus Engine CJKB	261213	Stub Axle	42	42	60		135.5			
	2012.07-	6AT	-	F	Bus Engine CJKB	261238	Stub Axle	26	30	62		114.5			
	2012.07-	MT	R	F	Bus Engine CJKB	203296	Drive Shaft	38	26	63	102.5	880			
	2012.07-	AT	R	F	Bus Engine CJKB	203353	Drive Shaft	38	37	63	102.5	1027			
	2012.07-	6MT	-	F	Bus Engine CJKB	261191	Stub Axle	26	42	60		135.5			
	2.0 TSI (150 kW)	2011.05-	5MT	-	F	Bus Engine CJKB	261190	Stub Axle	26	37	50		136.5		
		2011.05-	AT/MT	L/R	F	Bus Engine CJKB	861011	Outer Joint	38	29	63	102.5	70	M	
2011.05-		-	R	F	Bus Engine CJKB	261216	Stub Axle	26	37	50		145			
2011.05-		MT	L	F	Bus Engine CJKB	203360	Drive Shaft	38	42	63	102.5	617			
2011.05-		MT	L	F	Bus Engine CJKB	261269	Drive Shaft								
2011.05-		-	-	F	Bus Engine CJKB	261215	Stub Axle	26	42	60		143.5			
2011.05-		6AT	-	F	Bus Engine CJKB	261238	Stub Axle	26	30	62		114.5			
2011.05-		-	-	F	Bus Engine CJKB	261213	Stub Axle	42	42	60		135.5			
2011.05-		6MT	-	F	Bus Engine CJKB	261191	Stub Axle	26	42	60		135.5			
2011.05-		AT	R	F	Bus Engine CJKB	203353	Drive Shaft	38	37	63	102.5	1027			
2011.05-		MT	R	F	Bus Engine CJKB	203296	Drive Shaft	38	26	63	102.5	880			
2011.05-		-	-	F	Bus Engine CJKB	801467	Outer Joint	38	30	63	102.5	67.5	I		
2.0 TSI 4motion (150 kW)		2011.07-	AT/DCT	L	R	All-wheel Drive Bus Engine CJKB	661075	Inner Joint		28		26			





	YEAR	TRANSM	L/R	F/R	REMARKS	GSP Ref.	PRODUCT	ABS	Technical Specifications						
									A	B	C	H	L	P	
VW															
TRANSPORTER V (7HB 7HJ 7EB 7EJ 7EF 7EG 7HF 7EC)/TRANSPORTER/CARAVELLE															
2.0 TSI 4motion (150 kW)	2011.07.-	-	AT	L/R	F	All-wheel Drive Bus Engine CJKA	861011	Outer Joint		38	29	63	102.5	70	M
	2011.07.-	-	-	R	F	All-wheel Drive Bus Engine CJKA	261216	Stub Axle		26	37	50		145	
	2011.07.-	-	MT	R	F	All-wheel Drive Bus Engine CJKA	203360	Drive Shaft		38	42	63	102.5	617	
	2011.07.-	-	-	-	F	All-wheel Drive Bus Engine CJKA	261215	Stub Axle		26	42	60		143.5	
	2011.07.-	-	MT	R	F	All-wheel Drive Bus Engine CJKA	261269	Drive Shaft							
	2011.07.-	-	5MT	-	F	All-wheel Drive Bus Engine CJKA	261190	Stub Axle		26	37	50		136.5	
	2011.07.-	-	-	-	F	All-wheel Drive Bus Engine CJKA	261213	Stub Axle		42	42	60		135.5	
	2011.07.-	-	6AT	-	F	All-wheel Drive Bus Engine CJKA	261238	Stub Axle		26	30	62		114.5	
	2011.07.-	-	AT	R	F	All-wheel Drive Bus Engine CJKA	203353	Drive Shaft		38	37	63	102.5	1027	
	2011.07.-	-	-	-	F	All-wheel Drive Bus Engine CJKA	801467	Outer Joint		38	30	63	102.5	67.5	I
2011.07.-	-	6MT	-	F	All-wheel Drive Bus Engine CJKA	261191	Stub Axle		26	42	60		135.5		
2.5 TDi (120 kW)	2003.11-2009.11	-	-	R	F	Bus Engine BLJ	203246	Drive Shaft		38	26	63	102.5	858	
	2003.11-2009.11	MT	L/R	F	Bus Engine BLJ	861011	Outer Joint		38	29	63	102.5	70	M	
	2003.11-2009.11	5MT	-	F	Bus Engine BLJ	261190	Stub Axle		26	37	50		136.5		
	2003.11-2009.11	MT	L	F	Bus Engine BLJ	661029	Inner Joint		26	30	46.8		79		
	2003.11-2009.11	MT	R	F	Bus Engine BLJ	261140	Drive Shaft		38	26	63	102.5	873		
	2003.11-2009.11	-	R	F	Bus Engine BLJ	261084	Drive Shaft		38	26	63	102.5	613		
	2003.11-2009.11	-	-	F	Bus Engine BLJ	261215	Stub Axle		26	42	60		143.5		
	2003.11-2009.11	6AT	-	F	Bus Engine BLJ	261238	Stub Axle		26	30	62		114.5		
	2003.11-2009.11	-	-	F	Bus Engine BLJ	261213	Stub Axle		42	42	60		135.5		
	2003.11-2009.11	6MT	-	F	Bus Engine BLJ	261191	Stub Axle		26	42	60		135.5		
	2003.11-2009.11	-	R	F	Bus Engine BLJ	661020	Inner Joint		26	28	50	205.5	63		
	2003.11-2009.11	-	L/R	F	Bus Engine BLJ	861009	Outer Joint		38	27	63	102	66	M	
	2003.11-2009.11	-	L	F	Bus Engine BLJ	661041	Inner Joint			28		32			
	2003.11-2009.11	-	L	F	Bus Engine BLJ	261105	Drive Shaft		38		63	102.5	645		
2003.11-2009.11	MT	R	F	Bus Engine BLJ	661021	Inner Joint		26	30	50	288	78			
2.5 TDi (128 kW)	2003.04-2009.11	5MT	-	F	Bus Engine AXE/BPC	261190	Stub Axle		26	37	50		136.5		
	2003.04-2009.11	MT	L	F	Bus Engine AXE/BPC	661029	Inner Joint		26	30	46.8		79		
	2003.04-2009.11	AT/MT	L/R	F	Bus Engine AXE/BPC	861011	Outer Joint		38	29	63	102.5	70	M	
	2003.04-2009.11	MT	R	F	Bus Engine AXE/BPC	261140	Drive Shaft		38	26	63	102.5	873		
	2003.04-2009.11	AT	R	F	Bus Engine AXE/BPC	261210	Drive Shaft		38	26	63	102.5	925		
	2003.04-2009.11	MT	R	F	Bus Engine AXE/BPC	261084	Drive Shaft		38	26	63	102.5	613		
	2003.04-2009.11	-	-	F	Bus Engine AXE/BPC	261215	Stub Axle		26	42	60		143.5		
	2003.04-2009.11	6AT	-	F	Bus Engine AXE/BPC	261238	Stub Axle		26	30	62		114.5		
	2003.04-2009.11	-	-	F	Bus Engine AXE/BPC	261213	Stub Axle		42	42	60		135.5		
	2003.04-2009.11	AT	R	F	Bus Engine AXE/BPC	203267	Drive Shaft		38	26	63	102.5	925		
	2003.04-2009.11	6MT	-	F	Bus Engine AXE/BPC	261191	Stub Axle		26	42	60		135.5		
	2003.04-2009.11	MT	R	F	Bus Engine AXE/BPC	661021	Inner Joint		26	30	50	288	78		
	2.5 TDi (96 kW)	2003.04-2009.11	5MT	-	F	Bus Engine AXD/BNZ	261190	Stub Axle		26	37	50		136.5	
		2003.04-2009.11	MT	L	F	Bus Engine AXD/BNZ	661029	Inner Joint		26	30	46.8		79	
2003.04-2009.11		AT/MT	L/R	F	Bus Engine AXD/BNZ	861011	Outer Joint		38	29	63	102.5	70	M	
2003.04-2009.11		MT	R	F	Bus Engine AXD/BNZ	261140	Drive Shaft		38	26	63	102.5	873		
2003.04-2009.11		AT	R	F	Bus Engine AXD/BNZ	261210	Drive Shaft		38	26	63	102.5	925		
2003.04-2009.11		-	-	F	Bus Engine AXD/BNZ	261215	Stub Axle		26	42	60		143.5		
2003.04-2009.11		6AT	-	F	Bus Engine AXD/BNZ	261238	Stub Axle		26	30	62		114.5		
2003.04-2009.11		-	-	F	Bus Engine AXD/BNZ	261213	Stub Axle		42	42	60		135.5		
2003.04-2009.11		AT	R	F	Bus Engine AXD/BNZ	203267	Drive Shaft		38	26	63	102.5	925		
2003.04-2009.11		6MT	-	F	Bus Engine AXD/BNZ	261191	Stub Axle		26	42	60		135.5		
2003.04-2009.11		MT	R	F	Bus Engine AXD/BNZ	661021	Inner Joint		26	30	50	288	78		
2.5 TDi 4motion (128 kW)		2004.07-2009.11	5MT	-	F	All-wheel Drive Bus Engine AXE/BPC	261190	Stub Axle		26	37	50		136.5	
		2004.07-2009.11	MT	L/R	F	All-wheel Drive Bus Engine AXE/BPC	861011	Outer Joint		38	29	63	102.5	70	M
		2004.07-2009.11	MT	L	F	All-wheel Drive Bus Engine AXE/BPC	661029	Inner Joint		26	30	46.8		79	
	2004.07-2009.11	-	R	F	All-wheel Drive Bus Engine AXE/BPC	261210	Drive Shaft		38	26	63	102.5	925		
	2004.07-2009.11	6MT	R	F	All-wheel Drive Bus Engine AXE/BPC	261084	Drive Shaft		38	26	63	102.5	613		
	2004.07-2009.11	-	-	F	All-wheel Drive Bus Engine AXE/BPC	261215	Stub Axle		26	42	60		143.5		
	2004.07-2009.11	6AT	-	F	All-wheel Drive Bus Engine AXE/BPC	261238	Stub Axle		26	30	62		114.5		
	2004.07-2009.11	-	-	F	All-wheel Drive Bus Engine AXE/BPC	261213	Stub Axle		42	42	60		135.5		
	2004.07-2009.11	AT/MT	L	R	All-wheel Drive Bus Engine AXE/BPC	261257	Drive Shaft		38		59	100	683		
	2004.07-2009.11	6MT	-	F	All-wheel Drive Bus Engine AXE/BPC	261191	Stub Axle		26	42	60		135.5		
2004.07-2009.11	AT/MT	L	R	All-wheel Drive Bus Engine AXE/BPC	661075	Inner Joint			28		26				
2.5 TDi 4motion (96 kW)	2004.07-2009.11	5MT	-	F	All-wheel Drive Bus Engine BNZ	261190	Stub Axle		26	37	50		136.5		
	2004.07-2009.11	MT	L	F	All-wheel Drive Bus Engine BNZ	661029	Inner Joint		26	30	46.8		79		
	2004.07-2009.11	MT	L/R	F	All-wheel Drive Bus Engine BNZ	861011	Outer Joint		38	29	63	102.5	70	M	
	2004.07-2009.11	MT	R	F	All-wheel Drive Bus Engine BNZ	261084	Drive Shaft		38	26	63	102.5	613		
	2004.07-2009.11	-	-	F	All-wheel Drive Bus Engine BNZ	261215	Stub Axle		26	42	60		143.5		
	2004.07-2009.11	6AT	-	F	All-wheel Drive Bus Engine BNZ	261238	Stub Axle		26	30	62		114.5		

YEAR	TRANSM	L/R	F/R	REMARKS	GSP Ref.	PRODUCT	ABS	Technical Specifications					
								A	B	C	H	L	P
VW													
TRANSPORTER V (7HB 7HJ 7EB 7EJ 7EF 7EG 7HF 7EC)/TRANSPORTER/CARAVELLE													
2.5 TDI 4motion (96 kW)	2004.07-2009.11	-	-	F	All-wheel Drive Bus Engine BNZ	261213	Stub Axle	42	42	60		135.5	
	2004.07-2009.11	AT/MT	L	R	All-wheel Drive Bus Engine BNZ	261257	Drive Shaft	38		59	100	683	
	2004.07-2009.11	6MT	-	F	All-wheel Drive Bus Engine BNZ	261191	Stub Axle	26	42	60		135.5	
	2004.07-2009.11	AT/MT	L	R	All-wheel Drive Bus Engine BNZ	661075	Inner Joint		28		26		
3.2 V6 (170 kW)	2004.02-2004.06	AT	L/R	F	Bus Engine BDL	861011	Outer Joint	38	29	63	102.5	70 M	
	2004.02-2004.06	-	-	F	Bus Engine BDL	261215	Stub Axle	26	42	60		143.5	
	2004.02-2004.06	5MT	-	F	Bus Engine BDL	261190	Stub Axle	26	37	50		136.5	
	2004.02-2004.06	-	-	F	Bus Engine BDL	261213	Stub Axle	42	42	60		135.5	
	2004.02-2004.06	AT	R	F	Bus Engine BDL	203267	Drive Shaft	38	26	63	102.5	925	
	2004.02-2004.06	6AT	-	F	Bus Engine BDL	261238	Stub Axle	26	30	62		114.5	
3.2 V6 (173 kW)	2004.02-2004.06	6MT	-	F	Bus Engine BDL	261191	Stub Axle	26	42	60		135.5	
	2004.02-2009.11	5MT	-	F	Bus Engine BKK/CFLA	261190	Stub Axle	26	37	50		136.5	
	2004.02-2009.11	AT	L/R	F	Bus Engine BKK/CFLA	861011	Outer Joint	38	29	63	102.5	70 M	
	2004.02-2009.11	-	-	F	Bus Engine BKK/CFLA	261215	Stub Axle	26	42	60		143.5	
	2004.02-2009.11	6AT	-	F	Bus Engine BKK/CFLA	261238	Stub Axle	26	30	62		114.5	
	2004.02-2009.11	-	-	F	Bus Engine BKK/CFLA	261213	Stub Axle	42	42	60		135.5	
3.2 V6 4motion (173 kW)	2004.02-2009.11	AT	R	F	Bus Engine BKK/CFLA	203267	Drive Shaft	38	26	63	102.5	925	
	2004.02-2009.11	6MT	-	F	Bus Engine BKK/CFLA	261191	Stub Axle	26	42	60		135.5	
	2003.11-2009.11	5MT	-	F	All-wheel Drive Bus Engine BKK/CFLA	261190	Stub Axle	26	37	50		136.5	
	2003.11-2009.11	-	L/R	F	All-wheel Drive Bus Engine BKK/CFLA	861011	Outer Joint	38	29	63	102.5	70 M	
	2003.11-2009.11	-	-	F	All-wheel Drive Bus Engine BKK/CFLA	261215	Stub Axle	26	42	60		143.5	
	2003.11-2009.11	6AT	-	F	All-wheel Drive Bus Engine BKK/CFLA	261238	Stub Axle	26	30	62		114.5	
	2003.11-2009.11	-	-	F	All-wheel Drive Bus Engine BKK/CFLA	261213	Stub Axle	42	42	60		135.5	
	2003.11-2009.11	AT	R	F	All-wheel Drive Bus Engine BKK/CFLA	203267	Drive Shaft	38	26	63	102.5	925	
TRANSPORTER V (7JD 7JE 7JL 7JY 7JZ 7FD)	2003.11-2009.11	-	L	R	All-wheel Drive Bus Engine BKK/CFLA	261257	Drive Shaft	38		59	100	683	
	2003.11-2009.11	6MT	-	F	All-wheel Drive Bus Engine BKK/CFLA	261191	Stub Axle	26	42	60		135.5	
	2003.11-2009.11	-	L	R	All-wheel Drive Bus Engine BKK/CFLA	661075	Inner Joint		28		26		
	1.9 TDI (62 kW)	2006.01-2009.11	-	L/R	F	Platform/Chassis Engine BRR	861009	Outer Joint	38	27	63	102	66 M
		2006.01-2009.11	-	R	F	Platform/Chassis Engine BRR	203246	Drive Shaft	38	26	63	102.5	858
		2006.01-2009.11	5MT	-	F	Platform/Chassis Engine BRR	261190	Stub Axle	26	37	50		136.5
		2006.01-2009.11	-	-	-	Platform/Chassis Engine BRR	661010	Inner Joint		28		32	
		2006.01-2009.11	MT	R	F	Platform/Chassis Engine BRR	261084	Drive Shaft	38	26	63	102.5	613
		2006.01-2009.11	6AT	-	F	Platform/Chassis Engine BRR	261238	Stub Axle	26	30	62		114.5
		2006.01-2009.11	AT	R	F	Platform/Chassis Engine BRR	203267	Drive Shaft	38	26	63	102.5	925
2006.01-2009.11		6MT	-	F	Platform/Chassis Engine BRR	261191	Stub Axle	26	42	60		135.5	
2006.01-2009.11		MT	R	F	Platform/Chassis Engine BRR	661020	Inner Joint	26	28	50	205.5	63	
2006.01-2009.11		MT	L	F	Platform/Chassis Engine BRR	661041	Inner Joint		28		32		
1.9 TDI (63 kW)	2006.01-2009.11	-	L	F	Platform/Chassis Engine BRR	261105	Drive Shaft	38		63	102.5	645	
	2003.04-2009.11	5MT	R	F	Platform/Chassis Engine AXC	203246	Drive Shaft	38	26	63	102.5	858	
	2003.04-2009.11	5MT	-	F	Platform/Chassis Engine AXC	261190	Stub Axle	26	37	50		136.5	
	2003.04-2009.11	MT	R	F	Platform/Chassis Engine AXC	261084	Drive Shaft	38	26	63	102.5	613	
	2003.04-2009.11	-	-	-	Platform/Chassis Engine AXC	661010	Inner Joint		28		32		
	2003.04-2009.11	6AT	-	F	Platform/Chassis Engine AXC	261238	Stub Axle	26	30	62		114.5	
	2003.04-2009.11	AT	R	F	Platform/Chassis Engine AXC	203267	Drive Shaft	38	26	63	102.5	925	
	2003.04-2009.11	6MT	-	F	Platform/Chassis Engine AXC	261191	Stub Axle	26	42	60		135.5	
	2003.04-2009.11	MT	R	F	Platform/Chassis Engine AXC	661020	Inner Joint	26	28	50	205.5	63	
	2003.04-2009.11	MT	L	F	Platform/Chassis Engine AXC	661041	Inner Joint		28		32		
1.9 TDI (75 kW)	2003.04-2009.11	5MT	L	F	Platform/Chassis Engine AXC	261105	Drive Shaft	38		63	102.5	645	
	2003.04-2009.11	MT	L/R	F	Platform/Chassis Engine AXC	861009	Outer Joint	38	27	63	102	66 M	
	2006.06-2009.11	-	L/R	F	Platform/Chassis Engine BRS	861009	Outer Joint	38	27	63	102	66 M	
	2006.06-2009.11	-	R	F	Platform/Chassis Engine BRS	203246	Drive Shaft	38	26	63	102.5	858	
	2006.06-2009.11	5MT	-	F	Platform/Chassis Engine BRS	261190	Stub Axle	26	37	50		136.5	
	2006.06-2009.11	-	-	-	Platform/Chassis Engine BRS	661010	Inner Joint		28		32		
	2006.06-2009.11	MT	R	F	Platform/Chassis Engine BRS	261084	Drive Shaft	38	26	63	102.5	613	
	2006.06-2009.11	6AT	-	F	Platform/Chassis Engine BRS	261238	Stub Axle	26	30	62		114.5	
	2006.06-2009.11	AT	R	F	Platform/Chassis Engine BRS	203267	Drive Shaft	38	26	63	102.5	925	
	2006.06-2009.11	6MT	-	F	Platform/Chassis Engine BRS	261191	Stub Axle	26	42	60		135.5	
1.9 TDI (77 kW)	2006.06-2009.11	MT	R	F	Platform/Chassis Engine BRS	661020	Inner Joint	26	28	50	205.5	63	
	2006.06-2009.11	MT	L	F	Platform/Chassis Engine BRS	661041	Inner Joint		28		32		
	2006.06-2009.11	-	L	F	Platform/Chassis Engine BRS	261105	Drive Shaft	38		63	102.5	645	
	2003.04-2009.11	5MT	R	F	Platform/Chassis Engine AXB	203246	Drive Shaft	38	26	63	102.5	858	
	2003.04-2009.11	5MT	-	F	Platform/Chassis Engine AXB	261190	Stub Axle	26	37	50		136.5	





	YEAR	TRANSM	L/R	F/R	REMARKS	GSP Ref.	PRODUCT	ABS	Technical Specifications								
									A	B	C	H	L	P			
VW																	
TRANSPORTER V (7JD 7JE 7JL 7JY 7JZ 7FD)																	
1.9 TDI (77 kW)	2003.04-2009.11	AT	R	F	Platform/Chassis Engine AXB	203267	Drive Shaft		38	26	63	102.5	925				
	2003.04-2009.11	6MT	-	F	Platform/Chassis Engine AXB	261191	Stub Axle		26	42	60		135.5				
	2003.04-2009.11	MT	R	F	Platform/Chassis Engine AXB	661020	Inner Joint		26	28	50	205.5	63				
	2003.04-2009.11	MT	L	F	Platform/Chassis Engine AXB	661041	Inner Joint			28		32					
	2003.04-2009.11	5MT	L	F	Platform/Chassis Engine AXB	261105	Drive Shaft		38		63	102.5	645				
	2003.04-2009.11	MT	L/R	F	Platform/Chassis Engine AXB	861009	Outer Joint		38	27	63	102	66	M			
2.0 (85 kW)	2003.11- -	5MT	R	F	Platform/Chassis Engine AXA	203246	Drive Shaft		38	26	63	102.5	858				
	2003.11- -	5MT	-	F	Platform/Chassis Engine AXA	261190	Stub Axle		26	37	50		136.5				
	2003.11- -	-	R	F	Platform/Chassis Engine AXA	261216	Stub Axle		26	37	50		145				
	2003.11- -	MT	R	F	Platform/Chassis Engine AXA	261084	Drive Shaft		38	26	63	102.5	613				
	2003.11- -	-	-	-	Platform/Chassis Engine AXA	661010	Inner Joint			28		32					
	2003.11- -	6AT	-	F	Platform/Chassis Engine AXA	261238	Stub Axle		26	30	62		114.5				
	2003.11- -	MT	L	F	Platform/Chassis Engine AXA	203278	Drive Shaft		38		63	102	643				
	2003.11- -	6MT	-	F	Platform/Chassis Engine AXA	261191	Stub Axle		26	42	60		135.5				
	2003.11- -	MT	R	F	Platform/Chassis Engine AXA	661020	Inner Joint		26	28	50	205.5	63				
	2003.11- -	MT	R	F	Platform/Chassis Engine AXA	203279	Drive Shaft		38	26	63	102	856				
	2003.11- -	MT	L	F	Platform/Chassis Engine AXA	661041	Inner Joint			28		32					
	2003.11- -	5MT	L/R	F	Platform/Chassis Engine AXA	261105	Drive Shaft		38		63	102.5	645				
	2003.11- -	MT	L/R	F	Platform/Chassis Engine AXA	861009	Outer Joint		38	27	63	102	66	M			
	2.0 BiTDI (132 kW)	2009.09- -	-	-	F	Platform/Chassis Engine CFCA	801467	Outer Joint		38	30	63	102.5	67.5	I		
2009.09- -		7DCT/6MT	L/R	F	Platform/Chassis Engine CFCA	861011	Outer Joint		38	29	63	102.5	70	M			
2009.09- -		-	R	F	Platform/Chassis Engine CFCA	261216	Stub Axle		26	37	50		145				
2009.09- -		MT	L	F	Platform/Chassis Engine CFCA	203360	Drive Shaft		38	42	63	102.5	617				
2009.09- -		MT	L	F	Platform/Chassis Engine CFCA	261269	Drive Shaft										
2009.09- -		5MT	-	F	Platform/Chassis Engine CFCA	261190	Stub Axle		26	37	50		136.5				
2009.09- -		6AT	-	F	Platform/Chassis Engine CFCA	261238	Stub Axle		26	30	62		114.5				
2009.09- -		AT	L	F	Platform/Chassis Engine CFCA	203293	Drive Shaft		38	37	63	102.5	645				
2009.09- -		-	L	F	Platform/Chassis Engine CFCA	203278	Drive Shaft		38		63	102	643				
2009.09- -		-	R	F	Platform/Chassis Engine CFCA	203261	Drive Shaft		38	26	63	102	857				
2009.09- -		MT	R	F	Platform/Chassis Engine CFCA	203296	Drive Shaft		38	26	63	102.5	880				
2009.09- -		6MT	-	F	Platform/Chassis Engine CFCA	261191	Stub Axle		26	42	60		135.5				
2009.09- -		AT	R	F	Platform/Chassis Engine CFCA	203353	Drive Shaft		38	37	63	102.5	1027				
2009.09- -		-	L/R	F	Platform/Chassis Engine CFCA	861009	Outer Joint		38	27	63	102	66	M			
2.0 BiTDI 4motion (132 kW)	2009.09- -	-	-	F	All-wheel Drive Platform/Chassis Engine CFCA	801467	Outer Joint		38	30	63	102.5	67.5	I			
	2009.09- -	5MT	-	F	All-wheel Drive Platform/Chassis Engine CFCA	261190	Stub Axle		26	37	50		136.5				
	2009.09- -	-	L	R	All-wheel Drive Platform/Chassis Engine CFCA	661075	Inner Joint			28		26					
	2009.09- -	-	L/R	F	All-wheel Drive Platform/Chassis Engine CFCA	861011	Outer Joint		38	29	63	102.5	70	M			
	2009.09- -	-	R	F	All-wheel Drive Platform/Chassis Engine CFCA	261216	Stub Axle		26	37	50		145				
	2009.09- -	MT	R	F	All-wheel Drive Platform/Chassis Engine CFCA	203360	Drive Shaft		38	42	63	102.5	617				
	2009.09- -	MT	R	F	All-wheel Drive Platform/Chassis Engine CFCA	261269	Drive Shaft										
	2009.09- -	-	-	F	All-wheel Drive Platform/Chassis Engine CFCA	261215	Stub Axle		26	42	60		143.5				
	2009.09- -	6AT	-	F	All-wheel Drive Platform/Chassis Engine CFCA	261238	Stub Axle		26	30	62		114.5				
	2009.09- -	-	-	F	All-wheel Drive Platform/Chassis Engine CFCA	261213	Stub Axle		42	42	60		135.5				
	2009.09- -	6MT	-	F	All-wheel Drive Platform/Chassis Engine CFCA	261191	Stub Axle		26	42	60		135.5				
	2009.09- -	AT	R	F	All-wheel Drive Platform/Chassis Engine CFCA	203353	Drive Shaft		38	37	63	102.5	1027				
	2009.09- -	-	R	F	All-wheel Drive Platform/Chassis Engine CFCA	261216	Stub Axle		26	37	50		145				
	2010.05- -	AT/MT	L/R	F	Platform/Chassis Engine CAAE	861011	Outer Joint		38	29	63	102.5	70	M			
2010.05- -	MT	L	F	Platform/Chassis Engine CAAE	203360	Drive Shaft		38	42	63	102.5	617					
2010.05- -	5MT	-	F	Platform/Chassis Engine CAAE	261190	Stub Axle		26	37	50		136.5					
2010.05- -	MT	L	F	Platform/Chassis Engine CAAE	261269	Drive Shaft											
2010.05- -	6AT	-	F	Platform/Chassis Engine CAAE	261238	Stub Axle		26	30	62		114.5					
2010.05- -	AT	L	F	Platform/Chassis Engine CAAE	203293	Drive Shaft		38	37	63	102.5	645					
2010.05- -	6MT	-	F	Platform/Chassis Engine CAAE	261191	Stub Axle		26	42	60		135.5					
2010.05- -	MT	R	F	Platform/Chassis Engine CAAE	203296	Drive Shaft		38	26	63	102.5	880					
2010.05- -	-	-	F	Platform/Chassis Engine CAAE	801467	Outer Joint		38	30	63	102.5	67.5	I				
2.0 TDI (103 kW)	2009.09- -	-	-	F	Platform/Chassis Engine CAAC	801467	Outer Joint		38	30	63	102.5	67.5	I			
	2009.09- -	AT	L/R	F	Platform/Chassis Engine CAAC	861011	Outer Joint		38	29	63	102.5	70	M			
	2009.09- -	-	R	F	Platform/Chassis Engine CAAC	261216	Stub Axle		26	37	50		145				
	2009.09- -	MT	L	F	Platform/Chassis Engine CAAC	203360	Drive Shaft		38	42	63	102.5	617				
	2009.09- -	MT	L	F	Platform/Chassis Engine CAAC	261269	Drive Shaft										
	2009.09- -	5MT	-	F	Platform/Chassis Engine CAAC	261190	Stub Axle		26	37	50		136.5				
	2009.09- -	6AT	-	F	Platform/Chassis Engine CAAC	261238	Stub Axle		26	30	62		114.5				
	2009.09- -	AT	L	F	Platform/Chassis Engine CAAC	203293	Drive Shaft		38	37	63	102.5	645				
	2009.09- -	AT	R	F	Platform/Chassis Engine CAAC	203353	Drive Shaft		38	37	63	102.5	1027				
	2009.09- -	MT	R	F	Platform/Chassis Engine CAAC	203296	Drive Shaft		38	26	63	102.5	880				
	2009.09- -	6MT	-	F	Platform/Chassis Engine CAAC	261191	Stub Axle		26	42	60		135.5				

	 YEAR	TRANSM	L/R	F/R	REMARKS	GSP Ref.	 PRODUCT	 ABS	Technical Specifications						
									A	B	C	H	L	P	
VW															
TRANSPORTER V (7JD 7JE 7JL 7JY 7JZ 7FD)															
2.0 TDI (103 kW)	2009.09-	-	MT	L/R	F	Platform/Chassis Engine CAAC	861009	Outer Joint		38	27	63	102	66	M
2.0 TDI (62 kW)	2009.09-	-	-	R	F	Platform/Chassis Engine CAAA	261216	Stub Axle		26	37	50		145	
	2009.09-	-	5MT	-	F	Platform/Chassis Engine CAAA	261190	Stub Axle		26	37	50		136.5	
	2009.09-	-	6AT	-	F	Platform/Chassis Engine CAAA	261238	Stub Axle		26	30	62		114.5	
	2009.09-	-	-	L	F	Platform/Chassis Engine CAAA	203278	Drive Shaft		38		63	102	643	
	2009.09-	-	-	R	F	Platform/Chassis Engine CAAA	203261	Drive Shaft		38	26	63	102	857	
	2009.09-	-	6MT	-	F	Platform/Chassis Engine CAAA	261191	Stub Axle		26	42	60		135.5	
	2009.09-	-	-	L/R	F	Platform/Chassis Engine CAAA	861009	Outer Joint		38	27	63	102	66	M
2.0 TDI (75 kW)	2009.09-	-	-	R	F	Platform/Chassis Engine CAAB	261216	Stub Axle		26	37	50		145	
	2009.09-	-	5MT	-	F	Platform/Chassis Engine CAAB	261190	Stub Axle		26	37	50		136.5	
	2009.09-	-	6AT	-	F	Platform/Chassis Engine CAAB	261238	Stub Axle		26	30	62		114.5	
	2009.09-	-	-	L	F	Platform/Chassis Engine CAAB	203278	Drive Shaft		38		63	102	643	
	2009.09-	-	-	R	F	Platform/Chassis Engine CAAB	203261	Drive Shaft		38	26	63	102	857	
	2009.09-	-	6MT	-	F	Platform/Chassis Engine CAAB	261191	Stub Axle		26	42	60		135.5	
	2009.09-	-	-	L/R	F	Platform/Chassis Engine CAAB	861009	Outer Joint		38	27	63	102	66	M
2.0 TDI (84 kW)	2011.05-	-	-	L/R	F	Platform/Chassis Engine CAAD	861009	Outer Joint		38	27	63	102	66	M
	2011.05-	-	-	R	F	Platform/Chassis Engine CAAD	261216	Stub Axle		26	37	50		145	
	2011.05-	-	5MT	-	F	Platform/Chassis Engine CAAD	261190	Stub Axle		26	37	50		136.5	
	2011.05-	-	6AT	-	F	Platform/Chassis Engine CAAD	261238	Stub Axle		26	30	62		114.5	
	2011.05-	-	MT	L	F	Platform/Chassis Engine CAAD	203278	Drive Shaft		38		63	102	643	
	2011.05-	-	6MT	-	F	Platform/Chassis Engine CAAD	261191	Stub Axle		26	42	60		135.5	
	2011.05-	-	MT	R	F	Platform/Chassis Engine CAAD	203261	Drive Shaft		38	26	63	102	857	
2.0 TDI 4motion (100 kW)	2010.05-	-	-	-	F	All-wheel Drive Platform/Chassis Engine CAAE	801467	Outer Joint		38	30	63	102.5	67.5	I
	2010.05-	-	-	L	R	All-wheel Drive Platform/Chassis Engine CAAE	661075	Inner Joint			28		26		
	2010.05-	-	-	R	F	All-wheel Drive Platform/Chassis Engine CAAE	261216	Stub Axle		26	37	50		145	
	2010.05-	-	-	L/R	F	All-wheel Drive Platform/Chassis Engine CAAE	861011	Outer Joint		38	29	63	102.5	70	M
	2010.05-	-	5MT	-	F	All-wheel Drive Platform/Chassis Engine CAAE	261190	Stub Axle		26	37	50		136.5	
	2010.05-	-	MT	R	F	All-wheel Drive Platform/Chassis Engine CAAE	203360	Drive Shaft		38	42	63	102.5	617	
	2010.05-	-	6AT	-	F	All-wheel Drive Platform/Chassis Engine CAAE	261238	Stub Axle		26	30	62		114.5	
	2010.05-	-	6MT	-	F	All-wheel Drive Platform/Chassis Engine CAAE	261191	Stub Axle		26	42	60		135.5	
2.0 TDI 4motion (103 kW)	2009.09-	-	-	-	F	All-wheel Drive Platform/Chassis Engine CAAC	801467	Outer Joint		38	30	63	102.5	67.5	I
	2009.09-	-	-	L/R	F	All-wheel Drive Platform/Chassis Engine CAAC	861011	Outer Joint		38	29	63	102.5	70	M
	2009.09-	-	-	L	R	All-wheel Drive Platform/Chassis Engine CAAC	661075	Inner Joint			28		26		
	2009.09-	-	-	R	F	All-wheel Drive Platform/Chassis Engine CAAC	261216	Stub Axle		26	37	50		145	
	2009.09-	-	5MT	-	F	All-wheel Drive Platform/Chassis Engine CAAC	261190	Stub Axle		26	37	50		136.5	
	2009.09-	-	MT	R	F	All-wheel Drive Platform/Chassis Engine CAAC	203360	Drive Shaft		38	42	63	102.5	617	
	2009.09-	-	6AT	-	F	All-wheel Drive Platform/Chassis Engine CAAC	261238	Stub Axle		26	30	62		114.5	
	2009.09-	-	AT	L	F	All-wheel Drive Platform/Chassis Engine CAAC	203293	Drive Shaft		38	37	63	102.5	645	
	2009.09-	-	6MT	-	F	All-wheel Drive Platform/Chassis Engine CAAC	261191	Stub Axle		26	42	60		135.5	
	2009.09-	-	AT	R	F	All-wheel Drive Platform/Chassis Engine CAAC	203353	Drive Shaft		38	37	63	102.5	1027	
2.0 TSI (110 kW)	2012.07-	-	-	-	F	Platform/Chassis Engine CJKB	801467	Outer Joint		38	30	63	102.5	67.5	I
	2012.07-	-	-	R	F	Platform/Chassis Engine CJKB	261216	Stub Axle		26	37	50		145	
	2012.07-	-	MT	L/R	F	Platform/Chassis Engine CJKB	861011	Outer Joint		38	29	63	102.5	70	M
	2012.07-	-	MT	L	F	Platform/Chassis Engine CJKB	203360	Drive Shaft		38	42	63	102.5	617	
	2012.07-	-	MT	L	F	Platform/Chassis Engine CJKB	261269	Drive Shaft							
	2012.07-	-	5MT	-	F	Platform/Chassis Engine CJKB	261190	Stub Axle		26	37	50		136.5	
	2012.07-	-	6AT	-	F	Platform/Chassis Engine CJKB	261238	Stub Axle		26	30	62		114.5	
	2012.07-	-	MT	R	F	Platform/Chassis Engine CJKB	203296	Drive Shaft		38	26	63	102.5	880	
	2012.07-	-	6MT	-	F	Platform/Chassis Engine CJKB	261191	Stub Axle		26	42	60		135.5	
	2012.07-	-	AT	R	F	Platform/Chassis Engine CJKB	203353	Drive Shaft		38	37	63	102.5	1027	
2.5 TDI (128 kW)	2003.04-2009.11	-	MT	L	F	Platform/Chassis Engine AXE	661029	Inner Joint		26	30	46.8		79	
	2003.04-2009.11	-	6MT	R	F	Platform/Chassis Engine AXE	261140	Drive Shaft		38	26	63	102.5	873	
	2003.04-2009.11	-	5MT	-	F	Platform/Chassis Engine AXE	261190	Stub Axle		26	37	50		136.5	
	2003.04-2009.11	-	6AT	R	F	Platform/Chassis Engine AXE	261210	Drive Shaft		38	26	63	102.5	925	
	2003.04-2009.11	-	-	L/R	F	Platform/Chassis Engine AXE	861011	Outer Joint		38	29	63	102.5	70	M
	2003.04-2009.11	-	6AT	-	F	Platform/Chassis Engine AXE	261238	Stub Axle		26	30	62		114.5	
	2003.04-2009.11	-	AT	R	F	Platform/Chassis Engine AXE	203267	Drive Shaft		38	26	63	102.5	925	
	2003.04-2009.11	-	6MT	-	F	Platform/Chassis Engine AXE	261191	Stub Axle		26	42	60		135.5	
	2003.04-2009.11	-	MT	R	F	Platform/Chassis Engine AXE	661021	Inner Joint		26	30	50	288	78	
2.5 TDI (96 kW)	2003.04-2009.11	-	MT	L	F	Platform/Chassis Engine AXD/BNZ	661029	Inner Joint		26	30	46.8		79	
	2003.04-2009.11	-	6MT	R	F	Platform/Chassis Engine AXD/BNZ	261140	Drive Shaft		38	26	63	102.5	873	
	2003.04-2009.11	-	5MT	-	F	Platform/Chassis Engine AXD/BNZ	261190	Stub Axle		26	37	50		136.5	
	2003.04-2009.11	-	6AT	R	F	Platform/Chassis Engine AXD/BNZ	261210	Drive Shaft		38	26	63	102.5	925	
	2003.04-2009.11	-	-	L/R	F	Platform/Chassis Engine AXD/BNZ	861011	Outer Joint		38	29	63	102.5	70	M

YEAR	TRANSM	L/R	F/R	REMARKS	GSP Ref.	PRODUCT	ABS	Technical Specifications									
								A	B	C	H	L	P				
VW																	
TRANSPORTER V (7JD 7JE 7JL 7JY 7JZ 7FD)																	
2.5 TDI (96 kW)	2003.04-2009.11	6AT	-	F	Platform/Chassis Engine AXD/BNZ	261238	Stub Axle	26	30	62		114.5					
	2003.04-2009.11	AT	R	F	Platform/Chassis Engine AXD/BNZ	203267	Drive Shaft	38	26	63	102.5	925					
	2003.04-2009.11	6MT	-	F	Platform/Chassis Engine AXD/BNZ	261191	Stub Axle	26	42	60		135.5					
	2003.04-2009.11	MT	R	F	Platform/Chassis Engine AXD/BNZ	661021	Inner Joint	26	30	50	288	78					
2.5 TDI 4motion (128 kW)	2004.04-2009.11	MT	L	F	All-wheel Drive Platform/Chassis Engine AXE/BPC	661029	Inner Joint	26	30	46.8		79					
	2004.04-2009.11	AT	R	F	All-wheel Drive Platform/Chassis Engine AXE/BPC	261210	Drive Shaft	38	26	63	102.5	925					
	2004.04-2009.11	5MT	-	F	All-wheel Drive Platform/Chassis Engine AXE/BPC	261190	Stub Axle	26	37	50		136.5					
	2004.04-2009.11	-	L/R	F	All-wheel Drive Platform/Chassis Engine AXE/BPC	861011	Outer Joint	38	29	63	102.5	70	M				
	2004.04-2009.11	-	R	F	All-wheel Drive Platform/Chassis Engine AXE/BPC	261084	Drive Shaft	38	26	63	102.5	613					
	2004.04-2009.11	-	L	R	All-wheel Drive Platform/Chassis Engine AXE/BPC	261257	Drive Shaft	38		59	100	683					
	2004.04-2009.11	6AT	-	F	All-wheel Drive Platform/Chassis Engine AXE/BPC	261238	Stub Axle	26	30	62		114.5					
	2004.04-2009.11	-	L	R	All-wheel Drive Platform/Chassis Engine AXE/BPC	661075	Inner Joint		28		26						
	2004.04-2009.11	6MT	-	F	All-wheel Drive Platform/Chassis Engine AXE/BPC	261191	Stub Axle	26	42	60		135.5					
2.5 TDI 4motion (96 kW)	2004.07-2009.11	MT	L	F	All-wheel Drive Platform/Chassis Engine BNZ	661029	Inner Joint	26	30	46.8		79					
	2004.07-2009.11	AT	R	F	All-wheel Drive Platform/Chassis Engine BNZ	261210	Drive Shaft	38	26	63	102.5	925					
	2004.07-2009.11	5MT	-	F	All-wheel Drive Platform/Chassis Engine BNZ	261190	Stub Axle	26	37	50		136.5					
	2004.07-2009.11	-	L/R	F	All-wheel Drive Platform/Chassis Engine BNZ	861011	Outer Joint	38	29	63	102.5	70	M				
	2004.07-2009.11	6MT	R	F	All-wheel Drive Platform/Chassis Engine BNZ	261084	Drive Shaft	38	26	63	102.5	613					
	2004.07-2009.11	6AT	-	F	All-wheel Drive Platform/Chassis Engine BNZ	261238	Stub Axle	26	30	62		114.5					
	2004.07-2009.11	AT/MT	L	R	All-wheel Drive Platform/Chassis Engine BNZ	261257	Drive Shaft	38		59	100	683					
	2004.07-2009.11	AT/MT	L	R	All-wheel Drive Platform/Chassis Engine BNZ	661075	Inner Joint		28		26						
	2004.07-2009.11	6MT	-	F	All-wheel Drive Platform/Chassis Engine BNZ	261191	Stub Axle	26	42	60		135.5					
3.2 V6 (170 kW)	2004.02-2009.11	5MT	-	F	Platform/Chassis Engine BDL	261190	Stub Axle	26	37	50		136.5					
	2004.02-2009.11	AT	L/R	F	Platform/Chassis Engine BDL	861011	Outer Joint	38	29	63	102.5	70	M				
	2004.02-2009.11	6AT	-	F	Platform/Chassis Engine BDL	261238	Stub Axle	26	30	62		114.5					
	2004.02-2009.11	AT	R	F	Platform/Chassis Engine BDL	203267	Drive Shaft	38	26	63	102.5	925					
	2004.02-2009.11	6MT	-	F	Platform/Chassis Engine BDL	261191	Stub Axle	26	42	60		135.5					
3.2 V6 (173 kW)	2003.08-2006.05	AT	L/R	F	Platform/Chassis Engine BKK	861011	Outer Joint	38	29	63	102.5	70	M				
	2003.08-2006.05	AT	R	F	Platform/Chassis Engine BKK	203267	Drive Shaft	38	26	63	102.5	925					
TRANSPORTER VI (SFD SFE SFL SFZ)																	
2.0 TDI (103 kW)	2015.04-	-	-	F	Platform/Chassis Engine CAAC	801467	Outer Joint	38	30	63	102.5	67.5	I				
	2015.04-	-	L/R	F	Platform/Chassis Engine CAAC	261216	Stub Axle	26	37	50		145					
	2015.04-	7AT	L	F	Platform/Chassis Engine CAAC	203293	Drive Shaft	38	37	63	102.5	645					
2.0 TDI (110 kW)	2015.08-	-	-	F	Platform/Chassis Engine CXHA	801467	Outer Joint	38	30	63	102.5	67.5	I				
	2015.08-	7DCT	L/R	F	Platform/Chassis Engine CXHA	861011	Outer Joint	38	29	63	102.5	70	M				
	2015.08-	7AT	L	F	Platform/Chassis Engine CXHA	203293	Drive Shaft	38	37	63	102.5	645					
2.0 TDI (132 kW)	2015.04-	-	-	F	Platform/Chassis Engine CFCA	801467	Outer Joint	38	30	63	102.5	67.5	I				
	2015.04-	-	L/R	F	Platform/Chassis Engine CFCA	261216	Stub Axle	26	37	50		145					
	2015.04-	7AT	L	F	Platform/Chassis Engine CFCA	203293	Drive Shaft	38	37	63	102.5	645					
2.0 TDI (62 kW)	2015.04-	-	R	F	Platform/Chassis Engine CXGA	261216	Stub Axle	26	37	50		145					
	2015.04-	MT	L	F	Platform/Chassis Engine CXGA	203278	Drive Shaft	38		63	102	643					
2.0 TDI (75 kW)	2015.04-	-	L/R	F	Platform/Chassis Engine CXGB	261216	Stub Axle	26	37	50		145					
	2015.04-	MT	L	F	Platform/Chassis Engine CXGB	203278	Drive Shaft	38		63	102	643					
2.0 TDI 4motion (103 kW)	2015.06-	-	-	F	All-wheel Drive Platform/Chassis Engine CAAC	801467	Outer Joint	38	30	63	102.5	67.5	I				
	2015.06-	-	L	R	All-wheel Drive Platform/Chassis Engine CAAC	661075	Inner Joint		28		26						
	2015.06-	-	R	F	All-wheel Drive Platform/Chassis Engine CAAC	261216	Stub Axle	26	37	50		145					
	2015.06-	7AT	L	F	All-wheel Drive Platform/Chassis Engine CAAC	203293	Drive Shaft	38	37	63	102.5	645					
2.0 TDI 4motion (110 kW)	2016.05-	-	-	F	All-wheel Drive Platform/Chassis Engine CXHA	801467	Outer Joint	38	30	63	102.5	67.5	I				
	2016.05-	7AT	L	F	All-wheel Drive Platform/Chassis Engine CXHA	203293	Drive Shaft	38	37	63	102.5	645					
2.0 TDI 4motion (132 kW)	2015.06-	-	L	R	All-wheel Drive Platform/Chassis Engine CFCA	661075	Inner Joint		28		26						
	2015.06-	-	-	F	All-wheel Drive Platform/Chassis Engine CFCA	801467	Outer Joint	38	30	63	102.5	67.5	I				
	2015.06-	-	L/R	F	All-wheel Drive Platform/Chassis Engine CFCA	261216	Stub Axle	26	37	50		145					
	2015.06-	7AT	L	F	All-wheel Drive Platform/Chassis Engine CFCA	203293	Drive Shaft	38	37	63	102.5	645					
2.0 TSI (110 kW)	2015.04-	-	-	F	Platform/Chassis Engine CJKB	801467	Outer Joint	38	30	63	102.5	67.5	I				
	2015.04-	-	L/R	F	Platform/Chassis Engine CJKB	261216	Stub Axle	26	37	50		145					
	2015.04-	7AT	L	F	Platform/Chassis Engine CJKB	203293	Drive Shaft	38	37	63	102.5	645					
TRANSPORTER VI (SGA SGH)																	
2.0 TDI (103 kW)	2015.04-	-	-	F	Box Engine CAAC	801467	Outer Joint	38	30	63	102.5	67.5	I				
	2015.04-	-	L/R	F	Box Engine CAAC	261216	Stub Axle	26	37	50		145					
	2015.04-	7AT	L	F	Box Engine CAAC	203293	Drive Shaft	38	37	63	102.5	645					
2.0 TDI (110 kW)	2015.04-	-	-	F	Box Engine CXFA	801467	Outer Joint	38	30	63	102.5	67.5	I				
	2015.04-	-	L/R	F	Box Engine CXFA	261216	Stub Axle	26	37	50		145					
	2015.04-	7AT	L	F	Box Engine CXFA	203293	Drive Shaft	38	37	63	102.5	645					
2.0 TDI (132 kW)	2015.04-	-	-	F	Box Engine CFCA	801467	Outer Joint	38	30	63	102.5	67.5	I				
	2015.04-	-	L/R	F	Box Engine CFCA	261216	Stub Axle	26	37	50		145					
	2015.04-	7AT	L	F	Box Engine CFCA	203293	Drive Shaft	38	37	63	102.5	645					





	 YEAR	TRANSM	L/R	F/R	REMARKS	GSP Ref.	 PRODUCT	 ABS	Technical Specifications							
									A	B	C	H	L	P		
VW																
TRANSPORTER VI (SGA SGH)																
2.0 TDI (150 kW)	2015.06-	-		R	F	Box Engine CXEB	261216	Stub Axle		26	37	50		145		
2.0 TDI (62 kW)	2015.04-	-		L/R	F	Box Engine CAAA	261216	Stub Axle		26	37	50		145		
	2015.04-	-	MT	L	F	Box Engine CAAA	203278	Drive Shaft		38		63	102	643		
2.0 TDI (75 kW)	2015.04-	-		L/R	F	Box Engine CAAB/CXGB	261216	Stub Axle		26	37	50		145		
	2015.04-	-	MT	L	F	Box Engine CAAB/CXGB	203278	Drive Shaft		38		63	102	643		
2.0 TDI 4motion (103 kW)	2015.06-	-		-	F	All-wheel Drive Box Engine CAAC	801467	Outer Joint		38	30	63	102.5	67.5	I	
	2015.06-	-		-	L	R	All-wheel Drive Box Engine CAAC	661075	Inner Joint			28		26		
	2015.06-	-		-	L/R	F	All-wheel Drive Box Engine CAAC	261216	Stub Axle		26	37	50		145	
	2015.06-	-	7AT	L	F	All-wheel Drive Box Engine CAAC	203293	Drive Shaft		38	37	63	102.5	645		
2.0 TDI 4motion (110 kW)	2015.08-	-		-	L	R	All-wheel Drive Box Engine CXHA	661075	Inner Joint			28		26		
	2015.08-	-		-	-	F	All-wheel Drive Box Engine CXHA	801467	Outer Joint		38	30	63	102.5	67.5	I
	2015.08-	-	7AT	L	F	All-wheel Drive Box Engine CXHA	203293	Drive Shaft		38	37	63	102.5	645		
	2015.08-	-		-	-	F	All-wheel Drive Box Engine CXHA	801467	Outer Joint		38	30	63	102.5	67.5	I
2.0 TDI 4motion (132 kW)	2015.06-	-		-	L	R	All-wheel Drive Box Engine CFCA	661075	Inner Joint			28		26		
	2015.06-	-		-	-	F	All-wheel Drive Box Engine CFCA	801467	Outer Joint		38	30	63	102.5	67.5	I
	2015.06-	-		-	L/R	F	All-wheel Drive Box Engine CFCA	261216	Stub Axle		26	37	50		145	
	2015.06-	-	7AT	L	F	All-wheel Drive Box Engine CFCA	203293	Drive Shaft		38	37	63	102.5	645		
2.0 TDI 4motion (150 kW)	2015.06-	-		-	L	R	All-wheel Drive Box Engine CXEB	661075	Inner Joint			28		26		
	2015.06-	-		-	R	F	All-wheel Drive Box Engine CXEB	261216	Stub Axle		26	37	50		145	
2.0 TSI (110 kW)	2015.04-	-		-	-	F	Box Engine CJKB	801467	Outer Joint		38	30	63	102.5	67.5	I
	2015.04-	-		-	R	F	Box Engine CJKB	261216	Stub Axle		26	37	50		145	
	2015.04-	-	7AT	L	F	Box Engine CJKB	203293	Drive Shaft		38	37	63	102.5	645		
2.0 TSI (150 kW)	2015.04-	-		-	-	F	Box Engine CJKB	801467	Outer Joint		38	30	63	102.5	67.5	I
	2015.04-	-		-	R	F	Box Engine CJKB	261216	Stub Axle		26	37	50		145	
	2015.04-	-	7AT	L	F	Box Engine CJKB	203293	Drive Shaft		38	37	63	102.5	645		
2.0 TSI 4motion (150 kW)	2015.06-	-		-	L	R	All-wheel Drive Box Engine CJKB	661075	Inner Joint			28		26		
	2015.06-	-		-	-	F	All-wheel Drive Box Engine CJKB	801467	Outer Joint		38	30	63	102.5	67.5	I
	2015.06-	-		-	R	F	All-wheel Drive Box Engine CJKB	261216	Stub Axle		26	37	50		145	
	2015.06-	-	7AT	L	F	All-wheel Drive Box Engine CJKB	203293	Drive Shaft		38	37	63	102.5	645		
TRANSPORTER VI (SGB SGG SGJ)/TRANSPORTER/CARAVELLE																
2.0 TDI (103 kW)	2015.04-	-		-	-	F	Bus Engine CAAC	801467	Outer Joint		38	30	63	102.5	67.5	I
	2015.04-	-		-	L/R	F	Bus Engine CAAC	261216	Stub Axle		26	37	50		145	
	2015.04-	-	7AT	L	F	Bus Engine CAAC	203293	Drive Shaft		38	37	63	102.5	645		
2.0 TDI (110 kW)	2015.04-	-		-	-	F	Bus Engine CXFA/CXHA	801467	Outer Joint		38	30	63	102.5	67.5	I
	2015.04-	-		-	L/R	F	Bus Engine CXFA/CXHA	261216	Stub Axle		26	37	50		145	
	2015.04-	-	7AT	L	F	Bus Engine CXFA/CXHA	203293	Drive Shaft		38	37	63	102.5	645		
2.0 TDI (132 kW)	2015.04-	-		-	-	F	Bus Engine CFCA	801467	Outer Joint		38	30	63	102.5	67.5	I
	2015.04-	-		-	R	F	Bus Engine CFCA	261216	Stub Axle		26	37	50		145	
	2015.04-	-	7AT	L	F	Bus Engine CFCA	203293	Drive Shaft		38	37	63	102.5	645		
2.0 TDI (150 kW)	2015.06-	-		-	L/R	F	Bus Engine CXEB	261216	Stub Axle		26	37	50		145	
2.0 TDI (62 kW)	2015.04-	-		-	L/R	F	Bus Engine CAAA	261216	Stub Axle		26	37	50		145	
	2015.04-	-	MT	L	F	Bus Engine CAAA	203278	Drive Shaft		38		63	102	643		
2.0 TDI (75 kW)	2015.04-	-		-	L/R	F	Bus Engine CAAB/CXGB	261216	Stub Axle		26	37	50		145	
	2015.04-	-	MT	L	F	Bus Engine CAAB/CXGB	203278	Drive Shaft		38		63	102	643		
2.0 TDI 4motion (103 kW)	2015.06-	-		-	L	R	All-wheel Drive Bus Engine CAAC	661075	Inner Joint			28		26		
	2015.06-	-		-	-	F	All-wheel Drive Bus Engine CAAC	801467	Outer Joint		38	30	63	102.5	67.5	I
	2015.06-	-		-	R	F	All-wheel Drive Bus Engine CAAC	261216	Stub Axle		26	37	50		145	
	2015.06-	-	7AT	L	F	All-wheel Drive Bus Engine CAAC	203293	Drive Shaft		38	37	63	102.5	645		
2.0 TDI 4motion (110 kW)	2015.08-	-		-	L	R	All-wheel Drive Bus Engine CXFA/CXHA	661075	Inner Joint			28		26		
	2015.08-	-		-	-	F	All-wheel Drive Bus Engine CXFA/CXHA	801467	Outer Joint		38	30	63	102.5	67.5	I
	2015.08-	-	7AT	L	F	All-wheel Drive Bus Engine CXFA/CXHA	203293	Drive Shaft		38	37	63	102.5	645		
2.0 TDI 4motion (132 kW)	2015.06-	-		-	L	R	All-wheel Drive Bus Engine CFCA	661075	Inner Joint			28		26		
	2015.06-	-		-	-	F	All-wheel Drive Bus Engine CFCA	801467	Outer Joint		38	30	63	102.5	67.5	I
	2015.06-	-		-	L/R	F	All-wheel Drive Bus Engine CFCA	261216	Stub Axle		26	37	50		145	
	2015.06-	-	7AT	L	F	All-wheel Drive Bus Engine CFCA	203293	Drive Shaft		38	37	63	102.5	645		
2.0 TDI 4motion (150 kW)	2015.06-	-		-	L	R	All-wheel Drive Bus Engine CXEB	661075	Inner Joint			28		26		
	2015.06-	-		-	L/R	F	All-wheel Drive Bus Engine CXEB	261216	Stub Axle		26	37	50		145	
2.0 TSI (110 kW)	2015.04-	-		-	-	F	Bus Engine CJKB	801467	Outer Joint		38	30	63	102.5	67.5	I
	2015.04-	-		-	L/R	F	Bus Engine CJKB	261216	Stub Axle		26	37	50		145	
	2015.04-	-	7AT	L	F	Bus Engine CJKB	203293	Drive Shaft		38	37	63	102.5	645		
2.0 TSI (150 kW)	2015.04-	-		-	-	F	Bus Engine CJKB	801467	Outer Joint		38	30	63	102.5	67.5	I
	2015.04-	-		-	R	F	Bus Engine CJKB	261216	Stub Axle		26	37	50		145	
	2015.04-	-	7AT	L	F	Bus Engine CJKB	203293	Drive Shaft		38	37	63	102.5	645		
2.0 TSI 4motion (150 kW)	2015.06-	-		-	L	R	All-wheel Drive Bus Engine CJKB	661075	Inner Joint			28		26		
	2015.06-	-		-	-	F	All-wheel Drive Bus Engine CJKB	801467	Outer Joint		38	30	63	102.5	67.5	I
	2015.06-	-		-	L/R	F	All-wheel Drive Bus Engine CJKB	261216	Stub Axle		26	37	50		145	
	2015.06-	-	7AT	L	F	All-wheel Drive Bus Engine CJKB	203293	Drive Shaft		38	37	63	102.5	645		

YEAR	TRANSM	L/R	F/R	REMARKS	GSP Ref.	PRODUCT	ABS	Technical Specifications						
								A	B	C	H	L	P	
VW														
TRANSPORTER/CARAVELLE														
2.0 TDI 103KW	2009-	-	-	L -	140HP 103KW (Diesel) MK V/MK VI	861060	Outer Joint		38	30	63	102.5	68	I
	2009-	-	-	L -	140HP 103KW (Diesel) MK V/MK VI	661104	Inner Joint		42	30	46.8		109	
UP (121122 BL1 BL2)														
1.0 (44 kW)	2011.08-	-	MT	L/R F	Hatchback Engine CHYA	850170	Outer Joint		22	26	46	78	53	M
	2011.08-	-	-	L F	Hatchback Engine CHYA	250567	Drive Shaft		22	28	46	78	650	
	2011.08-	-	-	R F	Hatchback Engine CHYA	250543	Drive Shaft		22	28	46	78	814	
	2011.08-	-	-	- F	Hatchback Engine CHYA	850153	Outer Joint		22	26	46	78	55	M
1.0 (55 kW)	2011.08-	-	-	L/R F	Hatchback Engine CHYB	850170	Outer Joint		22	26	46	78	53	M
	2011.08-	-	-	L F	Hatchback Engine CHYB	250567	Drive Shaft		22	28	46	78	650	
	2011.08-	-	-	R F	Hatchback Engine CHYB	250543	Drive Shaft		22	28	46	78	814	
	2011.08-	-	-	- F	Hatchback Engine CHYB	850153	Outer Joint		22	26	46	78	55	M
1.0 EcoFuel (50 kW)	2012.11-	-	MT	L/R F	Hatchback Engine CPGA	850170	Outer Joint		22	26	46	78	53	M
	2012.11-	-	-	L F	Hatchback Engine CPGA	250567	Drive Shaft		22	28	46	78	650	
	2012.11-	-	-	R F	Hatchback Engine CPGA	250543	Drive Shaft		22	28	46	78	814	
	2012.11-	-	-	- F	Hatchback Engine CPGA	850153	Outer Joint		22	26	46	78	55	M
VARIANT ALEMAO														
2.0	1988.01-	1997.12	MT/AT	- - -		661022	Inner Joint			33		34		
2.0 16V	1983.01-	1997.12	MT	- - -		661022	Inner Joint			33		34		
	1983.01-	1997.12	MT	- - -		803070	Outer Joint		36	30	53	78	60	I
	1990.01-	1997.12	AT	- - -		661022	Inner Joint			33		34		
	1990.01-	1997.12	AT	- - -		803070	Outer Joint		36	30	53	78	60	I
2.8	1988.01-	1997.12	MT/AT	- - -		661022	Inner Joint			33		34		
	1988.01-	1997.12	MT/AT	- - -		803070	Outer Joint		36	30	53	78	60	I
VARIANT/4MOTION/SANTANA(460)														
-	2006-	2007	-	R - -		261152	Drive Shaft		36	26	59.5	40	873	
VARIANT/4MOTION/SANTANA(627)														
-	2008-	2008	-	R - -		261152	Drive Shaft		36	26	59.5	40	873	
VARIANT/4MOTION/SANTANA(656)														
-	2009-	2011	-	R - -		261152	Drive Shaft		36	26	59.5	40	873	
VARIANT/SANTANA(460)														
-	2006-	2007	-	R -	Allwheel Drive	261152	Drive Shaft		36	26	59.5	40	873	
VARIANT/SANTANA(627)														
-	2008-	2008	-	R -	Allwheel Drive	261152	Drive Shaft		36	26	59.5	40	873	
VARIANT/SANTANA(656)														
-	2009-	2011	-	R -	Allwheel Drive	261152	Drive Shaft		36	26	59.5	40	873	
VENTO														
1.4	2011-	2016	-	- - -		201584	Drive Shaft		36		59.5	40	530	
1.8 CL GT	1991.11-	-	-	R - -		861015	Outer Joint		22	30	50	78	61	I
1.9 TDi	1991.11-	-	-	R - -		861015	Outer Joint		22	30	50	78	61	I
2.0 GT	1991.11-	-	-	R - -		861015	Outer Joint		22	30	50	78	61	I
VENTO (1H2)														
1.4 (40 kW)	1991.11-	1998.09	MT	L/R F	Saloon Engine ABD/AEX	653001	Inner Joint			33		32		
	1991.11-	1998.09	MT	- -	Saloon Engine ABD/AEX	603006	Inner Joint			33		34		
	1991.11-	1998.09	MT	L F	Saloon Engine ABD/AEX	261172	Drive Shaft		22		53	78	584.5	
	1991.11-	1998.09	MT	R F	Saloon Engine ABD/AEX	261067	Drive Shaft		22		51	78.7	781	
	1991.11-	1998.09	MT	L/R F	Saloon Engine ABD/AEX	853008	Outer Joint		22	30	53	78.5	51	I
	1991.11-	1998.09	MT	R F	Saloon Engine ABD/AEX	261055	Drive Shaft		22		53	78.5	796	
1.4 (44 kW)	1991.11-	1998.09	MT	L/R F	Saloon Engine ABD/AEX	653001	Inner Joint			33		32		
	1991.11-	1998.09	MT	- -	Saloon Engine ABD/AEX	603006	Inner Joint			33		34		
	1991.11-	1998.09	MT	L/R F	Saloon Engine ABD/AEX	603005	Inner Joint			33		32		
	1991.11-	1998.09	MT	L F	Saloon Engine ABD/AEX	261172	Drive Shaft		22		53	78	584.5	
	1991.11-	1998.09	MT	R F	Saloon Engine ABD/AEX	261067	Drive Shaft		22		51	78.7	781	
	1991.11-	1998.09	MT	L/R F	Saloon Engine ABD/AEX	853008	Outer Joint		22	30	53	78.5	51	I
	1991.11-	1998.09	MT	R F	Saloon Engine ABD/AEX	261055	Drive Shaft		22		53	78.5	796	
	1991.11-	1998.09	MT	R F	Saloon Engine ABD/AEX	261055	Drive Shaft		22		53	78.5	796	
1.6 (55 kW)	1992.09-	1998.09	MT	L/R F	Saloon Engine ABU/AEA/AEE	653001	Inner Joint			33		32		
	1992.09-	1998.09	MT	L/R F	Saloon Engine ABU/AEA/AEE	603004	Inner Joint			33		32		
	1992.09-	1998.09	MT	- -	Saloon Engine ABU/AEA/AEE	603006	Inner Joint			33		34		
	1992.09-	1998.09	-	- F	Saloon Engine ABU/AEA/AEE	853006	Outer Joint		22	30	50	78.5	52	I
	1992.09-	1998.09	MT	L F	Saloon Engine ABU/AEA/AEE	253004	Drive Shaft		22		50	78.5	562	
	1992.09-	1998.09	MT	L/R F	Saloon Engine ABU/AEA/AEE	603005	Inner Joint			33		32		
	1992.09-	1998.09	MT	L F	Saloon Engine ABU/AEA/AEE	261172	Drive Shaft		22		53	78	584.5	
	1992.09-	1998.09	MT	R F	Saloon Engine ABU/AEA/AEE	261067	Drive Shaft		22		51	78.7	781	
	1992.09-	1998.09	MT	L/R F	Saloon Engine ABU/AEA/AEE	853008	Outer Joint		22	30	53	78.5	51	I
	1992.09-	1998.09	MT	R F	Saloon Engine ABU/AEA/AEE	261055	Drive Shaft		22		53	78.5	796	
1.6 (74 kW)	1994.10-	1998.09	AT	L/R F	Saloon Engine AEK/AFT	853007	Outer Joint		22	30	53.2	78	61	I

	 YEAR	TRANSM	L/R	F/R	REMARKS	GSP Ref.	 PRODUCT	 ABS	Technical Specifications							
									A	B	C	H	L	P		
VW																
VENTO (1H2)																
1.6 (74 kW)	1994.10-1998.09	MT	L/R	F	Saloon Engine AEK/AFT	603004	Inner Joint			33		32				
	1994.10-1998.09	MT	L	F	Saloon Engine AEK/AFT	253004	Drive Shaft	22		50	78.5	562				
	1994.10-1998.09	MT	L/R	F	Saloon Engine AEK/AFT	603005	Inner Joint		33		32					
	1994.10-1998.09	AT	L	F	Saloon Engine AEK/AFT	261011	Drive Shaft	22		53.2	78	547				
	1994.10-1998.09	-	-	F	Saloon Engine AEK/AFT	853006	Outer Joint	22	30	50	78.5	52	I			
	1994.10-1998.09	AT	R	F	Saloon Engine AEK/AFT	261028	Drive Shaft	22		53.2	78	767				
	1994.10-1998.09	MT	L/R	F	Saloon Engine AEK/AFT	853008	Outer Joint	22	30	53	78.5	51	I			
1.8 (55 kW)	1994.10-1998.09	MT	R	F	Saloon Engine AEK/AFT	261055	Drive Shaft	22		53	78.5	796				
	1991.11-1998.09	MT	L/R	F	Saloon Engine AAM	853007	Outer Joint	22	30	53.2	78	61	I			
	1991.11-1998.09	MT	R	F	Saloon Engine AAM	603009	Inner Joint		33		34					
	1991.11-1998.09	MT	R	F	Saloon Engine AAM	261012	Drive Shaft	22		50	78	792				
	1991.11-1998.09	AT	L	F	Saloon Engine AAM	261011	Drive Shaft	22		53.2	78	547				
	1991.11-1998.09	MT	L	F	Saloon Engine AAM	261001	Drive Shaft	22		53.2	78	557				
	1991.11-1998.09	-	-	F	Saloon Engine AAM	853004	Outer Joint	22	30	51	78	61	I			
1.8 (66 kW)	1991.11-1998.09	MT	L	F	Saloon Engine AAM	603011	Inner Joint		33		34					
	1991.11-1998.09	AT/MT	L/R	F	Saloon Engine ADD	853007	Outer Joint	22	30	53.2	78	61	I			
	1991.11-1998.09	AT/MT	R	F	Saloon Engine ADD	603009	Inner Joint		33		34					
	1991.11-1998.09	AT/MT	R	F	Saloon Engine ADD	261012	Drive Shaft	22		50	78	792				
	1991.11-1998.09	MT	R	F	Saloon Engine ADD	261009	Drive Shaft	22		53.2	78	789				
	1991.11-1998.09	AT/MT	L	F	Saloon Engine ADD	261001	Drive Shaft	22		53.2	78	557				
	1991.11-1998.09	AT	L	F	Saloon Engine ADD	261011	Drive Shaft	22		53.2	78	547				
1.9 D (48 kW)	1991.11-1998.09	AT	R	F	Saloon Engine ADD	261028	Drive Shaft	22		53.2	78	767				
	1991.11-1998.09	-	-	F	Saloon Engine ADD	853004	Outer Joint	22	30	51	78	61	I			
	1991.11-1998.09	AT/MT	L	F	Saloon Engine ADD	603011	Inner Joint		33		34					
	1991.11-1998.09	MT	L/R	F	Saloon Engine 1Y	603004	Inner Joint		33		32					
	1991.11-1998.09	MT	-	-	Saloon Engine 1Y	603006	Inner Joint		33		34					
	1991.11-1998.09	MT	L/R	F	Saloon Engine 1Y	603005	Inner Joint		33		32					
	1991.11-1998.09	MT	L	F	Saloon Engine 1Y	253004	Drive Shaft	22		50	78.5	562				
1.9 SDI (47 kW)	1991.11-1998.09	MT	L/R	F	Saloon Engine 1Y	853008	Outer Joint	22	30	53	78.5	51	I			
	1991.11-1998.09	MT	R	F	Saloon Engine 1Y	261055	Drive Shaft	22		53	78.5	796				
1.9 SDI (47 kW)	1997.04-1998.09	MT	-	-	Saloon Engine AEY	603006	Inner Joint		33		34					
	1997.04-1998.09	-	-	F	Saloon Engine AEY	853006	Outer Joint	22	30	50	78.5	52	I			
1.9 TD (55 kW)	1991.11-1998.09	AT/MT	L/R	F	Saloon Engine AAZ	853007	Outer Joint	22	30	53.2	78	61	I			
	1991.11-1998.09	AT/MT	R	F	Saloon Engine AAZ	603009	Inner Joint		33		34					
	1991.11-1998.09	MT	R	F	Saloon Engine AAZ	261012	Drive Shaft	22		50	78	792				
	1991.11-1998.09	MT	-	-	Saloon Engine AAZ	603006	Inner Joint		33		34					
	1991.11-1998.09	MT	R	F	Saloon Engine AAZ	261009	Drive Shaft	22		53.2	78	789				
	1991.11-1998.09	AT/MT	L	F	Saloon Engine AAZ	261001	Drive Shaft	22		53.2	78	557				
	1991.11-1998.09	AT	L	F	Saloon Engine AAZ	261011	Drive Shaft	22		53.2	78	547				
	1991.11-1998.09	AT	R	F	Saloon Engine AAZ	261028	Drive Shaft	22		53.2	78	767				
	1991.11-1998.09	-	-	F	Saloon Engine AAZ	853004	Outer Joint	22	30	51	78	61	I			
1991.11-1998.09	AT/MT	L	F	Saloon Engine AAZ	603011	Inner Joint		33		34						
1.9 TDI (66 kW)	1993.09-1998.09	MT	R	F	Saloon Engine 1Z	603009	Inner Joint		33		34					
	1993.09-1998.09	MT	R	F	Saloon Engine 1Z	261012	Drive Shaft	22		50	78	792				
	1993.09-1998.09	MT	L	F	Saloon Engine 1Z	261011	Drive Shaft	22		53.2	78	547				
	1993.09-1998.09	MT	L	F	Saloon Engine 1Z	261001	Drive Shaft	22		53.2	78	557				
	1993.09-1998.09	-	-	F	Saloon Engine 1Z	853004	Outer Joint	22	30	51	78	61	I			
	1993.09-1998.09	MT	R	F	Saloon Engine 1Z	261002	Drive Shaft	22		53	78.5	793				
	1993.09-1998.09	MT	L/R	F	Saloon Engine 1Z	861018	Outer Joint	22	30	53	78.5	61	I			
1.9 TDI (81 kW)	1993.09-1998.09	MT	L	F	Saloon Engine 1Z	603011	Inner Joint		33		34					
	1996.04-1998.09	MT	R	F	Saloon Engine AFN	603009	Inner Joint		33		34					
	1996.04-1998.09	MT	R	F	Saloon Engine AFN	261012	Drive Shaft	22		50	78	792				
	1996.04-1998.09	MT	L	F	Saloon Engine AFN	261001	Drive Shaft	22		53.2	78	557				
	1996.04-1998.09	MT	R	F	Saloon Engine AFN	261002	Drive Shaft	22		53	78.5	793				
	1996.04-1998.09	-	-	F	Saloon Engine AFN	853004	Outer Joint	22	30	51	78	61	I			
	1996.04-1998.09	MT	L/R	F	Saloon Engine AFN	861018	Outer Joint	22	30	53	78.5	61	I			
2.0 (85 kW)	1996.04-1998.09	MT	L	F	Saloon Engine AFN	603011	Inner Joint		33		34					
	1991.11-1998.09	AT/MT	L/R	F	Saloon Engine ADY	853007	Outer Joint	22	30	53.2	78	61	I			
	1991.11-1998.09	MT	R	F	Saloon Engine ADY	261012	Drive Shaft	22		50	78	792				
	1991.11-1998.09	AT/MT	R	F	Saloon Engine ADY	603009	Inner Joint		33		34					
	1991.11-1998.09	MT	R	F	Saloon Engine ADY	261009	Drive Shaft	22		53.2	78	789				
	1991.11-1998.09	-	-	F	Saloon Engine ADY	853004	Outer Joint	22	30	51	78	61	I			
	1991.11-1998.09	AT/MT	L	F	Saloon Engine ADY	261001	Drive Shaft	22		53.2	78	557				
	1991.11-1998.09	AT	L	F	Saloon Engine ADY	261011	Drive Shaft	22		53.2	78	547				
	1991.11-1998.09	AT	R	F	Saloon Engine ADY	261028	Drive Shaft	22		53.2	78	767				
1991.11-1998.09	MT	L	F	Saloon Engine ADY	299116	Drive Shaft	36		53.2	77.5	548.5					

YEAR	TRANSM	L/R	F/R	REMARKS	GSP Ref.	PRODUCT	ABS	Technical Specifications						
								A	B	C	H	L	P	
VW														
VENTO (1H2)														
2.0 (85 kW)	1991.11-1998.09	MT	L/R	F	Saloon Engine ADY	803036	Outer Joint		36	30	53.2	77.5	61	I
	1991.11-1998.09	AT/MT	L	F	Saloon Engine ADY	603011	Inner Joint			33		34		
2.8 VR6 (128 kW)	1992.01-1998.09	MT	R	F	Saloon Engine AAA	603009	Inner Joint			33		34		
	1992.01-1998.09	MT	R	F	Saloon Engine AAA	261062	Drive Shaft	36			53.2	77.5	788	
	1992.01-1998.09	-	L	F	Saloon Engine AAA	299116	Drive Shaft	36			53.2	77.5	548.5	
	1992.01-1998.09	-	-	F	Saloon Engine AAA	853004	Outer Joint	22	30	51	78	61	I	
	1992.01-1998.09	MT	L/R	F	Saloon Engine AAA	803036	Outer Joint	36	30	53.2	77.5	61	I	
	1992.01-1998.09	MT	L	F	Saloon Engine AAA	603011	Inner Joint			33		34		
VENTO(449)														
-	2005-2010	-	L	-	-	261153	Drive Shaft		36	26	59.5	40	583	
	2005-2010	-	L	-	-	261153	Drive Shaft		36	26	59.5	40	583	
VENTO/JETTA VARIANT(619)														
-	2008-2009	-	L	-	-	261153	Drive Shaft		36	26	59.5	40	583	
	2008-2009	-	L	-	-	261153	Drive Shaft		36	26	59.5	40	583	
VENTO/JETTA VARIANT(685)														
-	2010-2014	-	L	-	-	261153	Drive Shaft		36	26	59.5	40	583	
	2010-2014	-	L	-	-	261153	Drive Shaft		36	26	59.5	40	583	
VENTO/SYNCRO(692)														
-	2011-2014	-	L	-	-	261153	Drive Shaft		36	26	59.5	40	583	
	2011-2014	-	L	-	-	261153	Drive Shaft		36	26	59.5	40	583	
VOYAGE														
1.5	1982.08-1989.10	MT	-	-	-	618019	Inner Joint			33		32		
1.6 AE	1987.01-1996.12	MT	-	-	-	618019	Inner Joint			33		32		
1.6 AP	1987.01-1996.12	MT	-	-	-	618019	Inner Joint			33		32		
VW (FAW)														
BORA														
1.6 (74 kW)	2008.11-2016.03	AT	L	F	Saloon Engine BWH	261124	Drive Shaft		36	26	53	78	604	
	2008.11-2016.03	AT	R	F	Saloon Engine BWH	261151	Drive Shaft		36	26	53	78	904	
2.0 (88 kW)	2008.11-2010.12	AT	L	F	Saloon Engine CEN	261124	Drive Shaft		36	26	53	78	604	
	2008.11-2010.12	AT	R	F	Saloon Engine CEN	261151	Drive Shaft		36	26	53	78	904	
JETTA														
1.6 (64 kW)	2000.04-2004.10	AT	R	-	Saloon Engine ATK	261130	Drive Shaft				53.2	78	754	
1.6 (68 kW)	2004.10-2010.12	AT	L	-	Saloon Engine BJG	261069	Drive Shaft				53.2	78	521	
	2004.10-2010.12	AT	R	-	Saloon Engine BJG	261130	Drive Shaft				53.2	78	754	
1.6 (70 kW)	2005.01-2013.12	AT	R	-	Saloon Engine BJG	261130	Drive Shaft				53.2	78	754	
1.6 (81 kW)	2013.03-	MT	R	F	Saloon Engine CPD	261130	Drive Shaft				53.2	78	754	
JETTA (1G2 1J2)														
1.6 (53 kW)	1991.05-1999.12	AT	L	-	Saloon Engine ABX/ACR	261069	Drive Shaft				53.2	78	521	
	1991.05-1999.12	MT	L	-	Saloon Engine ABX/ACR	261091	Drive Shaft				53.2	78	535	
	1991.05-1999.12	AT	R	-	Saloon Engine ABX/ACR	261130	Drive Shaft				53.2	78	754	
1.6 (64 kW)	1999.10-2000.04	AT	R	-	Saloon Engine ATK	261130	Drive Shaft				53.2	78	754	
	1999.10-2000.04	AT	L	-	Saloon Engine ATK	261069	Drive Shaft				53.2	78	521	
1.6 (74 kW)	1998.01-2002.01	AT	R	-	Saloon Engine ATK	261130	Drive Shaft				53.2	78	754	
	1998.01-2002.01	AT	L	-	Saloon Engine ATK	261069	Drive Shaft				53.2	78	521	
	1998.01-2002.01	MT	R	-	Saloon Engine ATK	261090	Drive Shaft				53.2	78	769	
	1998.01-2002.01	MT	L	-	Saloon Engine ATK	261091	Drive Shaft				53.2	78	535	
MAGOTAN (B6)														
1.8 TSI (118 kW)	2007.06-2011.07	6AT	R	F	Saloon Engine BYJ	261112	Drive Shaft		36	26	59.5	40	883	
	2007.06-2011.07	5MT	R	F	Saloon Engine BYJ	261132	Drive Shaft				59.5	40	806	
2.0 (85 kW)	2007.06-2008.04	6AT	R	F	Saloon Engine BJZ	261112	Drive Shaft		36	26	59.5	40	883	
2.0 TSi (147 kW)	2008.04-2011.07	AT	L	-	Saloon Engine CBL	261111	Drive Shaft		36	26	59.5	40	584	
	2008.04-2011.07	AT	R	-	Saloon Engine CBL	261112	Drive Shaft		36	26	59.5	40	883	
	2008.04-2011.07	AT	R	-	Saloon Engine CBL	261162	Drive Shaft		36		59.5	40	785	
MAGOTAN (B7L)														
1.8 TSI (118 kW)	2011.07-	AT	L	-	Saloon Engine CEA	261111	Drive Shaft		36	26	59.5	40	584	
	2011.07-	AT	R	-	Saloon Engine CEA	261112	Drive Shaft		36	26	59.5	40	883	
	2011.07-	AT	R	-	Saloon Engine CEA	261132	Drive Shaft		36		59.5	40	806	
2.0 TSI (147 kW)	2011.07-	AT	L	-	Saloon Engine CGM	261111	Drive Shaft		36	26	59.5	40	584	
	2011.07-	AT	R	-	Saloon Engine CGM	261112	Drive Shaft		36	26	59.5	40	883	
	2011.07-	AT	R	-	Saloon Engine CGM	261162	Drive Shaft		36		59.5	40	785	
SAGITAR														
1.4 TSI (96 kW)	2009.09-2012.12	AT	-	-	Saloon Engine CFB	203237	Drive Shaft		36		59.5	40	787	
1.6 (74 kW)	2006.02-2012.12	6AT	R	F	Saloon Engine BWH	254004	Drive Shaft		36	26	59.5	40	881	
	2006.02-2012.12	6AT	L	F	Saloon Engine BWH	261108	Drive Shaft		36	26	59.5	40	585	
	2006.02-2012.12	5MT	L	F	Saloon Engine BWH	261109	Drive Shaft		36		59.5	40	545	

YEAR	TRANSM	L/R	F/R	REMARKS	GSP Ref.	PRODUCT	ABS	Technical Specifications							
								A	B	C	H	L	P		
VW (FAW)															
SAGITAR															
1.6 (74 kW)	2006.02-	2012.12	5MT	R	F	Saloon Engine BWH	261110	Drive Shaft		36		59.5	40	796	
1.6 (77 kW)	2012.03-	2015.02	AT	R	-	Saloon Engine CLR	254004	Drive Shaft		36	26	59.5	40	881	
	2012.03-	2015.02	AT	L	-	Saloon Engine CLR	261108	Drive Shaft		36	26	59.5	40	585	
	2012.03-	2015.02	MT/AT	L	-	Saloon Engine CLR	261109	Drive Shaft		36		59.5	40	545	
	2012.03-	2015.02	MT/AT	R	-	Saloon Engine CLR	261110	Drive Shaft		36		59.5	40	796	
1.8 TSI (118 kW)	2008.07-	2012.12	MT	L	-	Saloon Engine BYJ	261114	Drive Shaft		36		59.5	40	524	
	2012.03-	-	-	R	F	Saloon Engine CDAA	261114	Drive Shaft		36		59.5	40	524	
1.8 TURBO (110 kW)	2006.04-	2008.04	MT	L	-	Saloon Engine BPL	261114	Drive Shaft		36		59.5	40	524	
2.0 (85 kW)	2006.04-	2009.06	AT	R	-	Saloon Engine BJZ	254004	Drive Shaft		36	26	59.5	40	881	
	2006.04-	2009.06	AT	L	-	Saloon Engine BJZ	261108	Drive Shaft		36	26	59.5	40	585	
2.0 GLI (147 kW)	2013.04-	-	AT	R	F	Saloon Engine CGM	254004	Drive Shaft		36	26	59.5	40	881	
	2013.04-	-	AT	L	F	Saloon Engine CGM	261108	Drive Shaft		36	26	59.5	40	585	
230 TSI (96 kW)	2012.03-	-	AT	-	-	Saloon Engine DAG	203237	Drive Shaft		36		59.5	40	787	
VW (SVW)															
LAVIDA															
1.4 TSI (96 kW)	2010.03-	2012.08	-	-	-	Saloon Engine CFB	261151	Drive Shaft		36	26	53	78	904	
	2012.09-	2013.12	-	-	-	Saloon Engine CFB	261151	Drive Shaft		36	26	53	78	904	
1.6 (77 kW)	2008.04-	2012.08	-	-	-	Saloon Engine CDE	261151	Drive Shaft		36	26	53	78	904	
	2012.08-	2014.12	-	-	-	Saloon Engine CPJ	261151	Drive Shaft		36	26	53	78	904	
1.6 (81 kW)	2013.03-	-	-	-	-	Saloon Engine CSRA	261151	Drive Shaft		36	26	53	78	904	
2.0 (88 kW)	2008.04-	2012.08	-	-	-	Saloon Engine CEN	261151	Drive Shaft		36	26	53	78	904	
PASSAT (B5)															
1.8 Turbo (110 kW)	2001.01-	2009.04	7AT	R	-	Saloon Engine AWL/BGC	261222	Drive Shaft		36		59.5	40	806	
	2001.01-	2009.04	6AT	L	-	Saloon Engine AWL/BGC	261232	Drive Shaft		36	26	59.5	40	600	
	2001.01-	2009.04	6AT	R	-	Saloon Engine AWL/BGC	261233	Drive Shaft		36	26	59.5	40	899	
2.0 (85 kW)	2003.02-	2009.04	-	L	-	Saloon Engine BFF	261229	Drive Shaft		36		59.5	40	498	
	2003.02-	2009.04	-	R	-	Saloon Engine BFF	261230	Drive Shaft		36		59.5	40	791	
PASSAT (B7)															
1.8 TSI (118 kW)	2011.04-	-	7AT	R	-	Saloon Engine CEA	261222	Drive Shaft		36		59.5	40	806	
	2011.04-	-	6AT	L	-	Saloon Engine CEA	261232	Drive Shaft		36	26	59.5	40	600	
	2011.04-	-	6AT	R	-	Saloon Engine CEA	261233	Drive Shaft		36	26	59.5	40	899	
2.0 TSI (147 kW)	2011.04-	-	-	L	-	Saloon Engine CGM	261229	Drive Shaft		36		59.5	40	498	
	2011.04-	-	-	R	-	Saloon Engine CGM	261230	Drive Shaft		36		59.5	40	791	
POLO															
1.4 (55 kW)	2002.01-	2006.03	MT	L	-	Hatchback Engine BCC	261041	Drive Shaft		36		52	75.5	518	
	2003.06-	2006.03	MT	L	-	Saloon Engine BCC	261041	Drive Shaft		36		52	75.5	518	
POLO (6R)															
1.4 GTI (96 kW)	2012.09-	-	MT	L	-	Hatchback Engine CFB	261041	Drive Shaft		36		52	75.5	518	
POLO JINQIN (9N3)															
1.4 (55 kW)	2006.06-	2007.12	MT	L	F	Hatchback Engine BCC/BMG	261041	Drive Shaft		36		52	75.5	518	
1.4 (63 kW)	2007.12-	2012.12	MT	L	F	Hatchback Engine CDD	261041	Drive Shaft		36		52	75.5	518	
POLO JINQU															
1.4 (55 kW)	2006.06-	2007.12	MT	L	F	Saloon Engine BMG	261041	Drive Shaft		36		52	75.5	518	
1.4 (63 kW)	2007.12-	2012.12	MT	L	F	Saloon Engine CDD	261041	Drive Shaft		36		52	75.5	518	
SANTANA 2000															
1.8 (66 kW)	1995.04-	2004.03	MT	L/R	-	Saloon Engine JV	261129	Drive Shaft		22		51	78	628	
1.8 (72 kW)	1996.04-	2004.03	MT	L/R	-	Saloon Engine AFE	261129	Drive Shaft		22		51	78	628	
1.8 (74 kW)	1998.05-	2004.03	MT	L/R	-	Saloon Engine AYJ	261129	Drive Shaft		22		51	78	628	
SANTANA 3000															
1.8 (74 kW)	2004.03-	2007.10	MT	L/R	-	Saloon Engine AYJ	261129	Drive Shaft		22		51	78	628	
	2004.03-	2007.10	AT	R	-	Saloon Engine AYJ	261168	Drive Shaft		22		51	78	576.5	
	2004.03-	2007.10	AT	L	-	Saloon Engine AYJ	261167	Drive Shaft		22		51	78	510.5	
	2005.06-	2007.10	MT	L/R	-	Saloon Engine BKT	261129	Drive Shaft		22		51	78	628	
	2005.06-	2007.10	AT	R	-	Saloon Engine BKT	261168	Drive Shaft		22		51	78	576.5	
	2005.06-	2007.10	AT	L	-	Saloon Engine BKT	261167	Drive Shaft		22		51	78	510.5	
2.0 (80 kW)	2006.05-	2007.10	MT	-	-	Saloon Engine BTL	261129	Drive Shaft		22		51	78	628	
	2006.05-	2007.10	AT	-	-	Saloon Engine BTL	261168	Drive Shaft		22		51	78	576.5	
TIGUAN (5N)															
300 TSI (118 kW)	2010.03-	-	AT	L	-	Closed Off-Road Vehicle Engine CEA	261148	Drive Shaft		36	26	59.5	40	564	
	2010.03-	-	AT	R	-	Closed Off-Road Vehicle Engine CEA	261149	Drive Shaft		36	26	59.5	40	905	
300 TSI 4motion (118 kW)	2010.03-	-	AT	L	-	All-wheel Drive Closed Off-Road Vehicle Engine CEA	261148	Drive Shaft		36	26	59.5	40	564	
	2010.03-	-	AT	R	-	All-wheel Drive Closed Off-Road Vehicle Engine CEA	261149	Drive Shaft		36	26	59.5	40	905	
330 TSI 4motion (147 kW)	2010.03-	-	AT/MT	-	-	All-wheel Drive Closed Off-Road Vehicle Engine CGM	261166	Drive Shaft		36	40	59.5	40	611	

	 YEAR	TRANSM	L/R	F/R	REMARKS	GSP Ref.	 PRODUCT	 ABS	Technical Specifications					
									A	B	C	H	L	P
ZASTAVA														
YUGO														
60 EFI (44 kW)	1991.08-1995.06	MT	L/R	F	Hatchback Engine 100 GL.0.64/11 E 1.064	804001	Outer Joint		20	20	43.1	90.5	60.5	O
65 EFI (48 kW)	1991.08-1995.06	MT	L/R	F	Hatchback Engine 13 E 1.064	804001	Outer Joint		20	20	43.1	90.5	60.5	O
YUGO FLORIDA														
1.1 (44 kW)	1989.08-2008.11	MT	L/R	F	Hatchback Engine 138 B.0000	804001	Outer Joint		20	20	43.1	90.5	60.5	O
1.3 (50 kW)	1991.03-2008.11	MT	L/R	F	Hatchback Engine 13 E.3.064	804001	Outer Joint		20	20	43.1	90.5	60.5	O
ZAZ														
TAVRIA (1102)														
1.1 (37 kW)	1989.01-2007.12	AT/MT	L/R	F	Hatchback Engine MEMZ-245	864001	Outer Joint		22	22	42	92	66	I
	1989.01-2007.12	MT	R	F	Hatchback Engine MEMZ-245	264002	Drive Shaft		22	22	42	92	818.5	
	1989.01-2007.12	-	L	F	Hatchback Engine MEMZ-245	264001	Drive Shaft		22	22	42	92	587	
1.3 (44 kW)	1989.01-2007.12	AT/MT	L/R	F	Hatchback Engine MEMZ-310	864001	Outer Joint		22	22	42	92	66	I
	1989.01-2007.12	MT	R	F	Hatchback Engine MEMZ-310	264002	Drive Shaft		22	22	42	92	818.5	
	1989.01-2007.12	-	L	F	Hatchback Engine MEMZ-310	264001	Drive Shaft		22	22	42	92	587	
ZHONGHUA(BRILLIANCE)														
JUNJIE FRV (A1)														
1.3 (65 kW)	2010.03-2015.12	AT	L	-	Hatchback Engine 4A13	239111	Drive Shaft		36	25	53	78.5	638	
	2010.03-2015.12	AT	R	-	Hatchback Engine 4A13	239112	Drive Shaft		36	25	53	78.5	925	
1.3 (69 kW)	2008.07-2010.03	AT/MT	L	-	Hatchback Engine 4G13S	239111	Drive Shaft		36	25	53	78.5	638	
	2008.07-2010.03	AT/MT	R	-	Hatchback Engine 4G13S	239112	Drive Shaft		36	25	53	78.5	925	
1.5 (75 kW)	2009.05-2015.12	AT	-	-	Hatchback Engine 4 A 15	275065	Drive Shaft		36	25	53	78.5	646	
1.6 (74 kW)	2008.05-2010.03	AT/MT	L	-	Hatchback Engine 4 G 18	239111	Drive Shaft		36	25	53	78.5	638	
	2008.05-2010.03	AT/MT	R	-	Hatchback Engine 4 G 18	239112	Drive Shaft		36	25	53	78.5	925	
JUNJIE WAGON														
1.8 (100 kW)	2008.12-2011.12	MT	R	F	Estate Engine 4 G 93	239130	Drive Shaft	43T	25	25	54	96	985	
	2008.12-2011.12	MT	L	F	Estate Engine 4 G 93	239131	Drive Shaft	43T	25	25	54	96	677.5	
1.8 T (125 kW)	2008.12-	MT	R	F	Estate Engine BL18T	239130	Drive Shaft	43T	25	25	54	96	985	
	2008.12-	MT	L	F	Estate Engine BL18T	239131	Drive Shaft	43T	25	25	54	96	677.5	
2.0 (95 kW)	2008.12-2015.12	MT	R	F	Estate Engine 4G63S4	239130	Drive Shaft	43T	25	25	54	96	985	
	2008.12-2015.12	MT	L	F	Estate Engine 4G63S4	239131	Drive Shaft	43T	25	25	54	96	677.5	
ZUNCHI (M1)														
2.0 (108 kW)	2009.07-2012.12	AT/MT	L	-	Saloon Engine 4G63S4N	299123	Drive Shaft	29T	25	25	53.8	95	677.5	
	2009.07-2012.12	AT/MT	R	-	Saloon Engine 4G63S4N	299124	Drive Shaft	29T	25	25	53.8	95	985	
2.0 (95 kW)	2004.12-2009.07	AT/MT	L	-	Saloon Engine 4 G 63/4G63S4M	299123	Drive Shaft	29T	25	25	53.8	95	677.5	
	2004.12-2009.07	AT/MT	R	-	Saloon Engine 4 G 63/4G63S4M	299124	Drive Shaft	29T	25	25	53.8	95	985	

COMPETITOR	GSP Ref.	COMPETITOR	GSP Ref.	COMPETITOR	GSP Ref.	COMPETITOR	GSP Ref.	COMPETITOR	GSP Ref.
GKN		304757	203318	305989	205112	303043	210069	305130	210239
		304761	203319	305983	205112	304009	210070	304539	210241
301429	201020	304749	203320	305984	205113	303058	210072	304540	210242
305399	201105	304926	203321	305981	205114	303056	210082	302876	210246
305651	201108	304924	203345	305982	205115	301927	210085	305338	210248
305650	201109	304773	203346	305438	205116	301936	210090	305340	210249
305292	201114	305071	203347	305996	205117	303046	210102	305339	210250
305243	201120	305070	203352	305125	205119	303047	210103	304940	210251
305293	201121	304766	203355	305997	205121	303045	210104	305043	210251
304548	201127	304288	203362	305158	205134	303042	210105	304941	210253
306155	201129	304297	203363	305291	205134	302436	210113	305040	210254
305073	201132	305072	203364	304672	205140	302437	210114	305039	210255
305726	201387	305659	203365	304671	205141	301791	210117	304542	210259
305725	201390	305707	203366	305294	205149	301793	210117	304577	210259
305721	201402	305774	203369	302817	208024	302917	210118	303681	210264
304756	201582	305818	203372	302819	208024	303055	210120	304580	210265
303530	202001	305395	203373	302821	208024	303579	210121	304579	210266
303531	202002	304284	203374	306057	208077	304642	210121	304595	210267
303532	202003	300681	205001	304686	208082	304571	210124	304685	210268
303533	202004	300645	205002	302823	209002	304570	210125	304541	210276
304370	202005	300695	205003	302825	209002	303062	210127	301507	210278
304759	202009	300693	205004	302824	209028	303250	210128	305406	210295
304376	202009	300694	205007	302826	209028	301918	210130	305343	210302
304377	202011	304622	205017	302818	209039	303253	210131	304581	210310
301222	203001	304496	205018	302820	209039	301912	210132	304586	210311
301218	203002	304477	205022	302822	209039	303351	210138	304644	210312
301258	203003	304480	205022	303467	210001	303582	210139	304645	210313
303162	203004	304478	205023	303468	210002	303580	210140	304987	210314
301219	203005	304479	205023	301929	210004	303581	210141	305432	210314
303161	203006	304495	205029	301905	210005	303578	210142	305578	210314
301223	203007	304469	205032	301921	210007	303577	210143	305662	210314
301288	203008	305162	205032	301926	210008	303466	210144	304988	210320
303160	203011	304471	205033	301925	210009	304573	210144	305577	210320
301209	203012	304472	205034	301803	210010	303465	210146	305663	210320
301290	203015	304481	205036	303057	210012	304572	210146	304942	210325
303314	203019	304482	205037	303513	210013	303469	210147	304989	210335
303315	203020	304473	205038	303061	210014	303348	210152	304986	210342
303922	203022	304475	205038	302919	210015	303059	210155	304648	210348
303592	203023	304483	205038	303060	210016	303344	210156	305042	210362
305532	203025	304474	205039	303238	210017	303347	210157	304946	210363
304615	203036	304476	205039	303241	210018	302916	210159	304730	210364
301260	203044	304484	205039	303242	210019	303343	210161	304945	210380
303154	203046	305046	205039	302928	210020	303493	210162	304646	210381
303156	203046	304470	205040	303247	210021	303252	210163	304647	210382
301289	203048	305048	205040	302420	210022	301928	210164	305045	210383
301307	203050	304682	205042	302441	210023	302912	210164	305579	210384
301313	203051	305729	205043	303251	210023	303248	210165	305412	210413
304617	203052	304666	205044	301508	210024	301933	210167	305409	210414
304291	203057	304620	205047	302440	210025	302877	210167	304574	210419
304292	203058	304621	205048	302918	210026	303249	210167	304576	210420
301247	203059	304497	205049	303243	210026	302929	210174	304944	210421
301320	203060	304498	205050	303244	210027	301830	210177	305091	210422
301321	203061	304740	205051	303463	210030	303471	210181	305093	210423
304443	203063	305728	205052	303464	210031	302884	210189	305094	210424
304844	203066	304214	205053	303053	210032	302939	210189	305098	210425
304500	203246	304215	205054	303052	210033	303576	210192	304943	210427
305504	203261	304673	205062	301924	210034	302879	210193	303679	210430
304764	203265	304663	205062	303048	210035	302880	210194	305097	210431
304767	203266	305159	205073	305831	210035	302881	210195	305341	210435
304505	203267	304664	205074	303049	210036	302882	210196	305100	210440
305771	203270	304674	205074	303044	210037	302883	210197	301903	211001
304923	203273	304880	205075	301932	210038	302885	210199	303521	211002
305652	203278	304881	205076	301920	210039	302930	210200	303522	211003
305508	203279	304668	205078	301930	210040	302940	210202	301850	211004
304746	203294	304670	205078	303237	210040	302938	210202	304511	211012
304758	203294	304662	205078	301931	210042	303240	210203	304512	211012
304762	203294	305047	205079	303199	210043	303245	210204	304513	211014
304748	203295	305160	205079	303239	210043	303246	210205	304514	211014
305510	203296	305394	205085	301804	210044	303472	210206	302972	217001
301257	203297	304807	205091	303349	210048	303583	210207	305809	217013
304547	203300	304788	205098	303350	210049	303584	210208	303700	217015
305069	203310	305646	205104	303054	210052	305396	210218	303701	217016
305078	203311	305647	205105	303680	210057	305396	210225	303656	217018
304752	203313	305706	205106	303051	210066	304785	210231	303687	217020
305067	203316	305227	205107	303050	210067	304784	210232	303688	217021
305068	203317	305953	205110	301923	210068	305129	210238	303657	217022

COMPETITOR	GSP Ref.	COMPETITOR	GSP Ref.	COMPETITOR	GSP Ref.	COMPETITOR	GSP Ref.	COMPETITOR	GSP Ref.
GKN		301357	218179	302843	235002	304410	244038	301785	245111
		305156	218194	303152	235003	304411	244039	303575	245113
303648	217025	305254	218197	300745	235004	305055	244040	303574	245119
304366	217032	304532	218201	300749	235005	305056	244042	303682	245120
304367	217033	304531	218202	300689	235006	304420	244044	303570	245126
303658	217037	304537	218216	303355	235007	304400	244045	305131	245133
302971	217038	305486	218216	303356	235008	305204	244051	301829	245134
303659	217039	304538	218217	303357	235009	305205	244052	302924	245135
304907	217040	305344	218218	302865	235010	301708	244059	302925	245136
303650	217041	305345	218219	304515	235022	305789	244065	303215	245137
305057	217044	305466	218231	305790	235032	305719	244068	303214	245138
303653	217048	305467	218232	304378	235037	304401	244075	302921	245150
305815	217050	305716	218242	305034	235037	305051	244078	302922	245151
305814	217053	305484	218247	304379	235038	305059	244078	303488	245152
304526	217054	305485	218248	305553	235054	305060	244078	302429	245153
305862	217055	305711	218259	305792	235055	305052	244079	304791	245157
305838	217064	305712	218260	304806	235084	305058	244079	304792	245158
304656	217066	305035	218263	305621	235085	304875	244080	301842	245160
304660	217066	305036	218264	304544	235086	305218	244092	301838	245167
305054	217070	305655	218265	305441	235086	305222	244093	302920	245182
305053	217071	304781	218271	304549	235087	305223	244094	304593	245193
304655	217082	304779	218274	304218	238001	304398	244095	304592	245194
303649	217114	305157	218280	304219	238002	304399	244096	301792	245197
305275	217122	304270	218284	304213	238003	304432	244097	301837	245198
304658	217146	301347	218289	301376	241001	304433	244098	304590	245200
304659	217147	305103	218291	301375	241004	305206	244099	304591	245201
305830	217149	305064	218291	301377	241005	305220	244100	304594	245202
305585	217170	304783	218301	301394	241024	301802	245001	304588	245203
305586	217171	304535	218309	301374	241094	302923	245002	304589	245204
304657	217172	304536	218326	301378	241130	301799	245003	305401	245220
303683	217185	305116	218327	304999	241261	301834	245004	305402	245223
303684	217186	305126	218328	304889	241262	301788	245005	305749	245225
303652	217187	305127	218329	305330	241327	302926	245007	304731	245226
303654	217188	304534	218333	305329	241328	301848	245008	300758	248001
303655	217189	305907	218343	305168	241365	303208	245009	302946	248002
304374	217190	304533	218351	305853	241365	303209	245010	300672	248003
304375	217191	305104	218358	305000	241407	303207	245011	301878	250001
304522	217192	305105	218359	305002	241408	303206	245012	301879	250002
304523	217193	305468	218402	304998	241409	301795	245013	301873	250003
304568	217194	305584	218434	305166	241441	301835	245014	303233	250004
304368	217201	305713	218435	304995	241451	301801	245015	301849	250005
304369	217206	305403	218455	305001	241452	303217	245016	301859	250006
302403	218001	304450	218456	305012	241453	302427	245017	301883	250007
302400	218002	304448	218457	304996	241463	303489	245020	302888	250008
302405	218002	304519	218471	304997	241463	301836	245021	303064	250009
302404	218003	305582	218472	304797	241464	301510	245022	303220	250010
302406	218004	304874	221032	305165	241475	301509	245023	303221	250011
302397	218005	304873	221032	305327	241509	302428	245024	301861	250012
302399	218006	305212	221035	305328	241510	301833	245025	301862	250013
303545	218007	305213	221045	305167	241577	303490	245026	301890	250014
302831	218008	305207	221051	302385	244001	303202	245027	301891	250015
302835	218008	305211	221051	301505	244002	301798	245029	301893	250016
302830	218009	305233	221053	305224	244002	301797	245030	303234	250017
302832	218009	304431	221056	303495	244003	303204	245031	303461	250019
302834	218009	305202	221056	303219	244004	303205	245032	301887	250020
302838	218010	305408	221061	303218	244005	301832	245033	303065	250021
304272	218015	304435	221062	301885	244006	301831	245034	301886	250022
302398	218016	304428	221063	301709	244011	303203	245035	301865	250023
304273	218019	304434	221071	303503	244012	301796	245036	301870	250024
305710	218036	305210	221073	303496	244013	301789	245066	301866	250025
301359	218039	305918	221074	301706	244014	301922	245068	302908	250026
301360	218040	305234	221092	303502	244016	301841	245070	303067	250027
305037	218041	304278	223038	303500	244017	301847	245070	303078	250028
304232	218042	304279	223039	304906	244020	304507	245084	303066	250029
301358	218044	301430	223040	303514	244021	304508	245084	301858	250030
304233	218046	304275	223078	303498	244022	304509	245085	302435	250031
304234	218101	304274	223122	304405	244026	304510	245085	301869	250032
304236	218101	305928	223198	304404	244027	303200	245094	301876	250033
304235	218102	305601	223199	304426	244028	303216	245101	302906	250034
302833	218106	301467	228001	304424	244029	303470	245103	302905	250035
301346	218118	301468	228002	304427	244030	303571	245104	301880	250036
301369	218127	305644	230003	304425	244031	303572	245105	301881	250037
300659	218128	305643	230004	305219	244032	303491	245106	303455	250038
300660	218129	303786	234044	304415	244033	303494	245108	303615	250039
303544	218140	305112	234163	303553	244036	301845	245110	301895	250041
305709	218142	300690	235001	303554	244037	301786	245111	303550	250043

COMPETITOR	GSP Ref.	COMPETITOR	GSP Ref.	COMPETITOR	GSP Ref.	COMPETITOR	GSP Ref.	COMPETITOR	GSP Ref.
GKN		304343	250313	305188	250452	301715	253001	304750	261042
		303616	250314	305602	250453	301718	253002	303153	261045
303624	250043	303457	250316	304922	250455	301532	253003	303155	261045
301867	250044	302901	250319	304851	250460	301537	253003	302379	261052
302903	250046	303456	250320	302911	250461	301534	253004	301322	261052
302899	250047	303614	250323	304464	250462	301548	253004	302375	261052
301889	250050	303617	250324	304468	250462	301533	253005	301542	261054
301872	250052	303620	250325	305592	250465	301538	253005	301552	261055
303077	250054	303621	250326	304344	250471	301519	253006	301554	261055
303076	250055	303622	250327	305194	250483	304755	253007	300666	261056
303507	250057	303632	250328	305478	250493	304356	253010	304444	261063
303499	250058	303633	250329	304895	250494	301470	254001	302837	261065
303508	250059	303634	250330	304970	250495	301469	254002	301553	261067
303515	250060	303641	250331	304911	250496	304751	254011	304442	261074
303073	250074	304465	250339	304782	250497	304747	254013	304441	261075
302904	250093	305111	250346	304005	250506	305531	254013	303925	261082
301900	250095	304719	250348	305186	250514	302840	257039	303924	261083
303071	250099	304733	250353	305187	250515	302839	257040	304501	261084
303072	250100	305193	250353	304725	250516	305110	257077	304506	261084
304365	250102	304710	250354	304711	250517	305109	257078	304491	261084
302889	250105	304726	250354	304717	250518	305474	257165	302836	261085
303080	250130	304467	250356	304721	250519	304871	257197	305483	261087
303068	250131	303231	250357	304855	250520	304869	257221	301623	261092
302907	250134	303613	250358	304959	250521	304868	257222	304760	261093
301877	250138	304364	250359	304960	250522	304870	257223	304769	261094
301855	250145	305580	250364	304961	250523	305314	257265	304753	261096
301899	250150	304567	250365	304971	250524	304949	259268	304445	261098
303228	250150	304845	250366	305030	250525	304947	259316	304446	261099
303229	250151	304712	250369	305031	250526	304948	259317	305785	261100
303742	250160	304724	250372	304006	250527	304950	259447	305786	261101
305535	250162	305258	250373	304004	250527	305414	259493	304499	261105
303505	250166	304967	250377	305139	250538	305418	259494	304286	261115
302896	250171	305319	250379	305140	250539	304786	259495	304294	261115
304303	250193	304910	250380	305575	250540	305425	259520	301323	261119
304301	250194	305766	250383	305029	250541	305419	259552	303927	261121
303549	250197	305257	250386	305136	250542	305423	259553	301220	261122
303069	250199	303619	250389	305135	250544	305421	259589	304351	261123
303462	250200	304258	250390	304715	250554	305417	259621	304775	261126
301868	250201	304259	250391	305656	250557	305416	259633	305753	261133
301888	250205	304857	250391	304713	250562	305624	259635	304502	261140
303625	250207	304260	250392	305362	250570	305625	259636	305769	261147
304849	250207	304261	250393	305541	250571	305415	259657	305752	261150
303629	250208	304300	250394	305574	250572	305420	259658	305251	261156
303459	250211	304302	250395	305446	250573	305424	259659	304287	261157
303501	250214	304461	250397	305434	250574	305422	259660	301551	261172
302898	250215	304466	250398	303235	250579	305413	259662	304618	261183
303630	250219	304565	250399	305545	250586	301506	260002	305820	261184
304563	250219	304687	250400	305544	250587	302386	260002	304352	261186
303460	250221	304802	250400	303236	250588	304414	260013	305617	261190
304969	250223	304689	250401	303627	250590	304418	260013	305616	261191
303631	250226	304716	250402	305321	250591	305232	260016	305900	261192
303636	250227	304718	250403	305322	250592	304780	260022	304859	261204
303626	250228	304853	250404	305363	250593	305449	260022	304504	261210
304800	250245	304860	250405	304918	250596	305215	260026	304774	261211
303497	250246	304899	250405	305318	250604	305214	260027	305896	261213
303079	250247	305603	250410	305357	250605	304419	260035	305895	261215
303458	250247	305195	250411	304919	250622	301241	261001	304826	261223
303504	250249	305312	250416	305904	250625	301242	261002	304763	261224
303081	250252	305026	250423	304007	250627	303167	261003	304850	261236
303612	250253	305324	250425	305909	250630	303165	261004	305618	261238
304723	250256	305326	250426	305908	250632	300669	261005	304285	261243
304972	250260	305765	250427	304003	250634	300671	261005	304616	261252
304805	250261	305903	250428	301423	251001	301716	261006	304528	261257
304973	250263	305317	250429	301574	251004	303546	261007	305295	261257
305536	250263	304463	250437	301424	251010	304847	261007	304529	261258
303637	250268	304690	250438	304456	251021	301535	261008	305296	261258
303070	250271	304338	250440	301425	251023	301547	261008	305819	261267
304862	250279	304342	250441	305626	251036	301722	261009	305768	261296
305255	250280	304777	250442	304518	251068	303547	261010	305444	261298
303628	250281	304778	250442	304447	251069	301619	261011	304353	261312
304337	250284	304714	250443	304449	251070	301287	261019	303159	261312
303074	250295	304852	250444	304517	251071	305821	261025	303157	261314
303075	250296	304569	250445	304520	251072	301620	261028	304546	261323
301857	250300	304562	250446	302950	252001	300636	261031	304776	261342
302910	250301	304688	250447	302949	252001	304360	261033	301397	262001
303623	250311	304951	250451	302951	252002	302380	261034	301771	262001

COMPETITOR	GSP Ref.	COMPETITOR	GSP Ref.	COMPETITOR	GSP Ref.	COMPETITOR	GSP Ref.	COMPETITOR	GSP Ref.
GKN		302262	603009	302086	801001	303556	803027	302801	812019
		302257	603011	302080	801002	302153	803029	302803	812019
301398	262002	302261	603011	306193	801352	301048	803031	303339	812021
305561	262022	302249	603014	303270	802002	302152	803031	303908	812023
305515	262025	302217	603019	303113	802003	301939	803032	303906	812027
305516	262026	302233	603020	303117	802003	302151	803032	303910	812027
305513	262029	304558	603027	300913	802004	302941	803033	302451	812034
305560	262031	302225	605001	300919	802004	302961	803033	303173	812039
305514	262034	304608	610038	302001	802004	302962	803033	303836	814002
305664	262039	304605	617020	302002	802004	300846	803034	302026	814003
304743	262060	304610	617021	302006	802004	301940	803034	303976	814004
304744	262063	304609	617022	302009	802004	303551	803035	301968	814005
305722	262136	304603	617028	303112	802005	300905	803036	300894	814006
301421	264001	304606	617042	303114	802006	302024	803036	301990	814006
301422	264002	301142	618001	303118	802006	302963	803036	303975	814007
305469	275056	302238	618001	301086	802007	304327	803037	303830	814010
303492	299003	302207	618002	302188	802007	302059	803038	301967	814012
303345	299006	302252	618070	302189	802007	300850	803051	302784	814013
302914	299007	302875	634032	303115	802008	301951	803051	302449	814015
302915	299009	303540	635001	302025	802009	304331	803058	302366	814020
303346	299010	302271	635006	302190	802011	304335	803067	302450	814020
304796	299037	304832	635014	303196	802012	304952	803077	303835	814027
305038	299042	304904	635020	303275	802012	304735	803085	303912	814030
303661	299049	304559	635051	303194	802013	304956	803086	303832	814033
304745	299070	301124	644001	303273	802013	304958	803087	303831	814046
304801	299070	302228	644001	303609	802014	304954	803087	303833	814073
304339	299071	301144	644002	302004	802015	304962	803088	303834	814074
304341	299071	302253	644002	303193	802017	305119	803092	300886	817001
301210	299108	301123	644004	303272	802017	302203	803106	301976	817001
301221	299111	302227	644004	303914	802018	300946	804001	301977	817001
303313	299113	302254	644005	302456	802019	300948	804001	301980	817001
303923	299120	301174	648001	300932	802021	302035	804001	300906	817002
303506	299151	302299	648001	302187	802021	302038	804001	301041	817002
305221	299157	301169	648002	305364	802024	303892	808002	301997	817002
301840	299161	302297	648002	304811	802025	300936	808004	302141	817002
304564	299186	302303	648002	305366	802026	302027	808004	301998	817003
304856	299188	301138	648003	304329	803002	303900	808021	302011	817003
304582	299190	302267	648003	302193	803003	303898	808034	300918	817004
304583	299191	301129	648004	301047	803004	302075	809002	302007	817004
305404	299194	301136	648004	302149	803004	302988	809002	302008	817004
305348	299195	302240	648004	302155	803005	302989	809002	300947	817005
305349	299196	302241	648004	301052	803006	302990	809002	302036	817005
304643	299197	302251	648004	302150	803006	302983	809003	300883	817006
304340	299201	302266	648004	300971	803007	300981	809004	301974	817006
304545	299213	302277	648004	302060	803007	302073	809004	304380	817007
305132	299214	301117	653001	304623	803007	300979	810001	303195	817009
304667	299215	302215	653001	301027	803008	302070	810001	303274	817009
304669	299215	302229	653001	302128	803008	303403	810002	303608	817009
304665	299215	302317	654002	301026	803009	303474	810002	300866	817010
304798	299217	302318	654003	302129	803009	303434	810003	301966	817010
304993	299228	301177	661001	300853	803012	303475	810003	303269	817011
304994	299229	302305	661001	301950	803012	303435	810004	301979	817012
305027	299229	302374	661002	302181	803013	303430	810005	302010	817013
304585	299271	302464	661002	301075	803014	303535	810006	303189	817014
304587	299271	301137	661003	302182	803014	303536	810007	303268	817014
304584	299272	302255	661003	302183	803014	301092	810010	303188	817017
304212	299285	302269	661003	300855	803016	302199	810010	303267	817017
305191	299286	305530	661006	301952	803016	302995	810011	300915	817018
301103	602001	304837	661020	301953	803016	302997	810011	303266	817019
302211	602001	304841	661021	301954	803016	303099	810012	303186	817020
302282	602004	304843	661029	300857	803017	303096	810013	303265	817020
304313	602011	303999	661030	301957	803017	303098	810013	302452	817021
302287	603001	304839	661041	301960	803017	304816	810015	302453	817022
302463	603001	305400	661057	300841	803018	304818	810015	303111	817023
301134	603002	301126	662015	301955	803018	304799	810018	304900	817024
302246	603002	302243	662015	300856	803019	303537	810021	303921	817026
302248	603002	301149	699052	301961	803019	303405	810024	303920	817028
302247	603003	302273	699052	301962	803019	303936	810025	304964	817028
302260	603003	302307	699075	304333	803019	303928	810026	303607	817030
301116	603004	302644	699099	301956	803020	303407	810043	303916	817031
302230	603004	302702	699099	303409	803021	302998	810050	303116	817032
302231	603004	302721	699099	303408	803021	303565	810075	300884	817039
302232	603004	302279	699143	302031	803022	303419	810086	301975	817039
301141	603006	304556	699148	302061	803023	303174	812001	301978	817039
305021	603008	300992	801001	303557	803024	302984	812006	303271	817042
302258	603009	302085	801001	302184	803026	302985	812006	304653	817043

COMPETITOR	GSP Ref.	COMPETITOR	GSP Ref.	COMPETITOR	GSP Ref.	COMPETITOR	GSP Ref.	COMPETITOR	GSP Ref.
GKN		302083	823005	302814	831001	301989	841001	303358	844030
		302084	823005	301965	832001	303336	841003	303934	844034
304598	817045	300994	823006	301069	834001	303337	841003	300976	844041
304383	817051	302089	823006	302174	834001	302015	841006	302065	844041
304697	817051	302091	823006	301017	834002	302016	841007	302066	844041
304613	817052	302049	823007	302112	834002	302017	841008	302067	844046
304611	817053	302050	823008	300898	834003	300891	841009	300978	844051
305198	817053	300958	823010	301995	834003	301987	841009	302069	844051
304601	817055	302047	823010	301993	834004	301988	841010	300977	844055
304600	817060	300996	823011	303181	834005	303126	841011	302068	844055
305152	817063	302096	823011	303183	834005	303311	841012	301065	844056
305150	817070	302458	823011	303184	834006	303308	841013	302169	844056
303743	818002	302013	823013	300896	834007	303310	841013	301064	844057
303384	818003	302014	823014	301994	834007	303862	841016	302170	844057
303385	818003	300847	823016	303365	834008	303288	841021	305184	844085
300872	818004	301941	823016	303369	834008	303860	841021	305490	844090
302870	818004	301942	823016	303367	834010	304912	841025	303432	845001
300881	818006	300842	823017	303371	834010	303447	841028	303431	845004
301973	818006	301943	823017	305300	834015	303380	841030	303400	845006
302871	818006	300997	823018	302592	834019	303858	841031	303401	845006
303610	818007	300998	823021	302634	834019	304821	841037	303473	845011
302857	818011	302087	823021	302762	834025	303305	841040	303930	845033
303085	818011	302088	823021	302786	834025	303307	841040	303931	845045
302869	818012	302094	823021	303366	834026	303122	841045	305360	845058
302872	818012	301986	823022	303370	834026	304729	841046	303997	845065
303332	818013	303837	823023	303848	834056	305241	841047	304543	845067
303333	818013	303840	823024	303985	834072	304820	841048	303433	850008
301972	818015	301944	823026	303849	834080	304803	841052	303561	850026
303436	818016	303321	823028	301996	834081	304809	841057	303562	850056
302030	818017	303322	823028	302977	834082	303304	841058	303563	850105
300938	818018	304683	823030	303850	834100	303306	841058	305517	850150
302029	818018	303843	823032	305461	834110	302097	841059	305522	850152
300879	818019	304310	823033	303746	834130	301000	841060	305521	850161
301971	818019	305457	823033	304691	834135	302098	841060	305834	850170
302054	818019	305304	823034	302854	835001	302018	841061	302137	851001
300900	818021	304734	823036	303095	835001	302793	841063	302138	851001
302455	818021	305303	823039	305805	835001	302100	841073	301032	851002
302856	818024	302090	823041	303382	835002	300902	841078	302132	851002
303084	818024	300989	823042	303882	835004	302019	841078	303480	851003
303511	818025	302082	823042	303878	835005	302789	841078	303481	851004
303509	818026	302095	823042	302186	835018	302766	841083	302133	851005
301016	818027	302171	823044	303880	835022	302790	841083	302134	851006
302111	818027	303320	823047	303876	835023	303091	841084	303486	851007
302792	818028	303981	823047	304829	835026	304722	841086	302046	851009
303851	818029	303842	823059	302461	835033	302020	841087	300963	851010
300869	818030	303363	823063	304902	835034	303285	841095	302052	851010
302982	818030	300844	823071	304704	838002	305763	841142	303476	851011
302023	818031	301945	823071	304706	838003	302638	841163	300954	851012
302787	818032	302172	823081	302012	839001	300904	841168	302042	851012
302783	818033	303838	823083	301984	839002	302021	841168	302044	851013
303325	818034	303839	823083	303523	839007	302099	841170	302136	851017
303326	818034	304699	823095	303590	839008	300945	841172	303412	851020
302763	818035	303990	823159	300877	839009	302034	841172	302459	852001
302788	818035	303902	824002	301985	839009	304890	841240	301056	852002
303988	818036	303874	824004	301982	839011	305519	841244	302165	852002
305346	818067	303869	824011	302631	839014	305458	841284	302162	852003
305176	818203	305305	824036	303317	839015	302033	841287	302160	852004
305358	818207	304695	824041	303393	839016	303861	841314	302164	852004
305023	818230	303904	824046	303394	839016	304459	844001	302201	852007
302758	821001	305003	824095	301983	839019	304391	844002	301062	852010
302752	821002	305007	824152	303527	839021	304384	844003	302167	852010
302778	821002	303886	824173	303529	839022	304388	844004	302200	852011
304863	821038	302753	826001	304304	839024	304390	844005	304325	853001
301014	822001	302779	826001	302637	839027	302816	844006	304436	853002
302109	822001	302640	826003	303390	839036	302863	844006	302764	853005
300874	822002	302969	827001	303391	839036	302861	844007	302796	853005
301981	822002	303984	827003	300951	839040	304458	844011	301070	853007
304701	823001	303120	827005	302076	839040	303890	844013	301947	853007
303487	823002	303281	827007	302074	839054	303888	844014	302175	853007
300984	823003	303295	827010	303852	839054	302454	844020	302177	853007
302077	823003	305005	827080	303745	839084	304596	844020	301023	853008
302078	823003	301030	828002	303525	839098	303438	844025	302118	853008
300988	823004	302130	828002	304306	839102	303437	844026	302123	853008
302081	823004	300952	828005	302319	840001	304397	844027	302041	854001
302093	823004	302040	828005	302794	840001	304386	844028	303001	854001
300991	823005	302457	829001	300893	841001	303342	844030	303555	854002

COMPETITOR	GSP Ref.	COMPETITOR	GSP Ref.	COMPETITOR	GSP Ref.	COMPETITOR	GSP Ref.	COMPETITOR	GSP Ref.
GKN		305297	859154	25428	201108	25436	203365	20147	209028
		303868	859155	25427	201109	25484	203366	20149	209028
304624	854004	302799	859161	25068	201114	25581	203369	20141	209039
302106	856001	302860	859161	24994	201120	25172	203373	20143	209039
300929	856003	304650	859167	25069	201121	23608	203374	20145	209039
302022	856003	305309	859168	24228	201127	20541	205001	22115	210001
300848	856004	305450	859175	25961	201129	21998	205002	22116	210002
301946	856004	305252	859213	24814	201132	23568	205003	20654	210004
300895	856005	304823	859226	25530	201386	23564	205004	20606	210005
301991	856005	305133	860005	25532	201387	22000	205007	21616	210007
302781	856006	301018	861001	25531	201390	24306	205017	20607	210008
303986	856007	302113	861001	25498	201402	24149	205018	20650	210008
305465	856009	301022	861002	24483	201582	24130	205022	20649	210009
303987	856010	302117	861002	21576	202001	24133	205022	21638	210010
301007	856011	302122	861002	21577	202002	24131	205023	20955	210012
302102	856011	300861	861003	21578	202003	24132	205023	21644	210013
301009	856012	301963	861003	21579	202004	24148	205029	20959	210014
302104	856012	300862	861004	23788	202005	24122	205032	23353	210015
301012	856013	301964	861004	24486	202009	24903	205032	20958	210016
302107	856013	302363	861005	23795	202011	24124	205033	21116	210017
300868	856014	302446	861005	22684	203001	24125	205034	21122	210018
301969	856014	303450	861005	22683	203002	24134	205036	21123	210019
302782	856030	302447	861006	22538	203003	24135	205037	21697	210020
303870	856039	303451	861006	21021	203004	24126	205038	21128	210021
302173	856046	304814	861007	22685	203005	24128	205038	21673	210022
303871	856053	303993	861009	21020	203006	24136	205038	20670	210023
302980	857001	303995	861011	22688	203007	24127	205039	21132	210023
303178	857001	303605	861012	22687	203008	24129	205039	20627	210024
303004	857003	301020	861013	23616	203008	24137	205039	20669	210025
302628	857007	301021	861013	21019	203011	24774	205039	21124	210026
302586	857011	302115	861013	22679	203012	24123	205040	23352	210026
302629	857011	302121	861013	21173	203019	24776	205040	21125	210027
303128	857014	302124	861013	21174	203020	24370	205042	22111	210030
303739	857015	300849	861018	22253	203022	25535	205043	22112	210031
303872	857017	301948	861018	20579	203023	24304	205047	20951	210032
302777	857034	304640	861045	25309	203025	24305	205048	20950	210033
301970	857035	304557	861050	24299	203036	24150	205049	21648	210034
303740	857037	301028	862001	21013	203046	24151	205050	20946	210035
305464	857041	302148	862001	21015	203046	24467	205051	20947	210036
303179	857048	302192	862002	22676	203048	25534	205052	20942	210037
303873	857086	303427	862003	22589	203050	23279	205053	20655	210038
304914	857100	302142	862004	22590	203051	23280	205054	21615	210039
303884	857105	302143	862005	24301	203052	24361	205062	20653	210040
305808	857105	302057	862006	23628	203057	24351	205062	21115	210040
302108	859001	302058	862007	23629	203058	24900	205073	20656	210042
302110	859001	303416	862008	22502	203059	24352	205074	21036	210043
302800	859004	303526	862009	22619	203060	24362	205074	21119	210043
302859	859004	303560	862010	22618	203061	24609	205075	21343	210048
303866	859006	303426	862011	24096	203063	24610	205076	21344	210049
302768	859009	303423	862012	24571	203066	24356	205078	20952	210052
302967	859009	300950	864001	24153	203246	24775	205079	22870	210057
303867	859015	302039	864001	25281	203261	24901	205079	20949	210066
303283	859017	304908	875007	24491	203265	24534	205091	20948	210067
303587	859019	303933	899008	24494	203266	24515	205098	21647	210068
300878	859020	304831	899037	24652	203273	25423	205104	20941	210069
301992	859020	303372	899042	25429	203278	25483	205106	20688	210070
304322	859021	303141	899056	25285	203279	24978	205107	20956	210072
303894	859022	303538	899089	24473	203294	25759	205110	20954	210082
303445	859024	305154	899128	24485	203294	25795	205112	20652	210085
303896	859026	305174	899129	24489	203294	25789	205112	20663	210090
304827	859028	303482	899151	24475	203295	25787	205114	20944	210102
303291	859032	304308	899159	25287	203296	25788	205115	20945	210103
305455	859034	303330	899181	22537	203297	25802	205117	20943	210104
304693	859037	301063	899205	24200	203300	24866	205119	20940	210105
302785	859054	302168	899205	24797	203310	25803	205121	20657	210113
302791	859056	301061	899212	24819	203311	24899	205134	20658	210114
303277	859058	302166	899212	24479	203313	25067	205134	21620	210117
303278	859058	303364	899225	24795	203316	24360	205140	21622	210117
303864	859065	304893	899254	24796	203317	24359	205141	23351	210118
305451	859085	304312	899273	24484	203318	25070	205149	20953	210120
303323	859091	304728	899282	24488	203319	20140	208024	21967	210121
303324	859091	304983	899288	24655	203321	20142	208024	24328	210121
303865	859120	305520	899318	24653	203345	20144	208024	24251	210124
305308	859136	SPIDAN		24799	203347	24374	208082	24250	210125
304703	859137	SPIDAN		24798	203352	20146	209002	20648	210127
305307	859137	25176	201105	24493	203355	20148	209002	21131	210128

COMPETITOR	GSP Ref.	COMPETITOR	GSP Ref.	COMPETITOR	GSP Ref.	COMPETITOR	GSP Ref.	COMPETITOR	GSP Ref.
SPIDAN		25120	210302	25363	217171	24868	218329	25659	241365
		24261	210310	22873	217185	24187	218333	24728	241407
21605	210130	24270	210311	22874	217186	24186	218351	24730	241408
21134	210131	24330	210312	22842	217187	24845	218358	24726	241409
20618	210132	24331	210313	22844	217188	24846	218359	24907	241441
21345	210138	24715	210314	22845	217189	25245	218402	24729	241452
21970	210139	25209	210314	23792	217190	25361	218434	24740	241453
21968	210140	24716	210320	23793	217191	25490	218435	24724	241463
21969	210141	24671	210325	24175	217192	23303	218454	24725	241463
21966	210142	24717	210335	24176	217193	25180	218455	24524	241464
21965	210143	24714	210342	24248	217194	24103	218456	25104	241509
22114	210144	24334	210348	23786	217201	24101	218457	25105	241510
24253	210144	24770	210362	23787	217206	25359	218472	24918	241577
22113	210146	24675	210363	21513	218001	24603	221032	21471	244001
24252	210146	24457	210364	21521	218002	24600	221032	21407	244002
22117	210147	24674	210380	21523	218002	24963	221035	24975	244002
21342	210152	24332	210381	21514	218003	24964	221045	21962	244003
20957	210155	24333	210382	21520	218004	24958	221051	21052	244004
21338	210156	24773	210383	21512	218005	24962	221051	21051	244005
21341	210157	25189	210413	21518	218006	24984	221053	22077	244006
23350	210159	25186	210414	21707	218007	24084	221056	21433	244011
21337	210161	25188	210415	20151	218008	24953	221056	21549	244012
21960	210162	25356	210416	20155	218008	25185	221061	21963	244013
21133	210163	24254	210419	20150	218009	24088	221062	21408	244014
20651	210164	24256	210420	20152	218009	24081	221063	21060	244016
23346	210164	24673	210421	20154	218009	24087	221071	21058	244017
21129	210165	24832	210422	20158	218010	24961	221073	24635	244020
20662	210167	24834	210423	23356	218015	25724	221074	21284	244021
20672	210167	24835	210424	21511	218016	24985	221092	21056	244022
21130	210167	24839	210425	23357	218019	23362	223038	24057	244026
21698	210174	24672	210427	25487	218036	23589	223039	24056	244027
21666	210177	22869	210430	23607	218039	23359	223078	24079	244028
22119	210181	24838	210431	23619	218040	23358	223122	24077	244029
20631	210189	25118	210435	24765	218041	25734	223198	24080	244030
20679	210189	24841	210440	23298	218042	25378	223199	24078	244031
21964	210192	22065	211001	23621	218044	20815	228001	24970	244032
20674	210193	21545	211002	23299	218046	20816	228002	24068	244033
20675	210194	21546	211003	23300	218101	25421	230003	21583	244036
20676	210195	22007	211004	23301	218102	25420	230004	21584	244037
20677	210196	24164	211012	20153	218106	23891	234044	24062	244038
20678	210197	24165	211012	23726	218118	24853	234163	24063	244039
20680	210199	24166	211014	21757	218127	22695	235001	24783	244040
20632	210202	24167	211014	21781	218128	20163	235002	24784	244042
20630	210202	28082	216021	21799	218129	21011	235003	24073	244044
21120	210203	20342	217001	21706	218140	22702	235004	24052	244045
21126	210204	25615	217013	23609	218179	22697	235005	24955	244051
21127	210205	22890	217015	24897	218194	22704	235006	24956	244052
22120	210206	22891	217016	25011	218197	21192	235007	21434	244059
21971	210207	22846	217018	24185	218201	21193	235008	25595	244064
21972	210208	22877	217020	24184	218202	21194	235009	25596	244065
25173	210218	22878	217021	24190	218216	22716	235010	24053	244075
20673	210225	22847	217022	25263	218216	24168	235022	24788	244078
24512	210231	22838	217025	24191	218217	23796	235037	24779	244078
24511	210232	23784	217032	25121	218218	24762	235037	24787	244078
24871	210239	23785	217033	25122	218219	23797	235038	24780	244079
24192	210241	22848	217037	25243	218231	28081	235040	24786	244079
24193	210242	20341	217038	25244	218232	28080	235041	24604	244080
20671	210246	22849	217039	25493	218242	25330	235054	24969	244092
25115	210248	24636	217040	25261	218247	25599	235055	24973	244093
25117	210249	22840	217041	25262	218248	24533	235084	24974	244094
25116	210250	24785	217044	25488	218259	25398	235085	23999	244095
24669	210251	22843	217048	25489	218260	25218	235086	24000	244096
24771	210251	25621	217050	24763	218263	23284	238001	24085	244097
24670	210253	25620	217053	24764	218264	23285	238002	24086	244098
24768	210254	25668	217055	25432	218265	23278	238003	24957	244099
24767	210255	25644	217064	24508	218271	24415	241001	24971	244100
24195	210259	24344	217066	24506	218274	24410	241004	21635	245001
24257	210259	24348	217066	24898	218280	24414	241005	21637	245001
22871	210264	24782	217070	23336	218284	24426	241024	21692	245002
24260	210265	24781	217071	23728	218289	24411	241094	21631	245003
24259	210266	24343	217082	24844	218291	24416	241130	21659	245004
24279	210267	22839	217114	24510	218301	24727	241261	21613	245005
24373	210268	25035	217122	24188	218309	24618	241262	21695	245007
24194	210276	24346	217146	24189	218326	25107	241327	21671	245008
20628	210278	24347	217147	24857	218327	25106	241328	21045	245009
25183	210295	25362	217170	24867	218328	24919	241365	21046	245010

COMPETITOR	GSP Ref.	COMPETITOR	GSP Ref.	COMPETITOR	GSP Ref.	COMPETITOR	GSP Ref.	COMPETITOR	GSP Ref.
SPIDAN		21808	248003	22044	250201	23326	250392	25211	250574
		22069	250001	22086	250205	23327	250393	21068	250579
21044	245011	22068	250002	22327	250207	23663	250394	25322	250586
21043	245012	22055	250003	24576	250207	23665	250395	25321	250587
21627	245013	21066	250004	22331	250208	24114	250397	21069	250588
21662	245014	21063	250004	21568	250211	24119	250398	22329	250590
21636	245015	22006	250005	21059	250214	24245	250399	25098	250591
21050	245016	22028	250006	22125	250215	24375	250400	25099	250592
21684	245017	22074	250007	24243	250219	24529	250400	25140	250593
21956	245020	23338	250008	22332	250219	24377	250401	25095	250604
21661	245021	20960	250009	21569	250221	24444	250402	25134	250605
21641	245022	21053	250010	24697	250223	24446	250403	24648	250622
21642	245023	21054	250011	22333	250226	24580	250404	25710	250625
21683	245024	22033	250012	22338	250227	24587	250405	21603	250627
21660	245025	22031	250013	22328	250228	25380	250410	25715	250630
21957	245026	22083	250014	24527	250245	24946	250411	25714	250632
21039	245027	22088	250015	21055	250246	24754	250423	20851	251001
21628	245029	22018	250016	20975	250247	25101	250425	20861	251004
21629	245030	21067	250017	21567	250247	25103	250426	20852	251010
21041	245031	21570	250019	21550	250249	25572	250427	24109	251021
21042	245032	22084	250020	20977	250252	25094	250429	20853	251023
21656	245033	20961	250021	22314	250253	24116	250437	25403	251036
21655	245034	22082	250022	24451	250256	24378	250438	24171	251068
21040	245035	22043	250023	24700	250260	23739	250440	24100	251069
21626	245036	22046	250024	24532	250261	23743	250441	24102	251070
21618	245066	22042	250025	24701	250263	24504	250442	24170	251071
21617	245068	22137	250026	25313	250263	24505	250442	24173	251072
21670	245070	20963	250027	22339	250268	24442	250443	20197	252001
21672	245070	20974	250028	20966	250271	24579	250444	20196	252001
24160	245084	20962	250029	24589	250279	24249	250445	20198	252002
24161	245084	22026	250030	25012	250280	24242	250446	22495	253001
24162	245085	22131	250031	22330	250281	24376	250447	22437	253002
24163	245085	22047	250032	23699	250284	24680	250451	22466	253003
21037	245094	22064	250033	20970	250295	25379	250453	22462	253004
21049	245101	22135	250034	20971	250296	24651	250455	23542	253004
22118	245103	22134	250035	22025	250300	24578	250460	22467	253005
21730	245104	22071	250036	22146	250301	22147	250461	24482	253007
21731	245105	22070	250037	22325	250311	24117	250462	23774	253010
21958	245106	21564	250038	23744	250313	24121	250462	23150	254001
21961	245108	22317	250039	22318	250314	25369	250465	23151	254002
21657	245110	22067	250041	21566	250316	23745	250471	24478	254011
21611	245111	21721	250043	22128	250319	24945	250483	24474	254013
21734	245113	22326	250043	21565	250320	25255	250493	25308	254013
21733	245119	22045	250044	22316	250323	24624	250494	20160	257039
22872	245120	22132	250046	22319	250324	24698	250495	20159	257040
21729	245126	22126	250047	22322	250325	24640	250496	24851	257077
24872	245133	22085	250050	22323	250326	24509	250497	24850	257078
21665	245134	22050	250052	22324	250327	21599	250506	25251	257165
21693	245135	20973	250054	22334	250328	24937	250514	24598	257197
21694	245136	20972	250055	22335	250329	24938	250515	24596	257221
21048	245137	21553	250057	22336	250330	24453	250516	24595	257222
21047	245138	21057	250058	22343	250331	24399	250517	24597	257223
21690	245150	21554	250059	24118	250339	24445	250518	25091	257265
21691	245151	21286	250060	24852	250346	24449	250519	24678	259268
21955	245152	20969	250074	24447	250348	24582	250520	24676	259316
21686	245153	22133	250093	24460	250353	24688	250521	24677	259317
24518	245157	22090	250095	24944	250353	24689	250522	24679	259447
24519	245158	20967	250099	24398	250354	24690	250523	25191	259493
21669	245160	20968	250100	24120	250356	24699	250524	25195	259494
21663	245167	23783	250102	21064	250357	24758	250525	24513	259495
21689	245182	23339	250105	22315	250358	24759	250526	25202	259520
24277	245193	20976	250130	23782	250359	21600	250527	25196	259552
24276	245194	20964	250131	25357	250364	21598	250527	25200	259553
21621	245197	22136	250134	24572	250366	24880	250538	25198	259589
21664	245198	22063	250138	24400	250369	24881	250539	25193	259633
24274	245200	22022	250145	24452	250372	25352	250540	25401	259635
24275	245201	21061	250150	25015	250373	24757	250541	25402	259636
24278	245202	22089	250150	24696	250377	24877	250542	25192	259657
24272	245203	21062	250151	25096	250379	24876	250544	25197	259658
24273	245204	22928	250160	24639	250380	24443	250554	25201	259659
25178	245220	25312	250162	25573	250383	25433	250557	25199	259660
25179	245223	21551	250166	25014	250386	24441	250562	25190	259662
25555	245225	23366	250171	22321	250389	25139	250570	21406	260002
24458	245226	23666	250193	24324	250390	25318	250571	21470	260002
21894	248001	23664	250194	24325	250391	25351	250572	24066	260013
20193	248002	21711	250197	24584	250391	25223	250573	24983	260016

COMPETITOR	GSP Ref.	COMPETITOR	GSP Ref.	COMPETITOR	GSP Ref.	COMPETITOR	GSP Ref.	COMPETITOR	GSP Ref.
SPIDAN		24501	261211	23521	602004	20309	801001	23693	803058
		25702	261213	23677	602011	20310	801001	23697	803067
20965	250199	25701	261215	20273	603001	20304	801002	24681	803077
21571	250200	24553	261223	23845	603001	36015	801352	24462	803085
24507	260022	24490	261224	22487	603002	21149	802002	24685	803086
25226	260022	24577	261236	22522	603002	20993	802003	24687	803087
24966	260026	25395	261238	21312	603002	20997	802003	24683	803087
24965	260027	23612	261243	20289	603003	21233	802004	24691	803088
24072	260035	24300	261252	22545	603003	21238	802004	24860	803092
23544	261001	24181	261257	20258	603004	23830	802004	22568	803106
23547	261002	25071	261257	22405	603004	23838	802004	21105	804001
21025	261003	24182	261258	22793	603004	20992	802005	21250	804001
21023	261004	25072	261258	20414	603005	20994	802006	21255	804001
22477	261005	25625	261267	20438	603006	20998	802006	21824	808002
22479	261005	25575	261296	24749	603008	23518	802007	21080	808004
22428	261006	25221	261298	22498	603009	23823	802007	21865	808021
21708	261007	23771	261312	22497	603011	20995	802008	21847	808034
24574	261007	21018	261312	22632	603014	23839	802009	20353	809002
22463	261008	21016	261314	20272	603019	23831	802011	20354	809002
23541	261008	24199	261323	22631	603020	21154	802012	24210	809002
22622	261009	24503	261342	24238	603027	21152	802013	20637	809003
21709	261010	20833	262001	21989	605001	20208	802014	21381	809004
22931	261011	20834	262002	24292	610038	20026	802015	20665	810001
22686	261019	25338	262022	24289	617020	21151	802017	24914	810001
22930	261028	25292	262025	24294	617021	22203	802018	21075	810002
22419	261031	25293	262026	24293	617022	23844	802019	21288	810002
20600	261034	25290	262029	24287	617028	21326	802021	21097	810003
24477	261042	25337	262031	24290	617042	23517	802021	21289	810003
21012	261045	25291	262034	21561	618001	25141	802024	21098	810004
21014	261045	25441	262039	20439	618001	24538	802025	21093	810005
20601	261052	24470	262060	21752	618002	25143	802026	21580	810006
20591	261052	24471	262063	21241	618070	23691	803002	21581	810007
20599	261052	25499	262136	21727	635001	20271	803004	21257	810010
22435	261054	23157	264001	22701	635006	22778	803004	20633	810011
22626	261055	23158	264002	24559	635014	22572	803005	20987	810012
22630	261055	25246	275056	24633	635020	20276	803006	20986	810013
22431	261056	21959	299003	24239	635051	20260	803007	24543	810015
24097	261063	21339	299006	21467	644001	22773	803007	24545	810015
20157	261065	23348	299007	21457	644002	24307	803007	24526	810018
22628	261067	23349	299009	21476	644002	22543	803008	21582	810021
24095	261074	21340	299010	21451	644004	22544	803009	21076	810024
24094	261075	24523	299037	21498	644005	22550	803012	22276	810025
24303	261078	24766	299042	21850	648001	22560	803013	22268	810026
22256	261082	22851	299049	21882	648001	22566	803014	21077	810043
22255	261083	24472	299070	21490	648002	22581	803014	20634	810050
24154	261084	24528	299070	21897	648002	22541	803016	21593	810075
24159	261084	23740	299071	20394	648002	22552	803016	21078	810086
24144	261084	23742	299071	21821	648003	22591	803017	21027	812001
20156	261085	22678	299108	21311	648004	22639	803017	20351	812006
25260	261087	22682	299111	21327	648004	22681	803018	21482	812019
23516	261092	21172	299113	21888	648004	24910	803018	21189	812021
24487	261093	22254	299120	21896	648004	22763	803019	21949	812023
24496	261094	21552	299151	23522	648004	22804	803019	21947	812027
24480	261096	24972	299157	20286	653001	23695	803019	22197	812027
24476	261097	21667	299161	22455	653001	24912	803019	24811	812034
24098	261098	24244	299186	23154	654002	22747	803020	21026	812039
24099	261099	24583	299188	23155	654003	21091	803021	23941	814002
24152	261105	24262	299190	20597	661001	24917	803021	24804	814003
23614	261115	24263	299191	22902	661002	20285	803022	22957	814004
20592	261119	25181	299194	22407	661003	22542	803023	24807	814005
20598	261120	25125	299195	24915	661003	21587	803024	24805	814006
22267	261121	25126	299196	20643	661003	22748	803026	22956	814007
22689	261122	24329	299197	25307	661006	21586	803027	23935	814010
23769	261123	23741	299201	24564	661020	20295	803029	24806	814012
24502	261126	24198	299213	24568	661021	20294	803031	24813	814013
25559	261133	24873	299214	24570	661029	22458	803032	24809	814015
24155	261140	24355	299215	23626	661030	22546	803032	24810	814020
25005	261156	24525	299217	24566	661041	20338	803033	23940	814027
22625	261172	24721	299228	25177	661057	20339	803033	22199	814030
24302	261183	24722	299229	20934	662015	22547	803034	23937	814033
23770	261186	24269	299271	20542	699052	21522	803035	23936	814046
25394	261190	24271	299271	21761	699075	20340	803036	23938	814073
25393	261191	24268	299272	21084	699099	22627	803036	23939	814074
25706	261192	23277	299285	21085	699099	23689	803037	20526	817001
24586	261204	24942	299286	22714	699143	20257	803038	21234	817001
24157	261210	20020	602001	24236	699148	22551	803051	21235	817001

COMPETITOR	GSP Ref.	COMPETITOR	GSP Ref.	COMPETITOR	GSP Ref.	COMPETITOR	GSP Ref.	COMPETITOR	GSP Ref.
SPIDAN		24048	818033	20698	828002	23965	841021	21590	850056
		21175	818034	20817	828005	24641	841025	21591	850105
21329	817001	24047	818035	21336	829001	21531	841028	25294	850150
21290	817002	22969	818036	20136	831001	20232	841030	25299	850152
21307	817002	25123	818067	21081	832001	23963	841031	25298	850161
23519	817002	24927	818203	21371	834001	24548	841037	25640	850170
21242	817003	25135	818207	23506	834002	20079	841040	20918	851001
21232	817004	24751	818230	23077	834003	20085	841040	20919	851001
21239	817004	23200	821002	21368	834004	21004	841045	20914	851002
21252	817005	24590	821038	21033	834005	24456	841046	21537	851003
21213	817005	22306	822001	21034	834006	24992	841047	21538	851004
21258	817006	21484	822002	21649	834007	24547	841048	20889	851005
23798	817007	24389	823001	21197	834008	24530	841052	20894	851006
21153	817009	21544	823002	21199	834010	24536	841057	21543	851007
22212	817009	20302	823003	25076	834015	20090	841058	20895	851009
21230	817010	20303	823003	24040	834019	20094	841058	20899	851010
21148	817011	20305	823004	24045	834025	20903	841059	21533	851011
20527	817012	21387	823004	21198	834026	20904	841060	20898	851012
21237	817012	20307	823005	23953	834056	24409	841061	20896	851013
21240	817013	20308	823005	22966	834072	24440	841063	20920	851017
21147	817014	20319	823006	23954	834080	21315	841073	20604	851020
21146	817017	20320	823006	24008	834081	24434	841078	23639	852001
21227	817018	20892	823007	24051	834082	24439	841078	23657	852002
21145	817019	20893	823008	23955	834100	24438	841083	21906	852003
21144	817020	20890	823010	25238	834110	20983	841084	21907	852004
21247	817021	22348	823011	24379	834135	24450	841086	22109	852004
21248	817022	22360	823011	25083	834156	24435	841087	23659	852007
20991	817023	22355	823013	20985	835001	21160	841095	21909	852010
24629	817024	22352	823014	20176	835001	25569	841142	23658	852011
22252	817026	22354	823016	25611	835001	24437	841163	23687	853001
22251	817028	22365	823016	20228	835002	24436	841168	24089	853002
24693	817028	22349	823017	22264	835004	21308	841170	23675	853005
22213	817030	21388	823021	22260	835005	24433	841172	22494	853007
22208	817031	22353	823022	22690	835018	24619	841240	23548	853007
20996	817032	23942	823023	22262	835022	25296	841244	20399	853007
21224	817039	23945	823024	22258	835023	25235	841284	22461	853008
21231	817039	22350	823026	24556	835026	20902	841287	22669	853008
21236	817039	21179	823028	22711	835033	23966	841314	22782	853008
21150	817042	24371	823030	24631	835034	24112	844001	20639	854001
24341	817043	23948	823032	24392	838002	23992	844002	23152	854001
24282	817045	23673	823033	24394	838003	23985	844003	21585	854002
23984	817051	25234	823033	24213	839001	23989	844004	24308	854004
24385	817051	25080	823034	24215	839002	23991	844005	22162	856001
24297	817052	24461	823036	21718	839007	20183	844006	22179	856003
24295	817053	25079	823039	21790	839008	20181	844007	22175	856004
24949	817053	20536	823041	24216	839009	24111	844011	22177	856005
24285	817055	20306	823042	24212	839011	21800	844013	22185	856006
24284	817060	21385	823042	24225	839014	21822	844014	22967	856007
24893	817063	22356	823044	21176	839015	21429	844020	22968	856010
24891	817070	21178	823047	20926	839016	24280	844020	22151	856011
21449	818002	22962	823047	24214	839019	20713	844025	22154	856012
20322	818003	23947	823059	21759	839021	20712	844026	22166	856013
20186	818004	21528	823063	21747	839022	23997	844027	22174	856014
23738	818004	22351	823071	23667	839024	23987	844028	22184	856030
20187	818006	22357	823081	24226	839027	21195	844030	23975	856039
23736	818006	23943	823083	20924	839036	22274	844034	22164	856046
21363	818007	23944	823083	20184	839040	21450	844041	23976	856053
20979	818011	24387	823095	21382	839054	21452	844041	21030	857001
20188	818012	22971	823159	23957	839054	24913	844041	21090	857003
21184	818013	21975	824002	20621	839084	21432	844046	21087	857007
23735	818015	20689	824004	21720	839098	21428	844051	21088	857011
21099	818016	23974	824011	23669	839102	21496	844055	21007	857014
23734	818017	25082	824036	22996	840001	21427	844056	22935	857015
21751	818018	24383	824041	23162	840001	21497	844057	23977	857017
21753	818019	21977	824046	24432	841001	24935	844085	21089	857034
21760	818019	24731	824095	21188	841003	21095	845001	21082	857035
23610	818021	24735	824152	24430	841006	21094	845004	22936	857037
20978	818024	21802	824173	24431	841007	21074	845006	25241	857041
21574	818025	23201	826001	20900	841008	20300	845011	21031	857048
21572	818026	21483	826003	24428	841009	22270	845033	23978	857086
21370	818027	24049	827001	24429	841010	22271	845045	24643	857100
24044	818028	22965	827003	21006	841011	25137	845058	21516	857105
23956	818029	21002	827005	20099	841012	22121	845065	25614	857105
20636	818030	21157	827007	20104	841013	24196	845067	22305	859001
24007	818031	21166	827010	23967	841016	21096	850008	22307	859001
24046	818032	24733	827080	21162	841021	20357	850026	20179	859004

COMPETITOR	GSP Ref.	COMPETITOR	GSP Ref.	COMPETITOR	GSP Ref.	COMPETITOR	GSP Ref.	COMPETITOR	GSP Ref.
SPIDAN		24925	899129	17-0698	205017	17-0104	210118	17-0632	217002
		21539	899151	17-0925	205018	17-0139	210120	17-0631	217003
23971	859006	21182	899181	17-0216	205021	17-1109	210121	17-0649	217005
20180	859009	21455	899205	17-0924	205029	17-0641	210131	17-0650	217007
23972	859015	23656	899212	17-0915	205042	17-0522	210131	17-0635	217017
21158	859017	21529	899225	17-0914	205051	17-0388	210137	17-0245	217018
21765	859019	24622	899254	17-1099	205053	17-0330	210139	17-0235	217018
22311	859020	23676	899273	17-1164	205058	17-1110	210140	17-0636	217019
23683	859021	24455	899282	17-0917	205078	17-0329	210141	17-0246	217022
21843	859022	24711	899288	17-1251	208016	17-1115	210142	17-0236	217022
21297	859024	25297	899318	17-1101	208024	17-1114	210143	17-0220	217025
21845	859026	METELLI		17-0529	208059	17-0811	210146	17-0536	217032
24554	859028			17-0953	208059	17-0706	210147	17-0537	217033
21164	859032	17-0789	201010	17-0810	208082	17-0489	210152	17-0247	217037
25232	859034	17-0337	201020	17-1104	209028	17-0143	210155	17-0226	217038
24381	859037	17-1156	201054	17-1102	209039	17-0493	210156	17-0671	217038
22312	859054	17-1095	201112	17-1103	209067	17-0488	210157	17-0248	217039
22313	859056	17-0504	202001	17-0708	210001	17-0103	210159	17-0238	217039
21155	859058	17-0713	202001	17-0709	210002	17-0492	210161	17-1018	217044
23969	859065	17-0507	202002	17-0011	210004	17-0736	210162	17-0799	217045
25228	859085	17-0714	202002	17-0004	210005	17-1106	210163	17-0797	217045
21186	859091	17-0424	202005	17-0007	210007	17-0639	210163	17-0232	217048
23970	859120	17-0911	202008	17-0005	210008	17-0014	210164	17-0660	217048
25085	859136	17-0538	202009	17-0061	210008	17-0079	210167	17-1117	217052
24391	859137	17-0647	202009	17-0083	210008	17-0525	210167	17-0804	217059
25084	859137	17-0648	202009	17-0060	210009	17-0640	210167	17-1136	217061
25073	859154	17-0200	203001	17-0080	210009	17-0147	210174	17-1013	217070
23973	859155	17-0197	203002	17-0019	210010	17-0022	210177	17-0801	217070
20178	859161	17-0181	203003	17-0141	210012	17-0134	210187	17-1014	217071
24338	859167	17-0211	203004	17-0083	210013	17-0135	210188	17-0802	217071
25086	859168	17-0448	203004	17-0145	210014	17-0154	210189	17-1139	217076
25227	859175	17-0442	203004	17-0133	210015	17-0516	210189	17-0652	217077
25009	859213	17-0199	203005	17-0144	210016	17-0176	210190	17-0824	217077
24550	859226	17-0358	203006	17-0157	210017	17-0177	210191	17-0656	217080
24874	860005	17-0447	203006	17-0217	210018	17-1113	210192	17-1140	217081
22454	861001	17-0209	203006	17-0218	210019	17-0152	210196	17-0655	217099
22452	861002	17-0439	203006	17-0146	210020	17-0149	210197	17-0773	217099
22469	861002	17-0202	203007	17-0137	210023	17-0153	210197	17-0834	217101
20595	861003	17-0603	203008	17-0642	210023	17-0517	210197	17-0823	217108
20596	861004	17-0748	203011	17-0136	210025	17-1111	210200	17-0651	217108
21945	861005	17-0689	203012	17-0132	210026	17-0151	210202	17-1074	217110
22900	861005	17-1083	203012	17-0521	210027	17-1108	210202	17-0800	217111
21946	861006	17-0189	203014	17-0415	210030	17-0520	210204	17-0798	217111
22901	861006	17-0691	203019	17-0416	210031	17-0519	210225	17-0835	217112
24541	861007	17-0692	203020	17-0161	210032	17-0523	210226	17-1073	217117
23979	861009	17-0546	203022	17-0160	210033	17-0524	210227	17-1137	217119
23981	861011	17-0547	203023	17-0082	210034	17-0921	210231	17-1138	217120
21812	861012	17-0208	203046	17-0086	210035	17-0920	210232	17-1079	217122
22456	861013	17-0446	203046	17-0087	210036	17-1133	210238	17-1081	217123
22457	861013	17-0438	203046	17-0084	210037	17-1134	210239	17-1080	217124
22670	861013	17-0205	203050	17-0130	210038	17-1217	210248	17-0503	217131
23537	861013	17-0206	203051	17-0006	210039	17-1214	210249	17-0822	217137
22600	861018	17-0940	203052	17-0010	210040	17-1213	210250	17-1082	217145
24911	861018	17-0941	203052	17-0156	210040	17-1212	210253	17-0711	217149
24326	861045	17-0694	203058	17-0379	210043	17-0952	210259	17-1116	217151
24237	861050	17-0183	203059	17-0020	210044	17-0956	210264	17-1141	217152
20931	862001	17-0611	203063	17-0486	210048	17-0809	210268	17-1142	217153
20930	862002	17-0777	203063	17-0487	210049	17-0951	210276	17-0328	217159
20928	862003	17-0943	203066	17-0138	210052	17-1199	210281	17-1135	217165
20827	862004	17-1066	203246	17-0673	210057	17-1205	210287	17-0234	217189
20828	862005	17-1064	203266	17-0159	210066	17-1221	210306	17-0219	217197
20812	862006	17-0759	203294	17-0158	210067	17-1223	210306	17-0826	217227
20826	862007	17-0761	203295	17-1123	210069	17-1210	210311	17-0825	217230
20583	862008	17-0182	203297	17-0701	210070	17-1200	210326	17-0259	218001
21299	862009	17-0762	203313	17-0700	210071	17-1023	210385	17-0257	218002
20431	862010	17-0877	203319	17-0142	210072	17-1204	210433	17-0261	218002
20587	862011	17-1264	203330	17-0140	210082	17-0112	211001	17-0260	218003
20585	862012	17-0693	203352	17-0015	210085	17-0106	211004	17-0262	218004
23159	864001	17-1088	203362	17-0078	210090	17-0780	211006	17-0256	218005
24637	875007	17-0213	205001	17-0815	210102	17-0781	211007	17-0258	218006
22273	899008	17-0214	205002	17-0816	210103	17-0792	211012	17-0162	218007
24558	899037	17-0697	205002	17-0085	210104	17-0793	211014	17-0264	218007
21200	899042	17-1096	205004	17-1122	210105	17-0528	212011	17-0267	218008
21010	899056	17-0699	205006	17-0175	210113	17-0530	212025	17-0360	218009
21438	899089	17-1094	205007	17-0174	210114	17-0531	212044	17-0539	218011
24895	899128	17-0212	205014	17-0023	210117	17-0227	217001	17-0540	218015

COMPETITOR	GSP Ref.	COMPETITOR	GSP Ref.	COMPETITOR	GSP Ref.	COMPETITOR	GSP Ref.	COMPETITOR	GSP Ref.
METELLI		17-0945	238003	17-0069	245014	17-0397	250004	17-0047	250145
		17-0619	241001	17-0017	245015	17-0431	250004	17-0056	250150
17-0255	218016	17-1171	241002	17-0394	245016	17-0040	250005	17-0395	250150
17-0542	218019	17-0782	241003	17-0167	245017	17-0051	250006	17-0168	250150
17-0790	218027	17-0618	241004	17-0559	245017	17-0050	250007	17-0396	250151
17-0791	218028	17-0620	241005	17-0565	245017	17-0311	250008	17-1119	250153
17-0981	218034	17-0633	241006	17-0734	245020	17-0115	250009	17-0591	250160
17-0980	218036	17-0634	241007	17-0068	245021	17-0599	250009	17-0861	250166
17-0250	218039	17-1170	241020	17-0059	245022	17-0405	250010	17-0309	250174
17-0249	218040	17-0719	241024	17-0058	245023	17-0409	250010	17-0310	250175
17-0842	218041	17-1168	241081	17-0166	245024	17-0425	250010	17-1036	250193
17-0372	218042	17-0550	241083	17-0564	245024	17-0406	250011	17-1035	250194
17-0090	218044	17-0551	241084	17-0063	245025	17-0426	250011	17-0413	250197
17-0373	218046	17-0617	241094	17-0735	245026	17-0042	250012	17-0313	250200
17-0374	218101	17-0548	241156	17-0381	245027	17-0044	250012	17-0030	250205
17-0974	218101	17-0549	241193	17-1025	245027	17-0041	250013	17-0871	250207
17-0375	218102	17-0783	241201	17-0028	245029	17-0033	250015	17-0863	250208
17-0088	218118	17-1169	241206	17-0027	245030	17-0031	250015	17-0324	250211
17-0163	218140	17-0718	241280	17-0383	245031	17-0046	250016	17-1027	250214
17-0265	218140	17-0279	244001	17-0385	245032	17-0398	250017	17-0308	250215
17-0970	218141	17-0275	244002	17-0100	245033	17-0314	250019	17-1032	250219
17-1152	218142	17-0623	244002	17-0101	245034	17-1224	250020	17-0323	250221
17-0091	218179	17-0196	244003	17-0382	245035	17-0116	250021	17-0864	250226
17-0907	218189	17-0408	244004	17-1026	245035	17-0032	250022	17-1235	250227
17-0886	218190	17-0428	244004	17-0386	245035	17-0034	250022	17-0872	250228
17-0912	218194	17-0412	244004	17-0026	245036	17-0294	250022	17-0873	250228
17-0544	218201	17-0407	244005	17-0627	245066	17-1225	250022	17-0867	250246
17-0543	218202	17-0411	244005	17-0626	245068	17-0037	250023	17-0318	250247
17-0838	218216	17-0427	244005	17-0165	245070	17-0038	250024	17-0866	250260
17-0839	218217	17-0076	244006	17-0557	245070	17-0109	250024	17-0865	250261
17-1249	218247	17-0273	244011	17-0637	245084	17-0113	250024	17-0787	250263
17-1250	218248	17-0378	244013	17-0638	245085	17-0036	250025	17-1236	250268
17-0977	218260	17-0271	244014	17-0097	245092	17-0299	250026	17-0569	250271
17-0840	218263	17-1028	244016	17-0380	245094	17-0316	250027	17-1237	250279
17-0841	218264	17-0870	244017	17-0384	245094	17-0317	250028	17-0573	250295
17-0973	218265	17-0868	244021	17-0393	245101	17-0315	250029	17-0574	250296
17-1242	218271	17-0770	244026	17-1021	245101	17-0108	250030	17-0107	250300
17-0251	218284	17-0768	244026	17-0707	245103	17-0628	250031	17-0305	250301
17-0089	218289	17-0769	244027	17-0731	245104	17-0110	250032	17-0401	250303
17-0832	218291	17-0767	244027	17-0732	245105	17-0054	250033	17-0587	250307
17-1190	221032	17-0852	244028	17-0291	245106	17-0301	250034	17-0588	250308
17-0856	221055	17-0913	244029	17-0737	245108	17-0048	250036	17-0589	250309
17-1185	221056	17-0853	244030	17-0098	245111	17-0049	250037	17-0590	250310
17-1189	221062	17-0854	244030	17-0016	245111	17-0600	250038	17-0601	250311
17-0855	221063	17-0891	244031	17-0729	245113	17-0595	250039	17-0593	250313
17-1188	221071	17-1186	244032	17-0728	245119	17-0576	250039	17-0594	250314
17-1184	221073	17-0555	244033	17-0957	245120	17-0578	250039	17-0575	250314
17-0926	221102	17-0723	244036	17-0730	245126	17-0043	250041	17-0577	250314
17-0927	221103	17-1174	244036	17-0964	245133	17-0414	250043	17-0598	250316
17-1192	221110	17-0724	244037	17-0021	245134	17-0039	250044	17-0739	250324
17-1191	221111	17-0348	244038	17-0287	245135	17-0114	250044	17-0592	250325
17-0362	223040	17-0349	244039	17-0284	245136	17-0403	250045	17-0897	250348
17-0363	223078	17-1019	244040	17-0561	245137	17-0298	250046	17-0904	250353
17-0338	223122	17-1020	244042	17-0560	245138	17-0306	250047	17-0908	250354
17-0179	228001	17-1182	244043	17-1197	245146	17-0029	250050	17-1067	250366
17-0180	228002	17-1180	244043	17-1198	245147	17-0402	250051	17-1040	250369
17-1046	230003	17-0350	244044	17-0733	245152	17-0035	250052	17-1041	250372
17-1047	230004	17-0272	244048	17-0726	245153	17-0302	250053	17-0740	250389
17-1048	230004	17-0274	244059	17-0064	245155	17-0118	250054	17-1239	250390
17-0676	235001	17-0482	244060	17-0065	245156	17-0117	250055	17-1240	250391
17-0173	235002	17-0766	244075	17-0071	245156	17-0597	250055	17-1232	250400
17-0185	235003	17-0775	244076	17-0066	245157	17-1029	250057	17-0786	250401
17-0092	235004	17-0720	244077	17-0067	245158	17-0869	250058	17-0905	250402
17-0215	235006	17-1017	244079	17-0073	245158	17-1030	250059	17-0497	250421
17-0268	235007	17-0018	245001	17-0285	245159	17-0169	250063	17-1234	250440
17-0093	235010	17-0286	245002	17-0556	245160	17-0572	250074	17-0909	250442
17-0094	235010	17-0062	245004	17-0702	245178	17-0303	250075	17-1031	250446
17-0377	235011	17-0099	245005	17-0703	245179	17-0404	250082	17-0307	250461
17-0376	235016	17-0288	245007	17-0283	245182	17-0297	250093	17-0906	250494
17-1163	235018	17-0164	245008	17-1215	245200	17-0057	250095	17-0918	250506
17-1162	235027	17-0389	245009	17-1216	245201	17-0170	250095	17-1038	250514
17-0466	235037	17-0387	245009	17-1218	245203	17-0570	250099	17-1039	250515
17-0988	235037	17-0390	245010	17-1219	245204	17-0571	250100	17-0859	250516
17-0467	235038	17-0563	245011	17-1220	245221	17-0312	250105	17-0429	250521
17-0989	235038	17-0562	245012	17-0074	250001	17-0300	250134	17-0430	250522
17-1167	235038	17-0025	245013	17-0111	250003	17-0055	250138	17-0919	250527

COMPETITOR	GSP Ref.	COMPETITOR	GSP Ref.	COMPETITOR	GSP Ref.	COMPETITOR	GSP Ref.	COMPETITOR	GSP Ref.
METELLI		17-0472	261075	16-1014A	602004	15-1121	803014	15-1120	810013
		17-0473	261075	16-1020	602005	15-1140	803016	15-1224	810015
17-1248	250538	17-0875	261078	16-1005	602006	15-1188	803016	15-1546	810015
17-1247	250539	17-0610	261082	16-1015	602006	15-0195	803017	15-1286	810017
17-1244	250542	17-0609	261083	16-1014	603001	15-1174	803017	15-1222	810018
17-1243	250544	17-0764	261096	16-1012	603002	15-1195	803017	15-1281	810019
17-0850	250557	17-0763	261097	16-1010	603003	15-1239	803018	15-1263	810021
17-0851	250562	17-0613	261098	16-1004	603008	15-1267	803019	15-1302	810022
17-0331	251001	17-0614	261099	16-1022	603008	15-1436	803019	15-1446	810022
17-1045	251002	17-0883	261100	16-1010A	603009	15-1441	803019	15-1176	810024
17-0332	251010	17-0884	261101	16-1010B	603011	15-1641	803019	15-1456	810025
17-1044	251024	17-1087	261115	16-1010D	603011	15-1377	803020	15-1407	810026
17-1049	251030	17-0186	261119	16-1004A	603019	15-1381	803021	15-1497	810026
17-0339	253001	17-0444	261121	16-1007	618002	15-1035	803022	15-1646	810026
17-0615	253002	17-0201	261122	16-1002	618070	15-1185	803023	15-1182	810027
17-0002	253003	17-0443	261123	16-1028	628001	15-0414	803024	15-1455	810028
17-0121	253004	17-1069	261140	16-1028	628002	15-1414	803024	15-1264	810029
17-0003	253005	17-0747	261156	16-1030	635001	15-1308	803026	15-1142	810043
17-0052	253006	17-0352	261172	16-1032	635064	15-1397	803027	15-1470	810051
17-0881	253007	17-0742	261183	16-1006	644001	15-1413	803027	15-1469	810052
17-0882	253008	17-1266	261184	16-1026	644003	15-1181	803029	15-1561	810053
17-0119	254001	17-1267	261185	16-0008	644004	15-1128	803031	15-1585	810067
17-0435	254001	17-0607	261186	16-1008	644004	15-0050	803032	15-1558	810076
17-0120	254002	17-0741	261204	16-1016	648002	15-1050	803032	15-1498	810077
17-0436	254002	17-0874	261204	16-1002A	648004	15-1241	803033	15-1496	810085
17-1086	254011	17-0878	261211	16-0003	653001	15-1111	803034	15-1553	810096
17-1085	254013	17-0876	261223	16-0023	653001	15-1428	803035	15-1636	810098
17-1179	257087	17-0880	261223	16-1003	653001	15-1189	803036	15-1657	810118
17-1181	257087	17-1255	262001	16-1023	653001	15-1462	803037	15-1767	810124
17-0814	257176	17-0459	262001	16-1010C	653002	15-1464	803037	15-1729	810130
17-0813	257177	17-1256	262002	16-0019	661001	15-1467	803037	15-1711	810155
17-1054	259011	17-0460	262002	16-1019	661001	15-1049	803038	15-1797	810155
17-0892	259206	17-0292	299003	16-1024	661002	15-1091	803051	15-1764	810156
17-0893	259208	17-0494	299006	16-0001	661003	15-1203	803054	15-1311	812001
21-0001	259352	17-0495	299010	16-1001	661003	15-1435	803058	15-1115	812006
21-0002	259354	17-0072	299037	16-1031	661029	15-1554	803067	15-1279	812008
17-0857	259495	17-0843	299042	16-1029	699025	15-1552	803077	15-1655	812011
17-0894	259635	17-1070	299048	16-1033	699148	15-1551	803078	15-1234	812019
17-0895	259636	17-0532	299048	15-1113	801001	15-1697	803086	15-1402	812020
17-0276	260002	17-0533	299049	15-1099	801002	15-1688	803087	15-1280	812021
17-0280	260002	17-0765	299069	15-1183	802001	15-1689	803088	15-1395	812027
17-0554	260013	17-0477	299069	15-1297	802002	15-1277	803106	15-1340	812034
17-0721	260013	17-0903	299070	15-1211	802003	15-1001	804001	15-1160	814003
17-1195	260015	17-0896	299071	15-1093	802004	15-1019	804001	15-1295	814005
17-1196	260016	17-0860	299071	15-1110	802004	15-1630	805001	15-1159	814006
17-0624	260019	17-0690	299108	15-1210	802005	15-1664	805009	15-1359	814009
17-1187	260021	17-1084	299108	15-1212	802006	15-1725	805010	15-1097	814012
17-1241	260022	17-0198	299111	15-1153	802009	15-1344	806001	15-1294	814013
17-0123	261001	17-0696	299113	15-1152	802011	15-1401	808002	15-1333	814020
17-0187	261001	17-0862	299151	15-0244	802012	15-1068	808004	15-1013	817001
17-0124	261002	17-1227	299169	15-1244	802012	15-1080	808004	15-1105	817001
17-0755	261003	17-1158	299176	15-1300	802013	15-1235	808008	15-1103	817002
17-0605	261003	17-1157	299177	15-1418	802014	15-1656	808019	15-1094	817003
17-0757	261004	17-0629	299190	15-1083	802015	15-1530	808021	15-1016	817004
17-0606	261004	17-0630	299191	15-1245	802017	15-1527	808034	15-1109	817004
17-0001	261005	17-0805	299195	15-1374	802018	15-1693	808047	15-1002	817005
17-0418	261006	17-0806	299196	15-1213	802019	15-1813	808066	15-1055	817005
17-0127	261007	17-1231	299201	15-1596	802023	15-1048	809002	15-1065	817005
17-0122	261008	17-0483	299204	15-1595	802024	15-1064	809003	15-1003	817006
17-0188	261009	17-0484	299205	15-1550	802025	15-1162	809003	15-1420	817007
17-0128	261010	17-0480	299205	15-1597	802026	15-1026	809004	15-1309	817008
17-0751	261011	17-0849	299205	15-1463	803002	15-1356	809005	15-1388	817009
17-0604	261019	17-1153	299211	15-1150	803003	15-1438	809029	15-1440	817009
17-0752	261028	17-1154	299212	15-0025	803004	15-1330	809036	15-1067	817010
17-0608	261033	17-0965	299214	15-1025	803004	15-1815	809054	15-1306	817011
17-0760	261042	17-1024	299214	15-1219	803005	15-1015	810001	15-1032	817012
17-0207	261045	17-0916	299215	15-1127	803006	15-1177	810002	15-1155	817013
17-0445	261045	17-1245	299228	15-0096	803007	15-1175	810003	15-1296	817014
17-0437	261045	17-1246	299229	15-1096	803007	15-1208	810004	15-1358	817015
17-0354	261054	17-1209	299271	15-1653	803007	15-1206	810005	15-1416	817016
17-0355	261055	17-1211	299271	15-1066	803008	15-1179	810007	15-1225	817017
17-0357	261062	17-1208	299272	15-1122	803009	15-1180	810008	15-1240	817017
17-0612	261063	17-0944	299285	15-0112	803012	15-1063	810009	15-1095	817018
17-0743	261063	17-1037	299286	15-1112	803012	15-1020	810010	15-1231	817019
17-0353	261067	16-1017	602001	15-0119	803013	15-1132	810011	15-1232	817020
17-0474	261074	16-1025	602003	15-1119	803013	15-1236	810011	15-1226	817021

COMPETITOR	GSP Ref.	COMPETITOR	GSP Ref.	COMPETITOR	GSP Ref.	COMPETITOR	GSP Ref.	COMPETITOR	GSP Ref.
METELLI		15-1495	818098	15-1543	824091	15-1385	839021	15-1116	844020
		15-1549	818105	15-1757	824094	15-1492	839022	15-1437	844020
15-1227	817022	15-1563	818203	15-1830	824126	15-1628	839022	15-1453	844026
15-1209	817023	15-1777	818203	15-1836	824137	15-1668	839024	15-1713	844026
15-1410	817024	15-1490	818207	15-1791	824138	15-1148	839036	15-1613	844027
15-1396	817026	15-1788	818222	15-1736	824148	15-1215	839040	15-1505	844028
15-1458	817027	15-1763	818227	15-1075	826001	15-1130	839045	15-1287	844030
15-1449	817028	15-1677	818230	15-1398	827001	15-1104	839054	15-0007	844041
15-1493	817028	15-1754	818240	15-1405	827005	15-1662	839102	15-1007	844041
15-1409	817029	15-1753	818240	15-1145	827007	15-1617	839104	15-1029	844046
15-1387	817030	15-1752	818244	15-1663	827010	15-1615	839146	15-1289	844049
15-1419	817031	15-1761	818270	15-1654	827014	15-1524	839276	15-1056	844051
15-1612	817031	15-1078	821001	15-1518	827016	15-1184	840001	15-1057	844055
15-1214	817032	15-1076	821002	15-1609	827053	15-1163	841001	15-1051	844056
15-1154	817033	15-1355	821007	15-1645	827059	15-1293	841002	15-1052	844057
15-1481	817037	15-1599	821030	15-1798	827067	15-1275	841003	15-1391	844060
15-1106	817039	15-1690	821038	15-1611	827068	15-1172	841006	15-1618	844065
15-0258	817042	15-1812	821043	15-1548	827070	15-1173	841007	15-1307	844068
15-1258	817042	15-1030	822001	15-1570	827072	15-1088	841008	15-1555	844080
15-1457	817043	15-1666	822009	15-1715	827078	15-1164	841009	15-1390	844083
15-1494	817044	15-1427	823001	15-1223	828002	15-1165	841010	15-1724	844085
15-1726	817045	15-1399	823002	15-1081	828005	15-1323	841011	15-1216	845001
15-1507	817048	15-1010	823003	15-1448	829002	15-1194	841012	15-1292	845003
15-1506	817051	15-1011	823003	15-1186	829003	15-1193	841013	15-0292	845003
15-1506A	817051	15-1079	823004	15-1702	830012	15-1321	841014	15-1139	845004
15-1506B	817051	15-1071	823005	15-1701	830015	15-1312	841018	15-1282	845005
15-1593	817052	15-1044	823006	15-1207	831001	15-1349	841028	15-1259	845006
15-1592	817053	15-1220	823007	15-1339	831001	15-1348	841030	15-1382	845033
15-1717	817055	15-1242	823008	15-1117	832001	15-1187	841031	15-1588	845038
15-1411	817056	15-1221	823010	15-1042	834001	15-1600	841037	15-1569	845049
15-1718	817060	15-1054	823011	15-1058	834001	15-1509	841038	15-1468	845052
15-1687	817063	15-1131	823013	15-1069	834002	15-1196	841040	15-1499	845056
15-1601	817065	15-1131A	823014	15-1157	834003	15-1442	841046	15-1560	845057
15-1740	817068	15-1053	823016	15-1135	834004	15-1443	841047	15-1649	845057
15-1637	817070	15-1053A	823017	15-1384	834005	15-1634	841047	15-1515	845058
15-1648	817070	15-1072	823018	15-1372	834006	15-1647	841048	15-1629	845065
15-1429	818001	15-1260	823020	15-1138	834007	15-1445	841050	15-1568	845067
15-0192	818004	15-1045	823021	15-1472	834008	15-1475	841052	15-1720	845067
15-1192	818004	15-1101	823021	15-0474	834010	15-1477	841057	15-1108	850001
15-1565	818005	15-1251	823022	15-1474	834010	15-1197	841058	15-1317	850003
15-1125	818006	15-1255	823023	15-1603	834015	15-1027	841059	15-1378	850004
15-1640	818007	15-1301	823024	15-1137	834019	15-0028	841060	15-1422	850005
15-1432	818009	15-1250	823026	15-1335	834021	15-1028	841060	15-1082	850007
15-1669	818009	15-1424	823030	15-1643	834021	15-1100	841060	15-1204	850008
15-1202	818010	15-1699	823033	15-1304	834023	15-1098	841061	15-1285	850011
15-0200	818011	15-1678	823034	15-0146	834025	15-1249	841063	15-1353	850012
15-1200	818011	15-1679	823034	15-1146	834025	15-1060	841073	15-1316	850026
15-1283	818012	15-1423	823036	15-1473	834026	15-1248	841078	15-1102	850027
15-1354	818013	15-1425	823039	15-1256	834056	15-1276	841083	15-1576	850041
15-1430	818014	15-1086	823042	15-1304A	834058	15-1265	841084	15-0310	850043
15-1156	818015	15-1073	823044	15-1278	834074	15-1315	841087	15-1310	850043
15-1364	818016	15-1074	823044	15-1328	834082	15-1043	841095	15-1336	850045
15-1041	818017	15-1691	823060	15-1525	834084	15-1692	841099	15-1542	850069
15-1037	818018	15-1684	823080	15-1535	834093	15-1087	841105	15-1574	850079
15-1014	818019	15-1074A	823081	15-1610	834094	15-1324	841131	15-1502	850092
15-1092	818019	15-1337	823093	15-1821	834194	15-1476	841141	15-1579	850093
15-1233	818020	15-1682	823094	15-0298	835001	15-1508	841142	15-1580	850109
15-0198	818021	15-1426	823095	15-1298	835001	15-1136	841168	15-1503	850112
15-1198	818021	15-1685	823118	15-0373	835002	15-1085	841170	15-1522	850113
15-0201	818023	15-1681	823125	15-1373	835002	15-1129	841172	15-1573	850114
15-1201	818023	15-1832	823145	15-1434	835003	15-1784	841214	15-1523	850116
15-1444	818025	15-1680	823146	15-1709	835016	15-1667	841244	15-1650	850143
15-1389	818026	15-1686	823179	15-1367	835022	15-1698	841249	15-1793	850145
15-0024	818027	15-1047	824003	15-1604	835026	15-1635	841256	15-1840	850145
15-1024	818027	15-1406	824004	15-1606	835028	15-1785	841286	15-1803	850152
15-1291	818028	15-1370	824006	15-1454	838001	15-1394	844001	15-1727	850157
15-1171	818030	15-1734	824033	15-1480	838002	15-1451	844002	15-1728	850162
15-1059	818031	15-1742	824036	15-1520	838003	15-1504	844003	15-1850	850173
15-1254	818032	15-1608	824038	15-1147	839002	15-1452	844004	15-1284	851001
15-1261	818033	15-0541	824041	15-1639	839008	15-1439	844005	15-1090	851002
15-1141	818034	15-1541	824041	15-1329	839009	15-1289A	844006	15-1303	851003
15-1268	818035	15-1545	824046	15-1161	839011	15-1118	844007	15-1288	851004
15-1357	818059	15-1607	824047	15-1191	839014	15-1371	844008	15-1366	851005
15-1488	818067	15-1471	824061	15-1404	839016	15-1412	844011	15-1270	851006
15-1489	818067	15-1735	824072	15-1332	839019	15-1290	844012	15-1383	851007
15-1511	818069	15-1661	824090	15-1331	839020	15-1400	844013	15-1408	851008

COMPETITOR	GSP Ref.	COMPETITOR	GSP Ref.	COMPETITOR	GSP Ref.	COMPETITOR	GSP Ref.	COMPETITOR	GSP Ref.
METELLI		15-1696	859285	31607570274	201108	49501A4100	201207	36012420	201388
		15-1733	860005	31607570275	201109	49501A4350	201208	31272546	201388
15-1039	851009	15-1004	861001	31607558951	201109	49501A4050	201209	31367563	201388
15-1205	851010	15-1034	861002	31607570273	201109	49500A4100	201210	36012421	201389
15-1431	851011	15-1123	861003	31607607937	201110	4342002880	201222	30783076	201389
15-1089	851012	15-1124	861004	33201229371	201111	4341002A60	201223	36012424	201390
15-1038	851013	15-1230	861005	33211229140	201111	4341002A70	201224	31216448	201390
15-1299	851018	15-0229	861006	33211229374	201111	4342002C30	201225	31367561	201390
15-1537	851020	15-1229	861006	33201229449	201112	4341002A02	201226	36001071	201390
15-1269	852001	15-1466	861007	33201229441	201112	434100T070	201229	50566750	201390
15-1168	852002	15-1478	861009	33207508136	201113	434200T030	201230	AG9N3B436DB	201390
15-1170	852003	15-1533	861010	33201229730	201113	434100T060	201231	36051044	201391
15-1031	852004	15-1479	861011	1229730	201113	4341042150	201233	30735564	201391
15-1062	852004	15-1375	861012	33207523694	201114	4341042220	201234	8603977	201392
15-1169	852007	15-1005	861013	33207572688	201114	4341042260	201235	30735276	201402
15-1487	852008	15-1633	861042	33207589058	201115	4342002A90	201236	30735885	201402
15-1144	852010	15-1644	861042	33207839467	201116	434200F051	201237	8603801	201402
15-1166	852011	15-1658	861045	33208603108	201117	391001KB0A	201238	8601581	201402
15-1652	852012	15-1659	861050	33208603109	201118	495002Y610	201239	36001221	201403
15-1465	853001	15-1708	861059	33208609842	201119	495002Y810	201240	31280875	201403
15-1415	853002	15-1133	862001	33208603101	201119	49500B2400	201241	30783108	201403
15-1190	853005	15-1368	862002	33207617540	201119	49500B2500	201242	36051054	201404
15-1009	853007	15-1369	862004	33217505290	201120	49500C5200	201243	43410BZ140	201468
15-1021	853008	15-1376	862005	33217510622	201120	49500D7050	201244	43420BZ140	201469
15-1158	854001	15-1273	862006	33217527073	201121	49500D7060	201245	A2513302201	201561
15-1403	854002	15-1272	862007	33217561781	201121	49500D7070	201246	2513302201	201561
15-1531	854004	15-1538	862009	31367306	201122	49500D7080	201247	495001W000	201565
15-1018	856001	15-1706	862010	36002063	201122	49500D9130	201248	495011W000	201566
15-1151	856003	15-1642	862012	31367306AA	201122	49501B2500	201249	3815A453	201574
15-1084	856004	15-1673	862035	396001350R	201123	49501B2300	201249	3815A454	201575
15-1247	856005	15-1228	864001	51792340	201124	49501B2400	201250	1K0407271BC	201582
15-1017	856011	15-1572	899008	6843516	201125	49501C5250	201251	1K0407451EX	201582
15-1040	856012	15-1341	899012	6843866	201126	49501D7060	201252	1K0407272KE	201583
15-1046	856013	15-1594	899018	7L6407271A	201127	49501D7070	201253	1K0407272BL	201583
15-1274	856014	15-1590	899037	7L6407271H	201127	49501D7190	201254	1K0407271GR	201584
15-1077	856046	15-1501	899085	7L6407271HX	201127	49501D9140	201255	1K0407272QM	201586
15-1319	856053	15-1529	899128	8251512	201128	5N0407763F	201265	1K0407272NN	201586
15-1252	857003	15-1528	899128	9207804	201128	21902221501010	201290	1J0501204BX	201587
15-1114	857007	15-1564	899129	1534882	201129	21902221501110	201292	4E0407272Q	201588
15-1540	857009	15-1514	899151	6G9N4B402BA	201129	36011304	201370	4E0407452X	201588
15-1149	857011	15-1562	899155	RL6G9N4B402BX	201129	31367553	201370	4E0407271P	201589
15-1360	857012	15-1774	899155	30681132	201129	36001216	201371	4F0407272J	201590
15-1361	857013	15-1008	899205	50393540	201129	36000509	201371	4F0407452AX	201591
15-1266	857014	15-1167	899212	36000156	201129	36001220	201372	1K0407272HP	201594
15-1380	857035	15-1519	899213	8603680	201129	30783107	201372	1K0407764NX	201594
15-1365	857037	15-1486	899254	8603682	201130	36010055	201373	1K0407762GX	201594
15-1665	857039	15-1547	899268	8603709	201131	31325699	201373	3D0407272E	201595
15-1602	857042	15-1674	899270	8E0407451SX	201132	36010057	201374	3D0407272EX	201595
15-1794	857061	15-1738	899271	8E0407271BK	201132	31325700	201374	4E0407451X	201596
15-1614	857062	15-1557	899282	P04726091AB	201133	36010058	201375	4E0407271N	201596
15-1723	857100	15-1756	899284	495003R900	201146	31325110	201375	3C0501204	201597
15-1790	857103	15-1510	899288	49501C5450	201147	36010063	201376	3C0501204F	201597
15-1623	857140	15-1765	899288	49500A7600	201148	31437525	201376	3C0501204FX	201597
15-1070	859001	15-1616	899298	49500C5400	201149	31325704	201376	42341582	201616
15-1271	859013	15-1787	899318	49500A9300	201151	36010064	201377	5374209	201616
15-0351	859019	15-1710	899348	49501A7600	201152	31325701	201377	13335128	201619
15-1351	859019	15-1660	899351	49500C5300	201153	36010216	201378	42341583	201621
15-1346	859020	15-1675	899366	2303300XKZ13A	201154	31325111	201378	5747210	201621
15-1347	859021	OE		2303400XKZ13A	201155	36010217	201379	1K0407272PK	201653
15-1483	859022			49500D4300	201167	31325702	201379	1K0407272RD	201653
15-1513	859022	44010SR3020	201010	49501D4350	201168	36011291	201380	1K0407272JR	201653
15-1392	859025	44306SH3960	201013	495012T750	201171	30651672	201380	18212970	201653
15-1460	859026	44306SH3961	201013	495002T700	201172	36011292	201381	7E0407452SX	201665
15-1484	859028	44306SH3A00	201013	495004R200	201173	30711429	201381	7E0407272AK	201666
15-1447	859035	44306SH3A01	201013	49500D4100	201174	36011301	201382	7E0407452PX	201666
15-1539	859037	44306SH3G00	201013	49501D4150	201175	30651673	201382	391008228R	201721
15-1485	859042	44306SH3G01	201013	495003S800	201176	36011303	201383	391018618R	201722
15-1253	859054	44011SH3A02	201013	4342012831	201177	31272538	201383	495012Y810	201996
15-1134	859056	44306SEAN50	201047	4342012841	201178	30651679	201383	46307345	202001
15-1334	859058	3273LL	201105	496003T200	201179	36001191	201384	46307346	202002
15-1326	859060	3273LN	201105	496013T200	201180	36012415	201385	60651295	202002
15-1536	859081	9653263880	201105	43420YV020	201194	31367536	201385	46308025	202003
15-0459	859117	95833202420	201106	4341002820	201195	36012417	201386	46308071	202003
15-1450	859137	95B407271A	201107	4342002D30	201196	31216447	201386	60802018	202003
15-1325	859161	31607570272	201108	4341052310	201197	36012419	201387	46308026	202004
15-1544	859226	31607558952	201108	49500A4050	201206	36001183	201387	60802019	202004

COMPETITOR	GSP Ref.	COMPETITOR	GSP Ref.	COMPETITOR	GSP Ref.	COMPETITOR	GSP Ref.	COMPETITOR	GSP Ref.
OE		1J0407272CT	203011	1J0407272M	203046	7E0407452GX	203261	8E0407271AR	203310
		1J0407452GX	203011	1J0407452AV	203046	7E0407272N	203261	8E0407451QX	203310
46307687	202005	1J0407272CS	203011	1J0407452BV	203046	7E0407272NX	203261	8E0407272AR	203311
46307698	202005	8D0407271AC	203012	8D0407271BP	203048	7E0407272NV	203261	8E0407452PX	203311
46308024	202008	8D0407271BE	203012	8D0407272AL	203048	1K0407271ES	203265	1K0407272EN	203313
46307865	202008	8D0407271DK	203012	8D0407272BC	203048	1K0407271HM	203265	1K0407272RB	203313
46308072	202008	8D0407271DM	203012	8D0407272ED	203048	1K0407453BX	203265	1K0407454DX	203313
71787183	202008	8D0407417H	203012	4A0407272BD	203050	1K0407761HX	203265	1K0407764LX	203313
7178751	202008	8D0407451DV	203012	4A0407271BG	203050	1K0407761TX	203265	8R0407271B	203316
46307650	202009	8D0407451DX	203012	4A0407272DF	203050	1K0407452TX	203266	8R0407271	203316
46307651	202009	8D0407271AL	203015	4A0407452FX	203050	1K0407272CR	203266	8R0407271BX	203316
46307688	202009	8D0407271BC	203015	4A0407272BH	203051	5N0407764M	203269	8R0407271CX	203316
46307654	202011	8D0407271ED	203015	4A0407272DE	203051	5N0407764MX	203269	8R0407271A	203317
71783011	202011	4B0407271AP	203019	4A0407452EX	203051	5N0407764R	203269	8R0407271C	203317
8D0407272AQ	203001	4B0407271F	203019	8E0407271AA	203052	5N0407764RX	203269	1K0407451RX	203318
8D0407452AV	203001	4D0407272S	203019	8E0407271BE	203052	5N0407766	203270	1K0407271BD	203318
8D0407452AX	203001	4B0407451EX	203019	8E0407271BF	203052	5N0407766X	203270	1K0407271DH	203319
8D0407271AP	203002	4B0407451GX	203019	8E0407271T	203052	4F0407271H	203271	1K0407451BX	203319
8D0407271BA	203002	4B0407272AP	203020	8E0407451HX	203052	4F0407451BX	203271	1K0407451MX	203319
8D0407271DL	203002	4B0407272F	203020	8E0407451NX	203052	8K0407271D	203273	1K0407272GS	203319
8D0407451V	203002	4B0407418E	203020	8E0407451PX	203052	8K0407271Q	203273	1K0407272HC	203319
8D0407451X	203002	4B0407452GX	203020	8E0407451X	203052	8K0407451AV	203273	8K0407271S	203321
895407271D	203003	4D0407272AF	203020	8E0407271S	203057	8K0407451AX	203273	8K0407451EX	203321
8A0407271AE	203003	4D0407272J	203020	8E0407451GX	203057	8K0407451DX	203273	8J0407272K	203322
8A0407271H	203003	7M307271Q	203022	8E0407272S	203058	7E0407272S	203278	8J0407452BX	203322
8A0407271J	203003	7M3407271A	203022	8E0407452GX	203058	7E0407271H	203278	8N0407272E	203322
895407271C	203003	7M3407271E	203022	8E0407452JX	203058	7E0407451X	203278	8N0407452X	203322
895407271CV	203003	7M3407271Q	203022	8E0407272AT	203058	7E0407272AN	203279	4F0407272G	203329
895407271CX	203003	7M3407271QX	203022	893407271L	203059	7E0407272AA	203279	4F0272452AX	203329
895407271X	203003	7M3407451V	203022	4A0407271BS	203060	7E0407452BX	203279	6R0407761	203330
1J0407272	203004	7M3407451X	203022	4A0407271DG	203060	7G913B437BD	203288	6R0407761X	203330
1J0407272AG	203004	YM213B473BC	203022	4A0407451X	203060	1788206	203289	8K0407271AK	203337
1J0407272AH	203004	7M3407761A	203022	4A0407272BS	203061	7G913B436BF	203289	8K0407451KX	203337
1J0407272AT	203004	7M3407761AX	203022	4A0407272DG	203061	4F0407271G	203290	8K0407271C	203345
1J0407272C	203004	1254277	203022	4A0407452X	203061	4F0407451AX	203290	8K0407271P	203345
1J0407272JK	203004	1125045	203023	701407271CX	203061	8K0407271AJ	203291	8K0407451FX	203345
1J0407452V	203004	1233602	203023	6Q0407271AK	203063	8K0407451LX	203291	8K0407451V	203345
1J0407452X	203004	7M0407451A	203023	6Q0407271AL	203063	7E0407271L	203293	8K0407451X	203345
8D0407271AQ	203005	7M3407271	203023	6Q0407271AS	203063	7E0407451AX	203293	1K0407272KB	203346
8D0407451AV	203005	7M3407271F	203023	6Q0407271AT	203063	1K0407271AT	203294	1K0407454TX	203346
8D0407451AX	203005	7M3407271M	203023	6Q0407271BC	203063	1K0407451CX	203294	1K0407272BM	203346
1J0407271AP	203006	7M3407271N	203023	6Q0407451DX	203063	1K0407271CP	203294	8E0407271BA	203347
1J0407271FN	203006	7M3407271P	203023	6Q0407451EV	203063	1K0407451FX	203294	8E0407451KX	203347
1J0407271H	203006	7M3407271PX	203023	6Q0407451EX	203063	1K0407271DR	203294	8J0407271N	203350
1J0407271JD	203006	7M3407451A	203023	6Q0407451X	203063	1K0407451KX	203294	8K0407451X	203350
1J0407451AX	203006	7M3407451AV	203023	6QE407271G	203063	1K0407271BJ	203295	8J0407271AA	203350
1J0407451QX	203006	7M3407451AX	203023	4B0407271AS	203066	1K0407271EE	203295	8J0407451BX	203350
1J0407271AF	203006	7M3407451BV	203023	4B0407271BB	203066	1K0407271BN	203295	1K0407271FP	203350
1J0407271C	203006	7M3407451BX	203023	4B3407271G	203066	1K0407451DX	203295	1K0407761BX	203350
1J0407451AV	203006	7M3407761X	203023	4B3407451AX	203066	1K0407451TX	203295	8E0407271AT	203352
1J0407453DV	203006	YM213B437AB	203023	4B0407451PX	203066	1K0407453DX	203295	8E0407451JX	203352
1J0407453DX	203006	YM213B437AC	203023	4B3407271J	203066	7E0407452HX	203296	7E0407272BC	203353
8D0407272AN	203007	7M3407761	203023	4B0407451RX	203066	7E0407452X	203296	7E0407452JQ	203353
8D0407272BJ	203007	YM213B437A	203023	1K0501203AX	203236	7E0407272B	203296	5Q0407272BT	203354
8D0407272CL	203007	7M0407451AV	203023	1K0501203DX	203236	7E0407272AR	203296	5Q0407272J	203354
8D0407272DJ	203007	4E0407272P	203025	3C0407271T	203241	8A0407272H	203297	5Q0407762AX	203354
8D0407272DP	203007	4E0407452AX	203025	3C0407271TX	203241	895407272D	203297	5Q0407762AX	203354
8D0407452BV	203007	4F0407451CX	203025	7H0407272AJ	203246	8A0407272AE	203297	5Q0407762HX	203354
8D0407452BX	203007	4F0407271N	203025	7H0407272BC	203246	8A0407272J	203297	1Q0407272A	203354
8D0407452FX	203007	4F0407272H	203026	7H0407272BK	203246	8A0407452X	203297	1K0407272BR	203355
8D0407452FV	203007	4F0407452BX	203026	7H0407272CH	203246	7L6407271	203300	1K0407452RX	203355
3B0407271N	203008	8D0407271AM	203036	7H0407272S	203246	7L6407271BV	203300	7E0407271R	203360
8D0407271AJ	203008	8D0407417J	203036	7H0407452NV	203246	7L6407271BX	203300	7E0407451CX	203360
8D0407271BB	203008	8D0407271BF	203036	7H0407452NX	203246	7L6407271C	203300	7E0407276S	203361
8D0407271DT	203008	8D0407271DN	203036	7H0407452SX	203246	7L6407271GX	203300	8E0407272AH	203362
8D0407451CV	203008	8D0407451GX	203036	7H0407452TX	203246	7L6407271D	203300	8E0407452EX	203362
8D0407451CX	203008	895407272F	203044	7H0407452V	203246	7L6407271DX	203300	8E0407271BJ	203363
8D0407453EV	203008	8A0407272AT	203044	7H0407452X	203246	7L6407271G	203300	8E0407451LX	203363
8D0407271EH	203008	1J0407272AP	203046	7H0498104F	203246	1K0407271ET	203302	8E0407271BG	203364
8D0407451LX	203008	1J0407272BL	203046	7E0407272AB	203261	1K0407453AX	203302	8E0407451RX	203364
8D0407453EX	203008	1J0407272BM	203046	7E0407272AP	203261	8J0407761A	203303	7N0407763	203365
8D0407271EL	203008	1J0407272DA	203046	7E0407452CX	203261	8J0407761AX	203303	7N0407763X	203365
8D0407271EF	203008	1J0407272F	203046	7E0407272AH	203261	8N0407271E	203304	7N0407764N	203366
8D0407271EC	203008	1J0407452BX	203046	7E0407276K	203261	8N0407451X	203304		

COMPETITOR	GSP Ref.	COMPETITOR	GSP Ref.	COMPETITOR	GSP Ref.	COMPETITOR	GSP Ref.	COMPETITOR	GSP Ref.
OE		33217553562	205032	31607596060	205071	31602756795	205131	4808578	209039
		33217547072	205033	31608605466	205071	31602753397	205131	4808568L	209039
8K0501203MX	203367	33217547071	205034	33207572430	205073	31607589765	205131	4808578L	209039
8R0501203C	203368	33217561792	205036	33207572429	205073	31609806469	205132	4808580K	209039
8R0501203CX	203368	33217561791	205037	33217521630	205073	33207605486	205134	RX641883AE	209067
8R0501203BX	203368	33207561796	205038	33217526745	205073	33207604600	205134	RX274806AC	209073
5N0407764S	203369	33207580945	205038	33207524044	205074	33217561784	205134	04641884AE	209082
5N0407764SX	203369	33217553560	205038	33217529914	205074	33207591596	205134	3272ES	210001
4G0407271E	203370	33217553564	205038	31217540116	205074	33207605485	205135	3272ET	210001
8K0407271AL	203371	33207604592	205038	33207537608	205074	33217529918	205140	3273ES	210002
1K0407271DQ	203373	33207561795	205039	33217540116	205074	33207524042	205140	3273ET	210002
1K0407451LX	203373	33207580946	205039	31601229673	205075	33217529917	205141	327307	210004
1J0407271HJ	203374	33217553559	205039	31607503537	205075	33207524041	205141	95669014	210004
1J0407451RX	203374	33217553563	205039	31601229674	205076	33207637444	205147	96072989	210004
1J0407451SX	203374	33217561783	205039	31607503538	205076	33207637445	205148	3273Y2	210004
1J0407271HK	203374	33207604591	205039	31607524046	205078	33207564558	205149	3273Y3	210004
1J0407453GX	203374	33217547069	205040	31607529202	205078	33204567167	205149	95601868	210005
3Q0407271AC	203381	33217553561	205040	31603450564	205078	33207582141	205149	95624994	210005
3Q0407271AM	203381	31608605473	205041	31603450566	205078	22789359	207007	95648547	210005
3Q0407761MX	203381	33211229592	205042	33217561790	205079	96485019	208012	96033355	210005
33211226047	205001	33211229708	205042	33207572432	205079	96870387	208012	96042941	210005
33211226720	205001	31607545126	205043	33207564127	205081	96485020	208013	327265	210007
33211227032	205002	31607553946	205043	33208609838	205081	96870388	208013	327364	210007
33211227597	205002	31608605474	205045	33217532266	205082	4342020112	208016	327365	210007
33211227606	205002	31607502731	205047	33207578720	205082	4342020113	208016	327369	210007
33211229392	205002	31607505199	205047	33207572420	205082	2650112001	208016	327389	210007
33211229587	205002	31607505200	205048	33217561789	205085	4641975	208024	95591074	210007
33211225940	205003	33207500916	205049	33217547821	205091	4641981	208024	95619482	210007
33211225941	205003	33207500917	205049	33207568730	205091	4660487	208024	95654731	210007
33211226330	205003	33207500914	205050	7L8501201	205098	4808125	208024	32735Q	210007
33211226336	205003	33207500915	205050	7L8501201X	205098	4808135	208024	32735R	210007
33211226861	205003	33211229591	205051	6H424B457BA	205104	4808873	208024	3273G2	210007
33211226900	205003	33211229707	205051	TOB500320	205104	4808883	208024	3273L9	210007
33211225570	205003	31607545125	205052	7L8501201B	205106	4808965	208024	3273R6	210007
33211225891	205003	31607553945	205052	33207628251	205107	4808971	208024	3273Y0	210007
33211226329	205003	31607531721	205053	33207839468	205108	04641855AE	208024	327000	210008
33211226333	205003	31607533215	205053	33207597690	205109	04641883AD	208024	327368	210008
33211226563	205003	31607531722	205054	33207640260	205109	4641981K	208024	95601867	210008
33211226578	205003	31607533216	205054	33207597689	205110	4808883J	208024	95601887	210008
33411127093	205003	1643302301	205060	33207640261	205110	4808971K	208024	95624995	210008
33211225942	205004	A1643302301	205060	33207566074	205111	P4808883	208024	95648548	210008
33211225943	205004	A1643302701	205060	33207581029	205112	96257822	208059	96033369	210008
33211226860	205004	1643302701	205060	33207581027	205112	96238259	208071	96042942	210008
33211226901	205004	1643300801	205060	33207630183	205112	96238258	208072	32735J	210008
33211227912	205006	1643302801	205061	33207581028	205113	95981833	208072	3273E2	210008
33211229235	205006	A1643302401	205061	33207581030	205113	3273CY	208082	327356	210008
33211226904	205007	1643302401	205061	33207630184	205113	3273CZ	208082	3273C8	210008
33211226905	205007	A1643302801	205061	33207581021	205114	13271511	208107	32735C	210008
33211227404	205007	1643301901	205061	33207614290	205114	13334701	208107	327250	210009
33211227585	205007	A1643301901	205061	33207614289	205115	13271512	208108	327254	210009
33211227591	205007	31217540115	205062	33207581022	205115	13334702	208108	32728J	210009
33211229472	205007	33207537607	205062	33207566075	205116	13271534	208108	3272W5	210009
33211229473	205007	33217540115	205062	33207598037	205117	13334712	208108	32723J	210009
33211227172	205014	33207524043	205062	33207614492	205118	13371624	208108	95644403	210010
33211229588	205017	33203415955	205062	33207598036	205119	13386322	208108	96021730	210010
31607505004	205018	33213428179	205062	33207598035	205120	52104701AB	208115	3272R3	210010
31607505006	205018	33217529913	205062	33207598038	205121	52104591AB	208115	P0596T	210010
31607561342	205018	31607596059	205063	31607607938	205123	04880212AH	208137	32722L	210012
31607565314	205018	31608605467	205063	31607558949	205124	52104590AB	208150	32735X	210012
33201229141	205021	33201229377	205064	31607558950	205125	52104590AA	208150	3273V7	210012
33201229374	205021	33201229380	205064	31609806465	205126	52082688	208156	3273W0	210012
33211229420	205021	33211229749	205064	33209813707	205127	52104996	208157	9617303480	210013
33211229432	205021	33211229748	205064	33209806477	205127	95199674	208164	327306	210014
33217547073	205022	33207629301	205066	31609806470	205128	95199667	208165	327315	210014
33217547075	205022	33207624205	205066	9809174	205128	4511435	209002	9617408288	210014
33217547074	205023	33207597681	205066	31609806466	205129	4511443	209002	9626084088	210014
33217547076	205023	33207597677	205066	31607599262	205130	4511445	209002	32735Y	210014
31608605469	205024	33207629302	205067	31602753398	205130	4641528	209002	32737E	210014
31607609211	205024	33207597682	205067	31602756796	205130	4641672	209002	3273S1	210014
31607589763	205024	33207597678	205067	31607589766	205130	04641856AF	209005	32730W	210015
31607574866	205025	33207624206	205067	31607616144	205130	5066020AA	209018	32730X	210015
31607574869	205026	2513301901	205068	31608605472	205130	5066022AA	209018	32736A	210015
31607505005	205029	2513301801	205068	31608605471	205131	5066024AA	209018	3273X	210015
31607561341	205029	33207564128	205070	31607540979	205131	4511436	209028	9626083988	210016
31607565313	205029	33208609839	205070	31607559429					

COMPETITOR	GSP Ref.	COMPETITOR	GSP Ref.	COMPETITOR	GSP Ref.	COMPETITOR	GSP Ref.	COMPETITOR	GSP Ref.
OE		3273CN	210032	3272CR	210043	95624471	210091	3272FP	210131
		3273R2	210032	327387	210044	95631414	210091	3272FQ	210131
3272L0	210016	3273R3	210032	95644404	210044	95648545	210091	3272Z7	210131
3272V7	210016	3273ZZ	210032	96021731	210044	96048975	210091	3272Z8	210131
32732Y	210017	3273NC	210032	32735P	210044	327263	210093	95607391	210132
32732Z	210017	3273CP	210032	3273X8	210044	1495541080	210102	95618333	210132
32721F	210018	1478551080	210033	P0595T	210044	1495542080	210103	32730M	210137
32731C	210019	1487937088	210033	32728Q	210048	3273CH	210104	32721T	210138
32733Z	210019	32729K	210033	32729Q	210048	3273CJ	210104	32726Q	210138
32734H	210019	3272CN	210033	32737Q	210049	3273Q5	210104	32738J	210139
32734J	210019	3272J7	210033	32737R	210049	3273Q8	210104	32738K	210139
32736H	210019	3272J8	210033	9619947588	210052	3273Q9	210104	32738P	210139
24969905	210020	3272V3	210033	3272L9	210052	32736C	210110	3273EJ	210139
00003272X3	210020	3272V4	210033	3272M0	210052	327238	210113	32738L	210140
32727J	210020	3272V5	210033	32726L	210053	327239	210113	32738N	210140
3272G1	210020	3272NF	210033	32728L	210053	327290	210113	3273EH	210140
3272T9	210020	51872271	210033	1481449080	210057	95644258	210113	3273NY	210140
3272X4	210020	3272CP	210033	1495546080	210066	9614188080	210113	32722V	210141
3272AX	210020	327248	210034	1496137080	210066	32723N	210113	32728T	210141
32726F	210021	327285	210034	3273Q7	210066	3272J9	210113	32729T	210141
32727F	210021	327477	210034	1495545080	210067	95643956	210114	3272EJ	210141
32728F	210021	95555116	210034	3272J2	210067	9614188180	210114	32726T	210142
72728L	210021	95606803	210034	327362	210068	32736N	210114	32727T	210142
3272A1	210022	96184031	210034	327478	210068	3273A9	210114	32738G	210143
96031845	210023	9559529280	210034	95555117	210068	3273C0	210114	32738H	210143
96091416	210023	9607411180	210034	95606804	210068	3273H4	210114	3273EQ	210144
96167304	210023	9607411480	210034	96184033	210068	3273H8	210114	3273ER	210144
96171875	210023	9617303280	210034	9555511780	210068	327317	210117	3273HH	210144
96173636	210023	32727N	210034	9559529480	210068	327318	210117	3273SG	210144
32730R	210023	3272F9	210034	32736R	210068	327482	210117	3272EQ	210146
32730S	210023	1463107080	210035	3273C7	210068	327483	210117	3272ER	210146
32730T	210023	1491239080	210035	3273H1	210068	95602238	210117	3272HR	210146
32736K	210023	3272CK	210035	95569340	210069	95606796	210117	3272RT	210146
32737W	210023	3272J1	210035	1463106080	210069	96171858	210117	3272RH	210146
32739Z	210023	3272J6	210035	1491236080	210069	96177248	210117	9641777180	210147
3273AA	210023	3272CL	210035	9617303380	210069	32722N	210117	3272EX	210147
3273K2	210023	1463108080	210036	32736P	210070	3272A8	210117	3272EY	210147
3273K3	210023	1491240080	210036	3273T6	210070	3272C0	210117	32737K	210152
72737X	210023	32735T	210036	95644260	210071	327304	210118	32737L	210152
95602241	210024	3273CK	210036	96145818	210071	3273Y4	210118	3273S4	210155
95606797	210024	3273Q6	210036	32725N	210071	9619947688	210120	32737F	210156
95619480	210024	3273R0	210036	3272N0	210071	3273T3	210120	32737G	210156
96009410	210024	3273R1	210036	9617408188	210072	3273T4	210120	32724Q	210157
3273K4	210024	1463105080	210037	32732P	210076	32721V	210121	32725Q	210157
96091415	210025	3272CH	210037	32736E	210076	32721W	210121	3272T8	210159
96167303	210025	3272J0	210037	32736F	210076	3272EH	210121	32721Q	210161
96171874	210025	1495537080	210037	96086458	210078	3272NT	210121	32729P	210161
96173637	210025	327255	210038	96173638	210078	3272RA	210121	32725P	210162
3272A4	210025	9566694077	210038	32737X	210078	3272RC	210121	32726P	210162
3272A6	210025	9566694087	210038	32721L	210082	9642876780	210121	32720J	210163
32725L	210026	327200	210039	3272L1	210082	3273HF	210124	327251	210164
32726Y	210026	327220	210039	3272P5	210082	3273HG	210124	327256	210164
3272Y6	210026	327276	210039	327363	210085	3272HP	210125	95666908	210164
3272Y7	210026	327366	210039	3273E4	210085	3272HQ	210125	95666940	210164
3272Y8	210026	327367	210039	95666909	210085	95640036	210127	96048666	210164
32730V	210027	95591073	210039	96048667	210085	95655262	210127	96095217	210164
32738B	210028	95619481	210039	96095216	210085	3272L6	210127	96666908	210164
32737N	210028	95654730	210039	3273C9	210085	32721N	210128	32721K	210164
32735N	210028	32724K	210039	9566694187	210089	32726W	210128	32729J	210164
95605804	210029	3272K2	210039	32735L	210089	32727W	210128	3272V2	210164
3273N4	210029	3272R5	210039	95666941	210089	32728R	210128	3272W8	210164
3272EN	210030	327218	210040	32700000	210089	32729R	210128	32724J	210164
3272EP	210030	95669013	210040	32730H	210089	3272Y3	210128	3272X6	210164
3272FW	210030	96072988	210040	3273000	210089	3272Y4	210128	3272X8	210164
9638016580	210030	3272Z2	210040	3273.5L	210089	3272Y5	210128	32720H	210165
3272FX	210030	3272R7	210040	3273.E4	210089	327453	210130	32729L	210165
3273EA	210031	3272R8	210040	96171856	210090	327455	210130	3272Y2	210165
3273EN	210031	3272V1	210040	3272A9	210090	327459	210130	96049018	210167
3273EP	210031	9630767080	210043	3272C3	210090	327461	210130	96171857	210167
327309	210032	32726E	210043	3272E9	210090	95582409	210130	32730Q	210167
327310	210032	32727E	210043	3272F0	210090	95603330	210130	32731K	210167
327313	210032	32727G	210043	3272F7	210090	7910028946	210130	32736J	210167
1478552080	210032	3272CQ	210043	3272G3	210090	3274C4	210130	3273K5	210167
1487936088	210032	9638753080	210043	95624470	210090	32721S	210131	3273K7	210167
32735V	210032	9630767180	210043	96048974	210090	32722S	210131	327305	210174
32735W	210032	9638753480	210043	32736L	210091	32728S	210131	24969815	210174

COMPETITOR	GSP Ref.	COMPETITOR	GSP Ref.	COMPETITOR	GSP Ref.	COMPETITOR	GSP Ref.	COMPETITOR	GSP Ref.
OE		3272C1	210246	3272GH	210310	3273TT	210421	4342087211	214005
		3272LE	210248	3272PV	210311	3273QQ	210421	4342097242	214005
32730E	210174	3272LF	210248	3272PW	210311	3273QR	210421	4341087211	214006
32730F	210174	3273KS	210249	3272NW	210312	3272AS	210422	4341097242	214006
32735H	210174	3273KR	210249	3272QY	210312	3272AT	210422	4341087405	214022
3273N7	210174	9656135080	210249	3272ZZ	210312	1485686080	210422	4341087281	214024
327371	210177	3272VA	210250	3273NW	210313	3272CC	210423	43420BZ020	214025
3273J1	210177	3272TZ	210250	3273NX	210313	3272CE	210423	43410BZ020	214026
3272EV	210181	3272LG	210250	3273RH	210313	3272RJ	210424	43420BZ010	214027
3272EW	210181	3272LH	210250	3273RJ	210313	3272RK	210424	43410BZ010	214028
9639475180	210181	9683944580	210250	3272RX	210314	3273CE	210425	4342087406	214029
000032730A	210186	3273QH	210251	3272RY	210314	3273CC	210425	4341097205	214039
32735F	210186	3273QJ	210251	3272WG	210314	3272TH	210427	4342097209	214040
4246Y5	210186	3273VN	210251	3272WH	210314	3272QG	210427	43410B6010	214066
4246Y9	210186	3273VP	210251	3273SK	210320	3272QF	210427	4410579J00	214073
32730J	210186	3272PZ	210253	3273SL	210320	3273AV	210431	4410679J00	214074
3272Z2	210187	3272QA	210253	3273QK	210325	3273AW	210431	05105649AC	215051
3272G9	210189	9684135380	210253	3273QL	210325	3273LJ	210435	05105660AC	215052
3272Q5	210189	3273LR	210254	9684135480	210325	3273LK	210435	05085220AB	215053
3272Q6	210189	3272VH	210254	3272ZA	210335	9652248680	210435	05085224AB	215054
3272Q7	210189	9656329480	210254	3272SA	210335	9652263280	210435	52069711	215061
3272R0	210189	3272LX	210255	9682500880	210335	3273RY	210440	52069711AC	215061
95643952	210190	3272ZE	210255	9801388580	210340	3273PS	210440	52069887AB	215061
96145819	210190	9656329380	210255	3272VV	210340	3273PR	210440	52069887AD	215061
3273A6	210190	9650624180	210259	3272VT	210340	3273RZ	210440	52069887AE	215061
3273C1	210190	3273HS	210259	3273SH	210342	32720R	210441	46307695	216001
3273C6	210190	3273HT	210259	3273SJ	210342	32731T	210442	46307815	216002
3273H5	210190	3273HR	210259	9803966280	210346	32728V	210443	4713189	216003
327235	210191	3273PT	210259	9803966380	210347	32738W	210444	4720381	216003
327240	210191	9646326680	210259	3273RQ	210348	6001542122	211001	4720380	216004
327260	210191	9646327880	210259	3273RR	210348	6000591283	211002	O5012748AA	216006
327287	210191	9638226380	210259	3272QE	210362	7701348085	211004	O5012748AB	216006
32724T	210192	1481452080	210264	9660896080	210362	7701348086	211004	5012748AB	216006
32725T	210192	32724L	210264	3272YW	210362	7701498699	211004	05012749AB	216009
96171873	210193	32729C	210264	3272QC	210362	7711106127	211004	05012749AA	216009
3272G8	210194	7120925	210264	3273QS	210363	8200388903	211006	5012749AA	216009
3273P3	210195	3273EG	210265	3273QT	210363	6001548121	211006	5066021AA	216010
3272G7	210196	3273FA	210265	3273TW	210363	8201074123	211006	5066023AA	216010
3273P2	210197	3272GE	210266	3272NR	210364	6001543327	211006	52099497AE	216021
3273W8	210202	3272GF	210266	3272NS	210364	8200388900	211007	46307109	217001
3273W9	210202	3273KY	210267	3272PR	210364	6001548120	211007	7694584	217010
3273X3	210202	3273KZ	210267	3272PS	210364	6001548658	211012	7735107	217011
32734S	210203	3272FT	210268	3272QH	210380	6001548659	211012	46302200SX	217013
32729G	210204	3272FV	210268	3272QJ	210380	7711497479	211012	46307614	217013
32732Q	210205	3272JA	210276	3272TK	210380	8200499304	211012	46308133	217013
32733K	210205	3272JC	210276	3272HL	210381	8200503358	211012	46308200	217013
32734T	210205	95619479	210278	3272NY	210381	6001548660	211014	46302199SX	217014
32736G	210205	95648544	210278	3272QW	210381	6001548661	211014	7637734	217015
3273EV	210206	96009409	210278	3272QX	210381	7711497480	211014	7682656	217016
3273EW	210206	96173635	210278	3273HC	210382	8200499306	211014	46307674	217017
9639475280	210206	3273GF	210283	3273PG	210382	8200503359	211014	7740977	217018
32726V	210207	9640848280	210283	3273RF	210382	391019671R	211017	7739015	217018
32727V	210207	3273GG	210283	3273RG	210382	397953005R	211017	46307678	217019
3272EK	210207	3272GP	210285	3273QN	210383	391006331R	211018	7794472	217022
32738T	210208	9640848180	210285	3273QP	210383	391008310R	211018	7739016	217022
32738V	210208	3272LT	210286	9684135180	210383	391001162R	211019	7765363	217025
3273EK	210208	9637378180	210286	3273ZP	210383	391002885R	211020	46307466	217032
32725S	210218	1045574	210286	3273QX	210396	391019117R	211021	46307565	217032
32726S	210218	32724X	210286	3273TR	210413	392410919R	211021	46307467	217033
9628457980	210218	9660783380	210286	3273TS	210413	397415949R	211021	46307792	217033
96171871	210225	9639507880	210288	9683174180	210413	391018983R	211022	71787055	217033
3273JR	210231	1041558	210291	3272ZK	210414	391002615R	211023	51810404	217034
434100H050	210231	9639858280	210291	9683174280	210414	391011406R	211024	46307110	217038
434100H010A	210231	3273LC	210295	3273TL	210415	96257821	211011	46307408	217038
3272JY	210232	9657555580	210295	9686650380	210415	96870367	212015	46307147	217039
434200H050	210232	9644292980	210302	3273TP	210416	96549137	212015	73503002	217040
1497191088	210238	9803959580	210306	3273TQ	210416	96257823	212025	24451256	217040
3272NL	210238	9801611180	210306	3272HW	210419	96328842	212026	13250859	217044
1497192088	210239	1607237280	210306	3272HX	210419	96328841	212027	26119529	217044
1497192080	210239	9671573180	210307	9652371980	210419	96257824	212044	374632	217044
1497197080	210239	9671573280	210308	9652372280	210419	96549101	212045	374818	217044
9640848080	210239	3272DV	210309	3272HY	210420	96549102	212046	55700562	217045
3272FR	210241	3272VP	210309	3272HZ	210420	96348791	212057	55700560	217045
3272FS	210241	3272VQ	210309	3272PL	210420	96348790	212058	46470436	217048
3273CW	210242	9686025580	210309	9646326780	210420	4342087Z05	214003	46476614	217048
3273CX	210242	3272GG	210310	9646327980	210420	4341087Z05	214004	7699037	217048

COMPETITOR	GSP Ref.	COMPETITOR	GSP Ref.	COMPETITOR	GSP Ref.	COMPETITOR	GSP Ref.	COMPETITOR	GSP Ref.
OE		50504034	217124	3272HC	217221	7M0407272H	218008	94AG3A427EA	218039
		46307857	217136	3272CG	217221	7M0407272K	218008	R92AX3219DA	218039
1349785080	217050	46308259	217137	46308340	217222	7M0407450AX	218008	1014111	218040
3273PP	217050	46308008	217137	71795377	217222	7M0407452X	218008	5024574	218040
1369960080	217050	46308262	217141	51947026	217222	95VW3B436BA	218008	5024575	218040
71791003	217050	46307994	217141	51792341	217223	95VW3B436FA	218008	5026653	218040
1608505580	217050	46308275	217141	13238093	217223	7M3407452AX	218008	6596778	218040
3273PQ	217050	51807675	217143	51905707	217224	95VW3B436BB	218008	6596779	218040
1349786080	217050	71745016	217143	51905706	217225	7M0407272AX	218008	91AX3220DA	218040
3273PJ	217050	55700614	217143	46308161	217227	7M3407272A	218008	94AG3A428DA	218040
3273PK	217050	50517126	217145	46308147	217227	1016692	218009	R92AX3220DA	218040
71791000	217050	55702107	217146	K68079566AA	217228	1020967	218009	R97FX3220CA	218040
3273TC	217052	46308324	217146	P68193347AA	217228	1097318	218009	4490558	218041
1349788080	217053	51808105	217146	K68079565AA	217229	1097321	218009	5083616	218041
1369961080	217053	46308366	217147	P68193346AA	217229	1097322	218009	2T143B437FA	218041
71790994	217053	46308521	217147	51753392	217230	1132493	218009	2T143B437FB	218041
1608505480	217053	50517838	217148	46308094	217230	1132497	218009	2T143B437FC	218041
3272PH	217053	46308261	217149	46308093	217230	1132498	218009	2T143B437FD	218041
3272PG	217053	46308023	217150	1008428	218001	7201677	218009	3667428	218042
71724582	217053	3272SN	217151	5029044	218001	7M0407271A	218009	XS4W3B437DB	218042
46308409	217054	3272SL	217151	6757676	218001	7M0407271AV	218009	1345864	218042
46308523	217054	51783854	217151	7294553	218001	7M0407271AX	218009	5024576	218044
51934087	217055	55228304	217157	93BG3B437BD	218001	7M0407271F	218009	91AX3220EA	218044
51816768	217057	46307787	217158	R93BG3B437BD	218001	7M0407271J	218009	1122810	218046
51816764	217064	46307144	217159	R93BG3B437BE	218001	7M0407271L	218009	1348325	218046
51785056	217064	46307304	217159	1008402	218002	7M0407271Q	218009	1420536	218046
55700558	217066	46307316	217159	1023212	218002	7M0407271R	218009	1602942	218046
46308329	217066	46307342	217159	5029040	218002	7M0407449AX	218009	3667429	218046
46308522	217066	46307301	217159	5029041	218002	7M0407451AX	218009	XS4W3B436DB	218046
46308367	217066	46307888	217159	6757672	218002	95VW3B437BA	218009	4766808	218083
13149834	217070	51896520	217165	7024791	218002	95VW3B437FA	218009	5L843A428EA	218083
374791	217070	51787863	217170	7294551	218002	95VW3B437HA	218009	3652047	218101
13149833	217071	51955481	217170	93BG3B437AAE	218002	1097319	218010	3959551	218101
374790	217071	1541818	217170	93BG3B437ABD	218002	1132495	218010	XS4W3B437BC	218101
46307909	217077	9S513B437AA	217170	93BG3B437ABE	218002	7201678	218010	1328500	218101
46307863	217077	51787861	217171	R93BG3B437AAE	218002	7M0407271C	218010	1602965	218101
46308180	217077	51955476	217171	R93BG3B437ABD	218002	7M0407271M	218010	1S4W3B437AB	218101
46308066	217077	9S513B436AA	217171	R93BG3B437ABE	218002	7M0407271MX	218010	1S4W3B437AA	218101
46308112	217080	1541812	217171	5029039	218003	95VW3B437CB	218010	4166909	218101
46308115	217080	55702108	217172	6757668	218003	5029043	218016	4187268	218101
46308034	217080	46308330	217172	7294550	218003	7024792	218016	RM1S4W3B437AB	218101
46308035	217080	51808108	217172	93BG3B436BD	218003	93BG3B437AD	218016	1141768	218102
46307989	217080	51861637	217178	93BG3B436BE	218003	93BG3B437AE	218016	3652045	218102
46308345	217082	51861636	217180	R93BG3B436BD	218003	R93BG3B437AE	218016	XS4W3B436BB	218102
51808106	217082	51794995	217180	R93BG3B436BE	218003	1459756	218018	5026505	218118
55700561	217082	46308260	217181	1008381	218004	1701597	218018	90FX3220CA	218118
51947835	217082	46308274	217181	5029037	218004	6G913C083AA	218018	5018685	218127
51807676	217088	46477176	217187	6757666	218004	1S713B437AD	218027	87AX3219DA	218127
46307851	217099	7668798	217187	7294549	218004	1447468	218027	1020789	218128
46307852	217099	46476612	217188	93BG3B436ABD	218004	4106378	218027	1629459	218128
51757652	217102	7721633	217188	93BG3B436ABE	218004	C2S29731	218027	5018713	218128
51822813	217106	77216333	217188	R93BG3B436ABD	218004	1326261	218027	6747789	218128
46308178	217108	46409864	217189	R93BG3B436ABE	218004	1S713B436AC	218028	6962758	218128
46308179	217108	46476613	217189	5029038	218005	1447467	218028	85GG4234CA	218128
46307910	217108	46307368	217190	7024790	218005	1059520	218032	5018714	218129
71793054	217109	46307369	217191	93BG3B436AD	218005	R97FX3219DA	218032	1020794	218129
46307741	217110	46308405	217192	93BG3B436AE	218005	1634970	218033	6146498	218129
51947021	217111	51808314	217192	R93BG3B436AE	218005	V85BB3A427AA	218033	6747790	218129
55700557	217111	46308404	217193	1023209	218006	1754370	218034	6962759	218129
51754513	217111	51808313	217193	5029036	218006	1754373	218034	85GG4234DA	218129
51757653	217113	51795511	217194	7024789	218006	4421013	218034	R97FX3220DA	218141
50519320	217115	463078428	217201	93BG3B436AAD	218006	4166489	218034	1059528	218141
51876365	217115	46307428	217201	93BG3B436AAE	218006	4421008	218034	5024570	218179
50519319	217116	55199976	217202	R93BG3B436AAE	218006	1C153B437CF	218036	91AX3219EA	218179
46307343	217117	7783807	217203	1059534	218007	1C153B437CD	218036	1479769	218191
46308089	217117	46307429	217206	R94FX3220BA	218007	4104911	218036	1754453	218191
46307713	217118	9645249180	217217	1020964	218008	4166492	218036	1479771	218193
51787864	217119	3273TH	217217	1097313	218008	RM1C1J3B437CF	218036	1754456	218193
51812053	217121	3273CG	217217	1097317	218008	1049275	218038	8603360	218193
50517134	217122	3273GT	217217	1132482	218008	97AG3A381AA	218038	1223791	218194
46308297	217122	1485685080	217218	1132487	218008	1014109	218039	1305328	218194
50500528	217122	3272AZ	217220	7201674	218008	5024568	218039	1354068	218194
51876370	217122	3272CA	217220	7M0407272A	218008	5024569	218039	1456976	218194
71794541	217122	1485684080	217220	7M0407272AV	218008	5026652	218039	1475131	218194
50517138	217123	9645249080	217221	7M0407272E	218008	6596773	218039	3M513B437NE	218194
50500522	217124	3272SR	217221	7M0407272F	218008	91AX3219DA	218039	3M513B437NF	218194

COMPETITOR	GSP Ref.	COMPETITOR	GSP Ref.	COMPETITOR	GSP Ref.	COMPETITOR	GSP Ref.	COMPETITOR	GSP Ref.
OE		1305938	218219	1501263	218263	1841536	218292	3M513B436KE	218329
		1431359	218219	2T143B437CD	218263	1727121	218292	3M513B436KF	218329
3M513B437NG	218194	1474624	218219	2T143B437CE	218263	1793821	218292	3M513B436KG	218329
3M513B437NH	218194	1726275	218219	9T163B437AA	218263	1512912	218293	3M513B436KH	218329
30681130	218194	3M513B436DAC	218219	2T143B437CA	218263	1782560	218293	3M513B436KJ	218329
30711770	218194	3M513B436DAD	218219	1328365	218263	1841537	218293	3M513B436KC	218329
30783171	218194	3M513B436DAE	218219	1383755	218263	1712273	218294	30681129	218329
30787778	218194	3M513B436DAF	218219	1451465	218263	BV613B436CB	218294	30783002	218329
36000443	218194	3M513B436DAH	218219	2T143B437CB	218263	1686592	218295	30783168	218329
36000552	218194	30681127	218219	2T143B437CC	218263	AV613B437CB	218295	30787783	218329
8603251	218194	8603363	218219	4501957	218263	1686194	218295	31256930	218329
8603487	218194	36001652	218219	4994093	218263	BV613B437CA	218295	36000448	218329
3M513B437DD	218194	0504AA0020N	218223	9T163B437AAD	218263	1742276	218296	36000557	218329
3M513B437DE	218194	0504AA0030N	218224	RM2T143B437CB	218263	BV613B437BA	218296	36001360	218329
3M513B437DF	218194	538450101	218231	1501261	218264	4417909	218301	8603259	218329
3M513B437DG	218194	538450081	218231	1501262	218264	93856307	218301	1308638	218333
7711135956	218197	538450102	218232	2T143B436CA	218264	7711368832	218301	1318854	218333
8200278602	218197	538450082	218232	2T143B436CC	218264	8200452273	218301	1326339	218333
8V513B436AAC	218201	C2S29729	218240	2T143B436CF	218264	1333976	218309	1361879	218333
2S6W3B436AA	218201	4166490	218242	9T163B436AA	218264	1468577	218309	1478995	218333
4330604	218201	1C153B436CF	218242	1328363	218264	1513990	218309	1513996	218333
1142795	218202	4104909	218242	4615961	218265	1697493	218309	4S613B436AD	218333
1361898	218202	1C153B436CD	218242	1417747	218265	4N113B437CA	218309	4S613B436AE	218333
1478996	218202	RM1C1J3B436CF	218242	1600221	218265	4N113B437CB	218309	4S613B436AF	218333
1513991	218202	8200842365	218247	1C153B436CH	218265	4N113B437CD	218309	4S613B436AG	218333
1697348	218202	391012360R	218247	RL1C153B436CY	218265	1758156	218322	BK213B437AB	218334
2S613B437BB	218202	391012849R	218247	RM1C153B436CH	218265	AV613B437HA	218322	1774279	218334
2S613B437BC	218202	301012675R	218247	4417910	218271	1758155	218323	BK213B436AB	218335
2S613B437BD	218202	3910100Q3G	218247	93856308	218271	AV613B436HA	218323	1774275	218335
2S613B437BE	218202	4406234	218247	7711368831	218271	1333973	218326	1310250	218337
2S613B437BF	218202	3910100Q4E	218247	8200452268	218271	1468573	218326	1757879	218340
1510274	218206	3910100Q4F	218247	8200409664	218274	1496809	218326	1803654	218340
1C153B436AE	218209	4406518	218247	8200664841	218274	4N113B436CA	218326	AG913B437DC	218340
6M343B437CA	218210	4420055	218247	1223726	218280	4N113B436CB	218326	1807112	218341
1454573	218210	4422058	218247	3M513B436NC	218280	4N113B436CC	218326	1838455	218341
6M343B436DA	218210	93167651	218247	8603252	218280	1364029	218327	AG913B436DD	218341
1447140	218210	95513818	218247	1305326	218280	1454214	218327	RMAG913B436D1D	218341
6M343B436CA	218211	95514705	218247	1417777	218280	1475136	218327	C2C22868	218342
1454575	218211	95516047	218247	1444318	218280	1528657	218327	1746979	218343
6M343B437DA	218211	391012675R	218247	1456974	218280	1686116	218327	AV613B436EE	218343
1447178	218211	8200842369	218248	1475129	218280	3M513B437ASD	218327	1726342	218350
PP042550XA	218211	391004255R	218248	3M513B436NE	218280	3M513B437ASE	218327	8G913B436AD	218350
1C153B437AE	218213	391009620R	218248	3M513B436NF	218280	5M513B437SA	218327	1326340	218351
1142794	218216	3910000Q4G	218248	3M513B436NG	218280	5M513B437SB	218327	1361877	218351
1359345	218216	3910000Q3M	218248	3M513B436NH	218280	5M513B437SC	218327	1478997	218351
1506722	218216	3910000Q4H	218248	30681131	218280	5M513B437SD	218327	1520669	218351
2S613B437AB	218216	4406235	218248	30783004	218280	5M513B437SE	218327	4S613B437AD	218351
2S613B437AC	218216	4406519	218248	30783172	218280	5N513B437SE	218327	4S613B437AE	218351
2S613B437AD	218216	4420054	218248	30787788	218280	1223788	218328	4S613B437AF	218351
2S613B437AE	218216	4422057	218248	36000293	218280	1305327	218328	4S613B437AG	218351
8V513B437AAA	218216	391005187R	218248	36000453	218280	1353399	218328	1324168	218358
2S6W3B437AAA	218216	93167650	218248	36000562	218280	1456975	218328	1431161	218358
4330605	218216	95513819	218248	1059526	218284	1474893	218328	1450574	218358
1142790	218217	95514706	218248	R97FX3220BA	218284	1685799	218328	1567824	218358
1359342	218217	95516046	218248	5026504	218289	3M513B437KE	218328	1686113	218358
1468572	218217	1477841	218251	90FX3219CA	218289	3M513B437KF	218328	4M513B436JD	218358
1506723	218217	1798101	218251	1477842	218290	3M513B437KG	218328	4M513B436JE	218358
2S613B436AB	218217	4N513B436XK	218251	3M513B437RK	218290	3M513B437KH	218328	4M513B436JF	218358
2S613B436AC	218217	RM4N513B436XIK	218251	3273AX	218291	3M513B437KJ	218328	1474807	218358
2S613B436AD	218217	36002452	218251	3273AY	218291	3M513B437KC	218328	1324166	218359
2S613B436AE	218217	36000555	218251	3273GR	218291	30681128	218328	1431162	218359
2S613B436AG	218217	1236786	218252	3273TF	218291	30711772	218328	1475135	218359
1223785	218218	1328337	218252	3283TFC	218291	30783167	218328	1567848	218359
1305939	218218	2S713B437AA	218252	9645249380	218291	30787775	218328	1686114	218359
1353398	218218	3C113B437BC	218259	3273CA	218291	31256931	218328	4M513B437JA	218359
1437541	218218	4507300	218259	3273HV	218291	36000440	218328	4M513B437JC	218359
3M513B437DAC	218218	4602023	218259	3273HW	218291	36000549	218328	4M513B437JD	218359
3M513B437DAD	218218	RM3C113B437BC	218259	3273TG	218291	36001356	218328	4M513B437JE	218359
3M513B437DAE	218218	3C113B436BB	218260	71789667	218291	8063258	218328	391011KC0A	218361
3M513B437DAF	218218	3C113B436BC	218260	9645248980	218291	8603486	218328	391011KB0B	218362
3M513B437DAG	218218	4507298	218260	3273GQ	218291	1223725	218329	8G913B437AC	218363
30681126	218218	4615963	218260	1485691080	218291	1305325	218329	1726452	218363
8603362	218218	RM3C113B436BC	218260	8C114B436AD	218292	1437453	218329	391001KB0B	218365
1682285	218218	9M513B437BA	218261	1512911	218292	1456973	218329	8200278603	218366
3M513A327BB	218219	9M513B436BB	218262	8C113B436AD	218292	1474892	218329	538450085	218402
1223723	218219	1417751	218263	1782555	218292	1685795	218329	538450103	218402

COMPETITOR	GSP Ref.	COMPETITOR	GSP Ref.	COMPETITOR	GSP Ref.	COMPETITOR	GSP Ref.	COMPETITOR	GSP Ref.
OE		13191328	221055	44306TA0A52	223324	495001E000	224188	495011R610	224383
		374591	221055	44306TA0A51	223324	495001E010	224188	495001R610	224384
1840192	218405	24462250	221056	44306TA0A50	223324	495012D513	224203	495001R310	224385
1768178	218406	374552	221056	44305TA0A53	223325	495012D510	224203	495011R210	224386
D1B73B436CB	218406	13245911	221056	44305TA0A52	223325	495012D512	224203	495013X400	224387
1821964	218407	13170876	221061	44305TA0A51	223325	495002D513	224204	495003X400	224388
1822704	218407	13124680	221062	44305TA0A50	223325	495002D510	224204	495013Z150	224389
8V513B436CD	218407	374562	221062	44305TF0010	223326	495002D511	224204	495003Z100	224390
8V513B436HE	218407	13136382	221063	44305TF0000	223326	495002D512	224204	495013Z250	224391
391001KC0A	218414	374547	221063	44305TF0J01	223327	495001C560	224211	495003Z400	224392
FG0525500D	218421	1465780	221070	44306TF0J01	223328	495012E400	224216	49600B1100	224393
FA8125500A	218424	7G9N3B437HA	221070	42310SWA000	223329	4950126560	224217	495013V560	224394
FA8125500	218424	36011285	221070	42311SWA000	223330	4950126561	224217	495003V510	224395
3C113B437AB	218434	13124679	221071	44306TL1E02	223331	4956226200	224217	485012V000	224398
4507299	218434	374561	221071	44306TL1E01	223331	4950126510	224218	495013X000	224398
4602017	218434	374569	221073	44306TL1E00	223331	4950126511	224218	495012V000	224398
3C113B437AC	218434	24462251	221073	44305TL1E02	223332	495003K300	224220	495011R100	224408
3C113B436AB	218435	374886	221074	44305TL1E01	223332	495001F610	224221	495001R100	224409
3C113B436AC	218435	13335136	221074	44305TL1E00	223332	495013S260	224228	495001E111	224412
4615962	218435	95520493	221074	44306SZT001	223333	495013S280	224228	495003Y100	224416
4130009214	218438	13166588	221092	44306SZT000	223333	495013S261	224228	495001S000	224427
GP322550XD	218439	374625	221092	44305TL1E53	223334	495003S210	224229	495001S100	224428
GP322560XD	218440	44305SEAN00	222019	44306TR0J01	223345	495003S211	224229	495012L110	224429
1328490	218454	44306SCAG00	223011	44306SZA012	223346	495013W200	224230	495014N100	224432
1602943	218454	44306S74E51	223020	44305SZA021	223347	495003W200	224231	495002N000	224433
1S4W3B436AA	218454	44011SR3020	223020	44305SZA011	223347	495012P200	224232	495011S000	224438
4166907	218454	44306SNLT10	223022	44305SZA011RM	223347	495002P200	224233	495011S100	224439
RM1S4W3B436AA	218454	44306SNA000	223022	44306TK8A22	223348	495000X300	224240	495002L110	224440
1495673	218455	44305SNLT00	223023	44305TR0J01	223349	495000X310	224241	495002W100	224447
6C113B437DD	218455	44305SNA000	223023	44305TR0J02	223349	495001R000	224246	495002W400	224448
6C113B437DE	218455	44306SEFE00	223026	44306TF6N02	223350	495011R000	224247	495002W600	224449
TDB104960	218456	44305SEFE00	223027	44305TK8A21	223351	495011R500	224247	495012W450	224451
TDB104940	218457	44305SH3960	223030	4950038950	224003	495003X200	224248	495002B250A	224459
1469166	218472	44305SH3961	223030	4950038900	224004	495013X200	224249	495002B250	224459
1494215	218472	44305SH3A00	223030	495003K200	224031	495011R010	224259	495002B260	224460
1512912	218472	44305SH3A01	223030	495003K250	224032	495011R510	224259	495002B360	224462
1727122	218472	44305SH3G00	223030	4950002560	224033	495001R010	224260	495002B370	224462
1793822	218472	44305SH3G01	223030	4950002460	224033	495013S271	224261	495002B320	224462
8C113B437AB	218472	44305S5DA01A	223066	4950025200	224038	495013S251	224261	495002B620	224463
8C113B437AC	218472	44306S5DA01A	223068	495001E600	224045	495013V270	224261	495002B700	224464
8C113B437AD	218472	44306SELT00	223070	495001E650	224046	495003S201	224262	495002B750	224465
CC113B437BA	218472	44305SELT00	223071	495012D312	224053	495003Z200	224262	495002B800	224466
CC113B437BB	218472	44305S9A000	223074	495002D312	224054	495003V200	224262	495002B850	224467
RMCC113B437B1A	218472	44305SCAG00	223074	4956217100	224054	495003X100	224264	495002B900	224468
FA8225600B	218473	44305S5DA51	223097	495002H112	224076	495013X110	224265	495002H212	224469
FA8225600	218473	44305TF6N01	223173	495012H112	224077	495003V500	224270	495002H211	224469
FA8225600A	218473	44305TF6N02	223173	495011F220	224110	495003X110	224272	495002H210	224469
DV6P3B436MA	218509	44306TF6N01	223174	495002E500	224111	495002L010	224282	495002P100	224470
391002176R	218515	44305S5WV900	223175	4950729C10	224113	495012L010	224283	495002P301	224471
6M6Z3A329B	218520	44306SXSA10	223176	495002B510	224117	496002E000	224287	495003X410	224472
9L8Z3A329B	218521	44306SWA900	223176	495012P000	224117	495002V100	224288	495012B630	224473
9L8Z3A329A	218522	44306SWET10	223176	495001E610	224120	495012V100	224289	495012B800	224474
4410260A10	219009	44305TA0A00	223177	4950038362	224123	495001R200	224290	495012H000	224475
4410160A10	219011	44306TA0A00	223178	4950038312	224124	495011R200	224291	495012H212	224476
96870368	221021	44306SJHE02	223188	4950038791	224125	495001R300	224293	495012H210	224476
96549092	221021	44305SJHE02	223190	4950038741	224126	495011R300	224294	495012H211	224476
13109194	221032	44305SMJG01	223191	495003K410	224127	495012L210	224296	495012P250	224477
13166590	221032	42310SXSA01	223198	495003K460	224128	495002L210	224297	495012W650	224479
374537	221032	42310SXSA010M1	223198	4950025210	224129	495001J200	224304	4950025512	224482
13166587	221032	42311SXSA01	223199	495001C510	224141	495012L410	224305	49501C1250	224496
374470	221032	42311SXSA010M1	223199	495003L551	224142	495012L411	224305	49501D4250	224496
9186550	221032	44306SWY010	223216	495003L500	224143	495012Y800	224317	49500C1200	224497
374536	221032	44305S2H950	223249	495002D112	224149	495013V550	224320	49500D4200	224497
13245906	221035	44306S5TE50	223266	495002D113	224149	495013X100	224321	495012D303	224500
374811	221035	44306TLOG20	223270	495012D112	224150	495013Z450	224347	495002D302	224501
12762089	221036	44306SMTG00	223291	495012D113	224150	495001F800	224348	495002D413	224502
13228199	221045	44305SJK010	223296	495001J250	224153	495012E700	224352	495002D212	224503
374830	221050	44306SJK010	223297	495000X000	224156	495011F400	224352	495002D200	224503
13265648	221050	44306T0AA02	223306	495000X010	224157	495012Y101	224362	495002D202	224503
13214836	221051	44306T0AA00	223306	495003A312	224158	495002D012	224363	495002D213	224503
374641	221051	44306T0AA01	223306	495012E900	224172	495002D013	224363	495012D212	224504
13245912	221051	44306TL2E53	223311	495012E500	224172	495012D012	224364	495012D200	224504
374802	221051	44306TL2E52	223311	495002E550	224173	49500B4110	224366	495042D201	224504
13166589	221053	44306TL2E51	223311	495002E950	224173	495001R210	224368	495012D202	224504
374626	221053	44306TL2E50	223311	495002H010	224176	495004N100			

COMPETITOR	GSP Ref.	COMPETITOR	GSP Ref.	COMPETITOR	GSP Ref.	COMPETITOR	GSP Ref.	COMPETITOR	GSP Ref.
OE		0K5542550XA	227096	5M513B436SA	234163	C2S50486	235029	A6393501210	235093
		0K55222620A	227097	5M513B436SB	234163	C2S50485	235030	A6393502310	235093
4950025312	224507	0K5522560XA	227097	5M513B436SC	234163	1693601172	235032	A2043301500	235094
495012C111	224508	495001D200	227102	5M513B436SD	234163	1683603172	235037	A2043301400	235096
495012C110	224508	495001F500	227105	5M513B436SE	234163	1683702172	235037	A2213306400	235096
495013X410	224509	KK38825600A	227106	GD552550XA	234165	A1683603172	235037	A1643300701	235103
495003X000	224510	KK16825400	227108	GD552550XB	234165	A1683702172	235037	A2463307700	235104
495002H012	224511	KK16825600	227109	OK55222520A	234166	1683601972	235038	A2463302800	235104
495012H012	224512	495011D200	227111	OK5522550XA	234166	1683603372	235038	A2463308900	235104
495604Z250	224517	495014D201	227114	4959107091	234169	1683702272	235038	A2203509210	235105
495001C050	224520	495004D201	227115	495011Y010	234171	A1683603372	235038	A2053509608	235106
495012Y050	224522	495002F210	227130	495011Y210	234171	1693605272	235039	A1723500110	235107
495002Y100	224523	495012F210	227131	GG6325500A	234195	52099499AG	235040	A2303505710	235108
495002Y900	224523	4950007010	227132	4154570	234196	52853417AA	235040	A2053509708	235109
495002Y300	224525	4950007000	227132	4484605	234196	52853417AB	235040	A2033502556	235110
495000B050	224531	495001M010	227142	4621198	234196	52853417AC	235040	A2043501810	235111
495001C260	224533	495011M010	227143	MA042560XB	234211	52853417AD	235040	A1723500510	235112
495001C262	224533	495014D001	227151	MA042550XB	234212	52099498AE	235041	A1663301500	235113
495012Y300	224535	495014D700	227152	391004084R	234222	A2043301600	235044	A1663301701	235113
495002C113	224543	495001G011	227155	391017624R	234223	A2043302701	235044	A2043502110	235114
4950005110	224544	495001G051	227156	36000675	234224	A1693701572	235046	A2113500556	235115
495003K350	224545	495012F110	227168	AB393A427CA	234227	1693701572	235054	A2113500356	235116
4950005100	224547	495002F110	227169	1749218	234227	1693702772	235054	A2113503956	235117
49500A6300	224548	495001G150	227185	AB393A428CA	234228	1693705572	235054	A2113501656	235118
495002V000	224548	495001G110	227186	1749219	234228	1693706372	235054	A2213502010	235119
49500A7000	224548	495001G100	227186	FTB12550XA	234235	A1693705572	235054	A2213503510	235119
496002B010	224549	495011Y310	227191	FTB62560X	234236	1693701272	235055	A2213504010	235120
496002B000	224549	495001R600	227201	FTB22550XA	234237	1693702872	235055	A2213501810	235120
495002Y000	224550	495011R600	227202	FTB82550X	234238	1693704672	235055	A1663501210	235121
495001C352	224552	495013F030	227203	FTB82560X	234239	1693704772	235055	A2033502956	235122
495001C250	224553	495003F030	227204	RTA12560XA	234240	1693704872	235055	A2043501610	235123
495001C252	224553	4950007160	227206	FG3125600	234254	1693705672	235055	A2033504456	235124
495001C200	224553	4950007110	227207	495001Y010	234257	1693706472	235055	A2113502256	235125
495001C202	224553	495001Y310	227208	GG6125600A	234261	1693760242	235055	A2113501156	235126
496012W050	224554	495002Y200	227217	36000681	234270	A1693702872	235055	A2213501910	235127
496002W050	224555	49501A6200	227218	1243502910	235001	A1693704672	235055	A2303505610	235128
4960026211	224556	49500A6200	227219	1243508810	235001	A1693704772	235055	A2303507810	235129
4960026011	224557	495011Y610	227224	A1243508810	235001	A1693704872	235055	04578732AE	235130
4950025302	224558	495011Y110	227225	1343508810	235001	A1693705672	235055	04578733AE	235131
4950025301	224558	495001Y610	227226	6383340534	235002	A1693706472	235055	A1713501210	235132
49500A7010	224559	495001Y110	227227	6383340634	235002	A6393501910	235059	A2033503056	235133
495012B700	224561	495001F200	227231	6383341634	235002	1693603272	235062	2033502610	235133
495013Z550	224563	495011F200	227232	6383341734	235002	2513501410	235063	A2033503256	235133
495002W000	224567	495003W000	227233	A6383340634	235002	A2513501610	235063	A2093500410	235133
49501B4600	224570	495013W001	227234	A6383341734	235002	A2463303100	235067	A2043502010	235134
49500B4600	224571	495013W050	227235	6383342334	235003	A2463309400	235067	A2043504310	235134
94713061	226016	495003W100	227236	A6383342334	235003	A2463308800	235067	A2043501710	235134
495003C451	227002	495013W101	227237	1073500410	235004	A2463309200	235067	A2113500156	235136
OK2N42560X	227011	21082215011	228001	1073502710	235004	A2463302900	235067	A2113500816	235136
OK2N42540X	227012	21082215010	228002	1073502810	235004	A2463309000	235067	A2123502510	235137
4950002550	227017	21102215011	228003	1073503310	235004	1693607172	235074	A2123501810	235137
4950002450	227017	21102215010	228004	1073504310	235004	1693601272	235075	A2123502110	235137
OK56P25500A	227018	21212215011	228005	1233500410	235004	1693602972	235076	31601503307	238001
1K56P2550XA	227019	212122150111L	228005	1243503010	235005	6393300301	235084	31607514477	238001
OK56P25600A	227020	21212215010	228006	1293504010	235005	6393300701	235084	31607514479	238001
OK30A25600	227024	21212215011R	228006	2013501810	235006	7P0407271BX	235085	31607574852	238001
OK2NE2550XA	227030	TDB500090	230002	A2013508010	235006	7P0407271AX	235085	31601503306	238002
OK5582560XA	227037	TDB104990	230003	2023505610	235007	7P0407271CX	235085	31607514478	238002
KK33125600A	227040	TDB104980	230004	A2023505610	235007	7P0407271C	235085	31607514480	238002
KK33125400	227042	44102M79F70	232008	2103508210	235008	7P0407271A	235085	31607574850	238002
FDY12560X	227047	GJ0122510A	234001	2103508410	235009	95533202411	235086	31607518238	238003
3M353B436AA	227062	FDY22550X	234005	6313300236	235010	7L0501201A	235086	MR276870	239006
1328094	227062	MD0925500A	234019	6313300335	235010	7L0501201C	235086	MR276874	239006
2M353B437AA	227063	GD402560XA	234039	6313300501	235010	7L8501201A	235086	MR276871	239007
1339667	227063	5L843A427EA	234087	6313300701	235010	7L6501817C	235087	MR453383	239064
2M353B437CB	227063	GG3125600D	234091	6313301301	235010	7L6501817E	235087	MR453384	239095
495003E111	227064	FG0225500C	234101	6313370010	235010	7L6501201A	235087	MN156273	239118
495003E110	227064	GD552550XC	234120	A1633300501	235018	7L6501201C	235087	MN156274	239119
495013E111	227065	2M343B437AA	234132	A1633300301	235018	7L6501201E	235087	4950025955	239122
495003E000	227065	GD552560XA	234153	A1633300201	235018	7L6501817A	235087	4950125955	239123
OK01225500A	227067	GD552560XB	234153	6393500710	235022	A1663301300	235088	3815A307	239147
OK2C32550X	227070	1364028	234163	6393501510	235022	A1663301600	235089	3815A309	239147
1K2KB2560X	227071	1454211	234163	A6393500710	235022	A1663501110	235090	MN107605	239147
KK3892560x	227077	1475130	234163	A6393501510	235022	A6393501810	235093	MR580692	239148
OK55C25500A	227078	1528656							

COMPETITOR	GSP Ref.	COMPETITOR	GSP Ref.	COMPETITOR	GSP Ref.	COMPETITOR	GSP Ref.	COMPETITOR	GSP Ref.
OE		C9B11JD02B	241300	391011AA0C	241515	7711135279	244005	374187	244038
		38225JD22B	241300	39101CC40B	241516	8200052428	244005	374203	244038
495012F710	239185	39100JD02B	241301	39101JG04C	241521	8200178618	244005	374226	244038
495002F710	239186	39100BB02B	241301	391018H315	241522	8200485576	244005	374247	244038
495001J400	239189	39100BM580	241327	391018H710	241523	7700850487	244006	374315	244038
495001J450	239190	39101BM580	241328	39100JG32C	241524	7701351607	244006	374358	244038
495000X100	239191	39101JD52B	241329	391004M470	241525	7701351608	244006	90465499	244038
495000X110	239192	39100BB32B	241330	391014M470	241527	7701352288	244006	90496357	244038
495002K000	239210	391011HC0C	241337	391004M465	241530	7701465773	244006	90512983	244038
495002K400	239210	39100EE32B	241346	391014M465	241531	7701468452	244006	90543598	244038
4950025300	239211	39101EE32B	241347	391004M475	241532	374183	244011	9195432	244038
4950025510	239212	39101JY04A	241365	39101JN11A	241533	374235	244011	374103	244039
4950025500	239213	39101JD74D	241365	39100ED805	241535	90350824	244011	374249	244039
4950025310	239214	39101JG74D	241365	39101EE36A	241536	90350908	244011	90496976	244039
MR580503	239216	39101JN00A	241377	39100EE400	241537	90511247	244011	13150502	244040
MR567159	239217	39100JN00A	241378	39600JD60A	241538	90511255	244011	374792	244040
495002B350	239247	391002S660	241393	39101JA000	241539	90540865	244011	374793	244042
4950117150	239249	39100EB310	241394	391018J070	241540	90540533	244011	13150503	244042
3815A196	239261	39204EB31A	241394	391018J010	241540	8200178625	244012	4700645	244043
MR567160	239282	39100JUM10A	241399	39101JG34C	241542	4409208	244013	374323	244044
495012D413	239291	39101JG32C	241400	391001AA0A	241543	4414516	244013	9117409	244044
495012D400	239291	39101BC600	241407	391019N01A	241545	91166707	244013	90538604	244044
495012D402	239291	39101BH00A	241407	391019N00B	241545	91168794	244013	0374323	244044
495012D410	239291	39100BC600	241408	391019N00F	241545	8200069146	244013	374259	244049
495012D412	239291	39100BH00A	241408	391011HS0B	241546	8200169291	244013	374260	244050
495012D013	239295	391019U005	241409	391001HS0B	241547	7711135190	244013	374600	244051
GD702560XA	239302	391001KA0A	241428	39600EA000	241550	374145	244014	13189073	244051
GD702550XA	239303	391011HC3B	241437	39101EL10A	241553	9117957	244014	374549	244052
GD702550X	239303	391001189R	241441	39101EL10B	241554	90348324	244014	24462244	244052
3910173J20	241001	391002053R	241441	391003NTOA	241559	7701473014	244016	374184	244059
391002F210	241002	39100JD74B	241441	391013NTOA	241560	8200026912	244016	374236	244059
391012F011	241003	39100JY04B	241441	391013TA0B	241561	8200169277	244016	374275	244059
391012F001	241003	3910195F0A	241442	39100BM710	241562	7701473013	244017	374278	244059
3910073J00	241004	3740131000	241442	39100BM700	241562	8200052423	244017	374748	244059
3910073J20	241005	3910095F0C	241443	391004M771	241562	8200169272	244017	90350907	244059
46307998	241006	3910095F0B	241444	39100JA11F	241564	73503003	244020	90511248	244059
46307999	241007	3910195F0D	241445	396001LBOA	241565	24451255	244020	90540536	244059
46308347	241007	391011U600	241451	39100EA000	241566	374473	244020	90540911	244059
46307988	241007	39101BC500	241451	391001LBOB	241568	8200169286	244021	13250860	244064
3910071J10	241024	39101BC55A	241451	39100AV911	241576	7711135532	244022	374486	244064
391012F210	241025	391009U20A	241452	391016974R	241577	8200169273	244022	13335140	244064
391010M010	241035	391019U20A	241453	391019179R	241577	374468	244026	374890	244064
391001N010	241036	39100JA000	241456	39101JD72B	241577	26095017	244026	13250861	244065
39101BM710	241041	39100BC500	241463	39101JY02B	241577	374443	244026	374487	244065
39101BM700	241041	39100BC55A	241463	3815A423	241578	0374468	244026	36000930	244068
391014M771	241041	391001U600	241463	3815A424	241579	374466	244027	96832203	244069
3920570J25	241076	391000F000	241464	38230CA000	241588	26094867	244027	96832204	244070
391012F615	241081	391007F002	241464	374222	244001	374442	244027	96963323	244071
391012F605	241081	5458020	241464	374366	244001	0374466	244027	96963324	244072
391014F100	241083	391008H715	241474	26029828	244001	374371	244027	374370	244075
391004F100	241084	391003113R	241475	26032412	244001	374545	244028	0374370	244075
3910173J05	241094	391009742R	241475	93192081	244001	13136379	244028	90512387	244077
3910170N00	241094	39100JD74A	241475	374178	244002	13124675	244029	13248652	244078
3910072J20	241130	39100JY04A	241475	374211	244002	374543	244029	374825	244078
391008J060	241131	39100JG74A	241475	90350865	244002	374548	244030	13149829	244078
391014F401	241156	39101JG74B	241481	90444327	244002	24462241	244030	374788	244078
3910058G60	241178	39100JG74B	241482	374513	244002	13191326	244030	13149830	244079
39100VB001	241179	391001KA5B	241483	93299251	244002	13124676	244031	26119530	244079
391004F400	241193	391011KA5B	241484	90540520	244002	374544	244031	374633	244079
39101BM720	241195	391001HC3C	241485	4409210	244003	0374544	244031	374789	244079
39101EE405	241202	391003ZN0B	241486	4414517	244003	13101629	244032	13248675	244079
39100EE405	241203	39100BV80B	241487	91166708	244003	374523	244032	13166591	244080
39112F615	241206	391011HC3C	241488	91168795	244003	374322	244033	374593	244080
391002F615	241206	39101BV80B	241490	93852699	244003	9117408	244033	374397	244082
391002F605	241206	391013VD0B	241492	93856470	244003	13243461	244033	13159533	244092
39101VB001	241221	391013NA0B	241493	8200069147	244003	90538603	244033	374526	244092
391008J115	241253	391003NA0B	241494	8200179212	244003	374317	244036	13159534	244093
391004M776	241258	391003VA0A	241495	8200334338	244003	90576706	244036	374525	244093
391009U005	241261	39101B300A	241497	8200485589	244003	374318	244037	13116174	244094
39100EB300	241262	391011KB0A	241506	7700102980	244004	90576707	244037	374524	244094
3910170J10	241280	39101BM560	241509	7700102999	244004	0374318	244037	26076883	244095
39100EE36A	241291	39100BM560	241510	7711135277	244004	374261	244038	374373	244095
391018J065	241296	391001AA0B	241511	8200052426	244004	374282	244038	374801	244095
391008J065	241297	391003HC0B	241512	8200169281	244004	90498637	244038	93190108	244095
39100JD72B	241299	391013HC0B	241513	7700102978	244005	90511447	244038	26076882	244096
39101JD02B	241300	39101ED805	241514	7700102998	244005	0374261	244038	374372	244096

COMPETITOR	GSP Ref.	COMPETITOR	GSP Ref.	COMPETITOR	GSP Ref.	COMPETITOR	GSP Ref.	COMPETITOR	GSP Ref.
OE		32720F	245024	3273AE	245104	327480	245197	7711135280	250011
		32720G	245024	3273LP	245104	3273P7	245198	7701349172	250012
374800	244096	3273G1	245025	9637117780	245105	3272LA	245200	7701349660	250012
93190106	244096	3273Q2	245025	32721X	245105	3272LC	245200	7701463194	250012
13124206	244097	32721P	245026	32722X	245105	3273KP	245201	7701498957	250012
374559	244097	32722P	245026	3272LW	245105	3273KQ	245201	8200323961	250012
24462246	244098	32723C	245027	3272S7	245106	3272LL	245202	711106122	250013
374550	244098	32723L	245027	3272S8	245106	3272LN	245202	7701349359	250013
13214837	244099	32724C	245027	32736Y	245108	3272KZ	245203	7701498958	250013
374642	244099	327327	245029	32736Z	245108	3272KY	245203	7711106122	250013
374511	244100	327357	245029	327398	245110	3273KN	245204	771106222	250014
93299247	244100	327358	245029	327399	245110	3273KL	245204	7701349914	250014
327384	245001	327373	245029	327492	245111	9670634880	245220	7701351697	250014
327385	245001	327391	245029	9636786880	245113	3272XJ	245220	711106221	250015
327388	245001	3273H9	245029	3273AH	245113	3272XK	245220	7701349915	250015
32735E	245001	3273J5	245029	3273AJ	245113	3273VL	245221	7701351701	250015
3273Y7	245002	327204	245030	3273QV	245113	3273VK	245221	7701351801	250015
3273Y9	245002	327222	245030	32725X	245119	9803959680	245222	7711106221	250015
327329	245003	327291	245030	32726X	245119	9801611280	245222	711106129	250016
327275	245004	327330	245030	9636786780	245119	3273YC	245223	7701348152	250016
32724R	245004	327354	245030	1481451080	245120	3273YE	245223	7701348160	250016
3272H8	245004	32728E	245031	32733Q	245120	9670634780	245223	7701348256	250016
3272T2	245004	32729E	245031	71787905	245120	3272SZ	245225	7701498797	250016
327311	245005	9630767880	245032	32728W	245126	3272TA	245225	7701498799	250016
327312	245005	32725C	245032	32729W	245126	9680667380	245226	7700110482	250017
95582416	245005	32726C	245032	3272LV	245126	3273NR	245226	7701352774	250017
95592320	245005	327244	245033	1497187080	245133	3273NS	245226	7701352776	250017
3272S3	245007	327245	245033	71792565	245133	91133202414	248001	7701470721	250017
3272F6	245008	3272T4	245033	327201	245134	98633202450	248002	7701352631	250019
3272F8	245008	3273C3	245034	327202	245134	92333203302	248003	7701470175	250019
9630768280	245009	3273C4	245034	327293	245134	PW868211	249009	7701349915	250020
3272AP	245009	3273Z6	245034	32734Y	245137	PW868212	249010	7701351699	250020
3272Y0	245009	9630767280	245035	32734Z	245137	PW826963	249011	7701352223	250020
3272Y1	245009	32733L	245035	3272AA	245138	PW826964	249012	7701352420	250021
9630768080	245010	32733M	245035	3272AC	245138	43410BZ100	249013	7701352424	250021
32730N	245010	327351	245036	32734E	245147	43420BZ100	249014	7701352425	250021
3273AL	245011	327352	245036	32734F	245147	7701349880	250001	7701352473	250021
3273AN	245011	327390	245036	32728N	245152	7701351484	250001	7701352474	250021
3272AE	245012	3273AQ	245065	32729N	245152	7701351486	250001	7701352597	250021
3272AF	245012	327355	245066	3273L2	245153	7701351572	250001	7711497524	250021
327221	245013	32725K	245068	327283	245155	7711106227	250001	7701349916	250022
327348	245013	327378	245070	327284	245155	7701349874	250002	7701351695	250022
327349	245013	3273L4	245070	3273G9	245156	7701349972	250002	7701352224	250022
3273G3	245014	3273L7	245070	3273H0	245156	7701351479	250002	7701349726	250023
3273Q1	245014	3273N25A	245079	3273Q3	245156	7701351480	250002	7701349847	250023
3273Z5	245014	3272F5SA	245080	32722H	245157	7701351571	250002	7701351160	250023
327215	245015	6001547028	245084	32727C	245157	7711106228	250002	7711106217	250023
327216	245015	6001548102	245084	3272K4	245157	7701463343	250003	711106218	250024
327219	245015	7711497474	245084	3272L4	245157	7701499223	250003	7700109021	250024
32723K	245015	7711497477	245084	3272W0	245157	7700103731	250004	7701349741	250024
32730Y	245016	8200272322	245084	327325	245158	7700106007	250004	7701349803	250024
32730Z	245016	8200444438	245084	32733N	245158	7700111259	250004	7701349945	250024
3273E6	245017	8200985010	245084	32734V	245158	7700111506	250004	7701351194	250024
3273E9	245017	391018299R	245084	3273R8	245158	7700115011	250004	7701351290	250024
3272L2	245017	6001547029	245085	3273R9	245158	7701056621	250004	8200323960	250024
3272L3	245017	6001548103	245085	3272S2	245159	7711135246	250004	7700272531	250024
32731H	245017	7711497475	245085	3272E2	245160	8200410080	250004	7701349727	250025
32731J	245017	7711497478	245085	327209	245160	7701348098	250005	7701349848	250025
3273C5	245017	8200318010	245085	3272E7	245160	7701498698	250005	7701351162	250025
3273K6	245017	8200484373	245085	3272F5	245160	7701349769	250006	7711106216	250025
3273L1	245017	8200484376	245085	3272H3	245160	7701351172	250006	7701352133	250026
3273L3	245017	8201045819	245085	32720T	245166	7701498955	250006	7701352422	250027
327380	245017	391004298R	245085	3273PX	245174	7701349839	250007	7701352414	250028
32736T	245020	9630766880	245094	3272SS	245175	7701349921	250007	7701352415	250029
32736V	245020	32733X	245094	3272PF	245175	7701351264	250007	7701352417	250029
327277	245021	32733Y	245094	1355334080	245175	7701352025	250007	7701352730	250029
3272H7	245021	3273CQ	245094	327301	245178	7701349955	250008	7701349026	250030
3272T3	245021	3272YE	245101	3272T5	245178	7701351995	250008	7701351428	250030
327379	245022	327220	245101	3273Z9	245178	7701352471	250009	7701498918	250030
327381	245022	3272AJ	245101	3273Z7	245179	7701352595	250009	7701351841	250031
3273N2	245022	3272EZ	245101	3273Z8	245179	7701469374	250009	7701352021	250031
327210	245023	9639508780	245103	3273KW	245193	7711135233	250009	7701349740	250032
327211	245023	3273EX	245103	3273KX	245193	9109186	250010	7701351193	250032
327212	245023	3273EY	245103	3272LJ	245194	7700102979	250010	711106260	250033
3272E1	245024	9637117880	245104	3272LK	245194	7711135278	250010	7701349785	250033
327261	245024	3273AC	245104	327479	245197	7700102981	250011	7701351266	250033

COMPETITOR	GSP Ref.	COMPETITOR	GSP Ref.	COMPETITOR	GSP Ref.	COMPETITOR	GSP Ref.	COMPETITOR	GSP Ref.
OE		6001544964	250098	7701465455	250201	391004165R	250263	7701468843	250327
		7701352489	250099	7701349939	250205	8200534580	250263	7701469375	250327
7701352386	250034	7701469543	250099	7701351807	250205	7711368657	250263	7711134785	250328
7701354993	250034	7701352618	250100	7711134777	250207	8200274166	250263	8200014109	250328
7701468887	250034	7701469962	250100	8200079913	250207	7700112507	250268	7711134786	250329
7711130045	250034	7700109334	250102	8200470129	250207	7700112511	250268	8200030623	250329
7701349997	250035	7700112149	250102	8200014352	250207	8200032887	250268	7711134776	250330
7701352385	250035	7701349980	250102	8200243985	250207	8200063808	250268	8200014114	250330
7701349879	250036	7701352318	250102	7711135536	250207	7700100065	250271	8200079916	250330
7701351483	250036	7701468548	250102	7711134779	250208	7700101680	250271	8200387548	250330
7701349691	250037	8200231953	250102	8200014111	250208	7701352488	250271	7700103863	250331
7701349873	250037	7701349959	250105	7700872598	250211	7701469542	250271	7701352791	250331
7701351478	250037	7701351959	250105	7701352630	250211	7700105447	250272	8200531904	250346
7700105484	250038	7701352001	250105	8200029470	250211	7700114056	250272	8200531911	250346
7700105486	250038	7700104460	250130	7711135531	250214	7701472850	250272	8200613829	250346
7700111077	250038	7701352563	250130	8200169279	250214	7701472852	250272	8201187819	250346
7700111810	250038	7701352744	250130	7701352142	250215	8200169307	250272	8200472158	250348
7700111812	250038	7701352562	250131	7701352428	250215	8200411381	250278	6001548718	250353
7700111814	250038	7700104545	250132	8200030619	250219	8200511220	250278	8200261840	250353
7700875246	250038	7700109680	250132	7711134782	250219	8200255027	250279	8200440187	250353
8200168513	250038	7701352755	250132	7711135319	250219	7711368677	250280	8200499585	250353
7700111748	250039	7701684757	250132	8200107530	250219	7711497634	250280	8200511225	250353
7700111918	250039	7701352144	250134	8200232883	250219	8200543868	250280	8200618501	250353
7701352729	250039	7711130028	250134	8200035674	250219	8200014353	250281	7711368512	250353
7701468842	250039	7701349786	250138	7711134784	250219	8200233728	250281	7711497150	250353
7711135208	250039	7701351267	250138	7700106291	250221	8200531894	250281	8200559377	250353
7701349692	250041	711106130	250145	7701352628	250221	8200225099	250281	6001548720	250354
7701351127	250041	7700873326	250145	7711135267	250221	7711134783	250281	7711497417	250354
7701352750	250043	7701348968	250145	8200031149	250221	7711135236	250284	8200261841	250354
7701470700	250043	7701498923	250145	7711135265	250223	7700108465	250295	8200270510	250354
7701471377	250043	7701498924	250145	7700105450	250225	7701352907	250295	8200358168	250354
7711130057	250043	7711106130	250145	7700114057	250225	7701352622	250296	8200455157	250354
8200024622	250043	7700104727	250150	7711134780	250226	7701469966	250296	8200460992	250354
8200029444	250043	7700108248	250150	8200035673	250226	7701349034	250300	8200499586	250354
711106219	250044	7700109333	250150	7700112506	250227	7701394697	250300	8200618111	250354
7701349771	250044	7701351990	250150	7711135196	250227	7701498921	250300	8201055673	250354
7701349804	250044	7701352771	250150	8200032891	250227	7701349992	250301	8200358164	250354
7701349946	250044	7711135243	250150	7711135321	250228	7701352130	250301	7700106017	250356
7701351192	250044	8200231680	250150	8200079912	250228	7700112116	250311	7700106009	250357
7701351292	250044	7701352775	250151	8200169176	250228	7711134941	250311	8200106013	250357
7701351363	250044	7701352777	250151	8200387466	250228	8200087857	250313	7700110483	250357
8200323959	250044	7700111916	250160	8200236114	250245	7711135237	250313	7700111190	250357
7701470304	250044	7700115197	250160	8200274161	250245	7700111920	250314	7700114453	250357
7700111364	250045	7711135207	250160	8200571878	250245	8200064731	250314	7700115010	250357
7701352881	250045	7711135217	250160	7711135530	250246	7711368859	250314	7701352882	250357
7701352141	250046	8200110754	250160	8200052421	250246	7700105485	250316	7701471084	250357
7701352870	250046	8200128122	250162	7701352421	250247	7700105487	250316	7701471284	250357
7700869106	250046	7700111508	250162	8200169289	250249	7700111809	250316	8200105214	250357
7701352427	250047	8200116063	250162	7700106263	250253	7700111811	250316	7700111079	250358
7701349913	250050	8200142879	250162	7700112131	250253	7700111813	250316	8200090175	250358
7701349938	250050	8200624049	250162	7700115818	250253	7700111820	250316	7700112147	250359
7701351806	250050	8201236025	250162	7711135213	250253	7700873322	250316	7701352808	250359
7701349689	250052	7700113258	250162	7711135223	250253	7700875247	250316	7701352809	250359
7701349734	250052	8200178624	250166	8200088665	250253	7701352495	250319	7701468549	250359
7701349940	250052	8200485578	250166	8200283723	250253	7700107509	250320	7701470183	250359
7701351124	250052	4401727	250166	8200283724	250253	7700111818	250320	7701470298	250359
7701352020	250052	7711135287	250166	8200283725	250253	7700112114	250320	7701352319	250359
7701352024	250052	7701352190	250171	8200283726	250253	7700113086	250320	8200362064	250364
7701352598	250054	3910100QAA	250179	8200531861	250253	7700111313	250323	8200538738	250364
7700873311	250055	7711134959	250193	8200531886	250253	7700112132	250323	8200414937	250366
7701352596	250055	8200114426	250193	7700115958	250254	7711135215	250323	8200341698	250369
820029984	250057	7711134957	250194	8200079915	250256	7700112688	250324	7711368363	250369
8200164147	250057	8200065334	250194	8200470131	250256	7700115005	250324	8200378880	250372
8200299844	250057	7700107765	250197	8200236116	250260	7711135219	250324	7711368368	250372
8200477656	250057	7700110218	250197	8200622835	250260	7700111914	250325	8200749390	250373
7701473010	250058	7700112315	250197	8200626032	250260	7700115196	250325	7711368631	250375
8200052420	250058	7701352869	250197	7711368907	250260	7711135206	250325	7711368632	250376
8200164149	250059	8200031134	250197	8200613820	250260	7711135216	250325	8200676172	250377
8200477655	250059	8200031137	250197	7711368906	250260	8200173584	250325	8200934677	250377
8200169285	250060	7701352560	250199	7711135883	250260	7701352413	250326	7701210040	250379
7701352619	250074	7701352561	250199	7711135906	250261	7701352416	250326	8200441337	250379
7701469965	250074	7701352629	250200	8200236109	250261	7701352472	250326	8200618168	250380
7700111365	250082	7701470173	250200	8200236110	250261	7701468836	250326	8200725499	250383
7701352134	250093	7700109022	250201	391014440R	250261	77			

COMPETITOR	GSP Ref.	COMPETITOR	GSP Ref.	COMPETITOR	GSP Ref.	COMPETITOR	GSP Ref.	COMPETITOR	GSP Ref.
OE		8200117068	250442	8200331639	250506	8200485590	250557	8200387558	250633
		8200216519	250442	8200045471	250506	4411698	250562	7711135218	250634
8200276404	250386	8200327707	250442	391007857R	250507	93850890	250562	7700112478	250634
7700112689	250389	8200376095	250442	391009727R	250507	7711135440	250562	8200387408	250637
7711135220	250389	8200575490	250442	391017832R	250508	8200169163	250562	TDB104020	251002
7711135403	250390	8200626040	250442	8200216017	250509	391009101R	250563	TDB104030	251003
8200226056	250390	6001550794	250443	8200387522	250509	1S0407761B	250567	TDB000360	251009
8200228393	250390	8200261838	250443	8200725502	250510	1S0407761BX	250567	TOB500330	251036
8200470133	250390	8200383707	250444	391014946R	250512	6001551095	250570	IED000081	251036
7711135411	250391	8200276640	250445	7711368568	250514	8200863653	250570	IED500040	251036
8200171562	250391	8200416682	250445	7711368569	250514	8200863524	250570	05085250AG	251041
8200387439	250391	7711135307	250446	8200407659	250514	6001551096	250570	3815A176	251046
8200590972	250391	8200014107	250446	8200407660	250514	6001550690	250570	3272PT	251047
8200259911	250391	8200232886	250446	8200467490	250514	6001550691	250570	3815A075	251047
8200387424	250391	7701352552	250447	8200535798	250514	8201187935	250570	4410178K00	251048
7711368273	250391	7701352983	250447	8200535799	250514	7711368570	250571	4410165J01	251048
7711135401	250392	7711134419	250447	8200535800	250515	8200450241	250571	4410579K20	251049
8200226057	250392	8200197978	250447	8200379236	250516	8200666593	250572	3273PY	251050
8200467679	250392	8200285908	250447	8200432515	250516	8201236047	250572	TDB104890	251068
7711368091	250393	8200436365	250447	7711368470	250517	391009893R	250573	TDB104950	251069
8200133289	250393	8200790519	250447	8200087860	250517	391009067R	250573	TDB104970	251070
8200436849	250393	8200934678	250451	8200363697	250518	8200557126	250573	TDB104870	251071
8200439891	250393	8200618165	250451	8200236112	250519	8200696900	250574	TDB103301	251072
8200216625	250399	7711368621	250452	8200531889	250519	8201235822	250574	5057708	252001
7711135414	250400	8200379208	250452	8200613823	250519	8200531900	250574	5057682	252002
8200198015	250400	8200383708	250453	8200621196	250519	391016100R	250578	191407271H	253001
8200436366	250400	8200776962	250453	8200184199	250520	7700106015	250579	191407271HX	253001
8200790517	250400	8200387432	250454	7711134954	250521	7701352848	250579	191407271K	253001
7711497286	250400	8200934679	250455	8200027881	250521	7711134326	250579	191407271T	253001
7711135005	250401	8200618166	250455	7711135254	250521	7711134955	250579	191407272AG	253002
7711368656	250401	8200565217	250460	7700114988	250521	8200126445	250579	191407272BD	253002
8200236092	250401	7701349992	250461	7711134459	250522	8200235096	250579	191407272CV	253002
8200236107	250401	7701352129	250461	8200027842	250522	391016521R	250584	191407272CX	253002
8200240425	250401	8200626991	250462	7700114987	250522	391008165R	250586	191407272F	253002
8200274159	250401	8200626048	250462	7711135253	250522	391015061R	250587	191407274CX	253002
8200534635	250401	391009882R	250463	8200072831	250523	7700114751	250588	191407274DX	253002
8200571876	250401	391017275R	250464	7711135835	250524	7701352849	250588	191407272BN	253002
8200613822	250401	8201505590	250464	8200088974	250524	7701470884	250588	191407274CV	253002
8200236091	250401	8V413B436BD	250465	7711497282	250525	7711134327	250588	191407272BK	253002
8200330413	250402	1683585	250465	8200236103	250525	8200107090	250588	191407272BL	253002
8200375537	250403	1594943	250465	8200613818	250525	8200482431	250591	191407272BV	253002
8200432516	250403	8V413B437AC	250466	7700111504	250526	8201187698	250592	191407272BX	253002
8200511122	250405	1594946	250466	7711368650	250526	8200500683	250592	191407452BV	253002
8200531917	250405	7711134775	250471	8200231663	250526	6001550692	250593	191407452BX	253002
8200432514	250405	8200022321	250471	8200262685	250526	6001550693	250593	191407271A	253003
7711497228	250410	8200387550	250471	8200844453	250526	6001551093	250593	191407271B	253003
8200113931	250410	7711368885	250483	8200144764	250527	6001551094	250593	191407271C	253003
7711368905	250411	8200441340	250483	8200144765	250527	8200820344	250593	191407271CX	253003
8200622834	250411	8200598563	250483	8200269195	250527	8201187694	250593	191407271P	253003
391011327R	250415	3910101115R	250487	391019932R	250535	391008683R	250604	191407271Q	253003
391012991R	250415	391000926R	250488	391016076R	250535	8200725504	250604	191407271R	253003
8200930507	250416	391008239R	250489	8200966862	250535	8200586377	250605	191407271RV	253003
391003147R	250416	391018662R	250490	391009864R	250536	8200926133	250605	191407449X	253003
8601678	250421	8200500684	250493	391003813R	250536	8201187936	250605	191497449X	253003
8602095	250421	8201235775	250493	8200482436	250538	391012511R	250606	191407271	253004
8201235851	250422	7711135777	250494	8200661507	250539	391007525R	250612	191407271N	253004
391015402R	250423	8200117069	250494	8200666595	250540	391000044R	250612	191407271NV	253004
391009002R	250425	8200310122	250494	8201236028	250540	391001916R	250612	191407271NX	253004
391006777R	250425	8200376094	250494	391005791R	250541	391006849R	250615	191407272A	253005
8200847584	250426	8200575489	250494	8201272648	250541	8200647066	250616	191407272AE	253005
391016204R	250426	7711135316	250495	391001510R	250541	391010433R	250617	191407272C	253005
391001339R	250427	8200351249	250495	8200684084	250542	391005624R	250618	191407274BX	253005
8200725511	250427	8200375538	250495	8201235764	250542	391011305R	250619	191407450X	253005
391001702R	250429	8200659626	250496	1S0407762B	250543	391017355R	250619	191407272AC	253005
8200725513	250429	8201235787	250496	1S0407762BX	250543	7701209469	250619	6K0407272M	253005
7711135875	250438	93856309	250497	1S0407762D	250543	391016376R	250620	6K0407452DX	253005
8200236089	250438	93861972	250497	1S0407762DX	250543	8200726970	250622	1K0407271AP	253007
7700102136	250438	8200452272	250497	8200482429	250544	8200676174	250622	1K0407451X	253007
7711135775	250440	8200776535	250497	8201235782	250544	8200934673	250622	1K0407272DM	253008
8200167554	250440	8201187931	250497	7711497234	250554	391006802R	250625	8N0407272G	253010
8200267041	250440	397411935R	250498	4411699	250557	8200687910	250626	8N0407272P	253010
8200613828	250440	392413815R	250498	4430546	250557	8200176931	250627	8N0407452AX	253010
7711135425	250441	391016491R	250498	93850891	250557	8200174903	250627	115420214	254001
8200197979	250441	391006276R	250501	93856471	250557	82100174903	250627	115421210	254001
8200285909									

COMPETITOR	GSP Ref.	COMPETITOR	GSP Ref.	COMPETITOR	GSP Ref.	COMPETITOR	GSP Ref.	COMPETITOR	GSP Ref.
OE		LR041309	257165	4342012420	259072	4342006600	259475	4341033310	259654
		4410272K00	257166	4341012490	259073	TDB500080	259480	4233042060	259656
6U0407271FX	254001	4410172K00	257167	4342006390	259074	4342002D80	259493	434200F081	259657
115420217	254002	4410272K40	257168	4341006390	259075	434200F070	259493	4341005461	259658
6U0407272A	254002	4410172K20	257169	434100D120	259076	434200F071	259493	4342005412	259659
6U0407272AF	254002	96897322	257176	434200D100	259077	4342002B50	259493	4342005491	259660
6U0407272F	254002	96897321	257177	4341052131	259077	434100F040	259494	4342005441	259661
6U0407272FX	254002	95226870	257179	434300K022	259168	434100F041	259494	434100F071	259662
1K0407272ER	254011	4410163J01	257183	434300K022	259168	434100F090	259494	434100D341	259665
1K0407272KG	254011	4410162J00	257183	4341012670	259191	3272JZ	259495	434100D480	259666
1K0407272NK	254011	4410162J20	257183	4342012590	259192	434200H020	259495	4342074020	259667
1K0407272QE	254011	495000X410	257195	4341028080	259193	434200F011	259505	4341074020	259668
1K0407272QF	254011	4710021	257197	4342028070	259194	4342002B30	259507	4342074010	259669
1K0407272RG	254011	4410151K90	257197	4341012351	259195	4342002B40	259507	4342042240	259670
1K0407272HR	254011	44102M76M00	257211	4342012341	259196	4341002830	259509	4342042230	259671
1K0407272DQ	254011	4710013	257221	434100D430	259201	4341042210	259518	4341042240	259672
1K0407272EG	254011	93194650	257221	4341052210	259201	4341005430	259519	4342002A60	259673
1K0407454X	254011	4410151K00	257221	434100D280	259201	4342005430	259520	4341002850	259674
1K0407272TQ	254011	4710017	257222	4341052290	259201	4342005431	259520	4234052020	259675
1K0407764PX	254011	93194655	257222	4341052320	259201	434100F010	259531	4234052021	259675
1K0407454HX	254011	4410251K00	257222	4341052270	259201	TDB500110	259535	434300K051	259676
1K0407764BX	254011	4711022	257223	434200D420	259202	4341005450	259552	4341052300	259677
1K0407762CX	254011	4410251K90	257223	4342052210	259202	4341005451	259552	4342042220	259678
1K0407762QX	254011	44101M74L01	257228	434200D210	259202	4342005400	259553	434100F051	259679
1K0407271BF	254013	4410168L80	257234	4342052300	259202	4342005401	259553	434200D390	259680
1K0407271KA	254013	396004652R	257265	4342052261	259202	4342002710	259561	434200D310	259681
1K0407271KS	254013	8200939996	257265	434200D370	259206	4342042091	259561	4341042280	259685
1K0407271LG	254013	4410271LA1	257275	434200D170	259206	4342002A10	259561	4341030040	259686
1K0407271LK	254013	4410171LC1	257277	4342052180	259206	4341002660	259562	4342012730	259687
1K0407271BQ	254013	4410179J61	257281	4342005380	259207	4341012B00	259562	4342012731	259687
1K0407451QX	254013	71747566	257281	434100D380	259208	4342002C40	259572	4341002630	259688
1K0407271NT	254013	4410179J60	257281	434100D160	259208	4342012760	259583	4341012760	259688
1K0407761QX	254013	4410261M20	257282	434100D170	259208	434200D270	259585	4342012700	259689
1K0407271FB	254013	4411961MC0	257282	4341052180	259208	434100D220	259588	4342068010	259691
1K0407271HL	254013	4411861MC0	257282	4346009420	259217	4341005481	259589	4342052290	259693
1K0407271KB	254013	4410571L01	257283	4342002D90	259228	4341006880	259594	4341042250	259696
1K0407453CX	254013	4410671L01	257284	4341006660	259235	4342006A40	259595	434100D401	259697
1K0407271PA	254013	4410161MB0	257288	4342006710	259236	434100E070	259597	434200D411	259698
1K0407763AX	254013	4411961MB0	257288	4342002620	259268	434200E060	259598	434100D331	259699
1K0407763DX	254013	4411861MB0	257288	4342002621	259268	4341042160	259608	434200D331	259700
1K0407271LG	254013	4410261M10	257289	4342002270	259270	4342030030	259609	4341002590	259701
1K0407271LK	254013	4410155LC0	257291	4342005240	259272	4342028090	259610	4341002591	259701
1K0407271BQ	254013	4410155L20	257291	4342002701	259272	434200D190	259611	4342002630	259702
1K0407451QX	254013	4410255L01	257292	4341002710	259273	4342074050	259611	4342002631	259702
1K0407271NT	254013	44102H70L00	257293	4342002340	259274	4342012770	259612	4341002690	259714
1K0407761QX	254013	4410285L00	257296	4341052201	259294	434300C020	259613	4231126290	259728
1K0407271FB	254013	4410168L32	257297	4342052201	259295	4341012790	259614	4341160100	259729
1K0407271HL	254013	4411968L30	257297	4342002610	259316	4341012820	259615	4341260120	259730
28321KE060	256029	4411868L31	257297	4342002611	259316	4341012A40	259616	374188	260002
28321KE070	256030	4410268L32	257298	4341002570	259317	4341002670	259617	374210	260002
4410263J30	257004	4410255L80	257299	4341002571	259317	4342002720	259618	374221	260002
KK3892540x	257036	4410155LH2	257300	4341006A10	259323	4341044041	259619	374312	260002
4410180E00	257039	4421076820	257309	4341006A50	259323	434200F030	259621	26029827	260002
4410180E01000	257039	434300K200	259004	4341006640	259323	434200F031	259621	26032414	260002
4410280E00	257040	4341052070	259011	4342006A60	259324	4342042200	259622	93192082	260002
4410280E01	257040	4343060061	259015	4342006B00	259324	TDB500100	259623	374738	260002
4410280E0100	257040	4343060082	259015	4342006670	259324	4342006A00	259624	90540523	260002
4410280E01000	257040	4343060060	259015	434200D322	259343	4341006820	259625	374229	260002
4410276G60	257068	4342002320	259018	LR005870	259344	4342052271	259626	90444328	260002
4410176G60	257069	4343026021	259031	434100D292	259345	4341052260	259627	374321	260013
4410178G30	257070	4343035011	259031	LR006706	259346	434100F030	259633	9117407	260013
4410276G80	257071	4343035030	259038	LR002614	259346	434100F031	259633	90538602	260013
71743873	257074	4242016040	259049	4347009L30	259352	434200D180	259635	13166586	260016
4410179JC0	257074	4242016042	259049	4346009M60	259354	434100D180	259636	374472	260016
44101M72F12	257077	4342016040	259049	4341042200	259370	4233042050	259637	374535	260016
44101M72F13	257077	4342016042	259049	434200E100	259371	4342012A60	259639	9186553	260016
44102M72F12	257078	4341016040	259050	4342047030	259377	4341012B30	259640	13245907	260016
44102M72F13	257078	4341016042	259050	4342047020	259380	4342002B00	259643	374812	260016
9206563	257087	4342028030	259051	2650112003	259392	4342002B80	259643	374137	260019
44102M79F75	257128	4342052010	259057	4341012A30	259404	4342002B90	259643	90348317	260019
6G9N4B402AA	257165	4342033012	259059	4342012860	259405	4342002C00	259643	8200452269	260022
6G9N4B402AB	257165	4341033012	259060	4342042180	259417	4342008020	259644	4417912	260022
LR001160	257165	4341006370	259062	4342005372	259445	434200R010	259645	8200776538	260022
LR014491	257165	4342006360	259063	4341002580	259447	434200R030	259646	8201187933	260022
LR024525	257165	4341028030							

COMPETITOR	GSP Ref.	COMPETITOR	GSP Ref.	COMPETITOR	GSP Ref.	COMPETITOR	GSP Ref.	COMPETITOR	GSP Ref.
OE		1H0407272MX	261009	6Q0407271DJ	261078	1K0407454SX	261096	7H0407272BL	261140
		1H0407450BX	261009	6Q0407451PX	261078	1K0407272DR	261096	7H0407452AV	261140
93861971	260022	6N0407272	261010	6QE407271J	261078	1K0407271DJ	261097	7H0407452AX	261140
93856310	260022	6N0407272X	261010	6QE407271DJ	261078	1K0407451JX	261097	7H0407452JV	261140
374647	260025	6N0407450X	261010	6QE407451PX	261078	1K0407451AX	261097	7H0407452JX	261140
93189675	260025	1H0407271N	261011	5X3407271	261079	1K0407271AQ	261097	7H0407452PX	261140
13228204	260026	3B0407272M	261019	5X3407272	261080	6Q0407271BE	261098	5N0407763D	261146
374835	260026	8D0407272AJ	261019	8D0407272BQ	261082	6Q0407271BS	261098	5N0407763DX	261146
13219092	260027	8D0407272BB	261019	8D0407272EK	261082	6Q0407271DB	261098	5N0407766B	261147
374829	260027	8D0407272DT	261019	8D0407452M	261082	6Q0407271DE	261098	5N0407766BX	261147
13348258	260027	8D0407272EF	261019	8D0407452MX	261082	6Q0407451FX	261098	1K0407272RS	261147
374922	260027	8D0407452CV	261019	8D0407271BQ	261083	6Q0407272BK	261099	3C0407272BQ	261152
374328	260035	8D0407452CX	261019	8D0407271EK	261083	6Q0407272DH	261099	1K0407272EF	261152
374612	260035	8D0407454CV	261019	8D0407451N	261083	6Q0407452HX	261099	3C0407272D	261152
90539783	260035	8D0407454CX	261019	8D0407451NX	261083	6Q0407452LX	261099	3C0407272DX	261152
9117414	260035	8D0407452LX	261019	8D0407451TX	261083	2K0407271E	261100	1K0407271BP	261153
93187066	260035	4B0407271C	261019	7H0407271AF	261084	2K0407272E	261101	3C0407271AS	261153
357407271A	261001	4B0407451CX	261019	7H0407271AL	261084	2K0407272EX	261101	3C0407271D	261153
357407271EX	261001	1J0407271PL	261020	7H0407451TX	261084	3Q0407272AB	261101	3C0407271DV	261153
357407271G	261001	1H0407272AM	261028	7H0407451CV	261084	7H0407271AK	261105	3C0407271DX	261153
357407271GX	261001	1H0407452X	261028	7H0407271Q	261084	7H0407271E	261105	1J0407271CH	261156
357407271H	261001	113501201D	261031	7H0407271AA	261084	7H0407271T	261105	1J0407271CT	261156
357407271HX	261001	7D0407271A	261033	7H0407451AX	261084	7H0407451JX	261105	1J0407451CX	261156
357407271P	261001	7D0407451X	261033	7H0407452BV	261084	7H0407451X	261105	1J0407451DV	261156
357407271PX	261001	701407271AB	261034	7H0407452FV	261084	8E0407271AH	261115	1J0407451DX	261156
357407449AX	261001	1K0407272CC	261042	7H0407272AH	261084	8E0407451EX	261115	8D0407451PV	261157
1H0407271A	261001	1K0407272DN	261042	7H0407272AK	261084	701407271B	261119	8D0407271DF	261157
1H0407271AX	261001	1K0407272FR	261042	7H0407272AR	261084	701407271BV	261119	8D0407451RX	261157
357407272	261002	1K0407272GK	261042	7H0407272BG	261084	701407271BX	261119	8D0407271DQ	261157
1H0407272N	261002	1K0407272GM	261042	7H0407272BN	261084	701407449X	261119	8D0407271RX	261157
357407271B	261002	1K0407454BX	261042	7H0407272CJ	261084	701407271H	261120	8D0407451PX	261157
357407272B	261002	2K0407272F	261042	7H0407452BX	261084	701407271HV	261120	1K0407272SB	261162
357407272F	261002	1K0407272EC	261042	7H0407452FX	261084	701407271HX	261120	1H0407271	261172
357407272FX	261002	1K0407452DX	261042	7H0407452KX	261084	701407449BX	261120	1H0407271H	261172
357407272L	261002	1K0407452GX	261042	7H0407454X	261084	1J0407272BJ	261121	1H0407271V	261172
357407272M	261002	1K0407456CX	261042	7H0407451CX	261084	1J0407272GD	261121	1H0407271X	261172
357407272MV	261002	1Q0407272	261042	7H0407451DV	261084	1J0407272KT	261121	1H0407449X	261172
357407272MX	261002	1J0407271AC	261045	7E0407271S	261084	1J0407452Q	261121	2H0407271B	261173
357407450V	261002	1J0407271AH	261045	7M0407271D	261085	1J0407452QV	261121	2H0407271BX	261173
357407450X	261002	1J0407271AL	261045	7M0407271N	261085	1J0407452QX	261121	2H0407271D	261173
701407271M	261003	1J0407271AM	261045	7M3407271H	261085	8D0407271AN	261122	2H0407271DX	261173
701407451X	261003	1J0407271F	261045	7M3407271RX	261085	8D0407271BJ	261122	2H0407271E	261173
701407449FX	261003	1J0407271Q	261045	7M3407451CX	261085	8D0407271CL	261122	6Q0407272CL	261183
701407271P	261004	1J0407451BX	261045	95VW3B437DA	261085	8D0407271DJ	261122	6Q0407272J	261183
701407451A	261004	1J0407451V	261045	1016689	261085	8D0407271DP	261122	6Q0407452KX	261183
251501203B	261005	1J0407451X	261045	1097320	261085	8D0407451BV	261122	6R0407761A	261184
251501203BX	261005	701407271AC	261052	1122174	261085	8D0407451BX	261122	6R0407761AX	261184
251501203D	261005	171407272AG	261054	1250860	261085	8D0407451FX	261122	6R0407762A	261185
251501203DX	261005	1H0407272	261055	95VW3B437DB	261085	1J0407271AA	261123	6R0407762AX	261185
251501203G	261005	1H0407272AD	261055	YM213B437JB	261085	1J0407271CG	261123	1J0407452LX	261186
251501204A	261005	251501203	261056	7M3407451CV	261085	1J0407271EP	261123	1J0407272FQ	261186
251501204AX	261005	6Q0407272BC	261063	7M3407271R	261085	1J0407271ES	261123	1J0407272FL	261186
251501204B	261005	6Q0407272BD	261063	6M213B437AA	261087	1J0407271FD	261123	1J0407272FD	261186
251501204BX	261005	6Q0407272BE	261063	1449540	261087	1J0407271GC	261123	6E0407272H	261189
171407272AC	261006	6Q0407272BH	261063	7M3407271TX	261087	1J0407271LM	261123	6E0407452AX	261189
171407272AS	261006	6Q0407272DR	261063	7M3407271T	261087	1J0407271LN	261123	02Z409345B	261190
171407274DX	261006	6Q0407452EX	261063	1125046	261087	1J0407451HX	261123	0A5409355C	261191
171407274FX	261006	6Q0407452FX	261063	7M3407271G	261087	1J0407451P	261123	02N409345A	261192
191407272AS	261006	6Q0407452GX	261063	7M3407271S	261087	1J0407451PV	261123	1313097	261192
191407272BB	261006	7M0407272C	261065	7M3407271SX	261087	1J0407451PX	261123	3M213A426AA	261192
191407274FX	261006	7M0407272CX	261065	7M3407451DX	261087	1J0407271EF	261123	02N409345	261192
6N0407271	261007	7M0407272G	261065	1K0407271CP	261089	1K0407272NJ	261126	1121392	261192
6N0407271V	261007	7M3407272D	261065	3C0407271AE	261089	1K0407272KF	261126	YM213A426BA	261192
6N0407271X	261007	95VW3B436DA	261065	1Q0407271A	261089	1K0407762BX	261126	02N409344E	261193
6N0407449V	261007	1H0407272AC	261067	251407271J	261092	1K0407762PX	261126	1K0407271KP	261198
6N0407271B	261007	1H0407272AG	261067	1K0407271CQ	261093	1K0407454GX	261126	1K0407763GX	261198
6N0407451X	261007	1H0407274V	261067	1K0407451PX	261093	2K3407271B	261131	1K0407271JA	261198
191407272	261008	1H0407274X	261067	1K0407272FS	261094	2K3407271BX	261131	1K0407761MX	261198
191407272AA	261008	1H0407450AX	261067	1K0407452QX	261094	2K0407271EX	261131	1K0407271HQ	261198
191407272X	261008	6X0407272E	261074	1K0407272HK	261096	6Q0407272EP	261133	1K0407761DX	261198
191407274X	261008	6X0407452V	261074	1K0407272BG	261096	6Q0407272EN	261133	1K0407271HT	261198
1H0407272A	261009	6X0407452X	261074	1K0407272JT	261096	8Z0407272AC	261136	1K0407271AS	261198
1H0407272AF	261009	6X0407271H	261075	1K0407272HL	261096	7H0407272AC	261140	5Q0407762X	261199
1H0407272AX	261009	6X0407271K	261075	1K0407452BV	261096	7H0407272AL	261140	1K0407272PH	261199

COMPETITOR	GSP Ref.	COMPETITOR	GSP Ref.	COMPETITOR	GSP Ref.	COMPETITOR	GSP Ref.	COMPETITOR	GSP Ref.
OE		1K0407271BK	261268	1J0407451JX	261312	8602587	262029	36011289	262109
		5Q0407761FX	261268	1J0407451J	261312	30735348	262029	36000680	262110
1K0407456EX	261199	5Q0407272BN	261280	1J0407271AD	261314	8251779	262029	31280668	262110
1K0407271LA	261201	1K0407272SP	261280	1J0407271B	261314	8602578	262031	36011265	262111
1K0407271HH	261201	1K0407764RX	261280	357407271R	261314	30735121	262031	31367539	262111
1K0407761EX	261201	1K0407272ST	261280	1J0407451MX	261314	30783097	262031	36001972	262112
1K0407763CX	261201	1K0407271JJ	261281	357407271RX	261314	36000532	262031	31325762	262112
1K0407271JF	261201	1K0407761PX	261281	1J0407271EN	261314	8252049	262031	36011290	262113
1J0407272GE	261203	8J0407761C	261281	1J0407271AQ	261314	8601856	262031	31256252	262113
1J0407272JC	261203	1K0407271LB	261282	1J0407271DL	261314	8603793	262031	36011297	262114
6Q0407271CL	261204	1K0407763KX	261282	1J0407271DF	261314	8689214	262031	31256251	262114
6Q0407271J	261204	5Q0407271BR	261282	357407271RV	261314	9181256	262031	36002493	262115
6Q0407451JX	261204	1K0407272QN	261283	7L6201201B	261323	30735344	262034	36011266	262116
6Q0407271CE	261204	5Q0407272H	261283	7L6501201	261323	8601983	262034	31367540	262116
6N0407451DX	261205	5Q0407762EX	261283	7L6501201B	261323	8602589	262034	36010062	262117
6Q0407271EE	261206	1K0501203F	261284	7L6501201BX	261323	8603879	262034	31325117	262117
6Q0407451SX	261206	1K0501203FX	261284	7L6501201D	261323	8689226	262034	8251542	262118
7H0407272BE	261210	1K0501203A	261284	7L6501201DX	261323	8251778	262034	36010060	262119
7H0407272AP	261210	1K0501203D	261284	7N0407764R	261330	9207795	262034	31325116	262119
7H0407452HX	261210	5Q0407271L	261285	7N0407764RX	261330	8251547	262035	36002060	262120
7H0407272AF	261210	5Q0407271M	261285	7N0407764D	261330	8251548	262035	31280680	262120
7H0407272AS	261210	5Q0501203A	261286	1K0407272KP	261342	8251533	262035	36011351	262121
7H0407272BJ	261210	5Q0501204A	261287	1K0407762HX	261342	8251528	262035	31325961	262121
7H0407272BQ	261210	5Q0501204AX	261287	3Q0407762HX	261345	8251530	262035	36011350	262122
7H0407452DX	261210	1K0407271LH	261289	3Q0407272BB	261346	36000522	262039	31325960	262122
7H0407452QX	261210	1K0407763X	261289	3Q0407272BG	261347	8252039	262039	36012423	262123
7H0407452RX	261210	1K0407761JX	261289	5N0407766DX	261347	36002144	262053	31367546	262123
JZW0407450QX	261210	4G0407271F	261290	5N0407766D	261347	30783173	262060	36010056	262124
1K0407272HB	261211	4G0407451BX	261290	495602B150	261351	30787774	262060	31325109	262124
1K0407272KC	261211	8R0501203D	261291	495602P050	261351	36000183	262060	36012416	262125
1K0407452NX	261211	1K0501204F	261293	2E0501171E	261354	36000439	262060	31367531	262125
1K0407762X	261211	1K0501204FX	261293	8111306	262001	36000441	262060	36010054	262126
1K0407272DT	261211	1K0501204A	261293	9122569	262001	36000548	262060	31325108	262126
1K0407452CX	261211	1K0501204AX	261293	9163593	262001	36000550	262060	36001874	262127
0A6409343C	261214	1K0501204D	261293	9601096	262001	8603119	262060	31325686	262127
0A6409343B	261214	1K0501204DX	261293	91225698	262001	8603819	262060	36012437	262128
0A5409343A	261215	3AA407272D	261294	8601097	262002	30783174	262063	31367627	262128
02Z409345D	261216	3AA407762X	261294	9122570	262002	30787784	262063	31280676	262128
6Q0407272DM	261223	3C0407272CB	261295	9163592	262002	36000184	262063	36011267	262129
6Q0407452QX	261223	3C0407452RX	261295	91225706	262002	36000241	262063	36011353	262130
1K0407271DS	261224	5N0407763	261296	5003844	262002	36000449	262063	31325963	262130
1K0407761AX	261224	6R0407761K	261297	6843202	262002	36000450	262063	36011352	262131
02G409356C	261225	6R0407761KX	261297	8111305	262002	36000451	262063	31325962	262131
95533202401	261236	7P0501201GX	261298	8111310	262002	36000558	262063	36011269	262132
7L0501201BX	261236	7P0501201G	261298	36000521	262012	36000560	262063	31280682	262132
7L0501201B	261236	1K0407272JF	261300	8252037	262012	36051061	262063	36001875	262133
02Q409345	261237	1K0407454MX	261300	36000535	262015	8603120	262063	31325570	262133
09K409352	261238	6R0407762K	261301	8252052	262015	8603820	262063	36001059	262134
1J0407272HD	261243	6Q0407272EA	261301	8252046	262017	8251531	262064	31256095	262134
1J0407452SX	261243	6Q0407452RX	261301	30777065	262017	8251546	262072	36010213	262135
6Q0407451QX	261248	6R0407762KX	261301	8252056	262017	P31325135AC	262077	30651437	262136
6Q0407271DP	261248	6Q0407271DS	261302	8251550	262021	36001876	262077	30735277	262136
6Q0407272AR	261252	6R0407763K	261302	9480544	262022	36002896	262078	30735886	262136
6Q0407272BL	261252	5Q0407272F	261303	8689210	262022	31259517	262078	8601582	262136
6Q0407272DJ	261252	1K0407272PL	261303	8603789	262022	31367155	262081	8603884	262136
6Q0407272BA	261252	5Q0407762JX	261303	8602574	262022	31367154	262082	8251524	262137
6Q0407452MX	261252	5C0407272AA	261303	8601853	262022	30783088	262083	8251506	262138
02N409344F	261255	5Q0407271G	261304	30783082	262022	36000507	262083	8111309	262139
7H0501201D	261257	5Q0407761DX	261304	36000518	262022	36001215	262083	36000531	262140
7H0501201DX	261257	6Q0407272DL	261305	30735129	262022	36050314	262089	8252047	262140
7H0501201C	261257	6Q0407272EC	261305	8252033	262022	36000437	262097	8603888	262141
7H0501201CX	261257	5Q0407271A	261306	8251754	262023	36000181	262097	36000524	262141
7E0501201B	261257	5Q0407451X	261306	36001181	262024	8603816	262097	8252040	262141
7E0501201BX	261257	5Q0407272B	261307	8251781	262025	36000071	262097	8602531	262142
7H0501202C	261258	5Q0407762CX	261307	30735134	262025	36000546	262097	8251760	262143
7H0501202CX	261258	6R0407762B	261308	8602567	262025	36000561	262100	8602609	262143
7E0501202	261258	6R0407762BX	261308	8603786	262025	8603826	262100	4130005101	266002
7E0501202X	261258	6R0407761B	261311	8689203	262025	36000452	262100	4130008012	266003
6R0407761S	261260	1J0407271GD	261312	30735135	262026	36000445	262105	4130008001	266004
6R0407761SX	261260	1J0407271JL	261312	8251782	262026	36000554	262105	A212203010CA	268005
6R0407762S	261261	1J0407451NX	261312	8602568	262026	36000547	262106	538450086	275056
6R0407762SX	261261	1J0407451TX	261312	8603804	262026	36000438	262106	538450104	275056
6R0407764M	261261	1J0407451NV	261312	8689204	262026	36012479	262107	3273Z0	299003
6R0407764MX	261261	1J0407451TV	261312	8252035	262029	31256825	262107	3273Z1	299003
6QE407271H	261262	1J0407271BG	261312	8251777	262029	36001461	262108	3272ZQ	299006
6R0407762X	261267	1J0407271CJ	261312	8603800	262029	31272229	262108	3272ZQ	299006

COMPETITOR	GSP Ref.	COMPETITOR	GSP Ref.	COMPETITOR	GSP Ref.	COMPETITOR	GSP Ref.	COMPETITOR	GSP Ref.
OE		8200499895 374510	299151 299157	1497188088 71791561	299214 299214	13306854 700611	601210 602001	6Q0498103AX 483829	603008 603008
3272Q	299006	93299246	299157	31607529201	299215	46307515	602003	191498104	603009
3272X9	299007	8200531844	299169	31607524045	299215	46307223	602004	357498104	603009
32730L	299009	6C113B437BC	299179	31603450563	299215	46307457	602004	535498104	603009
32737H	299010	6C113B437BE	299179	31603450565	299215	46307103	602005	191498104A	603009
32737J	299010	7C113B436AB	299179	4950007060	299216	60812691	602005	321498103C	603009
32721H	299037	4341052110	299180	4950007050	299216	1493963	602006	321498103CV	603009
32723G	299037	4342052110	299181	8200352042	299217	46548165	602007	321498103CX	603009
1328362	299042	8200216626	299186	8200687739	299228	46307856	602007	357498104V	603009
2T143B436AC	299042	8200531908	299186	8201235754	299228	46307855	602007	357498104X	603009
2T143B436AD	299042	8200531910	299186	8200687740	299229	46308726	602009	191498103	603011
2T143B436AE	299042	8200531915	299186	8201235167	299229	71771196	602009	357498103	603011
2T143B436AF	299042	8200379235	299188	6C113B436BC	299244	46308272	602010	191498103A	603011
2T143B436AG	299042	Q0003234V006000000	299190	6C113B436BE	299244	46308278	602010	191498103C	603011
2T143B436AH	299042	Q0003234V007000000	299190	7C113B436AA	299244	71771198	602010	191498104C	603011
R97FX3220EA	299044	Q0003234V009000000	299190	13271519	299246	60584662	602011	1K0498103	603011
46307149	299049	Q0003234V010000000	299190	13334708	299246	7082704	602011	357498103A	603011
GD402550XA	299064	Q0003234V011000000	299190	13271549	299247	46308749	602014	357498103B	603011
26076879	299069	Q0003233V006000000	299191	13334715	299247	46308291	602014	357498103V	603011
7711368284	299070	Q0003233V007000000	299191	13371622	299247	251598101A	603001	357498103X	603011
8200356803	299070	Q0003233V009000000	299191	13386317	299247	431407331G	603001	1J0498103A	603011
8200388506	299070	Q0003233V010000000	299191	3273KJ	299271	431498103C	603001	1K0498103	603011
8200511116	299070	Q0003233V011000000	299191	3273KK	299271	431498103CX	603001	321498103D	603011
8200167535	299070	1495672	299194	3273PZ	299271	443407331D	603001	357498350V	603011
8200264664	299070	1496579	299194	3273QA	299271	443407331G	603001	191498103CV	603011
8200623807	299070	1782551	299194	3272KW	299272	443498103A	603001	191498103CX	603011
8200690053	299070	1445100	299194	3272KX	299272	4B0498103	603001	357498350X	603011
391010737R	299070	6C113B436DD	299194	495004D301	299278	431407331	603001	893498103B	603014
8200626043	299070	6C113B436DE	299194	31601493977	299285	431498104CX	603001	893498103BX	603014
8200661557	299070	3272FG	299195	31607514475	299285	1J0498103E	603001	1K0498103A	603016
7711368895	299070	3272FH	299195	31607518237	299285	443498103	603002	1K0407331	603016
7711135416	299071	3272FL	299195	3910100Q2E	299286	811407331	603002	1K0498103AX	603016
7711135417	299071	3272KL	299195	4417083	299286	3B0498103	603002	431498103	603019
8200167522	299071	3272LP	299195	8200414939	299286	431407331H	603002	4H0498103AX	603022
8200264665	299071	9642426680	299195	8201187929	299286	8D0498103	603002	8K0498103DX	603022
8200264668	299071	3272LQ	299195	4421271	299286	8D0498103A	603002	4H0498103A	603022
8200300713	299071	9642600180	299195	93189873	299286	8D0498103AX	603002	8K0498103D	603022
8200613827	299071	3273FG	299196	95507091	299286	3B0498103X	603002	8K0407271Q	603022
8200626038	299071	3273FH	299196	8200776522	299286	893498103	603003	8R0407271C	603022
8200167536	299071	3273JY	299196	8200776533	299286	1K0498103X	603003	4H0498103AV	603022
8200246665	299071	3273JZ	299196	1693603372	299296	321498103B	603003	7L0598103	603027
8200661558	299071	9642426780	299196	AL3Z4A376D	299302	811498103A	603003	95533290200	603027
4410163J21	299080	9642600080	299196	25859867	299303	893498103X	603003	7L0501331	603027
4410180E01	299097	3273GZ	299197	15860584	299303	357498103BX	603003	33211227599	605001
4341005370	299106	3273NT	299197	15114531	299304	6QD498103X	603003	98133202450	605013
4341005720	299106	3273RN	299197	15188059	299304	113501331	603004	A1643502910	605039
4342005320	299107	3273RP	299197	95833290300	601044	113598101	603004	A1643300801	605041
8D0407272AC	299108	33212228156	299199	95833290310	601044	171498103	603004	4230009101	605048
8D0407272BE	299108	33212228513	299199	95833290320	601044	321498103	603004	4230009100	605048
8D0407272DK	299108	5532718	299200	95833290330	601044	547498103	603004	33207581018	605074
8D0407272DM	299108	8200198016	299201	95833290340	601044	321498103V	603004	33212283458	605081
8D0407418H	299108	7711135420	299201	95833290200	601053	321498103X	603004	33207637445	605082
8D0407452DV	299108	24430493	299204	95833290210	601053	321498350V	603004	33207637444	605082
8D0407452DX	299108	24430495	299205	7711497235	601074	321498350X	603004	F03725500	608013
8D0407272AP	299111	6G913B437BE	299211	8200387541	601074	171498103CX	603004	F03725500A	608013
8D0407272DL	299111	1667774	299211	7N0498103BX	601075	JZW498350AX	603004	4410260G00	608017
8D0407452V	299111	36011293	299211	7N0498103B	601075	807407331	603005	4411772F00	608017
8D0407452X	299111	1437705	299212	36011296	601076	4402235	603005	4804590	608034
8D0407272BA	299111	6G913B436EB	299212	36011295	601077	1H0407331A	603005	93743414	608035
4B0407272C	299113	7L0407271EX	299213	36012413	601078	191407331	603006	96624724	608035
4B0407272M	299113	7L0407271E	299213	49582C5250	601096	191407331A	603006	4804589	608035
4B0407452CX	299113	7L0407271C	299213	49582D4350	601096	1H0407331B	603006	13318012	608039
1H0407271C	299116	7L0407271CX	299213	49582A4100	601103	1H0407331D	603006	13318013	608040
7M3407272B	299120	7L0407271A	299213	495922Y610	601106	321407331D	603006	13318014	608041
7M3407272C	299120	7L0407271B	299213	49582A4000	601112	171407331F	603008	13306856	608054
7M3407272E	299120	7L8407271	299213	49582A4050	601112	171498103C	603008	374691	608054
7M3407272EX	299120	95534903810	299213	49582A4051	601112	1J0498103	603008	15114531	608072
7M3407452V	299120	95534903811	299213	4304002280	601138	1K0498103B	603008	15114530	608073
7M3407452X	299120	95534903812	299213	4304002210	601139	321498103A	603008	25833034	608073
YM213B436AD	299120	7L0407271	299213	4304005141	601145	6Q0498103A	603008	25833035	608073
1132479	299120	7L0407271D	299213	39711BV81C	601146	ZBC407331	603008	46308391	610038
1254276	299120	7L0407271FX	299213	49535D7730	601149	1H0407331H	603008	46308487	610038
32727H	299135	3273NP	299214	49535D7731	601149	1K0498103BX	603008	46308498	610038
32728H	299135	3273NQ	299214	49535D7840	601150	431407331E	603008	1349786080	610038
8200169288	299151	1497188080							

COMPETITOR	GSP Ref.	COMPETITOR	GSP Ref.	COMPETITOR	GSP Ref.	COMPETITOR	GSP Ref.	COMPETITOR	GSP Ref.
OE		71771442	617028	44310SO4300	623020	495922Y800	624128	A1683603372	635010
		3272PG	617028	44310SO4300	623020	496002B010	624129	A1693606072	635011
3273YC	610067	3273PP	617028	44011SO4010	623021	496052BA00	624129	A1693605272	635011
3272XJ	610068	1349785080	617028	44310SO4900	623021	495923X0A0	624134	A1693604472	635012
9680667780	610080	9803959680	617030	44310S10901	623023	495923X1A0	624134	A1693606472	635012
9680667380	610082	55221323	617031	44310TL1305	623023	495923X2A0	624134	A1693605472	635012
3273RY	610160	71771199	617031	44310S10902	623023	495923X4A0	624134	A1693601572	635012
3272SZ	610161	55199295	617035	44310TAOA00	623023	496052HA00	624135	A1693603272	635012
3273VL	610165	51742366	617036	44310TLOG21	623037	495923X0A5	624137	A1683603172	635013
3273VK	610165	46308399	617042	44310STKA91	623038	49582C5200	624140	1693602972	635014
96273572	612001	46308497	617042	44010S47000	623044	49582D4300	624140	A1693604372	635014
96396135	612001	71771311	617042	44010SX0000	623044	49582C1150	624141	A1693602972	635014
96349956	612003	1349789080	617042	44011S47010	623044	49582D4150	624141	A1693604372	635014
96245286	612003	51742367	617043	44011SX1000	623044	496052BA30	624146	A1693608372	635014
96245311	612004	46308750	617055	44310TAOA61	623044	495052BA75	624147	9013300001	635020
96245288	612006	46308292	617055	42330S9A305	623046	495052PA10	624147	A20313300001	635020
93743419	612009	55197717	617056	44310TFOJ00	623050	49536C7001	624151	A2043301500	635023
4804594	612009	55209140	617058	44310TZ8305	623052	496002M200	624152	A1693705572	635024
43408B9350	614017	55228304	617059	44310TY4305	623052	495052PA20	624155	A1693706372	635024
52099260	616011	46308045	617062	44310TY4A00	623053	496052PA20	624156	A1693702772	635024
52098379	616011	46308810	617075	42330S0E306	623054	495013Z550	624159	A1693701572	635024
52098501	616011	71771200	617075	42330S71306	623054	495822W000	624160	1K0598099	635026
52099246	616011	60802065	617076	42320S0E300	623069	495921F200	627018	1K0598099X	635026
52098850	616011	153120188003	618001	44310T2AA00	623072	495922F000	627025	1K0501203GX	635026
55183134	617001	72GG4635BA	618001	44310TZ8H00	623077	495972Y200	627032	1693705672	635040
7672181	617001	92333203200	618001	44310SMB300	623079	49536A5101	627044	A1693706472	635040
60801882	617005	6073690	618002	44310TROJ10	623100	495922K450	627044	A1693704772	635040
46307865	617006	77TT3K177EB	618002	44310TRO300	623100	495052BA70	627052	A1693704872	635040
60802017	617006	6073691	618002	44310STXA12	623101	495052PA00	627052	491003E150	635045
46308442	617007	337498103	618018	4950538E00	624001	495922Y000	627056	491003E070	635045
46308729	617007	337407331A	618018	4950038442	624001	495923W000	627056	15922549	635045
71771189	617007	377498103A	618018	4950502A00	624002	495923W200	627057	15922550	635045
46308714	617008	ZBA407331	618019	MB297538	624003	21082215056	628001	15296383	635046
46308257	617008	ZBC407331A	618019	4950538C00	624008	21212215055	628003	22729203	635046
7660834	617009	1S653B418AA	618022	4950522A00	624009	21212215057	628003	10395274	635046
55197729	617011	XS463B418DA	618022	495051CB00	624009	21212215054	628004	3AMW3B413AE	635046
55197730	617012	F87A3K183B	618037	4950025300	624009	21212215056	628004	2L8Z4R602AA	635047
55186192	617014	XS4C3B418EB	618044	4950525B00	624010	21232215057	628006	2L8Z4R602DA	635047
46307543	617015	1451974	618044	495001C302	624010	21232215056	628007	7L8Z4R602A	635047
46307678	617015	36001360	618044	495051E050	624012	26117585922	630003	7L8Z4R602B	635047
46308336	617020	C9120B071000	618045	495052HA00	624013	4340917010	631001	7M6Z4R602A	635047
46308500	617020	XS4C3C092BA	618045	4950007000	624019	4340928010	631001	7L0598103A	635051
46308401	617020	1552939	618045	4959207000	624019	4304020020	631004	7L0501331A	635051
71771312	617020	1447554	618061	495002E550	624030	4303030040	631007	A2203300001	635059
40308336	617020	1355199	618061	495052EA00	624030	F03725600	634007	A2113301801	635060
1349787080	617021	42601388	618070	495052CA40	624030	F03725600A	634007	A2203300101	635061
1355333080	617021	42601892	618070	496822W050	624032	F03725600C	634007	A2113301701	635062
46308316	617021	96FG3B418CA	618072	495921H010	624039	0K2N122520	634008	A2113301101	635062
46308488	617021	55214684	618100	495972G500	624041	KK38825600	634008	55264146	635064
46308502	617021	1446283	618128	495052CA50	624043	GG0922520C	634013	55222107	635064
46308502	617021	36002891	618128	4950526800	624044	F06322520	634014	55197051	635064
1349790080	617022	1459773	618129	4950526E00	624044	F06122520	634014	55193595	635064
1355334080	617022	1459764	618129	495001C000	624045	FA5122520	634022	A6393501810	635069
1357488080	617022	36002894	618129	495001C010	624045	FA8125500A	634022	1447555	636001
46308315	617022	36000437	618159	495051CA00	624045	FA6022620	634027	MB176874	639002
46308488	617022	8251543	618171	49535B9000	624050	G56822620	634032	MB297927	639002
46308501	617022	1565594	618187	495012Y200	624053	G56822520	634033	MB620055	639002
3273PX	617022	LR025959	618187	49536A6202	624053	FG0222620	634047	MB196876	639005
3272PF	617022	36000931	618187	49535A5201	624053	FG0222620A	634047	MB526892	639005
3272PQ	617022	36000930	618187	495053JA00	624057	GG2822620A	634049	MB837166	639005
3273PN	617022	4558416	618274	495012P000	624058	FG0122620A	634091	MR196876	639005
3272PL	617022	4304702030	619001	495352L401	624061	FG0122620	634091	MR276445	639023
3272PE	617022	96489848	621005	495922Y050	624064	1749218	634117	MR331245	639023
3272SS	617022	46308725	621016	96888653	624068	GP2722620A	634142	MB399348	639028
1607113380	617022	46308288	621016	4950529A00	624072	36000681	634150	MR399351	639028
55207525	617025	46308712	621017	4950117050	624072	6383342334	635001	MR222052	639029
55209968	617026	55213545	621017	4950525A00	624076	7L6407331A	635001	MN171194	639032
46307884	617027	71771190	621017	4950526T00	624088	7L6498103	635001	MN171195	639033
55182803	617027	44310S9A305	623013	495052HA21	624093	7L6498103AX	635001	3815A184	639036
46775436	617027	44310S9A900	623013	495052BA30	624095	7L6498103V	635001	3817A318	639036
7702606	617027	44310TA0307	623013	495352L201	624098	7L6498103X	635001	3815A183	639037
55700559	617028	44310S10310	623017	495362L201	624098	1243508810	635003	3817A313	639037
1349788080	617028	44310S5A300	623018	495823S301	624100	2013500813	635006	3817A136	639040
46308335	617028	44310S5AJ00	623018	495823S300	624100	30713272	635008	MB526146	639049
46308488	617028	44500S7C900	623019	MR581872	624102	31216175	635008	MB160655	639049
46308499	617028	44010SO4010	623020	49535D7710	624126	31216177	635009	3717A016	639050

COMPETITOR	GSP Ref.	COMPETITOR	GSP Ref.	COMPETITOR	GSP Ref.	COMPETITOR	GSP Ref.	COMPETITOR	GSP Ref.
OE		7839614	644003	171498103D	653001	4304006040	659033	2374981032	661013
		374378	644003	171498103DV	653001	4342006151	659033	23750112012EH	661013
3274D0	639050	0374013	644004	171498103DX	653001	39711EE40A	659036	7H0407332P	661020
495361R001	639052	374013	644004	171498350X	653001	C97113HC0B	659036	7H0498104F	661020
495001R000	639052	374027	644004	1H0407331	653001	430400K010	659039	7H0498104K	661020
49592A63A5	639052	0374027	644004	6N0407331	653001	4304005070	659041	7H0498104L	661020
49535C7101	639052	90095159	644004	6N0498103	653001	4304002050	659042	7H0498104AK	661020
495361M001	639052	199051483	644004	861498103A	653001	4304020010	659046	7H0407332J	661021
495351R001	639052	374130	644005	JZV498350X	653001	4304002020	659046	7H0498104G	661021
MR980002	639057	4242328	644005	861498103AX	653001	4340302040	659047	7H0498104GX	661021
MN147089	639057	90304156	644005	6N0498350X	653001	4343060080	659049	7H0498104A	661021
MB526147	639061	1603272	644005	6N0498103X	653001	4340360040	659049	7H0407332	661021
4236022040	639089	0374130	644005	377498103E	653002	4340360020	659049	7M0498104	661028
GD6822520A	639114	1603236	644007	6X0407331	653002	4340360030	659065	7M0498104X	661028
3971102A05	641001	1603269	644008	6X0498103	653002	3272JZ	659069	7M0498350AX	661028
3971202A25	641001	374446	644009	115420171	654003	3273JS	659069	JZV498350FX	661028
3971135F10	641014	0374446	644009	6U0407331	654003	4304028010	659073	7H0498103C	661029
39710F4605	641032	93170397	644009	6U0498103A	654003	4304028011	659073	7H0407331E	661029
39710F4269	641038	1603409	644009	4411465J00	654006	430400D020	659077	7H0498103CX	661029
397718J105	641066	374088	644011	4411465J01	654006	430400D010	659077	7H0407331	661029
39205AV325	641067	374600	644011	4411768L80	654010	4303044021	659078	7D0498103	661030
391209AA0A	641073	13189073	644011	A4513570601	655001	4303044020	659078	7D0498331	661030
39100EA000	641100	9194469	644011	A4513570501	655001	4303028011	659078	7M3407332	661033
391269AA0A	641101	24405345	644011	28021AC210	656005	4303042020	659079	3C0498103GX	661038
39126EL000	641106	1603408	644012	28093AC040	656005	4303033041	659081	3C0498103G	661038
39711JD24C	641108	93190190	644012	28021AC130	656006	4303042040	659081	3C0498103A	661038
39101JG04C	641108	1603407	644014	28392AG000	656013	430400W030	659082	3C0498103AX	661038
39711JG34C	641108	93190189	644014	4410160G00	657002	4304042021	659084	3C0498103GV	661038
39720ET028	641117	55199297	644014	4410160G20	657005	4304042020	659084	6QD498103X	661039
391268H315	641122	13149834	644014	4410160G22	657005	434030D061	659092	6QD498103	661039
391208H315	641124	374791	644014	4410163B10	657009	434030W050	659092	7H0407331B	661041
39120EL005	641125	1603410	644017	4411560G22	657022	4304012120	659100	7H0498103	661041
39120ET000	641126	4130008001	644023	44101M79F10	657033	4304002120	659100	4E0498103	661044
39126ET000	641127	93033203400	648001	44127M79F01	657034	4340360010	659107	7M3498103H	661044
39126EL005	641133	1493962	648001	4411754G10	657036	4303042070	659108	7M3498103	661044
39720EW625	641133	414204	648002	495000X405	657109	4304028021	659109	8E0498103C	661044
3910095F0C	641134	90297728	648002	397112U600	657111	4304028020	659109	5N0498103A	661048
39771JD02B	641157	6383341734	648002	39600JD60A	657111	4303005100	659117	5N0498103AV	661048
39771JD22C	641167	91133203001	648002	1418957	657115	4341005180	659117	1K0498103CX	661050
39711JD22C	641168	91133292301	648002	4411565J00	657127	4304005150	659139	1K0498103E	661057
39101JD22C	641168	94433190100	648003	396004652R	657129	4341005450	659139	1K0407271NM	661057
397118J000	641182	4315132	648004	4411780J10	657137	4340312050	659160	1J0407363E	661057
397114M405	641185	9936769	648004	4411779J20	657137	430300E010	659191	1K0498103EX	661057
39711CC40A	641187	60806930	648004	4411771LA0	657151	430400E010	659192	3B0407341B	661057
397111LB0A	641195	82282139	648004	4411771LB0	657152	4303058011	659206	46307720	661057
397111LB0B	641203	92601388	648004	4410154PB1	657153	4304030030	659225	5Q0407271H	661069
397111HS0B	641206	92601892	648004	441054P10	657154	4303042100	659235	8R0521101B	661093
391007S000	641207	95133190100	648004	4411768L40	657157	434030D170	659236	8R0521101J	661093
397711AA0A	641208	4A0407341B	650019	4411768L30	657158	4303005200	659237	8R0521101P	661093
39600EA000	641209	3B0498103B	650019	4411755L20	657159	430400K060	659238	8R0521101Q	661093
397111HC3A	641210	391014031R	650040	4411757LA0	657161	4303042050	659241	7H3521102A	661094
39771CC40A	641211	8200531904	650040	4411579K00	657162	701498103	661001	1L2Z4A376AA	661100
39100AV911	641217	8200726970	650048	4411755LH1	657163	701407331A	661001	XL2Z4A376AA	661100
0374099	644001	391011406R	650057	4411755L80	657164	701498103X	661001	XL2Z4A37	661100
374099	644001	391017275R	650105	4411761MB0	657165	701498350X	661001	K4A376AFR	661100
0374100	644001	391009882R	650106	4411771LR0	657166	701407331B	661002	8V0598103	661103
374100	644001	391016376R	650107	4411761M00	657167	701498103A	661002	8V0598103X	661103
90142329	644001	8200934679	650110	4411779J80	657168	701498103AX	661002	95B501203	661106
90199039	644001	391006553R	650118	4411761MC0	657169	8E0498103A	661002	30735344	662012
374136	644001	391002615R	650124	4411761M10	657170	211598101	661003	36001181	662017
90348316	644001	391006331R	650134	4411757L71	657171	212501331	661003	36011299	662033
374048	644002	391008310R	650134	4411578K01	657172	251501331	661003	36000716	662040
374118	644002	391018983R	650134	4411755L00	657173	251598101	661003	36002066	662041
374148	644002	391017355R	650134	4341010090	659002	3015012031	661003	36011300	662043
374195	644002	391006270R	650135	4341010091	659002	211501331B	661003	36002669	662045
9317340	644002	391006849R	650136	4340310010	659002	251598101X	661003	36000561	662046
93173430	644002	391007525R	650137	4303005010	659004	1H0407331E	661004	36002670	662047
1603237	644002	391002885R	650138	4303020030	659004	6Q0498103D	661005	36001449	662048
0374195	644002	391005624R	650139	4303032040	659004	1J0407341D	661006	36000676	662050
90278734	644002	391010433R	650140	4303032060	659004	1J0407341F	661006	36002896	662052
374067	644002	391006802R	650148	4304032040	659005	1J0498103K	661006	B112203010BA	674001
0374118	644002	3817A141	651034	4304005110	659005	1J0498103KX	661006	MB886682	675004
90125876	644002	171407331C	653001	4340312060	659012	JJ0498103K	661006	46307542	699008
90157212	644002	171407331E	653001	4340335030	659015	1J0498103KV	661006	6613304801	699014
4242319	644002	171407331L	653001	4340316020	659017	1K0498103C	661011	MN156833	699019
374091	644003	171498103B	653001	4340310					

COMPETITOR	GSP Ref.	COMPETITOR	GSP Ref.	COMPETITOR	GSP Ref.	COMPETITOR	GSP Ref.	COMPETITOR	GSP Ref.
OE		44310S10A00	801006	46308266	802023	4A0407311C	803015	893407311	803032
		44310S10A10	801006	46308235	802024	4A0407305A	803016	893498099	803032
96489845	699025	44310SH3J00	801006	50500529	802024	4A0407305F	803016	171407311P	803032
932902609	699026	44310SK7J02	801006	46308798	802024	4A0498099B	803016	321498099C	803032
374402	699026	44310SIOA10	801006	46308710	802024	4A0498099C	803016	893498099X	803032
374547	699026	44310SL5N00	801006	717771180	802024	4A0498099J	803016	321498099CX	803032
13136382	699026	44310SM4310	801006	4630798	802024	895407305A	803016	150498099	803033
374320	699026	44310ST7900	801006	505C00529	802024	895498099C	803016	150498099A	803033
4304005060	699038	49580C5100	801038	46308070	802025	895498099D	803016	1J0498099	803033
4304002030	699038	49580C5200	801038	60802035	802025	441407305B	803017	1J0498099A	803033
4304032010	699040	49580D4300	801064	71783876	802025	4A0407305G	803017	1J0498099AX	803033
4304032010	699040	49580A4000	801069	46308276	802026	4A0407311B	803017	1J0407311	803033
434030A011	699046	49580A4050	801069	1K0407311J	803002	4A0498099	803017	SK1J0498099A	803033
7M049103	699053	4347009Y31	801083	1K0498099B	803002	4A0498099D	803017	893407305	803034
7M098103X	699053	49580C5050	801089	1KM498099	803002	893407305G	803017	893498099A	803034
7M0498350X	699053	49526D7050	801091	183498099A	803003	893498099L	803017	1J0407311R	803035
JZW498350EX	699053	49526D7070	801093	431407311C	803003	893498099LX	803017	1J0498099E	803035
ZBA407331A	699057	4346009X50	801143	431498099B	803003	8A0407305F	803017	1J0498099EX	803035
XS614K258AA	699072	434708Z203	801144	431407275	803004	3B0498099A	803018	1J0498099EV	803035
6069108	699075	7N0498099	801352	431407311A	803004	8D0407305G	803018	1J0407311K	803035
6069109	699075	4130009002	801408	431498099A	803004	8D0498099	803018	1J0498099H	803035
81TT3K177AA	699075	36011292	801424	431498099AX	803004	8D0498099B	803018	1J0498099HX	803035
81TT3K177AB	699075	MN147096	801443	431498099E	803004	8D0498099BX	803018	1H0407311	803036
44310TL1E00	699079	4410160DB1	801444	803407275A	803004	1H0407271CX	803019	1H0498099A	803036
44310SOA300	699079	4410160DG0	801444	803498099A	803004	1H0407271GX	803019	1H0498099E	803036
MB886681	699083	4410260DB1	801444	443407305C	803005	3B0498099E	803019	1J0407311C	803036
MN147088	699089	4410260DG0	801444	443498099E	803005	4D0407305B	803019	1J0407311D	803036
ADU4378EVA	699098	7E0498099CX	801467	443498099EX	803005	4D0498099	803019	1J0498099B	803036
RV705	699098	7E0498099C	801467	437407305	803006	4D0498099A	803019	1J0498099BX	803036
4950005100	699106	60589273	802001	443407305	803006	4D0498099X	803019	357498099E	803036
96391556	699107	46307308	802002	431498099D	803006	4D0598099	803019	357498099EV	803036
36000550	699109	60815250	802002	431498099F	803006	8D0407305J	803019	357498099EX	803036
GG0922620C	699113	46307032	802003	431498099DX	803006	8D0498099D	803019	1771289	803036
26035527	699117	46307171	802003	191598099	803007	8D0498099E	803019	1K0407311G	803037
92225296	699127	60812753	802003	377407311	803007	8E0498099A	803019	1K0407311H	803037
93225296	699127	7627971	802004	3054073111	803007	8E0498099G	803019	1K0407311L	803037
A1693603972	699136	7652958	802004	171407311L	803007	3B0498099EX	803019	1K0498099	803037
A1693606672	699136	7656949	802004	305407311B	803007	4D0498099AX	803019	1K0498099A	803037
374537	699138	7688157	802004	305407311C	803007	8D0407305H	803020	1K0498099C	803037
374470	699138	7692993	802004	321407311L	803007	8D0498099A	803020	1K0498099E	803037
374536	699138	7750300	802004	321407311M	803007	8D0498099C	803020	1K0498099X	803037
9186550	699138	60605055	802004	321498099A	803007	8D0498099CX	803020	1K0498099AX	803037
95534990200	699148	60811033	802004	321498099B	803007	3B0498099B	803021	321498099	803038
95534990201	699148	82486230	802004	321498099E	803007	3B0498099BX	803021	823407313	803038
7L0407331A	699148	7646402	802004	321498099EX	803007	3B0498099C	803021	171407311D	803038
7L0498103	699148	46307083	802005	321498099F	803007	8D0407305M	803021	ZBA407311	803038
7L0498103A	699148	60813096	802005	811498099F	803007	3B0498099H	803021	6R0498099A	803041
7L0498103AX	699148	46307034	802006	305407711C	803007	3B0498099CX	803021	6R0498099AX	803041
19495343219	699148	46307169	802006	377407311C	803007	3B0498099HX	803021	893407311D	803051
16870648	699148	60812760	802006	5Z0498099A	803007	861498099	803022	893498099B	803051
A2213306400	699166	46307134	802008	5X0498099A	803007	8614498099	803022	893498099F	803051
31216176	699195	60541802	802009	811498099E	803007	171407311E	803022	893498099H	803051
25775163	699239	60809609	802009	377498099L	803007	893407305C	803023	431498099C	803054
9R3Z4R602A	699240	82489521	802011	811498099EX	803007	893498099D	803023	443498099A	803054
44306SA5970	801001	46307246	802012	895407311	803008	6Q0407271DA	803024	437407311	803054
44306SA5971	801001	60815021	802012	893498099E	803008	6Q0407311Q	803024	437407305A	803054
44306SB0010	801001	46307299	802013	895407305	803009	6Q0498099E	803024	8E0407305A	803058
44306SB0040	801001	60815163	802013	893498099G	803009	6Q0498099EX	803024	8E0498099	803058
44305629671	801002	46308749	802013	893498099GX	803009	6Q0498099B	803024	8E0498099D	803058
44305692671	801002	46307685	802014	895498099B	803009	6QD498099	803024	8E0498099DX	803058
44306692671	801002	547679	802015	893407305N	803012	893498099P	803026	8E0498099X	803058
44014SP0000	801005	547682	802015	893498099M	803012	893498099PX	803026	8E0407305D	803058
44305SP0953	801005	548135	802015	893498099MX	803012	8A0407305G	803026	8E0407305B	803067
44011SP0951	801005	795283	802015	895407305B	803012	6Q0498099	803027	8E0498099C	803067
44306SP0952	801005	60504718	802015	895498099A	803012	6Q0498099D	803027	8E0498099EX	803069
44010SP0951	801005	60506536	802015	895498099H	803012	6Q0498099DX	803027	8E0498099GX	803069
44306SP0953	801005	7081591	802017	8A0498099	803012	6R0498099	803027	1J0498099F	803070
44305SP0952	801005	46307309	802017	8A0498099X	803012	6R0498099X	803027	4F0498099A	803077
44305SP0951	801005	46307901	802017	443407311	803013	811407305A	803029	8E0498099E	803078
44010S10A00	801006	46307301	802017	443498099D	803013	811498099A	803029	7L6407321E	803085
44010S10A10	801006	46307572	802018	443407305B	803014	855407311	803031	7L6498099A	803085
44010S17J30	801006	46307913	802018	443498099B	803014	855498099	803031	7L6498099B	803085
44010ST7J30	801006	46308205	802018	443498099BX	803014	855498099A	803031	7L6498099C	803085
44011S10A00	801006	60812880	802019	443498099C	803014	855498099B	803031	7L6498099CX	803085
44011ST7J30	801006	7L6498099B	803085	443498099CX	803014	811407311	803032	8K0407305C	803086
4401									

COMPETITOR	GSP Ref.	COMPETITOR	GSP Ref.	COMPETITOR	GSP Ref.	COMPETITOR	GSP Ref.	COMPETITOR	GSP Ref.
OE		A1643302001	805015	MB176464	809004	327212	810002	3273KP	810025
		A1643302101	805015	MB176864	809004	327371	810002	3272EN	810026
8K0498099BX	803086	26008330	806002	MB176865	809004	327379	810002	3272ES	810026
8K0407305F	803087	26020959	806002	MB176866	809004	327381	810002	3273ES	810026
8K0498099C	803087	26030481	806002	MB176867	809004	95615878	810002	327298	810027
8K0498099D	803087	26000690	806011	MB178865	809004	327202EH	810002	3272A1	810027
8K0407305D	803087	26008329	806011	MB297148	809004	95656495	810003	3273J6	810027
8K0498099	803087	26058362	807001	MB297341	809004	95656595	810003	3273J9	810027
8K0498099X	803087	96257803	808002	MB297343	809004	3272E5	810003	32721X	810028
8K0407305E	803088	96298465	808002	MB297344	809004	3273E6	810003	32728W	810028
8K0498099A	803088	96298466	808002	MB297345	809004	327283	810004	3273AC	810028
8K0498099AX	803088	96243574	808002	MB297346	809004	96141635	810004	327260	810029
7N0498099A	803095	96243571	808002	MB297347	809004	96164213	810004	3272N1	810029
7N0498099AX	803095	4410178010	808004	MB297348	809004	3273G9	810004	327378	810043
4E0498099AX	803099	4410178012	808004	MB297353	809004	3272E4	810005	3272F5	810043
5M0498099X	803100	4410182020	808004	MB297661	809004	95643689	810005	3273N2	810043
1K0498099G	803101	4410182021	808004	MB297662	809004	3273L5	810005	327200	810048
5Q0407271H	803101	4410182313	808004	MB297874	809004	95653010	810007	327220	810048
8K0498099E	803102	4410182611	808004	MB297999	809004	3273K1	810007	3272GL	810051
8K0498099EX	803102	4410186041	808004	MB525577	809004	327235	810008	3273GC	810051
8K0498099F	803103	4410278011	808004	MB526063	809004	95653009	810008	3272GE	810052
8K0498099FX	803103	4410278012	808004	MB526064	809004	3272N0	810008	3272GG	810052
443498099F	803106	4410282020	808004	MB526066	809004	3273A6	810008	3273EG	810052
447498099	803106	4410282021	808004	MB526067	809004	3273T6	810008	3272FW	810053
8R0498099	803107	4410282313	808004	MB526117	809004	32725N	810008	3273EA	810053
7P0498099	803117	4410282611	808004	MB526118	809004	32736P	810008	9619947580	810059
7P0498099A	803117	4410286041	808004	MB526443	809004	327355	810009	9619947588	810059
7P0498099B	803117	4411578010	808004	MB526444	809004	327364	810009	9619947680	810059
4087120	804001	4411582611	808004	MB526454	809004	327365	810009	9619947688	810059
4247399	804001	4410160DD0	808004	MB526531	809004	327366	810009	9621456388	810059
4308412	804001	7835070	808005	MB526547	809004	327367	810009	3272FG	810067
4308413	804001	7845070	808005	MB526548	809004	327369	810009	3272KL	810067
4308418	804001	7837075	808008	MB526581	809004	327389	810009	3272LE	810067
4313087	804001	7842037	808008	MB526582	809004	95598210	810009	3272LG	810067
4328468	804001	7843919	808008	MB526853	809004	327362	810010	3272LP	810067
4465504	804001	7845024	808008	MB526854	809004	327477	810010	3273KR	810067
4475837	804001	96273760	808019	MB526860	809004	327478	810010	32726W	810076
5944689	804001	96348790	808021	MB526865	809004	95606802	810010	32739Z	810076
5944690	804001	96348791	808021	MB526866	809004	95606803	810010	3272HR	810077
5959385	804001	96391550	808021	MB526873	809004	95606804	810010	3273HH	810077
5998706	804001	96391551	808021	MB526897	809004	95646292	810010	3272FT	810085
7076344	804001	96348782	808034	MB526898	809004	3273C7	810010	3273CY	810085
7643642	804001	96348783	808034	MB526999	809004	3273N4	810010	46308703	810094
06X039481190	804001	96391554	808034	MB620770	809004	1495545080	810011	71771178	810094
SE025141514B	804001	96391555	808034	4950728A00	809004	9566722380	810011	3272EH	810096
5998669	804001	96963323	808034	4950721A00	809004	9567582280	810011	3273GZ	810096
31607505005	805001	96963324	808034	4384702	809005	1496138080	810011	1497187088	810098
31607505006	805001	374646	808047	4384734	809005	51872271	810011	1497188088	810098
31607586433	805001	13296183	808047	326300*	809009	9567582298	810011	3272NP	810098
31607565313	805001	52105990AB	808078	326807	809011	1495537080	810013	3272NQ	810098
31607505199	805002	52123021AC	808078	4808883	809029	1495541080	810013	3272SE	810098
31607502731	805002	MB297372	809002	4641883AA	809029	9566722180	810013	3273NP	810098
31607505200	805002	MB297373	809002	4641883AC	809029	1481451080	810015	3273NQ	810098
LR032577	805004	MB297492	809002	05274807AD	809032	1481452080	810015	3273SV	810098
31607545125	805006	MB526350	809002	RX274806AC	809032	9617408188	810015	3273NK	810124
31607545126	805006	MB526353	809002	04880212AH	809051	9617408288	810015	3272NK	810124
31607545123	805006	MB526377	809002	04880213AG	809051	9626084088	810015	1497191088	810124
A1643302301	805007	MB526533	809002	K52123583AB	809054	32729C	810015	1497192088	810124
A1643302701	805007	MB526666	809002	K52123583AC	809054	3272GY	810015	3272S7	810127
A1643302401	805007	MB526829	809002	327317	810001	3272RL	810015	3272S8	810127
A164330280	805007	4950828E00	809003	327318	810001	32733Q	810015	3272PR	810130
31607585381	805008	MB297438	809003	327320	810001	3273GQ	810015	3272NR	810130
31607585382	805008	MB297678	809003	327321	810001	9621456488	810018	3272VP	810130
31607596059	805008	MB297696	809003	327323	810001	3273Z8	810019	3273NR	810130
31608605467	805008	MB297699	809003	327324	810001	3273E1	810021	3273WA	810130
31608605466	805008	MB526473	809003	327479	810001	3273W7	810021	3273TT	810155
31607589767	805009	MB526831	809003	327480	810001	3272FP	810022	3273XR	810155
31607589768	805009	4950721000	809004	327482	810001	3272Y3	810022	3272WX	810155
31604853486	805009	4950821000	809004	327483	810001	3272Z7	810022	3272TH	810155
31604853485	805009	4950528B01	809004	327485	810001	96141637	810024	3272QF	810155
31603450566	805010	4950724B00	809004	327486	810001	3272C7	810024	3273QQ	810155
31607529201	805010	4950821A00	809004	95604719	810001	32725X	810025	3272TK	810155
31607529202	805010	4950828A00	809004	327202	810002	3272KY	810025	3273TW	810155
31603450565	805010	MB176160	809004	327209	810002	3272LA	810025	3272TC	810156
31607524045	805010	MB176161	809004	327210	810002	3273AH	810025	3273TR	810156
31607524046	805010	MB176463	809004	327211	810002	3273KL	810025	510416	812001

COMPETITOR	GSP Ref.	COMPETITOR	GSP Ref.	COMPETITOR	GSP Ref.	COMPETITOR	GSP Ref.	COMPETITOR	GSP Ref.
OE		4342087604	814004	4341087715	814012	4341087715	814012	82333811	817002
		4342087605	814004	4342087722	814013	4342087722	814013	82362521	817002
510433	812001	4342087611	814004	4342087725	814013	4342087725	814013	82362523	817002
510736	812001	4341087717	814005	4342087730	814013	4342087730	814013	82362524	817002
513316	812001	4341087718	814005	4346087F86	814013	4346087F86	814013	82428432	817002
26010774	812001	4341087722	814005	4347087F88	814013	4347087F88	814013	82439756	817002
96257802	812001	4341087725	814005	4347087F89	814013	4347087F89	814013	82440166	817002
510736A	812001	4341087730	814005	4342087721	814013	4342087721	814013	82413699	817003
96243576	812004	4342087717	814005	4341087721	814014	4341087721	814014	82443532	817003
96251135	812004	4342087718	814005	4342087720	814014	4342087720	814014	5890430	817004
96251136	812004	4347087781	814005	4342087728	814016	4342087728	814016	7646401	817004
96160618A	812004	4346087F81	814005	4342087729	814016	4342087729	814016	7652957	817004
96183138	812005	4346087F88	814005	4341087606	814017	4341087606	814017	7656945	817004
96183139	812005	4347087F81	814005	4341087608	814017	4341087608	814017	7698900	817004
96225969	812005	4347087F82	814005	4341087253	814018	4341087253	814018	7700010	817004
96225970	812005	4341087103	814006	4341087265	814018	4341087265	814018	7750301	817004
4410478800000	812006	4341087104	814006	4342087254	814018	4342087254	814018	60810018	817004
4410578B00000	812006	4341087113	814006	4341087235	814018	4341087235	814018	82486231	817004
4410478800	812006	4341087114	814006	4341087246	814018	4341087246	814018	164001704701	817004
4410578B00	812006	4341087115	814006	4341087247	814018	4341087247	814018	7081660	817004
510418	812008	4341087119	814006	4341087248	814018	4341087248	814018	4390952	817005
96160589	812008	4341087120	814006	4341087249	814018	4341087249	814018	7560070	817005
96160590	812008	4341087123	814006	4341087250	814018	4341087250	814018	7577041	817005
96243573	812009	4341087126	814006	4341087252	814018	4341087252	814018	7599433	817005
96273759	812011	4342087103	814006	4341087256	814018	4341087256	814018	7656786	817005
96251183	812018	4342087104	814006	4341087257	814018	4341087257	814018	06X039534340	817005
96241974	812018	4342087113	814006	4341087258	814018	4341087258	814018	SE022141915	817005
510734	812019	4342087114	814006	4341087266	814018	4341087266	814018	SE138141915A	817005
513315	812019	4342087123	814006	4341087267	814018	4341087267	814018	737319	817006
26013813	812019	4341087013	814006	4341087268	814018	4341087268	814018	4393155	817006
26013831	812019	4346087180	814006	4341087269	814018	4341087269	814018	4393157	817006
26073810	812019	4346087181	814006	4341087275	814018	4341087275	814018	7573193	817006
96257804	812020	4347087180	814006	4341087276	814018	4341087276	814018	7608632	817006
96474834	812020	4347087181	814006	4342087239	814018	4342087239	814018	7698632	817006
96474835	812020	4341087701	814007	4342087240	814018	4342087240	814018	7703689	817006
96481061	812020	4341087702	814007	4342087241	814018	4342087241	814018	82443746	817006
96481062	812020	4342087701	814007	4342087243	814018	4342087243	814018	82448780	817006
93741015	812021	4349287701	814007	4342087246	814018	4342087246	814018	374471	817007
96273570	812021	4349287702	814007	4342087250	814018	4342087250	814018	374471	817007
96273571	812021	4349387703	814007	4342087255	814018	4342087255	814018	374472	817007
96564144	812021	4349487702	814007	4341087406	814019	4341087406	814019	374473	817007
96396134	812021	4341087251	814008	4341087408	814019	4341087408	814019	374474	817007
512395	812021	4346087682000	814008	4341087223	814020	4341087223	814020	1603233	817007
512292	812023	4346087295	814008	4341087225	814020	4341087225	814020	9186552	817007
96245285	812023	4346087682	814008	4341087226	814020	4341087226	814020	9186553	817007
96349953	812023	4347087294	814008	4342087223	814020	4342087223	814020	71740557	817007
96489832	812023	4347087298	814008	4342087225	814020	4342087225	814020	93173409	817007
510851	812027	4342087523	814008	4342087226	814020	4342087226	814020	51705516	817007
93486853	812027	4341087234	814009	4341087242	814020	4341087242	814020	51706611	817007
96243575	812027	4342087234	814009	4341087401	814027	4341087401	814027	46307394	817008
96256953	812027	4341087612	814010	4342087401	814027	4342087401	814027	46307742	817009
96256954	812027	4342087612	814010	43411B9070	814028	43411B9070	814028	46307887	817009
96256965	812027	4341087612000	814010	43412B9111	814028	43412B9111	814028	46307924	817009
96256966	812027	4342087612000	814010	43410B2010000	814028	43410B2010000	814028	60802000	817009
96257801	812027	4342087405	814011	43420B2010000	814028	43420B2010000	814028	7647244	817010
96298467	812027	4341087405	814011	96328841	814030	96328841	814030	7647245	817010
96298468	812027	4342087406	814011	96328842	814030	96328842	814030	7720510	817010
96391014	812027	432087727	814012	96481004	814030	96481004	814030	76472452A	817010
96486854	812027	4340087728	814012	4346087789	814034	4346087789	814034	46307234	817011
96489842	812027	4341087000	814012	4347087789	814034	4347087789	814034	60815368	817011
96257853	812027	4341087710	814012	4341087222	814036	4341087222	814036	7081971	817011
96257854	812027	4341087711	814012	4341087224	814036	4341087224	814036	7633434	817012
P96273570	812028	4341087726	814012	4341087227	814036	4341087227	814036	7656944	817012
4341087242	812034	4341087727	814012	4342087222	814036	4342087222	814036	7750299	817012
4341087746	814001	4341087731	814012	4342087224	814036	4342087224	814036	82466864	817013
4342087746	814001	4341087735	814012	4342087227	814036	4342087227	814036	46307557	817014
4341087402	814002	4342087000	814012	4341097404	814038	4341097404	814038	46307889	817014
4342087402	814002	4342087710	814012	4341097405	814038	4341097405	814038	46307322	817015
4341087703	814003	4342087711	814012	4342097403	814038	4342097403	814038	46307406	817016
4341087706	814003	4342087726	814012	4341097203	814040	4341097203	814040	7079221	817017
4342087703	814003	4342087727	814012	4341087747	814046	4341087747	814046	7758266	817017
4342087706	814003	4342087731	814012	4341097206	814052	4341097206	814052	46307047	817017
4347087780	814003	4342087735	814012	4341097221	814052	4341097221	814052	46307420	817017
4341087604	814004	4341087732	814012	4341097502	814052	4341097502	814052	823449123	817018
4341087605	814004	4341087712	814012	4341097503	814052	4341097503	814052	82480859	817018
4341087611	814004	4341087714	814						

COMPETITOR	GSP Ref.	COMPETITOR	GSP Ref.	COMPETITOR	GSP Ref.	COMPETITOR	GSP Ref.	COMPETITOR	GSP Ref.
OE		93182576	817051	4602016	818005	1690332	818017	G05325600C	818028
		1603411	817052	1C153A327BA	818005	6071774	818018	G06325500	818028
46307122	817019	46308337	817052	4119951	818005	79TT3K187AA	818018	G06325500A	818028
46307121	817020	55700562	817052	1078677	818006	79TT3K187M	818018	G06325600	818028
80078574	817020	93190193	817052	6195781	818006	R98AX3C242CA	818018	G06325600A	818028
46307094	817021	1603405	817053	6483685	818006	1690325	818018	G56422510A	818028
46307107	817022	46308322	817053	06483685	818006	1079589	818018	G56422610A	818028
46307108	817022	46308519	817053	92AG3K183BA	818006	6069110	818019	G5642510A	818028
46307082	817023	93190187	817053	92AG3K187BA	818006	6079195	818019	G56425500	818028
60813079	817023	46308707	817053	1326260	818007	6099110	818019	G56425600	818028
46307367	817024	51854039	817053	235280201	818007	79TT3K187BA	818019	G57022510A	818028
71720784	817024	51854040	817053	1S7W3B413AA	818007	81AG3K187AA	818019	G0632500A	818028
71720785	817024	46308369	817055	4106372	818008	81AG3K187M	818019	G05425500A	818029
46307886	817026	46308483	817055	4106377	818008	BD5M3W427A	818020	G05425600C	818029
1546264	817026	71771174	817055	1148219	818009	1079587	818021	G06425500	818029
46308735	817026	71790991	817055	2S6W3B437FC	818009	6485415	818021	G06425500A	818029
46308020	817027	71791000	817055	1539136	818009	92AG3K183M	818021	G06425600	818029
1603406	817027	1349786080	817055	C60225500A	818009	92AG3K187M	818021	G06425600A	818029
93190188	817027	1349789080	817055	C60225600	818009	1689902	818022	G56425500A	818029
46307710	817028	3272PA	817055	C20225600C	818009	1023250	818023	G57025600A	818029
46307877	817028	3272PC	817055	C20225500C	818009	1079584	818023	G05425600D	818029
46308067	817028	3273PJ	817055	C20225500A	818009	7024787	818023	B00225400	818030
46308518	817028	3273PK	817055	C20225600A	818009	7024788	818023	B00225400B	818030
51783824	817028	46307617	817056	7294547	818010	96BG3B413AAB	818023	B00225500	818030
46308524	817028	46308370	817060	93BG3B413BE	818010	1690328	818023	B00225500B	818030
51808107	817028	46308485	817060	1023247	818011	RE98BX3C242B1A	818023	B00225600	818030
4630808067	817028	71771176	817060	1079583	818011	R98BX3C242BA	818023	B00225600	818030
5187180	817028	3272PF	817060	6757622	818011	93BG3B413AAB	818024	B00225600B	818030
46307516	817029	3272SS	817060	7294548	818011	93BG3B413AB	818024	B00325400	818030
46307914	817030	3273PN	817060	93BG3B413ABB	818011	93BG3B413AE	818024	B00325400C	818030
46307659	817031	3273PX	817060	93BG3B413BB	818011	93BG3B413CE	818024	B00325400D	818030
46307906	817031	1349787080	817060	93BG3B413DD	818011	96BG3B413AB	818024	B00325600	818030
46308206	817031	1357488080	817060	93BG3B413DE	818011	1111900	818025	B00325600C	818030
46307182	817032	1355333080	817060	96BG3B413ABB	818011	7M0407321B	818025	B00325600D	818030
46429632	817032	1349790080	817060	R98BX3C242AA	818011	7M0498099A	818025	KK33122510	818030
60812755	817032	1355334080	817060	1003548	818012	7M0498099AX	818025	KK33122610	818030
82466865	817033	3272PQ	817060	1078670	818012	95VW3BA413AB	818025	KK33325400	818030
46307366	817037	46308706	817063	96AG3K183AB	818012	95VW3K187BB	818025	B00225600A	818030
7631082	817039	46308551	817063	1689895	818012	7M0498099A	818025	KK33325600	818030
7659161	817039	71771179	817063	92AG3K183CA	818012	1007695	818026	B00225600D	818030
46307080	817039	46308463	817063	1063498	818013	1084716	818026	G03325500	818031
46307241	817042	46308759	817063	1129668	818013	7M0407321A	818026	G03325500B	818031
0046307241	817042	51795511	817063	1361301	818013	7M0498099	818026	G03325600	818031
0046307398	817042	51809992	817063	3652045	818013	7M0498099V	818026	G03325600D	818031
46307398	817042	51783853	817063	3652047	818013	7M0498099X	818026	G04325500	818031
0060515370	817042	46308682	817064	3667428	818013	7M0498340X	818026	G04325500B	818031
60515370	817042	46308795	817064	3667429	818013	95VW3K187BA	818026	G04325600	818031
0060815227	817042	71771184	817064	XS4C3B413BA	818013	R98VW3C242AA	818026	G04325600D	818031
60815227	817042	46308564	817064	1134142	818013	1690336	818026	F00425500A	818032
0060815370	817042	71745011	817065	1602947	818013	JZW498340FX	818026	B00525400	818033
60815370	817042	71789090	817065	1142788	818014	R98VWX3C242AA	818026	B00525400D	818033
463007241	817042	3272SL	817068	1418951	818014	R98X3C242AA	818026	B00525600	818033
46308000	817043	1607735380	817068	XS614K258BA	818014	F00122540	818027	B00525600D	818033
1546263	817043	1608901980	817068	1100639	818014	F00125400	818027	K99999112	818033
9645248980	817044	3273TC	817068	2S613A327BA	818014	F00125400A	818027	F02422510	818034
46308371	817045	46308538	817070	2S613A327BB	818014	F00125400B	818027	F02422510B	818034
46308484	817045	46308552	817070	1078680	818015	F00125600A	818027	F02422510C	818034
1349785080	817045	3273SZ	817070	1659059	818015	F00125600B	818027	F02422610	818034
1349788080	817045	52036481	817091	6168423	818015	F00325400A	818027	F02422610A	818034
3272PG	817045	7087179	817093	6485414	818015	F00325400B	818027	F02425400	818034
3273PP	817045	1142787	818001	89FG3K187BA	818015	F00325600A	818027	F02425400A	818034
1608505480	817045	1537377	818001	89FG3K187CA	818015	F00325600B	818027	F02425400D	818034
1608505580	817045	2S6W3A327AB	818001	R98FX3C242EA	818015	F00525400	818027	F02425400E	818034
7077257	817046	235290201	818002	1690331	818015	F00525400A	818027	F02425600	818034
4543301101	817048	1S7W3B413DA	818002	89FG3K183CA	818015	F00525400B	818027	F0652560X	818034
A4543301101	817048	1063496	818003	1074308	818016	F00525400C	818027	F06922610C	818034
3815A201	817048	XS4C3B413AA	818003	1117155	818016	F00525600A	818027	F0692560XC	818034
MR980747	817048	XSC43B413AA	818003	98AG3K183BA	818016	F00525600B	818027	FA0922510A	818034
MR582021	817048	1003550	818004	98AGK183BA	818016	F00525600C	818027	G56022510A	818035
MR582022	817048	1078675	818004	98AX3C242DA	818016	F00725600A	818027	G56025500	818035
MR980748	817048	240608ENE0265	818004	1033616	818017	F00325400E	818027	G56025500A	818035
374843	817051	92AG3K183DA	818004	1078682	818017	F00325600E	818027	G56025600	818035
1603234	817051	96AG3K183BB	818004	6168422	818017	F00525400D	818027	G56025600A	818035
1603275	817051	97FU4K258CA	818004	6485412	818017	G05325500	818028	G56822510A	818035
46308230	817051	R98FX3C242BA	818004	89FG3K183AA	818017	G05325500B	818028	G56822510B	818035
93173410	817051	1328359	818005	R98FX3C242FA	818017	G05325600	818028	G56825500	818035

COMPETITOR	GSP Ref.	COMPETITOR	GSP Ref.	COMPETITOR	GSP Ref.	COMPETITOR	GSP Ref.	COMPETITOR	GSP Ref.
OE		6M343B437CA	818206	13296188	821057	44305SB0621	823005	44306SH3A01	823011
		4512586	818207	94760583	821058	44305SB0622	823005	44306SH3G00	823011
G56825500A	818035	4512588	818207	88957233	821071	44305SB0623	823005	44306SH3G01	823011
G56825500B	818035	1501263	818207	4341010150	822001	44305SB0624	823005	44306SH3G10	823011
G56825600	818035	2T143E327BA	818207	4341012020	822001	44306SA5020	823005	44306SH3G11	823011
G56825600A	818035	GP312550XA	818218	4341012021	822001	44306SA5620	823005	44010SH3962	823011
G56825600B	818035	GP312550XB	818218	4341012050	822001	44306SA5640	823005	44011SJ4J02	823011
G57225500	818035	GP312550XC	818218	4341012060	822001	44306SA5641	823005	44011SJ4J01	823011
G57225600	818035	GP312550XD	818218	4341012080	822001	44306SA5950	823005	44014SE0000	823012
G57622510A	818035	GP312550XE	818218	4341012120	822001	44306SA5951	823005	44014SE0J51	823012
G57625500	818035	GP312560XA	818218	4341012130	822001	44306SB0621	823005	44010SL5N01	823013
G57625600	818035	GP312560XB	818218	4341016050	822001	44306SB0622	823005	44010SM4010	823013
GD1922510	818035	GP312560XC	818218	4341016060	822001	44306SB0624	823005	44010SM4A00	823013
G56022510	818035	GP312560XD	818218	4341016080	822001	44306SB0670	823005	44010SS0010	823013
G56022510B	818035	GP312560XE	818218	4341016090	822001	44306SB0671	823005	44010SS0030	823013
G56025510	818035	1802807	818222	4342010150	822001	44305SB2750	823006	44010SS0960	823013
G56025510A	818035	1837849	818222	4342012020	822001	44305SB2751	823006	44010SV4000	823013
G56822510	818035	1539142	818222	4342012021	822001	44305SB2960	823006	44010SV4010	823013
G56825510A	818035	392111HC3A	818227	4342012030	822001	44305SB2961	823006	44010SVA000	823013
B00122510A	818036	TDJ500050	818229	4342012060	822001	44305SF4J21	823006	44011SL5N01	823013
B00225400A	818036	1223723	818230	4342012082	822001	44305SF4J22	823006	44011SM4981	823013
FA3425400	818036	1359656	818230	4342012090	822001	44305SF4J23	823006	44011SS0000	823013
FS2122610A	818036	1417775	818230	4342016050	822001	44305SF4J24	823006	44011SS0010	823013
E3FZ3B413B	818042	1431359	818230	4342016060	822001	44305SF4J40	823006	44011SS0030	823013
90AU3K183AA	818044	1474624	818230	4342016080	822001	44305SF4J41	823006	44011SS0940	823013
1329584	818067	1493007	818230	4342016090	822001	44305SF4J42	823006	44011SS0N00	823013
1329586	818067	3M513A327BB	818230	4346019095	822001	44306SB2750	823006	44011SS0N01	823013
1501261	818067	3M513B436DAC	818230	4346019096	822001	44306SB2751	823006	44011SS0N02	823013
4490557	818067	3M513B436DAE	818230	4347029107	822001	44306SB2960	823006	44011SS0N10	823013
4501957	818067	3M513B436DAF	818230	4341012081	822001	44306SB2961	823006	44011SV4N00	823013
4512587	818067	RM3M513B436DAD	818230	4341002020	822001	44306SF4J21	823006	44014SM4020	823013
4515857	818067	BV613A327BA	818238	4341012123	822001	44306SF4J22	823006	44014SV4000	823013
2T143B436AG	818067	BV613A328BA	818238	4342012080	822001	44306SF4J23	823006	44014SV4950	823013
2T143A327AA	818067	1710066	818238	4342012083	822001	44011SK3E00	823007	44305SF1915	823013
2T143A328AAK	818067	1809711	818238	8941246280	822002	GVC1069	823007	44305SM1000	823013
4512587K	818067	1710063	818238	8941246290	822002	44011SK3E10	823008	44305SM1010	823013
4166906	818069	1692088	818244	93743417	822009	03CGV1053	823010	44305SM4000	823013
1485695080	818098	4130009214	818247	4804592	822009	GVC1053	823010	44305SM4010	823013
9645249280	818098	4130009213	818247	44014S6FE01	823001	44010SH3981	823011	44305SM4020	823013
KS514K258AA	818099	LR025067	818250	44305S74E00	823002	44010SH3A03	823011	44305SM4030	823013
547407311A	818100	36002493	818269	44305S74E01	823002	44010SH3G12	823011	44305SM4040	823013
5474498099A	818100	36002494	818269	44305S74E51	823002	44011SH3G12	823011	44305SM4050	823013
551407311	818103	36011290	818269	TCV1123	823002	44305SE0000	823011	44305SM4980	823013
4413397	818105	36011297	818269	TFB000070	823002	44305SE0010	823011	44305SM4981	823013
4430547	818105	1797215	818270	44305634003	823003	44305SE0020	823011	44305SM4983	823013
8200069147	818105	1797218	818270	44305634013	823003	44305SE0G01	823011	44305SM4984	823013
8200334338	818105	1797214	818270	44305634023	823003	44305SE0G02	823011	44306SF1916	823013
8200485589	818105	1704639	818270	44305634033	823003	44305SE0J00	823011	44306SM1000	823013
1345638	818203	1704637	818270	44305671003	823003	44305SE0J01	823011	44306SM1010	823013
1345637	818203	1704636	818270	44305671023	823003	44305SH3960	823011	44306SM4000	823013
1345639	818203	1797219	818270	44305689601	823003	44305SH3961	823011	44306SM4010	823013
1476892	818203	7L1Z4602A	818279	44305692003	823003	44305SH3970	823011	44306SM4020	823013
1548224	818203	7849841	821001	44306634013	823003	44305SH3971	823011	44306SM4030	823013
1685799	818203	8941581302	821002	44306657000	823003	44305SH3980	823011	44306SM4040	823013
1322219	818203	8941581312	821002	44306657023	823003	44305SH3981	823011	44306SM4050	823013
1417776	818203	8944052272	821002	44306659000	823003	44305SH3A00	823011	44306SM4060	823013
1510273	818203	8944052282	821002	44306659010	823003	44305SH3A01	823011	44306SM4980	823013
1548227	818203	8944676690	821002	44306671003	823003	44305SH3G00	823011	44306SM4981	823013
1551332	818203	8944676700	821002	44306671033	823003	44305SH3G01	823011	44306SM4983	823013
3M513A327MA	818203	8944676710	821002	44306689601	823003	44305SH3G10	823011	44306SM4984	823013
3M514C062FA	818203	8944676720	821002	44306692003	823003	44305SH3G11	823011	44310SM4901	823013
3M514C062LA	818203	326763	821010	44305SA0003	823003	44306SE0000	823011	44310SM4980	823013
1322204	818203	93230068	821025	44306SA0013	823003	44306SE0010	823011	44010SL4020	823013
1369431	818203	93262105	821026	44306SA0013	823003	44306SE0020	823011	44010SL4950	823014
1479768	818203	1603291	821030	44305688000	823004	44306SE0980	823011	44010SL5N02	823014
1479770	818203	12793840	821030	44305688020	823004	44306SE0981	823011	44010SL5N80	823014
1492854	818203	374842	821038	44306688000	823004	44306SE0982	823011	44010SL5N82	823014
1548229	818203	1603452	821038	44306689020	823004	44306SE0G01	823011	44010SM4951	823014
1551135	818203	13296185	821038	44305SA5000	823004	44306SE0G02	823011	44010SS0930	823014
1551329	818203	13296057	821038	44305SA5010	823004	44306SH3960	823011	44010SS0980	823014
1551337	818203	93190460	821038	44306SA5000	823004	44306SH3961	823011	44010SS0981	823014
41226062	818204	93745994	821043	44306SA5010	823004	44306SH3970	823011	44010SS0982	823014
4126063	818204	13318006	821043	44305SA5020	823005	44306SH3971	823011	44010SS0983	823014
4126065	818204	93743421	821047	44305SA5620	823005	44306SH3980	823011	44010SS0J80	823014
4126066	818204	96624822	821047	44305SA5640	823005	44306SH3981	823011	44010SS0J81	823014
1447140	818206	4804595</							

COMPETITOR	GSP Ref.	COMPETITOR	GSP Ref.	COMPETITOR	GSP Ref.	COMPETITOR	GSP Ref.	COMPETITOR	GSP Ref.
OE		44306SM4J84	823014	44306SF1G14	823016	44305SE0J23	823021	44306S3N950	823029
		44010SM1952	823014	44306SF1G15	823016	44305SE7E01	823021	44306S3N951	823029
44010SS0J83	823014	44010SM4950	823014	44306SK7J21	823016	44306SE0910	823021	44306S3R951	823029
44010SS0J84	823014	44010SM4952	823014	44306SK7J22	823016	44306SE0911	823021	44306SOAJ60	823029
44010SV1000	823014	44010SM4953	823014	44306SK7J23	823016	44306SE0912	823021	44306SOAJ61	823029
44010SV1010	823014	44011SM4000	823014	44010S10010	823016	44306SE0913	823021	44010SOAJ50	823029
44010SV1950	823014	44011SM4010	823014	44010ST7J50	823017	44306SE0920	823021	44014SABN21	823030
44010SV1A00	823014	44011SM4951	823014	44014SF1971	823017	44306SE0921	823021	44333S04N01	823030
44010SV1A50	823014	44014SF1970	823014	44305SF0910	823017	44306SE0922	823021	44014SABN22	823030
44010SV1A51	823014	44014SM4000	823014	44305SF1405	823017	44306SE0923	823021	44014SELT00	823030
44010SV4950	823014	44014SV4010	823014	44305SF1970	823017	44306SE0924	823021	44014S0KCC00	823031
44010SV4951	823014	44014SV4951	823014	44305SF1971	823017	44306SE0G10	823021	44011SX1950	823032
44010SV4952	823014	44010S07000	823016	44305SF1972	823017	44306SE0G11	823021	44011SX1951	823032
44010SV4N60	823014	44010SR3J01	823016	44305SF1973	823017	44306SE0G12	823021	44014S0AJ52	823032
44010SV4N61	823014	44010SR3J02	823016	44305SH7J83	823017	44306SE0G13	823021	44014SZ3A51	823032
44011SL5N80	823014	44010SR3J03	823016	44305SK7J70	823017	44306SE0G20	823021	44010SOA950	823033
44011SM4J81	823014	44010SR3J04	823016	44305SK7J71	823017	44306SE0G21	823021	44010SOAN50	823033
44011SS0000	823014	44010SR3J05	823016	44305SK7J72	823017	44306SE0G22	823021	44011SOA950	823033
44011SS0930	823014	44010SR3J51	823016	44305SK7J73	823017	44306SE0G23	823021	44011SOAN50	823033
44011SS0980	823014	44010SR3J52	823016	44305SK7J74	823017	44306SE0G24	823021	44014S5AJ51	823033
44011SS0981	823014	44010SR3J53	823016	44305SK7J75	823017	44306SE0J20	823021	44014S5AJ52	823033
44011SS0982	823014	44010SR3J54	823016	44305SK7J81	823017	44306SE0J21	823021	44014S6M950	823033
44011SS0J82	823014	44010SR3J55	823016	44305SK7J82	823017	44306SE0J22	823021	44014S7AJ50	823033
44011SS0J84	823014	44010SR7000	823016	44305SK7J83	823017	44306SE0J23	823021	44014SDZT00	823033
44011SS0N60	823014	44010SR7010	823016	44305SK7J84	823017	44306SE0J24	823021	44014ST7C01	823033
44011SS0N91	823014	44010SR7020	823016	44306SF1405	823017	44306SE0J25	823021	44014ST7C51	823033
44011SV1A10	823014	44010SR7030	823016	44306SF1970	823017	44010S04J01	823023	44305S04J60	823033
44011SV1A60	823014	44010SR7040	823016	44306SF1971	823017	44010SR1003	823023	44305S2H951	823033
44011SV1N00	823014	44010ST7N00	823016	44306SF1972	823017	44010SR3020	823023	44305S5AJ50	823033
44011SV1N01	823014	44010ST7N50	823016	44306SF1973	823017	44010SR3030	823023	44305S5AJ60	823033
44011SV1N50	823014	44011S07000	823016	44306SF1974	823017	44010SR3040	823023	44305S5AJ61	823033
44011SV1N51	823014	44011SR3J01	823016	44306SK7J73	823017	44010SR3901	823023	44305S5C950	823033
44011SV4J00	823014	44011SR3J02	823016	44306SK7J74	823017	44010SR3902	823023	44305S5CN50	823033
44011SV4J50	823014	44011SR3J03	823016	44306SK7J75	823017	44010SR3903	823023	44305S5CN51	823033
44011SV4N01	823014	44011SR3J04	823016	44306SK7J81	823017	44010SR3952	823023	44305S7B950	823033
44011SV4N50	823014	44011SR3J50	823016	44306SK7J82	823017	44010ST7900	823023	44305S7C950	823033
44305SF1974	823014	44011SR3J51	823016	44306SK7J83	823017	44011S04J01	823023	44305SOA960	823033
44305SF1975	823014	44011SR3J52	823016	44010ST7N10	823017	44011SR3020	823023	44305SOAN60	823033
44305SM1950	823014	44011SR3J53	823016	44010ST7N60	823017	44011SR3030	823023	44306S2H950	823033
44305SM1951	823014	44011SR3J54	823016	44011SR3J55	823017	44011SR3040	823023	44306S5AJ51	823033
44305SM1980	823014	44011SR7000	823016	44310SR3A12	823017	44011SR3901	823023	44306S5AJ61	823033
44305SM1981	823014	44011SR7010	823016	440108T7N60	823017	44011SR3902	823023	44306S5AJ62	823033
44305SM1A80	823014	44011SR7020	823016	44305SH3N71	823017	44011SR3903	823023	44306S7B950	823033
44305SM1A81	823014	44011SR7030	823016	44010S07950	823017	44011SR3952	823023	44306SOA960	823033
44305SM4950	823014	44011SR7040	823016	44011SR7952	823017	44011ST7900	823023	44306SOAN60	823033
44305SM4951	823014	44011SR7954	823016	44305SA7000	823018	44011S04951	823024	44306S7C950	823033
44305SM4952	823014	44011ST7N00	823016	44306SA7000	823018	44011SOA951	823024	44306S5C952	823033
44305SM4953	823014	44011ST7N50	823016	44010S08000	823019	44014S04N52	823024	44305S2HN50	823033
44305SM4954	823014	44305SF1305	823016	44010SH9000	823020	44014S2G951	823024	44305S2H950	823033
44305SM4955	823014	44305SF1910	823016	44010SH9000	823020	44014S04952	823024	44305S5AJ62	823033
44305SM4J80	823014	44305SF1911	823016	44305SD9013	823020	44511SE0406	823026	44306S5C951	823033
44305SM4J81	823014	44305SF1912	823016	44305SH9000	823020	44014SE0910	823026	44305S2H010	823033
44305SM4J82	823014	44305SF1913	823016	44305SH9003	823020	44010SL5010	823028	44306S2H010	823033
44305SM4J83	823014	44305SF1914	823016	4306SH3J00	823021	44011SL5000	823028	44014SCAE01	823034
44305SM4J84	823014	44305SF1G10	823016	44014SE0930	823021	44010S10A60	823029	44014SDCA50	823034
44306SF1975	823014	44305SF1G11	823016	44305SE0912	823021	44010S30950	823029	44305S9AN00	823034
44306SF1976	823014	44305SF1G12	823016	44305SE0913	823021	44010S30N20	823029	44305SEAN00	823034
44306SF1J71	823014	44305SF1G13	823016	44305SE0920	823021	44010S30N50	823029	44306S9AN00	823034
44306SM1950	823014	44305SF1G14	823016	44305SE0921	823021	44010S47950	823029	44306SEAN00	823034
44306SM1951	823014	44305SK7J21	823016	44305SE0922	823021	44010SOAJ50	823029	44306SEAN50	823034
44306SM1952	823014	44305SK7J22	823016	44305SE0923	823021	44010SW5950	823029	44014S9A020	823034
44306SM1980	823014	44305SK7J23	823016	44305SE0924	823021	44010SX0950	823029	44014SDCA51	823034
44306SM1981	823014	44305SK7J24	823016	44305SE0925	823021	44011S10A50	823029	44010S47000	823035
44306SM1A80	823014	44306SF1305	823016	44305SE0G10	823021	44011S30950	823029	44010SW5000	823035
44306SM1A81	823014	44306SF1307	823016	44305SE0G11	823021	44011S30J50	823029	44010SX0000	823035
44306SM4950	823014	44306SF1315	823016	44305SE0G12	823021	44011S30N20	823029	44011S47000	823035
44306SM4951	823014	44306SF1406	823016	44305SE0G13	823021	44011S47951	823029	44011S47010	823035
44306SM4952	823014	44306SF1910	823016	44305SE0G20	823021	44011SW5950	823029	44011SW5000	823035
44306SM4953	823014	44306SF1911	823016	44305SE0G21	823021	44014S3X950	823029	44011SX1000	823035
44306SM4954	823014	44306SF1912	823016	44305SE0G22	823021	44014SX0C61	823029	44014S1AE00	823036
44306SM4955	823014	44306SF1913	823016	44305SE0G23	823021	44305S10C61	823029	44014S1AE01	823036
44306SM4956	823014	44306SF1914	823016	44305SE0G24	823021	44305S3N950	823029	44014S1BE01	823036
44306SM4J80	823014	44306SF1G10	823016	44305SE0G25	823021	44305S3N951	823029	44010S04010	823038
44306SM4J81	823014	44306SF1G11	823016</						

COMPETITOR	GSP Ref.	COMPETITOR	GSP Ref.	COMPETITOR	GSP Ref.	COMPETITOR	GSP Ref.	COMPETITOR	GSP Ref.
OE		44010S08950	823083	44014SXSA00	823124	44306SMB010	823192	4950038470	824029
		44010SL4951	823085	44014TA0A50	823124	44306SMC000	823192	495003A216	824029
44011S04020	823038	44010SL4952	823085	44014SWA010	823124	44306SMD000	823192	495013A211	824029
5860052290	823038	44010SM4954	823085	44014SMGE00	823125	44010S04901	823207	4950738F00	824029
44014S5A951	823039	44010SM4A80	823085	44014SMGE01	823125	44010SK7J13	823207	4950838F00	824029
44014S6DG50	823039	44010SV4N50	823085	44010S50951	823126	44010SK7J22	823207	4950725A00	824033
44305S5A950	823039	44010SW3950	823085	44014SWET00	823131	44010SR3A04	823207	4950725B00	824033
44305S5AN50	823039	44011SL4951	823085	44014TL1E01	823135	44010ST7040	823207	4950825A00	824033
44305S6A950	823039	44011SL4952	823085	44014TL1E00	823135	44010ST7J00	823207	4950825B00	824033
44306S5A950	823039	44011SM4J84	823085	44305TROJ01	823138	44011SK7J14	823207	4950017000	824036
44306S5AN50	823039	44011SS0N82	823085	44014S30C62	823139	44011SK7J22	823207	4950117000	824036
44306SA2030	823041	44011SS0N90	823085	44014S7A952	823139	44011SR3A04	823207	4950017050	824036
44305689010	823041	44011SV4N51	823085	44014TL1E52	823145	44011ST7040	823207	4950117050	824036
44305689030	823041	44305SM4N51	823085	44014STKA00	823145	44011ST7J00	823207	4950017510	824038
44305SA2010	823041	44010S04J51	823086	44014TL1E51	823145	44011ST7N10	823207	4950117510	824038
44305SA2030	823041	44011S04J51	823086	44014SEFE00	823146	44305SF1G00	823207	495072DA10	824038
44306689010	823041	44014S01952	823086	44014SEFE01	823146	44305SH3N11	823207	465001C060	824041
44306SA2010	823041	44010S04J00	823086	44305SEFE00	823146	44305SK7J14	823207	495001C050	824041
44010SH3010	823042	44010S09950	823086	44306SEFE00	823146	44306SF1G00	823207	495001C060	824041
44305SB2000	823042	44011S09950	823086	44305SMJG01	823147	44306SH3N11	823207	495001C000	824041
44305SB2010	823042	44014S5DA50	823087	44306SMJG01	823147	44306SK7J14	823207	495001C010	824041
44305SF4010	823042	44014S5DA51	823087	44014SZAA01	823148	44014SYY000	823208	495002D613	824044
44305SF4020	823042	44014SENPO0	823094	44306SWA900	823153	44014TL1E02	823221	495002D612	824044
44305SF4900	823042	44014TF0J00	823094	44014SWA000	823153	44014SZAA21	823251	495002C110	824044
44305SF4901	823042	44305TF0J00	823094	44305SNW000	823153	44014SZAA11	823251	495002C111	824044
44305SH3000	823042	44306TF0J00	823094	44305SWA900	823153	44306SZTG00	823253	495001C250	824046
44305SH3010	823042	44014S6DE01	823095	44306SNW000	823153	44014SJK000	823255	495001C260	824046
44305SH3A21	823042	44305SD5003	823098	44305TA1A00	823153	495012D002	824001	495001E011	824046
44306SB2000	823042	44305SD5013	823098	44305SNW010	823153	495002D000	824001	495001E310	824046
44306SB2010	823042	44306SD5003	823098	44306TA1A00	823153	495002D002	824001	495001C352	824046
44306SF4010	823042	44306SD5013	823098	44305SNA000	823155	4950828B00	824001	495000P050	824046
44306SF4020	823042	44010ST5003	823099	44305SNAN00	823155	4950722E00	824002	495001C450	824047
44306SH3000	823042	44010ST6003	823099	44305SYZ000	823155	4950822E00	824002	495001C460	824047
44306SH3010	823042	44011ST6003	823099	44306SNA000	823155	4950722A00	824002	495001C550	824047
44306SH3A21	823042	44305SD5023	823099	44306SNA900	823155	4950722B00	824002	495001E610	824047
302287	823043	44305SD5901	823099	44306SNAN00	823155	4950722C00	824002	495001E650	824047
44305SD4020	823044	44305SN4003	823099	44306SYZ000	823155	4950822A00	824002	49500C451	824047
44310SS0910	823046	44306SD5023	823099	44014S04N53	823156	4950822B00	824002	4410254G20	824050
44010SO4010	823047	44306SD5901	823099	42330SXSA01	823160	4950822C00	824002	4110154G50	824050
44011S04010	823047	44306SD5J01	823099	44014S3VA61	823162	4950724A00	824003	4410165G00	824050
44310S04300	823047	44306SN4003	823099	44305TF6N01	823165	4950724A01	824003	495003K300	824058
44310S04900	823047	44014TA0A00	823103	44305TL3000	823168	4950824A00	824003	495002D412	824060
44014SX8M02	823051	44305SAA000	823104	44306TL3000	823168	4950824A01	824003	495012C511	824060
44014SDCA00	823056	44306SAA000	823104	44305TA2J00	823168	MB297185	824003	4950017100	824061
44014SDETOOL	823056	44305SFA000	823104	44306TA2J00	823168	MB297186	824003	4950017150	824061
44305SDETOOL	823056	44306SFA000	823104	44305TA0J00	823168	MB297189	824003	4950117150	824061
44306SDETOOL	823056	44306SFB000	823104	44306TAQJ00	823168	MB526112	824003	495003K320	824062
44306SDCA00	823056	44014SD5A51	823105	44305TL1E00	823168	MB526490	824003	495003K370	824062
44305SDETO0	823056	44014SELTOO	823106	44306TL1E00	823168	MB620170	824003	495003K110	824062
44305SNG020	823056	44305SELTOOL	823106	44305SYY000	823173	4950702A00	824004	495003K160	824062
44306SDETO0	823056	44306SELTOOL	823106	44306SYY000	823173	4950702A10	824004	495003K060	824062
44014SDETO0	823056	44014SKNE01	823117	44010ST3F00	823179	4950705A10	824004	4950025301	824065
44014SNG000	823056	44014SKNE00	823117	44010ST3G01	823179	4950729A10	824004	4950725A20	824065
44305SNG010	823056	44014S3X951	823118	44011ST3E50	823179	4950805A10	824004	4950725A10	824065
44306SNG010	823056	44014S3X960	823118	44010ST3E59	823179	4950729A00	824006	4950725B20	824065
44305SA5622	823071	44014S3X961	823118	44010ST3E50	823179	4950828H00	824006	4950725B10	824065
44305SA5971	823071	44014S7A950	823118	44010ST3E70	823179	4950828H01	824006	4950825B10	824065
44305SEO923	823071	44014SX0C10	823118	44305S2K950	823182	4950828J00	824006	4950825B20	824065
44305SH3G21	823071	44014SX0C11	823118	44305S2L950	823182	4950828J01	824006	4950825A20	824065
44010S04951	823073	44014SX0C50	823118	44305SAP950	823182	4950828K00	824006	4950025311	824065
44010S04961	823073	44014SX0C60	823118	44306S2K950	823182	4950828K01	824006	495003A310	824066
44305S2G950	823073	44014SX0C62	823118	44306S2KN50	823182	4950829A00	824006	495003A311	824066
44305S2G960	823073	44305S0AJ60	823118	44306S2L950	823182	4950728J00	824008	495003A312	824066
44305S2T950	823073	44305S0AJ61	823118	44306SAP950	823182	4950728J01	824008	495013A390	824066
44306S2G950	823073	44305S1AE21	823118	44305TF0000	823184	4950728G00	824009	495013A392	824066
44306S2G960	823073	44305S3R951	823118	44306TF6N01	823184	4950728G01	824009	495002B360	824072
44306S2T950	823073	44305S47N50	823118	44014SMA000	823192	4950002010	824011	495002P200	824072
44010S2G950	823073	44305S7A950	823118	44014SMA010	823192	4950702A20	824011	495012P200	824072
44011S2G950	823073	44305SX0C51	823118	44014SMB000	823192	4950702A30	824011	495002B510	824072
44014S10A00	823080	44306S0AJ60	823118	44014SMB010	823192	4950802A30	824011	495002B500	824072
44014S10A50	823080	44306S0AJ61	823118	44014SMD000	823192	49508U5A01	824014	495002P100	824072
44014S10A51	823080	44306S1AE21	823118	44305SMA010	823192	4950802A11	824018	495012P300	824072
44014S10A52	823080	44306S47N50	823118	44305SMA010	823192	495001C302	824025	495017050	824074
44014S30C61	823080	44306S7A950	823118	44305SMC000	823192	49508			

COMPETITOR	GSP Ref.	COMPETITOR	GSP Ref.	COMPETITOR	GSP Ref.	COMPETITOR	GSP Ref.	COMPETITOR	GSP Ref.
OE		51620H1000	824173	0K2162560X	827006	OK30B25600	827070	G02225600	834001
		51624H1000	824173	0K25425400	827006	OK30B25400	827070	G02225600A	834001
495002H010	824077	496002E000	824178	0K25425600	827006	4950007010	827072	G02225600C	834001
495002H011	824077	495912Y250	824284	0K2A125400	827006	4950007060	827072	G00125500	834002
495012H002	824077	49580C1050	824299	0K2A125600	827006	4950107010	827072	G00125500A	834002
495002E250	824090	49580D4050	824299	0K2A225600	827006	4959107010	827072	G00125500B	834002
495002E500	824090	49580D4000	824299	105015	827007	4959107091	827072	G00125500D	834002
495002E550	824090	49580C5000	824301	G02425500	827007	4959107110	827072	G00125600	834002
495012E400	824090	495913X4B0	824302	G02425600	827007	4959107191	827072	G00125600A	834002
495072EE00	824090	496002M200	824313	4951038200	827008	495922F000	827073	G00125600B	834002
4950026111	824091	4960026211	824319	4951038500	827009	495912F310	827073	G00125600E	834002
4950026161	824091	4960026210	824319	495003A202	827009	495002F310	827073	G00525500	834002
4950026411	824091	496012W050	824321	495003A205	827009	4950007050	827077	G00525600	834002
4950026461	824091	496002B010	824323	495003A206	827009	4959107090	827077	G01125500	834002
4950026561	824091	495002H212	824329	495003A207	827009	4950107000	827077	G01125600	834002
4950126410	824091	495002L212	824339	495013A200	827009	1K30A2540X	827078	G02122510A	834002
4950126411	824091	495012L211	824339	495013A201	827009	1K30A2560X	827078	G02125500	834002
4950126560	824091	8941086343	826001	495013A202	827009	495001H110	827080	G02125500A	834002
4950126561	824091	8941086353	826001	0K2C022510	827010	495011H110	827080	G02125600	834002
4950026810	824091	8943643300	826001	0K2C122510	827010	495911H111	827080	G02125600A	834002
495002E600	824094	8943643320	826001	0K9A422510	827010	495911H112	827080	G02125600C	834002
495001H010	824095	8944676640	826001	0K9A425600	827010	495001L110	827080	B00425400A	834003
495001L010	824095	8944676670	826001	0K9A62550X	827010	495011L110	827080	B00425600A	834003
495011H010	824095	8944732250	826001	0K9B322510	827010	49526C8001	827110	F00622610A	834003
495011L010	824095	94426401	826002	0K9B322610	827010	21212215012	828002	F00625400	834003
495911H011	824095	94426402	826002	K9A422510	827010	21232215012	828004	F00625400A	834003
495911H012	824095	8944264013	826002	0K9A425500	827010	21082215010	828005	F00625400B	834003
495011H011	824095	8944264023	826002	0K2KB25600	827010	21082215011	828005	F00625400C	834003
495001C351	824098	8944230371	826002	0K20022610	827010	21082215012	828005	F00625500	834003
495001C361	824098	8944230381	826002	0K2KB25400	827010	21102215012	828005	F00625600	834003
495001C362	824098	8942476490	826003	0K9A222550	827010	111862215012	828010	F00625600A	834003
495004C362	824098	8970636220	826003	0K2C22510	827010	11186221501200	828010	F00625600B	834003
495001E111	824098	8941733042	826003	0K01222510	827011	21100221501200	828010	F00625600C	834003
495001E150	824098	8971368880	826004	495913E000	827014	21700221501287	828010	G01325500	834004
4950705A10	824099	8971390930	826004	495913E001	827014	21702215012	828010	G01325500A	834004
495001G050	824101	8973876640	826004	495913E201	827014	46307105	829001	G01325600	834004
495082EC00	824103	8972156971	826004	KK38822510	827016	51704100	829002	G02325500	834004
495072EC01	824103	8943126721	826004	KK38822610	827016	7770910	829003	G02325600	834004
495012S250	824124	8973499521	826004	KK38825400	827016	STC3204	830006	G01325600C	834004
495002S200	824124	8943126730	826004	KK38825600	827016	TDJ500040	830012	GA2325500A	834004
495002L210	824126	8973600460	826004	KK38825600A	827016	TDB500090	830012	GA2325600C	834004
495012L210	824126	8941539492	826005	MD192550X	827017	LR060382	830015	G01325500A	834004
495013A240	824130	8941539494	826005	MD202560XB	827017	TDJ500030	830015	GO1325600C	834004
495003A240	824130	8941539514	826005	MD1922510A	827017	4341020240	831001	F02825400	834006
495011R000	824131	8944676740	826005	MD1922510	827017	4341020241	831001	F0662550X	834006
495001M010	824132	8944676741	826005	MD232550X	827017	4342020190	831001	F07922610	834006
495011M010	824132	8944676760	826005	4551506	827017	4342020191	831001	F07922610A	834006
49591A63A5	824132	8944676761	826005	G024256	827027	4342020193	831001	0K2172560X	834006
495913X0B0	824132	8994676740	826005	GS0122610A	827027	4342020431	831001	0K2172540X	834006
495012K400	824137	8941539501	826006	GS022550XA	827027	4347039135	831001	F0245600H	834007
495011P200	824137	8941539521	826006	GS022560XA	827027	4410184012	832001	F06922610B	834007
495012K410	824137	8944676730	826006	OK2NC22510A	827032	4410184150	832001	FA0922510B	834007
49526A6101	824137	8944676750	826006	0K2N122610	827032	4410184330	832001	FA0922510C	834007
495803Z300	824138	8971172150	826007	0K2N222610	827032	4410184331	832001	F22425400A	834007
495803Z350	824138	8971172440	826007	0K2N225600	827032	4410284012	832001	FA5922510	834008
49581A4350	824138	8971839460	826007	0K2N42560X	827032	4410284150	832001	FA5922510A	834008
495804R200	824138	8971839480	826007	KK3892560XA	827033	4410284330	832001	FA6122510A	834008
495002F510	824139	8972001010	826007	0K55C22510	827053	4410284331	832001	FA6122510B	834008
495002E800	824148	8972001020	826007	0K55C25600	827053	4410184332	832001	GD2322510A	834008
495012E800	824148	0K20222510	827001	0K55C25500	827053	441084012	832001	F0152550X	834009
495001L210	824152	0K20222610	827001	0K55422610A	827053	G00225500	834001	F0152560X	834009
495001L310	824152	0K20225400	827001	495012F510	827055	G00225500A	834001	F01625500	834009
495011L210	824152	0K2A122610	827001	495003F750	827056	G00225500B	834001	F01625600	834009
495011L310	824152	0K20225400	827001	495911F210	827067	G00225600	834001	F01625600A	834009
495001H210	824152	0K20225600	827001	495001F210	827067	G00225600A	834001	F01725600D	834009
495001H310	824152	0K21125600	827001	495911G510	827068	G00225600B	834001	F0182560XA	834009
495011H210	824152	0K01122510	827002	495911G591	827068	G00625500	834001	F0352550X	834009
495011H310	824152	0K01122610	827002	0K30A22510	827070	G00625600	834001	F03625500	834009
495911H211	824152	0K2N225400	827004	0K30A22610	827070	G01222510	834001	F03625600A	834009
495911H212	824152	0K2N42540X	827004	0K30A25400	827070	G01225500A	834001	F03725600C	834009
495911H311	824152	KK33125400A	827005	0K30B22510	827070	G01225500B	834001	F03825600	834009
495911H312	824152	KK33125600	827005	0K30B22610	827070	G01225600	834001	F0392550X	834009
395003K320	824170	0K20322510	827006	0K30B25400	827070	G01225600C	834001	F0392560XA	834009
395003K370	824170	0K20322520	827006	0K30B25600	827070	G02225500	834001	F0472560X	834009
51610H1000	824173	0K20322610	827006	1K30B2560X	827070	G022			

COMPETITOR	GSP Ref.	COMPETITOR	GSP Ref.	COMPETITOR	GSP Ref.	COMPETITOR	GSP Ref.	COMPETITOR	GSP Ref.
OE		BS0525600	834018	GR272550XB	834048	GP182550XA	834110	FG0625600C	834174
		F00625400D	834018	GR272560XB	834048	GP202560X	834110	FG0525600A	834174
F06625500C	834009	F00625500E	834018	GR282550X	834048	GP182550X	834110	FG0525600D	834174
F0722560X	834009	F00625600F	834018	GR282560X	834048	GP062560XB	834110	FG0625600B	834174
FA143650XC	834009	FS1825400	834018	F02325400A	834051	GP062560XD	834110	G01625500C	834176
FF0125500	834009	FS1825400C	834018	F02325400C	834051	GF092560XC	834110	G01625600E	834176
FF022550X	834009	FS1825600	834018	GD0125500	834051	GP102560XB	834110	G02625500C	834176
GA0625500	834009	FS1825600C	834018	GD022550XA	834051	GP182560XF	834110	G02625600F	834176
GA072550X	834009	FS2125400A	834018	F02425600D	834055	GP182550XC	834110	GG3625500C	834177
GD1722510	834010	FS2125400C	834018	M07022510	834056	GP202560XB	834110	GG3425600E	834177
GD1725500	834010	FS2125600A	834018	M07022510A	834056	GA202550XB	834117	GG3425600G	834177
G03425500	834011	FS2125600C	834018	M07025500C	834056	GA202560XB	834117	GG6225500A	834177
G03425600	834011	F0062560A	834018	M07025500D	834056	GA222550X	834117	GG6225600B	834177
G0342560X	834011	F0062560B	834018	M07025600A	834056	GA222560X	834117	GG6625500	834177
G04425500	834011	F0062560C	834018	M07025600B	834056	GA322550X	834118	GG4625500A	834178
G04425500A	834011	F01325400	834019	F03922510B	834058	GA322550XA	834118	GG4625600A	834178
G04425600C	834011	F01325600	834019	F03925510B	834058	GA322550XB	834118	GG4625600C	834178
G0442560X	834011	F02322510	834019	F06925600B	834058	GA322560X	834118	GD622560XD	834180
GA4425500	834011	F02322520A	834019	FA61122610A	834060	GA322560XA	834118	FA8025500A	834181
G56425600A	834012	F02325400	834019	BS0525400	834062	GA322560XB	834118	FD8025500B	834181
G5642560X	834012	F02325600	834019	MD202550XB	834067	GD212550X	834120	FA8225500A	834181
GR0125500	834012	G07225500	834019	MD202560XD	834067	GD212560X	834120	FP0125500C	834181
GR012550X	834012	G07225600	834019	MD206060XD	834067	GG092550XD	834121	CTA125500	834181
GR0125600	834012	FA502540XA	834020	MD2022510A	834067	GG092550XE	834121	FA8125600B	834181
GR012560X	834012	FA502540XB	834020	MD2022510	834067	FA512550X	834123	FD8025600A	834181
GU0125500	834012	FA502560XB	834020	2M353B437AA	834067	FA512550XA	834123	FA8025600B	834181
GU012550XA	834012	FA522550X	834020	3M353B436AA	834067	FA512550XB	834123	FTA32550X	834189
GU012550XC	834012	FA582550X	834020	G0442550X	834068	FA512550XC	834123	F02525400B	834191
GU0125600	834012	FA602540X	834020	MD142550XA	834069	FA512560X	834123	F02525600C	834191
GU012560XA	834012	FA602560X	834020	MD0425500A	834069	FA522560XB	834123	FD0712560XB	834191
GU012560XD	834012	FD502560XA	834020	MD0425600	834069	FA522560XC	834123	F07925610A	834191
GD192560X	834013	FD5522510	834020	GF0922510	834070	FF042550X	834123	FA0222510E	834191
GR052550XE	834013	FD5522610	834020	GF0922510A	834070	FF042550XA	834123	FA022540XE	834191
GR052560XE	834013	FD502540XA	834020	GF0922610	834070	FF072560X	834123	FA022540XC	834191
G03725500	834014	FD552560X	834020	GF0922610A	834070	FD552550XA	834124	FA0225510C	834191
G03725500B	834014	F0502540XA	834020	GF1122610A	834070	FD552560AC	834124	FA082550XC	834191
G03725600	834014	F0502560XA	834020	GD172550XB	834072	FD552560XA	834124	FZ012540X	834191
G04725500	834014	F05522510	834020	GD172560X	834072	495004D301	834128	FZ022540XA	834191
G04725500A	834014	F05522610	834020	GD172560XA	834072	495014D301	834128	FZ022540XC	834191
G04725600	834014	GD192550XA	834021	GD172560XB	834072	FA4222510	834130	GA062560XA	834191
G04725600B	834014	GD192560XA	834021	G03425500A	834074	FS2022610	834130	F01325600D	834192
FG0125500D	834015	G56025500B	834021	G03425600A	834074	FS2122510A	834130	F02325400D	834192
FG0225500C	834015	G56025600B	834021	G03425600B	834074	FG0225500D	834131	F02325600D	834192
FG0225600C	834015	G56025600C	834021	G03425600C	834074	FG0225500E	834131	36000675	834194
FR012550X	834015	F02422510A	834022	G04425600	834074	FG0225600D	834131	36000681	834194
FR012560X	834015	F06925400	834022	GA4425500A	834074	FG0225600E	834131	RTA12550XA	834213
FR022550X	834015	F06925600	834022	GA4425600	834074	GD362560X	834135	0003300036	835001
GR252550XB	834015	F06925600C	834022	GA4425600C	834074	GD3822610	834135	3300036	835001
GR252560XB	834015	F02525400	834023	GS022550X	834075	GD602560X	834135	0003301585	835001
GG2525500C	834015	F02525600	834023	GS022560X	834075	GD602560XA	834135	3301585	835001
GG2525600C	834015	1N0025500	834024	F03725500B	834081	GD602560XB	834135	A0003301585	835001
G07425500	834016	1N0025600	834024	G57025500	834082	GD3622610	834135	A0003300036	835001
G07425600	834016	1N0125500	834024	G57025500A	834082	GD362560XA	834135	0003301885	835002
G0752550X	834016	1N0125600	834024	GD3822510A	834084	GD362560XB	834135	6383342334	835002
G07525600	834016	1N0225500	834024	GD382550XA	834084	G5722550X	834145	A6383342334	835002
G0752560X	834016	1N0225600	834024	GD3622610	834084	G5722560X	834145	A0003301885	835002
GD022560X	834016	1N0325500	834024	GD362560XA	834084	495000X004	834146	1683601872	835003
GD022560XA	834016	1N0325600	834024	GD362560XB	834084	495000X014	834146	1683702172	835003
GD022560XC	834016	1N0425500	834024	GG062550XD	834090	495000X414	834146	A1683702172	835004
M02525500A	834017	1N0425600	834024	GG062560XE	834090	GP342560XE	834173	A1683702272	835004
M02525500B	834017	1N0525500	834024	GG082560XC	834090	GP352560XB	834173	A1683700872	835005
M02525600A	834017	1N0525600	834024	GG182560X	834090	GP352550XB	834173	A1683701572	835005
M02525600B	834017	1N0625500	834024	GG362550X	834090	GP342550XC	834173	A6383340534	835007
MD1025500	834017	1N0625600	834024	GG062550XC	834090	GD762550XC	834173	6383340534	835007
MD1025600	834017	1N0725500	834024	GG062560XD	834090	GD762560XC	834173	A1633300401	835016
MD1325500A	834017	1N0725600	834024	GG062560XF	834090	FG0625600A	834174	A1633300501	835016
MD1325600	834017	3910064R00	834024	GG062560XG	834090	FG0525600B	834174	4603300935	835018
MD1525500A	834017	3910079R10	834024	GG362560X	834090	FG0525600C	834174	1683603172	835022
MD1525600	834017	39101179R10	834024	GG2925500A	834093	GG4525600B	834174	A1683603172	835022
MD2525500A	834017	3910164R00	834024	GG292550XA	834093	FG0525500B	834174	A1693603372	835022
MD2525600A	834017	F03725500A	834025	4959107210	834094	FG0525500C	834174	A1683603372	835022
B00422510	834018	FA5822510	834026	4959107291	834094	FG0625500A	834174	1683601972	835022
B00422610	834018	FA5822510B	834026	GF092550X	834110	GG4425500B	834174	1683603372	835022
B00425400	834018	FA782550XA	834026	GF092560X	834110	GG4425500D	834174	A1683602372	835023
B00425510	834018	GG2725500E	834048	GF092560XB	834110	FG0625500B	834174	A1683603272	835023
B00425600	834018	GG2825600C	834048	GF112560X	834110	FG0625500C	834174	A1683603472	835023

COMPETITOR	GSP Ref.	COMPETITOR	GSP Ref.	COMPETITOR	GSP Ref.	COMPETITOR	GSP Ref.	COMPETITOR	GSP Ref.
OE		MB526914	839009	MR110199	839016	MB297377	839054	MR336528	839136
		MB620034	839009	MR110207	839016	MB297385	839054	MR367165	839136
A1683604572	835023	MB837262	839009	MR110208	839016	MB297818	839054	MR367166	839136
1683604572	835023	MB837263	839009	MR176639	839016	MB526455	839054	MR515191	839136
1683603472	835023	MB837264	839009	MR176640	839016	MB526456	839054	MR515192	839136
1683602372	835023	MB837265	839009	MR196868	839016	MB526464	839054	3815A075	839137
1683603272	835023	MB837433	839009	MR196869	839016	MI208006	839054	3815A076	839137
1693603972	835026	MB837434	839009	MR196872	839016	MB297815	839054	MR528565	839141
1693604072	835026	MB837517	839009	MR232727	839017	MB176876	839054	MR528566	839141
1693601272	835026	MB837600	839009	MR276870	839018	MB526829	839054	MR567003	839141
1693605272	835026	MB837642	839009	MR276871	839018	MR567001	839059	MR567004	839141
1693606072	835026	MB837707	839009	RR276871G	839018	MR567002	839059	MR553009	839142
1693606272	835026	MB837708	839009	MB620653	839018	MR580375	839059	MR553010	839142
A1693601272	835026	MB886436	839009	MB896525	839019	MR580376	839059	MN147042	839143
A1693605272	835026	MB936359	839009	MB896526	839019	MR896315	839064	MN156463	839143
A1693606272	835026	MR110091	839009	MB937996	839019	MB896316	839064	MN156464	839143
1693607172	835026	MR110402	839009	MR111854	839019	MB936361	839064	MN156487	839143
1693607372	835026	MR110406	839009	MR111856	839020	MB936362	839064	MN156490	839143
1693608072	835026	MR110763	839009	MB896215	839020	MR936361	839064	MR498969	839143
A1693603972	835026	MR111061	839009	30871328	839021	MR165844	839064	MR498974	839143
A1693606072	835026	MR165842	839009	MR110029	839021	4950829C00	839067	MR580213	839143
1693606872	835026	MR936359	839009	MR110030	839021	MB896213	839079	MR580470	839143
1693606572	835026	MR176993	839009	MR111365	839021	MB896214	839079	MR580849	839143
169360407	835026	MB837641	839009	MR111366	839021	MR912134	839084	MR580850	839143
A1693607172	835027	MR111060	839009	MR1176551	839021	MR912135	839084	MR580851	839143
A1693607372	835027	MB936779	839009	MR263884	839021	MR912136	839084	MR581309	839143
A169360807	835027	MB936778	839009	MR377575	839021	MR377293	839098	3815A009	839146
6393500710	835028	MB886230	839009	MR377576	839021	MR377294	839098	3815A010	839146
A6393500710	835028	MB837261	839009	MR110031	839022	MR377715	839102	495002D100	839147
1633300401	835030	MB620957	839009	MR110032	839022	MR910890	839102	495002D102	839147
1633300501	835030	MB620363	839010	MR111367	839022	MR377713	839102	495012D101	839147
A1693705672	835030	MB526558	839011	MR111368	839022	4950738E00	839104	495012D102	839147
A1693702772	835030	MB526613	839011	MR176553	839022	4950838E00	839104	MR953745	839148
A1693706372	835030	MB526614	839011	MR263886	839022	4950025300	839105	MR222052	839149
A1693706472	835030	MB526859	839011	RR176553G	839022	LMN180244	839112	MR222053	839149
A1693704872	835030	MB526867	839011	3815A133	839022	LMR580861	839112	MR263947	839149
9013300001	835034	MB526868	839011	MB837399	839023	MN156219	839112	MR263948	839149
A9013300001	835034	MB526869	839011	MB837400	839023	MR498477	839112	MR263949	839149
A2043301600	835038	MB886539	839011	MB936148	839023	MR498478	839112	MR263950	839149
A2043302701	835038	MB886540	839011	MB886091	839023	MR580251	839112	MR196757	839150
A2213306400	835049	MB837524	839011	MR910297	839024	MR580252	839112	MR196758	839150
A2213306300	835049	MB837523	839011	MB620701	839025	MR580374	839112	3815A181	839159
A2043300585	835049	MB620754	839012	MB620702	839025	3815A189	839113	3815A182	839159
A2033300701	835053	MB886260	839012	MB526406	839026	3815A190	839113	MN110548	839159
A2203300101	835064	MR886257	839012	MB526145	839027	MR528569	839114	MN110546	839159
31607518247	838002	MR886260	839012	MB526270	839027	MR528570	839114	MN110547	839159
31607518248	838002	MB526147	839013	MB526271	839027	MR953583	839114	MR580452	839161
31601493977	838003	MB526544	839014	MB526272	839027	MR953584	839114	MN156752	839168
31601503306	838003	MB526551	839014	MB620251	839027	3815A065	839117	MN156272	839170
31601503307	838003	MB526553	839014	MB620833	839027	3815A068	839117	3715A031	839175
31607518261	838003	MB526911	839014	MB620834	839027	MR222962	839119	3715A032	839175
31607574852	838003	MB620247	839014	MB886761	839027	MR222963	839119	3274C9	839175
MB160653	839001	MB526772	839015	MR276859	839027	MR222966	839119	MR580861	839176
MB160654	839001	MB526774	839015	MR276860	839027	MR222967	839119	MN180244	839176
MB620325	839001	MB620481	839015	MB526142	839027	MR222050	839120	MR953569	839176
MB620326	839001	MB620752	839015	MB620253	839027	MR222051	839120	MR580864	839176
MB297991	839002	MB620755	839015	MB620625	839027	MR222960	839121	MR580896	839176
MB297992	839002	MB620756	839015	MB620252	839027	MR222961	839121	MR580862	839176
MB526972	839002	MB620758	839015	MR528643	839028	MR222964	839121	MR580863	839176
MB526973	839002	MB620807	839015	MB297871	839036	MR222965	839121	MN580862	839176
MB837697	839002	MB620808	839015	MB297872	839036	G07622510	839123	3815A008	839177
MB97992	839002	MR110883	839015	MB526908	839036	G07622610	839123	3815A011	839177
MR620166	839002	MR110886	839015	MB526909	839036	G07625500	839123	MR980745	839177
MR580561	839004	MR620482	839015	2081207	839040	G07625600	839123	MR980746	839177
MR580562	839004	MB620899	839016	MB896742	839040	G07822610	839123	3815A203	839178
MN156271	839005	MB620900	839016	MB896744	839040	MR453383	839124	3815A204	839178
MN156275	839005	MB837184	839016	MB886261	839042	MR453384	839124	3815A461	839178
MN156277	839005	MB837195	839016	MB620178	839045	MR580733	839124	3815A462	839178
MR528640	839006	MB837426	839016	4950728E00	839054	MR580734	839124	3815A464	839178
MR110193	839007	MB896778	839016	4950733A00	839054	MR580449	839134	3815A469	839178
MR377295	839007	MB896787	839016	4950733A10	839054	MR580450	839134	3815A470	839178
MR580553	839008	MB896788	839016	4950733A20	839054	3815A101	839134	3815A390	839178
MR580554	839008	MR896790	839016	4950733B10	839054	3815A102	839134	2815A189	839178
RR580553G	839008	MB936363	839016	MB176872	839054	MR580453	839135	2815A190	839178
MB526437	839009	MB936365	839016	MB297375	839054	MR580454	839135	495261J502	839181
MB526438	839009	MR110120	839016	MB297376	839054	MR336527	839136	495261J503	839181

COMPETITOR	GSP Ref.	COMPETITOR	GSP Ref.	COMPETITOR	GSP Ref.	COMPETITOR	GSP Ref.	COMPETITOR	GSP Ref.
OE		3910153Y00	841001	3910144B12	841013	391013J210	841024	3910052A00	841039
		3921150Y00	841001	392114F426	841013	3910165J15	841024	3910077A00	841039
MR470226	839186	9321150Y00	841001	3920164Y10	841014	3910170N10	841024	3910150A00	841039
MN147088	839200	3910050Y10	841002	392115V010	841015	3910170N15	841024	3910150A10	841039
MN147159	839200	3910051Y10	841002	3910058G00	841016	3910171N10	841024	3910152A00	841039
MR580577	839203	3910052Y10	841002	3910058G60	841016	3910175N10	841024	3910177A00	841039
3815A200	839207	3910053Y10	841002	3921158G00	841016	392111C100	841024	3910041F100	841040
3815A199	839207	3910150Y10	841002	3971135F10	841016	392115C510	841024	3910041F400	841040
3815A207	839211	3910150Y11	841002	3910088G00	841016	392117F000	841025	391004F100	841040
3815A208	839211	3910151Y10	841002	3910172J15	841017	392110F000	841025	3910141F100	841040
3815A205	839211	3910152Y10	841002	3971170A10	841017	391002F605	841028	3910141F400	841040
MR305601	839212	3910153Y10	841002	3910061E00	841018	391002F615	841028	3910145B00	841040
MR305602	839212	3921150Y10	841002	3910062E00	841018	392112F225	841028	391014F100	841040
MB526011	839214	3910060Y10	841003	3910161E00	841018	44014S7C950	841028	392114F125	841040
MB526012	839214	3910060Y15	841003	3910162E00	841018	391012F615	841028	3910047A00	841041
MR176647	839214	3910061Y16	841003	3910180E00	841018	391012F605	841028	3910147A00	841041
MR176648	839214	3910062Y00	841003	3910064E05	841018	391019F610	841028	3910164E00	841042
MB837698	839214	3910062Y10	841003	3910080E05	841018	391019F600	841028	3921161E06	841042
MB919125	839214	3910062Y15	841003	3910180E05	841018	391009F601	841028	3920202E25	841042
MB837266	839214	3910063Y10	841003	391001C100	841018	391009F611	841028	39101D4000	841042
MB936771	839214	3910063Y11	841003	391002J205	841018	391002F000	841029	3910064E00	841042
MB837267	839214	3910160Y10	841003	3910050R10	841018	392042F025	841029	392110E015	841043
MB936772	839214	3910160Y15	841003	3910065J00	841018	392112F026	841029	391010E417	841043
MR980743	839221	3910161Y17	841003	3910070N00	841018	391002F010	841030	391014U010	841044
MR980744	839221	3910162Y00	841003	3910070N05	841018	391012F011	841030	392112J200	841044
MR483674	839228	3910162Y10	841003	3910071N04	841018	3910024B00	841031	39211AY125	841046
MR483673	839228	3910162Y15	841003	3910071N05	841018	3910024B10	841031	39211AY625	841047
3815A148	839229	3910162Y16	841003	3910074N00	841018	3910124B00	841031	39211BC50J	841047
3815A151	839229	3910163Y11	841003	39100D4600	841018	3910124B10	841031	39211BM526	841048
PW820028	839234	3910163Y15	841003	391012J205	841018	3921124B00	841031	39101BM510	841048
PW820027	839234	3921160Y10	841003	3910150R00	841018	39100D0100	841032	39211AV325	841049
PW810534	839234	3910071J00	841005	3910150R10	841018	39100D3100	841032	C9211AU32A	841049
PW810533	839234	3910171J00	841005	3910165J00	841018	39202D0125	841032	39211AW325	841050
PW820032	839234	3910171J10	841005	3910165J05	841018	391000M600	841033	3910031G00	841051
PW820031	839234	3910172J00	841005	3910170N00	841018	391000M605	841033	39211BM726	841052
PW825977	839234	3910170J00	841006	3910170N05	841018	3910040Y00	841033	39101BN710	841052
PW825978	839234	3921171J25	841006	3910172N00	841018	3910040Y06	841033	39100BN710	841052
PW825953	839234	3921171J27	841006	3910174N00	841018	391004M500	841033	3910164E15	841054
PW825952	839234	3910071J10	841007	3910175N00	841018	3910140Y00	841033	391000E410	841054
3815A165	839236	3910170J10	841007	39101D4600	841018	3910140Y06	841033	391000E415	841054
3815A164	839236	3921171J26	841007	3921132R00	841018	3910162Y06	841033	391003J110	841054
MB297565	839245	3910055A00	841008	3921165J00	841018	3910163Y05	841033	3910064E15	841054
MB297981	839245	3910155A00	841008	3910031U10	841021	391010M600	841033	391010E410	841054
MB297982	839245	3921155A00	841008	391002Y016	841022	391010M605	841033	391010E415	841054
391005N410	839248	3910072J20	841009	391002Y115	841022	391004M510	841034	391010E410	841054
391015N410	839248	3910073J00	841009	3910032U15	841022	391004M570	841034	391002J211	841055
MN156841	839252	3910173J00	841009	3910032U16	841022	391014M570	841034	391002J216	841055
MN156842	839252	3921173J25	841009	391012Y115	841022	391014M575	841034	392115M427	841057
49500C8100	839261	3921173J26	841009	3910132U15	841022	391014M771	841034	39211BM427	841057
49525C8101	839261	3910072J10	841010	3921131U00	841022	391000M311	841034	392114F126	841058
MR196749	839270	3910073J20	841010	3921131U10	841022	391000M615	841034	39112M7225	841059
MR196750	839270	3910173J20	841010	3910063E00	841023	391000M915	841034	39100M7270	841059
MR222055	839270	3921172J25	841010	3910080E00	841023	3910040Y10	841034	39101M7270	841059
MR222056	839270	3921173J27	841010	3910163E00	841023	391004M776	841034	3910011A00	841060
MR222057	839270	3921185E00	841011	3910180E03	841023	391006N215	841034	3910011A10	841060
MR246960	839270	3910073N00	841011	3910164E05	841023	391010M311	841034	3910011A20	841060
MR305319	839270	3910173N00	841011	3910070A10	841023	391010M910	841034	3910011M00	841060
MR305771	839270	3910173N01	841011	3910070A20	841023	391010M915	841034	3910011M05	841060
MR305772	839270	3921199999	841011	3910071N00	841023	3910140Y10	841034	3910012A00	841060
MR336639	839270	39100173N10	841011	39100D4000	841023	3910163Y10	841034	3910012A10	841060
3817A320	839371	3921171E15	841011	39100G8100	841023	391016N215	841034	3910012A20	841060
3817A178	839371	3921158E10	841011	3910164J00	841023	3910055E01	841035	3910013A00	841060
3817A315	839371	3921158E15	841011	3910165J10	841023	3910087E10	841035	3910013A01	841060
3817A177	839371	391004F400	841012	3910170A10	841023	3910006R00	841035	3910013A10	841060
391000M000	841001	391014F400	841012	3910170A20	841023	3910155E01	841035	3910013A20	841060
391000M005	841001	392114F425	841012	3910171N00	841023	3910187E10	841035	3910015A05	841060
3910050Y00	841001	391014F401	841012	3910171N01	841023	3910031U00	841036	3910016R05	841060
3910051Y00	841001	392114F125	841012	3921165J10	841023	3910032U05	841036	3910110A01	841060
3910052Y00	841001	3924141F25	841012	3910064E10	841024	3910131U00	841036	3910111A00	841060
3910053Y00	841001	3910044B00	841013	391001C110	841024	3910132U05	841036	3910111A10	841060
391010M000	841001	3910044B02	841013	391003J210	841024	391009H610	841037	3910111A20	841060
391010M005	841001	3910044B10	841013	391005C510	841024	391018H710	841037	3910111M00	841060
3910150Y00	841001	3910044B12	841013	3910065J10	841024	391008H710	841037	3910111M05	841060
3910150Y01	841001	3910144B00	841013	3910070N10	841024	39211AV625	841038	3910112A00	841060
3910151Y00	841001	3910144B02	841013	3910071N15	841024				

COMPETITOR	GSP Ref.	COMPETITOR	GSP Ref.	COMPETITOR	GSP Ref.	COMPETITOR	GSP Ref.	COMPETITOR	GSP Ref.
OE		3910064Y10	841087	3910132U16	841157	391011V10C	841188	392115M426	841256
		3910064Y15	841087	391014M470	841159	391002J201	841189	39211EB31A	841257
3910113A00	841060	3910164Y10	841087	39211ED100	841167	391002J206	841189	C9211EB31A	841257
3910113A01	841060	3910164Y15	841087	C9211EL10A	841167	391005J016	841189	392111HS0B	841271
3910113A10	841060	392114F128	841090	3910165A05	841168	391006J011	841189	39211EW60A	841272
3910113A20	841060	39210F4125	841092	3020513A25	841170	391006J016	841189	3910103A00	841281
3910116R05	841060	39210A03G0	841095	3910001A00	841170	391012J201	841189	3910101M15	841281
3920511A25	841060	392115M300	841099	3910001M15	841170	391012J206	841189	39100AU115	841282
3930110A01	841060	391002S600	841100	3920213A91	841170	391012J211	841189	39101AU075	841282
3930111A00	841060	391002S660	841100	3910001B01	841172	391012J216	841189	391004M470	841284
3930112A00	841060	3921158G60	841100	3910001B02	841172	391015J016	841189	391004M475	841284
3930113A00	841060	3921150A00	841105	3910001B05	841172	391016J011	841189	39211EN100	841285
3930113A01	841060	391003J100	841106	3910001B11	841172	391016J016	841189	C9B11JD02B	841286
3910001E02	841061	39211BM525	841109	3910001B15	841172	392110M306	841210	C9211JD02B	841286
3910002E02	841061	39211BM725	841112	3910001B60	841172	392112N560	841210	39101JD02B	841286
3910101E02	841061	39210F4127	841112	3910101B00	841172	39100JA010	841214	39100JD02B	841286
3910102E02	841061	3910041B00	841114	3910101B05	841172	39101JD52B	841214	397111HC3C	841289
3910158E10	841062	3910041B05	841114	3910101B15	841172	C9211JD22B	841214	392111FA0B	841289
3910073N10	841062	3910045B00	841114	3920401B28	841172	C92AAJD22B	841214	3910001B06	841291
391010173N10	841062	3910141B00	841114	3971101B26	841172	C9211JA00A	841214	3910101B10	841291
3910016E00	841063	3910141B05	841114	3910078G00	841178	39100JD24B	841214	C92111KA0a	841294
3910026E00	841063	391000M801	841118	391002J210	841184	39101JD24B	841214	392111HS0A	841297
3910085E00	841063	391000M806	841118	391002J215	841184	39100JD52B	841214	39100ED105	841302
3910116E00	841063	3910040Y05	841118	391003J171	841184	39211JA00A	841214	39100ED305	841302
3910126E00	841063	391000M316	841118	391004N175	841184	C9211EL00B	841217	39101ED105	841302
3910185E00	841063	391000M806	841118	391004N275	841184	39125EL000	841217	39101ED305	841302
3910005E02	841063	39100WD200	841118	391005J010	841184	39100JN10A	841222	39101ED805	841302
3910010E02	841063	39100WD205	841118	391006J071	841184	39211EG000	841227	39100ED805	841302
3910016E02	841063	391010M801	841118	391006J076	841184	392118J100	841230	39100EE70A	841302
3910105E02	841063	391010M806	841118	391006J915	841184	39100EB70A	841231	39100EE70B	841302
3910110E02	841063	3910140Y05	841118	39100AE415	841184	39100CA100	841232	39101EE70A	841302
3910116E02	841063	391010M316	841118	39100AU415	841184	39101CA100	841232	39101EE70B	841302
3910085E10	841063	391010M806	841118	39100AU416	841184	39211CA100	841232	39100ED005	841303
3910185E10	841063	39101WD200	841118	39100AW010	841184	39100CC20B	841232	39100ED00A	841303
39100D5600	841063	39101WD205	841118	39100CX015	841184	392111AA0A	841232	39101ED005	841303
39100D5610	841063	3910144800	841119	39100CX016	841184	39211EL20B	841233	39101ED00A	841303
39101D5600	841063	3910144802	841119	39100CX115	841184	39211EL00B	841234	391003U007	841304
39101D5610	841063	326906	841135	39100CX215	841184	392115M425	841236	391003U507	841304
391008000L	841068	392115M325	841137	391010E478	841184	391004M400	841239	391004V51A	841304
3910050A00	841073	392118V010	841137	391012J215	841184	391004M465	841239	391004V70A	841304
3910050A05	841073	39211BM527	841141	391014N175	841184	39211EB30A	841240	391013U505	841304
3910150A05	841073	392115V471	841142	391014N177	841184	C9211EB30A	841240	391014V01C	841304
391000M301	841078	392119F626	841142	391014N275	841184	39211BM580	841243	391014V51A	841304
391000M900	841078	39211AU325	841142	391015J010	841184	39211BM528	841243	391014V70A	841304
391000M905	841078	39211BU025	841142	391016J010	841184	39211BC625	841244	392113U000	841304
391000M970	841078	391014U075	841142	391016J071	841184	39100CA000	841245	3910130R00	841305
3910060Y00	841078	C9211AU31A	841142	391016J076	841184	39101CA000	841245	3910153J10	841305
3910060Y05	841078	3921185E05	841151	391016J915	841184	39211JD72B	841249	3910153J00	841305
3910061Y06	841078	3921185E10	841151	39101AE415	841184	39211JG72B	841249	3910053J20	841305
3910062Y05	841078	392112Y010	841152	39101AU415	841184	39211JG74B	841249	3910053J00	841305
3910063Y00	841078	391002U010	841154	39101AU416	841184	39101JY04A	841249	3910030R00	841305
3910063Y01	841078	391002U210	841154	39101AW110	841184	39100JY04A	841249	391000E510	841306
391010M301	841078	3910041B10	841154	39101CX116	841184	39100CN200	841250	391000E515	841306
391010M900	841078	3910045B10	841154	39101WF715	841184	39101CN200	841250	391010E510	841306
391010M905	841078	391012U310	841154	39101WF716	841184	391009Y115	841250	391010E515	841306
3910160Y00	841078	3910141B10	841154	39100WF110	841184	391019Y110	841250	392115J000	841306
3910160Y05	841078	3910145B10	841154	39100WA015	841184	392119Y300	841250	391002B015	841307
3910161Y07	841078	391002U310	841154	39101WF110	841184	391009Y315	841250	391012B016	841307
3910162Y05	841078	391000M316	841155	39101WF115	841184	391019Y115	841250	39100EE32B	841308
3910163Y00	841078	391000M816	841155	39101OE478	841184	391019Y315	841250	39100EW605	841308
3910163Y01	841078	3910040Y15	841155	391008H515	841185	391011KDOA	841251	39100EE76A	841308
3921160Y00	841078	39100WD210	841155	391012Y070	841185	391001KDOA	841251	39101EE32B	841308
392118V000	841078	39100WD215	841155	391012Y175	841185	391009Y015	841251	39101EE76A	841308
1991909	841081	391000M811	841155	391012Y176	841185	391019Y015	841251	39101EW605	841308
335712	841083	391005M810	841155	391018H315	841185	39211JN30A	841251	391001KB0A	841309
326582	841084	391006M010	841155	391018H810	841185	392119Y015	841251	391011KB0A	841309
39210Y02G0	841084	391010M316	841155	391002Y076	841187	39211CN000	841251	39100JG32C	841311
3910020N00	841085	391010M811	841155	391002Y210	841187	39211CN100	841251	39100JG34C	841311
3921131G00	841086	391010M816	841155	391012Y076	841187	39100CN000	841251	39101JG32C	841311
3921178G00	841086	3910140Y15	841155	391012Y215	841187	39100EN100	841251	39101JG34C	841311
3910064Y00	841087	391015M810	841155	392112Y210	841187	39100EN110	841251	39100JG34B	841311
3910064Y05	841087	391016M010	841155	39100AX000	841188	39101CN000	841251	391012Y016	841314
3910164Y00	841087	39101WD210	841155	39100AX005	841188	39101EN000	841251	4342087745	841323
3910164Y05	841087	39101WD215	841155	39101AX000	841188	39101EN100	841251	4346087F98	841323
3921164Y00	841087	391012Y116	841157	3					

COMPETITOR	GSP Ref.	COMPETITOR	GSP Ref.	COMPETITOR	GSP Ref.	COMPETITOR	GSP Ref.	COMPETITOR	GSP Ref.
OE		374377	844020	3273L2	845004	7701352001	850026	8200433371	850131
		26032411	844020	3273L4	845004	7701348089	850027	8200470134	850131
39100EA000	841325	26089775	844020	3272S5	845005	7701348109	850027	82000141111	850133
391002J200	841338	93172150	844020	327206	845006	7701349769	850027	7701210040	850143
C92111KA0B	841343	4401720	844026	327375	845006	7701351172	850027	8200441337	850143
391011KA0B	841343	4401727	844026	32726E	845011	7701498775	850027	8200441340	850143
391001KA0B	841343	8200169277	844026	32727E	845011	7701498955	850027	8200598563	850143
39100CK005	841352	8200169281	844026	32728E	845011	8200079915	850041	7711497435	850145
391008J075	841354	8200169285	844026	32729E	845011	8200169177	850041	8200724499	850145
391008J065	841354	8200169288	844026	32733X	845011	8200436848	850041	8200725500	850145
3921150Y60	841355	8200178618	844026	32733Y	845011	8200436849	850041	3910009002R	850145
3921150Y70	841355	8200178624	844026	32723C	845033	8200467679	850041	8201353624	850145
391004N015	841360	1603270	844027	32724C	845033	8200470131	850041	8200725499	850145
391014N015	841360	93182571	844027	32724T	845038	8200647679	850041	8200934673	850150
392111LB0A	841393	93182577	844027	32738G	845038	7701352415	850043	8200934675	850150
391007S000	841403	374672	844028	3272AH	845049	7701352471	850043	8200618165	850152
39600EA000	841404	1603274	844028	32730Y	845049	7701351948	850045	1S0498099X	850153
396001AA0B	841413	93182543	844028	32725P	845052	7701352488	850056	391019671R	850157
4700644	844001	0374002	844030	32736Y	845052	7701352622	850056	391001162R	850157
4701110	844001	374002	844030	3272HP	845056	7701352907	850056	8200725504	850157
4705753	844001	90538427	844030	3273HF	845056	7701469542	850056	8200725503	850157
4705754	844001	93292610	844032	3272EQ	845057	7701469962	850056	8200725511	850157
93170265	844001	4414517	844034	3272FR	845057	7700111916	850058	8200725510	850157
93170266	844001	0374066	844041	3272KW	845057	7700111914	850058	8200618168	850161
4410283E10	844001	374066	844041	3273EQ	845057	7700112116	850058	8200618182	850161
4410183E11	844001	90157131	844041	3273KJ	845057	8200110754	850058	8200786810	850161
9204528	844001	0374077	844046	3272HY	845057	7700111077	850066	391014021R	850162
470110	844001	374077	844046	9801611180	845057	8200168513	850066	391011406R	850162
4410183E10	844001	374078	844046	3272EX	845057	8200236089	850066	391004751R	850162
0374403	844002	374092	844046	3272JZ	845058	8200236092	850066	391006276R	850162
374403	844002	0374092	844046	3273JS	845058	8200240425	850066	8200788674	850162
9201725	844002	7837456	844046	434100H020B	845058	8200240430	850066	8200788672	850162
1603273	844003	7837457	844046	434200H020	845058	7700111918	850069	391006802R	850168
93182575	844003	7839615	844046	4346009D00	845058	8200064731	850069	8201055673	850168
374671	844003	374003	844049	3272CQ	845065	8200236110	850069	1S0498099	850170
1603261	844004	0374003	844049	3273CQ	845065	82000236110	850069	391014946R	850173
1603398	844004	90538595	844049	3272CS	845067	8200535799	850069	391006270R	850212
93180019	844004	0374175	844051	3273CS	845067	8200535798	850069	391005624R	850213
93187468	844004	374175	844051	3272XJ	845067	8200535800	850069	391016376R	850213
1603251	844005	90334947	844051	3273YC	845067	7711497235	850078	44340SN7315	851001
93176743	844005	374014	844055	8942633	850001	8200387541	850078	44430SN7315	851001
374241	844006	0374147	844055	7701349992	850003	8200014111	850079	GCV1112	851001
374262	844006	374147	844055	7701351130	850003	8200035673	850079	GCV1117	851001
90496368	844006	90304775	844055	7711135246	850004	7700112688	850082	BAU5439	851002
90498412	844006	0374176	844056	7700111364	850004	7700115005	850082	BAU5440	851002
9503080	844006	374176	844056	7701352881	850004	8200255027	850082	GCV1088	851003
93172152	844006	90334948	844056	7701352133	850005	8200331518	850082	TFB000090	851003
374461	844006	0374015	844057	7701349994	850005	8200261840	850092	GCV1119	851004
374211	844007	374015	844057	7701349025	850007	8200261841	850092	TFB000110	851004
374213	844007	374126	844057	7701349026	850007	8200511225	850092	GVC1119	851004
374263	844007	90235271	844057	7701349028	850007	820011225	850092	GCV1076	851005
90345303	844007	0374126	844057	7701349034	850007	8200216519	850093	TDJ10016	851005
90498406	844007	374423	844060	7701349689	850007	8200216523	850093	GCV1075	851006
0374263	844007	374387	844065	7701349839	850007	8200432517	850093	GCV1146	851007
7700102978	844008	374410	844065	7701351124	850007	7701349958	850105	TFB000140	851007
7700102980	844008	9198504	844065	7701351264	850007	7701349990	850105	TFB000060	851008
7700102998	844008	93225242	844069	7701352020	850007	7701352128	850105	17H8600	851009
7700102999	844008	4707438	844080	7701352025	850007	7701352493	850105	CGV1053	851009
374351	844011	4410185E50	844080	7701394697	850007	7701352495	850105	GCV1105	851009
90538428	844011	4410285E50	844080	7701498918	850007	8200285909	850109	BAU5466	851010
0374351	844011	93180229	844080	7701498919	850007	8200436365	850109	GCV1181	851011
374346	844012	374068	844083	7701498921	850007	8200341698	850112	TDJ100580	851011
26060700	844012	4710013	844085	7701349874	850008	8200378880	850112	BAU4851	851012
0374346	844012	4710017	844085	7701349880	850008	8200684084	850112	27H7567	851013
0374053	844013	93194650	844085	7701349938	850008	8200482429	850112	BAU2018	851013
374053	844013	93194655	844085	7701351479	850008	7711134778	850113	BAU4444	851013
0374368	844013	4410151K00	844085	7701351480	850008	7711134777	850113	44340SN7003	851017
374368	844013	4410251K00	844085	7701351484	850008	8200169176	850113	GCV1118	851018
26060699	844013	94564013	844090	7701351571	850008	8200079913	850113	TDJ100470	851020
26067600	844013	94564015	844090	7701351572	850008	8200079912	850113	44011ST3E70	851021
374329	844014	9H2423B	844090	2991461XD	850008	8200470129	850113	44011ST3G50	851021
9117611	844014	3272E3	845001	299341X2	850009	8200327707	850116	44011ST3G70	851021
0374218	844020	3273L1	845001	7701469363	850011	8200575490	850116	44014ST3E51	851021
374218	844020	3272F6	845001	360113KTX	850012	8200575489	850116	4401ST3G70	851021
374221	844020	3272E0	845004	7701349955	850026	8200363697	850131	3815A149	851028
0374377	844020	3272E2	845004	7701351995	850026	8200363698	850131	3815A152	851028

COMPETITOR	GSP Ref.	COMPETITOR	GSP Ref.	COMPETITOR	GSP Ref.	COMPETITOR	GSP Ref.	COMPETITOR	GSP Ref.
OE		6U0498099A	854001	28021TA011	856007	28393AG001	856042	4410262B22	857007
		6U0498099	854001	28021TA021	856007	28393AG010	856042	4410263B10	857007
4410579K20	851030	115420174	854001	28021TA150	856007	28393AG011	856042	4410263B11	857007
4411879K20	851030	6Q0498099A	854002	28021TA160	856007	28393AG030	856042	4410263B20	857007
4242236	852001	6Q0498099C	854002	28021TA360	856007	23221GA593	856046	4410263B21	857007
4399325	852001	6Q0498099CX	854002	28021TA370	856007	23291GA191	856046	4411660B20	857007
4610580	852001	6QE498099B	854004	28091TA000	856007	28021TA031	856052	4411660B30	857007
30583376	852001	6QE407311C	854004	28091TA010	856007	28091TA040	856052	4411762B10	857007
8952905	852002	6C0498099A	854006	28091TA020	856007	28391KE040	856052	4411662B10	857007
4002911	852003	6C0498099AX	854006	28321KC000	856007	28391KE050	856052	4411663E10	857007
8963571	852003	4410254J00	854007	28321KC010	856007	28321KC150	856052	4411763B20	857007
8983571	852003	4410154J01	854007	28321KC060	856007	28321KE040	856052	4410160820	857007
8990574	852004	4410154J00	854007	28321KC070	856007	28321KC140	856052	4410160830	857007
9102880	852004	23221GA242	856001	28321KE000	856007	28321KC100	856052	4410160842	857007
4103263	852007	23221GA243	856001	28321KE010	856007	28321KC110	856052	4410163820	857007
4610572	852007	23221GA372	856002	28391KC000	856007	28321KC061	856052	4410163B21	857007
4686960	852008	23221GA373	856002	28391KC010	856007	28321KC071	856052	4410260B22	857007
5171186	852008	23221GA592	856002	28391KC020	856007	28321FE001	856057	4411660830	857007
5232897	852008	23221GA593	856002	28391KC030	856007	28321FE020	856057	4410262B10	857007
4000659	852010	23291GA182	856002	28391KE000	856007	28321FE110	856057	4410272F00	857008
4103255	852011	28021AA051	856003	28391KE010	856007	28321FE191	856058	4410278E00	857009
12804149	852012	28021AA052	856003	28391KE020	856007	28321FE192	856058	4410167D00	857009
12804150	852012	28021AA053	856003	28391KE030	856007	723221981	856060	4410167D01	857009
93186026	852012	28021AA150	856003	28021AC200	856009	28321FE040	856067	4410267D00	857009
1K0407311F	853001	28021AA151	856003	28091AC120	856009	28321FE041	856067	4410178E00	857009
1K0498099D	853001	28021AA152	856003	28093AC040	856009	28321FE061	856067	4410160A00	857010
1K0498099DX	853001	28021AA501	856003	28393FE020	856009	28321FE081	856067	4410160A01	857010
6Q0407311D	853002	302022	856003	4410175F02	856010	28321FE082	856067	4410160A10	857010
6Q0498099F	853002	28021AA021	856004	4410175F20	856010	28321FE090	856067	4413160A00	857010
6Q0498099FX	853002	28021AA022	856004	4410175F32	856010	28321FE091	856067	4410164B10	857011
6N0407311	853005	28021AA031	856004	4410275F32	856010	28321FE092	856067	4410164B11	857011
6N0498099	853005	28021AA032	856004	723221055	856011	28321FE130	856067	4410164B20	857011
6N0498099X	853005	28021AA033	856004	723291013	856011	28321FE131	856067	4410171C12	857011
JZW498340CX	853005	28021AA130	856004	723221392	856012	28321FE150	856067	4410264B10	857011
6N0498340X	853005	28021AA131	856004	723291003	856012	28321FE151	856067	4410264B11	857011
357407311	853007	28021AA132	856004	23221GA232	856013	28321FE170	856067	4410264B20	857011
357498099	853007	28021AA511	856004	23221GA233	856013	28321FE171	856067	4411664B10	857011
191407311B	853007	28021AA551	856004	723251001	856014	28321FE181	856067	4410180E21	857012
191407311C	853007	28021AC130	856004	723251011	856014	723221901	856077	4410280E21	857012
191407311F	853007	28091AA010	856004	723291130	856014	723291490	856077	44101M72F30	857013
191407311L	853007	28091AA012	856004	723291140	856014	723291500	856077	4410160G20	857014
191497311J	853007	28091AA014	856004	723291300	856014	44102M72F12	857001	4410160G22	857014
191498099A	853007	28091AA020	856004	723291301	856014	44102M72F21	857001	4410160G23	857015
191498099AV	853007	28091AA024	856004	723291310	856014	44102M72F41	857001	4410160G33	857015
191498099AX	853007	28021AA560	856004	723291311	856014	4410160G50	857002	4410160G62	857015
191498099B	853007	28021AC150	856004	723291570	856016	4410160G52	857002	4410260G23	857015
191498099BV	853007	28021FC031AT	856004	28094AC050	856021	4410260G50	857002	4410260G30	857015
1H0407311D	853007	28091AA011	856004	28021AC220	856026	4410260G52	857002	4410260G62	857015
1H0498099	853007	28091AA021	856004	28094AC060	856026	4410171C10	857003	4410260G60	857016
1H0498099V	853007	28091AA024AT	856004	28321AE012	856026	4410171C41	857003	4410160G61	857016
1H0498099X	853007	28091AA042	856004	28091KC000	856032	4411463B60	857003	4410260G80	857016
1H0498340X	853007	28091AA043	856004	28091KC010	856032	4410171C30	857003	4410177E00	857017
357498099A	853007	28021FC031	856004	28091KC030	856032	4410182013	857006	4410277E01	857017
357498099D	853007	28091AA014AT	856004	28321KC011	856032	4410282013	857006	4410277E02	857017
357498099X	853007	28091AA022	856004	28021FA110	856039	4411582020	857006	4410160G42	857018
191407311J	853007	28091AA023	856004	28021AC210	856040	4410162D00	857006	4410160G43	857018
JZW498340BX	853007	28091AA094AT	856004	28021AC280	856040	4410162D01	857006	4410160G44	857018
191498099BX	853007	28021AA003	856005	28021AC281	856040	4410170B12	857006	4410164B12	857018
171407311F	853008	28021AA011	856005	28021AC281	856040	4410170B50	857006	4410260G42	857018
191407311	853008	28021AA012	856005	28091AC091	856040	4410260A00	857006	4410171C11	857018
191498099	853008	28021AA013	856005	28091AC130	856040	4411663B20	857006	4410271C12	857018
171498099A	853008	28021AA160	856005	28093AC030	856040	4410160B12	857007	4410175F01	857024
171498099C	853008	28021AA161	856005	28321SA030	856041	4410160B20	857007	4410175F31	857024
191407311H	853008	28021AA162	856005	28321SA040	856041	4410160B30	857007	4410175F51	857024
191498099F	853008	28021AA481	856005	28321SA050	856041	4410162B10	857007	4410175F52	857024
191498099FV	853008	28021AA491	856005	28321SA051	856041	4410162B11	857007	4410178F20	857024
191498099FX	853008	28021AA541	856005	28321SA033	856041	4410162B12	857007		
191498340X	853008	28021AC090	856005	28321AG000	856042	4410162B22	857007		
1H0407311C	853008	28091AA094	856005	28321AG010	856042	4410163B10	857007		
JZW498340X	853008	28091AC090	856005	28321AG011	856042	4410163B11	857007		
115420170	854001	723220041	856006	28321AG012	856042	4410163B20	857007		
115420214	854001	723221971	856006	28321AG020	856042	4410260B12	857007		
115420217	854001	723291530	856006	28321AG021	856042	4410260B20	857007		
441072651586	854001	723291540	856006	28321AG022	856042	4410260B30	857007		
441072651706	854001	28021TA000	856007	28321AG023	856042	4410262B11	857007		
6U0407311	854001	28021TA001	856007	28393AG000	856042	4410262B12	857007		

COMPETITOR	GSP Ref.	COMPETITOR	GSP Ref.	COMPETITOR	GSP Ref.	COMPETITOR	GSP Ref.	COMPETITOR	GSP Ref.
OE		4410186G10	857062	396004652R	857203	4410286G60	857062	4346039275	859015
		4411765J00	857067	4410171LC1	857213	4410186G01	857062	9031660004	859015
4410178G30	857024	44101M79F10	857076	4341002010	859001	4341032141	859001	4346035070	859015
4410275F02	857024	4410186G60	857079	4341002011	859001	4341020530	859001	4343026013	859016
4410275F20	857024	4410286G50	857079	4341012030	859001	4233017020	859001	4343026021	859016
4410275F31	857024	4410186GA0	857081	4341012040	859001	4341012351	859001	4343026032	859016
44102M79F60	857027	4410286GD0	857081	4341012070	859001	4341012352	859001	4343026040	859016
44102M79F50	857027	4410179J21	857092	4341012090	859001	4341012353	859001	4343026041	859016
44101M79F50	857027	4410180J11	857092	4341012091	859001	4342020292	859001	4343035011	859016
44101M79F70	857027	4410162J20	857095	4341012100	859001	4341020310	859002	4343035012	859016
44101M79F60	857027	4410163J20	857095	4341012101	859001	4341020311	859002	4343035021	859016
44101M79F	857027	4410262J20	857095	4341012140	859001	4342020241	859002	4343035022	859016
44102M79F5	857027	4410262J30	857095	4341012141	859001	4347029395	859002	4346029067	859016
4401083000	857033	4410263J20	857095	4341012150	859001	4347029396	859002	4347019827	859017
4410180000	857034	4710021	857100	4341012151	859001	4341020281	859003	4342016201	859017
4410180001	857034	4711022	857100	4341012170	859001	4341020301	859003	4341016270	859017
4410280000	857034	93194659	857100	4341012171	859001	4341020730	859003	4341016281	859017
4410280001	857034	4410151K90	857100	4341012210	859001	4341032070	859003	4341016190	859017
4410160A20	857035	44101T51K90000	857100	4341020010	859001	4342020231	859003	4341012400	859018
4413160A01	857035	4410251K90	857100	4341020020	859001	4342020500	859003	4341032170	859018
4413260A00	857035	44102T51K90000	857100	4341020031	859001	4342032050	859003	4342012191	859018
4410260A10	857035	4700078	857103	4341020040	859001	4341006060	859004	4342020290	859018
441016DA10	857035	4710019	857103	4341020100	859001	4341006161	859004	4341012211	859018
441016DA20	857035	4710020	857103	4341020180	859001	4342006060	859004	4341012230	859018
4410160G00	857037	4410168L32	857103	4341020181	859001	4342006161	859004	4341012320	859018
4410160G01	857037	4410268L01	857103	4341020220	859001	4346009160	859004	4341020050	859018
4410160GB0	857037	4410268L32	857103	4341020342	859001	4340312040	859005	4341020110	859018
4410160GH0	857037	4410186G30	857105	4341032010	859001	4341010200	859005	4341020111	859018
4410160GN0	857037	4410286G30	857105	4341032011	859001	4341020142	859005	4341020160	859018
4410260G00	857037	4410286G30000	857105	4341032020	859001	4341020440	859005	4341020221	859018
4410260GB0	857037	4410186GG30	857105	4341032021	859001	4341020441	859005	4341020340	859018
4410260GH0	857037	4410168L80	857114	4341032022	859001	4346029098	859005	4341020350	859018
4410260GN0	857037	4410257KA0	857117	4341032030	859001	4341012190	859005	4341020351	859018
4410175H10	857039	4410176G40	857125	4341032031	859001	4342010180	859005	4341020420	859018
4410176G70	857039	4410176G60	857125	4341032040	859001	4342012031	859005	4341020720	859018
4410180G00	857039	4410176G61	857125	4341032041	859001	4342012160	859005	4341022020	859018
4410180G11	857039	4410276G40	857125	4341032060	859001	43420A12090	859005	4341032140	859018
4410272J10	857039	4410276G60	857125	4341032061	859001	4341010160	859006	4341032160	859018
4410276G70	857039	4410276G61	857125	4341042021	859001	4341010180	859006	4341032230	859018
4410279C00	857039	LR003162	857132	4342012040	859001	4341020515	859006	4341032231	859018
4410280G00	857039	LR001160	857132	4342012041	859001	434101060	859006	4341032250	859018
4410180G20	857039	71743873	857140	4342012070	859001	4347039355	859009	4341032251	859018
441080G00	857039	71746741	857140	4342012071	859001	4347039366	859009	4342012150	859018
4410160G21	857040	71747061	857140	4342012100	859001	4341032111	859010	4342012151	859018
4410160G22	857040	4410179J01	857140	4342012101	859001	4342032091	859010	4342012190	859018
4410154G50	857041	4410179JC0	857140	4342012110	859001	4341020670	859011	4342012210	859018
4410155G00	857041	4410180J01	857140	4342012111	859001	4341032130	859011	4342012211	859018
4410254G50	857041	4410180J10	857140	4342012140	859001	4341032131	859011	4342012310	859018
4410255G00	857041	4410180J22	857140	4342012141	859001	4341032180	859011	4341023230	859018
4410254G5000109	857041	4410279J00	857140	4342012331	859001	4341032181	859011	4342012370	859018
4410162J90	857042	4410279J30	857140	4342020010	859001	4341033010	859011	4342020030	859018
4410163J00	857042	4410280J00	857140	4342020020	859001	4342020430	859011	4342020080	859018
4410163J10	857042	4410280J10	857140	4342020060	859001	4342032110	859011	4342020090	859018
4410163J80	857042	4410180J50	857141	4342020070	859001	4342032111	859011	4342020130	859018
4410262J90	857042	4410180JE0	857141	4342020120	859001	4342033010	859011	4342020160	859018
4410263J00	857042	4410280J50	857141	4342020170	859001	4341020251	859012	4342020171	859018
4410263J30	857042	44101M70F10	857153	4342020291	859001	4341020680	859012	4342020341	859018
4410263J50	857042	44102M70F10	857153	4342020301	859001	4341032150	859012	4342032120	859018
4410263J80	857042	4410176G00	857157	4342020302	859001	4341033020	859012	4343032140	859018
4410162J01	857042	4410176G01	857157	4342020304	859001	4341033022	859012	4342032190	859018
4410160J00	857042	4410176G10	857157	4342032010	859001	4342020201	859012	4341012181	859019
4410163J01	857042	4410176G11	857157	4342032011	859001	4342020440	859012	4341012200	859019
4410180E00	857048	4410276G00	857157	4342032030	859001	4342033020	859012	4341012360	859019
4410280E00	857048	4410276G01	857157	4342032031	859001	4341010070	859013	4341012401	859019
4410180E01	857048	4410276G10	857157	4342032040	859001	4341010071	859013	4341012411	859019
4410280E01	857048	4410276G11	857157	4342032041	859001	4342010070	859013	4341020231	859019
4411584312	857053	4410160G31	857159	4342042021	859001	4342010071	859013	4341020291	859019
4411584332	857053	4410160G51	857159	4346019286	859001	4346019415	859013	4341020540	859019
4411584342	857053	4410160G70	857159	4346019306	859001	4341026040	859015	4341020580	859019
4411684332	857053	4410260G20	857159	4347019236	859001	4343026031	859015	4342012360	859019
4411684342	857053	4410260G70	857159	4347039086	859001	4343035010	859015	4342020490	859019
4410179FA0	857061	4410160G90	857160	4341012H00	859001	4346039025	859015	4342032121	859019
4410279FA0	857061	4410260G01	857160	4342051Y10	859001	4346039026	859015	4342032122	859019
44101M79F75	857061	4410260G10	857160	4341012180	859001	4346039027			

COMPETITOR	GSP Ref.	COMPETITOR	GSP Ref.	COMPETITOR	GSP Ref.	COMPETITOR	GSP Ref.	COMPETITOR	GSP Ref.
OE		4341020442	859020	4346059055	859029	4341020071	859056	4347059455	859137
		4341012351	859020	4347059055	859029	4341020072	859056	4341052110	859152
4341012220	859019	4341012352	859020	4343035030	859034	4341020073	859056	4342052110	859152
4341012221	859019	4341012353	859020	4346039065	859034	4342020040	859056	4341012600	859153
4341012370	859019	4342020292	859020	4346059125	859035	4342020041	859056	4341020780	859153
4341012410	859019	4341012191	859021	4347059065	859035	4342020042	859056	4341047010	859153
4341020230	859019	4341020101	859021	4347059115	859035	4342020050	859056	4341028051	859154
4341020570	859019	4341020331	859021	4341002180	859036	4342020051	859056	4341028060	859154
4341020581	859019	4341020444	859021	4341012500	859036	4342020052	859056	4341028061	859154
4341020610	859019	4342002080	859021	4341012530	859036	4342020053	859056	4341033230	859154
4341032200	859019	4342012161	859021	4341032301	859036	4341003010	859058	4341058010	859154
4341032201	859019	4342020121	859021	4342002200	859036	4342033030	859060	4342033200	859154
4341032240	859019	4346019365	859021	4342012450	859036	4342033120	859060	4342033230	859154
4341032241	859019	4347019316	859021	4342012580	859036	4347039185	859060	4342048070	859154
4341032260	859019	4341020432	859021	4342032231	859036	4441033030	859060	4342048081	859154
4341032261	859019	4237019115	859021	4341002240	859037	4341001030	859063	4347039385	859154
4341042010	859019	434602918	859021	4342002270	859037	4342001030	859063	4341020321	859155
4341042011	859019	4346029167	859021	4346009600	859037	4341033030	859065	4342020271	859155
4341044021	859019	4346009290	859022	4346009601	859037	4341012160	859070	4341033040	859161
4342012170	859019	4346009490	859022	4347009A14	859037	4341012161	859070	4342033140	859161
4342012171	859019	4347009500	859022	4341005330	859037	4343028040	859073	4342006180	859161
4342012200	859019	4347009740	859022	4347009Q30	859037	4341042120	859081	4342033040	859161
4342012201	859019	4346005180	859022	4341010101	859040	4341042140	859081	4342033130	859161
4342012340	859019	4347005240	859022	4341010110	859040	4347049196	859081	4342033172	859161
4342020180	859019	4347009480	859022	4341010121	859040	4346049035	859083	4343028050	859166
4342020181	859019	4341016070	859023	4342010101	859040	4343060020	859085	4341013050	859167
4342020390	859019	4341016071	859023	4342010110	859040	4343060040	859085	4342013030	859167
4342020421	859019	4341016111	859023	4342010121	859040	4346069145	859085	4342042050	859167
4342032160	859019	4341016131	859023	4346019496	859040	4341006050	859087	4346049065	859167
4342032161	859019	4341016150	859023	4346049146	859042	4342006050	859087	4346049125	859167
4342032162	859019	4341016151	859023	4347049226	859042	4341028010	859089	4346049126	859167
4342032200	859019	4341016160	859023	4346039165	859042	4341032211	859089	4346049165	859167
4342032201	859019	4341016161	859023	4347029605	859042	4346009420	859092	4346049166	859167
4342042010	859019	4341016210	859023	4347029635	859043	4341006151	859095	4346049167	859167
4342042011	859019	4342016070	859023	4347029636	859043	4346069185	859097	4347080064	859167
4342044021	859019	4342016071	859023	4346009611	859044	4343060060	859107	4342048042	859173
4347019655	859019	4342016101	859023	4343028011	859045	4346069055	859107	4341028030	859175
4347019659	859019	4342016121	859023	4346029056	859045	4346069105	859107	4341028040	859175
4347029228	859019	4342016122	859023	4346029057	859045	4343060061	859107	4341028080	859175
4347019657	859019	4342016140	859023	4341002220	859047	4410181A00	859117	4341028130	859175
4341042020	859019	4342016141	859023	4341012510	859047	4410281A00	859117	4341042060	859175
4341005060	859020	4342016151	859023	4341002230	859047	4410183350	859117	4341048050	859175
4341012122	859020	4346019165	859023	4341012520	859047	4410283350	859117	4341048071	859175
4341012131	859020	4346019167	859023	4341012610	859047	4410181A80	859117	4342028030	859175
4341012260	859020	4346019516	859023	4342002240	859047	4410281A80	859117	4347080040	859175
4341012270	859020	4346019536	859023	4342002260	859047	4410182A00	859117	4342042120	859175
4341012350	859020	4346019556	859023	4342012430	859047	4410282A00	859117	4342044120	859175
4341012420	859020	4346019626	859023	4342012440	859047	4341005140	859120	4342048091	859175
4341012430	859020	4347019137	859023	4342012460	859047	4341020582	859120	4341048061	859175
4341016132	859020	4347019496	859023	4342012530	859047	4342005100	859120	4342048061	859175
4341016191	859020	4347019516	859023	4342012540	859047	4342012330	859120	4341005412	859175
4341020151	859020	4347019536	859023	4342042090	859047	4341020242	859125	4341021070	859175
4341020152	859020	4346019166	859023	4341012680	859047	4341020243	859125	4341033240	859175
4341020341	859020	4342005130	859024	4341006180	859048	4342020192	859125	4341033260	859175
4341020342	859020	4346009331	859024	4341010010	859054	4341012660	859131	4341042100	859175
4341020430	859020	4346009510	859024	4341010020	859054	4347080020	859131	4341044040	859175
4341020431	859020	4347009541	859024	4341010021	859054	4346080125	859131	4341044050	859175
4341020450	859020	4347009760	859024	4341010030	859054	4347009W20	859131	4342020620	859175
4341020470	859020	4641005310	859024	4341010040	859054	4346009T10	859131	4342021050	859175
4342005020	859020	4646009331	859024	4341010050	859054	4346080001	859131	4342044040	859175
4342005080	859020	4347059015	859025	4341010060	859054	4347080015	859131	4342044060	859175
4342012091	859020	4346059015	859025	4341010090	859054	4347080095	859131	4342048060	859175
4342012250	859020	4341052050	859026	4341010130	859054	4346080004	859131	4342048100	859175
4342012260	859020	4341059050	859026	4342010020	859054	4346080043	859131	4342058030	859175
4342012331	859020	4342052040	859026	4342010021	859054	4347029655	859131	4341016141	859177
4342020111	859020	4342052050	859026	4342010030	859054	4341012490	859136	4342016130	859177
4342020112	859020	4342059050	859026	4342010060	859054	4341047020	859136	4346029425	859182
4342020281	859020	4346059025	859026	4342010090	859054	4342012420	859136	4347009330	859183
4342032163	859020	4347059025	859026	4342010130	859054	4342047020	859136	4341052120	859190
4346019276	859020	4341052040	859026	4346019085	859054	4341052070	859137	4341052130	859190
4346029099	859020	4346009270	859028	4346019086	859054	4342052070	859137	4342052120	859190
4346080094	859020	4347009440	859028	4341010131	859054	4346059045	859137	4342052130	859190
4346080145	859020	4347009560	859028	4341020060	859056	4347059045	859137	4346059115	859190
4347019216	859020	4347009480	859028	4341020061	859056				

COMPETITOR	GSP Ref.	COMPETITOR	GSP Ref.	COMPETITOR	GSP Ref.	COMPETITOR	GSP Ref.	COMPETITOR	GSP Ref.
OE		4341020600	859261	43420OE021	859304	4347039595	859453	3B0498099AV	861012
		4341020800	859261	43420OW190	859304	4346039305	859453	171407311J	861013
4346009V10	859199	4341021011	859261	434100E011	859305	4346039215	859453	171407311K	861013
4346080033	859199	4341021040	859261	434200E011	859305	4341030020	859453	171498099B	861013
4346080035	859199	4341021041	859261	434100E011	859305	4346039216	859453	171498099BX	861013
4346009V20	859199	4342020530	859261	434200E011	859305	4347039425	859453	171498099CX	861013
4343028031	859201	4342020560	859261	4341030021	859306	4347039426	859453	357498099DV	861018
4343028051	859201	4342020590	859261	4342030021	859306	4341012800	859459	357498099DX	861018
4342010190	859202	4342021030	859261	4341052180	859308	4342012740	859459	357498340AX	861018
4341032090	859203	4341012531	859262	4341052280	859308	4346019795	859459	8N0498099	861021
4341032271	859203	4341020781	859262	4342052180	859308	4347080018	859460	8N0498099A	861021
4342032070	859203	4341021060	859262	4342052280	859308	4341012670	859460	8N0498099AX	861021
4342032211	859203	4341032302	859262	4347029885	859314	4342042091	859460	377498099G	861023
4347059315	859206	4342020581	859262	4347080178	859314	4346019146	859462	377498099S	861024
434708Z210	859206	4342032232	859262	4347080167	859314	4346019255	859462	337407311C	861028
4346009X10	859206	43410B1020	859266	4347009S90	859318	4347010H00	859462	377498099N	861030
4347059696	859206	43410BZ020	859266	4347009T00	859318	4347010H03	859462	377498099F	861034
4347009T70	859206	43420B1020	859266	4341048010	859320	4341010250	859463	7L6407271B	861042
4347009T71	859206	43420BZ020	859266	4341048030	859320	4341010210	859472	7L6498099B	861042
4346009R40	859206	43410B1010	859268	4341048040	859320	4237049285	859485	3C0407311A	861045
4346009R41	859206	43410B1030	859268	4342048010	859320	4347080270	859486	3C0498099	861045
4341052290	859206	43410BZ010	859268	4342048030	859320	4347039486	859486	5N0498099X	861045
434100D110	859207	43420B1010	859268	4342048050	859320	4346009Y60	859496	3CD498099	861045
43420OD110	859207	43420BZ010	859268	4341058020	859321	8200452268	860005	5N0407311B	861045
4340502230	859213	43410B2030	859268	4342058010	859321	8200452273	860005	95534990100	861050
4341002570	859213	43410B2031	859268	4341042200	859321	8200776535	860005	95534990102	861050
4341002580	859213	43420B2030	859268	4341042160	859321	8200776537	860005	7L0407321D	861050
4342002610	859213	43420B2031	859268	4342028090	859321	4417910	860005	7L0498099	861050
4342002620	859213	4341005241	859269	4346009M50	859332	4417909	860005	7L0498099A	861050
4346009R20	859213	4342005260	859269	4343060071	859336	374651	860006	7L0498099AX	861050
4346009R30	859213	4347009420	859269	4341002031	859337	374653	860006	7L0498099C	861050
4347009S50	859213	4346009M60	859270	4346049405	859340	93189678	860006	7L0498099CX	861050
4347009S60	859213	4347009L30	859270	4347080267	859340	93189680	860006	5M0498099	861059
4346009R31	859213	43470	859270	434708Z034	859345	171407311	861001	2H0498099A	861062
4346009S50	859213	09L30	859270	4347080311	859357	171498099	861001	2H0498099	861062
434100E041	859214	4346009V60	859270	434708Z039	859365	871407311	861002	2H0498099AX	861062
4346009M20	859214	434708Z044	859270	4342042160	859383	871498099	861002	2H0498099X	861062
4347079115	859219	4346009V00	859270	4341042180	859383	871498099A	861002	2H0498099B	861062
4346039155	859225	434708Z012	859270	434100D190	859384	871498099AX	861002	2H0498099BX	861062
4347039376	859225	4341052210	859274	434200D190	859384	871498099X	861002	A2463600075	861065
4341002270	859226	4341052220	859274	4341074060	859384	701498099	861003	A2463600175	861065
4341005350	859226	4342052210	859274	4342074050	859384	701407321B	861003	6Q0498099G	861074
4342002300	859226	4342052220	859274	4342052190	859385	701498099V	861003	5003846	862001
4346009621	859226	43410522210	859274	4342052191	859385	701498099X	861003	5003847	862001
4346009A21	859226	434100D280	859274	4341052191	859385	701498340X	861003	6843198	862001
4346009A22	859226	4341052270	859274	4341052190	859385	701407321C	861004	8111303	862001
4346009P50	859226	4341052330	859274	4341047030	859386	701498099A	861004	8111304	862001
4346009P70	859226	4342052261	859274	4342047030	859386	701498099AV	861004	8601100	862001
4347009A15	859226	4342052271	859274	4341012760	859386	701498099AX	861004	8601101	862001
4347009A38	859226	LR003159	859285	4341012780	859386	701498340AX	861004	9122567	862001
4347009A39	859226	LR005870	859285	4342012700	859386	701407321D	861005	9122833	862001
434100D170	859232	36000363	859285	4341012790	859387	701498099B	861005	9163595	862001
434200D170	859232	36001194	859285	4341012810	859387	701498099BX	861005	5003911	862002
4346009M70	859232	36000716	859285	4342012730	859387	701498340BX	861005	5003912	862002
4347009L40	859232	4346049175	859288	4342012750	859387	701407321E	861006	8111307	862002
434100D160	859232	4346049385	859288	4342012731	859387	701407321G	861006	8111308	862002
4342008020	859234	4347049305	859288	4342012751	859387	701498099C	861006	8601102	862002
4341008030	859234	4347049595	859288	4237039135	859390	701498099CX	861006	8601103	862002
4346059316	859238	4237049026	859289	4342016200	859395	701498340CX	861006	9122919	862002
4347059336	859238	4238049026	859289	4347019826	859395	7D0498099	861006	9122920	862002
434300K030	859242	4238049045	859289	4347009V10	859407	6X0498099	861007	9163594	862002
434300K022	859242	4347039545	859290	4341097401	859423	6X0498099X	861007	34303966	862004
4346049406	859244	4341033290	859290	4341097402	859423	7H0407321A	861009	3433105	862005
4347080318	859244	4342006700	859290	4342097401	859423	7H0407321B	861009	34331058	862005
4346009S20	859244	4342033250	859290	4346009X60	859427	7H0498099	861009	34349050	862006
4346080153	859244	4347080013	859294	4341002A00	859428	6QE498099	861010	34331017	862007
4347080134	859244	4342048090	859294	4341002760	859428	7H0407321	861011	30611702	862008
4347080347	859244	4347059745	859297	4347039575	859431	7H0407321C	861011	8602574	862009
4347079016	859244	4343060070	859303	4347039465	859431	7H0407321D	861011	8602577	862009
4347079015	859244	4346069115	859303	4341033070	859446	7H0498099A	861011	8603794	862009
4347049665	859245	434100E020	859304	4341033120	859446	7H0498099B	861011	9463378	862009
4347080126	859245	434200E021	859304	4341033201	859446	7H0498099BX	861011	36000518	862009
4347080127	859245	434100W160	859304	4342033070	859446	3B0498099	861012	36000519	862009
4347080330	859245	43410OE020	859304	4342033181	859446	3B0498099D	861012	8251758	862009
4347049835	859245	434100W160	859304	434703920					

COMPETITOR	GSP Ref.	COMPETITOR	GSP Ref.	COMPETITOR	GSP Ref.	COMPETITOR	GSP Ref.	COMPETITOR	GSP Ref.
OE		7702096438	899076	3910065A00	899204	1359663	899288	3273QK	899366
		REN770209643	899076	3910065A10	899204	1493015	899288	3273LQ	899366
9463379	862010	7702096437EH	899076	3910070A00	899204	3M513B437DAF	899288	3272LX	899366
8601571	862010	8200261838	899085	3910160A00	899204	1676314	899288	3272LW	899366
8251517	862010	8200264664	899085	3910160A10	899204	36001448	899288	3272LT	899366
9463397	862010	8200264667	899085	3910165A00	899204	36002896	899288	3273LR	899366
30610835	862011	8200356803	899085	3910165A10	899204	36002897	899288	3272PZ	899366
8251532	862012	8200358163	899085	0374049	899205	36001450	899288	3273XP	899366
30611947	862012	8200358164	899085	374049	899205	36002144	899288	3272WV	899366
8251531	862012	8200408418	899085	0374061	899205	495082EH50	899289	3272QC	899366
8601967	862012	8200432514	899085	374061	899205	495072EH00	899289	3272TN	899366
8601968	862012	8200511122	899085	90125875	899205	495082EH00	899289		
8215531	862012	8200511220	899085	90147008	899205	495082EG00	899289		
8215530	862012	391000153R	899085	93225238	899205	43410B4010	899290		
8215533	862012	391015451R	899085	93225287	899205	43420B4010	899290		
86018314	862012	3910000Q4F	899085	44014ST3E01	899210	495002F000	899294		
8602132	862012	391004AA0A	899085	TDR100790	899211	495002F010	899294		
36000505	862035	3910100Q1G	899085	4000642	899212	495012F000	899294		
36000514	862035	391014AA0A	899085	E152120186009	899212	495012F010	899294		
1504139	862045	391014AD0B	899085	8200198016	899213	495912F000	899294		
1505645	862045	2203050	899103	8200436366	899213	495912F010	899294		
36011289	862045	4410183EC1	899110	3815A037	899230	495912F090	899294		
36011300	862045	4410183EC0	899110	3815A134	899230	495912F091	899294		
3M513A327DA	862048	4410183EC1000	899110	MR196310	899230	P52853431AA	899297		
36000676	862049	4410283EC0	899110	MR263174	899230	P52853432AA	899297		
96639350	868008	4410283EC0000	899110	TFB0000150	899242	52105728AD	899297		
4237029245	875002	4347019647	899122	44305S10J50	899248	52105758AD	899297		
614627	875007	4347019648	899122	44306S10J50	899248	46307934	899298		
614628	875007	4347029225	899122	39211BM727	899252	46308773	899298		
614694	875007	4347029226	899122	5390489	899254	46308648	899298		
3272AE	899008	4347029227	899122	6E0407311	899268	374939	899298		
3273AL	899008	4341020292	899124	6E0498099	899268	374945	899298		
111102215012	899012	4341020640	899124	1434479	899270	46307834	899298		
11112215012	899012	4347029445	899124	1434481	899270	43410BZ041	899299		
97FU4K258AA	899015	4347029446	899124	1483808	899271	43420BZ041	899299		
51733777	899018	4346009C80	899128	1493218	899271	4341005380	899302		
1603403	899018	4347009C90	899128	1667957	899271	4341005420	899302		
09118846	899020	3272JY	899128	1667941	899271	4342005331	899302		
09118847	899020	3273JR	899128	1667811	899271	4342005360	899302		
13296059	899023	434100H010A	899128	1437736	899271	1534270	899318		
13335209	899024	434100H010	899128	1460786	899271	1534271	899318		
5374051	899024	434030H010	899128	1667774	899271	1595088	899318		
4950705A00	899025	4346009C800	899128	1459738	899271	1595093	899318		
4950805A00	899025	1306055	899129	1446227	899271	1595105	899318		
RL11159AB	899032	1360389	899129	1446223	899271	1603121	899318		
52099499AG	899032	1493004	899129	1483807	899271	1603122	899318		
52099498AE	899032	1493012	899129	36001076	899271	8V413A327AA	899318		
52099499AD	899032	1702527	899129	36001531	899271	8V413A327AB	899318		
52098208	899032	1306777	899129	36001451	899271	8V413A327AX	899318		
52099422	899032	1420577	899129	36001075	899271	8V413A328AA	899318		
52099497AE	899032	1446232	899129	36000692	899271	8V413A328AB	899318		
52099498AB	899032	1474431	899129	36001452	899271	8V413A328AX	899318		
52099497AC	899032	1495063	899129	GD4022510	899273	9V4N3A327AA	899318		
52099497AD	899032	1420578	899129	GD4022510A	899273	9V4N3A328AA	899318		
52111593AA	899032	1446235	899129	GD402550XA	899273	1502118	899318		
52111593AD	899032	1474438	899129	GD402550XC	899273	1703321	899318		
52111591AA	899032	36001355	899129	GD402560XA	899273	1502109	899318		
52111596AA	899032	337407311F	899134	GD382550X	899273	1594945	899318		
1693601572	899037	GCV1194	899151	GD622550X	899273	1594946	899318		
1693602972	899037	TDJ100590	899151	GD622550XA	899273	4347009M10	899319		
1693604372	899037	547407311	899154	GD622550XB	899273	4347009M20	899319		
1693604472	899037	1322209	899155	GD622550XC	899273	4347049675	899320		
A1693601572	899037	1322221	899155	GD3622610A	899273	4347080352	899320		
A1693602972	899037	4130008001	899158	GD3822510	899273	4347049655	899320		
A1693604372	899037	44014S91010	899159	4346009530	899282	4410278K00	899322		
A1693604472	899037	44014S9A010	899159	4347009780	899282	4410265J00	899322		
1693601768	899037	44305SCAG00	899159	434100D020	899282	4410165J00	899322		
1693608372	899037	44306SCAG00	899159	434100D080	899282	4410178K00	899322		
GD1522510	899042	628126	899162	434100D150	899282	46308677	899348		
502623	899046	44010S50010	899162	434200D020	899282	4F0407271K	899351		
MD0422510	899046	44310S50300	899162	434200D080	899282	4F0407272K	899351		
OK01125500A	899053	B11XLB3AC2203030	899175	434200D150	899282	4F0498099B	899351		
4130005100X	899059	3910172J10	899203	1511458	899284	3d0498099a	899351		
4130008012	899059	3910051M00	899204	1426735	899284	3d0498099ax	899351		
7702096117	899075	3910060A00	899204	1223785	899288	4F0498099BX	899351		
7702096117EH	899075	3910060A10	899204	1302515	899288	3273LP	899366		

New applications (compared with catalogue 2018)

GSP Ref.	GSP Ref.	GSP Ref.	GSP Ref.	GSP Ref.	GSP Ref.
201001	205033	210077	212023	217056	218402
201002	205057	210078	212024	217057	218438
201003	205075	210079	212026	217058	218439
201004	205076	210080	212027	217062	218440
201006	205086	210081	212045	217063	218454
201015	205104	210083	212046	217064	218471
201016	205105	210084	214003	217067	219009
201017	205106	210091	214004	217068	219011
201018	205134	210092	214005	217069	221019
201019	205135	210093	214006	217076	221020
201022	205140	210094	214007	217078	221021
201025	205141	210097	214008	217079	221040
201026	207007	210103	214009	217081	221072
201027	208010	210104	214010	217088	221109
201028	208011	210106	214011	217089	221110
201035	208017	210107	214012	217098	221111
201036	208019	210108	214013	217102	222001
201037	208034	210111	214014	217106	222003
201039	208035	210112	214015	217113	222004
201052	208071	210136	214016	217114	222005
201054	208072	210137	214017	217140	222006
201290	208080	210177	214018	217185	223002
201292	208081	210184	214021	217186	223003
201583	208093	210185	214022	217188	223004
201584	208094	210196	214024	217189	223005
201587	208107	210230	214025	217192	223008
201589	208108	210270	214026	217193	223013
201590	208156	210281	214027	217197	223014
201591	208157	210296	214028	217201	223015
201594	209001	210308	214029	217217	223016
201595	209004	210326	214031	217218	223017
201597	209005	210346	214032	218001	223022
201616	209013	210375	214039	218043	223023
201619	209015	210415	214040	218056	223024
201621	209016	210433	214066	218057	223025
201721	209048	210440	215001	218058	223031
201996	209049	211002	215006	218077	223032
203009	209061	211003	215009	218078	223044
203010	209064	211017	215020	218081	223045
203013	209066	211018	215051	218087	223049
203014	210022	211019	215052	218093	223050
203026	210028	211020	215053	218094	223051
203028	210029	211021	215054	218103	223057
203029	210032	211022	217001	218137	223061
203030	210033	212003	217008	218138	223066
203055	210035	212004	217013	218139	223068
203242	210036	212005	217014	218143	223069
203278	210037	212006	217015	218148	223070
203296	210042	212007	217016	218153	223071
203354	210045	212008	217029	218178	223072
203360	210046	212009	217030	218179	223073
203361	210050	212010	217031	218231	223079
203370	210057	212011	217034	218232	223080
205003	210061	212012	217038	218261	223081
205005	210062	212013	217041	218262	223082
205011	210063	212015	217048	218265	223083
205013	210065	212016	217051	218274	223084
205014	210074	212017	217053	218297	223087
205019	210075	212018	217055	218334	223090

New applications (compared with catalogue 2018)

GSP Ref.	GSP Ref.	GSP Ref.	GSP Ref.	GSP Ref.	GSP Ref.
223091	224059	224293	227018	228003	239142
223116	224060	224294	227019	228004	239189
223117	224061	224296	227020	228007	239190
223118	224062	224297	227024	228008	239191
223119	224076	224301	227025	228011	239211
223120	224077	224306	227026	228012	239212
223124	224094	224320	227027	234001	239213
223127	224102	224321	227030	234005	239214
223128	224107	224348	227031	234011	241040
223129	224108	224363	227033	234013	241057
223134	224110	224364	227034	234019	241058
223135	224111	224366	227035	234046	241082
223149	224112	224368	227037	234055	241153
223150	224117	224381	227040	234067	241154
223175	224123	224382	227042	234068	241178
223176	224124	224383	227047	234069	241197
223177	224125	224384	227048	234071	241198
223178	224126	224385	227049	234076	241199
223202	224127	224386	227050	234077	241258
223225	224128	224387	227053	234078	241296
223251	224140	224388	227054	234079	241297
223284	224141	224389	227055	234080	241346
223291	224142	224390	227059	234101	241347
223306	224143	224391	227060	234132	241377
223311	224144	224392	227061	234133	241378
223324	224145	224393	227066	234167	241393
223325	224149	224394	227067	234168	241399
223326	224150	224395	227070	234169	241442
223331	224156	224416	227077	234220	241444
223332	224157	224427	227078	234221	241445
224001	224176	224428	227079	234235	241483
224002	224177	224432	227084	234236	241484
224003	224188	224433	227102	234237	241486
224004	224203	224438	227105	234238	241495
224009	224228	224439	227106	234239	241497
224010	224229	224440	227107	234240	241512
224011	224231	224451	227108	234270	241513
224012	224232	224468	227109	235002	241514
224014	224233	224471	227111	235003	241515
224015	224240	224481	227114	235011	241516
224016	224241	224503	227115	235014	241522
224017	224246	224504	227142	235016	241524
224018	224247	224507	227143	235021	241525
224019	224248	224525	227151	235024	241527
224020	224249	224535	227152	235038	241530
224021	224259	224554	227155	235043	241531
224024	224260	224557	227156	235062	241532
224028	224261	224558	227169	235074	241533
224029	224262	224563	227185	235093	241535
224031	224264	224567	227186	235096	241536
224032	224265	226004	227191	239023	241545
224035	224270	226006	227201	239024	241570
224036	224272	226016	227202	239094	241576
224043	224282	227001	227203	239104	244007
224044	224283	227002	227204	239105	244008
224045	224288	227005	227208	239118	244009
224046	224289	227006	227224	239119	244012
224053	224290	227011	227225	239122	244016
224054	224291	227012	227226	239123	244018

New applications (compared with catalogue 2018)

GSP Ref.	GSP Ref.	GSP Ref.	GSP Ref.	GSP Ref.	GSP Ref.
244019	250085	250399	259001	259646	299079
244022	250091	250403	259004	259666	299080
244041	250092	250415	259012	259668	299101
244047	250094	250416	259013	259669	299114
244049	250096	250427	259018	259681	299132
244050	250097	250428	259021	260004	299135
244058	250098	250441	259022	260006	299138
244061	250101	250451	259031	260009	299155
245011	250103	250455	259032	260010	299160
245012	250105	250495	259035	260011	299162
245018	250107	250535	259044	260012	299163
245032	250109	250568	259046	260014	299186
245038	250112	250584	259051	261012	299244
245040	250114	250585	259052	261022	299246
245041	250116	250596	259053	261023	299247
245042	250117	250603	259054	261024	299279
245046	250118	250606	259059	261030	601002
245048	250120	250612	259060	261033	601007
245063	250121	250615	259062	261034	603019
245064	250125	250617	259063	261052	603020
245065	250132	250618	259064	261060	603025
245069	250133	250619	259069	261066	605026
245073	250142	250620	259070	261077	605043
245074	250143	250622	259071	261079	605044
245075	250149	251001	259072	261080	606001
245079	250153	251008	259073	261117	606003
245080	250156	251009	259074	261118	606026
245086	250164	251010	259075	261120	608007
245092	250165	251011	259076	261152	608019
245093	250168	251013	259077	261153	608043
245094	250171	251014	259079	261225	608055
245098	250174	251017	259080	261243	608056
245115	250175	251023	259137	261262	608072
245116	250178	251024	259161	261264	608073
245117	250179	254003	259162	261265	608074
245118	250180	256001	259191	261269	609004
245134	250183	256002	259192	261277	609007
245165	250209	256006	259193	261278	609010
245189	250214	256007	259194	261286	609016
245191	250216	256014	259195	261289	609018
245192	250217	256017	259196	261300	609020
245220	250218	256018	259217	261330	609025
245221	250229	256019	259219	262073	609027
245222	250233	256020	259235	262074	609034
245223	250237	256029	259236	262077	610008
245225	250239	256030	259270	262078	610009
245226	250240	257005	259271	262081	610015
249005	250241	257009	259392	262082	610023
249006	250246	257010	259585	262089	610034
249009	250249	257068	259588	266001	614003
249010	250269	257069	259597	266003	614006
250008	250291	257070	259598	266004	614010
250018	250293	257071	259612	275056	614011
250027	250301	257074	259616	299001	615002
250048	250310	257075	259621	299012	616011
250058	250346	257128	259623	299013	617041
250060	250363	257246	259624	299018	617051
250065	250368	257247	259625	299043	617072
250084	250384	257265	259645	299053	617073

New applications (compared with catalogue 2018)

GSP Ref.	GSP Ref.	GSP Ref.	GSP Ref.	GSP Ref.	GSP Ref.
617085	641104	699253	814097	824039	839229
618026	641131	699257	814101	824042	839232
618027	641168	699258	814107	824049	839245
618038	641186	801001	814123	824055	839248
618053	641193	801002	815001	824059	839270
618055	644020	801050	816011	824089	839294
618056	645007	801186	817083	824101	841031
618061	645010	801408	817089	824119	841032
618067	645013	801443	818008	824121	841059
618168	645014	801444	818020	824142	841060
618218	645015	801467	818022	824185	841063
618256	645021	802007	818032	824188	841076
621005	648001	802020	818042	824206	841094
621006	648003	802021	818049	824222	841095
621029	648006	803006	818059	824294	841105
623007	650023	803011	818065	824296	841117
623029	650065	803022	818072	824305	841121
623030	651001	803029	818080	824325	841124
623031	651003	803031	818209	824331	841138
623043	651004	803038	818280	824333	841140
623106	656002	803041	818316	824334	841146
624003	656023	803054	821009	827053	841148
624012	657009	803091	821021	827055	841150
624025	657022	806004	821048	827056	841157
624041	657035	806005	821049	827059	841168
624042	657071	806021	821057	832001	841170
624136	659010	807001	821071	834001	841172
624143	659040	808003	822002	834002	841180
626002	659065	808005	822003	834033	841183
627024	659079	808007	822004	834097	841206
628002	659105	808010	822005	834144	841210
628003	659107	808012	822006	834149	841211
628004	659108	808020	822007	834156	841281
630003	659111	808023	823003	834160	841284
634004	659115	808042	823004	834176	841287
634026	659191	808078	823005	834179	841291
634086	659192	809015	823006	834189	841305
634117	659220	809021	823009	834191	841307
634142	661015	809023	823018	834192	841312
635004	661032	809026	823042	834195	841325
635008	661034	809058	823043	834203	841327
635039	661050	810046	823050	834213	841330
635045	661093	810066	823059	834223	841336
635046	661094	810072	823072	834249	841360
635047	661100	810083	823074	835056	841375
635059	675004	810174	823085	835068	841406
635060	699046	812003	823112	839013	841407
635064	699050	812007	823117	839032	844010
639032	699079	812016	823122	839069	844018
639033	699098	812039	823131	839075	844023
639040	699117	812049	823159	839095	844047
639044	699121	814003	823162	839096	844062
639061	699143	814007	823176	839127	844063
641001	699150	814015	823184	839140	844071
641004	699160	814028	823185	839162	844078
641036	699186	814036	823192	839201	844093
641089	699195	814065	823193	839212	844103
641091	699239	814093	823206	839215	845030
641092	699240	814094	823207	839228	845061

New applications (compared with catalogue 2018)

GSP Ref.	GSP Ref.	GSP Ref.	GSP Ref.	GSP Ref.	GSP Ref.
850010	859463				
850018	859472				
850027	859511				
850058	859513				
850068	861001				
850074	861013				
850091	861015				
850101	861022				
850106	861024				
850133	862015				
850135	899020				
850149	899066				
850161	899075				
851009	899084				
851012	899103				
851019	899130				
851046	899228				
851047	899234				
853006	899235				
854011	899237				
854013	899297				
856001	899300				
856011	899327				
856012					
856013					
856018					
856032					
856046					
856052					
856076					
857005					
857040					
857107					
857170					
857173					
857184					
857188					
859068					
859097					
859103					
859121					
859128					
859135					
859138					
859214					
859225					
859237					
859258					
859371					
859386					
859395					
859407					
859414					
859421					
859425					
859426					
859445					
859446					
859462					

GSP GROUP

No.1 Gaoxiang Road, High-tech Industrial Zone
Ouhai District, Wenzhou,China.
Tel. +86-577-86293118 86293268
Fax.+86-577-86293313
E-mail:internationalsales@gsp.cn
Http://www.gsp.cn

GSP Europe GmbH

Leyboldstraße 10
D 50354 Hürth
Germany
Tel: +49 2233 80 58 155
Fax: +49 2233 80 58 156
Email: info@gsp-europe.com

GSP North America (East Coast)

298 Commercial Road
Spartanburg SC 29303
Tel. +1-864-578-6900
Toll Free.+1-800-243-7225
Fax.+1-864-578-6978
E-mail:info@gspnorthamerica.com

GSP North America (West Coast)

15315 Marquardt Ave.
Santa Fe Springs, CA 90670
Tel: +1 562 926 3525
Fax: +1 562 376 8550
Email: sales@gspnorthamerica.com

GSP Latin America,Inc

3150 SW 38th Ave. Suite 1312,
Coral Gables, FL 33146
Tel: +1 305 446-7702 / +1 305 446-7703
Fax: +1 305 446-7701
E-mail:info@gsplatinamerica.com

GSP Nanjing Co.,Ltd

Shuanghu Road No.59 ,
Gaochun District, Nanjing

